

**MySQL 5.7 Reference Manual**  
**Including MySQL NDB Cluster 7.5 and NDB Cluster 7.6**

---

## Abstract

This is the MySQL Reference Manual. It documents MySQL 5.7 through 5.7.52, as well as NDB Cluster releases based on version 7.5 of NDB through 5.7.44-ndb-7.5.36, respectively. It may include documentation of features of MySQL versions that have not yet been released. For information about which versions have been released, see the [MySQL 5.7 Release Notes](#).

**MySQL 5.7 features.** This manual describes features that are not included in every edition of MySQL 5.7; such features may not be included in the edition of MySQL 5.7 licensed to you. If you have any questions about the features included in your edition of MySQL 5.7, refer to your MySQL 5.7 license agreement or contact your Oracle sales representative.

For notes detailing the changes in each release, see the [MySQL 5.7 Release Notes](#).

For legal information, including licensing information, see the [Preface and Legal Notices](#).

For help with using MySQL, please visit the [MySQL Forums](#), where you can discuss your issues with other MySQL users.

Document generated on: 2026-02-27 (revision: 84419)

---

---

# Table of Contents

Preface and Legal Notices .....	xxvii
1 General Information .....	1
1.1 About This Manual .....	2
1.2 Overview of the MySQL Database Management System .....	4
1.2.1 What is MySQL? .....	4
1.2.2 The Main Features of MySQL .....	6
1.2.3 History of MySQL .....	8
1.3 What Is New in MySQL 5.7 .....	9
1.4 Server and Status Variables and Options Added, Deprecated, or Removed in MySQL 5.7 .....	25
1.5 How to Report Bugs or Problems .....	41
1.6 MySQL Standards Compliance .....	46
1.6.1 MySQL Extensions to Standard SQL .....	47
1.6.2 MySQL Differences from Standard SQL .....	50
1.6.3 How MySQL Deals with Constraints .....	53
2 Installing and Upgrading MySQL .....	59
2.1 General Installation Guidance .....	62
2.1.1 Supported Platforms .....	62
2.1.2 Which MySQL Version and Distribution to Install .....	62
2.1.3 How to Get MySQL .....	63
2.1.4 Verifying Package Integrity Using MD5 Checksums or GnuPG .....	63
2.1.5 Installation Layouts .....	80
2.1.6 Compiler-Specific Build Characteristics .....	81
2.2 Installing MySQL on Unix/Linux Using Generic Binaries .....	81
2.3 Installing MySQL on Microsoft Windows .....	84
2.3.1 MySQL Installation Layout on Microsoft Windows .....	87
2.3.2 Choosing an Installation Package .....	88
2.3.3 MySQL Installer for Windows .....	89
2.3.4 Installing MySQL on Microsoft Windows Using a <code>noinstall</code> ZIP Archive .....	120
2.3.5 Troubleshooting a Microsoft Windows MySQL Server Installation .....	128
2.3.6 Windows Postinstallation Procedures .....	130
2.3.7 Windows Platform Restrictions .....	132
2.4 Installing MySQL on macOS .....	133
2.4.1 General Notes on Installing MySQL on macOS .....	134
2.4.2 Installing MySQL on macOS Using Native Packages .....	135
2.4.3 Installing a MySQL Launch Daemon .....	141
2.4.4 Installing and Using the MySQL Preference Pane .....	144
2.5 Installing MySQL on Linux .....	149
2.5.1 Installing MySQL on Linux Using the MySQL Yum Repository .....	150
2.5.2 Replacing a Third-Party Distribution of MySQL Using the MySQL Yum Repository .....	154
2.5.3 Installing MySQL on Linux Using the MySQL APT Repository .....	157
2.5.4 Installing MySQL on Linux Using the MySQL SLES Repository .....	157
2.5.5 Installing MySQL on Linux Using RPM Packages from Oracle .....	157
2.5.6 Installing MySQL on Linux Using Debian Packages from Oracle .....	162
2.5.7 Deploying MySQL on Linux with Docker .....	163
2.5.8 Installing MySQL on Linux from the Native Software Repositories .....	174
2.5.9 Installing MySQL on Linux with Juju .....	177
2.5.10 Managing MySQL Server with systemd .....	177
2.6 Installing MySQL Using Unbreakable Linux Network (ULN) .....	182
2.7 Installing MySQL on Solaris .....	183
2.7.1 Installing MySQL on Solaris Using a Solaris PKG .....	184
2.8 Installing MySQL from Source .....	185

2.8.1 Source Installation Methods .....	185
2.8.2 Source Installation Prerequisites .....	186
2.8.3 MySQL Layout for Source Installation .....	187
2.8.4 Installing MySQL Using a Standard Source Distribution .....	187
2.8.5 Installing MySQL Using a Development Source Tree .....	192
2.8.6 Configuring SSL Library Support .....	193
2.8.7 MySQL Source-Configuration Options .....	194
2.8.8 Dealing with Problems Compiling MySQL .....	220
2.8.9 MySQL Configuration and Third-Party Tools .....	221
2.9 Postinstallation Setup and Testing .....	222
2.9.1 Initializing the Data Directory .....	222
2.9.2 Starting the Server .....	228
2.9.3 Testing the Server .....	231
2.9.4 Securing the Initial MySQL Account .....	233
2.9.5 Starting and Stopping MySQL Automatically .....	235
2.10 Upgrading MySQL .....	236
2.10.1 Before You Begin .....	236
2.10.2 Upgrade Paths .....	237
2.10.3 Changes in MySQL 5.7 .....	237
2.10.4 Upgrading MySQL Binary or Package-based Installations on Unix/Linux .....	247
2.10.5 Upgrading MySQL with the MySQL Yum Repository .....	250
2.10.6 Upgrading MySQL with the MySQL APT Repository .....	252
2.10.7 Upgrading MySQL with the MySQL SLES Repository .....	252
2.10.8 Upgrading MySQL on Windows .....	252
2.10.9 Upgrading a Docker Installation of MySQL .....	254
2.10.10 Upgrading MySQL with Directly-Downloaded RPM Packages .....	254
2.10.11 Upgrade Troubleshooting .....	255
2.10.12 Rebuilding or Repairing Tables or Indexes .....	256
2.10.13 Copying MySQL Databases to Another Machine .....	257
2.11 Downgrading MySQL .....	258
2.11.1 Before You Begin .....	259
2.11.2 Downgrade Paths .....	259
2.11.3 Downgrade Notes .....	259
2.11.4 Downgrading Binary and Package-based Installations on Unix/Linux .....	262
2.11.5 Downgrade Troubleshooting .....	265
2.12 Perl Installation Notes .....	265
2.12.1 Installing Perl on Unix .....	265
2.12.2 Installing ActiveState Perl on Windows .....	266
2.12.3 Problems Using the Perl DBI/DBD Interface .....	267
3 Tutorial .....	269
3.1 Connecting to and Disconnecting from the Server .....	269
3.2 Entering Queries .....	270
3.3 Creating and Using a Database .....	273
3.3.1 Creating and Selecting a Database .....	274
3.3.2 Creating a Table .....	275
3.3.3 Loading Data into a Table .....	277
3.3.4 Retrieving Information from a Table .....	278
3.4 Getting Information About Databases and Tables .....	291
3.5 Using mysql in Batch Mode .....	292
3.6 Examples of Common Queries .....	294
3.6.1 The Maximum Value for a Column .....	294
3.6.2 The Row Holding the Maximum of a Certain Column .....	294
3.6.3 Maximum of Column per Group .....	295
3.6.4 The Rows Holding the Group-wise Maximum of a Certain Column .....	295

3.6.5 Using User-Defined Variables .....	296
3.6.6 Using Foreign Keys .....	296
3.6.7 Searching on Two Keys .....	299
3.6.8 Calculating Visits Per Day .....	299
3.6.9 Using AUTO_INCREMENT .....	299
3.7 Using MySQL with Apache .....	302
4 MySQL Programs .....	303
4.1 Overview of MySQL Programs .....	304
4.2 Using MySQL Programs .....	308
4.2.1 Invoking MySQL Programs .....	308
4.2.2 Specifying Program Options .....	309
4.2.3 Command Options for Connecting to the Server .....	323
4.2.4 Connecting to the MySQL Server Using Command Options .....	335
4.2.5 Connection Transport Protocols .....	338
4.2.6 Connection Compression Control .....	339
4.2.7 Setting Environment Variables .....	340
4.3 Server and Server-Startup Programs .....	341
4.3.1 mysqld — The MySQL Server .....	341
4.3.2 mysqld_safe — MySQL Server Startup Script .....	341
4.3.3 mysql.server — MySQL Server Startup Script .....	351
4.3.4 mysqld_multi — Manage Multiple MySQL Servers .....	353
4.4 Installation-Related Programs .....	359
4.4.1 comp_err — Compile MySQL Error Message File .....	359
4.4.2 mysql_install_db — Initialize MySQL Data Directory .....	361
4.4.3 mysql_plugin — Configure MySQL Server Plugins .....	370
4.4.4 mysql_secure_installation — Improve MySQL Installation Security .....	373
4.4.5 mysql_ssl_rsa_setup — Create SSL/RSA Files .....	378
4.4.6 mysql_tzinfo_to_sql — Load the Time Zone Tables .....	381
4.4.7 mysql_upgrade — Check and Upgrade MySQL Tables .....	382
4.5 Client Programs .....	393
4.5.1 mysql — The MySQL Command-Line Client .....	393
4.5.2 mysqladmin — A MySQL Server Administration Program .....	435
4.5.3 mysqlcheck — A Table Maintenance Program .....	450
4.5.4 mysqldump — A Database Backup Program .....	465
4.5.5 mysqlimport — A Data Import Program .....	501
4.5.6 mysqlpump — A Database Backup Program .....	515
4.5.7 mysqlshow — Display Database, Table, and Column Information .....	540
4.5.8 mysqlslap — A Load Emulation Client .....	550
4.6 Administrative and Utility Programs .....	568
4.6.1 innochecksum — Offline InnoDB File Checksum Utility .....	568
4.6.2 myisam_ftdump — Display Full-Text Index information .....	575
4.6.3 myisamchk — MyISAM Table-Maintenance Utility .....	576
4.6.4 myisamlog — Display MyISAM Log File Contents .....	596
4.6.5 myisampack — Generate Compressed, Read-Only MyISAM Tables .....	598
4.6.6 mysql_config_editor — MySQL Configuration Utility .....	605
4.6.7 mysqlbinlog — Utility for Processing Binary Log Files .....	611
4.6.8 mysqldumpslow — Summarize Slow Query Log Files .....	641
4.7 Program Development Utilities .....	644
4.7.1 mysql_config — Display Options for Compiling Clients .....	644
4.7.2 my_print_defaults — Display Options from Option Files .....	646
4.7.3 resolve_stack_dump — Resolve Numeric Stack Trace Dump to Symbols .....	647
4.8 Miscellaneous Programs .....	648
4.8.1 lz4_decompress — Decompress mysqlpump LZ4-Compressed Output .....	648
4.8.2 perror — Display MySQL Error Message Information .....	648

4.8.3	replace — A String-Replacement Utility .....	649
4.8.4	resolveip — Resolve Host name to IP Address or Vice Versa .....	650
4.8.5	zlib_decompress — Decompress mysqlpump ZLIB-Compressed Output .....	650
4.9	Environment Variables .....	650
4.10	Unix Signal Handling in MySQL .....	653
5	MySQL Server Administration .....	657
5.1	The MySQL Server .....	658
5.1.1	Configuring the Server .....	658
5.1.2	Server Configuration Defaults .....	660
5.1.3	Server Option, System Variable, and Status Variable Reference .....	661
5.1.4	Server System Variable Reference .....	702
5.1.5	Server Status Variable Reference .....	723
5.1.6	Server Command Options .....	738
5.1.7	Server System Variables .....	766
5.1.8	Using System Variables .....	891
5.1.9	Server Status Variables .....	909
5.1.10	Server SQL Modes .....	931
5.1.11	Connection Management .....	947
5.1.12	IPv6 Support .....	952
5.1.13	MySQL Server Time Zone Support .....	956
5.1.14	Server-Side Help Support .....	961
5.1.15	Server Tracking of Client Session State .....	962
5.1.16	The Server Shutdown Process .....	965
5.2	The MySQL Data Directory .....	967
5.3	The mysql System Database .....	967
5.4	MySQL Server Logs .....	970
5.4.1	Selecting General Query Log and Slow Query Log Output Destinations .....	971
5.4.2	The Error Log .....	974
5.4.3	The General Query Log .....	976
5.4.4	The Binary Log .....	978
5.4.5	The Slow Query Log .....	991
5.4.6	The DDL Log .....	993
5.4.7	Server Log Maintenance .....	993
5.5	MySQL Server Plugins .....	995
5.5.1	Installing and Uninstalling Plugins .....	996
5.5.2	Obtaining Server Plugin Information .....	1000
5.5.3	MySQL Enterprise Thread Pool .....	1001
5.5.4	The Rewriter Query Rewrite Plugin .....	1007
5.5.5	Version Tokens .....	1016
5.5.6	MySQL Plugin Services .....	1027
5.6	MySQL Server Loadable Functions .....	1035
5.6.1	Installing and Uninstalling Loadable Functions .....	1036
5.6.2	Obtaining Information About Loadable Functions .....	1037
5.7	Running Multiple MySQL Instances on One Machine .....	1038
5.7.1	Setting Up Multiple Data Directories .....	1039
5.7.2	Running Multiple MySQL Instances on Windows .....	1040
5.7.3	Running Multiple MySQL Instances on Unix .....	1043
5.7.4	Using Client Programs in a Multiple-Server Environment .....	1044
5.8	Debugging MySQL .....	1045
5.8.1	Debugging a MySQL Server .....	1045
5.8.2	Debugging a MySQL Client .....	1052
5.8.3	The DEBUG Package .....	1052
5.8.4	Tracing mysqld Using DTrace .....	1055
6	Security .....	1075

6.1 General Security Issues .....	1076
6.1.1 Security Guidelines .....	1076
6.1.2 Keeping Passwords Secure .....	1078
6.1.3 Making MySQL Secure Against Attackers .....	1087
6.1.4 Security-Related mysqld Options and Variables .....	1088
6.1.5 How to Run MySQL as a Normal User .....	1089
6.1.6 Security Considerations for LOAD DATA LOCAL .....	1090
6.1.7 Client Programming Security Guidelines .....	1092
6.2 Access Control and Account Management .....	1094
6.2.1 Account User Names and Passwords .....	1095
6.2.2 Privileges Provided by MySQL .....	1097
6.2.3 Grant Tables .....	1104
6.2.4 Specifying Account Names .....	1111
6.2.5 Access Control, Stage 1: Connection Verification .....	1113
6.2.6 Access Control, Stage 2: Request Verification .....	1116
6.2.7 Adding Accounts, Assigning Privileges, and Dropping Accounts .....	1118
6.2.8 Reserved Accounts .....	1121
6.2.9 When Privilege Changes Take Effect .....	1121
6.2.10 Assigning Account Passwords .....	1122
6.2.11 Password Management .....	1123
6.2.12 Server Handling of Expired Passwords .....	1126
6.2.13 Pluggable Authentication .....	1128
6.2.14 Proxy Users .....	1132
6.2.15 Account Locking .....	1139
6.2.16 Setting Account Resource Limits .....	1140
6.2.17 Troubleshooting Problems Connecting to MySQL .....	1142
6.2.18 SQL-Based Account Activity Auditing .....	1147
6.3 Using Encrypted Connections .....	1148
6.3.1 Configuring MySQL to Use Encrypted Connections .....	1150
6.3.2 Encrypted Connection TLS Protocols and Ciphers .....	1155
6.3.3 Creating SSL and RSA Certificates and Keys .....	1162
6.3.4 SSL Library-Dependent Capabilities .....	1171
6.3.5 Connecting to MySQL Remotely from Windows with SSH .....	1173
6.4 Security Plugins .....	1173
6.4.1 Authentication Plugins .....	1174
6.4.2 Connection Control Plugins .....	1243
6.4.3 The Password Validation Plugin .....	1249
6.4.4 The MySQL Keyring .....	1257
6.4.5 MySQL Enterprise Audit .....	1294
6.4.6 MySQL Enterprise Firewall .....	1365
6.5 MySQL Enterprise Data Masking and De-Identification .....	1381
6.5.1 MySQL Enterprise Data Masking and De-Identification Elements .....	1383
6.5.2 Installing or Uninstalling MySQL Enterprise Data Masking and De-Identification .....	1383
6.5.3 Using MySQL Enterprise Data Masking and De-Identification .....	1384
6.5.4 MySQL Enterprise Data Masking and De-Identification Function Reference .....	1390
6.5.5 MySQL Enterprise Data Masking and De-Identification Function Descriptions .....	1390
6.6 MySQL Enterprise Encryption .....	1399
6.6.1 MySQL Enterprise Encryption Installation .....	1400
6.6.2 MySQL Enterprise Encryption Usage and Examples .....	1401
6.6.3 MySQL Enterprise Encryption Function Reference .....	1403
6.6.4 MySQL Enterprise Encryption Function Descriptions .....	1403
6.7 SELinux .....	1407
6.7.1 Check if SELinux is Enabled .....	1408
6.7.2 Changing the SELinux Mode .....	1409

6.7.3 MySQL Server SELinux Policies .....	1409
6.7.4 SELinux File Context .....	1409
6.7.5 SELinux TCP Port Context .....	1411
6.7.6 Troubleshooting SELinux .....	1412
7 Backup and Recovery .....	1415
7.1 Backup and Recovery Types .....	1416
7.2 Database Backup Methods .....	1419
7.3 Example Backup and Recovery Strategy .....	1421
7.3.1 Establishing a Backup Policy .....	1422
7.3.2 Using Backups for Recovery .....	1424
7.3.3 Backup Strategy Summary .....	1424
7.4 Using mysqldump for Backups .....	1424
7.4.1 Dumping Data in SQL Format with mysqldump .....	1425
7.4.2 Reloading SQL-Format Backups .....	1426
7.4.3 Dumping Data in Delimited-Text Format with mysqldump .....	1427
7.4.4 Reloading Delimited-Text Format Backups .....	1428
7.4.5 mysqldump Tips .....	1428
7.5 Point-in-Time (Incremental) Recovery .....	1430
7.5.1 Point-in-Time Recovery Using Binary Log .....	1431
7.5.2 Point-in-Time Recovery Using Event Positions .....	1432
7.6 MyISAM Table Maintenance and Crash Recovery .....	1433
7.6.1 Using myisamchk for Crash Recovery .....	1434
7.6.2 How to Check MyISAM Tables for Errors .....	1435
7.6.3 How to Repair MyISAM Tables .....	1435
7.6.4 MyISAM Table Optimization .....	1438
7.6.5 Setting Up a MyISAM Table Maintenance Schedule .....	1438
8 Optimization .....	1441
8.1 Optimization Overview .....	1443
8.2 Optimizing SQL Statements .....	1444
8.2.1 Optimizing SELECT Statements .....	1444
8.2.2 Optimizing Subqueries, Derived Tables, and View References .....	1489
8.2.3 Optimizing INFORMATION_SCHEMA Queries .....	1500
8.2.4 Optimizing Data Change Statements .....	1505
8.2.5 Optimizing Database Privileges .....	1506
8.2.6 Other Optimization Tips .....	1507
8.3 Optimization and Indexes .....	1507
8.3.1 How MySQL Uses Indexes .....	1507
8.3.2 Primary Key Optimization .....	1509
8.3.3 Foreign Key Optimization .....	1509
8.3.4 Column Indexes .....	1509
8.3.5 Multiple-Column Indexes .....	1511
8.3.6 Verifying Index Usage .....	1512
8.3.7 InnoDB and MyISAM Index Statistics Collection .....	1512
8.3.8 Comparison of B-Tree and Hash Indexes .....	1514
8.3.9 Use of Index Extensions .....	1515
8.3.10 Optimizer Use of Generated Column Indexes .....	1517
8.3.11 Indexed Lookups from TIMESTAMP Columns .....	1519
8.4 Optimizing Database Structure .....	1521
8.4.1 Optimizing Data Size .....	1521
8.4.2 Optimizing MySQL Data Types .....	1523
8.4.3 Optimizing for Many Tables .....	1525
8.4.4 Internal Temporary Table Use in MySQL .....	1526
8.4.5 Limits on Number of Databases and Tables .....	1528
8.4.6 Limits on Table Size .....	1528



---

8.4.7 Limits on Table Column Count and Row Size .....	1530
8.5 Optimizing for InnoDB Tables .....	1532
8.5.1 Optimizing Storage Layout for InnoDB Tables .....	1532
8.5.2 Optimizing InnoDB Transaction Management .....	1533
8.5.3 Optimizing InnoDB Read-Only Transactions .....	1534
8.5.4 Optimizing InnoDB Redo Logging .....	1535
8.5.5 Bulk Data Loading for InnoDB Tables .....	1536
8.5.6 Optimizing InnoDB Queries .....	1537
8.5.7 Optimizing InnoDB DDL Operations .....	1537
8.5.8 Optimizing InnoDB Disk I/O .....	1538
8.5.9 Optimizing InnoDB Configuration Variables .....	1541
8.5.10 Optimizing InnoDB for Systems with Many Tables .....	1543
8.6 Optimizing for MyISAM Tables .....	1543
8.6.1 Optimizing MyISAM Queries .....	1543
8.6.2 Bulk Data Loading for MyISAM Tables .....	1544
8.6.3 Optimizing REPAIR TABLE Statements .....	1545
8.7 Optimizing for MEMORY Tables .....	1547
8.8 Understanding the Query Execution Plan .....	1547
8.8.1 Optimizing Queries with EXPLAIN .....	1547
8.8.2 EXPLAIN Output Format .....	1548
8.8.3 Extended EXPLAIN Output Format .....	1562
8.8.4 Obtaining Execution Plan Information for a Named Connection .....	1564
8.8.5 Estimating Query Performance .....	1565
8.9 Controlling the Query Optimizer .....	1566
8.9.1 Controlling Query Plan Evaluation .....	1566
8.9.2 Switchable Optimizations .....	1566
8.9.3 Optimizer Hints .....	1571
8.9.4 Index Hints .....	1577
8.9.5 The Optimizer Cost Model .....	1580
8.10 Buffering and Caching .....	1583
8.10.1 InnoDB Buffer Pool Optimization .....	1583
8.10.2 The MyISAM Key Cache .....	1584
8.10.3 The MySQL Query Cache .....	1588
8.10.4 Caching of Prepared Statements and Stored Programs .....	1595
8.11 Optimizing Locking Operations .....	1597
8.11.1 Internal Locking Methods .....	1597
8.11.2 Table Locking Issues .....	1599
8.11.3 Concurrent Inserts .....	1601
8.11.4 Metadata Locking .....	1601
8.11.5 External Locking .....	1604
8.12 Optimizing the MySQL Server .....	1606
8.12.1 System Factors .....	1606
8.12.2 Optimizing Disk I/O .....	1606
8.12.3 Using Symbolic Links .....	1608
8.12.4 Optimizing Memory Use .....	1611
8.13 Measuring Performance (Benchmarking) .....	1617
8.13.1 Measuring the Speed of Expressions and Functions .....	1618
8.13.2 Using Your Own Benchmarks .....	1618
8.13.3 Measuring Performance with performance_schema .....	1619
8.14 Examining Server Thread (Process) Information .....	1619
8.14.1 Accessing the Process List .....	1619
8.14.2 Thread Command Values .....	1621
8.14.3 General Thread States .....	1623
8.14.4 Query Cache Thread States .....	1629

8.14.5 Replication Source Thread States .....	1630
8.14.6 Replication Replica I/O Thread States .....	1630
8.14.7 Replication Replica SQL Thread States .....	1632
8.14.8 Replication Replica Connection Thread States .....	1632
8.14.9 NDB Cluster Thread States .....	1633
8.14.10 Event Scheduler Thread States .....	1634
8.15 Tracing the Optimizer .....	1634
8.15.1 Typical Usage .....	1634
8.15.2 System Variables Controlling Tracing .....	1634
8.15.3 Traceable Statements .....	1635
8.15.4 Tuning Trace Purging .....	1636
8.15.5 Tracing Memory Usage .....	1637
8.15.6 Privilege Checking .....	1637
8.15.7 Interaction with the --debug Option .....	1637
8.15.8 The optimizer_trace System Variable .....	1637
8.15.9 The end_markers_in_json System Variable .....	1637
8.15.10 Selecting Optimizer Features to Trace .....	1637
8.15.11 Trace General Structure .....	1638
8.15.12 Example .....	1638
8.15.13 Displaying Traces in Other Applications .....	1649
8.15.14 Preventing the Use of Optimizer Trace .....	1649
8.15.15 Testing Optimizer Trace .....	1649
8.15.16 Optimizer Trace Implementation .....	1650
9 Language Structure .....	1651
9.1 Literal Values .....	1651
9.1.1 String Literals .....	1651
9.1.2 Numeric Literals .....	1654
9.1.3 Date and Time Literals .....	1654
9.1.4 Hexadecimal Literals .....	1657
9.1.5 Bit-Value Literals .....	1659
9.1.6 Boolean Literals .....	1660
9.1.7 NULL Values .....	1660
9.2 Schema Object Names .....	1660
9.2.1 Identifier Length Limits .....	1662
9.2.2 Identifier Qualifiers .....	1663
9.2.3 Identifier Case Sensitivity .....	1665
9.2.4 Mapping of Identifiers to File Names .....	1667
9.2.5 Function Name Parsing and Resolution .....	1669
9.3 Keywords and Reserved Words .....	1673
9.4 User-Defined Variables .....	1697
9.5 Expressions .....	1701
9.6 Comments .....	1705
10 Character Sets, Collations, Unicode .....	1709
10.1 Character Sets and Collations in General .....	1710
10.2 Character Sets and Collations in MySQL .....	1711
10.2.1 Character Set Repertoire .....	1713
10.2.2 UTF-8 for Metadata .....	1714
10.3 Specifying Character Sets and Collations .....	1716
10.3.1 Collation Naming Conventions .....	1716
10.3.2 Server Character Set and Collation .....	1717
10.3.3 Database Character Set and Collation .....	1718
10.3.4 Table Character Set and Collation .....	1719
10.3.5 Column Character Set and Collation .....	1719
10.3.6 Character String Literal Character Set and Collation .....	1721

10.3.7	The National Character Set .....	1723
10.3.8	Character Set Introducers .....	1723
10.3.9	Examples of Character Set and Collation Assignment .....	1725
10.3.10	Compatibility with Other DBMSs .....	1726
10.4	Connection Character Sets and Collations .....	1726
10.5	Configuring Application Character Set and Collation .....	1732
10.6	Error Message Character Set .....	1734
10.7	Column Character Set Conversion .....	1735
10.8	Collation Issues .....	1736
10.8.1	Using COLLATE in SQL Statements .....	1736
10.8.2	COLLATE Clause Precedence .....	1737
10.8.3	Character Set and Collation Compatibility .....	1737
10.8.4	Collation Coercibility in Expressions .....	1737
10.8.5	The binary Collation Compared to _bin Collations .....	1739
10.8.6	Examples of the Effect of Collation .....	1741
10.8.7	Using Collation in INFORMATION_SCHEMA Searches .....	1742
10.9	Unicode Support .....	1744
10.9.1	The utf8mb4 Character Set (4-Byte UTF-8 Unicode Encoding) .....	1746
10.9.2	The utf8mb3 Character Set (3-Byte UTF-8 Unicode Encoding) .....	1747
10.9.3	The utf8 Character Set (Alias for utf8mb3) .....	1747
10.9.4	The ucs2 Character Set (UCS-2 Unicode Encoding) .....	1747
10.9.5	The utf16 Character Set (UTF-16 Unicode Encoding) .....	1748
10.9.6	The utf16le Character Set (UTF-16LE Unicode Encoding) .....	1748
10.9.7	The utf32 Character Set (UTF-32 Unicode Encoding) .....	1748
10.9.8	Converting Between 3-Byte and 4-Byte Unicode Character Sets .....	1749
10.10	Supported Character Sets and Collations .....	1751
10.10.1	Unicode Character Sets .....	1752
10.10.2	West European Character Sets .....	1758
10.10.3	Central European Character Sets .....	1759
10.10.4	South European and Middle East Character Sets .....	1760
10.10.5	Baltic Character Sets .....	1761
10.10.6	Cyrillic Character Sets .....	1761
10.10.7	Asian Character Sets .....	1762
10.10.8	The Binary Character Set .....	1766
10.11	Restrictions on Character Sets .....	1767
10.12	Setting the Error Message Language .....	1768
10.13	Adding a Character Set .....	1768
10.13.1	Character Definition Arrays .....	1770
10.13.2	String Collating Support for Complex Character Sets .....	1771
10.13.3	Multi-Byte Character Support for Complex Character Sets .....	1771
10.14	Adding a Collation to a Character Set .....	1772
10.14.1	Collation Implementation Types .....	1773
10.14.2	Choosing a Collation ID .....	1776
10.14.3	Adding a Simple Collation to an 8-Bit Character Set .....	1777
10.14.4	Adding a UCA Collation to a Unicode Character Set .....	1778
10.15	Character Set Configuration .....	1785
10.16	MySQL Server Locale Support .....	1786
11	Data Types .....	1791
11.1	Numeric Data Types .....	1792
11.1.1	Numeric Data Type Syntax .....	1792
11.1.2	Integer Types (Exact Value) - INTEGER, INT, SMALLINT, TINYINT, MEDIUMINT, BIGINT .....	1796
11.1.3	Fixed-Point Types (Exact Value) - DECIMAL, NUMERIC .....	1796
11.1.4	Floating-Point Types (Approximate Value) - FLOAT, DOUBLE .....	1797

11.1.5 Bit-Value Type - BIT .....	1797
11.1.6 Numeric Type Attributes .....	1797
11.1.7 Out-of-Range and Overflow Handling .....	1798
11.2 Date and Time Data Types .....	1800
11.2.1 Date and Time Data Type Syntax .....	1801
11.2.2 The DATE, DATETIME, and TIMESTAMP Types .....	1803
11.2.3 The TIME Type .....	1805
11.2.4 The YEAR Type .....	1806
11.2.5 2-Digit YEAR(2) Limitations and Migrating to 4-Digit YEAR .....	1806
11.2.6 Automatic Initialization and Updating for TIMESTAMP and DATETIME .....	1809
11.2.7 Fractional Seconds in Time Values .....	1813
11.2.8 What Calendar Is Used By MySQL? .....	1813
11.2.9 Conversion Between Date and Time Types .....	1814
11.2.10 2-Digit Years in Dates .....	1815
11.3 String Data Types .....	1815
11.3.1 String Data Type Syntax .....	1815
11.3.2 The CHAR and VARCHAR Types .....	1819
11.3.3 The BINARY and VARBINARY Types .....	1821
11.3.4 The BLOB and TEXT Types .....	1822
11.3.5 The ENUM Type .....	1824
11.3.6 The SET Type .....	1827
11.4 Spatial Data Types .....	1829
11.4.1 Spatial Data Types .....	1831
11.4.2 The OpenGIS Geometry Model .....	1832
11.4.3 Supported Spatial Data Formats .....	1838
11.4.4 Geometry Well-Formedness and Validity .....	1841
11.4.5 Creating Spatial Columns .....	1841
11.4.6 Populating Spatial Columns .....	1842
11.4.7 Fetching Spatial Data .....	1843
11.4.8 Optimizing Spatial Analysis .....	1843
11.4.9 Creating Spatial Indexes .....	1843
11.4.10 Using Spatial Indexes .....	1844
11.5 The JSON Data Type .....	1846
11.6 Data Type Default Values .....	1860
11.7 Data Type Storage Requirements .....	1862
11.8 Choosing the Right Type for a Column .....	1866
11.9 Using Data Types from Other Database Engines .....	1867
12 Functions and Operators .....	1869
12.1 Built-In Function and Operator Reference .....	1871
12.2 Loadable Function Reference .....	1891
12.3 Type Conversion in Expression Evaluation .....	1893
12.4 Operators .....	1896
12.4.1 Operator Precedence .....	1898
12.4.2 Comparison Functions and Operators .....	1899
12.4.3 Logical Operators .....	1905
12.4.4 Assignment Operators .....	1907
12.5 Flow Control Functions .....	1908
12.6 Numeric Functions and Operators .....	1910
12.6.1 Arithmetic Operators .....	1911
12.6.2 Mathematical Functions .....	1913
12.7 Date and Time Functions .....	1922
12.8 String Functions and Operators .....	1944
12.8.1 String Comparison Functions and Operators .....	1962
12.8.2 Regular Expressions .....	1965

---

12.8.3 Character Set and Collation of Function Results .....	1971
12.9 Full-Text Search Functions .....	1972
12.9.1 Natural Language Full-Text Searches .....	1973
12.9.2 Boolean Full-Text Searches .....	1977
12.9.3 Full-Text Searches with Query Expansion .....	1983
12.9.4 Full-Text Stopwords .....	1984
12.9.5 Full-Text Restrictions .....	1988
12.9.6 Fine-Tuning MySQL Full-Text Search .....	1989
12.9.7 Adding a User-Defined Collation for Full-Text Indexing .....	1992
12.9.8 ngram Full-Text Parser .....	1993
12.9.9 MeCab Full-Text Parser Plugin .....	1996
12.10 Cast Functions and Operators .....	2000
12.11 XML Functions .....	2007
12.12 Bit Functions and Operators .....	2018
12.13 Encryption and Compression Functions .....	2021
12.14 Locking Functions .....	2033
12.15 Information Functions .....	2035
12.16 Spatial Analysis Functions .....	2045
12.16.1 Spatial Function Reference .....	2045
12.16.2 Argument Handling by Spatial Functions .....	2051
12.16.3 Functions That Create Geometry Values from WKT Values .....	2052
12.16.4 Functions That Create Geometry Values from WKB Values .....	2055
12.16.5 MySQL-Specific Functions That Create Geometry Values .....	2058
12.16.6 Geometry Format Conversion Functions .....	2059
12.16.7 Geometry Property Functions .....	2060
12.16.8 Spatial Operator Functions .....	2069
12.16.9 Functions That Test Spatial Relations Between Geometry Objects .....	2072
12.16.10 Spatial Geohash Functions .....	2078
12.16.11 Spatial GeoJSON Functions .....	2080
12.16.12 Spatial Convenience Functions .....	2082
12.17 JSON Functions .....	2085
12.17.1 JSON Function Reference .....	2085
12.17.2 Functions That Create JSON Values .....	2087
12.17.3 Functions That Search JSON Values .....	2088
12.17.4 Functions That Modify JSON Values .....	2097
12.17.5 Functions That Return JSON Value Attributes .....	2107
12.17.6 JSON Utility Functions .....	2110
12.18 Functions Used with Global Transaction Identifiers (GTIDs) .....	2113
12.19 Aggregate Functions .....	2115
12.19.1 Aggregate Function Descriptions .....	2115
12.19.2 GROUP BY Modifiers .....	2122
12.19.3 MySQL Handling of GROUP BY .....	2126
12.19.4 Detection of Functional Dependence .....	2130
12.20 Miscellaneous Functions .....	2133
12.21 Precision Math .....	2141
12.21.1 Types of Numeric Values .....	2142
12.21.2 DECIMAL Data Type Characteristics .....	2142
12.21.3 Expression Handling .....	2143
12.21.4 Rounding Behavior .....	2145
12.21.5 Precision Math Examples .....	2146
13 SQL Statements .....	2151
13.1 Data Definition Statements .....	2152
13.1.1 ALTER DATABASE Statement .....	2152
13.1.2 ALTER EVENT Statement .....	2154

13.1.3 ALTER FUNCTION Statement .....	2155
13.1.4 ALTER INSTANCE Statement .....	2155
13.1.5 ALTER LOGFILE GROUP Statement .....	2156
13.1.6 ALTER PROCEDURE Statement .....	2157
13.1.7 ALTER SERVER Statement .....	2157
13.1.8 ALTER TABLE Statement .....	2158
13.1.9 ALTER TABLESPACE Statement .....	2181
13.1.10 ALTER VIEW Statement .....	2183
13.1.11 CREATE DATABASE Statement .....	2183
13.1.12 CREATE EVENT Statement .....	2184
13.1.13 CREATE FUNCTION Statement .....	2188
13.1.14 CREATE INDEX Statement .....	2188
13.1.15 CREATE LOGFILE GROUP Statement .....	2194
13.1.16 CREATE PROCEDURE and CREATE FUNCTION Statements .....	2196
13.1.17 CREATE SERVER Statement .....	2201
13.1.18 CREATE TABLE Statement .....	2202
13.1.19 CREATE TABLESPACE Statement .....	2252
13.1.20 CREATE TRIGGER Statement .....	2258
13.1.21 CREATE VIEW Statement .....	2260
13.1.22 DROP DATABASE Statement .....	2265
13.1.23 DROP EVENT Statement .....	2266
13.1.24 DROP FUNCTION Statement .....	2266
13.1.25 DROP INDEX Statement .....	2266
13.1.26 DROP LOGFILE GROUP Statement .....	2267
13.1.27 DROP PROCEDURE and DROP FUNCTION Statements .....	2267
13.1.28 DROP SERVER Statement .....	2268
13.1.29 DROP TABLE Statement .....	2268
13.1.30 DROP TABLESPACE Statement .....	2269
13.1.31 DROP TRIGGER Statement .....	2270
13.1.32 DROP VIEW Statement .....	2270
13.1.33 RENAME TABLE Statement .....	2271
13.1.34 TRUNCATE TABLE Statement .....	2272
13.2 Data Manipulation Statements .....	2273
13.2.1 CALL Statement .....	2273
13.2.2 DELETE Statement .....	2274
13.2.3 DO Statement .....	2278
13.2.4 HANDLER Statement .....	2279
13.2.5 INSERT Statement .....	2280
13.2.6 LOAD DATA Statement .....	2289
13.2.7 LOAD XML Statement .....	2300
13.2.8 REPLACE Statement .....	2308
13.2.9 SELECT Statement .....	2310
13.2.10 Subqueries .....	2327
13.2.11 UPDATE Statement .....	2340
13.3 Transactional and Locking Statements .....	2344
13.3.1 START TRANSACTION, COMMIT, and ROLLBACK Statements .....	2344
13.3.2 Statements That Cannot Be Rolled Back .....	2347
13.3.3 Statements That Cause an Implicit Commit .....	2347
13.3.4 SAVEPOINT, ROLLBACK TO SAVEPOINT, and RELEASE SAVEPOINT Statements .....	2348
13.3.5 LOCK TABLES and UNLOCK TABLES Statements .....	2349
13.3.6 SET TRANSACTION Statement .....	2355
13.3.7 XA Transactions .....	2358
13.4 Replication Statements .....	2363

---

13.4.1	SQL Statements for Controlling Replication Source Servers .....	2363
13.4.2	SQL Statements for Controlling Replica Servers .....	2366
13.4.3	SQL Statements for Controlling Group Replication .....	2381
13.5	Prepared Statements .....	2382
13.5.1	PREPARE Statement .....	2386
13.5.2	EXECUTE Statement .....	2386
13.5.3	DEALLOCATE PREPARE Statement .....	2386
13.6	Compound Statements .....	2387
13.6.1	BEGIN ... END Compound Statement .....	2387
13.6.2	Statement Labels .....	2387
13.6.3	DECLARE Statement .....	2388
13.6.4	Variables in Stored Programs .....	2388
13.6.5	Flow Control Statements .....	2390
13.6.6	Cursors .....	2395
13.6.7	Condition Handling .....	2397
13.7	Database Administration Statements .....	2425
13.7.1	Account Management Statements .....	2425
13.7.2	Table Maintenance Statements .....	2454
13.7.3	Plugin and Loadable Function Statements .....	2465
13.7.4	SET Statements .....	2468
13.7.5	SHOW Statements .....	2473
13.7.6	Other Administrative Statements .....	2526
13.8	Utility Statements .....	2537
13.8.1	DESCRIBE Statement .....	2537
13.8.2	EXPLAIN Statement .....	2537
13.8.3	HELP Statement .....	2540
13.8.4	USE Statement .....	2542
14	The InnoDB Storage Engine .....	2543
14.1	Introduction to InnoDB .....	2545
14.1.1	Benefits of Using InnoDB Tables .....	2546
14.1.2	Best Practices for InnoDB Tables .....	2547
14.1.3	Verifying that InnoDB is the Default Storage Engine .....	2548
14.1.4	Testing and Benchmarking with InnoDB .....	2548
14.1.5	Turning Off InnoDB .....	2549
14.2	InnoDB and the ACID Model .....	2549
14.3	InnoDB Multi-Versioning .....	2550
14.4	InnoDB Architecture .....	2552
14.5	InnoDB In-Memory Structures .....	2552
14.5.1	Buffer Pool .....	2552
14.5.2	Change Buffer .....	2557
14.5.3	Adaptive Hash Index .....	2561
14.5.4	Log Buffer .....	2562
14.6	InnoDB On-Disk Structures .....	2562
14.6.1	Tables .....	2562
14.6.2	Indexes .....	2586
14.6.3	Tablespaces .....	2594
14.6.4	InnoDB Data Dictionary .....	2609
14.6.5	Doublewrite Buffer .....	2609
14.6.6	Redo Log .....	2609
14.6.7	Undo Logs .....	2610
14.7	InnoDB Locking and Transaction Model .....	2612
14.7.1	InnoDB Locking .....	2612
14.7.2	InnoDB Transaction Model .....	2616
14.7.3	Locks Set by Different SQL Statements in InnoDB .....	2624

---

14.7.4 Phantom Rows .....	2628
14.7.5 Deadlocks in InnoDB .....	2629
14.8 InnoDB Configuration .....	2632
14.8.1 InnoDB Startup Configuration .....	2632
14.8.2 Configuring InnoDB for Read-Only Operation .....	2638
14.8.3 InnoDB Buffer Pool Configuration .....	2639
14.8.4 Configuring the Memory Allocator for InnoDB .....	2652
14.8.5 Configuring Thread Concurrency for InnoDB .....	2652
14.8.6 Configuring the Number of Background InnoDB I/O Threads .....	2653
14.8.7 Using Asynchronous I/O on Linux .....	2654
14.8.8 Configuring InnoDB I/O Capacity .....	2655
14.8.9 Configuring Spin Lock Polling .....	2656
14.8.10 Purge Configuration .....	2657
14.8.11 Configuring Optimizer Statistics for InnoDB .....	2658
14.8.12 Configuring the Merge Threshold for Index Pages .....	2670
14.9 InnoDB Table and Page Compression .....	2672
14.9.1 InnoDB Table Compression .....	2672
14.9.2 InnoDB Page Compression .....	2687
14.10 InnoDB File-Format Management .....	2691
14.10.1 Enabling File Formats .....	2692
14.10.2 Verifying File Format Compatibility .....	2692
14.10.3 Identifying the File Format in Use .....	2695
14.10.4 Modifying the File Format .....	2696
14.11 InnoDB Row Formats .....	2697
14.12 InnoDB Disk I/O and File Space Management .....	2703
14.12.1 InnoDB Disk I/O .....	2704
14.12.2 File Space Management .....	2705
14.12.3 InnoDB Checkpoints .....	2706
14.12.4 Defragmenting a Table .....	2706
14.12.5 Reclaiming Disk Space with TRUNCATE TABLE .....	2707
14.13 InnoDB and Online DDL .....	2707
14.13.1 Online DDL Operations .....	2708
14.13.2 Online DDL Performance and Concurrency .....	2720
14.13.3 Online DDL Space Requirements .....	2724
14.13.4 Simplifying DDL Statements with Online DDL .....	2724
14.13.5 Online DDL Failure Conditions .....	2725
14.13.6 Online DDL Limitations .....	2725
14.14 InnoDB Data-at-Rest Encryption .....	2726
14.15 InnoDB Startup Options and System Variables .....	2731
14.16 InnoDB INFORMATION_SCHEMA Tables .....	2815
14.16.1 InnoDB INFORMATION_SCHEMA Tables about Compression .....	2815
14.16.2 InnoDB INFORMATION_SCHEMA Transaction and Locking Information .....	2817
14.16.3 InnoDB INFORMATION_SCHEMA System Tables .....	2824
14.16.4 InnoDB INFORMATION_SCHEMA FULLTEXT Index Tables .....	2830
14.16.5 InnoDB INFORMATION_SCHEMA Buffer Pool Tables .....	2833
14.16.6 InnoDB INFORMATION_SCHEMA Metrics Table .....	2837
14.16.7 InnoDB INFORMATION_SCHEMA Temporary Table Info Table .....	2846
14.16.8 Retrieving InnoDB Tablespace Metadata from INFORMATION_SCHEMA.FILES ..	2847
14.17 InnoDB Integration with MySQL Performance Schema .....	2849
14.17.1 Monitoring ALTER TABLE Progress for InnoDB Tables Using Performance Schema .....	2851
14.17.2 Monitoring InnoDB Mutex Waits Using Performance Schema .....	2853
14.18 InnoDB Monitors .....	2856
14.18.1 InnoDB Monitor Types .....	2857



---

14.18.2	Enabling InnoDB Monitors .....	2857
14.18.3	InnoDB Standard Monitor and Lock Monitor Output .....	2859
14.19	InnoDB Backup and Recovery .....	2864
14.19.1	InnoDB Backup .....	2864
14.19.2	InnoDB Recovery .....	2865
14.20	InnoDB and MySQL Replication .....	2868
14.21	InnoDB memcached Plugin .....	2870
14.21.1	Benefits of the InnoDB memcached Plugin .....	2870
14.21.2	InnoDB memcached Architecture .....	2871
14.21.3	Setting Up the InnoDB memcached Plugin .....	2873
14.21.4	Security Considerations for the InnoDB memcached Plugin .....	2879
14.21.5	Writing Applications for the InnoDB memcached Plugin .....	2880
14.21.6	The InnoDB memcached Plugin and Replication .....	2893
14.21.7	InnoDB memcached Plugin Internals .....	2897
14.21.8	Troubleshooting the InnoDB memcached Plugin .....	2901
14.22	InnoDB Troubleshooting .....	2903
14.22.1	Troubleshooting InnoDB I/O Problems .....	2904
14.22.2	Forcing InnoDB Recovery .....	2905
14.22.3	Troubleshooting InnoDB Data Dictionary Operations .....	2906
14.22.4	InnoDB Error Handling .....	2911
14.23	InnoDB Limits .....	2911
14.24	InnoDB Restrictions and Limitations .....	2913
15	Alternative Storage Engines .....	2915
15.1	Setting the Storage Engine .....	2918
15.2	The MyISAM Storage Engine .....	2919
15.2.1	MyISAM Startup Options .....	2922
15.2.2	Space Needed for Keys .....	2923
15.2.3	MyISAM Table Storage Formats .....	2924
15.2.4	MyISAM Table Problems .....	2926
15.3	The MEMORY Storage Engine .....	2928
15.4	The CSV Storage Engine .....	2933
15.4.1	Repairing and Checking CSV Tables .....	2933
15.4.2	CSV Limitations .....	2934
15.5	The ARCHIVE Storage Engine .....	2934
15.6	The BLACKHOLE Storage Engine .....	2936
15.7	The MERGE Storage Engine .....	2938
15.7.1	MERGE Table Advantages and Disadvantages .....	2941
15.7.2	MERGE Table Problems .....	2942
15.8	The FEDERATED Storage Engine .....	2943
15.8.1	FEDERATED Storage Engine Overview .....	2944
15.8.2	How to Create FEDERATED Tables .....	2945
15.8.3	FEDERATED Storage Engine Notes and Tips .....	2948
15.8.4	FEDERATED Storage Engine Resources .....	2949
15.9	The EXAMPLE Storage Engine .....	2949
15.10	Other Storage Engines .....	2950
15.11	Overview of MySQL Storage Engine Architecture .....	2950
15.11.1	Pluggable Storage Engine Architecture .....	2950
15.11.2	The Common Database Server Layer .....	2951
16	Replication .....	2953
16.1	Configuring Replication .....	2955
16.1.1	Binary Log File Position Based Replication Configuration Overview .....	2955
16.1.2	Setting Up Binary Log File Position Based Replication .....	2956
16.1.3	Replication with Global Transaction Identifiers .....	2965
16.1.4	Changing Replication Modes on Online Servers .....	2987

16.1.5 MySQL Multi-Source Replication .....	2993
16.1.6 Replication and Binary Logging Options and Variables .....	2998
16.1.7 Common Replication Administration Tasks .....	3078
16.2 Replication Implementation .....	3084
16.2.1 Replication Formats .....	3084
16.2.2 Replication Channels .....	3091
16.2.3 Replication Threads .....	3095
16.2.4 Relay Log and Replication Metadata Repositories .....	3098
16.2.5 How Servers Evaluate Replication Filtering Rules .....	3104
16.3 Replication Solutions .....	3110
16.3.1 Using Replication for Backups .....	3111
16.3.2 Handling an Unexpected Halt of a Replica .....	3114
16.3.3 Using Replication with Different Source and Replica Storage Engines .....	3116
16.3.4 Using Replication for Scale-Out .....	3118
16.3.5 Replicating Different Databases to Different Replicas .....	3119
16.3.6 Improving Replication Performance .....	3120
16.3.7 Switching Sources During Failover .....	3121
16.3.8 Setting Up Replication to Use Encrypted Connections .....	3124
16.3.9 Semisynchronous Replication .....	3125
16.3.10 Delayed Replication .....	3131
16.4 Replication Notes and Tips .....	3132
16.4.1 Replication Features and Issues .....	3132
16.4.2 Replication Compatibility Between MySQL Versions .....	3158
16.4.3 Upgrading a Replication Topology .....	3159
16.4.4 Troubleshooting Replication .....	3161
16.4.5 How to Report Replication Bugs or Problems .....	3163
17 Group Replication .....	3165
17.1 Group Replication Background .....	3166
17.1.1 Replication Technologies .....	3167
17.1.2 Group Replication Use Cases .....	3169
17.1.3 Group Replication Details .....	3170
17.2 Getting Started .....	3172
17.2.1 Deploying Group Replication in Single-Primary Mode .....	3172
17.2.2 Deploying Group Replication Locally .....	3183
17.3 Requirements and Limitations .....	3184
17.3.1 Group Replication Requirements .....	3184
17.3.2 Group Replication Limitations .....	3186
17.4 Monitoring Group Replication .....	3188
17.4.1 Group Replication Server States .....	3189
17.4.2 The replication_group_members Table .....	3190
17.4.3 The replication_group_member_stats Table .....	3190
17.5 Group Replication Operations .....	3191
17.5.1 Deploying in Multi-Primary or Single-Primary Mode .....	3191
17.5.2 Tuning Recovery .....	3193
17.5.3 Network Partitioning .....	3194
17.5.4 Restarting a Group .....	3199
17.5.5 Using MySQL Enterprise Backup with Group Replication .....	3201
17.6 Group Replication Security .....	3206
17.6.1 Group Replication IP Address Allowlisting .....	3206
17.6.2 Group Replication Secure Socket Layer (SSL) Support .....	3208
17.6.3 Group Replication and Virtual Private Networks (VPNs) .....	3210
17.7 Group Replication Variables .....	3210
17.7.1 Group Replication System Variables .....	3211
17.7.2 Group Replication Status Variables .....	3232

17.8	Frequently Asked Questions .....	3232
17.9	Group Replication Technical Details .....	3236
17.9.1	Group Replication Plugin Architecture .....	3236
17.9.2	The Group .....	3237
17.9.3	Data Manipulation Statements .....	3237
17.9.4	Data Definition Statements .....	3238
17.9.5	Distributed Recovery .....	3238
17.9.6	Observability .....	3245
17.9.7	Group Replication Performance .....	3245
18	MySQL Shell .....	3251
19	Using MySQL as a Document Store .....	3253
19.1	Key Concepts .....	3254
19.2	Setting Up MySQL as a Document Store .....	3255
19.2.1	Installing MySQL Shell .....	3257
19.2.2	Starting MySQL Shell .....	3261
19.3	Quick-Start Guide: MySQL for Visual Studio .....	3261
19.4	X Plugin .....	3263
19.4.1	Using Encrypted Connections with X Plugin .....	3263
19.4.2	X Plugin Options and Variables .....	3264
19.4.3	Monitoring X Plugin .....	3277
20	InnoDB Cluster .....	3279
21	MySQL NDB Cluster 7.5 and NDB Cluster 7.6 .....	3281
21.1	General Information .....	3283
21.2	NDB Cluster Overview .....	3285
21.2.1	NDB Cluster Core Concepts .....	3287
21.2.2	NDB Cluster Nodes, Node Groups, Fragment Replicas, and Partitions .....	3290
21.2.3	NDB Cluster Hardware, Software, and Networking Requirements .....	3293
21.2.4	What is New in MySQL NDB Cluster .....	3294
21.2.5	NDB: Added, Deprecated, and Removed Options, Variables, and Parameters .....	3311
21.2.6	MySQL Server Using InnoDB Compared with NDB Cluster .....	3315
21.2.7	Known Limitations of NDB Cluster .....	3318
21.3	NDB Cluster Installation .....	3331
21.3.1	Installation of NDB Cluster on Linux .....	3333
21.3.2	Installing NDB Cluster on Windows .....	3341
21.3.3	Initial Configuration of NDB Cluster .....	3350
21.3.4	Initial Startup of NDB Cluster .....	3352
21.3.5	NDB Cluster Example with Tables and Data .....	3353
21.3.6	Safe Shutdown and Restart of NDB Cluster .....	3356
21.3.7	Upgrading and Downgrading NDB Cluster .....	3357
21.3.8	The NDB Cluster Auto-Installer (NDB 7.5) (NO LONGER SUPPORTED) .....	3361
21.3.9	The NDB Cluster Auto-Installer (NO LONGER SUPPORTED) .....	3361
21.4	Configuration of NDB Cluster .....	3361
21.4.1	Quick Test Setup of NDB Cluster .....	3362
21.4.2	Overview of NDB Cluster Configuration Parameters, Options, and Variables .....	3364
21.4.3	NDB Cluster Configuration Files .....	3383
21.4.4	Using High-Speed Interconnects with NDB Cluster .....	3570
21.5	NDB Cluster Programs .....	3570
21.5.1	ndbd — The NDB Cluster Data Node Daemon .....	3570
21.5.2	ndbinfo_select_all — Select From ndbinfo Tables .....	3581
21.5.3	ndbmtd — The NDB Cluster Data Node Daemon (Multi-Threaded) .....	3587
21.5.4	ndb_mgmd — The NDB Cluster Management Server Daemon .....	3588
21.5.5	ndb_mgm — The NDB Cluster Management Client .....	3600
21.5.6	ndb_blob_tool — Check and Repair BLOB and TEXT columns of NDB Cluster Tables .....	3606

21.5.7	<code>ndb_config</code> — Extract NDB Cluster Configuration Information .....	3612
21.5.8	<code>ndb_cpcd</code> — Automate Testing for NDB Development .....	3624
21.5.9	<code>ndb_delete_all</code> — Delete All Rows from an NDB Table .....	3624
21.5.10	<code>ndb_desc</code> — Describe NDB Tables .....	3629
21.5.11	<code>ndb_drop_index</code> — Drop Index from an NDB Table .....	3639
21.5.12	<code>ndb_drop_table</code> — Drop an NDB Table .....	3644
21.5.13	<code>ndb_error_reporter</code> — NDB Error-Reporting Utility .....	3648
21.5.14	<code>ndb_import</code> — Import CSV Data Into NDB .....	3650
21.5.15	<code>ndb_index_stat</code> — NDB Index Statistics Utility .....	3669
21.5.16	<code>ndb_move_data</code> — NDB Data Copy Utility .....	3677
21.5.17	<code>ndb_perror</code> — Obtain NDB Error Message Information .....	3683
21.5.18	<code>ndb_print_backup_file</code> — Print NDB Backup File Contents .....	3685
21.5.19	<code>ndb_print_file</code> — Print NDB Disk Data File Contents .....	3685
21.5.20	<code>ndb_print_frag_file</code> — Print NDB Fragment List File Contents .....	3686
21.5.21	<code>ndb_print_schema_file</code> — Print NDB Schema File Contents .....	3687
21.5.22	<code>ndb_print_sys_file</code> — Print NDB System File Contents .....	3687
21.5.23	<code>ndb_redo_log_reader</code> — Check and Print Content of Cluster Redo Log .....	3687
21.5.24	<code>ndb_restore</code> — Restore an NDB Cluster Backup .....	3690
21.5.25	<code>ndb_select_all</code> — Print Rows from an NDB Table .....	3721
21.5.26	<code>ndb_select_count</code> — Print Row Counts for NDB Tables .....	3728
21.5.27	<code>ndb_show_tables</code> — Display List of NDB Tables .....	3732
21.5.28	<code>ndb_size.pl</code> — NDBCLUSTER Size Requirement Estimator .....	3737
21.5.29	<code>ndb_top</code> — View CPU usage information for NDB threads .....	3740
21.5.30	<code>ndb_waiter</code> — Wait for NDB Cluster to Reach a Given Status .....	3747
21.6	Management of NDB Cluster .....	3754
21.6.1	Commands in the NDB Cluster Management Client .....	3755
21.6.2	NDB Cluster Log Messages .....	3761
21.6.3	Event Reports Generated in NDB Cluster .....	3780
21.6.4	Summary of NDB Cluster Start Phases .....	3792
21.6.5	Performing a Rolling Restart of an NDB Cluster .....	3794
21.6.6	NDB Cluster Single User Mode .....	3796
21.6.7	Adding NDB Cluster Data Nodes Online .....	3797
21.6.8	Online Backup of NDB Cluster .....	3808
21.6.9	Importing Data Into MySQL Cluster .....	3813
21.6.10	MySQL Server Usage for NDB Cluster .....	3814
21.6.11	NDB Cluster Disk Data Tables .....	3816
21.6.12	Online Operations with ALTER TABLE in NDB Cluster .....	3822
21.6.13	Distributed Privileges Using Shared Grant Tables .....	3826
21.6.14	NDB API Statistics Counters and Variables .....	3829
21.6.15	<code>ndbinfo</code> : The NDB Cluster Information Database .....	3840
21.6.16	INFORMATION_SCHEMA Tables for NDB Cluster .....	3914
21.6.17	Quick Reference: NDB Cluster SQL Statements .....	3914
21.6.18	NDB Cluster Security Issues .....	3923
21.7	NDB Cluster Replication .....	3930
21.7.1	NDB Cluster Replication: Abbreviations and Symbols .....	3932
21.7.2	General Requirements for NDB Cluster Replication .....	3932
21.7.3	Known Issues in NDB Cluster Replication .....	3933
21.7.4	NDB Cluster Replication Schema and Tables .....	3940
21.7.5	Preparing the NDB Cluster for Replication .....	3947
21.7.6	Starting NDB Cluster Replication (Single Replication Channel) .....	3949
21.7.7	Using Two Replication Channels for NDB Cluster Replication .....	3951
21.7.8	Implementing Failover with NDB Cluster Replication .....	3952
21.7.9	NDB Cluster Backups With NDB Cluster Replication .....	3954
21.7.10	NDB Cluster Replication: Bidirectional and Circular Replication .....	3960

---

21.7.11 NDB Cluster Replication Conflict Resolution .....	3965
21.8 NDB Cluster Release Notes .....	3978
22 Partitioning .....	3979
22.1 Overview of Partitioning in MySQL .....	3981
22.2 Partitioning Types .....	3984
22.2.1 RANGE Partitioning .....	3986
22.2.2 LIST Partitioning .....	3990
22.2.3 COLUMNS Partitioning .....	3992
22.2.4 HASH Partitioning .....	4000
22.2.5 KEY Partitioning .....	4003
22.2.6 Subpartitioning .....	4005
22.2.7 How MySQL Partitioning Handles NULL .....	4009
22.3 Partition Management .....	4013
22.3.1 Management of RANGE and LIST Partitions .....	4014
22.3.2 Management of HASH and KEY Partitions .....	4020
22.3.3 Exchanging Partitions and Subpartitions with Tables .....	4021
22.3.4 Maintenance of Partitions .....	4029
22.3.5 Obtaining Information About Partitions .....	4030
22.4 Partition Pruning .....	4032
22.5 Partition Selection .....	4035
22.6 Restrictions and Limitations on Partitioning .....	4041
22.6.1 Partitioning Keys, Primary Keys, and Unique Keys .....	4049
22.6.2 Partitioning Limitations Relating to Storage Engines .....	4052
22.6.3 Partitioning Limitations Relating to Functions .....	4053
22.6.4 Partitioning and Locking .....	4055
23 Stored Objects .....	4057
23.1 Defining Stored Programs .....	4058
23.2 Using Stored Routines .....	4059
23.2.1 Stored Routine Syntax .....	4060
23.2.2 Stored Routines and MySQL Privileges .....	4061
23.2.3 Stored Routine Metadata .....	4061
23.2.4 Stored Procedures, Functions, Triggers, and LAST_INSERT_ID() .....	4061
23.3 Using Triggers .....	4062
23.3.1 Trigger Syntax and Examples .....	4062
23.3.2 Trigger Metadata .....	4066
23.4 Using the Event Scheduler .....	4067
23.4.1 Event Scheduler Overview .....	4067
23.4.2 Event Scheduler Configuration .....	4068
23.4.3 Event Syntax .....	4070
23.4.4 Event Metadata .....	4070
23.4.5 Event Scheduler Status .....	4071
23.4.6 The Event Scheduler and MySQL Privileges .....	4072
23.5 Using Views .....	4075
23.5.1 View Syntax .....	4075
23.5.2 View Processing Algorithms .....	4075
23.5.3 Updatable and Insertable Views .....	4077
23.5.4 The View WITH CHECK OPTION Clause .....	4079
23.5.5 View Metadata .....	4080
23.6 Stored Object Access Control .....	4081
23.7 Stored Program Binary Logging .....	4084
23.8 Restrictions on Stored Programs .....	4090
23.9 Restrictions on Views .....	4094
24 INFORMATION_SCHEMA Tables .....	4097
24.1 Introduction .....	4098

---

24.2	INFORMATION_SCHEMA Table Reference .....	4101
24.3	INFORMATION_SCHEMA General Tables .....	4105
24.3.1	INFORMATION_SCHEMA General Table Reference .....	4105
24.3.2	The INFORMATION_SCHEMA CHARACTER_SETS Table .....	4106
24.3.3	The INFORMATION_SCHEMA COLLATIONS Table .....	4106
24.3.4	The INFORMATION_SCHEMA COLLATION_CHARACTER_SET_APPLICABILITY Table .....	4107
24.3.5	The INFORMATION_SCHEMA COLUMNS Table .....	4107
24.3.6	The INFORMATION_SCHEMA COLUMN_PRIVILEGES Table .....	4110
24.3.7	The INFORMATION_SCHEMA ENGINES Table .....	4111
24.3.8	The INFORMATION_SCHEMA EVENTS Table .....	4112
24.3.9	The INFORMATION_SCHEMA FILES Table .....	4116
24.3.10	The INFORMATION_SCHEMA GLOBAL_STATUS and SESSION_STATUS Tables .....	4123
24.3.11	The INFORMATION_SCHEMA GLOBAL_VARIABLES and SESSION_VARIABLES Tables .....	4123
24.3.12	The INFORMATION_SCHEMA KEY_COLUMN_USAGE Table .....	4124
24.3.13	The INFORMATION_SCHEMA ndb_transid_mysql_connection_map Table .....	4125
24.3.14	The INFORMATION_SCHEMA OPTIMIZER_TRACE Table .....	4126
24.3.15	The INFORMATION_SCHEMA PARAMETERS Table .....	4127
24.3.16	The INFORMATION_SCHEMA PARTITIONS Table .....	4128
24.3.17	The INFORMATION_SCHEMA PLUGINS Table .....	4132
24.3.18	The INFORMATION_SCHEMA PROCESSLIST Table .....	4133
24.3.19	The INFORMATION_SCHEMA PROFILING Table .....	4134
24.3.20	The INFORMATION_SCHEMA REFERENTIAL_CONSTRAINTS Table .....	4135
24.3.21	The INFORMATION_SCHEMA ROUTINES Table .....	4136
24.3.22	The INFORMATION_SCHEMA SCHEMATA Table .....	4139
24.3.23	The INFORMATION_SCHEMA SCHEMA_PRIVILEGES Table .....	4140
24.3.24	The INFORMATION_SCHEMA STATISTICS Table .....	4141
24.3.25	The INFORMATION_SCHEMA TABLES Table .....	4142
24.3.26	The INFORMATION_SCHEMA TABLESPACES Table .....	4146
24.3.27	The INFORMATION_SCHEMA TABLE_CONSTRAINTS Table .....	4146
24.3.28	The INFORMATION_SCHEMA TABLE_PRIVILEGES Table .....	4147
24.3.29	The INFORMATION_SCHEMA TRIGGERS Table .....	4148
24.3.30	The INFORMATION_SCHEMA USER_PRIVILEGES Table .....	4150
24.3.31	The INFORMATION_SCHEMA VIEWS Table .....	4150
24.4	INFORMATION_SCHEMA InnoDB Tables .....	4152
24.4.1	INFORMATION_SCHEMA InnoDB Table Reference .....	4152
24.4.2	The INFORMATION_SCHEMA INNODB_BUFFER_PAGE Table .....	4154
24.4.3	The INFORMATION_SCHEMA INNODB_BUFFER_PAGE_LRU Table .....	4157
24.4.4	The INFORMATION_SCHEMA INNODB_BUFFER_POOL_STATS Table .....	4160
24.4.5	The INFORMATION_SCHEMA INNODB_CMP and INNODB_CMP_RESET Tables .....	4163
24.4.6	The INFORMATION_SCHEMA INNODB_CMPMEM and INNODB_CMPMEM_RESET Tables .....	4164
24.4.7	The INFORMATION_SCHEMA INNODB_CMP_PER_INDEX and INNODB_CMP_PER_INDEX_RESET Tables .....	4166
24.4.8	The INFORMATION_SCHEMA INNODB_FT_BEING_DELETED Table .....	4167
24.4.9	The INFORMATION_SCHEMA INNODB_FT_CONFIG Table .....	4168
24.4.10	The INFORMATION_SCHEMA INNODB_FT_DEFAULT_STOPWORD Table .....	4169
24.4.11	The INFORMATION_SCHEMA INNODB_FT_DELETED Table .....	4170
24.4.12	The INFORMATION_SCHEMA INNODB_FT_INDEX_CACHE Table .....	4171
24.4.13	The INFORMATION_SCHEMA INNODB_FT_INDEX_TABLE Table .....	4173
24.4.14	The INFORMATION_SCHEMA INNODB_LOCKS Table .....	4174
24.4.15	The INFORMATION_SCHEMA INNODB_LOCK_WAITS Table .....	4176

24.4.16	The INFORMATION_SCHEMA INNODB_METRICS Table .....	4177
24.4.17	The INFORMATION_SCHEMA INNODB_SYS_COLUMNS Table .....	4179
24.4.18	The INFORMATION_SCHEMA INNODB_SYS_DATAFILES Table .....	4180
24.4.19	The INFORMATION_SCHEMA INNODB_SYS_FIELDS Table .....	4181
24.4.20	The INFORMATION_SCHEMA INNODB_SYS_FOREIGN Table .....	4182
24.4.21	The INFORMATION_SCHEMA INNODB_SYS_FOREIGN_COLS Table .....	4183
24.4.22	The INFORMATION_SCHEMA INNODB_SYS_INDEXES Table .....	4183
24.4.23	The INFORMATION_SCHEMA INNODB_SYS_TABLES Table .....	4185
24.4.24	The INFORMATION_SCHEMA INNODB_SYS_TABLESPACES Table .....	4186
24.4.25	The INFORMATION_SCHEMA INNODB_SYS_TABLESTATS View .....	4188
24.4.26	The INFORMATION_SCHEMA INNODB_SYS_VIRTUAL Table .....	4189
24.4.27	The INFORMATION_SCHEMA INNODB_TEMP_TABLE_INFO Table .....	4190
24.4.28	The INFORMATION_SCHEMA INNODB_TRX Table .....	4192
24.5	INFORMATION_SCHEMA Thread Pool Tables .....	4194
24.5.1	INFORMATION_SCHEMA Thread Pool Table Reference .....	4195
24.5.2	The INFORMATION_SCHEMA TP_THREAD_GROUP_STATE Table .....	4195
24.5.3	The INFORMATION_SCHEMA TP_THREAD_GROUP_STATS Table .....	4197
24.5.4	The INFORMATION_SCHEMA TP_THREAD_STATE Table .....	4199
24.6	INFORMATION_SCHEMA Connection Control Tables .....	4199
24.6.1	INFORMATION_SCHEMA Connection Control Table Reference .....	4199
24.6.2	The INFORMATION_SCHEMA CONNECTION_CONTROL_FAILED_LOGIN_ATTEMPTS Table .....	4200
24.7	INFORMATION_SCHEMA MySQL Enterprise Firewall Tables .....	4200
24.7.1	INFORMATION_SCHEMA Firewall Table Reference .....	4200
24.7.2	The INFORMATION_SCHEMA MYSQL_FIREWALL_USERS Table .....	4201
24.7.3	The INFORMATION_SCHEMA MYSQL_FIREWALL_WHITELIST Table .....	4201
24.8	Extensions to SHOW Statements .....	4201
25	MySQL Performance Schema .....	4205
25.1	Performance Schema Quick Start .....	4207
25.2	Performance Schema Build Configuration .....	4213
25.3	Performance Schema Startup Configuration .....	4214
25.4	Performance Schema Runtime Configuration .....	4216
25.4.1	Performance Schema Event Timing .....	4217
25.4.2	Performance Schema Event Filtering .....	4220
25.4.3	Event Pre-Filtering .....	4222
25.4.4	Pre-Filtering by Instrument .....	4223
25.4.5	Pre-Filtering by Object .....	4224
25.4.6	Pre-Filtering by Thread .....	4226
25.4.7	Pre-Filtering by Consumer .....	4228
25.4.8	Example Consumer Configurations .....	4231
25.4.9	Naming Instruments or Consumers for Filtering Operations .....	4236
25.4.10	Determining What Is Instrumented .....	4237
25.5	Performance Schema Queries .....	4237
25.6	Performance Schema Instrument Naming Conventions .....	4238
25.7	Performance Schema Status Monitoring .....	4241
25.8	Performance Schema Atom and Molecule Events .....	4244
25.9	Performance Schema Tables for Current and Historical Events .....	4245
25.10	Performance Schema Statement Digests .....	4246
25.11	Performance Schema General Table Characteristics .....	4250
25.12	Performance Schema Table Descriptions .....	4251
25.12.1	Performance Schema Table Reference .....	4251
25.12.2	Performance Schema Setup Tables .....	4255
25.12.3	Performance Schema Instance Tables .....	4260
25.12.4	Performance Schema Wait Event Tables .....	4265

25.12.5 Performance Schema Stage Event Tables .....	4271
25.12.6 Performance Schema Statement Event Tables .....	4277
25.12.7 Performance Schema Transaction Tables .....	4288
25.12.8 Performance Schema Connection Tables .....	4296
25.12.9 Performance Schema Connection Attribute Tables .....	4299
25.12.10 Performance Schema User-Defined Variable Tables .....	4302
25.12.11 Performance Schema Replication Tables .....	4303
25.12.12 Performance Schema Lock Tables .....	4314
25.12.13 Performance Schema System Variable Tables .....	4318
25.12.14 Performance Schema Status Variable Tables .....	4319
25.12.15 Performance Schema Summary Tables .....	4321
25.12.16 Performance Schema Miscellaneous Tables .....	4341
25.13 Performance Schema Option and Variable Reference .....	4353
25.14 Performance Schema Command Options .....	4357
25.15 Performance Schema System Variables .....	4358
25.16 Performance Schema Status Variables .....	4376
25.17 The Performance Schema Memory-Allocation Model .....	4379
25.18 Performance Schema and Plugins .....	4380
25.19 Using the Performance Schema to Diagnose Problems .....	4380
25.19.1 Query Profiling Using Performance Schema .....	4381
25.20 Migrating to Performance Schema System and Status Variable Tables .....	4383
25.21 Restrictions on Performance Schema .....	4385
26 MySQL sys Schema .....	4387
26.1 Prerequisites for Using the sys Schema .....	4387
26.2 Using the sys Schema .....	4388
26.3 sys Schema Progress Reporting .....	4389
26.4 sys Schema Object Reference .....	4390
26.4.1 sys Schema Object Index .....	4390
26.4.2 sys Schema Tables and Triggers .....	4395
26.4.3 sys Schema Views .....	4398
26.4.4 sys Schema Stored Procedures .....	4439
26.4.5 sys Schema Stored Functions .....	4459
27 Connectors and APIs .....	4473
27.1 MySQL Connector/C++ .....	4476
27.2 MySQL Connector/J .....	4476
27.3 MySQL Connector/NET .....	4476
27.4 MySQL Connector/ODBC .....	4476
27.5 MySQL Connector/Python .....	4476
27.6 libmysqld, the Embedded MySQL Server Library .....	4476
27.6.1 Compiling Programs with libmysqld .....	4477
27.6.2 Restrictions When Using the Embedded MySQL Server .....	4478
27.6.3 Options with the Embedded Server .....	4478
27.6.4 Embedded Server Examples .....	4479
27.7 MySQL C API .....	4482
27.8 MySQL PHP API .....	4482
27.9 MySQL Perl API .....	4482
27.10 MySQL Python API .....	4483
27.11 MySQL Ruby APIs .....	4483
27.11.1 The MySQL/Ruby API .....	4484
27.11.2 The Ruby/MySQL API .....	4484
27.12 MySQL Tcl API .....	4484
27.13 MySQL Eiffel Wrapper .....	4484
28 MySQL Enterprise Edition .....	4485
28.1 MySQL Enterprise Backup Overview .....	4485



---

28.2 MySQL Enterprise Security Overview .....	4486
28.3 MySQL Enterprise Encryption Overview .....	4486
28.4 MySQL Enterprise Audit Overview .....	4487
28.5 MySQL Enterprise Firewall Overview .....	4487
28.6 MySQL Enterprise Thread Pool Overview .....	4487
28.7 MySQL Enterprise Data Masking and De-Identification Overview .....	4487
28.8 MySQL Telemetry .....	4488
29 MySQL Workbench .....	4489
A MySQL 5.7 Frequently Asked Questions .....	4491
A.1 MySQL 5.7 FAQ: General .....	4491
A.2 MySQL 5.7 FAQ: Storage Engines .....	4493
A.3 MySQL 5.7 FAQ: Server SQL Mode .....	4494
A.4 MySQL 5.7 FAQ: Stored Procedures and Functions .....	4495
A.5 MySQL 5.7 FAQ: Triggers .....	4499
A.6 MySQL 5.7 FAQ: Views .....	4501
A.7 MySQL 5.7 FAQ: INFORMATION_SCHEMA .....	4502
A.8 MySQL 5.7 FAQ: Migration .....	4502
A.9 MySQL 5.7 FAQ: Security .....	4503
A.10 MySQL 5.7 FAQ: NDB Cluster .....	4505
A.11 MySQL 5.7 FAQ: MySQL Chinese, Japanese, and Korean Character Sets .....	4518
A.12 MySQL 5.7 FAQ: Connectors & APIs .....	4531
A.13 MySQL 5.7 FAQ: C API, libmysql .....	4531
A.14 MySQL 5.7 FAQ: Replication .....	4532
A.15 MySQL 5.7 FAQ: MySQL Enterprise Thread Pool .....	4536
A.16 MySQL 5.7 FAQ: InnoDB Change Buffer .....	4538
A.17 MySQL 5.7 FAQ: InnoDB Data-at-Rest Encryption .....	4539
A.18 MySQL 5.7 FAQ: Virtualization Support .....	4542
B Error Messages and Common Problems .....	4543
B.1 Error Message Sources and Elements .....	4543
B.2 Error Information Interfaces .....	4545
B.3 Problems and Common Errors .....	4547
B.3.1 How to Determine What Is Causing a Problem .....	4547
B.3.2 Common Errors When Using MySQL Programs .....	4548
B.3.3 Administration-Related Issues .....	4559
B.3.4 Query-Related Issues .....	4568
B.3.5 Optimizer-Related Issues .....	4575
B.3.6 Table Definition-Related Issues .....	4575
B.3.7 Known Issues in MySQL .....	4577
C Indexes .....	4581
MySQL Glossary .....	5301



---

# Preface and Legal Notices

This is the Reference Manual for the MySQL Database System, version 5.7, through release 5.7.44. Differences between minor versions of MySQL 5.7 are noted in the present text with reference to release numbers (5.7.x). For license information, see the [Legal Notices](#).

This manual is not intended for use with older versions of the MySQL software due to the many functional and other differences between MySQL 5.7 and previous versions. If you are using an earlier release of the MySQL software, please refer to the appropriate manual. For example, [MySQL 5.6 Reference Manual](#) covers the 5.6 series of MySQL software releases.

If you are using MySQL 8.0, please refer to the [MySQL 8.0 Reference Manual](#).

**Licensing information—MySQL 5.7.** This product may include third-party software, used under license. If you are using a *Commercial* release of MySQL 5.7, see the [MySQL 5.7 Commercial Release License Information User Manual](#) for licensing information, including licensing information relating to third-party software that may be included in this Commercial release. If you are using a *Community* release of MySQL 5.7, see the [MySQL 5.7 Community Release License Information User Manual](#) for licensing information, including licensing information relating to third-party software that may be included in this Community release.

**Licensing information—MySQL NDB Cluster 7.5.** This product may include third-party software, used under license. If you are using a *Commercial* release of NDB Cluster 7.5, see the [MySQL NDB Cluster 7.5 Commercial Release License Information User Manual](#) for licensing information relating to third-party software that may be included in this Commercial release. If you are using a *Community* release of NDB Cluster 7.5, see the [MySQL NDB Cluster 7.5 Community Release License Information User Manual](#) for licensing information relating to third-party software that may be included in this Community release.

**Licensing information—MySQL NDB Cluster 7.6.** If you are using a *Commercial* release of MySQL NDB Cluster 7.6, see the [MySQL NDB Cluster 7.6 Commercial Release License Information User Manual](#) for licensing information, including licensing information relating to third-party software that may be included in this Commercial release. If you are using a *Community* release of MySQL NDB Cluster 7.6, see the [MySQL NDB Cluster 7.6 Community Release License Information User Manual](#) for licensing information, including licensing information relating to third-party software that may be included in this Community release.

## Legal Notices

Copyright © 1997, 2026, Oracle and/or its affiliates.

### License Restrictions

This software and related documentation are provided under a license agreement containing restrictions on use and disclosure and are protected by intellectual property laws. Except as expressly permitted in your license agreement or allowed by law, you may not use, copy, reproduce, translate, broadcast, modify, license, transmit, distribute, exhibit, perform, publish, or display any part, in any form, or by any means. Reverse engineering, disassembly, or decompilation of this software, unless required by law for interoperability, is prohibited.

### Warranty Disclaimer

The information contained herein is subject to change without notice and is not warranted to be error-free. If you find any errors, please report them to us in writing.

### Restricted Rights Notice

If this is software, software documentation, data (as defined in the Federal Acquisition Regulation), or related documentation that is delivered to the U.S. Government or anyone licensing it on behalf of the U.S. Government, then the following notice is applicable:

U.S. GOVERNMENT END USERS: Oracle programs (including any operating system, integrated software, any programs embedded, installed, or activated on delivered hardware, and modifications of such programs) and Oracle computer documentation or other Oracle data delivered to or accessed by U.S. Government end users are "commercial computer software," "commercial computer software documentation," or "limited rights data" pursuant to the applicable Federal Acquisition Regulation and agency-specific supplemental regulations. As such, the use, reproduction, duplication, release, display, disclosure, modification, preparation of derivative works, and/or adaptation of i) Oracle programs (including any operating system, integrated software, any programs embedded, installed, or activated on delivered hardware, and modifications of such programs), ii) Oracle computer documentation and/or iii) other Oracle data, is subject to the rights and limitations specified in the license contained in the applicable contract. The terms governing the U.S. Government's use of Oracle cloud services are defined by the applicable contract for such services. No other rights are granted to the U.S. Government.

### **Hazardous Applications Notice**

This software or hardware is developed for general use in a variety of information management applications. It is not developed or intended for use in any inherently dangerous applications, including applications that may create a risk of personal injury. If you use this software or hardware in dangerous applications, then you shall be responsible to take all appropriate fail-safe, backup, redundancy, and other measures to ensure its safe use. Oracle Corporation and its affiliates disclaim any liability for any damages caused by use of this software or hardware in dangerous applications.

### **Trademark Notice**

Oracle, Java, MySQL, and NetSuite are registered trademarks of Oracle and/or its affiliates. Other names may be trademarks of their respective owners.

Intel and Intel Inside are trademarks or registered trademarks of Intel Corporation. All SPARC trademarks are used under license and are trademarks or registered trademarks of SPARC International, Inc. AMD, Epyc, and the AMD logo are trademarks or registered trademarks of Advanced Micro Devices. UNIX is a registered trademark of The Open Group.

### **Third-Party Content, Products, and Services Disclaimer**

This software or hardware and documentation may provide access to or information about content, products, and services from third parties. Oracle Corporation and its affiliates are not responsible for and expressly disclaim all warranties of any kind with respect to third-party content, products, and services unless otherwise set forth in an applicable agreement between you and Oracle. Oracle Corporation and its affiliates will not be responsible for any loss, costs, or damages incurred due to your access to or use of third-party content, products, or services, except as set forth in an applicable agreement between you and Oracle.

### **Use of This Documentation**

This documentation is NOT distributed under a GPL license. Use of this documentation is subject to the following terms:

You may create a printed copy of this documentation solely for your own personal use. Conversion to other formats is allowed as long as the actual content is not altered or edited in any way. You shall not publish or distribute this documentation in any form or on any media, except if you distribute the documentation in a manner similar to how Oracle disseminates it (that is, electronically for download on a Web site with the software) or on a CD-ROM or similar medium, provided however that the documentation is disseminated

together with the software on the same medium. Any other use, such as any dissemination of printed copies or use of this documentation, in whole or in part, in another publication, requires the prior written consent from an authorized representative of Oracle. Oracle and/or its affiliates reserve any and all rights to this documentation not expressly granted above.

## Documentation Accessibility

For information about Oracle's commitment to accessibility, visit the Oracle Accessibility Program website at <http://www.oracle.com/pls/topic/lookup?ctx=acc&id=docacc>.

## Access to Oracle Support for Accessibility

Oracle customers that have purchased support have access to electronic support through My Oracle Support. For information, visit <http://www.oracle.com/pls/topic/lookup?ctx=acc&id=info> or visit <http://www.oracle.com/pls/topic/lookup?ctx=acc&id=trs> if you are hearing impaired.



---

# Chapter 1 General Information

## Table of Contents

1.1 About This Manual .....	2
1.2 Overview of the MySQL Database Management System .....	4
1.2.1 What is MySQL? .....	4
1.2.2 The Main Features of MySQL .....	6
1.2.3 History of MySQL .....	8
1.3 What Is New in MySQL 5.7 .....	9
1.4 Server and Status Variables and Options Added, Deprecated, or Removed in MySQL 5.7 .....	25
1.5 How to Report Bugs or Problems .....	41
1.6 MySQL Standards Compliance .....	46
1.6.1 MySQL Extensions to Standard SQL .....	47
1.6.2 MySQL Differences from Standard SQL .....	50
1.6.3 How MySQL Deals with Constraints .....	53

The MySQL software delivers a very fast, multithreaded, multi-user, and robust SQL (Structured Query Language) database server. MySQL Server is intended for mission-critical, heavy-load production systems as well as for embedding into mass-deployed software. Oracle is a registered trademark of Oracle Corporation and/or its affiliates. MySQL is a trademark of Oracle Corporation and/or its affiliates, and shall not be used by Customer without Oracle's express written authorization. Other names may be trademarks of their respective owners.

The MySQL software is Dual Licensed. Users can choose to use the MySQL software as an Open Source product under the terms of the GNU General Public License (<http://www.fsf.org/licenses/>) or can purchase a standard commercial license from Oracle. See <http://www.mysql.com/company/legal/licensing/> for more information on our licensing policies.

The following list describes some sections of particular interest in this manual:

- For a discussion of MySQL Database Server capabilities, see [Section 1.2.2, “The Main Features of MySQL”](#).
- For an overview of new MySQL features, see [Section 1.3, “What Is New in MySQL 5.7”](#). For information about the changes in each version, see the [Release Notes](#).
- For installation instructions, see [Chapter 2, \*Installing and Upgrading MySQL\*](#). For information about upgrading MySQL, see [Section 2.10, “Upgrading MySQL”](#).
- For a tutorial introduction to the MySQL Database Server, see [Chapter 3, \*Tutorial\*](#).
- For information about configuring and administering MySQL Server, see [Chapter 5, \*MySQL Server Administration\*](#).
- For information about security in MySQL, see [Chapter 6, \*Security\*](#).
- For information about setting up replication servers, see [Chapter 16, \*Replication\*](#).
- For information about MySQL Enterprise, the commercial MySQL release with advanced features and management tools, see [Chapter 28, \*MySQL Enterprise Edition\*](#).
- For answers to a number of questions that are often asked concerning the MySQL Database Server and its capabilities, see [Appendix A, \*MySQL 5.7 Frequently Asked Questions\*](#).

- For a history of new features and bug fixes, see the [Release Notes](#).



### Important

To report problems or bugs, please use the instructions at [Section 1.5, “How to Report Bugs or Problems”](#). If you find a security bug in MySQL Server, please let us know immediately by sending an email message to [<secalert\\_us@oracle.com>](mailto:secalert_us@oracle.com). Exception: Support customers should report all problems, including security bugs, to Oracle Support.

## 1.1 About This Manual

This is the Reference Manual for the MySQL Database System, version 5.7, through release 5.7.44. Differences between minor versions of MySQL 5.7 are noted in the present text with reference to release numbers (5.7.x). For license information, see the [Legal Notices](#).

This manual is not intended for use with older versions of the MySQL software due to the many functional and other differences between MySQL 5.7 and previous versions. If you are using an earlier release of the MySQL software, please refer to the appropriate manual. For example, [MySQL 5.6 Reference Manual](#) covers the 5.6 series of MySQL software releases.

If you are using MySQL 8.0, please refer to the [MySQL 8.0 Reference Manual](#).

Because this manual serves as a reference, it does not provide general instruction on SQL or relational database concepts. It also does not teach you how to use your operating system or command-line interpreter.

The MySQL Database Software is under constant development, and the Reference Manual is updated frequently as well. The most recent version of the manual is available online in searchable form at <https://dev.mysql.com/doc/>. Other formats also are available there, including downloadable HTML and PDF versions.

If you have questions about using MySQL, join the [MySQL Community Slack](#). If you have suggestions concerning additions or corrections to the manual itself, please send them to the <http://www.mysql.com/company/contact/>.

## Typographical and Syntax Conventions

This manual uses certain typographical conventions:

- *Text in this style* is used for SQL statements; database, table, and column names; program listings and source code; and environment variables. Example: “To reload the grant tables, use the `FLUSH PRIVILEGES` statement.”
- *Text in this style* indicates input that you type in examples.
- *Text in this style* indicates the names of executable programs and scripts, examples being `mysql` (the MySQL command-line client program) and `mysqld` (the MySQL server executable).
- *Text in this style* is used for variable input for which you should substitute a value of your own choosing.
- *Text in this style* is used for emphasis.
- **Text in this style** is used in table headings and to convey especially strong emphasis.



- `Text in this style` is used to indicate a program option that affects how the program is executed, or that supplies information that is needed for the program to function in a certain way. *Example*: “The `--host` option (short form `-h`) tells the `mysql` client program the hostname or IP address of the MySQL server that it should connect to”.
- File names and directory names are written like this: “The global `my.cnf` file is located in the `/etc` directory.”
- Character sequences are written like this: “To specify a wildcard, use the `'%'` character.”

When commands or statements are prefixed by a prompt, we use these:

```
$> type a command here
#> type a command as root here
C:\> type a command here (Windows only)
mysql> type a mysql statement here
```

Commands are issued in your command interpreter. On Unix, this is typically a program such as `sh`, `csch`, or `bash`. On Windows, the equivalent program is `command.com` or `cmd.exe`, typically run in a console window. Statements prefixed by `mysql` are issued in the `mysql` command-line client.



### Note

When you enter a command or statement shown in an example, do not type the prompt shown in the example.

In some areas different systems may be distinguished from each other to show that commands should be executed in two different environments. For example, while working with replication the commands might be prefixed with `source` and `replica`:

```
source> type a mysql statement on the replication source here
replica> type a mysql statement on the replica here
```

Database, table, and column names must often be substituted into statements. To indicate that such substitution is necessary, this manual uses `db_name`, `tbl_name`, and `col_name`. For example, you might see a statement like this:

```
mysql> SELECT col_name FROM db_name.tbl_name;
```

This means that if you were to enter a similar statement, you would supply your own database, table, and column names, perhaps like this:

```
mysql> SELECT author_name FROM biblio_db.author_list;
```

SQL keywords are not case-sensitive and may be written in any lettercase. This manual uses uppercase.

In syntax descriptions, square brackets (“[” and “]”) indicate optional words or clauses. For example, in the following statement, `IF EXISTS` is optional:

```
DROP TABLE [IF EXISTS] tbl_name
```

When a syntax element consists of a number of alternatives, the alternatives are separated by vertical bars (“|”). When one member from a set of choices *may* be chosen, the alternatives are listed within square brackets (“[” and “]”):

```
TRIM([[BOTH | LEADING | TRAILING] [remstr] FROM] str)
```

When one member from a set of choices *must* be chosen, the alternatives are listed within braces (“{” and “}”):

```
{DESCRIBE | DESC} tbl_name [col_name | wild]
```

An ellipsis ( . . . ) indicates the omission of a section of a statement, typically to provide a shorter version of more complex syntax. For example, `SELECT ... INTO outfile` is shorthand for the form of `SELECT` statement that has an `INTO outfile` clause following other parts of the statement.

An ellipsis can also indicate that the preceding syntax element of a statement may be repeated. In the following example, multiple `reset_option` values may be given, with each of those after the first preceded by commas:

```
RESET reset_option [,reset_option] ...
```

Commands for setting shell variables are shown using Bourne shell syntax. For example, the sequence to set the `CC` environment variable and run the `configure` command looks like this in Bourne shell syntax:

```
$> CC=gcc ./configure
```

If you are using `csh` or `tcsh`, you must issue commands somewhat differently:

```
$> setenv CC gcc
$> ./configure
```

## Manual Authorship

The Reference Manual source files are written in DocBook XML format. The HTML version and other formats are produced automatically, primarily using the DocBook XSL stylesheets. For information about DocBook, see <http://docbook.org/>

This manual was originally written by David Axmark and Michael “Monty” Widenius. It is maintained by the MySQL Documentation Team, consisting of Edward Gilmore, Sudharsana Gomadam, Kim seong Loh, Garima Sharma, Carlos Ortiz, Daniel So, and Jon Stephens.

## 1.2 Overview of the MySQL Database Management System

### 1.2.1 What is MySQL?

MySQL, the most popular Open Source SQL database management system, is developed, distributed, and supported by Oracle Corporation.

The MySQL website (<http://www.mysql.com/>) provides the latest information about MySQL software.

- **MySQL is a database management system.**

A database is a structured collection of data. It may be anything from a simple shopping list to a picture gallery or the vast amounts of information in a corporate network. To add, access, and process data stored in a computer database, you need a database management system such as MySQL Server. Since computers are very good at handling large amounts of data, database management systems play a central role in computing, as standalone utilities, or as parts of other applications.

- **MySQL databases are relational.**

A relational database stores data in separate tables rather than putting all the data in one big storeroom. The database structures are organized into physical files optimized for speed. The logical model, with objects such as databases, tables, views, rows, and columns, offers a flexible programming environment. You set up rules governing the relationships between different data fields, such as one-to-one, one-to-many, unique, required or optional, and “pointers” between different tables. The database enforces these rules, so that with a well-designed database, your application never sees inconsistent, duplicate, orphan, out-of-date, or missing data.

The SQL part of “MySQL” stands for “Structured Query Language”. SQL is the most common standardized language used to access databases. Depending on your programming environment, you might enter SQL directly (for example, to generate reports), embed SQL statements into code written in another language, or use a language-specific API that hides the SQL syntax.

SQL is defined by the ANSI/ISO SQL Standard. The SQL standard has been evolving since 1986 and several versions exist. In this manual, “SQL-92” refers to the standard released in 1992, “SQL:1999” refers to the standard released in 1999, and “SQL:2003” refers to the current version of the standard. We use the phrase “the SQL standard” to mean the current version of the SQL Standard at any time.

- **MySQL software is Open Source.**

Open Source means that it is possible for anyone to use and modify the software. Anybody can download the MySQL software from the Internet and use it without paying anything. If you wish, you may study the source code and change it to suit your needs. The MySQL software uses the GPL (GNU General Public License), <http://www.fsf.org/licenses/>, to define what you may and may not do with the software in different situations. If you feel uncomfortable with the GPL or need to embed MySQL code into a commercial application, you can buy a commercially licensed version from us. See the MySQL Licensing Overview for more information (<http://www.mysql.com/company/legal/licensing/>).

- **The MySQL Database Server is very fast, reliable, scalable, and easy to use.**

If that is what you are looking for, you should give it a try. MySQL Server can run comfortably on a desktop or laptop, alongside your other applications, web servers, and so on, requiring little or no attention. If you dedicate an entire machine to MySQL, you can adjust the settings to take advantage of all the memory, CPU power, and I/O capacity available. MySQL can also scale up to clusters of machines, networked together.

MySQL Server was originally developed to handle large databases much faster than existing solutions and has been successfully used in highly demanding production environments for several years. Although under constant development, MySQL Server today offers a rich and useful set of functions. Its connectivity, speed, and security make MySQL Server highly suited for accessing databases on the Internet.

- **MySQL Server works in client/server or embedded systems.**

The MySQL Database Software is a client/server system that consists of a multithreaded SQL server that supports different back ends, several different client programs and libraries, administrative tools, and a wide range of application programming interfaces (APIs).

We also provide MySQL Server as an embedded multithreaded library that you can link into your application to get a smaller, faster, easier-to-manage standalone product.

- **A large amount of contributed MySQL software is available.**

MySQL Server has a practical set of features developed in close cooperation with our users. It is very likely that your favorite application or language supports the MySQL Database Server.

- **MySQL HeatWave.**

MySQL HeatWave is a fully managed database service, powered by the MySQL HeatWave in-memory query accelerator. It is the only cloud service that combines transactions, real-time analytics across data warehouses and data lakes, and machine learning in one MySQL Database; without the complexity, latency, risks, and cost of ETL duplication. It is available on OCI, AWS, and Azure. Learn more at: <https://www.oracle.com/mysql/>.

The official way to pronounce “MySQL” is “My Ess Que Ell” (not “my sequel”), but we do not mind if you pronounce it as “my sequel” or in some other localized way.

## 1.2.2 The Main Features of MySQL

This section describes some of the important characteristics of the MySQL Database Software. In most respects, the roadmap applies to all versions of MySQL. For information about features as they are introduced into MySQL on a series-specific basis, see the “In a Nutshell” section of the appropriate Manual:

- MySQL 8.4: [What Is New in MySQL 8.4 since MySQL 8.0](#)
- MySQL 8.0: [What Is New in MySQL 8.0](#)
- MySQL 5.7: [Section 1.3, “What Is New in MySQL 5.7”](#)

### Internals and Portability

- Written in C and C++.
- Tested with a broad range of different compilers.
- Works on many different platforms. See <https://www.mysql.com/support/supportedplatforms/database.html>.
- For portability, configured using [CMake](#).
- Tested with Purify (a commercial memory leakage detector) as well as with Valgrind, a GPL tool (<https://valgrind.org/>).
- Uses multi-layered server design with independent modules.
- Designed to be fully multithreaded using kernel threads, to easily use multiple CPUs if they are available.
- Provides transactional and nontransactional storage engines.
- Uses very fast B-tree disk tables ([MyISAM](#)) with index compression.
- Designed to make it relatively easy to add other storage engines. This is useful if you want to provide an SQL interface for an in-house database.
- Uses a very fast thread-based memory allocation system.
- Executes very fast joins using an optimized nested-loop join.
- Implements in-memory hash tables, which are used as temporary tables.
- Implements SQL functions using a highly optimized class library that should be as fast as possible. Usually there is no memory allocation at all after query initialization.
- Provides the server as a separate program for use in a client/server networked environment.

### Data Types

- Many data types: signed/unsigned integers 1, 2, 3, 4, and 8 bytes long, [FLOAT](#), [DOUBLE](#), [CHAR](#), [VARCHAR](#), [BINARY](#), [VARBINARY](#), [TEXT](#), [BLOB](#), [DATE](#), [TIME](#), [DATETIME](#), [TIMESTAMP](#), [YEAR](#), [SET](#), [ENUM](#), and OpenGIS spatial types. See [Chapter 11, Data Types](#).
- Fixed-length and variable-length string types.

## Statements and Functions

- Full operator and function support in the `SELECT` list and `WHERE` clause of queries. For example:

```
mysql> SELECT CONCAT(first_name, ' ', last_name)
-> FROM citizen
-> WHERE income/dependents > 10000 AND age > 30;
```

- Full support for SQL `GROUP BY` and `ORDER BY` clauses. Support for group functions (`COUNT()`, `AVG()`, `STD()`, `SUM()`, `MAX()`, `MIN()`, and `GROUP_CONCAT()`).
- Support for `LEFT OUTER JOIN` and `RIGHT OUTER JOIN` with both standard SQL and ODBC syntax.
- Support for aliases on tables and columns as required by standard SQL.
- Support for `DELETE`, `INSERT`, `REPLACE`, and `UPDATE` to return the number of rows that were changed (affected), or to return the number of rows matched instead by setting a flag when connecting to the server.
- Support for MySQL-specific `SHOW` statements that retrieve information about databases, storage engines, tables, and indexes. Support for the `INFORMATION_SCHEMA` database, implemented according to standard SQL.
- An `EXPLAIN` statement to show how the optimizer resolves a query.
- Independence of function names from table or column names. For example, `ABS` is a valid column name. The only restriction is that for a function call, no spaces are permitted between the function name and the "(" that follows it. See [Section 9.3, "Keywords and Reserved Words"](#).
- You can refer to tables from different databases in the same statement.

## Security

- A privilege and password system that is very flexible and secure, and that enables host-based verification.
- Password security by encryption of all password traffic when you connect to a server.

## Scalability and Limits

- Support for large databases. We use MySQL Server with databases that contain 50 million records. We also know of users who use MySQL Server with 200,000 tables and about 5,000,000,000 rows.
- Support for up to 64 indexes per table. Each index may consist of 1 to 16 columns or parts of columns. The maximum index width for `InnoDB` tables is either 767 bytes or 3072 bytes. See [Section 14.23, "InnoDB Limits"](#). The maximum index width for `MyISAM` tables is 1000 bytes. See [Section 15.2, "The MyISAM Storage Engine"](#). An index may use a prefix of a column for `CHAR`, `VARCHAR`, `BLOB`, or `TEXT` column types.

## Connectivity

- Clients can connect to MySQL Server using several protocols:
  - Clients can connect using TCP/IP sockets on any platform.
  - On Windows systems, clients can connect using named pipes if the server is started with the `named_pipe` system variable enabled. Windows servers also support shared-memory connections if started with the `shared_memory` system variable enabled. Clients can connect through shared memory by using the `--protocol=memory` option.

- On Unix systems, clients can connect using Unix domain socket files.
- MySQL client programs can be written in many languages. A client library written in C is available for clients written in C or C++, or for any language that provides C bindings.
- APIs for C, C++, Eiffel, Java, Perl, PHP, Python, Ruby, and Tcl are available, enabling MySQL clients to be written in many languages. See [Chapter 27, Connectors and APIs](#).
- The Connector/ODBC (MyODBC) interface provides MySQL support for client programs that use ODBC (Open Database Connectivity) connections. For example, you can use MS Access to connect to your MySQL server. Clients can be run on Windows or Unix. Connector/ODBC source is available. All ODBC 2.5 functions are supported, as are many others. See [MySQL Connector/ODBC Developer Guide](#).
- The Connector/J interface provides MySQL support for Java client programs that use JDBC connections. Clients can be run on Windows or Unix. Connector/J source is available. See [MySQL Connector/J Developer Guide](#).
- MySQL Connector/NET enables developers to easily create .NET applications that require secure, high-performance data connectivity with MySQL. It implements the required ADO.NET interfaces and integrates into ADO.NET aware tools. Developers can build applications using their choice of .NET languages. MySQL Connector/NET is a fully managed ADO.NET driver written in 100% pure C#. See [MySQL Connector/NET Developer Guide](#).

## Localization

- The server can provide error messages to clients in many languages. See [Section 10.12, “Setting the Error Message Language”](#).
- Full support for several different character sets, including `latin1` (cp1252), `german`, `big5`, `ujis`, several Unicode character sets, and more. For example, the Scandinavian characters “å”, “ä” and “ö” are permitted in table and column names.
- All data is saved in the chosen character set.
- Sorting and comparisons are done according to the default character set and collation. It is possible to change this when the MySQL server is started (see [Section 10.3.2, “Server Character Set and Collation”](#)). To see an example of very advanced sorting, look at the Czech sorting code. MySQL Server supports many different character sets that can be specified at compile time and runtime.
- The server time zone can be changed dynamically, and individual clients can specify their own time zone. See [Section 5.1.13, “MySQL Server Time Zone Support”](#).

## Clients and Tools

- MySQL includes several client and utility programs. These include both command-line programs such as `mysqldump` and `mysqladmin`, and graphical programs such as [MySQL Workbench](#).
- MySQL Server has built-in support for SQL statements to check, optimize, and repair tables. These statements are available from the command line through the `mysqlcheck` client. MySQL also includes `myisamchk`, a very fast command-line utility for performing these operations on `MyISAM` tables. See [Chapter 4, MySQL Programs](#).
- MySQL programs can be invoked with the `--help` or `-?` option to obtain online assistance.

### 1.2.3 History of MySQL

We started out with the intention of using the `mSQL` database system to connect to our tables using our own fast low-level (ISAM) routines. However, after some testing, we came to the conclusion that `mSQL` was

not fast enough or flexible enough for our needs. This resulted in a new SQL interface to our database but with almost the same API interface as `mSQL`. This API was designed to enable third-party code that was written for use with `mSQL` to be ported easily for use with MySQL.

MySQL is named after co-founder Monty Widenius's daughter, My.

The name of the MySQL Dolphin (our logo) is “Sakila,” which was chosen from a huge list of names suggested by users in our “Name the Dolphin” contest. The winning name was submitted by Ambrose Twebaze, an Open Source software developer from Eswatini (formerly Swaziland), Africa. According to Ambrose, the feminine name Sakila has its roots in SiSwati, the local language of Eswatini. Sakila is also the name of a town in Arusha, Tanzania, near Ambrose's country of origin, Uganda.

## 1.3 What Is New in MySQL 5.7

This section summarizes what has been added to, deprecated in, and removed from MySQL 5.7. A companion section lists MySQL server options and variables that have been added, deprecated, or removed in MySQL 5.7; see [Section 1.4, “Server and Status Variables and Options Added, Deprecated, or Removed in MySQL 5.7”](#).

- [Features Added in MySQL 5.7](#)
- [Features Deprecated in MySQL 5.7](#)
- [Features Removed in MySQL 5.7](#)

### Features Added in MySQL 5.7

The following features have been added to MySQL 5.7:

- **Security improvements.** These security enhancements were added:
  - In MySQL 8.0, `caching_sha2_password` is the default authentication plugin. To enable MySQL 5.7 clients to connect to 8.0 servers using accounts that authenticate using `caching_sha2_password`, the MySQL 5.7 client library and client programs support the `caching_sha2_password` client-side authentication plugin as of MySQL 5.7.23. This improves compatibility of MySQL 5.7 with MySQL 8.0 and higher servers. See [Section 6.4.1.4, “Caching SHA-2 Pluggable Authentication”](#).
  - The server now requires account rows in the `mysql.user` system table to have a nonempty `plugin` column value and disables accounts with an empty value. For server upgrade instructions, see [Section 2.10.3, “Changes in MySQL 5.7”](#). DBAs are advised to also convert accounts that use the `mysql_old_password` authentication plugin to use `mysql_native_password` instead, because support for `mysql_old_password` has been removed. For account upgrade instructions, see [Section 6.4.1.3, “Migrating Away from Pre-4.1 Password Hashing and the `mysql\_old\_password` Plugin”](#).
  - MySQL now enables database administrators to establish a policy for automatic password expiration: Any user who connects to the server using an account for which the password is past its permitted lifetime must change the password. For more information, see [Section 6.2.11, “Password Management”](#).
  - Administrators can lock and unlock accounts for better control over who can log in. For more information, see [Section 6.2.15, “Account Locking”](#).
  - To make it easier to support secure connections, MySQL servers compiled using OpenSSL can automatically generate missing SSL and RSA certificate and key files at startup. See [Section 6.3.3.1, “Creating SSL and RSA Certificates and Keys using MySQL”](#).

All servers, if not configured for SSL explicitly, attempt to enable SSL automatically at startup if they find the requisite SSL files in the data directory. See [Section 6.3.1, “Configuring MySQL to Use Encrypted Connections”](#).

In addition, MySQL distributions include a `mysql_ssl_rsa_setup` utility that can be invoked manually to create SSL and RSA key and certificate files. For more information, see [Section 4.4.5, “mysql\\_ssl\\_rsa\\_setup — Create SSL/RSA Files”](#).

- MySQL deployments installed using `mysqld --initialize` are secure by default. The following changes have been implemented as the default deployment characteristics:
  - The installation process creates only a single `root` account, `'root'@'localhost'`, automatically generates a random password for this account, and marks the password expired. The MySQL administrator must connect as `root` using the random password and assign a new password. (The server writes the random password to the error log.)
  - Installation creates no anonymous-user accounts.
  - Installation creates no `test` database.

For more information, see [Section 2.9.1, “Initializing the Data Directory”](#).

- MySQL Enterprise Edition now provides data masking and de-identification capabilities. Data masking hides sensitive information by replacing real values with substitutes. MySQL Enterprise Data Masking and De-Identification functions enable masking existing data using several methods such as obfuscation (removing identifying characteristics), generation of formatted random data, and data replacement or substitution. For more information, see [Section 6.5, “MySQL Enterprise Data Masking and De-Identification”](#).
- MySQL now sets the access control granted to clients on the named pipe to the minimum necessary for successful communication on Windows. Newer MySQL client software can open named pipe connections without any additional configuration. If older client software cannot be upgraded immediately, the new `named_pipe_full_access_group` system variable can be used to give a Windows group the necessary permissions to open a named pipe connection. Membership in the full-access group should be restricted and temporary.
- **SQL mode changes.** Strict SQL mode for transactional storage engines (`STRICT_TRANS_TABLES`) is now enabled by default.

Implementation for the `ONLY_FULL_GROUP_BY` SQL mode has been made more sophisticated, to no longer reject deterministic queries that previously were rejected. In consequence, this mode is now enabled by default, to prohibit only nondeterministic queries containing expressions not guaranteed to be uniquely determined within a group.

The `ERROR_FOR_DIVISION_BY_ZERO`, `NO_ZERO_DATE`, and `NO_ZERO_IN_DATE` SQL modes are now deprecated but enabled by default. The long term plan is to have them included in strict SQL mode and to remove them as explicit modes in a future MySQL release. See [SQL Mode Changes in MySQL 5.7](#).

The changes to the default SQL mode result in a default `sql_mode` system variable value with these modes enabled: `ONLY_FULL_GROUP_BY`, `STRICT_TRANS_TABLES`, `NO_ZERO_IN_DATE`, `NO_ZERO_DATE`, `ERROR_FOR_DIVISION_BY_ZERO`, `NO_AUTO_CREATE_USER`, and `NO_ENGINE_SUBSTITUTION`.



- **Online ALTER TABLE.** `ALTER TABLE` now supports a `RENAME INDEX` clause that renames an index. The change is made in place without a table-copy operation. It works for all storage engines. See [Section 13.1.8, “ALTER TABLE Statement”](#).
- **ngram and MeCab full-text parser plugins.** MySQL provides a built-in full-text ngram parser plugin that supports Chinese, Japanese, and Korean (CJK), and an installable MeCab full-text parser plugin for Japanese.

For more information, see [Section 12.9.8, “ngram Full-Text Parser”](#), and [Section 12.9.9, “MeCab Full-Text Parser Plugin”](#).

- **InnoDB enhancements.** These `InnoDB` enhancements were added:

- `VARCHAR` column size can be increased using an in-place `ALTER TABLE`, as in this example:

```
ALTER TABLE t1 ALGORITHM=INPLACE, CHANGE COLUMN c1 c1 VARCHAR(255);
```

This is true as long as the number of length bytes required by a `VARCHAR` column remains the same. For `VARCHAR` columns of 0 to 255 bytes in size, one length byte is required to encode the value. For `VARCHAR` columns of 256 bytes in size or more, two length bytes are required. As a result, in-place `ALTER TABLE` only supports increasing `VARCHAR` column size from 0 to 255 bytes, or from 256 bytes to a greater size. In-place `ALTER TABLE` does not support increasing the size of a `VARCHAR` column from less than 256 bytes to a size equal to or greater than 256 bytes. In this case, the number of required length bytes changes from 1 to 2, which is only supported by a table copy (`ALGORITHM=COPY`).

Decreasing `VARCHAR` size using in-place `ALTER TABLE` is not supported. Decreasing `VARCHAR` size requires a table copy (`ALGORITHM=COPY`).

For more information, see [Section 14.13.1, “Online DDL Operations”](#).

- DDL performance for `InnoDB` temporary tables is improved through optimization of `CREATE TABLE`, `DROP TABLE`, `TRUNCATE TABLE`, and `ALTER TABLE` statements.
- `InnoDB` temporary table metadata is no longer stored to `InnoDB` system tables. Instead, a new table, `INNODB_TEMP_TABLE_INFO`, provides users with a snapshot of active temporary tables. The table contains metadata and reports on all user and system-created temporary tables that are active within a given `InnoDB` instance. The table is created when the first `SELECT` statement is run against it.
- `InnoDB` now supports MySQL-supported spatial data types. Prior to this release, `InnoDB` would store spatial data as binary `BLOB` data. `BLOB` remains the underlying data type but spatial data types are now mapped to a new `InnoDB` internal data type, `DATA_GEOMETRY`.
- There is now a separate tablespace for all non-compressed `InnoDB` temporary tables. The new tablespace is always recreated on server startup and is located in `DATADIR` by default. A newly added configuration file option, `innodb_temp_data_file_path`, allows for a user-defined temporary data file path.
- `innochecksum` functionality is enhanced with several new options and extended capabilities. See [Section 4.6.1, “innochecksum — Offline InnoDB File Checksum Utility”](#).
- A new type of non-redo undo log for both normal and compressed temporary tables and related objects now resides in the temporary tablespace. For more information, see [Section 14.6.7, “Undo Logs”](#).
- `InnoDB` buffer pool dump and load operations are enhanced. A new system variable, `innodb_buffer_pool_dump_pct`, allows you to specify the percentage of most recently used

pages in each buffer pool to read out and dump. When there is other I/O activity being performed by InnoDB background tasks, InnoDB attempts to limit the number of buffer pool load operations per second using the `innodb_io_capacity` setting.

- Support is added to InnoDB for full-text parser plugins. For information about full-text parser plugins, see [Full-Text Parser Plugins](#) and [Writing Full-Text Parser Plugins](#).
- InnoDB supports multiple page cleaner threads for flushing dirty pages from buffer pool instances. A new system variable, `innodb_page_cleaners`, is used to specify the number of page cleaner threads. The default value of 1 maintains the previous configuration in which there is a single page cleaner thread. This enhancement builds on work completed in MySQL 5.6, which introduced a single page cleaner thread to offload buffer pool flushing work from the InnoDB master thread.
- Online DDL support is extended to the following operations for regular and partitioned InnoDB tables:
  - `OPTIMIZE TABLE`
  - `ALTER TABLE ... FORCE`
  - `ALTER TABLE ... ENGINE=INNODB` (when run on an InnoDB table)

Online DDL support reduces table rebuild time and permits concurrent DML. See [Section 14.13, “InnoDB and Online DDL”](#).

- The Fusion-io Non-Volatile Memory (NVM) file system on Linux provides [atomic](#) write capability, which makes the InnoDB [doublewrite buffer](#) redundant. The InnoDB doublewrite buffer is automatically disabled for system tablespace files ([ibdata files](#)) located on Fusion-io devices that support atomic writes.
- InnoDB supports the [Transportable Tablespace](#) feature for partitioned InnoDB tables and individual InnoDB table partitions. This enhancement eases backup procedures for partitioned tables and enables copying of partitioned tables and individual table partitions between MySQL instances. For more information, see [Section 14.6.1.3, “Importing InnoDB Tables”](#).
- The `innodb_buffer_pool_size` parameter is dynamic, allowing you to resize the buffer pool without restarting the server. The resizing operation, which involves moving pages to a new location in memory, is performed in chunks. Chunk size is configurable using the new `innodb_buffer_pool_chunk_size` configuration option. You can monitor resizing progress using the new `InnoDB_buffer_pool_resize_status` status variable. For more information, see [Configuring InnoDB Buffer Pool Size Online](#).
- Multithreaded page cleaner support (`innodb_page_cleaners`) is extended to shutdown and recovery phases.
- InnoDB supports indexing of spatial data types using `SPATIAL` indexes, including use of `ALTER TABLE ... ALGORITHM=INPLACE` for online operations (`ADD SPATIAL INDEX`).
- InnoDB performs a bulk load when creating or rebuilding indexes. This method of index creation is known as a “sorted index build”. This enhancement, which improves the efficiency of index creation, also applies to full-text indexes. A new global configuration option, `innodb_fill_factor`, defines the percentage of space on each page that is filled with data during a sorted index build, with the remaining space reserved for future index growth. For more information, see [Section 14.6.2.3, “Sorted Index Builds”](#).
- A new log record type (`MLOG_FILE_NAME`) is used to identify tablespaces that have been modified since the last checkpoint. This enhancement simplifies tablespace discovery during crash recovery

and eliminates scans on the file system prior to redo log application. For more information about the benefits of this enhancement, see [Tablespace Discovery During Crash Recovery](#).

This enhancement changes the redo log format, requiring that MySQL be shut down cleanly before upgrading to or downgrading from MySQL 5.7.5.

- You can truncate undo logs that reside in undo tablespaces. This feature is enabled using the `innodb_undo_log_truncate` configuration option. For more information, see [Truncating Undo Tablespaces](#).
- `InnoDB` supports native partitioning. Previously, `InnoDB` relied on the `ha_partition` handler, which creates a handler object for each partition. With native partitioning, a partitioned `InnoDB` table uses a single partition-aware handler object. This enhancement reduces the amount of memory required for partitioned `InnoDB` tables.

As of MySQL 5.7.9, `mysql_upgrade` looks for and attempts to upgrade partitioned `InnoDB` tables that were created using the `ha_partition` handler. Also in MySQL 5.7.9 and later, you can upgrade such tables by name in the `mysql` client using `ALTER TABLE ... UPGRADE PARTITIONING`.

- `InnoDB` supports the creation of general tablespaces using `CREATE TABLESPACE` syntax.

```
CREATE TABLESPACE `tablespace_name`
  ADD DATAFILE 'file_name.ibd'
  [FILE_BLOCK_SIZE = n]
```

General tablespaces can be created outside of the MySQL data directory, are capable of holding multiple tables, and support tables of all row formats.

Tables are added to a general tablespace using `CREATE TABLE tbl_name ... TABLESPACE [=] tablespace_name` or `ALTER TABLE tbl_name TABLESPACE [=] tablespace_name` syntax.

For more information, see [Section 14.6.3.3, “General Tablespaces”](#).

- `DYNAMIC` replaces `COMPACT` as the implicit default row format for `InnoDB` tables. A new configuration option, `innodb_default_row_format`, specifies the default `InnoDB` row format. For more information, see [Defining the Row Format of a Table](#).
- As of MySQL 5.7.11, `InnoDB` supports data-at-rest encryption for file-per-table tablespaces. Encryption is enabled by specifying the `ENCRYPTION` option when creating or altering an `InnoDB` table. This feature relies on a `keyring` plugin for encryption key management. For more information, see [Section 6.4.4, “The MySQL Keyring”](#), and [Section 14.14, “InnoDB Data-at-Rest Encryption”](#).
- As of MySQL 5.7.24, the `zlib` library version bundled with MySQL was raised from version 1.2.3 to version 1.2.11. MySQL implements compression with the help of the `zlib` library.

If you use `InnoDB` compressed tables, see [Section 2.10.3, “Changes in MySQL 5.7”](#) for related upgrade implications.

- **JSON support.** Beginning with MySQL 5.7.8, MySQL supports a native `JSON` type. JSON values are not stored as strings, instead using an internal binary format that permits quick read access to document elements. JSON documents stored in `JSON` columns are automatically validated whenever they are inserted or updated, with an invalid document producing an error. JSON documents are normalized on creation, and can be compared using most comparison operators such as `=`, `<`, `<=`, `>`, `>=`, `<>`, `!=`,

and `<=>`; for information about supported operators as well as precedence and other rules that MySQL follows when comparing `JSON` values, see [Comparison and Ordering of JSON Values](#).

MySQL 5.7.8 also introduces a number of functions for working with `JSON` values. These functions include those listed here:

- Functions that create `JSON` values: `JSON_ARRAY()`, `JSON_MERGE()`, and `JSON_OBJECT()`. See [Section 12.17.2, “Functions That Create JSON Values”](#).
- Functions that search `JSON` values: `JSON_CONTAINS()`, `JSON_CONTAINS_PATH()`, `JSON_EXTRACT()`, `JSON_KEYS()`, and `JSON_SEARCH()`. See [Section 12.17.3, “Functions That Search JSON Values”](#).
- Functions that modify `JSON` values: `JSON_APPEND()`, `JSON_ARRAY_APPEND()`, `JSON_ARRAY_INSERT()`, `JSON_INSERT()`, `JSON_QUOTE()`, `JSON_REMOVE()`, `JSON_REPLACE()`, `JSON_SET()`, and `JSON_UNQUOTE()`. See [Section 12.17.4, “Functions That Modify JSON Values”](#).
- Functions that provide information about `JSON` values: `JSON_DEPTH()`, `JSON_LENGTH()`, `JSON_TYPE()`, and `JSON_VALID()`. See [Section 12.17.5, “Functions That Return JSON Value Attributes”](#).

In MySQL 5.7.9 and later, you can use `column->path` as shorthand for `JSON_EXTRACT(column, path)`. This works as an alias for a column wherever a column identifier can occur in an SQL statement, including `WHERE`, `ORDER BY`, and `GROUP BY` clauses. This includes `SELECT`, `UPDATE`, `DELETE`, `CREATE TABLE`, and other SQL statements. The left hand side must be a `JSON` column identifier (and not an alias). The right hand side is a quoted `JSON` path expression which is evaluated against the `JSON` document returned as the column value.

MySQL 5.7.22 adds the following `JSON` functions:

- Two `JSON` aggregation functions `JSON_ARRAYAGG()` and `JSON_OBJECTAGG()`. `JSON_ARRAYAGG()` takes a column or expression as its argument, and aggregates the result as a single `JSON` array. The expression can evaluate to any MySQL data type; this does not have to be a `JSON` value. `JSON_OBJECTAGG()` takes two columns or expressions which it interprets as a key and a value; it returns the result as a single `JSON` object. For more information and examples, see [Section 12.19, “Aggregate Functions”](#).
- The `JSON` utility function `JSON_PRETTY()`, which outputs an existing `JSON` value in an easy-to-read format; each `JSON` object member or array value is printed on a separate line, and a child object or array is indented 2 spaces with respect to its parent.

This function also works with a string that can be parsed as a `JSON` value.

See also [Section 12.17.6, “JSON Utility Functions”](#).

- The `JSON` utility function `JSON_STORAGE_SIZE()`, which returns the storage space in bytes used for the binary representation of a `JSON` document prior to any partial update (see previous item).

This function also accepts a valid string representation of a `JSON` document. For such a value, `JSON_STORAGE_SIZE()` returns the space used by its binary representation following its conversion to a `JSON` document. For a variable containing the string representation of a `JSON` document, `JSON_STORAGE_FREE()` returns zero. Either function produces an error if its (non-null) argument cannot be parsed as a valid `JSON` document, and `NULL` if the argument is `NULL`.

For more information and examples, see [Section 12.17.6, “JSON Utility Functions”](#).

- A JSON merge function intended to conform to [RFC 7396](#). `JSON_MERGE_PATCH()`, when used on 2 JSON objects, merges them into a single JSON object that has as members a union of the following sets:
  - Each member of the first object for which there is no member with the same key in the second object.
  - Each member of the second object for which there is no member having the same key in the first object, and whose value is not the JSON `null` literal.
  - Each member having a key that exists in both objects, and whose value in the second object is not the JSON `null` literal.

As part of this work, the `JSON_MERGE()` function has been renamed `JSON_MERGE_PRESERVE()`. `JSON_MERGE()` continues to be recognized as an alias for `JSON_MERGE_PRESERVE()` in MySQL 5.7, but is now deprecated and is subject to removal in a future version of MySQL.

For more information and examples, see [Section 12.17.4, “Functions That Modify JSON Values”](#).

See [Section 12.17.3, “Functions That Search JSON Values”](#), for more information about `->` and `JSON_EXTRACT()`. For information about JSON path support in MySQL 5.7, see [Searching and Modifying JSON Values](#). See also [Indexing a Generated Column to Provide a JSON Column Index](#).

- **System and status variables.** System and status variable information is now available in Performance Schema tables, in preference to use of `INFORMATION_SCHEMA` tables to obtain these variable. This also affects the operation of the `SHOW VARIABLES` and `SHOW STATUS` statements. The value of the `show_compatibility_56` system variable affects the output produced from and privileges required for system and status variable statements and tables. For details, see the description of that variable in [Section 5.1.7, “Server System Variables”](#).



#### Note

The default for `show_compatibility_56` is `OFF`. Applications that require 5.6 behavior should set this variable to `ON` until such time as they have been migrated to the new behavior for system variables and status variables. See [Section 25.20, “Migrating to Performance Schema System and Status Variable Tables”](#)

- **sys schema.** MySQL distributions now include the `sys` schema, which is a set of objects that help DBAs and developers interpret data collected by the Performance Schema. `sys` schema objects can be used for typical tuning and diagnosis use cases. For more information, see [Chapter 26, MySQL sys Schema](#).
- **Condition handling.** MySQL now supports stacked diagnostics areas. When the diagnostics area stack is pushed, the first (current) diagnostics area becomes the second (stacked) diagnostics area and a new current diagnostics area is created as a copy of it. Within a condition handler, executed statements modify the new current diagnostics area, but `GET STACKED DIAGNOSTICS` can be used to inspect the stacked diagnostics area to obtain information about the condition that caused the handler to activate, independent of current conditions within the handler itself. (Previously, there was a single diagnostics area. To inspect handler-activating conditions within a handler, it was necessary to check this diagnostics area before executing any statements that could change it.) See [Section 13.6.7.3, “GET DIAGNOSTICS Statement”](#), and [Section 13.6.7.7, “The MySQL Diagnostics Area”](#).
- **Optimizer.** These optimizer enhancements were added:
  - `EXPLAIN` can be used to obtain the execution plan for an explainable statement executing in a named connection:

```
EXPLAIN [options] FOR CONNECTION connection_id;
```

For more information, see [Section 8.8.4, “Obtaining Execution Plan Information for a Named Connection”](#).

- It is possible to provide hints to the optimizer within individual SQL statements, which enables finer control over statement execution plans than can be achieved using the `optimizer_switch` system variable. Hints are also permitted in statements used with `EXPLAIN`, enabling you to see how hints affect execution plans. For more information, see [Section 8.9.3, “Optimizer Hints”](#).
- **prefer\_ordering\_index flag.** By default, MySQL attempts to use an ordered index for any `ORDER BY` or `GROUP BY` query that has a `LIMIT` clause, whenever the optimizer determines that this would result in faster execution. Because it is possible in some cases that choosing a different optimization for such queries actually performs better, it is possible as of MySQL 5.7.33 to disable this optimization by setting the `prefer_ordering_index` flag to `off`.

The default value for this flag is `on`.

For more information and examples, see [Section 8.9.2, “Switchable Optimizations”](#), and [Section 8.2.1.17, “LIMIT Query Optimization”](#).

- **Triggers.** Previously, a table could have at most one trigger for each combination of trigger event (`INSERT`, `UPDATE`, `DELETE`) and action time (`BEFORE`, `AFTER`). This limitation has been lifted and multiple triggers are permitted. For more information, see [Section 23.3, “Using Triggers”](#).
- **Logging.** These logging enhancements were added:
  - Previously, on Unix and Unix-like systems, MySQL support for sending the server error log to `syslog` was implemented by having `mysqld_safe` capture server error output and pass it to `syslog`. The server now includes native `syslog` support, which has been extended to include Windows. For more information about sending server error output to `syslog`, see [Section 5.4.2, “The Error Log”](#).
  - The `mysql` client now has a `--syslog` option that causes interactive statements to be sent to the system `syslog` facility. Logging is suppressed for statements that match the default “ignore” pattern list (`"*IDENTIFIED*: *PASSWORD*"`), as well as statements that match any patterns specified using the `--histignore` option. See [Section 4.5.1.3, “mysql Client Logging”](#).
- **Generated Columns.** MySQL now supports the specification of generated columns in `CREATE TABLE` and `ALTER TABLE` statements. Values of a generated column are computed from an expression specified at column creation time. Generated columns can be virtual (computed “on the fly” when rows are read) or stored (computed when rows are inserted or updated). For more information, see [Section 13.1.18.7, “CREATE TABLE and Generated Columns”](#).
- **mysql client.** Previously, **Control+C** in `mysql` interrupted the current statement if there was one, or exited `mysql` if not. Now **Control+C** interrupts the current statement if there was one, or cancels any partial input line otherwise, but does not exit.
- **Database name rewriting with mysqlbinlog.** Renaming of databases by `mysqlbinlog` when reading from binary logs written using the row-based format is now supported using the `--rewrite-db` option added in MySQL 5.7.1.

This option uses the format `--rewrite-db='dboldname->dbnewname'`. You can implement multiple rewrite rules, by specifying the option multiple times.

- **HANDLER with partitioned tables.** The `HANDLER` statement may now be used with user-partitioned tables. Such tables may use any of the available partitioning types (see [Section 22.2, “Partitioning Types”](#)).
- **Index condition pushdown support for partitioned tables.** Queries on partitioned tables using the `InnoDB` or `MyISAM` storage engine may employ the index condition pushdown optimization that was introduced in MySQL 5.6. See [Section 8.2.1.5, “Index Condition Pushdown Optimization”](#), for more information.
- **WITHOUT VALIDATION support for ALTER TABLE ... EXCHANGE PARTITION.** As of MySQL 5.7.5, `ALTER TABLE ... EXCHANGE PARTITION` syntax includes an optional `{WITH|WITHOUT} VALIDATION` clause. When `WITHOUT VALIDATION` is specified, `ALTER TABLE ... EXCHANGE PARTITION` does not perform row-by-row validation when exchanging a populated table with the partition, permitting database administrators to assume responsibility for ensuring that rows are within the boundaries of the partition definition. `WITH VALIDATION` is the default behavior and need not be specified explicitly. For more information, see [Section 22.3.3, “Exchanging Partitions and Subpartitions with Tables”](#).
- **Source dump thread improvements.** The source dump thread was refactored to reduce lock contention and improve source throughput. Previous to MySQL 5.7.2, the dump thread took a lock on the binary log whenever reading an event; in MySQL 5.7.2 and later, this lock is held only while reading the position at the end of the last successfully written event. This means both that multiple dump threads are now able to read concurrently from the binary log file, and that dump threads are now able to read while clients are writing to the binary log.
- **Character set support.** MySQL 5.7.4 includes a `gb18030` character set that supports the China National Standard GB18030 character set. For more information about MySQL character set support, see [Chapter 10, Character Sets, Collations, Unicode](#).
- **Changing the replication source without STOP SLAVE.** In MySQL 5.7.4 and later, the strict requirement to execute `STOP SLAVE` prior to issuing any `CHANGE MASTER TO` statement is removed. Instead of depending on whether the replica is stopped, the behavior of `CHANGE MASTER TO` now depends on the states of the replica SQL thread and replica I/O threads; which of these threads is stopped or running now determines the options that can or cannot be used with a `CHANGE MASTER TO` statement at a given point in time. The rules for making this determination are listed here:
  - If the SQL thread is stopped, you can execute `CHANGE MASTER TO` using any combination of `RELAY_LOG_FILE`, `RELAY_LOG_POS`, and `MASTER_DELAY` options, even if the replica I/O thread is running. No other options may be used with this statement when the I/O thread is running.
  - If the I/O thread is stopped, you can execute `CHANGE MASTER TO` using any of the options for this statement (in any allowed combination) *except* `RELAY_LOG_FILE`, `RELAY_LOG_POS`, or `MASTER_DELAY`, even when the SQL thread is running. These three options may not be used when the I/O thread is running.
  - Both the SQL thread and the I/O thread must be stopped before issuing `CHANGE MASTER TO ... MASTER_AUTO_POSITION = 1`.

You can check the current state of the replica SQL and I/O threads using `SHOW SLAVE STATUS`.

If you are using statement-based replication and temporary tables, it is possible for a `CHANGE MASTER TO` statement following a `STOP SLAVE` statement to leave behind temporary tables on the replica. As part of this set of improvements, a warning is now issued whenever `CHANGE MASTER TO` is issued

following `STOP SLAVE` when statement-based replication is in use and `Slave_open_temp_tables` remains greater than 0.

For more information, see [Section 13.4.2.1, “CHANGE MASTER TO Statement”](#), and [Section 16.3.7, “Switching Sources During Failover”](#).

- **Test suite.** The MySQL test suite now uses `InnoDB` as the default storage engine.
- **Multi-source replication is now possible.** MySQL Multi-Source Replication adds the ability to replicate from multiple sources to a replica. MySQL Multi-Source Replication topologies can be used to back up multiple servers to a single server, to merge table shards, and consolidate data from multiple servers to a single server. See [Section 16.1.5, “MySQL Multi-Source Replication”](#).

As part of MySQL Multi-Source Replication, replication channels have been added. Replication channels enable a replica to open multiple connections to replicate from, with each channel being a connection to a source. See [Section 16.2.2, “Replication Channels”](#).

- **Group Replication Performance Schema tables.** MySQL 5.7 adds a number of new tables to the Performance Schema to provide information about replication groups and channels. These include the following tables:

- `replication_applier_configuration`
- `replication_applier_status`
- `replication_applier_status_by_coordinator`
- `replication_applier_status_by_worker`
- `replication_connection_configuration`
- `replication_connection_status`
- `replication_group_members`
- `replication_group_member_stats`

All of these tables were added in MySQL 5.7.2, except for `replication_group_members` and `replication_group_member_stats`, which were added in MySQL 5.7.6. For more information, see [Section 25.12.11, “Performance Schema Replication Tables”](#).

- **Group Replication SQL.** The following statements were added in MySQL 5.7.6 for controlling Group Replication:
  - `START GROUP_REPLICATION`
  - `STOP GROUP_REPLICATION`

For more information, see [Section 13.4.3, “SQL Statements for Controlling Group Replication”](#).

## Features Deprecated in MySQL 5.7

The following features are deprecated in MySQL 5.7 and may be removed in a future series. Where alternatives are shown, applications should be updated to use them.

For applications that use features deprecated in MySQL 5.7 that have been removed in a higher MySQL series, statements may fail when replicated from a MySQL 5.7 source to a higher-series replica, or may



have different effects on source and replica. To avoid such problems, applications that use features deprecated in 5.7 should be revised to avoid them and use alternatives when possible.

- The `ERROR_FOR_DIVISION_BY_ZERO`, `NO_ZERO_DATE`, and `NO_ZERO_IN_DATE` SQL modes are now deprecated but enabled by default. The long term plan is to have them included in strict SQL mode and to remove them as explicit modes in a future MySQL release.

The deprecated `ERROR_FOR_DIVISION_BY_ZERO`, `NO_ZERO_DATE`, and `NO_ZERO_IN_DATE` SQL modes are still recognized so that statements that name them do not produce an error, but are expected to be removed in a future version of MySQL. To make advance preparation for versions of MySQL in which these mode names do not exist, applications should be modified not to refer to them. See [SQL Mode Changes in MySQL 5.7](#).

- These SQL modes are now deprecated; expect them to be removed in a future version of MySQL: `DB2`, `MAXDB`, `MSSQL`, `MYSQL323`, `MYSQL40`, `ORACLE`, `POSTGRESQL`, `NO_FIELD_OPTIONS`, `NO_KEY_OPTIONS`, `NO_TABLE_OPTIONS`. These deprecations have two implications:
  - Assigning a deprecated mode to the `sql_mode` system variable produces a warning.
  - With the `MAXDB` SQL mode enabled, using `CREATE TABLE` or `ALTER TABLE` to add a `TIMESTAMP` column to a table produces a warning.
- Changes to account-management statements make the following features obsolete. They are now deprecated:
  - Using `GRANT` to create users. Instead, use `CREATE USER`. Following this practice makes the `NO_AUTO_CREATE_USER` SQL mode immaterial for `GRANT` statements, so it too is deprecated.
  - Using `GRANT` to modify account properties other than privilege assignments. This includes authentication, SSL, and resource-limit properties. Instead, establish such properties at account-creation time with `CREATE USER` or modify them afterward with `ALTER USER`.
  - `IDENTIFIED BY PASSWORD 'auth_string'` syntax for `CREATE USER` and `GRANT`. Instead, use `IDENTIFIED WITH auth_plugin AS 'auth_string'` for `CREATE USER` and `ALTER USER`, where the `'auth_string'` value is in a format compatible with the named plugin.
  - The `PASSWORD()` function is deprecated and should be avoided in any context. Thus, `SET PASSWORD ... = PASSWORD('auth_string')` syntax is also deprecated. `SET PASSWORD ... = 'auth_string'` syntax is not deprecated; nevertheless, `ALTER USER` is now the preferred statement for assigning passwords.
  - The `old_passwords` system variable. Account authentication plugins can no longer be left unspecified in the `mysql.user` system table, so any statement that assigns a password from a cleartext string can unambiguously determine the hashing method to use on the string before storing it in the `mysql.user` table. This renders `old_passwords` superfluous.

- The query cache is deprecated. Deprecation includes these items:
  - The `FLUSH QUERY CACHE` and `RESET QUERY CACHE` statements.
  - The `SQL_CACHE` and `SQL_NO_CACHE SELECT` modifiers.
  - These system variables: `have_query_cache`, `ndb_cache_check_time`, `query_cache_limit`, `query_cache_min_res_unit`, `query_cache_size`, `query_cache_type`, `query_cache_wlock_invalidate`.
  - These status variables: `Qcache_free_blocks`, `Qcache_free_memory`, `Qcache_hits`, `Qcache_inserts`, `Qcache_lowmem_prunes`, `Qcache_not_cached`, `Qcache_queries_in_cache`, `Qcache_total_blocks`.
- Previously, the `--transaction-isolation` and `--transaction-read-only` server startup options corresponded to the `tx_isolation` and `tx_read_only` system variables. For better name correspondence between startup option and system variable names, `transaction_isolation` and `transaction_read_only` have been created as aliases for `tx_isolation` and `tx_read_only`. The `tx_isolation` and `tx_read_only` variables are now deprecated; expect them to be removed in MySQL 8.0. Applications should be adjusted to use `transaction_isolation` and `transaction_read_only` instead.
- The `--skip-innodb` option and its synonyms (`--innodb=OFF`, `--disable-innodb`, and so forth) are deprecated. These options have no effect as of MySQL 5.7, because InnoDB cannot be disabled.
- The client-side `--ssl` and `--ssl-verify-server-cert` options are deprecated. Use `--ssl-mode=REQUIRED` instead of `--ssl=1` or `--enable-ssl`. Use `--ssl-mode=DISABLED` instead of `--ssl=0`, `--skip-ssl`, or `--disable-ssl`. Use `--ssl-mode=VERIFY_IDENTITY` instead of `--ssl-verify-server-cert` options. (The server-side `--ssl` option is *not* deprecated.)

For the C API, `MYSQL_OPT_SSL_ENFORCE` and `MYSQL_OPT_SSL_VERIFY_SERVER_CERT` options for `mysql_options()` correspond to the client-side `--ssl` and `--ssl-verify-server-cert` options and are deprecated. Use `MYSQL_OPT_SSL_MODE` with an option value of `SSL_MODE_REQUIRED` or `SSL_MODE_VERIFY_IDENTITY` instead.

- The `log_warnings` system variable and `--log-warnings` server option are deprecated. Use the `log_error_verbosity` system variable instead.
- The `--temp-pool` server option is deprecated.
- The `binlog_max_flush_queue_time` system variable does nothing in MySQL 5.7, and is deprecated as of MySQL 5.7.9.
- The `innodb_support_xa` system variable, which enables InnoDB support for two-phase commit in XA transactions, is deprecated as of MySQL 5.7.10. InnoDB support for two-phase commit in XA transactions is always enabled as of MySQL 5.7.10.
- The `metadata_locks_cache_size` and `metadata_locks_hash_instances` system variables are deprecated. These do nothing as of MySQL 5.7.4.
- The `sync_frm` system variable is deprecated.
- The global `character_set_database` and `collation_database` system variables are deprecated; expect them to be removed in a future version of MySQL.

Assigning a value to the session `character_set_database` and `collation_database` system variables is deprecated and assignments produce a warning. The session variables are expected to

become read only in a future version of MySQL, and assignments to them to produce an error, while remaining possible to read the session variables to determine the database character set and collation for the default database.

- The global scope for the `sql_log_bin` system variable has been deprecated, and this variable can now be set with session scope only. The statement `SET GLOBAL SQL_LOG_BIN` now produces an error. It remains possible to read the global value of `sql_log_bin`, but doing so produces a warning. You should act now to remove from your applications any dependencies on reading this value; the global scope `sql_log_bin` is removed in MySQL 8.0.
- With the introduction of the data dictionary in MySQL 8.0, the `--ignore-db-dir` option and `ignore_db_dirs` system variable became superfluous and were removed in that version. Consequently, they are deprecated in MySQL 5.7.
- `GROUP BY` implicitly sorts by default (that is, in the absence of `ASC` or `DESC` designators), but relying on implicit `GROUP BY` sorting in MySQL 5.7 is deprecated. To achieve a specific sort order of grouped results, it is preferable to use To produce a given sort order, use explicit `ASC` or `DESC` designators for `GROUP BY` columns or provide an `ORDER BY` clause. `GROUP BY` sorting is a MySQL extension that may change in a future release; for example, to make it possible for the optimizer to order groupings in whatever manner it deems most efficient and to avoid the sorting overhead.
- The `EXTENDED` and `PARTITIONS` keywords for the `EXPLAIN` statement are deprecated. These keywords are still recognized but are now unnecessary because their effect is always enabled.
- The `ENCRYPT()`, `ENCODE()`, `DECODE()`, `DES_ENCRYPT()`, and `DES_DECRYPT()` encryption functions are deprecated. For `ENCRYPT()`, consider using `SHA2()` instead for one-way hashing. For the others, consider using `AES_ENCRYPT()` and `AES_DECRYPT()` instead. The `--des-key-file` option, the `have_crypt` system variable, the `DES_KEY_FILE` option for the `FLUSH` statement, and the `HAVE_CRYPT CMake` option also are deprecated.
- The `MBREqual()` spatial function is deprecated. Use `MBREquals()` instead.
- The functions described in [Section 12.16.4, “Functions That Create Geometry Values from WKB Values”](#) previously accepted either WKB strings or geometry arguments. Use of geometry arguments is deprecated. See that section for guidelines for migrating queries away from using geometry arguments.
- The `INFORMATION_SCHEMA PROFILING` table is deprecated. Use the Performance Schema instead; see [Chapter 25, MySQL Performance Schema](#).
- The `INFORMATION_SCHEMA INNODB_LOCKS` and `INNODB_LOCK_WAITS` tables are deprecated, to be removed in MySQL 8.0, which provides replacement Performance Schema tables.
- The Performance Schema `setup_timers` table is deprecated and is removed in MySQL 8.0, as is the `TICK` row in the `performance_timers` table.
- The `sys` schema `sys.version` view is deprecated; expect it be removed in a future version of MySQL. Affected applications should be adjusted to use an alternative instead. For example, use the `VERSION()` function to retrieve the MySQL server version.
- Treatment of `\N` as a synonym for `NULL` in SQL statements is deprecated and is removed in MySQL 8.0; use `NULL` instead.

This change does not affect text file import or export operations performed with `LOAD DATA` or `SELECT ... INTO OUTFILE`, for which `NULL` continues to be represented by `\N`. See [Section 13.2.6, “LOAD DATA Statement”](#).

- `PROCEDURE ANALYSE()` syntax is deprecated.

- Comment stripping by the `mysql` client and the options to control it (`--skip-comments`, `--comments`) are deprecated.
- `mysqld_safe` support for `syslog` output is deprecated. Use the native server `syslog` support used instead. See [Section 5.4.2, “The Error Log”](#).
- Conversion of pre-MySQL 5.1 database names containing special characters to 5.1 format with the addition of a `#mysql150#` prefix is deprecated. Because of this, the `--fix-db-names` and `--fix-table-names` options for `mysqlcheck` and the `UPGRADE DATA DIRECTORY NAME` clause for the `ALTER DATABASE` statement are also deprecated.

Upgrades are supported only from one release series to another (for example, 5.0 to 5.1, or 5.1 to 5.5), so there should be little remaining need for conversion of older 5.0 database names to current versions of MySQL. As a workaround, upgrade a MySQL 5.0 installation to MySQL 5.1 before upgrading to a more recent release.

- `mysql_install_db` functionality has been integrated into the MySQL server, `mysqld`. To use this capability to initialize a MySQL installation, if you previously invoked `mysql_install_db` manually, invoke `mysqld` with the `--initialize` or `--initialize-insecure` option, depending on whether you want the server to generate a random password for the initial `'root'@'localhost'` account.

`mysql_install_db` is now deprecated, as is the special `--bootstrap` option that `mysql_install_db` passes to `mysqld`.

- The `mysql_plugin` utility is deprecated. Alternatives include loading plugins at server startup using the `--plugin-load` or `--plugin-load-add` option, or at runtime using the `INSTALL PLUGIN` statement.
- The `resolveip` utility is deprecated. `nslookup`, `host`, or `dig` can be used instead.
- The `resolve_stack_dump` utility is deprecated. Stack traces from official MySQL builds are always symbolized, so there is no need to use `resolve_stack_dump`.
- The `mysql_kill()`, `mysql_list_fields()`, `mysql_list_processes()`, and `mysql_refresh()` C API functions are deprecated. The same is true of the corresponding `COM_PROCESS_KILL`, `COM_FIELD_LIST`, `COM_PROCESS_INFO`, and `COM_REFRESH` client/server protocol commands. Instead, use `mysql_query()` to execute a `KILL`, `SHOW COLUMNS`, `SHOW PROCESSLIST`, or `FLUSH` statement, respectively.
- The `mysql_shutdown()` C API function is deprecated. Instead, use `mysql_query()` to execute a `SHUTDOWN` statement.
- The `libmysqld` embedded server library is deprecated as of MySQL 5.7.19. These are also deprecated:
  - The `mysql_config --libmysqld-libs`, `--embedded-libs`, and `--embedded` options
  - The CMake `WITH_EMBEDDED_SERVER`, `WITH_EMBEDDED_SHARED_LIBRARY`, and `INSTALL_SECURE_FILE_PRIV_EMBEDDED` options
  - The (undocumented) `mysql --server-arg` option
  - The `mysqltest --embedded-server`, `--server-arg`, and `--server-file` options
  - The `mysqltest_embedded` and `mysql_client_test_embedded` test programs

Because `libmysqld` uses an API comparable to that of `libmysqlclient`, the migration path away from `libmysqld` is straightforward:

1. Bring up a standalone MySQL server (`mysqld`).
  2. Modify application code to remove API calls that are specific to `libmysqld`.
  3. Modify application code to connect to the standalone MySQL server.
  4. Modify build scripts to use `libmysqlclient` rather than `libmysqld`. For example, if you use `mysql_config`, invoke it with the `--libs` option rather than `--libmysqld-libs`.
- The `replace` utility is deprecated.
  - Support for DTrace is deprecated.
  - The `JSON_MERGE()` function is deprecated as of MySQL 5.7.22. Use `JSON_MERGE_PRESERVE()` instead.
  - Support for placing table partitions in shared `InnoDB` tablespaces is deprecated as of MySQL 5.7.24. Shared tablespaces include the `InnoDB` system tablespace and general tablespaces. For information about identifying partitions in shared tablespaces and moving them to file-per-table tablespaces, see [Preparing Your Installation for Upgrade](#).
  - Support for `TABLESPACE = innodb_file_per_table` and `TABLESPACE = innodb_temporary` clauses with `CREATE TEMPORARY TABLE` is deprecated as of MySQL 5.7.24.
  - The `--ndb_perror` option is deprecated. Use the `ndb_perror` utility instead.
  - The `myisam_repair_threads` system variable `myisam_repair_threads` are deprecated as of MySQL 5.7.38; expect support for both to be removed in a future release of MySQL.

From MySQL 5.7.38, values other than 1 (the default) for `myisam_repair_threads` produce a warning.

## Features Removed in MySQL 5.7

The following items are obsolete and have been removed in MySQL 5.7. Where alternatives are shown, applications should be updated to use them.

For MySQL 5.6 applications that use features removed in MySQL 5.7, statements may fail when replicated from a MySQL 5.6 source to a MySQL 5.7 replica, or may have different effects on source and replica. To avoid such problems, applications that use features removed in MySQL 5.7 should be revised to avoid them and use alternatives when possible.

- Support for passwords that use the older pre-4.1 password hashing format is removed, which involves the following changes. Applications that use any feature no longer supported must be modified.
  - The `mysql_old_password` authentication plugin is removed. Accounts that use this plugin are disabled at startup and the server writes an “unknown plugin” message to the error log. For instructions on upgrading accounts that use this plugin, see [Section 6.4.1.3, “Migrating Away from Pre-4.1 Password Hashing and the `mysql\_old\_password` Plugin”](#).
  - The `--secure-auth` option to the server and client programs is the default, but is now a no-op. It is deprecated; expect it to be removed in a future MySQL release.
  - The `--skip-secure-auth` option to the server and client programs is no longer supported and using it produces an error.
  - The `secure_auth` system variable permits only a value of 1; a value of 0 is no longer permitted.

- For the `old_passwords` system variable, a value of 1 (produce pre-4.1 hashes) is no longer permitted.
- The `OLD_PASSWORD()` function is removed.
- In MySQL 5.6.6, the 2-digit `YEAR(2)` data type was deprecated. Support for `YEAR(2)` is now removed. Once you upgrade to MySQL 5.7.5 or higher, any remaining 2-digit `YEAR(2)` columns must be converted to 4-digit `YEAR` columns to become usable again. For conversion strategies, see [Section 11.2.5, “2-Digit YEAR\(2\) Limitations and Migrating to 4-Digit YEAR”](#). For example, run `mysql_upgrade` after upgrading.
- The `innodb_mirrored_log_groups` system variable. The only supported value was 1, so it had no purpose.
- The `storage_engine` system variable. Use `default_storage_engine` instead.
- The `thread_concurrency` system variable.
- The `timed_mutexes` system variable, which had no effect.
- The `IGNORE` clause for `ALTER TABLE`.
- `INSERT DELAYED` is no longer supported. The server recognizes but ignores the `DELAYED` keyword, handles the insert as a nondelayed insert, and generates an `ER_WARN_LEGACY_SYNTAX_CONVERTED` warning. (“INSERT DELAYED is no longer supported. The statement was converted to INSERT.”) Similarly, `REPLACE DELAYED` is handled as a nondelayed replace. You should expect the `DELAYED` keyword to be removed in a future release.

In addition, several `DELAYED`-related options or features were removed:

- The `--delayed-insert` option for `mysqldump`.
- The `COUNT_WRITE_DELAYED`, `SUM_TIMER_WRITE_DELAYED`, `MIN_TIMER_WRITE_DELAYED`, `AVG_TIMER_WRITE_DELAYED`, and `MAX_TIMER_WRITE_DELAYED` columns of the Performance Schema `table_lock_waits_summary_by_table` table.
- `mysqlbinlog` no longer writes comments mentioning `INSERT DELAYED`.
- Database symlinking on Windows using `.sym` files has been removed because it is redundant with native symlink support available using `mklink`. Any `.sym` file symbolic links are now ignored and should be replaced with symlinks created using `mklink`. See [Section 8.12.3.3, “Using Symbolic Links for Databases on Windows”](#).
- The unused `--basedir`, `--datadir`, and `--tmpdir` options for `mysql_upgrade` were removed.
- Previously, program options could be specified in full or as any unambiguous prefix. For example, the `--compress` option could be given to `mysqldump` as `--compr`, but not as `--comp` because the latter is ambiguous. Option prefixes are no longer supported; only full options are accepted. This is because prefixes can cause problems when new options are implemented for programs and a prefix that is currently unambiguous might become ambiguous in the future. Some implications of this change:
  - The `--key-buffer` option must now be specified as `--key-buffer-size`.
  - The `--skip-grant` option must now be specified as `--skip-grant-tables`.
- `SHOW ENGINE INNODB MUTEX` output is removed. Comparable information can be generated by creating views on [Performance Schema](#) tables.

- The [InnoDB Tablespace Monitor](#) and [InnoDB Table Monitor](#) are removed. For the Table Monitor, equivalent information can be obtained from [InnoDB INFORMATION\\_SCHEMA](#) tables.
- The specially named tables used to enable and disable the standard [InnoDB Monitor](#) and [InnoDB Lock Monitor](#) ([innodb\\_monitor](#) and [innodb\\_lock\\_monitor](#)) are removed and replaced by two dynamic system variables: [innodb\\_status\\_output](#) and [innodb\\_status\\_output\\_locks](#). For additional information, see [Section 14.18, “InnoDB Monitors”](#).
- The [innodb\\_use\\_sys\\_malloc](#) and [innodb\\_additional\\_mem\\_pool\\_size](#) system variables, deprecated in MySQL 5.6.3, were removed.
- The [mysql2mysql](#), [mysql\\_convert\\_table\\_format](#), [mysql\\_find\\_rows](#), [mysql\\_fix\\_extensions](#), [mysql\\_setpermission](#), [mysql\\_waitpid](#), [mysql\\_zap](#), [mysqlaccess](#), and [mysqlbug](#) utilities.
- The [mysqlhotcopy](#) utility. Alternatives include [mysqldump](#) and MySQL Enterprise Backup.
- The [binary-configure.sh](#) script.
- The [INNOODB\\_PAGE\\_ATOMIC\\_REF\\_COUNT](#) CMake option is removed.
- The [innodb\\_create\\_intrinsic](#) option is removed.
- The [innodb\\_optimize\\_point\\_storage](#) option and related internal data types ([DATA\\_POINT](#) and [DATA\\_VAR\\_POINT](#)) are removed.
- The [innodb\\_log\\_checksum\\_algorithm](#) option is removed.
- The [myisam\\_repair\\_threads](#) system variable as of MySQL 5.7.39.

## 1.4 Server and Status Variables and Options Added, Deprecated, or Removed in MySQL 5.7

- [Options and Variables Introduced in MySQL 5.7](#)
- [Options and Variables Deprecated in MySQL 5.7](#)
- [Options and Variables Removed in MySQL 5.7](#)

This section lists server variables, status variables, and options that were added for the first time, have been deprecated, or have been removed in MySQL 5.7.

### Options and Variables Introduced in MySQL 5.7

The following system variables, status variables, and server options have been added in MySQL 5.7.

- [Audit\\_log\\_current\\_size](#): Audit log file current size. Added in MySQL 5.7.9.
- [Audit\\_log\\_event\\_max\\_drop\\_size](#): Size of largest dropped audited event. Added in MySQL 5.7.9.
- [Audit\\_log\\_events](#): Number of handled audited events. Added in MySQL 5.7.9.
- [Audit\\_log\\_events\\_filtered](#): Number of filtered audited events. Added in MySQL 5.7.9.
- [Audit\\_log\\_events\\_lost](#): Number of dropped audited events. Added in MySQL 5.7.9.
- [Audit\\_log\\_events\\_written](#): Number of written audited events. Added in MySQL 5.7.9.
- [Audit\\_log\\_total\\_size](#): Combined size of written audited events. Added in MySQL 5.7.9.

- `Audit_log_write_waits`: Number of write-delayed audited events. Added in MySQL 5.7.9.
- `Com_change_repl_filter`: Count of CHANGE REPLICATION FILTER statements. Added in MySQL 5.7.3.
- `Com_explain_other`: Count of EXPLAIN FOR CONNECTION statements. Added in MySQL 5.7.2.
- `Com_group_replication_start`: Count of START GROUP\_REPLICATION statements. Added in MySQL 5.7.6.
- `Com_group_replication_stop`: Count of STOP GROUP\_REPLICATION statements. Added in MySQL 5.7.6.
- `Com_show_create_user`: Count of SHOW CREATE USER statements. Added in MySQL 5.7.6.
- `Com_show_slave_status_nonblocking`: Count of SHOW REPLICA | SLAVE STATUS NONBLOCKING statements. Added in MySQL 5.7.0.
- `Com_shutdown`: Count of SHUTDOWN statements. Added in MySQL 5.7.9.
- `Connection_control_delay_generated`: How many times server delayed connection request. Added in MySQL 5.7.17.
- `Firewall_access_denied`: Number of statements rejected by MySQL Enterprise Firewall plugin. Added in MySQL 5.7.9.
- `Firewall_access_granted`: Number of statements accepted by MySQL Enterprise Firewall plugin. Added in MySQL 5.7.9.
- `Firewall_cached_entries`: Number of statements recorded by MySQL Enterprise Firewall plugin. Added in MySQL 5.7.9.
- `InnoDB_buffer_pool_resize_status`: Status of dynamic buffer pool resizing operation. Added in MySQL 5.7.5.
- `Locked_connects`: Number of attempts to connect to locked accounts. Added in MySQL 5.7.6.
- `Max_execution_time_exceeded`: Number of statements that exceeded execution timeout value. Added in MySQL 5.7.8.
- `Max_execution_time_set`: Number of statements for which execution timeout was set. Added in MySQL 5.7.8.
- `Max_execution_time_set_failed`: Number of statements for which execution timeout setting failed. Added in MySQL 5.7.8.
- `Max_statement_time_exceeded`: Number of statements that exceeded execution timeout value. Added in MySQL 5.7.4.
- `Max_statement_time_set`: Number of statements for which execution timeout was set. Added in MySQL 5.7.4.
- `Max_statement_time_set_failed`: Number of statements for which execution timeout setting failed. Added in MySQL 5.7.4.
- `Max_used_connections_time`: Time at which Max\_used\_connections reached its current value. Added in MySQL 5.7.5.
- `Performance_schema_index_stat_lost`: Number of indexes for which statistics were lost. Added in MySQL 5.7.6.



- `Performance_schema_memory_classes_lost`: How many memory instruments could not be loaded. Added in MySQL 5.7.2.
- `Performance_schema_metadata_lock_lost`: Number of metadata locks that could not be recorded. Added in MySQL 5.7.3.
- `Performance_schema_nested_statement_lost`: Number of stored program statements for which statistics were lost. Added in MySQL 5.7.2.
- `Performance_schema_prepared_statements_lost`: Number of prepared statements that could not be instrumented. Added in MySQL 5.7.4.
- `Performance_schema_program_lost`: Number of stored programs for which statistics were lost. Added in MySQL 5.7.2.
- `Performance_schema_table_lock_stat_lost`: Number of tables for which lock statistics were lost. Added in MySQL 5.7.6.
- `Rewriter_number_loaded_rules`: Number of rewrite rules successfully loaded into memory. Added in MySQL 5.7.6.
- `Rewriter_number_reloads`: Number of reloads of rules table into memory. Added in MySQL 5.7.6.
- `Rewriter_number_rewritten_queries`: Number of queries rewritten since plugin was loaded. Added in MySQL 5.7.6.
- `Rewriter_reload_error`: Whether error occurred when last loading rewriting rules into memory. Added in MySQL 5.7.6.
- `audit-log`: Whether to activate audit log plugin. Added in MySQL 5.7.9.
- `audit_log_buffer_size`: Size of audit log buffer. Added in MySQL 5.7.9.
- `audit_log_compression`: Audit log file compression method. Added in MySQL 5.7.21.
- `audit_log_connection_policy`: Audit logging policy for connection-related events. Added in MySQL 5.7.9.
- `audit_log_current_session`: Whether to audit current session. Added in MySQL 5.7.9.
- `audit_log_disable`: Whether to disable the audit log. Added in MySQL 5.7.37.
- `audit_log_encryption`: Audit log file encryption method. Added in MySQL 5.7.21.
- `audit_log_exclude_accounts`: Accounts not to audit. Added in MySQL 5.7.9.
- `audit_log_file`: Name of audit log file. Added in MySQL 5.7.9.
- `audit_log_filter_id`: ID of current audit log filter. Added in MySQL 5.7.13.
- `audit_log_flush`: Close and reopen audit log file. Added in MySQL 5.7.9.
- `audit_log_format`: Audit log file format. Added in MySQL 5.7.9.
- `audit_log_format_unix_timestamp`: Whether to include Unix timestamp in JSON-format audit log. Added in MySQL 5.7.35.
- `audit_log_include_accounts`: Accounts to audit. Added in MySQL 5.7.9.
- `audit_log_policy`: Audit logging policy. Added in MySQL 5.7.9.
- `audit_log_read_buffer_size`: Audit log file read buffer size. Added in MySQL 5.7.21.

- `audit_log_rotate_on_size`: Close and reopen audit log file at this size. Added in MySQL 5.7.9.
- `audit_log_statement_policy`: Audit logging policy for statement-related events. Added in MySQL 5.7.9.
- `audit_log_strategy`: Audit logging strategy. Added in MySQL 5.7.9.
- `authentication_ldap_sasl_auth_method_name`: Authentication method name. Added in MySQL 5.7.19.
- `authentication_ldap_sasl_bind_base_dn`: LDAP server base distinguished name. Added in MySQL 5.7.19.
- `authentication_ldap_sasl_bind_root_dn`: LDAP server root distinguished name. Added in MySQL 5.7.19.
- `authentication_ldap_sasl_bind_root_pwd`: LDAP server root bind password. Added in MySQL 5.7.19.
- `authentication_ldap_sasl_ca_path`: LDAP server certificate authority file name. Added in MySQL 5.7.19.
- `authentication_ldap_sasl_group_search_attr`: LDAP server group search attribute. Added in MySQL 5.7.19.
- `authentication_ldap_sasl_group_search_filter`: LDAP custom group search filter. Added in MySQL 5.7.21.
- `authentication_ldap_sasl_init_pool_size`: LDAP server initial connection pool size. Added in MySQL 5.7.19.
- `authentication_ldap_sasl_log_status`: LDAP server log level. Added in MySQL 5.7.19.
- `authentication_ldap_sasl_max_pool_size`: LDAP server maximum connection pool size. Added in MySQL 5.7.19.
- `authentication_ldap_sasl_server_host`: LDAP server host name or IP address. Added in MySQL 5.7.19.
- `authentication_ldap_sasl_server_port`: LDAP server port number. Added in MySQL 5.7.19.
- `authentication_ldap_sasl_tls`: Whether to use encrypted connections to LDAP server. Added in MySQL 5.7.19.
- `authentication_ldap_sasl_user_search_attr`: LDAP server user search attribute. Added in MySQL 5.7.19.
- `authentication_ldap_simple_auth_method_name`: Authentication method name. Added in MySQL 5.7.19.
- `authentication_ldap_simple_bind_base_dn`: LDAP server base distinguished name. Added in MySQL 5.7.19.
- `authentication_ldap_simple_bind_root_dn`: LDAP server root distinguished name. Added in MySQL 5.7.19.
- `authentication_ldap_simple_bind_root_pwd`: LDAP server root bind password. Added in MySQL 5.7.19.
- `authentication_ldap_simple_ca_path`: LDAP server certificate authority file name. Added in MySQL 5.7.19.

- `authentication_ldap_simple_group_search_attr`: LDAP server group search attribute. Added in MySQL 5.7.19.
- `authentication_ldap_simple_group_search_filter`: LDAP custom group search filter. Added in MySQL 5.7.21.
- `authentication_ldap_simple_init_pool_size`: LDAP server initial connection pool size. Added in MySQL 5.7.19.
- `authentication_ldap_simple_log_status`: LDAP server log level. Added in MySQL 5.7.19.
- `authentication_ldap_simple_max_pool_size`: LDAP server maximum connection pool size. Added in MySQL 5.7.19.
- `authentication_ldap_simple_server_host`: LDAP server host name or IP address. Added in MySQL 5.7.19.
- `authentication_ldap_simple_server_port`: LDAP server port number. Added in MySQL 5.7.19.
- `authentication_ldap_simple_tls`: Whether to use encrypted connections to LDAP server. Added in MySQL 5.7.19.
- `authentication_ldap_simple_user_search_attr`: LDAP server user search attribute. Added in MySQL 5.7.19.
- `authentication_windows_log_level`: Windows authentication plugin logging level. Added in MySQL 5.7.9.
- `authentication_windows_use_principal_name`: Whether to use Windows authentication plugin principal name. Added in MySQL 5.7.9.
- `auto_generate_certs`: Whether to autogenerate SSL key and certificate files. Added in MySQL 5.7.5.
- `avoid_temporal_upgrade`: Whether ALTER TABLE should upgrade pre-5.6.4 temporal columns. Added in MySQL 5.7.6.
- `binlog_error_action`: Controls what happens when server cannot write to binary log. Added in MySQL 5.7.6.
- `binlog_group_commit_sync_delay`: Sets number of microseconds to wait before synchronizing transactions to disk. Added in MySQL 5.7.5.
- `binlog_group_commit_sync_no_delay_count`: Sets maximum number of transactions to wait for before aborting current delay specified by `binlog_group_commit_sync_delay`. Added in MySQL 5.7.5.
- `binlog_gtid_simple_recovery`: Controls how binary logs are iterated during GTID recovery. Added in MySQL 5.7.6.
- `binlog_transaction_dependency_history_size`: Number of row hashes kept for looking up transaction that last updated some row. Added in MySQL 5.7.22.
- `binlog_transaction_dependency_tracking`: Source of dependency information (commit timestamps or transaction write sets) from which to assess which transactions can be executed in parallel by replica's multithreaded applier. Added in MySQL 5.7.22.
- `binlogging_impossible_mode`: Deprecated and later removed. Use `binlog_error_action` instead. Added in MySQL 5.7.5.
- `block_encryption_mode`: Mode for block-based encryption algorithms. Added in MySQL 5.7.4.

- [check\\_proxy\\_users](#): Whether built-in authentication plugins do proxying. Added in MySQL 5.7.7.
- [connection\\_control\\_failed\\_connections\\_threshold](#): Consecutive failed connection attempts before delays occur. Added in MySQL 5.7.17.
- [connection\\_control\\_max\\_connection\\_delay](#): Maximum delay (milliseconds) for server response to failed connection attempts. Added in MySQL 5.7.17.
- [connection\\_control\\_min\\_connection\\_delay](#): Minimum delay (milliseconds) for server response to failed connection attempts. Added in MySQL 5.7.17.
- [daemonize](#): Run as System V daemon. Added in MySQL 5.7.6.
- [default\\_authentication\\_plugin](#): Default authentication plugin. Added in MySQL 5.7.2.
- [default\\_password\\_lifetime](#): Age in days when passwords effectively expire. Added in MySQL 5.7.4.
- [disable-partition-engine-check](#): Whether to disable startup check for tables without native partitioning. Added in MySQL 5.7.17.
- [disabled\\_storage\\_engines](#): Storage engines that cannot be used to create tables. Added in MySQL 5.7.8.
- [disconnect\\_on\\_expired\\_password](#): Whether server disconnects clients with expired passwords if clients cannot handle such accounts. Added in MySQL 5.7.1.
- [early-plugin-load](#): Specify plugins to load before loading mandatory built-in plugins and before storage engine initialization. Added in MySQL 5.7.11.
- [executed\\_gtid\\_compression\\_period](#): Renamed to `gtid_executed_compression_period`. Added in MySQL 5.7.5.
- [group\\_replication\\_allow\\_local\\_disjoint\\_gtids\\_join](#): Allow current server to join group even if it has transactions not present in group. Added in MySQL 5.7.17.
- [group\\_replication\\_allow\\_local\\_lower\\_version\\_join](#): Allow current server to join group even if it has lower plugin version than group. Added in MySQL 5.7.17.
- [group\\_replication\\_auto\\_increment\\_increment](#): Determines interval between successive column values for transactions executing on this server. Added in MySQL 5.7.17.
- [group\\_replication\\_bootstrap\\_group](#): Configure this server to bootstrap group. Added in MySQL 5.7.17.
- [group\\_replication\\_components\\_stop\\_timeout](#): Timeout, in seconds, that plugin waits for each component when shutting down. Added in MySQL 5.7.17.
- [group\\_replication\\_compression\\_threshold](#): Value in bytes above which (LZ4) compression is enforced; when set to zero, deactivates compression. Added in MySQL 5.7.17.
- [group\\_replication\\_enforce\\_update\\_everywhere\\_checks](#): Enable or disable strict consistency checks for multi-source update everywhere. Added in MySQL 5.7.17.
- [group\\_replication\\_exit\\_state\\_action](#): How instance behaves when it leaves group involuntarily. Added in MySQL 5.7.24.
- [group\\_replication\\_flow\\_control\\_applier\\_threshold](#): Number of waiting transactions in applier queue which trigger flow control. Added in MySQL 5.7.17.

- [group\\_replication\\_flow\\_control\\_certifier\\_threshold](#): Number of waiting transactions in certifier queue that trigger flow control. Added in MySQL 5.7.17.
- [group\\_replication\\_flow\\_control\\_mode](#): Mode used for flow control. Added in MySQL 5.7.17.
- [group\\_replication\\_force\\_members](#): Comma separated list of peer addresses, such as host1:port1,host2:port2. Added in MySQL 5.7.17.
- [group\\_replication\\_group\\_name](#): Name of group. Added in MySQL 5.7.17.
- [group\\_replication\\_group\\_seeds](#): List of peer addresses, comma separated list such as host1:port1,host2:port2. Added in MySQL 5.7.17.
- [group\\_replication\\_gtid\\_assignment\\_block\\_size](#): Number of consecutive GTIDs that are reserved for each member; each member consumes its blocks and reserves more when needed. Added in MySQL 5.7.17.
- [group\\_replication\\_ip\\_whitelist](#): List of hosts permitted to connect to group. Added in MySQL 5.7.17.
- [group\\_replication\\_local\\_address](#): Local address in host:port format. Added in MySQL 5.7.17.
- [group\\_replication\\_member\\_weight](#): Chance of this member being elected as primary. Added in MySQL 5.7.20.
- [group\\_replication\\_poll\\_spin\\_loops](#): Number of times group communication thread waits. Added in MySQL 5.7.17.
- [group\\_replication\\_recovery\\_complete\\_at](#): Recovery policies when handling cached transactions after state transfer. Added in MySQL 5.7.17.
- [group\\_replication\\_recovery\\_reconnect\\_interval](#): Sleep time, in seconds, between reconnection attempts when no donor was found in group. Added in MySQL 5.7.17.
- [group\\_replication\\_recovery\\_retry\\_count](#): Number of times that joining member tries to connect to available donors before giving up. Added in MySQL 5.7.17.
- [group\\_replication\\_recovery\\_ssl\\_ca](#): File that contains list of trusted SSL Certificate Authorities. Added in MySQL 5.7.17.
- [group\\_replication\\_recovery\\_ssl\\_cpath](#): Directory that contains trusted SSL Certificate Authority certificate files. Added in MySQL 5.7.17.
- [group\\_replication\\_recovery\\_ssl\\_cert](#): Name of SSL certificate file to use for establishing encrypted connection. Added in MySQL 5.7.17.
- [group\\_replication\\_recovery\\_ssl\\_cipher](#): Permissible ciphers for SSL encryption. Added in MySQL 5.7.17.
- [group\\_replication\\_recovery\\_ssl\\_crl](#): File that contains certificate revocation lists. Added in MySQL 5.7.17.
- [group\\_replication\\_recovery\\_ssl\\_crlpath](#): Directory that contains certificate revocation-list files. Added in MySQL 5.7.17.
- [group\\_replication\\_recovery\\_ssl\\_key](#): Name of SSL key file to use for establishing encrypted connection. Added in MySQL 5.7.17.
- [group\\_replication\\_recovery\\_ssl\\_verify\\_server\\_cert](#): Make recovery process check server Common Name value in certificate sent by donor. Added in MySQL 5.7.17.

- `group_replication_recovery_use_ssl`: Whether Group Replication recovery connection should use SSL. Added in MySQL 5.7.17.
- `group_replication_single_primary_mode`: Instructs group to use single server for read/write workload. Added in MySQL 5.7.17.
- `group_replication_ssl_mode`: Desired security state of connection between Group Replication members. Added in MySQL 5.7.17.
- `group_replication_start_on_boot`: Whether server should start Group Replication during server startup. Added in MySQL 5.7.17.
- `group_replication_transaction_size_limit`: Sets maximum size of transaction in bytes which group accepts. Added in MySQL 5.7.19.
- `group_replication_unreachable_majority_timeout`: How long to wait for network partitions that result in minority to leave group. Added in MySQL 5.7.19.
- `gtid_executed_compression_period`: Compress `gtid_executed` table each time this many transactions have occurred. 0 means never compress this table. Applies only when binary logging is disabled. Added in MySQL 5.7.6.
- `have_statement_timeout`: Whether statement execution timeout is available. Added in MySQL 5.7.4.
- `initialize`: Whether to run in initialization mode (secure). Added in MySQL 5.7.6.
- `initialize-insecure`: Whether to run in initialization mode (insecure). Added in MySQL 5.7.6.
- `innodb_adaptive_hash_index_parts`: Partitions adaptive hash index search system into `n` partitions, with each partition protected by separate latch. Each index is bound to specific partition based on space ID and index ID attributes. Added in MySQL 5.7.8.
- `innodb_background_drop_list_empty`: Delays table creation until background drop list is empty (debug). Added in MySQL 5.7.10.
- `innodb_buffer_pool_chunk_size`: Chunk size used when resizing buffer pool. Added in MySQL 5.7.5.
- `innodb_buffer_pool_dump_pct`: Percentage of most recently used pages for each buffer pool to read out and dump. Added in MySQL 5.7.2.
- `innodb_compress_debug`: Compresses all tables using specified compression algorithm. Added in MySQL 5.7.8.
- `innodb_deadlock_detect`: Enables or disables deadlock detection. Added in MySQL 5.7.15.
- `innodb_default_row_format`: Default row format for InnoDB tables. Added in MySQL 5.7.9.
- `innodb_disable_resize_buffer_pool_debug`: Disables resizing of InnoDB buffer pool. Added in MySQL 5.7.6.
- `innodb_fill_factor`: Percentage for B-tree leaf and non-leaf page space to be filled with data. Remaining space is reserved for future growth. Added in MySQL 5.7.5.
- `innodb_flush_sync`: Enable `innodb_flush_sync` to ignore the `innodb_io_capacity` and `innodb_io_capacity_max` settings for bursts of I/O activity that occur at checkpoints. Disable `innodb_flush_sync` to adhere to limits on I/O activity as defined by `innodb_io_capacity` and `innodb_io_capacity_max`. Added in MySQL 5.7.8.

- `innodb_ft_result_cache_limit`: InnoDB FULLTEXT search query result cache limit. Added in MySQL 5.7.2.
- `innodb_ft_total_cache_size`: Total memory allocated for InnoDB FULLTEXT search index cache. Added in MySQL 5.7.2.
- `innodb_log_checkpoint_now`: Debug option that forces InnoDB to write checkpoint. Added in MySQL 5.7.2.
- `innodb_log_checksum_algorithm`: Specifies how to generate and verify checksum stored in each redo log disk block. Added in MySQL 5.7.8.
- `innodb_log_checksums`: Enables or disables checksums for redo log pages. Added in MySQL 5.7.9.
- `innodb_log_write_ahead_size`: Redo log write-ahead block size. Added in MySQL 5.7.4.
- `innodb_max_undo_log_size`: Sets threshold for truncating InnoDB undo log. Added in MySQL 5.7.5.
- `innodb_merge_threshold_set_all_debug`: Overrides current MERGE\_THRESHOLD setting with specified value for all indexes that are currently in dictionary cache. Added in MySQL 5.7.6.
- `innodb_numa_interleave`: Enables NUMA MPOL\_INTERLEAVE memory policy for allocation of InnoDB buffer pool. Added in MySQL 5.7.9.
- `innodb_optimize_point_storage`: Enable this option to store POINT data as fixed-length data rather than variable-length data. Added in MySQL 5.7.5.
- `innodb_page_cleaners`: Number of page cleaner threads. Added in MySQL 5.7.4.
- `innodb_purge_rseg_truncate_frequency`: Rate at which undo log purge should be invoked as part of purge action. Value = n invokes undo log purge on every nth iteration of purge invocation. Added in MySQL 5.7.5.
- `innodb_stats_include_delete_marked`: Include delete-marked records when calculating persistent InnoDB statistics. Added in MySQL 5.7.17.
- `innodb_status_output`: Used to enable or disable periodic output for standard InnoDB Monitor. Also used in combination with `innodb_status_output_locks` to enable and disable periodic output for InnoDB Lock Monitor. Added in MySQL 5.7.4.
- `innodb_status_output_locks`: Used to enable or disable periodic output for standard InnoDB Lock Monitor. `innodb_status_output` must also be enabled to produce periodic output for InnoDB Lock Monitor. Added in MySQL 5.7.4.
- `innodb_sync_debug`: Enables InnoDB sync debug checking. Added in MySQL 5.7.8.
- `innodb_temp_data_file_path`: Path to temporary tablespace data files and their sizes. Added in MySQL 5.7.1.
- `innodb_tmpdir`: Directory location for temporary table files created during online ALTER TABLE operations. Added in MySQL 5.7.11.
- `innodb_undo_log_truncate`: Enable this option to mark InnoDB undo tablespace for truncation. Added in MySQL 5.7.5.
- `internal_tmp_disk_storage_engine`: Storage engine for internal temporary tables. Added in MySQL 5.7.5.
- `keyring-migration-destination`: Key migration destination keyring plugin. Added in MySQL 5.7.21.

- `keyring-migration-host`: Host name for connecting to running server for key migration. Added in MySQL 5.7.21.
- `keyring-migration-password`: Password for connecting to running server for key migration. Added in MySQL 5.7.21.
- `keyring-migration-port`: TCP/IP port number for connecting to running server for key migration. Added in MySQL 5.7.21.
- `keyring-migration-socket`: Unix socket file or Windows named pipe for connecting to running server for key migration. Added in MySQL 5.7.21.
- `keyring-migration-source`: Key migration source keyring plugin. Added in MySQL 5.7.21.
- `keyring-migration-user`: User name for connecting to running server for key migration. Added in MySQL 5.7.21.
- `keyring_aws_cmk_id`: AWS keyring plugin customer master key ID value. Added in MySQL 5.7.19.
- `keyring_aws_conf_file`: AWS keyring plugin configuration file location. Added in MySQL 5.7.19.
- `keyring_aws_data_file`: AWS keyring plugin storage file location. Added in MySQL 5.7.19.
- `keyring_aws_region`: AWS keyring plugin region. Added in MySQL 5.7.19.
- `keyring_encrypted_file_data`: `keyring_encrypted_file` plugin data file. Added in MySQL 5.7.21.
- `keyring_encrypted_file_password`: `keyring_encrypted_file` plugin password. Added in MySQL 5.7.21.
- `keyring_file_data`: `keyring_file` plugin data file. Added in MySQL 5.7.11.
- `keyring_okv_conf_dir`: Oracle Key Vault keyring plugin configuration directory. Added in MySQL 5.7.12.
- `keyring_operations`: Whether keyring operations are enabled. Added in MySQL 5.7.21.
- `log_backward_compatible_user_definitions`: Whether to log CREATE/ALTER USER, GRANT in backward-compatible fashion. Added in MySQL 5.7.6.
- `log_built_in_as_identified_by_password`: Whether to log CREATE/ALTER USER, GRANT in backward-compatible fashion. Added in MySQL 5.7.9.
- `log_error_verbosity`: Error logging verbosity level. Added in MySQL 5.7.2.
- `log_slow_admin_statements`: Log slow OPTIMIZE, ANALYZE, ALTER and other administrative statements to slow query log if it is open. Added in MySQL 5.7.1.
- `log_slow_slave_statements`: Cause slow statements as executed by replica to be written to slow query log. Added in MySQL 5.7.1.
- `log_statements_unsafe_for_binlog`: Disables error 1592 warnings being written to error log. Added in MySQL 5.7.11.
- `log_syslog`: Whether to write error log to syslog. Added in MySQL 5.7.5.
- `log_syslog_facility`: Facility for syslog messages. Added in MySQL 5.7.5.
- `log_syslog_include_pid`: Whether to include server PID in syslog messages. Added in MySQL 5.7.5.



- `log_syslog_tag`: Tag for server identifier in syslog messages. Added in MySQL 5.7.5.
- `log_timestamps`: Log timestamp format. Added in MySQL 5.7.2.
- `max_digest_length`: Maximum digest size in bytes. Added in MySQL 5.7.6.
- `max_execution_time`: Statement execution timeout value. Added in MySQL 5.7.8.
- `max_points_in_geometry`: Maximum number of points in geometry values for `ST_Buffer_Strategy()`. Added in MySQL 5.7.8.
- `max_statement_time`: Statement execution timeout value. Added in MySQL 5.7.4.
- `mecab_charset`: Character set currently used by MeCab full-text parser plugin. Added in MySQL 5.7.6.
- `mecab_rc_file`: Path to mecabrc configuration file for MeCab parser for full-text search. Added in MySQL 5.7.6.
- `mysql_firewall_mode`: Whether MySQL Enterprise Firewall plugin is operational. Added in MySQL 5.7.9.
- `mysql_firewall_trace`: Whether to enable MySQL Enterprise Firewall plugin trace. Added in MySQL 5.7.9.
- `mysql_native_password_proxy_users`: Whether `mysql_native_password` authentication plugin does proxying. Added in MySQL 5.7.7.
- `mysqlx`: Whether X Plugin is initialized. Added in MySQL 5.7.12.
- `mysqlx_bind_address`: Network address X Plugin uses for connections. Added in MySQL 5.7.17.
- `mysqlx_connect_timeout`: Maximum permitted waiting time in seconds for a connection to set up a session. Added in MySQL 5.7.12.
- `mysqlx_idle_worker_thread_timeout`: Time in seconds after which idle worker threads are terminated. Added in MySQL 5.7.12.
- `mysqlx_max_allowed_packet`: Maximum size of network packets that can be received by X Plugin. Added in MySQL 5.7.12.
- `mysqlx_max_connections`: Maximum number of concurrent client connections X Plugin can accept. Added in MySQL 5.7.12.
- `mysqlx_min_worker_threads`: Minimum number of worker threads used for handling client requests. Added in MySQL 5.7.12.
- `mysqlx_port`: Port number on which X Plugin accepts TCP/IP connections. Added in MySQL 5.7.12.
- `mysqlx_port_open_timeout`: Time which X Plugin waits when accepting connections. Added in MySQL 5.7.17.
- `mysqlx_socket`: Path to socket where X Plugin listens for connections. Added in MySQL 5.7.15.
- `mysqlx_ssl_ca`: File that contains list of trusted SSL Certificate Authorities. Added in MySQL 5.7.12.
- `mysqlx_ssl_caphash`: Directory that contains trusted SSL Certificate Authority certificate files. Added in MySQL 5.7.12.
- `mysqlx_ssl_cert`: File that contains X.509 certificate. Added in MySQL 5.7.12.
- `mysqlx_ssl_cipher`: Permissible ciphers for connection encryption. Added in MySQL 5.7.12.

- `mysqlx_ssl_crl`: File that contains certificate revocation lists. Added in MySQL 5.7.12.
- `mysqlx_ssl_crlpath`: Directory that contains certificate revocation list files. Added in MySQL 5.7.12.
- `mysqlx_ssl_key`: File that contains X.509 key. Added in MySQL 5.7.12.
- `named_pipe_full_access_group`: Name of Windows group granted full access to named pipe. Added in MySQL 5.7.25.
- `ngram_token_size`: Defines n-gram token size for full-text search ngram parser. Added in MySQL 5.7.6.
- `offline_mode`: Whether server is offline. Added in MySQL 5.7.5.
- `parser_max_mem_size`: Maximum amount of memory available to parser. Added in MySQL 5.7.12.
- `performance-schema-consumer-events-transactions-current`: Configure events-transactions-current consumer. Added in MySQL 5.7.3.
- `performance-schema-consumer-events-transactions-history`: Configure events-transactions-history consumer. Added in MySQL 5.7.3.
- `performance-schema-consumer-events-transactions-history-long`: Configure events-transactions-history-long consumer. Added in MySQL 5.7.3.
- `performance_schema_events_transactions_history_long_size`: Number of rows in `events_transactions_history_long` table. Added in MySQL 5.7.3.
- `performance_schema_events_transactions_history_size`: Number of rows per thread in `events_transactions_history` table. Added in MySQL 5.7.3.
- `performance_schema_max_digest_length`: Maximum Performance Schema digest size in bytes. Added in MySQL 5.7.8.
- `performance_schema_max_index_stat`: Maximum number of indexes to keep statistics for. Added in MySQL 5.7.6.
- `performance_schema_max_memory_classes`: Maximum number of memory instruments. Added in MySQL 5.7.2.
- `performance_schema_max_metadata_locks`: Maximum number of metadata locks to track. Added in MySQL 5.7.3.
- `performance_schema_max_prepared_statements_instances`: Number of rows in `prepared_statements_instances` table. Added in MySQL 5.7.4.
- `performance_schema_max_program_instances`: Maximum number of stored programs for statistics. Added in MySQL 5.7.2.
- `performance_schema_max_sql_text_length`: Maximum number of bytes stored from SQL statements. Added in MySQL 5.7.6.
- `performance_schema_max_statement_stack`: Maximum stored program nesting for statistics. Added in MySQL 5.7.2.
- `performance_schema_max_table_lock_stat`: Maximum number of tables to keep lock statistics for. Added in MySQL 5.7.6.
- `performance_schema_show_processlist`: Select SHOW PROCESSLIST implementation. Added in MySQL 5.7.39.

- `range_optimizer_max_mem_size`: Limit on range optimizer memory consumption. Added in MySQL 5.7.9.
- `rbr_exec_mode`: Allows for switching server between IDEMPOTENT mode (key and some other errors suppressed) and STRICT mode; STRICT mode is default. Added in MySQL 5.7.1.
- `replication_optimize_for_static_plugin_config`: Shared locks for semisynchronous replication. Added in MySQL 5.7.33.
- `replication_sender_observe_commit_only`: Limited callbacks for semisynchronous replication. Added in MySQL 5.7.33.
- `require_secure_transport`: Whether client connections must use secure transport. Added in MySQL 5.7.8.
- `rewriter_enabled`: Whether query rewrite plugin is enabled. Added in MySQL 5.7.6.
- `rewriter_verbose`: For internal use. Added in MySQL 5.7.6.
- `rpl_semi_sync_master_wait_for_slave_count`: Number of replica acknowledgments source must receive per transaction before proceeding. Added in MySQL 5.7.3.
- `rpl_semi_sync_master_wait_point`: Wait point for replica transaction receipt acknowledgment. Added in MySQL 5.7.2.
- `rpl_stop_slave_timeout`: Number of seconds that STOP REPLICA or STOP SLAVE waits before timing out. Added in MySQL 5.7.2.
- `session_track_gtids`: Enables tracker which can be set to track different GTIDs. Added in MySQL 5.7.6.
- `session_track_schema`: Whether to track schema changes. Added in MySQL 5.7.4.
- `session_track_state_change`: Whether to track session state changes. Added in MySQL 5.7.4.
- `session_track_system_variables`: Session variables to track changes for. Added in MySQL 5.7.4.
- `session_track_transaction_info`: How to perform transaction tracking. Added in MySQL 5.7.8.
- `sha256_password_auto_generate_rsa_keys`: Whether to generate RSA key-pair files automatically. Added in MySQL 5.7.5.
- `sha256_password_proxy_users`: Whether sha256\_password authentication plugin does proxying. Added in MySQL 5.7.7.
- `show_compatibility_56`: Compatibility for SHOW STATUS/VARIABLES. Added in MySQL 5.7.6.
- `show_create_table_verbosity`: Whether to display ROW\_FORMAT in SHOW CREATE TABLE even if it has default value. Added in MySQL 5.7.22.
- `show_old_temporals`: Whether SHOW CREATE TABLE should indicate pre-5.6.4 temporal columns. Added in MySQL 5.7.6.
- `simplified_binlog_gtid_recovery`: Renamed to `binlog_gtid_simple_recovery`. Added in MySQL 5.7.5.
- `slave_parallel_type`: Tells replica to use timestamp information (LOGICAL\_CLOCK) or database partitioning (DATABASE) to parallelize transactions. Added in MySQL 5.7.2.
- `slave_preserve_commit_order`: Ensures that all commits by replica workers happen in same order as on source to maintain consistency when using parallel applier threads. Added in MySQL 5.7.5.

- `super_read_only`: Whether to ignore SUPER exceptions to read-only mode. Added in MySQL 5.7.8.
- `thread_pool_algorithm`: Thread pool algorithm. Added in MySQL 5.7.9.
- `thread_pool_high_priority_connection`: Whether current session is high priority. Added in MySQL 5.7.9.
- `thread_pool_max_unused_threads`: Maximum permissible number of unused threads. Added in MySQL 5.7.9.
- `thread_pool_prio_kickup_timer`: How long before statement is moved to high-priority execution. Added in MySQL 5.7.9.
- `thread_pool_size`: Number of thread groups in thread pool. Added in MySQL 5.7.9.
- `thread_pool_stall_limit`: How long before statement is defined as stalled. Added in MySQL 5.7.9.
- `tls_version`: Permissible TLS protocols for encrypted connections. Added in MySQL 5.7.10.
- `transaction_write_set_extraction`: Defines algorithm used to hash writes extracted during transaction. Added in MySQL 5.7.6.
- `validate_password_check_user_name`: Whether to check passwords against user name. Added in MySQL 5.7.15.
- `validate_password_dictionary_file_last_parsed`: When dictionary file was last parsed. Added in MySQL 5.7.8.
- `validate_password_dictionary_file_words_count`: Number of words in dictionary file. Added in MySQL 5.7.8.
- `version_tokens_session`: Client token list for Version Tokens. Added in MySQL 5.7.8.
- `version_tokens_session_number`: For internal use. Added in MySQL 5.7.8.

## Options and Variables Deprecated in MySQL 5.7

The following system variables, status variables, and options have been deprecated in MySQL 5.7.

- `Innodb_available_undo_logs`: Total number of InnoDB rollback segments; different from `innodb_rollback_segments`, which displays number of active rollback segments. Deprecated in MySQL 5.7.19.
- `Qcache_free_blocks`: Number of free memory blocks in query cache. Deprecated in MySQL 5.7.20.
- `Qcache_free_memory`: Amount of free memory for query cache. Deprecated in MySQL 5.7.20.
- `Qcache_hits`: Number of query cache hits. Deprecated in MySQL 5.7.20.
- `Qcache_inserts`: Number of query cache inserts. Deprecated in MySQL 5.7.20.
- `Qcache_lowmem_prunes`: Number of queries which were deleted from query cache due to lack of free memory in cache. Deprecated in MySQL 5.7.20.
- `Qcache_not_cached`: Number of noncached queries (not cacheable, or not cached due to `query_cache_type` setting). Deprecated in MySQL 5.7.20.
- `Qcache_queries_in_cache`: Number of queries registered in query cache. Deprecated in MySQL 5.7.20.
- `Qcache_total_blocks`: Total number of blocks in query cache. Deprecated in MySQL 5.7.20.

- [Slave\\_heartbeat\\_period](#): Replica's replication heartbeat interval, in seconds. Deprecated in MySQL 5.7.6.
- [Slave\\_last\\_heartbeat](#): Shows when latest heartbeat signal was received, in TIMESTAMP format. Deprecated in MySQL 5.7.6.
- [Slave\\_received\\_heartbeats](#): Number of heartbeats received by replica since previous reset. Deprecated in MySQL 5.7.6.
- [Slave\\_retried\\_transactions](#): Total number of times since startup that replication SQL thread has retried transactions. Deprecated in MySQL 5.7.6.
- [Slave\\_running](#): State of this server as replica (replication I/O thread status). Deprecated in MySQL 5.7.6.
- [avoid\\_temporal\\_upgrade](#): Whether ALTER TABLE should upgrade pre-5.6.4 temporal columns. Deprecated in MySQL 5.7.6.
- [binlog\\_max\\_flush\\_queue\\_time](#): How long to read transactions before flushing to binary log. Deprecated in MySQL 5.7.9.
- [bootstrap](#): Used by mysql installation scripts. Deprecated in MySQL 5.7.6.
- [des-key-file](#): Load keys for des\_encrypt() and des\_decrypt from given file. Deprecated in MySQL 5.7.6.
- [disable-partition-engine-check](#): Whether to disable startup check for tables without native partitioning. Deprecated in MySQL 5.7.17.
- [group\\_replication\\_allow\\_local\\_disjoint\\_gtids\\_join](#): Allow current server to join group even if it has transactions not present in group. Deprecated in MySQL 5.7.21.
- [have\\_crypt](#): Availability of crypt() system call. Deprecated in MySQL 5.7.6.
- [have\\_query\\_cache](#): Whether mysqld supports query cache. Deprecated in MySQL 5.7.20.
- [ignore-db-dir](#): Treat directory as nondatabase directory. Deprecated in MySQL 5.7.16.
- [ignore\\_db\\_dirs](#): Directories treated as nondatabase directories. Deprecated in MySQL 5.7.16.
- [innodb](#): Enable InnoDB (if this version of MySQL supports it). Deprecated in MySQL 5.7.5.
- [innodb\\_file\\_format](#): Format for new InnoDB tables. Deprecated in MySQL 5.7.7.
- [innodb\\_file\\_format\\_check](#): Whether InnoDB performs file format compatibility checking. Deprecated in MySQL 5.7.7.
- [innodb\\_file\\_format\\_max](#): File format tag in shared tablespace. Deprecated in MySQL 5.7.7.
- [innodb\\_large\\_prefix](#): Enables longer keys for column prefix indexes. Deprecated in MySQL 5.7.7.
- [innodb\\_support\\_xa](#): Enable InnoDB support for XA two-phase commit. Deprecated in MySQL 5.7.10.
- [innodb\\_undo\\_logs](#): Number of undo logs (rollback segments) used by InnoDB; alias for innodb\_rollback\_segments. Deprecated in MySQL 5.7.19.
- [innodb\\_undo\\_tablespaces](#): Number of tablespace files that rollback segments are divided between. Deprecated in MySQL 5.7.21.
- [log-warnings](#): Write some noncritical warnings to log file. Deprecated in MySQL 5.7.2.
- [metadata\\_locks\\_cache\\_size](#): Size of metadata locks cache. Deprecated in MySQL 5.7.4.

- `metadata_locks_hash_instances`: Number of metadata lock hashes. Deprecated in MySQL 5.7.4.
- `myisam_repair_threads`: Number of threads to use when repairing MyISAM tables. 1 disables parallel repair. Deprecated in MySQL 5.7.38.
- `old_passwords`: Selects password hashing method for PASSWORD(). Deprecated in MySQL 5.7.6.
- `partition`: Enable (or disable) partitioning support. Deprecated in MySQL 5.7.16.
- `query_cache_limit`: Do not cache results that are bigger than this. Deprecated in MySQL 5.7.20.
- `query_cache_min_res_unit`: Minimal size of unit in which space for results is allocated (last unit is trimmed after writing all result data). Deprecated in MySQL 5.7.20.
- `query_cache_size`: Memory allocated to store results from old queries. Deprecated in MySQL 5.7.20.
- `query_cache_type`: Query cache type. Deprecated in MySQL 5.7.20.
- `query_cache_wlock_invalidate`: Invalidate queries in query cache on LOCK for write. Deprecated in MySQL 5.7.20.
- `secure_auth`: Disallow authentication for accounts that have old (pre-4.1) passwords. Deprecated in MySQL 5.7.5.
- `show_compatibility_56`: Compatibility for SHOW STATUS/VARIABLES. Deprecated in MySQL 5.7.6.
- `show_old_temporals`: Whether SHOW CREATE TABLE should indicate pre-5.6.4 temporal columns. Deprecated in MySQL 5.7.6.
- `skip-partition`: Do not enable user-defined partitioning. Deprecated in MySQL 5.7.16.
- `sync_frm`: Sync .frm to disk on create. Enabled by default. Deprecated in MySQL 5.7.6.
- `temp-pool`: Using this option causes most temporary files created to use small set of names, rather than unique name for each new file. Deprecated in MySQL 5.7.18.
- `tx_isolation`: Default transaction isolation level. Deprecated in MySQL 5.7.20.
- `tx_read_only`: Default transaction access mode. Deprecated in MySQL 5.7.20.

## Options and Variables Removed in MySQL 5.7

The following system variables, status variables, and options have been removed in MySQL 5.7.

- `Com_show_slave_status_nonblocking`: Count of SHOW REPLICA | SLAVE STATUS NONBLOCKING statements. Removed in MySQL 5.7.6.
- `Max_statement_time_exceeded`: Number of statements that exceeded execution timeout value. Removed in MySQL 5.7.8.
- `Max_statement_time_set`: Number of statements for which execution timeout was set. Removed in MySQL 5.7.8.
- `Max_statement_time_set_failed`: Number of statements for which execution timeout setting failed. Removed in MySQL 5.7.8.
- `binlogging_impossible_mode`: Deprecated and later removed. Use `binlog_error_action` instead. Removed in MySQL 5.7.6.
- `default-authentication-plugin`: Default authentication plugin. Removed in MySQL 5.7.2.

- `executed_gtids_compression_period`: Renamed to `gtid_executed_compression_period`. Removed in MySQL 5.7.6.
- `innodb_additional_mem_pool_size`: Size of memory pool InnoDB uses to store data dictionary information and other internal data structures. Removed in MySQL 5.7.4.
- `innodb_log_checksum_algorithm`: Specifies how to generate and verify checksum stored in each redo log disk block. Removed in MySQL 5.7.9.
- `innodb_optimize_point_storage`: Enable this option to store POINT data as fixed-length data rather than variable-length data. Removed in MySQL 5.7.6.
- `innodb_use_sys_malloc`: Whether InnoDB uses OS or own memory allocator. Removed in MySQL 5.7.4.
- `log-slow-admin-statements`: Log slow OPTIMIZE, ANALYZE, ALTER and other administrative statements to slow query log if it is open. Removed in MySQL 5.7.1.
- `log-slow-slave-statements`: Cause slow statements as executed by replica to be written to slow query log. Removed in MySQL 5.7.1.
- `log_backward_compatible_user_definitions`: Whether to log CREATE/ALTER USER, GRANT in backward-compatible fashion. Removed in MySQL 5.7.9.
- `max_statement_time`: Statement execution timeout value. Removed in MySQL 5.7.8.
- `myisam_repair_threads`: Number of threads to use when repairing MyISAM tables. 1 disables parallel repair. Removed in MySQL 5.7.39.
- `simplified_binlog_gtid_recovery`: Renamed to `binlog_gtid_simple_recovery`. Removed in MySQL 5.7.6.
- `storage_engine`: Default storage engine. Removed in MySQL 5.7.5.
- `thread_concurrency`: Permits application to provide hint to threads system for desired number of threads which should be run at one time. Removed in MySQL 5.7.2.
- `timed_mutexes`: Specify whether to time mutexes (only InnoDB mutexes are currently supported). Removed in MySQL 5.7.5.

## 1.5 How to Report Bugs or Problems

Before posting a bug report about a problem, please try to verify that it is a bug and that it has not been reported already:

- Start by searching the MySQL online manual at <https://dev.mysql.com/doc/>. We try to keep the manual up to date by updating it frequently with solutions to newly found problems. In addition, the release notes accompanying the manual can be particularly useful since it is quite possible that a newer version contains a solution to your problem. The release notes are available at the location just given for the manual.
- If you get a parse error for an SQL statement, please check your syntax closely. If you cannot find something wrong with it, it is extremely likely that your current version of MySQL Server doesn't support the syntax you are using. If you are using the current version and the manual doesn't cover the syntax that you are using, MySQL Server doesn't support your statement.

If the manual covers the syntax you are using, but you have an older version of MySQL Server, you should check the MySQL change history to see when the syntax was implemented. In this case, you have the option of upgrading to a newer version of MySQL Server.

- For solutions to some common problems, see [Section B.3, “Problems and Common Errors”](#).
- Search the bugs database at <http://bugs.mysql.com/> to see whether the bug has been reported and fixed.
- You can also use <http://www.mysql.com/search/> to search all the Web pages (including the manual) that are located at the MySQL website.

If you cannot find an answer in the manual, the bugs database, or the mailing list archives, check with your local MySQL expert. If you still cannot find an answer to your question, please use the following guidelines for reporting the bug.

The normal way to report bugs is to visit <http://bugs.mysql.com/>, which is the address for our bugs database. This database is public and can be browsed and searched by anyone. If you log in to the system, you can enter new reports.

Bugs posted in the bugs database at <http://bugs.mysql.com/> that are corrected for a given release are noted in the release notes.

If you find a security bug in MySQL Server, please let us know immediately by sending an email message to [<secalert\\_us@oracle.com>](mailto:secalert_us@oracle.com). Exception: Support customers should report all problems, including security bugs, to Oracle Support at <http://support.oracle.com/>.

To discuss problems with other users, you can use the [MySQL Community Slack](#).

Writing a good bug report takes patience, but doing it right the first time saves time both for us and for yourself. A good bug report, containing a full test case for the bug, makes it very likely that we will fix the bug in the next release. This section helps you write your report correctly so that you do not waste your time doing things that may not help us much or at all. Please read this section carefully and make sure that all the information described here is included in your report.

Preferably, you should test the problem using the latest production or development version of MySQL Server before posting. Anyone should be able to repeat the bug by just using `mysql test <script_file` on your test case or by running the shell or Perl script that you include in the bug report. Any bug that we are able to repeat has a high chance of being fixed in the next MySQL release.

It is most helpful when a good description of the problem is included in the bug report. That is, give a good example of everything you did that led to the problem and describe, in exact detail, the problem itself. The best reports are those that include a full example showing how to reproduce the bug or problem. See [Section 5.8, “Debugging MySQL”](#).

Remember that it is possible for us to respond to a report containing too much information, but not to one containing too little. People often omit facts because they think they know the cause of a problem and assume that some details do not matter. A good principle to follow is that if you are in doubt about stating something, state it. It is faster and less troublesome to write a couple more lines in your report than to wait longer for the answer if we must ask you to provide information that was missing from the initial report.

The most common errors made in bug reports are (a) not including the version number of the MySQL distribution that you use, and (b) not fully describing the platform on which the MySQL server is installed (including the platform type and version number). These are highly relevant pieces of information, and in 99 cases out of 100, the bug report is useless without them. Very often we get questions like, “Why doesn't this work for me?” Then we find that the feature requested wasn't implemented in that MySQL version, or that a bug described in a report has been fixed in newer MySQL versions. Errors often are platform-dependent. In such cases, it is next to impossible for us to fix anything without knowing the operating system and the version number of the platform.

If you compiled MySQL from source, remember also to provide information about your compiler if it is related to the problem. Often people find bugs in compilers and think the problem is MySQL-related.



Most compilers are under development all the time and become better version by version. To determine whether your problem depends on your compiler, we need to know what compiler you used. Note that every compiling problem should be regarded as a bug and reported accordingly.

If a program produces an error message, it is very important to include the message in your report. If we try to search for something from the archives, it is better that the error message reported exactly matches the one that the program produces. (Even the lettercase should be observed.) It is best to copy and paste the entire error message into your report. You should never try to reproduce the message from memory.

If you have a problem with Connector/ODBC (MyODBC), please try to generate a trace file and send it with your report. See [How to Report Connector/ODBC Problems or Bugs](#).

If your report includes long query output lines from test cases that you run with the `mysql` command-line tool, you can make the output more readable by using the `--vertical` option or the `\G` statement terminator. The `EXPLAIN SELECT` example later in this section demonstrates the use of `\G`.

Please include the following information in your report:

- The version number of the MySQL distribution you are using (for example, MySQL 5.7.10). You can find out which version you are running by executing `mysqladmin version`. The `mysqladmin` program can be found in the `bin` directory under your MySQL installation directory.
- The manufacturer and model of the machine on which you experience the problem.
- The operating system name and version. If you work with Windows, you can usually get the name and version number by double-clicking your My Computer icon and pulling down the “Help/About Windows” menu. For most Unix-like operating systems, you can get this information by executing the command `uname -a`.
- Sometimes the amount of memory (real and virtual) is relevant. If in doubt, include these values.
- The contents of the `docs/INFO_BIN` file from your MySQL installation. This file contains information about how MySQL was configured and compiled.
- If you are using a source distribution of the MySQL software, include the name and version number of the compiler that you used. If you have a binary distribution, include the distribution name.
- If the problem occurs during compilation, include the exact error messages and also a few lines of context around the offending code in the file where the error occurs.
- If `mysqld` died, you should also report the statement that caused `mysqld` to unexpectedly exit. You can usually get this information by running `mysqld` with query logging enabled, and then looking in the log after `mysqld` exits. See [Section 5.8, “Debugging MySQL”](#).
- If a database table is related to the problem, include the output from the `SHOW CREATE TABLE db_name.tbl_name` statement in the bug report. This is a very easy way to get the definition of any table in a database. The information helps us create a situation matching the one that you have experienced.
- The SQL mode in effect when the problem occurred can be significant, so please report the value of the `sql_mode` system variable. For stored procedure, stored function, and trigger objects, the relevant `sql_mode` value is the one in effect when the object was created. For a stored procedure or function, the `SHOW CREATE PROCEDURE` or `SHOW CREATE FUNCTION` statement shows the relevant SQL mode, or you can query `INFORMATION_SCHEMA` for the information:

```
SELECT ROUTINE_SCHEMA, ROUTINE_NAME, SQL_MODE
FROM INFORMATION_SCHEMA.ROUTINES;
```

For triggers, you can use this statement:

```
SELECT EVENT_OBJECT_SCHEMA, EVENT_OBJECT_TABLE, TRIGGER_NAME, SQL_MODE
FROM INFORMATION_SCHEMA.TRIGGERS;
```

- For performance-related bugs or problems with `SELECT` statements, you should always include the output of `EXPLAIN SELECT ...`, and at least the number of rows that the `SELECT` statement produces. You should also include the output from `SHOW CREATE TABLE tbl_name` for each table that is involved. The more information you provide about your situation, the more likely it is that someone can help you.

The following is an example of a very good bug report. The statements are run using the `mysql` command-line tool. Note the use of the `\G` statement terminator for statements that would otherwise provide very long output lines that are difficult to read.

```
mysql> SHOW VARIABLES;
mysql> SHOW COLUMNS FROM ...\G
<output from SHOW COLUMNS>
mysql> EXPLAIN SELECT ...\G
<output from EXPLAIN>
mysql> FLUSH STATUS;
mysql> SELECT ...;
<A short version of the output from SELECT,
including the time taken to run the query>
mysql> SHOW STATUS;
<output from SHOW STATUS>
```

- If a bug or problem occurs while running `mysqld`, try to provide an input script that reproduces the anomaly. This script should include any necessary source files. The more closely the script can reproduce your situation, the better. If you can make a reproducible test case, you should upload it to be attached to the bug report.

If you cannot provide a script, you should at least include the output from `mysqladmin variables extended-status processlist` in your report to provide some information on how your system is performing.

- If you cannot produce a test case with only a few rows, or if the test table is too big to be included in the bug report (more than 10 rows), you should dump your tables using `mysqldump` and create a `README` file that describes your problem. Create a compressed archive of your files using `tar` and `gzip` or `zip`. After you initiate a bug report for our bugs database at <http://bugs.mysql.com/>, click the Files tab in the bug report for instructions on uploading the archive to the bugs database.
- If you believe that the MySQL server produces a strange result from a statement, include not only the result, but also your opinion of what the result should be, and an explanation describing the basis for your opinion.
- When you provide an example of the problem, it is better to use the table names, variable names, and so forth that exist in your actual situation than to come up with new names. The problem could be related to the name of a table or variable. These cases are rare, perhaps, but it is better to be safe than sorry. After all, it should be easier for you to provide an example that uses your actual situation, and it is by all means better for us. If you have data that you do not want to be visible to others in the bug report, you can upload it using the Files tab as previously described. If the information is really top secret and you do not want to show it even to us, go ahead and provide an example using other names, but please regard this as the last choice.
- Include all the options given to the relevant programs, if possible. For example, indicate the options that you use when you start the `mysqld` server, as well as the options that you use to run any MySQL client programs. The options to programs such as `mysqld` and `mysql`, and to the `configure` script, are often

key to resolving problems and are very relevant. It is never a bad idea to include them. If your problem involves a program written in a language such as Perl or PHP, please include the language processor's version number, as well as the version for any modules that the program uses. For example, if you have a Perl script that uses the `DBI` and `DBD: :mysql` modules, include the version numbers for Perl, `DBI`, and `DBD: :mysql`.

- If your question is related to the privilege system, please include the output of `mysqladmin reload`, and all the error messages you get when trying to connect. When you test your privileges, you should execute `mysqladmin reload version` and try to connect with the program that gives you trouble.
- If you have a patch for a bug, do include it. But do not assume that the patch is all we need, or that we can use it, if you do not provide some necessary information such as test cases showing the bug that your patch fixes. We might find problems with your patch or we might not understand it at all. If so, we cannot use it.

If we cannot verify the exact purpose of the patch, we will not use it. Test cases help us here. Show that the patch handles all the situations that may occur. If we find a borderline case (even a rare one) where the patch will not work, it may be useless.

- Guesses about what the bug is, why it occurs, or what it depends on are usually wrong. Even the MySQL team cannot guess such things without first using a debugger to determine the real cause of a bug.
- Indicate in your bug report that you have checked the reference manual and mail archive so that others know you have tried to solve the problem yourself.
- If your data appears corrupt or you get errors when you access a particular table, first check your tables with `CHECK TABLE`. If that statement reports any errors:
  - The `InnoDB` crash recovery mechanism handles cleanup when the server is restarted after being killed, so in typical operation there is no need to “repair” tables. If you encounter an error with `InnoDB` tables, restart the server and see whether the problem persists, or whether the error affected only cached data in memory. If data is corrupted on disk, consider restarting with the `innodb_force_recovery` option enabled so that you can dump the affected tables.
  - For non-transactional tables, try to repair them with `REPAIR TABLE` or with `myisamchk`. See [Chapter 5, MySQL Server Administration](#).

If you are running Windows, please verify the value of `lower_case_table_names` using the `SHOW VARIABLES LIKE 'lower_case_table_names'` statement. This variable affects how the server handles lettercase of database and table names. Its effect for a given value should be as described in [Section 9.2.3, “Identifier Case Sensitivity”](#).

- If you often get corrupted tables, you should try to find out when and why this happens. In this case, the error log in the MySQL data directory may contain some information about what happened. (This is the file with the `.err` suffix in the name.) See [Section 5.4.2, “The Error Log”](#). Please include any relevant information from this file in your bug report. Normally `mysqld` should *never* corrupt a table if nothing killed it in the middle of an update. If you can find the cause of `mysqld` dying, it is much easier for us to provide you with a fix for the problem. See [Section B.3.1, “How to Determine What Is Causing a Problem”](#).
- If possible, download and install the most recent version of MySQL Server and check whether it solves your problem. All versions of the MySQL software are thoroughly tested and should work without problems. We believe in making everything as backward-compatible as possible, and you should be able to switch MySQL versions without difficulty. See [Section 2.1.2, “Which MySQL Version and Distribution to Install”](#).

## 1.6 MySQL Standards Compliance

This section describes how MySQL relates to the ANSI/ISO SQL standards. MySQL Server has many extensions to the SQL standard, and here you can find out what they are and how to use them. You can also find information about functionality missing from MySQL Server, and how to work around some of the differences.

The SQL standard has been evolving since 1986 and several versions exist. In this manual, “SQL-92” refers to the standard released in 1992. “SQL:1999”, “SQL:2003”, “SQL:2008”, and “SQL:2011” refer to the versions of the standard released in the corresponding years, with the last being the most recent version. We use the phrase “the SQL standard” or “standard SQL” to mean the current version of the SQL Standard at any time.

One of our main goals with the product is to continue to work toward compliance with the SQL standard, but without sacrificing speed or reliability. We are not afraid to add extensions to SQL or support for non-SQL features if this greatly increases the usability of MySQL Server for a large segment of our user base. The `HANDLER` interface is an example of this strategy. See [Section 13.2.4, “HANDLER Statement”](#).

We continue to support transactional and nontransactional databases to satisfy both mission-critical 24/7 usage and heavy Web or logging usage.

MySQL Server was originally designed to work with medium-sized databases (10-100 million rows, or about 100MB per table) on small computer systems. Today MySQL Server handles terabyte-sized databases, but the code can also be compiled in a reduced version suitable for hand-held and embedded devices. The compact design of the MySQL server makes development in both directions possible without any conflicts in the source tree.

We are not targeting real-time support, although MySQL replication capabilities offer significant functionality.

MySQL supports ODBC levels 0 to 3.51.

MySQL supports high-availability database clustering using the `NDBCLUSTER` storage engine. See [Chapter 21, \*MySQL NDB Cluster 7.5 and NDB Cluster 7.6\*](#).

We implement XML functionality which supports most of the W3C XPath standard. See [Section 12.11, “XML Functions”](#).

MySQL (5.7.8 and later) supports a native JSON data type as defined by RFC 7159, and based on the ECMA Script standard (ECMA-262). See [Section 11.5, “The JSON Data Type”](#). MySQL also implements a subset of the SQL/JSON functions specified by a pre-publication draft of the SQL:2016 standard; see [Section 12.17, “JSON Functions”](#), for more information.

## Selecting SQL Modes

The MySQL server can operate in different SQL modes, and can apply these modes differently for different clients, depending on the value of the `sql_mode` system variable. DBAs can set the global SQL mode to match site server operating requirements, and each application can set its session SQL mode to its own requirements.

Modes affect the SQL syntax MySQL supports and the data validation checks it performs. This makes it easier to use MySQL in different environments and to use MySQL together with other database servers.

For more information on setting the SQL mode, see [Section 5.1.10, “Server SQL Modes”](#).

## Running MySQL in ANSI Mode

To run MySQL Server in ANSI mode, start `mysqld` with the `--ansi` option. Running the server in ANSI mode is the same as starting it with the following options:

```
--transaction-isolation=SERIALIZABLE --sql-mode=ANSI
```

To achieve the same effect at runtime, execute these two statements:

```
SET GLOBAL TRANSACTION ISOLATION LEVEL SERIALIZABLE;
SET GLOBAL sql_mode = 'ANSI';
```

You can see that setting the `sql_mode` system variable to `'ANSI'` enables all SQL mode options that are relevant for ANSI mode as follows:

```
mysql> SET GLOBAL sql_mode='ANSI';
mysql> SELECT @@GLOBAL.sql_mode;
-> 'REAL_AS_FLOAT,PIPES_AS_CONCAT,ANSI_QUOTES,IGNORE_SPACE,ANSI'
```

Running the server in ANSI mode with `--ansi` is not quite the same as setting the SQL mode to `'ANSI'` because the `--ansi` option also sets the transaction isolation level.

See [Section 5.1.6, “Server Command Options”](#).

### 1.6.1 MySQL Extensions to Standard SQL

MySQL Server supports some extensions that are likely not to be found in other SQL DBMSs. Be warned that if you use them, your code is not portable to other SQL servers. In some cases, you can write code that includes MySQL extensions, but is still portable, by using comments of the following form:

```
/*! MySQL-specific code */
```

In this case, MySQL Server parses and executes the code within the comment as it would any other SQL statement, but other SQL servers ignore the extensions. For example, MySQL Server recognizes the `STRAIGHT_JOIN` keyword in the following statement, but other servers do not:

```
SELECT /*! STRAIGHT_JOIN */ col1 FROM table1,table2 WHERE ...
```

If you add a version number after the `!` character, the syntax within the comment is executed only if the MySQL version is greater than or equal to the specified version number. The `KEY_BLOCK_SIZE` clause in the following comment is executed only by servers from MySQL 5.1.10 or higher:

```
CREATE TABLE t1(a INT, KEY (a)) /*!50110 KEY_BLOCK_SIZE=1024 */;
```

The following descriptions list MySQL extensions, organized by category.

- Organization of data on disk

MySQL Server maps each database to a directory under the MySQL data directory, and maps tables within a database to file names in the database directory. This has a few implications:

- Database and table names are case-sensitive in MySQL Server on operating systems that have case-sensitive file names (such as most Unix systems). See [Section 9.2.3, “Identifier Case Sensitivity”](#).
- You can use standard system commands to back up, rename, move, delete, and copy tables that are managed by the `MyISAM` storage engine. For example, it is possible to rename a `MyISAM` table by renaming the `.MYD`, `.MYI`, and `.frm` files to which the table corresponds. (Nevertheless, it is

preferable to use `RENAME TABLE` or `ALTER TABLE ... RENAME` and let the server rename the files.)

- General language syntax
  - By default, strings can be enclosed by `"` as well as `'`. If the `ANSI_QUOTES` SQL mode is enabled, strings can be enclosed only by `'` and the server interprets strings enclosed by `"` as identifiers.
  - `\` is the escape character in strings.
  - In SQL statements, you can access tables from different databases with the `db_name.tbl_name` syntax. Some SQL servers provide the same functionality but call this `User space`. MySQL Server does not support tablespaces such as used in statements like this: `CREATE TABLE ralph.my_table ... IN my_tablespace`.
- SQL statement syntax
  - The `ANALYZE TABLE`, `CHECK TABLE`, `OPTIMIZE TABLE`, and `REPAIR TABLE` statements.
  - The `CREATE DATABASE`, `DROP DATABASE`, and `ALTER DATABASE` statements. See [Section 13.1.11, “CREATE DATABASE Statement”](#), [Section 13.1.22, “DROP DATABASE Statement”](#), and [Section 13.1.1, “ALTER DATABASE Statement”](#).
  - The `DO` statement.
  - `EXPLAIN SELECT` to obtain a description of how tables are processed by the query optimizer.
  - The `FLUSH` and `RESET` statements.
  - The `SET` statement. See [Section 13.7.4.1, “SET Syntax for Variable Assignment”](#).
  - The `SHOW` statement. See [Section 13.7.5, “SHOW Statements”](#). The information produced by many of the MySQL-specific `SHOW` statements can be obtained in more standard fashion by using `SELECT` to query `INFORMATION_SCHEMA`. See [Chapter 24, INFORMATION\\_SCHEMA Tables](#).
  - Use of `LOAD DATA`. In many cases, this syntax is compatible with Oracle `LOAD DATA`. See [Section 13.2.6, “LOAD DATA Statement”](#).
  - Use of `RENAME TABLE`. See [Section 13.1.33, “RENAME TABLE Statement”](#).
  - Use of `REPLACE` instead of `DELETE` plus `INSERT`. See [Section 13.2.8, “REPLACE Statement”](#).
  - Use of `CHANGE col_name`, `DROP col_name`, or `DROP INDEX`, `IGNORE` or `RENAME` in `ALTER TABLE` statements. Use of multiple `ADD`, `ALTER`, `DROP`, or `CHANGE` clauses in an `ALTER TABLE` statement. See [Section 13.1.8, “ALTER TABLE Statement”](#).
  - Use of index names, indexes on a prefix of a column, and use of `INDEX` or `KEY` in `CREATE TABLE` statements. See [Section 13.1.18, “CREATE TABLE Statement”](#).
  - Use of `TEMPORARY` or `IF NOT EXISTS` with `CREATE TABLE`.
  - Use of `IF EXISTS` with `DROP TABLE` and `DROP DATABASE`.
  - The capability of dropping multiple tables with a single `DROP TABLE` statement.
  - The `ORDER BY` and `LIMIT` clauses of the `UPDATE` and `DELETE` statements.
  - `INSERT INTO tbl_name SET col_name = ...` syntax.

- The `DELAYED` clause of the `INSERT` and `REPLACE` statements.
- The `LOW_PRIORITY` clause of the `INSERT`, `REPLACE`, `DELETE`, and `UPDATE` statements.
- Use of `INTO OUTFILE` or `INTO DUMPFILE` in `SELECT` statements. See [Section 13.2.9, “SELECT Statement”](#).
- Options such as `STRAIGHT_JOIN` or `SQL_SMALL_RESULT` in `SELECT` statements.
- You don't need to name all selected columns in the `GROUP BY` clause. This gives better performance for some very specific, but quite normal queries. See [Section 12.19, “Aggregate Functions”](#).
- You can specify `ASC` and `DESC` with `GROUP BY`, not just with `ORDER BY`.
- The ability to set variables in a statement with the `:=` assignment operator. See [Section 9.4, “User-Defined Variables”](#).
- Data types
  - The `MEDIUMINT`, `SET`, and `ENUM` data types, and the various `BLOB` and `TEXT` data types.
  - The `AUTO_INCREMENT`, `BINARY`, `NULL`, `UNSIGNED`, and `ZEROFILL` data type attributes.
- Functions and operators
  - To make it easier for users who migrate from other SQL environments, MySQL Server supports aliases for many functions. For example, all string functions support both standard SQL syntax and ODBC syntax.
  - MySQL Server understands the `||` and `&&` operators to mean logical OR and AND, as in the C programming language. In MySQL Server, `||` and `OR` are synonyms, as are `&&` and `AND`. Because of this nice syntax, MySQL Server does not support the standard SQL `||` operator for string concatenation; use `CONCAT()` instead. Because `CONCAT()` takes any number of arguments, it is easy to convert use of the `||` operator to MySQL Server.
  - Use of `COUNT(DISTINCT value_list)` where `value_list` has more than one element.
  - String comparisons are case-insensitive by default, with sort ordering determined by the collation of the current character set, which is `latin1` (cp1252 West European) by default. To perform case-sensitive comparisons instead, you should declare your columns with the `BINARY` attribute or use the `BINARY` cast, which causes comparisons to be done using the underlying character code values rather than a lexical ordering.
  - The `%` operator is a synonym for `MOD()`. That is, `N % M` is equivalent to `MOD(N,M)`. `%` is supported for C programmers and for compatibility with PostgreSQL.
  - The `=`, `<>`, `<=`, `<`, `>=`, `>`, `<<`, `>>`, `<=>`, `AND`, `OR`, or `LIKE` operators may be used in expressions in the output column list (to the left of the `FROM`) in `SELECT` statements. For example:

```
mysql> SELECT col1=1 AND col2=2 FROM my_table;
```
  - The `LAST_INSERT_ID()` function returns the most recent `AUTO_INCREMENT` value. See [Section 12.15, “Information Functions”](#).
  - `LIKE` is permitted on numeric values.
  - The `REGEXP` and `NOT REGEXP` extended regular expression operators.

- `CONCAT()` or `CHAR()` with one argument or more than two arguments. (In MySQL Server, these functions can take a variable number of arguments.)
- The `BIT_COUNT()`, `CASE`, `ELT()`, `FROM_DAYS()`, `FORMAT()`, `IF()`, `PASSWORD()`, `ENCRYPT()`, `MD5()`, `ENCODE()`, `DECODE()`, `PERIOD_ADD()`, `PERIOD_DIFF()`, `TO_DAYS()`, and `WEEKDAY()` functions.
- Use of `TRIM()` to trim substrings. Standard SQL supports removal of single characters only.
- The `GROUP BY` functions `STD()`, `BIT_OR()`, `BIT_AND()`, `BIT_XOR()`, and `GROUP_CONCAT()`. See [Section 12.19, “Aggregate Functions”](#).

## 1.6.2 MySQL Differences from Standard SQL

We try to make MySQL Server follow the ANSI SQL standard and the ODBC SQL standard, but MySQL Server performs operations differently in some cases:

- There are several differences between the MySQL and standard SQL privilege systems. For example, in MySQL, privileges for a table are not automatically revoked when you delete a table. You must explicitly issue a `REVOKE` statement to revoke privileges for a table. For more information, see [Section 13.7.1.6, “REVOKE Statement”](#).
- The `CAST()` function does not support cast to `REAL` or `BIGINT`. See [Section 12.10, “Cast Functions and Operators”](#).

### 1.6.2.1 SELECT INTO TABLE Differences

MySQL Server does not support the `SELECT ... INTO TABLE` Sybase SQL extension. Instead, MySQL Server supports the `INSERT INTO ... SELECT` standard SQL syntax, which is basically the same thing. See [Section 13.2.5.1, “INSERT ... SELECT Statement”](#). For example:

```
INSERT INTO tbl_temp2 (fld_id)
  SELECT tbl_temp1.fld_order_id
  FROM tbl_temp1 WHERE tbl_temp1.fld_order_id > 100;
```

Alternatively, you can use `SELECT ... INTO OUTFILE` or `CREATE TABLE ... SELECT`.

You can use `SELECT ... INTO` with user-defined variables. The same syntax can also be used inside stored routines using cursors and local variables. See [Section 13.2.9.1, “SELECT ... INTO Statement”](#).

### 1.6.2.2 UPDATE Differences

If you access a column from the table to be updated in an expression, `UPDATE` uses the current value of the column. The second assignment in the following statement sets `col2` to the current (updated) `col1` value, not the original `col1` value. The result is that `col1` and `col2` have the same value. This behavior differs from standard SQL.

```
UPDATE t1 SET col1 = col1 + 1, col2 = col1;
```

### 1.6.2.3 FOREIGN KEY Constraint Differences

The MySQL implementation of foreign key constraints differs from the SQL standard in the following key respects:

- If there are several rows in the parent table with the same referenced key value, `InnoDB` performs a foreign key check as if the other parent rows with the same key value do not exist. For example, if you



define a `RESTRICT` type constraint, and there is a child row with several parent rows, `InnoDB` does not permit the deletion of any of the parent rows.

- If `ON UPDATE CASCADE` or `ON UPDATE SET NULL` recurses to update the *same table* it has previously updated during the same cascade, it acts like `RESTRICT`. This means that you cannot use self-referential `ON UPDATE CASCADE` or `ON UPDATE SET NULL` operations. This is to prevent infinite loops resulting from cascaded updates. A self-referential `ON DELETE SET NULL`, on the other hand, is possible, as is a self-referential `ON DELETE CASCADE`. Cascading operations may not be nested more than 15 levels deep.
- In an SQL statement that inserts, deletes, or updates many rows, foreign key constraints (like unique constraints) are checked row-by-row. When performing foreign key checks, `InnoDB` sets shared row-level locks on child or parent records that it must examine. MySQL checks foreign key constraints immediately; the check is not deferred to transaction commit. According to the SQL standard, the default behavior should be deferred checking. That is, constraints are only checked after the *entire SQL statement* has been processed. This means that it is not possible to delete a row that refers to itself using a foreign key.
- No storage engine, including `InnoDB`, recognizes or enforces the `MATCH` clause used in referential-integrity constraint definitions. Use of an explicit `MATCH` clause does not have the specified effect, and it causes `ON DELETE` and `ON UPDATE` clauses to be ignored. Specifying the `MATCH` should be avoided.

The `MATCH` clause in the SQL standard controls how `NULL` values in a composite (multiple-column) foreign key are handled when comparing to a primary key in the referenced table. MySQL essentially implements the semantics defined by `MATCH SIMPLE`, which permits a foreign key to be all or partially `NULL`. In that case, a (child table) row containing such a foreign key can be inserted even though it does not match any row in the referenced (parent) table. (It is possible to implement other semantics using triggers.)

- MySQL requires that the referenced columns be indexed for performance reasons. However, MySQL does not enforce a requirement that the referenced columns be `UNIQUE` or be declared `NOT NULL`.

A `FOREIGN KEY` constraint that references a non-`UNIQUE` key is not standard SQL but rather an `InnoDB` extension. The `NDB` storage engine, on the other hand, requires an explicit unique key (or primary key) on any column referenced as a foreign key.

The handling of foreign key references to nonunique keys or keys that contain `NULL` values is not well defined for operations such as `UPDATE` or `DELETE CASCADE`. You are advised to use foreign keys that reference only `UNIQUE` (including `PRIMARY`) and `NOT NULL` keys.

- For storage engines that do not support foreign keys (such as `MyISAM`), MySQL Server parses and ignores foreign key specifications.
- MySQL parses but ignores “inline `REFERENCES` specifications” (as defined in the SQL standard) where the references are defined as part of the column specification. MySQL accepts `REFERENCES` clauses only when specified as part of a separate `FOREIGN KEY` specification.

Defining a column to use a `REFERENCES tbl_name(col_name)` clause has no actual effect and *serves only as a memo or comment to you that the column which you are currently defining is intended to refer to a column in another table*. It is important to realize when using this syntax that:

- MySQL does not perform any sort of check to make sure that `col_name` actually exists in `tbl_name` (or even that `tbl_name` itself exists).
- MySQL does not perform any sort of action on `tbl_name` such as deleting rows in response to actions taken on rows in the table which you are defining; in other words, this syntax induces no `ON`

`DELETE` or `ON UPDATE` behavior whatsoever. (Although you can write an `ON DELETE` or `ON UPDATE` clause as part of the `REFERENCES` clause, it is also ignored.)

- This syntax creates a *column*; it does **not** create any sort of index or key.

You can use a column so created as a join column, as shown here:

```
CREATE TABLE person (
  id SMALLINT UNSIGNED NOT NULL AUTO_INCREMENT,
  name CHAR(60) NOT NULL,
  PRIMARY KEY (id)
);

CREATE TABLE shirt (
  id SMALLINT UNSIGNED NOT NULL AUTO_INCREMENT,
  style ENUM('t-shirt', 'polo', 'dress') NOT NULL,
  color ENUM('red', 'blue', 'orange', 'white', 'black') NOT NULL,
  owner SMALLINT UNSIGNED NOT NULL REFERENCES person(id),
  PRIMARY KEY (id)
);

INSERT INTO person VALUES (NULL, 'Antonio Paz');

SELECT @last := LAST_INSERT_ID();

INSERT INTO shirt VALUES
(NULL, 'polo', 'blue', @last),
(NULL, 'dress', 'white', @last),
(NULL, 't-shirt', 'blue', @last);

INSERT INTO person VALUES (NULL, 'Lilliana Angelovska');

SELECT @last := LAST_INSERT_ID();

INSERT INTO shirt VALUES
(NULL, 'dress', 'orange', @last),
(NULL, 'polo', 'red', @last),
(NULL, 'dress', 'blue', @last),
(NULL, 't-shirt', 'white', @last);

SELECT * FROM person;
+----+-----+
| id | name                |
+----+-----+
|  1 | Antonio Paz         |
|  2 | Lilliana Angelovska |
+----+-----+

SELECT * FROM shirt;
+----+-----+-----+-----+
| id | style  | color | owner |
+----+-----+-----+-----+
|  1 | polo   | blue  | 1     |
|  2 | dress  | white | 1     |
|  3 | t-shirt| blue  | 1     |
|  4 | dress  | orange| 2     |
|  5 | polo   | red   | 2     |
|  6 | dress  | blue  | 2     |
|  7 | t-shirt| white | 2     |
+----+-----+-----+-----+

SELECT s.* FROM person p INNER JOIN shirt s
  ON s.owner = p.id
 WHERE p.name LIKE 'Lilliana%'
    AND s.color <> 'white';
```

```
+-----+-----+-----+-----+
| id | style | color | owner |
+-----+-----+-----+-----+
| 4 | dress | orange | 2 |
| 5 | polo | red | 2 |
| 6 | dress | blue | 2 |
+-----+-----+-----+-----+
```

When used in this fashion, the `REFERENCES` clause is not displayed in the output of `SHOW CREATE TABLE` or `DESCRIBE`:

```
SHOW CREATE TABLE shirt\G
***** 1. row *****
Table: shirt
Create Table: CREATE TABLE `shirt` (
  `id` smallint(5) unsigned NOT NULL auto_increment,
  `style` enum('t-shirt','polo','dress') NOT NULL,
  `color` enum('red','blue','orange','white','black') NOT NULL,
  `owner` smallint(5) unsigned NOT NULL,
  PRIMARY KEY (`id`)
) ENGINE=MyISAM DEFAULT CHARSET=latin1
```

For information about foreign key constraints, see [Section 13.1.18.5, “FOREIGN KEY Constraints”](#).

### 1.6.2.4 '--' as the Start of a Comment

Standard SQL uses the C syntax `/* this is a comment */` for comments, and MySQL Server supports this syntax as well. MySQL also support extensions to this syntax that enable MySQL-specific SQL to be embedded in the comment; see [Section 9.6, “Comments”](#).

MySQL Server also uses `#` as the start comment character. This is nonstandard.

Standard SQL also uses “`--`” as a start-comment sequence. MySQL Server supports a variant of the `--` comment style; the `--` start-comment sequence is accepted as such, but must be followed by a whitespace character such as a space or newline. The space is intended to prevent problems with generated SQL queries that use constructs such as the following, which updates the balance to reflect a charge:

```
UPDATE account SET balance=balance-charge
WHERE account_id=user_id
```

Consider what happens when `charge` has a negative value such as `-1`, which might be the case when an amount is credited to the account. In this case, the generated statement looks like this:

```
UPDATE account SET balance=balance--1
WHERE account_id=5752;
```

`balance--1` is valid standard SQL, but `--` is interpreted as the start of a comment, and part of the expression is discarded. The result is a statement that has a completely different meaning than intended:

```
UPDATE account SET balance=balance
WHERE account_id=5752;
```

This statement produces no change in value at all. To keep this from happening, MySQL requires a whitespace character following the `--` for it to be recognized as a start-comment sequence in MySQL Server, so that an expression such as `balance-- 1` is always safe to use.

## 1.6.3 How MySQL Deals with Constraints

MySQL enables you to work both with transactional tables that permit rollback and with nontransactional tables that do not. Because of this, constraint handling is a bit different in MySQL than in other DBMSs. We

must handle the case when you have inserted or updated a lot of rows in a nontransactional table for which changes cannot be rolled back when an error occurs.

The basic philosophy is that MySQL Server tries to produce an error for anything that it can detect while parsing a statement to be executed, and tries to recover from any errors that occur while executing the statement. We do this in most cases, but not yet for all.

The options MySQL has when an error occurs are to stop the statement in the middle or to recover as well as possible from the problem and continue. By default, the server follows the latter course. This means, for example, that the server may coerce invalid values to the closest valid values.

Several SQL mode options are available to provide greater control over handling of bad data values and whether to continue statement execution or abort when errors occur. Using these options, you can configure MySQL Server to act in a more traditional fashion that is like other DBMSs that reject improper input. The SQL mode can be set globally at server startup to affect all clients. Individual clients can set the SQL mode at runtime, which enables each client to select the behavior most appropriate for its requirements. See [Section 5.1.10, “Server SQL Modes”](#).

The following sections describe how MySQL Server handles different types of constraints.

### 1.6.3.1 PRIMARY KEY and UNIQUE Index Constraints

Normally, errors occur for data-change statements (such as `INSERT` or `UPDATE`) that would violate primary-key, unique-key, or foreign-key constraints. If you are using a transactional storage engine such as `InnoDB`, MySQL automatically rolls back the statement. If you are using a nontransactional storage engine, MySQL stops processing the statement at the row for which the error occurred and leaves any remaining rows unprocessed.

MySQL supports an `IGNORE` keyword for `INSERT`, `UPDATE`, and so forth. If you use it, MySQL ignores primary-key or unique-key violations and continues processing with the next row. See the section for the statement that you are using ([Section 13.2.5, “INSERT Statement”](#), [Section 13.2.11, “UPDATE Statement”](#), and so forth).

You can get information about the number of rows actually inserted or updated with the `mysql_info()` C API function. You can also use the `SHOW WARNINGS` statement. See `mysql_info()`, and [Section 13.7.5.40, “SHOW WARNINGS Statement”](#).

`InnoDB` and `NDB` tables support foreign keys. See [Section 1.6.3.2, “FOREIGN KEY Constraints”](#).

### 1.6.3.2 FOREIGN KEY Constraints

Foreign keys let you cross-reference related data across tables, and [foreign key constraints](#) help keep this spread-out data consistent.

MySQL supports `ON UPDATE` and `ON DELETE` foreign key references in `CREATE TABLE` and `ALTER TABLE` statements. The available referential actions are `RESTRICT` (the default), `CASCADE`, `SET NULL`, and `NO ACTION`.

`SET DEFAULT` is also supported by the MySQL Server but is currently rejected as invalid by `InnoDB`. Since MySQL does not support deferred constraint checking, `NO ACTION` is treated as `RESTRICT`. For the exact syntax supported by MySQL for foreign keys, see [Section 13.1.18.5, “FOREIGN KEY Constraints”](#).

`MATCH FULL`, `MATCH PARTIAL`, and `MATCH SIMPLE` are allowed, but their use should be avoided, as they cause the MySQL Server to ignore any `ON DELETE` or `ON UPDATE` clause used in the same statement. `MATCH` options do not have any other effect in MySQL, which in effect enforces `MATCH SIMPLE` semantics full-time.

MySQL requires that foreign key columns be indexed; if you create a table with a foreign key constraint but no index on a given column, an index is created.

You can obtain information about foreign keys from the Information Schema `KEY_COLUMN_USAGE` table. An example of a query against this table is shown here:

```
mysql> SELECT TABLE_SCHEMA, TABLE_NAME, COLUMN_NAME, CONSTRAINT_NAME
> FROM INFORMATION_SCHEMA.KEY_COLUMN_USAGE
> WHERE REFERENCED_TABLE_SCHEMA IS NOT NULL;
```

TABLE_SCHEMA	TABLE_NAME	COLUMN_NAME	CONSTRAINT_NAME
fk1	myuser	myuser_id	f
fk1	product_order	customer_id	f2
fk1	product_order	product_id	f1

```
3 rows in set (0.01 sec)
```

Information about foreign keys on `InnoDB` tables can also be found in the `INNODB_SYS_FOREIGN` and `INNODB_SYS_FOREIGN_COLS` tables, in the `INFORMATION_SCHEMA` database.

`InnoDB` and `NDB` tables support foreign keys.

### 1.6.3.3 Constraints on Invalid Data

MySQL 5.7.5 and later uses strict SQL mode by default, which treats invalid values such that the server rejects them and aborts the statement in which they occur (see [Section 5.1.10, “Server SQL Modes”](#)). Previously, MySQL was much more forgiving of incorrect values used in data entry; this now requires disabling of strict mode, which is not recommended. The remainder of this section discusses the old behavior followed by MySQL when strict mode has been disabled.

If you are not using strict mode, then whenever you insert an “incorrect” value into a column, such as a `NULL` into a `NOT NULL` column or a too-large numeric value into a numeric column, MySQL sets the column to the “best possible value” instead of producing an error: The following rules describe in more detail how this works:

- If you try to store an out of range value into a numeric column, MySQL Server instead stores zero, the smallest possible value, or the largest possible value, whichever is closest to the invalid value.
- For strings, MySQL stores either the empty string or as much of the string as can be stored in the column.
- If you try to store a string that does not start with a number into a numeric column, MySQL Server stores 0.
- Invalid values for `ENUM` and `SET` columns are handled as described in [Section 1.6.3.4, “ENUM and SET Constraints”](#).
- MySQL permits you to store certain incorrect date values into `DATE` and `DATETIME` columns (such as `'2000-02-31'` or `'2000-02-00'`). In this case, when an application has not enabled strict SQL mode, it up to the application to validate the dates before storing them. If MySQL can store a date value and retrieve exactly the same value, MySQL stores it as given. If the date is totally wrong (outside the server's ability to store it), the special “zero” date value `'0000-00-00'` is stored in the column instead.
- If you try to store `NULL` into a column that does not take `NULL` values, an error occurs for single-row `INSERT` statements. For multiple-row `INSERT` statements or for `INSERT INTO ... SELECT` statements, MySQL Server stores the implicit default value for the column data type. In general, this is 0 for numeric types, the empty string (`' '`) for string types, and the “zero” value for date and time types. Implicit default values are discussed in [Section 11.6, “Data Type Default Values”](#).

- If an `INSERT` statement specifies no value for a column, MySQL inserts its default value if the column definition includes an explicit `DEFAULT` clause. If the definition has no such `DEFAULT` clause, MySQL inserts the implicit default value for the column data type.

The reason for using the preceding rules when strict mode is not in effect is that we cannot check these conditions until the statement has begun executing. We cannot just roll back if we encounter a problem after updating a few rows, because the storage engine may not support rollback. The option of terminating the statement is not that good; in this case, the update would be “half done,” which is probably the worst possible scenario. In this case, it is better to “do the best you can” and then continue as if nothing happened.

You can select stricter treatment of input values by using the `STRICT_TRANS_TABLES` or `STRICT_ALL_TABLES` SQL modes:

```
SET sql_mode = 'STRICT_TRANS_TABLES';
SET sql_mode = 'STRICT_ALL_TABLES';
```

`STRICT_TRANS_TABLES` enables strict mode for transactional storage engines, and also to some extent for nontransactional engines. It works like this:

- For transactional storage engines, bad data values occurring anywhere in a statement cause the statement to abort and roll back.
- For nontransactional storage engines, a statement aborts if the error occurs in the first row to be inserted or updated. (When the error occurs in the first row, the statement can be aborted to leave the table unchanged, just as for a transactional table.) Errors in rows after the first do not abort the statement, because the table has already been changed by the first row. Instead, bad data values are adjusted and result in warnings rather than errors. In other words, with `STRICT_TRANS_TABLES`, a wrong value causes MySQL to roll back all updates done so far, if that can be done without changing the table. But once the table has been changed, further errors result in adjustments and warnings.

For even stricter checking, enable `STRICT_ALL_TABLES`. This is the same as `STRICT_TRANS_TABLES` except that for nontransactional storage engines, errors abort the statement even for bad data in rows following the first row. This means that if an error occurs partway through a multiple-row insert or update for a nontransactional table, a partial update results. Earlier rows are inserted or updated, but those from the point of the error on are not. To avoid this for nontransactional tables, either use single-row statements or else use `STRICT_TRANS_TABLES` if conversion warnings rather than errors are acceptable. To avoid problems in the first place, do not use MySQL to check column content. It is safest (and often faster) to let the application ensure that it passes only valid values to the database.

With either of the strict mode options, you can cause errors to be treated as warnings by using `INSERT IGNORE` or `UPDATE IGNORE` rather than `INSERT` or `UPDATE` without `IGNORE`.

### 1.6.3.4 ENUM and SET Constraints

`ENUM` and `SET` columns provide an efficient way to define columns that can contain only a given set of values. See [Section 11.3.5, “The ENUM Type”](#), and [Section 11.3.6, “The SET Type”](#).

Unless strict mode is disabled (not recommended, but see [Section 5.1.10, “Server SQL Modes”](#)), the definition of a `ENUM` or `SET` column acts as a constraint on values entered into the column. An error occurs for values that do not satisfy these conditions:

- An `ENUM` value must be one of those listed in the column definition, or the internal numeric equivalent thereof. The value cannot be the error value (that is, 0 or the empty string). For a column defined as `ENUM('a', 'b', 'c')`, values such as `'`, `'d'`, or `'ax'` are invalid and are rejected.

- A `SET` value must be the empty string or a value consisting only of the values listed in the column definition separated by commas. For a column defined as `SET('a', 'b', 'c')`, values such as `'d'` or `'a,b,c,d'` are invalid and are rejected.

Errors for invalid values can be suppressed in strict mode if you use `INSERT IGNORE` or `UPDATE IGNORE`. In this case, a warning is generated rather than an error. For `ENUM`, the value is inserted as the error member (0). For `SET`, the value is inserted as given except that any invalid substrings are deleted. For example, `'a,x,b,y'` results in a value of `'a,b'`.





---

# Chapter 2 Installing and Upgrading MySQL

## Table of Contents

2.1 General Installation Guidance .....	62
2.1.1 Supported Platforms .....	62
2.1.2 Which MySQL Version and Distribution to Install .....	62
2.1.3 How to Get MySQL .....	63
2.1.4 Verifying Package Integrity Using MD5 Checksums or GnuPG .....	63
2.1.5 Installation Layouts .....	80
2.1.6 Compiler-Specific Build Characteristics .....	81
2.2 Installing MySQL on Unix/Linux Using Generic Binaries .....	81
2.3 Installing MySQL on Microsoft Windows .....	84
2.3.1 MySQL Installation Layout on Microsoft Windows .....	87
2.3.2 Choosing an Installation Package .....	88
2.3.3 MySQL Installer for Windows .....	89
2.3.4 Installing MySQL on Microsoft Windows Using a <code>noinstall</code> ZIP Archive .....	120
2.3.5 Troubleshooting a Microsoft Windows MySQL Server Installation .....	128
2.3.6 Windows Postinstallation Procedures .....	130
2.3.7 Windows Platform Restrictions .....	132
2.4 Installing MySQL on macOS .....	133
2.4.1 General Notes on Installing MySQL on macOS .....	134
2.4.2 Installing MySQL on macOS Using Native Packages .....	135
2.4.3 Installing a MySQL Launch Daemon .....	141
2.4.4 Installing and Using the MySQL Preference Pane .....	144
2.5 Installing MySQL on Linux .....	149
2.5.1 Installing MySQL on Linux Using the MySQL Yum Repository .....	150
2.5.2 Replacing a Third-Party Distribution of MySQL Using the MySQL Yum Repository .....	154
2.5.3 Installing MySQL on Linux Using the MySQL APT Repository .....	157
2.5.4 Installing MySQL on Linux Using the MySQL SLES Repository .....	157
2.5.5 Installing MySQL on Linux Using RPM Packages from Oracle .....	157
2.5.6 Installing MySQL on Linux Using Debian Packages from Oracle .....	162
2.5.7 Deploying MySQL on Linux with Docker .....	163
2.5.8 Installing MySQL on Linux from the Native Software Repositories .....	174
2.5.9 Installing MySQL on Linux with Juju .....	177
2.5.10 Managing MySQL Server with <code>systemd</code> .....	177
2.6 Installing MySQL Using Unbreakable Linux Network (ULN) .....	182
2.7 Installing MySQL on Solaris .....	183
2.7.1 Installing MySQL on Solaris Using a Solaris PKG .....	184
2.8 Installing MySQL from Source .....	185
2.8.1 Source Installation Methods .....	185
2.8.2 Source Installation Prerequisites .....	186
2.8.3 MySQL Layout for Source Installation .....	187
2.8.4 Installing MySQL Using a Standard Source Distribution .....	187
2.8.5 Installing MySQL Using a Development Source Tree .....	192
2.8.6 Configuring SSL Library Support .....	193
2.8.7 MySQL Source-Configuration Options .....	194
2.8.8 Dealing with Problems Compiling MySQL .....	220
2.8.9 MySQL Configuration and Third-Party Tools .....	221
2.9 Postinstallation Setup and Testing .....	222
2.9.1 Initializing the Data Directory .....	222
2.9.2 Starting the Server .....	228

2.9.3 Testing the Server .....	231
2.9.4 Securing the Initial MySQL Account .....	233
2.9.5 Starting and Stopping MySQL Automatically .....	235
2.10 Upgrading MySQL .....	236
2.10.1 Before You Begin .....	236
2.10.2 Upgrade Paths .....	237
2.10.3 Changes in MySQL 5.7 .....	237
2.10.4 Upgrading MySQL Binary or Package-based Installations on Unix/Linux .....	247
2.10.5 Upgrading MySQL with the MySQL Yum Repository .....	250
2.10.6 Upgrading MySQL with the MySQL APT Repository .....	252
2.10.7 Upgrading MySQL with the MySQL SLES Repository .....	252
2.10.8 Upgrading MySQL on Windows .....	252
2.10.9 Upgrading a Docker Installation of MySQL .....	254
2.10.10 Upgrading MySQL with Directly-Downloaded RPM Packages .....	254
2.10.11 Upgrade Troubleshooting .....	255
2.10.12 Rebuilding or Repairing Tables or Indexes .....	256
2.10.13 Copying MySQL Databases to Another Machine .....	257
2.11 Downgrading MySQL .....	258
2.11.1 Before You Begin .....	259
2.11.2 Downgrade Paths .....	259
2.11.3 Downgrade Notes .....	259
2.11.4 Downgrading Binary and Package-based Installations on Unix/Linux .....	262
2.11.5 Downgrade Troubleshooting .....	265
2.12 Perl Installation Notes .....	265
2.12.1 Installing Perl on Unix .....	265
2.12.2 Installing ActiveState Perl on Windows .....	266
2.12.3 Problems Using the Perl DBI/DBD Interface .....	267

This chapter describes how to obtain and install MySQL. A summary of the procedure follows and later sections provide the details. If you plan to upgrade an existing version of MySQL to a newer version rather than install MySQL for the first time, see [Section 2.10, “Upgrading MySQL”](#), for information about upgrade procedures and about issues that you should consider before upgrading.

If you are interested in migrating to MySQL from another database system, see [Section A.8, “MySQL 5.7 FAQ: Migration”](#), which contains answers to some common questions concerning migration issues.

Installation of MySQL generally follows the steps outlined here:

- 1. Determine whether MySQL runs and is supported on your platform.**

Please note that not all platforms are equally suitable for running MySQL, and that not all platforms on which MySQL is known to run are officially supported by Oracle Corporation. For information about those platforms that are officially supported, see <https://www.mysql.com/support/supportedplatforms/database.html> on the MySQL website.

- 2. Choose which distribution to install.**

Several versions of MySQL are available, and most are available in several distribution formats. You can choose from pre-packaged distributions containing binary (precompiled) programs or source code. When in doubt, use a binary distribution. Oracle also provides access to the MySQL source code for those who want to see recent developments and test new code. To determine which version and type of distribution you should use, see [Section 2.1.2, “Which MySQL Version and Distribution to Install”](#).

- 3. Download the distribution that you want to install.**

---

For instructions, see [Section 2.1.3, “How to Get MySQL”](#). To verify the integrity of the distribution, use the instructions in [Section 2.1.4, “Verifying Package Integrity Using MD5 Checksums or GnuPG”](#).

#### 4. Install the distribution.

To install MySQL from a binary distribution, use the instructions in [Section 2.2, “Installing MySQL on Unix/Linux Using Generic Binaries”](#). Alternatively, use the [Secure Deployment Guide](#), which provides procedures for deploying a generic binary distribution of MySQL Enterprise Edition Server with features for managing the security of your MySQL installation.

To install MySQL from a source distribution or from the current development source tree, use the instructions in [Section 2.8, “Installing MySQL from Source”](#).

#### 5. Perform any necessary postinstallation setup.

After installing MySQL, see [Section 2.9, “Postinstallation Setup and Testing”](#) for information about making sure the MySQL server is working properly. Also refer to the information provided in [Section 2.9.4, “Securing the Initial MySQL Account”](#). This section describes how to secure the initial MySQL `root` user account, *which has no password* until you assign one. The section applies whether you install MySQL using a binary or source distribution.

6. If you want to run the MySQL benchmark scripts, Perl support for MySQL must be available. See [Section 2.12, “Perl Installation Notes”](#).

Instructions for installing MySQL on different platforms and environments is available on a platform by platform basis:

##### • **Unix, Linux**

For instructions on installing MySQL on most Linux and Unix platforms using a generic binary (for example, a `.tar.gz` package), see [Section 2.2, “Installing MySQL on Unix/Linux Using Generic Binaries”](#).

For information on building MySQL entirely from the source code distributions or the source code repositories, see [Section 2.8, “Installing MySQL from Source”](#)

For specific platform help on installation, configuration, and building from source see the corresponding platform section:

- Linux, including notes on distribution specific methods, see [Section 2.5, “Installing MySQL on Linux”](#).
- Solaris, including PKG and IPS formats, see [Section 2.7, “Installing MySQL on Solaris”](#).
- IBM AIX, see [Section 2.7, “Installing MySQL on Solaris”](#).

##### • **Microsoft Windows**

For instructions on installing MySQL on Microsoft Windows, using either the MySQL Installer or Zipped binary, see [Section 2.3, “Installing MySQL on Microsoft Windows”](#).

For details and instructions on building MySQL from source code using Microsoft Visual Studio, see [Section 2.8, “Installing MySQL from Source”](#).

##### • **macOS**

For installation on macOS, including using both the binary package and native PKG formats, see [Section 2.4, “Installing MySQL on macOS”](#).

For information on making use of an macOS Launch Daemon to automatically start and stop MySQL, see [Section 2.4.3, “Installing a MySQL Launch Daemon”](#).

For information on the MySQL Preference Pane, see [Section 2.4.4, “Installing and Using the MySQL Preference Pane”](#).

## 2.1 General Installation Guidance

The immediately following sections contain the information necessary to choose, download, and verify your distribution. The instructions in later sections of the chapter describe how to install the distribution that you choose. For binary distributions, see the instructions at [Section 2.2, “Installing MySQL on Unix/Linux Using Generic Binaries”](#) or the corresponding section for your platform if available. To build MySQL from source, use the instructions in [Section 2.8, “Installing MySQL from Source”](#).

### 2.1.1 Supported Platforms

MySQL platform support evolves over time; please refer to <https://www.mysql.com/support/supportedplatforms/database.html> for the latest updates.

### 2.1.2 Which MySQL Version and Distribution to Install

When preparing to install MySQL, decide which version and distribution format (binary or source) to use.

First, decide whether to install a development release or a General Availability (GA) release. Development releases have the newest features, but are not recommended for production use. GA releases, also called production or stable releases, are meant for production use. We recommend using the most recent GA release.

The naming scheme in MySQL 5.7 uses release names that consist of three numbers and an optional suffix; for example, **mysql-5.7.1-m1**. The numbers within the release name are interpreted as follows:

- The first number (**5**) is the major version number.
- The second number (**7**) is the minor version number. Taken together, the major and minor numbers constitute the release series number. The series number describes the stable feature set.
- The third number (**1**) is the version number within the release series. This is incremented for each new bugfix release. In most cases, the most recent version within a series is the best choice.

Release names can also include a suffix to indicate the stability level of the release. Releases within a series progress through a set of suffixes to indicate how the stability level improves. The possible suffixes are:

- **mN** (for example, **m1**, **m2**, **m3**, ...) indicates a milestone number. MySQL development uses a milestone model, in which each milestone introduces a small subset of thoroughly tested features. From one milestone to the next, feature interfaces may change or features may even be removed, based on feedback provided by community members who try these early releases. Features within milestone releases may be considered to be of pre-production quality.
- **rc** indicates a Release Candidate (RC). Release candidates are believed to be stable, having passed all of MySQL's internal testing. New features may still be introduced in RC releases, but the focus shifts to fixing bugs to stabilize features introduced earlier within the series.
- Absence of a suffix indicates a General Availability (GA) or Production release. GA releases are stable, having successfully passed through the earlier release stages, and are believed to be reliable, free of serious bugs, and suitable for use in production systems.

Development within a series begins with milestone releases, followed by RC releases, and finally reaches GA status releases.

After choosing which MySQL version to install, decide which distribution format to install for your operating system. For most use cases, a binary distribution is the right choice. Binary distributions are available in native format for many platforms, such as RPM packages for Linux or DMG packages for macOS. Distributions are also available in more generic formats such as Zip archives or compressed `tar` files. On Windows, you can use [the MySQL Installer](#) to install a binary distribution.

Under some circumstances, it may be preferable to install MySQL from a source distribution:

- You want to install MySQL at some explicit location. The standard binary distributions are ready to run at any installation location, but you might require even more flexibility to place MySQL components where you want.
- You want to configure `mysqld` with features that might not be included in the standard binary distributions. Here is a list of the most common extra options used to ensure feature availability:
  - `-DWITH_LIBWRAP=1` for TCP wrappers support.
  - `-DWITH_ZLIB={system|bundled}` for features that depend on compression
  - `-DWITH_DEBUG=1` for debugging support

For additional information, see [Section 2.8.7, “MySQL Source-Configuration Options”](#).

- You want to configure `mysqld` without some features that are included in the standard binary distributions. For example, distributions normally are compiled with support for all character sets. If you want a smaller MySQL server, you can recompile it with support for only the character sets you need.
- You want to read or modify the C and C++ code that makes up MySQL. For this purpose, obtain a source distribution.
- Source distributions contain more tests and examples than binary distributions.

### 2.1.3 How to Get MySQL

Check our downloads page at <https://dev.mysql.com/downloads/> for information about the current version of MySQL and for downloading instructions.

For RPM-based Linux platforms that use Yum as their package management system, MySQL can be installed using the [MySQL Yum Repository](#). See [Section 2.5.1, “Installing MySQL on Linux Using the MySQL Yum Repository”](#) for details.

For Debian-based Linux platforms, MySQL can be installed using the [MySQL APT Repository](#). See [Section 2.5.3, “Installing MySQL on Linux Using the MySQL APT Repository”](#) for details.

For SUSE Linux Enterprise Server (SLES) platforms, MySQL can be installed using the [MySQL SLES Repository](#). See [Section 2.5.4, “Installing MySQL on Linux Using the MySQL SLES Repository”](#) for details.

To obtain the latest development source, see [Section 2.8.5, “Installing MySQL Using a Development Source Tree”](#).

### 2.1.4 Verifying Package Integrity Using MD5 Checksums or GnuPG

After downloading the MySQL package that suits your needs and before attempting to install it, make sure that it is intact and has not been tampered with. There are three means of integrity checking:

- MD5 checksums
- Cryptographic signatures using [GnuPG](#), the GNU Privacy Guard
- For RPM packages, the built-in RPM integrity verification mechanism

The following sections describe how to use these methods.

If you notice that the MD5 checksum or GPG signatures do not match, first try to download the respective package one more time, perhaps from another mirror site.

### 2.1.4.1 Verifying the MD5 Checksum

After you have downloaded a MySQL package, you should make sure that its MD5 checksum matches the one provided on the MySQL download pages. Each package has an individual checksum that you can verify against the package that you downloaded. The correct MD5 checksum is listed on the downloads page for each MySQL product; compare it against the MD5 checksum of the file (product) that you download.

Each operating system and setup offers its own version of tools for checking the MD5 checksum. Typically the command is named `md5sum`, or it may be named `md5`, and some operating systems do not ship it at all. On Linux, it is part of the **GNU Text Utilities** package, which is available for a wide range of platforms. You can also download the source code from <http://www.gnu.org/software/textutils/>. If you have OpenSSL installed, you can use the command `openssl md5 package_name` instead. A Windows implementation of the `md5` command line utility is available from <http://www.fourmilab.ch/md5/>. `winMd5Sum` is a graphical MD5 checking tool that can be obtained from <http://www.nullriver.com/index/products/winmd5sum>. Our Microsoft Windows examples assume the name `md5.exe`.

Linux and Microsoft Windows examples:

```
$> md5sum mysql-standard-5.7.44-linux-i686.tar.gz
aaab65abbec64d5e907dcd41b8699945  mysql-standard-5.7.44-linux-i686.tar.gz
```

```
$> md5.exe mysql-installer-community-5.7.44.msi
aaab65abbec64d5e907dcd41b8699945  mysql-installer-community-5.7.44.msi
```

You should verify that the resulting checksum (the string of hexadecimal digits) matches the one displayed on the download page immediately below the respective package.



#### Note

Make sure to verify the checksum of the *archive file* (for example, the `.zip`, `.tar.gz`, or `.msi` file) and not of the files that are contained inside of the archive. In other words, verify the file before extracting its contents.

### 2.1.4.2 Signature Checking Using GnuPG

Another method of verifying the integrity and authenticity of a package is to use cryptographic signatures. This is more reliable than using [MD5 checksums](#), but requires more work.

We sign MySQL downloadable packages with [GnuPG](#) (GNU Privacy Guard). [GnuPG](#) is an Open Source alternative to the well-known Pretty Good Privacy ([PGP](#)) by Phil Zimmermann. Most Linux distributions ship with [GnuPG](#) installed by default. Otherwise, see <http://www.gnupg.org/> for more information about [GnuPG](#) and how to obtain and install it.

To verify the signature for a specific package, you first need to obtain a copy of our public GPG build key, which you can download from <http://pgp.mit.edu/>. The key that you want to obtain is named `mysql-`

[build@oss.oracle.com](mailto:build@oss.oracle.com). The keyID for MySQL 5.7.37 packages and higher is **3A79BD29**. After obtaining this key, you should compare it with the key shown following, before using it to verify MySQL packages. Alternatively, you can copy and paste the key directly from the text below.



**Note**

The following public GPG build key is for MySQL 5.7.37 packages and higher. For the public GPG build key for earlier MySQL release packages (keyID **5072E1F5**), see [Section 2.1.4.5, “GPG Public Build Key for Archived Packages”](#).

```
-----BEGIN PGP PUBLIC KEY BLOCK-----
Version: SKS 1.1.6
Comment: Hostname: pgp.mit.edu

mQINBGG4urcBEACrbsRa7tSSyxSfFkB+KXSbnM9rxYqoB78u107skReefq4/+Y72TpDvlDZL
mdv/lk0IpLa3bnvsM9IE1trNLrfi+JES62kaQ6hePPgn2RqxyIirt2seSi3Z3n3jLEg+mSdh
AvW+b+hFnqxo+TY0U+RBWd14o00YzHefkYPSmNPdlxRPQBMv4GPTNfxERx6XvVSPcLl+jQ4R
2cQFBryNhidBFikoCoszjWhm+WnbURSLheBp7571qEyrpCufz77z1q2gEi+wtPHItfqsx3rz
xSRqatzMGYzPNUHNBjkr13npZtGW+kdN/xu980QLZxN+bZ88pNoOuzD6dKcpMJ0LkdUmTx5
z9ewiFiFbUDZ7PECOm2g3veJrwr79CXDLel+39Hr8rDM2kDhSr9tAlPtNHDcaYIGgSNIBc
YfLmt91133klHQHBIIdWCNVtWJjq5YcLQJ9TxG9GQzGABPrm6NDdl1t9j7w1L7uwBvMB1wgpI
RTPVfnUSCd+025PEF+wTcBhfnzLtFj5xD7mNsmDmeHkF/sDFNOFAzTE1v2wq0ndYU60xbL6/
yl/Nipy7rWiQJCG0m3WfkkjVDTfs7/DXUqHFDou4WMF9v+oqwpJXmAeGhQTWZC/QhWtrjrNJ
AgwKpp263gDSdW70ekhrZsoklHJwXlSfxHJYCMFs2aH6ppzNsQARAQABtDZNeVNRtCBSZwXl
YXNlIEVUz21uZWVyaW5nIDxtexNxbC1idWlsZEBvc3Mub3JhY2xlLmNvbT6JAlQEEwEIAID4W
IQSfm+jXyYb1OEMlGcJGe5QtOnm9KQUCYbi6twIbAwUJA8JnAAULCQGHAGYVVCgkICwIEFgID
AQIeAQIXgAAKCRBGe5QtOnm9KUEwD/992sS31WLG0UQ6NoL7qOB4CErkkqXtMzpjAKKg2jTBG
G3rKE1/0VAg1D8AwEK4LcCO407wohnH0hNiUbeDck5x20pgS5SplQpuXX1K9vPzHeL/WNTb9
8S3H2Mzj4o9obED6EY52tTupttMF8pC9TJ93LxbJlCHIKKwCA1cXud3GycRN72eqSqZfJGds
aeWlMfmHf6oe27d8XLoNjbyAxna/4jdWoTqmp8oT3bgv/TBco23NzqUSVPI+71js1hHvcJu
oYJqaztGrAef/lWIGdf1/kLEh8IYx80BNuOjh9mzCDLwbs83CBqoUdlzLNDdwmzu34Aw7xKl
4RAVinGFCpo/7EwoX6weyB/zqevUIE89UABTEFoGih/hx2jdQV/NQntHTW0jH0hmPnaJBV
AJPYwAu082rx2pnZCxDATMn0elOkTue3PCmzHBF/GT6c65aQC4aojj0+Veh787Q1lQ9FrWbw
nTz+4fnZu/MBZtyLZ4JnsiWUS9eJ2V1g/A+RiIKu357QgyltLqLgYiWfzHF1YjdtbPKjDa
ScnvtY8VO2Rktm7XiV4zKFKiaWp+vuVYpR0/7Adgnlj5Jt9lQQGOr+Z2VYx8SvBcC+by3XAt
YkRRhtX5u4MLlVS3gcoWfDiWwCpvqdK21EsXjQJxRr3dbSn0HaVj4FJZX0QQ7WZm6WLkCDQRh
uLq3ARA6RYjgfc0YcLGKvHhoBnsX29vy9Wnly2JYpEnPUIB8X0VOyZ5/ALv4Hqt14THkH+m
mMuhtndog2BkCCk508jWBvKS1S+Bd2esB45BDDmIhuX3ozu9Xza4i1FsPnLkQ0uMZJv30ls2
pXFmskhYzmo6aOmH2536LdtPSlXtywfnV1HEr69V/AHbrEzfoQkJ/qvPzELBOjfwjwDPDeP
iVgW9LhktzVzn/Bj07XlJxw4PGcxJG6VapsXmM3t2fPN9eIHduq8ocbHdJ4en8/bJDXZd9eb
QoILUuCG46hE3p6nTXfnPwSRnIRnsgCzeAz4rxDR4/Gv1XpZv5wqpL21XQi3nvZK1cv7J1IR
VdphK66De9GpVQVTqC102gqJUerdjGmxmyCA100ORqEPfKTrXz5YUGSwwpH+4xCuNQpQmre
Rw3ghrH8potIr0iOVXfic5vJfBTgtcuEB6E6ulAN+3jqBGTaBML0jxg3Z5VC5HKVbpg2Ddb
/wrLwFHNAbzV5hj2oS5Zmva0ySP1YHB26pAW8dwB38GBaQvFzq3ezM4cRAo/iJ/GsVE98dZ
EBO+Ml+0KYj+ZG+vyxzo20sweun7ZKT+9qZM90f6cQz3qX6IfXZHHmQJBNv73mcZWNhdQOHs
4wBoq+FGQWNqLU9xaZxdXw80rlviDAwOy13EutcVbTkAEQEAAyKCPAQYAQgAJhYhBIWb6NfF
hvU4QwsZwkZ71C06eb0pBQJhuLq3AhsMBQkDwmcAAAJEEZ71C06eb0pS18P/iy+dNnxrtiE
Nn9vkkA7AmZ8RsvPXYVeDCDSsL7Ufhbs77r2LlqTa2aB3gAZUDIOXln511SxMeeLtOequLME
V2Xi5km70rdtnja5SmWfc9fyExunXns0hg6UG872At5CGEZU0c2Nt/hlGtOR3xbt3O/Uw1+d
ErQPA4BUbW5K1T7OC6oPvtlKfF4bGZFl0hgt2yE9YSNWzstPe6XJSapemHZLPoxJLnhS3VBi
rWE31QS0br15Az10/fg7ia65vQGMOCOTLpgChTbcZHTozeFqva4IEgeE4xn+6r8WtgSYeGGD
RmeMEVjPM9dzQObf+SvGd58u2z9f2agPK1h32c69RLoA0mHRe7Wkv4izeJUc5tumUY0e80jd
enZZjT3hjLh6tM+mrp2oWnQIoed4LxUwldhMOj0rYXv61aLgJ1Fsw5eSke7ohBLcfBBTKnMC
BohROHy2E63Wggsfdn3UYzfqZ8cfbXetkXuLS/OM3MXbiNjg+ElYzjgWrkayu7yLakZx+mx6
sHPiJYm2hzkniMG29d5mG17ZT9emP9b+CfGUXoXJkjs0gnD144bwGJ0dmIBu3aJVAaHODXY
Y/zdDMGjskfEYbNXcAY2FRZSE58tgTvPKD++Kd2Kgp1MU2EIFT7JYfKhHAB5DGMkx92HUMid
sTSKHe+QnnnoFmu4gnmDU3li
=Xqbo
-----END PGP PUBLIC KEY BLOCK-----
```

To import the build key into your personal public GPG keyring, use `gpg --import`. For example, if you have saved the key in a file named `mysql_pubkey.asc`, the import command looks like this:

```
$> gpg --import mysql_pubkey.asc
```

```
gpg: key 3A79BD29: public key "MySQL Release Engineering
<mysql-build@oss.oracle.com>" imported
gpg: Total number processed: 1
gpg:          imported: 1
gpg: no ultimately trusted keys found
```

You can also download the key from the public keyserver using the public key id, [3A79BD29](#):

```
$> gpg --recv-keys 3A79BD29
gpg: requesting key 3A79BD29 from hkp server keys.gnupg.net
gpg: key 3A79BD29: "MySQL Release Engineering <mysql-build@oss.oracle.com>"
1 new user ID
gpg: key 3A79BD29: "MySQL Release Engineering <mysql-build@oss.oracle.com>"
53 new signatures
gpg: no ultimately trusted keys found
gpg: Total number processed: 1
gpg:          new user IDs: 1
gpg:          new signatures: 53
```

If you want to import the key into your RPM configuration to validate RPM install packages, you should be able to import the key directly:

```
$> rpm --import mysql_pubkey.asc
```

If you experience problems or require RPM specific information, see [Section 2.1.4.4, "Signature Checking Using RPM"](#).

After you have downloaded and imported the public build key, download your desired MySQL package and the corresponding signature, which also is available from the download page. The signature file has the same name as the distribution file with an `.asc` extension, as shown by the examples in the following table.

**Table 2.1 MySQL Package and Signature Files for Source files**

File Type	File Name
Distribution file	<code>mysql-standard-5.7.44-linux-i686.tar.gz</code>
Signature file	<code>mysql-standard-5.7.44-linux-i686.tar.gz.asc</code>

Make sure that both files are stored in the same directory and then run the following command to verify the signature for the distribution file:

```
$> gpg --verify package_name.asc
```

If the downloaded package is valid, you should see a [Good signature](#) message similar to this one:

```
$> gpg --verify mysql-standard-5.7.44-linux-i686.tar.gz.asc
gpg: Signature made Tue 01 Feb 2011 02:38:30 AM CST using DSA key ID 3A79BD29
gpg: Good signature from "MySQL Release Engineering <mysql-build@oss.oracle.com>"
```

The [Good signature](#) message indicates that the file signature is valid, when compared to the signature listed on our site. But you might also see warnings, like so:

```
$> gpg --verify mysql-standard-5.7.44-linux-i686.tar.gz.asc
gpg: Signature made Wed 23 Jan 2013 02:25:45 AM PST using DSA key ID 3A79BD29
gpg: checking the trustdb
gpg: no ultimately trusted keys found
```



```
gpg: Good signature from "MySQL Release Engineering <mysql-build@oss.oracle.com>"
gpg: WARNING: This key is not certified with a trusted signature!
gpg:       There is no indication that the signature belongs to the owner.
Primary key fingerprint: A4A9 4068 76FC BD3C 4567 70C8 8C71 8D3B 5072 E1F5
```

That is normal, as they depend on your setup and configuration. Here are explanations for these warnings:

- *gpg: no ultimately trusted keys found*: This means that the specific key is not "ultimately trusted" by you or your web of trust, which is okay for the purposes of verifying file signatures.
- *WARNING: This key is not certified with a trusted signature! There is no indication that the signature belongs to the owner.*: This refers to your level of trust in your belief that you possess our real public key. This is a personal decision. Ideally, a MySQL developer would hand you the key in person, but more commonly, you downloaded it. Was the download tampered with? Probably not, but this decision is up to you. Setting up a web of trust is one method for trusting them.

See the GPG documentation for more information on how to work with public keys.

### 2.1.4.3 Signature Checking Using Gpg4win for Windows

The [Section 2.1.4.2, "Signature Checking Using GnuPG"](#) section describes how to verify MySQL downloads using GPG. That guide also applies to Microsoft Windows, but another option is to use a GUI tool like [Gpg4win](#). You may use a different tool but our examples are based on Gpg4win, and utilize its bundled [Kleopatra](#) GUI.

Download and install Gpg4win, and then load Kleopatra. The dialog should look similar to:

**Figure 2.1 Kleopatra: Initial Screen**

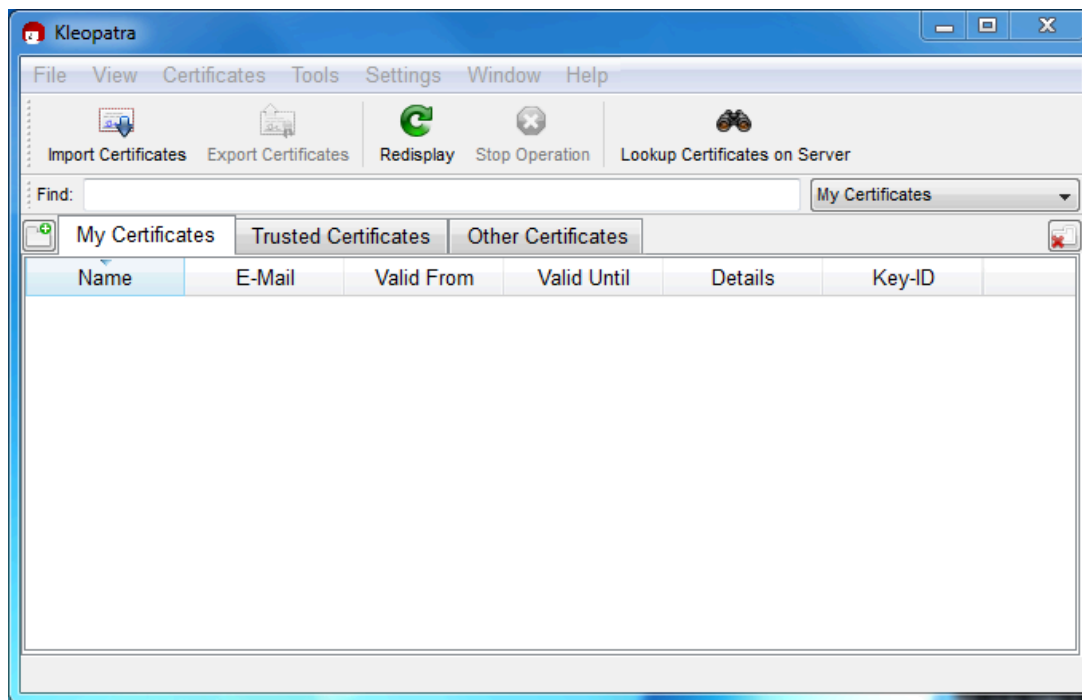

Next, add the MySQL Release Engineering certificate. Do this by clicking **File, Lookup Certificates on Server**. Type "Mysql Release Engineering" into the search box and press **Search**.

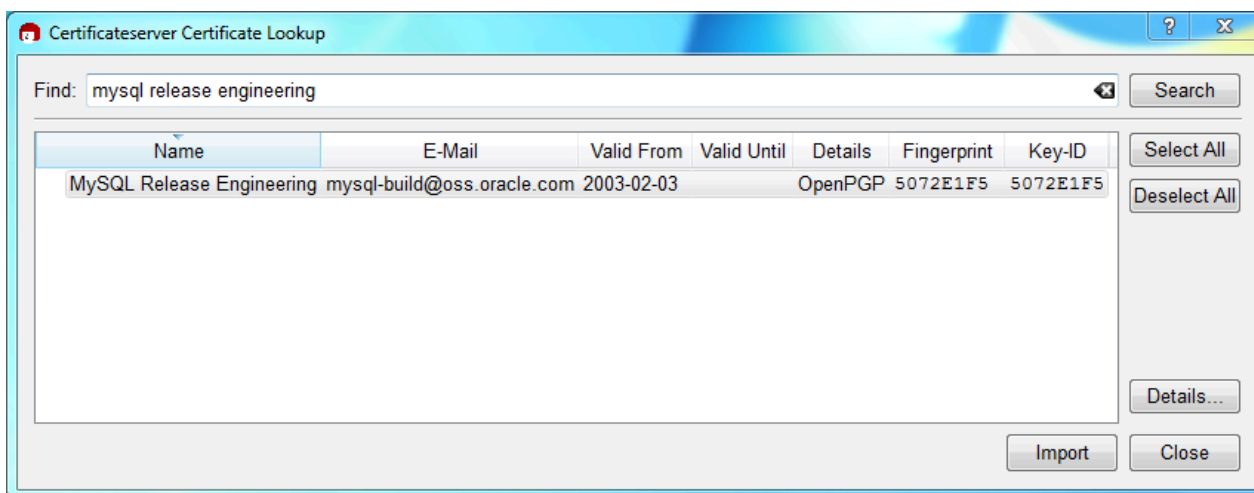
**Figure 2.2 Kleopatra: Lookup Certificates on Server Wizard: Finding a Certificate**

Select the "MySQL Release Engineering" certificate. The Fingerprint and Key-ID must be "3A79BD29" for MySQL 5.7.37 and higher or "5072E1F5" for MySQL 5.7.36 and earlier, or choose **Details...** to confirm the certificate is valid. Now, import it by clicking **Import**. An import dialog is displayed; choose **Okay**, and this certificate should now be listed under the **Imported Certificates** tab.

Next, configure the trust level for our certificate. Select our certificate, then from the main menu select **Certificates, Change Owner Trust....** We suggest choosing **I believe checks are very accurate** for our certificate, as otherwise you might not be able to verify our signature. Select **I believe checks are very accurate** to enable "full trust" and then press **OK**.

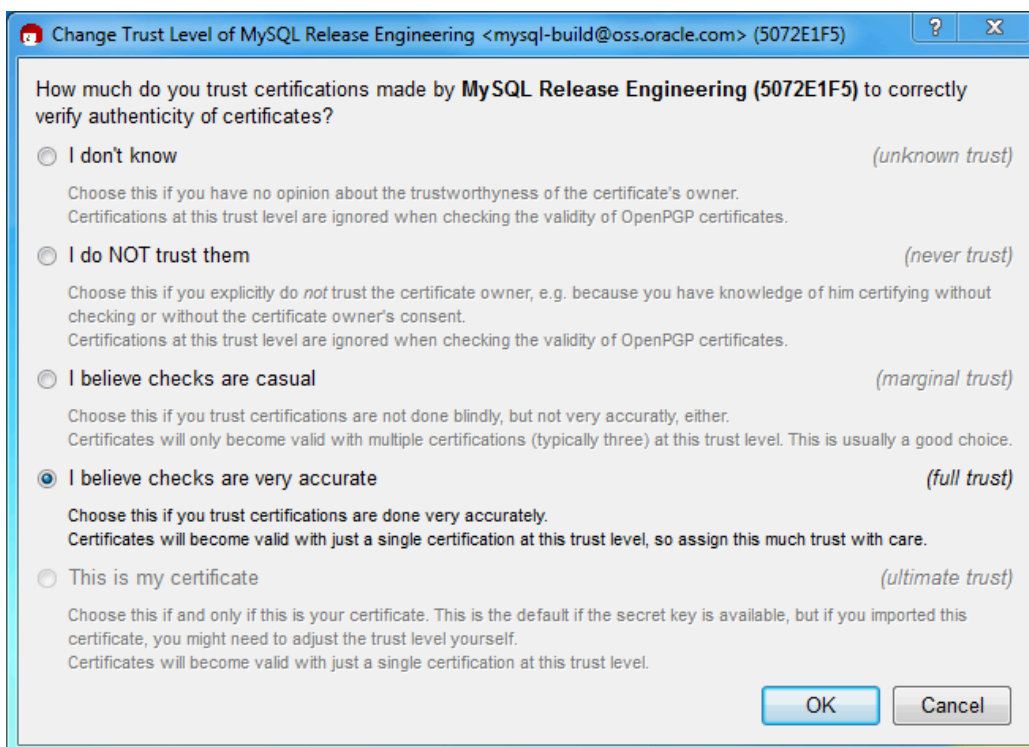
**Figure 2.3 Kleopatra: Change Trust level for MySQL Release Engineering**

Next, verify the downloaded MySQL package file. This requires files for both the packaged file, and the signature. The signature file must have the same name as the packaged file but with an appended `.asc` extension, as shown by the example in the following table. The signature is linked to on the downloads page for each MySQL product. You must create the `.asc` file with this signature.

**Table 2.2 MySQL Package and Signature Files for MySQL Installer for Microsoft Windows**

File Type	File Name
Distribution file	<code>mysql-installer-community-5.7.44.msi</code>
Signature file	<code>mysql-installer-community-5.7.44.msi.asc</code>

Make sure that both files are stored in the same directory and then run the following command to verify the signature for the distribution file. Either drag and drop the signature (`.asc`) file into Kleopatra, or load the dialog from **File, Decrypt/Verify Files...**, and then choose either the `.msi` or `.asc` file.

**Figure 2.4 Kleopatra: The Decrypt and Verify Files Dialog**

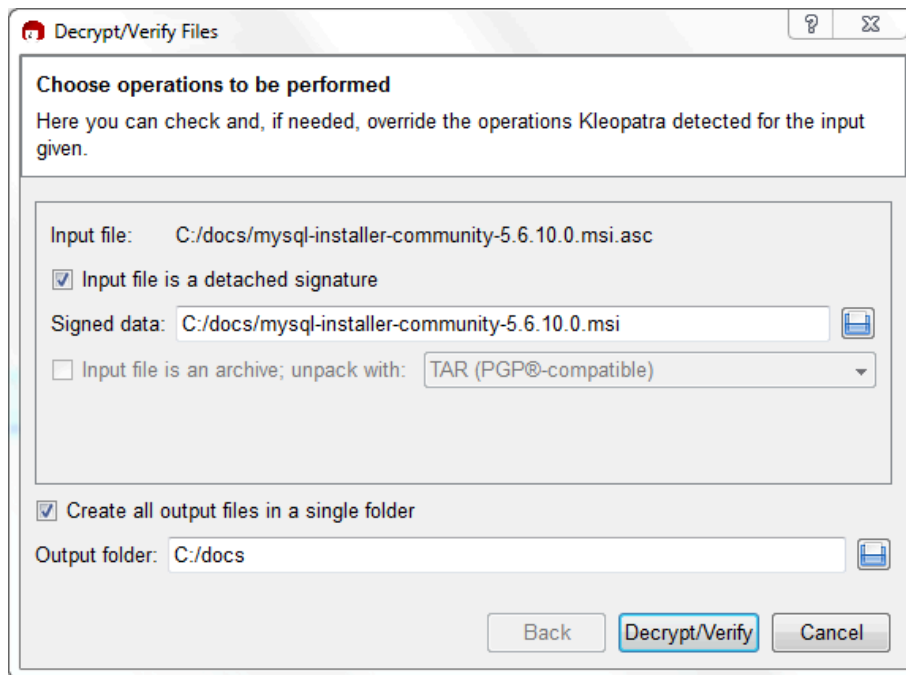

Click **Decrypt/Verify** to check the file. The two most common results look like the following, and although the yellow warning looks problematic, the following means that the file check passed with success. You may now run this installer.

**Figure 2.5 Kleopatra: the Decrypt and Verify Results Dialog: All operations completed**

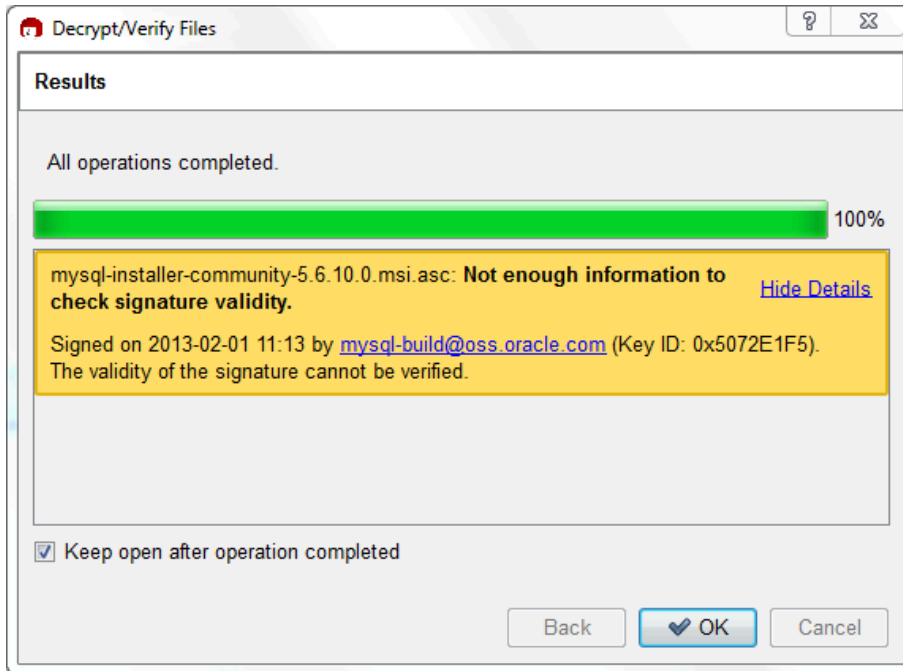

Seeing a red "The signature is bad" error means the file is invalid. Do not execute the MSI file if you see this error.

**Figure 2.6 Kleopatra: the Decrypt and Verify Results Dialog: Bad**

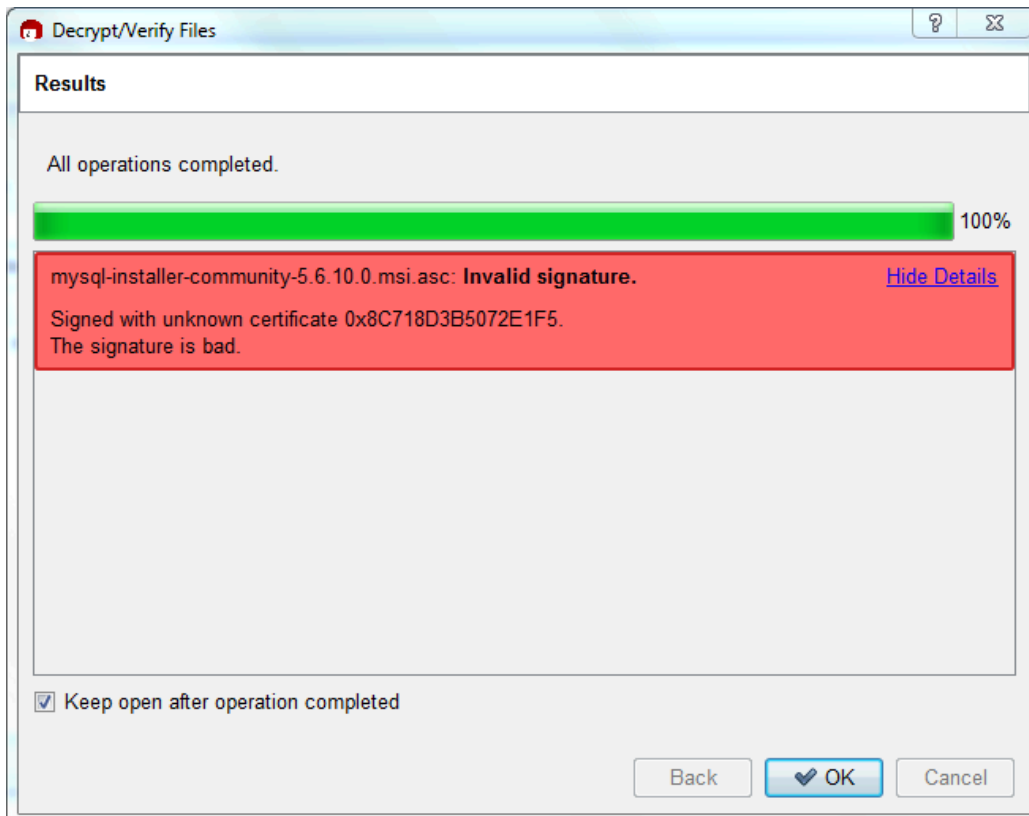

The [Section 2.1.4.2, “Signature Checking Using GnuPG”](#) section explains why you probably don't see a green `Good signature` result.

#### 2.1.4.4 Signature Checking Using RPM

For RPM packages, there is no separate signature. RPM packages have a built-in GPG signature and MD5 checksum. You can verify a package by running the following command:

```
$> rpm --checksig package_name.rpm
```

Example:

```
$> rpm --checksig mysql-community-server-5.7.44-1.el8.x86_64.rpm
MySQL-server-5.7.44-1.el8.x86_64.rpm: digests signatures OK
```



#### Note

If you are using RPM 4.1 and it complains about `(GPG) NOT OK (MISSING KEYS: GPG#3a79bd29)`, even though you have imported the MySQL public build key into your own GPG keyring, you need to import the key into the RPM keyring first. RPM 4.1 no longer uses your personal GPG keyring (or GPG itself). Rather, RPM maintains a separate keyring because it is a system-wide application and a user's GPG public keyring is a user-specific file. To import the MySQL public key into the RPM keyring, first obtain the key, then use `rpm --import` to import the key. For example:

```
$> gpg --export -a 3a79bd29 > 3a79bd29.asc
$> rpm --import 3a79bd29.asc
```

Alternatively, `rpm` also supports loading the key directly from a URL:

```
$> rpm --import https://repo.mysql.com/RPM-GPG-KEY-mysql-2022
```

You can also obtain the MySQL public key from this manual page: [Section 2.1.4.2, “Signature Checking Using GnuPG”](#).

#### 2.1.4.5 GPG Public Build Key for Archived Packages

The following GPG public build key (keyID `5072E1F5`) can be used to verify the authenticity and integrity of MySQL 5.7.36 packages and earlier. For signature checking instructions, see [Section 2.1.4.2, “Signature Checking Using GnuPG”](#).

#### GPG Public Build Key for MySQL 5.7.36 Packages and Earlier

```
-----BEGIN PGP PUBLIC KEY BLOCK-----
Version: SKS 1.1.6
Comment: Hostname: pgp.mit.edu

mQGIBD4+owwRBAC14GIUFuCyEDSIePvEW3SAFUdJBtoQHH/nJKZyQT7h9bPlUWC3RODjQRey
CITRrdwyrKUGku2FmeVGwn2u2WmDMNABLnpprWPKbDck96+OmSLN9brZfw2vOUgCmYv2hW0h
yDHuvYlQA/BThQoADgj8AW6/0Lo7V1W9/8VuHP0gQwCgvzV3BqOxRznNCRCAuAuVztHRcE
AJooQkL+iSiunZMYD1WufeXfshc57S/+yeJkegNWhxwR9pRWVArNYJdDRT+rf2RUe3vpquKN
QU/hnEIUHRJrQqYHo8gTxvxXNQC7fJYLvk2HtkrPbP72vwsEKMYhhr0eKCbLgfls9krjj6sB
gACyP/Vb7hiPwxh6rDZ7ITnEkYpXBACmWpP8NJTkamEnPCia2ZoOHODANwpUkP43I7jsDmgt
obZX9qnrAXw+uNDIQJEXM6FSbi0LLtZciNlYsafwAPEOMDKpMqAK6IyisNtPvaLd8lH0bPAN
Wqcyefeprv0sxxqUEMcM3o7wwgfN83P0kDasDbs3pjwPhxvzh6//62zQJ7Q2TXL1TUUwgUmVs
ZWFZzS5BFbmdpbmVlcm1uZyA8bXlzcWwtYnVpbGRab3NzLm9yYWNsZS5jb20+iEYEEBECAAYF
AlldBj4ACgkQvcMmpx2w8a2MYQCgga9wXfwOe/52xg0RTkhsbdQhvdAAAN30njwoLbHkDdBxk
hVmwZQvzdYyniGYEEeXECACYCGyMGCwkIBwMCBBUCCAMEFgIDAQIeAQIXgAUCtnc+KgUJE/sC
FQAKCRMcY07UHLh9SbMAJ411+qBz2BZNSGCZwwA6YbhGPC7FwCgp8z5tZw4YQuL5NGJ/sy
0oSazqmIZgQTEQIAJgUCtnc9dglbIwUJEPPzpwYLCQgHawIEFQIIAwQWAgMBah4BAheAAAJ
EIXxjTtQcuHlUt4AoIKjhdF70899d+7JFq3LD7zeeyI0AJ9Z+YyE1HZSnzYi73brScilbIV6
sYhpBBMRagApAhsjBgsJCAcDagQVAggDBBYCAwECHgECF4ACGQEFAlGUkToFCRU3IaoACgkQ
```

## Verifying Package Integrity Using MD5 Checksums or GnuPG

jHGN01By4fWLQACfV6wP8ppZqMz2Z/gPZbPP7sDHE7EAn2kDDatXTZIR9pMgcnN0cffltsX6  
iGkEExECACkCgYMGcWkIBwMCCBUCCEMEFgIDAQIEAQIXgAIZAQUCUwHUZgUJGmbLwYAKCRCM  
cY07UHLh9V+DAKCjSjGwGvI/eut+5L+12v3yb1+ZgCcD7ZoA341HtoroV3U6xRD09fUgeqI  
bAQTEQIALAIBlWIEAQIXgAIZAQUCUwHUZgUJGmbLwYAKCRCMcY07UHLh9V+DAKCjSjGwGvI  
EIXxjTtQcuHlwrMAnRGuzVbrIMR077KTGAVhJF2uKjIPAJ9rCpXYFve2IdxST2i7w8nygefV  
a4hsBBMRAGAsAhsjAh4BAhaAAhkBBgsJCAcDagYVCgkIAGMFFgIDAQAFAlinBSAFcR4qYRQA  
CgkQjHGN01By4fVXBQCeOqVmlXfAwdq+QqaTAtbZskN3HkYAnlT8LlbIktFREeVlKrqEA7fg  
6HrQiGwEExECACwCgYMGcWkIBwMCCBUCCEMEFgIDAQIEAQIXgAIZAQUCUwHUZgUJGmbLwYAKCRCM  
5AAKCRCMcY07UHLh9V+DAKCjSjGwGvI/eut+5L+12v3yb1+ZgCcD7ZoA341HtoroV3U6xRD09fUgeqI  
kZkorbyJARwEAECAAYFALAS6+UACgkQ8aIC+GoXHivrWwf/dtLk/x+NC2VMDlg+vOeM0qgG  
l1lhXZfiNsEisvGaz4m8fSFRGe+lbvVfDoKRhxIGXU48RusjixzvBb6KTMuY6JpOVfz9Dj3  
H9spYriHa+i6rYsXZIpOhfLiMnTy7NH20vYcYnZSS/ciIUACIFh/2NH8zNT5CNFluPNR57H  
sHzz7pOlTjtTWiF4cq/Ij6Z6CNrmdj+SiMvjN9u6sdEKGtoNtpycgD5HGKR+I7Nd/7v56y  
haUe4FpuvsNXI1g86K9tI6MUFSS8CjYy7Hj3kVBZOUWVBM053knGdALSyGQR50DA3jMGKV14Zn  
Hje2RvWRmFTr5YwOrTMxUSQPMLpBNiKBHAQQAQIABgUCU1B+vQAKCRAohbcD0zcc8dWwCACW  
XXNDXICAWRUw+j3ph8dr9u3SItlJn3wBc7clpckWPUlvTz7LGgzlVB0s8hH4xgkSA+zLz16  
u56mpUzskf17f1I3Ac9GGpM40M5vmmR9hwlDlHdZtGfbd+wkjlgqitNLoRcGdRf/+U7x09Gh  
SS7Bf339sunIX6sMgXSC4L32D3ZdjF5icGdb0kj+3lCrRmp853dGyA3ff9yUiBkxcKNawpi7  
Vz3D2ddUpOF3BP+8NKPg4P2+srKkGfbd4HidcISQct3rY4vaTkEkLKG0nNA6U4r0YgOa7wIT  
SsxFlntMMzarg53QtK0+YkH0KuZr3GY8B7pi+tlgycyVR7mIFo7riQEcBBABAgAGBQJcSESc  
AAoJENWpi/UwTWr2X/YH/0JLr/qBW7cDlx9adm5+vPoUl6U6SGzCkIlfK24j90kU0oJxDn  
FVvc9tccGtXk8n6AEc5G0FQzjuXeYQlSAHXquZ9CeGjidmsrRLVXkXw0IcFZPBmfS9JBzdHa9  
Wlb99NWH0ehWWNyIITVZ1KeBlI7uoyXkvZgVp0Red37XWgGyEHt0JwAXnk4obH6djY3T/Hf  
D70piciuF7u684IRAgEIVeUcaDppU/1QluDiOnViq6MAki85Z+uoM6ojuZTwmqXDSYIPzRHctfx  
Vdv3HS423RuvfcPmUGG94r7tTOSXhS9rcs6lzLnKl84J0xzI5bWS/Fw+5h40Gpd4HTR/kiE  
Xu2JARwEAEIAAYFALABV3QACgkQRm7hv+CThQqT0wf9Ge3sRxx+NlKlKsHYBTktjY0yv49  
48ja5s9awR0bzapKOMaluEgfwtkD8/NCgYeIVYyaZlYmS1FP5lyAtuzdvZXAIODAITyM4d1S  
RCESjCCiZ028eIEcoem/j+UXrwo4+I7/abFhiSakzsfZ/eQHnsMnkJOLf8kug3vMXjSoiz+n  
T14++fBK2mCVtulSct877X8R7xufOKYAGibny+RAi7E2JVTmtWfdtJaqt315y6ouTrL0M9d  
3ZeEMdYLlPCmXrwZ4+u7oTNC26yLSbpL+weAreqH8jGsVlUmWMMXvkm+ixmrnN66WvSLqQ6K  
P5jWnowV9+KEHnNBWA4T4Iu8rYkBIgQQQAQIADAUCtndBLgUDABJ1AAAKCRcxELibyletFAnx  
B/9t79Q72ap+hzawzKHAYk3j990FbB8uQDXyVdAM5Ay/Af0eyYS0d9SBgpeyFlGL404dd7U  
/uXwbZpAu5EKGb/16Mq9EVPO5YxCR0ir7oqi6XG/qh+QJy/d3XG07ZbudvnLFyLUE+tF8YU  
Z5sm9lrnwPKYI2DIAObTOA7Pi95q82Yjb4YgNCxjrr61g09n4LHDN1i74cNX0eas19zp14Zs  
acGftJGORPEk+ChNCGKFNq/qR9Hn/ank29D8fzg6BLoa0ix8Zz25QPMI/+SF4xep/07IoI4  
da+0m4iPz76B+ke0RTsgNRVKjdz2fQ9214G9yWwNuLgcI3FBZTiYGi3iQeIBBABAqAMBQJO  
iLYZBQMAEnUAAAOJEJCQuJvKV618tkAH/2hGrH40L3xRAP/CXEJHK30+L8y4+duBBQ8scRqn  
XS28SLfdL8f/ENH+1wah9jhyMC+jmyRldd5ar3cC/s8AJRvOSDRFR5KvagvrDLrrf+i/vYDB  
K5f6JRyq0poupEuK0zTbLxolFX+CAq+3tQy8aY6+znItplWhvK8ZoULYKV+Q063YyVWdBk  
KadgELA6S08aQTGK7bJkyJ9xgbfBykcpUUBn0p4XZwz3jFgzwcmmqRIYZbfTosVVLJ5HAb7B  
u22AukPlsz9PZvd8X8nfmtoJlWt15qtFOrxrKA+X5cZswz5H3jprDqOY6yA0EStu+8h1CPo  
u50BmP7yKZxdXYqJASIEEAECaAwFAk6Z2dEFaWASDQAACgkQlXc4m8pXrXwC8ggAgQXVkn5H  
LtY50oXmh5D/KdphSKDM33Z9b/3MHzK5CwECQUkaJlgxtyLW1HWyLOIhUkW6xHdmieoA8Yr9  
JSLr1jopYUGZztz1ScQeSWr8190xnZVVIjKReVY2rDSxtv7PV5wR3gby72PmKWUw7UHFqtBr  
JgA+h5ctfx1jhXIUtUZpDTStZAFgVmudXoBNZtYYk/ffYlJ8KTjNmrqRcRbTurSy3dgGAA  
Z01DIR5KJrh3ikFFJfErXz0qDoYochxqI4Xoc7o8uv19GUuvk5sKBT4b2ASF+JXAMRX0T7v8  
Gralhn3CGGQpZDN2ldm1Mzbi5oSETTUQ87nN4I7bXirqYkBIgQQQAQIADAUCtqumAQUDABJ1  
AAAKCRcxELibyletFMBH/9/0733PXrdjkVlUjF7HKpdD8xy324oe5cRwDEVhsdj11AsPhLv  
c37M3uCF2mCV5BwGjJdypVRX3ht+1r9Vsur201ETKmu8zhdjxgTlZ931t/KDerU9sJWOT33m  
wEX7b50j31hgqy2Bc+qOUfSNR8TIOZ7E6P6GynxFzreS+QjHfpUFrg41FgV58YCEoMyKAvZg  
CFzVSQa2QZ04uaUIbAhXqW+INkPdEl/nfv1UWdoe/t5d/BDELAT4HEbcJRGUN/GNRExOYw/I  
AbauEOnmhNQS+oNglusJlTFg6atK08XgXNfCp6sVc1SRTNKHSMntHEch/WULEOzsPUXWGW  
VC40iQeIBBABAqAMBQJOvNkcBQMAEnUAAAOJEJCQuJvKV618xSkh/izTt1ERQsgGcDUPqqvd  
8exAlmpsC7IOW+AYYtbOjIQoz7UkUWVpr4R4sijXfzoZTYNqaYMLbcngHv25CE14PZnVN  
xWDhwDrhJ8X8Idxrlyh5FKt0CK53NT9yAsa1cg/85oVqZeB0zECGwgsVtIc8JmTjvTsmFVrz  
7F4hUOsrUchJmw0hfL9JlrxTbpLY9VnaJXh9a8psnUCBrw3o05Zj8Pw/aaLdBuK5mB/OSYo  
vmJ0f/BIP+cup10AnOyx0JzWNkQZWTmsVhxY6skBed4/+2ydv9TEoESw207t7c3Z7+stWcTK  
RUG7TrqHPfkr9U0FNkHeTeqPhc8rjUgFLaJASIEEAECaAwFAk70o7wFAwASDQAACgkQlXc4  
m8pXrXzA3Af/QjONcvE3jme8h8SMLv1r6L11UwPHywcvagkRjWu0jRrSVPghUAhJzEob4w  
CzZ4ebRR8q7AazmOW5Fn1GoqtzrWxjRdBX3/vOdj0NvXqCFfTgmOsc4qz98+LzUu8qQH9DE1  
ZLyptv96tGZb5w82NtHFmu9LkkjAVYcDXqJ4USm90CApXqd+8lvOrWuM8NycgD0Ik3ZKZQXH  
LDHdJfZohntqbwGMMwdjqwKHOBShESjZ/WarXEF0+oTLjZSbrymtGpPInsiJHWD9QMOR55RwC  
DtPw+JPPu5elLdaurjPOjJi6l0l8sNHekjmdZmRI0ZMyjprJITg4G3yLU9zU+boCYkBIgQQ  
AQIADAUCtvi8VgUDABJ1AAAKCRcxELibyletFNEIB/OWdt7SWBw8z61g5YwuG/mBcmLZVQFo  
vGnJFeb+QlybEicqrUYJ3fIPj8Usc27dlwLP+6SU8BtdYjQ7p7CrQtaxG2SWYmNaJ50f6Eb  
Jp0/31WSWiNEGF3ycFonoZ3yuWMwEdMxBa+NAVv/gUtElBmoew+NwKsrYN30FymkZe+v+Ckq  
SYwlg0r9+19lFwKfVfk0jX1ZGk6GP27zTw49yopW9kFw/AUZxLwQH0YAL3gns1wPz5LwiTyJ

# Verifying Package Integrity Using MD5 Checksums or GnuPG

QkxAYYvdByZk4GjOi+HzqGSPniQIEUteXzfbPz0fWET64tudegYu/fN5QVLGS/WHfkuFkuo  
gwNBFcu5TPEYcWgKue/IzZeniQEiBBABAgAMBQJPBAKXBQMAEnUAAAoJEJcQuJvKV618AG8H  
/OLRllyM6osBLahOzcKmd//jSOZ2FIBXGKUmK8/onlu5sUcMmVVPnJuO/mHiFMbYFC655Di  
rVUKLIzB6sdx2E/K+ZkZHPWvF1BAaHUO/QGh3Zzc8LVJg9KtFLAJkmQkc61VEF2MriaRlvlo  
VPnr50iv2THOPgVxdV3goBL6EdAdgdwCvy23Z44vOp0QVNQt4aJKg2f49XO/Nl+Gd2mEr7wX  
aN9DZQq5zTU7uTrif3FlXHQ4bp8TWBK3Mu/sLlqZyTf3z7GH4w3QbwyA2CwKGGTgWqWyU8Fh  
JQdrqXG10w0y6JusjJWdwTlfxA6Eia3wrSw2f8Rlu6V0k0ZhsMu3s7iJASIEEAECaAwFAk8V  
1NwFAwASdQAACgkQlxC4m8pXrXziJaf7Bn+4ul7NedLGKB4fWyKdVZARcys13kNucIl2KDdu  
j4r1liaY3vXT+bnP7rdcpQRa13r+SdqM5uByROHNZ+014rVJlVAY+ahhk/ORmdJTsv791JJSkT  
FuPzjYbkthqCsLIwa2XFHLBYSZuLvZMPL8k4rSMuI529XL48et1K7QNNVDtwmHUGY+xpVvPP  
GOZwjmx7sHsrTEdkerjmcMughpVAnPyPsFe8ErQCOOrPhDikZBSNcLur7zwj6m0+85eUTmcj8  
luIik4wjp39tY3UrBisLzR9m4VrOd9AVw/JRoPDJFq6f4reQSOLbBd5yr7IyYtQSNtVMqxR4  
4vnQcPqEcftt4kBIgQQAQIADAUCTzltCwUDABJ1AAAKCRCXELibyletfa09CACWRtSxOvve  
Sr6Fo6TSMq1odYRtEwQYysEjcxSf5EM7pX/zLgm2fTgRgNzwaBkwFqH6Y6B4g2rFLyNEhxM  
NWlle/YxZgVryMyRUEp6qGL+kYsOZR2Z23COU+/dn58xMxGYChwj3zWJj+Cjw9U+D/6etHpw  
UrbHGc5HxNpyKQkEV5J+SQ5GDW0POONi/UHlkgSSmmV6mXlqEkEGrtylifN1jpiTRLPQnzAR  
198tJo3GtG5YutGFbn1Tun1sXN9v/s4dzbv0mcHvAq/lW+2AT6OJDD204pp/mFxFKBFi4XqF6  
74HbmBz1S7zyWjT2ZnujFDqEMKfske/OHSuGZI34qJ3iQEiBBABAgAMBQJPSPctBQMAEnUA  
AAoJEJcQuJvKV618L1QH/ijaCALgzQIVeSk/QZTxQo6Hf7/ObUM3tB7iRjaIK0XWmUodBpOC  
3kWWBEIVqJdxw/tbMbP8WebGidHWV4uX6R9GXD18+egj8BY8LL807gKXkqeOxKax0NSk5vBn  
gpiX2KVLHtWIm7azB0AiCdcFTCuVElHsIrhMAqtN6idGBVKTXXHW3//z9xiPvcLuryhJ8orS  
IeJctLCjji7KF2IUgCyyPjEfr/YT7DTCOC897E1I01E4dDymNur41NjobAogaxp6PDRNHBDum  
y8pFzLvF30Y4Cv+SEa/EHmCOTHTamKan6Jry/rpofqtueiMkwCi81RLgQd0ee6W/iui8LwP  
/2KJASIEEAECaAwFAk8V2xofAwASdQAACgkQlxC4m8pXrXy9UQgAsVc8HNwa7VKdBqsEvPjg  
xVlm6Y+9JcqdQcA77qSMClc8n6oVF1RpI2yFfnFUpjlmvJuW7iix98tRO3QKWJIMjEPovgZcS  
bhVhgKXlU87dtWwmcYhMsXBAyczbsSaNWhOIpWkHuq+rYRevd0xGD0013P7pocZJR850tm9e  
5809bzdsRYZpFW5MkrD7Aity5GpD65xYmAkBwTjN4eNlPonHvDsbVf4Fsjve6JC6yzKOGFB  
VU1TtAR2uPK6xxpn8ffzCNTAlvKXEM8Hgjjyq4LWSdDTBIEvuAqkz4T2eGJLXimhGpTXy7vz+  
wnYxQ9edAdrnfcgLfz8s/wmCoH4GJAFNIkBIgQQAQIADAUCT2eddwUDABJ1AAAKCRCXELib  
yletffBEB/9RmWSSkUmPwib2EhHPuBL6Xti9NopLomj5MFzHcLtqoommKvpOUwr1xv0cZMej  
ZenU3cWlAvvY287oJwmkFRFu9LJvILSGub9hxtQLhjd5qNaGRFLeJv8Y0vtz+se2FWLPSvpj  
mWfFdXppWQO/kIgvZoxCgJQrQWcetmLLgU9pxRcLASO/e5/wynFXmgSaJxWzWHmVehvJTOq  
siYwSxgT/XawQTyJHkpyJoXx4XKXnocvc8+X3QkxAFfOHCwWhYI+7CN8znDqxYuX//PKfDG  
2u0JHP1za8rponwq7c58Eo3WKIRw0TkeSwo01cSunfFcrPenmlh2p70EvNRAINiQEiBBAB  
AgAMBQJPekdGBQMAEnUAAAoJEJcQuJvKV618YwoIAMn3uqSB4GelD61m0pIXJfOcC6BhCZvM  
mV3xTp4ZJcDcQzjRV3rZRkt0DwyOvYpLzLgDgvrRwXjOzm0oblDvYHFA7DnGTGUSBLDX/xZ  
5gRvDtKd6w8b/+r2/eQiSu7ey/riYwB6dm3GzKR7FEbIK6bEuPOUBwv2tYkZRGTYqXq7NBL  
uNv7c80GWhC/pqvdhFn4KavL0PjvIgr5+mdXyviKqG7uvguYBdtDUMXlqgZpi+fb7EsbJYf  
EkBR63jQcQ04UnqD1EXWds17gj+yp4IHbkJmEJMS8d2NIzMPb1lHmN+haTA73DwnKbVD1ata  
qSLiFIGXRYzY87fikLVl1jOJASIEEAECaAwFAk+KdAUFAwASdQAACgkQlxC4m8pXrXwIUQgA  
mmkFtxXv4kExFK+ShRwBYOglI/a6D3MbDkUHwn3Q8N58pYIqzlonRj/ZO8zme2rkMT1LZpdu  
WgJbrvghWmWCqWExngC1j0Gv6ji8nlLzjjCkCYwVzo2cQ8VodCRD5t0lilFul32XNqAk/br  
U/dL5L1PZR4dV04kGBYir0xuziWdnNayd19DguzPro+p7jy2RTyHD6d+VvL33ioja06WT+74  
j+u1s3PnMNj3WixxdNGXaNXWoGApjDAJfHIHeP1/JWLGX7tCeptNZwIguJUUV665ik/QeN2go  
2qHMSC4BRBAS4H2aw9Nd9raEb7fZlIdmnMjlxSvYierQo7q7k2PdMYkBIgQQAQIADAUCT5xA  
QQUDABJ1AAAKCRCXELibyletfoLsCADHzAnM10PtSWB0qasAr/9ioftqtKyxfdd/jmxUcO1  
RUDjngNd4GtmmL7MS6jTejkGEC5/fxzB9uRXqm3WYLY3QV1+nLi/thEecotivu2vqv4NGfUvW  
CJfnJvEKBJr8sDGTcXxZQoYoAFbGTP1v9t4Rdo7asy37smFR2ka4/kU1FDxYtFYFwwZCjPNL  
hhw0MCI2StI/wIwTA/7TiFCNqHHAKAGeSzkVykrPdJn8yt7Js2dm6t2NUOwXQ563S4s6JZdr  
lXUV9oYh1v+gFAud57UHvinn6rdoXxg3juoBmk9rWqJDNYgnfwtf1BcQXJnea+rMavGQWihx  
eV40+BZPx9G61QEiBBABAgAMBQJPrg39BQMAEnUAAAoJEJcQuJvKV618M4YIAIp9yNcVLGta  
URSthhmmgE/sMT5h2Uga6a3mXq8GbGa3/k4SGqv51bc6iLlIm2b0K8lu5m6nxqdZ8XNNMmY9  
E+yYtjPsSt7cIoUzbaJkEws63WlEUrj/1E2NetvAjoS2gJB+ktxkn/9IHngwrGogUofwb6T  
hymURI+egyoddBp91lQD8Uuq91X+I+c1PPu+NCQyCtAhQzH+8p7eJeQATEZE2aB1cdUWgqY  
evEnYNNK8zv/X3OMYl67YyEgofKoSYKtqEuPHIITmkAfn0qVsBA4/VtLbzGVGYQECmbbA34s  
51bMLrYeERF5DnSKcIa665srQ+pRCfJhz6VQXGsWlyWJASIEEAECaAwFAk+/2VUFAwASdQAA  
CgkQlxC4m8pXrXwDof+JEUUKliqO+iqOLV+LvI091U4ww7YfXcqx4B9yNG0e5Vprfs7nQ0P  
tmf5d67rJ6tNgkuHdoCb+w0/31pPEi7BFKXIoSgOz3f5dVKBG08GBsX+/G/TKSiTenov0PEU  
7/D1dwmvSGExmgmsSQgEWTA3ylaVxc9EVC9x0Fi/czNN1Spj5Qec7Ee9LoyX4snRL1dx30L  
lu9h9puZgm8b15FLemPuv/LdrRLDqG9j4m2dACS3TlN14cwiBAF/NvxX3DEPOYTS6fWvKGLY  
nHl0mKRCwLJ6PArpvdYjFUGwCS7r4KoMCKY5tkvDof3FhggrQWgmzuPltBkTBQ7s4sGCNww  
6okBIgQQAQIADAUCT9G1zWUDABJ1AAAKCRCXELibyletfdJ1B/9N01u6faG1D5xFZquz7Hw  
EsSjB/ho9XJRClmdX/Sq+ErOULSmz2FA9wDQCw6OGq0I3oLLwpdsr908+b0P82TodbAPU+ib  
OsLUWtBLAYUi5NH6WW4pKnubObnKbTAmzlw+rVfUibfVFRBTyd2Muur1g5/kvUvW2qZw4BTg  
Tx3rWfUzUJAlkwyvT3TUUrArOdKF+nLtvG3bn8EBKPx2GfKcFhAsUpOg4kHoKd0mF10Vt9Hh  
KKuoBhlmDdd6oaEHLK0QcTXhsUxZYvIF022ycBWFgftaDMGzyUX010yFp/RVBT/jpXSBwtG  
lctH+LGSKL4/hwz985CSp3qnCpaRpe3qiQEiBBABAgAMBQJP43EgBQMAEnUAAAoJEJcQuJvK

## Verifying Package Integrity Using MD5 Checksums or GnuPG

V6l8UEEIALr7RnQkNw1qo7E4bUpWJjopid00IvynA0r5Eo0r83VX5YYlAfuoMzBGg6ffKiCs  
drHjEh45aIguu8crQ7p2tLU00zKYiFFKbZdsT/yliYRu4n28eHdv8VMKGZIA7t0ONIp1YPd2  
9pjjvYk4M0o9lNfWxM5+tcIzbyL9g+DuhQbYDmy8TVv7KKyY/gqZU1YB6kS49lycQw8WCine  
FoEd1fb6aP9u0MFivqn2QCahjXueKC01M200jR0wu7jdojN50Jgeo6U0eIHTj2Qmzn8wYG  
MX2o+1ybSTjHjIp3X8ldYx01Sa3AqwKEBclLdg5yIyAjHq2phRod2s/gjqrWt+uJASIEEAEC  
AAwFAk/1PVUFAwASdQAACgkQlxC4m8pXrXwn3AgAjWU3l1xsQcXo8pdF7XniUSlqnmKYxT+  
UZOP71l1xeaV/yjY+gwyZvf8TWT4RlRp5IGg6aNLwLaDB3lxcXBGUxAANGUr+kblewviHnCY3Z  
+Pwiuiusl+ofjbs8tFAR3LN3Abj70dME7GOhLyplP2mXIoAlnMDJ0AyrKx5EeA2js8zCWCu  
zii0j4ZwUZAESXchps09V9Q86YiPtp+ikV0hmYgZpIXRncHOpXnVYEW/95MFwi4gpG+VoN57  
kWBXv6csfac04BEIu9X/7y40LbNuvzcinnHa0Pde5RnRlbePQBBZyst2YzviWTFsbG8K2xok  
dotdZDabvrRGMhRzBUWQeokBiGQQAQIADAUCUAZhawUDABJ1AAAKCRCXELibyleftDJUCAC+  
68SXRk4aSeJY6W+4cs6xS//7YYIGDqpX4gS1W1tMIKCIWNhHkZqXKnWClnmvgGhw6VsZ2N0k  
YdOnIrzEPWL7qplZRIe1GDY85dRXNw0SxAGGi7A8s6J9yZPAAPtVpMS/cv1JO+IveFaBRhbI  
RRndS3QgZVXq48RH2Q1Hep3o7c964WTB/41oZPJ7iOKgsDLqjC1kJRfO9iY0s/3QrjL7nJq  
5ml4uYl6rbqaIoL81C7iyc0UKU9sZGMcPV7H0oOIAy206A3hYSrutyOtici1PnfVZjh14ek2C  
g+Uc+4B8LQf5Lpha4xuB9xvp1X5Gt3wiPrMzcH89yOaxhR8490+0iQEiBBABAGAMBQJQGC19  
BQMAENUAAAJEJCQujVkv618CbcIAJXCXDbUt96B3xGYghOx+cUb+x8zcy9lyNV8QC2xjd9Mr  
02LJTQHfJfQ9T6Lfuorb7nQHOqJK1/lWE28t9tlH7I+i7ujYwA/fWardRzqCulNXrgFEiQK  
ZFAdjRYyM0jWg/sA3/Rq2CMBNhbCccTduZ8VvRdm0xMPpyavP8D2dM9WBkPHOik4yAIIlVkr  
hWmr0Up0JhRoelfeyqcn/6ClUgeRMiYBYthA55fk2X5+CerommlpDfJlJlFQOv64VSzS68NG8  
j9yf66uuL3bB00dzOMW6Yq/P9wskCDlMbYm/UnHfB5wAuxWpDeAvt/u+vU4xqqEjkUQGp03b  
0v1x179maSuJASIEEGEKAawFAlWg3HIFgweGH4AACgkQSjPs1Sbi/EsPUQf/Z6Htrj7WDWU8  
vLYv3Fw23ZuJ8t8U/aksNwbq6UGwgqke+5MKClfPk90ekzu5Q6N78XUII3Qg8HnfdTU0ihYq  
qd3AlQm06CG2HExz5oxR1jzjzIRcbb1J7qEw8N/KzBcTkHB4+ag6bjFY9U4f9xU3TjPIu7F2V  
BklAX+cmDo8yzPjDnP4ro0Yabbg0Q9xzvaK/7pFRz+vL/u/lxw7ie7n6vXTiaYlXnIt5xAXX  
dwfLYmWeAgdc9KXFN1t4lfuqrETnCHme+JI+B2Tz2gHmMVLHiDV59eLC0uU/uVsOXEd26ib  
JC4f3KqY9kxuQm325kNzxnMxiwMPCVzsEh7lsYp+OokBMWQQAQgAHRYhBADTXowDFG1lEoOK  
6KPAYq+7WPawBQJasiYMAAOJEEPAYq+7WPawox0H/i96nkg1ID6lux+i20cOhVZylNJ770Vv  
0zfXddWRN/67SuMVjLiD/WfnDpw6ow6NM7vFEwbmvolqeFF7rWWTPlm57uzfTk73un3fbaL  
JiDZyrUSTqKK/yhGAZmwulOqQ7XBm+u8G9UcFi4XQxuoc5I/v/lUgbxXBADlxlzpkIDwOaB  
s23RDiMcWZGcosUkYHXlmscU0tRANVLQ/PHgttUl13x2PLzrdQm3YUDKUJ9+yn02jN2sYwt  
laSohj4UbLnq6pI4CXWZR7JXWqs+NX7P3R359FDtw7OhyKoVuIkrFZl1jY0i3wQgw1/Sm2Dag9  
3lsZDVc/avEUa00+VujuvJ+JATMEAEIAB0WIQQGfX4znGT7HFjpuwT3iPLiBOWzfAUCXJ7Q  
KwAKCRD3iPLIbOWzfGoXB/wN0P3m27fy/6UXTL0Ua3H+24ueUdLipsvr8ZTwefnwkhLrbggE  
0Em7ZuhZkzv7j856gv/tOekYYqWGg1CLalD3y371LAGq1tjY3k/g2RwLxLXNdzgXEYfvaNQA  
oQa9aC2Q7FOyEMwVkkXrGa4MML7IBkrtMds9QPKtFipachPf6tQOFC12zHRjXMZi0eRwyQue  
0sLLiJZPn7N8bBAJyZ9IjEpkhNrKS+9J5D1Refj+DwBKDh04kQXZFEZzhxcungQW5oMBQgr  
uW2hULTLeiEV+C516OnwWJoz6XKJp0Jp8PY0b08pGgToGIYHkoX2x64yORuZasFDv7sFGX6  
7QxyiQEzBBABCAAdFiEENOMfMPATUAXIzAoioM0DCORwFAlv/EJiACgkQoioM0DCORw  
uAf+IVXpob2S3UqzWJLSQyWG0wQ5lgo4IBVpHv6hKUHDFj47YdUbyW0+cGgnbjc7FVz54PUM  
PIdxImGHE1NHH+DNR8hvvAi+YpqqdT3g+OgZ6XoYevret5B2b5fRgN1/HWUjaJ/n5g6SMSc  
+3DrmdMu1FEdnKv/lHwQvOQXKt/U2rXELILOmVdMavRJEwkrk2SVwbdeass2EInZVsmWL+ot  
9dU5hrkmLal6iHUoK6zF6Wailoi7UU2kgUF2DNyZG/5AumsNhx608EAs1zEdn8wibXL48vq  
Z4Ue9GvImokdlq/r/4BMUdF1qLEZHBkbaklK1zXxl7uMiW3Z1cqpq5HgwYkBMWQQAQgAHRYh  
BBTHGHD/thBaJaf4NhhRzPE15/icBQJZ+o/AAoJEBhrZPE15/iCyfMH/3YP3ND8jFqIwkmG  
JaITHP9GhAQda73g7BFIRbHeL033tcltUbEHXvnIZzulo7jju9oQBjQvgGg1l5AgHlm7lHaD  
iAL3VmuUFZ4wys7SODHVszUw1aPLeD0oLKeig9J6elu0d/xWZmj86IaHMHrUEmlitMoo0m+U  
MwVNLFNZrAjcn82DiS6s0A52t0lPq/jR4v9AYfMZSnd1MLM/CZaZpzWq6aqm7ef7CDFsUvU  
w7VsL3p1s+Jg06+8RwQ1W2Lgt5ORthvpjPKE1z0qgDpoXTkPoi8M20taD5UZbpbzYZMzPJXXr  
+LBrRbs48ICpVhx8sxHMh1HsQCIXHDGITSaJlqJATMEAEIAB0WIQQazDqcUxAL9VrKN9zd  
LyyJ+reorGUCW4YZiAAKCRDDLyyvJ+reorPtWCACoIgfRvhbr3c1WVq16LJ8UmQLk/6uFFZPN  
CiR6ZbvzOd+a3gk1G8AhDEW2zoNhFg9+I7yqUBGqn+B1nDZ6psyu8d5EoRUFtm3PghqEccy5  
KixqoPxBTquzkKGBn8PDLUY5KvpTOLLlYZxlHszSHw4roPsU4rxZtxyu98sSW0cm47VPr069p  
91p9rCoHY8Fng7r3w28tVfVLUz1SK4jtykIvw+M/pVBk9rQVCAJ0JjkaHkT0pkHqsVBYhtu7  
mzsXfkQZkeuxdNx6X1fMrbJofzh0GYTT8Knn75Ljhr3hozrsL4Kz4J9gsLHCjkD5XKzLwCFK  
R6UhhZzr7uhufbqZiYTLiQEzBBABCAAdFiEELLeCvUfxyJI8qMqHHSVPZ6Jn8NCFAltZjFMA  
CgkQHSPVZ6Jn8NfKSGgApk065wFrqx2uqkZKFjGw2mSgeDVjGq9tMKUweYVxTNxjiYly8Dc  
/jrOS3AU6q7X7tAAcmvaXobfW3xEXIXMSH73GeinVG7wnlab6GKPRDKJzXfJ88rF07pX8R1pc  
ZH+eikiFsn9bcnEYch82bonS7dzyoo6yq2zBqntsmWYLDg2hcoTw4UHAwpdX6+n99m3Vz0Qo  
8ThQI9hqpUYGvP5qyYahFf+39HSViof+Kq5KKhvSois9NzFzYZ0Zsyt+2jzUpAM6XqtEGu  
TMzXhKE+/V4y13hIsVhNkXKgDrqjwA+UmT1R4/gBoiRhZ8r4mnlgyI08darQmkppf9MEbcDz  
U4kBMWQQAQgAHRYhBC1hIxvZohEBMIEUF5vAD7YfMhCBQJcns2XAAAJEJvAD7YfMhCC0UH  
/R8c5xy96ntPI2b6wn5i0BGD/2Ido+VdnBUney4k9t2fXKDRtq6LAR2PAD00ehSe4qiR6hw  
ldaC8yiyg+zgpZusbCLGxbsBdYEGMwTIEFsa8DyPMAAnPj0XLkGGf8oC7+6RuAJv1m6DR1lurr  
U93/QIG6M2SNsmnPgSZWYV4Y5/G7Xxyj0Fc3gnjjjGGP61CBR01W6rgNpn35sZ9GYCZcG1QA  
GGrT8mSvUoHPgPCXkz2dZDzsmDhn7rULB6bXcsHiC/nW/wFBpoVOIFIXND0rb1SYyJzPdPtO  
K6S+o+ancZctBed/4UJPBGqrBsUFS1SKzvJfPXjHGtZBitqQE7h57SjATMEAEIAB0WIQQt



## Verifying Package Integrity Using MD5 Checksums or GnuPG

9h/1MHY0zPQOK+NHNO96zf003AUCXK2H5QAKCRBHNO96zf0030JtB/wKbQN4IjvNkmWxSaBc  
JABRU/WsbNjto/auJV6IRUBpwR130izMw239w5suuWxlphjPq3PdglBaKKeQNdeRoIUdJd  
hydON1cq2wh90073WU2GHeZLi48MopUNksrhHfd/XWV//0LcSpERSqIBVUIi+8DHwFvpCzCz  
zIRg91OcQmEtJAFFUTkF9FEeZgO2NPO3fEwkjKDeJYUib+md9BliyxhU8apUx/c2zaFgQOCr  
Mlln/gHztAWdcIadK/tujqRWR4wnJ0+ny/HP+bwd18+YjhcWzUQ8FytG+DA3oylQ1d0w0emt  
qfn0zqiFkjqdG0M4qtItJYEHYlYpG2yoQHcCiQEzBBABCAAdFiEERVx3frY8Ya0hcAGjZrN  
vi2vIgfUfAlnScGAACgkQjZrNvi2vIgw5IQf8DKjeoHF9ChDcb4T01uJjiaAU6lxewSRD7iwd  
6MjCsaxgmifTD7Bzvdem4finoOul2YAPtLlFifVtVrtGG97R/Wvs3yji9NSzXkDGueE7/IIi  
4dKlCkKviJkg7G6A8+MGXaQTW8iOePI/44IyG5yogKjno7L4h0f3WguGzmCRUJcgYm23IsaTh  
Pvdq39ARyHALrk0hXZ+OqsYBr1W7KLyPrbPA3N+/2RkMz6m+T8ZksOrEdF/90nC9Rky4Wbg4  
SJqWQNNMSMfgTOrQL2Qvne598FKmltrTJuwBtIrSeuL/dbKt+hkLgnRjnmT5yPaf0gXvMtFU  
P9goQMMWD+A2BU/bXJokBMwQQAQgAHRyhBFBgHh7ZZZpG0pg7f1ToXvZveJ/LBQJblegAAoJ  
EFTToXvZveJ/LS0YH/jpcVprMEGnlC0mYG2MlRqeK4T8Y6UnHE2zBPC125P4QcQfhgUJ98m4  
0B5UkzljreFr9Zebk3pE8r4NBSamlJvi8sGbzONTsX4D3oW9ks0eicKocTZJgtX5RmSNFh63  
+EHbqTneK/NTQIuqRSCoufQC0H6QY1PVsICBlFZUPmfuxr1O7EwHKNIHPVBZNLm7AXxdjCMU  
kXvda8V14kActblw7NWxWx05q4hkQ2K3FsmBWXvz+YBhJ8FnRjdzWNUoWveggOD6u4H7GuOg  
kCyXn1fVnbCyJWSXQT9polJrNIAJMatykCYVLNS/IS65U+K1cMshcF+Gi19BuGyckBRuNaSJ  
ATMEEAEIAB0WlQRh2+o6RdTFb7cS1WG3d+zE2Q5m7gUCWdJutAAKCRc3d+zE2Q5m7rgjB/9k  
c+prmrnjsq/Lt6d90LqYoavvIeFkAoDhhWgQeEOADlwgyHlP56qoMKgvBlvda2r0bmk1kUL2  
xQaidj36wB5yJHauOnFX+3ZJ6QCYUaeoWtqO2ROHvTiyUdVKC5NtKaHpM1/lp/jl/1ZRWay  
idggH7EnwDMT+900x0D02n5J29Vp9uP0lGtMVsvSiJCGcOxwNBgNiXX1BpZbN4bRm5F8DAGiN  
v4Zl69QZFwbpj8wFVJ/rV4ouvcFP1utVEAUilKpAj35joXDFJhMvPpnPj84iocGqYPZHKR6j  
a90+08dZw3hXobFowjcxSJuQUTVkpUhzqr6kEulampaQ8OGpXCZHiQEzBBABCAAdFiEEZ/mr  
TQXcCZjglXUwqzhtKKq2evsFAltbmWkACgkQgZhtKKq2evsdrAgAubfUg1vWX3TTG/vYyrfM  
1aSlRoc034ePoJHK5rLT00/TnnnObw38kJM1juyu4Ebfou+ZAlspiWgHad62R1B29Kys/6uC  
qG2Jvbf716da4oLXeLYd9eb+IKVEiSb2yfbSLtLLB0c/kBdcHup6Alzz0HV81lHWj1Wx8cFU  
MV7aAQoOfnNBbnNWLzNXXLYGHh47/QmjifE5V8r6UJZGsyv/1hP4JHsQ2nqcM8Vfj+K+HEeu  
nnxzgWacQXP/0hI1lVwoWhsJlHW+4kwW02DDopdBfLTzCtzcDokfBcCg8hsmC4Jpxw5eHm  
saYsIB32keCpikVOCgdGDBRH7+da8knzokBMwQQAQgAHRyhBG4VA/IlW5kLV/vchhLcHkBr  
mersBQJax4N4AAoJEBLcHkBrmersksUH/3M0cypXBnyGI1/yE576MDa0G1xJvcip0EleyhJ  
48Y7IARXiQDtIpt8lIiPFf8iaw56vJw5H6UKraOcJZHOh1SWdr5gAWJgMqnglFX/DxVKif  
UST81KX0tHN6t6oMESgm2jRkvcWjh6PvEZlIARxZG4IjrErqWIJjUJR86xzkLyhRVtKUL/Yk  
uNl1i013Alad/0CGuanjrLUUxypadtNr7/qsBx8dG6B/VMLWToEDEon76b8BzL/Cqr0eRyg  
Qz6Kwi3hmsK+mE4+2VoDGWuHquM90uS9Z+7LUws24mX5QE7fz+AT9F5pthJQzN9BTvgvGc  
kpI2sz3PNvzBL5WJATMEEAEIAB0WlQR00X0/mB27LBoNhwQL60sMns+mzQUCWoyYfgAKCRAL  
60sMns+mzYgnB/9y+G1B/9tGDC+9pitnVtCL2yCHGpGAg+TKhQsabXzzQfyykTgzCHhvqRQc  
XhZ5NSgR0Io+kbGMUuQCaen60lCOrVxYIuivZekJOAG+9kiqWRbyTv4aR6zvh805wCyEhhyi  
ifi65PM7y91D6i22qtT/JoDnFkP5Ri6Af/fz9iaIaluQKJCU5xYlLt/BorGlrGvX5KiZD8xc  
AjhJRAT70CJ21gbxISsXELAfH42KzGAVjw/0hARRMk1/eK0HVDpD47mcmC5h/O/HlwPYi0hn  
xB+6/nuwrtRgMdbufNV0StU43njxCYmGI9/Ilz5Vs+zhz8ypw/xCr1U7aAPZQdSSsfEViQEz  
BBABCAAdFiEEe1R8OpStCJs7bhrK1TniJxBsvzsFAlv+8d0ACgkQ1TniJxBsvzsiFwf/a31t  
OuSrFs4M03YVp6LoCM6CwZfvcFl+6B0TaurOicja9lsNmbusSx0ad7bZy6/kHDXH/eqomXeu  
O4hkxxBvGK3gZt7iQsr9vsUSbbJnc1zMyOZKlhdXAOLOskttqtPs6hiJ9kUHFGZe47V3c77G  
GMgi/aklU5Pxxzht7+/bbAsW0iK60aXCZ5nAbWlZTQJGJnYr1k4b920rZGe8nDGTGzGmSjGnb  
YvuD9zi40DZRwVf1tXqCY643AXFYoOhRrxj54uHnMLYhc0I65u2ZGwRiTI0g/en5E8i7WoejA  
/sR0+cYs711iJw1nrwfgmnnJWRGEEHcJ3N52k3X7ayq3qmr3K4kBMwQQAQgAHRyhBJSRYHFB  
cqf4Tl2vzE+YN4Ly8sn+BQJae/KHAAoJEE+YN4Ly8sn+5ckH/juc2h7bC40GmRHcZBLAG2vW  
WEMTc8dAr9ZyJYXzR25W1/Cz/JXgJgMjSrE6m9ptycpvWc6IRlrQM/Iqg+ywYFPwNp3PYsc0  
1N33yC15W7DRPDtTJE+9yUbSY9FeYraV4ghxiBxD1cDwd7DFNGNRvBDH7yQHmXBW0K8x6yX  
Mwllgj2/MvdFUKmz8Lku94OmrbDOi83cnaJUNbn15Wle7hWAIRALt3P1VusjV/YzxvcSffB  
mt3CgBCyK9CNyEr27CVkhZ8pcabITx9afMdlUTEii90+qzgcJwcr46bJPZBdavMt56kVCeC0  
kG44030ok+OahKXzW4YspZMO046gYRkKJATMEEAEIAB0WlQSm5fcyEkLUw6FcN0ZJlMjHnz28  
bgUCXTJMCQAKCRBJlMjHnz28bsgCB/96PlBUdsKgnh/RpmPB+piFQf60g+97L4fxHuQbzK0E  
UNCSWNf7saVa5VaPxbV/9jdCTPZI5vBtNjebXtkmLoWFSZaCYb49SiJfvrSRAeX5QSQIrd4  
3Kmu07nAvbPVyTmChCo/g1T3riF2icC6pgvmNZWm5Nu4pkLzRmQv8U33BAKL7EYIjZzAc/9h  
o4Sh41/gLNItoXmDsD34sJwBLvElpQOalxNj4kfqSRD/8ufake5wfsie/s04w/2Cp7RD9H0  
VLD+7FwP0lHQ3XjJonVozj6uVdwCC5fcmBxb2bbj/xE4YVL3xmwWz5m2w+kBSpaZ6VHNocB  
8S20mIIPpr70iQEzBBABCAAdFiEEp6WxZJrn5Z0o967I/htVRVztQSYFAlqnkGEACgkQ/htV  
RVztQSYV2Af9E7FLIuI8lqOyYyZuX6skNf5rNSew+7i5NsI9pQzZMdsCJh9eJzyLrePlp7q  
9HUOHMF/Fc0SgbdTKSbfsidXkeaQ2twPj4rPlxxYBc00Y0OX4fNVA50/pTI9nxIVQCDTljl  
/WLY+fnj88lCkaKwoRJItaotjFmYt+gbJMBn3MMYf0V0DeIrozV//NdkzFXKmJ3fsCDGXXF  
CVWm1Fn3M91o1fh3FSgKd+0sexUDn5afwWCqjGgiXDsE7fEdwsbnz1rDzWvuqCoZyIh1RXQf  
QVbiakpZfvtdytC3Vo6F2KzPz9d69Adhfn2ydAYxL/Xuvk9pWdeBNF4T+Hfs9Z30BokBMwQQ  
AQgAHRyhBjPJCf6TG7RrucA13q1lKfneVsJZHBQJawgLRaAoJEFflkfnEvsJZHgNsIAIaSJ3gF  
tBtF0WLXyIo5zhNclXOnfgUUNjGrXHm5NxoI4Eulpx9dQYcJ++whMFbpxZQTgFAUq8q342EZ  
raLCWwALZEZmkZjv+FX6bk8sgqZESpUOLJAiqpobKpaawOQ7LS+XW00SchH1oLFAGdyBeIDZ  
N/LiTLIdkJeLxpDQDtGUHawksqMChIaBe60B5xvmlNkhnrmM1p+e3LUd4j+XxACdcy5LSqV

## Verifying Package Integrity Using MD5 Checksums or GnuPG

zVT40yDlWkKz8EAASUI8xysNBEeX9/8/EXaAcIECQb3MkYxTQZ4WqCLU0GCG16Sx2fY5zI6  
4Y1j/Sfn3JHikJots8eRlD/UxrXOUg5n9VUY/4tTa0UGPuCJAU4EEAEIADgWIQRLXddYAQl0  
69GnwU+qS4a3H5yDGUCX6xjgBoUGAAAAANAARyZW1AZ251cGcub3JnYW5uaQAKCRCqS4a3  
H5yDGkRfE/9z/5MuAWLwoRLJtnJQzEOW7jsfzYpepL3oct9tdGcs8jJTH3vh2x4Kp2d0Zaxx  
Zs7R8ehZ05XJQ/DWdhH+7cifoexMAEqDnlKSXZQZY/bg054tM6zes3tFTH3dCrn7LF59fQOG  
OaZHgbFRQJ06F++90mj9WAgeqGxyEhAlFLxFW4Cuul80ZAUIfq7YISnpkg2Tm/Q0SRRDJE4i  
/7WJE/HVMB0Rf9KJXuk2BjLRIPqz8Cf+GVZ5aGILXdM58Qknprno1lxoTKhrE74rAGHW7nRD  
xIxOoP8odiXbLzn//g2ml23usqncCKWZONDDVupax3RQ7xsIuFc9Kx40tjwPQftziQFOBBAB  
CAA4FiEE6hBKAqPbyggOC7fUwpbDMFWG9MsFA18u+m8aFIAAAAAADQAECmVtQGdudXBnLm9y  
Z2FubmkACgkQwpbDMFWG9MsIvggAhrfd2Z5WLR6hGxOHu+A+ysjX6xKjCqshCYr8jRuOfLFN  
vxuqQ0oFM5pqr15TyhokaU78aDUoIbLnKcxmH114hXxcRtg/9Y22TidOVN4jjNbc69KvCC4  
uANYuAJaI3o5fbljv8Lx820iRDmhtRqyTdsGdU5//8X5FXct+HhhzpsNoNtpxyhsKP0PAWao  
zuETqvxy7t0uy0f10tbZLI5nb52DxjBdZlThnJ2L9RwR2nSghxjHTFg8LrZWgWNTY5HG+vk9  
qbCwaC6ovNJ0G98i0DMrLbyGCbxa4Rv332nlxPfl/EPYwMNP1Mu0V3bSCqxVa5u3etA5fw3r  
qIm333vgFIkBsWQQAQoAHRyhBJTatFFgHAZYHkTw9GcRGDP/RljgBQJa7LubAAoJEGcRGDP/  
RljgNu8L/jn8j4HSgppnzJ0+3dfjVg7FUHJF6BZ84tv9huhmyrByaIreFf9ArN80izKgdP  
/wTl+KXarvsxdnEDLYSat3HS/sEw3BmZjAeTwpI0ShloisjYgYRbg3irDskqUHML4hhvMx0  
x9nZiag2XoSSH7kPed5jOb8cd7jJeoGg6Z9Z91MHuyqTGi0T/EbnhjQfVTxWkSkcDvdxbSuW  
D96mvZrRnrMebXKkISb0uVUN3/o11iUo9jXs+Q/03Tb9i0H3e0liP1kcB/kggu9xblIPM+J  
VaK5Z+zAVLPKtQJi+sP/ayEux0xZzfbz96WERNzT4E7Wwv8MvaLbybtID280y9YoBBYv7CrC  
tyfrHhlt4v2AeDRSZcTPKAaQ5NtLAVIdex0kOvvoFagi+7nmgV00vCZFBsXetvBMZkCapW09  
vF7wcahXpF+0Sp19vE2JiesST7uQobCumlEjxJP0vMdcOlvIfJHlbiHb/f3PE3rXZIZYtdL  
s3Kb400NAufNy9jYtYkCHAQAQIABgUCVJqCugAKCRB3MepTnaVyot2+D/9wAQ+p03lVmpYS  
gMWNMLgjq3z7qrNONYNpxUAonxECjUzZKSUPGci+fPKxl3ZUenk+rLgtgJmjmUOR6ulDov  
BpDFzhfqBipjgtMDrnY5sWqxJ+CH2Rb5okEEDJ5qE9DwIMP5ixbf4xjnbOyPiq3sp983PLvy  
8ttidwe9FDf8JuhWHLRHJHODQjC6LufcHSWKG9fLmCjL2KSPN1696MwR+N95EKcivLL2PLG8c  
f08Xd81wLS0cLh/6TEuZtAnVeoONUOGUXOPpyhTPP/xhfLeKbkxjtm6rg/jBaIjuuQgUyNN  
hKnP96/GRWRRHvioeBPAlhUcvImSrChnqLRpdyMxmK67ZkZS3YsH0ixozJYE0mNevZ2heY  
wB+05H11qK22YwFvNCLH2ZZWTu2TCUjGZP8hbo2nSoyENlxZio9GL/v4ypjdlgrwjjnnZvxom  
yOFeuc47AuzP5QjhtlrWv12C4hyi3YLZvklVFD0CxAE/CDuHk/4eFG4UC4Mor6+BXwVG7NE1  
4qQwRAHjLQ2/sHmpsUqY/5X7+StG/78PLP0HP+PIBCDDTa7W0+6kf0EaGVHKW43IiKvNI2Ps  
b44tTT+Xhc2mHk44LuzL4Axlywv+CxP9NcKLNfWk4Ck1M8Np6cAKlu+Dw6gjOY1aGHgtdsBQ  
cIqZj/+ETD0+9NKDXEoeDIkCHAQAQIABgUCUliwPAAKCRciKuTrQynFRXZdD/9vb+690GSR  
t456C6wmlB1+0cv9XeaCTiJjLgAL2G6wBRH2g2VcNhnU/VMTD2YLVu0eP7ubsirVrmR7nAgL  
sQlMkKwvTI+p5aAvn4sL3x3P8vzmGoDAigZ458yGuVpVsBkSPjJBMAkMDfm9kdWxCanzuKXS  
b591fTg4EtCHPDzoSgABntASgfioVxP2TVPfre282cibeYS+RDlaMTVH25yElrWDuF2U1CVW  
SMWY9mskr1+XjPno2jz0+jhKB7jyMMfSmJzqzCBNGezFbzX2fPmNmMZzEucVFFHmIhNVmL2  
rOwc/s1tSHERG5YIdL3HOJek5xJljjzjfFdRdjmML+n06nO78oePoLNdglQQSqn0yW6gZv8  
EIQ/NlnSi/LEW60z8BFfxzo08TqXMMX9QRLbVE6p+7C0nqohlzF6UEiDIIm+PihFlvPFSV54  
+70oLobCshe2g4pbRGWPHIJ4X3ILBQwFMZbn+cIuY3h3B/UpbZE/YSDgRFu5TLtCfBE/lQKX  
7QhJknJhQhJ+Dx+Y8h1Cx61Qr0KP5DmOkHYZfAQtdacgrqEr/qNen4QYRdKp0gTne8AV7svB  
8eI/8PkzvUPaHrax0g6ZSbeWbWew6czm0qUGJX7iMLJSauIJPrbojvXT7qIsaqZRRiUSWXo+  
m+jzK5qdeRheIUmlJI/tU/RsGokCMwQQAQgAHRyhBEW+vuyVcr0Fzw71w1CgTQw7ZRfyBQJd  
hy3eAAoJEFcG7ZRFcTg4P/3Igs5dYm0fhposI5iwBGtN5SsxYTZGte2cz+dXvclwLIzC  
RylnDu/SFXPUS0lQBj7/Bc2kl8934+pUtte+B5KZI2s/28Gn98C2Ijxxu+YZ1X1LbUkx0cPA  
jFWjUh/Jsfu6HiF2JONAG3meySnlmpxl6oZeTojeWo1t39PF4N/ay7S2TqIjGSBfxvDlpeIU  
bnziKsyM5ULbkMdgHssQvvyZvrVzQxaczPK424jXtKR6B2oA0wqMcP4c69UmVKEIKIzJNYrn4  
Kjs+An8vZvJYAVbiWEyEseTto3XJePdBNs1xxK2vWLA5PeLkE8bmzHr8iQ3ha0NaY7jSjP3e  
GrhWidXV+nfc1rFUPghYr5z+lJCSK5sow+aRiED39qd1Y+0iUAY94cqY3MQ4ayGgnB/+YuSx  
B5jNjCByJetFWWSJXnkbiYRLjU88dfLXCrTbhkSuCu3ag0jsBJYUyg/clZ4eCQgpTWB2cjYQ  
0ucK0SwT8U6qsl12qwYLR0Rfcp2aCwTtnWixqIN9F6iMafOsG+za8JY+B8PDJxxwWWz8vCvX  
ChTYrfiFei8oUqoHYTbw07cxaxkDd2CgXsQMmOcZSoXZXPae8AhsUibdl+BZs/vLZT7HrXtt  
/ggz8LzVCcyQqwmChurvgjauwjk6IcyZ5CzHFUTYWUjvFqYfAoN15xUZbvPYiQIzBBABCAAd  
FiEERsRGITzmkuU5Tzu635zONxKwpCkFAlxFLcAACgkQ35zONxKwpC1KVw/+PfrtIVHFSodl  
2crWBS05Hifvx9Vn2nPINKERYgB+tPWDS4UwzVUnpZfXCM7bKJFFPeKbitYxN3BlDmVhZMkc  
LDZMATIPsSt02oX7Tv/C0W0ZPlAWkp5mODPV3iGbGZjwmy5wz8fNtaWyxteUeaEXY8j151gm  
Wf1lLMvgwnFsQ74xobnCPssLgmogXfOLFQNF/VUfRveJ2Ci8raWyAdXFbDAIreJawAx5MMhO  
/LEfQ3W3f9bqtJZ5DZLbxQ3Xtqs+RY1ihvly12lr9vLpgKKGMz92Kdvjv2UXhd7XZ90aPMj7  
Rx0MQ1d+5d/ENQ8rLrLGuJl7nqHmLHMz67TvRtP14aNP7Mss80HiEKLYq23kGqXN+6cJG3UM  
i290uJZaAnTno65Cgsyn7JfKyXdtOmp3TSoyVsPFq92qgd/jFBf3dJj8c+mZEVXkUFeeUEK  
3LEMGFCH+oE8un7nu+XWqFyFSw5wn+PGYDXkSd6z/NyIN5DXa326KV+qpUmIWOLcyymm7cmZ4  
KJQt7zgWCxh2DuWQzRltjeQd8Iw62V8tIOBokWP9Thes18Qk2GOUeCnvczLdevT4lqr8Izvv  
nSwX/LQyxmmz2/dmPhzJ6kA6KQKQGSF6WnV/WuD4kESFKwtABFi6mYQilF6CynpVw/nu535C  
4fFG4d+A5G6skJx//hJOCgmJAjMEEAeIAB0WIQRGxYhPOaRRtLNm7rfnM43ErCkQUcXa6e  
YgAKCRDfnM43ErCkKfNXD/0cTejvQlgyy3UI3xfhYtRng8fsRXcACjMaJnrVYCoRceWwF6D+  
Ekvh5hNqqrZsxxD6nozY+iJhkaQitIj4qw7i4KY03fo613FjeLFXWqf4sflTANSsRNxawEo  
/JxPlJeOtOgYtKikW0kgZWS/mqVHAXJZrVq/Zhz06OugfOYVGMGZonU7zPl2toiWParIZ9

## Verifying Package Integrity Using MD5 Checksums or GnuPG

hcZ/byxfNoXEtSQtyUH01Tu8Fdypmk0zYUGZK2kGwXs1fOGj5m0M5nfUuVwq5C5mWtOI6ZngT  
LPJ32tRW526KIXXZMTC0PzRqQvTFHEWRLdc3MAOI1gumHzSE9fgIBjvzBUvs665ChAVE7p2  
lG6nx1tC4DojuXWECVmlqLOHKjC5xvml112QhseV7Da341I0k5TcLRcomkbkv8IhcCI5g08  
1gUq1YwZAMf1IenJt4zRPVSPyYKa4sfPuIz1PlyXB01lGEpuE5UKJ941d+BjU04alQJ6jKz2  
DUDh/Vg/1L7YJNALV2cHKsis2z9JBarG/AsFGN139XqoOatJ8yDs+FtSylt12ulwaT33TqJ0  
nHZ8nuAfyUmpdG74RC0twbv94EvCebmqVg2lJlxcxarDU0ZiSDZJNBXjcgVA4gvIRCYbad19  
OTHPTKUYrOZ2hN1LUKV0LmWkps04J2D1T5wXgcSH5DfdToMd88RGhkhH7YkCMwQQAQgAHRyh  
BH+P4y2Z05oUXOVHZQCWLgt3v4UBQJhrDYPAAoJEAXCWLgt3v4Uh2oQAMS3sK0MentPE+gu  
71Li9rMbD/305nlAxBJLX4MzLi2xP1648YV5nq9WMMT6qyp+OVWDXefneYNMgfU2/uu/Wi/o  
XTHBJuU361mfZhrWPj2h/vtfgDIYG2wio0DNJyaUQwLEi6gqPm0AHhKS4td69R+7qyQsbUIa  
BFgoytFzXDb5o2hiceOXa573m4myfAdCx5ucYfq+jlXJW9WgW7ERnFlv9xQDXiuryXWFRdv  
U00WzVPU9T0gPkcG8NABwqxs280c7n9A19HM2FtDakD0LiCm/I4ZehFVqvG6Hj966+FeuICw  
OaefFhth0oi3yc0+pkj1IePz/TmnsplTvvZOXH+6XEMPPPRQpvf5IZKJyrvuzoU8vkXY2h/  
gUHi9HiSIQ/BVEpvp6UjXvIbnPLK31I88qx9Eft/tv434w1ZpC6V1FzE2LtxyNcj/+0Uvj  
9hK0J71KOVpsnBbGiWg809s4sCIZ/ifLfWAKOJgxAEk/GcRkkkCqGNx7HA+coteNHqXLa/Lb  
2/r8gGn6kH9YhQootJsGhhSsY+6CW5TM5E+FhSRJU7MFHRpA94N7Hn6OFUK20XtHyRhx8E67  
R+ChJaZxbtoQvNv2Rv9yoZrBki3RoQ6/6/fcnRlx2moTMYg7K8AMMv7ZCfap6AjpOjTVnMV  
CpNy1Ao7smOzLafKbbeXiQIzBBABCAADfIEEjy2YV7IZJ8NHv36cSrDCiWqTaaEFAMF9XbsA  
CgkQRSDciwqTaaFUGw//WSUO22Csa60I6VN8yJQmf0wCo9sIEWDXcdHZ+CB0+gu0I3EMyR2a  
gL8lqCd6M79fpP8DiLKOJvn9mhXCsJyJtJQUsuNi5kQ/O9gwarRsr7EjJ7R8u8lpSh9YPLMS  
yN6XXFo4Qy5H0w9idJdb3owKAXSjurdi/hUEXja8TWliYwrfwiVDQi/aCoLZ4b9p6SFGR3Y  
gE8UIZLZtdWgsPJHkvdvntTpi4fwMsadBfa2f+m4Wq2CAU5KSFysVpKawSQ10sdUZUK7g+Ui  
jy//ad7ez+Bac75blHs7ua2iiF8Sc7MC55ZM5ldkv+0lqJ7td5vOCT1LKJg5PKKUC7YTTh9U  
PHLERJ/SwCHNES1YhwLvUO2VR01PN9HlQkPnEMBOobpmYkNqYLBfWioJ3ilptYY0IUX5qBM  
5UkwgyqMsdYrL+2ozIYc+/A8KUnZxozOAG9LP8gBE5jBJSIkbsi9Fumf7Q63++g4ojcYpOZ  
F92X6kQMgqBvkvs8UajR5f/n6QH0je4XFPj4141VM/PPfZSShNGD00i41+KwozICnQ1+fhwh  
N0VG4eALSJ6XQEefJ18PrBRS3sdC7OVEMLevEC8ojsQeZEL1ClelqAUoEcmgmXjs0DaJn2tt  
qNYUwCFoYcFnzgWL679C9FVp+Dag9jzDMKsqwo/Lt3IDNF19ZUC93WJAjMEEAEKAB0WIQSC  
PcNYXCP+FB0H/9bX9Pbut3FAu7gUCW8YgHQAKCRB9bbut3FAu7mOad/9QJ1MiyKw9rYqTvkU  
OSDSL88g6NP5R9ozgGZegInZ/NzT8u5emYccflnLlFvRQZPnT7YIH4+h25CCGQ5HzXUGENx  
ndeuG4dm3B10A8hXv+abEM9VYDgqSivF6z1xObvENOPmgmlmFdDi909d6jFFy4Hd6/BwejbU  
4M3kfuD39RxaT1OEwfqvTvf4GkiLqM71glNB8WrTqxt2t/Mo2h6UPCF7/wPF/idMabKen0ye  
blWDCaZVXxAQETfNo129hPb2qxPgoCWGw24ySpGrM5We4Nd3bbdGITsZ0mATNM1+m9FY9j30  
vpePFzYZGZ+23EcpXU+7jWbjZ42ssCW6kx2/ERLvmA7FuneEAqUc3gZr/3ZdZOVmVseg8c0  
n66D/NRLgMcpOQK62qJfSrxQj6sJCGRY4dxAfdTZWrxcu8UvvcInezGIToQ0y+Mc5LM1vMod  
srXcaVnuJTfWorOeqnFecnClcOwKNAKBXje8bSANUBKlrw0Rlpye/IilrKGEmaYkP2nnnNZE  
GPmumGkejDStWGmnHi5IogN8ibzyywsbNs0+qd1UFA2bmVhh2uK7M95kyuMH3GnWbz4IiMx  
RyUVEyK8yKnEmgOmLg4WiJjksPljIPf3ztTEVVDJxy1gt3R361sxd+OabnPOgizloFewKaur  
aWX1e0E6BWJ95ufookCMwQQAQoAHRyHbM8z5mfkMwAXdpG1bLdws0L0i1qEBQJcBML7AAoJ  
ELdws0L0i1qEmxwP/jDweTwTh1s+7Pp39L6aLB7nuQzdMleTksPGgmtguRBZiPbOYoryEozK  
9h13Hq/ymV/loInV6GZhieDoZvxrv9eEKg02eUE0IletSy7znlhV6MB7PBoc29dbCMf5L4qo  
xUG/f+XfHkrZekjZRWMlitLERL1DU5gHAQ3skLuT9bu3aZkGdBgw0U5qjVvGzYxp2LFPNXLf  
Tr1n3RZ0EVBRI+E9BPILqZFIzCzp/fxRRNkXyogkrGD+0PANfSjySQkd/rr8/Z4is13AM8CZ7  
s4tMWM4Dvj20ygnrcMuIEJdXVSR0LnlqJLuQ9HpWehve0d7/cIzkn7a0fqqE7bMvSPyxwL3m  
yTA4FwdbrebBr2y7ixlXZ6WtX/rqTvo2HTDFLle0ZwMbbfAtofX0M01PtXTLmJA15w1G8Nj8  
bthWdN4kVfyOpqPt70Xc/G1YNLzcyYQXX5e8Uskmg400H5cQV50FEG8qpxTg53wANDdxXGzs  
NUqe84Qkoyk75nzwVfsi00/OhTzmfIC48esXcs0kTrkSprFchktSMoYpMhfV3dTF17ifjz5a  
C2SL22R+RokWuzGxxpveaQAWIyCt6izfla+CjnXPD2Jw3yDC/Oeg68XYiSrbeFdCRzQbs9Yp  
ipUFilHuCinZeG3rFL2N2JodXg2LGORJz1RKazT7uAfRr5z7W1FtdtNeVNRtCBQYwNrYwdl  
IHNpZ25pbmga2V5ICh3d3cubXlzcWwuY29tKSA8YnVpbGRABXlzcWwuY29tPohGBBARAgAG  
BQI/r0OvAAoJEK/FI0h4g3QP9pYaoNtSISDDAAU2HafyAYLLD/yUC4hKAJ0czMsBLboM/xp  
aJ60x9Q5Hmw2uIhGBBARAgAGBQI/tEN3AAoJEIWWr6swc05mXsMAnRag9X61Ygu1kbfBiQDk  
u4czTd9pAJ4q5W8KZ0+2ujTrEPN55NdWtnxj4YhGBBARAgAGBQJDW7PqAAoJEIvYlM8wuUtc  
f3QAnRCyqf0CmCPTdIGc7bd05I7CIMhTAJ0UTGx001d/VvwdiKwJ45N2tNbYIhGBBARAgAG  
BQJEG8nAAoJEAssGHlMQ+blg3AAn0LFZP1xoiExchVUNyEf91re86gTAKDYbKp3F/FVH7Ng  
c8T77xt8vUUPYhGBBARAgAGBQJFMJ7XAAoJEDi0JeizQZWMhYAmwXMOYCIotEUwybHTYri  
Q3Lvt6hAJ4kqvYk2i44BR2W2os1FPGq7FQgeYhGBBARAgAGBQJFoaNrAAoJELvbtOQbsCq+  
m48An2u2SuJv15k9PEsrIOAxKGZyuC/VAKC10b7mIN+cG2WmfMVE4ffHYhlP5ohGBBARAgAG  
BQJEG8TmAAoJEPZJxPRgkLMMcNEAoIm2pP0sIcVh9Y0OYyGaqORrTOL3AJwIbcy+e8HMNSoN  
V5u51RnrVkie34hMBBARAgAMBQJBGcsBBYMGItmLAAoJEBhZ0B9ne6HsQo0AnA/LCTQ3P5kv  
JvDhg1DsFVTFnJxpA49WFJg/kIcaN5iP1JfaBAITZI3H4hMBBARAgAMBQJBGcs0BYMGItlY  
AAoJEIHC9+viE7aSiManRVTVVAFMxvJhV6D5uHfWeeD046TAJ4kjpW2bHyd6DjCymq+BdED  
z63axohMBBARAgAMBQJBGctiBYMGItkqAAoJEGT7n1dw/RzCaoAmwWM6+Rj1z14D/PIys5n  
W48Hq13hAJ0blOABthv96g+7oUy9Uj09Uh411F4hMBBARAgAMBQJJB0JMkBYMFLBFoAAoJEH01  
ygrBKafCYlUAoIb1r5D6qMLMPM01krHk3MNbX5b5AJ4vryx5fw6iJctC5GWJ+Y8ytXab34hM  
BBARAgAMBQJCK1u6BYMFeUjSAAoJEOYbpIkV67mr8xMAoJMy+UJC0sqXMPsXh3BUSdcmfFS+  
AJ9+Z15LpoOnAidTT/K9iODXGviK6ohMBBIRAgAMBQJAKl6BYMHektSAAoJEDyhHzSU+vhh

## Verifying Package Integrity Using MD5 Checksums or GnuPG

JlWAnA/gOdW0Thj080+dFtdbPkuImfXJAJ0TL53QKp92EzscZS491D2YkoEqohMBBIRAgAM  
BQJAPfqc6BYMHZqnSAAoJEPILXXGPjngWcst8AoLQ3MJWqt tMNHDbLxSyZxHfGhRU8AJ4ukRzf  
NjQe1HQH00ZM2WnCVNZOUihMBBIRAgAMBQJBDGqEByMGlpoIAAoJEDnKK/Q9aopf/N0AniE2  
fcCKO1wDIwusUGVlC+JvnnWbAKDDoUSEYUln5qzRbrzWW5zBno/Nb4hMBBIRAgAMBQJCGKU0  
BYMFI/9YAAoJEAQNwIV8g5+o4yQAnA9QOFLV5POCddyUMqB/fnctu09eAJ4sJbLKP/Z3SAiT  
pKrNo+XZRxaugIhMBBIRAgAMBQI+PqPRBYMJZgC7AAoJEElQ4SgycpHyJOEAnlmxHijft00b  
KXvucSo/pECUmpaiAJ41M9MRVj5VcdH/KN/KjRtW6tHFpYhMBBIRAgAMBQI+QoIDBYMJYiKJ  
AAoJELblzU3GuiQ/lpEAOIhpp6BozKI8p6eaabzF5MlJH58pAKCu/ROofK8JEG2aLos+5zEY  
rB/LsohMBBIRAgAMBQI+TU2EByMJVlcIAAoJEC27dr+t1MkzBQwAoJU+RuTVSn+TI+uWxUpT  
82/ds5NKAJ9bnNodfyMMK7GyMiv/TzifitD+4hMBBIRAgAMBQJb14B2BYMFzSQWAAoJEGbv  
28jNgv0+P7WAn13uu8YkhfNMJHwDpK2/qM/4AQAJ40drnKW2qJ5EEIjWtxpwapgrzWiYhM  
BBMIRAgAMBQJCGIEOBYMFjcn+AAoJEHbBAxyiMw6ho04An0Ith3Kx5/sixbjZR9aEjoePGTNK  
AJ94SldLiESaYaJx2lGILD9bbVoHQYhdBBMIRAgAdBQI+PqMMBQkZJgGABQSHCGMEAXUDAgMW  
AgECF4AACgkQjHGNO1By4fVxjgCeKVTBNefwxq1A61BrR9s/Gu8r+AIAniKdI1lFhOduUKH  
AVpr03s8XerMiF0EEXECABOFakeslLQFCQ0wWkGFCwKAwQDFQMCAxYCAQIXgAAKCRMcY07  
UHLh9a6SAJ9/PgZQSPNeQ6LvVVzCALEBJObt7QCFgsv+Wp18JutdZc7XiawgAN9vmmIXQQT  
EQIAHQUR6yUzUJDTBYqAULBwoDBAMVawIDFgIBaheAAoJEIxxjTtQcuHldCoAoLC6RtsD  
9K3N7NOxcp3PYOzH2oqzAKCFHn0jSgkx7E8by3sh+Ay8yVv0BYhdBBMIRAgAdBQSHCGMEAXUD  
AgMWAgECF4AFakequSEFCQ0ufRUACgkQjHGNO1By4fUdtwCFRNcueXikBMy7tE2BbfwEyTLB  
TFAAnifGbkmcARV57nqauGhelED/vdgiF0EEXECAB0FCwKAwQDFQMCAxYCAQIXgAU3Au  
ZQJUEPpyWQAKCRMcY07UHLh9aA+AKCHDKOBKBrGb8tOg9B1ub3LFhMvHQCeIOotlhHHUls  
TIXAURd8+ubiEzaiZQQTEQIAHQUCPj6jDAUJCWYBgAULBwoDBAMVawIDFgIBaheAABIJEIxx  
jTtQcuH1B2VHUECAAFxjgCeKVTBNefwxq1A61BrR9s/Gu8r+AIAniKdI1lFhOduUKHAVpr  
03s8XerMiF0EEXECABOFakeslLQFCQ0wWkGFCwKAwQDFQMCAxYCAQIXgAAKCRMcY07UHLh  
9Qdlr1BHAAEBRpIAn38+B1BI815Dou9VXMIAsQEk4G3tAJ9+Cz69Y/Xwm6111zteJrCAA32+  
aYh1BBMIRAgAdBQSHCGMEAXUDAgMWAgECF4AFaktwL8oFCRDz86cAEgdLr1BHAAEBRCRMCY07  
UHLh9bDbAJ4mWARqsvx4TJ8N1hPjF2oTjkeSgCemVJ1jxmd+Jd4SscjSvTgFG6Q1WC1bwQw  
EQIALWUCtnc9rSgdIGJ1aWxkQG15c3FsLmNvbSB3aWxsIHN0b3Agd29ya2luZyBzb29uAAoJ  
EIXxjTtQcuH1t0An3EMrSjEkUv290X05JkLlVfQrODPAJwKtLllycnLPv15pGMvSzav8JyWN  
3Ih7BDARAgA7BQJCdzX1NB0AT29wcy4uLiBzaG91bGQgaGF2ZSbiZWVuIGxvY2FsISBJJ20g  
KnNvKiBzdHVwaWQuLi4ACgkQ0cor9D1qil/vRwCdFo08f66oKLiueAqzlf9iDlPozEEAn2Eg  
vCYLCCHjfgosrkrU3WK5NFVgiI8EMBECAE8FAkVvAL9IHQBTA91bGQgaGF2ZSbiZWVuIGEGE  
bG9jYwWgc21nbf0dXJlLCBvciBzb21ldGhpbmcgLSBXVEYgd2FzIEkgdGhpbmtpbmc/AAoJ  
EDnKK/Q9aopf/0sAn3BVQK0alJeF0xPSvLR90PsRlmgAJ44oisY7Tl3NjBpGZal8W32fbqg  
bIkBHAQSAQIABGUCS8IiAwAKCRDc9Osew28OLx5CB/91LHRH0qWjPPyIrv3DTQ06x2gljQ1r  
Q1MWZNUoedFRcmgbrZxdiBzf5Mmd361iFiLmDIGLEX8vyT+Q9U/Nf1bRh/AKfkOx9PDSINWY  
bE6zCI2PNKjSWFarzr+cQvfQqGX0CEILVcUlHDxZlir1nWpRccnasMBFP52+koc6PNFjQ13  
HpHbM3IcPhaaV8JD3ANyFYS410C/S4etDQdX37GruVb9Dcv9XkC5TS2KjDIBsEs89isHrH2+  
3Z1xdLsE7LxJ9DwLxZAND90iuiThjAGk/pYJb+hyLluloCg85ZX81/ZLqEOKy155xutvCq1  
tSPmSUObCuWAH+OagBdYsduxIQEiBBABAgAMBQJJKmigBQMAEnUAAoJEJcQuJvKV618U4wI  
AKk/45VnuUf9w1j7fvdzgdWjT9Lk9dLQAGB13gEVZEVYqtYF5cEZzyx18c7NUTCTNX3qLId  
ul114A4CQQDg5U9bUwUKAuFGLaz380mtKtM9V9A4f19H2GFsdumr8RPDQihfUUqju+d0ycd  
mcUSc j48Nctx0xhCCWNjOFPERHi9hjrQq7x6RKyFTLjM5ftdInHCo9S+mzyqz90+iMgX68Mm  
+AVgdWSc9L6yGn6H97GD28oRMGWBTzsmCyqf9I3YtH8mGXRot3QbsJD7/AeZVh1BQwVoJn  
CT8Eo1pc/OYZkRRndElthrX0yjuFwTeozvqehlgzEW/FtOCBw7iR0WSJASIEEAECAAwFAkoz  
TogFAwAsdQAACgkQ1xc4m8pXrXwXiAf+Ked6Mgd98YyTyNiLHh11PulboCnKgJ430jLzkfgv  
7ytVCulxMfKrRWRw3fA9LCL19mzNQX/So/o/ywsk0nUG2sfEs5FiMk+ac957Ic/MDagmXqKap  
ZROJbzbZ/KNj9rPCG9kXPGA9sUn6vk39nnv4hri30tNKpM0fMxRhpcoNoCrN14rs/QTpdRpp  
7KBuNameTDU7R70jMDL4qt+BcCmYMIYW4dIV7tmaC0VxtcszZcVckxSigRMPZHwxSx37GdCx  
9/+Tq1A4vGL6NQSzXkV+Kqa+WtqBngOl6YGO6FxdixELiNRpflmafz6h8XgYXFGpehjuX1n  
60Iz0BffuWbpl4kBiGQQAQIADAUCSkRyCgUDABJ1AAAKCRCXELibyletPaaB/9FCsmYwz7m  
vzofHZO1EAYeLnCS29XGW89o4FYTbw0PB0ulygyqj2TMCK68RCNU2KFs/bXBHeS+dDzitMA  
fSaULYi7LJuCmrdm5SX5aLsJ6+TxdQDR1K1Z3E3y6qd4Kx3Veeon7Wu+oLj/3Jjbb0uYcQ  
+/PniRra9f0Z0neTeXZ7CGTvbIsKs1CnKBTR26MZMOom2eTRZwGFUX1PzuW/dbZ4Z0+J6XMD  
Tm2td70YWPbv3noblKUrxyjtGt03ip3Oe3zSCWHUFMAaEuXOMw8tN51wy6ybcPVAH0hoiBw  
b3iCFJ/20QqaZEno6edYzkqf0pwvrcTmiPb+Vj0fnjBjIQEiBBABAgAMBQJKVj5HBQMAEnUA  
AAoJEJcQuJvKV61845AH/R3IkGIGOB/7x3fI0gOkOS0uFljDxysim8FV06BfXbFpRgFMZxAh  
NFUdKCDN98MDkFbd5S5aGkvhAHS7PvWq8/BIyJaJeUG3AXmrpFV/c9kYn1+YW5OQ9E7tKu5l  
5U0j1Y/weNtC04u6RH/nrp6CvMBH2nvhSBZ+2k02auqtFohuK6+wUHgixt5EK8RAKs3Sf6n  
kP2EJUHzy1Q8ec5YDIAv24AVkPFBZMCKpD3Z+seIGrL4zUkV7PPY4zd9g340qj8JvtN4AD/  
Z1vBLuJlLixcQdt9aieoYSA9DAVgHbe2wVS4zi5nBURsmD5u96CUOWNK1sOV+ACTdIv/T5qSU  
VveJASIEEAECAAwFAkpoCoQFAwAsdQAACgkQ1xc4m8pXrXysfQf+IjYIPhTphk0kGPQY3v9e  
3znw30vahyZx0L6q25eQWGMVeTFLU4JThUEyzgYGip8i9qBsFPJ9XgOL5bxTgV7/WOK7eX8  
e+gXHB3A2QYbrM0GFZKN3BCKbA++HmvJXU58tf+aBCB00bG+rPn6QUNSP1bu4tp65TaPVPSV  
HjNTTICXu3sneHB+okJcc5z1ubme8nAytKb6x0JM/keNSXAev2ZN7zG5m+Pqw7/DQ/gCogzG  
ML1bulP2rSh8bYpJPC3vAVuHTmxsbhRBg4l7j5KiHf4gMBrVzRy+YiHhwpf2p8JbCGF141+H  
UD1VMeGeXnNO/9SO+dC2OGUf8WrV4fIpxIkBiGQQAQIADAUCSnkuCgUDABJ1AAAKCRCXELib

## Verifying Package Integrity Using MD5 Checksums or GnuPG

```
yletfBjrcACDd/zvoveoNlNiUUBazelcGXwaxSvUMSROUQNkxkoMzfA+aFpYFHWEdfLqndp
oJTIkkgESd5fODJT26oLFekLvX3mpzfGz8l39KzDMLi6+7MtG7DnA3kvfVIuZBNdWqoTS6hH
KcGa0MJDgzZQJ9Ke/7T7eY+HzktUBLjzUY2kv5VV8Ji0p6xY27jT73xiDov00ZbBFN+xBtx
2iRmjgnPtjt/zU5sLiv9fUOA+Pb53gBT+mXMNx2tsG07Kmuz7vfjR5ydoY7guyB3XlvUK9y
AmCWlGq67eRG934SuJzFiko/ozUrwRrQu2jj5v8B7xwctCFcdpZAIrAbD4BTglvPiQEiBBAB
AgAMBQJKjl+9BQMAEnUAAAJEJcQuJvKV618DTwH/3DzIl1zwr6TtTfTBH9FSdhdvauUEPKC
bLT3WZwzIHREaLEENcQ85cGoYoBeJXVBIwBczUPGy4pQfjYcWQ9vKfM2Nt1Nrs+v9tKc+9G
ECH0Y1a+9GDYqnepcN20/3HLASCEpXfWqHve01G+lupGgqYfMgTG9RByTkMzVXB9ER5giJGC
zjTf1YAOfUX2eBBLYa3w/ZzPt+nwRmEUADpFwq06UPrzMZuho17SGPZUNz41z4p2NF8Td9bk
hOiJ3+gORRohbq0HdarDvSDoP/aGsQltfeF5p0KEcpIHx5B05H1twIkoGFTxyx3nTWqauEJy
2a+wL5ZBl0hB2TqWAe9Z54KJASIEEAECaAwFAkqgEkFAwASdQAACgkQlxc4m8pXrXwyXwf/
UPzz+D+n19JWlvha71aUxuZMQCKTcEjFCu4QVZlrcqBFPOz0Tt74/X75QdmxZizxQL6E1bf
EsbVjL2Mt5zjedS1vbSbrmn4hV4pHzr08dbf1ZkNX105g8ZlpsqQ7VyUt5YtWCn0tGNn4B5
Eb6WMeqxQteujV3B7AtMH+CD0ja+A2/pOrHIpqScz8aupksBMCrYqhoT+7/qXNEVkjNmcu2N
mHxfv6dL5Xy/0iJjie2umStu8WTfRTPymnv2gEhCbdb/zhfVg61GgTBjQv9MvBVGRxnJfD41
Nqlucsad+UM7Wjv3V5VuN2r9KD9wod/s22ELCRA2wKccvR/nWBkIkBIgQQAQIADAUCSggQ
AAUDABJ1AAAKCRCXELibyletfaT8B/9cPhH8DlHoiv+cK8rAJMmZqVqOyy4BwsRrakycV1g
7/yvMs74anynSoF0LgSxADQ29Hmrpf+zC5E5/jPGWNK81x2VBVoB8nZkMSAnkZfOw+mWu9I
Aj2NLcsvt9JYnMaq5R7RrirHsDQ2DIYxRgaE/5CVEVry9YQEj18A13/SYyoB4FwPDI4fRfUW
JbUJrYmfG0p+4zL0YS9F11UhsHUu+g1WlC83N54ozIlv013HUwVayzII4E/YNrIkpoAo+o8R
z9g6M6jCg3mwn+OfiZVJO++VOiguJF5KzoZIIcMXE3t5hL87Kroi7UkNwm+YHw3ZaLEBm0B
WAXw4DsZcpViQEiBBABAgAMBQJKuceJBQMAEnUAAAJEJcQuJvKV6188KEH/24QK2LV1142
4Wx3T9G4bJFRWWuEkTpYJw6ss72lqus9t7BsoGaNLMHQzKAlca9wLTqY826q4nv9anEqwWZ
+d18ke+UAMUx2BFTLQEvOMJ6il1Zye8cUFVb1+09tpBWJJS7t3z00uMMmznGuHzSm4MgCnGhA
sOgiuHdPWSlnHnqNja/SB6UVQxtcDOaqQLIvhd2HVqrOBrtER3td/YgLO6HSxXpXtz8DBa2
NYQYSwAdlqJAPLBNbSLXwbCswuIDMZzV8BjWUNBEJkokOMv5CXxhPrP5kxWvyBvsIhTk8ph2
Gh/ZRVNDAsChbuULeJBACpwaMrCgwpPtI7/KTgeZVSJASIEEAECaAwFAkrcMYFAwASdQAA
CgkQlxc4m8pXrXyOQqf7BvRm/3PvFCCKsyjBW4EVBW7z/ps/kBK6bIE9Q7f7QlXFicGGUIdP
arufXwbV+G4a3Z8LFEJFTovNePfguwPFjneUzn1CG+oVSlAfddvYhAsgkLhQqMbaNJlJ14D/
H3xvCna/s7Teufud0JLXoLBedFXeB5Cg2K1EoxINqMo+lM/VGjmykqwoRvxZLDfnbFag5zG
59+OWw4TC8nzlIQYIBn22YiWRk5zsCJA400+KL1lvBiFDrREhALQc/YBJKyrRX3ZV4U/EeYD
KBONCBk1w1tXGcEE3uhM0S5Vfcl1j7Pg58ECuntH5xOy+KMNFljiQvWfbaFTJvCjFQS+OplX
b4kBIgQQAQIADAUCS86VAUDABJ1AAAKCRCXELibyletfgs8CACTeI2BmKs24GF80JewTOQI
cvhncDv7hKZ01tbnPBBDv6q2t3iX2Gva10iYhI5Eg30jt/hKFJTMlFYZyI1peFodGjv7Lk51
u7zaNBvtlpBCP+eJspi6rGpSuhtMSb405jPclRBmby+w9wctLyZflzG+s1Sdw8adCRXQNFqr
vVlZYOMu2S8FunqLfxpjewiFiDPzAzmbWzMo02PLCYFhwV6Eh2j0330GbvBmyHNFZBfX5F/+
kiyeT47MEhrfhytJ6Z0dpxtX8HvzbvzPzCdL0I80W6rPTG76KW06ZiZrJ81YCa6a7D01y7BYy
W2HoxZyuumjRkGF4nqK4Mw+wefCp0H/iQEiBBABAgAMBQJLAF3aBQMAEnUAAAJEJcQuJvK
V618/qOH/ibXDQGT2MqC1LoT4H+ezXjPgDg8a1uz6f4xibTmrO+L4ScMX+zK0KZVwp6Kau28
Nx+g00oAUW8mNxd+c10ZaY+7RIkxEvKooKksArBmZT+xrE6CgHlAs3D4Mc+14nfd0aZaUbe
iobWx1YL27MELLCWyeM1gbeNoucc473JddvmHSRRM5F9Qp28CvWDEXYqhql1a0a08+cei
pvzyu030TjuAOqheFOHzAvFrRli99ML8xzF1Z0vBct+36SuYxDXyIhksd7aG9Us01W6W5Si
JYt4cDyI0JDbhZn0tzWYKcKMZMxf8w3jW4sfQL0prhHrARqqPiU80TUH/VNX5CJASIEEAEC
AAwFAksRgAsFAwASdQAACgkQlxc4m8pXrXydogf/a31ofmYFM0E3p9Sqt/v28y00j9A1Lm
qKwEhJkxff/X/Qa7pafGQ9J90JQkxYKMxydWpSpTbDFMccZwKBK132vZp9Q3FHKpndPLK2S
25miTReeAAQNgMMFLeyy7ZH15YsKwLbKxcSo7/m0jlitNYlmt94imFNpg/mHGsy60+rLeQTA
opuIzP3VwN6ItL5gIFxqWpMf/V0Xh/vxTwLqJ66vEcd8vyHrHblUzgiXHgyYbZPxAa2SRRd3
4V38phaZ/QsTkss+Sd/QeHChWyU9d6KengWwcr/nDO+K/hhmn05Oqz02Upwyxrgi6484HQUN
/Smf44VBsSDlDBjaAKjMr4kBIgQQAQIADAUCSNN1AUDABJ1AAAKCRCXELibyletfcwiB/9c
EZtdFVcsxpE3hJzM6PBPf+1QKuJorve/7MqNEb3TMWFgBxyOfvd7uMpCjYOrqq5AbUQfZfj9
K7qmqWUMuoYceGIlbDmHFBjWtmaF0BiyHaobgY/9RbdCnCbtrW34feiW9aDZyvCoLHEVkcCC
QACSv3FwdYVkkRB5eihvpvJk5tPscdIA12YLqzmVTFdhrZuYvtDdQHjgoLM08B9s9kok7D2T
SpveVzXXPH68Z3JkVubhHT7cs+n+9PrvcaVJtsX2VTUY5eFVqmGuAUUVrVP2aN8cKQ+mVcCQR
VVlHt9o8YB5925Mux2VJm10y0nkBQUmZyzMEOVGkuU/G+pVrRmmAIQEiBBABAgAMBQJLJyaS
BQMAEnUAAAJEJcQuJvKV618eU0IAKnVh6ymId9C3ZqVyXwTnOB8RMQceJzwCLqk2RT0dPhN
5ZwUCQn7LCP9hymMutC8FdkRk/ESK21vJF2/576Pln4fIeOIbycBAEvqrL14epATj53uBizo
NOTuwbLkximFERuW3MP4XiFUJB0tPws2vr5UU3t6GoQJjWNoIbz9DK2L6X/Qz3Tb9if6bPSK
U6JR1Yn3Hos9ogg21vWCXgMTKUuPAYhmYjSvkqH3BihXi+c17MVvE7W5GJbQHuoJ+MgSxu04
4qnvDHZpf4Mzc30XcG1ohjxefNyei12ybdI2yCaCtmW0LcW1Sc2oiE0zW061d4hY5XmC2Xq1
MLsKB5VNxJGJASIEEAECaAwFAks4Ze4FAwASdQAACgkQlxc4m8pXrXyWxggAon2abiNvRzx9
7364Mjx41lFvM1tVebzNbOkDwZSLABqTDGgq/ffZA/VZrU+h2eL97cQyGxJEQ5kkm/vliobE
ZEFMT0pv9WMzfIdqzhdKdcpbbxdaErIjD5fBACKdjaZUeH7zce2v+bbN019LZorixBnugG9
381kJE24ZTYffvftL/e4RzOgqr9VD/A5MzxfXfbcVharHbeT8OwZy4Oz2UDAzsHsNKoG1WN
pOSf2HTMPPNcsOSY/hIBRWnxzdYOKwt71aeLnmN1eUEwzk4J7GnlambPictOdoEURimsaey
TkLZGejKni/PqARyDW1FsReKNHD753ZMViUnAsq2IkBIgQQAQIADAUCS0oyJwUDABJ1AAAK
CRCXELibyletfgodCAC5hjmXwquHSb8ZL0RifIL3j3iU6U7qLk1TQKkTqgELFuzeF9f8NuNR
txLmzNk1T7YI9iji6NAtnuy43v610ombqlkV8x69qNP36Oww408wXxet0s5ViZuVOZJAY075c
```

```
YRhopgfmhkh4hbkaOKCLaJ0R0WUEESDHsqj8XLJuGRREURY8TJWaB/cotXsgijf99gt+gIw
In8tyb3+WVIUHWf2+Drpd3nfcMqge054PePJo0BWWjaar+wgC/76Se286IHCYMrml/Adnvx
ZaIKmxZmkTmDMCfMnVjRYSKKBGjQ9Uu7dws7SMsbbd34f8Jt9nyuRqMcl4INAXthWY/S3Sdil
iQIiBBABAgAMBQJLW/5mBQMAEnUAAoJEJcQuJvKV6181L8IAKq3ZQHQzqaOoz5wnvj51YG8
nZoW5RG7H0b3mL1D9b+FTTzaIXsLf7STagPwKtM57rU/7ehHIu0/9QQNQ3Mudwl7ZiwD015X
7iG8/AflWnc6bXfTz18IplRuqyVc0qQeJZht7MBpk1cS4ZGZHPQdtAh4Aw5YXihrbbq6jV7j
CzUmFz4XcT8CKJHIUGoFR0vTmFq1At2K1imwGMh2IEamPOJ0wsTbBfZbhmkb03RToEjIipGZ
M+NtKs/NL2RJYWZ+FCCcEMoRgmlVmAtWw3natgLWwN4Z6K4rGXONwi/0wyFgxZpmjdHmjCxA
Igz8EroVsLbnaV/8yG7cgK5e6M0Fk1iJASIEEAECAwFAkttIfgFAwASdQAACgkQ1xc4m8pX
rXyR3QgAksvAMfqc+ACUEWSVAlepDFR1xI45UwBa2UeBY7Kj00CiZlkGREvx20IOv1gExyPl
zNxDeqmYs12mleEoH6QlXaJRd8MxIVfAnjAt8izwU2dfDwflTTWgGQYf8q7qeAv1XC34yNge
0JaTD1C55Qpmc051f2ojMsAi36bBJO4Dr59jhVYiDjQADS/d7FpAznlhH9SGUq6ekYb2jxCS
rvt0wRtMyk6YGts4xEHCN0wC9VTobaXo9xvsqhtUK44Gdvptq1cBFX8byzD6fN8nXp+v8qh
t1PYDqb4muqTh2UXX1WmtvPXo7kkZQ8CvI3YbZ10F1IDLt20VJWFZaJYL2fzyokIggQAQIA
DAUCQYHLhQWDBiLZBwAKCRCq4+boZqFEaKgvEACCErnaHGyUYa0wETjj6DLEXsqeOixAd4i9
aBQxnD35GugcFofc/nCY4XcnCMMEnmdQ9ofUuU30BJ6BNJlBfusAabgLoeobP/3KEaiCIiyh
HYU5jarpZAh+Zopgs30c1lmQ1tIaS69iJxrGTLodkAsAJAeEUwTPq9fHFFzCleGBysyfWg4
biJz/zc1I+qyTbFA5g6tRoixTo8ko7QhY2AA5UGEg+83Hdb6akC04Z2QRErxKqRphHzj8Xp
jVosQAdAi/qVKQeNKRO1J+iq6+YesmcWGFzeb87dGNweVFDJIGA0qY27pTb21ExYjsRFN4Cb
13NfodAbMTOxcAWZ7jAPCxAPlHUG++mHMrhQXEToznBFE4nbnC7vOBNGWdjUgXcPkUCkop4b
17BFpR+k8ZtYLS58p2LLz4uAeCcSm2/msJxT7rC/FvoH8428oHincgs2ICo9zo/Ud4Hmm000
+SszdVKIiJinQyOVWb400zkAlnnhEZ3o6hAhcREIsBgPweYVTj/9ZdC0A044Nj9cU7awaqgt
rnwWfr/o4V2g18bLsk1tZU27/29Heu0eFGj1Fe0YrDd/aRNsxyb2028H4sG1CVZmC5uK1iQ
BDiSyA70QbbdfCwoqzm5tWlpKwN80e0ub9XP5p/svfcK4FceWFHwv+/PC9RzS1331Q6vM2
wIkCIgQTAQIADAUCQp8KHAWDBQWacAAKCRDYwgoJWiRXzyE+D/9uc7z6fIsalfOYoLN60aja
bQbI/uRKBfugyZ5Roaitusn9Z2rAtn61WrFhu4uCSJtFNlny2RERg40f56pTghKrD+YEt+Nz
e6+FKQ5AbGIdfSR/2bUk+ZZRst83e14Lcb6ii/fJfzkoIox91tkifQxqY7Tvk4noKu4oLSc8
01wSfc/y0B9sYUUCmUfcng58DEmGie9ovUslmyt5NPnveXxp5UeaRc5Rqt9tK2B4A+7/cqEN
rdZJbAMSunt2+2fKyiRunAFPkPBdJBsY1sxeL/A9aKe0viKEXQdAWqdnZKNCi8rd/oOP99/9
lMbFudAbX6nL2DSb1OG2Z7NWEqgIAzjmpwYYPCKeVz5Q8R+if9/fe5+STY/550aI33fJ2H3v
+U435VjYqbrerWe36xJitcJeqUzW71fQtXi1CTE13w2ch7VF5oj/QyjabLnAlHgSlkSi6p7B
y5C2MnbCHlCfPnIinPhFoRcRGPjJe9nFwGs+QblvS/Chzc2WX3s/2SWM4gEUKRX4zsAJ5ocy
fa/vkxCKSxK/erWlCPf/J1T70+i5waXDN/E3enSet/WL7h94pQKpJz80dGL4JSBHuaVGA+a+
dknqnPF0KMKLhJrgV+L7084FhbmAP7PXm3xmiMPriXf+el5fZZequQoIagf8rdRHHhRjXqG9
0HNknkaOqs8dtrkCDQQ+PqMdeAgA7+GJfxbMdY4wslPnjH9rF4N2qfWsen/lxaZoJYc3a6M0
2WCnH16ahT2/tBK2w1QI4YFteR47gCvtgb60lJHfFo2HfLmRDRiRjdlDTCheqYX7CHhcgj
/dNRlW2Z015QFecmV9U0Vhp3aFfWC4Ujfs3LU+hkAWzE7zaD5cH9J7yv/6xuZVw411x0h4Uq
sTcWmu0im1BzELqX1DY7LwoPEB/O9Rkbf4fmLe11EzIaCa4PqARXQZc4dhSinMt6K3X4BrRs
KTFozBu74F47D8I1bf5vSYHbuE5p/1oIDznkg/p8kW+3FxuWrycciqFtCnz215yyX39LXFnl
LzKUb/F5GwADBQf+Lwqqa8CGRfS0AJxim63CHfTy5mUc5rUSnTslGYEIOCR1BeQauyPZbPD
sDD9MZ1ZaSafanFvFg6Llx9xkU7tzq+vKLoWkm4u5xf3vn55VjnSdlaQ9eQnUcXiL4cnBGO
TbOWI39Ecyzgs1zBdC++mpjCQtCA7p6JUVsP6oAB3FQWg54tuUo0Ec8bsM8b3Ev42LmuQT5N
dKHGwHsTPTl0klk4bQk40aJHsiy1BMahpT27jWjJlMiJc+IwJ0mghkKht926s/ymfdf5Hkd
Q1cyvsz5tryVI3F78XeSYfQvuuwqp2H139pXGEkg0n6KdUOetdZwHe70YGNPwlyjWJT1IhM
BBgRAGAMBQI+PqMdBQkZgGAAoJEIxxjTtQcuH17p4An3r1QpVC9yhnW2cSAjq+kr72GX0e
AJ4295kl6NxyEuFapmrl+0uUq/SlSyhMBBgRAGAMBQJHrJT8BQkNMFjFAAoJEIxxjTtQcuH1
pc4An0I965H3JY2GTrizp+dCeZxbhexaAJ48FhocFyVfhtZtgeUWb6aPvgQZHT4hUBBgRAGAM
BQI+PqMdBQkZgGAAIJEIxxjTtQcuH1B2VHUEcAAQHungCfevVClUL3KGdbZxICOr6SvvYZ
fR4Anjb3mSx03FgS4UCmavX7S5Sr9KwxiFQEGBECAwFAk53Pe0FCRP7AbgAEgd1R1BHAAEZ
CRCMcy07UHLh9RSbAJsfivb5sESf8vYE5yfd1n9AVa6FEwCgpWAIWbl9p1DcB+L5RCUBw6mG
uck=
=ya9
-----END PGP PUBLIC KEY BLOCK-----
```

## 2.1.5 Installation Layouts

The installation layout differs for different installation types (for example, native packages, binary tarballs, and source tarballs), which can lead to confusion when managing different systems or using different installation sources. The individual layouts are given in the corresponding installation type or platform chapter, as described following. Note that the layout of installations from vendors other than Oracle may differ from these layouts.

- [Section 2.3.1, “MySQL Installation Layout on Microsoft Windows”](#)

- [Section 2.8.3, “MySQL Layout for Source Installation”](#)
- [Table 2.3, “MySQL Installation Layout for Generic Unix/Linux Binary Package”](#)
- [Table 2.12, “MySQL Installation Layout for Linux RPM Packages from the MySQL Developer Zone”](#)
- [Table 2.7, “MySQL Installation Layout on macOS”](#)

## 2.1.6 Compiler-Specific Build Characteristics

In some cases, the compiler used to build MySQL affects the features available for use. The notes in this section apply for binary distributions provided by Oracle Corporation or that you compile yourself from source.

### **icc (Intel C++ Compiler) Builds**

A server built with `icc` has these characteristics:

- SSL support is not included.

## 2.2 Installing MySQL on Unix/Linux Using Generic Binaries

Oracle provides a set of binary distributions of MySQL. These include generic binary distributions in the form of compressed `tar` files (files with a `.tar.gz` extension) for a number of platforms, and binaries in platform-specific package formats for selected platforms.

This section covers the installation of MySQL from a compressed `tar` file binary distribution on Unix/Linux platforms. For Linux-generic binary distribution installation instructions with a focus on MySQL security features, refer to the [Secure Deployment Guide](#). For other platform-specific binary package formats, see the other platform-specific sections in this manual. For example, for Windows distributions, see [Section 2.3, “Installing MySQL on Microsoft Windows”](#). See [Section 2.1.3, “How to Get MySQL”](#) on how to obtain MySQL in different distribution formats.

MySQL compressed `tar` file binary distributions have names of the form `mysql-VERSION-OS.tar.gz`, where `VERSION` is a number (for example, `5.7.44`), and `OS` indicates the type of operating system for which the distribution is intended (for example, `pc-linux-i686` or `winx64`).



### Warnings

- If you have previously installed MySQL using your operating system native package management system, such as Yum or APT, you may experience problems installing using a native binary. Make sure your previous MySQL installation has been removed entirely (using your package management system), and that any additional files, such as old versions of your data files, have also been removed. You should also check for configuration files such as `/etc/my.cnf` or the `/etc/mysql` directory and delete them.

For information about replacing third-party packages with official MySQL packages, see the related [APT guide](#) or [Yum guide](#).

- MySQL has a dependency on the `libaio` library. Data directory initialization and subsequent server startup steps fail if this library is not installed locally. If necessary, install it using the appropriate package manager. For example, on Yum-based systems:

```
$> yum search libaio # search for info
```

```
$> yum install libaio # install library
```

Or, on APT-based systems:

```
$> apt-cache search libaio # search for info
$> apt-get install libaio1 # install library
```

- *For MySQL 5.7.19 and later:* Support for Non-Uniform Memory Access (NUMA) has been added to the generic Linux build, which has a dependency now on the `libnuma` library; if the library has not been installed on your system, use your system's package manager to search for and install it (see the preceding item for some sample commands).
- **SLES 11:** As of MySQL 5.7.19, the Linux Generic tarball package format is EL6 instead of EL5. As a side effect, the MySQL client `bin/mysql` needs `libtinfo.so.5`.

A workaround is to create a symlink, such as `ln -s libncurses.so.5.6 /lib64/libtinfo.so.5` on 64-bit systems or `ln -s libncurses.so.5.6 /lib/libtinfo.so.5` on 32-bit systems.

- If no RPM or `.deb` file specific to your distribution is provided by Oracle (or by your Linux vendor), you can try the generic binaries. In some cases, due to library incompatibilities or other issues, these may not work with your Linux installation. In such cases, you can try to compile and install MySQL from source. See [Section 2.8, “Installing MySQL from Source”](#), for more information and instructions.

To install a compressed `tar` file binary distribution, unpack it at the installation location you choose (typically `/usr/local/mysql`). This creates the directories shown in the following table.

**Table 2.3 MySQL Installation Layout for Generic Unix/Linux Binary Package**

Directory	Contents of Directory
<code>bin</code>	<code>mysqld</code> server, client and utility programs
<code>docs</code>	MySQL manual in Info format
<code>man</code>	Unix manual pages
<code>include</code>	Include (header) files
<code>lib</code>	Libraries
<code>share</code>	Error messages, dictionary, and SQL for database installation
<code>support-files</code>	Miscellaneous support files

Debug versions of the `mysqld` binary are available as `mysqld-debug`. To compile your own debug version of MySQL from a source distribution, use the appropriate configuration options to enable debugging support. See [Section 2.8, “Installing MySQL from Source”](#).

To install and use a MySQL binary distribution, the command sequence looks like this:

```
$> groupadd mysql
$> useradd -r -g mysql -s /bin/false mysql
$> cd /usr/local
$> tar zxvf /path/to/mysql-VERSION-OS.tar.gz
$> ln -s full-path-to-mysql-VERSION-OS mysql
$> cd mysql
```



```
$> mkdir mysql-files
$> chown mysql:mysql mysql-files
$> chmod 750 mysql-files
$> bin/mysqld --initialize --user=mysql
$> bin/mysql_ssl_rsa_setup
$> bin/mysqld_safe --user=mysql &
# Next command is optional
$> cp support-files/mysql.server /etc/init.d/mysql.server
```



### Note

This procedure assumes that you have `root` (administrator) access to your system. Alternatively, you can prefix each command using the `sudo` (Linux) or `pfexec` (Solaris) command.

The `mysql-files` directory provides a convenient location to use as the value for the `secure_file_priv` system variable, which limits import and export operations to a specific directory. See [Section 5.1.7, “Server System Variables”](#).

A more detailed version of the preceding description for installing a binary distribution follows.

## Create a mysql User and Group

If your system does not already have a user and group to use for running `mysqld`, you may need to create them. The following commands add the `mysql` group and the `mysql` user. You might want to call the user and group something else instead of `mysql`. If so, substitute the appropriate name in the following instructions. The syntax for `useradd` and `groupadd` may differ slightly on different versions of Unix/Linux, or they may have different names such as `adduser` and `addgroup`.

```
$> groupadd mysql
$> useradd -r -g mysql -s /bin/false mysql
```



### Note

Because the user is required only for ownership purposes, not login purposes, the `useradd` command uses the `-r` and `-s /bin/false` options to create a user that does not have login permissions to your server host. Omit these options if your `useradd` does not support them.

## Obtain and Unpack the Distribution

Pick the directory under which you want to unpack the distribution and change location into it. The example here unpacks the distribution under `/usr/local`. The instructions, therefore, assume that you have permission to create files and directories in `/usr/local`. If that directory is protected, you must perform the installation as `root`.

```
$> cd /usr/local
```

Obtain a distribution file using the instructions in [Section 2.1.3, “How to Get MySQL”](#). For a given release, binary distributions for all platforms are built from the same MySQL source distribution.

Unpack the distribution, which creates the installation directory. `tar` can uncompress and unpack the distribution if it has `z` option support:

```
$> tar zxvf /path/to/mysql-VERSION-OS.tar.gz
```

The `tar` command creates a directory named `mysql-VERSION-OS`.

To install MySQL from a compressed `tar` file binary distribution, your system must have GNU `gunzip` to uncompress the distribution and a reasonable `tar` to unpack it. If your `tar` program supports the `z` option, it can both uncompress and unpack the file.

GNU `tar` is known to work. The standard `tar` provided with some operating systems is not able to unpack the long file names in the MySQL distribution. You should download and install GNU `tar`, or if available, use a preinstalled version of GNU `tar`. Usually this is available as `gnutar`, `gtar`, or as `tar` within a GNU or Free Software directory, such as `/usr/sfw/bin` or `/usr/local/bin`. GNU `tar` is available from <http://www.gnu.org/software/tar/>.

If your `tar` does not have `z` option support, use `gunzip` to unpack the distribution and `tar` to unpack it. Replace the preceding `tar` command with the following alternative command to uncompress and extract the distribution:

```
$> gunzip < /path/to/mysql-VERSION-OS.tar.gz | tar xvf -
```

Next, create a symbolic link to the installation directory created by `tar`:

```
$> ln -s full-path-to-mysql-VERSION-OS mysql
```

The `ln` command makes a symbolic link to the installation directory. This enables you to refer more easily to it as `/usr/local/mysql`. To avoid having to type the path name of client programs always when you are working with MySQL, you can add the `/usr/local/mysql/bin` directory to your `PATH` variable:

```
$> export PATH=$PATH:/usr/local/mysql/bin
```

## Perform Postinstallation Setup

The remainder of the installation process involves setting distribution ownership and access permissions, initializing the data directory, starting the MySQL server, and setting up the configuration file. For instructions, see [Section 2.9, “Postinstallation Setup and Testing”](#).

## 2.3 Installing MySQL on Microsoft Windows



### Important

MySQL Community 5.7 Server requires the Microsoft Visual C++ 2019 Redistributable Package to run on Windows platforms. Users should make sure the package has been installed on the system before installing the server. The package is available at the [Microsoft Download Center](#).

This requirement changed over time: MySQL 5.7.37 and below requires the Microsoft Visual C++ 2013 Redistributable Package, MySQL 5.7.38 and 5.7.39 require both, and only the Microsoft Visual C++ 2019 Redistributable Package is required as of MySQL 5.7.40.

MySQL is available for Microsoft Windows, for both 32-bit and 64-bit versions. For supported Windows platform information, see <https://www.mysql.com/support/supportedplatforms/database.html>.



### Important

If your operating system is Windows 2008 R2 or Windows 7 and you do not have Service Pack 1 (SP1) installed, MySQL 5.7 regularly restarts with the following message in the MySQL server error log file:

```
mysqld got exception 0xc000001d
```

This error message occurs because you are also using a CPU that does not support the VPSRLQ instruction, indicating that the CPU instruction that was attempted is not supported.

To fix this error, you *must* install SP1. This adds the required operating system support for CPU capability detection and disables that support when the CPU does not have the required instructions.

Alternatively, install an older version of MySQL, such as 5.6.

There are different methods to install MySQL on Microsoft Windows.

## MySQL Installer Method

The simplest and recommended method is to download MySQL Installer (for Windows) and let it install and configure all of the MySQL products on your system. Here is how:

1. Download MySQL Installer from <https://dev.mysql.com/downloads/installer/> and execute it.



### Note

Unlike the standard MySQL Installer, the smaller "web-community" version does not bundle any MySQL applications but rather downloads the MySQL products you choose to install.

2. Choose the appropriate **Setup Type** for your system. Typically you should choose **Developer Default** to install MySQL server and other MySQL tools related to MySQL development, helpful tools like MySQL Workbench. Choose the **Custom** setup type instead to manually select your desired MySQL products.



### Note

Multiple versions of MySQL server can exist on a single system. You can choose one or multiple versions.

3. Complete the installation process by following the instructions. This installs several MySQL products and starts the MySQL server.

MySQL is now installed. If you configured MySQL as a service, then Windows automatically starts MySQL server every time you restart your system.



### Note

You probably also installed other helpful MySQL products like MySQL Workbench on your system. Consider loading [Chapter 29, MySQL Workbench](#) to check your new MySQL server connection. By default, this program automatically starts after installing MySQL.

This process also installs the MySQL Installer application on your system, and later you can use MySQL Installer to upgrade or reconfigure your MySQL products.

## Additional Installation Information

It is possible to run MySQL as a standard application or as a Windows service. By using a service, you can monitor and control the operation of the server through the standard Windows service management tools. For more information, see [Section 2.3.4.8, "Starting MySQL as a Windows Service"](#).

Generally, you should install MySQL on Windows using an account that has administrator rights. Otherwise, you may encounter problems with certain operations such as editing the `PATH` environment variable or accessing the `Service Control Manager`. When installed, MySQL does not need to be executed using a user with Administrator privileges.

For a list of limitations on the use of MySQL on the Windows platform, see [Section 2.3.7, “Windows Platform Restrictions”](#).

In addition to the MySQL Server package, you may need or want additional components to use MySQL with your application or development environment. These include, but are not limited to:

- To connect to the MySQL server using ODBC, you must have a Connector/ODBC driver. For more information, including installation and configuration instructions, see [MySQL Connector/ODBC Developer Guide](#).



**Note**

MySQL Installer installs and configures Connector/ODBC for you.

- To use MySQL server with .NET applications, you must have the Connector/.NET driver. For more information, including installation and configuration instructions, see [MySQL Connector/.NET Developer Guide](#).



**Note**

MySQL Installer installs and configures MySQL Connector/.NET for you.

MySQL distributions for Windows can be downloaded from <https://dev.mysql.com/downloads/>. See [Section 2.1.3, “How to Get MySQL”](#).

MySQL for Windows is available in several distribution formats, detailed here. Generally speaking, you should use MySQL Installer. It contains more features and MySQL products than the older MSI, is simpler to use than the compressed file, and you need no additional tools to get MySQL up and running. MySQL Installer automatically installs MySQL Server and additional MySQL products, creates an options file, starts the server, and enables you to create default user accounts. For more information on choosing a package, see [Section 2.3.2, “Choosing an Installation Package”](#).

- A MySQL Installer distribution includes MySQL Server and additional MySQL products, including MySQL Workbench. MySQL Installer can also be used to upgrade these products in the future.

For instructions on installing MySQL using MySQL Installer, see [Section 2.3.3, “MySQL Installer for Windows”](#).

- The standard binary distribution (packaged as a compressed file) contains all of the necessary files that you unpack into your chosen location. This package contains all of the files in the full Windows MSI Installer package, but does not include an installation program.

For instructions on installing MySQL using the compressed file, see [Section 2.3.4, “Installing MySQL on Microsoft Windows Using a `noinstall` ZIP Archive”](#).

- The source distribution format contains all the code and support files for building the executables using the Visual Studio compiler system.

For instructions on building MySQL from source on Windows, see [Section 2.8, “Installing MySQL from Source”](#).

## MySQL on Windows Considerations

- **Large Table Support**

If you need tables with a size larger than 4 GB, install MySQL on an NTFS or newer file system. Do not forget to use `MAX_ROWS` and `AVG_ROW_LENGTH` when you create tables. See [Section 13.1.18, “CREATE TABLE Statement”](#).



**Note**

InnoDB tablespace files cannot exceed 4 GB on Windows 32-bit systems.

- **MySQL and Virus Checking Software**

Virus-scanning software such as Norton/Symantec Anti-Virus on directories containing MySQL data and temporary tables can cause issues, both in terms of the performance of MySQL and the virus-scanning software misidentifying the contents of the files as containing spam. This is due to the fingerprinting mechanism used by the virus-scanning software, and the way in which MySQL rapidly updates different files, which may be identified as a potential security risk.

After installing MySQL Server, it is recommended that you disable virus scanning on the main directory (`datadir`) used to store your MySQL table data. There is usually a system built into the virus-scanning software to enable specific directories to be ignored.

In addition, by default, MySQL creates temporary files in the standard Windows temporary directory. To prevent the temporary files also being scanned, configure a separate temporary directory for MySQL temporary files and add this directory to the virus scanning exclusion list. To do this, add a configuration option for the `tmpdir` parameter to your `my.ini` configuration file. For more information, see [Section 2.3.4.2, “Creating an Option File”](#).

- **Running MySQL on a 4K Sector Hard Drive**

Running the MySQL server on a 4K sector hard drive on Windows is not supported with `innodb_flush_method=async_unbuffered`, which is the default setting. The workaround is to use `innodb_flush_method=normal`.

### 2.3.1 MySQL Installation Layout on Microsoft Windows

For MySQL 5.7 on Windows, the default installation directory is `C:\Program Files\MySQL\MySQL Server 5.7` for installations performed with MySQL Installer. If you use the ZIP archive method to install MySQL, you may prefer to install in `C:\mysql`. However, the layout of the subdirectories remains the same.

All of the files are located within this parent directory, using the structure shown in the following table.

**Table 2.4 Default MySQL Installation Layout for Microsoft Windows**

Directory	Contents of Directory	Notes
<code>bin</code>	<code>mysqld</code> server, client and utility programs	
<code>%PROGRAMDATA%\MySQL\MySQL Server 5.7\</code>	Log files, databases	The Windows system variable <code>%PROGRAMDATA%</code> defaults to <code>C:\ProgramData</code> .

Directory	Contents of Directory	Notes
<code>docs</code>	Release documentation	With MySQL Installer, use the <a href="#">Modify</a> operation to select this optional folder.
<code>include</code>	Include (header) files	
<code>lib</code>	Libraries	
<code>share</code>	Miscellaneous support files, including error messages, character set files, sample configuration files, SQL for database installation	

## 2.3.2 Choosing an Installation Package

For MySQL 5.7, there are multiple installation package formats to choose from when installing MySQL on Windows. The package formats described in this section are:

- [MySQL Installer](#)
- [MySQL noinstall ZIP Archives](#)
- [MySQL Docker Images](#)

Program Database (PDB) files (with file name extension `pdb`) provide information for debugging your MySQL installation in the event of a problem. These files are included in ZIP Archive distributions (but not MSI distributions) of MySQL.

### MySQL Installer

This package has a file name similar to `mysql-installer-community-5.7.44.0.msi` or `mysql-installer-commercial-5.7.44.0.msi`, and uses MSIs to automatically install MySQL server and other products. MySQL Installer downloads and apply updates to itself, and for each of the installed products. It also configures the installed MySQL server (including a sandbox InnoDB cluster test setup) and MySQL Router. MySQL Installer is recommended for most users.

MySQL Installer can install and manage (add, modify, upgrade, and remove) many other MySQL products, including:

- Applications – MySQL Workbench, MySQL for Visual Studio, MySQL Utilities, MySQL Shell, MySQL Router
- Connectors – MySQL Connector/C++, MySQL Connector/NET, Connector/ODBC, MySQL Connector/Python, MySQL Connector/J, MySQL Connector/Node.js
- Documentation – MySQL Manual (PDF format), samples and examples

MySQL Installer operates on all MySQL supported versions of Windows (see <https://www.mysql.com/support/supportedplatforms/database.html>).



#### Note

Because MySQL Installer is not a native component of Microsoft Windows and depends on .NET, it does not work on installations with minimal options like the Server Core version of Windows Server.

For instructions on how to install MySQL using MySQL Installer, see [Section 2.3.3, “MySQL Installer for Windows”](#).

## MySQL noinstall ZIP Archives

These packages contain the files found in the complete MySQL Server installation package, with the exception of the GUI. This format does not include an automated installer, and must be manually installed and configured.

The `noinstall` ZIP archives are split into two separate compressed files. The main package is named `mysql-VERSION-winx64.zip` for 64-bit and `mysql-VERSION-win32.zip` for 32-bit. This contains the components needed to use MySQL on your system. The optional MySQL test suite, MySQL benchmark suite, and debugging binaries/information components (including PDB files) are in a separate compressed file named `mysql-VERSION-winx64-debug-test.zip` for 64-bit and `mysql-VERSION-win32-debug-test.zip` for 32-bit.

If you choose to install a `noinstall` ZIP archive, see [Section 2.3.4, “Installing MySQL on Microsoft Windows Using a noinstall ZIP Archive”](#).

## MySQL Docker Images

For information on using the MySQL Docker images provided by Oracle on Windows platform, see [Section 2.5.7.3, “Deploying MySQL on Windows and Other Non-Linux Platforms with Docker”](#).



### Warning

The MySQL Docker images provided by Oracle are built specifically for Linux platforms. Other platforms are not supported, and users running the MySQL Docker images from Oracle on them are doing so at their own risk.

## 2.3.3 MySQL Installer for Windows

MySQL Installer is a standalone application designed to ease the complexity of installing and configuring MySQL products that run on Microsoft Windows. It is downloaded with and supports the following MySQL products:

- MySQL Servers

MySQL Installer can install and manage multiple, separate MySQL server instances on the same host at the same time. For example, MySQL Installer can install, configure, and upgrade separate instances of MySQL 5.7 and MySQL 8.0 on the same host. MySQL Installer does not permit server upgrades between major and minor version numbers, but does permit upgrades within a release series (such as 8.0.36 to 8.0.37).



### Note

MySQL Installer cannot install both *Community* and *Commercial* releases of MySQL server on the same host. If you require both releases on the same host, consider using the [ZIP archive](#) distribution to install one of the releases.

- MySQL Applications

MySQL Workbench, MySQL Shell, and MySQL Router.

- MySQL Connectors

These are not supported, instead install from <https://dev.mysql.com/downloads/>. These connectors include MySQL Connector/NET, MySQL Connector/Python, MySQL Connector/ODBC, MySQL Connector/J, MySQL Connector/Node.js, and MySQL Connector/C++.

**Note**

The connectors were bundled before MySQL Installer 1.6.7 (MySQL Server 8.0.34), and MySQL Installer could install each connector up to version 8.0.33 until MySQL Installer 1.6.11 (MySQL Server 8.0.37). MySQL Installer now only detects these old connector versions to uninstall them.

## Installation Requirements

MySQL Installer requires Microsoft .NET Framework 4.5.2 or later. If this version is not installed on the host computer, you can download it by visiting the [Microsoft website](#).

To invoke MySQL Installer after a successful installation:

1. Right-click Windows Start, select **Run**, and then click **Browse**. Navigate to `Program Files (x86) > MySQL > MySQL Installer for Windows` to open the program folder.
2. Select one of the following files:
  - `MySQLInstaller.exe` to open the graphical application.
  - `MySQLInstallerConsole.exe` to open the command-line application.
3. Click **Open** and then click **OK** in the Run window. If you are prompted to allow the application to make changes to the device, select **Yes**.

Each time you invoke MySQL Installer, the initialization process looks for the presence of an internet connection and prompts you to enable offline mode if it finds no internet access (and offline mode is disabled). Select **Yes** to run MySQL Installer without internet-connection capabilities. MySQL product availability is limited to only those products currently in the product cache when you enable offline mode. To download MySQL products, click the offline mode **Disable** quick action shown on the dashboard.

An internet connection is required to download a manifest containing metadata for the latest MySQL products that are not part of a full bundle. MySQL Installer attempts to download the manifest when you start the application for the first time and then periodically in configurable intervals (see [MySQL Installer options](#)). Alternatively, you can retrieve an updated manifest manually by clicking **Catalog** in the [MySQL Installer dashboard](#).

**Note**

If the first-time or subsequent manifest download is unsuccessful, an error is logged and you may have limited access to MySQL products during your session. MySQL Installer attempts to download the manifest with each startup until the initial manifest structure is updated. For help finding a product, see [Locating Products to Install](#).

## MySQL Installer Community Release

Download software from <https://dev.mysql.com/downloads/installer/> to install the Community release of all MySQL products for Windows. Select one of the following MySQL Installer package options:

- *Web*: Contains MySQL Installer and configuration files only. The web package option downloads only the MySQL products you select to install, but it requires an internet connection for each download.



The size of this file is approximately 2 MB. The file name has the form `mysql-installer-community-web-VERSION.N.msi` in which `VERSION` is the MySQL server version number such as 8.0 and `N` is the package number, which begins at 0.

- *Full or Current Bundle*: Bundles all of the MySQL products for Windows (including the MySQL server). The file size is over 300 MB, and the name has the form `mysql-installer-community-VERSION.N.msi` in which `VERSION` is the MySQL Server version number such as 8.0 and `N` is the package number, which begins at 0.

## MySQL Installer Commercial Release

Download software from <https://edelivery.oracle.com/> to install the Commercial release (Standard or Enterprise Edition) of MySQL products for Windows. If you are logged in to your My Oracle Support (MOS) account, the Commercial release includes all of the current and previous GA versions available in the Community release, but it excludes development-milestone versions. When you are not logged in, you see only the list of bundled products that you downloaded already.

The Commercial release also includes the following products:

- Workbench SE/EE
- MySQL Enterprise Backup
- MySQL Enterprise Firewall

The Commercial release integrates with your MOS account. For knowledge-base content and patches, see [My Oracle Support](#).

### 2.3.3.1 MySQL Installer Initial Setup

- [Choosing a Setup Type](#)
- [Path Conflicts](#)
- [Check Requirements](#)
- [MySQL Installer Configuration Files](#)

When you download MySQL Installer for the first time, a setup wizard guides you through the initial installation of MySQL products. As the following figure shows, the initial setup is a one-time activity in the overall process. MySQL Installer detects existing MySQL products installed on the host during its initial setup and adds them to the list of products to be managed.

**Figure 2.7 MySQL Installer Process Overview**

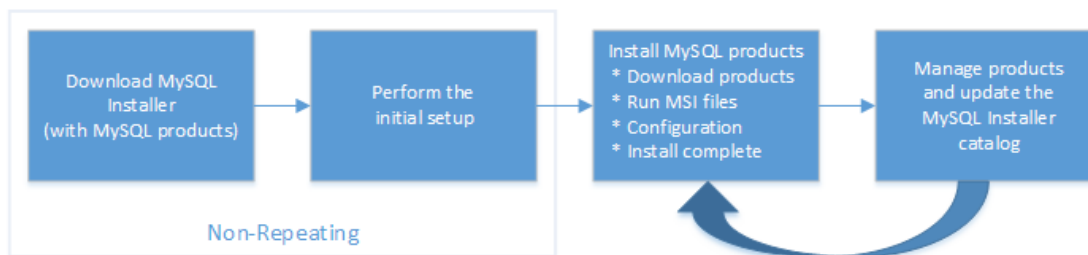

MySQL Installer extracts configuration files (described later) to the hard drive of the host during the initial setup. Although MySQL Installer is a 32-bit application, it can install both 32-bit and 64-bit binaries.

The initial setup adds a link to the Start menu under the **MySQL** folder group. Click **Start, MySQL**, and **MySQL Installer - [Community | Commercial]** to open the community or commercial release of the graphical tool.

## Choosing a Setup Type

During the initial setup, you are prompted to select the MySQL products to be installed on the host. One alternative is to use a predetermined setup type that matches your setup requirements. By default, both GA and pre-release products are included in the download and installation with the **Client only** and **Full** setup types. Select the **Only install GA products** option to restrict the product set to include GA products only when using these setup types.



### Note

Commercial-only MySQL products, such as MySQL Enterprise Backup, are available to select and install if you are using the Commercial version of MySQL Installer (see [MySQL Installer Commercial Release](#)).

Choosing one of the following setup types determines the initial installation only and does not limit your ability to install or update MySQL products for Windows later:

- **Server only:** Only install the MySQL server. This setup type installs the general availability (GA) or development release server that you selected when you downloaded MySQL Installer. It uses the default installation and data paths.
- **Client only:** Only install the most recent MySQL applications (such as MySQL Shell, MySQL Router, and MySQL Workbench). This setup type excludes MySQL server or the client programs typically bundled with the server, such as `mysql` or `mysqladmin`.
- **Full:** Install all available MySQL products, excluding MySQL connectors.
- **Custom:** The custom setup type enables you to filter and select individual MySQL products from the [MySQL Installer catalog](#).

Use the [Custom](#) setup type to install:

- A product or product version that is not available from the usual download locations. The catalog contains all product releases, including the other releases between pre-release (or development) and GA.
- An instance of MySQL server using an alternative installation path, data path, or both. For instructions on how to adjust the paths, see [Section 2.3.3.2, "Setting Alternative Server Paths with MySQL Installer"](#).
- Two or more MySQL server versions on the same host at the same time (for example, 5.7 and 8.0).
- A specific combination of products and features not offered as a predetermine setup type. For example, you can install a single product, such as MySQL Workbench, instead of installing all client applications for Windows.

## Path Conflicts

When the default installation or data folder (required by MySQL server) for a product to be installed already exists on the host, the wizard displays the **Path Conflict** step to identify each conflict and enable you to take action to avoid having files in the existing folder overwritten by the new installation. You see this step in the initial setup only when MySQL Installer detects a conflict.

To resolve the path conflict, do one of the following:

- Select a product from the list to display the conflict options. A warning symbol indicates which path is in conflict. Use the browse button to choose a new path and then click **Next**.
- Click **Back** to choose a different setup type or product version, if applicable. The **Custom** setup type enables you to select individual product versions.
- Click **Next** to ignore the conflict and overwrite files in the existing folder.
- Delete the existing product. Click **Cancel** to stop the initial setup and close MySQL Installer. Open MySQL Installer again from the Start menu and delete the installed product from the host using the Delete operation from the [MySQL Installer dashboard](#).

## Check Requirements

MySQL Installer uses entries in the `package-rules.xml` file to determine whether the prerequisite software for each product is installed on the host. When the requirements check fails, MySQL Installer displays the **Check Requirements** step to help you update the host. Requirements are evaluated each time you download a new product (or version) for installation. The following figure identifies and describes the key areas of this step.

**Figure 2.8 Check Requirements**

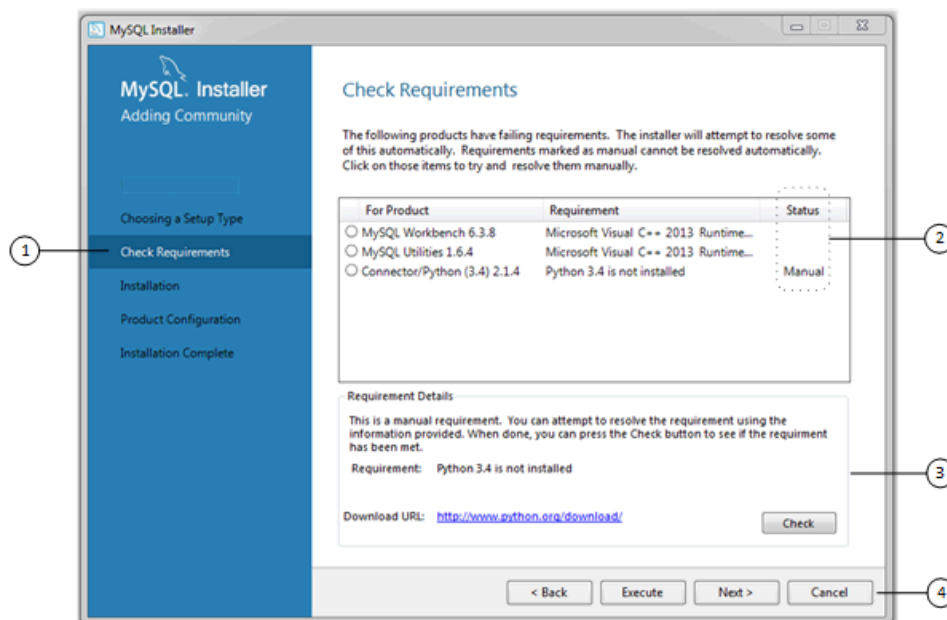

### Description of Check Requirements Elements

1. Shows the current step in the initial setup. Steps in this list may change slightly depending on the products already installed on the host, the availability of prerequisite software, and the products to be installed on the host.
2. Lists all pending installation requirements by product and indicates the status as follows:
  - A blank space in the **Status** column means that MySQL Installer can attempt to download and install the required software for you.
  - The word *Manual* in the **Status** column means that you must satisfy the requirement manually. Select each product in the list to see its requirement details.

3. Describes the requirement in detail to assist you with each manual resolution. When possible, a download URL is provided. After you download and install the required software, click **Check** to verify that the requirement has been met.
4. Provides the following set operations to proceed:
  - **Back** – Return to the previous step. This action enables you to select a different the setup type.
  - **Execute** – Have MySQL Installer attempt to download and install the required software for all items without a manual status. Manual requirements are resolved by you and verified by clicking **Check**.
  - **Next** – Do not execute the request to apply the requirements automatically and proceed to the installation without including the products that fail the check requirements step.
  - **Cancel** – Stop the installation of MySQL products. Because MySQL Installer is already installed, the initial setup begins again when you open MySQL Installer from the Start menu and click **Add** from the dashboard. For a description of the available management operations, see [Product Catalog](#).

## MySQL Installer Configuration Files

All MySQL Installer files are located within the `C:\Program Files (x86)` and `C:\ProgramData` folders. The following table describes the files and folders that define MySQL Installer as a standalone application.



### Note

Installed MySQL products are neither altered nor removed when you update or uninstall MySQL Installer.

**Table 2.5 MySQL Installer Configuration Files**

File or Folder	Description	Folder Hierarchy
<code>MySQL Installer for Windows</code>	This folder contains all of the files needed to run MySQL Installer and <code>MySQLInstallerConsole.exe</code> , a command-line program with similar functionality.	<code>C:\Program Files (x86)</code>
<code>Templates</code>	The <code>Templates</code> folder has one file for each version of MySQL server. Template files contain keys and formulas to calculate some values dynamically.	<code>C:\ProgramData\MySQL\MySQL Installer for Windows\Manifest</code>
<code>package-rules.xml</code>	This file contains the prerequisites for every product to be installed.	<code>C:\ProgramData\MySQL\MySQL Installer for Windows\Manifest</code>
<code>products.xml</code>	The <code>products</code> file (or product catalog) contains a list of all products available for download.	<code>C:\ProgramData\MySQL\MySQL Installer for Windows\Manifest</code>
<code>Product Cache</code>	The <code>Product Cache</code> folder contains all standalone <code>.msi</code> files bundled with the full package or downloaded afterward.	<code>C:\ProgramData\MySQL\MySQL Installer for Windows</code>

### 2.3.3.2 Setting Alternative Server Paths with MySQL Installer

You can change the default installation path, the data path, or both when you install MySQL server. After you have installed the server, the paths cannot be altered without removing and reinstalling the server instance.



#### Note

Starting with MySQL Installer 1.4.39, if you move the data directory of an installed server manually, MySQL Installer identifies the change and can process a reconfiguration operation without errors.

#### To change paths for MySQL server

1. Identify the MySQL server to change and enable the **Advanced Options** link as follows:
  - a. Navigate to the **Select Products** page by doing one of the following:
    - i. If this is an [initial setup](#) of MySQL Installer, select the [Custom](#) setup type and click **Next**.
    - ii. If MySQL Installer is installed on your computer, click **Add** from the dashboard.
  - b. Click **Edit** to apply a filter on the product list shown in **Available Products** (see [Locating Products to Install](#)).
  - c. With the server instance selected, use the arrow to move the selected server to the **Products To Be Installed** list.
  - d. Click the server to select it. When you select the server, the **Advanced Options** link is enabled below the list of products to be installed (see the following figure).
2. Click **Advanced Options** to open a dialog box where you can enter alternative path names. After the path names are validated, click **Next** to continue with the configuration steps.

**Figure 2.9** Change MySQL Server Path

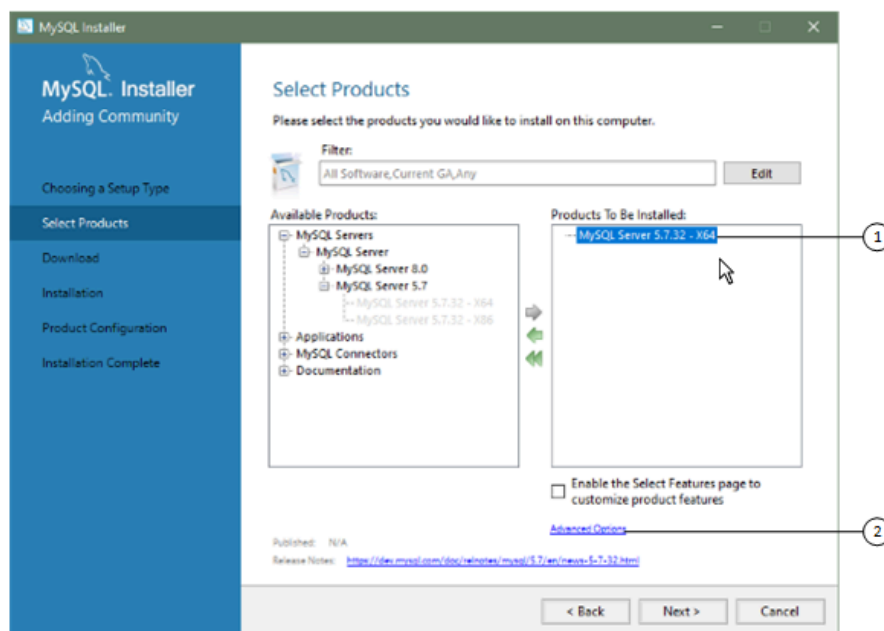

### 2.3.3.3 Installation Workflows with MySQL Installer

MySQL Installer provides a wizard-like tool to install and configure new MySQL products for Windows. Unlike the initial setup, which runs only once, MySQL Installer invokes the wizard each time you download or install a new product. For first-time installations, the steps of the initial setup proceed directly into the steps of the installation. For assistance with product selection, see [Locating Products to Install](#).



#### Note

Full permissions are granted to the user executing MySQL Installer to all generated files, such as `my.ini`. This does not apply to files and directories for specific products, such as the MySQL server data directory in `%ProgramData%` that is owned by `SYSTEM`.

Products installed and configured on a host follow a general pattern that might require your input during the various steps. If you attempt to install a product that is incompatible with the existing MySQL server version (or a version selected for upgrade), you are alerted about the possible mismatch.

MySQL Installer provides the following sequence of actions that apply to different workflows:

- **Select Products.** If you selected the [Custom](#) setup type during the initial setup or clicked **Add** from the [MySQL Installer dashboard](#), MySQL Installer includes this action in the sidebar. From this page, you can apply a filter to modify the Available Products list and then select one or more products to move (using arrow keys) to the Products To Be Installed list.

Select the check box on this page to activate the Select Features action where you can customize the products features after the product is downloaded.

- **Download.** If you installed the full (not web) MySQL Installer package, all `.msi` files were loaded to the [Product Cache](#) folder during the initial setup and are not downloaded again. Otherwise, click **Execute** to begin the download. The status of each product changes from [Ready to Download](#), to [Downloading](#), and then to [Downloaded](#).

To retry a single unsuccessful download, click the **Try Again** link.

To retry all unsuccessful downloads, click **Try All**.

- **Select Features To Install (disabled by default).** After MySQL Installer downloads a product's `.msi` file, you can customize the features if you enabled the optional check box previously during the Select Products action.

To customize product features after the installation, click **Modify** in the [MySQL Installer dashboard](#).

- **Installation.** The status of each product in the list changes from [Ready to Install](#), to [Installing](#), and lastly to [Complete](#). During the process, click **Show Details** to view the installation actions.

If you cancel the installation at this point, the products are installed, but the server (if installed) is not yet configured. To restart the server configuration, open MySQL Installer from the Start menu and click **Reconfigure** next to the appropriate server in the dashboard.

- **Product configuration.** This step applies to MySQL Server, MySQL Router, and samples only. The status for each item in the list should indicate [Ready to Configure](#). Click **Next** to start the configuration wizard for all items in the list. The configuration options presented during this step are specific to the version of database or router that you selected to install.

Click **Execute** to begin applying the configuration options or click **Back** (repeatedly) to return to each configuration page.

- **Installation complete.** This step finalizes the installation for products that do not require configuration. It enables you to copy the log to a clipboard and to start certain applications, such as MySQL Workbench and MySQL Shell. Click **Finish** to open the [MySQL Installer dashboard](#).

### MySQL Server Configuration with MySQL Installer

MySQL Installer performs the initial configuration of the MySQL server. For example:

- It creates the configuration file (`my.ini`) that is used to configure the MySQL server. The values written to this file are influenced by choices you make during the installation process. Some definitions are host dependent.
- By default, a Windows service for the MySQL server is added.
- Provides default installation and data paths for MySQL server. For instructions on how to change the default paths, see [Section 2.3.3.2, “Setting Alternative Server Paths with MySQL Installer”](#).
- It can optionally create MySQL server user accounts with configurable permissions based on general roles, such as DB Administrator, DB Designer, and Backup Admin. It optionally creates a Windows user named `MysqLsYs` with limited privileges, which would then run the MySQL Server.

User accounts may also be added and configured in MySQL Workbench.

- Checking **Show Advanced Options** enables additional **Logging Options** to be set. This includes defining custom file paths for the error log, general log, slow query log (including the configuration of seconds it requires to execute a query), and the binary log.

During the configuration process, click **Next** to proceed to the next step or **Back** to return to the previous step. Click **Execute** at the final step to apply the server configuration.

The sections that follow describe the server configuration options that apply to MySQL server on Windows. The server version you installed will determine which steps and options you can configure. Configuring MySQL server may include some or all of the steps.

### Type and Networking

- Server Configuration Type

Choose the MySQL server configuration type that describes your setup. This setting defines the amount of system resources (memory) to assign to your MySQL server instance.

- **Development:** A computer that hosts many other applications, and typically this is your personal workstation. This setting configures MySQL to use the least amount of memory.
- **Server:** Several other applications are expected to run on this computer, such as a web server. The Server setting configures MySQL to use a medium amount of memory.
- **Dedicated:** A computer that is dedicated to running the MySQL server. Because no other major applications run on this server, this setting configures MySQL to use the majority of available memory.
- **Manual**

Prevents MySQL Installer from attempting to optimize the server installation, and instead, sets the default values to the server variables included in the `my.ini` configuration file. With the [Manual](#)

type selected, MySQL Installer uses the default value of 16M for the `tmp_table_size` variable assignment.

- Connectivity

Connectivity options control how the connection to MySQL is made. Options include:

- **TCP/IP:** This option is selected by default. You may disable TCP/IP Networking to permit local host connections only. With the TCP/IP connection option selected, you can modify the following items:
  - **Port** for classic MySQL protocol connections. The default value is `3306`.
  - **X Protocol Port** shown when configuring MySQL 8.0 server only. The default value is `33060`
  - **Open Windows Firewall port for network access**, which is selected by default for TCP/IP connections.

If a port number is in use already, you will see the information icon (  ) next to the default value and **Next** is disabled until you provide a new port number.

- **Named Pipe:** Enable and define the pipe name, similar to setting the `named_pipe` system variable. The default name is `MySQL`.

When you select **Named Pipe** connectivity, and then proceed to the next step, you are prompted to set the level of access control granted to client software on named-pipe connections. Some clients require only minimum access control for communication, while other clients require full access to the named pipe.

You can set the level of access control based on the Windows user (or users) running the client as follows:

- **Minimum access to all users (RECOMMENDED).** This level is enabled by default because it is the most secure.
  - **Full access to members of a local group.** If the minimum-access option is too restrictive for the client software, use this option to reduce the number of users who have full access on the named pipe. The group must be established on Windows before you can select it from the list. Membership in this group should be limited and managed. Windows requires a newly added member to first log out and then log in again to join a local group.
  - **Full access to all users (NOT RECOMMENDED).** This option is less secure and should be set only when other safeguards are implemented.
  - **Shared Memory:** Enable and define the memory name, similar to setting the `shared_memory` system variable. The default name is `MySQL`.
- Advanced Configuration

Check **Show Advanced and Logging Options** to set custom logging and advanced options in later steps. The Logging Options step enables you to define custom file paths for the error log, general log, slow query log (including the configuration of seconds it requires to execute a query), and the binary log. The Advanced Options step enables you to set the unique server ID required when binary logging is enabled in a replication topology.



- MySQL Enterprise Firewall (Enterprise Edition only)

The **Enable MySQL Enterprise Firewall** check box is deselected by default. Select this option to enable a security list that offers protection against certain types of attacks. Additional post-installation configuration is required (see [Section 6.4.6, “MySQL Enterprise Firewall”](#)).

## Authentication Method

The **Authentication Method** step is visible only during the installation or upgrade of MySQL 8.0.4 or higher. It introduces a choice between two server-side authentication options. The MySQL user accounts that you create in the next step will use the authentication method that you select in this step.

MySQL 8.0 connectors and community drivers that use `libmysqlclient` 8.0 now support the `caching_sha2_password` default authentication plugin. However, if you are unable to update your clients and applications to support this new authentication method, you can configure the MySQL server to use `mysql_native_password` for legacy authentication. For more information about the implications of this change, see [caching\\_sha2\\_password as the Preferred Authentication Plugin](#).

If you are installing or upgrading to MySQL 8.0.4 or higher, select one of the following authentication methods:

- Use Strong Password Encryption for Authentication (RECOMMENDED)

MySQL 8.0 supports a new authentication based on improved, stronger SHA256-based password methods. It is recommended that all new MySQL server installations use this method going forward.



### Important

The `caching_sha2_password` authentication plugin on the server requires new versions of connectors and clients, which add support for the new MySQL 8.0 default authentication.

- Use Legacy Authentication Method (Retain MySQL 5.x Compatibility)

Using the old MySQL 5.x legacy authentication method should be considered only in the following cases:

- Applications cannot be updated to use MySQL 8.0 connectors and drivers.
- Recompilation of an existing application is not feasible.
- An updated, language-specific connector or driver is not available yet.

## Accounts and Roles

- Root Account Password

Assigning a root password is required and you will be asked for it when performing other MySQL Installer operations. Password strength is evaluated when you repeat the password in the box provided. For descriptive information regarding password requirements or status, move your mouse pointer over

the information icon (  ) when it appears.

- MySQL User Accounts (Optional)

Click **Add User** or **Edit User** to create or modify MySQL user accounts with predefined roles. Next, enter the required account credentials:

- **User Name:** MySQL user names can be up to 32 characters long.

- **Host:** Select `localhost` for local connections only or `<All Hosts (%)>` when remote connections to the server are required.
- **Role:** Each predefined role, such as `DB Admin`, is configured with its own set of privileges. For example, the `DB Admin` role has more privileges than the `DB Designer` role. The **Role** drop-down list contains a description of each role.
- **Password:** Password strength assessment is performed while you type the password. Passwords must be confirmed. MySQL permits a blank or empty password (considered to be insecure).

**MySQL Installer Commercial Release Only:** MySQL Enterprise Edition for Windows, a commercial product, also supports an authentication method that performs external authentication on Windows. Accounts authenticated by the Windows operating system can access the MySQL server without providing an additional password.

To create a new MySQL account that uses Windows authentication, enter the user name and then select a value for **Host** and **Role**. Click **Windows** authentication to enable the `authentication_windows` plugin. In the Windows Security Tokens area, enter a token for each Windows user (or group) who can authenticate with the MySQL user name. MySQL accounts can include security tokens for both local Windows users and Windows users that belong to a domain. Multiple security tokens are separated by the semicolon character (`;`) and use the following format for local and domain accounts:

- Local account

Enter the simple Windows user name as the security token for each local user or group; for example, `finley;jeffrey;admin`.

- Domain account

Use standard Windows syntax (`domain\domainuser`) or MySQL syntax (`domain\domainuser`) to enter Windows domain users and groups.

For domain accounts, you may need to use the credentials of an administrator within the domain if the account running MySQL Installer lacks the permissions to query the Active Directory. If this is the case, select **Validate Active Directory users with** to activate the domain administrator credentials.

Windows authentication permits you to test all of the security tokens each time you add or modify a token. Click **Test Security Tokens** to validate (or revalidate) each token. Invalid tokens generate a descriptive error message along with a red `x` icon and red token text. When all tokens resolve as valid (green text without an `x` icon), you can click **OK** to save the changes.

### Windows Service

On the Windows platform, MySQL server can run as a named service managed by the operating system and be configured to start up automatically when Windows starts. Alternatively, you can configure MySQL server to run as an executable program that requires manual configuration.

- **Configure MySQL server as a Windows service** (Selected by default.)

When the default configuration option is selected, you can also select the following:

- **Start the MySQL Server at System Startup**

When selected (default), the service startup type is set to Automatic; otherwise, the startup type is set to Manual.

- **Run Windows Service as**

When **Standard System Account** is selected (default), the service logs on as Network Service.

The **Custom User** option must have privileges to log on to Microsoft Windows as a service. The **Next** button will be disabled until this user is configured with the required privileges.

A custom user account is configured in Windows by searching for "local security policy" in the Start menu. In the Local Security Policy window, select **Local Policies, User Rights Assignment**, and then **Log On As A Service** to open the property dialog. Click **Add User or Group** to add the custom user and then click **OK** in each dialog to save the changes.

- Deselect the Windows Service option.

### Server File Permissions

Optionally, permissions set on the folders and files located at `C:\ProgramData\MySQL\MySQL Server 8.0\Data` can be managed during the server configuration operation. You have the following options:

- MySQL Installer can configure the folders and files with full control granted exclusively to the user running the Windows service, if applicable, and to the Administrators group.

All other groups and users are denied access. This is the default option.

- Have MySQL Installer use a configuration option similar to the one just described, but also have MySQL Installer show which users could have full control.

You are then able to decide if a group or user should be given full control. If not, you can move the qualified members from this list to a second list that restricts all access.

- Have MySQL Installer skip making file-permission changes during the configuration operation.

If you select this option, you are responsible for securing the `Data` folder and its related files manually after the server configuration finishes.

### Logging Options

This step is available if the **Show Advanced Configuration** check box was selected during the **Type and Networking** step. To enable this step now, click **Back** to return to the **Type and Networking** step and select the check box.

Advanced configuration options are related to the following MySQL log files:

- [Error Log](#)
- [General Log](#)
- [Slow Query Log](#)
- [Bin Log](#)



#### Note

The binary log is enabled by default.

## Advanced Options

This step is available if the **Show Advanced Configuration** check box was selected during the **Type and Networking** step. To enable this step now, click **Back** to return to the **Type and Networking** step and select the check box.

The advanced-configuration options include:

- **Server ID**

Set the unique identifier used in a replication topology. If binary logging is enabled, you must specify a server ID. The default ID value depends on the server version. For more information, see the description of the `server_id` system variable.

- **Table Names Case**

You can set the following options during the initial and subsequent configuration the server. For the MySQL 8.0 release series, these options apply only to the initial configuration of the server.

- Lower Case

Sets the `lower_case_table_names` option value to 1 (default), in which table names are stored in lowercase on disk and comparisons are not case-sensitive.

- Preserve Given Case

Sets the `lower_case_table_names` option value to 2, in which table names are stored as given but compared in lowercase.

## Apply Server Configuration

All configuration settings are applied to the MySQL server when you click **Execute**. Use the **Configuration Steps** tab to follow the progress of each action; the icon for each toggles from white to green (with a check mark) on success. Otherwise, the process stops and displays an error message if an individual action times out. Click the **Log** tab to view the log.

When the installation completes successfully and you click **Finish**, MySQL Installer and the installed MySQL products are added to the Microsoft Windows Start menu under the `MySQL` group. Opening MySQL Installer loads the `dashboard` where installed MySQL products are listed and other MySQL Installer operations are available.

## MySQL Router Configuration with MySQL Installer

During the `initial setup`, choose any predetermined setup type, except `Server only`, to install the latest GA version of the tools. Use the `Custom` setup type to install an individual tool or specific version. If MySQL Installer is installed on the host already, use the **Add** operation to select and install tools from the MySQL Installer dashboard.

## MySQL Router Configuration

MySQL Installer provides a configuration wizard that can bootstrap an installed instance of MySQL Router 8.0 to direct traffic between MySQL applications and an InnoDB Cluster. When configured, MySQL Router runs as a local Windows service.



### Note

You are prompted to configure MySQL Router after the initial installation and when you reconfigure an installed router explicitly. In contrast, the upgrade operation does not require or prompt you to configure the upgraded product.

To configure MySQL Router, do the following:

1. Set up InnoDB Cluster.
2. Using MySQL Installer, download and install the MySQL Router application. After the installation finishes, the configuration wizard prompts you for information. Select the **Configure MySQL Router for InnoDB Cluster** check box to begin the configuration and provide the following configuration values:
  - **Hostname:** Host name of the primary (seed) server in the InnoDB Cluster (`localhost` by default).
  - **Port:** The port number of the primary (seed) server in the InnoDB Cluster (`3306` by default).
  - **Management User:** An administrative user with root-level privileges.
  - **Password:** The password for the management user.
  - **Classic MySQL protocol connections to InnoDB Cluster**

**Read/Write:** Set the first base port number to one that is unused (between 80 and 65532) and the wizard will select the remaining ports for you.

The figure that follows shows an example of the MySQL Router configuration page, with the first base port number specified as 6446 and the remaining ports set by the wizard to 6447, 6448, and 6449.

**Figure 2.10 MySQL Router Configuration**

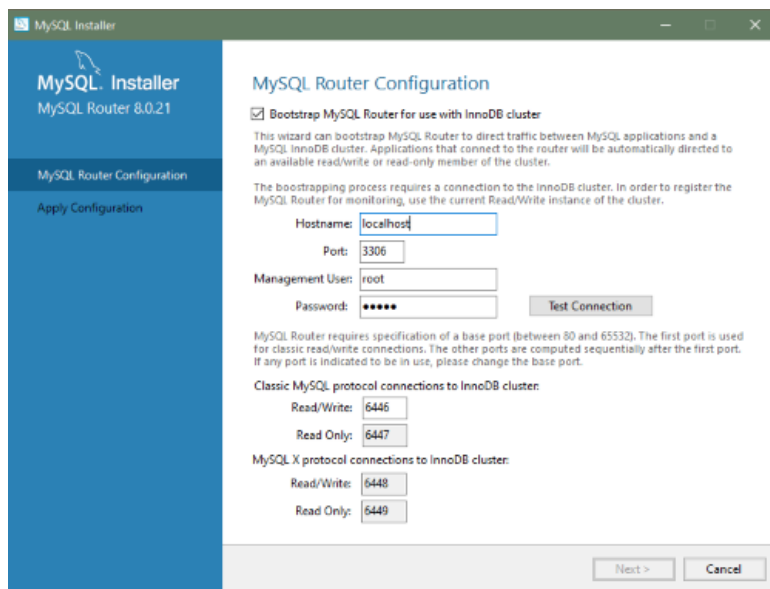

3. Click **Next** and then **Execute** to apply the configuration. Click **Finish** to close MySQL Installer or return to the [MySQL Installer dashboard](#).

After configuring MySQL Router, the root account exists in the user table as `root@localhost` (local) only, instead of `root@%` (remote). Regardless of where the router and client are located, even if both are located on the same host as the seed server, any connection that passes through the router is viewed by server as being remote, not local. As a result, a connection made to the server using the local host (see the example that follows), does not authenticate.

```
$> \c root@localhost:6446
```

### 2.3.3.4 MySQL Installer Product Catalog and Dashboard

This section describes the MySQL Installer product catalog, the dashboard, and other actions related to product selection and upgrades.

- [Product Catalog](#)
- [MySQL Installer Dashboard](#)
- [Locating Products to Install](#)
- [Upgrading MySQL Server](#)
- [Removing MySQL Server](#)
- [Upgrading MySQL Installer](#)

#### Product Catalog

The product catalog stores the complete list of released MySQL products for Microsoft Windows that are available to download from [MySQL Downloads](#). By default, and when an Internet connection is present, MySQL Installer attempts to update the catalog at startup every seven days. You can also update the catalog manually from the dashboard (described later).

An up-to-date catalog performs the following actions:

- Populates the **Available Products** pane of the Select Products page. This step appears when you select:
  - The **Custom** setup type during the **initial setup**.
  - The **Add** operation from the dashboard.
- Identifies when product updates are available for the installed products listed in the dashboard.

The catalog includes all development releases (Pre-Release), general releases (Current GA), and minor releases (Other Releases). Products in the catalog will vary somewhat, depending on the MySQL Installer release that you download.

#### MySQL Installer Dashboard

The MySQL Installer dashboard is the default view that you see when you start MySQL Installer after the **initial setup** finishes. If you closed MySQL Installer before the setup was finished, MySQL Installer resumes the initial setup before it displays the dashboard.



#### Note

Products covered under Oracle Lifetime Sustaining Support, if installed, may appear in the dashboard. These products, such as MySQL for Excel and MySQL Notifier, can be modified or removed only.

Figure 2.11 MySQL Installer Dashboard Elements

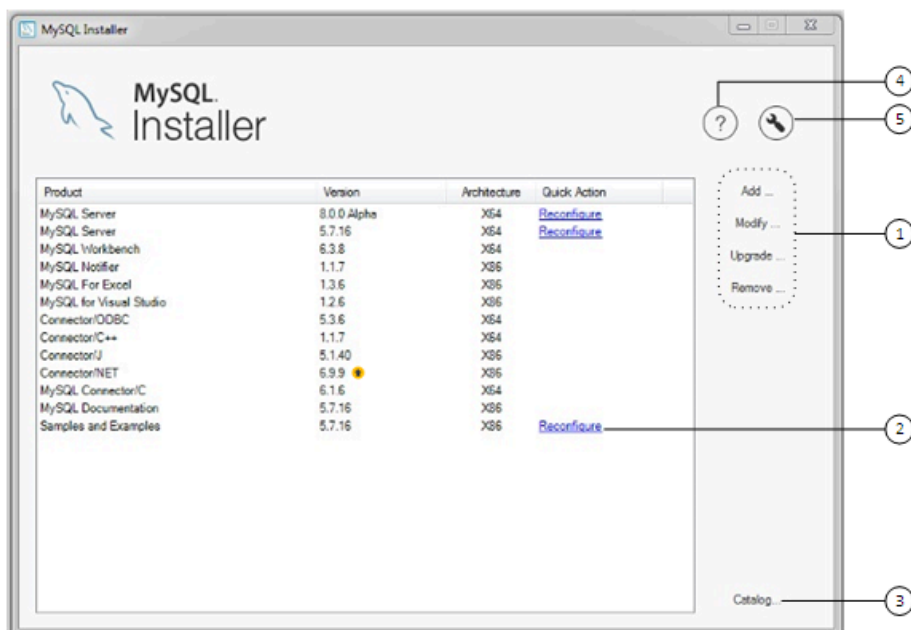

### Description of MySQL Installer Dashboard Elements

- MySQL Installer dashboard operations provide a variety of actions that apply to installed products or products listed in the catalog. To initiate the following operations, first click the operation link and then select the product or products to manage:
  - Add:** This operation opens the Select Products page. From there you can adjust the filter, select one or more products to download (as needed), and begin the installation. For hints about using the filter, see [Locating Products to Install](#).
 

Use the directional arrows to move each product from the **Available Products** column to the **Products To Be Installed** column. To enable the Product Features page where you can customize features, click the related check box (disabled by default).
  - Modify:** Use this operation to add or remove the features associated with installed products. Features that you can modify vary in complexity by product. When the **Program Shortcut** check box is selected, the product appears in the Start menu under the [MySQL](#) group.
  - Upgrade:** This operation loads the Select Products to Upgrade page and populates it with all the upgrade candidates. An installed product can have more than one upgrade version and the operation requires a current product catalog. MySQL Installer upgrades all of the selected products in one action. Click **Show Details** to view the actions performed by MySQL Installer.
  - Remove:** This operation opens the Remove Products page and populates it with the MySQL products installed on the host. Select the MySQL products you want to remove (uninstall) and then click **Execute** to begin the removal process. During the operation, an indicator shows the number of steps that are executed as a percentage of all steps.

To select products to remove, do one of the following:

- Select the check box for one or more products.
- Select the **Product** check box to select all products.

2. The **Reconfigure** link in the Quick Action column next to each installed server loads the current configuration values for the server and then cycles through all configuration steps enabling you to change the options and values. You must provide credentials with root privileges to reconfigure these items. Click the **Log** tab to show the output of each configuration step performed by MySQL Installer.

On completion, MySQL Installer stops the server, applies the configuration changes, and restarts the server for you. For a description of each configuration option, see [MySQL Server Configuration with MySQL Installer](#). Installed [Samples and Examples](#) associated with a specific MySQL server version can be also be reconfigured to apply new feature settings, if any.

3. The **Catalog** link enables you to download the latest catalog of MySQL products manually and then to integrate those product changes with MySQL Installer. The catalog-download action does not perform an upgrade of the products already installed on the host. Instead, it returns to the dashboard and adds an arrow icon to the Version column for each installed product that has a newer version. Use the **Upgrade** operation to install the newer product version.

You can also use the **Catalog** link to display the current change history of each product without downloading the new catalog. Select the **Do not update at this time** check box to view the change history only.

4. The MySQL Installer About icon () shows the current version of MySQL Installer and general information about MySQL. The version number is located above the **Back** button.



**Tip**

Always include this version number when reporting a problem with MySQL Installer.

In addition to the About MySQL information () , you can also select the following icons from the side panel:

- License icon () for MySQL Installer.

This product may include third-party software, used under license. If you are using a Commercial release of MySQL Installer, the icon opens the MySQL Installer Commercial License Information User Manual for licensing information, including licensing information relating to third-party software that may be included in this Commercial release. If you are using a Community release of MySQL Installer, the icon opens the MySQL Installer Community License Information User Manual for licensing information, including licensing information relating to third-party software that may be included in this Community release.

- Resource links icon () to the latest MySQL product documentation, blogs, webinars, and more.

5. The MySQL Installer Options icon () includes the following tabs:

- **General:** Enables or disables the Offline mode option. If selected, this option configures MySQL Installer to run without depending on internet-connection capabilities. When running MySQL Installer in offline mode, you see a warning together with a **Disable** quick action on the dashboard. The warning serves to remind you that running MySQL Installer in offline mode prevents you from



downloading the latest MySQL products and product catalog updates. Offline mode persists until you disable the option.

At startup, MySQL Installer determines whether an internet connection is present, and, if not, prompts you to enable offline mode to resume working without a connection.

- **Product Catalog:** Manages the automatic catalog updates. By default, MySQL Installer checks for catalog updates at startup every seven days. When new products or product versions are available, MySQL Installer adds them to the catalog and then inserts an arrow icon (  ) next to the version number of installed products listed in the dashboard.

Use the product catalog option to enable or disable automatic updates and to reset the number of days between automatic catalog downloads. At startup, MySQL Installer uses the number of days you set to determine whether a download should be attempted. This action is repeated during next startup if MySQL Installer encounters an error downloading the catalog.

- **Connectivity Settings:** Several operations performed by MySQL Installer require internet access. This option enables you to use a default value to validate the connection or to use a different URL, one selected from a list or added by you manually. With the **Manual** option selected, new URLs can be added and all URLs in the list can be moved or deleted. When the **Automatic** option is selected, MySQL Installer attempts to connect to each default URL in the list (in order) until a connection is made. If no connection can be made, it raises an error.
- **Proxy:** MySQL Installer provides multiple proxy modes that enable you to download MySQL products, updates, or even the product catalog in most network environments. The mode are:

- **No proxy**

Select this mode to prevent MySQL Installer from looking for system settings. This mode disables any proxy settings.

- **Automatic**

Select this mode to have MySQL Installer look for system settings and to use those settings if found, or to use no proxy if nothing is found. This mode is the default.

- **Manual**

Select this mode to have MySQL Installer use your authentication details to configuration proxy access to the internet. Specifically:

- A proxy-server address (<http://address-to-server>) and port number
- A user name and password for authentication

### Locating Products to Install

MySQL products in the catalog are listed by category: MySQL Servers, Applications, MySQL Connectors, and Documentation. Only the latest GA versions appear in the **Available Products** pane by default. If you are looking for a pre-release or older version of a product, it may not be visible in the default list.



#### Note

Keep the product catalog up-to-date. Click **Catalog** on the MySQL Installer dashboard to download the latest manifest.

To change the default product list, click **Add** in the dashboard to open the Select Products page, and then click **Edit** to open the dialog box shown in the figure that follows. Modify the settings and then click **Filter**.

**Figure 2.12 Filter Available Products**

Reset one or more of the following fields to modify the list of available products:

- Text: Filter by text.
- Category: All Software (default), MySQL Servers, Applications, MySQL Connectors, or Documentation (for samples and documentation).
- Maturity: Current Bundle (appears initially with the full package only), Pre-Release, Current GA, or Other Releases. If you see a warning, confirm that you have the most recent product manifest by clicking **Catalog** on the MySQL Installer dashboard. If MySQL Installer is unable to download the manifest, the range of products you see is limited to bundled products, standalone product MSIs located in the [Product Cache](#) folder already, or both.



#### Note

The Commercial release of MySQL Installer does not display any MySQL products when you select the Pre-Release maturity filter. Products in development are available from the Community release of MySQL Installer only.

- Already Downloaded (the check box is deselected by default). Permits you to view and manage downloaded products only.
- Architecture: Any (default), 32-bit, or 64-bit.

## Upgrading MySQL Server

Important server upgrade conditions:

- MySQL Installer does not permit server upgrades between major release versions or minor release versions, but does permit upgrades within a release series, such as an upgrade from 8.0.36 to 8.0.37.
- Upgrades between milestone releases (or from a milestone release to a GA release) are not supported. Significant development changes take place in milestone releases and you may encounter compatibility issues or problems starting the server.
- For upgrades, a check box enables you to skip the upgrade check and process for system tables, while checking and processing data dictionary tables normally. MySQL Installer does not prompt you with the check box when the previous server upgrade was skipped or when the server was configured as a sandbox InnoDB Cluster. This behavior represents a change in how MySQL Server performs an upgrade (see [What the MySQL Upgrade Process Upgrades](#)) and it alters the sequence of steps that MySQL Installer applies to the configuration process.

If you select **Skip system tables upgrade check and process. (Not recommended)**, MySQL Installer starts the upgraded server with the `--upgrade=MINIMAL` server option, which upgrades the data dictionary only. If you stop and then restart the server without the `--upgrade=MINIMAL` option, the server upgrades the system tables automatically, if needed.

The following information appears in the **Log** tab and log file after the upgrade configuration (with system tables skipped) is complete:

```
WARNING: The system tables upgrade was skipped after upgrading MySQL Server. The
server will be started now with the --upgrade=MINIMAL option, but then each
time the server is started it will attempt to upgrade the system tables, unless
you modify the Windows service (command line) to add --upgrade=MINIMAL to bypass
the upgrade.

FOR THE BEST RESULTS: Run mysqld.exe --upgrade=FORCE on the command line to upgrade
the system tables manually.
```

To choose a new server version:

1. Click **Upgrade**. Confirm that the check box next to product name in the **Upgradeable Products** pane has a check mark. Deselect the products that you do not intend to upgrade at this time.



#### Note

For server milestone releases in the same release series, MySQL Installer deselects the server upgrade and displays a warning to indicate that the upgrade is not supported, identifies the risks of continuing, and provides a summary of the steps to perform a logical upgrade manually. You can reselect server upgrade at your own risk. For instructions on how to perform a logical upgrade with a milestone release, see [Logical Upgrade](#).

2. Click a product in the list to highlight it. This action populates the **Upgradeable Versions** pane with the details of each available version for the selected product: version number, published date, and a [Changes](#) link to open the release notes for that version.

## Removing MySQL Server

To remove a local MySQL server:

1. Determine whether the local data directory should be removed. If you retain the data directory, another server installation can reuse the data. This option is enabled by default (removes the data directory).
2. Click **Execute** to begin uninstalling the local server. Note that all products that you selected to remove are also uninstalled at this time.
3. (Optional) Click the **Log** tab to display the current actions performed by MySQL Installer.

## Upgrading MySQL Installer

MySQL Installer remains installed on your computer, and like other software, MySQL Installer can be upgraded from the previous version. In some cases, other MySQL software may require that you upgrade MySQL Installer for compatibility. This section describes how to identify the current version of MySQL Installer and how to upgrade MySQL Installer manually.

**To locate the installed version of MySQL Installer:**

1. Start MySQL Installer from the search menu. The MySQL Installer dashboard opens.

- Click the MySQL Installer About icon (  ). The version number is located above the **Back** button.

**To initiate an on-demand upgrade of MySQL Installer:**

1. Connect the computer with MySQL Installer installed to the internet.
2. Start MySQL Installer from the search menu. The MySQL Installer dashboard opens.
3. Click **Catalog** on the bottom of the dashboard to open the Update Catalog window.
4. Click **Execute** to begin the process. If the installed version of MySQL Installer can be upgraded, you will be prompted to start the upgrade.
5. Click **Next** to review all changes to the catalog and then click **Finish** to return to the dashboard.
6. Verify the (new) installed version of MySQL Installer (see the previous procedure).

### 2.3.3.5 MySQL Installer Console Reference

`MySQLInstallerConsole.exe` provides command-line functionality that is similar to MySQL Installer. This reference includes:

- [MySQL Product Names](#)
- [Command Syntax](#)
- [Command Actions](#)

The console is installed when MySQL Installer is initially executed and then available within the [MySQL Installer for Windows](#) directory. By default, the directory location is `C:\Program Files (x86)\MySQL\MySQL Installer for Windows`. You must run the console as administrator.

To use the console:

1. Open a command prompt with administrative privileges by selecting **Windows System** from **Start**, then right-click **Command Prompt**, select **More**, and select **Run as administrator**.
2. From the command line, optionally change the directory to where the `MySQLInstallerConsole.exe` command is located. For example, to use the default installation location:

```
cd Program Files (x86)\MySQL\MySQL Installer for Windows
```

3. Type `MySQLInstallerConsole.exe` (or `mysqlinstallerconsole`) followed by a command action to perform a task. For example, to show the console's help:

```
MySQLInstallerConsole.exe --help

===== Start Initialization =====
MySQL Installer is running in Community mode

Attempting to update manifest.
Initializing product requirements.
Loading product catalog.
Checking for product packages in the bundle.
Categorizing product catalog.
Finding all installed packages.
Your product catalog was last updated at 23/08/2022 12:41:05 p. m.
Your product catalog has version number 671.
===== End Initialization =====

The following actions are available:
```

```

Configure - Configures one or more of your installed programs.
Help      - Provides list of available command actions.
Install   - Installs and configures one or more available MySQL programs.
List      - Lists all available MySQL products.
Modify    - Modifies the features of installed products.
Remove    - Removes one or more products from your system.
Set       - Configures the general options of MySQL Installer.
Status    - Shows the status of all installed products.
Update    - Updates the current product catalog.
Upgrade   - Upgrades one or more of your installed programs.
    
```

The basic syntax for using MySQL Installer command actions. Brackets denote optional entities. Curly braces denote a list of possible entities.

...

## MySQL Product Names

Many of the `MySQLInstallerConsole` command actions accept one or more abbreviated phrases that can match a MySQL product (or products) in the catalog. The current set of valid short phrases for use with commands is shown in the following table.



### Note

Starting with MySQL Installer 1.6.7 (8.0.34), the `install`, `list`, and `upgrade` command options no longer apply to MySQL for Visual Studio (now EOL), MySQL Connector/NET, MySQL Connector/ODBC, MySQL Connector/C++, MySQL Connector/Python, and MySQL Connector/J. To install newer MySQL connectors, visit <https://dev.mysql.com/downloads/>.

**Table 2.6 MySQL Product Phrases for use with the `MySQLInstallerConsole.exe` command**

Phrase	MySQL Product
<code>server</code>	MySQL Server
<code>workbench</code>	MySQL Workbench
<code>shell</code>	MySQL Shell
<code>visual</code>	MySQL for Visual Studio
<code>router</code>	MySQL Router
<code>backup</code>	MySQL Enterprise Backup (requires the commercial release)
<code>net</code>	MySQL Connector/NET
<code>odbc</code>	MySQL Connector/ODBC
<code>c++</code>	MySQL Connector/C++
<code>python</code>	MySQL Connector/Python
<code>j</code>	MySQL Connector/J
<code>documentation</code>	MySQL Server Documentation
<code>samples</code>	MySQL Samples (sakila and world databases)

## Command Syntax

The `MySQLInstallerConsole.exe` command can be issued with or without the file extension (`.exe`) and the command is not case-sensitive.

```
mysqlinstallerconsole[.exe] [[[--]action] [action_blocks_list] [options_list]]
```

## Description:

*action* One of the permitted operational actions. If omitted, the default action is equivalent to the `--status` action. Using the `--` prefix is optional for all actions.

Possible actions are: `[--]configure`, `[--]help`, `[--]install`, `[--]list`, `[--]modify`, `[--]remove`, `[--]set`, `[--]status`, `[--]update`, and `[--]upgrade`.

*action\_blocks\_list* A list of blocks in which each represents a different item depending on the selected action. Blocks are separated by commas.

The `--remove` and `--upgrade` actions permit specifying an asterisk character (\*) to indicate all products. If the \* character is detected at the start of this block, it is assumed all products are to be processed and the remainder of the block is ignored.

Syntax: `*|action_block[,action_block][,action_block]...`

*action\_block*: Contains a product selector followed by an indefinite number of argument blocks that behave differently depending on the selected action (see [Command Actions](#)).

*options\_list* Zero or more options with possible values separated by spaces. See [Command Actions](#) to identify the options permitted for the corresponding action.

Syntax: `option_value_pair[ option_value_pair][ option_value_pair]...`

*option\_value\_pair*: A single option (for example, `--silent`) or a tuple of a key and a corresponding value with an options prefix. The key-value pair is in the form of `--key[=value]`.

## Command Actions

`MySQLInstallerConsole.exe` supports the following command actions:



### Note

Configuration block (or *arguments\_block*) values that contain a colon character (:) must be wrapped in quotation marks. For example, `install_dir="C:\MySQL\MySQL Server 8.0"`.

- `[--]configure [product1]:[configuration_argument]=[value], [product2]:[configuration_argument]=[value], [...]`

Configures one or more MySQL products on your system. Multiple `configuration_argument=value` pairs can be configured for each product.

### Options:

`--continue` Continues processing the next product when an error is caught while processing the action blocks containing arguments for each product. If not specified the whole operation is aborted in case of an error.

<code>--help</code>	Shows the options and available arguments for the corresponding action. If present the action is not executed, only the help is shown, so other action-related options are ignored as well.
<code>--show-settings</code>	Displays the available options for the selected product by passing in the product name after <code>--show-settings</code> .
<code>--silent</code>	Disables confirmation prompts.

Examples:

```
MySQLInstallerConsole --configure --show-settings server
```

```
mysqlinstallerconsole.exe --configure server:port=3307
```

- `[--]help`

Displays a help message with usage examples and then exits. Pass in an additional command action to receive help specific to that action.

Options:

<code>--action=[action]</code>	Shows the help for a specific action. Same as using the <code>--help</code> option with an action.  Permitted values are: <code>all</code> , <code>configure</code> , <code>help</code> (default), <code>install</code> , <code>list</code> , <code>modify</code> , <code>remove</code> , <code>status</code> , <code>update</code> , <code>upgrade</code> , and <code>set</code> .
<code>--help</code>	Shows the options and available arguments for the corresponding action. If present the action is not executed, only the help is shown, so other action-related options are ignored as well.

Examples:

```
MySQLInstallerConsole help
```

```
MySQLInstallerConsole help --action=install
```

- `[--]install [product1]:[features]:[config block]:[config block], [product2]:[config block], [...]`

Installs one or more MySQL products on your system. If pre-release products are available, both GA and pre-release products are installed when the value of the `--type` option value is `Client` or `Full`. Use the `--only_ga_products` option to restrict the product set to GA products only when using these setup types.

Description:

<code>[product]</code>	Each product can be specified by a <code>product phrase</code> with or without a semicolon-separated version qualifier. Passing in a product keyword alone selects the latest version of the product. If multiple architectures are available for that version of the product, the command returns the first one in the manifest list for interactive confirmation. Alternatively,
------------------------	--

you can pass in the exact version and architecture (`x86` or `x64`) after the product keyword using the `--silent` option.

#### [`features`]

All features associated with a MySQL product are installed by default. The feature block is a semicolon-separated list of features or an asterisk character (\*) that selects all features. To remove a feature, use the `modify` command.

#### [`config block`]

One or more configuration blocks can be specified. Each configuration block is a semicolon-separated list of key-value pairs. A block can include either a `config` or `user` type key; `config` is the default type if one is not defined.

Configuration block values that contain a colon character (:) must be wrapped in quotation marks. For example, `installdir="C:\MySQL\MySQL Server 8.0"`. Only one configuration type block can be defined for each product. A user block should be defined for each user to be created during the product installation.



#### Note

The `user` type key is not supported when a product is being reconfigured.

#### Options:

##### `--auto-handle-prereqs`

If present, MySQL Installer attempts to download and install some software prerequisites, not currently present, that can be resolved with minimal intervention. If the `--silent` option is not present, you are presented with installation pages for each prerequisite. If the `--auto-handle-prereqs` option is omitted, packages with missing prerequisites are not installed.

##### `--continue`

Continues processing the next product when an error is caught while processing the action blocks containing arguments for each product. If not specified the whole operation is aborted in case of an error.

##### `--help`

Shows the options and available arguments for the corresponding action. If present the action is not executed, only the help is shown, so other action-related options are ignored as well.

##### `--mos-password=password`

Sets the My Oracle Support (MOS) user's password for commercial versions of the MySQL Installer.

##### `--mos-user=user_name`

Specifies the My Oracle Support (MOS) user name for access to the commercial version of MySQL Installer. If not present, only the products in the bundle, if any, are available to be installed.



<code>--only-ga-products</code>	Restricts the product set to include GA products only.
<code>--setup-type=<i>setup_type</i></code>	<p>Installs a predefined set of software. The setup type can be one of the following:</p> <ul style="list-style-type: none"> <li>• <b>Server</b>: Installs a single MySQL server</li> <li>• <b>Client</b>: Installs client programs and libraries (excludes MySQL connectors)</li> <li>• <b>Full</b>: Installs everything (excludes MySQL connectors)</li> <li>• <b>Custom</b>: Installs user-selected products. This is the default option.</li> </ul>
	<div style="display: flex; align-items: center;">  <div style="border-left: 2px solid black; padding-left: 10px;"> <p><b>Note</b></p> <p>Non-custom setup types are valid only when no other MySQL products are installed.</p> </div> </div>
<code>--show-settings</code>	Displays the available options for the selected product, by passing in the product name after <code>-showsettings</code> .
<code>--silent</code>	Disable confirmation prompts.

Examples:

```
mysqlinstallerconsole.exe --install j;8.0.29, net;8.0.28 --silent
```

```
MySQLInstallerConsole install server;8.0.30:*:port=3307;server_id=2:type=user;user=foo
```

An example that passes in additional configuration blocks, separated by ^ to fit:

```
MySQLInstallerConsole --install server;8.0.30;x64:*:type=config;open_win_firewall=true; ^
  general_log=true;bin_log=true;server_id=3306;tcp_ip=true;port=3306;root_passwd=pass; ^
  install_dir="C:\MySQL\MySQL Server 8.0":type=user;user_name=foo;password=bar;role=DBManager
```

- `[--]list`

When this action is used without options, it activates an interactive list from which all of the available MySQL products can be searched. Enter `MySQLInstallerConsole --list` and specify a substring to search.

Options:

<code>--all</code>	Lists all available products. If this option is used, all other options are ignored.
<code>--arch=architecture</code>	Lists that contain the specified architecture. Permitted values are: <code>x86</code> , <code>x64</code> , and <code>any</code> (default). This option can be combined with the <code>--name</code> and <code>--version</code> options.
<code>--help</code>	Shows the options and available arguments for the corresponding action. If present the action is not executed, only the help is shown, so other action-related options are ignored as well.
<code>--name=package_name</code>	Lists products that contain the specified name (see <a href="#">product phrase</a> ), This option can be combined with the <code>--version</code> and <code>--arch</code> options.
<code>--version=version</code>	Lists products that contain the specified version, such as 8.0 or 5.7. This option can be combined with the <code>--name</code> and <code>--arch</code> options.

Examples:

```
MySQLInstallerConsole --list --name=net --version=8.0
```

- `[--]modify [product1:-removelist|+addlist], [product2:-removelist|+addlist] [...]`

Modifies or displays features of a previously installed MySQL product. To display the features of a product, append the product keyword to the command, for example:

```
MySQLInstallerConsole --modify server
```

Options:

<code>--help</code>	Shows the options and available arguments for the corresponding action. If present the action is not executed, only the help is shown, so other action-related options are ignored as well.
<code>--silent</code>	Disable confirmation prompts.

Examples:

```
MySQLInstallerConsole --modify server:+documentation
```

```
MySQLInstallerConsole modify server:-debug
```

- `[--]remove [product1], [product2] [...]`

Removes one or more products from your system. An asterisk character (\*) can be passed in to remove all MySQL products with one command.

Options:

<code>--continue</code>	Continue the operation even if an error occurs.
<code>--help</code>	Shows the options and available arguments for the corresponding action. If present the action is not executed, only the help is shown, so other action-related options are ignored as well.
<code>--keep-datadir</code>	Skips the removal of the data directory when removing MySQL Server products.
<code>--silent</code>	Disable confirmation prompts.

Examples:

```
mysqlinstallerconsole.exe remove *
```

```
MySQLInstallerConsole --remove server --continue
```

- `[--]set`

Sets one or more configurable options that affect how the MySQL Installer program connects to the internet and whether the automatic products-catalog updates feature is activated.

Options:

<code>--catalog-update=bool_value</code>	Enables ( <code>true</code> , default) or disables ( <code>false</code> ) the automatic products catalog update. This option requires an active connection to the internet.
<code>--catalog-update-days=int_value</code>	Accepts an integer between 1 (default) and 365 to indicate the number of days between checks for a new catalog update when MySQL Installer is started. If <code>--catalog-update</code> is <code>false</code> , this option is ignored.
<code>--connection-validation=validation_type</code>	Sets how MySQL Installer performs the check for an internet connection. Permitted values are <code>automatic</code> (default) and <code>manual</code> .
<code>--connection-validation-urls=url_list</code>	A double-quote enclosed and comma-separated string that defines the list of URLs to use for checking the internet connection when <code>--connection-validation</code> is set to <code>manual</code> . Checks are made in

	the same order provided. If the first URL fails, the next URL in the list is used and so on.
<code>--offline-mode=bool_value</code>	Enables MySQL Installer to run with or without internet capabilities. Valid modes are: <ul style="list-style-type: none"> <li>• <code>True</code> to enable offline mode (run without an internet connection).</li> <li>• <code>False</code> (default) to disable offline mode (run with an internet connection). Set this mode before downloading the product catalog or any products to install.</li> </ul>
<code>--proxy-mode</code>	Specifies the proxy mode. Valid modes are: <ul style="list-style-type: none"> <li>• <code>Automatic</code> to automatically identify the proxy based on the system settings.</li> <li>• <code>None</code> to ensure that no proxy is configured.</li> <li>• <code>Manual</code> to set the proxy details manually (<code>--proxy-server</code>, <code>--proxy-port</code>, <code>--proxy-username</code>, <code>--proxy-password</code>).</li> </ul>
<code>--proxy-password</code>	The password used to authenticate to the proxy server.
<code>--proxy-port</code>	The port used for the proxy server.
<code>--proxy-server</code>	The URL that point to the proxy server.
<code>--proxy-username</code>	The user name used to authenticate to the proxy server.
<code>--reset-defaults</code>	Resets the MySQL Installer options associated with the <code>--set</code> action to the default values.

**Examples:**

```
MySQLIntallerConsole.exe set --reset-defaults
```

```
mysqlintallerconsole.exe --set --catalog-update=false
```

```
MySQLIntallerConsole --set --catalog-update-days=3
```

```
mysqlintallerconsole --set --connection-validation=manual
--connection-validation-urls="https://www.bing.com,http://www.google.com"
```

- `[--]status`

Provides a quick overview of the MySQL products that are installed on the system. Information includes product name and version, architecture, date installed, and install location.

**Options:**

`--help` Shows the options and available arguments for the corresponding action. If present the action is not executed, only the help is shown, so other action-related options are ignored as well.

**Examples:**

```
MySQLInstallerConsole status
```

- `[--]update`

Downloads the latest MySQL product catalog to your system. On success, the catalog is applied the next time either `MySQLInstaller` or `MySQLInstallerConsole.exe` is executed.

MySQL Installer automatically checks for product catalog updates when it is started if *n* days have passed since the last check. Starting with MySQL Installer 1.6.4, the default value is 1 day. Previously, the default value was 7 days.

Options:

`--help` Shows the options and available arguments for the corresponding action. If present the action is not executed, only the help is shown, so other action-related options are ignored as well.

Examples:

```
MySQLInstallerConsole update
```

- `[--]upgrade [product1:version], [product2:version] [...]`

Upgrades one or more products on your system. The following characters are permitted for this action:

`*` Pass in `*` to upgrade all products to the latest version, or pass in specific products.

`!` Pass in `!` as a version number to upgrade the MySQL product to its latest version.

Options:

`--continue` Continue the operation even if an error occurs.

`--help` Shows the options and available arguments for the corresponding action. If present the action is not executed, only the help is shown, so other action-related options are ignored as well.

`--mos-password=password` Sets the My Oracle Support (MOS) user's password for commercial versions of the MySQL Installer.

`--mos-user=user_name` Specifies the My Oracle Support (MOS) user name for access to the commercial version of MySQL Installer. If not present, only the products in the bundle, if any, are available to be installed.

`--silent` Disable confirmation prompts.

Examples:

```
MySQLInstallerConsole upgrade *
```

```
MySQLInstallerConsole upgrade workbench:8.0.31
```

```
MySQLInstallerConsole upgrade workbench:!
```

```
MySQLInstallerConsole --upgrade server;8.0.30:!, j;8.0.29:!
```

## 2.3.4 Installing MySQL on Microsoft Windows Using a `noinstall` ZIP Archive

Users who are installing from the `noinstall` package can use the instructions in this section to manually install MySQL. The process for installing MySQL from a ZIP Archive package is as follows:

1. Extract the main archive to the desired install directory

*Optional:* also extract the debug-test archive if you plan to execute the MySQL benchmark and test suite

2. Create an option file
3. Choose a MySQL server type
4. Initialize MySQL
5. Start the MySQL server
6. Secure the default user accounts

This process is described in the sections that follow.

### 2.3.4.1 Extracting the Install Archive

To install MySQL manually, do the following:

1. If you are upgrading from a previous version please refer to [Section 2.10.8, “Upgrading MySQL on Windows”](#), before beginning the upgrade process.
2. Make sure that you are logged in as a user with administrator privileges.
3. Choose an installation location. Traditionally, the MySQL server is installed in `C:\mysql`. If you do not install MySQL at `C:\mysql`, you must specify the path to the install directory during startup or in an option file. See [Section 2.3.4.2, “Creating an Option File”](#).



#### Note

The MySQL Installer installs MySQL under `C:\Program Files\MySQL`.

4. Extract the install archive to the chosen installation location using your preferred file-compression tool. Some tools may extract the archive to a folder within your chosen installation location. If this occurs, you can move the contents of the subfolder into the chosen installation location.

### 2.3.4.2 Creating an Option File

If you need to specify startup options when you run the server, you can indicate them on the command line or place them in an option file. For options that are used every time the server starts, you may find it most convenient to use an option file to specify your MySQL configuration. This is particularly true under the following circumstances:

- The installation or data directory locations are different from the default locations (`C:\Program Files\MySQL\MySQL Server 5.7` and `C:\Program Files\MySQL\MySQL Server 5.7\data`).
- You need to tune the server settings, such as memory, cache, or InnoDB configuration information.

When the MySQL server starts on Windows, it looks for option files in several locations, such as the Windows directory, `C:\`, and the MySQL installation directory (for the full list of locations, see

Section 4.2.2.2, “Using Option Files”). The Windows directory typically is named something like `C:\WINDOWS`. You can determine its exact location from the value of the `WINDIR` environment variable using the following command:

```
C:\> echo %WINDIR%
```

MySQL looks for options in each location first in the `my.ini` file, and then in the `my.cnf` file. However, to avoid confusion, it is best if you use only one file. If your PC uses a boot loader where `C:` is not the boot drive, your only option is to use the `my.ini` file. Whichever option file you use, it must be a plain text file.



#### Note

When using the MySQL Installer to install MySQL Server, it creates the `my.ini` in the default location, and the user executing MySQL Installer is granted full permissions to this new `my.ini` file.

In other words, be sure that the MySQL Server user has permission to read the `my.ini` file.

You can also make use of the example option files included with your MySQL distribution; see Section 5.1.2, “Server Configuration Defaults”.

An option file can be created and modified with any text editor, such as Notepad. For example, if MySQL is installed in `E:\mysql` and the data directory is in `E:\mydata\data`, you can create an option file containing a `[mysqld]` section to specify values for the `basedir` and `datadir` options:

```
[mysqld]
# set basedir to your installation path
basedir=E:/mysql
# set datadir to the location of your data directory
datadir=E:/mydata/data
```

Microsoft Windows path names are specified in option files using (forward) slashes rather than backslashes. If you do use backslashes, double them:

```
[mysqld]
# set basedir to your installation path
basedir=E:\\mysql
# set datadir to the location of your data directory
datadir=E:\\mydata\\data
```

The rules for use of backslash in option file values are given in Section 4.2.2.2, “Using Option Files”.

As of MySQL 5.7.6, the ZIP archive no longer includes a `data` directory. To initialize a MySQL installation by creating the data directory and populating the tables in the mysql system database, initialize MySQL using either `--initialize` or `--initialize-insecure`. For additional information, see Section 2.9.1, “Initializing the Data Directory”.

If you would like to use a data directory in a different location, you should copy the entire contents of the `data` directory to the new location. For example, if you want to use `E:\mydata` as the data directory instead, you must do two things:

1. Move the entire `data` directory and all of its contents from the default location (for example `C:\Program Files\MySQL\MySQL Server 5.7\data`) to `E:\mydata`.
2. Use a `--datadir` option to specify the new data directory location each time you start the server.

### 2.3.4.3 Selecting a MySQL Server Type

The following table shows the available servers for Windows in MySQL 5.7.

Binary	Description
<code>mysqld</code>	Optimized binary with named-pipe support
<code>mysqld-debug</code>	Like <code>mysqld</code> , but compiled with full debugging and automatic memory allocation checking

All of the preceding binaries are optimized for modern Intel processors, but should work on any Intel i386-class or higher processor.

Each of the servers in a distribution support the same set of storage engines. The `SHOW ENGINES` statement displays which engines a given server supports.

All Windows MySQL 5.7 servers have support for symbolic linking of database directories.

MySQL supports TCP/IP on all Windows platforms. MySQL servers on Windows also support named pipes, if you start the server with the `named_pipe` system variable enabled. It is necessary to enable this variable explicitly because some users have experienced problems with shutting down the MySQL server when named pipes were used. The default is to use TCP/IP regardless of platform because named pipes are slower than TCP/IP in many Windows configurations.

#### 2.3.4.4 Initializing the Data Directory

If you installed MySQL using the `noinstall` package, you may need to initialize the data directory:

- Windows distributions prior to MySQL 5.7.7 include a data directory with a set of preinitialized accounts in the `mysql` database.
- As of 5.7.7, Windows installation operations performed using the `noinstall` package do not include a data directory. To initialize the data directory, use the instructions at [Section 2.9.1, “Initializing the Data Directory”](#).

#### 2.3.4.5 Starting the Server for the First Time

This section gives a general overview of starting the MySQL server. The following sections provide more specific information for starting the MySQL server from the command line or as a Windows service.

The information here applies primarily if you installed MySQL using the `noinstall` version, or if you wish to configure and test MySQL manually rather than with the GUI tools.

The examples in these sections assume that MySQL is installed under the default location of `C:\Program Files\MySQL\MySQL Server 5.7`. Adjust the path names shown in the examples if you have MySQL installed in a different location.

Clients have two options. They can use TCP/IP, or they can use a named pipe if the server supports named-pipe connections.

MySQL for Windows also supports shared-memory connections if the server is started with the `shared_memory` system variable enabled. Clients can connect through shared memory by using the `--protocol=MEMORY` option.

For information about which server binary to run, see [Section 2.3.4.3, “Selecting a MySQL Server Type”](#).

Testing is best done from a command prompt in a console window (or “DOS window”). In this way you can have the server display status messages in the window where they are easy to see. If something is wrong with your configuration, these messages make it easier for you to identify and fix any problems.



**Note**

The database must be initialized before MySQL can be started. For additional information about the initialization process, see [Section 2.9.1, “Initializing the Data Directory”](#).

To start the server, enter this command:

```
C:\> "C:\Program Files\MySQL\MySQL Server 5.7\bin\mysqld" --console
```

For a server that includes `InnoDB` support, you should see the messages similar to those following as it starts (the path names and sizes may differ):

```
InnoDB: The first specified datafile c:\ibdata\ibdata1 did not exist:
InnoDB: a new database to be created!
InnoDB: Setting file c:\ibdata\ibdata1 size to 209715200
InnoDB: Database physically writes the file full: wait...
InnoDB: Log file c:\iblogs\ib_logfile0 did not exist: new to be created
InnoDB: Setting log file c:\iblogs\ib_logfile0 size to 31457280
InnoDB: Log file c:\iblogs\ib_logfile1 did not exist: new to be created
InnoDB: Setting log file c:\iblogs\ib_logfile1 size to 31457280
InnoDB: Log file c:\iblogs\ib_logfile2 did not exist: new to be created
InnoDB: Setting log file c:\iblogs\ib_logfile2 size to 31457280
InnoDB: Doublewrite buffer not found: creating new
InnoDB: Doublewrite buffer created
InnoDB: creating foreign key constraint system tables
InnoDB: foreign key constraint system tables created
011024 10:58:25 InnoDB: Started
```

When the server finishes its startup sequence, you should see something like this, which indicates that the server is ready to service client connections:

```
mysqld: ready for connections
Version: '5.7.44' socket: '' port: 3306
```

The server continues to write to the console any further diagnostic output it produces. You can open a new console window in which to run client programs.

If you omit the `--console` option, the server writes diagnostic output to the error log in the data directory (`C:\Program Files\MySQL\MySQL Server 5.7\data` by default). The error log is the file with the `.err` extension, and may be set using the `--log-error` option.

**Note**

The initial `root` account in the MySQL grant tables has no password. After starting the server, you should set up a password for it using the instructions in [Section 2.9.4, “Securing the Initial MySQL Account”](#).

### 2.3.4.6 Starting MySQL from the Windows Command Line

The MySQL server can be started manually from the command line. This can be done on any version of Windows.

To start the `mysqld` server from the command line, you should start a console window (or “DOS window”) and enter this command:

```
C:\> "C:\Program Files\MySQL\MySQL Server 5.7\bin\mysqld"
```

The path to `mysqld` may vary depending on the install location of MySQL on your system.

You can stop the MySQL server by executing this command:

```
C:\> "C:\Program Files\MySQL\MySQL Server 5.7\bin\mysqladmin" -u root shutdown
```

**Note**

If the MySQL `root` user account has a password, you need to invoke `mysqladmin` with the `-p` option and supply the password when prompted.

This command invokes the MySQL administrative utility `mysqladmin` to connect to the server and tell it to shut down. The command connects as the MySQL `root` user, which is the default administrative account in the MySQL grant system.

**Note**

Users in the MySQL grant system are wholly independent from any operating system users under Microsoft Windows.

If `mysqld` does not start, check the error log to see whether the server wrote any messages there to indicate the cause of the problem. By default, the error log is located in the `C:\Program Files\MySQL\MySQL Server 5.7\data` directory. It is the file with a suffix of `.err`, or may be specified by passing in the `--log-error` option. Alternatively, you can try to start the server with the `--console` option; in this case, the server may display some useful information on the screen to help solve the problem.

The last option is to start `mysqld` with the `--standalone` and `--debug` options. In this case, `mysqld` writes a log file `C:\mysqld.trace` that should contain the reason why `mysqld` doesn't start. See [Section 5.8.3, "The DEBUG Package"](#).

Use `mysqld --verbose --help` to display all the options that `mysqld` supports.

### 2.3.4.7 Customizing the PATH for MySQL Tools

**Warning**

You must exercise great care when editing your system `PATH` by hand; accidental deletion or modification of any portion of the existing `PATH` value can leave you with a malfunctioning or even unusable system.

To make it easier to invoke MySQL programs, you can add the path name of the MySQL `bin` directory to your Windows system `PATH` environment variable:

- On the Windows desktop, right-click the **My Computer** icon, and select **Properties**.
- Next select the **Advanced** tab from the **System Properties** menu that appears, and click the **Environment Variables** button.
- Under **System Variables**, select **Path**, and then click the **Edit** button. The **Edit System Variable** dialogue should appear.
- Place your cursor at the end of the text appearing in the space marked **Variable Value**. (Use the **End** key to ensure that your cursor is positioned at the very end of the text in this space.) Then enter the complete path name of your MySQL `bin` directory (for example, `C:\Program Files\MySQL\MySQL Server 5.7\bin`)

**Note**

There must be a semicolon separating this path from any values present in this field.

Dismiss this dialogue, and each dialogue in turn, by clicking **OK** until all of the dialogues that were opened have been dismissed. The new `PATH` value should now be available to any new command

shell you open, allowing you to invoke any MySQL executable program by typing its name at the DOS prompt from any directory on the system, without having to supply the path. This includes the servers, the `mysql` client, and all MySQL command-line utilities such as `mysqladmin` and `mysqldump`.

You should not add the MySQL `bin` directory to your Windows `PATH` if you are running multiple MySQL servers on the same machine.

### 2.3.4.8 Starting MySQL as a Windows Service

On Windows, the recommended way to run MySQL is to install it as a Windows service, so that MySQL starts and stops automatically when Windows starts and stops. A MySQL server installed as a service can also be controlled from the command line using `NET` commands, or with the graphical `Services` utility. Generally, to install MySQL as a Windows service you should be logged in using an account that has administrator rights.

The `Services` utility (the Windows `Service Control Manager`) can be found in the Windows Control Panel. To avoid conflicts, it is advisable to close the `Services` utility while performing server installation or removal operations from the command line.

#### Installing the service

Before installing MySQL as a Windows service, you should first stop the current server if it is running by using the following command:

```
C:\> "C:\Program Files\MySQL\MySQL Server 5.7\bin\mysqladmin"
      -u root shutdown
```



#### Note

If the MySQL `root` user account has a password, you need to invoke `mysqladmin` with the `-p` option and supply the password when prompted.

This command invokes the MySQL administrative utility `mysqladmin` to connect to the server and tell it to shut down. The command connects as the MySQL `root` user, which is the default administrative account in the MySQL grant system.



#### Note

Users in the MySQL grant system are wholly independent from any operating system users under Windows.

Install the server as a service using this command:

```
C:\> "C:\Program Files\MySQL\MySQL Server 5.7\bin\mysqld" --install
```

The service-installation command does not start the server. Instructions for that are given later in this section.

To make it easier to invoke MySQL programs, you can add the path name of the MySQL `bin` directory to your Windows system `PATH` environment variable:

- On the Windows desktop, right-click the **My Computer** icon, and select **Properties**.
- Next select the **Advanced** tab from the **System Properties** menu that appears, and click the **Environment Variables** button.
- Under **System Variables**, select **Path**, and then click the **Edit** button. The **Edit System Variable** dialogue should appear.

- Place your cursor at the end of the text appearing in the space marked **Variable Value**. (Use the **End** key to ensure that your cursor is positioned at the very end of the text in this space.) Then enter the complete path name of your MySQL `bin` directory (for example, `C:\Program Files\MySQL\MySQL Server 5.7\bin`), and there should be a semicolon separating this path from any values present in this field. Dismiss this dialogue, and each dialogue in turn, by clicking **OK** until all of the dialogues that were opened have been dismissed. You should now be able to invoke any MySQL executable program by typing its name at the DOS prompt from any directory on the system, without having to supply the path. This includes the servers, the `mysql` client, and all MySQL command-line utilities such as `mysqladmin` and `mysqldump`.

You should not add the MySQL `bin` directory to your Windows `PATH` if you are running multiple MySQL servers on the same machine.



### Warning

You must exercise great care when editing your system `PATH` by hand; accidental deletion or modification of any portion of the existing `PATH` value can leave you with a malfunctioning or even unusable system.

The following additional arguments can be used when installing the service:

- You can specify a service name immediately following the `--install` option. The default service name is `MySQL`.
- If a service name is given, it can be followed by a single option. By convention, this should be `--defaults-file=file_name` to specify the name of an option file from which the server should read options when it starts.

The use of a single option other than `--defaults-file` is possible but discouraged. `--defaults-file` is more flexible because it enables you to specify multiple startup options for the server by placing them in the named option file.

- You can also specify a `--local-service` option following the service name. This causes the server to run using the `LocalService` Windows account that has limited system privileges. If both `--defaults-file` and `--local-service` are given following the service name, they can be in any order.

For a MySQL server that is installed as a Windows service, the following rules determine the service name and option files that the server uses:

- If the service-installation command specifies no service name or the default service name (`MySQL`) following the `--install` option, the server uses the service name of `MySQL` and reads options from the `[mysqld]` group in the standard option files.
- If the service-installation command specifies a service name other than `MySQL` following the `--install` option, the server uses that service name. It reads options from the `[mysqld]` group and the group that has the same name as the service in the standard option files. This enables you to use the `[mysqld]` group for options that should be used by all MySQL services, and an option group with the service name for use by the server installed with that service name.
- If the service-installation command specifies a `--defaults-file` option after the service name, the server reads options the same way as described in the previous item, except that it reads options only from the named file and ignores the standard option files.

As a more complex example, consider the following command:

```
C:\> "C:\Program Files\MySQL\MySQL Server 5.7\bin\mysqld"
      --install MySQL --defaults-file=C:\my-opts.cnf
```

Here, the default service name (`MySQL`) is given after the `--install` option. If no `--defaults-file` option had been given, this command would have the effect of causing the server to read the `[mysqld]` group from the standard option files. However, because the `--defaults-file` option is present, the server reads options from the `[mysqld]` option group, and only from the named file.



#### Note

On Windows, if the server is started with the `--defaults-file` and `--install` options, `--install` must be first. Otherwise, `mysqld.exe` attempts to start the MySQL server.

You can also specify options as Start parameters in the Windows `Services` utility before you start the MySQL service.

Finally, before trying to start the MySQL service, make sure the user variables `%TEMP%` and `%TMP%` (and also `%TMPDIR%`, if it has ever been set) for the operating system user who is to run the service are pointing to a folder to which the user has write access. The default user for running the MySQL service is `LocalSystem`, and the default value for its `%TEMP%` and `%TMP%` is `C:\Windows\Temp`, a directory `LocalSystem` has write access to by default. However, if there are any changes to that default setup (for example, changes to the user who runs the service or to the mentioned user variables, or the `--tmpdir` option has been used to put the temporary directory somewhere else), the MySQL service might fail to run because write access to the temporary directory has not been granted to the proper user.

## Starting the service

After a MySQL server instance has been installed as a service, Windows starts the service automatically whenever Windows starts. The service also can be started immediately from the `Services` utility, or by using an `sc start mysql_service_name` or `NET START mysql_service_name` command. `SC` and `NET` commands are not case-sensitive.

When run as a service, `mysqld` has no access to a console window, so no messages can be seen there. If `mysqld` does not start, check the error log to see whether the server wrote any messages there to indicate the cause of the problem. The error log is located in the MySQL data directory (for example, `C:\Program Files\MySQL\MySQL Server 5.7\data`). It is the file with a suffix of `.err`.

When a MySQL server has been installed as a service, and the service is running, Windows stops the service automatically when Windows shuts down. The server also can be stopped manually using the `Services` utility, the `sc stop mysql_service_name` command, the `NET STOP mysql_service_name` command, or the `mysqladmin shutdown` command.

You also have the choice of installing the server as a manual service if you do not wish for the service to be started automatically during the boot process. To do this, use the `--install-manual` option rather than the `--install` option:

```
C:\> "C:\Program Files\MySQL\MySQL Server 5.7\bin\mysqld" --install-manual
```

## Removing the service

To remove a server that is installed as a service, first stop it if it is running by executing `SC STOP mysql_service_name` or `NET STOP mysql_service_name`. Then use `SC DELETE mysql_service_name` to remove it:

```
C:\> SC DELETE mysql
```

Alternatively, use the `mysqld --remove` option to remove the service.

```
C:\> "C:\Program Files\MySQL\MySQL Server 5.7\bin\mysqld" --remove
```

If `mysqld` is not running as a service, you can start it from the command line. For instructions, see [Section 2.3.4.6, “Starting MySQL from the Windows Command Line”](#).

If you encounter difficulties during installation, see [Section 2.3.5, “Troubleshooting a Microsoft Windows MySQL Server Installation”](#).

For more information about stopping or removing a Windows service, see [Section 5.7.2.2, “Starting Multiple MySQL Instances as Windows Services”](#).

### 2.3.4.9 Testing The MySQL Installation

You can test whether the MySQL server is working by executing any of the following commands:

```
C:\> "C:\Program Files\MySQL\MySQL Server 5.7\bin\mysqlshow"
C:\> "C:\Program Files\MySQL\MySQL Server 5.7\bin\mysqlshow" -u root mysql
C:\> "C:\Program Files\MySQL\MySQL Server 5.7\bin\mysqladmin" version status proc
C:\> "C:\Program Files\MySQL\MySQL Server 5.7\bin\mysql" test
```

If `mysqld` is slow to respond to TCP/IP connections from client programs, there is probably a problem with your DNS. In this case, start `mysqld` with the `skip_name_resolve` system variable enabled and use only `localhost` and IP addresses in the `Host` column of the MySQL grant tables. (Be sure that an account exists that specifies an IP address or you may not be able to connect.)

You can force a MySQL client to use a named-pipe connection rather than TCP/IP by specifying the `--pipe` or `--protocol=PIPE` option, or by specifying `.` (period) as the host name. Use the `--socket` option to specify the name of the pipe if you do not want to use the default pipe name.

If you have set a password for the `root` account, deleted the anonymous account, or created a new user account, then to connect to the MySQL server you must use the appropriate `-u` and `-p` options with the commands shown previously. See [Section 4.2.4, “Connecting to the MySQL Server Using Command Options”](#).

For more information about `mysqlshow`, see [Section 4.5.7, “mysqlshow — Display Database, Table, and Column Information”](#).

## 2.3.5 Troubleshooting a Microsoft Windows MySQL Server Installation

When installing and running MySQL for the first time, you may encounter certain errors that prevent the MySQL server from starting. This section helps you diagnose and correct some of these errors.

Your first resource when troubleshooting server issues is the [error log](#). The MySQL server uses the error log to record information relevant to the error that prevents the server from starting. The error log is located in the [data directory](#) specified in your `my.ini` file. The default data directory location is `C:\Program Files\MySQL\MySQL Server 5.7\data`, or `C:\ProgramData\MySQL` on Windows 7 and Windows Server 2008. The `C:\ProgramData` directory is hidden by default. You need to change your folder options to see the directory and contents. For more information on the error log and understanding the content, see [Section 5.4.2, “The Error Log”](#).

For information regarding possible errors, also consult the console messages displayed when the MySQL service is starting. Use the `SC START mysqld_service_name` or `NET START mysqld_service_name` command from the command line after installing `mysqld` as a service to see any error messages regarding the starting of the MySQL server as a service. See [Section 2.3.4.8, “Starting MySQL as a Windows Service”](#).

The following examples show other common error messages you might encounter when installing MySQL and starting the server for the first time:

- If the MySQL server cannot find the `mysql` privileges database or other critical files, it displays these messages:

```
System error 1067 has occurred.
Fatal error: Can't open and lock privilege tables:
Table 'mysql.user' doesn't exist
```

These messages often occur when the MySQL base or data directories are installed in different locations than the default locations (C:\Program Files\MySQL\MySQL Server 5.7 and C:\Program Files\MySQL\MySQL Server 5.7\data, respectively).

This situation can occur when MySQL is upgraded and installed to a new location, but the configuration file is not updated to reflect the new location. In addition, old and new configuration files might conflict. Be sure to delete or rename any old configuration files when upgrading MySQL.

If you have installed MySQL to a directory other than C:\Program Files\MySQL\MySQL Server 5.7, ensure that the MySQL server is aware of this through the use of a configuration (`my.ini`) file. Put the `my.ini` file in your Windows directory, typically C:\WINDOWS. To determine its exact location from the value of the `WINDIR` environment variable, issue the following command from the command prompt:

```
C:\> echo %WINDIR%
```

You can create or modify an option file with any text editor, such as Notepad. For example, if MySQL is installed in E:\mysql and the data directory is D:\MySQLdata, you can create the option file and set up a `[mysqld]` section to specify values for the `basedir` and `datadir` options:

```
[mysqld]
# set basedir to your installation path
basedir=E:/mysql
# set datadir to the location of your data directory
datadir=D:/MySQLdata
```

Microsoft Windows path names are specified in option files using (forward) slashes rather than backslashes. If you do use backslashes, double them:

```
[mysqld]
# set basedir to your installation path
basedir=C:\\Program Files\\MySQL\\MySQL Server 5.7
# set datadir to the location of your data directory
datadir=D:\\MySQLdata
```

The rules for use of backslash in option file values are given in [Section 4.2.2.2, "Using Option Files"](#).

If you change the `datadir` value in your MySQL configuration file, you must move the contents of the existing MySQL data directory before restarting the MySQL server.

See [Section 2.3.4.2, "Creating an Option File"](#).

- If you reinstall or upgrade MySQL without first stopping and removing the existing MySQL service and install MySQL using the MySQL Installer, you might see this error:

```
Error: Cannot create Windows service for MySql. Error: 0
```

This occurs when the Configuration Wizard tries to install the service and finds an existing service with the same name.

One solution to this problem is to choose a service name other than `mysql` when using the configuration wizard. This enables the new service to be installed correctly, but leaves the outdated service in place. Although this is harmless, it is best to remove old services that are no longer in use.

To permanently remove the old `mysql` service, execute the following command as a user with administrative privileges, on the command line:

```
C:\> SC DELETE mysql
[SC] DeleteService SUCCESS
```

If the `SC` utility is not available for your version of Windows, download the `delsrv` utility from <http://www.microsoft.com/windows2000/techinfo/reskit/tools/existing/delsrv-o.asp> and use the `delsrv mysql` syntax.

## 2.3.6 Windows Postinstallation Procedures

GUI tools exist that perform most of the tasks described in this section, including:

- **MySQL Installer:** Used to install and upgrade MySQL products.
- **MySQL Workbench:** Manages the MySQL server and edits SQL statements.

If necessary, initialize the data directory and create the MySQL grant tables. Windows distributions prior to MySQL 5.7.7 include a data directory with a set of preinitialized accounts in the `mysql` database. As of 5.7.7, Windows installation operations performed by MySQL Installer initialize the data directory automatically. For installation from a ZIP Archive package, initialize the data directory as described at [Section 2.9.1, “Initializing the Data Directory”](#).

Regarding passwords, if you installed MySQL using the MySQL Installer, you may have already assigned a password to the initial `root` account. (See [Section 2.3.3, “MySQL Installer for Windows”](#).) Otherwise, use the password-assignment procedure given in [Section 2.9.4, “Securing the Initial MySQL Account”](#).

Before assigning a password, you might want to try running some client programs to make sure that you can connect to the server and that it is operating properly. Make sure that the server is running (see [Section 2.3.4.5, “Starting the Server for the First Time”](#)). You can also set up a MySQL service that runs automatically when Windows starts (see [Section 2.3.4.8, “Starting MySQL as a Windows Service”](#)).

These instructions assume that your current location is the MySQL installation directory and that it has a `bin` subdirectory containing the MySQL programs used here. If that is not true, adjust the command path names accordingly.

If you installed MySQL using MySQL Installer (see [Section 2.3.3, “MySQL Installer for Windows”](#)), the default installation directory is `C:\Program Files\MySQL\MySQL Server 5.7`:

```
C:\> cd "C:\Program Files\MySQL\MySQL Server 5.7"
```

A common installation location for installation from a ZIP archive is `C:\mysql`:

```
C:\> cd C:\mysql
```

Alternatively, add the `bin` directory to your `PATH` environment variable setting. That enables your command interpreter to find MySQL programs properly, so that you can run a program by typing only its name, not its path name. See [Section 2.3.4.7, “Customizing the PATH for MySQL Tools”](#).

With the server running, issue the following commands to verify that you can retrieve information from the server. The output should be similar to that shown here.

Use `mysqlshow` to see what databases exist:

```
C:\> bin\mysqlshow
+-----+
| Databases |
+-----+
| information_schema |
| mysql          |
| performance_schema |
```



```
| sys |
+-----+
```

The list of installed databases may vary, but always includes at least `mysql` and `information_schema`. Before MySQL 5.7.7, a `test` database may also be created automatically.

The preceding command (and commands for other MySQL programs such as `mysql`) may not work if the correct MySQL account does not exist. For example, the program may fail with an error, or you may not be able to view all databases. If you install MySQL using MySQL Installer, the `root` user is created automatically with the password you supplied. In this case, you should use the `-u root` and `-p` options. (You must use those options if you have already secured the initial MySQL accounts.) With `-p`, the client program prompts for the `root` password. For example:

```
C:\> bin\mysqlshow -u root -p
Enter password: (enter root password here)
+-----+
| Databases |
+-----+
| information_schema |
| mysql |
| performance_schema |
| sys |
+-----+
```

If you specify a database name, `mysqlshow` displays a list of the tables within the database:

```
C:\> bin\mysqlshow mysql
Database: mysql
+-----+
| Tables |
+-----+
| columns_priv |
| db |
| engine_cost |
| event |
| func |
| general_log |
| gtid_executed |
| help_category |
| help_keyword |
| help_relation |
| help_topic |
| innodb_index_stats |
| innodb_table_stats |
| ndb_binlog_index |
| plugin |
| proc |
| procs_priv |
| proxies_priv |
| server_cost |
| servers |
| slave_master_info |
| slave_relay_log_info |
| slave_worker_info |
| slow_log |
| tables_priv |
| time_zone |
| time_zone_leap_second |
| time_zone_name |
| time_zone_transition |
| time_zone_transition_type |
| user |
+-----+
```

Use the `mysql` program to select information from a table in the `mysql` database:

```
C:\> bin\mysql -e "SELECT User, Host, plugin FROM mysql.user" mysql
+-----+-----+-----+
| User | Host      | plugin                |
+-----+-----+-----+
| root | localhost | mysql_native_password |
+-----+-----+-----+
```

For more information about `mysql` and `mysqlshow`, see [Section 4.5.1, “mysql — The MySQL Command-Line Client”](#), and [Section 4.5.7, “mysqlshow — Display Database, Table, and Column Information”](#).

## 2.3.7 Windows Platform Restrictions

The following restrictions apply to use of MySQL on the Windows platform:

- **Process memory**

On Windows 32-bit platforms, it is not possible by default to use more than 2GB of RAM within a single process, including MySQL. This is because the physical address limit on Windows 32-bit is 4GB and the default setting within Windows is to split the virtual address space between kernel (2GB) and user/applications (2GB).

Some versions of Windows have a boot time setting to enable larger applications by reducing the kernel application. Alternatively, to use more than 2GB, use a 64-bit version of Windows.

- **File system aliases**

When using `MyISAM` tables, you cannot use aliases within Windows link to the data files on another volume and then link back to the main MySQL `datadir` location.

This facility is often used to move the data and index files to a RAID or other fast solution, while retaining the main `.frm` files in the default data directory configured with the `datadir` option.

- **Limited number of ports**

Windows systems have about 4,000 ports available for client connections, and after a connection on a port closes, it takes two to four minutes before the port can be reused. In situations where clients connect to and disconnect from the server at a high rate, it is possible for all available ports to be used up before closed ports become available again. If this happens, the MySQL server appears to be unresponsive even though it is running. Ports may be used by other applications running on the machine as well, in which case the number of ports available to MySQL is lower.

For more information about this problem, see <https://support.microsoft.com/kb/196271>.

- **DATA DIRECTORY and INDEX DIRECTORY**

The `DATA DIRECTORY` clause of the `CREATE TABLE` statement is supported on Windows for `InnoDB` tables only, as described in [Section 14.6.1.2, “Creating Tables Externally”](#). For `MyISAM` and other storage engines, the `DATA DIRECTORY` and `INDEX DIRECTORY` clauses for `CREATE TABLE` are ignored on Windows and any other platforms with a nonfunctional `realpath()` call.

- **DROP DATABASE**

You cannot drop a database that is in use by another session.

- **Case-insensitive names**

File names are not case-sensitive on Windows, so MySQL database and table names are also not case-sensitive on Windows. The only restriction is that database and table names must be specified using the same case throughout a given statement. See [Section 9.2.3, “Identifier Case Sensitivity”](#).

- **Directory and file names**

On Windows, MySQL Server supports only directory and file names that are compatible with the current ANSI code pages. For example, the following Japanese directory name does not work in the Western locale (code page 1252):

```
datadir="C:/私たちのプロジェクトのデータ"
```

The same limitation applies to directory and file names referred to in SQL statements, such as the data file path name in `LOAD DATA`.

- **The `\` path name separator character**

Path name components in Windows are separated by the `\` character, which is also the escape character in MySQL. If you are using `LOAD DATA` or `SELECT ... INTO OUTFILE`, use Unix-style file names with `/` characters:

```
mysql> LOAD DATA INFILE 'C:/tmp/skr.txt' INTO TABLE skr;
mysql> SELECT * INTO OUTFILE 'C:/tmp/skr.txt' FROM skr;
```

Alternatively, you must double the `\` character:

```
mysql> LOAD DATA INFILE 'C:\\tmp\\skr.txt' INTO TABLE skr;
mysql> SELECT * INTO OUTFILE 'C:\\tmp\\skr.txt' FROM skr;
```

- **Problems with pipes**

Pipes do not work reliably from the Windows command-line prompt. If the pipe includes the character `^Z` / `CHAR(24)`, Windows thinks that it has encountered end-of-file and aborts the program.

This is mainly a problem when you try to apply a binary log as follows:

```
C:\> mysqlbinlog binary_log_file | mysql --user=root
```

If you have a problem applying the log and suspect that it is because of a `^Z` / `CHAR(24)` character, you can use the following workaround:

```
C:\> mysqlbinlog binary_log_file --result-file=/tmp/bin.sql
C:\> mysql --user=root --execute "source /tmp/bin.sql"
```

The latter command also can be used to reliably read any SQL file that may contain binary data.

## 2.4 Installing MySQL on macOS

For a list of macOS versions that the MySQL server supports, see <https://www.mysql.com/support/supportedplatforms/database.html>.

MySQL for macOS is available in a number of different forms:

- Native Package Installer, which uses the native macOS installer (DMG) to walk you through the installation of MySQL. For more information, see [Section 2.4.2, “Installing MySQL on macOS Using Native Packages”](#). You can use the package installer with macOS. The user you use to perform the installation must have administrator privileges.
- Compressed TAR archive, which uses a file packaged using the Unix `tar` and `gzip` commands. To use this method, you 'to open a [Terminal](#) window. You do not need administrator privileges using this method, as you can install the MySQL server anywhere using this method. For more information on using this method, you can use the generic instructions for using a tarball, [Section 2.2, “Installing MySQL on Unix/Linux Using Generic Binaries”](#).

In addition to the core installation, the Package Installer also includes [Section 2.4.3, “Installing a MySQL Launch Daemon”](#) and [Section 2.4.4, “Installing and Using the MySQL Preference Pane”](#), both of which simplify the management of your installation.

For additional information on using MySQL on macOS, see [Section 2.4.1, “General Notes on Installing MySQL on macOS”](#).

## 2.4.1 General Notes on Installing MySQL on macOS

You should keep the following issues and notes in mind:

- As of macOS 10.14 (Mojave), the macOS MySQL 5.7 Installer application requires permission to control *System Events* so it can display a generated (temporary) MySQL root password. Choosing "Don't Allow" means this password won't be visible for use.

If previously disallowed, the fix is enabling *System Events.app* for *Installer.app* under the *Security & Privacy | Automation | Privacy* tab.

- A launchd daemon is installed, and it includes MySQL configuration options. Consider editing it if needed, see the documentation below for additional information. Also, macOS 10.10 removed startup item support in favor of launchd daemons. The optional MySQL preference pane under macOS **System Preferences** uses the launchd daemon.
- You may need (or want) to create a specific `mysql` user to own the MySQL directory and data. You can do this through the [Directory Utility](#), and the `mysql` user should already exist. For use in single user mode, an entry for `_mysql` (note the underscore prefix) should already exist within the `system / etc/passwd` file.
- Because the MySQL package installer installs the MySQL contents into a version and platform specific directory, you can use this to upgrade and migrate your database between versions. You need either to copy the `data` directory from the old version to the new version, or to specify an alternative `datadir` value to set location of the data directory. By default, the MySQL directories are installed under `/usr/local/`.
- You might want to add aliases to your shell's resource file to make it easier to access commonly used programs such as `mysql` and `mysqladmin` from the command line. The syntax for `bash` is:

```
alias mysql=/usr/local/mysql/bin/mysql
alias mysqladmin=/usr/local/mysql/bin/mysqladmin
```

For `tcsh`, use:

```
alias mysql /usr/local/mysql/bin/mysql
alias mysqladmin /usr/local/mysql/bin/mysqladmin
```

Even better, add `/usr/local/mysql/bin` to your `PATH` environment variable. You can do this by modifying the appropriate startup file for your shell. For more information, see [Section 4.2.1, “Invoking MySQL Programs”](#).

- After you have copied over the MySQL database files from the previous installation and have successfully started the new server, you should consider removing the old installation files to save disk space. Additionally, you should also remove older versions of the Package Receipt directories located in `/Library/Receipts/mysql-VERSION.pkg`.

## 2.4.2 Installing MySQL on macOS Using Native Packages

The package is located inside a disk image (`.dmg`) file that you first need to mount by double-clicking its icon in the Finder. It should then mount the image and display its contents.



### Note

Before proceeding with the installation, be sure to stop all running MySQL server instances by using either the MySQL Manager Application (on macOS Server), the preference pane, or `mysqladmin shutdown` on the command line.

To install MySQL using the package installer:

1. Download the disk image (`.dmg`) file (the community version is available [here](#)) that contains the MySQL package installer. Double-click the file to mount the disk image and see its contents.

**Figure 2.13 MySQL Package Installer: DMG Contents**

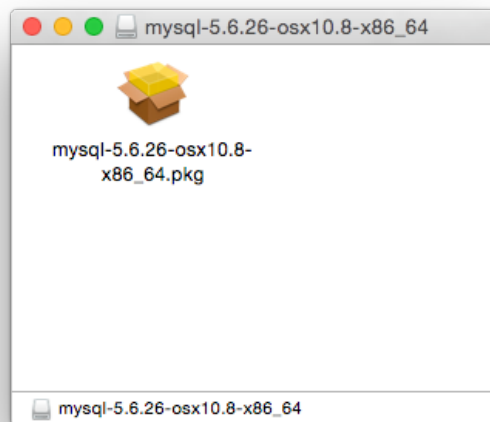

2. Double-click the MySQL installer package from the disk. It is named according to the version of MySQL you have downloaded. For example, for MySQL server 5.7.44 it might be named `mysql-5.7.44-macos-10.13-x86_64.pkg`.
3. The initial wizard introduction screen references the MySQL server version to install. Click **Continue** to begin the installation.

Figure 2.14 MySQL Package Installer Wizard: Introduction

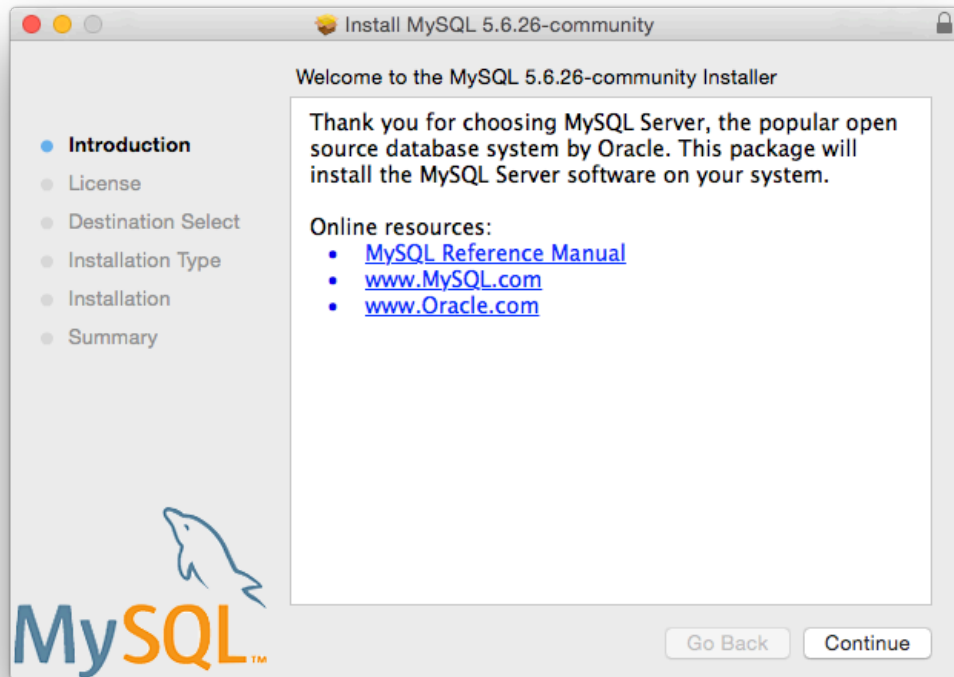

4. The MySQL community edition shows a copy of the relevant GNU General Public License. Click **Continue** and then **Agree** to continue.

- From the **Installation Type** page you can either click **Install** to execute the installation wizard using all defaults, click **Customize** to alter which components to install (MySQL server, Preference Pane, Launchd Support -- all enabled by default).



**Note**

Although the **Change Install Location** option is visible, the installation location cannot be changed.

**Figure 2.15 MySQL Package Installer Wizard: Installation Type**

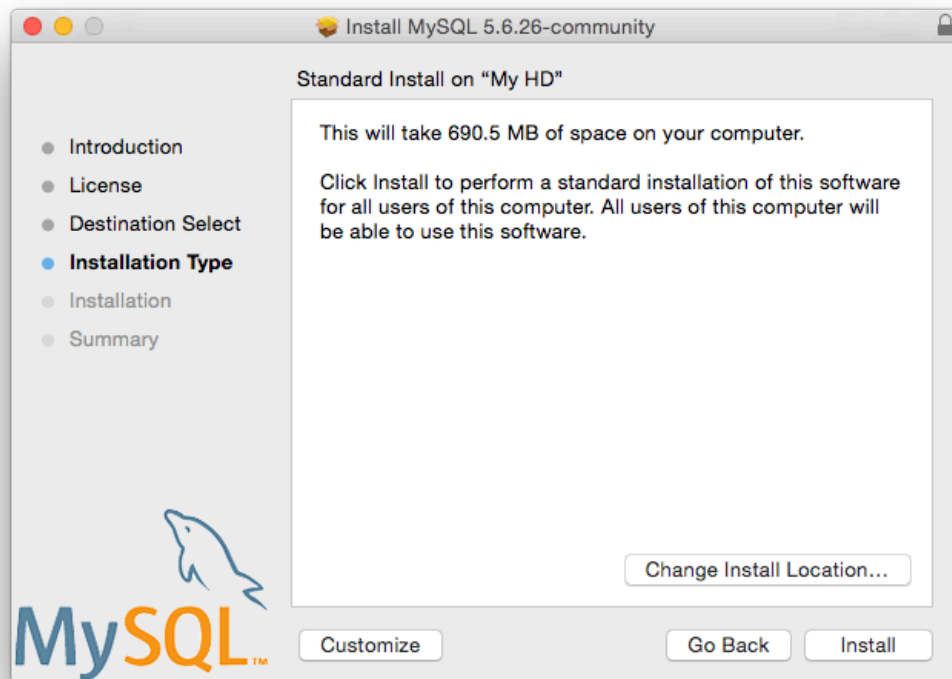
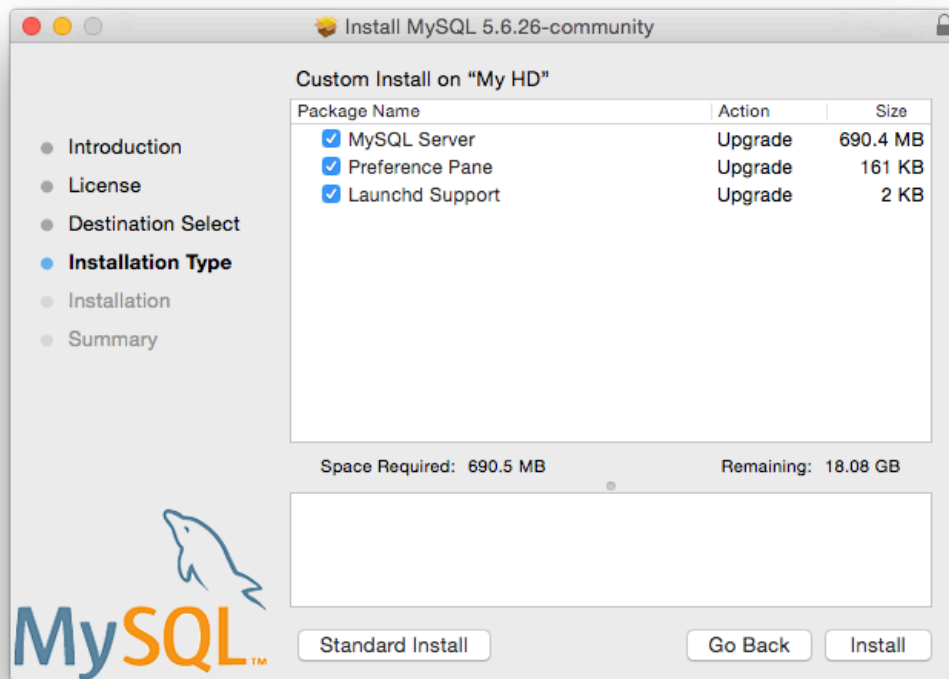

Figure 2.16 MySQL Package Installer Wizard: Customize



6. Click **Install** to begin the installation process.



7. After a successful installation, the installer displays a window with your temporary root password. This cannot be recovered so you must save this password for the initial login to MySQL. For example:

**Figure 2.17 MySQL Package Installer Wizard: Temporary Root Password**

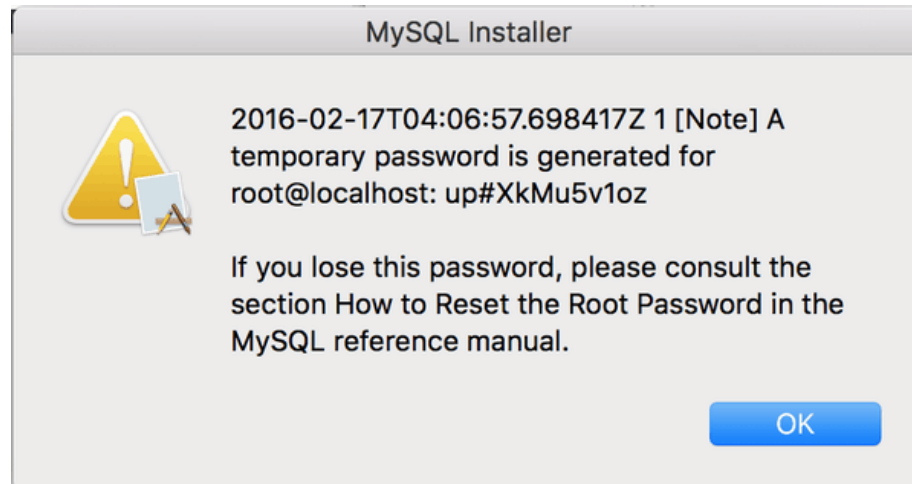

**Note**

MySQL expires this temporary root password after the initial login and requires you to create a new password.

8. **Summary** is the final step and references a successful and complete MySQL Server installation. **Close** the wizard.

**Figure 2.18 MySQL Package Installer Wizard: Summary**



MySQL server is now installed, but it is not loaded (or started) by default. Use either `launchctl` from the command line, or start MySQL by clicking "Start" using the MySQL preference pane. For additional information, see [Section 2.4.3, "Installing a MySQL Launch Daemon"](#), and [Section 2.4.4, "Installing and Using the MySQL Preference Pane"](#). Use the MySQL Preference Pane or `launchd` to configure MySQL to automatically start at bootup.

When installing using the package installer, the files are installed into a directory within `/usr/local` matching the name of the installation version and platform. For example, the installer file `mysql-5.7.44-macos10.13-x86_64.dmg` installs MySQL into `/usr/local/mysql-5.7.44-macos10.13-x86_64/`. The following table shows the layout of the installation directory.

**Table 2.7 MySQL Installation Layout on macOS**

Directory	Contents of Directory
<code>bin</code>	<code>mysqld</code> server, client and utility programs
<code>data</code>	Log files, databases
<code>docs</code>	Helper documents, like the Release Notes and build information
<code>include</code>	Include (header) files
<code>lib</code>	Libraries
<code>man</code>	Unix manual pages

Directory	Contents of Directory
<code>mysql-test</code>	MySQL test suite
<code>share</code>	Miscellaneous support files, including error messages, sample configuration files, SQL for database installation
<code>support-files</code>	Scripts and sample configuration files
<code>/tmp/mysql.sock</code>	Location of the MySQL Unix socket

During the package installer process, a symbolic link from `/usr/local/mysql` to the version/platform specific directory created during installation is created automatically.

## 2.4.3 Installing a MySQL Launch Daemon

macOS uses launch daemons to automatically start, stop, and manage processes and applications such as MySQL.

By default, the installation package (DMG) on macOS installs a launchd file named `/Library/LaunchDaemons/com.oracle.oss.mysql.mysqld.plist` that contains a plist definition similar to:

```
<?xml version="1.0" encoding="utf-8"?>
<!DOCTYPE plist PUBLIC "-//Apple Computer//DTD PLIST 1.0//EN" "http://www.apple.com/DTDs/PropertyList-1.0.0.dtd">
<plist version="1.0">
<dict>
<key>Label</key> <string>com.oracle.oss.mysql.mysqld</string>
<key>ProcessType</key> <string>Interactive</string>
<key>Disabled</key> <false/>
<key>RunAtLoad</key> <true/>
<key>KeepAlive</key> <true/>
<key>SessionCreate</key> <true/>
<key>LaunchOnlyOnce</key> <false/>
<key>UserName</key> <string>_mysql</string>
<key>GroupName</key> <string>_mysql</string>
<key>ExitTimeOut</key> <integer>600</integer>
<key>Program</key> <string>/usr/local/mysql/bin/mysqld</string>
<key>ProgramArguments</key>
<array>
<string>/usr/local/mysql/bin/mysqld</string>
<string>--user=_mysql</string>
<string>--basedir=/usr/local/mysql</string>
<string>--datadir=/usr/local/mysql/data</string>
<string>--plugin-dir=/usr/local/mysql/lib/plugin</string>
<string>--log-error=/usr/local/mysql/data/mysqld.local.err</string>
<string>--pid-file=/usr/local/mysql/data/mysqld.local.pid</string>
</array>
<key>WorkingDirectory</key> <string>/usr/local/mysql</string>
</dict>
</plist>
```



### Note

Some users report that adding a plist DOCTYPE declaration causes the launchd operation to fail, despite it passing the lint check. We suspect it's a copy-n-paste error. The md5 checksum of a file containing the above snippet is `24710a27dc7a28fb7ee6d825129cd3cf`.

To enable the launchd service, you can either:

- Click **Start MySQL Server** from the MySQL preference pane.

**Figure 2.19 MySQL Preference Pane: Location**

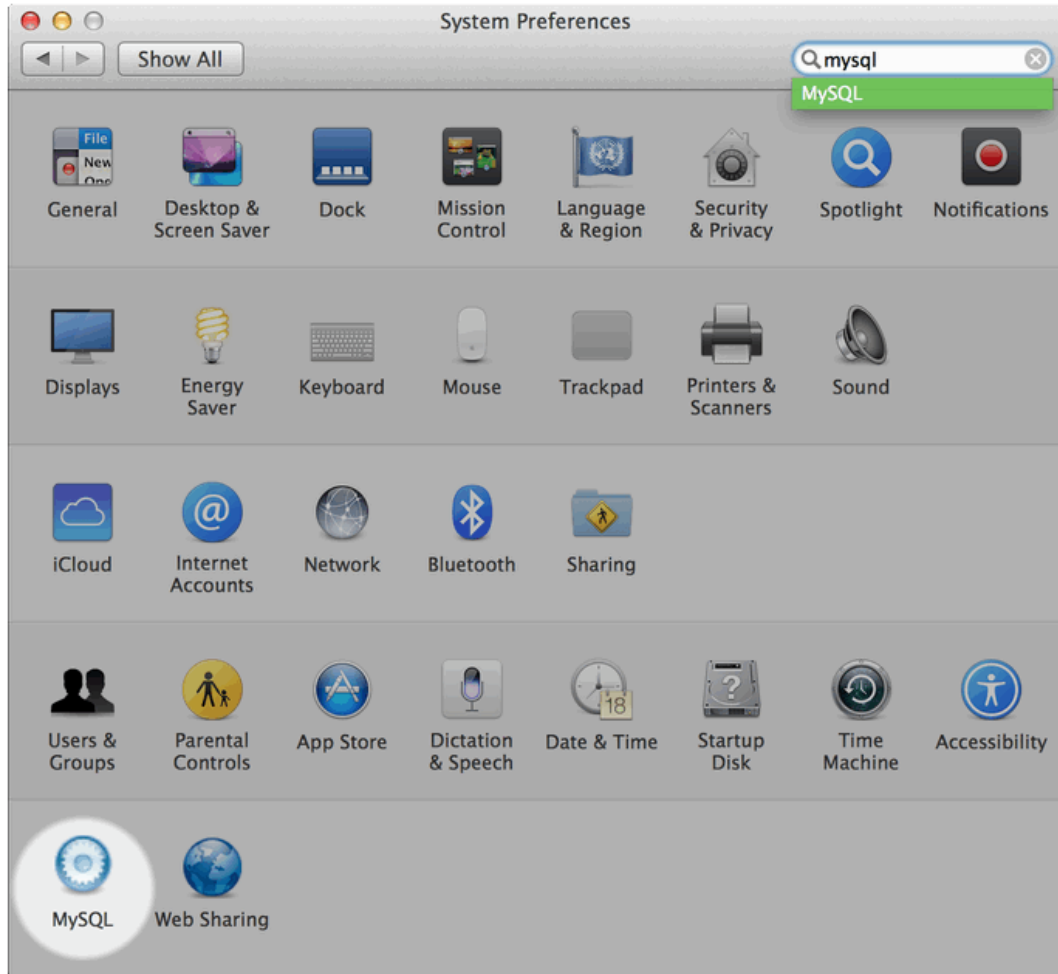
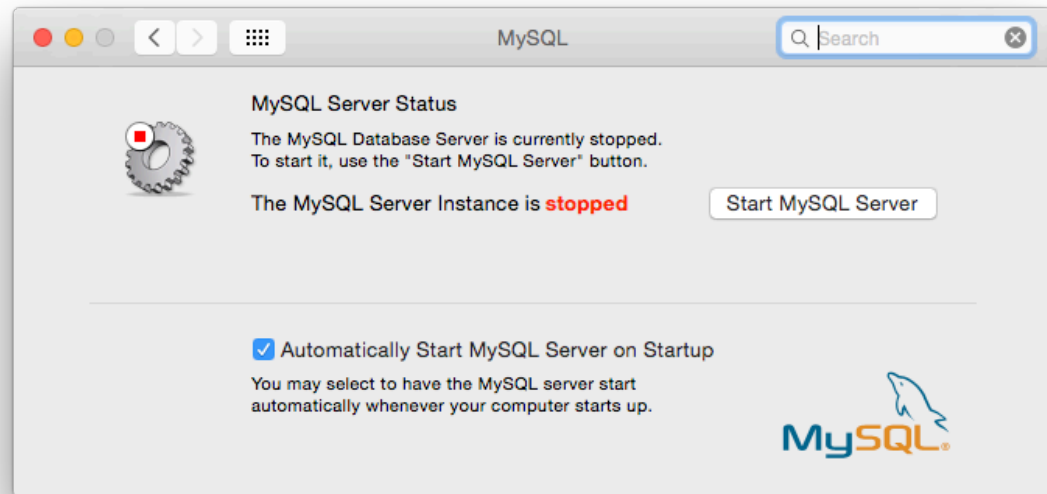

Figure 2.20 MySQL Preference Pane: Usage



- Or, manually load the launchd file.

```
$> cd /Library/LaunchDaemons
$> sudo launchctl load -F com.oracle.oss.mysql.mysqlld.plist
```

- To configure MySQL to automatically start at bootup, you can:

```
$> sudo launchctl load -w com.oracle.oss.mysql.mysqlld.plist
```



#### Note

When upgrading MySQL server, the launchd installation process removes the old startup items that were installed with MySQL server 5.7.7 and earlier.

Upgrading also replaces your existing `launchd` file of the same name.

Additional `launchd` related information:

- The `plist` entries override `my.cnf` entries, because they are passed in as command line arguments. For additional information about passing in program options, see [Section 4.2.2, “Specifying Program Options”](#).
- The **ProgramArguments** section defines the command line options that are passed into the program, which is the `mysqld` binary in this case.
- The default `plist` definition is written with less sophisticated use cases in mind. For more complicated setups, you may want to remove some of the arguments and instead rely on a MySQL configuration file, such as `my.cnf`.
- If you edit the `plist` file, then uncheck the installer option when reinstalling or upgrading MySQL. Otherwise, your edited `plist` file is overwritten, with the loss of any changes you have made.

Because the default `plist` definition defines several **ProgramArguments**, you might remove most of these arguments and instead rely upon your `my.cnf` MySQL configuration file to define them. For example:

```
<?xml version="1.0" encoding="utf-8"?>
<!DOCTYPE plist PUBLIC "-//Apple Computer//DTD PLIST 1.0//EN" "http://www.apple.com/DTDs/PropertyList-1.0.dtd"
<plist version="1.0">
<dict>
  <key>Label</key>          <string>com.oracle.oss.mysql.mysql</string>
  <key>ProcessType</key>   <string>Interactive</string>
  <key>Disabled</key>      <false/>
  <key>RunAtLoad</key>     <true/>
  <key>KeepAlive</key>     <true/>
  <key>SessionCreate</key> <true/>
  <key>LaunchOnlyOnce</key> <false/>
  <key>UserName</key>      <string>_mysql</string>
  <key>GroupName</key>    <string>_mysql</string>
  <key>ExitTimeOut</key>   <integer>600</integer>
  <key>Program</key>       <string>/usr/local/mysql/bin/mysqld</string>
  <key>WorkingDirectory</key> <string>/usr/local/mysql</string>
  <key>ProgramArguments</key>
    <array>
      <string>/usr/local/mysql/bin/mysqld</string>
      <string>--user=_mysql</string>
    </array>
</dict>
</plist>
```

In this case, the `basedir`, `datadir`, `plugin_dir`, `log_error`, and `pid_file` options were removed from the `plist` definition, and then you might define them in `my.cnf`.

### 2.4.4 Installing and Using the MySQL Preference Pane

The MySQL Installation Package includes a MySQL preference pane that enables you to start, stop, and control automated startup during boot of your MySQL installation.

This preference pane is installed by default, and is listed under your system's *System Preferences* window.

Figure 2.21 MySQL Preference Pane: Location

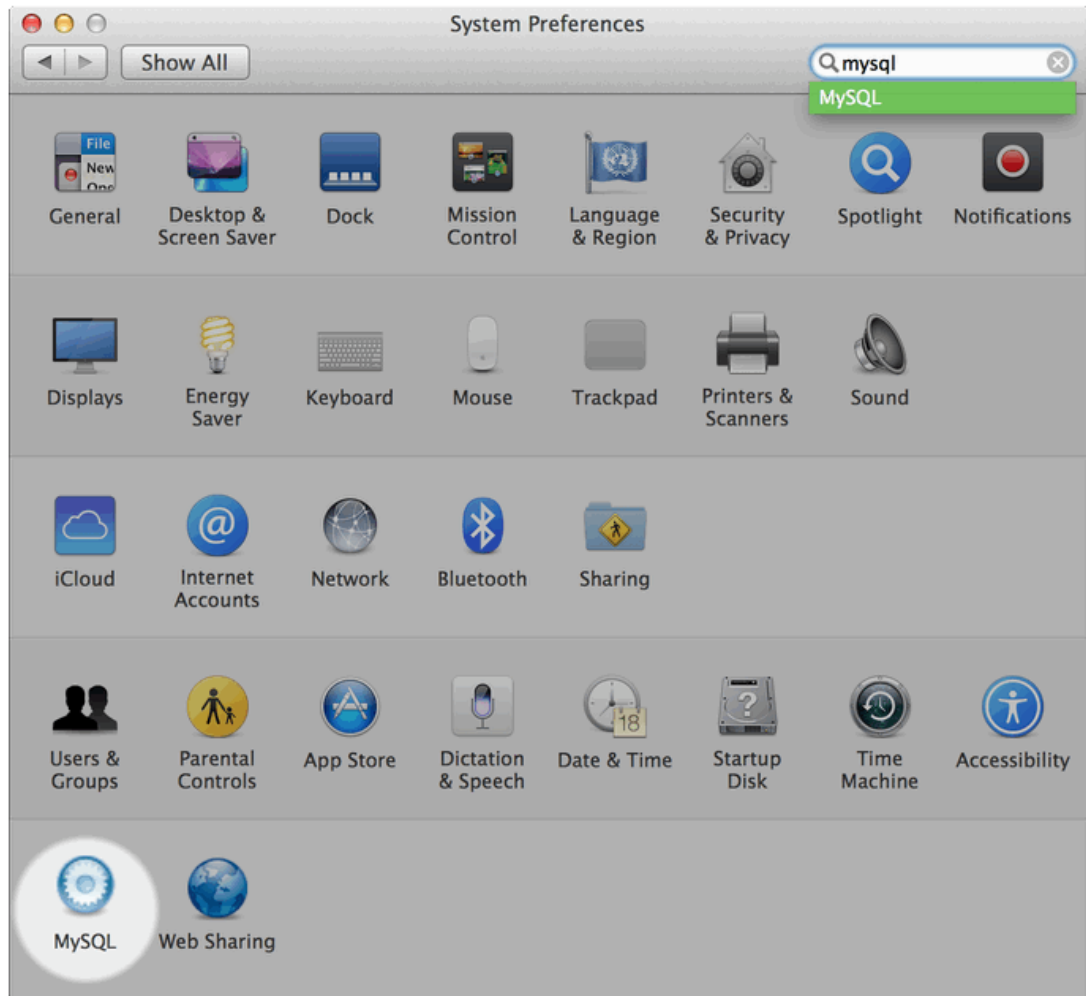

To install the MySQL Preference Pane:

1. Download the disk image (.dmg) file (the community version is available [here](#)) that contains the MySQL package installer. Double-click the file to mount the disk image and see its contents.

**Figure 2.22 MySQL Package Installer: DMG Contents**

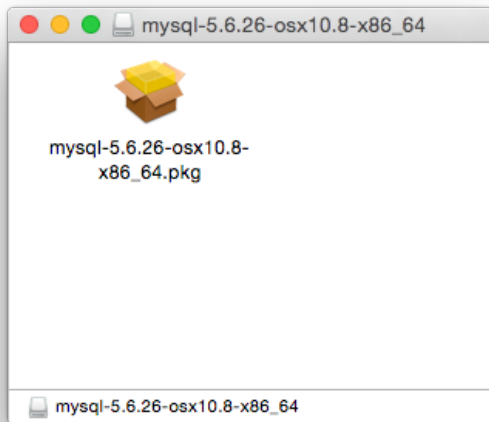

2. Go through the process of installing the MySQL server, as described in the documentation at [Section 2.4.2, "Installing MySQL on macOS Using Native Packages"](#).



3. Click **Customize** at the **Installation Type** step. The "Preference Pane" option is listed there and enabled by default; make sure it is not deselected.

**Figure 2.23 MySQL Installer on macOS: Customize**

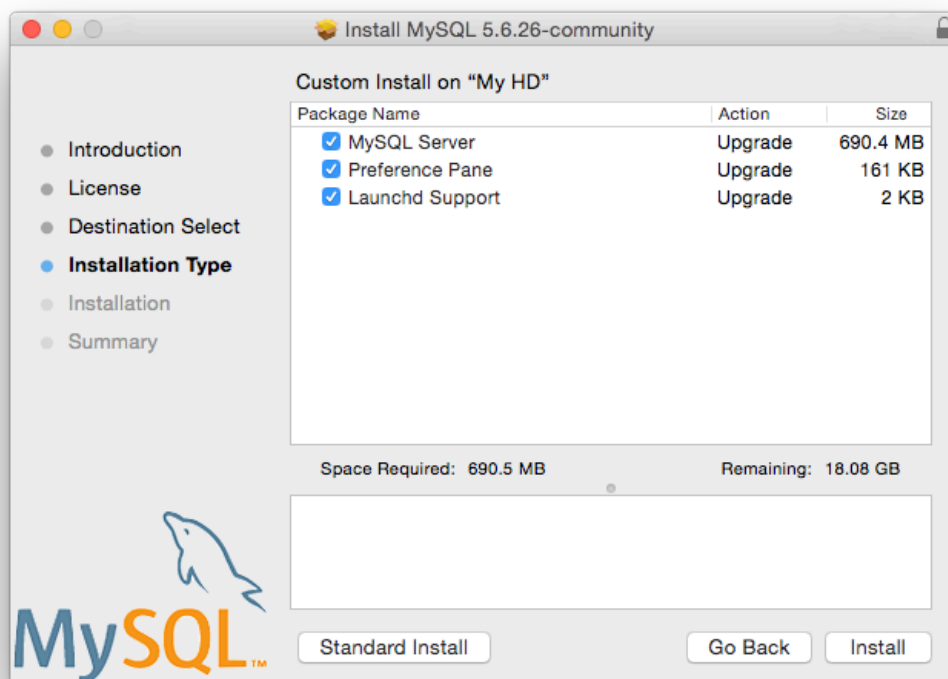

4. Complete the MySQL server installation process.



#### Note

The MySQL preference pane only starts and stops MySQL installation installed from the MySQL package installation that have been installed in the default location.

Once the MySQL preference pane has been installed, you can control your MySQL server instance using the preference pane. To use the preference pane, open the **System Preferences...** from the Apple menu. Select the MySQL preference pane by clicking the MySQL icon within the preference panes list.

Figure 2.24 MySQL Preference Pane: Location

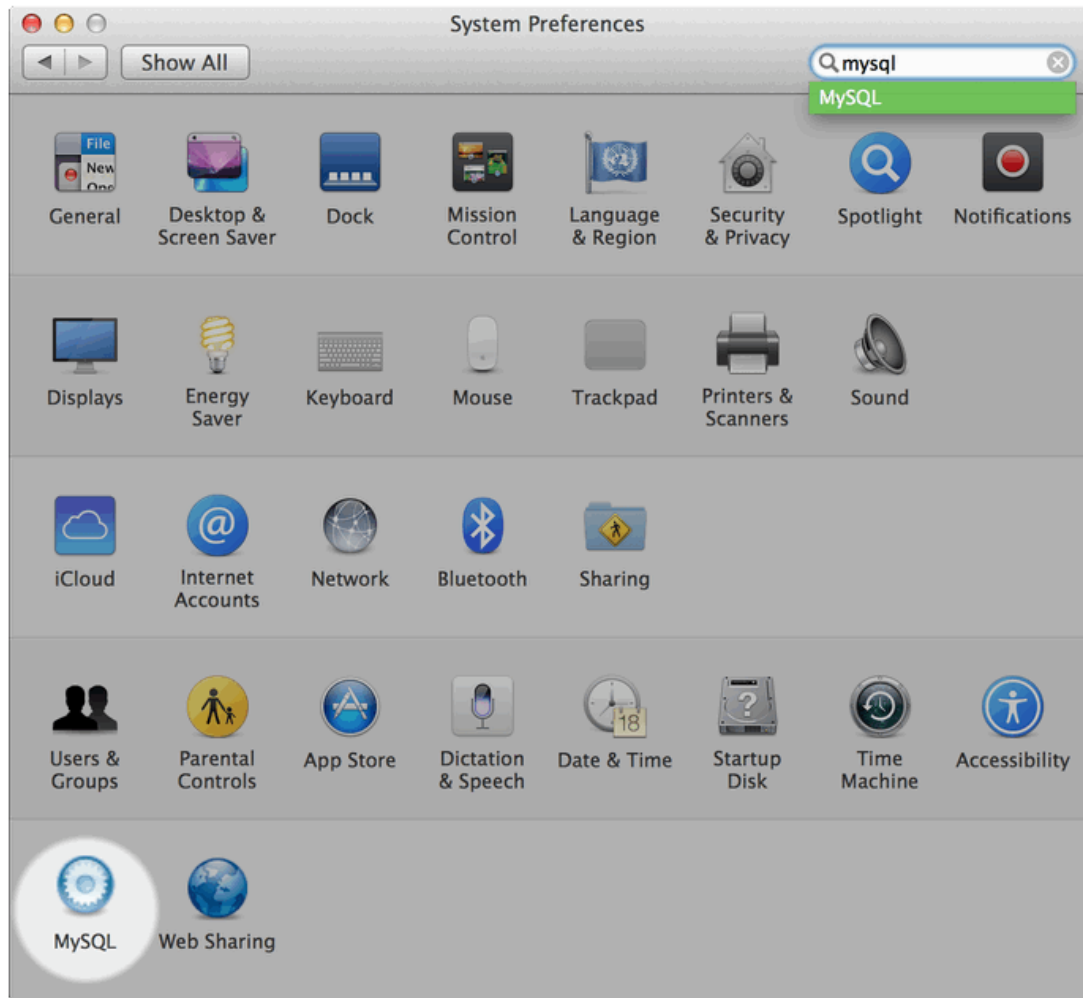

Figure 2.25 MySQL Preference Pane: Usage



The MySQL Preference Pane shows the current status of the MySQL server, showing **stopped** (in red) if the server is not running and **running** (in green) if the server has already been started. The preference pane also shows the current setting for whether the MySQL server has been set to start automatically.

- **To start the MySQL server using the preference pane:**

Click **Start MySQL Server**. You may be prompted for the username and password of a user with administrator privileges to start the MySQL server.

- **To stop the MySQL server using the preference pane:**

Click **Stop MySQL Server**. You may be prompted for the username and password of a user with administrator privileges to stop the MySQL server.

- **To automatically start the MySQL server when the system boots:**

Check the check box next to **Automatically Start MySQL Server on Startup**.

- **To disable automatic MySQL server startup when the system boots:**

Uncheck the check box next to **Automatically Start MySQL Server on Startup**.

You can close the [System Preferences...](#) window once you have completed your settings.

## 2.5 Installing MySQL on Linux

Linux supports a number of different solutions for installing MySQL. We recommend that you use one of the distributions from Oracle, for which several methods for installation are available:

**Table 2.8 Linux Installation Methods and Information**

Type	Setup Method	Additional Information
Apt	Enable the <a href="#">MySQL Apt repository</a>	<a href="#">Documentation</a>

Type	Setup Method	Additional Information
Yum	Enable the <a href="#">MySQL Yum repository</a>	<a href="#">Documentation</a>
Zypper	Enable the <a href="#">MySQL SLES repository</a>	<a href="#">Documentation</a>
RPM	<a href="#">Download</a> a specific package	<a href="#">Documentation</a>
DEB	<a href="#">Download</a> a specific package	<a href="#">Documentation</a>
Generic	<a href="#">Download</a> a generic package	<a href="#">Documentation</a>
Source	Compile from <a href="#">source</a>	<a href="#">Documentation</a>
Docker	Use the <a href="#">Oracle Container Registry</a> . You can also use <a href="#">My Oracle Support</a> for the MySQL Enterprise Edition.	<a href="#">Documentation</a>
Oracle Unbreakable Linux Network	Use ULN channels	<a href="#">Documentation</a>

As an alternative, you can use the package manager on your system to automatically download and install MySQL with packages from the native software repositories of your Linux distribution. These native packages are often several versions behind the currently available release. You also normally cannot install development milestone releases (DMRs), as these are not usually made available in the native repositories. For more information on using the native package installers, see [Section 2.5.8, “Installing MySQL on Linux from the Native Software Repositories”](#).



#### Note

For many Linux installations, you may want to set up MySQL to be started automatically when your machine starts. Many of the native package installations perform this operation for you, but for source, binary and RPM solutions you may need to set this up separately. The required script, `mysql.server`, can be found in the `support-files` directory under the MySQL installation directory or in a MySQL source tree. You can install it as `/etc/init.d/mysql` for automatic MySQL startup and shutdown. See [Section 4.3.3, “mysql.server — MySQL Server Startup Script”](#).

## 2.5.1 Installing MySQL on Linux Using the MySQL Yum Repository

The [MySQL Yum repository](#) for Oracle Linux, Red Hat Enterprise Linux and CentOS provides RPM packages for installing the MySQL server, client, MySQL Workbench, MySQL Utilities, MySQL Router, MySQL Shell, Connector/ODBC, Connector/Python and so on (not all packages are available for all the distributions; see [Installing Additional MySQL Products and Components with Yum](#) for details).

### Before You Start

As a popular, open-source software, MySQL, in its original or re-packaged form, is widely installed on many systems from various sources, including different software download sites, software repositories, and so on. The following instructions assume that MySQL is not already installed on your system using a third-party-distributed RPM package; if that is not the case, follow the instructions given in [Section 2.10.5, “Upgrading MySQL with the MySQL Yum Repository”](#) or [Section 2.5.2, “Replacing a Third-Party Distribution of MySQL Using the MySQL Yum Repository”](#).

## Steps for a Fresh Installation of MySQL

Follow the steps below to install the latest GA version of MySQL with the MySQL Yum repository:

### Adding the MySQL Yum Repository

First, add the MySQL Yum repository to your system's repository list. This is a one-time operation, which can be performed by installing an RPM provided by MySQL. Follow these steps:

- Go to the Download MySQL Yum Repository page (<https://dev.mysql.com/downloads/repo/yum/>) in the MySQL Developer Zone.
- Select and download the release package for your platform.
- Install the downloaded release package with the following command, replacing *platform-and-version-specific-package-name* with the name of the downloaded RPM package:

```
$> sudo yum localinstall platform-and-version-specific-package-name.rpm
```

For an EL6-based system, the command is in the form of:

```
$> sudo yum localinstall mysql57-community-release-el6-{version-number}.noarch.rpm
```

For an EL7-based system:

```
$> sudo yum localinstall mysql57-community-release-el7-{version-number}.noarch.rpm
```

For an EL8-based system:

```
$> sudo yum localinstall mysql57-community-release-el8-{version-number}.noarch.rpm
```

For Fedora:

MySQL 5.7 does not support Fedora; support was removed in MySQL 5.7.30. For details, see the [MySQL Product Support EOL Announcements](#).

The installation command adds the MySQL Yum repository to your system's repository list and downloads the GnuPG key to check the integrity of the software packages. See [Section 2.1.4.2, “Signature Checking Using GnuPG”](#) for details on GnuPG key checking.

You can check that the MySQL Yum repository has been successfully added by the following command:

```
$> yum repolist enabled | grep "mysql.*-community.*"
```



#### Note

Once the MySQL Yum repository is enabled on your system, any system-wide update by the `yum update` command upgrades MySQL packages on your system and replaces any native third-party packages, if Yum finds replacements for them in the MySQL Yum repository; see [Section 2.10.5, “Upgrading MySQL with the MySQL Yum Repository”](#) and, for a discussion on some possible effects of that on your system, see [Upgrading the Shared Client Libraries](#).

### Selecting a Release Series

When using the MySQL Yum repository, the latest GA series (currently MySQL 5.7) is selected for installation by default. If this is what you want, you can skip to the next step, [Installing MySQL](#).

Within the MySQL Yum repository, different release series of the MySQL Community Server are hosted in different subrepositories. The subrepository for the latest GA series (currently MySQL 5.7) is enabled by default, and the subrepositories for all other series (for example, the MySQL 5.6 series) are disabled by default. Use this command to see all the subrepositories in the MySQL Yum repository, and see which of them are enabled or disabled:

```
$> yum repolist all | grep mysql
```

To install the latest release from the latest GA series, no configuration is needed. To install the latest release from a specific series other than the latest GA series, disable the subrepository for the latest GA series and enable the subrepository for the specific series before running the installation command. If your platform supports `yum-config-manager`, you can do that by issuing these commands, which disable the subrepository for the 5.7 series and enable the one for the 5.6 series:

```
$> sudo yum-config-manager --disable mysql57-community
$> sudo yum-config-manager --enable mysql56-community
```

For Fedora platforms:

```
$> sudo dnf config-manager --disable mysql57-community
$> sudo dnf config-manager --enable mysql56-community
```

Besides using `yum-config-manager` or the `dnf config-manager` command, you can also select a release series by editing manually the `/etc/yum.repos.d/mysql-community.repo` file. This is a typical entry for a release series' subrepository in the file:

```
[mysql57-community]
name=MySQL 5.7 Community Server
baseurl=http://repo.mysql.com/yum/mysql-5.7-community/el/6/$basearch/
enabled=1
gpgcheck=1
gpgkey=file:///etc/pki/rpm-gpg/RPM-GPG-KEY-mysql
```

Find the entry for the subrepository you want to configure, and edit the `enabled` option. Specify `enabled=0` to disable a subrepository, or `enabled=1` to enable a subrepository. For example, to install MySQL 5.6, make sure you have `enabled=0` for the above subrepository entry for MySQL 5.7, and have `enabled=1` for the entry for the 5.6 series:

```
# Enable to use MySQL 5.6
[mysql56-community]
name=MySQL 5.6 Community Server
baseurl=http://repo.mysql.com/yum/mysql-5.6-community/el/6/$basearch/
enabled=1
gpgcheck=1
gpgkey=file:///etc/pki/rpm-gpg/RPM-GPG-KEY-mysql
```

You should only enable subrepository for one release series at any time. When subrepositories for more than one release series are enabled, the latest series is used by Yum.

Verify that the correct subrepositories have been enabled and disabled by running the following command and checking its output:

```
$> yum repolist enabled | grep mysql
```

## Disabling the Default MySQL Module

(EL8 systems only) EL8-based systems such as RHEL8 and Oracle Linux 8 include a MySQL module that is enabled by default. Unless this module is disabled, it masks packages provided by MySQL

repositories. To disable the included module and make the MySQL repository packages visible, use the following command (for dnf-enabled systems, replace `yum` in the command with `dnf`):

```
$> sudo yum module disable mysql
```

### Installing MySQL

Install MySQL by the following command:

```
$> sudo yum install mysql-community-server
```

This installs the package for MySQL server (`mysql-community-server`) and also packages for the components required to run the server, including packages for the client (`mysql-community-client`), the common error messages and character sets for client and server (`mysql-community-common`), and the shared client libraries (`mysql-community-libs`).

### Starting the MySQL Server

Start the MySQL server with the following command:

```
$> sudo service mysqld start
Starting mysqld: [ OK ]
```

You can check the status of the MySQL server with the following command:

```
$> sudo service mysqld status
mysqld (pid 3066) is running.
```

At the initial start up of the server, the following happens, given that the data directory of the server is empty:

- The server is initialized.
- SSL certificate and key files are generated in the data directory.
- `validate_password` is installed and enabled.
- A superuser account `'root'@'localhost'` is created. A password for the superuser is set and stored in the error log file. To reveal it, use the following command:

```
$> sudo grep 'temporary password' /var/log/mysqld.log
```

Change the root password as soon as possible by logging in with the generated, temporary password and set a custom password for the superuser account:

```
$> mysql -uroot -p
```

```
mysql> ALTER USER 'root'@'localhost' IDENTIFIED BY 'MyNewPass4!';
```



#### Note

`validate_password` is installed by default. The default password policy implemented by `validate_password` requires that passwords contain at least one uppercase letter, one lowercase letter, one digit, and one special character, and that the total password length is at least 8 characters.

For more information on the postinstallation procedures, see [Section 2.9, “Postinstallation Setup and Testing”](#).

**Note**

*Compatibility Information for EL7-based platforms:* The following RPM packages from the native software repositories of the platforms are incompatible with the package from the MySQL Yum repository that installs the MySQL server. Once you have installed MySQL using the MySQL Yum repository, you cannot install these packages (and vice versa).

- akonadi-mysql

## Installing Additional MySQL Products and Components with Yum

You can use Yum to install and manage individual components of MySQL. Some of these components are hosted in sub-repositories of the MySQL Yum repository: for example, the MySQL Connectors are to be found in the MySQL Connectors Community sub-repository, and the MySQL Workbench in MySQL Tools Community. You can use the following command to list the packages for all the MySQL components available for your platform from the MySQL Yum repository:

```
$> sudo yum --disablerepo=\* --enablerepo='mysql*-community*' list available
```

Install any packages of your choice with the following command, replacing *package-name* with name of the package:

```
$> sudo yum install package-name
```

For example, to install MySQL Workbench on Fedora:

```
$> sudo dnf install mysql-workbench-community
```

To install the shared client libraries:

```
$> sudo yum install mysql-community-libs
```

## Updating MySQL with Yum

Besides installation, you can also perform updates for MySQL products and components using the MySQL Yum repository. See [Section 2.10.5, “Upgrading MySQL with the MySQL Yum Repository”](#) for details.

## 2.5.2 Replacing a Third-Party Distribution of MySQL Using the MySQL Yum Repository

For supported Yum-based platforms (see [Section 2.5.1, “Installing MySQL on Linux Using the MySQL Yum Repository”](#), for a list), you can replace a third-party distribution of MySQL with the latest GA release (from the MySQL 5.7 series currently) from the MySQL Yum repository. According to how your third-party distribution of MySQL was installed, there are different steps to follow:

### Replacing a Native Third-Party Distribution of MySQL

If you have installed a third-party distribution of MySQL from a native software repository (that is, a software repository provided by your own Linux distribution), follow these steps:

### Backing Up Your Database

To avoid loss of data, always back up your database before trying to replace your MySQL installation using the MySQL Yum repository. See [Chapter 7, Backup and Recovery](#), on how to back up your database.



## Adding the MySQL Yum Repository

Add the MySQL Yum repository to your system's repository list by following the instructions given in [Adding the MySQL Yum Repository](#).

## Replacing the Native Third-Party Distribution by a Yum Update or a DNF Upgrade

By design, the MySQL Yum repository replaces your native third-party MySQL with the latest GA release (from the MySQL 5.7 series currently) from the MySQL Yum repository when you perform a `yum update` command on the system, or a `yum update mysql-server`.

After updating MySQL using the Yum repository, applications compiled with older versions of the shared client libraries should continue to work. However, *if you want to recompile applications and dynamically link them with the updated libraries*, see [Upgrading the Shared Client Libraries](#), for some special considerations.

## Replacing a Nonnative Third-Party Distribution of MySQL

If you have installed a third-party distribution of MySQL from a nonnative software repository (that is, a software repository not provided by your own Linux distribution), follow these steps:

### Backing Up Your Database

To avoid loss of data, always back up your database before trying to replace your MySQL installation using the MySQL Yum repository. See [Chapter 7, Backup and Recovery](#), on how to back up your database.

## Stopping Yum from Receiving MySQL Packages from Third-Party, Nonnative Repositories

Before you can use the MySQL Yum repository for installing MySQL, you must stop your system from receiving MySQL packages from any third-party, nonnative Yum repositories.

For example, if you have installed MariaDB using their own software repository, get a list of the installed MariaDB packages using the following command:

```
$> yum list installed mariadb*
MariaDB-common.i686                10.0.4-1                @mariadb
MariaDB-compat.i686                10.0.4-1                @mariadb
MariaDB-server.i686                10.0.4-1                @mariadb
```

From the command output, we can identify the installed packages ([MariaDB-common](#), [MariaDB-compat](#), and [MariaDB-server](#)) and the source of them (a nonnative software repository named [mariadb](#)).

As another example, if you have installed Percona using their own software repository, get a list of the installed Percona packages using the following command:

```
$> yum list installed Percona*
Percona-Server-client-55.i686      5.5.39-rel136.0.e16    @percona-release-i386
Percona-Server-server-55.i686     5.5.39-rel136.0.e16    @percona-release-i386
Percona-Server-shared-55.i686     5.5.39-rel136.0.e16    @percona-release-i386
percona-release.noarch             0.1-3                  @/percona-release-0.1-3.noarch
```

From the command output, we can identify the installed packages ([Percona-Server-client](#), [Percona-Server-server](#), [Percona-Server-shared](#), and [percona-release.noarch](#)) and the source of them (a nonnative software repository named [percona-release](#)).

If you are not sure which third-party MySQL fork you have installed, this command should reveal it and list the RPM packages installed for it, as well as the third-party repository that supplies the packages:

```
$> yum --disablerepo=\* provides mysql\*
```

The next step is to stop Yum from receiving packages from the nonnative repository. If the `yum-config-manager` utility is supported on your platform, you can, for example, use this command for stopping delivery from MariaDB:

```
$> sudo yum-config-manager --disable mariadb
```

Use this command for stopping delivery from Percona:

```
$> sudo yum-config-manager --disable percona-release
```

You can perform the same task by removing the entry for the software repository existing in one of the repository files under the `/etc/yum.repos.d/` directory. This is how the entry typically looks for MariaDB:

```
[mariadb] name = MariaDB
baseurl = [base URL for repository]
gpgkey = [URL for GPG key]
gpgcheck =1
```

The entry is usually found in the file `/etc/yum.repos.d/MariaDB.repo` for MariaDB—delete the file, or remove entry from it (or from the file in which you find the entry).



### Note

This step is not necessary for an installation that was configured with a Yum repository release package (like Percona) if you are going to remove the release package (`percona-release.noarch` for Percona), as shown in the `uninstall` command for Percona in Step 3 below.

## Uninstalling the Nonnative Third-Party MySQL Distribution of MySQL

The nonnative third-party MySQL distribution must first be uninstalled before you can use the MySQL Yum repository to install MySQL. For the MariaDB packages found in Step 2 above, uninstall them with the following command:

```
$> sudo yum remove MariaDB-common MariaDB-compat MariaDB-server
```

For the Percona packages we found in Step 2 above:

```
$> sudo yum remove Percona-Server-client-55 Percona-Server-server-55 \
Percona-Server-shared-55.i686 percona-release
```

## Installing MySQL with the MySQL Yum Repository

Then, install MySQL with the MySQL Yum repository by following the instructions given in [Section 2.5.1, “Installing MySQL on Linux Using the MySQL Yum Repository”](#):



### Important

If you have chosen to replace your third-party MySQL distribution with a newer version of MySQL from the MySQL Yum repository, remember to run `mysql_upgrade` after the server starts, to check and possibly resolve any incompatibilities between the old data and the upgraded

software. `mysql_upgrade` also performs other functions; see [Section 4.4.7, “mysql\\_upgrade — Check and Upgrade MySQL Tables”](#) for details.

*For EL7-based platforms:* See [Compatibility Information for EL7-based platforms \[154\]](#).

### 2.5.3 Installing MySQL on Linux Using the MySQL APT Repository

The MySQL APT repository provides `deb` packages for installing and managing the MySQL server, client, and other components on the current Debian and Ubuntu releases.

Instructions for using the MySQL APT Repository are available in [A Quick Guide to Using the MySQL APT Repository](#).

### 2.5.4 Installing MySQL on Linux Using the MySQL SLES Repository

The MySQL SLES repository provides RPM packages for installing and managing the MySQL server, client, and other components on SUSE Enterprise Linux Server.

Instructions for using the MySQL SLES repository are available in [A Quick Guide to Using the MySQL SLES Repository](#).

### 2.5.5 Installing MySQL on Linux Using RPM Packages from Oracle

The recommended way to install MySQL on RPM-based Linux distributions is by using the RPM packages provided by Oracle. There are two sources for obtaining them, for the Community Edition of MySQL:

- From the MySQL software repositories:
  - The MySQL Yum repository (see [Section 2.5.1, “Installing MySQL on Linux Using the MySQL Yum Repository”](#) for details).
  - The MySQL SLES repository (see [Section 2.5.4, “Installing MySQL on Linux Using the MySQL SLES Repository”](#) for details).
- From the [Download MySQL Community Server](#) page in the [MySQL Developer Zone](#).



#### Note

RPM distributions of MySQL are also provided by other vendors. Be aware that they may differ from those built by Oracle in features, capabilities, and conventions (including communication setup), and that the installation instructions in this manual do not necessarily apply to them. The vendor's instructions should be consulted instead.

If you have such a third-party distribution of MySQL running on your system and now want to migrate to Oracle's distribution using the RPM packages downloaded from the MySQL Developer Zone, see [Compatibility with RPM Packages from Other Vendors](#) below. The preferred method of migration, however, is to use the [MySQL Yum repository](#) or [MySQL SLES repository](#).

RPM packages for MySQL are listed in the following tables:

**Table 2.9 RPM Packages for MySQL Community Edition**

Package Name	Summary
<code>mysql-community-server</code>	Database server and related tools

Package Name	Summary
<code>mysql-community-client</code>	MySQL client applications and tools
<code>mysql-community-common</code>	Common files for server and client libraries
<code>mysql-community-devel</code>	Development header files and libraries for MySQL database client applications
<code>mysql-community-libs</code>	Shared libraries for MySQL database client applications
<code>mysql-community-libs-compat</code>	Shared compatibility libraries for previous MySQL installations
<code>mysql-community-embedded</code>	MySQL embedded library
<code>mysql-community-embedded-devel</code>	Development header files and libraries for MySQL as an embeddable library
<code>mysql-community-test</code>	Test suite for the MySQL server

Table 2.10 RPM Packages for the MySQL Enterprise Edition

Package Name	Summary
<code>mysql-commercial-server</code>	Database server and related tools
<code>mysql-commercial-client</code>	MySQL client applications and tools
<code>mysql-commercial-common</code>	Common files for server and client libraries
<code>mysql-commercial-devel</code>	Development header files and libraries for MySQL database client applications
<code>mysql-commercial-libs</code>	Shared libraries for MySQL database client applications
<code>mysql-commercial-libs-compat</code>	Shared compatibility libraries for previous MySQL installations
<code>mysql-commercial-embedded</code>	MySQL embedded library
<code>mysql-commercial-embedded-devel</code>	Development header files and libraries for MySQL as an embeddable library
<code>mysql-commercial-test</code>	Test suite for the MySQL server

The full names for the RPMs have the following syntax:

```
packagename-version-distribution-arch.rpm
```

The *distribution* and *arch* values indicate the Linux distribution and the processor type for which the package was built. See the table below for lists of the distribution identifiers:

Table 2.11 MySQL Linux RPM Package Distribution Identifiers

distribution Value	Intended Use
<code>el{version}</code> where <i>{version}</i> is the major Enterprise Linux version, such as <code>el8</code>	EL6 (8.0), EL7, EL8, EL9, and EL10-based platforms (for example, the corresponding versions of Oracle Linux, Red Hat Enterprise Linux, and CentOS)
<code>sles12</code>	SUSE Linux Enterprise Server 12

To see all files in an RPM package (for example, `mysql-community-server`), use the following command:

```
$> rpm -qpl mysql-community-server-version-distribution-arch.rpm
```

The discussion in the rest of this section applies only to an installation process using the RPM packages directly downloaded from Oracle, instead of through a MySQL repository.

Dependency relationships exist among some of the packages. If you plan to install many of the packages, you may wish to download the RPM bundle `tar` file instead, which contains all the RPM packages listed above, so that you need not download them separately.

In most cases, you need to install the `mysql-community-server`, `mysql-community-client`, `mysql-community-libs`, `mysql-community-common`, and `mysql-community-libs-compat` packages to get a functional, standard MySQL installation. To perform such a standard, basic installation, go to the folder that contains all those packages (and, preferably, no other RPM packages with similar names), and issue the following command for platforms *other than* Red Hat Enterprise Linux/Oracle Linux/CentOS:

```
$> sudo yum install mysql-community-{server,client,common,libs}-*
```

Replace `yum` with `zypper` for SLES.

For Red Hat Enterprise Linux/Oracle Linux/CentOS systems:

```
$> sudo yum install mysql-community-{server,client,common,libs}-* mysql-5.*
```

While it is much preferable to use a high-level package management tool like `yum` to install the packages, users who prefer direct `rpm` commands can replace the `yum install` command with the `rpm -Uvh` command; however, using `rpm -Uvh` instead makes the installation process more prone to failure, due to potential dependency issues the installation process might run into.

To install only the client programs, you can skip `mysql-community-server` in your list of packages to install; issue the following command for platforms *other than* Red Hat Enterprise Linux/Oracle Linux/CentOS:

```
$> sudo yum install mysql-community-{client,common,libs}-*
```

Replace `yum` with `zypper` for SLES.

For Red Hat Enterprise Linux/Oracle Linux/CentOS systems:

```
$> sudo yum install mysql-community-{client,common,libs}-* mysql-5.*
```

A standard installation of MySQL using the RPM packages result in files and resources created under the system directories, shown in the following table.

**Table 2.12 MySQL Installation Layout for Linux RPM Packages from the MySQL Developer Zone**

Files or Resources	Location
Client programs and scripts	<code>/usr/bin</code>
<code>mysqld</code> server	<code>/usr/sbin</code>
Configuration file	<code>/etc/my.cnf</code>
Data directory	<code>/var/lib/mysql</code>
Error log file	For RHEL, Oracle Linux, CentOS or Fedora platforms: <code>/var/log/mysqld.log</code> For SLES: <code>/var/log/mysql/mysqld.log</code>
Value of <code>secure_file_priv</code>	<code>/var/lib/mysql-files</code>

Files or Resources	Location
System V init script	For RHEL, Oracle Linux, CentOS or Fedora platforms: <code>/etc/init.d/mysqld</code> For SLES: <code>/etc/init.d/mysql</code>
Systemd service	For RHEL, Oracle Linux, CentOS or Fedora platforms: <code>mysqld</code> For SLES: <code>mysql</code>
Pid file	<code>/var/run/mysql/mysqld.pid</code>
Socket	<code>/var/lib/mysql/mysql.sock</code>
Keyring directory	<code>/var/lib/mysql-keyring</code>
Unix manual pages	<code>/usr/share/man</code>
Include (header) files	<code>/usr/include/mysql</code>
Libraries	<code>/usr/lib/mysql</code>
Miscellaneous support files (for example, error messages, and character set files)	<code>/usr/share/mysql</code>

The installation also creates a user named `mysql` and a group named `mysql` on the system.



#### Notes

- The `mysql` user is created using the `-r` and `-s /bin/false` options of the `useradd` command, so that it does not have login permissions to your server host (see [Creating the mysql User and Group](#) for details). To switch to the `mysql` user on your OS, use the `--shell=/bin/bash` option for the `su` command:

```
su - mysql --shell=/bin/bash
```

- Installation of previous versions of MySQL using older packages might have created a configuration file named `/usr/my.cnf`. It is highly recommended that you examine the contents of the file and migrate the desired settings inside to the file `/etc/my.cnf` file, then remove `/usr/my.cnf`.

MySQL is not automatically started at the end of the installation process. For Red Hat Enterprise Linux, Oracle Linux, CentOS, and Fedora systems, use the following command to start MySQL:

```
$> sudo service mysqld start
```

For SLES systems, the command is the same, but the service name is different:

```
$> sudo service mysql start
```

If the operating system is systemd enabled, standard `service` commands such as `stop`, `start`, `status` and `restart` should be used to manage the MySQL server service. The `mysqld` service is enabled by default, and it starts at system reboot. Notice that certain things might work differently on systemd platforms: for example, changing the location of the data directory might cause issues. See [Section 2.5.10, “Managing MySQL Server with systemd”](#) for additional information.

During an upgrade installation using RPM and DEB packages, if the MySQL server is running when the upgrade occurs then the MySQL server is stopped, the upgrade occurs, and the MySQL server is restarted. One exception: if the edition also changes during an upgrade (such as community to commercial, or vice-versa), then MySQL server is not restarted.

At the initial start up of the server, the following happens, given that the data directory of the server is empty:

- The server is initialized.
- An SSL certificate and key files are generated in the data directory.
- `validate_password` is installed and enabled.
- A superuser account `'root'@'localhost'` is created. A password for the superuser is set and stored in the error log file. To reveal it, use the following command for RHEL, Oracle Linux, CentOS, and Fedora systems:

```
$> sudo grep 'temporary password' /var/log/mysqld.log
```

Use the following command for SLES systems:

```
$> sudo grep 'temporary password' /var/log/mysql/mysqld.log
```

The next step is to log in with the generated, temporary password and set a custom password for the superuser account:

```
$> mysql -uroot -p
```

```
mysql> ALTER USER 'root'@'localhost' IDENTIFIED BY 'MyNewPass4!';
```



### Note

`validate_password` is installed by default. The default password policy implemented by `validate_password` requires that passwords contain at least one uppercase letter, one lowercase letter, one digit, and one special character, and that the total password length is at least 8 characters.

If something goes wrong during installation, you might find debug information in the error log file `/var/log/mysqld.log`.

For some Linux distributions, it might be necessary to increase the limit on number of file descriptors available to `mysqld`. See [Section B.3.2.16, “File Not Found and Similar Errors”](#)

**Compatibility with RPM Packages from Other Vendors.** If you have installed packages for MySQL from your Linux distribution's local software repository, it is much preferable to install the new, directly-downloaded packages from Oracle using the package management system of your platform (`yum`, `dnf`, or `zypper`), as described above. The command replaces old packages with new ones to ensure compatibility of old applications with the new installation; for example, the old `mysql-libs` package is replaced with the `mysql-community-libs-compat` package, which provides a replacement-compatible client library for applications that were using your older MySQL installation. If there was an older version of `mysql-community-libs-compat` on the system, it also gets replaced.

If you have installed third-party packages for MySQL that are NOT from your Linux distribution's local software repository (for example, packages directly downloaded from a vendor other than Oracle), you should uninstall all those packages before installing the new, directly-downloaded packages from Oracle. This is because conflicts may arise between those vendor's RPM packages and Oracle's: for example, a vendor's convention about which files belong with the server and which belong with the client library may differ from that used for Oracle packages. Attempts to install an Oracle RPM may then result in messages saying that files in the RPM to be installed conflict with files from an installed package.

**Installing Client Libraries from Multiple MySQL Versions.** It is possible to install multiple client library versions, such as for the case that you want to maintain compatibility with older applications linked against

previous libraries. To install an older client library, use the `--oldpackage` option with `rpm`. For example, to install `mysql-community-libs-5.5` on an EL6 system that has `libmysqlclient.20` from MySQL 5.7, use a command like this:

```
$> rpm --oldpackage -ivh mysql-community-libs-5.5.50-2.el6.x86_64.rpm
```

**Debug Package.** A special variant of MySQL Server compiled with the [debug package](#) has been included in the server RPM packages. It performs debugging and memory allocation checks and produces a trace file when the server is running. To use that debug version, start MySQL with `/usr/sbin/mysqld-debug`, instead of starting it as a service or with `/usr/sbin/mysqld`. See [Section 5.8.3, “The DEBUG Package”](#) for the debug options you can use.



#### Note

The default plugin directory for debug builds changed from `/usr/lib64/mysql/plugin` to `/usr/lib64/mysql/plugin/debug` in 5.7.21. Previously, it was necessary to change `plugin_dir` to `/usr/lib64/mysql/plugin/debug` for debug builds.

**Rebuilding RPMs from source SRPMs.** Source code SRPM packages for MySQL are available for download. They can be used as-is to rebuild the MySQL RPMs with the standard `rpmbuild` tool chain.

**root passwords for pre-GA releases.** For MySQL 5.7.4 and 5.7.5, the initial random `root` password is written to the `.mysql_secret` file in the directory named by the `HOME` environment variable. When trying to access the file, bear in mind that depending on operating system, using a command such as `sudo` may cause the value of `HOME` to refer to the home directory of the `root` system user. `.mysql_secret` is created with mode 600 to be accessible only to the system user for whom it is created. Before MySQL 5.7.4, the accounts (including `root`) created in the MySQL grant tables for an RPM installation initially have no passwords; after starting the server, you should assign passwords to them using the instructions in [Section 2.9, “Postinstallation Setup and Testing”](#).

## 2.5.6 Installing MySQL on Linux Using Debian Packages from Oracle

Oracle provides Debian packages for installing MySQL on Debian or Debian-like Linux systems. The packages are available through two different channels:

- The [MySQL APT Repository](#). This is the preferred method for installing MySQL on Debian-like systems, as it provides a simple and convenient way to install and update MySQL products. For details, see [Section 2.5.3, “Installing MySQL on Linux Using the MySQL APT Repository”](#).
- The [MySQL Developer Zone's Download Area](#). For details, see [Section 2.1.3, “How to Get MySQL”](#). The following are some information on the Debian packages available there and the instructions for installing them:
  - Various Debian packages are provided in the MySQL Developer Zone for installing different components of MySQL on different Debian or Ubuntu platforms. The preferred method is to use the tarball bundle, which contains the packages needed for a basic setup of MySQL. The tarball bundles have names in the format of `mysql-server_MVER-DVER_CPU.deb-bundle.tar`. `MVER` is the MySQL version and `DVER` is the Linux distribution version. The `CPU` value indicates the processor type or family for which the package is built, as shown in the following table:

**Table 2.13 MySQL Debian and Ubuntu Installation Packages CPU Identifiers**

<i>CPU</i> Value	Intended Processor Type or Family
i386	Pentium processor or better, 32 bit



CPU Value	Intended Processor Type or Family
amd64	64-bit x86 processor

- After downloading the tarball, unpack it with the following command:

```
$> tar -xvf mysql-server_MVER-DVER_CPU.deb-bundle.tar
```

- You may need to install the `libaio` library if it is not already present on your system:

```
$> sudo apt-get install libaio1
```

- Preconfigure the MySQL server package with the following command:

```
$> sudo dpkg-preconfigure mysql-community-server_*.deb
```

You are asked to provide a password for the root user for your MySQL installation. You might also be asked other questions regarding the installation.



### Important

Make sure you remember the root password you set. Users who want to set a password later can leave the **password** field blank in the dialogue box and just press **OK**; in that case, root access to the server is authenticated using the [MySQL Socket Peer-Credential Authentication Plugin](#) for connections using a Unix socket file. You can set the root password later using [mysql\\_secure\\_installation](#).

- For a basic installation of the MySQL server, install the database common files package, the client package, the client metapackage, the server package, and the server metapackage (in that order); you can do that with a single command:

```
$> sudo dpkg -i mysql-{common,community-client,client,community-server,server}*.deb
```

If you are being warned of unmet dependencies by `dpkg`, you can fix them using `apt-get`:

```
sudo apt-get -f install
```

Here are where the files are installed on the system:

- All configuration files (like `my.cnf`) are under `/etc/mysql`
- All binaries, libraries, headers, etc., are under `/usr/bin` and `/usr/sbin`
- The data directory is `/var/lib/mysql`



### Note

Debian distributions of MySQL are also provided by other vendors. Be aware that they may differ from those built by Oracle in features, capabilities, and conventions (including communication setup), and that the instructions in this manual do not necessarily apply to installing them. The vendor's instructions should be consulted instead.

## 2.5.7 Deploying MySQL on Linux with Docker

The Docker deployment framework supports easy installation and configuration of MySQL Server. This section explains how to use a MySQL Server Docker image.

You need to have Docker installed on your system before you can use a MySQL Server Docker image. See [Install Docker](#) for instructions.



#### Warning

Beware of the security concerns with running Docker containers. See [Docker security](#) for details.

The instructions for using the MySQL Docker container are divided into two sections.

### 2.5.7.1 Basic Steps for MySQL Server Deployment with Docker



#### Warning

The MySQL Docker images maintained by the MySQL team are built specifically for Linux platforms. Other platforms are not supported, and users using these MySQL Docker images on them are doing so at their own risk. See [the discussion here](#) for some known limitations for running these containers on non-Linux operating systems.

- [Downloading a MySQL Server Docker Image](#)
- [Starting a MySQL Server Instance](#)
- [Connecting to MySQL Server from within the Container](#)
- [Container Shell Access](#)
- [Stopping and Deleting a MySQL Container](#)
- [Upgrading a MySQL Server Container](#)
- [More Topics on Deploying MySQL Server with Docker](#)

### Downloading a MySQL Server Docker Image



#### Important

*For users of MySQL Enterprise Edition:* A subscription is required to use the Docker images for MySQL Enterprise Edition. Subscriptions work by a Bring Your Own License model; see [How to Buy MySQL Products and Services](#) for details.

Downloading the server image in a separate step is not strictly necessary; however, performing this step before you create your Docker container ensures your local image is up to date. To download the MySQL Community Edition image, run this command:

```
docker pull mysql/mysql-server:tag
```

The `tag` is the label for the image version you want to pull (for example, `5.6`, `5.7`, `8.0`, or `latest`). If `:tag` is omitted, the `latest` label is used, and the image for the latest GA version of MySQL Community Server is downloaded. Refer to the list of tags for available versions on the [mysql/mysql-server page in the Docker Hub](#).

To download the MySQL Community Edition image from the Oracle Container Registry (OCR), run this command:

```
docker pull container-registry.oracle.com/mysql/mysql-server:tag
```

To download the MySQL Enterprise Edition image from the OCR, you need to first accept the license agreement on the OCR and log in to the container repository with your Docker client:

- Visit the OCR at <https://container-registry.oracle.com/> and choose **MySQL**.
- Under the list of MySQL repositories, choose `enterprise-server`.
- If you have not signed in to the OCR yet, click the **Sign in** button on the right of the page, and then enter your Oracle account credentials when prompted to.
- Follow the instructions on the right of the page to accept the license agreement.
- Log in to the OCR with your Docker client (the `docker` command) using the `docker login` command:

```
# docker login container-registry.oracle.com
Username: Oracle-Account-ID
Password: password
Login successful.
```

Download the Docker image for MySQL Enterprise Edition from the OCR with this command:

```
docker pull container-registry.oracle.com/mysql/enterprise-server:tag
```

There are different choices for `tag`, corresponding to different versions of MySQL Docker images provided by the OCR:

- `8.0`, `8.0.x` (`x` is the latest version number in the 8.0 series), `latest`: MySQL 8.0, the latest GA
- `5.7`, `5.7.y` (`y` is the latest version number in the 5.7 series): MySQL 5.7

To download the MySQL Enterprise Edition image, visit the [My Oracle Support](#) website, sign in to your Oracle account, and perform these steps once you are on the landing page:

- Select the **Patches and Updates** tab.
- Go to the **Patch Search** region and, on the **Search** tab, switch to the **Product or Family (Advanced)** subtab.
- Enter “MySQL Server” for the **Product** field, and the desired version number in the **Release** field.
- Use the dropdowns for additional filters to select **Description—contains**, and enter “Docker” in the text field.

The following figure shows the search settings for a MySQL Enterprise Edition image:

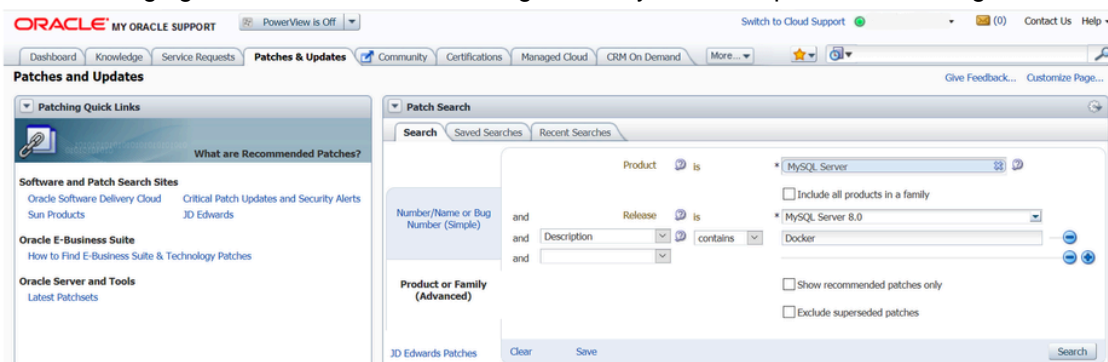

- Click the **Search** button and, from the result list, select the version you want, and click the **Download** button.

- In the **File Download** dialogue box that appears, click and download the `.zip` file for the Docker image.

Unzip the downloaded `.zip` archive to obtain the tarball inside (`mysql-enterprise-server-version.tar`), and then load the image by running this command:

```
docker load -i mysql-enterprise-server-version.tar
```

You can list downloaded Docker images with this command:

```
$> docker images
REPOSITORY          TAG                IMAGE ID           CREATED            SIZE
mysql/mysql-server  latest            3157d7f55f8d     4 weeks ago      241MB
```

## Starting a MySQL Server Instance

To start a new Docker container for a MySQL Server, use the following command:

```
docker run --name=container_name -d image_name:tag
```

The image name can be obtained using the `docker images` command, as explained in [Downloading a MySQL Server Docker Image](#). The `--name` option, for supplying a custom name for your server container, is optional; if no container name is supplied, a random one is generated.

For example, to start a new Docker container for the MySQL Community Server, use this command:

```
docker run --name=mysql11 -d mysql/mysql-server:5.7
```

To start a new Docker container for the MySQL Enterprise Server with a Docker image downloaded from the OCR, use this command:

```
docker run --name=mysql11 -d container-registry.oracle.com/mysql/enterprise-server:5.7
```

To start a new Docker container for the MySQL Enterprise Server with a Docker image downloaded from My Oracle Support, use this command:

```
docker run --name=mysql11 -d mysql/enterprise-server:5.7
```

If the Docker image of the specified name and tag has not been downloaded by an earlier `docker pull` or `docker run` command, the image is now downloaded. Initialization for the container begins, and the container appears in the list of running containers when you run the `docker ps` command. For example:

```
$> docker ps
CONTAINER ID   IMAGE                COMMAND                  CREATED        STATUS
a24888f0d6f4  mysql/mysql-server  "/entrypoint.sh my..."  14 seconds ago  Up 13 seconds (health: starti
```

The container initialization might take some time. When the server is ready for use, the **STATUS** of the container in the output of the `docker ps` command changes from (`health: starting`) to (`healthy`).

The `-d` option used in the `docker run` command above makes the container run in the background. Use this command to monitor the output from the container:

```
docker logs mysql11
```

Once initialization is finished, the command's output is going to contain the random password generated for the root user; check the password with, for example, this command:

```
$> docker logs mysql11 2>&1 | grep GENERATED
```

```
GENERATED ROOT PASSWORD: Axegh3kAJyDLaRuBemecis&EShOs
```

## Connecting to MySQL Server from within the Container

Once the server is ready, you can run the `mysql` client within the MySQL Server container you just started, and connect it to the MySQL Server. Use the `docker exec -it` command to start a `mysql` client inside the Docker container you have started, like the following:

```
docker exec -it mysql1 mysql -uroot -p
```

When asked, enter the generated root password (see the last step in [Starting a MySQL Server Instance](#) above on how to find the password). Because the `MYSQL_ONETIME_PASSWORD` option is true by default, after you have connected a `mysql` client to the server, you must reset the server root password by issuing this statement:

```
mysql> ALTER USER 'root'@'localhost' IDENTIFIED BY 'password';
```

Substitute `password` with the password of your choice. Once the password is reset, the server is ready for use.

## Container Shell Access

To have shell access to your MySQL Server container, use the `docker exec -it` command to start a bash shell inside the container:

```
$> docker exec -it mysql1 bash
bash-4.2#
```

You can then run Linux commands inside the container. For example, to view contents in the server's data directory inside the container, use this command:

```
bash-4.2# ls /var/lib/mysql
auto.cnf      ca.pem      client-key.pem  ib_logfile0  ibdata1  mysql      mysql.sock.lock  private_key.p
ca-key.pem   client-cert.pem  ib_buffer_pool  ib_logfile1  ibtmp1   mysql.sock  performance_schema  public_
```

## Stopping and Deleting a MySQL Container

To stop the MySQL Server container we have created, use this command:

```
docker stop mysql1
```

`docker stop` sends a SIGTERM signal to the `mysqld` process, so that the server is shut down gracefully.

Also notice that when the main process of a container (`mysqld` in the case of a MySQL Server container) is stopped, the Docker container stops automatically.

To start the MySQL Server container again:

```
docker start mysql1
```

To stop and start again the MySQL Server container with a single command:

```
docker restart mysql1
```

To delete the MySQL container, stop it first, and then use the `docker rm` command:

```
docker stop mysql1
```

```
docker rm mysql1
```

If you want the [Docker volume for the server's data directory](#) to be deleted at the same time, add the `-v` option to the `docker rm` command.

## Upgrading a MySQL Server Container



### Important

- Before performing any upgrade to MySQL, follow carefully the instructions in [Section 2.10, “Upgrading MySQL”](#). Among other instructions discussed there, it is especially important to back up your database before the upgrade.
- The instructions in this section require that the server's data and configuration have been persisted on the host. See [Persisting Data and Configuration Changes](#) for details.

Follow these steps to upgrade a Docker installation of MySQL 5.6 to 5.7:

- Stop the MySQL 5.6 server (container name is `mysql56` in this example):

```
docker stop mysql56
```

- Download the MySQL 5.7 Server Docker image. See instructions in [Downloading a MySQL Server Docker Image](#); make sure you use the right tag for MySQL 5.7.
- Start a new MySQL 5.7 Docker container (named `mysql57` in this example) with the old server data and configuration (with proper modifications if needed—see [Section 2.10, “Upgrading MySQL”](#)) that have been persisted on the host (by [bind-mounting](#) in this example). For the MySQL Community Server, run this command:

```
docker run --name=mysql57 \
  --mount type=bind,src=/path-on-host-machine/my.cnf,dst=/etc/my.cnf \
  --mount type=bind,src=/path-on-host-machine/datadir,dst=/var/lib/mysql \
  -d mysql/mysql-server:5.7
```

If needed, adjust `mysql/mysql-server` to the correct image name—for example, replace it with `container-registry.oracle.com/mysql/enterprise-server` for MySQL Enterprise Edition images downloaded from the OCR, or `mysql/enterprise-server` for MySQL Enterprise Edition images downloaded from [My Oracle Support](#).

- Wait for the server to finish startup. You can check the status of the server using the `docker ps` command (see [Starting a MySQL Server Instance](#) for how to do that).
- Run the `mysql_upgrade` utility in the MySQL 5.7 Server container:

```
docker exec -it mysql57 mysql_upgrade -uroot -p
```

When prompted, enter the root password for your old MySQL 5.6 Server.

- Finish the upgrade by restarting the MySQL 5.7 Server container:

```
docker restart mysql57
```

## More Topics on Deploying MySQL Server with Docker

For more topics on deploying MySQL Server with Docker like server configuration, persisting data and configuration, server error log, and container environment variables, see [Section 2.5.7.2, “More Topics on Deploying MySQL Server with Docker”](#).

## 2.5.7.2 More Topics on Deploying MySQL Server with Docker



### Note

Most of the sample commands below have `mysql/mysql-server` as the Docker image repository when that has to be specified (like with the `docker pull` and `docker run` commands); change that if your image is from another repository—for example, replace it with `container-registry.oracle.com/mysql/enterprise-server` for MySQL Enterprise Edition images downloaded from the Oracle Container Registry (OCR), or `mysql/enterprise-server` for MySQL Enterprise Edition images downloaded from [My Oracle Support](#).

- [The Optimized MySQL Installation for Docker](#)
- [Configuring the MySQL Server](#)
- [Persisting Data and Configuration Changes](#)
- [Running Additional Initialization Scripts](#)
- [Connect to MySQL from an Application in Another Docker Container](#)
- [Server Error Log](#)
- [Known Issues](#)
- [Docker Environment Variables](#)

### The Optimized MySQL Installation for Docker

Docker images for MySQL are optimized for code size, which means they only include crucial components that are expected to be relevant for the majority of users who run MySQL instances in Docker containers. A MySQL Docker installation is different from a common, non-Docker installation in the following aspects:

- Included binaries are limited to:
  - `/usr/bin/my_print_defaults`
  - `/usr/bin/mysql`
  - `/usr/bin/mysql_config`
  - `/usr/bin/mysql_install_db`
  - `/usr/bin/mysql_tzinfo_to_sql`
  - `/usr/bin/mysql_upgrade`
  - `/usr/bin/mysqladmin`
  - `/usr/bin/mysqlcheck`
  - `/usr/bin/mysqldump`
  - `/usr/bin/mysqldump`
  - `/usr/bin/mysqldump`
  - `/usr/sbin/mysqld`
- All binaries are stripped; they contain no debug information.

## Configuring the MySQL Server

When you start the MySQL Docker container, you can pass configuration options to the server through the `docker run` command. For example:

```
docker run --name mysql1 -d mysql/mysql-server:tag --character-set-server=utf8mb4 --collation-server=utf8mb4_c
```

The command starts your MySQL Server with `utf8mb4` as the default character set and `utf8mb4_col` as the default collation for your databases.

Another way to configure the MySQL Server is to prepare a configuration file and mount it at the location of the server configuration file inside the container. See [Persisting Data and Configuration Changes](#) for details.

## Persisting Data and Configuration Changes

Docker containers are in principle ephemeral, and any data or configuration are expected to be lost if the container is deleted or corrupted (see discussions [here](#)). [Docker volumes](#), however, provides a mechanism to persist data created inside a Docker container. At its initialization, the MySQL Server container creates a Docker volume for the server data directory. The JSON output for running the `docker inspect` command on the container has a `Mount` key, whose value provides information on the data directory volume:

```
$> docker inspect mysql1
...
  "Mounts": [
    {
      "Type": "volume",
      "Name": "4f2d463cfc4bdd4baebcb098c97d7da3337195ed2c6572bc0b89f7e845d27652",
      "Source": "/var/lib/docker/volumes/4f2d463cfc4bdd4baebcb098c97d7da3337195ed2c6572bc0b89f7e845d27652/_data",
      "Destination": "/var/lib/mysql",
      "Driver": "local",
      "Mode": "",
      "RW": true,
      "Propagation": ""
    }
  ],
  ...
```

The output shows that the source folder `/var/lib/docker/volumes/4f2d463cfc4bdd4baebcb098c97d7da3337195ed2c6572bc0b89f7e845d27652/_data`, in which data is persisted on the host, has been mounted at `/var/lib/mysql`, the server data directory inside the container.

Another way to preserve data is to [bind-mount](#) a host directory using the `--mount` option when creating the container. The same technique can be used to persist the configuration of the server. The following command creates a MySQL Server container and bind-mounts both the data directory and the server configuration file:

```
docker run --name=mysql1 \
--mount type=bind,src=/path-on-host-machine/my.cnf,dst=/etc/my.cnf \
--mount type=bind,src=/path-on-host-machine/datadir,dst=/var/lib/mysql \
-d mysql/mysql-server:tag
```

The command mounts `path-on-host-machine/my.cnf` at `/etc/my.cnf` (the server configuration file inside the container), and `path-on-host-machine/datadir` at `/var/lib/mysql` (the data directory inside the container). The following conditions must be met for the bind-mounting to work:

- The configuration file `path-on-host-machine/my.cnf` must already exist, and it must contain the specification for starting the server using the user `mysql`:

```
[mysqld]
```



```
user=mysql
```

You can also include other server configuration options in the file.

- The data directory `path-on-host-machine/datadir` must already exist. For server initialization to happen, the directory must be empty. You can also mount a directory prepopulated with data and start the server with it; however, you must make sure you start the Docker container with the same configuration as the server that created the data, and any host files or directories required are mounted when starting the container.

## Running Additional Initialization Scripts

If there are any `.sh` or `.sql` scripts you want to run on the database immediately after it has been created, you can put them into a host directory and then mount the directory at `/docker-entrypoint-initdb.d/` inside the container. For example:

```
docker run --name=mysql1 \
--mount type=bind,src=/path-on-host-machine/scripts/,dst=/docker-entrypoint-initdb.d/ \
-d mysql/mysql-server:tag
```

## Connect to MySQL from an Application in Another Docker Container

By setting up a Docker network, you can allow multiple Docker containers to communicate with each other, so that a client application in another Docker container can access the MySQL Server in the server container. First, create a Docker network:

```
docker network create my-custom-net
```

Then, when you are creating and starting the server and the client containers, use the `--network` option to put them on network you created. For example:

```
docker run --name=mysql1 --network=my-custom-net -d mysql/mysql-server
```

```
docker run --name=myapp1 --network=my-custom-net -d myapp
```

The `myapp1` container can then connect to the `mysql1` container with the `mysql1` hostname and vice versa, as Docker automatically sets up a DNS for the given container names. In the following example, we run the `mysql` client from inside the `myapp1` container to connect to host `mysql1` in its own container:

```
docker exec -it myapp1 mysql --host=mysql1 --user=myuser --password
```

For other networking techniques for containers, see the [Docker container networking](#) section in the Docker Documentation.

## Server Error Log

When the MySQL Server is first started with your server container, a [server error log](#) is NOT generated if either of the following conditions is true:

- A server configuration file from the host has been mounted, but the file does not contain the system variable `log_error` (see [Persisting Data and Configuration Changes](#) on bind-mounting a server configuration file).
- A server configuration file from the host has not been mounted, but the Docker environment variable `MYSQL_LOG_CONSOLE` is `true` (the variable's default state for MySQL 5.7 server containers is `false`). The MySQL Server's error log is then redirected to `stderr`, so that the error log goes into the Docker container's log and is viewable using the `docker logs mysqld-container` command.

To make MySQL Server generate an error log when either of the two conditions is true, use the `--log-error` option to [configure the server](#) to generate the error log at a specific location inside the container. To persist the error log, mount a host file at the location of the error log inside the container as explained in

[Persisting Data and Configuration Changes](#). However, you must make sure your MySQL Server inside its container has write access to the mounted host file.

## Known Issues

- When using the server system variable `audit_log_file` to configure the audit log file name, use the `loose` option modifier with it, or Docker will be unable to start the server.

## Docker Environment Variables

When you create a MySQL Server container, you can configure the MySQL instance by using the `--env` option (`-e` in short) and specifying one or more of the following environment variables.



### Notes

- None of the variables below has any effect if the data directory you mount is not empty, as no server initialization is going to be attempted then (see [Persisting Data and Configuration Changes](#) for more details). Any pre-existing contents in the folder, including any old server settings, are not modified during the container startup.
- The boolean variables including `MYSQL_RANDOM_ROOT_PASSWORD`, `MYSQL_ONETIME_PASSWORD`, `MYSQL_ALLOW_EMPTY_PASSWORD`, and `MYSQL_LOG_CONSOLE` are made true by setting them with any strings of nonzero lengths. Therefore, setting them to, for example, “0”, “false”, or “no” does not make them false, but actually makes them true. This is a known issue of the MySQL Server containers.
- `MYSQL_RANDOM_ROOT_PASSWORD`: When this variable is true (which is its default state, unless `MYSQL_ROOT_PASSWORD` is set or `MYSQL_ALLOW_EMPTY_PASSWORD` is set to true), a random password for the server's root user is generated when the Docker container is started. The password is printed to `stdout` of the container and can be found by looking at the container's log (see [Starting a MySQL Server Instance](#)).
- `MYSQL_ONETIME_PASSWORD`: When the variable is true (which is its default state, unless `MYSQL_ROOT_PASSWORD` is set or `MYSQL_ALLOW_EMPTY_PASSWORD` is set to true), the root user's password is set as expired and must be changed before MySQL can be used normally.
- `MYSQL_DATABASE`: This variable allows you to specify the name of a database to be created on image startup. If a user name and a password are supplied with `MYSQL_USER` and `MYSQL_PASSWORD`, the user is created and granted superuser access to this database (corresponding to `GRANT ALL`). The specified database is created by a `CREATE DATABASE IF NOT EXIST` statement, so that the variable has no effect if the database already exists.
- `MYSQL_USER`, `MYSQL_PASSWORD`: These variables are used in conjunction to create a user and set that user's password, and the user is granted superuser permissions for the database specified by the `MYSQL_DATABASE` variable. Both `MYSQL_USER` and `MYSQL_PASSWORD` are required for a user to be created—if any of the two variables is not set, the other is ignored. If both variables are set but `MYSQL_DATABASE` is not, the user is created without any privileges.



### Note

There is no need to use this mechanism to create the root superuser, which is created by default with the password set by either one of the mechanisms discussed in the descriptions for `MYSQL_ROOT_PASSWORD` and `MYSQL_RANDOM_ROOT_PASSWORD`, unless `MYSQL_ALLOW_EMPTY_PASSWORD` is true.

- **MYSQL\_ROOT\_HOST**: By default, MySQL creates the 'root'@'localhost' account. This account can only be connected to from inside the container as described in [Connecting to MySQL Server from within the Container](#). To allow root connections from other hosts, set this environment variable. For example, the value `172.17.0.1`, which is the default Docker gateway IP, allows connections from the host machine that runs the container. The option accepts only one entry, but wildcards are allowed (for example, `MYSQL_ROOT_HOST=172.*.*.*` or `MYSQL_ROOT_HOST=%`).
- **MYSQL\_LOG\_CONSOLE**: When the variable is true (the variable's default state for MySQL 5.7 server containers is `false`), the MySQL Server's error log is redirected to `stderr`, so that the error log goes into the Docker container's log and is viewable using the `docker logs mysqld-container` command.

**Note**

The variable has no effect if a server configuration file from the host has been mounted (see [Persisting Data and Configuration Changes](#) on bind-mounting a configuration file).

- **MYSQL\_ROOT\_PASSWORD**: This variable specifies a password that is set for the MySQL root account.

**Warning**

Setting the MySQL root user password on the command line is insecure. As an alternative to specifying the password explicitly, you can set the variable with a container file path for a password file, and then mount a file from your host that contains the password at the container file path. This is still not very secure, as the location of the password file is still exposed. It is preferable to use the default settings of `MYSQL_RANDOM_ROOT_PASSWORD` and `MYSQL_ONETIME_PASSWORD` both being true.

- **MYSQL\_ALLOW\_EMPTY\_PASSWORD**. Set it to true to allow the container to be started with a blank password for the root user.

**Warning**

Setting this variable to true is insecure, because it is going to leave your MySQL instance completely unprotected, allowing anyone to gain complete superuser access. It is preferable to use the default settings of `MYSQL_RANDOM_ROOT_PASSWORD` and `MYSQL_ONETIME_PASSWORD` both being true.

### 2.5.7.3 Deploying MySQL on Windows and Other Non-Linux Platforms with Docker

**Warning**

The MySQL Docker images provided by Oracle are built specifically for Linux platforms. Other platforms are not supported, and users running the MySQL Docker images from Oracle on them are doing so at their own risk. This section discusses some known issues for the images when used on non-Linux platforms.

Known Issues for using the MySQL Server Docker images from Oracle on Windows include:

- If you are bind-mounting on the container's MySQL data directory (see [Persisting Data and Configuration Changes](#) for details), you have to set the location of the server socket file with the `--socket` option to somewhere outside of the MySQL data directory; otherwise, the server fails to start. This is because the way Docker for Windows handles file mounting does not allow a host file from being bind-mounted on the socket file.

## 2.5.8 Installing MySQL on Linux from the Native Software Repositories

Many Linux distributions include a version of the MySQL server, client tools, and development components in their native software repositories and can be installed with the platforms' standard package management systems. This section provides basic instructions for installing MySQL using those package management systems.



### Important

Native packages are often several versions behind the currently available release. You also normally cannot install development milestone releases (DMRs), as these are not usually made available in the native repositories. Before proceeding, we recommend that you check out the other installation options described in [Section 2.5, “Installing MySQL on Linux”](#).

Distribution specific instructions are shown below:

- **Red Hat Linux, Fedora, CentOS**



### Note

For a number of Linux distributions, you can install MySQL using the MySQL Yum repository instead of the platform's native software repository. See [Section 2.5.1, “Installing MySQL on Linux Using the MySQL Yum Repository”](#) for details.

For Red Hat and similar distributions, the MySQL distribution is divided into a number of separate packages, `mysql` for the client tools, `mysql-server` for the server and associated tools, and `mysql-libs` for the libraries. The libraries are required if you want to provide connectivity from different languages and environments such as Perl, Python and others.

To install, use the `yum` command to specify the packages that you want to install. For example:

```
#> yum install mysql mysql-server mysql-libs mysql-server
Loaded plugins: presto, refresh-packagekit
Setting up Install Process
Resolving Dependencies
--> Running transaction check
----> Package mysql.x86_64 0:5.1.48-2.fc13 set to be updated
----> Package mysql-libs.x86_64 0:5.1.48-2.fc13 set to be updated
----> Package mysql-server.x86_64 0:5.1.48-2.fc13 set to be updated
--> Processing Dependency: perl-DBD-MySQL for package: mysql-server-5.1.48-2.fc13.x86_64
--> Running transaction check
----> Package perl-DBD-MySQL.x86_64 0:4.017-1.fc13 set to be updated
--> Finished Dependency Resolution

Dependencies Resolved

=====
Package                Arch             Version           Repository        Size
=====
Installing:
mysql                  x86_64           5.1.48-2.fc13    updates           889 k
mysql-libs              x86_64           5.1.48-2.fc13    updates           1.2 M
mysql-server           x86_64           5.1.48-2.fc13    updates           8.1 M
Installing for dependencies:
perl-DBD-MySQL         x86_64           4.017-1.fc13    updates           136 k

Transaction Summary
=====
Install                4 Package(s)
```

```

Upgrade      0 Package(s)

Total download size: 10 M
Installed size: 30 M
Is this ok [y/N]: y
Downloading Packages:
Setting up and reading Presto delta metadata
Processing delta metadata
Package(s) data still to download: 10 M
(1/4): mysql-5.1.48-2.fc13.x86_64.rpm           | 889 kB      00:04
(2/4): mysql-libs-5.1.48-2.fc13.x86_64.rpm      | 1.2 MB      00:06
(3/4): mysql-server-5.1.48-2.fc13.x86_64.rpm    | 8.1 MB      00:40
(4/4): perl-DBD-MySQL-4.017-1.fc13.x86_64.rpm   | 136 kB      00:00
-----
Total                                           201 kB/s | 10 MB      00:52
Running rpm_check_debug
Running Transaction Test
Transaction Test Succeeded
Running Transaction
  Installing      : mysql-libs-5.1.48-2.fc13.x86_64          1/4
  Installing      : mysql-5.1.48-2.fc13.x86_64              2/4
  Installing      : perl-DBD-MySQL-4.017-1.fc13.x86_64       3/4
  Installing      : mysql-server-5.1.48-2.fc13.x86_64        4/4

Installed:
mysql.x86_64 0:5.1.48-2.fc13          mysql-libs.x86_64 0:5.1.48-2.fc13
mysql-server.x86_64 0:5.1.48-2.fc13

Dependency Installed:
perl-DBD-MySQL.x86_64 0:4.017-1.fc13

Complete!

```

MySQL and the MySQL server should now be installed. A sample configuration file is installed into `/etc/my.cnf`. An init script, to start and stop the server, is installed into `/etc/init.d/mysqld`. To start the MySQL server use `service`:

```
#> service mysqld start
```

To enable the server to be started and stopped automatically during boot, use `chkconfig`:

```
#> chkconfig --levels 235 mysqld on
```

Which enables the MySQL server to be started (and stopped) automatically at the specified the run levels.

The database tables are automatically created for you, if they do not already exist. You should, however, run `mysql_secure_installation` to set the root passwords on your server.

- **Debian, Ubuntu, Kubuntu**



#### Note

On Debian, Ubuntu, and Kubuntu, MySQL can be installed using the [MySQL APT Repository](#) instead of the platform's native software repository. See [Section 2.5.3, "Installing MySQL on Linux Using the MySQL APT Repository"](#) for details.

On Debian and related distributions, there are two packages for MySQL in their software repositories, `mysql-client` and `mysql-server`, for the client and server components respectively. You should

specify an explicit version, for example `mysql-client-5.1`, to ensure that you install the version of MySQL that you want.

To download and install, including any dependencies, use the `apt-get` command, specifying the packages that you want to install.



### Note

Before installing, make sure that you update your `apt-get` index files to ensure you are downloading the latest available version.

A sample installation of the MySQL packages might look like this (some sections trimmed for clarity):

```
#> apt-get install mysql-client-5.1 mysql-server-5.1
Reading package lists... Done
Building dependency tree
Reading state information... Done
The following packages were automatically installed and are no longer required:
  linux-headers-2.6.28-11 linux-headers-2.6.28-11-generic
Use 'apt-get autoremove' to remove them.
The following extra packages will be installed:
  bsd-mailx libdbd-mysql-perl libdbi-perl libhtml-template-perl
  libmysqlclient15off libmysqlclient16 libnet-daemon-perl libplrpc-perl mailx
  mysql-common postfix
Suggested packages:
  dbshell libipc-sharedcache-perl tinyca procmail postfix-mysql postfix-pgsql
  postfix-ldap postfix-pcre sasl2-bin resolvconf postfix-cdb
The following NEW packages will be installed
  bsd-mailx libdbd-mysql-perl libdbi-perl libhtml-template-perl
  libmysqlclient15off libmysqlclient16 libnet-daemon-perl libplrpc-perl mailx
  mysql-client-5.1 mysql-common mysql-server-5.1 postfix
0 upgraded, 13 newly installed, 0 to remove and 182 not upgraded.
Need to get 1907kB/25.3MB of archives.
After this operation, 59.5MB of additional disk space will be used.
Do you want to continue [Y/n]? Y
Get: 1 http://gb.archive.ubuntu.com jaunty-updates/main mysql-common 5.1.30really5.0.75-0ubuntu10.5 [63.6kB]
Get: 2 http://gb.archive.ubuntu.com jaunty-updates/main libmysqlclient15off 5.1.30really5.0.75-0ubuntu10.5 [
Fetched 1907kB in 9s (205kB/s)
Preconfiguring packages ...
Selecting previously deselected package mysql-common.
(Reading database ... 121260 files and directories currently installed.)
...
Processing 1 added doc-base file(s)...
Registering documents with scrollkeeper...
Setting up libnet-daemon-perl (0.43-1) ...
Setting up libplrpc-perl (0.2020-1) ...
Setting up libdbi-perl (1.607-1) ...
Setting up libmysqlclient15off (5.1.30really5.0.75-0ubuntu10.5) ...

Setting up libdbd-mysql-perl (4.008-1) ...
Setting up libmysqlclient16 (5.1.31-lubuntu2) ...

Setting up mysql-client-5.1 (5.1.31-lubuntu2) ...

Setting up mysql-server-5.1 (5.1.31-lubuntu2) ...
* Stopping MySQL database server mysqld
  ...done.
2013-09-24T13:03:09.048353Z 0 [Note] InnoDB: 5.7.44 started; log sequence number 1566036
2013-09-24T13:03:10.057269Z 0 [Note] InnoDB: Starting shutdown...
2013-09-24T13:03:10.857032Z 0 [Note] InnoDB: Shutdown completed; log sequence number 1566036
* Starting MySQL database server mysqld
  ...done.
* Checking for corrupt, not cleanly closed and upgrade needing tables.
...
Processing triggers for libc6 ...
```

```
ldconfig deferred processing now taking place
```



### Note

The `apt-get` command installs a number of packages, including the MySQL server, in order to provide the typical tools and application environment. This can mean that you install a large number of packages in addition to the main MySQL package.

During installation, the initial database is created, and you are prompted for the MySQL root password (and confirmation). A configuration file is created in `/etc/mysql/my.cnf`. An init script is created in `/etc/init.d/mysql`.

The server is already started. You can manually start and stop the server using:

```
#> service mysql [start|stop]
```

The service is automatically added to run levels 2, 3, and 4, with stop scripts in the single, shutdown, and restart levels.

## 2.5.9 Installing MySQL on Linux with Juju

The Juju deployment framework supports easy installation and configuration of MySQL servers. For instructions, see <https://jujucharms.com/mysql/>.

### 2.5.10 Managing MySQL Server with systemd

If you install MySQL using an RPM or Debian package on the following Linux platforms, server startup and shutdown is managed by systemd:

- RPM package platforms:
  - Enterprise Linux variants version 7 and higher
  - SUSE Linux Enterprise Server 12 and higher
- Debian family platforms:
  - Debian platforms
  - Ubuntu platforms

If you install MySQL from a generic binary distribution on a platform that uses systemd, you can manually configure systemd support for MySQL following the instructions provided in the post-installation setup section of the [MySQL 5.7 Secure Deployment Guide](#).

If you install MySQL from a source distribution on a platform that uses systemd, obtain systemd support for MySQL by configuring the distribution using the `-DWITH_SYSTEMD=1` CMake option. See [Section 2.8.7, “MySQL Source-Configuration Options”](#).

The following discussion covers these topics:

- [Overview of systemd](#)
- [Configuring systemd for MySQL](#)
- [Configuring Multiple MySQL Instances Using systemd](#)
- [Migrating from `mysqld\_safe` to systemd](#)

**Note**

On platforms for which systemd support for MySQL is installed, scripts such as `mysqld_safe` and the System V initialization script are unnecessary and are not installed. For example, `mysqld_safe` can handle server restarts, but systemd provides the same capability, and does so in a manner consistent with management of other services rather than by using an application-specific program.

One implication of the non-use of `mysqld_safe` on platforms that use systemd for server management is that use of `[mysqld_safe]` or `[safe_mysqld]` sections in option files is not supported and might lead to unexpected behavior.

Because systemd has the capability of managing multiple MySQL instances on platforms for which systemd support for MySQL is installed, `mysqld_multi` and `mysqld_multi.server` are unnecessary and are not installed.

**Overview of systemd**

systemd provides automatic MySQL server startup and shutdown. It also enables manual server management using the `systemctl` command. For example:

```
systemctl {start|stop|restart|status} mysqld
```

Alternatively, use the `service` command (with the arguments reversed), which is compatible with System V systems:

```
service mysqld {start|stop|restart|status}
```

**Note**

For the `systemctl` or `service` commands, if the MySQL service name is not `mysqld`, use the appropriate name. For example, use `mysql` rather than `mysqld` on Debian-based and SLES systems.

Support for systemd includes these files:

- `mysqld.service` (RPM platforms), `mysql.service` (Debian platforms): systemd service unit configuration file, with details about the MySQL service.
- `mysqld@.service` (RPM platforms), `mysql@.service` (Debian platforms): Like `mysqld.service` or `mysql.service`, but used for managing multiple MySQL instances.
- `mysqld.tmpfiles.d`: File containing information to support the `tmpfiles` feature. This file is installed under the name `mysql.conf`.
- `mysqld_pre_systemd` (RPM platforms), `mysql-system-start` (Debian platforms): Support script for the unit file. This script assists in creating the error log file only if the log location matches a pattern (`/var/log/mysql/*.log` for RPM platforms, `/var/log/mysql/*.log` for Debian platforms). In other cases, the error log directory must be writable or the error log must be present and writable for the user running the `mysqld` process.

**Configuring systemd for MySQL**

To add or change systemd options for MySQL, these methods are available:

- Use a localized systemd configuration file.
- Arrange for systemd to set environment variables for the MySQL server process.



- Set the `MYSQLD_OPTS` systemd variable.

To use a localized systemd configuration file, create the `/etc/systemd/system/mysql.service.d` directory if it does not exist. In that directory, create a file that contains a `[Service]` section listing the desired settings. For example:

```
[Service]
LimitNOFILE=max_open_files
PIDFile=/path/to/pid/file
Nice=nice_level
LimitCore=core_file_limit
Environment="LD_PRELOAD=/path/to/malloc/library"
Environment="TZ=time_zone_setting"
```

The discussion here uses `override.conf` as the name of this file. Newer versions of systemd support the following command, which opens an editor and permits you to edit the file:

```
systemctl edit mysqld # RPM platforms
systemctl edit mysql # Debian platforms
```

Whenever you create or change `override.conf`, reload the systemd configuration, then tell systemd to restart the MySQL service:

```
systemctl daemon-reload
systemctl restart mysqld # RPM platforms
systemctl restart mysql # Debian platforms
```

With systemd, the `override.conf` configuration method must be used for certain parameters, rather than settings in a `[mysqld]`, `[mysqld_safe]`, or `[safe_mysqld]` group in a MySQL option file:

- For some parameters, `override.conf` must be used because systemd itself must know their values and it cannot read MySQL option files to get them.
- Parameters that specify values otherwise settable only using options known to `mysqld_safe` must be specified using systemd because there is no corresponding `mysqld` parameter.

For additional information about using systemd rather than `mysqld_safe`, see [Migrating from mysqld\\_safe to systemd](#).

You can set the following parameters in `override.conf`:

- To specify the process ID file:
  - As of MySQL 5.7.10: Use `override.conf` and change both `PIDFile` and `ExecStart` to name the PID file path name. Any setting of the process ID file in MySQL option files is ignored. To modify `ExecStart`, it must first be cleared. For example:

```
[Service]
PIDFile=/var/run/mysqld/mysqld-custom.pid
ExecStart=
ExecStart=/usr/sbin/mysqld --pid-file=/var/run/mysqld/mysqld-custom.pid $MYSQLD_OPTS
```

- Before MySQL 5.7.10: Use `PIDFile` in `override.conf` rather than the `--pid-file` option for `mysqld` or `mysqld_safe`. systemd must know the PID file location so that it can restart or stop the server. If the PID file value is specified in a MySQL option file, the value must match the `PIDFile` value or MySQL startup may fail.
- To set the number of file descriptors available to the MySQL server, use `LimitNOFILE` in `override.conf` rather than the `open_files_limit` system variable for `mysqld` or `--open-files-limit` option for `mysqld_safe`.

- To set the maximum core file size, use `LimitCore` in `override.conf` rather than the `--core-file-size` option for `mysqld_safe`.
- To set the scheduling priority for the MySQL server, use `Nice` in `override.conf` rather than the `--nice` option for `mysqld_safe`.

Some MySQL parameters are configured using environment variables:

- `LD_PRELOAD`: Set this variable if the MySQL server should use a specific memory-allocation library.
- `TZ`: Set this variable to specify the default time zone for the server.

There are multiple ways to specify environment variable values for use by the MySQL server process managed by systemd:

- Use `Environment` lines in the `override.conf` file. For the syntax, see the example in the preceding discussion that describes how to use this file.
- Specify the values in the `/etc/sysconfig/mysql` file (create the file if it does not exist). Assign values using the following syntax:

```
LD_PRELOAD=/path/to/malloc/library
TZ=time_zone_setting
```

After modifying `/etc/sysconfig/mysql`, restart the server to make the changes effective:

```
systemctl restart mysqld # RPM platforms
systemctl restart mysql  # Debian platforms
```

To specify options for `mysqld` without modifying systemd configuration files directly, set or unset the `MYSQLD_OPTS` systemd variable. For example:

```
systemctl set-environment MYQSLD_OPTS="--general_log=1"
systemctl unset-environment MYQSLD_OPTS
```

`MYSQLD_OPTS` can also be set in the `/etc/sysconfig/mysql` file.

After modifying the systemd environment, restart the server to make the changes effective:

```
systemctl restart mysqld # RPM platforms
systemctl restart mysql  # Debian platforms
```

For platforms that use systemd, the data directory is initialized if empty at server startup. This might be a problem if the data directory is a remote mount that has temporarily disappeared: The mount point would appear to be an empty data directory, which then would be initialized as a new data directory. As of MySQL 5.7.20, to suppress this automatic initialization behavior, specify the following line in the `/etc/sysconfig/mysql` file (create the file if it does not exist):

```
NO_INIT=true
```

## Configuring Multiple MySQL Instances Using systemd

This section describes how to configure systemd for multiple instances of MySQL.



### Note

Because systemd has the capability of managing multiple MySQL instances on platforms for which systemd support is installed, `mysqld_multi` and `mysqld_multi.server` are unnecessary and are not installed. This is true as of MySQL 5.7.13 for RPM platforms, 5.7.19 for Debian platforms.

To use multiple-instance capability, modify the `my.cnf` option file to include configuration of key options for each instance. These file locations are typical:

- `/etc/my.cnf` or `/etc/mysql/my.cnf` (RPM platforms)
- `/etc/mysql/mysql.conf.d/mysqld.cnf` (Debian platforms)

For example, to manage two instances named `replica01` and `replica02`, add something like this to the option file:

RPM platforms:

```
[mysqld@replica01]
datadir=/var/lib/mysql-replica01
socket=/var/lib/mysql-replica01/mysql.sock
port=3307
log-error=/var/log/mysqld-replica01.log

[mysqld@replica02]
datadir=/var/lib/mysql-replica02
socket=/var/lib/mysql-replica02/mysql.sock
port=3308
log-error=/var/log/mysqld-replica02.log
```

Debian platforms:

```
[mysqld@replica01]
datadir=/var/lib/mysql-replica01
socket=/var/lib/mysql-replica01/mysql.sock
port=3307
log-error=/var/log/mysql/replica01.log

[mysqld@replica02]
datadir=/var/lib/mysql-replica02
socket=/var/lib/mysql-replica02/mysql.sock
port=3308
log-error=/var/log/mysql/replica02.log
```

The replica names shown here use `@` as the delimiter because that is the only delimiter supported by `systemd`.

Instances then are managed by normal `systemd` commands, such as:

```
systemctl start mysqld@replica01
systemctl start mysqld@replica02
```

To enable instances to run at boot time, do this:

```
systemctl enable mysqld@replica01
systemctl enable mysqld@replica02
```

Use of wildcards is also supported. For example, this command displays the status of all replica instances:

```
systemctl status 'mysqld@replica*'
```

For management of multiple MySQL instances on the same machine, `systemd` automatically uses a different unit file:

- `mysqld@.service` rather than `mysqld.service` (RPM platforms)
- `mysql@.service` rather than `mysql.service` (Debian platforms)

In the unit file, `%I` and `%i` reference the parameter passed in after the `@` marker and are used to manage the specific instance. For a command such as this:

```
systemctl start mysqld@replica01
```

systemd starts the server using a command such as this:

```
mysqld --defaults-group-suffix=%I ...
```

The result is that the `[server]`, `[mysqld]`, and `[mysqld@replica01]` option groups are read and used for that instance of the service.



#### Note

On Debian platforms, AppArmor prevents the server from reading or writing `/var/lib/mysql-replica*`, or anything other than the default locations. To address this, you must customize or disable the profile in `/etc/apparmor.d/usr.sbin.mysqld`.



#### Note

On Debian platforms, the packaging scripts for MySQL uninstallation cannot currently handle `mysqld@` instances. Before removing or upgrading the package, you must stop any extra instances manually first.

## Migrating from `mysqld_safe` to `systemd`

Because `mysqld_safe` is not installed on platforms that use `systemd` to manage MySQL, options previously specified for that program (for example, in an `[mysqld_safe]` or `[safe_mysqld]` option group) must be specified another way:

- Some `mysqld_safe` options are also understood by `mysqld` and can be moved from the `[mysqld_safe]` or `[safe_mysqld]` option group to the `[mysqld]` group. This does *not* include `--pid-file`, `--open-files-limit`, or `--nice`. To specify those options, use the `override.conf` `systemd` file, described previously.



#### Note

On `systemd` platforms, use of `[mysqld_safe]` and `[safe_mysqld]` option groups is not supported and may lead to unexpected behavior.

- For some `mysqld_safe` options, there are similar `mysqld` options. For example, the `mysqld_safe` option for enabling `syslog` logging is `--syslog`, which is deprecated. For `mysqld`, enable the `log_syslog` system variable instead. For details, see [Section 5.4.2, “The Error Log”](#).
- `mysqld_safe` options not understood by `mysqld` can be specified in `override.conf` or environment variables. For example, with `mysqld_safe`, if the server should use a specific memory allocation library, this is specified using the `--malloc-lib` option. For installations that manage the server with `systemd`, arrange to set the `LD_PRELOAD` environment variable instead, as described previously.

## 2.6 Installing MySQL Using Unbreakable Linux Network (ULN)

Linux supports a number of different solutions for installing MySQL, covered in [Section 2.5, “Installing MySQL on Linux”](#). One of the methods, covered in this section, is installing from Oracle's Unbreakable Linux Network (ULN). You can find information about Oracle Linux and ULN under <http://linux.oracle.com/>.

To use ULN, you need to obtain a ULN login and register the machine used for installation with ULN. This is described in detail in the [ULN FAQ](#). The page also describes how to install and update packages. The MySQL packages are in the “MySQL for Oracle Linux 6” and “MySQL for Oracle Linux 7” channels for your system architecture on ULN.

**Note**

ULN provides MySQL 5.7 for Oracle Linux 6 and Oracle Linux 7. Alternatively, Oracle Linux 8 supports MySQL 8.0. In addition, Enterprise packages are available as of MySQL 8.0.21.

Once MySQL has been installed using ULN, you can find information on starting and stopping the server, and more, in [this section](#), particularly under [Section 2.5.5, “Installing MySQL on Linux Using RPM Packages from Oracle”](#).

If you are changing your package source to use ULN and not changing which build of MySQL you are using, then back up your data, remove your existing binaries, and replace them with those from ULN. If a change of build is involved, we recommend the backup be a dump (`mysqldump` or `mysqlpump` or from [MySQL Shell's backup utility](#)) just in case you need to rebuild your data after the new binaries are in place. If this shift to ULN crosses a version boundary, consult this section before proceeding: [Section 2.10, “Upgrading MySQL”](#).

## 2.7 Installing MySQL on Solaris

**Note**

MySQL 5.7 supports Solaris 11 (Update 3 and later).

MySQL on Solaris is available in a number of different formats.

- For information on installing using the native Solaris PKG format, see [Section 2.7.1, “Installing MySQL on Solaris Using a Solaris PKG”](#).
- To use a standard `tar` binary installation, use the notes provided in [Section 2.2, “Installing MySQL on Unix/Linux Using Generic Binaries”](#). Check the notes and hints at the end of this section for Solaris specific notes that you may need before or after installation.

**Important**

The installation packages have a dependency on the Oracle Developer Studio 12.5 Runtime Libraries, which must be installed before you run the MySQL installation package. See the download options for Oracle Developer Studio [here](#). The installation package enables you to install the runtime libraries only instead of the full Oracle Developer Studio; see instructions in [Installing Only the Runtime Libraries on Oracle Solaris 11](#).

To obtain a binary MySQL distribution for Solaris in tarball or PKG format, <https://dev.mysql.com/downloads/mysql/5.7.html>.

Additional notes to be aware of when installing and using MySQL on Solaris:

- If you want to use MySQL with the `mysql` user and group, use the `groupadd` and `useradd` commands:

```
groupadd mysql
useradd -g mysql -s /bin/false mysql
```

- If you install MySQL using a binary tarball distribution on Solaris, because the Solaris `tar` cannot handle long file names, use GNU `tar` (`gtar`) to unpack the distribution. If you do not have GNU `tar` on your system, install it with the following command:

```
pkg install archiver/gnu-tar
```

- You should mount any file systems on which you intend to store [InnoDB](#) files with the `forcedirectio` option. (By default mounting is done without this option.) Failing to do so causes a significant drop in performance when using the [InnoDB](#) storage engine on this platform.
- If you would like MySQL to start automatically, you can copy `support-files/mysql.server` to `/etc/init.d` and create a symbolic link to it named `/etc/rc3.d/S99mysql.server`.
- If too many processes try to connect very rapidly to `mysqld`, you should see this error in the MySQL log:

```
Error in accept: Protocol error
```

You might try starting the server with the `--back_log=50` option as a workaround for this.

- To configure the generation of core files on Solaris you should use the `coreadm` command. Because of the security implications of generating a core on a `setuid()` application, by default, Solaris does not support core files on `setuid()` programs. However, you can modify this behavior using `coreadm`. If you enable `setuid()` core files for the current user, they are generated using mode 600, and are owned by the superuser.

## 2.7.1 Installing MySQL on Solaris Using a Solaris PKG

You can install MySQL on Solaris using a binary package of the native Solaris PKG format instead of the binary tarball distribution.



### Important

The installation package has a dependency on the Oracle Developer Studio 12.5 Runtime Libraries, which must be installed before you run the MySQL installation package. See the download options for Oracle Developer Studio [here](#). The installation package enables you to install the runtime libraries only instead of the full Oracle Developer Studio; see instructions in [Installing Only the Runtime Libraries on Oracle Solaris 11](#).

To use this package, download the corresponding `mysql-VERSION-solaris11-PLATFORM.pkg.gz` file, then uncompress it. For example:

```
$> gunzip mysql-5.7.44-solaris11-x86_64.pkg.gz
```

To install a new package, use `pkgadd` and follow the onscreen prompts. You must have root privileges to perform this operation:

```
$> pkgadd -d mysql-5.7.44-solaris11-x86_64.pkg

The following packages are available:
 1  mysql      MySQL Community Server (GPL)
      (i86pc) 5.7.44

Select package(s) you wish to process (or 'all' to process
all packages). (default: all) [?,??,q]:
```

The PKG installer installs all of the files and tools needed, and then initializes your database if one does not exist. To complete the installation, you should set the root password for MySQL as provided in the instructions at the end of the installation. Alternatively, you can run the `mysql_secure_installation` script that comes with the installation.

By default, the PKG package installs MySQL under the root path `/opt/mysql`. You can change only the installation root path when using `pkgadd`, which can be used to install MySQL in a different Solaris zone. If you need to install in a specific directory, use a binary `tar` file distribution.

The `pkg` installer copies a suitable startup script for MySQL into `/etc/init.d/mysql`. To enable MySQL to startup and shutdown automatically, you should create a link between this file and the init script directories. For example, to ensure safe startup and shutdown of MySQL you could use the following commands to add the right links:

```
$> ln /etc/init.d/mysql /etc/rc3.d/S91mysql
$> ln /etc/init.d/mysql /etc/rc0.d/K02mysql
```

To remove MySQL, the installed package name is `mysql`. You can use this in combination with the `pkgrm` command to remove the installation.

To upgrade when using the Solaris package file format, you must remove the existing installation before installing the updated package. Removal of the package does not delete the existing database information, only the server, binaries and support files. The typical upgrade sequence is therefore:

```
$> mysqladmin shutdown
$> pkgrm mysql
$> pkgadd -d mysql-5.7.44-solaris11-x86_64.pkg
$> mysqld_safe &
$> mysql_upgrade
```

You should check the notes in [Section 2.10, “Upgrading MySQL”](#) before performing any upgrade.

## 2.8 Installing MySQL from Source

Building MySQL from the source code enables you to customize build parameters, compiler optimizations, and installation location. For a list of systems on which MySQL is known to run, see <https://www.mysql.com/support/supportedplatforms/database.html>.

Before you proceed with an installation from source, check whether Oracle produces a precompiled binary distribution for your platform and whether it works for you. We put a great deal of effort into ensuring that our binaries are built with the best possible options for optimal performance. Instructions for installing binary distributions are available in [Section 2.2, “Installing MySQL on Unix/Linux Using Generic Binaries”](#).

If you are interested in building MySQL from a source distribution using build options the same as or similar to those used by Oracle to produce binary distributions on your platform, obtain a binary distribution, unpack it, and look in the `docs/INFO_BIN` file, which contains information about how that MySQL distribution was configured and compiled.



### Warning

Building MySQL with nonstandard options may lead to reduced functionality, performance, or security.

### 2.8.1 Source Installation Methods

There are two methods for installing MySQL from source:

- Use a standard MySQL source distribution. To obtain a standard distribution, see [Section 2.1.3, “How to Get MySQL”](#). For instructions on building from a standard distribution, see [Section 2.8.4, “Installing MySQL Using a Standard Source Distribution”](#).

Standard distributions are available as compressed `tar` files, Zip archives, or RPM packages. Distribution files have names of the form `mysql-VERSION.tar.gz`, `mysql-VERSION.zip`, or `mysql-VERSION.rpm`, where `VERSION` is a number like `5.7.44`. File names for source distributions can be distinguished from those for precompiled binary distributions in that source distribution names are generic and include no platform name, whereas binary distribution names include a platform name

indicating the type of system for which the distribution is intended (for example, `pc-linux-i686` or `winx64`).

- Use a MySQL development tree. For information on building from one of the development trees, see [Section 2.8.5, “Installing MySQL Using a Development Source Tree”](#).

## 2.8.2 Source Installation Prerequisites

Installation of MySQL from source requires several development tools. Some of these tools are needed no matter whether you use a standard source distribution or a development source tree. Other tool requirements depend on which installation method you use.

To install MySQL from source, the following system requirements must be satisfied, regardless of installation method:

- `CMake`, which is used as the build framework on all platforms. `CMake` can be downloaded from <http://www.cmake.org>.
- A good `make` program. Although some platforms come with their own `make` implementations, it is highly recommended that you use GNU `make` 3.75 or later. It may already be available on your system as `gmake`. GNU `make` is available from <http://www.gnu.org/software/make/>.

On Unix-like systems, including Linux, you can check your system's version of `make` like this:

```
$> make --version
GNU Make 4.2.1
```

- A working ANSI C++ compiler. See the description of the `FORCE_UNSUPPORTED_COMPILER` option for some guidelines.
- An SSL library is required for support of encrypted connections, entropy for random number generation, and other encryption-related operations. By default, the build uses the OpenSSL library installed on the host system. To specify the library explicitly, use the `WITH_SSL` option when you invoke `CMake`. For additional information, see [Section 2.8.6, “Configuring SSL Library Support”](#).
- The Boost C++ libraries are required to build MySQL (but not to use it). Boost 1.59.0 must be installed. To obtain Boost and its installation instructions, visit [the official Boost web site](#). After Boost is installed, tell the build system where the Boost files are placed according to the value set for the `WITH_BOOST` option when you invoke `CMake`. For example:

```
cmake . -DWITH_BOOST=/usr/local/boost_version_number
```

Adjust the path as necessary to match your installation.

- The `ncurses` library.
- Sufficient free memory. If you encounter build errors such as `internal compiler error` when compiling large source files, it may be that you have too little memory. If compiling on a virtual machine, try increasing the memory allocation.
- Perl is needed if you intend to run test scripts. Most Unix-like systems include Perl. For Windows, you can use [ActiveState Perl](#). or [Strawberry Perl](#).

To install MySQL from a standard source distribution, one of the following tools is required to unpack the distribution file:

- For a `.tar.gz` compressed `tar` file: GNU `gunzip` to uncompress the distribution and a reasonable `tar` to unpack it. If your `tar` program supports the `z` option, it can both uncompress and unpack the file.



GNU `tar` is known to work. The standard `tar` provided with some operating systems is not able to unpack the long file names in the MySQL distribution. You should download and install GNU `tar`, or if available, use a preinstalled version of GNU `tar`. Usually this is available as `gnutar`, `gtar`, or as `tar` within a GNU or Free Software directory, such as `/usr/sfw/bin` or `/usr/local/bin`. GNU `tar` is available from <https://www.gnu.org/software/tar/>.

- For a `.zip` Zip archive: `WinZip` or another tool that can read `.zip` files.
- For an `.rpm` RPM package: The `rpmbuild` program used to build the distribution unpacks it.

To install MySQL from a development source tree, the following additional tools are required:

- The Git revision control system is required to obtain the development source code. [GitHub Help](#) provides instructions for downloading and installing Git on different platforms.
- `bison` 2.1 or later, available from <http://www.gnu.org/software/bison/>. (Version 1 is no longer supported.) Use the latest version of `bison` where possible; if you experience problems, upgrade to a later version, rather than revert to an earlier one.

`bison` is available from <http://www.gnu.org/software/bison/>. `bison` for Windows can be downloaded from <http://gnuwin32.sourceforge.net/packages/bison.htm>. Download the package labeled “Complete package, excluding sources”. On Windows, the default location for `bison` is the `C:\Program Files\GnuWin32` directory. Some utilities may fail to find `bison` because of the space in the directory name. Also, Visual Studio may simply hang if there are spaces in the path. You can resolve these problems by installing into a directory that does not contain a space (for example `C:\GnuWin32`).

- On Solaris Express, `m4` must be installed in addition to `bison`. `m4` is available from <http://www.gnu.org/software/m4/>.



#### Note

If you have to install any programs, modify your `PATH` environment variable to include any directories in which the programs are located. See [Section 4.2.7, “Setting Environment Variables”](#).

If you run into problems and need to file a bug report, please use the instructions in [Section 1.5, “How to Report Bugs or Problems”](#).

## 2.8.3 MySQL Layout for Source Installation

By default, when you install MySQL after compiling it from source, the installation step installs files under `/usr/local/mysql`. The component locations under the installation directory are the same as for binary distributions. See [Table 2.3, “MySQL Installation Layout for Generic Unix/Linux Binary Package”](#), and [Section 2.3.1, “MySQL Installation Layout on Microsoft Windows”](#). To configure installation locations different from the defaults, use the options described at [Section 2.8.7, “MySQL Source-Configuration Options”](#).

## 2.8.4 Installing MySQL Using a Standard Source Distribution

To install MySQL from a standard source distribution:

1. Verify that your system satisfies the tool requirements listed at [Section 2.8.2, “Source Installation Prerequisites”](#).
2. Obtain a distribution file using the instructions in [Section 2.1.3, “How to Get MySQL”](#).
3. Configure, build, and install the distribution using the instructions in this section.

4. Perform postinstallation procedures using the instructions in [Section 2.9, “Postinstallation Setup and Testing”](#).

MySQL uses `CMake` as the build framework on all platforms. The instructions given here should enable you to produce a working installation. For additional information on using `CMake` to build MySQL, see [How to Build MySQL Server with CMake](#).

If you start from a source RPM, use the following command to make a binary RPM that you can install. If you do not have `rpmbuild`, use `rpm` instead.

```
$> rpmbuild --rebuild --clean MySQL-VERSION.src.rpm
```

The result is one or more binary RPM packages that you install as indicated in [Section 2.5.5, “Installing MySQL on Linux Using RPM Packages from Oracle”](#).

The sequence for installation from a compressed `tar` file or Zip archive source distribution is similar to the process for installing from a generic binary distribution (see [Section 2.2, “Installing MySQL on Unix/Linux Using Generic Binaries”](#)), except that it is used on all platforms and includes steps to configure and compile the distribution. For example, with a compressed `tar` file source distribution on Unix, the basic installation command sequence looks like this:

```
# Preconfiguration setup
$> groupadd mysql
$> useradd -r -g mysql -s /bin/false mysql
# Beginning of source-build specific instructions
$> tar zxvf mysql-VERSION.tar.gz
$> cd mysql-VERSION
$> mkdir bld
$> cd bld
$> cmake ..
$> make
$> make install
# End of source-build specific instructions
# Postinstallation setup
$> cd /usr/local/mysql
$> mkdir mysql-files
$> chown mysql:mysql mysql-files
$> chmod 750 mysql-files
$> bin/mysqld --initialize --user=mysql
$> bin/mysql_ssl_rsa_setup
$> bin/mysqld_safe --user=mysql &
# Next command is optional
$> cp support-files/mysql.server /etc/init.d/mysql.server
```

A more detailed version of the source-build specific instructions is shown following.



#### Note

The procedure shown here does not set up any passwords for MySQL accounts. After following the procedure, proceed to [Section 2.9, “Postinstallation Setup and Testing”](#), for postinstallation setup and testing.

- [Perform Preconfiguration Setup](#)
- [Obtain and Unpack the Distribution](#)
- [Configure the Distribution](#)
- [Build the Distribution](#)
- [Install the Distribution](#)
- [Perform Postinstallation Setup](#)

## Perform Preconfiguration Setup

On Unix, set up the `mysql` user that owns the database directory and that should be used to run and execute the MySQL server, and the group to which this user belongs. For details, see [Create a mysql User and Group](#). Then perform the following steps as the `mysql` user, except as noted.

## Obtain and Unpack the Distribution

Pick the directory under which you want to unpack the distribution and change location into it.

Obtain a distribution file using the instructions in [Section 2.1.3, “How to Get MySQL”](#).

Unpack the distribution into the current directory:

- To unpack a compressed `tar` file, `tar` can decompress and unpack the distribution if it has `z` option support:

```
$> tar zxvf mysql-VERSION.tar.gz
```

If your `tar` does not have `z` option support, use `gunzip` to decompress the distribution and `tar` to unpack it:

```
$> gunzip < mysql-VERSION.tar.gz | tar xvf -
```

Alternatively, `CMake` can decompress and unpack the distribution:

```
$> cmake -E tar zxvf mysql-VERSION.tar.gz
```

- To unpack a Zip archive, use `WinZip` or another tool that can read `.zip` files.

Unpacking the distribution file creates a directory named `mysql-VERSION`.

## Configure the Distribution

Change location into the top-level directory of the unpacked distribution:

```
$> cd mysql-VERSION
```

Build outside of the source tree to keep the tree clean. If the top-level source directory is named `mysql-src` under your current working directory, you can build in a directory named `build` at the same level. Create the directory and go there:

```
$> mkdir bld
$> cd bld
```

Configure the build directory. The minimum configuration command includes no options to override configuration defaults:

```
$> cmake ../mysql-src
```

The build directory need not be outside the source tree. For example, you can build in a directory named `build` under the top-level source tree. To do this, starting with `mysql-src` as your current working directory, create the directory `build` and then go there:

```
$> mkdir build
$> cd build
```

Configure the build directory. The minimum configuration command includes no options to override configuration defaults:

```
$> cmake ..
```

If you have multiple source trees at the same level (for example, to build multiple versions of MySQL), the second strategy can be advantageous. The first strategy places all build directories at the same level, which requires that you choose a unique name for each. With the second strategy, you can use the same name for the build directory within each source tree. The following instructions assume this second strategy.

On Windows, specify the development environment. For example, the following commands configure MySQL for 32-bit or 64-bit builds, respectively:

```
$> cmake .. -G "Visual Studio 12 2013"
$> cmake .. -G "Visual Studio 12 2013 Win64"
```

On macOS, to use the Xcode IDE:

```
$> cmake .. -G Xcode
```

When you run `Cmake`, you might want to add options to the command line. Here are some examples:

- `-DBUILD_CONFIG=mysql_release`: Configure the source with the same build options used by Oracle to produce binary distributions for official MySQL releases.
- `-DCMAKE_INSTALL_PREFIX=dir_name`: Configure the distribution for installation under a particular location.
- `-DCPACK_MONOLITHIC_INSTALL=1`: Cause `make package` to generate a single installation file rather than multiple files.
- `-DWITH_DEBUG=1`: Build the distribution with debugging support.

For a more extensive list of options, see [Section 2.8.7, “MySQL Source-Configuration Options”](#).

To list the configuration options, use one of the following commands:

```
$> cmake .. -L # overview
$> cmake .. -LH # overview with help text
$> cmake .. -LAH # all params with help text
$> ccmake .. # interactive display
```

If `CMake` fails, you might need to reconfigure by running it again with different options. If you do reconfigure, take note of the following:

- If `CMake` is run after it has previously been run, it may use information that was gathered during its previous invocation. This information is stored in `CMakeCache.txt`. When `CMake` starts, it looks for that file and reads its contents if it exists, on the assumption that the information is still correct. That assumption is invalid when you reconfigure.
- Each time you run `CMake`, you must run `make` again to recompile. However, you may want to remove old object files from previous builds first because they were compiled using different configuration options.

To prevent old object files or configuration information from being used, run these commands in the build directory on Unix before re-running `CMake`:

```
$> make clean
$> rm CMakeCache.txt
```

Or, on Windows:

```
$> devenv MySQL.sln /clean
$> del CMakeCache.txt
```

Before asking on the [MySQL Community Slack](#), check the files in the `CMakeFiles` directory for useful information about the failure. To file a bug report, please use the instructions in [Section 1.5, “How to Report Bugs or Problems”](#).

## Build the Distribution

On Unix:

```
$> make
$> make VERBOSE=1
```

The second command sets `VERBOSE` to show the commands for each compiled source.

Use `gmake` instead on systems where you are using GNU `make` and it has been installed as `gmake`.

On Windows:

```
$> devenv MySQL.sln /build RelWithDebInfo
```

If you have gotten to the compilation stage, but the distribution does not build, see [Section 2.8.8, “Dealing with Problems Compiling MySQL”](#), for help. If that does not solve the problem, please enter it into our bugs database using the instructions given in [Section 1.5, “How to Report Bugs or Problems”](#). If you have installed the latest versions of the required tools, and they crash trying to process our configuration files, please report that also. However, if you get a `command not found` error or a similar problem for required tools, do not report it. Instead, make sure that all the required tools are installed and that your `PATH` variable is set correctly so that your shell can find them.

## Install the Distribution

On Unix:

```
$> make install
```

This installs the files under the configured installation directory (by default, `/usr/local/mysql`). You might need to run the command as `root`.

To install in a specific directory, add a `DESTDIR` parameter to the command line:

```
$> make install DESTDIR="/opt/mysql"
```

Alternatively, generate installation package files that you can install where you like:

```
$> make package
```

This operation produces one or more `.tar.gz` files that can be installed like generic binary distribution packages. See [Section 2.2, “Installing MySQL on Unix/Linux Using Generic Binaries”](#). If you run `CMake` with `-DCPACK_MONOLITHIC_INSTALL=1`, the operation produces a single file. Otherwise, it produces multiple files.

On Windows, generate the data directory, then create a `.zip` archive installation package:

```
$> devenv MySQL.sln /build RelWithDebInfo /project initial_database
$> devenv MySQL.sln /build RelWithDebInfo /project package
```

You can install the resulting `.zip` archive where you like. See [Section 2.3.4, “Installing MySQL on Microsoft Windows Using a `noinstall` ZIP Archive”](#).

## Perform Postinstallation Setup

The remainder of the installation process involves setting up the configuration file, creating the core databases, and starting the MySQL server. For instructions, see [Section 2.9, “Postinstallation Setup and Testing”](#).

**Note**

The accounts that are listed in the MySQL grant tables initially have no passwords. After starting the server, you should set up passwords for them using the instructions in [Section 2.9, “Postinstallation Setup and Testing”](#).

## 2.8.5 Installing MySQL Using a Development Source Tree

This section describes how to install MySQL from the latest development source code, which is hosted on [GitHub](#). To obtain the MySQL Server source code from this repository hosting service, you can set up a local MySQL Git repository.

On [GitHub](#), MySQL Server and other MySQL projects are found on the [MySQL](#) page. The MySQL Server project is a single repository that contains branches for several MySQL series.

- [Prerequisites for Installing from Development Source](#)
- [Setting Up a MySQL Git Repository](#)

### Prerequisites for Installing from Development Source

To install MySQL from a development source tree, your system must satisfy the tool requirements listed at [Section 2.8.2, “Source Installation Prerequisites”](#).

### Setting Up a MySQL Git Repository

To set up a MySQL Git repository on your machine:

1. Clone the MySQL Git repository to your machine. The following command clones the MySQL Git repository to a directory named `mysql-server`. The initial download may take some time to complete, depending on the speed of your connection.

```
$> git clone https://github.com/mysql/mysql-server.git
Cloning into 'mysql-server'...
remote: Counting objects: 1198513, done.
remote: Total 1198513 (delta 0), reused 0 (delta 0), pack-reused 1198513
Receiving objects: 100% (1198513/1198513), 1.01 GiB | 7.44 MiB/s, done.
Resolving deltas: 100% (993200/993200), done.
Checking connectivity... done.
Checking out files: 100% (25510/25510), done.
```

2. When the clone operation completes, the contents of your local MySQL Git repository appear similar to the following:

```
~> cd mysql-server
~/mysql-server> ls
client          extra           msys           storage
cmake           include        packaging      strings
CMakeLists.txt  INSTALL       plugin         support-files
components      libbinlogevents  README        testclients
config.h.cmake  libchangestreams  router        unittest
configure.cmake libmysql       run_doxygen.cmake  utilities
Docs           libservices     scripts        VERSION
Doxyfile-ignored  LICENSE      share         vio
Doxyfile.in     man           sql           win
doxygen_resources  mysql-test    sql-common
```

3. Use the `git branch -r` command to view the remote tracking branches for the MySQL repository.

```
~/mysql-server> git branch -r
origin/5.7
origin/8.0
```

```
origin/HEAD -> origin/trunk
origin/cluster-7.4
origin/cluster-7.5
origin/cluster-7.6
origin/trunk
```

4. To view the branch that is checked out in your local repository, issue the `git branch` command. When you clone the MySQL Git repository, the latest MySQL branch is checked out automatically. The asterisk identifies the active branch.

```
~/mysql-server$ git branch
* trunk
```

5. To check out an earlier MySQL branch, run the `git checkout` command, specifying the branch name. For example, to check out the MySQL 5.7 branch:

```
~/mysql-server$ git checkout 5.7
Checking out files: 100% (9600/9600), done.
Branch 5.7 set up to track remote branch 5.7 from origin.
Switched to a new branch '5.7'
```

6. To obtain changes made after your initial setup of the MySQL Git repository, switch to the branch you want to update and issue the `git pull` command:

```
~/mysql-server$ git checkout 8.0
~/mysql-server$ git pull
```

To examine the commit history, use the `git log` command:

```
~/mysql-server$ git log
```

You can also browse commit history and source code on the GitHub [MySQL](#) site.

If you see changes or code that you have a question about, ask on [MySQL Community Slack](#).

7. After you have cloned the MySQL Git repository and have checked out the branch you want to build, you can build MySQL Server from the source code. Instructions are provided in [Section 2.8.4, “Installing MySQL Using a Standard Source Distribution”](#), except that you skip the part about obtaining and unpacking the distribution.

Be careful about installing a build from a distribution source tree on a production machine. The installation command may overwrite your live release installation. If you already have MySQL installed and do not want to overwrite it, run `CMake` with values for the `CMAKE_INSTALL_PREFIX`, `MYSQL_TCP_PORT`, and `MYSQL_UNIX_ADDR` options different from those used by your production server. For additional information about preventing multiple servers from interfering with each other, see [Section 5.7, “Running Multiple MySQL Instances on One Machine”](#).

Play hard with your new installation. For example, try to make new features crash. Start by running `make test`. See [The MySQL Test Suite](#).

## 2.8.6 Configuring SSL Library Support

An SSL library is required for support of encrypted connections, entropy for random number generation, and other encryption-related operations. Your system must support either OpenSSL or yaSSL:

- All MySQL Enterprise Edition binary distributions are compiled using OpenSSL. It is not possible to use yaSSL with MySQL Enterprise Edition.
- Prior to MySQL 5.7.28, MySQL Community Edition binary distributions are compiled using yaSSL. As of MySQL 5.7.28, support for yaSSL is removed and all MySQL builds use OpenSSL.

- Prior to MySQL 5.7.28, MySQL Community Edition source distributions can be compiled using either OpenSSL or yaSSL. As of MySQL 5.7.28, support for yaSSL is removed.

If you compile MySQL from a source distribution, `CMake` configures the distribution to use the installed OpenSSL library by default.

To compile using OpenSSL, use this procedure:

1. Ensure that OpenSSL 1.0.1 or newer is installed on your system. If the installed OpenSSL version is older than 1.0.1, `CMake` produces an error at MySQL configuration time. If it is necessary to obtain OpenSSL, visit <http://www.openssl.org>.
2. The `WITH_SSL` `CMake` option determines which SSL library to use for compiling MySQL (see [Section 2.8.7, “MySQL Source-Configuration Options”](#)). The default is `-DWITH_SSL=system`, which uses OpenSSL. To make this explicit, specify that option. For example:

```
cmake . -DWITH_SSL=system
```

That command configures the distribution to use the installed OpenSSL library. Alternatively, to explicitly specify the path name to the OpenSSL installation, use the following syntax. This can be useful if you have multiple versions of OpenSSL installed, to prevent `CMake` from choosing the wrong one:

```
cmake . -DWITH_SSL=path_name
```

3. Compile and install the distribution.

To check whether a `mysqld` server supports encrypted connections, examine the value of the `have_ssl` system variable:

```
mysql> SHOW VARIABLES LIKE 'have_ssl';
+-----+-----+
| Variable_name | Value |
+-----+-----+
| have_ssl      | YES   |
+-----+-----+
```

If the value is `YES`, the server supports encrypted connections. If the value is `DISABLED`, the server is capable of supporting encrypted connections but was not started with the appropriate `--ssl-xxx` options to enable encrypted connections to be used; see [Section 6.3.1, “Configuring MySQL to Use Encrypted Connections”](#).

To determine whether a server was compiled using OpenSSL or yaSSL, check the existence of any of the system or status variables that are present only for OpenSSL. See [Section 6.3.4, “SSL Library-Dependent Capabilities”](#).

## 2.8.7 MySQL Source-Configuration Options

The `CMake` program provides a great deal of control over how you configure a MySQL source distribution. Typically, you do this using options on the `CMake` command line. For information about options supported by `CMake`, run either of these commands in the top-level source directory:

```
$> cmake . -LH
$> ccmake .
```

You can also affect `CMake` using certain environment variables. See [Section 4.9, “Environment Variables”](#).

For boolean options, the value may be specified as `1` or `ON` to enable the option, or as `0` or `OFF` to disable the option.



Many options configure compile-time defaults that can be overridden at server startup. For example, the `CMAKE_INSTALL_PREFIX`, `MYSQL_TCP_PORT`, and `MYSQL_UNIX_ADDR` options that configure the default installation base directory location, TCP/IP port number, and Unix socket file can be changed at server startup with the `--basedir`, `--port`, and `--socket` options for `mysqld`. Where applicable, configuration option descriptions indicate the corresponding `mysqld` startup option.

The following sections provide more information about CMake options.

- [CMake Option Reference](#)
- [General Options](#)
- [Installation Layout Options](#)
- [Storage Engine Options](#)
- [Feature Options](#)
- [Compiler Flags](#)
- [CMake Options for Compiling NDB Cluster](#)

## CMake Option Reference

The following table shows the available CMake options. In the `Default` column, `PREFIX` stands for the value of the `CMAKE_INSTALL_PREFIX` option, which specifies the installation base directory. This value is used as the parent location for several of the installation subdirectories.

**Table 2.14 MySQL Source-Configuration Option Reference (CMake)**

Formats	Description	Default	Introduced	Removed
<code>BUILD_CONFIG</code>	Use same build options as official releases			
<code>CMAKE_BUILD_TYPE</code>	Type of build to produce	<code>RelWithDebInfo</code>		
<code>CMAKE_CXX_FLAGS</code>	Flags for C++ Compiler			
<code>CMAKE_C_FLAGS</code>	Flags for C Compiler			
<code>CMAKE_INSTALL_PREFIX</code>	Installation base directory	<code>/usr/local/mysql</code>		
<code>COMPILATION_COMMENT</code>	Comment about compilation environment			
<code>CPACK_MONOLITHIC_BUILD</code>	Whether package build produces single file	<code>OFF</code>		
<code>DEFAULT_CHARSET</code>	The default server character set	<code>latin1</code>		
<code>DEFAULT_COLLATION</code>	The default server collation	<code>latin1_swedish_ci</code>		
<code>DISABLE_PSI_COND</code>	Exclude Performance	<code>OFF</code>		

## MySQL Source-Configuration Options

Formats	Description	Default	Introduced	Removed
	Schema condition instrumentation			
<code>DISABLE_PSI_FILE</code>	Exclude Performance Schema file instrumentation	<code>OFF</code>		
<code>DISABLE_PSI_IDLE</code>	Exclude Performance Schema idle instrumentation	<code>OFF</code>		
<code>DISABLE_PSI_MEMORY</code>	Exclude Performance Schema memory instrumentation	<code>OFF</code>		
<code>DISABLE_PSI_METADATA</code>	Exclude Performance Schema metadata instrumentation	<code>OFF</code>		
<code>DISABLE_PSI_MUTEX</code>	Exclude Performance Schema mutex instrumentation	<code>OFF</code>		
<code>DISABLE_PSI_PS</code>	Exclude the performance schema prepared statements	<code>OFF</code>		
<code>DISABLE_PSI_RWLOCK</code>	Exclude Performance Schema rwlock instrumentation	<code>OFF</code>		
<code>DISABLE_PSI_SOCKET</code>	Exclude Performance Schema socket instrumentation	<code>OFF</code>		
<code>DISABLE_PSI_SP</code>	Exclude Performance Schema stored program instrumentation	<code>OFF</code>		
<code>DISABLE_PSI_STAGE</code>	Exclude Performance Schema stage instrumentation	<code>OFF</code>		
<code>DISABLE_PSI_STATEMENT</code>	Exclude Performance Schema statement instrumentation	<code>OFF</code>		

MySQL Source-Configuration Options

Formats	Description	Default	Introduced	Removed
<code>DISABLE_PSI_STATEMENTS_DIGEST</code>	Exclude Performance Schema statements_digest instrumentation	OFF		
<code>DISABLE_PSI_TABLES</code>	Exclude Performance Schema table instrumentation	OFF		
<code>DISABLE_PSI_THREADS</code>	Exclude the performance schema thread instrumentation	OFF		
<code>DISABLE_PSI_TRANSACTIONS</code>	Exclude the performance schema transaction instrumentation	OFF		
<code>DOWNLOAD_BOOST</code>	Whether to download the Boost library	OFF		
<code>DOWNLOAD_BOOST_TIMEOUT</code>	Timeout in seconds for downloading the Boost library	600		
<code>ENABLED_LOCAL_INFILE</code>	Whether to enable LOCAL for LOAD DATA	OFF		
<code>ENABLED_PROFILING</code>	Whether to enable query profiling code	ON		
<code>ENABLE_DOWNLOADS</code>	Whether to download optional files	OFF		
<code>ENABLE_DTRACE</code>	Whether to include DTrace support			
<code>ENABLE_GCOV</code>	Whether to include gcov support			
<code>ENABLE_GPROF</code>	Enable gprof (optimized Linux builds only)	OFF		
<code>FORCE_UNSUPPORTED_COMPILER</code>	Whether to permit unsupported compilers	OFF		
<code>IGNORE_AIO_CHECK</code>	With <code>-DBUILD_CONFIG=mysql_release</code> , ignore libaio check	OFF		
<code>INSTALL_BINDIR</code>	User executables directory	<code>PREFIX/bin</code>		

## MySQL Source-Configuration Options

Formats	Description	Default	Introduced	Removed
INSTALL_DOCDIR	Documentation directory	PREFIX/docs		
INSTALL_DOCREADM	README file directory	PREFIX		
INSTALL_INCLUDEDIR	Header file directory	PREFIX/include		
INSTALL_INFODIR	Info file directory	PREFIX/docs		
INSTALL_LAYOUT	Select predefined installation layout	STANDALONE		
INSTALL_LIBDIR	Library file directory	PREFIX/lib		
INSTALL_MANDIR	Manual page directory	PREFIX/man		
INSTALL_MYSQLKEYRING	Directory for keyring_file plugin data file	platform specific	5.7.11	
INSTALL_MYSQLSHAREDIR	Shared data directory	PREFIX/share		
INSTALL_MYSQLTESTDIR	mysql-test directory	PREFIX/mysql-test		
INSTALL_PKGCONFIGDIR	Directory for mysqlclient.pc pkg-config file	INSTALL_LIBDIR/pkgconfig		
INSTALL_PLUGINDIR	Plugin directory	PREFIX/lib/plugin		
INSTALL_SBINDIR	Server executable directory	PREFIX/bin		
INSTALL_SCRIPTDIR	Scripts directory	PREFIX/scripts		
INSTALL_SECURE_FILE_PRIV	secure_file_priv default value	platform specific		
INSTALL_SECURE_FILE_PRIV_EMBEDDED	secure_file_priv default value for libmysqld			
INSTALL_SHAREDIR	local/mysql.m4 installation directory	PREFIX/share		
INSTALL_SUPPORTDIR	Extra support files directory	PREFIX/support-files		
MAX_INDEXES	Maximum indexes per table	64		
MEMCACHED_HOME	Path to memcached; obsolete	[none]		5.7.33
MUTEX_TYPE	InnoDB mutex type	event		
MYSQLX_TCP_PORT	TCP/IP port number used by X Plugin	33060	5.7.17	

## MySQL Source-Configuration Options

Formats	Description	Default	Introduced	Removed
<code>MYSQLX_UNIX_ADDR</code>	Unix socket file used by X Plugin	<code>/tmp/mysqlx.sock</code>	5.7.15	
<code>MYSQL_DATADIR</code>	Data directory			
<code>MYSQL_MAINTAINER</code>	Whether to enable MySQL maintainer-specific development environment	<code>OFF</code>		
<code>MYSQL_PROJECT_NAME</code>	Windows/macOS project name	<code>MySQL</code>		
<code>MYSQL_TCP_PORT</code>	TCP/IP port number	<code>3306</code>		
<code>MYSQL_UNIX_ADDR</code>	Unix socket file	<code>/tmp/mysql.sock</code>		
<code>ODBC_INCLUDES</code>	ODBC includes directory			
<code>ODBC_LIB_DIR</code>	ODBC library directory			
<code>OPTIMIZER_TRACE</code>	Whether to support optimizer tracing			
<code>REPRODUCIBLE_BUILD</code>	Take extra care to create a build result independent of build location and time		5.7.19	
<code>SUNPRO_CXX_LIBRARIES</code>	Client link library on Solaris 10+			
<code>SYSCONFDIR</code>	Option file directory			
<code>SYSTEMD_PID_DIR</code>	Directory for PID file under systemd	<code>/var/run/mysqld</code>		
<code>SYSTEMD_SERVICE_NAME</code>	Name of MySQL service under systemd	<code>mysqld</code>		
<code>TMPDIR</code>	tmpdir default value			
<code>WIN_DEBUG_NO_INLINE</code>	Whether to disable function inlining	<code>OFF</code>		
<code>WITHOUT_SERVER</code>	Do not build the server; internal use only	<code>OFF</code>		
<code>WITHOUT_xxx_STORAGE_ENGINE</code>	Exclude storage engine xxx from build			
<code>WITH_ASAN</code>	Enable AddressSanitizer	<code>OFF</code>		
<code>WITH_ASAN_SCOPE</code>	Enable AddressSanitizer - fsanitize-address-	<code>OFF</code>	5.7.21	

MySQL Source-Configuration Options

Formats	Description	Default	Introduced	Removed
	use-after-scope Clang flag			
<a href="#">WITH_AUTHENTICATE</a>	Whether to report error if LDAP authentication plugins cannot be built	OFF	5.7.19	
<a href="#">WITH_AUTHENTICATE_PAM</a>	Build PAM authentication plugin	OFF		
<a href="#">WITH_AWS_SDK</a>	Location of Amazon Web Services software development kit		5.7.19	
<a href="#">WITH_BOOST</a>	The location of the Boost library sources			
<a href="#">WITH_BUNDLED_LIBEVENT</a>	Use bundled libevent when building ndbmemcache; obsolete	ON		5.7.33
<a href="#">WITH_BUNDLED_MEMCACHED</a>	Use bundled memcached when building ndbmemcache; obsolete	ON		5.7.33
<a href="#">WITH_CLASSPATH</a>	Classpath to use when building MySQL Cluster Connector for Java. Default is an empty string.			
<a href="#">WITH_CLIENT_PROTOCOL_TRACING</a>	Build client-side protocol tracing framework	ON		
<a href="#">WITH_CURL</a>	Location of curl library		5.7.19	
<a href="#">WITH_DEBUG</a>	Whether to include debugging support	OFF		
<a href="#">WITH_DEFAULT_COMPILER_OPTIONS</a>	Whether to use default compiler options	ON		
<a href="#">WITH_DEFAULT_FEATURE_SET</a>	Whether to use default feature set	ON		

MySQL Source-Configuration Options

Formats	Description	Default	Introduced	Removed
WITH_EDITLINE	Which libedit/ editline library to use	bundled		
WITH_EMBEDDED_SERVER	Whether to build embedded server	OFF		
WITH_EMBEDDED_SHARED_SERVER	Whether to build a shared embedded server library	OFF		
WITH_ERROR_INJECTION	Enable error injection in the NDB storage engine. Should not be used for building binaries intended for production.	OFF		
WITH_EXTRA_CHARSETS	Which extra character sets to include	all		
WITH_GMOCK	Path to googlemock distribution			
WITH_INNO_DB_EXTRA_DEBUG	Whether to include extra debugging support for InnoDB.	OFF		
WITH_INNO_DB_MEMCACHED	Whether to generate memcached shared libraries.	OFF		
WITH_KEYRING_TEST	Build the keyring test program	OFF	5.7.11	
WITH_LDAP	Internal use only		5.7.29	
WITH_LIBEVENT	Which libevent library to use	bundled		
WITH_LIBWRAP	Whether to include libwrap (TCP wrappers) support	OFF		
WITH_LZ4	Type of LZ4 library support	bundled	5.7.14	
WITH_MECAB	Compiles MeCab			
WITH_MSAN	Enable MemorySanitizer	OFF		
WITH_MSVCRT_DEBUG	Enable Visual Studio CRT memory leak tracing	OFF		
WITH_NDBAPI_EXAMPLES	Build API example programs.	OFF		

MySQL Source-Configuration Options

Formats	Description	Default	Introduced	Removed
<code>WITH_NDBCLUSTER</code>	NDB 8.0.30 and earlier: Build NDB storage engine. NDB 8.0.31 and later: Deprecated; use <code>WITH_NDB</code> instead	<code>ON</code>		
<code>WITH_NDBCLUSTER</code>	<del>Prior to NDB 8.0.31, this was for internal use only. NDB 8.0.31 and later: toggles (only) inclusion of NDBCLUSTER storage engine</del>	<code>ON</code>		
<code>WITH_NDBMTD</code>	Build multithreaded data node binary	<code>ON</code>		
<code>WITH_NDB_BINLOG</code>	Enable binary logging by default by <code>mysqld</code> .	<code>ON</code>		
<code>WITH_NDB_DEBUG</code>	Produce a debug build for testing or troubleshooting.	<code>OFF</code>		
<code>WITH_NDB_JAVA</code>	Enable building of Java and ClusterJ support. Enabled by default. Supported in MySQL Cluster only.	<code>ON</code>		
<code>WITH_NDB_PORT</code>	Default port used by a management server built with this option. If this option was not used to build it, the management server's default port is 1186.	<code>[none]</code>		
<code>WITH_NDB_TEST</code>	Include NDB API test programs.	<code>OFF</code>		
<code>WITH_NUMA</code>	Set NUMA memory allocation policy		5.7.17	
<code>WITH_PROTOBUF</code>	Which Protocol Buffers package to use	<code>bundled</code>	5.7.12	
<code>WITH_RAPID</code>	Whether to build rapid development cycle plugins	<code>ON</code>	5.7.12	



Formats	Description	Default	Introduced	Removed
<code>WITH_SASL</code>	Internal use only		5.7.29	
<code>WITH_SSL</code>	Type of SSL support	<code>system</code>		
<code>WITH_SYSTEMD</code>	Enable installation of systemd support files	<code>OFF</code>		
<code>WITH_TEST_TRACE</code>	Builds test protocol trace plugin	<code>OFF</code>		
<code>WITH_UBSAN</code>	Enable Undefined Behavior Sanitizer	<code>OFF</code>		
<code>WITH_UNIT_TESTS</code>	Compile MySQL with unit tests	<code>ON</code>		
<code>WITH_UNIXODBC</code>	Enable unixODBC support	<code>OFF</code>		
<code>WITH_VALGRIND</code>	Whether to compile in Valgrind header files	<code>OFF</code>		
<code>WITH_ZLIB</code>	Type of zlib support	<code>bundled</code>		
<code>WITH_XXX_STORAGE_ENGINE</code>	Compile storage engine xxx statically into server			

## General Options

- `-DBUILD_CONFIG=mysql_release`

This option configures a source distribution with the same build options used by Oracle to produce binary distributions for official MySQL releases.

- `-DCMAKE_BUILD_TYPE=type`

The type of build to produce:

- `RelWithDebInfo`: Enable optimizations and generate debugging information. This is the default MySQL build type.
- `Debug`: Disable optimizations and generate debugging information. This build type is also used if the `WITH_DEBUG` option is enabled. That is, `-DWITH_DEBUG=1` has the same effect as `-DCMAKE_BUILD_TYPE=Debug`.
- `-DCPACK_MONOLITHIC_INSTALL=bool`

This option affects whether the `make package` operation produces multiple installation package files or a single file. If disabled, the operation produces multiple installation package files, which may be useful if you want to install only a subset of a full MySQL installation. If enabled, it produces a single file for installing everything.

## Installation Layout Options

The `CMAKE_INSTALL_PREFIX` option indicates the base installation directory. Other options with names of the form `INSTALL_xxx` that indicate component locations are interpreted relative to the prefix and their values are relative pathnames. Their values should not include the prefix.

- `-DCMAKE_INSTALL_PREFIX=dir_name`

The installation base directory.

This value can be set at server startup using the `--basedir` option.

- `-DINSTALL_BINDIR=dir_name`

Where to install user programs.

- `-DINSTALL_DOCDIR=dir_name`

Where to install documentation.

- `-DINSTALL_DOCREADMEDIR=dir_name`

Where to install `README` files.

- `-DINSTALL_INCLUDEDIR=dir_name`

Where to install header files.

- `-DINSTALL_INFODIR=dir_name`

Where to install Info files.

- `-DINSTALL_LAYOUT=name`

Select a predefined installation layout:

- `STANDALONE`: Same layout as used for `.tar.gz` and `.zip` packages. This is the default.
- `RPM`: Layout similar to RPM packages.
- `SVR4`: Solaris package layout.
- `DEB`: DEB package layout (experimental).

You can select a predefined layout but modify individual component installation locations by specifying other options. For example:

```
cmake . -DINSTALL_LAYOUT=SVR4 -DMYSQL_DATADIR=/var/mysql/data
```

The `INSTALL_LAYOUT` value determines the default value of the `secure_file_priv`, `keyring_encrypted_file_data`, and `keyring_file_data` system variables. See the descriptions of those variables in [Section 5.1.7, “Server System Variables”](#), and [Section 6.4.4.12, “Keyring System Variables”](#).

- `-DINSTALL_LIBDIR=dir_name`

Where to install library files.

- `-DINSTALL_MANDIR=dir_name`

Where to install manual pages.

- `-DINSTALL_MYSQLKEYRINGDIR=dir_path`

The default directory to use as the location of the `keyring_file` plugin data file. The default value is platform specific and depends on the value of the `INSTALL_LAYOUT` CMake option; see the description of the `keyring_file_data` system variable in [Section 5.1.7, “Server System Variables”](#).

This option was added in MySQL 5.7.11.

- `-DINSTALL_MYSQLSHAREDIR=dir_name`

Where to install shared data files.

- `-DINSTALL_MYSQLTESTDIR=dir_name`

Where to install the `mysql-test` directory. To suppress installation of this directory, explicitly set the option to the empty value (`-DINSTALL_MYSQLTESTDIR=`).

- `-DINSTALL_PKGCONFIGDIR=dir_name`

The directory in which to install the `mysqlclient.pc` file for use by `pkg-config`. The default value is `INSTALL_LIBDIR/pkgconfig`, unless `INSTALL_LIBDIR` ends with `/mysql`, in which case that is removed first.

- `-DINSTALL_PLUGINDIR=dir_name`

The location of the plugin directory.

This value can be set at server startup with the `--plugin_dir` option.

- `-DINSTALL_SBINDIR=dir_name`

Where to install the `mysqld` server.

- `-DINSTALL_SCRIPTDIR=dir_name`

Where to install `mysql_install_db`.

- `-DINSTALL_SECURE_FILE_PRIVDIR=dir_name`

The default value for the `secure_file_priv` system variable. The default value is platform specific and depends on the value of the `INSTALL_LAYOUT` CMake option; see the description of the `secure_file_priv` system variable in [Section 5.1.7, “Server System Variables”](#).

To set the value for the `libmysqld` embedded server, use `INSTALL_SECURE_FILE_PRIV_EMBEDDED`.

- `-DINSTALL_SECURE_FILE_PRIV_EMBEDDED=dir_name`

The default value for the `secure_file_priv` system variable, for the `libmysqld` embedded server.



**Note**

The `libmysqld` embedded server library is deprecated as of MySQL 5.7.19; expect it to be removed in MySQL 8.0.

- `-DINSTALL_SHAREDIR=dir_name`

Where to install `aclocal/mysql.m4`.

- `-DINSTALL_SUPPORTFILES_DIR=dir_name`

Where to install extra support files.

- `-DMYSQL_DATADIR=dir_name`

The location of the MySQL data directory.

This value can be set at server startup with the `--datadir` option.

- `-DODBC_INCLUDES=dir_name`

The location of the ODBC includes directory, which may be used while configuring Connector/ODBC.

- `-DODBC_LIB_DIR=dir_name`

The location of the ODBC library directory, which may be used while configuring Connector/ODBC.

- `-DSYSCONFDIR=dir_name`

The default `my.cnf` option file directory.

This location cannot be set at server startup, but you can start the server with a given option file using the `--defaults-file=file_name` option, where `file_name` is the full path name to the file.

- `-DSYSTEMD_PID_DIR=dir_name`

The name of the directory in which to create the PID file when MySQL is managed by `systemd`. The default is `/var/run/mysqld`; this might be changed implicitly according to the `INSTALL_LAYOUT` value.

This option is ignored unless `WITH_SYSTEMD` is enabled.

- `-DSYSTEMD_SERVICE_NAME=name`

The name of the MySQL service to use when MySQL is managed by `systemd`. The default is `mysqld`; this might be changed implicitly according to the `INSTALL_LAYOUT` value.

This option is ignored unless `WITH_SYSTEMD` is enabled.

- `-DTMPDIR=dir_name`

The default location to use for the `tmpdir` system variable. If unspecified, the value defaults to `P_tmpdir` in `<stdio.h>`.

## Storage Engine Options

Storage engines are built as plugins. You can build a plugin as a static module (compiled into the server) or a dynamic module (built as a dynamic library that must be installed into the server using the `INSTALL_PLUGIN` statement or the `--plugin-load` option before it can be used). Some plugins might not support static or dynamic building.

The `InnoDB`, `MyISAM`, `MERGE`, `MEMORY`, and `CSV` engines are mandatory (always compiled into the server) and need not be installed explicitly.

To compile a storage engine statically into the server, use `-DWITH_engine_STORAGE_ENGINE=1`. Some permissible *engine* values are `ARCHIVE`, `BLACKHOLE`, `EXAMPLE`, `FEDERATED`, and `PARTITION` (partitioning support). Examples:

```
-DWITH_ARCHIVE_STORAGE_ENGINE=1
-DWITH_BLACKHOLE_STORAGE_ENGINE=1
```

To build MySQL with support for NDB Cluster, use the `WITH_NDBCLUSTER` option.



### Note

`WITH_NDBCLUSTER` is supported only when building NDB Cluster using the NDB Cluster sources. It cannot be used to enable clustering support in other MySQL source trees or distributions. In NDB Cluster source distributions, it is enabled by default. See [Section 21.3.1.4, “Building NDB Cluster from Source on Linux”](#), and [Section 21.3.2.2, “Compiling and Installing NDB Cluster from Source on Windows”](#), for more information.



### Note

It is not possible to compile without Performance Schema support. If it is desired to compile without particular types of instrumentation, that can be done with the following `CMake` options:

```
DISABLE_PSI_COND
DISABLE_PSI_FILE
DISABLE_PSI_IDLE
DISABLE_PSI_MEMORY
DISABLE_PSI_METADATA
DISABLE_PSI_MUTEX
DISABLE_PSI_PS
DISABLE_PSI_RWLOCK
DISABLE_PSI_SOCKET
DISABLE_PSI_SP
DISABLE_PSI_STAGE
DISABLE_PSI_STATEMENT
DISABLE_PSI_STATEMENT_DIGEST
DISABLE_PSI_TABLE
DISABLE_PSI_THREAD
DISABLE_PSI_TRANSACTION
```

For example, to compile without mutex instrumentation, configure MySQL using `-DDISABLE_PSI_MUTEX=1`.

To exclude a storage engine from the build, use `-DWITH_engine_STORAGE_ENGINE=0`. Examples:

```
-DWITH_EXAMPLE_STORAGE_ENGINE=0
-DWITH_FEDERATED_STORAGE_ENGINE=0
-DWITH_PARTITION_STORAGE_ENGINE=0
```

It is also possible to exclude a storage engine from the build using `-DWITHOUT_engine_STORAGE_ENGINE=1` (but `-DWITH_engine_STORAGE_ENGINE=0` is preferred). Examples:

```
-DWITHOUT_EXAMPLE_STORAGE_ENGINE=1
-DWITHOUT_FEDERATED_STORAGE_ENGINE=1
-DWITHOUT_PARTITION_STORAGE_ENGINE=1
```

If neither `-DWITH_engine_STORAGE_ENGINE` nor `-DWITHOUT_engine_STORAGE_ENGINE` are specified for a given storage engine, the engine is built as a shared module, or excluded if it cannot be built as a shared module.

## Feature Options

- `-DCOMPILATION_COMMENT=string`

A descriptive comment about the compilation environment.

- `-DDEFAULT_CHARSET=charset_name`

The server character set. By default, MySQL uses the `latin1` (cp1252 West European) character set.

`charset_name` may be one of `binary`, `armscii8`, `ascii`, `big5`, `cp1250`, `cp1251`, `cp1256`, `cp1257`, `cp850`, `cp852`, `cp866`, `cp932`, `dec8`, `eucjpms`, `euckr`, `gb2312`, `gbk`, `geostd8`, `greek`, `hebrew`, `hp8`, `keybcs2`, `koi8r`, `koi8u`, `latin1`, `latin2`, `latin5`, `latin7`, `macce`, `macroman`, `sjis`, `swe7`, `tis620`, `ucs2`, `ujis`, `utf8`, `utf8mb4`, `utf16`, `utf16le`, `utf32`. The permissible character sets are listed in the `cmake/character_sets.cmake` file as the value of `CHARSETS_AVAILABLE`.

This value can be set at server startup with the `--character-set-server` option.

- `-DDEFAULT_COLLATION=collation_name`

The server collation. By default, MySQL uses `latin1_swedish_ci`. Use the `SHOW COLLATION` statement to determine which collations are available for each character set.

This value can be set at server startup with the `--collation_server` option.

- `-DDISABLE_PSI_COND=bool`

Whether to exclude the Performance Schema condition instrumentation. The default is `OFF` (include).

- `-DDISABLE_PSI_FILE=bool`

Whether to exclude the Performance Schema file instrumentation. The default is `OFF` (include).

- `-DDISABLE_PSI_IDLE=bool`

Whether to exclude the Performance Schema idle instrumentation. The default is `OFF` (include).

- `-DDISABLE_PSI_MEMORY=bool`

Whether to exclude the Performance Schema memory instrumentation. The default is `OFF` (include).

- `-DDISABLE_PSI_METADATA=bool`

Whether to exclude the Performance Schema metadata instrumentation. The default is `OFF` (include).

- `-DDISABLE_PSI_MUTEX=bool`

Whether to exclude the Performance Schema mutex instrumentation. The default is `OFF` (include).

- `-DDISABLE_PSI_RWLOCK=bool`

Whether to exclude the Performance Schema rlock instrumentation. The default is `OFF` (include).

- `-DDISABLE_PSI_SOCKET=bool`

Whether to exclude the Performance Schema socket instrumentation. The default is `OFF` (include).

- `-DDISABLE_PSI_SP=bool`

Whether to exclude the Performance Schema stored program instrumentation. The default is `OFF` (include).

- `-DDISABLE_PSI_STAGE=bool`

Whether to exclude the Performance Schema stage instrumentation. The default is `OFF` (include).

- `-DDISABLE_PSI_STATEMENT=bool`

Whether to exclude the Performance Schema statement instrumentation. The default is `OFF` (include).

- `-DDISABLE_PSI_STATEMENT_DIGEST=bool`

Whether to exclude the Performance Schema statement digest instrumentation. The default is `OFF` (include).

- `-DDISABLE_PSI_TABLE=bool`

Whether to exclude the Performance Schema table instrumentation. The default is `OFF` (include).

- `-DDISABLE_PSI_PS=bool`

Exclude the Performance Schema prepared statements instances instrumentation. The default is `OFF` (include).

- `-DDISABLE_PSI_THREAD=bool`

Exclude the Performance Schema thread instrumentation. The default is `OFF` (include).

Only disable threads when building without any instrumentation, because other instrumentations have a dependency on threads.

- `-DDISABLE_PSI_TRANSACTION=bool`

Exclude the Performance Schema transaction instrumentation. The default is `OFF` (include).

- `-DDOWNLOAD_BOOST=bool`

Whether to download the Boost library. The default is `OFF`.

See the `WITH_BOOST` option for additional discussion about using Boost.

- `-DDOWNLOAD_BOOST_TIMEOUT=seconds`

The timeout in seconds for downloading the Boost library. The default is 600 seconds.

See the `WITH_BOOST` option for additional discussion about using Boost.

- `-DENABLE_DOWNLOADS=bool`

Whether to download optional files. For example, with this option enabled, `CMake` downloads the Google Test distribution that is used by the test suite to run unit tests.

- `-DENABLE_DTRACE=bool`

Whether to include support for DTrace probes. For information about DTrace, see [Section 5.8.4, “Tracing mysqld Using DTrace”](#)

This option is deprecated because support for DTrace is deprecated in MySQL 5.7 and is removed in MySQL 8.0.

- `-DENABLE_GCOV=bool`

Whether to include `gcov` support (Linux only).

- `-DENABLE_GPROF=bool`

Whether to enable `gprof` (optimized Linux builds only).

- `-DISABLED_LOCAL_INFILE=bool`

This option controls the compiled-in default `LOCAL` capability for the MySQL client library. Clients that make no explicit arrangements therefore have `LOCAL` capability disabled or enabled according to the `ENABLED_LOCAL_INFILE` setting specified at MySQL build time.

By default, the client library in MySQL binary distributions is compiled with `ENABLED_LOCAL_INFILE` disabled. (Prior to MySQL 5.7.6, it was enabled by default.) If you compile MySQL from source, configure it with `ENABLED_LOCAL_INFILE` disabled or enabled based on whether clients that make no explicit arrangements should have `LOCAL` capability disabled or enabled, respectively.

`ENABLED_LOCAL_INFILE` controls the default for client-side `LOCAL` capability. For the server, the `local_infile` system variable controls server-side `LOCAL` capability. To explicitly cause the server to refuse or permit `LOAD DATA LOCAL` statements (regardless of how client programs and libraries are configured at build time or runtime), start `mysqld` with `--local-infile` disabled or enabled, respectively. `local_infile` can also be set at runtime. See [Section 6.1.6, “Security Considerations for LOAD DATA LOCAL”](#).

- `-DISABLED_PROFILING=bool`

Whether to enable query profiling code (for the `SHOW PROFILE` and `SHOW PROFILES` statements).

- `-DFORCE_UNSUPPORTED_COMPILER=bool`

By default, `CMake` checks for minimum versions of supported compilers: Visual Studio 2013 (Windows); GCC 4.4 or Clang 3.3 (Linux); Developer Studio 12.5 (Solaris server); Developer Studio 12.2 or GCC 4.4 (Solaris client library); Clang 3.3 (macOS), Clang 3.3 (FreeBSD). To disable this check, use `-DFORCE_UNSUPPORTED_COMPILER=ON`.

- `-DIGNORE_AIO_CHECK=bool`

If the `-DBUILD_CONFIG=mysql_release` option is given on Linux, the `libaio` library must be linked in by default. If you do not have `libaio` or do not want to install it, you can suppress the check for it by specifying `-DIGNORE_AIO_CHECK=1`.

- `-DMAX_INDEXES=num`

The maximum number of indexes per table. The default is 64. The maximum is 255. Values smaller than 64 are ignored and the default of 64 is used.



- `-DMYSQL_MAINTAINER_MODE=bool`

Whether to enable a MySQL maintainer-specific development environment. If enabled, this option causes compiler warnings to become errors.

- `-DMUTEX_TYPE=type`

The mutex type used by `InnoDB`. Options include:

- `event`: Use event mutexes. This is the default value and the original `InnoDB` mutex implementation.
- `sys`: Use POSIX mutexes on UNIX systems. Use `CRITICAL_SECTION` objects on Windows, if available.
- `futex`: Use Linux futexes instead of condition variables to schedule waiting threads.

- `-DMYSQLX_TCP_PORT=port_num`

The port number on which X Plugin listens for TCP/IP connections. The default is 33060.

This value can be set at server startup with the `mysqlx_port` system variable.

- `-DMYSQLX_UNIX_ADDR=file_name`

The Unix socket file path on which the server listens for X Plugin socket connections. This must be an absolute path name. The default is `/tmp/mysqlx.sock`.

This value can be set at server startup with the `mysqlx_port` system variable.

- `-DMYSQL_PROJECT_NAME=name`

For Windows or macOS, the project name to incorporate into the project file name.

- `-DMYSQL_TCP_PORT=port_num`

The port number on which the server listens for TCP/IP connections. The default is 3306.

This value can be set at server startup with the `--port` option.

- `-DMYSQL_UNIX_ADDR=file_name`

The Unix socket file path on which the server listens for socket connections. This must be an absolute path name. The default is `/tmp/mysql.sock`.

This value can be set at server startup with the `--socket` option.

- `-DOPTIMIZER_TRACE=bool`

Whether to support optimizer tracing. See [Section 8.15, “Tracing the Optimizer”](#).

- `-DREPRODUCIBLE_BUILD=bool`

For builds on Linux systems, this option controls whether to take extra care to create a build result independent of build location and time.

This option was added in MySQL 5.7.19.

- `-DWIN_DEBUG_NO_INLINE=bool`

Whether to disable function inlining on Windows. The default is `OFF` (inlining enabled).

- `-DWITH_ASAN=bool`

Whether to enable the AddressSanitizer, for compilers that support it. The default is `OFF`.

- `-DWITH_ASAN_SCOPE=bool`

Whether to enable the AddressSanitizer `-fsanitize-address-use-after-scope` Clang flag for use-after-scope detection. The default is off. To use this option, `-DWITH_ASAN` must also be enabled.

- `-DWITH_AUTHENTICATION_LDAP=bool`

Whether to report an error if the LDAP authentication plugins cannot be built:

- If this option is disabled (the default), the LDAP plugins are built if the required header files and libraries are found. If they are not, `CMake` displays a note about it.
- If this option is enabled, a failure to find the required header file and libraries causes `CMake` to produce an error, preventing the server from being built.

For information about LDAP authentication, see [Section 6.4.1.9, “LDAP Pluggable Authentication”](#). This option was added in MySQL 5.7.19.

- `-DWITH_AUTHENTICATION_PAM=bool`

Whether to build the PAM authentication plugin, for source trees that include this plugin. (See [Section 6.4.1.7, “PAM Pluggable Authentication”](#).) If this option is specified and the plugin cannot be compiled, the build fails.

- `-DWITH_AWS_SDK=path_name`

The location of the Amazon Web Services software development kit.

This option was added in MySQL 5.7.19.

- `-DWITH_BOOST=path_name`

The Boost library is required to build MySQL. These `CMake` options enable control over the library source location, and whether to download it automatically:

- `-DWITH_BOOST=path_name` specifies the Boost library directory location. It is also possible to specify the Boost location by setting the `BOOST_ROOT` or `WITH_BOOST` environment variable.

As of MySQL 5.7.11, `-DWITH_BOOST=system` is also permitted and indicates that the correct version of Boost is installed on the compilation host in the standard location. In this case, the installed version of Boost is used rather than any version included with a MySQL source distribution.

- `-DDOWNLOAD_BOOST=bool` specifies whether to download the Boost source if it is not present in the specified location. The default is `OFF`.
- `-DDOWNLOAD_BOOST_TIMEOUT=seconds` the timeout in seconds for downloading the Boost library. The default is 600 seconds.

For example, if you normally build MySQL placing the object output in the `bld` subdirectory of your MySQL source tree, you can build with Boost like this:

```
mkdir bld
cd bld
```

```
cmake .. -DDOWNLOAD_BOOST=ON -DWITH_BOOST=$HOME/my_boost
```

This causes Boost to be downloaded into the `my_boost` directory under your home directory. If the required Boost version is already there, no download is done. If the required Boost version changes, the newer version is downloaded.

If Boost is already installed locally and your compiler finds the Boost header files on its own, it may not be necessary to specify the preceding CMake options. However, if the version of Boost required by MySQL changes and the locally installed version has not been upgraded, you may have build problems. Using the CMake options should give you a successful build.

With the above settings that allow Boost download into a specified location, when the required Boost version changes, you need to remove the `bld` folder, recreate it, and perform the `cmake` step again. Otherwise, the new Boost version might not get downloaded, and compilation might fail.

- `-DWITH_CLIENT_PROTOCOL_TRACING=bool`

Whether to build the client-side protocol tracing framework into the client library. By default, this option is enabled.

For information about writing protocol trace client plugins, see [Writing Protocol Trace Plugins](#).

See also the `WITH_TEST_TRACE_PLUGIN` option.

- `-DWITH_CURL=curl_type`

The location of the `curl` library. `curl_type` can be `system` (use the system `curl` library) or a path name to the `curl` library.

This option was added in MySQL 5.7.19.

- `-DWITH_DEBUG=bool`

Whether to include debugging support.

Configuring MySQL with debugging support enables you to use the `--debug="d,parser_debug"` option when you start the server. This causes the Bison parser that is used to process SQL statements to dump a parser trace to the server's standard error output. Typically, this output is written to the error log.

Sync debug checking for the `InnoDB` storage engine is defined under `UNIV_DEBUG` and is available when debugging support is compiled in using the `WITH_DEBUG` option. When debugging support is compiled in, the `innodb_sync_debug` configuration option can be used to enable or disable `InnoDB` sync debug checking.

As of MySQL 5.7.18, enabling `WITH_DEBUG` also enables Debug Sync. For a description of the Debug Sync facility and how to use synchronization points, see [MySQL Internals: Test Synchronization](#).

- `-DWITH_DEFAULT_FEATURE_SET=bool`

Whether to use the flags from `cmake/build_configurations/feature_set.cmake`.

- `-DWITH_EDITLINE=value`

Which `libedit/editline` library to use. The permitted values are `bundled` (the default) and `system`.

`WITH_EDITLINE` replaces `WITH_LIBEDIT`, which has been removed.

- `-DWITH_EMBEDDED_SERVER=bool`

Whether to build the `libmysqld` embedded server library.



**Note**

The `libmysqld` embedded server library is deprecated as of MySQL 5.7.17 and has been removed in MySQL 8.0.

- `-DWITH_EMBEDDED_SHARED_LIBRARY=bool`

Whether to build a shared `libmysqld` embedded server library.



**Note**

The `libmysqld` embedded server library is deprecated as of MySQL 5.7.17 and has been removed in MySQL 8.0.

- `-DWITH_EXTRA_CHARSETS=name`

Which extra character sets to include:

- `all`: All character sets. This is the default.
- `complex`: Complex character sets.
- `none`: No extra character sets.

- `-DWITH_GMOCK=path_name`

The path to the googletest distribution, for use with Google Test-based unit tests. The option value is the path to the distribution Zip file. Alternatively, set the `WITH_GMOCK` environment variable to the path name. It is also possible to use `-DENABLE_DOWNLOADS=1`, in which case `CMake` downloads the distribution from GitHub.

If you build MySQL without the Google Test unit tests (by configuring without `WITH_GMOCK`), `CMake` displays a message indicating how to download it.

- `-DWITH_INNODB_EXTRA_DEBUG=bool`

Whether to include extra InnoDB debugging support.

Enabling `WITH_INNODB_EXTRA_DEBUG` turns on extra InnoDB debug checks. This option can only be enabled when `WITH_DEBUG` is enabled.

- `-DWITH_INNODB_MEMCACHED=bool`

Whether to generate memcached shared libraries (`libmemcached.so` and `innodb_engine.so`).

- `-DWITH_KEYRING_TEST=bool`

Whether to build the test program that accompanies the `keyring_file` plugin. The default is `OFF`. Test file source code is located in the `plugin/keyring/keyring-test` directory.

This option was added in MySQL 5.7.11.

- `-DWITH_LDAP=value`

Internal use only. This option was added in MySQL 5.7.29.

- `-DWITH_LIBEVENT=string`

Which `libevent` library to use. Permitted values are `bundled` (default) and `system`. Prior to MySQL 5.7.31, if you specify `system`, the system `libevent` library is used if present, and an error occurs otherwise. In MySQL 5.7.31 and later, if `system` is specified and no system `libevent` library can be found, an error occurs regardless, and the bundled `libevent` is not used.

The `libevent` library is required by InnoDB memcached and X Plugin.

- `-DWITH_LIBWRAP=bool`

Whether to include `libwrap` (TCP wrappers) support.

- `-DWITH_LZ4=lz4_type`

The `WITH_LZ4` option indicates the source of `zlib` support:

- `bundled`: Use the `lz4` library bundled with the distribution. This is the default.
- `system`: Use the system `lz4` library. If `WITH_LZ4` is set to this value, the `lz4_decompress` utility is not built. In this case, the system `lz4` command can be used instead.
- `-DWITH_MECAB={disabled|system|path_name}`

Use this option to compile the MeCab parser. If you have installed MeCab to its default installation directory, set `-DWITH_MECAB=system`. The `system` option applies to MeCab installations performed from source or from binaries using a native package management utility. If you installed MeCab to a custom installation directory, specify the path to the MeCab installation, for example, `-DWITH_MECAB=/opt/mecab`. If the `system` option does not work, specifying the MeCab installation path should work in all cases.

For related information, see [Section 12.9.9, “MeCab Full-Text Parser Plugin”](#).

- `-DWITH_MSAN=bool`

Whether to enable MemorySanitizer, for compilers that support it. The default is off.

For this option to have an effect if enabled, all libraries linked to MySQL must also have been compiled with the option enabled.

- `-DWITH_MSVCRT_DEBUG=bool`

Whether to enable Visual Studio CRT memory leak tracing. The default is `OFF`.

- `-DWITH_NUMA=bool`

Explicitly set the NUMA memory allocation policy. `CMake` sets the default `WITH_NUMA` value based on whether the current platform has NUMA support. For platforms without NUMA support, `CMake` behaves as follows:

- With no NUMA option (the normal case), `CMake` continues normally, producing only this warning: `NUMA library missing or required version not available`.
- With `-DWITH_NUMA=ON`, `CMake` aborts with this error: `NUMA library missing or required version not available`.

This option was added in MySQL 5.7.17.

- `-DWITH_PROTOBUF=protobuf_type`

Which Protocol Buffers package to use. `protobuf_type` can be one of the following values:

- `bundled`: Use the package bundled with the distribution. This is the default.
- `system`: Use the package installed on the system.

Other values are ignored, with a fallback to `bundled`.

This option was added in MySQL 5.7.12.

- `-DWITH_RAPID=bool`

Whether to build the rapid development cycle plugins. When enabled, a `rapid` directory is created in the build tree containing these plugins. When disabled, no `rapid` directory is created in the build tree. The default is `ON`, unless the `rapid` directory is removed from the source tree, in which case the default becomes `OFF`. This option was added in MySQL 5.7.12.

- `-DWITH_SASL=value`

Internal use only. This option was added in MySQL 5.7.29. Not supported on Windows.

- `-DWITH_SSL={ssl_type|path_name}`

For support of encrypted connections, entropy for random number generation, and other encryption-related operations, MySQL must be built using an SSL library. This option specifies which SSL library to use.

- `ssl_type` can be one of the following values:

- `yes`: Use the system OpenSSL library if present, else the library bundled with the distribution.
- `bundled`: Use the SSL library bundled with the distribution. This is the default prior to MySQL 5.7.28. As of 5.7.28, this is no longer a permitted value and the default is `system`.
- `system`: Use the system OpenSSL library. This is the default as of MySQL 5.7.28.
- `path_name` is the path name to the OpenSSL installation to use. This can be preferable to using the `ssl_type` value of `system` because it can prevent CMake from detecting and using an older or incorrect OpenSSL version installed on the system. (Another permitted way to do the same thing is to set `WITH_SSL` to `system` and set the `CMAKE_PREFIX_PATH` option to `path_name`.)

For additional information about configuring the SSL library, see [Section 2.8.6, “Configuring SSL Library Support”](#).

- `-DWITH_SYSTEMD=bool`

Whether to enable installation of `systemd` support files. By default, this option is disabled. When enabled, `systemd` support files are installed, and scripts such as `mysqld_safe` and the System V initialization script are not installed. On platforms where `systemd` is not available, enabling `WITH_SYSTEMD` results in an error from CMake.

For more information about using `systemd`, see [Section 2.5.10, “Managing MySQL Server with systemd”](#). That section also includes information about specifying options otherwise specified in `[mysqld_safe]` option groups. Because `mysqld_safe` is not installed when `systemd` is used, such options must be specified another way.

- `-DWITH_TEST_TRACE_PLUGIN=bool`

Whether to build the test protocol trace client plugin (see [Using the Test Protocol Trace Plugin](#)). By default, this option is disabled. Enabling this option has no effect unless the `WITH_CLIENT_PROTOCOL_TRACING` option is enabled. If MySQL is configured with both options enabled, the `libmysqlclient` client library is built with the test protocol trace plugin built in, and all the standard MySQL clients load the plugin. However, even when the test plugin is enabled, it has no effect by default. Control over the plugin is afforded using environment variables; see [Using the Test Protocol Trace Plugin](#).



**Note**

Do *not* enable the `WITH_TEST_TRACE_PLUGIN` option if you want to use your own protocol trace plugins because only one such plugin can be loaded at a time and an error occurs for attempts to load a second one. If you have already built MySQL with the test protocol trace plugin enabled to see how it works, you must rebuild MySQL without it before you can use your own plugins.

For information about writing trace plugins, see [Writing Protocol Trace Plugins](#).

- `-DWITH_UBSAN=bool`

Whether to enable the Undefined Behavior Sanitizer, for compilers that support it. The default is off.

- `-DWITH_UNIT_TESTS={ON|OFF}`

If enabled, compile MySQL with unit tests. The default is `ON` unless the server is not being compiled.

- `-DWITH_UNIXODBC=1`

Enables unixODBC support, for Connector/ODBC.

- `-DWITH_VALGRIND=bool`

Whether to compile in the Valgrind header files, which exposes the Valgrind API to MySQL code. The default is `OFF`.

To generate a Valgrind-aware debug build, `-DWITH_VALGRIND=1` normally is combined with `-DWITH_DEBUG=1`. See [Building Debug Configurations](#).

- `-DWITH_ZLIB=zlib_type`

Some features require that the server be built with compression library support, such as the `COMPRESS()` and `UNCOMPRESS()` functions, and compression of the client/server protocol. The `WITH_ZLIB` option indicates the source of `zlib` support:

- `bundled`: Use the `zlib` library bundled with the distribution. This is the default.
- `system`: Use the system `zlib` library.

- `-DWITHOUT_SERVER=bool`

Whether to build without MySQL Server. The default is `OFF`, which does build the server.

This is considered an experimental option; it is preferred to build with the server.

## Compiler Flags

- `-DCMAKE_C_FLAGS="flags"`

Flags for the C compiler.

- `-DCMAKE_CXX_FLAGS="flags"`

Flags for the C++ compiler.

- `-DWITH_DEFAULT_COMPILER_OPTIONS=bool`

Whether to use the flags from `cmake/build_configurations/compiler_options.cmake`.



### Note

All optimization flags are carefully chosen and tested by the MySQL build team. Overriding them can lead to unexpected results and is done at your own risk.

- `-DSUNPRO_CXX_LIBRARY="lib_name"`

Enable linking against `libCstd` instead of `stlport4` on Solaris 10 or later. This works only for client code because the server depends on C++98.

To specify your own C and C++ compiler flags, for flags that do not affect optimization, use the `CMAKE_C_FLAGS` and `CMAKE_CXX_FLAGS` CMake options.

When providing your own compiler flags, you might want to specify `CMAKE_BUILD_TYPE` as well.

For example, to create a 32-bit release build on a 64-bit Linux machine, do this:

```
$> mkdir build
$> cd build
$> cmake .. -DCMAKE_C_FLAGS=-m32 \
-DMAKE_CXX_FLAGS=-m32 \
-DMAKE_BUILD_TYPE=RelWithDebInfo
```

If you set flags that affect optimization (`-Onumber`), you must set the `CMAKE_C_FLAGS_build_type` and/or `CMAKE_CXX_FLAGS_build_type` options, where `build_type` corresponds to the `CMAKE_BUILD_TYPE` value. To specify a different optimization for the default build type (`RelWithDebInfo`) set the `CMAKE_C_FLAGS_RELWITHDEBINFO` and `CMAKE_CXX_FLAGS_RELWITHDEBINFO` options. For example, to compile on Linux with `-O3` and with debug symbols, do this:

```
$> cmake .. -DCMAKE_C_FLAGS_RELWITHDEBINFO="-O3 -g" \
-DMAKE_CXX_FLAGS_RELWITHDEBINFO="-O3 -g"
```

## CMake Options for Compiling NDB Cluster

The following options are for use when building NDB Cluster with the NDB Cluster sources; they are not currently supported when using sources from the MySQL 5.7 Server tree.

- `-DMECACHED_HOME=dir_name`

NDB support for memcached was removed in NDB 7.5.21 and NDB 7.6.17; thus, this option is no longer supported for building NDB in these or later versions.

- `-DWITH_BUNDLED_LIBEVENT={ON|OFF}`



NDB support for memcached was removed in NDB 7.5.21 and NDB 7.6.17, and thus this option is no longer supported for building NDB in these or later versions.

- `-DWITH_BUNDLED_MEMCACHED={ON|OFF}`

NDB support for memcached was removed in NDB 7.5.21 and NDB 7.6.17, and thus this option is no longer supported for building NDB in these or later versions.

- `-DWITH_CLASSPATH=path`

Sets the classpath for building MySQL NDB Cluster Connector for Java. The default is empty. This option is ignored if `-DWITH_NDB_JAVA=OFF` is used.

- `-DWITH_ERROR_INSERT={ON|OFF}`

Enables error injection in the NDB kernel. For testing only; not intended for use in building production binaries. The default is `OFF`.

- `-DWITH_NDBAPI_EXAMPLES={ON|OFF}`

Build NDB API example programs in `storage/ndb/ndbapi-examples/`. See [NDB API Examples](#), for information about these.

- `-DWITH_NDBCLUSTER_STORAGE_ENGINE={ON|OFF}`

For internal use only; may not always work as expected. To build with NDB support, use `WITH_NDBCLUSTER` instead.

- `-DWITH_NDBCLUSTER={ON|OFF}`

Build and link in support for the NDB storage engine in `mysqld`. The default is `ON`.

- `-DWITH_NDBMTD={ON|OFF}`

Build the multithreaded data node executable `ndbmtd`. The default is `ON`.

- `-DWITH_NDB_BINLOG={ON|OFF}`

Enable binary logging by default in the `mysqld` built using this option. `ON` by default.

- `-DWITH_NDB_DEBUG={ON|OFF}`

Enable building the debug versions of the NDB Cluster binaries. This is `OFF` by default.

- `-DWITH_NDB_JAVA={ON|OFF}`

Enable building NDB Cluster with Java support, including support for ClusterJ (see [MySQL NDB Cluster Connector for Java](#)).

This option is `ON` by default. If you do not wish to compile NDB Cluster with Java support, you must disable it explicitly by specifying `-DWITH_NDB_JAVA=OFF` when running `CMake`. Otherwise, if Java cannot be found, configuration of the build fails.

- `-DWITH_NDB_PORT=port`

Causes the NDB Cluster management server (`ndb_mgmd`) that is built to use this `port` by default. If this option is unset, the resulting management server tries to use port 1186 by default.

- `-DWITH_NDB_TEST={ON|OFF}`

If enabled, include a set of NDB API test programs. The default is `OFF`.

## 2.8.8 Dealing with Problems Compiling MySQL

The solution to many problems involves reconfiguring. If you do reconfigure, take note of the following:

- If `CMake` is run after it has previously been run, it may use information that was gathered during its previous invocation. This information is stored in `CMakeCache.txt`. When `CMake` starts, it looks for that file and reads its contents if it exists, on the assumption that the information is still correct. That assumption is invalid when you reconfigure.
- Each time you run `CMake`, you must run `make` again to recompile. However, you may want to remove old object files from previous builds first because they were compiled using different configuration options.

To prevent old object files or configuration information from being used, run the following commands before re-running `CMake`:

On Unix:

```
$> make clean
$> rm CMakeCache.txt
```

On Windows:

```
$> devenv MySQL.sln /clean
$> del CMakeCache.txt
```

If you build outside of the source tree, remove and recreate your build directory before re-running `CMake`. For instructions on building outside of the source tree, see [How to Build MySQL Server with CMake](#).

On some systems, warnings may occur due to differences in system include files. The following list describes other problems that have been found to occur most often when compiling MySQL:

- To define which C and C++ compilers to use, you can define the `CC` and `CXX` environment variables. For example:

```
$> CC=gcc
$> CXX=g++
$> export CC CXX
```

While this can be done on the command line, as just shown, you may prefer to define these values in a build script, in which case the `export` command is not needed.

To specify your own C and C++ compiler flags, use the `CMAKE_C_FLAGS` and `CMAKE_CXX_FLAGS` CMake options. See [Compiler Flags](#).

To see what flags you might need to specify, invoke `mysql_config` with the `--cflags` and `--cxxflags` options.

- To see what commands are executed during the compile stage, after using `CMake` to configure MySQL, run `make VERBOSE=1` rather than just `make`.
- If compilation fails, check whether the `MYSQL_MAINTAINER_MODE` option is enabled. This mode causes compiler warnings to become errors, so disabling it may enable compilation to proceed.
- If your compile fails with errors such as any of the following, you must upgrade your version of `make` to GNU `make`:

```
make: Fatal error in reader: Makefile, line 18:  
Badly formed macro assignment
```

Or:

```
make: file `Makefile' line 18: Must be a separator (:
```

Or:

```
pthread.h: No such file or directory
```

Solaris and FreeBSD are known to have troublesome `make` programs.

GNU `make` 3.75 is known to work.

- The `sql_yacc.cc` file is generated from `sql_yacc.yy`. Normally, the build process does not need to create `sql_yacc.cc` because MySQL comes with a pregenerated copy. However, if you do need to re-create it, you might encounter this error:

```
"sql_yacc.yy", line xxx fatal: default action causes potential...
```

This is a sign that your version of `yacc` is deficient. You probably need to install a recent version of `bison` (the GNU version of `yacc`) and use that instead.

Versions of `bison` older than 1.75 may report this error:

```
sql_yacc.yy:#####: fatal error: maximum table size (32767) exceeded
```

The maximum table size is not actually exceeded; the error is caused by bugs in older versions of `bison`.

For information about acquiring or updating tools, see the system requirements in [Section 2.8, "Installing MySQL from Source"](#).

### 2.8.9 MySQL Configuration and Third-Party Tools

Third-party tools that need to determine the MySQL version from the MySQL source can read the `VERSION` file in the top-level source directory. The file lists the pieces of the version separately. For example, if the version is MySQL 5.7.4-m14, the file looks like this:

```
MYSQL_VERSION_MAJOR=5  
MYSQL_VERSION_MINOR=7  
MYSQL_VERSION_PATCH=4  
MYSQL_VERSION_EXTRA=-m14
```

If the source is not for a MySQL Server General Availability (GA) release, the `MYSQL_VERSION_EXTRA` value is nonempty. In the preceding example, the value corresponds to Milestone 14.

`MYSQL_VERSION_EXTRA` is also nonempty for NDB Cluster releases (including GA releases of NDB Cluster), as shown here:

```
MYSQL_VERSION_MAJOR=5  
MYSQL_VERSION_MINOR=7  
MYSQL_VERSION_PATCH=32  
MYSQL_VERSION_EXTRA=-ndb-7.5.21
```

To construct a five-digit number from the version components, use this formula:

```
MYSQL_VERSION_MAJOR*10000 + MYSQL_VERSION_MINOR*100 + MYSQL_VERSION_PATCH
```

## 2.9 Postinstallation Setup and Testing

This section discusses tasks that you should perform after installing MySQL:

- If necessary, initialize the data directory and create the MySQL grant tables. For some MySQL installation methods, data directory initialization may be done for you automatically:
  - Windows installation operations performed by MySQL Installer.
  - Installation on Linux using a server RPM or Debian distribution from Oracle.
  - Installation using the native packaging system on many platforms, including Debian Linux, Ubuntu Linux, Gentoo Linux, and others.
  - Installation on macOS using a DMG distribution.

For other platforms and installation types, you must initialize the data directory manually. These include installation from generic binary and source distributions on Unix and Unix-like system, and installation from a ZIP Archive package on Windows. For instructions, see [Section 2.9.1, “Initializing the Data Directory”](#).

- Start the server and make sure that it can be accessed. For instructions, see [Section 2.9.2, “Starting the Server”](#), and [Section 2.9.3, “Testing the Server”](#).
- Assign passwords to the initial `root` account in the grant tables, if that was not already done during data directory initialization. Passwords prevent unauthorized access to the MySQL server. For instructions, see [Section 2.9.4, “Securing the Initial MySQL Account”](#).
- Optionally, arrange for the server to start and stop automatically when your system starts and stops. For instructions, see [Section 2.9.5, “Starting and Stopping MySQL Automatically”](#).
- Optionally, populate time zone tables to enable recognition of named time zones. For instructions, see [Section 5.1.13, “MySQL Server Time Zone Support”](#).

When you are ready to create additional user accounts, you can find information on the MySQL access control system and account management in [Section 6.2, “Access Control and Account Management”](#).

### 2.9.1 Initializing the Data Directory

After MySQL is installed, the data directory must be initialized, including the tables in the `mysql` system database:

- For some MySQL installation methods, data directory initialization is automatic, as described in [Section 2.9, “Postinstallation Setup and Testing”](#).
- For other installation methods, you must initialize the data directory manually. These include installation from generic binary and source distributions on Unix and Unix-like systems, and installation from a ZIP Archive package on Windows.

This section describes how to initialize the data directory manually for MySQL installation methods for which data directory initialization is not automatic. For some suggested commands that enable testing whether the server is accessible and working properly, see [Section 2.9.3, “Testing the Server”](#).

- [Data Directory Initialization Overview](#)
- [Data Directory Initialization Procedure](#)

- [Server Actions During Data Directory Initialization](#)
- [Post-Initialization root Password Assignment](#)

## Data Directory Initialization Overview

In the examples shown here, the server is intended to run under the user ID of the `mysql` login account. Either create the account if it does not exist (see [Create a mysql User and Group](#)), or substitute the name of a different existing login account that you plan to use for running the server.

1. Change location to the top-level directory of your MySQL installation, which is typically `/usr/local/mysql` (adjust the path name for your system as necessary):

```
cd /usr/local/mysql
```

Within this directory are several files and subdirectories, including the `bin` subdirectory that contains the server as well as client and utility programs.

2. The `secure_file_priv` system variable limits import and export operations to a specific directory. Create a directory whose location can be specified as the value of that variable:

```
mkdir mysql-files
```

Grant directory user and group ownership to the `mysql` user and `mysql` group, and set the directory permissions appropriately:

```
chown mysql:mysql mysql-files
chmod 750 mysql-files
```

3. Use the server to initialize the data directory, including the `mysql` database containing the initial MySQL grant tables that determine how users are permitted to connect to the server. For example:

```
bin/mysqld --initialize --user=mysql
```

For important information about the command, especially regarding command options you might use, see [Data Directory Initialization Procedure](#). For details about how the server performs initialization, see [Server Actions During Data Directory Initialization](#).

Typically, data directory initialization need be done only after you first install MySQL. (For upgrades to an existing installation, perform the upgrade procedure instead; see [Section 2.10, "Upgrading MySQL"](#).) However, the command that initializes the data directory does not overwrite any existing `mysql` database tables, so it is safe to run in any circumstances.



### Note

Initialization of the data directory might fail if required system libraries are missing. For example, you might see an error like this:

```
bin/mysqld: error while loading shared libraries:
libnuma.so.1: cannot open shared object file:
No such file or directory
```

If this happens, you must install the missing libraries manually or with your system's package manager. Then retry the data directory initialization command.

4. If you want to deploy the server with automatic support for secure connections, use the `mysql_ssl_rsa_setup` utility to create default SSL and RSA files:

```
bin/mysql_ssl_rsa_setup
```

For more information, see [Section 4.4.5, “mysql\\_ssl\\_rsa\\_setup — Create SSL/RSA Files”](#).

5. In the absence of any option files, the server starts with its default settings. (See [Section 5.1.2, “Server Configuration Defaults”](#).) To explicitly specify options that the MySQL server should use at startup, put them in an option file such as `/etc/my.cnf` or `/etc/mysql/my.cnf`. (See [Section 4.2.2.2, “Using Option Files”](#).) For example, you can use an option file to set the `secure_file_priv` system variable.
6. To arrange for MySQL to start without manual intervention at system boot time, see [Section 2.9.5, “Starting and Stopping MySQL Automatically”](#).
7. Data directory initialization creates time zone tables in the `mysql` database but does not populate them. To do so, use the instructions in [Section 5.1.13, “MySQL Server Time Zone Support”](#).

## Data Directory Initialization Procedure

Change location to the top-level directory of your MySQL installation, which is typically `/usr/local/mysql` (adjust the path name for your system as necessary):

```
cd /usr/local/mysql
```

To initialize the data directory, invoke `mysqld` with the `--initialize` or `--initialize-insecure` option, depending on whether you want the server to generate a random initial password for the `'root'@'localhost'` account, or to create that account with no password:

- Use `--initialize` for “secure by default” installation (that is, including generation of a random initial `root` password). In this case, the password is marked as expired and you must choose a new one.
- With `--initialize-insecure`, no `root` password is generated. This is insecure; it is assumed that you assign a password to the account in timely fashion before putting the server into production use.

For instructions on assigning a new `'root'@'localhost'` password, see [Post-Initialization root Password Assignment](#).



### Note

The server writes any messages (including any initial password) to its standard error output. This may be redirected to the error log, so look there if you do not see the messages on your screen. For information about the error log, including where it is located, see [Section 5.4.2, “The Error Log”](#).

On Windows, use the `--console` option to direct messages to the console.

On Unix and Unix-like systems, it is important for the database directories and files to be owned by the `mysql` login account so that the server has read and write access to them when you run it later. To ensure this, start `mysqld` from the system `root` account and include the `--user` option as shown here:

```
bin/mysqld --initialize --user=mysql
bin/mysqld --initialize-insecure --user=mysql
```

Alternatively, execute `mysqld` while logged in as `mysql`, in which case you can omit the `--user` option from the command.

On Windows, use one of these commands:

```
bin\mysqld --initialize --console
bin\mysqld --initialize-insecure --console
```



### Note

Data directory initialization might fail if required system libraries are missing. For example, you might see an error like this:

```
bin/mysqld: error while loading shared libraries:
libnuma.so.1: cannot open shared object file:
No such file or directory
```

If this happens, you must install the missing libraries manually or with your system's package manager. Then retry the data directory initialization command.

It might be necessary to specify other options such as `--basedir` or `--datadir` if `mysqld` cannot identify the correct locations for the installation directory or data directory. For example (enter the command on a single line):

```
bin/mysqld --initialize --user=mysql
--basedir=/opt/mysql/mysql
--datadir=/opt/mysql/mysql/data
```

Alternatively, put the relevant option settings in an option file and pass the name of that file to `mysqld`. For Unix and Unix-like systems, suppose that the option file name is `/opt/mysql/mysql/etc/my.cnf`. Put these lines in the file:

```
[mysqld]
basedir=/opt/mysql/mysql
datadir=/opt/mysql/mysql/data
```

Then invoke `mysqld` as follows (enter the command on a single line, with the `--defaults-file` option first):

```
bin/mysqld --defaults-file=/opt/mysql/mysql/etc/my.cnf
--initialize --user=mysql
```

On Windows, suppose that `C:\my.ini` contains these lines:

```
[mysqld]
basedir=C:\\Program Files\\MySQL\\MySQL Server 5.7
datadir=D:\\MySQLdata
```

Then invoke `mysqld` as follows (again, you should enter the command on a single line, with the `--defaults-file` option first):

```
bin\\mysqld --defaults-file=C:\\my.ini
--initialize --console
```



### Important

When initializing the data directory, you should not specify any options other than those used for setting directory locations such as `--basedir` or `--datadir`, and the `--user` option if needed. Options to be employed by the MySQL server during normal use can be set when restarting it following initialization. See the description of the `--initialize` option for further information.

## Server Actions During Data Directory Initialization



### Note

The data directory initialization sequence performed by the server does not substitute for the actions performed by `mysql_secure_installation` and

`mysql_ssl_rsa_setup`. See [Section 4.4.4, “mysql\\_secure\\_installation — Improve MySQL Installation Security”](#), and [Section 4.4.5, “mysql\\_ssl\\_rsa\\_setup — Create SSL/RSA Files”](#).

When invoked with the `--initialize` or `--initialize-insecure` option, `mysqld` performs the following actions during the data directory initialization sequence:

1. The server checks for the existence of the data directory as follows:

- If no data directory exists, the server creates it.
- If the data directory exists but is not empty (that is, it contains files or subdirectories), the server exits after producing an error message:

```
[ERROR] --initialize specified but the data directory exists. Aborting.
```

In this case, remove or rename the data directory and try again.

As of MySQL 5.7.11, an existing data directory is permitted to be nonempty if every entry either has a name that begins with a period (.) or is named using an `--ignore-db-dir` option.



### Note

Avoid the use of the `--ignore-db-dir` option, which has been deprecated since MySQL 5.7.16.

2. Within the data directory, the server creates the `mysql` system database and its tables, including the grant tables, time zone tables, and server-side help tables. See [Section 5.3, “The mysql System Database”](#).
3. The server initializes the `system tablespace` and related data structures needed to manage `InnoDB` tables.



### Note

After `mysqld` sets up the `InnoDB system tablespace`, certain changes to tablespace characteristics require setting up a whole new `instance`. Qualifying changes include the file name of the first file in the system tablespace and the number of undo logs. If you do not want to use the default values, make sure that the settings for the `innodb_data_file_path` and `innodb_log_file_size` configuration parameters are in place in the MySQL `configuration file` *before* running `mysqld`. Also make sure to specify as necessary other parameters that affect the creation and location of `InnoDB` files, such as `innodb_data_home_dir` and `innodb_log_group_home_dir`.

If those options are in your configuration file but that file is not in a location that MySQL reads by default, specify the file location using the `--defaults-extra-file` option when you run `mysqld`.

4. The server creates a `'root'@'localhost'` superuser account and other reserved accounts (see [Section 6.2.8, “Reserved Accounts”](#)). Some reserved accounts are locked and cannot be used by clients, but `'root'@'localhost'` is intended for administrative use and you should assign it a password.

Server actions with respect to a password for the `'root'@'localhost'` account depend on how you invoke it:



- With `--initialize` but not `--initialize-insecure`, the server generates a random password, marks it as expired, and writes a message displaying the password:

```
[Warning] A temporary password is generated for root@localhost:
iTag*AfrH5ej
```

- With `--initialize-insecure`, (either with or without `--initialize` because `--initialize-insecure` implies `--initialize`), the server does not generate a password or mark it expired, and writes a warning message:

```
[Warning] root@localhost is created with an empty password ! Please
consider switching off the --initialize-insecure option.
```

For instructions on assigning a new `'root'@'localhost'` password, see [Post-Initialization root Password Assignment](#).

5. The server populates the server-side help tables used for the `HELP` statement (see [Section 13.8.3, “HELP Statement”](#)). The server does not populate the time zone tables. To do so manually, see [Section 5.1.13, “MySQL Server Time Zone Support”](#).
6. If the `init_file` system variable was given to name a file of SQL statements, the server executes the statements in the file. This option enables you to perform custom bootstrapping sequences.

When the server operates in bootstrap mode, some functionality is unavailable that limits the statements permitted in the file. These include statements that relate to account management (such as `CREATE USER` or `GRANT`), replication, and global transaction identifiers.

7. The server exits.

### Post-Initialization root Password Assignment

After you initialize the data directory by starting the server with `--initialize` or `--initialize-insecure`, start the server normally (that is, without either of those options) and assign the `'root'@'localhost'` account a new password:

1. Start the server. For instructions, see [Section 2.9.2, “Starting the Server”](#).
2. Connect to the server:

- If you used `--initialize` but not `--initialize-insecure` to initialize the data directory, connect to the server as `root`:

```
mysql -u root -p
```

Then, at the password prompt, enter the random password that the server generated during the initialization sequence:

```
Enter password: (enter the random root password here)
```

Look in the server error log if you do not know this password.

- If you used `--initialize-insecure` to initialize the data directory, connect to the server as `root` without a password:

```
mysql -u root --skip-password
```

3. After connecting, use an `ALTER USER` statement to assign a new `root` password:

```
ALTER USER 'root'@'localhost' IDENTIFIED BY 'root-password';
```

See also [Section 2.9.4, “Securing the Initial MySQL Account”](#).



#### Note

Attempts to connect to the host `127.0.0.1` normally resolve to the `localhost` account. However, this fails if the server is run with `skip_name_resolve` enabled. If you plan to do that, make sure that an account exists that can accept a connection. For example, to be able to connect as `root` using `--host=127.0.0.1` or `--host=::1`, create these accounts:

```
CREATE USER 'root'@'127.0.0.1' IDENTIFIED BY 'root-password';
CREATE USER 'root'@'::1' IDENTIFIED BY 'root-password';
```

It is possible to put those statements in a file to be executed using the `init_file` system variable, as discussed in [Server Actions During Data Directory Initialization](#).

## 2.9.2 Starting the Server

This section describes how start the server on Unix and Unix-like systems. (For Windows, see [Section 2.3.4.5, “Starting the Server for the First Time”](#).) For some suggested commands that you can use to test whether the server is accessible and working properly, see [Section 2.9.3, “Testing the Server”](#).

Start the MySQL server like this if your installation includes `mysqld_safe`:

```
$> bin/mysqld_safe --user=mysql &
```



#### Note

For Linux systems on which MySQL is installed using RPM packages, server startup and shutdown is managed using `systemd` rather than `mysqld_safe`, and `mysqld_safe` is not installed. See [Section 2.5.10, “Managing MySQL Server with systemd”](#).

Start the server like this if your installation includes `systemd` support:

```
$> systemctl start mysqld
```

Substitute the appropriate service name if it differs from `mysqld` (for example, `mysql` on SLES systems).

It is important that the MySQL server be run using an unprivileged (non-`root`) login account. To ensure this, run `mysqld_safe` as `root` and include the `--user` option as shown. Otherwise, you should execute the program while logged in as `mysql`, in which case you can omit the `--user` option from the command.

For further instructions for running MySQL as an unprivileged user, see [Section 6.1.5, “How to Run MySQL as a Normal User”](#).

If the command fails immediately and prints `mysqld ended`, look for information in the error log (which by default is the `host_name.err` file in the data directory).

If the server is unable to access the data directory it starts or read the grant tables in the `mysql` database, it writes a message to its error log. Such problems can occur if you neglected to create the grant tables by initializing the data directory before proceeding to this step, or if you ran the command that initializes the data directory without the `--user` option. Remove the `data` directory and run the command with the `--user` option.

If you have other problems starting the server, see [Section 2.9.2.1, “Troubleshooting Problems Starting the MySQL Server”](#). For more information about `mysqld_safe`, see [Section 4.3.2, “mysqld\\_safe — MySQL Server Startup Script”](#). For more information about `systemd` support, see [Section 2.5.10, “Managing MySQL Server with systemd”](#).

## 2.9.2.1 Troubleshooting Problems Starting the MySQL Server

This section provides troubleshooting suggestions for problems starting the server. For additional suggestions for Windows systems, see [Section 2.3.5, “Troubleshooting a Microsoft Windows MySQL Server Installation”](#).

If you have problems starting the server, here are some things to try:

- Check the [error log](#) to see why the server does not start. Log files are located in the [data directory](#) (typically `C:\Program Files\MySQL\MySQL Server 5.7\data` on Windows, `/usr/local/mysql/data` for a Unix/Linux binary distribution, and `/usr/local/var` for a Unix/Linux source distribution). Look in the data directory for files with names of the form `host_name.err` and `host_name.log`, where `host_name` is the name of your server host. Then examine the last few lines of these files. Use `tail` to display them:

```
$> tail host_name.err
$> tail host_name.log
```

- Specify any special options needed by the storage engines you are using. You can create a `my.cnf` file and specify startup options for the engines that you plan to use. If you are going to use storage engines that support transactional tables ([InnoDB](#), [NDB](#)), be sure that you have them configured the way you want before starting the server. If you are using [InnoDB](#) tables, see [Section 14.8, “InnoDB Configuration”](#) for guidelines and [Section 14.15, “InnoDB Startup Options and System Variables”](#) for option syntax.

Although storage engines use default values for options that you omit, Oracle recommends that you review the available options and specify explicit values for any options whose defaults are not appropriate for your installation.

- Make sure that the server knows where to find the [data directory](#). The `mysqld` server uses this directory as its current directory. This is where it expects to find databases and where it expects to write log files. The server also writes the pid (process ID) file in the data directory.

The default data directory location is hardcoded when the server is compiled. To determine what the default path settings are, invoke `mysqld` with the `--verbose` and `--help` options. If the data directory is located somewhere else on your system, specify that location with the `--datadir` option to `mysqld` or `mysqld_safe`, on the command line or in an option file. Otherwise, the server does not work properly. As an alternative to the `--datadir` option, you can specify `mysqld` the location of the base directory under which MySQL is installed with the `--basedir`, and `mysqld` looks for the `data` directory there.

To check the effect of specifying path options, invoke `mysqld` with those options followed by the `--verbose` and `--help` options. For example, if you change location to the directory where `mysqld` is installed and then run the following command, it shows the effect of starting the server with a base directory of `/usr/local`:

```
$> ./mysqld --basedir=/usr/local --verbose --help
```

You can specify other options such as `--datadir` as well, but `--verbose` and `--help` must be the last options.

Once you determine the path settings you want, start the server without `--verbose` and `--help`.

If `mysqld` is currently running, you can find out what path settings it is using by executing this command:

```
$> mysqladmin variables
```

Or:

```
$> mysqladmin -h host_name variables
```

*host\_name* is the name of the MySQL server host.

- Make sure that the server can access the [data directory](#). The ownership and permissions of the data directory and its contents must allow the server to read and modify them.

If you get `Errcode 13` (which means `Permission denied`) when starting `mysqld`, this means that the privileges of the data directory or its contents do not permit server access. In this case, you change the permissions for the involved files and directories so that the server has the right to use them. You can also start the server as `root`, but this raises security issues and should be avoided.

Change location to the data directory and check the ownership of the data directory and its contents to make sure the server has access. For example, if the data directory is `/usr/local/mysql/var`, use this command:

```
$> ls -la /usr/local/mysql/var
```

If the data directory or its files or subdirectories are not owned by the login account that you use for running the server, change their ownership to that account. If the account is named `mysql`, use these commands:

```
$> chown -R mysql /usr/local/mysql/var
$> chgrp -R mysql /usr/local/mysql/var
```

Even with correct ownership, MySQL might fail to start up if there is other security software running on your system that manages application access to various parts of the file system. In this case, reconfigure that software to enable `mysqld` to access the directories it uses during normal operation.

- Verify that the network interfaces the server wants to use are available.

If either of the following errors occur, it means that some other program (perhaps another `mysqld` server) is using the TCP/IP port or Unix socket file that `mysqld` is trying to use:

```
Can't start server: Bind on TCP/IP port: Address already in use
Can't start server: Bind on unix socket...
```

Use `ps` to determine whether you have another `mysqld` server running. If so, shut down the server before starting `mysqld` again. (If another server is running, and you really want to run multiple servers, you can find information about how to do so in [Section 5.7, "Running Multiple MySQL Instances on One Machine"](#).)

If no other server is running, execute the command `telnet your_host_name tcp_ip_port_number`. (The default MySQL port number is 3306.) Then press Enter a couple of times. If you do not get an error message like `telnet: Unable to connect to remote host: Connection refused`, some other program is using the TCP/IP port that `mysqld` is trying to use. Track down what program this is and disable it, or tell `mysqld` to listen to a different port with the `--`

`port` option. In this case, specify the same non-default port number for client programs when connecting to the server using TCP/IP.

Another reason the port might be inaccessible is that you have a firewall running that blocks connections to it. If so, modify the firewall settings to permit access to the port.

If the server starts but you cannot connect to it, make sure that you have an entry in `/etc/hosts` that looks like this:

```
127.0.0.1    localhost
```

- If you cannot get `mysqld` to start, try to make a trace file to find the problem by using the `--debug` option. See [Section 5.8.3, “The DEBUG Package”](#).

## 2.9.3 Testing the Server

After the data directory is initialized and you have started the server, perform some simple tests to make sure that it works satisfactorily. This section assumes that your current location is the MySQL installation directory and that it has a `bin` subdirectory containing the MySQL programs used here. If that is not true, adjust the command path names accordingly.

Alternatively, add the `bin` directory to your `PATH` environment variable setting. That enables your shell (command interpreter) to find MySQL programs properly, so that you can run a program by typing only its name, not its path name. See [Section 4.2.7, “Setting Environment Variables”](#).

Use `mysqladmin` to verify that the server is running. The following commands provide simple tests to check whether the server is up and responding to connections:

```
$> bin/mysqladmin version
$> bin/mysqladmin variables
```

If you cannot connect to the server, specify a `-u root` option to connect as `root`. If you have assigned a password for the `root` account already, you'll also need to specify `-p` on the command line and enter the password when prompted. For example:

```
$> bin/mysqladmin -u root -p version
Enter password: (enter root password here)
```

The output from `mysqladmin version` varies slightly depending on your platform and version of MySQL, but should be similar to that shown here:

```
$> bin/mysqladmin version
mysqladmin Ver 14.12 Distrib 5.7.44, for pc-linux-gnu on i686
...

Server version          5.7.44
Protocol version        10
Connection              Localhost via UNIX socket
UNIX socket             /var/lib/mysql/mysql.sock
Uptime:                 14 days 5 hours 5 min 21 sec

Threads: 1  Questions: 366  Slow queries: 0
Opens: 0  Flush tables: 1  Open tables: 19
Queries per second avg: 0.000
```

To see what else you can do with `mysqladmin`, invoke it with the `--help` option.

Verify that you can shut down the server (include a `-p` option if the `root` account has a password already):

```
$> bin/mysqladmin -u root shutdown
```

Verify that you can start the server again. Do this by using `mysqld_safe` or by invoking `mysqld` directly. For example:

```
$> bin/mysqld_safe --user=mysql &
```

If `mysqld_safe` fails, see [Section 2.9.2.1, “Troubleshooting Problems Starting the MySQL Server”](#).

Run some simple tests to verify that you can retrieve information from the server. The output should be similar to that shown here.

Use `mysqlshow` to see what databases exist:

```
$> bin/mysqlshow
+-----+
| Databases |
+-----+
| information_schema |
| mysql |
| performance_schema |
| sys |
+-----+
```

The list of installed databases may vary, but always includes at least `mysql` and `information_schema`.

If you specify a database name, `mysqlshow` displays a list of the tables within the database:

```
$> bin/mysqlshow mysql
Database: mysql
+-----+
| Tables |
+-----+
| columns_priv |
| db |
| engine_cost |
| event |
| func |
| general_log |
| gtid_executed |
| help_category |
| help_keyword |
| help_relation |
| help_topic |
| innodb_index_stats |
| innodb_table_stats |
| ndb_binlog_index |
| plugin |
| proc |
| procs_priv |
| proxies_priv |
| server_cost |
| servers |
| slave_master_info |
| slave_relay_log_info |
| slave_worker_info |
| slow_log |
| tables_priv |
| time_zone |
| time_zone_leap_second |
| time_zone_name |
| time_zone_transition |
| time_zone_transition_type |
| user |
+-----+
```

Use the `mysql` program to select information from a table in the `mysql` database:

```
$> bin/mysql -e "SELECT User, Host, plugin FROM mysql.user" mysql
+-----+-----+-----+
| User | Host      | plugin                |
+-----+-----+-----+
| root | localhost | mysql_native_password |
+-----+-----+-----+
```

At this point, your server is running and you can access it. To tighten security if you have not yet assigned a password to the initial account, follow the instructions in [Section 2.9.4, “Securing the Initial MySQL Account”](#).

For more information about `mysql`, `mysqladmin`, and `mysqlshow`, see [Section 4.5.1, “mysql — The MySQL Command-Line Client”](#), [Section 4.5.2, “mysqladmin — A MySQL Server Administration Program”](#), and [Section 4.5.7, “mysqlshow — Display Database, Table, and Column Information”](#).

## 2.9.4 Securing the Initial MySQL Account

The MySQL installation process involves initializing the data directory, including the grant tables in the `mysql` system database that define MySQL accounts. For details, see [Section 2.9.1, “Initializing the Data Directory”](#).

This section describes how to assign a password to the initial `root` account created during the MySQL installation procedure, if you have not already done so.



### Note

Alternative means for performing the process described in this section:

- On Windows, you can perform the process during installation with MySQL Installer (see [Section 2.3.3, “MySQL Installer for Windows”](#)).
- On all platforms, the MySQL distribution includes `mysql_secure_installation`, a command-line utility that automates much of the process of securing a MySQL installation.
- On all platforms, MySQL Workbench is available and offers the ability to manage user accounts (see [Chapter 29, MySQL Workbench](#)).

A password may already be assigned to the initial account under these circumstances:

- On Windows, installations performed using MySQL Installer give you the option of assigning a password.
- Installation using the macOS installer generates an initial random password, which the installer displays to the user in a dialog box.
- Installation using RPM packages generates an initial random password, which is written to the server error log.
- Installations using Debian packages give you the option of assigning a password.
- For data directory initialization performed manually using `mysqld --initialize`, `mysqld` generates an initial random password, marks it expired, and writes it to the server error log. See [Section 2.9.1, “Initializing the Data Directory”](#).

The `mysql.user` grant table defines the initial MySQL user account and its access privileges. Installation of MySQL creates only a `'root'@'localhost'` superuser account that has all privileges and can do anything. If the `root` account has an empty password, your MySQL installation is unprotected: Anyone can connect to the MySQL server as `root` *without a password* and be granted all privileges.

The 'root'@'localhost' account also has a row in the `mysql.proxies_priv` table that enables granting the `PROXY` privilege for ' '@ ' ', that is, for all users and all hosts. This enables `root` to set up proxy users, as well as to delegate to other accounts the authority to set up proxy users. See [Section 6.2.14, “Proxy Users”](#).

To assign a password for the initial MySQL `root` account, use the following procedure. Replace `root-password` in the examples with the password that you want to use.

Start the server if it is not running. For instructions, see [Section 2.9.2, “Starting the Server”](#).

The initial `root` account may or may not have a password. Choose whichever of the following procedures applies:

- If the `root` account exists with an initial random password that has been expired, connect to the server as `root` using that password, then choose a new password. This is the case if the data directory was initialized using `mysqld --initialize`, either manually or using an installer that does not give you the option of specifying a password during the install operation. Because the password exists, you must use it to connect to the server. But because the password is expired, you cannot use the account for any purpose other than to choose a new password, until you do choose one.

1. If you do not know the initial random password, look in the server error log.
2. Connect to the server as `root` using the password:

```
$> mysql -u root -p
Enter password: (enter the random root password here)
```

3. Choose a new password to replace the random password:

```
mysql> ALTER USER 'root'@'localhost' IDENTIFIED BY 'root-password';
```

- If the `root` account exists but has no password, connect to the server as `root` using no password, then assign a password. This is the case if you initialized the data directory using `mysqld --initialize-insecure`.

1. Connect to the server as `root` using no password:

```
$> mysql -u root --skip-password
```

2. Assign a password:

```
mysql> ALTER USER 'root'@'localhost' IDENTIFIED BY 'root-password';
```

After assigning the `root` account a password, you must supply that password whenever you connect to the server using the account. For example, to connect to the server using the `mysql` client, use this command:

```
$> mysql -u root -p
Enter password: (enter root password here)
```

To shut down the server with `mysqladmin`, use this command:

```
$> mysqladmin -u root -p shutdown
Enter password: (enter root password here)
```



#### Note

For additional information about setting passwords, see [Section 6.2.10, “Assigning Account Passwords”](#). If you forget your `root` password after setting it, see [Section B.3.3.2, “How to Reset the Root Password”](#).



To set up additional accounts, see [Section 6.2.7, “Adding Accounts, Assigning Privileges, and Dropping Accounts”](#).

## 2.9.5 Starting and Stopping MySQL Automatically

This section discusses methods for starting and stopping the MySQL server.

Generally, you start the `mysqld` server in one of these ways:

- Invoke `mysqld` directly. This works on any platform.
- On Windows, you can set up a MySQL service that runs automatically when Windows starts. See [Section 2.3.4.8, “Starting MySQL as a Windows Service”](#).
- On Unix and Unix-like systems, you can invoke `mysqld_safe`, which tries to determine the proper options for `mysqld` and then runs it with those options. See [Section 4.3.2, “mysqld\\_safe — MySQL Server Startup Script”](#).
- On Linux systems that support `systemd`, you can use it to control the server. See [Section 2.5.10, “Managing MySQL Server with systemd”](#).
- On systems that use System V-style run directories (that is, `/etc/init.d` and run-level specific directories), invoke `mysql.server`. This script is used primarily at system startup and shutdown. It usually is installed under the name `mysql`. The `mysql.server` script starts the server by invoking `mysqld_safe`. See [Section 4.3.3, “mysql.server — MySQL Server Startup Script”](#).
- On macOS, install a `launchd` daemon to enable automatic MySQL startup at system startup. The daemon starts the server by invoking `mysqld_safe`. For details, see [Section 2.4.3, “Installing a MySQL Launch Daemon”](#). A MySQL Preference Pane also provides control for starting and stopping MySQL through the System Preferences. See [Section 2.4.4, “Installing and Using the MySQL Preference Pane”](#).
- On Solaris, use the service management framework (SMF) system to initiate and control MySQL startup.

`systemd`, the `mysqld_safe` and `mysql.server` scripts, Solaris SMF, and the macOS Startup Item (or MySQL Preference Pane) can be used to start the server manually, or automatically at system startup time. `systemd`, `mysql.server`, and the Startup Item also can be used to stop the server.

The following table shows which option groups the server and startup scripts read from option files.

**Table 2.15 MySQL Startup Scripts and Supported Server Option Groups**

Script	Option Groups
<code>mysqld</code>	<code>[mysqld]</code> , <code>[server]</code> , <code>[mysqld-major_version]</code>
<code>mysqld_safe</code>	<code>[mysqld]</code> , <code>[server]</code> , <code>[mysqld_safe]</code>
<code>mysql.server</code>	<code>[mysqld]</code> , <code>[mysql.server]</code> , <code>[server]</code>

`[mysqld-major_version]` means that groups with names like `[mysqld-5.6]` and `[mysqld-5.7]` are read by servers having versions 5.6.x, 5.7.x, and so forth. This feature can be used to specify options that can be read only by servers within a given release series.

For backward compatibility, `mysql.server` also reads the `[mysql_server]` group and `mysqld_safe` also reads the `[safe_mysqld]` group. To be current, you should update your option files to use the `[mysql.server]` and `[mysqld_safe]` groups instead.

For more information on MySQL configuration files and their structure and contents, see [Section 4.2.2.2, “Using Option Files”](#).

## 2.10 Upgrading MySQL

This section describes the steps to upgrade a MySQL installation.

Upgrading is a common procedure, as you pick up bug fixes within the same MySQL release series or significant features between major MySQL releases. You perform this procedure first on some test systems to make sure everything works smoothly, and then on the production systems.



### Note

In the following discussion, MySQL commands that must be run using a MySQL account with administrative privileges include `-u root` on the command line to specify the MySQL `root` user. Commands that require a password for `root` also include a `-p` option. Because `-p` is followed by no option value, such commands prompt for the password. Type the password when prompted and press Enter.

SQL statements can be executed using the `mysql` command-line client (connect as `root` to ensure that you have the necessary privileges).

### 2.10.1 Before You Begin

Review the information in this section before upgrading. Perform any recommended actions.

- Protect your data by creating a backup. The backup should include the `mysql` system database, which contains the MySQL system tables. See [Section 7.2, “Database Backup Methods”](#).
- Review [Section 2.10.2, “Upgrade Paths”](#) to ensure that your intended upgrade path is supported.
- Review [Section 2.10.3, “Changes in MySQL 5.7”](#) for changes that you should be aware of before upgrading. Some changes may require action.
- Review [Section 1.3, “What Is New in MySQL 5.7”](#) for deprecated and removed features. An upgrade may require changes with respect to those features if you use any of them.
- Review [Section 1.4, “Server and Status Variables and Options Added, Deprecated, or Removed in MySQL 5.7”](#). If you use deprecated or removed variables, an upgrade may require configuration changes.
- Review the [Release Notes](#) for information about fixes, changes, and new features.
- If you use replication, review [Section 16.4.3, “Upgrading a Replication Topology”](#).
- Upgrade procedures vary by platform and how the initial installation was performed. Use the procedure that applies to your current MySQL installation:
  - For binary and package-based installations on non-Windows platforms, refer to [Section 2.10.4, “Upgrading MySQL Binary or Package-based Installations on Unix/Linux”](#).



### Note

For supported Linux distributions, the preferred method for upgrading package-based installations is to use the MySQL software repositories (MySQL Yum Repository, MySQL APT Repository, and MySQL SLES Repository).

- For installations on an Enterprise Linux platform or Fedora using the MySQL Yum Repository, refer to [Section 2.10.5, “Upgrading MySQL with the MySQL Yum Repository”](#).
- For installations on Ubuntu using the MySQL APT repository, refer to [Section 2.10.6, “Upgrading MySQL with the MySQL APT Repository”](#).
- For installations on SLES using the MySQL SLES repository, refer to [Section 2.10.7, “Upgrading MySQL with the MySQL SLES Repository”](#).
- For installations performed using Docker, refer to [Section 2.10.9, “Upgrading a Docker Installation of MySQL”](#).
- For installations on Windows, refer to [Section 2.10.8, “Upgrading MySQL on Windows”](#).
- If your MySQL installation contains a large amount of data that might take a long time to convert after an in-place upgrade, it may be useful to create a test instance for assessing the conversions that are required and the work involved to perform them. To create a test instance, make a copy of your MySQL instance that contains the `mysql` database and other databases without the data. Run the upgrade procedure on the test instance to assess the work involved to perform the actual data conversion.
- Rebuilding and reinstalling MySQL language interfaces is recommended when you install or upgrade to a new release of MySQL. This applies to MySQL interfaces such as PHP `mysql` extensions and the Perl `DBD::mysql` module.

## 2.10.2 Upgrade Paths

- Upgrade is only supported between General Availability (GA) releases.
- Upgrade from MySQL 5.6 to 5.7 is supported. Upgrading to the latest release is recommended before upgrading to the next version. For example, upgrade to the latest MySQL 5.6 release before upgrading to MySQL 5.7.
- Upgrade that skips versions is not supported. For example, upgrading directly from MySQL 5.5 to 5.7 is not supported.
- Upgrade within a release series is supported. For example, upgrading from MySQL 5.7.*x* to 5.7.*y* is supported. Skipping a release is also supported. For example, upgrading from MySQL 5.7.*x* to 5.7.*z* is supported.

## 2.10.3 Changes in MySQL 5.7

Before upgrading to MySQL 5.7, review the changes described in this section to identify those that apply to your current MySQL installation and applications. Perform any recommended actions.

Changes marked as **Incompatible change** are incompatibilities with earlier versions of MySQL, and may require your attention *before upgrading*. Our aim is to avoid these changes, but occasionally they are necessary to correct problems that would be worse than an incompatibility between releases. If an upgrade issue applicable to your installation involves an incompatibility, follow the instructions given in the description. Sometimes this involves dumping and reloading tables, or use of a statement such as `CHECK TABLE` or `REPAIR TABLE`.

For dump and reload instructions, see [Section 2.10.12, “Rebuilding or Repairing Tables or Indexes”](#). Any procedure that involves `REPAIR TABLE` with the `USE_FRM` option *must* be done before upgrading. Use of this statement with a version of MySQL different from the one used to create the table (that is, using it after upgrading) may damage the table. See [Section 13.7.2.5, “REPAIR TABLE Statement”](#).

- [Configuration Changes](#)
- [System Table Changes](#)
- [Server Changes](#)
- [InnoDB Changes](#)
- [SQL Changes](#)

## Configuration Changes

- **Incompatible change:** In MySQL 5.7.11, the default `--early-plugin-load` value is the name of the `keyring_file` plugin library file, causing that plugin to be loaded by default. In MySQL 5.7.12 and higher, the default `--early-plugin-load` value is empty; to load the `keyring_file` plugin, you must explicitly specify the option with a value naming the `keyring_file` plugin library file.

`InnoDB` tablespace encryption requires that the keyring plugin to be used be loaded prior to `InnoDB` initialization, so this change of default `--early-plugin-load` value introduces an incompatibility for upgrades from 5.7.11 to 5.7.12 or higher. Administrators who have encrypted `InnoDB` tablespaces must take explicit action to ensure continued loading of the keyring plugin: Start the server with an `--early-plugin-load` option that names the plugin library file. For additional information, see [Section 6.4.4.1, “Keyring Plugin Installation”](#).

- **Incompatible change:** The `INFORMATION_SCHEMA` has tables that contain system and status variable information (see [Section 24.3.11, “The INFORMATION\\_SCHEMA GLOBAL\\_VARIABLES and SESSION\\_VARIABLES Tables”](#), and [Section 24.3.10, “The INFORMATION\\_SCHEMA GLOBAL\\_STATUS and SESSION\\_STATUS Tables”](#)). As of MySQL 5.7.6, the Performance Schema also contains system and status variable tables (see [Section 25.12.13, “Performance Schema System Variable Tables”](#), and [Section 25.12.14, “Performance Schema Status Variable Tables”](#)). The Performance Schema tables are intended to replace the `INFORMATION_SCHEMA` tables, which are deprecated as of MySQL 5.7.6 and are removed in MySQL 8.0.

For advice on migrating away from the `INFORMATION_SCHEMA` tables to the Performance Schema tables, see [Section 25.20, “Migrating to Performance Schema System and Status Variable Tables”](#). To assist in the migration, you can use the `show_compatibility_56` system variable, which affects how system and status variable information is provided by the `INFORMATION_SCHEMA` and Performance Schema tables, and also by the `SHOW VARIABLES` and `SHOW STATUS` statements. `show_compatibility_56` is enabled by default in 5.7.6 and 5.7.7, and disabled by default in MySQL 5.7.8.

For details about the effects of `show_compatibility_56`, see [Section 5.1.7, “Server System Variables”](#). For better understanding, it is strongly recommended that you read also these sections:

- [Section 25.12.13, “Performance Schema System Variable Tables”](#)
- [Section 25.12.14, “Performance Schema Status Variable Tables”](#)
- [Section 25.12.15.10, “Status Variable Summary Tables”](#)
- **Incompatible change:** As of MySQL 5.7.6, data directory initialization creates only a single `root` account, `'root'@'localhost'`. (See [Section 2.9.1, “Initializing the Data Directory”](#).) An attempt to connect to the host `127.0.0.1` normally resolves to the `localhost` account. However, this fails if the server is run with `skip_name_resolve` enabled. If you plan to do that, make sure that an account exists that can accept a connection. For example, to be able to connect as `root` using `--host=127.0.0.1` or `--host=:1`, create these accounts:

```
CREATE USER 'root'@'127.0.0.1' IDENTIFIED BY 'root-password';
CREATE USER 'root'@':::1' IDENTIFIED BY 'root-password';
```

- **Incompatible change:** As of MySQL 5.7.6, for some Linux platforms, when MySQL is installed using RPM and Debian packages, server startup and shutdown now is managed using `systemd` rather than `mysqld_safe`, and `mysqld_safe` is not installed. This may require some adjustment to the manner in which you specify server options. For details, see [Section 2.5.10, “Managing MySQL Server with systemd”](#).
- **Incompatible change:** In MySQL 5.7.5, the executable binary version of `mysql_install_db` is located in the `bin` installation directory, whereas the Perl version was located in the `scripts` installation directory. For upgrades from an older version of MySQL, you may find a version in both directories. To avoid confusion, remove the version in the `scripts` directory. For fresh installations of MySQL 5.7.5 or later, `mysql_install_db` is only found in the `bin` directory, and the `scripts` directory is no longer present. Applications that expect to find `mysql_install_db` in the `scripts` directory should be updated to look in the `bin` directory instead.

The location of `mysql_install_db` becomes less material as of MySQL 5.7.6 because as of that version it is deprecated in favor of `mysqld --initialize` (or `mysqld --initialize-insecure`). See [Section 2.9.1, “Initializing the Data Directory”](#)

- **Incompatible change:** In MySQL 5.7.5, these SQL mode changes were made:
  - Strict SQL mode for transactional storage engines (`STRICT_TRANS_TABLES`) is now enabled by default.
  - Implementation of the `ONLY_FULL_GROUP_BY` SQL mode has been made more sophisticated, to no longer reject deterministic queries that previously were rejected. In consequence, `ONLY_FULL_GROUP_BY` is now enabled by default, to prohibit nondeterministic queries containing expressions not guaranteed to be uniquely determined within a group.
  - The changes to the default SQL mode result in a default `sql_mode` system variable value with these modes enabled: `ONLY_FULL_GROUP_BY`, `STRICT_TRANS_TABLES`, `NO_ENGINE_SUBSTITUTION`.
  - The `ONLY_FULL_GROUP_BY` mode is also now included in the modes comprised by the `ANSI SQL` mode.

If you find that having `ONLY_FULL_GROUP_BY` enabled causes queries for existing applications to be rejected, either of these actions should restore operation:

- If it is possible to modify an offending query, do so, either so that nondeterministic nonaggregated columns are functionally dependent on `GROUP BY` columns, or by referring to nonaggregated columns using `ANY_VALUE()`.
- If it is not possible to modify an offending query (for example, if it is generated by a third-party application), set the `sql_mode` system variable at server startup to not enable `ONLY_FULL_GROUP_BY`.

For more information about SQL modes and `GROUP BY` queries, see [Section 5.1.10, “Server SQL Modes”](#), and [Section 12.19.3, “MySQL Handling of GROUP BY”](#).

## System Table Changes

- **Incompatible change:** The `Password` column of the `mysql.user` system table was removed in MySQL 5.7.6. All credentials are stored in the `authentication_string` column, including those formerly stored in the `Password` column. If performing an in-place upgrade to MySQL 5.7.6 or later,

---

run `mysql_upgrade` as directed by the [in-place upgrade procedure](#) to migrate the `Password` column contents to the `authentication_string` column.

If performing a [logical upgrade](#) using a `mysqldump` dump file from a pre-5.7.6 MySQL installation, you must observe these conditions for the `mysqldump` command used to generate the dump file:

- You must include the `--add-drop-table` option
- You must not include the `--flush-privileges` option

As outlined in the [logical upgrade procedure](#), load the pre-5.7.6 dump file into the 5.7.6 (or later) server before running `mysql_upgrade`.

## Server Changes

- **Incompatible change:** As of MySQL 5.7.5, support for passwords that use the older pre-4.1 password hashing format is removed, which involves the following changes. Applications that use any feature no longer supported must be modified.
  - The `mysql_old_password` authentication plugin that used pre-4.1 password hash values is removed. Accounts that use this plugin are disabled at startup and the server writes an “unknown plugin” message to the error log. For instructions on upgrading accounts that use this plugin, see [Section 6.4.1.3, “Migrating Away from Pre-4.1 Password Hashing and the `mysql\_old\_password` Plugin”](#).
  - For the `old_passwords` system variable, a value of 1 (produce pre-4.1 hash values) is no longer permitted.
  - The `--secure-auth` option to the server and client programs is the default, but is now a no-op. It is deprecated; expect it to be removed in a future MySQL release.
  - The `--skip-secure-auth` option to the server and client programs is no longer supported and using it produces an error.
  - The `secure_auth` system variable permits only a value of 1; a value of 0 is no longer permitted.
  - The `OLD_PASSWORD( )` function is removed.
- **Incompatible change:** In MySQL 5.6.6, the 2-digit `YEAR(2)` data type was deprecated. In MySQL 5.7.5, support for `YEAR(2)` is removed. Once you upgrade to MySQL 5.7.5 or higher, any remaining 2-digit `YEAR(2)` columns must be converted to 4-digit `YEAR` columns to become usable again. For conversion strategies, see [Section 11.2.5, “2-Digit YEAR\(2\) Limitations and Migrating to 4-Digit YEAR”](#). Running `mysql_upgrade` after upgrading is one of the possible conversion strategies.
- As of MySQL 5.7.7, `CHECK TABLE ... FOR UPGRADE` reports a table as needing a rebuild if it contains old temporal columns in pre-5.6.4 format (`TIME`, `DATETIME`, and `TIMESTAMP` columns without support for fractional seconds precision) and the `avoid_temporal_upgrade` system variable is disabled. This helps `mysql_upgrade` to detect and upgrade tables containing old temporal columns. If `avoid_temporal_upgrade` is enabled, `FOR UPGRADE` ignores the old temporal columns present in the table; consequently, `mysql_upgrade` does not upgrade them.

As of MySQL 5.7.7, `REPAIR TABLE` upgrades a table if it contains old temporal columns in pre-5.6.4 format and the `avoid_temporal_upgrade` system variable is disabled. If `avoid_temporal_upgrade` is enabled, `REPAIR TABLE` ignores the old temporal columns present in the table and does not upgrade them.

To check for tables that contain such temporal columns and need a rebuild, disable `avoid_temporal_upgrade` before executing `CHECK TABLE ... FOR UPGRADE`.

To upgrade tables that contain such temporal columns, disable `avoid_temporal_upgrade` before executing `REPAIR TABLE` or `mysql_upgrade`.

- **Incompatible change:** As of MySQL 5.7.2, the server requires account rows in the `mysql.user` system table to have a nonempty `plugin` column value and disables accounts with an empty value.

This requires that you upgrade your `mysql.user` table to fill in all `plugin` values. As of MySQL 5.7.6, use this procedure:

If you plan to upgrade using the data directory from your existing MySQL installation:

1. Stop the old (MySQL 5.6) server
2. Upgrade the MySQL binaries in place by replacing the old binaries with the new ones
3. Start the MySQL 5.7 server normally (no special options)
4. Run `mysql_upgrade` to upgrade the system tables
5. Restart the MySQL 5.7 server

If you plan to upgrade by reloading a dump file generated from your existing MySQL installation:

1. To generate the dump file, run `mysqldump` with the `--add-drop-table` option and without the `--flush-privileges` option
2. Stop the old (MySQL 5.6) server
3. Upgrade the MySQL binaries in place (replace the old binaries with the new ones)
4. Start the MySQL 5.7 server normally (no special options)
5. Reload the dump file (`mysql < dump_file`)
6. Run `mysql_upgrade` to upgrade the system tables
7. Restart the MySQL 5.7 server

Before MySQL 5.7.6, the procedure is more involved:

If you plan to upgrade using the data directory from your existing MySQL installation:

1. Stop the old (MySQL 5.6) server
2. Upgrade the MySQL binaries in place (replace the old binaries with the new ones)
3. Restart the server with the `--skip-grant-tables` option to disable privilege checking
4. Run `mysql_upgrade` to upgrade the system tables
5. Restart the server normally (without `--skip-grant-tables`)

If you plan to upgrade by reloading a dump file generated from your existing MySQL installation:

1. To generate the dump file, run `mysqldump` without the `--flush-privileges` option
2. Stop the old (MySQL 5.6) server
3. Upgrade the MySQL binaries in place (replace the old binaries with the new ones)
4. Restart the server with the `--skip-grant-tables` option to disable privilege checking
5. Reload the dump file (`mysql < dump_file`)



6. Run `mysql_upgrade` to upgrade the system tables
7. Restart the server normally (without `--skip-grant-tables`)

`mysql_upgrade` runs by default as the MySQL `root` user. For the preceding procedures, if the `root` password is expired when you run `mysql_upgrade`, it displays a message informing you that your password is expired and that `mysql_upgrade` failed as a result. To correct this, reset the `root` password and run `mysql_upgrade` again:

```
$> mysql -u root -p
Enter password: **** <- enter root password here
mysql> ALTER USER USER() IDENTIFIED BY 'root-password'; # MySQL 5.7.6 and up
mysql> SET PASSWORD = PASSWORD('root-password'); # Before MySQL 5.7.6
mysql> quit

$> mysql_upgrade -p
Enter password: **** <- enter root password here
```

The password-resetting statement normally does not work if the server is started with `--skip-grant-tables`, but the first invocation of `mysql_upgrade` flushes the privileges, so when you run `mysql`, the statement is accepted.

If `mysql_upgrade` itself expires the `root` password, you must reset the password again in the same manner.

After following the preceding instructions, DBAs are advised also to convert accounts that use the `mysql_old_password` authentication plugin to use `mysql_native_password` instead, because support for `mysql_old_password` has been removed. For account upgrade instructions, see [Section 6.4.1.3, “Migrating Away from Pre-4.1 Password Hashing and the `mysql\_old\_password` Plugin”](#).

- **Incompatible change:** It is possible for a column `DEFAULT` value to be valid for the `sql_mode` value at table-creation time but invalid for the `sql_mode` value when rows are inserted or updated. Example:

```
SET sql_mode = '';
CREATE TABLE t (d DATE DEFAULT 0);
SET sql_mode = 'NO_ZERO_DATE,STRICT_ALL_TABLES';
INSERT INTO t (d) VALUES(DEFAULT);
```

In this case, 0 should be accepted for the `CREATE TABLE` but rejected for the `INSERT`. However, previously the server did not evaluate `DEFAULT` values used for inserts or updates against the current `sql_mode`. In the example, the `INSERT` succeeds and inserts '0000-00-00' into the `DATE` column.

As of MySQL 5.7.2, the server applies the proper `sql_mode` checks to generate a warning or error at insert or update time.

A resulting incompatibility for replication if you use statement-based logging (`binlog_format=STATEMENT`) is that if a replica is upgraded, a source which has not been upgraded executes the preceding example without error, whereas the `INSERT` fails on the replica and replication stops.

To deal with this, stop all new statements on the source and wait until the replicas catch up. Then upgrade the replicas followed by the source. Alternatively, if you cannot stop new statements, temporarily change to row-based logging on the source (`binlog_format=ROW`) and wait until all replicas have processed all binary logs produced up to the point of this change. Then upgrade the replicas followed by the source and change the source back to statement-based logging.

- **Incompatible change:** Several changes were made to the audit log plugin for better compatibility with Oracle Audit Vault. For upgrading purpose, the main issue is that the default format of the audit log file

has changed: Information within `<AUDIT_RECORD>` elements previously written using attributes now is written using subelements.

Example of old `<AUDIT_RECORD>` format:

```
<AUDIT_RECORD
  TIMESTAMP="2013-04-15T15:27:27"
  NAME="Query"
  CONNECTION_ID="3"
  STATUS="0"
  SQLTEXT="SELECT 1"
/>
```

Example of new format:

```
<AUDIT_RECORD>
  <TIMESTAMP>2013-04-15T15:27:27 UTC</TIMESTAMP>
  <RECORD_ID>3998_2013-04-15T15:27:27</RECORD_ID>
  <NAME>Query</NAME>
  <CONNECTION_ID>3</CONNECTION_ID>
  <STATUS>0</STATUS>
  <STATUS_CODE>0</STATUS_CODE>
  <USER>root[root] @ localhost [127.0.0.1]</USER>
  <OS_LOGIN></OS_LOGIN>
  <HOST>localhost</HOST>
  <IP>127.0.0.1</IP>
  <COMMAND_CLASS>select</COMMAND_CLASS>
  <SQLTEXT>SELECT 1</SQLTEXT>
</AUDIT_RECORD>
```

If you previously used an older version of the audit log plugin, use this procedure to avoid writing new-format log entries to an existing log file that contains old-format entries:

1. Stop the server.
2. Rename the current audit log file manually. This file contains log entries using only the old format.
3. Update the server and restart it. The audit log plugin creates a new log file, which contains log entries using only the new format.

For information about the audit log plugin, see [Section 6.4.5, “MySQL Enterprise Audit”](#).

- As of MySQL 5.7.7, the default connection timeout for a replica was changed from 3600 seconds (one hour) to 60 seconds (one minute). The new default is applied when a replica without a setting for the `slave_net_timeout` system variable is upgraded to MySQL 5.7. The default setting for the heartbeat interval, which regulates the heartbeat signal to stop the connection timeout occurring in the absence of data if the connection is still good, is calculated as half the value of `slave_net_timeout`. The heartbeat interval is recorded in the replica's source info log (the `mysql.slave_master_info` table or `master.info` file), and it is not changed automatically when the value or default setting of `slave_net_timeout` is changed. A MySQL 5.6 replica that used the default connection timeout and heartbeat interval, and was then upgraded to MySQL 5.7, therefore has a heartbeat interval that is much longer than the connection timeout.

If the level of activity on the source is such that updates to the binary log are sent to the replica at least once every 60 seconds, this situation is not an issue. However, if no data is received from the source, because the heartbeat is not being sent, the connection timeout expires. The replica therefore thinks the connection to the source has been lost and makes multiple reconnection attempts (as controlled by the `MASTER_CONNECT_RETRY` and `MASTER_RETRY_COUNT` settings, which can also be seen in the source info log). The reconnection attempts spawn numerous zombie dump threads that the source must kill, causing the error log on the source to contain multiple errors of the form

---

While initializing dump thread for slave with UUID `uuid`, found a zombie dump thread with the same UUID. Master is killing the zombie dump thread `threadid`. To avoid this issue, immediately before upgrading a replica to MySQL 5.7, check whether the `slave_net_timeout` system variable is using the default setting. If so, issue `CHANGE MASTER TO` with the `MASTER_HEARTBEAT_PERIOD` option, and set the heartbeat interval to 30 seconds, so that it works with the new connection timeout of 60 seconds that applies after the upgrade.

- **Incompatible change:** MySQL 5.6.22 and later recognized the `REFERENCES` privilege but did not entirely enforce it; a user with at least one of `SELECT`, `INSERT`, `UPDATE`, `DELETE`, or `REFERENCES` could create a foreign key constraint on a table. MySQL 5.7 (and later) requires the user to have the `REFERENCES` privilege to do this. This means that if you migrate users from a MySQL 5.6 server (any version) to one running MySQL 5.7, you must make sure to grant this privilege explicitly to any users which need to be able to create foreign keys. This includes the user account employed to import dumps containing tables with foreign keys.

## InnoDB Changes

- As of MySQL 5.7.24, the `zlib library` version bundled with MySQL was raised from version 1.2.3 to version 1.2.11.

The `zlib compressBound()` function in `zlib 1.2.11` returns a slightly higher estimate of the buffer size required to compress a given length of bytes than it did in `zlib version 1.2.3`. The `compressBound()` function is called by `InnoDB` functions that determine the maximum row size permitted when creating compressed `InnoDB` tables or inserting rows into compressed `InnoDB` tables. As a result, `CREATE TABLE ... ROW_FORMAT=COMPRESSED` or `INSERT` operations with row sizes very close to the maximum row size that were successful in earlier releases could now fail.

If you have compressed `InnoDB` tables with large rows, it is recommended that you test compressed table `CREATE TABLE` statements on a MySQL 5.7 test instance prior to upgrading.

- **Incompatible change:** To simplify `InnoDB` tablespace discovery during crash recovery, new redo log record types were introduced in MySQL 5.7.5. This enhancement changes the redo log format. Before performing an in-place upgrade, perform a clean shutdown using an `innodb_fast_shutdown` setting of 0 or 1. A slow shutdown using `innodb_fast_shutdown=0` is a recommended step in [In-Place Upgrade](#).
- **Incompatible change:** MySQL 5.7.8 and 5.7.9 undo logs may contain insufficient information about spatial columns, which could result in a upgrade failure (Bug #21508582). Before performing an in-place upgrade from MySQL 5.7.8 or 5.7.9 to 5.7.10 or higher, perform a slow shutdown using `innodb_fast_shutdown=0` to clear the undo logs. A slow shutdown using `innodb_fast_shutdown=0` is a recommended step in [In-Place Upgrade](#).
- **Incompatible change:** MySQL 5.7.8 undo logs may contain insufficient information about virtual columns and virtual column indexes, which could result in a upgrade failure (Bug #21869656). Before performing an in-place upgrade from MySQL 5.7.8 to MySQL 5.7.9 or higher, perform a slow shutdown using `innodb_fast_shutdown=0` to clear the undo logs. A slow shutdown using `innodb_fast_shutdown=0` is a recommended step in [In-Place Upgrade](#).
- **Incompatible change:** As of MySQL 5.7.9, the redo log header of the first redo log file (`ib_logfile0`) includes a format version identifier and a text string that identifies the MySQL version that created the redo log files. This enhancement changes the redo log format, requiring that MySQL be shutdown cleanly using an `innodb_fast_shutdown` setting of 0 or 1 before performing an in-place upgrade to MySQL 5.7.9 or higher. A slow shutdown using `innodb_fast_shutdown=0` is a recommended step in [In-Place Upgrade](#).

- In MySQL 5.7.9, `DYNAMIC` replaces `COMPACT` as the implicit default row format for `InnoDB` tables. A new configuration option, `innodb_default_row_format`, specifies the default `InnoDB` row format. Permitted values include `DYNAMIC` (the default), `COMPACT`, and `REDUNDANT`.

After upgrading to 5.7.9, any new tables that you create use the row format defined by `innodb_default_row_format` unless you explicitly define a row format (`ROW_FORMAT`).

For existing tables that do not explicitly define a `ROW_FORMAT` option or that use `ROW_FORMAT=DEFAULT`, any operation that rebuilds a table also silently changes the row format of the table to the format defined by `innodb_default_row_format`. Otherwise, existing tables retain their current row format setting. For more information, see [Defining the Row Format of a Table](#).

- Beginning with MySQL 5.7.6, the `InnoDB` storage engine uses its own built-in (“native”) partitioning handler for any new partitioned tables created using `InnoDB`. Partitioned `InnoDB` tables created in previous versions of MySQL are not automatically upgraded. You can easily upgrade such tables to use `InnoDB` native partitioning in MySQL 5.7.9 or later using either of the following methods:
  - To upgrade an individual table from the generic partitioning handler to `InnoDB` native partitioning, execute the statement `ALTER TABLE table_name UPGRADE PARTITIONING`.
  - To upgrade all `InnoDB` tables that use the generic partitioning handler to use the native partitioning handler instead, run `mysql_upgrade`.

## SQL Changes

- **Incompatible change:** The `GET_LOCK()` function was reimplemented in MySQL 5.7.5 using the metadata locking (MDL) subsystem and its capabilities have been extended:
  - Previously, `GET_LOCK()` permitted acquisition of only one named lock at a time, and a second `GET_LOCK()` call released any existing lock. Now `GET_LOCK()` permits acquisition of more than one simultaneous named lock and does not release existing locks.

Applications that rely on the behavior of `GET_LOCK()` releasing any previous lock must be modified for the new behavior.

- The capability of acquiring multiple locks introduces the possibility of deadlock among clients. The MDL subsystem detects deadlock and returns an `ER_USER_LOCK_DEADLOCK` error when this occurs.
- The MDL subsystem imposes a limit of 64 characters on lock names, so this limit now also applies to named locks. Previously, no length limit was enforced.
- Locks acquired with `GET_LOCK()` now appear in the Performance Schema `metadata_locks` table. The `OBJECT_TYPE` column says `USER LEVEL LOCK` and the `OBJECT_NAME` column indicates the lock name.
- A new function, `RELEASE_ALL_LOCKS()` permits release of all acquired named locks at once.

For more information, see [Section 12.14, “Locking Functions”](#).

- The optimizer now handles derived tables and views in the `FROM` clause in consistent fashion to better avoid unnecessary materialization and to enable use of pushed-down conditions that produce more efficient execution plans.

However in MySQL 5.7 before MySQL 5.7.11, and for statements such as `DELETE` or `UPDATE` that modify tables, using the merge strategy for a derived table that previously was materialized can result in an `ER_UPDATE_TABLE_USED` error:

```
mysql> DELETE FROM t1
-> WHERE id IN (SELECT id
->                FROM (SELECT t1.id
->                        FROM t1 INNER JOIN t2 USING (id)
->                        WHERE t2.status = 0) AS t);
ERROR 1093 (HY000): You can't specify target table 't1'
for update in FROM clause
```

The error occurs when merging a derived table into the outer query block results in a statement that both selects from and modifies a table. (Materialization does not cause the problem because, in effect, it converts the derived table to a separate table.) The workaround to avoid this error was to disable the `derived_merge` flag of the `optimizer_switch` system variable before executing the statement:

```
SET optimizer_switch = 'derived_merge=off';
```

The `derived_merge` flag controls whether the optimizer attempts to merge subqueries and views in the `FROM` clause into the outer query block, assuming that no other rule prevents merging. By default, the flag is `on` to enable merging. Setting the flag to `off` prevents merging and avoids the error just described. For more information, see [Section 8.2.2.4, “Optimizing Derived Tables and View References with Merging or Materialization”](#).

- Some keywords may be reserved in MySQL 5.7 that were not reserved in MySQL 5.6. See [Section 9.3, “Keywords and Reserved Words”](#). This can cause words previously used as identifiers to become illegal. To fix affected statements, use identifier quoting. See [Section 9.2, “Schema Object Names”](#).
- After upgrading, it is recommended that you test optimizer hints specified in application code to ensure that the hints are still required to achieve the desired optimization strategy. Optimizer enhancements can sometimes render certain optimizer hints unnecessary. In some cases, an unnecessary optimizer hint may even be counterproductive.
- In `UNION` statements, to apply `ORDER BY` or `LIMIT` to an individual `SELECT`, place the clause inside the parentheses that enclose the `SELECT`:

```
(SELECT a FROM t1 WHERE a=10 AND B=1 ORDER BY a LIMIT 10)
UNION
(SELECT a FROM t2 WHERE a=11 AND B=2 ORDER BY a LIMIT 10);
```

Previous versions of MySQL may permit such statements without parentheses. In MySQL 5.7, the requirement for parentheses is enforced.

## 2.10.4 Upgrading MySQL Binary or Package-based Installations on Unix/Linux

This section describes how to upgrade MySQL binary and package-based installations on Unix/Linux. In-place and logical upgrade methods are described.

- [In-Place Upgrade](#)
- [Logical Upgrade](#)

### In-Place Upgrade

An in-place upgrade involves shutting down the old MySQL server, replacing the old MySQL binaries or packages with the new ones, restarting MySQL on the existing data directory, and upgrading any remaining parts of the existing installation that require upgrading.

**Note**

Only upgrade a MySQL server instance that was properly shut down. If the instance unexpectedly shutdown, then restart the instance and shut it down with `innodb_fast_shutdown=0` before upgrade.

**Note**

If you upgrade an installation originally produced by installing multiple RPM packages, upgrade all the packages, not just some. For example, if you previously installed the server and client RPMs, do not upgrade just the server RPM.

For some Linux platforms, MySQL installation from RPM or Debian packages includes `systemd` support for managing MySQL server startup and shutdown. On these platforms, `mysqld_safe` is not installed. In such cases, use `systemd` for server startup and shutdown instead of the methods used in the following instructions. See [Section 2.5.10, “Managing MySQL Server with systemd”](#).

To perform an in-place upgrade:

1. If you use XA transactions with `InnoDB`, run `XA RECOVER` before upgrading to check for uncommitted XA transactions. If results are returned, either commit or rollback the XA transactions by issuing an `XA COMMIT` or `XA ROLLBACK` statement.
2. Configure MySQL to perform a slow shutdown by setting `innodb_fast_shutdown` to 0. For example:

```
mysql -u root -p --execute="SET GLOBAL innodb_fast_shutdown=0"
```

With a slow shutdown, `InnoDB` performs a full purge and change buffer merge before shutting down, which ensures that data files are fully prepared in case of file format differences between releases.

3. Shut down the old MySQL server. For example:

```
mysqladmin -u root -p shutdown
```

4. Upgrade the MySQL binary installation or packages. If upgrading a binary installation, unpack the new MySQL binary distribution package. See [Obtain and Unpack the Distribution](#). For package-based installations, install the new packages.
5. Start the MySQL 5.7 server, using the existing data directory. For example:

```
mysqld_safe --user=mysql --datadir=/path/to/existing-datadir &
```

6. Run `mysql_upgrade`. For example:

```
mysql_upgrade -u root -p
```

`mysql_upgrade` examines all tables in all databases for incompatibilities with the current version of MySQL. `mysql_upgrade` also upgrades the `mysql` system database so that you can take advantage of new privileges or capabilities.

**Note**

`mysql_upgrade` does not upgrade the contents of the time zone tables or help tables. For upgrade instructions, see [Section 5.1.13, “MySQL Server Time Zone Support”](#), and [Section 5.1.14, “Server-Side Help Support”](#).

7. Shut down and restart the MySQL server to ensure that any changes made to the system tables take effect. For example:

```
mysqladmin -u root -p shutdown
mysqld_safe --user=mysql --datadir=/path/to/existing-datadir &
```

## Logical Upgrade

A logical upgrade involves exporting SQL from the old MySQL instance using a backup or export utility such as `mysqldump` or `mysqlpump`, installing the new MySQL server, and applying the SQL to your new MySQL instance.



### Note

For some Linux platforms, MySQL installation from RPM or Debian packages includes `systemd` support for managing MySQL server startup and shutdown. On these platforms, `mysqld_safe` is not installed. In such cases, use `systemd` for server startup and shutdown instead of the methods used in the following instructions. See [Section 2.5.10, “Managing MySQL Server with systemd”](#).

To perform a logical upgrade:

1. Review the information in [Section 2.10.1, “Before You Begin”](#).
2. Export your existing data from the previous MySQL installation:

```
mysqldump -u root -p
--add-drop-table --routines --events
--all-databases --force > data-for-upgrade.sql
```



### Note

Use the `--routines` and `--events` options with `mysqldump` (as shown above) if your databases include stored programs. The `--all-databases` option includes all databases in the dump, including the `mysql` database that holds the system tables.



### Important

If you have tables that contain generated columns, use the `mysqldump` utility provided with MySQL 5.7.9 or higher to create your dump files. The `mysqldump` utility provided in earlier releases uses incorrect syntax for generated column definitions (Bug #20769542). You can use the Information Schema `COLUMNS` table to identify tables with generated columns.

3. Shut down the old MySQL server. For example:

```
mysqladmin -u root -p shutdown
```

4. Install MySQL 5.7. For installation instructions, see [Chapter 2, \*Installing and Upgrading MySQL\*](#).
5. Initialize a new data directory, as described at [Section 2.9.1, “Initializing the Data Directory”](#). For example:

```
mysqld --initialize --datadir=/path/to/5.7-datadir
```

Copy the temporary `'root'@'localhost'` password displayed to your screen or written to your error log for later use.

6. Start the MySQL 5.7 server, using the new data directory. For example:

```
mysqld_safe --user=mysql --datadir=/path/to/5.7-datadir &
```

7. Reset the `root` password:

```
$> mysql -u root -p
Enter password: **** <- enter temporary root password
```

```
mysql> ALTER USER USER() IDENTIFIED BY 'your new password';
```

8. Load the previously created dump file into the new MySQL server. For example:

```
mysql -u root -p --force < data-for-upgrade.sql
```



#### Note

It is not recommended to load a dump file when GTIDs are enabled on the server (`gtid_mode=ON`), if your dump file includes system tables. `mysqldump` issues DML instructions for the system tables which use the non-transactional MyISAM storage engine, and this combination is not permitted when GTIDs are enabled. Also be aware that loading a dump file from a server with GTIDs enabled, into another server with GTIDs enabled, causes different transaction identifiers to be generated.

9. Run `mysql_upgrade`. For example:

```
mysql_upgrade -u root -p
```

`mysql_upgrade` examines all tables in all databases for incompatibilities with the current version of MySQL. `mysql_upgrade` also upgrades the `mysql` system database so that you can take advantage of new privileges or capabilities.



#### Note

`mysql_upgrade` does not upgrade the contents of the time zone tables or help tables. For upgrade instructions, see [Section 5.1.13, “MySQL Server Time Zone Support”](#), and [Section 5.1.14, “Server-Side Help Support”](#).

10. Shut down and restart the MySQL server to ensure that any changes made to the system tables take effect. For example:

```
mysqladmin -u root -p shutdown
mysqld_safe --user=mysql --datadir=/path/to/5.7-datadir &
```

## 2.10.5 Upgrading MySQL with the MySQL Yum Repository

For supported Yum-based platforms (see [Section 2.5.1, “Installing MySQL on Linux Using the MySQL Yum Repository”](#), for a list), you can perform an in-place upgrade for MySQL (that is, replacing the old version and then running the new version using the old data files) with the MySQL Yum repository.



#### Notes

- Before performing any update to MySQL, follow carefully the instructions in [Section 2.10, “Upgrading MySQL”](#). Among other instructions discussed there, it is especially important to back up your database before the update.
- The following instructions assume you have installed MySQL with the MySQL Yum repository or with an RPM package directly downloaded from [MySQL Developer Zone's MySQL Download page](#); if that is not the case, following the instructions in [Section 2.5.2, “Replacing a Third-Party Distribution of MySQL Using the MySQL Yum Repository”](#).



## Selecting a Target Series

By default, the MySQL Yum repository updates MySQL to the latest version in the release series you have chosen during installation (see [Selecting a Release Series](#) for details), which means, for example, a 5.6.x installation is *not* updated to a 5.7.x release automatically. To update to another release series, you need first to disable the subrepository for the series that has been selected (by default, or by yourself) and enable the subrepository for your target series. To do that, see the general instructions given in [Selecting a Release Series](#). For upgrading from MySQL 5.6 to 5.7, perform the *reverse* of the steps illustrated in [Selecting a Release Series](#), disabling the subrepository for the MySQL 5.6 series and enabling that for the MySQL 5.7 series.

As a general rule, to upgrade from one release series to another, go to the next series rather than skipping a series. For example, if you are currently running MySQL 5.5 and wish to upgrade to 5.7, upgrade to MySQL 5.6 first before upgrading to 5.7.



### Important

For important information about upgrading from MySQL 5.6 to 5.7, see [Upgrading from MySQL 5.6 to 5.7](#).

## Upgrading MySQL

Upgrade MySQL and its components by the following command, for platforms that are not dnf-enabled:

```
sudo yum update mysql-server
```

For platforms that are dnf-enabled:

```
sudo dnf upgrade mysql-server
```

Alternatively, you can update MySQL by telling Yum to update everything on your system, which might take considerably more time. For platforms that are not dnf-enabled:

```
sudo yum update
```

For platforms that are dnf-enabled:

```
sudo dnf upgrade
```

## Restarting MySQL

The MySQL server always restarts after an update by Yum. Once the server restarts, run `mysql_upgrade` to check and possibly resolve any incompatibilities between the old data and the upgraded software. `mysql_upgrade` also performs other functions; see [Section 4.4.7](#), “`mysql_upgrade` — Check and Upgrade MySQL Tables” for details.

You can also update only a specific component. Use the following command to list all the installed packages for the MySQL components (for dnf-enabled systems, replace `yum` in the command with `dnf`):

```
sudo yum list installed | grep "^mysql"
```

After identifying the package name of the component of your choice, update the package with the following command, replacing `package-name` with the name of the package. For platforms that are not dnf-enabled:

```
sudo yum update package-name
```

For dnf-enabled platforms:

```
sudo dnf upgrade package-name
```

## Upgrading the Shared Client Libraries

After updating MySQL using the Yum repository, applications compiled with older versions of the shared client libraries should continue to work.

*If you recompile applications and dynamically link them with the updated libraries:* As typical with new versions of shared libraries where there are differences or additions in symbol versioning between the newer and older libraries (for example, between the newer, standard 5.7 shared client libraries and some older—prior or variant—versions of the shared libraries shipped natively by the Linux distributions' software repositories, or from some other sources), any applications compiled using the updated, newer shared libraries require those updated libraries on systems where the applications are deployed. If those libraries are not in place, the applications requiring the shared libraries fail. For this reason, be sure to deploy the packages for the shared libraries from MySQL on those systems. To do this, add the MySQL Yum repository to the systems (see [Adding the MySQL Yum Repository](#)) and install the latest shared libraries using the instructions given in [Installing Additional MySQL Products and Components with Yum](#).

### 2.10.6 Upgrading MySQL with the MySQL APT Repository

On Debian and Ubuntu platforms, to perform an in-place upgrade of MySQL and its components, use the MySQL APT repository. See [Upgrading MySQL with the MySQL APT Repository](#) in [A Quick Guide to Using the MySQL APT Repository](#).

### 2.10.7 Upgrading MySQL with the MySQL SLES Repository

On the SUSE Linux Enterprise Server (SLES) platform, to perform an in-place upgrade of MySQL and its components, use the MySQL SLES repository. See [Upgrading MySQL with the MySQL SLES Repository](#) in [A Quick Guide to Using the MySQL SLES Repository](#).

### 2.10.8 Upgrading MySQL on Windows

There are two approaches for upgrading MySQL on Windows:

- [Using MySQL Installer](#)
- [Using the Windows ZIP archive distribution](#)

The approach you select depends on how the existing installation was performed. Before proceeding, review [Section 2.10, “Upgrading MySQL”](#) for additional information on upgrading MySQL that is not specific to Windows.



#### Note

Whichever approach you choose, always back up your current MySQL installation before performing an upgrade. See [Section 7.2, “Database Backup Methods”](#).

Upgrades between milestone releases (or from a milestone release to a GA release) are not supported. Significant development changes take place in milestone releases and you may encounter compatibility issues or problems starting the server. For instructions on how to perform a logical upgrade with a milestone release, see [Logical Upgrade](#).



#### Note

MySQL Installer does not support upgrades between *Community* releases and *Commercial* releases. If you require this type of upgrade, perform it using the [ZIP archive](#) approach.

## Upgrading MySQL with MySQL Installer

Performing an upgrade with MySQL Installer is the best approach when the current server installation was performed with it and the upgrade is within the current release series. MySQL Installer does not support upgrades between release series, such as from 5.6 to 5.7, and it does not provide an upgrade indicator to prompt you to upgrade. For instructions on upgrading between release series, see [Upgrading MySQL Using the Windows ZIP Distribution](#).

To perform an upgrade using MySQL Installer:

1. Start MySQL Installer.
2. From the dashboard, click **Catalog** to download the latest changes to the catalog. The installed server can be upgraded only if the dashboard displays an arrow next to the version number of the server.
3. Click **Upgrade**. All products that have a newer version now appear in a list.



### Note

MySQL Installer deselects the server upgrade option for milestone releases (Pre-Release) in the same release series. In addition, it displays a warning to indicate that the upgrade is not supported, identifies the risks of continuing, and provides a summary of the steps to perform a logical upgrade manually. You can reselect server upgrade and proceed at your own risk.

4. Deselect all but the MySQL server product, unless you intend to upgrade other products at this time, and click **Next**.
5. Click **Execute** to start the download. When the download finishes, click **Next** to begin the upgrade operation.
6. Configure the server.

## Upgrading MySQL Using the Windows ZIP Distribution

To perform an upgrade using the Windows ZIP archive distribution:

1. Download the latest Windows ZIP Archive distribution of MySQL from <https://dev.mysql.com/downloads/>.
2. If the server is running, stop it. If the server is installed as a service, stop the service with the following command from the command prompt:

```
C:\> SC STOP mysql_d_service_name
```

Alternatively, use `NET STOP mysql_d_service_name`.

If you are not running the MySQL server as a service, use `mysqladmin` to stop it. For example, before upgrading from MySQL 5.6 to 5.7, use `mysqladmin` from MySQL 5.6 as follows:

```
C:\> "C:\Program Files\MySQL\MySQL Server 5.6\bin\mysqladmin" -u root shutdown
```



### Note

If the MySQL `root` user account has a password, invoke `mysqladmin` with the `-p` option and enter the password when prompted.

3. Extract the ZIP archive. You may either overwrite your existing MySQL installation (usually located at `C:\mysql`), or install it into a different directory, such as `C:\mysql5`. Overwriting the existing installation is recommended.
4. Restart the server. For example, use the `SC START mysqld_service_name` or `NET START mysqld_service_name` command if you run MySQL as a service, or invoke `mysqld` directly otherwise.
5. As Administrator, run `mysql_upgrade` to check your tables, attempt to repair them if necessary, and update your grant tables if they have changed so that you can take advantage of any new capabilities. See [Section 4.4.7, “mysql\\_upgrade — Check and Upgrade MySQL Tables”](#).
6. If you encounter errors, see [Section 2.3.5, “Troubleshooting a Microsoft Windows MySQL Server Installation”](#).

## 2.10.9 Upgrading a Docker Installation of MySQL

To upgrade a Docker installation of MySQL, refer to [Upgrading a MySQL Server Container](#).

## 2.10.10 Upgrading MySQL with Directly-Downloaded RPM Packages

It is preferable to use the [MySQL Yum repository](#) or [MySQL SLES Repository](#) to upgrade MySQL on RPM-based platforms. However, if you have to upgrade MySQL using the RPM packages downloaded directly from the [MySQL Developer Zone](#) (see [Section 2.5.5, “Installing MySQL on Linux Using RPM Packages from Oracle”](#) for information on the packages), go to the folder that contains all the downloaded packages (and, preferably, no other RPM packages with similar names), and issue the following command:

```
yum install mysql-community-{server,client,common,libs}-*
```

Replace `yum` with `zypper` for SLES systems, and with `dnf` for dnf-enabled systems.

While it is much preferable to use a high-level package management tool like `yum` to install the packages, users who preferred direct `rpm` commands can replace the `yum install` command with the `rpm -Uvh` command; however, using `rpm -Uvh` instead makes the installation process more prone to failure, due to potential dependency issues the installation process might run into.

For an upgrade installation using RPM packages, the MySQL server is automatically restarted at the end of the installation if it was running when the upgrade installation began. If the server was not running when the upgrade installation began, you have to restart the server yourself after the upgrade installation is completed; do that with, for example, the follow command:

```
service mysqld start
```

Once the server restarts, run `mysql_upgrade` to check and possibly resolve any incompatibilities between the old data and the upgraded software. `mysql_upgrade` also performs other functions; see [Section 4.4.7, “mysql\\_upgrade — Check and Upgrade MySQL Tables”](#) for details.



### Note

Because of the dependency relationships among the RPM packages, all of the installed packages must be of the same version. Therefore, always update all your installed packages for MySQL. For example, do not just update the server without also upgrading the client, the common files for server and client libraries, and so on.

**Migration and Upgrade from installations by older RPM packages.** Some older versions of MySQL Server RPM packages have names in the form of `MySQL-*` (for example, `MySQL-server-*` and `MySQL-`

client-\*) . The latest versions of RPMs, when installed using the standard package management tool ([yum](#), [dnf](#), or [zypper](#)), seamlessly upgrade those older installations, making it unnecessary to uninstall those old packages before installing the new ones. Here are some differences in behavior between the older and the current RPM packages:

**Table 2.16 Differences Between the Previous and the Current RPM Packages for Installing MySQL**

Feature	Behavior of Previous Packages	Behavior of Current Packages
Service starts after installation is finished	Yes	No, unless it is an upgrade installation, and the server was running when the upgrade began.
Service name	mysql	For RHEL, Oracle Linux, CentOS, and Fedora: <a href="#">mysqld</a>  For SLES: <a href="#">mysql</a>
Error log file	At <code>/var/lib/mysql/hostname.err</code>	For RHEL, Oracle Linux, CentOS, and Fedora: at <code>/var/log/mysqld.log</code>  For SLES: at <code>/var/log/mysql/mysqld.log</code>
Shipped with the <code>/etc/my.cnf</code> file	No	Yes
Multilib support	No	Yes



#### Note

Installation of previous versions of MySQL using older packages might have created a configuration file named `/usr/my.cnf`. It is highly recommended that you examine the contents of the file and migrate the desired settings inside to the file `/etc/my.cnf` file, then remove `/usr/my.cnf`.

**Upgrading to MySQL Enterprise Server.** Upgrading from a community version to a commercial version of MySQL requires that you first uninstall the community version and then install the commercial version. In this case, you must restart the server manually after the upgrade.

**Interoperability with operating system native MySQL packages.** Many Linux distributions ship MySQL as an integrated part of the operating system. The latest versions of RPMs from Oracle, when installed using the standard package management tool ([yum](#), [dnf](#), or [zypper](#)), seamlessly upgrades and replaces the version of MySQL that comes with the operating system, and the package manager automatically replaces system compatibility packages such as `mysql-community-libs-compat` with the relevant new versions.

**Upgrading from non-native MySQL packages.** If you have installed MySQL with third-party packages NOT from your Linux distribution's native software repository (for example, packages directly downloaded from the vendor), you must uninstall all those packages before you can upgrade using the packages from Oracle.

## 2.10.11 Upgrade Troubleshooting

- If problems occur, such as that the new `mysqld` server does not start, verify that you do not have an old `my.cnf` file from your previous installation. You can check this with the `--print-defaults` option (for

example, `mysqld --print-defaults`). If this command displays anything other than the program name, you have an active `my.cnf` file that affects server or client operation.

- If, after an upgrade, you experience problems with compiled client programs, such as [Commands out of sync](#) or unexpected core dumps, you probably have used old header or library files when compiling your programs. In this case, check the date for your `mysql.h` file and `libmysqlclient.a` library to verify that they are from the new MySQL distribution. If not, recompile your programs with the new headers and libraries. Recompilation might also be necessary for programs compiled against the shared client library if the library major version number has changed (for example, from `libmysqlclient.so.15` to `libmysqlclient.so.16`).
- If you have created a loadable function with a given name and upgrade MySQL to a version that implements a new built-in function with the same name, the loadable function becomes inaccessible. To correct this, use `DROP FUNCTION` to drop the loadable function, and then use `CREATE FUNCTION` to re-create the loadable function with a different nonconflicting name. The same is true if the new version of MySQL implements a built-in function with the same name as an existing stored function. See [Section 9.2.5, “Function Name Parsing and Resolution”](#), for the rules describing how the server interprets references to different kinds of functions.

## 2.10.12 Rebuilding or Repairing Tables or Indexes

This section describes how to rebuild or repair tables or indexes, which may be necessitated by:

- Changes to how MySQL handles data types or character sets. For example, an error in a collation might have been corrected, necessitating a table rebuild to update the indexes for character columns that use the collation.
- Required table repairs or upgrades reported by `CHECK TABLE`, `mysqlcheck`, or `mysql_upgrade`.

Methods for rebuilding a table include:

- [Dump and Reload Method](#)
- [ALTER TABLE Method](#)
- [REPAIR TABLE Method](#)

### Dump and Reload Method

If you are rebuilding tables because a different version of MySQL cannot handle them after a binary (in-place) upgrade or downgrade, you must use the dump-and-reload method. Dump the tables *before* upgrading or downgrading using your original version of MySQL. Then reload the tables *after* upgrading or downgrading.

If you use the dump-and-reload method of rebuilding tables only for the purpose of rebuilding indexes, you can perform the dump either before or after upgrading or downgrading. Reloading still must be done afterward.

If you need to rebuild an [InnoDB](#) table because a `CHECK TABLE` operation indicates that a table upgrade is required, use `mysqldump` to create a dump file and `mysql` to reload the file. If the `CHECK TABLE` operation indicates that there is a corruption or causes [InnoDB](#) to fail, refer to [Section 14.22.2, “Forcing InnoDB Recovery”](#) for information about using the `innodb_force_recovery` option to restart [InnoDB](#). To understand the type of problem that `CHECK TABLE` may be encountering, refer to the [InnoDB](#) notes in [Section 13.7.2.2, “CHECK TABLE Statement”](#).

To rebuild a table by dumping and reloading it, use `mysqldump` to create a dump file and `mysql` to reload the file:

```
mysqldump db_name t1 > dump.sql
mysql db_name < dump.sql
```

To rebuild all the tables in a single database, specify the database name without any following table name:

```
mysqldump db_name > dump.sql
mysql db_name < dump.sql
```

To rebuild all tables in all databases, use the `--all-databases` option:

```
mysqldump --all-databases > dump.sql
mysql < dump.sql
```

### ALTER TABLE Method

To rebuild a table with `ALTER TABLE`, use a “null” alteration; that is, an `ALTER TABLE` statement that “changes” the table to use the storage engine that it already has. For example, if `t1` is an `InnoDB` table, use this statement:

```
ALTER TABLE t1 ENGINE = InnoDB;
```

If you are not sure which storage engine to specify in the `ALTER TABLE` statement, use `SHOW CREATE TABLE` to display the table definition.

### REPAIR TABLE Method

The `REPAIR TABLE` method is only applicable to `MyISAM`, `ARCHIVE`, and `CSV` tables.

You can use `REPAIR TABLE` if the table checking operation indicates that there is a corruption or that an upgrade is required. For example, to repair a `MyISAM` table, use this statement:

```
REPAIR TABLE t1;
```

`mysqlcheck --repair` provides command-line access to the `REPAIR TABLE` statement. This can be a more convenient means of repairing tables because you can use the `--databases` or `--all-databases` option to repair all tables in specific databases or all databases, respectively:

```
mysqlcheck --repair --databases db_name ...
mysqlcheck --repair --all-databases
```

## 2.10.13 Copying MySQL Databases to Another Machine

In cases where you need to transfer databases between different architectures, you can use `mysqldump` to create a file containing SQL statements. You can then transfer the file to the other machine and feed it as input to the `mysql` client.

Use `mysqldump --help` to see what options are available.

The easiest (although not the fastest) way to move a database between two machines is to run the following commands on the machine on which the database is located:

```
mysqladmin -h 'other_hostname' create db_name
mysqldump db_name | mysql -h 'other_hostname' db_name
```

If you want to copy a database from a remote machine over a slow network, you can use these commands:

```
mysqladmin create db_name
```

```
mysqldump -h 'other_hostname' --compress db_name | mysql db_name
```

You can also store the dump in a file, transfer the file to the target machine, and then load the file into the database there. For example, you can dump a database to a compressed file on the source machine like this:

```
mysqldump --quick db_name | gzip > db_name.gz
```

Transfer the file containing the database contents to the target machine and run these commands there:

```
mysqladmin create db_name  
gunzip < db_name.gz | mysql db_name
```

You can also use `mysqldump` and `mysqlimport` to transfer the database. For large tables, this is much faster than simply using `mysqldump`. In the following commands, `DUMPDIR` represents the full path name of the directory you use to store the output from `mysqldump`.

First, create the directory for the output files and dump the database:

```
mkdir DUMPDIR  
mysqldump --tab=DUMPDIR db_name
```

Then transfer the files in the `DUMPDIR` directory to some corresponding directory on the target machine and load the files into MySQL there:

```
mysqladmin create db_name # create database  
cat DUMPDIR/*.sql | mysql db_name # create tables in database  
mysqlimport db_name DUMPDIR/*.txt # load data into tables
```

Do not forget to copy the `mysql` database because that is where the grant tables are stored. You might have to run commands as the MySQL `root` user on the new machine until you have the `mysql` database in place.

After you import the `mysql` database on the new machine, execute `mysqladmin flush-privileges` so that the server reloads the grant table information.



### Note

You can copy the `.frm`, `.MYI`, and `.MYD` files for `MyISAM` tables between different architectures that support the same floating-point format. (MySQL takes care of any byte-swapping issues.) See [Section 15.2, “The MyISAM Storage Engine”](#).

## 2.11 Downgrading MySQL

This section describes the steps to downgrade a MySQL installation.

Downgrading is a less common operation than upgrade. Downgrading is typically performed because of a compatibility or performance issue that occurs on a production system, and was not uncovered during initial upgrade verification on the test systems. As with the upgrade procedure [Section 2.10, “Upgrading MySQL”](#)), perform and verify the downgrade procedure on some test systems first, before using it on a production system.



### Note

In the following discussion, MySQL commands that must be run using a MySQL account with administrative privileges include `-u root` on the command line to



specify the MySQL `root` user. Commands that require a password for `root` also include a `-p` option. Because `-p` is followed by no option value, such commands prompt for the password. Type the password when prompted and press Enter.

SQL statements can be executed using the `mysql` command-line client (connect as `root` to ensure that you have the necessary privileges).

## 2.11.1 Before You Begin

Review the information in this section before downgrading. Perform any recommended actions.

- Protect your data by taking a backup. The backup should include the `mysql` database, which contains the MySQL system tables. See [Section 7.2, “Database Backup Methods”](#).
- Review [Section 2.11.2, “Downgrade Paths”](#) to ensure that your intended downgrade path is supported.
- Review [Section 2.11.3, “Downgrade Notes”](#) for items that may require action before downgrading.



### Note

The downgrade procedures described in the following sections assume you are downgrading with data files created or modified by the newer MySQL version. However, if you did not modify your data after upgrading, downgrading using backups taken *before* upgrading to the new MySQL version is recommended. Many of the changes described in [Section 2.11.3, “Downgrade Notes”](#) that require action are not applicable when downgrading using backups taken *before* upgrading to the new MySQL version.

- Use of new features, new configuration options, or new configuration option values that are not supported by a previous release may cause downgrade errors or failures. Before downgrading, reverse changes resulting from the use of new features and remove configuration settings that are not supported by the release you are downgrading to.

## 2.11.2 Downgrade Paths

- Downgrade is only supported between General Availability (GA) releases.
- Downgrade from MySQL 5.7 to 5.6 is supported using the *logical downgrade* method.
- Downgrade that skips versions is not supported. For example, downgrading directly from MySQL 5.7 to 5.5 is not supported.
- Downgrade within a release series is supported. For example, downgrading from MySQL 5.7.*z* to 5.7.*y* is supported. Skipping a release is also supported. For example, downgrading from MySQL 5.7.*z* to 5.7.*x* is supported.

## 2.11.3 Downgrade Notes

Before downgrading from MySQL 5.7, review the information in this section. Some items may require action before downgrading.

- [System Table Changes](#)
- [InnoDB Changes](#)
- [Logging Changes](#)

- [SQL Changes](#)

## System Table Changes

- In MySQL 5.7.13, system table columns that store user@host string values were increased in length. Before downgrading to a previous release, ensure that there are no user@host values that exceed the previous 77 character length limit, and perform the following `mysql` system table alterations:

```
ALTER TABLE mysql.proc MODIFY definer char(77) CHARACTER SET utf8 COLLATE utf8_bin NOT NULL DEFAULT '';
ALTER TABLE mysql.event MODIFY definer char(77) CHARACTER SET utf8 COLLATE utf8_bin NOT NULL DEFAULT '';
ALTER TABLE mysql.tables_priv MODIFY Grantor char(77) COLLATE utf8_bin NOT NULL DEFAULT '';
ALTER TABLE mysql.procs_priv MODIFY Grantor char(77) COLLATE utf8_bin NOT NULL DEFAULT '';
```

- The maximum length of MySQL user names was increased from 16 characters to 32 characters in MySQL 5.7.8. Before downgrading to a previous release, ensure that there are no user names greater than 16 characters in length, and perform the following `mysql` system table alterations:

```
ALTER TABLE mysql.tables_priv MODIFY User char(16) NOT NULL default '';
ALTER TABLE mysql.columns_priv MODIFY User char(16) NOT NULL default '';
ALTER TABLE mysql.user MODIFY User char(16) NOT NULL default '';
ALTER TABLE mysql.db MODIFY User char(16) NOT NULL default '';
ALTER TABLE mysql.procs_priv MODIFY User char(16) binary DEFAULT '' NOT NULL;
```

- The `Password` column of the `mysql.user` system table was removed in MySQL 5.7.6. All credentials are stored in the `authentication_string` column, including those formerly stored in the `Password` column. To make the `mysql.user` table compatible with previous releases, perform the following alterations before downgrading:

```
ALTER TABLE mysql.user ADD Password char(41) character set latin1
  collate latin1_bin NOT NULL default '' AFTER user;
UPDATE mysql.user SET password = authentication_string WHERE
  LENGTH(authentication_string) = 41 AND plugin = 'mysql_native_password';
UPDATE mysql.user SET authentication_string = '' WHERE
  LENGTH(authentication_string) = 41 AND plugin = 'mysql_native_password';
```

- The `help_*` and `time_zone*` system tables changed from `MyISAM` to `InnoDB` in MySQL 5.7.5. Before downgrading to a previous release, change each affected table back to `MyISAM` by running the following statements:

```
ALTER TABLE mysql.help_category ENGINE='MyISAM' STATS_PERSISTENT=DEFAULT;
ALTER TABLE mysql.help_keyword ENGINE='MyISAM' STATS_PERSISTENT=DEFAULT;
ALTER TABLE mysql.help_relation ENGINE='MyISAM' STATS_PERSISTENT=DEFAULT;
ALTER TABLE mysql.help_topic ENGINE='MyISAM' STATS_PERSISTENT=DEFAULT;
ALTER TABLE mysql.time_zone ENGINE='MyISAM' STATS_PERSISTENT=DEFAULT;
ALTER TABLE mysql.time_zone_leap_second ENGINE='MyISAM' STATS_PERSISTENT=DEFAULT;
ALTER TABLE mysql.time_zone_name ENGINE='MyISAM' STATS_PERSISTENT=DEFAULT;
ALTER TABLE mysql.time_zone_transition ENGINE='MyISAM' STATS_PERSISTENT=DEFAULT;
ALTER TABLE mysql.time_zone_transition_type ENGINE='MyISAM' STATS_PERSISTENT=DEFAULT;
```

- The `mysql.plugin` and `mysql.servers` system tables changed from `MyISAM` to `InnoDB` in MySQL 5.7.6. Before downgrading to a previous release, change each affected table back to `MyISAM` by running the following statements:

```
ALTER TABLE mysql.plugin ENGINE='MyISAM' STATS_PERSISTENT=DEFAULT;
ALTER TABLE mysql.servers ENGINE='MyISAM' STATS_PERSISTENT=DEFAULT;
```

- The definition of the `plugin` column in the `mysql.user` system table differs in MySQL 5.7. Before downgrading to a MySQL 5.6 server for versions 5.6.23 and higher, alter the `plugin` column definition using this statement:

```
ALTER TABLE mysql.user MODIFY plugin CHAR(64) COLLATE utf8_bin
  DEFAULT 'mysql_native_password';
```

Before downgrading to a MySQL 5.6.22 server or older, alter the `plugin` column definition using this statement:

```
ALTER TABLE mysql.user MODIFY plugin CHAR(64) COLLATE utf8_bin DEFAULT '';
```

- As of MySQL 5.7.7, the `sys` schema is installed by default during data directory installation. Before downgrading to a previous version, it is recommended that you drop the `sys` schema:

```
DROP DATABASE sys;
```

If you are downgrading to a release that includes the `sys` schema, `mysql_upgrade` recreates the `sys` schema in a compatible form. The `sys` schema is not included in MySQL 5.6.

## InnoDB Changes

- As of MySQL 5.7.5, the `FIL_PAGE_FLUSH_LSN` field, written to the first page of each InnoDB system tablespace file and to InnoDB undo tablespace files, is only written to the first file of the InnoDB system tablespace (page number 0:0). As a result, if you have a multiple-file system tablespace and decide to downgrade from MySQL 5.7 to MySQL 5.6, you may encounter an invalid message on MySQL 5.6 startup stating that `the log sequence numbers x and y in ibdata files do not match the log sequence number y in the ib_logfiles`. If you encounter this message, restart MySQL 5.6. The invalid message should no longer appear.
- To simplify InnoDB tablespace discovery during crash recovery, new redo log record types were introduced in MySQL 5.7.5. This enhancement changes the redo log format. Before performing an in-place downgrade from MySQL 5.7.5 or later, perform a clean shutdown using an `innodb_fast_shutdown` setting of 0 or 1. A slow shutdown using `innodb_fast_shutdown=0` is a recommended step in [In-Place Downgrade](#).
- MySQL 5.7.8 and 5.7.9 undo logs could contain insufficient information about spatial columns (Bug #21508582). Before performing an in-place downgrade from MySQL 5.7.10 or higher to MySQL 5.7.9 or earlier, perform a slow shutdown using `innodb_fast_shutdown=0` to clear the undo logs. A slow shutdown using `innodb_fast_shutdown=0` is a recommended step in [In-Place Downgrade](#).
- MySQL 5.7.8 undo logs could contain insufficient information about virtual columns and virtual column indexes (Bug #21869656). Before performing an in-place downgrade from MySQL 5.7.9 or later to MySQL 5.7.8 or earlier, perform a slow shutdown using `innodb_fast_shutdown=0` to clear the undo logs. A slow shutdown using `innodb_fast_shutdown=0` is a recommended step in [In-Place Downgrade](#).
- As of MySQL 5.7.9, the redo log header of the first redo log file (`ib_logfile0`) includes a format version identifier and a text string that identifies the MySQL version that created the redo log files. This enhancement changes the redo log format. To prevent older versions of MySQL from starting on redo log files created in MySQL 5.7.9 or later, the checksum for redo log checkpoint pages was changed. As a result, you must perform a slow shutdown of MySQL (using `innodb_fast_shutdown=0`) and remove the redo log files (the `ib_logfile*` files) before performing an in-place downgrade. A slow shutdown using `innodb_fast_shutdown=0` and removing the redo log files are recommended steps in [In-Place Downgrade](#).
- A new compression version used by the InnoDB page compression feature was added in MySQL 5.7.32. The new compression version is not compatible with earlier MySQL releases. Creating a page compressed table in MySQL 5.7.32 or higher and accessing the table after downgrading to a release earlier than MySQL 5.7.32 causes a failure. As a workaround, uncompress such tables before downgrading. To uncompress a table, run `ALTER TABLE tbl_name COMPRESSION='None'` and `OPTIMIZE TABLE`. For information about the InnoDB page compression feature, see [Section 14.9.2, "InnoDB Page Compression"](#).

## Logging Changes

- Support for sending the server error log to `syslog` in MySQL 5.7.5 and up differs from older versions. If you use `syslog` and downgrade to a version older than 5.7.5, you must stop using the relevant `mysqld` system variables and use the corresponding `mysqld_safe` command options instead. Suppose that you use `syslog` by setting these system variables in the `[mysqld]` group of an option file:

```
[mysqld]
log_syslog=ON
log_syslog_tag=mytag
```

To downgrade, remove those settings and add option settings in the `[mysqld_safe]` option file group:

```
[mysqld_safe]
syslog
syslog-tag=mytag
```

`syslog`-related system variables that have no corresponding `mysqld_safe` option cannot be used after a downgrade.

## SQL Changes

- A trigger can have triggers for different combinations of trigger event (`INSERT`, `UPDATE`, `DELETE`) and action time (`BEFORE`, `AFTER`), but before MySQL 5.7.2 cannot have multiple triggers that have the same trigger event and action time. MySQL 5.7.2 lifts this limitation and multiple triggers are permitted. This change has implications for downgrades.

If you downgrade a server that supports multiple triggers to an older version that does not, the downgrade has these effects:

- For each table that has triggers, all trigger definitions remain in the `.TRG` file for the table. However, if there are multiple triggers with the same trigger event and action time, the server executes only one of them when the trigger event occurs. For information about `.TRG` files, see [Table Trigger Storage](#).
- If triggers for the table are added or dropped subsequent to the downgrade, the server rewrites the table's `.TRG` file. The rewritten file retains only one trigger per combination of trigger event and action time; the others are lost.

To avoid these problems, modify your triggers before downgrading. For each table that has multiple triggers per combination of trigger event and action time, convert each such set of triggers to a single trigger as follows:

1. For each trigger, create a stored routine that contains all the code in the trigger. Values accessed using `NEW` and `OLD` can be passed to the routine using parameters. If the trigger needs a single result value from the code, you can put the code in a stored function and have the function return the value. If the trigger needs multiple result values from the code, you can put the code in a stored procedure and return the values using `OUT` parameters.
2. Drop all triggers for the table.
3. Create one new trigger for the table that invokes the stored routines just created. The effect for this trigger is thus the same as the multiple triggers it replaces.

### 2.11.4 Downgrading Binary and Package-based Installations on Unix/Linux

This section describes how to downgrade MySQL binary and package-based installations on Unix/Linux. In-place and logical downgrade methods are described.

- [In-Place Downgrade](#)
- [Logical Downgrade](#)

## In-Place Downgrade

In-place downgrade involves shutting down the new MySQL version, replacing the new MySQL binaries or packages with the old ones, and restarting the old MySQL version on the existing data directory.

In-place downgrade is supported for downgrades between GA releases within the same release series.

In-place downgrade is not supported for MySQL APT, SLES, and Yum repository installations.



### Note

For some Linux platforms, MySQL installation from RPM or Debian packages includes systemd support for managing MySQL server startup and shutdown. On these platforms, `mysqld_safe` is not installed. In such cases, use systemd for server startup and shutdown instead of the methods used in the following instructions. See [Section 2.5.10, “Managing MySQL Server with systemd”](#).

To perform an in-place downgrade:

1. Review the information in [Section 2.11.1, “Before You Begin”](#).
2. If you use XA transactions with [InnoDB](#), run `XA RECOVER` before downgrading to check for uncommitted XA transactions. If results are returned, either commit or rollback the XA transactions by issuing an `XA COMMIT` or `XA ROLLBACK` statement.
3. Configure MySQL to perform a slow shutdown by setting `innodb_fast_shutdown` to 0. For example:

```
mysql -u root -p --execute="SET GLOBAL innodb_fast_shutdown=0"
```

With a slow shutdown, [InnoDB](#) performs a full purge and change buffer merge before shutting down, which ensures that data files are fully prepared in case of file format differences between releases.

4. Shut down the newer MySQL server. For example:

```
mysqladmin -u root -p shutdown
```

5. After the slow shutdown, remove the [InnoDB](#) redo log files (the `ib_logfile*` files) from the `data` directory to avoid downgrade issues related to redo log file format changes that may have occurred between releases.

```
rm ib_logfile*
```

6. Downgrade the MySQL binaries or packages in-place by replacing the newer binaries or packages with the older ones.
7. Start the older (downgraded) MySQL server, using the existing data directory. For example:

```
mysqld_safe --user=mysql --datadir=/path/to/existing-datadir
```

8. Run `mysql_upgrade`. For example:

```
mysql_upgrade -u root -p
```

`mysql_upgrade` examines all tables in all databases for incompatibilities with the current version of MySQL, and attempts to repair the tables if problems are found.

9. Shut down and restart the MySQL server to ensure that any changes made to the system tables take effect. For example:

```
mysqladmin -u root -p shutdown
mysqld_safe --user=mysql --datadir=/path/to/existing-datadir
```

## Logical Downgrade

Logical downgrade involves using `mysqldump` to dump all tables from the new MySQL version, and then loading the dump file into the old MySQL version.

Logical downgrades are supported for downgrades between releases within the same release series and for downgrades to the previous release level. Only downgrades between General Availability (GA) releases are supported. Before proceeding, review [Section 2.11.1, “Before You Begin”](#).



### Note

For some Linux platforms, MySQL installation from RPM or Debian packages includes `systemd` support for managing MySQL server startup and shutdown. On these platforms, `mysqld_safe` is not installed. In such cases, use `systemd` for server startup and shutdown instead of the methods used in the following instructions. See [Section 2.5.10, “Managing MySQL Server with systemd”](#).

For MySQL APT, SLES, and Yum repository installations, only downgrades to the previous release level are supported. Where the instructions call for initializing an older instance, use the package management utility to remove MySQL 5.7 packages and install MySQL 5.6 packages.

To perform a logical downgrade:

1. Review the information in [Section 2.11.1, “Before You Begin”](#).
2. Dump all databases. For example:

```
mysqldump -u root -p
--add-drop-table --routines --events
--all-databases --force > data-for-downgrade.sql
```

3. Shut down the newer MySQL server. For example:

```
mysqladmin -u root -p shutdown
```

4. To initialize a MySQL 5.7 instance, use `mysqld` with the `--initialize` or `--initialize-insecure` option.

```
mysqld --initialize --user=mysql
```

5. Start the older MySQL server, using the new data directory. For example:

```
mysqld_safe --user=mysql --datadir=/path/to/new-datadir
```

6. Load the dump file into the older MySQL server. For example:

```
mysql -u root -p --force < data-for-upgrade.sql
```

7. Run `mysql_upgrade`. For example:

```
mysql_upgrade -u root -p
```

`mysql_upgrade` examines all tables in all databases for incompatibilities with the current version of MySQL, and attempts to repair the tables if problems are found.

- Shut down and restart the MySQL server to ensure that any changes made to the system tables take effect. For example:

```
mysqladmin -u root -p shutdown
mysqld_safe --user=mysql --datadir=/path/to/new-datadir
```

## 2.11.5 Downgrade Troubleshooting

If you downgrade from one release series to another, there may be incompatibilities in table storage formats. In this case, use `mysqldump` to dump your tables before downgrading. After downgrading, reload the dump file using `mysql` or `mysqlimport` to re-create your tables. For examples, see [Section 2.10.13, “Copying MySQL Databases to Another Machine”](#).

A typical symptom of a downward-incompatible table format change when you downgrade is that you cannot open tables. In that case, use the following procedure:

- Stop the older MySQL server that you are downgrading to.
- Restart the newer MySQL server you are downgrading from.
- Dump any tables that were inaccessible to the older server by using `mysqldump` to create a dump file.
- Stop the newer MySQL server and restart the older one.
- Reload the dump file into the older server. Your tables should be accessible.

## 2.12 Perl Installation Notes

The Perl [DBI](#) module provides a generic interface for database access. You can write a [DBI](#) script that works with many different database engines without change. To use [DBI](#), you must install the [DBI](#) module, as well as a DataBase Driver (DBD) module for each type of database server you want to access. For MySQL, this driver is the [DBD: :mysql](#) module.



### Note

Perl support is not included with MySQL distributions. You can obtain the necessary modules from <http://search.cpan.org> for Unix, or by using the ActiveState [ppm](#) program on Windows. The following sections describe how to do this.

The [DBI/DBD](#) interface requires Perl 5.6.0, and 5.6.1 or later is preferred. *DBI does not work* if you have an older version of Perl. You should use [DBD: :mysql](#) 4.009 or higher. Although earlier versions are available, they do not support the full functionality of MySQL 5.7.

### 2.12.1 Installing Perl on Unix

MySQL Perl support requires that you have installed MySQL client programming support (libraries and header files). Most installation methods install the necessary files. If you install MySQL from RPM files on Linux, be sure to install the developer RPM as well. The client programs are in the client RPM, but client programming support is in the developer RPM.

The files you need for Perl support can be obtained from the CPAN (Comprehensive Perl Archive Network) at <http://search.cpan.org>.

The easiest way to install Perl modules on Unix is to use the [CPAN](#) module. For example:

```
$> perl -MCPAN -e shell
cpan> install DBI
```

```
cpan> install DBD:mysql
```

The `DBD:mysql` installation runs a number of tests. These tests attempt to connect to the local MySQL server using the default user name and password. (The default user name is your login name on Unix, and `ODBC` on Windows. The default password is “no password.”) If you cannot connect to the server with those values (for example, if your account has a password), the tests fail. You can use `force install DBD:mysql` to ignore the failed tests.

`DBI` requires the `Data:Dumper` module. It may be installed; if not, you should install it before installing `DBI`.

It is also possible to download the module distributions in the form of compressed `tar` archives and build the modules manually. For example, to unpack and build a `DBI` distribution, use a procedure such as this:

1. Unpack the distribution into the current directory:

```
$> gunzip < DBI-VERSION.tar.gz | tar xvf -
```

This command creates a directory named `DBI-VERSION`.

2. Change location into the top-level directory of the unpacked distribution:

```
$> cd DBI-VERSION
```

3. Build the distribution and compile everything:

```
$> perl Makefile.PL
$> make
$> make test
$> make install
```

The `make test` command is important because it verifies that the module is working. Note that when you run that command during the `DBD:mysql` installation to exercise the interface code, the MySQL server must be running or the test fails.

It is a good idea to rebuild and reinstall the `DBD:mysql` distribution whenever you install a new release of MySQL. This ensures that the latest versions of the MySQL client libraries are installed correctly.

If you do not have access rights to install Perl modules in the system directory or if you want to install local Perl modules, the following reference may be useful: <http://learn.perl.org/faq/perlfaq8.html#How-do-I-keep-my-own-module-library-directory->

## 2.12.2 Installing ActiveState Perl on Windows

On Windows, you should do the following to install the MySQL `DBD` module with ActiveState Perl:

1. Get ActiveState Perl from <http://www.activestate.com/Products/ActivePerl/> and install it.
2. Open a console window.
3. If necessary, set the `HTTP_proxy` variable. For example, you might try a setting like this:

```
C:\> set HTTP_proxy=my.proxy.com:3128
```

4. Start the PPM program:

```
C:\> C:\perl\bin\ppm.pl
```

5. If you have not previously done so, install `DBI`:



```
ppm> install DBI
```

6. If this succeeds, run the following command:

```
ppm> install DBD-mysql
```

This procedure should work with ActiveState Perl 5.6 or higher.

If you cannot get the procedure to work, you should install the ODBC driver instead and connect to the MySQL server through ODBC:

```
use DBI;
$dbh= DBI->connect("DBI:ODBC:$dsn",$user,$password) ||
die "Got error $DBI::errstr when connecting to $dsn\n";
```

## 2.12.3 Problems Using the Perl DBI/DBD Interface

If Perl reports that it cannot find the `../mysql/mysql.so` module, the problem is probably that Perl cannot locate the `libmysqlclient.so` shared library. You should be able to fix this problem by one of the following methods:

- Copy `libmysqlclient.so` to the directory where your other shared libraries are located (probably `/usr/lib` or `/lib`).
- Modify the `-L` options used to compile `DBD:mysql` to reflect the actual location of `libmysqlclient.so`.
- On Linux, you can add the path name of the directory where `libmysqlclient.so` is located to the `/etc/ld.so.conf` file.
- Add the path name of the directory where `libmysqlclient.so` is located to the `LD_RUN_PATH` environment variable. Some systems use `LD_LIBRARY_PATH` instead.

Note that you may also need to modify the `-L` options if there are other libraries that the linker fails to find. For example, if the linker cannot find `libc` because it is in `/lib` and the link command specifies `-L/usr/lib`, change the `-L` option to `-L/lib` or add `-L/lib` to the existing link command.

If you get the following errors from `DBD:mysql`, you are probably using `gcc` (or using an old binary compiled with `gcc`):

```
/usr/bin/perl: can't resolve symbol '__moddi3'
/usr/bin/perl: can't resolve symbol '__divdi3'
```

Add `-L/usr/lib/gcc-lib/... -lgcc` to the link command when the `mysql.so` library gets built (check the output from `make` for `mysql.so` when you compile the Perl client). The `-L` option should specify the path name of the directory where `libgcc.a` is located on your system.

Another cause of this problem may be that Perl and MySQL are not both compiled with `gcc`. In this case, you can solve the mismatch by compiling both with `gcc`.



---

# Chapter 3 Tutorial

## Table of Contents

3.1 Connecting to and Disconnecting from the Server .....	269
3.2 Entering Queries .....	270
3.3 Creating and Using a Database .....	273
3.3.1 Creating and Selecting a Database .....	274
3.3.2 Creating a Table .....	275
3.3.3 Loading Data into a Table .....	277
3.3.4 Retrieving Information from a Table .....	278
3.4 Getting Information About Databases and Tables .....	291
3.5 Using <code>mysql</code> in Batch Mode .....	292
3.6 Examples of Common Queries .....	294
3.6.1 The Maximum Value for a Column .....	294
3.6.2 The Row Holding the Maximum of a Certain Column .....	294
3.6.3 Maximum of Column per Group .....	295
3.6.4 The Rows Holding the Group-wise Maximum of a Certain Column .....	295
3.6.5 Using User-Defined Variables .....	296
3.6.6 Using Foreign Keys .....	296
3.6.7 Searching on Two Keys .....	299
3.6.8 Calculating Visits Per Day .....	299
3.6.9 Using <code>AUTO_INCREMENT</code> .....	299
3.7 Using MySQL with Apache .....	302

This chapter provides a tutorial introduction to MySQL by showing how to use the `mysql` client program to create and use a simple database. `mysql` (sometimes referred to as the “terminal monitor” or just “monitor”) is an interactive program that enables you to connect to a MySQL server, run queries, and view the results. `mysql` may also be used in batch mode: you place your queries in a file beforehand, then tell `mysql` to execute the contents of the file. Both ways of using `mysql` are covered here.

To see a list of options provided by `mysql`, invoke it with the `--help` option:

```
$> mysql --help
```

This chapter assumes that `mysql` is installed on your machine and that a MySQL server is available to which you can connect. If this is not true, contact your MySQL administrator. (If *you* are the administrator, you need to consult the relevant portions of this manual, such as [Chapter 5, MySQL Server Administration](#).)

This chapter describes the entire process of setting up and using a database. If you are interested only in accessing an existing database, you may want to skip the sections that describe how to create the database and the tables it contains.

Because this chapter is tutorial in nature, many details are necessarily omitted. Consult the relevant sections of the manual for more information on the topics covered here.

## 3.1 Connecting to and Disconnecting from the Server

To connect to the server, you usually need to provide a MySQL user name when you invoke `mysql` and, most likely, a password. If the server runs on a machine other than the one where you log in, you also

need to specify a host name. Contact your administrator to find out what connection parameters you should use to connect (that is, what host, user name, and password to use). Once you know the proper parameters, you should be able to connect like this:

```
$> mysql -h host -u user -p
Enter password: *****
```

`host` and `user` represent the host name where your MySQL server is running and the user name of your MySQL account. Substitute appropriate values for your setup. The `*****` represents your password; enter it when `mysql` displays the `Enter password:` prompt.

If that works, you should see some introductory information followed by a `mysql>` prompt:

```
$> mysql -h host -u user -p
Enter password: *****
Welcome to the MySQL monitor.  Commands end with ; or \g.
Your MySQL connection id is 25338 to server version: 5.7.44-standard

Type 'help;' or '\h' for help. Type '\c' to clear the buffer.

mysql>
```

The `mysql>` prompt tells you that `mysql` is ready for you to enter SQL statements.

If you are logging in on the same machine that MySQL is running on, you can omit the host, and simply use the following:

```
$> mysql -u user -p
```

If, when you attempt to log in, you get an error message such as `ERROR 2002 (HY000): Can't connect to local MySQL server through socket '/tmp/mysql.sock' (2)`, it means that the MySQL server daemon (Unix) or service (Windows) is not running. Consult the administrator or see the section of [Chapter 2, Installing and Upgrading MySQL](#) that is appropriate to your operating system.

For help with other problems often encountered when trying to log in, see [Section B.3.2, "Common Errors When Using MySQL Programs"](#).

Some MySQL installations permit users to connect as the anonymous (unnamed) user to the server running on the local host. If this is the case on your machine, you should be able to connect to that server by invoking `mysql` without any options:

```
$> mysql
```

After you have connected successfully, you can disconnect any time by typing `QUIT` (or `\q`) at the `mysql>` prompt:

```
mysql> QUIT
Bye
```

On Unix, you can also disconnect by pressing Control+D.

Most examples in the following sections assume that you are connected to the server. They indicate this by the `mysql>` prompt.

## 3.2 Entering Queries

Make sure that you are connected to the server, as discussed in the previous section. Doing so does not in itself select any database to work with, but that is okay. At this point, it is more important to find out a little about how to issue queries than to jump right in creating tables, loading data into them, and retrieving data

from them. This section describes the basic principles of entering queries, using several queries you can try out to familiarize yourself with how `mysql` works.

Here is a simple query that asks the server to tell you its version number and the current date. Type it in as shown here following the `mysql>` prompt and press Enter:

```
mysql> SELECT VERSION(), CURRENT_DATE;
+-----+-----+
| VERSION() | CURRENT_DATE |
+-----+-----+
| 5.7.1-m4-log | 2012-12-25 |
+-----+-----+
1 row in set (0.01 sec)
mysql>
```

This query illustrates several things about `mysql`:

- A query normally consists of an SQL statement followed by a semicolon. (There are some exceptions where a semicolon may be omitted. `QUIT`, mentioned earlier, is one of them. We'll get to others later.)
- When you issue a query, `mysql` sends it to the server for execution and displays the results, then prints another `mysql>` prompt to indicate that it is ready for another query.
- `mysql` displays query output in tabular form (rows and columns). The first row contains labels for the columns. The rows following are the query results. Normally, column labels are the names of the columns you fetch from database tables. If you're retrieving the value of an expression rather than a table column (as in the example just shown), `mysql` labels the column using the expression itself.
- `mysql` shows how many rows were returned and how long the query took to execute, which gives you a rough idea of server performance. These values are imprecise because they represent wall clock time (not CPU or machine time), and because they are affected by factors such as server load and network latency. (For brevity, the "rows in set" line is sometimes not shown in the remaining examples in this chapter.)

Keywords may be entered in any lettercase. The following queries are equivalent:

```
mysql> SELECT VERSION(), CURRENT_DATE;
mysql> select version(), current_date;
mysql> SeLeCt vErSiOn(), current_DATE;
```

Here is another query. It demonstrates that you can use `mysql` as a simple calculator:

```
mysql> SELECT SIN(PI()/4), (4+1)*5;
+-----+-----+
| SIN(PI()/4) | (4+1)*5 |
+-----+-----+
| 0.70710678118655 | 25 |
+-----+-----+
1 row in set (0.02 sec)
```

The queries shown thus far have been relatively short, single-line statements. You can even enter multiple statements on a single line. Just end each one with a semicolon:

```
mysql> SELECT VERSION(); SELECT NOW();
+-----+
| VERSION() |
+-----+
| 5.7.10-ndb-7.5.1 |
+-----+
1 row in set (0.00 sec)
+-----+
```

```
| NOW() |
+-----+
| 2016-01-29 18:02:55 |
+-----+
1 row in set (0.00 sec)
```

A query need not be given all on a single line, so lengthy queries that require several lines are not a problem. `mysql` determines where your statement ends by looking for the terminating semicolon, not by looking for the end of the input line. (In other words, `mysql` accepts free-format input: it collects input lines but does not execute them until it sees the semicolon.)

Here is a simple multiple-line statement:

```
mysql> SELECT
-> USER()
-> ,
-> CURRENT_DATE;
+-----+-----+
| USER() | CURRENT_DATE |
+-----+-----+
| jon@localhost | 2010-08-06 |
+-----+-----+
```

In this example, notice how the prompt changes from `mysql>` to `->` after you enter the first line of a multiple-line query. This is how `mysql` indicates that it has not yet seen a complete statement and is waiting for the rest. The prompt is your friend, because it provides valuable feedback. If you use that feedback, you can always be aware of what `mysql` is waiting for.

If you decide you do not want to execute a query that you are in the process of entering, cancel it by typing `\c`:

```
mysql> SELECT
-> USER()
-> \c
mysql>
```

Here, too, notice the prompt. It switches back to `mysql>` after you type `\c`, providing feedback to indicate that `mysql` is ready for a new query.

The following table shows each of the prompts you may see and summarizes what they mean about the state that `mysql` is in.

Prompt	Meaning
<code>mysql&gt;</code>	Ready for new query
<code>-&gt;</code>	Waiting for next line of multiple-line query
<code>'&gt;</code>	Waiting for next line, waiting for completion of a string that began with a single quote ( ' )
<code>"&gt;</code>	Waiting for next line, waiting for completion of a string that began with a double quote ( " )
<code>`&gt;</code>	Waiting for next line, waiting for completion of an identifier that began with a backtick ( ` )
<code>/*&gt;</code>	Waiting for next line, waiting for completion of a comment that began with /*

Multiple-line statements commonly occur by accident when you intend to issue a query on a single line, but forget the terminating semicolon. In this case, `mysql` waits for more input:

```
mysql> SELECT USER()
->
```

If this happens to you (you think you've entered a statement but the only response is a `->` prompt), most likely `mysql` is waiting for the semicolon. If you don't notice what the prompt is telling you, you might sit there for a while before realizing what you need to do. Enter a semicolon to complete the statement, and `mysql` executes it:

```
mysql> SELECT USER()
-> ;
+-----+
| USER() |
+-----+
| jon@localhost |
+-----+
```

The `'>` and `>>` prompts occur during string collection (another way of saying that MySQL is waiting for completion of a string). In MySQL, you can write strings surrounded by either `'` or `"` characters (for example, `'hello'` or `"goodbye"`), and `mysql` lets you enter strings that span multiple lines. When you see a `'>` or `>>` prompt, it means that you have entered a line containing a string that begins with a `'` or `"` quote character, but have not yet entered the matching quote that terminates the string. This often indicates that you have inadvertently left out a quote character. For example:

```
mysql> SELECT * FROM my_table WHERE name = 'Smith AND age < 30;
'>
```

If you enter this `SELECT` statement, then press **Enter** and wait for the result, nothing happens. Instead of wondering why this query takes so long, notice the clue provided by the `'>` prompt. It tells you that `mysql` expects to see the rest of an unterminated string. (Do you see the error in the statement? The string `'Smith` is missing the second single quotation mark.)

At this point, what do you do? The simplest thing is to cancel the query. However, you cannot just type `\c` in this case, because `mysql` interprets it as part of the string that it is collecting. Instead, enter the closing quote character (so `mysql` knows you've finished the string), then type `\c`:

```
mysql> SELECT * FROM my_table WHERE name = 'Smith AND age < 30;
'> '\c
mysql>
```

The prompt changes back to `mysql>`, indicating that `mysql` is ready for a new query.

The ``>` prompt is similar to the `'>` and `>>` prompts, but indicates that you have begun but not completed a backtick-quoted identifier.

It is important to know what the `'>`, `>>`, and ``>` prompts signify, because if you mistakenly enter an unterminated string, any further lines you type appear to be ignored by `mysql`—including a line containing `QUIT`. This can be quite confusing, especially if you do not know that you need to supply the terminating quote before you can cancel the current query.



#### Note

Multiline statements from this point on are written without the secondary (`->` or other) prompts, to make it easier to copy and paste the statements to try for yourself.

## 3.3 Creating and Using a Database

Once you know how to enter SQL statements, you are ready to access a database.

Suppose that you have several pets in your home (your menagerie) and you would like to keep track of various types of information about them. You can do so by creating tables to hold your data and loading them with the desired information. Then you can answer different sorts of questions about your animals by retrieving data from the tables. This section shows you how to perform the following operations:

- Create a database
- Create a table
- Load data into the table
- Retrieve data from the table in various ways
- Use multiple tables

The menagerie database is simple (deliberately), but it is not difficult to think of real-world situations in which a similar type of database might be used. For example, a database like this could be used by a farmer to keep track of livestock, or by a veterinarian to keep track of patient records. A menagerie distribution containing some of the queries and sample data used in the following sections can be obtained from the MySQL website. It is available in both compressed `tar` file and Zip formats at <https://dev.mysql.com/doc/>.

Use the `SHOW` statement to find out what databases currently exist on the server:

```
mysql> SHOW DATABASES;
+-----+
| Database |
+-----+
| mysql   |
| test    |
| tmp     |
+-----+
```

The `mysql` database describes user access privileges. The `test` database often is available as a workspace for users to try things out.

The list of databases displayed by the statement may be different on your machine; `SHOW DATABASES` does not show databases that you have no privileges for if you do not have the `SHOW DATABASES` privilege. See [Section 13.7.5.14, “SHOW DATABASES Statement”](#).

If the `test` database exists, try to access it:

```
mysql> USE test
Database changed
```

`USE`, like `QUIT`, does not require a semicolon. (You can terminate such statements with a semicolon if you like; it does no harm.) The `USE` statement is special in another way, too: it must be given on a single line.

You can use the `test` database (if you have access to it) for the examples that follow, but anything you create in that database can be removed by anyone else with access to it. For this reason, you should probably ask your MySQL administrator for permission to use a database of your own. Suppose that you want to call yours `menagerie`. The administrator needs to execute a statement like this:

```
mysql> GRANT ALL ON menagerie.* TO 'your_mysql_name'@'your_client_host';
```

where `your_mysql_name` is the MySQL user name assigned to you and `your_client_host` is the host from which you connect to the server.

### 3.3.1 Creating and Selecting a Database



If the administrator creates your database for you when setting up your permissions, you can begin using it. Otherwise, you need to create it yourself:

```
mysql> CREATE DATABASE menagerie;
```

Under Unix, database names are case-sensitive (unlike SQL keywords), so you must always refer to your database as `menagerie`, not as `Menagerie`, `MENAGERIE`, or some other variant. This is also true for table names. (Under Windows, this restriction does not apply, although you must refer to databases and tables using the same lettercase throughout a given query. However, for a variety of reasons, the recommended best practice is always to use the same lettercase that was used when the database was created.)



**Note**

If you get an error such as `ERROR 1044 (42000): Access denied for user 'micah'@'localhost' to database 'menagerie'` when attempting to create a database, this means that your user account does not have the necessary privileges to do so. Discuss this with the administrator or see [Section 6.2, “Access Control and Account Management”](#).

Creating a database does not select it for use; you must do that explicitly. To make `menagerie` the current database, use this statement:

```
mysql> USE menagerie
Database changed
```

Your database needs to be created only once, but you must select it for use each time you begin a `mysql` session. You can do this by issuing a `USE` statement as shown in the example. Alternatively, you can select the database on the command line when you invoke `mysql`. Just specify its name after any connection parameters that you might need to provide. For example:

```
$> mysql -h host -u user -p menagerie
Enter password: *****
```



**Important**

`menagerie` in the command just shown is **not** your password. If you want to supply your password on the command line after the `-p` option, you must do so with no intervening space (for example, as `-ppassword`, not as `-p password`). However, putting your password on the command line is not recommended, because doing so exposes it to snooping by other users logged in on your machine.



**Note**

You can see at any time which database is currently selected using `SELECT DATABASE()`.

### 3.3.2 Creating a Table

Creating the database is the easy part, but at this point it is empty, as `SHOW TABLES` tells you:

```
mysql> SHOW TABLES;
Empty set (0.00 sec)
```

The harder part is deciding what the structure of your database should be: what tables you need and what columns should be in each of them.

You want a table that contains a record for each of your pets. This can be called the `pet` table, and it should contain, as a bare minimum, each animal's name. Because the name by itself is not very interesting, the table should contain other information. For example, if more than one person in your family keeps pets, you might want to list each animal's owner. You might also want to record some basic descriptive information such as species and sex.

How about age? That might be of interest, but it is not a good thing to store in a database. Age changes as time passes, which means you'd have to update your records often. Instead, it is better to store a fixed value such as date of birth. Then, whenever you need age, you can calculate it as the difference between the current date and the birth date. MySQL provides functions for doing date arithmetic, so this is not difficult. Storing birth date rather than age has other advantages, too:

- You can use the database for tasks such as generating reminders for upcoming pet birthdays. (If you think this type of query is somewhat silly, note that it is the same question you might ask in the context of a business database to identify clients to whom you need to send out birthday greetings in the current week or month, for that computer-assisted personal touch.)
- You can calculate age in relation to dates other than the current date. For example, if you store death date in the database, you can easily calculate how old a pet was when it died.

You can probably think of other types of information that would be useful in the `pet` table, but the ones identified so far are sufficient: name, owner, species, sex, birth, and death.

Use a `CREATE TABLE` statement to specify the layout of your table:

```
mysql> CREATE TABLE pet (name VARCHAR(20), owner VARCHAR(20),
    species VARCHAR(20), sex CHAR(1), birth DATE, death DATE);
```

`VARCHAR` is a good choice for the `name`, `owner`, and `species` columns because the column values vary in length. The lengths in those column definitions need not all be the same, and need not be `20`. You can normally pick any length from `1` to `65535`, whatever seems most reasonable to you. If you make a poor choice and it turns out later that you need a longer field, MySQL provides an `ALTER TABLE` statement.

Several types of values can be chosen to represent sex in animal records, such as `'m'` and `'f'`, or perhaps `'male'` and `'female'`. It is simplest to use the single characters `'m'` and `'f'`.

The use of the `DATE` data type for the `birth` and `death` columns is a fairly obvious choice.

Once you have created a table, `SHOW TABLES` should produce some output:

```
mysql> SHOW TABLES;
+-----+
| Tables in menagerie |
+-----+
| pet                |
+-----+
```

To verify that your table was created the way you expected, use a `DESCRIBE` statement:

```
mysql> DESCRIBE pet;
+-----+-----+-----+-----+-----+-----+
| Field | Type          | Null | Key | Default | Extra |
+-----+-----+-----+-----+-----+-----+
| name  | varchar(20)   | YES  |     | NULL    |       |
| owner | varchar(20)   | YES  |     | NULL    |       |
| species | varchar(20)  | YES  |     | NULL    |       |
| sex   | char(1)       | YES  |     | NULL    |       |
| birth | date          | YES  |     | NULL    |       |
| death | date          | YES  |     | NULL    |       |
+-----+-----+-----+-----+-----+-----+
```

You can use [DESCRIBE](#) any time, for example, if you forget the names of the columns in your table or what types they have.

For more information about MySQL data types, see [Chapter 11, Data Types](#).

### 3.3.3 Loading Data into a Table

After creating your table, you need to populate it. The [LOAD DATA](#) and [INSERT](#) statements are useful for this.

Suppose that your pet records can be described as shown here. (Observe that MySQL expects dates in `'YYYY-MM-DD'` format; this may differ from what you are used to.)

name	owner	species	sex	birth	death
Fluffy	Harold	cat	f	1993-02-04	
Claws	Gwen	cat	m	1994-03-17	
Buffy	Harold	dog	f	1989-05-13	
Fang	Benny	dog	m	1990-08-27	
Bowser	Diane	dog	m	1979-08-31	1995-07-29
Chirpy	Gwen	bird	f	1998-09-11	
Whistler	Gwen	bird		1997-12-09	
Slim	Benny	snake	m	1996-04-29	

Because you are beginning with an empty table, an easy way to populate it is to create a text file containing a row for each of your animals, then load the contents of the file into the table with a single statement.

You could create a text file `pet.txt` containing one record per line, with values separated by tabs, and given in the order in which the columns were listed in the [CREATE TABLE](#) statement. For missing values (such as unknown sexes or death dates for animals that are still living), you can use [NULL](#) values. To represent these in your text file, use `\N` (backslash, capital-N). For example, the record for Whistler the bird would look like this (where the whitespace between values is a single tab character):

```
Whistler      Gwen      bird      \N      1997-12-09      \N
```

To load the text file `pet.txt` into the `pet` table, use this statement:

```
mysql> LOAD DATA LOCAL INFILE '/path/pet.txt' INTO TABLE pet;
```

If you created the file on Windows with an editor that uses `\r\n` as a line terminator, you should use this statement instead:

```
mysql> LOAD DATA LOCAL INFILE '/path/pet.txt' INTO TABLE pet
      LINES TERMINATED BY '\r\n';
```

(On an Apple machine running macOS, you would likely want to use `LINES TERMINATED BY '\r'`.)

You can specify the column value separator and end of line marker explicitly in the [LOAD DATA](#) statement if you wish, but the defaults are tab and linefeed. These are sufficient for the statement to read the file `pet.txt` properly.

If the statement fails, it is likely that your MySQL installation does not have local file capability enabled by default. See [Section 6.1.6, "Security Considerations for LOAD DATA LOCAL"](#), for information on how to change this.

When you want to add new records one at a time, the `INSERT` statement is useful. In its simplest form, you supply values for each column, in the order in which the columns were listed in the `CREATE TABLE` statement. Suppose that Diane gets a new hamster named “Puffball.” You could add a new record using an `INSERT` statement like this:

```
mysql> INSERT INTO pet
VALUES ('Puffball','Diane','hamster','f','1999-03-30',NULL);
```

String and date values are specified as quoted strings here. Also, with `INSERT`, you can insert `NULL` directly to represent a missing value. You do not use `\N` like you do with `LOAD DATA`.

From this example, you should be able to see that there would be a lot more typing involved to load your records initially using several `INSERT` statements rather than a single `LOAD DATA` statement.

### 3.3.4 Retrieving Information from a Table

The `SELECT` statement is used to pull information from a table. The general form of the statement is:

```
SELECT what_to_select
FROM which_table
WHERE conditions_to_satisfy;
```

*what\_to\_select* indicates what you want to see. This can be a list of columns, or `*` to indicate “all columns.” *which\_table* indicates the table from which you want to retrieve data. The `WHERE` clause is optional. If it is present, *conditions\_to\_satisfy* specifies one or more conditions that rows must satisfy to qualify for retrieval.

#### 3.3.4.1 Selecting All Data

The simplest form of `SELECT` retrieves everything from a table:

```
mysql> SELECT * FROM pet;
```

name	owner	species	sex	birth	death
Fluffy	Harold	cat	f	1993-02-04	NULL
Claws	Gwen	cat	m	1994-03-17	NULL
Buffy	Harold	dog	f	1989-05-13	NULL
Fang	Benny	dog	m	1990-08-27	NULL
Bowser	Diane	dog	m	1979-08-31	1995-07-29
Chirpy	Gwen	bird	f	1998-09-11	NULL
Whistler	Gwen	bird	NULL	1997-12-09	NULL
Slim	Benny	snake	m	1996-04-29	NULL
Puffball	Diane	hamster	f	1999-03-30	NULL

This form of `SELECT` uses `*`, which is shorthand for “select all columns.” This is useful if you want to review your entire table, for example, after you’ve just loaded it with your initial data set. For example, you may happen to think that the birth date for Bowser does not seem quite right. Consulting your original pedigree papers, you find that the correct birth year should be 1989, not 1979.

There are at least two ways to fix this:

- Edit the file `pet.txt` to correct the error, then empty the table and reload it using `DELETE` and `LOAD DATA`:

```
mysql> DELETE FROM pet;
mysql> LOAD DATA LOCAL INFILE '/path/pet.txt' INTO TABLE pet;
```

However, if you do this, you must also re-enter the record for Puffball.

- Fix only the erroneous record with an `UPDATE` statement:

```
mysql> UPDATE pet SET birth = '1989-08-31' WHERE name = 'Bowser';
```

The `UPDATE` changes only the record in question and does not require you to reload the table.

### 3.3.4.2 Selecting Particular Rows

As shown in the preceding section, it is easy to retrieve an entire table. Just omit the `WHERE` clause from the `SELECT` statement. But typically you don't want to see the entire table, particularly when it becomes large. Instead, you're usually more interested in answering a particular question, in which case you specify some constraints on the information you want. Let's look at some selection queries in terms of questions about your pets that they answer.

You can select only particular rows from your table. For example, if you want to verify the change that you made to Bowser's birth date, select Bowser's record like this:

```
mysql> SELECT * FROM pet WHERE name = 'Bowser';
```

name	owner	species	sex	birth	death
Bowser	Diane	dog	m	1989-08-31	1995-07-29

The output confirms that the year is correctly recorded as 1989, not 1979.

String comparisons normally are case-insensitive, so you can specify the name as `'bowser'`, `'BOWSER'`, and so forth. The query result is the same.

You can specify conditions on any column, not just `name`. For example, if you want to know which animals were born during or after 1998, test the `birth` column:

```
mysql> SELECT * FROM pet WHERE birth >= '1998-1-1';
```

name	owner	species	sex	birth	death
Chirpy	Gwen	bird	f	1998-09-11	NULL
Puffball	Diane	hamster	f	1999-03-30	NULL

You can combine conditions, for example, to locate female dogs:

```
mysql> SELECT * FROM pet WHERE species = 'dog' AND sex = 'f';
```

name	owner	species	sex	birth	death
Buffy	Harold	dog	f	1989-05-13	NULL

The preceding query uses the `AND` logical operator. There is also an `OR` operator:

```
mysql> SELECT * FROM pet WHERE species = 'snake' OR species = 'bird';
```

name	owner	species	sex	birth	death
Chirpy	Gwen	bird	f	1998-09-11	NULL
Whistler	Gwen	bird	NULL	1997-12-09	NULL
Slim	Benny	snake	m	1996-04-29	NULL

`AND` and `OR` may be intermixed, although `AND` has higher precedence than `OR`. If you use both operators, it is a good idea to use parentheses to indicate explicitly how conditions should be grouped:

```
mysql> SELECT * FROM pet WHERE (species = 'cat' AND sex = 'm')
      OR (species = 'dog' AND sex = 'f');
+-----+-----+-----+-----+-----+-----+
| name  | owner | species | sex  | birth      | death |
+-----+-----+-----+-----+-----+-----+
| Claws | Gwen  | cat     | m    | 1994-03-17 | NULL  |
| Buffy | Harold | dog     | f    | 1989-05-13 | NULL  |
+-----+-----+-----+-----+-----+-----+
```

### 3.3.4.3 Selecting Particular Columns

If you do not want to see entire rows from your table, just name the columns in which you are interested, separated by commas. For example, if you want to know when your animals were born, select the `name` and `birth` columns:

```
mysql> SELECT name, birth FROM pet;
+-----+-----+
| name  | birth      |
+-----+-----+
| Fluffy | 1993-02-04 |
| Claws  | 1994-03-17 |
| Buffy  | 1989-05-13 |
| Fang   | 1990-08-27 |
| Bowser | 1989-08-31 |
| Chirpy | 1998-09-11 |
| Whistler | 1997-12-09 |
| Slim   | 1996-04-29 |
| Puffball | 1999-03-30 |
+-----+-----+
```

To find out who owns pets, use this query:

```
mysql> SELECT owner FROM pet;
+-----+
| owner |
+-----+
| Harold |
| Gwen  |
| Harold |
| Benny |
| Diane |
| Gwen  |
| Gwen  |
| Benny |
| Diane |
+-----+
```

Notice that the query simply retrieves the `owner` column from each record, and some of them appear more than once. To minimize the output, retrieve each unique output record just once by adding the keyword `DISTINCT`:

```
mysql> SELECT DISTINCT owner FROM pet;
+-----+
| owner |
+-----+
| Benny |
| Diane |
| Gwen  |
| Harold |
+-----+
```

You can use a `WHERE` clause to combine row selection with column selection. For example, to get birth dates for dogs and cats only, use this query:

```
mysql> SELECT name, species, birth FROM pet
        WHERE species = 'dog' OR species = 'cat';
```

name	species	birth
Fluffy	cat	1993-02-04
Claws	cat	1994-03-17
Buffy	dog	1989-05-13
Fang	dog	1990-08-27
Bowser	dog	1989-08-31

### 3.3.4.4 Sorting Rows

You may have noticed in the preceding examples that the result rows are displayed in no particular order. It is often easier to examine query output when the rows are sorted in some meaningful way. To sort a result, use an `ORDER BY` clause.

Here are animal birthdays, sorted by date:

```
mysql> SELECT name, birth FROM pet ORDER BY birth;
```

name	birth
Buffy	1989-05-13
Bowser	1989-08-31
Fang	1990-08-27
Fluffy	1993-02-04
Claws	1994-03-17
Slim	1996-04-29
Whistler	1997-12-09
Chirpy	1998-09-11
Puffball	1999-03-30

On character type columns, sorting—like all other comparison operations—is normally performed in a case-insensitive fashion. This means that the order is undefined for columns that are identical except for their case. You can force a case-sensitive sort for a column by using `BINARY` like so: `ORDER BY BINARY col_name`.

The default sort order is ascending, with smallest values first. To sort in reverse (descending) order, add the `DESC` keyword to the name of the column you are sorting by:

```
mysql> SELECT name, birth FROM pet ORDER BY birth DESC;
```

name	birth
Puffball	1999-03-30
Chirpy	1998-09-11
Whistler	1997-12-09
Slim	1996-04-29
Claws	1994-03-17
Fluffy	1993-02-04
Fang	1990-08-27
Bowser	1989-08-31
Buffy	1989-05-13

You can sort on multiple columns, and you can sort different columns in different directions. For example, to sort by type of animal in ascending order, then by birth date within animal type in descending order (youngest animals first), use the following query:

```
mysql> SELECT name, species, birth FROM pet
```

```
ORDER BY species, birth DESC;
```

name	species	birth
Chirpy	bird	1998-09-11
Whistler	bird	1997-12-09
Claws	cat	1994-03-17
Fluffy	cat	1993-02-04
Fang	dog	1990-08-27
Bowser	dog	1989-08-31
Buffy	dog	1989-05-13
Puffball	hamster	1999-03-30
Slim	snake	1996-04-29

The `DESC` keyword applies only to the column name immediately preceding it (`birth`); it does not affect the `species` column sort order.

### 3.3.4.5 Date Calculations

MySQL provides several functions that you can use to perform calculations on dates, for example, to calculate ages or extract parts of dates.

To determine how many years old each of your pets is, use the `TIMESTAMPDIFF()` function. Its arguments are the unit in which you want the result expressed, and the two dates for which to take the difference. The following query shows, for each pet, the birth date, the current date, and the age in years. An *alias* (`age`) is used to make the final output column label more meaningful.

```
mysql> SELECT name, birth, CURDATE(),
TIMESTAMPDIFF(YEAR,birth,CURDATE()) AS age
FROM pet;
```

name	birth	CURDATE()	age
Fluffy	1993-02-04	2003-08-19	10
Claws	1994-03-17	2003-08-19	9
Buffy	1989-05-13	2003-08-19	14
Fang	1990-08-27	2003-08-19	12
Bowser	1989-08-31	2003-08-19	13
Chirpy	1998-09-11	2003-08-19	4
Whistler	1997-12-09	2003-08-19	5
Slim	1996-04-29	2003-08-19	7
Puffball	1999-03-30	2003-08-19	4

The query works, but the result could be scanned more easily if the rows were presented in some order. This can be done by adding an `ORDER BY name` clause to sort the output by name:

```
mysql> SELECT name, birth, CURDATE(),
TIMESTAMPDIFF(YEAR,birth,CURDATE()) AS age
FROM pet ORDER BY name;
```

name	birth	CURDATE()	age
Bowser	1989-08-31	2003-08-19	13
Buffy	1989-05-13	2003-08-19	14
Chirpy	1998-09-11	2003-08-19	4
Claws	1994-03-17	2003-08-19	9
Fang	1990-08-27	2003-08-19	12
Fluffy	1993-02-04	2003-08-19	10
Puffball	1999-03-30	2003-08-19	4
Slim	1996-04-29	2003-08-19	7
Whistler	1997-12-09	2003-08-19	5



To sort the output by `age` rather than `name`, just use a different `ORDER BY` clause:

```
mysql> SELECT name, birth, CURDATE(),
        TIMESTAMPDIFF(YEAR,birth,CURDATE()) AS age
        FROM pet ORDER BY age;
```

name	birth	CURDATE()	age
Chirpy	1998-09-11	2003-08-19	4
Puffball	1999-03-30	2003-08-19	4
Whistler	1997-12-09	2003-08-19	5
Slim	1996-04-29	2003-08-19	7
Claws	1994-03-17	2003-08-19	9
Fluffy	1993-02-04	2003-08-19	10
Fang	1990-08-27	2003-08-19	12
Bowser	1989-08-31	2003-08-19	13
Buffy	1989-05-13	2003-08-19	14

A similar query can be used to determine age at death for animals that have died. You determine which animals these are by checking whether the `death` value is `NULL`. Then, for those with non-`NULL` values, compute the difference between the `death` and `birth` values:

```
mysql> SELECT name, birth, death,
        TIMESTAMPDIFF(YEAR,birth,death) AS age
        FROM pet WHERE death IS NOT NULL ORDER BY age;
```

name	birth	death	age
Bowser	1989-08-31	1995-07-29	5

The query uses `death IS NOT NULL` rather than `death <> NULL` because `NULL` is a special value that cannot be compared using the usual comparison operators. This is discussed later. See [Section 3.3.4.6, “Working with NULL Values”](#).

What if you want to know which animals have birthdays next month? For this type of calculation, year and day are irrelevant; you simply want to extract the month part of the `birth` column. MySQL provides several functions for extracting parts of dates, such as `YEAR()`, `MONTH()`, and `DAYOFMONTH()`. `MONTH()` is the appropriate function here. To see how it works, run a simple query that displays the value of both `birth` and `MONTH(birth)`:

```
mysql> SELECT name, birth, MONTH(birth) FROM pet;
```

name	birth	MONTH(birth)
Fluffy	1993-02-04	2
Claws	1994-03-17	3
Buffy	1989-05-13	5
Fang	1990-08-27	8
Bowser	1989-08-31	8
Chirpy	1998-09-11	9
Whistler	1997-12-09	12
Slim	1996-04-29	4
Puffball	1999-03-30	3

Finding animals with birthdays in the upcoming month is also simple. Suppose that the current month is April. Then the month value is `4` and you can look for animals born in May (month `5`) like this:

```
mysql> SELECT name, birth FROM pet WHERE MONTH(birth) = 5;
```

name	birth
------	-------

```
| Buffy | 1989-05-13 |
+-----+-----+
```

There is a small complication if the current month is December. You cannot merely add one to the month number (12) and look for animals born in month 13, because there is no such month. Instead, you look for animals born in January (month 1).

You can write the query so that it works no matter what the current month is, so that you do not have to use the number for a particular month. `DATE_ADD()` enables you to add a time interval to a given date. If you add a month to the value of `CURDATE()`, then extract the month part with `MONTH()`, the result produces the month in which to look for birthdays:

```
mysql> SELECT name, birth FROM pet
        WHERE MONTH(birth) = MONTH(DATE_ADD(CURDATE(),INTERVAL 1 MONTH));
```

A different way to accomplish the same task is to add 1 to get the next month after the current one after using the modulo function (`MOD`) to wrap the month value to 0 if it is currently 12:

```
mysql> SELECT name, birth FROM pet
        WHERE MONTH(birth) = MOD(MONTH(CURDATE()), 12) + 1;
```

`MONTH()` returns a number between 1 and 12. And `MOD(something,12)` returns a number between 0 and 11. So the addition has to be after the `MOD()`, otherwise we would go from November (11) to January (1).

If a calculation uses invalid dates, the calculation fails and produces warnings:

```
mysql> SELECT '2018-10-31' + INTERVAL 1 DAY;
+-----+
| '2018-10-31' + INTERVAL 1 DAY |
+-----+
| 2018-11-01 |
+-----+
mysql> SELECT '2018-10-32' + INTERVAL 1 DAY;
+-----+
| '2018-10-32' + INTERVAL 1 DAY |
+-----+
| NULL |
+-----+
mysql> SHOW WARNINGS;
+-----+
| Level | Code | Message |
+-----+
| Warning | 1292 | Incorrect datetime value: '2018-10-32' |
+-----+
```

### 3.3.4.6 Working with NULL Values

The `NULL` value can be surprising until you get used to it. Conceptually, `NULL` means “a missing unknown value” and it is treated somewhat differently from other values.

To test for `NULL`, use the `IS NULL` and `IS NOT NULL` operators, as shown here:

```
mysql> SELECT 1 IS NULL, 1 IS NOT NULL;
+-----+
| 1 IS NULL | 1 IS NOT NULL |
+-----+
| 0 | 1 |
+-----+
```

You cannot use arithmetic comparison operators such as `=`, `<`, or `>` to test for `NULL`. To demonstrate this for yourself, try the following query:

```
mysql> SELECT 1 = NULL, 1 <> NULL, 1 < NULL, 1 > NULL;
+-----+-----+-----+-----+
| 1 = NULL | 1 <> NULL | 1 < NULL | 1 > NULL |
+-----+-----+-----+-----+
| NULL | NULL | NULL | NULL |
+-----+-----+-----+-----+
```

Because the result of any arithmetic comparison with `NULL` is also `NULL`, you cannot obtain any meaningful results from such comparisons.

In MySQL, `0` or `NULL` means false and anything else means true. The default truth value from a boolean operation is `1`.

This special treatment of `NULL` is why, in the previous section, it was necessary to determine which animals are no longer alive using `death IS NOT NULL` instead of `death <> NULL`.

Two `NULL` values are regarded as equal in a `GROUP BY`.

When doing an `ORDER BY`, `NULL` values are presented first if you do `ORDER BY ... ASC` and last if you do `ORDER BY ... DESC`.

A common error when working with `NULL` is to assume that it is not possible to insert a zero or an empty string into a column defined as `NOT NULL`, but this is not the case. These are in fact values, whereas `NULL` means “not having a value.” You can test this easily enough by using `IS [NOT] NULL` as shown:

```
mysql> SELECT 0 IS NULL, 0 IS NOT NULL, '' IS NULL, '' IS NOT NULL;
+-----+-----+-----+-----+
| 0 IS NULL | 0 IS NOT NULL | '' IS NULL | '' IS NOT NULL |
+-----+-----+-----+-----+
| 0 | 1 | 0 | 1 |
+-----+-----+-----+-----+
```

Thus it is entirely possible to insert a zero or empty string into a `NOT NULL` column, as these are in fact `NOT NULL`. See [Section B.3.4.3, “Problems with NULL Values”](#).

### 3.3.4.7 Pattern Matching

MySQL provides standard SQL pattern matching as well as a form of pattern matching based on extended regular expressions similar to those used by Unix utilities such as `vi`, `grep`, and `sed`.

SQL pattern matching enables you to use `_` to match any single character and `%` to match an arbitrary number of characters (including zero characters). In MySQL, SQL patterns are case-insensitive by default. Some examples are shown here. Do not use `=` or `<>` when you use SQL patterns. Use the `LIKE` or `NOT LIKE` comparison operators instead.

To find names beginning with `b`:

```
mysql> SELECT * FROM pet WHERE name LIKE 'b%';
+-----+-----+-----+-----+-----+-----+
| name | owner | species | sex | birth | death |
+-----+-----+-----+-----+-----+-----+
| Buffy | Harold | dog | f | 1989-05-13 | NULL |
| Bowser | Diane | dog | m | 1989-08-31 | 1995-07-29 |
+-----+-----+-----+-----+-----+-----+
```

To find names ending with `fy`:

```
mysql> SELECT * FROM pet WHERE name LIKE '%fy';
+-----+-----+-----+-----+-----+-----+
| name | owner | species | sex | birth | death |
+-----+-----+-----+-----+-----+-----+
| Fluffy | Harold | cat | f | 1993-02-04 | NULL |
+-----+-----+-----+-----+-----+-----+
```

```
| Buffy | Harold | dog | f | 1989-05-13 | NULL |
+-----+-----+-----+-----+-----+-----+
```

To find names containing a `w`:

```
mysql> SELECT * FROM pet WHERE name LIKE '%w%';
+-----+-----+-----+-----+-----+-----+
| name | owner | species | sex | birth | death |
+-----+-----+-----+-----+-----+-----+
| Claws | Gwen | cat | m | 1994-03-17 | NULL |
| Bowser | Diane | dog | m | 1989-08-31 | 1995-07-29 |
| Whistler | Gwen | bird | NULL | 1997-12-09 | NULL |
+-----+-----+-----+-----+-----+-----+
```

To find names containing exactly five characters, use five instances of the `_` pattern character:

```
mysql> SELECT * FROM pet WHERE name LIKE '_____';
+-----+-----+-----+-----+-----+-----+
| name | owner | species | sex | birth | death |
+-----+-----+-----+-----+-----+-----+
| Claws | Gwen | cat | m | 1994-03-17 | NULL |
| Buffy | Harold | dog | f | 1989-05-13 | NULL |
+-----+-----+-----+-----+-----+-----+
```

The other type of pattern matching provided by MySQL uses extended regular expressions. When you test for a match for this type of pattern, use the `REGEXP` and `NOT REGEXP` operators (or `RLIKE` and `NOT RLIKE`, which are synonyms).

The following list describes some characteristics of extended regular expressions:

- `.` matches any single character.
- A character class `[...]` matches any character within the brackets. For example, `[abc]` matches `a`, `b`, or `c`. To name a range of characters, use a dash. `[a-z]` matches any letter, whereas `[0-9]` matches any digit.
- `*` matches zero or more instances of the thing preceding it. For example, `x*` matches any number of `x` characters, `[0-9]*` matches any number of digits, and `.*` matches any number of anything.
- A regular expression pattern match succeeds if the pattern matches anywhere in the value being tested. (This differs from a `LIKE` pattern match, which succeeds only if the pattern matches the entire value.)
- To anchor a pattern so that it must match the beginning or end of the value being tested, use `^` at the beginning or `$` at the end of the pattern.

To demonstrate how extended regular expressions work, the `LIKE` queries shown previously are rewritten here to use `REGEXP`.

To find names beginning with `b`, use `^` to match the beginning of the name:

```
mysql> SELECT * FROM pet WHERE name REGEXP '^b';
+-----+-----+-----+-----+-----+-----+
| name | owner | species | sex | birth | death |
+-----+-----+-----+-----+-----+-----+
| Buffy | Harold | dog | f | 1989-05-13 | NULL |
| Bowser | Diane | dog | m | 1989-08-31 | 1995-07-29 |
+-----+-----+-----+-----+-----+-----+
```

To force a `REGEXP` comparison to be case-sensitive, use the `BINARY` keyword to make one of the strings a binary string. This query matches only lowercase `b` at the beginning of a name:

```
SELECT * FROM pet WHERE name REGEXP BINARY '^b';
```

To find names ending with `fy`, use `$` to match the end of the name:

```
mysql> SELECT * FROM pet WHERE name REGEXP 'fy$';
```

name	owner	species	sex	birth	death
Fluffy	Harold	cat	f	1993-02-04	NULL
Buffy	Harold	dog	f	1989-05-13	NULL

To find names containing a `w`, use this query:

```
mysql> SELECT * FROM pet WHERE name REGEXP 'w';
```

name	owner	species	sex	birth	death
Claws	Gwen	cat	m	1994-03-17	NULL
Bowser	Diane	dog	m	1989-08-31	1995-07-29
Whistler	Gwen	bird	NULL	1997-12-09	NULL

Because a regular expression pattern matches if it occurs anywhere in the value, it is not necessary in the previous query to put a wildcard on either side of the pattern to get it to match the entire value as would be true with an SQL pattern.

To find names containing exactly five characters, use `^` and `$` to match the beginning and end of the name, and five instances of `.` in between:

```
mysql> SELECT * FROM pet WHERE name REGEXP '^.....$';
```

name	owner	species	sex	birth	death
Claws	Gwen	cat	m	1994-03-17	NULL
Buffy	Harold	dog	f	1989-05-13	NULL

You could also write the previous query using the `{n}` (“repeat-*n*-times”) operator:

```
mysql> SELECT * FROM pet WHERE name REGEXP '^.{5}$';
```

name	owner	species	sex	birth	death
Claws	Gwen	cat	m	1994-03-17	NULL
Buffy	Harold	dog	f	1989-05-13	NULL

For more information about the syntax for regular expressions, see [Section 12.8.2, “Regular Expressions”](#).

### 3.3.4.8 Counting Rows

Databases are often used to answer the question, “How often does a certain type of data occur in a table?” For example, you might want to know how many pets you have, or how many pets each owner has, or you might want to perform various kinds of census operations on your animals.

Counting the total number of animals you have is the same question as “How many rows are in the `pet` table?” because there is one record per pet. `COUNT(*)` counts the number of rows, so the query to count your animals looks like this:

```
mysql> SELECT COUNT(*) FROM pet;
```

COUNT(*)
9

Earlier, you retrieved the names of the people who owned pets. You can use `COUNT()` if you want to find out how many pets each owner has:

```
mysql> SELECT owner, COUNT(*) FROM pet GROUP BY owner;
```

owner	COUNT(*)
Benny	2
Diane	2
Gwen	3
Harold	2

The preceding query uses `GROUP BY` to group all records for each `owner`. The use of `COUNT()` in conjunction with `GROUP BY` is useful for characterizing your data under various groupings. The following examples show different ways to perform animal census operations.

Number of animals per species:

```
mysql> SELECT species, COUNT(*) FROM pet GROUP BY species;
```

species	COUNT(*)
bird	2
cat	2
dog	3
hamster	1
snake	1

Number of animals per sex:

```
mysql> SELECT sex, COUNT(*) FROM pet GROUP BY sex;
```

sex	COUNT(*)
NULL	1
f	4
m	4

(In this output, `NULL` indicates that the sex is unknown.)

Number of animals per combination of species and sex:

```
mysql> SELECT species, sex, COUNT(*) FROM pet GROUP BY species, sex;
```

species	sex	COUNT(*)
bird	NULL	1
bird	f	1
cat	f	1
cat	m	1
dog	f	1
dog	m	2
hamster	f	1
snake	m	1

You need not retrieve an entire table when you use `COUNT()`. For example, the previous query, when performed just on dogs and cats, looks like this:

```
mysql> SELECT species, sex, COUNT(*) FROM pet
```

```

WHERE species = 'dog' OR species = 'cat'
GROUP BY species, sex;
+-----+-----+-----+
| species | sex | COUNT(*) |
+-----+-----+-----+
| cat     | f   | 1         |
| cat     | m   | 1         |
| dog     | f   | 1         |
| dog     | m   | 2         |
+-----+-----+-----+

```

Or, if you wanted the number of animals per sex only for animals whose sex is known:

```

mysql> SELECT species, sex, COUNT(*) FROM pet
WHERE sex IS NOT NULL
GROUP BY species, sex;
+-----+-----+-----+
| species | sex | COUNT(*) |
+-----+-----+-----+
| bird    | f   | 1         |
| cat     | f   | 1         |
| cat     | m   | 1         |
| dog     | f   | 1         |
| dog     | m   | 2         |
| hamster | f   | 1         |
| snake   | m   | 1         |
+-----+-----+-----+

```

If you name columns to select in addition to the `COUNT()` value, a `GROUP BY` clause should be present that names those same columns. Otherwise, the following occurs:

- If the `ONLY_FULL_GROUP_BY` SQL mode is enabled, an error occurs:

```

mysql> SET sql_mode = 'ONLY_FULL_GROUP_BY';
Query OK, 0 rows affected (0.00 sec)

mysql> SELECT owner, COUNT(*) FROM pet;
ERROR 1140 (42000): In aggregated query without GROUP BY, expression
#1 of SELECT list contains nonaggregated column 'menagerie.pet.owner';
this is incompatible with sql_mode=only_full_group_by

```

- If `ONLY_FULL_GROUP_BY` is not enabled, the query is processed by treating all rows as a single group, but the value selected for each named column is nondeterministic. The server is free to select the value from any row:

```

mysql> SET sql_mode = '';
Query OK, 0 rows affected (0.00 sec)

mysql> SELECT owner, COUNT(*) FROM pet;
+-----+-----+
| owner | COUNT(*) |
+-----+-----+
| Harold | 8         |
+-----+-----+
1 row in set (0.00 sec)

```

See also [Section 12.19.3, “MySQL Handling of GROUP BY”](#). See [Section 12.19.1, “Aggregate Function Descriptions”](#) for information about `COUNT(expr)` behavior and related optimizations.

### 3.3.4.9 Using More Than one Table

The `pet` table keeps track of which pets you have. If you want to record other information about them, such as events in their lives like visits to the vet or when litters are born, you need another table. What should this table look like? It needs to contain the following information:

- The pet name so that you know which animal each event pertains to.
- A date so that you know when the event occurred.
- A field to describe the event.
- An event type field, if you want to be able to categorize events.

Given these considerations, the `CREATE TABLE` statement for the `event` table might look like this:

```
mysql> CREATE TABLE event (name VARCHAR(20), date DATE,
type VARCHAR(15), remark VARCHAR(255));
```

As with the `pet` table, it is easiest to load the initial records by creating a tab-delimited text file containing the following information.

name	date	type	remark
Fluffy	1995-05-15	litter	4 kittens, 3 female, 1 male
Buffy	1993-06-23	litter	5 puppies, 2 female, 3 male
Buffy	1994-06-19	litter	3 puppies, 3 female
Chirpy	1999-03-21	vet	needed beak straightened
Slim	1997-08-03	vet	broken rib
Bowser	1991-10-12	kennel	
Fang	1991-10-12	kennel	
Fang	1998-08-28	birthday	Gave him a new chew toy
Claws	1998-03-17	birthday	Gave him a new flea collar
Whistler	1998-12-09	birthday	First birthday

Load the records like this:

```
mysql> LOAD DATA LOCAL INFILE 'event.txt' INTO TABLE event;
```

Based on what you have learned from the queries that you have run on the `pet` table, you should be able to perform retrievals on the records in the `event` table; the principles are the same. But when is the `event` table by itself insufficient to answer questions you might ask?

Suppose that you want to find out the ages at which each pet had its litters. We saw earlier how to calculate ages from two dates. The litter date of the mother is in the `event` table, but to calculate her age on that date you need her birth date, which is stored in the `pet` table. This means the query requires both tables:

```
mysql> SELECT pet.name,
TIMESTAMPDIFF(YEAR,birth,date) AS age,
remark
FROM pet INNER JOIN event
ON pet.name = event.name
WHERE event.type = 'litter';
```

name	age	remark



Fluffy	2	4 kittens, 3 female, 1 male
Buffy	4	5 puppies, 2 female, 3 male
Buffy	5	3 puppies, 3 female

There are several things to note about this query:

- The `FROM` clause joins two tables because the query needs to pull information from both of them.
- When combining (joining) information from multiple tables, you need to specify how records in one table can be matched to records in the other. This is easy because they both have a `name` column. The query uses an `ON` clause to match up records in the two tables based on the `name` values.

The query uses an `INNER JOIN` to combine the tables. An `INNER JOIN` permits rows from either table to appear in the result if and only if both tables meet the conditions specified in the `ON` clause. In this example, the `ON` clause specifies that the `name` column in the `pet` table must match the `name` column in the `event` table. If a name appears in one table but not the other, the row does not appear in the result because the condition in the `ON` clause fails.

- Because the `name` column occurs in both tables, you must be specific about which table you mean when referring to the column. This is done by prepending the table name to the column name.

You need not have two different tables to perform a join. Sometimes it is useful to join a table to itself, if you want to compare records in a table to other records in that same table. For example, to find breeding pairs among your pets, you can join the `pet` table with itself to produce candidate pairs of live males and females of like species:

```
mysql> SELECT p1.name, p1.sex, p2.name, p2.sex, p1.species
        FROM pet AS p1 INNER JOIN pet AS p2
            ON p1.species = p2.species
            AND p1.sex = 'f' AND p1.death IS NULL
            AND p2.sex = 'm' AND p2.death IS NULL;
```

name	sex	name	sex	species
Fluffy	f	Claws	m	cat
Buffy	f	Fang	m	dog

In this query, we specify aliases for the table name to refer to the columns and keep straight which instance of the table each column reference is associated with.

## 3.4 Getting Information About Databases and Tables

What if you forget the name of a database or table, or what the structure of a given table is (for example, what its columns are called)? MySQL addresses this problem through several statements that provide information about the databases and tables it supports.

You have previously seen `SHOW DATABASES`, which lists the databases managed by the server. To find out which database is currently selected, use the `DATABASE()` function:

```
mysql> SELECT DATABASE();
+-----+
| DATABASE() |
+-----+
| menagerie  |
+-----+
```

If you have not yet selected any database, the result is `NULL`.

To find out what tables the default database contains (for example, when you are not sure about the name of a table), use this statement:

```
mysql> SHOW TABLES;
+-----+
| Tables_in_menagerie |
+-----+
| event                |
| pet                  |
+-----+
```

The name of the column in the output produced by this statement is always `Tables_in_db_name`, where `db_name` is the name of the database. See [Section 13.7.5.37, “SHOW TABLES Statement”](#), for more information.

If you want to find out about the structure of a table, the `DESCRIBE` statement is useful; it displays information about each of a table's columns:

```
mysql> DESCRIBE pet;
+-----+-----+-----+-----+-----+-----+
| Field | Type          | Null | Key | Default | Extra |
+-----+-----+-----+-----+-----+-----+
| name  | varchar(20)   | YES  |     | NULL    |       |
| owner | varchar(20)   | YES  |     | NULL    |       |
| species | varchar(20)  | YES  |     | NULL    |       |
| sex   | char(1)       | YES  |     | NULL    |       |
| birth | date          | YES  |     | NULL    |       |
| death | date          | YES  |     | NULL    |       |
+-----+-----+-----+-----+-----+-----+
```

`Field` indicates the column name, `Type` is the data type for the column, `NULL` indicates whether the column can contain `NULL` values, `Key` indicates whether the column is indexed, and `Default` specifies the column's default value. `Extra` displays special information about columns: If a column was created with the `AUTO_INCREMENT` option, the value is `auto_increment` rather than empty.

`DESC` is a short form of `DESCRIBE`. See [Section 13.8.1, “DESCRIBE Statement”](#), for more information.

You can obtain the `CREATE TABLE` statement necessary to create an existing table using the `SHOW CREATE TABLE` statement. See [Section 13.7.5.10, “SHOW CREATE TABLE Statement”](#).

If you have indexes on a table, `SHOW INDEX FROM tbl_name` produces information about them. See [Section 13.7.5.22, “SHOW INDEX Statement”](#), for more about this statement.

## 3.5 Using mysql in Batch Mode

In the previous sections, you used `mysql` interactively to enter statements and view the results. You can also run `mysql` in batch mode. To do this, put the statements you want to run in a file, then tell `mysql` to read its input from the file:

```
$> mysql < batch-file
```

If you are running `mysql` under Windows and have some special characters in the file that cause problems, you can do this:

```
C:\> mysql -e "source batch-file"
```

If you need to specify connection parameters on the command line, the command might look like this:

```
$> mysql -h host -u user -p < batch-file
Enter password: *****
```

When you use `mysql` this way, you are creating a script file, then executing the script.

If you want the script to continue even if some of the statements in it produce errors, you should use the `--force` command-line option.

Why use a script? Here are a few reasons:

- If you run a query repeatedly (say, every day or every week), making it a script enables you to avoid retyping it each time you execute it.
- You can generate new queries from existing ones that are similar by copying and editing script files.
- Batch mode can also be useful while you are developing a query, particularly for multiple-line statements or multiple-statement sequences. If you make a mistake, you do not have to retype everything. Just edit your script to correct the error, then tell `mysql` to execute it again.
- If you have a query that produces a lot of output, you can run the output through a pager rather than watching it scroll off the top of your screen:

```
$> mysql < batch-file | more
```

- You can catch the output in a file for further processing:

```
$> mysql < batch-file > mysql.out
```

- You can distribute your script to other people so that they can also run the statements.
- Some situations do not allow for interactive use, for example, when you run a query from a `cron` job. In this case, you must use batch mode.

The default output format is different (more concise) when you run `mysql` in batch mode than when you use it interactively. For example, the output of `SELECT DISTINCT species FROM pet` looks like this when `mysql` is run interactively:

```
+-----+
| species |
+-----+
| bird    |
| cat     |
| dog     |
| hamster |
| snake   |
+-----+
```

In batch mode, the output looks like this instead:

```
species
bird
cat
dog
hamster
snake
```

If you want to get the interactive output format in batch mode, use `mysql -t`. To echo to the output the statements that are executed, use `mysql -v`.

You can also use scripts from the `mysql` prompt by using the `source` command or `\.` command:

```
mysql> source filename;
mysql> \. filename
```

See [Section 4.5.1.5, “Executing SQL Statements from a Text File”](#), for more information.

## 3.6 Examples of Common Queries

Here are examples of how to solve some common problems with MySQL.

Some of the examples use the table `shop` to hold the price of each article (item number) for certain traders (dealers). Supposing that each trader has a single fixed price per article, then `(article, dealer)` is a primary key for the records.

Start the command-line tool `mysql` and select a database:

```
$> mysql your-database-name
```

To create and populate the example table, use these statements:

```
CREATE TABLE shop (
  article INT UNSIGNED DEFAULT '0000' NOT NULL,
  dealer CHAR(20) DEFAULT '' NOT NULL,
  price DECIMAL(16,2) DEFAULT '0.00' NOT NULL,
  PRIMARY KEY(article, dealer));
INSERT INTO shop VALUES
  (1, 'A', 3.45), (1, 'B', 3.99), (2, 'A', 10.99), (3, 'B', 1.45),
  (3, 'C', 1.69), (3, 'D', 1.25), (4, 'D', 19.95);
```

After issuing the statements, the table should have the following contents:

```
SELECT * FROM shop ORDER BY article;
```

```
+-----+-----+-----+
| article | dealer | price |
+-----+-----+-----+
|      1 | A     |  3.45 |
|      1 | B     |  3.99 |
|      2 | A     | 10.99 |
|      3 | B     |  1.45 |
|      3 | C     |  1.69 |
|      3 | D     |  1.25 |
|      4 | D     | 19.95 |
+-----+-----+-----+
```

### 3.6.1 The Maximum Value for a Column

“What is the highest item number?”

```
SELECT MAX(article) AS article FROM shop;
```

```
+-----+
| article |
+-----+
|      4 |
+-----+
```

### 3.6.2 The Row Holding the Maximum of a Certain Column

*Task: Find the number, dealer, and price of the most expensive article.*

This is easily done with a subquery:

```
SELECT article, dealer, price
FROM shop
WHERE price=(SELECT MAX(price) FROM shop);
```

```
+-----+-----+-----+
| article | dealer | price |
+-----+-----+-----+
```

```
+-----+-----+
| 0004 | D      | 19.95 |
+-----+-----+
```

Another solution is to use a `LEFT JOIN`, as shown here:

```
SELECT s1.article, s1.dealer, s1.price
FROM shop s1
LEFT JOIN shop s2 ON s1.price < s2.price
WHERE s2.article IS NULL;
```

You can also do this by sorting all rows descending by price and get only the first row using the MySQL-specific `LIMIT` clause, like this:

```
SELECT article, dealer, price
FROM shop
ORDER BY price DESC
LIMIT 1;
```



#### Note

If there were several most expensive articles, each with a price of 19.95, the `LIMIT` solution would show only one of them.

### 3.6.3 Maximum of Column per Group

*Task: Find the highest price per article.*

```
SELECT article, MAX(price) AS price
FROM shop
GROUP BY article
ORDER BY article;
```

```
+-----+-----+
| article | price |
+-----+-----+
| 0001   | 3.99  |
| 0002   | 10.99 |
| 0003   | 1.69  |
| 0004   | 19.95 |
+-----+-----+
```

### 3.6.4 The Rows Holding the Group-wise Maximum of a Certain Column

*Task: For each article, find the dealer or dealers with the most expensive price.*

This problem can be solved with a subquery like this one:

```
SELECT article, dealer, price
FROM shop s1
WHERE price=(SELECT MAX(s2.price)
             FROM shop s2
             WHERE s1.article = s2.article)
ORDER BY article;
```

```
+-----+-----+-----+
| article | dealer | price |
+-----+-----+-----+
| 0001   | B      | 3.99  |
| 0002   | A      | 10.99 |
| 0003   | C      | 1.69  |
| 0004   | D      | 19.95 |
+-----+-----+-----+
```

The preceding example uses a correlated subquery, which can be inefficient (see [Section 13.2.10.7, “Correlated Subqueries”](#)). Other possibilities for solving the problem are to use an uncorrelated subquery in the `FROM` clause or a `LEFT JOIN`.

Uncorrelated subquery:

```
SELECT s1.article, dealer, s1.price
FROM shop s1
JOIN (
  SELECT article, MAX(price) AS price
  FROM shop
  GROUP BY article) AS s2
ON s1.article = s2.article AND s1.price = s2.price
ORDER BY article;
```

`LEFT JOIN`:

```
SELECT s1.article, s1.dealer, s1.price
FROM shop s1
LEFT JOIN shop s2 ON s1.article = s2.article AND s1.price < s2.price
WHERE s2.article IS NULL
ORDER BY s1.article;
```

The `LEFT JOIN` works on the basis that when `s1.price` is at its maximum value, there is no `s2.price` with a greater value and thus the corresponding `s2.article` value is `NULL`. See [Section 13.2.9.2, “JOIN Clause”](#).

### 3.6.5 Using User-Defined Variables

You can employ MySQL user variables to remember results without having to store them in temporary variables in the client. (See [Section 9.4, “User-Defined Variables”](#).)

For example, to find the articles with the highest and lowest price you can do this:

```
mysql> SELECT @min_price:=MIN(price),@max_price:=MAX(price) FROM shop;
mysql> SELECT * FROM shop WHERE price=@min_price OR price=@max_price;
+-----+-----+-----+
| article | dealer | price |
+-----+-----+-----+
| 0003 | D | 1.25 |
| 0004 | D | 19.95 |
+-----+-----+-----+
```



#### Note

It is also possible to store the name of a database object such as a table or a column in a user variable and then to use this variable in an SQL statement; however, this requires the use of a prepared statement. See [Section 13.5, “Prepared Statements”](#), for more information.

### 3.6.6 Using Foreign Keys

MySQL supports foreign keys, which permit cross-referencing related data across tables, and foreign key constraints, which help keep the related data consistent.

A foreign key relationship involves a parent table that holds the initial column values, and a child table with column values that reference the parent column values. A foreign key constraint is defined on the child table.

This following example relates `parent` and `child` tables through a single-column foreign key and shows how a foreign key constraint enforces referential integrity.

Create the parent and child tables using the following SQL statements:

```
CREATE TABLE parent (
  id INT NOT NULL,
  PRIMARY KEY (id)
) ENGINE=INNODB;

CREATE TABLE child (
  id INT,
  parent_id INT,
  INDEX par_ind (parent_id),
  FOREIGN KEY (parent_id)
  REFERENCES parent(id)
) ENGINE=INNODB;
```

Insert a row into the parent table, like this:

```
mysql> INSERT INTO parent (id) VALUES (1);
```

Verify that the data was inserted. You can do this simply by selecting all rows from `parent`, as shown here:

```
mysql> SELECT * FROM parent;
+-----+
| id |
+-----+
| 1 |
+-----+
```

Insert a row into the child table using the following SQL statement:

```
mysql> INSERT INTO child (id,parent_id) VALUES (1,1);
```

The insert operation is successful because `parent_id` 1 is present in the parent table.

Insertion of a row into the child table with a `parent_id` value that is not present in the parent table is rejected with an error, as you can see here:

```
mysql> INSERT INTO child (id,parent_id) VALUES(2,2);
ERROR 1452 (23000): Cannot add or update a child row: a foreign key constraint fails
(`test`.`child`, CONSTRAINT `child_ibfk_1` FOREIGN KEY (`parent_id`)
REFERENCES `parent` (`id`))
```

The operation fails because the specified `parent_id` value does not exist in the parent table.

Trying to delete the previously inserted row from the parent table also fails, as shown here:

```
mysql> DELETE FROM parent WHERE id = 1;
ERROR 1451 (23000): Cannot delete or update a parent row: a foreign key constraint fails
(`test`.`child`, CONSTRAINT `child_ibfk_1` FOREIGN KEY (`parent_id`)
REFERENCES `parent` (`id`))
```

This operation fails because the record in the child table contains the referenced id (`parent_id`) value.

When an operation affects a key value in the parent table that has matching rows in the child table, the result depends on the referential action specified by `ON UPDATE` and `ON DELETE` subclauses of the `FOREIGN KEY` clause. Omitting `ON DELETE` and `ON UPDATE` clauses (as in the current child table definition) is the same as specifying the `RESTRICT` option, which rejects operations that affect a key value in the parent table that has matching rows in the parent table.

To demonstrate `ON DELETE` and `ON UPDATE` referential actions, drop the child table and recreate it to include `ON UPDATE` and `ON DELETE` subclauses with the `CASCADE` option. The `CASCADE` option

automatically deletes or updates matching rows in the child table when deleting or updating rows in the parent table.

```
DROP TABLE child;

CREATE TABLE child (
  id INT,
  parent_id INT,
  INDEX par_ind (parent_id),
  FOREIGN KEY (parent_id)
    REFERENCES parent(id)
    ON UPDATE CASCADE
    ON DELETE CASCADE
) ENGINE=INNODB;
```

Insert some rows into the child table using the statement shown here:

```
mysql> INSERT INTO child (id,parent_id) VALUES(1,1),(2,1),(3,1);
```

Verify that the data was inserted, like this:

```
mysql> SELECT * FROM child;
+-----+-----+
| id   | parent_id |
+-----+-----+
| 1   | 1         |
| 2   | 1         |
| 3   | 1         |
+-----+-----+
```

Update the ID in the parent table, changing it from 1 to 2, using the SQL statement shown here:

```
mysql> UPDATE parent SET id = 2 WHERE id = 1;
```

Verify that the update was successful by selecting all rows from the parent table, as shown here:

```
mysql> SELECT * FROM parent;
+-----+
| id |
+-----+
| 2 |
+-----+
```

Verify that the `ON UPDATE CASCADE` referential action updated the child table, like this:

```
mysql> SELECT * FROM child;
+-----+-----+
| id   | parent_id |
+-----+-----+
| 1   | 2         |
| 2   | 2         |
| 3   | 2         |
+-----+-----+
```

To demonstrate the `ON DELETE CASCADE` referential action, delete records from the parent table where `parent_id = 2`; this deletes all records in the parent table.

```
mysql> DELETE FROM parent WHERE id = 2;
```

Because all records in the child table are associated with `parent_id = 2`, the `ON DELETE CASCADE` referential action removes all records from the child table, as shown here:

```
mysql> SELECT * FROM child;
Empty set (0.00 sec)
```



For more information about foreign key constraints, see [Section 13.1.18.5, “FOREIGN KEY Constraints”](#).

### 3.6.7 Searching on Two Keys

An `OR` using a single key is well optimized, as is the handling of `AND`.

The one tricky case is that of searching on two different keys combined with `OR`:

```
SELECT field1_index, field2_index FROM test_table
WHERE field1_index = '1' OR field2_index = '1'
```

This case is optimized. See [Section 8.2.1.3, “Index Merge Optimization”](#).

You can also solve the problem efficiently by using a `UNION` that combines the output of two separate `SELECT` statements. See [Section 13.2.9.3, “UNION Clause”](#).

Each `SELECT` searches only one key and can be optimized:

```
SELECT field1_index, field2_index
FROM test_table WHERE field1_index = '1'
UNION
SELECT field1_index, field2_index
FROM test_table WHERE field2_index = '1';
```

### 3.6.8 Calculating Visits Per Day

The following example shows how you can use the bit group functions to calculate the number of days per month a user has visited a Web page.

```
CREATE TABLE t1 (year YEAR, month INT UNSIGNED,
day INT UNSIGNED);
INSERT INTO t1 VALUES(2000,1,1),(2000,1,20),(2000,1,30),(2000,2,2),
(2000,2,23),(2000,2,23);
```

The example table contains year-month-day values representing visits by users to the page. To determine how many different days in each month these visits occur, use this query:

```
SELECT year,month,BIT_COUNT(BIT_OR(1<<day)) AS days FROM t1
GROUP BY year,month;
```

Which returns:

```
+-----+-----+-----+
| year | month | days |
+-----+-----+-----+
| 2000 |     1 |     3 |
| 2000 |     2 |     2 |
+-----+-----+-----+
```

The query calculates how many different days appear in the table for each year/month combination, with automatic removal of duplicate entries.

### 3.6.9 Using AUTO\_INCREMENT

The `AUTO_INCREMENT` attribute can be used to generate a unique identity for new rows:

```
CREATE TABLE animals (
id MEDIUMINT NOT NULL AUTO_INCREMENT,
name CHAR(30) NOT NULL,
PRIMARY KEY (id)
);
```

```
INSERT INTO animals (name) VALUES
  ('dog'),('cat'),('penguin'),
  ('lax'),('whale'),('ostrich');

SELECT * FROM animals;
```

Which returns:

```
+-----+-----+
| id | name |
+-----+-----+
| 1 | dog |
| 2 | cat |
| 3 | penguin |
| 4 | lax |
| 5 | whale |
| 6 | ostrich |
+-----+-----+
```

No value was specified for the [AUTO\\_INCREMENT](#) column, so MySQL assigned sequence numbers automatically. You can also explicitly assign 0 to the column to generate sequence numbers, unless the [NO\\_AUTO\\_VALUE\\_ON\\_ZERO](#) SQL mode is enabled. For example:

```
INSERT INTO animals (id,name) VALUES(0,'groundhog');
```

If the column is declared `NOT NULL`, it is also possible to assign `NULL` to the column to generate sequence numbers. For example:

```
INSERT INTO animals (id,name) VALUES(NULL,'squirrel');
```

When you insert any other value into an [AUTO\\_INCREMENT](#) column, the column is set to that value and the sequence is reset so that the next automatically generated value follows sequentially from the largest column value. For example:

```
INSERT INTO animals (id,name) VALUES(100,'rabbit');
INSERT INTO animals (id,name) VALUES(NULL,'mouse');
SELECT * FROM animals;
```

```
+-----+-----+
| id | name |
+-----+-----+
| 1 | dog |
| 2 | cat |
| 3 | penguin |
| 4 | lax |
| 5 | whale |
| 6 | ostrich |
| 7 | groundhog |
| 8 | squirrel |
| 100 | rabbit |
| 101 | mouse |
+-----+-----+
```

Updating an existing [AUTO\\_INCREMENT](#) column value in an [InnoDB](#) table does not reset the [AUTO\\_INCREMENT](#) sequence as it does for [MyISAM](#) and [NDB](#) tables.

You can retrieve the most recent automatically generated [AUTO\\_INCREMENT](#) value with the [LAST\\_INSERT\\_ID\(\)](#) SQL function or the [mysql\\_insert\\_id\(\)](#) C API function. These functions are connection-specific, so their return values are not affected by another connection which is also performing inserts.

Use the smallest integer data type for the [AUTO\\_INCREMENT](#) column that is large enough to hold the maximum sequence value you need. When the column reaches the upper limit of the data type, the next attempt to generate a sequence number fails. Use the [UNSIGNED](#) attribute if possible to allow a

greater range. For example, if you use `TINYINT`, the maximum permissible sequence number is 127. For `TINYINT UNSIGNED`, the maximum is 255. See [Section 11.1.2, “Integer Types \(Exact Value\) - INTEGER, INT, SMALLINT, TINYINT, MEDIUMINT, BIGINT”](#) for the ranges of all the integer types.



### Note

For a multiple-row insert, `LAST_INSERT_ID()` and `mysql_insert_id()` actually return the `AUTO_INCREMENT` key from the *first* of the inserted rows. This enables multiple-row inserts to be reproduced correctly on other servers in a replication setup.

To start with an `AUTO_INCREMENT` value other than 1, set that value with `CREATE TABLE` or `ALTER TABLE`, like this:

```
mysql> ALTER TABLE tbl AUTO_INCREMENT = 100;
```

## InnoDB Notes

For information about `AUTO_INCREMENT` usage specific to InnoDB, see [Section 14.6.1.6, “AUTO\\_INCREMENT Handling in InnoDB”](#).

## MyISAM Notes

- For MyISAM tables, you can specify `AUTO_INCREMENT` on a secondary column in a multiple-column index. In this case, the generated value for the `AUTO_INCREMENT` column is calculated as `MAX(auto_increment_column) + 1 WHERE prefix=given-prefix`. This is useful when you want to put data into ordered groups.

```
CREATE TABLE animals (
  grp ENUM('fish','mammal','bird') NOT NULL,
  id MEDIUMINT NOT NULL AUTO_INCREMENT,
  name CHAR(30) NOT NULL,
  PRIMARY KEY (grp,id)
) ENGINE=MyISAM;

INSERT INTO animals (grp,name) VALUES
  ('mammal','dog'),('mammal','cat'),
  ('bird','penguin'),('fish','lax'),('mammal','whale'),
  ('bird','ostrich');

SELECT * FROM animals ORDER BY grp,id;
```

Which returns:

```
+-----+-----+-----+
| grp   | id   | name  |
+-----+-----+-----+
| fish  | 1    | lax   |
| mammal| 1    | dog   |
| mammal| 2    | cat   |
| mammal| 3    | whale |
| bird  | 1    | penguin|
| bird  | 2    | ostrich|
+-----+-----+-----+
```

In this case (when the `AUTO_INCREMENT` column is part of a multiple-column index), `AUTO_INCREMENT` values are reused if you delete the row with the biggest `AUTO_INCREMENT` value in any group. This happens even for MyISAM tables, for which `AUTO_INCREMENT` values normally are not reused.

- If the `AUTO_INCREMENT` column is part of multiple indexes, MySQL generates sequence values using the index that begins with the `AUTO_INCREMENT` column, if there is one. For example, if the `animals`

table contained indexes `PRIMARY KEY (grp, id)` and `INDEX (id)`, MySQL would ignore the `PRIMARY KEY` for generating sequence values. As a result, the table would contain a single sequence, not a sequence per `grp` value.

## Further Reading

More information about `AUTO_INCREMENT` is available here:

- How to assign the `AUTO_INCREMENT` attribute to a column: [Section 13.1.18, “CREATE TABLE Statement”](#), and [Section 13.1.8, “ALTER TABLE Statement”](#).
- How `AUTO_INCREMENT` behaves depending on the `NO_AUTO_VALUE_ON_ZERO` SQL mode: [Section 5.1.10, “Server SQL Modes”](#).
- How to use the `LAST_INSERT_ID()` function to find the row that contains the most recent `AUTO_INCREMENT` value: [Section 12.15, “Information Functions”](#).
- Setting the `AUTO_INCREMENT` value to be used: [Section 5.1.7, “Server System Variables”](#).
- [Section 14.6.1.6, “AUTO\\_INCREMENT Handling in InnoDB”](#)
- `AUTO_INCREMENT` and replication: [Section 16.4.1.1, “Replication and AUTO\\_INCREMENT”](#).
- Server-system variables related to `AUTO_INCREMENT` (`auto_increment_increment` and `auto_increment_offset`) that can be used for replication: [Section 5.1.7, “Server System Variables”](#).

## 3.7 Using MySQL with Apache

There are programs that let you authenticate your users from a MySQL database and also let you write your log files into a MySQL table.

You can change the Apache logging format to be easily readable by MySQL by putting the following into the Apache configuration file:

```
LogFormat \
    "%h %Y%m%d%H%M%S>t, %>s, \"%b\", \"%{Content-Type}o\", \
    \"%U\", \"%{Referer}i\", \"%{User-Agent}i\""
```

To load a log file in that format into MySQL, you can use a statement something like this:

```
LOAD DATA INFILE '/local/access_log' INTO TABLE tbl_name
FIELDS TERMINATED BY ',' OPTIONALLY ENCLOSED BY '"' ESCAPED BY '\\'
```

The named table should be created to have columns that correspond to those that the `LogFormat` line writes to the log file.

---

# Chapter 4 MySQL Programs

## Table of Contents

4.1 Overview of MySQL Programs .....	304
4.2 Using MySQL Programs .....	308
4.2.1 Invoking MySQL Programs .....	308
4.2.2 Specifying Program Options .....	309
4.2.3 Command Options for Connecting to the Server .....	323
4.2.4 Connecting to the MySQL Server Using Command Options .....	335
4.2.5 Connection Transport Protocols .....	338
4.2.6 Connection Compression Control .....	339
4.2.7 Setting Environment Variables .....	340
4.3 Server and Server-Startup Programs .....	341
4.3.1 mysqld — The MySQL Server .....	341
4.3.2 mysqld_safe — MySQL Server Startup Script .....	341
4.3.3 mysql.server — MySQL Server Startup Script .....	351
4.3.4 mysqld_multi — Manage Multiple MySQL Servers .....	353
4.4 Installation-Related Programs .....	359
4.4.1 comp_err — Compile MySQL Error Message File .....	359
4.4.2 mysql_install_db — Initialize MySQL Data Directory .....	361
4.4.3 mysql_plugin — Configure MySQL Server Plugins .....	370
4.4.4 mysql_secure_installation — Improve MySQL Installation Security .....	373
4.4.5 mysql_ssl_rsa_setup — Create SSL/RSA Files .....	378
4.4.6 mysql_tzinfo_to_sql — Load the Time Zone Tables .....	381
4.4.7 mysql_upgrade — Check and Upgrade MySQL Tables .....	382
4.5 Client Programs .....	393
4.5.1 mysql — The MySQL Command-Line Client .....	393
4.5.2 mysqladmin — A MySQL Server Administration Program .....	435
4.5.3 mysqlcheck — A Table Maintenance Program .....	450
4.5.4 mysqldump — A Database Backup Program .....	465
4.5.5 mysqlimport — A Data Import Program .....	501
4.5.6 mysqlpump — A Database Backup Program .....	515
4.5.7 mysqlshow — Display Database, Table, and Column Information .....	540
4.5.8 mysqlslap — A Load Emulation Client .....	550
4.6 Administrative and Utility Programs .....	568
4.6.1 innochecksum — Offline InnoDB File Checksum Utility .....	568
4.6.2 myisam_ftdump — Display Full-Text Index information .....	575
4.6.3 myisamchk — MyISAM Table-Maintenance Utility .....	576
4.6.4 myisamlog — Display MyISAM Log File Contents .....	596
4.6.5 myisampack — Generate Compressed, Read-Only MyISAM Tables .....	598
4.6.6 mysql_config_editor — MySQL Configuration Utility .....	605
4.6.7 mysqlbinlog — Utility for Processing Binary Log Files .....	611
4.6.8 mysqldumpslow — Summarize Slow Query Log Files .....	641
4.7 Program Development Utilities .....	644
4.7.1 mysql_config — Display Options for Compiling Clients .....	644
4.7.2 my_print_defaults — Display Options from Option Files .....	646
4.7.3 resolve_stack_dump — Resolve Numeric Stack Trace Dump to Symbols .....	647
4.8 Miscellaneous Programs .....	648
4.8.1 lz4_decompress — Decompress mysqlpump LZ4-Compressed Output .....	648
4.8.2 perror — Display MySQL Error Message Information .....	648
4.8.3 replace — A String-Replacement Utility .....	649

4.8.4 resolveip — Resolve Host name to IP Address or Vice Versa .....	650
4.8.5 zlib_decompress — Decompress mysqlpump ZLIB-Compressed Output .....	650
4.9 Environment Variables .....	650
4.10 Unix Signal Handling in MySQL .....	653

This chapter provides a brief overview of the MySQL command-line programs provided by Oracle Corporation. It also discusses the general syntax for specifying options when you run these programs. Most programs have options that are specific to their own operation, but the option syntax is similar for all of them. Finally, the chapter provides more detailed descriptions of individual programs, including which options they recognize.

## 4.1 Overview of MySQL Programs

There are many different programs in a MySQL installation. This section provides a brief overview of them. Later sections provide a more detailed description of each one, with the exception of NDB Cluster programs. Each program's description indicates its invocation syntax and the options that it supports. [Section 21.5, “NDB Cluster Programs”](#), describes programs specific to NDB Cluster.

Most MySQL distributions include all of these programs, except for those programs that are platform-specific. (For example, the server startup scripts are not used on Windows.) The exception is that RPM distributions are more specialized. There is one RPM for the server, another for client programs, and so forth. If you appear to be missing one or more programs, see [Chapter 2, \*Installing and Upgrading MySQL\*](#), for information on types of distributions and what they contain. It may be that you have a distribution that does not include all programs and you need to install an additional package.

Each MySQL program takes many different options. Most programs provide a `--help` option that you can use to get a description of the program's different options. For example, try `mysql --help`.

You can override default option values for MySQL programs by specifying options on the command line or in an option file. See [Section 4.2, “Using MySQL Programs”](#), for general information on invoking programs and specifying program options.

The MySQL server, `mysqld`, is the main program that does most of the work in a MySQL installation. The server is accompanied by several related scripts that assist you in starting and stopping the server:

- `mysqld`

The SQL daemon (that is, the MySQL server). To use client programs, `mysqld` must be running, because clients gain access to databases by connecting to the server. See [Section 4.3.1, “mysqld — The MySQL Server”](#).

- `mysqld_safe`

A server startup script. `mysqld_safe` attempts to start `mysqld`. See [Section 4.3.2, “mysqld\\_safe — MySQL Server Startup Script”](#).

- `mysql.server`

A server startup script. This script is used on systems that use System V-style run directories containing scripts that start system services for particular run levels. It invokes `mysqld_safe` to start the MySQL server. See [Section 4.3.3, “mysql.server — MySQL Server Startup Script”](#).

- `mysqld_multi`

A server startup script that can start or stop multiple servers installed on the system. See [Section 4.3.4, “mysqld\\_multi — Manage Multiple MySQL Servers”](#).

Several programs perform setup operations during MySQL installation or upgrading:

- `comp_err`

This program is used during the MySQL build/installation process. It compiles error message files from the error source files. See [Section 4.4.1, “comp\\_err — Compile MySQL Error Message File”](#).

- `mysql_install_db`

This program initializes the MySQL data directory, creates the `mysql` database and initializes its grant tables with default privileges, and sets up the `InnoDB` system tablespace. It is usually executed only once, when first installing MySQL on a system. See [Section 4.4.2, “mysql\\_install\\_db — Initialize MySQL Data Directory”](#), and [Section 2.9, “Postinstallation Setup and Testing”](#).

- `mysql_plugin`

This program configures MySQL server plugins. See [Section 4.4.3, “mysql\\_plugin — Configure MySQL Server Plugins”](#).

- `mysql_secure_installation`

This program enables you to improve the security of your MySQL installation. See [Section 4.4.4, “mysql\\_secure\\_installation — Improve MySQL Installation Security”](#).

- `mysql_ssl_rsa_setup`

This program creates the SSL certificate and key files and RSA key-pair files required to support secure connections, if those files are missing. Files created by `mysql_ssl_rsa_setup` can be used for secure connections using SSL or RSA. See [Section 4.4.5, “mysql\\_ssl\\_rsa\\_setup — Create SSL/RSA Files”](#).

- `mysql_tzinfo_to_sql`

This program loads the time zone tables in the `mysql` database using the contents of the host system `zoneinfo` database (the set of files describing time zones). See [Section 4.4.6, “mysql\\_tzinfo\\_to\\_sql — Load the Time Zone Tables”](#).

- `mysql_upgrade`

This program is used after a MySQL upgrade operation. It updates the grant tables with any changes that have been made in newer versions of MySQL, and checks tables for incompatibilities and repairs them if necessary. See [Section 4.4.7, “mysql\\_upgrade — Check and Upgrade MySQL Tables”](#).

MySQL client programs that connect to the MySQL server:

- `mysql`

The command-line tool for interactively entering SQL statements or executing them from a file in batch mode. See [Section 4.5.1, “mysql — The MySQL Command-Line Client”](#).

- `mysqladmin`

A client that performs administrative operations, such as creating or dropping databases, reloading the grant tables, flushing tables to disk, and reopening log files. `mysqladmin` can also be used to retrieve version, process, and status information from the server. See [Section 4.5.2, “mysqladmin — A MySQL Server Administration Program”](#).

- `mysqlcheck`

A table-maintenance client that checks, repairs, analyzes, and optimizes tables. See [Section 4.5.3, “mysqlcheck — A Table Maintenance Program”](#).

- `mysqldump`

A client that dumps a MySQL database into a file as SQL, text, or XML. See [Section 4.5.4, “mysqldump — A Database Backup Program”](#).

- `mysqlimport`

A client that imports text files into their respective tables using `LOAD DATA`. See [Section 4.5.5, “mysqlimport — A Data Import Program”](#).

- `mysqlpump`

A client that dumps a MySQL database into a file as SQL. See [Section 4.5.6, “mysqlpump — A Database Backup Program”](#).

- `mysqlsh`

MySQL Shell is an advanced client and code editor for MySQL Server. See [MySQL Shell 8.0](#). In addition to the provided SQL functionality, similar to `mysql`, MySQL Shell provides scripting capabilities for JavaScript and Python and includes APIs for working with MySQL. X DevAPI enables you to work with both relational and document data, see [Chapter 19, Using MySQL as a Document Store](#). AdminAPI enables you to work with InnoDB Cluster, see [MySQL AdminAPI](#).

- `mysqlshow`

A client that displays information about databases, tables, columns, and indexes. See [Section 4.5.7, “mysqlshow — Display Database, Table, and Column Information”](#).

- `mysqlslap`

A client that is designed to emulate client load for a MySQL server and report the timing of each stage. It works as if multiple clients are accessing the server. See [Section 4.5.8, “mysqlslap — A Load Emulation Client”](#).

MySQL administrative and utility programs:

- `innochecksum`

An offline InnoDB offline file checksum utility. See [Section 4.6.1, “innochecksum — Offline InnoDB File Checksum Utility”](#).

- `myisam_ftdump`

A utility that displays information about full-text indexes in MyISAM tables. See [Section 4.6.2, “myisam\\_ftdump — Display Full-Text Index information”](#).

- `myisamchk`

A utility to describe, check, optimize, and repair MyISAM tables. See [Section 4.6.3, “myisamchk — MyISAM Table-Maintenance Utility”](#).

- `myisamlog`

A utility that processes the contents of a MyISAM log file. See [Section 4.6.4, “myisamlog — Display MyISAM Log File Contents”](#).

- `myisampack`



A utility that compresses [MyISAM](#) tables to produce smaller read-only tables. See [Section 4.6.5, “mysampack — Generate Compressed, Read-Only MyISAM Tables”](#).

- `mysql_config_editor`

A utility that enables you to store authentication credentials in a secure, encrypted login path file named `.mylogin.cnf`. See [Section 4.6.6, “mysql\\_config\\_editor — MySQL Configuration Utility”](#).

- `mysqlbinlog`

A utility for reading statements from a binary log. The log of executed statements contained in the binary log files can be used to help recover from a crash. See [Section 4.6.7, “mysqlbinlog — Utility for Processing Binary Log Files”](#).

- `mysqldumpslow`

A utility to read and summarize the contents of a slow query log. See [Section 4.6.8, “mysqldumpslow — Summarize Slow Query Log Files”](#).

MySQL program-development utilities:

- `mysql_config`

A shell script that produces the option values needed when compiling MySQL programs. See [Section 4.7.1, “mysql\\_config — Display Options for Compiling Clients”](#).

- `my_print_defaults`

A utility that shows which options are present in option groups of option files. See [Section 4.7.2, “my\\_print\\_defaults — Display Options from Option Files”](#).

- `resolve_stack_dump`

A utility program that resolves a numeric stack trace dump to symbols. See [Section 4.7.3, “resolve\\_stack\\_dump — Resolve Numeric Stack Trace Dump to Symbols”](#).

Miscellaneous utilities:

- `lz4_decompress`

A utility that decompresses `mysqlpump` output that was created using LZ4 compression. See [Section 4.8.1, “lz4\\_decompress — Decompress mysqlpump LZ4-Compressed Output”](#).

- `perror`

A utility that displays the meaning of system or MySQL error codes. See [Section 4.8.2, “perror — Display MySQL Error Message Information”](#).

- `replace`

A utility program that performs string replacement in the input text. See [Section 4.8.3, “replace — A String-Replacement Utility”](#).

- `resolveip`

A utility program that resolves a host name to an IP address or vice versa. See [Section 4.8.4, “resolveip — Resolve Host name to IP Address or Vice Versa”](#).

- `zlib_decompress`

A utility that decompresses `mysqlpump` output that was created using ZLIB compression. See [Section 4.8.5, “zlib\\_decompress — Decompress mysqlpump ZLIB-Compressed Output”](#).

Oracle Corporation also provides the [MySQL Workbench](#) GUI tool, which is used to administer MySQL servers and databases, to create, execute, and evaluate queries, and to migrate schemas and data from other relational database management systems for use with MySQL.

MySQL client programs that communicate with the server using the MySQL client/server library use the following environment variables.

Environment Variable	Meaning
<code>MYSQL_UNIX_PORT</code>	The default Unix socket file; used for connections to <code>localhost</code>
<code>MYSQL_TCP_PORT</code>	The default port number; used for TCP/IP connections
<code>MYSQL_PWD</code>	The default password
<code>MYSQL_DEBUG</code>	Debug trace options when debugging
<code>TMPDIR</code>	The directory where temporary tables and files are created

For a full list of environment variables used by MySQL programs, see [Section 4.9, “Environment Variables”](#).

Use of `MYSQL_PWD` is insecure. See [Section 6.1.2.1, “End-User Guidelines for Password Security”](#).

## 4.2 Using MySQL Programs

### 4.2.1 Invoking MySQL Programs

To invoke a MySQL program from the command line (that is, from your shell or command prompt), enter the program name followed by any options or other arguments needed to instruct the program what you want it to do. The following commands show some sample program invocations. `$>` represents the prompt for your command interpreter; it is not part of what you type. The particular prompt you see depends on your command interpreter. Typical prompts are `$` for `sh`, `ksh`, or `bash`, `%` for `csch` or `tcsh`, and `C:\>` for the Windows `command.com` or `cmd.exe` command interpreters.

```
$> mysql --user=root test
$> mysqladmin extended-status variables
$> mysqlshow --help
$> mysqldump -u root personnel
```

Arguments that begin with a single or double dash (`-`, `--`) specify program options. Options typically indicate the type of connection a program should make to the server or affect its operational mode. Option syntax is described in [Section 4.2.2, “Specifying Program Options”](#).

Nonoption arguments (arguments with no leading dash) provide additional information to the program. For example, the `mysql` program interprets the first nonoption argument as a database name, so the command `mysql --user=root test` indicates that you want to use the `test` database.

Later sections that describe individual programs indicate which options a program supports and describe the meaning of any additional nonoption arguments.

Some options are common to a number of programs. The most frequently used of these are the `--host` (or `-h`), `--user` (or `-u`), and `--password` (or `-p`) options that specify connection parameters. They indicate the host where the MySQL server is running, and the user name and password of your MySQL account. All MySQL client programs understand these options; they enable you to specify which server to connect to and the account to use on that server. Other connection options are `--port` (or `-P`) to specify a TCP/IP port number and `--socket` (or `-S`) to specify a Unix socket file on Unix (or named-pipe name on Windows). For more information on options that specify connection options, see [Section 4.2.4, “Connecting to the MySQL Server Using Command Options”](#).

You may find it necessary to invoke MySQL programs using the path name to the `bin` directory in which they are installed. This is likely to be the case if you get a “program not found” error whenever you attempt to run a MySQL program from any directory other than the `bin` directory. To make it more convenient to use MySQL, you can add the path name of the `bin` directory to your `PATH` environment variable setting. That enables you to run a program by typing only its name, not its entire path name. For example, if `mysql` is installed in `/usr/local/mysql/bin`, you can run the program by invoking it as `mysql`, and it is not necessary to invoke it as `/usr/local/mysql/bin/mysql`.

Consult the documentation for your command interpreter for instructions on setting your `PATH` variable. The syntax for setting environment variables is interpreter-specific. (Some information is given in [Section 4.2.7, “Setting Environment Variables”](#).) After modifying your `PATH` setting, open a new console window on Windows or log in again on Unix so that the setting goes into effect.

## 4.2.2 Specifying Program Options

There are several ways to specify options for MySQL programs:

- List the options on the command line following the program name. This is common for options that apply to a specific invocation of the program.
- List the options in an option file that the program reads when it starts. This is common for options that you want the program to use each time it runs.
- List the options in environment variables (see [Section 4.2.7, “Setting Environment Variables”](#)). This method is useful for options that you want to apply each time the program runs. In practice, option files are used more commonly for this purpose, but [Section 5.7.3, “Running Multiple MySQL Instances on Unix”](#), discusses one situation in which environment variables can be very helpful. It describes a handy technique that uses such variables to specify the TCP/IP port number and Unix socket file for the server and for client programs.

Options are processed in order, so if an option is specified multiple times, the last occurrence takes precedence. The following command causes `mysql` to connect to the server running on `localhost`:

```
mysql -h example.com -h localhost
```

There is one exception: For `mysqld`, the *first* instance of the `--user` option is used as a security precaution, to prevent a user specified in an option file from being overridden on the command line.

If conflicting or related options are given, later options take precedence over earlier options. The following command runs `mysql` in “no column names” mode:

```
mysql --column-names --skip-column-names
```

MySQL programs determine which options are given first by examining environment variables, then by processing option files, and then by checking the command line. Because later options take precedence over earlier ones, the processing order means that environment variables have the lowest precedence and command-line options the highest.

You can take advantage of the way that MySQL programs process options by specifying default option values for a program in an option file. That enables you to avoid typing them each time you run the program while enabling you to override the defaults if necessary by using command-line options.

### 4.2.2.1 Using Options on the Command Line

Program options specified on the command line follow these rules:

- Options are given after the command name.
- An option argument begins with one dash or two dashes, depending on whether it is a short form or long form of the option name. Many options have both short and long forms. For example, `-?` and `--help` are the short and long forms of the option that instructs a MySQL program to display its help message.
- Option names are case-sensitive. `-v` and `-V` are both legal and have different meanings. (They are the corresponding short forms of the `--verbose` and `--version` options.)
- Some options take a value following the option name. For example, `-h localhost` or `--host=localhost` indicate the MySQL server host to a client program. The option value tells the program the name of the host where the MySQL server is running.
- For a long option that takes a value, separate the option name and the value by an `=` sign. For a short option that takes a value, the option value can immediately follow the option letter, or there can be a space between: `-hlocalhost` and `-h localhost` are equivalent. An exception to this rule is the option for specifying your MySQL password. This option can be given in long form as `--password=pass_val` or as `--password`. In the latter case (with no password value given), the program interactively prompts you for the password. The password option also may be given in short form as `-ppass_val` or as `-p`. However, for the short form, if the password value is given, it must follow the option letter with *no intervening space*: If a space follows the option letter, the program has no way to tell whether a following argument is supposed to be the password value or some other kind of argument. Consequently, the following two commands have two completely different meanings:

```
mysql -ptest
mysql -p test
```

The first command instructs `mysql` to use a password value of `test`, but specifies no default database. The second instructs `mysql` to prompt for the password value and to use `test` as the default database.

- Within option names, dash (`-`) and underscore (`_`) may be used interchangeably in most cases, although the leading dashes *cannot* be given as underscores. For example, `--skip-grant-tables` and `--skip_grant_tables` are equivalent.

In this Manual, we use dashes in option names, except where underscores are significant. This is the case with, for example, `--log-bin` and `--log_bin`, which are different options. We encourage you to do so as well.

- The MySQL server has certain command options that may be specified only at startup, and a set of system variables, some of which may be set at startup, at runtime, or both. System variable names use underscores rather than dashes, and when referenced at runtime (for example, using `SET` or `SELECT` statements), must be written using underscores:

```
SET GLOBAL general_log = ON;
SELECT @@GLOBAL.general_log;
```

At server startup, the syntax for system variables is the same as for command options, so within variable names, dashes and underscores may be used interchangeably. For example, `--general_log=ON` and `--general-log=ON` are equivalent. (This is also true for system variables set within option files.)

- For options that take a numeric value, the value can be given with a suffix of **K**, **M**, or **G** (either uppercase or lowercase) to indicate a multiplier of 1024, 1024<sup>2</sup> or 1024<sup>3</sup>. For example, the following command tells `mysqladmin` to ping the server 1024 times, sleeping 10 seconds between each ping:

```
mysqladmin --count=1K --sleep=10 ping
```

- When specifying file names as option values, avoid the use of the `~` shell metacharacter. It might not be interpreted as you expect.

Option values that contain spaces must be quoted when given on the command line. For example, the `--execute` (or `-e`) option can be used with `mysql` to pass one or more semicolon-separated SQL statements to the server. When this option is used, `mysql` executes the statements in the option value and exits. The statements must be enclosed by quotation marks. For example:

```
$> mysql -u root -p -e "SELECT VERSION();SELECT NOW()"
Enter password: *****
+-----+
| VERSION() |
+-----+
| 5.7.29    |
+-----+
+-----+
| NOW()     |
+-----+
| 2019-09-03 10:36:28 |
+-----+
$>
```



#### Note

The long form (`--execute`) is followed by an equal sign (=).

To use quoted values within a statement, you must either escape the inner quotation marks, or use a different type of quotation marks within the statement from those used to quote the statement itself. The capabilities of your command processor dictate your choices for whether you can use single or double quotation marks and the syntax for escaping quote characters. For example, if your command processor supports quoting with single or double quotation marks, you can use double quotation marks around the statement, and single quotation marks for any quoted values within the statement.

### 4.2.2.2 Using Option Files

Most MySQL programs can read startup options from option files (sometimes called configuration files). Option files provide a convenient way to specify commonly used options so that they need not be entered on the command line each time you run a program.

To determine whether a program reads option files, invoke it with the `--help` option. (For `mysqld`, use `--verbose` and `--help`.) If the program reads option files, the help message indicates which files it looks for and which option groups it recognizes.



#### Note

A MySQL program started with the `--no-defaults` option reads no option files other than `.mylogin.cnf`.

Many option files are plain text files, created using any text editor. The exception is the `.mylogin.cnf` file that contains login path options. This is an encrypted file created by the `mysql_config_editor` utility. See [Section 4.6.6, “mysql\\_config\\_editor — MySQL Configuration Utility”](#). A “login path” is an option group

that permits only certain options: `host`, `user`, `password`, `port` and `socket`. Client programs specify which login path to read from `.mylogin.cnf` using the `--login-path` option.

To specify an alternative login path file name, set the `MYSQL_TEST_LOGIN_FILE` environment variable. This variable is used by the `mysql-test-run.pl` testing utility, but also is recognized by `mysql_config_editor` and by MySQL clients such as `mysql`, `mysqladmin`, and so forth.

MySQL looks for option files in the order described in the following discussion and reads any that exist. If an option file you want to use does not exist, create it using the appropriate method, as just discussed.



#### Note

For information about option files used with NDB Cluster programs, see [Section 21.4, “Configuration of NDB Cluster”](#).

- [Option File Processing Order](#)
- [Option File Syntax](#)
- [Option File Inclusions](#)

## Option File Processing Order

On Windows, MySQL programs read startup options from the files shown in the following table, in the specified order (files listed first are read first, files read later take precedence).

**Table 4.1 Option Files Read on Windows Systems**

File Name	Purpose
<code>%WINDIR%\my.ini, %WINDIR%\my.cnf</code>	Global options
<code>C:\my.ini, C:\my.cnf</code>	Global options
<code>BASEDIR\my.ini, BASEDIR\my.cnf</code>	Global options
<code>defaults-extra-file</code>	The file specified with <code>--defaults-extra-file</code> , if any
<code>%APPDATA%\MySQL\mylogin.cnf</code>	Login path options (clients only)

In the preceding table, `%WINDIR%` represents the location of your Windows directory. This is commonly `C:\WINDOWS`. Use the following command to determine its exact location from the value of the `WINDIR` environment variable:

```
C:\> echo %WINDIR%
```

`%APPDATA%` represents the value of the Windows application data directory. Use the following command to determine its exact location from the value of the `APPDATA` environment variable:

```
C:\> echo %APPDATA%
```

`BASEDIR` represents the MySQL base installation directory. When MySQL 5.7 has been installed using MySQL Installer, this is typically `C:\PROGRAMDIR\MySQL\MySQL Server 5.7` in which `PROGRAMDIR` represents the programs directory (usually `Program Files` for English-language versions of Windows). See [Section 2.3.3, “MySQL Installer for Windows”](#).



#### Important

Although MySQL Installer places most files under `PROGRAMDIR`, it installs `my.ini` under the `C:\ProgramData\MySQL\MySQL Server 5.7\` directory by default.

On Unix and Unix-like systems, MySQL programs read startup options from the files shown in the following table, in the specified order (files listed first are read first, files read later take precedence).



### Note

On Unix platforms, MySQL ignores configuration files that are world-writable. This is intentional as a security measure.

**Table 4.2 Option Files Read on Unix and Unix-Like Systems**

File Name	Purpose
<code>/etc/my.cnf</code>	Global options
<code>/etc/mysql/my.cnf</code>	Global options
<code>\$SYSCONFDIR/my.cnf</code>	Global options
<code>\$MYSQL_HOME/my.cnf</code>	Server-specific options (server only)
<code>defaults-extra-file</code>	The file specified with <code>--defaults-extra-file</code> , if any
<code>~/.my.cnf</code>	User-specific options
<code>~/.mylogin.cnf</code>	User-specific login path options (clients only)

In the preceding table, `~` represents the current user's home directory (the value of `$HOME`).

`$SYSCONFDIR` represents the directory specified with the `$SYSCONFDIR` option to `CMake` when MySQL was built. By default, this is the `etc` directory located under the compiled-in installation directory.

`$MYSQL_HOME` is an environment variable containing the path to the directory in which the server-specific `my.cnf` file resides. If `$MYSQL_HOME` is not set and you start the server using the `mysqld_safe` program, `mysqld_safe` sets it to `$BASEDIR`, the MySQL base installation directory.

`$DATADIR` is commonly `/usr/local/mysql/data`, although this can vary per platform or installation method. The value is the data directory location built in when MySQL was compiled, not the location specified with the `--datadir` option when `mysqld` starts. Use of `--datadir` at runtime has no effect on where the server looks for option files that it reads before processing any options.

If multiple instances of a given option are found, the last instance takes precedence, with one exception: For `mysqld`, the *first* instance of the `--user` option is used as a security precaution, to prevent a user specified in an option file from being overridden on the command line.

## Option File Syntax

The following description of option file syntax applies to files that you edit manually. This excludes `.mylogin.cnf`, which is created using `mysql_config_editor` and is encrypted.

Any long option that may be given on the command line when running a MySQL program can be given in an option file as well. To get the list of available options for a program, run it with the `--help` option. (For `mysqld`, use `--verbose` and `--help`.)

The syntax for specifying options in an option file is similar to command-line syntax (see [Section 4.2.2.1, “Using Options on the Command Line”](#)). However, in an option file, you omit the leading two dashes from the option name and you specify only one option per line. For example, `--quick` and `--host=localhost` on the command line should be specified as `quick` and `host=localhost` on separate lines in an option file. To specify an option of the form `--loose-opt_name` in an option file, write it as `loose-opt_name`.

Empty lines in option files are ignored. Nonempty lines can take any of the following forms:

- `#comment, ;comment`

Comment lines start with `#` or `;`. A `#` comment can start in the middle of a line as well.

- `[group]`

`group` is the name of the program or group for which you want to set options. After a group line, any option-setting lines apply to the named group until the end of the option file or another group line is given. Option group names are not case-sensitive.

- `opt_name`

This is equivalent to `--opt_name` on the command line.

- `opt_name=value`

This is equivalent to `--opt_name=value` on the command line. In an option file, you can have spaces around the `=` character, something that is not true on the command line. The value optionally can be enclosed within single quotation marks or double quotation marks, which is useful if the value contains a `#` comment character.

Leading and trailing spaces are automatically deleted from option names and values.

You can use the escape sequences `\b`, `\t`, `\n`, `\r`, `\\`, and `\s` in option values to represent the backspace, tab, newline, carriage return, backslash, and space characters. In option files, these escaping rules apply:

- A backslash followed by a valid escape sequence character is converted to the character represented by the sequence. For example, `\s` is converted to a space.
- A backslash not followed by a valid escape sequence character remains unchanged. For example, `\S` is retained as is.

The preceding rules mean that a literal backslash can be given as `\\`, or as `\` if it is not followed by a valid escape sequence character.

The rules for escape sequences in option files differ slightly from the rules for escape sequences in string literals in SQL statements. In the latter context, if `"x"` is not a valid escape sequence character, `\x` becomes `"x"` rather than `\x`. See [Section 9.1.1, "String Literals"](#).

The escaping rules for option file values are especially pertinent for Windows path names, which use `\` as a path name separator. A separator in a Windows path name must be written as `\\` if it is followed by an escape sequence character. It can be written as `\\` or `\` if it is not. Alternatively, `/` may be used in Windows path names and is treated as `\`. Suppose that you want to specify a base directory of `C:\Program Files\MySQL\MySQL Server 5.7` in an option file. This can be done several ways. Some examples:

```
basedir="C:\Program Files\MySQL\MySQL Server 5.7"
basedir="C:\\Program Files\\MySQL\\MySQL Server 5.7"
basedir="C:/Program Files/MySQL/MySQL Server 5.7"
basedir=C:\\Program\sFiles\\MySQL\\MySQL\sServer\s5.7
```

If an option group name is the same as a program name, options in the group apply specifically to that program. For example, the `[mysqld]` and `[mysql]` groups apply to the `mysqld` server and the `mysql` client program, respectively.



The `[client]` option group is read by all client programs provided in MySQL distributions (but *not* by `mysqld`). To understand how third-party client programs that use the C API can use option files, see the C API documentation at [mysql\\_options\(\)](#).

The `[client]` group enables you to specify options that apply to all clients. For example, `[client]` is the appropriate group to use to specify the password for connecting to the server. (But make sure that the option file is accessible only by yourself, so that other people cannot discover your password.) Be sure not to put an option in the `[client]` group unless it is recognized by *all* client programs that you use. Programs that do not understand the option quit after displaying an error message if you try to run them.

List more general option groups first and more specific groups later. For example, a `[client]` group is more general because it is read by all client programs, whereas a `[mysqldump]` group is read only by `mysqldump`. Options specified later override options specified earlier, so putting the option groups in the order `[client]`, `[mysqldump]` enables `mysqldump`-specific options to override `[client]` options.

Here is a typical global option file:

```
[client]
port=3306
socket=/tmp/mysql.sock

[mysqld]
port=3306
socket=/tmp/mysql.sock
key_buffer_size=16M
max_allowed_packet=8M

[mysqldump]
quick
```

Here is a typical user option file:

```
[client]
# The following password is sent to all standard MySQL clients
password="my password"

[mysql]
no-auto-rehash
connect_timeout=2
```

To create option groups to be read only by `mysqld` servers from specific MySQL release series, use groups with names of `[mysqld-5.6]`, `[mysqld-5.7]`, and so forth. The following group indicates that the `sql_mode` setting should be used only by MySQL servers with 5.7.x version numbers:

```
[mysqld-5.7]
sql_mode=TRADITIONAL
```

## Option File Inclusions

It is possible to use `!include` directives in option files to include other option files and `!includedir` to search specific directories for option files. For example, to include the `/home/mydir/myopt.cnf` file, use the following directive:

```
!include /home/mydir/myopt.cnf
```

To search the `/home/mydir` directory and read option files found there, use this directive:

```
!includedir /home/mydir
```

MySQL makes no guarantee about the order in which option files in the directory are read.

**Note**

Any files to be found and included using the `!includedir` directive on Unix operating systems *must* have file names ending in `.cnf`. On Windows, this directive checks for files with the `.ini` or `.cnf` extension.

Write the contents of an included option file like any other option file. That is, it should contain groups of options, each preceded by a `[group]` line that indicates the program to which the options apply.

While an included file is being processed, only those options in groups that the current program is looking for are used. Other groups are ignored. Suppose that a `my.cnf` file contains this line:

```
!include /home/mydir/myopt.cnf
```

And suppose that `/home/mydir/myopt.cnf` looks like this:

```
[mysqladmin]
force

[mysqld]
key_buffer_size=16M
```

If `my.cnf` is processed by `mysqld`, only the `[mysqld]` group in `/home/mydir/myopt.cnf` is used. If the file is processed by `mysqladmin`, only the `[mysqladmin]` group is used. If the file is processed by any other program, no options in `/home/mydir/myopt.cnf` are used.

The `!includedir` directive is processed similarly except that all option files in the named directory are read.

If an option file contains `!include` or `!includedir` directives, files named by those directives are processed whenever the option file is processed, no matter where they appear in the file.

For inclusion directives to work, the file path should not be specified within quotes and should have no escape sequences. For example, the following statements provided in `my.ini` read the option file `myopts.ini`:

```
!include C:/ProgramData/MySQL/MySQL Server/myopts.ini
!include C:\ProgramData\MySQL\MySQL Server\myopts.ini
!include C:\\ProgramData\\MySQL\\MySQL Server\\myopts.ini
```

On Windows, if `!include /path/to/extra.ini` is the last line in the file, make sure that a newline is appended at the end or the line is ignored.

### 4.2.2.3 Command-Line Options that Affect Option-File Handling

Most MySQL programs that support option files handle the following options. Because these options affect option-file handling, they must be given on the command line and not in an option file. To work properly, each of these options must be given before other options, with these exceptions:

- `--print-defaults` may be used immediately after `--defaults-file`, `--defaults-extra-file`, or `--login-path`.
- On Windows, if the server is started with the `--defaults-file` and `--install` options, `--install` must be first. See [Section 2.3.4.8, “Starting MySQL as a Windows Service”](#).

When specifying file names as option values, avoid the use of the `~` shell metacharacter because it might not be interpreted as you expect.

**Table 4.3 Option File Option Summary**

Option Name	Description
<code>--defaults-extra-file</code>	Read named option file in addition to usual option files
<code>--defaults-file</code>	Read only named option file
<code>--defaults-group-suffix</code>	Option group suffix value
<code>--login-path</code>	Read login path options from <code>.mylogin.cnf</code>
<code>--no-defaults</code>	Read no option files

- `--defaults-extra-file=filename`

Command-Line Format	<code>--defaults-extra-file=filename</code>
Type	File name
Default Value	[none]

Read this option file after the global option file but (on Unix) before the user option file and (on all platforms) before the login path file. (For information about the order in which option files are used, see [Section 4.2.2.2, “Using Option Files”](#).) If the file does not exist or is otherwise inaccessible, an error occurs. If `filename` is not an absolute path name, it is interpreted relative to the current directory.

See the introduction to this section regarding constraints on the position in which this option may be specified.

- `--defaults-file=filename`

Command-Line Format	<code>--defaults-file=filename</code>
Type	File name
Default Value	[none]

Read only the given option file. If the file does not exist or is otherwise inaccessible, an error occurs. `filename` is interpreted relative to the current directory if given as a relative path name rather than a full path name.

Exception: Even with `--defaults-file`, client programs read `.mylogin.cnf`.

See the introduction to this section regarding constraints on the position in which this option may be specified.

- `--defaults-group-suffix=string`

Command-Line Format	<code>--defaults-group-suffix=string</code>
Type	String
Default Value	[none]

Read not only the usual option groups, but also groups with the usual names and a suffix of `string`. For example, the `mysql` client normally reads the `[client]` and `[mysql]` groups. If this option is given as `--defaults-group-suffix=_other`, `mysql` also reads the `[client_other]` and `[mysql_other]` groups.

- `--login-path=name`

Command-Line Format	<code>--login-path=name</code>
Type	String
Default Value	<code>[none]</code>

Read options from the named login path in the `.mylogin.cnf` login path file. A “login path” is an option group containing options that specify which MySQL server to connect to and which account to authenticate as. To create or modify a login path file, use the `mysql_config_editor` utility. See [Section 4.6.6, “mysql\\_config\\_editor — MySQL Configuration Utility”](#).

A client program reads the option group corresponding to the named login path, in addition to option groups that the program reads by default. Consider this command:

```
mysql --login-path=mypath
```

By default, the `mysql` client reads the `[client]` and `[mysql]` option groups. So for the command shown, `mysql` reads `[client]` and `[mysql]` from other option files, and `[client]`, `[mysql]`, and `[mypath]` from the login path file.

Client programs read the login path file even when the `--no-defaults` option is used.

To specify an alternate login path file name, set the `MYSQL_TEST_LOGIN_FILE` environment variable.

See the introduction to this section regarding constraints on the position in which this option may be specified.

- `--no-defaults`

Command-Line Format	<code>--no-defaults</code>
Type	Boolean
Default Value	<code>false</code>

Do not read any option files. If program startup fails due to reading unknown options from an option file, `--no-defaults` can be used to prevent them from being read.

The exception is that client programs read the `.mylogin.cnf` login path file, if it exists, even when `--no-defaults` is used. This permits passwords to be specified in a safer way than on the command line even if `--no-defaults` is present. To create `.mylogin.cnf`, use the `mysql_config_editor` utility. See [Section 4.6.6, “mysql\\_config\\_editor — MySQL Configuration Utility”](#).

- `--print-defaults`

Command-Line Format	<code>--print-defaults</code>
Type	Boolean
Default Value	<code>false</code>

Print the program name and all options that it gets from option files. Password values are masked.

See the introduction to this section regarding constraints on the position in which this option may be specified.

#### 4.2.2.4 Program Option Modifiers

Some options are “boolean” and control behavior that can be turned on or off. For example, the `mysql` client supports a `--column-names` option that determines whether or not to display a row of column names at the beginning of query results. By default, this option is enabled. However, you may want to disable it in some instances, such as when sending the output of `mysql` into another program that expects to see only data and not an initial header line.

To disable column names, you can specify the option using any of these forms:

```
--disable-column-names
--skip-column-names
--column-names=0
```

The `--disable` and `--skip` prefixes and the `=0` suffix all have the same effect: They turn the option off.

The “enabled” form of the option may be specified in any of these ways:

```
--column-names
--enable-column-names
--column-names=1
```

The values `ON`, `TRUE`, `OFF`, and `FALSE` are also recognized for boolean options (not case-sensitive).

If an option is prefixed by `--loose`, a program does not exit with an error if it does not recognize the option, but instead issues only a warning:

```
$> mysql --loose-no-such-option
mysql: WARNING: unknown option '--loose-no-such-option'
```

The `--loose` prefix can be useful when you run programs from multiple installations of MySQL on the same machine and list options in an option file. An option that may not be recognized by all versions of a program can be given using the `--loose` prefix (or `loose` in an option file). Versions of the program that recognize the option process it normally, and versions that do not recognize it issue a warning and ignore it.

The `--maximum` prefix is available for `mysqld` only and permits a limit to be placed on how large client programs can set session system variables. To do this, use a `--maximum` prefix with the variable name. For example, `--maximum-max_heap_table_size=32M` prevents any client from making the heap table size limit larger than 32M.

The `--maximum` prefix is intended for use with system variables that have a session value. If applied to a system variable that has only a global value, an error occurs. For example, with `--maximum-back_log=200`, the server produces this error:

```
Maximum value of 'back_log' cannot be set
```

#### 4.2.2.5 Using Options to Set Program Variables

Many MySQL programs have internal variables that can be set at runtime using the `SET` statement. See [Section 13.7.4.1, “SET Syntax for Variable Assignment”](#), and [Section 5.1.8, “Using System Variables”](#).

Most of these program variables also can be set at server startup by using the same syntax that applies to specifying program options. For example, `mysql` has a `max_allowed_packet` variable that controls the maximum size of its communication buffer. To set the `max_allowed_packet` variable for `mysql` to a value of 16MB, use either of the following commands:

```
mysql --max_allowed_packet=16777216
mysql --max_allowed_packet=16M
```

The first command specifies the value in bytes. The second specifies the value in megabytes. For variables that take a numeric value, the value can be given with a suffix of **K**, **M**, or **G** (either uppercase or lowercase) to indicate a multiplier of 1024, 1024<sup>2</sup> or 1024<sup>3</sup>. (For example, when used to set `max_allowed_packet`, the suffixes indicate units of kilobytes, megabytes, or gigabytes.)

In an option file, variable settings are given without the leading dashes:

```
[mysql]
max_allowed_packet=16777216
```

Or:

```
[mysql]
max_allowed_packet=16M
```

If you like, underscores in an option name can be specified as dashes. The following option groups are equivalent. Both set the size of the server's key buffer to 512MB:

```
[mysqld]
key_buffer_size=512M
```

```
[mysqld]
key-buffer-size=512M
```

In older versions of MySQL, program options could be specified in full or as any unambiguous prefix. For example, the `--compress` option could be given to `mysqldump` as `--compr`, but not as `--comp` because the latter is ambiguous. In MySQL 5.7, option prefixes are no longer supported; only full options are accepted. This is because prefixes can cause problems when new options are implemented for programs and a prefix that is currently unambiguous might become ambiguous in the future. Some implications of this change:

- The `--key-buffer` option must now be specified as `--key-buffer-size`.
- The `--skip-grant` option must now be specified as `--skip-grant-tables`.

Suffixes for specifying a value multiplier can be used when setting a variable at program invocation time, but not to set the value with `SET` at runtime. On the other hand, with `SET`, you can assign a variable's value using an expression, which is not true when you set a variable at server startup. For example, the first of the following lines is legal at program invocation time, but the second is not:

```
$> mysql --max_allowed_packet=16M
$> mysql --max_allowed_packet=16*1024*1024
```

Conversely, the second of the following lines is legal at runtime, but the first is not:

```
mysql> SET GLOBAL max_allowed_packet=16M;
mysql> SET GLOBAL max_allowed_packet=16*1024*1024;
```

#### 4.2.2.6 Option Defaults, Options Expecting Values, and the = Sign

By convention, long forms of options that assign a value are written with an equals (=) sign, like this:

```
mysql --host=tonfisk --user=jon
```

For options that require a value (that is, not having a default value), the equal sign is not required, and so the following is also valid:

```
mysql --host tonfisk --user jon
```

In both cases, the `mysql` client attempts to connect to a MySQL server running on the host named "tonfisk" using an account with the user name "jon".

Due to this behavior, problems can occasionally arise when no value is provided for an option that expects one. Consider the following example, where a user connects to a MySQL server running on host `tonfisk` as user `jon`:

```
$> mysql --host 85.224.35.45 --user jon
Welcome to the MySQL monitor.  Commands end with ; or \g.
Your MySQL connection id is 3
Server version: 5.7.44 Source distribution

Type 'help;' or '\h' for help. Type '\c' to clear the buffer.

mysql> SELECT CURRENT_USER();
+-----+
| CURRENT_USER() |
+-----+
| jon@%          |
+-----+
1 row in set (0.00 sec)
```

Omitting the required value for one of these option yields an error, such as the one shown here:

```
$> mysql --host 85.224.35.45 --user
mysql: option '--user' requires an argument
```

In this case, `mysql` was unable to find a value following the `--user` option because nothing came after it on the command line. However, if you omit the value for an option that is *not* the last option to be used, you obtain a different error that you may not be expecting:

```
$> mysql --host --user jon
ERROR 2005 (HY000): Unknown MySQL server host '--user' (1)
```

Because `mysql` assumes that any string following `--host` on the command line is a host name, `--host --user` is interpreted as `--host=--user`, and the client attempts to connect to a MySQL server running on a host named “--user”.

Options having default values always require an equal sign when assigning a value; failing to do so causes an error. For example, the MySQL server `--log-error` option has the default value `host_name.err`, where `host_name` is the name of the host on which MySQL is running. Assume that you are running MySQL on a computer whose host name is “tonfisk”, and consider the following invocation of `mysqld_safe`:

```
$> mysqld_safe &
[1] 11699
$> 080112 12:53:40 mysqld_safe Logging to '/usr/local/mysql/var/tonfisk.err'.
080112 12:53:40 mysqld_safe Starting mysqld daemon with databases from /usr/local/mysql/var
$>
```

After shutting down the server, restart it as follows:

```
$> mysqld_safe --log-error &
[1] 11699
$> 080112 12:53:40 mysqld_safe Logging to '/usr/local/mysql/var/tonfisk.err'.
080112 12:53:40 mysqld_safe Starting mysqld daemon with databases from /usr/local/mysql/var
$>
```

The result is the same, since `--log-error` is not followed by anything else on the command line, and it supplies its own default value. (The `&` character tells the operating system to run MySQL in the background; it is ignored by MySQL itself.) Now suppose that you wish to log errors to a file named `my-errors.err`. You might try starting the server with `--log-error my-errors`, but this does not have the intended effect, as shown here:

```
$> mysqld_safe --log-error my-errors &
[1] 31357
$> 080111 22:53:31 mysqld_safe Logging to '/usr/local/mysql/var/tonfisk.err'.
```

```
080111 22:53:32 mysqld_safe Starting mysqld daemon with databases from /usr/local/mysql/var
080111 22:53:34 mysqld_safe mysqld from pid file /usr/local/mysql/var/tonfisk.pid ended

[1]+  Done                  ./mysqld_safe --log-error my-errors
```

The server attempted to start using `/usr/local/mysql/var/tonfisk.err` as the error log, but then shut down. Examining the last few lines of this file shows the reason:

```
$> tail /usr/local/mysql/var/tonfisk.err
2013-09-24T15:36:22.278034Z 0 [ERROR] Too many arguments (first extra is 'my-errors').
2013-09-24T15:36:22.278059Z 0 [Note] Use --verbose --help to get a list of available options!
2013-09-24T15:36:22.278076Z 0 [ERROR] Aborting
2013-09-24T15:36:22.279704Z 0 [Note] InnoDB: Starting shutdown...
2013-09-24T15:36:23.777471Z 0 [Note] InnoDB: Shutdown completed; log sequence number 2319086
2013-09-24T15:36:23.780134Z 0 [Note] mysqld: Shutdown complete
```

Because the `--log-error` option supplies a default value, you must use an equal sign to assign a different value to it, as shown here:

```
$> mysqld_safe --log-error=my-errors &
[1] 31437
$> 080111 22:54:15 mysqld_safe Logging to '/usr/local/mysql/var/my-errors.err'.
080111 22:54:15 mysqld_safe Starting mysqld daemon with databases from /usr/local/mysql/var

$>
```

Now the server has been started successfully, and is logging errors to the file `/usr/local/mysql/var/my-errors.err`.

Similar issues can arise when specifying option values in option files. For example, consider a `my.cnf` file that contains the following:

```
[mysql]
host
user
```

When the `mysql` client reads this file, these entries are parsed as `--host --user` or `--host=--user`, with the result shown here:

```
$> mysql
ERROR 2005 (HY000): Unknown MySQL server host '--user' (1)
```

However, in option files, an equal sign is not assumed. Suppose the `my.cnf` file is as shown here:

```
[mysql]
user jon
```

Trying to start `mysql` in this case causes a different error:

```
$> mysql
mysql: unknown option '--user jon'
```

A similar error would occur if you were to write `host tonfisk` in the option file rather than `host=tonfisk`. Instead, you must use the equal sign:

```
[mysql]
user=jon
```

Now the login attempt succeeds:

```
$> mysql
Welcome to the MySQL monitor.  Commands end with ; or \g.
Your MySQL connection id is 5
```



```

Server version: 5.7.44 Source distribution

Type 'help;' or '\h' for help. Type '\c' to clear the buffer.

mysql> SELECT USER();
+-----+
| USER() |
+-----+
| jon@localhost |
+-----+
1 row in set (0.00 sec)
    
```

This is not the same behavior as with the command line, where the equal sign is not required:

```

$> mysql --user jon --host tonfisk
Welcome to the MySQL monitor.  Commands end with ; or \g.
Your MySQL connection id is 6
Server version: 5.7.44 Source distribution

Type 'help;' or '\h' for help. Type '\c' to clear the buffer.

mysql> SELECT USER();
+-----+
| USER() |
+-----+
| jon@tonfisk |
+-----+
1 row in set (0.00 sec)
    
```

Specifying an option requiring a value without a value in an option file causes the server to abort with an error.

## 4.2.3 Command Options for Connecting to the Server

This section describes options supported by most MySQL client programs that control how client programs establish connections to the server and whether connections are encrypted. These options can be given on the command line or in an option file.

- [Command Options for Connection Establishment](#)
- [Command Options for Encrypted Connections](#)

### Command Options for Connection Establishment

This section describes options that control how client programs establish connections to the server. For additional information and examples showing how to use them, see [Section 4.2.4, “Connecting to the MySQL Server Using Command Options”](#).

**Table 4.4 Connection-Establishment Option Summary**

Option Name	Description	Deprecated
<a href="#">--default-auth</a>	Authentication plugin to use	
<a href="#">--host</a>	Host on which MySQL server is located	
<a href="#">--password</a>	Password to use when connecting to server	
<a href="#">--pipe</a>	Connect to server using named pipe (Windows only)	
<a href="#">--plugin-dir</a>	Directory where plugins are installed	

Option Name	Description	Deprecated
<code>--port</code>	TCP/IP port number for connection	
<code>--protocol</code>	Transport protocol to use	
<code>--secure-auth</code>	Do not send passwords to server in old (pre-4.1) format	Yes
<code>--shared-memory-base-name</code>	Shared-memory name for shared-memory connections (Windows only)	
<code>--socket</code>	Unix socket file or Windows named pipe to use	
<code>--user</code>	MySQL user name to use when connecting to server	

- `--default-auth=plugin`

Command-Line Format	<code>--default-auth=plugin</code>
Type	String

A hint about which client-side authentication plugin to use. See [Section 6.2.13, “Pluggable Authentication”](#).

- `--host=host_name, -h host_name`

Command-Line Format	<code>--host=host_name</code>
Type	String
Default Value	<code>localhost</code>

The host on which the MySQL server is running. The value can be a host name, IPv4 address, or IPv6 address. The default value is `localhost`.

- `--password[=pass_val], -p[pass_val]`

Command-Line Format	<code>--password[=password]</code>
Type	String
Default Value	<code>[none]</code>

The password of the MySQL account used for connecting to the server. The password value is optional. If not given, the client program prompts for one. If given, there must be *no space* between `--password=` or `-p` and the password following it. If no password option is specified, the default is to send no password.

Specifying a password on the command line should be considered insecure. To avoid giving the password on the command line, use an option file. See [Section 6.1.2.1, “End-User Guidelines for Password Security”](#).

To explicitly specify that there is no password and that the client program should not prompt for one, use the `--skip-password` option.

- `--pipe, -W`

Command-Line Format	<code>--pipe</code>
Type	String

On Windows, connect to the server using a named pipe. This option applies only if the server was started with the `named_pipe` system variable enabled to support named-pipe connections. In addition, the user making the connection must be a member of the Windows group specified by the `named_pipe_full_access_group` system variable.

- `--plugin-dir=dir_name`

Command-Line Format	<code>--plugin-dir=dir_name</code>
Type	Directory name

The directory in which to look for plugins. Specify this option if the `--default-auth` option is used to specify an authentication plugin but the client program does not find it. See [Section 6.2.13, “Pluggable Authentication”](#).

- `--port=port_num, -P port_num`

Command-Line Format	<code>--port=port_num</code>
Type	Numeric
Default Value	3306

For TCP/IP connections, the port number to use. The default port number is 3306.

- `--protocol={TCP | SOCKET | PIPE | MEMORY}`

Command-Line Format	<code>--protocol=type</code>
Type	String
Default Value	[see text]
Valid Values	TCP SOCKET PIPE

MEMORY

This option explicitly specifies which transport protocol to use for connecting to the server. It is useful when other connection parameters normally result in use of a protocol other than the one you want. For example, connections on Unix to `localhost` are made using a Unix socket file by default:

```
mysql --host=localhost
```

To force TCP/IP transport to be used instead, specify a `--protocol` option:

```
mysql --host=localhost --protocol=TCP
```

The following table shows the permissible `--protocol` option values and indicates the applicable platforms for each value. The values are not case-sensitive.

<code>--protocol</code> Value	Transport Protocol Used	Applicable Platforms
TCP	TCP/IP transport to local or remote server	All
SOCKET	Unix socket-file transport to local server	Unix and Unix-like systems
PIPE	Named-pipe transport to local server	Windows
MEMORY	Shared-memory transport to local server	Windows

See also [Section 4.2.5, “Connection Transport Protocols”](#)

- `--secure-auth`

Command-Line Format	<code>--secure-auth</code>
Deprecated	Yes

Do not send passwords to the server in old (pre-4.1) format. This prevents connections except for servers that use the newer password format.

As of MySQL 5.7.5, this option is deprecated; expect it to be removed in a future MySQL release. It is always enabled and attempting to disable it (`--skip-secure-auth`, `--secure-auth=0`) produces an error. Before MySQL 5.7.5, this option is enabled by default but can be disabled.



**Note**

Passwords that use the pre-4.1 hashing method are less secure than passwordss that use the native password hashing method and should be avoided. Pre-4.1 passwordss are deprecated and support for them was removed in MySQL 5.7.5. For account upgrade instructions, see [Section 6.4.1.3, “Migrating Away from Pre-4.1 Password Hashing and the `mysql\_old\_password` Plugin”](#).

- `--shared-memory-base-name=name`

Command-Line Format	<code>--shared-memory-base-name=name</code>
Platform Specific	Windows

On Windows, the shared-memory name to use for connections made using shared memory to a local server. The default value is `MYSQL`. The shared-memory name is case-sensitive.

This option applies only if the server was started with the `shared_memory` system variable enabled to support shared-memory connections.

- `--socket=path, -S path`

Command-Line Format	<code>--socket={file_name pipe_name}</code>
Type	String

On Unix, the name of the Unix socket file to use for connections made using a named pipe to a local server. The default Unix socket file name is `/tmp/mysql.sock`.

On Windows, the name of the named pipe to use for connections to a local server. The default Windows pipe name is `MySQL`. The pipe name is not case-sensitive.

On Windows, this option applies only if the server was started with the `named_pipe` system variable enabled to support named-pipe connections. In addition, the user making the connection must be a member of the Windows group specified by the `named_pipe_full_access_group` system variable.

- `--user=user_name, -u user_name`

Command-Line Format	<code>--user=user_name</code>
Type	String

The user name of the MySQL account to use for connecting to the server. The default user name is `ODBC` on Windows or your Unix login name on Unix.

## Command Options for Encrypted Connections

This section describes options for client programs that specify whether to use encrypted connections to the server, the names of certificate and key files, and other parameters related to encrypted-connection support. For examples of suggested use and how to check whether a connection is encrypted, see [Section 6.3.1, “Configuring MySQL to Use Encrypted Connections”](#).



### Note

These options have an effect only for connections that use a transport protocol subject to encryption; that is, TCP/IP and Unix socket-file connections. See [Section 4.2.5, “Connection Transport Protocols”](#)

For information about using encrypted connections from the MySQL C API, see [Support for Encrypted Connections](#).

**Table 4.5 Connection-Encryption Option Summary**

Option Name	Description	Introduced
<code>--get-server-public-key</code>	Request RSA public key from server	5.7.23
<code>--server-public-key-path</code>	Path name to file containing RSA public key	

Option Name	Description	Introduced
<code>--skip-ssl</code>	Disable connection encryption	
<code>--ssl</code>	Enable connection encryption	
<code>--ssl-ca</code>	File that contains list of trusted SSL Certificate Authorities	
<code>--ssl-capath</code>	Directory that contains trusted SSL Certificate Authority certificate files	
<code>--ssl-cert</code>	File that contains X.509 certificate	
<code>--ssl-cipher</code>	Permissible ciphers for connection encryption	
<code>--ssl-crl</code>	File that contains certificate revocation lists	
<code>--ssl-crlpath</code>	Directory that contains certificate revocation-list files	
<code>--ssl-key</code>	File that contains X.509 key	
<code>--ssl-mode</code>	Desired security state of connection to server	5.7.11
<code>--ssl-verify-server-cert</code>	Verify host name against server certificate Common Name identity	
<code>--tls-version</code>	Permissible TLS protocols for encrypted connections	5.7.10

- `--get-server-public-key`

Command-Line Format	<code>--get-server-public-key</code>
Introduced	5.7.23
Type	Boolean

Request from the server the public key required for RSA key pair-based password exchange. This option applies to clients that authenticate with the `caching_sha2_password` authentication plugin. For that plugin, the server does not send the public key unless requested. This option is ignored for accounts that do not authenticate with that plugin. It is also ignored if RSA-based password exchange is not used, as is the case when the client connects to the server using a secure connection.

If `--server-public-key-path=file_name` is given and specifies a valid public key file, it takes precedence over `--get-server-public-key`.

For information about the `caching_sha2_password` plugin, see [Section 6.4.1.4, “Caching SHA-2 Pluggable Authentication”](#).

The `--get-server-public-key` option was added in MySQL 5.7.23.

- `--server-public-key-path=file_name`

Command-Line Format	<code>--server-public-key-path=file_name</code>
Type	File name

The path name to a file in PEM format containing a client-side copy of the public key required by the server for RSA key pair-based password exchange. This option applies to clients that authenticate with the `sha256_password` or `caching_sha2_password` authentication plugin. This option is ignored for accounts that do not authenticate with one of those plugins. It is also ignored if RSA-based password exchange is not used, as is the case when the client connects to the server using a secure connection.

This option is available only if MySQL was built using OpenSSL.

For information about the `sha256_password` and `caching_sha2_password` plugins, see [Section 6.4.1.5, “SHA-256 Pluggable Authentication”](#), and [Section 6.4.1.4, “Caching SHA-2 Pluggable Authentication”](#).

- `--ssl, --skip-ssl`

Command-Line Format	<code>--ssl</code>
Disabled by	<code>skip-ssl</code>
Type	Boolean
Default Value	<code>FALSE</code>

Command-Line Format	<code>--skip-ssl</code>
---------------------	-------------------------



#### Note

The client-side `--ssl` option is deprecated as of MySQL 5.7.11 and is removed in MySQL 8.0. For client programs, use `--ssl-mode` instead:

- Use `--ssl-mode=REQUIRED` instead of `--ssl=1` or `--enable-ssl`.
- Use `--ssl-mode=DISABLED` instead of `--ssl=0`, `--skip-ssl`, or `--disable-ssl`.
- No explicit `--ssl-mode` option is equivalent to no explicit `--ssl` option.

The server-side `--ssl` option is *not* deprecated.

By default, MySQL client programs attempt to establish an encrypted connection if the server supports encrypted connections, with further control available through the `--ssl` option: The client-side `--ssl` option works as follows:

- In the absence of an `--ssl` option, clients attempt to connect using encryption, falling back to an unencrypted connection if an encrypted connection cannot be established.
- The presence of an explicit `--ssl` option or a synonym (`--ssl=1`, `--enable-ssl`) is prescriptive: Clients require an encrypted connection and fail if one cannot be established.
- With an `--ssl=0` option or a synonym (`--skip-ssl`, `--disable-ssl`), clients use an unencrypted connection.

To require use of encrypted connections by a MySQL account, use `CREATE USER` to create the account with a `REQUIRE SSL` clause, or use `ALTER USER` for an existing account to add a `REQUIRE SSL`

clause. This causes connection attempts by clients that use the account to be rejected unless MySQL supports encrypted connections and an encrypted connection can be established.

The `REQUIRE` clause permits other encryption-related options, which can be used to enforce security requirements stricter than `REQUIRE SSL`. For additional details about which command options may or must be specified by clients that connect using accounts configured using the various `REQUIRE` options, see [CREATE USER SSL/TLS Options](#).

To specify additional parameters for encrypted connections, consider setting at least the `ssl_cert` and `ssl_key` system variables on the server side and the `--ssl-ca` option on the client side. See [Section 6.3.1, “Configuring MySQL to Use Encrypted Connections”](#), which also describes server capabilities for certificate and key file autogeneration and autodiscovery.

- `--ssl-ca=file_name`

Command-Line Format	<code>--ssl-ca=file_name</code>
Type	File name

The path name of the Certificate Authority (CA) certificate file in PEM format. The file contains a list of trusted SSL Certificate Authorities.

To tell the client not to authenticate the server certificate when establishing an encrypted connection to the server, specify neither `--ssl-ca` nor `--ssl-capath`. The server still verifies the client according to any applicable requirements established for the client account, and it still uses any `ssl_ca` or `ssl_capath` system variable values specified on the server side.

To specify the CA file for the server, set the `ssl_ca` system variable.

- `--ssl-capath=dir_name`

Command-Line Format	<code>--ssl-capath=dir_name</code>
Type	Directory name

The path name of the directory that contains trusted SSL certificate authority (CA) certificate files in PEM format. Support for this capability depends on the SSL library used to compile MySQL; see [Section 6.3.4, “SSL Library-Dependent Capabilities”](#).

To tell the client not to authenticate the server certificate when establishing an encrypted connection to the server, specify neither `--ssl-ca` nor `--ssl-capath`. The server still verifies the client according to any applicable requirements established for the client account, and it still uses any `ssl_ca` or `ssl_capath` system variable values specified on the server side.

To specify the CA directory for the server, set the `ssl_capath` system variable.

- `--ssl-cert=file_name`

Command-Line Format	<code>--ssl-cert=file_name</code>
Type	File name

The path name of the client SSL public key certificate file in PEM format.

To specify the server SSL public key certificate file, set the `ssl_cert` system variable.



- `--ssl-cipher=cipher_list`

Command-Line Format	<code>--ssl-cipher=name</code>
Type	String

The list of permissible ciphers for connection encryption. If no cipher in the list is supported, encrypted connections do not work.

For greatest portability, `cipher_list` should be a list of one or more cipher names, separated by colons. This format is understood both by OpenSSL and yaSSL. Examples:

```
--ssl-cipher=AES128-SHA
--ssl-cipher=DHE-RSA-AES128-GCM-SHA256:AES128-SHA
```

OpenSSL supports a more flexible syntax for specifying ciphers, as described in the OpenSSL documentation at <https://www.openssl.org/docs/manmaster/man1/ciphers.html>. yaSSL does not, so attempts to use that extended syntax fail for a MySQL distribution compiled using yaSSL.

For information about which encryption ciphers MySQL supports, see [Section 6.3.2, “Encrypted Connection TLS Protocols and Ciphers”](#).

To specify the encryption ciphers for the server, set the `ssl_cipher` system variable.

- `--ssl-crl=file_name`

Command-Line Format	<code>--ssl-crl=file_name</code>
Type	File name

The path name of the file containing certificate revocation lists in PEM format. Support for revocation-list capability depends on the SSL library used to compile MySQL. See [Section 6.3.4, “SSL Library-Dependent Capabilities”](#).

If neither `--ssl-crl` nor `--ssl-crlpath` is given, no CRL checks are performed, even if the CA path contains certificate revocation lists.

To specify the revocation-list file for the server, set the `ssl_crl` system variable.

- `--ssl-crlpath=dir_name`

Command-Line Format	<code>--ssl-crlpath=dir_name</code>
Type	Directory name

The path name of the directory that contains certificate revocation-list files in PEM format. Support for revocation-list capability depends on the SSL library used to compile MySQL. See [Section 6.3.4, “SSL Library-Dependent Capabilities”](#).

If neither `--ssl-crl` nor `--ssl-crlpath` is given, no CRL checks are performed, even if the CA path contains certificate revocation lists.

To specify the revocation-list directory for the server, set the `ssl_crlpath` system variable.

- `--ssl-key=file_name`

Command-Line Format	<code>--ssl-key=file_name</code>
Type	File name

The path name of the client SSL private key file in PEM format. For better security, use a certificate with an RSA key size of at least 2048 bits.

If the key file is protected by a passphrase, the client program prompts the user for the passphrase. The password must be given interactively; it cannot be stored in a file. If the passphrase is incorrect, the program continues as if it could not read the key.

To specify the server SSL private key file, set the `ssl_key` system variable.

- `--ssl-mode=mode`

Command-Line Format	<code>--ssl-mode=mode</code>
Introduced	5.7.11
Type	Enumeration
Default Value	<code>PREFERRED</code>
Valid Values	<code>DISABLED</code> <code>PREFERRED</code> <code>REQUIRED</code> <code>VERIFY_CA</code> <code>VERIFY_IDENTITY</code>

This option specifies the desired security state of the connection to the server. These mode values are permissible, in order of increasing strictness:

- `DISABLED`: Establish an unencrypted connection. This is like the legacy `--ssl=0` option or its synonyms (`--skip-ssl`, `--disable-ssl`).
- `PREFERRED`: Establish an encrypted connection if the server supports encrypted connections, falling back to an unencrypted connection if an encrypted connection cannot be established. This is the default if `--ssl-mode` is not specified.

Connections over Unix socket files are not encrypted with a mode of `PREFERRED`. To enforce encryption for Unix socket-file connections, use a mode of `REQUIRED` or stricter. (However, socket-file transport is secure by default, so encrypting a socket-file connection makes it no more secure and increases CPU load.)

- `REQUIRED`: Establish an encrypted connection if the server supports encrypted connections. The connection attempt fails if an encrypted connection cannot be established.
- `VERIFY_CA`: Like `REQUIRED`, but additionally verify the server Certificate Authority (CA) certificate against the configured CA certificates. The connection attempt fails if no valid matching CA certificates are found.

- `VERIFY_IDENTITY`: Like `VERIFY_CA`, but additionally perform host name identity verification by checking the host name the client uses for connecting to the server against the identity in the certificate that the server sends to the client:
  - As of MySQL 5.7.23, if the client uses OpenSSL 1.0.2 or higher, the client checks whether the host name that it uses for connecting matches either the Subject Alternative Name value or the Common Name value in the server certificate. Host name identity verification also works with certificates that specify the Common Name using wildcards.
  - Otherwise, the client checks whether the host name that it uses for connecting matches the Common Name value in the server certificate.

The connection fails if there is a mismatch. For encrypted connections, this option helps prevent man-in-the-middle attacks. This is like the legacy `--ssl-verify-server-cert` option.



#### Note

Host name identity verification with `VERIFY_IDENTITY` does not work with self-signed certificates that are created automatically by the server or manually using `mysql_ssl_rsa_setup` (see [Section 6.3.3.1, “Creating SSL and RSA Certificates and Keys using MySQL”](#)). Such self-signed certificates do not contain the server name as the Common Name value.



#### Important

The default setting, `--ssl-mode=PREFERRED`, produces an encrypted connection if the other default settings are unchanged. However, to help prevent sophisticated man-in-the-middle attacks, it is important for the client to verify the server’s identity. The settings `--ssl-mode=VERIFY_CA` and `--ssl-mode=VERIFY_IDENTITY` are a better choice than the default setting to help prevent this type of attack. To implement one of these settings, you must first ensure that the CA certificate for the server is reliably available to all the clients that use it in your environment, otherwise availability issues will result. For this reason, they are not the default setting.

The `--ssl-mode` option interacts with CA certificate options as follows:

- If `--ssl-mode` is not explicitly set otherwise, use of `--ssl-ca` or `--ssl-capath` implies `--ssl-mode=VERIFY_CA`.
- For `--ssl-mode` values of `VERIFY_CA` or `VERIFY_IDENTITY`, `--ssl-ca` or `--ssl-capath` is also required, to supply a CA certificate that matches the one used by the server.
- An explicit `--ssl-mode` option with a value other than `VERIFY_CA` or `VERIFY_IDENTITY`, together with an explicit `--ssl-ca` or `--ssl-capath` option, produces a warning that no verification of the server certificate is performed, despite a CA certificate option being specified.

The `--ssl-mode` option was added in MySQL 5.7.11.

To require use of encrypted connections by a MySQL account, use `CREATE USER` to create the account with a `REQUIRE SSL` clause, or use `ALTER USER` for an existing account to add a `REQUIRE SSL`

clause. This causes connection attempts by clients that use the account to be rejected unless MySQL supports encrypted connections and an encrypted connection can be established.

The `REQUIRE` clause permits other encryption-related options, which can be used to enforce security requirements stricter than `REQUIRE SSL`. For additional details about which command options may or must be specified by clients that connect using accounts configured using the various `REQUIRE` options, see [CREATE USER SSL/TLS Options](#).

- `--ssl-verify-server-cert`

Command-Line Format	<code>--ssl-verify-server-cert</code>
Type	Boolean
Default Value	<code>FALSE</code>



#### Note

The `--ssl-verify-server-cert` option is deprecated as of MySQL 5.7.11 and is removed in MySQL 8.0. Use `--ssl-mode=VERIFY_IDENTITY` instead.

This option causes the client to perform host name identity verification by checking the host name the client uses for connecting to the server against the identity in the certificate that the server sends to the client:

- As of MySQL 5.7.23, if the client uses OpenSSL 1.0.2 or higher, the client checks whether the host name that it uses for connecting matches either the Subject Alternative Name value or the Common Name value in the server certificate.
- Otherwise, the client checks whether the host name that it uses for connecting matches the Common Name value in the server certificate.

The connection fails if there is a mismatch. For encrypted connections, this option helps prevent man-in-the-middle attacks. Host name identity verification is disabled by default.



#### Note

Host name identity verification does not work with self-signed certificates created automatically by the server, or manually using `mysql_ssl_rsa_setup` (see [Section 6.3.3.1, “Creating SSL and RSA Certificates and Keys using MySQL”](#)). Such self-signed certificates do not contain the server name as the Common Name value.

Host name identity verification also does not work with certificates that specify the Common Name using wildcards because that name is compared verbatim to the server name.

- `--tls-version=protocol_list`

Command-Line Format	<code>--tls-version=protocol_list</code>
Introduced	5.7.10
Type	String
Default Value (≥ 5.7.28)	<code>TLSv1, TLSv1.1, TLSv1.2</code>
Default Value (≤ 5.7.27)	<code>TLSv1, TLSv1.1, TLSv1.2 (OpenSSL)</code>

<code>TLSv1, TLSv1.1</code> (yaSSL)
-------------------------------------

This option specifies the TLS protocols the client permits for encrypted connections. The value is a list of one or more comma-separated protocol versions. For example:

```
mysql --tls-version="TLSv1.1,TLSv1.2"
```

The protocols that can be named for this option depend on the SSL library used to compile MySQL. Permitted protocols should be chosen such as not to leave “holes” in the list. For example, these values do not have holes:

```
--tls-version="TLSv1,TLSv1.1,TLSv1.2"
--tls-version="TLSv1.1,TLSv1.2"
--tls-version="TLSv1.2"
```

This value does have a hole and should not be used:

```
--tls-version="TLSv1,TLSv1.2"
```

For details, see [Section 6.3.2, “Encrypted Connection TLS Protocols and Ciphers”](#).

This option was added in MySQL 5.7.10.

To specify which TLS protocols the server permits, set the `tls_version` system variable.

## 4.2.4 Connecting to the MySQL Server Using Command Options

This section describes use of command-line options to specify how to establish connections to the MySQL server, for clients such as `mysql` or `mysqldump`. For additional information if you are unable to connect, see [Section 6.2.17, “Troubleshooting Problems Connecting to MySQL”](#).

For a client program to connect to the MySQL server, it must use the proper connection parameters, such as the name of the host where the server is running and the user name and password of your MySQL account. Each connection parameter has a default value, but you can override default values as necessary using program options specified either on the command line or in an option file.

The examples here use the `mysql` client program, but the principles apply to other clients such as `mysqldump`, `mysqladmin`, or `mysqlshow`.

This command invokes `mysql` without specifying any explicit connection parameters:

```
mysql
```

Because there are no parameter options, the default values apply:

- The default host name is `localhost`. On Unix, this has a special meaning, as described later.
- The default user name is `ODBC` on Windows or your Unix login name on Unix.
- No password is sent because neither `--password` nor `-p` is given.
- For `mysql`, the first nonoption argument is taken as the name of the default database. Because there is no such argument, `mysql` selects no default database.

To specify the host name and user name explicitly, as well as a password, supply appropriate options on the command line. To select a default database, add a database-name argument. Examples:

```
mysql --host=localhost --user=myname --password=password mydb
```

```
mysql -h localhost -u myname -ppassword mydb
```

For password options, the password value is optional:

- If you use a `--password` or `-p` option and specify a password value, there must be *no space* between `--password=` or `-p` and the password following it.
- If you use `--password` or `-p` but do not specify a password value, the client program prompts you to enter the password. The password is not displayed as you enter it. This is more secure than giving the password on the command line, which might enable other users on your system to see the password line by executing a command such as `ps`. See [Section 6.1.2.1, “End-User Guidelines for Password Security”](#).
- To explicitly specify that there is no password and that the client program should not prompt for one, use the `--skip-password` option.

As just mentioned, including the password value on the command line is a security risk. To avoid this risk, specify the `--password` or `-p` option without any following password value:

```
mysql --host=localhost --user=myname --password mydb
mysql -h localhost -u myname -p mydb
```

When the `--password` or `-p` option is given with no password value, the client program prints a prompt and waits for you to enter the password. (In these examples, `mydb` is *not* interpreted as a password because it is separated from the preceding password option by a space.)

On some systems, the library routine that MySQL uses to prompt for a password automatically limits the password to eight characters. That limitation is a property of the system library, not MySQL. Internally, MySQL does not have any limit for the length of the password. To work around the limitation on systems affected by it, specify your password in an option file (see [Section 4.2.2.2, “Using Option Files”](#)). Another workaround is to change your MySQL password to a value that has eight or fewer characters, but that has the disadvantage that shorter passwords tend to be less secure.

Client programs determine what type of connection to make as follows:

- If the host is not specified or is `localhost`, a connection to the local host occurs:
  - On Windows, the client connects using shared memory, if the server was started with the `shared_memory` system variable enabled to support shared-memory connections.
  - On Unix, MySQL programs treat the host name `localhost` specially, in a way that is likely different from what you expect compared to other network-based programs: the client connects using a Unix socket file. The `--socket` option or the `MYSQL_UNIX_PORT` environment variable may be used to specify the socket name.
- On Windows, if `host` is `.` (period), or TCP/IP is not enabled and `--socket` is not specified or the host is empty, the client connects using a named pipe, if the server was started with the `named_pipe` system variable enabled to support named-pipe connections. If named-pipe connections are not supported or if the user making the connection is not a member of the Windows group specified by the `named_pipe_full_access_group` system variable, an error occurs.
- Otherwise, the connection uses TCP/IP.

The `--protocol` option enables you to use a particular transport protocol even when other options normally result in use of a different protocol. That is, `--protocol` specifies the transport protocol explicitly and overrides the preceding rules, even for `localhost`.

Only connection options that are relevant to the selected transport protocol are used or checked. Other connection options are ignored. For example, with `--host=localhost` on Unix, the client attempts to

connect to the local server using a Unix socket file, even if a `--port` or `-P` option is given to specify a TCP/IP port number.

To ensure that the client makes a TCP/IP connection to the local server, use `--host` or `-h` to specify a host name value of `127.0.0.1` (instead of `localhost`), or the IP address or name of the local server. You can also specify the transport protocol explicitly, even for `localhost`, by using the `--protocol=TCP` option. Examples:

```
mysql --host=127.0.0.1
mysql --protocol=TCP
```

If the server is configured to accept IPv6 connections, clients can connect to the local server over IPv6 using `--host>:::1`. See [Section 5.1.12, “IPv6 Support”](#).

On Windows, to force a MySQL client to use a named-pipe connection, specify the `--pipe` or `--protocol=PIPE` option, or specify `.` (period) as the host name. If the server was not started with the `named_pipe` system variable enabled to support named-pipe connections or if the user making the connection is not a member of the Windows group specified by the `named_pipe_full_access_group` system variable, an error occurs. Use the `--socket` option to specify the name of the pipe if you do not want to use the default pipe name.

Connections to remote servers use TCP/IP. This command connects to the server running on `remote.example.com` using the default port number (3306):

```
mysql --host=remote.example.com
```

To specify a port number explicitly, use the `--port` or `-P` option:

```
mysql --host=remote.example.com --port=13306
```

You can specify a port number for connections to a local server, too. However, as indicated previously, connections to `localhost` on Unix use a socket file by default, so unless you force a TCP/IP connection as previously described, any option that specifies a port number is ignored.

For this command, the program uses a socket file on Unix and the `--port` option is ignored:

```
mysql --port=13306 --host=localhost
```

To cause the port number to be used, force a TCP/IP connection. For example, invoke the program in either of these ways:

```
mysql --port=13306 --host=127.0.0.1
mysql --port=13306 --protocol=TCP
```

For additional information about options that control how client programs establish connections to the server, see [Section 4.2.3, “Command Options for Connecting to the Server”](#).

It is possible to specify connection parameters without entering them on the command line each time you invoke a client program:

- Specify the connection parameters in the `[client]` section of an option file. The relevant section of the file might look like this:

```
[client]
host=host_name
user=user_name
password=password
```

For more information, see [Section 4.2.2.2, “Using Option Files”](#).

- Some connection parameters can be specified using environment variables. Examples:
  - To specify the host for `mysql`, use `MYSQL_HOST`.
  - On Windows, to specify the MySQL user name, use `USER`.
  - To specify the password, use `MYSQL_PWD`. However, this is insecure; see [Section 6.1.2.1, “End-User Guidelines for Password Security”](#).

For a list of supported environment variables, see [Section 4.9, “Environment Variables”](#).

## 4.2.5 Connection Transport Protocols

For programs that use the MySQL client library (for example, `mysql` and `mysqldump`), MySQL supports connections to the server based on several transport protocols: TCP/IP, Unix socket file, named pipe, and shared memory. This section describes how to select these protocols, and how they are similar and different.

- [Transport Protocol Selection](#)
- [Transport Support for Local and Remote Connections](#)
- [Interpretation of localhost](#)
- [Encryption and Security Characteristics](#)
- [Connection Compression](#)

### Transport Protocol Selection

For a given connection, if the transport protocol is not specified explicitly, it is determined implicitly. For example, connections to `localhost` result in a socket file connection on Unix and Unix-like systems, and a TCP/IP connection to `127.0.0.1` otherwise. For additional information, see [Section 4.2.4, “Connecting to the MySQL Server Using Command Options”](#).

To specify the protocol explicitly, use the `--protocol` command option. The following table shows the permissible values for `--protocol` and indicates the applicable platforms for each value. The values are not case-sensitive.

<code>--protocol</code> Value	Transport Protocol Used	Applicable Platforms
TCP	TCP/IP	All
SOCKET	Unix socket file	Unix and Unix-like systems
PIPE	Named pipe	Windows
MEMORY	Shared memory	Windows

### Transport Support for Local and Remote Connections

TCP/IP transport supports connections to local or remote MySQL servers.

Socket-file, named-pipe, and shared-memory transports support connections only to local MySQL servers. (Named-pipe transport does allow for remote connections, but this capability is not implemented in MySQL.)



## Interpretation of localhost

If the transport protocol is not specified explicitly, `localhost` is interpreted as follows:

- On Unix and Unix-like systems, a connection to `localhost` results in a socket-file connection.
- Otherwise, a connection to `localhost` results in a TCP/IP connection to `127.0.0.1`.

If the transport protocol is specified explicitly, `localhost` is interpreted with respect to that protocol. For example, with `--protocol=TCP`, a connection to `localhost` results in a TCP/IP connection to `127.0.0.1` on all platforms.

## Encryption and Security Characteristics

TCP/IP and socket-file transports are subject to TLS/SSL encryption, using the options described in [Command Options for Encrypted Connections](#). Named-pipe and shared-memory transports are not subject to TLS/SSL encryption.

A connection is secure by default if made over a transport protocol that is secure by default. Otherwise, for protocols that are subject to TLS/SSL encryption, a connection may be made secure using encryption:

- TCP/IP connections are not secure by default, but can be encrypted to make them secure.
- Socket-file connections are secure by default. They can also be encrypted, but encrypting a socket-file connection makes it no more secure and increases CPU load.
- Named-pipe connections are not secure by default, and are not subject to encryption to make them secure. However, the `named_pipe_full_access_group` system variable is available to control which MySQL users are permitted to use named-pipe connections.
- Shared-memory connections are secure by default.

If the `require_secure_transport` system variable is enabled, the server permits only connections that use some form of secure transport. Per the preceding remarks, connections that use TCP/IP encrypted using TLS/SSL, a socket file, or shared memory are secure connections. TCP/IP connections not encrypted using TLS/SSL and named-pipe connections are not secure.

See also [Configuring Encrypted Connections as Mandatory](#).

## Connection Compression

All transport protocols are subject to use of compression on the traffic between the client and server. If both compression and encryption are used for a given connection, compression occurs before encryption. For more information, see [Section 4.2.6, “Connection Compression Control”](#).

### 4.2.6 Connection Compression Control

Connections to the server can use compression on the traffic between client and server to reduce the number of bytes sent over the connection. By default, connections are uncompressed, but can be compressed if the server and the client both support compression.

Compressed connections originate on the client side but affect CPU load on both the client and server sides because both sides perform compression and decompression operations. Because enabling compression decreases performance, its benefits occur primarily when there is low network bandwidth, network transfer time dominates the cost of compression and decompression operations, and result sets are large.

Compression control applies to connections to the server by client programs and by servers participating in source/replica replication. Compression control does not apply to Group Replication connections, X Protocol connections, or connections for `FEDERATED` tables.

These configuration parameters are available for controlling connection compression:

- Client programs support a `--compress` command-line option to specify use of compression for the connection to the server.
- For programs that use the MySQL C API, enabling the `MYSQL_OPT_COMPRESS` option for the `mysql_options()` function specifies use of compression for the connection to the server.
- For source/replica replication, enabling the `slave_compressed_protocol` system variable specifies use of compression for replica connections to the source.

In each case, when use of compression is specified, the connection uses the `zlib` compression algorithm if both sides support it, with fallback to an uncompressed connection otherwise.

## 4.2.7 Setting Environment Variables

Environment variables can be set at the command prompt to affect the current invocation of your command processor, or set permanently to affect future invocations. To set a variable permanently, you can set it in a startup file or by using the interface provided by your system for this purpose. Consult the documentation for your command interpreter for specific details. [Section 4.9, “Environment Variables”](#), lists all environment variables that affect MySQL program operation.

To specify a value for an environment variable, use the syntax appropriate for your command processor. For example, on Windows, you can set the `USER` variable to specify your MySQL account name. To do so, use this syntax:

```
SET USER=your_name
```

The syntax on Unix depends on your shell. Suppose that you want to specify the TCP/IP port number using the `MYSQL_TCP_PORT` variable. Typical syntax (such as for `sh`, `ksh`, `bash`, `zsh`, and so on) is as follows:

```
MYSQL_TCP_PORT=3306  
export MYSQL_TCP_PORT
```

The first command sets the variable, and the `export` command exports the variable to the shell environment so that its value becomes accessible to MySQL and other processes.

For `csh` and `tcsh`, use `setenv` to make the shell variable available to the environment:

```
setenv MYSQL_TCP_PORT 3306
```

The commands to set environment variables can be executed at your command prompt to take effect immediately, but the settings persist only until you log out. To have the settings take effect each time you log in, use the interface provided by your system or place the appropriate command or commands in a startup file that your command interpreter reads each time it starts.

On Windows, you can set environment variables using the System Control Panel (under Advanced).

On Unix, typical shell startup files are `.bashrc` or `.bash_profile` for `bash`, or `.tcshrc` for `tcsh`.

Suppose that your MySQL programs are installed in `/usr/local/mysql/bin` and that you want to make it easy to invoke these programs. To do this, set the value of the `PATH` environment variable to include that directory. For example, if your shell is `bash`, add the following line to your `.bashrc` file:

```
PATH=${PATH}:/usr/local/mysql/bin
```

`bash` uses different startup files for login and nonlogin shells, so you might want to add the setting to `.bashrc` for login shells and to `.bash_profile` for nonlogin shells to make sure that `PATH` is set regardless.

If your shell is `tcsh`, add the following line to your `.tcshrc` file:

```
setenv PATH ${PATH}:/usr/local/mysql/bin
```

If the appropriate startup file does not exist in your home directory, create it with a text editor.

After modifying your `PATH` setting, open a new console window on Windows or log in again on Unix so that the setting goes into effect.

## 4.3 Server and Server-Startup Programs

This section describes `mysqld`, the MySQL server, and several programs that are used to start the server.

### 4.3.1 `mysqld` — The MySQL Server

`mysqld`, also known as MySQL Server, is a single multithreaded program that does most of the work in a MySQL installation. It does not spawn additional processes. MySQL Server manages access to the MySQL data directory that contains databases and tables. The data directory is also the default location for other information such as log files and status files.



#### Note

Some installation packages contain a debugging version of the server named `mysqld-debug`. Invoke this version instead of `mysqld` for debugging support, memory allocation checking, and trace file support (see [Section 5.8.1.2, “Creating Trace Files”](#)).

When MySQL server starts, it listens for network connections from client programs and manages access to databases on behalf of those clients.

The `mysqld` program has many options that can be specified at startup. For a complete list of options, run this command:

```
mysqld --verbose --help
```

MySQL Server also has a set of system variables that affect its operation as it runs. System variables can be set at server startup, and many of them can be changed at runtime to effect dynamic server reconfiguration. MySQL Server also has a set of status variables that provide information about its operation. You can monitor these status variables to access runtime performance characteristics.

For a full description of MySQL Server command options, system variables, and status variables, see [Section 5.1, “The MySQL Server”](#). For information about installing MySQL and setting up the initial configuration, see [Chapter 2, \*Installing and Upgrading MySQL\*](#).

### 4.3.2 `mysqld_safe` — MySQL Server Startup Script

`mysqld_safe` is the recommended way to start a `mysqld` server on Unix. `mysqld_safe` adds some safety features such as restarting the server when an error occurs and logging runtime information to an error log. A description of error logging is given later in this section.

**Note**

For some Linux platforms, MySQL installation from RPM or Debian packages includes systemd support for managing MySQL server startup and shutdown. On these platforms, `mysql_safe` is not installed because it is unnecessary. For more information, see [Section 2.5.10, “Managing MySQL Server with systemd”](#).

One implication of the non-use of `mysql_safe` on platforms that use systemd for server management is that use of `[mysql_safe]` or `[safe_mysql]` sections in option files is not supported and might lead to unexpected behavior.

`mysql_safe` tries to start an executable named `mysqld`. To override the default behavior and specify explicitly the name of the server you want to run, specify a `--mysqld` or `--mysqld-version` option to `mysql_safe`. You can also use `--ledir` to indicate the directory where `mysql_safe` should look for the server.

Many of the options to `mysql_safe` are the same as the options to `mysqld`. See [Section 5.1.6, “Server Command Options”](#).

Options unknown to `mysql_safe` are passed to `mysqld` if they are specified on the command line, but ignored if they are specified in the `[mysql_safe]` group of an option file. See [Section 4.2.2.2, “Using Option Files”](#).

`mysql_safe` reads all options from the `[mysqld]`, `[server]`, and `[mysql_safe]` sections in option files. For example, if you specify a `[mysqld]` section like this, `mysql_safe` finds and uses the `--log-error` option:

```
[mysqld]
log-error=error.log
```

For backward compatibility, `mysql_safe` also reads `[safe_mysql]` sections, but to be current you should rename such sections to `[mysql_safe]`.

`mysql_safe` accepts options on the command line and in option files, as described in the following table. For information about option files used by MySQL programs, see [Section 4.2.2.2, “Using Option Files”](#).

**Table 4.6 mysql\_safe Options**

Option Name	Description	Introduced	Deprecated
<code>--basedir</code>	Path to MySQL installation directory		
<code>--core-file-size</code>	Size of core file that <code>mysqld</code> should be able to create		
<code>--datadir</code>	Path to data directory		
<code>--defaults-extra-file</code>	Read named option file in addition to usual option files		
<code>--defaults-file</code>	Read only named option file		
<code>--help</code>	Display help message and exit		
<code>--ledir</code>	Path to directory where server is located		

Option Name	Description	Introduced	Deprecated
<a href="#">--log-error</a>	Write error log to named file		
<a href="#">--malloc-lib</a>	Alternative malloc library to use for mysqld		
<a href="#">--mysqld</a>	Name of server program to start (in ledir directory)		
<a href="#">--mysqld-safe-log-timestamps</a>	Timestamp format for logging	5.7.11	
<a href="#">--mysqld-version</a>	Suffix for server program name		
<a href="#">--nice</a>	Use nice program to set server scheduling priority		
<a href="#">--no-defaults</a>	Read no option files		
<a href="#">--open-files-limit</a>	Number of files that mysqld should be able to open		
<a href="#">--pid-file</a>	Path name of server process ID file		
<a href="#">--plugin-dir</a>	Directory where plugins are installed		
<a href="#">--port</a>	Port number on which to listen for TCP/IP connections		
<a href="#">--skip-kill-mysqld</a>	Do not try to kill stray mysqld processes		
<a href="#">--skip-syslog</a>	Do not write error messages to syslog; use error log file		Yes
<a href="#">--socket</a>	Socket file on which to listen for Unix socket connections		
<a href="#">--syslog</a>	Write error messages to syslog		Yes
<a href="#">--syslog-tag</a>	Tag suffix for messages written to syslog		Yes
<a href="#">--timezone</a>	Set TZ time zone environment variable to named value		
<a href="#">--user</a>	Run mysqld as user having name user_name or numeric user ID user_id		

- [--help](#)

Command-Line Format	<a href="#">--help</a>
---------------------	------------------------

Command-Line Format	<code>--help</code>
---------------------	---------------------

Display a help message and exit.

- `--basedir=dir_name`

Command-Line Format	<code>--basedir=dir_name</code>
Type	Directory name

Command-Line Format	<code>--basedir=dir_name</code>
Type	Directory name

The path to the MySQL installation directory.

- `--core-file-size=size`

Command-Line Format	<code>--core-file-size=size</code>
Type	String

Command-Line Format	<code>--core-file-size=size</code>
Type	String

The size of the core file that `mysqld` should be able to create. The option value is passed to `ulimit -c`.

- `--datadir=dir_name`

Command-Line Format	<code>--datadir=dir_name</code>
Type	Directory name

Command-Line Format	<code>--datadir=dir_name</code>
Type	Directory name

The path to the data directory.

- `--defaults-extra-file=file_name`

Command-Line Format	<code>--defaults-extra-file=file_name</code>
Type	File name

Command-Line Format	<code>--defaults-extra-file=file_name</code>
Type	File name

Read this option file in addition to the usual option files. If the file does not exist or is otherwise inaccessible, the server exits with an error. If `file_name` is not an absolute path name, it is interpreted relative to the current directory. This must be the first option on the command line if it is used.

For additional information about this and other option-file options, see [Section 4.2.2.3, “Command-Line Options that Affect Option-File Handling”](#).

- `--defaults-file=file_name`

Command-Line Format	<code>--defaults-file=file_name</code>
Type	File name

Use only the given option file. If the file does not exist or is otherwise inaccessible, the server exits with an error. If `file_name` is not an absolute path name, it is interpreted relative to the current directory. This must be the first option on the command line if it is used.

For additional information about this and other option-file options, see [Section 4.2.2.3, “Command-Line Options that Affect Option-File Handling”](#).

- `--ledir=dir_name`

Command-Line Format	<code>--ledir=dir_name</code>
Type	Directory name

If `mysqld_safe` cannot find the server, use this option to indicate the path name to the directory where the server is located.

As of MySQL 5.7.17, this option is accepted only on the command line, not in option files. On platforms that use `systemd`, the value can be specified in the value of `MYSQLD_OPTS`. See [Section 2.5.10, “Managing MySQL Server with `systemd`”](#).

- `--log-error=file_name`

Command-Line Format	<code>--log-error=file_name</code>
Type	File name

Write the error log to the given file. See [Section 5.4.2, “The Error Log”](#).

- `--mysqld-safe-log-timestamps`

Command-Line Format	<code>--mysqld-safe-log-timestamps=type</code>
Introduced	5.7.11
Type	Enumeration
Default Value	<code>utc</code>
Valid Values	<code>system</code> <code>hyphen</code> <code>legacy</code>

This option controls the format for timestamps in log output produced by `mysqld_safe`. The following list describes the permitted values. For any other value, `mysqld_safe` logs a warning and uses `UTC` format.

- UTC, `utc`

ISO 8601 UTC format (same as `--log_timestamps=UTC` for the server). This is the default.

- SYSTEM, `system`

ISO 8601 local time format (same as `--log_timestamps=SYSTEM` for the server).

- HYPHEN, `hyphen`

`YY-MM-DD h:mm:ss` format, as in `mysql_d_safe` for MySQL 5.6.

- LEGACY, `legacy`

`YYMMDD hh:mm:ss` format, as in `mysql_d_safe` prior to MySQL 5.6.

This option was added in MySQL 5.7.11.

- `--malloc-lib=[lib_name]`

Command-Line Format	<code>--malloc-lib=[lib-name]</code>
Type	String

The name of the library to use for memory allocation instead of the system `malloc()` library. As of MySQL 5.7.15, the option value must be one of the directories `/usr/lib`, `/usr/lib64`, `/usr/lib/i386-linux-gnu`, or `/usr/lib/x86_64-linux-gnu`. Prior to MySQL 5.7.15, any library can be used by specifying its path name, but there is a shortcut form to enable use of the `tcmalloc` library that is shipped with binary MySQL distributions for Linux in MySQL 5.7. It is possible for the shortcut form not to work under certain configurations, in which case you should specify a path name instead.



#### Note

As of MySQL 5.7.13, MySQL distributions no longer include a `tcmalloc` library.

The `--malloc-lib` option works by modifying the `LD_PRELOAD` environment value to affect dynamic linking to enable the loader to find the memory-allocation library when `mysqld` runs:

- If the option is not given, or is given without a value (`--malloc-lib=`), `LD_PRELOAD` is not modified and no attempt is made to use `tcmalloc`.
- Prior to MySQL 5.7.31, if the option is given as `--malloc-lib=tcmalloc`, `mysqld_safe` looks for a `tcmalloc` library in `/usr/lib` and then in the MySQL `pkglibdir` location (for example, `/usr/local/mysql/lib` or whatever is appropriate). If `tmalloc` is found, its path name is added to the



beginning of the `LD_PRELOAD` value for `mysqld`. If `tcmalloc` is not found, `mysqld_safe` aborts with an error.

As of MySQL 5.7.31, `tcmalloc` is not a permitted value for the `--malloc-lib` option.

- If the option is given as `--malloc-lib=/path/to/some/library`, that full path is added to the beginning of the `LD_PRELOAD` value. If the full path points to a nonexistent or unreadable file, `mysqld_safe` aborts with an error.
- For cases where `mysqld_safe` adds a path name to `LD_PRELOAD`, it adds the path to the beginning of any existing value the variable already has.



**Note**

On systems that manage the server using `systemd`, `mysqld_safe` is not available. Instead, specify the allocation library by setting `LD_PRELOAD` in `/etc/sysconfig/mysql`.

Linux users can use the `libtcmalloc_minimal.so` included in binary packages by adding these lines to the `my.cnf` file:

```
[mysqld_safe]
malloc-lib=tcmalloc
```

Those lines also suffice for users on any platform who have installed a `tcmalloc` package in `/usr/lib`. To use a specific `tcmalloc` library, specify its full path name. Example:

```
[mysqld_safe]
malloc-lib=/opt/lib/libtcmalloc_minimal.so
```

- `--mysqld=prog_name`

Command-Line Format	<code>--mysqld=file_name</code>
Type	File name

The name of the server program (in the `ledir` directory) that you want to start. This option is needed if you use the MySQL binary distribution but have the data directory outside of the binary distribution. If `mysqld_safe` cannot find the server, use the `--ledir` option to indicate the path name to the directory where the server is located.

As of MySQL 5.7.15, this option is accepted only on the command line, not in option files. On platforms that use `systemd`, the value can be specified in the value of `MYSQLD_OPTS`. See [Section 2.5.10, “Managing MySQL Server with systemd”](#).

- `--mysqld-version=suffix`

Command-Line Format	<code>--mysqld-version=suffix</code>
Type	String

This option is similar to the `--mysqld` option, but you specify only the suffix for the server program name. The base name is assumed to be `mysqld`. For example, if you use `--mysqld-`

`version=debug`, `mysql_safe` starts the `mysqld-debug` program in the `ledir` directory. If the argument to `--mysqld-version` is empty, `mysql_safe` uses `mysqld` in the `ledir` directory.

As of MySQL 5.7.15, this option is accepted only on the command line, not in option files. On platforms that use `systemd`, the value can be specified in the value of `MYSQLD_OPTS`. See [Section 2.5.10, “Managing MySQL Server with `systemd`”](#).

- `--nice=priority`

Command-Line Format	<code>--nice=priority</code>
Type	Numeric

Use the `nice` program to set the server's scheduling priority to the given value.

- `--no-defaults`

Command-Line Format	<code>--no-defaults</code>
Type	String

Do not read any option files. If program startup fails due to reading unknown options from an option file, `--no-defaults` can be used to prevent them from being read. This must be the first option on the command line if it is used.

For additional information about this and other option-file options, see [Section 4.2.2.3, “Command-Line Options that Affect Option-File Handling”](#).

- `--open-files-limit=count`

Command-Line Format	<code>--open-files-limit=count</code>
Type	String

The number of files that `mysqld` should be able to open. The option value is passed to `ulimit -n`.



#### Note

You must start `mysql_safe` as `root` for this to function properly.

- `--pid-file=file_name`

Command-Line Format	<code>--pid-file=file_name</code>
Type	File name

The path name that `mysqld` should use for its process ID file.

From MySQL 5.7.2 to 5.7.17, `mysql_safe` has its own process ID file, which is always named `mysql_safe.pid` and located in the MySQL data directory.

- `--plugin-dir=dir_name`

Command-Line Format	<code>--plugin-dir=dir_name</code>
---------------------	------------------------------------

Type	Directory name
------	----------------

The path name of the plugin directory.

- `--port=port_num`

Command-Line Format	<code>--port=number</code>
Type	Numeric

The port number that the server should use when listening for TCP/IP connections. The port number must be 1024 or higher unless the server is started by the `root` operating system user.

- `--skip-kill-mysqld`

Command-Line Format	<code>--skip-kill-mysqld</code>
---------------------	---------------------------------

Do not try to kill stray `mysqld` processes at startup. This option works only on Linux.

- `--socket=path`

Command-Line Format	<code>--socket=file_name</code>
Type	File name

The Unix socket file that the server should use when listening for local connections.

- `--syslog, --skip-syslog`

Command-Line Format	<code>--syslog</code>
Deprecated	Yes

Command-Line Format	<code>--skip-syslog</code>
Deprecated	Yes

`--syslog` causes error messages to be sent to `syslog` on systems that support the `logger` program. `--skip-syslog` suppresses the use of `syslog`; messages are written to an error log file.

When `syslog` is used for error logging, the `daemon.err` facility/severity is used for all log messages.

Using these options to control `mysqld` logging is deprecated as of MySQL 5.7.5. Use the server `log_syslog` system variable instead. To control the facility, use the server `log_syslog_facility` system variable. See [Section 5.4.2.3, “Error Logging to the System Log”](#).

- `--syslog-tag=tag`

Deprecated	Yes
------------	-----

For logging to `syslog`, messages from `mysqld_safe` and `mysqld` are written with identifiers of `mysqld_safe` and `mysqld`, respectively. To specify a suffix for the identifiers, use `--syslog-tag=tag`, which modifies the identifiers to be `mysqld_safe-tag` and `mysqld-tag`.

Using this option to control `mysqld` logging is deprecated as of MySQL 5.7.5. Use the server `log_syslog_tag` system variable instead. See [Section 5.4.2.3, “Error Logging to the System Log”](#).

- `--timezone=timezone`

Command-Line Format	<code>--timezone=timezone</code>
Type	String

Set the `TZ` time zone environment variable to the given option value. Consult your operating system documentation for legal time zone specification formats.

- `--user={user_name|user_id}`

Command-Line Format	<code>--user={user_name user_id}</code>
Type	String
Type	Numeric

Run the `mysqld` server as the user having the name `user_name` or the numeric user ID `user_id`. (“User” in this context refers to a system login account, not a MySQL user listed in the grant tables.)

If you execute `mysqld_safe` with the `--defaults-file` or `--defaults-extra-file` option to name an option file, the option must be the first one given on the command line or the option file is not used. For example, this command does not use the named option file:

```
mysql> mysqld_safe --port=port_num --defaults-file=file_name
```

Instead, use the following command:

```
mysql> mysqld_safe --defaults-file=file_name --port=port_num
```

The `mysqld_safe` script is written so that it normally can start a server that was installed from either a source or a binary distribution of MySQL, even though these types of distributions typically install the server in slightly different locations. (See [Section 2.1.5, “Installation Layouts”](#).) `mysqld_safe` expects one of the following conditions to be true:

- The server and databases can be found relative to the working directory (the directory from which `mysqld_safe` is invoked). For binary distributions, `mysqld_safe` looks under its working directory for `bin` and `data` directories. For source distributions, it looks for `libexec` and `var` directories. This condition should be met if you execute `mysqld_safe` from your MySQL installation directory (for example, `/usr/local/mysql` for a binary distribution).
- If the server and databases cannot be found relative to the working directory, `mysqld_safe` attempts to locate them by absolute path names. Typical locations are `/usr/local/libexec` and `/usr/local/var`. The actual locations are determined from the values configured into the distribution at the time it was built. They should be correct if MySQL is installed in the location specified at configuration time.

Because `mysqld_safe` tries to find the server and databases relative to its own working directory, you can install a binary distribution of MySQL anywhere, as long as you run `mysqld_safe` from the MySQL installation directory:

```
cd mysql_installation_directory
bin/mysqld_safe &
```

If `mysqld_safe` fails, even when invoked from the MySQL installation directory, specify the `--ledir` and `--datadir` options to indicate the directories in which the server and databases are located on your system.

`mysqld_safe` tries to use the `sleep` and `date` system utilities to determine how many times per second it has attempted to start. If these utilities are present and the attempted starts per second is greater than 5, `mysqld_safe` waits 1 full second before starting again. This is intended to prevent excessive CPU usage in the event of repeated failures. (Bug #11761530, Bug #54035)

When you use `mysqld_safe` to start `mysqld`, `mysqld_safe` arranges for error (and notice) messages from itself and from `mysqld` to go to the same destination.

There are several `mysqld_safe` options for controlling the destination of these messages:

- `--log-error=filename`: Write error messages to the named error file.
- `--syslog`: Write error messages to `syslog` on systems that support the `logger` program.
- `--skip-syslog`: Do not write error messages to `syslog`. Messages are written to the default error log file (`hostname.err` in the data directory), or to a named file if the `--log-error` option is given.

If none of these options is given, the default is `--skip-syslog`.

When `mysqld_safe` writes a message, notices go to the logging destination (`syslog` or the error log file) and `stdout`. Errors go to the logging destination and `stderr`.



#### Note

Controlling `mysqld` logging from `mysqld_safe` is deprecated as of MySQL 5.7.5. Use the server's native `syslog` support instead. For more information, see [Section 5.4.2.3, “Error Logging to the System Log”](#).

### 4.3.3 mysql.server — MySQL Server Startup Script

MySQL distributions on Unix and Unix-like system include a script named `mysql.server`, which starts the MySQL server using `mysqld_safe`. It can be used on systems such as Linux and Solaris that use System V-style run directories to start and stop system services. It is also used by the macOS Startup Item for MySQL.

`mysql.server` is the script name as used within the MySQL source tree. The installed name might be different (for example, `mysqld` or `mysql`). In the following discussion, adjust the name `mysql.server` as appropriate for your system.



#### Note

For some Linux platforms, MySQL installation from RPM or Debian packages includes `systemd` support for managing MySQL server startup and shutdown. On these platforms, `mysql.server` and `mysqld_safe` are not installed because they

are unnecessary. For more information, see [Section 2.5.10, “Managing MySQL Server with systemd”](#).

To start or stop the server manually using the `mysql.server` script, invoke it from the command line with `start` or `stop` arguments:

```
mysql.server start
mysql.server stop
```

`mysql.server` changes location to the MySQL installation directory, then invokes `mysqld_safe`. To run the server as some specific user, add an appropriate `user` option to the `[mysqld]` group of the global `/etc/my.cnf` option file, as shown later in this section. (It is possible that you must edit `mysql.server` if you've installed a binary distribution of MySQL in a nonstandard location. Modify it to change location into the proper directory before it runs `mysqld_safe`. If you do this, your modified version of `mysql.server` may be overwritten if you upgrade MySQL in the future; make a copy of your edited version that you can reinstall.)

`mysql.server stop` stops the server by sending a signal to it. You can also stop the server manually by executing `mysqldadmin shutdown`.

To start and stop MySQL automatically on your server, you must add start and stop commands to the appropriate places in your `/etc/rc*` files:

- If you use the Linux server RPM package (`MySQL-server-VERSION.rpm`), or a native Linux package installation, the `mysql.server` script may be installed in the `/etc/init.d` directory with the name `mysqld` or `mysql`. See [Section 2.5.5, “Installing MySQL on Linux Using RPM Packages from Oracle”](#), for more information on the Linux RPM packages.
- If you install MySQL from a source distribution or using a binary distribution format that does not install `mysql.server` automatically, you can install the script manually. It can be found in the `support-files` directory under the MySQL installation directory or in a MySQL source tree. Copy the script to the `/etc/init.d` directory with the name `mysql` and make it executable:

```
cp mysql.server /etc/init.d/mysql
chmod +x /etc/init.d/mysql
```

After installing the script, the commands needed to activate it to run at system startup depend on your operating system. On Linux, you can use `chkconfig`:

```
chkconfig --add mysql
```

On some Linux systems, the following command also seems to be necessary to fully enable the `mysql` script:

```
chkconfig --level 345 mysql on
```

- On FreeBSD, startup scripts generally should go in `/usr/local/etc/rc.d/`. Install the `mysql.server` script as `/usr/local/etc/rc.d/mysql.server.sh` to enable automatic startup. The `rc(8)` manual page states that scripts in this directory are executed only if their base name matches the `*.sh` shell file name pattern. Any other files or directories present within the directory are silently ignored.
- As an alternative to the preceding setup, some operating systems also use `/etc/rc.local` or `/etc/init.d/boot.local` to start additional services on startup. To start up MySQL using this method, append a command like the one following to the appropriate startup file:

```
/bin/sh -c 'cd /usr/local/mysql; ./bin/mysqld_safe --user=mysql &'
```

- For other systems, consult your operating system documentation to see how to install startup scripts.

`mysql.server` reads options from the `[mysql.server]` and `[mysqld]` sections of option files. For backward compatibility, it also reads `[mysql_server]` sections, but to be current you should rename such sections to `[mysql.server]`.

You can add options for `mysql.server` in a global `/etc/my.cnf` file. A typical `my.cnf` file might look like this:

```
[mysqld]
datadir=/usr/local/mysql/var
socket=/var/tmp/mysql.sock
port=3306
user=mysql

[mysql.server]
basedir=/usr/local/mysql
```

The `mysql.server` script supports the options shown in the following table. If specified, they *must* be placed in an option file, not on the command line. `mysql.server` supports only `start` and `stop` as command-line arguments.

**Table 4.7 mysql.server Option-File Options**

Option Name	Description	Type
<code>basedir</code>	Path to MySQL installation directory	Directory name
<code>datadir</code>	Path to MySQL data directory	Directory name
<code>pid-file</code>	File in which server should write its process ID	File name
<code>service-startup-timeout</code>	How long to wait for server startup	Integer

- `basedir=dir_name`

The path to the MySQL installation directory.

- `datadir=dir_name`

The path to the MySQL data directory.

- `pid-file=file_name`

The path name of the file in which the server should write its process ID. The server creates the file in the data directory unless an absolute path name is given to specify a different directory.

If this option is not given, `mysql.server` uses a default value of `host_name.pid`. The PID file value passed to `mysqld_safe` overrides any value specified in the `[mysqld_safe]` option file group. Because `mysql.server` reads the `[mysqld]` option file group but not the `[mysqld_safe]` group, you can ensure that `mysqld_safe` gets the same value when invoked from `mysql.server` as when invoked manually by putting the same `pid-file` setting in both the `[mysqld_safe]` and `[mysqld]` groups.

- `service-startup-timeout=seconds`

How long in seconds to wait for confirmation of server startup. If the server does not start within this time, `mysql.server` exits with an error. The default value is 900. A value of 0 means not to wait at all for startup. Negative values mean to wait forever (no timeout).

## 4.3.4 mysqld\_multi — Manage Multiple MySQL Servers

`mysql_d_multi` is designed to manage several `mysqld` processes that listen for connections on different Unix socket files and TCP/IP ports. It can start or stop servers, or report their current status.



### Note

For some Linux platforms, MySQL installation from RPM or Debian packages includes `systemd` support for managing MySQL server startup and shutdown. On these platforms, `mysql_d_multi` is not installed because it is unnecessary. For information about using `systemd` to handle multiple MySQL instances, see [Section 2.5.10, “Managing MySQL Server with `systemd`”](#).

`mysql_d_multi` searches for groups named `[mysqldN]` in `my.cnf` (or in the file named by the `--defaults-file` option). `N` can be any positive integer. This number is referred to in the following discussion as the option group number, or `GNR`. Group numbers distinguish option groups from one another and are used as arguments to `mysql_d_multi` to specify which servers you want to start, stop, or obtain a status report for. Options listed in these groups are the same that you would use in the `[mysqld]` group used for starting `mysqld`. (See, for example, [Section 2.9.5, “Starting and Stopping MySQL Automatically”](#).) However, when using multiple servers, it is necessary that each one use its own value for options such as the Unix socket file and TCP/IP port number. For more information on which options must be unique per server in a multiple-server environment, see [Section 5.7, “Running Multiple MySQL Instances on One Machine”](#).

To invoke `mysql_d_multi`, use the following syntax:

```
mysql_d_multi [options] {start|stop|reload|report} [GNR[,GNR] ...]
```

`start`, `stop`, `reload` (stop and restart), and `report` indicate which operation to perform. You can perform the designated operation for a single server or multiple servers, depending on the `GNR` list that follows the option name. If there is no list, `mysql_d_multi` performs the operation for all servers in the option file.

Each `GNR` value represents an option group number or range of group numbers. The value should be the number at the end of the group name in the option file. For example, the `GNR` for a group named `[mysqld17]` is `17`. To specify a range of numbers, separate the first and last numbers by a dash. The `GNR` value `10-13` represents groups `[mysqld10]` through `[mysqld13]`. Multiple groups or group ranges can be specified on the command line, separated by commas. There must be no whitespace characters (spaces or tabs) in the `GNR` list; anything after a whitespace character is ignored.

This command starts a single server using option group `[mysqld17]`:

```
mysql_d_multi start 17
```

This command stops several servers, using option groups `[mysqld8]` and `[mysqld10]` through `[mysqld13]`:

```
mysql_d_multi stop 8,10-13
```

For an example of how you might set up an option file, use this command:

```
mysql_d_multi --example
```

`mysql_d_multi` searches for option files as follows:

- With `--no-defaults`, no option files are read.

Command-Line Format	<code>--no-defaults</code>
Type	Boolean
Default Value	<code>false</code>



- With `--defaults-file=file_name`, only the named file is read.

Command-Line Format	<code>--defaults-file=filename</code>
Type	File name
Default Value	<code>[none]</code>

- Otherwise, option files in the standard list of locations are read, including any file named by the `--defaults-extra-file=file_name` option, if one is given. (If the option is given multiple times, the last value is used.)

Command-Line Format	<code>--defaults-extra-file=filename</code>
Type	File name
Default Value	<code>[none]</code>

For additional information about these and other option-file options, see [Section 4.2.2.3, “Command-Line Options that Affect Option-File Handling”](#).

Option files read are searched for `[mysqld_multi]` and `[mysqldN]` option groups. The `[mysqld_multi]` group can be used for options to `mysqld_multi` itself. `[mysqldN]` groups can be used for options passed to specific `mysqld` instances.

The `[mysqld]` or `[mysqld_safe]` groups can be used for common options read by all instances of `mysqld` or `mysqld_safe`. You can specify a `--defaults-file=file_name` option to use a different configuration file for that instance, in which case the `[mysqld]` or `[mysqld_safe]` groups from that file are used for that instance.

`mysqld_multi` supports the following options.

- `--help`

Command-Line Format	<code>--help</code>
Type	Boolean
Default Value	<code>false</code>

Display a help message and exit.

- `--example`

Command-Line Format	<code>--example</code>
Type	Boolean
Default Value	<code>false</code>

Display a sample option file.

- `--log=file_name`

Command-Line Format	<code>--log=path</code>
---------------------	-------------------------

Type	File name
Default Value	<code>/var/log/mysqld_multi.log</code>

Specify the name of the log file. If the file exists, log output is appended to it.

- `--mysqladmin=prog_name`

Command-Line Format	<code>--mysqladmin=file</code>
Type	File name
Default Value	<code>[none]</code>

The `mysqladmin` binary to be used to stop servers.

- `--mysqld=prog_name`

Command-Line Format	<code>--mysqld=file</code>
Type	File name
Default Value	<code>[none]</code>

The `mysqld` binary to be used. Note that you can specify `mysqld_safe` as the value for this option also. If you use `mysqld_safe` to start the server, you can include the `mysqld` or `ledir` options in the corresponding `[mysqldN]` option group. These options indicate the name of the server that `mysqld_safe` should start and the path name of the directory where the server is located. (See the descriptions for these options in [Section 4.3.2, “mysqld\\_safe — MySQL Server Startup Script”](#).)  
Example:

```
[mysqld38]
mysqld = mysqld-debug
ledir = /opt/local/mysql/libexec
```

- `--no-log`

Command-Line Format	<code>--no-log</code>
Type	Boolean
Default Value	<code>false</code>

Print log information to `stdout` rather than to the log file. By default, output goes to the log file.

- `--password=password`

Command-Line Format	<code>--password=string</code>
Type	String
Default Value	<code>[none]</code>

The password of the MySQL account to use when invoking `mysqladmin`. Note that the password value is not optional for this option, unlike for other MySQL programs.

- `--silent`

Command-Line Format	<code>--silent</code>
Type	Boolean
Default Value	<code>false</code>

Silent mode; disable warnings.

- `--tcp-ip`

Command-Line Format	<code>--tcp-ip</code>
Type	Boolean
Default Value	<code>false</code>

Connect to each MySQL server through the TCP/IP port instead of the Unix socket file. (If a socket file is missing, the server might still be running, but accessible only through the TCP/IP port.) By default, connections are made using the Unix socket file. This option affects `stop` and `report` operations.

- `--user=user_name`

Command-Line Format	<code>--user=name</code>
Type	String
Default Value	<code>root</code>

The user name of the MySQL account to use when invoking `mysqladmin`.

- `--verbose`

Command-Line Format	<code>--verbose</code>
Type	Boolean
Default Value	<code>false</code>

Be more verbose.

- `--version`

Command-Line Format	<code>--version</code>
Type	Boolean
Default Value	<code>false</code>

Display version information and exit.

Some notes about `mysqld_multi`:

- **Most important:** Before using `mysqld_multi` be sure that you understand the meanings of the options that are passed to the `mysqld` servers and *why* you would want to have separate `mysqld` processes. Beware of the dangers of using multiple `mysqld` servers with the same data directory. Use separate data directories, unless you *know* what you are doing. Starting multiple servers with the same data

directory does *not* give you extra performance in a threaded system. See [Section 5.7, “Running Multiple MySQL Instances on One Machine”](#).



### Important

Make sure that the data directory for each server is fully accessible to the Unix account that the specific `mysqld` process is started as. *Do not* use the Unix `root` account for this, unless you *know* what you are doing. See [Section 6.1.5, “How to Run MySQL as a Normal User”](#).

- Make sure that the MySQL account used for stopping the `mysqld` servers (with the `mysqladmin` program) has the same user name and password for each server. Also, make sure that the account has the `SHUTDOWN` privilege. If the servers that you want to manage have different user names or passwords for the administrative accounts, you might want to create an account on each server that has the same user name and password. For example, you might set up a common `multi_admin` account by executing the following commands for each server:

```
$> mysql -u root -S /tmp/mysql.sock -p
Enter password:
mysql> CREATE USER 'multi_admin'@'localhost' IDENTIFIED BY 'multipass';
mysql> GRANT SHUTDOWN ON *.* TO 'multi_admin'@'localhost';
```

See [Section 6.2, “Access Control and Account Management”](#). You have to do this for each `mysqld` server. Change the connection parameters appropriately when connecting to each one. Note that the host name part of the account name must permit you to connect as `multi_admin` from the host where you want to run `mysqld_multi`.

- The Unix socket file and the TCP/IP port number must be different for every `mysqld`. (Alternatively, if the host has multiple network addresses, you can set the `bind_address` system variable to cause different servers to listen to different interfaces.)
- The `--pid-file` option is very important if you are using `mysqld_safe` to start `mysqld` (for example, `--mysqld=mysqld_safe`) Every `mysqld` should have its own process ID file. The advantage of using `mysqld_safe` instead of `mysqld` is that `mysqld_safe` monitors its `mysqld` process and restarts it if the process terminates due to a signal sent using `kill -9` or for other reasons, such as a segmentation fault.
- You might want to use the `--user` option for `mysqld`, but to do this you need to run the `mysqld_multi` script as the Unix superuser (`root`). Having the option in the option file does not matter; you just get a warning if you are not the superuser and the `mysqld` processes are started under your own Unix account.

The following example shows how you might set up an option file for use with `mysqld_multi`. The order in which the `mysqld` programs are started or stopped depends on the order in which they appear in the option file. Group numbers need not form an unbroken sequence. The first and fifth `[mysqldN]` groups were intentionally omitted from the example to illustrate that you can have “gaps” in the option file. This gives you more flexibility.

```
# This is an example of a my.cnf file for mysql_multi.
# Usually this file is located in home dir ~/.my.cnf or /etc/my.cnf

[mysqld_multi]
mysqld      = /usr/local/mysql/bin/mysqld_safe
mysqladmin  = /usr/local/mysql/bin/mysqladmin
user        = multi_admin
password    = my_password

[mysqld2]
socket      = /tmp/mysql.sock2
```

```

port = 3307
pid-file = /usr/local/mysql/data2/hostname.pid2
datadir = /usr/local/mysql/data2
language = /usr/local/mysql/share/mysql/english
user = unix_user1

[mysqld3]
mysqld = /path/to/mysqld_safe
ledir = /path/to/mysqld-binary/
mysqladmin = /path/to/mysqladmin
socket = /tmp/mysql.sock3
port = 3308
pid-file = /usr/local/mysql/data3/hostname.pid3
datadir = /usr/local/mysql/data3
language = /usr/local/mysql/share/mysql/swedish
user = unix_user2

[mysqld4]
socket = /tmp/mysql.sock4
port = 3309
pid-file = /usr/local/mysql/data4/hostname.pid4
datadir = /usr/local/mysql/data4
language = /usr/local/mysql/share/mysql/estonia
user = unix_user3

[mysqld6]
socket = /tmp/mysql.sock6
port = 3311
pid-file = /usr/local/mysql/data6/hostname.pid6
datadir = /usr/local/mysql/data6
language = /usr/local/mysql/share/mysql/japanese
user = unix_user4

```

See [Section 4.2.2.2, “Using Option Files”](#).

## 4.4 Installation-Related Programs

The programs in this section are used when installing or upgrading MySQL.

### 4.4.1 `comp_err` — Compile MySQL Error Message File

`comp_err` creates the `errmsg.sys` file that is used by `mysqld` to determine the error messages to display for different error codes. `comp_err` normally is run automatically when MySQL is built. It compiles the `errmsg.sys` file from the text-format error information file located at `sql/share/errmsg-utf8.txt` in MySQL source distributions.

`comp_err` also generates the `mysqld_error.h`, `mysqld_ename.h`, and `sql_state.h` header files.

For more information about how error messages are defined, see the [MySQL Internals Manual](#).

Invoke `comp_err` like this:

```
comp_err [options]
```

`comp_err` supports the following options.

- `--help, -?`

Command-Line Format	<code>--help</code>
Type	Boolean
Default Value	<code>false</code>

Display a help message and exit.

- `--charset=dir_name, -C dir_name`

Command-Line Format	<code>--charset</code>
Type	String
Default Value	<code>../share/charsets</code>

The character set directory. The default is `../sql/share/charsets`.

- `--debug=debug_options, -# debug_options`

Command-Line Format	<code>--debug=options</code>
Type	String
Default Value	<code>d:t:0,/tmp/comp_err.trace</code>

In debug builds, write a debugging log. A typical `debug_options` string is `d:t:0,file_name`. The default is `d:t:0,/tmp/comp_err.trace`.

For non-debug builds, this option is non-functional and causes the program to exit with an explanatory message.



#### Note

The short form of this option is `-#`, using a literal `#` character.

- `--debug-info, -T`

Command-Line Format	<code>--debug-info</code>
Type	Boolean
Default Value	<code>false</code>

Print some debugging information when the program exits.

- `--header-file=file_name, -H file_name`

Command-Line Format	<code>--header-file=name</code>
Type	File name
Default Value	<code>mysqld_error.h</code>

The name of the error header file. The default is `mysqld_error.h`.

- `--in-file=file_name, -F file_name`

Command-Line Format	<code>--in-file=path</code>
Type	File name
Default Value	<code>[none]</code>

The name of the input file that defines error messages. The default is `../sql/share/errmsg-utf8.txt`.

- `--name-file=file_name, -N file_name`

Command-Line Format	<code>--name-file=name</code>
Type	File name
Default Value	<code>mysqld_ename.h</code>

The name of the error name file. The default is `mysqld_ename.h`.

- `--out-dir=dir_name, -D dir_name`

Command-Line Format	<code>--out-dir=path</code>
Type	String
Default Value	<code>../share/</code>

The name of the output base directory. The default is `../sql/share/`.

- `--out-file=file_name, -O file_name`

Command-Line Format	<code>--out-file=name</code>
Type	File name
Default Value	<code>errmsg.sys</code>

The name of the output file. The default is `errmsg.sys`.

- `--state-file=file_name, -S file_name`

Command-Line Format	<code>--state-file=name</code>
Type	File name
Default Value	<code>sql_state.h</code>

The name for the SQLSTATE header file. The default is `sql_state.h`.

- `--version, -V`

Command-Line Format	<code>--version</code>
Type	Boolean
Default Value	<code>false</code>

Display version information and exit.

**Note**

`mysql_install_db` is deprecated as of MySQL 5.7.6 because its functionality has been integrated into `mysqld`, the MySQL server. To initialize a MySQL installation, invoke `mysqld` with the `--initialize` or `--initialize-insecure` option. For more information, see [Section 2.9.1, “Initializing the Data Directory”](#). You should expect `mysql_install_db` to be removed in a future MySQL release.

`mysql_install_db` handles initialization tasks that must be performed before the MySQL server, `mysqld`, is ready to use:

- It initializes the MySQL data directory and creates the system tables that it contains.
- It initializes the [system tablespace](#) and related data structures needed to manage [InnoDB](#) tables.
- It loads the server-side help tables.
- It installs the `sys` schema.
- It creates an administrative account. Older versions of `mysql_install_db` may create anonymous-user accounts.

**Secure-by-Default Deployment**

Current versions of `mysql_install_db` produce a MySQL deployment that is secure by default, with these characteristics:

- A single administrative account named `'root'@'localhost'` is created with a randomly generated password, which is marked expired.
- No anonymous-user accounts are created.
- No `test` database accessible by all users is created.
- `--admin-xxx` options are available to control characteristics of the administrative account.
- The `--random-password-file` option is available to control where the random password is written.
- The `--insecure` option is available to suppress random password generation.

If `mysql_install_db` generates a random administrative password, it writes the password to a file and displays the file name. The password entry includes a timestamp to indicate when it was written. By default, the file is `.mysql_secret` in the home directory of the effective user running the script. `.mysql_secret` is created with mode 600 to be accessible only to the operating system user for whom it is created.

**Important**

When `mysql_install_db` generates a random password for the administrative account, it is necessary after `mysql_install_db` has been run to start the server, connect using the administrative account with the password written to the `.mysql_secret` file, and specify a new administrative password. Until this is done, the administrative account cannot be used for anything else. To change the password, you can use the `SET PASSWORD` statement (for example, with the `mysql` or `mysqladmin` client). After resetting the password, remove the `.mysql_secret` file; otherwise, if you run `mysql_secure_installation`, that command may see the file and expire the `root` password again as part of ensuring secure deployment.



## Invocation Syntax

Change location to the MySQL installation directory and use this invocation syntax:

```
bin/mysql_install_db --datadir=path/to/datadir [other_options]
```

The `--datadir` option is mandatory. `mysql_install_db` creates the data directory, which must not already exist:

- If the data directory does already exist, you are performing an upgrade operation (not an install operation) and should run `mysql_upgrade`, not `mysql_install_db`. See [Section 4.4.7, “mysql\\_upgrade — Check and Upgrade MySQL Tables”](#).
- If the data directory does not exist but `mysql_install_db` fails, you must remove any partially created data directory before running `mysql_install_db` again.

Because the MySQL server, `mysqld`, must access the data directory when it runs later, you should either run `mysql_install_db` from the same system account used for running `mysqld`, or run it as `root` and specify the `--user` option to indicate the user name that `mysqld` runs under. It might be necessary to specify other options such as `--basedir` if `mysql_install_db` does not use the correct location for the installation directory. For example:

```
bin/mysql_install_db --user=mysql \  
  --basedir=/opt/mysql/mysql \  
  --datadir=/opt/mysql/mysql/data
```



### Note

After `mysql_install_db` sets up the [InnoDB system tablespace](#), changes to some tablespace characteristics require setting up a whole new [instance](#). This includes the file name of the first file in the system tablespace and the number of undo logs. If you do not want to use the default values, make sure that the settings for the `innodb_data_file_path` and `innodb_log_file_size` configuration parameters are in place in the MySQL [configuration file](#) before running `mysql_install_db`. Also make sure to specify as necessary other parameters that affect the creation and location of [InnoDB files](#), such as `innodb_data_home_dir` and `innodb_log_group_home_dir`.

If those options are in your configuration file but that file is not in a location that MySQL reads by default, specify the file location using the `--defaults-extra-file` option when you run `mysql_install_db`.



### Note

If you have set a custom `TMPDIR` environment variable when performing the installation, and the specified directory is not accessible, `mysql_install_db` may fail. If so, unset `TMPDIR` or set `TMPDIR` to point to the system temporary directory (usually `/tmp`).

## Administrative Account Creation

`mysql_install_db` creates an administrative account named `'root'@'localhost'` by default.

`mysql_install_db` provides options that enable you to control several aspects of the administrative account:

- To change the user or host parts of the account name, use `--login-path`, or `--admin-user` and `--admin-host`.

- `--insecure` suppresses generation of a random password.
- `--admin-auth-plugin` specifies the authentication plugin.
- `--admin-require-ssl` specifies whether the account must use SSL connections.

For more information, see the descriptions of those options.

`mysql_install_db` assigns `mysql.user` system table rows a nonempty `plugin` column value to set the authentication plugin. The default value is `mysql_native_password`. The value can be changed using the `--admin-auth-plugin` option.

## Default my.cnf File

`mysql_install_db` creates no default `my.cnf` file.



### Note

As of MySQL 5.7.18, `my-default.cnf` is no longer included in or installed by distribution packages.

With one exception, the settings in the default option file are commented and have no effect. The exception is that the file sets the `sql_mode` system variable to `NO_ENGINE_SUBSTITUTION, STRICT_TRANS_TABLES`. This setting produces a server configuration that results in errors rather than warnings for bad data in operations that modify transactional tables. See [Section 5.1.10, “Server SQL Modes”](#).

## Command Options

`mysql_install_db` supports the following options, which can be specified on the command line or in the `[mysql_install_db]` group of an option file. For information about option files used by MySQL programs, see [Section 4.2.2.2, “Using Option Files”](#).

**Table 4.8** `mysql_install_db` Options

Option Name	Description
<code>--admin-auth-plugin</code>	Administrative account authentication plugin
<code>--admin-host</code>	Administrative account name host part
<code>--admin-require-ssl</code>	Require SSL for administrative account
<code>--admin-user</code>	Administrative account name user part
<code>--basedir</code>	Path to base directory
<code>--builddir</code>	Path to build directory (for out-of-source builds)
<code>--datadir</code>	Path to data directory
<code>--defaults</code>	Read default option files
<code>--defaults-extra-file</code>	Read named option file in addition to usual option files
<code>--defaults-file</code>	Read only named option file
<code>--extra-sql-file</code>	Optional SQL file to execute during bootstrap
<code>--help</code>	Display help message and exit
<code>--insecure</code>	Do not generate administrative account random password
<code>--lc-messages</code>	Locale for error messages

Option Name	Description
<code>--lc-messages-dir</code>	Directory where error messages are installed
<code>--login-file</code>	File to read for login path information
<code>--login-path</code>	Read login path options from <code>.mylogin.cnf</code>
<code>--mysqld-file</code>	Path to <code>mysqld</code> binary
<code>--no-defaults</code>	Read no option files
<code>--random-password-file</code>	File in which to write administrative account random password
<code>--skip-sys-schema</code>	Do not install or upgrade the <code>sys</code> schema
<code>--srcdir</code>	For internal use
<code>--user</code>	Operating system user under which to execute <code>mysqld</code>
<code>--verbose</code>	Verbose mode
<code>--version</code>	Display version information and exit

- `--help, -?`

Command-Line Format	<code>--help</code>
---------------------	---------------------

Display a help message and exit.

- `--admin-auth-plugin=plugin_name`

Command-Line Format	<code>--admin-auth-plugin=plugin_name</code>
Type	String

The authentication plugin to use for the administrative account. The default is `mysql_native_password`.

- `--admin-host=host_name`

Command-Line Format	<code>--admin-host=host_name</code>
Type	String

The host part to use for the administrative account name. The default is `localhost`. This option is ignored if `--login-path` is also specified.

- `--admin-require-ssl`

Command-Line Format	<code>--admin-require-ssl</code>
Type	Boolean
Default Value	<code>FALSE</code>

Whether to require SSL for the administrative account. The default is not to require it. With this option

clause. As a result, the administrative account must use secure connections when connecting to the server.

- `--admin-user=user_name`

Command-Line Format	<code>--admin-user=user_name</code>
Type	String

The user part to use for the administrative account name. The default is `root`. This option is ignored if `--login-path` is also specified.

- `--basedir=dir_name`

Command-Line Format	<code>--basedir=dir_name</code>
Type	Directory name

The path to the MySQL installation directory.

- `--builddir=dir_name`

Command-Line Format	<code>--builddir=dir_name</code>
Type	Directory name

For use with `--srcdir` and out-of-source builds. Set this to the location of the directory where the built files reside.

- `--datadir=dir_name`

Command-Line Format	<code>--datadir=dir_name</code>
Type	Directory name

The path to the MySQL data directory. Only the last component of the path name is created if it does not exist; the parent directory must already exist or an error occurs.



#### Note

The `--datadir` option is mandatory and the data directory must not already exist.

- `--defaults`

Command-Line Format	<code>--defaults</code>
Type	Boolean
Default Value	<code>FALSE</code>

files from being read. This may help if program startup fails due to reading unknown options from an option file.

- `--defaults-extra-file=file_name`

Command-Line Format	<code>--defaults-extra-file=file_name</code>
Type	File name

Read this option file after the global option file but (on Unix) before the user option file. If the file does not exist or is otherwise inaccessible, an error occurs. If `file_name` is not an absolute path name, it is interpreted relative to the current directory.

This option is passed by `mysql_install_db` to `mysqld`.

For additional information about this and other option-file options, see [Section 4.2.2.3, “Command-Line Options that Affect Option-File Handling”](#).

- `--defaults-file=file_name`

Command-Line Format	<code>--defaults-file=file_name</code>
Type	File name

Use only the given option file. If the file does not exist or is otherwise inaccessible, an error occurs. If `file_name` is not an absolute path name, it is interpreted relative to the current directory.

This option is passed by `mysql_install_db` to `mysqld`.

For additional information about this and other option-file options, see [Section 4.2.2.3, “Command-Line Options that Affect Option-File Handling”](#).

- `--extra-sql-file=file_name, -f file_name`

Command-Line Format	<code>--extra-sql-file=file_name</code>
Type	File name

This option names a file containing additional SQL statements to be executed after the standard bootstrapping statements. Accepted statement syntax in the file is like that of the `mysql` command-line client, including support for multiple-line C-style comments and delimiter handling to enable definition of stored programs.

- `--insecure`

Command-Line Format	<code>--insecure</code>
Type	Boolean
Default Value	<code>FALSE</code>

Do not generate a random password for the administrative account.

specify a new administrative password. Until this is done, the administrative account cannot be used for anything else. To change the password, you can use the `SET PASSWORD` statement (for example, with the `mysql` or `mysqladmin` client). After resetting the password, remove the `.mysql_secret` file; otherwise, if you run `mysql_secure_installation`, that command may see the file and expire the `root` password again as part of ensuring secure deployment.

- `--lc-messages=name`

Command-Line Format	<code>--lc-messages=name</code>
Type	String
Default Value	<code>en_US</code>

The locale to use for error messages. The default is `en_US`. The argument is converted to a language name and combined with the value of `--lc-messages-dir` to produce the location for the error message file. See [Section 10.12, “Setting the Error Message Language”](#).

- `--lc-messages-dir=dir_name`

Command-Line Format	<code>--lc-messages-dir=dir_name</code>
Type	Directory name

The directory where error messages are located. The value is used together with the value of `--lc-messages` to produce the location for the error message file. See [Section 10.12, “Setting the Error Message Language”](#).

- `--login-file=file_name`

Command-Line Format	<code>--login-file=file_name</code>
Type	File name

The file from which to read the login path if the `--login-path=file_name` option is specified. The default file is `.mylogin.cnf`.

- `--login-path=name`

Command-Line Format	<code>--login-path=name</code>
Type	String

Read options from the named login path in the `.mylogin.cnf` login path file. The default login path is `client`. (To read a different file, use the `--login-file=name` option.) A “login path” is an option group containing options that specify which MySQL server to connect to and which account to authenticate as. To create or modify a login path file, use the `mysql_config_editor` utility. See [Section 4.6.6, “mysql\\_config\\_editor — MySQL Configuration Utility”](#).

an error occurs, unless the `--insecure` option is also specified. In addition, with `--login-path`, any `--admin-host` and `--admin-user` options are ignored.

For additional information about this and other option-file options, see [Section 4.2.2.3, “Command-Line Options that Affect Option-File Handling”](#).

- `--mysqld-file=file_name`

Command-Line Format	<code>--mysqld-file=file_name</code>
Type	File name

The path name of the `mysqld` binary to execute. The option value must be an absolute path name or an error occurs.

If this option is not given, `mysql_install_db` searches for `mysqld` in these locations:

- In the `bin` directory under the `--basedir` option value, if that option was given.
  - In the `bin` directory under the `--srcdir` option value, if that option was given.
  - In the `bin` directory under the `--builddir` option value, if that option was given.
  - In the local directory and in the `bin` and `sbin` directories under the local directory.
  - In `/usr/bin`, `/usr/sbin`, `/usr/local/bin`, `/usr/local/sbin`, `/opt/local/bin`, `/opt/local/sbin`.
- `--no-defaults`

Command-Line Format	<code>--no-defaults</code>
---------------------	----------------------------

For behavior of this option, see the description of `--defaults`.

For additional information about this and other option-file options, see [Section 4.2.2.3, “Command-Line Options that Affect Option-File Handling”](#).

- `--random-password-file=file_name`

Command-Line Format	<code>--random-password-file=file_name</code>
Type	File name

The path name of the file in which to write the randomly generated password for the administrative account. The option value must be an absolute path name or an error occurs. The default is `$HOME/.mysql_secret`.

- `--skip-sys-schema`

Command-Line Format	<code>--skip-sys-schema</code>
Type	Boolean

Default Value	FALSE
---------------	-------

`mysql_install_db` installs the `sys` schema. The `--skip-sys-schema` option suppresses this behavior.

- `--srcdir=dir_name`

Command-Line Format	<code>--srcdir=dir_name</code>
Type	Directory name

For internal use. This option specifies the directory under which `mysql_install_db` looks for support files such as the error message file and the file for populating the help tables.

- `--user=user_name, -u user_name`

Command-Line Format	<code>--user=user_name</code>
---------------------	-------------------------------

The system (login) user name to use for running `mysqld`. Files and directories created by `mysqld` are owned by this user. You must be the system `root` user to use this option. By default, `mysqld` runs using your current login name; files and directories that it creates are owned by you.

- `--verbose, -v`

Command-Line Format	<code>--verbose</code>
---------------------	------------------------

Verbose mode. Print more information about what the program does. You can use this option to see the `mysqld` command that `mysql_install_db` invokes to start the server in bootstrap mode.

- `--version, -V`

Command-Line Format	<code>--version</code>
---------------------	------------------------

Display version information and exit.

### 4.4.3 mysql\_plugin — Configure MySQL Server Plugins



#### Note

`mysql_plugin` is deprecated as of MySQL 5.7.11 and removed in MySQL 8.0. Alternatives include loading plugins at server startup using the `--plugin-load` or `--plugin-load-add` option, or at runtime using the `INSTALL PLUGIN` statement.

The `mysql_plugin` utility enables MySQL administrators to manage which plugins a MySQL server loads. It provides an alternative to manually specifying the `--plugin-load` option at server startup or using the `INSTALL PLUGIN` and `UNINSTALL PLUGIN` statements at runtime.

Depending on whether `mysql_plugin` is invoked to enable or disable plugins, it inserts or deletes rows in the `mysql.plugin` table that serves as a plugin registry. (To perform this operation, `mysql_plugin` invokes the MySQL server in bootstrap mode. This means that the server must not already be running.)



For normal server startups, the server loads and enables plugins listed in `mysql.plugin` automatically. For additional control over plugin activation, use `--plugin_name` options named for specific plugins, as described in [Section 5.5.1, “Installing and Uninstalling Plugins”](#).

Each invocation of `mysql_plugin` reads a configuration file to determine how to configure the plugins contained in a single plugin library file. To invoke `mysql_plugin`, use this syntax:

```
mysql_plugin [options] plugin {ENABLE|DISABLE}
```

`plugin` is the name of the plugin to configure. `ENABLE` or `DISABLE` (not case-sensitive) specify whether to enable or disable components of the plugin library named in the configuration file. The order of the `plugin` and `ENABLE` or `DISABLE` arguments does not matter.

For example, to configure components of a plugin library file named `myplugins.so` on Linux or `myplugins.dll` on Windows, specify a `plugin` value of `myplugins`. Suppose that this plugin library contains three plugins, `plugin1`, `plugin2`, and `plugin3`, all of which should be configured under `mysql_plugin` control. By convention, configuration files have a suffix of `.ini` and the same base name as the plugin library, so the default configuration file name for this plugin library is `myplugins.ini`. The configuration file contents look like this:

```
myplugins
plugin1
plugin2
plugin3
```

The first line in the `myplugins.ini` file is the name of the library file, without any extension such as `.so` or `.dll`. The remaining lines are the names of the components to be enabled or disabled. Each value in the file should be on a separate line. Lines on which the first character is `#` are taken as comments and ignored.

To enable the plugins listed in the configuration file, invoke `mysql_plugin` this way:

```
mysql_plugin myplugins ENABLE
```

To disable the plugins, use `DISABLE` rather than `ENABLE`.

An error occurs if `mysql_plugin` cannot find the configuration file or plugin library file, or if `mysql_plugin` cannot start the MySQL server.

`mysql_plugin` supports the following options, which can be specified on the command line or in the `[mysqld]` group of any option file. For options specified in a `[mysqld]` group, `mysql_plugin` recognizes the `--basedir`, `--datadir`, and `--plugin-dir` options and ignores others. For information about option files used by MySQL programs, see [Section 4.2.2.2, “Using Option Files”](#).

**Table 4.9 mysql\_plugin Options**

Option Name	Description
<code>--basedir</code>	The server base directory
<code>--datadir</code>	The server data directory
<code>--help</code>	Display help message and exit
<code>--my-print-defaults</code>	Path to <code>my_print_defaults</code>
<code>--mysqld</code>	Path to server
<code>--no-defaults</code>	Do not read configuration file

Option Name	Description
<code>--plugin-dir</code>	Directory where plugins are installed
<code>--plugin-ini</code>	The plugin configuration file
<code>--print-defaults</code>	Show configuration file defaults
<code>--verbose</code>	Verbose mode
<code>--version</code>	Display version information and exit

- `--help, -?`

Command-Line Format	<code>--help</code>
---------------------	---------------------

Display a help message and exit.

- `--basedir=dir_name, -b dir_name`

Command-Line Format	<code>--basedir=dir_name</code>
Type	Directory name

The server base directory.

- `--datadir=dir_name, -d dir_name`

Command-Line Format	<code>--datadir=dir_name</code>
Type	Directory name

The server data directory.

- `--my-print-defaults=file_name, -b file_name`

Command-Line Format	<code>--my-print-defaults=file_name</code>
Type	File name

The path to the `my_print_defaults` program.

- `--mysqld=file_name, -b file_name`

Command-Line Format	<code>--mysqld=file_name</code>
Type	File name

The path to the `mysqld` server.

- `--no-defaults, -p`

Command-Line Format	<code>--no-defaults</code>
---------------------	----------------------------

Do not read values from the configuration file. This option enables an administrator to skip reading defaults from the configuration file.

With `mysql_plugin`, this option need not be given first on the command line, unlike most other MySQL programs that support `--no-defaults`.

- `--plugin-dir=dir_name, -p dir_name`

Command-Line Format	<code>--plugin-dir=dir_name</code>
Type	Directory name

The server plugin directory.

- `--plugin-ini=file_name, -i file_name`

Command-Line Format	<code>--plugin-ini=file_name</code>
Type	File name

The `mysql_plugin` configuration file. Relative path names are interpreted relative to the current directory. If this option is not given, the default is `plugin.ini` in the plugin directory, where `plugin` is the `plugin` argument on the command line.

- `--print-defaults, -P`

Command-Line Format	<code>--print-defaults</code>
---------------------	-------------------------------

Display the default values from the configuration file. This option causes `mysql_plugin` to print the defaults for `--basedir`, `--datadir`, and `--plugin-dir` if they are found in the configuration file. If no value for a variable is found, nothing is shown.

With `mysql_plugin`, this option need not be given first on the command line, unlike most other MySQL programs that support `--print-defaults`.

- `--verbose, -v`

Command-Line Format	<code>--verbose</code>
---------------------	------------------------

Verbose mode. Print more information about what the program does. This option can be used multiple times to increase the amount of information.

- `--version, -V`

Command-Line Format	<code>--version</code>
---------------------	------------------------

Display version information and exit.

#### 4.4.4 mysql\_secure\_installation — Improve MySQL Installation Security

This program enables you to improve the security of your MySQL installation in the following ways:

- You can set a password for `root` accounts.
- You can remove `root` accounts that are accessible from outside the local host.

- You can remove anonymous-user accounts.
- You can remove the `test` database (which by default can be accessed by all users, even anonymous users), and privileges that permit anyone to access databases with names that start with `test_`.

`mysql_secure_installation` helps you implement security recommendations similar to those described at [Section 2.9.4, “Securing the Initial MySQL Account”](#).

Normal usage is to connect to the local MySQL server; invoke `mysql_secure_installation` without arguments:

```
mysql_secure_installation
```

When executed, `mysql_secure_installation` prompts you to determine which actions to perform.

The `validate_password` plugin can be used for password strength checking. If the plugin is not installed, `mysql_secure_installation` prompts the user whether to install it. Any passwords entered later are checked using the plugin if it is enabled.

Most of the usual MySQL client options such as `--host` and `--port` can be used on the command line and in option files. For example, to connect to the local server over IPv6 using port 3307, use this command:

```
mysql_secure_installation --host=::1 --port=3307
```

`mysql_secure_installation` supports the following options, which can be specified on the command line or in the `[mysql_secure_installation]` and `[client]` groups of an option file. For information about option files used by MySQL programs, see [Section 4.2.2.2, “Using Option Files”](#).

**Table 4.10 mysql\_secure\_installation Options**

Option Name	Description	Introduced
<code>--defaults-extra-file</code>	Read named option file in addition to usual option files	
<code>--defaults-file</code>	Read only named option file	
<code>--defaults-group-suffix</code>	Option group suffix value	
<code>--help</code>	Display help message and exit	
<code>--host</code>	Host on which MySQL server is located	
<code>--no-defaults</code>	Read no option files	
<code>--password</code>	Accepted but always ignored. Whenever <code>mysql_secure_installation</code> is invoked, the user is prompted for a password, regardless	
<code>--port</code>	TCP/IP port number for connection	
<code>--print-defaults</code>	Print default options	
<code>--protocol</code>	Transport protocol to use	
<code>--socket</code>	Unix socket file or Windows named pipe to use	

Option Name	Description	Introduced
<code>--ssl</code>	Enable connection encryption	
<code>--ssl-ca</code>	File that contains list of trusted SSL Certificate Authorities	
<code>--ssl-capath</code>	Directory that contains trusted SSL Certificate Authority certificate files	
<code>--ssl-cert</code>	File that contains X.509 certificate	
<code>--ssl-cipher</code>	Permissible ciphers for connection encryption	
<code>--ssl-crl</code>	File that contains certificate revocation lists	
<code>--ssl-crlpath</code>	Directory that contains certificate revocation-list files	
<code>--ssl-key</code>	File that contains X.509 key	
<code>--ssl-mode</code>	Desired security state of connection to server	5.7.11
<code>--ssl-verify-server-cert</code>	Verify host name against server certificate Common Name identity	
<code>--tls-version</code>	Permissible TLS protocols for encrypted connections	5.7.10
<code>--use-default</code>	Execute with no user interactivity	
<code>--user</code>	MySQL user name to use when connecting to server	

- `--help, -?`

Command-Line Format	<code>--help</code>
---------------------	---------------------

Display a help message and exit.

- `--defaults-extra-file=file_name`

Command-Line Format	<code>--defaults-extra-file=file_name</code>
Type	File name

Read this option file after the global option file but (on Unix) before the user option file. If the file does not exist or is otherwise inaccessible, an error occurs. If `file_name` is not an absolute path name, it is interpreted relative to the current directory.

For additional information about this and other option-file options, see [Section 4.2.2.3, “Command-Line Options that Affect Option-File Handling”](#).

- `--defaults-file=file_name`

Command-Line Format	<code>--defaults-file=file_name</code>
Type	File name

Use only the given option file. If the file does not exist or is otherwise inaccessible, an error occurs. If *file\_name* is not an absolute path name, it is interpreted relative to the current directory.

For additional information about this and other option-file options, see [Section 4.2.2.3, “Command-Line Options that Affect Option-File Handling”](#).

- `--defaults-group-suffix=str`

Command-Line Format	<code>--defaults-group-suffix=str</code>
Type	String

Read not only the usual option groups, but also groups with the usual names and a suffix of *str*. For example, `mysql_secure_installation` normally reads the `[client]` and `[mysql_secure_installation]` groups. If this option is given as `--defaults-group-suffix=_other`, `mysql_secure_installation` also reads the `[client_other]` and `[mysql_secure_installation_other]` groups.

For additional information about this and other option-file options, see [Section 4.2.2.3, “Command-Line Options that Affect Option-File Handling”](#).

- `--host=host_name, -h host_name`

Command-Line Format	<code>--host</code>
---------------------	---------------------

Connect to the MySQL server on the given host.

- `--no-defaults`

Command-Line Format	<code>--no-defaults</code>
---------------------	----------------------------

Do not read any option files. If program startup fails due to reading unknown options from an option file, `--no-defaults` can be used to prevent them from being read.

The exception is that the `.mylogin.cnf` file is read in all cases, if it exists. This permits passwords to be specified in a safer way than on the command line even when `--no-defaults` is used. To create `.mylogin.cnf`, use the `mysql_config_editor` utility. See [Section 4.6.6, “mysql\\_config\\_editor — MySQL Configuration Utility”](#).

For additional information about this and other option-file options, see [Section 4.2.2.3, “Command-Line Options that Affect Option-File Handling”](#).

- `--password=password, -p password`

Command-Line Format	<code>--password=password</code>
Type	String
Default Value	<code>[none]</code>

This option is accepted but ignored. Whether or not this option is used,

- `--port=port_num, -P port_num`

Command-Line Format	<code>--port=port_num</code>
Type	Numeric
Default Value	3306

For TCP/IP connections, the port number to use.

- `--print-defaults`

Command-Line Format	<code>--print-defaults</code>
---------------------	-------------------------------

Print the program name and all options that it gets from option files.

For additional information about this and other option-file options, see [Section 4.2.2.3, “Command-Line Options that Affect Option-File Handling”](#).

- `--protocol={TCP|SOCKET|PIPE|MEMORY}`

Command-Line Format	<code>--protocol=type</code>
Type	String
Default Value	[see text]
Valid Values	TCP  SOCKET  PIPE  MEMORY

The transport protocol to use for connecting to the server. It is useful when the other connection parameters normally result in use of a protocol other than the one you want. For details on the permissible values, see [Section 4.2.5, “Connection Transport Protocols”](#).

- `--socket=path, -S path`

Command-Line Format	<code>--socket={file_name pipe_name}</code>
Type	String

For connections to `localhost`, the Unix socket file to use, or, on Windows, the name of the named pipe to use.

On Windows, this option applies only if the server was started with the `named_pipe` system variable enabled to support named-pipe connections. In addition, the user making the connection must be a member of the Windows group specified by the `named_pipe_full_access_group` system variable.

- `--ssl*`

Options that begin with `--ssl` specify whether to connect to the server using encryption and indicate where to find SSL keys and certificates. See [Command Options for Encrypted Connections](#).

- `--tls-version=protocol_list`

Command-Line Format	<code>--tls-version=protocol_list</code>
Introduced	5.7.10
Type	String
Default Value ( $\geq$ 5.7.28)	<code>TLSv1, TLSv1.1, TLSv1.2</code>
Default Value ( $\leq$ 5.7.27)	<code>TLSv1, TLSv1.1, TLSv1.2</code> (OpenSSL) <code>TLSv1, TLSv1.1</code> (yaSSL)

The permissible TLS protocols for encrypted connections. The value is a list of one or more comma-separated protocol names. The protocols that can be named for this option depend on the SSL library used to compile MySQL. For details, see [Section 6.3.2, “Encrypted Connection TLS Protocols and Ciphers”](#).

This option was added in MySQL 5.7.10.

- `--use-default`

Command-Line Format	<code>--use-default</code>
Type	Boolean

Execute noninteractively. This option can be used for unattended installation operations.

- `--user=user_name, -u user_name`

Command-Line Format	<code>--user=user_name</code>
Type	String

The user name of the MySQL account to use for connecting to the server.

## 4.4.5 mysql\_ssl\_rsa\_setup — Create SSL/RSA Files

This program creates the SSL certificate and key files and RSA key-pair files required to support secure connections using SSL and secure password exchange using RSA over unencrypted connections, if those files are missing. `mysql_ssl_rsa_setup` can also be used to create new SSL files if the existing ones have expired.



### Note

`mysql_ssl_rsa_setup` uses the `openssl` command, so its use is contingent on having OpenSSL installed on your machine.

Another way to generate SSL and RSA files, for MySQL distributions compiled using OpenSSL, is to have the server generate them automatically. See [Section 6.3.3.1, “Creating SSL and RSA Certificates and Keys using MySQL”](#).



### Important

`mysql_ssl_rsa_setup` helps lower the barrier to using SSL by making it easier to generate the required files. However, certificates generated by



`mysql_ssl_rsa_setup` are self-signed, which is not very secure. After you gain experience using the files created by `mysql_ssl_rsa_setup`, consider obtaining a CA certificate from a registered certificate authority.

Invoke `mysql_ssl_rsa_setup` like this:

```
mysql_ssl_rsa_setup [options]
```

Typical options are `--datadir` to specify where to create the files, and `--verbose` to see the `openssl` commands that `mysql_ssl_rsa_setup` executes.

`mysql_ssl_rsa_setup` attempts to create SSL and RSA files using a default set of file names. It works as follows:

1. `mysql_ssl_rsa_setup` checks for the `openssl` binary at the locations specified by the `PATH` environment variable. If `openssl` is not found, `mysql_ssl_rsa_setup` does nothing. If `openssl` is present, `mysql_ssl_rsa_setup` looks for default SSL and RSA files in the MySQL data directory specified by the `--datadir` option, or the compiled-in data directory if the `--datadir` option is not given.
2. `mysql_ssl_rsa_setup` checks the data directory for SSL files with the following names:

```
ca.pem
server-cert.pem
server-key.pem
```

3. If any of those files are present, `mysql_ssl_rsa_setup` creates no SSL files. Otherwise, it invokes `openssl` to create them, plus some additional files:

ca.pem	Self-signed CA certificate
ca-key.pem	CA private key
server-cert.pem	Server certificate
server-key.pem	Server private key
client-cert.pem	Client certificate
client-key.pem	Client private key

These files enable secure client connections using SSL; see [Section 6.3.1, “Configuring MySQL to Use Encrypted Connections”](#).

4. `mysql_ssl_rsa_setup` checks the data directory for RSA files with the following names:

private_key.pem	Private member of private/public key pair
public_key.pem	Public member of private/public key pair

5. If any of these files are present, `mysql_ssl_rsa_setup` creates no RSA files. Otherwise, it invokes `openssl` to create them. These files enable secure password exchange using RSA over unencrypted connections for accounts authenticated by the `sha256_password` plugin; see [Section 6.4.1.5, “SHA-256 Pluggable Authentication”](#).

For information about the characteristics of files created by `mysql_ssl_rsa_setup`, see [Section 6.3.3.1, “Creating SSL and RSA Certificates and Keys using MySQL”](#).

At startup, the MySQL server automatically uses the SSL files created by `mysql_ssl_rsa_setup` to enable SSL if no explicit SSL options are given other than `--ssl` (possibly along with `ssl_cipher`). If you prefer to designate the files explicitly, invoke clients with the `--ssl-ca`, `--ssl-cert`, and `--ssl-key` options at startup to name the `ca.pem`, `server-cert.pem`, and `server-key.pem` files, respectively.

The server also automatically uses the RSA files created by `mysql_ssl_rsa_setup` to enable RSA if no explicit RSA options are given.

If the server is SSL-enabled, clients use SSL by default for the connection. To specify certificate and key files explicitly, use the `--ssl-ca`, `--ssl-cert`, and `--ssl-key` options to name the `ca.pem`, `client-cert.pem`, and `client-key.pem` files, respectively. However, some additional client setup may be required first because `mysql_ssl_rsa_setup` by default creates those files in the data directory. The permissions for the data directory normally enable access only to the system account that runs the MySQL server, so client programs cannot use files located there. To make the files available, copy them to a directory that is readable (but *not* writable) by clients:

- For local clients, the MySQL installation directory can be used. For example, if the data directory is a subdirectory of the installation directory and your current location is the data directory, you can copy the files like this:

```
cp ca.pem client-cert.pem client-key.pem ..
```

- For remote clients, distribute the files using a secure channel to ensure they are not tampered with during transit.

If the SSL files used for a MySQL installation have expired, you can use `mysql_ssl_rsa_setup` to create new ones:

1. Stop the server.
2. Rename or remove the existing SSL files. You may wish to make a backup of them first. (The RSA files do not expire, so you need not remove them. `mysql_ssl_rsa_setup` sees that they exist and not overwrite them.)
3. Run `mysql_ssl_rsa_setup` with the `--datadir` option to specify where to create the new files.
4. Restart the server.

`mysql_ssl_rsa_setup` supports the following command-line options, which can be specified on the command line or in the `[mysql_ssl_rsa_setup]`, `[mysql_install_db]`, and `[mysqld]` groups of an option file. For information about option files used by MySQL programs, see [Section 4.2.2.2, “Using Option Files”](#).

**Table 4.11** `mysql_ssl_rsa_setup` Options

Option Name	Description
<code>--datadir</code>	Path to data directory
<code>--help</code>	Display help message and exit
<code>--suffix</code>	Suffix for X.509 certificate Common Name attribute
<code>--uid</code>	Name of effective user to use for file permissions
<code>--verbose</code>	Verbose mode
<code>--version</code>	Display version information and exit

- `--help, ?`

Command-Line Format	<code>--help</code>
---------------------	---------------------

Display a help message and exit.

- `--datadir=dir_name`

Command-Line Format	<code>--datadir=dir_name</code>
Type	Directory name

The path to the directory that `mysql_ssl_rsa_setup` should check for default SSL and RSA files and in which it should create files if they are missing. The default is the compiled-in data directory.

- `--suffix=str`

Command-Line Format	<code>--suffix=str</code>
Type	String

The suffix for the Common Name attribute in X.509 certificates. The suffix value is limited to 17 characters. The default is based on the MySQL version number.

- `--uid=name, -v`

Command-Line Format	<code>--uid=name</code>
---------------------	-------------------------

The name of the user who should be the owner of any created files. The value is a user name, not a numeric user ID. In the absence of this option, files created by `mysql_ssl_rsa_setup` are owned by the user who executes it. This option is valid only if you execute the program as `root` on a system that supports the `chown()` system call.

- `--verbose, -v`

Command-Line Format	<code>--verbose</code>
---------------------	------------------------

Verbose mode. Produce more output about what the program does. For example, the program shows the `openssl` commands it runs, and produces output to indicate whether it skips SSL or RSA file creation because some default file already exists.

- `--version, -V`

Command-Line Format	<code>--version</code>
---------------------	------------------------

Display version information and exit.

## 4.4.6 mysql\_tzinfo\_to\_sql — Load the Time Zone Tables

The `mysql_tzinfo_to_sql` program loads the time zone tables in the `mysql` database. It is used on systems that have a `zoneinfo` database (the set of files describing time zones). Examples of such systems are Linux, FreeBSD, Solaris, and macOS. One likely location for these files is the `/usr/share/zoneinfo` directory (`/usr/share/lib/zoneinfo` on Solaris). If your system does not have a `zoneinfo` database, you can use the downloadable package described in [Section 5.1.13, “MySQL Server Time Zone Support”](#).

`mysql_tzinfo_to_sql` can be invoked several ways:

```
mysql_tzinfo_to_sql tz_dir
```

```
mysql_tzinfo_to_sql tz_file tz_name
mysql_tzinfo_to_sql --leap tz_file
```

For the first invocation syntax, pass the zoneinfo directory path name to `mysql_tzinfo_to_sql` and send the output into the `mysql` program. For example:

```
mysql_tzinfo_to_sql /usr/share/zoneinfo | mysql -u root mysql
```

`mysql_tzinfo_to_sql` reads your system's time zone files and generates SQL statements from them. `mysql` processes those statements to load the time zone tables.

The second syntax causes `mysql_tzinfo_to_sql` to load a single time zone file `tz_file` that corresponds to a time zone name `tz_name`:

```
mysql_tzinfo_to_sql tz_file tz_name | mysql -u root mysql
```

If your time zone needs to account for leap seconds, invoke `mysql_tzinfo_to_sql` using the third syntax, which initializes the leap second information. `tz_file` is the name of your time zone file:

```
mysql_tzinfo_to_sql --leap tz_file | mysql -u root mysql
```

After running `mysql_tzinfo_to_sql`, it is best to restart the server so that it does not continue to use any previously cached time zone data.

## 4.4.7 mysql\_upgrade — Check and Upgrade MySQL Tables

Each time you upgrade MySQL, you should execute `mysql_upgrade`, which looks for incompatibilities with the upgraded MySQL server:

- It upgrades the system tables in the `mysql` schema so that you can take advantage of new privileges or capabilities that might have been added.
- It upgrades the Performance Schema and `sys` schema.
- It examines user schemas.

If `mysql_upgrade` finds that a table has a possible incompatibility, it performs a table check and, if problems are found, attempts a table repair. If the table cannot be repaired, see [Section 2.10.12, “Rebuilding or Repairing Tables or Indexes”](#) for manual table repair strategies.

`mysql_upgrade` communicates directly with the MySQL server, sending it the SQL statements required to perform an upgrade.



### Important

In MySQL 5.7.11, the default `--early-plugin-load` value is the name of the `keyring_file` plugin library file, causing that plugin to be loaded by default. In MySQL 5.7.12 and higher, the default `--early-plugin-load` value is empty; to load the `keyring_file` plugin, you must explicitly specify the option with a value naming the `keyring_file` plugin library file.

InnoDB tablespace encryption requires that the keyring plugin to be used be loaded prior to InnoDB initialization, so this change of default `--early-plugin-load` value introduces an incompatibility for upgrades from 5.7.11 to 5.7.12 or higher. Administrators who have encrypted InnoDB tablespaces must take explicit action to ensure continued loading of the keyring plugin: Start the server with an `--early-`

`plugin-load` option that names the plugin library file. For additional information, see [Section 6.4.4.1, “Keyring Plugin Installation”](#).



### Important

If you upgrade to MySQL 5.7.2 or later from a version older than 5.7.2, a change to the `mysql.user` table requires a special sequence of steps to perform an upgrade using `mysql_upgrade`. For details, see [Section 2.10.3, “Changes in MySQL 5.7”](#).



### Note

On Windows, you must run `mysql_upgrade` with administrator privileges. You can do this by running a Command Prompt as Administrator and running the command. Failure to do so may result in the upgrade failing to execute correctly.



### Caution

You should always back up your current MySQL installation *before* performing an upgrade. See [Section 7.2, “Database Backup Methods”](#).

Some upgrade incompatibilities may require special handling *before* upgrading your MySQL installation and running `mysql_upgrade`. See [Section 2.10, “Upgrading MySQL”](#), for instructions on determining whether any such incompatibilities apply to your installation and how to handle them.

Use `mysql_upgrade` like this:

1. Ensure that the server is running.
2. Invoke `mysql_upgrade` to upgrade the system tables in the `mysql` schema and check and repair tables in other schemas:

```
mysql_upgrade [options]
```

3. Stop the server and restart it so that any system table changes take effect.

If you have multiple MySQL server instances to upgrade, invoke `mysql_upgrade` with connection parameters appropriate for connecting to each of the desired servers. For example, with servers running on the local host on ports 3306 through 3308, upgrade each of them by connecting to the appropriate port:

```
mysql_upgrade --protocol=tcp -P 3306 [other_options]
mysql_upgrade --protocol=tcp -P 3307 [other_options]
mysql_upgrade --protocol=tcp -P 3308 [other_options]
```

For local host connections on Unix, the `--protocol=tcp` option forces a connection using TCP/IP rather than the Unix socket file.

By default, `mysql_upgrade` runs as the MySQL `root` user. If the `root` password is expired when you run `mysql_upgrade`, it displays a message telling you that your password is expired and that `mysql_upgrade` failed as a result. To correct this, reset the `root` password to unexpire it and run `mysql_upgrade` again. First, connect to the server as `root`:

```
$> mysql -u root -p
Enter password: **** <- enter root password here
```

Reset the password using `ALTER USER`:

```
mysql> ALTER USER USER() IDENTIFIED BY 'root-password';
```

Then exit `mysql` and run `mysql_upgrade` again:

```
$> mysql_upgrade [options]
```



#### Note

If you run the server with the `disabled_storage_engines` system variable set to disable certain storage engines (for example, `MyISAM`), `mysql_upgrade` might fail with an error like this:

```
mysql_upgrade: [ERROR] 3161: Storage engine MyISAM is disabled
(Table creation is disallowed).
```

To handle this, restart the server with `disabled_storage_engines` disabled. Then you should be able to run `mysql_upgrade` successfully. After that, restart the server with `disabled_storage_engines` set to its original value.

Unless invoked with the `--upgrade-system-tables` option, `mysql_upgrade` processes all tables in all user schemas as necessary. Table checking might take a long time to complete. Each table is locked and therefore unavailable to other sessions while it is being processed. Check and repair operations can be time-consuming, particularly for large tables. Table checking uses the `FOR UPGRADE` option of the `CHECK TABLE` statement. For details about what this option entails, see [Section 13.7.2.2, “CHECK TABLE Statement”](#).

`mysql_upgrade` marks all checked and repaired tables with the current MySQL version number. This ensures that the next time you run `mysql_upgrade` with the same version of the server, it can be determined whether there is any need to check or repair a given table again.

`mysql_upgrade` saves the MySQL version number in a file named `mysql_upgrade_info` in the data directory. This is used to quickly check whether all tables have been checked for this release so that table-checking can be skipped. To ignore this file and perform the check regardless, use the `--force` option.

`mysql_upgrade` checks `mysql.user` system table rows and, for any row with an empty `plugin` column, sets that column to `'mysql_native_password'` or `'mysql_old_password'` depending on the hash format of the `Password` column value.

Support for pre-4.1 password hashing and `mysql_old_password` has been removed, so `mysql_upgrade` sets empty `plugin` values to `'mysql_native_password'` if the credentials use a hash format compatible with that plugin. Rows with a pre-4.1 password hash must be upgraded manually. For account upgrade instructions, see [Section 6.4.1.3, “Migrating Away from Pre-4.1 Password Hashing and the `mysql\_old\_password` Plugin”](#).

`mysql_upgrade` does not upgrade the contents of the time zone tables or help tables. For upgrade instructions, see [Section 5.1.13, “MySQL Server Time Zone Support”](#), and [Section 5.1.14, “Server-Side Help Support”](#).

Unless invoked with the `--skip-sys-schema` option, `mysql_upgrade` installs the `sys` schema if it is not installed, and upgrades it to the current version otherwise. An error occurs if a `sys` schema exists but has no `version` view, on the assumption that its absence indicates a user-created schema:

```
A sys schema exists with no sys.version view. If
you have a user created sys schema, this must be renamed for the
upgrade to succeed.
```

To upgrade in this case, remove or rename the existing `sys` schema first.

`mysql_upgrade` checks for partitioned `InnoDB` tables that were created using the generic partitioning handler and attempts to upgrade them to `InnoDB` native partitioning. (Bug #76734, Bug #20727344)

You can upgrade such tables individually in the `mysql` client using the `ALTER TABLE ... UPGRADE PARTITIONING` SQL statement.

`mysql_upgrade` supports the following options, which can be specified on the command line or in the `[mysql_upgrade]` and `[client]` groups of an option file. For information about option files used by MySQL programs, see [Section 4.2.2.2, “Using Option Files”](#).

**Table 4.12 mysql\_upgrade Options**

Option Name	Description	Introduced
<code>--bind-address</code>	Use specified network interface to connect to MySQL Server	
<code>--character-sets-dir</code>	Directory where character sets are installed	
<code>--compress</code>	Compress all information sent between client and server	
<code>--debug</code>	Write debugging log	
<code>--debug-check</code>	Print debugging information when program exits	
<code>--debug-info</code>	Print debugging information, memory, and CPU statistics when program exits	
<code>--default-auth</code>	Authentication plugin to use	
<code>--default-character-set</code>	Specify default character set	
<code>--defaults-extra-file</code>	Read named option file in addition to usual option files	
<code>--defaults-file</code>	Read only named option file	
<code>--defaults-group-suffix</code>	Option group suffix value	
<code>--force</code>	Force execution even if <code>mysql_upgrade</code> has already been executed for current MySQL version	
<code>--help</code>	Display help message and exit	
<code>--host</code>	Host on which MySQL server is located	
<code>--login-path</code>	Read login path options from <code>.mylogin.cnf</code>	
<code>--max-allowed-packet</code>	Maximum packet length to send to or receive from server	
<code>--net-buffer-length</code>	Buffer size for TCP/IP and socket communication	
<code>--no-defaults</code>	Read no option files	
<code>--password</code>	Password to use when connecting to server	
<code>--pipe</code>	Connect to server using named pipe (Windows only)	

Option Name	Description	Introduced
<code>--plugin-dir</code>	Directory where plugins are installed	
<code>--port</code>	TCP/IP port number for connection	
<code>--print-defaults</code>	Print default options	
<code>--protocol</code>	Transport protocol to use	
<code>--shared-memory-base-name</code>	Shared-memory name for shared-memory connections (Windows only)	
<code>--skip-sys-schema</code>	Do not install or upgrade sys schema	
<code>--socket</code>	Unix socket file or Windows named pipe to use	
<code>--ssl</code>	Enable connection encryption	
<code>--ssl-ca</code>	File that contains list of trusted SSL Certificate Authorities	
<code>--ssl-capath</code>	Directory that contains trusted SSL Certificate Authority certificate files	
<code>--ssl-cert</code>	File that contains X.509 certificate	
<code>--ssl-cipher</code>	Permissible ciphers for connection encryption	
<code>--ssl-crl</code>	File that contains certificate revocation lists	
<code>--ssl-crlpath</code>	Directory that contains certificate revocation-list files	
<code>--ssl-key</code>	File that contains X.509 key	
<code>--ssl-mode</code>	Desired security state of connection to server	5.7.11
<code>--ssl-verify-server-cert</code>	Verify host name against server certificate Common Name identity	
<code>--tls-version</code>	Permissible TLS protocols for encrypted connections	5.7.10
<code>--upgrade-system-tables</code>	Update only system tables, not user schemas	
<code>--user</code>	MySQL user name to use when connecting to server	
<code>--verbose</code>	Verbose mode	
<code>--version-check</code>	Check for proper server version	
<code>--write-binlog</code>	Write all statements to binary log	

- `--help`

Command-Line Format
---------------------

<code>--help</code>
---------------------



Display a short help message and exit.

- `--bind-address=ip_address`

Command-Line Format	<code>--bind-address=ip_address</code>
---------------------	--

On a computer having multiple network interfaces, use this option to select which interface to use for connecting to the MySQL server.

- `--character-sets-dir=dir_name`

Command-Line Format	<code>--character-sets-dir=dir_name</code>
Type	Directory name

The directory where character sets are installed. See [Section 10.15, “Character Set Configuration”](#).

- `--compress, -C`

Command-Line Format	<code>--compress[={OFF ON}]</code>
Type	Boolean
Default Value	OFF

Compress all information sent between the client and the server if possible. See [Section 4.2.6, “Connection Compression Control”](#).

- `--debug[=debug_options], -# [debug_options]`

Command-Line Format	<code>--debug[=#]</code>
Type	String
Default Value	<code>d:t:0,/tmp/mysql_upgrade.trace</code>

Write a debugging log. A typical `debug_options` string is `d:t:0,file_name`. The default is `d:t:0,/tmp/mysql_upgrade.trace`.

- `--debug-check`

Command-Line Format	<code>--debug-check</code>
Type	Boolean

Print some debugging information when the program exits.

- `--debug-info, -T`

Command-Line Format	<code>--debug-info</code>
Type	Boolean
Default Value	FALSE

Print debugging information and memory and CPU usage statistics when the program exits.

- `--default-auth=plugin`

Command-Line Format	<code>--default-auth=plugin</code>
Type	String

A hint about which client-side authentication plugin to use. See [Section 6.2.13, “Pluggable Authentication”](#).

- `--default-character-set=charset_name`

Command-Line Format	<code>--default-character-set=name</code>
Type	String

Use `charset_name` as the default character set. See [Section 10.15, “Character Set Configuration”](#).

- `--defaults-extra-file=file_name`

Command-Line Format	<code>--defaults-extra-file=file_name</code>
Type	File name

Read this option file after the global option file but (on Unix) before the user option file. If the file does not exist or is otherwise inaccessible, an error occurs. If `file_name` is not an absolute path name, it is interpreted relative to the current directory.

For additional information about this and other option-file options, see [Section 4.2.2.3, “Command-Line Options that Affect Option-File Handling”](#).

- `--defaults-file=file_name`

Command-Line Format	<code>--defaults-file=file_name</code>
Type	File name

Use only the given option file. If the file does not exist or is otherwise inaccessible, an error occurs. If `file_name` is not an absolute path name, it is interpreted relative to the current directory.

For additional information about this and other option-file options, see [Section 4.2.2.3, “Command-Line Options that Affect Option-File Handling”](#).

- `--defaults-group-suffix=str`

Command-Line Format	<code>--defaults-group-suffix=str</code>
Type	String

this option is given as `--defaults-group-suffix=_other`, `mysql_upgrade` also reads the `[client_other]` and `[mysql_upgrade_other]` groups.

For additional information about this and other option-file options, see [Section 4.2.2.3, “Command-Line Options that Affect Option-File Handling”](#).

- `--force`

Command-Line Format	<code>--force</code>
Type	Boolean

Ignore the `mysql_upgrade_info` file and force execution even if `mysql_upgrade` has already been executed for the current version of MySQL.

- `--host=host_name, -h host_name`

Command-Line Format	<code>--host=name</code>
Type	String

Connect to the MySQL server on the given host.

- `--login-path=name`

Command-Line Format	<code>--login-path=name</code>
Type	String

Read options from the named login path in the `.mylogin.cnf` login path file. A “login path” is an option group containing options that specify which MySQL server to connect to and which account to authenticate as. To create or modify a login path file, use the `mysql_config_editor` utility. See [Section 4.6.6, “mysql\\_config\\_editor — MySQL Configuration Utility”](#).

For additional information about this and other option-file options, see [Section 4.2.2.3, “Command-Line Options that Affect Option-File Handling”](#).

- `--max-allowed-packet=value`

Command-Line Format	<code>--max-allowed-packet=value</code>
Type	Integer
Default Value	25165824
Minimum Value	4096
Maximum Value	2147483648

The maximum size of the buffer for client/server communication. The default value is 24MB. The minimum and maximum values are 4KB and 2GB.

- `--net-buffer-length=value`

Command-Line Format	<code>--net-buffer-length=value</code>
Type	Integer

Default Value	1047552
Minimum Value	4096
Maximum Value	16777216

The initial size of the buffer for client/server communication. The default value is 1MB – 1KB. The minimum and maximum values are 4KB and 16MB.

- `--no-defaults`

Command-Line Format	<code>--no-defaults</code>
---------------------	----------------------------

Do not read any option files. If program startup fails due to reading unknown options from an option file, `--no-defaults` can be used to prevent them from being read.

The exception is that the `.mylogin.cnf` file is read in all cases, if it exists. This permits passwords to be specified in a safer way than on the command line even when `--no-defaults` is used. To create `.mylogin.cnf`, use the `mysql_config_editor` utility. See [Section 4.6.6, “mysql\\_config\\_editor — MySQL Configuration Utility”](#).

For additional information about this and other option-file options, see [Section 4.2.2.3, “Command-Line Options that Affect Option-File Handling”](#).

- `--password[=password], -p[password]`

Command-Line Format	<code>--password[=name]</code>
Type	String

The password of the MySQL account used for connecting to the server. The password value is optional. If not given, `mysql_upgrade` prompts for one. If given, there must be *no space* between `--password=` or `-p` and the password following it. If no password option is specified, the default is to send no password.

Specifying a password on the command line should be considered insecure. To avoid giving the password on the command line, use an option file. See [Section 6.1.2.1, “End-User Guidelines for Password Security”](#).

To explicitly specify that there is no password and that `mysql_upgrade` should not prompt for one, use the `--skip-password` option.

- `--pipe, -W`

Command-Line Format	<code>--pipe</code>
Type	String

On Windows, connect to the server using a named pipe. This option applies only if the server was started with the `named_pipe` system variable enabled to support named-pipe connections. In addition, the user making the connection must be a member of the Windows group specified by the `named_pipe_full_access_group` system variable.

- `--plugin-dir=dir_name`

Command-Line Format	<code>--plugin-dir=dir_name</code>
Type	Directory name

The directory in which to look for plugins. Specify this option if the `--default-auth` option is used to specify an authentication plugin but `mysql_upgrade` does not find it. See [Section 6.2.13, “Pluggable Authentication”](#).

- `--port=port_num, -P port_num`

Command-Line Format	<code>--port=#</code>
Type	Numeric

For TCP/IP connections, the port number to use.

- `--print-defaults`

Command-Line Format	<code>--print-defaults</code>
---------------------	-------------------------------

Print the program name and all options that it gets from option files.

- `--protocol={TCP|SOCKET|PIPE|MEMORY}`

Command-Line Format	<code>--protocol=name</code>
Type	String

The transport protocol to use for connecting to the server. It is useful when the other connection parameters normally result in use of a protocol other than the one you want. For details on the permissible values, see [Section 4.2.5, “Connection Transport Protocols”](#).

- `--shared-memory-base-name=name`

Command-Line Format	<code>--shared-memory-base-name=name</code>
Platform Specific	Windows

On Windows, the shared-memory name to use for connections made using shared memory to a local server. The default value is `MYSQL`. The shared-memory name is case-sensitive.

This option applies only if the server was started with the `shared_memory` system variable enabled to support shared-memory connections.

- `--skip-sys-schema`

Command-Line Format	<code>--skip-sys-schema</code>
---------------------	--------------------------------

Default Value	FALSE
---------------	-------

By default, `mysql_upgrade` installs the `sys` schema if it is not installed, and upgrades it to the current version otherwise. The `--skip-sys-schema` option suppresses this behavior.

- `--socket=path, -S path`

Command-Line Format	<code>--socket={file_name pipe_name}</code>
Type	String

For connections to `localhost`, the Unix socket file to use, or, on Windows, the name of the named pipe to use.

On Windows, this option applies only if the server was started with the `named_pipe` system variable enabled to support named-pipe connections. In addition, the user making the connection must be a member of the Windows group specified by the `named_pipe_full_access_group` system variable.

- `--ssl*`

Options that begin with `--ssl` specify whether to connect to the server using encryption and indicate where to find SSL keys and certificates. See [Command Options for Encrypted Connections](#).

- `--tls-version=protocol_list`

Command-Line Format	<code>--tls-version=protocol_list</code>
Introduced	5.7.10
Type	String
Default Value (≥ 5.7.28)	<code>TLSv1, TLSv1.1, TLSv1.2</code>
Default Value (≤ 5.7.27)	<code>TLSv1, TLSv1.1, TLSv1.2 (OpenSSL)</code> <code>TLSv1, TLSv1.1 (yaSSL)</code>

The permissible TLS protocols for encrypted connections. The value is a list of one or more comma-separated protocol names. The protocols that can be named for this option depend on the SSL library used to compile MySQL. For details, see [Section 6.3.2, “Encrypted Connection TLS Protocols and Ciphers”](#).

This option was added in MySQL 5.7.10.

- `--upgrade-system-tables, -s`

Command-Line Format	<code>--upgrade-system-tables</code>
Type	Boolean

---

Upgrade only the system tables in the `mysql` schema, do not upgrade user schemas.

- `--user=user_name, -u user_name`

Type	String
------	--------

The user name of the MySQL account to use for connecting to the server. The default user name is `root`.

- `--verbose`

Command-Line Format	<code>--verbose</code>
Type	Boolean

Verbose mode. Print more information about what the program does.

- `--version-check, -k`

Command-Line Format	<code>--version-check</code>
Type	Boolean

Check the version of the server to which `mysql_upgrade` is connecting to verify that it is the same as the version for which `mysql_upgrade` was built. If not, `mysql_upgrade` exits. This option is enabled by default; to disable the check, use `--skip-version-check`.

- `--write-binlog`

Command-Line Format	<code>--write-binlog</code>
Type	Boolean
Default Value	OFF

By default, binary logging by `mysql_upgrade` is disabled. Invoke the program with `--write-binlog` if you want its actions to be written to the binary log.

When the server is running with global transaction identifiers (GTIDs) enabled (`gtid_mode=ON`), do not enable binary logging by `mysql_upgrade`.

## 4.5 Client Programs

This section describes client programs that connect to the MySQL server.

### 4.5.1 `mysql` — The MySQL Command-Line Client

`mysql` is a simple SQL shell with input line editing capabilities. It supports interactive and noninteractive use. When used interactively, query results are presented in an ASCII-table format. When used noninteractively (for example, as a filter), the result is presented in tab-separated format. The output format can be changed using command options.

---

If you have problems due to insufficient memory for large result sets, use the `--quick` option. This forces `mysql` to retrieve results from the server a row at a time rather than retrieving the entire result set and buffering it in memory before displaying it. This is done by returning the result set using the `mysql_use_result()` C API function in the client/server library rather than `mysql_store_result()`.

**Note**

Alternatively, MySQL Shell offers access to the X DevAPI. For details, see [MySQL Shell 8.0](#).

Using `mysql` is very easy. Invoke it from the prompt of your command interpreter as follows:

```
mysql db_name
```

Or:

```
mysql --user=user_name --password db_name
```

In this case, you'll need to enter your password in response to the prompt that `mysql` displays:

```
Enter password: your_password
```

Then type an SQL statement, end it with `;`, `\g`, or `\G` and press Enter.

Typing **Control+C** interrupts the current statement if there is one, or cancels any partial input line otherwise.

You can execute SQL statements in a script file (batch file) like this:

```
mysql db_name < script.sql > output.tab
```

On Unix, the `mysql` client logs statements executed interactively to a history file. See [Section 4.5.1.3](#), “`mysql` Client Logging”.

### 4.5.1.1 mysql Client Options

`mysql` supports the following options, which can be specified on the command line or in the `[mysql]` and `[client]` groups of an option file. For information about option files used by MySQL programs, see [Section 4.2.2.2](#), “Using Option Files”.

**Table 4.13 mysql Client Options**

Option Name	Description	Introduced	Deprecated
<code>--auto-rehash</code>	Enable automatic rehashing		
<code>--auto-vertical-output</code>	Enable automatic vertical result set display		
<code>--batch</code>	Do not use history file		
<code>--binary-as-hex</code>	Display binary values in hexadecimal notation	5.7.19	
<code>--binary-mode</code>	Disable <code>\r\n</code> - to - <code>\n</code> translation and treatment of <code>\0</code> as end-of-query		
<code>--bind-address</code>	Use specified network interface to connect to MySQL Server		
<code>--character-sets-dir</code>	Directory where character sets are installed		
<code>--column-names</code>	Write column names in results		



Option Name	Description	Introduced	Deprecated
<code>--column-type-info</code>	Display result set metadata		
<code>--commands</code>	Enable or disable processing of local mysql client commands	5.7.44-ndb-7.6.35	
<code>--comments</code>	Whether to retain or strip comments in statements sent to the server		
<code>--compress</code>	Compress all information sent between client and server		
<code>--connect-expired-password</code>	Indicate to server that client can handle expired-password sandbox mode		
<code>--connect-timeout</code>	Number of seconds before connection timeout		
<code>--database</code>	The database to use		
<code>--debug</code>	Write debugging log; supported only if MySQL was built with debugging support		
<code>--debug-check</code>	Print debugging information when program exits		
<code>--debug-info</code>	Print debugging information, memory, and CPU statistics when program exits		
<code>--default-auth</code>	Authentication plugin to use		
<code>--default-character-set</code>	Specify default character set		
<code>--defaults-extra-file</code>	Read named option file in addition to usual option files		
<code>--defaults-file</code>	Read only named option file		
<code>--defaults-group-suffix</code>	Option group suffix value		
<code>--delimiter</code>	Set the statement delimiter		
<code>--enable-cleartext-plugin</code>	Enable cleartext authentication plugin		
<code>--execute</code>	Execute the statement and quit		

Option Name	Description	Introduced	Deprecated
<code>--force</code>	Continue even if an SQL error occurs		
<code>--get-server-public-key</code>	Request RSA public key from server	5.7.23	
<code>--help</code>	Display help message and exit		
<code>--histignore</code>	Patterns specifying which statements to ignore for logging		
<code>--host</code>	Host on which MySQL server is located		
<code>--html</code>	Produce HTML output		
<code>--ignore-spaces</code>	Ignore spaces after function names		
<code>--init-command</code>	SQL statement to execute after connecting		
<code>--line-numbers</code>	Write line numbers for errors		
<code>--local-infile</code>	Enable or disable for LOCAL capability for LOAD DATA		
<code>--login-path</code>	Read login path options from .mylogin.cnf		
<code>--max-allowed-packet</code>	Maximum packet length to send to or receive from server		
<code>--max-join-size</code>	The automatic limit for rows in a join when using <code>--safe-updates</code>		
<code>--named-commands</code>	Enable named mysql commands		
<code>--net-buffer-length</code>	Buffer size for TCP/IP and socket communication		
<code>--no-auto-rehash</code>	Disable automatic rehashing		
<code>--no-beep</code>	Do not beep when errors occur		
<code>--no-defaults</code>	Read no option files		
<code>--one-database</code>	Ignore statements except those for the default database named on the command line		
<code>--pager</code>	Use the given command for paging query output		

Option Name	Description	Introduced	Deprecated
<code>--password</code>	Password to use when connecting to server		
<code>--pipe</code>	Connect to server using named pipe (Windows only)		
<code>--plugin-dir</code>	Directory where plugins are installed		
<code>--port</code>	TCP/IP port number for connection		
<code>--print-defaults</code>	Print default options		
<code>--prompt</code>	Set the prompt to the specified format		
<code>--protocol</code>	Transport protocol to use		
<code>--quick</code>	Do not cache each query result		
<code>--raw</code>	Write column values without escape conversion		
<code>--reconnect</code>	If the connection to the server is lost, automatically try to reconnect		
<code>--safe-updates, --i-am-a-dummy</code>	Allow only UPDATE and DELETE statements that specify key values		
<code>--secure-auth</code>	Do not send passwords to server in old (pre-4.1) format		Yes
<code>--select-limit</code>	The automatic limit for SELECT statements when using <code>--safe-updates</code>		
<code>--server-public-key-path</code>	Path name to file containing RSA public key		
<code>--shared-memory-base-name</code>	Shared-memory name for shared-memory connections (Windows only)		
<code>--show-warnings</code>	Show warnings after each statement if there are any		
<code>--sigint-ignore</code>	Ignore SIGINT signals (typically the result of typing Control+C)		

Option Name	Description	Introduced	Deprecated
<code>--silent</code>	Silent mode		
<code>--skip-auto-rehash</code>	Disable automatic rehashing		
<code>--skip-column-names</code>	Do not write column names in results		
<code>--skip-line-numbers</code>	Skip line numbers for errors		
<code>--skip-named-commands</code>	Disable named mysql commands		
<code>--skip-pager</code>	Disable paging		
<code>--skip-reconnect</code>	Disable reconnecting		
<code>--socket</code>	Unix socket file or Windows named pipe to use		
<code>--ssl</code>	Enable connection encryption		
<code>--ssl-ca</code>	File that contains list of trusted SSL Certificate Authorities		
<code>--ssl-capath</code>	Directory that contains trusted SSL Certificate Authority certificate files		
<code>--ssl-cert</code>	File that contains X.509 certificate		
<code>--ssl-cipher</code>	Permissible ciphers for connection encryption		
<code>--ssl-crl</code>	File that contains certificate revocation lists		
<code>--ssl-crlpath</code>	Directory that contains certificate revocation-list files		
<code>--ssl-key</code>	File that contains X.509 key		
<code>--ssl-mode</code>	Desired security state of connection to server	5.7.11	
<code>--ssl-verify-server-cert</code>	Verify host name against server certificate Common Name identity		
<code>--syslog</code>	Log interactive statements to syslog		
<code>--table</code>	Display output in tabular format		
<code>--tee</code>	Append a copy of output to named file		

Option Name	Description	Introduced	Deprecated
<code>--tls-version</code>	Permissible TLS protocols for encrypted connections	5.7.10	
<code>--unbuffered</code>	Flush the buffer after each query		
<code>--user</code>	MySQL user name to use when connecting to server		
<code>--verbose</code>	Verbose mode		
<code>--version</code>	Display version information and exit		
<code>--vertical</code>	Print query output rows vertically (one line per column value)		
<code>--wait</code>	If the connection cannot be established, wait and retry instead of aborting		
<code>--xml</code>	Produce XML output		

- `--help, -?`

Command-Line Format	<code>--help</code>
---------------------	---------------------

Display a help message and exit.

- `--auto-rehash`

Command-Line Format	<code>--auto-rehash</code>
Disabled by	<code>skip-auto-rehash</code>

Enable automatic rehashing. This option is on by default, which enables database, table, and column name completion. Use `--disable-auto-rehash` to disable rehashing. That causes `mysql` to start faster, but you must issue the `rehash` command or its `\#` shortcut if you want to use name completion.

To complete a name, enter the first part and press Tab. If the name is unambiguous, `mysql` completes it. Otherwise, you can press Tab again to see the possible names that begin with what you have typed so far. Completion does not occur if there is no default database.



#### Note

This feature requires a MySQL client that is compiled with the **readline** library. Typically, the **readline** library is not available on Windows.

- `--auto-vertical-output`

Command-Line Format	<code>--auto-vertical-output</code>
---------------------	-------------------------------------

Cause result sets to be displayed vertically if they are too wide for the current window, and using normal tabular format otherwise. (This applies to statements terminated by `;` or `\G`.)

- `--batch, -B`

Command-Line Format	<code>--batch</code>
---------------------	----------------------

Print results using tab as the column separator, with each row on a new line. With this option, `mysql` does not use the history file.

Batch mode results in nontabular output format and escaping of special characters. Escaping may be disabled by using raw mode; see the description for the `--raw` option.

- `--binary-as-hex`

Command-Line Format	<code>--binary-as-hex</code>
Introduced	5.7.19
Type	Boolean
Default Value	<code>FALSE</code>

When this option is given, `mysql` displays binary data using hexadecimal notation (`0xvalue`). This occurs whether the overall output display format is tabular, vertical, HTML, or XML.

`--binary-as-hex` when enabled affects display of all binary strings, including those returned by functions such as `CHAR()` and `UNHEX()`. The following example demonstrates this using the ASCII code for `A` (65 decimal, 41 hexadecimal):

- `--binary-as-hex` disabled:

```
mysql> SELECT CHAR(0x41), UNHEX('41');
+-----+-----+
| CHAR(0x41) | UNHEX('41') |
+-----+-----+
| A          | A          |
+-----+-----+
```

- `--binary-as-hex` enabled:

```
mysql> SELECT CHAR(0x41), UNHEX('41');
+-----+-----+
| CHAR(0x41) | UNHEX('41') |
+-----+-----+
| 0x41       | 0x41       |
+-----+-----+
```

To write a binary string expression so that it displays as a character string regardless of whether `--binary-as-hex` is enabled, use these techniques:

- The `CHAR()` function has a `USING charset` clause:

```
mysql> SELECT CHAR(0x41 USING utf8mb4);
```

```

+-----+
| CHAR(0x41 USING utf8mb4) |
+-----+
| A |
+-----+

```

- More generally, use `CONVERT()` to convert an expression to a given character set:

```

mysql> SELECT CONVERT(UNHEX('41') USING utf8mb4);
+-----+
| CONVERT(UNHEX('41') USING utf8mb4) |
+-----+
| A |
+-----+

```

This option was added in MySQL 5.7.19.

- `--binary-mode`

Command-Line Format	<code>--binary-mode</code>
---------------------	----------------------------

This option helps when processing `mysqlbinlog` output that may contain `BLOB` values. By default, `mysql` translates `\r\n` in statement strings to `\n` and interprets `\0` as the statement terminator. `--binary-mode` disables both features. It also disables all `mysql` commands except `charset` and `delimiter` in noninteractive mode (for input piped to `mysql` or loaded using the `source` command).

(*NDB Cluster 7.6.35 and later:*) `--binary-mode`, when enabled, causes the server to disregard any setting for `--commands`.

- `--bind-address=ip_address`

Command-Line Format	<code>--bind-address=ip_address</code>
---------------------	--

On a computer having multiple network interfaces, use this option to select which interface to use for connecting to the MySQL server.

- `--character-sets-dir=dir_name`

Command-Line Format	<code>--character-sets-dir=dir_name</code>
Type	Directory name

The directory where character sets are installed. See [Section 10.15, “Character Set Configuration”](#).

- `--column-names`

Command-Line Format	<code>--column-names</code>
---------------------	-----------------------------

Write column names in results.

- `--column-type-info`

Command-Line Format	<code>--column-type-info</code>
---------------------	---------------------------------

Display result set metadata. This information corresponds to the contents of C API `MYSQL_FIELD` data structures. See [C API Basic Data Structures](#).

- `--commands`

Command-Line Format	<code>--commands</code>
---------------------	-------------------------



Introduced

5.7.44-ndb-7.6.35

Whether to enable or disable processing of local `mysql` client commands. Setting this option to `FALSE` disables such processing, and has the effects listed here:

- The following `mysql` client commands are disabled:

- `charset` (`/C` remains enabled)
- `clear`
- `connect`
- `edit`
- `ego`
- `exit`
- `go`
- `help`
- `nopager`
- `notee`
- `nowarning`
- `pager`
- `print`
- `prompt`
- `query_attributes`
- `quit`
- `rehash`
- `resetconnection`
- `ssl_session_data_print`
- `source`
- `status`
- `system`
- `tee`
- `\u` (`use` is passed to the server)
- `warnings`

- The `\C` and `delimiter` commands remain enabled.
- The `--system-command` option is ignored, and has no effect.

This option has no effect when `--binary-mode` is enabled.

When `--commands` is enabled, it is possible to disable (only) the system command using the `--system-command` option.

This option was added in NDB Cluster 7.6.35.

- `--comments, -c`

Command-Line Format	<code>--comments</code>
Type	Boolean
Default Value	<code>FALSE</code>

Whether to strip or preserve comments in statements sent to the server. The default is `--skip-comments` (strip comments), enable with `--comments` (preserve comments).



#### Note

In MySQL 5.7, the `mysql` client always passes optimizer hints to the server, regardless of whether this option is given. To ensure that optimizer hints are not stripped if you are using an older version of the `mysql` client with a version of the server that understands optimizer hints, invoke `mysql` with the `--comments` option.

Comment stripping is deprecated as of MySQL 5.7.20. You should expect this feature and the options to control it to be removed in a future MySQL release.

- `--compress, -C`

Command-Line Format	<code>--compress[={OFF ON}]</code>
Type	Boolean
Default Value	<code>OFF</code>

Compress all information sent between the client and the server if possible. See [Section 4.2.6, “Connection Compression Control”](#).

- `--connect-expired-password`

Command-Line Format	<code>--connect-expired-password</code>
---------------------	---

Indicate to the server that the client can handle sandbox mode if the account used to connect has an expired password. This can be useful for noninteractive invocations of `mysql` because normally the server disconnects noninteractive clients that attempt to connect using an account with an expired password. (See [Section 6.2.12, “Server Handling of Expired Passwords”](#).)

- `--connect-timeout=value`

Command-Line Format	<code>--connect-timeout=value</code>
Type	Numeric
Default Value	0

The number of seconds before connection timeout. (Default value is 0.)

- `--database=db_name, -D db_name`

Command-Line Format	<code>--database=dbname</code>
Type	String

The database to use. This is useful primarily in an option file.

- `--debug[=debug_options], -# [debug_options]`

Command-Line Format	<code>--debug[=debug_options]</code>
Type	String
Default Value	<code>d:t:o,/tmp/mysql.trace</code>

Write a debugging log. A typical `debug_options` string is `d:t:o,file_name`. The default is `d:t:o,/tmp/mysql.trace`.

This option is available only if MySQL was built using `WITH_DEBUG`. MySQL release binaries provided by Oracle are *not* built using this option.

- `--debug-check`

Command-Line Format	<code>--debug-check</code>
Type	Boolean
Default Value	<code>FALSE</code>

Print some debugging information when the program exits.

This option is available only if MySQL was built using `WITH_DEBUG`. MySQL release binaries provided by Oracle are *not* built using this option.

- `--debug-info, -T`

Command-Line Format	<code>--debug-info</code>
Type	Boolean
Default Value	<code>FALSE</code>

Print debugging information and memory and CPU usage statistics when the program exits.

This option is available only if MySQL was built using `WITH_DEBUG`. MySQL release binaries provided by Oracle are *not* built using this option.

- `--default-auth=plugin`

Command-Line Format	<code>--default-auth=plugin</code>
Type	String

A hint about which client-side authentication plugin to use. See [Section 6.2.13, “Pluggable Authentication”](#).

- `--default-character-set=charset_name`

Command-Line Format	<code>--default-character-set=charset_name</code>
Type	String

Use `charset_name` as the default character set for the client and connection.

This option can be useful if the operating system uses one character set and the `mysql` client by default uses another. In this case, output may be formatted incorrectly. You can usually fix such issues by using this option to force the client to use the system character set instead.

For more information, see [Section 10.4, “Connection Character Sets and Collations”](#), and [Section 10.15, “Character Set Configuration”](#).

- `--defaults-extra-file=file_name`

Command-Line Format	<code>--defaults-extra-file=file_name</code>
Type	File name

Read this option file after the global option file but (on Unix) before the user option file. If the file does not exist or is otherwise inaccessible, an error occurs. If `file_name` is not an absolute path name, it is interpreted relative to the current directory.

For additional information about this and other option-file options, see [Section 4.2.2.3, “Command-Line Options that Affect Option-File Handling”](#).

- `--defaults-file=file_name`

Command-Line Format	<code>--defaults-file=file_name</code>
Type	File name

Use only the given option file. If the file does not exist or is otherwise inaccessible, an error occurs. If `file_name` is not an absolute path name, it is interpreted relative to the current directory.

Exception: Even with `--defaults-file`, client programs read `.mylogin.cnf`.

- `--defaults-group-suffix=str`

Type	String
------	--------

Read not only the usual option groups, but also groups with the usual names and a suffix of *str*. For example, `mysql` normally reads the `[client]` and `[mysql]` groups. If this option is given as `--defaults-group-suffix=_other`, `mysql` also reads the `[client_other]` and `[mysql_other]` groups.

For additional information about this and other option-file options, see [Section 4.2.2.3, “Command-Line Options that Affect Option-File Handling”](#).

- `--delimiter=str`

Command-Line Format	<code>--delimiter=str</code>
Type	String
Default Value	<code>;</code>

Set the statement delimiter. The default is the semicolon character (`;`).

- `--disable-named-commands`

Disable named commands. Use the `\*` form only, or use named commands only at the beginning of a line ending with a semicolon (`;`). `mysql` starts with this option *enabled* by default. However, even with this option, long-format commands still work from the first line. See [Section 4.5.1.2, “mysql Client Commands”](#).

- `--enable-cleartext-plugin`

Command-Line Format	<code>--enable-cleartext-plugin</code>
Type	Boolean
Default Value	<code>FALSE</code>

Enable the `mysql_clear_password` cleartext authentication plugin. (See [Section 6.4.1.6, “Client-Side Cleartext Pluggable Authentication”](#).)

- `--execute=statement, -e statement`

Command-Line Format	<code>--execute=statement</code>
Type	String

Execute the statement and quit. The default output format is like that produced with `--batch`. See [Section 4.2.2.1, “Using Options on the Command Line”](#), for some examples. With this option, `mysql` does not use the history file.

- `--force, -f`

Command-Line Format	<code>--force</code>
---------------------	----------------------

- `--get-server-public-key`

Command-Line Format	<code>--get-server-public-key</code>
Introduced	5.7.23
Type	Boolean

Request from the server the public key required for RSA key pair-based password exchange. This option applies to clients that authenticate with the `caching_sha2_password` authentication plugin. For that plugin, the server does not send the public key unless requested. This option is ignored for accounts that do not authenticate with that plugin. It is also ignored if RSA-based password exchange is not used, as is the case when the client connects to the server using a secure connection.

If `--server-public-key-path=file_name` is given and specifies a valid public key file, it takes precedence over `--get-server-public-key`.

For information about the `caching_sha2_password` plugin, see [Section 6.4.1.4, “Caching SHA-2 Pluggable Authentication”](#).

The `--get-server-public-key` option was added in MySQL 5.7.23.

- `--histignore`

Command-Line Format	<code>--histignore=pattern_list</code>
Type	String

A list of one or more colon-separated patterns specifying statements to ignore for logging purposes. These patterns are added to the default pattern list ("`*IDENTIFIED*:*PASSWORD*`"). The value specified for this option affects logging of statements written to the history file, and to `syslog` if the `--syslog` option is given. For more information, see [Section 4.5.1.3, “mysql Client Logging”](#).

- `--host=host_name, -h host_name`

Command-Line Format	<code>--host=host_name</code>
Type	String
Default Value	<code>localhost</code>

Connect to the MySQL server on the given host.

- `--html, -H`

Command-Line Format	<code>--html</code>
---------------------	---------------------

Produce HTML output.

- `--ignore-spaces, -i`

Command-Line Format	<code>--ignore-spaces</code>
---------------------	------------------------------

Ignore spaces after function names. The effect of this is described in the discussion for the `IGNORE_SPACE` SQL mode (see [Section 5.1.10, “Server SQL Modes”](#)).

- `--init-command=str`

Command-Line Format	<code>--init-command=str</code>
---------------------	---------------------------------

SQL statement to execute after connecting to the server. If auto-reconnect is enabled, the statement is executed again after reconnection occurs.

- `--line-numbers`

Command-Line Format	<code>--line-numbers</code>
Disabled by	<code>skip-line-numbers</code>

Write line numbers for errors. Disable this with `--skip-line-numbers`.

- `--local-infile[={0|1}]`

Command-Line Format	<code>--local-infile[={0 1}]</code>
Type	Boolean
Default Value	<code>FALSE</code>

By default, `LOCAL` capability for `LOAD DATA` is determined by the default compiled into the MySQL client library. To enable or disable `LOCAL` data loading explicitly, use the `--local-infile` option. When given with no value, the option enables `LOCAL` data loading. When given as `--local-infile=0` or `--local-infile=1`, the option disables or enables `LOCAL` data loading.

Successful use of `LOCAL` load operations within `mysql` also requires that the server permits local loading; see [Section 6.1.6, “Security Considerations for LOAD DATA LOCAL”](#)

- `--login-path=name`

Command-Line Format	<code>--login-path=name</code>
Type	String

Read options from the named login path in the `.mylogin.cnf` login path file. A “login path” is an option group containing options that specify which MySQL server to connect to and which account to authenticate as. To create or modify a login path file, use the `mysql_config_editor` utility. See [Section 4.6.6, “mysql\\_config\\_editor — MySQL Configuration Utility”](#). 409

For additional information about this and other option-file options, see [Section 4.2.2.3 “Command-Line](#)

- `--max-allowed-packet=value`

Command-Line Format	<code>--max-allowed-packet=value</code>
Type	Numeric
Default Value	16777216

The maximum size of the buffer for client/server communication. The default is 16MB, the maximum is 1GB.

- `--max-join-size=value`

Command-Line Format	<code>--max-join-size=value</code>
Type	Numeric
Default Value	1000000

The automatic limit for rows in a join when using `--safe-updates`. (Default value is 1,000,000.)

- `--named-commands, -G`

Command-Line Format	<code>--named-commands</code>
Disabled by	<code>skip-named-commands</code>

Enable named `mysql` commands. Long-format commands are permitted, not just short-format commands. For example, `quit` and `\q` both are recognized. Use `--skip-named-commands` to disable named commands. See [Section 4.5.1.2, “mysql Client Commands”](#).

- `--net-buffer-length=value`

Command-Line Format	<code>--net-buffer-length=value</code>
Type	Numeric
Default Value	16384

The buffer size for TCP/IP and socket communication. (Default value is 16KB.)

- `--no-auto-rehash, -A`

Command-Line Format	<code>--no-auto-rehash</code>
Deprecated	Yes

This has the same effect as `--skip-auto-rehash`. See the description for `--auto-rehash`.

- `--no-beep, -b`

Command-Line Format	<code>no-beep</code>
---------------------	----------------------



- `--no-defaults`

Command-Line Format	<code>--no-defaults</code>
---------------------	----------------------------

Do not read any option files. If program startup fails due to reading unknown options from an option file, `--no-defaults` can be used to prevent them from being read.

The exception is that the `.mylogin.cnf` file is read in all cases, if it exists. This permits passwords to be specified in a safer way than on the command line even when `--no-defaults` is used. To create `.mylogin.cnf`, use the `mysql_config_editor` utility. See [Section 4.6.6, “mysql\\_config\\_editor — MySQL Configuration Utility”](#).

For additional information about this and other option-file options, see [Section 4.2.2.3, “Command-Line Options that Affect Option-File Handling”](#).

- `--one-database, -o`

Command-Line Format	<code>--one-database</code>
---------------------	-----------------------------

Ignore statements except those that occur while the default database is the one named on the command line. This option is rudimentary and should be used with care. Statement filtering is based only on `USE` statements.

Initially, `mysql` executes statements in the input because specifying a database `db_name` on the command line is equivalent to inserting `USE db_name` at the beginning of the input. Then, for each `USE` statement encountered, `mysql` accepts or rejects following statements depending on whether the database named is the one on the command line. The content of the statements is immaterial.

Suppose that `mysql` is invoked to process this set of statements:

```
DELETE FROM db2.t2;
USE db2;
DROP TABLE db1.t1;
CREATE TABLE db1.t1 (i INT);
USE db1;
INSERT INTO t1 (i) VALUES(1);
CREATE TABLE db2.t1 (j INT);
```

If the command line is `mysql --force --one-database db1`, `mysql` handles the input as follows:

- The `DELETE` statement is executed because the default database is `db1`, even though the statement names a table in a different database.
- The `DROP TABLE` and `CREATE TABLE` statements are not executed because the default database is not `db1`, even though the statements name a table in `db1`.
- The `INSERT` and `CREATE TABLE` statements are executed because the default database is `db1`, even though the `CREATE TABLE` statement names a table in a different database.

- `--pager [=command]`

Command-Line Format	<code>--pager [=command]</code>
Disabled by	<code>skip-pager</code>
Type	String

Use the given command for paging query output. If the command is omitted, the default pager is the value of your `PAGER` environment variable. Valid pagers are `less`, `more`, `cat [> filename]`, and so forth. This option works only on Unix and only in interactive mode. To disable paging, use `--skip-pager`. [Section 4.5.1.2, “mysql Client Commands”](#), discusses output paging further.

- `--password[=password]`, `-p[password]`

Command-Line Format	<code>--password[=password]</code>
Type	String

The password of the MySQL account used for connecting to the server. The password value is optional. If not given, `mysql` prompts for one. If given, there must be *no space* between `--password=` or `-p` and the password following it. If no password option is specified, the default is to send no password.

Specifying a password on the command line should be considered insecure. To avoid giving the password on the command line, use an option file. See [Section 6.1.2.1, “End-User Guidelines for Password Security”](#).

To explicitly specify that there is no password and that `mysql` should not prompt for one, use the `--skip-password` option.

- `--pipe, -W`

Command-Line Format	<code>--pipe</code>
Type	String

On Windows, connect to the server using a named pipe. This option applies only if the server was started with the `named_pipe` system variable enabled to support named-pipe connections. In addition, the user making the connection must be a member of the Windows group specified by the `named_pipe_full_access_group` system variable.

- `--plugin-dir=dir_name`

Command-Line Format	<code>--plugin-dir=dir_name</code>
Type	Directory name

The directory in which to look for plugins. Specify this option if the `--default-auth` option is used to specify an authentication plugin but `mysql` does not find it. See [Section 6.2.13, “Pluggable Authentication”](#).

- `--port=port_num, -P port_num`

Command-Line Format	<code>--port=port_num</code>
Type	Numeric
Default Value	3306

For TCP/IP connections, the port number to use.

- `--print-defaults`

Command-Line Format	<code>--print-defaults</code>
---------------------	-------------------------------

Print the program name and all options that it gets from option files.

For additional information about this and other option-file options, see [Section 4.2.2.3, “Command-Line Options that Affect Option-File Handling”](#).

- `--prompt=format_str`

Command-Line Format	<code>--prompt=format_str</code>
Type	String
Default Value	<code>mysql&gt;</code>

Set the prompt to the specified format. The default is `mysql>`. The special sequences that the prompt can contain are described in [Section 4.5.1.2, “mysql Client Commands”](#).

- `--protocol={TCP|SOCKET|PIPE|MEMORY}`

Command-Line Format	<code>--protocol=type</code>
Type	String
Default Value	[see text]
Valid Values	TCP SOCKET PIPE MEMORY

The transport protocol to use for connecting to the server. It is useful when the other connection parameters normally result in use of a protocol other than the one you want. For details on the permissible values, see [Section 4.2.5, “Connection Transport Protocols”](#).

- `--quick, -q`

Command-Line Format	<code>--quick</code>
---------------------	----------------------

Do not cache each query result, print each row as it is received. This may slow down the server if the output is suspended. With this option, `mysql` does not use the history file.

By default, `mysql` fetches all result rows before producing any output; while storing these, it calculates a running maximum column length from the actual value of each column in succession. When printing the output, it uses this maximum to format it. When `--quick` is specified, `mysql` does not have the rows for which to calculate the length before starting, and so uses the maximum length. In the following example, table `t1` has a single column of type `BIGINT` and containing 4 rows. The default output is 9 characters wide; this width is equal the maximum number of characters in any of the column values in the rows returned (5), plus 2 characters each for the spaces used as padding and the `|` characters used as column delimiters). The output when using the `--quick` option is 25 characters wide; this is equal to the number of characters needed to represent `-9223372036854775808`, which is the longest possible

value that can be stored in a (signed) `BIGINT` column, or 19 characters, plus the 4 characters used for padding and column delimiters. The difference can be seen here:

```
$> mysql -t test -e "SELECT * FROM t1"
+-----+
| c1      |
+-----+
| 100    |
| 1000   |
| 10000  |
| 10     |
+-----+

$> mysql --quick -t test -e "SELECT * FROM t1"
+-----+
| c1      |
+-----+
|          |
|          |
|          |
|          |
|          |
|          |
|          |
|          |
|          |
|          |
+-----+
```

- `--raw, -r`

Command-Line Format	<code>--raw</code>
---------------------	--------------------

For tabular output, the “boxing” around columns enables one column value to be distinguished from another. For nontabular output (such as is produced in batch mode or when the `--batch` or `--silent` option is given), special characters are escaped in the output so they can be identified easily. Newline, tab, `NUL`, and backslash are written as `\n`, `\t`, `\0`, and `\\`. The `--raw` option disables this character escaping.

The following example demonstrates tabular versus nontabular output and the use of raw mode to disable escaping:

```
% mysql
mysql> SELECT CHAR(92);
+-----+
| CHAR(92) |
+-----+
| \        |
+-----+

% mysql -s
mysql> SELECT CHAR(92);
CHAR(92)
\\

% mysql -s -r
mysql> SELECT CHAR(92);
CHAR(92)
\
```

- `--reconnect`

Command-Line Format	<code>--reconnect</code>
---------------------	--------------------------

Disabled by	<code>skip-reconnect</code>
-------------	-----------------------------

If the connection to the server is lost, automatically try to reconnect. A single reconnect attempt is made each time the connection is lost. To suppress reconnection behavior, use `--skip-reconnect`.

- `--safe-updates`, `--i-am-a-dummy`, `-U`

Command-Line Format	<code>--safe-updates</code> <code>--i-am-a-dummy</code>
Type	Boolean
Default Value	<code>FALSE</code>

If this option is enabled, `UPDATE` and `DELETE` statements that do not use a key in the `WHERE` clause or a `LIMIT` clause produce an error. In addition, restrictions are placed on `SELECT` statements that produce (or are estimated to produce) very large result sets. If you have set this option in an option file, you can use `--skip-safe-updates` on the command line to override it. For more information about this option, see [Using Safe-Updates Mode \(`--safe-updates`\)](#).

- `--secure-auth`

Command-Line Format	<code>--secure-auth</code>
Deprecated	Yes

Do not send passwords to the server in old (pre-4.1) format. This prevents connections except for servers that use the newer password format.

As of MySQL 5.7.5, this option is deprecated; expect it to be removed in a future MySQL release. It is always enabled and attempting to disable it (`--skip-secure-auth`, `--secure-auth=0`) produces an error. Before MySQL 5.7.5, this option is enabled by default but can be disabled.



#### Note

Passwords that use the pre-4.1 hashing method are less secure than passwords that use the native password hashing method and should be avoided. Pre-4.1 passwords are deprecated and support for them was removed in MySQL 5.7.5. For account upgrade instructions, see [Section 6.4.1.3, “Migrating Away from Pre-4.1 Password Hashing and the `mysql\_old\_password` Plugin”](#).

- `--select-limit=value`

Command-Line Format	<code>--select-limit=value</code>
Type	Numeric
Default Value	<code>1000</code>

The automatic limit for `SELECT` statements when using `--safe-updates`. (Default value is 1,000.)

- `--server-public-key-path=file_name`

Command-Line Format	<code>--server-public-key-path=file_name</code>
---------------------	---

Type	File name
------	-----------

The path name to a file in PEM format containing a client-side copy of the public key required by the server for RSA key pair-based password exchange. This option applies to clients that authenticate with the `sha256_password` or `caching_sha2_password` authentication plugin. This option is ignored for accounts that do not authenticate with one of those plugins. It is also ignored if RSA-based password exchange is not used, as is the case when the client connects to the server using a secure connection.

If `--server-public-key-path=file_name` is given and specifies a valid public key file, it takes precedence over `--get-server-public-key`.

For `sha256_password`, this option applies only if MySQL was built using OpenSSL.

For information about the `sha256_password` and `caching_sha2_password` plugins, see [Section 6.4.1.5, “SHA-256 Pluggable Authentication”](#), and [Section 6.4.1.4, “Caching SHA-2 Pluggable Authentication”](#).

- `--shared-memory-base-name=name`

Command-Line Format	<code>--shared-memory-base-name=name</code>
Platform Specific	Windows

On Windows, the shared-memory name to use for connections made using shared memory to a local server. The default value is `MYSQL`. The shared-memory name is case-sensitive.

This option applies only if the server was started with the `shared_memory` system variable enabled to support shared-memory connections.

- `--show-warnings`

Command-Line Format	<code>--show-warnings</code>
---------------------	------------------------------

Cause warnings to be shown after each statement if there are any. This option applies to interactive and batch mode.

- `--sigint-ignore`

Command-Line Format	<code>--sigint-ignore</code>
---------------------	------------------------------

Ignore `SIGINT` signals (typically the result of typing **Control+C**).

Without this option, typing **Control+C** interrupts the current statement if there is one, or cancels any partial input line otherwise.

- `--silent, -s`

Command-Line Format	<code>--silent</code>
---------------------	-----------------------

Silent mode. Produce less output. This option can be given multiple times to produce less and less output.

This option results in nontabular output format and escaping of special characters. Escaping may be disabled by using raw mode; see the description for the `--raw` option.

- `--skip-column-names, -N`

Command-Line Format	<code>--skip-column-names</code>
---------------------	----------------------------------

Do not write column names in results. Use of this option causes the output to be right-aligned, as shown here:

```
$> echo "SELECT * FROM t1" | mysql -t test
+-----+
| c1      |
+-----+
| a,c,d   |
| c       |
+-----+
$> echo "SELECT * FROM t1" | ./mysql -uroot -Nt test
+-----+
| a,c,d   |
|         c |
+-----+
```

- `--skip-line-numbers, -L`

Command-Line Format	<code>--skip-line-numbers</code>
---------------------	----------------------------------

Do not write line numbers for errors. Useful when you want to compare result files that include error messages.

- `--socket=path, -S path`

Command-Line Format	<code>--socket={file_name pipe_name}</code>
Type	String

For connections to `localhost`, the Unix socket file to use, or, on Windows, the name of the named pipe to use.

On Windows, this option applies only if the server was started with the `named_pipe` system variable enabled to support named-pipe connections. In addition, the user making the connection must be a member of the Windows group specified by the `named_pipe_full_access_group` system variable.

- `--ssl*`

Options that begin with `--ssl` specify whether to connect to the server using encryption and indicate

- `--syslog, -j`

Command-Line Format	<code>--syslog</code>
---------------------	-----------------------

This option causes `mysql` to send interactive statements to the system logging facility. On Unix, this is `syslog`; on Windows, it is the Windows Event Log. The destination where logged messages appear is system dependent. On Linux, the destination is often the `/var/log/messages` file.

Here is a sample of output generated on Linux by using `--syslog`. This output is formatted for readability; each logged message actually takes a single line.

```
Mar  7 12:39:25 myhost MysqlClient[20824]:
  SYSTEM_USER:'oscar', MYSQL_USER:'my_oscar', CONNECTION_ID:23,
  DB_SERVER:'127.0.0.1', DB:'--', QUERY:'USE test;'
Mar  7 12:39:28 myhost MysqlClient[20824]:
  SYSTEM_USER:'oscar', MYSQL_USER:'my_oscar', CONNECTION_ID:23,
  DB_SERVER:'127.0.0.1', DB:'test', QUERY:'SHOW TABLES;'
```

For more information, see [Section 4.5.1.3, “mysql Client Logging”](#).

- `--table, -t`

Command-Line Format	<code>--table</code>
---------------------	----------------------

Display output in table format. This is the default for interactive use, but can be used to produce table output in batch mode.

- `--tee=file_name`

Command-Line Format	<code>--tee=file_name</code>
Type	File name

Append a copy of output to the given file. This option works only in interactive mode. [Section 4.5.1.2, “mysql Client Commands”](#), discusses tee files further.

- `--tls-version=protocol_list`

Command-Line Format	<code>--tls-version=protocol_list</code>
Introduced	5.7.10
Type	String
Default Value (≥ 5.7.28)	TLSv1, TLSv1.1, TLSv1.2
Default Value (≤ 5.7.27)	TLSv1, TLSv1.1, TLSv1.2 (OpenSSL) TLSv1, TLSv1.1 (yaSSL)



- `--unbuffered, -n`

Command-Line Format	<code>--unbuffered</code>
---------------------	---------------------------

Flush the buffer after each query.

- `--user=user_name, -u user_name`

Command-Line Format	<code>--user=user_name</code>
Type	String

The user name of the MySQL account to use for connecting to the server.

- `--verbose, -v`

Command-Line Format	<code>--verbose</code>
---------------------	------------------------

Verbose mode. Produce more output about what the program does. This option can be given multiple times to produce more and more output. (For example, `-v -v -v` produces table output format even in batch mode.)

- `--version, -V`

Command-Line Format	<code>--version</code>
---------------------	------------------------

Display version information and exit.

- `--vertical, -E`

Command-Line Format	<code>--vertical</code>
---------------------	-------------------------

Print query output rows vertically (one line per column value). Without this option, you can specify vertical output for individual statements by terminating them with `\G`.

- `--wait, -w`

Command-Line Format	<code>--wait</code>
---------------------	---------------------

If the connection cannot be established, wait and retry instead of aborting.

- `--xml, -X`

Command-Line Format	<code>--xml</code>
---------------------	--------------------

Produce XML output.

```
<field name="column_name">NULL</field>
```

The output when `--xml` is used with `mysql` matches that of `mysqldump --xml`. See [Section 4.5.4, “mysqldump — A Database Backup Program”](#), for details.

The XML output also uses an XML namespace, as shown here:

```
$> mysql --xml -uroot -e "SHOW VARIABLES LIKE 'version%'"
<?xml version="1.0"?>

<resultset statement="SHOW VARIABLES LIKE 'version%'" xmlns:xsi="http://www.w3.org/2001/XMLSchema-instance">
<row>
<field name="Variable_name">version</field>
<field name="Value">5.0.40-debug</field>
</row>

<row>
<field name="Variable_name">version_comment</field>
<field name="Value">Source distribution</field>
</row>

<row>
<field name="Variable_name">version_compile_machine</field>
<field name="Value">i686</field>
</row>

<row>
<field name="Variable_name">version_compile_os</field>
<field name="Value">suse-linux-gnu</field>
</row>
</resultset>
```

### 4.5.1.2 mysql Client Commands

`mysql` sends each SQL statement that you issue to the server to be executed. There is also a set of commands that `mysql` itself interprets. For a list of these commands, type `help` or `\h` at the `mysql` prompt:

```
mysql> help

List of all MySQL commands:
Note that all text commands must be first on line and end with ';'
?          (?) Synonym for 'help'.
clear      (\c) Clear the current input statement.
connect    (\r) Reconnect to the server. Optional arguments are db and host.
delimiter (\d) Set statement delimiter.
edit       (\e) Edit command with $EDITOR.
ego        (\G) Send command to mysql server, display result vertically.
exit       (\q) Exit mysql. Same as quit.
go         (\g) Send command to mysql server.
help       (\h) Display this help.
nopager    (\n) Disable pager, print to stdout.
notee      (\t) Don't write into outfile.
pager      (\P) Set PAGER [to_pager]. Print the query results via PAGER.
print      (\p) Print current command.
prompt     (\R) Change your mysql prompt.
quit       (\q) Quit mysql.
rehash     (\#) Rebuild completion hash.
source     (\.) Execute an SQL script file. Takes a file name as an argument.
status     (\s) Get status information from the server.
system     (\!) Execute a system shell command.
tee        (\T) Set outfile [to_outfile]. Append everything into given
           outfile.
use        (\u) Use another database. Takes database name as argument.
charset    (\C) Switch to another charset. Might be needed for processing
           binlog with multi-byte charsets.
warnings   (\W) Show warnings after every statement.
nowarning  (\w) Don't show warnings after every statement.
resetconnection(\x) Clean session context.
```

```
For server side help, type 'help contents'
```

If `mysql` is invoked with the `--binary-mode` option, all `mysql` commands are disabled except `charset` and `delimiter` in noninteractive mode (for input piped to `mysql` or loaded using the `source` command).

Each command has both a long and short form. The long form is not case-sensitive; the short form is. The long form can be followed by an optional semicolon terminator, but the short form should not.

The use of short-form commands within multiple-line `/* ... */` comments is not supported. Short-form commands do work within single-line `/*! ... */` version comments, as do `/*+ ... */` optimizer-hint comments, which are stored in object definitions. If there is a concern that optimizer-hint comments may be stored in object definitions so that dump files when reloaded with `mysql` would result in execution of such commands, either invoke `mysql` with the `--binary-mode` option or use a reload client other than `mysql`.

- `help [arg], \h [arg], \? [arg], ? [arg]`

Display a help message listing the available `mysql` commands.

If you provide an argument to the `help` command, `mysql` uses it as a search string to access server-side help from the contents of the MySQL Reference Manual. For more information, see [Section 4.5.1.4, “mysql Client Server-Side Help”](#).

- `charset charset_name, \C charset_name`

Change the default character set and issue a `SET NAMES` statement. This enables the character set to remain synchronized on the client and server if `mysql` is run with auto-reconnect enabled (which is not recommended), because the specified character set is used for reconnects.

- `clear, \c`

Clear the current input. Use this if you change your mind about executing the statement that you are entering.

- `connect [db_name [host_name]], \r [db_name [host_name]]`

Reconnect to the server. The optional database name and host name arguments may be given to specify the default database or the host where the server is running. If omitted, the current values are used.

- `delimiter str, \d str`

Change the string that `mysql` interprets as the separator between SQL statements. The default is the semicolon character (`;`).

The delimiter string can be specified as an unquoted or quoted argument on the `delimiter` command line. Quoting can be done with either single quote (`'`), double quote (`"`), or backtick (```) characters. To include a quote within a quoted string, either quote the string with a different quote character or escape the quote with a backslash (`\`) character. Backslash should be avoided outside of quoted strings because it is the escape character for MySQL. For an unquoted argument, the delimiter is read up to the first space or end of line. For a quoted argument, the delimiter is read up to the matching quote on the line.

`mysql` interprets instances of the delimiter string as a statement delimiter anywhere it occurs, except within quoted strings. Be careful about defining a delimiter that might occur within other words. For example, if you define the delimiter as `X`, it is not possible to use the word `INDEX` in statements. `mysql` interprets this as `INDE` followed by the delimiter `X`.

When the delimiter recognized by `mysql` is set to something other than the default of `;`, instances of that character are sent to the server without interpretation. However, the server itself still interprets `;` as a statement delimiter and processes statements accordingly. This behavior on the server side comes into play for multiple-statement execution (see [Multiple Statement Execution Support](#)), and for parsing the body of stored procedures and functions, triggers, and events (see [Section 23.1, “Defining Stored Programs”](#)).

- `edit, \e`

Edit the current input statement. `mysql` checks the values of the `EDITOR` and `VISUAL` environment variables to determine which editor to use. The default editor is `vi` if neither variable is set.

The `edit` command works only in Unix.

- `ego, \G`

Send the current statement to the server to be executed and display the result using vertical format.

- `exit, \q`

Exit `mysql`.

- `go, \g`

Send the current statement to the server to be executed.

- `nopager, \n`

Disable output paging. See the description for `pager`.

The `nopager` command works only in Unix.

- `notee, \t`

Disable output copying to the tee file. See the description for `tee`.

- `nowarning, \w`

Disable display of warnings after each statement.

- `pager [command], \P [command]`

Enable output paging. By using the `--pager` option when you invoke `mysql`, it is possible to browse or search query results in interactive mode with Unix programs such as `less`, `more`, or any other similar program. If you specify no value for the option, `mysql` checks the value of the `PAGER` environment variable and sets the pager to that. Pager functionality works only in interactive mode.

Output paging can be enabled interactively with the `pager` command and disabled with `nopager`. The command takes an optional argument; if given, the paging program is set to that. With no argument, the pager is set to the pager that was set on the command line, or `stdout` if no pager was specified.

Output paging works only in Unix because it uses the `popen()` function, which does not exist on Windows. For Windows, the `tee` option can be used instead to save query output, although it is not as convenient as `pager` for browsing output in some situations.

- `print, \p`

Print the current input statement without executing it.

- `prompt [str], \R [str]`

Reconfigure the `mysql` prompt to the given string. The special character sequences that can be used in the prompt are described later in this section.

If you specify the `prompt` command with no argument, `mysql` resets the prompt to the default of `mysql>`.

- `quit, \q`

Exit `mysql`.

- `rehash, \#`

Rebuild the completion hash that enables database, table, and column name completion while you are entering statements. (See the description for the `--auto-rehash` option.)

- `resetconnection, \x`

Reset the connection to clear the session state.

Resetting a connection has effects similar to `mysql_change_user()` or an auto-reconnect except that the connection is not closed and reopened, and re-authentication is not done. See `mysql_change_user()`, and [Automatic Reconnection Control](#).

This example shows how `resetconnection` clears a value maintained in the session state:

```
mysql> SELECT LAST_INSERT_ID(3);
+-----+
| LAST_INSERT_ID(3) |
+-----+
|                   3 |
+-----+

mysql> SELECT LAST_INSERT_ID();
+-----+
| LAST_INSERT_ID() |
+-----+
|                   3 |
+-----+

mysql> resetconnection;

mysql> SELECT LAST_INSERT_ID();
+-----+
| LAST_INSERT_ID() |
+-----+
|                   0 |
+-----+
```

- `source file_name, \. file_name`

Read the named file and executes the statements contained therein. On Windows, specify path name separators as `/` or `\\`.

Quote characters are taken as part of the file name itself. For best results, the name should not include space characters.

- `status, \s`

Provide status information about the connection and the server you are using. If you are running with `--safe-updates` enabled, `status` also prints the values for the `mysql` variables that affect your queries.

- `system command, \! command`

Execute the given command using your default command interpreter.

The `system` command works only in Unix.

- `tee [file_name], \T [file_name]`

By using the `--tee` option when you invoke `mysql`, you can log statements and their output. All the data displayed on the screen is appended into a given file. This can be very useful for debugging purposes also. `mysql` flushes results to the file after each statement, just before it prints its next prompt. Tee functionality works only in interactive mode.

You can enable this feature interactively with the `tee` command. Without a parameter, the previous file is used. The `tee` file can be disabled with the `notee` command. Executing `tee` again re-enables logging.

- `use db_name, \u db_name`

Use `db_name` as the default database.

- `warnings, \W`

Enable display of warnings after each statement (if there are any).

Here are a few tips about the `pager` command:

- You can use it to write to a file and the results go only to the file:

```
mysql> pager cat > /tmp/log.txt
```

You can also pass any options for the program that you want to use as your pager:

```
mysql> pager less -n -i -S
```

- In the preceding example, note the `-S` option. You may find it very useful for browsing wide query results. Sometimes a very wide result set is difficult to read on the screen. The `-S` option to `less` can make the result set much more readable because you can scroll it horizontally using the left-arrow and right-arrow keys. You can also use `-S` interactively within `less` to switch the horizontal-browse mode on and off. For more information, read the `less` manual page:

```
man less
```

- The `-F` and `-X` options may be used with `less` to cause it to exit if output fits on one screen, which is convenient when no scrolling is necessary:

```
mysql> pager less -n -i -S -F -X
```

- You can specify very complex pager commands for handling query output:

```
mysql> pager cat | tee /dr1/tmp/res.txt \  
          | tee /dr2/tmp/res2.txt | less -n -i -S
```

In this example, the command would send query results to two files in two different directories on two different file systems, mounted on `/dr1` and `/dr2`, yet still display the results onscreen using `less`.

You can also combine the `tee` and `pager` functions. Have a `tee` file enabled and `pager` set to `less`, and you are able to browse the results using the `less` program and still have everything appended into a file the same time. The difference between the Unix `tee` used with the `pager` command and the `mysql` built-in `tee` command is that the built-in `tee` works even if you do not have the Unix `tee` available. The built-in `tee` also logs everything that is printed on the screen, whereas the Unix `tee` used with `pager` does not log quite that much. Additionally, `tee` file logging can be turned on and off interactively from within `mysql`. This is useful when you want to log some queries to a file, but not others.

The `prompt` command reconfigures the default `mysql>` prompt. The string for defining the prompt can contain the following special sequences.

Option	Description
<code>\C</code>	The current connection identifier
<code>\c</code>	A counter that increments for each statement you issue
<code>\D</code>	The full current date
<code>\d</code>	The default database
<code>\h</code>	The server host
<code>\l</code>	The current delimiter
<code>\m</code>	Minutes of the current time
<code>\n</code>	A newline character
<code>\O</code>	The current month in three-letter format (Jan, Feb, ...)
<code>\o</code>	The current month in numeric format
<code>\P</code>	am/pm
<code>\p</code>	The current TCP/IP port or socket file
<code>\R</code>	The current time, in 24-hour military time (0–23)
<code>\r</code>	The current time, standard 12-hour time (1–12)
<code>\S</code>	Semicolon
<code>\s</code>	Seconds of the current time
<code>\t</code>	A tab character
<code>\U</code>	Your full <code>user_name@host_name</code> account name
<code>\u</code>	Your user name
<code>\v</code>	The server version
<code>\w</code>	The current day of the week in three-letter format (Mon, Tue, ...)
<code>\Y</code>	The current year, four digits
<code>\y</code>	The current year, two digits
<code>\_</code>	A space
<code>\</code>	A space (a space follows the backslash)
<code>\'</code>	Single quote
<code>\"</code>	Double quote
<code>\\</code>	A literal <code>\</code> backslash character

Option	Description
<code>\x</code>	<code>x</code> , for any “ <code>x</code> ” not listed above

You can set the prompt in several ways:

- *Use an environment variable.* You can set the `MYSQL_PS1` environment variable to a prompt string. For example:

```
export MYSQL_PS1="(\\u@\\h) [\\d]> "
```

- *Use a command-line option.* You can set the `--prompt` option on the command line to `mysql`. For example:

```
$> mysql --prompt="(\\u@\\h) [\\d]> "
(user@host) [database]>
```

- *Use an option file.* You can set the `prompt` option in the `[mysql]` group of any MySQL option file, such as `/etc/my.cnf` or the `.my.cnf` file in your home directory. For example:

```
[mysql]
prompt=(\\u@\\h) [\\d]>\\_
```

In this example, note that the backslashes are doubled. If you set the prompt using the `prompt` option in an option file, it is advisable to double the backslashes when using the special prompt options. There is some overlap in the set of permissible prompt options and the set of special escape sequences that are recognized in option files. (The rules for escape sequences in option files are listed in [Section 4.2.2.2, “Using Option Files”](#).) The overlap may cause you problems if you use single backslashes. For example, `\\s` is interpreted as a space rather than as the current seconds value. The following example shows how to define a prompt within an option file to include the current time in `hh:mm:ss>` format:

```
[mysql]
prompt="\\r:\\m:\\s> "
```

- *Set the prompt interactively.* You can change your prompt interactively by using the `prompt` (or `\\R`) command. For example:

```
mysql> prompt (\\u@\\h) [\\d]>\\_
PROMPT set to '(\\u@\\h) [\\d]>\\_'
(user@host) [database]>
(user@host) [database]> prompt
Returning to default PROMPT of mysql>
mysql>
```

### 4.5.1.3 mysql Client Logging

The `mysql` client can do these types of logging for statements executed interactively:

- On Unix, `mysql` writes the statements to a history file. By default, this file is named `.mysql_history` in your home directory. To specify a different file, set the value of the `MYSQL_HISTFILE` environment variable.
- On all platforms, if the `--syslog` option is given, `mysql` writes the statements to the system logging facility. On Unix, this is `syslog`; on Windows, it is the Windows Event Log. The destination where logged messages appear is system dependent. On Linux, the destination is often the `/var/log/messages` file.

The following discussion describes characteristics that apply to all logging types and provides information specific to each logging type.



- [How Logging Occurs](#)
- [Controlling the History File](#)
- [syslog Logging Characteristics](#)

## How Logging Occurs

For each enabled logging destination, statement logging occurs as follows:

- Statements are logged only when executed interactively. Statements are noninteractive, for example, when read from a file or a pipe. It is also possible to suppress statement logging by using the `--batch` or `--execute` option.
- Statements are ignored and not logged if they match any pattern in the “ignore” list. This list is described later.
- `mysql` logs each nonignored, nonempty statement line individually.
- If a nonignored statement spans multiple lines (not including the terminating delimiter), `mysql` concatenates the lines to form the complete statement, maps newlines to spaces, and logs the result, plus a delimiter.

Consequently, an input statement that spans multiple lines can be logged twice. Consider this input:

```
mysql> SELECT
-> 'Today is'
-> ,
-> CURDATE()
-> ;
```

In this case, `mysql` logs the “SELECT”, “‘Today is’”, “,”, “CURDATE()”, and “;” lines as it reads them. It also logs the complete statement, after mapping `SELECT\n'Today is'\n,\nCURDATE()` to `SELECT 'Today is' , CURDATE()`, plus a delimiter. Thus, these lines appear in logged output:

```
SELECT
'Today is'
,
CURDATE()
;
SELECT 'Today is' , CURDATE();
```

`mysql` ignores for logging purposes statements that match any pattern in the “ignore” list. By default, the pattern list is `"*IDENTIFIED*:*PASSWORD*"`, to ignore statements that refer to passwords. Pattern matching is not case-sensitive. Within patterns, two characters are special:

- `?` matches any single character.
- `*` matches any sequence of zero or more characters.

To specify additional patterns, use the `--histignore` option or set the `MYSQL_HISTIGNORE` environment variable. (If both are specified, the option value takes precedence.) The value should be a list of one or more colon-separated patterns, which are appended to the default pattern list.

Patterns specified on the command line might need to be quoted or escaped to prevent your command interpreter from treating them specially. For example, to suppress logging for `UPDATE` and `DELETE` statements in addition to statements that refer to passwords, invoke `mysql` like this:

```
mysql --histignore="*UPDATE*:*DELETE*"
```

## Controlling the History File

The `.mysql_history` file should be protected with a restrictive access mode because sensitive information might be written to it, such as the text of SQL statements that contain passwords. See [Section 6.1.2.1, “End-User Guidelines for Password Security”](#). Statements in the file are accessible from the `mysql` client when the **up-arrow** key is used to recall the history. See [Disabling Interactive History](#).

If you do not want to maintain a history file, first remove `.mysql_history` if it exists. Then use either of the following techniques to prevent it from being created again:

- Set the `MYSQL_HISTFILE` environment variable to `/dev/null`. To cause this setting to take effect each time you log in, put it in one of your shell's startup files.
- Create `.mysql_history` as a symbolic link to `/dev/null`; this need be done only once:

```
ln -s /dev/null $HOME/.mysql_history
```

## syslog Logging Characteristics

If the `--syslog` option is given, `mysql` writes interactive statements to the system logging facility. Message logging has the following characteristics.

Logging occurs at the “information” level. This corresponds to the `LOG_INFO` priority for `syslog` on Unix/Linux `syslog` capability and to `EVENTLOG_INFORMATION_TYPE` for the Windows Event Log. Consult your system documentation for configuration of your logging capability.

Message size is limited to 1024 bytes.

Messages consist of the identifier `MysqlClient` followed by these values:

- `SYSTEM_USER`

The operating system user name (login name) or `--` if the user is unknown.

- `MYSQL_USER`

The MySQL user name (specified with the `--user` option) or `--` if the user is unknown.

- `CONNECTION_ID`:

The client connection identifier. This is the same as the `CONNECTION_ID()` function value within the session.

- `DB_SERVER`

The server host or `--` if the host is unknown.

- `DB`

The default database or `--` if no database has been selected.

- `QUERY`

The text of the logged statement.

Here is a sample of output generated on Linux by using `--syslog`. This output is formatted for readability; each logged message actually takes a single line.

```
Mar  7 12:39:25 myhost MysqlClient[20824]:
  SYSTEM_USER:'oscar', MYSQL_USER:'my_oscar', CONNECTION_ID:23,
```

```
DB_SERVER:'127.0.0.1', DB:'--', QUERY:'USE test;'
Mar  7 12:39:28 myhost MysqlClient[20824]:
SYSTEM_USER:'oscar', MYSQL_USER:'my_oscar', CONNECTION_ID:23,
DB_SERVER:'127.0.0.1', DB:'test', QUERY:'SHOW TABLES;'
```

#### 4.5.1.4 mysql Client Server-Side Help

```
mysql> help search_string
```

If you provide an argument to the `help` command, `mysql` uses it as a search string to access server-side help from the contents of the MySQL Reference Manual. The proper operation of this command requires that the help tables in the `mysql` database be initialized with help topic information (see [Section 5.1.14, “Server-Side Help Support”](#)).

If there is no match for the search string, the search fails:

```
mysql> help me

Nothing found
Please try to run 'help contents' for a list of all accessible topics
```

Use `help contents` to see a list of the help categories:

```
mysql> help contents
You asked for help about help category: "Contents"
For more information, type 'help <item>', where <item> is one of the
following categories:
  Account Management
  Administration
  Data Definition
  Data Manipulation
  Data Types
  Functions
  Functions and Modifiers for Use with GROUP BY
  Geographic Features
  Language Structure
  Plugins
  Storage Engines
  Stored Routines
  Table Maintenance
  Transactions
  Triggers
```

If the search string matches multiple items, `mysql` shows a list of matching topics:

```
mysql> help logs
Many help items for your request exist.
To make a more specific request, please type 'help <item>',
where <item> is one of the following topics:
  SHOW
  SHOW BINARY LOGS
  SHOW ENGINE
  SHOW LOGS
```

Use a topic as the search string to see the help entry for that topic:

```
mysql> help show binary logs
Name: 'SHOW BINARY LOGS'
Description:
Syntax:
SHOW BINARY LOGS
SHOW MASTER LOGS

Lists the binary log files on the server. This statement is used as
part of the procedure described in [purge-binary-logs], that shows how
to determine which logs can be purged.
```

```
mysql> SHOW BINARY LOGS;
+-----+-----+
| Log_name      | File_size |
+-----+-----+
| binlog.000015 | 724935   |
| binlog.000016 | 733481   |
+-----+-----+
```

The search string can contain the wildcard characters `%` and `_`. These have the same meaning as for pattern-matching operations performed with the `LIKE` operator. For example, `HELP rep%` returns a list of topics that begin with `rep`:

```
mysql> HELP rep%
Many help items for your request exist.
To make a more specific request, please type 'help <item>',
where <item> is one of the following
topics:
  REPAIR TABLE
  REPEAT FUNCTION
  REPEAT LOOP
  REPLACE
  REPLACE FUNCTION
```

#### 4.5.1.5 Executing SQL Statements from a Text File

The `mysql` client typically is used interactively, like this:

```
mysql db_name
```

However, it is also possible to put your SQL statements in a file and then tell `mysql` to read its input from that file. To do so, create a text file `text_file` that contains the statements you wish to execute. Then invoke `mysql` as shown here:

```
mysql db_name < text_file
```

If you place a `USE db_name` statement as the first statement in the file, it is unnecessary to specify the database name on the command line:

```
mysql < text_file
```

If you are already running `mysql`, you can execute an SQL script file using the `source` command or `\.` command:

```
mysql> source file_name
mysql> \. file_name
```

Sometimes you may want your script to display progress information to the user. For this you can insert statements like this:

```
SELECT '<info_to_display>' AS ' ';
```

The statement shown outputs `<info_to_display>`.

You can also invoke `mysql` with the `--verbose` option, which causes each statement to be displayed before the result that it produces.

`mysql` ignores Unicode byte order mark (BOM) characters at the beginning of input files. Previously, it read them and sent them to the server, resulting in a syntax error. Presence of a BOM does not cause `mysql` to change its default character set. To do that, invoke `mysql` with an option such as `--default-character-set=utf8`.

For more information about batch mode, see [Section 3.5, “Using mysql in Batch Mode”](#).

### 4.5.1.6 mysql Client Tips

This section provides information about techniques for more effective use of `mysql` and about `mysql` operational behavior.

- [Input-Line Editing](#)
- [Disabling Interactive History](#)
- [Unicode Support on Windows](#)
- [Displaying Query Results Vertically](#)
- [Using Safe-Updates Mode \(--safe-updates\)](#)
- [Disabling mysql Auto-Reconnect](#)
- [mysql Client Parser Versus Server Parser](#)

#### Input-Line Editing

`mysql` supports input-line editing, which enables you to modify the current input line in place or recall previous input lines. For example, the **left-arrow** and **right-arrow** keys move horizontally within the current input line, and the **up-arrow** and **down-arrow** keys move up and down through the set of previously entered lines. **Backspace** deletes the character before the cursor and typing new characters enters them at the cursor position. To enter the line, press **Enter**.

On Windows, the editing key sequences are the same as supported for command editing in console windows. On Unix, the key sequences depend on the input library used to build `mysql` (for example, the `libedit` or `readline` library).

Documentation for the `libedit` and `readline` libraries is available online. To change the set of key sequences permitted by a given input library, define key bindings in the library startup file. This is a file in your home directory: `.editrc` for `libedit` and `.inputrc` for `readline`.

For example, in `libedit`, **Control+W** deletes everything before the current cursor position and **Control+U** deletes the entire line. In `readline`, **Control+W** deletes the word before the cursor and **Control+U** deletes everything before the current cursor position. If `mysql` was built using `libedit`, a user who prefers the `readline` behavior for these two keys can put the following lines in the `.editrc` file (creating the file if necessary):

```
bind "^W" ed-delete-prev-word
bind "^U" vi-kill-line-prev
```

To see the current set of key bindings, temporarily put a line that says only `bind` at the end of `.editrc`. Then `mysql` shows the bindings when it starts.

#### Disabling Interactive History

The **up-arrow** key enables you to recall input lines from current and previous sessions. In cases where a console is shared, this behavior may be unsuitable. `mysql` supports disabling the interactive history partially or fully, depending on the host platform.

On Windows, the history is stored in memory. **Alt+F7** deletes all input lines stored in memory for the current history buffer. It also deletes the list of sequential numbers in front of the input lines displayed with **F7** and recalled (by number) with **F9**. New input lines entered after you press **Alt+F7** repopulate the current history buffer. Clearing the buffer does not prevent logging to the Windows Event Viewer, if the `--syslog` option was used to start `mysql`. Closing the console window also clears the current history buffer.

To disable interactive history on Unix, first delete the `.mysql_history` file, if it exists (previous entries are recalled otherwise). Then start `mysql` with the `--histignore="*"`  option to ignore all new input lines. To re-enable the recall (and logging) behavior, restart `mysql` without the option.

If you prevent the `.mysql_history` file from being created (see [Controlling the History File](#)) and use `--histignore="*"`  to start the `mysql` client, the interactive history recall facility is disabled fully. Alternatively, if you omit the `--histignore` option, you can recall the input lines entered during the current session.

## Unicode Support on Windows

Windows provides APIs based on UTF-16LE for reading from and writing to the console; the `mysql` client for Windows is able to use these APIs. The Windows installer creates an item in the MySQL menu named [MySQL command line client - Unicode](#). This item invokes the `mysql` client with properties set to communicate through the console to the MySQL server using Unicode.

To take advantage of this support manually, run `mysql` within a console that uses a compatible Unicode font and set the default character set to a Unicode character set that is supported for communication with the server:

1. Open a console window.
2. Go to the console window properties, select the font tab, and choose Lucida Console or some other compatible Unicode font. This is necessary because console windows start by default using a DOS raster font that is inadequate for Unicode.
3. Execute `mysql.exe` with the `--default-character-set=utf8` (or `utf8mb4`) option. This option is necessary because `utf16le` is one of the character sets that cannot be used as the client character set. See [Impermissible Client Character Sets](#).

With those changes, `mysql` can use the Windows APIs to communicate with the console using UTF-16LE, and communicate with the server using UTF-8. (The menu item mentioned previously sets the font and character set as just described.)

To avoid those steps each time you run `mysql`, you can create a shortcut that invokes `mysql.exe`. The shortcut should set the console font to Lucida Console or some other compatible Unicode font, and pass the `--default-character-set=utf8` (or `utf8mb4`) option to `mysql.exe`.

Alternatively, create a shortcut that only sets the console font, and set the character set in the `[mysql]` group of your `my.ini` file:

```
[mysql]
default-character-set=utf8
```

## Displaying Query Results Vertically

Some query results are much more readable when displayed vertically, instead of in the usual horizontal table format. Queries can be displayed vertically by terminating the query with `\G` instead of a semicolon. For example, longer text values that include newlines often are much easier to read with vertical output:

```
mysql> SELECT * FROM mails WHERE LENGTH(txt) < 300 LIMIT 300,1\G
***** 1. row *****
  msg_nro: 3068
    date: 2000-03-01 23:29:50
time_zone: +0200
mail_from: Jones
      reply: jones@example.com
mail_to: "John Smith" <smith@example.com>
      sbj: UTF-8
```

```

txt: >>>> "John" == John Smith writes:

John> Hi. I think this is a good idea. Is anyone familiar
John> with UTF-8 or Unicode? Otherwise, I'll put this on my
John> TODO list and see what happens.

Yes, please do that.

Regards,
Jones
  file: inbox-jani-1
  hash: 190402944
1 row in set (0.09 sec)

```

## Using Safe-Updates Mode (--safe-updates)

For beginners, a useful startup option is `--safe-updates` (or `--i-am-a-dummy`, which has the same effect). Safe-updates mode is helpful for cases when you might have issued an `UPDATE` or `DELETE` statement but forgotten the `WHERE` clause indicating which rows to modify. Normally, such statements update or delete all rows in the table. With `--safe-updates`, you can modify rows only by specifying the key values that identify them, or a `LIMIT` clause, or both. This helps prevent accidents. Safe-updates mode also restricts `SELECT` statements that produce (or are estimated to produce) very large result sets.

The `--safe-updates` option causes `mysql` to execute the following statement when it connects to the MySQL server, to set the session values of the `sql_safe_updates`, `sql_select_limit`, and `max_join_size` system variables:

```
SET sql_safe_updates=1, sql_select_limit=1000, max_join_size=1000000;
```

The `SET` statement affects statement processing as follows:

- Enabling `sql_safe_updates` causes `UPDATE` and `DELETE` statements to produce an error if they do not specify a key constraint in the `WHERE` clause, or provide a `LIMIT` clause, or both. For example:

```
UPDATE tbl_name SET not_key_column=val WHERE key_column=val;
UPDATE tbl_name SET not_key_column=val LIMIT 1;
```

- Setting `sql_select_limit` to 1,000 causes the server to limit all `SELECT` result sets to 1,000 rows unless the statement includes a `LIMIT` clause.
- Setting `max_join_size` to 1,000,000 causes multiple-table `SELECT` statements to produce an error if the server estimates it must examine more than 1,000,000 row combinations.

To specify result set limits different from 1,000 and 1,000,000, you can override the defaults by using the `--select-limit` and `--max-join-size` options when you invoke `mysql`:

```
mysql --safe-updates --select-limit=500 --max-join-size=10000
```

It is possible for `UPDATE` and `DELETE` statements to produce an error in safe-updates mode even with a key specified in the `WHERE` clause, if the optimizer decides not to use the index on the key column:

- Range access on the index cannot be used if memory usage exceeds that permitted by the `range_optimizer_max_mem_size` system variable. The optimizer then falls back to a table scan. See [Limiting Memory Use for Range Optimization](#).
- If key comparisons require type conversion, the index may not be used (see [Section 8.3.1, “How MySQL Uses Indexes”](#)). Suppose that an indexed string column `c1` is compared to a numeric value using `WHERE c1 = 2222`. For such comparisons, the string value is converted to a number and the operands are compared numerically (see [Section 12.3, “Type Conversion in Expression Evaluation”](#)), preventing use of the index. If safe-updates mode is enabled, an error occurs.

As of MySQL 5.7.25, safe-updates mode also includes these behaviors:

- `EXPLAIN` with `UPDATE` and `DELETE` statements does not produce safe-updates errors. This enables use of `EXPLAIN` plus `SHOW WARNINGS` to see why an index is not used, which can be helpful in cases such as when a `range_optimizer_max_mem_size` violation or type conversion occurs and the optimizer does not use an index even though a key column was specified in the `WHERE` clause.
- When a safe-updates error occurs, the error message includes the first diagnostic that was produced, to provide information about the reason for failure. For example, the message may indicate that the `range_optimizer_max_mem_size` value was exceeded or type conversion occurred, either of which can preclude use of an index.
- For multiple-table deletes and updates, an error is produced with safe updates enabled only if any target table uses a table scan.

## Disabling mysql Auto-Reconnect

If the `mysql` client loses its connection to the server while sending a statement, it immediately and automatically tries to reconnect once to the server and send the statement again. However, even if `mysql` succeeds in reconnecting, your first connection has ended and all your previous session objects and settings are lost: temporary tables, the autocommit mode, and user-defined and session variables. Also, any current transaction rolls back. This behavior may be dangerous for you, as in the following example where the server was shut down and restarted between the first and second statements without you knowing it:

```
mysql> SET @a=1;
Query OK, 0 rows affected (0.05 sec)

mysql> INSERT INTO t VALUES(@a);
ERROR 2006: MySQL server has gone away
No connection. Trying to reconnect...
Connection id: 1
Current database: test

Query OK, 1 row affected (1.30 sec)

mysql> SELECT * FROM t;
+-----+
| a     |
+-----+
| NULL  |
+-----+
1 row in set (0.05 sec)
```

The `@a` user variable has been lost with the connection, and after the reconnection it is undefined. If it is important to have `mysql` terminate with an error if the connection has been lost, you can start the `mysql` client with the `--skip-reconnect` option.

For more information about auto-reconnect and its effect on state information when a reconnection occurs, see [Automatic Reconnection Control](#).

## mysql Client Parser Versus Server Parser

The `mysql` client uses a parser on the client side that is not a duplicate of the complete parser used by the `mysqld` server on the server side. This can lead to differences in treatment of certain constructs. Examples:

- The server parser treats strings delimited by `"` characters as identifiers rather than as plain strings if the `ANSI_QUOTES` SQL mode is enabled.



The `mysql` client parser does not take the `ANSI_QUOTES` SQL mode into account. It treats strings delimited by `"`, `'`, and ``` characters the same, regardless of whether `ANSI_QUOTES` is enabled.

- Within `/*! ... */` comments, the `mysql` client parser interprets short-form `mysql` commands. The server parser does not interpret them because these commands have no meaning on the server side.

If it is desirable for `mysql` not to interpret short-form commands within comments, a partial workaround is to use the `--binary-mode` option, which causes all `mysql` commands to be disabled except `\C` and `\d` in noninteractive mode (for input piped to `mysql` or loaded using the `source` command).

## 4.5.2 mysqladmin — A MySQL Server Administration Program

`mysqladmin` is a client for performing administrative operations. You can use it to check the server's configuration and current status, to create and drop databases, and more.

Invoke `mysqladmin` like this:

```
mysqladmin [options] command [command-arg] [command [command-arg]] ...
```

`mysqladmin` supports the following commands. Some of the commands take an argument following the command name.

- `create db_name`

Create a new database named `db_name`.

- `debug`

Tell the server to write debug information to the error log. The connected user must have the `SUPER` privilege. Format and content of this information is subject to change.

This includes information about the Event Scheduler. See [Section 23.4.5, “Event Scheduler Status”](#).

- `drop db_name`

Delete the database named `db_name` and all its tables.

- `extended-status`

Display the server status variables and their values.

- `flush-hosts`

Flush all information in the host cache. See [Section 5.1.11.2, “DNS Lookups and the Host Cache”](#).

- `flush-logs [log_type ...]`

Flush all logs.

The `mysqladmin flush-logs` command permits optional log types to be given, to specify which logs to flush. Following the `flush-logs` command, you can provide a space-separated list of one or more of the following log types: `binary`, `engine`, `error`, `general`, `relay`, `slow`. These correspond to the log types that can be specified for the `FLUSH LOGS` SQL statement.

- `flush-privileges`

Reload the grant tables (same as `reload`).

- `flush-status`

Clear status variables.

- `flush-tables`

Flush all tables.

- `flush-threads`

Flush the thread cache.

- `kill id,id,...`

Kill server threads. If multiple thread ID values are given, there must be no spaces in the list.

To kill threads belonging to other users, the connected user must have the `SUPER` privilege.

- `old-password new_password`

This is like the `password` command but stores the password using the old (pre-4.1) password-hashing format. (See [Section 6.1.2.4, “Password Hashing in MySQL”](#).)

This command was removed in MySQL 5.7.5.

- `password new_password`

Set a new password. This changes the password to `new_password` for the account that you use with `mysqladmin` for connecting to the server. Thus, the next time you invoke `mysqladmin` (or any other client program) using the same account, you must specify the new password.



### Warning

Setting a password using `mysqladmin` should be considered *insecure*. On some systems, your password becomes visible to system status programs such as `ps` that may be invoked by other users to display command lines. MySQL clients typically overwrite the command-line password argument with zeros during their initialization sequence. However, there is still a brief interval during which the value is visible. Also, on some systems this overwriting strategy is ineffective and the password remains visible to `ps`. (SystemV Unix systems and perhaps others are subject to this problem.)

If the `new_password` value contains spaces or other characters that are special to your command interpreter, you need to enclose it within quotation marks. On Windows, be sure to use double quotation marks rather than single quotation marks; single quotation marks are not stripped from the password, but rather are interpreted as part of the password. For example:

```
mysqladmin password "my new password"
```

The new password can be omitted following the `password` command. In this case, `mysqladmin` prompts for the password value, which enables you to avoid specifying the password on the command line. Omitting the password value should be done only if `password` is the final command on the `mysqladmin` command line. Otherwise, the next argument is taken as the password.



### Caution

Do not use this command used if the server was started with the `--skip-grant-tables` option. No password change is applied. This is true even if you precede the `password` command with `flush-privileges` on the same

command line to re-enable the grant tables because the flush operation occurs after you connect. However, you can use `mysqladmin flush-privileges` to re-enable the grant table and then use a separate `mysqladmin password` command to change the password.

- `ping`

Check whether the server is available. The return status from `mysqladmin` is 0 if the server is running, 1 if it is not. This is 0 even in case of an error such as `Access denied`, because this means that the server is running but refused the connection, which is different from the server not running.

- `processlist`

Show a list of active server threads. This is like the output of the `SHOW PROCESSLIST` statement. If the `--verbose` option is given, the output is like that of `SHOW FULL PROCESSLIST`. (See [Section 13.7.5.29, “SHOW PROCESSLIST Statement”](#).)

- `reload`

Reload the grant tables.

- `refresh`

Flush all tables and close and open log files.

- `shutdown`

Stop the server.

- `start-slave`

Start replication on a replica server.

- `status`

Display a short server status message.

- `stop-slave`

Stop replication on a replica server.

- `variables`

Display the server system variables and their values.

- `version`

Display version information from the server.

All commands can be shortened to any unique prefix. For example:

```
$> mysqladmin proc stat
+-----+-----+-----+-----+-----+-----+-----+
| Id | User | Host | db | Command | Time | State | Info |
+-----+-----+-----+-----+-----+-----+-----+
| 51 | jones | localhost | | Query | 0 | | show processlist |
+-----+-----+-----+-----+-----+-----+-----+
Uptime: 1473624 Threads: 1 Questions: 39487
Slow queries: 0 Opens: 541 Flush tables: 1
Open tables: 19 Queries per second avg: 0.0268
```

The `mysqladmin status` command result displays the following values:

- `Uptime`  
The number of seconds the MySQL server has been running.
- `Threads`  
The number of active threads (clients).
- `Questions`  
The number of questions (queries) from clients since the server was started.
- `Slow queries`  
The number of queries that have taken more than `long_query_time` seconds. See [Section 5.4.5, “The Slow Query Log”](#).
- `Opens`  
The number of tables the server has opened.
- `Flush tables`  
The number of `flush-*`, `refresh`, and `reload` commands the server has executed.
- `Open tables`  
The number of tables that currently are open.

If you execute `mysqladmin shutdown` when connecting to a local server using a Unix socket file, `mysqladmin` waits until the server's process ID file has been removed, to ensure that the server has stopped properly.

`mysqladmin` supports the following options, which can be specified on the command line or in the `[mysqladmin]` and `[client]` groups of an option file. For information about option files used by MySQL programs, see [Section 4.2.2.2, “Using Option Files”](#).

**Table 4.14 mysqladmin Options**

Option Name	Description	Introduced	Deprecated
<code>--bind-address</code>	Use specified network interface to connect to MySQL Server		
<code>--character-sets-dir</code>	Directory where character sets can be found		
<code>--compress</code>	Compress all information sent between client and server		
<code>--connect-timeout</code>	Number of seconds before connection timeout		
<code>--count</code>	Number of iterations to make for repeated command execution		

Option Name	Description	Introduced	Deprecated
<code>--debug</code>	Write debugging log		
<code>--debug-check</code>	Print debugging information when program exits		
<code>--debug-info</code>	Print debugging information, memory, and CPU statistics when program exits		
<code>--default-auth</code>	Authentication plugin to use		
<code>--default-character-set</code>	Specify default character set		
<code>--defaults-extra-file</code>	Read named option file in addition to usual option files		
<code>--defaults-file</code>	Read only named option file		
<code>--defaults-group-suffix</code>	Option group suffix value		
<code>--enable-cleartext-plugin</code>	Enable cleartext authentication plugin		
<code>--force</code>	Continue even if an SQL error occurs		
<code>--get-server-public-key</code>	Request RSA public key from server	5.7.23	
<code>--help</code>	Display help message and exit		
<code>--host</code>	Host on which MySQL server is located		
<code>--login-path</code>	Read login path options from <code>.mylogin.cnf</code>		
<code>--no-beep</code>	Do not beep when errors occur		
<code>--no-defaults</code>	Read no option files		
<code>--password</code>	Password to use when connecting to server		
<code>--pipe</code>	Connect to server using named pipe (Windows only)		
<code>--plugin-dir</code>	Directory where plugins are installed		
<code>--port</code>	TCP/IP port number for connection		
<code>--print-defaults</code>	Print default options		
<code>--protocol</code>	Transport protocol to use		

Option Name	Description	Introduced	Deprecated
<code>--relative</code>	Show the difference between the current and previous values when used with the <code>--sleep</code> option		
<code>--secure-auth</code>	Do not send passwords to server in old (pre-4.1) format		Yes
<code>--server-public-key-path</code>	Path name to file containing RSA public key	5.7.23	
<code>--shared-memory-base-name</code>	Shared-memory name for shared-memory connections (Windows only)		
<code>--show-warnings</code>	Show warnings after statement execution		
<code>--shutdown-timeout</code>	The maximum number of seconds to wait for server shutdown		
<code>--silent</code>	Silent mode		
<code>--sleep</code>	Execute commands repeatedly, sleeping for delay seconds in between		
<code>--socket</code>	Unix socket file or Windows named pipe to use		
<code>--ssl</code>	Enable connection encryption		
<code>--ssl-ca</code>	File that contains list of trusted SSL Certificate Authorities		
<code>--ssl-capath</code>	Directory that contains trusted SSL Certificate Authority certificate files		
<code>--ssl-cert</code>	File that contains X.509 certificate		
<code>--ssl-cipher</code>	Permissible ciphers for connection encryption		
<code>--ssl-crl</code>	File that contains certificate revocation lists		
<code>--ssl-crlpath</code>	Directory that contains certificate revocation-list files		

Option Name	Description	Introduced	Deprecated
<code>--ssl-key</code>	File that contains X.509 key		
<code>--ssl-mode</code>	Desired security state of connection to server	5.7.11	
<code>--ssl-verify-server-cert</code>	Verify host name against server certificate Common Name identity		
<code>--tls-version</code>	Permissible TLS protocols for encrypted connections	5.7.10	
<code>--user</code>	MySQL user name to use when connecting to server		
<code>--verbose</code>	Verbose mode		
<code>--version</code>	Display version information and exit		
<code>--vertical</code>	Print query output rows vertically (one line per column value)		
<code>--wait</code>	If the connection cannot be established, wait and retry instead of aborting		

- `--help, -?`

Command-Line Format	<code>--help</code>
---------------------	---------------------

Display a help message and exit.

- `--bind-address=ip_address`

Command-Line Format	<code>--bind-address=ip_address</code>
---------------------	--

On a computer having multiple network interfaces, use this option to select which interface to use for connecting to the MySQL server.

- `--character-sets-dir=dir_name`

Command-Line Format	<code>--character-sets-dir=path</code>
Type	String
Default Value	[none]

The directory where character sets are installed. See [Section 10.15, “Character Set Configuration”](#).

- `--compress, -C`

Command-Line Format	<code>--compress[={OFF ON}]</code>
---------------------	------------------------------------

Type	Boolean
Default Value	OFF

Compress all information sent between the client and the server if possible. See [Section 4.2.6, “Connection Compression Control”](#).

- `--connect-timeout=value`

Command-Line Format	<code>--connect-timeout=value</code>
Type	Numeric
Default Value	43200

The maximum number of seconds before connection timeout. The default value is 43200 (12 hours).

- `--count=N, -c N`

Command-Line Format	<code>--count=#</code>
---------------------	------------------------

The number of iterations to make for repeated command execution if the `--sleep` option is given.

- `--debug[=debug_options], -# [debug_options]`

Command-Line Format	<code>--debug[=debug_options]</code>
Type	String
Default Value	<code>d:t:o,/tmp/mysqladmin.trace</code>

Write a debugging log. A typical `debug_options` string is `d:t:o,file_name`. The default is `d:t:o,/tmp/mysqladmin.trace`.

This option is available only if MySQL was built using `WITH_DEBUG`. MySQL release binaries provided by Oracle are *not* built using this option.

- `--debug-check`

Command-Line Format	<code>--debug-check</code>
Type	Boolean
Default Value	FALSE

Print some debugging information when the program exits.

This option is available only if MySQL was built using `WITH_DEBUG`. MySQL release binaries provided by Oracle are *not* built using this option.

- `--debug-info`



Default Value	FALSE
---------------	-------

Print debugging information and memory and CPU usage statistics when the program exits.

This option is available only if MySQL was built using `WITH_DEBUG`. MySQL release binaries provided by Oracle are *not* built using this option.

- `--default-auth=plugin`

Command-Line Format	<code>--default-auth=plugin</code>
Type	String

A hint about which client-side authentication plugin to use. See [Section 6.2.13, “Pluggable Authentication”](#).

- `--default-character-set=charset_name`

Command-Line Format	<code>--default-character-set=charset_name</code>
Type	String

Use `charset_name` as the default character set. See [Section 10.15, “Character Set Configuration”](#).

- `--defaults-extra-file=file_name`

Command-Line Format	<code>--defaults-extra-file=file_name</code>
Type	File name

Read this option file after the global option file but (on Unix) before the user option file. If the file does not exist or is otherwise inaccessible, an error occurs. If `file_name` is not an absolute path name, it is interpreted relative to the current directory.

For additional information about this and other option-file options, see [Section 4.2.2.3, “Command-Line Options that Affect Option-File Handling”](#).

- `--defaults-file=file_name`

Command-Line Format	<code>--defaults-file=file_name</code>
Type	File name

Use only the given option file. If the file does not exist or is otherwise inaccessible, an error occurs. If `file_name` is not an absolute path name, it is interpreted relative to the current directory.

Exception: Even with `--defaults-file`, client programs read `.mylogin.cnf`.

For additional information about this and other option-file options, see [Section 4.2.2.3, “Command-Line Options that Affect Option-File Handling”](#).

- `--defaults-group-suffix=str`

Command-Line Format	<code>--defaults-group-suffix=str</code>
---------------------	--

Type	String
------	--------

Read not only the usual option groups, but also groups with the usual names and a suffix of *str*. For example, `mysqladmin` normally reads the `[client]` and `[mysqladmin]` groups. If this option is given as `--defaults-group-suffix=_other`, `mysqladmin` also reads the `[client_other]` and `[mysqladmin_other]` groups.

For additional information about this and other option-file options, see [Section 4.2.2.3, “Command-Line Options that Affect Option-File Handling”](#).

- `--enable-cleartext-plugin`

Command-Line Format	<code>--enable-cleartext-plugin</code>
Type	Boolean
Default Value	<code>FALSE</code>

Enable the `mysql_clear_password` cleartext authentication plugin. (See [Section 6.4.1.6, “Client-Side Cleartext Pluggable Authentication”](#).)

- `--force, -f`

Command-Line Format	<code>--force</code>
---------------------	----------------------

Do not ask for confirmation for the `drop db_name` command. With multiple commands, continue even if an error occurs.

- `--get-server-public-key`

Command-Line Format	<code>--get-server-public-key</code>
Introduced	5.7.23
Type	Boolean

Request from the server the public key required for RSA key pair-based password exchange. This option applies to clients that authenticate with the `caching_sha2_password` authentication plugin. For that plugin, the server does not send the public key unless requested. This option is ignored for accounts that do not authenticate with that plugin. It is also ignored if RSA-based password exchange is not used, as is the case when the client connects to the server using a secure connection.

If `--server-public-key-path=file_name` is given and specifies a valid public key file, it takes precedence over `--get-server-public-key`.

For information about the `caching_sha2_password` plugin, see [Section 6.4.1.4, “Caching SHA-2 Pluggable Authentication”](#).

The `--get-server-public-key` option was added in MySQL 5.7.23.

- `--host=host_name, -h host_name`

Command-Line Format	<code>--host=host_name</code>
Type	String

Default Value	localhost
---------------	-----------

Connect to the MySQL server on the given host.

- `--login-path=name`

Command-Line Format	<code>--login-path=name</code>
Type	String

Read options from the named login path in the `.mylogin.cnf` login path file. A “login path” is an option group containing options that specify which MySQL server to connect to and which account to authenticate as. To create or modify a login path file, use the `mysql_config_editor` utility. See [Section 4.6.6, “mysql\\_config\\_editor — MySQL Configuration Utility”](#).

For additional information about this and other option-file options, see [Section 4.2.2.3, “Command-Line Options that Affect Option-File Handling”](#).

- `--no-beep, -b`

Command-Line Format	<code>--no-beep</code>
---------------------	------------------------

Suppress the warning beep that is emitted by default for errors such as a failure to connect to the server.

- `--no-defaults`

Command-Line Format	<code>--no-defaults</code>
---------------------	----------------------------

Do not read any option files. If program startup fails due to reading unknown options from an option file, `--no-defaults` can be used to prevent them from being read.

The exception is that the `.mylogin.cnf` file is read in all cases, if it exists. This permits passwords to be specified in a safer way than on the command line even when `--no-defaults` is used. To create `.mylogin.cnf`, use the `mysql_config_editor` utility. See [Section 4.6.6, “mysql\\_config\\_editor — MySQL Configuration Utility”](#).

For additional information about this and other option-file options, see [Section 4.2.2.3, “Command-Line Options that Affect Option-File Handling”](#).

- `--password[=password], -p[password]`

Command-Line Format	<code>--password[=password]</code>
---------------------	------------------------------------

Type	String
------	--------

The password of the MySQL account used for connecting to the server. The password value is optional. If not given, `mysqladmin` prompts for one. If given, there must be *no space* between `--password=` or `-p` and the password following it. If no password option is specified, the default is to send no password.

Specifying a password on the command line should be considered insecure. To avoid giving the password on the command line, use an option file. See [Section 6.1.2.1, “End-User Guidelines for Password Security”](#).

To explicitly specify that there is no password and that `mysqladmin` should not prompt for one, use the `--skip-password` option.

- `--pipe, -W`

Command-Line Format	<code>--pipe</code>
Type	String

On Windows, connect to the server using a named pipe. This option applies only if the server was started with the `named_pipe` system variable enabled to support named-pipe connections. In addition, the user making the connection must be a member of the Windows group specified by the `named_pipe_full_access_group` system variable.

- `--plugin-dir=dir_name`

Command-Line Format	<code>--plugin-dir=dir_name</code>
Type	Directory name

The directory in which to look for plugins. Specify this option if the `--default-auth` option is used to specify an authentication plugin but `mysqladmin` does not find it. See [Section 6.2.13, “Pluggable Authentication”](#).

- `--port=port_num, -P port_num`

Command-Line Format	<code>--port=port_num</code>
Type	Numeric
Default Value	3306

For TCP/IP connections, the port number to use.

- `--print-defaults`

Command-Line Format	<code>--print-defaults</code>
---------------------	-------------------------------

Print the program name and all options that it gets from option files.

For additional information about this and other option-file options, see [Section 4.2.2.3, “Command-Line Options that Affect Option-File Handling”](#).

- `--protocol={TCP | SOCKET | PIPE | MEMORY}`

Command-Line Format	<code>--protocol=type</code>
Type	String
Default Value	[see text]
Valid Values	TCP  SOCKET  PIPE  MEMORY

The transport protocol to use for connecting to the server. It is useful when the other connection parameters normally result in use of a protocol other than the one you want. For details on the permissible values, see [Section 4.2.5, “Connection Transport Protocols”](#).

- `--relative, -r`

Command-Line Format	<code>--relative</code>
---------------------	-------------------------

Show the difference between the current and previous values when used with the `--sleep` option. This option works only with the `extended-status` command.

- `--show-warnings`

Command-Line Format	<code>--show-warnings</code>
---------------------	------------------------------

Show warnings resulting from execution of statements sent to the server.

- `--secure-auth`

Command-Line Format	<code>--secure-auth</code>
Deprecated	Yes

Do not send passwords to the server in old (pre-4.1) format. This prevents connections except for servers that use the newer password format.

As of MySQL 5.7.5, this option is deprecated; expect it to be removed in a future MySQL release. It is always enabled and attempting to disable it (`--skip-secure-auth`, `--secure-auth=0`) produces an error. Before MySQL 5.7.5, this option is enabled by default but can be disabled.



#### Note

Passwords that use the pre-4.1 hashing method are less secure than passwordss that use the native password hashing method and should be avoided. Pre-4.1 passwordss are deprecated and support for them was removed in MySQL 5.7.5. For account upgrade instructions, see [Section 6.4.1.3, “Migrating Away from Pre-4.1 Password Hashing and the `mysql\_old\_password` Plugin”](#).

- `--server-public-key-path=file_name`

Command-Line Format	<code>--server-public-key-path=file_name</code>
Introduced	5.7.23
Type	File name

The path name to a file in PEM format containing a client-side copy of the public key required by the server for RSA key pair-based password exchange. This option applies to clients that authenticate with the `sha256_password` or `caching_sha2_password` authentication plugin. This option is ignored for accounts that do not authenticate with one of those plugins. It is also ignored if RSA-based password exchange is not used, as is the case when the client connects to the server using a secure connection.

If `--server-public-key-path=file_name` is given and specifies a valid public key file, it takes precedence over `--get-server-public-key`.

For `sha256_password`, this option applies only if MySQL was built using OpenSSL.

For information about the `sha256_password` and `caching_sha2_password` plugins, see [Section 6.4.1.5, “SHA-256 Pluggable Authentication”](#), and [Section 6.4.1.4, “Caching SHA-2 Pluggable Authentication”](#).

The `--server-public-key-path` option was added in MySQL 5.7.23.

- `--shared-memory-base-name=name`

Command-Line Format	<code>--shared-memory-base-name=name</code>
Platform Specific	Windows

On Windows, the shared-memory name to use for connections made using shared memory to a local server. The default value is `MYSQL`. The shared-memory name is case-sensitive.

This option applies only if the server was started with the `shared_memory` system variable enabled to support shared-memory connections.

- `--shutdown-timeout=value`

Command-Line Format	<code>--shutdown-timeout=seconds</code>
Type	Numeric
Default Value	3600

The maximum number of seconds to wait for server shutdown. The default value is 3600 (1 hour).

- `--silent, -s`

Command-Line Format	<code>--silent</code>
---------------------	-----------------------

Exit silently if a connection to the server cannot be established.

- `--sleep=delay, -i delay`

Command-Line Format	<code>--sleep=delay</code>
---------------------	----------------------------

Execute commands repeatedly, sleeping for *delay* seconds in between. The `--count` option determines the number of iterations. If `--count` is not given, `mysqladmin` executes commands indefinitely until interrupted.

- `--socket=path, -S path`

Command-Line Format	<code>--socket={file_name pipe_name}</code>
Type	String

For connections to `localhost`, the Unix socket file to use, or, on Windows, the name of the named pipe to use.

On Windows, this option applies only if the server was started with the `named_pipe` system variable enabled to support named-pipe connections. In addition, the user making the connection must be a member of the Windows group specified by the `named_pipe_full_access_group` system variable.

- `--ssl*`

Options that begin with `--ssl` specify whether to connect to the server using encryption and indicate where to find SSL keys and certificates. See [Command Options for Encrypted Connections](#).

- `--tls-version=protocol_list`

Command-Line Format	<code>--tls-version=protocol_list</code>
Introduced	5.7.10
Type	String
Default Value ( $\geq$ 5.7.28)	<code>TLSv1, TLSv1.1, TLSv1.2</code>
Default Value ( $\leq$ 5.7.27)	<code>TLSv1, TLSv1.1, TLSv1.2 (OpenSSL)</code> <code>TLSv1, TLSv1.1 (yaSSL)</code>

The permissible TLS protocols for encrypted connections. The value is a list of one or more comma-separated protocol names. The protocols that can be named for this option depend on the SSL library used to compile MySQL. For details, see [Section 6.3.2, “Encrypted Connection TLS Protocols and Ciphers”](#).

This option was added in MySQL 5.7.10.

- `--user=user_name, -u user_name`

Command-Line Format	<code>--user=user_name,</code>
Type	String

The user name of the MySQL account to use for connecting to the server.

- `--verbose, -v`

Command-Line Format	<code>--verbose</code>
---------------------	------------------------

Verbose mode. Print more information about what the program does.

- `--version, -V`

Command-Line Format	<code>--version</code>
---------------------	------------------------

Display version information and exit.

- `--vertical, -E`

Command-Line Format	<code>--vertical</code>
---------------------	-------------------------

Print output vertically. This is similar to `--relative`, but prints output vertically.

- `--wait[=count], -w[count]`

Command-Line Format	<code>--wait</code>
---------------------	---------------------

If the connection cannot be established, wait and retry instead of aborting. If a *count* value is given, it indicates the number of times to retry. The default is one time.

### 4.5.3 mysqlcheck — A Table Maintenance Program

The `mysqlcheck` client performs table maintenance: It checks, repairs, optimizes, or analyzes tables.

Each table is locked and therefore unavailable to other sessions while it is being processed, although for check operations, the table is locked with a `READ` lock only (see [Section 13.3.5, “LOCK TABLES and UNLOCK TABLES Statements”](#), for more information about `READ` and `WRITE` locks). Table maintenance operations can be time-consuming, particularly for large tables. If you use the `--databases` or `--all-databases` option to process all tables in one or more databases, an invocation of `mysqlcheck` might take a long time. (This is also true for the MySQL upgrade procedure if it determines that table checking is needed because it processes tables the same way.)

`mysqlcheck` must be used when the `mysqld` server is running, which means that you do not have to stop the server to perform table maintenance.

`mysqlcheck` uses the SQL statements `CHECK TABLE`, `REPAIR TABLE`, `ANALYZE TABLE`, and `OPTIMIZE TABLE` in a convenient way for the user. It determines which statements to use for the operation you want to perform, and then sends the statements to the server to be executed. For details about which storage engines each statement works with, see the descriptions for those statements in [Section 13.7.2, “Table Maintenance Statements”](#).

All storage engines do not necessarily support all four maintenance operations. In such cases, an error message is displayed. For example, if `test.t` is an `MEMORY` table, an attempt to check it produces this result:

```
$> mysqlcheck test t
test.t
note      : The storage engine for the table doesn't support check
```



If `mysqlcheck` is unable to repair a table, see [Section 2.10.12, “Rebuilding or Repairing Tables or Indexes”](#) for manual table repair strategies. This is the case, for example, for `InnoDB` tables, which can be checked with `CHECK TABLE`, but not repaired with `REPAIR TABLE`.



### Caution

It is best to make a backup of a table before performing a table repair operation; under some circumstances the operation might cause data loss. Possible causes include but are not limited to file system errors.

There are three general ways to invoke `mysqlcheck`:

```
mysqlcheck [options] db_name [tbl_name ...]
mysqlcheck [options] --databases db_name ...
mysqlcheck [options] --all-databases
```

If you do not name any tables following `db_name` or if you use the `--databases` or `--all-databases` option, entire databases are checked.

`mysqlcheck` has a special feature compared to other client programs. The default behavior of checking tables (`--check`) can be changed by renaming the binary. If you want to have a tool that repairs tables by default, you should just make a copy of `mysqlcheck` named `mysqlrepair`, or make a symbolic link to `mysqlcheck` named `mysqlrepair`. If you invoke `mysqlrepair`, it repairs tables.

The names shown in the following table can be used to change `mysqlcheck` default behavior.

Command	Meaning
<code>mysqlrepair</code>	The default option is <code>--repair</code>
<code>mysqlanalyze</code>	The default option is <code>--analyze</code>
<code>mysqloptimize</code>	The default option is <code>--optimize</code>

`mysqlcheck` supports the following options, which can be specified on the command line or in the `[mysqlcheck]` and `[client]` groups of an option file. For information about option files used by MySQL programs, see [Section 4.2.2.2, “Using Option Files”](#).

**Table 4.15 mysqlcheck Options**

Option Name	Description	Introduced	Deprecated
<code>--all-databases</code>	Check all tables in all databases		
<code>--all-in-1</code>	Execute a single statement for each database that names all the tables from that database		
<code>--analyze</code>	Analyze the tables		
<code>--auto-repair</code>	If a checked table is corrupted, automatically fix it		
<code>--bind-address</code>	Use specified network interface to connect to MySQL Server		

Option Name	Description	Introduced	Deprecated
<code>--character-sets-dir</code>	Directory where character sets are installed		
<code>--check</code>	Check the tables for errors		
<code>--check-only-changed</code>	Check only tables that have changed since the last check		
<code>--check-upgrade</code>	Invoke CHECK TABLE with the FOR UPGRADE option		
<code>--compress</code>	Compress all information sent between client and server		
<code>--databases</code>	Interpret all arguments as database names		
<code>--debug</code>	Write debugging log		
<code>--debug-check</code>	Print debugging information when program exits		
<code>--debug-info</code>	Print debugging information, memory, and CPU statistics when program exits		
<code>--default-auth</code>	Authentication plugin to use		
<code>--default-character-set</code>	Specify default character set		
<code>--defaults-extra-file</code>	Read named option file in addition to usual option files		
<code>--defaults-file</code>	Read only named option file		
<code>--defaults-group-suffix</code>	Option group suffix value		
<code>--enable-cleartext-plugin</code>	Enable cleartext authentication plugin	5.7.10	
<code>--extended</code>	Check and repair tables		
<code>--fast</code>	Check only tables that have not been closed properly		
<code>--fix-db-names</code>	Convert database names to 5.1 format		Yes
<code>--fix-table-names</code>	Convert table names to 5.1 format		Yes

Option Name	Description	Introduced	Deprecated
<code>--force</code>	Continue even if an SQL error occurs		
<code>--get-server-public-key</code>	Request RSA public key from server	5.7.23	
<code>--help</code>	Display help message and exit		
<code>--host</code>	Host on which MySQL server is located		
<code>--login-path</code>	Read login path options from <code>.mylogin.cnf</code>		
<code>--medium-check</code>	Do a check that is faster than an <code>--extended</code> operation		
<code>--no-defaults</code>	Read no option files		
<code>--optimize</code>	Optimize the tables		
<code>--password</code>	Password to use when connecting to server		
<code>--pipe</code>	Connect to server using named pipe (Windows only)		
<code>--plugin-dir</code>	Directory where plugins are installed		
<code>--port</code>	TCP/IP port number for connection		
<code>--print-defaults</code>	Print default options		
<code>--protocol</code>	Transport protocol to use		
<code>--quick</code>	The fastest method of checking		
<code>--repair</code>	Perform a repair that can fix almost anything except unique keys that are not unique		
<code>--secure-auth</code>	Do not send passwords to server in old (pre-4.1) format		Yes
<code>--server-public-key-path</code>	Path name to file containing RSA public key	5.7.23	
<code>--shared-memory-base-name</code>	Shared-memory name for shared-memory connections (Windows only)		
<code>--silent</code>	Silent mode		

Option Name	Description	Introduced	Deprecated
<code>--skip-database</code>	Omit this database from performed operations		
<code>--socket</code>	Unix socket file or Windows named pipe to use		
<code>--ssl</code>	Enable connection encryption		
<code>--ssl-ca</code>	File that contains list of trusted SSL Certificate Authorities		
<code>--ssl-capath</code>	Directory that contains trusted SSL Certificate Authority certificate files		
<code>--ssl-cert</code>	File that contains X.509 certificate		
<code>--ssl-cipher</code>	Permissible ciphers for connection encryption		
<code>--ssl-crl</code>	File that contains certificate revocation lists		
<code>--ssl-crlpath</code>	Directory that contains certificate revocation-list files		
<code>--ssl-key</code>	File that contains X.509 key		
<code>--ssl-mode</code>	Desired security state of connection to server	5.7.11	
<code>--ssl-verify-server-cert</code>	Verify host name against server certificate Common Name identity		
<code>--tables</code>	Overrides the <code>--databases</code> or <code>-B</code> option		
<code>--tls-version</code>	Permissible TLS protocols for encrypted connections	5.7.10	
<code>--use-frm</code>	For repair operations on MyISAM tables		
<code>--user</code>	MySQL user name to use when connecting to server		
<code>--verbose</code>	Verbose mode		
<code>--version</code>	Display version information and exit		
<code>--write-binlog</code>	Log ANALYZE, OPTIMIZE, REPAIR statements to binary log.		

Option Name	Description	Introduced	Deprecated
	--skip-write-binlog adds NO_WRITE_TO_BINLOG to these statements		

- `--help, -?`

Command-Line Format	<code>--help</code>
---------------------	---------------------

Display a help message and exit.

- `--all-databases, -A`

Command-Line Format	<code>--all-databases</code>
---------------------	------------------------------

Check all tables in all databases. This is the same as using the `--databases` option and naming all the databases on the command line, except that the `INFORMATION_SCHEMA` and `performance_schema` databases are not checked. They can be checked by explicitly naming them with the `--databases` option.

- `--all-in-1, -1`

Command-Line Format	<code>--all-in-1</code>
---------------------	-------------------------

Instead of issuing a statement for each table, execute a single statement for each database that names all the tables from that database to be processed.

- `--analyze, -a`

Command-Line Format	<code>--analyze</code>
---------------------	------------------------

Analyze the tables.

- `--auto-repair`

Command-Line Format	<code>--auto-repair</code>
---------------------	----------------------------

If a checked table is corrupted, automatically fix it. Any necessary repairs are done after all tables have been checked.

- `--bind-address=ip_address`

Command-Line Format	<code>--bind-address=ip_address</code>
---------------------	--

On a computer having multiple network interfaces, use this option to select which interface to use for connecting to the MySQL server.

- `--character-sets-dir=dir_name`

Command-Line Format	<code>--character-sets-dir=dir_name</code>
---------------------	--

Type	Directory name
------	----------------

The directory where character sets are installed. See [Section 10.15, “Character Set Configuration”](#).

- `--check, -c`

Command-Line Format	<code>--check</code>
---------------------	----------------------

Check the tables for errors. This is the default operation.

- `--check-only-changed, -C`

Command-Line Format	<code>--check-only-changed</code>
---------------------	-----------------------------------

Check only tables that have changed since the last check or that have not been closed properly.

- `--check-upgrade, -g`

Command-Line Format	<code>--check-upgrade</code>
---------------------	------------------------------

Invoke `CHECK TABLE` with the `FOR UPGRADE` option to check tables for incompatibilities with the current version of the server. This option automatically enables the `--fix-db-names` and `--fix-table-names` options.

- `--compress`

Command-Line Format	<code>--compress[={OFF ON}]</code>
Type	Boolean
Default Value	OFF

Compress all information sent between the client and the server if possible. See [Section 4.2.6, “Connection Compression Control”](#).

- `--databases, -B`

Command-Line Format	<code>--databases</code>
---------------------	--------------------------

Process all tables in the named databases. Normally, `mysqlcheck` treats the first name argument on the command line as a database name and any following names as table names. With this option, it treats all name arguments as database names.

- `--debug[=debug_options], -# [debug_options]`

Command-Line Format	<code>--debug[=debug_options]</code>
Type	String
Default Value	<code>d:t:o</code>

Write a debugging log. A typical `debug_options` string is `d:t:o,file_name`. The default is `d:t:o`.

This option is available only if MySQL was built using `WITH_DEBUG`. MySQL release binaries provided by Oracle are *not* built using this option.

- `--debug-check`

Command-Line Format	<code>--debug-check</code>
Type	Boolean
Default Value	<code>FALSE</code>

Print some debugging information when the program exits.

This option is available only if MySQL was built using `WITH_DEBUG`. MySQL release binaries provided by Oracle are *not* built using this option.

- `--debug-info`

Command-Line Format	<code>--debug-info</code>
Type	Boolean
Default Value	<code>FALSE</code>

Print debugging information and memory and CPU usage statistics when the program exits.

This option is available only if MySQL was built using `WITH_DEBUG`. MySQL release binaries provided by Oracle are *not* built using this option.

- `--default-character-set=charset_name`

Command-Line Format	<code>--default-character-set=charset_name</code>
Type	String

Use `charset_name` as the default character set. See [Section 10.15, “Character Set Configuration”](#).

- `--defaults-extra-file=file_name`

Command-Line Format	<code>--defaults-extra-file=file_name</code>
Type	File name

Read this option file after the global option file but (on Unix) before the user option file. If the file does not exist or is otherwise inaccessible, an error occurs. If `file_name` is not an absolute path name, it is interpreted relative to the current directory.

For additional information about this and other option-file options, see [Section 4.2.2.3, “Command-Line Options that Affect Option-File Handling”](#).

- `--defaults-file=file_name`

Command-Line Format	<code>--defaults-file=file_name</code>
Type	File name

Use only the given option file. If the file does not exist or is otherwise inaccessible, an error occurs. If *file\_name* is not an absolute path name, it is interpreted relative to the current directory.

Exception: Even with `--defaults-file`, client programs read `.mylogin.cnf`.

For additional information about this and other option-file options, see [Section 4.2.2.3, “Command-Line Options that Affect Option-File Handling”](#).

- `--defaults-group-suffix=str`

Command-Line Format	<code>--defaults-group-suffix=str</code>
Type	String

Read not only the usual option groups, but also groups with the usual names and a suffix of *str*. For example, `mysqlcheck` normally reads the `[client]` and `[mysqlcheck]` groups. If this option is given as `--defaults-group-suffix=_other`, `mysqlcheck` also reads the `[client_other]` and `[mysqlcheck_other]` groups.

For additional information about this and other option-file options, see [Section 4.2.2.3, “Command-Line Options that Affect Option-File Handling”](#).

- `--extended, -e`

Command-Line Format	<code>--extended</code>
---------------------	-------------------------

If you are using this option to check tables, it ensures that they are 100% consistent but takes a long time.

If you are using this option to repair tables, it runs an extended repair that may not only take a long time to execute, but may produce a lot of garbage rows also!

- `--default-auth=plugin`

Command-Line Format	<code>--default-auth=plugin</code>
Type	String

A hint about which client-side authentication plugin to use. See [Section 6.2.13, “Pluggable Authentication”](#).

- `--enable-cleartext-plugin`

Command-Line Format	<code>--enable-cleartext-plugin</code>
Introduced	5.7.10
Type	Boolean



Default Value	FALSE
---------------	-------

Enable the `mysql_clear_password` cleartext authentication plugin. (See [Section 6.4.1.6](#), “Client-Side Cleartext Pluggable Authentication”.)

This option was added in MySQL 5.7.10.

- `--fast, -F`

Command-Line Format	<code>--fast</code>
---------------------	---------------------

Check only tables that have not been closed properly.

- `--fix-db-names`

Command-Line Format	<code>--fix-db-names</code>
Deprecated	Yes

Convert database names to 5.1 format. Only database names that contain special characters are affected.

This option is deprecated in MySQL 5.7.6; expect it to be removed in a future version of MySQL. If it is necessary to convert MySQL 5.0 database or table names, a workaround is to upgrade a MySQL 5.0 installation to MySQL 5.1 before upgrading to a more recent release.

- `--fix-table-names`

Command-Line Format	<code>--fix-table-names</code>
Deprecated	Yes

Convert table names to 5.1 format. Only table names that contain special characters are affected. This option also applies to views.

This option is deprecated in MySQL 5.7.6; expect it to be removed in a future version of MySQL. If it is necessary to convert MySQL 5.0 database or table names, a workaround is to upgrade a MySQL 5.0 installation to MySQL 5.1 before upgrading to a more recent release.

- `--force, -f`

Command-Line Format	<code>--force</code>
---------------------	----------------------

Continue even if an SQL error occurs.

- `--get-server-public-key`

Command-Line Format	<code>--get-server-public-key</code>
---------------------	--------------------------------------

Type	Boolean
------	---------

Request from the server the public key required for RSA key pair-based password exchange. This option applies to clients that authenticate with the `caching_sha2_password` authentication plugin. For that plugin, the server does not send the public key unless requested. This option is ignored for accounts that do not authenticate with that plugin. It is also ignored if RSA-based password exchange is not used, as is the case when the client connects to the server using a secure connection.

If `--server-public-key-path=file_name` is given and specifies a valid public key file, it takes precedence over `--get-server-public-key`.

For information about the `caching_sha2_password` plugin, see [Section 6.4.1.4, “Caching SHA-2 Pluggable Authentication”](#).

The `--get-server-public-key` option was added in MySQL 5.7.23.

- `--host=host_name, -h host_name`

Command-Line Format	<code>--host=host_name</code>
Type	String
Default Value	<code>localhost</code>

Connect to the MySQL server on the given host.

- `--login-path=name`

Command-Line Format	<code>--login-path=name</code>
Type	String

Read options from the named login path in the `.mylogin.cnf` login path file. A “login path” is an option group containing options that specify which MySQL server to connect to and which account to authenticate as. To create or modify a login path file, use the `mysql_config_editor` utility. See [Section 4.6.6, “mysql\\_config\\_editor — MySQL Configuration Utility”](#).

For additional information about this and other option-file options, see [Section 4.2.2.3, “Command-Line Options that Affect Option-File Handling”](#).

- `--medium-check, -m`

Command-Line Format	<code>--medium-check</code>
---------------------	-----------------------------

Do a check that is faster than an `--extended` operation. This finds only 99.99% of all errors, which should be good enough in most cases.

- `--no-defaults`

Command-Line Format	<code>--no-defaults</code>
---------------------	----------------------------

Do not read any option files. If program startup fails due to reading unknown options from an option file, `--no-defaults` can be used to prevent them from being read.

The exception is that the `.mylogin.cnf` file is read in all cases, if it exists. This permits passwords to be specified in a safer way than on the command line even when `--no-defaults` is used. To create `.mylogin.cnf`, use the `mysql_config_editor` utility. See [Section 4.6.6, “mysql\\_config\\_editor — MySQL Configuration Utility”](#).

For additional information about this and other option-file options, see [Section 4.2.2.3, “Command-Line Options that Affect Option-File Handling”](#).

- `--optimize, -o`

Command-Line Format	<code>--optimize</code>
---------------------	-------------------------

Optimize the tables.

- `--password[=password], -p[password]`

Command-Line Format	<code>--password[=password]</code>
Type	String

The password of the MySQL account used for connecting to the server. The password value is optional. If not given, `mysqlcheck` prompts for one. If given, there must be *no space* between `--password=` or `-p` and the password following it. If no password option is specified, the default is to send no password.

Specifying a password on the command line should be considered insecure. To avoid giving the password on the command line, use an option file. See [Section 6.1.2.1, “End-User Guidelines for Password Security”](#).

To explicitly specify that there is no password and that `mysqlcheck` should not prompt for one, use the `--skip-password` option.

- `--pipe, -W`

Command-Line Format	<code>--pipe</code>
Type	String

On Windows, connect to the server using a named pipe. This option applies only if the server was started with the `named_pipe` system variable enabled to support named-pipe connections. In addition, the user making the connection must be a member of the Windows group specified by the `named_pipe_full_access_group` system variable.

- `--plugin-dir=dir_name`

Command-Line Format	<code>--plugin-dir=dir_name</code>
Type	Directory name

The directory in which to look for plugins. Specify this option if the `--default-auth` option is used to specify an authentication plugin but `mysqlcheck` does not find it. See [Section 6.2.13, “Pluggable Authentication”](#).

- `--port=port_num, -P port_num`

Command-Line Format	<code>--port=port_num</code>
Type	Numeric
Default Value	3306

For TCP/IP connections, the port number to use.

- `--print-defaults`

Command-Line Format	<code>--print-defaults</code>
---------------------	-------------------------------

Print the program name and all options that it gets from option files.

For additional information about this and other option-file options, see [Section 4.2.2.3, “Command-Line Options that Affect Option-File Handling”](#).

- `--protocol={TCP|SOCKET|PIPE|MEMORY}`

Command-Line Format	<code>--protocol=type</code>
Type	String
Default Value	[see text]
Valid Values	TCP  SOCKET  PIPE  MEMORY

The transport protocol to use for connecting to the server. It is useful when the other connection parameters normally result in use of a protocol other than the one you want. For details on the permissible values, see [Section 4.2.5, “Connection Transport Protocols”](#).

- `--quick, -q`

Command-Line Format	<code>--quick</code>
---------------------	----------------------

If you are using this option to check tables, it prevents the check from scanning the rows to check for incorrect links. This is the fastest check method.

If you are using this option to repair tables, it tries to repair only the index tree. This is the fastest repair method.

- `--repair, -r`

Command-Line Format	<code>--repair</code>
---------------------	-----------------------

Perform a repair that can fix almost anything except unique keys that are not unique.

- `--secure-auth`

Command-Line Format	<code>--secure-auth</code>
Deprecated	Yes

Do not send passwords to the server in old (pre-4.1) format. This prevents connections except for servers that use the newer password format.

As of MySQL 5.7.5, this option is deprecated; expect it to be removed in a future MySQL release. It is always enabled and attempting to disable it (`--skip-secure-auth`, `--secure-auth=0`) produces an error. Before MySQL 5.7.5, this option is enabled by default but can be disabled.



#### Note

Passwords that use the pre-4.1 hashing method are less secure than passwords that use the native password hashing method and should be avoided. Pre-4.1 passwords are deprecated and support for them was removed in MySQL 5.7.5. For account upgrade instructions, see [Section 6.4.1.3, “Migrating Away from Pre-4.1 Password Hashing and the `mysql\_old\_password` Plugin”](#).

- `--server-public-key-path=file_name`

Command-Line Format	<code>--server-public-key-path=file_name</code>
Introduced	5.7.23
Type	File name

The path name to a file in PEM format containing a client-side copy of the public key required by the server for RSA key pair-based password exchange. This option applies to clients that authenticate with the `sha256_password` or `caching_sha2_password` authentication plugin. This option is ignored for accounts that do not authenticate with one of those plugins. It is also ignored if RSA-based password exchange is not used, as is the case when the client connects to the server using a secure connection.

If `--server-public-key-path=file_name` is given and specifies a valid public key file, it takes precedence over `--get-server-public-key`.

For `sha256_password`, this option applies only if MySQL was built using OpenSSL.

For information about the `sha256_password` and `caching_sha2_password` plugins, see [Section 6.4.1.5, “SHA-256 Pluggable Authentication”](#), and [Section 6.4.1.4, “Caching SHA-2 Pluggable Authentication”](#).

The `--server-public-key-path` option was added in MySQL 5.7.23.

- `--shared-memory-base-name=name`

Command-Line Format	<code>--shared-memory-base-name=name</code>
---------------------	---

Platform Specific	Windows
-------------------	---------

On Windows, the shared-memory name to use for connections made using shared memory to a local server. The default value is `MYSQL`. The shared-memory name is case-sensitive.

This option applies only if the server was started with the `shared_memory` system variable enabled to support shared-memory connections.

- `--silent, -s`

Command-Line Format	<code>--silent</code>
---------------------	-----------------------

Silent mode. Print only error messages.

- `--skip-database=db_name`

Command-Line Format	<code>--skip-database=db_name</code>
---------------------	--------------------------------------

Do not include the named database (case-sensitive) in the operations performed by `mysqlcheck`.

- `--socket=path, -S path`

Command-Line Format	<code>--socket={file_name pipe_name}</code>
Type	String

For connections to `localhost`, the Unix socket file to use, or, on Windows, the name of the named pipe to use.

On Windows, this option applies only if the server was started with the `named_pipe` system variable enabled to support named-pipe connections. In addition, the user making the connection must be a member of the Windows group specified by the `named_pipe_full_access_group` system variable.

- `--ssl*`

Options that begin with `--ssl` specify whether to connect to the server using encryption and indicate where to find SSL keys and certificates. See [Command Options for Encrypted Connections](#).

- `--tables`

Command-Line Format	<code>--tables</code>
---------------------	-----------------------

Override the `--databases` or `-B` option. All name arguments following the option are regarded as table names.

- `--tls-version=protocol_list`

Command-Line Format	<code>--tls-version=protocol_list</code>
Introduced	5.7.10
Type	String
Default Value (≥ 5.7.28)	<code>TLSv1, TLSv1.1, TLSv1.2</code>

Default Value (≤ 5.7.27)	TLSv1 , TLSv1.1 , TLSv1.2 (OpenSSL) TLSv1 , TLSv1.1 (yaSSL)
--------------------------	--

The permissible TLS protocols for encrypted connections. The value is a list of one or more comma-separated protocol names. The protocols that can be named for this option depend on the SSL library used to compile MySQL. For details, see [Section 6.3.2, “Encrypted Connection TLS Protocols and Ciphers”](#).

This option was added in MySQL 5.7.10.

- `--use-frm`

Command-Line Format	<code>--use-frm</code>
---------------------	------------------------

For repair operations on [MyISAM](#) tables, get the table structure from the `.frm` file so that the table can be repaired even if the `.MYI` header is corrupted.

- `--user=user_name, -u user_name`

Command-Line Format	<code>--user=user_name,</code>
Type	String

The user name of the MySQL account to use for connecting to the server.

- `--verbose, -v`

Command-Line Format	<code>--verbose</code>
---------------------	------------------------

Verbose mode. Print information about the various stages of program operation.

- `--version, -V`

Command-Line Format	<code>--version</code>
---------------------	------------------------

Display version information and exit.

- `--write-binlog`

Command-Line Format	<code>--write-binlog</code>
---------------------	-----------------------------

This option is enabled by default, so that [ANALYZE TABLE](#), [OPTIMIZE TABLE](#), and [REPAIR TABLE](#) statements generated by `mysqlcheck` are written to the binary log. Use `--skip-write-binlog` to cause `NO_WRITE_TO_BINLOG` to be added to the statements so that they are not logged. Use the `--skip-write-binlog` when these statements should not be sent to replicas or run when using the

The `mysqldump` client utility performs [logical backups](#), producing a set of SQL statements that can be executed to reproduce the original database object definitions and table data. It dumps one or more MySQL databases for backup or transfer to another SQL server. The `mysqldump` command can also generate output in CSV, other delimited text, or XML format.

- [Performance and Scalability Considerations](#)
- [Invocation Syntax](#)
- [Option Syntax - Alphabetical Summary](#)
- [Connection Options](#)
- [Option-File Options](#)
- [DDL Options](#)
- [Debug Options](#)
- [Help Options](#)
- [Internationalization Options](#)
- [Replication Options](#)
- [Format Options](#)
- [Filtering Options](#)
- [Performance Options](#)
- [Transactional Options](#)
- [Option Groups](#)
- [Examples](#)
- [Restrictions](#)

`mysqldump` requires at least the `SELECT` privilege for dumped tables, `SHOW VIEW` for dumped views, `TRIGGER` for dumped triggers, `LOCK TABLES` if the `--single-transaction` option is not used, and (as of MySQL 5.7.31) `PROCESS` if the `--no-tablespaces` option is not used. Certain options might require other privileges as noted in the option descriptions.

To reload a dump file, you must have the privileges required to execute the statements that it contains, such as the appropriate `CREATE` privileges for objects created by those statements.

`mysqldump` output can include `ALTER DATABASE` statements that change the database collation. These may be used when dumping stored programs to preserve their character encodings. To reload a dump file containing such statements, the `ALTER` privilege for the affected database is required.



#### Note

A dump made using PowerShell on Windows with output redirection creates a file that has UTF-16 encoding:

```
mysqldump [options] > dump.sql
```

However, UTF-16 is not permitted as a connection character set (see [Impermissible Client Character Sets](#)), so the dump file cannot be loaded correctly. To work around



this issue, use the `--result-file` option, which creates the output in ASCII format:

```
mysqldump [options] --result-file=dump.sql
```

It is not recommended to load a dump file when GTIDs are enabled on the server (`gtid_mode=ON`), if your dump file includes system tables. `mysqldump` issues DML instructions for the system tables which use the non-transactional MyISAM storage engine, and this combination is not permitted when GTIDs are enabled.

## Performance and Scalability Considerations

`mysqldump` advantages include the convenience and flexibility of viewing or even editing the output before restoring. You can clone databases for development and DBA work, or produce slight variations of an existing database for testing. It is not intended as a fast or scalable solution for backing up substantial amounts of data. With large data sizes, even if the backup step takes a reasonable time, restoring the data can be very slow because replaying the SQL statements involves disk I/O for insertion, index creation, and so on.

For large-scale backup and restore, a [physical](#) backup is more appropriate, to copy the data files in their original format that can be restored quickly:

- If your tables are primarily [InnoDB](#) tables, or if you have a mix of [InnoDB](#) and [MyISAM](#) tables, consider using the `mysqlbackup` command of the MySQL Enterprise Backup product. (Available as part of the Enterprise subscription.) It provides the best performance for [InnoDB](#) backups with minimal disruption; it can also back up tables from [MyISAM](#) and other storage engines; and it provides a number of convenient options to accommodate different backup scenarios. See [Section 28.1, “MySQL Enterprise Backup Overview”](#).

`mysqldump` can retrieve and dump table contents row by row, or it can retrieve the entire content from a table and buffer it in memory before dumping it. Buffering in memory can be a problem if you are dumping large tables. To dump tables row by row, use the `--quick` option (or `--opt`, which enables `--quick`). The `--opt` option (and hence `--quick`) is enabled by default, so to enable memory buffering, use `--skip-quick`.

If you are using a recent version of `mysqldump` to generate a dump to be reloaded into a very old MySQL server, use the `--skip-opt` option instead of the `--opt` or `--extended-insert` option.

For additional information about `mysqldump`, see [Section 7.4, “Using mysqldump for Backups”](#).

## Invocation Syntax

There are in general three ways to use `mysqldump`—in order to dump a set of one or more tables, a set of one or more complete databases, or an entire MySQL server—as shown here:

```
mysqldump [options] db_name [tbl_name ...]
mysqldump [options] --databases db_name ...
mysqldump [options] --all-databases
```

To dump entire databases, do not name any tables following `db_name`, or use the `--databases` or `--all-databases` option.

To see a list of the options your version of `mysqldump` supports, issue the command `mysqldump --help`.

## Option Syntax - Alphabetical Summary

`mysqldump` supports the following options, which can be specified on the command line or in the `[mysqldump]` and `[client]` groups of an option file. For information about option files used by MySQL programs, see [Section 4.2.2.2, “Using Option Files”](#).

**Table 4.16 mysqldump Options**

Option Name	Description	Introduced	Deprecated
<code>--add-drop-database</code>	Add DROP DATABASE statement before each CREATE DATABASE statement		
<code>--add-drop-table</code>	Add DROP TABLE statement before each CREATE TABLE statement		
<code>--add-drop-trigger</code>	Add DROP TRIGGER statement before each CREATE TRIGGER statement		
<code>--add-locks</code>	Surround each table dump with LOCK TABLES and UNLOCK TABLES statements		
<code>--all-databases</code>	Dump all tables in all databases		
<code>--allow-keywords</code>	Allow creation of column names that are keywords		
<code>--apply-slave-statements</code>	Include STOP SLAVE prior to CHANGE MASTER statement and START SLAVE at end of output		
<code>--bind-address</code>	Use specified network interface to connect to MySQL Server		
<code>--character-sets-dir</code>	Directory where character sets are installed		
<code>--comments</code>	Add comments to dump file		
<code>--compact</code>	Produce more compact output		
<code>--compatible</code>	Produce output that is more compatible with other database systems or with older MySQL servers		
<code>--complete-insert</code>	Use complete INSERT statements that include column names		
<code>--compress</code>	Compress all information sent between client and server		

Option Name	Description	Introduced	Deprecated
<a href="#">--create-options</a>	Include all MySQL-specific table options in CREATE TABLE statements		
<a href="#">--databases</a>	Interpret all name arguments as database names		
<a href="#">--debug</a>	Write debugging log		
<a href="#">--debug-check</a>	Print debugging information when program exits		
<a href="#">--debug-info</a>	Print debugging information, memory, and CPU statistics when program exits		
<a href="#">--default-auth</a>	Authentication plugin to use		
<a href="#">--default-character-set</a>	Specify default character set		
<a href="#">--defaults-extra-file</a>	Read named option file in addition to usual option files		
<a href="#">--defaults-file</a>	Read only named option file		
<a href="#">--defaults-group-suffix</a>	Option group suffix value		
<a href="#">--delete-master-logs</a>	On a replication source server, delete the binary logs after performing the dump operation		
<a href="#">--disable-keys</a>	For each table, surround INSERT statements with statements to disable and enable keys		
<a href="#">--dump-date</a>	Include dump date as "Dump completed on" comment if --comments is given		
<a href="#">--dump-slave</a>	Include CHANGE MASTER statement that lists binary log coordinates of replica's source		
<a href="#">--enable-cleartext-plugin</a>	Enable cleartext authentication plugin	5.7.10	
<a href="#">--events</a>	Dump events from dumped databases		

Option Name	Description	Introduced	Deprecated
<code>--extended-insert</code>	Use multiple-row INSERT syntax		
<code>--fields-enclosed-by</code>	This option is used with the <code>--tab</code> option and has the same meaning as the corresponding clause for LOAD DATA		
<code>--fields-escaped-by</code>	This option is used with the <code>--tab</code> option and has the same meaning as the corresponding clause for LOAD DATA		
<code>--fields-optionally-enclosed-by</code>	This option is used with the <code>--tab</code> option and has the same meaning as the corresponding clause for LOAD DATA		
<code>--fields-terminated-by</code>	This option is used with the <code>--tab</code> option and has the same meaning as the corresponding clause for LOAD DATA		
<code>--flush-logs</code>	Flush MySQL server log files before starting dump		
<code>--flush-privileges</code>	Emit a FLUSH PRIVILEGES statement after dumping mysql database		
<code>--force</code>	Continue even if an SQL error occurs during a table dump		
<code>--get-server-public-key</code>	Request RSA public key from server	5.7.23	
<code>--help</code>	Display help message and exit		
<code>--hex-blob</code>	Dump binary columns using hexadecimal notation		
<code>--host</code>	Host on which MySQL server is located		
<code>--ignore-error</code>	Ignore specified errors		
<code>--ignore-table</code>	Do not dump given table		
<code>--include-master-host-port</code>	Include MASTER_HOST/MASTER_PORT options in CHANGE MASTER statement produced with <code>--dump-slave</code>		

Option Name	Description	Introduced	Deprecated
<code>--insert-ignore</code>	Write INSERT IGNORE rather than INSERT statements		
<code>--lines-terminated-by</code>	This option is used with the <code>--tab</code> option and has the same meaning as the corresponding clause for LOAD DATA		
<code>--lock-all-tables</code>	Lock all tables across all databases		
<code>--lock-tables</code>	Lock all tables before dumping them		
<code>--log-error</code>	Append warnings and errors to named file		
<code>--login-path</code>	Read login path options from <code>.mylogin.cnf</code>		
<code>--master-data</code>	Write the binary log file name and position to the output		
<code>--max-allowed-packet</code>	Maximum packet length to send to or receive from server		
<code>--net-buffer-length</code>	Buffer size for TCP/IP and socket communication		
<code>--no-autocommit</code>	Enclose the INSERT statements for each dumped table within SET autocommit = 0 and COMMIT statements		
<code>--no-create-db</code>	Do not write CREATE DATABASE statements		
<code>--no-create-info</code>	Do not write CREATE TABLE statements that re-create each dumped table		
<code>--no-data</code>	Do not dump table contents		
<code>--no-defaults</code>	Read no option files		
<code>--no-set-names</code>	Same as <code>--skip-set-charset</code>		
<code>--no-tablespaces</code>	Do not write any CREATE LOGFILE GROUP or CREATE TABLESPACE statements in output		

Option Name	Description	Introduced	Deprecated
<code>--opt</code>	Shorthand for <code>--add-drop-table --add-locks --create-options --disable-keys --extended-insert --lock-tables --quick --set-charset</code>		
<code>--order-by-primary</code>	Dump each table's rows sorted by its primary key, or by its first unique index		
<code>--password</code>	Password to use when connecting to server		
<code>--pipe</code>	Connect to server using named pipe (Windows only)		
<code>--plugin-dir</code>	Directory where plugins are installed		
<code>--port</code>	TCP/IP port number for connection		
<code>--print-defaults</code>	Print default options		
<code>--protocol</code>	Transport protocol to use		
<code>--quick</code>	Retrieve rows for a table from the server a row at a time		
<code>--quote-names</code>	Quote identifiers within backtick characters		
<code>--replace</code>	Write REPLACE statements rather than INSERT statements		
<code>--result-file</code>	Direct output to a given file		
<code>--routines</code>	Dump stored routines (procedures and functions) from dumped databases		
<code>--secure-auth</code>	Do not send passwords to server in old (pre-4.1) format		Yes
<code>--server-public-key-path</code>	Path name to file containing RSA public key	5.7.23	
<code>--set-charset</code>	Add SET NAMES default_character_set to output		
<code>--set-gtid-purged</code>	Whether to add SET @@GLOBAL.GTID_PURGED to output		

Option Name	Description	Introduced	Deprecated
<code>--shared-memory-base-name</code>	Shared-memory name for shared-memory connections (Windows only)		
<code>--single-transaction</code>	Issue a BEGIN SQL statement before dumping data from server		
<code>--skip-add-drop-table</code>	Do not add a DROP TABLE statement before each CREATE TABLE statement		
<code>--skip-add-locks</code>	Do not add locks		
<code>--skip-comments</code>	Do not add comments to dump file		
<code>--skip-compact</code>	Do not produce more compact output		
<code>--skip-disable-keys</code>	Do not disable keys		
<code>--skip-extended-insert</code>	Turn off extended-insert		
<code>--skip-mysql-schema</code>	Do not drop the mysql schema	5.7.36	
<code>--skip-opt</code>	Turn off options set by --opt		
<code>--skip-quick</code>	Do not retrieve rows for a table from the server a row at a time		
<code>--skip-quote-names</code>	Do not quote identifiers		
<code>--skip-set-charset</code>	Do not write SET NAMES statement		
<code>--skip-triggers</code>	Do not dump triggers		
<code>--skip-tz-utc</code>	Turn off tz-utc		
<code>--socket</code>	Unix socket file or Windows named pipe to use		
<code>--ssl</code>	Enable connection encryption		
<code>--ssl-ca</code>	File that contains list of trusted SSL Certificate Authorities		
<code>--ssl-capath</code>	Directory that contains trusted SSL Certificate Authority certificate files		
<code>--ssl-cert</code>	File that contains X.509 certificate		

Option Name	Description	Introduced	Deprecated
<code>--ssl-cipher</code>	Permissible ciphers for connection encryption		
<code>--ssl-crl</code>	File that contains certificate revocation lists		
<code>--ssl-crlpath</code>	Directory that contains certificate revocation-list files		
<code>--ssl-key</code>	File that contains X.509 key		
<code>--ssl-mode</code>	Desired security state of connection to server	5.7.11	
<code>--ssl-verify-server-cert</code>	Verify host name against server certificate Common Name identity		
<code>--tab</code>	Produce tab-separated data files		
<code>--tables</code>	Override <code>--databases</code> or <code>-B</code> option		
<code>--tls-version</code>	Permissible TLS protocols for encrypted connections	5.7.10	
<code>--triggers</code>	Dump triggers for each dumped table		
<code>--tz-utc</code>	Add SET TIME_ZONE='+00:00' to dump file		
<code>--user</code>	MySQL user name to use when connecting to server		
<code>--verbose</code>	Verbose mode		
<code>--version</code>	Display version information and exit		
<code>--where</code>	Dump only rows selected by given WHERE condition		
<code>--xml</code>	Produce XML output		

## Connection Options

The `mysqldump` command logs into a MySQL server to extract information. The following options specify how to connect to the MySQL server, either on the same machine or a remote system.

- `--bind-address=ip_address`

Command-Line Format	<code>--bind-address=ip_address</code>
---------------------	--



On a computer having multiple network interfaces, use this option to select which interface to use for connecting to the MySQL server.

- `--compress, -C`

Command-Line Format	<code>--compress[={OFF ON}]</code>
Type	Boolean
Default Value	<code>OFF</code>

Compress all information sent between the client and the server if possible. See [Section 4.2.6, “Connection Compression Control”](#).

- `--default-auth=plugin`

Command-Line Format	<code>--default-auth=plugin</code>
Type	String

A hint about which client-side authentication plugin to use. See [Section 6.2.13, “Pluggable Authentication”](#).

- `--enable-cleartext-plugin`

Command-Line Format	<code>--enable-cleartext-plugin</code>
Introduced	5.7.10
Type	Boolean
Default Value	<code>FALSE</code>

Enable the `mysql_clear_password` cleartext authentication plugin. (See [Section 6.4.1.6, “Client-Side Cleartext Pluggable Authentication”](#).)

This option was added in MySQL 5.7.10.

- `--get-server-public-key`

Command-Line Format	<code>--get-server-public-key</code>
Introduced	5.7.23
Type	Boolean

Request from the server the public key required for RSA key pair-based password exchange. This option applies to clients that authenticate with the `caching_sha2_password` authentication plugin. For that plugin, the server does not send the public key unless requested. This option is ignored for accounts that

do not authenticate with that plugin. It is also ignored if RSA-based password exchange is not used, as is the case when the client connects to the server using a secure connection.

If `--server-public-key-path=file_name` is given and specifies a valid public key file, it takes precedence over `--get-server-public-key`.

For information about the `caching_sha2_password` plugin, see [Section 6.4.1.4, “Caching SHA-2 Pluggable Authentication”](#).

The `--get-server-public-key` option was added in MySQL 5.7.23.

- `--host=host_name, -h host_name`

Command-Line Format	<code>--host</code>
---------------------	---------------------

Dump data from the MySQL server on the given host. The default host is `localhost`.

- `--login-path=name`

Command-Line Format	<code>--login-path=name</code>
Type	String

Read options from the named login path in the `.mylogin.cnf` login path file. A “login path” is an option group containing options that specify which MySQL server to connect to and which account to authenticate as. To create or modify a login path file, use the `mysql_config_editor` utility. See [Section 4.6.6, “mysql\\_config\\_editor — MySQL Configuration Utility”](#).

For additional information about this and other option-file options, see [Section 4.2.2.3, “Command-Line Options that Affect Option-File Handling”](#).

- `--password[=password], -p[password]`

Command-Line Format	<code>--password[=password]</code>
Type	String

The password of the MySQL account used for connecting to the server. The password value is optional. If not given, `mysqldump` prompts for one. If given, there must be *no space* between `--password=` or `-p` and the password following it. If no password option is specified, the default is to send no password.

Specifying a password on the command line should be considered insecure. To avoid giving the password on the command line, use an option file. See [Section 6.1.2.1, “End-User Guidelines for Password Security”](#).

To explicitly specify that there is no password and that `mysqldump` should not prompt for one, use the `--skip-password` option.

- `--pipe, -W`

Command-Line Format	<code>--pipe</code>
---------------------	---------------------

Type	String
------	--------

On Windows, connect to the server using a named pipe. This option applies only if the server was started with the `named_pipe` system variable enabled to support named-pipe connections. In addition, the user making the connection must be a member of the Windows group specified by the `named_pipe_full_access_group` system variable.

- `--plugin-dir=dir_name`

Command-Line Format	<code>--plugin-dir=dir_name</code>
Type	Directory name

The directory in which to look for plugins. Specify this option if the `--default-auth` option is used to specify an authentication plugin but `mysqldump` does not find it. See [Section 6.2.13, “Pluggable Authentication”](#).

- `--port=port_num, -P port_num`

Command-Line Format	<code>--port=port_num</code>
Type	Numeric
Default Value	3306

For TCP/IP connections, the port number to use.

- `--protocol={TCP|SOCKET|PIPE|MEMORY}`

Command-Line Format	<code>--protocol=type</code>
Type	String
Default Value	[see text]
Valid Values	TCP SOCKET PIPE MEMORY

The transport protocol to use for connecting to the server. It is useful when the other connection parameters normally result in use of a protocol other than the one you want. For details on the permissible values, see [Section 4.2.5, “Connection Transport Protocols”](#).

- `--secure-auth`

Command-Line Format	<code>--secure-auth</code>
Deprecated	Yes

Do not send passwords to the server in old (pre-4.1) format. This prevents connections except for servers that use the newer password format.

As of MySQL 5.7.5, this option is deprecated; expect it to be removed in a future MySQL release. It is always enabled and attempting to disable it (`--skip-secure-auth`, `--secure-auth=0`) produces an error. Before MySQL 5.7.5, this option is enabled by default but can be disabled.



### Note

Passwords that use the pre-4.1 hashing method are less secure than passwords that use the native password hashing method and should be avoided. Pre-4.1 passwords are deprecated and support for them was removed in MySQL 5.7.5. For account upgrade instructions, see [Section 6.4.1.3, “Migrating Away from Pre-4.1 Password Hashing and the `mysql\_old\_password` Plugin”](#).

- `--server-public-key-path=file_name`

Command-Line Format	<code>--server-public-key-path=file_name</code>
Introduced	5.7.23
Type	File name

The path name to a file in PEM format containing a client-side copy of the public key required by the server for RSA key pair-based password exchange. This option applies to clients that authenticate with the `sha256_password` or `caching_sha2_password` authentication plugin. This option is ignored for accounts that do not authenticate with one of those plugins. It is also ignored if RSA-based password exchange is not used, as is the case when the client connects to the server using a secure connection.

If `--server-public-key-path=file_name` is given and specifies a valid public key file, it takes precedence over `--get-server-public-key`.

For `sha256_password`, this option applies only if MySQL was built using OpenSSL.

For information about the `sha256_password` and `caching_sha2_password` plugins, see [Section 6.4.1.5, “SHA-256 Pluggable Authentication”](#), and [Section 6.4.1.4, “Caching SHA-2 Pluggable Authentication”](#).

The `--server-public-key-path` option was added in MySQL 5.7.23.

- `--skip-mysql-schema`

Command-Line Format	<code>--skip-mysql-schema</code>
Introduced	5.7.36
Type	Boolean

Do not drop the `mysql` schema when the dump file is restored. By default, the schema is dropped.

This option was added in MySQL 5.7.36.

- `--socket=path, -S path`

Command-Line Format	<code>--socket={file_name pipe_name}</code>
---------------------	---

Type	String
------	--------

For connections to `localhost`, the Unix socket file to use, or, on Windows, the name of the named pipe to use.

On Windows, this option applies only if the server was started with the `named_pipe` system variable enabled to support named-pipe connections. In addition, the user making the connection must be a member of the Windows group specified by the `named_pipe_full_access_group` system variable.

- `--ssl*`

Options that begin with `--ssl` specify whether to connect to the server using encryption and indicate where to find SSL keys and certificates. See [Command Options for Encrypted Connections](#).

- `--tls-version=protocol_list`

Command-Line Format	<code>--tls-version=protocol_list</code>
Introduced	5.7.10
Type	String
Default Value ( $\geq$ 5.7.28)	<code>TLSv1, TLSv1.1, TLSv1.2</code>
Default Value ( $\leq$ 5.7.27)	<code>TLSv1, TLSv1.1, TLSv1.2 (OpenSSL)</code> <code>TLSv1, TLSv1.1 (yaSSL)</code>

The permissible TLS protocols for encrypted connections. The value is a list of one or more comma-separated protocol names. The protocols that can be named for this option depend on the SSL library used to compile MySQL. For details, see [Section 6.3.2, “Encrypted Connection TLS Protocols and Ciphers”](#).

This option was added in MySQL 5.7.10.

- `--user=user_name, -u user_name`

Command-Line Format	<code>--user=user_name</code>
Type	String

The user name of the MySQL account to use for connecting to the server.

## Option-File Options

These options are used to control which option files to read.

- `--defaults-extra-file=file_name`

Command-Line Format	<code>--defaults-extra-file=file_name</code>
Type	File name

Read this option file after the global option file but (on Unix) before the user option file. If the file does not exist or is otherwise inaccessible, an error occurs. If `file_name` is not an absolute path name, it is interpreted relative to the current directory.

For additional information about this and other option-file options, see [Section 4.2.2.3, “Command-Line Options that Affect Option-File Handling”](#).

- `--defaults-file=file_name`

Command-Line Format	<code>--defaults-file=file_name</code>
Type	File name

Use only the given option file. If the file does not exist or is otherwise inaccessible, an error occurs. If `file_name` is not an absolute path name, it is interpreted relative to the current directory.

Exception: Even with `--defaults-file`, client programs read `.mylogin.cnf`.

For additional information about this and other option-file options, see [Section 4.2.2.3, “Command-Line Options that Affect Option-File Handling”](#).

- `--defaults-group-suffix=str`

Command-Line Format	<code>--defaults-group-suffix=str</code>
Type	String

Read not only the usual option groups, but also groups with the usual names and a suffix of `str`. For example, `mysqldump` normally reads the `[client]` and `[mysqldump]` groups. If this option is given as `--defaults-group-suffix=_other`, `mysqldump` also reads the `[client_other]` and `[mysqldump_other]` groups.

For additional information about this and other option-file options, see [Section 4.2.2.3, “Command-Line Options that Affect Option-File Handling”](#).

- `--no-defaults`

Command-Line Format	<code>--no-defaults</code>
---------------------	----------------------------

Do not read any option files. If program startup fails due to reading unknown options from an option file, `--no-defaults` can be used to prevent them from being read.

The exception is that the `.mylogin.cnf` file is read in all cases, if it exists. This permits passwords to be specified in a safer way than on the command line even when `--no-defaults` is used. To create `.mylogin.cnf`, use the `mysql_config_editor` utility. See [Section 4.6.6, “mysql\\_config\\_editor — MySQL Configuration Utility”](#).

For additional information about this and other option-file options, see [Section 4.2.2.3, “Command-Line Options that Affect Option-File Handling”](#).

- `--print-defaults`

Command-Line Format	<code>--print-defaults</code>
---------------------	-------------------------------

Print the program name and all options that it gets from option files.

For additional information about this and other option-file options, see [Section 4.2.2.3, “Command-Line Options that Affect Option-File Handling”](#).

## DDL Options

Usage scenarios for `mysqldump` include setting up an entire new MySQL instance (including database tables), and replacing data inside an existing instance with existing databases and tables. The following options let you specify which things to tear down and set up when restoring a dump, by encoding various DDL statements within the dump file.

- `--add-drop-database`

Command-Line Format	<code>--add-drop-database</code>
---------------------	----------------------------------

Write a `DROP DATABASE` statement before each `CREATE DATABASE` statement. This option is typically used in conjunction with the `--all-databases` or `--databases` option because no `CREATE DATABASE` statements are written unless one of those options is specified.

- `--add-drop-table`

Command-Line Format	<code>--add-drop-table</code>
---------------------	-------------------------------

Write a `DROP TABLE` statement before each `CREATE TABLE` statement.

- `--add-drop-trigger`

Command-Line Format	<code>--add-drop-trigger</code>
---------------------	---------------------------------

Write a `DROP TRIGGER` statement before each `CREATE TRIGGER` statement.

- `--all-tablespaces, -Y`

Command-Line Format	<code>--all-tablespaces</code>
---------------------	--------------------------------

Adds to a table dump all SQL statements needed to create any tablespaces used by an `NDB` table. This information is not otherwise included in the output from `mysqldump`. This option is currently relevant only to `NDB` Cluster tables, which are not supported in MySQL 5.7.

- `--no-create-db, -n`

Command-Line Format	<code>--no-create-db</code>
---------------------	-----------------------------

Suppress the `CREATE DATABASE` statements that are otherwise included in the output if the `--databases` or `--all-databases` option is given.

- `--no-create-info, -t`

Command-Line Format	<code>--no-create-info</code>
---------------------	-------------------------------

Do not write `CREATE TABLE` statements that create each dumped table.



#### Note

This option does *not* exclude statements creating log file groups or tablespaces from `mysqldump` output; however, you can use the `--no-tablespaces` option for this purpose.

- `--no-tablespaces, -y`

Command-Line Format	<code>--no-tablespaces</code>
---------------------	-------------------------------

This option suppresses all `CREATE LOGFILE GROUP` and `CREATE TABLESPACE` statements in the output of `mysqldump`.

- `--replace`

Command-Line Format	<code>--replace</code>
---------------------	------------------------

Write `REPLACE` statements rather than `INSERT` statements.

## Debug Options

The following options print debugging information, encode debugging information in the dump file, or let the dump operation proceed regardless of potential problems.

- `--allow-keywords`

Command-Line Format	<code>--allow-keywords</code>
---------------------	-------------------------------

Permit creation of column names that are keywords. This works by prefixing each column name with the table name.

- `--comments, -i`

Command-Line Format	<code>--comments</code>
---------------------	-------------------------

Write additional information in the dump file such as program version, server version, and host. This option is enabled by default. To suppress this additional information, use `--skip-comments`.

- `--debug[=debug_options], -# [debug_options]`

Command-Line Format	<code>--debug[=debug_options]</code>
Type	String
Default Value	<code>d:t:o,/tmp/mysqldump.trace</code>



Write a debugging log. A typical `debug_options` string is `d:t:o,file_name`. The default value is `d:t:o,/tmp/mysqldump.trace`.

This option is available only if MySQL was built using `WITH_DEBUG`. MySQL release binaries provided by Oracle are *not* built using this option.

- `--debug-check`

Command-Line Format	<code>--debug-check</code>
Type	Boolean
Default Value	<code>FALSE</code>

Print some debugging information when the program exits.

This option is available only if MySQL was built using `WITH_DEBUG`. MySQL release binaries provided by Oracle are *not* built using this option.

- `--debug-info`

Command-Line Format	<code>--debug-info</code>
Type	Boolean
Default Value	<code>FALSE</code>

Print debugging information and memory and CPU usage statistics when the program exits.

This option is available only if MySQL was built using `WITH_DEBUG`. MySQL release binaries provided by Oracle are *not* built using this option.

- `--dump-date`

Command-Line Format	<code>--dump-date</code>
Type	Boolean
Default Value	<code>TRUE</code>

If the `--comments` option is given, `mysqldump` produces a comment at the end of the dump of the following form:

```
-- Dump completed on DATE
```

However, the date causes dump files taken at different times to appear to be different, even if the data are otherwise identical. `--dump-date` and `--skip-dump-date` control whether the date is added to the comment. The default is `--dump-date` (include the date in the comment). `--skip-dump-date` suppresses date printing.

- `--force, -f`

Command-Line Format	<code>--force</code>
---------------------	----------------------

Ignore all errors; continue even if an SQL error occurs during a table dump.

One use for this option is to cause `mysqldump` to continue executing even when it encounters a view that has become invalid because the definition refers to a table that has been dropped. Without `--force`, `mysqldump` exits with an error message. With `--force`, `mysqldump` prints the error message, but it also writes an SQL comment containing the view definition to the dump output and continues executing.

If the `--ignore-error` option is also given to ignore specific errors, `--force` takes precedence.

- `--log-error=file_name`

Command-Line Format	<code>--log-error=file_name</code>
Type	File name

Log warnings and errors by appending them to the named file. The default is to do no logging.

- `--skip-comments`

Command-Line Format	<code>--skip-comments</code>
---------------------	------------------------------

See the description for the `--comments` option.

- `--verbose, -v`

Command-Line Format	<code>--verbose</code>
---------------------	------------------------

Verbose mode. Print more information about what the program does.

## Help Options

The following options display information about the `mysqldump` command itself.

- `--help, -?`

Command-Line Format	<code>--help</code>
---------------------	---------------------

Display a help message and exit.

- `--version, -V`

Command-Line Format	<code>--version</code>
---------------------	------------------------

## Internationalization Options

The following options change how the `mysqldump` command represents character data with national language settings.

- `--character-sets-dir=dir_name`

Command-Line Format	<code>--character-sets-dir=dir_name</code>
Type	Directory name

The directory where character sets are installed. See [Section 10.15, “Character Set Configuration”](#).

- `--default-character-set=charset_name`

Command-Line Format	<code>--default-character-set=charset_name</code>
Type	String
Default Value	<code>utf8</code>

Use `charset_name` as the default character set. See [Section 10.15, “Character Set Configuration”](#). If no character set is specified, `mysqldump` uses `utf8`.

- `--no-set-names, -N`

Command-Line Format	<code>--no-set-names</code>
Deprecated	Yes

Turns off the `--set-charset` setting, the same as specifying `--skip-set-charset`.

- `--set-charset`

Command-Line Format	<code>--set-charset</code>
Disabled by	<code>skip-set-charset</code>

Write `SET NAMES default_character_set` to the output. This option is enabled by default. To suppress the `SET NAMES` statement, use `--skip-set-charset`.

## Replication Options

The `mysqldump` command is frequently used to create an empty instance, or an instance including data, on a replica server in a replication configuration. The following options apply to dumping and restoring data on replication source and replica servers.

- `--apply-slave-statements`

Command-Line Format	<code>--apply-slave-statements</code>
Type	Boolean

For a replica dump produced with the `--dump-slave` option, add a `STOP SLAVE` statement before the `CHANGE MASTER TO` statement and a `START SLAVE` statement at the end of the output.

- `--delete-master-logs`

Command-Line Format	<code>--delete-master-logs</code>
---------------------	-----------------------------------

On a source replication server, delete the binary logs by sending a `PURGE BINARY LOGS` statement to the server after performing the dump operation. This option requires the `RELOAD` privilege as well as privileges sufficient to execute that statement. This option automatically enables `--master-data`.

- `--dump-slave[=value]`

Command-Line Format	<code>--dump-slave[=<i>value</i>]</code>
Type	Numeric
Default Value	1
Valid Values	1 2

This option is similar to `--master-data` except that it is used to dump a replication replica server to produce a dump file that can be used to set up another server as a replica that has the same source as the dumped server. It causes the dump output to include a `CHANGE MASTER TO` statement that indicates the binary log coordinates (file name and position) of the dumped replica's source. The `CHANGE MASTER TO` statement reads the values of `Relay_Master_Log_File` and `Exec_Master_Log_Pos` from the `SHOW SLAVE STATUS` output and uses them for `MASTER_LOG_FILE` and `MASTER_LOG_POS` respectively. These are the source server coordinates from which the replica should start replicating.



#### Note

Inconsistencies in the sequence of transactions from the relay log which have been executed can cause the wrong position to be used. See [Section 16.4.1.32, “Replication and Transaction Inconsistencies”](#) for more information.

`--dump-slave` causes the coordinates from the source to be used rather than those of the dumped server, as is done by the `--master-data` option. In addition, specifying this option causes the `--master-data` option to be overridden, if used, and effectively ignored.



#### Warning

This option should not be used if the server where the dump is going to be applied uses `gtid_mode=ON` and `MASTER_AUTOPOSITION=1`.

The option value is handled the same way as for `--master-data` (setting no value or 1 causes a `CHANGE MASTER TO` statement to be written to the dump, setting 2 causes the statement to be written

but encased in SQL comments) and has the same effect as `--master-data` in terms of enabling or disabling other options and in how locking is handled.

This option causes `mysqldump` to stop the replica SQL thread before the dump and restart it again after.

`--dump-slave` sends a `SHOW SLAVE STATUS` statement to the server to obtain information, so it requires privileges sufficient to execute that statement.

In conjunction with `--dump-slave`, the `--apply-slave-statements` and `--include-master-host-port` options can also be used.

- `--include-master-host-port`

Command-Line Format	<code>--include-master-host-port</code>
Type	Boolean
Default Value	<code>FALSE</code>

For the `CHANGE MASTER TO` statement in a replica dump produced with the `--dump-slave` option, add `MASTER_HOST` and `MASTER_PORT` options for the host name and TCP/IP port number of the replica's source.

- `--master-data[=value]`

Command-Line Format	<code>--master-data[=value]</code>
Type	Numeric
Default Value	1
Valid Values	1 2

Use this option to dump a source replication server to produce a dump file that can be used to set up another server as a replica of the source. It causes the dump output to include a `CHANGE MASTER TO` statement that indicates the binary log coordinates (file name and position) of the dumped server. These are the source server coordinates from which the replica should start replicating after you load the dump file into the replica.

If the option value is 2, the `CHANGE MASTER TO` statement is written as an SQL comment, and thus is informative only; it has no effect when the dump file is reloaded. If the option value is 1, the statement is not written as a comment and takes effect when the dump file is reloaded. If no option value is specified, the default value is 1.

`--master-data` sends a `SHOW MASTER STATUS` statement to the server to obtain information, so it requires privileges sufficient to execute that statement. This option also requires the `RELOAD` privilege and the binary log must be enabled.

The `--master-data` option automatically turns off `--lock-tables`. It also turns on `--lock-all-tables`, unless `--single-transaction` also is specified, in which case, a global read lock is acquired only for a short time at the beginning of the dump (see the description for `--single-transaction`). In all cases, any action on logs happens at the exact moment of the dump.

It is also possible to set up a replica by dumping an existing replica of the source, using the `--dump-slave` option, which overrides `--master-data` and causes it to be ignored if both options are used.

- `--set-gtid-purged=value`

Command-Line Format	<code>--set-gtid-purged=value</code>
Type	Enumeration
Default Value	<code>AUTO</code>
Valid Values	<code>OFF</code>  <code>ON</code>  <code>AUTO</code>

This option enables control over global transaction ID (GTID) information written to the dump file, by indicating whether to add a `SET @@GLOBAL.gtid_purged` statement to the output. This option may also cause a statement to be written to the output that disables binary logging while the dump file is being reloaded.

The following table shows the permitted option values. The default value is `AUTO`.

Value	Meaning
<code>OFF</code>	Add no <code>SET</code> statement to the output.
<code>ON</code>	Add a <code>SET</code> statement to the output. An error occurs if GTIDs are not enabled on the server.
<code>AUTO</code>	Add a <code>SET</code> statement to the output if GTIDs are enabled on the server.

A partial dump from a server that is using GTID-based replication requires the `--set-gtid-purged={ON|OFF}` option to be specified. Use `ON` if the intention is to deploy a new replication replica using only some of the data from the dumped server. Use `OFF` if the intention is to repair a table by copying it within a topology. Use `OFF` if the intention is to copy a table between replication topologies that are disjoint and for them to remain so.

The `--set-gtid-purged` option has the following effect on binary logging when the dump file is reloaded:

- `--set-gtid-purged=OFF`: `SET @@SESSION.SQL_LOG_BIN=0;` is not added to the output.
- `--set-gtid-purged=ON`: `SET @@SESSION.SQL_LOG_BIN=0;` is added to the output.
- `--set-gtid-purged=AUTO`: `SET @@SESSION.SQL_LOG_BIN=0;` is added to the output if GTIDs are enabled on the server you are backing up (that is, if `AUTO` evaluates to `ON`).

Using this option with the `--single-transaction` option can lead to inconsistencies in the output. If `--set-gtid-purged=ON` is required, it can be used with `--lock-all-tables`, but this can prevent parallel queries while `mysqldump` is being run.

It is not recommended to load a dump file when GTIDs are enabled on the server (`gtid_mode=ON`), if your dump file includes system tables. `mysqldump` issues DML instructions for the system tables which use the non-transactional MyISAM storage engine, and this combination is not permitted when GTIDs are enabled. Also be aware that loading a dump file from a server with GTIDs enabled, into another server with GTIDs enabled, causes different transaction identifiers to be generated.

## Format Options

The following options specify how to represent the entire dump file or certain kinds of data in the dump file. They also control whether certain optional information is written to the dump file.

- `--compact`

Command-Line Format	<code>--compact</code>
---------------------	------------------------

Produce more compact output. This option enables the `--skip-add-drop-table`, `--skip-add-locks`, `--skip-comments`, `--skip-disable-keys`, and `--skip-set-charset` options.

- `--compatible=name`

Command-Line Format	<code>--compatible=name[,name,...]</code>
Type	String
Default Value	<code>''</code>
Valid Values	<code>ansi</code>

Produce output that is more compatible with other database systems or with older MySQL servers. The value of *name* can be `ansi`, `mysql323`, `mysql40`, `postgresql`, `oracle`, `mssql`, `db2`, `maxdb`, `no_key_options`, `no_table_options`, or `no_field_options`. To use several values, separate them by commas. These values have the same meaning as the corresponding options for setting the server SQL mode. See [Section 5.1.10, “Server SQL Modes”](#).

This option does not guarantee compatibility with other servers. It only enables those SQL mode values that are currently available for making dump output more compatible. For example, `--compatible=oracle` does not map data types to Oracle types or use Oracle comment syntax.

- `--complete-insert, -c`

Command-Line Format	<code>--complete-insert</code>
---------------------	--------------------------------

Use complete `INSERT` statements that include column names.

- `--create-options`

Command-Line Format	<code>--create-options</code>
---------------------	-------------------------------

Include all MySQL-specific table options in the `CREATE TABLE` statements.

- `--fields-terminated-by=...`, `--fields-enclosed-by=...`, `--fields-optionally-enclosed-by=...`, `--fields-escaped-by=...`

Command-Line Format	<code>--fields-terminated-by=string</code>
Type	String

Command-Line Format	<code>--fields-enclosed-by=string</code>
Type	String

Command-Line Format	<code>--fields-optionally-enclosed-by=string</code>
Type	String

Command-Line Format	<code>--fields-escaped-by</code>
Type	String

These options are used with the `--tab` option and have the same meaning as the corresponding `FIELDS` clauses for `LOAD DATA`. See [Section 13.2.6, “LOAD DATA Statement”](#).

- `--hex-blob`

Command-Line Format	<code>--hex-blob</code>
---------------------	-------------------------

Dump binary columns using hexadecimal notation (for example, 'abc' becomes `0x616263`). The affected data types are `BINARY`, `VARBINARY`, `BLOB` types, `BIT`, all spatial data types, and other non-binary data types when used with the `binary character set`.

The `--hex-blob` option is ignored when the `--tab` is used.

- `--lines-terminated-by=...`

Command-Line Format	<code>--lines-terminated-by=string</code>
Type	String

This option is used with the `--tab` option and has the same meaning as the corresponding `LINES` clause for `LOAD DATA`. See [Section 13.2.6, “LOAD DATA Statement”](#).

- `--quote-names, -Q`

Command-Line Format	<code>--quote-names</code>
Disabled by	<code>skip-quote-names</code>

Quote identifiers (such as database, table, and column names) within ``` characters. If the `ANSI_QUOTES` SQL mode is enabled, identifiers are quoted within `"` characters. This option is enabled by default. It can be disabled with `--skip-quote-names`, but this option should be given after any option such as `--compatible` that may enable `--quote-names`.

- `--result-file=file_name, -r file_name`

Command-Line Format	<code>--result-file=file_name</code>
---------------------	--------------------------------------



Type	File name
------	-----------

Direct output to the named file. The result file is created and its previous contents overwritten, even if an error occurs while generating the dump.

This option should be used on Windows to prevent newline `\n` characters from being converted to `\r\n` carriage return/newline sequences.

- `--tab=dir_name, -T dir_name`

Command-Line Format	<code>--tab=dir_name</code>
Type	Directory name

Produce tab-separated text-format data files. For each dumped table, `mysqldump` creates a `tbl_name.sql` file that contains the `CREATE TABLE` statement that creates the table, and the server writes a `tbl_name.txt` file that contains its data. The option value is the directory in which to write the files.



#### Note

This option should be used only when `mysqldump` is run on the same machine as the `mysqld` server. Because the server creates `*.txt` files in the directory that you specify, the directory must be writable by the server and the MySQL account that you use must have the `FILE` privilege. Because `mysqldump` creates `*.sql` in the same directory, it must be writable by your system login account.

By default, the `.txt` data files are formatted using tab characters between column values and a newline at the end of each line. The format can be specified explicitly using the `--fields-xxx` and `--lines-terminated-by` options.

Column values are converted to the character set specified by the `--default-character-set` option.

- `--tz-utc`

Command-Line Format	<code>--tz-utc</code>
Disabled by	<code>skip-tz-utc</code>

This option enables `TIMESTAMP` columns to be dumped and reloaded between servers in different time zones. `mysqldump` sets its connection time zone to UTC and adds `SET TIME_ZONE='+00:00'` to the dump file. Without this option, `TIMESTAMP` columns are dumped and reloaded in the time zones local to the source and destination servers, which can cause the values to change if the servers are in different time zones. `--tz-utc` also protects against changes due to daylight saving time. `--tz-utc` is enabled by default. To disable it, use `--skip-tz-utc`.

- `--xml, -X`

Command-Line Format	<code>--xml</code>
---------------------	--------------------

Write dump output as well-formed XML.

**NULL, 'NULL', and Empty Values:** For a column named `column_name`, the `NULL` value, an empty string, and the string value `'NULL'` are distinguished from one another in the output generated by this option as follows.

Value:	XML Representation:
<code>NULL</code> ( <i>unknown value</i> )	<code>&lt;field name="column_name" xsi:nil="true" /&gt;</code>
<code>' '</code> ( <i>empty string</i> )	<code>&lt;field name="column_name"&gt;&lt;/field&gt;</code>
<code>'NULL'</code> ( <i>string value</i> )	<code>&lt;field name="column_name"&gt;NULL&lt;/field&gt;</code>

The output from the `mysql` client when run using the `--xml` option also follows the preceding rules. (See [Section 4.5.1.1, "mysql Client Options"](#).)

XML output from `mysqldump` includes the XML namespace, as shown here:

```
$> mysqldump --xml -u root world City
<?xml version="1.0"?>
<mysqldump xmlns:xsi="http://www.w3.org/2001/XMLSchema-instance">
<database name="world">
<table_structure name="City">
<field Field="ID" Type="int(11)" Null="NO" Key="PRI" Extra="auto_increment" />
<field Field="Name" Type="char(35)" Null="NO" Key="" Default="" Extra="" />
<field Field="CountryCode" Type="char(3)" Null="NO" Key="" Default="" Extra="" />
<field Field="District" Type="char(20)" Null="NO" Key="" Default="" Extra="" />
<field Field="Population" Type="int(11)" Null="NO" Key="" Default="0" Extra="" />
<key Table="City" Non_unique="0" Key_name="PRIMARY" Seq_in_index="1" Column_name="ID"
Collation="A" Cardinality="4079" Null="" Index_type="BTREE" Comment="" />
<options Name="City" Engine="MyISAM" Version="10" Row_format="Fixed" Rows="4079"
Avg_row_length="67" Data_length="273293" Max_data_length="18858823439613951"
Index_length="43008" Data_free="0" Auto_increment="4080"
Create_time="2007-03-31 01:47:01" Update_time="2007-03-31 01:47:02"
Collation="latin1_swedish_ci" Create_options="" Comment="" />
</table_structure>
<table_data name="City">
<row>
<field name="ID">1</field>
<field name="Name">Kabul</field>
<field name="CountryCode">AFG</field>
<field name="District">Kabul</field>
<field name="Population">1780000</field>
</row>
...
<row>
<field name="ID">4079</field>
<field name="Name">Rafah</field>
<field name="CountryCode">PSE</field>
<field name="District">Rafah</field>
<field name="Population">92020</field>
</row>
</table_data>
</database>
```

&lt;/mysqldump&gt;

## Filtering Options

The following options control which kinds of schema objects are written to the dump file: by category, such as triggers or events; by name, for example, choosing which databases and tables to dump; or even filtering rows from the table data using a [WHERE](#) clause.

- `--all-databases, -A`

Command-Line Format	<code>--all-databases</code>
---------------------	------------------------------

Dump all tables in all databases. This is the same as using the `--databases` option and naming all the databases on the command line.

- `--databases, -B`

Command-Line Format	<code>--databases</code>
---------------------	--------------------------

Dump several databases. Normally, `mysqldump` treats the first name argument on the command line as a database name and following names as table names. With this option, it treats all name arguments as database names. `CREATE DATABASE` and `USE` statements are included in the output before each new database.

This option may be used to dump the `INFORMATION_SCHEMA` and `performance_schema` databases, which normally are not dumped even with the `--all-databases` option. (Also use the `--skip-lock-tables` option.)

- `--events, -E`

Command-Line Format	<code>--events</code>
---------------------	-----------------------

Include Event Scheduler events for the dumped databases in the output. This option requires the `EVENT` privileges for those databases.

The output generated by using `--events` contains `CREATE EVENT` statements to create the events. However, these statements do not include attributes such as the event creation and modification timestamps, so when the events are reloaded, they are created with timestamps equal to the reload time.

If you require events to be created with their original timestamp attributes, do not use `--events`. Instead, dump and reload the contents of the `mysql.event` table directly, using a MySQL account that has appropriate privileges for the `mysql` database.

- `--ignore-error=error[,error]...`

Command-Line Format	<code>--ignore-error=error[,error]...</code>
Type	String

Ignore the specified errors. The option value is a list of comma-separated error numbers specifying the errors to ignore during `mysqldump` execution. If the `--force` option is also given to ignore all errors, `--force` takes precedence.

- `--ignore-table=db_name.tbl_name`

Command-Line Format	<code>--ignore-table=db_name.tbl_name</code>
Type	String

Do not dump the given table, which must be specified using both the database and table names. To ignore multiple tables, use this option multiple times. This option also can be used to ignore views.

- `--no-data, -d`

Command-Line Format	<code>--no-data</code>
---------------------	------------------------

Do not write any table row information (that is, do not dump table contents). This is useful if you want to dump only the `CREATE TABLE` statement for the table (for example, to create an empty copy of the table by loading the dump file).

- `--routines, -R`

Command-Line Format	<code>--routines</code>
---------------------	-------------------------

Include stored routines (procedures and functions) for the dumped databases in the output. This option requires the `SELECT` privilege for the `mysql.proc` table.

The output generated by using `--routines` contains `CREATE PROCEDURE` and `CREATE FUNCTION` statements to create the routines. However, these statements do not include attributes such as the routine creation and modification timestamps, so when the routines are reloaded, they are created with timestamps equal to the reload time.

If you require routines to be created with their original timestamp attributes, do not use `--routines`. Instead, dump and reload the contents of the `mysql.proc` table directly, using a MySQL account that has appropriate privileges for the `mysql` database.

- `--tables`

Command-Line Format	<code>--tables</code>
---------------------	-----------------------

Override the `--databases` or `-B` option. `mysqldump` regards all name arguments following the option as table names.

- `--triggers`

Command-Line Format	<code>--triggers</code>
---------------------	-------------------------

Disabled by	<code>skip-triggers</code>
-------------	----------------------------

Include triggers for each dumped table in the output. This option is enabled by default; disable it with `--skip-triggers`.

To be able to dump a table's triggers, you must have the `TRIGGER` privilege for the table.

Multiple triggers are permitted. `mysqldump` dumps triggers in activation order so that when the dump file is reloaded, triggers are created in the same activation order. However, if a `mysqldump` dump file contains multiple triggers for a table that have the same trigger event and action time, an error occurs for attempts to load the dump file into an older server that does not support multiple triggers. (For a workaround, see [Section 2.11.3, "Downgrade Notes"](#); you can convert triggers to be compatible with older servers.)

- `--where='where_condition', -w 'where_condition'`

Command-Line Format	<code>--where='where_condition'</code>
---------------------	--

Dump only rows selected by the given `WHERE` condition. Quotes around the condition are mandatory if it contains spaces or other characters that are special to your command interpreter.

Examples:

```
--where="user='jimf'"
-w"userid>1"
-w"userid<1"
```

## Performance Options

The following options are the most relevant for the performance particularly of the restore operations. For large data sets, restore operation (processing the `INSERT` statements in the dump file) is the most time-consuming part. When it is urgent to restore data quickly, plan and test the performance of this stage in advance. For restore times measured in hours, you might prefer an alternative backup and restore solution, such as [MySQL Enterprise Backup](#) for `InnoDB`-only and mixed-use databases.

Performance is also affected by the [transactional options](#), primarily for the dump operation.

- `--disable-keys, -K`

Command-Line Format	<code>--disable-keys</code>
---------------------	-----------------------------

For each table, surround the `INSERT` statements with `/*!40000 ALTER TABLE tbl_name DISABLE KEYS */;` and `/*!40000 ALTER TABLE tbl_name ENABLE KEYS */;` statements. This makes loading the dump file faster because the indexes are created after all rows are inserted. This option is effective only for nonunique indexes of `MyISAM` tables.

- `--extended-insert, -e`

Command-Line Format	<code>--extended-insert</code>
Disabled by	<code>skip-extended-insert</code>

Write `INSERT` statements using multiple-row syntax that includes several `VALUES` lists. This results in a smaller dump file and speeds up inserts when the file is reloaded.

- `--insert-ignore`

Command-Line Format	<code>--insert-ignore</code>
---------------------	------------------------------

Write `INSERT IGNORE` statements rather than `INSERT` statements.

- `--max-allowed-packet=value`

Command-Line Format	<code>--max-allowed-packet=value</code>
Type	Numeric
Default Value	25165824

The maximum size of the buffer for client/server communication. The default is 24MB, the maximum is 1GB.



#### Note

The value of this option is specific to `mysqldump` and should not be confused with the MySQL server's `max_allowed_packet` system variable; the server value cannot be exceeded by a single packet from `mysqldump`, regardless of any setting for the `mysqldump` option, even if the latter is larger.

- `--net-buffer-length=value`

Command-Line Format	<code>--net-buffer-length=value</code>
Type	Numeric
Default Value	16384

The initial size of the buffer for client/server communication. When creating multiple-row `INSERT` statements (as with the `--extended-insert` or `--opt` option), `mysqldump` creates rows up to `--net-buffer-length` bytes long. If you increase this variable, ensure that the MySQL server `net_buffer_length` system variable has a value at least this large.

- `--opt`

Command-Line Format	<code>--opt</code>
Disabled by	<code>skip-opt</code>

This option, enabled by default, is shorthand for the combination of `--add-drop-table` `--add-locks` `--create-options` `--disable-keys` `--extended-insert` `--lock-tables` `--quick` `--set-charset`. It gives a fast dump operation and produces a dump file that can be reloaded into a MySQL server quickly.

Because the `--opt` option is enabled by default, you only specify its converse, the `--skip-opt` to turn off several default settings. See the discussion of `mysqldump` [option groups](#) for information about selectively enabling or disabling a subset of the options affected by `--opt`.

- `--quick, -q`

Command-Line Format	<code>--quick</code>
---------------------	----------------------

Disabled by	<code>skip-quick</code>
-------------	-------------------------

This option is useful for dumping large tables. It forces `mysqldump` to retrieve rows for a table from the server a row at a time rather than retrieving the entire row set and buffering it in memory before writing it out.

- `--skip-opt`

Command-Line Format	<code>--skip-opt</code>
---------------------	-------------------------

See the description for the `--opt` option.

## Transactional Options

The following options trade off the performance of the dump operation, against the reliability and consistency of the exported data.

- `--add-locks`

Command-Line Format	<code>--add-locks</code>
---------------------	--------------------------

Surround each table dump with `LOCK TABLES` and `UNLOCK TABLES` statements. This results in faster inserts when the dump file is reloaded. See [Section 8.2.4.1, “Optimizing INSERT Statements”](#).

- `--flush-logs, -F`

Command-Line Format	<code>--flush-logs</code>
---------------------	---------------------------

Flush the MySQL server log files before starting the dump. This option requires the `RELOAD` privilege. If you use this option in combination with the `--all-databases` option, the logs are flushed *for each database dumped*. The exception is when using `--lock-all-tables`, `--master-data`, or `--single-transaction`: In this case, the logs are flushed only once, corresponding to the moment that all tables are locked by `FLUSH TABLES WITH READ LOCK`. If you want your dump and the log flush to happen at exactly the same moment, you should use `--flush-logs` together with `--lock-all-tables`, `--master-data`, or `--single-transaction`.

- `--flush-privileges`

Command-Line Format	<code>--flush-privileges</code>
---------------------	---------------------------------

Add a `FLUSH PRIVILEGES` statement to the dump output after dumping the `mysql` database. This option should be used any time the dump contains the `mysql` database and any other database that depends on the data in the `mysql` database for proper restoration.

Because the dump file contains a `FLUSH PRIVILEGES` statement, reloading the file requires privileges sufficient to execute that statement.

**Note**

For upgrades to MySQL 5.7 or higher from older versions, do not use `--flush-privileges`. For upgrade instructions in this case, see [Section 2.10.3, “Changes in MySQL 5.7”](#).

- `--lock-all-tables, -x`

Command-Line Format	<code>--lock-all-tables</code>
---------------------	--------------------------------

Lock all tables across all databases. This is achieved by acquiring a global read lock for the duration of the whole dump. This option automatically turns off `--single-transaction` and `--lock-tables`.

- `--lock-tables, -l`

Command-Line Format	<code>--lock-tables</code>
---------------------	----------------------------

For each dumped database, lock all tables to be dumped before dumping them. The tables are locked with `READ LOCAL` to permit concurrent inserts in the case of `MyISAM` tables. For transactional tables such as `InnoDB`, `--single-transaction` is a much better option than `--lock-tables` because it does not need to lock the tables at all.

Because `--lock-tables` locks tables for each database separately, this option does not guarantee that the tables in the dump file are logically consistent between databases. Tables in different databases may be dumped in completely different states.

Some options, such as `--opt`, automatically enable `--lock-tables`. If you want to override this, use `--skip-lock-tables` at the end of the option list.

- `--no-autocommit`

Command-Line Format	<code>--no-autocommit</code>
---------------------	------------------------------

Enclose the `INSERT` statements for each dumped table within `SET autocommit = 0` and `COMMIT` statements.

- `--order-by-primary`

Command-Line Format	<code>--order-by-primary</code>
---------------------	---------------------------------

Dump each table's rows sorted by its primary key, or by its first unique index, if such an index exists. This is useful when dumping a `MyISAM` table to be loaded into an `InnoDB` table, but makes the dump operation take considerably longer.

- `--shared-memory-base-name=name`

Command-Line Format	<code>--shared-memory-base-name=name</code>
---------------------	---



Platform Specific	Windows
-------------------	---------

On Windows, the shared-memory name to use for connections made using shared memory to a local server. The default value is `MYSQL`. The shared-memory name is case-sensitive.

This option applies only if the server was started with the `shared_memory` system variable enabled to support shared-memory connections.

- `--single-transaction`

Command-Line Format	<code>--single-transaction</code>
---------------------	-----------------------------------

This option sets the transaction isolation mode to `REPEATABLE READ` and sends a `START TRANSACTION` SQL statement to the server before dumping data. It is useful only with transactional tables such as `InnoDB`, because then it dumps the consistent state of the database at the time when `START TRANSACTION` was issued without blocking any applications.

The `RELOAD` or `FLUSH_TABLES` privilege is required with `--single-transaction` if both `gtid_mode=ON` and `--set-gtid=purged=ON|AUTO`. This requirement was added in MySQL 8.0.32.

When using this option, you should keep in mind that only `InnoDB` tables are dumped in a consistent state. For example, any `MyISAM` or `MEMORY` tables dumped while using this option may still change state.

While a `--single-transaction` dump is in process, to ensure a valid dump file (correct table contents and binary log coordinates), no other connection should use the following statements: `ALTER TABLE`, `CREATE TABLE`, `DROP TABLE`, `RENAME TABLE`, `TRUNCATE TABLE`. A consistent read is not isolated from those statements, so use of them on a table to be dumped can cause the `SELECT` that is performed by `mysqldump` to retrieve the table contents to obtain incorrect contents or fail.

The `--single-transaction` option and the `--lock-tables` option are mutually exclusive because `LOCK TABLES` causes any pending transactions to be committed implicitly.

Using `--single-transaction` together with the `--set-gtid-purged` option is not recommended; doing so can lead to inconsistencies in the output of `mysqldump`.

To dump large tables, combine the `--single-transaction` option with the `--quick` option.

## Option Groups

- The `--opt` option turns on several settings that work together to perform a fast dump operation. All of these settings are on by default, because `--opt` is on by default. Thus you rarely if ever specify `--opt`. Instead, you can turn these settings off as a group by specifying `--skip-opt`, then optionally re-enable certain settings by specifying the associated options later on the command line.
- The `--compact` option turns off several settings that control whether optional statements and comments appear in the output. Again, you can follow this option with other options that re-enable certain settings, or turn all the settings on by using the `--skip-compact` form.

When you selectively enable or disable the effect of a group option, order is important because options are processed first to last. For example, `--disable-keys --lock-tables --skip-opt` would not have the intended effect; it is the same as `--skip-opt` by itself.

## Examples

To make a backup of an entire database:

```
mysqldump db_name > backup-file.sql
```

To load the dump file back into the server:

```
mysql db_name < backup-file.sql
```

Another way to reload the dump file:

```
mysql -e "source /path-to-backup/backup-file.sql" db_name
```

`mysqldump` is also very useful for populating databases by copying data from one MySQL server to another:

```
mysqldump --opt db_name | mysql --host=remote_host -C db_name
```

You can dump several databases with one command:

```
mysqldump --databases db_name1 [db_name2 ...] > my_databases.sql
```

To dump all databases, use the `--all-databases` option:

```
mysqldump --all-databases > all_databases.sql
```

For `InnoDB` tables, `mysqldump` provides a way of making an online backup:

```
mysqldump --all-databases --master-data --single-transaction > all_databases.sql
```

This backup acquires a global read lock on all tables (using `FLUSH TABLES WITH READ LOCK`) at the beginning of the dump. As soon as this lock has been acquired, the binary log coordinates are read and the lock is released. If long updating statements are running when the `FLUSH` statement is issued, the MySQL server may get stalled until those statements finish. After that, the dump becomes lock free and does not disturb reads and writes on the tables. If the update statements that the MySQL server receives are short (in terms of execution time), the initial lock period should not be noticeable, even with many updates.

For point-in-time recovery (also known as “roll-forward,” when you need to restore an old backup and replay the changes that happened since that backup), it is often useful to rotate the binary log (see [Section 5.4.4, “The Binary Log”](#)) or at least know the binary log coordinates to which the dump corresponds:

```
mysqldump --all-databases --master-data=2 > all_databases.sql
```

Or:

```
mysqldump --all-databases --flush-logs --master-data=2 > all_databases.sql
```

The `--master-data` and `--single-transaction` options can be used simultaneously, which provides a convenient way to make an online backup suitable for use prior to point-in-time recovery if tables are stored using the `InnoDB` storage engine.

For more information on making backups, see [Section 7.2, “Database Backup Methods”](#), and [Section 7.3, “Example Backup and Recovery Strategy”](#).

- To select the effect of `--opt` except for some features, use the `--skip` option for each feature. To disable extended inserts and memory buffering, use `--opt --skip-extended-insert --skip-quick`. (Actually, `--skip-extended-insert --skip-quick` is sufficient because `--opt` is on by default.)

- To reverse `--opt` for all features except index disabling and table locking, use `--skip-opt --disable-keys --lock-tables`.

## Restrictions

`mysqldump` does not dump the `INFORMATION_SCHEMA`, `performance_schema`, or `sys` schema by default. To dump any of these, name them explicitly on the command line. You can also name them with the `--databases` option. For `INFORMATION_SCHEMA` and `performance_schema`, also use the `--skip-lock-tables` option.

`mysqldump` does not dump the NDB Cluster `ndbinfo` information database.

`mysqldump` does not dump `InnoDB CREATE TABLESPACE` statements.

`mysqldump` always strips the `NO_AUTO_CREATE_USER` SQL mode as `NO_AUTO_CREATE_USER` is not compatible with MySQL 8.0. It remains stripped even when importing back into MySQL 5.7, which means that stored routines could behave differently after restoring a dump if they rely upon this particular `sql_mode`. It is stripped as of `mysqldump` 5.7.24.

It is not recommended to restore from a dump made using `mysqldump` to a MySQL 5.6.9 or earlier server that has GTIDs enabled. See [Section 16.1.3.6, “Restrictions on Replication with GTIDs”](#).

`mysqldump` includes statements to recreate the `general_log` and `slow_query_log` tables for dumps of the `mysql` database. Log table contents are not dumped.

If you encounter problems backing up views due to insufficient privileges, see [Section 23.9, “Restrictions on Views”](#) for a workaround.

## 4.5.5 mysqlimport — A Data Import Program

The `mysqlimport` client provides a command-line interface to the `LOAD DATA` SQL statement. Most options to `mysqlimport` correspond directly to clauses of `LOAD DATA` syntax. See [Section 13.2.6, “LOAD DATA Statement”](#).

Invoke `mysqlimport` like this:

```
mysqlimport [options] db_name textfile1 [textfile2 ...]
```

For each text file named on the command line, `mysqlimport` strips any extension from the file name and uses the result to determine the name of the table into which to import the file’s contents. For example, files named `patient.txt`, `patient.text`, and `patient` all would be imported into a table named `patient`.

`mysqlimport` supports the following options, which can be specified on the command line or in the `[mysqlimport]` and `[client]` groups of an option file. For information about option files used by MySQL programs, see [Section 4.2.2.2, “Using Option Files”](#).

**Table 4.17 mysqlimport Options**

Option Name	Description	Introduced	Deprecated
<code>--bind-address</code>	Use specified network interface to connect to MySQL Server		
<code>--character-sets-dir</code>	Directory where character sets can be found		
<code>--columns</code>	This option takes a comma-separated list		

Option Name	Description	Introduced	Deprecated
	of column names as its value		
<code>--compress</code>	Compress all information sent between client and server		
<code>--debug</code>	Write debugging log		
<code>--debug-check</code>	Print debugging information when program exits		
<code>--debug-info</code>	Print debugging information, memory, and CPU statistics when program exits		
<code>--default-auth</code>	Authentication plugin to use		
<code>--default-character-set</code>	Specify default character set		
<code>--defaults-extra-file</code>	Read named option file in addition to usual option files		
<code>--defaults-file</code>	Read only named option file		
<code>--defaults-group-suffix</code>	Option group suffix value		
<code>--delete</code>	Empty the table before importing the text file		
<code>--enable-cleartext-plugin</code>	Enable cleartext authentication plugin	5.7.10	
<code>--fields-enclosed-by</code>	This option has the same meaning as the corresponding clause for LOAD DATA		
<code>--fields-escaped-by</code>	This option has the same meaning as the corresponding clause for LOAD DATA		
<code>--fields-optionally-enclosed-by</code>	This option has the same meaning as the corresponding clause for LOAD DATA		
<code>--fields-terminated-by</code>	This option has the same meaning as the corresponding clause for LOAD DATA		
<code>--force</code>	Continue even if an SQL error occurs		

Option Name	Description	Introduced	Deprecated
<code>--get-server-public-key</code>	Request RSA public key from server	5.7.23	
<code>--help</code>	Display help message and exit		
<code>--host</code>	Host on which MySQL server is located		
<code>--ignore</code>	See the description for the <code>--replace</code> option		
<code>--ignore-lines</code>	Ignore the first N lines of the data file		
<code>--lines-terminated-by</code>	This option has the same meaning as the corresponding clause for LOAD DATA		
<code>--local</code>	Read input files locally from the client host		
<code>--lock-tables</code>	Lock all tables for writing before processing any text files		
<code>--login-path</code>	Read login path options from <code>.mylogin.cnf</code>		
<code>--low-priority</code>	Use <code>LOW_PRIORITY</code> when loading the table		
<code>--no-defaults</code>	Read no option files		
<code>--password</code>	Password to use when connecting to server		
<code>--pipe</code>	Connect to server using named pipe (Windows only)		
<code>--plugin-dir</code>	Directory where plugins are installed		
<code>--port</code>	TCP/IP port number for connection		
<code>--print-defaults</code>	Print default options		
<code>--protocol</code>	Transport protocol to use		
<code>--replace</code>	The <code>--replace</code> and <code>--ignore</code> options control handling of input rows that duplicate existing rows on unique key values		
<code>--secure-auth</code>	Do not send passwords to server in old (pre-4.1) format		Yes

Option Name	Description	Introduced	Deprecated
<code>--server-public-key-path</code>	Path name to file containing RSA public key	5.7.23	
<code>--shared-memory-base-name</code>	Shared-memory name for shared-memory connections (Windows only)		
<code>--silent</code>	Produce output only when errors occur		
<code>--socket</code>	Unix socket file or Windows named pipe to use		
<code>--ssl</code>	Enable connection encryption		
<code>--ssl-ca</code>	File that contains list of trusted SSL Certificate Authorities		
<code>--ssl-capath</code>	Directory that contains trusted SSL Certificate Authority certificate files		
<code>--ssl-cert</code>	File that contains X.509 certificate		
<code>--ssl-cipher</code>	Permissible ciphers for connection encryption		
<code>--ssl-crl</code>	File that contains certificate revocation lists		
<code>--ssl-crlpath</code>	Directory that contains certificate revocation-list files		
<code>--ssl-key</code>	File that contains X.509 key		
<code>--ssl-mode</code>	Desired security state of connection to server	5.7.11	
<code>--ssl-verify-server-cert</code>	Verify host name against server certificate Common Name identity		
<code>--tls-version</code>	Permissible TLS protocols for encrypted connections	5.7.10	
<code>--use-threads</code>	Number of threads for parallel file-loading		
<code>--user</code>	MySQL user name to use when connecting to server		
<code>--verbose</code>	Verbose mode		

Option Name	Description	Introduced	Deprecated
<code>--version</code>	Display version information and exit		

- `--help, -?`

Command-Line Format	<code>--help</code>
---------------------	---------------------

Display a help message and exit.

- `--bind-address=ip_address`

Command-Line Format	<code>--bind-address=ip_address</code>
---------------------	--

On a computer having multiple network interfaces, use this option to select which interface to use for connecting to the MySQL server.

- `--character-sets-dir=dir_name`

Command-Line Format	<code>--character-sets-dir=path</code>
Type	String
Default Value	[none]

The directory where character sets are installed. See [Section 10.15, “Character Set Configuration”](#).

- `--columns=column_list, -c column_list`

Command-Line Format	<code>--columns=column_list</code>
---------------------	------------------------------------

This option takes a list of comma-separated column names as its value. The order of the column names indicates how to match data file columns with table columns.

- `--compress, -C`

Command-Line Format	<code>--compress[={OFF ON}]</code>
Type	Boolean
Default Value	OFF

Compress all information sent between the client and the server if possible. See [Section 4.2.6, “Connection Compression Control”](#).

- `--debug[=debug_options], -# [debug_options]`

Command-Line Format	<code>--debug[=debug_options]</code>
---------------------	--------------------------------------

Default Value	<code>d:t:o</code>
---------------	--------------------

Write a debugging log. A typical `debug_options` string is `d:t:o,file_name`. The default is `d:t:o`.

This option is available only if MySQL was built using `WITH_DEBUG`. MySQL release binaries provided by Oracle are *not* built using this option.

- `--debug-check`

Command-Line Format	<code>--debug-check</code>
Type	Boolean
Default Value	<code>FALSE</code>

Print some debugging information when the program exits.

This option is available only if MySQL was built using `WITH_DEBUG`. MySQL release binaries provided by Oracle are *not* built using this option.

- `--debug-info`

Command-Line Format	<code>--debug-info</code>
Type	Boolean
Default Value	<code>FALSE</code>

Print debugging information and memory and CPU usage statistics when the program exits.

This option is available only if MySQL was built using `WITH_DEBUG`. MySQL release binaries provided by Oracle are *not* built using this option.

- `--default-character-set=charset_name`

Command-Line Format	<code>--default-character-set=charset_name</code>
Type	String

Use `charset_name` as the default character set. See [Section 10.15, “Character Set Configuration”](#).

- `--default-auth=plugin`

Command-Line Format	<code>--default-auth=plugin</code>
Type	String

A hint about which client-side authentication plugin to use. See [Section 6.2.13, “Pluggable Authentication”](#).

- `--defaults-extra-file=file_name`

Command-Line Format	<code>--defaults-extra-file=file_name</code>
Type	File name



Read this option file after the global option file but (on Unix) before the user option file. If the file does not exist or is otherwise inaccessible, an error occurs. If *file\_name* is not an absolute path name, it is interpreted relative to the current directory.

For additional information about this and other option-file options, see [Section 4.2.2.3, “Command-Line Options that Affect Option-File Handling”](#).

- `--defaults-file=file_name`

Command-Line Format	<code>--defaults-file=file_name</code>
Type	File name

Use only the given option file. If the file does not exist or is otherwise inaccessible, an error occurs. If *file\_name* is not an absolute path name, it is interpreted relative to the current directory.

Exception: Even with `--defaults-file`, client programs read `.mylogin.cnf`.

For additional information about this and other option-file options, see [Section 4.2.2.3, “Command-Line Options that Affect Option-File Handling”](#).

- `--defaults-group-suffix=str`

Command-Line Format	<code>--defaults-group-suffix=str</code>
Type	String

Read not only the usual option groups, but also groups with the usual names and a suffix of *str*. For example, `mysqlimport` normally reads the `[client]` and `[mysqlimport]` groups. If this option is given as `--defaults-group-suffix=_other`, `mysqlimport` also reads the `[client_other]` and `[mysqlimport_other]` groups.

For additional information about this and other option-file options, see [Section 4.2.2.3, “Command-Line Options that Affect Option-File Handling”](#).

- `--delete, -D`

Command-Line Format	<code>--delete</code>
---------------------	-----------------------

Empty the table before importing the text file.

- `--enable-cleartext-plugin`

Command-Line Format	<code>--enable-cleartext-plugin</code>
Introduced	5.7.10
Type	Boolean

Default Value	FALSE
---------------	-------

Enable the `mysql_clear_password` cleartext authentication plugin. (See [Section 6.4.1.6, “Client-Side Cleartext Pluggable Authentication”](#).)

This option was added in MySQL 5.7.10.

- `--fields-terminated-by=...`, `--fields-enclosed-by=...`, `--fields-optionally-enclosed-by=...`, `--fields-escaped-by=...`

Command-Line Format	<code>--fields-terminated-by=string</code>
Type	String

Command-Line Format	<code>--fields-enclosed-by=string</code>
Type	String

Command-Line Format	<code>--fields-optionally-enclosed-by=string</code>
Type	String

Command-Line Format	<code>--fields-escaped-by</code>
Type	String

These options have the same meaning as the corresponding clauses for `LOAD DATA`. See [Section 13.2.6, “LOAD DATA Statement”](#).

- `--force, -f`

Command-Line Format	<code>--force</code>
---------------------	----------------------

Ignore errors. For example, if a table for a text file does not exist, continue processing any remaining files. Without `--force`, `mysqlimport` exits if a table does not exist.

- `--get-server-public-key`

Command-Line Format	<code>--get-server-public-key</code>
Introduced	5.7.23
Type	Boolean

do not authenticate with that plugin. It is also ignored if RSA-based password exchange is not used, as is the case when the client connects to the server using a secure connection.

If `--server-public-key-path=file_name` is given and specifies a valid public key file, it takes precedence over `--get-server-public-key`.

For information about the `caching_sha2_password` plugin, see [Section 6.4.1.4, “Caching SHA-2 Pluggable Authentication”](#).

The `--get-server-public-key` option was added in MySQL 5.7.23.

- `--host=host_name, -h host_name`

Command-Line Format	<code>--host=host_name</code>
Type	String
Default Value	<code>localhost</code>

Import data to the MySQL server on the given host. The default host is `localhost`.

- `--ignore, -i`

Command-Line Format	<code>--ignore</code>
---------------------	-----------------------

See the description for the `--replace` option.

- `--ignore-lines=N`

Command-Line Format	<code>--ignore-lines=#</code>
Type	Numeric

Ignore the first *N* lines of the data file.

- `--lines-terminated-by=...`

Command-Line Format	<code>--lines-terminated-by=string</code>
Type	String

This option has the same meaning as the corresponding clause for `LOAD DATA`. For example, to import Windows files that have lines terminated with carriage return/linefeed pairs, use `--lines-terminated-by="\r\n"`. (You might have to double the backslashes, depending on the escaping conventions of your command interpreter.) See [Section 13.2.6, “LOAD DATA Statement”](#).

- `--local, -L`

Command-Line Format	<code>--local</code>
Type	Boolean

Default Value	FALSE
---------------	-------

By default, files are read by the server on the server host. With this option, `mysqlimport` reads input files locally on the client host.

Successful use of `LOCAL` load operations within `mysqlimport` also requires that the server permits local loading; see [Section 6.1.6, “Security Considerations for LOAD DATA LOCAL”](#)

- `--lock-tables, -l`

Command-Line Format	<code>--lock-tables</code>
---------------------	----------------------------

Lock *all* tables for writing before processing any text files. This ensures that all tables are synchronized on the server.

- `--login-path=name`

Command-Line Format	<code>--login-path=name</code>
Type	String

Read options from the named login path in the `.mylogin.cnf` login path file. A “login path” is an option group containing options that specify which MySQL server to connect to and which account to authenticate as. To create or modify a login path file, use the `mysql_config_editor` utility. See [Section 4.6.6, “mysql\\_config\\_editor — MySQL Configuration Utility”](#).

For additional information about this and other option-file options, see [Section 4.2.2.3, “Command-Line Options that Affect Option-File Handling”](#).

- `--low-priority`

Command-Line Format	<code>--low-priority</code>
---------------------	-----------------------------

Use `LOW_PRIORITY` when loading the table. This affects only storage engines that use only table-level locking (such as `MyISAM`, `MEMORY`, and `MERGE`).

- `--no-defaults`

Command-Line Format	<code>--no-defaults</code>
---------------------	----------------------------

Do not read any option files. If program startup fails due to reading unknown options from an option file, `--no-defaults` can be used to prevent them from being read.

The exception is that the `.mylogin.cnf` file is read in all cases, if it exists. This permits passwords to be specified in a safer way than on the command line even when `--no-defaults` is used. To create `.mylogin.cnf`, use the `mysql_config_editor` utility. See [Section 4.6.6, “mysql\\_config\\_editor — MySQL Configuration Utility”](#).

For additional information about this and other option-file options, see [Section 4.2.2.3, “Command-Line Options that Affect Option-File Handling”](#).

- `--password[=password], -p[password]`

Command-Line Format	<code>--password[=password]</code>
Type	String

The password of the MySQL account used for connecting to the server. The password value is optional. If not given, `mysqlimport` prompts for one. If given, there must be *no space* between `--password=` or `-p` and the password following it. If no password option is specified, the default is to send no password.

Specifying a password on the command line should be considered insecure. To avoid giving the password on the command line, use an option file. See [Section 6.1.2.1, “End-User Guidelines for Password Security”](#).

To explicitly specify that there is no password and that `mysqlimport` should not prompt for one, use the `--skip-password` option.

- `--pipe, -W`

Command-Line Format	<code>--pipe</code>
Type	String

On Windows, connect to the server using a named pipe. This option applies only if the server was started with the `named_pipe` system variable enabled to support named-pipe connections. In addition, the user making the connection must be a member of the Windows group specified by the `named_pipe_full_access_group` system variable.

- `--plugin-dir=dir_name`

Command-Line Format	<code>--plugin-dir=dir_name</code>
Type	Directory name

The directory in which to look for plugins. Specify this option if the `--default-auth` option is used to specify an authentication plugin but `mysqlimport` does not find it. See [Section 6.2.13, “Pluggable Authentication”](#).

- `--port=port_num, -P port_num`

Command-Line Format	<code>--port=port_num</code>
Type	Numeric
Default Value	3306

For TCP/IP connections, the port number to use.

- `--print-defaults`

Command-Line Format	<code>--print-defaults</code>
---------------------	-------------------------------

Print the program name and all options that it gets from option files.

For additional information about this and other option-file options, see [Section 4.2.2.3, “Command-Line Options that Affect Option-File Handling”](#).

- `--protocol={TCP|SOCKET|PIPE|MEMORY}`

Command-Line Format	<code>--protocol=type</code>
Type	String
Default Value	[see text]
Valid Values	TCP  SOCKET  PIPE  MEMORY

The transport protocol to use for connecting to the server. It is useful when the other connection parameters normally result in use of a protocol other than the one you want. For details on the permissible values, see [Section 4.2.5, “Connection Transport Protocols”](#).

- `--replace, -r`

Command-Line Format	<code>--replace</code>
---------------------	------------------------

The `--replace` and `--ignore` options control handling of input rows that duplicate existing rows on unique key values. If you specify `--replace`, new rows replace existing rows that have the same unique key value. If you specify `--ignore`, input rows that duplicate an existing row on a unique key value are skipped. If you do not specify either option, an error occurs when a duplicate key value is found, and the rest of the text file is ignored.

- `--secure-auth`

Command-Line Format	<code>--secure-auth</code>
---------------------	----------------------------

Deprecated	Yes
------------	-----

Do not send passwords to the server in old (pre-4.1) format. This prevents connections except for servers that use the newer password format.

As of MySQL 5.7.5, this option is deprecated; expect it to be removed in a future MySQL release. It is always enabled and attempting to disable it (`--skip-secure-auth`, `--secure-auth=0`) produces an error. Before MySQL 5.7.5, this option is enabled by default but can be disabled.



#### Note

Passwords that use the pre-4.1 hashing method are less secure than passwords that use the native password hashing method and should be avoided. Pre-4.1 passwords are deprecated and support for them was removed in MySQL 5.7.5. For account upgrade instructions, see [Section 6.4.1.3, “Migrating Away from Pre-4.1 Password Hashing and the `mysql\_old\_password` Plugin”](#).

- `--server-public-key-path=file_name`

Command-Line Format	<code>--server-public-key-path=file_name</code>
Introduced	5.7.23
Type	File name

The path name to a file in PEM format containing a client-side copy of the public key required by the server for RSA key pair-based password exchange. This option applies to clients that authenticate with the `sha256_password` or `caching_sha2_password` authentication plugin. This option is ignored for accounts that do not authenticate with one of those plugins. It is also ignored if RSA-based password exchange is not used, as is the case when the client connects to the server using a secure connection.

If `--server-public-key-path=file_name` is given and specifies a valid public key file, it takes precedence over `--get-server-public-key`.

For `sha256_password`, this option applies only if MySQL was built using OpenSSL.

For information about the `sha256_password` and `caching_sha2_password` plugins, see [Section 6.4.1.5, “SHA-256 Pluggable Authentication”](#), and [Section 6.4.1.4, “Caching SHA-2 Pluggable Authentication”](#).

The `--server-public-key-path` option was added in MySQL 5.7.23.

- `--shared-memory-base-name=name`

Command-Line Format	<code>--shared-memory-base-name=name</code>
Platform Specific	Windows

On Windows, the shared-memory name to use for connections made using shared memory to a local server. The default value is `MYSQL`. The shared-memory name is case-sensitive.

This option applies only if the server was started with the `shared_memory` system variable enabled to support shared-memory connections.

- `--silent, -s`

Command-Line Format	<code>--silent</code>
---------------------	-----------------------

Silent mode. Produce output only when errors occur.

- `--socket=path, -S path`

Command-Line Format	<code>--socket={file_name pipe_name}</code>
Type	String

For connections to `localhost`, the Unix socket file to use, or, on Windows, the name of the named pipe to use.

On Windows, this option applies only if the server was started with the `named_pipe` system variable enabled to support named-pipe connections. In addition, the user making the connection must be a member of the Windows group specified by the `named_pipe_full_access_group` system variable.

- `--ssl*`

Options that begin with `--ssl` specify whether to connect to the server using encryption and indicate where to find SSL keys and certificates. See [Command Options for Encrypted Connections](#).

- `--tls-version=protocol_list`

Command-Line Format	<code>--tls-version=protocol_list</code>
Introduced	5.7.10
Type	String
Default Value (≥ 5.7.28)	<code>TLSv1, TLSv1.1, TLSv1.2</code>
Default Value (≤ 5.7.27)	<code>TLSv1, TLSv1.1, TLSv1.2 (OpenSSL)</code> <code>TLSv1, TLSv1.1 (yaSSL)</code>

The permissible TLS protocols for encrypted connections. The value is a list of one or more comma-separated protocol names. The protocols that can be named for this option depend on the SSL library used to compile MySQL. For details, see [Section 6.3.2, “Encrypted Connection TLS Protocols and Ciphers”](#).

This option was added in MySQL 5.7.10.

- `--user=user_name, -u user_name`

Command-Line Format	<code>--user=user_name,</code>
Type	String

The user name of the MySQL account to use for connecting to the server.

- `--use-threads=N`

Command-Line Format	<code>--use-threads=#</code>
---------------------	------------------------------



Type	Numeric
------	---------

Load files in parallel using *N* threads.

- `--verbose, -v`

Command-Line Format	<code>--verbose</code>
---------------------	------------------------

Verbose mode. Print more information about what the program does.

- `--version, -V`

Command-Line Format	<code>--version</code>
---------------------	------------------------

Display version information and exit.

Here is a sample session that demonstrates use of `mysqlimport`:

```
$> mysql -e 'CREATE TABLE impptest(id INT, n VARCHAR(30))' test
$> ed
a
100      Max Sydow
101      Count Dracula
.
w impptest.txt
32
q
$> od -c impptest.txt
0000000  1  0  0  \t  M  a  x           S  y  d  o  w  \n  1  0
0000020  1  \t  C  o  u  n  t           D  r  a  c  u  l  a  \n
0000040
$> mysqlimport --local test impptest.txt
test.impptest: Records: 2 Deleted: 0 Skipped: 0 Warnings: 0
$> mysql -e 'SELECT * FROM impptest' test
+-----+-----+
| id  | n                |
+-----+-----+
| 100 | Max Sydow       |
| 101 | Count Dracula   |
+-----+-----+
```

## 4.5.6 mysqlpump — A Database Backup Program

- [mysqlpump Invocation Syntax](#)
- [mysqlpump Option Summary](#)
- [mysqlpump Option Descriptions](#)
- [mysqlpump Object Selection](#)
- [mysqlpump Parallel Processing](#)
- [mysqlpump Restrictions](#)

The `mysqlpump` client utility performs [logical backups](#), producing a set of SQL statements that can be executed to reproduce the original database object definitions and table data. It dumps one or more MySQL databases for backup or transfer to another SQL server.

`mysqlpump` features include:

- Parallel processing of databases, and of objects within databases, to speed up the dump process
- Better control over which databases and database objects (tables, stored programs, user accounts) to dump
- Dumping of user accounts as account-management statements (`CREATE USER`, `GRANT`) rather than as inserts into the `mysql` system database
- Capability of creating compressed output
- Progress indicator (the values are estimates)
- For dump file reloading, faster secondary index creation for `InnoDB` tables by adding indexes after rows are inserted

`mysqlpump` requires at least the `SELECT` privilege for dumped tables, `SHOW VIEW` for dumped views, `TRIGGER` for dumped triggers, and `LOCK TABLES` if the `--single-transaction` option is not used. The `SELECT` privilege on the `mysql` system database is required to dump user definitions. Certain options might require other privileges as noted in the option descriptions.

To reload a dump file, you must have the privileges required to execute the statements that it contains, such as the appropriate `CREATE` privileges for objects created by those statements.



#### Note

A dump made using PowerShell on Windows with output redirection creates a file that has UTF-16 encoding:

```
mysqlpump [options] > dump.sql
```

However, UTF-16 is not permitted as a connection character set (see [Section 10.4, “Connection Character Sets and Collations”](#)), so the dump file does not load correctly. To work around this issue, use the `--result-file` option, which creates the output in ASCII format:

```
mysqlpump [options] --result-file=dump.sql
```

## mysqlpump Invocation Syntax

By default, `mysqlpump` dumps all databases (with certain exceptions noted in [mysqlpump Restrictions](#)). To specify this behavior explicitly, use the `--all-databases` option:

```
mysqlpump --all-databases
```

To dump a single database, or certain tables within that database, name the database on the command line, optionally followed by table names:

```
mysqlpump db_name
mysqlpump db_name tbl_name1 tbl_name2 ...
```

To treat all name arguments as database names, use the `--databases` option:

```
mysqlpump --databases db_name1 db_name2 ...
```

By default, `mysqlpump` does not dump user account definitions, even if you dump the `mysql` system database that contains the grant tables. To dump grant table contents as logical definitions in the form of `CREATE USER` and `GRANT` statements, use the `--users` option and suppress all database dumping:

```
mysqlpump --exclude-databases=% --users
```

In the preceding command, `%` is a wildcard that matches all database names for the `--exclude-databases` option.

`mysqlpump` supports several options for including or excluding databases, tables, stored programs, and user definitions. See [mysqlpump Object Selection](#).

To reload a dump file, execute the statements that it contains. For example, use the `mysql` client:

```
mysqlpump [options] > dump.sql
mysql < dump.sql
```

The following discussion provides additional `mysqlpump` usage examples.

To see a list of the options `mysqlpump` supports, issue the command `mysqlpump --help`.

## mysqlpump Option Summary

`mysqlpump` supports the following options, which can be specified on the command line or in the `[mysqlpump]` and `[client]` groups of an option file. (Prior to MySQL 5.7.30, `mysqlpump` read the `[mysql_dump]` group rather than `[mysqlpump]`. As of 5.7.30, `[mysql_dump]` is still accepted but is deprecated.) For information about option files used by MySQL programs, see [Section 4.2.2.2, “Using Option Files”](#).

**Table 4.18 mysqlpump Options**

Option Name	Description	Introduced
<code>--add-drop-database</code>	Add DROP DATABASE statement before each CREATE DATABASE statement	
<code>--add-drop-table</code>	Add DROP TABLE statement before each CREATE TABLE statement	
<code>--add-drop-user</code>	Add DROP USER statement before each CREATE USER statement	
<code>--add-locks</code>	Surround each table dump with LOCK TABLES and UNLOCK TABLES statements	
<code>--all-databases</code>	Dump all databases	
<code>--bind-address</code>	Use specified network interface to connect to MySQL Server	
<code>--character-sets-dir</code>	Directory where character sets are installed	
<code>--complete-insert</code>	Use complete INSERT statements that include column names	
<code>--compress</code>	Compress all information sent between client and server	
<code>--compress-output</code>	Output compression algorithm	
<code>--databases</code>	Interpret all name arguments as database names	
<code>--debug</code>	Write debugging log	

Option Name	Description	Introduced
<code>--debug-check</code>	Print debugging information when program exits	
<code>--debug-info</code>	Print debugging information, memory, and CPU statistics when program exits	
<code>--default-auth</code>	Authentication plugin to use	
<code>--default-character-set</code>	Specify default character set	
<code>--default-parallelism</code>	Default number of threads for parallel processing	
<code>--defaults-extra-file</code>	Read named option file in addition to usual option files	
<code>--defaults-file</code>	Read only named option file	
<code>--defaults-group-suffix</code>	Option group suffix value	
<code>--defer-table-indexes</code>	For reloading, defer index creation until after loading table rows	
<code>--events</code>	Dump events from dumped databases	
<code>--exclude-databases</code>	Databases to exclude from dump	
<code>--exclude-events</code>	Events to exclude from dump	
<code>--exclude-routines</code>	Routines to exclude from dump	
<code>--exclude-tables</code>	Tables to exclude from dump	
<code>--exclude-triggers</code>	Triggers to exclude from dump	
<code>--exclude-users</code>	Users to exclude from dump	
<code>--extended-insert</code>	Use multiple-row INSERT syntax	
<code>--get-server-public-key</code>	Request RSA public key from server	5.7.23
<code>--help</code>	Display help message and exit	
<code>--hex-blob</code>	Dump binary columns using hexadecimal notation	
<code>--host</code>	Host on which MySQL server is located	
<code>--include-databases</code>	Databases to include in dump	
<code>--include-events</code>	Events to include in dump	
<code>--include-routines</code>	Routines to include in dump	
<code>--include-tables</code>	Tables to include in dump	
<code>--include-triggers</code>	Triggers to include in dump	
<code>--include-users</code>	Users to include in dump	
<code>--insert-ignore</code>	Write INSERT IGNORE rather than INSERT statements	
<code>--log-error-file</code>	Append warnings and errors to named file	

Option Name	Description	Introduced
<code>--login-path</code>	Read login path options from <code>.mylogin.cnf</code>	
<code>--max-allowed-packet</code>	Maximum packet length to send to or receive from server	
<code>--net-buffer-length</code>	Buffer size for TCP/IP and socket communication	
<code>--no-create-db</code>	Do not write CREATE DATABASE statements	
<code>--no-create-info</code>	Do not write CREATE TABLE statements that re-create each dumped table	
<code>--no-defaults</code>	Read no option files	
<code>--parallel-schemas</code>	Specify schema-processing parallelism	
<code>--password</code>	Password to use when connecting to server	
<code>--plugin-dir</code>	Directory where plugins are installed	
<code>--port</code>	TCP/IP port number for connection	
<code>--print-defaults</code>	Print default options	
<code>--protocol</code>	Transport protocol to use	
<code>--replace</code>	Write REPLACE statements rather than INSERT statements	
<code>--result-file</code>	Direct output to a given file	
<code>--routines</code>	Dump stored routines (procedures and functions) from dumped databases	
<code>--secure-auth</code>	Do not send passwords to server in old (pre-4.1) format	
<code>--server-public-key-path</code>	Path name to file containing RSA public key	5.7.23
<code>--set-charset</code>	Add SET NAMES <code>default_character_set</code> to output	
<code>--set-gtid-purged</code>	Whether to add SET @@GLOBAL.GTID_PURGED to output	5.7.18
<code>--single-transaction</code>	Dump tables within single transaction	
<code>--skip-definer</code>	Omit DEFINER and SQL SECURITY clauses from view and stored program CREATE statements	
<code>--skip-dump-rows</code>	Do not dump table rows	

Option Name	Description	Introduced
<code>--socket</code>	Unix socket file or Windows named pipe to use	
<code>--ssl</code>	Enable connection encryption	
<code>--ssl-ca</code>	File that contains list of trusted SSL Certificate Authorities	
<code>--ssl-capath</code>	Directory that contains trusted SSL Certificate Authority certificate files	
<code>--ssl-cert</code>	File that contains X.509 certificate	
<code>--ssl-cipher</code>	Permissible ciphers for connection encryption	
<code>--ssl-crl</code>	File that contains certificate revocation lists	
<code>--ssl-crlpath</code>	Directory that contains certificate revocation-list files	
<code>--ssl-key</code>	File that contains X.509 key	
<code>--ssl-mode</code>	Desired security state of connection to server	5.7.11
<code>--ssl-verify-server-cert</code>	Verify host name against server certificate Common Name identity	
<code>--tls-version</code>	Permissible TLS protocols for encrypted connections	5.7.10
<code>--triggers</code>	Dump triggers for each dumped table	
<code>--tz-utc</code>	Add SET TIME_ZONE='+00:00' to dump file	
<code>--user</code>	MySQL user name to use when connecting to server	
<code>--users</code>	Dump user accounts	
<code>--version</code>	Display version information and exit	
<code>--watch-progress</code>	Display progress indicator	

## mysqlpump Option Descriptions

- `--help, -?`

Command-Line Format	<code>--help</code>
---------------------	---------------------

Display a help message and exit.

- `--add-drop-database`

Command-Line Format	<code>--add-drop-database</code>
---------------------	----------------------------------

Write a `DROP DATABASE` statement before each `CREATE DATABASE` statement.

- `--add-drop-table`

Command-Line Format	<code>--add-drop-table</code>
---------------------	-------------------------------

Write a `DROP TABLE` statement before each `CREATE TABLE` statement.

- `--add-drop-user`

Command-Line Format	<code>--add-drop-user</code>
---------------------	------------------------------

Write a `DROP USER` statement before each `CREATE USER` statement.

- `--add-locks`

Command-Line Format	<code>--add-locks</code>
---------------------	--------------------------

Surround each table dump with `LOCK TABLES` and `UNLOCK TABLES` statements. This results in faster inserts when the dump file is reloaded. See [Section 8.2.4.1, “Optimizing INSERT Statements”](#).

This option does not work with parallelism because `INSERT` statements from different tables can be interleaved and `UNLOCK TABLES` following the end of the inserts for one table could release locks on tables for which inserts remain.

`--add-locks` and `--single-transaction` are mutually exclusive.

- `--all-databases, -A`

Command-Line Format	<code>--all-databases</code>
---------------------	------------------------------

Dump all databases (with certain exceptions noted in [mysqlpump Restrictions](#)). This is the default behavior if no other is specified explicitly.

`--all-databases` and `--databases` are mutually exclusive.

- `--bind-address=ip_address`

Command-Line Format	<code>--bind-address=ip_address</code>
---------------------	--

On a computer having multiple network interfaces, use this option to select which interface to use for connecting to the MySQL server.

- `--character-sets-dir=path`

Command-Line Format	<code>--character-sets-dir=dir_name</code>
---------------------	--

- `--complete-insert`

Command-Line Format	<code>--complete-insert</code>
---------------------	--------------------------------

Write complete `INSERT` statements that include column names.

- `--compress, -C`

Command-Line Format	<code>--compress[={OFF ON}]</code>
Type	Boolean
Default Value	OFF

Compress all information sent between the client and the server if possible. See [Section 4.2.6, “Connection Compression Control”](#).

- `--compress-output=algorithm`

Command-Line Format	<code>--compress-output=algorithm</code>
Type	Enumeration
Valid Values	LZ4 ZLIB

By default, `mysqlpump` does not compress output. This option specifies output compression using the specified algorithm. Permitted algorithms are `LZ4` and `ZLIB`.

To uncompress compressed output, you must have an appropriate utility. If the system commands `lz4` and `openssl zlib` are not available, as of MySQL 5.7.10, MySQL distributions include `lz4_decompress` and `zlib_decompress` utilities that can be used to decompress `mysqlpump` output that was compressed using the `--compress-output=LZ4` and `--compress-output=ZLIB` options. For more information, see [Section 4.8.1, “lz4\\_decompress — Decompress mysqlpump LZ4-Compressed Output”](#), and [Section 4.8.5, “zlib\\_decompress — Decompress mysqlpump ZLIB-Compressed Output”](#).

Alternatives include the `lz4` and `openssl` commands, if they are installed on your system. For example, `lz4` can uncompress `LZ4` output:

```
lz4 -d input_file output_file
```

`ZLIB` output can be uncompressed like this:

```
openssl zlib -d < input_file > output_file
```

- `--databases, -B`

Command-Line Format	<code>--databases</code>
---------------------	--------------------------

Normally, `mysqlpump` treats the first name argument on the command line as a database name and any following names as table names. With this option, it treats all name arguments as database names. `CREATE DATABASE` statements are included in the output before each new database.



- `--debug[=debug_options], -# [debug_options]`

Command-Line Format	<code>--debug[=debug_options]</code>
Type	String
Default Value	<code>d:t:O,/tmp/mysqlpump.trace</code>

Write a debugging log. A typical `debug_options` string is `d:t:o,file_name`. The default is `d:t:O,/tmp/mysqlpump.trace`.

This option is available only if MySQL was built using `WITH_DEBUG`. MySQL release binaries provided by Oracle are *not* built using this option.

- `--debug-check`

Command-Line Format	<code>--debug-check</code>
Type	Boolean
Default Value	<code>FALSE</code>

Print some debugging information when the program exits.

This option is available only if MySQL was built using `WITH_DEBUG`. MySQL release binaries provided by Oracle are *not* built using this option.

- `--debug-info, -T`

Command-Line Format	<code>--debug-info</code>
Type	Boolean
Default Value	<code>FALSE</code>

Print debugging information and memory and CPU usage statistics when the program exits.

This option is available only if MySQL was built using `WITH_DEBUG`. MySQL release binaries provided by Oracle are *not* built using this option.

- `--default-auth=plugin`

Command-Line Format	<code>--default-auth=plugin</code>
Type	String

A hint about which client-side authentication plugin to use. See [Section 6.2.13, “Pluggable Authentication”](#).

- `--default-character-set=charset_name`

Command-Line Format	<code>--default-character-set=charset_name</code>
Type	String

Default Value	utf8
---------------	------

Use `charset_name` as the default character set. See [Section 10.15, “Character Set Configuration”](#). If no character set is specified, `mysqlpump` uses `utf8`.

- `--default-parallelism=N`

Command-Line Format	<code>--default-parallelism=N</code>
Type	Integer
Default Value	2

The default number of threads for each parallel processing queue. The default is 2.

The `--parallel-schemas` option also affects parallelism and can be used to override the default number of threads. For more information, see [mysqlpump Parallel Processing](#).

With `--default-parallelism=0` and no `--parallel-schemas` options, `mysqlpump` runs as a single-threaded process and creates no queues.

With parallelism enabled, it is possible for output from different databases to be interleaved.



#### Note

Before MySQL 5.7.11, use of the `--single-transaction` option is mutually exclusive with parallelism. To use `--single-transaction`, disable parallelism by setting `--default-parallelism` to 0 and not using any instances of `--parallel-schemas`:

```
mysqlpump --single-transaction --default-parallelism=0
```

- `--defaults-extra-file=file_name`

Command-Line Format	<code>--defaults-extra-file=file_name</code>
Type	File name

Read this option file after the global option file but (on Unix) before the user option file. If the file does not exist or is otherwise inaccessible, an error occurs. If `file_name` is not an absolute path name, it is interpreted relative to the current directory.

For additional information about this and other option-file options, see [Section 4.2.2.3, “Command-Line Options that Affect Option-File Handling”](#).

- `--defaults-file=file_name`

Command-Line Format	<code>--defaults-file=file_name</code>
Type	File name

Use only the given option file. If the file does not exist or is otherwise inaccessible, an error occurs. If `file_name` is not an absolute path name, it is interpreted relative to the current directory.

Exception: Even with `--defaults-file`, client programs read `.mylogin.cnf`.

For additional information about this and other option-file options, see [Section 4.2.2.3, “Command-Line Options that Affect Option-File Handling”](#).

- `--defaults-group-suffix=str`

Command-Line Format	<code>--defaults-group-suffix=str</code>
Type	String

Read not only the usual option groups, but also groups with the usual names and a suffix of `str`. For example, `mysqlpump` normally reads the `[client]` and `[mysqlpump]` groups. If this option is given as `--defaults-group-suffix=_other`, `mysqlpump` also reads the `[client_other]` and `[mysqlpump_other]` groups.

For additional information about this and other option-file options, see [Section 4.2.2.3, “Command-Line Options that Affect Option-File Handling”](#).

- `--defer-table-indexes`

Command-Line Format	<code>--defer-table-indexes</code>
Type	Boolean
Default Value	<code>TRUE</code>

In the dump output, defer index creation for each table until after its rows have been loaded. This works for all storage engines, but for `InnoDB` applies only for secondary indexes.

This option is enabled by default; use `--skip-defer-table-indexes` to disable it.

- `--events`

Command-Line Format	<code>--events</code>
Type	Boolean
Default Value	<code>TRUE</code>

Include Event Scheduler events for the dumped databases in the output. Event dumping requires the `EVENT` privileges for those databases.

The output generated by using `--events` contains `CREATE EVENT` statements to create the events. However, these statements do not include attributes such as the event creation and modification timestamps, so when the events are reloaded, they are created with timestamps equal to the reload time.

If you require events to be created with their original timestamp attributes, do not use `--events`. Instead, dump and reload the contents of the `mysql.event` table directly, using a MySQL account that has appropriate privileges for the `mysql` database.

This option is enabled by default; use `--skip-events` to disable it.

- `--exclude-databases=db_list`

Command-Line Format	<code>--exclude-databases=db_list</code>
---------------------	--

Type	String
------	--------

Do not dump the databases in *db\_list*, which is a list of one or more comma-separated database names. Multiple instances of this option are additive. For more information, see [mysqlpump Object Selection](#).

- `--exclude-events=event_list`

Command-Line Format	<code>--exclude-events=event_list</code>
Type	String

Do not dump the databases in *event\_list*, which is a list of one or more comma-separated event names. Multiple instances of this option are additive. For more information, see [mysqlpump Object Selection](#).

- `--exclude-routines=routine_list`

Command-Line Format	<code>--exclude-routines=routine_list</code>
Type	String

Do not dump the events in *routine\_list*, which is a list of one or more comma-separated routine (stored procedure or function) names. Multiple instances of this option are additive. For more information, see [mysqlpump Object Selection](#).

- `--exclude-tables=table_list`

Command-Line Format	<code>--exclude-tables=table_list</code>
Type	String

Do not dump the tables in *table\_list*, which is a list of one or more comma-separated table names. Multiple instances of this option are additive. For more information, see [mysqlpump Object Selection](#).

- `--exclude-triggers=trigger_list`

Command-Line Format	<code>--exclude-triggers=trigger_list</code>
Type	String

Do not dump the triggers in *trigger\_list*, which is a list of one or more comma-separated trigger names. Multiple instances of this option are additive. For more information, see [mysqlpump Object Selection](#).

- `--exclude-users=user_list`

Command-Line Format	<code>--exclude-users=user_list</code>
---------------------	--

Type	String
------	--------

Do not dump the user accounts in `user_list`, which is a list of one or more comma-separated account names. Multiple instances of this option are additive. For more information, see [mysqlpump Object Selection](#).

- `--extended-insert=N`

Command-Line Format	<code>--extended-insert=N</code>
---------------------	----------------------------------

Write `INSERT` statements using multiple-row syntax that includes several `VALUES` lists. This results in a smaller dump file and speeds up inserts when the file is reloaded.

The option value indicates the number of rows to include in each `INSERT` statement. The default is 250. A value of 1 produces one `INSERT` statement per table row.

- `--get-server-public-key`

Command-Line Format	<code>--get-server-public-key</code>
Introduced	5.7.23
Type	Boolean

Request from the server the public key required for RSA key pair-based password exchange. This option applies to clients that authenticate with the `caching_sha2_password` authentication plugin. For that plugin, the server does not send the public key unless requested. This option is ignored for accounts that do not authenticate with that plugin. It is also ignored if RSA-based password exchange is not used, as is the case when the client connects to the server using a secure connection.

If `--server-public-key-path=file_name` is given and specifies a valid public key file, it takes precedence over `--get-server-public-key`.

For information about the `caching_sha2_password` plugin, see [Section 6.4.1.4, “Caching SHA-2 Pluggable Authentication”](#).

The `--get-server-public-key` option was added in MySQL 5.7.23.

- `--hex-blob`

Command-Line Format	<code>--hex-blob</code>
---------------------	-------------------------

Dump binary columns using hexadecimal notation (for example, `'abc'` becomes `0x616263`). The affected data types are `BINARY`, `VARBINARY`, `BLOB` types, `BIT`, all spatial data types, and other non-binary data types when used with the [binary character set](#).

- `--host=host_name, -h host_name`

Command-Line Format	<code>--host</code>
---------------------	---------------------

Dump data from the MySQL server on the given host.

- `--include-databases=db_list`

Command-Line Format	<code>--include-databases=db_list</code>
Type	String

Dump the databases in *db\_list*, which is a list of one or more comma-separated database names. The dump includes all objects in the named databases. Multiple instances of this option are additive. For more information, see [mysqlpump Object Selection](#).

- `--include-events=event_list`

Command-Line Format	<code>--include-events=event_list</code>
Type	String

Dump the events in *event\_list*, which is a list of one or more comma-separated event names. Multiple instances of this option are additive. For more information, see [mysqlpump Object Selection](#).

- `--include-routines=routine_list`

Command-Line Format	<code>--include-routines=routine_list</code>
Type	String

Dump the routines in *routine\_list*, which is a list of one or more comma-separated routine (stored procedure or function) names. Multiple instances of this option are additive. For more information, see [mysqlpump Object Selection](#).

- `--include-tables=table_list`

Command-Line Format	<code>--include-tables=table_list</code>
Type	String

Dump the tables in *table\_list*, which is a list of one or more comma-separated table names. Multiple instances of this option are additive. For more information, see [mysqlpump Object Selection](#).

- `--include-triggers=trigger_list`

Command-Line Format	<code>--include-triggers=trigger_list</code>
Type	String

Dump the triggers in *trigger\_list*, which is a list of one or more comma-separated trigger names. Multiple instances of this option are additive. For more information, see [mysqlpump Object Selection](#).

- `--include-users=user_list`

Command-Line Format	<code>--include-users=user_list</code>
Type	String

Dump the user accounts in *user\_list*, which is a list of one or more comma-separated user names. Multiple instances of this option are additive. For more information, see [mysqlpump Object Selection](#).

- `--insert-ignore`

Command-Line Format	<code>--insert-ignore</code>
---------------------	------------------------------

Write `INSERT IGNORE` statements rather than `INSERT` statements.

- `--log-error-file=file_name`

Command-Line Format	<code>--log-error-file=file_name</code>
Type	File name

Log warnings and errors by appending them to the named file. If this option is not given, `mysqlpump` writes warnings and errors to the standard error output.

- `--login-path=name`

Command-Line Format	<code>--login-path=name</code>
Type	String

Read options from the named login path in the `.mylogin.cnf` login path file. A “login path” is an option group containing options that specify which MySQL server to connect to and which account to authenticate as. To create or modify a login path file, use the `mysql_config_editor` utility. See [Section 4.6.6, “mysql\\_config\\_editor — MySQL Configuration Utility”](#).

For additional information about this and other option-file options, see [Section 4.2.2.3, “Command-Line Options that Affect Option-File Handling”](#).

- `--max-allowed-packet=N`

Command-Line Format	<code>--max-allowed-packet=N</code>
Type	Numeric
Default Value	25165824

The maximum size of the buffer for client/server communication. The default is 24MB, the maximum is 1GB.

- `--net-buffer-length=N`

Command-Line Format	<code>--net-buffer-length=N</code>
Type	Numeric
Default Value	1047552

The initial size of the buffer for client/server communication. When creating multiple-row `INSERT` statements (as with the `--extended-insert` option), `mysqlpump` creates rows up to `N` bytes long. If you use this option to increase the value, ensure that the MySQL server `net_buffer_length` system

- `--no-create-db`

Command-Line Format	<code>--no-create-db</code>
---------------------	-----------------------------

Suppress any `CREATE DATABASE` statements that might otherwise be included in the output.

- `--no-create-info, -t`

Command-Line Format	<code>--no-create-info</code>
---------------------	-------------------------------

Do not write `CREATE TABLE` statements that create each dumped table.

- `--no-defaults`

Command-Line Format	<code>--no-defaults</code>
---------------------	----------------------------

Do not read any option files. If program startup fails due to reading unknown options from an option file, `--no-defaults` can be used to prevent them from being read.

The exception is that the `.mylogin.cnf` file is read in all cases, if it exists. This permits passwords to be specified in a safer way than on the command line even when `--no-defaults` is used. To create `.mylogin.cnf`, use the `mysql_config_editor` utility. See [Section 4.6.6, “mysql\\_config\\_editor — MySQL Configuration Utility”](#).

For additional information about this and other option-file options, see [Section 4.2.2.3, “Command-Line Options that Affect Option-File Handling”](#).

- `--parallel-schemas=[N:]db_list`

Command-Line Format	<code>--parallel-schemas=[N:]schema_list</code>
Type	String

Create a queue for processing the databases in `db_list`, which is a list of one or more comma-separated database names. If `N` is given, the queue uses `N` threads. If `N` is not given, the `--default-parallelism` option determines the number of queue threads.

Multiple instances of this option create multiple queues. `mysqldump` also creates a default queue to use for databases not named in any `--parallel-schemas` option, and for dumping user definitions if command options select them. For more information, see [mysqldump Parallel Processing](#).

- `--password[=password], -p[password]`

Command-Line Format	<code>--password[=password]</code>
---------------------	------------------------------------



Type	String
------	--------

The password of the MySQL account used for connecting to the server. The password value is optional. If not given, `mysqlpump` prompts for one. If given, there must be *no space* between `--password=` or `-p` and the password following it. If no password option is specified, the default is to send no password.

Specifying a password on the command line should be considered insecure. To avoid giving the password on the command line, use an option file. See [Section 6.1.2.1, “End-User Guidelines for Password Security”](#).

To explicitly specify that there is no password and that `mysqlpump` should not prompt for one, use the `--skip-password` option.

- `--plugin-dir=dir_name`

Command-Line Format	<code>--plugin-dir=dir_name</code>
Type	Directory name

The directory in which to look for plugins. Specify this option if the `--default-auth` option is used to specify an authentication plugin but `mysqlpump` does not find it. See [Section 6.2.13, “Pluggable Authentication”](#).

- `--port=port_num, -P port_num`

Command-Line Format	<code>--port=port_num</code>
Type	Numeric
Default Value	3306

For TCP/IP connections, the port number to use.

- `--print-defaults`

Command-Line Format	<code>--print-defaults</code>
---------------------	-------------------------------

Print the program name and all options that it gets from option files.

For additional information about this and other option-file options, see [Section 4.2.2.3, “Command-Line Options that Affect Option-File Handling”](#).

- `--protocol={TCP | SOCKET | PIPE | MEMORY}`

Command-Line Format	<code>--protocol=type</code>
Type	String
Default Value	[see text]
Valid Values	TCP SOCKET

MEMORY
--------

The transport protocol to use for connecting to the server. It is useful when the other connection parameters normally result in use of a protocol other than the one you want. For details on the permissible values, see [Section 4.2.5, “Connection Transport Protocols”](#).

- `--replace`

Command-Line Format	<code>--replace</code>
---------------------	------------------------

Write `REPLACE` statements rather than `INSERT` statements.

- `--result-file=file_name`

Command-Line Format	<code>--result-file=file_name</code>
Type	File name

Direct output to the named file. The result file is created and its previous contents overwritten, even if an error occurs while generating the dump.

This option should be used on Windows to prevent newline `\n` characters from being converted to `\r\n` carriage return/newline sequences.

- `--routines`

Command-Line Format	<code>--routines</code>
Type	Boolean
Default Value	<code>TRUE</code>

Include stored routines (procedures and functions) for the dumped databases in the output. This option requires the `SELECT` privilege for the `mysql.proc` table.

The output generated by using `--routines` contains `CREATE PROCEDURE` and `CREATE FUNCTION` statements to create the routines. However, these statements do not include attributes such as the routine creation and modification timestamps, so when the routines are reloaded, they are created with timestamps equal to the reload time.

If you require routines to be created with their original timestamp attributes, do not use `--routines`. Instead, dump and reload the contents of the `mysql.proc` table directly, using a MySQL account that has appropriate privileges for the `mysql` database.

This option is enabled by default; use `--skip-routines` to disable it.

- `--secure-auth`

Command-Line Format	<code>--secure-auth</code>
---------------------	----------------------------

Do not send passwords to the server in old (pre-4.1) format. This prevents connections except for servers that use the newer password format.

This option is deprecated; expect it to be removed in a future MySQL release. It is always enabled and attempting to disable it (`--skip-secure-auth`, `--secure-auth=0`) produces an error.

- `--server-public-key-path=file_name`

Command-Line Format	<code>--server-public-key-path=file_name</code>
Introduced	5.7.23
Type	File name

The path name to a file in PEM format containing a client-side copy of the public key required by the server for RSA key pair-based password exchange. This option applies to clients that authenticate with the `sha256_password` or `caching_sha2_password` authentication plugin. This option is ignored for accounts that do not authenticate with one of those plugins. It is also ignored if RSA-based password exchange is not used, as is the case when the client connects to the server using a secure connection.

If `--server-public-key-path=file_name` is given and specifies a valid public key file, it takes precedence over `--get-server-public-key`.

For `sha256_password`, this option applies only if MySQL was built using OpenSSL.

For information about the `sha256_password` and `caching_sha2_password` plugins, see [Section 6.4.1.5, “SHA-256 Pluggable Authentication”](#), and [Section 6.4.1.4, “Caching SHA-2 Pluggable Authentication”](#).

The `--server-public-key-path` option was added in MySQL 5.7.23.

- `--set-charset`

Command-Line Format	<code>--set-charset</code>
---------------------	----------------------------

Write `SET NAMES default_character_set` to the output.

This option is enabled by default. To disable it and suppress the `SET NAMES` statement, use `--skip-set-charset`.

- `--set-gtid-purged=value`

Command-Line Format	<code>--set-gtid-purged=value</code>
Introduced	5.7.18
Type	Enumeration
Default Value	<code>AUTO</code>
Valid Values	<code>OFF</code> <code>ON</code>

	AUTO
--	------

This option enables control over global transaction ID (GTID) information written to the dump file, by indicating whether to add a `SET @@GLOBAL.gtid_purged` statement to the output. This option may also cause a statement to be written to the output that disables binary logging while the dump file is being reloaded.

The following table shows the permitted option values. The default value is `AUTO`.

Value	Meaning
OFF	Add no <code>SET</code> statement to the output.
ON	Add a <code>SET</code> statement to the output. An error occurs if GTIDs are not enabled on the server.
AUTO	Add a <code>SET</code> statement to the output if GTIDs are enabled on the server.

The `--set-gtid-purged` option has the following effect on binary logging when the dump file is reloaded:

- `--set-gtid-purged=OFF`: `SET @@SESSION.SQL_LOG_BIN=0`; is not added to the output.
- `--set-gtid-purged=ON`: `SET @@SESSION.SQL_LOG_BIN=0`; is added to the output.
- `--set-gtid-purged=AUTO`: `SET @@SESSION.SQL_LOG_BIN=0`; is added to the output if GTIDs are enabled on the server you are backing up (that is, if `AUTO` evaluates to `ON`).

This option was added in MySQL 5.7.18.

- `--single-transaction`

Command-Line Format	<code>--single-transaction</code>
---------------------	-----------------------------------

This option sets the transaction isolation mode to `REPEATABLE READ` and sends a `START TRANSACTION` SQL statement to the server before dumping data. It is useful only with transactional tables such as `InnoDB`, because then it dumps the consistent state of the database at the time when `START TRANSACTION` was issued without blocking any applications.

When using this option, you should keep in mind that only `InnoDB` tables are dumped in a consistent state. For example, any `MyISAM` or `MEMORY` tables dumped while using this option may still change state.

While a `--single-transaction` dump is in process, to ensure a valid dump file (correct table contents and binary log coordinates), no other connection should use the following statements: `ALTER TABLE`, `CREATE TABLE`, `DROP TABLE`, `RENAME TABLE`, `TRUNCATE TABLE`. A consistent read is not

isolated from those statements, so use of them on a table to be dumped can cause the `SELECT` that is performed by `mysqlpump` to retrieve the table contents to obtain incorrect contents or fail.

`--add-locks` and `--single-transaction` are mutually exclusive.



#### Note

Before MySQL 5.7.11, use of the `--single-transaction` option is mutually exclusive with parallelism. To use `--single-transaction`, disable parallelism by setting `--default-parallelism` to 0 and not using any instances of `--parallel-schemas`:

```
mysqlpump --single-transaction --default-parallelism=0
```

- `--skip-definer`

Command-Line Format	<code>--skip-definer</code>
Type	Boolean
Default Value	FALSE

Omit `DEFINER` and `SQL SECURITY` clauses from the `CREATE` statements for views and stored programs. The dump file, when reloaded, creates objects that use the default `DEFINER` and `SQL SECURITY` values. See [Section 23.6, “Stored Object Access Control”](#).

- `--skip-dump-rows, -d`

Command-Line Format	<code>--skip-dump-rows</code>
Type	Boolean
Default Value	FALSE

Do not dump table rows.

- `--socket=path, -S path`

Command-Line Format	<code>--socket={file_name pipe_name}</code>
Type	String

For connections to `localhost`, the Unix socket file to use, or, on Windows, the name of the named pipe to use.

On Windows, this option applies only if the server was started with the `named_pipe` system variable enabled to support named-pipe connections. In addition, the user making the connection must be a member of the Windows group specified by the `named_pipe_full_access_group` system variable.

- `--ssl*`

Options that begin with `--ssl` specify whether to connect to the server using encryption and indicate where to find SSL keys and certificates. See [Command Options for Encrypted Connections](#).

- `--tls-version=protocol_list`

Command-Line Format	<code>--tls-version=protocol_list</code>
---------------------	--

Introduced	5.7.10
Type	String
Default Value ( $\geq$ 5.7.28)	<code>TLsv1, TLsv1.1, TLsv1.2</code>
Default Value ( $\leq$ 5.7.27)	<code>TLsv1, TLsv1.1, TLsv1.2</code> (OpenSSL) <code>TLsv1, TLsv1.1</code> (yaSSL)

The permissible TLS protocols for encrypted connections. The value is a list of one or more comma-separated protocol names. The protocols that can be named for this option depend on the SSL library used to compile MySQL. For details, see [Section 6.3.2, “Encrypted Connection TLS Protocols and Ciphers”](#).

This option was added in MySQL 5.7.10.

- `--triggers`

Command-Line Format	<code>--triggers</code>
Type	Boolean
Default Value	TRUE

Include triggers for each dumped table in the output.

This option is enabled by default; use `--skip-triggers` to disable it.

- `--tz-utc`

Command-Line Format	<code>--tz-utc</code>
---------------------	-----------------------

This option enables `TIMESTAMP` columns to be dumped and reloaded between servers in different time zones. `mysqlpump` sets its connection time zone to UTC and adds `SET TIME_ZONE=' +00:00 '` to the dump file. Without this option, `TIMESTAMP` columns are dumped and reloaded in the time zones local to the source and destination servers, which can cause the values to change if the servers are in different time zones. `--tz-utc` also protects against changes due to daylight saving time.

This option is enabled by default; use `--skip-tz-utc` to disable it.

- `--user=user_name, -u user_name`

Command-Line Format	<code>--user=user_name</code>
Type	String

The user name of the MySQL account to use for connecting to the server.

- `--users`

Command-Line Format	<code>--users</code>
Type	Boolean
Default Value	FALSE

Dump user accounts as logical definitions in the form of `CREATE USER` and `GRANT` statements.

User definitions are stored in the grant tables in the `mysql` system database. By default, `mysqlpump` does not include the grant tables in `mysql` database dumps. To dump the contents of the grant tables as logical definitions, use the `--users` option and suppress all database dumping:

```
mysqlpump --exclude-databases=% --users
```

- `--version, -V`

Command-Line Format	<code>--version</code>
---------------------	------------------------

Display version information and exit.

- `--watch-progress`

Command-Line Format	<code>--watch-progress</code>
Type	Boolean
Default Value	<code>TRUE</code>

Periodically display a progress indicator that provides information about the completed and total number of tables, rows, and other objects.

This option is enabled by default; use `--skip-watch-progress` to disable it.

## mysqlpump Object Selection

`mysqlpump` has a set of inclusion and exclusion options that enable filtering of several object types and provide flexible control over which objects to dump:

- `--include-databases` and `--exclude-databases` apply to databases and all objects within them.
- `--include-tables` and `--exclude-tables` apply to tables. These options also affect triggers associated with tables unless the trigger-specific options are given.
- `--include-triggers` and `--exclude-triggers` apply to triggers.
- `--include-routines` and `--exclude-routines` apply to stored procedures and functions. If a routine option matches a stored procedure name, it also matches a stored function of the same name.
- `--include-events` and `--exclude-events` apply to Event Scheduler events.
- `--include-users` and `--exclude-users` apply to user accounts.

Any inclusion or exclusion option may be given multiple times. The effect is additive. Order of these options does not matter.

The value of each inclusion and exclusion option is a list of comma-separated names of the appropriate object type. For example:

```
--exclude-databases=test,world
--include-tables=customer,invoice
```

Wildcard characters are permitted in the object names:

- `%` matches any sequence of zero or more characters.

- `_` matches any single character.

For example, `--include-tables=t%,__tmp` matches all table names that begin with `t` and all five-character table names that end with `tmp`.

For users, a name specified without a host part is interpreted with an implied host of `%`. For example, `u1` and `u1@%` are equivalent. This is the same equivalence that applies in MySQL generally (see [Section 6.2.4](#), “Specifying Account Names”).

Inclusion and exclusion options interact as follows:

- By default, with no inclusion or exclusion options, `mysqlpump` dumps all databases (with certain exceptions noted in [mysqlpump Restrictions](#)).
- If inclusion options are given in the absence of exclusion options, only the objects named as included are dumped.
- If exclusion options are given in the absence of inclusion options, all objects are dumped except those named as excluded.
- If inclusion and exclusion options are given, all objects named as excluded and not named as included are not dumped. All other objects are dumped.

If multiple databases are being dumped, it is possible to name tables, triggers, and routines in a specific database by qualifying the object names with the database name. The following command dumps databases `db1` and `db2`, but excludes tables `db1.t1` and `db2.t2`:

```
mysqlpump --include-databases=db1,db2 --exclude-tables=db1.t1,db2.t2
```

The following options provide alternative ways to specify which databases to dump:

- The `--all-databases` option dumps all databases (with certain exceptions noted in [mysqlpump Restrictions](#)). It is equivalent to specifying no object options at all (the default `mysqlpump` action is to dump everything).  
`--include-databases=%` is similar to `--all-databases`, but selects all databases for dumping, even those that are exceptions for `--all-databases`.
- The `--databases` option causes `mysqlpump` to treat all name arguments as names of databases to dump. It is equivalent to an `--include-databases` option that names the same databases.

## mysqlpump Parallel Processing

`mysqlpump` can use parallelism to achieve concurrent processing. You can select concurrency between databases (to dump multiple databases simultaneously) and within databases (to dump multiple objects from a given database simultaneously).

By default, `mysqlpump` sets up one queue with two threads. You can create additional queues and control the number of threads assigned to each one, including the default queue:

- `--default-parallelism=N` specifies the default number of threads used for each queue. In the absence of this option, `N` is 2.

The default queue always uses the default number of threads. Additional queues use the default number of threads unless you specify otherwise.

- `--parallel-schemas=[N:]db_list` sets up a processing queue for dumping the databases named in `db_list` and optionally specifies how many threads the queue uses. `db_list` is a list of comma-



separated database names. If the option argument begins with *N*, the queue uses *N* threads. Otherwise, the `--default-parallelism` option determines the number of queue threads.

Multiple instances of the `--parallel-schemas` option create multiple queues.

Names in the database list are permitted to contain the same `%` and `_` wildcard characters supported for filtering options (see [mysqlpump Object Selection](#)).

`mysqlpump` uses the default queue for processing any databases not named explicitly with a `--parallel-schemas` option, and for dumping user definitions if command options select them.

In general, with multiple queues, `mysqlpump` uses parallelism between the sets of databases processed by the queues, to dump multiple databases simultaneously. For a queue that uses multiple threads, `mysqlpump` uses parallelism within databases, to dump multiple objects from a given database simultaneously. Exceptions can occur; for example, `mysqlpump` may block queues while it obtains from the server lists of objects in databases.

With parallelism enabled, it is possible for output from different databases to be interleaved. For example, `INSERT` statements from multiple tables dumped in parallel can be interleaved; the statements are not written in any particular order. This does not affect reloading because output statements qualify object names with database names or are preceded by `USE` statements as required.

The granularity for parallelism is a single database object. For example, a single table cannot be dumped in parallel using multiple threads.

Examples:

```
mysqlpump --parallel-schemas=db1,db2 --parallel-schemas=db3
```

`mysqlpump` sets up a queue to process `db1` and `db2`, another queue to process `db3`, and a default queue to process all other databases. All queues use two threads.

```
mysqlpump --parallel-schemas=db1,db2 --parallel-schemas=db3
--default-parallelism=4
```

This is the same as the previous example except that all queues use four threads.

```
mysqlpump --parallel-schemas=5:db1,db2 --parallel-schemas=3:db3
```

The queue for `db1` and `db2` uses five threads, the queue for `db3` uses three threads, and the default queue uses the default of two threads.

As a special case, with `--default-parallelism=0` and no `--parallel-schemas` options, `mysqlpump` runs as a single-threaded process and creates no queues.



#### Note

Before MySQL 5.7.11, use of the `--single-transaction` option is mutually exclusive with parallelism. To use `--single-transaction`, disable parallelism by setting `--default-parallelism` to 0 and not using any instances of `--parallel-schemas`:

```
mysqlpump --single-transaction --default-parallelism=0
```

## mysqlpump Restrictions

`mysqlpump` does not dump the `INFORMATION_SCHEMA`, `performance_schema`, `ndbinfo`, or `sys` schema by default. To dump any of these, name them explicitly on the command line. You can also name them with the `--databases` or `--include-databases` option.

`mysqlpump` does not dump InnoDB `CREATE TABLESPACE` statements.

`mysqlpump` dumps user accounts in logical form using `CREATE USER` and `GRANT` statements (for example, when you use the `--include-users` or `--users` option). For this reason, dumps of the `mysql` system database do not by default include the grant tables that contain user definitions: `user`, `db`, `tables_priv`, `columns_priv`, `procs_priv`, or `proxies_priv`. To dump any of the grant tables, name the `mysql` database followed by the table names:

```
mysqlpump mysql user db ...
```

## 4.5.7 mysqlshow — Display Database, Table, and Column Information

The `mysqlshow` client can be used to quickly see which databases exist, their tables, or a table's columns or indexes.

`mysqlshow` provides a command-line interface to several SQL `SHOW` statements. See [Section 13.7.5, “SHOW Statements”](#). The same information can be obtained by using those statements directly. For example, you can issue them from the `mysql` client program.

Invoke `mysqlshow` like this:

```
mysqlshow [options] [db_name [tbl_name [col_name]]]
```

- If no database is given, a list of database names is shown.
- If no table is given, all matching tables in the database are shown.
- If no column is given, all matching columns and column types in the table are shown.

The output displays only the names of those databases, tables, or columns for which you have some privileges.

If the last argument contains shell or SQL wildcard characters (`*`, `?`, `%`, or `_`), only those names that are matched by the wildcard are shown. If a database name contains any underscores, those should be escaped with a backslash (some Unix shells require two) to get a list of the proper tables or columns. `*` and `?` characters are converted into SQL `%` and `_` wildcard characters. This might cause some confusion when you try to display the columns for a table with a `_` in the name, because in this case, `mysqlshow` shows you only the table names that match the pattern. This is easily fixed by adding an extra `%` last on the command line as a separate argument.

`mysqlshow` supports the following options, which can be specified on the command line or in the `[mysqlshow]` and `[client]` groups of an option file. For information about option files used by MySQL programs, see [Section 4.2.2.2, “Using Option Files”](#).

**Table 4.19 mysqlshow Options**

Option Name	Description	Introduced	Deprecated
<code>--bind-address</code>	Use specified network interface to connect to MySQL Server		
<code>--character-sets-dir</code>	Directory where character sets can be found		
<code>--compress</code>	Compress all information sent between client and server		

Option Name	Description	Introduced	Deprecated
<code>--count</code>	Show the number of rows per table		
<code>--debug</code>	Write debugging log		
<code>--debug-check</code>	Print debugging information when program exits		
<code>--debug-info</code>	Print debugging information, memory, and CPU statistics when program exits		
<code>--default-auth</code>	Authentication plugin to use		
<code>--default-character-set</code>	Specify default character set		
<code>--defaults-extra-file</code>	Read named option file in addition to usual option files		
<code>--defaults-file</code>	Read only named option file		
<code>--defaults-group-suffix</code>	Option group suffix value		
<code>--enable-cleartext-plugin</code>	Enable cleartext authentication plugin	5.7.10	
<code>--get-server-public-key</code>	Request RSA public key from server	5.7.23	
<code>--help</code>	Display help message and exit		
<code>--host</code>	Host on which MySQL server is located		
<code>--keys</code>	Show table indexes		
<code>--login-path</code>	Read login path options from <code>.mylogin.cnf</code>		
<code>--no-defaults</code>	Read no option files		
<code>--password</code>	Password to use when connecting to server		
<code>--pipe</code>	Connect to server using named pipe (Windows only)		
<code>--plugin-dir</code>	Directory where plugins are installed		
<code>--port</code>	TCP/IP port number for connection		
<code>--print-defaults</code>	Print default options		
<code>--protocol</code>	Transport protocol to use		

Option Name	Description	Introduced	Deprecated
<code>--secure-auth</code>	Do not send passwords to server in old (pre-4.1) format		Yes
<code>--server-public-key-path</code>	Path name to file containing RSA public key	5.7.23	
<code>--shared-memory-base-name</code>	Shared-memory name for shared-memory connections (Windows only)		
<code>--show-table-type</code>	Show a column indicating the table type		
<code>--socket</code>	Unix socket file or Windows named pipe to use		
<code>--ssl</code>	Enable connection encryption		
<code>--ssl-ca</code>	File that contains list of trusted SSL Certificate Authorities		
<code>--ssl-capath</code>	Directory that contains trusted SSL Certificate Authority certificate files		
<code>--ssl-cert</code>	File that contains X.509 certificate		
<code>--ssl-cipher</code>	Permissible ciphers for connection encryption		
<code>--ssl-crl</code>	File that contains certificate revocation lists		
<code>--ssl-crlpath</code>	Directory that contains certificate revocation-list files		
<code>--ssl-key</code>	File that contains X.509 key		
<code>--ssl-mode</code>	Desired security state of connection to server	5.7.11	
<code>--ssl-verify-server-cert</code>	Verify host name against server certificate Common Name identity		
<code>--status</code>	Display extra information about each table		
<code>--tls-version</code>	Permissible TLS protocols for encrypted connections	5.7.10	

Option Name	Description	Introduced	Deprecated
<code>--user</code>	MySQL user name to use when connecting to server		
<code>--verbose</code>	Verbose mode		
<code>--version</code>	Display version information and exit		

- `--help, -?`

Command-Line Format	<code>--help</code>
---------------------	---------------------

Display a help message and exit.

- `--bind-address=ip_address`

Command-Line Format	<code>--bind-address=ip_address</code>
---------------------	--

On a computer having multiple network interfaces, use this option to select which interface to use for connecting to the MySQL server.

- `--character-sets-dir=dir_name`

Command-Line Format	<code>--character-sets-dir=path</code>
Type	String
Default Value	[none]

The directory where character sets are installed. See [Section 10.15, “Character Set Configuration”](#).

- `--compress, -C`

Command-Line Format	<code>--compress[={OFF ON}]</code>
Type	Boolean
Default Value	OFF

Compress all information sent between the client and the server if possible. See [Section 4.2.6, “Connection Compression Control”](#).

- `--count`

Command-Line Format	<code>--count</code>
---------------------	----------------------

Show the number of rows per table. This can be slow for non-MyISAM tables.

- `--debug[=debug_options], -# [debug_options]`

Command-Line Format	<code>--debug[=debug_options]</code>
Type	String

Default Value	<code>d:t:o</code>
---------------	--------------------

Write a debugging log. A typical `debug_options` string is `d:t:o,file_name`. The default is `d:t:o`.

This option is available only if MySQL was built using `WITH_DEBUG`. MySQL release binaries provided by Oracle are *not* built using this option.

- `--debug-check`

Command-Line Format	<code>--debug-check</code>
Type	Boolean
Default Value	<code>FALSE</code>

Print some debugging information when the program exits.

This option is available only if MySQL was built using `WITH_DEBUG`. MySQL release binaries provided by Oracle are *not* built using this option.

- `--debug-info`

Command-Line Format	<code>--debug-info</code>
Type	Boolean
Default Value	<code>FALSE</code>

Print debugging information and memory and CPU usage statistics when the program exits.

This option is available only if MySQL was built using `WITH_DEBUG`. MySQL release binaries provided by Oracle are *not* built using this option.

- `--default-character-set=charset_name`

Command-Line Format	<code>--default-character-set=charset_name</code>
Type	String

Use `charset_name` as the default character set. See [Section 10.15, “Character Set Configuration”](#).

- `--default-auth=plugin`

Command-Line Format	<code>--default-auth=plugin</code>
Type	String

A hint about which client-side authentication plugin to use. See [Section 6.2.13, “Pluggable Authentication”](#).

- `--defaults-extra-file=file_name`

Command-Line Format	<code>--defaults-extra-file=file_name</code>
Type	File name

Read this option file after the global option file but (on Unix) before the user option file. If the file does not exist or is otherwise inaccessible, an error occurs. If `file_name` is not an absolute path name, it is interpreted relative to the current directory.

For additional information about this and other option-file options, see [Section 4.2.2.3, “Command-Line Options that Affect Option-File Handling”](#).

- `--defaults-file=file_name`

Command-Line Format	<code>--defaults-file=file_name</code>
Type	File name

Use only the given option file. If the file does not exist or is otherwise inaccessible, an error occurs. If `file_name` is not an absolute path name, it is interpreted relative to the current directory.

Exception: Even with `--defaults-file`, client programs read `.mylogin.cnf`.

For additional information about this and other option-file options, see [Section 4.2.2.3, “Command-Line Options that Affect Option-File Handling”](#).

- `--defaults-group-suffix=str`

Command-Line Format	<code>--defaults-group-suffix=str</code>
Type	String

Read not only the usual option groups, but also groups with the usual names and a suffix of `str`. For example, `mysqlshow` normally reads the `[client]` and `[mysqlshow]` groups. If this option is given as `--defaults-group-suffix=_other`, `mysqlshow` also reads the `[client_other]` and `[mysqlshow_other]` groups.

For additional information about this and other option-file options, see [Section 4.2.2.3, “Command-Line Options that Affect Option-File Handling”](#).

- `--enable-cleartext-plugin`

Command-Line Format	<code>--enable-cleartext-plugin</code>
Introduced	5.7.10
Type	Boolean
Default Value	<code>FALSE</code>

Enable the `mysql_clear_password` cleartext authentication plugin. (See [Section 6.4.1.6, “Client-Side Cleartext Pluggable Authentication”](#).)

This option was added in MySQL 5.7.10.

- `--get-server-public-key`

Command-Line Format	<code>--get-server-public-key</code>
Introduced	5.7.23

Type	Boolean
------	---------

Request from the server the RSA public key that it uses for key pair-based password exchange. This option applies to clients that connect to the server using an account that authenticates with the `caching_sha2_password` authentication plugin. For connections by such accounts, the server does not send the public key to the client unless requested. The option is ignored for accounts that do not authenticate with that plugin. It is also ignored if RSA-based password exchange is not needed, as is the case when the client connects to the server using a secure connection.

If `--server-public-key-path=file_name` is given and specifies a valid public key file, it takes precedence over `--get-server-public-key`.

For information about the `caching_sha2_password` plugin, see [Section 6.4.1.4, “Caching SHA-2 Pluggable Authentication”](#).

The `--get-server-public-key` option was added in MySQL 5.7.23.

- `--host=host_name, -h host_name`

Command-Line Format	<code>--host=host_name</code>
Type	String
Default Value	<code>localhost</code>

Connect to the MySQL server on the given host.

- `--keys, -k`

Command-Line Format	<code>--keys</code>
---------------------	---------------------

Show table indexes.

- `--login-path=name`

Command-Line Format	<code>--login-path=name</code>
Type	String

Read options from the named login path in the `.mylogin.cnf` login path file. A “login path” is an option group containing options that specify which MySQL server to connect to and which account to authenticate as. To create or modify a login path file, use the `mysql_config_editor` utility. See [Section 4.6.6, “mysql\\_config\\_editor — MySQL Configuration Utility”](#).

For additional information about this and other option-file options, see [Section 4.2.2.3, “Command-Line Options that Affect Option-File Handling”](#).

- `--no-defaults`

Command-Line Format	<code>--no-defaults</code>
---------------------	----------------------------

Do not read any option files. If program startup fails due to reading unknown options from an option file, `--no-defaults` can be used to prevent them from being read.



The exception is that the `.mylogin.cnf` file is read in all cases, if it exists. This permits passwords to be specified in a safer way than on the command line even when `--no-defaults` is used. To create `.mylogin.cnf`, use the `mysql_config_editor` utility. See [Section 4.6.6, “mysql\\_config\\_editor — MySQL Configuration Utility”](#).

For additional information about this and other option-file options, see [Section 4.2.2.3, “Command-Line Options that Affect Option-File Handling”](#).

- `--password[=password], -p[password]`

Command-Line Format	<code>--password[=password]</code>
Type	String

The password of the MySQL account used for connecting to the server. The password value is optional. If not given, `mysqlshow` prompts for one. If given, there must be *no space* between `--password=` or `-p` and the password following it. If no password option is specified, the default is to send no password.

Specifying a password on the command line should be considered insecure. To avoid giving the password on the command line, use an option file. See [Section 6.1.2.1, “End-User Guidelines for Password Security”](#).

To explicitly specify that there is no password and that `mysqlshow` should not prompt for one, use the `--skip-password` option.

- `--pipe, -W`

Command-Line Format	<code>--pipe</code>
Type	String

On Windows, connect to the server using a named pipe. This option applies only if the server was started with the `named_pipe` system variable enabled to support named-pipe connections. In addition, the user making the connection must be a member of the Windows group specified by the `named_pipe_full_access_group` system variable.

- `--plugin-dir=dir_name`

Command-Line Format	<code>--plugin-dir=dir_name</code>
Type	Directory name

The directory in which to look for plugins. Specify this option if the `--default-auth` option is used to specify an authentication plugin but `mysqlshow` does not find it. See [Section 6.2.13, “Pluggable Authentication”](#).

- `--port=port_num, -P port_num`

Command-Line Format	<code>--port=port_num</code>
Type	Numeric

Default Value	3306
---------------	------

For TCP/IP connections, the port number to use.

- `--print-defaults`

Command-Line Format	<code>--print-defaults</code>
---------------------	-------------------------------

Print the program name and all options that it gets from option files.

For additional information about this and other option-file options, see [Section 4.2.2.3, “Command-Line Options that Affect Option-File Handling”](#).

- `--protocol={TCP|SOCKET|PIPE|MEMORY}`

Command-Line Format	<code>--protocol=type</code>
Type	String
Default Value	[see text]
Valid Values	TCP  SOCKET  PIPE  MEMORY

The transport protocol to use for connecting to the server. It is useful when the other connection parameters normally result in use of a protocol other than the one you want. For details on the permissible values, see [Section 4.2.5, “Connection Transport Protocols”](#).

- `--secure-auth`

Command-Line Format	<code>--secure-auth</code>
Deprecated	Yes

Do not send passwords to the server in old (pre-4.1) format. This prevents connections except for servers that use the newer password format.

As of MySQL 5.7.5, this option is deprecated; expect it to be removed in a future MySQL release. It is always enabled and attempting to disable it (`--skip-secure-auth`, `--secure-auth=0`) produces an error. Before MySQL 5.7.5, this option is enabled by default but can be disabled.



#### Note

Passwords that use the pre-4.1 hashing method are less secure than passwordss that use the native password hashing method and should be avoided. Pre-4.1 passwordss are deprecated and support for them was removed in MySQL 5.7.5. For account upgrade instructions, see [Section 6.4.1.3, “Migrating Away from Pre-4.1 Password Hashing and the mysql\\_old\\_password Plugin”](#).

- `--server-public-key-path=file_name`

Command-Line Format	<code>--server-public-key-path=file_name</code>
Introduced	5.7.23
Type	File name

The path name to a file in PEM format containing a client-side copy of the public key required by the server for RSA key pair-based password exchange. This option applies to clients that authenticate with the `sha256_password` or `caching_sha2_password` authentication plugin. This option is ignored for accounts that do not authenticate with one of those plugins. It is also ignored if RSA-based password exchange is not used, as is the case when the client connects to the server using a secure connection.

If `--server-public-key-path=file_name` is given and specifies a valid public key file, it takes precedence over `--get-server-public-key`.

For `sha256_password`, this option applies only if MySQL was built using OpenSSL.

For information about the `sha256_password` and `caching_sha2_password` plugins, see [Section 6.4.1.5, “SHA-256 Pluggable Authentication”](#), and [Section 6.4.1.4, “Caching SHA-2 Pluggable Authentication”](#).

The `--server-public-key-path` option was added in MySQL 5.7.23.

- `--shared-memory-base-name=name`

Command-Line Format	<code>--shared-memory-base-name=name</code>
Platform Specific	Windows

On Windows, the shared-memory name to use for connections made using shared memory to a local server. The default value is `MYSQL`. The shared-memory name is case-sensitive.

This option applies only if the server was started with the `shared_memory` system variable enabled to support shared-memory connections.

- `--show-table-type, -t`

Command-Line Format	<code>--show-table-type</code>
---------------------	--------------------------------

Show a column indicating the table type, as in `SHOW FULL TABLES`. The type is `BASE TABLE` or `VIEW`.

- `--socket=path, -S path`

Command-Line Format	<code>--socket={file_name pipe_name}</code>
Type	String

For connections to `localhost`, the Unix socket file to use, or, on Windows, the name of the named pipe to use.

On Windows, this option applies only if the server was started with the `named_pipe` system variable enabled to support named-pipe connections. In addition, the user making the connection must be a member of the Windows group specified by the `named_pipe_full_access_group` system variable.

- `--ssl*`

Options that begin with `--ssl` specify whether to connect to the server using encryption and indicate where to find SSL keys and certificates. See [Command Options for Encrypted Connections](#).

- `--status, -i`

Command-Line Format	<code>--status</code>
---------------------	-----------------------

Display extra information about each table.

- `--tls-version=protocol_list`

Command-Line Format	<code>--tls-version=protocol_list</code>
Introduced	5.7.10
Type	String
Default Value (≥ 5.7.28)	<code>TLSv1, TLSv1.1, TLSv1.2</code>
Default Value (≤ 5.7.27)	<code>TLSv1, TLSv1.1, TLSv1.2 (OpenSSL)</code> <code>TLSv1, TLSv1.1 (yaSSL)</code>

The permissible TLS protocols for encrypted connections. The value is a list of one or more comma-separated protocol names. The protocols that can be named for this option depend on the SSL library used to compile MySQL. For details, see [Section 6.3.2, “Encrypted Connection TLS Protocols and Ciphers”](#).

This option was added in MySQL 5.7.10.

- `--user=user_name, -u user_name`

Command-Line Format	<code>--user=user_name,</code>
Type	String

The user name of the MySQL account to use for connecting to the server.

- `--verbose, -v`

Command-Line Format	<code>--verbose</code>
---------------------	------------------------

Verbose mode. Print more information about what the program does. This option can be used multiple times to increase the amount of information.

- `--version, -V`

Command-Line Format	<code>--version</code>
---------------------	------------------------

Display version information and exit.

## 4.5.8 mysqlslap — A Load Emulation Client

`mysqlslap` is a diagnostic program designed to emulate client load for a MySQL server and to report the timing of each stage. It works as if multiple clients are accessing the server.

Invoke `mysqlslap` like this:

```
mysqlslap [options]
```

Some options such as `--create` or `--query` enable you to specify a string containing an SQL statement or a file containing statements. If you specify a file, by default it must contain one statement per line. (That is, the implicit statement delimiter is the newline character.) Use the `--delimiter` option to specify a different delimiter, which enables you to specify statements that span multiple lines or place multiple statements on a single line. You cannot include comments in a file; `mysqlslap` does not understand them.

`mysqlslap` runs in three stages:

1. Create schema, table, and optionally any stored programs or data to use for the test. This stage uses a single client connection.
2. Run the load test. This stage can use many client connections.
3. Clean up (disconnect, drop table if specified). This stage uses a single client connection.

Examples:

Supply your own create and query SQL statements, with 50 clients querying and 200 selects for each (enter the command on a single line):

```
mysqlslap --delimiter=";"
--create="CREATE TABLE a (b int);INSERT INTO a VALUES (23)"
--query="SELECT * FROM a" --concurrency=50 --iterations=200
```

Let `mysqlslap` build the query SQL statement with a table of two `INT` columns and three `VARCHAR` columns. Use five clients querying 20 times each. Do not create the table or insert the data (that is, use the previous test's schema and data):

```
mysqlslap --concurrency=5 --iterations=20
--number-int-cols=2 --number-char-cols=3
--auto-generate-sql
```

Tell the program to load the create, insert, and query SQL statements from the specified files, where the `create.sql` file has multiple table creation statements delimited by `;` and multiple insert statements delimited by `;`. The `--query` file has multiple queries delimited by `;`. Run all the load statements, then run all the queries in the query file with five clients (five times each):

```
mysqlslap --concurrency=5
--iterations=5 --query=query.sql --create=create.sql
--delimiter=";"
```

`mysqlslap` supports the following options, which can be specified on the command line or in the `[mysqlslap]` and `[client]` groups of an option file. For information about option files used by MySQL programs, see [Section 4.2.2.2, “Using Option Files”](#).

**Table 4.20 mysqlslap Options**

Option Name	Description	Introduced	Deprecated
<code>--auto-generate-sql</code>	Generate SQL statements automatically when they are not supplied in files or using command options		

Option Name	Description	Introduced	Deprecated
<code>--auto-generate-sql-add-autoincrement</code>	Add AUTO_INCREMENT column to automatically generated tables		
<code>--auto-generate-sql-execute-number</code>	Specify how many queries to generate automatically		
<code>--auto-generate-sql-guid-primary</code>	Add a GUID-based primary key to automatically generated tables		
<code>--auto-generate-sql-load-type</code>	Specify the test load type		
<code>--auto-generate-sql-secondary-indexes</code>	Specify how many secondary indexes to add to automatically generated tables		
<code>--auto-generate-sql-unique-query-number</code>	How many different queries to generate for automatic tests		
<code>--auto-generate-sql-unique-write-number</code>	How many different queries to generate for <code>--auto-generate-sql-write-number</code>		
<code>--auto-generate-sql-write-number</code>	How many row inserts to perform on each thread		
<code>--commit</code>	How many statements to execute before committing		
<code>--compress</code>	Compress all information sent between client and server		
<code>--concurrency</code>	Number of clients to simulate when issuing the SELECT statement		
<code>--create</code>	File or string containing the statement to use for creating the table		
<code>--create-schema</code>	Schema in which to run the tests		
<code>--csv</code>	Generate output in comma-separated values format		
<code>--debug</code>	Write debugging log		
<code>--debug-check</code>	Print debugging information when program exits		

Option Name	Description	Introduced	Deprecated
<a href="#">--debug-info</a>	Print debugging information, memory, and CPU statistics when program exits		
<a href="#">--default-auth</a>	Authentication plugin to use		
<a href="#">--defaults-extra-file</a>	Read named option file in addition to usual option files		
<a href="#">--defaults-file</a>	Read only named option file		
<a href="#">--defaults-group-suffix</a>	Option group suffix value		
<a href="#">--delimiter</a>	Delimiter to use in SQL statements		
<a href="#">--detach</a>	Detach (close and reopen) each connection after each N statements		
<a href="#">--enable-cleartext-plugin</a>	Enable cleartext authentication plugin		
<a href="#">--engine</a>	Storage engine to use for creating the table		
<a href="#">--get-server-public-key</a>	Request RSA public key from server	5.7.23	
<a href="#">--help</a>	Display help message and exit		
<a href="#">--host</a>	Host on which MySQL server is located		
<a href="#">--iterations</a>	Number of times to run the tests		
<a href="#">--login-path</a>	Read login path options from .mylogin.cnf		
<a href="#">--no-defaults</a>	Read no option files		
<a href="#">--no-drop</a>	Do not drop any schema created during the test run		
<a href="#">--number-char-cols</a>	Number of VARCHAR columns to use if --auto-generate-sql is specified		
<a href="#">--number-int-cols</a>	Number of INT columns to use if --auto-generate-sql is specified		
<a href="#">--number-of-queries</a>	Limit each client to approximately this number of queries		

Option Name	Description	Introduced	Deprecated
<code>--only-print</code>	Do not connect to databases. mysqlslap only prints what it would have done		
<code>--password</code>	Password to use when connecting to server		
<code>--pipe</code>	Connect to server using named pipe (Windows only)		
<code>--plugin-dir</code>	Directory where plugins are installed		
<code>--port</code>	TCP/IP port number for connection		
<code>--post-query</code>	File or string containing the statement to execute after the tests have completed		
<code>--post-system</code>	String to execute using system() after the tests have completed		
<code>--pre-query</code>	File or string containing the statement to execute before running the tests		
<code>--pre-system</code>	String to execute using system() before running the tests		
<code>--print-defaults</code>	Print default options		
<code>--protocol</code>	Transport protocol to use		
<code>--query</code>	File or string containing the SELECT statement to use for retrieving data		
<code>--secure-auth</code>	Do not send passwords to server in old (pre-4.1) format		Yes
<code>--server-public-key-path</code>	Path name to file containing RSA public key	5.7.23	
<code>--shared-memory-base-name</code>	Shared-memory name for shared-memory connections (Windows only)		
<code>--silent</code>	Silent mode		
<code>--socket</code>	Unix socket file or Windows named pipe to use		



Option Name	Description	Introduced	Deprecated
<code>--sql-mode</code>	Set SQL mode for client session		
<code>--ssl</code>	Enable connection encryption		
<code>--ssl-ca</code>	File that contains list of trusted SSL Certificate Authorities		
<code>--ssl-capath</code>	Directory that contains trusted SSL Certificate Authority certificate files		
<code>--ssl-cert</code>	File that contains X.509 certificate		
<code>--ssl-cipher</code>	Permissible ciphers for connection encryption		
<code>--ssl-crl</code>	File that contains certificate revocation lists		
<code>--ssl-crlpath</code>	Directory that contains certificate revocation-list files		
<code>--ssl-key</code>	File that contains X.509 key		
<code>--ssl-mode</code>	Desired security state of connection to server	5.7.11	
<code>--ssl-verify-server-cert</code>	Verify host name against server certificate Common Name identity		
<code>--tls-version</code>	Permissible TLS protocols for encrypted connections	5.7.10	
<code>--user</code>	MySQL user name to use when connecting to server		
<code>--verbose</code>	Verbose mode		
<code>--version</code>	Display version information and exit		

- `--help, -?`

Command-Line Format	<code>--help</code>
---------------------	---------------------

Display a help message and exit.

- `--auto-generate-sql, -a`

Command-Line Format	<code>--auto-generate-sql</code>
Type	Boolean

Default Value	FALSE
---------------	-------

Generate SQL statements automatically when they are not supplied in files or using command options.

- `--auto-generate-sql-add-autoincrement`

Command-Line Format	<code>--auto-generate-sql-add-autoincrement</code>
Type	Boolean
Default Value	FALSE

Add an `AUTO_INCREMENT` column to automatically generated tables.

- `--auto-generate-sql-execute-number=N`

Command-Line Format	<code>--auto-generate-sql-execute-number=#</code>
Type	Numeric

Specify how many queries to generate automatically.

- `--auto-generate-sql-guid-primary`

Command-Line Format	<code>--auto-generate-sql-guid-primary</code>
Type	Boolean
Default Value	FALSE

Add a GUID-based primary key to automatically generated tables.

- `--auto-generate-sql-load-type=type`

Command-Line Format	<code>--auto-generate-sql-load-type=type</code>
Type	Enumeration
Default Value	<code>mixed</code>
Valid Values	<code>read</code> <code>write</code> <code>key</code> <code>update</code> <code>mixed</code>

- `--auto-generate-sql-secondary-indexes=N`

Command-Line Format	<code>--auto-generate-sql-secondary-indexes=#</code>
Type	Numeric
Default Value	0

Specify how many secondary indexes to add to automatically generated tables. By default, none are added.

- `--auto-generate-sql-unique-query-number=N`

Command-Line Format	<code>--auto-generate-sql-unique-query-number=#</code>
Type	Numeric
Default Value	10

How many different queries to generate for automatic tests. For example, if you run a `key` test that performs 1000 selects, you can use this option with a value of 1000 to run 1000 unique queries, or with a value of 50 to perform 50 different selects. The default is 10.

- `--auto-generate-sql-unique-write-number=N`

Command-Line Format	<code>--auto-generate-sql-unique-write-number=#</code>
Type	Numeric
Default Value	10

How many different queries to generate for `--auto-generate-sql-write-number`. The default is 10.

- `--auto-generate-sql-write-number=N`

Command-Line Format	<code>--auto-generate-sql-write-number=#</code>
Type	Numeric
Default Value	100

How many row inserts to perform. The default is 100.

- `--commit=N`

Command-Line Format	<code>--commit=#</code>
Type	Numeric
Default Value	0

- `--compress, -C`

Command-Line Format	<code>--compress[={OFF ON}]</code>
Type	Boolean
Default Value	OFF

Compress all information sent between the client and the server if possible. See [Section 4.2.6, “Connection Compression Control”](#).

- `--concurrency=N, -c N`

Command-Line Format	<code>--concurrency=#</code>
Type	Numeric

The number of parallel clients to simulate.

- `--create=value`

Command-Line Format	<code>--create=value</code>
Type	String

The file or string containing the statement to use for creating the table.

- `--create-schema=value`

Command-Line Format	<code>--create-schema=value</code>
Type	String

The schema in which to run the tests.



#### Note

If the `--auto-generate-sql` option is also given, `mysqlslap` drops the schema at the end of the test run. To avoid this, use the `--no-drop` option as well.

- `--csv[=file_name]`

Command-Line Format	<code>--csv=[file]</code>
Type	File name

Generate output in comma-separated values format. The output goes to the named file, or to the standard output if no file is given.

- `--debug[=debug_options], -# [debug_options]`

Command-Line Format	<code>--debug[=debug_options]</code>
Type	String

Default Value	<code>d:t:o,/tmp/mysqlslap.trace</code>
---------------	---

Write a debugging log. A typical `debug_options` string is `d:t:o,file_name`. The default is `d:t:o,/tmp/mysqlslap.trace`.

This option is available only if MySQL was built using `WITH_DEBUG`. MySQL release binaries provided by Oracle are *not* built using this option.

- `--debug-check`

Command-Line Format	<code>--debug-check</code>
Type	Boolean
Default Value	<code>FALSE</code>

Print some debugging information when the program exits.

This option is available only if MySQL was built using `WITH_DEBUG`. MySQL release binaries provided by Oracle are *not* built using this option.

- `--debug-info, -T`

Command-Line Format	<code>--debug-info</code>
Type	Boolean
Default Value	<code>FALSE</code>

Print debugging information and memory and CPU usage statistics when the program exits.

This option is available only if MySQL was built using `WITH_DEBUG`. MySQL release binaries provided by Oracle are *not* built using this option.

- `--default-auth=plugin`

Command-Line Format	<code>--default-auth=plugin</code>
Type	String

A hint about which client-side authentication plugin to use. See [Section 6.2.13, “Pluggable Authentication”](#).

- `--defaults-extra-file=file_name`

Command-Line Format	<code>--defaults-extra-file=file_name</code>
Type	File name

Read this option file after the global option file but (on Unix) before the user option file. If the file does not exist or is otherwise inaccessible, an error occurs. If `file_name` is not an absolute path name, it is interpreted relative to the current directory.

For additional information about this and other option-file options, see [Section 4.2.2.3, “Command-Line Options that Affect Option-File Handling”](#).

- `--defaults-file=file_name`

Command-Line Format	<code>--defaults-file=file_name</code>
Type	File name

Use only the given option file. If the file does not exist or is otherwise inaccessible, an error occurs. If `file_name` is not an absolute path name, it is interpreted relative to the current directory.

Exception: Even with `--defaults-file`, client programs read `.mylogin.cnf`.

For additional information about this and other option-file options, see [Section 4.2.2.3, “Command-Line Options that Affect Option-File Handling”](#).

- `--defaults-group-suffix=str`

Command-Line Format	<code>--defaults-group-suffix=str</code>
Type	String

Read not only the usual option groups, but also groups with the usual names and a suffix of `str`. For example, `mysqlslap` normally reads the `[client]` and `[mysqlslap]` groups. If this option is given as `--defaults-group-suffix=_other`, `mysqlslap` also reads the `[client_other]` and `[mysqlslap_other]` groups.

For additional information about this and other option-file options, see [Section 4.2.2.3, “Command-Line Options that Affect Option-File Handling”](#).

- `--delimiter=str, -F str`

Command-Line Format	<code>--delimiter=str</code>
Type	String

The delimiter to use in SQL statements supplied in files or using command options.

- `--detach=N`

Command-Line Format	<code>--detach=#</code>
Type	Numeric
Default Value	0

Detach (close and reopen) each connection after each `N` statements. The default is 0 (connections are not detached).

- `--enable-cleartext-plugin`

Command-Line Format	<code>--enable-cleartext-plugin</code>
Type	Boolean

Default Value	FALSE
---------------	-------

Enable the `mysql_clear_password` cleartext authentication plugin. (See [Section 6.4.1.6](#), “Client-Side Cleartext Pluggable Authentication”.)

- `--engine=engine_name, -e engine_name`

Command-Line Format	<code>--engine=engine_name</code>
Type	String

The storage engine to use for creating tables.

- `--get-server-public-key`

Command-Line Format	<code>--get-server-public-key</code>
Introduced	5.7.23
Type	Boolean

Request from the server the RSA public key that it uses for key pair-based password exchange. This option applies to clients that connect to the server using an account that authenticates with the `caching_sha2_password` authentication plugin. For connections by such accounts, the server does not send the public key to the client unless requested. The option is ignored for accounts that do not authenticate with that plugin. It is also ignored if RSA-based password exchange is not needed, as is the case when the client connects to the server using a secure connection.

If `--server-public-key-path=file_name` is given and specifies a valid public key file, it takes precedence over `--get-server-public-key`.

For information about the `caching_sha2_password` plugin, see [Section 6.4.1.4](#), “Caching SHA-2 Pluggable Authentication”.

The `--get-server-public-key` option was added in MySQL 5.7.23.

- `--host=host_name, -h host_name`

Command-Line Format	<code>--host=host_name</code>
Type	String
Default Value	<code>localhost</code>

Connect to the MySQL server on the given host.

- `--iterations=N, -i N`

Command-Line Format	<code>--iterations=#</code>
Type	Numeric

The number of times to run the tests.

- `--login-path=name`

Command-Line Format	<code>--login-path=name</code>
Type	String

Read options from the named login path in the `.mylogin.cnf` login path file. A “login path” is an option group containing options that specify which MySQL server to connect to and which account to authenticate as. To create or modify a login path file, use the `mysql_config_editor` utility. See [Section 4.6.6, “mysql\\_config\\_editor — MySQL Configuration Utility”](#).

For additional information about this and other option-file options, see [Section 4.2.2.3, “Command-Line Options that Affect Option-File Handling”](#).

- `--no-drop`

Command-Line Format	<code>--no-drop</code>
Type	Boolean
Default Value	<code>FALSE</code>

Prevent `mysqlslap` from dropping any schema it creates during the test run.

- `--no-defaults`

Command-Line Format	<code>--no-defaults</code>
---------------------	----------------------------

Do not read any option files. If program startup fails due to reading unknown options from an option file, `--no-defaults` can be used to prevent them from being read.

The exception is that the `.mylogin.cnf` file is read in all cases, if it exists. This permits passwords to be specified in a safer way than on the command line even when `--no-defaults` is used. To create `.mylogin.cnf`, use the `mysql_config_editor` utility. See [Section 4.6.6, “mysql\\_config\\_editor — MySQL Configuration Utility”](#).

For additional information about this and other option-file options, see [Section 4.2.2.3, “Command-Line Options that Affect Option-File Handling”](#).

- `--number-char-cols=N, -x N`

Command-Line Format	<code>--number-char-cols=#</code>
Type	Numeric

The number of `VARCHAR` columns to use if `--auto-generate-sql` is specified.

- `--number-int-cols=N, -y N`

Command-Line Format	<code>--number-int-cols=#</code>
Type	Numeric



- `--number-of-queries=N`

Command-Line Format	<code>--number-of-queries=#</code>
Type	Numeric

Limit each client to approximately this many queries. Query counting takes into account the statement delimiter. For example, if you invoke `mysqlslap` as follows, the `;` delimiter is recognized so that each instance of the query string counts as two queries. As a result, 5 rows (not 10) are inserted.

```
mysqlslap --delimiter=";" --number-of-queries=10
         --query="use test;insert into t values(null)"
```

- `--only-print`

Command-Line Format	<code>--only-print</code>
Type	Boolean
Default Value	<code>FALSE</code>

Do not connect to databases. `mysqlslap` only prints what it would have done.

- `--password[=password], -p[password]`

Command-Line Format	<code>--password[=password]</code>
Type	String

The password of the MySQL account used for connecting to the server. The password value is optional. If not given, `mysqlslap` prompts for one. If given, there must be *no space* between `--password=` or `-p` and the password following it. If no password option is specified, the default is to send no password.

Specifying a password on the command line should be considered insecure. To avoid giving the password on the command line, use an option file. See [Section 6.1.2.1, “End-User Guidelines for Password Security”](#).

To explicitly specify that there is no password and that `mysqlslap` should not prompt for one, use the `--skip-password` option.

- `--pipe, -W`

Command-Line Format	<code>--pipe</code>
Type	String

On Windows, connect to the server using a named pipe. This option applies only if the server was started with the `named_pipe` system variable enabled to support named-pipe connections. In addition, the user making the connection must be a member of the Windows group specified by the `named_pipe_full_access_group` system variable.

- `--plugin-dir=dir_name`

Command-Line Format	<code>--plugin-dir=dir_name</code>
Type	Directory name

The directory in which to look for plugins. Specify this option if the `--default-auth` option is used to specify an authentication plugin but `mysqlslap` does not find it. See [Section 6.2.13, “Pluggable Authentication”](#).

- `--port=port_num, -P port_num`

Command-Line Format	<code>--port=port_num</code>
Type	Numeric
Default Value	3306

For TCP/IP connections, the port number to use.

- `--post-query=value`

Command-Line Format	<code>--post-query=value</code>
Type	String

The file or string containing the statement to execute after the tests have completed. This execution is not counted for timing purposes.

- `--post-system=str`

Command-Line Format	<code>--post-system=str</code>
Type	String

The string to execute using `system()` after the tests have completed. This execution is not counted for timing purposes.

- `--pre-query=value`

Command-Line Format	<code>--pre-query=value</code>
Type	String

The file or string containing the statement to execute before running the tests. This execution is not counted for timing purposes.

- `--pre-system=str`

Command-Line Format	<code>--pre-system=str</code>
Type	String

The string to execute using `system()` before running the tests. This execution is not counted for timing purposes.

- `--print-defaults`

Command-Line Format	<code>--print-defaults</code>
---------------------	-------------------------------

Print the program name and all options that it gets from option files.

For additional information about this and other option-file options, see [Section 4.2.2.3, “Command-Line Options that Affect Option-File Handling”](#).

- `--protocol={TCP|SOCKET|PIPE|MEMORY}`

Command-Line Format	<code>--protocol=type</code>
Type	String
Default Value	[see text]
Valid Values	TCP SOCKET PIPE MEMORY

The transport protocol to use for connecting to the server. It is useful when the other connection parameters normally result in use of a protocol other than the one you want. For details on the permissible values, see [Section 4.2.5, “Connection Transport Protocols”](#).

- `--query=value, -q value`

Command-Line Format	<code>--query=value</code>
Type	String

The file or string containing the `SELECT` statement to use for retrieving data.

- `--secure-auth`

Command-Line Format	<code>--secure-auth</code>
Deprecated	Yes

Do not send passwords to the server in old (pre-4.1) format. This prevents connections except for servers that use the newer password format.

As of MySQL 5.7.5, this option is deprecated; expect it to be removed in a future MySQL release. It is always enabled and attempting to disable it (`--skip-secure-auth, --secure-auth=0`) produces an error. Before MySQL 5.7.5, this option is enabled by default but can be disabled.



#### Note

Passwords that use the pre-4.1 hashing method are less secure than passwordss that use the native password hashing method and should be avoided. Pre-4.1 passwordss are deprecated and support for them was removed in MySQL 5.7.5. For account upgrade instructions, see [Section 6.4.1.3, “Migrating Away from Pre-4.1 Password Hashing and the mysql\\_old\\_password Plugin”](#).

- `--server-public-key-path=file_name`

Command-Line Format	<code>--server-public-key-path=file_name</code>
Introduced	5.7.23
Type	File name

The path name to a file in PEM format containing a client-side copy of the public key required by the server for RSA key pair-based password exchange. This option applies to clients that authenticate with the `sha256_password` or `caching_sha2_password` authentication plugin. This option is ignored for accounts that do not authenticate with one of those plugins. It is also ignored if RSA-based password exchange is not used, as is the case when the client connects to the server using a secure connection.

If `--server-public-key-path=file_name` is given and specifies a valid public key file, it takes precedence over `--get-server-public-key`.

For `sha256_password`, this option applies only if MySQL was built using OpenSSL.

For information about the `sha256_password` and `caching_sha2_password` plugins, see [Section 6.4.1.5, “SHA-256 Pluggable Authentication”](#), and [Section 6.4.1.4, “Caching SHA-2 Pluggable Authentication”](#).

The `--server-public-key-path` option was added in MySQL 5.7.23.

- `--shared-memory-base-name=name`

Command-Line Format	<code>--shared-memory-base-name=name</code>
Platform Specific	Windows

On Windows, the shared-memory name to use for connections made using shared memory to a local server. The default value is `MYSQL`. The shared-memory name is case-sensitive.

This option applies only if the server was started with the `shared_memory` system variable enabled to support shared-memory connections.

- `--silent, -s`

Command-Line Format	<code>--silent</code>
---------------------	-----------------------

Silent mode. No output.

- `--socket=path, -S path`

Command-Line Format	<code>--socket={file_name pipe_name}</code>
Type	String

For connections to `localhost`, the Unix socket file to use, or, on Windows, the name of the named pipe to use.

On Windows, this option applies only if the server was started with the `named_pipe` system variable enabled to support named-pipe connections. In addition, the user making the connection must be a member of the Windows group specified by the `named_pipe_full_access_group` system variable.

- `--sql-mode=mode`

Command-Line Format	<code>--sql-mode=mode</code>
Type	String

Set the SQL mode for the client session.

- `--ssl*`

Options that begin with `--ssl` specify whether to connect to the server using encryption and indicate where to find SSL keys and certificates. See [Command Options for Encrypted Connections](#).

- `--tls-version=protocol_list`

Command-Line Format	<code>--tls-version=protocol_list</code>
Introduced	5.7.10
Type	String
Default Value ( $\geq$ 5.7.28)	<code>TLsv1, TLsv1.1, TLsv1.2</code>
Default Value ( $\leq$ 5.7.27)	<code>TLsv1, TLsv1.1, TLsv1.2 (OpenSSL)</code> <code>TLsv1, TLsv1.1 (yaSSL)</code>

The permissible TLS protocols for encrypted connections. The value is a list of one or more comma-separated protocol names. The protocols that can be named for this option depend on the SSL library used to compile MySQL. For details, see [Section 6.3.2, “Encrypted Connection TLS Protocols and Ciphers”](#).

This option was added in MySQL 5.7.10.

- `--user=user_name, -u user_name`

Command-Line Format	<code>--user=user_name,</code>
Type	String

The user name of the MySQL account to use for connecting to the server.

- `--verbose, -v`

Command-Line Format	<code>--verbose</code>
---------------------	------------------------

Verbose mode. Print more information about what the program does. This option can be used multiple times to increase the amount of information.

- `--version, -V`

Command-Line Format	<code>--version</code>
---------------------	------------------------

## 4.6 Administrative and Utility Programs

This section describes administrative programs and programs that perform miscellaneous utility operations.

### 4.6.1 innchecksum — Offline InnoDB File Checksum Utility

`innchecksum` prints checksums for `InnoDB` files. This tool reads an `InnoDB` tablespace file, calculates the checksum for each page, compares the calculated checksum to the stored checksum, and reports mismatches, which indicate damaged pages. It was originally developed to speed up verifying the integrity of tablespace files after power outages but can also be used after file copies. Because checksum mismatches cause `InnoDB` to deliberately shut down a running server, it may be preferable to use this tool rather than waiting for an in-production server to encounter the damaged pages.

`innchecksum` cannot be used on tablespace files that the server already has open. For such files, you should use `CHECK TABLE` to check tables within the tablespace. Attempting to run `innchecksum` on a tablespace that the server already has open results in an `Unable to lock file` error.

If checksum mismatches are found, restore the tablespace from backup or start the server and attempt to use `mysqldump` to make a backup of the tables within the tablespace.

Invoke `innchecksum` like this:

```
innchecksum [options] file_name
```

### innchecksum Options

`innchecksum` supports the following options. For options that refer to page numbers, the numbers are zero-based.

- `--help, -?`

Command-Line Format	<code>--help</code>
Type	Boolean
Default Value	<code>false</code>

Displays command line help. Example usage:

```
innchecksum --help
```

- `--info, -I`

Command-Line Format	<code>--info</code>
Type	Boolean
Default Value	<code>false</code>

Synonym for `--help`. Displays command line help. Example usage:

```
innchecksum --info
```

- `--version, -V`

Command-Line Format	<code>--version</code>
Type	Boolean

Default Value	false
---------------	-------

Displays version information. Example usage:

```
innochecksum --version
```

- `--verbose, -v`

Command-Line Format	<code>--verbose</code>
Type	Boolean
Default Value	false

Verbose mode; prints a progress indicator to the log file every five seconds. In order for the progress indicator to be printed, the log file must be specified using the `--log option`. To turn on `verbose` mode, run:

```
innochecksum --verbose
```

To turn off verbose mode, run:

```
innochecksum --verbose=FALSE
```

The `--verbose` option and `--log` option can be specified at the same time. For example:

```
innochecksum --verbose --log=/var/lib/mysql/test/logtest.txt
```

To locate the progress indicator information in the log file, you can perform the following search:

```
cat ./logtest.txt | grep -i "okay"
```

The progress indicator information in the log file appears similar to the following:

```
page 1663 okay: 2.863% done
page 8447 okay: 14.537% done
page 13695 okay: 23.568% done
page 18815 okay: 32.379% done
page 23039 okay: 39.648% done
page 28351 okay: 48.789% done
page 33023 okay: 56.828% done
page 37951 okay: 65.308% done
page 44095 okay: 75.881% done
page 49407 okay: 85.022% done
page 54463 okay: 93.722% done
...
```

- `--count, -c`

Command-Line Format	<code>--count</code>
Type	Base name
Default Value	true

Print a count of the number of pages in the file and exit. Example usage:

```
innochecksum --count ../data/test/tab1.ibd
```

- `--start-page=num, -s num`

Command-Line Format	<code>--start-page=#</code>
Type	Numeric
Default Value	0

Start at this page number. Example usage:

```
innochecksum --start-page=600 ../data/test/tab1.ibd
```

or:

```
innochecksum -s 600 ../data/test/tab1.ibd
```

- `--end-page=num, -e num`

Command-Line Format	<code>--end-page=#</code>
Type	Numeric
Default Value	0
Minimum Value	0
Maximum Value	18446744073709551615

End at this page number. Example usage:

```
innochecksum --end-page=700 ../data/test/tab1.ibd
```

or:

```
innochecksum --p 700 ../data/test/tab1.ibd
```

- `--page=num, -p num`

Command-Line Format	<code>--page=#</code>
Type	Integer
Default Value	0

Check only this page number. Example usage:

```
innochecksum --page=701 ../data/test/tab1.ibd
```

- `--strict-check, -C`

Command-Line Format	<code>--strict-check=algorithm</code>
Type	Enumeration
Default Value	<code>crc32</code>
Valid Values	<code>innodb</code>
	<code>crc32</code>



	none
--	------

Specify a strict checksum algorithm. Options include `innodb`, `crc32`, and `none`.

In this example, the `innodb` checksum algorithm is specified:

```
innochecksum --strict-check=innodb ../data/test/tab1.ibd
```

In this example, the `crc32` checksum algorithm is specified:

```
innochecksum -C crc32 ../data/test/tab1.ibd
```

The following conditions apply:

- If you do not specify the `--strict-check` option, `innochecksum` validates against `innodb`, `crc32` and `none`.
- If you specify the `none` option, only checksums generated by `none` are allowed.
- If you specify the `innodb` option, only checksums generated by `innodb` are allowed.
- If you specify the `crc32` option, only checksums generated by `crc32` are allowed.
- `--no-check`, `-n`

Command-Line Format	<code>--no-check</code>
Type	Boolean
Default Value	false

Ignore the checksum verification when rewriting a checksum. This option may only be used with the `innochecksum --write` option. If the `--write` option is not specified, `innochecksum` terminates.

In this example, an `innodb` checksum is rewritten to replace an invalid checksum:

```
innochecksum --no-check --write innodb ../data/test/tab1.ibd
```

- `--allow-mismatches`, `-a`

Command-Line Format	<code>--allow-mismatches=#</code>
Type	Integer
Default Value	0
Minimum Value	0
Maximum Value	18446744073709551615

The maximum number of checksum mismatches allowed before `innochecksum` terminates. The default setting is 0. If `--allow-mismatches=N`, where  $N \geq 0$ ,  $N$  mismatches are permitted and

`innochecksum` terminates at  $N+1$ . When `--allow-mismatches` is set to 0, `innochecksum` terminates on the first checksum mismatch.

In this example, an existing `innodb` checksum is rewritten to set `--allow-mismatches` to 1.

```
innochecksum --allow-mismatches=1 --write innodb ../data/test/tab1.ibd
```

With `--allow-mismatches` set to 1, if there is a mismatch at page 600 and another at page 700 on a file with 1000 pages, the checksum is updated for pages 0-599 and 601-699. Because `--allow-mismatches` is set to 1, the checksum tolerates the first mismatch and terminates on the second mismatch, leaving page 600 and pages 700-999 unchanged.

- `--write=name, -w num`

Command-Line Format	<code>--write=algorithm</code>
Type	Enumeration
Default Value	<code>crc32</code>
Valid Values	<code>innodb</code>  <code>crc32</code>  <code>none</code>

Rewrite a checksum. When rewriting an invalid checksum, the `--no-check` option must be used together with the `--write` option. The `--no-check` option tells `innochecksum` to ignore verification of the invalid checksum. You do not have to specify the `--no-check` option if the current checksum is valid.

An algorithm must be specified when using the `--write` option. Possible values for the `--write` option are:

- `innodb`: A checksum calculated in software, using the original algorithm from `InnoDB`.
- `crc32`: A checksum calculated using the `crc32` algorithm, possibly done with a hardware assist.
- `none`: A constant number.

The `--write` option rewrites entire pages to disk. If the new checksum is identical to the existing checksum, the new checksum is not written to disk in order to minimize I/O.

`innochecksum` obtains an exclusive lock when the `--write` option is used.

In this example, a `crc32` checksum is written for `tab1.ibd`:

```
innochecksum -w crc32 ../data/test/tab1.ibd
```

In this example, a `crc32` checksum is rewritten to replace an invalid `crc32` checksum:

```
innochecksum --no-check --write crc32 ../data/test/tab1.ibd
```

- `--page-type-summary, -S`

Command-Line Format	<code>--page-type-summary</code>
Type	Boolean

Default Value	false
---------------	-------

Display a count of each page type in a tablespace. Example usage:

```
innochecksum --page-type-summary ../data/test/tab1.ibd
```

Sample output for `--page-type-summary`:

```
File:../data/test/tab1.ibd
=====PAGE TYPE SUMMARY=====
#PAGE_COUNT PAGE_TYPE
=====
      2      Index page
      0      Undo log page
      1      Inode page
      0      Insert buffer free list page
      2      Freshly allocated page
      1      Insert buffer bitmap
      0      System page
      0      Transaction system page
      1      File Space Header
      0      Extent descriptor page
      0      BLOB page
      0      Compressed BLOB page
      0      Other type of page
=====
Additional information:
Undo page type: 0 insert, 0 update, 0 other
Undo page state: 0 active, 0 cached, 0 to_free, 0 to_purge, 0 prepared, 0 other
```

- `--page-type-dump, -D`

Command-Line Format	<code>--page-type-dump=name</code>
Type	String
Default Value	[none]

Dump the page type information for each page in a tablespace to `stderr` or `stdout`. Example usage:

```
innochecksum --page-type-dump=/tmp/a.txt ../data/test/tab1.ibd
```

- `--log, -l`

Command-Line Format	<code>--log=path</code>
Type	File name
Default Value	[none]

Log output for the `innochecksum` tool. A log file name must be provided. Log output contains checksum values for each tablespace page. For uncompressed tables, LSN values are also provided. The `--log` replaces the `--debug` option, which was available in earlier releases. Example usage:

```
innochecksum --log=/tmp/log.txt ../data/test/tab1.ibd
```

or:

```
innochecksum -l /tmp/log.txt ../data/test/tab1.ibd
```

- `-` option.

Specify the `-` option to read from standard input. If the `-` option is missing when “read from standard in” is expected, `innochecksum` prints `innochecksum` usage information indicating that the “-” option was omitted. Example usages:

```
cat t1.ibd | innochecksum -
```

In this example, `innochecksum` writes the `crc32` checksum algorithm to `a.ibd` without changing the original `t1.ibd` file.

```
cat t1.ibd | innochecksum --write=crc32 - > a.ibd
```

## Running innochecksum on Multiple User-defined Tablespace Files

The following examples demonstrate how to run `innochecksum` on multiple user-defined tablespace files (`.ibd` files).

Run `innochecksum` for all tablespace (`.ibd`) files in the “test” database:

```
innochecksum ./data/test/*.ibd
```

Run `innochecksum` for all tablespace files (`.ibd` files) that have a file name starting with “t”:

```
innochecksum ./data/test/t*.ibd
```

Run `innochecksum` for all tablespace files (`.ibd` files) in the `data` directory:

```
innochecksum ./data/*/*.ibd
```



### Note

Running `innochecksum` on multiple user-defined tablespace files is not supported on Windows operating systems, as Windows shells such as `cmd.exe` do not support glob pattern expansion. On Windows systems, `innochecksum` must be run separately for each user-defined tablespace file. For example:

```
innochecksum.exe t1.ibd
innochecksum.exe t2.ibd
innochecksum.exe t3.ibd
```

## Running innochecksum on Multiple System Tablespace Files

By default, there is only one InnoDB system tablespace file (`ibdata1`) but multiple files for the system tablespace can be defined using the `innodb_data_file_path` option. In the following example, three files for the system tablespace are defined using the `innodb_data_file_path` option: `ibdata1`, `ibdata2`, and `ibdata3`.

```
./bin/mysqld --no-defaults --innodb-data-file-path="ibdata1:10M;ibdata2:10M;ibdata3:10M:autoextend"
```

The three files (`ibdata1`, `ibdata2`, and `ibdata3`) form one logical system tablespace. To run `innochecksum` on multiple files that form one logical system tablespace, `innochecksum` requires the `-` option to read tablespace files in from standard input, which is equivalent to concatenating multiple files to create one single file. For the example provided above, the following `innochecksum` command would be used:

```
cat ibdata* | innochecksum -
```

Refer to the [innochecksum](#) options information for more information about the “-” option.



### Note

Running [innochecksum](#) on multiple files in the same tablespace is not supported on Windows operating systems, as Windows shells such as `cmd.exe` do not support glob pattern expansion. On Windows systems, [innochecksum](#) must be run separately for each system tablespace file. For example:

```
innochecksum.exe ibdata1
innochecksum.exe ibdata2
innochecksum.exe ibdata3
```

## 4.6.2 myisam\_ftdump — Display Full-Text Index information

[myisam\\_ftdump](#) displays information about `FULLTEXT` indexes in `MyISAM` tables. It reads the `MyISAM` index file directly, so it must be run on the server host where the table is located. Before using [myisam\\_ftdump](#), be sure to issue a `FLUSH TABLES` statement first if the server is running.

[myisam\\_ftdump](#) scans and dumps the entire index, which is not particularly fast. On the other hand, the distribution of words changes infrequently, so it need not be run often.

Invoke [myisam\\_ftdump](#) like this:

```
myisam_ftdump [options] tbl_name index_num
```

The `tbl_name` argument should be the name of a `MyISAM` table. You can also specify a table by naming its index file (the file with the `.MYI` suffix). If you do not invoke [myisam\\_ftdump](#) in the directory where the table files are located, the table or index file name must be preceded by the path name to the table's database directory. Index numbers begin with 0.

Example: Suppose that the `test` database contains a table named `mytexttable` that has the following definition:

```
CREATE TABLE mytexttable
(
  id   INT NOT NULL,
  txt  TEXT NOT NULL,
  PRIMARY KEY (id),
  FULLTEXT (txt)
) ENGINE=MyISAM;
```

The index on `id` is index 0 and the `FULLTEXT` index on `txt` is index 1. If your working directory is the `test` database directory, invoke [myisam\\_ftdump](#) as follows:

```
myisam_ftdump mytexttable 1
```

If the path name to the `test` database directory is `/usr/local/mysql/data/test`, you can also specify the table name argument using that path name. This is useful if you do not invoke [myisam\\_ftdump](#) in the database directory:

```
myisam_ftdump /usr/local/mysql/data/test/mytexttable 1
```

You can use [myisam\\_ftdump](#) to generate a list of index entries in order of frequency of occurrence like this on Unix-like systems:

```
myisam_ftdump -c mytexttable 1 | sort -r
```

On Windows, use:

```
myisam_ftdump -c mytexttable 1 | sort /R
```

`myisam_ftdump` supports the following options:

- `--help, -h -?`

Command-Line Format	<code>--help</code>
---------------------	---------------------

Display a help message and exit.

- `--count, -c`

Command-Line Format	<code>--count</code>
---------------------	----------------------

Calculate per-word statistics (counts and global weights).

- `--dump, -d`

Command-Line Format	<code>--dump</code>
---------------------	---------------------

Dump the index, including data offsets and word weights.

- `--length, -l`

Command-Line Format	<code>--length</code>
---------------------	-----------------------

Report the length distribution.

- `--stats, -s`

Command-Line Format	<code>--stats</code>
---------------------	----------------------

Report global index statistics. This is the default operation if no other operation is specified.

- `--verbose, -v`

Command-Line Format	<code>--verbose</code>
---------------------	------------------------

Verbose mode. Print more output about what the program does.

### 4.6.3 myisamchk — MyISAM Table-Maintenance Utility

The `myisamchk` utility gets information about your database tables or checks, repairs, or optimizes them. `myisamchk` works with MyISAM tables (tables that have `.MYD` and `.MYI` files for storing data and indexes).

The use of `myisamchk` with partitioned tables is not supported.



### Caution

It is best to make a backup of a table before performing a table repair operation; under some circumstances the operation might cause data loss. Possible causes include but are not limited to file system errors.

Invoke `myisamchk` like this:

```
myisamchk [options] tbl_name ...
```

The `options` specify what you want `myisamchk` to do. They are described in the following sections. You can also get a list of options by invoking `myisamchk --help`.

With no options, `myisamchk` simply checks your table as the default operation. To get more information or to tell `myisamchk` to take corrective action, specify options as described in the following discussion.

`tbl_name` is the database table you want to check or repair. If you run `myisamchk` somewhere other than in the database directory, you must specify the path to the database directory, because `myisamchk` has no idea where the database is located. In fact, `myisamchk` does not actually care whether the files you are working on are located in a database directory. You can copy the files that correspond to a database table into some other location and perform recovery operations on them there.

You can name several tables on the `myisamchk` command line if you wish. You can also specify a table by naming its index file (the file with the `.MYI` suffix). This enables you to specify all tables in a directory by using the pattern `*.MYI`. For example, if you are in a database directory, you can check all the `MyISAM` tables in that directory like this:

```
myisamchk *.MYI
```

If you are not in the database directory, you can check all the tables there by specifying the path to the directory:

```
myisamchk /path/to/database_dir/*.MYI
```

You can even check all tables in all databases by specifying a wildcard with the path to the MySQL data directory:

```
myisamchk /path/to/datadir/*/*.MYI
```

The recommended way to quickly check all `MyISAM` tables is:

```
myisamchk --silent --fast /path/to/datadir/*/*.MYI
```

If you want to check all `MyISAM` tables and repair any that are corrupted, you can use the following command:

```
myisamchk --silent --force --fast --update-state \
  --key_buffer_size=64M --myisam_sort_buffer_size=64M \
  --read_buffer_size=1M --write_buffer_size=1M \
  /path/to/datadir/*/*.MYI
```

This command assumes that you have more than 64MB free. For more information about memory allocation with `myisamchk`, see [Section 4.6.3.6, “myisamchk Memory Usage”](#).

For additional information about using `myisamchk`, see [Section 7.6, “MyISAM Table Maintenance and Crash Recovery”](#).



### Important

You must ensure that no other program is using the tables while you are running `myisamchk`. The most effective means of doing so is to shut down the MySQL server while running `myisamchk`, or to lock all tables that `myisamchk` is being used on.

Otherwise, when you run `myisamchk`, it may display the following error message:

```
warning: clients are using or haven't closed the table properly
```

This means that you are trying to check a table that has been updated by another program (such as the `mysqld` server) that hasn't yet closed the file or that has died without closing the file properly, which can sometimes lead to the corruption of one or more `MyISAM` tables.

If `mysqld` is running, you must force it to flush any table modifications that are still buffered in memory by using `FLUSH TABLES`. You should then ensure that no one is using the tables while you are running `myisamchk`.

However, the easiest way to avoid this problem is to use `CHECK TABLE` instead of `myisamchk` to check tables. See [Section 13.7.2.2, “CHECK TABLE Statement”](#).

`myisamchk` supports the following options, which can be specified on the command line or in the `[myisamchk]` group of an option file. For information about option files used by MySQL programs, see [Section 4.2.2.2, “Using Option Files”](#).

**Table 4.21 myisamchk Options**

Option Name	Description
<code>--analyze</code>	Analyze the distribution of key values
<code>--backup</code>	Make a backup of the <code>.MYD</code> file as <code>file_name-time.BAK</code>
<code>--block-search</code>	Find the record that a block at the given offset belongs to
<code>--character-sets-dir</code>	Directory where character sets can be found
<code>--check</code>	Check the table for errors
<code>--check-only-changed</code>	Check only tables that have changed since the last check
<code>--correct-checksum</code>	Correct the checksum information for the table
<code>--data-file-length</code>	Maximum length of the data file (when re-creating data file when it is full)
<code>--debug</code>	Write debugging log
<code>--decode_bits</code>	Decode_bits
<code>--defaults-extra-file</code>	Read named option file in addition to usual option files
<code>--defaults-file</code>	Read only named option file
<code>--defaults-group-suffix</code>	Option group suffix value
<code>--description</code>	Print some descriptive information about the table



Option Name	Description
<code>--extend-check</code>	Do very thorough table check or repair that tries to recover every possible row from the data file
<code>--fast</code>	Check only tables that haven't been closed properly
<code>--force</code>	Do a repair operation automatically if myisamchk finds any errors in the table
<code>--force</code>	Overwrite old temporary files. For use with the <code>-r</code> or <code>-o</code> option
<code>--ft_max_word_len</code>	Maximum word length for FULLTEXT indexes
<code>--ft_min_word_len</code>	Minimum word length for FULLTEXT indexes
<code>--ft_stopword_file</code>	Use stopwords from this file instead of built-in list
<code>--HELP</code>	Display help message and exit
<code>--help</code>	Display help message and exit
<code>--information</code>	Print informational statistics about the table that is checked
<code>--key_buffer_size</code>	Size of buffer used for index blocks for MyISAM tables
<code>--keys-used</code>	A bit-value that indicates which indexes to update
<code>--max-record-length</code>	Skip rows larger than the given length if myisamchk cannot allocate memory to hold them
<code>--medium-check</code>	Do a check that is faster than an <code>--extend-check</code> operation
<code>--myisam_block_size</code>	Block size to be used for MyISAM index pages
<code>--myisam_sort_buffer_size</code>	The buffer that is allocated when sorting the index when doing a REPAIR or when creating indexes with CREATE INDEX or ALTER TABLE
<code>--no-defaults</code>	Read no option files
<code>--parallel-recover</code>	Uses the same technique as <code>-r</code> and <code>-n</code> , but creates all the keys in parallel, using different threads (beta)
<code>--print-defaults</code>	Print default options
<code>--quick</code>	Achieve a faster repair by not modifying the data file
<code>--read_buffer_size</code>	Each thread that does a sequential scan allocates a buffer of this size for each table it scans
<code>--read-only</code>	Do not mark the table as checked
<code>--recover</code>	Do a repair that can fix almost any problem except unique keys that aren't unique
<code>--safe-recover</code>	Do a repair using an old recovery method that reads through all rows in order and updates all index trees based on the rows found
<code>--set-auto-increment</code>	Force AUTO_INCREMENT numbering for new records to start at the given value
<code>--set-collation</code>	Specify the collation to use for sorting table indexes
<code>--silent</code>	Silent mode

Option Name	Description
--sort_buffer_size	The buffer that is allocated when sorting the index when doing a REPAIR or when creating indexes with CREATE INDEX or ALTER TABLE
--sort-index	Sort the index tree blocks in high-low order
--sort_key_blocks	sort_key_blocks
--sort-records	Sort records according to a particular index
--sort-recover	Force myisamchk to use sorting to resolve the keys even if the temporary files would be very large
--stats_method	Specifies how MyISAM index statistics collection code should treat NULLs
--tmpdir	Directory to be used for storing temporary files
--unpack	Unpack a table that was packed with myisampack
--update-state	Store information in the .MYI file to indicate when the table was checked and whether the table crashed
--verbose	Verbose mode
--version	Display version information and exit
--wait	Wait for locked table to be unlocked, instead of terminating
--write_buffer_size	Write buffer size

### 4.6.3.1 myisamchk General Options

The options described in this section can be used for any type of table maintenance operation performed by `myisamchk`. The sections following this one describe options that pertain only to specific operations, such as table checking or repairing.

- `--help, -?`

Command-Line Format	<code>--help</code>
---------------------	---------------------

Display a help message and exit. Options are grouped by type of operation.

- `--HELP, -H`

Command-Line Format	<code>--HELP</code>
---------------------	---------------------

Display a help message and exit. Options are presented in a single list.

- `--debug=debug_options, -# debug_options`

Command-Line Format	<code>--debug[=<i>debug_options</i>]</code>
Type	String
Default Value	<code>d:t:o,/tmp/myisamchk.trace</code>

Write a debugging log. A typical *debug\_options* string is `d:t:o,file_name`. The default is `d:t:o,/tmp/myisamchk.trace`.

This option is available only if MySQL was built using `WITH_DEBUG`. MySQL release binaries provided by Oracle are *not* built using this option.

- `--defaults-extra-file=file_name`

Command-Line Format	<code>--defaults-extra-file=file_name</code>
Type	File name

Read this option file after the global option file but (on Unix) before the user option file. If the file does not exist or is otherwise inaccessible, an error occurs. If *file\_name* is not an absolute path name, it is interpreted relative to the current directory.

For additional information about this and other option-file options, see [Section 4.2.2.3, “Command-Line Options that Affect Option-File Handling”](#).

- `--defaults-file=file_name`

Command-Line Format	<code>--defaults-file=file_name</code>
Type	File name

Use only the given option file. If the file does not exist or is otherwise inaccessible, an error occurs. If *file\_name* is not an absolute path name, it is interpreted relative to the current directory.

For additional information about this and other option-file options, see [Section 4.2.2.3, “Command-Line Options that Affect Option-File Handling”](#).

- `--defaults-group-suffix=str`

Command-Line Format	<code>--defaults-group-suffix=str</code>
Type	String

Read not only the usual option groups, but also groups with the usual names and a suffix of *str*. For example, `myisamchk` normally reads the `[myisamchk]` group. If this option is given as `--defaults-group-suffix=_other`, `myisamchk` also reads the `[myisamchk_other]` group.

For additional information about this and other option-file options, see [Section 4.2.2.3, “Command-Line Options that Affect Option-File Handling”](#).

- `--no-defaults`

Command-Line Format	<code>--no-defaults</code>
---------------------	----------------------------

Do not read any option files. If program startup fails due to reading unknown options from an option file, `--no-defaults` can be used to prevent them from being read.

The exception is that the `.mylogin.cnf` file is read in all cases, if it exists. This permits passwords to

`.mylogin.cnf`, use the `mysql_config_editor` utility. See [Section 4.6.6, “mysql\\_config\\_editor — MySQL Configuration Utility”](#).

For additional information about this and other option-file options, see [Section 4.2.2.3, “Command-Line Options that Affect Option-File Handling”](#).

- `--print-defaults`

Command-Line Format	<code>--print-defaults</code>
---------------------	-------------------------------

Print the program name and all options that it gets from option files.

For additional information about this and other option-file options, see [Section 4.2.2.3, “Command-Line Options that Affect Option-File Handling”](#).

- `--silent, -s`

Command-Line Format	<code>--silent</code>
---------------------	-----------------------

Silent mode. Write output only when errors occur. You can use `-s` twice (`-ss`) to make `myisamchk` very silent.

- `--verbose, -v`

Command-Line Format	<code>--verbose</code>
---------------------	------------------------

Verbose mode. Print more information about what the program does. This can be used with `-d` and `-e`. Use `-v` multiple times (`-vv`, `-vvv`) for even more output.

- `--version, -V`

Command-Line Format	<code>--version</code>
---------------------	------------------------

Display version information and exit.

- `--wait, -w`

Command-Line Format	<code>--wait</code>
Type	Boolean
Default Value	<code>false</code>

Instead of terminating with an error if the table is locked, wait until the table is unlocked before continuing. If you are running `mysqld` with external locking disabled, the table can be locked only by another `myisamchk` command.

You can also set the following variables by using `--var_name=value` syntax:

Variable	Default Value
<code>decode_bits</code>	9
<code>ft_max_word_len</code>	version-dependent

Variable	Default Value
<code>ft_min_word_len</code>	4
<code>ft_stopword_file</code>	built-in list
<code>key_buffer_size</code>	523264
<code>myisam_block_size</code>	1024
<code>myisam_sort_key_blocks</code>	16
<code>read_buffer_size</code>	262136
<code>sort_buffer_size</code>	2097144
<code>sort_key_blocks</code>	16
<code>stats_method</code>	nulls_unequal
<code>write_buffer_size</code>	262136

The possible `myisamchk` variables and their default values can be examined with `myisamchk --help`:

`myisam_sort_buffer_size` is used when the keys are repaired by sorting keys, which is the normal case when you use `--recover`. `sort_buffer_size` is a deprecated synonym for `myisam_sort_buffer_size`.

`key_buffer_size` is used when you are checking the table with `--extend-check` or when the keys are repaired by inserting keys row by row into the table (like when doing normal inserts). Repairing through the key buffer is used in the following cases:

- You use `--safe-recover`.
- The temporary files needed to sort the keys would be more than twice as big as when creating the key file directly. This is often the case when you have large key values for `CHAR`, `VARCHAR`, or `TEXT` columns, because the sort operation needs to store the complete key values as it proceeds. If you have lots of temporary space and you can force `myisamchk` to repair by sorting, you can use the `--sort-recover` option.

Repairing through the key buffer takes much less disk space than using sorting, but is also much slower.

If you want a faster repair, set the `key_buffer_size` and `myisam_sort_buffer_size` variables to about 25% of your available memory. You can set both variables to large values, because only one of them is used at a time.

`myisam_block_size` is the size used for index blocks.

`stats_method` influences how `NULL` values are treated for index statistics collection when the `--analyze` option is given. It acts like the `myisam_stats_method` system variable. For more information, see the description of `myisam_stats_method` in [Section 5.1.7, “Server System Variables”](#), and [Section 8.3.7, “InnoDB and MyISAM Index Statistics Collection”](#).

`ft_min_word_len` and `ft_max_word_len` indicate the minimum and maximum word length for `FULLTEXT` indexes on `MyISAM` tables. `ft_stopword_file` names the stopword file. These need to be set under the following circumstances.

If you use `myisamchk` to perform an operation that modifies table indexes (such as repair or analyze), the `FULLTEXT` indexes are rebuilt using the default full-text parameter values for minimum and maximum word length and the stopword file unless you specify otherwise. This can result in queries failing.

The problem occurs because these parameters are known only by the server. They are not stored in `MyISAM` index files. To avoid the problem if you have modified the minimum or maximum word length

or the stopword file in the server, specify the same `ft_min_word_len`, `ft_max_word_len`, and `ft_stopword_file` values to `myisamchk` that you use for `mysqld`. For example, if you have set the minimum word length to 3, you can repair a table with `myisamchk` like this:

```
myisamchk --recover --ft_min_word_len=3 tbl_name.MYI
```

To ensure that `myisamchk` and the server use the same values for full-text parameters, you can place each one in both the `[mysqld]` and `[myisamchk]` sections of an option file:

```
[mysqld]
ft_min_word_len=3

[myisamchk]
ft_min_word_len=3
```

An alternative to using `myisamchk` is to use the `REPAIR TABLE`, `ANALYZE TABLE`, `OPTIMIZE TABLE`, or `ALTER TABLE`. These statements are performed by the server, which knows the proper full-text parameter values to use.

### 4.6.3.2 myisamchk Check Options

`myisamchk` supports the following options for table checking operations:

- `--check, -c`

Command-Line Format	<code>--check</code>
---------------------	----------------------

Check the table for errors. This is the default operation if you specify no option that selects an operation type explicitly.

- `--check-only-changed, -C`

Command-Line Format	<code>--check-only-changed</code>
---------------------	-----------------------------------

Check only tables that have changed since the last check.

- `--extend-check, -e`

Command-Line Format	<code>--extend-check</code>
---------------------	-----------------------------

Check the table very thoroughly. This is quite slow if the table has many indexes. This option should only be used in extreme cases. Normally, `myisamchk` or `myisamchk --medium-check` should be able to determine whether there are any errors in the table.

If you are using `--extend-check` and have plenty of memory, setting the `key_buffer_size` variable to a large value helps the repair operation run faster.

See also the description of this option under table repair options.

For a description of the output format, see [Section 4.6.3.5, “Obtaining Table Information with myisamchk”](#).

- `--fast, -F`

Command-Line Format	<code>--fast</code>
---------------------	---------------------

Check only tables that haven't been closed properly.

- `--force, -f`

Command-Line Format	<code>--force</code>
---------------------	----------------------

Do a repair operation automatically if `myisamchk` finds any errors in the table. The repair type is the same as that specified with the `--recover` or `-r` option.

- `--information, -i`

Command-Line Format	<code>--information</code>
---------------------	----------------------------

Print informational statistics about the table that is checked.

- `--medium-check, -m`

Command-Line Format	<code>--medium-check</code>
---------------------	-----------------------------

Do a check that is faster than an `--extend-check` operation. This finds only 99.99% of all errors, which should be good enough in most cases.

- `--read-only, -T`

Command-Line Format	<code>--read-only</code>
---------------------	--------------------------

Do not mark the table as checked. This is useful if you use `myisamchk` to check a table that is in use by some other application that does not use locking, such as `mysqld` when run with external locking disabled.

- `--update-state, -U`

Command-Line Format	<code>--update-state</code>
---------------------	-----------------------------

Store information in the `.MYI` file to indicate when the table was checked and whether the table crashed. This should be used to get full benefit of the `--check-only-changed` option, but you shouldn't use this option if the `mysqld` server is using the table and you are running it with external locking disabled.

### 4.6.3.3 myisamchk Repair Options

`myisamchk` supports the following options for table repair operations (operations performed when an option such as `--recover` or `--safe-recover` is given):

- `--backup, -B`

Command-Line Format	<code>--backup</code>
---------------------	-----------------------

Make a backup of the `.MYD` file as `file_name-time.BAK`

- `--character-sets-dir=dir_name`

Command-Line Format	<code>--character-sets-dir=path</code>
Type	String
Default Value	[none]

The directory where character sets are installed. See [Section 10.15, “Character Set Configuration”](#).

- `--correct-checksum`

Command-Line Format	<code>--correct-checksum</code>
---------------------	---------------------------------

Correct the checksum information for the table.

- `--data-file-length=len, -D len`

Command-Line Format	<code>--data-file-length=len</code>
Type	Numeric

The maximum length of the data file (when re-creating data file when it is “full”).

- `--extend-check, -e`

Command-Line Format	<code>--extend-check</code>
---------------------	-----------------------------

Do a repair that tries to recover every possible row from the data file. Normally, this also finds a lot of garbage rows. Do not use this option unless you are desperate.

See also the description of this option under table checking options.

For a description of the output format, see [Section 4.6.3.5, “Obtaining Table Information with myisamchk”](#).

- `--force, -f`

Command-Line Format	<code>--force</code>
---------------------	----------------------

Overwrite old intermediate files (files with names like `tbl_name.TMD`) instead of aborting.

- `--keys-used=val, -k val`

Command-Line Format	<code>--keys-used=val</code>
Type	Numeric

For `myisamchk`, the option value is a bit value that indicates which indexes to update. Each binary bit of the option value corresponds to a table index, where the first index is bit 0. An option value of 0 disables updates to all indexes, which can be used to get faster inserts. Deactivated indexes can be reactivated by using `myisamchk -r`.

- `--max-record-length=len`



Command-Line Format	<code>--max-record-length=len</code>
Type	Numeric

Skip rows larger than the given length if `myisamchk` cannot allocate memory to hold them.

- `--parallel-recover, -p`

Command-Line Format	<code>--parallel-recover</code>
---------------------	---------------------------------



**Note**

This option is deprecated in MySQL 5.7.38 and removed in MySQL 5.7.39.

Use the same technique as `-r` and `-n`, but create all the keys in parallel, using different threads. *This is beta-quality code. Use at your own risk!*

- `--quick, -q`

Command-Line Format	<code>--quick</code>
---------------------	----------------------

Achieve a faster repair by modifying only the index file, not the data file. You can specify this option twice to force `myisamchk` to modify the original data file in case of duplicate keys.

- `--recover, -r`

Command-Line Format	<code>--recover</code>
---------------------	------------------------

Do a repair that can fix almost any problem except unique keys that are not unique (which is an extremely unlikely error with `MyISAM` tables). If you want to recover a table, this is the option to try first. You should try `--safe-recover` only if `myisamchk` reports that the table cannot be recovered using `--recover`. (In the unlikely case that `--recover` fails, the data file remains intact.)

If you have lots of memory, you should increase the value of `myisam_sort_buffer_size`.

- `--safe-recover, -o`

Command-Line Format	<code>--safe-recover</code>
---------------------	-----------------------------

Do a repair using an old recovery method that reads through all rows in order and updates all index trees based on the rows found. This is an order of magnitude slower than `--recover`, but can handle a couple of very unlikely cases that `--recover` cannot. This recovery method also uses much less disk space than `--recover`. Normally, you should repair first using `--recover`, and then with `--safe-recover` only if `--recover` fails.

If you have lots of memory, you should increase the value of `key_buffer_size`.

- `--set-collation=name`

Command-Line Format	<code>--set-collation=name</code>
---------------------	-----------------------------------

Type	String
------	--------

Specify the collation to use for sorting table indexes. The character set name is implied by the first part of the collation name.

- `--sort-recover, -n`

Command-Line Format	<code>--sort-recover</code>
---------------------	-----------------------------

Force `myisamchk` to use sorting to resolve the keys even if the temporary files would be very large.

- `--tmpdir=dir_name, -t dir_name`

Command-Line Format	<code>--tmpdir=dir_name</code>
Type	Directory name

The path of the directory to be used for storing temporary files. If this is not set, `myisamchk` uses the value of the `TMPDIR` environment variable. `--tmpdir` can be set to a list of directory paths that are used successively in round-robin fashion for creating temporary files. The separator character between directory names is the colon (`:`) on Unix and the semicolon (`;`) on Windows.

- `--unpack, -u`

Command-Line Format	<code>--unpack</code>
---------------------	-----------------------

Unpack a table that was packed with `myisampack`.

#### 4.6.3.4 Other myisamchk Options

`myisamchk` supports the following options for actions other than table checks and repairs:

- `--analyze, -a`

Command-Line Format	<code>--analyze</code>
---------------------	------------------------

Analyze the distribution of key values. This improves join performance by enabling the join optimizer to better choose the order in which to join the tables and which indexes it should use. To obtain information about the key distribution, use a `myisamchk --description --verbose tbl_name` command or the `SHOW INDEX FROM tbl_name` statement.

- `--block-search=offset, -b offset`

Command-Line Format	<code>--block-search=offset</code>
Type	Numeric

Find the record that a block at the given offset belongs to.

- `--description, -d`

Command-Line Format	<code>--description</code>
---------------------	----------------------------

Print some descriptive information about the table. Specifying the `--verbose` option once or twice produces additional information. See [Section 4.6.3.5, “Obtaining Table Information with myisamchk”](#).

- `--set-auto-increment[=value], -A[value]`

Force `AUTO_INCREMENT` numbering for new records to start at the given value (or higher, if there are existing records with `AUTO_INCREMENT` values this large). If `value` is not specified, `AUTO_INCREMENT` numbers for new records begin with the largest value currently in the table, plus one.

- `--sort-index, -S`

Command-Line Format	<code>--sort-index</code>
---------------------	---------------------------

Sort the index tree blocks in high-low order. This optimizes seeks and makes table scans that use indexes faster.

- `--sort-records=N, -R N`

Command-Line Format	<code>--sort-records=#</code>
Type	Numeric

Sort records according to a particular index. This makes your data much more localized and may speed up range-based `SELECT` and `ORDER BY` operations that use this index. (The first time you use this option to sort a table, it may be very slow.) To determine a table's index numbers, use `SHOW INDEX`, which displays a table's indexes in the same order that `myisamchk` sees them. Indexes are numbered beginning with 1.

If keys are not packed (`PACK_KEYS=0`), they have the same length, so when `myisamchk` sorts and moves records, it just overwrites record offsets in the index. If keys are packed (`PACK_KEYS=1`), `myisamchk` must unpack key blocks first, then re-create indexes and pack the key blocks again. (In this case, re-creating indexes is faster than updating offsets for each index.)

### 4.6.3.5 Obtaining Table Information with myisamchk

To obtain a description of a `MyISAM` table or statistics about it, use the commands shown here. The output from these commands is explained later in this section.

- `myisamchk -d tbl_name`

Runs `myisamchk` in “describe mode” to produce a description of your table. If you start the MySQL server with external locking disabled, `myisamchk` may report an error for a table that is updated while it runs. However, because `myisamchk` does not change the table in describe mode, there is no risk of destroying data.

- `myisamchk -dv tbl_name`

Adding `-v` runs `myisamchk` in verbose mode so that it produces more information about the table. Adding `-v` a second time produces even more information.

- `myisamchk -eis tbl_name`

Shows only the most important information from a table. This operation is slow because it must read the entire table.

- `myisamchk -eiv tbl_name`

This is like `-eis`, but tells you what is being done.

The `tbl_name` argument can be either the name of a MyISAM table or the name of its index file, as described in Section 4.6.3, “myisamchk — MyISAM Table-Maintenance Utility”. Multiple `tbl_name` arguments can be given.

Suppose that a table named `person` has the following structure. (The `MAX_ROWS` table option is included so that in the example output from `myisamchk` shown later, some values are smaller and fit the output format more easily.)

```
CREATE TABLE person
(
  id          INT NOT NULL AUTO_INCREMENT,
  last_name   VARCHAR(20) NOT NULL,
  first_name  VARCHAR(20) NOT NULL,
  birth       DATE,
  death       DATE,
  PRIMARY KEY (id),
  INDEX (last_name, first_name),
  INDEX (birth)
) MAX_ROWS = 1000000 ENGINE=MYISAM;
```

Suppose also that the table has these data and index file sizes:

```
-rw-rw---- 1 mysql mysql 9347072 Aug 19 11:47 person.MYD
-rw-rw---- 1 mysql mysql 6066176 Aug 19 11:47 person.MYI
```

Example of `myisamchk -dvv` output:

```
MyISAM file:      person
Record format:    Packed
Character set:    latin1_swedish_ci (8)
File-version:     1
Creation time:    2009-08-19 16:47:41
Recover time:     2009-08-19 16:47:56
Status:           checked,analyzed,optimized keys
Auto increment key: 1 Last value: 306688
Data records:     306688 Deleted blocks: 0
Datafile parts:   306688 Deleted data: 0
Datafile pointer (bytes): 4 Keyfile pointer (bytes): 3
Datafile length: 9347072 Keyfile length: 6066176
Max datafile length: 4294967294 Max keyfile length: 17179868159
Recordlength:    54

table description:
Key Start Len Index Type Rec/key Root Blocksize
1 2 4 unique long 1 99328 1024
2 6 20 multip. varchar prefix 512 3563520 1024
 27 20 varchar 512
3 48 3 multip. uint24 NULL 306688 6065152 1024

Field Start Length Nullpos Nullbit Type
1 1 1
2 2 4 no zeros
3 6 21 varchar
4 27 21 varchar
5 48 3 1 1 no zeros
6 51 3 1 2 no zeros
```

Explanations for the types of information `myisamchk` produces are given here. “Keyfile” refers to the index file. “Record” and “row” are synonymous, as are “field” and “column.”

The initial part of the table description contains these values:

- `MyISAM file`  
Name of the `MyISAM` (index) file.
- `Record format`  
The format used to store table rows. The preceding examples use `Fixed length`. Other possible values are `Compressed` and `Packed`. (`Packed` corresponds to what `SHOW TABLE STATUS` reports as `Dynamic`.)
- `Character set`  
The table default character set.
- `File-version`  
Version of `MyISAM` format. Always 1.
- `Creation time`  
When the data file was created.
- `Recover time`  
When the index/data file was last reconstructed.
- `Status`  
Table status flags. Possible values are `crashed`, `open`, `changed`, `analyzed`, `optimized keys`, and `sorted index pages`.
- `Auto increment key, Last value`  
The key number associated the table's `AUTO_INCREMENT` column, and the most recently generated value for this column. These fields do not appear if there is no such column.
- `Data records`  
The number of rows in the table.
- `Deleted blocks`  
How many deleted blocks still have reserved space. You can optimize your table to minimize this space. See [Section 7.6.4, "MyISAM Table Optimization"](#).
- `Datafile parts`  
For dynamic-row format, this indicates how many data blocks there are. For an optimized table without fragmented rows, this is the same as `Data records`.
- `Deleted data`  
How many bytes of unreclaimed deleted data there are. You can optimize your table to minimize this space. See [Section 7.6.4, "MyISAM Table Optimization"](#).
- `Datafile pointer`  
The size of the data file pointer, in bytes. It is usually 2, 3, 4, or 5 bytes. Most tables manage with 2 bytes, but this cannot be controlled from MySQL yet. For fixed tables, this is a row address. For dynamic tables, this is a byte address.

- `Keyfile pointer`

The size of the index file pointer, in bytes. It is usually 1, 2, or 3 bytes. Most tables manage with 2 bytes, but this is calculated automatically by MySQL. It is always a block address.

- `Max datafile length`

How long the table data file can become, in bytes.

- `Max keyfile length`

How long the table index file can become, in bytes.

- `Recordlength`

How much space each row takes, in bytes.

The `table description` part of the output includes a list of all keys in the table. For each key, `myisamchk` displays some low-level information:

- `Key`

This key's number. This value is shown only for the first column of the key. If this value is missing, the line corresponds to the second or later column of a multiple-column key. For the table shown in the example, there are two `table description` lines for the second index. This indicates that it is a multiple-part index with two parts.

- `Start`

Where in the row this portion of the index starts.

- `Len`

How long this portion of the index is. For packed numbers, this should always be the full length of the column. For strings, it may be shorter than the full length of the indexed column, because you can index a prefix of a string column. The total length of a multiple-part key is the sum of the `Len` values for all key parts.

- `Index`

Whether a key value can exist multiple times in the index. Possible values are `unique` or `multip.` (multiple).

- `Type`

What data type this portion of the index has. This is a `MyISAM` data type with the possible values `packed`, `stripped`, or `empty`.

- `Root`

Address of the root index block.

- `Blocksize`

The size of each index block. By default this is 1024, but the value may be changed at compile time when MySQL is built from source.

- `Rec/key`

This is a statistical value used by the optimizer. It tells how many rows there are per value for this index. A unique index always has a value of 1. This may be updated after a table is loaded (or greatly changed) with `myisamchk -a`. If this is not updated at all, a default value of 30 is given.

The last part of the output provides information about each column:

- `Field`

The column number.

- `Start`

The byte position of the column within table rows.

- `Length`

The length of the column in bytes.

- `Nullpos, Nullbit`

For columns that can be `NULL`, MyISAM stores `NULL` values as a flag in a byte. Depending on how many nullable columns there are, there can be one or more bytes used for this purpose. The `Nullpos` and `Nullbit` values, if nonempty, indicate which byte and bit contains that flag indicating whether the column is `NULL`.

The position and number of bytes used to store `NULL` flags is shown in the line for field 1. This is why there are six `Field` lines for the `person` table even though it has only five columns.

- `Type`

The data type. The value may contain any of the following descriptors:

- `constant`

All rows have the same value.

- `no endspace`

Do not store endspace.

- `no endspace, not_always`

Do not store endspace and do not do endspace compression for all values.

- `no endspace, no empty`

Do not store endspace. Do not store empty values.

- `table-lookup`

The column was converted to an `ENUM`.

- `zerofill(N)`

The most significant `N` bytes in the value are always 0 and are not stored.

- `no zeros`

Do not store zeros.

- `always zero`

Zero values are stored using one bit.

- `Huff tree`

The number of the Huffman tree associated with the column.

- `Bits`

The number of bits used in the Huffman tree.

The `Huff tree` and `Bits` fields are displayed if the table has been compressed with `myisampack`. See [Section 4.6.5, “myisampack — Generate Compressed, Read-Only MyISAM Tables”](#), for an example of this information.

Example of `myisamchk -eiv` output:

```
Checking MyISAM file: person
Data records: 306688 Deleted blocks: 0
- check file-size
- check record delete-chain
No recordlinks
- check key delete-chain
block_size 1024:
- check index reference
- check data record references index: 1
Key: 1: Keyblocks used: 98% Packed: 0% Max levels: 3
- check data record references index: 2
Key: 2: Keyblocks used: 99% Packed: 97% Max levels: 3
- check data record references index: 3
Key: 3: Keyblocks used: 98% Packed: -14% Max levels: 3
Total: Keyblocks used: 98% Packed: 89%

- check records and index references
*** LOTS OF ROW NUMBERS DELETED ***

Records: 306688 M.recordlength: 25 Packed: 83%
Recordspace used: 97% Empty space: 2% Blocks/Record: 1.00
Record blocks: 306688 Delete blocks: 0
Record data: 7934464 Deleted data: 0
Lost space: 256512 Linkdata: 1156096

User time 43.08, System time 1.68
Maximum resident set size 0, Integral resident set size 0
Non-physical pagefaults 0, Physical pagefaults 0, Swaps 0
Blocks in 0 out 7, Messages in 0 out 0, Signals 0
Voluntary context switches 0, Involuntary context switches 0
Maximum memory usage: 1046926 bytes (1023k)
```

`myisamchk -eiv` output includes the following information:

- `Data records`

The number of rows in the table.

- `Deleted blocks`

How many deleted blocks still have reserved space. You can optimize your table to minimize this space. See [Section 7.6.4, “MyISAM Table Optimization”](#).



- `Key`

The key number.

- `Keyblocks used`

What percentage of the keyblocks are used. When a table has just been reorganized with `myisamchk`, the values are very high (very near theoretical maximum).

- `Packed`

MySQL tries to pack key values that have a common suffix. This can only be used for indexes on `CHAR` and `VARCHAR` columns. For long indexed strings that have similar leftmost parts, this can significantly reduce the space used. In the preceding example, the second key is 40 bytes long and a 97% reduction in space is achieved.

- `Max levels`

How deep the B-tree for this key is. Large tables with long key values get high values.

- `Records`

How many rows are in the table.

- `M.recordlength`

The average row length. This is the exact row length for tables with fixed-length rows, because all rows have the same length.

- `Packed`

MySQL strips spaces from the end of strings. The `Packed` value indicates the percentage of savings achieved by doing this.

- `Recordspace used`

What percentage of the data file is used.

- `Empty space`

What percentage of the data file is unused.

- `Blocks/Record`

Average number of blocks per row (that is, how many links a fragmented row is composed of). This is always 1.0 for fixed-format tables. This value should stay as close to 1.0 as possible. If it gets too large, you can reorganize the table. See [Section 7.6.4, “MyISAM Table Optimization”](#).

- `Recordblocks`

How many blocks (links) are used. For fixed-format tables, this is the same as the number of rows.

- `Deleteblocks`

How many blocks (links) are deleted.

- `Recorddata`

How many bytes in the data file are used.

- Deleted data

How many bytes in the data file are deleted (unused).

- Lost space

If a row is updated to a shorter length, some space is lost. This is the sum of all such losses, in bytes.

- Linkdata

When the dynamic table format is used, row fragments are linked with pointers (4 to 7 bytes each). [Linkdata](#) is the sum of the amount of storage used by all such pointers.

#### 4.6.3.6 myisamchk Memory Usage

Memory allocation is important when you run [myisamchk](#). [myisamchk](#) uses no more memory than its memory-related variables are set to. If you are going to use [myisamchk](#) on very large tables, you should first decide how much memory you want it to use. The default is to use only about 3MB to perform repairs. By using larger values, you can get [myisamchk](#) to operate faster. For example, if you have more than 512MB RAM available, you could use options such as these (in addition to any other options you might specify):

```
myisamchk --myisam_sort_buffer_size=256M \
  --key_buffer_size=512M \
  --read_buffer_size=64M \
  --write_buffer_size=64M ...
```

Using `--myisam_sort_buffer_size=16M` is probably enough for most cases.

Be aware that [myisamchk](#) uses temporary files in `TMPDIR`. If `TMPDIR` points to a memory file system, out of memory errors can easily occur. If this happens, run [myisamchk](#) with the `--tmpdir=dir_name` option to specify a directory located on a file system that has more space.

When performing repair operations, [myisamchk](#) also needs a lot of disk space:

- Twice the size of the data file (the original file and a copy). This space is not needed if you do a repair with `--quick`; in this case, only the index file is re-created. *This space must be available on the same file system as the original data file*, as the copy is created in the same directory as the original.
- Space for the new index file that replaces the old one. The old index file is truncated at the start of the repair operation, so you usually ignore this space. This space must be available on the same file system as the original data file.
- When using `--recover` or `--sort-recover` (but not when using `--safe-recover`), you need space on disk for sorting. This space is allocated in the temporary directory (specified by `TMPDIR` or `--tmpdir=dir_name`). The following formula yields the amount of space required:

```
(largest_key + row_pointer_length) * number_of_rows * 2
```

You can check the length of the keys and the `row_pointer_length` with `myisamchk -dv tbl_name` (see [Section 4.6.3.5, "Obtaining Table Information with myisamchk"](#)). The `row_pointer_length` and `number_of_rows` values are the `Datafile pointer` and `Data records` values in the table description. To determine the `largest_key` value, check the `Key` lines in the table description. The `Len` column indicates the number of bytes for each key part. For a multiple-column index, the key size is the sum of the `Len` values for all key parts.

If you have a problem with disk space during repair, you can try `--safe-recover` instead of `--recover`.

#### 4.6.4 myisamlog — Display MyISAM Log File Contents

`myisamlog` processes the contents of a `MyISAM` log file. To create such a file, start the server with a `--log-isam=log_file` option.

Invoke `myisamlog` like this:

```
myisamlog [options] [file_name [tbl_name] ...]
```

The default operation is update (`-u`). If a recovery is done (`-r`), all writes and possibly updates and deletes are done and errors are only counted. The default log file name is `myisam.log` if no `log_file` argument is given. If tables are named on the command line, only those tables are updated.

`myisamlog` supports the following options:

- `-?, -I`  
Display a help message and exit.
- `-c N`  
Execute only `N` commands.
- `-f N`  
Specify the maximum number of open files.
- `-F filepath/`  
Specify the file path with a trailing slash.
- `-i`  
Display extra information before exiting.
- `-o offset`  
Specify the starting offset.
- `-p N`  
Remove `N` components from path.
- `-r`  
Perform a recovery operation.
- `-R record_pos_file record_pos`  
Specify record position file and record position.
- `-u`  
Perform an update operation.
- `-v`  
Verbose mode. Print more output about what the program does. This option can be given multiple times to produce more and more output.
- `-w write_file`  
Specify the write file.

- `-V`

Display version information.

## 4.6.5 myisampack — Generate Compressed, Read-Only MyISAM Tables

The `myisampack` utility compresses MyISAM tables. `myisampack` works by compressing each column in the table separately. Usually, `myisampack` packs the data file 40% to 70%.

When the table is used later, the server reads into memory the information needed to decompress columns. This results in much better performance when accessing individual rows, because you only have to uncompress exactly one row.

MySQL uses `mmap()` when possible to perform memory mapping on compressed tables. If `mmap()` does not work, MySQL falls back to normal read/write file operations.

Please note the following:

- If the `mysqld` server was invoked with external locking disabled, it is not a good idea to invoke `myisampack` if the table might be updated by the server during the packing process. It is safest to compress tables with the server stopped.
- After packing a table, it becomes read only. This is generally intended (such as when accessing packed tables on a CD).
- `myisampack` does not support partitioned tables.

Invoke `myisampack` like this:

```
myisampack [options] file_name ...
```

Each file name argument should be the name of an index (`.MYI`) file. If you are not in the database directory, you should specify the path name to the file. It is permissible to omit the `.MYI` extension.

After you compress a table with `myisampack`, use `myisamchk -rq` to rebuild its indexes. [Section 4.6.3, “myisamchk — MyISAM Table-Maintenance Utility”](#).

`myisampack` supports the following options. It also reads option files and supports the options for processing them described at [Section 4.2.2.3, “Command-Line Options that Affect Option-File Handling”](#).

- `--help, -?`

Command-Line Format	<code>--help</code>
---------------------	---------------------

Display a help message and exit.

- `--backup, -b`

Command-Line Format	<code>--backup</code>
---------------------	-----------------------

Make a backup of each table's data file using the name `tbl_name.OLD`.

- `--character-sets-dir=dir_name`

Command-Line Format	<code>--character-sets-dir=dir_name</code>
Type	Directory name

The directory where character sets are installed. See [Section 10.15, “Character Set Configuration”](#).

- `--debug[=debug_options], -# [debug_options]`

Command-Line Format	<code>--debug[=<i>debug_options</i>]</code>
Type	String
Default Value	<code>d:t:o</code>

Write a debugging log. A typical *debug\_options* string is `d:t:o,file_name`. The default is `d:t:o`.

This option is available only if MySQL was built using `WITH_DEBUG`. MySQL release binaries provided by Oracle are *not* built using this option.

- `--force, -f`

Command-Line Format	<code>--force</code>
---------------------	----------------------

Produce a packed table even if it becomes larger than the original or if the intermediate file from an earlier invocation of `myisampack` exists. (`myisampack` creates an intermediate file named *tbl\_name*.TMD in the database directory while it compresses the table. If you kill `myisampack`, the .TMD file might not be deleted.) Normally, `myisampack` exits with an error if it finds that *tbl\_name*.TMD exists. With `--force`, `myisampack` packs the table anyway.

- `--join=big_tbl_name, -j big_tbl_name`

Command-Line Format	<code>--join=<i>big_tbl_name</i></code>
Type	String

Join all tables named on the command line into a single packed table *big\_tbl\_name*. All tables that are to be combined *must* have identical structure (same column names and types, same indexes, and so forth).

*big\_tbl\_name* must not exist prior to the join operation. All source tables named on the command line to be merged into *big\_tbl\_name* must exist. The source tables are read for the join operation but not modified.

- `--silent, -s`

Command-Line Format	<code>--silent</code>
---------------------	-----------------------

Silent mode. Write output only when errors occur.

- `--test, -t`

Command-Line Format	<code>--test</code>
---------------------	---------------------

Do not actually pack the table, just test packing it.

- `--tmpdir=dir_name, -T dir_name`

Command-Line Format	<code>--tmpdir=dir_name</code>
Type	Directory name

Use the named directory as the location where `myisampack` creates temporary files.

- `--verbose, -v`

Command-Line Format	<code>--verbose</code>
---------------------	------------------------

Verbose mode. Write information about the progress of the packing operation and its result.

- `--version, -V`

Command-Line Format	<code>--version</code>
---------------------	------------------------

Display version information and exit.

- `--wait, -w`

Command-Line Format	<code>--wait</code>
---------------------	---------------------

Wait and retry if the table is in use. If the `mysqld` server was invoked with external locking disabled, it is not a good idea to invoke `myisampack` if the table might be updated by the server during the packing process.

The following sequence of commands illustrates a typical table compression session:

```
$> ls -l station.*
-rw-rw-r-- 1 jones  my      994128 Apr 17 19:00 station.MYD
-rw-rw-r-- 1 jones  my      53248  Apr 17 19:00 station.MYI
-rw-rw-r-- 1 jones  my       5767  Apr 17 19:00 station.frm

$> myisamchk -dvv station

MyISAM file:      station
Isam-version:    2
Creation time:   1996-03-13 10:08:58
Recover time:    1997-02-02  3:06:43
Data records:    1192  Deleted blocks:      0
Datafile parts:  1192  Deleted data:      0
Datafile pointer (bytes): 2  Keyfile pointer (bytes): 2
Max datafile length: 54657023  Max keyfile length: 33554431
Recordlength:    834
Record format:   Fixed length

table description:
Key Start Len Index  Type          Root  Blocksize  Rec/key
1  2    4  unique  unsigned long  1024   1024      1
2  32   30  multip. text    10240  1024      1

Field Start Length Type
1     1     1
2     2     4
3     6     4
4    10     1
```

```
5 11 20
6 31 1
7 32 30
8 62 35
9 97 35
10 132 35
11 167 4
12 171 16
13 187 35
14 222 4
15 226 16
16 242 20
17 262 20
18 282 20
19 302 30
20 332 4
21 336 4
22 340 1
23 341 8
24 349 8
25 357 8
26 365 2
27 367 2
28 369 4
29 373 4
30 377 1
31 378 2
32 380 8
33 388 4
34 392 4
35 396 4
36 400 4
37 404 1
38 405 4
39 409 4
40 413 4
41 417 4
42 421 4
43 425 4
44 429 20
45 449 30
46 479 1
47 480 1
48 481 79
49 560 79
50 639 79
51 718 79
52 797 8
53 805 1
54 806 1
55 807 20
56 827 4
57 831 4

$> myisampack station.MYI
Compressing station.MYI: (1192 records)
- Calculating statistics

normal:      20  empty-space:   16  empty-zero:    12  empty-fill:   11
pre-space:   0  end-space:    12  table-lookups: 5  zero:         7
Original trees: 57  After join: 17
- Compressing file
87.14%
Remember to run myisamchk -rq on compressed tables

$> myisamchk -rq station
- check record delete-chain
```

```

- recovering (with sort) MyISAM-table 'station'
Data records: 1192
- Fixing index 1
- Fixing index 2

$> mysqladmin -uroot flush-tables

$> ls -l station.*
-rw-rw-r--  1 jones  my           127874 Apr 17 19:00 station.MYD
-rw-rw-r--  1 jones  my           55296 Apr 17 19:04 station.MYI
-rw-rw-r--  1 jones  my           5767 Apr 17 19:00 station.frm

$> myisamchk -dvv station

MyISAM file:      station
Isam-version:    2
Creation time:   1996-03-13 10:08:58
Recover time:   1997-04-17 19:04:26
Data records:   1192 Deleted blocks:      0
Datafile parts: 1192 Deleted data:        0
Datafile pointer (bytes): 3 Keyfile pointer (bytes): 1
Max datafile length: 16777215 Max keyfile length: 131071
Recordlength:   834
Record format:  Compressed

table description:
Key Start Len Index  Type                Root  Blocksize  Rec/key
1  2    4  unique unsigned long  10240  1024      1
2  32   30  multip. text        54272  1024      1

Field Start Length Type                Huff tree  Bits
1  1    1  constant                1  0
2  2    4  zerofill(1)             2  9
3  6    4  no zeros, zerofill(1)  2  9
4  10   1  3  9
5  11   20  table-lookup           4  0
6  31    1  3  9
7  32   30  no endspace, not_always 5  9
8  62   35  no endspace, not_always, no empty 6  9
9  97   35  no empty                7  9
10 132  35  no endspace, not_always, no empty 6  9
11 167   4  zerofill(1)            2  9
12 171  16  no endspace, not_always, no empty 5  9
13 187  35  no endspace, not_always, no empty 6  9
14 222   4  zerofill(1)            2  9
15 226  16  no endspace, not_always, no empty 5  9
16 242  20  no endspace, not_always  8  9
17 262  20  no endspace, no empty   8  9
18 282  20  no endspace, no empty   5  9
19 302  30  no endspace, no empty   6  9
20 332   4  always zero            2  9
21 336   4  always zero            2  9
22 340   1  3  9
23 341   8  table-lookup           9  0
24 349   8  table-lookup          10  0
25 357   8  always zero            2  9
26 365   2  2  9
27 367   2  no zeros, zerofill(1)  2  9
28 369   4  no zeros, zerofill(1)  2  9
29 373   4  table-lookup          11  0
30 377   1  3  9
31 378   2  no zeros, zerofill(1)  2  9
32 380   8  no zeros                2  9
33 388   4  always zero            2  9
34 392   4  table-lookup          12  0
35 396   4  no zeros, zerofill(1)  13  9
36 400   4  no zeros, zerofill(1)  2  9

```



37	404	1		2	9
38	405	4	no zeros	2	9
39	409	4	always zero	2	9
40	413	4	no zeros	2	9
41	417	4	always zero	2	9
42	421	4	no zeros	2	9
43	425	4	always zero	2	9
44	429	20	no empty	3	9
45	449	30	no empty	3	9
46	479	1		14	4
47	480	1		14	4
48	481	79	no endspace, no empty	15	9
49	560	79	no empty	2	9
50	639	79	no empty	2	9
51	718	79	no endspace	16	9
52	797	8	no empty	2	9
53	805	1		17	1
54	806	1		3	9
55	807	20	no empty	3	9
56	827	4	no zeros, zerofill(2)	2	9
57	831	4	no zeros, zerofill(1)	2	9

`myisampack` displays the following kinds of information:

- `normal`

The number of columns for which no extra packing is used.

- `empty-space`

The number of columns containing values that are only spaces. These occupy one bit.

- `empty-zero`

The number of columns containing values that are only binary zeros. These occupy one bit.

- `empty-fill`

The number of integer columns that do not occupy the full byte range of their type. These are changed to a smaller type. For example, a `BIGINT` column (eight bytes) can be stored as a `TINYINT` column (one byte) if all its values are in the range from `-128` to `127`.

- `pre-space`

The number of decimal columns that are stored with leading spaces. In this case, each value contains a count for the number of leading spaces.

- `end-space`

The number of columns that have a lot of trailing spaces. In this case, each value contains a count for the number of trailing spaces.

- `table-lookup`

The column had only a small number of different values, which were converted to an `ENUM` before Huffman compression.

- `zero`

The number of columns for which all values are zero.

- `Original trees`

The initial number of Huffman trees.

- `After join`

The number of distinct Huffman trees left after joining trees to save some header space.

After a table has been compressed, the `Field` lines displayed by `myisamchk -dvv` include additional information about each column:

- `Type`

The data type. The value may contain any of the following descriptors:

- `constant`

All rows have the same value.

- `no endspace`

Do not store endspace.

- `no endspace, not_always`

Do not store endspace and do not do endspace compression for all values.

- `no endspace, no empty`

Do not store endspace. Do not store empty values.

- `table-lookup`

The column was converted to an `ENUM`.

- `zerofill(N)`

The most significant `N` bytes in the value are always 0 and are not stored.

- `no zeros`

Do not store zeros.

- `always zero`

Zero values are stored using one bit.

- `Huff tree`

The number of the Huffman tree associated with the column.

- `Bits`

The number of bits used in the Huffman tree.

After you run `myisampack`, use `myisamchk` to re-create any indexes. At this time, you can also sort the index blocks and create statistics needed for the MySQL optimizer to work more efficiently:

```
myisamchk -rq --sort-index --analyze tbl_name.MYI
```

After you have installed the packed table into the MySQL database directory, you should execute `mysqladmin flush-tables` to force `mysqld` to start using the new table.

To unpack a packed table, use the `--unpack` option to `myisamchk`.

## 4.6.6 mysql\_config\_editor — MySQL Configuration Utility

The `mysql_config_editor` utility enables you to store authentication credentials in an obfuscated login path file named `.mylogin.cnf`. The file location is the `%APPDATA%\MySQL` directory on Windows and the current user's home directory on non-Windows systems. The file can be read later by MySQL client programs to obtain authentication credentials for connecting to MySQL Server.

The unobfuscated format of the `.mylogin.cnf` login path file consists of option groups, similar to other option files. Each option group in `.mylogin.cnf` is called a “login path,” which is a group that permits only certain options: `host`, `user`, `password`, `port` and `socket`. Think of a login path option group as a set of options that specify which MySQL server to connect to and which account to authenticate as. Here is an unobfuscated example:

```
[client]
user = mydefaultname
password = mydefaultpass
host = 127.0.0.1
[mypath]
user = myothername
password = myotherpass
host = localhost
```

When you invoke a client program to connect to the server, the client uses `.mylogin.cnf` in conjunction with other option files. Its precedence is higher than other option files, but less than options specified explicitly on the client command line. For information about the order in which option files are used, see [Section 4.2.2.2, “Using Option Files”](#).

To specify an alternate login path file name, set the `MYSQL_TEST_LOGIN_FILE` environment variable. This variable is recognized by `mysql_config_editor`, by standard MySQL clients (`mysql`, `mysqladmin`, and so forth), and by the `mysql-test-run.pl` testing utility.

Programs use groups in the login path file as follows:

- `mysql_config_editor` operates on the `client` login path by default if you specify no `--login-path=name` option to indicate explicitly which login path to use.
- Without a `--login-path` option, client programs read the same option groups from the login path file that they read from other option files. Consider this command:

```
mysql
```

By default, the `mysql` client reads the `[client]` and `[mysql]` groups from other option files, so it reads them from the login path file as well.

- With a `--login-path` option, client programs additionally read the named login path from the login path file. The option groups read from other option files remain the same. Consider this command:

```
mysql --login-path=mypath
```

The `mysql` client reads `[client]` and `[mysql]` from other option files, and `[client]`, `[mysql]`, and `[mypath]` from the login path file.

- Client programs read the login path file even when the `--no-defaults` option is used, unless `--no-login-paths` is set. This permits passwords to be specified in a safer way than on the command line even if `--no-defaults` is present.

`mysql_config_editor` obfuscates the `.mylogin.cnf` file so it cannot be read as cleartext, and its contents when unobfuscated by client programs are used only in memory. In this way, passwords can be stored in a file in non-cleartext format and used later without ever needing to be exposed on the command line or in an environment variable. `mysql_config_editor` provides a `print` command for displaying the login path file contents, but even in this case, password values are masked so as never to appear in a way that other users can see them.

The obfuscation used by `mysql_config_editor` prevents passwords from appearing in `.mylogin.cnf` as cleartext and provides a measure of security by preventing inadvertent password exposure. For example, if you display a regular unobfuscated `my.cnf` option file on the screen, any passwords it contains are visible for anyone to see. With `.mylogin.cnf`, that is not true, but the obfuscation used is not likely to deter a determined attacker and you should not consider it unbreakable. A user who can gain system administration privileges on your machine to access your files could unobfuscate the `.mylogin.cnf` file with some effort.

The login path file must be readable and writable to the current user, and inaccessible to other users. Otherwise, `mysql_config_editor` ignores it, and client programs do not use it, either.

Invoke `mysql_config_editor` like this:

```
mysql_config_editor [program_options] command [command_options]
```

If the login path file does not exist, `mysql_config_editor` creates it.

Command arguments are given as follows:

- `program_options` consists of general `mysql_config_editor` options.
- `command` indicates what action to perform on the `.mylogin.cnf` login path file. For example, `set` writes a login path to the file, `remove` removes a login path, and `print` displays login path contents.
- `command_options` indicates any additional options specific to the command, such as the login path name and the values to use in the login path.

The position of the command name within the set of program arguments is significant. For example, these command lines have the same arguments, but produce different results:

```
mysql_config_editor --help set
mysql_config_editor set --help
```

The first command line displays a general `mysql_config_editor` help message, and ignores the `set` command. The second command line displays a help message specific to the `set` command.

Suppose that you want to establish a `client` login path that defines your default connection parameters, and an additional login path named `remote` for connecting to the MySQL server the host `remote.example.com`. You want to log in as follows:

- By default, to the local server with a user name and password of `localuser` and `localpass`
- To the remote server with a user name and password of `remoteuser` and `remotepass`

To set up the login paths in the `.mylogin.cnf` file, use the following `set` commands. Enter each command on a single line, and enter the appropriate passwords when prompted:

```
$> mysql_config_editor set --login-path=client
    --host=localhost --user=localuser --password
Enter password: enter password "localpass" here
$> mysql_config_editor set --login-path=remote
    --host=remote.example.com --user=remoteuser --password
Enter password: enter password "remotepass" here
```

`mysql_config_editor` uses the `client` login path by default, so the `--login-path=client` option can be omitted from the first command without changing its effect.

To see what `mysql_config_editor` writes to the `.mylogin.cnf` file, use the `print` command:

```
$> mysql_config_editor print --all
[client]
user = localuser
password = *****
host = localhost
[remote]
user = remoteuser
password = *****
host = remote.example.com
```

The `print` command displays each login path as a set of lines beginning with a group header indicating the login path name in square brackets, followed by the option values for the login path. Password values are masked and do not appear as cleartext.

If you do not specify `--all` to display all login paths or `--login-path=name` to display a named login path, the `print` command displays the `client` login path by default, if there is one.

As shown by the preceding example, the login path file can contain multiple login paths. In this way, `mysql_config_editor` makes it easy to set up multiple “personalities” for connecting to different MySQL servers, or for connecting to a given server using different accounts. Any of these can be selected by name later using the `--login-path` option when you invoke a client program. For example, to connect to the remote server, use this command:

```
mysql --login-path=remote
```

Here, `mysql` reads the `[client]` and `[mysql]` option groups from other option files, and the `[client]`, `[mysql]`, and `[remote]` groups from the login path file.

To connect to the local server, use this command:

```
mysql --login-path=client
```

Because `mysql` reads the `client` and `mysql` login paths by default, the `--login-path` option does not add anything in this case. That command is equivalent to this one:

```
mysql
```

Options read from the login path file take precedence over options read from other option files. Options read from login path groups appearing later in the login path file take precedence over options read from groups appearing earlier in the file.

`mysql_config_editor` adds login paths to the login path file in the order you create them, so you should create more general login paths first and more specific paths later. If you need to move a login path within the file, you can remove it, then recreate it to add it to the end. For example, a `client` login path is more general because it is read by all client programs, whereas a `mysqldump` login path is read only by `mysqldump`. Options specified later override options specified earlier, so putting the login paths in the order `client`, `mysqldump` enables `mysqldump`-specific options to override `client` options.

When you use the `set` command with `mysql_config_editor` to create a login path, you need not specify all possible option values (host name, user name, password, port, socket). Only those values given are written to the path. Any missing values required later can be specified when you invoke a client path to connect to the MySQL server, either in other option files or on the command line. Any options specified on the command line override those specified in the login path file or other option files. For example, if the credentials in the `remote` login path also apply for the host `remote2.example.com`, connect to the server on that host like this:

```
mysql --login-path=remote --host=remote2.example.com
```

## mysql\_config\_editor General Options

`mysql_config_editor` supports the following general options, which may be used preceding any command named on the command line. For descriptions of command-specific options, see [mysql\\_config\\_editor Commands and Command-Specific Options](#).

**Table 4.22 mysql\_config\_editor General Options**

Option Name	Description
<code>--debug</code>	Write debugging log
<code>--help</code>	Display help message and exit
<code>--verbose</code>	Verbose mode
<code>--version</code>	Display version information and exit

- `--help, -?`

Command-Line Format	<code>--help</code>
---------------------	---------------------

Display a general help message and exit.

To see a command-specific help message, invoke `mysql_config_editor` as follows, where *command* is a command other than `help`:

```
mysql_config_editor command --help
```

- `--debug[=debug_options], -# debug_options`

Command-Line Format	<code>--debug[=<i>debug_options</i>]</code>
Type	String
Default Value	<code>d:t:o</code>

Write a debugging log. A typical *debug\_options* string is `d:t:o,file_name`. The default is `d:t:o,/tmp/mysql_config_editor.trace`.

This option is available only if MySQL was built using `WITH_DEBUG`. MySQL release binaries provided by Oracle are *not* built using this option.

- `--verbose, -v`

Command-Line Format	<code>--verbose</code>
---------------------	------------------------

Verbose mode. Print more information about what the program does. This option may be helpful in diagnosing problems if an operation does not have the effect you expect.

- `--version, -V`

Command-Line Format	<code>--version</code>
---------------------	------------------------

Display version information and exit.

## mysql\_config\_editor Commands and Command-Specific Options

This section describes the permitted `mysql_config_editor` commands, and, for each one, the command-specific options permitted following the command name on the command line.

In addition, `mysql_config_editor` supports general options that can be used preceding any command. For descriptions of these options, see [mysql\\_config\\_editor General Options](#).

`mysql_config_editor` supports these commands:

- `help`

Display a general help message and exit. This command takes no following options.

To see a command-specific help message, invoke `mysql_config_editor` as follows, where `command` is a command other than `help`:

```
mysql_config_editor command --help
```

- `print [options]`

Print the contents of the login path file in unobfuscated form, with the exception that passwords are displayed as `*****`.

The default login path name is `client` if no login path is named. If both `--all` and `--login-path` are given, `--all` takes precedence.

The `print` command permits these options following the command name:

- `--help, -?`

Display a help message for the `print` command and exit.

To see a general help message, use `mysql_config_editor --help`.

- `--all`

Print the contents of all login paths in the login path file.

- `--login-path=name, -G name`

Print the contents of the named login path.

- `remove [options]`

Remove a login path from the login path file, or modify a login path by removing options from it.

This command removes from the login path only such options as are specified with the `--host`, `--password`, `--port`, `--socket`, and `--user` options. If none of those options are given, `remove` removes the entire login path. For example, this command removes only the `user` option from the `mypath` login path rather than the entire `mypath` login path:

```
mysql_config_editor remove --login-path=mypath --user
```

This command removes the entire `mypath` login path:

```
mysql_config_editor remove --login-path=mypath
```

The `remove` command permits these options following the command name:

- `--help, -?`

Display a help message for the `remove` command and exit.

To see a general help message, use `mysql_config_editor --help`.

- `--host, -h`

Remove the host name from the login path.

- `--login-path=name, -G name`

The login path to remove or modify. The default login path name is `client` if this option is not given.

- `--password, -p`

Remove the password from the login path.

- `--port, -P`

Remove the TCP/IP port number from the login path.

- `--socket, -S`

Remove the Unix socket file name from the login path.

- `--user, -u`

Remove the user name from the login path.

- `--warn, -w`

Warn and prompt the user for confirmation if the command attempts to remove the default login path (`client`) and `--login-path=client` was not specified. This option is enabled by default; use `--skip-warn` to disable it.

- `reset [options]`

Empty the contents of the login path file.

The `reset` command permits these options following the command name:

- `--help, -?`

Display a help message for the `reset` command and exit.

To see a general help message, use `mysql_config_editor --help`.



- `set [options]`

Write a login path to the login path file.

This command writes to the login path only such options as are specified with the `--host`, `--password`, `--port`, `--socket`, and `--user` options. If none of those options are given, `mysql_config_editor` writes the login path as an empty group.

The `set` command permits these options following the command name:

- `--help, -?`

Display a help message for the `set` command and exit.

To see a general help message, use `mysql_config_editor --help`.

- `--host=host_name, -h host_name`

The host name to write to the login path.

- `--login-path=name, -G name`

The login path to create. The default login path name is `client` if this option is not given.

- `--password, -p`

Prompt for a password to write to the login path. After `mysql_config_editor` displays the prompt, type the password and press Enter. To prevent other users from seeing the password, `mysql_config_editor` does not echo it.

To specify an empty password, press Enter at the password prompt. The resulting login path written to the login path file includes a line like this:

```
password =
```

- `--port=port_num, -P port_num`

The TCP/IP port number to write to the login path.

- `--socket=file_name, -S file_name`

The Unix socket file name to write to the login path.

- `--user=user_name, -u user_name`

The user name to write to the login path.

- `--warn, -w`

Warn and prompt the user for confirmation if the command attempts to overwrite an existing login path. This option is enabled by default; use `--skip-warn` to disable it.

## 4.6.7 mysqlbinlog — Utility for Processing Binary Log Files

The server's binary log consists of files containing “events” that describe modifications to database contents. The server writes these files in binary format. To display their contents in text format, use the `mysqlbinlog` utility. You can also use `mysqlbinlog` to display the contents of relay log files written by a replica server in a replication setup because relay logs have the same format as binary logs. The binary log

and relay log are discussed further in [Section 5.4.4, “The Binary Log”](#), and [Section 16.2.4, “Relay Log and Replication Metadata Repositories”](#).

Invoke `mysqlbinlog` like this:

```
mysqlbinlog [options] log_file ...
```

For example, to display the contents of the binary log file named `binlog.000003`, use this command:

```
mysqlbinlog binlog.000003
```

The output includes events contained in `binlog.000003`. For statement-based logging, event information includes the SQL statement, the ID of the server on which it was executed, the timestamp when the statement was executed, how much time it took, and so forth. For row-based logging, the event indicates a row change rather than an SQL statement. See [Section 16.2.1, “Replication Formats”](#), for information about logging modes.

Events are preceded by header comments that provide additional information. For example:

```
# at 141
#100309 9:28:36 server id 123  end_log_pos 245
  Query thread_id=3350  exec_time=11  error_code=0
```

In the first line, the number following `at` indicates the file offset, or starting position, of the event in the binary log file.

The second line starts with a date and time indicating when the statement started on the server where the event originated. For replication, this timestamp is propagated to replica servers. `server id` is the `server_id` value of the server where the event originated. `end_log_pos` indicates where the next event starts (that is, it is the end position of the current event + 1). `thread_id` indicates which thread executed the event. `exec_time` is the time spent executing the event, on a replication source server. On a replica, it is the difference of the end execution time on the replica minus the beginning execution time on the source. The difference serves as an indicator of how much replication lags behind the source. `error_code` indicates the result from executing the event. Zero means that no error occurred.



#### Note

When using event groups, the file offsets of events may be grouped together and the comments of events may be grouped together. Do not mistake these grouped events for blank file offsets.

The output from `mysqlbinlog` can be re-executed (for example, by using it as input to `mysql`) to redo the statements in the log. This is useful for recovery operations after an unexpected server exit. For other usage examples, see the discussion later in this section and in [Section 7.5, “Point-in-Time \(Incremental\) Recovery”](#).

You can use `mysqlbinlog` to read binary log files directly and apply them to the local MySQL server. You can also read binary logs from a remote server by using the `--read-from-remote-server` option. To read remote binary logs, the connection parameter options can be given to indicate how to connect to the server. These options are `--host`, `--password`, `--port`, `--protocol`, `--socket`, and `--user`.

When running `mysqlbinlog` against a large binary log, be careful that the filesystem has enough space for the resulting files. To configure the directory that `mysqlbinlog` uses for temporary files, use the `TMPDIR` environment variable.

`mysqlbinlog` sets the value of `pseudo_slave_mode` to true before executing any SQL statements. This system variable affects the handling of XA transactions.

`mysqlbinlog` supports the following options, which can be specified on the command line or in the `[mysqlbinlog]` and `[client]` groups of an option file. For information about option files used by MySQL programs, see [Section 4.2.2.2, “Using Option Files”](#).

**Table 4.23 mysqlbinlog Options**

Option Name	Description	Introduced	Deprecated
<code>--base64-output</code>	Print binary log entries using base-64 encoding		
<code>--bind-address</code>	Use specified network interface to connect to MySQL Server		
<code>--binlog-row-event-max-size</code>	Binary log max event size		
<code>--character-sets-dir</code>	Directory where character sets are installed		
<code>--connection-server-id</code>	Used for testing and debugging. See text for applicable default values and other particulars		
<code>--database</code>	List entries for just this database		
<code>--debug</code>	Write debugging log		
<code>--debug-check</code>	Print debugging information when program exits		
<code>--debug-info</code>	Print debugging information, memory, and CPU statistics when program exits		
<code>--default-auth</code>	Authentication plugin to use		
<code>--defaults-extra-file</code>	Read named option file in addition to usual option files		
<code>--defaults-file</code>	Read only named option file		
<code>--defaults-group-suffix</code>	Option group suffix value		
<code>--disable-log-bin</code>	Disable binary logging		
<code>--exclude-gtids</code>	Do not show any of the groups in the GTID set provided		
<code>--force-if-open</code>	Read binary log files even if open or not closed properly		
<code>--force-read</code>	If mysqlbinlog reads a binary log event that it		

Option Name	Description	Introduced	Deprecated
	does not recognize, it prints a warning		
<code>--get-server-public-key</code>	Request RSA public key from server	5.7.23	
<code>--help</code>	Display help message and exit		
<code>--hexdump</code>	Display a hex dump of the log in comments		
<code>--host</code>	Host on which MySQL server is located		
<code>--idempotent</code>	Cause the server to use idempotent mode while processing binary log updates from this session only		
<code>--include-gtids</code>	Show only the groups in the GTID set provided		
<code>--local-load</code>	Prepare local temporary files for LOAD DATA in the specified directory		
<code>--login-path</code>	Read login path options from .mylogin.cnf		
<code>--no-defaults</code>	Read no option files		
<code>--offset</code>	Skip the first N entries in the log		
<code>--open-files-limit</code>	Specify the number of open file descriptors to reserve		
<code>--password</code>	Password to use when connecting to server		
<code>--plugin-dir</code>	Directory where plugins are installed		
<code>--port</code>	TCP/IP port number for connection		
<code>--print-defaults</code>	Print default options		
<code>--protocol</code>	Transport protocol to use		
<code>--raw</code>	Write events in raw (binary) format to output files		
<code>--read-from-remote-master</code>	Read the binary log from a MySQL replication source server rather than reading a local log file		

Option Name	Description	Introduced	Deprecated
<code>--read-from-remote-server</code>	Read binary log from MySQL server rather than local log file		
<code>--result-file</code>	Direct output to named file		
<code>--rewrite-db</code>	Create rewrite rules for databases when playing back from logs written in row-based format. Can be used multiple times		
<code>--secure-auth</code>	Do not send passwords to server in old (pre-4.1) format		Yes
<code>--server-id</code>	Extract only those events created by the server having the given server ID		
<code>--server-id-bits</code>	Tell mysqlbinlog how to interpret server IDs in binary log when log was written by a mysqld having its server-id-bits set to less than the maximum; supported only by MySQL Cluster version of mysqlbinlog		
<code>--server-public-key-path</code>	Path name to file containing RSA public key	5.7.23	
<code>--set-charset</code>	Add a SET NAMES charset_name statement to the output		
<code>--shared-memory-base-name</code>	Shared-memory name for shared-memory connections (Windows only)		
<code>--short-form</code>	Display only the statements contained in the log		
<code>--skip-gtids</code>	Do not include the GTIDs from the binary log files in the output dump file		
<code>--socket</code>	Unix socket file or Windows named pipe to use		
<code>--ssl</code>	Enable connection encryption		

Option Name	Description	Introduced	Deprecated
<code>--ssl-ca</code>	File that contains list of trusted SSL Certificate Authorities		
<code>--ssl-capath</code>	Directory that contains trusted SSL Certificate Authority certificate files		
<code>--ssl-cert</code>	File that contains X.509 certificate		
<code>--ssl-cipher</code>	Permissible ciphers for connection encryption		
<code>--ssl-crl</code>	File that contains certificate revocation lists		
<code>--ssl-crlpath</code>	Directory that contains certificate revocation-list files		
<code>--ssl-key</code>	File that contains X.509 key		
<code>--ssl-mode</code>	Desired security state of connection to server	5.7.11	
<code>--ssl-verify-server-cert</code>	Verify host name against server certificate Common Name identity		
<code>--start-datetime</code>	Read binary log from first event with timestamp equal to or later than datetime argument		
<code>--start-position</code>	Decode binary log from first event with position equal to or greater than argument		
<code>--stop-datetime</code>	Stop reading binary log at first event with timestamp equal to or greater than datetime argument		
<code>--stop-never</code>	Stay connected to server after reading last binary log file		
<code>--stop-never-slave-server-id</code>	Slave server ID to report when connecting to server		
<code>--stop-position</code>	Stop decoding binary log at first event with position equal to or greater than argument		

Option Name	Description	Introduced	Deprecated
<code>--tls-version</code>	Permissible TLS protocols for encrypted connections	5.7.10	
<code>--to-last-log</code>	Do not stop at the end of requested binary log from a MySQL server, but rather continue printing to end of last binary log		
<code>--user</code>	MySQL user name to use when connecting to server		
<code>--verbose</code>	Reconstruct row events as SQL statements		
<code>--verify-binlog-checksum</code>	Verify checksums in binary log		
<code>--version</code>	Display version information and exit		

- `--help, -?`

Command-Line Format	<code>--help</code>
---------------------	---------------------

Display a help message and exit.

- `--base64-output=value`

Command-Line Format	<code>--base64-output=value</code>
Type	String
Default Value	<code>AUTO</code>
Valid Values	<code>AUTO</code> <code>NEVER</code> <code>DECODE-ROWS</code>

This option determines when events should be displayed encoded as base-64 strings using `BINLOG` statements. The option has these permissible values (not case-sensitive):

- `AUTO` ("automatic") or `UNSPEC` ("unspecified") displays `BINLOG` statements automatically when necessary (that is, for format description events and row events). If no `--base64-output` option is given, the effect is the same as `--base64-output=AUTO`.



#### Note

Automatic `BINLOG` display is the only safe behavior if you intend to use the output of `mysqlbinlog` to re-execute binary log file contents. The other option values are intended only for debugging or testing purposes because they may produce output that does not include all events in executable form.

- `NEVER` causes `BINLOG` statements not to be displayed. `mysqlbinlog` exits with an error if a row event is found that must be displayed using `BINLOG`.
- `DECODE-ROWS` specifies to `mysqlbinlog` that you intend for row events to be decoded and displayed as commented SQL statements by also specifying the `--verbose` option. Like `NEVER`, `DECODE-ROWS` suppresses display of `BINLOG` statements, but unlike `NEVER`, it does not exit with an error if a row event is found.

For examples that show the effect of `--base64-output` and `--verbose` on row event output, see [Section 4.6.7.2, “mysqlbinlog Row Event Display”](#).

- `--bind-address=ip_address`

Command-Line Format	<code>--bind-address=ip_address</code>
---------------------	--

On a computer having multiple network interfaces, use this option to select which interface to use for connecting to the MySQL server.

- `--binlog-row-event-max-size=N`

Command-Line Format	<code>--binlog-row-event-max-size=#</code>
Type	Numeric
Default Value	4294967040
Minimum Value	256
Maximum Value	18446744073709547520

Specify the maximum size of a row-based binary log event, in bytes. Rows are grouped into events smaller than this size if possible. The value should be a multiple of 256. The default is 4GB.

- `--character-sets-dir=dir_name`

Command-Line Format	<code>--character-sets-dir=dir_name</code>
Type	Directory name

The directory where character sets are installed. See [Section 10.15, “Character Set Configuration”](#).

- `--connection-server-id=server_id`

Command-Line Format	<code>--connection-server-id=#]</code>
Type	Integer
Default Value	0 (1)
Minimum Value	0 (1)



Maximum Value	4294967295
---------------	------------

This option is used to test a MySQL server for support of the `BINLOG_DUMP_NON_BLOCK` connection flag. It is not required for normal operations.

The effective default and minimum values for this option depend on whether `mysqlbinlog` is run in blocking mode or non-blocking mode. When `mysqlbinlog` is run in blocking mode, the default (and minimum) value is 1; when run in non-blocking mode, the default (and minimum) value is 0.

- `--database=db_name, -d db_name`

Command-Line Format	<code>--database=db_name</code>
Type	String

This option causes `mysqlbinlog` to output entries from the binary log (local log only) that occur while `db_name` is been selected as the default database by `USE`.

The `--database` option for `mysqlbinlog` is similar to the `--binlog-do-db` option for `mysqld`, but can be used to specify only one database. If `--database` is given multiple times, only the last instance is used.

The effects of this option depend on whether the statement-based or row-based logging format is in use, in the same way that the effects of `--binlog-do-db` depend on whether statement-based or row-based logging is in use.

**Statement-based logging.** The `--database` option works as follows:

- While `db_name` is the default database, statements are output whether they modify tables in `db_name` or a different database.
- Unless `db_name` is selected as the default database, statements are not output, even if they modify tables in `db_name`.
- There is an exception for `CREATE DATABASE`, `ALTER DATABASE`, and `DROP DATABASE`. The database being *created*, *altered*, or *dropped* is considered to be the default database when determining whether to output the statement.

Suppose that the binary log was created by executing these statements using statement-based-logging:

```
INSERT INTO test.t1 (i) VALUES(100);
INSERT INTO db2.t2 (j) VALUES(200);
USE test;
INSERT INTO test.t1 (i) VALUES(101);
INSERT INTO t1 (i) VALUES(102);
INSERT INTO db2.t2 (j) VALUES(201);
USE db2;
INSERT INTO test.t1 (i) VALUES(103);
INSERT INTO db2.t2 (j) VALUES(202);
```

```
INSERT INTO t2 (j) VALUES(203);
```

`mysqlbinlog --database=test` does not output the first two `INSERT` statements because there is no default database. It outputs the three `INSERT` statements following `USE test`, but not the three `INSERT` statements following `USE db2`.

`mysqlbinlog --database=db2` does not output the first two `INSERT` statements because there is no default database. It does not output the three `INSERT` statements following `USE test`, but does output the three `INSERT` statements following `USE db2`.

**Row-based logging.** `mysqlbinlog` outputs only entries that change tables belonging to `db_name`. The default database has no effect on this. Suppose that the binary log just described was created using row-based logging rather than statement-based logging. `mysqlbinlog --database=test` outputs only those entries that modify `t1` in the test database, regardless of whether `USE` was issued or what the default database is.

If a server is running with `binlog_format` set to `MIXED` and you want it to be possible to use `mysqlbinlog` with the `--database` option, you must ensure that tables that are modified are in the database selected by `USE`. (In particular, no cross-database updates should be used.)

When used together with the `--rewrite-db` option, the `--rewrite-db` option is applied first; then the `--database` option is applied, using the rewritten database name. The order in which the options are provided makes no difference in this regard.

- `--debug[=debug_options], -# [debug_options]`

Command-Line Format	<code>--debug[=debug_options]</code>
Type	String
Default Value	<code>d:t:o,/tmp/mysqlbinlog.trace</code>

Write a debugging log. A typical `debug_options` string is `d:t:o,file_name`. The default is `d:t:o,/tmp/mysqlbinlog.trace`.

This option is available only if MySQL was built using `WITH_DEBUG`. MySQL release binaries provided by Oracle are *not* built using this option.

- `--debug-check`

Command-Line Format	<code>--debug-check</code>
Type	Boolean
Default Value	<code>FALSE</code>

Print some debugging information when the program exits.

This option is available only if MySQL was built using `WITH_DEBUG`. MySQL release binaries provided by Oracle are *not* built using this option.

- `--debug-info`

Command-Line Format	<code>--debug-info</code>
Type	Boolean
Default Value	<code>FALSE</code>

Print debugging information and memory and CPU usage statistics when the program exits.

This option is available only if MySQL was built using `WITH_DEBUG`. MySQL release binaries provided by Oracle are *not* built using this option.

- `--default-auth=plugin`

Command-Line Format	<code>--default-auth=plugin</code>
Type	String

A hint about which client-side authentication plugin to use. See [Section 6.2.13, “Pluggable Authentication”](#).

- `--defaults-extra-file=file_name`

Command-Line Format	<code>--defaults-extra-file=file_name</code>
Type	File name

Read this option file after the global option file but (on Unix) before the user option file. If the file does not exist or is otherwise inaccessible, an error occurs. If `file_name` is not an absolute path name, it is interpreted relative to the current directory.

For additional information about this and other option-file options, see [Section 4.2.2.3, “Command-Line Options that Affect Option-File Handling”](#).

- `--defaults-file=file_name`

Command-Line Format	<code>--defaults-file=file_name</code>
Type	File name

Use only the given option file. If the file does not exist or is otherwise inaccessible, an error occurs. If `file_name` is not an absolute path name, it is interpreted relative to the current directory.

Exception: Even with `--defaults-file`, client programs read `.mylogin.cnf`.

For additional information about this and other option-file options, see [Section 4.2.2.3, “Command-Line Options that Affect Option-File Handling”](#).

- `--defaults-group-suffix=str`

Command-Line Format	<code>--defaults-group-suffix=str</code>
Type	String

Read not only the usual option groups, but also groups with the usual names and a suffix of `str`. For example, `mysqlbinlog` normally reads the `[client]` and `[mysqlbinlog]` groups. If this option is

given as `--defaults-group-suffix=_other`, `mysqlbinlog` also reads the `[client_other]` and `[mysqlbinlog_other]` groups.

For additional information about this and other option-file options, see [Section 4.2.2.3, “Command-Line Options that Affect Option-File Handling”](#).

- `--disable-log-bin, -D`

Command-Line Format	<code>--disable-log-bin</code>
---------------------	--------------------------------

Disable binary logging. This is useful for avoiding an endless loop if you use the `--to-last-log` option and are sending the output to the same MySQL server. This option also is useful when restoring after an unexpected exit to avoid duplication of the statements you have logged.

This option causes `mysqlbinlog` to include a `SET sql_log_bin = 0` statement in its output to disable binary logging of the remaining output. Manipulating the session value of the `sql_log_bin` system variable is a restricted operation, so this option requires that you have privileges sufficient to set restricted session variables. See [Section 5.1.8.1, “System Variable Privileges”](#).

- `--exclude-gtids=gtid_set`

Command-Line Format	<code>--exclude-gtids=gtid_set</code>
Type	String
Default Value	

Do not display any of the groups listed in the `gtid_set`.

- `--force-if-open, -F`

Command-Line Format	<code>--force-if-open</code>
---------------------	------------------------------

Read binary log files even if they are open or were not closed properly.

- `--force-read, -f`

Command-Line Format	<code>--force-read</code>
---------------------	---------------------------

With this option, if `mysqlbinlog` reads a binary log event that it does not recognize, it prints a warning, ignores the event, and continues. Without this option, `mysqlbinlog` stops if it reads such an event.

- `--get-server-public-key`

Command-Line Format	<code>--get-server-public-key</code>
Introduced	5.7.23
Type	Boolean

do not authenticate with that plugin. It is also ignored if RSA-based password exchange is not used, as is the case when the client connects to the server using a secure connection.

If `--server-public-key-path=file_name` is given and specifies a valid public key file, it takes precedence over `--get-server-public-key`.

For information about the `caching_sha2_password` plugin, see [Section 6.4.1.4, “Caching SHA-2 Pluggable Authentication”](#).

The `--get-server-public-key` option was added in MySQL 5.7.23.

- `--hexdump, -H`

Command-Line Format	<code>--hexdump</code>
---------------------	------------------------

Display a hex dump of the log in comments, as described in [Section 4.6.7.1, “mysqlbinlog Hex Dump Format”](#). The hex output can be helpful for replication debugging.

- `--host=host_name, -h host_name`

Command-Line Format	<code>--host=host_name</code>
Type	String
Default Value	<code>localhost</code>

Get the binary log from the MySQL server on the given host.

- `--idempotent`

Command-Line Format	<code>--idempotent</code>
Type	Boolean
Default Value	<code>true</code>

Tell the MySQL Server to use idempotent mode while processing updates; this causes suppression of any duplicate-key or key-not-found errors that the server encounters in the current session while processing updates. This option may prove useful whenever it is desirable or necessary to replay one or more binary logs to a MySQL Server which may not contain all of the data to which the logs refer.

The scope of effect for this option includes the current `mysqlbinlog` client and session only.

- `--include-gtids=gtid_set`

Command-Line Format	<code>--include-gtids=gtid_set</code>
Type	String
Default Value	

Display only the groups listed in the `gtid_set`.

- `--local-load=dir_name, -l dir_name`

Command-Line Format	<code>--local-load=dir_name</code>
---------------------	------------------------------------

Type	Directory name
------	----------------

For data loading operations corresponding to `LOAD DATA` statements, `mysqlbinlog` extracts the files from the binary log events, writes them as temporary files to the local file system, and writes `LOAD DATA LOCAL` statements to cause the files to be loaded. By default, `mysqlbinlog` writes these temporary files to an operating system-specific directory. The `--local-load` option can be used to explicitly specify the directory where `mysqlbinlog` should prepare local temporary files.



### Important

These temporary files are not automatically removed by `mysqlbinlog` or any other MySQL program.

- `--login-path=name`

Command-Line Format	<code>--login-path=name</code>
Type	String

Read options from the named login path in the `.mylogin.cnf` login path file. A “login path” is an option group containing options that specify which MySQL server to connect to and which account to authenticate as. To create or modify a login path file, use the `mysql_config_editor` utility. See [Section 4.6.6, “mysql\\_config\\_editor — MySQL Configuration Utility”](#).

For additional information about this and other option-file options, see [Section 4.2.2.3, “Command-Line Options that Affect Option-File Handling”](#).

- `--no-defaults`

Command-Line Format	<code>--no-defaults</code>
---------------------	----------------------------

Do not read any option files. If program startup fails due to reading unknown options from an option file, `--no-defaults` can be used to prevent them from being read.

The exception is that the `.mylogin.cnf` file is read in all cases, if it exists. This permits passwords to be specified in a safer way than on the command line even when `--no-defaults` is used. To create `.mylogin.cnf`, use the `mysql_config_editor` utility. See [Section 4.6.6, “mysql\\_config\\_editor — MySQL Configuration Utility”](#).

For additional information about this and other option-file options, see [Section 4.2.2.3, “Command-Line Options that Affect Option-File Handling”](#).

- `--offset=N, -o N`

Command-Line Format	<code>--offset=#</code>
Type	Numeric

Skip the first `N` entries in the log.

- `--open-files-limit=N`

Command-Line Format	<code>--open-files-limit=#</code>
---------------------	-----------------------------------

Type	Numeric
Default Value	8
Minimum Value	1
Maximum Value	[platform dependent]

Specify the number of open file descriptors to reserve.

- `--password[=password], -p[password]`

Command-Line Format	<code>--password[=password]</code>
Type	String

The password of the MySQL account used for connecting to the server. The password value is optional. If not given, `mysqlbinlog` prompts for one. If given, there must be *no space* between `--password=` or `-p` and the password following it. If no password option is specified, the default is to send no password.

Specifying a password on the command line should be considered insecure. To avoid giving the password on the command line, use an option file. See [Section 6.1.2.1, “End-User Guidelines for Password Security”](#).

To explicitly specify that there is no password and that `mysqlbinlog` should not prompt for one, use the `--skip-password` option.

- `--plugin-dir=dir_name`

Command-Line Format	<code>--plugin-dir=dir_name</code>
Type	Directory name

The directory in which to look for plugins. Specify this option if the `--default-auth` option is used to specify an authentication plugin but `mysqlbinlog` does not find it. See [Section 6.2.13, “Pluggable Authentication”](#).

- `--port=port_num, -P port_num`

Command-Line Format	<code>--port=port_num</code>
Type	Numeric
Default Value	3306

The TCP/IP port number to use for connecting to a remote server.

- `--print-defaults`

Command-Line Format	<code>--print-defaults</code>
---------------------	-------------------------------

Print the program name and all options that it gets from option files.

For additional information about this and other option-file options, see [Section 4.2.2.3, “Command-Line Options that Affect Option-File Handling”](#).

- `--protocol={TCP|SOCKET|PIPE|MEMORY}`

Command-Line Format	<code>--protocol=type</code>
Type	String
Default Value	[see text]
Valid Values	TCP  SOCKET  PIPE  MEMORY

The transport protocol to use for connecting to the server. It is useful when the other connection parameters normally result in use of a protocol other than the one you want. For details on the permissible values, see [Section 4.2.5, “Connection Transport Protocols”](#).

- `--raw`

Command-Line Format	<code>--raw</code>
Type	Boolean
Default Value	FALSE

By default, `mysqlbinlog` reads binary log files and writes events in text format. The `--raw` option tells `mysqlbinlog` to write them in their original binary format. Its use requires that `--read-from-remote-server` also be used because the files are requested from a server. `mysqlbinlog` writes one output file for each file read from the server. The `--raw` option can be used to make a backup of a server's binary log. With the `--stop-never` option, the backup is “live” because `mysqlbinlog` stays connected to the server. By default, output files are written in the current directory with the same names as the original log files. Output file names can be modified using the `--result-file` option. For more information, see [Section 4.6.7.3, “Using mysqlbinlog to Back Up Binary Log Files”](#).

- `--read-from-remote-master=type`

Command-Line Format	<code>--read-from-remote-master=type</code>
---------------------	---

Read binary logs from a MySQL server with the `COM_BINLOG_DUMP` or `COM_BINLOG_DUMP_GTID` commands by setting the option value to either `BINLOG-DUMP-NON-GTIDS` or `BINLOG-DUMP-GTIDS`, respectively. If `--read-from-remote-master=BINLOG-DUMP-GTIDS` is combined with `--exclude-gtids`, transactions can be filtered out on the source, avoiding unnecessary network traffic.

The connection parameter options are used with this option or the `--read-from-remote-server` option. These options are `--host`, `--password`, `--port`, `--protocol`, `--socket`, and `--user`. If neither of the remote options is specified, the connection parameter options are ignored.

The `REPLICATION SLAVE` privilege is required to use this option.

- `--read-from-remote-server=file_name, -R`

Command-Line Format	<code>--read-from-remote-server=file_name</code>
---------------------	--



Read the binary log from a MySQL server rather than reading a local log file. This option requires that the remote server be running. It works only for binary log files on the remote server, not relay log files, and takes only the binary log file name (including the numeric suffix) as its argument, while ignoring any path.

The connection parameter options are used with this option or the `--read-from-remote-master` option. These options are `--host`, `--password`, `--port`, `--protocol`, `--socket`, and `--user`. If neither of the remote options is specified, the connection parameter options are ignored.

The `REPLICATION SLAVE` privilege is required to use this option.

This option is like `--read-from-remote-master=BINLOG-DUMP-NON-GTIDS`.

- `--result-file=name, -r name`

Command-Line Format	<code>--result-file=name</code>
---------------------	---------------------------------

Without the `--raw` option, this option indicates the file to which `mysqlbinlog` writes text output. With `--raw`, `mysqlbinlog` writes one binary output file for each log file transferred from the server, writing them by default in the current directory using the same names as the original log file. In this case, the `--result-file` option value is treated as a prefix that modifies output file names.

- `--rewrite-db='from_name->to_name'`

Command-Line Format	<code>--rewrite-db='oldname-&gt;newname'</code>
Type	String
Default Value	[none]

When reading from a row-based or statement-based log, rewrite all occurrences of `from_name` to `to_name`. Rewriting is done on the rows, for row-based logs, as well as on the `USE` clauses, for statement-based logs. In MySQL versions prior to 5.7.8, this option was only for use when restoring tables logged using the row-based format.



### Warning

Statements in which table names are qualified with database names are not rewritten to use the new name when using this option.

The rewrite rule employed as a value for this option is a string having the form `'from_name->to_name'`, as shown previously, and for this reason must be enclosed by quotation marks.

To employ multiple rewrite rules, specify the option multiple times, as shown here:

```
mysqlbinlog --rewrite-db='dbcurrent->dbold' --rewrite-db='dbtest->dbcurrent' \
  binlog.00001 > /tmp/statements.sql
```

When used together with the `--database` option, the `--rewrite-db` option is applied first; then `--database` option is applied, using the rewritten database name. The order in which the options are provided makes no difference in this regard.

This means that, for example, if `mysqlbinlog` is started with `--rewrite-db='mydb->yourdb' --database=yourdb`, then all updates to any tables in databases `mydb` and `yourdb` are included in the output. On the other hand, if it is started with `--rewrite-db='mydb->yourdb' --database=mydb`,

then `mysqlbinlog` outputs no statements at all: since all updates to `mydb` are first rewritten as updates to `yourdb` before applying the `--database` option, there remain no updates that match `--database=mydb`.

- `--secure-auth`

Command-Line Format	<code>--secure-auth</code>
Deprecated	Yes

Do not send passwords to the server in old (pre-4.1) format. This prevents connections except for servers that use the newer password format.

As of MySQL 5.7.5, this option is deprecated; expect it to be removed in a future MySQL release. It is always enabled and attempting to disable it (`--skip-secure-auth`, `--secure-auth=0`) produces an error. Before MySQL 5.7.5, this option is enabled by default but can be disabled.



#### Note

Passwords that use the pre-4.1 hashing method are less secure than passwords that use the native password hashing method and should be avoided. Pre-4.1 passwords are deprecated and support for them was removed in MySQL 5.7.5. For account upgrade instructions, see [Section 6.4.1.3, “Migrating Away from Pre-4.1 Password Hashing and the `mysql\_old\_password` Plugin”](#).

- `--server-id=id`

Command-Line Format	<code>--server-id=id</code>
Type	Numeric

Display only those events created by the server having the given server ID.

- `--server-id-bits=N`

Command-Line Format	<code>--server-id-bits=#</code>
Type	Numeric
Default Value	32
Minimum Value	7
Maximum Value	32

Use only the first *N* bits of the `server_id` to identify the server. If the binary log was written by a `mysqld` with `server-id-bits` set to less than 32 and user data stored in the most significant bit, running `mysqlbinlog` with `--server-id-bits` set to 32 enables this data to be seen.

This option is supported only by the version of `mysqlbinlog` supplied with the NDB Cluster distribution, or built with NDB Cluster support.

- `--server-public-key-path=file_name`

Command-Line Format	<code>--server-public-key-path=file_name</code>
Introduced	5.7.23

Type	File name
------	-----------

The path name to a file in PEM format containing a client-side copy of the public key required by the server for RSA key pair-based password exchange. This option applies to clients that authenticate with the `sha256_password` or `caching_sha2_password` authentication plugin. This option is ignored for accounts that do not authenticate with one of those plugins. It is also ignored if RSA-based password exchange is not used, as is the case when the client connects to the server using a secure connection.

If `--server-public-key-path=file_name` is given and specifies a valid public key file, it takes precedence over `--get-server-public-key`.

For `sha256_password`, this option applies only if MySQL was built using OpenSSL.

For information about the `sha256_password` and `caching_sha2_password` plugins, see [Section 6.4.1.5, “SHA-256 Pluggable Authentication”](#), and [Section 6.4.1.4, “Caching SHA-2 Pluggable Authentication”](#).

The `--server-public-key-path` option was added in MySQL 5.7.23.

- `--set-charset=charset_name`

Command-Line Format	<code>--set-charset=charset_name</code>
Type	String

Add a `SET NAMES charset_name` statement to the output to specify the character set to be used for processing log files.

- `--shared-memory-base-name=name`

Command-Line Format	<code>--shared-memory-base-name=name</code>
Platform Specific	Windows

On Windows, the shared-memory name to use for connections made using shared memory to a local server. The default value is `MYSQL`. The shared-memory name is case-sensitive.

This option applies only if the server was started with the `shared_memory` system variable enabled to support shared-memory connections.

- `--short-form, -s`

Command-Line Format	<code>--short-form</code>
---------------------	---------------------------

Display only the statements contained in the log, without any extra information or row-based events. This is for testing only, and should not be used in production systems.

- `--skip-gtids[=(true|false)]`

Command-Line Format	<code>--skip-gtids[=(true false)]</code>
Type	Boolean

Default Value	false
---------------	-------

Do not include the GTIDs from the binary log files in the output dump file. For example:

```
mysqlbinlog --skip-gtids binlog.000001 > /tmp/dump.sql
mysql -u root -p -e "source /tmp/dump.sql"
```

You should not normally use this option in production or in recovery, except in the specific, and rare, scenarios where the GTIDs are actively unwanted. For example, an administrator might want to duplicate selected transactions (such as table definitions) from a deployment to another, unrelated, deployment that will not replicate to or from the original. In that scenario, `--skip-gtids` can be used to enable the administrator to apply the transactions as if they were new, and ensure that the deployments remain unrelated. However, you should only use this option if the inclusion of the GTIDs causes a known issue for your use case.

- `--socket=path, -S path`

Command-Line Format	<code>--socket={file_name pipe_name}</code>
Type	String

For connections to `localhost`, the Unix socket file to use, or, on Windows, the name of the named pipe to use.

On Windows, this option applies only if the server was started with the `named_pipe` system variable enabled to support named-pipe connections. In addition, the user making the connection must be a member of the Windows group specified by the `named_pipe_full_access_group` system variable.

- `--ssl*`

Options that begin with `--ssl` specify whether to connect to the server using encryption and indicate where to find SSL keys and certificates. See [Command Options for Encrypted Connections](#).

- `--start-datetime=datetime`

Command-Line Format	<code>--start-datetime=datetime</code>
Type	Datetime

Start reading the binary log at the first event having a timestamp equal to or later than the `datetime` argument. The `datetime` value is relative to the local time zone on the machine where you run `mysqlbinlog`. The value should be in a format accepted for the `DATETIME` or `TIMESTAMP` data types. For example:

```
mysqlbinlog --start-datetime="2005-12-25 11:25:56" binlog.000003
```

This option is useful for point-in-time recovery. See [Section 7.5, "Point-in-Time \(Incremental\) Recovery"](#).

- `--start-position=N, -j N`

Command-Line Format	<code>--start-position=#</code>
---------------------	---------------------------------

Type	Numeric
------	---------

Start reading the binary log at the first event having a position equal to or greater than *N*. This option applies to the first log file named on the command line.

This option is useful for point-in-time recovery. See [Section 7.5, “Point-in-Time \(Incremental\) Recovery”](#).

- `--stop-datetime=datetime`

Command-Line Format	<code>--stop-datetime=datetime</code>
---------------------	---------------------------------------

Stop reading the binary log at the first event having a timestamp equal to or later than the *datetime* argument. See the description of the `--start-datetime` option for information about the *datetime* value.

This option is useful for point-in-time recovery. See [Section 7.5, “Point-in-Time \(Incremental\) Recovery”](#).

- `--stop-never`

Command-Line Format	<code>--stop-never</code>
Type	Boolean
Default Value	<code>FALSE</code>

This option is used with `--read-from-remote-server`. It tells `mysqlbinlog` to remain connected to the server. Otherwise `mysqlbinlog` exits when the last log file has been transferred from the server. `--stop-never` implies `--to-last-log`, so only the first log file to transfer need be named on the command line.

`--stop-never` is commonly used with `--raw` to make a live binary log backup, but also can be used without `--raw` to maintain a continuous text display of log events as the server generates them.

- `--stop-never-slave-server-id=id`

Command-Line Format	<code>--stop-never-slave-server-id=#</code>
Type	Numeric
Default Value	<code>65535</code>
Minimum Value	<code>1</code>

With `--stop-never`, `mysqlbinlog` reports a server ID of 65535 when it connects to the server. `--stop-never-slave-server-id` explicitly specifies the server ID to report. It can be used to avoid a conflict with the ID of a replica server or another `mysqlbinlog` process. See [Section 4.6.7.4, “Specifying the mysqlbinlog Server ID”](#).

- `--stop-position=N`

Command-Line Format	<code>--stop-position=#</code>
---------------------	--------------------------------

Type	Numeric
------	---------

Stop reading the binary log at the first event having a position equal to or greater than *N*. This option applies to the last log file named on the command line.

This option is useful for point-in-time recovery. See [Section 7.5, “Point-in-Time \(Incremental\) Recovery”](#).

- `--tls-version=protocol_list`

Command-Line Format	<code>--tls-version=protocol_list</code>
Introduced	5.7.10
Type	String
Default Value (≥ 5.7.28)	TLSv1, TLSv1.1, TLSv1.2
Default Value (≤ 5.7.27)	TLSv1, TLSv1.1, TLSv1.2 (OpenSSL) TLSv1, TLSv1.1 (yaSSL)

The permissible TLS protocols for encrypted connections. The value is a list of one or more comma-separated protocol names. The protocols that can be named for this option depend on the SSL library used to compile MySQL. For details, see [Section 6.3.2, “Encrypted Connection TLS Protocols and Ciphers”](#).

This option was added in MySQL 5.7.10.

- `--to-last-log, -t`

Command-Line Format	<code>--to-last-log</code>
---------------------	----------------------------

Do not stop at the end of the requested binary log from a MySQL server, but rather continue printing until the end of the last binary log. If you send the output to the same MySQL server, this may lead to an endless loop. This option requires `--read-from-remote-server`.

- `--user=user_name, -u user_name`

Command-Line Format	<code>--user=user_name,</code>
Type	String

The user name of the MySQL account to use when connecting to a remote server.

- `--verbose, -v`

Command-Line Format	<code>--verbose</code>
---------------------	------------------------

Reconstruct row events and display them as commented SQL statements. If this option is given twice (by passing in either `-vv` or `--verbose --verbose`), the output includes comments to indicate column data types and some metadata, and row query log events if so configured.

For examples that show the effect of `--base64-output` and `--verbose` on row event output, see [Section 4.6.7.2, “mysqlbinlog Row Event Display”](#).

- `--verify-binlog-checksum, -c`

Command-Line Format	<code>--verify-binlog-checksum</code>
---------------------	---------------------------------------

Verify checksums in binary log files.

- `--version, -V`

Command-Line Format	<code>--version</code>
---------------------	------------------------

Display version information and exit.

In MySQL 5.7, the version number shown by `mysqlbinlog` when using this option is 3.4.

You can pipe the output of `mysqlbinlog` into the `mysql` client to execute the events contained in the binary log. This technique is used to recover from an unexpected exit when you have an old backup (see [Section 7.5, “Point-in-Time \(Incremental\) Recovery”](#)). For example:

```
mysqlbinlog binlog.000001 | mysql -u root -p
```

Or:

```
mysqlbinlog binlog.[0-9]* | mysql -u root -p
```

If the statements produced by `mysqlbinlog` may contain `BLOB` values, these may cause problems when `mysql` processes them. In this case, invoke `mysql` with the `--binary-mode` option.

You can also redirect the output of `mysqlbinlog` to a text file instead, if you need to modify the statement log first (for example, to remove statements that you do not want to execute for some reason). After editing the file, execute the statements that it contains by using it as input to the `mysql` program:

```
mysqlbinlog binlog.000001 > tmpfile
... edit tmpfile ...
mysql -u root -p < tmpfile
```

When `mysqlbinlog` is invoked with the `--start-position` option, it displays only those events with an offset in the binary log greater than or equal to a given position (the given position must match the start of one event). It also has options to stop and start when it sees an event with a given date and time. This enables you to perform point-in-time recovery using the `--stop-datetime` option (to be able to say, for example, “roll forward my databases to how they were today at 10:30 a.m.”).

**Processing multiple files.** If you have more than one binary log to execute on the MySQL server, the safe method is to process them all using a single connection to the server. Here is an example that demonstrates what may be *unsafe*:

```
mysqlbinlog binlog.000001 | mysql -u root -p # DANGER!!
mysqlbinlog binlog.000002 | mysql -u root -p # DANGER!!
```

Processing binary logs this way using multiple connections to the server causes problems if the first log file contains a `CREATE TEMPORARY TABLE` statement and the second log contains a statement that uses the temporary table. When the first `mysql` process terminates, the server drops the temporary table. When the second `mysql` process attempts to use the table, the server reports “unknown table.”

To avoid problems like this, use a *single* `mysql` process to execute the contents of all binary logs that you want to process. Here is one way to do so:

```
mysqlbinlog binlog.000001 binlog.000002 | mysql -u root -p
```

Another approach is to write all the logs to a single file and then process the file:

```
mysqlbinlog binlog.000001 > /tmp/statements.sql
mysqlbinlog binlog.000002 >> /tmp/statements.sql
mysql -u root -p -e "source /tmp/statements.sql"
```

`mysqlbinlog` can produce output that reproduces a `LOAD DATA` operation without the original data file. `mysqlbinlog` copies the data to a temporary file and writes a `LOAD DATA LOCAL` statement that refers to the file. The default location of the directory where these files are written is system-specific. To specify a directory explicitly, use the `--local-load` option.

Because `mysqlbinlog` converts `LOAD DATA` statements to `LOAD DATA LOCAL` statements (that is, it adds `LOCAL`), both the client and the server that you use to process the statements must be configured with the `LOCAL` capability enabled. See [Section 6.1.6, “Security Considerations for LOAD DATA LOCAL”](#).



### Warning

The temporary files created for `LOAD DATA LOCAL` statements are *not* automatically deleted because they are needed until you actually execute those statements. You should delete the temporary files yourself after you no longer need the statement log. The files can be found in the temporary file directory and have names like `original_file_name-#-#`.

## 4.6.7.1 mysqlbinlog Hex Dump Format

The `--hexdump` option causes `mysqlbinlog` to produce a hex dump of the binary log contents:

```
mysqlbinlog --hexdump master-bin.000001
```

The hex output consists of comment lines beginning with `#`, so the output might look like this for the preceding command:

```
/*!40019 SET @@SESSION.max_insert_delayed_threads=0*/;
/*!50003 SET @OLD_COMPLETION_TYPE=@@COMPLETION_TYPE,COMPLETION_TYPE=0*/;
# at 4
#051024 17:24:13 server id 1 end_log_pos 98
# Position Timestamp Type Master ID Size Master Pos Flags
# 00000004 9d fc 5c 43 0f 01 00 00 00 5e 00 00 00 62 00 00 00 00 00
# 00000017 04 00 35 2e 30 2e 31 35 2d 64 65 62 75 67 2d 6c |..5.0.15.debug.l|
# 00000027 6f 67 00 00 00 00 00 00 00 00 00 00 00 00 00 00 |og.....|
# 00000037 00 00 00 00 00 00 00 00 00 00 00 00 00 00 00 00 |.....|
# 00000047 00 00 00 00 9d fc 5c 43 13 38 0d 00 08 00 12 00 |.....C.8.....|
# 00000057 04 04 04 04 12 00 00 4b 00 04 1a |.....K...|
# Start: binlog v 4, server v 5.0.15-debug-log created 051024 17:24:13
# at startup
ROLLBACK;
```

Hex dump output currently contains the elements in the following list. This format is subject to change. For more information about binary log format, see [MySQL Internals: The Binary Log](#).

- **Position:** The byte position within the log file.
- **Timestamp:** The event timestamp. In the example shown, '9d fc 5c 43' is the representation of '051024 17:24:13' in hexadecimal.
- **Type:** The event type code.
- **Master ID:** The server ID of the replication source server that created the event.
- **Size:** The size in bytes of the event.



- **Master Pos:** The position of the next event in the original source log file.
- **Flags:** Event flag values.

#### 4.6.7.2 mysqlbinlog Row Event Display

The following examples illustrate how `mysqlbinlog` displays row events that specify data modifications. These correspond to events with the `WRITE_ROWS_EVENT`, `UPDATE_ROWS_EVENT`, and `DELETE_ROWS_EVENT` type codes. The `--base64-output=DECODE-ROWS` and `--verbose` options may be used to affect row event output.

Suppose that the server is using row-based binary logging and that you execute the following sequence of statements:

```
CREATE TABLE t
(
  id INT NOT NULL,
  name VARCHAR(20) NOT NULL,
  date DATE NULL
) ENGINE = InnoDB;

START TRANSACTION;
INSERT INTO t VALUES(1, 'apple', NULL);
UPDATE t SET name = 'pear', date = '2009-01-01' WHERE id = 1;
DELETE FROM t WHERE id = 1;
COMMIT;
```

By default, `mysqlbinlog` displays row events encoded as base-64 strings using `BINLOG` statements. Omitting extraneous lines, the output for the row events produced by the preceding statement sequence looks like this:

```
$> mysqlbinlog log_file
...
# at 218
#080828 15:03:08 server id 1  end_log_pos 258   Write_rows: table id 17 flags: STMT_END_F

BINLOG '
fAS3SBMBAAAAALAAAAANoAAAAABEAAAAAAAAABHRLc3QAAXQAaWMPcgIUAAQ=
fAS3SBcBAAAAKAAAAAIBAAAQABEAAAAAAAAEAA//8AQAAAAVhcHBsZQ==
'/*!*/;
...
# at 302
#080828 15:03:08 server id 1  end_log_pos 356   Update_rows: table id 17 flags: STMT_END_F

BINLOG '
fAS3SBMBAAAAALAAAA4BAAAAABEAAAAAAAAABHRLc3QAAXQAaWMPcgIUAAQ=
fAS3SBgBAAAAngAAAGQBAAAQABEAAAAAAAAEAAA//AEAAAAFYXBwbGx4AQAAAAARwZWYyIbIP
'/*!*/;
...
# at 400
#080828 15:03:08 server id 1  end_log_pos 442   Delete_rows: table id 17 flags: STMT_END_F

BINLOG '
fAS3SBMBAAAAALAAAAJABAAAAABEAAAAAAAAABHRLc3QAAXQAaWMPcgIUAAQ=
fAS3SBkBAAAAKgAAALoBAAAQABEAAAAAAAAEAA//4AQAAAAARwZWYyIbIP
'/*!*/;
```

To see the row events as comments in the form of “pseudo-SQL” statements, run `mysqlbinlog` with the `--verbose` or `-v` option. The output contains lines beginning with `###`:

```
$> mysqlbinlog -v log_file
...
# at 218
#080828 15:03:08 server id 1  end_log_pos 258   Write_rows: table id 17 flags: STMT_END_F
```

```

BINLOG '
fAS3SBMBAAAAALAAAAANoAAAAABEAAAAAAAAABHRlc3QAAXQAawMPCgIUAAQ=
fAS3SBcBAAAAKAAAAAIBAAAQABEAAAAAAAAEAA//8AQAAAAVhcHBsZQ==
'/*!*/;
### INSERT INTO test.t
### SET
### @1=1
### @2='apple'
### @3=NULL
...
# at 302
#080828 15:03:08 server id 1 end_log_pos 356 Update_rows: table id 17 flags: STMT_END_F

BINLOG '
fAS3SBMBAAAAALAAAAAC4BAAAAABEAAAAAAAAABHRlc3QAAXQAawMPCgIUAAQ=
fAS3SBgBAAAAngAAAGQBAAAQABEAAAAAAAAEAAA//AEAAAAFYXBwbGx4AQAAAAARwZWYyIbIP
'/*!*/;
### UPDATE test.t
### WHERE
### @1=1
### @2='apple'
### @3=NULL
### SET
### @1=1
### @2='pear'
### @3='2009:01:01'
...
# at 400
#080828 15:03:08 server id 1 end_log_pos 442 Delete_rows: table id 17 flags: STMT_END_F

BINLOG '
fAS3SBMBAAAAALAAAAAJABAAAAABEAAAAAAAAABHRlc3QAAXQAawMPCgIUAAQ=
fAS3SBkBAAAAkGAAALoBAAAQABEAAAAAAAAEAAA//4AQAAAAARwZWYyIbIP
'/*!*/;
### DELETE FROM test.t
### WHERE
### @1=1
### @2='pear'
### @3='2009:01:01'

```

Specify `--verbose` or `-v` twice to also display data types and some metadata for each column. The output contains an additional comment following each column change:

```

$> mysqlbinlog -vv log_file
...
# at 218
#080828 15:03:08 server id 1 end_log_pos 258 Write_rows: table id 17 flags: STMT_END_F

BINLOG '
fAS3SBMBAAAAALAAAAANoAAAAABEAAAAAAAAABHRlc3QAAXQAawMPCgIUAAQ=
fAS3SBcBAAAAKAAAAAIBAAAQABEAAAAAAAAEAA//8AQAAAAVhcHBsZQ==
'/*!*/;
### INSERT INTO test.t
### SET
### @1=1 /* INT meta=0 nullable=0 is_null=0 */
### @2='apple' /* VARSTRING(20) meta=20 nullable=0 is_null=0 */
### @3=NULL /* VARSTRING(20) meta=0 nullable=1 is_null=1 */
...
# at 302
#080828 15:03:08 server id 1 end_log_pos 356 Update_rows: table id 17 flags: STMT_END_F

BINLOG '
fAS3SBMBAAAAALAAAAAC4BAAAAABEAAAAAAAAABHRlc3QAAXQAawMPCgIUAAQ=
fAS3SBgBAAAAngAAAGQBAAAQABEAAAAAAAAEAAA//AEAAAAFYXBwbGx4AQAAAAARwZWYyIbIP
'/*!*/;
### UPDATE test.t

```

```

### WHERE
### @1=1 /* INT meta=0 nullable=0 is_null=0 */
### @2='apple' /* VARSTRING(20) meta=20 nullable=0 is_null=0 */
### @3=NULL /* VARSTRING(20) meta=0 nullable=1 is_null=1 */
### SET
### @1=1 /* INT meta=0 nullable=0 is_null=0 */
### @2='pear' /* VARSTRING(20) meta=20 nullable=0 is_null=0 */
### @3='2009:01:01' /* DATE meta=0 nullable=1 is_null=0 */
...
# at 400
#080828 15:03:08 server id 1 end_log_pos 442 Delete_rows: table id 17 flags: STMT_END_F

BINLOG '
fAS3SBMBAAAAAALAAAAJABAAAAABEAAAAAAAAABHRLc3QAAXQAawMPCgIUAAQ=
fAS3SBkBAAAAKgAAALoBAAAQABEAAAAAAAAEAA//4AQAAARwZWFyIbIP
'/*!*/;
### DELETE FROM test.t
### WHERE
### @1=1 /* INT meta=0 nullable=0 is_null=0 */
### @2='pear' /* VARSTRING(20) meta=20 nullable=0 is_null=0 */
### @3='2009:01:01' /* DATE meta=0 nullable=1 is_null=0 */

```

You can tell `mysqlbinlog` to suppress the `BINLOG` statements for row events by using the `--base64-output=DECODE-ROWS` option. This is similar to `--base64-output=NEVER` but does not exit with an error if a row event is found. The combination of `--base64-output=DECODE-ROWS` and `--verbose` provides a convenient way to see row events only as SQL statements:

```

$> mysqlbinlog -v --base64-output=DECODE-ROWS log_file
...
# at 218
#080828 15:03:08 server id 1 end_log_pos 258 Write_rows: table id 17 flags: STMT_END_F
### INSERT INTO test.t
### SET
### @1=1
### @2='apple'
### @3=NULL
...
# at 302
#080828 15:03:08 server id 1 end_log_pos 356 Update_rows: table id 17 flags: STMT_END_F
### UPDATE test.t
### WHERE
### @1=1
### @2='apple'
### @3=NULL
### SET
### @1=1
### @2='pear'
### @3='2009:01:01'
...
# at 400
#080828 15:03:08 server id 1 end_log_pos 442 Delete_rows: table id 17 flags: STMT_END_F
### DELETE FROM test.t
### WHERE
### @1=1
### @2='pear'
### @3='2009:01:01'

```



### Note

You should not suppress `BINLOG` statements if you intend to re-execute `mysqlbinlog` output.

The SQL statements produced by `--verbose` for row events are much more readable than the corresponding `BINLOG` statements. However, they do not correspond exactly to the original SQL statements that generated the events. The following limitations apply:

- The original column names are lost and replaced by @*N*, where *N* is a column number.
- Character set information is not available in the binary log, which affects string column display:
  - There is no distinction made between corresponding binary and nonbinary string types ([BINARY](#) and [CHAR](#), [VARBINARY](#) and [VARCHAR](#), [BLOB](#) and [TEXT](#)). The output uses a data type of [STRING](#) for fixed-length strings and [VARSTRING](#) for variable-length strings.
  - For multibyte character sets, the maximum number of bytes per character is not present in the binary log, so the length for string types is displayed in bytes rather than in characters. For example, [STRING\(4\)](#) is used as the data type for values from either of these column types:

```
CHAR(4) CHARACTER SET latin1
CHAR(2) CHARACTER SET ucs2
```

- Due to the storage format for events of type [UPDATE\\_ROWS\\_EVENT](#), [UPDATE](#) statements are displayed with the [WHERE](#) clause preceding the [SET](#) clause.

Proper interpretation of row events requires the information from the format description event at the beginning of the binary log. Because [mysqlbinlog](#) does not know in advance whether the rest of the log contains row events, by default it displays the format description event using a [BINLOG](#) statement in the initial part of the output.

If the binary log is known not to contain any events requiring a [BINLOG](#) statement (that is, no row events), the [--base64-output=NEVER](#) option can be used to prevent this header from being written.

### 4.6.7.3 Using mysqlbinlog to Back Up Binary Log Files

By default, [mysqlbinlog](#) reads binary log files and displays their contents in text format. This enables you to examine events within the files more easily and to re-execute them (for example, by using the output as input to [mysql](#)). [mysqlbinlog](#) can read log files directly from the local file system, or, with the [--read-from-remote-server](#) option, it can connect to a server and request binary log contents from that server. [mysqlbinlog](#) writes text output to its standard output, or to the file named as the value of the [--result-file=file\\_name](#) option if that option is given.

- [mysqlbinlog Backup Capabilities](#)
- [mysqlbinlog Backup Options](#)
- [Static and Live Backups](#)
- [Output File Naming](#)
- [Example: mysqldump + mysqlbinlog for Backup and Restore](#)
- [mysqlbinlog Backup Restrictions](#)

#### mysqlbinlog Backup Capabilities

[mysqlbinlog](#) can read binary log files and write new files containing the same content—that is, in binary format rather than text format. This capability enables you to easily back up a binary log in its original format. [mysqlbinlog](#) can make a static backup, backing up a set of log files and stopping when the end of the last file is reached. It can also make a continuous (“live”) backup, staying connected to the server when it reaches the end of the last log file and continuing to copy new events as they are generated. In continuous-backup operation, [mysqlbinlog](#) runs until the connection ends (for example, when the server exits) or [mysqlbinlog](#) is forcibly terminated. When the connection ends, [mysqlbinlog](#) does not wait and retry the connection, unlike a replica server. To continue a live backup after the server has been restarted, you must also restart [mysqlbinlog](#).

## mysqlbinlog Backup Options

Binary log backup requires that you invoke `mysqlbinlog` with two options at minimum:

- The `--read-from-remote-server` (or `-R`) option tells `mysqlbinlog` to connect to a server and request its binary log. (This is similar to a replica server connecting to its replication source server.)
- The `--raw` option tells `mysqlbinlog` to write raw (binary) output, not text output.

Along with `--read-from-remote-server`, it is common to specify other options: `--host` indicates where the server is running, and you may also need to specify connection options such as `--user` and `--password`.

Several other options are useful in conjunction with `--raw`:

- `--stop-never`: Stay connected to the server after reaching the end of the last log file and continue to read new events.
- `--stop-never-slave-server-id=id`: The server ID that `mysqlbinlog` reports to the server when `--stop-never` is used. The default is 65535. This can be used to avoid a conflict with the ID of a replica server or another `mysqlbinlog` process. See [Section 4.6.7.4, “Specifying the mysqlbinlog Server ID”](#).
- `--result-file`: A prefix for output file names, as described later.

## Static and Live Backups

To back up a server's binary log files with `mysqlbinlog`, you must specify file names that actually exist on the server. If you do not know the names, connect to the server and use the `SHOW BINARY LOGS` statement to see the current names. Suppose that the statement produces this output:

```
mysql> SHOW BINARY LOGS;
+-----+
| Log_name      | File_size |
+-----+
| binlog.000130 |    27459 |
| binlog.000131 |    13719 |
| binlog.000132 |    43268 |
+-----+
```

With that information, you can use `mysqlbinlog` to back up the binary log to the current directory as follows (enter each command on a single line):

- To make a static backup of `binlog.000130` through `binlog.000132`, use either of these commands:

```
mysqlbinlog --read-from-remote-server --host=host_name --raw
  binlog.000130 binlog.000131 binlog.000132

mysqlbinlog --read-from-remote-server --host=host_name --raw
  --to-last-log binlog.000130
```

The first command specifies every file name explicitly. The second names only the first file and uses `--to-last-log` to read through the last. A difference between these commands is that if the server happens to open `binlog.000133` before `mysqlbinlog` reaches the end of `binlog.000132`, the first command does not read it, but the second command does.

- To make a live backup in which `mysqlbinlog` starts with `binlog.000130` to copy existing log files, then stays connected to copy new events as the server generates them:

```
mysqlbinlog --read-from-remote-server --host=host_name --raw
  --stop-never binlog.000130
```

With `--stop-never`, it is not necessary to specify `--to-last-log` to read to the last log file because that option is implied.

## Output File Naming

Without `--raw`, `mysqlbinlog` produces text output and the `--result-file` option, if given, specifies the name of the single file to which all output is written. With `--raw`, `mysqlbinlog` writes one binary output file for each log file transferred from the server. By default, `mysqlbinlog` writes the files in the current directory with the same names as the original log files. To modify the output file names, use the `--result-file` option. In conjunction with `--raw`, the `--result-file` option value is treated as a prefix that modifies the output file names.

Suppose that a server currently has binary log files named `binlog.000999` and up. If you use `mysqlbinlog --raw` to back up the files, the `--result-file` option produces output file names as shown in the following table. You can write the files to a specific directory by beginning the `--result-file` value with the directory path. If the `--result-file` value consists only of a directory name, the value must end with the pathname separator character. Output files are overwritten if they exist.

<code>--result-file</code> Option	Output File Names
<code>--result-file=x</code>	<code>xbinlog.000999</code> and up
<code>--result-file=/tmp/</code>	<code>/tmp/binlog.000999</code> and up
<code>--result-file=/tmp/x</code>	<code>/tmp/xbinlog.000999</code> and up

## Example: mysqldump + mysqlbinlog for Backup and Restore

The following example describes a simple scenario that shows how to use `mysqldump` and `mysqlbinlog` together to back up a server's data and binary log, and how to use the backup to restore the server if data loss occurs. The example assumes that the server is running on host `host_name` and its first binary log file is named `binlog.000999`. Enter each command on a single line.

Use `mysqlbinlog` to make a continuous backup of the binary log:

```
mysqlbinlog --read-from-remote-server --host=host_name --raw
--stop-never binlog.000999
```

Use `mysqldump` to create a dump file as a snapshot of the server's data. Use `--all-databases`, `--events`, and `--routines` to back up all data, and `--master-data=2` to include the current binary log coordinates in the dump file.

```
mysqldump --host=host_name --all-databases --events --routines --master-data=2> dump_file
```

Execute the `mysqldump` command periodically to create newer snapshots as desired.

If data loss occurs (for example, if the server unexpectedly exits), use the most recent dump file to restore the data:

```
mysql --host=host_name -u root -p < dump_file
```

Then use the binary log backup to re-execute events that were written after the coordinates listed in the dump file. Suppose that the coordinates in the file look like this:

```
-- CHANGE MASTER TO MASTER_LOG_FILE='binlog.001002', MASTER_LOG_POS=27284;
```

If the most recent backed-up log file is named `binlog.001004`, re-execute the log events like this:

```
mysqlbinlog --start-position=27284 binlog.001002 binlog.001003 binlog.001004
| mysql --host=host_name -u root -p
```

You might find it easier to copy the backup files (dump file and binary log files) to the server host to make it easier to perform the restore operation, or if MySQL does not allow remote `root` access.

## mysqlbinlog Backup Restrictions

Binary log backups with `mysqlbinlog` are subject to these restrictions:

- `mysqlbinlog` does not automatically reconnect to the MySQL server if the connection is lost (for example, if a server restart occurs or there is a network outage).
- Prior to MySQL 5.7.19, `mysqlbinlog` does not get all events as they are committed, even if the server is configured with `sync_binlog=1`. This means that some of the most recent events may be missing. To ensure that `mysqlbinlog` sees the most recent events, flush the binary log on the server that you are backing up.
- The delay for a backup is similar to the delay for a replica server.

### 4.6.7.4 Specifying the mysqlbinlog Server ID

When invoked with the `--read-from-remote-server` option, `mysqlbinlog` connects to a MySQL server, specifies a server ID to identify itself, and requests binary log files from the server. You can use `mysqlbinlog` to request log files from a server in several ways:

- Specify an explicitly named set of files: For each file, `mysqlbinlog` connects and issues a `Binlog dump` command. The server sends the file and disconnects. There is one connection per file.
- Specify the beginning file and `--to-last-log`: `mysqlbinlog` connects and issues a `Binlog dump` command for all files. The server sends all files and disconnects.
- Specify the beginning file and `--stop-never` (which implies `--to-last-log`): `mysqlbinlog` connects and issues a `Binlog dump` command for all files. The server sends all files, but does not disconnect after sending the last one.

With `--read-from-remote-server` only, `mysqlbinlog` connects using a server ID of 0, which tells the server to disconnect after sending the last requested log file.

With `--read-from-remote-server` and `--stop-never`, `mysqlbinlog` connects using a nonzero server ID, so the server does not disconnect after sending the last log file. The server ID is 65535 by default, but this can be changed with `--stop-never-slave-server-id`.

Thus, for the first two ways of requesting files, the server disconnects because `mysqlbinlog` specifies a server ID of 0. It does not disconnect if `--stop-never` is given because `mysqlbinlog` specifies a nonzero server ID.

## 4.6.8 mysqldumpslow — Summarize Slow Query Log Files

The MySQL slow query log contains information about queries that take a long time to execute (see [Section 5.4.5, “The Slow Query Log”](#)). `mysqldumpslow` parses MySQL slow query log files and summarizes their contents.

Normally, `mysqldumpslow` groups queries that are similar except for the particular values of number and string data values. It “abstracts” these values to `N` and `'S'` when displaying summary output. To modify value abstracting behavior, use the `-a` and `-n` options.

Invoke `mysqldumpslow` like this:

```
mysqldumpslow [options] [log_file ...]
```

Example output with no options given:

```
Reading mysql slow query log from /usr/local/mysql/data/mysqld57-slow.log
Count: 1 Time=4.32s (4s) Lock=0.00s (0s) Rows=0.0 (0), root[root]@localhost
insert into t2 select * from t1

Count: 3 Time=2.53s (7s) Lock=0.00s (0s) Rows=0.0 (0), root[root]@localhost
insert into t2 select * from t1 limit N

Count: 3 Time=2.13s (6s) Lock=0.00s (0s) Rows=0.0 (0), root[root]@localhost
insert into t1 select * from t1
```

`mysqldumpslow` supports the following options.

**Table 4.24 mysqldumpslow Options**

Option Name	Description
<code>-a</code>	Do not abstract all numbers to N and strings to 'S'
<code>-n</code>	Abstract numbers with at least the specified digits
<code>--debug</code>	Write debugging information
<code>-g</code>	Only consider statements that match the pattern
<code>--help</code>	Display help message and exit
<code>-h</code>	Host name of the server in the log file name
<code>-i</code>	Name of the server instance
<code>-l</code>	Do not subtract lock time from total time
<code>-r</code>	Reverse the sort order
<code>-s</code>	How to sort output
<code>-t</code>	Display only first num queries
<code>--verbose</code>	Verbose mode

- `--help`

Command-Line Format	<code>--help</code>
---------------------	---------------------

Display a help message and exit.

- `-a`

Do not abstract all numbers to N and strings to 'S'.

- `--debug, -d`

Command-Line Format	<code>--debug</code>
---------------------	----------------------

Run in debug mode.

This option is available only if MySQL was built using `WITH_DEBUG`. MySQL release binaries provided by Oracle are *not* built using this option.

- `-g pattern`

Type	String
------	--------



Consider only queries that match the ([grep-style](#)) pattern.

- `-h host_name`

Type	String
Default Value	*

Host name of MySQL server for `*-slow.log` file name. The value can contain a wildcard. The default is `*` (match all).

- `-i name`

Type	String
------	--------

Name of server instance (if using `mysql.server` startup script).

- `-l`

Do not subtract lock time from total time.

- `-n N`

Type	Numeric
------	---------

Abstract numbers with at least *N* digits within names.

- `-r`

Reverse the sort order.

- `-s sort_type`

Type	String
Default Value	<code>at</code>

How to sort the output. The value of `sort_type` should be chosen from the following list:

- `t, at`: Sort by query time or average query time
- `l, al`: Sort by lock time or average lock time
- `r, ar`: Sort by rows sent or average rows sent
- `c`: Sort by count

By default, `mysqldumpslow` sorts by average query time (equivalent to `-s at`).

- `-t N`

Type	Numeric
------	---------

Display only the first *N* queries in the output.

- `--verbose, -v`

Command-Line Format	<code>--verbose</code>
---------------------	------------------------

Verbose mode. Print more information about what the program does.

## 4.7 Program Development Utilities

This section describes some utilities that you may find useful when developing MySQL programs.

In shell scripts, you can use the `my_print_defaults` program to parse option files and see what options would be used by a given program. The following example shows the output that `my_print_defaults` might produce when asked to show the options found in the `[client]` and `[mysql]` groups:

```
$> my_print_defaults client mysql
--port=3306
--socket=/tmp/mysql.sock
--no-auto-rehash
```

Note for developers: Option file handling is implemented in the C client library simply by processing all options in the appropriate group or groups before any command-line arguments. This works well for programs that use the last instance of an option that is specified multiple times. If you have a C or C++ program that handles multiply specified options this way but that does not read option files, you need add only two lines to give it that capability. Check the source code of any of the standard MySQL clients to see how to do this.

Several other language interfaces to MySQL are based on the C client library, and some of them provide a way to access option file contents. These include Perl and Python. For details, see the documentation for your preferred interface.

### 4.7.1 `mysql_config` — Display Options for Compiling Clients

`mysql_config` provides you with useful information for compiling your MySQL client and connecting it to MySQL. It is a shell script, so it is available only on Unix and Unix-like systems.



**Note**

As of MySQL 5.7.9, `pkg-config` can be used as an alternative to `mysql_config` for obtaining information such as compiler flags or link libraries required to compile MySQL applications. For more information, see [Building C API Client Programs Using pkg-config](#).



**Note**

As of MySQL 5.7.4, for binary distributions for Solaris, `mysql_config` does not provide arguments for linking with the embedded library. To get linking arguments for the embedded library, use the `mysql_server_config` script instead.

`mysql_config` supports the following options.

- `--cflags`

C Compiler flags to find include files and critical compiler flags and defines used when compiling the `libmysqlclient` library. The options returned are tied to the specific compiler that was used when the

library was created and might clash with the settings for your own compiler. Use `--include` for more portable options that contain only include paths.

- `--cxxflags`

Like `--cflags`, but for C++ compiler flags.

- `--include`

Compiler options to find MySQL include files.

- `--libmysqld-libs`, `--embedded-libs`, `--embedded`

Libraries and options required to link with `libmysqld`, the MySQL embedded server.



#### Note

The `libmysqld` embedded server library is deprecated as of MySQL 5.7.19 and has been removed in MySQL 8.0.

- `--libs`

Libraries and options required to link with the MySQL client library.

- `--libs_r`

Libraries and options required to link with the thread-safe MySQL client library. In MySQL 5.7, all client libraries are thread-safe, so this option need not be used. The `--libs` option can be used in all cases.

- `--plugindir`

The default plugin directory path name, defined when configuring MySQL.

- `--port`

The default TCP/IP port number, defined when configuring MySQL.

- `--socket`

The default Unix socket file, defined when configuring MySQL.

- `--variable=var_name`

Display the value of the named configuration variable. Permitted `var_name` values are `pkgincludedir` (the header file directory), `pkglibdir` (the library directory), and `plugindir` (the plugin directory).

- `--version`

Version number for the MySQL distribution.

If you invoke `mysql_config` with no options, it displays a list of all options that it supports, and their values:

```
$> mysql_config
Usage: /usr/local/mysql/bin/mysql_config [options]
Options:
--cflags          [-I/usr/local/mysql/include/mysql -mcpu=pentiumpro]
--cxxflags       [-I/usr/local/mysql/include/mysql -mcpu=pentiumpro]
--include        [-I/usr/local/mysql/include/mysql]
--libs           [-L/usr/local/mysql/lib/mysql -lmysqlclient
                 -lpthread -lm -lrt -lssl -lcrypto -ldl]
```

```

--libs_r      [-L/usr/local/mysql/lib/mysql -lmysqlclient_r
              -lpthread -lm -lrt -lssl -lcrypto -ldl]
--plugindir   [/usr/local/mysql/lib/plugin]
--socket      [/tmp/mysql.sock]
--port        [3306]
--version     [5.7.9]
--libmysqld-libs [-L/usr/local/mysql/lib/mysql -lmysqld
                 -lpthread -lm -lrt -lssl -lcrypto -ldl -lcrypt]
--variable=VAR VAR is one of:
                pkgincludedir [/usr/local/mysql/include]
                pkglibdir     [/usr/local/mysql/lib]
                plugindir     [/usr/local/mysql/lib/plugin]

```

You can use `mysql_config` within a command line using backticks to include the output that it produces for particular options. For example, to compile and link a MySQL client program, use `mysql_config` as follows:

```

gcc -c `mysql_config --cflags` progname.c
gcc -o progname progname.o `mysql_config --libs`

```

## 4.7.2 my\_print\_defaults — Display Options from Option Files

`my_print_defaults` displays the options that are present in option groups of option files. The output indicates what options are used by programs that read the specified option groups. For example, the `mysqlcheck` program reads the `[mysqlcheck]` and `[client]` option groups. To see what options are present in those groups in the standard option files, invoke `my_print_defaults` like this:

```

$> my_print_defaults mysqlcheck client
--user=myusername
--password=password
--host=localhost

```

The output consists of options, one per line, in the form that they would be specified on the command line.

`my_print_defaults` supports the following options.

- `--help, -?`  
Display a help message and exit.
- `--config-file=file_name, --defaults-file=file_name, -c file_name`  
Read only the given option file.
- `--debug=debug_options, -# debug_options`  
Write a debugging log. A typical `debug_options` string is `d:t:o,file_name`. The default is `d:t:o,/tmp/my_print_defaults.trace`.
- `--defaults-extra-file=file_name, --extra-file=file_name, -e file_name`  
Read this option file after the global option file but (on Unix) before the user option file.  
For additional information about this and other option-file options, see [Section 4.2.2.3, “Command-Line Options that Affect Option-File Handling”](#).
- `--defaults-group-suffix=suffix, -g suffix`  
In addition to the groups named on the command line, read groups that have the given suffix.  
For additional information about this and other option-file options, see [Section 4.2.2.3, “Command-Line Options that Affect Option-File Handling”](#).

- `--login-path=name, -l name`

Read options from the named login path in the `.mylogin.cnf` login path file. A “login path” is an option group containing options that specify which MySQL server to connect to and which account to authenticate as. To create or modify a login path file, use the `mysql_config_editor` utility. See [Section 4.6.6, “mysql\\_config\\_editor — MySQL Configuration Utility”](#).

For additional information about this and other option-file options, see [Section 4.2.2.3, “Command-Line Options that Affect Option-File Handling”](#).

- `--no-defaults, -n`

Return an empty string.

For additional information about this and other option-file options, see [Section 4.2.2.3, “Command-Line Options that Affect Option-File Handling”](#).

- `--show, -s`

As of MySQL 5.7.8, `my_print_defaults` masks passwords by default. Use this option to display passwords in cleartext.

- `--verbose, -v`

Verbose mode. Print more information about what the program does.

- `--version, -V`

Display version information and exit.

### 4.7.3 resolve\_stack\_dump — Resolve Numeric Stack Trace Dump to Symbols

`resolve_stack_dump` resolves a numeric stack dump to symbols.



#### Note

`resolve_stack_dump` is deprecated and is removed in MySQL 8.0. Stack traces from official MySQL builds are always symbolized, so there is no need to use `resolve_stack_dump`.

Invoke `resolve_stack_dump` like this:

```
resolve_stack_dump [options] symbols_file [numeric_dump_file]
```

The symbols file should include the output from the `nm --numeric-sort mysqld` command. The numeric dump file should contain a numeric stack track from `mysqld`. If no numeric dump file is named on the command line, the stack trace is read from the standard input.

`resolve_stack_dump` supports the following options.

- `--help, -h`

Display a help message and exit.

- `--numeric-dump-file=file_name, -n file_name`

Read the stack trace from the given file.

- `--symbols-file=file_name, -s file_name`

Use the given symbols file.

- `--version, -V`

Display version information and exit.

For more information, see [Section 5.8.1.5, “Using a Stack Trace”](#).

## 4.8 Miscellaneous Programs

### 4.8.1 `lz4_decompress` — Decompress `mysqlpump` LZ4-Compressed Output

The `lz4_decompress` utility decompresses `mysqlpump` output that was created using LZ4 compression. `lz4_decompress` was added in MySQL 5.7.10.

Invoke `lz4_decompress` like this:

```
lz4_decompress input_file output_file
```

Example:

```
mysqlpump --compress-output=LZ4 > dump.lz4
lz4_decompress dump.lz4 dump.txt
```

To see a help message, invoke `lz4_decompress` with no arguments.

To decompress `mysqlpump` ZLIB-compressed output, use `zlib_decompress`. See [Section 4.8.5, “zlib\\_decompress — Decompress `mysqlpump` ZLIB-Compressed Output”](#).

### 4.8.2 `perror` — Display MySQL Error Message Information

For most system errors, MySQL displays, in addition to an internal text message, the system error code in one of the following styles:

```
message ... (errno: #)
message ... (Errcode: #)
```

You can find out what the error code means by examining the documentation for your system or by using the `perror` utility.

`perror` prints a description for a system error code or for a storage engine (table handler) error code.

Invoke `perror` like this:

```
perror [options] errorcode ...
```

Examples:

```
$> perror 1231
MySQL error code 1231 (ER_WRONG_VALUE_FOR_VAR): Variable '%-.64s' can't
be set to the value of '%-.200s'
```

```
$> perror 13 64
OS error code 13: Permission denied
OS error code 64: Machine is not on the network
```

To obtain the error message for a MySQL Cluster error code, use the `ndb_perror` utility.

The meaning of system error messages may be dependent on your operating system. A given error code may mean different things on different operating systems.

`perror` supports the following options.

- `--help`, `--info`, `-I`, `-?`

Display a help message and exit.

- `--ndb`

Print the error message for an NDB Cluster error code.

This option is deprecated in NDB 7.6.4 and later, where `perror` prints a warning if it is used, and is removed in NDB Cluster 8.0. Use the `ndb_perror` utility instead.

- `--silent`, `-s`

Silent mode. Print only the error message.

- `--verbose`, `-v`

Verbose mode. Print error code and message. This is the default behavior.

- `--version`, `-V`

Display version information and exit.

### 4.8.3 replace — A String-Replacement Utility

The `replace` utility program changes strings in place in files or on the standard input.



#### Note

The `replace` utility is deprecated as of MySQL 5.7.18 and is removed in MySQL 8.0.

Invoke `replace` in one of the following ways:

```
replace from to [from to] ... -- file_name [file_name] ...
replace from to [from to] ... < file_name
```

`from` represents a string to look for and `to` represents its replacement. There can be one or more pairs of strings.

Use the `--` option to indicate where the string-replacement list ends and the file names begin. In this case, any file named on the command line is modified in place, so you may want to make a copy of the original before converting it. `replace` prints a message indicating which of the input files it actually modifies.

If the `--` option is not given, `replace` reads the standard input and writes to the standard output.

`replace` uses a finite state machine to match longer strings first. It can be used to swap strings. For example, the following command swaps `a` and `b` in the given files, `file1` and `file2`:

```
replace a b b a -- file1 file2 ...
```

`replace` supports the following options.

- `-?`, `-I`

Display a help message and exit.

- `-#debug_options`

Enable debugging.

- `-s`  
Silent mode. Print less information what the program does.
- `-v`  
Verbose mode. Print more information about what the program does.
- `-V`  
Display version information and exit.

#### 4.8.4 resolveip — Resolve Host name to IP Address or Vice Versa

The `resolveip` utility resolves host names to IP addresses and vice versa.



##### Note

`resolveip` is deprecated and is removed in MySQL 8.0. `nslookup`, `host`, or `dig` can be used instead.

Invoke `resolveip` like this:

```
resolveip [options] {host_name|ip-addr} ...
```

`resolveip` supports the following options.

- `--help`, `--info`, `-?`, `-I`  
Display a help message and exit.
- `--silent`, `-s`  
Silent mode. Produce less output.
- `--version`, `-V`  
Display version information and exit.

#### 4.8.5 zlib\_decompress — Decompress mysqlpump ZLIB-Compressed Output

The `zlib_decompress` utility decompresses `mysqlpump` output that was created using ZLIB compression. `zlib_decompress` was added in MySQL 5.7.10.

Invoke `zlib_decompress` like this:

```
zlib_decompress input_file output_file
```

Example:

```
mysqlpump --compress-output=ZLIB > dump.zlib
zlib_decompress dump.zlib dump.txt
```

To see a help message, invoke `zlib_decompress` with no arguments.

To decompress `mysqlpump` LZ4-compressed output, use `lz4_decompress`. See [Section 4.8.1, “lz4\\_decompress — Decompress mysqlpump LZ4-Compressed Output”](#).

## 4.9 Environment Variables



This section lists environment variables that are used directly or indirectly by MySQL. Most of these can also be found in other places in this manual.

Options on the command line take precedence over values specified in option files and environment variables, and values in option files take precedence over values in environment variables. In many cases, it is preferable to use an option file instead of environment variables to modify the behavior of MySQL. See [Section 4.2.2.2, “Using Option Files”](#).

Variable	Description
<code>AUTHENTICATION_LDAP_CLIENT_LOG</code>	Client-side LDAP authentication logging level.
<code>AUTHENTICATION_PAM_LOG</code>	<a href="#">PAM</a> authentication plugin debug logging settings.
<code>CC</code>	The name of your C compiler (for running <code>CMake</code> ).
<code>CXX</code>	The name of your C++ compiler (for running <code>CMake</code> ).
<code>CC</code>	The name of your C compiler (for running <code>CMake</code> ).
<code>DBI_USER</code>	The default user name for Perl DBI.
<code>DBI_TRACE</code>	Trace options for Perl DBI.
<code>HOME</code>	The default path for the <code>mysql</code> history file is <code>\$HOME/.mysql_history</code> .
<code>LD_RUN_PATH</code>	Used to specify the location of <code>libmysqlclient.so</code> .
<code>LIBMYSQL_ENABLE_CLEARTEXT_PLUGIN</code>	Enable <code>mysql_clear_password</code> authentication plugin; see <a href="#">Section 6.4.1.6, “Client-Side Cleartext Pluggable Authentication”</a> .
<code>LIBMYSQL_PLUGIN_DIR</code>	Directory in which to look for client plugins.
<code>LIBMYSQL_PLUGINS</code>	Client plugins to preload.
<code>MYSQL_DEBUG</code>	Debug trace options when debugging.
<code>MYSQL_GROUP_SUFFIX</code>	Option group suffix value (like specifying <code>--defaults-group-suffix</code> ).
<code>MYSQL_HISTFILE</code>	The path to the <code>mysql</code> history file. If this variable is set, its value overrides the default for <code>\$HOME/.mysql_history</code> .
<code>MYSQL_HISTIGNORE</code>	Patterns specifying statements that <code>mysql</code> should not log to <code>\$HOME/.mysql_history</code> , or <code>syslog</code> if <code>--syslog</code> is given.
<code>MYSQL_HOME</code>	The path to the directory in which the server-specific <code>my.cnf</code> file resides.
<code>MYSQL_HOST</code>	The default host name used by the <code>mysql</code> command-line client.
<code>MYSQL_OPENSSL_UDF_DH_BITS_THRESHOLD</code>	Maximum key length for <code>create_dh_parameters()</code> . See <a href="#">Section 6.6.2, “MySQL Enterprise Encryption Usage and Examples”</a> .
<code>MYSQL_OPENSSL_UDF_DSA_BITS_THRESHOLD</code>	Maximum DSA key length for <code>create_asymmetric_priv_key()</code> . See <a href="#">Section 6.6.2, “MySQL Enterprise Encryption Usage and Examples”</a> .

Variable	Description
<code>MYSQL_OPENSSL_UDF_RSA_BITS_THRESHOLD</code>	Maximum RSA key length for <code>create_asymmetric_priv_key()</code> . See <a href="#">Section 6.6.2, “MySQL Enterprise Encryption Usage and Examples”</a> .
<code>MYSQL_PS1</code>	The command prompt to use in the <code>mysql</code> command-line client.
<code>MYSQL_PWD</code>	The default password when connecting to <code>mysqld</code> . Using this is insecure. See <a href="#">Section 6.1.2.1, “End-User Guidelines for Password Security”</a> .
<code>MYSQL_TCP_PORT</code>	The default TCP/IP port number.
<code>MYSQL_TEST_LOGIN_FILE</code>	The name of the <code>.mylogin.cnf</code> login path file.
<code>MYSQL_TEST_TRACE_CRASH</code>	Whether the test protocol trace plugin crashes clients. See note following table.
<code>MYSQL_TEST_TRACE_DEBUG</code>	Whether the test protocol trace plugin produces output. See note following table.
<code>MYSQL_UNIX_PORT</code>	The default Unix socket file name; used for connections to <code>localhost</code> .
<code>MYSQLX_TCP_PORT</code>	The X Plugin default TCP/IP port number.
<code>MYSQLX_UNIX_PORT</code>	The X Plugin default Unix socket file name; used for connections to <code>localhost</code> .
<code>PATH</code>	Used by the shell to find MySQL programs.
<code>PKG_CONFIG_PATH</code>	Location of <code>mysqlclient.pc</code> <code>pkg-config</code> file. See note following table.
<code>TMPDIR</code>	The directory in which temporary files are created.
<code>TZ</code>	This should be set to your local time zone. See <a href="#">Section B.3.3.7, “Time Zone Problems”</a> .
<code>UMASK</code>	The user-file creation mode when creating files. See note following table.
<code>UMASK_DIR</code>	The user-directory creation mode when creating directories. See note following table.
<code>USER</code>	The default user name on Windows when connecting to <code>mysqld</code> .

For information about the `mysql` history file, see [Section 4.5.1.3, “mysql Client Logging”](#).

`MYSQL_TEST_LOGIN_FILE` is the path name of the login path file (the file created by `mysql_config_editor`). If not set, the default value is `%APPDATA%\MySQL\.mylogin.cnf` directory on Windows and `$HOME/.mylogin.cnf` on non-Windows systems. See [Section 4.6.6, “mysql\\_config\\_editor — MySQL Configuration Utility”](#).

The `MYSQL_TEST_TRACE_DEBUG` and `MYSQL_TEST_TRACE_CRASH` variables control the test protocol trace client plugin, if MySQL is built with that plugin enabled. For more information, see [Using the Test Protocol Trace Plugin](#).

The default `UMASK` and `UMASK_DIR` values are `0640` and `0750`, respectively. MySQL assumes that the value for `UMASK` or `UMASK_DIR` is in octal if it starts with a zero. For example, setting `UMASK=0600` is equivalent to `UMASK=384` because `0600` octal is `384` decimal.

The `UMASK` and `UMASK_DIR` variables, despite their names, are used as modes, not masks:

- If `UMASK` is set, `mysqld` uses `( $\$UMASK$  | 0600)` as the mode for file creation, so that newly created files have a mode in the range from 0600 to 0666 (all values octal).
- If `UMASK_DIR` is set, `mysqld` uses `( $\$UMASK\_DIR$  | 0700)` as the base mode for directory creation, which then is AND-ed with `~(~ $\$UMASK$  & 0666)`, so that newly created directories have a mode in the range from 0700 to 0777 (all values octal). The AND operation may remove read and write permissions from the directory mode, but not execute permissions.

See also [Section B.3.3.1, “Problems with File Permissions”](#).

It may be necessary to set `PKG_CONFIG_PATH` if you use `pkg-config` for building MySQL programs. See [Building C API Client Programs Using pkg-config](#).

## 4.10 Unix Signal Handling in MySQL

On Unix and Unix-like systems, a process can be the recipient of signals sent to it by the `root` system account or the system account that owns the process. Signals can be sent using the `kill` command. Some command interpreters associate certain key sequences with signals, such as **Control+C** to send a `SIGINT` signal. This section describes how the MySQL server and client programs respond to signals.

- [Server Response to Signals](#)
- [Client Response to Signals](#)

### Server Response to Signals

`mysqld` responds to signals as follows:

- `SIGTERM` causes the server to shut down. This is like executing a `SHUTDOWN` statement without having to connect to the server (which for shutdown requires an account that has the `SHUTDOWN` privilege).
- `SIGHUP` causes the server to reload the grant tables and to flush tables, logs, the thread cache, and the host cache. These actions are like various forms of the `FLUSH` statement. Sending the signal enables the flush operations to be performed without having to connect to the server, which requires a MySQL account that has privileges sufficient for those operations. The server also writes a status report to the error log that has this format:

```
Status information:

Current dir: /var/mysql/data/
Running threads: 4  Stack size: 262144
Current locks:
lock: 0x7f742c02c0e0:

lock: 0x2cee2a20:
:
lock: 0x207a080:

Key caches:
default
Buffer_size:      8388608
Block_size:      1024
Division_limit:  100
Age_limit:       300
blocks used:     4
not flushed:     0
w_requests:      0
writes:          0
r_requests:      8
```

```

reads:                4

handler status:
read_key:             13
read_next:            4
read_rnd              0
read_first:           13
write:                1
delete                0
update:               0

Table status:
Opened tables:        121
Open tables:          114
Open files:           18
Open streams:         0

Memory status:
<malloc version="1">
<heap nr="0">
<sizes>
  <size from="17" to="32" total="32" count="1"/>
  <size from="33" to="48" total="96" count="2"/>
  <size from="33" to="33" total="33" count="1"/>
  <size from="97" to="97" total="6014" count="62"/>
  <size from="113" to="113" total="904" count="8"/>
  <size from="193" to="193" total="193" count="1"/>
  <size from="241" to="241" total="241" count="1"/>
  <size from="609" to="609" total="609" count="1"/>
  <size from="16369" to="16369" total="49107" count="3"/>
  <size from="24529" to="24529" total="98116" count="4"/>
  <size from="32689" to="32689" total="32689" count="1"/>
  <unsorted from="241" to="7505" total="7746" count="2"/>
</sizes>
<total type="fast" count="3" size="128"/>
<total type="rest" count="84" size="195652"/>
<system type="current" size="690774016"/>
<system type="max" size="690774016"/>
<aspace type="total" size="690774016"/>
<aspace type="mprotect" size="690774016"/>
</heap>
:
<total type="fast" count="85" size="5520"/>
<total type="rest" count="116" size="316820"/>
<total type="mmap" count="82" size="939954176"/>
<system type="current" size="695717888"/>
<system type="max" size="695717888"/>
<aspace type="total" size="695717888"/>
<aspace type="mprotect" size="695717888"/>
</malloc>

Events status:
LLA = Last Locked At  LUA = Last Unlocked At
WOC = Waiting On Condition  DL = Data Locked

Event scheduler status:
State      : INITIALIZED
Thread id  : 0
LLA        : n/a:0
LUA        : n/a:0
WOC        : NO
Workers    : 0
Executed   : 0
Data locked: NO

Event queue status:
Element count : 0

```

```
Data locked      : NO
Attempting lock  : NO
LLA             : init_queue:95
LUA             : init_queue:103
WOC             : NO
Next activation  : never
```

- `SIGINT` normally is ignored by the server. Starting the server with the `--gdb` option installs an interrupt handler for `SIGINT` for debugging purposes. See [Section 5.8.1.4, “Debugging mysqld under gdb”](#).

## Client Response to Signals

MySQL client programs respond to signals as follows:

- The `mysql` client interprets `SIGINT` (typically the result of typing **Control+C**) as instruction to interrupt the current statement if there is one, or to cancel any partial input line otherwise. This behavior can be disabled using the `--sigint-ignore` option to ignore `SIGINT` signals.
- Client programs that use the MySQL client library block `SIGPIPE` signals by default. These variations are possible:
  - Client can install their own `SIGPIPE` handler to override the default behavior. See [Writing C API Threaded Client Programs](#).
  - Clients can prevent installation of `SIGPIPE` handlers by specifying the `CLIENT_IGNORE_SIGPIPE` option to `mysql_real_connect()` at connect time. See [mysql\\_real\\_connect\(\)](#).



---

# Chapter 5 MySQL Server Administration

## Table of Contents

5.1 The MySQL Server .....	658
5.1.1 Configuring the Server .....	658
5.1.2 Server Configuration Defaults .....	660
5.1.3 Server Option, System Variable, and Status Variable Reference .....	661
5.1.4 Server System Variable Reference .....	702
5.1.5 Server Status Variable Reference .....	723
5.1.6 Server Command Options .....	738
5.1.7 Server System Variables .....	766
5.1.8 Using System Variables .....	891
5.1.9 Server Status Variables .....	909
5.1.10 Server SQL Modes .....	931
5.1.11 Connection Management .....	947
5.1.12 IPv6 Support .....	952
5.1.13 MySQL Server Time Zone Support .....	956
5.1.14 Server-Side Help Support .....	961
5.1.15 Server Tracking of Client Session State .....	962
5.1.16 The Server Shutdown Process .....	965
5.2 The MySQL Data Directory .....	967
5.3 The mysql System Database .....	967
5.4 MySQL Server Logs .....	970
5.4.1 Selecting General Query Log and Slow Query Log Output Destinations .....	971
5.4.2 The Error Log .....	974
5.4.3 The General Query Log .....	976
5.4.4 The Binary Log .....	978
5.4.5 The Slow Query Log .....	991
5.4.6 The DDL Log .....	993
5.4.7 Server Log Maintenance .....	993
5.5 MySQL Server Plugins .....	995
5.5.1 Installing and Uninstalling Plugins .....	996
5.5.2 Obtaining Server Plugin Information .....	1000
5.5.3 MySQL Enterprise Thread Pool .....	1001
5.5.4 The Rewriter Query Rewrite Plugin .....	1007
5.5.5 Version Tokens .....	1016
5.5.6 MySQL Plugin Services .....	1027
5.6 MySQL Server Loadable Functions .....	1035
5.6.1 Installing and Uninstalling Loadable Functions .....	1036
5.6.2 Obtaining Information About Loadable Functions .....	1037
5.7 Running Multiple MySQL Instances on One Machine .....	1038
5.7.1 Setting Up Multiple Data Directories .....	1039
5.7.2 Running Multiple MySQL Instances on Windows .....	1040
5.7.3 Running Multiple MySQL Instances on Unix .....	1043
5.7.4 Using Client Programs in a Multiple-Server Environment .....	1044
5.8 Debugging MySQL .....	1045
5.8.1 Debugging a MySQL Server .....	1045
5.8.2 Debugging a MySQL Client .....	1052
5.8.3 The DBUG Package .....	1052
5.8.4 Tracing mysqld Using DTrace .....	1055

MySQL Server (`mysqld`) is the main program that does most of the work in a MySQL installation. This chapter provides an overview of MySQL Server and covers general server administration:

- Server configuration
- The data directory, particularly the `mysql` system database
- The server log files
- Management of multiple servers on a single machine

For additional information on administrative topics, see also:

- [Chapter 6, Security](#)
- [Chapter 7, Backup and Recovery](#)
- [Chapter 16, Replication](#)

## 5.1 The MySQL Server

`mysqld` is the MySQL server. The following discussion covers these MySQL server configuration topics:

- Startup options that the server supports. You can specify these options on the command line, through configuration files, or both.
- Server system variables. These variables reflect the current state and values of the startup options, some of which can be modified while the server is running.
- Server status variables. These variables contain counters and statistics about runtime operation.
- How to set the server SQL mode. This setting modifies certain aspects of SQL syntax and semantics, for example for compatibility with code from other database systems, or to control the error handling for particular situations.
- How the server manages client connections.
- Configuring and using IPv6 support.
- Configuring and using time zone support.
- Server-side help capabilities.
- The server shutdown process. There are performance and reliability considerations depending on the type of table (transactional or nontransactional) and whether you use replication.

For listings of MySQL server variables and options that have been added, deprecated, or removed in MySQL 5.7, see [Section 1.4, “Server and Status Variables and Options Added, Deprecated, or Removed in MySQL 5.7”](#).



### Note

Not all storage engines are supported by all MySQL server binaries and configurations. To find out how to determine which storage engines your MySQL server installation supports, see [Section 13.7.5.16, “SHOW ENGINES Statement”](#).

### 5.1.1 Configuring the Server



The MySQL server, `mysqld`, has many command options and system variables that can be set at startup to configure its operation. To determine the default command option and system variable values used by the server, execute this command:

```
$> mysqld --verbose --help
```

The command produces a list of all `mysqld` options and configurable system variables. Its output includes the default option and variable values and looks something like this:

```

abort-slave-event-count      0
allow-suspicious-udfs       FALSE
archive                      ON
auto-increment-increment    1
auto-increment-offset       1
autocommit                   TRUE
automatic-sp-privileges      TRUE
avoid-temporal-upgrade       FALSE
back-log                     80
basedir                      /home/jon/bin/mysql-5.7/
...
tmpdir                      /tmp
transaction-alloc-block-size 8192
transaction-isolation        REPEATABLE-READ
transaction-prealloc-size    4096
transaction-read-only        FALSE
transaction-write-set-extraction OFF
updatable-views-with-limit   YES
validate-user-plugins        TRUE
verbose                      TRUE
wait-timeout                 28800

```

To see the current system variable values actually used by the server as it runs, connect to it and execute this statement:

```
mysql> SHOW VARIABLES;
```

To see some statistical and status indicators for a running server, execute this statement:

```
mysql> SHOW STATUS;
```

System variable and status information also is available using the `mysqladmin` command:

```
$> mysqladmin variables
$> mysqladmin extended-status
```

For a full description of all command options, system variables, and status variables, see these sections:

- [Section 5.1.6, “Server Command Options”](#)
- [Section 5.1.7, “Server System Variables”](#)
- [Section 5.1.9, “Server Status Variables”](#)

More detailed monitoring information is available from the Performance Schema; see [Chapter 25, MySQL Performance Schema](#). In addition, the MySQL `sys` schema is a set of objects that provides convenient access to data collected by the Performance Schema; see [Chapter 26, MySQL sys Schema](#).

MySQL uses algorithms that are very scalable, so you can usually run with very little memory. However, normally better performance results from giving MySQL more memory.

When tuning a MySQL server, the two most important variables to configure are `key_buffer_size` and `table_open_cache`. You should first feel confident that you have these set appropriately before trying to change any other variables.

The following examples indicate some typical variable values for different runtime configurations.

- If you have at least 1-2GB of memory and many tables and want maximum performance with a moderate number of clients, use something like this:

```
$> mysqld_safe --key_buffer_size=384M --table_open_cache=4000 \
      --sort_buffer_size=4M --read_buffer_size=1M &
```

- If you have only 256MB of memory and only a few tables, but you still do a lot of sorting, you can use something like this:

```
$> mysqld_safe --key_buffer_size=64M --sort_buffer_size=1M
```

If there are very many simultaneous connections, swapping problems may occur unless `mysqld` has been configured to use very little memory for each connection. `mysqld` performs better if you have enough memory for all connections.

- With little memory and lots of connections, use something like this:

```
$> mysqld_safe --key_buffer_size=512K --sort_buffer_size=100K \
      --read_buffer_size=100K &
```

Or even this:

```
$> mysqld_safe --key_buffer_size=512K --sort_buffer_size=16K \
      --table_open_cache=32 --read_buffer_size=8K \
      --net_buffer_length=1K &
```

If you are performing `GROUP BY` or `ORDER BY` operations on tables that are much larger than your available memory, increase the value of `read_rnd_buffer_size` to speed up the reading of rows following sorting operations.

If you specify an option on the command line for `mysqld` or `mysqld_safe`, it remains in effect only for that invocation of the server. To use the option every time the server runs, put it in an option file. See [Section 4.2.2.2, “Using Option Files”](#).

## 5.1.2 Server Configuration Defaults

The MySQL server has many operating parameters, which you can change at server startup using command-line options or configuration files (option files). It is also possible to change many parameters at runtime. For general instructions on setting parameters at startup or runtime, see [Section 5.1.6, “Server Command Options”](#), and [Section 5.1.7, “Server System Variables”](#).

On Windows, MySQL Installer interacts with the user and creates a file named `my.ini` in the base installation directory as the default option file. If you install on Windows from a Zip archive, you can copy the `my-default.ini` template file in the base installation directory to `my.ini` and use the latter as the default option file.



### Note

As of MySQL 5.7.18, `my-default.ini` is no longer included in or installed by distribution packages.



### Note

On Windows, the `.ini` or `.cnf` option file extension might not be displayed.

After completing the installation process, you can edit the default option file at any time to modify the parameters used by the server. For example, to use a parameter setting in the file that is commented with

a # character at the beginning of the line, remove the #, and modify the parameter value if necessary. To disable a setting, either add a # to the beginning of the line or remove it.

For non-Windows platforms, no default option file is created during either the server installation or the data directory initialization process. Create your option file by following the instructions given in [Section 4.2.2.2, “Using Option Files”](#). Without an option file, the server just starts with its default settings—see [Section 5.1.2, “Server Configuration Defaults”](#) on how to check those settings.

For additional information about option file format and syntax, see [Section 4.2.2.2, “Using Option Files”](#).

### 5.1.3 Server Option, System Variable, and Status Variable Reference

The following table lists all command-line options, system variables, and status variables applicable within `mysqld`.

The table lists command-line options (Cmd-line), options valid in configuration files (Option file), server system variables (System Var), and status variables (Status var) in one unified list, with an indication of where each option or variable is valid. If a server option set on the command line or in an option file differs from the name of the corresponding system variable, the variable name is noted immediately below the corresponding option. For system and status variables, the scope of the variable (Var Scope) is Global, Session, or both. Please see the corresponding item descriptions for details on setting and using the options and variables. Where appropriate, direct links to further information about the items are provided.

For a version of this table that is specific to NDB Cluster, see [Section 21.4.2.5, “NDB Cluster `mysqld` Option and Variable Reference”](#).

**Table 5.1 Command-Line Option, System Variable, and Status Variable Summary**

Name	Cmd-Line	Option File	System Var	Status Var	Var Scope	Dynamic
<a href="#">abort-slave-event-count</a>	Yes	Yes				
<a href="#">Aborted_clients</a>				Yes	Global	No
<a href="#">Aborted_connects</a>				Yes	Global	No
<a href="#">allow-suspicious-udfs</a>	Yes	Yes				
<a href="#">ansi</a>	Yes	Yes				
<a href="#">audit-log</a>	Yes	Yes				
<a href="#">audit_log_buffer_size</a>	Yes	Yes	Yes		Global	No
<a href="#">audit_log_compression</a>	Yes	Yes	Yes		Global	No
<a href="#">audit_log_connection_policy</a>	Yes	Yes	Yes		Global	Yes
<a href="#">audit_log_current_session</a>			Yes		Both	No
<a href="#">Audit_log_current_size</a>				Yes	Global	No
<a href="#">audit_log_disable</a>	Yes	Yes	Yes		Global	Yes
<a href="#">audit_log_encryption</a>	Yes	Yes	Yes		Global	No
<a href="#">Audit_log_event_max_drop_size</a>				Yes	Global	No
<a href="#">Audit_log_events</a>				Yes	Global	No
<a href="#">Audit_log_events_filtered</a>				Yes	Global	No
<a href="#">Audit_log_events_lost</a>				Yes	Global	No

Name	Cmd-Line	Option File	System Var	Status Var	Var Scope	Dynamic
Audit_log_events_written				Yes	Global	No
audit_log_exclude_accounts	Yes	Yes	Yes		Global	Yes
audit_log_file	Yes	Yes	Yes		Global	No
audit_log_filter_id			Yes		Both	No
audit_log_flush			Yes		Global	Yes
audit_log_format	Yes	Yes	Yes		Global	No
audit_log_format_unix_timestamp	Yes	Yes	Yes		Global	Yes
audit_log_include_accounts	Yes	Yes	Yes		Global	Yes
audit_log_policy	Yes	Yes	Yes		Global	No
audit_log_read_buffer_size	Yes	Yes	Yes		Varies	Varies
audit_log_rotate_size	Yes	Yes	Yes		Global	Yes
audit_log_statement_policy	Yes	Yes	Yes		Global	Yes
audit_log_strategy	Yes	Yes	Yes		Global	No
Audit_log_total_size				Yes	Global	No
Audit_log_write_waits				Yes	Global	No
authentication_mechanism_sasl_auth_method_name	Yes	Yes	Yes		Global	Yes
authentication_mechanism_sasl_bind_dn	Yes	Yes	Yes		Global	Yes
authentication_mechanism_sasl_bind_dn_host	Yes	Yes	Yes		Global	Yes
authentication_mechanism_sasl_bind_dn_pwd	Yes	Yes	Yes		Global	Yes
authentication_mechanism_sasl_ca_path	Yes	Yes	Yes		Global	Yes
authentication_mechanism_sasl_group_search_attr	Yes	Yes	Yes		Global	Yes
authentication_mechanism_sasl_group_search_filter	Yes	Yes	Yes		Global	Yes
authentication_mechanism_sasl_init_pool_size	Yes	Yes	Yes		Global	Yes
authentication_mechanism_sasl_log_status	Yes	Yes	Yes		Global	Yes
authentication_mechanism_sasl_max_pool_size	Yes	Yes	Yes		Global	Yes
authentication_mechanism_sasl_server_host	Yes	Yes	Yes		Global	Yes
authentication_mechanism_sasl_server_port	Yes	Yes	Yes		Global	Yes
authentication_mechanism_sasl_tls	Yes	Yes	Yes		Global	Yes
authentication_mechanism_sasl_user_search_attr	Yes	Yes	Yes		Global	Yes
authentication_mechanism_simple_auth_method_name	Yes	Yes	Yes		Global	Yes
authentication_mechanism_simple_bind_base_dn	Yes	Yes	Yes		Global	Yes
authentication_mechanism_simple_bind_root_dn	Yes	Yes	Yes		Global	Yes
authentication_mechanism_simple_bind_root_pwd	Yes	Yes	Yes		Global	Yes
authentication_mechanism_simple_ca_path	Yes	Yes	Yes		Global	Yes
authentication_mechanism_simple_group_search_attr	Yes	Yes	Yes		Global	Yes
authentication_mechanism_simple_group_search_filter	Yes	Yes	Yes		Global	Yes
authentication_mechanism_simple_init_pool_size	Yes	Yes	Yes		Global	Yes
authentication_mechanism_simple_log_status	Yes	Yes	Yes		Global	Yes

Name	Cmd-Line	Option File	System Var	Status Var	Var Scope	Dynamic
authentication	Yes	Yes	pool_size	Yes	Global	Yes
authentication	Yes	Yes	simple_server_host	Yes	Global	Yes
authentication	Yes	Yes	simple_server_port	Yes	Global	Yes
authentication	Yes	Yes	simple_tls	Yes	Global	Yes
authentication	Yes	Yes	simple_user_search_attr	Yes	Global	Yes
authentication	Yes	Yes	slow_log_level	Yes	Global	No
authentication	Yes	Yes	slow_use_principal_name	Yes	Global	No
auto_generate	Yes	Yes	ts	Yes	Global	No
auto_increment	Yes	Yes	increment	Yes	Both	Yes
auto_increment	Yes	Yes	offset	Yes	Both	Yes
autocommit	Yes	Yes		Yes	Both	Yes
automatic_sp_privileges	Yes	Yes		Yes	Global	Yes
avoid_temporal_upgrade	Yes	Yes		Yes	Global	Yes
back_log	Yes	Yes		Yes	Global	No
basedir	Yes	Yes		Yes	Global	No
big_tables	Yes	Yes		Yes	Both	Yes
bind_address	Yes	Yes		Yes	Global	No
Binlog_cache_disk_use				Yes	Global	No
binlog_cache_size	Yes	Yes	Yes		Global	Yes
Binlog_cache_use				Yes	Global	No
binlog-checksum	Yes	Yes				
binlog_checksum	Yes	Yes	Yes		Global	Yes
binlog_direct_non_transactional_updates	Yes	Yes		Yes	Both	Yes
binlog-do-db	Yes	Yes				
binlog_error_action	Yes	Yes	Yes		Global	Yes
binlog_format	Yes	Yes	Yes		Both	Yes
binlog_group_commit_sync_delay	Yes	Yes	Yes		Global	Yes
binlog_group_commit_sync_no_delay_count	Yes	Yes	Yes		Global	Yes
binlog_gtid_simple_recovery	Yes	Yes	Yes		Global	No
binlog-ignore-db	Yes	Yes				
binlog_max_flush_queue_time	Yes	Yes	Yes		Global	Yes
binlog_order_commits	Yes	Yes	Yes		Global	Yes
binlog-row-event-max-size	Yes	Yes				
binlog_row_image	Yes	Yes	Yes		Both	Yes
binlog_rows_query_log_events	Yes	Yes	Yes		Both	Yes

Name	Cmd-Line	Option File	System Var	Status Var	Var Scope	Dynamic
Binlog_stmt_cache_disk_use				Yes	Global	No
binlog_stmt_cache_size	Yes	Yes	Yes		Global	Yes
Binlog_stmt_cache_use				Yes	Global	No
binlog_transaction_dependency_history_size	Yes	Yes	Yes		Global	Yes
binlog_transaction_dependency_tracking	Yes	Yes	Yes		Global	Yes
block_encryption_mode	Yes	Yes	Yes		Both	Yes
bootstrap	Yes	Yes				
bulk_insert_buffer_size	Yes	Yes	Yes		Both	Yes
Bytes_received				Yes	Both	No
Bytes_sent				Yes	Both	No
character_set_client			Yes		Both	Yes
character-set-client-handshake	Yes	Yes				
character_set_connection			Yes		Both	Yes
character_set_database (note 1)			Yes		Both	Yes
character_set_filesystem	Yes	Yes	Yes		Both	Yes
character_set_results			Yes		Both	Yes
character_set_server	Yes	Yes	Yes		Both	Yes
character_set_system			Yes		Global	No
character_sets_dir	Yes	Yes	Yes		Global	No
check_proxy_users	Yes	Yes	Yes		Global	Yes
chroot	Yes	Yes				
collation_connection			Yes		Both	Yes
collation_database (note 1)			Yes		Both	Yes
collation_server	Yes	Yes	Yes		Both	Yes
Com_admin_commands				Yes	Both	No
Com_alter_db				Yes	Both	No
Com_alter_db_upgrade				Yes	Both	No
Com_alter_event				Yes	Both	No
Com_alter_function				Yes	Both	No
Com_alter_procedure				Yes	Both	No
Com_alter_server				Yes	Both	No
Com_alter_table				Yes	Both	No
Com_alter_tablespace				Yes	Both	No
Com_alter_user				Yes	Both	No
Com_analyze				Yes	Both	No

Name	Cmd-Line	Option File	System Var	Status Var	Var Scope	Dynamic
Com_assign_to_keycache				Yes	Both	No
Com_begin				Yes	Both	No
Com_binlog				Yes	Both	No
Com_call_procedure				Yes	Both	No
Com_change_db				Yes	Both	No
Com_change_master				Yes	Both	No
Com_change_repl_filter				Yes	Both	No
Com_check				Yes	Both	No
Com_checksum				Yes	Both	No
Com_commit				Yes	Both	No
Com_create_db				Yes	Both	No
Com_create_event				Yes	Both	No
Com_create_function				Yes	Both	No
Com_create_index				Yes	Both	No
Com_create_procedure				Yes	Both	No
Com_create_server				Yes	Both	No
Com_create_table				Yes	Both	No
Com_create_trigger				Yes	Both	No
Com_create_udf				Yes	Both	No
Com_create_user				Yes	Both	No
Com_create_view				Yes	Both	No
Com_dealloc_sql				Yes	Both	No
Com_delete				Yes	Both	No
Com_delete_multi				Yes	Both	No
Com_do				Yes	Both	No
Com_drop_db				Yes	Both	No
Com_drop_event				Yes	Both	No
Com_drop_function				Yes	Both	No
Com_drop_index				Yes	Both	No
Com_drop_procedure				Yes	Both	No
Com_drop_server				Yes	Both	No
Com_drop_table				Yes	Both	No
Com_drop_trigger				Yes	Both	No
Com_drop_user				Yes	Both	No
Com_drop_view				Yes	Both	No
Com_empty_query				Yes	Both	No
Com_execute_sql				Yes	Both	No
Com_explain_other				Yes	Both	No

Name	Cmd-Line	Option File	System Var	Status Var	Var Scope	Dynamic
Com_flush				Yes	Both	No
Com_get_diagnostics				Yes	Both	No
Com_grant				Yes	Both	No
Com_group_replication_start				Yes	Global	No
Com_group_replication_stop				Yes	Global	No
Com_ha_close				Yes	Both	No
Com_ha_open				Yes	Both	No
Com_ha_read				Yes	Both	No
Com_help				Yes	Both	No
Com_insert				Yes	Both	No
Com_insert_select				Yes	Both	No
Com_install_plugin				Yes	Both	No
Com_kill				Yes	Both	No
Com_load				Yes	Both	No
Com_lock_tables				Yes	Both	No
Com_optimize				Yes	Both	No
Com_preload_keys				Yes	Both	No
Com_prepare_sql				Yes	Both	No
Com_purge				Yes	Both	No
Com_purge_before_date				Yes	Both	No
Com_release_savepoint				Yes	Both	No
Com_rename_table				Yes	Both	No
Com_rename_user				Yes	Both	No
Com_repair				Yes	Both	No
Com_replace				Yes	Both	No
Com_replace_select				Yes	Both	No
Com_reset				Yes	Both	No
Com_resignal				Yes	Both	No
Com_revoke				Yes	Both	No
Com_revoke_all				Yes	Both	No
Com_rollback				Yes	Both	No
Com_rollback_to_savepoint				Yes	Both	No
Com_savepoint				Yes	Both	No
Com_select				Yes	Both	No
Com_set_option				Yes	Both	No
Com_show_authors				Yes	Both	No
Com_show_binlog_events				Yes	Both	No
Com_show_binlogs				Yes	Both	No



Name	Cmd-Line	Option File	System Var	Status Var	Var Scope	Dynamic
<a href="#">Com_show_charsets</a>				Yes	Both	No
<a href="#">Com_show_collations</a>				Yes	Both	No
<a href="#">Com_show_contributors</a>				Yes	Both	No
<a href="#">Com_show_create_db</a>				Yes	Both	No
<a href="#">Com_show_create_event</a>				Yes	Both	No
<a href="#">Com_show_create_func</a>				Yes	Both	No
<a href="#">Com_show_create_proc</a>				Yes	Both	No
<a href="#">Com_show_create_table</a>				Yes	Both	No
<a href="#">Com_show_create_trigger</a>				Yes	Both	No
<a href="#">Com_show_create_user</a>				Yes	Both	No
<a href="#">Com_show_databases</a>				Yes	Both	No
<a href="#">Com_show_engine_logs</a>				Yes	Both	No
<a href="#">Com_show_engine_mutex</a>				Yes	Both	No
<a href="#">Com_show_engine_status</a>				Yes	Both	No
<a href="#">Com_show_errors</a>				Yes	Both	No
<a href="#">Com_show_events</a>				Yes	Both	No
<a href="#">Com_show_fields</a>				Yes	Both	No
<a href="#">Com_show_function_code</a>				Yes	Both	No
<a href="#">Com_show_function_status</a>				Yes	Both	No
<a href="#">Com_show_grants</a>				Yes	Both	No
<a href="#">Com_show_keys</a>				Yes	Both	No
<a href="#">Com_show_master_status</a>				Yes	Both	No
<a href="#">Com_show_ndb_status</a>				Yes	Both	No
<a href="#">Com_show_open_tables</a>				Yes	Both	No
<a href="#">Com_show_plugins</a>				Yes	Both	No
<a href="#">Com_show_privileges</a>				Yes	Both	No
<a href="#">Com_show_procedure_code</a>				Yes	Both	No
<a href="#">Com_show_procedure_status</a>				Yes	Both	No
<a href="#">Com_show_processlist</a>				Yes	Both	No
<a href="#">Com_show_profile</a>				Yes	Both	No
<a href="#">Com_show_profiles</a>				Yes	Both	No
<a href="#">Com_show_relaylog_events</a>				Yes	Both	No
<a href="#">Com_show_slave_hosts</a>				Yes	Both	No
<a href="#">Com_show_slave_status</a>				Yes	Both	No
<a href="#">Com_show_status</a>				Yes	Both	No
<a href="#">Com_show_storage_engines</a>				Yes	Both	No
<a href="#">Com_show_table_status</a>				Yes	Both	No
<a href="#">Com_show_tables</a>				Yes	Both	No

Name	Cmd-Line	Option File	System Var	Status Var	Var Scope	Dynamic
Com_show_triggers				Yes	Both	No
Com_show_variables				Yes	Both	No
Com_show_warnings				Yes	Both	No
Com_shutdown				Yes	Both	No
Com_signal				Yes	Both	No
Com_slave_start				Yes	Both	No
Com_slave_stop				Yes	Both	No
Com_stmt_close				Yes	Both	No
Com_stmt_execute				Yes	Both	No
Com_stmt_fetch				Yes	Both	No
Com_stmt_prepare				Yes	Both	No
Com_stmt_reprepare				Yes	Both	No
Com_stmt_reset				Yes	Both	No
Com_stmt_send_long_data				Yes	Both	No
Com_truncate				Yes	Both	No
Com_uninstall_plugin				Yes	Both	No
Com_unlock_tables				Yes	Both	No
Com_update				Yes	Both	No
Com_update_multi				Yes	Both	No
Com_xa_commit				Yes	Both	No
Com_xa_end				Yes	Both	No
Com_xa_prepare				Yes	Both	No
Com_xa_recover				Yes	Both	No
Com_xa_rollback				Yes	Both	No
Com_xa_start				Yes	Both	No
completion_type	Yes	Yes	Yes		Both	Yes
Compression				Yes	Session	No
concurrent_insert	Yes	Yes	Yes		Global	Yes
connect_timeout	Yes	Yes	Yes		Global	Yes
Connection_control_delay_generated				Yes	Global	No
connection_control_failed_connections_threshold	Yes	Yes	Yes		Global	Yes
connection_control_max_connection_delay	Yes	Yes	Yes		Global	Yes
connection_control_min_connection_delay	Yes	Yes	Yes		Global	Yes
Connection_errors_accept				Yes	Global	No
Connection_errors_internal				Yes	Global	No
Connection_errors_max_connections				Yes	Global	No
Connection_errors_peer_address				Yes	Global	No
Connection_errors_select				Yes	Global	No

Name	Cmd-Line	Option File	System Var	Status Var	Var Scope	Dynamic
Connection_errors_tcpwrap				Yes	Global	No
Connections				Yes	Global	No
console	Yes	Yes				
core-file	Yes	Yes				
core_file			Yes		Global	No
Created_tmp_disk_tables				Yes	Both	No
Created_tmp_files				Yes	Global	No
Created_tmp_tables				Yes	Both	No
daemon_memcached_enable_log	Yes	Yes	Yes		Global	No
daemon_memcached_engine_name	Yes	Yes	Yes		Global	No
daemon_memcached_engine_path	Yes	Yes	Yes		Global	No
daemon_memcached_option	Yes	Yes	Yes		Global	No
daemon_memcached_r_batch_size	Yes	Yes	Yes		Global	No
daemon_memcached_w_batch_size	Yes	Yes	Yes		Global	No
daemonize	Yes	Yes				
datadir	Yes	Yes	Yes		Global	No
date_format			Yes		Global	No
datetime_format			Yes		Global	No
debug	Yes	Yes	Yes		Both	Yes
debug_sync			Yes		Session	Yes
debug-sync-timeout	Yes	Yes				
default_authentication_plugin	Yes	Yes	Yes		Global	No
default_password_lifetime	Yes	Yes	Yes		Global	Yes
default_storage_engine	Yes	Yes	Yes		Both	Yes
default-time-zone	Yes	Yes				
default_tmp_storage_engine	Yes	Yes	Yes		Both	Yes
default_week_format	Yes	Yes	Yes		Both	Yes
defaults-extra-file	Yes					
defaults-file	Yes					
defaults-group-suffix	Yes					
delay_key_write	Yes	Yes	Yes		Global	Yes
Delayed_errors				Yes	Global	No
delayed_insert_limit	Yes	Yes	Yes		Global	Yes
Delayed_insert_threads				Yes	Global	No
delayed_insert_timeout	Yes	Yes	Yes		Global	Yes

Name	Cmd-Line	Option File	System Var	Status Var	Var Scope	Dynamic
delayed_queue_size	Yes	Yes	Yes		Global	Yes
Delayed_writes				Yes	Global	No
des-key-file	Yes	Yes				
disable-partition-engine-check	Yes	Yes				
disabled_storage_engines	Yes	Yes	Yes		Global	No
disconnect_on_expired_password	Yes	Yes	Yes		Global	No
disconnect-slave-event-count	Yes	Yes				
div_precision_increment	Yes	Yes	Yes		Both	Yes
early-plugin-load	Yes	Yes				
end_markers_in_json	Yes	Yes	Yes		Both	Yes
enforce_gtid_consistency	Yes	Yes	Yes		Global	Varies
eq_range_index_prefix_limit	Yes	Yes	Yes		Both	Yes
error_count			Yes		Session	No
event_scheduler	Yes	Yes	Yes		Global	Yes
exit-info	Yes	Yes				
expire_logs_days	Yes	Yes	Yes		Global	Yes
explicit_defaults_for_timestamp	Yes	Yes	Yes		Both	Yes
external-locking	Yes	Yes				
- Variable: skip_external_locking						
external_user			Yes		Session	No
federated	Yes	Yes				
Firewall_access_denied				Yes	Global	No
Firewall_access_granted				Yes	Global	No
Firewall_access_suspicious				Yes	Global	No
Firewall_cached_entries				Yes	Global	No
flush	Yes	Yes	Yes		Global	Yes
Flush_commands				Yes	Global	No
flush_time	Yes	Yes	Yes		Global	Yes
foreign_key_checks			Yes		Both	Yes
ft_boolean_syntax	Yes	Yes	Yes		Global	Yes
ft_max_word_len	Yes	Yes	Yes		Global	No
ft_min_word_len	Yes	Yes	Yes		Global	No
ft_query_expansion_limit	Yes	Yes	Yes		Global	No

Name	Cmd-Line	Option File	System Var	Status Var	Var Scope	Dynamic
<a href="#">ft_stopword_file</a>	Yes	Yes	Yes		Global	No
<a href="#">gdb</a>	Yes	Yes				
<a href="#">general_log</a>	Yes	Yes	Yes		Global	Yes
<a href="#">general_log_file</a>	Yes	Yes	Yes		Global	Yes
<a href="#">group_concat_max_len</a>	Yes	Yes	Yes		Both	Yes
<a href="#">group_replication_allow_local_discovery</a>	Yes	Yes	Yes		Global	Yes
<a href="#">group_replication_allow_local_discovery_version</a>	Yes	Yes	Yes		Global	Yes
<a href="#">group_replication_auto_increment_increment</a>	Yes	Yes	Yes		Global	Yes
<a href="#">group_replication_bootstrap_group</a>	Yes	Yes	Yes		Global	Yes
<a href="#">group_replication_components</a>	Yes	Yes	Yes		Global	Yes
<a href="#">group_replication_compression_threshold</a>	Yes	Yes	Yes		Global	Yes
<a href="#">group_replication_enforce_update_everywhere_checks</a>	Yes	Yes	Yes		Global	Yes
<a href="#">group_replication_exit_state_action</a>	Yes	Yes	Yes		Global	Yes
<a href="#">group_replication_flow_control_applier_threshold</a>	Yes	Yes	Yes		Global	Yes
<a href="#">group_replication_flow_control_certifier_threshold</a>	Yes	Yes	Yes		Global	Yes
<a href="#">group_replication_flow_control_mode</a>	Yes	Yes	Yes		Global	Yes
<a href="#">group_replication_force_memory</a>	Yes	Yes	Yes		Global	Yes
<a href="#">group_replication_group_name</a>	Yes	Yes	Yes		Global	Yes
<a href="#">group_replication_group_seeds</a>	Yes	Yes	Yes		Global	Yes
<a href="#">group_replication_group_tid_assignment_block_size</a>	Yes	Yes	Yes		Global	Yes
<a href="#">group_replication_ignore_local_updates</a>	Yes	Yes	Yes		Global	Yes
<a href="#">group_replication_local_address</a>	Yes	Yes	Yes		Global	Yes
<a href="#">group_replication_local_address2</a>	Yes	Yes	Yes		Global	Yes
<a href="#">group_replication_member_weight</a>	Yes	Yes	Yes		Global	Yes
<a href="#">group_replication_poll_spin_loops</a>	Yes	Yes	Yes		Global	Yes
<a href="#">group_replication_primary_member</a>				Yes	Global	No
<a href="#">group_replication_recovery_completeness_at_completion</a>	Yes	Yes	Yes		Global	Yes
<a href="#">group_replication_recovery_reconnect_interval</a>	Yes	Yes	Yes		Global	Yes
<a href="#">group_replication_recovery_reconnect_count</a>	Yes	Yes	Yes		Global	Yes
<a href="#">group_replication_recovery_ssl</a>	Yes	Yes	Yes		Global	Yes
<a href="#">group_replication_recovery_ssl_certificate_path</a>	Yes	Yes	Yes		Global	Yes
<a href="#">group_replication_recovery_ssl_certificate</a>	Yes	Yes	Yes		Global	Yes
<a href="#">group_replication_recovery_ssl_cipher</a>	Yes	Yes	Yes		Global	Yes
<a href="#">group_replication_recovery_ssl_cipher_suite</a>	Yes	Yes	Yes		Global	Yes
<a href="#">group_replication_recovery_ssl_certificate_path2</a>	Yes	Yes	Yes		Global	Yes
<a href="#">group_replication_recovery_ssl_certificate2</a>	Yes	Yes	Yes		Global	Yes
<a href="#">group_replication_recovery_ssl_cipher2</a>	Yes	Yes	Yes		Global	Yes
<a href="#">group_replication_recovery_ssl_cipher_suite2</a>	Yes	Yes	Yes		Global	Yes
<a href="#">group_replication_recovery_ssl_verify_server_certificate</a>	Yes	Yes	Yes		Global	Yes
<a href="#">group_replication_recovery_use_ssl</a>	Yes	Yes	Yes		Global	Yes
<a href="#">group_replication_single_primary_mode</a>	Yes	Yes	Yes		Global	Yes

Name	Cmd-Line	Option File	System Var	Status Var	Var Scope	Dynamic
group_replication_enable_ssl_mode	Yes	Yes	Yes		Global	Yes
group_replication_enable_start_on_boot	Yes	Yes	Yes		Global	Yes
group_replication_enable_transaction_log_compression	Yes	Yes	Yes		Global	Yes
group_replication_enable_unreachable_server_timeout	Yes	Yes	Yes		Global	Yes
gtid_executed			Yes		Varies	No
gtid_executed_log_compression_period	Yes	Yes	Yes		Global	Yes
gtid_mode	Yes	Yes	Yes		Global	Varies
gtid_next			Yes		Session	Yes
gtid_owned			Yes		Both	No
gtid_purged			Yes		Global	Yes
Handler_commit				Yes	Both	No
Handler_delete				Yes	Both	No
Handler_discover				Yes	Both	No
Handler_external_lock				Yes	Both	No
Handler_mrr_init				Yes	Both	No
Handler_prepare				Yes	Both	No
Handler_read_first				Yes	Both	No
Handler_read_key				Yes	Both	No
Handler_read_last				Yes	Both	No
Handler_read_next				Yes	Both	No
Handler_read_prev				Yes	Both	No
Handler_read_rnd				Yes	Both	No
Handler_read_rnd_next				Yes	Both	No
Handler_rollback				Yes	Both	No
Handler_savepoint				Yes	Both	No
Handler_savepoint_rollback				Yes	Both	No
Handler_update				Yes	Both	No
Handler_write				Yes	Both	No
have_compress			Yes		Global	No
have_crypt			Yes		Global	No
have_dynamic_loading			Yes		Global	No
have_geometry			Yes		Global	No
have_openssl			Yes		Global	No
have_profiling			Yes		Global	No
have_query_cache			Yes		Global	No
have_rtree_keys			Yes		Global	No
have_ssl			Yes		Global	No
have_statement_timeout			Yes		Global	No

Name	Cmd-Line	Option File	System Var	Status Var	Var Scope	Dynamic
have_symlink			Yes		Global	No
help	Yes	Yes				
host_cache_size	Yes	Yes	Yes		Global	Yes
hostname			Yes		Global	No
identity			Yes		Session	Yes
ignore_builtin_innodb	Yes	Yes	Yes		Global	No
ignore-db-dir	Yes	Yes				
ignore_db_dirs			Yes		Global	No
init_connect	Yes	Yes	Yes		Global	Yes
init_file	Yes	Yes	Yes		Global	No
init_slave	Yes	Yes	Yes		Global	Yes
initialize	Yes	Yes				
initialize-insecure	Yes	Yes				
innodb	Yes	Yes				
innodb_adaptive_flushing	Yes	Yes	Yes		Global	Yes
innodb_adaptive_flushing_lwm	Yes	Yes	Yes		Global	Yes
innodb_adaptive_hash_index	Yes	Yes	Yes		Global	Yes
innodb_adaptive_hash_index_parts	Yes	Yes	Yes		Global	No
innodb_adaptive_max_sleep_delay	Yes	Yes	Yes		Global	Yes
innodb_api_bk_commit_interval	Yes	Yes	Yes		Global	Yes
innodb_api_disable_rowlock	Yes	Yes	Yes		Global	No
innodb_api_enable_binlog	Yes	Yes	Yes		Global	No
innodb_api_enable_mdlog	Yes	Yes	Yes		Global	No
innodb_api_trx_level	Yes	Yes	Yes		Global	Yes
innodb_autoextend_increment	Yes	Yes	Yes		Global	Yes
innodb_autoinc_lock_mode	Yes	Yes	Yes		Global	No
Innodb_available_undo_logs				Yes	Global	No
innodb_background_drop_list_empty	Yes	Yes	Yes		Global	Yes
Innodb_buffer_pool_bytes_data				Yes	Global	No
Innodb_buffer_pool_bytes_dirty				Yes	Global	No
innodb_buffer_pool_chunk_size	Yes	Yes	Yes		Global	No
innodb_buffer_pool_dump_at_shutdown	Yes	Yes	Yes		Global	Yes
innodb_buffer_pool_dump_now	Yes	Yes	Yes		Global	Yes
innodb_buffer_pool_dump_pct	Yes	Yes	Yes		Global	Yes
Innodb_buffer_pool_dump_status				Yes	Global	No
innodb_buffer_pool_filename	Yes	Yes	Yes		Global	Yes
innodb_buffer_pool_instances	Yes	Yes	Yes		Global	No

Name	Cmd-Line	Option File	System Var	Status Var	Var Scope	Dynamic
innodb_buffer_Yes_load_abort	Yes	Yes	Yes		Global	Yes
innodb_buffer_Yes_load_at_startup	Yes	Yes	Yes		Global	No
innodb_buffer_Yes_load_now	Yes	Yes	Yes		Global	Yes
Innodb_buffer_pool_load_status				Yes	Global	No
Innodb_buffer_pool_pages_data				Yes	Global	No
Innodb_buffer_pool_pages_dirty				Yes	Global	No
Innodb_buffer_pool_pages_flushed				Yes	Global	No
Innodb_buffer_pool_pages_free				Yes	Global	No
Innodb_buffer_pool_pages_latched				Yes	Global	No
Innodb_buffer_pool_pages_misc				Yes	Global	No
Innodb_buffer_pool_pages_total				Yes	Global	No
Innodb_buffer_pool_read_ahead				Yes	Global	No
Innodb_buffer_pool_read_ahead_evicted				Yes	Global	No
Innodb_buffer_pool_read_ahead_rnd				Yes	Global	No
Innodb_buffer_pool_read_requests				Yes	Global	No
Innodb_buffer_pool_reads				Yes	Global	No
Innodb_buffer_pool_resize_status				Yes	Global	No
innodb_buffer_Yes_size	Yes	Yes	Yes		Global	Varies
Innodb_buffer_pool_wait_free				Yes	Global	No
Innodb_buffer_pool_write_requests				Yes	Global	No
innodb_change_Yes_buffer_max_size	Yes	Yes	Yes		Global	Yes
innodb_change_Yes_buffering	Yes	Yes	Yes		Global	Yes
innodb_change_Yes_buffering_debug	Yes	Yes	Yes		Global	Yes
innodb_checks_Yes_algorithm	Yes	Yes	Yes		Global	Yes
innodb_checks_Yes	Yes	Yes	Yes		Global	No
innodb_cmp_Yes_index_enabled	Yes	Yes	Yes		Global	Yes
innodb_commit_Yes_currency	Yes	Yes	Yes		Global	Yes
innodb_compress_Yes_debug	Yes	Yes	Yes		Global	Yes
innodb_compress_Yes_inn_failure_threshold_pct	Yes	Yes	Yes		Global	Yes
innodb_compress_Yes_level	Yes	Yes	Yes		Global	Yes
innodb_compress_Yes_inn_pad_pct_x	Yes	Yes	Yes		Global	Yes
innodb_concurrency_Yes_tickets	Yes	Yes	Yes		Global	Yes
innodb_data_file_path	Yes	Yes	Yes		Global	No
Innodb_data_fsycs				Yes	Global	No
innodb_data_Yes_dir	Yes	Yes	Yes		Global	No
Innodb_data_pending_fsycs				Yes	Global	No
Innodb_data_pending_reads				Yes	Global	No
Innodb_data_pending_writes				Yes	Global	No



Name	Cmd-Line	Option File	System Var	Status Var	Var Scope	Dynamic
InnoDB_data_read				Yes	Global	No
InnoDB_data_reads				Yes	Global	No
InnoDB_data_writes				Yes	Global	No
InnoDB_data_written				Yes	Global	No
InnoDB_dblwr_pages_written				Yes	Global	No
InnoDB_dblwr_writes				Yes	Global	No
innodb_deadlock_detect	Yes	Yes	Yes		Global	Yes
innodb_default_file_format	Yes	Yes	Yes		Global	Yes
innodb_disable_size_buffer_debug	Yes	Yes	Yes		Global	Yes
innodb_disable_fast_file_cache	Yes	Yes	Yes		Global	Yes
innodb_doublewrite	Yes	Yes	Yes		Global	No
innodb_fast_shutdown	Yes	Yes	Yes		Global	Yes
innodb_file_make_page_dirty_debug	Yes	Yes	Yes		Global	Yes
innodb_file_format	Yes	Yes	Yes		Global	Yes
innodb_file_format_check	Yes	Yes	Yes		Global	No
innodb_file_format_max	Yes	Yes	Yes		Global	Yes
innodb_file_per_table	Yes	Yes	Yes		Global	Yes
innodb_fill_factor	Yes	Yes	Yes		Global	Yes
innodb_flush_log_at_timeout	Yes	Yes	Yes		Global	Yes
innodb_flush_log_at_trx_commit	Yes	Yes	Yes		Global	Yes
innodb_flush_method	Yes	Yes	Yes		Global	No
innodb_flush_neighbors	Yes	Yes	Yes		Global	Yes
innodb_flush_sync	Yes	Yes	Yes		Global	Yes
innodb_flushing_log_loops	Yes	Yes	Yes		Global	Yes
innodb_force_load_corrupted	Yes	Yes	Yes		Global	No
innodb_force_recovery	Yes	Yes	Yes		Global	No
innodb_ft_aux_table			Yes		Global	Yes
innodb_ft_cache_size	Yes	Yes	Yes		Global	No
innodb_ft_enable_diag_print	Yes	Yes	Yes		Global	Yes
innodb_ft_enable_stopword	Yes	Yes	Yes		Both	Yes
innodb_ft_max_index_size	Yes	Yes	Yes		Global	No
innodb_ft_min_index_size	Yes	Yes	Yes		Global	No
innodb_ft_num_anti_synonym_optimize	Yes	Yes	Yes		Global	Yes
innodb_ft_result_cache_limit	Yes	Yes	Yes		Global	Yes
innodb_ft_server_stopword_table	Yes	Yes	Yes		Global	Yes
innodb_ft_sort_degree	Yes	Yes	Yes		Global	No
innodb_ft_total_cache_size	Yes	Yes	Yes		Global	No
innodb_ft_user_stopword_table	Yes	Yes	Yes		Both	Yes

Name	Cmd-Line	Option File	System Var	Status Var	Var Scope	Dynamic
InnoDB_have_atomic_builtins				Yes	Global	No
innodb_io_capacity	Yes	Yes	Yes		Global	Yes
innodb_io_capacity_max	Yes	Yes	Yes		Global	Yes
innodb_large_prefix	Yes	Yes	Yes		Global	Yes
innodb_limit_operations	Yes	Yes	Yes		Global	Yes
innodb_lock_wait_timeout	Yes	Yes	Yes		Both	Yes
innodb_locks_unsafe_for_binlog	Yes	Yes	Yes		Global	No
innodb_log_buffer_size	Yes	Yes	Yes		Global	No
innodb_log_checkpoint_now	Yes	Yes	Yes		Global	Yes
innodb_log_checksums	Yes	Yes	Yes		Global	Yes
innodb_log_compressed_pages	Yes	Yes	Yes		Global	Yes
innodb_log_file_size	Yes	Yes	Yes		Global	No
innodb_log_files_in_group	Yes	Yes	Yes		Global	No
innodb_log_group_home_dir	Yes	Yes	Yes		Global	No
InnoDB_log_waits				Yes	Global	No
innodb_log_writeahead_size	Yes	Yes	Yes		Global	Yes
InnoDB_log_write_requests				Yes	Global	No
InnoDB_log_writes				Yes	Global	No
innodb_lru_scan_depth	Yes	Yes	Yes		Global	Yes
innodb_max_dirty_pages_pct	Yes	Yes	Yes		Global	Yes
innodb_max_dirty_pages_pct_inverted	Yes	Yes	Yes		Global	Yes
innodb_max_purge_lag	Yes	Yes	Yes		Global	Yes
innodb_max_purge_lag_delay	Yes	Yes	Yes		Global	Yes
innodb_max_undo_log_size	Yes	Yes	Yes		Global	Yes
innodb_merge_threshold_set	Yes	Yes	Yes		Global	Yes
innodb_monitor_enabled	Yes	Yes	Yes		Global	Yes
innodb_monitor_expire_time	Yes	Yes	Yes		Global	Yes
innodb_monitor_reset	Yes	Yes	Yes		Global	Yes
innodb_monitor_reset_all	Yes	Yes	Yes		Global	Yes
InnoDB_num_open_files				Yes	Global	No
innodb_numa_memory_aware	Yes	Yes	Yes		Global	No
innodb_old_blocks_pct	Yes	Yes	Yes		Global	Yes
innodb_old_blocks_time	Yes	Yes	Yes		Global	Yes
innodb_online_log_max_log_size	Yes	Yes	Yes		Global	Yes
innodb_open_files	Yes	Yes	Yes		Global	No
innodb_optimize_fulltext_only	Yes	Yes	Yes		Global	Yes
InnoDB_os_log_fsyncs				Yes	Global	No
InnoDB_os_log_pending_fsyncs				Yes	Global	No

Name	Cmd-Line	Option File	System Var	Status Var	Var Scope	Dynamic
Innodb_os_log_pending_writes				Yes	Global	No
Innodb_os_log_written				Yes	Global	No
innodb_page_cleaners	Yes	Yes	Yes		Global	No
Innodb_page_size				Yes	Global	No
innodb_page_size	Yes	Yes	Yes		Global	No
Innodb_pages_created				Yes	Global	No
Innodb_pages_read				Yes	Global	No
Innodb_pages_written				Yes	Global	No
innodb_print_all_deadlocks	Yes	Yes	Yes		Global	Yes
innodb_purge_purge_size	Yes	Yes	Yes		Global	Yes
innodb_purge_purge_truncate_frequency	Yes	Yes	Yes		Global	Yes
innodb_purge_threads	Yes	Yes	Yes		Global	No
innodb_random_read_ahead	Yes	Yes	Yes		Global	Yes
innodb_read_ahead_threshold	Yes	Yes	Yes		Global	Yes
innodb_read_io_threads	Yes	Yes	Yes		Global	No
innodb_read_only	Yes	Yes	Yes		Global	No
innodb_replication_delay	Yes	Yes	Yes		Global	Yes
innodb_rollback_timeout	Yes	Yes	Yes		Global	No
innodb_rollback_segments	Yes	Yes	Yes		Global	Yes
Innodb_row_lock_current_waits				Yes	Global	No
Innodb_row_lock_time				Yes	Global	No
Innodb_row_lock_time_avg				Yes	Global	No
Innodb_row_lock_time_max				Yes	Global	No
Innodb_row_lock_waits				Yes	Global	No
Innodb_rows_deleted				Yes	Global	No
Innodb_rows_inserted				Yes	Global	No
Innodb_rows_read				Yes	Global	No
Innodb_rows_updated				Yes	Global	No
innodb_saved_purge_number	Yes	Yes	Yes		Global	Yes
innodb_sort_buffer_size	Yes	Yes	Yes		Global	No
innodb_spin_wait_delay	Yes	Yes	Yes		Global	Yes
innodb_stats_automem_recalc	Yes	Yes	Yes		Global	Yes
innodb_stats_index_delete_not_packed	Yes	Yes	Yes		Global	Yes
innodb_stats_method	Yes	Yes	Yes		Global	Yes
innodb_stats_on_metadata	Yes	Yes	Yes		Global	Yes
innodb_stats_persistent	Yes	Yes	Yes		Global	Yes
innodb_stats_persistent_sample_pages	Yes	Yes	Yes		Global	Yes
innodb_stats_sample_pages	Yes	Yes	Yes		Global	Yes

Name	Cmd-Line	Option File	System Var	Status Var	Var Scope	Dynamic
innodb_stats_transient_sample_pages	Yes	Yes	Yes		Global	Yes
innodb-status-file	Yes	Yes				
innodb_status_output	Yes	Yes	Yes		Global	Yes
innodb_status_output_locks	Yes	Yes	Yes		Global	Yes
innodb_strict_mode	Yes	Yes	Yes		Both	Yes
innodb_support_large_page	Yes	Yes	Yes		Both	Yes
innodb_sync_ahead_size	Yes	Yes	Yes		Global	No
innodb_sync_debug	Yes	Yes	Yes		Global	No
innodb_sync_spin_loops	Yes	Yes	Yes		Global	Yes
innodb_table_locks	Yes	Yes	Yes		Both	Yes
innodb_temp_data_file_path	Yes	Yes	Yes		Global	No
innodb_thread_obsolete_routines_enabled	Yes	Yes	Yes		Global	Yes
innodb_thread_read_delay	Yes	Yes	Yes		Global	Yes
innodb_tmpdir	Yes	Yes	Yes		Both	Yes
InnoDB_truncated_status_writes				Yes	Global	No
innodb_trx_purge_view_updates_only_debug	Yes	Yes	Yes		Global	Yes
innodb_trx_rseg_slots_debug	Yes	Yes	Yes		Global	Yes
innodb_undo_directory	Yes	Yes	Yes		Global	No
innodb_undo_logs_truncate	Yes	Yes	Yes		Global	Yes
innodb_undo_logs	Yes	Yes	Yes		Global	Yes
innodb_undo_tablespaces	Yes	Yes	Yes		Global	No
innodb_use_native_aio	Yes	Yes	Yes		Global	No
innodb_version			Yes		Global	No
innodb_write_io_threads	Yes	Yes	Yes		Global	No
insert_id			Yes		Session	Yes
install	Yes					
install-manual	Yes					
interactive_timeout	Yes	Yes	Yes		Both	Yes
internal_tmp_disk_storage_engine	Yes	Yes	Yes		Global	Yes
join_buffer_size	Yes	Yes	Yes		Both	Yes
keep_files_on_create	Yes	Yes	Yes		Both	Yes
Key_blocks_not_flushed				Yes	Global	No
Key_blocks_unused				Yes	Global	No
Key_blocks_used				Yes	Global	No
key_buffer_size	Yes	Yes	Yes		Global	Yes
key_cache_age_threshold	Yes	Yes	Yes		Global	Yes
key_cache_block_size	Yes	Yes	Yes		Global	Yes

Name	Cmd-Line	Option File	System Var	Status Var	Var Scope	Dynamic
key_cache_divis	Yes limit	Yes	Yes		Global	Yes
Key_read_requests				Yes	Global	No
Key_reads				Yes	Global	No
Key_write_requests				Yes	Global	No
Key_writes				Yes	Global	No
keyring_aws_c	Yes id	Yes	Yes		Global	Yes
keyring_aws_c	Yes file	Yes	Yes		Global	No
keyring_aws_c	Yes file	Yes	Yes		Global	No
keyring_aws_re	Yes gen	Yes	Yes		Global	Yes
keyring_encrypt	Yes file_data	Yes	Yes		Global	Yes
keyring_encrypt	Yes file_password	Yes	Yes		Global	Yes
keyring_file_data	Yes	Yes	Yes		Global	Yes
keyring- migration- destination	Yes	Yes				
keyring- migration- host	Yes	Yes				
keyring- migration- password	Yes	Yes				
keyring- migration- port	Yes	Yes				
keyring- migration- socket	Yes	Yes				
keyring- migration- source	Yes	Yes				
keyring- migration- user	Yes	Yes				
keyring_okv_c	Yes dir	Yes	Yes		Global	Yes
keyring_operations			Yes		Global	Yes
language	Yes	Yes	Yes		Global	No
large_files_support			Yes		Global	No
large_page_size			Yes		Global	No
large_pages	Yes	Yes	Yes		Global	No
last_insert_id			Yes		Session	Yes
Last_query_cost				Yes	Session	No
Last_query_partial_plans				Yes	Session	No

Name	Cmd-Line	Option File	System Var	Status Var	Var Scope	Dynamic
lc_messages	Yes	Yes	Yes		Both	Yes
lc_messages_dir	Yes	Yes	Yes		Global	No
lc_time_names	Yes	Yes	Yes		Both	Yes
license			Yes		Global	No
local_infile	Yes	Yes	Yes		Global	Yes
local-service	Yes					
lock_wait_timeout	Yes	Yes	Yes		Both	Yes
Locked_connects				Yes	Global	No
locked_in_memory			Yes		Global	No
log-bin	Yes	Yes				
log_bin			Yes		Global	No
log_bin_basename			Yes		Global	No
log_bin_index	Yes	Yes	Yes		Global	No
log_bin_trust_function_creators	Yes	Yes	Yes		Global	Yes
log_bin_use_v1_logs	Yes	Yes	Yes		Global	Yes
log_builtin_as_identified_by_password	Yes	Yes	Yes		Global	Yes
log_error	Yes	Yes	Yes		Global	No
log_error_verbosity	Yes	Yes	Yes		Global	Yes
log-isam	Yes	Yes				
log_output	Yes	Yes	Yes		Global	Yes
log_queries_not_using_indexes	Yes	Yes	Yes		Global	Yes
log-raw	Yes	Yes				
log-short-format	Yes	Yes				
log_slave_updates	Yes	Yes	Yes		Global	No
log_slow_admin_statements	Yes	Yes	Yes		Global	Yes
log_slow_slave_statements	Yes	Yes	Yes		Global	Yes
log_statements_safe_for_binlog	Yes	Yes	Yes		Global	Yes
log_syslog	Yes	Yes	Yes		Global	Yes
log_syslog_facility	Yes	Yes	Yes		Global	Yes
log_syslog_include_pid	Yes	Yes	Yes		Global	Yes
log_syslog_tag	Yes	Yes	Yes		Global	Yes
log-tc	Yes	Yes				
log-tc-size	Yes	Yes				
log_throttle_queries_not_using_indexes	Yes	Yes	Yes		Global	Yes
log_timestamps	Yes	Yes	Yes		Global	Yes
log_warnings	Yes	Yes	Yes		Global	Yes
long_query_time	Yes	Yes	Yes		Both	Yes

Name	Cmd-Line	Option File	System Var	Status Var	Var Scope	Dynamic
low_priority_updates	Yes	Yes	Yes		Both	Yes
lower_case_file_system			Yes		Global	No
lower_case_table_names	Yes	Yes	Yes		Global	No
master-info-file	Yes	Yes				
master_info_repository	Yes	Yes	Yes		Global	Yes
master-retry-count	Yes	Yes				
master_verify_checksum	Yes	Yes	Yes		Global	Yes
max_allowed_packet	Yes	Yes	Yes		Both	Yes
max_binlog_cache_size	Yes	Yes	Yes		Global	Yes
max-binlog-dump-events	Yes	Yes				
max_binlog_size	Yes	Yes	Yes		Global	Yes
max_binlog_stmt_cache_size	Yes	Yes	Yes		Global	Yes
max_connect_errors	Yes	Yes	Yes		Global	Yes
max_connections	Yes	Yes	Yes		Global	Yes
max_delayed_threads	Yes	Yes	Yes		Both	Yes
max_digest_length	Yes	Yes	Yes		Global	No
max_error_count	Yes	Yes	Yes		Both	Yes
max_execution_time	Yes	Yes	Yes		Both	Yes
Max_execution_time_exceeded				Yes	Both	No
Max_execution_time_set				Yes	Both	No
Max_execution_time_set_failed				Yes	Both	No
max_heap_table_size	Yes	Yes	Yes		Both	Yes
max_insert_delayed_threads			Yes		Both	Yes
max_join_size	Yes	Yes	Yes		Both	Yes
max_length_for_sort_data	Yes	Yes	Yes		Both	Yes
max_points_in_geometry	Yes	Yes	Yes		Both	Yes
max_prepared_stmt_count	Yes	Yes	Yes		Global	Yes
max_relay_log_size	Yes	Yes	Yes		Global	Yes
max_seeks_for_index	Yes	Yes	Yes		Both	Yes
max_sort_length	Yes	Yes	Yes		Both	Yes
max_sp_recursion_depth	Yes	Yes	Yes		Both	Yes
max_tmp_tables			Yes		Both	Yes
Max_used_connections				Yes	Global	No
Max_used_connections_time				Yes	Global	No
max_user_connections	Yes	Yes	Yes		Both	Yes
max_write_lock_count	Yes	Yes	Yes		Global	Yes

Name	Cmd-Line	Option File	System Var	Status Var	Var Scope	Dynamic
mecab_charset				Yes	Global	No
mecab_rc_file	Yes	Yes	Yes		Global	No
memlock	Yes	Yes				
- Variable: locked_in_memory						
metadata_locks_lease_size	Yes	Yes	Yes		Global	No
metadata_locks_flush_instances	Yes	Yes	Yes		Global	No
min_examined_row_limit	Yes	Yes	Yes		Both	Yes
multi_range_copy	Yes	Yes	Yes		Both	Yes
mysam-block-size	Yes	Yes				
mysam_data_block_size	Yes	Yes	Yes		Global	Yes
mysam_max_size	Yes	Yes	Yes		Global	Yes
mysam_mmap_size	Yes	Yes	Yes		Global	No
mysam_recovery_options	Yes	Yes	Yes		Global	No
mysam_repair_threads	Yes	Yes	Yes		Both	Yes
mysam_sort_buffer_size	Yes	Yes	Yes		Both	Yes
mysam_stats_method	Yes	Yes	Yes		Both	Yes
mysam_use_mmap	Yes	Yes	Yes		Global	Yes
mysql_firewall_enable	Yes	Yes	Yes		Global	Yes
mysql_firewall_mode	Yes	Yes	Yes		Global	Yes
mysql_native_password_proxy_users	Yes	Yes	Yes		Global	Yes
mysqlx	Yes	Yes				
Mysqlx_address				Yes	Global	No
mysqlx_bind_address	Yes	Yes	Yes		Global	No
Mysqlx_bytes_received				Yes	Both	No
Mysqlx_bytes_sent				Yes	Both	No
mysqlx_connection_timeout	Yes	Yes	Yes		Global	Yes
Mysqlx_connection_accept_errors				Yes	Both	No
Mysqlx_connection_errors				Yes	Both	No
Mysqlx_connections_accepted				Yes	Global	No
Mysqlx_connections_closed				Yes	Global	No
Mysqlx_connections_rejected				Yes	Global	No
Mysqlx_crud_create_view				Yes	Both	No
Mysqlx_crud_delete				Yes	Both	No
Mysqlx_crud_drop_view				Yes	Both	No
Mysqlx_crud_find				Yes	Both	No
Mysqlx_crud_insert				Yes	Both	No



Name	Cmd-Line	Option File	System Var	Status Var	Var Scope	Dynamic
Mysqlx_crud_modify_view				Yes	Both	No
Mysqlx_crud_update				Yes	Both	No
Mysqlx_errors_sent				Yes	Both	No
Mysqlx_errors_unknown_message_type				Yes	Both	No
Mysqlx_expect_close				Yes	Both	No
Mysqlx_expect_open				Yes	Both	No
mysqlx_idle_worker_thread_timeout	Yes	Yes	Yes		Global	Yes
Mysqlx_init_error				Yes	Both	No
mysqlx_max_allowed_packet	Yes	Yes	Yes		Global	Yes
mysqlx_max_connections	Yes	Yes	Yes		Global	Yes
mysqlx_min_worker_threads	Yes	Yes	Yes		Global	Yes
Mysqlx_notice_other_sent				Yes	Both	No
Mysqlx_notice_warning_sent				Yes	Both	No
Mysqlx_port				Yes	Global	No
mysqlx_port	Yes	Yes	Yes		Global	No
mysqlx_port_open_timeout	Yes	Yes	Yes		Global	No
Mysqlx_rows_sent				Yes	Both	No
Mysqlx_sessions				Yes	Global	No
Mysqlx_sessions_accepted				Yes	Global	No
Mysqlx_sessions_closed				Yes	Global	No
Mysqlx_sessions_fatal_error				Yes	Global	No
Mysqlx_sessions_killed				Yes	Global	No
Mysqlx_sessions_rejected				Yes	Global	No
Mysqlx_socket				Yes	Global	No
mysqlx_socket	Yes	Yes	Yes		Global	No
Mysqlx_ssl_accept_renegotiates				Yes	Global	No
Mysqlx_ssl_accepts				Yes	Global	No
Mysqlx_ssl_active				Yes	Both	No
mysqlx_ssl_ca	Yes	Yes	Yes		Global	No
mysqlx_ssl_capath	Yes	Yes	Yes		Global	No
mysqlx_ssl_cert	Yes	Yes	Yes		Global	No
Mysqlx_ssl_cipher				Yes	Both	No
mysqlx_ssl_cipher	Yes	Yes	Yes		Global	No
Mysqlx_ssl_cipher_list				Yes	Both	No
mysqlx_ssl_crl	Yes	Yes	Yes		Global	No
mysqlx_ssl_crlpath	Yes	Yes	Yes		Global	No
Mysqlx_ssl_ctx_verify_depth				Yes	Both	No
Mysqlx_ssl_ctx_verify_mode				Yes	Both	No

Name	Cmd-Line	Option File	System Var	Status Var	Var Scope	Dynamic
Mysqlx_ssl_finished_accepts				Yes	Global	No
mysqlx_ssl_key	Yes	Yes	Yes		Global	No
Mysqlx_ssl_server_not_after				Yes	Global	No
Mysqlx_ssl_server_not_before				Yes	Global	No
Mysqlx_ssl_verify_depth				Yes	Global	No
Mysqlx_ssl_verify_mode				Yes	Global	No
Mysqlx_ssl_version				Yes	Both	No
Mysqlx_stmt_create_collection				Yes	Both	No
Mysqlx_stmt_create_collection_index				Yes	Both	No
Mysqlx_stmt_disable_notices				Yes	Both	No
Mysqlx_stmt_drop_collection				Yes	Both	No
Mysqlx_stmt_drop_collection_index				Yes	Both	No
Mysqlx_stmt_enable_notices				Yes	Both	No
Mysqlx_stmt_ensure_collection				Yes	Both	No
Mysqlx_stmt_execute_mysqlx				Yes	Both	No
Mysqlx_stmt_execute_sql				Yes	Both	No
Mysqlx_stmt_execute_xplugin				Yes	Both	No
Mysqlx_stmt_kill_client				Yes	Both	No
Mysqlx_stmt_list_clients				Yes	Both	No
Mysqlx_stmt_list_notices				Yes	Both	No
Mysqlx_stmt_list_objects				Yes	Both	No
Mysqlx_stmt_ping				Yes	Both	No
Mysqlx_worker_threads				Yes	Global	No
Mysqlx_worker_threads_active				Yes	Global	No
named_pipe	Yes	Yes	Yes		Global	No
named_pipe_full_access_group	Yes	Yes	Yes		Global	No
ndb_allow_copy_to	Yes	Yes	Yes		Both	Yes
Ndb_api_adaptive_send_deferred_count				Yes	Global	No
Ndb_api_adaptive_send_deferred_count_session				Yes	Global	No
Ndb_api_adaptive_send_deferred_count_slave				Yes	Global	No
Ndb_api_adaptive_send_forced_count				Yes	Global	No
Ndb_api_adaptive_send_forced_count_session				Yes	Global	No
Ndb_api_adaptive_send_forced_count_slave				Yes	Global	No
Ndb_api_adaptive_send_unforced_count				Yes	Global	No
Ndb_api_adaptive_send_unforced_count_session				Yes	Global	No
Ndb_api_adaptive_send_unforced_count_slave				Yes	Global	No
Ndb_api_bytes_received_count				Yes	Global	No
Ndb_api_bytes_received_count_session				Yes	Session	No

Name	Cmd-Line	Option File	System Var	Status Var	Var Scope	Dynamic
Ndb_api_bytes_received_count_slave				Yes	Global	No
Ndb_api_bytes_sent_count				Yes	Global	No
Ndb_api_bytes_sent_count_session				Yes	Session	No
Ndb_api_bytes_sent_count_slave				Yes	Global	No
Ndb_api_event_bytes_count				Yes	Global	No
Ndb_api_event_bytes_count_injector				Yes	Global	No
Ndb_api_event_data_count				Yes	Global	No
Ndb_api_event_data_count_injector				Yes	Global	No
Ndb_api_event_nondata_count				Yes	Global	No
Ndb_api_event_nondata_count_injector				Yes	Global	No
Ndb_api_pk_op_count				Yes	Global	No
Ndb_api_pk_op_count_session				Yes	Session	No
Ndb_api_pk_op_count_slave				Yes	Global	No
Ndb_api_pruned_scan_count				Yes	Global	No
Ndb_api_pruned_scan_count_session				Yes	Session	No
Ndb_api_pruned_scan_count_slave				Yes	Global	No
Ndb_api_range_scan_count				Yes	Global	No
Ndb_api_range_scan_count_session				Yes	Session	No
Ndb_api_range_scan_count_slave				Yes	Global	No
Ndb_api_read_row_count				Yes	Global	No
Ndb_api_read_row_count_session				Yes	Session	No
Ndb_api_read_row_count_slave				Yes	Global	No
Ndb_api_scan_batch_count				Yes	Global	No
Ndb_api_scan_batch_count_session				Yes	Session	No
Ndb_api_scan_batch_count_slave				Yes	Global	No
Ndb_api_table_scan_count				Yes	Global	No
Ndb_api_table_scan_count_session				Yes	Session	No
Ndb_api_table_scan_count_slave				Yes	Global	No
Ndb_api_trans_abort_count				Yes	Global	No
Ndb_api_trans_abort_count_session				Yes	Session	No
Ndb_api_trans_abort_count_slave				Yes	Global	No
Ndb_api_trans_close_count				Yes	Global	No
Ndb_api_trans_close_count_session				Yes	Session	No
Ndb_api_trans_close_count_slave				Yes	Global	No
Ndb_api_trans_commit_count				Yes	Global	No
Ndb_api_trans_commit_count_session				Yes	Session	No
Ndb_api_trans_commit_count_slave				Yes	Global	No
Ndb_api_trans_local_read_row_count				Yes	Global	No

Name	Cmd-Line	Option File	System Var	Status Var	Var Scope	Dynamic
Ndb_api_trans_local_read_row_count_session				Yes	Session	No
Ndb_api_trans_local_read_row_count_slave				Yes	Global	No
Ndb_api_trans_start_count				Yes	Global	No
Ndb_api_trans_start_count_session				Yes	Session	No
Ndb_api_trans_start_count_slave				Yes	Global	No
Ndb_api_uk_op_count				Yes	Global	No
Ndb_api_uk_op_count_session				Yes	Session	No
Ndb_api_uk_op_count_slave				Yes	Global	No
Ndb_api_wait_exec_complete_count				Yes	Global	No
Ndb_api_wait_exec_complete_count_session				Yes	Session	No
Ndb_api_wait_exec_complete_count_slave				Yes	Global	No
Ndb_api_wait_meta_request_count				Yes	Global	No
Ndb_api_wait_meta_request_count_session				Yes	Session	No
Ndb_api_wait_meta_request_count_slave				Yes	Global	No
Ndb_api_wait_nanos_count				Yes	Global	No
Ndb_api_wait_nanos_count_session				Yes	Session	No
Ndb_api_wait_nanos_count_slave				Yes	Global	No
Ndb_api_wait_scan_result_count				Yes	Global	No
Ndb_api_wait_scan_result_count_session				Yes	Session	No
Ndb_api_wait_scan_result_count_slave				Yes	Global	No
ndb_autoincrement_size	Yes	Yes	Yes		Both	Yes
ndb_batch_size	Yes	Yes	Yes		Both	Yes
ndb_blob_read_batch_bytes	Yes	Yes	Yes		Both	Yes
ndb_blob_write_batch_bytes	Yes	Yes	Yes		Both	Yes
ndb_cache_checkpoint_time	Yes	Yes	Yes		Global	Yes
ndb_clear_apply_status	Yes		Yes		Global	Yes
ndb_cluster_connection_pool	Yes	Yes	Yes		Global	No
ndb_cluster_connection_pool_size	Yes	Yes	Yes		Global	No
Ndb_cluster_node_id				Yes	Global	No
Ndb_config_from_host				Yes	Both	No
Ndb_config_from_port				Yes	Both	No
Ndb_conflict_fn_epoch				Yes	Global	No
Ndb_conflict_fn_epoch_trans				Yes	Global	No
Ndb_conflict_fn_epoch2				Yes	Global	No
Ndb_conflict_fn_epoch2_trans				Yes	Global	No
Ndb_conflict_fn_max				Yes	Global	No
Ndb_conflict_fn_max_del_win				Yes	Global	No
Ndb_conflict_fn_old				Yes	Global	No

Name	Cmd-Line	Option File	System Var	Status Var	Var Scope	Dynamic
Ndb_conflict_last_conflict_epoch				Yes	Global	No
Ndb_conflict_last_stable_epoch				Yes	Global	No
Ndb_conflict_reflected_op_discard_count				Yes	Global	No
Ndb_conflict_reflected_op_prepare_count				Yes	Global	No
Ndb_conflict_refresh_op_count				Yes	Global	No
Ndb_conflict_trans_conflict_commit_count				Yes	Global	No
Ndb_conflict_trans_detect_iter_count				Yes	Global	No
Ndb_conflict_trans_reject_count				Yes	Global	No
Ndb_conflict_trans_row_conflict_count				Yes	Global	No
Ndb_conflict_trans_row_reject_count				Yes	Global	No
ndb-connectstring	Yes	Yes				
ndb_data_node_Yes_ighbour	Yes	Yes	Yes		Global	Yes
ndb_default_col_Yesn_format	Yes	Yes	Yes		Global	Yes
ndb_default_col_Yesn_format	Yes	Yes	Yes		Global	Yes
ndb_deferred_Yesconstraints	Yes	Yes	Yes		Both	Yes
ndb_deferred_Yesconstraints	Yes	Yes	Yes		Both	Yes
ndb_distribution_Yes	Yes	Yes	Yes		Global	Yes
ndb_distribution_Yes	Yes	Yes	Yes		Global	Yes
Ndb_epoch_delete_delete_count				Yes	Global	No
ndb_eventbuffer_Yesfee_percent	Yes	Yes	Yes		Global	Yes
ndb_eventbuffer_Yesmax_alloc	Yes	Yes	Yes		Global	Yes
Ndb_execute_count				Yes	Global	No
ndb_extra_logg_Yes	Yes	Yes	Yes		Global	Yes
ndb_force_send_Yes	Yes	Yes	Yes		Both	Yes
ndb_fully_replic_Yesd	Yes	Yes	Yes		Both	Yes
ndb_index_stat_Yesable	Yes	Yes	Yes		Both	Yes
ndb_index_stat_Yesrtion	Yes	Yes	Yes		Both	Yes
ndb_join_pushdown			Yes		Both	Yes
Ndb_last_commit_epoch_server				Yes	Global	No
Ndb_last_commit_epoch_session				Yes	Session	No
ndb_log_apply_Yesatus	Yes	Yes	Yes		Global	No
ndb_log_apply_Yesatus	Yes	Yes	Yes		Global	No
ndb_log_bin	Yes		Yes		Both	No
ndb_log_binlog_Yeslex	Yes		Yes		Global	Yes
ndb_log_empty_Yesepochs	Yes	Yes	Yes		Global	Yes
ndb_log_empty_Yesepochs	Yes	Yes	Yes		Global	Yes
ndb_log_empty_Yesepdate	Yes	Yes	Yes		Global	Yes

Name	Cmd-Line	Option File	System Var	Status Var	Var Scope	Dynamic
ndb_log_empty_date	Yes	Yes	Yes		Global	Yes
ndb_log_exclusive_reads	Yes	Yes	Yes		Both	Yes
ndb_log_exclusive_reads	Yes	Yes	Yes		Both	Yes
ndb_log_fail_terminate	Yes	Yes	Yes		Global	No
ndb_log_orig	Yes	Yes	Yes		Global	No
ndb_log_orig	Yes	Yes	Yes		Global	No
ndb_log_transaction_id	Yes	Yes	Yes		Global	No
ndb_log_transaction_id			Yes		Global	No
ndb_log_update_write	Yes	Yes	Yes		Global	Yes
ndb_log_update_minimal	Yes	Yes	Yes		Global	Yes
ndb_log_update_only	Yes	Yes	Yes		Global	Yes
ndb-mgmd-host	Yes	Yes				
ndb_nodeid	Yes	Yes		Yes	Global	No
Ndb_number_of_data_nodes				Yes	Global	No
ndb_optimization_delay	Yes	Yes	Yes		Global	Yes
ndb_optimized_selection	Yes	Yes	Yes		Global	Yes
ndb_optimized_selection	Yes	Yes	Yes		Global	No
Ndb_pruned_scan_count				Yes	Global	No
Ndb_pushed_queries_defined				Yes	Global	No
Ndb_pushed_queries_dropped				Yes	Global	No
Ndb_pushed_queries_executed				Yes	Global	No
Ndb_pushed_reads				Yes	Global	No
ndb_read_backlog	Yes	Yes	Yes		Global	Yes
ndb_rcv_thread_activation_threshold	Yes	Yes	Yes		Global	Yes
ndb_rcv_thread_cpu_mask	Yes	Yes	Yes		Global	Yes
ndb_report_thread_binlog_epoch_slip	Yes	Yes	Yes		Global	Yes
ndb_report_thread_binlog_message	Yes	Yes	Yes		Global	Yes
ndb_row_checksum			Yes		Both	Yes
Ndb_scan_count				Yes	Global	No
ndb_show_foreign_key_mock_tables	Yes	Yes	Yes		Global	Yes
ndb_slave_connection_role	Yes	Yes	Yes		Global	Yes
Ndb_slave_max_replicated_epoch				Yes	Global	No
Ndb_system_name			Yes		Global	No
ndb_table_no_logging			Yes		Session	Yes
ndb_table_temporary			Yes		Session	Yes
ndb-transid-mysql-	Yes					

Name	Cmd-Line	Option File	System Var	Status Var	Var Scope	Dynamic
connection-map						
ndb_use_copying_alter_table			Yes		Both	No
ndb_use_exact_count			Yes		Both	Yes
ndb_use_transactions	Yes	Yes	Yes		Both	Yes
ndb_version			Yes		Global	No
ndb_version_string			Yes		Global	No
ndb_wait_connect	Yes	Yes	Yes		Global	No
ndb_wait_setup	Yes	Yes	Yes		Global	No
ndbcluster	Yes	Yes				
ndbinfo_database			Yes		Global	No
ndbinfo_max_bytes	Yes		Yes		Both	Yes
ndbinfo_max_rows	Yes		Yes		Both	Yes
ndbinfo_offline			Yes		Global	Yes
ndbinfo_show_hidden	Yes		Yes		Both	Yes
ndbinfo_table_prefix			Yes		Global	No
ndbinfo_version			Yes		Global	No
net_buffer_length	Yes	Yes	Yes		Both	Yes
net_read_timeout	Yes	Yes	Yes		Both	Yes
net_retry_count	Yes	Yes	Yes		Both	Yes
net_write_timeout	Yes	Yes	Yes		Both	Yes
new	Yes	Yes	Yes		Both	Yes
ngram_token_size	Yes	Yes	Yes		Global	No
no-defaults	Yes					
Not_flushed_delayed_rows				Yes	Global	No
offline_mode	Yes	Yes	Yes		Global	Yes
old	Yes	Yes	Yes		Global	No
old_alter_table	Yes	Yes	Yes		Both	Yes
old_passwords	Yes	Yes	Yes		Both	Yes
old-style-user-limits	Yes	Yes				
Ongoing_anonymous_gtid_violating_transaction_count				Yes	Global	No
Ongoing_anonymous_transaction_count				Yes	Global	No
Ongoing_automatic_gtid_violating_transaction_count				Yes	Global	No
Open_files				Yes	Global	No
open_files_limit	Yes	Yes	Yes		Global	No
Open_streams				Yes	Global	No
Open_table_definitions				Yes	Global	No

Name	Cmd-Line	Option File	System Var	Status Var	Var Scope	Dynamic
Open_tables				Yes	Both	No
Opened_files				Yes	Global	No
Opened_table_definitions				Yes	Both	No
Opened_tables				Yes	Both	No
optimizer_prune_level	Yes	Yes	Yes		Both	Yes
optimizer_search_depth	Yes	Yes	Yes		Both	Yes
optimizer_switch	Yes	Yes	Yes		Both	Yes
optimizer_trace	Yes	Yes	Yes		Both	Yes
optimizer_trace_features	Yes	Yes	Yes		Both	Yes
optimizer_trace_log	Yes	Yes	Yes		Both	Yes
optimizer_trace_max_mem_size	Yes	Yes	Yes		Both	Yes
optimizer_trace_offset	Yes	Yes	Yes		Both	Yes
parser_max_mem_size	Yes	Yes	Yes		Both	Yes
partition	Yes	Yes				
performance_schema	Yes	Yes	Yes		Global	No
Performance_schema_accounts_lost				Yes	Global	No
performance_schema_accounts_size	Yes	Yes	Yes		Global	No
Performance_schema_cond_classes_lost				Yes	Global	No
Performance_schema_cond_instances_lost				Yes	Global	No
performance-schema-consumer-events-stages-current	Yes	Yes				
performance-schema-consumer-events-stages-history	Yes	Yes				
performance-schema-consumer-events-stages-history-long	Yes	Yes				
performance-schema-consumer-events-statements-current	Yes	Yes				



Name	Cmd-Line	Option File	System Var	Status Var	Var Scope	Dynamic
performance-schema-consumer-events-statements-history	Yes	Yes				
performance-schema-consumer-events-statements-history-long	Yes	Yes				
performance-schema-consumer-events-transactions-current	Yes	Yes				
performance-schema-consumer-events-transactions-history	Yes	Yes				
performance-schema-consumer-events-transactions-history-long	Yes	Yes				
performance-schema-consumer-events-waits-current	Yes	Yes				
performance-schema-consumer-events-waits-history	Yes	Yes				
performance-schema-consumer-events-waits-history-long	Yes	Yes				
performance-schema-consumer-	Yes	Yes				

Name	Cmd-Line	Option File	System Var	Status Var	Var Scope	Dynamic
global-instrumentation						
performance-schema-consumer-statements-digest	Yes	Yes				
performance-schema-consumer-thread-instrumentation	Yes	Yes				
Performance_schema_digest_lost				Yes	Global	No
performance_schema_digests_lost	Yes	Yes	Yes		Global	No
performance_schema_events_instances_history_log_size	Yes	Yes	Yes		Global	No
performance_schema_events_instances_history_size	Yes	Yes	Yes		Global	No
performance_schema_events_statements_history_long_size	Yes	Yes	Yes		Global	No
performance_schema_events_statements_history_size	Yes	Yes	Yes		Global	No
performance_schema_events_transactions_history_long_size	Yes	Yes	Yes		Global	No
performance_schema_events_transactions_history_size	Yes	Yes	Yes		Global	No
performance_schema_events_transactions_history_size	Yes	Yes	Yes		Global	No
Performance_schema_file_classes_lost				Yes	Global	No
Performance_schema_file_handles_lost				Yes	Global	No
Performance_schema_file_instances_lost				Yes	Global	No
Performance_schema_hosts_lost				Yes	Global	No
performance_schema_hosts_size	Yes	Yes	Yes		Global	No
Performance_schema_index_stat_lost				Yes	Global	No
performance-schema-instrument	Yes	Yes				
Performance_schema_locker_lost				Yes	Global	No
performance_schema_max_classes	Yes	Yes	Yes		Global	No
performance_schema_max_instances	Yes	Yes	Yes		Global	No
performance_schema_max_digest_length	Yes	Yes	Yes		Global	No
performance_schema_max_file_classes	Yes	Yes	Yes		Global	No
performance_schema_max_file_handles	Yes	Yes	Yes		Global	No
performance_schema_max_file_instances	Yes	Yes	Yes		Global	No
performance_schema_max_index_stat	Yes	Yes	Yes		Global	No
performance_schema_max_memory_classes	Yes	Yes	Yes		Global	No
performance_schema_max_metadata_locks	Yes	Yes	Yes		Global	No

Name	Cmd-Line	Option File	System Var	Status Var	Var Scope	Dynamic
performance_schema_max_memory_classes	Yes	Yes	Yes		Global	No
performance_schema_max_memory_instances	Yes	Yes	Yes		Global	No
performance_schema_max_prepared_statements_instances	Yes	Yes	Yes		Global	No
performance_schema_max_program_instances	Yes	Yes	Yes		Global	No
performance_schema_max_rwlock_classes	Yes	Yes	Yes		Global	No
performance_schema_max_rwlock_instances	Yes	Yes	Yes		Global	No
performance_schema_max_socket_classes	Yes	Yes	Yes		Global	No
performance_schema_max_socket_instances	Yes	Yes	Yes		Global	No
performance_schema_max_sql_text_length	Yes	Yes	Yes		Global	No
performance_schema_max_stage_classes	Yes	Yes	Yes		Global	No
performance_schema_max_statement_classes	Yes	Yes	Yes		Global	No
performance_schema_max_statement_stack	Yes	Yes	Yes		Global	No
performance_schema_max_table_handles	Yes	Yes	Yes		Global	No
performance_schema_max_table_instances	Yes	Yes	Yes		Global	No
performance_schema_max_table_lock_stat	Yes	Yes	Yes		Global	No
performance_schema_max_thread_classes	Yes	Yes	Yes		Global	No
performance_schema_max_thread_instances	Yes	Yes	Yes		Global	No
Performance_schema_memory_classes_lost				Yes	Global	No
Performance_schema_metadata_lock_lost				Yes	Global	No
Performance_schema_mutex_classes_lost				Yes	Global	No
Performance_schema_mutex_instances_lost				Yes	Global	No
Performance_schema_nested_statement_lost				Yes	Global	No
Performance_schema_prepared_statements_lost				Yes	Global	No
Performance_schema_program_lost				Yes	Global	No
Performance_schema_rwlock_classes_lost				Yes	Global	No
Performance_schema_rwlock_instances_lost				Yes	Global	No
Performance_schema_session_connect_attrs_lost				Yes	Global	No
performance_schema_session_connect_attrs_instances	Yes	Yes	Yes		Global	No
performance_schema_setup_actors_size	Yes	Yes	Yes		Global	No
performance_schema_setup_objects_size	Yes	Yes	Yes		Global	No
performance_schema_show_processlist	Yes	Yes	Yes		Global	Yes
Performance_schema_socket_classes_lost				Yes	Global	No
Performance_schema_socket_instances_lost				Yes	Global	No
Performance_schema_stage_classes_lost				Yes	Global	No
Performance_schema_statement_classes_lost				Yes	Global	No
Performance_schema_table_handles_lost				Yes	Global	No
Performance_schema_table_instances_lost				Yes	Global	No
Performance_schema_table_lock_stat_lost				Yes	Global	No

Name	Cmd-Line	Option File	System Var	Status Var	Var Scope	Dynamic
Performance_schema_thread_classes_lost				Yes	Global	No
Performance_schema_thread_instances_lost				Yes	Global	No
Performance_schema_users_lost				Yes	Global	No
performance_schema_users_size	Yes	Yes	Yes		Global	No
pid_file	Yes	Yes	Yes		Global	No
plugin_dir	Yes	Yes	Yes		Global	No
plugin-load	Yes	Yes				
plugin-load-add	Yes	Yes				
plugin-xxx	Yes	Yes				
port	Yes	Yes	Yes		Global	No
port-open-timeout	Yes	Yes				
preload_buffer_size	Yes	Yes	Yes		Both	Yes
Prepared_stmt_count				Yes	Global	No
print-defaults	Yes					
profiling			Yes		Both	Yes
profiling_history_size	Yes	Yes	Yes		Both	Yes
protocol_version			Yes		Global	No
proxy_user			Yes		Session	No
pseudo_slave_mode			Yes		Session	Yes
pseudo_thread_id			Yes		Session	Yes
Qcache_free_blocks				Yes	Global	No
Qcache_free_memory				Yes	Global	No
Qcache_hits				Yes	Global	No
Qcache_inserts				Yes	Global	No
Qcache_lowmem_prunes				Yes	Global	No
Qcache_not_cached				Yes	Global	No
Qcache_queries_in_cache				Yes	Global	No
Qcache_total_blocks				Yes	Global	No
Queries				Yes	Both	No
query_alloc_block_size	Yes	Yes	Yes		Both	Yes
query_cache_limit	Yes	Yes	Yes		Global	Yes
query_cache_memres_unit	Yes	Yes	Yes		Global	Yes
query_cache_size	Yes	Yes	Yes		Global	Yes
query_cache_type	Yes	Yes	Yes		Both	Yes
query_cache_wlock_invalidate	Yes	Yes	Yes		Both	Yes
query_prealloc_size	Yes	Yes	Yes		Both	Yes

Name	Cmd-Line	Option File	System Var	Status Var	Var Scope	Dynamic
Questions				Yes	Both	No
rand_seed1			Yes		Session	Yes
rand_seed2			Yes		Session	Yes
range_alloc_block_size	Yes	Yes	Yes		Both	Yes
range_optimizer_max_mem_size	Yes	Yes	Yes		Both	Yes
rbr_exec_mode			Yes		Session	Yes
read_buffer_size	Yes	Yes	Yes		Both	Yes
read_only	Yes	Yes	Yes		Global	Yes
read_rnd_buffer_size	Yes	Yes	Yes		Both	Yes
relay_log	Yes	Yes	Yes		Global	No
relay_log_basename			Yes		Global	No
relay_log_index	Yes	Yes	Yes		Global	No
relay_log_info_repository	Yes	Yes	Yes		Global	No
relay_log_info_dir	Yes	Yes	Yes		Global	Yes
relay_log_purge	Yes	Yes	Yes		Global	Yes
relay_log_recovery	Yes	Yes	Yes		Global	No
relay_log_space_limit	Yes	Yes	Yes		Global	No
remove	Yes					
replicate-do-db	Yes	Yes				
replicate-do-table	Yes	Yes				
replicate-ignore-db	Yes	Yes				
replicate-ignore-table	Yes	Yes				
replicate-rewrite-db	Yes	Yes				
replicate-same-server-id	Yes	Yes				
replicate-wild-do-table	Yes	Yes				
replicate-wild-ignore-table	Yes	Yes				
replication_optimize_for_static_plugins	Yes	Yes	Yes		Global	Yes
replication_send_observers_only	Yes	Yes	Yes		Global	Yes
report_host	Yes	Yes	Yes		Global	No
report_password	Yes	Yes	Yes		Global	No
report_port	Yes	Yes	Yes		Global	No

Name	Cmd-Line	Option File	System Var	Status Var	Var Scope	Dynamic
report_user	Yes	Yes	Yes		Global	No
require_secure_transport	Yes	Yes	Yes		Global	Yes
rewriter_enabled			Yes		Global	Yes
Rewriter_number_loaded_rules				Yes	Global	No
Rewriter_number_reloads				Yes	Global	No
Rewriter_number_rewritten_queries				Yes	Global	No
Rewriter_reload_error				Yes	Global	No
rewriter_verbose			Yes		Global	Yes
Rpl_semi_sync_master_clients				Yes	Global	No
rpl_semi_sync_master_enabled	Yes	Yes	Yes		Global	Yes
Rpl_semi_sync_master_net_avg_wait_time				Yes	Global	No
Rpl_semi_sync_master_net_wait_time				Yes	Global	No
Rpl_semi_sync_master_net_waits				Yes	Global	No
Rpl_semi_sync_master_no_times				Yes	Global	No
Rpl_semi_sync_master_no_tx				Yes	Global	No
Rpl_semi_sync_master_status				Yes	Global	No
Rpl_semi_sync_master_timefunc_failures				Yes	Global	No
rpl_semi_sync_master_timeout	Yes	Yes	Yes		Global	Yes
rpl_semi_sync_master_trace_level	Yes	Yes	Yes		Global	Yes
Rpl_semi_sync_master_tx_avg_wait_time				Yes	Global	No
Rpl_semi_sync_master_tx_wait_time				Yes	Global	No
Rpl_semi_sync_master_tx_waits				Yes	Global	No
rpl_semi_sync_master_wait_for_slave_count	Yes	Yes	Yes		Global	Yes
rpl_semi_sync_master_wait_for_slave	Yes	Yes	Yes		Global	Yes
rpl_semi_sync_master_wait_point	Yes	Yes	Yes		Global	Yes
Rpl_semi_sync_master_wait_pos_backtraverse				Yes	Global	No
Rpl_semi_sync_master_wait_sessions				Yes	Global	No
Rpl_semi_sync_master_yes_tx				Yes	Global	No
rpl_semi_sync_slave_enabled	Yes	Yes	Yes		Global	Yes
Rpl_semi_sync_slave_status				Yes	Global	No
rpl_semi_sync_slave_trace_level	Yes	Yes	Yes		Global	Yes
rpl_stop_slave_timeout	Yes	Yes	Yes		Global	Yes
Rsa_public_key				Yes	Global	No
safe-user-create	Yes	Yes				
secure_auth	Yes	Yes	Yes		Global	Yes
secure_file_priv	Yes	Yes	Yes		Global	No
Select_full_join				Yes	Both	No

Name	Cmd-Line	Option File	System Var	Status Var	Var Scope	Dynamic
Select_full_range_join				Yes	Both	No
Select_range				Yes	Both	No
Select_range_check				Yes	Both	No
Select_scan				Yes	Both	No
server_id	Yes	Yes	Yes		Global	Yes
server_id_bits	Yes	Yes	Yes		Global	No
server_uuid			Yes		Global	No
session_track_tables	Yes	Yes	Yes		Both	Yes
session_track_tables_innodb	Yes	Yes	Yes		Both	Yes
session_track_tables_change	Yes	Yes	Yes		Both	Yes
session_track_tables_system_variables	Yes	Yes	Yes		Both	Yes
session_track_tables_transaction_info	Yes	Yes	Yes		Both	Yes
sha256_password_auto_generate_rsa_keys	Yes	Yes	Yes		Global	No
sha256_password_private_key_path	Yes	Yes	Yes		Global	No
sha256_password_proxy_users	Yes	Yes	Yes		Global	Yes
sha256_password_public_key_path	Yes	Yes	Yes		Global	No
shared_memory	Yes	Yes	Yes		Global	No
shared_memory_base_name	Yes	Yes	Yes		Global	No
show_compatibility_56	Yes	Yes	Yes		Global	Yes
show_create_tables_verbosity	Yes	Yes	Yes		Both	Yes
show_old_temporals	Yes	Yes	Yes		Both	Yes
show-slave-auth-info	Yes	Yes				
skip-character-set-client-handshake	Yes	Yes				
skip_external_logging	Yes	Yes	Yes		Global	No
skip-grant-tables	Yes	Yes				
skip-host-cache	Yes	Yes				
skip_name_resolve	Yes	Yes	Yes		Global	No
skip-ndbcluster	Yes	Yes				
skip_networking	Yes	Yes	Yes		Global	No
skip-new	Yes	Yes				
skip-partition	Yes	Yes				
skip_show_data_base	Yes	Yes	Yes		Global	No
skip_slave_start	Yes	Yes	Yes		Global	No

Name	Cmd-Line	Option File	System Var	Status Var	Var Scope	Dynamic
skip-ssl	Yes	Yes				
skip-stack-trace	Yes	Yes				
slave_allow_batching	Yes	Yes	Yes		Global	Yes
slave_checkpoint_group	Yes	Yes	Yes		Global	Yes
slave_checkpoint_period	Yes	Yes	Yes		Global	Yes
slave_compression_protocol	Yes	Yes	Yes		Global	Yes
slave_exec_mode	Yes	Yes	Yes		Global	Yes
Slave_heartbeat_period				Yes	Global	No
Slave_last_heartbeat				Yes	Global	No
slave_load_tmp_tables	Yes	Yes	Yes		Global	No
slave_max_allowed_packet	Yes	Yes	Yes		Global	Yes
slave_net_timeout	Yes	Yes	Yes		Global	Yes
Slave_open_temp_tables				Yes	Global	No
slave_parallel_type	Yes	Yes	Yes		Global	Yes
slave_parallel_workers	Yes	Yes	Yes		Global	Yes
slave_pending_connections_size_max	Yes	Yes	Yes		Global	Yes
slave_preserve_commit_order	Yes	Yes	Yes		Global	Yes
Slave_received_heartbeats				Yes	Global	No
Slave_retried_transactions				Yes	Global	No
Slave_rows_last_search_algorithm_used				Yes	Global	No
slave_rows_search_algorithms	Yes	Yes	Yes		Global	Yes
Slave_running				Yes	Global	No
slave_skip_errors	Yes	Yes	Yes		Global	No
slave-sql-verify-checksum	Yes	Yes				
slave_sql_verify_checksum	Yes	Yes	Yes		Global	Yes
slave_transaction_retries	Yes	Yes	Yes		Global	Yes
slave_type_conversions	Yes	Yes	Yes		Global	Yes
Slow_launch_threads				Yes	Both	No
slow_launch_time	Yes	Yes	Yes		Global	Yes
Slow_queries				Yes	Both	No
slow_query_log	Yes	Yes	Yes		Global	Yes
slow_query_log_file	Yes	Yes	Yes		Global	Yes
slow-start-timeout	Yes	Yes				
socket	Yes	Yes	Yes		Global	No
sort_buffer_size	Yes	Yes	Yes		Both	Yes



Name	Cmd-Line	Option File	System Var	Status Var	Var Scope	Dynamic
<a href="#">Sort_merge_passes</a>				Yes	Both	No
<a href="#">Sort_range</a>				Yes	Both	No
<a href="#">Sort_rows</a>				Yes	Both	No
<a href="#">Sort_scan</a>				Yes	Both	No
<a href="#">sporadic-binlog-dump-fail</a>	Yes	Yes				
<a href="#">sql_auto_is_null</a>			Yes		Both	Yes
<a href="#">sql_big_selects</a>			Yes		Both	Yes
<a href="#">sql_buffer_result</a>			Yes		Both	Yes
<a href="#">sql_log_bin</a>			Yes		Session	Yes
<a href="#">sql_log_off</a>			Yes		Both	Yes
<a href="#">sql_mode</a>	Yes	Yes	Yes		Both	Yes
<a href="#">sql_notes</a>			Yes		Both	Yes
<a href="#">sql_quote_show_create</a>			Yes		Both	Yes
<a href="#">sql_safe_updates</a>			Yes		Both	Yes
<a href="#">sql_select_limit</a>			Yes		Both	Yes
<a href="#">sql_slave_skip_counter</a>			Yes		Global	Yes
<a href="#">sql_warnings</a>			Yes		Both	Yes
<a href="#">ssl</a>	Yes	Yes				
<a href="#">Ssl_accept_renegotiates</a>				Yes	Global	No
<a href="#">Ssl_accepts</a>				Yes	Global	No
<a href="#">ssl_ca</a>	Yes	Yes	Yes		Global	No
<a href="#">Ssl_callback_cache_hits</a>				Yes	Global	No
<a href="#">ssl_capath</a>	Yes	Yes	Yes		Global	No
<a href="#">ssl_cert</a>	Yes	Yes	Yes		Global	No
<a href="#">Ssl_cipher</a>				Yes	Both	No
<a href="#">ssl_cipher</a>	Yes	Yes	Yes		Global	No
<a href="#">Ssl_cipher_list</a>				Yes	Both	No
<a href="#">Ssl_client_connects</a>				Yes	Global	No
<a href="#">Ssl_connect_renegotiates</a>				Yes	Global	No
<a href="#">ssl_crl</a>	Yes	Yes	Yes		Global	No
<a href="#">ssl_crlpath</a>	Yes	Yes	Yes		Global	No
<a href="#">Ssl_ctx_verify_depth</a>				Yes	Global	No
<a href="#">Ssl_ctx_verify_mode</a>				Yes	Global	No
<a href="#">Ssl_default_timeout</a>				Yes	Both	No
<a href="#">Ssl_finished_accepts</a>				Yes	Global	No
<a href="#">Ssl_finished_connects</a>				Yes	Global	No

Name	Cmd-Line	Option File	System Var	Status Var	Var Scope	Dynamic
ssl_key	Yes	Yes	Yes		Global	No
Ssl_server_not_after				Yes	Both	No
Ssl_server_not_before				Yes	Both	No
Ssl_session_cache_hits				Yes	Global	No
Ssl_session_cache_misses				Yes	Global	No
Ssl_session_cache_mode				Yes	Global	No
Ssl_session_cache_overflows				Yes	Global	No
Ssl_session_cache_size				Yes	Global	No
Ssl_session_cache_timeouts				Yes	Global	No
Ssl_sessions_reused				Yes	Session	No
Ssl_used_session_cache_entries				Yes	Global	No
Ssl_verify_depth				Yes	Both	No
Ssl_verify_mode				Yes	Both	No
Ssl_version				Yes	Both	No
standalone	Yes	Yes				
stored_program_cache	Yes	Yes	Yes		Global	Yes
super-large-pages	Yes	Yes				
super_read_only	Yes	Yes	Yes		Global	Yes
symbolic-links	Yes	Yes				
sync_binlog	Yes	Yes	Yes		Global	Yes
sync_frm	Yes	Yes	Yes		Global	Yes
sync_master_info	Yes	Yes	Yes		Global	Yes
sync_relay_log	Yes	Yes	Yes		Global	Yes
sync_relay_log_info	Yes	Yes	Yes		Global	Yes
sysdate-is-now	Yes	Yes				
system_time_zone			Yes		Global	No
table_definition_cache	Yes	Yes	Yes		Global	Yes
Table_locks_immediate				Yes	Global	No
Table_locks_waited				Yes	Global	No
table_open_cache	Yes	Yes	Yes		Global	Yes
Table_open_cache_hits				Yes	Both	No
table_open_cache_instances	Yes	Yes	Yes		Global	No
Table_open_cache_misses				Yes	Both	No
Table_open_cache_overflows				Yes	Both	No
tc-heuristic-recover	Yes	Yes				
Tc_log_max_pages_used				Yes	Global	No

Name	Cmd-Line	Option File	System Var	Status Var	Var Scope	Dynamic
Tc_log_page_size				Yes	Global	No
Tc_log_page_waits				Yes	Global	No
temp-pool	Yes	Yes				
thread_cache_size	Yes	Yes	Yes		Global	Yes
thread_handling	Yes	Yes	Yes		Global	No
thread_pool_algorithm	Yes	Yes	Yes		Global	No
thread_pool_high_priority_connection	Yes	Yes	Yes		Both	Yes
thread_pool_max_unused_threads	Yes	Yes	Yes		Global	Yes
thread_pool_preemptive_scheduler	Yes	Yes	Yes		Global	Yes
thread_pool_size	Yes	Yes	Yes		Global	No
thread_pool_stack_limit	Yes	Yes	Yes		Global	Yes
thread_stack	Yes	Yes	Yes		Global	No
Threads_cached				Yes	Global	No
Threads_connected				Yes	Global	No
Threads_created				Yes	Global	No
Threads_running				Yes	Global	No
time_format			Yes		Global	No
time_zone			Yes		Both	Yes
timestamp			Yes		Session	Yes
tls_version	Yes	Yes	Yes		Global	No
tmp_table_size	Yes	Yes	Yes		Both	Yes
tmpdir	Yes	Yes	Yes		Global	No
transaction_alloc_block_size	Yes	Yes	Yes		Both	Yes
transaction_allow_batching			Yes		Session	Yes
transaction_isolation	Yes	Yes			Both	Yes
- Variable: tx_isolation			Yes		Both	Yes
transaction_prealloc_size	Yes	Yes	Yes		Both	Yes
transaction_read_only	Yes	Yes			Both	Yes
- Variable: tx_read_only			Yes		Both	Yes
transaction_write_set_extraction	Yes	Yes	Yes		Both	Yes
tx_isolation			Yes		Both	Yes
tx_read_only			Yes		Both	Yes
unique_checks			Yes		Both	Yes
updatable_views_with_limit	Yes	Yes	Yes		Both	Yes
Uptime				Yes	Global	No
Uptime_since_flush_status				Yes	Global	No

Name	Cmd-Line	Option File	System Var	Status Var	Var Scope	Dynamic
<a href="#">user</a>	Yes	Yes				
<a href="#">validate-password</a>	Yes	Yes				
<a href="#">validate_password_check_user_name</a>	Yes	Yes	Yes		Global	Yes
<a href="#">validate_password_dictionary_file</a>	Yes	Yes	Yes		Global	Varies
<a href="#">validate_password_dictionary_file_last_parsed</a>				Yes	Global	No
<a href="#">validate_password_dictionary_file_words_count</a>				Yes	Global	No
<a href="#">validate_password_length</a>	Yes	Yes	Yes		Global	Yes
<a href="#">validate_password_mixed_case_count</a>	Yes	Yes	Yes		Global	Yes
<a href="#">validate_password_number_count</a>	Yes	Yes	Yes		Global	Yes
<a href="#">validate_password_policy</a>	Yes	Yes	Yes		Global	Yes
<a href="#">validate_password_special_char_count</a>	Yes	Yes	Yes		Global	Yes
<a href="#">validate-user-plugins</a>	Yes	Yes				
<a href="#">verbose</a>	Yes	Yes				
<a href="#">version</a>			Yes		Global	No
<a href="#">version_comment</a>			Yes		Global	No
<a href="#">version_compile_machine</a>			Yes		Global	No
<a href="#">version_compile_os</a>			Yes		Global	No
<a href="#">version_tokens_session</a>	Yes	Yes	Yes		Both	Yes
<a href="#">version_tokens_session_number</a>	Yes	Yes	Yes		Both	No
<a href="#">wait_timeout</a>	Yes	Yes	Yes		Both	Yes
<a href="#">warning_count</a>			Yes		Session	No

**Notes:**

1. This option is dynamic, but should be set only by server. You should not set this variable manually.

## 5.1.4 Server System Variable Reference

The following table lists all system variables applicable within `mysqld`.

The table lists command-line options (Cmd-line), options valid in configuration files (Option file), server system variables (System Var), and status variables (Status var) in one unified list, with an indication of where each option or variable is valid. If a server option set on the command line or in an option file differs from the name of the corresponding system variable, the variable name is noted immediately below the corresponding option. The scope of the variable (Var Scope) is Global, Session, or both. Please see the corresponding item descriptions for details on setting and using the variables. Where appropriate, direct links to further information about the items are provided.

**Table 5.2 System Variable Summary**

Name	Cmd-Line	Option File	System Var	Var Scope	Dynamic
<a href="#">audit_log_buffer_size</a>	Yes	Yes	Yes	Global	No
<a href="#">audit_log_compression</a>	Yes	Yes	Yes	Global	No

Server System Variable Reference

Name	Cmd-Line	Option File	System Var	Var Scope	Dynamic
audit_log_connect	Yes_policy	Yes	Yes	Global	Yes
audit_log_current_session			Yes	Both	No
audit_log_disable	Yes	Yes	Yes	Global	Yes
audit_log_encrypt	Yes	Yes	Yes	Global	No
audit_log_exclude	Yes_counts	Yes	Yes	Global	Yes
audit_log_file	Yes	Yes	Yes	Global	No
audit_log_filter_id			Yes	Both	No
audit_log_flush			Yes	Global	Yes
audit_log_format	Yes	Yes	Yes	Global	No
audit_log_format_timestamp	Yes_timestamp	Yes	Yes	Global	Yes
audit_log_include	Yes_counts	Yes	Yes	Global	Yes
audit_log_policy	Yes	Yes	Yes	Global	No
audit_log_read_buffer_size	Yes_buffer_size	Yes	Yes	Varies	Varies
audit_log_rotate_buffer_size	Yes_rotate_size	Yes	Yes	Global	Yes
audit_log_statement_policy	Yes_policy	Yes	Yes	Global	Yes
audit_log_strategy	Yes	Yes	Yes	Global	No
authentication_Idap_sasl_auth_method_name	Yes_sasl_auth_method_name	Yes	Yes	Global	Yes
authentication_Idap_sasl_bind_base_dn	Yes_sasl_bind_base_dn	Yes	Yes	Global	Yes
authentication_Idap_sasl_bind_root_dn	Yes_sasl_bind_root_dn	Yes	Yes	Global	Yes
authentication_Idap_sasl_bind_root_password	Yes_sasl_bind_root_pwd	Yes	Yes	Global	Yes
authentication_Idap_sasl_ca_path	Yes_sasl_ca_path	Yes	Yes	Global	Yes
authentication_Idap_sasl_group_search_attr	Yes_sasl_group_search_attr	Yes	Yes	Global	Yes
authentication_Idap_sasl_group_search_filter	Yes_sasl_group_search_filter	Yes	Yes	Global	Yes
authentication_Idap_sasl_init_pool_size	Yes_sasl_init_pool_size	Yes	Yes	Global	Yes
authentication_Idap_sasl_log_status	Yes_sasl_log_status	Yes	Yes	Global	Yes
authentication_Idap_sasl_max_pool_size	Yes_sasl_max_pool_size	Yes	Yes	Global	Yes
authentication_Idap_sasl_server_host	Yes_sasl_server_host	Yes	Yes	Global	Yes
authentication_Idap_sasl_server_port	Yes_sasl_server_port	Yes	Yes	Global	Yes
authentication_Idap_sasl_tls	Yes_sasl_tls	Yes	Yes	Global	Yes
authentication_Idap_sasl_user_search_attr	Yes_sasl_user_search_attr	Yes	Yes	Global	Yes
authentication_Idap_simple_auth_method_name	Yes_simple_auth_method_name	Yes	Yes	Global	Yes
authentication_Idap_simple_bind_base_dn	Yes_simple_bind_base_dn	Yes	Yes	Global	Yes
authentication_Idap_simple_bind_root_dn	Yes_simple_bind_root_dn	Yes	Yes	Global	Yes
authentication_Idap_simple_bind_root_password	Yes_simple_bind_root_pwd	Yes	Yes	Global	Yes
authentication_Idap_simple_ca_path	Yes_simple_ca_path	Yes	Yes	Global	Yes
authentication_Idap_simple_group_search_attr	Yes_simple_group_search_attr	Yes	Yes	Global	Yes
authentication_Idap_simple_group_search_filter	Yes_simple_group_search_filter	Yes	Yes	Global	Yes
authentication_Idap_simple_init_pool_size	Yes_simple_init_pool_size	Yes	Yes	Global	Yes

Name	Cmd-Line	Option File	System Var	Var Scope	Dynamic
authentication_Id	Yes simple_log_status	Yes	Yes	Global	Yes
authentication_Id	Yes simple_max_pos	Yes size	Yes	Global	Yes
authentication_Id	Yes simple_server	Yes	Yes	Global	Yes
authentication_Id	Yes simple_server	Yes	Yes	Global	Yes
authentication_Id	Yes simple_tls	Yes	Yes	Global	Yes
authentication_Id	Yes simple_user_s	Yes sh_attr	Yes	Global	Yes
authentication_wi	Yes ws_log_level	Yes	Yes	Global	No
authentication_wi	Yes ws_use_principal	Yes name	Yes	Global	No
auto_generate_cer	Yes	Yes	Yes	Global	No
auto_increment_in	Yes crement	Yes	Yes	Both	Yes
auto_increment_of	Yes	Yes	Yes	Both	Yes
autocommit	Yes	Yes	Yes	Both	Yes
automatic_sp_priv	Yes es	Yes	Yes	Global	Yes
avoid_temporal_up	Yes ade	Yes	Yes	Global	Yes
back_log	Yes	Yes	Yes	Global	No
basedir	Yes	Yes	Yes	Global	No
big_tables	Yes	Yes	Yes	Both	Yes
bind_address	Yes	Yes	Yes	Global	No
binlog_cache_size	Yes	Yes	Yes	Global	Yes
binlog_checksum	Yes	Yes	Yes	Global	Yes
binlog_direct_non	Yes nsactional_up	Yes	Yes	Both	Yes
binlog_error_actio	Yes	Yes	Yes	Global	Yes
binlog_format	Yes	Yes	Yes	Both	Yes
binlog_group_com	Yes _sync_delay	Yes	Yes	Global	Yes
binlog_group_com	Yes _sync_no_delay	Yes count	Yes	Global	Yes
binlog_gtid_simpl	Yes ecovery	Yes	Yes	Global	No
binlog_max_flush	Yes ue_time	Yes	Yes	Global	Yes
binlog_order_com	Yes	Yes	Yes	Global	Yes
binlog_row_image	Yes	Yes	Yes	Both	Yes
binlog_rows_query	Yes _log_events	Yes	Yes	Both	Yes
binlog_stmt_cache	Yes _size	Yes	Yes	Global	Yes
binlog_transaction	Yes _dependency_hist	Yes _size	Yes	Global	Yes
binlog_transaction	Yes _dependency_trac	Yes _ing	Yes	Global	Yes
block_encryption_	Yes ade	Yes	Yes	Both	Yes
bulk_insert_buffer	Yes _size	Yes	Yes	Both	Yes
character_set_clie			Yes	Both	Yes
character_set_con			Yes	Both	Yes

Server System Variable Reference

Name	Cmd-Line	Option File	System Var	Var Scope	Dynamic
<a href="#">character_set_database</a> (note 1)			Yes	Both	Yes
<a href="#">character_set_filesystem</a>	Yes	Yes	Yes	Both	Yes
<a href="#">character_set_results</a>			Yes	Both	Yes
<a href="#">character_set_server</a>	Yes	Yes	Yes	Both	Yes
<a href="#">character_set_system</a>			Yes	Global	No
<a href="#">character_sets_dir</a>	Yes	Yes	Yes	Global	No
<a href="#">check_proxy_users</a>	Yes	Yes	Yes	Global	Yes
<a href="#">collation_connection</a>			Yes	Both	Yes
<a href="#">collation_database</a> (note 1)			Yes	Both	Yes
<a href="#">collation_server</a>	Yes	Yes	Yes	Both	Yes
<a href="#">completion_type</a>	Yes	Yes	Yes	Both	Yes
<a href="#">concurrent_insert</a>	Yes	Yes	Yes	Global	Yes
<a href="#">connect_timeout</a>	Yes	Yes	Yes	Global	Yes
<a href="#">connection_control_failed_connection_threshold</a>	Yes	Yes	Yes	Global	Yes
<a href="#">connection_control_max_connection_delay</a>	Yes	Yes	Yes	Global	Yes
<a href="#">connection_control_min_connection_delay</a>	Yes	Yes	Yes	Global	Yes
<a href="#">core_file</a>			Yes	Global	No
<a href="#">daemon_memcached_enable_binlog</a>	Yes	Yes	Yes	Global	No
<a href="#">daemon_memcached_engine_lib_name</a>	Yes	Yes	Yes	Global	No
<a href="#">daemon_memcached_engine_lib_path</a>	Yes	Yes	Yes	Global	No
<a href="#">daemon_memcached_option</a>	Yes	Yes	Yes	Global	No
<a href="#">daemon_memcached_r_batch_size</a>	Yes	Yes	Yes	Global	No
<a href="#">daemon_memcached_w_batch_size</a>	Yes	Yes	Yes	Global	No
<a href="#">datadir</a>	Yes	Yes	Yes	Global	No
<a href="#">date_format</a>			Yes	Global	No
<a href="#">datetime_format</a>			Yes	Global	No
<a href="#">debug</a>	Yes	Yes	Yes	Both	Yes
<a href="#">debug_sync</a>			Yes	Session	Yes
<a href="#">default_authentication_plugin</a>	Yes	Yes	Yes	Global	No
<a href="#">default_password_lifetime</a>	Yes	Yes	Yes	Global	Yes
<a href="#">default_storage_engine</a>	Yes	Yes	Yes	Both	Yes
<a href="#">default_tmp_storage_engine</a>	Yes	Yes	Yes	Both	Yes
<a href="#">default_week_format</a>	Yes	Yes	Yes	Both	Yes
<a href="#">delay_key_write</a>	Yes	Yes	Yes	Global	Yes
<a href="#">delayed_insert_limit</a>	Yes	Yes	Yes	Global	Yes
<a href="#">delayed_insert_timeout</a>	Yes	Yes	Yes	Global	Yes

Server System Variable Reference

Name	Cmd-Line	Option File	System Var	Var Scope	Dynamic
delayed_queue_size	Yes	Yes	Yes	Global	Yes
disabled_storage_engines	Yes	Yes	Yes	Global	No
disconnect_on_expired_password	Yes	Yes	Yes	Global	No
div_precision_increment	Yes	Yes	Yes	Both	Yes
end_markers_in_json	Yes	Yes	Yes	Both	Yes
enforce_gtid_consistency	Yes	Yes	Yes	Global	Varies
eq_range_index_ded_limit	Yes	Yes	Yes	Both	Yes
error_count			Yes	Session	No
event_scheduler	Yes	Yes	Yes	Global	Yes
expire_logs_days	Yes	Yes	Yes	Global	Yes
explicit_defaults_for_timestamp	Yes	Yes	Yes	Both	Yes
external_user			Yes	Session	No
flush	Yes	Yes	Yes	Global	Yes
flush_time	Yes	Yes	Yes	Global	Yes
foreign_key_checks			Yes	Both	Yes
ft_boolean_syntax	Yes	Yes	Yes	Global	Yes
ft_max_word_len	Yes	Yes	Yes	Global	No
ft_min_word_len	Yes	Yes	Yes	Global	No
ft_query_expansion_limit	Yes	Yes	Yes	Global	No
ft_stopword_file	Yes	Yes	Yes	Global	No
general_log	Yes	Yes	Yes	Global	Yes
general_log_file	Yes	Yes	Yes	Global	Yes
group_concat_max_len	Yes	Yes	Yes	Both	Yes
group_replication_allow_local_disjoint_gtids_join	Yes	Yes	Yes	Global	Yes
group_replication_allow_local_lower_version_join	Yes	Yes	Yes	Global	Yes
group_replication_auto_increment_increment	Yes	Yes	Yes	Global	Yes
group_replication_auto_increment_offset	Yes	Yes	Yes	Global	Yes
group_replication_bootstrap_group	Yes	Yes	Yes	Global	Yes
group_replication_components_stop_on_timeout	Yes	Yes	Yes	Global	Yes
group_replication_compression_threshold	Yes	Yes	Yes	Global	Yes
group_replication_force_update_anywhere_checks	Yes	Yes	Yes	Global	Yes
group_replication_force_state_action	Yes	Yes	Yes	Global	Yes
group_replication_flow_control_apply_threshold	Yes	Yes	Yes	Global	Yes
group_replication_flow_control_certificate_threshold	Yes	Yes	Yes	Global	Yes
group_replication_flow_control_mode	Yes	Yes	Yes	Global	Yes
group_replication_flow_control_members	Yes	Yes	Yes	Global	Yes
group_replication_flow_control_name	Yes	Yes	Yes	Global	Yes
group_replication_flow_control_seeds	Yes	Yes	Yes	Global	Yes
group_replication_flow_control_assignment_block_size	Yes	Yes	Yes	Global	Yes



Server System Variable Reference

Name	Cmd-Line	Option File	System Var	Var Scope	Dynamic
group_replication	Yes whitelist	Yes	Yes	Global	Yes
group_replication	Yes address	Yes	Yes	Global	Yes
group_replication	Yes member_weight	Yes	Yes	Global	Yes
group_replication	Yes spin_loops	Yes	Yes	Global	Yes
group_replication	Yes recovery_complete	Yes	Yes	Global	Yes
group_replication	Yes recovery_reconnect	Yes interval	Yes	Global	Yes
group_replication	Yes recovery_retry_co	Yes	Yes	Global	Yes
group_replication	Yes recovery_ssl_ca	Yes	Yes	Global	Yes
group_replication	Yes recovery_ssl_cap	Yes	Yes	Global	Yes
group_replication	Yes recovery_ssl_cert	Yes	Yes	Global	Yes
group_replication	Yes recovery_ssl_cip	Yes	Yes	Global	Yes
group_replication	Yes recovery_ssl_crl	Yes	Yes	Global	Yes
group_replication	Yes recovery_ssl_crip	Yes	Yes	Global	Yes
group_replication	Yes recovery_ssl_key	Yes	Yes	Global	Yes
group_replication	Yes recovery_ssl_ver	Yes server_cert	Yes	Global	Yes
group_replication	Yes recovery_use_ssl	Yes	Yes	Global	Yes
group_replication	Yes single_primary_m	Yes	Yes	Global	Yes
group_replication	Yes mode	Yes	Yes	Global	Yes
group_replication	Yes start_on_boot	Yes	Yes	Global	Yes
group_replication	Yes transaction_size	Yes	Yes	Global	Yes
group_replication	Yes reachable_maj	Yes	Yes	Global	Yes
group_replication	Yes recovery_timeout	Yes	Yes	Global	Yes
gtid_executed			Yes	Varies	No
gtid_executed_com	Yes session_period	Yes	Yes	Global	Yes
gtid_mode	Yes	Yes	Yes	Global	Varies
gtid_next			Yes	Session	Yes
gtid_owned			Yes	Both	No
gtid_purged			Yes	Global	Yes
have_compress			Yes	Global	No
have_crypt			Yes	Global	No
have_dynamic_loading			Yes	Global	No
have_geometry			Yes	Global	No
have_openssl			Yes	Global	No
have_profiling			Yes	Global	No
have_query_cache			Yes	Global	No
have_rtree_keys			Yes	Global	No
have_ssl			Yes	Global	No
have_statement_timeout			Yes	Global	No
have_symlink			Yes	Global	No

Name	Cmd-Line	Option File	System Var	Var Scope	Dynamic
host_cache_size	Yes	Yes	Yes	Global	Yes
hostname			Yes	Global	No
identity			Yes	Session	Yes
ignore_builtin_innodb	Yes	Yes	Yes	Global	No
ignore_db_dirs			Yes	Global	No
init_connect	Yes	Yes	Yes	Global	Yes
init_file	Yes	Yes	Yes	Global	No
init_slave	Yes	Yes	Yes	Global	Yes
innodb_adaptive_flushing	Yes	Yes	Yes	Global	Yes
innodb_adaptive_flushing_lwm	Yes	Yes	Yes	Global	Yes
innodb_adaptive_flush_index	Yes	Yes	Yes	Global	Yes
innodb_adaptive_flush_index_parts	Yes	Yes	Yes	Global	No
innodb_adaptive_flush_sleep_delay	Yes	Yes	Yes	Global	Yes
innodb_api_bk_commit_interval	Yes	Yes	Yes	Global	Yes
innodb_api_disable_rowlock	Yes	Yes	Yes	Global	No
innodb_api_enable_binlog	Yes	Yes	Yes	Global	No
innodb_api_enable_ddl	Yes	Yes	Yes	Global	No
innodb_api_trx_level	Yes	Yes	Yes	Global	Yes
innodb_autoextend_increment	Yes	Yes	Yes	Global	Yes
innodb_autoinc_lock_mode	Yes	Yes	Yes	Global	No
innodb_background_drop_list_empty	Yes	Yes	Yes	Global	Yes
innodb_buffer_pool_chunk_size	Yes	Yes	Yes	Global	No
innodb_buffer_pool_dump_at_shutdown	Yes	Yes	Yes	Global	Yes
innodb_buffer_pool_dump_now	Yes	Yes	Yes	Global	Yes
innodb_buffer_pool_dump_pct	Yes	Yes	Yes	Global	Yes
innodb_buffer_pool_filename	Yes	Yes	Yes	Global	Yes
innodb_buffer_pool_instances	Yes	Yes	Yes	Global	No
innodb_buffer_pool_load_abort	Yes	Yes	Yes	Global	Yes
innodb_buffer_pool_load_at_startup	Yes	Yes	Yes	Global	No
innodb_buffer_pool_load_now	Yes	Yes	Yes	Global	Yes
innodb_buffer_pool_size	Yes	Yes	Yes	Global	Varies
innodb_change_buffer_max_size	Yes	Yes	Yes	Global	Yes
innodb_change_buffering	Yes	Yes	Yes	Global	Yes
innodb_change_buffering_debug	Yes	Yes	Yes	Global	Yes
innodb_checksum_algorithm	Yes	Yes	Yes	Global	Yes
innodb_checksums	Yes	Yes	Yes	Global	No
innodb_cmp_per_index_enabled	Yes	Yes	Yes	Global	Yes
innodb_commit_concurrency	Yes	Yes	Yes	Global	Yes

Server System Variable Reference

Name	Cmd-Line	Option File	System Var	Var Scope	Dynamic
innodb_compress	Yes debug	Yes	Yes	Global	Yes
innodb_compression_failure_threshold_pct	Yes failure_threshold_pct	Yes	Yes	Global	Yes
innodb_compression_level	Yes level	Yes	Yes	Global	Yes
innodb_compression_pad_pct_max	Yes pad_pct_max	Yes	Yes	Global	Yes
innodb_concurrency_tickets	Yes tickets	Yes	Yes	Global	Yes
innodb_data_file_path	Yes	Yes	Yes	Global	No
innodb_data_home_dir	Yes dir	Yes	Yes	Global	No
innodb_deadlock_detect	Yes detect	Yes	Yes	Global	Yes
innodb_default_row_format	Yes format	Yes	Yes	Global	Yes
innodb_disable_buffer_pool	Yes buffer_pool_debug	Yes	Yes	Global	Yes
innodb_disable_sort_file_cache	Yes file_cache	Yes	Yes	Global	Yes
innodb_doublewrite	Yes	Yes	Yes	Global	No
innodb_fast_shutdown	Yes	Yes	Yes	Global	Yes
innodb_file_format	Yes	Yes	Yes	Global	Yes
innodb_file_format_check	Yes check	Yes	Yes	Global	No
innodb_file_format_max	Yes max	Yes	Yes	Global	Yes
innodb_file_per_table	Yes	Yes	Yes	Global	Yes
innodb_fill_factor	Yes	Yes	Yes	Global	Yes
innodb_flush_log_timeout	Yes timeout	Yes	Yes	Global	Yes
innodb_flush_log_trx_commit	Yes trx_commit	Yes	Yes	Global	Yes
innodb_flush_method	Yes	Yes	Yes	Global	No
innodb_flush_neighbors	Yes neighbors	Yes	Yes	Global	Yes
innodb_flush_sync	Yes	Yes	Yes	Global	Yes
innodb_flushing_avg_loops	Yes loops	Yes	Yes	Global	Yes
innodb_force_load_corrupted	Yes corrupted	Yes	Yes	Global	No
innodb_force_recovery	Yes	Yes	Yes	Global	No
innodb_ft_aux_table			Yes	Global	Yes
innodb_ft_cache_size	Yes	Yes	Yes	Global	No
innodb_ft_enable_debug_print	Yes debug_print	Yes	Yes	Global	Yes
innodb_ft_enable_stopword	Yes stopword	Yes	Yes	Both	Yes
innodb_ft_max_token_size	Yes size	Yes	Yes	Global	No
innodb_ft_min_token_size	Yes size	Yes	Yes	Global	No
innodb_ft_num_wopt	Yes optimize	Yes	Yes	Global	Yes
innodb_ft_result_cache_limit	Yes cache_limit	Yes	Yes	Global	Yes
innodb_ft_server_stopword_table	Yes stopword_table	Yes	Yes	Global	Yes
innodb_ft_sort_pll_degree	Yes degree	Yes	Yes	Global	No
innodb_ft_total_cache_size	Yes size	Yes	Yes	Global	No

Name	Cmd-Line	Option File	System Var	Var Scope	Dynamic
innodb_ft_user_stopword_table	Yes	Yes	Yes	Both	Yes
innodb_io_capacity	Yes	Yes	Yes	Global	Yes
innodb_io_capacity_max	Yes	Yes	Yes	Global	Yes
innodb_large_prefix	Yes	Yes	Yes	Global	Yes
innodb_limit_optimizations	Yes	Yes	Yes	Global	Yes
innodb_lock_wait_timeout	Yes	Yes	Yes	Both	Yes
innodb_locks_unsafe_for_binlog	Yes	Yes	Yes	Global	No
innodb_log_buffer_size	Yes	Yes	Yes	Global	No
innodb_log_checkpoints_now	Yes	Yes	Yes	Global	Yes
innodb_log_checkpoints	Yes	Yes	Yes	Global	Yes
innodb_log_compensated_pages	Yes	Yes	Yes	Global	Yes
innodb_log_file_size	Yes	Yes	Yes	Global	No
innodb_log_files_in_group	Yes	Yes	Yes	Global	No
innodb_log_group_home_dir	Yes	Yes	Yes	Global	No
innodb_log_write_ahead_size	Yes	Yes	Yes	Global	Yes
innodb_lru_scan_depth	Yes	Yes	Yes	Global	Yes
innodb_max_dirty_pages_pct	Yes	Yes	Yes	Global	Yes
innodb_max_dirty_pages_pct_lwm	Yes	Yes	Yes	Global	Yes
innodb_max_purge_age	Yes	Yes	Yes	Global	Yes
innodb_max_purge_age_delay	Yes	Yes	Yes	Global	Yes
innodb_max_undo_log_size	Yes	Yes	Yes	Global	Yes
innodb_merge_threads_old_set_all_defaults	Yes	Yes	Yes	Global	Yes
innodb_monitor_disable	Yes	Yes	Yes	Global	Yes
innodb_monitor_enable	Yes	Yes	Yes	Global	Yes
innodb_monitor_reset	Yes	Yes	Yes	Global	Yes
innodb_monitor_reset_all	Yes	Yes	Yes	Global	Yes
innodb_numa_interleave	Yes	Yes	Yes	Global	No
innodb_old_blocks_pct	Yes	Yes	Yes	Global	Yes
innodb_old_blocks_time	Yes	Yes	Yes	Global	Yes
innodb_online_alter_log_max_size	Yes	Yes	Yes	Global	Yes
innodb_open_files	Yes	Yes	Yes	Global	No
innodb_optimize_text_only	Yes	Yes	Yes	Global	Yes
innodb_page_cleaners	Yes	Yes	Yes	Global	No
innodb_page_size	Yes	Yes	Yes	Global	No
innodb_print_all_deadlocks	Yes	Yes	Yes	Global	Yes
innodb_purge_batch_size	Yes	Yes	Yes	Global	Yes
innodb_purge_rseg_untruncate_frequency	Yes	Yes	Yes	Global	Yes
innodb_purge_threads	Yes	Yes	Yes	Global	No

Name	Cmd-Line	Option File	System Var	Var Scope	Dynamic
<a href="#">innodb_random_read_ahead</a>	Yes	Yes	Yes	Global	Yes
<a href="#">innodb_read_ahead_threshold</a>	Yes	Yes	Yes	Global	Yes
<a href="#">innodb_read_io_threads</a>	Yes	Yes	Yes	Global	No
<a href="#">innodb_read_only</a>	Yes	Yes	Yes	Global	No
<a href="#">innodb_replication_delay</a>	Yes	Yes	Yes	Global	Yes
<a href="#">innodb_rollback_on_timeout</a>	Yes	Yes	Yes	Global	No
<a href="#">innodb_rollback_segments</a>	Yes	Yes	Yes	Global	Yes
<a href="#">innodb_saved_page_number_debug</a>	Yes	Yes	Yes	Global	Yes
<a href="#">innodb_sort_buffer_size</a>	Yes	Yes	Yes	Global	No
<a href="#">innodb_spin_wait_delay</a>	Yes	Yes	Yes	Global	Yes
<a href="#">innodb_stats_auto_escalate</a>	Yes	Yes	Yes	Global	Yes
<a href="#">innodb_stats_include_delete_marked</a>	Yes	Yes	Yes	Global	Yes
<a href="#">innodb_stats_method</a>	Yes	Yes	Yes	Global	Yes
<a href="#">innodb_stats_on_metadata</a>	Yes	Yes	Yes	Global	Yes
<a href="#">innodb_stats_persistent</a>	Yes	Yes	Yes	Global	Yes
<a href="#">innodb_stats_persistent_sample_pages</a>	Yes	Yes	Yes	Global	Yes
<a href="#">innodb_stats_sample_pages</a>	Yes	Yes	Yes	Global	Yes
<a href="#">innodb_stats_transient_sample_pages</a>	Yes	Yes	Yes	Global	Yes
<a href="#">innodb_status_output</a>	Yes	Yes	Yes	Global	Yes
<a href="#">innodb_status_output_locks</a>	Yes	Yes	Yes	Global	Yes
<a href="#">innodb_strict_mode</a>	Yes	Yes	Yes	Both	Yes
<a href="#">innodb_support_xa</a>	Yes	Yes	Yes	Both	Yes
<a href="#">innodb_sync_array_size</a>	Yes	Yes	Yes	Global	No
<a href="#">innodb_sync_debug</a>	Yes	Yes	Yes	Global	No
<a href="#">innodb_sync_spin_ops</a>	Yes	Yes	Yes	Global	Yes
<a href="#">innodb_table_locks</a>	Yes	Yes	Yes	Both	Yes
<a href="#">innodb_temp_data_file_path</a>	Yes	Yes	Yes	Global	No
<a href="#">innodb_thread_concurrency</a>	Yes	Yes	Yes	Global	Yes
<a href="#">innodb_thread_sleep_delay</a>	Yes	Yes	Yes	Global	Yes
<a href="#">innodb_tmpdir</a>	Yes	Yes	Yes	Both	Yes
<a href="#">innodb_trx_purge_without_update_only_debug</a>	Yes	Yes	Yes	Global	Yes
<a href="#">innodb_trx_rseg_nots_debug</a>	Yes	Yes	Yes	Global	Yes
<a href="#">innodb_undo_directory</a>	Yes	Yes	Yes	Global	No
<a href="#">innodb_undo_log_annotate</a>	Yes	Yes	Yes	Global	Yes
<a href="#">innodb_undo_logs</a>	Yes	Yes	Yes	Global	Yes
<a href="#">innodb_undo_tablespaces</a>	Yes	Yes	Yes	Global	No
<a href="#">innodb_use_native_io</a>	Yes	Yes	Yes	Global	No
<a href="#">innodb_version</a>			Yes	Global	No

Name	Cmd-Line	Option File	System Var	Var Scope	Dynamic
innodb_write_io_threads	Yes	Yes	Yes	Global	No
insert_id			Yes	Session	Yes
interactive_timeout	Yes	Yes	Yes	Both	Yes
internal_tmp_disk_storage_engine	Yes	Yes	Yes	Global	Yes
join_buffer_size	Yes	Yes	Yes	Both	Yes
keep_files_on_create	Yes	Yes	Yes	Both	Yes
key_buffer_size	Yes	Yes	Yes	Global	Yes
key_cache_age_threshold	Yes	Yes	Yes	Global	Yes
key_cache_block_size	Yes	Yes	Yes	Global	Yes
key_cache_division_limit	Yes	Yes	Yes	Global	Yes
keyring_aws_cmackey	Yes	Yes	Yes	Global	Yes
keyring_aws_conf_file	Yes	Yes	Yes	Global	No
keyring_aws_data_file	Yes	Yes	Yes	Global	No
keyring_aws_reg_dir	Yes	Yes	Yes	Global	Yes
keyring_encrypted_data_file	Yes	Yes	Yes	Global	Yes
keyring_encrypted_password_file	Yes	Yes	Yes	Global	Yes
keyring_file_data	Yes	Yes	Yes	Global	Yes
keyring_okv_conf_file	Yes	Yes	Yes	Global	Yes
keyring_operations			Yes	Global	Yes
language	Yes	Yes	Yes	Global	No
large_files_support			Yes	Global	No
large_page_size			Yes	Global	No
large_pages	Yes	Yes	Yes	Global	No
last_insert_id			Yes	Session	Yes
lc_messages	Yes	Yes	Yes	Both	Yes
lc_messages_dir	Yes	Yes	Yes	Global	No
lc_time_names	Yes	Yes	Yes	Both	Yes
license			Yes	Global	No
local_infile	Yes	Yes	Yes	Global	Yes
lock_wait_timeout	Yes	Yes	Yes	Both	Yes
locked_in_memory			Yes	Global	No
log_bin			Yes	Global	No
log_bin_basename			Yes	Global	No
log_bin_index	Yes	Yes	Yes	Global	No
log_bin_trust_function_creators	Yes	Yes	Yes	Global	Yes
log_bin_use_v1_events	Yes	Yes	Yes	Global	Yes
log_builtin_as_identified_by_password	Yes	Yes	Yes	Global	Yes
log_error	Yes	Yes	Yes	Global	No

Name	Cmd-Line	Option File	System Var	Var Scope	Dynamic
log_error_verbosity	Yes	Yes	Yes	Global	Yes
log_output	Yes	Yes	Yes	Global	Yes
log_queries_not_using_indexes	Yes	Yes	Yes	Global	Yes
log_slave_updates	Yes	Yes	Yes	Global	No
log_slow_admin_statements	Yes	Yes	Yes	Global	Yes
log_slow_slave_statements	Yes	Yes	Yes	Global	Yes
log_statements_unsafe_for_binlog	Yes	Yes	Yes	Global	Yes
log_syslog	Yes	Yes	Yes	Global	Yes
log_syslog_facility	Yes	Yes	Yes	Global	Yes
log_syslog_include_pid	Yes	Yes	Yes	Global	Yes
log_syslog_tag	Yes	Yes	Yes	Global	Yes
log_throttle_queries_not_using_indexes	Yes	Yes	Yes	Global	Yes
log_timestamps	Yes	Yes	Yes	Global	Yes
log_warnings	Yes	Yes	Yes	Global	Yes
long_query_time	Yes	Yes	Yes	Both	Yes
low_priority_updates	Yes	Yes	Yes	Both	Yes
lower_case_file_system			Yes	Global	No
lower_case_table_names	Yes	Yes	Yes	Global	No
master_info_repository	Yes	Yes	Yes	Global	Yes
master_verify_checksum	Yes	Yes	Yes	Global	Yes
max_allowed_packet	Yes	Yes	Yes	Both	Yes
max_binlog_cache_size	Yes	Yes	Yes	Global	Yes
max_binlog_size	Yes	Yes	Yes	Global	Yes
max_binlog_stmt_cache_size	Yes	Yes	Yes	Global	Yes
max_connect_errors	Yes	Yes	Yes	Global	Yes
max_connections	Yes	Yes	Yes	Global	Yes
max_delayed_threads	Yes	Yes	Yes	Both	Yes
max_digest_length	Yes	Yes	Yes	Global	No
max_error_count	Yes	Yes	Yes	Both	Yes
max_execution_time	Yes	Yes	Yes	Both	Yes
max_heap_table_size	Yes	Yes	Yes	Both	Yes
max_insert_delayed_threads			Yes	Both	Yes
max_join_size	Yes	Yes	Yes	Both	Yes
max_length_for_sort_data	Yes	Yes	Yes	Both	Yes
max_points_in_geometry	Yes	Yes	Yes	Both	Yes
max_prepared_stmt_count	Yes	Yes	Yes	Global	Yes
max_relay_log_size	Yes	Yes	Yes	Global	Yes
max_seeks_for_key	Yes	Yes	Yes	Both	Yes

Name	Cmd-Line	Option File	System Var	Var Scope	Dynamic
max_sort_length	Yes	Yes	Yes	Both	Yes
max_sp_recursion_depth	Yes	Yes	Yes	Both	Yes
max_tmp_tables			Yes	Both	Yes
max_user_connections	Yes	Yes	Yes	Both	Yes
max_write_lock_count	Yes	Yes	Yes	Global	Yes
mecab_rc_file	Yes	Yes	Yes	Global	No
metadata_locks_cache_size	Yes	Yes	Yes	Global	No
metadata_locks_hash_instances	Yes	Yes	Yes	Global	No
min_examined_row_limit	Yes	Yes	Yes	Both	Yes
multi_range_count	Yes	Yes	Yes	Both	Yes
myisam_data_pointer_size	Yes	Yes	Yes	Global	Yes
myisam_max_sort_file_size	Yes	Yes	Yes	Global	Yes
myisam_mmap_size	Yes	Yes	Yes	Global	No
myisam_recover_options	Yes	Yes	Yes	Global	No
myisam_repair_threads	Yes	Yes	Yes	Both	Yes
myisam_sort_buffer_size	Yes	Yes	Yes	Both	Yes
myisam_stats_method	Yes	Yes	Yes	Both	Yes
myisam_use_mmap	Yes	Yes	Yes	Global	Yes
mysql_firewall_mode	Yes	Yes	Yes	Global	Yes
mysql_firewall_traverse	Yes	Yes	Yes	Global	Yes
mysql_native_password_proxy_users	Yes	Yes	Yes	Global	Yes
mysqlx_bind_address	Yes	Yes	Yes	Global	No
mysqlx_connect_timeout	Yes	Yes	Yes	Global	Yes
mysqlx_idle_worker_thread_timeout	Yes	Yes	Yes	Global	Yes
mysqlx_max_allowed_packet	Yes	Yes	Yes	Global	Yes
mysqlx_max_connections	Yes	Yes	Yes	Global	Yes
mysqlx_min_worker_threads	Yes	Yes	Yes	Global	Yes
mysqlx_port	Yes	Yes	Yes	Global	No
mysqlx_port_open_timeout	Yes	Yes	Yes	Global	No
mysqlx_socket	Yes	Yes	Yes	Global	No
mysqlx_ssl_ca	Yes	Yes	Yes	Global	No
mysqlx_ssl_capath	Yes	Yes	Yes	Global	No
mysqlx_ssl_cert	Yes	Yes	Yes	Global	No
mysqlx_ssl_cipher	Yes	Yes	Yes	Global	No
mysqlx_ssl_crl	Yes	Yes	Yes	Global	No
mysqlx_ssl_crlpath	Yes	Yes	Yes	Global	No
mysqlx_ssl_key	Yes	Yes	Yes	Global	No
named_pipe	Yes	Yes	Yes	Global	No



Server System Variable Reference

Name	Cmd-Line	Option File	System Var	Var Scope	Dynamic
named_pipe_full_access_group	Yes	Yes	Yes	Global	No
ndb_allow_copying	Yes	Yes	Yes	Both	Yes
ndb_autoincrement_prefetch_sz	Yes	Yes	Yes	Both	Yes
ndb_batch_size	Yes	Yes	Yes	Both	Yes
ndb_blob_read_bytes	Yes	Yes	Yes	Both	Yes
ndb_blob_write_bytes	Yes	Yes	Yes	Both	Yes
ndb_cache_check	Yes	Yes	Yes	Global	Yes
ndb_clear_apply_status	Yes		Yes	Global	Yes
ndb_cluster_connection_pool	Yes	Yes	Yes	Global	No
ndb_cluster_connection_pool_nodeid	Yes	Yes	Yes	Global	No
ndb_data_node_neighbour	Yes	Yes	Yes	Global	Yes
ndb_default_column_format	Yes	Yes	Yes	Global	Yes
ndb_default_column_format	Yes	Yes	Yes	Global	Yes
ndb_deferred_constraints	Yes	Yes	Yes	Both	Yes
ndb_deferred_constraints	Yes	Yes	Yes	Both	Yes
ndb_distribution	Yes	Yes	Yes	Global	Yes
ndb_distribution	Yes	Yes	Yes	Global	Yes
ndb_eventbuffer_percent	Yes	Yes	Yes	Global	Yes
ndb_eventbuffer_alloc	Yes	Yes	Yes	Global	Yes
ndb_extra_logging	Yes	Yes	Yes	Global	Yes
ndb_force_send	Yes	Yes	Yes	Both	Yes
ndb_fully_replicated	Yes	Yes	Yes	Both	Yes
ndb_index_stat_enable	Yes	Yes	Yes	Both	Yes
ndb_index_stat_option	Yes	Yes	Yes	Both	Yes
ndb_join_pushdown			Yes	Both	Yes
ndb_log_apply_status	Yes	Yes	Yes	Global	No
ndb_log_apply_status	Yes	Yes	Yes	Global	No
ndb_log_bin	Yes		Yes	Both	No
ndb_log_binlog_index	Yes		Yes	Global	Yes
ndb_log_empty_epochs	Yes	Yes	Yes	Global	Yes
ndb_log_empty_epochs	Yes	Yes	Yes	Global	Yes
ndb_log_empty_updates	Yes	Yes	Yes	Global	Yes
ndb_log_empty_updates	Yes	Yes	Yes	Global	Yes
ndb_log_exclusive_reads	Yes	Yes	Yes	Both	Yes
ndb_log_exclusive_reads	Yes	Yes	Yes	Both	Yes
ndb_log_fail_terminate	Yes	Yes	Yes	Global	No
ndb_log_orig	Yes	Yes	Yes	Global	No
ndb_log_orig	Yes	Yes	Yes	Global	No

Name	Cmd-Line	Option File	System Var	Var Scope	Dynamic
ndb_log_transaction_id	Yes	Yes	Yes	Global	No
ndb_log_transaction_id			Yes	Global	No
ndb_log_update_as_write	Yes	Yes	Yes	Global	Yes
ndb_log_update_normal	Yes	Yes	Yes	Global	Yes
ndb_log_updated_Yes	Yes	Yes	Yes	Global	Yes
ndb_optimization_Yes	Yes	Yes	Yes	Global	Yes
ndb_optimized_no_selection	Yes	Yes	Yes	Global	Yes
ndb_optimized_no_selection	Yes	Yes	Yes	Global	No
ndb_read_backup	Yes	Yes	Yes	Global	Yes
ndb_rcv_thread_activation_threshold	Yes	Yes	Yes	Global	Yes
ndb_rcv_thread_mask	Yes	Yes	Yes	Global	Yes
ndb_report_threshold_log_epoch_size	Yes	Yes	Yes	Global	Yes
ndb_report_threshold_log_mem_usage	Yes	Yes	Yes	Global	Yes
ndb_row_checksum			Yes	Both	Yes
ndb_show_foreign_key_mock_tables	Yes	Yes	Yes	Global	Yes
ndb_slave_conflict_resolution	Yes	Yes	Yes	Global	Yes
Ndb_system_name			Yes	Global	No
ndb_table_no_logging			Yes	Session	Yes
ndb_table_temporary			Yes	Session	Yes
ndb_use_copying_alter_table			Yes	Both	No
ndb_use_exact_count			Yes	Both	Yes
ndb_use_transactions	Yes	Yes	Yes	Both	Yes
ndb_version			Yes	Global	No
ndb_version_string			Yes	Global	No
ndb_wait_connected	Yes	Yes	Yes	Global	No
ndb_wait_setup	Yes	Yes	Yes	Global	No
ndbinfo_database			Yes	Global	No
ndbinfo_max_bytes	Yes		Yes	Both	Yes
ndbinfo_max_rows	Yes		Yes	Both	Yes
ndbinfo_offline			Yes	Global	Yes
ndbinfo_show_hidden	Yes		Yes	Both	Yes
ndbinfo_table_prefix			Yes	Global	No
ndbinfo_version			Yes	Global	No
net_buffer_length	Yes	Yes	Yes	Both	Yes
net_read_timeout	Yes	Yes	Yes	Both	Yes
net_retry_count	Yes	Yes	Yes	Both	Yes
net_write_timeout	Yes	Yes	Yes	Both	Yes
new	Yes	Yes	Yes	Both	Yes

Server System Variable Reference

Name	Cmd-Line	Option File	System Var	Var Scope	Dynamic
<a href="#">ngram_token_size</a>	Yes	Yes	Yes	Global	No
<a href="#">offline_mode</a>	Yes	Yes	Yes	Global	Yes
<a href="#">old</a>	Yes	Yes	Yes	Global	No
<a href="#">old_alter_table</a>	Yes	Yes	Yes	Both	Yes
<a href="#">old_passwords</a>	Yes	Yes	Yes	Both	Yes
<a href="#">open_files_limit</a>	Yes	Yes	Yes	Global	No
<a href="#">optimizer_prune_keys</a>	Yes	Yes	Yes	Both	Yes
<a href="#">optimizer_search_depth</a>	Yes	Yes	Yes	Both	Yes
<a href="#">optimizer_switch</a>	Yes	Yes	Yes	Both	Yes
<a href="#">optimizer_trace</a>	Yes	Yes	Yes	Both	Yes
<a href="#">optimizer_trace_features</a>	Yes	Yes	Yes	Both	Yes
<a href="#">optimizer_trace_limit</a>	Yes	Yes	Yes	Both	Yes
<a href="#">optimizer_trace_memory_size</a>	Yes	Yes	Yes	Both	Yes
<a href="#">optimizer_trace_off</a>	Yes	Yes	Yes	Both	Yes
<a href="#">parser_max_memory_size</a>	Yes	Yes	Yes	Both	Yes
<a href="#">performance_schema</a>	Yes	Yes	Yes	Global	No
<a href="#">performance_schema_accounts_size</a>	Yes	Yes	Yes	Global	No
<a href="#">performance_schema_digests_size</a>	Yes	Yes	Yes	Global	No
<a href="#">performance_schema_events_stages_history_long_size</a>	Yes	Yes	Yes	Global	No
<a href="#">performance_schema_events_stages_history_size</a>	Yes	Yes	Yes	Global	No
<a href="#">performance_schema_events_statements_history_long_size</a>	Yes	Yes	Yes	Global	No
<a href="#">performance_schema_events_statements_history_size</a>	Yes	Yes	Yes	Global	No
<a href="#">performance_schema_events_transactions_history_long_size</a>	Yes	Yes	Yes	Global	No
<a href="#">performance_schema_events_transactions_history_size</a>	Yes	Yes	Yes	Global	No
<a href="#">performance_schema_events_waits_history_long_size</a>	Yes	Yes	Yes	Global	No
<a href="#">performance_schema_events_waits_history_size</a>	Yes	Yes	Yes	Global	No
<a href="#">performance_schema_hosts_size</a>	Yes	Yes	Yes	Global	No
<a href="#">performance_schema_max_cond_classes</a>	Yes	Yes	Yes	Global	No
<a href="#">performance_schema_max_cond_instances</a>	Yes	Yes	Yes	Global	No
<a href="#">performance_schema_max_digest_length</a>	Yes	Yes	Yes	Global	No
<a href="#">performance_schema_max_file_classes</a>	Yes	Yes	Yes	Global	No
<a href="#">performance_schema_max_file_handles</a>	Yes	Yes	Yes	Global	No
<a href="#">performance_schema_max_file_instances</a>	Yes	Yes	Yes	Global	No
<a href="#">performance_schema_max_index_size</a>	Yes	Yes	Yes	Global	No
<a href="#">performance_schema_max_memory_classes</a>	Yes	Yes	Yes	Global	No
<a href="#">performance_schema_max_metadata_locks</a>	Yes	Yes	Yes	Global	No
<a href="#">performance_schema_max_mutex_classes</a>	Yes	Yes	Yes	Global	No
<a href="#">performance_schema_max_mutex_instances</a>	Yes	Yes	Yes	Global	No

Server System Variable Reference

Name	Cmd-Line	Option File	System Var	Var Scope	Dynamic
performance_scheduler_max_prepared_statements_instances	Yes	Yes	Yes	Global	No
performance_scheduler_max_program_instances	Yes	Yes	Yes	Global	No
performance_scheduler_max_rwlock_instances	Yes	Yes	Yes	Global	No
performance_scheduler_max_rwlock_instances	Yes	Yes	Yes	Global	No
performance_scheduler_max_socket_instances	Yes	Yes	Yes	Global	No
performance_scheduler_max_socket_instances	Yes	Yes	Yes	Global	No
performance_scheduler_max_sql_text_length	Yes	Yes	Yes	Global	No
performance_scheduler_max_stage_instances	Yes	Yes	Yes	Global	No
performance_scheduler_max_statement_classes	Yes	Yes	Yes	Global	No
performance_scheduler_max_statement_stack	Yes	Yes	Yes	Global	No
performance_scheduler_max_table_instances	Yes	Yes	Yes	Global	No
performance_scheduler_max_table_instances	Yes	Yes	Yes	Global	No
performance_scheduler_max_table_locks_stat	Yes	Yes	Yes	Global	No
performance_scheduler_max_thread_instances	Yes	Yes	Yes	Global	No
performance_scheduler_max_thread_instances	Yes	Yes	Yes	Global	No
performance_scheduler_session_compatibility_attrs_size	Yes	Yes	Yes	Global	No
performance_scheduler_setup_actors_size	Yes	Yes	Yes	Global	No
performance_scheduler_setup_objects_size	Yes	Yes	Yes	Global	No
performance_scheduler_show_processes	Yes	Yes	Yes	Global	Yes
performance_scheduler_users_size	Yes	Yes	Yes	Global	No
pid_file	Yes	Yes	Yes	Global	No
plugin_dir	Yes	Yes	Yes	Global	No
port	Yes	Yes	Yes	Global	No
preload_buffer_size	Yes	Yes	Yes	Both	Yes
profiling			Yes	Both	Yes
profiling_history_size	Yes	Yes	Yes	Both	Yes
protocol_version			Yes	Global	No
proxy_user			Yes	Session	No
pseudo_slave_mode			Yes	Session	Yes
pseudo_thread_id			Yes	Session	Yes
query_alloc_block_size	Yes	Yes	Yes	Both	Yes
query_cache_limit	Yes	Yes	Yes	Global	Yes
query_cache_min_expires_unit	Yes	Yes	Yes	Global	Yes
query_cache_size	Yes	Yes	Yes	Global	Yes
query_cache_type	Yes	Yes	Yes	Both	Yes
query_cache_wlock_invalidate	Yes	Yes	Yes	Both	Yes
query_prealloc_size	Yes	Yes	Yes	Both	Yes
rand_seed1			Yes	Session	Yes

Server System Variable Reference

Name	Cmd-Line	Option File	System Var	Var Scope	Dynamic
rand_seed2			Yes	Session	Yes
range_alloc_block_size	Yes	Yes	Yes	Both	Yes
range_optimizer_max_mem_size	Yes	Yes	Yes	Both	Yes
rbr_exec_mode			Yes	Session	Yes
read_buffer_size	Yes	Yes	Yes	Both	Yes
read_only	Yes	Yes	Yes	Global	Yes
read_rnd_buffer_size	Yes	Yes	Yes	Both	Yes
relay_log	Yes	Yes	Yes	Global	No
relay_log_basename			Yes	Global	No
relay_log_index	Yes	Yes	Yes	Global	No
relay_log_info_file	Yes	Yes	Yes	Global	No
relay_log_info_repository	Yes	Yes	Yes	Global	Yes
relay_log_purge	Yes	Yes	Yes	Global	Yes
relay_log_recovery	Yes	Yes	Yes	Global	No
relay_log_space_limit	Yes	Yes	Yes	Global	No
replication_optimizer_for_static_plugins	Yes	Yes	Yes	Global	Yes
replication_serve_commit_only	Yes	Yes	Yes	Global	Yes
report_host	Yes	Yes	Yes	Global	No
report_password	Yes	Yes	Yes	Global	No
report_port	Yes	Yes	Yes	Global	No
report_user	Yes	Yes	Yes	Global	No
require_secure_transport	Yes	Yes	Yes	Global	Yes
rewriter_enabled			Yes	Global	Yes
rewriter_verbose			Yes	Global	Yes
rpl_semi_sync_master_enabled	Yes	Yes	Yes	Global	Yes
rpl_semi_sync_master_timeout	Yes	Yes	Yes	Global	Yes
rpl_semi_sync_master_trace_level	Yes	Yes	Yes	Global	Yes
rpl_semi_sync_master_wait_for_slave_count	Yes	Yes	Yes	Global	Yes
rpl_semi_sync_master_wait_no_slave	Yes	Yes	Yes	Global	Yes
rpl_semi_sync_master_wait_point	Yes	Yes	Yes	Global	Yes
rpl_semi_sync_slave_enabled	Yes	Yes	Yes	Global	Yes
rpl_semi_sync_slave_trace_level	Yes	Yes	Yes	Global	Yes
rpl_stop_slave_timeout	Yes	Yes	Yes	Global	Yes
secure_auth	Yes	Yes	Yes	Global	Yes
secure_file_priv	Yes	Yes	Yes	Global	No
server_id	Yes	Yes	Yes	Global	Yes
server_id_bits	Yes	Yes	Yes	Global	No
server_uuid			Yes	Global	No

Name	Cmd-Line	Option File	System Var	Var Scope	Dynamic
session_track_gtids	Yes	Yes	Yes	Both	Yes
session_track_schema	Yes	Yes	Yes	Both	Yes
session_track_state_change	Yes	Yes	Yes	Both	Yes
session_track_system_variables	Yes	Yes	Yes	Both	Yes
session_track_transaction_info	Yes	Yes	Yes	Both	Yes
sha256_password_auto_generate_keys	Yes	Yes	Yes	Global	No
sha256_password_private_key_path	Yes	Yes	Yes	Global	No
sha256_password_proxy_users	Yes	Yes	Yes	Global	Yes
sha256_password_public_key_path	Yes	Yes	Yes	Global	No
shared_memory	Yes	Yes	Yes	Global	No
shared_memory_base_name	Yes	Yes	Yes	Global	No
show_compatibility_56	Yes	Yes	Yes	Global	Yes
show_create_table_verbosity	Yes	Yes	Yes	Both	Yes
show_old_temporales	Yes	Yes	Yes	Both	Yes
skip_external_locking	Yes	Yes	Yes	Global	No
skip_name_resolve	Yes	Yes	Yes	Global	No
skip_networking	Yes	Yes	Yes	Global	No
skip_show_databases	Yes	Yes	Yes	Global	No
skip_slave_start	Yes	Yes	Yes	Global	No
slave_allow_batching	Yes	Yes	Yes	Global	Yes
slave_checkpoint_group	Yes	Yes	Yes	Global	Yes
slave_checkpoint_period	Yes	Yes	Yes	Global	Yes
slave_compressed_protocol	Yes	Yes	Yes	Global	Yes
slave_exec_mode	Yes	Yes	Yes	Global	Yes
slave_load_tmpdir	Yes	Yes	Yes	Global	No
slave_max_allowed_packet	Yes	Yes	Yes	Global	Yes
slave_net_timeout	Yes	Yes	Yes	Global	Yes
slave_parallel_type	Yes	Yes	Yes	Global	Yes
slave_parallel_workers	Yes	Yes	Yes	Global	Yes
slave_pending_jobs_size_max	Yes	Yes	Yes	Global	Yes
slave_preserve_commit_order	Yes	Yes	Yes	Global	Yes
slave_rows_search_algorithms	Yes	Yes	Yes	Global	Yes
slave_skip_errors	Yes	Yes	Yes	Global	No
slave_sql_verify_checksum	Yes	Yes	Yes	Global	Yes
slave_transaction_retries	Yes	Yes	Yes	Global	Yes
slave_type_convertions	Yes	Yes	Yes	Global	Yes
slow_launch_time	Yes	Yes	Yes	Global	Yes
slow_query_log	Yes	Yes	Yes	Global	Yes

Name	Cmd-Line	Option File	System Var	Var Scope	Dynamic
<a href="#">slow_query_log_file</a>	Yes	Yes	Yes	Global	Yes
<a href="#">socket</a>	Yes	Yes	Yes	Global	No
<a href="#">sort_buffer_size</a>	Yes	Yes	Yes	Both	Yes
<a href="#">sql_auto_is_null</a>			Yes	Both	Yes
<a href="#">sql_big_selects</a>			Yes	Both	Yes
<a href="#">sql_buffer_result</a>			Yes	Both	Yes
<a href="#">sql_log_bin</a>			Yes	Session	Yes
<a href="#">sql_log_off</a>			Yes	Both	Yes
<a href="#">sql_mode</a>	Yes	Yes	Yes	Both	Yes
<a href="#">sql_notes</a>			Yes	Both	Yes
<a href="#">sql_quote_show_create</a>			Yes	Both	Yes
<a href="#">sql_safe_updates</a>			Yes	Both	Yes
<a href="#">sql_select_limit</a>			Yes	Both	Yes
<a href="#">sql_slave_skip_counter</a>			Yes	Global	Yes
<a href="#">sql_warnings</a>			Yes	Both	Yes
<a href="#">ssl_ca</a>	Yes	Yes	Yes	Global	No
<a href="#">ssl_capath</a>	Yes	Yes	Yes	Global	No
<a href="#">ssl_cert</a>	Yes	Yes	Yes	Global	No
<a href="#">ssl_cipher</a>	Yes	Yes	Yes	Global	No
<a href="#">ssl_crl</a>	Yes	Yes	Yes	Global	No
<a href="#">ssl_crlpath</a>	Yes	Yes	Yes	Global	No
<a href="#">ssl_key</a>	Yes	Yes	Yes	Global	No
<a href="#">stored_program_cache</a>	Yes	Yes	Yes	Global	Yes
<a href="#">super_read_only</a>	Yes	Yes	Yes	Global	Yes
<a href="#">sync_binlog</a>	Yes	Yes	Yes	Global	Yes
<a href="#">sync_frm</a>	Yes	Yes	Yes	Global	Yes
<a href="#">sync_master_info</a>	Yes	Yes	Yes	Global	Yes
<a href="#">sync_relay_log</a>	Yes	Yes	Yes	Global	Yes
<a href="#">sync_relay_log_info</a>	Yes	Yes	Yes	Global	Yes
<a href="#">system_time_zone</a>			Yes	Global	No
<a href="#">table_definition_cache</a>	Yes	Yes	Yes	Global	Yes
<a href="#">table_open_cache</a>	Yes	Yes	Yes	Global	Yes
<a href="#">table_open_cache_instances</a>	Yes	Yes	Yes	Global	No
<a href="#">thread_cache_size</a>	Yes	Yes	Yes	Global	Yes
<a href="#">thread_handling</a>	Yes	Yes	Yes	Global	No
<a href="#">thread_pool_algorithm</a>	Yes	Yes	Yes	Global	No
<a href="#">thread_pool_high_priority_connections</a>	Yes	Yes	Yes	Both	Yes
<a href="#">thread_pool_max_used_threads</a>	Yes	Yes	Yes	Global	Yes

Name	Cmd-Line	Option File	System Var	Var Scope	Dynamic
thread_pool_prio	Yes	Yes	Yes	Global	Yes
thread_pool_size	Yes	Yes	Yes	Global	No
thread_pool_stall	Yes	Yes	Yes	Global	Yes
thread_stack	Yes	Yes	Yes	Global	No
time_format			Yes	Global	No
time_zone			Yes	Both	Yes
timestamp			Yes	Session	Yes
tls_version	Yes	Yes	Yes	Global	No
tmp_table_size	Yes	Yes	Yes	Both	Yes
tmpdir	Yes	Yes	Yes	Global	No
transaction_alloc	Yes	Yes	Yes	Both	Yes
transaction_allow	Yes		Yes	Session	Yes
transaction_isolation	Yes	Yes			Yes
- Variable: tx_isolation			Yes	Both	Yes
transaction_preall	Yes	Yes	Yes	Both	Yes
transaction_read	Yes	Yes			Yes
- Variable: tx_read_only			Yes	Both	Yes
transaction_write	Yes	Yes	Yes	Both	Yes
tx_isolation			Yes	Both	Yes
tx_read_only			Yes	Both	Yes
unique_checks			Yes	Both	Yes
updatable_views	Yes	Yes	Yes	Both	Yes
validate_password	Yes	Yes	Yes	Global	Yes
validate_password	Yes	Yes	Yes	Global	Varies
validate_password	Yes	Yes	Yes	Global	Yes
validate_password	Yes	Yes	Yes	Global	Yes
validate_password	Yes	Yes	Yes	Global	Yes
validate_password	Yes	Yes	Yes	Global	Yes
validate_password	Yes	Yes	Yes	Global	Yes
version			Yes	Global	No
version_comment			Yes	Global	No
version_compile			Yes	Global	No
version_compile			Yes	Global	No
version_tokens	Yes	Yes	Yes	Both	Yes
version_tokens	Yes	Yes	Yes	Both	No
wait_timeout	Yes	Yes	Yes	Both	Yes



Name	Cmd-Line	Option File	System Var	Var Scope	Dynamic
<a href="#">warning_count</a>			Yes	Session	No

**Notes:**

1. This option is dynamic, but should be set only by server. You should not set this variable manually.

## 5.1.5 Server Status Variable Reference

The following table lists all status variables applicable within `mysqld`.

The table lists each variable's data type and scope. The last column indicates whether the scope for each variable is Global, Session, or both. Please see the corresponding item descriptions for details on setting and using the variables. Where appropriate, direct links to further information about the items are provided.

**Table 5.3 Status Variable Summary**

Variable Name	Variable Type	Variable Scope
<a href="#">Aborted_clients</a>	Integer	Global
<a href="#">Aborted_connects</a>	Integer	Global
<a href="#">Audit_log_current_size</a>	Integer	Global
<a href="#">Audit_log_event_max_drop_size</a>	Integer	Global
<a href="#">Audit_log_events</a>	Integer	Global
<a href="#">Audit_log_events_filtered</a>	Integer	Global
<a href="#">Audit_log_events_lost</a>	Integer	Global
<a href="#">Audit_log_events_written</a>	Integer	Global
<a href="#">Audit_log_total_size</a>	Integer	Global
<a href="#">Audit_log_write_waits</a>	Integer	Global
<a href="#">Binlog_cache_disk_use</a>	Integer	Global
<a href="#">Binlog_cache_use</a>	Integer	Global
<a href="#">Binlog_stmt_cache_disk_use</a>	Integer	Global
<a href="#">Binlog_stmt_cache_use</a>	Integer	Global
<a href="#">Bytes_received</a>	Integer	Both
<a href="#">Bytes_sent</a>	Integer	Both
<a href="#">Com_admin_commands</a>	Integer	Both
<a href="#">Com_alter_db</a>	Integer	Both
<a href="#">Com_alter_db_upgrade</a>	Integer	Both
<a href="#">Com_alter_event</a>	Integer	Both
<a href="#">Com_alter_function</a>	Integer	Both
<a href="#">Com_alter_procedure</a>	Integer	Both
<a href="#">Com_alter_server</a>	Integer	Both
<a href="#">Com_alter_table</a>	Integer	Both
<a href="#">Com_alter_tablespace</a>	Integer	Both
<a href="#">Com_alter_user</a>	Integer	Both
<a href="#">Com_analyze</a>	Integer	Both

Variable Name	Variable Type	Variable Scope
<a href="#">Com_assign_to_keycache</a>	Integer	Both
<a href="#">Com_begin</a>	Integer	Both
<a href="#">Com_binlog</a>	Integer	Both
<a href="#">Com_call_procedure</a>	Integer	Both
<a href="#">Com_change_db</a>	Integer	Both
<a href="#">Com_change_master</a>	Integer	Both
<a href="#">Com_change_repl_filter</a>	Integer	Both
<a href="#">Com_check</a>	Integer	Both
<a href="#">Com_checksum</a>	Integer	Both
<a href="#">Com_commit</a>	Integer	Both
<a href="#">Com_create_db</a>	Integer	Both
<a href="#">Com_create_event</a>	Integer	Both
<a href="#">Com_create_function</a>	Integer	Both
<a href="#">Com_create_index</a>	Integer	Both
<a href="#">Com_create_procedure</a>	Integer	Both
<a href="#">Com_create_server</a>	Integer	Both
<a href="#">Com_create_table</a>	Integer	Both
<a href="#">Com_create_trigger</a>	Integer	Both
<a href="#">Com_create_udf</a>	Integer	Both
<a href="#">Com_create_user</a>	Integer	Both
<a href="#">Com_create_view</a>	Integer	Both
<a href="#">Com_dealloc_sql</a>	Integer	Both
<a href="#">Com_delete</a>	Integer	Both
<a href="#">Com_delete_multi</a>	Integer	Both
<a href="#">Com_do</a>	Integer	Both
<a href="#">Com_drop_db</a>	Integer	Both
<a href="#">Com_drop_event</a>	Integer	Both
<a href="#">Com_drop_function</a>	Integer	Both
<a href="#">Com_drop_index</a>	Integer	Both
<a href="#">Com_drop_procedure</a>	Integer	Both
<a href="#">Com_drop_server</a>	Integer	Both
<a href="#">Com_drop_table</a>	Integer	Both
<a href="#">Com_drop_trigger</a>	Integer	Both
<a href="#">Com_drop_user</a>	Integer	Both
<a href="#">Com_drop_view</a>	Integer	Both
<a href="#">Com_empty_query</a>	Integer	Both
<a href="#">Com_execute_sql</a>	Integer	Both
<a href="#">Com_explain_other</a>	Integer	Both

Variable Name	Variable Type	Variable Scope
<a href="#">Com_flush</a>	Integer	Both
<a href="#">Com_get_diagnostics</a>	Integer	Both
<a href="#">Com_grant</a>	Integer	Both
<a href="#">Com_group_replication_start</a>	Integer	Global
<a href="#">Com_group_replication_stop</a>	Integer	Global
<a href="#">Com_ha_close</a>	Integer	Both
<a href="#">Com_ha_open</a>	Integer	Both
<a href="#">Com_ha_read</a>	Integer	Both
<a href="#">Com_help</a>	Integer	Both
<a href="#">Com_insert</a>	Integer	Both
<a href="#">Com_insert_select</a>	Integer	Both
<a href="#">Com_install_plugin</a>	Integer	Both
<a href="#">Com_kill</a>	Integer	Both
<a href="#">Com_load</a>	Integer	Both
<a href="#">Com_lock_tables</a>	Integer	Both
<a href="#">Com_optimize</a>	Integer	Both
<a href="#">Com_preload_keys</a>	Integer	Both
<a href="#">Com_prepare_sql</a>	Integer	Both
<a href="#">Com_purge</a>	Integer	Both
<a href="#">Com_purge_before_date</a>	Integer	Both
<a href="#">Com_release_savepoint</a>	Integer	Both
<a href="#">Com_rename_table</a>	Integer	Both
<a href="#">Com_rename_user</a>	Integer	Both
<a href="#">Com_repair</a>	Integer	Both
<a href="#">Com_replace</a>	Integer	Both
<a href="#">Com_replace_select</a>	Integer	Both
<a href="#">Com_reset</a>	Integer	Both
<a href="#">Com_resignal</a>	Integer	Both
<a href="#">Com_revoke</a>	Integer	Both
<a href="#">Com_revoke_all</a>	Integer	Both
<a href="#">Com_rollback</a>	Integer	Both
<a href="#">Com_rollback_to_savepoint</a>	Integer	Both
<a href="#">Com_savepoint</a>	Integer	Both
<a href="#">Com_select</a>	Integer	Both
<a href="#">Com_set_option</a>	Integer	Both
<a href="#">Com_show_authors</a>	Integer	Both
<a href="#">Com_show_binlog_events</a>	Integer	Both
<a href="#">Com_show_binlogs</a>	Integer	Both

Variable Name	Variable Type	Variable Scope
<a href="#">Com_show_charsets</a>	Integer	Both
<a href="#">Com_show_collations</a>	Integer	Both
<a href="#">Com_show_contributors</a>	Integer	Both
<a href="#">Com_show_create_db</a>	Integer	Both
<a href="#">Com_show_create_event</a>	Integer	Both
<a href="#">Com_show_create_func</a>	Integer	Both
<a href="#">Com_show_create_proc</a>	Integer	Both
<a href="#">Com_show_create_table</a>	Integer	Both
<a href="#">Com_show_create_trigger</a>	Integer	Both
<a href="#">Com_show_create_user</a>	Integer	Both
<a href="#">Com_show_databases</a>	Integer	Both
<a href="#">Com_show_engine_logs</a>	Integer	Both
<a href="#">Com_show_engine_mutex</a>	Integer	Both
<a href="#">Com_show_engine_status</a>	Integer	Both
<a href="#">Com_show_errors</a>	Integer	Both
<a href="#">Com_show_events</a>	Integer	Both
<a href="#">Com_show_fields</a>	Integer	Both
<a href="#">Com_show_function_code</a>	Integer	Both
<a href="#">Com_show_function_status</a>	Integer	Both
<a href="#">Com_show_grants</a>	Integer	Both
<a href="#">Com_show_keys</a>	Integer	Both
<a href="#">Com_show_master_status</a>	Integer	Both
<a href="#">Com_show_ndb_status</a>	Integer	Both
<a href="#">Com_show_open_tables</a>	Integer	Both
<a href="#">Com_show_plugins</a>	Integer	Both
<a href="#">Com_show_privileges</a>	Integer	Both
<a href="#">Com_show_procedure_code</a>	Integer	Both
<a href="#">Com_show_procedure_status</a>	Integer	Both
<a href="#">Com_show_processlist</a>	Integer	Both
<a href="#">Com_show_profile</a>	Integer	Both
<a href="#">Com_show_profiles</a>	Integer	Both
<a href="#">Com_show_relaylog_events</a>	Integer	Both
<a href="#">Com_show_slave_hosts</a>	Integer	Both
<a href="#">Com_show_slave_status</a>	Integer	Both
<a href="#">Com_show_status</a>	Integer	Both
<a href="#">Com_show_storage_engines</a>	Integer	Both
<a href="#">Com_show_table_status</a>	Integer	Both
<a href="#">Com_show_tables</a>	Integer	Both

Variable Name	Variable Type	Variable Scope
<a href="#">Com_show_triggers</a>	Integer	Both
<a href="#">Com_show_variables</a>	Integer	Both
<a href="#">Com_show_warnings</a>	Integer	Both
<a href="#">Com_shutdown</a>	Integer	Both
<a href="#">Com_signal</a>	Integer	Both
<a href="#">Com_slave_start</a>	Integer	Both
<a href="#">Com_slave_stop</a>	Integer	Both
<a href="#">Com_stmt_close</a>	Integer	Both
<a href="#">Com_stmt_execute</a>	Integer	Both
<a href="#">Com_stmt_fetch</a>	Integer	Both
<a href="#">Com_stmt_prepare</a>	Integer	Both
<a href="#">Com_stmt_reprepare</a>	Integer	Both
<a href="#">Com_stmt_reset</a>	Integer	Both
<a href="#">Com_stmt_send_long_data</a>	Integer	Both
<a href="#">Com_truncate</a>	Integer	Both
<a href="#">Com_uninstall_plugin</a>	Integer	Both
<a href="#">Com_unlock_tables</a>	Integer	Both
<a href="#">Com_update</a>	Integer	Both
<a href="#">Com_update_multi</a>	Integer	Both
<a href="#">Com_xa_commit</a>	Integer	Both
<a href="#">Com_xa_end</a>	Integer	Both
<a href="#">Com_xa_prepare</a>	Integer	Both
<a href="#">Com_xa_recover</a>	Integer	Both
<a href="#">Com_xa_rollback</a>	Integer	Both
<a href="#">Com_xa_start</a>	Integer	Both
<a href="#">Compression</a>	Integer	Session
<a href="#">Connection_control_delay_generate</a>	Integer	Global
<a href="#">Connection_errors_accept</a>	Integer	Global
<a href="#">Connection_errors_internal</a>	Integer	Global
<a href="#">Connection_errors_max_connections</a>	Integer	Global
<a href="#">Connection_errors_peer_address</a>	Integer	Global
<a href="#">Connection_errors_select</a>	Integer	Global
<a href="#">Connection_errors_tcpwrap</a>	Integer	Global
<a href="#">Connections</a>	Integer	Global
<a href="#">Created_tmp_disk_tables</a>	Integer	Both
<a href="#">Created_tmp_files</a>	Integer	Global
<a href="#">Created_tmp_tables</a>	Integer	Both
<a href="#">Delayed_errors</a>	Integer	Global

## Server Status Variable Reference

Variable Name	Variable Type	Variable Scope
<a href="#">Delayed_insert_threads</a>	Integer	Global
<a href="#">Delayed_writes</a>	Integer	Global
<a href="#">Firewall_access_denied</a>	Integer	Global
<a href="#">Firewall_access_granted</a>	Integer	Global
<a href="#">Firewall_access_suspicious</a>	Integer	Global
<a href="#">Firewall_cached_entries</a>	Integer	Global
<a href="#">Flush_commands</a>	Integer	Global
<a href="#">group_replication_primary_member</a>	String	Global
<a href="#">Handler_commit</a>	Integer	Both
<a href="#">Handler_delete</a>	Integer	Both
<a href="#">Handler_discover</a>	Integer	Both
<a href="#">Handler_external_lock</a>	Integer	Both
<a href="#">Handler_mrr_init</a>	Integer	Both
<a href="#">Handler_prepare</a>	Integer	Both
<a href="#">Handler_read_first</a>	Integer	Both
<a href="#">Handler_read_key</a>	Integer	Both
<a href="#">Handler_read_last</a>	Integer	Both
<a href="#">Handler_read_next</a>	Integer	Both
<a href="#">Handler_read_prev</a>	Integer	Both
<a href="#">Handler_read_rnd</a>	Integer	Both
<a href="#">Handler_read_rnd_next</a>	Integer	Both
<a href="#">Handler_rollback</a>	Integer	Both
<a href="#">Handler_savepoint</a>	Integer	Both
<a href="#">Handler_savepoint_rollback</a>	Integer	Both
<a href="#">Handler_update</a>	Integer	Both
<a href="#">Handler_write</a>	Integer	Both
<a href="#">Innodb_available_undo_logs</a>	Integer	Global
<a href="#">Innodb_buffer_pool_bytes_data</a>	Integer	Global
<a href="#">Innodb_buffer_pool_bytes_dirty</a>	Integer	Global
<a href="#">Innodb_buffer_pool_dump_status</a>	String	Global
<a href="#">Innodb_buffer_pool_load_status</a>	String	Global
<a href="#">Innodb_buffer_pool_pages_data</a>	Integer	Global
<a href="#">Innodb_buffer_pool_pages_dirty</a>	Integer	Global
<a href="#">Innodb_buffer_pool_pages_flushed</a>	Integer	Global
<a href="#">Innodb_buffer_pool_pages_free</a>	Integer	Global
<a href="#">Innodb_buffer_pool_pages_latched</a>	Integer	Global
<a href="#">Innodb_buffer_pool_pages_misc</a>	Integer	Global
<a href="#">Innodb_buffer_pool_pages_total</a>	Integer	Global

## Server Status Variable Reference

Variable Name	Variable Type	Variable Scope
<a href="#">Innodb_buffer_pool_read_ahead</a>	Integer	Global
<a href="#">Innodb_buffer_pool_read_ahead_evicted</a>	Integer	Global
<a href="#">Innodb_buffer_pool_read_ahead_requests</a>	Integer	Global
<a href="#">Innodb_buffer_pool_read_requests</a>	Integer	Global
<a href="#">Innodb_buffer_pool_reads</a>	Integer	Global
<a href="#">Innodb_buffer_pool_resize_status</a>	String	Global
<a href="#">Innodb_buffer_pool_wait_free</a>	Integer	Global
<a href="#">Innodb_buffer_pool_write_requests</a>	Integer	Global
<a href="#">Innodb_data_fsyncs</a>	Integer	Global
<a href="#">Innodb_data_pending_fsyncs</a>	Integer	Global
<a href="#">Innodb_data_pending_reads</a>	Integer	Global
<a href="#">Innodb_data_pending_writes</a>	Integer	Global
<a href="#">Innodb_data_read</a>	Integer	Global
<a href="#">Innodb_data_reads</a>	Integer	Global
<a href="#">Innodb_data_writes</a>	Integer	Global
<a href="#">Innodb_data_written</a>	Integer	Global
<a href="#">Innodb_dblwr_pages_written</a>	Integer	Global
<a href="#">Innodb_dblwr_writes</a>	Integer	Global
<a href="#">Innodb_have_atomic_builtins</a>	Integer	Global
<a href="#">Innodb_log_waits</a>	Integer	Global
<a href="#">Innodb_log_write_requests</a>	Integer	Global
<a href="#">Innodb_log_writes</a>	Integer	Global
<a href="#">Innodb_num_open_files</a>	Integer	Global
<a href="#">Innodb_os_log_fsyncs</a>	Integer	Global
<a href="#">Innodb_os_log_pending_fsyncs</a>	Integer	Global
<a href="#">Innodb_os_log_pending_writes</a>	Integer	Global
<a href="#">Innodb_os_log_written</a>	Integer	Global
<a href="#">Innodb_page_size</a>	Integer	Global
<a href="#">Innodb_pages_created</a>	Integer	Global
<a href="#">Innodb_pages_read</a>	Integer	Global
<a href="#">Innodb_pages_written</a>	Integer	Global
<a href="#">Innodb_row_lock_current_waits</a>	Integer	Global
<a href="#">Innodb_row_lock_time</a>	Integer	Global
<a href="#">Innodb_row_lock_time_avg</a>	Integer	Global
<a href="#">Innodb_row_lock_time_max</a>	Integer	Global
<a href="#">Innodb_row_lock_waits</a>	Integer	Global
<a href="#">Innodb_rows_deleted</a>	Integer	Global
<a href="#">Innodb_rows_inserted</a>	Integer	Global

## Server Status Variable Reference

Variable Name	Variable Type	Variable Scope
<a href="#">Innodb_rows_read</a>	Integer	Global
<a href="#">Innodb_rows_updated</a>	Integer	Global
<a href="#">Innodb_truncated_status_writes</a>	Integer	Global
<a href="#">Key_blocks_not_flushed</a>	Integer	Global
<a href="#">Key_blocks_unused</a>	Integer	Global
<a href="#">Key_blocks_used</a>	Integer	Global
<a href="#">Key_read_requests</a>	Integer	Global
<a href="#">Key_reads</a>	Integer	Global
<a href="#">Key_write_requests</a>	Integer	Global
<a href="#">Key_writes</a>	Integer	Global
<a href="#">Last_query_cost</a>	Numeric	Session
<a href="#">Last_query_partial_plans</a>	Integer	Session
<a href="#">Locked_connects</a>	Integer	Global
<a href="#">Max_execution_time_exceeded</a>	Integer	Both
<a href="#">Max_execution_time_set</a>	Integer	Both
<a href="#">Max_execution_time_set_failed</a>	Integer	Both
<a href="#">Max_used_connections</a>	Integer	Global
<a href="#">Max_used_connections_time</a>	Datetime	Global
<a href="#">mecab_charset</a>	String	Global
<a href="#">Mysqlx_address</a>	String	Global
<a href="#">Mysqlx_bytes_received</a>	Integer	Both
<a href="#">Mysqlx_bytes_sent</a>	Integer	Both
<a href="#">Mysqlx_connection_accept_errors</a>	Integer	Both
<a href="#">Mysqlx_connection_errors</a>	Integer	Both
<a href="#">Mysqlx_connections_accepted</a>	Integer	Global
<a href="#">Mysqlx_connections_closed</a>	Integer	Global
<a href="#">Mysqlx_connections_rejected</a>	Integer	Global
<a href="#">Mysqlx_crud_create_view</a>	Integer	Both
<a href="#">Mysqlx_crud_delete</a>	Integer	Both
<a href="#">Mysqlx_crud_drop_view</a>	Integer	Both
<a href="#">Mysqlx_crud_find</a>	Integer	Both
<a href="#">Mysqlx_crud_insert</a>	Integer	Both
<a href="#">Mysqlx_crud_modify_view</a>	Integer	Both
<a href="#">Mysqlx_crud_update</a>	Integer	Both
<a href="#">Mysqlx_errors_sent</a>	Integer	Both
<a href="#">Mysqlx_errors_unknown_message</a>	Integer	Both
<a href="#">Mysqlx_expect_close</a>	Integer	Both
<a href="#">Mysqlx_expect_open</a>	Integer	Both



Variable Name	Variable Type	Variable Scope
<a href="#">Mysqlx_init_error</a>	Integer	Both
<a href="#">Mysqlx_notice_other_sent</a>	Integer	Both
<a href="#">Mysqlx_notice_warning_sent</a>	Integer	Both
<a href="#">Mysqlx_port</a>	String	Global
<a href="#">Mysqlx_rows_sent</a>	Integer	Both
<a href="#">Mysqlx_sessions</a>	Integer	Global
<a href="#">Mysqlx_sessions_accepted</a>	Integer	Global
<a href="#">Mysqlx_sessions_closed</a>	Integer	Global
<a href="#">Mysqlx_sessions_fatal_error</a>	Integer	Global
<a href="#">Mysqlx_sessions_killed</a>	Integer	Global
<a href="#">Mysqlx_sessions_rejected</a>	Integer	Global
<a href="#">Mysqlx_socket</a>	String	Global
<a href="#">Mysqlx_ssl_accept_renegotiates</a>	Integer	Global
<a href="#">Mysqlx_ssl_accepts</a>	Integer	Global
<a href="#">Mysqlx_ssl_active</a>	Integer	Both
<a href="#">Mysqlx_ssl_cipher</a>	Integer	Both
<a href="#">Mysqlx_ssl_cipher_list</a>	Integer	Both
<a href="#">Mysqlx_ssl_ctx_verify_depth</a>	Integer	Both
<a href="#">Mysqlx_ssl_ctx_verify_mode</a>	Integer	Both
<a href="#">Mysqlx_ssl_finished_accepts</a>	Integer	Global
<a href="#">Mysqlx_ssl_server_not_after</a>	Integer	Global
<a href="#">Mysqlx_ssl_server_not_before</a>	Integer	Global
<a href="#">Mysqlx_ssl_verify_depth</a>	Integer	Global
<a href="#">Mysqlx_ssl_verify_mode</a>	Integer	Global
<a href="#">Mysqlx_ssl_version</a>	Integer	Both
<a href="#">Mysqlx_stmt_create_collection</a>	Integer	Both
<a href="#">Mysqlx_stmt_create_collection_index</a>	Integer	Both
<a href="#">Mysqlx_stmt_disable_notices</a>	Integer	Both
<a href="#">Mysqlx_stmt_drop_collection</a>	Integer	Both
<a href="#">Mysqlx_stmt_drop_collection_index</a>	Integer	Both
<a href="#">Mysqlx_stmt_enable_notices</a>	Integer	Both
<a href="#">Mysqlx_stmt_ensure_collection</a>	String	Both
<a href="#">Mysqlx_stmt_execute_mysqlx</a>	Integer	Both
<a href="#">Mysqlx_stmt_execute_sql</a>	Integer	Both
<a href="#">Mysqlx_stmt_execute_xplugin</a>	Integer	Both
<a href="#">Mysqlx_stmt_kill_client</a>	Integer	Both
<a href="#">Mysqlx_stmt_list_clients</a>	Integer	Both
<a href="#">Mysqlx_stmt_list_notices</a>	Integer	Both

## Server Status Variable Reference

Variable Name	Variable Type	Variable Scope
<a href="#">Mysqlx_stmt_list_objects</a>	Integer	Both
<a href="#">Mysqlx_stmt_ping</a>	Integer	Both
<a href="#">Mysqlx_worker_threads</a>	Integer	Global
<a href="#">Mysqlx_worker_threads_active</a>	Integer	Global
<a href="#">Ndb_api_adaptive_send_deferred_count</a>	Integer	Global
<a href="#">Ndb_api_adaptive_send_deferred_count_session</a>	Integer	Global
<a href="#">Ndb_api_adaptive_send_deferred_count_slave</a>	Integer	Global
<a href="#">Ndb_api_adaptive_send_forced_count</a>	Integer	Global
<a href="#">Ndb_api_adaptive_send_forced_count_session</a>	Integer	Global
<a href="#">Ndb_api_adaptive_send_forced_count_slave</a>	Integer	Global
<a href="#">Ndb_api_adaptive_send_unforced_count</a>	Integer	Global
<a href="#">Ndb_api_adaptive_send_unforced_count_session</a>	Integer	Global
<a href="#">Ndb_api_adaptive_send_unforced_count_slave</a>	Integer	Global
<a href="#">Ndb_api_bytes_received_count</a>	Integer	Global
<a href="#">Ndb_api_bytes_received_count_session</a>	Integer	Session
<a href="#">Ndb_api_bytes_received_count_slave</a>	Integer	Global
<a href="#">Ndb_api_bytes_sent_count</a>	Integer	Global
<a href="#">Ndb_api_bytes_sent_count_session</a>	Integer	Session
<a href="#">Ndb_api_bytes_sent_count_slave</a>	Integer	Global
<a href="#">Ndb_api_event_bytes_count</a>	Integer	Global
<a href="#">Ndb_api_event_bytes_count_injected</a>	Integer	Global
<a href="#">Ndb_api_event_data_count</a>	Integer	Global
<a href="#">Ndb_api_event_data_count_injected</a>	Integer	Global
<a href="#">Ndb_api_event_nondata_count</a>	Integer	Global
<a href="#">Ndb_api_event_nondata_count_injected</a>	Integer	Global
<a href="#">Ndb_api_pk_op_count</a>	Integer	Global
<a href="#">Ndb_api_pk_op_count_session</a>	Integer	Session
<a href="#">Ndb_api_pk_op_count_slave</a>	Integer	Global
<a href="#">Ndb_api_pruned_scan_count</a>	Integer	Global
<a href="#">Ndb_api_pruned_scan_count_session</a>	Integer	Session
<a href="#">Ndb_api_pruned_scan_count_slave</a>	Integer	Global
<a href="#">Ndb_api_range_scan_count</a>	Integer	Global
<a href="#">Ndb_api_range_scan_count_session</a>	Integer	Session
<a href="#">Ndb_api_range_scan_count_slave</a>	Integer	Global
<a href="#">Ndb_api_read_row_count</a>	Integer	Global
<a href="#">Ndb_api_read_row_count_session</a>	Integer	Session
<a href="#">Ndb_api_read_row_count_slave</a>	Integer	Global
<a href="#">Ndb_api_scan_batch_count</a>	Integer	Global

Server Status Variable Reference

Variable Name	Variable Type	Variable Scope
Ndb_api_scan_batch_count_session	Integer	Session
Ndb_api_scan_batch_count_slave	Integer	Global
Ndb_api_table_scan_count	Integer	Global
Ndb_api_table_scan_count_session	Integer	Session
Ndb_api_table_scan_count_slave	Integer	Global
Ndb_api_trans_abort_count	Integer	Global
Ndb_api_trans_abort_count_session	Integer	Session
Ndb_api_trans_abort_count_slave	Integer	Global
Ndb_api_trans_close_count	Integer	Global
Ndb_api_trans_close_count_session	Integer	Session
Ndb_api_trans_close_count_slave	Integer	Global
Ndb_api_trans_commit_count	Integer	Global
Ndb_api_trans_commit_count_session	Integer	Session
Ndb_api_trans_commit_count_slave	Integer	Global
Ndb_api_trans_local_read_row_count	Integer	Global
Ndb_api_trans_local_read_row_count_session	Integer	Session
Ndb_api_trans_local_read_row_count_slave	Integer	Global
Ndb_api_trans_start_count	Integer	Global
Ndb_api_trans_start_count_session	Integer	Session
Ndb_api_trans_start_count_slave	Integer	Global
Ndb_api_uk_op_count	Integer	Global
Ndb_api_uk_op_count_session	Integer	Session
Ndb_api_uk_op_count_slave	Integer	Global
Ndb_api_wait_exec_complete_count	Integer	Global
Ndb_api_wait_exec_complete_count_session	Integer	Session
Ndb_api_wait_exec_complete_count_slave	Integer	Global
Ndb_api_wait_meta_request_count	Integer	Global
Ndb_api_wait_meta_request_count_session	Integer	Session
Ndb_api_wait_meta_request_count_slave	Integer	Global
Ndb_api_wait_nanos_count	Integer	Global
Ndb_api_wait_nanos_count_session	Integer	Session
Ndb_api_wait_nanos_count_slave	Integer	Global
Ndb_api_wait_scan_result_count	Integer	Global
Ndb_api_wait_scan_result_count_session	Integer	Session
Ndb_api_wait_scan_result_count_slave	Integer	Global
Ndb_cluster_node_id	Integer	Global
Ndb_config_from_host	Integer	Both
Ndb_config_from_port	Integer	Both

Server Status Variable Reference

Variable Name	Variable Type	Variable Scope
Ndb_conflict_fn_epoch	Integer	Global
Ndb_conflict_fn_epoch_trans	Integer	Global
Ndb_conflict_fn_epoch2	Integer	Global
Ndb_conflict_fn_epoch2_trans	Integer	Global
Ndb_conflict_fn_max	Integer	Global
Ndb_conflict_fn_max_del_win	Integer	Global
Ndb_conflict_fn_old	Integer	Global
Ndb_conflict_last_conflict_epoch	Integer	Global
Ndb_conflict_last_stable_epoch	Integer	Global
Ndb_conflict_reflected_op_discard	Integer	Global
Ndb_conflict_reflected_op_prepare	Integer	Global
Ndb_conflict_refresh_op_count	Integer	Global
Ndb_conflict_trans_conflict_commit	Integer	Global
Ndb_conflict_trans_detect_iter_count	Integer	Global
Ndb_conflict_trans_reject_count	Integer	Global
Ndb_conflict_trans_row_conflict_count	Integer	Global
Ndb_conflict_trans_row_reject_count	Integer	Global
Ndb_epoch_delete_delete_count	Integer	Global
Ndb_execute_count	Integer	Global
Ndb_last_commit_epoch_server	Integer	Global
Ndb_last_commit_epoch_session	Integer	Session
Ndb_cluster_node_id	Integer	Global
Ndb_number_of_data_nodes	Integer	Global
Ndb_pruned_scan_count	Integer	Global
Ndb_pushed_queries_defined	Integer	Global
Ndb_pushed_queries_dropped	Integer	Global
Ndb_pushed_queries_executed	Integer	Global
Ndb_pushed_reads	Integer	Global
Ndb_scan_count	Integer	Global
Ndb_slave_max_replicated_epoch	Integer	Global
Not_flushed_delayed_rows	Integer	Global
Ongoing_anonymous_gtid_violating_transaction_count	Integer	Global
Ongoing_anonymous_transaction_count	Integer	Global
Ongoing_automatic_gtid_violating_transaction_count	Integer	Global
Open_files	Integer	Global
Open_streams	Integer	Global
Open_table_definitions	Integer	Global
Open_tables	Integer	Both

Variable Name	Variable Type	Variable Scope
Opened_files	Integer	Global
Opened_table_definitions	Integer	Both
Opened_tables	Integer	Both
Performance_schema_accounts_lost	Integer	Global
Performance_schema_cond_classes_lost	Integer	Global
Performance_schema_cond_instances_lost	Integer	Global
Performance_schema_digest_lost	Integer	Global
Performance_schema_file_classes_lost	Integer	Global
Performance_schema_file_handles_lost	Integer	Global
Performance_schema_file_instances_lost	Integer	Global
Performance_schema_hosts_lost	Integer	Global
Performance_schema_index_statistics_lost	Integer	Global
Performance_schema_locker_lost	Integer	Global
Performance_schema_memory_classes_lost	Integer	Global
Performance_schema_metadata_locks_lost	Integer	Global
Performance_schema_mutex_classes_lost	Integer	Global
Performance_schema_mutex_instances_lost	Integer	Global
Performance_schema_nested_statement_instances_lost	Integer	Global
Performance_schema_prepared_statement_instances_lost	Integer	Global
Performance_schema_program_instances_lost	Integer	Global
Performance_schema_rwlock_classes_lost	Integer	Global
Performance_schema_rwlock_instances_lost	Integer	Global
Performance_schema_session_connect_attempts_lost	Integer	Global
Performance_schema_socket_classes_lost	Integer	Global
Performance_schema_socket_instances_lost	Integer	Global
Performance_schema_stage_classes_lost	Integer	Global
Performance_schema_statement_classes_lost	Integer	Global
Performance_schema_table_handles_lost	Integer	Global
Performance_schema_table_instances_lost	Integer	Global
Performance_schema_table_lock_statistics_lost	Integer	Global
Performance_schema_thread_classes_lost	Integer	Global
Performance_schema_thread_instances_lost	Integer	Global
Performance_schema_users_lost	Integer	Global
Prepared_stmt_count	Integer	Global
Qcache_free_blocks	Integer	Global
Qcache_free_memory	Integer	Global
Qcache_hits	Integer	Global
Qcache_inserts	Integer	Global

Server Status Variable Reference

Variable Name	Variable Type	Variable Scope
<a href="#">Qcache_lowmem_prunes</a>	Integer	Global
<a href="#">Qcache_not_cached</a>	Integer	Global
<a href="#">Qcache_queries_in_cache</a>	Integer	Global
<a href="#">Qcache_total_blocks</a>	Integer	Global
<a href="#">Queries</a>	Integer	Both
<a href="#">Questions</a>	Integer	Both
<a href="#">Rewriter_number_loaded_rules</a>	Integer	Global
<a href="#">Rewriter_number_reloads</a>	Integer	Global
<a href="#">Rewriter_number_rewritten_queries</a>	Integer	Global
<a href="#">Rewriter_reload_error</a>	Boolean	Global
<a href="#">Rpl_semi_sync_master_clients</a>	Integer	Global
<a href="#">Rpl_semi_sync_master_net_avg_wait_time</a>	Integer	Global
<a href="#">Rpl_semi_sync_master_net_wait_time</a>	Integer	Global
<a href="#">Rpl_semi_sync_master_net_waits</a>	Integer	Global
<a href="#">Rpl_semi_sync_master_no_times</a>	Integer	Global
<a href="#">Rpl_semi_sync_master_no_tx</a>	Integer	Global
<a href="#">Rpl_semi_sync_master_status</a>	Boolean	Global
<a href="#">Rpl_semi_sync_master_timefunc_failures</a>	Integer	Global
<a href="#">Rpl_semi_sync_master_tx_avg_wait_time</a>	Integer	Global
<a href="#">Rpl_semi_sync_master_tx_wait_time</a>	Integer	Global
<a href="#">Rpl_semi_sync_master_tx_waits</a>	Integer	Global
<a href="#">Rpl_semi_sync_master_wait_pos_backlog</a>	Integer	Global
<a href="#">Rpl_semi_sync_master_wait_sessions</a>	Integer	Global
<a href="#">Rpl_semi_sync_master_yes_tx</a>	Integer	Global
<a href="#">Rpl_semi_sync_slave_status</a>	Boolean	Global
<a href="#">Rsa_public_key</a>	String	Global
<a href="#">Select_full_join</a>	Integer	Both
<a href="#">Select_full_range_join</a>	Integer	Both
<a href="#">Select_range</a>	Integer	Both
<a href="#">Select_range_check</a>	Integer	Both
<a href="#">Select_scan</a>	Integer	Both
<a href="#">Slave_heartbeat_period</a>	Numeric	Global
<a href="#">Slave_last_heartbeat</a>	Datetime	Global
<a href="#">Slave_open_temp_tables</a>	Integer	Global
<a href="#">Slave_received_heartbeats</a>	Integer	Global
<a href="#">Slave_retried_transactions</a>	Integer	Global
<a href="#">Slave_rows_last_search_algorithm</a>	String	Global
<a href="#">Slave_running</a>	String	Global

Variable Name	Variable Type	Variable Scope
<a href="#">Slow_launch_threads</a>	Integer	Both
<a href="#">Slow_queries</a>	Integer	Both
<a href="#">Sort_merge_passes</a>	Integer	Both
<a href="#">Sort_range</a>	Integer	Both
<a href="#">Sort_rows</a>	Integer	Both
<a href="#">Sort_scan</a>	Integer	Both
<a href="#">Ssl_accept_renegotiates</a>	Integer	Global
<a href="#">Ssl_accepts</a>	Integer	Global
<a href="#">Ssl_callback_cache_hits</a>	Integer	Global
<a href="#">Ssl_cipher</a>	String	Both
<a href="#">Ssl_cipher_list</a>	String	Both
<a href="#">Ssl_client_connects</a>	Integer	Global
<a href="#">Ssl_connect_renegotiates</a>	Integer	Global
<a href="#">Ssl_ctx_verify_depth</a>	Integer	Global
<a href="#">Ssl_ctx_verify_mode</a>	Integer	Global
<a href="#">Ssl_default_timeout</a>	Integer	Both
<a href="#">Ssl_finished_accepts</a>	Integer	Global
<a href="#">Ssl_finished_connects</a>	Integer	Global
<a href="#">Ssl_server_not_after</a>	Integer	Both
<a href="#">Ssl_server_not_before</a>	Integer	Both
<a href="#">Ssl_session_cache_hits</a>	Integer	Global
<a href="#">Ssl_session_cache_misses</a>	Integer	Global
<a href="#">Ssl_session_cache_mode</a>	String	Global
<a href="#">Ssl_session_cache_overflows</a>	Integer	Global
<a href="#">Ssl_session_cache_size</a>	Integer	Global
<a href="#">Ssl_session_cache_timeouts</a>	Integer	Global
<a href="#">Ssl_sessions_reused</a>	Integer	Session
<a href="#">Ssl_used_session_cache_entries</a>	Integer	Global
<a href="#">Ssl_verify_depth</a>	Integer	Both
<a href="#">Ssl_verify_mode</a>	Integer	Both
<a href="#">Ssl_version</a>	String	Both
<a href="#">Table_locks_immediate</a>	Integer	Global
<a href="#">Table_locks_waited</a>	Integer	Global
<a href="#">Table_open_cache_hits</a>	Integer	Both
<a href="#">Table_open_cache_misses</a>	Integer	Both
<a href="#">Table_open_cache_overflows</a>	Integer	Both
<a href="#">Tc_log_max_pages_used</a>	Integer	Global
<a href="#">Tc_log_page_size</a>	Integer	Global

Variable Name	Variable Type	Variable Scope
<a href="#">Tc_log_page_waits</a>	Integer	Global
<a href="#">Threads_cached</a>	Integer	Global
<a href="#">Threads_connected</a>	Integer	Global
<a href="#">Threads_created</a>	Integer	Global
<a href="#">Threads_running</a>	Integer	Global
<a href="#">Uptime</a>	Integer	Global
<a href="#">Uptime_since_flush_status</a>	Integer	Global
<a href="#">validate_password_dictionary_file</a>	Datetime	Global
<a href="#">validate_password_dictionary_file</a>	Integer count	Global

## 5.1.6 Server Command Options

When you start the `mysqld` server, you can specify program options using any of the methods described in [Section 4.2.2, “Specifying Program Options”](#). The most common methods are to provide options in an option file or on the command line. However, in most cases it is desirable to make sure that the server uses the same options each time it runs. The best way to ensure this is to list them in an option file. See [Section 4.2.2.2, “Using Option Files”](#). That section also describes option file format and syntax.

`mysqld` reads options from the `[mysqld]` and `[server]` groups. `mysqld_safe` reads options from the `[mysqld]`, `[server]`, `[mysqld_safe]`, and `[safe_mysqld]` groups. `mysql.server` reads options from the `[mysqld]` and `[mysql.server]` groups.

An embedded MySQL server usually reads options from the `[server]`, `[embedded]`, and `[xxxxx_SERVER]` groups, where `xxxxx` is the name of the application into which the server is embedded.

`mysqld` accepts many command options. For a brief summary, execute this command:

```
mysqld --help
```

To see the full list, use this command:

```
mysqld --verbose --help
```

Some of the items in the list are actually system variables that can be set at server startup. These can be displayed at runtime using the `SHOW VARIABLES` statement. Some items displayed by the preceding `mysqld` command do not appear in `SHOW VARIABLES` output; this is because they are options only and not system variables.

The following list shows some of the most common server options. Additional options are described in other sections:

- Options that affect security: See [Section 6.1.4, “Security-Related `mysqld` Options and Variables”](#).
- SSL-related options: See [Command Options for Encrypted Connections](#).
- Binary log control options: See [Section 5.4.4, “The Binary Log”](#).
- Replication-related options: See [Section 16.1.6, “Replication and Binary Logging Options and Variables”](#).
- Options for loading plugins such as pluggable storage engines: See [Section 5.5.1, “Installing and Uninstalling Plugins”](#).
- Options specific to particular storage engines: See [Section 14.15, “InnoDB Startup Options and System Variables”](#) and [Section 15.2.1, “MyISAM Startup Options”](#).



Some options control the size of buffers or caches. For a given buffer, the server might need to allocate internal data structures. These structures typically are allocated from the total memory allocated to the buffer, and the amount of space required might be platform dependent. This means that when you assign a value to an option that controls a buffer size, the amount of space actually available might differ from the value assigned. In some cases, the amount might be less than the value assigned. It is also possible that the server adjusts a value upward. For example, if you assign a value of 0 to an option for which the minimal value is 1024, the server sets the value to 1024.

Values for buffer sizes, lengths, and stack sizes are given in bytes unless otherwise specified.

Some options take file name values. Unless otherwise specified, the default file location is the data directory if the value is a relative path name. To specify the location explicitly, use an absolute path name. Suppose that the data directory is `/var/mysql/data`. If a file-valued option is given as a relative path name, it is located under `/var/mysql/data`. If the value is an absolute path name, its location is as given by the path name.

You can also set the values of server system variables at server startup by using variable names as options. To assign a value to a server system variable, use an option of the form `--var_name=value`. For example, `--sort_buffer_size=384M` sets the `sort_buffer_size` variable to a value of 384MB.

When you assign a value to a variable, MySQL might automatically correct the value to stay within a given range, or adjust the value to the closest permissible value if only certain values are permitted.

To restrict the maximum value to which a system variable can be set at runtime with the `SET` statement, specify this maximum by using an option of the form `--maximum-var_name=value` at server startup.

You can change the values of most system variables at runtime with the `SET` statement. See [Section 13.7.4.1, “SET Syntax for Variable Assignment”](#).

[Section 5.1.7, “Server System Variables”](#), provides a full description for all variables, and additional information for setting them at server startup and runtime. For information on changing system variables, see [Section 5.1.1, “Configuring the Server”](#).

- `--help, -?`

Command-Line Format	<code>--help</code>
---------------------	---------------------

Display a short help message and exit. Use both the `--verbose` and `--help` options to see the full message.

- `--allow-suspicious-udfs`

Command-Line Format	<code>--allow-suspicious-udfs[={OFF ON} ]</code>
Type	Boolean
Default Value	<code>OFF</code>

This option controls whether loadable functions that have only an `xxx` symbol for the main function can be loaded. By default, the option is off and only loadable functions that have at least one auxiliary symbol can be loaded; this prevents attempts at loading functions from shared object files other than those containing legitimate functions. See [Loadable Function Security Precautions](#).

- `--ansi`

Command-Line Format	<code>--ansi</code>
---------------------	---------------------

Use standard (ANSI) SQL syntax instead of MySQL syntax. For more precise control over the server SQL mode, use the `--sql-mode` option instead. See [Section 1.6, “MySQL Standards Compliance”](#), and [Section 5.1.10, “Server SQL Modes”](#).

- `--basedir=dir_name, -b dir_name`

Command-Line Format	<code>--basedir=dir_name</code>
System Variable	<code>basedir</code>
Scope	Global
Dynamic	No
Type	Directory name
Default Value	<code>configuration-dependent default</code>

The path to the MySQL installation directory. This option sets the `basedir` system variable.

- `--bootstrap`

Command-Line Format	<code>--bootstrap</code>
Deprecated	Yes

This option is used by the `mysql_install_db` program to create the MySQL privilege tables without having to start a full MySQL server.



#### Note

`mysql_install_db` is deprecated because its functionality has been integrated into `mysqld`, the MySQL server. Consequently, the `--bootstrap` server option that `mysql_install_db` passes to `mysqld` is also deprecated. To initialize a MySQL installation, invoke `mysqld` with the `--initialize` or `--initialize-insecure` option. For more information, see [Section 2.9.1, “Initializing the Data Directory”](#). Expect `mysql_install_db` and the `--bootstrap` server option to be removed in a future release of MySQL.

`--bootstrap` is mutually exclusive with `--daemonize`, `--initialize`, and `--initialize-insecure`.

Global transaction identifiers (GTIDs) are not disabled when `--bootstrap` is used. `--bootstrap` was used (Bug #20980271). See [Section 16.1.3, “Replication with Global Transaction Identifiers”](#).

When the server operates in bootstrap mode, some functionality is unavailable that limits the statements permitted in any file named by the `init_file` system variable. For more information, see the description of that variable. In addition, the `disabled_storage_engines` system variable has no effect.

- `--character-set-client-handshake`

Command-Line Format	<code>--character-set-client-handshake[={OFF ON}]</code>
Type	Boolean

Default Value	ON
---------------	----

Do not ignore character set information sent by the client. To ignore client information and use the default server character set, use `--skip-character-set-client-handshake`; this makes MySQL behave like MySQL 4.0.

- `--chroot=dir_name, -r dir_name`

Command-Line Format	<code>--chroot=dir_name</code>
Type	Directory name

Put the `mysqld` server in a closed environment during startup by using the `chroot()` system call. This is a recommended security measure. Use of this option somewhat limits `LOAD DATA` and `SELECT ... INTO OUTFILE`.

- `--console`

Command-Line Format	<code>--console</code>
Platform Specific	Windows

(Windows only.) Write the error log to `stderr` and `stdout` (the console). `mysqld` does not close the console window if this option is used.

`--console` takes precedence over `--log-error` if both are given. (In MySQL 5.5 and 5.6, this is reversed: `--log-error` takes precedence over `--console` if both are given.)

- `--core-file`

Command-Line Format	<code>--core-file</code>
---------------------	--------------------------

When this option is used, write a core file if `mysqld` dies; no arguments are needed (or accepted). The name and location of the core file is system dependent. On Linux, a core file named `core.pid` is written to the current working directory of the process, which for `mysqld` is the data directory. `pid` represents the process ID of the server process. On macOS, a core file named `core.pid` is written to the `/cores` directory. On Solaris, use the `coreadm` command to specify where to write the core file and how to name it.

For some systems, to get a core file you must also specify the `--core-file-size` option to `mysqld_safe`. See [Section 4.3.2, “mysqld\\_safe — MySQL Server Startup Script”](#). On some systems, such as Solaris, you do not get a core file if you are also using the `--user` option. There might be additional restrictions or limitations. For example, it might be necessary to execute `ulimit -c unlimited` before starting the server. Consult your system documentation.

- `--daemonize`

Command-Line Format	<code>--daemonize[={OFF ON}]</code>
Type	Boolean

Default Value	OFF
---------------	-----

This option causes the server to run as a traditional, forking daemon, permitting it to work with operating systems that use `systemd` for process control. For more information, see [Section 2.5.10, “Managing MySQL Server with `systemd`”](#).

`--daemonize` is mutually exclusive with `--bootstrap`, `--initialize`, and `--initialize-insecure`.

- `--datadir=dir_name, -h dir_name`

Command-Line Format	<code>--datadir=dir_name</code>
System Variable	<code>datadir</code>
Scope	Global
Dynamic	No
Type	Directory name

The path to the MySQL server data directory. This option sets the `datadir` system variable. See the description of that variable.

- `--debug[=debug_options], -# [debug_options]`

Command-Line Format	<code>--debug[=debug_options]</code>
System Variable	<code>debug</code>
Scope	Global, Session
Dynamic	Yes
Type	String
Default Value (Unix)	<code>d:t:i:o,/tmp/mysql.trace</code>
Default Value (Windows)	<code>d:t:i:0,\mysql.trace</code>

If MySQL is configured with the `-DWITH_DEBUG=1` CMake option, you can use this option to get a trace file of what `mysqld` is doing. A typical `debug_options` string is `d:t:o,file_name`. The default is `d:t:i:o,/tmp/mysql.trace` on Unix and `d:t:i:0,\mysql.trace` on Windows.

Using `-DWITH_DEBUG=1` to configure MySQL with debugging support enables you to use the `--debug="d,parser_debug"` option when you start the server. This causes the Bison parser that is used to process SQL statements to dump a parser trace to the server's standard error output. Typically, this output is written to the error log.

This option may be given multiple times. Values that begin with `+` or `-` are added to or subtracted from the previous value. For example, `--debug=T --debug=+P` sets the value to `P:T`.

For more information, see [Section 5.8.3, “The DBUG Package”](#).

- `--debug-sync-timeout[=N]`

Command-Line Format	<code>--debug-sync-timeout[=#]</code>
Type	Integer

Controls whether the Debug Sync facility for testing and debugging is enabled. Use of Debug Sync requires that MySQL be configured with the `-DWITH_DEBUG=ON` CMake option (see [Section 2.8.7,](#)

“MySQL Source-Configuration Options”). If Debug Sync is not compiled in, this option is not available. The option value is a timeout in seconds. The default value is 0, which disables Debug Sync. To enable it, specify a value greater than 0; this value also becomes the default timeout for individual synchronization points. If the option is given without a value, the timeout is set to 300 seconds.

For a description of the Debug Sync facility and how to use synchronization points, see [MySQL Internals: Test Synchronization](#).

- `--default-time-zone=timezone`

Command-Line Format	<code>--default-time-zone=name</code>
Type	String

Set the default server time zone. This option sets the global `time_zone` system variable. If this option is not given, the default time zone is the same as the system time zone (given by the value of the `system_time_zone` system variable).

The `system_time_zone` variable differs from `time_zone`. Although they might have the same value, the latter variable is used to initialize the time zone for each client that connects. See [Section 5.1.13, “MySQL Server Time Zone Support”](#).

- `--defaults-extra-file=file_name`

Read this option file after the global option file but (on Unix) before the user option file. If the file does not exist or is otherwise inaccessible, an error occurs. If `file_name` is not an absolute path name, it is interpreted relative to the current directory. This must be the first option on the command line if it is used.

For additional information about this and other option-file options, see [Section 4.2.2.3, “Command-Line Options that Affect Option-File Handling”](#).

- `--defaults-file=file_name`

Read only the given option file. If the file does not exist or is otherwise inaccessible, an error occurs. If `file_name` is not an absolute path name, it is interpreted relative to the current directory.



#### Note

This must be the first option on the command line if it is used, except that if the server is started with the `--defaults-file` and `--install` (or `--install-manual`) options, `--install` (or `--install-manual`) must be first.

For additional information about this and other option-file options, see [Section 4.2.2.3, “Command-Line Options that Affect Option-File Handling”](#).

- `--defaults-group-suffix=str`

Read not only the usual option groups, but also groups with the usual names and a suffix of `str`. For example, `mysqld` normally reads the `[mysqld]` group. If this option is given as `--defaults-group-suffix=_other`, `mysqld` also reads the `[mysqld_other]` group.

For additional information about this and other option-file options, see [Section 4.2.2.3, “Command-Line Options that Affect Option-File Handling”](#).

- `--des-key-file=file_name`

Command-Line Format	<code>--des-key-file=file_name</code>
---------------------	---------------------------------------

Deprecated	Yes
------------	-----

Read the default DES keys from this file. These keys are used by the `DES_ENCRYPT()` and `DES_DECRYPT()` functions.



#### Note

The `DES_ENCRYPT()` and `DES_DECRYPT()` functions are deprecated in MySQL 5.7, are removed in MySQL 8.0, and should no longer be used. Consequently, `--des-key-file` also is deprecated and is removed in MySQL 8.0.

- `--disable-partition-engine-check`

Command-Line Format	<code>--disable-partition-engine-check[={OFF ON}]</code>
Introduced	5.7.17
Deprecated	5.7.17
Type	Boolean
Default Value (≥ 5.7.21)	ON
Default Value (≥ 5.7.17, ≤ 5.7.20)	OFF

Whether to disable the startup check for tables with nonnative partitioning.

As of MySQL 5.7.17, the generic partitioning handler in the MySQL server is deprecated, and is removed in MySQL 8.0, when the storage engine used for a given table is expected to provide its own (“native”) partitioning handler. Currently, only the `InnoDB` and `NDB` storage engines do this.

Use of tables with nonnative partitioning results in an `ER_WARN_DEPRECATED_SYNTAX` warning. In MySQL 5.7.17 through 5.7.20, the server automatically performs a check at startup to identify tables that use nonnative partitioning; for any that are found, the server writes a message to its error log. To disable this check, use the `--disable-partition-engine-check` option. In MySQL 5.7.21 and later, this check is *not* performed; in these versions, you must start the server with `--disable-partition-engine-check=false`, if you wish for the server to check for tables using the generic partitioning handler (Bug #85830, Bug #25846957).

Use of tables with nonnative partitioning results in an `ER_WARN_DEPRECATED_SYNTAX` warning. Also, the server performs a check at startup to identify tables that use nonnative partitioning; for any found, the server writes a message to its error log. To disable this check, use the `--disable-partition-engine-check` option.

To prepare for migration to MySQL 8.0, any table with nonnative partitioning should be changed to use an engine that provides native partitioning, or be made nonpartitioned. For example, to change a table to `InnoDB`, execute this statement:

```
ALTER TABLE table_name ENGINE = INNODB;
```

- `--early-plugin-load=plugin_list`

Command-Line Format	<code>--early-plugin-load=plugin_list</code>
Introduced	5.7.11
Type	String
Default Value (≥ 5.7.12)	empty string

Default Value (5.7.11)	<code>keyring_file plugin library file name</code>
------------------------	--

This option tells the server which plugins to load before loading mandatory built-in plugins and before storage engine initialization. Early loading is supported only for plugins compiled with `PLUGIN_OPT_ALLOW_EARLY`. If multiple `--early-plugin-load` options are given, only the last one applies.

The option value is a semicolon-separated list of `plugin_library` and `name=plugin_library` values. Each `plugin_library` is the name of a library file that contains plugin code, and each `name` is the name of a plugin to load. If a plugin library is named without any preceding plugin name, the server loads all plugins in the library. With a preceding plugin name, the server loads only the named plugin from the library. The server looks for plugin library files in the directory named by the `plugin_dir` system variable.

For example, if plugins named `myplug1` and `myplug2` are contained in the plugin library files `myplug1.so` and `myplug2.so`, use this option to perform an early plugin load:

```
mysqld --early-plugin-load="myplug1=myplug1.so;myplug2=myplug2.so"
```

Quotes surround the argument value because otherwise some command interpreters interpret semicolon (`;`) as a special character. (For example, Unix shells treat it as a command terminator.)

Each named plugin is loaded early for a single invocation of `mysqld` only. After a restart, the plugin is not loaded early unless `--early-plugin-load` is used again.

If the server is started using `--initialize` or `--initialize-insecure`, plugins specified by `--early-plugin-load` are not loaded.

If the server is run with `--help`, plugins specified by `--early-plugin-load` are loaded but not initialized. This behavior ensures that plugin options are displayed in the help message.

`InnoDB` tablespace encryption relies on the MySQL Keyring for encryption key management, and the keyring plugin to be used must be loaded prior to storage engine initialization to facilitate `InnoDB` recovery for encrypted tables. For example, administrators who want the `keyring_file` plugin loaded at startup should use `--early-plugin-load` with the appropriate option value (such as `keyring_file.so` on Unix and Unix-like systems or `keyring_file.dll` on Windows).



### Important

In MySQL 5.7.11, the default `--early-plugin-load` value is the name of the `keyring_file` plugin library file, causing that plugin to be loaded by default. In MySQL 5.7.12 and higher, the default `--early-plugin-load` value is empty; to load the `keyring_file` plugin, you must explicitly specify the option with a value naming the `keyring_file` plugin library file.

This change of default `--early-plugin-load` value introduces an incompatibility for `InnoDB` tablespace encryption for upgrades from 5.7.11 to 5.7.12 or higher. Administrators who have encrypted `InnoDB` tablespaces must take explicit action to ensure continued loading of the keyring plugin: Start the server with an `--early-plugin-load` option that names the plugin library file. For additional information, see [Section 6.4.4.1, “Keyring Plugin Installation”](#).

For information about `InnoDB` tablespace encryption, see [Section 14.14, “InnoDB Data-at-Rest Encryption”](#). For general information about plugin loading, see [Section 5.5.1, “Installing and Uninstalling Plugins”](#).

- `--exit-info[=flags], -T [flags]`

Command-Line Format	<code>--exit-info[=<i>flags</i>]</code>
Type	Integer

This is a bitmask of different flags that you can use for debugging the `mysqld` server. Do not use this option unless you know *exactly* what it does!

- `--external-locking`

Command-Line Format	<code>--external-locking[={OFF ON}]</code>
Type	Boolean
Default Value	OFF

Enable external locking (system locking), which is disabled by default. If you use this option on a system on which `lockd` does not fully work (such as Linux), it is easy for `mysqld` to deadlock.

To disable external locking explicitly, use `--skip-external-locking`.

External locking affects only `MyISAM` table access. For more information, including conditions under which it can and cannot be used, see [Section 8.11.5, “External Locking”](#).

- `--flush`

Command-Line Format	<code>--flush[={OFF ON}]</code>
System Variable	<code>flush</code>
Scope	Global
Dynamic	Yes
Type	Boolean
Default Value	OFF

Flush (synchronize) all changes to disk after each SQL statement. Normally, MySQL does a write of all changes to disk only after each SQL statement and lets the operating system handle the synchronizing to disk. See [Section B.3.3.3, “What to Do If MySQL Keeps Crashing”](#).



#### Note

If `--flush` is specified, the value of `flush_time` does not matter and changes to `flush_time` have no effect on flush behavior.

- `--gdb`

Command-Line Format	<code>--gdb[={OFF ON}]</code>
Type	Boolean
Default Value	OFF

Install an interrupt handler for `SIGINT` (needed to stop `mysqld` with `^C` to set breakpoints) and disable stack tracing and core file handling. See [Section 5.8.1.4, “Debugging mysqld under gdb”](#).



- `--ignore-db-dir=dir_name`

Command-Line Format	<code>--ignore-db-dir=dir_name</code>
Deprecated	5.7.16
Type	Directory name

This option tells the server to ignore the given directory name for purposes of the `SHOW DATABASES` statement or `INFORMATION_SCHEMA` tables. For example, if a MySQL configuration locates the data directory at the root of a file system on Unix, the system might create a `lost+found` directory there that the server should ignore. Starting the server with `--ignore-db-dir=lost+found` causes that name not to be listed as a database.

To specify more than one name, use this option multiple times, once for each name. Specifying the option with an empty value (that is, as `--ignore-db-dir=`) resets the directory list to the empty list.

Instances of this option given at server startup are used to set the `ignore_db_dirs` system variable.

This option is deprecated in MySQL 5.7. With the introduction of the data dictionary in MySQL 8.0, it became superfluous and was removed in that version.

- `--initialize`

Command-Line Format	<code>--initialize[={OFF ON}]</code>
Type	Boolean
Default Value	OFF

This option is used to initialize a MySQL installation by creating the data directory and populating the tables in the `mysql` system database. For more information, see [Section 2.9.1, “Initializing the Data Directory”](#).

This option limits the effects of, or is not compatible with, a number of other startup options for the MySQL server. Some of the most common issues of this sort are noted here:

- We strongly recommend, when initializing the data directory with `--initialize`, that you specify no additional options other than `--datadir`, other options used for setting directory locations such as `--basedir`, and possibly `--user`, if required. Options for the running MySQL server can be specified when starting it once initialization has been completed and `mysqld` has shut down. This also applies when using `--initialize-insecure` instead of `--initialize`.
- When the server is started with `--initialize`, some functionality is unavailable that limits the statements permitted in any file named by the `init_file` system variable. For more information, see the description of that variable. In addition, the `disabled_storage_engines` system variable has no effect.
- The `--ndbcluster` option is ignored when used together with `--initialize`.
- `--initialize` is mutually exclusive with `--bootstrap` and `--daemonize`.

The items in the preceding list also apply when initializing the server using the `--initialize-insecure` option.

- `--initialize-insecure`

Command-Line Format	<code>--initialize-insecure[={OFF ON}]</code>
---------------------	---

Type	Boolean
Default Value	OFF

This option is used to initialize a MySQL installation by creating the data directory and populating the tables in the `mysql` system database. This option implies `--initialize`, and the same restrictions and limitations apply; for more information, see the description of that option, and [Section 2.9.1, “Initializing the Data Directory”](#).



**Warning**

This option creates a MySQL `root` user with an empty password, which is insecure. For this reason, do not use it in production without setting this password manually. See [Post-Initialization root Password Assignment](#), for information about how to do this.

- `--innodb-xxx`

Set an option for the `InnoDB` storage engine. The `InnoDB` options are listed in [Section 14.15, “InnoDB Startup Options and System Variables”](#).

- `--install [service_name]`

Command-Line Format	<code>--install [service_name]</code>
Platform Specific	Windows

(Windows only) Install the server as a Windows service that starts automatically during Windows startup. The default service name is `MySQL` if no `service_name` value is given. For more information, see [Section 2.3.4.8, “Starting MySQL as a Windows Service”](#).



**Note**

If the server is started with the `--defaults-file` and `--install` options, `--install` must be first.

- `--install-manual [service_name]`

Command-Line Format	<code>--install-manual [service_name]</code>
Platform Specific	Windows

(Windows only) Install the server as a Windows service that must be started manually. It does not start automatically during Windows startup. The default service name is `MySQL` if no `service_name` value is given. For more information, see [Section 2.3.4.8, “Starting MySQL as a Windows Service”](#).



**Note**

If the server is started with the `--defaults-file` and `--install-manual` options, `--install-manual` must be first.

- `--language=lang_name, -L lang_name`

Command-Line Format	<code>--language=name</code>
Deprecated	Yes; use <code>lc-messages-dir</code> instead
System Variable	<code>language</code>

Scope	Global
Dynamic	No
Type	Directory name
Default Value	<code>/usr/local/mysql/share/mysql/english/</code>

The language to use for error messages. `lang_name` can be given as the language name or as the full path name to the directory where the language files are installed. See [Section 10.12, “Setting the Error Message Language”](#).

`--lc-messages-dir` and `--lc-messages` should be used rather than `--language`, which is deprecated (and handled as a synonym for `--lc-messages-dir`). You should expect the `--language` option to be removed in a future release of MySQL.

- `--large-pages`

Command-Line Format	<code>--large-pages[={OFF ON}]</code>
System Variable	<code>large_pages</code>
Scope	Global
Dynamic	No
Platform Specific	Linux
Type	Boolean
Default Value	<code>OFF</code>

Some hardware/operating system architectures support memory pages greater than the default (usually 4KB). The actual implementation of this support depends on the underlying hardware and operating system. Applications that perform a lot of memory accesses may obtain performance improvements by using large pages due to reduced Translation Lookaside Buffer (TLB) misses.

MySQL supports the Linux implementation of large page support (which is called HugeTLB in Linux). See [Section 8.12.4.3, “Enabling Large Page Support”](#). For Solaris support of large pages, see the description of the `--super-large-pages` option.

`--large-pages` is disabled by default.

- `--lc-messages=locale_name`

Command-Line Format	<code>--lc-messages=name</code>
System Variable	<code>lc_messages</code>
Scope	Global, Session
Dynamic	Yes
Type	String
Default Value	<code>en_US</code>

The locale to use for error messages. The default is `en_US`. The server converts the argument to a language name and combines it with the value of `--lc-messages-dir` to produce the location for the error message file. See [Section 10.12, “Setting the Error Message Language”](#).

- `--lc-messages-dir=dir_name`

Command-Line Format	<code>--lc-messages-dir=dir_name</code>
System Variable	<code>lc_messages_dir</code>
Scope	Global
Dynamic	No
Type	Directory name

The directory where error messages are located. The server uses the value together with the value of `--lc-messages` to produce the location for the error message file. See [Section 10.12, “Setting the Error Message Language”](#).

- `--local-service`

Command-Line Format	<code>--local-service</code>
---------------------	------------------------------

(Windows only) A `--local-service` option following the service name causes the server to run using the `LocalService` Windows account that has limited system privileges. If both `--defaults-file` and `--local-service` are given following the service name, they can be in any order. See [Section 2.3.4.8, “Starting MySQL as a Windows Service”](#).

- `--log-error[=file_name]`

Command-Line Format	<code>--log-error[=file_name]</code>
System Variable	<code>log_error</code>
Scope	Global
Dynamic	No
Type	File name

Write the error log and startup messages to this file. See [Section 5.4.2, “The Error Log”](#).

If the option names no file, the error log file name on Unix and Unix-like systems is `host_name.err` in the data directory. The file name on Windows is the same, unless the `--pid-file` option is specified. In that case, the file name is the PID file base name with a suffix of `.err` in the data directory.

If the option names a file, the error log file has that name (with an `.err` suffix added if the name has no suffix), located under the data directory unless an absolute path name is given to specify a different location.

On Windows, `--console` takes precedence over `--log-error` if both are given. In this case, the server writes the error log to the console rather than to a file. (In MySQL 5.5 and 5.6, this is reversed: `--log-error` takes precedence over `--console` if both are given.)

- `--log-isam[=file_name]`

Command-Line Format	<code>--log-isam[=file_name]</code>
Type	File name

Log all [MyISAM](#) changes to this file (used only when debugging [MyISAM](#)).

- `--log-raw`

Command-Line Format	<code>--log-raw[={OFF ON} ]</code>
Type	Boolean
Default Value	<code>OFF</code>

Passwords in certain statements written to the general query log, slow query log, and binary log are rewritten by the server not to occur literally in plain text. Password rewriting can be suppressed for the general query log by starting the server with the `--log-raw` option. This option may be useful for diagnostic purposes, to see the exact text of statements as received by the server, but for security reasons is not recommended for production use.

If a query rewrite plugin is installed, the `--log-raw` option affects statement logging as follows:

- Without `--log-raw`, the server logs the statement returned by the query rewrite plugin. This may differ from the statement as received.
- With `--log-raw`, the server logs the original statement as received.

For more information, see [Section 6.1.2.3, “Passwords and Logging”](#).

- `--log-short-format`

Command-Line Format	<code>--log-short-format[={OFF ON} ]</code>
Type	Boolean
Default Value	<code>OFF</code>

Log less information to the slow query log, if it has been activated.

- `--log-tc=file_name`

Command-Line Format	<code>--log-tc=file_name</code>
Type	File name
Default Value	<code>tc.log</code>

The name of the memory-mapped transaction coordinator log file (for XA transactions that affect multiple storage engines when the binary log is disabled). The default name is `tc.log`. The file is created under the data directory if not given as a full path name. This option is unused.

- `--log-tc-size=size`

Command-Line Format	<code>--log-tc-size=#</code>
Type	Integer
Default Value (64-bit platforms, ≥ 5.7.21)	<code>6 * page size</code>
Default Value (64-bit platforms, ≤ 5.7.20)	<code>24576</code>
Default Value (32-bit platforms, ≥ 5.7.21)	<code>6 * page size</code>
Default Value (32-bit platforms, ≤ 5.7.20)	<code>24576</code>
Minimum Value	<code>6 * page size</code>
Maximum Value (64-bit platforms)	<code>18446744073709551615</code>
Maximum Value (32-bit platforms)	<code>4294967295</code>

The size in bytes of the memory-mapped transaction coordinator log. The default and minimum values are 6 times the page size, and the value must be a multiple of the page size. (Before MySQL 5.7.21, the default size is 24KB.)

- `--log-warnings[=level], -W [level]`

Command-Line Format	<code>--log-warnings[=#]</code>
Deprecated	Yes
System Variable	<code>log_warnings</code>
Scope	Global
Dynamic	Yes
Type	Integer
Default Value	2
Minimum Value	0
Maximum Value (64-bit platforms)	18446744073709551615
Maximum Value (32-bit platforms)	4294967295



#### Note

The `log_error_verbosity` system variable is preferred over, and should be used instead of, the `--log-warnings` option or `log_warnings` system variable. For more information, see the descriptions of `log_error_verbosity` and `log_warnings`. The `--log-warnings` command-line option and `log_warnings` system variable are deprecated; expect them to be removed in a future release of MySQL.

Whether to produce additional warning messages to the error log. This option is enabled by default. To disable it, use `--log-warnings=0`. Specifying the option without a *level* value increments the current value by 1. The server logs messages about statements that are unsafe for statement-based logging if the value is greater than 0. Aborted connections and access-denied errors for new connection attempts are logged if the value is greater than 1. See [Section B.3.2.9, “Communication Errors and Aborted Connections”](#).

- `--memlock`

Command-Line Format	<code>--memlock[={OFF ON}]</code>
Type	Boolean
Default Value	OFF

Lock the `mysqld` process in memory. This option might help if you have a problem where the operating system is causing `mysqld` to swap to disk.

`--memlock` works on systems that support the `mlockall()` system call; this includes Solaris, most Linux distributions that use a 2.4 or higher kernel, and perhaps other Unix systems. On Linux systems,

you can tell whether or not `mlockall()` (and thus this option) is supported by checking to see whether or not it is defined in the system `mman.h` file, like this:

```
$> grep mlockall /usr/include/sys/mman.h
```

If `mlockall()` is supported, you should see in the output of the previous command something like the following:

```
extern int mlockall (int __flags) __THROW;
```



### Important

Use of this option may require you to run the server as `root`, which, for reasons of security, is normally not a good idea. See [Section 6.1.5, “How to Run MySQL as a Normal User”](#).

On Linux and perhaps other systems, you can avoid the need to run the server as `root` by changing the `limits.conf` file. See the notes regarding the `memlock` limit in [Section 8.12.4.3, “Enabling Large Page Support”](#).

You must not use this option on a system that does not support the `mlockall()` system call; if you do so, `mysqld` is very likely to exit as soon as you try to start it.

- `--myisam-block-size=N`

Command-Line Format	<code>--myisam-block-size=#</code>
Type	Integer
Default Value	1024
Minimum Value	1024
Maximum Value	16384

The block size to be used for `MyISAM` index pages.

- `--no-defaults`

Do not read any option files. If program startup fails due to reading unknown options from an option file, `--no-defaults` can be used to prevent them from being read. This must be the first option on the command line if it is used.

For additional information about this and other option-file options, see [Section 4.2.2.3, “Command-Line Options that Affect Option-File Handling”](#).

- `--old-style-user-limits`

Command-Line Format	<code>--old-style-user-limits[={OFF ON}]</code>
Type	Boolean
Default Value	OFF

Enable old-style user limits. (Before MySQL 5.0.3, account resource limits were counted separately for each host from which a user connected rather than per account row in the `user` table.) See [Section 6.2.16, “Setting Account Resource Limits”](#).

- `--partition[=value]`

Command-Line Format	<code>--partition[={OFF ON}]</code>
Deprecated	5.7.16
Disabled by	<code>skip-partition</code>
Type	Boolean
Default Value	ON

Enables or disables user-defined partitioning support in the MySQL Server.

This option is deprecated in MySQL 5.7.16, and is removed from MySQL 8.0 because in MySQL 8.0, the partitioning engine is replaced by native partitioning, which cannot be disabled.

- `--performance-schema-xxx`

Configure a Performance Schema option. For details, see [Section 25.14, “Performance Schema Command Options”](#).

- `--plugin-load=plugin_list`

Command-Line Format	<code>--plugin-load=plugin_list</code>
Type	String

This option tells the server to load the named plugins at startup. If multiple `--plugin-load` options are given, only the last one applies. Additional plugins to load may be specified using `--plugin-load-add` options.

The option value is a semicolon-separated list of `plugin_library` and `name=plugin_library` values. Each `plugin_library` is the name of a library file that contains plugin code, and each `name` is the name of a plugin to load. If a plugin library is named without any preceding plugin name, the server loads all plugins in the library. With a preceding plugin name, the server loads only the named plugin from the library. The server looks for plugin library files in the directory named by the `plugin_dir` system variable.

For example, if plugins named `myplug1` and `myplug2` are contained in the plugin library files `myplug1.so` and `myplug2.so`, use this option to perform an early plugin load:

```
mysqld --plugin-load="myplug1=myplug1.so;myplug2=myplug2.so"
```

Quotes surround the argument value because otherwise some command interpreters interpret semicolon (`;`) as a special character. (For example, Unix shells treat it as a command terminator.)

Each named plugin is loaded for a single invocation of `mysqld` only. After a restart, the plugin is not loaded unless `--plugin-load` is used again. This is in contrast to `INSTALL PLUGIN`, which adds an entry to the `mysql.plugins` table to cause the plugin to be loaded for every normal server startup.

During the normal startup sequence, the server determines which plugins to load by reading the `mysql.plugins` system table. If the server is started with the `--skip-grant-tables` option, plugins registered in the `mysql.plugins` table are not loaded and are unavailable. `--plugin-load` enables



plugins to be loaded even when `--skip-grant-tables` is given. `--plugin-load` also enables plugins to be loaded at startup that cannot be loaded at runtime.

This option does not set a corresponding system variable. The output of `SHOW PLUGINS` provides information about loaded plugins. More detailed information can be found in the Information Schema `PLUGINS` table. See [Section 5.5.2, “Obtaining Server Plugin Information”](#).

For additional information about plugin loading, see [Section 5.5.1, “Installing and Uninstalling Plugins”](#).

- `--plugin-load-add=plugin_list`

Command-Line Format	<code>--plugin-load-add=plugin_list</code>
Type	String

This option complements the `--plugin-load` option. `--plugin-load-add` adds a plugin or plugins to the set of plugins to be loaded at startup. The argument format is the same as for `--plugin-load`. `--plugin-load-add` can be used to avoid specifying a large set of plugins as a single long unwieldy `--plugin-load` argument.

`--plugin-load-add` can be given in the absence of `--plugin-load`, but any instance of `--plugin-load-add` that appears before `--plugin-load` has no effect because `--plugin-load` resets the set of plugins to load. In other words, these options:

```
--plugin-load=x --plugin-load-add=y
```

are equivalent to this option:

```
--plugin-load="x/y"
```

But these options:

```
--plugin-load-add=y --plugin-load=x
```

are equivalent to this option:

```
--plugin-load=x
```

This option does not set a corresponding system variable. The output of `SHOW PLUGINS` provides information about loaded plugins. More detailed information can be found in the Information Schema `PLUGINS` table. See [Section 5.5.2, “Obtaining Server Plugin Information”](#).

For additional information about plugin loading, see [Section 5.5.1, “Installing and Uninstalling Plugins”](#).

- `--plugin-xxx`

Specifies an option that pertains to a server plugin. For example, many storage engines can be built as plugins, and for such engines, options for them can be specified with a `--plugin` prefix. Thus, the `--innodb-file-per-table` option for InnoDB can be specified as `--plugin-innodb-file-per-table`.

For boolean options that can be enabled or disabled, the `--skip` prefix and other alternative formats are supported as well (see [Section 4.2.2.4, “Program Option Modifiers”](#)). For example, `--skip-plugin-innodb-file-per-table` disables `innodb-file-per-table`.

The rationale for the `--plugin` prefix is that it enables plugin options to be specified unambiguously if there is a name conflict with a built-in server option. For example, were a plugin writer to name a plugin “sql” and implement a “mode” option, the option name might be `--sql-mode`, which would conflict with

the built-in option of the same name. In such cases, references to the conflicting name are resolved in favor of the built-in option. To avoid the ambiguity, users can specify the plugin option as `--plugin-sql-mode`. Use of the `--plugin` prefix for plugin options is recommended to avoid any question of ambiguity.

- `--port=port_num, -P port_num`

Command-Line Format	<code>--port=port_num</code>
System Variable	<code>port</code>
Scope	Global
Dynamic	No
Type	Integer
Default Value	3306
Minimum Value	0
Maximum Value	65535

The port number to use when listening for TCP/IP connections. On Unix and Unix-like systems, the port number must be 1024 or higher unless the server is started by the `root` operating system user. Setting this option to 0 causes the default value to be used.

- `--port-open-timeout=num`

Command-Line Format	<code>--port-open-timeout=#</code>
Type	Integer
Default Value	0

On some systems, when the server is stopped, the TCP/IP port might not become available immediately. If the server is restarted quickly afterward, its attempt to reopen the port can fail. This option indicates how many seconds the server should wait for the TCP/IP port to become free if it cannot be opened. The default is not to wait.

- `--print-defaults`

Print the program name and all options that it gets from option files. Password values are masked. This must be the first option on the command line if it is used, except that it may be used immediately after `--defaults-file` or `--defaults-extra-file`.

For additional information about this and other option-file options, see [Section 4.2.2.3, “Command-Line Options that Affect Option-File Handling”](#).

- `--remove [service_name]`

Command-Line Format	<code>--remove [service_name]</code>
Platform Specific	Windows

(Windows only) Remove a MySQL Windows service. The default service name is `MySQL` if no `service_name` value is given. For more information, see [Section 2.3.4.8, “Starting MySQL as a Windows Service”](#).

- `--safe-user-create`

Command-Line Format	<code>--safe-user-create[={OFF ON}]</code>
Type	Boolean
Default Value	<code>OFF</code>

If this option is enabled, a user cannot create new MySQL users by using the `GRANT` statement unless the user has the `INSERT` privilege for the `mysql.user` system table or any column in the table. If you want a user to have the ability to create new users that have those privileges that the user has the right to grant, you should grant the user the following privilege:

```
GRANT INSERT(user) ON mysql.user TO 'user_name'@'host_name';
```

This ensures that the user cannot change any privilege columns directly, but has to use the `GRANT` statement to give privileges to other users.

- `--skip-grant-tables`

Command-Line Format	<code>--skip-grant-tables[={OFF ON}]</code>
Type	Boolean

Default Value	OFF
---------------	-----

This option affects the server startup sequence:

- `--skip-grant-tables` causes the server not to read the grant tables in the `mysql` system database, and thus to start without using the privilege system at all. This gives anyone with access to the server *unrestricted access to all databases*.

To cause a server started with `--skip-grant-tables` to load the grant tables at runtime, perform a privilege-flushing operation, which can be done in these ways:

- Issue a MySQL `FLUSH PRIVILEGES` statement after connecting to the server.
- Execute a `mysqladmin flush-privileges` or `mysqladmin reload` command from the command line.

Privilege flushing might also occur implicitly as a result of other actions performed after startup, thus causing the server to start using the grant tables. For example, `mysql_upgrade` flushes the privileges during the upgrade procedure.

- `--skip-grant-tables` causes the server not to load certain other objects registered in the `mysql` system database:

- Plugins installed using `INSTALL PLUGIN` and registered in the `mysql.plugin` system table.

To cause plugins to be loaded even when using `--skip-grant-tables`, use the `--plugin-load` or `--plugin-load-add` option.

- Scheduled events installed using `CREATE EVENT` and registered in the `mysql.event` system table.
- Loadable functions installed using `CREATE FUNCTION` and registered in the `mysql.func` system table.
- `--skip-grant-tables` causes the `disabled_storage_engines` system variable to have no effect.

- `--skip-host-cache`

Command-Line Format	<code>--skip-host-cache</code>
---------------------	--------------------------------

Disable use of the internal host cache for faster name-to-IP resolution. With the cache disabled, the server performs a DNS lookup every time a client connects.

Use of `--skip-host-cache` is similar to setting the `host_cache_size` system variable to 0, but `host_cache_size` is more flexible because it can also be used to resize, enable, or disable the host cache at runtime, not just at server startup.

Starting the server with `--skip-host-cache` does not prevent runtime changes to the value of `host_cache_size`, but such changes have no effect and the cache is not re-enabled even if `host_cache_size` is set larger than 0.

For more information about how the host cache works, see [Section 5.1.11.2, “DNS Lookups and the Host Cache”](#).

- `--skip-innodb`

Disable the `InnoDB` storage engine. In this case, because the default storage engine is `InnoDB`, the server cannot start unless you also use `--default-storage-engine` and `--default-tmp-storage-engine` to set the default to some other engine for both permanent and `TEMPORARY` tables.

The `InnoDB` storage engine cannot be disabled, and the `--skip-innodb` option is deprecated and has no effect. Its use results in a warning. Expect this option to be removed in a future release of MySQL.

- `--skip-new`

Command-Line Format	<code>--skip-new</code>
---------------------	-------------------------

This option disables (what used to be considered) new, possibly unsafe behaviors. It results in these settings: `delay_key_write=OFF`, `concurrent_insert=NEVER`, `automatic_sp_privileges=OFF`. It also causes `OPTIMIZE TABLE` to be mapped to `ALTER TABLE` for storage engines for which `OPTIMIZE TABLE` is not supported.

- `--skip-partition`

Command-Line Format	<code>--skip-partition</code> <code>--disable-partition</code>
Deprecated	5.7.16

Disables user-defined partitioning. Partitioned tables can be seen using `SHOW TABLES` or by querying the Information Schema `TABLES` table, but cannot be created or modified, nor can data in such tables be accessed. All partition-specific columns in the Information Schema `PARTITIONS` table display `NULL`.

Since `DROP TABLE` removes table definition (`.frm`) files, this statement works on partitioned tables even when partitioning is disabled using the option. The statement, however, does not remove partition definitions associated with partitioned tables in such cases. For this reason, you should avoid dropping partitioned tables with partitioning disabled, or take action to remove orphaned `.par` files manually (if present).



**Note**

In MySQL 5.7, partition definition (`.par`) files are no longer created for partitioned `InnoDB` tables. Instead, partition definitions are stored in the `InnoDB` internal data dictionary. Partition definition (`.par`) files continue to be used for partitioned `MyISAM` tables.

This option is deprecated in MySQL 5.7.16, and is removed from MySQL 8.0 because in MySQL 8.0, the partitioning engine is replaced by native partitioning, which cannot be disabled.

- `--skip-show-database`

Command-Line Format	<code>--skip-show-database</code>
System Variable	<code>skip_show_database</code>
Scope	Global
Dynamic	No
Type	Boolean

Default Value	OFF
---------------	-----

This option sets the `skip_show_database` system variable that controls who is permitted to use the `SHOW DATABASES` statement. See [Section 5.1.7, “Server System Variables”](#).

- `--skip-stack-trace`

Command-Line Format	<code>--skip-stack-trace</code>
---------------------	---------------------------------

Do not write stack traces. This option is useful when you are running `mysqld` under a debugger. On some systems, you also must use this option to get a core file. See [Section 5.8, “Debugging MySQL”](#).

- `--slow-start-timeout=timeout`

Command-Line Format	<code>--slow-start-timeout=#</code>
Type	Integer
Default Value	15000

This option controls the Windows service control manager's service start timeout. The value is the maximum number of milliseconds that the service control manager waits before trying to kill the windows service during startup. The default value is 15000 (15 seconds). If the MySQL service takes too long to start, you may need to increase this value. A value of 0 means there is no timeout.

- `--socket=path`

Command-Line Format	<code>--socket={file_name pipe_name}</code>
System Variable	<code>socket</code>
Scope	Global
Dynamic	No
Type	String
Default Value (Windows)	MySQL
Default Value (Other)	<code>/tmp/mysql.sock</code>

On Unix, this option specifies the Unix socket file to use when listening for local connections. The default value is `/tmp/mysql.sock`. If this option is given, the server creates the file in the data directory unless an absolute path name is given to specify a different directory. On Windows, the option specifies the pipe name to use when listening for local connections that use a named pipe. The default value is `MySQL` (not case-sensitive).

- `--sql-mode=value[,value[,value...]]`

Command-Line Format	<code>--sql-mode=name</code>
System Variable	<code>sql_mode</code>
Scope	Global, Session
Dynamic	Yes
Type	Set
Default Value	<code>ONLY_FULL_GROUP_BY STRICT_TRANS_TABLES NO_ZERO_IN_DATE NO_ZERO_DATE ERROR_FOR_DIVISION_BY_ZERO</code>

	NO_AUTO_CREATE_USER NO_ENGINE_SUBSTITUTION
Valid Values	ALLOW_INVALID_DATES ANSI_QUOTES ERROR_FOR_DIVISION_BY_ZERO HIGH_NOT_PRECEDENCE IGNORE_SPACE NO_AUTO_CREATE_USER NO_AUTO_VALUE_ON_ZERO NO_BACKSLASH_ESCAPES NO_DIR_IN_CREATE NO_ENGINE_SUBSTITUTION NO_FIELD_OPTIONS NO_KEY_OPTIONS NO_TABLE_OPTIONS NO_UNSIGNED_SUBTRACTION NO_ZERO_DATE NO_ZERO_IN_DATE ONLY_FULL_GROUP_BY PAD_CHAR_TO_FULL_LENGTH PIPES_AS_CONCAT REAL_AS_FLOAT STRICT_ALL_TABLES STRICT_TRANS_TABLES

Set the SQL mode. See [Section 5.1.10, “Server SQL Modes”](#).



**Note**

MySQL installation programs may configure the SQL mode during the installation process. If the SQL mode differs from the default or from what you expect, check for a setting in an option file that the server reads at startup.

- `--ssl, --skip-ssl`

Command-Line Format	<code>--ssl[={OFF ON}]</code>
---------------------	-------------------------------

Disabled by	<code>skip-ssl</code>
Type	Boolean
Default Value	ON

The `--ssl` option specifies that the server permits but does not require encrypted connections. This option is enabled by default.

`--ssl` can be specified in negated form as `--skip-ssl` or a synonym (`--ssl=OFF`, `--disable-ssl`). In this case, the option specifies that the server does *not* permit encrypted connections, regardless of the settings of the `tls_xxx` and `ssl_xxx` system variables.

For more information about configuring whether the server permits clients to connect using SSL and indicating where to find SSL keys and certificates, see [Section 6.3.1, “Configuring MySQL to Use Encrypted Connections”](#), which also describes server capabilities for certificate and key file autogeneration and autodiscovery. Consider setting at least the `ssl_cert` and `ssl_key` system variables on the server side and the `--ssl-ca` (or `--ssl-capath`) option on the client side.

- `--standalone`

Command-Line Format	<code>--standalone</code>
Platform Specific	Windows

Available on Windows only; instructs the MySQL server not to run as a service.

- `--super-large-pages`

Command-Line Format	<code>--super-large-pages[={OFF ON}]</code>
Platform Specific	Solaris
Type	Boolean
Default Value	OFF

Standard use of large pages in MySQL attempts to use the largest size supported, up to 4MB. Under Solaris, a “super large pages” feature enables uses of pages up to 256MB. This feature is available for recent SPARC platforms. It can be enabled or disabled by using the `--super-large-pages` or `--skip-super-large-pages` option.

- `--symbolic-links`, `--skip-symbolic-links`

Command-Line Format	<code>--symbolic-links[={OFF ON}]</code>
Type	Boolean
Default Value	ON

Enable or disable symbolic link support. On Unix, enabling symbolic links means that you can link a [MyISAM](#) index file or data file to another directory with the `INDEX DIRECTORY` or `DATA DIRECTORY` option of the `CREATE TABLE` statement. If you delete or rename the table, the files that its symbolic links point to also are deleted or renamed. See [Section 8.12.3.2, “Using Symbolic Links for MyISAM Tables on Unix”](#).

This option has no meaning on Windows.



- `--sysdate-is-now`

Command-Line Format	<code>--sysdate-is-now[={OFF ON}]</code>
Type	Boolean
Default Value	OFF

`SYSDATE()` by default returns the time at which it executes, not the time at which the statement in which it occurs begins executing. This differs from the behavior of `NOW()`. This option causes `SYSDATE()` to be a synonym for `NOW()`. For information about the implications for binary logging and replication, see the description for `SYSDATE()` in Section 12.7, “Date and Time Functions” and for `SET TIMESTAMP` in Section 5.1.7, “Server System Variables”.

- `--tc-heuristic-recover={COMMIT|ROLLBACK}`

Command-Line Format	<code>--tc-heuristic-recover=name</code>
Type	Enumeration
Default Value	OFF
Valid Values	OFF COMMIT ROLLBACK

The decision to use in a manual heuristic recovery.

If a `--tc-heuristic-recover` option is specified, the server exits regardless of whether manual heuristic recovery is successful.

On systems with more than one storage engine capable of two-phase commit, the `ROLLBACK` option is not safe and causes recovery to halt with the following error:

```
[ERROR] --tc-heuristic-recover rollback
strategy is not safe on systems with more than one 2-phase-commit-capable
storage engine. Aborting crash recovery.
```

- `--temp-pool`

Command-Line Format	<code>--temp-pool[={OFF ON}]</code>
Deprecated	5.7.18
Type	Boolean
Default Value (Linux)	ON
Default Value (Other)	OFF

This option is ignored except on Linux. On Linux, it causes most temporary files created by the server to use a small set of names, rather than a unique name for each new file. This works around a problem in the Linux kernel dealing with creating many new files with different names. With the old behavior, Linux seems to “leak” memory, because it is being allocated to the directory entry cache rather than to the disk cache.

As of MySQL 5.7.18, this option is deprecated and is removed in MySQL 8.0.

- `--transaction-isolation=level`

Command-Line Format	<code>--transaction-isolation=name</code>
System Variable (≥ 5.7.20)	<code>transaction_isolation</code>
Scope (≥ 5.7.20)	Global, Session
Dynamic (≥ 5.7.20)	Yes
Type	Enumeration
Default Value	<code>REPEATABLE-READ</code>
Valid Values	<code>READ-UNCOMMITTED</code>  <code>READ-COMMITTED</code>  <code>REPEATABLE-READ</code>  <code>SERIALIZABLE</code>

Sets the default transaction isolation level. The `level` value can be `READ-UNCOMMITTED`, `READ-COMMITTED`, `REPEATABLE-READ`, or `SERIALIZABLE`. See [Section 13.3.6, “SET TRANSACTION Statement”](#).

The default transaction isolation level can also be set at runtime using the `SET TRANSACTION` statement or by setting the `tx_isolation` (or, as of MySQL 5.7.20, `transaction_isolation`) system variable.

- `--transaction-read-only`

Command-Line Format	<code>--transaction-read-only[={OFF ON}]</code>
System Variable (≥ 5.7.20)	<code>transaction_read_only</code>
Scope (≥ 5.7.20)	Global, Session
Dynamic (≥ 5.7.20)	Yes
Type	Boolean
Default Value	<code>OFF</code>

Sets the default transaction access mode. By default, read-only mode is disabled, so the mode is read/write.

To set the default transaction access mode at runtime, use the `SET TRANSACTION` statement or set the `tx_read_only` (or, as of MySQL 5.7.20, `transaction_read_only`) system variable. See [Section 13.3.6, “SET TRANSACTION Statement”](#).

- `--tmpdir=dir_name, -t dir_name`

Command-Line Format	<code>--tmpdir=dir_name</code>
System Variable	<code>tmpdir</code>
Scope	Global
Dynamic	No

Type	Directory name
------	----------------

The path of the directory to use for creating temporary files. It might be useful if your default `/tmp` directory resides on a partition that is too small to hold temporary tables. This option accepts several paths that are used in round-robin fashion. Paths should be separated by colon characters (`:`) on Unix and semicolon characters (`;`) on Windows.

`--tmpdir` can be a non-permanent location, such as a directory on a memory-based file system or a directory that is cleared when the server host restarts. If the MySQL server is acting as a replica, and you are using a non-permanent location for `--tmpdir`, consider setting a different temporary directory for the replica using the `slave_load_tmpdir` system variable. For a replication replica, the temporary files used to replicate `LOAD DATA` statements are stored in this directory, so with a permanent location they can survive machine restarts, although replication can now continue after a restart if the temporary files have been removed.

For more information about the storage location of temporary files, see [Section B.3.3.5, “Where MySQL Stores Temporary Files”](#).

- `--user={user_name|user_id}, -u {user_name|user_id}`

Command-Line Format	<code>--user=name</code>
Type	String

Run the `mysqld` server as the user having the name `user_name` or the numeric user ID `user_id`. (“User” in this context refers to a system login account, not a MySQL user listed in the grant tables.)

This option is *mandatory* when starting `mysqld` as `root`. The server changes its user ID during its startup sequence, causing it to run as that particular user rather than as `root`. See [Section 6.1.1, “Security Guidelines”](#).

To avoid a possible security hole where a user adds a `--user=root` option to a `my.cnf` file (thus causing the server to run as `root`), `mysqld` uses only the first `--user` option specified and produces a warning if there are multiple `--user` options. Options in `/etc/my.cnf` and `$MYSQL_HOME/my.cnf` are processed before command-line options, so it is recommended that you put a `--user` option in `/etc/my.cnf` and specify a value other than `root`. The option in `/etc/my.cnf` is found before any other `--user` options, which ensures that the server runs as a user other than `root`, and that a warning results if any other `--user` option is found.

- `--validate-user-plugins[={OFF|ON}]`

Command-Line Format	<code>--validate-user-plugins[={OFF ON}]</code>
Type	Boolean

Default Value	ON
---------------	----

If this option is enabled (the default), the server checks each user account and produces a warning if conditions are found that would make the account unusable:

- The account requires an authentication plugin that is not loaded.
- The account requires the `sha256_password` authentication plugin but the server was started with neither SSL nor RSA enabled as required by this plugin.

Enabling `--validate-user-plugins` slows down server initialization and `FLUSH PRIVILEGES`. If you do not require the additional checking, you can disable this option at startup to avoid the performance decrement.

- `--verbose, -v`

Use this option with the `--help` option for detailed help.

- `--version, -V`

Display version information and exit.

## 5.1.7 Server System Variables

The MySQL server maintains many system variables that affect its operation. Most system variables can be set at server startup using options on the command line or in an option file. Most of them can be changed dynamically at runtime using the `SET` statement, which enables you to modify operation of the server without having to stop and restart it. Some variables are read-only, and their values are determined by the system environment, by how MySQL is installed on the system, or possibly by the options used to compile MySQL. Most system variables have a default value, but there are exceptions, including read-only variables. You can also use system variable values in expressions.

At runtime, setting a global system variable value requires the `SUPER` privilege. Setting a session system variable value normally requires no special privileges and can be done by any user, although there are exceptions. For more information, see [Section 5.1.8.1, “System Variable Privileges”](#)

There are several ways to see the names and values of system variables:

- To see the values that a server uses based on its compiled-in defaults and any option files that it reads, use this command:

```
mysqld --verbose --help
```

- To see the values that a server uses based on only its compiled-in defaults, ignoring the settings in any option files, use this command:

```
mysqld --no-defaults --verbose --help
```

- To see the current values used by a running server, use the `SHOW VARIABLES` statement or the Performance Schema system variable tables. See [Section 25.12.13, “Performance Schema System Variable Tables”](#).

This section provides a description of each system variable. For a system variable summary table, see [Section 5.1.4, “Server System Variable Reference”](#). For more information about manipulation of system variables, see [Section 5.1.8, “Using System Variables”](#).

For additional system variable information, see these sections:

- [Section 5.1.8, “Using System Variables”](#), discusses the syntax for setting and displaying system variable values.
- [Section 5.1.8.2, “Dynamic System Variables”](#), lists the variables that can be set at runtime.
- Information on tuning system variables can be found in [Section 5.1.1, “Configuring the Server”](#).
- [Section 14.15, “InnoDB Startup Options and System Variables”](#), lists `InnoDB` system variables.
- [NDB Cluster System Variables](#), lists system variables which are specific to NDB Cluster.
- For information on server system variables specific to replication, see [Section 16.1.6, “Replication and Binary Logging Options and Variables”](#).

**Note**

Some of the following variable descriptions refer to “enabling” or “disabling” a variable. These variables can be enabled with the `SET` statement by setting them to `ON` or `1`, or disabled by setting them to `OFF` or `0`. Boolean variables can be set at startup to the values `ON`, `TRUE`, `OFF`, and `FALSE` (not case-sensitive), as well as `1` and `0`. See [Section 4.2.2.4, “Program Option Modifiers”](#).

Some system variables control the size of buffers or caches. For a given buffer, the server might need to allocate internal data structures. These structures typically are allocated from the total memory allocated to the buffer, and the amount of space required might be platform dependent. This means that when you assign a value to a system variable that controls a buffer size, the amount of space actually available might differ from the value assigned. In some cases, the amount might be less than the value assigned. It is also possible for the server to adjust a value upward. For example, if you assign a value of 0 to a variable for which the minimal value is 1024, the server sets the value to 1024.

Values for buffer sizes, lengths, and stack sizes are given in bytes unless otherwise specified.

**Note**

Some system variable descriptions include a block size, in which case a value that is not an integer multiple of the stated block size is rounded down to the next lower multiple of the block size before being stored by the server, that is to `FLOOR(value) * block_size`.

*Example:* Suppose that the block size for a given variable is given as 4096, and you set the value of the variable to 100000 (we assume that the variable's maximum value is greater than this number). Since  $100000 / 4096 = 24.4140625$ , the server automatically lowers the value to 98304 ( $24 * 4096$ ) before storing it.

In some cases, the stated maximum for a variable is the maximum allowed by the MySQL parser, but is not an exact multiple of the block size. In such cases, the effective maximum is the next lower multiple of the block size.

*Example:* A system variable's maximum value is shown as  $4294967295 (2^{32}-1)$ , and its block size is 1024.  $4294967295 / 1024 = 4194303.9990234375$ , so if you set this variable to its stated maximum, the value actually stored is  $4194303 * 1024 = 4294966272$ .

Some system variables take file name values. Unless otherwise specified, the default file location is the data directory if the value is a relative path name. To specify the location explicitly, use an absolute path name. Suppose that the data directory is `/var/mysql/data`. If a file-valued variable is given as a relative path name, it is located under `/var/mysql/data`. If the value is an absolute path name, its location is as given by the path name.

- `authentication_windows_log_level`

Command-Line Format	<code>--authentication-windows-log-level=#</code>
System Variable	<code>authentication_windows_log_level</code>
Scope	Global
Dynamic	No
Type	Integer
Default Value	2
Minimum Value	0
Maximum Value	4

This variable is available only if the `authentication_windows` Windows authentication plugin is enabled and debugging code is enabled. See [Section 6.4.1.8, “Windows Pluggable Authentication”](#).

This variable sets the logging level for the Windows authentication plugin. The following table shows the permitted values.

Value	Description
0	No logging
1	Log only error messages
2	Log level 1 messages and warning messages
3	Log level 2 messages and information notes
4	Log level 3 messages and debug messages

- `authentication_windows_use_principal_name`

Command-Line Format	<code>--authentication-windows-use-principal-name[={OFF ON}]</code>
System Variable	<code>authentication_windows_use_principal_name</code>
Scope	Global
Dynamic	No
Type	Boolean
Default Value	ON

This variable is available only if the `authentication_windows` Windows authentication plugin is enabled. See [Section 6.4.1.8, “Windows Pluggable Authentication”](#).

A client that authenticates using the `InitSecurityContext()` function should provide a string identifying the service to which it connects (*targetName*). MySQL uses the principal name (UPN) of the account under which the server is running. The UPN has the form `user_id@computer_name` and need not be registered anywhere to be used. This UPN is sent by the server at the beginning of authentication handshake.

This variable controls whether the server sends the UPN in the initial challenge. By default, the variable is enabled. For security reasons, it can be disabled to avoid sending the server's account name to a

client as cleartext. If the variable is disabled, the server always sends a `0x00` byte in the first challenge, the client does not specify `targetName`, and as a result, NTLM authentication is used.

If the server fails to obtain its UPN (which happens primarily in environments that do not support Kerberos authentication), the UPN is not sent by the server and NTLM authentication is used.

- `autocommit`

Command-Line Format	<code>--autocommit[={OFF ON}]</code>
System Variable	<code>autocommit</code>
Scope	Global, Session
Dynamic	Yes
Type	Boolean
Default Value	<code>ON</code>

The `autocommit` mode. If set to 1, all changes to a table take effect immediately. If set to 0, you must use `COMMIT` to accept a transaction or `ROLLBACK` to cancel it. If `autocommit` is 0 and you change it to 1, MySQL performs an automatic `COMMIT` of any open transaction. Another way to begin a transaction is to use a `START TRANSACTION` or `BEGIN` statement. See [Section 13.3.1, “START TRANSACTION, COMMIT, and ROLLBACK Statements”](#).

By default, client connections begin with `autocommit` set to 1. To cause clients to begin with a default of 0, set the global `autocommit` value by starting the server with the `--autocommit=0` option. To set the variable using an option file, include these lines:

```
[mysqld]
autocommit=0
```

- `automatic_sp_privileges`

Command-Line Format	<code>--automatic-sp-privileges[={OFF ON}]</code>
System Variable	<code>automatic_sp_privileges</code>
Scope	Global
Dynamic	Yes
Type	Boolean
Default Value	<code>ON</code>

When this variable has a value of 1 (the default), the server automatically grants the `EXECUTE` and `ALTER ROUTINE` privileges to the creator of a stored routine, if the user cannot already execute and alter or drop the routine. (The `ALTER ROUTINE` privilege is required to drop the routine.) The server also automatically drops those privileges from the creator when the routine is dropped. If `automatic_sp_privileges` is 0, the server does not automatically add or drop these privileges.

The creator of a routine is the account used to execute the `CREATE` statement for it. This might not be the same as the account named as the `DEFINER` in the routine definition.

If you start `mysqld` with `--skip-new`, `automatic_sp_privileges` is set to `OFF`.

See also [Section 23.2.2, “Stored Routines and MySQL Privileges”](#).

- `auto_generate_certs`

Command-Line Format	<code>--auto-generate-certs[={OFF ON}]</code>
System Variable	<code>auto_generate_certs</code>
Scope	Global
Dynamic	No
Type	Boolean
Default Value	ON

This variable is available if the server was compiled using OpenSSL (see [Section 6.3.4, “SSL Library-Dependent Capabilities”](#)). It controls whether the server autogenerates SSL key and certificate files in the data directory, if they do not already exist.

At startup, the server automatically generates server-side and client-side SSL certificate and key files in the data directory if the `auto_generate_certs` system variable is enabled, no SSL options other than `--ssl` are specified, and the server-side SSL files are missing from the data directory. These files enable secure client connections using SSL; see [Section 6.3.1, “Configuring MySQL to Use Encrypted Connections”](#).

For more information about SSL file autogeneration, including file names and characteristics, see [Section 6.3.3.1, “Creating SSL and RSA Certificates and Keys using MySQL”](#)

The `sha256_password_auto_generate_rsa_keys` system variable is related but controls autogeneration of RSA key-pair files needed for secure password exchange using RSA over unencrypted connections.

- `avoid_temporal_upgrade`

Command-Line Format	<code>--avoid-temporal-upgrade[={OFF ON}]</code>
Deprecated	Yes
System Variable	<code>avoid_temporal_upgrade</code>
Scope	Global
Dynamic	Yes
Type	Boolean
Default Value	OFF

This variable controls whether `ALTER TABLE` implicitly upgrades temporal columns found to be in pre-5.6.4 format (`TIME`, `DATETIME`, and `TIMESTAMP` columns without support for fractional seconds precision). Upgrading such columns requires a table rebuild, which prevents any use of fast alterations that might otherwise apply to the operation to be performed.

This variable is disabled by default. Enabling it causes `ALTER TABLE` not to rebuild temporal columns and thereby be able to take advantage of possible fast alterations.

This variable is deprecated; expect it to be removed in a future release of MySQL.

- `back_log`

Command-Line Format	<code>--back-log=#</code>
System Variable	<code>back_log</code>



Scope	Global
Dynamic	No
Type	Integer
Default Value	-1 (signifies autosizing; do not assign this literal value)
Minimum Value	1
Maximum Value	65535

The number of outstanding connection requests MySQL can have. This comes into play when the main MySQL thread gets very many connection requests in a very short time. It then takes some time (although very little) for the main thread to check the connection and start a new thread. The `back_log` value indicates how many requests can be stacked during this short time before MySQL momentarily stops answering new requests. You need to increase this only if you expect a large number of connections in a short period of time.

In other words, this value is the size of the listen queue for incoming TCP/IP connections. Your operating system has its own limit on the size of this queue. The manual page for the Unix `listen()` system call should have more details. Check your OS documentation for the maximum value for this variable. `back_log` cannot be set higher than your operating system limit.

The default value is based on the following formula, capped to a limit of 900:

```
50 + (max_connections / 5)
```

- `basedir`

Command-Line Format	<code>--basedir=dir_name</code>
System Variable	<code>basedir</code>
Scope	Global
Dynamic	No
Type	Directory name
Default Value	<code>configuration-dependent default</code>

The path to the MySQL installation base directory.

- `big_tables`

Command-Line Format	<code>--big-tables[={OFF ON}]</code>
System Variable	<code>big_tables</code>
Scope	Global, Session
Dynamic	Yes
Type	Boolean

Default Value	OFF
---------------	-----

If enabled, the server stores all temporary tables on disk rather than in memory. This prevents most `The table tbl_name is full` errors for `SELECT` operations that require a large temporary table, but also slows down queries for which in-memory tables would suffice.

The default value for new connections is `OFF` (use in-memory temporary tables). Normally, it should never be necessary to enable this variable because the server is able to handle large result sets automatically by using memory for small temporary tables and switching to disk-based tables as required.

- `bind_address`

Command-Line Format	<code>--bind-address=addr</code>
System Variable	<code>bind_address</code>
Scope	Global
Dynamic	No
Type	String
Default Value	*

The MySQL server listens on a single network socket for TCP/IP connections. This socket is bound to a single address, but it is possible for an address to map onto multiple network interfaces. To specify an address, set `bind_address=addr` at server startup, where `addr` is an IPv4 or IPv6 address or a host name. If `addr` is a host name, the server resolves the name to an IP address and binds to that address. If a host name resolves to multiple IP addresses, the server uses the first IPv4 address if there are any, or the first IPv6 address otherwise.

The server treats different types of addresses as follows:

- If the address is `*`, the server accepts TCP/IP connections on all server host IPv4 interfaces, and, if the server host supports IPv6, on all IPv6 interfaces. Use this address to permit both IPv4 and IPv6 connections on all server interfaces. This value is the default.
- If the address is `0.0.0.0`, the server accepts TCP/IP connections on all server host IPv4 interfaces.
- If the address is `::`, the server accepts TCP/IP connections on all server host IPv4 and IPv6 interfaces.
- If the address is an IPv4-mapped address, the server accepts TCP/IP connections for that address, in either IPv4 or IPv6 format. For example, if the server is bound to `::ffff:127.0.0.1`, clients can connect using `--host=127.0.0.1` or `--host>::ffff:127.0.0.1`.
- If the address is a “regular” IPv4 or IPv6 address (such as `127.0.0.1` or `:::1`), the server accepts TCP/IP connections only for that IPv4 or IPv6 address.

If binding to the address fails, the server produces an error and does not start.

If you intend to bind the server to a specific address, be sure that the `mysql.user` system table contains an account with administrative privileges that you can use to connect to that address. Otherwise, you cannot shut down the server. For example, if you bind the server to `*`, you can connect to it using all existing accounts. But if you bind the server to `:::1`, it accepts connections only on that

address. In that case, first make sure that the `'root'@':::1'` account is present in the `mysql.user` table so you can still connect to the server to shut it down.

This variable has no effect for the embedded server (`libmysqld`) and is not visible within the embedded server.

- `block_encryption_mode`

Command-Line Format	<code>--block-encryption-mode=#</code>
System Variable	<code>block_encryption_mode</code>
Scope	Global, Session
Dynamic	Yes
Type	String
Default Value	<code>aes-128-ecb</code>

This variable controls the block encryption mode for block-based algorithms such as AES. It affects encryption for `AES_ENCRYPT()` and `AES_DECRYPT()`.

`block_encryption_mode` takes a value in `aes-keylen-mode` format, where `keylen` is the key length in bits and `mode` is the encryption mode. The value is not case-sensitive. Permitted `keylen` values are 128, 192, and 256. Permitted encryption modes depend on whether MySQL was compiled using OpenSSL or yaSSL:

- For OpenSSL, permitted `mode` values are: `ECB`, `CBC`, `CFB1`, `CFB8`, `CFB128`, `OFB`
- For yaSSL, permitted `mode` values are: `ECB`, `CBC`

For example, this statement causes the AES encryption functions to use a key length of 256 bits and the CBC mode:

```
SET block_encryption_mode = 'aes-256-cbc';
```

An error occurs for attempts to set `block_encryption_mode` to a value containing an unsupported key length or a mode that the SSL library does not support.

- `bulk_insert_buffer_size`

Command-Line Format	<code>--bulk-insert-buffer-size=#</code>
System Variable	<code>bulk_insert_buffer_size</code>
Scope	Global, Session
Dynamic	Yes
Type	Integer
Default Value	<code>8388608</code>
Minimum Value	<code>0</code>
Maximum Value (64-bit platforms)	<code>18446744073709551615</code>
Maximum Value (32-bit platforms)	<code>4294967295</code>
Unit	bytes/thread

MyISAM uses a special tree-like cache to make bulk inserts faster for `INSERT ... SELECT`, `INSERT ... VALUES (...), (...), ...`, and `LOAD DATA` when adding data to nonempty tables.

This variable limits the size of the cache tree in bytes per thread. Setting it to 0 disables this optimization. The default value is 8MB.

- `character_set_client`

System Variable	<code>character_set_client</code>
Scope	Global, Session
Dynamic	Yes
Type	String
Default Value	<code>utf8</code>

The character set for statements that arrive from the client. The session value of this variable is set using the character set requested by the client when the client connects to the server. (Many clients support a `--default-character-set` option to enable this character set to be specified explicitly. See also [Section 10.4, “Connection Character Sets and Collations”](#).) The global value of the variable is used to set the session value in cases when the client-requested value is unknown or not available, or the server is configured to ignore client requests:

- The client requests a character set not known to the server. For example, a Japanese-enabled client requests `sjis` when connecting to a server not configured with `sjis` support.
- The client is from a version of MySQL older than MySQL 4.1, and thus does not request a character set.
- `mysqld` was started with the `--skip-character-set-client-handshake` option, which causes it to ignore client character set configuration. This reproduces MySQL 4.0 behavior and is useful should you wish to upgrade the server without upgrading all the clients.

Some character sets cannot be used as the client character set. Attempting to use them as the `character_set_client` value produces an error. See [Impermissible Client Character Sets](#).

- `character_set_connection`

System Variable	<code>character_set_connection</code>
Scope	Global, Session
Dynamic	Yes
Type	String
Default Value	<code>utf8</code>

The character set used for literals specified without a character set introducer and for number-to-string conversion. For information about introducers, see [Section 10.3.8, “Character Set Introducers”](#).

- `character_set_database`

System Variable	<code>character_set_database</code>
Scope	Global, Session
Dynamic	Yes
Type	String
Default Value	<code>latin1</code>

Footnote	This option is dynamic, but should be set only by server. You should not set this variable manually.
----------	--

The character set used by the default database. The server sets this variable whenever the default database changes. If there is no default database, the variable has the same value as `character_set_server`.

The global `character_set_database` and `collation_database` system variables are deprecated in MySQL 5.7; expect them to be removed in a future version of MySQL.

Assigning a value to the session `character_set_database` and `collation_database` system variables is deprecated in MySQL 5.7 and assignments produce a warning. You should expect the session variables to become read only in a future version of MySQL and assignments to produce an error, while remaining possible to access the session variables to determine the database character set and collation for the default database.

- `character_set_filesystem`

Command-Line Format	<code>--character-set-filesystem=name</code>
System Variable	<code>character_set_filesystem</code>
Scope	Global, Session
Dynamic	Yes
Type	String
Default Value	<code>binary</code>

The file system character set. This variable is used to interpret string literals that refer to file names, such as in the `LOAD DATA` and `SELECT ... INTO OUTFILE` statements and the `LOAD_FILE()` function. Such file names are converted from `character_set_client` to `character_set_filesystem` before the file opening attempt occurs. The default value is `binary`, which means that no conversion occurs. For systems on which multibyte file names are permitted, a different value may be more appropriate. For example, if the system represents file names using UTF-8, set `character_set_filesystem` to `'utf8mb4'`.

- `character_set_results`

System Variable	<code>character_set_results</code>
Scope	Global, Session
Dynamic	Yes
Type	String
Default Value	<code>utf8</code>

The character set used for returning query results to the client. This includes result data such as column values, result metadata such as column names, and error messages.

- `character_set_server`

Command-Line Format	<code>--character-set-server=name</code>
System Variable	<code>character_set_server</code>
Scope	Global, Session
Dynamic	Yes

Type	String
Default Value	latin1

The server's default character set. See [Section 10.15, “Character Set Configuration”](#). If you set this variable, you should also set `collation_server` to specify the collation for the character set.

- `character_set_system`

System Variable	<code>character_set_system</code>
Scope	Global
Dynamic	No
Type	String
Default Value	utf8

The character set used by the server for storing identifiers. The value is always `utf8`.

- `character_sets_dir`

Command-Line Format	<code>--character-sets-dir=dir_name</code>
System Variable	<code>character_sets_dir</code>
Scope	Global
Dynamic	No
Type	Directory name

The directory where character sets are installed. See [Section 10.15, “Character Set Configuration”](#).

- `check_proxy_users`

Command-Line Format	<code>--check-proxy-users[={OFF ON}]</code>
System Variable	<code>check_proxy_users</code>
Scope	Global
Dynamic	Yes
Type	Boolean
Default Value	OFF

Some authentication plugins implement proxy user mapping for themselves (for example, the PAM and Windows authentication plugins). Other authentication plugins do not support proxy users by default. Of these, some can request that the MySQL server itself map proxy users according to granted proxy privileges: `mysql_native_password`, `sha256_password`.

If the `check_proxy_users` system variable is enabled, the server performs proxy user mapping for any authentication plugins that make such a request. However, it may also be necessary to enable plugin-specific system variables to take advantage of server proxy user mapping support:

- For the `mysql_native_password` plugin, enable `mysql_native_password_proxy_users`.
- For the `sha256_password` plugin, enable `sha256_password_proxy_users`.

- `collation_connection`

System Variable	<code>collation_connection</code>
Scope	Global, Session
Dynamic	Yes
Type	String

The collation of the connection character set. `collation_connection` is important for comparisons of literal strings. For comparisons of strings with column values, `collation_connection` does not matter because columns have their own collation, which has a higher collation precedence (see [Section 10.8.4, “Collation Coercibility in Expressions”](#)).

- `collation_database`

System Variable	<code>collation_database</code>
Scope	Global, Session
Dynamic	Yes
Type	String
Default Value	<code>latin1_swedish_ci</code>
Footnote	This option is dynamic, but should be set only by server. You should not set this variable manually.

The collation used by the default database. The server sets this variable whenever the default database changes. If there is no default database, the variable has the same value as `collation_server`.

The global `character_set_database` and `collation_database` system variables are deprecated in MySQL 5.7; expect them to be removed in a future version of MySQL.

Assigning a value to the session `character_set_database` and `collation_database` system variables is deprecated in MySQL 5.7 and assignments produce a warning. Expect the session variables to become read only in a future version of MySQL and assignments to produce an error, while remaining possible to access the session variables to determine the database character set and collation for the default database.

- `collation_server`

Command-Line Format	<code>--collation-server=name</code>
System Variable	<code>collation_server</code>
Scope	Global, Session
Dynamic	Yes
Type	String
Default Value	<code>latin1_swedish_ci</code>

The server's default collation. See [Section 10.15, “Character Set Configuration”](#).

- `completion_type`

Command-Line Format	<code>--completion-type=#</code>
System Variable	<code>completion_type</code>

Scope	Global, Session
Dynamic	Yes
Type	Enumeration
Default Value	NO_CHAIN
Valid Values	NO_CHAIN  CHAIN  RELEASE  0  1  2

The transaction completion type. This variable can take the values shown in the following table. The variable can be assigned using either the name values or corresponding integer values.

Value	Description
NO_CHAIN (or 0)	COMMIT and ROLLBACK are unaffected. This is the default value.
CHAIN (or 1)	COMMIT and ROLLBACK are equivalent to COMMIT AND CHAIN and ROLLBACK AND CHAIN, respectively. (A new transaction starts immediately with the same isolation level as the just-terminated transaction.)
RELEASE (or 2)	COMMIT and ROLLBACK are equivalent to COMMIT RELEASE and ROLLBACK RELEASE, respectively. (The server disconnects after terminating the transaction.)

`completion_type` affects transactions that begin with `START TRANSACTION` or `BEGIN` and end with `COMMIT` or `ROLLBACK`. It does not apply to implicit commits resulting from execution of the statements listed in [Section 13.3.3, “Statements That Cause an Implicit Commit”](#). It also does not apply for `XA COMMIT`, `XA ROLLBACK`, or when `autocommit=1`.

- `concurrent_insert`

Command-Line Format	<code>--concurrent-insert[=value]</code>
System Variable	<code>concurrent_insert</code>
Scope	Global
Dynamic	Yes
Type	Enumeration
Default Value	AUTO
Valid Values	NEVER  AUTO  ALWAYS



	0
	1
	2

If `AUTO` (the default), MySQL permits `INSERT` and `SELECT` statements to run concurrently for `MyISAM` tables that have no free blocks in the middle of the data file.

This variable can take the values shown in the following table. The variable can be assigned using either the name values or corresponding integer values.

Value	Description
<code>NEVER</code> (or 0)	Disables concurrent inserts
<code>AUTO</code> (or 1)	(Default) Enables concurrent insert for <code>MyISAM</code> tables that do not have holes
<code>ALWAYS</code> (or 2)	Enables concurrent inserts for all <code>MyISAM</code> tables, even those that have holes. For a table with a hole, new rows are inserted at the end of the table if it is in use by another thread. Otherwise, MySQL acquires a normal write lock and inserts the row into the hole.

If you start `mysqld` with `--skip-new, concurrent_insert` is set to `NEVER`.

See also [Section 8.11.3, “Concurrent Inserts”](#).

- `connect_timeout`

Command-Line Format	<code>--connect-timeout=#</code>
System Variable	<code>connect_timeout</code>
Scope	Global
Dynamic	Yes
Type	Integer
Default Value	10
Minimum Value	2
Maximum Value	31536000
Unit	seconds

The number of seconds that the `mysqld` server waits for a connect packet before responding with `Bad handshake`. The default value is 10 seconds.

Increasing the `connect_timeout` value might help if clients frequently encounter errors of the form `Lost connection to MySQL server at 'XXX', system error: errno`.

- `core_file`

System Variable	<code>core_file</code>
Scope	Global

Dynamic	No
Type	Boolean
Default Value	OFF

Whether to write a core file if the server unexpectedly exits. This variable is set by the `--core-file` option.

- `datadir`

Command-Line Format	<code>--datadir=dir_name</code>
System Variable	<code>datadir</code>
Scope	Global
Dynamic	No
Type	Directory name

The path to the MySQL server data directory. Relative paths are resolved with respect to the current directory. If you expect the server to be started automatically (that is, in contexts for which you cannot assume what the current directory is), it is best to specify the `datadir` value as an absolute path.

- `date_format`

This variable is unused. It is deprecated and is removed in MySQL 8.0.

- `datetime_format`

This variable is unused. It is deprecated and is removed in MySQL 8.0.

- `debug`

Command-Line Format	<code>--debug[=debug_options]</code>
System Variable	<code>debug</code>
Scope	Global, Session
Dynamic	Yes
Type	String
Default Value (Unix)	<code>d:t:i:o,/tmp/mysqld.trace</code>
Default Value (Windows)	<code>d:t:i:0,\mysqld.trace</code>

This variable indicates the current debugging settings. It is available only for servers built with debugging support. The initial value comes from the value of instances of the `--debug` option given at server startup. The global and session values may be set at runtime.

Setting the session value of this system variable is a restricted operation. The session user must have privileges sufficient to set restricted session variables. See [Section 5.1.8.1, “System Variable Privileges”](#).

Assigning a value that begins with `+` or `-` cause the value to added to or subtracted from the current value:

```
mysql> SET debug = 'T';
mysql> SELECT @@debug;
+-----+
| @@debug |
+-----+
```

```

| T      |
+-----+

mysql> SET debug = '+P';
mysql> SELECT @@debug;
+-----+
| @@debug |
+-----+
| P:T     |
+-----+

mysql> SET debug = '-P';
mysql> SELECT @@debug;
+-----+
| @@debug |
+-----+
| T       |
+-----+

```

For more information, see [Section 5.8.3, “The DEBUG Package”](#).

- `debug_sync`

System Variable	<code>debug_sync</code>
Scope	Session
Dynamic	Yes
Type	String

This variable is the user interface to the Debug Sync facility. Use of Debug Sync requires that MySQL be configured with the `-DWITH_DEBUG=ON` CMake option (see [Section 2.8.7, “MySQL Source-Configuration Options”](#)); otherwise, this system variable is not available.

The global variable value is read only and indicates whether the facility is enabled. By default, Debug Sync is disabled and the value of `debug_sync` is `OFF`. If the server is started with `--debug-sync-timeout=N`, where `N` is a timeout value greater than 0, Debug Sync is enabled and the value of `debug_sync` is `ON - current signal` followed by the signal name. Also, `N` becomes the default timeout for individual synchronization points.

The session value can be read by any user and has the same value as the global variable. The session value can be set to control synchronization points.

Setting the session value of this system variable is a restricted operation. The session user must have privileges sufficient to set restricted session variables. See [Section 5.1.8.1, “System Variable Privileges”](#).

For a description of the Debug Sync facility and how to use synchronization points, see [MySQL Server Doxygen Documentation](#).

- `default_authentication_plugin`

Command-Line Format	<code>--default-authentication-plugin=plugin_name</code>
System Variable	<code>default_authentication_plugin</code>
Scope	Global
Dynamic	No
Type	Enumeration

Default Value	<code>mysql_native_password</code>
Valid Values	<code>mysql_native_password</code> <code>sha256_password</code>

The default authentication plugin. These values are permitted:

- `mysql_native_password`: Use MySQL native passwords; see [Section 6.4.1.1, “Native Pluggable Authentication”](#).
- `sha256_password`: Use SHA-256 passwords; see [Section 6.4.1.5, “SHA-256 Pluggable Authentication”](#).



**Note**

If this variable has a value other than `mysql_native_password`, clients older than MySQL 5.5.7 cannot connect because, of the permitted default authentication plugins, they understand only the `mysql_native_password` authentication protocol.

The `default_authentication_plugin` value affects these aspects of server operation:

- It determines which authentication plugin the server assigns to new accounts created by `CREATE USER` and `GRANT` statements that do not explicitly specify an authentication plugin.
- The `old_passwords` system variable affects password hashing for accounts that use the `mysql_native_password` or `sha256_password` authentication plugin. If the default authentication plugin is one of those plugins, the server sets `old_passwords` at startup to the value required by the plugin password hashing method.
- For an account created with either of the following statements, the server associates the account with the default authentication plugin and assigns the account the given password, hashed as required by that plugin:

```
CREATE USER ... IDENTIFIED BY 'cleartext password';
GRANT ... IDENTIFIED BY 'cleartext password';
```

- For an account created with either of the following statements, the server associates the account with the default authentication plugin and assigns the account the given password hash, if the password hash has the format required by the plugin:

```
CREATE USER ... IDENTIFIED BY PASSWORD 'encrypted password';
GRANT ... IDENTIFIED BY PASSWORD 'encrypted password';
```

If the password hash is not in the format required by the default authentication plugin, the statement fails.

- `default_password_lifetime`

Command-Line Format	<code>--default-password-lifetime=#</code>
System Variable	<code>default_password_lifetime</code>
Scope	Global
Dynamic	Yes
Type	Integer

Default Value ( $\geq$ 5.7.11)	0
Default Value ( $\leq$ 5.7.10)	360
Minimum Value	0
Maximum Value	65535
Unit	days

This variable defines the global automatic password expiration policy. The default `default_password_lifetime` value is 0, which disables automatic password expiration. If the value of `default_password_lifetime` is a positive integer  $N$ , it indicates the permitted password lifetime; passwords must be changed every  $N$  days.

The global password expiration policy can be overridden as desired for individual accounts using the password expiration options of the `ALTER USER` statement. See [Section 6.2.11, “Password Management”](#).



#### Note

Prior to MySQL 5.7.11, the default `default_password_lifetime` value is 360 (passwords must be changed approximately once per year). For those versions, be aware that, if you make no changes to the `default_password_lifetime` variable or to individual user accounts, all user passwords expire after 360 days, and all user accounts start running in restricted mode when this happens. Clients (which are effectively users) connecting to the server then get an error indicating that the password must be changed: `ERROR 1820 (HY000): You must reset your password using ALTER USER statement before executing this statement.`

However, this is easy to miss for clients that automatically connect to the server, such as connections made from scripts. To avoid having such clients suddenly stop working due to a password expiring, make sure to change the password expiration settings for those clients, like this:

```
ALTER USER 'script'@'localhost' PASSWORD EXPIRE NEVER;
```

Alternatively, set the `default_password_lifetime` variable to 0, thus disabling automatic password expiration for all users.

- `default_storage_engine`

Command-Line Format	<code>--default-storage-engine=name</code>
System Variable	<code>default_storage_engine</code>
Scope	Global, Session
Dynamic	Yes
Type	Enumeration
Default Value	InnoDB

The default storage engine for tables. See [Chapter 15, Alternative Storage Engines](#). This variable sets the storage engine for permanent tables only. To set the storage engine for `TEMPORARY` tables, set the `default_tmp_storage_engine` system variable.

To see which storage engines are available and enabled, use the `SHOW ENGINES` statement or query the `INFORMATION_SCHEMA.ENGINES` table.

If you disable the default storage engine at server startup, you must set the default engine for both permanent and `TEMPORARY` tables to a different engine or the server cannot start.

- `default_tmp_storage_engine`

Command-Line Format	<code>--default-tmp-storage-engine=name</code>
System Variable	<code>default_tmp_storage_engine</code>
Scope	Global, Session
Dynamic	Yes
Type	Enumeration
Default Value	InnoDB

The default storage engine for `TEMPORARY` tables (created with `CREATE TEMPORARY TABLE`). To set the storage engine for permanent tables, set the `default_storage_engine` system variable. Also see the discussion of that variable regarding possible values.

If you disable the default storage engine at server startup, you must set the default engine for both permanent and `TEMPORARY` tables to a different engine or the server cannot start.

- `default_week_format`

Command-Line Format	<code>--default-week-format=#</code>
System Variable	<code>default_week_format</code>
Scope	Global, Session
Dynamic	Yes
Type	Integer
Default Value	0
Minimum Value	0
Maximum Value	7

The default mode value to use for the `WEEK()` function. See [Section 12.7, “Date and Time Functions”](#).

- `delay_key_write`

Command-Line Format	<code>--delay-key-write[={OFF ON ALL}]</code>
System Variable	<code>delay_key_write</code>
Scope	Global
Dynamic	Yes
Type	Enumeration
Default Value	ON
Valid Values	OFF ON

ALL

This variable specifies how to use delayed key writes. It applies only to `MyISAM` tables. Delayed key writing causes key buffers not to be flushed between writes. See also [Section 15.2.1, “MyISAM Startup Options”](#).

This variable can have one of the following values to affect handling of the `DELAY_KEY_WRITE` table option that can be used in `CREATE TABLE` statements.

Option	Description
OFF	<code>DELAY_KEY_WRITE</code> is ignored.
ON	MySQL honors any <code>DELAY_KEY_WRITE</code> option specified in <code>CREATE TABLE</code> statements. This is the default value.
ALL	All new opened tables are treated as if they were created with the <code>DELAY_KEY_WRITE</code> option enabled.

**Note**

If you set this variable to `ALL`, you should not use `MyISAM` tables from within another program (such as another MySQL server or `myisamchk`) when the tables are in use. Doing so leads to index corruption.

If `DELAY_KEY_WRITE` is enabled for a table, the key buffer is not flushed for the table on every index update, but only when the table is closed. This speeds up writes on keys a lot, but if you use this feature, you should add automatic checking of all `MyISAM` tables by starting the server with the `myisam_recover_options` system variable set (for example, `myisam_recover_options='BACKUP,FORCE'`). See [Section 5.1.7, “Server System Variables”](#), and [Section 15.2.1, “MyISAM Startup Options”](#).

If you start `mysqld` with `--skip-new`, `delay_key_write` is set to `OFF`.

**Warning**

If you enable external locking with `--external-locking`, there is no protection against index corruption for tables that use delayed key writes.

- `delayed_insert_limit`

Command-Line Format	<code>--delayed-insert-limit=#</code>
Deprecated	Yes
System Variable	<code>delayed_insert_limit</code>
Scope	Global
Dynamic	Yes
Type	Integer
Default Value	100
Minimum Value	1
Maximum Value (64-bit platforms)	18446744073709551615

Maximum Value (32-bit platforms)	4294967295
----------------------------------	------------

This system variable is deprecated (because `DELAYED` inserts are not supported); expect it to be removed in a future release.

- `delayed_insert_timeout`

Command-Line Format	<code>--delayed-insert-timeout=#</code>
Deprecated	Yes
System Variable	<code>delayed_insert_timeout</code>
Scope	Global
Dynamic	Yes
Type	Integer
Default Value	300
Minimum Value	1
Maximum Value	31536000
Unit	seconds

This system variable is deprecated (because `DELAYED` inserts are not supported); expect it to be removed in a future release.

- `delayed_queue_size`

Command-Line Format	<code>--delayed-queue-size=#</code>
Deprecated	Yes
System Variable	<code>delayed_queue_size</code>
Scope	Global
Dynamic	Yes
Type	Integer
Default Value	1000
Minimum Value	1
Maximum Value (64-bit platforms)	18446744073709551615
Maximum Value (32-bit platforms)	4294967295

This system variable is deprecated (because `DELAYED` inserts are not supported); expect it to be removed in a future release.

- `disabled_storage_engines`

Command-Line Format	<code>--disabled-storage-engines=engine[,engine]...</code>
System Variable	<code>disabled_storage_engines</code>
Scope	Global
Dynamic	No
Type	String



Default Value	<code>empty string</code>
---------------	---------------------------

This variable indicates which storage engines cannot be used to create tables or tablespaces. For example, to prevent new `MyISAM` or `FEDERATED` tables from being created, start the server with these lines in the server option file:

```
[mysqld]
disabled_storage_engines="MyISAM,FEDERATED"
```

By default, `disabled_storage_engines` is empty (no engines disabled), but it can be set to a comma-separated list of one or more engines (not case-sensitive). Any engine named in the value cannot be used to create tables or tablespaces with `CREATE TABLE` or `CREATE TABLESPACE`, and cannot be used with `ALTER TABLE ... ENGINE` or `ALTER TABLESPACE ... ENGINE` to change the storage engine of existing tables or tablespaces. Attempts to do so result in an `ER_DISABLED_STORAGE_ENGINE` error.

`disabled_storage_engines` does not restrict other DDL statements for existing tables, such as `CREATE INDEX`, `TRUNCATE TABLE`, `ANALYZE TABLE`, `DROP TABLE`, or `DROP TABLESPACE`. This permits a smooth transition so that existing tables or tablespaces that use a disabled engine can be migrated to a permitted engine by means such as `ALTER TABLE ... ENGINE permitted_engine`.

It is permitted to set the `default_storage_engine` or `default_tmp_storage_engine` system variable to a storage engine that is disabled. This could cause applications to behave erratically or fail, although that might be a useful technique in a development environment for identifying applications that use disabled engines, so that they can be modified.

`disabled_storage_engines` is disabled and has no effect if the server is started with any of these options: `--bootstrap`, `--initialize`, `--initialize-insecure`, `--skip-grant-tables`.



#### Note

Setting `disabled_storage_engines` might cause an issue with `mysql_upgrade`. For details, see [Section 4.4.7, “mysql\\_upgrade — Check and Upgrade MySQL Tables”](#).

- `disconnect_on_expired_password`

Command-Line Format	<code>--disconnect-on-expired-password[={OFF ON} ]</code>
System Variable	<code>disconnect_on_expired_password</code>
Scope	Global
Dynamic	No
Type	Boolean
Default Value	<code>ON</code>

This variable controls how the server handles clients with expired passwords:

- If the client indicates that it can handle expired passwords, the value of `disconnect_on_expired_password` is irrelevant. The server permits the client to connect but puts it in sandbox mode.

- If the client does not indicate that it can handle expired passwords, the server handles the client according to the value of `disconnect_on_expired_password`:
  - If `disconnect_on_expired_password`: is enabled, the server disconnects the client.
  - If `disconnect_on_expired_password`: is disabled, the server permits the client to connect but puts it in sandbox mode.

For more information about the interaction of client and server settings relating to expired-password handling, see [Section 6.2.12, “Server Handling of Expired Passwords”](#).

- `div_precision_increment`

Command-Line Format	<code>--div-precision-increment=#</code>
System Variable	<code>div_precision_increment</code>
Scope	Global, Session
Dynamic	Yes
Type	Integer
Default Value	4
Minimum Value	0
Maximum Value	30

This variable indicates the number of digits by which to increase the scale of the result of division operations performed with the `/` operator. The default value is 4. The minimum and maximum values are 0 and 30, respectively. The following example illustrates the effect of increasing the default value.

```
mysql> SELECT 1/7;
+-----+
| 1/7   |
+-----+
| 0.1429 |
+-----+
mysql> SET div_precision_increment = 12;
mysql> SELECT 1/7;
+-----+
| 1/7           |
+-----+
| 0.142857142857 |
+-----+
```

- `end_markers_in_json`

Command-Line Format	<code>--end-markers-in-json[={OFF ON}]</code>
System Variable	<code>end_markers_in_json</code>
Scope	Global, Session
Dynamic	Yes
Type	Boolean
Default Value	OFF

Whether optimizer JSON output should add end markers. See [Section 8.15.9, “The `end\_markers\_in\_json` System Variable”](#).

- `eq_range_index_dive_limit`

Command-Line Format	<code>--eq-range-index-dive-limit=#</code>
System Variable	<code>eq_range_index_dive_limit</code>
Scope	Global, Session
Dynamic	Yes
Type	Integer
Default Value	200
Minimum Value	0
Maximum Value	4294967295

This variable indicates the number of equality ranges in an equality comparison condition when the optimizer should switch from using index dives to index statistics in estimating the number of qualifying rows. It applies to evaluation of expressions that have either of these equivalent forms, where the optimizer uses a nonunique index to look up `col_name` values:

```
col_name IN(val1, ..., valN)
col_name = val1 OR ... OR col_name = valN
```

In both cases, the expression contains  $N$  equality ranges. The optimizer can make row estimates using index dives or index statistics. If `eq_range_index_dive_limit` is greater than 0, the optimizer uses existing index statistics instead of index dives if there are `eq_range_index_dive_limit` or more equality ranges. Thus, to permit use of index dives for up to  $N$  equality ranges, set `eq_range_index_dive_limit` to  $N + 1$ . To disable use of index statistics and always use index dives regardless of  $N$ , set `eq_range_index_dive_limit` to 0.

For more information, see [Equality Range Optimization of Many-Valued Comparisons](#).

To update table index statistics for best estimates, use `ANALYZE TABLE`.

- `error_count`

The number of errors that resulted from the last statement that generated messages. This variable is read only. See [Section 13.7.5.17, “SHOW ERRORS Statement”](#).

- `event_scheduler`

Command-Line Format	<code>--event-scheduler[=value]</code>
System Variable	<code>event_scheduler</code>
Scope	Global
Dynamic	Yes
Type	Enumeration
Default Value	OFF
Valid Values	OFF ON DISABLED

This variable enables or disables, and starts or stops, the Event Scheduler. The possible status values are `ON`, `OFF`, and `DISABLED`. Turning the Event Scheduler `OFF` is not the same as disabling the Event

Scheduler, which requires setting the status to `DISABLED`. This variable and its effects on the Event Scheduler's operation are discussed in greater detail in [Section 23.4.2, “Event Scheduler Configuration”](#)

- `explicit_defaults_for_timestamp`

Command-Line Format	<code>--explicit-defaults-for-timestamp[={OFF ON}]</code>
Deprecated	Yes
System Variable	<code>explicit_defaults_for_timestamp</code>
Scope	Global, Session
Dynamic	Yes
Type	Boolean
Default Value	<code>OFF</code>

This system variable determines whether the server enables certain nonstandard behaviors for default values and `NULL`-value handling in `TIMESTAMP` columns. By default, `explicit_defaults_for_timestamp` is disabled, which enables the nonstandard behaviors.

If `explicit_defaults_for_timestamp` is disabled, the server enables the nonstandard behaviors and handles `TIMESTAMP` columns as follows:

- `TIMESTAMP` columns not explicitly declared with the `NULL` attribute are automatically declared with the `NOT NULL` attribute. Assigning such a column a value of `NULL` is permitted and sets the column to the current timestamp.
- The first `TIMESTAMP` column in a table, if not explicitly declared with the `NULL` attribute or an explicit `DEFAULT` or `ON UPDATE` attribute, is automatically declared with the `DEFAULT CURRENT_TIMESTAMP` and `ON UPDATE CURRENT_TIMESTAMP` attributes.
- `TIMESTAMP` columns following the first one, if not explicitly declared with the `NULL` attribute or an explicit `DEFAULT` attribute, are automatically declared as `DEFAULT '0000-00-00 00:00:00'` (the “zero” timestamp). For inserted rows that specify no explicit value for such a column, the column is assigned `'0000-00-00 00:00:00'` and no warning occurs.

Depending on whether strict SQL mode or the `NO_ZERO_DATE` SQL mode is enabled, a default value of `'0000-00-00 00:00:00'` may be invalid. Be aware that the `TRADITIONAL` SQL mode includes strict mode and `NO_ZERO_DATE`. See [Section 5.1.10, “Server SQL Modes”](#).

The nonstandard behaviors just described are deprecated; expect them to be removed in a future release of MySQL.

If `explicit_defaults_for_timestamp` is enabled, the server disables the nonstandard behaviors and handles `TIMESTAMP` columns as follows:

- It is not possible to assign a `TIMESTAMP` column a value of `NULL` to set it to the current timestamp. To assign the current timestamp, set the column to `CURRENT_TIMESTAMP` or a synonym such as `NOW()`.
- `TIMESTAMP` columns not explicitly declared with the `NOT NULL` attribute are automatically declared with the `NULL` attribute and permit `NULL` values. Assigning such a column a value of `NULL` sets it to `NULL`, not the current timestamp.
- `TIMESTAMP` columns declared with the `NOT NULL` attribute do not permit `NULL` values. For inserts that specify `NULL` for such a column, the result is either an error for a single-row insert if strict SQL mode

is enabled, or '0000-00-00 00:00:00' is inserted for multiple-row inserts with strict SQL mode disabled. In no case does assigning the column a value of `NULL` set it to the current timestamp.

- `TIMESTAMP` columns explicitly declared with the `NOT NULL` attribute and without an explicit `DEFAULT` attribute are treated as having no default value. For inserted rows that specify no explicit value for such a column, the result depends on the SQL mode. If strict SQL mode is enabled, an error occurs. If strict SQL mode is not enabled, the column is declared with the implicit default of '0000-00-00 00:00:00' and a warning occurs. This is similar to how MySQL treats other temporal types such as `DATETIME`.
- No `TIMESTAMP` column is automatically declared with the `DEFAULT CURRENT_TIMESTAMP` or `ON UPDATE CURRENT_TIMESTAMP` attributes. Those attributes must be explicitly specified.
- The first `TIMESTAMP` column in a table is not handled differently from `TIMESTAMP` columns following the first one.

If `explicit_defaults_for_timestamp` is disabled at server startup, this warning appears in the error log:

```
[Warning] TIMESTAMP with implicit DEFAULT value is deprecated.
Please use --explicit_defaults_for_timestamp server option (see
documentation for more details).
```

As indicated by the warning, to disable the deprecated nonstandard behaviors, enable the `explicit_defaults_for_timestamp` system variable at server startup.



#### Note

`explicit_defaults_for_timestamp` is itself deprecated because its only purpose is to permit control over deprecated `TIMESTAMP` behaviors that are to be removed in a future release of MySQL. When removal of those behaviors occurs, `explicit_defaults_for_timestamp` no longer has any purpose, and you can expect it to be removed as well.

For additional information, see [Section 11.2.6, “Automatic Initialization and Updating for `TIMESTAMP` and `DATETIME`”](#).

- `external_user`

System Variable	<code>external_user</code>
Scope	Session
Dynamic	No
Type	String

The external user name used during the authentication process, as set by the plugin used to authenticate the client. With native (built-in) MySQL authentication, or if the plugin does not set the value, this variable is `NULL`. See [Section 6.2.14, “Proxy Users”](#).

- `flush`

Command-Line Format	<code>--flush[={OFF ON}]</code>
System Variable	<code>flush</code>
Scope	Global
Dynamic	Yes

Type	Boolean
Default Value	OFF

If `ON`, the server flushes (synchronizes) all changes to disk after each SQL statement. Normally, MySQL does a write of all changes to disk only after each SQL statement and lets the operating system handle the synchronizing to disk. See [Section B.3.3.3, “What to Do If MySQL Keeps Crashing”](#). This variable is set to `ON` if you start `mysqld` with the `--flush` option.

**Note**

If `flush` is enabled, the value of `flush_time` does not matter and changes to `flush_time` have no effect on flush behavior.

- `flush_time`

Command-Line Format	<code>--flush-time=#</code>
System Variable	<code>flush_time</code>
Scope	Global
Dynamic	Yes
Type	Integer
Default Value	0
Minimum Value	0
Maximum Value	31536000
Unit	seconds

If this is set to a nonzero value, all tables are closed every `flush_time` seconds to free up resources and synchronize unflushed data to disk. This option is best used only on systems with minimal resources.

**Note**

If `flush` is enabled, the value of `flush_time` does not matter and changes to `flush_time` have no effect on flush behavior.

- `foreign_key_checks`

System Variable	<code>foreign_key_checks</code>
Scope	Global, Session
Dynamic	Yes
Type	Boolean
Default Value	<code>ON</code>

If set to 1 (the default), foreign key constraints are checked. If set to 0, foreign key constraints are ignored, with a couple of exceptions. When re-creating a table that was dropped, an error is returned if the table definition does not conform to the foreign key constraints referencing the table. Likewise, an `ALTER TABLE` operation returns an error if a foreign key definition is incorrectly formed. For more information, see [Section 13.1.18.5, “FOREIGN KEY Constraints”](#).

Setting this variable has the same effect on `NDB` tables as it does for `InnoDB` tables. Typically you leave this setting enabled during normal operation, to enforce [referential integrity](#). Disabling foreign

key checking can be useful for reloading `InnoDB` tables in an order different from that required by their parent/child relationships. See [Section 13.1.18.5, “FOREIGN KEY Constraints”](#).

Setting `foreign_key_checks` to 0 also affects data definition statements: `DROP SCHEMA` drops a schema even if it contains tables that have foreign keys that are referred to by tables outside the schema, and `DROP TABLE` drops tables that have foreign keys that are referred to by other tables.



### Note

Setting `foreign_key_checks` to 1 does not trigger a scan of the existing table data. Therefore, rows added to the table while `foreign_key_checks=0` are not verified for consistency.

Dropping an index required by a foreign key constraint is not permitted, even with `foreign_key_checks=0`. The foreign key constraint must be removed before dropping the index (Bug #70260).

- `ft_boolean_syntax`

Command-Line Format	<code>--ft-boolean-syntax=name</code>
System Variable	<code>ft_boolean_syntax</code>
Scope	Global
Dynamic	Yes
Type	String
Default Value	<code>+ -&gt;&lt;()~*:""&amp; </code>

The list of operators supported by boolean full-text searches performed using `IN BOOLEAN MODE`. See [Section 12.9.2, “Boolean Full-Text Searches”](#).

The default variable value is `'+ -><()~*:""&|'`. The rules for changing the value are as follows:

- Operator function is determined by position within the string.
  - The replacement value must be 14 characters.
  - Each character must be an ASCII nonalphanumeric character.
  - Either the first or second character must be a space.
  - No duplicates are permitted except the phrase quoting operators in positions 11 and 12. These two characters are not required to be the same, but they are the only two that may be.
  - Positions 10, 13, and 14 (which by default are set to `:`, `&`, and `|`) are reserved for future extensions.
- `ft_max_word_len`

Command-Line Format	<code>--ft-max-word-len=#</code>
System Variable	<code>ft_max_word_len</code>
Scope	Global
Dynamic	No
Type	Integer
Default Value	84

Minimum Value	10
Maximum Value	84

The maximum length of the word to be included in a `MyISAM FULLTEXT` index.

**Note**

`FULLTEXT` indexes on `MyISAM` tables must be rebuilt after changing this variable. Use `REPAIR TABLE tbl_name QUICK`.

- `ft_min_word_len`

Command-Line Format	<code>--ft-min-word-len=#</code>
System Variable	<code>ft_min_word_len</code>
Scope	Global
Dynamic	No
Type	Integer
Default Value	4
Minimum Value	1
Maximum Value	82

The minimum length of the word to be included in a `MyISAM FULLTEXT` index.

**Note**

`FULLTEXT` indexes on `MyISAM` tables must be rebuilt after changing this variable. Use `REPAIR TABLE tbl_name QUICK`.

- `ft_query_expansion_limit`

Command-Line Format	<code>--ft-query-expansion-limit=#</code>
System Variable	<code>ft_query_expansion_limit</code>
Scope	Global
Dynamic	No
Type	Integer
Default Value	20
Minimum Value	0
Maximum Value	1000

The number of top matches to use for full-text searches performed using `WITH QUERY EXPANSION`.

- `ft_stopword_file`

Command-Line Format	<code>--ft-stopword-file=file_name</code>
System Variable	<code>ft_stopword_file</code>
Scope	Global
Dynamic	No
Type	File name



The file from which to read the list of stopwords for full-text searches on [MyISAM](#) tables. The server looks for the file in the data directory unless an absolute path name is given to specify a different directory. All the words from the file are used; comments are *not* honored. By default, a built-in list of stopwords is used (as defined in the `storage/myisam/ft_static.c` file). Setting this variable to the empty string ( `'` ) disables stopwords filtering. See also [Section 12.9.4, “Full-Text Stopwords”](#).

**Note**

`FULLTEXT` indexes on [MyISAM](#) tables must be rebuilt after changing this variable or the contents of the stopwords file. Use `REPAIR TABLE tbl_name QUICK`.

- [general\\_log](#)

Command-Line Format	<code>--general-log[={OFF ON}]</code>
System Variable	<a href="#">general_log</a>
Scope	Global
Dynamic	Yes
Type	Boolean
Default Value	<code>OFF</code>

Whether the general query log is enabled. The value can be 0 (or `OFF`) to disable the log or 1 (or `ON`) to enable the log. The destination for log output is controlled by the `log_output` system variable; if that value is `NONE`, no log entries are written even if the log is enabled.

- [general\\_log\\_file](#)

Command-Line Format	<code>--general-log-file=file_name</code>
System Variable	<a href="#">general_log_file</a>
Scope	Global
Dynamic	Yes
Type	File name
Default Value	<code>host_name.log</code>

The name of the general query log file. The default value is `host_name.log`, but the initial value can be changed with the `--general_log_file` option.

- [group\\_concat\\_max\\_len](#)

Command-Line Format	<code>--group-concat-max-len=#</code>
System Variable	<a href="#">group_concat_max_len</a>
Scope	Global, Session
Dynamic	Yes
Type	Integer
Default Value	<code>1024</code>
Minimum Value	<code>4</code>
Maximum Value (64-bit platforms)	<code>18446744073709551615</code>
Maximum Value (32-bit platforms)	<code>4294967295</code>

The maximum permitted result length in bytes for the `GROUP_CONCAT()` function. The default is 1024.

- `have_compress`

**YES** if the `zlib` compression library is available to the server, **NO** if not. If not, the `COMPRESS()` and `UNCOMPRESS()` functions cannot be used.

- `have_crypt`

**YES** if the `crypt()` system call is available to the server, **NO** if not. If not, the `ENCRYPT()` function cannot be used.



**Note**

The `ENCRYPT()` function is deprecated in MySQL 5.7, will be removed in a future release of MySQL, and should no longer be used. (For one-way hashing, consider using `SHA2()` instead.) Consequently, `have_crypt` also is deprecated; expect it to be removed in a future release.

- `have_dynamic_loading`

**YES** if `mysqld` supports dynamic loading of plugins, **NO** if not. If the value is **NO**, you cannot use options such as `--plugin-load` to load plugins at server startup, or the `INSTALL PLUGIN` statement to load plugins at runtime.

- `have_geometry`

**YES** if the server supports spatial data types, **NO** if not.

- `have_openssl`

This variable is a synonym for `have_ssl`.

- `have_profiling`

**YES** if statement profiling capability is present, **NO** if not. If present, the `profiling` system variable controls whether this capability is enabled or disabled. See [Section 13.7.5.31, “SHOW PROFILES Statement”](#).

This variable is deprecated; expect it to be removed in a future release of MySQL.

- `have_query_cache`

**YES** if `mysqld` supports the query cache, **NO** if not.



**Note**

The query cache is deprecated as of MySQL 5.7.20, and is removed in MySQL 8.0. Deprecation includes `have_query_cache`.

- `have_rtree_keys`

**YES** if `RTREE` indexes are available, **NO** if not. (These are used for spatial indexes in `MyISAM` tables.)

- `have_ssl`

System Variable	<code>have_ssl</code>
-----------------	-----------------------

Scope	Global
Dynamic	No
Type	String
Valid Values	<code>YES</code> (SSL support available) <code>DISABLED</code> (SSL support was compiled into server, but server was not started with necessary options to enable it)

`YES` if `mysqld` supports SSL connections, `DISABLED` if the server was compiled with SSL support, but was not started with the appropriate connection-encryption options. For more information, see [Section 2.8.6, “Configuring SSL Library Support”](#).

- `have_statement_timeout`

System Variable	<code>have_statement_timeout</code>
Scope	Global
Dynamic	No
Type	Boolean

Whether the statement execution timeout feature is available (see [Statement Execution Time Optimizer Hints](#)). The value can be `NO` if the background thread used by this feature could not be initialized.

- `have_symlink`

`YES` if symbolic link support is enabled, `NO` if not. This is required on Unix for support of the `DATA DIRECTORY` and `INDEX DIRECTORY` table options. If the server is started with the `--skip-symbolic-links` option, the value is `DISABLED`.

This variable has no meaning on Windows.

- `host_cache_size`

Command-Line Format	<code>--host-cache-size=#</code>
System Variable	<code>host_cache_size</code>
Scope	Global
Dynamic	Yes
Type	Integer
Default Value	<code>-1</code> (signifies autosizing; do not assign this literal value)
Minimum Value	<code>0</code>
Maximum Value	<code>65536</code>

The MySQL server maintains an in-memory host cache that contains client host name and IP address information and is used to avoid Domain Name System (DNS) lookups; see [Section 5.1.11.2, “DNS Lookups and the Host Cache”](#).

The `host_cache_size` variable controls the size of the host cache, as well as the size of the Performance Schema `host_cache` table that exposes the cache contents. Setting `host_cache_size` has these effects:

- Setting the size to 0 disables the host cache. With the cache disabled, the server performs a DNS lookup every time a client connects.
- Changing the size at runtime causes an implicit host cache flushing operation that clears the host cache, truncates the `host_cache` table, and unblocks any blocked hosts.

The default value is autosized to 128, plus 1 for a value of `max_connections` up to 500, plus 1 for every increment of 20 over 500 in the `max_connections` value, capped to a limit of 2000.

Using the `--skip-host-cache` option is similar to setting the `host_cache_size` system variable to 0, but `host_cache_size` is more flexible because it can also be used to resize, enable, and disable the host cache at runtime, not just at server startup.

Starting the server with `--skip-host-cache` does not prevent runtime changes to the value of `host_cache_size`, but such changes have no effect and the cache is not re-enabled even if `host_cache_size` is set larger than 0.

Setting the `host_cache_size` system variable rather than the `--skip-host-cache` option is preferred for the reasons given in the previous paragraph. In addition, the `--skip-host-cache` option is deprecated in MySQL 8.0, and its removal is expected in a future version of MySQL.

- `hostname`

System Variable	<code>hostname</code>
Scope	Global
Dynamic	No
Type	String

The server sets this variable to the server host name at startup.

- `identity`

This variable is a synonym for the `last_insert_id` variable. It exists for compatibility with other database systems. You can read its value with `SELECT @@identity`, and set it using `SET identity`.

- `ignore_db_dirs`

Deprecated	5.7.16
System Variable	<code>ignore_db_dirs</code>
Scope	Global
Dynamic	No
Type	String

A comma-separated list of names that are not considered as database directories in the data directory. The value is set from any instances of `--ignore-db-dir` given at server startup.

As of MySQL 5.7.11, `--ignore-db-dir` can be used at data directory initialization time with `mysqld --initialize` to specify directories that the server should ignore for purposes of assessing whether an existing data directory is considered empty. See [Section 2.9.1, “Initializing the Data Directory”](#).

This system variable is deprecated in MySQL 5.7. With the introduction of the data dictionary in MySQL 8.0, it became superfluous and was removed in that version.

- `init_connect`

Command-Line Format	<code>--init-connect=name</code>
System Variable	<code>init_connect</code>
Scope	Global
Dynamic	Yes
Type	String

A string to be executed by the server for each client that connects. The string consists of one or more SQL statements, separated by semicolon characters.

For users that have the `SUPER` privilege, the content of `init_connect` is not executed. This is done so that an erroneous value for `init_connect` does not prevent all clients from connecting. For example, the value might contain a statement that has a syntax error, thus causing client connections to fail. Not executing `init_connect` for users that have the `SUPER` privilege enables them to open a connection and fix the `init_connect` value.

As of MySQL 5.7.22, `init_connect` execution is skipped for any client user with an expired password. This is done because such a user cannot execute arbitrary statements, and thus `init_connect` execution fails, leaving the client unable to connect. Skipping `init_connect` execution enables the user to connect and change password.

The server discards any result sets produced by statements in the value of `init_connect`.

- `init_file`

Command-Line Format	<code>--init-file=file_name</code>
System Variable	<code>init_file</code>
Scope	Global
Dynamic	No
Type	File name

If specified, this variable names a file containing SQL statements to be read and executed during the startup process. Each statement must be on a single line and should not include comments.

If the server is started with any of the `--bootstrap`, `--initialize`, or `--initialize-insecure` options, it operates in bootstrap mode and some functionality is unavailable that limits the statements permitted in the file. These include statements that relate to account management (such as `CREATE USER` or `GRANT`), replication, and global transaction identifiers. See [Section 16.1.3, “Replication with Global Transaction Identifiers”](#).

- `innodb_xxx`

`InnoDB` system variables are listed in [Section 14.15, “InnoDB Startup Options and System Variables”](#). These variables control many aspects of storage, memory use, and I/O patterns for `InnoDB` tables, and are especially important now that `InnoDB` is the default storage engine.

- `insert_id`

The value to be used by the following `INSERT` or `ALTER TABLE` statement when inserting an `AUTO_INCREMENT` value. This is mainly used with the binary log.

- `interactive_timeout`

Command-Line Format	<code>--interactive-timeout=#</code>
System Variable	<code>interactive_timeout</code>
Scope	Global, Session
Dynamic	Yes
Type	Integer
Default Value	28800
Minimum Value	1
Maximum Value	31536000
Unit	seconds

The number of seconds the server waits for activity on an interactive connection before closing it. An interactive client is defined as a client that uses the `CLIENT_INTERACTIVE` option to `mysql_real_connect()`. See also `wait_timeout`.

- `internal_tmp_disk_storage_engine`

Command-Line Format	<code>--internal-tmp-disk-storage-engine=#</code>
System Variable	<code>internal_tmp_disk_storage_engine</code>
Scope	Global
Dynamic	Yes
Type	Enumeration
Default Value	<code>INNODB</code>
Valid Values	<code>MYISAM</code> <code>INNODB</code>

The storage engine for on-disk internal temporary tables (see [Section 8.4.4, “Internal Temporary Table Use in MySQL”](#)). Permitted values are `MYISAM` and `INNODB` (the default).

The `optimizer` uses the storage engine defined by `internal_tmp_disk_storage_engine` for on-disk internal temporary tables.

When using `internal_tmp_disk_storage_engine=INNODB` (the default), queries that generate on-disk internal temporary tables that exceed `InnoDB row or column limits` return `Row size too large` or `Too many columns` errors. The workaround is to set `internal_tmp_disk_storage_engine` to `MYISAM`.

- `join_buffer_size`

Command-Line Format	<code>--join-buffer-size=#</code>
System Variable	<code>join_buffer_size</code>
Scope	Global, Session
Dynamic	Yes
Type	Integer
Default Value	262144
Minimum Value	128

Maximum Value (Windows)	4294967168
Maximum Value (Other, 64-bit platforms)	18446744073709551488
Maximum Value (Other, 32-bit platforms)	4294967168
Unit	bytes
Block Size	128

The minimum size of the buffer that is used for plain index scans, range index scans, and joins that do not use indexes and thus perform full table scans. Normally, the best way to get fast joins is to add indexes. Increase the value of `join_buffer_size` to get a faster full join when adding indexes is not possible. One join buffer is allocated for each full join between two tables. For a complex join between several tables for which indexes are not used, multiple join buffers might be necessary.

The default is 256KB. The maximum permissible setting for `join_buffer_size` is 4GB-1. Larger values are permitted for 64-bit platforms (except 64-bit Windows, for which large values are truncated to 4GB-1 with a warning). The block size is 128, and a value that is not an exact multiple of the block size is rounded down to the next lower multiple of the block size by MySQL Server before storing the value for the system variable. The parser allows values up to the maximum unsigned integer value for the platform (4294967295 or  $2^{32}-1$  for a 32-bit system, 18446744073709551615 or  $2^{64}-1$  for a 64-bit system) but the actual maximum is a block size lower.

Unless a Block Nested-Loop or Batched Key Access algorithm is used, there is no gain from setting the buffer larger than required to hold each matching row, and all joins allocate at least the minimum size, so use caution in setting this variable to a large value globally. It is better to keep the global setting small and change the session setting to a larger value only in sessions that are doing large joins. Memory allocation time can cause substantial performance drops if the global size is larger than needed by most queries that use it.

When Block Nested-Loop is used, a larger join buffer can be beneficial up to the point where all required columns from all rows in the first table are stored in the join buffer. This depends on the query; the optimal size may be smaller than holding all rows from the first tables.

When Batched Key Access is used, the value of `join_buffer_size` defines how large the batch of keys is in each request to the storage engine. The larger the buffer, the more sequential access is made to the right hand table of a join operation, which can significantly improve performance.

For additional information about join buffering, see [Section 8.2.1.6, “Nested-Loop Join Algorithms”](#). For information about Batched Key Access, see [Section 8.2.1.11, “Block Nested-Loop and Batched Key Access Joins”](#).

- `keep_files_on_create`

Command-Line Format	<code>--keep-files-on-create[={OFF ON}]</code>
System Variable	<code>keep_files_on_create</code>
Scope	Global, Session
Dynamic	Yes
Type	Boolean
Default Value	OFF

If a `MyISAM` table is created with no `DATA DIRECTORY` option, the `.MYD` file is created in the database directory. By default, if `MyISAM` finds an existing `.MYD` file in this case, it overwrites it. The same applies to `.MYI` files for tables created with no `INDEX DIRECTORY` option. To suppress this behavior, set the

`keep_files_on_create` variable to `ON` (1), in which case `MyISAM` does not overwrite existing files and returns an error instead. The default value is `OFF` (0).

If a `MyISAM` table is created with a `DATA DIRECTORY` or `INDEX DIRECTORY` option and an existing `.MYD` or `.MYI` file is found, `MyISAM` always returns an error. It does not overwrite a file in the specified directory.

- `key_buffer_size`

Command-Line Format	<code>--key-buffer-size=#</code>
System Variable	<code>key_buffer_size</code>
Scope	Global
Dynamic	Yes
Type	Integer
Default Value	8388608
Minimum Value	0
Maximum Value (64-bit platforms)	<code>OS_PER_PROCESS_LIMIT</code>
Maximum Value (32-bit platforms)	4294967295
Unit	bytes

Index blocks for `MyISAM` tables are buffered and are shared by all threads. `key_buffer_size` is the size of the buffer used for index blocks. The key buffer is also known as the key cache.

The minimum permissible setting is 0, but you cannot set `key_buffer_size` to 0 dynamically. A setting of 0 drops the key cache, which is not permitted at runtime. Setting `key_buffer_size` to 0 is permitted only at startup, in which case the key cache is not initialized. Changing the `key_buffer_size` setting at runtime from a value of 0 to a permitted non-zero value initializes the key cache.

`key_buffer_size` can be increased or decreased only in increments or multiples of 4096 bytes. Increasing or decreasing the setting by a nonconforming value produces a warning and truncates the setting to a conforming value.

The maximum permissible setting for `key_buffer_size` is 4GB–1 on 32-bit platforms. Larger values are permitted for 64-bit platforms. The effective maximum size might be less, depending on your available physical RAM and per-process RAM limits imposed by your operating system or hardware platform. The value of this variable indicates the amount of memory requested. Internally, the server allocates as much memory as possible up to this amount, but the actual allocation might be less.

You can increase the value to get better index handling for all reads and multiple writes; on a system whose primary function is to run MySQL using the `MyISAM` storage engine, 25% of the machine's total memory is an acceptable value for this variable. However, you should be aware that, if you make the value too large (for example, more than 50% of the machine's total memory), your system might start to page and become extremely slow. This is because MySQL relies on the operating system to perform file system caching for data reads, so you must leave some room for the file system cache. You should also consider the memory requirements of any other storage engines that you may be using in addition to `MyISAM`.

For even more speed when writing many rows at the same time, use `LOCK TABLES`. See [Section 8.2.4.1, “Optimizing INSERT Statements”](#).

You can check the performance of the key buffer by issuing a `SHOW STATUS` statement and examining the `Key_read_requests`, `Key_reads`, `Key_write_requests`, and `Key_writes` status variables.



(See [Section 13.7.5, “SHOW Statements”](#).) The `Key_reads/Key_read_requests` ratio should normally be less than 0.01. The `Key_writes/Key_write_requests` ratio is usually near 1 if you are using mostly updates and deletes, but might be much smaller if you tend to do updates that affect many rows at the same time or if you are using the `DELAY_KEY_WRITE` table option.

The fraction of the key buffer in use can be determined using `key_buffer_size` in conjunction with the `Key_blocks_unused` status variable and the buffer block size, which is available from the `key_cache_block_size` system variable:

```
1 - ((Key_blocks_unused * key_cache_block_size) / key_buffer_size)
```

This value is an approximation because some space in the key buffer is allocated internally for administrative structures. Factors that influence the amount of overhead for these structures include block size and pointer size. As block size increases, the percentage of the key buffer lost to overhead tends to decrease. Larger blocks results in a smaller number of read operations (because more keys are obtained per read), but conversely an increase in reads of keys that are not examined (if not all keys in a block are relevant to a query).

It is possible to create multiple `MyISAM` key caches. The size limit of 4GB applies to each cache individually, not as a group. See [Section 8.10.2, “The MyISAM Key Cache”](#).

- `key_cache_age_threshold`

Command-Line Format	<code>--key-cache-age-threshold=#</code>
System Variable	<code>key_cache_age_threshold</code>
Scope	Global
Dynamic	Yes
Type	Integer
Default Value	300
Minimum Value	100
Maximum Value (64-bit platforms)	18446744073709551516
Maximum Value (32-bit platforms)	4294967196
Block Size	100

This value controls the demotion of buffers from the hot sublist of a key cache to the warm sublist. Lower values cause demotion to happen more quickly. The minimum value is 100. The default value is 300. See [Section 8.10.2, “The MyISAM Key Cache”](#).

- `key_cache_block_size`

Command-Line Format	<code>--key-cache-block-size=#</code>
System Variable	<code>key_cache_block_size</code>
Scope	Global
Dynamic	Yes
Type	Integer
Default Value	1024
Minimum Value	512
Maximum Value	16384

Unit	bytes
<a href="#">Block Size</a>	512

The size in bytes of blocks in the key cache. The default value is 1024. See [Section 8.10.2, “The MyISAM Key Cache”](#).

- [key\\_cache\\_division\\_limit](#)

Command-Line Format	<code>--key-cache-division-limit=#</code>
System Variable	<a href="#">key_cache_division_limit</a>
Scope	Global
Dynamic	Yes
Type	Integer
Default Value	100
Minimum Value	1
Maximum Value	100

The division point between the hot and warm sublists of the key cache buffer list. The value is the percentage of the buffer list to use for the warm sublist. Permissible values range from 1 to 100. The default value is 100. See [Section 8.10.2, “The MyISAM Key Cache”](#).

- [large\\_files\\_support](#)

System Variable	<a href="#">large_files_support</a>
Scope	Global
Dynamic	No
Type	Boolean

Whether `mysqld` was compiled with options for large file support.

- [large\\_pages](#)

Command-Line Format	<code>--large-pages[={OFF ON}]</code>
System Variable	<a href="#">large_pages</a>
Scope	Global
Dynamic	No
Platform Specific	Linux
Type	Boolean
Default Value	OFF

Whether large page support is enabled (via the `--large-pages` option). See [Section 8.12.4.3, “Enabling Large Page Support”](#).

- [large\\_page\\_size](#)

System Variable	<a href="#">large_page_size</a>
Scope	Global

Dynamic	No
Type	Integer
Default Value	0
Minimum Value	0
Maximum Value	65535
Unit	bytes

If large page support is enabled, this shows the size of memory pages. Large memory pages are supported only on Linux; on other platforms, the value of this variable is always 0. See [Section 8.12.4.3, “Enabling Large Page Support”](#).

- `last_insert_id`

The value to be returned from `LAST_INSERT_ID()`. This is stored in the binary log when you use `LAST_INSERT_ID()` in a statement that updates a table. Setting this variable does not update the value returned by the `mysql_insert_id()` C API function.

- `lc_messages`

Command-Line Format	<code>--lc-messages=name</code>
System Variable	<code>lc_messages</code>
Scope	Global, Session
Dynamic	Yes
Type	String
Default Value	<code>en_US</code>

The locale to use for error messages. The default is `en_US`. The server converts the argument to a language name and combines it with the value of `lc_messages_dir` to produce the location for the error message file. See [Section 10.12, “Setting the Error Message Language”](#).

- `lc_messages_dir`

Command-Line Format	<code>--lc-messages-dir=dir_name</code>
System Variable	<code>lc_messages_dir</code>
Scope	Global
Dynamic	No
Type	Directory name

The directory where error messages are located. The server uses the value together with the value of `lc_messages` to produce the location for the error message file. See [Section 10.12, “Setting the Error Message Language”](#).

- `lc_time_names`

Command-Line Format	<code>--lc-time-names=value</code>
System Variable	<code>lc_time_names</code>
Scope	Global, Session
Dynamic	Yes

Type	String
------	--------

This variable specifies the locale that controls the language used to display day and month names and abbreviations. This variable affects the output from the `DATE_FORMAT()`, `DAYNAME()` and `MONTHNAME()` functions. Locale names are POSIX-style values such as 'ja\_JP' or 'pt\_BR'. The default value is 'en\_US' regardless of your system's locale setting. For further information, see [Section 10.16, “MySQL Server Locale Support”](#).

- `license`

System Variable	<code>license</code>
Scope	Global
Dynamic	No
Type	String
Default Value	GPL

The type of license the server has.

- `local_infile`

Command-Line Format	<code>--local-infile[={OFF ON}]</code>
System Variable	<code>local_infile</code>
Scope	Global
Dynamic	Yes
Type	Boolean
Default Value	ON

This variable controls server-side `LOCAL` capability for `LOAD DATA` statements. Depending on the `local_infile` setting, the server refuses or permits local data loading by clients that have `LOCAL` enabled on the client side.

To explicitly cause the server to refuse or permit `LOAD DATA LOCAL` statements (regardless of how client programs and libraries are configured at build time or runtime), start `mysqld` with `local_infile` disabled or enabled, respectively. `local_infile` can also be set at runtime. For more information, see [Section 6.1.6, “Security Considerations for LOAD DATA LOCAL”](#).

- `lock_wait_timeout`

Command-Line Format	<code>--lock-wait-timeout=#</code>
System Variable	<code>lock_wait_timeout</code>
Scope	Global, Session
Dynamic	Yes
Type	Integer
Default Value	31536000
Minimum Value	1
Maximum Value	31536000

Unit	seconds
------	---------

This variable specifies the timeout in seconds for attempts to acquire metadata locks. The permissible values range from 1 to 31536000 (1 year). The default is 31536000.

This timeout applies to all statements that use metadata locks. These include DML and DDL operations on tables, views, stored procedures, and stored functions, as well as `LOCK TABLES`, `FLUSH TABLES WITH READ LOCK`, and `HANDLER` statements.

This timeout does not apply to implicit accesses to system tables in the `mysql` database, such as grant tables modified by `GRANT` or `REVOKE` statements or table logging statements. The timeout does apply to system tables accessed directly, such as with `SELECT` or `UPDATE`.

The timeout value applies separately for each metadata lock attempt. A given statement can require more than one lock, so it is possible for the statement to block for longer than the `lock_wait_timeout` value before reporting a timeout error. When lock timeout occurs, `ER_LOCK_WAIT_TIMEOUT` is reported.

`lock_wait_timeout` does not apply to delayed inserts, which always execute with a timeout of 1 year. This is done to avoid unnecessary timeouts because a session that issues a delayed insert receives no notification of delayed insert timeouts.

- `locked_in_memory`

System Variable	<code>locked_in_memory</code>
Scope	Global
Dynamic	No
Type	Boolean
Default Value	<code>OFF</code>

Whether `mysqld` was locked in memory with `--memlock`.

- `log_error`

Command-Line Format	<code>--log-error[=file_name]</code>
System Variable	<code>log_error</code>
Scope	Global
Dynamic	No
Type	File name

The error log output destination. If the destination is the console, the value is `stderr`. Otherwise, the destination is a file and the `log_error` value is the file name. See [Section 5.4.2, “The Error Log”](#).

- `log_error_verbosity`

Command-Line Format	<code>--log-error-verbosity=#</code>
System Variable	<code>log_error_verbosity</code>
Scope	Global
Dynamic	Yes
Type	Integer
Default Value	3

Minimum Value	1
Maximum Value	3

The verbosity of the server in writing error, warning, and note messages to the error log. The following table shows the permitted values. The default is 3.

log_error_verbosity Value	Permitted Messages
1	Error messages
2	Error and warning messages
3	Error, warning, and information messages

`log_error_verbosity` was added in MySQL 5.7.2. It is preferred over, and should be used instead of, the older `log_warnings` system variable. See the description of `log_warnings` for information about how that variable relates to `log_error_verbosity`. In particular, assigning a value to `log_warnings` assigns a value to `log_error_verbosity` and vice versa.

- `log_output`

Command-Line Format	<code>--log-output=name</code>
System Variable	<code>log_output</code>
Scope	Global
Dynamic	Yes
Type	Set
Default Value	<code>FILE</code>
Valid Values	<code>TABLE</code> <code>FILE</code> <code>NONE</code>

The destination or destinations for general query log and slow query log output. The value is a list one or more comma-separated words chosen from `TABLE`, `FILE`, and `NONE`. `TABLE` selects logging to the `general_log` and `slow_log` tables in the `mysql` system database. `FILE` selects logging to log files. `NONE` disables logging. If `NONE` is present in the value, it takes precedence over any other words that are present. `TABLE` and `FILE` can both be given to select both log output destinations.

This variable selects log output destinations, but does not enable log output. To do that, enable the `general_log` and `slow_query_log` system variables. For `FILE` logging, the `general_log_file` and `slow_query_log_file` system variables determine the log file locations. For more information, see [Section 5.4.1, “Selecting General Query Log and Slow Query Log Output Destinations”](#).

- `log_queries_not_using_indexes`

Command-Line Format	<code>--log-queries-not-using-indexes[={OFF ON}]</code>
System Variable	<code>log_queries_not_using_indexes</code>
Scope	Global
Dynamic	Yes
Type	Boolean

Default Value	OFF
---------------	-----

If you enable this variable with the slow query log enabled, queries that are expected to retrieve all rows are logged. See [Section 5.4.5, “The Slow Query Log”](#). This option does not necessarily mean that no index is used. For example, a query that uses a full index scan uses an index but would be logged because the index would not limit the number of rows.

- `log_slow_admin_statements`

Command-Line Format	<code>--log-slow-admin-statements[={OFF ON}]</code>
System Variable	<code>log_slow_admin_statements</code>
Scope	Global
Dynamic	Yes
Type	Boolean
Default Value	OFF

Include slow administrative statements in the statements written to the slow query log. Administrative statements include [ALTER TABLE](#), [ANALYZE TABLE](#), [CHECK TABLE](#), [CREATE INDEX](#), [DROP INDEX](#), [OPTIMIZE TABLE](#), and [REPAIR TABLE](#).

- `log_syslog`

Command-Line Format	<code>--log-syslog[={OFF ON}]</code>
System Variable	<code>log_syslog</code>
Scope	Global
Dynamic	Yes
Type	Boolean
Default Value (Unix)	OFF
Default Value (Windows)	ON

Whether to write error log output to the system log. This is the Event Log on Windows, and `syslog` on Unix and Unix-like systems. The default value is platform specific:

- On Windows, Event Log output is enabled by default.
- On Unix and Unix-like systems, `syslog` output is disabled by default.

Regardless of the default, `log_syslog` can be set explicitly to control output on any supported platform.

System log output control is distinct from sending error output to a file or the console. Error output can be directed to a file or the console in addition to or instead of the system log as desired. See [Section 5.4.2, “The Error Log”](#).

- `log_syslog_facility`

Command-Line Format	<code>--log-syslog-facility=value</code>
System Variable	<code>log_syslog_facility</code>
Scope	Global

Dynamic	Yes
Type	String
Default Value	<code>daemon</code>

The facility for error log output written to `syslog` (what type of program is sending the message). This variable has no effect unless the `log_syslog` system variable is enabled. See [Section 5.4.2.3, “Error Logging to the System Log”](#).

The permitted values can vary per operating system; consult your system `syslog` documentation.

This variable does not exist on Windows.

- `log_syslog_include_pid`

Command-Line Format	<code>--log-syslog-include-pid[={OFF ON}]</code>
System Variable	<code>log_syslog_include_pid</code>
Scope	Global
Dynamic	Yes
Type	Boolean
Default Value	<code>ON</code>

Whether to include the server process ID in each line of error log output written to `syslog`. This variable has no effect unless the `log_syslog` system variable is enabled. See [Section 5.4.2.3, “Error Logging to the System Log”](#).

This variable does not exist on Windows.

- `log_syslog_tag`

Command-Line Format	<code>--log-syslog-tag=tag</code>
System Variable	<code>log_syslog_tag</code>
Scope	Global
Dynamic	Yes
Type	String
Default Value	<code>empty string</code>

The tag to be added to the server identifier in error log output written to `syslog`. This variable has no effect unless the `log_syslog` system variable is enabled. See [Section 5.4.2.3, “Error Logging to the System Log”](#).

By default, the server identifier is `mysqld` with no tag. If a tag value of `tag` is specified, it is appended to the server identifier with a leading hyphen, resulting in an identifier of `mysqld-tag`.

On Windows, to use a tag that does not already exist, the server must be run from an account with Administrator privileges, to permit creation of a registry entry for the tag. Elevated privileges are not required if the tag already exists.

- `log_timestamps`

Command-Line Format	<code>--log-timestamps=#</code>
---------------------	---------------------------------



System Variable	<code>log_timestamps</code>
Scope	Global
Dynamic	Yes
Type	Enumeration
Default Value	UTC
Valid Values	UTC SYSTEM

This variable controls the time zone of timestamps in messages written to the error log, and in general query log and slow query log messages written to files. It does not affect the time zone of general query log and slow query log messages written to tables (`mysql.general_log`, `mysql.slow_log`). Rows retrieved from those tables can be converted from the local system time zone to any desired time zone with `CONVERT_TZ()` or by setting the session `time_zone` system variable.

Permitted `log_timestamps` values are `UTC` (the default) and `SYSTEM` (local system time zone).

Timestamps are written using ISO 8601 / RFC 3339 format: `YYYY-MM-DDThh:mm:ss.uuuuuu` plus a tail value of `Z` signifying Zulu time (UTC) or `+hh:mm` (an offset from UTC).

- `log_throttle_queries_not_using_indexes`

Command-Line Format	<code>--log-throttle-queries-not-using-indexes=#</code>
System Variable	<code>log_throttle_queries_not_using_indexes</code>
Scope	Global
Dynamic	Yes
Type	Integer
Default Value	0
Minimum Value	0
Maximum Value	4294967295

If `log_queries_not_using_indexes` is enabled, the `log_throttle_queries_not_using_indexes` variable limits the number of such queries per minute that can be written to the slow query log. A value of 0 (the default) means “no limit”. For more information, see [Section 5.4.5, “The Slow Query Log”](#).

- `log_warnings`

Command-Line Format	<code>--log-warnings[=#]</code>
Deprecated	Yes
System Variable	<code>log_warnings</code>
Scope	Global
Dynamic	Yes
Type	Integer
Default Value	2
Minimum Value	0

Maximum Value (64-bit platforms)	18446744073709551615
Maximum Value (32-bit platforms)	4294967295

Whether to produce additional warning messages to the error log. As of MySQL 5.7.2, information items previously governed by `log_warnings` are governed by `log_error_verbosity`, which is preferred over, and should be used instead of, the older `log_warnings` system variable. (The `log_warnings` system variable and `--log-warnings` command-line option are deprecated; expect them to be removed in a future release of MySQL.)

`log_warnings` is enabled by default (the default is 1 before MySQL 5.7.2, 2 as of 5.7.2). To disable it, set it to 0. If the value is greater than 0, the server logs messages about statements that are unsafe for statement-based logging. If the value is greater than 1, the server logs aborted connections and access-denied errors for new connection attempts. See [Section B.3.2.9, “Communication Errors and Aborted Connections”](#).

If you use replication, enabling this variable by setting it greater than 0 is recommended, to get more information about what is happening, such as messages about network failures and reconnections.

If a replica server is started with `log_warnings` enabled, the replica prints messages to the error log to provide information about its status, such as the binary log and relay log coordinates where it starts its job, when it is switching to another relay log, when it reconnects after a disconnect, and so forth.

Assigning a value to `log_warnings` assigns a value to `log_error_verbosity` and vice versa. The variables are related as follows:

- Suppression of all `log_warnings` items, achieved with `log_warnings=0`, is achieved with `log_error_verbosity=1` (errors only).
- Items printed for `log_warnings=1` or higher count as warnings and are printed for `log_error_verbosity=2` or higher.
- Items printed for `log_warnings=2` count as notes and are printed for `log_error_verbosity=3`.

As of MySQL 5.7.2, the default log level is controlled by `log_error_verbosity`, which has a default of 3. In addition, the default for `log_warnings` changes from 1 to 2, which corresponds to `log_error_verbosity=3`. To achieve a logging level similar to the previous default, set `log_error_verbosity=2`.

In MySQL 5.7.2 and higher, use of `log_warnings` is still permitted but maps onto use of `log_error_verbosity` as follows:

- Setting `log_warnings=0` is equivalent to `log_error_verbosity=1` (errors only).
- Setting `log_warnings=1` is equivalent to `log_error_verbosity=2` (errors, warnings).
- Setting `log_warnings=2` (or higher) is equivalent to `log_error_verbosity=3` (errors, warnings, notes), and the server sets `log_warnings` to 2 if a larger value is specified.
- `long_query_time`

Command-Line Format	<code>--long-query-time=#</code>
System Variable	<code>long_query_time</code>
Scope	Global, Session
Dynamic	Yes

Type	Numeric
Default Value	10
Minimum Value	0
Maximum Value	31536000
Unit	seconds

If a query takes longer than this many seconds, the server increments the `Slow_queries` status variable. If the slow query log is enabled, the query is logged to the slow query log file. This value is measured in real time, not CPU time, so a query that is under the threshold on a lightly loaded system might be above the threshold on a heavily loaded one. The minimum and default values of `long_query_time` are 0 and 10, respectively. The maximum is 31536000, which is 365 days in seconds. The value can be specified to a resolution of microseconds. See [Section 5.4.5, “The Slow Query Log”](#).

Smaller values of this variable result in more statements being considered long-running, with the result that more space is required for the slow query log. For very small values (less than one second), the log may grow quite large in a small time. Increasing the number of statements considered long-running may also result in false positives for the “excessive Number of Long Running Processes” alert in MySQL Enterprise Monitor, especially if Group Replication is enabled. For these reasons, very small values should be used in test environments only, or, in production environments, only for a short period.

- `low_priority_updates`

Command-Line Format	<code>--low-priority-updates[={OFF ON}]</code>
System Variable	<code>low_priority_updates</code>
Scope	Global, Session
Dynamic	Yes
Type	Boolean
Default Value	<code>OFF</code>

If set to 1, all `INSERT`, `UPDATE`, `DELETE`, and `LOCK TABLE WRITE` statements wait until there is no pending `SELECT` or `LOCK TABLE READ` on the affected table. The same effect can be obtained using `{INSERT | REPLACE | DELETE | UPDATE} LOW_PRIORITY ...` to lower the priority of only one query. This variable affects only storage engines that use only table-level locking (such as `MyISAM`, `MEMORY`, and `MERGE`). See [Section 8.11.2, “Table Locking Issues”](#).

- `lower_case_file_system`

System Variable	<code>lower_case_file_system</code>
Scope	Global
Dynamic	No
Type	Boolean

This variable describes the case sensitivity of file names on the file system where the data directory is located. `OFF` means file names are case-sensitive, `ON` means they are not case-sensitive. This variable is read only because it reflects a file system attribute and setting it would have no effect on the file system.

- `lower_case_table_names`

Command-Line Format	<code>--lower-case-table-names[=#]</code>
System Variable	<code>lower_case_table_names</code>
Scope	Global
Dynamic	No
Type	Integer
Default Value (macOS)	2
Default Value (Unix)	0
Default Value (Windows)	1
Minimum Value	0
Maximum Value	2

If set to 0, table names are stored as specified and comparisons are case-sensitive. If set to 1, table names are stored in lowercase on disk and comparisons are not case-sensitive. If set to 2, table names are stored as given but compared in lowercase. This option also applies to database names and table aliases. For additional details, see [Section 9.2.3, “Identifier Case Sensitivity”](#).

The default value of this variable is platform-dependent (see `lower_case_file_system`). On Linux and other Unix-like systems, the default is 0. On Windows the default value is 1. On macOS, the default value is 2. On Linux (and other Unix-like systems), setting the value to 2 is not supported; the server forces the value to 0 instead.

You should *not* set `lower_case_table_names` to 0 if you are running MySQL on a system where the data directory resides on a case-insensitive file system (such as on Windows or macOS). It is an unsupported combination that could result in a hang condition when running an `INSERT INTO ... SELECT ... FROM tbl_name` operation with the wrong `tbl_name` lettercase. With `MyISAM`, accessing table names using different lettercases could cause index corruption.

An error message is printed and the server exits if you attempt to start the server with `--lower_case_table_names=0` on a case-insensitive file system.

The setting of this variable affects the behavior of replication filtering options with regard to case sensitivity. For more information, see [Section 16.2.5, “How Servers Evaluate Replication Filtering Rules”](#).

- `max_allowed_packet`

Command-Line Format	<code>--max-allowed-packet=#</code>
System Variable	<code>max_allowed_packet</code>
Scope	Global, Session
Dynamic	Yes
Type	Integer
Default Value	4194304
Minimum Value	1024
Maximum Value	1073741824
Unit	bytes

Block Size	1024
------------	------

The maximum size of one packet or any generated/intermediate string, or any parameter sent by the `mysql_stmt_send_long_data()` C API function. The default is 4MB.

The packet message buffer is initialized to `net_buffer_length` bytes, but can grow up to `max_allowed_packet` bytes when needed. This value by default is small, to catch large (possibly incorrect) packets.

You must increase this value if you are using large `BLOB` columns or long strings. It should be as big as the largest `BLOB` you want to use. The protocol limit for `max_allowed_packet` is 1GB. The value should be a multiple of 1024; nonmultiples are rounded down to the nearest multiple.

When you change the message buffer size by changing the value of the `max_allowed_packet` variable, you should also change the buffer size on the client side if your client program permits it. The default `max_allowed_packet` value built in to the client library is 1GB, but individual client programs might override this. For example, `mysql` and `mysqldump` have defaults of 16MB and 24MB, respectively. They also enable you to change the client-side value by setting `max_allowed_packet` on the command line or in an option file.

The session value of this variable is read only. The client can receive up to as many bytes as the session value. However, the server cannot send to the client more bytes than the current global `max_allowed_packet` value. (The global value could be less than the session value if the global value is changed after the client connects.)

- `max_connect_errors`

Command-Line Format	<code>--max-connect-errors=#</code>
System Variable	<code>max_connect_errors</code>
Scope	Global
Dynamic	Yes
Type	Integer
Default Value	100
Minimum Value	1
Maximum Value (64-bit platforms)	18446744073709551615
Maximum Value (32-bit platforms)	4294967295

After `max_connect_errors` successive connection requests from a host are interrupted without a successful connection, the server blocks that host from further connections. If a connection from a host is established successfully within fewer than `max_connect_errors` attempts after a previous connection was interrupted, the error count for the host is cleared to zero. To unblock blocked hosts, flush the host cache; see [Flushing the Host Cache](#).

- `max_connections`

Command-Line Format	<code>--max-connections=#</code>
System Variable	<code>max_connections</code>
Scope	Global
Dynamic	Yes
Type	Integer

Default Value	151
Minimum Value	1
Maximum Value	100000

The maximum permitted number of simultaneous client connections. The maximum effective value is the lesser of the effective value of `open_files_limit - 810`, and the value actually set for `max_connections`.

For more information, see [Section 5.1.11.1, “Connection Interfaces”](#).

- `max_delayed_threads`

Command-Line Format	<code>--max-delayed-threads=#</code>
Deprecated	Yes
System Variable	<code>max_delayed_threads</code>
Scope	Global, Session
Dynamic	Yes
Type	Integer
Default Value	20
Minimum Value	0
Maximum Value	16384

This system variable is deprecated (because `DELAYED` inserts are not supported); expect it to be removed in a future release.

- `max_digest_length`

Command-Line Format	<code>--max-digest-length=#</code>
System Variable	<code>max_digest_length</code>
Scope	Global
Dynamic	No
Type	Integer
Default Value	1024
Minimum Value	0
Maximum Value	1048576
Unit	bytes

The maximum number of bytes of memory reserved per session for computation of normalized statement digests. Once that amount of space is used during digest computation, truncation occurs: no further tokens from a parsed statement are collected or figure into its digest value. Statements that differ only after that many bytes of parsed tokens produce the same normalized statement digest and are considered identical if compared or if aggregated for digest statistics.

The length used for calculating a normalized statement digest is the sum of the length of the normalized statement digest and the length of the statement digest. Since the length of the statement digest is

always 64, when the value of `max_digest_length` is 1024 (the default), the maximum length for a normalized SQL statement before truncation occurs is  $1024 - 64 = 960$  bytes.



### Warning

Setting `max_digest_length` to zero disables digest production, which also disables server functionality that requires digests, such as MySQL Enterprise Firewall.

Decreasing the `max_digest_length` value reduces memory use but causes the digest value of more statements to become indistinguishable if they differ only at the end. Increasing the value permits longer statements to be distinguished but increases memory use, particularly for workloads that involve large numbers of simultaneous sessions (the server allocates `max_digest_length` bytes per session).

The parser uses this system variable as a limit on the maximum length of normalized statement digests that it computes. The Performance Schema, if it tracks statement digests, makes a copy of the digest value, using the `performance_schema_max_digest_length` system variable as a limit on the maximum length of digests that it stores. Consequently, if `performance_schema_max_digest_length` is less than `max_digest_length`, digest values stored in the Performance Schema are truncated relative to the original digest values.

For more information about statement digesting, see [Section 25.10, “Performance Schema Statement Digests”](#).

- `max_error_count`

Command-Line Format	<code>--max-error-count=#</code>
System Variable	<code>max_error_count</code>
Scope	Global, Session
Dynamic	Yes
Type	Integer
Default Value	64
Minimum Value	0
Maximum Value	65535

The maximum number of error, warning, and information messages to be stored for display by the `SHOW ERRORS` and `SHOW WARNINGS` statements. This is the same as the number of condition areas in the diagnostics area, and thus the number of conditions that can be inspected by `GET DIAGNOSTICS`.

- `max_execution_time`

Command-Line Format	<code>--max-execution-time=#</code>
System Variable	<code>max_execution_time</code>
Scope	Global, Session
Dynamic	Yes
Type	Integer
Default Value	0
Minimum Value	0
Maximum Value	4294967295

Unit	milliseconds
------	--------------

The execution timeout for `SELECT` statements, in milliseconds. If the value is 0, timeouts are not enabled.

`max_execution_time` applies as follows:

- The global `max_execution_time` value provides the default for the session value for new connections. The session value applies to `SELECT` executions executed within the session that include no `MAX_EXECUTION_TIME(N)` optimizer hint or for which `N` is 0.
- `max_execution_time` applies to read-only `SELECT` statements. Statements that are not read only are those that invoke a stored function that modifies data as a side effect.
- `max_execution_time` is ignored for `SELECT` statements in stored programs.
- `max_heap_table_size`

Command-Line Format	<code>--max-heap-table-size=#</code>
System Variable	<code>max_heap_table_size</code>
Scope	Global, Session
Dynamic	Yes
Type	Integer
Default Value	16777216
Minimum Value	16384
Maximum Value (64-bit platforms)	18446744073709550592
Maximum Value (32-bit platforms)	4294966272
Unit	bytes
Block Size	1024

This variable sets the maximum size to which user-created `MEMORY` tables are permitted to grow. The value of the variable is used to calculate `MEMORY` table `MAX_ROWS` values.

Setting this variable has no effect on any existing `MEMORY` table, unless the table is re-created with a statement such as `CREATE TABLE` or altered with `ALTER TABLE` or `TRUNCATE TABLE`. A server restart also sets the maximum size of existing `MEMORY` tables to the global `max_heap_table_size` value.

This variable is also used in conjunction with `tmp_table_size` to limit the size of internal in-memory tables. See [Section 8.4.4, “Internal Temporary Table Use in MySQL”](#).

`max_heap_table_size` is not replicated. See [Section 16.4.1.20, “Replication and MEMORY Tables”](#), and [Section 16.4.1.37, “Replication and Variables”](#), for more information.

- `max_insert_delayed_threads`

Deprecated	Yes
System Variable	<code>max_insert_delayed_threads</code>
Scope	Global, Session
Dynamic	Yes
Type	Integer



Default Value	0
Minimum Value	20
Maximum Value	16384

This variable is a synonym for `max_delayed_threads`.

This system variable is deprecated (because `DELAYED` inserts are not supported); expect it to be removed in a future release.

- `max_join_size`

Command-Line Format	<code>--max-join-size=#</code>
System Variable	<code>max_join_size</code>
Scope	Global, Session
Dynamic	Yes
Type	Integer
Default Value	18446744073709551615
Minimum Value	1
Maximum Value	18446744073709551615

Do not permit statements that probably need to examine more than `max_join_size` rows (for single-table statements) or row combinations (for multiple-table statements) or that are likely to do more than `max_join_size` disk seeks. By setting this value, you can catch statements where keys are not used properly and that would probably take a long time. Set it if your users tend to perform joins that lack a `WHERE` clause, that take a long time, or that return millions of rows. For more information, see [Using Safe-Updates Mode \(`--safe-updates`\)](#).

Setting this variable to a value other than `DEFAULT` resets the value of `sql_big_selects` to 0. If you set the `sql_big_selects` value again, the `max_join_size` variable is ignored.

If a query result is in the query cache, no result size check is performed, because the result has previously been computed and it does not burden the server to send it to the client.

- `max_length_for_sort_data`

Command-Line Format	<code>--max-length-for-sort-data=#</code>
System Variable	<code>max_length_for_sort_data</code>
Scope	Global, Session
Dynamic	Yes
Type	Integer
Default Value	1024
Minimum Value	4
Maximum Value	8388608
Unit	bytes

The cutoff on the size of index values that determines which `filesort` algorithm to use. See [Section 8.2.1.14, “ORDER BY Optimization”](#).

- `max_points_in_geometry`

Command-Line Format	<code>--max-points-in-geometry=#</code>
System Variable	<code>max_points_in_geometry</code>
Scope	Global, Session
Dynamic	Yes
Type	Integer
Default Value	65536
Minimum Value	3
Maximum Value	1048576

The maximum value of the `points_per_circle` argument to the `ST_Buffer_Strategy()` function.

- `max_prepared_stmt_count`

Command-Line Format	<code>--max-prepared-stmt-count=#</code>
System Variable	<code>max_prepared_stmt_count</code>
Scope	Global
Dynamic	Yes
Type	Integer
Default Value	16382
Minimum Value	0
Maximum Value	1048576

This variable limits the total number of prepared statements in the server. It can be used in environments where there is the potential for denial-of-service attacks based on running the server out of memory by preparing huge numbers of statements. If the value is set lower than the current number of prepared statements, existing statements are not affected and can be used, but no new statements can be prepared until the current number drops below the limit. Setting the value to 0 disables prepared statements.

- `max_seeks_for_key`

Command-Line Format	<code>--max-seeks-for-key=#</code>
System Variable	<code>max_seeks_for_key</code>
Scope	Global, Session
Dynamic	Yes
Type	Integer
Default Value (Windows)	4294967295
Default Value (Other, 64-bit platforms)	18446744073709551615
Default Value (Other, 32-bit platforms)	4294967295
Minimum Value	1
Maximum Value (Windows)	4294967295
Maximum Value (Other, 64-bit platforms)	18446744073709551615
Maximum Value (Other, 32-bit platforms)	4294967295

Limit the assumed maximum number of seeks when looking up rows based on a key. The MySQL optimizer assumes that no more than this number of key seeks are required when searching for matching rows in a table by scanning an index, regardless of the actual cardinality of the index (see [Section 13.7.5.22, “SHOW INDEX Statement”](#)). By setting this to a low value (say, 100), you can force MySQL to prefer indexes instead of table scans.

- `max_sort_length`

Command-Line Format	<code>--max-sort-length=#</code>
System Variable	<code>max_sort_length</code>
Scope	Global, Session
Dynamic	Yes
Type	Integer
Default Value	1024
Minimum Value	4
Maximum Value	8388608
Unit	bytes

The number of bytes to use when sorting data values. The server uses only the first `max_sort_length` bytes of each value and ignores the rest. Consequently, values that differ only after the first `max_sort_length` bytes compare as equal for `GROUP BY`, `ORDER BY`, and `DISTINCT` operations.

Increasing the value of `max_sort_length` may require increasing the value of `sort_buffer_size` as well. For details, see [Section 8.2.1.14, “ORDER BY Optimization”](#)

- `max_sp_recursion_depth`

Command-Line Format	<code>--max-sp-recursion-depth[=#]</code>
System Variable	<code>max_sp_recursion_depth</code>
Scope	Global, Session
Dynamic	Yes
Type	Integer
Default Value	0
Minimum Value	0
Maximum Value	255

The number of times that any given stored procedure may be called recursively. The default value for this option is 0, which completely disables recursion in stored procedures. The maximum value is 255.

Stored procedure recursion increases the demand on thread stack space. If you increase the value of `max_sp_recursion_depth`, it may be necessary to increase thread stack size by increasing the value of `thread_stack` at server startup.

- `max_tmp_tables`

This variable is unused. It is deprecated and is removed in MySQL 8.0.

- `max_user_connections`

Command-Line Format	<code>--max-user-connections=#</code>
System Variable	<code>max_user_connections</code>
Scope	Global, Session
Dynamic	Yes
Type	Integer
Default Value	0
Minimum Value	0
Maximum Value	4294967295

The maximum number of simultaneous connections permitted to any given MySQL user account. A value of 0 (the default) means “no limit.”

This variable has a global value that can be set at server startup or runtime. It also has a read-only session value that indicates the effective simultaneous-connection limit that applies to the account associated with the current session. The session value is initialized as follows:

- If the user account has a nonzero `MAX_USER_CONNECTIONS` resource limit, the session `max_user_connections` value is set to that limit.
- Otherwise, the session `max_user_connections` value is set to the global value.

Account resource limits are specified using the `CREATE USER` or `ALTER USER` statement. See [Section 6.2.16, “Setting Account Resource Limits”](#).

- `max_write_lock_count`

Command-Line Format	<code>--max-write-lock-count=#</code>
System Variable	<code>max_write_lock_count</code>
Scope	Global
Dynamic	Yes
Type	Integer
Default Value (Windows)	4294967295
Default Value (Other, 64-bit platforms)	18446744073709551615
Default Value (Other, 32-bit platforms)	4294967295
Minimum Value	1
Maximum Value (Windows)	4294967295
Maximum Value (Other, 64-bit platforms)	18446744073709551615
Maximum Value (Other, 32-bit platforms)	4294967295

After this many write locks, permit some pending read lock requests to be processed in between. Write lock requests have higher priority than read lock requests. However, if `max_write_lock_count` is set to some low value (say, 10), read lock requests may be preferred over pending write lock requests if the read lock requests have already been passed over in favor of 10 write lock requests. Normally this behavior does not occur because `max_write_lock_count` by default has a very large value.

- `mecab_rc_file`

Command-Line Format	<code>--mecab-rc-file=file_name</code>
System Variable	<code>mecab_rc_file</code>
Scope	Global
Dynamic	No
Type	File name

The `mecab_rc_file` option is used when setting up the MeCab full-text parser.

The `mecab_rc_file` option defines the path to the `mecabrc` configuration file, which is the configuration file for MeCab. The option is read-only and can only be set at startup. The `mecabrc` configuration file is required to initialize MeCab.

For information about the MeCab full-text parser, see [Section 12.9.9, “MeCab Full-Text Parser Plugin”](#).

For information about options that can be specified in the MeCab `mecabrc` configuration file, refer to the [MeCab Documentation](#) on the [Google Developers](#) site.

- `metadata_locks_cache_size`

Command-Line Format	<code>--metadata-locks-cache-size=#</code>
Deprecated	Yes
System Variable	<code>metadata_locks_cache_size</code>
Scope	Global
Dynamic	No
Type	Integer
Default Value	1024
Minimum Value	1
Maximum Value	1048576
Unit	bytes

The size of the metadata locks cache. The server uses this cache to avoid creation and destruction of synchronization objects. This is particularly helpful on systems where such operations are expensive, such as Windows XP.

In MySQL 5.7.4, metadata locking implementation changes make this variable unnecessary, and so it is deprecated; expect it to be removed in a future release of MySQL.

- `metadata_locks_hash_instances`

Command-Line Format	<code>--metadata-locks-hash-instances=#</code>
Deprecated	Yes
System Variable	<code>metadata_locks_hash_instances</code>
Scope	Global
Dynamic	No
Type	Integer

Default Value	8
Minimum Value	1
Maximum Value	1024

The set of metadata locks can be partitioned into separate hashes to permit connections accessing different objects to use different locking hashes and reduce contention. The `metadata_locks_hash_instances` system variable specifies the number of hashes (default 8).

In MySQL 5.7.4, metadata locking implementation changes make this variable unnecessary, and so it is deprecated; expect it to be removed in a future release of MySQL.

- `min_examined_row_limit`

Command-Line Format	<code>--min-examined-row-limit=#</code>
System Variable	<code>min_examined_row_limit</code>
Scope	Global, Session
Dynamic	Yes
Type	Integer
Default Value	0
Minimum Value	0
Maximum Value (64-bit platforms)	18446744073709551615
Maximum Value (32-bit platforms)	4294967295

Queries that examine fewer than this number of rows are not logged to the slow query log.

- `multi_range_count`

Command-Line Format	<code>--multi-range-count=#</code>
Deprecated	Yes
System Variable	<code>multi_range_count</code>
Scope	Global, Session
Dynamic	Yes
Type	Integer
Default Value	256
Minimum Value	1
Maximum Value	4294967295

This variable has no effect. It is deprecated and is removed in MySQL 8.0.

- `myisam_data_pointer_size`

Command-Line Format	<code>--myisam-data-pointer-size=#</code>
System Variable	<code>myisam_data_pointer_size</code>
Scope	Global
Dynamic	Yes
Type	Integer

Default Value	6
Minimum Value	2
Maximum Value	7
Unit	bytes

The default pointer size in bytes, to be used by `CREATE TABLE` for `MyISAM` tables when no `MAX_ROWS` option is specified. This variable cannot be less than 2 or larger than 7. The default value is 6. See [Section B.3.2.10, “The table is full”](#).

- `myisam_max_sort_file_size`

Command-Line Format	<code>--myisam-max-sort-file-size=#</code>
System Variable	<code>myisam_max_sort_file_size</code>
Scope	Global
Dynamic	Yes
Type	Integer
Default Value (Windows)	2146435072
Default Value (Other, 64-bit platforms)	9223372036853727232
Default Value (Other, 32-bit platforms)	2147483648
Minimum Value	0
Maximum Value (Windows)	2146435072
Maximum Value (Other, 64-bit platforms)	9223372036853727232
Maximum Value (Other, 32-bit platforms)	2147483648
Unit	bytes

The maximum size of the temporary file that MySQL is permitted to use while re-creating a `MyISAM` index (during `REPAIR TABLE`, `ALTER TABLE`, or `LOAD DATA`). If the file size would be larger than this value, the index is created using the key cache instead, which is slower. The value is given in bytes.

If `MyISAM` index files exceed this size and disk space is available, increasing the value may help performance. The space must be available in the file system containing the directory where the original index file is located.

- `myisam_mmap_size`

Command-Line Format	<code>--myisam-mmap-size=#</code>
System Variable	<code>myisam_mmap_size</code>
Scope	Global
Dynamic	No
Type	Integer
Default Value (64-bit platforms)	18446744073709551615
Default Value (32-bit platforms)	4294967295
Minimum Value	7
Maximum Value (64-bit platforms)	18446744073709551615
Maximum Value (32-bit platforms)	4294967295

Unit	bytes
------	-------

The maximum amount of memory to use for memory mapping compressed [MyISAM](#) files. If many compressed [MyISAM](#) tables are used, the value can be decreased to reduce the likelihood of memory-swapping problems.

- [myisam\\_recover\\_options](#)

Command-Line Format	<code>--myisam-recover-options[=<i>list</i>]</code>
System Variable	<code>myisam_recover_options</code>
Scope	Global
Dynamic	No
Type	Enumeration
Default Value	OFF
Valid Values	OFF  DEFAULT  BACKUP  FORCE  QUICK

Set the [MyISAM](#) storage engine recovery mode. The variable value is any combination of the values of [OFF](#), [DEFAULT](#), [BACKUP](#), [FORCE](#), or [QUICK](#). If you specify multiple values, separate them by commas. Specifying the variable with no value at server startup is the same as specifying [DEFAULT](#), and specifying with an explicit value of " " disables recovery (same as a value of [OFF](#)). If recovery is enabled, each time `mysqld` opens a [MyISAM](#) table, it checks whether the table is marked as crashed or was not closed properly. (The last option works only if you are running with external locking disabled.) If this is the case, `mysqld` runs a check on the table. If the table was corrupted, `mysqld` attempts to repair it.

The following options affect how the repair works.

Option	Description
<a href="#">OFF</a>	No recovery.
<a href="#">DEFAULT</a>	Recovery without backup, forcing, or quick checking.
<a href="#">BACKUP</a>	If the data file was changed during recovery, save a backup of the <code>tbl_name.MYD</code> file as <code>tbl_name-datetime.BAK</code> .
<a href="#">FORCE</a>	Run recovery even if we would lose more than one row from the <code>.MYD</code> file.
<a href="#">QUICK</a>	Do not check the rows in the table if there are not any delete blocks.

Before the server automatically repairs a table, it writes a note about the repair to the error log. If you want to be able to recover from most problems without user intervention, you should use the options



`BACKUP`, `FORCE`. This forces a repair of a table even if some rows would be deleted, but it keeps the old data file as a backup so that you can later examine what happened.

See [Section 15.2.1, “MyISAM Startup Options”](#).

- `myisam_repair_threads`

Command-Line Format	<code>--myisam-repair-threads=#</code>
Deprecated	5.7.38 (removed in 5.7.39)
System Variable	<code>myisam_repair_threads</code>
Scope	Global, Session
Dynamic	Yes
Type	Integer
Default Value	1
Minimum Value	1
Maximum Value (64-bit platforms)	18446744073709551615
Maximum Value (32-bit platforms)	4294967295



#### Note

This system variable is deprecated in MySQL 5.7; expect it to be removed in a future release of MySQL.

From MySQL 5.7.38, values other than 1 produce a warning.

If this value is greater than 1, `MyISAM` table indexes are created in parallel (each index in its own thread) during the `Repair by sorting` process. The default value is 1.



#### Note

Multithreaded repair is *beta-quality* code.

- `myisam_sort_buffer_size`

Command-Line Format	<code>--myisam-sort-buffer-size=#</code>
System Variable	<code>myisam_sort_buffer_size</code>
Scope	Global, Session
Dynamic	Yes
Type	Integer
Default Value	8388608
Minimum Value	4096
Maximum Value (64-bit platforms)	18446744073709551615
Maximum Value (32-bit platforms)	4294967295
Unit	bytes

The size of the buffer that is allocated when sorting `MyISAM` indexes during a `REPAIR TABLE` or when creating indexes with `CREATE INDEX` or `ALTER TABLE`.

- `myisam_stats_method`

Command-Line Format	<code>--myisam-stats-method=name</code>
System Variable	<code>myisam_stats_method</code>
Scope	Global, Session
Dynamic	Yes
Type	Enumeration
Default Value	<code>nulls_unequal</code>
Valid Values	<code>nulls_unequal</code> <code>nulls_equal</code> <code>nulls_ignored</code>

How the server treats `NULL` values when collecting statistics about the distribution of index values for `MyISAM` tables. This variable has three possible values, `nulls_equal`, `nulls_unequal`, and `nulls_ignored`. For `nulls_equal`, all `NULL` index values are considered equal and form a single value group that has a size equal to the number of `NULL` values. For `nulls_unequal`, `NULL` values are considered unequal, and each `NULL` forms a distinct value group of size 1. For `nulls_ignored`, `NULL` values are ignored.

The method that is used for generating table statistics influences how the optimizer chooses indexes for query execution, as described in [Section 8.3.7, “InnoDB and MyISAM Index Statistics Collection”](#).

- `myisam_use_mmap`

Command-Line Format	<code>--myisam-use-mmap[={OFF ON} ]</code>
System Variable	<code>myisam_use_mmap</code>
Scope	Global
Dynamic	Yes
Type	Boolean
Default Value	<code>OFF</code>

Use memory mapping for reading and writing `MyISAM` tables.

- `mysql_native_password_proxy_users`

Command-Line Format	<code>--mysql-native-password-proxy-users[={OFF ON} ]</code>
System Variable	<code>mysql_native_password_proxy_users</code>
Scope	Global
Dynamic	Yes
Type	Boolean
Default Value	<code>OFF</code>

This variable controls whether the `mysql_native_password` built-in authentication plugin supports proxy users. It has no effect unless the `check_proxy_users` system variable is enabled. For information about user proxying, see [Section 6.2.14, “Proxy Users”](#).

- `named_pipe`

Command-Line Format	<code>--named-pipe[={OFF ON}]</code>
System Variable	<code>named_pipe</code>
Scope	Global
Dynamic	No
Platform Specific	Windows
Type	Boolean
Default Value	<code>OFF</code>

(Windows only.) Indicates whether the server supports connections over named pipes.

- `named_pipe_full_access_group`

Command-Line Format	<code>--named-pipe-full-access-group=value</code>
Introduced	5.7.25
System Variable	<code>named_pipe_full_access_group</code>
Scope	Global
Dynamic	No
Platform Specific	Windows
Type	String
Default Value	<code>empty string</code>
Valid Values	<code>empty string</code>  <code>valid Windows local group name</code>  <code>*everyone*</code>

(Windows only.) The access control granted to clients on the named pipe created by the MySQL server is set to the minimum necessary for successful communication when the `named_pipe` system variable is enabled to support named-pipe connections. Some MySQL client software can open named pipe connections without any additional configuration; however, other client software may still require full access to open a named pipe connection.

This variable sets the name of a Windows local group whose members are granted sufficient access by the MySQL server to use named-pipe clients. As of MySQL 5.7.34, the default value is set to an empty string, which means that no Windows user is granted full access to the named pipe.

A new Windows local group name (for example, `mysql_access_client_users`) can be created in Windows and then used to replace the default value when access is absolutely necessary. In this case, limit the membership of the group to as few users as possible, removing users from the group when their client software is upgraded. A non-member of the group who attempts to open a connection to MySQL with the affected named-pipe client is denied access until a Windows administrator adds the user to the group. Newly added users must log out and log in again to join the group (required by Windows).

Setting the value to `'*everyone*'` provides a language-independent way of referring to the Everyone group on Windows. The Everyone group is not secure by default.

- [net\\_buffer\\_length](#)

Command-Line Format	<code>--net-buffer-length=#</code>
System Variable	<a href="#">net_buffer_length</a>
Scope	Global, Session
Dynamic	Yes
Type	Integer
Default Value	16384
Minimum Value	1024
Maximum Value	1048576
Unit	bytes
Block Size	1024

Each client thread is associated with a connection buffer and result buffer. Both begin with a size given by [net\\_buffer\\_length](#) but are dynamically enlarged up to [max\\_allowed\\_packet](#) bytes as needed. The result buffer shrinks to [net\\_buffer\\_length](#) after each SQL statement.

This variable should not normally be changed, but if you have very little memory, you can set it to the expected length of statements sent by clients. If statements exceed this length, the connection buffer is automatically enlarged. The maximum value to which [net\\_buffer\\_length](#) can be set is 1MB.

The session value of this variable is read only.

- [net\\_read\\_timeout](#)

Command-Line Format	<code>--net-read-timeout=#</code>
System Variable	<a href="#">net_read_timeout</a>
Scope	Global, Session
Dynamic	Yes
Type	Integer
Default Value	30
Minimum Value	1
Maximum Value	31536000
Unit	seconds

The number of seconds to wait for more data from a connection before aborting the read. When the server is reading from the client, [net\\_read\\_timeout](#) is the timeout value controlling when to abort. When the server is writing to the client, [net\\_write\\_timeout](#) is the timeout value controlling when to abort. See also [slave\\_net\\_timeout](#).

- [net\\_retry\\_count](#)

Command-Line Format	<code>--net-retry-count=#</code>
System Variable	<a href="#">net_retry_count</a>
Scope	Global, Session
Dynamic	Yes

Type	Integer
Default Value	10
Minimum Value	1
Maximum Value (64-bit platforms)	18446744073709551615
Maximum Value (32-bit platforms)	4294967295

If a read or write on a communication port is interrupted, retry this many times before giving up. This value should be set quite high on FreeBSD because internal interrupts are sent to all threads.

- `net_write_timeout`

Command-Line Format	<code>--net-write-timeout=#</code>
System Variable	<code>net_write_timeout</code>
Scope	Global, Session
Dynamic	Yes
Type	Integer
Default Value	60
Minimum Value	1
Maximum Value	31536000
Unit	seconds

The number of seconds to wait for a block to be written to a connection before aborting the write. See also `net_read_timeout`.

- `new`

Command-Line Format	<code>--new[={OFF ON}]</code>
System Variable	<code>new</code>
Scope	Global, Session
Dynamic	Yes
Disabled by	<code>skip-new</code>
Type	Boolean
Default Value	OFF

This variable was used in MySQL 4.0 to turn on some 4.1 behaviors, and is retained for backward compatibility. Its value is always `OFF`.

In NDB Cluster, setting this variable to `ON` makes it possible to employ partitioning types other than `KEY` or `LINEAR KEY` with `NDB` tables. This experimental feature is not supported in production, and is now deprecated and thus subject to removal in a future release. For additional information, see [User-defined partitioning and the NDB storage engine \(NDB Cluster\)](#).

- `ngram_token_size`

Command-Line Format	<code>--ngram-token-size=#</code>
System Variable	<code>ngram_token_size</code>
Scope	Global

Dynamic	No
Type	Integer
Default Value	2
Minimum Value	1
Maximum Value	10

Defines the n-gram token size for the n-gram full-text parser. The `ngram_token_size` option is read-only and can only be modified at startup. The default value is 2 (bigram). The maximum value is 10.

For more information about how to configure this variable, see [Section 12.9.8, “ngram Full-Text Parser”](#).

- `offline_mode`

Command-Line Format	<code>--offline-mode[={OFF ON}]</code>
System Variable	<code>offline_mode</code>
Scope	Global
Dynamic	Yes
Type	Boolean
Default Value	<code>OFF</code>

Whether the server is in “offline mode”, which has these characteristics:

- Connected client users who do not have the `SUPER` privilege are disconnected on the next request, with an appropriate error. Disconnection includes terminating running statements and releasing locks. Such clients also cannot initiate new connections, and receive an appropriate error.
- Connected client users who have the `SUPER` privilege are not disconnected, and can initiate new connections to manage the server.
- Replica threads are permitted to keep applying data to the server.

Only users who have the `SUPER` privilege can control offline mode. To put a server in offline mode, change the value of the `offline_mode` system variable from `OFF` to `ON`. To resume normal operations, change `offline_mode` from `ON` to `OFF`. In offline mode, clients that are refused access receive an `ER_SERVER_OFFLINE_MODE` error.

- `old`

Command-Line Format	<code>--old[={OFF ON}]</code>
System Variable	<code>old</code>
Scope	Global
Dynamic	No
Type	Boolean
Default Value	<code>OFF</code>

`old` is a compatibility variable. It is disabled by default, but can be enabled at startup to revert the server to behaviors present in older versions.

When `old` is enabled, it changes the default scope of index hints to that used prior to MySQL 5.1.17. That is, index hints with no `FOR` clause apply only to how indexes are used for row retrieval and not

to resolution of `ORDER BY` or `GROUP BY` clauses. (See [Section 8.9.4, “Index Hints”](#).) Take care about enabling this in a replication setup. With statement-based binary logging, having different modes for the source and replicas might lead to replication errors.

- `old_alter_table`

Command-Line Format	<code>--old-alter-table[={OFF ON}]</code>
System Variable	<code>old_alter_table</code>
Scope	Global, Session
Dynamic	Yes
Type	Boolean
Default Value	<code>OFF</code>

When this variable is enabled, the server does not use the optimized method of processing an `ALTER TABLE` operation. It reverts to using a temporary table, copying over the data, and then renaming the temporary table to the original, as used by MySQL 5.0 and earlier. For more information on the operation of `ALTER TABLE`, see [Section 13.1.8, “ALTER TABLE Statement”](#).

- `old_passwords`

Command-Line Format	<code>--old-passwords=value</code>
Deprecated	Yes
System Variable	<code>old_passwords</code>
Scope	Global, Session
Dynamic	Yes
Type	Enumeration
Default Value	0
Valid Values	0 2



#### Note

This system variable is deprecated in MySQL 5.7; expect it to be removed in a future release of MySQL.

This variable controls the password hashing method used by the `PASSWORD()` function. It also influences password hashing performed by `CREATE USER` and `GRANT` statements that specify a password using an `IDENTIFIED BY` clause.

The following table shows, for each password hashing method, the permitted value of `old_passwords` and which authentication plugins use the hashing method.

Password Hashing Method	<code>old_passwords</code> Value	Associated Authentication Plugin
MySQL 4.1 native hashing	0	<code>mysql_native_password</code>

Password Hashing Method	old_passwords Value	Associated Authentication Plugin
SHA-256 hashing	2	<code>sha256_password</code>

If you set `old_passwords=2`, follow the instructions for using the `sha256_password` plugin at [Section 6.4.1.5, “SHA-256 Pluggable Authentication”](#).

The server sets the global `old_passwords` value during startup to be consistent with the password hashing method required by the authentication plugin indicated by the `default_authentication_plugin` system variable.

When a client successfully connects to the server, the server sets the session `old_passwords` value appropriately for the account authentication method. For example, if the account uses the `sha256_password` authentication plugin, the server sets `old_passwords=2`.

For additional information about authentication plugins and hashing formats, see [Section 6.2.13, “Pluggable Authentication”](#), and [Section 6.1.2.4, “Password Hashing in MySQL”](#).

- `open_files_limit`

Command-Line Format	<code>--open-files-limit=#</code>
System Variable	<code>open_files_limit</code>
Scope	Global
Dynamic	No
Type	Integer
Default Value	5000, with possible adjustment
Minimum Value	0
Maximum Value	platform dependent

The number of file descriptors available to `mysqld` from the operating system:

- At startup, `mysqld` reserves descriptors with `setrlimit()`, using the value requested at by setting this variable directly or by using the `--open-files-limit` option to `mysqld_safe`. If `mysqld` produces the error `Too many open files`, try increasing the `open_files_limit` value. Internally, the maximum value for this variable is the maximum unsigned integer value, but the actual maximum is platform dependent.
- At runtime, the value of `open_files_limit` indicates the number of file descriptors actually permitted to `mysqld` by the operating system, which might differ from the value requested at startup. If the number of file descriptors requested during startup cannot be allocated, `mysqld` writes a warning to the error log.

The effective `open_files_limit` value is based on the value specified at system startup (if any) and the values of `max_connections` and `table_open_cache`, using these formulas:

- $10 + \text{max\_connections} + (\text{table\_open\_cache} * 2)$
- $\text{max\_connections} * 5$
- The operating system limit if that limit is positive but not Infinity.



- If the operating system limit is Infinity: `open_files_limit` value if specified at startup, 5000 if not.

The server attempts to obtain the number of file descriptors using the maximum of those values. If that many descriptors cannot be obtained, the server attempts to obtain as many as the system permits.

The effective value is 0 on systems where MySQL cannot change the number of open files.

On Unix, the value cannot be set greater than the value displayed by the `ulimit -n` command. On Linux systems using `systemd`, the value cannot be set greater than `LimitNOFile` (this is `DefaultLimitNOFILE`, if `LimitNOFile` is not set); otherwise, on Linux, the value of `open_files_limit` cannot exceed `ulimit -n`.

- `optimizer_prune_level`

Command-Line Format	<code>--optimizer-prune-level=#</code>
System Variable	<code>optimizer_prune_level</code>
Scope	Global, Session
Dynamic	Yes
Type	Integer
Default Value	1
Minimum Value	0
Maximum Value	1

Controls the heuristics applied during query optimization to prune less-promising partial plans from the optimizer search space. A value of 0 disables heuristics so that the optimizer performs an exhaustive search. A value of 1 causes the optimizer to prune plans based on the number of rows retrieved by intermediate plans.

- `optimizer_search_depth`

Command-Line Format	<code>--optimizer-search-depth=#</code>
System Variable	<code>optimizer_search_depth</code>
Scope	Global, Session
Dynamic	Yes
Type	Integer
Default Value	62
Minimum Value	0
Maximum Value	62

The maximum depth of search performed by the query optimizer. Values larger than the number of relations in a query result in better query plans, but take longer to generate an execution plan for a query. Values smaller than the number of relations in a query return an execution plan quicker, but the resulting plan may be far from being optimal. If set to 0, the system automatically picks a reasonable value.

- `optimizer_switch`

Command-Line Format	<code>--optimizer-switch=value</code>
---------------------	---------------------------------------

## Server System Variables

System Variable	<code>optimizer_switch</code>
Scope	Global, Session
Dynamic	Yes
Type	Set
Valid Values ( $\geq 5.7.33$ )	<code>batched_key_access={on off}</code> <code>block_nested_loop={on off}</code> <code>condition_fanout_filter={on off}</code> <code>derived_merge={on off}</code> <code>duplicateweedout={on off}</code> <code>engine_condition_pushdown={on off}</code> <code>firstmatch={on off}</code> <code>index_condition_pushdown={on off}</code> <code>index_merge={on off}</code> <code>index_merge_intersection={on off}</code> <code>index_merge_sort_union={on off}</code> <code>index_merge_union={on off}</code> <code>loosescan={on off}</code> <code>materialization={on off}</code> <code>mrr={on off}</code> <code>mrr_cost_based={on off}</code> <code>prefer_ordering_index={on off}</code> <code>semijoin={on off}</code> <code>subquery_materialization_cost_based={on off}</code> <code>use_index_extensions={on off}</code>
Valid Values ( $\leq 5.7.32$ )	<code>batched_key_access={on off}</code> <code>block_nested_loop={on off}</code> <code>condition_fanout_filter={on off}</code> <code>derived_merge={on off}</code> <code>duplicateweedout={on off}</code> <code>engine_condition_pushdown={on off}</code>

	<pre> firstmatch={on off} index_condition_pushdown={on off} index_merge={on off} index_merge_intersection={on off} index_merge_sort_union={on off} index_merge_union={on off} loosescan={on off} materialization={on off} mrr={on off} mrr_cost_based={on off} semijoin={on off} subquery_materialization_cost_based={on off} use_index_extensions={on off} </pre>
--	--

The `optimizer_switch` system variable enables control over optimizer behavior. The value of this variable is a set of flags, each of which has a value of `on` or `off` to indicate whether the corresponding optimizer behavior is enabled or disabled. This variable has global and session values and can be changed at runtime. The global default can be set at server startup.

To see the current set of optimizer flags, select the variable value:

```

mysql> SELECT @@optimizer_switch\G
***** 1. row *****
@@optimizer_switch: index_merge=on,index_merge_union=on,
                    index_merge_sort_union=on,
                    index_merge_intersection=on,
                    engine_condition_pushdown=on,
                    index_condition_pushdown=on,
                    mrr=on,mrr_cost_based=on,
                    block_nested_loop=on,batched_key_access=off,
                    materialization=on,semijoin=on,loosescan=on,
                    firstmatch=on,duplicateweedout=on,
                    subquery_materialization_cost_based=on,
                    use_index_extensions=on,
                    condition_fanout_filter=on,derived_merge=on,
                    prefer_ordering_index=on

```

For more information about the syntax of this variable and the optimizer behaviors that it controls, see [Section 8.9.2, “Switchable Optimizations”](#).

- `optimizer_trace`

Command-Line Format	<code>--optimizer-trace=value</code>
System Variable	<code>optimizer_trace</code>
Scope	Global, Session

Dynamic	Yes
Type	String

This variable controls optimizer tracing. For details, see [Section 8.15, “Tracing the Optimizer”](#).

- `optimizer_trace_features`

Command-Line Format	<code>--optimizer-trace-features=value</code>
System Variable	<code>optimizer_trace_features</code>
Scope	Global, Session
Dynamic	Yes
Type	String

This variable enables or disables selected optimizer tracing features. For details, see [Section 8.15, “Tracing the Optimizer”](#).

- `optimizer_trace_limit`

Command-Line Format	<code>--optimizer-trace-limit=#</code>
System Variable	<code>optimizer_trace_limit</code>
Scope	Global, Session
Dynamic	Yes
Type	Integer
Default Value	1
Minimum Value	0
Maximum Value	2147483647

The maximum number of optimizer traces to display. For details, see [Section 8.15, “Tracing the Optimizer”](#).

- `optimizer_trace_max_mem_size`

Command-Line Format	<code>--optimizer-trace-max-mem-size=#</code>
System Variable	<code>optimizer_trace_max_mem_size</code>
Scope	Global, Session
Dynamic	Yes
Type	Integer
Default Value	16384
Minimum Value	0
Maximum Value	4294967295
Unit	bytes

The maximum cumulative size of stored optimizer traces. For details, see [Section 8.15, “Tracing the Optimizer”](#).

- `optimizer_trace_offset`

Command-Line Format	<code>--optimizer-trace-offset=#</code>
System Variable	<code>optimizer_trace_offset</code>
Scope	Global, Session
Dynamic	Yes
Type	Integer
Default Value	-1
Minimum Value	-2147483647
Maximum Value	2147483647

The offset of optimizer traces to display. For details, see [Section 8.15, “Tracing the Optimizer”](#).

- `performance_schema_xxx`

Performance Schema system variables are listed in [Section 25.15, “Performance Schema System Variables”](#). These variables may be used to configure Performance Schema operation.

- `parser_max_mem_size`

Command-Line Format	<code>--parser-max-mem-size=#</code>
Introduced	5.7.12
System Variable	<code>parser_max_mem_size</code>
Scope	Global, Session
Dynamic	Yes
Type	Integer
Default Value (64-bit platforms)	18446744073709551615
Default Value (32-bit platforms)	4294967295
Minimum Value	10000000
Maximum Value (64-bit platforms)	18446744073709551615
Maximum Value (32-bit platforms)	4294967295
Unit	bytes

The maximum amount of memory available to the parser. The default value places no limit on memory available. The value can be reduced to protect against out-of-memory situations caused by parsing long or complex SQL statements.

- `pid_file`

Command-Line Format	<code>--pid-file=file_name</code>
System Variable	<code>pid_file</code>
Scope	Global
Dynamic	No

Type	File name
------	-----------

The path name of the file in which the server writes its process ID. The server creates the file in the data directory unless an absolute path name is given to specify a different directory. If you specify this variable, you must specify a value. If you do not specify this variable, MySQL uses a default value of `host_name.pid`, where `host_name` is the name of the host machine.

The process ID file is used by other programs such as `mysqld_safe` to determine the server's process ID. On Windows, this variable also affects the default error log file name. See [Section 5.4.2, “The Error Log”](#).

- `plugin_dir`

Command-Line Format	<code>--plugin-dir=dir_name</code>
System Variable	<code>plugin_dir</code>
Scope	Global
Dynamic	No
Type	Directory name
Default Value	<code>BASEDIR/lib/plugin</code>

The path name of the plugin directory.

If the plugin directory is writable by the server, it may be possible for a user to write executable code to a file in the directory using `SELECT ... INTO DUMPFILE`. This can be prevented by making `plugin_dir` read only to the server or by setting `secure_file_priv` to a directory where `SELECT` writes can be made safely.

- `port`

Command-Line Format	<code>--port=port_num</code>
System Variable	<code>port</code>
Scope	Global
Dynamic	No
Type	Integer
Default Value	<code>3306</code>
Minimum Value	<code>0</code>
Maximum Value	<code>65535</code>

The number of the port on which the server listens for TCP/IP connections. This variable can be set with the `--port` option.

- `preload_buffer_size`

Command-Line Format	<code>--preload-buffer-size=#</code>
System Variable	<code>preload_buffer_size</code>
Scope	Global, Session
Dynamic	Yes
Type	Integer

Default Value	32768
Minimum Value	1024
Maximum Value	1073741824
Unit	bytes

The size of the buffer that is allocated when preloading indexes.

- `profiling`

If set to 0 or `OFF` (the default), statement profiling is disabled. If set to 1 or `ON`, statement profiling is enabled and the `SHOW PROFILE` and `SHOW PROFILES` statements provide access to profiling information. See [Section 13.7.5.31, “SHOW PROFILES Statement”](#).

This variable is deprecated; expect it to be removed in a future release of MySQL.

- `profiling_history_size`

The number of statements for which to maintain profiling information if `profiling` is enabled. The default value is 15. The maximum value is 100. Setting the value to 0 effectively disables profiling. See [Section 13.7.5.31, “SHOW PROFILES Statement”](#).

This variable is deprecated; expect it to be removed in a future release of MySQL.

- `protocol_version`

System Variable	<code>protocol_version</code>
Scope	Global
Dynamic	No
Type	Integer
Default Value	10
Minimum Value	0
Maximum Value	4294967295

The version of the client/server protocol used by the MySQL server.

- `proxy_user`

System Variable	<code>proxy_user</code>
Scope	Session
Dynamic	No
Type	String

If the current client is a proxy for another user, this variable is the proxy user account name. Otherwise, this variable is `NULL`. See [Section 6.2.14, “Proxy Users”](#).

- `pseudo_slave_mode`

System Variable	<code>pseudo_slave_mode</code>
Scope	Session
Dynamic	Yes

Type	Boolean
------	---------

This system variable is for internal server use. `pseudo_slave_mode` assists with the correct handling of transactions that originated on older or newer servers than the server currently processing them. `mysqlbinlog` sets the value of `pseudo_slave_mode` to true before executing any SQL statements.

`pseudo_slave_mode` has the following effects on the handling of prepared XA transactions, which can be attached to or detached from the handling session (by default, the session that issues `XA START`):

- If true, and the handling session has executed an internal-use `BINLOG` statement, XA transactions are automatically detached from the session as soon as the first part of the transaction up to `XA PREPARE` finishes, so they can be committed or rolled back by any session that has the `XA_RECOVER_ADMIN` privilege.
- If false, XA transactions remain attached to the handling session as long as that session is alive, during which time no other session can commit the transaction. The prepared transaction is only detached if the session disconnects or the server restarts.

- `pseudo_thread_id`

System Variable	<code>pseudo_thread_id</code>
Scope	Session
Dynamic	Yes
Type	Integer
Default Value	2147483647
Minimum Value	0
Maximum Value	2147483647

This variable is for internal server use.



**Warning**

Changing the session value of the `pseudo_thread_id` system variable changes the value returned by the `CONNECTION_ID()` function.

- `query_alloc_block_size`

Command-Line Format	<code>--query-alloc-block-size=#</code>
System Variable	<code>query_alloc_block_size</code>
Scope	Global, Session
Dynamic	Yes
Type	Integer
Default Value	8192
Minimum Value	1024
Maximum Value	4294966272
Unit	bytes



Block Size	1024
------------	------

The allocation size in bytes of memory blocks that are allocated for objects created during statement parsing and execution. If you have problems with memory fragmentation, it might help to increase this parameter.

The block size for the byte number is 1024. A value that is not an exact multiple of the block size is rounded down to the next lower multiple of the block size by MySQL Server before storing the value for the system variable. The parser allows values up to the maximum unsigned integer value for the platform (4294967295 or  $2^{32}-1$  for a 32-bit system, 18446744073709551615 or  $2^{64}-1$  for a 64-bit system) but the actual maximum is a block size lower.

- `query_cache_limit`

Command-Line Format	<code>--query-cache-limit=#</code>
Deprecated	5.7.20
System Variable	<code>query_cache_limit</code>
Scope	Global
Dynamic	Yes
Type	Integer
Default Value	1048576
Minimum Value	0
Maximum Value (64-bit platforms)	18446744073709551615
Maximum Value (32-bit platforms)	4294967295
Unit	bytes

Do not cache results that are larger than this number of bytes. The default value is 1MB.



**Note**

The query cache is deprecated as of MySQL 5.7.20, and is removed in MySQL 8.0. Deprecation includes `query_cache_limit`.

- `query_cache_min_res_unit`

Command-Line Format	<code>--query-cache-min-res-unit=#</code>
Deprecated	5.7.20
System Variable	<code>query_cache_min_res_unit</code>
Scope	Global
Dynamic	Yes
Type	Integer
Default Value	4096
Minimum Value	512
Maximum Value (64-bit platforms)	18446744073709551615
Maximum Value (32-bit platforms)	4294967295

Unit	bytes
------	-------

The minimum size (in bytes) for blocks allocated by the query cache. The default value is 4096 (4KB). Tuning information for this variable is given in [Section 8.10.3.3, “Query Cache Configuration”](#).

**Note**

The query cache is deprecated as of MySQL 5.7.20, and is removed in MySQL 8.0. Deprecation includes `query_cache_min_res_unit`.

- `query_cache_size`

Command-Line Format	<code>--query-cache-size=#</code>
Deprecated	5.7.20
System Variable	<code>query_cache_size</code>
Scope	Global
Dynamic	Yes
Type	Integer
Default Value	1048576
Minimum Value	0
Maximum Value (64-bit platforms)	18446744073709551615
Maximum Value (32-bit platforms)	4294967295
Unit	bytes

The amount of memory allocated for caching query results. By default, the query cache is disabled. This is achieved using a default value of 1M, with a default for `query_cache_type` of 0. (To reduce overhead significantly if you set the size to 0, you should also start the server with `query_cache_type=0`.)

The permissible values are multiples of 1024; other values are rounded down to the nearest multiple. For nonzero values of `query_cache_size`, that many bytes of memory are allocated even if `query_cache_type=0`. See [Section 8.10.3.3, “Query Cache Configuration”](#), for more information.

The query cache needs a minimum size of about 40KB to allocate its structures. (The exact size depends on system architecture.) If you set the value of `query_cache_size` too small, a warning occurs, as described in [Section 8.10.3.3, “Query Cache Configuration”](#).

**Note**

The query cache is deprecated as of MySQL 5.7.20, and is removed in MySQL 8.0. Deprecation includes `query_cache_size`.

- `query_cache_type`

Command-Line Format	<code>--query-cache-type=#</code>
Deprecated	5.7.20
System Variable	<code>query_cache_type</code>
Scope	Global, Session
Dynamic	Yes

Type	Enumeration
Default Value	0
Valid Values	0 1 2

Set the query cache type. Setting the [GLOBAL](#) value sets the type for all clients that connect thereafter. Individual clients can set the [SESSION](#) value to affect their own use of the query cache. Possible values are shown in the following table.

Option	Description
0 or <a href="#">OFF</a>	Do not cache results in or retrieve results from the query cache. Note that this does not deallocate the query cache buffer. To do that, you should set <a href="#">query_cache_size</a> to 0.
1 or <a href="#">ON</a>	Cache all cacheable query results except for those that begin with <a href="#">SELECT SQL_NO_CACHE</a> .
2 or <a href="#">DEMAND</a>	Cache results only for cacheable queries that begin with <a href="#">SELECT SQL_CACHE</a> .

This variable defaults to [OFF](#).

If the server is started with [query\\_cache\\_type](#) set to 0, it does not acquire the query cache mutex at all, which means that the query cache cannot be enabled at runtime and there is reduced overhead in query execution.



#### Note

The query cache is deprecated as of MySQL 5.7.20, and is removed in MySQL 8.0. Deprecation includes [query\\_cache\\_type](#).

- [query\\_cache\\_wlock\\_invalidate](#)

Command-Line Format	<code>--query-cache-wlock-invalidate[={OFF ON} ]</code>
Deprecated	5.7.20
System Variable	<a href="#">query_cache_wlock_invalidate</a>
Scope	Global, Session
Dynamic	Yes
Type	Boolean
Default Value	<a href="#">OFF</a>

Normally, when one client acquires a [WRITE](#) lock on a table, other clients are not blocked from issuing statements that read from the table if the query results are present in the query cache. Setting this variable to 1 causes acquisition of a [WRITE](#) lock for a table to invalidate any queries in the query cache

that refer to the table. This forces other clients that attempt to access the table to wait while the lock is in effect.



#### Note

The query cache is deprecated as of MySQL 5.7.20, and is removed in MySQL 8.0. Deprecation includes `query_cache_wlock_invalidate`.

- `query_prealloc_size`

Command-Line Format	<code>--query-prealloc-size=#</code>
System Variable	<code>query_prealloc_size</code>
Scope	Global, Session
Dynamic	Yes
Type	Integer
Default Value	8192
Minimum Value	8192
Maximum Value (64-bit platforms)	18446744073709550592
Maximum Value (32-bit platforms)	4294966272
Unit	bytes
Block Size	1024

The size in bytes of the persistent buffer used for statement parsing and execution. This buffer is not freed between statements. If you are running complex queries, a larger `query_prealloc_size` value might be helpful in improving performance, because it can reduce the need for the server to perform memory allocation during query execution operations. You should be aware that doing this does not necessarily eliminate allocation completely; the server may still allocate memory in some situations, such as for operations relating to transactions, or to stored programs.

- `rand_seed1`

System Variable	<code>rand_seed1</code>
Scope	Session
Dynamic	Yes
Type	Integer
Default Value	N/A
Minimum Value	0
Maximum Value	4294967295

The `rand_seed1` and `rand_seed2` variables exist as session variables only, and can be set but not read. The variables—but not their values—are shown in the output of `SHOW VARIABLES`.

The purpose of these variables is to support replication of the `RAND()` function. For statements that invoke `RAND()`, the source passes two values to the replica, where they are used to seed the random number generator. The replica uses these values to set the session variables `rand_seed1` and `rand_seed2` so that `RAND()` on the replica generates the same value as on the source.

- [rand\\_seed2](#)

See the description for [rand\\_seed1](#).

- [range\\_alloc\\_block\\_size](#)

Command-Line Format	<code>--range-alloc-block-size=#</code>
System Variable	<a href="#">range_alloc_block_size</a>
Scope	Global, Session
Dynamic	Yes
Type	Integer
Default Value	4096
Minimum Value	4096
Maximum Value (64-bit platforms)	18446744073709550592
Maximum Value	4294966272
Unit	bytes
Block Size	1024

The size in bytes of blocks that are allocated when doing range optimization.

The block size for the byte number is 1024. A value that is not an exact multiple of the block size is rounded down to the next lower multiple of the block size by MySQL Server before storing the value for the system variable. The parser allows values up to the maximum unsigned integer value for the platform (4294967295 or  $2^{32}-1$  for a 32-bit system, 18446744073709551615 or  $2^{64}-1$  for a 64-bit system) but the actual maximum is a block size lower.

- [range\\_optimizer\\_max\\_mem\\_size](#)

Command-Line Format	<code>--range-optimizer-max-mem-size=#</code>
System Variable	<a href="#">range_optimizer_max_mem_size</a>
Scope	Global, Session
Dynamic	Yes
Type	Integer
Default Value ( $\geq$ 5.7.12)	8388608
Default Value ( $\leq$ 5.7.11)	1536000
Minimum Value	0
Maximum Value	18446744073709551615
Unit	bytes

The limit on memory consumption for the range optimizer. A value of 0 means “no limit.” If an execution plan considered by the optimizer uses the range access method but the optimizer estimates that the amount of memory needed for this method would exceed the limit, it abandons the plan and considers other plans. For more information, see [Limiting Memory Use for Range Optimization](#).

- [rbr\\_exec\\_mode](#)

System Variable	<a href="#">rbr_exec_mode</a>	847
-----------------	-------------------------------	-----

Scope	Session
Dynamic	Yes
Type	Enumeration
Default Value	<code>STRICT</code>
Valid Values	<code>STRICT</code> <code>IDEMPOTENT</code>

For internal use by `mysqlbinlog`. This variable switches the server between `IDEMPOTENT` mode and `STRICT` mode. `IDEMPOTENT` mode causes suppression of duplicate-key and no-key-found errors in `BINLOG` statements generated by `mysqlbinlog`. This mode is useful when replaying a row-based binary log on a server that causes conflicts with existing data. `mysqlbinlog` sets this mode when you specify the `--idempotent` option by writing the following to the output:

```
SET SESSION RBR_EXEC_MODE=IDEMPOTENT;
```

- `read_buffer_size`

Command-Line Format	<code>--read-buffer-size=#</code>
System Variable	<code>read_buffer_size</code>
Scope	Global, Session
Dynamic	Yes
Type	Integer
Default Value	131072
Minimum Value	8192
Maximum Value	2147479552
Unit	bytes
Block Size	4096

Each thread that does a sequential scan for a `MyISAM` table allocates a buffer of this size (in bytes) for each table it scans. If you do many sequential scans, you might want to increase this value, which defaults to 131072. The value of this variable should be a multiple of 4KB. If it is set to a value that is not a multiple of 4KB, its value is rounded down to the nearest multiple of 4KB.

This option is also used in the following context for all storage engines:

- For caching the indexes in a temporary file (not a temporary table), when sorting rows for `ORDER BY`.
- For bulk insert into partitions.
- For caching results of nested queries.

`read_buffer_size` is also used in one other storage engine-specific way: to determine the memory block size for `MEMORY` tables.

For more information about memory use during different operations, see [Section 8.12.4.1, “How MySQL Uses Memory”](#).

- `read_only`

Command-Line Format	<code>--read-only[={OFF ON}]</code>
System Variable	<code>read_only</code>
Scope	Global
Dynamic	Yes
Type	Boolean
Default Value	<code>OFF</code>

If the `read_only` system variable is enabled, the server permits no client updates except from users who have the `SUPER` privilege. This variable is disabled by default.

The server also supports a `super_read_only` system variable (disabled by default), which has these effects:

- If `super_read_only` is enabled, the server prohibits client updates, even from users who have the `SUPER` privilege.
- Setting `super_read_only` to `ON` implicitly forces `read_only` to `ON`.
- Setting `read_only` to `OFF` implicitly forces `super_read_only` to `OFF`.

Even with `read_only` enabled, the server permits these operations:

- Updates performed by replication threads, if the server is a replica. In replication setups, it can be useful to enable `read_only` on replica servers to ensure that replicas accept updates only from the source server and not from clients.
- Use of `ANALYZE TABLE` or `OPTIMIZE TABLE` statements. The purpose of read-only mode is to prevent changes to table structure or contents. Analysis and optimization do not qualify as such changes. This means, for example, that consistency checks on read-only replicas can be performed with `mysqlcheck --all-databases --analyze`.
- Use of `FLUSH STATUS` statements, which are always written to the binary log.
- Operations on `TEMPORARY` tables.
- Inserts into the log tables (`mysql.general_log` and `mysql.slow_log`); see [Section 5.4.1, “Selecting General Query Log and Slow Query Log Output Destinations”](#).
- As of MySQL 5.7.16, updates to Performance Schema tables, such as `UPDATE` or `TRUNCATE TABLE` operations.

Changes to `read_only` on a replication source server are not replicated to replica servers. The value can be set on a replica independent of the setting on the source.

The following conditions apply to attempts to enable `read_only` (including implicit attempts resulting from enabling `super_read_only`):

- The attempt fails and an error occurs if you have any explicit locks (acquired with `LOCK TABLES`) or have a pending transaction.
- The attempt blocks while other clients have any ongoing statement, active `LOCK TABLES WRITE`, or ongoing commit, until the locks are released and the statements and transactions end. While

the attempt to enable `read_only` is pending, requests by other clients for table locks or to begin transactions also block until `read_only` has been set.

- The attempt blocks if there are active transactions that hold metadata locks, until those transactions end.
- `read_only` can be enabled while you hold a global read lock (acquired with `FLUSH TABLES WITH READ LOCK`) because that does not involve table locks.
- `read_rnd_buffer_size`

Command-Line Format	<code>--read-rnd-buffer-size=#</code>
System Variable	<code>read_rnd_buffer_size</code>
Scope	Global, Session
Dynamic	Yes
Type	Integer
Default Value	262144
Minimum Value	1
Maximum Value	2147483647
Unit	bytes

This variable is used for reads from `MyISAM` tables, and, for any storage engine, for Multi-Range Read optimization.

When reading rows from a `MyISAM` table in sorted order following a key-sorting operation, the rows are read through this buffer to avoid disk seeks. See [Section 8.2.1.14, “ORDER BY Optimization”](#). Setting the variable to a large value can improve `ORDER BY` performance by a lot. However, this is a buffer allocated for each client, so you should not set the global variable to a large value. Instead, change the session variable only from within those clients that need to run large queries.

For more information about memory use during different operations, see [Section 8.12.4.1, “How MySQL Uses Memory”](#). For information about Multi-Range Read optimization, see [Section 8.2.1.10, “Multi-Range Read Optimization”](#).

- `require_secure_transport`

Command-Line Format	<code>--require-secure-transport[={OFF ON}]</code>
System Variable	<code>require_secure_transport</code>
Scope	Global
Dynamic	Yes
Type	Boolean
Default Value	OFF

Whether client connections to the server are required to use some form of secure transport. When this variable is enabled, the server permits only TCP/IP connections encrypted using TLS/SSL, or



connections that use a socket file (on Unix) or shared memory (on Windows). The server rejects nonsecure connection attempts, which fail with an `ER_SECURE_TRANSPORT_REQUIRED` error.

This capability supplements per-account SSL requirements, which take precedence. For example, if an account is defined with `REQUIRE SSL`, enabling `require_secure_transport` does not make it possible to use the account to connect using a Unix socket file.

It is possible for a server to have no secure transports available. For example, a server on Windows supports no secure transports if started without specifying any SSL certificate or key files and with the `shared_memory` system variable disabled. Under these conditions, attempts to enable `require_secure_transport` at startup cause the server to write a message to the error log and exit. Attempts to enable the variable at runtime fail with an `ER_NO_SECURE_TRANSPORTS_CONFIGURED` error.

See also [Configuring Encrypted Connections as Mandatory](#).

- `secure_auth`

Command-Line Format	<code>--secure-auth[={OFF ON} ]</code>
Deprecated	Yes
System Variable	<code>secure_auth</code>
Scope	Global
Dynamic	Yes
Type	Boolean
Default Value	ON
Valid Values	ON

If this variable is enabled, the server blocks connections by clients that attempt to use accounts that have passwords stored in the old (pre-4.1) format. Enable this variable to prevent all use of passwords employing the old format (and hence insecure communication over the network).

This variable is deprecated; expect it to be removed in a future release of MySQL. It is always enabled and attempting to disable it produces an error.

Server startup fails with an error if this variable is enabled and the privilege tables are in pre-4.1 format. See [Section 6.4.1.3, “Migrating Away from Pre-4.1 Password Hashing and the `mysql\_old\_password` Plugin”](#).



#### Note

Passwords that use the pre-4.1 hashing method are less secure than passwordss that use the native password hashing method and should be avoided. Pre-4.1 passwordss are deprecated and support for them is removed in MySQL 5.7.5. For account upgrade instructions, see [Section 6.4.1.3, “Migrating Away from Pre-4.1 Password Hashing and the `mysql\_old\_password` Plugin”](#).

- `secure_file_priv`

Command-Line Format	<code>--secure-file-priv=dir_name</code>
System Variable	<code>secure_file_priv</code>
Scope	Global

Dynamic	No
Type	String
Default Value	platform specific
Valid Values	empty string dirname NULL

This variable is used to limit the effect of data import and export operations, such as those performed by the `LOAD DATA` and `SELECT ... INTO OUTFILE` statements and the `LOAD_FILE()` function. These operations are permitted only to users who have the `FILE` privilege.

`secure_file_priv` may be set as follows:

- If empty, the variable has no effect. This is not a secure setting.
- If set to the name of a directory, the server limits import and export operations to work only with files in that directory. The directory must exist; the server does not create it.
- If set to `NULL`, the server disables import and export operations.

The default value is platform specific and depends on the value of the `INSTALL_LAYOUT` CMake option, as shown in the following table. To specify the default `secure_file_priv` value explicitly if you are building from source, use the `INSTALL_SECURE_FILE_PRIVDIR` CMake option.

<code>INSTALL_LAYOUT</code> Value	Default <code>secure_file_priv</code> Value
<code>STANDALONE, WIN</code>	<code>NULL</code> ( $\geq$ MySQL 5.7.16), empty ( $<$ MySQL 5.7.16)
<code>DEB, RPM, SLES, SVR4</code>	<code>/var/lib/mysql-files</code>
Otherwise	<code>mysql-files</code> under the <code>CMAKE_INSTALL_PREFIX</code> value

To set the default `secure_file_priv` value for the `libmysqld` embedded server, use the `INSTALL_SECURE_FILE_PRIV_EMBEDDED` CMake option. The default value for this option is `NULL`.

The server checks the value of `secure_file_priv` at startup and writes a warning to the error log if the value is insecure. A non-`NULL` value is considered insecure if it is empty, or the value is the data directory or a subdirectory of it, or a directory that is accessible by all users. If `secure_file_priv` is set to a nonexistent path, the server writes an error message to the error log and exits.

- `session_track_gtids`

Command-Line Format	<code>--session-track-gtids=value</code>
System Variable	<code>session_track_gtids</code>
Scope	Global, Session
Dynamic	Yes
Type	Enumeration
Default Value	<code>OFF</code>
Valid Values	<code>OFF</code>  <code>OWN_GTID</code>

ALL_GTIDS
-----------

Controls whether the server returns GTIDs to the client, enabling the client to use them to track the server state. Depending on the variable value, at the end of executing each transaction, the server's GTIDs are captured and returned to the client as part of the acknowledgement. The possible values for `session_track_gtids` are as follows:

- **OFF**: The server does not return GTIDs to the client. This is the default.
- **OWN\_GTID**: The server returns the GTIDs for all transactions that were successfully committed by this client in its current session since the last acknowledgement. Typically, this is the single GTID for the last transaction committed, but if a single client request resulted in multiple transactions, the server returns a GTID set containing all the relevant GTIDs.
- **ALL\_GTIDS**: The server returns the global value of its `gtid_executed` system variable, which it reads at a point after the transaction is successfully committed. As well as the GTID for the transaction just committed, this GTID set includes all transactions committed on the server by any client, and can include transactions committed after the point when the transaction currently being acknowledged was committed.

`session_track_gtids` cannot be set within transactional context.

For more information about session state tracking, see [Section 5.1.15, "Server Tracking of Client Session State"](#).

- `session_track_schema`

Command-Line Format	<code>--session-track-schema[={OFF ON}]</code>
System Variable	<code>session_track_schema</code>
Scope	Global, Session
Dynamic	Yes
Type	Boolean
Default Value	ON

Controls whether the server tracks when the default schema (database) is set within the current session and notifies the client to make the schema name available.

If the schema name tracker is enabled, name notification occurs each time the default schema is set, even if the new schema name is the same as the old.

For more information about session state tracking, see [Section 5.1.15, "Server Tracking of Client Session State"](#).

- `session_track_state_change`

Command-Line Format	<code>--session-track-state-change[={OFF ON}]</code>
System Variable	<code>session_track_state_change</code>
Scope	Global, Session
Dynamic	Yes
Type	Boolean

Default Value	OFF
---------------	-----

Controls whether the server tracks changes to the state of the current session and notifies the client when state changes occur. Changes can be reported for these attributes of client session state:

- The default schema (database).
- Session-specific values for system variables.
- User-defined variables.
- Temporary tables.
- Prepared statements.

If the session state tracker is enabled, notification occurs for each change that involves tracked session attributes, even if the new attribute values are the same as the old. For example, setting a user-defined variable to its current value results in a notification.

The `session_track_state_change` variable controls only notification of when changes occur, not what the changes are. For example, state-change notifications occur when the default schema is set or tracked session system variables are assigned, but the notification does not include the schema name or variable values. To receive notification of the schema name or session system variable values, use the `session_track_schema` or `session_track_system_variables` system variable, respectively.



**Note**

Assigning a value to `session_track_state_change` itself is not considered a state change and is not reported as such. However, if its name listed in the value of `session_track_system_variables`, any assignments to it do result in notification of the new value.

For more information about session state tracking, see [Section 5.1.15, “Server Tracking of Client Session State”](#).

- `session_track_system_variables`

Command-Line Format	<code>--session-track-system-variables=#</code>
System Variable	<code>session_track_system_variables</code>
Scope	Global, Session
Dynamic	Yes
Type	String
Default Value	<code>time_zone, autocommit, character_set_client, character_set_results, character_set_connection</code>

Controls whether the server tracks assignments to session system variables and notifies the client of the name and value of each assigned variable. The variable value is a comma-separated list of variables for which to track assignments. By default, notification is enabled for `time_zone`, `autocommit`,

`character_set_client`, `character_set_results`, and `character_set_connection`. (The latter three variables are those affected by `SET NAMES`.)

The special value `*` causes the server to track assignments to all session variables. If given, this value must be specified by itself without specific system variable names.

To disable notification of session variable assignments, set `session_track_system_variables` to the empty string.

If session system variable tracking is enabled, notification occurs for all assignments to tracked session variables, even if the new values are the same as the old.

For more information about session state tracking, see [Section 5.1.15, “Server Tracking of Client Session State”](#).

- `session_track_transaction_info`

Command-Line Format	<code>--session-track-transaction-info=value</code>
System Variable	<code>session_track_transaction_info</code>
Scope	Global, Session
Dynamic	Yes
Type	Enumeration
Default Value	<code>OFF</code>
Valid Values	<code>OFF</code>  <code>STATE</code>  <code>CHARACTERISTICS</code>

Controls whether the server tracks the state and characteristics of transactions within the current session and notifies the client to make this information available. These `session_track_transaction_info` values are permitted:

- `OFF`: Disable transaction state tracking. This is the default.
- `STATE`: Enable transaction state tracking without characteristics tracking. State tracking enables the client to determine whether a transaction is in progress and whether it could be moved to a different session without being rolled back.
- `CHARACTERISTICS`: Enable transaction state tracking, including characteristics tracking. Characteristics tracking enables the client to determine how to restart a transaction in another session so that it has the same characteristics as in the original session. The following characteristics are relevant for this purpose:

```
ISOLATION LEVEL
READ ONLY
READ WRITE
WITH CONSISTENT SNAPSHOT
```

For a client to safely relocate a transaction to another session, it must track not only transaction state but also transaction characteristics. In addition, the client must track the `transaction_isolation`

and `transaction_read_only` system variables to correctly determine the session defaults. (To track these variables, list them in the value of the `session_track_system_variables` system variable.)

For more information about session state tracking, see [Section 5.1.15, “Server Tracking of Client Session State”](#).

- `sha256_password_auto_generate_rsa_keys`

Command-Line Format	<code>--sha256-password-auto-generate-rsa-keys[={OFF ON}]</code>
System Variable	<code>sha256_password_auto_generate_rsa_keys</code>
Scope	Global
Dynamic	No
Type	Boolean
Default Value	ON

This variable is available if the server was compiled using OpenSSL (see [Section 6.3.4, “SSL Library-Dependent Capabilities”](#)). It controls whether the server autogenerates RSA private/public key-pair files in the data directory, if they do not already exist.

At startup, the server automatically generates RSA private/public key-pair files in the data directory if the `sha256_password_auto_generate_rsa_keys` system variable is enabled, no RSA options are specified, and the RSA files are missing from the data directory. These files enable secure password exchange using RSA over unencrypted connections for accounts authenticated by the `sha256_password` plugin; see [Section 6.4.1.5, “SHA-256 Pluggable Authentication”](#).

For more information about RSA file autogeneration, including file names and characteristics, see [Section 6.3.3.1, “Creating SSL and RSA Certificates and Keys using MySQL”](#)

The `auto_generate_certs` system variable is related but controls autogeneration of SSL certificate and key files needed for secure connections using SSL.

- `sha256_password_private_key_path`

Command-Line Format	<code>--sha256-password-private-key-path=file_name</code>
System Variable	<code>sha256_password_private_key_path</code>
Scope	Global
Dynamic	No
Type	File name
Default Value	<code>private_key.pem</code>

This variable is available if MySQL was compiled using OpenSSL (see [Section 6.3.4, “SSL Library-Dependent Capabilities”](#)). Its value is the path name of the RSA private key file for the

`sha256_password` authentication plugin. If the file is named as a relative path, it is interpreted relative to the server data directory. The file must be in PEM format.



### Important

Because this file stores a private key, its access mode should be restricted so that only the MySQL server can read it.

For information about `sha256_password`, see [Section 6.4.1.5, “SHA-256 Pluggable Authentication”](#).

- `sha256_password_proxy_users`

Command-Line Format	<code>--sha256-password-proxy-users[={OFF ON}]</code>
System Variable	<code>sha256_password_proxy_users</code>
Scope	Global
Dynamic	Yes
Type	Boolean
Default Value	OFF

This variable controls whether the `sha256_password` built-in authentication plugin supports proxy users. It has no effect unless the `check_proxy_users` system variable is enabled. For information about user proxying, see [Section 6.2.14, “Proxy Users”](#).

- `sha256_password_public_key_path`

Command-Line Format	<code>--sha256-password-public-key-path=file_name</code>
System Variable	<code>sha256_password_public_key_path</code>
Scope	Global
Dynamic	No
Type	File name
Default Value	<code>public_key.pem</code>

This variable is available if MySQL was compiled using OpenSSL (see [Section 6.3.4, “SSL Library-Dependent Capabilities”](#)). Its value is the path name of the RSA public key file for the `sha256_password` authentication plugin. If the file is named as a relative path, it is interpreted relative to the server data directory. The file must be in PEM format. Because this file stores a public key, copies can be freely distributed to client users. (Clients that explicitly specify a public key when connecting to the server using RSA password encryption must use the same public key as that used by the server.)

For information about `sha256_password`, including information about how clients specify the RSA public key, see [Section 6.4.1.5, “SHA-256 Pluggable Authentication”](#).

- `shared_memory`

Command-Line Format	<code>--shared-memory[={OFF ON}]</code>
System Variable	<code>shared_memory</code>
Scope	Global
Dynamic	No

Platform Specific	Windows
Type	Boolean
Default Value	OFF

(Windows only.) Whether the server permits shared-memory connections.

- [shared\\_memory\\_base\\_name](#)

Command-Line Format	<code>--shared-memory-base-name=name</code>
System Variable	<code>shared_memory_base_name</code>
Scope	Global
Dynamic	No
Platform Specific	Windows
Type	String
Default Value	<code>MYSQL</code>

(Windows only.) The name of shared memory to use for shared-memory connections. This is useful when running multiple MySQL instances on a single physical machine. The default name is `MYSQL`. The name is case-sensitive.

This variable applies only if the server is started with the `shared_memory` system variable enabled to support shared-memory connections.

- [show\\_compatibility\\_56](#)

Command-Line Format	<code>--show-compatibility-56[={OFF ON}]</code>
Deprecated	Yes
System Variable	<code>show_compatibility_56</code>
Scope	Global
Dynamic	Yes
Type	Boolean
Default Value	OFF

The `INFORMATION_SCHEMA` has tables that contain system and status variable information (see [Section 24.3.11](#), “The `INFORMATION_SCHEMA GLOBAL_VARIABLES` and `SESSION_VARIABLES` Tables”, and [Section 24.3.10](#), “The `INFORMATION_SCHEMA GLOBAL_STATUS` and `SESSION_STATUS` Tables”). As of MySQL 5.7.6, the Performance Schema also contains system and status variable tables (see [Section 25.12.13](#), “Performance Schema System Variable Tables”, and [Section 25.12.14](#), “Performance Schema Status Variable Tables”). The Performance Schema tables are intended to replace the `INFORMATION_SCHEMA` tables, which are deprecated as of MySQL 5.7.6 and are removed in MySQL 8.0.

For advice on migrating away from the `INFORMATION_SCHEMA` tables to the Performance Schema tables, see [Section 25.20](#), “Migrating to Performance Schema System and Status Variable Tables”. To assist in the migration, you can use the `show_compatibility_56` system variable, which affects whether MySQL 5.6 compatibility is enabled with respect to how system and status variable information



is provided by the [INFORMATION\\_SCHEMA](#) and Performance Schema tables, and also by the [SHOW VARIABLES](#) and [SHOW STATUS](#) statements.

**Note**

`show_compatibility_56` is deprecated because its only purpose is to permit control over deprecated system and status variable information sources which you can expect to be removed in a future release of MySQL. When those sources are removed, `show_compatibility_56` no longer has any purpose, and you can expect it be removed as well.

The following discussion describes the effects of `show_compatibility_56`:

- [Overview of show\\_compatibility\\_56 Effects](#)
- [Effect of show\\_compatibility\\_56 on SHOW Statements](#)
- [Effect of show\\_compatibility\\_56 on INFORMATION\\_SCHEMA Tables](#)
- [Effect of show\\_compatibility\\_56 on Performance Schema Tables](#)
- [Effect of show\\_compatibility\\_56 on Slave Status Variables](#)
- [Effect of show\\_compatibility\\_56 on FLUSH STATUS](#)

For better understanding, it is strongly recommended that you also read these sections:

- [Section 25.12.13, “Performance Schema System Variable Tables”](#)
- [Section 25.12.14, “Performance Schema Status Variable Tables”](#)
- [Section 25.12.15.10, “Status Variable Summary Tables”](#)

## Overview of show\_compatibility\_56 Effects

The `show_compatibility_56` system variable affects these aspects of server operation regarding system and status variables:

- Information available from the [SHOW VARIABLES](#) and [SHOW STATUS](#) statements
- Information available from the [INFORMATION\\_SCHEMA](#) tables that provide system and status variable information
- Information available from the Performance Schema tables that provide system and status variable information
- The effect of the [FLUSH STATUS](#) statement on status variables

This list summarizes the effects of `show_compatibility_56`, with additional details given later:

- When `show_compatibility_56` is `ON`, compatibility with MySQL 5.6 is enabled. Older variable information sources ([SHOW](#) statements, [INFORMATION\\_SCHEMA](#) tables) produce the same output as in MySQL 5.6.
- When `show_compatibility_56` is `OFF`, compatibility with MySQL 5.6 is disabled. Selecting from the [INFORMATION\\_SCHEMA](#) tables produces an error because the Performance Schema tables are

intended to replace them. The `INFORMATION_SCHEMA` tables are deprecated as of MySQL 5.7.6 and are removed in MySQL 8.0.

To obtain system and status variable information When `show_compatibility_56=OFF`, use the Performance Schema tables or the `SHOW` statements.



#### Note

When `show_compatibility_56=OFF`, the `SHOW VARIABLES` and `SHOW STATUS` statements display rows from the Performance Schema `global_variables`, `session_variables`, `global_status`, and `session_status` tables.

As of MySQL 5.7.9, those tables are world readable and accessible without the `SELECT` privilege, which means that `SELECT` is not needed to use the `SHOW` statements, either. Before MySQL 5.7.9, the `SELECT` privilege is required to access those Performance Schema tables, either directly, or indirectly through the `SHOW` statements.

- Several `Slave_xxx` status variables are available from `SHOW STATUS` when `show_compatibility_56` is `ON`. When `show_compatibility_56` is `OFF`, some of those variables are not exposed to `SHOW STATUS`. The information they provide is available in replication-related Performance Schema tables, as described later.
- `show_compatibility_56` has no effect on system variable access using `@@` notation: `@@GLOBAL.var_name`, `@@SESSION.var_name`, `@@var_name`.
- `show_compatibility_56` has no effect for the embedded server, which produces 5.6-compatible output in all cases.

The following descriptions detail the effect of setting `show_compatibility_56` to `ON` or `OFF` in the contexts in which this variable applies.

## Effect of `show_compatibility_56` on `SHOW` Statements

`SHOW GLOBAL VARIABLES` statement:

- `ON`: MySQL 5.6 output.
- `OFF`: Output displays rows from the Performance Schema `global_variables` table.

`SHOW [SESSION | LOCAL] VARIABLES` statement:

- `ON`: MySQL 5.6 output.
- `OFF`: Output displays rows from the Performance Schema `session_variables` table. (In MySQL 5.7.6 and 5.7.7, `OFF` output does not fully reflect all system variable values in effect for the current session; it includes no rows for global variables that have no session counterpart. This is corrected in MySQL 5.7.8.)

`SHOW GLOBAL STATUS` statement:

- `ON`: MySQL 5.6 output.

- **OFF**: Output displays rows from the Performance Schema `global_status` table, plus the `Com_xxx` statement execution counters.

**OFF** output includes no rows for session variables that have no global counterpart, unlike **ON** output.

`SHOW [SESSION | LOCAL] STATUS` statement:

- **ON**: MySQL 5.6 output.
- **OFF**: Output displays rows from the Performance Schema `session_status` table, plus the `Com_xxx` statement execution counters. (In MySQL 5.7.6 and 5.7.7, **OFF** output does not fully reflect all status variable values in effect for the current session; it includes no rows for global variables that have no session counterpart. This is corrected in MySQL 5.7.8.)

In MySQL 5.7.6 and 5.7.7, for each of the `SHOW` statements just described, use of a `WHERE` clause produces a warning when `show_compatibility_56=ON` and an error when `show_compatibility_56=OFF`. (This applies to `WHERE` clauses that are not optimized away. For example, `WHERE 1` is trivially true, is optimized away, and thus produces no warning or error.) This behavior does not occur as of MySQL 5.7.8; `WHERE` is supported as before 5.7.6.

## Effect of `show_compatibility_56` on `INFORMATION_SCHEMA` Tables

`INFORMATION_SCHEMA` tables (`GLOBAL_VARIABLES`, `SESSION_VARIABLES`, `GLOBAL_STATUS`, and `SESSION_STATUS`):

- **ON**: MySQL 5.6 output, with a deprecation warning.
- **OFF**: Selecting from these tables produces an error. (Before 5.7.9, selecting from these tables produces no output, with a deprecation warning.)

## Effect of `show_compatibility_56` on Performance Schema Tables

Performance Schema system variable tables:

- **OFF**:
  - `global_variables`: Global system variables only.
  - `session_variables`: System variables in effect for the current session: A row for each session variable, and a row for each global variable that has no session counterpart.
  - `variables_by_thread`: Session system variables only, for each active session.

- **ON**: Same output as for **OFF**. (Before 5.7.8, these tables produce no output.)

Performance Schema status variable tables:

- **OFF**:
  - `global_status`: Global status variables only.
  - `session_status`: Status variables in effect the current session: A row for each session variable, and a row for each global variable that has no session counterpart.
  - `status_by_account`: Session status variables only, aggregated per account.
  - `status_by_host`: Session status variables only, aggregated per host name.
  - `status_by_thread`: Session status variables only, for each active session.
  - `status_by_user`: Session status variables only, aggregated per user name.

The Performance Schema does not collect statistics for `Com_xxx` status variables in the status variable tables. To obtain global and per-session statement execution counts, use the `events_statements_summary_global_by_event_name` and `events_statements_summary_by_thread_by_event_name` tables, respectively.

- **ON**: Same output as for **OFF**. (Before 5.7.9, these tables produce no output.)

## Effect of `show_compatibility_56` on Slave Status Variables

Replica status variables:

- **ON**: Several `Slave_xxx` status variables are available from `SHOW STATUS`.
- **OFF**: Some of those replica variables are not exposed to `SHOW STATUS` or the Performance Schema status variable tables. The information they provide is available in replication-related Performance Schema tables. The following table shows which `Slave_xxx` status variables become unavailable in `SHOW STATUS` and their locations in Performance Schema replication tables.

Status Variable	Performance Schema Location
<code>Slave_heartbeat_period</code>	<code>replication_connection_configuration</code> table, <code>HEARTBEAT_INTERVAL</code> column
<code>Slave_last_heartbeat</code>	<code>replication_connection_status</code> table, <code>LAST_HEARTBEAT_TIMESTAMP</code> column
<code>Slave_received_heartbeats</code>	<code>replication_connection_status</code> table, <code>COUNT_RECEIVED_HEARTBEATS</code> column
<code>Slave_retried_transactions</code>	<code>replication_applier_status</code> table, <code>COUNT_TRANSACTIONS_RETRIES</code> column

Status Variable	Performance Schema Location
<code>Slave_running</code>	<code>replication_connection_status</code> and <code>replication_applier_status</code> tables, <code>SERVICE_STATE</code> column

## Effect of `show_compatibility_56` on FLUSH STATUS

`FLUSH STATUS` statement:

- **ON:** This statement produces MySQL 5.6 behavior. It adds the current thread's session status variable values to the global values and resets the session values to zero. Some global variables may be reset to zero as well. It also resets the counters for key caches (default and named) to zero and sets `Max_used_connections` to the current number of open connections.
- **OFF:** This statement adds the session status from all active sessions to the global status variables, resets the status of all active sessions, and resets account, host, and user status values aggregated from disconnected sessions.
- `show_create_table_verbosity`

Command-Line Format	<code>--show-create-table-verbosity[={OFF ON}]</code>
Introduced	5.7.22
System Variable	<code>show_create_table_verbosity</code>
Scope	Global, Session
Dynamic	Yes
Type	Boolean
Default Value	<code>OFF</code>

`SHOW CREATE TABLE` normally does not show the `ROW_FORMAT` table option if the row format is the default format. Enabling this variable causes `SHOW CREATE TABLE` to display `ROW_FORMAT` regardless of whether it is the default format.

- `show_old_temporals`

Command-Line Format	<code>--show-old-temporals[={OFF ON}]</code>
Deprecated	Yes
System Variable	<code>show_old_temporals</code>
Scope	Global, Session
Dynamic	Yes
Type	Boolean
Default Value	<code>OFF</code>

Whether `SHOW CREATE TABLE` output includes comments to flag temporal columns found to be in pre-5.6.4 format (`TIME`, `DATETIME`, and `TIMESTAMP` columns without support for fractional seconds precision). This variable is disabled by default. If enabled, `SHOW CREATE TABLE` output looks like this:

```
CREATE TABLE `mytbl` (
  `ts` timestamp /* 5.5 binary format */ NOT NULL DEFAULT CURRENT_TIMESTAMP,
  `dt` datetime /* 5.5 binary format */ DEFAULT NULL,
```

```
`t` time /* 5.5 binary format */ DEFAULT NULL
) DEFAULT CHARSET=latin1
```

Output for the `COLUMN_TYPE` column of the Information Schema `COLUMNS` table is affected similarly.

This variable is deprecated; expect it to be removed in a future release of MySQL.

- `skip_external_locking`

Command-Line Format	<code>--skip-external-locking[={OFF ON}]</code>
System Variable	<code>skip_external_locking</code>
Scope	Global
Dynamic	No
Type	Boolean
Default Value	ON

This is `OFF` if `mysqld` uses external locking (system locking), `ON` if external locking is disabled. This affects only `MyISAM` table access.

This variable is set by the `--external-locking` or `--skip-external-locking` option. External locking is disabled by default.

External locking affects only `MyISAM` table access. For more information, including conditions under which it can and cannot be used, see [Section 8.11.5, “External Locking”](#).

- `skip_name_resolve`

Command-Line Format	<code>--skip-name-resolve[={OFF ON}]</code>
System Variable	<code>skip_name_resolve</code>
Scope	Global
Dynamic	No
Type	Boolean
Default Value	OFF

Whether to resolve host names when checking client connections. If this variable is `OFF`, `mysqld` resolves host names when checking client connections. If it is `ON`, `mysqld` uses only IP numbers; in this case, all `Host` column values in the grant tables must be IP addresses. See [Section 5.1.11.2, “DNS Lookups and the Host Cache”](#).

Depending on the network configuration of your system and the `Host` values for your accounts, clients may need to connect using an explicit `--host` option, such as `--host=127.0.0.1` or `--host>:::1`.

An attempt to connect to the host `127.0.0.1` normally resolves to the `localhost` account. However, this fails if the server is run with `skip_name_resolve` enabled. If you plan to do that, make sure an account exists that can accept a connection. For example, to be able to connect as `root` using `--host=127.0.0.1` or `--host>:::1`, create these accounts:

```
CREATE USER 'root'@'127.0.0.1' IDENTIFIED BY 'root-password';
CREATE USER 'root'@':::1' IDENTIFIED BY 'root-password';
```

- `skip_networking`

Command-Line Format	<code>--skip-networking[={OFF ON}]</code>
System Variable	<code>skip_networking</code>
Scope	Global
Dynamic	No
Type	Boolean
Default Value	<code>OFF</code>

This variable controls whether the server permits TCP/IP connections. By default, it is disabled (permit TCP connections). If enabled, the server permits only local (non-TCP/IP) connections and all interaction with `mysqld` must be made using named pipes or shared memory (on Windows) or Unix socket files (on Unix). This option is highly recommended for systems where only local clients are permitted. See [Section 5.1.11.2, “DNS Lookups and the Host Cache”](#).

- `skip_show_database`

Command-Line Format	<code>--skip-show-database</code>
System Variable	<code>skip_show_database</code>
Scope	Global
Dynamic	No
Type	Boolean
Default Value	<code>OFF</code>

This prevents people from using the `SHOW DATABASES` statement if they do not have the `SHOW DATABASES` privilege. This can improve security if you have concerns about users being able to see databases belonging to other users. Its effect depends on the `SHOW DATABASES` privilege: If the variable value is `ON`, the `SHOW DATABASES` statement is permitted only to users who have the `SHOW DATABASES` privilege, and the statement displays all database names. If the value is `OFF`, `SHOW DATABASES` is permitted to all users, but displays the names of only those databases for which the user has the `SHOW DATABASES` or other privilege.



#### Caution

Because a global privilege is considered a privilege for all databases, *any* global privilege enables a user to see all database names with `SHOW DATABASES` or by examining the `INFORMATION_SCHEMA.SCHEMATA` table.

- `slow_launch_time`

Command-Line Format	<code>--slow-launch-time=#</code>
System Variable	<code>slow_launch_time</code>
Scope	Global
Dynamic	Yes
Type	Integer
Default Value	<code>2</code>
Minimum Value	<code>0</code>
Maximum Value	<code>31536000</code>

Unit	seconds
------	---------

If creating a thread takes longer than this many seconds, the server increments the `Slow_launch_threads` status variable.

- `slow_query_log`

Command-Line Format	<code>--slow-query-log[={OFF ON}]</code>
System Variable	<code>slow_query_log</code>
Scope	Global
Dynamic	Yes
Type	Boolean
Default Value	<code>OFF</code>

Whether the slow query log is enabled. The value can be 0 (or `OFF`) to disable the log or 1 (or `ON`) to enable the log. The destination for log output is controlled by the `log_output` system variable; if that value is `NONE`, no log entries are written even if the log is enabled.

“Slow” is determined by the value of the `long_query_time` variable. See [Section 5.4.5, “The Slow Query Log”](#).

- `slow_query_log_file`

Command-Line Format	<code>--slow-query-log-file=file_name</code>
System Variable	<code>slow_query_log_file</code>
Scope	Global
Dynamic	Yes
Type	File name
Default Value	<code>host_name-slow.log</code>

The name of the slow query log file. The default value is `host_name-slow.log`, but the initial value can be changed with the `--slow_query_log_file` option.

- `socket`

Command-Line Format	<code>--socket={file_name pipe_name}</code>
System Variable	<code>socket</code>
Scope	Global
Dynamic	No
Type	String
Default Value (Windows)	<code>MySQL</code>
Default Value (Other)	<code>/tmp/mysql.sock</code>

On Unix platforms, this variable is the name of the socket file that is used for local client connections. The default is `/tmp/mysql.sock`. (For some distribution formats, the directory might be different, such as `/var/lib/mysql` for RPMs.)

On Windows, this variable is the name of the named pipe that is used for local client connections. The default value is `MySQL` (not case-sensitive).



- `sort_buffer_size`

Command-Line Format	<code>--sort-buffer-size=#</code>
System Variable	<code>sort_buffer_size</code>
Scope	Global, Session
Dynamic	Yes
Type	Integer
Default Value	262144
Minimum Value	32768
Maximum Value (Windows)	4294967295
Maximum Value (Other, 64-bit platforms)	18446744073709551615
Maximum Value (Other, 32-bit platforms)	4294967295
Unit	bytes

Each session that must perform a sort allocates a buffer of this size. `sort_buffer_size` is not specific to any storage engine and applies in a general manner for optimization. At minimum the `sort_buffer_size` value must be large enough to accommodate fifteen tuples in the sort buffer. Also, increasing the value of `max_sort_length` may require increasing the value of `sort_buffer_size`. For more information, see [Section 8.2.1.14, “ORDER BY Optimization”](#)

If you see many `Sort_merge_passes` per second in `SHOW GLOBAL STATUS` output, you can consider increasing the `sort_buffer_size` value to speed up `ORDER BY` or `GROUP BY` operations that cannot be improved with query optimization or improved indexing.

The optimizer tries to work out how much space is needed but can allocate more, up to the limit. Setting it larger than required globally slows down most queries that sort. It is best to increase it as a session setting, and only for the sessions that need a larger size. On Linux, there are thresholds of 256KB and 2MB where larger values may significantly slow down memory allocation, so you should consider staying below one of those values. Experiment to find the best value for your workload. See [Section B.3.3.5, “Where MySQL Stores Temporary Files”](#).

The maximum permissible setting for `sort_buffer_size` is 4GB-1. Larger values are permitted for 64-bit platforms (except 64-bit Windows, for which large values are truncated to 4GB-1 with a warning).

- `sql_auto_is_null`

System Variable	<code>sql_auto_is_null</code>
Scope	Global, Session
Dynamic	Yes
Type	Boolean
Default Value	<code>OFF</code>

If this variable is enabled, then after a statement that successfully inserts an automatically generated `AUTO_INCREMENT` value, you can find that value by issuing a statement of the following form:

```
SELECT * FROM tbl_name WHERE auto_col IS NULL
```

If the statement returns a row, the value returned is the same as if you invoked the `LAST_INSERT_ID()` function. For details, including the return value after a multiple-row insert, see [Section 12.15,](#)

“Information Functions”. If no `AUTO_INCREMENT` value was successfully inserted, the `SELECT` statement returns no row.

The behavior of retrieving an `AUTO_INCREMENT` value by using an `IS NULL` comparison is used by some ODBC programs, such as Access. See [Obtaining Auto-Increment Values](#). This behavior can be disabled by setting `sql_auto_is_null` to `OFF`.

The default value of `sql_auto_is_null` is `OFF`.

- `sql_big_selects`

System Variable	<code>sql_big_selects</code>
Scope	Global, Session
Dynamic	Yes
Type	Boolean
Default Value	<code>ON</code>

If set to `OFF`, MySQL aborts `SELECT` statements that are likely to take a very long time to execute (that is, statements for which the optimizer estimates that the number of examined rows exceeds the value of `max_join_size`). This is useful when an inadvisable `WHERE` statement has been issued. The default value for a new connection is `ON`, which permits all `SELECT` statements.

If you set the `max_join_size` system variable to a value other than `DEFAULT`, `sql_big_selects` is set to `OFF`.

- `sql_buffer_result`

System Variable	<code>sql_buffer_result</code>
Scope	Global, Session
Dynamic	Yes
Type	Boolean
Default Value	<code>OFF</code>

If enabled, `sql_buffer_result` forces results from `SELECT` statements to be put into temporary tables. This helps MySQL free the table locks early and can be beneficial in cases where it takes a long time to send results to the client. The default value is `OFF`.

- `sql_log_off`

System Variable	<code>sql_log_off</code>
Scope	Global, Session
Dynamic	Yes
Type	Boolean
Default Value	<code>OFF</code>
Valid Values	<code>OFF</code> (enable logging) <code>ON</code> (disable logging)

This variable controls whether logging to the general query log is disabled for the current session (assuming that the general query log itself is enabled). The default value is `OFF` (that is, enable logging).

To disable or enable general query logging for the current session, set the session `sql_log_off` variable to `ON` or `OFF`.

Setting the session value of this system variable is a restricted operation. The session user must have privileges sufficient to set restricted session variables. See [Section 5.1.8.1, “System Variable Privileges”](#).

- `sql_mode`

Command-Line Format	<code>--sql-mode=name</code>
System Variable	<code>sql_mode</code>
Scope	Global, Session
Dynamic	Yes
Type	Set
Default Value	<code>ONLY_FULL_GROUP_BY STRICT_TRANS_TABLES NO_ZERO_IN_DATE NO_ZERO_DATE ERROR_FOR_DIVISION_BY_ZERO NO_AUTO_CREATE_USER NO_ENGINE_SUBSTITUTION</code>
Valid Values	<code>ALLOW_INVALID_DATES  ANSI_QUOTES  ERROR_FOR_DIVISION_BY_ZERO  HIGH_NOT_PRECEDENCE  IGNORE_SPACE  NO_AUTO_CREATE_USER  NO_AUTO_VALUE_ON_ZERO  NO_BACKSLASH_ESCAPES  NO_DIR_IN_CREATE  NO_ENGINE_SUBSTITUTION  NO_FIELD_OPTIONS  NO_KEY_OPTIONS  NO_TABLE_OPTIONS  NO_UNSIGNED_SUBTRACTION  NO_ZERO_DATE  NO_ZERO_IN_DATE  ONLY_FULL_GROUP_BY  PAD_CHAR_TO_FULL_LENGTH</code>

	PIPES_AS_CONCAT
	REAL_AS_FLOAT
	STRICT_ALL_TABLES
	STRICT_TRANS_TABLES

The current server SQL mode, which can be set dynamically. For details, see [Section 5.1.10, “Server SQL Modes”](#).



**Note**

MySQL installation programs may configure the SQL mode during the installation process. If the SQL mode differs from the default or from what you expect, check for a setting in an option file that the server reads at startup.

- [sql\\_notes](#)

System Variable	<a href="#">sql_notes</a>
Scope	Global, Session
Dynamic	Yes
Type	Boolean
Default Value	ON

If enabled (the default), diagnostics of [Note](#) level increment [warning\\_count](#) and the server records them. If disabled, [Note](#) diagnostics do not increment [warning\\_count](#) and the server does not record them. [mysqldump](#) includes output to disable this variable so that reloading the dump file does not produce warnings for events that do not affect the integrity of the reload operation.

- [sql\\_quote\\_show\\_create](#)

System Variable	<a href="#">sql_quote_show_create</a>
Scope	Global, Session
Dynamic	Yes
Type	Boolean
Default Value	ON

If enabled (the default), the server quotes identifiers for [SHOW CREATE TABLE](#) and [SHOW CREATE DATABASE](#) statements. If disabled, quoting is disabled. This option is enabled by default so that replication works for identifiers that require quoting. See [Section 13.7.5.10, “SHOW CREATE TABLE Statement”](#), and [Section 13.7.5.6, “SHOW CREATE DATABASE Statement”](#).

- [sql\\_safe\\_updates](#)

System Variable	<a href="#">sql_safe_updates</a>
Scope	Global, Session
Dynamic	Yes
Type	Boolean
Default Value	OFF

If this variable is enabled, `UPDATE` and `DELETE` statements that do not use a key in the `WHERE` clause or a `LIMIT` clause produce an error. This makes it possible to catch `UPDATE` and `DELETE` statements where keys are not used properly and that would probably change or delete a large number of rows. The default value is `OFF`.

For the `mysql` client, `sql_safe_updates` can be enabled by using the `--safe-updates` option. For more information, see [Using Safe-Updates Mode \(--safe-updates\)](#).

- `sql_select_limit`

System Variable	<code>sql_select_limit</code>
Scope	Global, Session
Dynamic	Yes
Type	Integer
Default Value	18446744073709551615
Minimum Value	0
Maximum Value	18446744073709551615

The maximum number of rows to return from `SELECT` statements. For more information, see [Using Safe-Updates Mode \(--safe-updates\)](#).

The default value for a new connection is the maximum number of rows that the server permits per table. Typical default values are  $(2^{32})-1$  or  $(2^{64})-1$ . If you have changed the limit, the default value can be restored by assigning a value of `DEFAULT`.

If a `SELECT` has a `LIMIT` clause, the `LIMIT` takes precedence over the value of `sql_select_limit`.

- `sql_warnings`

System Variable	<code>sql_warnings</code>
Scope	Global, Session
Dynamic	Yes
Type	Boolean
Default Value	<code>OFF</code>

This variable controls whether single-row `INSERT` statements produce an information string if warnings occur. The default is `OFF`. Set the value to `ON` to produce an information string.

- `ssl_ca`

Command-Line Format	<code>--ssl-ca=file_name</code>
System Variable	<code>ssl_ca</code>
Scope	Global
Dynamic	No
Type	File name

Default Value	NULL
---------------	------

The path name of the Certificate Authority (CA) certificate file in PEM format. The file contains a list of trusted SSL Certificate Authorities.

- `ssl_capath`

Command-Line Format	<code>--ssl-capath=dir_name</code>
System Variable	<code>ssl_capath</code>
Scope	Global
Dynamic	No
Type	Directory name
Default Value	NULL

The path name of the directory that contains trusted SSL Certificate Authority (CA) certificate files in PEM format. You must run OpenSSL `rehash` on the directory specified by this option prior to using it. On Linux systems, you can invoke `rehash` like this:

```
$> openssl rehash path/to/directory
```

On Windows platforms, you can use the `c_rehash` script in a command prompt, like this:

```
\> c_rehash path/to/directory
```

See [openssl-rehash](#) for complete syntax and other information.

Support for this capability depends on the SSL library used to compile MySQL; see [Section 6.3.4, “SSL Library-Dependent Capabilities”](#).

- `ssl_cert`

Command-Line Format	<code>--ssl-cert=file_name</code>
System Variable	<code>ssl_cert</code>
Scope	Global
Dynamic	No
Type	File name
Default Value	NULL

The path name of the server SSL public key certificate file in PEM format.

If the server is started with `ssl_cert` set to a certificate that uses any restricted cipher or cipher category, the server starts with support for encrypted connections disabled. For information about cipher restrictions, see [Connection Cipher Configuration](#).

- `ssl_cipher`

Command-Line Format	<code>--ssl-cipher=name</code>
System Variable	<code>ssl_cipher</code>
Scope	Global
Dynamic	No

Type	String
Default Value	NULL

The list of permissible ciphers for connection encryption. If no cipher in the list is supported, encrypted connections do not work.

For greatest portability, the cipher list should be a list of one or more cipher names, separated by colons. This format is understood both by OpenSSL and yaSSL. The following example shows two cipher names separated by a colon:

```
[mysqld]
ssl_cipher="DHE-RSA-AES128-GCM-SHA256:AES128-SHA"
```

OpenSSL supports a more flexible syntax for specifying ciphers, as described in the OpenSSL documentation at <https://www.openssl.org/docs/manmaster/man1/openssl-ciphers.html>. yaSSL does not, so attempts to use that extended syntax fail for a MySQL distribution compiled using yaSSL.

For information about which encryption ciphers MySQL supports, see [Section 6.3.2, “Encrypted Connection TLS Protocols and Ciphers”](#).

- `ssl_crl`

Command-Line Format	<code>--ssl-crl=file_name</code>
System Variable	<code>ssl_crl</code>
Scope	Global
Dynamic	No
Type	File name
Default Value	NULL

The path name of the file containing certificate revocation lists in PEM format. Support for revocation-list capability depends on the SSL library used to compile MySQL. See [Section 6.3.4, “SSL Library-Dependent Capabilities”](#).

- `ssl_crlpath`

Command-Line Format	<code>--ssl-crlpath=dir_name</code>
System Variable	<code>ssl_crlpath</code>
Scope	Global
Dynamic	No
Type	Directory name
Default Value	NULL

The path of the directory that contains certificate revocation-list files in PEM format. Support for revocation-list capability depends on the SSL library used to compile MySQL. See [Section 6.3.4, “SSL Library-Dependent Capabilities”](#).

- `ssl_key`

Command-Line Format	<code>--ssl-key=file_name</code>
System Variable	<code>ssl_key</code>

Scope	Global
Dynamic	No
Type	File name
Default Value	NULL

The path name of the server SSL private key file in PEM format. For better security, use a certificate with an RSA key size of at least 2048 bits.

If the key file is protected by a passphrase, the server prompts the user for the passphrase. The password must be given interactively; it cannot be stored in a file. If the passphrase is incorrect, the program continues as if it could not read the key.

- [stored\\_program\\_cache](#)

Command-Line Format	<code>--stored-program-cache=#</code>
System Variable	<code>stored_program_cache</code>
Scope	Global
Dynamic	Yes
Type	Integer
Default Value	256
Minimum Value	16
Maximum Value	524288

Sets a soft upper limit for the number of cached stored routines per connection. The value of this variable is specified in terms of the number of stored routines held in each of the two caches maintained by the MySQL Server for, respectively, stored procedures and stored functions.

Whenever a stored routine is executed this cache size is checked before the first or top-level statement in the routine is parsed; if the number of routines of the same type (stored procedures or stored functions according to which is being executed) exceeds the limit specified by this variable, the corresponding cache is flushed and memory previously allocated for cached objects is freed. This allows the cache to be flushed safely, even when there are dependencies between stored routines.

- [super\\_read\\_only](#)

Command-Line Format	<code>--super-read-only[={OFF ON}]</code>
System Variable	<code>super_read_only</code>
Scope	Global
Dynamic	Yes
Type	Boolean
Default Value	OFF

If the `read_only` system variable is enabled, the server permits no client updates except from users who have the `SUPER` privilege. If the `super_read_only` system variable is also enabled, the server prohibits client updates even from users who have `SUPER`. See the description of the `read_only`



system variable for a description of read-only mode and information about how `read_only` and `super_read_only` interact.

Client updates prevented when `super_read_only` is enabled include operations that do not necessarily appear to be updates, such as `CREATE FUNCTION` (to install a loadable function) and `INSTALL PLUGIN`. These operations are prohibited because they involve changes to tables in the `mysql` system database.

Changes to `super_read_only` on a replication source server are not replicated to replica servers. The value can be set on a replica independent of the setting on the source.

- `sync_frm`

Command-Line Format	<code>--sync_frm[={OFF ON} ]</code>
Deprecated	Yes
System Variable	<code>sync_frm</code>
Scope	Global
Dynamic	Yes
Type	Boolean
Default Value	ON

If this variable is set to 1, when any nontemporary table is created its `.frm` file is synchronized to disk (using `fdatasync()`). This is slower but safer in case of a crash. The default is 1.

This variable is deprecated in MySQL 5.7 and is removed in MySQL 8.0 (when `.frm` files become obsolete).

- `system_time_zone`

System Variable	<code>system_time_zone</code>
Scope	Global
Dynamic	No
Type	String

The server system time zone. When the server begins executing, it inherits a time zone setting from the machine defaults, possibly modified by the environment of the account used for running the server or the startup script. The value is used to set `system_time_zone`. To explicitly specify the system time zone, set the `TZ` environment variable or use the `--timezone` option of the `mysqld_safe` script.

The `system_time_zone` variable differs from the `time_zone` variable. Although they might have the same value, the latter variable is used to initialize the time zone for each client that connects. See [Section 5.1.13, “MySQL Server Time Zone Support”](#).

- `table_definition_cache`

Command-Line Format	<code>--table-definition-cache=#</code>
System Variable	<code>table_definition_cache</code>
Scope	Global
Dynamic	Yes
Type	Integer

Default Value	-1 (signifies autosizing; do not assign this literal value)
Minimum Value	400
Maximum Value	524288

The number of table definitions (from `.frm` files) that can be stored in the table definition cache. If you use a large number of tables, you can create a large table definition cache to speed up opening of tables. The table definition cache takes less space and does not use file descriptors, unlike the normal table cache. The minimum value is 400. The default value is based on the following formula, capped to a limit of 2000:

```
400 + (table_open_cache / 2)
```

For `InnoDB`, the `table_definition_cache` setting acts as a soft limit for the number of table instances in the `InnoDB` data dictionary cache and the number file-per-table tablespaces that can be open at one time.

If the number of table instances in the `InnoDB` data dictionary cache exceeds the `table_definition_cache` limit, an LRU mechanism begins marking table instances for eviction and eventually removes them from the `InnoDB` data dictionary cache. The number of open tables with cached metadata can be higher than the `table_definition_cache` limit due to table instances with foreign key relationships, which are not placed on the LRU list.

The number of file-per-table tablespaces that can be open at one time is limited by both the `table_definition_cache` and `innodb_open_files` settings. If both variables are set, the highest setting is used. If neither variable is set, the `table_definition_cache` setting, which has a higher default value, is used. If the number of open tablespaces exceeds the limit defined by `table_definition_cache` or `innodb_open_files`, an LRU mechanism searches the LRU list for tablespace files that are fully flushed and not currently being extended. This process is performed each time a new tablespace is opened. Only inactive tablespaces are closed.

- `table_open_cache`

Command-Line Format	<code>--table-open-cache=#</code>
System Variable	<code>table_open_cache</code>
Scope	Global
Dynamic	Yes
Type	Integer
Default Value	2000
Minimum Value	1
Maximum Value	524288

The number of open tables for all threads. Increasing this value increases the number of file descriptors that `mysqld` requires. The effective value of this variable is the greater of the effective value of `open_files_limit - 10` - the effective value of `max_connections / 2`, and 400; that is

```
MAX(
    (open_files_limit - 10 - max_connections) / 2,
    400
```

)

You can check whether you need to increase the table cache by checking the `Opened_tables` status variable. If the value of `Opened_tables` is large and you do not use `FLUSH TABLES` often (which just forces all tables to be closed and reopened), then you should increase the value of the `table_open_cache` variable. For more information about the table cache, see [Section 8.4.3.1, "How MySQL Opens and Closes Tables"](#).

- `table_open_cache_instances`

Command-Line Format	<code>--table-open-cache-instances=#</code>
System Variable	<code>table_open_cache_instances</code>
Scope	Global
Dynamic	No
Type	Integer
Default Value	16
Minimum Value	1
Maximum Value	64

The number of open tables cache instances. To improve scalability by reducing contention among sessions, the open tables cache can be partitioned into several smaller cache instances of size `table_open_cache / table_open_cache_instances`. A session needs to lock only one instance to access it for DML statements. This segments cache access among instances, permitting higher performance for operations that use the cache when there are many sessions accessing tables. (DDL statements still require a lock on the entire cache, but such statements are much less frequent than DML statements.)

A value of 8 or 16 is recommended on systems that routinely use 16 or more cores. However, if you have many large triggers on your tables that cause a high memory load, the default setting for `table_open_cache_instances` might lead to excessive memory usage. In that situation, it can be helpful to set `table_open_cache_instances` to 1 in order to restrict memory usage.

- `thread_cache_size`

Command-Line Format	<code>--thread-cache-size=#</code>
System Variable	<code>thread_cache_size</code>
Scope	Global
Dynamic	Yes
Type	Integer
Default Value	-1 (signifies autosizing; do not assign this literal value)
Minimum Value	0
Maximum Value	16384

How many threads the server should cache for reuse. When a client disconnects, the client's threads are put in the cache if there are fewer than `thread_cache_size` threads there. Requests for threads are satisfied by reusing threads taken from the cache if possible, and only when the cache is empty is a new thread created. This variable can be increased to improve performance if you have a lot of new connections. Normally, this does not provide a notable performance improvement if you have a good

thread implementation. However, if your server sees hundreds of connections per second you should normally set `thread_cache_size` high enough so that most new connections use cached threads. By examining the difference between the `Connections` and `Threads_created` status variables, you can see how efficient the thread cache is. For details, see [Section 5.1.9, “Server Status Variables”](#).

The default value is based on the following formula, capped to a limit of 100:

```
8 + (max_connections / 100)
```

This variable has no effect for the embedded server (`libmysqld`) and as of MySQL 5.7.2 is no longer visible within the embedded server.

- `thread_handling`

Command-Line Format	<code>--thread-handling=name</code>
System Variable	<code>thread_handling</code>
Scope	Global
Dynamic	No
Type	Enumeration
Default Value	<code>one-thread-per-connection</code>
Valid Values	<code>no-threads</code>  <code>one-thread-per-connection</code>  <code>loaded-dynamically</code>

The thread-handling model used by the server for connection threads. The permissible values are `no-threads` (the server uses a single thread to handle one connection), `one-thread-per-connection` (the server uses one thread to handle each client connection), and `loaded-dynamically` (set by the thread pool plugin when it initializes). `no-threads` is useful for debugging under Linux; see [Section 5.8, “Debugging MySQL”](#).

This variable has no effect for the embedded server (`libmysqld`) and as of MySQL 5.7.2 is no longer visible within the embedded server.

- `thread_pool_algorithm`

Command-Line Format	<code>--thread-pool-algorithm=#</code>
System Variable	<code>thread_pool_algorithm</code>
Scope	Global

Dynamic	No
---------	----

This variable controls which algorithm the thread pool plugin uses:

- A value of 0 (the default) uses a conservative low-concurrency algorithm which is most well tested and is known to produce very good results.
- A value of 1 increases the concurrency and uses a more aggressive algorithm which at times has been known to perform 5–10% better on optimal thread counts, but has degrading performance as the number of connections increases. Its use should be considered as experimental and not supported.

This variable is available only if the thread pool plugin is enabled. See [Section 5.5.3, “MySQL Enterprise Thread Pool”](#).

- `thread_pool_high_priority_connection`

Command-Line Format	<code>--thread-pool-high-priority-connection=#</code>
System Variable	<code>thread_pool_high_priority_connection</code>
Scope	Global, Session
Dynamic	Yes
Type	Integer
Default Value	0
Minimum Value	0
Maximum Value	1

This variable affects queuing of new statements prior to execution. If the value is 0 (false, the default), statement queuing uses both the low-priority and high-priority queues. If the value is 1 (true), queued statements always go to the high-priority queue.

This variable is available only if the thread pool plugin is enabled. See [Section 5.5.3, “MySQL Enterprise Thread Pool”](#).

- `thread_pool_max_unused_threads`

Command-Line Format	<code>--thread-pool-max-unused-threads=#</code>
System Variable	<code>thread_pool_max_unused_threads</code>
Scope	Global
Dynamic	Yes

The maximum permitted number of unused threads in the thread pool. This variable makes it possible to limit the amount of memory used by sleeping threads.

A value of 0 (the default) means no limit on the number of sleeping threads. A value of  $N$  where  $N$  is greater than 0 means 1 consumer thread and  $N-1$  reserve threads. In this case, if a thread is ready to sleep but the number of sleeping threads is already at the maximum, the thread exits rather than going to sleep.

A sleeping thread is either sleeping as a consumer thread or a reserve thread. The thread pool permits one thread to be the consumer thread when sleeping. If a thread goes to sleep and there is no existing consumer thread, it sleeps as a consumer thread. When a thread must be woken up, a consumer thread

is selected if there is one. A reserve thread is selected only when there is no consumer thread to wake up.

This variable is available only if the thread pool plugin is enabled. See [Section 5.5.3, “MySQL Enterprise Thread Pool”](#).

- `thread_pool_prio_kickup_timer`

Command-Line Format	<code>--thread-pool-prio-kickup-timer=#</code>
System Variable	<code>thread_pool_prio_kickup_timer</code>
Scope	Global
Dynamic	Yes

This variable affects statements waiting for execution in the low-priority queue. The value is the number of milliseconds before a waiting statement is moved to the high-priority queue. The default is 1000 (1 second).

This variable is available only if the thread pool plugin is enabled. See [Section 5.5.3, “MySQL Enterprise Thread Pool”](#).

- `thread_pool_size`

Command-Line Format	<code>--thread-pool-size=#</code>
System Variable	<code>thread_pool_size</code>
Scope	Global
Dynamic	No
Type	Integer
Default Value	16
Minimum Value	1
Maximum Value	64

The number of thread groups in the thread pool. This is the most important parameter controlling thread pool performance. It affects how many statements can execute simultaneously. If a value outside the range of permissible values is specified, the thread pool plugin does not load and the server writes a message to the error log.

This variable is available only if the thread pool plugin is enabled. See [Section 5.5.3, “MySQL Enterprise Thread Pool”](#).

- `thread_pool_stall_limit`

Command-Line Format	<code>--thread-pool-stall-limit=#</code>
System Variable	<code>thread_pool_stall_limit</code>
Scope	Global
Dynamic	Yes
Type	Integer
Default Value	6
Minimum Value	4

Maximum Value	600
Unit	milliseconds * 10

This variable affects executing statements. The value is the amount of time a statement has to finish after starting to execute before it becomes defined as stalled, at which point the thread pool permits the thread group to begin executing another statement. The value is measured in 10 millisecond units, so the default of 6 means 60ms. Short wait values permit threads to start more quickly. Short values are also better for avoiding deadlock situations. Long wait values are useful for workloads that include long-running statements, to avoid starting too many new statements while the current ones execute.

This variable is available only if the thread pool plugin is enabled. See [Section 5.5.3, “MySQL Enterprise Thread Pool”](#).

- `thread_stack`

Command-Line Format	<code>--thread-stack=#</code>
System Variable	<code>thread_stack</code>
Scope	Global
Dynamic	No
Type	Integer
Default Value (64-bit platforms)	262144
Default Value (32-bit platforms)	196608
Minimum Value	131072
Maximum Value (64-bit platforms)	18446744073709550592
Maximum Value (32-bit platforms)	4294966272
Unit	bytes
Block Size	1024

The stack size for each thread. The default is large enough for normal operation. If the thread stack size is too small, it limits the complexity of the SQL statements that the server can handle, the recursion depth of stored procedures, and other memory-consuming actions.

- `time_format`

This variable is unused. It is deprecated and is removed in MySQL 8.0.

- `time_zone`

System Variable	<code>time_zone</code>
Scope	Global, Session
Dynamic	Yes
Type	String
Default Value	<code>SYSTEM</code>
Minimum Value	<code>-12:59</code>
Maximum Value	<code>+13:00</code>

The current time zone. This variable is used to initialize the time zone for each client that connects. By default, the initial value of this is '`SYSTEM`' (which means, “use the value of `system_time_zone`”).

The value can be specified explicitly at server startup with the `--default-time-zone` option. See [Section 5.1.13, “MySQL Server Time Zone Support”](#).



#### Note

If set to `SYSTEM`, every MySQL function call that requires a time zone calculation makes a system library call to determine the current system time zone. This call may be protected by a global mutex, resulting in contention.

- `timestamp`

System Variable	<code>timestamp</code>
Scope	Session
Dynamic	Yes
Type	Numeric
Default Value	<code>UNIX_TIMESTAMP()</code>
Minimum Value	1
Maximum Value	2147483647

Set the time for this client. This is used to get the original timestamp if you use the binary log to restore rows. `timestamp_value` should be a Unix epoch timestamp (a value like that returned by `UNIX_TIMESTAMP()`, not a value in `'YYYY-MM-DD hh:mm:ss'` format) or `DEFAULT`.

Setting `timestamp` to a constant value causes it to retain that value until it is changed again. Setting `timestamp` to `DEFAULT` causes its value to be the current date and time as of the time it is accessed. The maximum value corresponds to `'2038-01-19 03:14:07'` UTC, the same as for the `TIMESTAMP` data type.

`timestamp` is a `DOUBLE` rather than `BIGINT` because its value includes a microseconds part.

`SET timestamp` affects the value returned by `NOW()` but not by `SYSDATE()`. This means that `timestamp` settings in the binary log have no effect on invocations of `SYSDATE()`. The server can be started with the `--sysdate-is-now` option to cause `SYSDATE()` to be a synonym for `NOW()`, in which case `SET timestamp` affects both functions.

- `tls_version`

Command-Line Format	<code>--tls-version=protocol_list</code>
Introduced	5.7.10
System Variable	<code>tls_version</code>
Scope	Global
Dynamic	No
Type	String
Default Value (≥ 5.7.28)	<code>TLSv1, TLSv1.1, TLSv1.2</code>
Default Value (≤ 5.7.27)	<code>TLSv1, TLSv1.1, TLSv1.2 (OpenSSL)</code> <code>TLSv1, TLSv1.1 (yaSSL)</code>

Which protocols the server permits for encrypted connections. The value is a comma-separated list containing one or more protocol versions. The protocols that can be named for this variable depend



on the SSL library used to compile MySQL. Permitted protocols should be chosen such as not to leave “holes” in the list. For details, see [Section 6.3.2, “Encrypted Connection TLS Protocols and Ciphers”](#).

**Note**

As of MySQL 5.7.35, the TLSv1 and TLSv1.1 connection protocols are deprecated and support for them is subject to removal in a future version of MySQL. See [Deprecated TLS Protocols](#).

Setting this variable to an empty string disables encrypted connections.

- `tmp_table_size`

Command-Line Format	<code>--tmp-table-size=#</code>
System Variable	<code>tmp_table_size</code>
Scope	Global, Session
Dynamic	Yes
Type	Integer
Default Value	<code>16777216</code>
Minimum Value	<code>1024</code>
Maximum Value	<code>18446744073709551615</code>
Unit	bytes

The maximum size of internal in-memory temporary tables. This variable does not apply to user-created `MEMORY` tables.

The actual limit is the smaller of `tmp_table_size` and `max_heap_table_size`. When an in-memory temporary table exceeds the limit, MySQL automatically converts it to an on-disk temporary table. The `internal_tmp_disk_storage_engine` option defines the storage engine used for on-disk temporary tables.

Increase the value of `tmp_table_size` (and `max_heap_table_size` if necessary) if you do many advanced `GROUP BY` queries and you have lots of memory.

You can compare the number of internal on-disk temporary tables created to the total number of internal temporary tables created by comparing `Created_tmp_disk_tables` and `Created_tmp_tables` values.

See also [Section 8.4.4, “Internal Temporary Table Use in MySQL”](#).

- `tmpdir`

Command-Line Format	<code>--tmpdir=dir_name</code>
System Variable	<code>tmpdir</code>
Scope	Global
Dynamic	No
Type	Directory name

The path of the directory to use for creating temporary files. It might be useful if your default `/tmp` directory resides on a partition that is too small to hold temporary tables. This variable can be set to a list

of several paths that are used in round-robin fashion. Paths should be separated by colon characters (:) on Unix and semicolon characters (;) on Windows.

`tmpdir` can be a non-permanent location, such as a directory on a memory-based file system or a directory that is cleared when the server host restarts. If the MySQL server is acting as a replica, and you are using a non-permanent location for `tmpdir`, consider setting a different temporary directory for the replica using the `slave_load_tmpdir` variable. For a replica, the temporary files used to replicate `LOAD DATA` statements are stored in this directory, so with a permanent location they can survive machine restarts, although replication can now continue after a restart if the temporary files have been removed.

For more information about the storage location of temporary files, see [Section B.3.3.5, “Where MySQL Stores Temporary Files”](#).

- `transaction_alloc_block_size`

Command-Line Format	<code>--transaction-alloc-block-size=#</code>
System Variable	<code>transaction_alloc_block_size</code>
Scope	Global, Session
Dynamic	Yes
Type	Integer
Default Value	8192
Minimum Value	1024
Maximum Value	131072
Unit	bytes
Block Size	1024

The amount in bytes by which to increase a per-transaction memory pool which needs memory. See the description of `transaction_prealloc_size`.

- `transaction_isolation`

Command-Line Format	<code>--transaction-isolation=name</code>
System Variable (≥ 5.7.20)	<code>transaction_isolation</code>
Scope (≥ 5.7.20)	Global, Session
Dynamic (≥ 5.7.20)	Yes
Type	Enumeration
Default Value	<code>REPEATABLE-READ</code>
Valid Values	<code>READ-UNCOMMITTED</code> <code>READ-COMMITTED</code> <code>REPEATABLE-READ</code>

SERIALIZABLE
--------------

The transaction isolation level. The default is `REPEATABLE-READ`.

The transaction isolation level has three scopes: global, session, and next transaction. This three-scope implementation leads to some nonstandard isolation-level assignment semantics, as described later.

To set the global transaction isolation level at startup, use the `--transaction-isolation` server option.

At runtime, the isolation level can be set directly using the `SET` statement to assign a value to the `transaction_isolation` system variable, or indirectly using the `SET TRANSACTION` statement. If you set `transaction_isolation` directly to an isolation level name that contains a space, the name should be enclosed within quotation marks, with the space replaced by a dash. For example, use this `SET` statement to set the global value:

```
SET GLOBAL transaction_isolation = 'READ-COMMITTED';
```

Setting the global `transaction_isolation` value sets the isolation level for all subsequent sessions. Existing sessions are unaffected.

To set the session or next-level `transaction_isolation` value, use the `SET` statement. For most session system variables, these statements are equivalent ways to set the value:

```
SET @@SESSION.var_name = value;
SET SESSION var_name = value;
SET var_name = value;
SET @@var_name = value;
```

As mentioned previously, the transaction isolation level has a next-transaction scope, in addition to the global and session scopes. To enable the next-transaction scope to be set, `SET` syntax for assigning session system variable values has nonstandard semantics for `transaction_isolation`:

- To set the session isolation level, use any of these syntaxes:

```
SET @@SESSION.transaction_isolation = value;
SET SESSION transaction_isolation = value;
```

```
SET transaction_isolation = value;
```

For each of those syntaxes, these semantics apply:

- Sets the isolation level for all subsequent transactions performed within the session.
- Permitted within transactions, but does not affect the current ongoing transaction.
- If executed between transactions, overrides any preceding statement that sets the next-transaction isolation level.
- Corresponds to `SET SESSION TRANSACTION ISOLATION LEVEL` (with the `SESSION` keyword).
- To set the next-transaction isolation level, use this syntax:

```
SET @@transaction_isolation = value;
```

For that syntax, these semantics apply:

- Sets the isolation level only for the next single transaction performed within the session.
- Subsequent transactions revert to the session isolation level.
- Not permitted within transactions.
- Corresponds to `SET TRANSACTION ISOLATION LEVEL` (without the `SESSION` keyword).

For more information about `SET TRANSACTION` and its relationship to the `transaction_isolation` system variable, see [Section 13.3.6, “SET TRANSACTION Statement”](#).



#### Note

`transaction_isolation` was added in MySQL 5.7.20 as a synonym for `tx_isolation`, which is now deprecated and is removed in MySQL 8.0. Applications should be adjusted to use `transaction_isolation` in preference to `tx_isolation`.

- `transaction_prealloc_size`

Command-Line Format	<code>--transaction-prealloc-size=#</code>
System Variable	<code>transaction_prealloc_size</code>
Scope	Global, Session
Dynamic	Yes
Type	Integer
Default Value	4096
Minimum Value	1024
Maximum Value	131072
Unit	bytes
Block Size	1024

There is a per-transaction memory pool from which various transaction-related allocations take memory. The initial size of the pool in bytes is `transaction_prealloc_size`. For every allocation that cannot be satisfied from the pool because it has insufficient memory available, the pool is increased

by `transaction_alloc_block_size` bytes. When the transaction ends, the pool is truncated to `transaction_prealloc_size` bytes.

By making `transaction_prealloc_size` sufficiently large to contain all statements within a single transaction, you can avoid many `malloc()` calls.

- `transaction_read_only`

Command-Line Format	<code>--transaction-read-only[={OFF ON}]</code>
System Variable (≥ 5.7.20)	<code>transaction_read_only</code>
Scope (≥ 5.7.20)	Global, Session
Dynamic (≥ 5.7.20)	Yes
Type	Boolean
Default Value	<code>OFF</code>

The transaction access mode. The value can be `OFF` (read/write; the default) or `ON` (read only).

The transaction access mode has three scopes: global, session, and next transaction. This three-scope implementation leads to some nonstandard access-mode assignment semantics, as described later.

To set the global transaction access mode at startup, use the `--transaction-read-only` server option.

At runtime, the access mode can be set directly using the `SET` statement to assign a value to the `transaction_read_only` system variable, or indirectly using the `SET TRANSACTION` statement. For example, use this `SET` statement to set the global value:

```
SET GLOBAL transaction_read_only = ON;
```

Setting the global `transaction_read_only` value sets the access mode for all subsequent sessions. Existing sessions are unaffected.

To set the session or next-level `transaction_read_only` value, use the `SET` statement. For most session system variables, these statements are equivalent ways to set the value:

```
SET @@SESSION.var_name = value;
SET SESSION var_name = value;
SET var_name = value;
SET @@var_name = value;
```

As mentioned previously, the transaction access mode has a next-transaction scope, in addition to the global and session scopes. To enable the next-transaction scope to be set, `SET` syntax for assigning session system variable values has nonstandard semantics for `transaction_read_only`,

- To set the session access mode, use any of these syntaxes:

```
SET @@SESSION.transaction_read_only = value;
SET SESSION transaction_read_only = value;
```

```
SET transaction_read_only = value;
```

For each of those syntaxes, these semantics apply:

- Sets the access mode for all subsequent transactions performed within the session.
- Permitted within transactions, but does not affect the current ongoing transaction.
- If executed between transactions, overrides any preceding statement that sets the next-transaction access mode.
- Corresponds to `SET SESSION TRANSACTION {READ WRITE | READ ONLY}` (with the `SESSION` keyword).
- To set the next-transaction access mode, use this syntax:

```
SET @@transaction_read_only = value;
```

For that syntax, these semantics apply:

- Sets the access mode only for the next single transaction performed within the session.
- Subsequent transactions revert to the session access mode.
- Not permitted within transactions.
- Corresponds to `SET TRANSACTION {READ WRITE | READ ONLY}` (without the `SESSION` keyword).

For more information about `SET TRANSACTION` and its relationship to the `transaction_read_only` system variable, see [Section 13.3.6, “SET TRANSACTION Statement”](#).



**Note**

`transaction_read_only` was added in MySQL 5.7.20 as a synonym for `tx_read_only`, which is now deprecated and is removed in MySQL 8.0. Applications should be adjusted to use `transaction_read_only` in preference to `tx_read_only`.

- `tx_isolation`

Deprecated	5.7.20
System Variable	<code>tx_isolation</code>
Scope	Global, Session
Dynamic	Yes
Type	Enumeration
Default Value	<code>REPEATABLE-READ</code>
Valid Values	<code>READ-UNCOMMITTED</code> <code>READ-COMMITTED</code> <code>REPEATABLE-READ</code>

SERIALIZABLE

The default transaction isolation level. Defaults to `REPEATABLE-READ`.

**Note**

`transaction_isolation` was added in MySQL 5.7.20 as a synonym for `tx_isolation`, which is now deprecated and is removed in MySQL 8.0. Applications should be adjusted to use `transaction_isolation` in preference to `tx_isolation`. See the description of `transaction_isolation` for details.

- `tx_read_only`

Deprecated	5.7.20
System Variable	<code>tx_read_only</code>
Scope	Global, Session
Dynamic	Yes
Type	Boolean
Default Value	<code>OFF</code>

The default transaction access mode. The value can be `OFF` (read/write, the default) or `ON` (read only).

**Note**

`transaction_read_only` was added in MySQL 5.7.20 as a synonym for `tx_read_only`, which is now deprecated and is removed in MySQL 8.0. Applications should be adjusted to use `transaction_read_only` in preference to `tx_read_only`. See the description of `transaction_read_only` for details.

- `unique_checks`

System Variable	<code>unique_checks</code>
Scope	Global, Session
Dynamic	Yes
Type	Boolean
Default Value	<code>ON</code>

If set to 1 (the default), uniqueness checks for secondary indexes in `InnoDB` tables are performed. If set to 0, storage engines are permitted to assume that duplicate keys are not present in input data. If you know for certain that your data does not contain uniqueness violations, you can set this to 0 to speed up large table imports to `InnoDB`.

Setting this variable to 0 does not *require* storage engines to ignore duplicate keys. An engine is still permitted to check for them and issue duplicate-key errors if it detects them.

- `updatable_views_with_limit`

Command-Line Format	<code>--updatable-views-with-limit[={OFF ON} ]</code>
---------------------	---

System Variable	<code>updatable_views_with_limit</code>
Scope	Global, Session
Dynamic	Yes
Type	Boolean
Default Value	1

This variable controls whether updates to a view can be made when the view does not contain all columns of the primary key defined in the underlying table, if the update statement contains a [LIMIT](#) clause. (Such updates often are generated by GUI tools.) An update is an [UPDATE](#) or [DELETE](#) statement. Primary key here means a [PRIMARY KEY](#), or a [UNIQUE](#) index in which no column can contain [NULL](#).

The variable can have two values:

- 1 or [YES](#): Issue a warning only (not an error message). This is the default value.
- 0 or [NO](#): Prohibit the update.
- `validate_password_xxx`

The `validate_password` plugin implements a set of system variables having names of the form `validate_password_xxx`. These variables affect password testing by that plugin; see [Section 6.4.3.2](#), “[Password Validation Plugin Options and Variables](#)”.

- `version`

The version number for the server. The value might also include a suffix indicating server build or configuration information. `-log` indicates that one or more of the general log, slow query log, or binary log are enabled. `-debug` indicates that the server was built with debugging support enabled.

- `version_comment`

System Variable	<code>version_comment</code>
Scope	Global
Dynamic	No
Type	String

The `CMake` configuration program has a `COMPILATION_COMMENT` option that permits a comment to be specified when building MySQL. This variable contains the value of that comment. See [Section 2.8.7](#), “[MySQL Source-Configuration Options](#)”.

- `version_compile_machine`

System Variable	<code>version_compile_machine</code>
Scope	Global
Dynamic	No
Type	String

The type of the server binary.

- `version_compile_os`

System Variable	<code>version_compile_os</code>
-----------------	---------------------------------



Scope	Global
Dynamic	No
Type	String

The type of operating system on which MySQL was built.

- `wait_timeout`

Command-Line Format	<code>--wait-timeout=#</code>
System Variable	<code>wait_timeout</code>
Scope	Global, Session
Dynamic	Yes
Type	Integer
Default Value	28800
Minimum Value	1
Maximum Value (Windows)	2147483
Maximum Value (Other)	31536000
Unit	seconds

The number of seconds the server waits for activity on a noninteractive connection before closing it.

On thread startup, the session `wait_timeout` value is initialized from the global `wait_timeout` value or from the global `interactive_timeout` value, depending on the type of client (as defined by the `CLIENT_INTERACTIVE` connect option to `mysql_real_connect()`). See also `interactive_timeout`.

- `warning_count`

The number of errors, warnings, and notes that resulted from the last statement that generated messages. This variable is read only. See [Section 13.7.5.40, “SHOW WARNINGS Statement”](#).

## 5.1.8 Using System Variables

The MySQL server maintains many system variables that configure its operation. [Section 5.1.7, “Server System Variables”](#), describes the meaning of these variables. Each system variable has a default value. System variables can be set at server startup using options on the command line or in an option file. Most of them can be changed dynamically while the server is running by means of the `SET` statement, which enables you to modify operation of the server without having to stop and restart it. You can also use system variable values in expressions.

Many system variables are built in. System variables implemented by a server plugin are exposed when the plugin is installed and have names that begin with the plugin name. For example, the `audit_log` plugin implements a system variable named `audit_log_policy`.

There are two scopes in which system variables exist. Global variables affect the overall operation of the server. Session variables affect its operation for individual client connections. A given system variable can have both a global and a session value. Global and session system variables are related as follows:

- When the server starts, it initializes each global variable to its default value. These defaults can be changed by options specified on the command line or in an option file. (See [Section 4.2.2, “Specifying Program Options”](#).)

- The server also maintains a set of session variables for each client that connects. The client's session variables are initialized at connect time using the current values of the corresponding global variables. For example, a client's SQL mode is controlled by the session `sql_mode` value, which is initialized when the client connects to the value of the global `sql_mode` value.

For some system variables, the session value is not initialized from the corresponding global value; if so, that is indicated in the variable description.

System variable values can be set globally at server startup by using options on the command line or in an option file. At startup, the syntax for system variables is the same as for command options, so within variable names, dashes and underscores may be used interchangeably. For example, `--general_log=ON` and `--general-log=ON` are equivalent.

When you use a startup option to set a variable that takes a numeric value, the value can be given with a suffix of `K`, `M`, or `G` (either uppercase or lowercase) to indicate a multiplier of 1024, 1024<sup>2</sup> or 1024<sup>3</sup>; that is, units of kilobytes, megabytes, or gigabytes, respectively. Thus, the following command starts the server with an `InnoDB` log file size of 16 megabytes and a maximum packet size of one gigabyte:

```
mysqld --innodb-log-file-size=16M --max-allowed-packet=1G
```

Within an option file, those variables are set like this:

```
[mysqld]
innodb_log_file_size=16M
max_allowed_packet=1G
```

The lettercase of suffix letters does not matter; `16M` and `16m` are equivalent, as are `1G` and `1g`.

To restrict the maximum value to which a system variable can be set at runtime with the `SET` statement, specify this maximum by using an option of the form `--maximum-var_name=value` at server startup. For example, to prevent the value of `innodb_log_file_size` from being increased to more than 32MB at runtime, use the option `--maximum-innodb-log-file-size=32M`.

Many system variables are dynamic and can be changed at runtime by using the `SET` statement. For a list, see [Section 5.1.8.2, “Dynamic System Variables”](#). To change a system variable with `SET`, refer to it by name, optionally preceded by a modifier. At runtime, system variable names must be written using underscores, not dashes. The following examples briefly illustrate this syntax:

- Set a global system variable:

```
SET GLOBAL max_connections = 1000;
SET @@GLOBAL.max_connections = 1000;
```

- Set a session system variable:

```
SET SESSION sql_mode = 'TRADITIONAL';
SET @@SESSION.sql_mode = 'TRADITIONAL';
SET @@sql_mode = 'TRADITIONAL';
```

For complete details about `SET` syntax, see [Section 13.7.4.1, “SET Syntax for Variable Assignment”](#). For a description of the privilege requirements for setting system variables, see [Section 5.1.8.1, “System Variable Privileges”](#)

Suffixes for specifying a value multiplier can be used when setting a variable at server startup, but not to set the value with `SET` at runtime. On the other hand, with `SET` you can assign a variable's value using an expression, which is not true when you set a variable at server startup. For example, the first of the following lines is legal at server startup, but the second is not:

```
$> mysql --max_allowed_packet=16M
$> mysql --max_allowed_packet=16*1024*1024
```

Conversely, the second of the following lines is legal at runtime, but the first is not:

```
mysql> SET GLOBAL max_allowed_packet=16M;
mysql> SET GLOBAL max_allowed_packet=16*1024*1024;
```

To display system variable names and values, use the `SHOW VARIABLES` statement:

```
mysql> SHOW VARIABLES;
```

Variable_name	Value
auto_increment_increment	1
auto_increment_offset	1
automatic_sp_privileges	ON
back_log	50
basedir	/home/mysql/
binlog_cache_size	32768
bulk_insert_buffer_size	8388608
character_set_client	utf8
character_set_connection	utf8
character_set_database	latin1
character_set_filesystem	binary
character_set_results	utf8
character_set_server	latin1
character_set_system	utf8
character_sets_dir	/home/mysql/share/mysql/charsets/
collation_connection	utf8_general_ci
collation_database	latin1_swedish_ci
collation_server	latin1_swedish_ci
...	
innodb_autoextend_increment	8
innodb_buffer_pool_size	8388608
innodb_checksums	ON
innodb_commit_concurrency	0
innodb_concurrency_tickets	500
innodb_data_file_path	ibdata1:10M:autoextend
innodb_data_home_dir	
...	
version	5.7.18-log
version_comment	Source distribution
version_compile_machine	i686
version_compile_os	suse-linux
wait_timeout	28800

With a `LIKE` clause, the statement displays only those variables that match the pattern. To obtain a specific variable name, use a `LIKE` clause as shown:

```
SHOW VARIABLES LIKE 'max_join_size';
SHOW SESSION VARIABLES LIKE 'max_join_size';
```

To get a list of variables whose name match a pattern, use the `%` wildcard character in a `LIKE` clause:

```
SHOW VARIABLES LIKE '%size%';
SHOW GLOBAL VARIABLES LIKE '%size%';
```

Wildcard characters can be used in any position within the pattern to be matched. Strictly speaking, because `_` is a wildcard that matches any single character, you should escape it as `\_` to match it literally. In practice, this is rarely necessary.

For `SHOW VARIABLES`, if you specify neither `GLOBAL` nor `SESSION`, MySQL returns `SESSION` values.

The reason for requiring the `GLOBAL` keyword when setting `GLOBAL`-only variables but not when retrieving them is to prevent problems in the future:

- Were a `SESSION` variable to be removed that has the same name as a `GLOBAL` variable, a client with privileges sufficient to modify global variables might accidentally change the `GLOBAL` variable rather than just the `SESSION` variable for its own session.
- Were a `SESSION` variable to be added with the same name as a `GLOBAL` variable, a client that intends to change the `GLOBAL` variable might find only its own `SESSION` variable changed.

### 5.1.8.1 System Variable Privileges

A system variable can have a global value that affects server operation as a whole, a session value that affects only the current session, or both. To modify system variable runtime values, use the `SET` statement. See [Section 13.7.4.1, “SET Syntax for Variable Assignment”](#). This section describes the privileges required to assign values to system variables at runtime.

Setting a global system variable runtime value requires the `SUPER` privilege.

To set a session system variable runtime value, use the `SET SESSION` statement. In contrast to setting global runtime values, setting session runtime values normally requires no special privileges and can be done by any user to affect the current session. For some system variables, setting the session value may have effects outside the current session and thus is a restricted operation that can be done only by users who have the `SUPER` privilege. If a session system variable is restricted in this way, the variable description indicates that restriction. Examples include `binlog_format` and `sql_log_bin`. Setting the session value of these variables affects binary logging for the current session, but may also have wider implications for the integrity of server replication and backups.

### 5.1.8.2 Dynamic System Variables

Many server system variables are dynamic and can be set at runtime. See [Section 13.7.4.1, “SET Syntax for Variable Assignment”](#). For a description of the privilege requirements for setting system variables, see [Section 5.1.8.1, “System Variable Privileges”](#)

The following table lists all dynamic system variables applicable within `mysqld`.

The table lists each variable's data type and scope. The last column indicates whether the scope for each variable is Global, Session, or both. Please see the corresponding item descriptions for details on setting and using the variables. Where appropriate, direct links to further information about the items are provided.

Variables that have a type of “string” take a string value. Variables that have a type of “numeric” take a numeric value. Variables that have a type of “boolean” can be set to 0, 1, `ON` or `OFF`. Variables that are marked as “enumeration” normally should be set to one of the available values for the variable, but can also be set to the number that corresponds to the desired enumeration value. For enumerated system variables, the first enumeration value corresponds to 0. This differs from the `ENUM` data type used for table columns, for which the first enumeration value corresponds to 1.

**Table 5.4 Dynamic System Variable Summary**

Variable Name	Variable Type	Variable Scope
<a href="#">audit_log_connection_policy</a>	Enumeration	Global
<a href="#">audit_log_disable</a>	Boolean	Global
<a href="#">audit_log_exclude_accounts</a>	String	Global
<a href="#">audit_log_flush</a>	Boolean	Global
<a href="#">audit_log_format_unix_timestamp</a>	Boolean	Global
<a href="#">audit_log_include_accounts</a>	String	Global
<a href="#">audit_log_read_buffer_size</a>	Integer	Varies

Variable Name	Variable Type	Variable Scope
audit_log_rotate_on_size	Integer	Global
audit_log_statement_policy	Enumeration	Global
authentication_ldap_sasl_auth_method	String	Global
authentication_ldap_sasl_bind_base	String	Global
authentication_ldap_sasl_bind_root	String	Global
authentication_ldap_sasl_bind_root_password	String	Global
authentication_ldap_sasl_ca_path	String	Global
authentication_ldap_sasl_group_search_attr	String	Global
authentication_ldap_sasl_group_search_filter	String	Global
authentication_ldap_sasl_init_pool_size	Integer	Global
authentication_ldap_sasl_log_status	Integer	Global
authentication_ldap_sasl_max_pool_size	Integer	Global
authentication_ldap_sasl_server_host	String	Global
authentication_ldap_sasl_server_port	Integer	Global
authentication_ldap_sasl_tls	Boolean	Global
authentication_ldap_sasl_user_search_attr	String	Global
authentication_ldap_simple_auth_method	String	Global
authentication_ldap_simple_bind_base	String	Global
authentication_ldap_simple_bind_root	String	Global
authentication_ldap_simple_bind_root_password	String	Global
authentication_ldap_simple_ca_path	String	Global
authentication_ldap_simple_group_search_attr	String	Global
authentication_ldap_simple_group_search_filter	String	Global
authentication_ldap_simple_init_pool_size	Integer	Global
authentication_ldap_simple_log_status	Integer	Global
authentication_ldap_simple_max_pool_size	Integer	Global
authentication_ldap_simple_server_host	String	Global
authentication_ldap_simple_server_port	Integer	Global
authentication_ldap_simple_tls	Boolean	Global
authentication_ldap_simple_user_search_attr	String	Global
auto_increment_increment	Integer	Both
auto_increment_offset	Integer	Both
autocommit	Boolean	Both
automatic_sp_privileges	Boolean	Global
avoid_temporal_upgrade	Boolean	Global
big_tables	Boolean	Both
binlog_cache_size	Integer	Global
binlog_checksum	String	Global

Variable Name	Variable Type	Variable Scope
binlog_direct_non_transactional_updates	Boolean	Both
binlog_error_action	Enumeration	Global
binlog_format	Enumeration	Both
binlog_group_commit_sync_delay	Integer	Global
binlog_group_commit_sync_no_delay_ticker	Integer	Global
binlog_max_flush_queue_time	Integer	Global
binlog_order_commits	Boolean	Global
binlog_row_image	Enumeration	Both
binlog_rows_query_log_events	Boolean	Both
binlog_stmt_cache_size	Integer	Global
binlog_transaction_dependency_history_size	Integer	Global
binlog_transaction_dependency_tracking	Enumeration	Global
block_encryption_mode	String	Both
bulk_insert_buffer_size	Integer	Both
character_set_client	String	Both
character_set_connection	String	Both
character_set_database	String	Both
character_set_filesystem	String	Both
character_set_results	String	Both
character_set_server	String	Both
check_proxy_users	Boolean	Global
collation_connection	String	Both
collation_database	String	Both
collation_server	String	Both
completion_type	Enumeration	Both
concurrent_insert	Enumeration	Global
connect_timeout	Integer	Global
connection_control_failed_connection_threshold	Integer	Global
connection_control_max_connection_age	Integer	Global
connection_control_min_connection_age	Integer	Global
debug	String	Both
debug_sync	String	Session
default_password_lifetime	Integer	Global
default_storage_engine	Enumeration	Both
default_tmp_storage_engine	Enumeration	Both
default_week_format	Integer	Both
delay_key_write	Enumeration	Global
delayed_insert_limit	Integer	Global

Variable Name	Variable Type	Variable Scope
delayed_insert_timeout	Integer	Global
delayed_queue_size	Integer	Global
div_precision_increment	Integer	Both
end_markers_in_json	Boolean	Both
enforce_gtid_consistency	Enumeration	Global
eq_range_index_dive_limit	Integer	Both
event_scheduler	Enumeration	Global
expire_logs_days	Integer	Global
explicit_defaults_for_timestamp	Boolean	Both
flush	Boolean	Global
flush_time	Integer	Global
foreign_key_checks	Boolean	Both
ft_boolean_syntax	String	Global
general_log	Boolean	Global
general_log_file	File name	Global
group_concat_max_len	Integer	Both
group_replication_allow_local_disjoint_indexes_join	Boolean	Global
group_replication_allow_local_lower_indexes_join	Boolean	Global
group_replication_auto_increment_increment	Integer	Global
group_replication_bootstrap_group	Boolean	Global
group_replication_components_stop_on_timeout	Integer	Global
group_replication_compression_threshold	Integer	Global
group_replication_enforce_update_conflicts	Boolean	Global
group_replication_exit_state_action	Enumeration	Global
group_replication_flow_control_apply_threshold	Integer	Global
group_replication_flow_control_certificate_threshold	Integer	Global
group_replication_flow_control_mode	Enumeration	Global
group_replication_force_members	String	Global
group_replication_group_name	String	Global
group_replication_group_seeds	String	Global
group_replication_gtid_assignment_increment	Integer	Global
group_replication_ip_whitelist	String	Global
group_replication_local_address	String	Global
group_replication_member_weight	Integer	Global
group_replication_poll_spin_loops	Integer	Global
group_replication_recovery_complete_at	Enumeration	Global
group_replication_recovery_reconnect_interval	Integer	Global
group_replication_recovery_retry_count	Integer	Global

Variable Name	Variable Type	Variable Scope
group_replication_recovery_ssl_ca	String	Global
group_replication_recovery_ssl_certificate	String	Global
group_replication_recovery_ssl_certificate_key	String	Global
group_replication_recovery_ssl_cipher	String	Global
group_replication_recovery_ssl_crl	File name	Global
group_replication_recovery_ssl_crl_dir	Directory name	Global
group_replication_recovery_ssl_key	String	Global
group_replication_recovery_ssl_verify_cert	Boolean	Global
group_replication_recovery_use_ssl	Boolean	Global
group_replication_single_primary_mode	Boolean	Global
group_replication_ssl_mode	Enumeration	Global
group_replication_start_on_boot	Boolean	Global
group_replication_transaction_size_limit	Integer	Global
group_replication_unreachable_majority_timeout	Integer	Global
gtid_executed_compression_period	Integer	Global
gtid_mode	Enumeration	Global
gtid_next	Enumeration	Session
gtid_purged	String	Global
host_cache_size	Integer	Global
identity	Integer	Session
init_connect	String	Global
init_slave	String	Global
innodb_adaptive_flushing	Boolean	Global
innodb_adaptive_flushing_lwm	Integer	Global
innodb_adaptive_hash_index	Boolean	Global
innodb_adaptive_max_sleep_delay	Integer	Global
innodb_api_bk_commit_interval	Integer	Global
innodb_api_trx_level	Integer	Global
innodb_autoextend_increment	Integer	Global
innodb_background_drop_list_empty	Boolean	Global
innodb_buffer_pool_dump_at_shutdown	Boolean	Global
innodb_buffer_pool_dump_now	Boolean	Global
innodb_buffer_pool_dump_pct	Integer	Global
innodb_buffer_pool_filename	File name	Global
innodb_buffer_pool_load_abort	Boolean	Global
innodb_buffer_pool_load_now	Boolean	Global
innodb_buffer_pool_size	Integer	Global
innodb_change_buffer_max_size	Integer	Global



Variable Name	Variable Type	Variable Scope
<a href="#">innodb_change_buffering</a>	Enumeration	Global
<a href="#">innodb_change_buffering_debug</a>	Integer	Global
<a href="#">innodb_checksum_algorithm</a>	Enumeration	Global
<a href="#">innodb_cmp_per_index_enabled</a>	Boolean	Global
<a href="#">innodb_commit_concurrency</a>	Integer	Global
<a href="#">innodb_compress_debug</a>	Enumeration	Global
<a href="#">innodb_compression_failure_threshold</a>	Integer	Global
<a href="#">innodb_compression_level</a>	Integer	Global
<a href="#">innodb_compression_pad_pct_max</a>	Integer	Global
<a href="#">innodb_concurrency_tickets</a>	Integer	Global
<a href="#">innodb_deadlock_detect</a>	Boolean	Global
<a href="#">innodb_default_row_format</a>	Enumeration	Global
<a href="#">innodb_disable_resize_buffer_pool</a>	Boolean	Global
<a href="#">innodb_disable_sort_file_cache</a>	Boolean	Global
<a href="#">innodb_fast_shutdown</a>	Integer	Global
<a href="#">innodb_fil_make_page_dirty_debug</a>	Integer	Global
<a href="#">innodb_file_format</a>	String	Global
<a href="#">innodb_file_format_max</a>	String	Global
<a href="#">innodb_file_per_table</a>	Boolean	Global
<a href="#">innodb_fill_factor</a>	Integer	Global
<a href="#">innodb_flush_log_at_timeout</a>	Integer	Global
<a href="#">innodb_flush_log_at_trx_commit</a>	Enumeration	Global
<a href="#">innodb_flush_neighbors</a>	Enumeration	Global
<a href="#">innodb_flush_sync</a>	Boolean	Global
<a href="#">innodb_flushing_avg_loops</a>	Integer	Global
<a href="#">innodb_ft_aux_table</a>	String	Global
<a href="#">innodb_ft_enable_diag_print</a>	Boolean	Global
<a href="#">innodb_ft_enable_stopword</a>	Boolean	Both
<a href="#">innodb_ft_num_word_optimize</a>	Integer	Global
<a href="#">innodb_ft_result_cache_limit</a>	Integer	Global
<a href="#">innodb_ft_server_stopword_table</a>	String	Global
<a href="#">innodb_ft_user_stopword_table</a>	String	Both
<a href="#">innodb_io_capacity</a>	Integer	Global
<a href="#">innodb_io_capacity_max</a>	Integer	Global
<a href="#">innodb_large_prefix</a>	Boolean	Global
<a href="#">innodb_limit_optimistic_insert_debug</a>	Integer	Global
<a href="#">innodb_lock_wait_timeout</a>	Integer	Both
<a href="#">innodb_log_checkpoint_now</a>	Boolean	Global

Variable Name	Variable Type	Variable Scope
<a href="#">innodb_log_checksums</a>	Boolean	Global
<a href="#">innodb_log_compressed_pages</a>	Boolean	Global
<a href="#">innodb_log_write_ahead_size</a>	Integer	Global
<a href="#">innodb_lru_scan_depth</a>	Integer	Global
<a href="#">innodb_max_dirty_pages_pct</a>	Numeric	Global
<a href="#">innodb_max_dirty_pages_pct_lwm</a>	Numeric	Global
<a href="#">innodb_max_purge_lag</a>	Integer	Global
<a href="#">innodb_max_purge_lag_delay</a>	Integer	Global
<a href="#">innodb_max_undo_log_size</a>	Integer	Global
<a href="#">innodb_merge_threshold_set_all_data</a>	Integer	Global
<a href="#">innodb_monitor_disable</a>	String	Global
<a href="#">innodb_monitor_enable</a>	String	Global
<a href="#">innodb_monitor_reset</a>	Enumeration	Global
<a href="#">innodb_monitor_reset_all</a>	Enumeration	Global
<a href="#">innodb_old_blocks_pct</a>	Integer	Global
<a href="#">innodb_old_blocks_time</a>	Integer	Global
<a href="#">innodb_online_alter_log_max_size</a>	Integer	Global
<a href="#">innodb_optimize_fulltext_only</a>	Boolean	Global
<a href="#">innodb_print_all_deadlocks</a>	Boolean	Global
<a href="#">innodb_purge_batch_size</a>	Integer	Global
<a href="#">innodb_purge_rseg_truncate_frequency</a>	Integer	Global
<a href="#">innodb_random_read_ahead</a>	Boolean	Global
<a href="#">innodb_read_ahead_threshold</a>	Integer	Global
<a href="#">innodb_replication_delay</a>	Integer	Global
<a href="#">innodb_rollback_segments</a>	Integer	Global
<a href="#">innodb_saved_page_number_debug</a>	Integer	Global
<a href="#">innodb_spin_wait_delay</a>	Integer	Global
<a href="#">innodb_stats_auto_recalc</a>	Boolean	Global
<a href="#">innodb_stats_include_delete_marked</a>	Boolean	Global
<a href="#">innodb_stats_method</a>	Enumeration	Global
<a href="#">innodb_stats_on_metadata</a>	Boolean	Global
<a href="#">innodb_stats_persistent</a>	Boolean	Global
<a href="#">innodb_stats_persistent_sample_pages</a>	Integer	Global
<a href="#">innodb_stats_sample_pages</a>	Integer	Global
<a href="#">innodb_stats_transient_sample_pages</a>	Integer	Global
<a href="#">innodb_status_output</a>	Boolean	Global
<a href="#">innodb_status_output_locks</a>	Boolean	Global
<a href="#">innodb_strict_mode</a>	Boolean	Both

Variable Name	Variable Type	Variable Scope
<a href="#">innodb_support_xa</a>	Boolean	Both
<a href="#">innodb_sync_spin_loops</a>	Integer	Global
<a href="#">innodb_table_locks</a>	Boolean	Both
<a href="#">innodb_thread_concurrency</a>	Integer	Global
<a href="#">innodb_thread_sleep_delay</a>	Integer	Global
<a href="#">innodb_tmpdir</a>	Directory name	Both
<a href="#">innodb_trx_purge_view_update_only</a>	Boolean	Global
<a href="#">innodb_trx_rseg_n_slots_debug</a>	Integer	Global
<a href="#">innodb_undo_log_truncate</a>	Boolean	Global
<a href="#">innodb_undo_logs</a>	Integer	Global
<a href="#">insert_id</a>	Integer	Session
<a href="#">interactive_timeout</a>	Integer	Both
<a href="#">internal_tmp_disk_storage_engine</a>	Enumeration	Global
<a href="#">join_buffer_size</a>	Integer	Both
<a href="#">keep_files_on_create</a>	Boolean	Both
<a href="#">key_buffer_size</a>	Integer	Global
<a href="#">key_cache_age_threshold</a>	Integer	Global
<a href="#">key_cache_block_size</a>	Integer	Global
<a href="#">key_cache_division_limit</a>	Integer	Global
<a href="#">keyring_aws_cmk_id</a>	String	Global
<a href="#">keyring_aws_region</a>	Enumeration	Global
<a href="#">keyring_encrypted_file_data</a>	File name	Global
<a href="#">keyring_encrypted_file_password</a>	String	Global
<a href="#">keyring_file_data</a>	File name	Global
<a href="#">keyring_okv_conf_dir</a>	Directory name	Global
<a href="#">keyring_operations</a>	Boolean	Global
<a href="#">last_insert_id</a>	Integer	Session
<a href="#">lc_messages</a>	String	Both
<a href="#">lc_time_names</a>	String	Both
<a href="#">local_infile</a>	Boolean	Global
<a href="#">lock_wait_timeout</a>	Integer	Both
<a href="#">log_bin_trust_function_creators</a>	Boolean	Global
<a href="#">log_bin_use_v1_row_events</a>	Boolean	Global
<a href="#">log_builtin_as_identified_by_password</a>	Boolean	Global
<a href="#">log_error_verbosity</a>	Integer	Global
<a href="#">log_output</a>	Set	Global
<a href="#">log_queries_not_using_indexes</a>	Boolean	Global
<a href="#">log_slow_admin_statements</a>	Boolean	Global

Variable Name	Variable Type	Variable Scope
<a href="#">log_slow_slave_statements</a>	Boolean	Global
<a href="#">log_statements_unsafe_for_binlog</a>	Boolean	Global
<a href="#">log_syslog</a>	Boolean	Global
<a href="#">log_syslog_facility</a>	String	Global
<a href="#">log_syslog_include_pid</a>	Boolean	Global
<a href="#">log_syslog_tag</a>	String	Global
<a href="#">log_throttle_queries_not_using_indexes</a>	Integer	Global
<a href="#">log_timestamps</a>	Enumeration	Global
<a href="#">log_warnings</a>	Integer	Global
<a href="#">long_query_time</a>	Numeric	Both
<a href="#">low_priority_updates</a>	Boolean	Both
<a href="#">master_info_repository</a>	String	Global
<a href="#">master_verify_checksum</a>	Boolean	Global
<a href="#">max_allowed_packet</a>	Integer	Both
<a href="#">max_binlog_cache_size</a>	Integer	Global
<a href="#">max_binlog_size</a>	Integer	Global
<a href="#">max_binlog_stmt_cache_size</a>	Integer	Global
<a href="#">max_connect_errors</a>	Integer	Global
<a href="#">max_connections</a>	Integer	Global
<a href="#">max_delayed_threads</a>	Integer	Both
<a href="#">max_error_count</a>	Integer	Both
<a href="#">max_execution_time</a>	Integer	Both
<a href="#">max_heap_table_size</a>	Integer	Both
<a href="#">max_insert_delayed_threads</a>	Integer	Both
<a href="#">max_join_size</a>	Integer	Both
<a href="#">max_length_for_sort_data</a>	Integer	Both
<a href="#">max_points_in_geometry</a>	Integer	Both
<a href="#">max_prepared_stmt_count</a>	Integer	Global
<a href="#">max_relay_log_size</a>	Integer	Global
<a href="#">max_seeks_for_key</a>	Integer	Both
<a href="#">max_sort_length</a>	Integer	Both
<a href="#">max_sp_recursion_depth</a>	Integer	Both
<a href="#">max_tmp_tables</a>	Integer	Both
<a href="#">max_user_connections</a>	Integer	Both
<a href="#">max_write_lock_count</a>	Integer	Global
<a href="#">min_examined_row_limit</a>	Integer	Both
<a href="#">multi_range_count</a>	Integer	Both
<a href="#">myisam_data_pointer_size</a>	Integer	Global

Variable Name	Variable Type	Variable Scope
<a href="#">mysam_max_sort_file_size</a>	Integer	Global
<a href="#">mysam_repair_threads</a>	Integer	Both
<a href="#">mysam_sort_buffer_size</a>	Integer	Both
<a href="#">mysam_stats_method</a>	Enumeration	Both
<a href="#">mysam_use_mmap</a>	Boolean	Global
<a href="#">mysql_firewall_mode</a>	Boolean	Global
<a href="#">mysql_firewall_trace</a>	Boolean	Global
<a href="#">mysql_native_password_proxy_use</a>	Boolean	Global
<a href="#">mysqlx_connect_timeout</a>	Integer	Global
<a href="#">mysqlx_idle_worker_thread_timeout</a>	Integer	Global
<a href="#">mysqlx_max_allowed_packet</a>	Integer	Global
<a href="#">mysqlx_max_connections</a>	Integer	Global
<a href="#">mysqlx_min_worker_threads</a>	Integer	Global
<a href="#">ndb_allow_copying_alter_table</a>	Boolean	Both
<a href="#">ndb_autoincrement_prefetch_sz</a>	Integer	Both
<a href="#">ndb_batch_size</a>	Integer	Both
<a href="#">ndb_blob_read_batch_bytes</a>	Integer	Both
<a href="#">ndb_blob_write_batch_bytes</a>	Integer	Both
<a href="#">ndb_cache_check_time</a>	Integer	Global
<a href="#">ndb_clear_apply_status</a>	Boolean	Global
<a href="#">ndb_data_node_neighbour</a>	Integer	Global
<a href="#">ndb_default_column_format</a>	Enumeration	Global
<a href="#">ndb_default_column_format</a>	Enumeration	Global
<a href="#">ndb_deferred_constraints</a>	Integer	Both
<a href="#">ndb_deferred_constraints</a>	Integer	Both
<a href="#">ndb_distribution</a>	Enumeration	Global
<a href="#">ndb_distribution</a>	Enumeration	Global
<a href="#">ndb_eventbuffer_free_percent</a>	Integer	Global
<a href="#">ndb_eventbuffer_max_alloc</a>	Integer	Global
<a href="#">ndb_extra_logging</a>	Integer	Global
<a href="#">ndb_force_send</a>	Boolean	Both
<a href="#">ndb_fully_replicated</a>	Boolean	Both
<a href="#">ndb_index_stat_enable</a>	Boolean	Both
<a href="#">ndb_index_stat_option</a>	String	Both
<a href="#">ndb_join_pushdown</a>	Boolean	Both
<a href="#">ndb_log_binlog_index</a>	Boolean	Global
<a href="#">ndb_log_empty_epochs</a>	Boolean	Global
<a href="#">ndb_log_empty_epochs</a>	Boolean	Global

Variable Name	Variable Type	Variable Scope
<a href="#">ndb_log_empty_update</a>	Boolean	Global
<a href="#">ndb_log_empty_update</a>	Boolean	Global
<a href="#">ndb_log_exclusive_reads</a>	Boolean	Both
<a href="#">ndb_log_exclusive_reads</a>	Boolean	Both
<a href="#">ndb_log_update_as_write</a>	Boolean	Global
<a href="#">ndb_log_update_minimal</a>	Boolean	Global
<a href="#">ndb_log_updated_only</a>	Boolean	Global
<a href="#">ndb_optimization_delay</a>	Integer	Global
<a href="#">ndb_optimized_node_selection</a>	Integer	Global
<a href="#">ndb_read_backup</a>	Boolean	Global
<a href="#">ndb_rcv_thread_activation_threshold</a>	Integer	Global
<a href="#">ndb_rcv_thread_cpu_mask</a>	Bitmap	Global
<a href="#">ndb_report_thresh_binlog_epoch_size</a>	Integer	Global
<a href="#">ndb_report_thresh_binlog_mem_usage</a>	Integer	Global
<a href="#">ndb_row_checksum</a>	Integer	Both
<a href="#">ndb_show_foreign_key_mock_tables</a>	Boolean	Global
<a href="#">ndb_slave_conflict_role</a>	Enumeration	Global
<a href="#">ndb_table_no_logging</a>	Boolean	Session
<a href="#">ndb_table_temporary</a>	Boolean	Session
<a href="#">ndb_use_exact_count</a>	Boolean	Both
<a href="#">ndb_use_transactions</a>	Boolean	Both
<a href="#">ndbinfo_max_bytes</a>	Integer	Both
<a href="#">ndbinfo_max_rows</a>	Integer	Both
<a href="#">ndbinfo_offline</a>	Boolean	Global
<a href="#">ndbinfo_show_hidden</a>	Boolean	Both
<a href="#">net_buffer_length</a>	Integer	Both
<a href="#">net_read_timeout</a>	Integer	Both
<a href="#">net_retry_count</a>	Integer	Both
<a href="#">net_write_timeout</a>	Integer	Both
<a href="#">new</a>	Boolean	Both
<a href="#">offline_mode</a>	Boolean	Global
<a href="#">old_alter_table</a>	Boolean	Both
<a href="#">old_passwords</a>	Enumeration	Both
<a href="#">optimizer_prune_level</a>	Integer	Both
<a href="#">optimizer_search_depth</a>	Integer	Both
<a href="#">optimizer_switch</a>	Set	Both
<a href="#">optimizer_trace</a>	String	Both
<a href="#">optimizer_trace_features</a>	String	Both

Variable Name	Variable Type	Variable Scope
optimizer_trace_limit	Integer	Both
optimizer_trace_max_mem_size	Integer	Both
optimizer_trace_offset	Integer	Both
parser_max_mem_size	Integer	Both
performance_schema_show_proces	Boolean	Global
preload_buffer_size	Integer	Both
profiling	Boolean	Both
profiling_history_size	Integer	Both
pseudo_slave_mode	Boolean	Session
pseudo_thread_id	Integer	Session
query_alloc_block_size	Integer	Both
query_cache_limit	Integer	Global
query_cache_min_res_unit	Integer	Global
query_cache_size	Integer	Global
query_cache_type	Enumeration	Both
query_cache_wlock_invalidate	Boolean	Both
query_prealloc_size	Integer	Both
rand_seed1	Integer	Session
rand_seed2	Integer	Session
range_alloc_block_size	Integer	Both
range_optimizer_max_mem_size	Integer	Both
rbr_exec_mode	Enumeration	Session
read_buffer_size	Integer	Both
read_only	Boolean	Global
read_rnd_buffer_size	Integer	Both
relay_log_info_repository	String	Global
relay_log_purge	Boolean	Global
replication_optimize_for_static_plug	Boolean	Global
replication_sender_observe_commi	Boolean	Global
require_secure_transport	Boolean	Global
rewriter_enabled	Boolean	Global
rewriter_verbosity	Integer	Global
rpl_semi_sync_master_enabled	Boolean	Global
rpl_semi_sync_master_timeout	Integer	Global
rpl_semi_sync_master_trace_level	Integer	Global
rpl_semi_sync_master_wait_for_slave	Integer	Global
rpl_semi_sync_master_wait_no_slave	Boolean	Global
rpl_semi_sync_master_wait_point	Enumeration	Global

Variable Name	Variable Type	Variable Scope
<a href="#">rpl_semi_sync_slave_enabled</a>	Boolean	Global
<a href="#">rpl_semi_sync_slave_trace_level</a>	Integer	Global
<a href="#">rpl_stop_slave_timeout</a>	Integer	Global
<a href="#">secure_auth</a>	Boolean	Global
<a href="#">server_id</a>	Integer	Global
<a href="#">session_track_gtids</a>	Enumeration	Both
<a href="#">session_track_schema</a>	Boolean	Both
<a href="#">session_track_state_change</a>	Boolean	Both
<a href="#">session_track_system_variables</a>	String	Both
<a href="#">session_track_transaction_info</a>	Enumeration	Both
<a href="#">sha256_password_proxy_users</a>	Boolean	Global
<a href="#">show_compatibility_56</a>	Boolean	Global
<a href="#">show_create_table_verbosity</a>	Boolean	Both
<a href="#">show_old_temporals</a>	Boolean	Both
<a href="#">slave_allow_batching</a>	Boolean	Global
<a href="#">slave_checkpoint_group</a>	Integer	Global
<a href="#">slave_checkpoint_period</a>	Integer	Global
<a href="#">slave_compressed_protocol</a>	Boolean	Global
<a href="#">slave_exec_mode</a>	Enumeration	Global
<a href="#">slave_max_allowed_packet</a>	Integer	Global
<a href="#">slave_net_timeout</a>	Integer	Global
<a href="#">slave_parallel_type</a>	Enumeration	Global
<a href="#">slave_parallel_workers</a>	Integer	Global
<a href="#">slave_pending_jobs_size_max</a>	Integer	Global
<a href="#">slave_preserve_commit_order</a>	Boolean	Global
<a href="#">slave_rows_search_algorithms</a>	Set	Global
<a href="#">slave_sql_verify_checksum</a>	Boolean	Global
<a href="#">slave_transaction_retries</a>	Integer	Global
<a href="#">slave_type_conversions</a>	Set	Global
<a href="#">slow_launch_time</a>	Integer	Global
<a href="#">slow_query_log</a>	Boolean	Global
<a href="#">slow_query_log_file</a>	File name	Global
<a href="#">sort_buffer_size</a>	Integer	Both
<a href="#">sql_auto_is_null</a>	Boolean	Both
<a href="#">sql_big_selects</a>	Boolean	Both
<a href="#">sql_buffer_result</a>	Boolean	Both
<a href="#">sql_log_bin</a>	Boolean	Session
<a href="#">sql_log_off</a>	Boolean	Both



Variable Name	Variable Type	Variable Scope
<a href="#">sql_mode</a>	Set	Both
<a href="#">sql_notes</a>	Boolean	Both
<a href="#">sql_quote_show_create</a>	Boolean	Both
<a href="#">sql_safe_updates</a>	Boolean	Both
<a href="#">sql_select_limit</a>	Integer	Both
<a href="#">sql_slave_skip_counter</a>	Integer	Global
<a href="#">sql_warnings</a>	Boolean	Both
<a href="#">stored_program_cache</a>	Integer	Global
<a href="#">super_read_only</a>	Boolean	Global
<a href="#">sync_binlog</a>	Integer	Global
<a href="#">sync_frm</a>	Boolean	Global
<a href="#">sync_master_info</a>	Integer	Global
<a href="#">sync_relay_log</a>	Integer	Global
<a href="#">sync_relay_log_info</a>	Integer	Global
<a href="#">table_definition_cache</a>	Integer	Global
<a href="#">table_open_cache</a>	Integer	Global
<a href="#">thread_cache_size</a>	Integer	Global
<a href="#">thread_pool_high_priority_connections_max</a>	Integer	Both
<a href="#">thread_pool_max_unused_threads</a>		Global
<a href="#">thread_pool_prio_kickup_timer</a>		Global
<a href="#">thread_pool_stall_limit</a>	Integer	Global
<a href="#">time_zone</a>	String	Both
<a href="#">timestamp</a>	Numeric	Session
<a href="#">tmp_table_size</a>	Integer	Both
<a href="#">transaction_alloc_block_size</a>	Integer	Both
<a href="#">transaction_allow_batching</a>	Boolean	Session
<a href="#">transaction_isolation</a>	Enumeration	Both
<a href="#">transaction_prealloc_size</a>	Integer	Both
<a href="#">transaction_read_only</a>	Boolean	Both
<a href="#">transaction_write_set_extraction</a>	Enumeration	Both
<a href="#">tx_isolation</a>	Enumeration	Both
<a href="#">tx_read_only</a>	Boolean	Both
<a href="#">unique_checks</a>	Boolean	Both
<a href="#">updatable_views_with_limit</a>	Boolean	Both
<a href="#">validate_password_check_user_name</a>	Boolean	Global
<a href="#">validate_password_dictionary_file</a>	File name	Global
<a href="#">validate_password_length</a>	Integer	Global
<a href="#">validate_password_mixed_case_count_2</a>	Integer	Global

Variable Name	Variable Type	Variable Scope
<a href="#">validate_password_number_count</a>	Integer	Global
<a href="#">validate_password_policy</a>	Enumeration	Global
<a href="#">validate_password_special_char_count</a>	Integer	Global
<a href="#">version_tokens_session</a>	String	Both
<a href="#">wait_timeout</a>	Integer	Both

### 5.1.8.3 Structured System Variables

A structured variable differs from a regular system variable in two respects:

- Its value is a structure with components that specify server parameters considered to be closely related.
- There might be several instances of a given type of structured variable. Each one has a different name and refers to a different resource maintained by the server.

MySQL supports one structured variable type, which specifies parameters governing the operation of key caches. A key cache structured variable has these components:

- `key_buffer_size`
- `key_cache_block_size`
- `key_cache_division_limit`
- `key_cache_age_threshold`

This section describes the syntax for referring to structured variables. Key cache variables are used for syntax examples, but specific details about how key caches operate are found elsewhere, in [Section 8.10.2, “The MyISAM Key Cache”](#).

To refer to a component of a structured variable instance, you can use a compound name in `instance_name.component_name` format. Examples:

```
hot_cache.key_buffer_size
hot_cache.key_cache_block_size
cold_cache.key_cache_block_size
```

For each structured system variable, an instance with the name of `default` is always predefined. If you refer to a component of a structured variable without any instance name, the `default` instance is used. Thus, `default.key_buffer_size` and `key_buffer_size` both refer to the same system variable.

Structured variable instances and components follow these naming rules:

- For a given type of structured variable, each instance must have a name that is unique *within* variables of that type. However, instance names need not be unique *across* structured variable types. For example, each structured variable has an instance named `default`, so `default` is not unique across variable types.
- The names of the components of each structured variable type must be unique across all system variable names. If this were not true (that is, if two different types of structured variables could share component member names), it would not be clear which default structured variable to use for references to member names that are not qualified by an instance name.
- If a structured variable instance name is not legal as an unquoted identifier, refer to it as a quoted identifier using backticks. For example, `hot-cache` is not legal, but ``hot-cache`` is.

- `global`, `session`, and `local` are not legal instance names. This avoids a conflict with notation such as `@@GLOBAL.var_name` for referring to nonstructured system variables.

Currently, the first two rules have no possibility of being violated because the only structured variable type is the one for key caches. These rules may assume greater significance if some other type of structured variable is created in the future.

With one exception, you can refer to structured variable components using compound names in any context where simple variable names can occur. For example, you can assign a value to a structured variable using a command-line option:

```
$> mysql --hot_cache.key_buffer_size=64K
```

In an option file, use this syntax:

```
[mysqld]
hot_cache.key_buffer_size=64K
```

If you start the server with this option, it creates a key cache named `hot_cache` with a size of 64KB in addition to the default key cache that has a default size of 8MB.

Suppose that you start the server as follows:

```
$> mysql --key_buffer_size=256K \
        --extra_cache.key_buffer_size=128K \
        --extra_cache.key_cache_block_size=2048
```

In this case, the server sets the size of the default key cache to 256KB. (You could also have written `--default.key_buffer_size=256K`.) In addition, the server creates a second key cache named `extra_cache` that has a size of 128KB, with the size of block buffers for caching table index blocks set to 2048 bytes.

The following example starts the server with three different key caches having sizes in a 3:1:1 ratio:

```
$> mysql --key_buffer_size=6M \
        --hot_cache.key_buffer_size=2M \
        --cold_cache.key_buffer_size=2M
```

Structured variable values may be set and retrieved at runtime as well. For example, to set a key cache named `hot_cache` to a size of 10MB, use either of these statements:

```
mysql> SET GLOBAL hot_cache.key_buffer_size = 10*1024*1024;
mysql> SET @@GLOBAL.hot_cache.key_buffer_size = 10*1024*1024;
```

To retrieve the cache size, do this:

```
mysql> SELECT @@GLOBAL.hot_cache.key_buffer_size;
```

However, the following statement does not work. The variable is not interpreted as a compound name, but as a simple string for a `LIKE` pattern-matching operation:

```
mysql> SHOW GLOBAL VARIABLES LIKE 'hot_cache.key_buffer_size';
```

This is the exception to being able to use structured variable names anywhere a simple variable name may occur.

## 5.1.9 Server Status Variables

The MySQL server maintains many status variables that provide information about its operation. You can view these variables and their values by using the `SHOW [GLOBAL | SESSION] STATUS` statement (see [Section 13.7.5.35, "SHOW STATUS Statement"](#)). The optional `GLOBAL` keyword aggregates the values over all connections, and `SESSION` shows the values for the current connection.

```
mysql> SHOW GLOBAL STATUS;
+-----+-----+
| Variable_name | Value |
+-----+-----+
| Aborted_clients | 0 |
| Aborted_connects | 0 |
| Bytes_received | 155372598 |
| Bytes_sent | 1176560426 |
| ... | ... |
| Connections | 30023 |
| Created_tmp_disk_tables | 0 |
| Created_tmp_files | 3 |
| Created_tmp_tables | 2 |
| ... | ... |
| Threads_created | 217 |
| Threads_running | 88 |
| Uptime | 1389872 |
+-----+-----+
```

Many status variables are reset to 0 by the `FLUSH STATUS` statement.

This section provides a description of each status variable. For a status variable summary, see [Section 5.1.5, “Server Status Variable Reference”](#). For information about status variables specific to NDB Cluster, see [NDB Cluster Status Variables](#).

The status variables have the meanings shown in the following list.

- `Aborted_clients`

The number of connections that were aborted because the client died without closing the connection properly. See [Section B.3.2.9, “Communication Errors and Aborted Connections”](#).

- `Aborted_connects`

The number of failed attempts to connect to the MySQL server. See [Section B.3.2.9, “Communication Errors and Aborted Connections”](#).

For additional connection-related information, check the `Connection_errors_xxx` status variables and the `host_cache` table.

As of MySQL 5.7.3, `Aborted_connects` is not visible in the embedded server because for that server it is not updated and is not meaningful.

- `Binlog_cache_disk_use`

The number of transactions that used the temporary binary log cache but that exceeded the value of `binlog_cache_size` and used a temporary file to store statements from the transaction.

The number of nontransactional statements that caused the binary log transaction cache to be written to disk is tracked separately in the `Binlog_stmt_cache_disk_use` status variable.

- `Binlog_cache_use`

The number of transactions that used the binary log cache.

- `Binlog_stmt_cache_disk_use`

The number of nontransaction statements that used the binary log statement cache but that exceeded the value of `binlog_stmt_cache_size` and used a temporary file to store those statements.

- `Binlog_stmt_cache_use`

The number of nontransactional statements that used the binary log statement cache.

- `Bytes_received`

The number of bytes received from all clients.

- `Bytes_sent`

The number of bytes sent to all clients.

- `Com_xxx`

The `Com_xxx` statement counter variables indicate the number of times each `xxx` statement has been executed. There is one status variable for each type of statement. For example, `Com_delete` and `Com_update` count `DELETE` and `UPDATE` statements, respectively. `Com_delete_multi` and `Com_update_multi` are similar but apply to `DELETE` and `UPDATE` statements that use multiple-table syntax.

If a query result is returned from query cache, the server increments the `Qcache_hits` status variable, not `Com_select`. See [Section 8.10.3.4, “Query Cache Status and Maintenance”](#).

All `Com_stmt_xxx` variables are increased even if a prepared statement argument is unknown or an error occurred during execution. In other words, their values correspond to the number of requests issued, not to the number of requests successfully completed. For example, because status variables are initialized for each server startup and do not persist across restarts, the `Com_shutdown` variable that tracks `SHUTDOWN` statements normally has a value of zero, but can be nonzero if `SHUTDOWN` statements were executed but failed.

The `Com_stmt_xxx` status variables are as follows:

- `Com_stmt_prepare`
- `Com_stmt_execute`
- `Com_stmt_fetch`
- `Com_stmt_send_long_data`
- `Com_stmt_reset`
- `Com_stmt_close`

Those variables stand for prepared statement commands. Their names refer to the `COM_xxx` command set used in the network layer. In other words, their values increase whenever prepared statement API calls such as `mysql_stmt_prepare()`, `mysql_stmt_execute()`, and so forth are executed. However, `Com_stmt_prepare`, `Com_stmt_execute` and `Com_stmt_close` also increase for `PREPARE`, `EXECUTE`, or `DEALLOCATE PREPARE`, respectively. Additionally, the values of the older statement counter variables `Com_prepare_sql`, `Com_execute_sql`, and `Com_dealloc_sql`

increase for the `PREPARE`, `EXECUTE`, and `DEALLOCATE PREPARE` statements. `Com_stmt_fetch` stands for the total number of network round-trips issued when fetching from cursors.

`Com_stmt_reprepare` indicates the number of times statements were automatically reprepared by the server after metadata changes to tables or views referred to by the statement. A reprepare operation increments `Com_stmt_reprepare`, and also `Com_stmt_prepare`.

`Com_explain_other` indicates the number of `EXPLAIN FOR CONNECTION` statements executed. See [Section 8.8.4, “Obtaining Execution Plan Information for a Named Connection”](#).

`Com_change_repl_filter` indicates the number of `CHANGE REPLICATION FILTER` statements executed.

- `Compression`

Whether the client connection uses compression in the client/server protocol.

- `Connection_errors_xxx`

These variables provide information about errors that occur during the client connection process. They are global only and represent error counts aggregated across connections from all hosts. These variables track errors not accounted for by the host cache (see [Section 5.1.11.2, “DNS Lookups and the Host Cache”](#)), such as errors that are not associated with TCP connections, occur very early in the connection process (even before an IP address is known), or are not specific to any particular IP address (such as out-of-memory conditions).

As of MySQL 5.7.3, the `Connection_errors_xxx` status variables are not visible in the embedded server because for that server they are not updated and are not meaningful.

- `Connection_errors_accept`

The number of errors that occurred during calls to `accept()` on the listening port.

- `Connection_errors_internal`

The number of connections refused due to internal errors in the server, such as failure to start a new thread or an out-of-memory condition.

- `Connection_errors_max_connections`

The number of connections refused because the server `max_connections` limit was reached.

- `Connection_errors_peer_address`

The number of errors that occurred while searching for connecting client IP addresses.

- `Connection_errors_select`

The number of errors that occurred during calls to `select()` or `poll()` on the listening port. (Failure of this operation does not necessarily mean a client connection was rejected.)

- `Connection_errors_tcpwrap`

The number of connections refused by the `libwrap` library.

- `Connections`

The number of connection attempts (successful or not) to the MySQL server.

- `Created_tmp_disk_tables`

The number of internal on-disk temporary tables created by the server while executing statements.

You can compare the number of internal on-disk temporary tables created to the total number of internal temporary tables created by comparing `Created_tmp_disk_tables` and `Created_tmp_tables` values.

See also [Section 8.4.4, “Internal Temporary Table Use in MySQL”](#).

- `Created_tmp_files`

How many temporary files `mysqld` has created.

- `Created_tmp_tables`

The number of internal temporary tables created by the server while executing statements.

You can compare the number of internal on-disk temporary tables created to the total number of internal temporary tables created by comparing `Created_tmp_disk_tables` and `Created_tmp_tables` values.

See also [Section 8.4.4, “Internal Temporary Table Use in MySQL”](#).

Each invocation of the `SHOW STATUS` statement uses an internal temporary table and increments the global `Created_tmp_tables` value.

- `Delayed_errors`

This status variable is deprecated (because `DELAYED` inserts are not supported); expect it to be removed in a future release.

- `Delayed_insert_threads`

This status variable is deprecated (because `DELAYED` inserts are not supported); expect it to be removed in a future release.

- `Delayed_writes`

This status variable is deprecated (because `DELAYED` inserts are not supported); expect it to be removed in a future release.

- `Flush_commands`

The number of times the server flushes tables, whether because a user executed a `FLUSH TABLES` statement or due to internal server operation. It is also incremented by receipt of a `COM_REFRESH` packet. This is in contrast to `Com_flush`, which indicates how many `FLUSH` statements have been executed, whether `FLUSH TABLES`, `FLUSH LOGS`, and so forth.

- `group_replication_primary_member`

Shows the primary member's UUID when the group is operating in single-primary mode. If the group is operating in multi-primary mode, shows an empty string.

- `Handler_commit`

The number of internal `COMMIT` statements.

- `Handler_delete`

The number of times that rows have been deleted from tables.

- `Handler_external_lock`

The server increments this variable for each call to its `external_lock()` function, which generally occurs at the beginning and end of access to a table instance. There might be differences among storage engines. This variable can be used, for example, to discover for a statement that accesses a partitioned table how many partitions were pruned before locking occurred: Check how much the counter increased for the statement, subtract 2 (2 calls for the table itself), then divide by 2 to get the number of partitions locked.

- `Handler_mrr_init`

The number of times the server uses a storage engine's own Multi-Range Read implementation for table access.

- `Handler_prepare`

A counter for the prepare phase of two-phase commit operations.

- `Handler_read_first`

The number of times the first entry in an index was read. If this value is high, it suggests that the server is doing a lot of full index scans (for example, `SELECT coll FROM foo`, assuming that `coll` is indexed).

- `Handler_read_key`

The number of requests to read a row based on a key. If this value is high, it is a good indication that your tables are properly indexed for your queries.

- `Handler_read_last`

The number of requests to read the last key in an index. With `ORDER BY`, the server issues a first-key request followed by several next-key requests, whereas with `ORDER BY DESC`, the server issues a last-key request followed by several previous-key requests.

- `Handler_read_next`

The number of requests to read the next row in key order. This value is incremented if you are querying an index column with a range constraint or if you are doing an index scan.

- `Handler_read_prev`

The number of requests to read the previous row in key order. This read method is mainly used to optimize `ORDER BY ... DESC`.

- `Handler_read_rnd`

The number of requests to read a row based on a fixed position. This value is high if you are doing a lot of queries that require sorting of the result. You probably have a lot of queries that require MySQL to scan entire tables or you have joins that do not use keys properly.

- `Handler_read_rnd_next`

The number of requests to read the next row in the data file. This value is high if you are doing a lot of table scans. Generally this suggests that your tables are not properly indexed or that your queries are not written to take advantage of the indexes you have.



- `Handler_rollback`  
The number of requests for a storage engine to perform a rollback operation.
- `Handler_savepoint`  
The number of requests for a storage engine to place a savepoint.
- `Handler_savepoint_rollback`  
The number of requests for a storage engine to roll back to a savepoint.
- `Handler_update`  
The number of requests to update a row in a table.
- `Handler_write`  
The number of requests to insert a row in a table.
- `InnoDB_available_undo_logs`

**Note**

The `InnoDB_available_undo_logs` status variable is deprecated as of MySQL 5.7.19; expect it to be removed in a future release.

The total number of available **InnoDB rollback segments**. Supplements the `innodb_rollback_segments` system variable, which defines the number of active rollback segments.

One rollback segment always resides in the system tablespace, and 32 rollback segments are reserved for use by temporary tables and are hosted in the temporary tablespace (`ibtmp1`). See [Section 14.6.7, “Undo Logs”](#).

If you initiate a MySQL instance with 32 or fewer rollback segments, **InnoDB** still assigns one rollback segment to the system tablespace and 32 rollback segments to the temporary tablespace. In this case, `InnoDB_available_undo_logs` reports 33 available rollback segments even though the instance was initialized with a lesser `innodb_rollback_segments` value.

- `InnoDB_buffer_pool_dump_status`  
The progress of an operation to record the **pages** held in the **InnoDB buffer pool**, triggered by the setting of `innodb_buffer_pool_dump_at_shutdown` or `innodb_buffer_pool_dump_now`.  
  
For related information and examples, see [Section 14.8.3.6, “Saving and Restoring the Buffer Pool State”](#).
- `InnoDB_buffer_pool_load_status`  
The progress of an operation to **warm up** the **InnoDB buffer pool** by reading in a set of **pages** corresponding to an earlier point in time, triggered by the setting of `innodb_buffer_pool_load_at_startup` or `innodb_buffer_pool_load_now`. If the operation introduces too much overhead, you can cancel it by setting `innodb_buffer_pool_load_abort`.  
  
For related information and examples, see [Section 14.8.3.6, “Saving and Restoring the Buffer Pool State”](#).
- `InnoDB_buffer_pool_bytes_data`

The total number of bytes in the [InnoDB buffer pool](#) containing data. The number includes both [dirty](#) and clean pages. For more accurate memory usage calculations than with [Innodb\\_buffer\\_pool\\_pages\\_data](#), when [compressed](#) tables cause the buffer pool to hold pages of different sizes.

- [Innodb\\_buffer\\_pool\\_pages\\_data](#)

The number of [pages](#) in the [InnoDB buffer pool](#) containing data. The number includes both [dirty](#) and clean pages. When using [compressed tables](#), the reported [Innodb\\_buffer\\_pool\\_pages\\_data](#) value may be larger than [Innodb\\_buffer\\_pool\\_pages\\_total](#) (Bug #59550).

- [Innodb\\_buffer\\_pool\\_bytes\\_dirty](#)

The total current number of bytes held in [dirty pages](#) in the [InnoDB buffer pool](#). For more accurate memory usage calculations than with [Innodb\\_buffer\\_pool\\_pages\\_dirty](#), when [compressed](#) tables cause the buffer pool to hold pages of different sizes.

- [Innodb\\_buffer\\_pool\\_pages\\_dirty](#)

The current number of [dirty pages](#) in the [InnoDB buffer pool](#).

- [Innodb\\_buffer\\_pool\\_pages\\_flushed](#)

The number of requests to [flush pages](#) from the [InnoDB buffer pool](#).

- [Innodb\\_buffer\\_pool\\_pages\\_free](#)

The number of free [pages](#) in the [InnoDB buffer pool](#).

- [Innodb\\_buffer\\_pool\\_pages\\_latched](#)

The number of latched [pages](#) in the [InnoDB buffer pool](#). These are pages currently being read or written, or that cannot be [flushed](#) or removed for some other reason. Calculation of this variable is expensive, so it is available only when the [UNIV\\_DEBUG](#) system is defined at server build time.

- [Innodb\\_buffer\\_pool\\_pages\\_misc](#)

The number of [pages](#) in the [InnoDB buffer pool](#) that are busy because they have been allocated for administrative overhead, such as [row locks](#) or the [adaptive hash index](#). This value can also be calculated as  $\text{Innodb\_buffer\_pool\_pages\_total} - \text{Innodb\_buffer\_pool\_pages\_free} - \text{Innodb\_buffer\_pool\_pages\_data}$ . When using [compressed tables](#), [Innodb\\_buffer\\_pool\\_pages\\_misc](#) may report an out-of-bounds value (Bug #59550).

- [Innodb\\_buffer\\_pool\\_pages\\_total](#)

The total size of the [InnoDB buffer pool](#), in [pages](#). When using [compressed tables](#), the reported [Innodb\\_buffer\\_pool\\_pages\\_data](#) value may be larger than [Innodb\\_buffer\\_pool\\_pages\\_total](#) (Bug #59550)

- [Innodb\\_buffer\\_pool\\_read\\_ahead](#)

The number of [pages](#) read into the [InnoDB buffer pool](#) by the [read-ahead](#) background thread.

- [Innodb\\_buffer\\_pool\\_read\\_ahead\\_evicted](#)

The number of [pages](#) read into the [InnoDB buffer pool](#) by the [read-ahead](#) background thread that were subsequently [evicted](#) without having been accessed by queries.

- `Innodb_buffer_pool_read_ahead_rnd`

The number of “random” read-aheads initiated by `InnoDB`. This happens when a query scans a large portion of a table but in random order.
- `Innodb_buffer_pool_read_requests`

The number of logical read requests.
- `Innodb_buffer_pool_reads`

The number of logical reads that `InnoDB` could not satisfy from the `buffer pool`, and had to read directly from disk.
- `Innodb_buffer_pool_resize_status`

The status of an operation to resize the `InnoDB buffer pool` dynamically, triggered by setting the `innodb_buffer_pool_size` parameter dynamically. The `innodb_buffer_pool_size` parameter is dynamic, which allows you to resize the buffer pool without restarting the server. See [Configuring InnoDB Buffer Pool Size Online](#) for related information.
- `Innodb_buffer_pool_wait_free`

Normally, writes to the `InnoDB buffer pool` happen in the background. When `InnoDB` needs to read or create a `page` and no clean pages are available, `InnoDB` flushes some `dirty pages` first and waits for that operation to finish. This counter counts instances of these waits. If `innodb_buffer_pool_size` has been set properly, this value should be small.
- `Innodb_buffer_pool_write_requests`

The number of writes done to the `InnoDB buffer pool`.
- `Innodb_data_fsyncs`

The number of `fsync()` operations so far. The frequency of `fsync()` calls is influenced by the setting of the `innodb_flush_method` configuration option.
- `Innodb_data_pending_fsyncs`

The current number of pending `fsync()` operations. The frequency of `fsync()` calls is influenced by the setting of the `innodb_flush_method` configuration option.
- `Innodb_data_pending_reads`

The current number of pending reads.
- `Innodb_data_pending_writes`

The current number of pending writes.
- `Innodb_data_read`

The amount of data read since the server was started (in bytes).
- `Innodb_data_reads`

The total number of data reads (OS file reads).
- `Innodb_data_writes`

The total number of data writes.

- `Innodb_data_written`

The amount of data written so far, in bytes.

- `Innodb_dblwr_pages_written`

The number of [pages](#) that have been written to the [doublewrite buffer](#). See [Section 14.12.1, “InnoDB Disk I/O”](#).

- `Innodb_dblwr_writes`

The number of doublewrite operations that have been performed. See [Section 14.12.1, “InnoDB Disk I/O”](#).

- `Innodb_have_atomic_builtins`

Indicates whether the server was built with [atomic instructions](#).

- `Innodb_log_waits`

The number of times that the [log buffer](#) was too small and a [wait](#) was required for it to be [flushed](#) before continuing.

- `Innodb_log_write_requests`

The number of write requests for the [InnoDB redo log](#).

- `Innodb_log_writes`

The number of physical writes to the [InnoDB redo log](#) file.

- `Innodb_num_open_files`

The number of files [InnoDB](#) currently holds open.

- `Innodb_os_log_fsyncs`

The number of `fsync()` writes done to the [InnoDB redo log](#) files.

- `Innodb_os_log_pending_fsyncs`

The number of pending `fsync()` operations for the [InnoDB redo log](#) files.

- `Innodb_os_log_pending_writes`

The number of pending writes to the [InnoDB redo log](#) files.

- `Innodb_os_log_written`

The number of bytes written to the [InnoDB redo log](#) files.

- `Innodb_page_size`

[InnoDB](#) page size (default 16KB). Many values are counted in pages; the page size enables them to be easily converted to bytes.

- `Innodb_pages_created`

The number of pages created by operations on `InnoDB` tables.

- `Innodb_pages_read`

The number of pages read from the `InnoDB` buffer pool by operations on `InnoDB` tables.

- `Innodb_pages_written`

The number of pages written by operations on `InnoDB` tables.

- `Innodb_row_lock_current_waits`

The number of **row locks** currently being waited for by operations on `InnoDB` tables.

- `Innodb_row_lock_time`

The total time spent in acquiring **row locks** for `InnoDB` tables, in milliseconds.

- `Innodb_row_lock_time_avg`

The average time to acquire a **row lock** for `InnoDB` tables, in milliseconds.

- `Innodb_row_lock_time_max`

The maximum time to acquire a **row lock** for `InnoDB` tables, in milliseconds.

- `Innodb_row_lock_waits`

The number of times operations on `InnoDB` tables had to wait for a **row lock**.

- `Innodb_rows_deleted`

The number of rows deleted from `InnoDB` tables.

- `Innodb_rows_inserted`

The number of rows inserted into `InnoDB` tables.

- `Innodb_rows_read`

The number of rows read from `InnoDB` tables.

- `Innodb_rows_updated`

The estimated number of rows updated in `InnoDB` tables.



**Note**

This value is not meant to be 100% accurate. For an accurate (but more expensive) result, use `ROW_COUNT()`.

- `Innodb_truncated_status_writes`

The number of times output from the `SHOW ENGINE INNODB STATUS` statement has been truncated.

- `Key_blocks_not_flushed`

The number of key blocks in the `MyISAM` key cache that have changed but have not yet been flushed to disk.

- `Key_blocks_unused`

The number of unused blocks in the `MyISAM` key cache. You can use this value to determine how much of the key cache is in use; see the discussion of `key_buffer_size` in [Section 5.1.7, “Server System Variables”](#).

- `Key_blocks_used`

The number of used blocks in the `MyISAM` key cache. This value is a high-water mark that indicates the maximum number of blocks that have ever been in use at one time.

- `Key_read_requests`

The number of requests to read a key block from the `MyISAM` key cache.

- `Key_reads`

The number of physical reads of a key block from disk into the `MyISAM` key cache. If `Key_reads` is large, then your `key_buffer_size` value is probably too small. The cache miss rate can be calculated as  $Key\_reads/Key\_read\_requests$ .

- `Key_write_requests`

The number of requests to write a key block to the `MyISAM` key cache.

- `Key_writes`

The number of physical writes of a key block from the `MyISAM` key cache to disk.

- `Last_query_cost`

The total cost of the last compiled query as computed by the query optimizer. This is useful for comparing the cost of different query plans for the same query. The default value of 0 means that no query has been compiled yet. The default value is 0. `Last_query_cost` has session scope.

`Last_query_cost` can be computed accurately only for simple, “flat” queries, but not for complex queries such as those containing subqueries or `UNION`. For the latter, the value is set to 0.

- `Last_query_partial_plans`

The number of iterations the query optimizer made in execution plan construction for the previous query.

`Last_query_partial_plans` has session scope.

- `Locked_connects`

The number of attempts to connect to locked user accounts. For information about account locking and unlocking, see [Section 6.2.15, “Account Locking”](#).

- `Max_execution_time_exceeded`

The number of `SELECT` statements for which the execution timeout was exceeded.

- `Max_execution_time_set`

The number of `SELECT` statements for which a nonzero execution timeout was set. This includes statements that include a nonzero `MAX_EXECUTION_TIME` optimizer hint, and statements that include no such hint but execute while the timeout indicated by the `max_execution_time` system variable is nonzero.

- `Max_execution_time_set_failed`

The number of `SELECT` statements for which the attempt to set an execution timeout failed.
- `Max_used_connections`

The maximum number of connections that have been in use simultaneously since the server started.
- `Max_used_connections_time`

The time at which `Max_used_connections` reached its current value.
- `Not_flushed_delayed_rows`

This status variable is deprecated (because `DELAYED` inserts are not supported); expect it to be removed in a future release.
- `mecab_charset`

The character set currently used by the MeCab full-text parser plugin. For related information, see [Section 12.9.9, “MeCab Full-Text Parser Plugin”](#).
- `Ongoing_anonymous_transaction_count`

Shows the number of ongoing transactions which have been marked as anonymous. This can be used to ensure that no further transactions are waiting to be processed.
- `Ongoing_anonymous_gtid_violating_transaction_count`

This status variable is only available in debug builds. Shows the number of ongoing transactions which use `gtid_next=ANONYMOUS` and that violate GTID consistency.
- `Ongoing_automatic_gtid_violating_transaction_count`

This status variable is only available in debug builds. Shows the number of ongoing transactions which use `gtid_next=AUTOMATIC` and that violate GTID consistency.
- `Open_files`

The number of files that are open. This count includes regular files opened by the server. It does not include other types of files such as sockets or pipes. Also, the count does not include files that storage engines open using their own internal functions rather than asking the server level to do so.
- `Open_streams`

The number of streams that are open (used mainly for logging).
- `Open_table_definitions`

The number of cached `.frm` files.
- `Open_tables`

The number of tables that are open.
- `Opened_files`

The number of files that have been opened with `my_open()` (a `mysys` library function). Parts of the server that open files without using this function do not increment the count.

- [Opened\\_table\\_definitions](#)

The number of `.frm` files that have been cached.

- [Opened\\_tables](#)

The number of tables that have been opened. If `Opened_tables` is big, your `table_open_cache` value is probably too small.

- [Performance\\_schema\\_xxx](#)

Performance Schema status variables are listed in [Section 25.16, “Performance Schema Status Variables”](#). These variables provide information about instrumentation that could not be loaded or created due to memory constraints.

- [Prepared\\_stmt\\_count](#)

The current number of prepared statements. (The maximum number of statements is given by the `max_prepared_stmt_count` system variable.)

- [Qcache\\_free\\_blocks](#)

The number of free memory blocks in the query cache.

**Note**

The query cache is deprecated as of MySQL 5.7.20, and is removed in MySQL 8.0. Deprecation includes [Qcache\\_free\\_blocks](#).

- [Qcache\\_free\\_memory](#)

The amount of free memory for the query cache.

**Note**

The query cache is deprecated as of MySQL 5.7.20, and is removed in MySQL 8.0. Deprecation includes [Qcache\\_free\\_memory](#).

- [Qcache\\_hits](#)

The number of query cache hits.

The discussion at the beginning of this section indicates how to relate this statement-counting status variable to other such variables.

**Note**

The query cache is deprecated as of MySQL 5.7.20, and is removed in MySQL 8.0. Deprecation includes [Qcache\\_hits](#).

- [Qcache\\_inserts](#)

The number of queries added to the query cache.

**Note**

The query cache is deprecated as of MySQL 5.7.20, and is removed in MySQL 8.0. Deprecation includes [Qcache\\_inserts](#).



- [Qcache\\_lowmem\\_prunes](#)

The number of queries that were deleted from the query cache because of low memory.

**Note**

The query cache is deprecated as of MySQL 5.7.20, and is removed in MySQL 8.0. Deprecation includes [Qcache\\_lowmem\\_prunes](#).

- [Qcache\\_not\\_cached](#)

The number of noncached queries (not cacheable, or not cached due to the [query\\_cache\\_type](#) setting).

**Note**

The query cache is deprecated as of MySQL 5.7.20, and is removed in MySQL 8.0. Deprecation includes [Qcache\\_not\\_cached](#).

- [Qcache\\_queries\\_in\\_cache](#)

The number of queries registered in the query cache.

**Note**

The query cache is deprecated as of MySQL 5.7.20, and is removed in MySQL 8.0. Deprecation includes [Qcache\\_queries\\_in\\_cache](#).

- [Qcache\\_total\\_blocks](#)

The total number of blocks in the query cache.

**Note**

The query cache is deprecated as of MySQL 5.7.20, and is removed in MySQL 8.0. Deprecation includes [Qcache\\_total\\_blocks](#).

- [Queries](#)

The number of statements executed by the server. This variable includes statements executed within stored programs, unlike the [Questions](#) variable. It does not count [COM\\_PING](#) or [COM\\_STATISTICS](#) commands.

The discussion at the beginning of this section indicates how to relate this statement-counting status variable to other such variables.

- [Questions](#)

The number of statements executed by the server. This includes only statements sent to the server by clients and not statements executed within stored programs, unlike the [Queries](#) variable. This variable does not count [COM\\_PING](#), [COM\\_STATISTICS](#), [COM\\_STMT\\_PREPARE](#), [COM\\_STMT\\_CLOSE](#), or [COM\\_STMT\\_RESET](#) commands.

The discussion at the beginning of this section indicates how to relate this statement-counting status variable to other such variables.

- `Rpl_semi_sync_master_clients`

The number of semisynchronous replicas.

This variable is available only if the source-side semisynchronous replication plugin is installed.
- `Rpl_semi_sync_master_net_avg_wait_time`

The average time in microseconds the source waited for a replica reply. This variable is deprecated, always 0; expect it to be in a future version.

This variable is available only if the source-side semisynchronous replication plugin is installed.
- `Rpl_semi_sync_master_net_wait_time`

The total time in microseconds the source waited for replica replies. This variable is deprecated, and is always 0; expect it to be removed in a future version.

This variable is available only if the source-side semisynchronous replication plugin is installed.
- `Rpl_semi_sync_master_net_waits`

The total number of times the source waited for replica replies.

This variable is available only if the source-side semisynchronous replication plugin is installed.
- `Rpl_semi_sync_master_no_times`

The number of times the source turned off semisynchronous replication.

This variable is available only if the source-side semisynchronous replication plugin is installed.
- `Rpl_semi_sync_master_no_tx`

The number of commits that were not acknowledged successfully by a replica.

This variable is available only if the source-side semisynchronous replication plugin is installed.
- `Rpl_semi_sync_master_status`

Whether semisynchronous replication currently is operational on the source. The value is `ON` if the plugin has been enabled and a commit acknowledgment has occurred. It is `OFF` if the plugin is not enabled or the source has fallen back to asynchronous replication due to commit acknowledgment timeout.

This variable is available only if the source-side semisynchronous replication plugin is installed.
- `Rpl_semi_sync_master_timefunc_failures`

The number of times the source failed when calling time functions such as `gettimeofday()`.

This variable is available only if the source-side semisynchronous replication plugin is installed.
- `Rpl_semi_sync_master_tx_avg_wait_time`

The average time in microseconds the source waited for each transaction.

This variable is available only if the source-side semisynchronous replication plugin is installed.
- `Rpl_semi_sync_master_tx_wait_time`

The total time in microseconds the source waited for transactions.

This variable is available only if the source-side semisynchronous replication plugin is installed.

- `Rpl_semi_sync_master_tx_waits`

The total number of times the source waited for transactions.

This variable is available only if the source-side semisynchronous replication plugin is installed.

- `Rpl_semi_sync_master_wait_pos_backtraverse`

The total number of times the source waited for an event with binary coordinates lower than events waited for previously. This can occur when the order in which transactions start waiting for a reply is different from the order in which their binary log events are written.

This variable is available only if the source-side semisynchronous replication plugin is installed.

- `Rpl_semi_sync_master_wait_sessions`

The number of sessions currently waiting for replica replies.

This variable is available only if the source-side semisynchronous replication plugin is installed.

- `Rpl_semi_sync_master_yes_tx`

The number of commits that were acknowledged successfully by a replica.

This variable is available only if the source-side semisynchronous replication plugin is installed.

- `Rpl_semi_sync_slave_status`

Whether semisynchronous replication currently is operational on the replica. This is `ON` if the plugin has been enabled and the replica I/O thread is running, `OFF` otherwise.

This variable is available only if the replica-side semisynchronous replication plugin is installed.

- `Rsa_public_key`

This variable is available if MySQL was compiled using OpenSSL (see [Section 6.3.4, “SSL Library-Dependent Capabilities”](#)). Its value is the public key used by the `sha256_password` authentication plugin for RSA key pair-based password exchange. The value is nonempty only if the server successfully initializes the private and public keys in the files named by the `sha256_password_private_key_path` and `sha256_password_public_key_path` system variables. The value of `Rsa_public_key` comes from the latter file.

For information about `sha256_password`, see [Section 6.4.1.5, “SHA-256 Pluggable Authentication”](#).

- `Select_full_join`

The number of joins that perform table scans because they do not use indexes. If this value is not 0, you should carefully check the indexes of your tables.

- `Select_full_range_join`

The number of joins that used a range search on a reference table.

- `Select_range`

The number of joins that used ranges on the first table. This is normally not a critical issue even if the value is quite large.

- [Select\\_range\\_check](#)

The number of joins without keys that check for key usage after each row. If this is not 0, you should carefully check the indexes of your tables.

- [Select\\_scan](#)

The number of joins that did a full scan of the first table.

- [Slave\\_heartbeat\\_period](#)

Shows the replication heartbeat interval (in seconds) on a replication replica.

This variable is affected by the value of the [show\\_compatibility\\_56](#) system variable. For details, see [Effect of show\\_compatibility\\_56 on Slave Status Variables](#).

**Note**

This variable only shows the status of the default replication channel. To monitor any replication channel, use the [HEARTBEAT\\_INTERVAL](#) column in the [replication\\_connection\\_configuration](#) table for the replication channel. [Slave\\_heartbeat\\_period](#) is deprecated and is removed in MySQL 8.0.

- [Slave\\_last\\_heartbeat](#)

Shows when the most recent heartbeat signal was received by a replica, as a [TIMESTAMP](#) value.

This variable is affected by the value of the [show\\_compatibility\\_56](#) system variable. For details, see [Effect of show\\_compatibility\\_56 on Slave Status Variables](#).

**Note**

This variable only shows the status of the default replication channel. To monitor any replication channel, use the [LAST\\_HEARTBEAT\\_TIMESTAMP](#) column in the [replication\\_connection\\_status](#) table for the replication channel. [Slave\\_last\\_heartbeat](#) is deprecated and is removed in MySQL 8.0.

- [Slave\\_open\\_temp\\_tables](#)

The number of temporary tables that the replica SQL thread currently has open. If the value is greater than zero, it is not safe to shut down the replica; see [Section 16.4.1.29, “Replication and Temporary Tables”](#). This variable reports the total count of open temporary tables for *all* replication channels.

- [Slave\\_received\\_heartbeats](#)

This counter increments with each replication heartbeat received by a replication replica since the last time that the replica was restarted or reset, or a `CHANGE MASTER TO` statement was issued.

This variable is affected by the value of the `show_compatibility_56` system variable. For details, see [Effect of show\\_compatibility\\_56 on Slave Status Variables](#).

**Note**

This variable only shows the status of the default replication channel. To monitor any replication channel, use the `COUNT_RECEIVED_HEARTBEATS` column in the `replication_connection_status` table for the replication channel. `Slave_received_heartbeats` is deprecated and is removed in MySQL 8.0.

- [Slave\\_retried\\_transactions](#)

The total number of times since startup that the replication replica SQL thread has retried transactions.

This variable is affected by the value of the `show_compatibility_56` system variable. For details, see [Effect of show\\_compatibility\\_56 on Slave Status Variables](#).

**Note**

This variable only shows the status of the default replication channel. To monitor any replication channel, use the `COUNT_TRANSACTIONS_RETRIES` column in the `replication_applier_status` table for the replication channel. `Slave_retried_transactions` is deprecated and is removed in MySQL 8.0.

- [Slave\\_rows\\_last\\_search\\_algorithm\\_used](#)

The search algorithm that was most recently used by this replica to locate rows for row-based replication. The result shows whether the replica used indexes, a table scan, or hashing as the search algorithm for the last transaction executed on any channel.

The method used depends on the setting for the `slave_rows_search_algorithms` system variable, and the keys that are available on the relevant table.

This variable is available only for debug builds of MySQL.

- [Slave\\_running](#)

This is `ON` if this server is a replica that is connected to a replication source, and both the I/O and SQL threads are running; otherwise, it is `OFF`.

This variable is affected by the value of the `show_compatibility_56` system variable. For details, see [Effect of show\\_compatibility\\_56 on Slave Status Variables](#).

**Note**

This variable only shows the status of the default replication channel. To monitor any replication channel, use the `SERVICE_STATE` column in the `replication_applier_status` or `replication_connection_status` tables of the replication channel. `Slave_running` is deprecated and is removed in MySQL 8.0.

- `Slow_launch_threads`

The number of threads that have taken more than `slow_launch_time` seconds to create.

This variable is not meaningful in the embedded server (`libmysqld`) and as of MySQL 5.7.2 is no longer visible within the embedded server.

- `Slow_queries`

The number of queries that have taken more than `long_query_time` seconds. This counter increments regardless of whether the slow query log is enabled. For information about that log, see [Section 5.4.5, “The Slow Query Log”](#).

- `Sort_merge_passes`

The number of merge passes that the sort algorithm has had to do. If this value is large, you should consider increasing the value of the `sort_buffer_size` system variable.

- `Sort_range`

The number of sorts that were done using ranges.

- `Sort_rows`

The number of sorted rows.

- `Sort_scan`

The number of sorts that were done by scanning the table.

- `Ssl_accept_renegotiates`

The number of negotiates needed to establish the connection.

- `Ssl_accepts`

The number of accepted SSL connections.

- `Ssl_callback_cache_hits`

The number of callback cache hits.

- `Ssl_cipher`

The current encryption cipher (empty for unencrypted connections).

- `Ssl_cipher_list`

The list of possible SSL ciphers (empty for non-SSL connections).

- `Ssl_client_connects`

The number of SSL connection attempts to an SSL-enabled source.

- `Ssl_connect_renegotiates`

The number of negotiates needed to establish the connection to an SSL-enabled source.

- `Ssl_ctx_verify_depth`

The SSL context verification depth (how many certificates in the chain are tested).

- `Ssl_ctx_verify_mode`

The SSL context verification mode.

- `Ssl_default_timeout`

The default SSL timeout.

- `Ssl_finished_accepts`

The number of successful SSL connections to the server.

- `Ssl_finished_connects`

The number of successful replica connections to an SSL-enabled source.

- `Ssl_server_not_after`

The last date for which the SSL certificate is valid. To check SSL certificate expiration information, use this statement:

```
mysql> SHOW STATUS LIKE 'Ssl_server_not%';
+-----+-----+
| Variable_name | Value |
+-----+-----+
| Ssl_server_not_after | Apr 28 14:16:39 2025 GMT |
| Ssl_server_not_before | May 1 14:16:39 2015 GMT |
+-----+-----+
```

- `Ssl_server_not_before`

The first date for which the SSL certificate is valid.

- `Ssl_session_cache_hits`

The number of SSL session cache hits.

- `Ssl_session_cache_misses`

The number of SSL session cache misses.

- `Ssl_session_cache_mode`

The SSL session cache mode.

- `Ssl_session_cache_overflows`

The number of SSL session cache overflows.

- `Ssl_session_cache_size`

The SSL session cache size.

- `Ssl_session_cache_timeouts`

The number of SSL session cache timeouts.

- `Ssl_sessions_reused`

This is equal to 0 if TLS was not used in the current MySQL session, or if a TLS session has not been reused; otherwise it is equal to 1.

`Ssl_sessions_reused` has session scope.

- `Ssl_used_session_cache_entries`

How many SSL session cache entries were used.

- `Ssl_verify_depth`

The verification depth for replication SSL connections.

- `Ssl_verify_mode`

The verification mode used by the server for a connection that uses SSL. The value is a bitmask; bits are defined in the `openssl/ssl.h` header file:

```
# define SSL_VERIFY_NONE          0x00
# define SSL_VERIFY_PEER         0x01
# define SSL_VERIFY_FAIL_IF_NO_PEER_CERT 0x02
# define SSL_VERIFY_CLIENT_ONCE  0x04
```

`SSL_VERIFY_PEER` indicates that the server asks for a client certificate. If the client supplies one, the server performs verification and proceeds only if verification is successful. `SSL_VERIFY_CLIENT_ONCE` indicates that a request for the client certificate is done only in the initial handshake.

- `Ssl_version`

The SSL protocol version of the connection (for example, TLSv1). If the connection is not encrypted, the value is empty.

- `Table_locks_immediate`

The number of times that a request for a table lock could be granted immediately.

- `Table_locks_waited`

The number of times that a request for a table lock could not be granted immediately and a wait was needed. If this is high and you have performance problems, you should first optimize your queries, and then either split your table or tables or use replication.

- `Table_open_cache_hits`

The number of hits for open tables cache lookups.

- `Table_open_cache_misses`

The number of misses for open tables cache lookups.

- `Table_open_cache_overflows`

The number of overflows for the open tables cache. This is the number of times, after a table is opened or closed, a cache instance has an unused entry and the size of the instance is larger than `table_open_cache / table_open_cache_instances`.



- `Tc_log_max_pages_used`

For the memory-mapped implementation of the log that is used by `mysqld` when it acts as the transaction coordinator for recovery of internal XA transactions, this variable indicates the largest number of pages used for the log since the server started. If the product of `Tc_log_max_pages_used` and `Tc_log_page_size` is always significantly less than the log size, the size is larger than necessary and can be reduced. (The size is set by the `--log-tc-size` option. This variable is unused: It is unneeded for binary log-based recovery, and the memory-mapped recovery log method is not used unless the number of storage engines that are capable of two-phase commit and that support XA transactions is greater than one. (`InnoDB` is the only applicable engine.)

- `Tc_log_page_size`

The page size used for the memory-mapped implementation of the XA recovery log. The default value is determined using `getpagesize()`. This variable is unused for the same reasons as described for `Tc_log_max_pages_used`.

- `Tc_log_page_waits`

For the memory-mapped implementation of the recovery log, this variable increments each time the server was not able to commit a transaction and had to wait for a free page in the log. If this value is large, you might want to increase the log size (with the `--log-tc-size` option). For binary log-based recovery, this variable increments each time the binary log cannot be closed because there are two-phase commits in progress. (The close operation waits until all such transactions are finished.)

- `Threads_cached`

The number of threads in the thread cache.

This variable is not meaningful in the embedded server (`libmysqld`) and as of MySQL 5.7.2 is no longer visible within the embedded server.

- `Threads_connected`

The number of currently open connections.

- `Threads_created`

The number of threads created to handle connections. If `Threads_created` is big, you may want to increase the `thread_cache_size` value. The cache miss rate can be calculated as `Threads_created/Connections`.

- `Threads_running`

The number of threads that are not sleeping.

- `Uptime`

The number of seconds that the server has been up.

- `Uptime_since_flush_status`

The number of seconds since the most recent `FLUSH STATUS` statement.

## 5.1.10 Server SQL Modes

The MySQL server can operate in different SQL modes, and can apply these modes differently for different clients, depending on the value of the `sql_mode` system variable. DBAs can set the global SQL mode to

match site server operating requirements, and each application can set its session SQL mode to its own requirements.

Modes affect the SQL syntax MySQL supports and the data validation checks it performs. This makes it easier to use MySQL in different environments and to use MySQL together with other database servers.

- [Setting the SQL Mode](#)
- [The Most Important SQL Modes](#)
- [Full List of SQL Modes](#)
- [Combination SQL Modes](#)
- [Strict SQL Mode](#)
- [Comparison of the IGNORE Keyword and Strict SQL Mode](#)
- [SQL Mode Changes in MySQL 5.7](#)

For answers to questions often asked about server SQL modes in MySQL, see [Section A.3, “MySQL 5.7 FAQ: Server SQL Mode”](#).

When working with `InnoDB` tables, consider also the `innodb_strict_mode` system variable. It enables additional error checks for `InnoDB` tables.

## Setting the SQL Mode

The default SQL mode in MySQL 5.7 includes these modes: `ONLY_FULL_GROUP_BY`, `STRICT_TRANS_TABLES`, `NO_ZERO_IN_DATE`, `NO_ZERO_DATE`, `ERROR_FOR_DIVISION_BY_ZERO`, `NO_AUTO_CREATE_USER`, and `NO_ENGINE_SUBSTITUTION`.

These modes were added to the default SQL mode in MySQL 5.7: The `ONLY_FULL_GROUP_BY` and `STRICT_TRANS_TABLES` modes were added in MySQL 5.7.5. The `NO_AUTO_CREATE_USER` mode was added in MySQL 5.7.7. The `ERROR_FOR_DIVISION_BY_ZERO`, `NO_ZERO_DATE`, and `NO_ZERO_IN_DATE` modes were added in MySQL 5.7.8. For additional discussion regarding these changes to the default SQL mode value, see [SQL Mode Changes in MySQL 5.7](#).

To set the SQL mode at server startup, use the `--sql-mode="modes"` option on the command line, or `sql-mode="modes"` in an option file such as `my.cnf` (Unix operating systems) or `my.ini` (Windows). `modes` is a list of different modes separated by commas. To clear the SQL mode explicitly, set it to an empty string using `--sql-mode=""` on the command line, or `sql-mode=""` in an option file.



### Note

MySQL installation programs may configure the SQL mode during the installation process. If the SQL mode differs from the default or from what you expect, check for a setting in an option file that the server reads at startup.

To change the SQL mode at runtime, set the global or session `sql_mode` system variable using a `SET` statement:

```
SET GLOBAL sql_mode = 'modes';
SET SESSION sql_mode = 'modes';
```

Setting the `GLOBAL` variable requires the `SUPER` privilege and affects the operation of all clients that connect from that time on. Setting the `SESSION` variable affects only the current client. Each client can change its session `sql_mode` value at any time.

To determine the current global or session `sql_mode` setting, select its value:

```
SELECT @@GLOBAL.sql_mode;
SELECT @@SESSION.sql_mode;
```



### Important

**SQL mode and user-defined partitioning.** Changing the server SQL mode after creating and inserting data into partitioned tables can cause major changes in the behavior of such tables, and could lead to loss or corruption of data. It is strongly recommended that you never change the SQL mode once you have created tables employing user-defined partitioning.

When replicating partitioned tables, differing SQL modes on the source and replica can also lead to problems. For best results, you should always use the same server SQL mode on the source and replica.

For more information, see [Section 22.6, “Restrictions and Limitations on Partitioning”](#).

## The Most Important SQL Modes

The most important `sql_mode` values are probably these:

- `ANSI`

This mode changes syntax and behavior to conform more closely to standard SQL. It is one of the special [combination modes](#) listed at the end of this section.

- `STRICT_TRANS_TABLES`

If a value could not be inserted as given into a transactional table, abort the statement. For a nontransactional table, abort the statement if the value occurs in a single-row statement or the first row of a multiple-row statement. More details are given later in this section.

As of MySQL 5.7.5, the default SQL mode includes `STRICT_TRANS_TABLES`.

- `TRADITIONAL`

Make MySQL behave like a “traditional” SQL database system. A simple description of this mode is “give an error instead of a warning” when inserting an incorrect value into a column. It is one of the special [combination modes](#) listed at the end of this section.



### Note

With `TRADITIONAL` mode enabled, an `INSERT` or `UPDATE` aborts as soon as an error occurs. If you are using a nontransactional storage engine, this may not be what you want because data changes made prior to the error may not be rolled back, resulting in a “partially done” update.

When this manual refers to “strict mode,” it means a mode with either or both `STRICT_TRANS_TABLES` or `STRICT_ALL_TABLES` enabled.

## Full List of SQL Modes

The following list describes all supported SQL modes:

- `ALLOW_INVALID_DATES`

Do not perform full checking of dates. Check only that the month is in the range from 1 to 12 and the day is in the range from 1 to 31. This may be useful for Web applications that obtain year, month, and day in three different fields and store exactly what the user inserted, without date validation. This mode applies to `DATE` and `DATETIME` columns. It does not apply to `TIMESTAMP` columns, which always require a valid date.

With `ALLOW_INVALID_DATES` disabled, the server requires that month and day values be legal, and not merely in the range 1 to 12 and 1 to 31, respectively. With strict mode disabled, invalid dates such as `'2004-04-31'` are converted to `'0000-00-00'` and a warning is generated. With strict mode enabled, invalid dates generate an error. To permit such dates, enable `ALLOW_INVALID_DATES`.

- `ANSI_QUOTES`

Treat `"` as an identifier quote character (like the ``` quote character) and not as a string quote character. You can still use ``` to quote identifiers with this mode enabled. With `ANSI_QUOTES` enabled, you cannot use double quotation marks to quote literal strings because they are interpreted as identifiers.

- `ERROR_FOR_DIVISION_BY_ZERO`

The `ERROR_FOR_DIVISION_BY_ZERO` mode affects handling of division by zero, which includes `MOD(N, 0)`. For data-change operations (`INSERT`, `UPDATE`), its effect also depends on whether strict SQL mode is enabled.

- If this mode is not enabled, division by zero inserts `NULL` and produces no warning.
- If this mode is enabled, division by zero inserts `NULL` and produces a warning.
- If this mode and strict mode are enabled, division by zero produces an error, unless `IGNORE` is given as well. For `INSERT IGNORE` and `UPDATE IGNORE`, division by zero inserts `NULL` and produces a warning.

For `SELECT`, division by zero returns `NULL`. Enabling `ERROR_FOR_DIVISION_BY_ZERO` causes a warning to be produced as well, regardless of whether strict mode is enabled.

`ERROR_FOR_DIVISION_BY_ZERO` is deprecated. `ERROR_FOR_DIVISION_BY_ZERO` is not part of strict mode, but should be used in conjunction with strict mode and is enabled by default. A warning occurs if `ERROR_FOR_DIVISION_BY_ZERO` is enabled without also enabling strict mode or vice versa. For additional discussion, see [SQL Mode Changes in MySQL 5.7](#).

Because `ERROR_FOR_DIVISION_BY_ZERO` is deprecated; expect it to be removed in a future release of MySQL as a separate mode name and its effect included in the effects of strict SQL mode.

- `HIGH_NOT_PRECEDENCE`

The precedence of the `NOT` operator is such that expressions such as `NOT a BETWEEN b AND c` are parsed as `NOT (a BETWEEN b AND c)`. In some older versions of MySQL, the expression was parsed as `(NOT a) BETWEEN b AND c`. The old higher-precedence behavior can be obtained by enabling the `HIGH_NOT_PRECEDENCE` SQL mode.

```
mysql> SET sql_mode = '';
mysql> SELECT NOT 1 BETWEEN -5 AND 5;
-> 0
mysql> SET sql_mode = 'HIGH_NOT_PRECEDENCE';
mysql> SELECT NOT 1 BETWEEN -5 AND 5;
-> 1
```

- `IGNORE_SPACE`

Permit spaces between a function name and the `(` character. This causes built-in function names to be treated as reserved words. As a result, identifiers that are the same as function names must be quoted as described in [Section 9.2, “Schema Object Names”](#). For example, because there is a `COUNT()` function, the use of `count` as a table name in the following statement causes an error:

```
mysql> CREATE TABLE count (i INT);
ERROR 1064 (42000): You have an error in your SQL syntax
```

The table name should be quoted:

```
mysql> CREATE TABLE `count` (i INT);
Query OK, 0 rows affected (0.00 sec)
```

The `IGNORE_SPACE` SQL mode applies to built-in functions, not to loadable functions or stored functions. It is always permissible to have spaces after a loadable function or stored function name, regardless of whether `IGNORE_SPACE` is enabled.

For further discussion of `IGNORE_SPACE`, see [Section 9.2.5, “Function Name Parsing and Resolution”](#).

- `NO_AUTO_CREATE_USER`

Prevent the `GRANT` statement from automatically creating new user accounts if it would otherwise do so, unless authentication information is specified. The statement must specify a nonempty password using `IDENTIFIED BY` or an authentication plugin using `IDENTIFIED WITH`.

It is preferable to create MySQL accounts with `CREATE USER` rather than `GRANT`. `NO_AUTO_CREATE_USER` is deprecated and the default SQL mode includes `NO_AUTO_CREATE_USER`. Assignments to `sql_mode` that change the `NO_AUTO_CREATE_USER` mode state produce a warning, except assignments that set `sql_mode` to `DEFAULT`. Expect `NO_AUTO_CREATE_USER` to be removed in a future release of MySQL, and its effect to be enabled at all times (and for `GRANT` not to create accounts any longer).

Previously, before `NO_AUTO_CREATE_USER` was deprecated, one reason not to enable it was that it was not replication safe. Now it can be enabled and replication-safe user management performed with `CREATE USER IF NOT EXISTS`, `DROP USER IF EXISTS`, and `ALTER USER IF EXISTS` rather than `GRANT`. These statements enable safe replication when replicas may have different grants than those on the source. See [Section 13.7.1.2, “CREATE USER Statement”](#), [Section 13.7.1.3, “DROP USER Statement”](#), and [Section 13.7.1.1, “ALTER USER Statement”](#).

- `NO_AUTO_VALUE_ON_ZERO`

`NO_AUTO_VALUE_ON_ZERO` affects handling of `AUTO_INCREMENT` columns. Normally, you generate the next sequence number for the column by inserting either `NULL` or `0` into it. `NO_AUTO_VALUE_ON_ZERO` suppresses this behavior for `0` so that only `NULL` generates the next sequence number.

This mode can be useful if `0` has been stored in a table's `AUTO_INCREMENT` column. (Storing `0` is not a recommended practice, by the way.) For example, if you dump the table with `mysqldump` and then reload it, MySQL normally generates new sequence numbers when it encounters the `0` values, resulting in a table with contents different from the one that was dumped. Enabling `NO_AUTO_VALUE_ON_ZERO` before reloading the dump file solves this problem. For this reason, `mysqldump` automatically includes in its output a statement that enables `NO_AUTO_VALUE_ON_ZERO`.

- [NO\\_BACKSLASH\\_ESCAPES](#)

Enabling this mode disables the use of the backslash character (\) as an escape character within strings and identifiers. With this mode enabled, backslash becomes an ordinary character like any other, and the default escape sequence for [LIKE](#) expressions is changed so that no escape character is used.

- [NO\\_DIR\\_IN\\_CREATE](#)

When creating a table, ignore all [INDEX DIRECTORY](#) and [DATA DIRECTORY](#) directives. This option is useful on replica replication servers.

- [NO\\_ENGINE\\_SUBSTITUTION](#)

Control automatic substitution of the default storage engine when a statement such as [CREATE TABLE](#) or [ALTER TABLE](#) specifies a storage engine that is disabled or not compiled in.

By default, [NO\\_ENGINE\\_SUBSTITUTION](#) is enabled.

Because storage engines can be pluggable at runtime, unavailable engines are treated the same way:

With [NO\\_ENGINE\\_SUBSTITUTION](#) disabled, for [CREATE TABLE](#) the default engine is used and a warning occurs if the desired engine is unavailable. For [ALTER TABLE](#), a warning occurs and the table is not altered.

With [NO\\_ENGINE\\_SUBSTITUTION](#) enabled, an error occurs and the table is not created or altered if the desired engine is unavailable.

- [NO\\_FIELD\\_OPTIONS](#)

Do not print MySQL-specific column options in the output of [SHOW CREATE TABLE](#). This mode is used by [mysqldump](#) in portability mode.

**Note**

As of MySQL 5.7.22, [NO\\_FIELD\\_OPTIONS](#) is deprecated. It is removed in MySQL 8.0.

- [NO\\_KEY\\_OPTIONS](#)

Do not print MySQL-specific index options in the output of [SHOW CREATE TABLE](#). This mode is used by [mysqldump](#) in portability mode.

**Note**

As of MySQL 5.7.22, [NO\\_KEY\\_OPTIONS](#) is deprecated. It is removed in MySQL 8.0.

- [NO\\_TABLE\\_OPTIONS](#)

Do not print MySQL-specific table options (such as [ENGINE](#)) in the output of [SHOW CREATE TABLE](#). This mode is used by [mysqldump](#) in portability mode.

**Note**

As of MySQL 5.7.22, [NO\\_TABLE\\_OPTIONS](#) is deprecated. It is removed in MySQL 8.0.

- [NO\\_UNSIGNED\\_SUBTRACTION](#)

Subtraction between integer values, where one is of type `UNSIGNED`, produces an unsigned result by default. If the result would otherwise have been negative, an error results:

```
mysql> SET sql_mode = '';
Query OK, 0 rows affected (0.00 sec)

mysql> SELECT CAST(0 AS UNSIGNED) - 1;
ERROR 1690 (22003): BIGINT UNSIGNED value is out of range in '(cast(0 as unsigned) - 1)'
```

If the `NO_UNSIGNED_SUBTRACTION` SQL mode is enabled, the result is negative:

```
mysql> SET sql_mode = 'NO_UNSIGNED_SUBTRACTION';
mysql> SELECT CAST(0 AS UNSIGNED) - 1;
+-----+
| CAST(0 AS UNSIGNED) - 1 |
+-----+
| -1 |
+-----+
```

If the result of such an operation is used to update an `UNSIGNED` integer column, the result is clipped to the maximum value for the column type, or clipped to 0 if `NO_UNSIGNED_SUBTRACTION` is enabled. With strict SQL mode enabled, an error occurs and the column remains unchanged.

When `NO_UNSIGNED_SUBTRACTION` is enabled, the subtraction result is signed, *even if any operand is unsigned*. For example, compare the type of column `c2` in table `t1` with that of column `c2` in table `t2`:

```
mysql> SET sql_mode='';
mysql> CREATE TABLE test (c1 BIGINT UNSIGNED NOT NULL);
mysql> CREATE TABLE t1 SELECT c1 - 1 AS c2 FROM test;
mysql> DESCRIBE t1;
+-----+-----+-----+-----+-----+-----+
| Field | Type                | Null | Key | Default | Extra |
+-----+-----+-----+-----+-----+-----+
| c2    | bigint(21) unsigned | NO   |     | 0        |       |
+-----+-----+-----+-----+-----+-----+

mysql> SET sql_mode='NO_UNSIGNED_SUBTRACTION';
mysql> CREATE TABLE t2 SELECT c1 - 1 AS c2 FROM test;
mysql> DESCRIBE t2;
+-----+-----+-----+-----+-----+-----+
| Field | Type                | Null | Key | Default | Extra |
+-----+-----+-----+-----+-----+-----+
| c2    | bigint(21)         | NO   |     | 0        |       |
+-----+-----+-----+-----+-----+-----+
```

This means that `BIGINT UNSIGNED` is not 100% usable in all contexts. See [Section 12.10, “Cast Functions and Operators”](#).

- [NO\\_ZERO\\_DATE](#)

The [NO\\_ZERO\\_DATE](#) mode affects whether the server permits '0000-00-00' as a valid date. Its effect also depends on whether strict SQL mode is enabled.

- If this mode is not enabled, '0000-00-00' is permitted and inserts produce no warning.
- If this mode is enabled, '0000-00-00' is permitted and inserts produce a warning.
- If this mode and strict mode are enabled, '0000-00-00' is not permitted and inserts produce an error, unless [IGNORE](#) is given as well. For [INSERT IGNORE](#) and [UPDATE IGNORE](#), '0000-00-00' is permitted and inserts produce a warning.

[NO\\_ZERO\\_DATE](#) is deprecated. [NO\\_ZERO\\_DATE](#) is not part of strict mode, but should be used in conjunction with strict mode and is enabled by default. A warning occurs if [NO\\_ZERO\\_DATE](#) is enabled without also enabling strict mode or vice versa. For additional discussion, see [SQL Mode Changes in MySQL 5.7](#).

Because [NO\\_ZERO\\_DATE](#) is deprecated; expect it to be removed in a future release of MySQL as a separate mode name and its effect included in the effects of strict SQL mode.

- [NO\\_ZERO\\_IN\\_DATE](#)

The [NO\\_ZERO\\_IN\\_DATE](#) mode affects whether the server permits dates in which the year part is nonzero but the month or day part is 0. (This mode affects dates such as '2010-00-01' or '2010-01-00', but not '0000-00-00'. To control whether the server permits '0000-00-00', use the [NO\\_ZERO\\_DATE](#) mode.) The effect of [NO\\_ZERO\\_IN\\_DATE](#) also depends on whether strict SQL mode is enabled.

- If this mode is not enabled, dates with zero parts are permitted and inserts produce no warning.
- If this mode is enabled, dates with zero parts are inserted as '0000-00-00' and produce a warning.
- If this mode and strict mode are enabled, dates with zero parts are not permitted and inserts produce an error, unless [IGNORE](#) is given as well. For [INSERT IGNORE](#) and [UPDATE IGNORE](#), dates with zero parts are inserted as '0000-00-00' and produce a warning.

[NO\\_ZERO\\_IN\\_DATE](#) is deprecated. [NO\\_ZERO\\_IN\\_DATE](#) is not part of strict mode, but should be used in conjunction with strict mode and is enabled by default. A warning occurs if [NO\\_ZERO\\_IN\\_DATE](#) is enabled without also enabling strict mode or vice versa. For additional discussion, see [SQL Mode Changes in MySQL 5.7](#).

Because [NO\\_ZERO\\_IN\\_DATE](#) is deprecated; expect it to be removed in a future release of MySQL as a separate mode name and its effect included in the effects of strict SQL mode.

- [ONLY\\_FULL\\_GROUP\\_BY](#)

Reject queries for which the select list, [HAVING](#) condition, or [ORDER BY](#) list refer to nonaggregated columns that are neither named in the [GROUP BY](#) clause nor are functionally dependent on (uniquely determined by) [GROUP BY](#) columns.

As of MySQL 5.7.5, the default SQL mode includes [ONLY\\_FULL\\_GROUP\\_BY](#). (Before 5.7.5, MySQL does not detect functional dependency and [ONLY\\_FULL\\_GROUP\\_BY](#) is not enabled by default.)

A MySQL extension to standard SQL permits references in the [HAVING](#) clause to aliased expressions in the select list. Before MySQL 5.7.5, enabling [ONLY\\_FULL\\_GROUP\\_BY](#) disables this extension, thus requiring the [HAVING](#) clause to be written using unaliased expressions. As of MySQL 5.7.5,



this restriction is lifted so that the `HAVING` clause can refer to aliases regardless of whether `ONLY_FULL_GROUP_BY` is enabled.

For additional discussion and examples, see [Section 12.19.3, “MySQL Handling of GROUP BY”](#).

- `PAD_CHAR_TO_FULL_LENGTH`

By default, trailing spaces are trimmed from `CHAR` column values on retrieval. If `PAD_CHAR_TO_FULL_LENGTH` is enabled, trimming does not occur and retrieved `CHAR` values are padded to their full length. This mode does not apply to `VARCHAR` columns, for which trailing spaces are retained on retrieval.

```
mysql> CREATE TABLE t1 (c1 CHAR(10));
Query OK, 0 rows affected (0.37 sec)

mysql> INSERT INTO t1 (c1) VALUES('xy');
Query OK, 1 row affected (0.01 sec)

mysql> SET sql_mode = '';
Query OK, 0 rows affected (0.00 sec)

mysql> SELECT c1, CHAR_LENGTH(c1) FROM t1;
+-----+-----+
| c1    | CHAR_LENGTH(c1) |
+-----+-----+
| xy    |                2 |
+-----+-----+
1 row in set (0.00 sec)

mysql> SET sql_mode = 'PAD_CHAR_TO_FULL_LENGTH';
Query OK, 0 rows affected (0.00 sec)

mysql> SELECT c1, CHAR_LENGTH(c1) FROM t1;
+-----+-----+
| c1    | CHAR_LENGTH(c1) |
+-----+-----+
| xy    |                10 |
+-----+-----+
1 row in set (0.00 sec)
```

- `PIPES_AS_CONCAT`

Treat `||` as a string concatenation operator (same as `CONCAT()`) rather than as a synonym for `OR`.

- `REAL_AS_FLOAT`

Treat `REAL` as a synonym for `FLOAT`. By default, MySQL treats `REAL` as a synonym for `DOUBLE`.

- `STRICT_ALL_TABLES`

Enable strict SQL mode for all storage engines. Invalid data values are rejected. For details, see [Strict SQL Mode](#).

From MySQL 5.7.4 through 5.7.7, `STRICT_ALL_TABLES` includes the effect of the `ERROR_FOR_DIVISION_BY_ZERO`, `NO_ZERO_DATE`, and `NO_ZERO_IN_DATE` modes. For additional discussion, see [SQL Mode Changes in MySQL 5.7](#).

- `STRICT_TRANS_TABLES`

Enable strict SQL mode for transactional storage engines, and when possible for nontransactional storage engines. For details, see [Strict SQL Mode](#).

From MySQL 5.7.4 through 5.7.7, `STRICT_TRANS_TABLES` includes the effect of the `ERROR_FOR_DIVISION_BY_ZERO`, `NO_ZERO_DATE`, and `NO_ZERO_IN_DATE` modes. For additional discussion, see [SQL Mode Changes in MySQL 5.7](#).

## Combination SQL Modes

The following special modes are provided as shorthand for combinations of mode values from the preceding list.

- [ANSI](#)

Equivalent to `REAL_AS_FLOAT`, `PIPES_AS_CONCAT`, `ANSI_QUOTES`, `IGNORE_SPACE`, and (as of MySQL 5.7.5) `ONLY_FULL_GROUP_BY`.

`ANSI` mode also causes the server to return an error for queries where a set function `S` with an outer reference `S(outer_ref)` cannot be aggregated in the outer query against which the outer reference has been resolved. This is such a query:

```
SELECT * FROM t1 WHERE t1.a IN (SELECT MAX(t1.b) FROM t2 WHERE ...);
```

Here, `MAX(t1.b)` cannot be aggregated in the outer query because it appears in the `WHERE` clause of that query. Standard SQL requires an error in this situation. If `ANSI` mode is not enabled, the server treats `S(outer_ref)` in such queries the same way that it would interpret `S(const)`.

See [Section 1.6, “MySQL Standards Compliance”](#).

- [DB2](#)

Equivalent to `PIPES_AS_CONCAT`, `ANSI_QUOTES`, `IGNORE_SPACE`, `NO_KEY_OPTIONS`, `NO_TABLE_OPTIONS`, `NO_FIELD_OPTIONS`.



### Note

As of MySQL 5.7.22, `DB2` is deprecated. It is removed in MySQL 8.0.

- [MAXDB](#)

Equivalent to `PIPES_AS_CONCAT`, `ANSI_QUOTES`, `IGNORE_SPACE`, `NO_KEY_OPTIONS`, `NO_TABLE_OPTIONS`, `NO_FIELD_OPTIONS`, `NO_AUTO_CREATE_USER`.



### Note

As of MySQL 5.7.22, `MAXDB` is deprecated. It is removed in MySQL 8.0.

- [MSSQL](#)

Equivalent to `PIPES_AS_CONCAT`, `ANSI_QUOTES`, `IGNORE_SPACE`, `NO_KEY_OPTIONS`, `NO_TABLE_OPTIONS`, `NO_FIELD_OPTIONS`.



### Note

As of MySQL 5.7.22, `MSSQL` is deprecated. It is removed in MySQL 8.0.

- [MYSQL323](#)

Equivalent to `MYSQL323`, `HIGH_NOT_PRECEDENCE`. This means `HIGH_NOT_PRECEDENCE` plus some `SHOW CREATE TABLE` behaviors specific to `MYSQL323`:

- `TIMESTAMP` column display does not include `DEFAULT` or `ON UPDATE` attributes.
- String column display does not include character set and collation attributes. For `CHAR` and `VARCHAR` columns, if the collation is binary, `BINARY` is appended to the column type.
- The `ENGINE=engine_name` table option displays as `TYPE=engine_name`.
- For `MEMORY` tables, the storage engine is displayed as `HEAP`.



#### Note

As of MySQL 5.7.22, `MYSQL323` is deprecated. It is removed in MySQL 8.0.

- `MYSQL40`

Equivalent to `MYSQL40`, `HIGH_NOT_PRECEDENCE`. This means `HIGH_NOT_PRECEDENCE` plus some behaviors specific to `MYSQL40`. These are the same as for `MYSQL323`, except that `SHOW CREATE TABLE` does not display `HEAP` as the storage engine for `MEMORY` tables.



#### Note

As of MySQL 5.7.22, `MYSQL40` is deprecated. It is removed in MySQL 8.0.

- `ORACLE`

Equivalent to `PIPES_AS_CONCAT`, `ANSI_QUOTES`, `IGNORE_SPACE`, `NO_KEY_OPTIONS`, `NO_TABLE_OPTIONS`, `NO_FIELD_OPTIONS`, `NO_AUTO_CREATE_USER`.



#### Note

As of MySQL 5.7.22, `ORACLE` is deprecated. It is removed in MySQL 8.0.

- `POSTGRESQL`

Equivalent to `PIPES_AS_CONCAT`, `ANSI_QUOTES`, `IGNORE_SPACE`, `NO_KEY_OPTIONS`, `NO_TABLE_OPTIONS`, `NO_FIELD_OPTIONS`.



#### Note

As of MySQL 5.7.22, `POSTGRESQL` is deprecated. It is removed in MySQL 8.0.

- `TRADITIONAL`

Before MySQL 5.7.4, and in MySQL 5.7.8 and later, `TRADITIONAL` is equivalent to `STRICT_TRANS_TABLES`, `STRICT_ALL_TABLES`, `NO_ZERO_IN_DATE`, `NO_ZERO_DATE`, `ERROR_FOR_DIVISION_BY_ZERO`, `NO_AUTO_CREATE_USER`, and `NO_ENGINE_SUBSTITUTION`.

From MySQL 5.7.4 though 5.7.7, `TRADITIONAL` is equivalent to `STRICT_TRANS_TABLES`, `STRICT_ALL_TABLES`, `NO_AUTO_CREATE_USER`, and `NO_ENGINE_SUBSTITUTION`. The `NO_ZERO_IN_DATE`, `NO_ZERO_DATE`, and `ERROR_FOR_DIVISION_BY_ZERO` modes are not named because in those versions their effects are included in the effects of strict SQL mode (`STRICT_ALL_TABLES` or `STRICT_TRANS_TABLES`). Thus, the effects of `TRADITIONAL` are the same

in all MySQL 5.7 versions (and the same as in MySQL 5.6). For additional discussion, see [SQL Mode Changes in MySQL 5.7](#).

## Strict SQL Mode

Strict mode controls how MySQL handles invalid or missing values in data-change statements such as [INSERT](#) or [UPDATE](#). A value can be invalid for several reasons. For example, it might have the wrong data type for the column, or it might be out of range. A value is missing when a new row to be inserted does not contain a value for a non-[NULL](#) column that has no explicit [DEFAULT](#) clause in its definition. (For a [NULL](#) column, [NULL](#) is inserted if the value is missing.) Strict mode also affects DDL statements such as [CREATE TABLE](#).

If strict mode is not in effect, MySQL inserts adjusted values for invalid or missing values and produces warnings (see [Section 13.7.5.40, “SHOW WARNINGS Statement”](#)). In strict mode, you can produce this behavior by using [INSERT IGNORE](#) or [UPDATE IGNORE](#).

For statements such as [SELECT](#) that do not change data, invalid values generate a warning in strict mode, not an error.

Strict mode produces an error for attempts to create a key that exceeds the maximum key length. When strict mode is not enabled, this results in a warning and truncation of the key to the maximum key length.

Strict mode does not affect whether foreign key constraints are checked. [foreign\\_key\\_checks](#) can be used for that. (See [Section 5.1.7, “Server System Variables”](#).)

Strict SQL mode is in effect if either [STRICT\\_ALL\\_TABLES](#) or [STRICT\\_TRANS\\_TABLES](#) is enabled, although the effects of these modes differ somewhat:

- For transactional tables, an error occurs for invalid or missing values in a data-change statement when either [STRICT\\_ALL\\_TABLES](#) or [STRICT\\_TRANS\\_TABLES](#) is enabled. The statement is aborted and rolled back.
- For nontransactional tables, the behavior is the same for either mode if the bad value occurs in the first row to be inserted or updated: The statement is aborted and the table remains unchanged. If the statement inserts or modifies multiple rows and the bad value occurs in the second or later row, the result depends on which strict mode is enabled:
  - For [STRICT\\_ALL\\_TABLES](#), MySQL returns an error and ignores the rest of the rows. However, because the earlier rows have been inserted or updated, the result is a partial update. To avoid this, use single-row statements, which can be aborted without changing the table.
  - For [STRICT\\_TRANS\\_TABLES](#), MySQL converts an invalid value to the closest valid value for the column and inserts the adjusted value. If a value is missing, MySQL inserts the implicit default value for the column data type. In either case, MySQL generates a warning rather than an error and continues processing the statement. Implicit defaults are described in [Section 11.6, “Data Type Default Values”](#).

Strict mode affects handling of division by zero, zero dates, and zeros in dates as follows:

- Strict mode affects handling of division by zero, which includes [MOD\(N, 0\)](#):

For data-change operations ([INSERT](#), [UPDATE](#)):

- If strict mode is not enabled, division by zero inserts [NULL](#) and produces no warning.
- If strict mode is enabled, division by zero produces an error, unless [IGNORE](#) is given as well. For [INSERT IGNORE](#) and [UPDATE IGNORE](#), division by zero inserts [NULL](#) and produces a warning.

For `SELECT`, division by zero returns `NULL`. Enabling strict mode causes a warning to be produced as well.

- Strict mode affects whether the server permits '0000-00-00' as a valid date:
  - If strict mode is not enabled, '0000-00-00' is permitted and inserts produce no warning.
  - If strict mode is enabled, '0000-00-00' is not permitted and inserts produce an error, unless `IGNORE` is given as well. For `INSERT IGNORE` and `UPDATE IGNORE`, '0000-00-00' is permitted and inserts produce a warning.
- Strict mode affects whether the server permits dates in which the year part is nonzero but the month or day part is 0 (dates such as '2010-00-01' or '2010-01-00'):
  - If strict mode is not enabled, dates with zero parts are permitted and inserts produce no warning.
  - If strict mode is enabled, dates with zero parts are not permitted and inserts produce an error, unless `IGNORE` is given as well. For `INSERT IGNORE` and `UPDATE IGNORE`, dates with zero parts are inserted as '0000-00-00' (which is considered valid with `IGNORE`) and produce a warning.

For more information about strict mode with respect to `IGNORE`, see [Comparison of the IGNORE Keyword and Strict SQL Mode](#).

Before MySQL 5.7.4, and in MySQL 5.7.8 and later, strict mode affects handling of division by zero, zero dates, and zeros in dates in conjunction with the `ERROR_FOR_DIVISION_BY_ZERO`, `NO_ZERO_DATE`, and `NO_ZERO_IN_DATE` modes. From MySQL 5.7.4 through 5.7.7, the `ERROR_FOR_DIVISION_BY_ZERO`, `NO_ZERO_DATE`, and `NO_ZERO_IN_DATE` modes do nothing when named explicitly and their effects are included in the effects of strict mode. For additional discussion, see [SQL Mode Changes in MySQL 5.7](#).

## Comparison of the IGNORE Keyword and Strict SQL Mode

This section compares the effect on statement execution of the `IGNORE` keyword (which downgrades errors to warnings) and strict SQL mode (which upgrades warnings to errors). It describes which statements they affect, and which errors they apply to.

The following table presents a summary comparison of statement behavior when the default is to produce an error versus a warning. An example of when the default is to produce an error is inserting a `NULL` into a `NOT NULL` column. An example of when the default is to produce a warning is inserting a value of the wrong data type into a column (such as inserting the string 'abc' into an integer column).

Operational Mode	When Statement Default is Error	When Statement Default is Warning
Without <code>IGNORE</code> or strict SQL mode	Error	Warning
With <code>IGNORE</code>	Warning	Warning (same as without <code>IGNORE</code> or strict SQL mode)
With strict SQL mode	Error (same as without <code>IGNORE</code> or strict SQL mode)	Error
With <code>IGNORE</code> and strict SQL mode	Warning	Warning

One conclusion to draw from the table is that when the `IGNORE` keyword and strict SQL mode are both in effect, `IGNORE` takes precedence. This means that, although `IGNORE` and strict SQL mode can be considered to have opposite effects on error handling, they do not cancel when used together.

- [The Effect of IGNORE on Statement Execution](#)

- [The Effect of Strict SQL Mode on Statement Execution](#)

## The Effect of IGNORE on Statement Execution

Several statements in MySQL support an optional `IGNORE` keyword. This keyword causes the server to downgrade certain types of errors and generate warnings instead. For a multiple-row statement, downgrading an error to a warning may enable a row to be processed. Otherwise, `IGNORE` causes the statement to skip to the next row instead of aborting. (For nonignorable errors, an error occurs regardless of the `IGNORE` keyword.)

Example: If the table `t` has a primary key column `i` containing unique values, attempting to insert the same value of `i` into multiple rows normally produces a duplicate-key error:

```
mysql> CREATE TABLE t (i INT NOT NULL PRIMARY KEY);
mysql> INSERT INTO t (i) VALUES(1),(1);
ERROR 1062 (23000): Duplicate entry '1' for key 'PRIMARY'
```

With `IGNORE`, the row containing the duplicate key still is not inserted, but a warning occurs instead of an error:

```
mysql> INSERT IGNORE INTO t (i) VALUES(1),(1);
Query OK, 1 row affected, 1 warning (0.01 sec)
Records: 2  Duplicates: 1  Warnings: 1

mysql> SHOW WARNINGS;
+-----+-----+-----+
| Level   | Code | Message                                     |
+-----+-----+-----+
| Warning | 1062 | Duplicate entry '1' for key 'PRIMARY'      |
+-----+-----+-----+
1 row in set (0.00 sec)
```

Example: If the table `t2` has a `NOT NULL` column `id`, attempting to insert `NULL` produces an error in strict SQL mode:

```
mysql> CREATE TABLE t2 (id INT NOT NULL);
mysql> INSERT INTO t2 (id) VALUES(1),(NULL),(3);
ERROR 1048 (23000): Column 'id' cannot be null
mysql> SELECT * FROM t2;
Empty set (0.00 sec)
```

If the SQL mode is not strict, `IGNORE` causes the `NULL` to be inserted as the column implicit default (0 in this case), which enables the row to be handled without skipping it:

```
mysql> INSERT INTO t2 (id) VALUES(1),(NULL),(3);
mysql> SELECT * FROM t2;
+----+
| id |
+----+
| 1  |
| 0  |
| 3  |
+----+
```

These statements support the `IGNORE` keyword:

- `CREATE TABLE ... SELECT`: `IGNORE` does not apply to the `CREATE TABLE` or `SELECT` parts of the statement but to inserts into the table of rows produced by the `SELECT`. Rows that duplicate an existing row on a unique key value are discarded.
- `DELETE`: `IGNORE` causes MySQL to ignore errors during the process of deleting rows.
- `INSERT`: With `IGNORE`, rows that duplicate an existing row on a unique key value are discarded. Rows set to values that would cause data conversion errors are set to the closest valid values instead.

For partitioned tables where no partition matching a given value is found, `IGNORE` causes the insert operation to fail silently for rows containing the unmatched value.

- `LOAD DATA`, `LOAD XML`: With `IGNORE`, rows that duplicate an existing row on a unique key value are discarded.
- `UPDATE`: With `IGNORE`, rows for which duplicate-key conflicts occur on a unique key value are not updated. Rows updated to values that would cause data conversion errors are updated to the closest valid values instead.

The `IGNORE` keyword applies to the following ignorable errors:

- `ER_BAD_NULL_ERROR`
- `ER_DUP_ENTRY`
- `ER_DUP_ENTRY_WITH_KEY_NAME`
- `ER_DUP_KEY`
- `ER_NO_PARTITION_FOR_GIVEN_VALUE`
- `ER_NO_PARTITION_FOR_GIVEN_VALUE_SILENT`
- `ER_NO_REFERENCED_ROW_2`
- `ER_ROW_DOES_NOT_MATCH_GIVEN_PARTITION_SET`
- `ER_ROW_IS_REFERENCED_2`
- `ER_SUBQUERY_NO_1_ROW`
- `ER_VIEW_CHECK_FAILED`

## The Effect of Strict SQL Mode on Statement Execution

The MySQL server can operate in different SQL modes, and can apply these modes differently for different clients, depending on the value of the `sql_mode` system variable. In “strict” SQL mode, the server upgrades certain warnings to errors.

For example, in non-strict SQL mode, inserting the string `'abc'` into an integer column results in conversion of the value to 0 and a warning:

```
mysql> SET sql_mode = '';
Query OK, 0 rows affected (0.00 sec)

mysql> INSERT INTO t (i) VALUES('abc');
Query OK, 1 row affected, 1 warning (0.01 sec)

mysql> SHOW WARNINGS;
+-----+-----+-----+
| Level | Code | Message                                     |
+-----+-----+-----+
| Warning | 1366 | Incorrect integer value: 'abc' for column 'i' at row 1 |
+-----+-----+-----+
1 row in set (0.00 sec)
```

In strict SQL mode, the invalid value is rejected with an error:

```
mysql> SET sql_mode = 'STRICT_ALL_TABLES';
Query OK, 0 rows affected (0.00 sec)
```

```
mysql> INSERT INTO t (i) VALUES('abc');
ERROR 1366 (HY000): Incorrect integer value: 'abc' for column 'i' at row 1
```

For more information about possible settings of the `sql_mode` system variable, see [Section 5.1.10, “Server SQL Modes”](#).

Strict SQL mode applies to the following statements under conditions for which some value might be out of range or an invalid row is inserted into or deleted from a table:

- ALTER TABLE
- CREATE TABLE
- CREATE TABLE ... SELECT
- DELETE (both single table and multiple table)
- INSERT
- LOAD DATA
- LOAD XML
- SELECT SLEEP( )
- UPDATE (both single table and multiple table)

Within stored programs, individual statements of the types just listed execute in strict SQL mode if the program was defined while strict mode was in effect.

Strict SQL mode applies to the following errors, which represent a class of errors in which an input value is either invalid or missing. A value is invalid if it has the wrong data type for the column or might be out of range. A value is missing if a new row to be inserted does not contain a value for a `NOT NULL` column that has no explicit `DEFAULT` clause in its definition.

```
ER_BAD_NULL_ERROR
ER_CUT_VALUE_GROUP_CONCAT
ER_DATA_TOO_LONG
ER_DATETIME_FUNCTION_OVERFLOW
ER_DIVISION_BY_ZERO
ER_INVALID_ARGUMENT_FOR_LOGARITHM
ER_NO_DEFAULT_FOR_FIELD
ER_NO_DEFAULT_FOR_VIEW_FIELD
ER_TOO_LONG_KEY
ER_TRUNCATED_WRONG_VALUE
ER_TRUNCATED_WRONG_VALUE_FOR_FIELD
ER_WARN_DATA_OUT_OF_RANGE
ER_WARN_NULL_TO_NOTNULL
ER_WARN_TOO_FEW_RECORDS
ER_WRONG_ARGUMENTS
ER_WRONG_VALUE_FOR_TYPE
WARN_DATA_TRUNCATED
```



#### Note

Because continued MySQL development defines new errors, there may be errors not in the preceding list to which strict SQL mode applies.

## SQL Mode Changes in MySQL 5.7

In MySQL 5.7.22, these SQL modes are deprecated and are removed in MySQL 8.0: `DB2`, `MAXDB`, `MSSQL`, `MYSQL323`, `MYSQL40`, `ORACLE`, `POSTGRESQL`, `NO_FIELD_OPTIONS`, `NO_KEY_OPTIONS`, `NO_TABLE_OPTIONS`.



In MySQL 5.7, the [ONLY\\_FULL\\_GROUP\\_BY](#) SQL mode is enabled by default because [GROUP BY](#) processing has become more sophisticated to include detection of functional dependencies. However, if you find that having [ONLY\\_FULL\\_GROUP\\_BY](#) enabled causes queries for existing applications to be rejected, either of these actions should restore operation:

- If it is possible to modify an offending query, do so, either so that nonaggregated columns are functionally dependent on [GROUP BY](#) columns, or by referring to nonaggregated columns using [ANY\\_VALUE\(\)](#).
- If it is not possible to modify an offending query (for example, if it is generated by a third-party application), set the [sql\\_mode](#) system variable at server startup to not enable [ONLY\\_FULL\\_GROUP\\_BY](#).

In MySQL 5.7, the [ERROR\\_FOR\\_DIVISION\\_BY\\_ZERO](#), [NO\\_ZERO\\_DATE](#), and [NO\\_ZERO\\_IN\\_DATE](#) SQL modes are deprecated. The long term plan is to have the three modes be included in strict SQL mode and to remove them as explicit modes in a future release of MySQL. For compatibility in MySQL 5.7 with MySQL 5.6 strict mode and to provide additional time for affected applications to be modified, the following behaviors apply:

- [ERROR\\_FOR\\_DIVISION\\_BY\\_ZERO](#), [NO\\_ZERO\\_DATE](#), and [NO\\_ZERO\\_IN\\_DATE](#) are not part of strict SQL mode, but it is intended that they be used together with strict mode. As a reminder, a warning occurs if they are enabled without also enabling strict mode or vice versa.
- [ERROR\\_FOR\\_DIVISION\\_BY\\_ZERO](#), [NO\\_ZERO\\_DATE](#), and [NO\\_ZERO\\_IN\\_DATE](#) are enabled by default.

With the preceding changes, stricter data checking is still enabled by default, but the individual modes can be disabled in environments where it is currently desirable or necessary to do so.

## 5.1.11 Connection Management

This section describes how MySQL Server manages connections. This includes a description of the available connection interfaces, how the server uses connection handler threads, details about the administrative connection interface, and management of DNS lookups.

### 5.1.11.1 Connection Interfaces

This section describes aspects of how the MySQL server manages client connections.

- [Network Interfaces and Connection Manager Threads](#)
- [Client Connection Thread Management](#)
- [Connection Volume Management](#)

#### Network Interfaces and Connection Manager Threads

The server is capable of listening for client connections on multiple network interfaces. Connection manager threads handle client connection requests on the network interfaces that the server listens to:

- On all platforms, one manager thread handles TCP/IP connection requests.
- On Unix, the same manager thread also handles Unix socket file connection requests.
- On Windows, one manager thread handles shared-memory connection requests, and another handles named-pipe connection requests.

The server does not create threads to handle interfaces that it does not listen to. For example, a Windows server that does not have support for named-pipe connections enabled does not create a thread to handle them.

Individual server plugins or components may implement their own connection interface:

- X Plugin enables MySQL Server to communicate with clients using X Protocol. See [Section 19.4, “X Plugin”](#).

## Client Connection Thread Management

Connection manager threads associate each client connection with a thread dedicated to it that handles authentication and request processing for that connection. Manager threads create a new thread when necessary but try to avoid doing so by consulting the thread cache first to see whether it contains a thread that can be used for the connection. When a connection ends, its thread is returned to the thread cache if the cache is not full.

In this connection thread model, there are as many threads as there are clients currently connected, which has some disadvantages when server workload must scale to handle large numbers of connections. For example, thread creation and disposal becomes expensive. Also, each thread requires server and kernel resources, such as stack space. To accommodate a large number of simultaneous connections, the stack size per thread must be kept small, leading to a situation where it is either too small or the server consumes large amounts of memory. Exhaustion of other resources can occur as well, and scheduling overhead can become significant.

MySQL Enterprise Edition includes a thread pool plugin that provides an alternative thread-handling model designed to reduce overhead and improve performance. It implements a thread pool that increases server performance by efficiently managing statement execution threads for large numbers of client connections. See [Section 5.5.3, “MySQL Enterprise Thread Pool”](#).

To control and monitor how the server manages threads that handle client connections, several system and status variables are relevant. (See [Section 5.1.7, “Server System Variables”](#), and [Section 5.1.9, “Server Status Variables”](#).)

- The `thread_cache_size` system variable determines the thread cache size. By default, the server autosizes the value at startup, but it can be set explicitly to override this default. A value of 0 disables caching, which causes a thread to be set up for each new connection and disposed of when the connection terminates. To enable *N* inactive connection threads to be cached, set `thread_cache_size` to *N* at server startup or at runtime. A connection thread becomes inactive when the client connection with which it was associated terminates.
- To monitor the number of threads in the cache and how many threads have been created because a thread could not be taken from the cache, check the `Threads_cached` and `Threads_created` status variables.
- When the thread stack is too small, this limits the complexity of the SQL statements the server can handle, the recursion depth of stored procedures, and other memory-consuming actions. To set a stack size of *N* bytes for each thread, start the server with `thread_stack` set to *N*.

## Connection Volume Management

To control the maximum number of clients the server permits to connect simultaneously, set the `max_connections` system variable at server startup or at runtime. It may be necessary to increase `max_connections` if more clients attempt to connect simultaneously than the server is configured to handle (see [Section B.3.2.5, “Too many connections”](#)).

`mysqld` actually permits `max_connections` + 1 client connections. The extra connection is reserved for use by accounts that have the `SUPER` privilege. By granting the privilege to administrators and not to normal users (who should not need it), an administrator who also has the `PROCESS` privilege can connect to the server and use `SHOW PROCESSLIST` to diagnose problems even if the maximum number of unprivileged clients are connected. See [Section 13.7.5.29, “SHOW PROCESSLIST Statement”](#).

If the server refuses a connection because the `max_connections` limit is reached, it increments the `Connection_errors_max_connections` status variable.

The maximum number of connections MySQL supports (that is, the maximum value to which `max_connections` can be set) depends on several factors:

- The quality of the thread library on a given platform.
- The amount of RAM available.
- The amount of RAM is used for each connection.
- The workload from each connection.
- The desired response time.
- The number of file descriptors available.

Linux or Solaris should be able to support at least 500 to 1000 simultaneous connections routinely and as many as 10,000 connections if you have many gigabytes of RAM available and the workload from each is low or the response time target undemanding.

Increasing the `max_connections` value increases the number of file descriptors that `mysqld` requires. If the required number of descriptors are not available, the server reduces the value of `max_connections`. For comments on file descriptor limits, see [Section 8.4.3.1, “How MySQL Opens and Closes Tables”](#).

Increasing the `open_files_limit` system variable may be necessary, which may also require raising the operating system limit on how many file descriptors can be used by MySQL. Consult your operating system documentation to determine whether it is possible to increase the limit and how to do so. See also [Section B.3.2.16, “File Not Found and Similar Errors”](#).

### 5.1.11.2 DNS Lookups and the Host Cache

The MySQL server maintains an in-memory host cache that contains information about clients: IP address, host name, and error information. The Performance Schema `host_cache` table exposes the contents of the host cache so that it can be examined using `SELECT` statements. This may help you diagnose the causes of connection problems. See [Section 25.12.16.1, “The host\\_cache Table”](#).

The following sections discuss how the host cache works, as well as other topics such as how to configure and monitor the cache.

- [Host Cache Operation](#)
- [Configuring the Host Cache](#)
- [Monitoring the Host Cache](#)
- [Flushing the Host Cache](#)
- [Dealing with Blocked Hosts](#)

#### Host Cache Operation

The server uses the host cache only for non-localhost TCP connections. It does not use the cache for TCP connections established using a loopback interface address (for example, `127.0.0.1` or `:::1`), or for connections established using a Unix socket file, named pipe, or shared memory.

The server uses the host cache for several purposes:

- By caching the results of IP-to-host name lookups, the server avoids doing a Domain Name System (DNS) lookup for each client connection. Instead, for a given host, it needs to perform a lookup only for the first connection from that host.
- The cache contains information about errors that occur during the client connection process. Some errors are considered “blocking.” If too many of these occur successively from a given host without a successful connection, the server blocks further connections from that host. The `max_connect_errors` system variable determines the permitted number of successive errors before blocking occurs.

For each applicable new client connection, the server uses the client IP address to check whether the client host name is in the host cache. If so, the server refuses or continues to process the connection request depending on whether or not the host is blocked. If the host is not in the cache, the server attempts to resolve the host name. First, it resolves the IP address to a host name and resolves that host name back to an IP address. Then it compares the result to the original IP address to ensure that they are the same. The server stores information about the result of this operation in the host cache. If the cache is full, the least recently used entry is discarded.

The server performs host name resolution using the `getaddrinfo()` system call.

The server handles entries in the host cache like this:

1. When the first TCP client connection reaches the server from a given IP address, a new cache entry is created to record the client IP, host name, and client lookup validation flag. Initially, the host name is set to `NULL` and the flag is false. This entry is also used for subsequent client TCP connections from the same originating IP.
2. If the validation flag for the client IP entry is false, the server attempts an IP-to-host name-to-IP DNS resolution. If that is successful, the host name is updated with the resolved host name and the validation flag is set to true. If resolution is unsuccessful, the action taken depends on whether the error is permanent or transient. For permanent failures, the host name remains `NULL` and the validation flag is set to true. For transient failures, the host name and validation flag remain unchanged. (In this case, another DNS resolution attempt occurs the next time a client connects from this IP.)
3. If an error occurs while processing an incoming client connection from a given IP address, the server updates the corresponding error counters in the entry for that IP. For a description of the errors recorded, see [Section 25.12.16.1, “The host\\_cache Table”](#).

To unblock blocked hosts, flush the host cache; see [Dealing with Blocked Hosts](#).

It is possible for a blocked host to become unblocked even without flushing the host cache if activity from other hosts occurs:

- If the cache is full when a connection arrives from a client IP not in the cache, the server discards the least recently used cache entry to make room for the new entry.
- If the discarded entry is for a blocked host, that host becomes unblocked.

Some connection errors are not associated with TCP connections, occur very early in the connection process (even before an IP address is known), or are not specific to any particular IP address (such as out-of-memory conditions). For information about these errors, check the `Connection_errors_xxx` status variables (see [Section 5.1.9, “Server Status Variables”](#)).

## Configuring the Host Cache

The host cache is enabled by default. The `host_cache_size` system variable controls its size, as well as the size of the Performance Schema `host_cache` table that exposes the cache contents. The cache

size can be set at server startup and changed at runtime. For example, to set the size to 100 at startup, put these lines in the server `my.cnf` file:

```
[mysqld]
host_cache_size=200
```

To change the size to 300 at runtime, do this:

```
SET GLOBAL host_cache_size=300;
```

Setting `host_cache_size` to 0, either at server startup or at runtime, disables the host cache. With the cache disabled, the server performs a DNS lookup every time a client connects.

Changing the cache size at runtime causes an implicit host cache flushing operation that clears the host cache, truncates the `host_cache` table, and unblocks any blocked hosts; see [Flushing the Host Cache](#).

Using the `--skip-host-cache` option is similar to setting the `host_cache_size` system variable to 0, but `host_cache_size` is more flexible because it can also be used to resize, enable, and disable the host cache at runtime, not just at server startup. Starting the server with `--skip-host-cache` does not prevent runtime changes to the value of `host_cache_size`, but such changes have no effect and the cache is not re-enabled even if `host_cache_size` is set larger than 0.

To disable DNS host name lookups, start the server with the `skip_name_resolve` system variable enabled. In this case, the server uses only IP addresses and not host names to match connecting hosts to rows in the MySQL grant tables. Only accounts specified in those tables using IP addresses can be used. (A client may not be able to connect if no account exists that specifies the client IP address.)

If you have a very slow DNS and many hosts, you might be able to improve performance either by enabling `skip_name_resolve` to disable DNS lookups, or by increasing the value of `host_cache_size` to make the host cache larger.

To disallow TCP/IP connections entirely, start the server with the `skip_networking` system variable enabled.

To adjust the permitted number of successive connection errors before host blocking occurs, set the `max_connect_errors` system variable. For example, to set the value at startup put these lines in the server `my.cnf` file:

```
[mysqld]
max_connect_errors=10000
```

To change the value at runtime, do this:

```
SET GLOBAL max_connect_errors=10000;
```

## Monitoring the Host Cache

The Performance Schema `host_cache` table exposes the contents of the host cache. This table can be examined using `SELECT` statements, which may help you diagnose the causes of connection problems. The Performance Schema must be enabled or this table is empty. For information about this table, see [Section 25.12.16.1, “The host\\_cache Table”](#).

## Flushing the Host Cache

Flushing the host cache might be advisable or desirable under these conditions:

- Some of your client hosts change IP address.
- The error message `Host 'host_name' is blocked` occurs for connections from legitimate hosts. (See [Dealing with Blocked Hosts](#).)

Flushing the host cache has these effects:

- It clears the in-memory host cache.
- It removes all rows from the Performance Schema `host_cache` table that exposes the cache contents.
- It unblocks any blocked hosts. This enables further connection attempts from those hosts.

To flush the host cache, use any of these methods:

- Change the value of the `host_cache_size` system variable. This requires the `SUPER` privilege.
- Execute a `TRUNCATE TABLE` statement that truncates the Performance Schema `host_cache` table. This requires the `DROP` privilege for the table.
- Execute a `FLUSH HOSTS` statement. This requires the `RELOAD` privilege.
- Execute a `mysqladmin flush-hosts` command. This requires the `RELOAD` privilege.

## Dealing with Blocked Hosts

The server uses the host cache to track errors that occur during the client connection process. If the following error occurs, it means that `mysqld` has received many connection requests from the given host that were interrupted in the middle:

```
Host 'host_name' is blocked because of many connection errors.  
Unblock with 'mysqladmin flush-hosts'
```

The value of the `max_connect_errors` system variable determines how many successive interrupted connection requests the server permits before blocking a host. After `max_connect_errors` failed requests without a successful connection, the server assumes that something is wrong (for example, that someone is trying to break in), and blocks the host from further connection requests.

To unblock blocked hosts, flush the host cache; see [Flushing the Host Cache](#).

Alternatively, to avoid having the error message occur, set `max_connect_errors` as described in [Configuring the Host Cache](#). The default value of `max_connect_errors` is 100. Increasing `max_connect_errors` to a large value makes it less likely that a host reaches the threshold and becomes blocked. However, if the `Host 'host_name' is blocked` error message occurs, first verify that there is nothing wrong with TCP/IP connections from the blocked hosts. It does no good to increase the value of `max_connect_errors` if there are network problems.

## 5.1.12 IPv6 Support

Support for IPv6 in MySQL includes these capabilities:

- MySQL Server can accept TCP/IP connections from clients connecting over IPv6. For example, this command connects over IPv6 to the MySQL server on the local host:

```
$> mysql -h ::1
```

To use this capability, two things must be true:

- Your system must be configured to support IPv6. See [Section 5.1.12.1, “Verifying System Support for IPv6”](#).
- The default MySQL server configuration permits IPv6 connections in addition to IPv4 connections. To change the default configuration, start the server with the `bind_address` system variable set to an appropriate value. See [Section 5.1.7, “Server System Variables”](#).

- MySQL account names permit IPv6 addresses to enable DBAs to specify privileges for clients that connect to the server over IPv6. See [Section 6.2.4, “Specifying Account Names”](#). IPv6 addresses can be specified in account names in statements such as `CREATE USER`, `GRANT`, and `REVOKE`. For example:

```
mysql> CREATE USER 'bill'@':::1' IDENTIFIED BY 'secret';
mysql> GRANT SELECT ON mydb.* TO 'bill'@':::1';
```

- IPv6 functions enable conversion between string and internal format IPv6 address formats, and checking whether values represent valid IPv6 addresses. For example, `INET6_ATON()` and `INET6_NTOA()` are similar to `INET_ATON()` and `INET_NTOA()`, but handle IPv6 addresses in addition to IPv4 addresses. See [Section 12.20, “Miscellaneous Functions”](#).

The following sections describe how to set up MySQL so that clients can connect to the server over IPv6.

### 5.1.12.1 Verifying System Support for IPv6

Before MySQL Server can accept IPv6 connections, the operating system on your server host must support IPv6. As a simple test to determine whether that is true, try this command:

```
$> ping6 ::1
16 bytes from ::1, icmp_seq=0 hlim=64 time=0.171 ms
16 bytes from ::1, icmp_seq=1 hlim=64 time=0.077 ms
...
```

To produce a description of your system's network interfaces, invoke `ifconfig -a` and look for IPv6 addresses in the output.

If your host does not support IPv6, consult your system documentation for instructions on enabling it. It might be that you need only reconfigure an existing network interface to add an IPv6 address. Or a more extensive change might be needed, such as rebuilding the kernel with IPv6 options enabled.

These links may be helpful in setting up IPv6 on various platforms:

- [Windows](#)
- [Gentoo Linux](#)
- [Ubuntu Linux](#)
- [Linux \(Generic\)](#)
- [macOS](#)

### 5.1.12.2 Configuring the MySQL Server to Permit IPv6 Connections

The MySQL server listens on a single network socket for TCP/IP connections. This socket is bound to a single address, but it is possible for an address to map onto multiple network interfaces. To specify an address, set `bind_address=addr` at server startup, where `addr` is an IPv4 or IPv6 address or a host name. For details, see the `bind_address` description in [Section 5.1.7, “Server System Variables”](#).

### 5.1.12.3 Connecting Using the IPv6 Local Host Address

The following procedure shows how to configure MySQL to permit IPv6 connections by clients that connect to the local server using the `:::1` local host address. The instructions given here assume that your system supports IPv6.

1. Start the MySQL server with an appropriate `bind_address` setting to permit it to accept IPv6 connections. For example, put the following lines in the server option file and restart the server:

```
[mysqld]
bind_address = *
```

Alternatively, you can bind the server to `::1`, but that makes the server more restrictive for TCP/IP connections. It accepts only IPv6 connections for that single address and rejects IPv4 connections. For more information, see the `bind_address` description in [Section 5.1.7, “Server System Variables”](#).

2. As an administrator, connect to the server and create an account for a local user who connects from the `::1` local IPv6 host address:

```
mysql> CREATE USER 'ipv6user'@'::1' IDENTIFIED BY 'ipv6pass';
```

For the permitted syntax of IPv6 addresses in account names, see [Section 6.2.4, “Specifying Account Names”](#). In addition to the `CREATE USER` statement, you can issue `GRANT` statements that give specific privileges to the account, although that is not necessary for the remaining steps in this procedure.

3. Invoke the `mysql` client to connect to the server using the new account:

```
$> mysql -h ::1 -u ipv6user -pipv6pass
```

4. Try some simple statements that show connection information:

```
mysql> STATUS
...
Connection:  ::1 via TCP/IP
...

mysql> SELECT CURRENT_USER(), @@bind_address;
+-----+-----+
| CURRENT_USER() | @@bind_address |
+-----+-----+
| ipv6user@::1   | ::             |
+-----+-----+
```

### 5.1.12.4 Connecting Using IPv6 Nonlocal Host Addresses

The following procedure shows how to configure MySQL to permit IPv6 connections by remote clients. It is similar to the preceding procedure for local clients, but the server and client hosts are distinct and each has its own nonlocal IPv6 address. The example uses these addresses:

```
Server host: 2001:db8:0:f101::1
Client host: 2001:db8:0:f101::2
```

These addresses are chosen from the nonroutable address range recommended by [IANA](#) for documentation purposes and suffice for testing on your local network. To accept IPv6 connections from clients outside the local network, the server host must have a public address. If your network provider assigns you an IPv6 address, you can use that. Otherwise, another way to obtain an address is to use an IPv6 broker; see [Section 5.1.12.5, “Obtaining an IPv6 Address from a Broker”](#).

1. Start the MySQL server with an appropriate `bind_address` setting to permit it to accept IPv6 connections. For example, put the following lines in the server option file and restart the server:

```
[mysqld]
bind_address = *
```

Alternatively, you can bind the server to `2001:db8:0:f101::1`, but that makes the server more restrictive for TCP/IP connections. It accepts only IPv6 connections for that single address and rejects IPv4 connections. For more information, see the `bind_address` description in [Section 5.1.7, “Server System Variables”](#).



- On the server host (2001:db8:0:f101::1), create an account for a user who connects from the client host (2001:db8:0:f101::2):

```
mysql> CREATE USER 'remoteipv6user'@'2001:db8:0:f101::2' IDENTIFIED BY 'remoteipv6pass';
```

- On the client host (2001:db8:0:f101::2), invoke the `mysql` client to connect to the server using the new account:

```
$> mysql -h 2001:db8:0:f101::1 -u remoteipv6user -premoteipv6pass
```

- Try some simple statements that show connection information:

```
mysql> STATUS
...
Connection: 2001:db8:0:f101::1 via TCP/IP
...

mysql> SELECT CURRENT_USER(), @@bind_address;
+-----+-----+
| CURRENT_USER() | @@bind_address |
+-----+-----+
| remoteipv6user@2001:db8:0:f101::2 | :: |
+-----+-----+
```

### 5.1.12.5 Obtaining an IPv6 Address from a Broker

If you do not have a public IPv6 address that enables your system to communicate over IPv6 outside your local network, you can obtain one from an IPv6 broker. The [Wikipedia IPv6 Tunnel Broker page](#) lists several brokers and their features, such as whether they provide static addresses and the supported routing protocols.

After configuring your server host to use a broker-supplied IPv6 address, start the MySQL server with an appropriate `bind_address` setting to permit the server to accept IPv6 connections. For example, put the following lines in the server option file and restart the server:

```
[mysqld]
bind_address = *
```

Alternatively, you can bind the server to the specific IPv6 address provided by the broker, but that makes the server more restrictive for TCP/IP connections. It accepts only IPv6 connections for that single address and rejects IPv4 connections. For more information, see the `bind_address` description in [Section 5.1.7, "Server System Variables"](#). In addition, if the broker allocates dynamic addresses, the address provided for your system might change the next time you connect to the broker. If so, any accounts you create that name the original address become invalid. To bind to a specific address but avoid this change-of-address problem, you may be able to arrange with the broker for a static IPv6 address.

The following example shows how to use Freenet6 as the broker and the `gogoc` IPv6 client package on Gentoo Linux.

- Create an account at Freenet6 by visiting this URL and signing up:

```
http://gogonet.gogo6.com
```

- After creating the account, go to this URL, sign in, and create a user ID and password for the IPv6 broker:

```
http://gogonet.gogo6.com/page/freenet6-registration
```

- As `root`, install `gogoc`:

```
$> emerge gogoc
```

4. Edit `/etc/gogoc/gogoc.conf` to set the `userid` and `password` values. For example:

```
userid=gogouser
passwd=gogopass
```

5. Start `gogoc`:

```
$> /etc/init.d/gogoc start
```

To start `gogoc` each time your system boots, execute this command:

```
$> rc-update add gogoc default
```

6. Use `ping6` to try to ping a host:

```
$> ping6 ipv6.google.com
```

7. To see your IPv6 address:

```
$> ifconfig tun
```

## 5.1.13 MySQL Server Time Zone Support

This section describes the time zone settings maintained by MySQL, how to load the system tables required for named time support, how to stay current with time zone changes, and how to enable leap-second support.

For information about time zone settings in replication setups, see [Section 16.4.1.15, “Replication and System Functions”](#) and [Section 16.4.1.31, “Replication and Time Zones”](#).

- [Time Zone Variables](#)
- [Populating the Time Zone Tables](#)
- [Staying Current with Time Zone Changes](#)
- [Time Zone Leap Second Support](#)

### Time Zone Variables

MySQL Server maintains several time zone settings:

- The server system time zone. When the server starts, it attempts to determine the time zone of the host machine and uses it to set the `system_time_zone` system variable. The value does not change thereafter.

To explicitly specify the system time zone for MySQL Server at startup, set the `TZ` environment variable before you start `mysqld`. If you start the server using `mysqld_safe`, its `--timezone` option provides another way to set the system time zone. The permissible values for `TZ` and `--timezone` are system dependent. Consult your operating system documentation to see what values are acceptable.

- The server current time zone. The global `time_zone` system variable indicates the time zone the server currently is operating in. The initial `time_zone` value is `'SYSTEM'`, which indicates that the server time zone is the same as the system time zone.



#### Note

If set to `SYSTEM`, every MySQL function call that requires a time zone calculation makes a system library call to determine the current system time zone. This call may be protected by a global mutex, resulting in contention.

The initial global server time zone value can be specified explicitly at startup with the `--default-time-zone` option on the command line, or you can use the following line in an option file:

```
default-time-zone='timezone'
```

If you have the `SUPER` privilege, you can set the global server time zone value at runtime with this statement:

```
SET GLOBAL time_zone = timezone;
```

- Per-session time zones. Each client that connects has its own session time zone setting, given by the session `time_zone` variable. Initially, the session variable takes its value from the global `time_zone` variable, but the client can change its own time zone with this statement:

```
SET time_zone = timezone;
```

The session time zone setting affects display and storage of time values that are zone-sensitive. This includes the values displayed by functions such as `NOW()` or `CURTIME()`, and values stored in and retrieved from `TIMESTAMP` columns. Values for `TIMESTAMP` columns are converted from the session time zone to UTC for storage, and from UTC to the session time zone for retrieval.

The session time zone setting does not affect values displayed by functions such as `UTC_TIMESTAMP()` or values in `DATE`, `TIME`, or `DATETIME` columns. Nor are values in those data types stored in UTC; the time zone applies for them only when converting from `TIMESTAMP` values. If you want locale-specific arithmetic for `DATE`, `TIME`, or `DATETIME` values, convert them to UTC, perform the arithmetic, and then convert back.

The current global and session time zone values can be retrieved like this:

```
SELECT @@GLOBAL.time_zone, @@SESSION.time_zone;
```

`timezone` values can be given in several formats, none of which are case-sensitive:

- As the value `'SYSTEM'`, indicating that the server time zone is the same as the system time zone.
- As a string indicating an offset from UTC of the form `[H]H:MM`, prefixed with a `+` or `-`, such as `'+10:00'`, `'-6:00'`, or `'+05:30'`. A leading zero can optionally be used for hours values less than 10; MySQL prepends a leading zero when storing and retrieving the value in such cases. MySQL converts `'-00:00'` or `'-0:00'` to `'+00:00'`.

A time zone offset must be in the range `'-12:59'` to `'+13:00'`, inclusive.

- As a named time zone, such as `'Europe/Helsinki'`, `'US/Eastern'`, `'MET'`, or `'UTC'`.



#### Note

Named time zones can be used only if the time zone information tables in the `mysql` database have been created and populated. Otherwise, use of a named time zone results in an error:

```
mysql> SET time_zone = 'UTC';
ERROR 1298 (HY000): Unknown or incorrect time zone: 'UTC'
```

## Populating the Time Zone Tables

Several tables in the `mysql` system database exist to store time zone information (see [Section 5.3, “The mysql System Database”](#)). The MySQL installation procedure creates the time zone tables, but does not load them. To do so manually, use the following instructions.

**Note**

Loading the time zone information is not necessarily a one-time operation because the information changes occasionally. When such changes occur, applications that use the old rules become out of date and you may find it necessary to reload the time zone tables to keep the information used by your MySQL server current. See [Staying Current with Time Zone Changes](#).

If your system has its own *zoneinfo* database (the set of files describing time zones), use the `mysql_tzinfo_to_sql` program to load the time zone tables. Examples of such systems are Linux, macOS, FreeBSD, and Solaris. One likely location for these files is the `/usr/share/zoneinfo` directory. If your system has no *zoneinfo* database, you can use a downloadable package, as described later in this section.

To load the time zone tables from the command line, pass the *zoneinfo* directory path name to `mysql_tzinfo_to_sql` and send the output into the `mysql` program. For example:

```
mysql_tzinfo_to_sql /usr/share/zoneinfo | mysql -u root -p mysql
```

The `mysql` command shown here assumes that you connect to the server using an account such as `root` that has privileges for modifying tables in the `mysql` system database. Adjust the connection parameters as required.

`mysql_tzinfo_to_sql` reads your system's time zone files and generates SQL statements from them. `mysql` processes those statements to load the time zone tables.

`mysql_tzinfo_to_sql` also can be used to load a single time zone file or generate leap second information:

- To load a single time zone file `tz_file` that corresponds to a time zone name `tz_name`, invoke `mysql_tzinfo_to_sql` like this:

```
mysql_tzinfo_to_sql tz_file tz_name | mysql -u root -p mysql
```

With this approach, you must execute a separate command to load the time zone file for each named zone that the server needs to know about.

- If your time zone must account for leap seconds, initialize leap second information like this, where `tz_file` is the name of your time zone file:

```
mysql_tzinfo_to_sql --leap tz_file | mysql -u root -p mysql
```

After running `mysql_tzinfo_to_sql`, restart the server so that it does not continue to use any previously cached time zone data.

If your system has no *zoneinfo* database (for example, Windows), you can use a package containing SQL statements that is available for download at the MySQL Developer Zone:

```
https://dev.mysql.com/downloads/timezones.html
```

**Warning**

Do *not* use a downloadable time zone package if your system has a *zoneinfo* database. Use the `mysql_tzinfo_to_sql` utility instead. Otherwise, you may cause a difference in datetime handling between MySQL and other applications on your system.

To use an SQL-statement time zone package that you have downloaded, unpack it, then load the unpacked file contents into the time zone tables:

```
mysql -u root -p mysql < file_name
```

Then restart the server.



### Warning

Do *not* use a downloadable time zone package that contains [MyISAM](#) tables. That is intended for older MySQL versions. MySQL 5.7 and higher uses [InnoDB](#) for the time zone tables. Trying to replace them with [MyISAM](#) tables causes problems.

## Staying Current with Time Zone Changes

When time zone rules change, applications that use the old rules become out of date. To stay current, it is necessary to make sure that your system uses current time zone information is used. For MySQL, there are multiple factors to consider in staying current:

- The operating system time affects the value that the MySQL server uses for times if its time zone is set to [SYSTEM](#). Make sure that your operating system is using the latest time zone information. For most operating systems, the latest update or service pack prepares your system for the time changes. Check the website for your operating system vendor for an update that addresses the time changes.
- If you replace the system's `/etc/localtime` time zone file with a version that uses rules differing from those in effect at `mysqld` startup, restart `mysqld` so that it uses the updated rules. Otherwise, `mysqld` might not notice when the system changes its time.
- If you use named time zones with MySQL, make sure that the time zone tables in the `mysql` database are up to date:
  - If your system has its own zoneinfo database, reload the MySQL time zone tables whenever the zoneinfo database is updated.
  - For systems that do not have their own zoneinfo database, check the MySQL Developer Zone for updates. When a new update is available, download it and use it to replace the content of your current time zone tables.

For instructions for both methods, see [Populating the Time Zone Tables](#). `mysqld` caches time zone information that it looks up, so after updating the time zone tables, restart `mysqld` to make sure that it does not continue to serve outdated time zone data.

If you are uncertain whether named time zones are available, for use either as the server's time zone setting or by clients that set their own time zone, check whether your time zone tables are empty. The following query determines whether the table that contains time zone names has any rows:

```
mysql> SELECT COUNT(*) FROM mysql.time_zone_name;
+-----+
| COUNT(*) |
+-----+
|         0 |
+-----+
```

A count of zero indicates that the table is empty. In this case, no applications currently are using named time zones, and you need not update the tables (unless you want to enable named time zone support). A count greater than zero indicates that the table is not empty and that its contents are available to be used for named time zone support. In this case, be sure to reload your time zone tables so that applications that use named time zones obtain correct query results.

To check whether your MySQL installation is updated properly for a change in Daylight Saving Time rules, use a test like the one following. The example uses values that are appropriate for the 2007 DST 1-hour change that occurs in the United States on March 11 at 2 a.m.

The test uses this query:

```
SELECT
  CONVERT_TZ('2007-03-11 2:00:00','US/Eastern','US/Central') AS time1,
  CONVERT_TZ('2007-03-11 3:00:00','US/Eastern','US/Central') AS time2;
```

The two time values indicate the times at which the DST change occurs, and the use of named time zones requires that the time zone tables be used. The desired result is that both queries return the same result (the input time, converted to the equivalent value in the 'US/Central' time zone).

Before updating the time zone tables, you see an incorrect result like this:

```
+-----+-----+
| time1          | time2          |
+-----+-----+
| 2007-03-11 01:00:00 | 2007-03-11 02:00:00 |
+-----+-----+
```

After updating the tables, you should see the correct result:

```
+-----+-----+
| time1          | time2          |
+-----+-----+
| 2007-03-11 01:00:00 | 2007-03-11 01:00:00 |
+-----+-----+
```

## Time Zone Leap Second Support

Leap second values are returned with a time part that ends with `:59:59`. This means that a function such as `NOW()` can return the same value for two or three consecutive seconds during the leap second. It remains true that literal temporal values having a time part that ends with `:59:60` or `:59:61` are considered invalid.

If it is necessary to search for `TIMESTAMP` values one second before the leap second, anomalous results may be obtained if you use a comparison with `'YYYY-MM-DD hh:mm:ss'` values. The following example demonstrates this. It changes the session time zone to UTC so there is no difference between internal `TIMESTAMP` values (which are in UTC) and displayed values (which have time zone correction applied).

```
mysql> CREATE TABLE t1 (
  a INT,
  ts TIMESTAMP DEFAULT CURRENT_TIMESTAMP,
  PRIMARY KEY (ts)
);
Query OK, 0 rows affected (0.01 sec)

mysql> -- change to UTC
mysql> SET time_zone = '+00:00';
Query OK, 0 rows affected (0.00 sec)

mysql> -- Simulate NOW() = '2008-12-31 23:59:59'
mysql> SET timestamp = 1230767999;
Query OK, 0 rows affected (0.00 sec)

mysql> INSERT INTO t1 (a) VALUES (1);
Query OK, 1 row affected (0.00 sec)

mysql> -- Simulate NOW() = '2008-12-31 23:59:60'
mysql> SET timestamp = 1230768000;
Query OK, 0 rows affected (0.00 sec)

mysql> INSERT INTO t1 (a) VALUES (2);
```

```

Query OK, 1 row affected (0.00 sec)

mysql> -- values differ internally but display the same
mysql> SELECT a, ts, UNIX_TIMESTAMP(ts) FROM t1;
+-----+-----+-----+
| a    | ts                | UNIX_TIMESTAMP(ts) |
+-----+-----+-----+
| 1    | 2008-12-31 23:59:59 | 1230767999         |
| 2    | 2008-12-31 23:59:59 | 1230768000         |
+-----+-----+-----+
2 rows in set (0.00 sec)

mysql> -- only the non-leap value matches
mysql> SELECT * FROM t1 WHERE ts = '2008-12-31 23:59:59';
+-----+-----+
| a    | ts                |
+-----+-----+
| 1    | 2008-12-31 23:59:59 |
+-----+-----+
1 row in set (0.00 sec)

mysql> -- the leap value with seconds=60 is invalid
mysql> SELECT * FROM t1 WHERE ts = '2008-12-31 23:59:60';
Empty set, 2 warnings (0.00 sec)

```

To work around this, you can use a comparison based on the UTC value actually stored in the column, which has the leap second correction applied:

```

mysql> -- selecting using UNIX_TIMESTAMP value return leap value
mysql> SELECT * FROM t1 WHERE UNIX_TIMESTAMP(ts) = 1230768000;
+-----+-----+
| a    | ts                |
+-----+-----+
| 2    | 2008-12-31 23:59:59 |
+-----+-----+
1 row in set (0.00 sec)

```

## 5.1.14 Server-Side Help Support

MySQL Server supports a [HELP](#) statement that returns information from the MySQL Reference Manual (see [Section 13.8.3, “HELP Statement”](#)). This information is stored in several tables in the `mysql` database (see [Section 5.3, “The mysql System Database”](#)). Proper operation of the [HELP](#) statement requires that these help tables be initialized.

For a new installation of MySQL using a binary or source distribution on Unix, help-table content initialization occurs when you initialize the data directory (see [Section 2.9.1, “Initializing the Data Directory”](#)). For an RPM distribution on Linux or binary distribution on Windows, content initialization occurs as part of the MySQL installation process.

For a MySQL upgrade using a binary distribution, help-table content is not upgraded automatically, but you can upgrade it manually. Locate the `fill_help_tables.sql` file in the `share` or `share/mysql` directory. Change location into that directory and process the file with the `mysql` client as follows:

```
mysql -u root -p mysql < fill_help_tables.sql
```

The command shown here assumes that you connect to the server using an account such as `root` that has privileges for modifying tables in the `mysql` database. Adjust the connection parameters as required.

If you are working with Git and a MySQL development source tree, the source tree contains only a “stub” version of `fill_help_tables.sql`. To obtain a non-stub copy, use one from a source or binary distribution.

**Note**

Each MySQL series has its own series-specific reference manual, so help-table content is series specific as well. This has implications for replication because help-table content should match the MySQL series. If you load MySQL 5.7 help content into a MySQL 5.7 source server, it does not make sense to replicate that content to a replica server from a different MySQL series and for which that content is not appropriate. For this reason, as you upgrade individual servers in a replication scenario, you should upgrade each server's help tables, using the instructions given earlier.

## 5.1.15 Server Tracking of Client Session State

The MySQL server implements several session state trackers. A client can enable these trackers to receive notification of changes to its session state.

- [Uses for Session State Trackers](#)
- [Available Session State Trackers](#)
- [C API Session State Tracker Support](#)
- [Test Suite Session State Tracker Support](#)

### Uses for Session State Trackers

Session state trackers have uses such as these:

- To facilitate session migration.
- To facilitate transaction switching.

One use for the tracker mechanism is to provide a means for MySQL connectors and client applications to determine whether any session context is available to permit session migration from one server to another. (To change sessions in a load-balanced environment, it is necessary to detect whether there is session state to take into consideration when deciding whether a switch can be made.)

Another use for the tracker mechanism is to permit applications to know when transactions can be moved from one session to another. Transaction state tracking enables this, which is useful for applications that may wish to move transactions from a busy server to one that is less loaded. For example, a load-balancing connector managing a client connection pool could move transactions between available sessions in the pool.

However, session switching cannot be done at arbitrary times. If a session is in the middle of a transaction for which reads or writes have been done, switching to a different session implies a transaction rollback on the original session. A session switch must be done only when a transaction does not yet have any reads or writes performed within it.

Examples of when transactions might reasonably be switched:

- Immediately after `START TRANSACTION`
- After `COMMIT AND CHAIN`

In addition to knowing transaction state, it is useful to know transaction characteristics, so as to use the same characteristics if the transaction is moved to a different session. The following characteristics are relevant for this purpose:

```
READ ONLY
READ WRITE
```



```
ISOLATION LEVEL
WITH CONSISTENT SNAPSHOT
```

## Available Session State Trackers

To support the session-tracking activities, notification is available for these types of client session state information:

- Changes to these attributes of client session state:
  - The default schema (database).
  - Session-specific values for system variables.
  - User-defined variables.
  - Temporary tables.
  - Prepared statements.

The `session_track_state_change` system variable controls this tracker.

- Changes to the default schema name. The `session_track_schema` system variable controls this tracker.
- Changes to the session values of system variables. The `session_track_system_variables` system variable controls this tracker.
- Available GTIDs. The `session_track_gtids` system variable controls this tracker.
- Information about transaction state and characteristics. The `session_track_transaction_info` system variable controls this tracker.

For descriptions of the tracker-related system variables, see [Section 5.1.7, “Server System Variables”](#). Those system variables permit control over which change notifications occur, but do not provide a way to access notification information. Notification occurs in the MySQL client/server protocol, which includes tracker information in OK packets so that session state changes can be detected.

## C API Session State Tracker Support

To enable client applications to extract state-change information from OK packets returned by the server, the MySQL C API provides a pair of functions:

- `mysql_session_track_get_first()` fetches the first part of the state-change information received from the server. See `mysql_session_track_get_first()`.
- `mysql_session_track_get_next()` fetches any remaining state-change information received from the server. Following a successful call to `mysql_session_track_get_first()`, call this function repeatedly as long as it returns success. See `mysql_session_track_get_next()`.

## Test Suite Session State Tracker Support

The `mysqltest` program has `disable_session_track_info` and `enable_session_track_info` commands that control whether session tracker notifications occur. You can use these commands to see from the command line what notifications SQL statements produce. Suppose that a file `testscript` contains the following `mysqltest` script:

```
DROP TABLE IF EXISTS test.t1;
CREATE TABLE test.t1 (i INT, f FLOAT);
--enable_session_track_info
```

```

SET @@SESSION.session_track_schema=ON;
SET @@SESSION.session_track_system_variables='*';
SET @@SESSION.session_track_state_change=ON;
USE information_schema;
SET NAMES 'utf8mb4';
SET @@SESSION.session_track_transaction_info='CHARACTERISTICS';
SET TRANSACTION ISOLATION LEVEL SERIALIZABLE;
SET TRANSACTION READ WRITE;
START TRANSACTION;
SELECT 1;
INSERT INTO test.t1 () VALUES();
INSERT INTO test.t1 () VALUES(1, RAND());
COMMIT;

```

Run the script as follows to see the information provided by the enabled trackers. For a description of the [Tracker](#): information displayed by `mysqltest` for the various trackers, see [mysql\\_session\\_track\\_get\\_first\(\)](#).

```

$> mysqltest < testscript
DROP TABLE IF EXISTS test.t1;
CREATE TABLE test.t1 (i INT, f FLOAT);
SET @@SESSION.session_track_schema=ON;
SET @@SESSION.session_track_system_variables='*';
-- Tracker : SESSION_TRACK_SYSTEM_VARIABLES
-- session_track_system_variables
-- *

SET @@SESSION.session_track_state_change=ON;
-- Tracker : SESSION_TRACK_SYSTEM_VARIABLES
-- session_track_state_change
-- ON

USE information_schema;
-- Tracker : SESSION_TRACK_SCHEMA
-- information_schema

-- Tracker : SESSION_TRACK_STATE_CHANGE
-- 1

SET NAMES 'utf8mb4';
-- Tracker : SESSION_TRACK_SYSTEM_VARIABLES
-- character_set_client
-- utf8mb4
-- character_set_connection
-- utf8mb4
-- character_set_results
-- utf8mb4

-- Tracker : SESSION_TRACK_STATE_CHANGE
-- 1

SET @@SESSION.session_track_transaction_info='CHARACTERISTICS';
-- Tracker : SESSION_TRACK_SYSTEM_VARIABLES
-- session_track_transaction_info
-- CHARACTERISTICS

-- Tracker : SESSION_TRACK_STATE_CHANGE
-- 1

-- Tracker : SESSION_TRACK_TRANSACTION_CHARACTERISTICS
--

-- Tracker : SESSION_TRACK_TRANSACTION_STATE
-- _____

SET TRANSACTION ISOLATION LEVEL SERIALIZABLE;
-- Tracker : SESSION_TRACK_TRANSACTION_CHARACTERISTICS

```

```
-- SET TRANSACTION ISOLATION LEVEL SERIALIZABLE;

SET TRANSACTION READ WRITE;
-- Tracker : SESSION_TRACK_TRANSACTION_CHARACTERISTICS
-- SET TRANSACTION ISOLATION LEVEL SERIALIZABLE; SET TRANSACTION READ WRITE;

START TRANSACTION;
-- Tracker : SESSION_TRACK_TRANSACTION_CHARACTERISTICS
-- SET TRANSACTION ISOLATION LEVEL SERIALIZABLE; START TRANSACTION READ WRITE;

-- Tracker : SESSION_TRACK_TRANSACTION_STATE
-- T_____

SELECT 1;
1
1
-- Tracker : SESSION_TRACK_TRANSACTION_STATE
-- T_____S_

INSERT INTO test.t1 () VALUES();
-- Tracker : SESSION_TRACK_TRANSACTION_STATE
-- T___W_S_

INSERT INTO test.t1 () VALUES(1, RAND());
-- Tracker : SESSION_TRACK_TRANSACTION_STATE
-- T___WsS_

COMMIT;
-- Tracker : SESSION_TRACK_TRANSACTION_CHARACTERISTICS
--

-- Tracker : SESSION_TRACK_TRANSACTION_STATE
-- _____

ok
```

Preceding the `START TRANSACTION` statement, two `SET TRANSACTION` statements execute that set the isolation level and access mode characteristics for the next transaction. The `SESSION_TRACK_TRANSACTION_CHARACTERISTICS` value indicates those next-transaction values that have been set.

Following the `COMMIT` statement that ends the transaction, the `SESSION_TRACK_TRANSACTION_CHARACTERISTICS` value is reported as empty. This indicates that the next-transaction characteristics that were set preceding the start of the transaction have been reset, and that the session defaults apply. To track changes to those session defaults, track the session values of the `transaction_isolation` and `transaction_read_only` system variables.

To see information about GTIDs, enable the `SESSION_TRACK_GTIDS` tracker using the `session_track_gtids` system system variable.

### 5.1.16 The Server Shutdown Process

The server shutdown process takes place as follows:

1. The shutdown process is initiated.

This can occur initiated several ways. For example, a user with the `SHUTDOWN` privilege can execute a `mysqladmin shutdown` command. `mysqladmin` can be used on any platform supported by MySQL. Other operating system-specific shutdown initiation methods are possible as well: The server shuts down on Unix when it receives a `SIGTERM` signal. A server running as a service on Windows shuts down when the services manager tells it to.

2. The server creates a shutdown thread if necessary.

Depending on how shutdown was initiated, the server might create a thread to handle the shutdown process. If shutdown was requested by a client, a shutdown thread is created. If shutdown is the result of receiving a `SIGTERM` signal, the signal thread might handle shutdown itself, or it might create a separate thread to do so. If the server tries to create a shutdown thread and cannot (for example, if memory is exhausted), it issues a diagnostic message that appears in the error log:

```
Error: Can't create thread to kill server
```

3. The server stops accepting new connections.

To prevent new activity from being initiated during shutdown, the server stops accepting new client connections by closing the handlers for the network interfaces to which it normally listens for connections: the TCP/IP port, the Unix socket file, the Windows named pipe, and shared memory on Windows.

4. The server terminates current activity.

For each thread associated with a client connection, the server breaks the connection to the client and marks the thread as killed. Threads die when they notice that they are so marked. Threads for idle connections die quickly. Threads that currently are processing statements check their state periodically and take longer to die. For additional information about thread termination, see [Section 13.7.6.4, “KILL Statement”](#), in particular for the instructions about killed `REPAIR TABLE` or `OPTIMIZE TABLE` operations on `MyISAM` tables.

For threads that have an open transaction, the transaction is rolled back. If a thread is updating a nontransactional table, an operation such as a multiple-row `UPDATE` or `INSERT` may leave the table partially updated because the operation can terminate before completion.

If the server is a source replication server, it treats threads associated with currently connected replicas like other client threads. That is, each one is marked as killed and exits when it next checks its state.

If the server is a replica, it stops the I/O and SQL threads, if they are active, before marking client threads as killed. The SQL thread is permitted to finish its current statement (to avoid causing replication problems), and then stops. If the SQL thread is in the middle of a transaction at this point, the server waits until the current replication event group (if any) has finished executing, or until the user issues a `KILL QUERY` or `KILL CONNECTION` statement. See also [Section 13.4.2.6, “STOP SLAVE Statement”](#). Since nontransactional statements cannot be rolled back, in order to guarantee crash-safe replication, only transactional tables should be used.



### Note

To guarantee crash safety on the replica, you must run the replica with `--relay-log-recovery` enabled.

See also [Section 16.2.4, “Relay Log and Replication Metadata Repositories”](#).

5. The server shuts down or closes storage engines.

At this stage, the server flushes the table cache and closes all open tables.

Each storage engine performs any actions necessary for tables that it manages. `InnoDB` flushes its buffer pool to disk (unless `innodb_fast_shutdown` is 2), writes the current LSN to the tablespace, and terminates its own internal threads. `MyISAM` flushes any pending index writes for a table.

6. The server exits.

To provide information to management processes, the server returns one of the exit codes described in the following list. The phrase in parentheses indicates the action taken by systemd in response to the code, for platforms on which systemd is used to manage the server.

- 0 = successful termination (no restart done)
- 1 = unsuccessful termination (no restart done)
- 2 = unsuccessful termination (restart done)

## 5.2 The MySQL Data Directory

Information managed by the MySQL server is stored under a directory known as the data directory. The following list briefly describes the items typically found in the data directory, with cross references for additional information:

- Data directory subdirectories. Each subdirectory of the data directory is a database directory and corresponds to a database managed by the server. All MySQL installations have certain standard databases:
  - The `mysql` directory corresponds to the `mysql` system database, which contains information required by the MySQL server as it runs. See [Section 5.3, “The mysql System Database”](#).
  - The `performance_schema` directory corresponds to the Performance Schema, which provides information used to inspect the internal execution of the server at runtime. See [Chapter 25, MySQL Performance Schema](#).
  - The `sys` directory corresponds to the `sys` schema, which provides a set of objects to help interpret Performance Schema information more easily. See [Chapter 26, MySQL sys Schema](#).
  - The `ndbinfo` directory corresponds to the `ndbinfo` database that stores information specific to NDB Cluster (present only for installations built to include NDB Cluster). See [Section 21.6.15, “ndbinfo: The NDB Cluster Information Database”](#).

Other subdirectories correspond to databases created by users or applications.



### Note

`INFORMATION_SCHEMA` is a standard database, but its implementation uses no corresponding database directory.

- Log files written by the server. See [Section 5.4, “MySQL Server Logs”](#).
- InnoDB tablespace and log files. See [Chapter 14, The InnoDB Storage Engine](#).
- Default/autogenerated SSL and RSA certificate and key files. See [Section 6.3.3, “Creating SSL and RSA Certificates and Keys”](#).
- The server process ID file (while the server is running).

Some items in the preceding list can be relocated elsewhere by reconfiguring the server. In addition, the `--datadir` option enables the location of the data directory itself to be changed. For a given MySQL installation, check the server configuration to determine whether items have been moved.

## 5.3 The mysql System Database

The `mysql` database is the system database. It contains tables that store information required by the MySQL server as it runs.

Tables in the `mysql` database fall into these categories:

- [Grant System Tables](#)
- [Object Information System Tables](#)
- [Log System Tables](#)
- [Server-Side Help System Tables](#)
- [Time Zone System Tables](#)
- [Replication System Tables](#)
- [Optimizer System Tables](#)
- [Miscellaneous System Tables](#)

The remainder of this section enumerates the tables in each category, with cross references for additional information. System tables use the `MyISAM` storage engine unless otherwise indicated.



### Warning

Do *not* convert MySQL system tables in the `mysql` database from `MyISAM` to `InnoDB` tables. This is an unsupported operation. If you do this, MySQL does not restart until you restore the old system tables from a backup or regenerate them by reinitializing the data directory (see [Section 2.9.1, “Initializing the Data Directory”](#)).

## Grant System Tables

These system tables contain grant information about user accounts and the privileges held by them:

- `user`: User accounts, global privileges, and other nonprivilege columns.
- `db`: Database-level privileges.
- `tables_priv`: Table-level privileges.
- `columns_priv`: Column-level privileges.
- `procs_priv`: Stored procedure and function privileges.
- `proxies_priv`: Proxy-user privileges.

For more information about the structure, contents, and purpose of the grant tables, see [Section 6.2.3, “Grant Tables”](#).

## Object Information System Tables

These system tables contain information about stored programs, loadable functions, and server-side plugins:

- `event`: The registry for Event Scheduler events installed using `CREATE EVENT`. If the server is started with the `--skip-grant-tables` option, the event scheduler is disabled and events registered in the table do not run. See [Section 23.4.2, “Event Scheduler Configuration”](#).
- `func`: The registry for loadable functions installed using `CREATE FUNCTION`. During the normal startup sequence, the server loads functions registered in this table. If the server is started with the `--skip-grant-tables` option, functions registered in the table are not loaded and are unavailable. See [Section 5.6.1, “Installing and Uninstalling Loadable Functions”](#).

- `plugin`: The registry for server-side plugins installed using `INSTALL PLUGIN`. During the normal startup sequence, the server loads plugins registered in this table. If the server is started with the `--skip-grant-tables` option, plugins registered in the table are not loaded and are unavailable. See [Section 5.5.1, “Installing and Uninstalling Plugins”](#).

The `plugin` table uses the `InnoDB` storage engine as of MySQL 5.7.6, `MyISAM` before that.

- `proc`: Information about stored procedures and functions. See [Section 23.2, “Using Stored Routines”](#).

## Log System Tables

The server uses these system tables for logging:

- `general_log`: The general query log table.
- `slow_log`: The slow query log table.

Log tables use the `CSV` storage engine.

For more information, see [Section 5.4, “MySQL Server Logs”](#).

## Server-Side Help System Tables

These system tables contain server-side help information:

- `help_category`: Information about help categories.
- `help_keyword`: Keywords associated with help topics.
- `help_relation`: Mappings between help keywords and topics.
- `help_topic`: Help topic contents.

These tables use the `InnoDB` storage engine as of MySQL 5.7.5, `MyISAM` before that.

For more information, see [Section 5.1.14, “Server-Side Help Support”](#).

## Time Zone System Tables

These system tables contain time zone information:

- `time_zone`: Time zone IDs and whether they use leap seconds.
- `time_zone_leap_second`: When leap seconds occur.
- `time_zone_name`: Mappings between time zone IDs and names.
- `time_zone_transition`, `time_zone_transition_type`: Time zone descriptions.

These tables use the `InnoDB` storage engine as of MySQL 5.7.5, `MyISAM` before that.

For more information, see [Section 5.1.13, “MySQL Server Time Zone Support”](#).

## Replication System Tables

The server uses these system tables to support replication:

- `gtid_executed`: Table for storing GTID values. See [mysql.gtid\\_executed Table](#).

The `gtid_executed` table uses the `InnoDB` storage engine.

- `ndb_binlog_index`: Binary log information for NDB Cluster replication. See [Section 21.7.4, “NDB Cluster Replication Schema and Tables”](#).

Prior to NDB 7.5.2, this table employed the `MyISAM` storage engine. In NDB 7.5.2 and later, it uses `InnoDB`. If you are planning an upgrade from a NDB Cluster previous release to NDB 7.5.2 or later, see [Section 21.3.7, “Upgrading and Downgrading NDB Cluster”](#), for important information relating to this change.

- `slave_master_info`, `slave_relay_log_info`, `slave_worker_info`: Used to store replication information on replica servers. See [Section 16.2.4, “Relay Log and Replication Metadata Repositories”](#).

All three of these tables use the `InnoDB` storage engine.

## Optimizer System Tables

These system tables are for use by the optimizer:

- `innodb_index_stats`, `innodb_table_stats`: Used for `InnoDB` persistent optimizer statistics. See [Section 14.8.11.1, “Configuring Persistent Optimizer Statistics Parameters”](#).
- `server_cost`, `engine_cost`: The optimizer cost model uses tables that contain cost estimate information about operations that occur during query execution. `server_cost` contains optimizer cost estimates for general server operations. `engine_cost` contains estimates for operations specific to particular storage engines. See [Section 8.9.5, “The Optimizer Cost Model”](#).

These tables use the `InnoDB` storage engine.

## Miscellaneous System Tables

Other system tables do not fall into the preceding categories:

- `audit_log_filter`, `audit_log_user`: If MySQL Enterprise Audit is installed, these tables provide persistent storage of audit log filter definitions and user accounts. See [Audit Log Tables](#).
- `firewall_users`, `firewall_whitelist`: If MySQL Enterprise Firewall is installed, these tables provide persistent storage for information used by the firewall. See [Section 6.4.6, “MySQL Enterprise Firewall”](#).
- `servers`: Used by the `FEDERATED` storage engine. See [Section 15.8.2.2, “Creating a FEDERATED Table Using CREATE SERVER”](#).

The `servers` table uses the `InnoDB` storage engine as of MySQL 5.7.6, `MyISAM` before that.

## 5.4 MySQL Server Logs

MySQL Server has several logs that can help you find out what activity is taking place.

Log Type	Information Written to Log
Error log	Problems encountered starting, running, or stopping <code>mysqld</code>
General query log	Established client connections and statements received from clients
Binary log	Statements that change data (also used for replication)



Log Type	Information Written to Log
Relay log	Data changes received from a replication source server
Slow query log	Queries that took more than <code>long_query_time</code> seconds to execute
DDL log (metadata log)	Metadata operations performed by DDL statements

By default, no logs are enabled, except the error log on Windows. (The DDL log is always created when required, and has no user-configurable options; see [Section 5.4.6, “The DDL Log”](#).) The following log-specific sections provide information about the server options that enable logging.

By default, the server writes files for all enabled logs in the data directory. You can force the server to close and reopen the log files (or in some cases switch to a new log file) by flushing the logs. Log flushing occurs when you issue a `FLUSH LOGS` statement; execute `mysqladmin` with a `flush-logs` or `refresh` argument; or execute `mysqldump` with a `--flush-logs` option. See [Section 13.7.6.3, “FLUSH Statement”](#), [Section 4.5.2, “mysqladmin — A MySQL Server Administration Program”](#), and [Section 4.5.4, “mysqldump — A Database Backup Program”](#). In addition, the binary log is flushed when its size reaches the value of the `max_binlog_size` system variable.

You can control the general query and slow query logs during runtime. You can enable or disable logging, or change the log file name. You can tell the server to write general query and slow query entries to log tables, log files, or both. For details, see [Section 5.4.1, “Selecting General Query Log and Slow Query Log Output Destinations”](#), [Section 5.4.3, “The General Query Log”](#), and [Section 5.4.5, “The Slow Query Log”](#).

The relay log is used only on replicas, to hold data changes from the replication source server that must also be made on the replica. For discussion of relay log contents and configuration, see [Section 16.2.4.1, “The Relay Log”](#).

For information about log maintenance operations such as expiration of old log files, see [Section 5.4.7, “Server Log Maintenance”](#).

For information about keeping logs secure, see [Section 6.1.2.3, “Passwords and Logging”](#).

## 5.4.1 Selecting General Query Log and Slow Query Log Output Destinations

MySQL Server provides flexible control over the destination of output written to the general query log and the slow query log, if those logs are enabled. Possible destinations for log entries are log files or the `general_log` and `slow_log` tables in the `mysql` system database. File output, table output, or both can be selected.

- [Log Control at Server Startup](#)
- [Log Control at Runtime](#)
- [Log Table Benefits and Characteristics](#)

### Log Control at Server Startup

The `log_output` system variable specifies the destination for log output. Setting this variable does not in itself enable the logs; they must be enabled separately.

- If `log_output` is not specified at startup, the default logging destination is `FILE`.
- If `log_output` is specified at startup, its value is a list one or more comma-separated words chosen from `TABLE` (log to tables), `FILE` (log to files), or `NONE` (do not log to tables or files). `NONE`, if present, takes precedence over any other specifiers.

The `general_log` system variable controls logging to the general query log for the selected log destinations. If specified at server startup, `general_log` takes an optional argument of 1 or 0 to enable or disable the log. To specify a file name other than the default for file logging, set the `general_log_file` variable. Similarly, the `slow_query_log` variable controls logging to the slow query log for the selected destinations and setting `slow_query_log_file` specifies a file name for file logging. If either log is enabled, the server opens the corresponding log file and writes startup messages to it. However, further logging of queries to the file does not occur unless the `FILE` log destination is selected.

Examples:

- To write general query log entries to the log table and the log file, use `--log_output=TABLE,FILE` to select both log destinations and `--general_log` to enable the general query log.
- To write general and slow query log entries only to the log tables, use `--log_output=TABLE` to select tables as the log destination and `--general_log` and `--slow_query_log` to enable both logs.
- To write slow query log entries only to the log file, use `--log_output=FILE` to select files as the log destination and `--slow_query_log` to enable the slow query log. In this case, because the default log destination is `FILE`, you could omit the `log_output` setting.

## Log Control at Runtime

The system variables associated with log tables and files enable runtime control over logging:

- The `log_output` variable indicates the current logging destination. It can be modified at runtime to change the destination.
- The `general_log` and `slow_query_log` variables indicate whether the general query log and slow query log are enabled (`ON`) or disabled (`OFF`). You can set these variables at runtime to control whether the logs are enabled.
- The `general_log_file` and `slow_query_log_file` variables indicate the names of the general query log and slow query log files. You can set these variables at server startup or at runtime to change the names of the log files.
- To disable or enable general query logging for the current session, set the session `sql_log_off` variable to `ON` or `OFF`. (This assumes that the general query log itself is enabled.)

## Log Table Benefits and Characteristics

The use of tables for log output offers the following benefits:

- Log entries have a standard format. To display the current structure of the log tables, use these statements:

```
SHOW CREATE TABLE mysql.general_log;
SHOW CREATE TABLE mysql.slow_log;
```

- Log contents are accessible through SQL statements. This enables the use of queries that select only those log entries that satisfy specific criteria. For example, to select log contents associated with a particular client (which can be useful for identifying problematic queries from that client), it is easier to do this using a log table than a log file.
- Logs are accessible remotely through any client that can connect to the server and issue queries (if the client has the appropriate log table privileges). It is not necessary to log in to the server host and directly access the file system.

The log table implementation has the following characteristics:

- In general, the primary purpose of log tables is to provide an interface for users to observe the runtime execution of the server, not to interfere with its runtime execution.
- `CREATE TABLE`, `ALTER TABLE`, and `DROP TABLE` are valid operations on a log table. For `ALTER TABLE` and `DROP TABLE`, the log table cannot be in use and must be disabled, as described later.
- By default, the log tables use the `CSV` storage engine that writes data in comma-separated values format. For users who have access to the `.CSV` files that contain log table data, the files are easy to import into other programs such as spreadsheets that can process CSV input.

The log tables can be altered to use the `MyISAM` storage engine. You cannot use `ALTER TABLE` to alter a log table that is in use. The log must be disabled first. No engines other than `CSV` or `MyISAM` are legal for the log tables.

### Log Tables and “Too many open files” Errors.

If you select `TABLE` as a log destination and the log tables use the `CSV` storage engine, you may find that disabling and enabling the general query log or slow query log repeatedly at runtime results in a number of open file descriptors for the `.CSV` file, possibly resulting in a “Too many open files” error. To work around this issue, execute `FLUSH TABLES` or ensure that the value of `open_files_limit` is greater than the value of `table_open_cache_instances`.

- To disable logging so that you can alter (or drop) a log table, you can use the following strategy. The example uses the general query log; the procedure for the slow query log is similar but uses the `slow_log` table and `slow_query_log` system variable.

```
SET @old_log_state = @@GLOBAL.general_log;
SET GLOBAL general_log = 'OFF';
ALTER TABLE mysql.general_log ENGINE = MyISAM;
SET GLOBAL general_log = @old_log_state;
```

- `TRUNCATE TABLE` is a valid operation on a log table. It can be used to expire log entries.
- `RENAME TABLE` is a valid operation on a log table. You can atomically rename a log table (to perform log rotation, for example) using the following strategy:

```
USE mysql;
DROP TABLE IF EXISTS general_log2;
CREATE TABLE general_log2 LIKE general_log;
RENAME TABLE general_log TO general_log_backup, general_log2 TO general_log;
```

- `CHECK TABLE` is a valid operation on a log table.
- `LOCK TABLES` cannot be used on a log table.
- `INSERT`, `DELETE`, and `UPDATE` cannot be used on a log table. These operations are permitted only internally to the server itself.
- `FLUSH TABLES WITH READ LOCK` and the state of the `read_only` system variable have no effect on log tables. The server can always write to the log tables.
- Entries written to the log tables are not written to the binary log and thus are not replicated to replicas.
- To flush the log tables or log files, use `FLUSH TABLES` or `FLUSH LOGS`, respectively.
- Partitioning of log tables is not permitted.
- A `mysqldump` dump includes statements to recreate those tables so that they are not missing after reloading the dump file. Log table contents are not dumped.

## 5.4.2 The Error Log

This section discusses how to configure the MySQL server for logging of diagnostic messages to the error log. For information about selecting the error message character set and language, see [Section 10.6, “Error Message Character Set”](#), and [Section 10.12, “Setting the Error Message Language”](#).

The error log contains a record of `mysqld` startup and shutdown times. It also contains diagnostic messages such as errors, warnings, and notes that occur during server startup and shutdown, and while the server is running. For example, if `mysqld` notices that a table needs to be automatically checked or repaired, it writes a message to the error log.

On some operating systems, the error log contains a stack trace if `mysqld` exits abnormally. The trace can be used to determine where `mysqld` exited. See [Section 5.8, “Debugging MySQL”](#).

If used to start `mysqld`, `mysqld_safe` may write messages to the error log. For example, when `mysqld_safe` notices abnormal `mysqld` exits, it restarts `mysqld` and writes a `mysqld restarted` message to the error log.

The following sections discuss aspects of configuring error logging. In the discussion, “console” means `stderr`, the standard error output. This is your terminal or console window unless the standard error output has been redirected to a different destination.

The server interprets options that determine where to write error messages somewhat differently for Windows and Unix systems. Be sure to configure error logging using the information appropriate to your platform.

### 5.4.2.1 Error Logging on Windows

On Windows, `mysqld` uses the `--log-error`, `--pid-file`, and `--console` options to determine whether `mysqld` writes the error log to the console or a file, and, if to a file, the file name:

- If `--console` is given, `mysqld` writes the error log to the console. (`--console` takes precedence over `--log-error` if both are given, and the following items regarding `--log-error` do not apply. Prior to MySQL 5.7, this is reversed: `--log-error` takes precedence over `--console`.)
- If `--log-error` is not given, or is given without naming a file, `mysqld` writes the error log to a file named `host_name.err` in the data directory, unless the `--pid-file` option is specified. In that case, the file name is the PID file base name with a suffix of `.err` in the data directory.
- If `--log-error` is given to name a file, `mysqld` writes the error log to that file (with an `.err` suffix added if the name has no suffix). The file location is under the data directory unless an absolute path name is given to specify a different location.

If the server writes the error log to the console, it sets the `log_error` system variable to `stderr`. Otherwise, the server writes the error log to a file and sets `log_error` to the file name.

In addition, the server by default writes events and error messages to the Windows Event Log within the Application log:

- Entries marked as `Error`, `Warning`, and `Note` are written to the Event Log, but not messages such as information statements from individual storage engines.
- Event Log entries have a source of `MySQL`.
- Information written to the Event Log is controlled using the `log_syslog` system variable, which on Windows is enabled by default. See [Section 5.4.2.3, “Error Logging to the System Log”](#).

### 5.4.2.2 Error Logging on Unix and Unix-Like Systems

On Unix and Unix-like systems, `mysqld` uses the `--log-error` option to determine whether `mysqld` writes the error log to the console or a file, and, if to a file, the file name:

- If `--log-error` is not given, `mysqld` writes the error log to the console.
- If `--log-error` is given without naming a file, `mysqld` writes the error log to a file named `host_name.err` in the data directory.
- If `--log-error` is given to name a file, `mysqld` writes the error log to that file (with an `.err` suffix added if the name has no suffix). The file location is under the data directory unless an absolute path name is given to specify a different location.
- If `--log-error` is given in an option file in a `[mysqld]`, `[server]`, or `[mysqld_safe]` section, on systems that use `mysqld_safe` to start the server, `mysqld_safe` finds and uses the option, and passes it to `mysqld`.



#### Note

It is common for Yum or APT package installations to configure an error log file location under `/var/log` with an option like `log-error=/var/log/mysqld.log` in a server configuration file. Removing the path name from the option causes the `host_name.err` file in the data directory to be used.

If the server writes the error log to the console, it sets the `log_error` system variable to `stderr`. Otherwise, the server writes the error log to a file and sets `log_error` to the file name.

### 5.4.2.3 Error Logging to the System Log

It is possible to have `mysqld` write the error log to the system log (the Event Log on Windows, and `syslog` on Unix and Unix-like systems). To do so, use these system variables:

- `log_syslog`: Enable this variable to send the error log to the system log. (On Windows, `log_syslog` is enabled by default.)

If `log_syslog` is enabled, the following system variables can also be used for finer control.

- `log_syslog_facility`: The default facility for `syslog` messages is `daemon`. Set this variable to specify a different facility.
- `log_syslog_include_pid`: Whether to include the server process ID in each line of `syslog` output.
- `log_syslog_tag`: This variable defines a tag to add to the server identifier (`mysqld`) in `syslog` messages. If defined, the tag is appended to the identifier with a leading hyphen.



#### Note

Error logging to the system log may require additional system configuration. Consult the system log documentation for your platform.

On Unix and Unix-like systems, control of output to `syslog` is also available using `mysqld_safe`, which can capture server error output and pass it to `syslog`.



#### Note

Using `mysqld_safe` for `syslog` error logging is deprecated; you should use the server system variables instead.

`mysqld_safe` has three error-logging options, `--syslog`, `--skip-syslog`, and `--log-error`. The default with no logging options or with `--skip-syslog` is to use the default log file. To explicitly specify use of an error log file, specify `--log-error=file_name` to `mysqld_safe`, which then arranges for `mysqld` to write messages to a log file. To use `syslog`, specify the `--syslog` option. For `syslog` output, a tag can be specified with `--syslog-tag=tag_val`; this is appended to the `mysqld` server identifier with a leading hyphen.

#### 5.4.2.4 Error Log Filtering

The `log_error_verbosity` system variable controls server verbosity for writing error, warning, and note messages to the error log. Permitted values are 1 (errors only), 2 (errors and warnings), 3 (errors, warnings, and notes), with a default of 3. If the value is greater than 2, the server logs aborted connections and access-denied errors for new connection attempts. See [Section B.3.2.9, “Communication Errors and Aborted Connections”](#).

#### 5.4.2.5 Error Log Output Format

The ID included in error log messages is that of the thread within `mysqld` responsible for writing the message. This indicates which part of the server produced the message, and is consistent with general query log and slow query log messages, which include the connection thread ID.

The `log_timestamps` system variable controls the time zone of timestamps in messages written to the error log (as well as to general query log and slow query log files).

Permitted `log_timestamps` values are `UTC` (the default) and `SYSTEM` (the local system time zone). Timestamps are written using ISO 8601 / RFC 3339 format: `YYYY-MM-DDThh:mm:ss.uuuuuu` plus a tail value of `Z` signifying Zulu time (UTC) or `+hh:mm` (an offset that indicates the local system time zone adjustment relative to UTC). For example:

```
2020-08-07T15:02:00.832521Z          (UTC)
2020-08-07T10:02:00.832521-05:00   (SYSTEM)
```

#### 5.4.2.6 Error Log File Flushing and Renaming

If you flush the error log using a `FLUSH ERROR LOGS` or `FLUSH LOGS` statement, or a `mysqladmin flush-logs` command, the server closes and reopens any error log file to which it is writing. To rename an error log file, do so manually before flushing. Flushing the logs then opens a new file with the original file name. For example, assuming a log file name of `host_name.err`, use the following commands to rename the file and create a new one:

```
mv host_name.err host_name.err-old
mysqladmin flush-logs error
mv host_name.err-old backup-directory
```

On Windows, use `rename` rather than `mv`.

If the location of the error log file is not writable by the server, the log-flushing operation fails to create a new log file. For example, on Linux, the server might write the error log to the `/var/log/mysqld.log` file, where the `/var/log` directory is owned by `root` and is not writable by `mysqld`. For information about handling this case, see [Section 5.4.7, “Server Log Maintenance”](#).

If the server is not writing to a named error log file, no error log file renaming occurs when the error log is flushed.

### 5.4.3 The General Query Log

The general query log is a general record of what `mysqld` is doing. The server writes information to this log when clients connect or disconnect, and it logs each SQL statement received from clients. The general

query log can be very useful when you suspect an error in a client and want to know exactly what the client sent to `mysqld`.

Each line that shows when a client connects also includes `using connection_type` to indicate the protocol used to establish the connection. `connection_type` is one of `TCP/IP` (TCP/IP connection established without SSL), `SSL/TLS` (TCP/IP connection established with SSL), `Socket` (Unix socket file connection), `Named Pipe` (Windows named pipe connection), or `Shared Memory` (Windows shared memory connection).

`mysqld` writes statements to the query log in the order that it receives them, which might differ from the order in which they are executed. This logging order is in contrast with that of the binary log, for which statements are written after they are executed but before any locks are released. In addition, the query log may contain statements that only select data while such statements are never written to the binary log.

When using statement-based binary logging on a replication source server, statements received by its replicas are written to the query log of each replica. Statements are written to the query log of the source if a client reads events with the `mysqlbinlog` utility and passes them to the server.

However, when using row-based binary logging, updates are sent as row changes rather than SQL statements, and thus these statements are never written to the query log when `binlog_format` is `ROW`. A given update also might not be written to the query log when this variable is set to `MIXED`, depending on the statement used. See [Section 16.2.1.1, “Advantages and Disadvantages of Statement-Based and Row-Based Replication”](#), for more information.

By default, the general query log is disabled. To specify the initial general query log state explicitly, use `--general_log[={0|1}]`. With no argument or an argument of 1, `--general_log` enables the log. With an argument of 0, this option disables the log. To specify a log file name, use `--general_log_file=file_name`. To specify the log destination, use the `log_output` system variable (as described in [Section 5.4.1, “Selecting General Query Log and Slow Query Log Output Destinations”](#)).



#### Note

If you specify the `TABLE` log destination, see [Log Tables and “Too many open files” Errors](#).

If you specify no name for the general query log file, the default name is `host_name.log`. The server creates the file in the data directory unless an absolute path name is given to specify a different directory.

To disable or enable the general query log or change the log file name at runtime, use the global `general_log` and `general_log_file` system variables. Set `general_log` to 0 (or `OFF`) to disable the log or to 1 (or `ON`) to enable it. Set `general_log_file` to specify the name of the log file. If a log file already is open, it is closed and the new file is opened.

When the general query log is enabled, the server writes output to any destinations specified by the `log_output` system variable. If you enable the log, the server opens the log file and writes startup messages to it. However, further logging of queries to the file does not occur unless the `FILE` log destination is selected. If the destination is `NONE`, the server writes no queries even if the general log is enabled. Setting the log file name has no effect on logging if the log destination value does not contain `FILE`.

Server restarts and log flushing do not cause a new general query log file to be generated (although flushing closes and reopens it). To rename the file and create a new one, use the following commands:

```
$> mv host_name.log host_name-old.log
$> mysqladmin flush-logs general
$> mv host_name-old.log backup-directory
```

On Windows, use `rename` rather than `mv`.

You can also rename the general query log file at runtime by disabling the log:

```
SET GLOBAL general_log = 'OFF';
```

With the log disabled, rename the log file externally (for example, from the command line). Then enable the log again:

```
SET GLOBAL general_log = 'ON';
```

This method works on any platform and does not require a server restart.

To disable or enable general query logging for the current session, set the session `sql_log_off` variable to `ON` or `OFF`. (This assumes that the general query log itself is enabled.)

Passwords in statements written to the general query log are rewritten by the server not to occur literally in plain text. Password rewriting can be suppressed for the general query log by starting the server with the `--log-raw` option. This option may be useful for diagnostic purposes, to see the exact text of statements as received by the server, but for security reasons is not recommended for production use. See also [Section 6.1.2.3, “Passwords and Logging”](#).

An implication of password rewriting is that statements that cannot be parsed (due, for example, to syntax errors) are not written to the general query log because they cannot be known to be password free. Use cases that require logging of all statements including those with errors should use the `--log-raw` option, bearing in mind that this also bypasses password rewriting.

Password rewriting occurs only when plain text passwords are expected. For statements with syntax that expect a password hash value, no rewriting occurs. If a plain text password is supplied erroneously for such syntax, the password is logged as given, without rewriting. For example, the following statement is logged as shown because a password hash value is expected:

```
CREATE USER 'user1'@'localhost' IDENTIFIED BY PASSWORD 'not-so-secret';
```

The `log_timestamps` system variable controls the time zone of timestamps in messages written to the general query log file (as well as to the slow query log file and the error log). It does not affect the time zone of general query log and slow query log messages written to log tables, but rows retrieved from those tables can be converted from the local system time zone to any desired time zone with `CONVERT_TZ()` or by setting the session `time_zone` system variable.

## 5.4.4 The Binary Log

The binary log contains “events” that describe database changes such as table creation operations or changes to table data. It also contains events for statements that potentially could have made changes (for example, a `DELETE` which matched no rows), unless row-based logging is used. The binary log also contains information about how long each statement took that updated data. The binary log has two important purposes:

- For replication, the binary log on a replication source server provides a record of the data changes to be sent to replicas. The source sends the events contained in its binary log to its replicas, which execute those events to make the same data changes that were made on the source. See [Section 16.2, “Replication Implementation”](#).
- Certain data recovery operations require use of the binary log. After a backup has been restored, the events in the binary log that were recorded after the backup was made are re-executed. These events bring databases up to date from the point of the backup. See [Section 7.5, “Point-in-Time \(Incremental\) Recovery”](#).



The binary log is not used for statements such as `SELECT` or `SHOW` that do not modify data. To log all statements (for example, to identify a problem query), use the general query log. See [Section 5.4.3, “The General Query Log”](#).

Running a server with binary logging enabled makes performance slightly slower. However, the benefits of the binary log in enabling you to set up replication and for restore operations generally outweigh this minor performance decrement.

The binary log is generally resilient to unexpected halts because only complete transactions are logged or read back. See [Section 16.3.2, “Handling an Unexpected Halt of a Replica”](#) for more information.

Passwords in statements written to the binary log are rewritten by the server not to occur literally in plain text. See also [Section 6.1.2.3, “Passwords and Logging”](#).

The following discussion describes some of the server options and variables that affect the operation of binary logging. For a complete list, see [Section 16.1.6.4, “Binary Logging Options and Variables”](#).

To enable the binary log, start the server with the `--log-bin[=base_name]` option. If no *base\_name* value is given, the default name is the value of the `--pid-file` option (which by default is the name of host machine) followed by `-bin`. If the base name is given, the server writes the file in the data directory unless the base name is given with a leading absolute path name to specify a different directory. It is recommended that you specify a base name explicitly rather than using the default of the host name; see [Section B.3.7, “Known Issues in MySQL”](#), for the reason.

If you supply an extension in the log name (for example, `--log-bin=base_name.extension`), the extension is silently removed and ignored.

`mysqld` appends a numeric extension to the binary log base name to generate binary log file names. The number increases each time the server creates a new log file, thus creating an ordered series of files. The server creates a new file in the series each time any of the following events occurs:

- The server is started or restarted
- The server flushes the logs.
- The size of the current log file reaches `max_binlog_size`.

A binary log file may become larger than `max_binlog_size` if you are using large transactions because a transaction is written to the file in one piece, never split between files.

To keep track of which binary log files have been used, `mysqld` also creates a binary log index file that contains the names of the binary log files. By default, this has the same base name as the binary log file, with the extension `'.index'`. You can change the name of the binary log index file with the `--log-bin-index[=file_name]` option. You should not manually edit this file while `mysqld` is running; doing so would confuse `mysqld`.

The term “binary log file” generally denotes an individual numbered file containing database events. The term “binary log” collectively denotes the set of numbered binary log files plus the index file.

A client that has privileges sufficient to set restricted session system variables (see [Section 5.1.8.1, “System Variable Privileges”](#)) can disable binary logging of its own statements by using a `SET sql_log_bin=OFF` statement.

By default, the server logs the length of the event as well as the event itself and uses this to verify that the event was written correctly. You can also cause the server to write checksums for the events by setting the `binlog_checksum` system variable. When reading back from the binary log, the source uses the event length by default, but can be made to use checksums if available by enabling the

`master_verify_checksum` system variable. The replication I/O thread also verifies events received from the source. You can cause the replication SQL thread to use checksums if available when reading from the relay log by enabling the `slave_sql_verify_checksum` system variable.

The format of the events recorded in the binary log is dependent on the binary logging format. Three format types are supported, row-based logging, statement-based logging and mixed-base logging. The binary logging format used depends on the MySQL version. For general descriptions of the logging formats, see [Section 5.4.4.1, “Binary Logging Formats”](#). For detailed information about the format of the binary log, see [MySQL Internals: The Binary Log](#).

The server evaluates the `--binlog-do-db` and `--binlog-ignore-db` options in the same way as it does the `--replicate-do-db` and `--replicate-ignore-db` options. For information about how this is done, see [Section 16.2.5.1, “Evaluation of Database-Level Replication and Binary Logging Options”](#).

A replica by default does not write to its own binary log any data modifications that are received from the source. To log these modifications, start the replica with the `--log-slave-updates` option in addition to the `--log-bin` option (see [Section 16.1.6.3, “Replica Server Options and Variables”](#)). This is done when a replica is also to act as a source to other replicas in chained replication.

You can delete all binary log files with the `RESET MASTER` statement, or a subset of them with `PURGE BINARY LOGS`. See [Section 13.7.6.6, “RESET Statement”](#), and [Section 13.4.1.1, “PURGE BINARY LOGS Statement”](#).

If you are using replication, you should not delete old binary log files on the source until you are sure that no replica still needs to use them. For example, if your replicas never run more than three days behind, once a day you can execute `mysqladmin flush-logs binary` on the source and then remove any logs that are more than three days old. You can remove the files manually, but it is preferable to use `PURGE BINARY LOGS`, which also safely updates the binary log index file for you (and which can take a date argument). See [Section 13.4.1.1, “PURGE BINARY LOGS Statement”](#).

You can display the contents of binary log files with the `mysqlbinlog` utility. This can be useful when you want to reprocess statements in the log for a recovery operation. For example, you can update a MySQL server from the binary log as follows:

```
$> mysqlbinlog log_file | mysql -h server_name
```

`mysqlbinlog` also can be used to display relay log file contents because they are written using the same format as binary log files. For more information on the `mysqlbinlog` utility and how to use it, see [Section 4.6.7, “mysqlbinlog — Utility for Processing Binary Log Files”](#). For more information about the binary log and recovery operations, see [Section 7.5, “Point-in-Time \(Incremental\) Recovery”](#).

Binary logging is done immediately after a statement or transaction completes but before any locks are released or any commit is done. This ensures that the log is logged in commit order.

Updates to nontransactional tables are stored in the binary log immediately after execution.

Within an uncommitted transaction, all updates (`UPDATE`, `DELETE`, or `INSERT`) that change transactional tables such as `InnoDB` tables are cached until a `COMMIT` statement is received by the server. At that point, `mysqld` writes the entire transaction to the binary log before the `COMMIT` is executed.

Modifications to nontransactional tables cannot be rolled back. If a transaction that is rolled back includes modifications to nontransactional tables, the entire transaction is logged with a `ROLLBACK` statement at the end to ensure that the modifications to those tables are replicated.

When a thread that handles the transaction starts, it allocates a buffer of `binlog_cache_size` to buffer statements. If a statement is bigger than this, the thread opens a temporary file to store the transaction. The temporary file is deleted when the thread ends.

The `Binlog_cache_use` status variable shows the number of transactions that used this buffer (and possibly a temporary file) for storing statements. The `Binlog_cache_disk_use` status variable shows how many of those transactions actually had to use a temporary file. These two variables can be used for tuning `binlog_cache_size` to a large enough value that avoids the use of temporary files.

The `max_binlog_cache_size` system variable (default 4GB, which is also the maximum) can be used to restrict the total size used to cache a multiple-statement transaction. If a transaction is larger than this many bytes, it fails and rolls back. The minimum value is 4096.

If you are using the binary log and row based logging, concurrent inserts are converted to normal inserts for `CREATE ... SELECT` or `INSERT ... SELECT` statements. This is done to ensure that you can re-create an exact copy of your tables by applying the log during a backup operation. If you are using statement-based logging, the original statement is written to the log.

The binary log format has some known limitations that can affect recovery from backups. See [Section 16.4.1, “Replication Features and Issues”](#).

Binary logging for stored programs is done as described in [Section 23.7, “Stored Program Binary Logging”](#).

Note that the binary log format differs in MySQL 5.7 from previous versions of MySQL, due to enhancements in replication. See [Section 16.4.2, “Replication Compatibility Between MySQL Versions”](#).

If the server is unable to write to the binary log, flush binary log files, or synchronize the binary log to disk, the binary log on the source can become inconsistent and replicas can lose synchronization with the source. The `binlog_error_action` system variable controls the action taken if an error of this type is encountered with the binary log.

- The default setting, `ABORT_SERVER`, makes the server halt binary logging and shut down. At this point, you can identify and correct the cause of the error. On restart, recovery proceeds as in the case of an unexpected server halt (see [Section 16.3.2, “Handling an Unexpected Halt of a Replica”](#)).
- The setting `IGNORE_ERROR` provides backward compatibility with older versions of MySQL. With this setting, the server continues the ongoing transaction and logs the error, then halts binary logging, but continues to perform updates. At this point, you can identify and correct the cause of the error. To resume binary logging, `log_bin` must be enabled again, which requires a server restart. Only use this option if you require backward compatibility, and the binary log is non-essential on this MySQL server instance. For example, you might use the binary log only for intermittent auditing or debugging of the server, and not use it for replication from the server or rely on it for point-in-time restore operations.

By default, the binary log is synchronized to disk at each write (`sync_binlog=1`). If `sync_binlog` was not enabled, and the operating system or machine (not only the MySQL server) crashed, there is a chance that the last statements of the binary log could be lost. To prevent this, enable the `sync_binlog` system variable to synchronize the binary log to disk after every *N* commit groups. See [Section 5.1.7, “Server System Variables”](#). The safest value for `sync_binlog` is 1 (the default), but this is also the slowest.

For example, if you are using `InnoDB` tables and the MySQL server processes a `COMMIT` statement, it writes many prepared transactions to the binary log in sequence, synchronizes the binary log, and then commits this transaction into `InnoDB`. If the server unexpectedly exits between those two operations, the transaction is rolled back by `InnoDB` at restart but still exists in the binary log. Such an issue is resolved assuming `--innodb_support_xa` is set to 1, the default. Although this option is related to the support of XA transactions in `InnoDB`, it also ensures that the binary log and `InnoDB` data files are synchronized. For this option to provide a greater degree of safety, the MySQL server should also be configured to synchronize the binary log and the `InnoDB` logs to disk before committing the transaction. The `InnoDB` logs are synchronized by default, and `sync_binlog=1` can be used to synchronize the binary log. The effect of this option is that at restart after a crash, after doing a rollback of transactions, the MySQL server scans the latest binary log file to collect transaction `xid` values and calculate the last valid position in the binary log file. The MySQL server then tells `InnoDB` to complete any prepared transactions that were

successfully written to the to the binary log, and truncates the binary log to the last valid position. This ensures that the binary log reflects the exact data of `InnoDB` tables, and therefore the replica remains in synchrony with the source because it does not receive a statement which has been rolled back.



#### Note

`innodb_support_xa` is deprecated; expect it to be removed in a future release. `InnoDB` support for two-phase commit in XA transactions is always enabled as of MySQL 5.7.10.

If the MySQL server discovers at crash recovery that the binary log is shorter than it should have been, it lacks at least one successfully committed `InnoDB` transaction. This should not happen if `sync_binlog=1` and the disk/file system do an actual sync when they are requested to (some do not), so the server prints an error message `The binary log file_name is shorter than its expected size`. In this case, this binary log is not correct and replication should be restarted from a fresh snapshot of the source's data.

The session values of the following system variables are written to the binary log and honored by the replica when parsing the binary log:

- `sql_mode` (except that the `NO_DIR_IN_CREATE` mode is not replicated; see [Section 16.4.1.37](#), “Replication and Variables”)
- `foreign_key_checks`
- `unique_checks`
- `character_set_client`
- `collation_connection`
- `collation_database`
- `collation_server`
- `sql_auto_is_null`

### 5.4.4.1 Binary Logging Formats

The server uses several logging formats to record information in the binary log. The exact format employed depends on the version of MySQL being used. There are three logging formats:

- Replication capabilities in MySQL originally were based on propagation of SQL statements from source to replica. This is called *statement-based logging*. You can cause this format to be used by starting the server with `--binlog-format=STATEMENT`.
- In *row-based logging*, the source writes events to the binary log that indicate how individual table rows are affected. It is important therefore that tables always use a primary key to ensure rows can be efficiently identified. You can cause the server to use row-based logging by starting it with `--binlog-format=ROW`.
- A third option is also available: *mixed logging*. With mixed logging, statement-based logging is used by default, but the logging mode switches automatically to row-based in certain cases as described below. You can cause MySQL to use mixed logging explicitly by starting `mysqld` with the option `--binlog-format=MIXED`.

The logging format can also be set or limited by the storage engine being used. This helps to eliminate issues when replicating certain statements between a source and replica which are using different storage engines.

With statement-based replication, there may be issues with replicating nondeterministic statements. In deciding whether or not a given statement is safe for statement-based replication, MySQL determines whether it can guarantee that the statement can be replicated using statement-based logging. If MySQL cannot make this guarantee, it marks the statement as potentially unreliable and issues the warning, `Statement may not be safe to log in statement format`.

You can avoid these issues by using MySQL's row-based replication instead.

#### 5.4.4.2 Setting The Binary Log Format

You can select the binary logging format explicitly by starting the MySQL server with `--binlog-format=type`. The supported values for `type` are:

- `STATEMENT` causes logging to be statement based.
- `ROW` causes logging to be row based.
- `MIXED` causes logging to use mixed format.

Setting the binary logging format does not activate binary logging for the server. The setting only takes effect when binary logging is enabled on the server, which is the case when the `log_bin` system variable is set to `ON`. In MySQL 5.7, binary logging is not enabled by default, and you enable it using the `--log-bin` option.

The logging format also can be switched at runtime, although note that there are a number of situations in which you cannot do this, as discussed later in this section. Set the global value of the `binlog_format` system variable to specify the format for clients that connect subsequent to the change:

```
mysql> SET GLOBAL binlog_format = 'STATEMENT';
mysql> SET GLOBAL binlog_format = 'ROW';
mysql> SET GLOBAL binlog_format = 'MIXED';
```

An individual client can control the logging format for its own statements by setting the session value of `binlog_format`:

```
mysql> SET SESSION binlog_format = 'STATEMENT';
mysql> SET SESSION binlog_format = 'ROW';
mysql> SET SESSION binlog_format = 'MIXED';
```

Changing the global `binlog_format` value requires privileges sufficient to set global system variables. Changing the session `binlog_format` value requires privileges sufficient to set restricted session system variables. See [Section 5.1.8.1, “System Variable Privileges”](#).

There are several reasons why a client might want to set binary logging on a per-session basis:

- A session that makes many small changes to the database might want to use row-based logging.
- A session that performs updates that match many rows in the `WHERE` clause might want to use statement-based logging because it is more efficient to log a few statements than many rows.
- Some statements require a lot of execution time on the source, but result in just a few rows being modified. It might therefore be beneficial to replicate them using row-based logging.

There are exceptions when you cannot switch the replication format at runtime:

- From within a stored function or a trigger.
- If the `NDB` storage engine is enabled.
- If the session is currently in row-based replication mode and has open temporary tables.

Trying to switch the format in any of these cases results in an error.

Switching the replication format at runtime is not recommended when any temporary tables exist, because temporary tables are logged only when using statement-based replication, whereas with row-based replication they are not logged. With mixed replication, temporary tables are usually logged; exceptions happen with loadable functions and with the `UUID()` function.

Switching the replication format while replication is ongoing can also cause issues. Each MySQL Server can set its own and only its own binary logging format (true whether `binlog_format` is set with global or session scope). This means that changing the logging format on a replication source server does not cause a replica to change its logging format to match. When using `STATEMENT` mode, the `binlog_format` system variable is not replicated. When using `MIXED` or `ROW` logging mode, it is replicated but is ignored by the replica.

A replica is not able to convert binary log entries received in `ROW` logging format to `STATEMENT` format for use in its own binary log. The replica must therefore use `ROW` or `MIXED` format if the source does. Changing the binary logging format on the source from `STATEMENT` to `ROW` or `MIXED` while replication is ongoing to a replica with `STATEMENT` format can cause replication to fail with errors such as `Error executing row event: 'Cannot execute statement: impossible to write to binary log since statement is in row format and BINLOG_FORMAT = STATEMENT.'` Changing the binary logging format on the replica to `STATEMENT` format when the source is still using `MIXED` or `ROW` format also causes the same type of replication failure. To change the format safely, you must stop replication and ensure that the same change is made on both the source and the replica.

If you are using `InnoDB` tables and the transaction isolation level is `READ COMMITTED` or `READ UNCOMMITTED`, only row-based logging can be used. It is *possible* to change the logging format to `STATEMENT`, but doing so at runtime leads very rapidly to errors because `InnoDB` can no longer perform inserts.

With the binary log format set to `ROW`, many changes are written to the binary log using the row-based format. Some changes, however, still use the statement-based format. Examples include all DDL (data definition language) statements such as `CREATE TABLE`, `ALTER TABLE`, or `DROP TABLE`.

The `--binlog-row-event-max-size` option is available for servers that are capable of row-based replication. Rows are stored into the binary log in chunks having a size in bytes not exceeding the value of this option. The value must be a multiple of 256. The default value is 8192.



### Warning

When using *statement-based logging* for replication, it is possible for the data on the source and replica to become different if a statement is designed in such a way that the data modification is *nondeterministic*; that is, it is left to the will of the query optimizer. In general, this is not a good practice even outside of replication. For a detailed explanation of this issue, see [Section B.3.7, “Known Issues in MySQL”](#).

#### 5.4.4.3 Mixed Binary Logging Format

When running in `MIXED` logging format, the server automatically switches from statement-based to row-based logging under the following conditions:

- When a DML statement updates an `NDBCLUSTER` table.
- When a function contains `UUID()`.
- When one or more tables with `AUTO_INCREMENT` columns are updated and a trigger or stored function is invoked. Like all other unsafe statements, this generates a warning if `binlog_format = STATEMENT`.

For more information, see [Section 16.4.1.1, “Replication and AUTO\\_INCREMENT”](#).

- When the body of a view requires row-based replication, the statement creating the view also uses it. For example, this occurs when the statement creating a view uses the `UUID()` function.
- When a call to a loadable function is involved.
- If a statement is logged by row and the session that executed the statement has any temporary tables, logging by row is used for all subsequent statements (except for those accessing temporary tables) until all temporary tables in use by that session are dropped.

This is true whether or not any temporary tables are actually logged.

Temporary tables cannot be logged using row-based format; thus, once row-based logging is used, all subsequent statements using that table are unsafe. The server approximates this condition by treating all statements executed during the session as unsafe until the session no longer holds any temporary tables.

- When `FOUND_ROWS()` or `ROW_COUNT()` is used. (Bug #12092, Bug #30244)
- When `USER()`, `CURRENT_USER()`, or `CURRENT_USER` is used. (Bug #28086)
- When a statement refers to one or more system variables. (Bug #31168)

**Exception.** The following system variables, when used with session scope (only), do not cause the logging format to switch:

- `auto_increment_increment`
- `auto_increment_offset`
- `character_set_client`
- `character_set_connection`
- `character_set_database`
- `character_set_server`
- `collation_connection`
- `collation_database`
- `collation_server`
- `foreign_key_checks`
- `identity`
- `last_insert_id`
- `lc_time_names`
- `pseudo_thread_id`
- `sql_auto_is_null`
- `time_zone`

- `timestamp`
- `unique_checks`

For information about determining system variable scope, see [Section 5.1.8, “Using System Variables”](#).

For information about how replication treats `sql_mode`, see [Section 16.4.1.37, “Replication and Variables”](#).

- When one of the tables involved is a log table in the `mysql` database.
- When the `LOAD_FILE()` function is used. (Bug #39701)



**Note**

A warning is generated if you try to execute a statement using statement-based logging that should be written using row-based logging. The warning is shown both in the client (in the output of `SHOW WARNINGS`) and through the `mysqld` error log. A warning is added to the `SHOW WARNINGS` table each time such a statement is executed. However, only the first statement that generated the warning for each client session is written to the error log to prevent flooding the log.

In addition to the decisions above, individual engines can also determine the logging format used when information in a table is updated. The logging capabilities of an individual engine can be defined as follows:

- If an engine supports row-based logging, the engine is said to be *row-logging capable*.
- If an engine supports statement-based logging, the engine is said to be *statement-logging capable*.

A given storage engine can support either or both logging formats. The following table lists the formats supported by each engine.

Storage Engine	Row Logging Supported	Statement Logging Supported
<code>ARCHIVE</code>	Yes	Yes
<code>BLACKHOLE</code>	Yes	Yes
<code>CSV</code>	Yes	Yes
<code>EXAMPLE</code>	Yes	No
<code>FEDERATED</code>	Yes	Yes
<code>HEAP</code>	Yes	Yes
<code>InnoDB</code>	Yes	Yes when the transaction isolation level is <code>REPEATABLE READ</code> or <code>SERIALIZABLE</code> ; No otherwise.
<code>MyISAM</code>	Yes	Yes
<code>MERGE</code>	Yes	Yes
<code>NDB</code>	Yes	No

Whether a statement is to be logged and the logging mode to be used is determined according to the type of statement (safe, unsafe, or binary injected), the binary logging format (`STATEMENT`, `ROW`, or `MIXED`), and the logging capabilities of the storage engine (statement capable, row capable, both, or neither). (Binary injection refers to logging a change that must be logged using `ROW` format.)

Statements may be logged with or without a warning; failed statements are not logged, but generate errors in the log. This is shown in the following decision table. **Type**, **binlog\_format**, **SLC**, and **RLC** columns



outline the conditions, and **Error / Warning** and **Logged as** columns represent the corresponding actions. **SLC** stands for “statement-logging capable”, and **RLC** stands for “row-logging capable”.

Type	binlog_format	SLC	RLC	Error / Warning	Logged as
*	*	No	No	Error: Cannot execute statement: Binary logging is impossible since at least one engine is involved that is both row-incapable and statement-incapable.	-
Safe	STATEMENT	Yes	No	-	STATEMENT
Safe	MIXED	Yes	No	-	STATEMENT
Safe	ROW	Yes	No	Error: Cannot execute statement: Binary logging is impossible since BINLOG_FORMAT = ROW and at least one table uses a storage engine that is not capable of row-based logging.	-
Unsafe	STATEMENT	Yes	No	Warning: Unsafe statement binlogged in statement format, since BINLOG_FORMAT = STATEMENT	STATEMENT
Unsafe	MIXED	Yes	No	Error: Cannot execute statement: Binary logging of an unsafe statement is impossible when the storage engine is limited to	-

Type	binlog_format	SLC	RLC	Error / Warning	Logged as
				statement-based logging, even if <code>BINLOG_FORMAT = MIXED</code> .	
Unsafe	ROW	Yes	No	<code>Error: Cannot execute statement: Binary logging is impossible since <code>BINLOG_FORMAT = ROW</code> and at least one table uses a storage engine that is not capable of row-based logging.</code>	-
Row Injection	STATEMENT	Yes	No	<code>Error: Cannot execute row injection: Binary logging is not possible since at least one table uses a storage engine that is not capable of row-based logging.</code>	-
Row Injection	MIXED	Yes	No	<code>Error: Cannot execute row injection: Binary logging is not possible since at least one table uses a storage engine that is not capable of row-based logging.</code>	-
Row Injection	ROW	Yes	No	<code>Error: Cannot execute row injection: Binary logging is not possible since at least one table uses a storage engine</code>	-

Type	binlog_format	SLC	RLC	Error / Warning	Logged as
				that is not capable of row-based logging.	
Safe	STATEMENT	No	Yes	Error: Cannot execute statement: Binary logging is impossible since BINLOG_FORMAT = STATEMENT and at least one table uses a storage engine that is not capable of statement-based logging.	-
Safe	MIXED	No	Yes	-	ROW
Safe	ROW	No	Yes	-	ROW
Unsafe	STATEMENT	No	Yes	Error: Cannot execute statement: Binary logging is impossible since BINLOG_FORMAT = STATEMENT and at least one table uses a storage engine that is not capable of statement-based logging.	-
Unsafe	MIXED	No	Yes	-	ROW
Unsafe	ROW	No	Yes	-	ROW
Row Injection	STATEMENT	No	Yes	Error: Cannot execute row injection: Binary logging is not possible since BINLOG_FORMAT = STATEMENT.	-
Row Injection	MIXED	No	Yes	-	ROW
Row Injection	ROW	No	Yes	-	ROW

Type	binlog_format	SLC	RLC	Error / Warning	Logged as
Safe	STATEMENT	Yes	Yes	-	STATEMENT
Safe	MIXED	Yes	Yes	-	STATEMENT
Safe	ROW	Yes	Yes	-	ROW
Unsafe	STATEMENT	Yes	Yes	Warning: Unsafe statement binlogged in statement format since BINLOG_FORMAT = STATEMENT.	STATEMENT
Unsafe	MIXED	Yes	Yes	-	ROW
Unsafe	ROW	Yes	Yes	-	ROW
Row Injection	STATEMENT	Yes	Yes	Error: Cannot execute row injection: Binary logging is not possible because BINLOG_FORMAT = STATEMENT.	-
Row Injection	MIXED	Yes	Yes	-	ROW
Row Injection	ROW	Yes	Yes	-	ROW

When a warning is produced by the determination, a standard MySQL warning is produced (and is available using `SHOW WARNINGS`). The information is also written to the `mysqld` error log. Only one error for each error instance per client connection is logged to prevent flooding the log. The log message includes the SQL statement that was attempted.

If `log_error_verbosity` is 2 or greater on a replica, the replica prints messages to the error log to provide information about its status, such as the binary log and relay log coordinates where it starts its job, when it is switching to another relay log, when it reconnects after a disconnect, statements that are unsafe for statement-based logging, and so forth.

#### 5.4.4.4 Logging Format for Changes to `mysql` Database Tables

The contents of the grant tables in the `mysql` database can be modified directly (for example, with `INSERT` or `DELETE`) or indirectly (for example, with `GRANT` or `CREATE USER`). Statements that affect `mysql` database tables are written to the binary log using the following rules:

- Data manipulation statements that change data in `mysql` database tables directly are logged according to the setting of the `binlog_format` system variable. This pertains to statements such as `INSERT`, `UPDATE`, `DELETE`, `REPLACE`, `DO`, `LOAD DATA`, `SELECT`, and `TRUNCATE TABLE`.
- Statements that change the `mysql` database indirectly are logged as statements regardless of the value of `binlog_format`. This pertains to statements such as `GRANT`, `REVOKE`, `SET PASSWORD`, `RENAME USER`, `CREATE` (all forms except `CREATE TABLE ... SELECT`), `ALTER` (all forms), and `DROP` (all forms).

`CREATE TABLE ... SELECT` is a combination of data definition and data manipulation. The `CREATE TABLE` part is logged using statement format and the `SELECT` part is logged according to the value of `binlog_format`.

## 5.4.5 The Slow Query Log

The slow query log consists of SQL statements that take more than `long_query_time` seconds to execute and require at least `min_examined_row_limit` rows to be examined. The slow query log can be used to find queries that take a long time to execute and are therefore candidates for optimization. However, examining a long slow query log can be a time-consuming task. To make this easier, you can use the `mysqldumpslow` command to process a slow query log file and summarize its contents. See [Section 4.6.8, “mysqldumpslow — Summarize Slow Query Log Files”](#).

The time to acquire the initial locks is not counted as execution time. `mysqld` writes a statement to the slow query log after it has been executed and after all locks have been released, so log order might differ from execution order.

- [Slow Query Log Parameters](#)
- [Slow Query Log Contents](#)

### Slow Query Log Parameters

The minimum and default values of `long_query_time` are 0 and 10, respectively. The value can be specified to a resolution of microseconds.

By default, administrative statements are not logged, nor are queries that do not use indexes for lookups. This behavior can be changed using `log_slow_admin_statements` and `log_queries_not_using_indexes`, as described later.

By default, the slow query log is disabled. To specify the initial slow query log state explicitly, use `--slow_query_log[={0|1}]`. With no argument or an argument of 1, `--slow_query_log` enables the log. With an argument of 0, this option disables the log. To specify a log file name, use `--slow_query_log_file=file_name`. To specify the log destination, use the `log_output` system variable (as described in [Section 5.4.1, “Selecting General Query Log and Slow Query Log Output Destinations”](#)).



#### Note

If you specify the `TABLE` log destination, see [Log Tables and “Too many open files” Errors](#).

If you specify no name for the slow query log file, the default name is `host_name-slow.log`. The server creates the file in the data directory unless an absolute path name is given to specify a different directory.

To disable or enable the slow query log or change the log file name at runtime, use the global `slow_query_log` and `slow_query_log_file` system variables. Set `slow_query_log` to 0 to disable the log or to 1 to enable it. Set `slow_query_log_file` to specify the name of the log file. If a log file already is open, it is closed and the new file is opened.

The server writes less information to the slow query log if you use the `--log-short-format` option.

To include slow administrative statements in the slow query log, enable the `log_slow_admin_statements` system variable. Administrative statements include `ALTER TABLE`, `ANALYZE TABLE`, `CHECK TABLE`, `CREATE INDEX`, `DROP INDEX`, `OPTIMIZE TABLE`, and `REPAIR TABLE`.

To include queries that do not use indexes for row lookups in the statements written to the slow query log, enable the `log_queries_not_using_indexes` system variable. (Even with that variable enabled, the server does not log queries that would not benefit from the presence of an index due to the table having fewer than two rows.)

When queries that do not use an index are logged, the slow query log may grow quickly. It is possible to put a rate limit on these queries by setting the `log_throttle_queries_not_using_indexes` system variable. By default, this variable is 0, which means there is no limit. Positive values impose a per-minute limit on logging of queries that do not use indexes. The first such query opens a 60-second window within which the server logs queries up to the given limit, then suppresses additional queries. If there are suppressed queries when the window ends, the server logs a summary that indicates how many there were and the aggregate time spent in them. The next 60-second window begins when the server logs the next query that does not use indexes.

The server uses the controlling parameters in the following order to determine whether to write a query to the slow query log:

1. The query must either not be an administrative statement, or `log_slow_admin_statements` must be enabled.
2. The query must have taken at least `long_query_time` seconds, or `log_queries_not_using_indexes` must be enabled and the query used no indexes for row lookups.
3. The query must have examined at least `min_examined_row_limit` rows.
4. The query must not be suppressed according to the `log_throttle_queries_not_using_indexes` setting.

The `log_timestamps` system variable controls the time zone of timestamps in messages written to the slow query log file (as well as to the general query log file and the error log). It does not affect the time zone of general query log and slow query log messages written to log tables, but rows retrieved from those tables can be converted from the local system time zone to any desired time zone with `CONVERT_TZ()` or by setting the session `time_zone` system variable.

The server does not log queries handled by the query cache.

By default, a replica does not write replicated queries to the slow query log. To change this, enable the `log_slow_slave_statements` system variable. Note that if row-based replication is in use (`binlog_format=ROW`), `log_slow_slave_statements` has no effect. Queries are only added to the replica's slow query log when they are logged in statement format in the binary log, that is, when `binlog_format=STATEMENT` is set, or when `binlog_format=MIXED` is set and the statement is logged in statement format. Slow queries that are logged in row format when `binlog_format=MIXED` is set, or that are logged when `binlog_format=ROW` is set, are not added to the replica's slow query log, even if `log_slow_slave_statements` is enabled.

## Slow Query Log Contents

When the slow query log is enabled, the server writes output to any destinations specified by the `log_output` system variable. If you enable the log, the server opens the log file and writes startup messages to it. However, further logging of queries to the file does not occur unless the `FILE` log destination is selected. If the destination is `NONE`, the server writes no queries even if the slow query log is enabled. Setting the log file name has no effect on logging if `FILE` is not selected as an output destination.

If the slow query log is enabled and `FILE` is selected as an output destination, each statement written to the log is preceded by a line that begins with a `#` character and has these fields (with all fields on a single line):

- `Query_time: duration`

The statement execution time in seconds.

- `Lock_time: duration`

The time to acquire locks in seconds.

- `Rows_sent: N`

The number of rows sent to the client.

- `Rows_examined:`

The number of rows examined by the server layer (not counting any processing internal to storage engines).

Each statement written to the slow query log file is preceded by a `SET` statement that includes a timestamp indicating when the slow statement was logged (which occurs after the statement finishes executing).

Passwords in statements written to the slow query log are rewritten by the server not to occur literally in plain text. See [Section 6.1.2.3, “Passwords and Logging”](#).

From MySQL 5.7.38, statements that cannot be parsed (due, for example, to syntax errors) are not written to the slow query log.

## 5.4.6 The DDL Log

The DDL log, or metadata log, records metadata operations generated by data definition statements affecting table partitioning, such as `ALTER TABLE t3 DROP PARTITION p2`, where we must make certain that the partition is completely dropped and that its definition is removed from the list of partitions for table `t3`. MySQL uses this log to recover from a crash occurring in the middle of a partitioning metadata operation.

A record of partitioning metadata operations is written to the file `ddl_log.log`, in the MySQL data directory. This is a binary file; it is not intended to be human-readable, and you should not attempt to modify its contents in any way.

`ddl_log.log` is not created until it is actually needed for recording metadata statements, and is removed following a successful start of `mysqld`. Thus, it is possible for this file not to be present on a MySQL server that is functioning in a completely normal manner.

`ddl_log.log` can hold up to 1048573 entries, equivalent to 4 GB in size. Once this limit is exceeded, you must rename or remove the file before it is possible to execute any additional DDL statements. This is a known issue (Bug #83708).

There are no user-configurable server options or variables associated with this file.

## 5.4.7 Server Log Maintenance

As described in [Section 5.4, “MySQL Server Logs”](#), MySQL Server can create several different log files to help you see what activity is taking place. However, you must clean up these files regularly to ensure that the logs do not take up too much disk space.

When using MySQL with logging enabled, you may want to back up and remove old log files from time to time and tell MySQL to start logging to new files. See [Section 7.2, “Database Backup Methods”](#).

On a Linux (Red Hat) installation, you can use the `mysql-log-rotate` script for log maintenance. If you installed MySQL from an RPM distribution, this script should have been installed automatically. Be careful with this script if you are using the binary log for replication. You should not remove binary logs until you are certain that their contents have been processed by all replicas.

On other systems, you must install a short script yourself that you start from `cron` (or its equivalent) for handling log files.

For the binary log, you can set the `expire_logs_days` system variable to expire binary log files automatically after a given number of days (see [Section 5.1.7, “Server System Variables”](#)). If you are using replication, you should set the variable no lower than the maximum number of days your replicas might lag behind the source. To remove binary logs on demand, use the `PURGE BINARY LOGS` statement (see [Section 13.4.1.1, “PURGE BINARY LOGS Statement”](#)).

To force MySQL to start using new log files, flush the logs. Log flushing occurs when you execute a `FLUSH LOGS` statement or a `mysqladmin flush-logs`, `mysqladmin refresh`, `mysqldump --flush-logs`, or `mysqldump --master-data` command. See [Section 13.7.6.3, “FLUSH Statement”](#), [Section 4.5.2, “mysqladmin — A MySQL Server Administration Program”](#), and [Section 4.5.4, “mysqldump — A Database Backup Program”](#). In addition, the server flushes the binary log automatically when current binary log file size reaches the value of the `max_binlog_size` system variable.

`FLUSH LOGS` supports optional modifiers to enable selective flushing of individual logs (for example, `FLUSH BINARY LOGS`). See [Section 13.7.6.3, “FLUSH Statement”](#).

A log-flushing operation has the following effects:

- If binary logging is enabled, the server closes the current binary log file and opens a new log file with the next sequence number.
- If general query logging or slow query logging to a log file is enabled, the server closes and reopens the log file.
- If the server was started with the `--log-error` option to cause the error log to be written to a file, the server closes and reopens the log file.

Execution of log-flushing statements or commands requires connecting to the server using an account that has the `RELOAD` privilege. On Unix and Unix-like systems, another way to flush the logs is to send a `SIGHUP` signal to the server, which can be done by `root` or the account that owns the server process. Signals enable log flushing to be performed without having to connect to the server. However, `SIGHUP` has additional effects other than log flushing that might be undesirable. For details, see [Section 4.10, “Unix Signal Handling in MySQL”](#).

As mentioned previously, flushing the binary log creates a new binary log file, whereas flushing the general query log, slow query log, or error log just closes and reopens the log file. For the latter logs, to cause a new log file to be created on Unix, rename the current log file first before flushing it. At flush time, the server opens the new log file with the original name. For example, if the general query log, slow query log, and error log files are named `mysql.log`, `mysql-slow.log`, and `err.log`, you can use a series of commands like this from the command line:

```
cd mysql-data-directory
mv mysql.log mysql.log.old
mv mysql-slow.log mysql-slow.log.old
mv err.log err.log.old
mysqladmin flush-logs
```

On Windows, use `rename` rather than `mv`.



At this point, you can make a backup of `mysql.log.old`, `mysql-slow.log.old`, and `err.log.old`, then remove them from disk.

To rename the general query log or slow query log at runtime, first connect to the server and disable the log:

```
SET GLOBAL general_log = 'OFF';
SET GLOBAL slow_query_log = 'OFF';
```

With the logs disabled, rename the log files externally (for example, from the command line). Then enable the logs again:

```
SET GLOBAL general_log = 'ON';
SET GLOBAL slow_query_log = 'ON';
```

This method works on any platform and does not require a server restart.



### Note

For the server to recreate a given log file after you have renamed the file externally, the file location must be writable by the server. This may not always be the case. For example, on Linux, the server might write the error log as `/var/log/mysql.log`, where `/var/log` is owned by `root` and not writable by `mysqld`. In this case, log-flushing operations fail to create a new log file.

To handle this situation, you must manually create the new log file with the proper ownership after renaming the original log file. For example, execute these commands as `root`:

```
mv /var/log/mysql.log /var/log/mysql.log.old
install -omysql -gmysql -m0644 /dev/null /var/log/mysql.log
```

## 5.5 MySQL Server Plugins

MySQL supports an plugin API that enables creation of server plugins. Plugins can be loaded at server startup, or loaded and unloaded at runtime without restarting the server. The plugins supported by this interface include, but are not limited to, storage engines, `INFORMATION_SCHEMA` tables, full-text parser plugins, partitioning support, and server extensions.

MySQL distributions include several plugins that implement server extensions:

- Plugins for authenticating attempts by clients to connect to MySQL Server. Plugins are available for several authentication protocols. See [Section 6.2.13, “Pluggable Authentication”](#).
- A connection control plugin that enables administrators to introduce an increasing delay after a certain number of consecutive failed client connection attempts. See [Section 6.4.2, “Connection Control Plugins”](#).
- A password-validation plugin implements password strength policies and assesses the strength of potential passwords. See [Section 6.4.3, “The Password Validation Plugin”](#).
- Semisynchronous replication plugins implement an interface to replication capabilities that permit the source to proceed as long as at least one replica has responded to each transaction. See [Section 16.3.9, “Semisynchronous Replication”](#).
- Group Replication enables you to create a highly available distributed MySQL service across a group of MySQL server instances, with data consistency, conflict detection and resolution, and group membership services all built-in. See [Chapter 17, Group Replication](#).

- MySQL Enterprise Edition includes a thread pool plugin that manages connection threads to increase server performance by efficiently managing statement execution threads for large numbers of client connections. See [Section 5.5.3, “MySQL Enterprise Thread Pool”](#).
- MySQL Enterprise Edition includes an audit plugin for monitoring and logging of connection and query activity. See [Section 6.4.5, “MySQL Enterprise Audit”](#).
- MySQL Enterprise Edition includes a firewall plugin that implements an application-level firewall to enable database administrators to permit or deny SQL statement execution based on matching against allowlists of accepted statement patterns. See [Section 6.4.6, “MySQL Enterprise Firewall”](#).
- A query rewrite plugin examines statements received by MySQL Server and possibly rewrites them before the server executes them. See [Section 5.5.4, “The Rewriter Query Rewrite Plugin”](#).
- Version Tokens enables creation of and synchronization around server tokens that applications can use to prevent accessing incorrect or out-of-date data. Version Tokens is based on a plugin library that implements a `version_tokens` plugin and a set of loadable functions. See [Section 5.5.5, “Version Tokens”](#).
- Keyring plugins provide secure storage for sensitive information. See [Section 6.4.4, “The MySQL Keyring”](#).
- X Plugin extends MySQL Server to be able to function as a document store. Running X Plugin enables MySQL Server to communicate with clients using the X Protocol, which is designed to expose the ACID compliant storage abilities of MySQL as a document store. See [Section 19.4, “X Plugin”](#).
- Test framework plugins test server services. For information about these plugins, see the Plugins for Testing Plugin Services section of the MySQL Server Doxygen documentation, available at <https://dev.mysql.com/doc/index-other.html>.

The following sections describe how to install and uninstall plugins, and how to determine at runtime which plugins are installed and obtain information about them. For information about writing plugins, see [The MySQL Plugin API](#).

### 5.5.1 Installing and Uninstalling Plugins

Server plugins must be loaded into the server before they can be used. MySQL supports plugin loading at server startup and runtime. It is also possible to control the activation state of loaded plugins at startup, and to unload them at runtime.

While a plugin is loaded, information about it is available as described in [Section 5.5.2, “Obtaining Server Plugin Information”](#).

- [Installing Plugins](#)
- [Controlling Plugin Activation State](#)
- [Uninstalling Plugins](#)

#### Installing Plugins

Before a server plugin can be used, it must be installed using one of the following methods. In the descriptions, `plugin_name` stands for a plugin name such as `innodb`, `csv`, or `validate_password`.

- [Built-in Plugins](#)
- [Plugins Registered in the `mysql.plugin` System Table](#)

- [Plugins Named with Command-Line Options](#)
- [Plugins Installed with the `INSTALL PLUGIN` Statement](#)

## Built-in Plugins

A built-in plugin is known by the server automatically. By default, the server enables the plugin at startup. Some built-in plugins permit this to be changed with the `--plugin_name[=activation_state]` option.

## Plugins Registered in the `mysql.plugin` System Table

The `mysql.plugin` system table serves as a registry of plugins (other than built-in plugins, which need not be registered). During the normal startup sequence, the server loads plugins registered in the table. By default, for a plugin loaded from the `mysql.plugin` table, the server also enables the plugin. This can be changed with the `--plugin_name[=activation_state]` option.

If the server is started with the `--skip-grant-tables` option, plugins registered in the `mysql.plugin` table are not loaded and are unavailable.

## Plugins Named with Command-Line Options

A plugin located in a plugin library file can be loaded at server startup with the `--plugin-load`, `--plugin-load-add`, or `--early-plugin-load` option. Normally, for a plugin loaded at startup, the server also enables the plugin. This can be changed with the `--plugin_name[=activation_state]` option.

The `--plugin-load` and `--plugin-load-add` options load plugins after built-in plugins and storage engines have initialized during the server startup sequence. The `--early-plugin-load` option is used to load plugins that must be available prior to initialization of built-in plugins and storage engines.

The value of each plugin-loading option is a semicolon-separated list of `plugin_library` and `name=plugin_library` values. Each `plugin_library` is the name of a library file that contains plugin code, and each `name` is the name of a plugin to load. If a plugin library is named without any preceding plugin name, the server loads all plugins in the library. With a preceding plugin name, the server loads only the named plugin from the library. The server looks for plugin library files in the directory named by the `plugin_dir` system variable.

Plugin-loading options do not register any plugin in the `mysql.plugin` table. For subsequent restarts, the server loads the plugin again only if `--plugin-load`, `--plugin-load-add`, or `--early-plugin-load` is given again. That is, the option produces a one-time plugin-installation operation that persists for a single server invocation.

`--plugin-load`, `--plugin-load-add`, and `--early-plugin-load` enable plugins to be loaded even when `--skip-grant-tables` is given (which causes the server to ignore the `mysql.plugin` table). `--plugin-load`, `--plugin-load-add`, and `--early-plugin-load` also enable plugins to be loaded at startup that cannot be loaded at runtime.

The `--plugin-load-add` option complements the `--plugin-load` option:

- Each instance of `--plugin-load` resets the set of plugins to load at startup, whereas `--plugin-load-add` adds a plugin or plugins to the set of plugins to be loaded without resetting the current set. Consequently, if multiple instances of `--plugin-load` are specified, only the last one applies. With multiple instances of `--plugin-load-add`, all of them apply.
- The argument format is the same as for `--plugin-load`, but multiple instances of `--plugin-load-add` can be used to avoid specifying a large set of plugins as a single long unwieldy `--plugin-load` argument.

- `--plugin-load-add` can be given in the absence of `--plugin-load`, but any instance of `--plugin-load-add` that appears before `--plugin-load` has no effect because `--plugin-load` resets the set of plugins to load.

For example, these options:

```
--plugin-load=x --plugin-load-add=y
```

are equivalent to these options:

```
--plugin-load-add=x --plugin-load-add=y
```

and are also equivalent to this option:

```
--plugin-load="x;y"
```

But these options:

```
--plugin-load-add=y --plugin-load=x
```

are equivalent to this option:

```
--plugin-load=x
```

## Plugins Installed with the `INSTALL PLUGIN` Statement

A plugin located in a plugin library file can be loaded at runtime with the `INSTALL PLUGIN` statement. The statement also registers the plugin in the `mysql.plugin` table to cause the server to load it on subsequent restarts. For this reason, `INSTALL PLUGIN` requires the `INSERT` privilege for the `mysql.plugin` table.

The plugin library file base name depends on your platform. Common suffixes are `.so` for Unix and Unix-like systems, `.dll` for Windows.

Example: The `--plugin-load-add` option installs a plugin at server startup. To install a plugin named `myplugin` from a plugin library file named `somepluglib.so`, use these lines in a `my.cnf` file:

```
[mysqld]
plugin-load-add=myplugin=somepluglib.so
```

In this case, the plugin is not registered in `mysql.plugin`. Restarting the server without the `--plugin-load-add` option causes the plugin not to be loaded at startup.

Alternatively, the `INSTALL PLUGIN` statement causes the server to load the plugin code from the library file at runtime:

```
INSTALL PLUGIN myplugin SONAME 'somepluglib.so';
```

`INSTALL PLUGIN` also causes “permanent” plugin registration: The plugin is listed in the `mysql.plugin` table to ensure that the server loads it on subsequent restarts.

Many plugins can be loaded either at server startup or at runtime. However, if a plugin is designed such that it must be loaded and initialized during server startup, attempts to load it at runtime using `INSTALL PLUGIN` produce an error:

```
mysql> INSTALL PLUGIN myplugin SONAME 'somepluglib.so';
ERROR 1721 (HY000): Plugin 'myplugin' is marked as not dynamically
installable. You have to stop the server to install it.
```

In this case, you must use `--plugin-load`, `--plugin-load-add`, or `--early-plugin-load`.

If a plugin is named both using a `--plugin-load`, `--plugin-load-add`, or `--early-plugin-load` option and (as a result of an earlier `INSTALL PLUGIN` statement) in the `mysql.plugin` table, the server starts but writes these messages to the error log:

```
[ERROR] Function 'plugin_name' already exists
[Warning] Couldn't load plugin named 'plugin_name'
with soname 'plugin_object_file'.
```

## Controlling Plugin Activation State

If the server knows about a plugin when it starts (for example, because the plugin is named using a `--plugin-load-add` option or is registered in the `mysql.plugin` table), the server loads and enables the plugin by default. It is possible to control activation state for such a plugin using a `--plugin_name[=activation_state]` startup option, where *plugin\_name* is the name of the plugin to affect, such as `innodb`, `csv`, or `validate_password`. As with other options, dashes and underscores are interchangeable in option names. Also, activation state values are not case-sensitive. For example, `--my_plugin=ON` and `--my-plugin=on` are equivalent.

- `--plugin_name=OFF`

Tells the server to disable the plugin. This may not be possible for certain built-in plugins, such as `mysql_native_password`.

- `--plugin_name[=ON]`

Tells the server to enable the plugin. (Specifying the option as `--plugin_name` without a value has the same effect.) If the plugin fails to initialize, the server runs with the plugin disabled.

- `--plugin_name=FORCE`

Tells the server to enable the plugin, but if plugin initialization fails, the server does not start. In other words, this option forces the server to run with the plugin enabled or not at all.

- `--plugin_name=FORCE_PLUS_PERMANENT`

Like `FORCE`, but in addition prevents the plugin from being unloaded at runtime. If a user attempts to do so with `UNINSTALL PLUGIN`, an error occurs.

Plugin activation states are visible in the `LOAD_OPTION` column of the Information Schema `PLUGINS` table.

Suppose that `CSV`, `BLACKHOLE`, and `ARCHIVE` are built-in pluggable storage engines and that you want the server to load them at startup, subject to these conditions: The server is permitted to run if `CSV` initialization fails, must require that `BLACKHOLE` initialization succeeds, and should disable `ARCHIVE`. To accomplish that, use these lines in an option file:

```
[mysqld]
csv=ON
blackhole=FORCE
archive=OFF
```

The `--enable-plugin_name` option format is a synonym for `--plugin_name=ON`. The `--disable-plugin_name` and `--skip-plugin_name` option formats are synonyms for `--plugin_name=OFF`.

If a plugin is disabled, either explicitly with `OFF` or implicitly because it was enabled with `ON` but fails to initialize, aspects of server operation that require the plugin change. For example, if the plugin implements a storage engine, existing tables for the storage engine become inaccessible, and attempts to create new tables for the storage engine result in tables that use the default storage engine unless the `NO_ENGINE_SUBSTITUTION` SQL mode is enabled to cause an error to occur instead.

Disabling a plugin may require adjustment to other options. For example, if you start the server using `--skip-innodb` to disable `InnoDB`, other `innodb_xxx` options likely need to be omitted at startup. In addition, because `InnoDB` is the default storage engine, it cannot start unless you specify another available storage engine with `--default_storage_engine`. You must also set `--default_tmp_storage_engine`.

## Uninstalling Plugins

At runtime, the `UNINSTALL PLUGIN` statement disables and uninstalls a plugin known to the server. The statement unloads the plugin and removes it from the `mysql.plugin` system table, if it is registered there. For this reason, `UNINSTALL PLUGIN` statement requires the `DELETE` privilege for the `mysql.plugin` table. With the plugin no longer registered in the table, the server does not load the plugin during subsequent restarts.

`UNINSTALL PLUGIN` can unload a plugin regardless of whether it was loaded at runtime with `INSTALL PLUGIN` or at startup with a plugin-loading option, subject to these conditions:

- It cannot unload plugins that are built in to the server. These can be identified as those that have a library name of `NULL` in the output from `INFORMATION_SCHEMA.PLUGINS` or `SHOW PLUGINS`.
- It cannot unload plugins for which the server was started with `--plugin_name=FORCE_PLUS_PERMANENT`, which prevents plugin unloading at runtime. These can be identified from the `LOAD_OPTION` column of the Information Schema `PLUGINS` table.

To uninstall a plugin that currently is loaded at server startup with a plugin-loading option, use this procedure.

1. Remove from the `my.cnf` file any options related to the plugin.
2. Restart the server.
3. Plugins normally are installed using either a plugin-loading option at startup or with `INSTALL PLUGIN` at runtime, but not both. However, removing options for a plugin from the `my.cnf` file may not be sufficient to uninstall it if at some point `INSTALL PLUGIN` has also been used. If the plugin still appears in the output from `INFORMATION_SCHEMA.PLUGINS` or `SHOW PLUGINS`, use `UNINSTALL PLUGIN` to remove it from the `mysql.plugin` table. Then restart the server again.

## 5.5.2 Obtaining Server Plugin Information

There are several ways to determine which plugins are installed in the server:

- The Information Schema `PLUGINS` table contains a row for each loaded plugin. Any that have a `PLUGIN_LIBRARY` value of `NULL` are built in and cannot be unloaded.

```
mysql> SELECT * FROM INFORMATION_SCHEMA.PLUGINS\G
***** 1. row *****
      PLUGIN_NAME: binlog
      PLUGIN_VERSION: 1.0
      PLUGIN_STATUS: ACTIVE
      PLUGIN_TYPE: STORAGE ENGINE
      PLUGIN_TYPE_VERSION: 50158.0
      PLUGIN_LIBRARY: NULL
      PLUGIN_LIBRARY_VERSION: NULL
      PLUGIN_AUTHOR: MySQL AB
      PLUGIN_DESCRIPTION: This is a pseudo storage engine to represent the binlog in a transaction
      PLUGIN_LICENSE: GPL
      LOAD_OPTION: FORCE
      ...
***** 10. row *****
```

```

    PLUGIN_NAME: InnoDB
    PLUGIN_VERSION: 1.0
    PLUGIN_STATUS: ACTIVE
    PLUGIN_TYPE: STORAGE ENGINE
    PLUGIN_TYPE_VERSION: 50158.0
    PLUGIN_LIBRARY: ha_innodb_plugin.so
    PLUGIN_LIBRARY_VERSION: 1.0
    PLUGIN_AUTHOR: Innobase Oy
    PLUGIN_DESCRIPTION: Supports transactions, row-level locking,
                        and foreign keys
    PLUGIN_LICENSE: GPL
    LOAD_OPTION: ON
...

```

- The `SHOW PLUGINS` statement displays a row for each loaded plugin. Any that have a `Library` value of `NULL` are built in and cannot be unloaded.

```

mysql> SHOW PLUGINS\G
***** 1. row *****
    Name: binlog
    Status: ACTIVE
    Type: STORAGE ENGINE
    Library: NULL
    License: GPL
    ...
***** 10. row *****
    Name: InnoDB
    Status: ACTIVE
    Type: STORAGE ENGINE
    Library: ha_innodb_plugin.so
    License: GPL
    ...

```

- The `mysql.plugin` table shows which plugins have been registered with `INSTALL PLUGIN`. The table contains only plugin names and library file names, so it does not provide as much information as the `PLUGINS` table or the `SHOW PLUGINS` statement.

### 5.5.3 MySQL Enterprise Thread Pool



#### Note

MySQL Enterprise Thread Pool is an extension included in MySQL Enterprise Edition, a commercial product. To learn more about commercial products, <https://www.mysql.com/products/>.

MySQL Enterprise Edition includes MySQL Enterprise Thread Pool, implemented using a server plugin. The default thread-handling model in MySQL Server executes statements using one thread per client connection. As more clients connect to the server and execute statements, overall performance degrades. The thread pool plugin provides an alternative thread-handling model designed to reduce overhead and improve performance. The plugin implements a thread pool that increases server performance by efficiently managing statement execution threads for large numbers of client connections.

The thread pool addresses several problems of the model that uses one thread per connection:

- Too many thread stacks make CPU caches almost useless in highly parallel execution workloads. The thread pool promotes thread stack reuse to minimize the CPU cache footprint.
- With too many threads executing in parallel, context switching overhead is high. This also presents a challenge to the operating system scheduler. The thread pool controls the number of active threads to keep the parallelism within the MySQL server at a level that it can handle and that is appropriate for the server host on which MySQL is executing.

- Too many transactions executing in parallel increases resource contention. In [InnoDB](#), this increases the time spent holding central mutexes. The thread pool controls when transactions start to ensure that not too many execute in parallel.

## Additional Resources

[Section A.15, “MySQL 5.7 FAQ: MySQL Enterprise Thread Pool”](#)

### 5.5.3.1 Thread Pool Elements

MySQL Enterprise Thread Pool comprises these elements:

- A plugin library file implements a plugin for the thread pool code as well as several associated monitoring tables that provide information about thread pool operation.

For a detailed description of how the thread pool works, see [Section 5.5.3.3, “Thread Pool Operation”](#).

The `INFORMATION_SCHEMA` tables are named `TP_THREAD_STATE`, `TP_THREAD_GROUP_STATE`, and `TP_THREAD_GROUP_STATS`. These tables provide information about thread pool operation. For more information, see [Section 24.5, “INFORMATION\\_SCHEMA Thread Pool Tables”](#).

- Several system variables are related to the thread pool. The `thread_handling` system variable has a value of `loaded-dynamically` when the server successfully loads the thread pool plugin.

The other related system variables are implemented by the thread pool plugin and are not available unless it is enabled. For information about using these variables, see [Section 5.5.3.3, “Thread Pool Operation”](#), and [Section 5.5.3.4, “Thread Pool Tuning”](#).

- The Performance Schema has instruments that expose information about the thread pool and may be used to investigate operational performance. To identify them, use this query:

```
SELECT * FROM performance_schema.setup_instruments
WHERE NAME LIKE '%thread_pool%';
```

For more information, see [Chapter 25, MySQL Performance Schema](#).

### 5.5.3.2 Thread Pool Installation

This section describes how to install MySQL Enterprise Thread Pool. For general information about installing plugins, see [Section 5.5.1, “Installing and Uninstalling Plugins”](#).

To be usable by the server, the plugin library file must be located in the MySQL plugin directory (the directory named by the `plugin_dir` system variable). If necessary, configure the plugin directory location by setting the value of `plugin_dir` at server startup.

The plugin library file base name is `thread_pool`. The file name suffix differs per platform (for example, `.so` for Unix and Unix-like systems, `.dll` for Windows).

To enable thread pool capability, load the plugins to be used by starting the server with the `--plugin-load-add` option. For example, if you name only the plugin library file, the server loads all plugins that it contains (that is, the thread pool plugin and all the `INFORMATION_SCHEMA` tables). To do this, put these lines in the server `my.cnf` file, adjusting the `.so` suffix for your platform as necessary:

```
[mysqld]
plugin-load-add=thread_pool.so
```

That is equivalent to loading all thread pool plugins by naming them individually:

```
[mysqld]
```



```
plugin-load-add=thread_pool=thread_pool.so
plugin-load-add=tp_thread_state=thread_pool.so
plugin-load-add=tp_thread_group_state=thread_pool.so
plugin-load-add=tp_thread_group_stats=thread_pool.so
```

If desired, you can load individual plugins from the library file. To load the thread pool plugin but not the `INFORMATION_SCHEMA` tables, use an option like this:

```
[mysqld]
plugin-load-add=thread_pool=thread_pool.so
```

To load the thread pool plugin and only the `TP_THREAD_STATE INFORMATION_SCHEMA` table, use options like this:

```
[mysqld]
plugin-load-add=thread_pool=thread_pool.so
plugin-load-add=tp_thread_state=thread_pool.so
```



### Note

If you do not load all the `INFORMATION_SCHEMA` tables, some or all MySQL Enterprise Monitor thread pool graphs are empty.

To verify plugin installation, examine the Information Schema `PLUGINS` table or use the `SHOW PLUGINS` statement (see [Section 5.5.2, “Obtaining Server Plugin Information”](#)). For example:

```
mysql> SELECT PLUGIN_NAME, PLUGIN_STATUS
FROM INFORMATION_SCHEMA.PLUGINS
WHERE PLUGIN_NAME LIKE 'thread%' OR PLUGIN_NAME LIKE 'tp%';
+-----+-----+
| PLUGIN_NAME          | PLUGIN_STATUS |
+-----+-----+
| thread_pool         | ACTIVE        |
| TP_THREAD_STATE     | ACTIVE        |
| TP_THREAD_GROUP_STATE | ACTIVE        |
| TP_THREAD_GROUP_STATS | ACTIVE        |
+-----+-----+
```

If the server loads the thread pool plugin successfully, it sets the `thread_handling` system variable to `loaded-dynamically`.

If a plugin fails to initialize, check the server error log for diagnostic messages.

### 5.5.3.3 Thread Pool Operation

The thread pool consists of a number of thread groups, each of which manages a set of client connections. As connections are established, the thread pool assigns them to thread groups in round-robin fashion.

The thread pool exposes system variables that may be used to configure its operation:

- `thread_pool_algorithm`: The concurrency algorithm to use for scheduling.
- `thread_pool_high_priority_connection`: How to schedule statement execution for a session.
- `thread_pool_max_unused_threads`: How many sleeping threads to permit.
- `thread_pool_prio_kickup_timer`: How long before the thread pool moves a statement awaiting execution from the low-priority queue to the high-priority queue.
- `thread_pool_size`: The number of thread groups in the thread pool. This is the most important parameter controlling thread pool performance.
- `thread_pool_stall_limit`: The time before an executing statement is considered to be stalled.

To configure the number of thread groups, use the `thread_pool_size` system variable. The default number of groups is 16. For guidelines on setting this variable, see [Section 5.5.3.4, “Thread Pool Tuning”](#).

The maximum number of threads per group is 4096 (or 4095 on some systems where one thread is used internally).

The thread pool separates connections and threads, so there is no fixed relationship between connections and the threads that execute statements received from those connections. This differs from the default thread-handling model that associates one thread with one connection such that a given thread executes all statements from its connection.

The thread pool tries to ensure a maximum of one thread executing in each group at any time, but sometimes permits more threads to execute temporarily for best performance:

- Each thread group has a listener thread that listens for incoming statements from the connections assigned to the group. When a statement arrives, the thread group either begins executing it immediately or queues it for later execution:
  - Immediate execution occurs if the statement is the only one received and no statements are queued or currently executing.
  - Queuing occurs if the statement cannot begin executing immediately.
- If immediate execution occurs, the listener thread performs it. (This means that temporarily no thread in the group is listening.) If the statement finishes quickly, the executing thread returns to listening for statements. Otherwise, the thread pool considers the statement stalled and starts another thread as a listener thread (creating it if necessary). To ensure that no thread group becomes blocked by stalled statements, the thread pool has a background thread that regularly monitors thread group states.

By using the listening thread to execute a statement that can begin immediately, there is no need to create an additional thread if the statement finishes quickly. This ensures the most efficient execution possible in the case of a low number of concurrent threads.

When the thread pool plugin starts, it creates one thread per group (the listener thread), plus the background thread. Additional threads are created as necessary to execute statements.

- The value of the `thread_pool_stall_limit` system variable determines the meaning of “finishes quickly” in the previous item. The default time before threads are considered stalled is 60ms but can be set to a maximum of 6s. This parameter is configurable to enable you to strike a balance appropriate for the server work load. Short wait values permit threads to start more quickly. Short values are also better for avoiding deadlock situations. Long wait values are useful for workloads that include long-running statements, to avoid starting too many new statements while the current ones execute.
- The thread pool focuses on limiting the number of concurrent short-running statements. Before an executing statement reaches the stall time, it prevents other statements from beginning to execute. If the statement executes past the stall time, it is permitted to continue but no longer prevents other statements from starting. In this way, the thread pool tries to ensure that in each thread group there is never more than one short-running statement, although there might be multiple long-running statements. It is undesirable to let long-running statements prevent other statements from executing because there is no limit on the amount of waiting that might be necessary. For example, on a replication source, a thread that is sending binary log events to a replica effectively runs forever.
- A statement becomes blocked if it encounters a disk I/O operation or a user level lock (row lock or table lock). The block would cause the thread group to become unused, so there are callbacks to the thread pool to ensure that the thread pool can immediately start a new thread in this group to execute another statement. When a blocked thread returns, the thread pool permits it to restart immediately.

- There are two queues, a high-priority queue and a low-priority queue. The first statement in a transaction goes to the low-priority queue. Any following statements for the transaction go to the high-priority queue if the transaction is ongoing (statements for it have begun executing), or to the low-priority queue otherwise. Queue assignment can be affected by enabling the `thread_pool_high_priority_connection` system variable, which causes all queued statements for a session to go into the high-priority queue.

Statements for a nontransactional storage engine, or a transactional engine if `autocommit` is enabled, are treated as low-priority statements because in this case each statement is a transaction. Thus, given a mix of statements for `InnoDB` and `MyISAM` tables, the thread pool prioritizes those for `InnoDB` over those for `MyISAM` unless `autocommit` is enabled. With `autocommit` enabled, all statements are low priority.

- When the thread group selects a queued statement for execution, it first looks in the high-priority queue, then in the low-priority queue. If a statement is found, it is removed from its queue and begins to execute.
- If a statement stays in the low-priority queue too long, the thread pool moves to the high-priority queue. The value of the `thread_pool_prio_kickup_timer` system variable controls the time before movement. For each thread group, a maximum of one statement per 10ms (100 per second) is moved from the low-priority queue to the high-priority queue.
- The thread pool reuses the most active threads to obtain a much better use of CPU caches. This is a small adjustment that has a great impact on performance.
- While a thread executes a statement from a user connection, Performance Schema instrumentation accounts thread activity to the user connection. Otherwise, Performance Schema accounts activity to the thread pool.

Here are examples of conditions under which a thread group might have multiple threads started to execute statements:

- One thread begins executing a statement, but runs long enough to be considered stalled. The thread group permits another thread to begin executing another statement even though the first thread is still executing.
- One thread begins executing a statement, then becomes blocked and reports this back to the thread pool. The thread group permits another thread to begin executing another statement.
- One thread begins executing a statement, becomes blocked, but does not report back that it is blocked because the block does not occur in code that has been instrumented with thread pool callbacks. In this case, the thread appears to the thread group to be still running. If the block lasts long enough for the statement to be considered stalled, the group permits another thread to begin executing another statement.

The thread pool is designed to be scalable across an increasing number of connections. It is also designed to avoid deadlocks that can arise from limiting the number of actively executing statements. It is important that threads that do not report back to the thread pool do not prevent other statements from executing and thus cause the thread pool to become deadlocked. Examples of such statements follow:

- Long-running statements. These would lead to all resources used by only a few statements and they could prevent all others from accessing the server.
- Binary log dump threads that read the binary log and send it to replicas. This is a kind of long-running “statement” that runs for a very long time, and that should not prevent other statements from executing.
- Statements blocked on a row lock, table lock, sleep, or any other blocking activity that has not been reported back to the thread pool by MySQL Server or a storage engine.

In each case, to prevent deadlock, the statement is moved to the stalled category when it does not complete quickly, so that the thread group can permit another statement to begin executing. With this design, when a thread executes or becomes blocked for an extended time, the thread pool moves the thread to the stalled category and for the rest of the statement's execution, it does not prevent other statements from executing.

The maximum number of threads that can occur is the sum of `max_connections` and `thread_pool_size`. This can happen in a situation where all connections are in execution mode and an extra thread is created per group to listen for more statements. This is not necessarily a state that happens often, but it is theoretically possible.

### 5.5.3.4 Thread Pool Tuning

This section provides guidelines on setting thread pool system variables for best performance, measured using a metric such as transactions per second.

`thread_pool_size` is the most important parameter controlling thread pool performance. It can be set only at server startup. Our experience in testing the thread pool indicates the following:

- If the primary storage engine is `InnoDB`, the optimal `thread_pool_size` setting is likely to be between 16 and 36, with the most common optimal values tending to be from 24 to 36. We have not seen any situation where the setting has been optimal beyond 36. There may be special cases where a value smaller than 16 is optimal.

For workloads such as DBT2 and Sysbench, the optimum for `InnoDB` seems to be usually around 36. For very write-intensive workloads, the optimal setting can sometimes be lower.

- If the primary storage engine is `MyISAM`, the `thread_pool_size` setting should be fairly low. Optimal performance is often seen with values from 4 to 8. Higher values tend to have a slightly negative but not dramatic impact on performance.

Another system variable, `thread_pool_stall_limit`, is important for handling of blocked and long-running statements. If all calls that block the MySQL Server are reported to the thread pool, it would always know when execution threads are blocked. However, this may not always be true. For example, blocks could occur in code that has not been instrumented with thread pool callbacks. For such cases, the thread pool must be able to identify threads that appear to be blocked. This is done by means of a timeout that can be tuned using the `thread_pool_stall_limit` system variable, the value of which is measured in 10ms units. This parameter ensures that the server does not become completely blocked. The value of `thread_pool_stall_limit` has an upper limit of 6 seconds to prevent the risk of a deadlocked server.

`thread_pool_stall_limit` also enables the thread pool to handle long-running statements. If a long-running statement was permitted to block a thread group, all other connections assigned to the group would be blocked and unable to start execution until the long-running statement completed. In the worst case, this could take hours or even days.

The value of `thread_pool_stall_limit` should be chosen such that statements that execute longer than its value are considered stalled. Stalled statements generate a lot of extra overhead since they involve extra context switches and in some cases even extra thread creations. On the other hand, setting the `thread_pool_stall_limit` parameter too high means that long-running statements block a number of short-running statements for longer than necessary. Short wait values permit threads to start more quickly. Short values are also better for avoiding deadlock situations. Long wait values are useful for workloads that include long-running statements, to avoid starting too many new statements while the current ones execute.

Suppose a server executes a workload where 99.9% of the statements complete within 100ms even when the server is loaded, and the remaining statements take between 100ms and 2 hours fairly evenly spread.

In this case, it would make sense to set `thread_pool_stall_limit` to 10 ( $10 \times 10\text{ms} = 100\text{ms}$ ). The default value of 6 (60ms) is suitable for servers that primarily execute very simple statements.

The `thread_pool_stall_limit` parameter can be changed at runtime to enable you to strike a balance appropriate for the server work load. Assuming that the `TP_THREAD_GROUP_STATS` table is enabled, you can use the following query to determine the fraction of executed statements that stalled:

```
SELECT SUM(STALLED_QUERIES_EXECUTED) / SUM(QUERIES_EXECUTED)
FROM INFORMATION_SCHEMA.TP_THREAD_GROUP_STATS;
```

This number should be as low as possible. To decrease the likelihood of statements stalling, increase the value of `thread_pool_stall_limit`.

When a statement arrives, what is the maximum time it can be delayed before it actually starts executing? Suppose that the following conditions apply:

- There are 200 statements queued in the low-priority queue.
- There are 10 statements queued in the high-priority queue.
- `thread_pool_prio_kickup_timer` is set to 10000 (10 seconds).
- `thread_pool_stall_limit` is set to 100 (1 second).

In the worst case, the 10 high-priority statements represent 10 transactions that continue executing for a long time. Thus, in the worst case, no statements are moved to the high-priority queue because it already contains statements awaiting execution. After 10 seconds, the new statement is eligible to be moved to the high-priority queue. However, before it can be moved, all the statements before it must be moved as well. This could take another 2 seconds because a maximum of 100 statements per second are moved to the high-priority queue. Now when the statement reaches the high-priority queue, there could potentially be many long-running statements ahead of it. In the worst case, every one of those becomes stalled and it takes 1 second for each statement before the next statement is retrieved from the high-priority queue. Thus, in this scenario, it takes 222 seconds before the new statement starts executing.

This example shows a worst case for an application. How to handle it depends on the application. If the application has high requirements for the response time, it should most likely throttle users at a higher level itself. Otherwise, it can use the thread pool configuration parameters to set some kind of a maximum waiting time.

## 5.5.4 The Rewriter Query Rewrite Plugin

MySQL supports query rewrite plugins that can examine and possibly modify SQL statements received by the server before the server executes them. See [Query Rewrite Plugins](#).

MySQL distributions include a postparse query rewrite plugin named `Rewriter` and scripts for installing the plugin and its associated elements. These elements work together to provide `SELECT` rewriting capability:

- A server-side plugin named `Rewriter` examines `SELECT` statements and may rewrite them, based on its in-memory cache of rewrite rules. Standalone `SELECT` statements and `SELECT` statements in prepared statements are subject to rewriting. `SELECT` statements occurring within view definitions or stored programs are not subject to rewriting.
- The `Rewriter` plugin uses a database named `query_rewrite` containing a table named `rewrite_rules`. The table provides persistent storage for the rules that the plugin uses to decide whether to rewrite statements. Users communicate with the plugin by modifying the set of rules stored in this table. The plugin communicates with users by setting the `message` column of table rows.

- The `query_rewrite` database contains a stored procedure named `flush_rewrite_rules()` that loads the contents of the rules table into the plugin.
- A loadable function named `load_rewrite_rules()` is used by the `flush_rewrite_rules()` stored procedure.
- The `Rewriter` plugin exposes system variables that enable plugin configuration and status variables that provide runtime operational information.

The following sections describe how to install and use the `Rewriter` plugin, and provide reference information for its associated elements.

### 5.5.4.1 Installing or Uninstalling the Rewriter Query Rewrite Plugin



#### Note

If installed, the `Rewriter` plugin involves some overhead even when disabled. To avoid this overhead, do not install the plugin unless you plan to use it.

To install or uninstall the `Rewriter` query rewrite plugin, choose the appropriate script located in the `share` directory of your MySQL installation:

- `install_rewriter.sql`: Choose this script to install the `Rewriter` plugin and its associated elements.
- `uninstall_rewriter.sql`: Choose this script to uninstall the `Rewriter` plugin and its associated elements.

Run the chosen script as follows:

```
$> mysql -u root -p < install_rewriter.sql
Enter password: (enter root password here)
```

The example here uses the `install_rewriter.sql` installation script. Substitute `uninstall_rewriter.sql` if you are uninstalling the plugin.

Running an installation script should install and enable the plugin. To verify that, connect to the server and execute this statement:

```
mysql> SHOW GLOBAL VARIABLES LIKE 'rewriter_enabled';
+-----+-----+
| Variable_name | Value |
+-----+-----+
| rewriter_enabled | ON   |
+-----+-----+
```

For usage instructions, see [Section 5.5.4.2, “Using the Rewriter Query Rewrite Plugin”](#). For reference information, see [Section 5.5.4.3, “Rewriter Query Rewrite Plugin Reference”](#).

### 5.5.4.2 Using the Rewriter Query Rewrite Plugin

To enable or disable the plugin, enable or disable the `rewriter_enabled` system variable. By default, the `Rewriter` plugin is enabled when you install it (see [Section 5.5.4.1, “Installing or Uninstalling the Rewriter Query Rewrite Plugin”](#)). To set the initial plugin state explicitly, you can set the variable at server startup. For example, to enable the plugin in an option file, use these lines:

```
[mysqld]
rewriter_enabled=ON
```

It is also possible to enable or disable the plugin at runtime:

```
SET GLOBAL rewriter_enabled = ON;
SET GLOBAL rewriter_enabled = OFF;
```

Assuming that the [Rewriter](#) plugin is enabled, it examines and possibly modifies each [SELECT](#) statement received by the server. The plugin determines whether to rewrite statements based on its in-memory cache of rewriting rules, which are loaded from the [rewrite\\_rules](#) table in the [query\\_rewrite](#) database.

- [Adding Rewrite Rules](#)
- [How Statement Matching Works](#)
- [Rewriting Prepared Statements](#)
- [Rewriter Plugin Operational Information](#)
- [Rewriter Plugin Use of Character Sets](#)

## Adding Rewrite Rules

To add rules for the [Rewriter](#) plugin, add rows to the [rewrite\\_rules](#) table, then invoke the [flush\\_rewrite\\_rules\(\)](#) stored procedure to load the rules from the table into the plugin. The following example creates a simple rule to match statements that select a single literal value:

```
INSERT INTO query_rewrite.rewrite_rules (pattern, replacement)
VALUES('SELECT ?', 'SELECT ? + 1');
```

The resulting table contents look like this:

```
mysql> SELECT * FROM query_rewrite.rewrite_rules\G
***** 1. row *****
      id: 1
      pattern: SELECT ?
      pattern_database: NULL
      replacement: SELECT ? + 1
      enabled: YES
      message: NULL
      pattern_digest: NULL
      normalized_pattern: NULL
```

The rule specifies a pattern template indicating which [SELECT](#) statements to match, and a replacement template indicating how to rewrite matching statements. However, adding the rule to the [rewrite\\_rules](#) table is not sufficient to cause the [Rewriter](#) plugin to use the rule. You must invoke [flush\\_rewrite\\_rules\(\)](#) to load the table contents into the plugin in-memory cache:

```
mysql> CALL query_rewrite.flush_rewrite_rules();
```



### Tip

If your rewrite rules seem not to be working properly, make sure that you have reloaded the rules table by calling [flush\\_rewrite\\_rules\(\)](#).

When the plugin reads each rule from the rules table, it computes a normalized (statement digest) form from the pattern and a digest hash value, and uses them to update the [normalized\\_pattern](#) and [pattern\\_digest](#) columns:

```
mysql> SELECT * FROM query_rewrite.rewrite_rules\G
***** 1. row *****
      id: 1
      pattern: SELECT ?
      pattern_database: NULL
      replacement: SELECT ? + 1
      enabled: YES
      message: NULL
```

```
pattern_digest: 46b876e64cd5c41009d91c754921f1d4
normalized_pattern: select ?
```

For information about statement digesting, normalized statements, and digest hash values, see [Section 25.10, “Performance Schema Statement Digests”](#).

If a rule cannot be loaded due to some error, calling `flush_rewrite_rules()` produces an error:

```
mysql> CALL query_rewrite.flush_rewrite_rules();
ERROR 1644 (45000): Loading of some rule(s) failed.
```

When this occurs, the plugin writes an error message to the `message` column of the rule row to communicate the problem. Check the `rewrite_rules` table for rows with non-NULL `message` column values to see what problems exist.

Patterns use the same syntax as prepared statements (see [Section 13.5.1, “PREPARE Statement”](#)). Within a pattern template, `?` characters act as parameter markers that match data values. The `?` characters should not be enclosed within quotation marks. Parameter markers can be used only where data values should appear, and they cannot be used for SQL keywords, identifiers, functions, and so on. The plugin parses a statement to identify the literal values (as defined in [Section 9.1, “Literal Values”](#)), so you can put a parameter marker in place of any literal value.

Like the pattern, the replacement can contain `?` characters. For a statement that matches a pattern template, the plugin rewrites it, replacing `?` parameter markers in the replacement using data values matched by the corresponding markers in the pattern. The result is a complete statement string. The plugin asks the server to parse it, and returns the result to the server as the representation of the rewritten statement.

After adding and loading the rule, check whether rewriting occurs according to whether statements match the rule pattern:

```
mysql> SELECT PI();
+-----+
| PI()   |
+-----+
| 3.141593 |
+-----+
1 row in set (0.01 sec)

mysql> SELECT 10;
+-----+
| 10 + 1 |
+-----+
|      11 |
+-----+
1 row in set, 1 warning (0.00 sec)
```

No rewriting occurs for the first `SELECT` statement, but does for the second. The second statement illustrates that when the `Rewriter` plugin rewrites a statement, it produces a warning message. To view the message, use `SHOW WARNINGS`:

```
mysql> SHOW WARNINGS\G
***** 1. row *****
Level: Note
Code: 1105
Message: Query 'SELECT 10' rewritten to 'SELECT 10 + 1' by a query rewrite plugin
```

To enable or disable an existing rule, modify its `enabled` column and reload the table into the plugin. To disable rule 1:

```
UPDATE query_rewrite.rewrite_rules SET enabled = 'NO' WHERE id = 1;
CALL query_rewrite.flush_rewrite_rules();
```



This enables you to deactivate a rule without removing it from the table.

To re-enable rule 1:

```
UPDATE query_rewrite.rewrite_rules SET enabled = 'YES' WHERE id = 1;
CALL query_rewrite.flush_rewrite_rules();
```

The `rewrite_rules` table contains a `pattern_database` column that `Rewriter` uses for matching table names that are not qualified with a database name:

- Qualified table names in statements match qualified names in the pattern if corresponding database and table names are identical.
- Unqualified table names in statements match unqualified names in the pattern only if the default database is the same as `pattern_database` and the table names are identical.

Suppose that a table named `appdb.users` has a column named `id` and that applications are expected to select rows from the table using a query of one of these forms, where the second can be used when `appdb` is the default database:

```
SELECT * FROM users WHERE appdb.id = id_value;
SELECT * FROM users WHERE id = id_value;
```

Suppose also that the `id` column is renamed to `user_id` (perhaps the table must be modified to add another type of ID and it is necessary to indicate more specifically what type of ID the `id` column represents).

The change means that applications must refer to `user_id` rather than `id` in the `WHERE` clause, but old applications that cannot be updated no longer work properly. The `Rewriter` plugin can solve this problem by matching and rewriting problematic statements. To match the statement `SELECT * FROM appdb.users WHERE id = value` and rewrite it as `SELECT * FROM appdb.users WHERE user_id = value`, you can insert a row representing a replacement rule into the rewrite rules table. If you also want to match this `SELECT` using the unqualified table name, it is also necessary to add an explicit rule. Using `?` as a value placeholder, the two `INSERT` statements needed look like this:

```
INSERT INTO query_rewrite.rewrite_rules
(pattern, replacement) VALUES(
'SELECT * FROM appdb.users WHERE id = ?',
'SELECT * FROM appdb.users WHERE user_id = ?'
);
INSERT INTO query_rewrite.rewrite_rules
(pattern, replacement, pattern_database) VALUES(
'SELECT * FROM users WHERE id = ?',
'SELECT * FROM users WHERE user_id = ?',
'appdb'
);
```

After adding the two new rules, execute the following statement to cause them to take effect:

```
CALL query_rewrite.flush_rewrite_rules();
```

`Rewriter` uses the first rule to match statements that use the qualified table name, and the second to match statements that use the unqualified name. The second rule works only when `appdb` is the default database.

## How Statement Matching Works

The `Rewriter` plugin uses statement digests and digest hash values to match incoming statements against rewrite rules in stages. The `max_digest_length` system variable determines the size of the buffer used for computing statement digests. Larger values enable computation of digests that distinguish

longer statements. Smaller values use less memory but increase the likelihood of longer statements colliding with the same digest value.

The plugin matches each statement to the rewrite rules as follows:

1. Compute the statement digest hash value and compare it to the rule digest hash values. This is subject to false positives, but serves as a quick rejection test.
2. If the statement digest hash value matches any pattern digest hash values, match the normalized (statement digest) form of the statement to the normalized form of the matching rule patterns.
3. If the normalized statement matches a rule, compare the literal values in the statement and the pattern. A `?` character in the pattern matches any literal value in the statement. If the statement prepares a `SELECT` statement, `?` in the pattern also matches `?` in the statement. Otherwise, corresponding literals must be the same.

If multiple rules match a statement, it is nondeterministic which one the plugin uses to rewrite the statement.

If a pattern contains more markers than the replacement, the plugin discards excess data values. If a pattern contains fewer markers than the replacement, it is an error. The plugin notices this when the rules table is loaded, writes an error message to the `message` column of the rule row to communicate the problem, and sets the `Rewriter_reload_error` status variable to `ON`.

## Rewriting Prepared Statements

Prepared statements are rewritten at parse time (that is, when they are prepared), not when they are executed later.

Prepared statements differ from nonprepared statements in that they may contain `?` characters as parameter markers. To match a `?` in a prepared statement, a `Rewriter` pattern must contain `?` in the same location. Suppose that a rewrite rule has this pattern:

```
SELECT ?, 3
```

The following table shows several prepared `SELECT` statements and whether the rule pattern matches them.

Prepared Statement	Whether Pattern Matches Statement
<code>PREPARE s AS 'SELECT 3, 3'</code>	Yes
<code>PREPARE s AS 'SELECT ?, 3'</code>	Yes
<code>PREPARE s AS 'SELECT 3, ?'</code>	No
<code>PREPARE s AS 'SELECT ?, ?'</code>	No

## Rewriter Plugin Operational Information

The `Rewriter` plugin makes information available about its operation by means of several status variables:

```
mysql> SHOW GLOBAL STATUS LIKE 'Rewriter%';
+-----+
| Variable_name | Value |
+-----+
| Rewriter_number_loaded_rules | 1 |
| Rewriter_number_reloads | 5 |
| Rewriter_number_rewritten_queries | 1 |
| Rewriter_reload_error | ON |
+-----+
```

For descriptions of these variables, see [Rewriter Query Rewrite Plugin Status Variables](#).

When you load the rules table by calling the `flush_rewrite_rules()` stored procedure, if an error occurs for some rule, the `CALL` statement produces an error, and the plugin sets the `Rewriter_reload_error` status variable to `ON`:

```
mysql> CALL query_rewrite.flush_rewrite_rules();
ERROR 1644 (45000): Loading of some rule(s) failed.

mysql> SHOW GLOBAL STATUS LIKE 'Rewriter_reload_error';
+-----+-----+
| Variable_name | Value |
+-----+-----+
| Rewriter_reload_error | ON |
+-----+-----+
```

In this case, check the `rewrite_rules` table for rows with non-NULL `message` column values to see what problems exist.

## Rewriter Plugin Use of Character Sets

When the `rewrite_rules` table is loaded into the `Rewriter` plugin, the plugin interprets statements using the current global value of the `character_set_client` system variable. If the global `character_set_client` value is changed subsequently, the rules table must be reloaded.

A client must have a session `character_set_client` value identical to what the global value was when the rules table was loaded or rule matching does not work for that client.

### 5.5.4.3 Rewriter Query Rewrite Plugin Reference

The following discussion serves as a reference to these elements associated with the `Rewriter` query rewrite plugin:

- The `Rewriter` rules table in the `query_rewrite` database
- `Rewriter` procedures and functions
- `Rewriter` system and status variables

## Rewriter Query Rewrite Plugin Rules Table

The `rewrite_rules` table in the `query_rewrite` database provides persistent storage for the rules that the `Rewriter` plugin uses to decide whether to rewrite statements.

Users communicate with the plugin by modifying the set of rules stored in this table. The plugin communicates information to users by setting the table's `message` column.



#### Note

The rules table is loaded into the plugin by the `flush_rewrite_rules` stored procedure. Unless that procedure has been called following the most recent table modification, the table contents do not necessarily correspond to the set of rules the plugin is using.

The `rewrite_rules` table has these columns:

- `id`

The rule ID. This column is the table primary key. You can use the ID to uniquely identify any rule.

- `pattern`

The template that indicates the pattern for statements that the rule matches. Use `?` to represent parameter markers that match data values.

- `pattern_database`

The database used to match unqualified table names in statements. Qualified table names in statements match qualified names in the pattern if corresponding database and table names are identical. Unqualified table names in statements match unqualified names in the pattern only if the default database is the same as `pattern_database` and the table names are identical.

- `replacement`

The template that indicates how to rewrite statements matching the `pattern` column value. Use `?` to represent parameter markers that match data values. In rewritten statements, the plugin replaces `?` parameter markers in `replacement` using data values matched by the corresponding markers in `pattern`.

- `enabled`

Whether the rule is enabled. Load operations (performed by invoking the `flush_rewrite_rules()` stored procedure) load the rule from the table into the `Rewriter` in-memory cache only if this column is `YES`.

This column makes it possible to deactivate a rule without removing it: Set the column to a value other than `YES` and reload the table into the plugin.

- `message`

The plugin uses this column for communicating with users. If no error occurs when the rules table is loaded into memory, the plugin sets the `message` column to `NULL`. A non-`NULL` value indicates an error and the column contents are the error message. Errors can occur under these circumstances:

- Either the pattern or the replacement is an incorrect SQL statement that produces syntax errors.
- The replacement contains more `?` parameter markers than the pattern.

If a load error occurs, the plugin also sets the `Rewriter_reload_error` status variable to `ON`.

- `pattern_digest`

This column is used for debugging and diagnostics. If the column exists when the rules table is loaded into memory, the plugin updates it with the pattern digest. This column may be useful if you are trying to determine why some statement fails to be rewritten.

- `normalized_pattern`

This column is used for debugging and diagnostics. If the column exists when the rules table is loaded into memory, the plugin updates it with the normalized form of the pattern. This column may be useful if you are trying to determine why some statement fails to be rewritten.

## Rewriter Query Rewrite Plugin Procedures and Functions

`Rewriter` plugin operation uses a stored procedure that loads the rules table into its in-memory cache, and a helper loadable function. Under normal operation, users invoke only the stored procedure. The function is intended to be invoked by the stored procedure, not directly by users.

- `flush_rewrite_rules()`

This stored procedure uses the `load_rewrite_rules()` function to load the contents of the `rewrite_rules` table into the `Rewriter` in-memory cache.

Calling `flush_rewrite_rules()` implies `COMMIT`.

Invoke this procedure after you modify the rules table to cause the plugin to update its cache from the new table contents. If any errors occur, the plugin sets the `message` column for the appropriate rule rows in the table and sets the `Rewriter_reload_error` status variable to `ON`.

- `load_rewrite_rules()`

This function is a helper routine used by the `flush_rewrite_rules()` stored procedure.

### Rewriter Query Rewrite Plugin System Variables

The `Rewriter` query rewrite plugin supports the following system variables. These variables are available only if the plugin is installed (see [Section 5.5.4.1, “Installing or Uninstalling the Rewriter Query Rewrite Plugin”](#)).

- `rewriter_enabled`

System Variable	<code>rewriter_enabled</code>
Scope	Global
Dynamic	Yes
Type	Boolean
Default Value	<code>ON</code>
Valid Values	<code>OFF</code>

Whether the `Rewriter` query rewrite plugin is enabled.

- `rewriter_verbose`

System Variable	<code>rewriter_verbose</code>
Scope	Global
Dynamic	Yes
Type	Integer

For internal use.

### Rewriter Query Rewrite Plugin Status Variables

The `Rewriter` query rewrite plugin supports the following status variables. These variables are available only if the plugin is installed (see [Section 5.5.4.1, “Installing or Uninstalling the Rewriter Query Rewrite Plugin”](#)).

- `Rewriter_number_loaded_rules`

The number of rewrite plugin rewrite rules successfully loaded from the `rewrite_rules` table into memory for use by the `Rewriter` plugin.

- `Rewriter_number_reloads`

The number of times the `rewrite_rules` table has been loaded into the in-memory cache used by the `Rewriter` plugin.

- `Rewriter_number_rewritten_queries`

The number of queries rewritten by the `Rewriter` query rewrite plugin since it was loaded.

- `Rewriter_reload_error`

Whether an error occurred the most recent time that the `rewrite_rules` table was loaded into the in-memory cache used by the `Rewriter` plugin. If the value is `OFF`, no error occurred. If the value is `ON`, an error occurred; check the `message` column of the `rewriter_rules` table for error messages.

## 5.5.5 Version Tokens

MySQL includes Version Tokens, a feature that enables creation of and synchronization around server tokens that applications can use to prevent accessing incorrect or out-of-date data.

The Version Tokens interface has these characteristics:

- Version tokens are pairs consisting of a name that serves as a key or identifier, plus a value.
- Version tokens can be locked. An application can use token locks to indicate to other cooperating applications that tokens are in use and should not be modified.
- Version token lists are established per server (for example, to specify the server assignment or operational state). In addition, an application that communicates with a server can register its own list of tokens that indicate the state it requires the server to be in. An SQL statement sent by the application to a server not in the required state produces an error. This is a signal to the application that it should seek a different server in the required state to receive the SQL statement.

The following sections describe the elements of Version Tokens, discuss how to install and use it, and provide reference information for its elements.

### 5.5.5.1 Version Tokens Elements

Version Tokens is based on a plugin library that implements these elements:

- A server-side plugin named `version_tokens` holds the list of version tokens associated with the server and subscribes to notifications for statement execution events. The `version_tokens` plugin uses the `audit plugin API` to monitor incoming statements from clients and matches each client's session-specific version token list against the server version token list. If there is a match, the plugin lets the statement through and the server continues to process it. Otherwise, the plugin returns an error to the client and the statement fails.
- A set of loadable functions provides an SQL-level API for manipulating and inspecting the list of server version tokens maintained by the plugin. The `SUPER` privilege is required to call any of the Version Token functions.
- A system variable enables clients to specify the list of version tokens that register the required server state. If the server has a different state when a client sends a statement, the client receives an error.

### 5.5.5.2 Installing or Uninstalling Version Tokens



#### Note

If installed, Version Tokens involves some overhead. To avoid this overhead, do not install it unless you plan to use it.

This section describes how to install or uninstall Version Tokens, which is implemented in a plugin library file containing a plugin and loadable functions. For general information about installing or uninstalling plugins and loadable functions, see [Section 5.5.1, “Installing and Uninstalling Plugins”](#), and [Section 5.6.1, “Installing and Uninstalling Loadable Functions”](#).

To be usable by the server, the plugin library file must be located in the MySQL plugin directory (the directory named by the `plugin_dir` system variable). If necessary, configure the plugin directory location by setting the value of `plugin_dir` at server startup.

The plugin library file base name is `version_tokens`. The file name suffix differs per platform (for example, `.so` for Unix and Unix-like systems, `.dll` for Windows).

To install the Version Tokens plugin and functions, use the `INSTALL PLUGIN` and `CREATE FUNCTION` statements, adjusting the `.so` suffix for your platform as necessary:

```
INSTALL PLUGIN version_tokens SONAME 'version_token.so';
CREATE FUNCTION version_tokens_set RETURNS STRING
  SONAME 'version_token.so';
CREATE FUNCTION version_tokens_show RETURNS STRING
  SONAME 'version_token.so';
CREATE FUNCTION version_tokens_edit RETURNS STRING
  SONAME 'version_token.so';
CREATE FUNCTION version_tokens_delete RETURNS STRING
  SONAME 'version_token.so';
CREATE FUNCTION version_tokens_lock_shared RETURNS INT
  SONAME 'version_token.so';
CREATE FUNCTION version_tokens_lock_exclusive RETURNS INT
  SONAME 'version_token.so';
CREATE FUNCTION version_tokens_unlock RETURNS INT
  SONAME 'version_token.so';
```

You must install the functions to manage the server's version token list, but you must also install the plugin because the functions do not work correctly without it.

If the plugin and functions are used on a replication source server, install them on all replica servers as well to avoid replication problems.

Once installed as just described, the plugin and functions remain installed until uninstalled. To remove them, use the `UNINSTALL PLUGIN` and `DROP FUNCTION` statements:

```
UNINSTALL PLUGIN version_tokens;
DROP FUNCTION version_tokens_set;
DROP FUNCTION version_tokens_show;
DROP FUNCTION version_tokens_edit;
DROP FUNCTION version_tokens_delete;
DROP FUNCTION version_tokens_lock_shared;
DROP FUNCTION version_tokens_lock_exclusive;
DROP FUNCTION version_tokens_unlock;
```

### 5.5.5.3 Using Version Tokens

Before using Version Tokens, install it according to the instructions provided at [Section 5.5.5.2, “Installing or Uninstalling Version Tokens”](#).

A scenario in which Version Tokens can be useful is a system that accesses a collection of MySQL servers but needs to manage them for load balancing purposes by monitoring them and adjusting server assignments according to load changes. Such a system comprises these elements:

- The collection of MySQL servers to be managed.

- An administrative or management application that communicates with the servers and organizes them into high-availability groups. Groups serve different purposes, and servers within each group may have different assignments. Assignment of a server within a certain group can change at any time.
- Client applications that access the servers to retrieve and update data, choosing servers according to the purposes assigned them. For example, a client should not send an update to a read-only server.

Version Tokens permit server access to be managed according to assignment without requiring clients to repeatedly query the servers about their assignments:

- The management application performs server assignments and establishes version tokens on each server to reflect its assignment. The application caches this information to provide a central access point to it.

If at some point the management application needs to change a server assignment (for example, to change it from permitting writes to read only), it changes the server's version token list and updates its cache.

- To improve performance, client applications obtain cache information from the management application, enabling them to avoid having to retrieve information about server assignments for each statement. Based on the type of statements it issues (for example, reads versus writes), a client selects an appropriate server and connects to it.
- In addition, the client sends to the server its own client-specific version tokens to register the assignment it requires of the server. For each statement sent by the client to the server, the server compares its own token list with the client token list. If the server token list contains all tokens present in the client token list with the same values, there is a match and the server executes the statement.

On the other hand, perhaps the management application has changed the server assignment and its version token list. In this case, the new server assignment may now be incompatible with the client requirements. A token mismatch between the server and client token lists occurs and the server returns an error in reply to the statement. This is an indication to the client to refresh its version token information from the management application cache, and to select a new server to communicate with.

The client-side logic for detecting version token errors and selecting a new server can be implemented different ways:

- The client can handle all version token registration, mismatch detection, and connection switching itself.
- The logic for those actions can be implemented in a connector that manages connections between clients and MySQL servers. Such a connector might handle mismatch error detection and statement resending itself, or it might pass the error to the application and leave it to the application to resend the statement.

The following example illustrates the preceding discussion in more concrete form.

When Version Tokens initializes on a given server, the server's version token list is empty. Token list maintenance is performed by calling functions. The `SUPER` privilege is required to call any of the Version Token functions, so token list modification is expected to be done by a management or administrative application that has that privilege.

Suppose that a management application communicates with a set of servers that are queried by clients to access employee and product databases (named `emp` and `prod`, respectively). All servers are permitted to process data retrieval statements, but only some of them are permitted to make database updates. To handle this on a database-specific basis, the management application establishes a list of version tokens on each server. In the token list for a given server, token names represent database names and token



values are `read` or `write` depending on whether the database must be used in read-only fashion or whether it can take reads and writes.

Client applications register a list of version tokens they require the server to match by setting a system variable. Variable setting occurs on a client-specific basis, so different clients can register different requirements. By default, the client token list is empty, which matches any server token list. When a client sets its token list to a nonempty value, matching may succeed or fail, depending on the server version token list.

To define the version token list for a server, the management application calls the `version_tokens_set()` function. (There are also functions for modifying and displaying the token list, described later.) For example, the application might send these statements to a group of three servers:

Server 1:

```
mysql> SELECT version_tokens_set('emp=read;prod=read');
+-----+
| version_tokens_set('emp=read;prod=read') |
+-----+
| 2 version tokens set.                    |
+-----+
```

Server 2:

```
mysql> SELECT version_tokens_set('emp=write;prod=read');
+-----+
| version_tokens_set('emp=write;prod=read') |
+-----+
| 2 version tokens set.                    |
+-----+
```

Server 3:

```
mysql> SELECT version_tokens_set('emp=read;prod=write');
+-----+
| version_tokens_set('emp=read;prod=write') |
+-----+
| 2 version tokens set.                    |
+-----+
```

The token list in each case is specified as a semicolon-separated list of `name=value` pairs. The resulting token list values result in these server assignments:

- Any server accepts reads for either database.
- Only server 2 accepts updates for the `emp` database.
- Only server 3 accepts updates for the `prod` database.

In addition to assigning each server a version token list, the management application also maintains a cache that reflects the server assignments.

Before communicating with the servers, a client application contacts the management application and retrieves information about server assignments. Then the client selects a server based on those assignments. Suppose that a client wants to perform both reads and writes on the `emp` database. Based on the preceding assignments, only server 2 qualifies. The client connects to server 2 and registers its server requirements there by setting its `version_tokens_session` system variable:

```
mysql> SET @@SESSION.version_tokens_session = 'emp=write';
```

For subsequent statements sent by the client to server 2, the server compares its own version token list to the client list to check whether they match. If so, statements execute normally:

```
mysql> UPDATE emp.employee SET salary = salary * 1.1 WHERE id = 4981;
Query OK, 1 row affected (0.07 sec)
Rows matched: 1  Changed: 1  Warnings: 0

mysql> SELECT last_name, first_name FROM emp.employee WHERE id = 4981;
+-----+-----+
| last_name | first_name |
+-----+-----+
| Smith    | Abe        |
+-----+-----+
1 row in set (0.01 sec)
```

Discrepancies between the server and client version token lists can occur two ways:

- A token name in the `version_tokens_session` value is not present in the server token list. In this case, an `ER_VTOKEN_PLUGIN_TOKEN_NOT_FOUND` error occurs.
- A token value in the `version_tokens_session` value differs from the value of the corresponding token in the server token list. In this case, an `ER_VTOKEN_PLUGIN_TOKEN_MISMATCH` error occurs.

As long as the assignment of server 2 does not change, the client continues to use it for reads and writes. But suppose that the management application wants to change server assignments so that writes for the `emp` database must be sent to server 1 instead of server 2. To do this, it uses `version_tokens_edit()` to modify the `emp` token value on the two servers (and updates its cache of server assignments):

Server 1:

```
mysql> SELECT version_tokens_edit('emp=write');
+-----+-----+
| version_tokens_edit('emp=write') |
+-----+-----+
| 1 version tokens updated.         |
+-----+-----+
```

Server 2:

```
mysql> SELECT version_tokens_edit('emp=read');
+-----+-----+
| version_tokens_edit('emp=read') |
+-----+-----+
| 1 version tokens updated.         |
+-----+-----+
```

`version_tokens_edit()` modifies the named tokens in the server token list and leaves other tokens unchanged.

The next time the client sends a statement to server 2, its own token list no longer matches the server token list and an error occurs:

```
mysql> UPDATE emp.employee SET salary = salary * 1.1 WHERE id = 4982;
ERROR 3136 (42000): Version token mismatch for emp. Correct value read
```

In this case, the client should contact the management application to obtain updated information about server assignments, select a new server, and send the failed statement to the new server.



#### Note

Each client must cooperate with Version Tokens by sending only statements in accordance with the token list that it registers with a given server. For example, if

a client registers a token list of 'emp=read', there is nothing in Version Tokens to prevent the client from sending updates for the emp database. The client itself must refrain from doing so.

For each statement received from a client, the server implicitly uses locking, as follows:

- Take a shared lock for each token named in the client token list (that is, in the `version_tokens_session` value)
- Perform the comparison between the server and client token lists
- Execute the statement or produce an error depending on the comparison result
- Release the locks

The server uses shared locks so that comparisons for multiple sessions can occur without blocking, while preventing changes to the tokens for any session that attempts to acquire an exclusive lock before it manipulates tokens of the same names in the server token list.

The preceding example uses only a few of the functions included in the Version Tokens plugin library, but there are others. One set of functions permits the server's list of version tokens to be manipulated and inspected. Another set of functions permits version tokens to be locked and unlocked.

These functions permit the server's list of version tokens to be created, changed, removed, and inspected:

- `version_tokens_set()` completely replaces the current list and assigns a new list. The argument is a semicolon-separated list of `name=value` pairs.
- `version_tokens_edit()` enables partial modifications to the current list. It can add new tokens or change the values of existing tokens. The argument is a semicolon-separated list of `name=value` pairs.
- `version_tokens_delete()` deletes tokens from the current list. The argument is a semicolon-separated list of token names.
- `version_tokens_show()` displays the current token list. It takes no argument.

Each of those functions, if successful, returns a binary string indicating what action occurred. The following example establishes the server token list, modifies it by adding a new token, deletes some tokens, and displays the resulting token list:

```
mysql> SELECT version_tokens_set('tok1=a;tok2=b');
+-----+
| version_tokens_set('tok1=a;tok2=b') |
+-----+
| 2 version tokens set.                |
+-----+
mysql> SELECT version_tokens_edit('tok3=c');
+-----+
| version_tokens_edit('tok3=c') |
+-----+
| 1 version tokens updated.      |
+-----+
mysql> SELECT version_tokens_delete('tok2;tok1');
+-----+
| version_tokens_delete('tok2;tok1') |
+-----+
| 2 version tokens deleted.          |
+-----+
mysql> SELECT version_tokens_show();
+-----+
```

```
| version_tokens_show() |
+-----+
| tok3=c;                |
+-----+
```

Warnings occur if a token list is malformed:

```
mysql> SELECT version_tokens_set('tok1=a; =c');
+-----+
| version_tokens_set('tok1=a; =c') |
+-----+
| 1 version tokens set.            |
+-----+
1 row in set, 1 warning (0.00 sec)

mysql> SHOW WARNINGS\G
***** 1. row *****
Level: Warning
Code: 42000
Message: Invalid version token pair encountered. The list provided
        is only partially updated.
1 row in set (0.00 sec)
```

As mentioned previously, version tokens are defined using a semicolon-separated list of *name=value* pairs. Consider this invocation of `version_tokens_set()`:

```
mysql> SELECT version_tokens_set('tok1=b;;; tok2= a = b ; tok1 = 1\'2 3"4')
+-----+
| version_tokens_set('tok1=b;;; tok2= a = b ; tok1 = 1\'2 3"4') |
+-----+
| 3 version tokens set.                                          |
+-----+
```

Version Tokens interprets the argument as follows:

- Whitespace around names and values is ignored. Whitespace within names and values is permitted. (For `version_tokens_delete()`, which takes a list of names without values, whitespace around names is ignored.)
- There is no quoting mechanism.
- Order of tokens is not significant except that if a token list contains multiple instances of a given token name, the last value takes precedence over earlier values.

Given those rules, the preceding `version_tokens_set()` call results in a token list with two tokens: `tok1` has the value `1'2 3"4`, and `tok2` has the value `a = b`. To verify this, call `version_tokens_show()`:

```
mysql> SELECT version_tokens_show();
+-----+
| version_tokens_show() |
+-----+
| tok2=a = b;tok1=1'2 3"4; |
+-----+
```

If the token list contains two tokens, why did `version_tokens_set()` return the value `3 version tokens set`? That occurred because the original token list contained two definitions for `tok1`, and the second definition replaced the first.

The Version Tokens token-manipulation functions place these constraints on token names and values:

- Token names cannot contain `=` or `;` characters and have a maximum length of 64 characters.

- Token values cannot contain `;` characters. Length of values is constrained by the value of the `max_allowed_packet` system variable.
- Version Tokens treats token names and values as binary strings, so comparisons are case-sensitive.

Version Tokens also includes a set of functions enabling tokens to be locked and unlocked:

- `version_tokens_lock_exclusive()` acquires exclusive version token locks. It takes a list of one or more lock names and a timeout value.
- `version_tokens_lock_shared()` acquires shared version token locks. It takes a list of one or more lock names and a timeout value.
- `version_tokens_unlock()` releases version token locks (exclusive and shared). It takes no argument.

Each locking function returns nonzero for success. Otherwise, an error occurs:

```
mysql> SELECT version_tokens_lock_shared('lock1', 'lock2', 0);
+-----+
| version_tokens_lock_shared('lock1', 'lock2', 0) |
+-----+
|                                     1 |
+-----+

mysql> SELECT version_tokens_lock_shared(NULL, 0);
ERROR 3131 (42000): Incorrect locking service lock name '(null)'.
```

Locking using Version Tokens locking functions is advisory; applications must agree to cooperate.

It is possible to lock nonexistent token names. This does not create the tokens.



#### Note

Version Tokens locking functions are based on the locking service described at [Section 5.5.6.1, “The Locking Service”](#), and thus have the same semantics for shared and exclusive locks. (Version Tokens uses the locking service routines built into the server, not the locking service function interface, so those functions need not be installed to use Version Tokens.) Locks acquired by Version Tokens use a locking service namespace of `version_token_locks`. Locking service locks can be monitored using the Performance Schema, so this is also true for Version Tokens locks. For details, see [Locking Service Monitoring](#).

For the Version Tokens locking functions, token name arguments are used exactly as specified. Surrounding whitespace is not ignored and `=` and `;` characters are permitted. This is because Version Tokens simply passes the token names to be locked as is to the locking service.

### 5.5.5.4 Version Tokens Reference

The following discussion serves as a reference to these Version Tokens elements:

- [Version Tokens Functions](#)
- [Version Tokens System Variables](#)

### Version Tokens Functions

The Version Tokens plugin library includes several functions. One set of functions permits the server's list of version tokens to be manipulated and inspected. Another set of functions permits version tokens to be locked and unlocked. The `SUPER` privilege is required to invoke any Version Tokens function.

The following functions permit the server's list of version tokens to be created, changed, removed, and inspected. Interpretation of *name\_list* and *token\_list* arguments (including whitespace handling) occurs as described in [Section 5.5.5.3, "Using Version Tokens"](#), which provides details about the syntax for specifying tokens, as well as additional examples.

- `version_tokens_delete(name_list)`

Deletes tokens from the server's list of version tokens using the *name\_list* argument and returns a binary string that indicates the outcome of the operation. *name\_list* is a semicolon-separated list of version token names to delete.

```
mysql> SELECT version_tokens_delete('tok1;tok3');
+-----+
| version_tokens_delete('tok1;tok3') |
+-----+
| 2 version tokens deleted.          |
+-----+
```

An argument of `NULL` is treated as an empty string, which has no effect on the token list.

`version_tokens_delete()` deletes the tokens named in its argument, if they exist. (It is not an error to delete nonexistent tokens.) To clear the token list entirely without knowing which tokens are in the list, pass `NULL` or a string containing no tokens to `version_tokens_set()`:

```
mysql> SELECT version_tokens_set(NULL);
+-----+
| version_tokens_set(NULL)          |
+-----+
| Version tokens list cleared.      |
+-----+
mysql> SELECT version_tokens_set('');
+-----+
| version_tokens_set('')           |
+-----+
| Version tokens list cleared.      |
+-----+
```

- `version_tokens_edit(token_list)`

Modifies the server's list of version tokens using the *token\_list* argument and returns a binary string that indicates the outcome of the operation. *token\_list* is a semicolon-separated list of *name=value* pairs specifying the name of each token to be defined and its value. If a token exists, its value is updated with the given value. If a token does not exist, it is created with the given value. If the argument is `NULL` or a string containing no tokens, the token list remains unchanged.

```
mysql> SELECT version_tokens_set('tok1=value1;tok2=value2');
+-----+
| version_tokens_set('tok1=value1;tok2=value2') |
+-----+
| 2 version tokens set.                        |
+-----+
mysql> SELECT version_tokens_edit('tok2=new_value2;tok3=new_value3');
+-----+
| version_tokens_edit('tok2=new_value2;tok3=new_value3') |
+-----+
| 2 version tokens updated.                    |
+-----+
```

- `version_tokens_set(token_list)`

Replaces the server's list of version tokens with the tokens defined in the *token\_list* argument and returns a binary string that indicates the outcome of the operation. *token\_list* is a semicolon-

separated list of *name=value* pairs specifying the name of each token to be defined and its value. If the argument is *NULL* or a string containing no tokens, the token list is cleared.

```
mysql> SELECT version_tokens_set('tok1=value1;tok2=value2');
+-----+
| version_tokens_set('tok1=value1;tok2=value2') |
+-----+
| 2 version tokens set.                          |
+-----+
```

- `version_tokens_show()`

Returns the server's list of version tokens as a binary string containing a semicolon-separated list of *name=value* pairs.

```
mysql> SELECT version_tokens_show();
+-----+
| version_tokens_show()      |
+-----+
| tok2=value2;tok1=value1;  |
+-----+
```

The following functions permit version tokens to be locked and unlocked:

- `version_tokens_lock_exclusive(token_name[, token_name] ..., timeout)`

Acquires exclusive locks on one or more version tokens, specified by name as strings, timing out with an error if the locks are not acquired within the given timeout value.

```
mysql> SELECT version_tokens_lock_exclusive('lock1', 'lock2', 10);
+-----+
| version_tokens_lock_exclusive('lock1', 'lock2', 10) |
+-----+
|                                                    1 |
+-----+
```

- `version_tokens_lock_shared(token_name[, token_name] ..., timeout)`

Acquires shared locks on one or more version tokens, specified by name as strings, timing out with an error if the locks are not acquired within the given timeout value.

```
mysql> SELECT version_tokens_lock_shared('lock1', 'lock2', 10);
+-----+
| version_tokens_lock_shared('lock1', 'lock2', 10) |
+-----+
|                                                    1 |
+-----+
```

- `version_tokens_unlock()`

Releases all locks that were acquired within the current session using `version_tokens_lock_exclusive()` and `version_tokens_lock_shared()`.

```
mysql> SELECT version_tokens_unlock();
+-----+
| version_tokens_unlock() |
+-----+
|                        1 |
+-----+
```

The locking functions share these characteristics:

- The return value is nonzero for success. Otherwise, an error occurs.

- Token names are strings.
- In contrast to argument handling for the functions that manipulate the server token list, whitespace surrounding token name arguments is not ignored and = and ; characters are permitted.
- It is possible to lock nonexistent token names. This does not create the tokens.
- Timeout values are nonnegative integers representing the time in seconds to wait to acquire locks before timing out with an error. If the timeout is 0, there is no waiting and the function produces an error if locks cannot be acquired immediately.
- Version Tokens locking functions are based on the locking service described at [Section 5.5.6.1, “The Locking Service”](#).

## Version Tokens System Variables

Version Tokens supports the following system variables. These variables are unavailable unless the Version Tokens plugin is installed (see [Section 5.5.5.2, “Installing or Uninstalling Version Tokens”](#)).

System variables:

- `version_tokens_session`

Command-Line Format	<code>--version-tokens-session=value</code>
System Variable	<code>version_tokens_session</code>
Scope	Global, Session
Dynamic	Yes
Type	String
Default Value	<code>NULL</code>

The session value of this variable specifies the client version token list and indicates the tokens that the client session requires the server version token list to have.

If the `version_tokens_session` variable is `NULL` (the default) or has an empty value, any server version token list matches. (In effect, an empty value disables matching requirements.)

If the `version_tokens_session` variable has a nonempty value, any mismatch between its value and the server version token list results in an error for any statement the session sends to the server. A mismatch occurs under these conditions:

- A token name in the `version_tokens_session` value is not present in the server token list. In this case, an `ER_VTOKEN_PLUGIN_TOKEN_NOT_FOUND` error occurs.
- A token value in the `version_tokens_session` value differs from the value of the corresponding token in the server token list. In this case, an `ER_VTOKEN_PLUGIN_TOKEN_MISMATCH` error occurs.

It is not a mismatch for the server version token list to include a token not named in the `version_tokens_session` value.

Suppose that a management application has set the server token list as follows:

```
mysql> SELECT version_tokens_set('tok1=a;tok2=b;tok3=c');
+-----+
| version_tokens_set('tok1=a;tok2=b;tok3=c') |
+-----+
| 3 version tokens set. |
+-----+
```



A client registers the tokens it requires the server to match by setting its `version_tokens_session` value. Then, for each subsequent statement sent by the client, the server checks its token list against the client `version_tokens_session` value and produces an error if there is a mismatch:

```
mysql> SET @@SESSION.version_tokens_session = 'tok1=a;tok2=b';
mysql> SELECT 1;
+----+
| 1 |
+----+

mysql> SET @@SESSION.version_tokens_session = 'tok1=b';
mysql> SELECT 1;
ERROR 3136 (42000): Version token mismatch for tok1. Correct value a
```

The first `SELECT` succeeds because the client tokens `tok1` and `tok2` are present in the server token list and each token has the same value in the server list. The second `SELECT` fails because, although `tok1` is present in the server token list, it has a different value than specified by the client.

At this point, any statement sent by the client fails, unless the server token list changes such that it matches again. Suppose that the management application changes the server token list as follows:

```
mysql> SELECT version_tokens_edit('tok1=b');
+-----+
| version_tokens_edit('tok1=b') |
+-----+
| 1 version tokens updated.      |
+-----+

mysql> SELECT version_tokens_show();
+-----+
| version_tokens_show() |
+-----+
| tok3=c;tok1=b;tok2=b; |
+-----+
```

Now the client `version_tokens_session` value matches the server token list and the client can once again successfully execute statements:

```
mysql> SELECT 1;
+----+
| 1 |
+----+

mysql> SELECT 1;
+----+
| 1 |
+----+
```

- `version_tokens_session_number`

Command-Line Format	<code>--version-tokens-session-number=#</code>
System Variable	<code>version_tokens_session_number</code>
Scope	Global, Session
Dynamic	No
Type	Integer
Default Value	0

This variable is for internal use.

## 5.5.6 MySQL Plugin Services

MySQL server plugins have access to server “plugin services.” The plugin services interface complements the plugin API by exposing server functionality that plugins can call. For developer information about writing plugin services, see [MySQL Services for Plugins](#). The following sections describe plugin services available at the SQL and C-language levels.

### 5.5.6.1 The Locking Service

MySQL distributions provide a locking interface that is accessible at two levels:

- At the SQL level, as a set of loadable functions that each map onto calls to the service routines.
- As a C language interface, callable as a plugin service from server plugins or loadable functions.

For general information about plugin services, see [Section 5.5.6, “MySQL Plugin Services”](#). For general information about loadable functions, see [Adding a Loadable Function](#).

The locking interface has these characteristics:

- Locks have three attributes: Lock namespace, lock name, and lock mode:
  - Locks are identified by the combination of namespace and lock name. The namespace enables different applications to use the same lock names without colliding by creating locks in separate namespaces. For example, if applications A and B use namespaces of `ns1` and `ns2`, respectively, each application can use lock names `lock1` and `lock2` without interfering with the other application.
  - A lock mode is either read or write. Read locks are shared: If a session has a read lock on a given lock identifier, other sessions can acquire a read lock on the same identifier. Write locks are exclusive: If a session has a write lock on a given lock identifier, other sessions cannot acquire a read or write lock on the same identifier.
- Namespace and lock names must be non-NULL, nonempty, and have a maximum length of 64 characters. A namespace or lock name specified as NULL, the empty string, or a string longer than 64 characters results in an `ER_LOCKING_SERVICE_WRONG_NAME` error.
- The locking interface treats namespace and lock names as binary strings, so comparisons are case-sensitive.
- The locking interface provides functions to acquire locks and release locks. No special privilege is required to call these functions. Privilege checking is the responsibility of the calling application.
- Locks can be waited for if not immediately available. Lock acquisition calls take an integer timeout value that indicates how many seconds to wait to acquire locks before giving up. If the timeout is reached without successful lock acquisition, an `ER_LOCKING_SERVICE_TIMEOUT` error occurs. If the timeout is 0, there is no waiting and the call produces an error if locks cannot be acquired immediately.
- The locking interface detects deadlock between lock-acquisition calls in different sessions. In this case, the locking service chooses a caller and terminates its lock-acquisition request with an `ER_LOCKING_SERVICE_DEADLOCK` error. This error does not cause transactions to roll back. To choose a session in case of deadlock, the locking service prefers sessions that hold read locks over sessions that hold write locks.
- A session can acquire multiple locks with a single lock-acquisition call. For a given call, lock acquisition is atomic: The call succeeds if all locks are acquired. If acquisition of any lock fails, the call acquires no locks and fails, typically with an `ER_LOCKING_SERVICE_TIMEOUT` or `ER_LOCKING_SERVICE_DEADLOCK` error.
- A session can acquire multiple locks for the same lock identifier (namespace and lock name combination). These lock instances can be read locks, write locks, or a mix of both.

- Locks acquired within a session are released explicitly by calling a release-locks function, or implicitly when the session terminates (either normally or abnormally). Locks are not released when transactions commit or roll back.
- Within a session, all locks for a given namespace when released are released together.

The interface provided by the locking service is distinct from that provided by `GET_LOCK()` and related SQL functions (see [Section 12.14, “Locking Functions”](#)). For example, `GET_LOCK()` does not implement namespaces and provides only exclusive locks, not distinct read and write locks.

## The Locking Service C Interface

This section describes how to use the locking service C language interface. To use the function interface instead, see [The Locking Service Function Interface](#). For general characteristics of the locking service interface, see [Section 5.5.6.1, “The Locking Service”](#). For general information about plugin services, see [Section 5.5.6, “MySQL Plugin Services”](#).

Source files that use the locking service should include this header file:

```
#include <mysql/service_locking.h>
```

To acquire one or more locks, call this function:

```
int mysql_acquire_locking_service_locks(MYSQL_THD opaque_thd,
                                       const char* lock_namespace,
                                       const char**lock_names,
                                       size_t lock_num,
                                       enum enum_locking_service_lock_type lock_type,
                                       unsigned long lock_timeout);
```

The arguments have these meanings:

- `opaque_thd`: A thread handle. If specified as `NULL`, the handle for the current thread is used.
- `lock_namespace`: A null-terminated string that indicates the lock namespace.
- `lock_names`: An array of null-terminated strings that provides the names of the locks to acquire.
- `lock_num`: The number of names in the `lock_names` array.
- `lock_type`: The lock mode, either `LOCKING_SERVICE_READ` or `LOCKING_SERVICE_WRITE` to acquire read locks or write locks, respectively.
- `lock_timeout`: An integer number of seconds to wait to acquire the locks before giving up.

To release locks acquired for a given namespace, call this function:

```
int mysql_release_locking_service_locks(MYSQL_THD opaque_thd,
                                       const char* lock_namespace);
```

The arguments have these meanings:

- `opaque_thd`: A thread handle. If specified as `NULL`, the handle for the current thread is used.
- `lock_namespace`: A null-terminated string that indicates the lock namespace.

Locks acquired or waited for by the locking service can be monitored at the SQL level using the Performance Schema. For details, see [Locking Service Monitoring](#).

## The Locking Service Function Interface

This section describes how to use the locking service interface provided by its loadable functions. To use the C language interface instead, see [The Locking Service C Interface](#). For general characteristics of

the locking service interface, see [Section 5.5.6.1, “The Locking Service”](#). For general information about loadable functions, see [Adding a Loadable Function](#).

- [Installing or Uninstalling the Locking Service Function Interface](#)
- [Using the Locking Service Function Interface](#)
- [Locking Service Monitoring](#)
- [Locking Service Interface Function Reference](#)

## Installing or Uninstalling the Locking Service Function Interface

The locking service routines described in [The Locking Service C Interface](#) need not be installed because they are built into the server. The same is not true of the loadable functions that map onto calls to the service routines: The functions must be installed before use. This section describes how to do that. For general information about loadable function installation, see [Section 5.6.1, “Installing and Uninstalling Loadable Functions”](#).

The locking service functions are implemented in a plugin library file located in the directory named by the `plugin_dir` system variable. The file base name is `locking_service`. The file name suffix differs per platform (for example, `.so` for Unix and Unix-like systems, `.dll` for Windows).

To install the locking service functions, use the `CREATE FUNCTION` statement, adjusting the `.so` suffix for your platform as necessary:

```
CREATE FUNCTION service_get_read_locks RETURNS INT
  SONAME 'locking_service.so';
CREATE FUNCTION service_get_write_locks RETURNS INT
  SONAME 'locking_service.so';
CREATE FUNCTION service_release_locks RETURNS INT
  SONAME 'locking_service.so';
```

If the functions are used on a replication source server, install them on all replica servers as well to avoid replication problems.

Once installed, the functions remain installed until uninstalled. To remove them, use the `DROP FUNCTION` statement:

```
DROP FUNCTION service_get_read_locks;
DROP FUNCTION service_get_write_locks;
DROP FUNCTION service_release_locks;
```

## Using the Locking Service Function Interface

Before using the locking service functions, install them according to the instructions provided at [Installing or Uninstalling the Locking Service Function Interface](#).

To acquire one or more read locks, call this function:

```
mysql> SELECT service_get_read_locks('myspace', 'rlock1', 'rlock2', 10);
+-----+-----+-----+-----+
| service_get_read_locks('myspace', 'rlock1', 'rlock2', 10) |
+-----+-----+-----+-----+
|                                                                | 1 |
+-----+-----+-----+-----+
```

The first argument is the lock namespace. The final argument is an integer timeout indicating how many seconds to wait to acquire the locks before giving up. The arguments in between are the lock names.

For the example just shown, the function acquires locks with lock identifiers (`myspace, rlock1`) and (`myspace, rlock2`).

To acquire write locks rather than read locks, call this function:

```
mysql> SELECT service_get_write_locks('myspace', 'wlock1', 'wlock2', 10);
+-----+-----+-----+
| service_get_write_locks('myspace', 'wlock1', 'wlock2', 10) |
+-----+-----+-----+
|                                                                | 1 |
+-----+-----+-----+
```

In this case, the lock identifiers are `(myspace, wlock1)` and `(myspace, wlock2)`.

To release all locks for a namespace, use this function:

```
mysql> SELECT service_release_locks('myspace');
+-----+-----+
| service_release_locks('myspace') |
+-----+-----+
|                                  | 1 |
+-----+-----+
```

Each locking function returns nonzero for success. If the function fails, an error occurs. For example, the following error occurs because lock names cannot be empty:

```
mysql> SELECT service_get_read_locks('myspace', '', 10);
ERROR 3131 (42000): Incorrect locking service lock name ''.
```

A session can acquire multiple locks for the same lock identifier. As long as a different session does not have a write lock for an identifier, the session can acquire any number of read or write locks. Each lock request for the identifier acquires a new lock. The following statements acquire three write locks with the same identifier, then three read locks for the same identifier:

```
SELECT service_get_write_locks('ns', 'lock1', 'lock1', 'lock1', 0);
SELECT service_get_read_locks('ns', 'lock1', 'lock1', 'lock1', 0);
```

If you examine the Performance Schema `metadata_locks` table at this point, you find that the session holds six distinct locks with the same `(ns, lock1)` identifier. (For details, see [Locking Service Monitoring](#).)

Because the session holds at least one write lock on `(ns, lock1)`, no other session can acquire a lock for it, either read or write. If the session held only read locks for the identifier, other sessions could acquire read locks for it, but not write locks.

Locks for a single lock-acquisition call are acquired atomically, but atomicity does not hold across calls. Thus, for a statement such as the following, where `service_get_write_locks()` is called once per row of the result set, atomicity holds for each individual call, but not for the statement as a whole:

```
SELECT service_get_write_locks('ns', 'lock1', 'lock2', 0) FROM t1 WHERE ... ;
```



### Caution

Because the locking service returns a separate lock for each successful request for a given lock identifier, it is possible for a single statement to acquire a large number of locks. For example:

```
INSERT INTO ... SELECT service_get_write_locks('ns', t1.col_name, 0) FROM t1;
```

These types of statements may have certain adverse effects. For example, if the statement fails part way through and rolls back, locks acquired up to the point of failure still exist. If the intent is for there to be a correspondence between rows inserted and locks acquired, that intent is not satisfied. Also, if it is important that locks are granted in a certain order, be aware that result set order may differ

depending on which execution plan the optimizer chooses. For these reasons, it may be best to limit applications to a single lock-acquisition call per statement.

## Locking Service Monitoring

The locking service is implemented using the MySQL Server metadata locks framework, so you monitor locking service locks acquired or waited for by examining the Performance Schema `metadata_locks` table.

First, enable the metadata lock instrument:

```
mysql> UPDATE performance_schema.setup_instruments SET ENABLED = 'YES'
-> WHERE NAME = 'wait/lock/metadata/sql/mdl';
```

Then acquire some locks and check the contents of the `metadata_locks` table:

```
mysql> SELECT service_get_write_locks('myspace', 'lock1', 0);
+-----+
| service_get_write_locks('myspace', 'lock1', 0) |
+-----+
| 1 |
+-----+
mysql> SELECT service_get_read_locks('myspace', 'lock2', 0);
+-----+
| service_get_read_locks('myspace', 'lock2', 0) |
+-----+
| 1 |
+-----+
mysql> SELECT OBJECT_TYPE, OBJECT_SCHEMA, OBJECT_NAME, LOCK_TYPE, LOCK_STATUS
-> FROM performance_schema.metadata_locks
-> WHERE OBJECT_TYPE = 'LOCKING SERVICE'\G
***** 1. row *****
OBJECT_TYPE: LOCKING SERVICE
OBJECT_SCHEMA: myspace
OBJECT_NAME: lock1
LOCK_TYPE: EXCLUSIVE
LOCK_STATUS: GRANTED
***** 2. row *****
OBJECT_TYPE: LOCKING SERVICE
OBJECT_SCHEMA: myspace
OBJECT_NAME: lock2
LOCK_TYPE: SHARED
LOCK_STATUS: GRANTED
```

Locking service locks have an `OBJECT_TYPE` value of `LOCKING SERVICE`. This is distinct from, for example, locks acquired with the `GET_LOCK()` function, which have an `OBJECT_TYPE` of `USER LEVEL LOCK`.

The lock namespace, name, and mode appear in the `OBJECT_SCHEMA`, `OBJECT_NAME`, and `LOCK_TYPE` columns. Read and write locks have `LOCK_TYPE` values of `SHARED` and `EXCLUSIVE`, respectively.

The `LOCK_STATUS` value is `GRANTED` for an acquired lock, `PENDING` for a lock that is being waited for. You see `PENDING` if one session holds a write lock and another session is attempting to acquire a lock having the same identifier.

## Locking Service Interface Function Reference

The SQL interface to the locking service implements the loadable functions described in this section. For usage examples, see [Using the Locking Service Function Interface](#).

The functions share these characteristics:

- The return value is nonzero for success. Otherwise, an error occurs.

- Namespace and lock names must be non-NULL, nonempty, and have a maximum length of 64 characters.
- Timeout values must be integers indicating how many seconds to wait to acquire locks before giving up with an error. If the timeout is 0, there is no waiting and the function produces an error if locks cannot be acquired immediately.

These locking service functions are available:

- `service_get_read_locks(namespace, lock_name[, lock_name] ..., timeout)`

Acquires one or more read (shared) locks in the given namespace using the given lock names, timing out with an error if the locks are not acquired within the given timeout value.

- `service_get_write_locks(namespace, lock_name[, lock_name] ..., timeout)`

Acquires one or more write (exclusive) locks in the given namespace using the given lock names, timing out with an error if the locks are not acquired within the given timeout value.

- `service_release_locks(namespace)`

For the given namespace, releases all locks that were acquired within the current session using `service_get_read_locks()` and `service_get_write_locks()`.

It is not an error for there to be no locks in the namespace.

### 5.5.6.2 The Keyring Service

MySQL Server supports a keyring service that enables internal server components and plugins to securely store sensitive information for later retrieval. MySQL distributions provide a keyring interface that is accessible at two levels:

- At the SQL level, as a set of loadable functions that each map onto calls to the service routines.
- As a C language interface, callable as a plugin service from server plugins or loadable functions.

This section describes how to use the keyring service functions to store, retrieve, and remove keys in the MySQL keyring keystore. For information about the SQL interface that uses functions, [Section 6.4.4.8, “General-Purpose Keyring Key-Management Functions”](#). For general keyring information, see [Section 6.4.4, “The MySQL Keyring”](#).

The keyring service uses whatever underlying keyring plugin is enabled, if any. If no keyring plugin is enabled, keyring service calls fail.

A “record” in the keystore consists of data (the key itself) and a unique identifier through which the key is accessed. The identifier has two parts:

- `key_id`: The key ID or name. `key_id` values that begin with `mysql_` are reserved by MySQL Server.
- `user_id`: The session effective user ID. If there is no user context, this value can be `NULL`. The value need not actually be a “user”; the meaning depends on the application.

Functions that implement the keyring function interface pass the value of `CURRENT_USER()` as the `user_id` value to keyring service functions.

The keyring service functions have these characteristics in common:

- Each function returns 0 for success, 1 for failure.

- The `key_id` and `user_id` arguments form a unique combination indicating which key in the keyring to use.
- The `key_type` argument provides additional information about the key, such as its encryption method or intended use.
- Keyring service functions treat key IDs, user names, types, and values as binary strings, so comparisons are case-sensitive. For example, IDs of `MyKey` and `mykey` refer to different keys.

These keyring service functions are available:

- `my_key_fetch()`

Deobfuscates and retrieves a key from the keyring, along with its type. The function allocates the memory for the buffers used to store the returned key and key type. The caller should zero or obfuscate the memory when it is no longer needed, then free it.

Syntax:

```
my_bool my_key_fetch(const char *key_id, const char **key_type,
                    const char* user_id, void **key, size_t *key_len)
```

Arguments:

- `key_id`, `user_id`: Null-terminated strings that as a pair form a unique identifier indicating which key to fetch.
- `key_type`: The address of a buffer pointer. The function stores into it a pointer to a null-terminated string that provides additional information about the key (stored when the key was added).
- `key`: The address of a buffer pointer. The function stores into it a pointer to the buffer containing the fetched key data.
- `key_len`: The address of a variable into which the function stores the size in bytes of the `*key` buffer.

Return value:

Returns 0 for success, 1 for failure.

- `my_key_generate()`

Generates a new random key of a given type and length and stores it in the keyring. The key has a length of `key_len` and is associated with the identifier formed from `key_id` and `user_id`. The type and length values must be consistent with the values supported by the underlying keyring plugin. See [Section 6.4.4.6, “Supported Keyring Key Types and Lengths”](#).

Syntax:

```
my_bool my_key_generate(const char *key_id, const char *key_type,
                       const char *user_id, size_t key_len)
```

Arguments:

- `key_id`, `user_id`: Null-terminated strings that as a pair form a unique identifier for the key to be generated.
- `key_type`: A null-terminated string that provides additional information about the key.
- `key_len`: The size in bytes of the key to be generated.



Return value:

Returns 0 for success, 1 for failure.

- `my_key_remove()`

Removes a key from the keyring.

Syntax:

```
my_bool my_key_remove(const char *key_id, const char* user_id)
```

Arguments:

- `key_id`, `user_id`: Null-terminated strings that as a pair form a unique identifier for the key to be removed.

Return value:

Returns 0 for success, 1 for failure.

- `my_key_store()`

Obfuscates and stores a key in the keyring.

Syntax:

```
my_bool my_key_store(const char *key_id, const char *key_type,
                    const char* user_id, void *key, size_t key_len)
```

Arguments:

- `key_id`, `user_id`: Null-terminated strings that as a pair form a unique identifier for the key to be stored.
- `key_type`: A null-terminated string that provides additional information about the key.
- `key`: The buffer containing the key data to be stored.
- `key_len`: The size in bytes of the `key` buffer.

Return value:

Returns 0 for success, 1 for failure.

## 5.6 MySQL Server Loadable Functions

MySQL supports loadable functions, that is, functions that are not built in but can be loaded at runtime (either during startup or later) to extend server capabilities, or unloaded to remove capabilities. For a table describing the available loadable functions, see [Section 12.2, “Loadable Function Reference”](#). Loadable functions contrast with built-in (native) functions, which are implemented as part of the server and are always available; for a table, see [Section 12.1, “Built-In Function and Operator Reference”](#).



### Note

Loadable functions previously were known as user-defined functions (UDFs). That terminology was something of a misnomer because “user-defined” also can apply

to other types of functions, such as stored functions (a type of stored object written using SQL) and native functions added by modifying the server source code.

MySQL distributions include loadable functions that implement, in whole or in part, these server capabilities:

- MySQL Enterprise Edition includes functions that perform encryption operations based on the OpenSSL library. See [Section 6.6, “MySQL Enterprise Encryption”](#).
- MySQL Enterprise Edition includes functions that provide an SQL-level API for masking and de-identification operations. See [Section 6.5.1, “MySQL Enterprise Data Masking and De-Identification Elements”](#).
- MySQL Enterprise Edition includes audit logging for monitoring and logging of connection and query activity. See [Section 6.4.5, “MySQL Enterprise Audit”](#).
- MySQL Enterprise Edition includes a firewall capability that implements an application-level firewall to enable database administrators to permit or deny SQL statement execution based on matching against patterns for accepted statement. See [Section 6.4.6, “MySQL Enterprise Firewall”](#).
- A query rewriter examines statements received by MySQL Server and possibly rewrites them before the server executes them. See [Section 5.5.4, “The Rewriter Query Rewrite Plugin”](#)
- Version Tokens enables creation of and synchronization around server tokens that applications can use to prevent accessing incorrect or out-of-date data. See [Section 5.5.5, “Version Tokens”](#).
- The MySQL Keyring provides secure storage for sensitive information. See [Section 6.4.4, “The MySQL Keyring”](#).
- A locking service provides a locking interface for application use. See [Section 5.5.6.1, “The Locking Service”](#).

The following sections describe how to install and uninstall loadable functions, and how to determine at runtime which loadable functions are installed and obtain information about them.

For information about writing loadable functions, see [Adding Functions to MySQL](#).

## 5.6.1 Installing and Uninstalling Loadable Functions

Loadable functions, as the name implies, must be loaded into the server before they can be used. MySQL supports automatic function loading during server startup and manual loading thereafter.

While a loadable function is loaded, information about it is available as described in [Section 5.6.2, “Obtaining Information About Loadable Functions”](#).

- [Installing Loadable Functions](#)
- [Uninstalling Loadable Functions](#)
- [Reinstalling or Upgrading Loadable Functions](#)

### Installing Loadable Functions

To load a loadable function manually, use the `CREATE FUNCTION` statement. For example:

```
CREATE FUNCTION metaphon
  RETURNS STRING
  SONAME 'udf_example.so';
```

The file base name depends on your platform. Common suffixes are `.so` for Unix and Unix-like systems, `.dll` for Windows.

`CREATE FUNCTION` has these effects:

- It loads the function into the server to make it available immediately.
- It registers the function in the `mysql.func` system table to make it persistent across server restarts. For this reason, `CREATE FUNCTION` requires the `INSERT` privilege for the `mysql` system database.

Automatic loading of loadable functions occurs during the normal server startup sequence. The server loads functions registered in the `mysql.func` table. If the server is started with the `--skip-grant-tables` option, functions registered in the table are not loaded and are unavailable.

## Uninstalling Loadable Functions

To remove a loadable function, use the `DROP FUNCTION` statement. For example:

```
DROP FUNCTION metaphor;
```

`DROP FUNCTION` has these effects:

- It unloads the function to make it unavailable.
- It removes the function from the `mysql.func` system table. For this reason, `DROP FUNCTION` requires the `DELETE` privilege for the `mysql` system database. With the function no longer registered in the `mysql.func` table, the server does not load the function during subsequent restarts.

While a loadable function is loaded, information about it is available from the `mysql.func` system table. See [Section 5.6.2, “Obtaining Information About Loadable Functions”](#). `CREATE FUNCTION` adds the function to the table and `DROP FUNCTION` removes it.

## Reinstalling or Upgrading Loadable Functions

To reinstall or upgrade the shared library associated with a loadable function, issue a `DROP FUNCTION` statement, upgrade the shared library, and then issue a `CREATE FUNCTION` statement. If you upgrade the shared library first and then use `DROP FUNCTION`, the server may unexpectedly shut down.

## 5.6.2 Obtaining Information About Loadable Functions

The `mysql.func` system table shows which loadable functions have been registered using `CREATE FUNCTION`:

```
SELECT * FROM mysql.func;
```

The `func` table has these columns:

- `name`  
The function name as referred to in SQL statements.
- `ret`  
The function return value type. Permitted values are 0 (`STRING`), 1 (`REAL`), 2 (`INTEGER`), 3 (`ROW`), or 4 (`DECIMAL`).
- `dl`  
The name of the function library file containing the executable function code. The file is located in the directory named by the `plugin_dir` system variable.

- `type`

The function type, either `function` (scalar) or `aggregate`.

## 5.7 Running Multiple MySQL Instances on One Machine

In some cases, you might want to run multiple instances of MySQL on a single machine. You might want to test a new MySQL release while leaving an existing production setup undisturbed. Or you might want to give different users access to different `mysqld` servers that they manage themselves. (For example, you might be an Internet Service Provider that wants to provide independent MySQL installations for different customers.)

It is possible to use a different MySQL server binary per instance, or use the same binary for multiple instances, or any combination of the two approaches. For example, you might run a server from MySQL 5.6 and one from MySQL 5.7, to see how different versions handle a given workload. Or you might run multiple instances of the current production version, each managing a different set of databases.

Whether or not you use distinct server binaries, each instance that you run must be configured with unique values for several operating parameters. This eliminates the potential for conflict between instances. Parameters can be set on the command line, in option files, or by setting environment variables. See [Section 4.2.2, “Specifying Program Options”](#). To see the values used by a given instance, connect to it and execute a `SHOW VARIABLES` statement.

The primary resource managed by a MySQL instance is the data directory. Each instance should use a different data directory, the location of which is specified using the `--datadir=dir_name` option. For methods of configuring each instance with its own data directory, and warnings about the dangers of failing to do so, see [Section 5.7.1, “Setting Up Multiple Data Directories”](#).

In addition to using different data directories, several other options must have different values for each server instance:

- `--port=port_num`

`--port` controls the port number for TCP/IP connections. Alternatively, if the host has multiple network addresses, you can set the `bind_address` system variable to cause each server to listen to a different address.

- `--socket={file_name|pipe_name}`

`--socket` controls the Unix socket file path on Unix or the named-pipe name on Windows. On Windows, it is necessary to specify distinct pipe names only for those servers configured to permit named-pipe connections.

- `--shared-memory-base-name=name`

This option is used only on Windows. It designates the shared-memory name used by a Windows server to permit clients to connect using shared memory. It is necessary to specify distinct shared-memory names only for those servers configured to permit shared-memory connections.

- `--pid-file=file_name`

This option indicates the path name of the file in which the server writes its process ID.

If you use the following log file options, their values must differ for each server:

- `--general_log_file=file_name`

- `--log-bin[=file_name]`
- `--slow_query_log_file=file_name`
- `--log-error[=file_name]`

For further discussion of log file options, see [Section 5.4, “MySQL Server Logs”](#).

To achieve better performance, you can specify the following option differently for each server, to spread the load between several physical disks:

- `--tmpdir=dir_name`

Having different temporary directories also makes it easier to determine which MySQL server created any given temporary file.

If you have multiple MySQL installations in different locations, you can specify the base directory for each installation with the `--basedir=dir_name` option. This causes each instance to automatically use a different data directory, log files, and PID file because the default for each of those parameters is relative to the base directory. In that case, the only other options you need to specify are the `--socket` and `--port` options. Suppose that you install different versions of MySQL using `tar` file binary distributions. These install in different locations, so you can start the server for each installation using the command `bin/mysqld_safe` under its corresponding base directory. `mysqld_safe` determines the proper `--basedir` option to pass to `mysqld`, and you need specify only the `--socket` and `--port` options to `mysqld_safe`.

As discussed in the following sections, it is possible to start additional servers by specifying appropriate command options or by setting environment variables. However, if you need to run multiple servers on a more permanent basis, it is more convenient to use option files to specify for each server those option values that must be unique to it. The `--defaults-file` option is useful for this purpose.

## 5.7.1 Setting Up Multiple Data Directories

Each MySQL Instance on a machine should have its own data directory. The location is specified using the `--datadir=dir_name` option.

There are different methods of setting up a data directory for a new instance:

- Create a new data directory.
- Copy an existing data directory.

The following discussion provides more detail about each method.



### Warning

Normally, you should never have two servers that update data in the same databases. This may lead to unpleasant surprises if your operating system does not support fault-free system locking. If (despite this warning) you run multiple servers using the same data directory and they have logging enabled, you must use the appropriate options to specify log file names that are unique to each server. Otherwise, the servers try to log to the same files.

Even when the preceding precautions are observed, this kind of setup works only with `MyISAM` and `MERGE` tables, and not with any of the other storage engines. Also, this warning against sharing a data directory among servers always applies in an NFS environment. Permitting multiple MySQL servers to access a common data

directory over NFS is a *very bad idea*. The primary problem is that NFS is the speed bottleneck. It is not meant for such use. Another risk with NFS is that you must devise a way to ensure that two or more servers do not interfere with each other. Usually NFS file locking is handled by the `lockd` daemon, but at the moment there is no platform that performs locking 100% reliably in every situation.

## Create a New Data Directory

With this method, the data directory is in the same state as when you first install MySQL. It has the default set of MySQL accounts and no user data.

On Unix, initialize the data directory. See [Section 2.9, “Postinstallation Setup and Testing”](#).

On Windows, the data directory is included in the MySQL distribution:

- MySQL Zip archive distributions for Windows contain an unmodified data directory. You can unpack such a distribution into a temporary location, then copy it `data` directory to where you are setting up the new instance.
- Windows MSI package installers create and set up the data directory that the installed server uses, but also create a pristine “template” data directory named `data` under the installation directory. After an installation has been performed using an MSI package, the template data directory can be copied to set up additional MySQL instances.

## Copy an Existing Data Directory

With this method, any MySQL accounts or user data present in the data directory are carried over to the new data directory.

1. Stop the existing MySQL instance using the data directory. This must be a clean shutdown so that the instance flushes any pending changes to disk.
2. Copy the data directory to the location where the new data directory should be.
3. Copy the `my.cnf` or `my.ini` option file used by the existing instance. This serves as a basis for the new instance.
4. Modify the new option file so that any pathnames referring to the original data directory refer to the new data directory. Also, modify any other options that must be unique per instance, such as the TCP/IP port number and the log files. For a list of parameters that must be unique per instance, see [Section 5.7, “Running Multiple MySQL Instances on One Machine”](#).
5. Start the new instance, telling it to use the new option file.

## 5.7.2 Running Multiple MySQL Instances on Windows

You can run multiple servers on Windows by starting them manually from the command line, each with appropriate operating parameters, or by installing several servers as Windows services and running them that way. General instructions for running MySQL from the command line or as a service are given in [Section 2.3, “Installing MySQL on Microsoft Windows”](#). The following sections describe how to start each server with different values for those options that must be unique per server, such as the data directory. These options are listed in [Section 5.7, “Running Multiple MySQL Instances on One Machine”](#).

### 5.7.2.1 Starting Multiple MySQL Instances at the Windows Command Line

The procedure for starting a single MySQL server manually from the command line is described in [Section 2.3.4.6, “Starting MySQL from the Windows Command Line”](#). To start multiple servers this way,

you can specify the appropriate options on the command line or in an option file. It is more convenient to place the options in an option file, but it is necessary to make sure that each server gets its own set of options. To do this, create an option file for each server and tell the server the file name with a `--defaults-file` option when you run it.

Suppose that you want to run one instance of `mysqld` on port 3307 with a data directory of `C:\mydata1`, and another instance on port 3308 with a data directory of `C:\mydata2`. Use this procedure:

1. Make sure that each data directory exists, including its own copy of the `mysql` database that contains the grant tables.
2. Create two option files. For example, create one file named `C:\my-opts1.cnf` that looks like this:

```
[mysqld]
datadir = C:/mydata1
port = 3307
```

Create a second file named `C:\my-opts2.cnf` that looks like this:

```
[mysqld]
datadir = C:/mydata2
port = 3308
```

3. Use the `--defaults-file` option to start each server with its own option file:

```
C:\> C:\mysql\bin\mysqld --defaults-file=C:\my-opts1.cnf
C:\> C:\mysql\bin\mysqld --defaults-file=C:\my-opts2.cnf
```

Each server starts in the foreground (no new prompt appears until the server exits later), so you must issue those two commands in separate console windows.

To shut down the servers, connect to each using the appropriate port number:

```
C:\> C:\mysql\bin\mysqladmin --port=3307 --host=127.0.0.1 --user=root --password shutdown
C:\> C:\mysql\bin\mysqladmin --port=3308 --host=127.0.0.1 --user=root --password shutdown
```

Servers configured as just described permit clients to connect over TCP/IP. If your version of Windows supports named pipes and you also want to permit named-pipe connections, specify options that enable the named pipe and specify its name. Each server that supports named-pipe connections must use a unique pipe name. For example, the `C:\my-opts1.cnf` file might be written like this:

```
[mysqld]
datadir = C:/mydata1
port = 3307
enable-named-pipe
socket = mypipe1
```

Modify `C:\my-opts2.cnf` similarly for use by the second server. Then start the servers as described previously.

A similar procedure applies for servers that you want to permit shared-memory connections. Enable such connections by starting the server with the `shared_memory` system variable enabled and specify a unique shared-memory name for each server by setting the `shared_memory_base_name` system variable.

### 5.7.2.2 Starting Multiple MySQL Instances as Windows Services

On Windows, a MySQL server can run as a Windows service. The procedures for installing, controlling, and removing a single MySQL service are described in [Section 2.3.4.8, "Starting MySQL as a Windows Service"](#).

To set up multiple MySQL services, you must make sure that each instance uses a different service name in addition to the other parameters that must be unique per instance.

For the following instructions, suppose that you want to run the `mysqld` server from two different versions of MySQL that are installed at `C:\mysql-5.7.9` and `C:\mysql-5.7.44`, respectively. (This might be the case if you are running 5.7.9 as your production server, but also want to conduct tests using 5.7.44.)

To install MySQL as a Windows service, use the `--install` or `--install-manual` option. For information about these options, see [Section 2.3.4.8, “Starting MySQL as a Windows Service”](#).

Based on the preceding information, you have several ways to set up multiple services. The following instructions describe some examples. Before trying any of them, shut down and remove any existing MySQL services.

- **Approach 1:** Specify the options for all services in one of the standard option files. To do this, use a different service name for each server. Suppose that you want to run the 5.7.9 `mysqld` using the service name of `mysqld1` and the 5.7.44 `mysqld` using the service name `mysqld2`. In this case, you can use the `[mysqld1]` group for 5.7.9 and the `[mysqld2]` group for 5.7.44. For example, you can set up `C:\my.cnf` like this:

```
# options for mysqld1 service
[mysqld1]
basedir = C:/mysql-5.7.9
port = 3307
enable-named-pipe
socket = mypipe1

# options for mysqld2 service
[mysqld2]
basedir = C:/mysql-5.7.44
port = 3308
enable-named-pipe
socket = mypipe2
```

Install the services as follows, using the full server path names to ensure that Windows registers the correct executable program for each service:

```
C:\> C:\mysql-5.7.9\bin\mysqld --install mysqld1
C:\> C:\mysql-5.7.44\bin\mysqld --install mysqld2
```

To start the services, use the services manager, or `NET START` or `SC START` with the appropriate service names:

```
C:\> SC START mysqld1
C:\> SC START mysqld2
```

To stop the services, use the services manager, or use `NET STOP` or `SC STOP` with the appropriate service names:

```
C:\> SC STOP mysqld1
C:\> SC STOP mysqld2
```

- **Approach 2:** Specify options for each server in separate files and use `--defaults-file` when you install the services to tell each server what file to use. In this case, each file should list options using a `[mysqld]` group.

With this approach, to specify options for the 5.7.9 `mysqld`, create a file `C:\my-opts1.cnf` that looks like this:

```
[mysqld]
basedir = C:/mysql-5.7.9
```



```
port = 3307
enable-named-pipe
socket = mypipe1
```

For the 5.7.44 `mysqld`, create a file `C:\my-opts2.cnf` that looks like this:

```
[mysqld]
basedir = C:/mysql-5.7.44
port = 3308
enable-named-pipe
socket = mypipe2
```

Install the services as follows (enter each command on a single line):

```
C:\> C:\mysql-5.7.9\bin\mysqld --install mysqld1
      --defaults-file=C:\my-opts1.cnf
C:\> C:\mysql-5.7.44\bin\mysqld --install mysqld2
      --defaults-file=C:\my-opts2.cnf
```

When you install a MySQL server as a service and use a `--defaults-file` option, the service name must precede the option.

After installing the services, start and stop them the same way as in the preceding example.

To remove multiple services, use `SC DELETE mysqld_service_name` for each one. Alternatively, use `mysqld --remove` for each one, specifying a service name following the `--remove` option. If the service name is the default (`MySQL`), you can omit it when using `mysqld --remove`.

## 5.7.3 Running Multiple MySQL Instances on Unix



### Note

The discussion here uses `mysqld_safe` to launch multiple instances of MySQL. For MySQL installation using an RPM distribution, server startup and shutdown is managed by `systemd` on several Linux platforms. On these platforms, `mysqld_safe` is not installed because it is unnecessary. For information about using `systemd` to handle multiple MySQL instances, see [Section 2.5.10, “Managing MySQL Server with systemd”](#).

One way is to run multiple MySQL instances on Unix is to compile different servers with different default TCP/IP ports and Unix socket files so that each one listens on different network interfaces. Compiling in different base directories for each installation also results automatically in a separate, compiled-in data directory, log file, and PID file location for each server.

Assume that an existing 5.6 server is configured for the default TCP/IP port number (3306) and Unix socket file (`/tmp/mysql.sock`). To configure a new 5.7.44 server to have different operating parameters, use a `CMake` command something like this:

```
$> cmake . -DMYSQL_TCP_PORT=port_number \
      -DMYSQL_UNIX_ADDR=file_name \
      -DCMAKE_INSTALL_PREFIX=/usr/local/mysql-5.7.44
```

Here, `port_number` and `file_name` must be different from the default TCP/IP port number and Unix socket file path name, and the `CMAKE_INSTALL_PREFIX` value should specify an installation directory different from the one under which the existing MySQL installation is located.

If you have a MySQL server listening on a given port number, you can use the following command to find out what operating parameters it is using for several important configurable variables, including the base directory and Unix socket file name:

```
$> mysqladmin --host=host_name --port=port_number variables
```

With the information displayed by that command, you can tell what option values *not* to use when configuring an additional server.

If you specify `localhost` as the host name, `mysqladmin` defaults to using a Unix socket file rather than TCP/IP. To explicitly specify the transport protocol, use the `--protocol={TCP|SOCKET|PIPE|MEMORY}` option.

You need not compile a new MySQL server just to start with a different Unix socket file and TCP/IP port number. It is also possible to use the same server binary and start each invocation of it with different parameter values at runtime. One way to do so is by using command-line options:

```
$> mysqld_safe --socket=file_name --port=port_number
```

To start a second server, provide different `--socket` and `--port` option values, and pass a `--datadir=dir_name` option to `mysqld_safe` so that the server uses a different data directory.

Alternatively, put the options for each server in a different option file, then start each server using a `--defaults-file` option that specifies the path to the appropriate option file. For example, if the option files for two server instances are named `/usr/local/mysql/my.cnf` and `/usr/local/mysql/my.cnf2`, start the servers like this: command:

```
$> mysqld_safe --defaults-file=/usr/local/mysql/my.cnf
$> mysqld_safe --defaults-file=/usr/local/mysql/my.cnf2
```

Another way to achieve a similar effect is to use environment variables to set the Unix socket file name and TCP/IP port number:

```
$> MYSQL_UNIX_PORT=/tmp/mysqld-new.sock
$> MYSQL_TCP_PORT=3307
$> export MYSQL_UNIX_PORT MYSQL_TCP_PORT
$> mysqld --initialize --user=mysql
...set root password...
$> mysqld_safe --datadir=/path/to/datadir &
```

This is a quick way of starting a second server to use for testing. The nice thing about this method is that the environment variable settings apply to any client programs that you invoke from the same shell. Thus, connections for those clients are automatically directed to the second server.

[Section 4.9, “Environment Variables”](#), includes a list of other environment variables you can use to affect MySQL programs.

On Unix, the `mysqld_multi` script provides another way to start multiple servers. See [Section 4.3.4, “mysqld\\_multi — Manage Multiple MySQL Servers”](#).

## 5.7.4 Using Client Programs in a Multiple-Server Environment

To connect with a client program to a MySQL server that is listening to different network interfaces from those compiled into your client, you can use one of the following methods:

- Start the client with `--host=host_name --port=port_number` to connect using TCP/IP to a remote server, with `--host=127.0.0.1 --port=port_number` to connect using TCP/IP to a local server, or with `--host=localhost --socket=file_name` to connect to a local server using a Unix socket file or a Windows named pipe.
- Start the client with `--protocol=TCP` to connect using TCP/IP, `--protocol=SOCKET` to connect using a Unix socket file, `--protocol=PIPE` to connect using a named pipe, or `--protocol=MEMORY` to connect using shared memory. For TCP/IP connections, you may also need to specify `--host` and

`--port` options. For the other types of connections, you may need to specify a `--socket` option to specify a Unix socket file or Windows named-pipe name, or a `--shared-memory-base-name` option to specify the shared-memory name. Shared-memory connections are supported only on Windows.

- On Unix, set the `MYSQL_UNIX_PORT` and `MYSQL_TCP_PORT` environment variables to point to the Unix socket file and TCP/IP port number before you start your clients. If you normally use a specific socket file or port number, you can place commands to set these environment variables in your `.login` file so that they apply each time you log in. See [Section 4.9, “Environment Variables”](#).
- Specify the default Unix socket file and TCP/IP port number in the `[client]` group of an option file. For example, you can use `C:\my.cnf` on Windows, or the `.my.cnf` file in your home directory on Unix. See [Section 4.2.2.2, “Using Option Files”](#).
- In a C program, you can specify the socket file or port number arguments in the `mysql_real_connect()` call. You can also have the program read option files by calling `mysql_options()`. See [C API Basic Function Descriptions](#).
- If you are using the Perl `DBD::mysql` module, you can read options from MySQL option files. For example:

```
$dsn = "DBI:mysql:test;mysql_read_default_group=client;"
      . "mysql_read_default_file=/usr/local/mysql/data/my.cnf";
$dbh = DBI->connect($dsn, $user, $password);
```

See [Section 27.9, “MySQL Perl API”](#).

Other programming interfaces may provide similar capabilities for reading option files.

## 5.8 Debugging MySQL

This section describes debugging techniques that assist efforts to track down problems in MySQL.

### 5.8.1 Debugging a MySQL Server

If you are using some functionality that is very new in MySQL, you can try to run `mysqld` with the `--skip-new` option (which disables all new, potentially unsafe functionality). See [Section B.3.3.3, “What to Do If MySQL Keeps Crashing”](#).

If `mysqld` does not want to start, verify that you have no `my.cnf` files that interfere with your setup! You can check your `my.cnf` arguments with `mysqld --print-defaults` and avoid using them by starting with `mysqld --no-defaults ....`

If `mysqld` starts to eat up CPU or memory or if it “hangs,” you can use `mysqladmin processlist status` to find out if someone is executing a query that takes a long time. It may be a good idea to run `mysqladmin -i10 processlist status` in some window if you are experiencing performance problems or problems when new clients cannot connect.

The command `mysqladmin debug` dumps some information about locks in use, used memory and query usage to the MySQL log file. This may help solve some problems. This command also provides some useful information even if you have not compiled MySQL for debugging!

If the problem is that some tables are getting slower and slower you should try to optimize the table with `OPTIMIZE TABLE` or `myisamchk`. See [Chapter 5, MySQL Server Administration](#). You should also check the slow queries with `EXPLAIN`.

You should also read the OS-specific section in this manual for problems that may be unique to your environment. See [Section 2.1, “General Installation Guidance”](#).

### 5.8.1.1 Compiling MySQL for Debugging

If you have some very specific problem, you can always try to debug MySQL. To do this you must configure MySQL with the `-DWITH_DEBUG=1` option. You can check whether MySQL was compiled with debugging by doing: `mysqld --help`. If the `--debug` flag is listed with the options then you have debugging enabled. `mysqladmin ver` also lists the `mysqld` version as `mysql ... --debug` in this case.

If `mysqld` stops crashing when you configure it with the `-DWITH_DEBUG=1` CMake option, you probably have found a compiler bug or a timing bug within MySQL. In this case, you can try to add `-g` using the `CMAKE_C_FLAGS` and `CMAKE_CXX_FLAGS` CMake options and not use `-DWITH_DEBUG=1`. If `mysqld` dies, you can at least attach to it with `gdb` or use `gdb` on the core file to find out what happened.

When you configure MySQL for debugging you automatically enable a lot of extra safety check functions that monitor the health of `mysqld`. If they find something “unexpected,” an entry is written to `stderr`, which `mysqld_safe` directs to the error log! This also means that if you are having some unexpected problems with MySQL and are using a source distribution, the first thing you should do is to configure MySQL for debugging. If you believe that you have found a bug, please use the instructions at [Section 1.5, “How to Report Bugs or Problems”](#).

In the Windows MySQL distribution, `mysqld.exe` is by default compiled with support for trace files.

### 5.8.1.2 Creating Trace Files

If the `mysqld` server does not start or it crashes easily, you can try to create a trace file to find the problem.

To do this, you must have a `mysqld` that has been compiled with debugging support. You can check this by executing `mysqld -v`. If the version number ends with `-debug`, it is compiled with support for trace files. (On Windows, the debugging server is named `mysqld-debug` rather than `mysqld`.)

Start the `mysqld` server with a trace log in `/tmp/mysqld.trace` on Unix or `\mysqld.trace` on Windows:

```
$> mysqld --debug
```

On Windows, you should also use the `--standalone` flag to not start `mysqld` as a service. In a console window, use this command:

```
C:\> mysqld-debug --debug --standalone
```

After this, you can use the `mysql.exe` command-line tool in a second console window to reproduce the problem. You can stop the `mysqld` server with `mysqladmin shutdown`.

The trace file can become **very large!** To generate a smaller trace file, you can use debugging options something like this:

```
mysqld --debug=d,info,error,query,general,where:0,/tmp/mysqld.trace
```

This only prints information with the most interesting tags to the trace file.

If you file a bug, please add only those lines from the trace file to the bug report that indicate where something seems to go wrong. If you cannot locate the wrong place, open a bug report and upload the whole trace file to the report, so that a MySQL developer can take a look at it. For instructions, see [Section 1.5, “How to Report Bugs or Problems”](#).

The trace file is made with the DBUG package by Fred Fish. See [Section 5.8.3, “The DBUG Package”](#).

### 5.8.1.3 Using WER with PDB to create a Windows crashdump

Program Database files (with suffix `pdb`) are included in the **ZIP Archive Debug Binaries & Test Suite** distribution of MySQL. These files provide information for debugging your MySQL installation in the event of a problem. This is a separate download from the standard MSI or Zip file.



#### Note

The PDB files are available in a separate file labeled "ZIP Archive Debug Binaries & Test Suite".

The PDB file contains more detailed information about `mysqld` and other tools that enables more detailed trace and dump files to be created. You can use these with `WinDbg` or Visual Studio to debug `mysqld`.

For more information on PDB files, see [Microsoft Knowledge Base Article 121366](#). For more information on the debugging options available, see [Debugging Tools for Windows](#).

To use `WinDbg`, either install the full Windows Driver Kit (WDK) or install the standalone version.



#### Important

The `.exe` and `.pdb` files must be an exact match (both version number and MySQL server edition) or `WinDBG` complains while attempting to load the symbols.

1. To generate a minidump `mysqld.dmp`, enable the `core-file` option under the `[mysqld]` section in `my.ini`. Restart the MySQL server after making these changes.
2. Create a directory to store the generated files, such as `c:\symbols`
3. Determine the path to your `windbg.exe` executable using the Find GUI or from the command line, for example: `dir /s /b windbg.exe` -- a common default is `C:\Program Files\Debugging Tools for Windows (x64)\windbg.exe`
4. Launch `windbg.exe` giving it the paths to `mysqld-debug.exe`, `mysqld.pdb`, `mysqld.dmp`, and the source code. Alternatively, pass in each path from the `WinDbg` GUI. For example:

```
windbg.exe -i "C:\mysql-5.7.44-winx64\bin\"^
-z "C:\mysql-5.7.44-winx64\data\mysqld.dmp"^
-srcpath "E:\ade\mysql_archives\5.7\5.7.44\mysql-5.7.44"^
-y "C:\mysql-5.7.44-winx64\bin;SRV*c:\symbols*http://msdl.microsoft.com/download/symbols"^
-v -n -c "!analyze -vvvvv"
```



#### Note

The `^` character and newline are removed by the Windows command line processor, so be sure the spaces remain intact.

### 5.8.1.4 Debugging `mysqld` under `gdb`

On most systems you can also start `mysqld` from `gdb` to get more information if `mysqld` crashes.

With some older `gdb` versions on Linux you must use `run --one-thread` if you want to be able to debug `mysqld` threads. In this case, you can only have one thread active at a time.

NPTL threads (the new thread library on Linux) may cause problems while running `mysqld` under `gdb`. Some symptoms are:

- `mysqld` hangs during startup (before it writes `ready for connections`).
- `mysqld` crashes during a `pthread_mutex_lock()` or `pthread_mutex_unlock()` call.

In this case, you should set the following environment variable in the shell before starting `gdb`:

```
LD_ASSUME_KERNEL=2.4.1
export LD_ASSUME_KERNEL
```

When running `mysqld` under `gdb`, you should disable the stack trace with `--skip-stack-trace` to be able to catch segfaults within `gdb`.

Use the `--gdb` option to `mysqld` to install an interrupt handler for `SIGINT` (needed to stop `mysqld` with `^C` to set breakpoints) and disable stack tracing and core file handling.

It is very hard to debug MySQL under `gdb` if you do a lot of new connections the whole time as `gdb` does not free the memory for old threads. You can avoid this problem by starting `mysqld` with `thread_cache_size` set to a value equal to `max_connections + 1`. In most cases just using `--thread_cache_size=5'` helps a lot!

If you want to get a core dump on Linux if `mysqld` dies with a `SIGSEGV` signal, you can start `mysqld` with the `--core-file` option. This core file can be used to make a backtrace that may help you find out why `mysqld` died:

```
$> gdb mysqld core
gdb> backtrace full
gdb> quit
```

See [Section B.3.3.3, “What to Do If MySQL Keeps Crashing”](#).

If you are using `gdb` on Linux, you should install a `.gdb` file, with the following information, in your current directory:

```
set print sevenbit off
handle SIGUSR1 nostop noprint
handle SIGUSR2 nostop noprint
handle SIGWAITING nostop noprint
handle SIGLWP nostop noprint
handle SIGPIPE nostop
handle SIGALRM nostop
handle SIGHUP nostop
handle SIGTERM nostop noprint
```

Here is an example how to debug `mysqld`:

```
$> gdb /usr/local/libexec/mysqld
gdb> run
...
backtrace full # Do this when mysqld crashes
```

Include the preceding output in a bug report, which you can file using the instructions in [Section 1.5, “How to Report Bugs or Problems”](#).

If `mysqld` hangs, you can try to use some system tools like `strace` or `/usr/proc/bin/pstack` to examine where `mysqld` has hung.

```
strace /tmp/log libexec/mysqld
```

If you are using the Perl `DBI` interface, you can turn on debugging information by using the `trace` method or by setting the `DBI_TRACE` environment variable.

### 5.8.1.5 Using a Stack Trace

On some operating systems, the error log contains a stack trace if `mysqld` dies unexpectedly. You can use this to find out where (and maybe why) `mysqld` died. See [Section 5.4.2, “The Error Log”](#). To get

a stack trace, you must not compile `mysqld` with the `-fomit-frame-pointer` option to gcc. See [Section 5.8.1.1, “Compiling MySQL for Debugging”](#).

A stack trace in the error log looks something like this:

```
mysqld got signal 11;
Attempting backtrace. You can use the following information
to find out where mysqld died. If you see no messages after
this, something went terribly wrong...

stack_bottom = 0x41fd0110 thread_stack 0x40000
mysqld(my_print_stacktrace+0x32)[0x9da402]
mysqld(handle_segfault+0x28a)[0x6648e9]
/lib/libpthread.so.0[0x7f1a5af000f0]
/lib/libc.so.6(strcmp+0x2)[0x7f1a5a10f0f2]
mysqld(_Z21check_change_passwordP3THDPKcS2_Pcj+0x7c)[0x7412cb]
mysqld(_ZN16set_var_password5checkEP3THD+0xd0)[0x688354]
mysqld(_Z17sql_set_variablesP3THDP4ListI12set_var_baseE+0x68)[0x688494]
mysqld(_Z21mysql_execute_commandP3THD+0x41a0)[0x67a170]
mysqld(_Z11mysql_parseP3THDPKcjPS2_+0x282)[0x67f0ad]
mysqld(_Z16dispatch_command19enum_server_commandP3THDPcj+0xbb7)[0x67fdf8]
mysqld(_Z10do_commandP3THD+0x24d)[0x6811b6]
mysqld(handle_one_connection+0x11c)[0x66e05e]
```

If resolution of function names for the trace fails, the trace contains less information:

```
mysqld got signal 11;
Attempting backtrace. You can use the following information
to find out where mysqld died. If you see no messages after
this, something went terribly wrong...

stack_bottom = 0x41fd0110 thread_stack 0x40000
[0x9da402]
[0x6648e9]
[0x7f1a5af000f0]
[0x7f1a5a10f0f2]
[0x7412cb]
[0x688354]
[0x688494]
[0x67a170]
[0x67f0ad]
[0x67fdf8]
[0x6811b6]
[0x66e05e]
```

In the latter case, you can use the `resolve_stack_dump` utility to determine where `mysqld` died by using the following procedure:

1. Copy the numbers from the stack trace to a file, for example `mysqld.stack`. The numbers should not include the surrounding square brackets:

```
0x9da402
0x6648e9
0x7f1a5af000f0
0x7f1a5a10f0f2
0x7412cb
0x688354
0x688494
0x67a170
0x67f0ad
0x67fdf8
0x6811b6
0x66e05e
```

2. Make a symbol file for the `mysqld` server:

```
$> nm -n libexec/mysqld > /tmp/mysqld.sym
```

If `mysqld` is not linked statically, use the following command instead:

```
$> nm -D -n libexec/mysqld > /tmp/mysqld.sym
```

If you want to decode C++ symbols, use the `--demangle`, if available, to `nm`. If your version of `nm` does not have this option, you must use the `c++filt` command after the stack dump has been produced to demangle the C++ names.

- Execute the following command:

```
$> resolve_stack_dump -s /tmp/mysqld.sym -n mysqld.stack
```

If you were not able to include demangled C++ names in your symbol file, process the `resolve_stack_dump` output using `c++filt`:

```
$> resolve_stack_dump -s /tmp/mysqld.sym -n mysqld.stack | c++filt
```

This prints out where `mysqld` died. If that does not help you find out why `mysqld` died, you should create a bug report and include the output from the preceding command with the bug report.

However, in most cases it does not help us to have just a stack trace to find the reason for the problem. To be able to locate the bug or provide a workaround, in most cases we need to know the statement that killed `mysqld` and preferably a test case so that we can repeat the problem! See [Section 1.5, “How to Report Bugs or Problems”](#).

Newer versions of `glibc` stack trace functions also print the address as relative to the object. On `glibc`-based systems (Linux), the trace for an unexpected exit within a plugin looks something like:

```
plugin/auth/auth_test_plugin.so(+0x9a6)[0x7ff4d11c29a6]
```

To translate the relative address (`+0x9a6`) into a file name and line number, use this command:

```
$> addr2line -fie auth_test_plugin.so 0x9a6
auth_test_plugin
mysql-trunk/plugin/auth/test_plugin.c:65
```

The `addr2line` utility is part of the `binutils` package on Linux.

On Solaris, the procedure is similar. The Solaris `printstack()` already prints relative addresses:

```
plugin/auth/auth_test_plugin.so:0x1510
```

To translate, use this command:

```
$> gaddr2line -fie auth_test_plugin.so 0x1510
mysql-trunk/plugin/auth/test_plugin.c:88
```

Windows already prints the address, function name and line:

```
000007FEF07E10A4 auth_test_plugin.dll!auth_test_plugin()[test_plugin.c:72]
```

### 5.8.1.6 Using Server Logs to Find Causes of Errors in `mysqld`

Note that before starting `mysqld` with the general query log enabled, you should check all your tables with `myisamchk`. See [Chapter 5, MySQL Server Administration](#).

If `mysqld` dies or hangs, you should start `mysqld` with the general query log enabled. See [Section 5.4.3, “The General Query Log”](#). When `mysqld` dies again, you can examine the end of the log file for the query that killed `mysqld`.



If you use the default general query log file, the log is stored in the database directory as `host_name.log`. In most cases it is the last query in the log file that killed `mysqld`, but if possible you should verify this by restarting `mysqld` and executing the found query from the `mysql` command-line tools. If this works, you should also test all complicated queries that did not complete.

You can also try the command `EXPLAIN` on all `SELECT` statements that takes a long time to ensure that `mysqld` is using indexes properly. See [Section 13.8.2, “EXPLAIN Statement”](#).

You can find the queries that take a long time to execute by starting `mysqld` with the slow query log enabled. See [Section 5.4.5, “The Slow Query Log”](#).

If you find the text `mysqld restarted` in the error log (normally a file named `host_name.err`) you probably have found a query that causes `mysqld` to fail. If this happens, you should check all your tables with `myisamchk` (see [Chapter 5, MySQL Server Administration](#)), and test the queries in the MySQL log files to see whether one fails. If you find such a query, try first upgrading to the newest MySQL version. If this does not help, report a bug, see [Section 1.5, “How to Report Bugs or Problems”](#).

If you have started `mysqld` with the `myisam_recover_options` system variable set, MySQL automatically checks and tries to repair MyISAM tables if they are marked as 'not closed properly' or 'crashed'. If this happens, MySQL writes an entry in the `hostname.err` file 'Warning: Checking table ...' which is followed by `Warning: Repairing table` if the table needs to be repaired. If you get a lot of these errors, without `mysqld` having died unexpectedly just before, then something is wrong and needs to be investigated further. See [Section 5.1.6, “Server Command Options”](#).

When the server detects MyISAM table corruption, it writes additional information to the error log, such as the name and line number of the source file, and the list of threads accessing the table. Example: `Got an error from thread_id=1, mi_dynrec.c:368`. This is useful information to include in bug reports.

It is not a good sign if `mysqld` did die unexpectedly, but in this case, you should not investigate the `Checking table...` messages, but instead try to find out why `mysqld` died.

### 5.8.1.7 Making a Test Case If You Experience Table Corruption

The following procedure applies to MyISAM tables. For information about steps to take when encountering InnoDB table corruption, see [Section 1.5, “How to Report Bugs or Problems”](#).

If you encounter corrupted MyISAM tables or if `mysqld` always fails after some update statements, you can test whether the issue is reproducible by doing the following:

1. Stop the MySQL daemon with `mysqladmin shutdown`.
2. Make a backup of the tables to guard against the very unlikely case that the repair does something bad.
3. Check all tables with `myisamchk -s database/*.MYI`. Repair any corrupted tables with `myisamchk -r database/table.MYI`.
4. Make a second backup of the tables.
5. Remove (or move away) any old log files from the MySQL data directory if you need more space.
6. Start `mysqld` with the binary log enabled. If you want to find a statement that crashes `mysqld`, you should start the server with the general query log enabled as well. See [Section 5.4.3, “The General Query Log”](#), and [Section 5.4.4, “The Binary Log”](#).
7. When you have gotten a crashed table, stop the `mysqld` server.
8. Restore the backup.

9. Restart the `mysqld` server *without* the binary log enabled.
10. Re-execute the statements with `mysqlbinlog binary-log-file | mysql`. The binary log is saved in the MySQL database directory with the name `hostname-bin.NNNNNNN`.
11. If the tables are corrupted again or you can get `mysqld` to die with the above command, you have found a reproducible bug. FTP the tables and the binary log to our bugs database using the instructions given in [Section 1.5, “How to Report Bugs or Problems”](#). If you are a support customer, you can use the MySQL Customer Support Center (<https://www.mysql.com/support/>) to alert the MySQL team about the problem and have it fixed as soon as possible.

## 5.8.2 Debugging a MySQL Client

To be able to debug a MySQL client with the integrated debug package, you should configure MySQL with `-DWITH_DEBUG=1`. See [Section 2.8.7, “MySQL Source-Configuration Options”](#).

Before running a client, you should set the `MYSQL_DEBUG` environment variable:

```
$> MYSQL_DEBUG=d:t:0,/tmp/client.trace
$> export MYSQL_DEBUG
```

This causes clients to generate a trace file in `/tmp/client.trace`.

If you have problems with your own client code, you should attempt to connect to the server and run your query using a client that is known to work. Do this by running `mysql` in debugging mode (assuming that you have compiled MySQL with debugging on):

```
$> mysql --debug=d:t:0,/tmp/client.trace
```

This provides useful information in case you mail a bug report. See [Section 1.5, “How to Report Bugs or Problems”](#).

If your client crashes at some 'legal' looking code, you should check that your `mysql.h` include file matches your MySQL library file. A very common mistake is to use an old `mysql.h` file from an old MySQL installation with new MySQL library.

## 5.8.3 The DEBUG Package

The MySQL server and most MySQL clients are compiled with the `DEBUG` package originally created by Fred Fish. When you have configured MySQL for debugging, this package makes it possible to get a trace file of what the program is doing. See [Section 5.8.1.2, “Creating Trace Files”](#).

This section summarizes the argument values that you can specify in debug options on the command line for MySQL programs that have been built with debugging support.

The `DEBUG` package can be used by invoking a program with the `--debug[=debug_options]` or `-#[debug_options]` option. If you specify the `--debug` or `-#` option without a `debug_options` value, most MySQL programs use a default value. The server default is `d:t:i:0,/tmp/mysqld.trace` on Unix and `d:t:i:0,\mysqld.trace` on Windows. The effect of this default is:

- `d`: Enable output for all debug macros
- `t`: Trace function calls and exits
- `i`: Add PID to output lines
- `o,/tmp/mysqld.trace,0,\mysqld.trace`: Set the debug output file.

Most client programs use a default *debug\_options* value of `d:t:o,/tmp/program_name.trace`, regardless of platform.

Here are some example debug control strings as they might be specified on a shell command line:

```
--debug=d:t
--debug=d:f,main,subr1:F:L:t,20
--debug=d,input,output,files:n
--debug=d:t:i:0,\\mysqld.trace
```

For `mysqld`, it is also possible to change `DEBUG` settings at runtime by setting the `debug` system variable. This variable has global and session values:

```
mysql> SET GLOBAL debug = 'debug_options';
mysql> SET SESSION debug = 'debug_options';
```

Changing the global `debug` value requires privileges sufficient to set global system variables. Changing the session `debug` value requires privileges sufficient to set restricted session system variables. See [Section 5.1.8.1, “System Variable Privileges”](#).

The *debug\_options* value is a sequence of colon-separated fields:

```
field_1:field_2:...:field_N
```

Each field within the value consists of a mandatory flag character, optionally preceded by a `+` or `-` character, and optionally followed by a comma-separated list of modifiers:

```
[+|-]flag[,modifier,modifier,...,modifier]
```

The following table describes the permitted flag characters. Unrecognized flag characters are silently ignored.

Flag	Description
<code>d</code>	Enable output from <code>DEBUG_XXX</code> macros for the current state. May be followed by a list of keywords, which enables output only for the <code>DEBUG</code> macros with that keyword. An empty list of keywords enables output for all macros.  In MySQL, common debug macro keywords to enable are <code>enter</code> , <code>exit</code> , <code>error</code> , <code>warning</code> , <code>info</code> , and <code>loop</code> .
<code>D</code>	Delay after each debugger output line. The argument is the delay, in tenths of seconds, subject to machine capabilities. For example, <code>D,20</code> specifies a delay of two seconds.
<code>f</code>	Limit debugging, tracing, and profiling to the list of named functions. An empty list enables all functions. The appropriate <code>d</code> or <code>t</code> flags must still be given; this flag only limits their actions if they are enabled.
<code>F</code>	Identify the source file name for each line of debug or trace output.
<code>i</code>	Identify the process with the PID or thread ID for each line of debug or trace output.
<code>L</code>	Identify the source file line number for each line of debug or trace output.

Flag	Description
<code>n</code>	Print the current function nesting depth for each line of debug or trace output.
<code>N</code>	Number each line of debug output.
<code>o</code>	Redirect the debugger output stream to the specified file. The default output is <code>stderr</code> .
<code>O</code>	Like <code>o</code> , but the file is really flushed between each write. When needed, the file is closed and reopened between each write.
<code>a</code>	Like <code>o</code> , but opens for append.
<code>A</code>	Like <code>O</code> , but opens for append.
<code>p</code>	Limit debugger actions to specified processes. A process must be identified with the <code>DEBUG_PROCESS</code> macro and match one in the list for debugger actions to occur.
<code>P</code>	Print the current process name for each line of debug or trace output.
<code>r</code>	When pushing a new state, do not inherit the previous state's function nesting level. Useful when the output is to start at the left margin.
<code>t</code>	Enable function call/exit trace lines. May be followed by a list (containing only one modifier) giving a numeric maximum trace level, beyond which no output occurs for either debugging or tracing macros. The default is a compile time option.
<code>T</code>	Print the current timestamp for every line of output.

The leading `+` or `-` character and trailing list of modifiers are used for flag characters such as `d` or `f` that can enable a debug operation for all applicable modifiers or just some of them:

- With no leading `+` or `-`, the flag value is set to exactly the modifier list as given.
- With a leading `+` or `-`, the modifiers in the list are added to or subtracted from the current modifier list.

The following examples show how this works for the `d` flag. An empty `d` list enabled output for all debug macros. A nonempty list enables output only for the macro keywords in the list.

These statements set the `d` value to the modifier list as given:

```
mysql> SET debug = 'd';
mysql> SELECT @@debug;
+-----+
| @@debug |
+-----+
| d       |
+-----+
mysql> SET debug = 'd,error,warning';
mysql> SELECT @@debug;
+-----+
| @@debug |
+-----+
| d,error,warning |
+-----+
```

A leading + or - adds to or subtracts from the current `d` value:

```
mysql> SET debug = '+d,loop';
mysql> SELECT @@debug;
+-----+
| @@debug |
+-----+
| d,error,warning,loop |
+-----+
mysql> SET debug = '-d,error,loop';
mysql> SELECT @@debug;
+-----+
| @@debug |
+-----+
| d,warning |
+-----+
```

Adding to “all macros enabled” results in no change:

```
mysql> SET debug = 'd';
mysql> SELECT @@debug;
+-----+
| @@debug |
+-----+
| d |
+-----+
mysql> SET debug = '+d,loop';
mysql> SELECT @@debug;
+-----+
| @@debug |
+-----+
| d |
+-----+
```

Disabling all enabled macros disables the `d` flag entirely:

```
mysql> SET debug = 'd,error,loop';
mysql> SELECT @@debug;
+-----+
| @@debug |
+-----+
| d,error,loop |
+-----+
mysql> SET debug = '-d,error,loop';
mysql> SELECT @@debug;
+-----+
| @@debug |
+-----+
| |
+-----+
```

## 5.8.4 Tracing mysqld Using DTrace

Support for DTrace is deprecated in MySQL 5.7 and is removed in MySQL 8.0.

The DTrace probes in the MySQL server are designed to provide information about the execution of queries within MySQL and the different areas of the system being utilized during that process. The organization and triggering of the probes means that the execution of an entire query can be monitored with one level of probes (`query-start` and `query-done`) but by monitoring other probes you can get successively more detailed information about the execution of the query in terms of the locks used, sort methods and even row-by-row and storage-engine level execution information.

The DTrace probes are organized so that you can follow the entire query process, from the point of connection from a client, through the query execution, row-level operations, and back out again. You

can think of the probes as being fired within a specific sequence during a typical client connect/execute/disconnect sequence, as shown in the following figure.

**Figure 5.1 DTrace Probe Sequence**

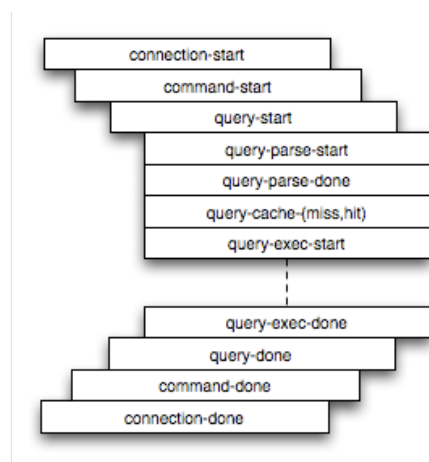

Global information is provided in the arguments to the DTrace probes at various levels. Global information, that is, the connection ID and user/host and where relevant the query string, is provided at key levels (`connection-start`, `command-start`, `query-start`, and `query-exec-start`). As you go deeper into the probes, it is assumed either you are only interested in the individual executions (row-level probes provide information on the database and table name only), or that you intend to combine the row-level probes with the notional parent probes to provide the information about a specific query. Examples of this are given as the format and arguments of each probe are provided.

MySQL includes support for DTrace probes on these platforms:

- Solaris 10 Update 5 (Solaris 5/08) on SPARC, x86 and x86\_64 platforms
- OS X / macOS 10.4 and higher
- Oracle Linux 6 and higher with UEK kernel (as of MySQL 5.7.5)

Enabling the probes should be automatic on these platforms. To explicitly enable or disable the probes during building, use the `-DENABLE_DTRACE=1` or `-DENABLE_DTRACE=0` option to `CMake`.

If a non-Solaris platform includes DTrace support, building `mysqld` on that platform includes DTrace support.

## Additional Resources

- For more information on DTrace and writing DTrace scripts, read the [DTrace User Guide](#).
- For an introduction to DTrace, see the MySQL Dev Zone article [Getting started with DTracing MySQL](#).

### 5.8.4.1 mysqld DTrace Probe Reference

MySQL supports the following static probes, organized into groups of functionality.

**Table 5.5 MySQL DTrace Probes**

Group	Probes
Connection	<code>connection-start</code> , <code>connection-done</code>
Command	<code>command-start</code> , <code>command-done</code>

Group	Probes
Query	query-start, query-done
Query Parsing	query-parse-start, query-parse-done
Query Cache	query-cache-hit, query-cache-miss
Query Execution	query-exec-start, query-exec-done
Row Level	insert-row-start, insert-row-done
	update-row-start, update-row-done
	delete-row-start, delete-row-done
Row Reads	read-row-start, read-row-done
Index Reads	index-read-row-start, index-read-row-done
Lock	handler-rdlock-start, handler-rdlock-done
	handler-wrlock-start, handler-wrlock-done
	handler-unlock-start, handler-unlock-done
Filesort	filesort-start, filesort-done
Statement	select-start, select-done
	insert-start, insert-done
	insert-select-start, insert-select-done
	update-start, update-done
	multi-update-start, multi-update-done
	delete-start, delete-done
	multi-delete-start, multi-delete-done
Network	net-read-start, net-read-done, net-write-start, net-write-done
Keycache	keycache-read-start, keycache-read-block, keycache-read-done, keycache-read-hit, keycache-read-miss, keycache-write-start, keycache-write-block, keycache-write-done



### Note

When extracting the argument data from the probes, each argument is available as `argN`, starting with `arg0`. To identify each argument within the definitions they are provided with a descriptive name, but you must access the information using the corresponding `argN` parameter.

## Connection Probes

The `connection-start` and `connection-done` probes enclose a connection from a client, regardless of whether the connection is through a socket or network connection.

```
connection-start(connectionid, user, host)
```

```
connection-done(status, connectionid)
```

- `connection-start`: Triggered after a connection and successful login/authentication have been completed by a client. The arguments contain the connection information:
  - `connectionid`: An `unsigned long` containing the connection ID. This is the same as the process ID shown as the `Id` value in the output from `SHOW PROCESSLIST`.
  - `user`: The username used when authenticating. The value is blank for the anonymous user.
  - `host`: The host of the client connection. For a connection made using Unix sockets, the value is blank.
- `connection-done`: Triggered just as the connection to the client has been closed. The arguments are:
  - `status`: The status of the connection when it was closed. A logout operation has a value of 0; any other termination of the connection has a nonzero value.
  - `connectionid`: The connection ID of the connection that was closed.

The following D script quantifies and summarizes the average duration of individual connections, and provides a count, dumping the information every 60 seconds:

```
#!/usr/sbin/dtrace -s

mysql*:::connection-start
{
    self->start = timestamp;
}

mysql*:::connection-done
/self->start/
{
    @ = quantize((timestamp - self->start)/1000000);
    self->start = 0;
}

tick-60s
{
    printa(@);
}
```

When executed on a server with a large number of clients you might see output similar to this:

```
1 57413          :tick-60s

      value  ----- Distribution ----- count
      -1 | 0
      0 | @@@@@@@@@@@@@@@@@@@@@@@@@@@@@@@@@@@@@@@@@@@@@@@@@@@@@@@@@ 30011
      1 | 59
      2 | 5
      4 | 20
      8 | 29
     16 | 18
     32 | 27
     64 | 30
    128 | 11
    256 | 10
    512 | 1
   1024 | 6
   2048 | 8
   4096 | 9
   8192 | 8
  16384 | 2
```



32768		1
65536		1
131072		0
262144		1
524288		0

## Command Probes

The command probes are executed before and after a client command is executed, including any SQL statement that might be executed during that period. Commands include operations such as the initialization of the DB, use of the [COM\\_CHANGE\\_USER](#) operation (supported by the MySQL protocol), and manipulation of prepared statements. Many of these commands are used only by the MySQL client API from various connectors such as PHP and Java.

```
command-start(connectionid, command, user, host)
command-done(status)
```

- `command-start`: Triggered when a command is submitted to the server.
  - `connectionid`: The connection ID of the client executing the command.
  - `command`: An integer representing the command that was executed. Possible values are shown in the following table.

Value	Name	Description
00	COM_SLEEP	Internal thread state
01	COM_QUIT	Close connection
02	COM_INIT_DB	Select database ( <a href="#">USE ...</a> )
03	COM_QUERY	Execute a query
04	COM_FIELD_LIST	Get a list of fields
05	COM_CREATE_DB	Create a database (deprecated)
06	COM_DROP_DB	Drop a database (deprecated)
07	COM_REFRESH	Refresh connection
08	COM_SHUTDOWN	Shutdown server
09	COM_STATISTICS	Get statistics
10	COM_PROCESS_INFO	Get processes ( <a href="#">SHOW PROCESSLIST</a> )
11	COM_CONNECT	Initialize connection
12	COM_PROCESS_KILL	Kill process
13	COM_DEBUG	Get debug information
14	COM_PING	Ping
15	COM_TIME	Internal thread state
16	COM_DELAYED_INSERT	Internal thread state
17	COM_CHANGE_USER	Change user
18	COM_BINLOG_DUMP	Used by a replica or <a href="#">mysqlbinlog</a> to initiate a binary log read
19	COM_TABLE_DUMP	Used by a replica to get the source table information

Value	Name	Description
20	COM_CONNECT_OUT	Used by a replica to log a connection to the server
21	COM_REGISTER_SLAVE	Used by a replica during registration
22	COM_STMT_PREPARE	Prepare a statement
23	COM_STMT_EXECUTE	Execute a statement
24	COM_STMT_SEND_LONG_DATA	Used by a client when requesting extended data
25	COM_STMT_CLOSE	Close a prepared statement
26	COM_STMT_RESET	Reset a prepared statement
27	COM_SET_OPTION	Set a server option
28	COM_STMT_FETCH	Fetch a prepared statement

- `user`: The user executing the command.
- `host`: The client host.
- `command-done`: Triggered when the command execution completes. The `status` argument contains 0 if the command executed successfully, or 1 if the statement was terminated before normal completion.

The `command-start` and `command-done` probes are best used when combined with the statement probes to get an idea of overall execution time.

## Query Probes

The `query-start` and `query-done` probes are triggered when a specific query is received by the server and when the query has been completed and the information has been successfully sent to the client.

```
query-start(query, connectionid, database, user, host)
query-done(status)
```

- `query-start`: Triggered after the query string has been received from the client. The arguments are:
  - `query`: The full text of the submitted query.
  - `connectionid`: The connection ID of the client that submitted the query. The connection ID equals the connection ID returned when the client first connects and the `Id` value in the output from `SHOW PROCESSLIST`.
  - `database`: The database name on which the query is being executed.
  - `user`: The username used to connect to the server.
  - `host`: The hostname of the client.
- `query-done`: Triggered once the query has been executed and the information has been returned to the client. The probe includes a single argument, `status`, which returns 0 when the query is successfully executed and 1 if there was an error.

You can get a simple report of the execution time for each query using the following D script:

```
#!/usr/sbin/dtrace -s
```

```
#pragma D option quiet

dtrace::BEGIN
{
    printf("%-20s %-20s %-40s %-9s\n", "Who", "Database", "Query", "Time(ms)");
}

mysql*:::query-start
{
    self->query = copyinstr(arg0);
    self->connid = arg1;
    self->db     = copyinstr(arg2);
    self->who    = strjoin(copyinstr(arg3),strjoin("@",copyinstr(arg4)));
    self->querystart = timestamp;
}

mysql*:::query-done
{
    printf("%-20s %-20s %-40s %-9d\n",self->who,self->db,self->query,
          (timestamp - self->querystart) / 1000000);
}
```

When executing the above script you should get a basic idea of the execution time of your queries:

```
$> ./query.d
Who                Database          Query                                                    Time(ms)
root@localhost     test              select * from t1 order by i limit 10                    0
root@localhost     test              set global query_cache_size=0                          0
root@localhost     test              select * from t1 order by i limit 10                    776
root@localhost     test              select * from t1 order by i limit 10                    773
root@localhost     test              select * from t1 order by i desc limit 10 795
```

## Query Parsing Probes

The query parsing probes are triggered before the original SQL statement is parsed and when the parsing of the statement and determination of the execution model required to process the statement has been completed:

```
query-parse-start(query)
query-parse-done(status)
```

- **query-parse-start**: Triggered just before the statement is parsed by the MySQL query parser. The single argument, **query**, is a string containing the full text of the original query.
- **query-parse-done**: Triggered when the parsing of the original statement has been completed. The **status** is an integer describing the status of the operation. A **0** indicates that the query was successfully parsed. A **1** indicates that the parsing of the query failed.

For example, you could monitor the execution time for parsing a given query using the following D script:

```
#!/usr/sbin/dtrace -s

#pragma D option quiet

mysql*:::query-parse-start
{
    self->parsestart = timestamp;
    self->parsequery = copyinstr(arg0);
}

mysql*:::query-parse-done
/arg0 == 0/
{
    printf("Parsing %s: %d microseconds\n", self->parsequery,((timestamp - self->parsestart)/1000));
}
```

```

}

mysql*:::query-parse-done
/arg0 != 0/
{
    printf("Error parsing %s: %d microseconds\n", self->parsequery,((timestamp - self->parsestart)/1000));
}

```

In the above script a predicate is used on `query-parse-done` so that different output is generated based on the status value of the probe.

When running the script and monitoring the execution:

```

$> ./query-parsing.d
Error parsing select from t1 join (t2) on (t1.i = t2.i) order by t1.s,t1.i limit 10: 36 ms
Parsing select * from t1 join (t2) on (t1.i = t2.i) order by t1.s,t1.i limit 10: 176 ms

```

## Query Cache Probes

The query cache probes are fired when executing any query. The `query-cache-hit` query is triggered when a query exists in the query cache and can be used to return the query cache information. The arguments contain the original query text and the number of rows returned from the query cache for the query. If the query is not within the query cache, or the query cache is not enabled, then the `query-cache-miss` probe is triggered instead.

```

query-cache-hit(query, rows)
query-cache-miss(query)

```

- `query-cache-hit`: Triggered when the query has been found within the query cache. The first argument, `query`, contains the original text of the query. The second argument, `rows`, is an integer containing the number of rows in the cached query.
- `query-cache-miss`: Triggered when the query is not found within the query cache. The first argument, `query`, contains the original text of the query.

The query cache probes are best combined with a probe on the main query so that you can determine the differences in times between using or not using the query cache for specified queries. For example, in the following D script, the query and query cache information are combined into the information output during monitoring:

```

#!/usr/sbin/dtrace -s

#pragma D option quiet

dtrace:::BEGIN
{
    printf("%-20s %-20s %-40s %2s %-9s\n", "Who", "Database", "Query", "QC", "Time(ms)");
}

mysql*:::query-start
{
    self->query = copyinstr(arg0);
    self->connid = arg1;
    self->db = copyinstr(arg2);
    self->who = strjoin(copyinstr(arg3),strjoin("@",copyinstr(arg4)));
    self->querystart = timestamp;
    self->qc = 0;
}

mysql*:::query-cache-hit
{
    self->qc = 1;
}

```

```
mysql*:::query-cache-miss
{
    self->qc = 0;
}

mysql*:::query-done
{
    printf("%-20s %-20s %-40s %-2s %-9d\n",self->who,self->db,self->query,(self->qc ? "Y" : "N"),
        (timestamp - self->querystart) / 1000000);
}
```

When executing the script you can see the effects of the query cache. Initially the query cache is disabled. If you set the query cache size and then execute the query multiple times you should see that the query cache is being used to return the query data:

```
$> ./query-cache.d
root@localhost      test          select * from t1 order by i limit 10      N 1072
root@localhost      test          set global query_cache_size=262144      N 0
root@localhost      test          select * from t1 order by i limit 10      N 781
root@localhost      test          select * from t1 order by i limit 10      Y 0
```

## Query Execution Probes

The query execution probe is triggered when the actual execution of the query starts, after the parsing and checking the query cache but before any privilege checks or optimization. By comparing the difference between the start and done probes you can monitor the time actually spent servicing the query (instead of just handling the parsing and other elements of the query).

```
query-exec-start(query, connectionid, database, user, host, exec_type)
query-exec-done(status)
```



### Note

The information provided in the arguments for `query-start` and `query-exec-start` are almost identical and designed so that you can choose to monitor either the entire query process (using `query-start`) or only the execution (using `query-exec-start`) while exposing the core information about the user, client, and query being executed.

- `query-exec-start`: Triggered when the execution of a individual query is started. The arguments are:
  - `query`: The full text of the submitted query.
  - `connectionid`: The connection ID of the client that submitted the query. The connection ID equals the connection ID returned when the client first connects and the `Id` value in the output from `SHOW PROCESSLIST`.
  - `database`: The database name on which the query is being executed.
  - `user`: The username used to connect to the server.
  - `host`: The hostname of the client.
  - `exec_type`: The type of execution. Execution types are determined based on the contents of the query and where it was submitted. The values for each type are shown in the following table.

Value	Description
0	Executed query from <code>sql_parse</code> , top-level query.

Value	Description
1	Executed prepared statement
2	Executed cursor statement
3	Executed query in stored procedure

- `query-exec-done`: Triggered when the execution of the query has completed. The probe includes a single argument, `status`, which returns 0 when the query is successfully executed and 1 if there was an error.

## Row-Level Probes

The `*row-{start,done}` probes are triggered each time a row operation is pushed down to a storage engine. For example, if you execute an `INSERT` statement with 100 rows of data, then the `insert-row-start` and `insert-row-done` probes are triggered 100 times each, for each row insert.

```
insert-row-start(database, table)
insert-row-done(status)

update-row-start(database, table)
update-row-done(status)

delete-row-start(database, table)
delete-row-done(status)
```

- `insert-row-start`: Triggered before a row is inserted into a table.
- `insert-row-done`: Triggered after a row is inserted into a table.
- `update-row-start`: Triggered before a row is updated in a table.
- `update-row-done`: Triggered before a row is updated in a table.
- `delete-row-start`: Triggered before a row is deleted from a table.
- `delete-row-done`: Triggered before a row is deleted from a table.

The arguments supported by the probes are consistent for the corresponding `start` and `done` probes in each case:

- `database`: The database name.
- `table`: The table name.
- `status`: The status; 0 for success or 1 for failure.

Because the row-level probes are triggered for each individual row access, these probes can be triggered many thousands of times each second, which may have a detrimental effect on both the monitoring script and MySQL. The DTrace environment should limit the triggering on these probes to prevent the performance being adversely affected. Either use the probes sparingly, or use counter or aggregation functions to report on these probes and then provide a summary when the script terminates or as part of a `query-done` or `query-exec-done` probes.

The following example script summarizes the duration of each row operation within a larger query:

```
#!/usr/sbin/dtrace -s
#pragma D option quiet
```

```

dtrace:::BEGIN
{
    printf("%-2s %-10s %-10s %9s %9s %-s \n",
           "St", "Who", "DB", "ConnID", "Dur ms", "Query");
}

mysql*:::query-start
{
    self->query = copyinstr(arg0);
    self->who   = strjoin(copyinstr(arg3),strjoin("@",copyinstr(arg4)));
    self->db    = copyinstr(arg2);
    self->connid = arg1;
    self->querystart = timestamp;
    self->rowdur = 0;
}

mysql*:::query-done
{
    this->elapsed = (timestamp - self->querystart) /1000000;
    printf("%2d %-10s %-10s %9d %9d %s\n",
           arg0, self->who, self->db,
           self->connid, this->elapsed, self->query);
}

mysql*:::query-done
/ self->rowdur /
{
    printf("%34s %9d %s\n", "", (self->rowdur/1000000), "-> Row ops");
}

mysql*:::insert-row-start
{
    self->rowstart = timestamp;
}

mysql*:::delete-row-start
{
    self->rowstart = timestamp;
}

mysql*:::update-row-start
{
    self->rowstart = timestamp;
}

mysql*:::insert-row-done
{
    self->rowdur += (timestamp-self->rowstart);
}

mysql*:::delete-row-done
{
    self->rowdur += (timestamp-self->rowstart);
}

mysql*:::update-row-done
{
    self->rowdur += (timestamp-self->rowstart);
}

```

Running the above script with a query that inserts data into a table, you can monitor the exact time spent performing the raw row insertion:

St	Who	DB	ConnID	Dur ms	Query
0	@localhost	test	13	20767	insert into t1(select * from t2)
				4827	-> Row ops

## Read Row Probes

The read row probes are triggered at a storage engine level each time a row read operation occurs. These probes are specified within each storage engine (as opposed to the `*row-start` probes which are in the storage engine interface). These probes can therefore be used to monitor individual storage engine row-level operations and performance. Because these probes are triggered around the storage engine row read interface, they may be hit a significant number of times during a basic query.

```
read-row-start(database, table, scan_flag)
read-row-done(status)
```

- `read-row-start`: Triggered when a row is read by the storage engine from the specified `database` and `table`. The `scan_flag` is set to 1 (true) when the read is part of a table scan (that is, a sequential read), or 0 (false) when the read is of a specific record.
- `read-row-done`: Triggered when a row read operation within a storage engine completes. The `status` returns 0 on success, or a positive value on failure.

## Index Probes

The index probes are triggered each time a row is read using one of the indexes for the specified table. The probe is triggered within the corresponding storage engine for the table.

```
index-read-row-start(database, table)
index-read-row-done(status)
```

- `index-read-row-start`: Triggered when a row is read by the storage engine from the specified `database` and `table`.
- `index-read-row-done`: Triggered when an indexed row read operation within a storage engine completes. The `status` returns 0 on success, or a positive value on failure.

## Lock Probes

The lock probes are called whenever an external lock is requested by MySQL for a table using the corresponding lock mechanism on the table as defined by the table's engine type. There are three different types of lock, the read lock, write lock, and unlock operations. Using the probes you can determine the duration of the external locking routine (that is, the time taken by the storage engine to implement the lock, including any time waiting for another lock to become free) and the total duration of the lock/unlock process.

```
handler-rdlock-start(database, table)
handler-rdlock-done(status)

handler-wrlock-start(database, table)
handler-wrlock-done(status)

handler-unlock-start(database, table)
handler-unlock-done(status)
```

- `handler-rdlock-start`: Triggered when a read lock is requested on the specified `database` and `table`.
- `handler-wrlock-start`: Triggered when a write lock is requested on the specified `database` and `table`.
- `handler-unlock-start`: Triggered when an unlock request is made on the specified `database` and `table`.



- `handler-rdlock-done`: Triggered when a read lock request completes. The `status` is 0 if the lock operation succeeded, or `>0` on failure.
- `handler-wrlock-done`: Triggered when a write lock request completes. The `status` is 0 if the lock operation succeeded, or `>0` on failure.
- `handler-unlock-done`: Triggered when an unlock request completes. The `status` is 0 if the unlock operation succeeded, or `>0` on failure.

You can use arrays to monitor the locking and unlocking of individual tables and then calculate the duration of the entire table lock using the following script:

```
#!/usr/sbin/dtrace -s

#pragma D option quiet

mysql*:::handler-rdlock-start
{
    self->rdlockstart = timestamp;
    this->lockref = strjoin(copyinstr(arg0),strjoin("@",copyinstr(arg1)));
    self->lockmap[this->lockref] = self->rdlockstart;
    printf("Start: Lock->Read   %s.%s\n",copyinstr(arg0),copyinstr(arg1));
}

mysql*:::handler-wrlock-start
{
    self->wrlockstart = timestamp;
    this->lockref = strjoin(copyinstr(arg0),strjoin("@",copyinstr(arg1)));
    self->lockmap[this->lockref] = self->rdlockstart;
    printf("Start: Lock->Write  %s.%s\n",copyinstr(arg0),copyinstr(arg1));
}

mysql*:::handler-unlock-start
{
    self->unlockstart = timestamp;
    this->lockref = strjoin(copyinstr(arg0),strjoin("@",copyinstr(arg1)));
    printf("Start: Lock->Unlock %s.%s (%d ms lock duration)\n",
        copyinstr(arg0),copyinstr(arg1),
        (timestamp - self->lockmap[this->lockref])/1000000);
}

mysql*:::handler-rdlock-done
{
    printf("End:   Lock->Read   %d ms\n",
        (timestamp - self->rdlockstart)/1000000);
}

mysql*:::handler-wrlock-done
{
    printf("End:   Lock->Write  %d ms\n",
        (timestamp - self->wrlockstart)/1000000);
}

mysql*:::handler-unlock-done
{
    printf("End:   Lock->Unlock %d ms\n",
        (timestamp - self->unlockstart)/1000000);
}
```

When executed, you should get information both about the duration of the locking process itself, and of the locks on a specific table:

```
Start: Lock->Read   test.t2
End:   Lock->Read   0 ms
Start: Lock->Unlock test.t2 (25743 ms lock duration)
```

```

End:   Lock->Unlock 0 ms
Start: Lock->Read  test.t2
End:   Lock->Read  0 ms
Start: Lock->Unlock test.t2 (1 ms lock duration)
End:   Lock->Unlock 0 ms
Start: Lock->Read  test.t2
End:   Lock->Read  0 ms
Start: Lock->Unlock test.t2 (1 ms lock duration)
End:   Lock->Unlock 0 ms
Start: Lock->Read  test.t2
End:   Lock->Read  0 ms

```

## Filesort Probes

The filesort probes are triggered whenever a filesort operation is applied to a table. For more information on filesort and the conditions under which it occurs, see [Section 8.2.1.14, “ORDER BY Optimization”](#).

```

filesort-start(database, table)
filesort-done(status, rows)

```

- **filesort-start**: Triggered when the filesort operation starts on a table. The two arguments to the probe, `database` and `table`, identify the table being sorted.
- **filesort-done**: Triggered when the filesort operation completes. Two arguments are supplied, the `status` (0 for success, 1 for failure), and the number of rows sorted during the filesort process.

An example of this is in the following script, which tracks the duration of the filesort process in addition to the duration of the main query:

```

#!/usr/sbin/dtrace -s

#pragma D option quiet

dtrace:::BEGIN
{
    printf("%-2s %-10s %-10s %9s %18s %-s \n",
          "St", "Who", "DB", "ConnID", "Dur microsec", "Query");
}

mysql*:::query-start
{
    self->query = copyinstr(arg0);
    self->who   = strjoin(copyinstr(arg3), strjoin("@", copyinstr(arg4)));
    self->db    = copyinstr(arg2);
    self->connid = arg1;
    self->querystart = timestamp;
    self->filesort = 0;
    self->fsdb = "";
    self->fstable = "";
}

mysql*:::filesort-start
{
    self->filesort = timestamp;
    self->fsdb = copyinstr(arg0);
    self->fstable = copyinstr(arg1);
}

mysql*:::filesort-done
{
    this->elapsed = (timestamp - self->filesort) / 1000;
    printf("%2d %-10s %-10s %9d %18d Filesort on %s\n",
          arg0, self->who, self->fsdb,
          self->connid, this->elapsed, self->fstable);
}

```

```
mysql*:::query-done
{
    this->elapsed = (timestamp - self->querystart) /1000;
    printf("%2d %-10s %-10s %9d %18d %s\n",
        arg0, self->who, self->db,
        self->connid, this->elapsed, self->query);
}
```

Executing a query on a large table with an `ORDER BY` clause that triggers a filesort, and then creating an index on the table and then repeating the same query, you can see the difference in execution speed:

St	Who	DB	ConnID	Dur	microsec	Query
0	@localhost	test	14	11335469		Filesort on t1
0	@localhost	test	14	11335787		select * from t1 order by i limit 100
0	@localhost	test	14	466734378		create index t1a on t1 (i)
0	@localhost	test	14	26472		select * from t1 order by i limit 100

## Statement Probes

The individual statement probes are provided to give specific information about different statement types. For the start probes the string of the query is provided as the only argument. Depending on the statement type, the information provided by the corresponding done probe can differ. For all done probes the status of the operation (0 for success, >0 for failure) is provided. For `SELECT`, `INSERT`, `INSERT ... (SELECT FROM ...)`, `DELETE`, and `DELETE FROM t1,t2` operations the number of rows affected is returned.

For `UPDATE` and `UPDATE t1,t2 ...` statements the number of rows matched and the number of rows actually changed is provided. This is because the number of rows actually matched by the corresponding `WHERE` clause, and the number of rows changed can differ. MySQL does not update the value of a row if the value already matches the new setting.

```
select-start(query)
select-done(status,rows)

insert-start(query)
insert-done(status,rows)

insert-select-start(query)
insert-select-done(status,rows)

update-start(query)
update-done(status,rowsmatched,rowschanged)

multi-update-start(query)
multi-update-done(status,rowsmatched,rowschanged)

delete-start(query)
delete-done(status,rows)

multi-delete-start(query)
multi-delete-done(status,rows)
```

- `select-start`: Triggered before a `SELECT` statement.
- `select-done`: Triggered at the end of a `SELECT` statement.
- `insert-start`: Triggered before a `INSERT` statement.
- `insert-done`: Triggered at the end of an `INSERT` statement.
- `insert-select-start`: Triggered before an `INSERT ... SELECT` statement.
- `insert-select-done`: Triggered at the end of an `INSERT ... SELECT` statement.

- `update-start`: Triggered before an `UPDATE` statement.
- `update-done`: Triggered at the end of an `UPDATE` statement.
- `multi-update-start`: Triggered before an `UPDATE` statement involving multiple tables.
- `multi-update-done`: Triggered at the end of an `UPDATE` statement involving multiple tables.
- `delete-start`: Triggered before a `DELETE` statement.
- `delete-done`: Triggered at the end of a `DELETE` statement.
- `multi-delete-start`: Triggered before a `DELETE` statement involving multiple tables.
- `multi-delete-done`: Triggered at the end of a `DELETE` statement involving multiple tables.

The arguments for the statement probes are:

- `query`: The query string.
- `status`: The status of the query. `0` for success, and `>0` for failure.
- `rows`: The number of rows affected by the statement. This returns the number rows found for `SELECT`, the number of rows deleted for `DELETE`, and the number of rows successfully inserted for `INSERT`.
- `rowsmatched`: The number of rows matched by the `WHERE` clause of an `UPDATE` operation.
- `rowschanged`: The number of rows actually changed during an `UPDATE` operation.

You use these probes to monitor the execution of these statement types without having to monitor the user or client executing the statements. A simple example of this is to track the execution times:

```
#!/usr/sbin/dtrace -s
#pragma D option quiet
dtrace:::BEGIN
{
    printf("%-60s %-8s %-8s %-8s\n", "Query", "RowsU", "RowsM", "Dur (ms)");
}

mysql*:::update-start, mysql*:::insert-start,
mysql*:::delete-start, mysql*:::multi-delete-start,
mysql*:::multi-delete-done, mysql*:::select-start,
mysql*:::insert-select-start, mysql*:::multi-update-start
{
    self->query = copyinstr(arg0);
    self->querystart = timestamp;
}

mysql*:::insert-done, mysql*:::select-done,
mysql*:::delete-done, mysql*:::multi-delete-done, mysql*:::insert-select-done
/ self->querystart /
{
    this->elapsed = ((timestamp - self->querystart)/1000000);
    printf("%-60s %-8d %-8d %-8d\n",
        self->query,
        0,
        arg1,
        this->elapsed);
    self->querystart = 0;
}
```

```
mysql*:::update-done, mysql*:::multi-update-done
/ self->querystart /
{
    this->elapsed = ((timestamp - self->querystart)/1000000);
    printf("%-60s %-8d %-8d %d\n",
        self->query,
        arg1,
        arg2,
        this->elapsed);
    self->querystart = 0;
}
```

When executed you can see the basic execution times and rows matches:

Query	RowsU	RowsM	Dur (ms)
select * from t2	0	275	0
insert into t2 (select * from t2)	0	275	9
update t2 set i=5 where i > 75	110	110	8
update t2 set i=5 where i < 25	254	134	12
delete from t2 where i < 5	0	0	0

Another alternative is to use the aggregation functions in DTrace to aggregate the execution time of individual statements together:

```
#!/usr/sbin/dtrace -s

#pragma D option quiet

mysql*:::update-start, mysql*:::insert-start,
mysql*:::delete-start, mysql*:::multi-delete-start,
mysql*:::multi-delete-done, mysql*:::select-start,
mysql*:::insert-select-start, mysql*:::multi-update-start
{
    self->querystart = timestamp;
}

mysql*:::select-done
{
    @statements["select"] = sum(((timestamp - self->querystart)/1000000));
}

mysql*:::insert-done, mysql*:::insert-select-done
{
    @statements["insert"] = sum(((timestamp - self->querystart)/1000000));
}

mysql*:::update-done, mysql*:::multi-update-done
{
    @statements["update"] = sum(((timestamp - self->querystart)/1000000));
}

mysql*:::delete-done, mysql*:::multi-delete-done
{
    @statements["delete"] = sum(((timestamp - self->querystart)/1000000));
}

tick-30s
{
    printa(@statements);
}
```

The script just shown aggregates the times spent doing each operation, which could be used to help benchmark a standard suite of tests.

```
delete
```

```
0
```

update	0
insert	23
select	2484
delete	0
update	0
insert	39
select	10744
delete	0
update	26
insert	56
select	10944
delete	0
update	26
insert	2287
select	15985

## Network Probes

The network probes monitor the transfer of information from the MySQL server and clients of all types over the network. The probes are defined as follows:

```
net-read-start()
net-read-done(status, bytes)
net-write-start(bytes)
net-write-done(status)
```

- **net-read-start**: Triggered when a network read operation is started.
- **net-read-done**: Triggered when the network read operation completes. The `status` is an `integer` representing the return status for the operation, `0` for success and `1` for failure. The `bytes` argument is an integer specifying the number of bytes read during the process.
- **net-start-bytes**: Triggered when data is written to a network socket. The single argument, `bytes`, specifies the number of bytes written to the network socket.
- **net-write-done**: Triggered when the network write operation has completed. The single argument, `status`, is an integer representing the return status for the operation, `0` for success and `1` for failure.

You can use the network probes to monitor the time spent reading from and writing to network clients during execution. The following D script provides an example of this. Both the cumulative time for the read or write is calculated, and the number of bytes. Note that the dynamic variable size has been increased (using the `dynvarsize` option) to cope with the rapid firing of the individual probes for the network reads/writes.

```
#!/usr/sbin/dtrace -s

#pragma D option quiet
#pragma D option dynvarsize=4m

dtrace:::BEGIN
{
    printf("%-2s %-30s %-10s %9s %18s %-s \n",
          "St", "Who", "DB", "ConnID", "Dur microsec", "Query");
}

mysql*:::query-start
{
    self->query = copyinstr(arg0);
    self->who   = strjoin(copyinstr(arg3), strjoin("@", copyinstr(arg4)));
    self->db    = copyinstr(arg2);
}
```

```

self->connid = arg1;
self->querystart = timestamp;
self->netwrite = 0;
self->netwritecum = 0;
self->netwritebase = 0;
self->netread = 0;
self->netreadcum = 0;
self->netreadbase = 0;
}

mysql*:::net-write-start
{
    self->netwrite += arg0;
    self->netwritebase = timestamp;
}

mysql*:::net-write-done
{
    self->netwritecum += (timestamp - self->netwritebase);
    self->netwritebase = 0;
}

mysql*:::net-read-start
{
    self->netreadbase = timestamp;
}

mysql*:::net-read-done
{
    self->netread += arg1;
    self->netreadcum += (timestamp - self->netreadbase);
    self->netreadbase = 0;
}

mysql*:::query-done
{
    this->elapsed = (timestamp - self->querystart) /1000000;
    printf("%2d %-30s %-10s %9d %18d %s\n",
        arg0, self->who, self->db,
        self->connid, this->elapsed, self->query);
    printf("Net read: %d bytes (%d ms) write: %d bytes (%d ms)\n",
        self->netread, (self->netreadcum/1000000),
        self->netwrite, (self->netwritecum/1000000));
}

```

When executing the above script on a machine with a remote client, you can see that approximately a third of the time spent executing the query is related to writing the query results back to the client.

St	Who	DB	ConnID	Dur	microsec	Query
0	root@::ffff:198.51.100.108	test	31		3495	select * from t1 limit 100000
Net read: 0 bytes (0 ms) write: 10000075 bytes (1220 ms)						

## Keycache Probes

The keycache probes are triggered when using the index key cache used with the MyISAM storage engine. Probes exist to monitor when data is read into the keycache, cached key data is written from the cache into a cached file, or when accessing the keycache.

Keycache usage indicates when data is read or written from the index files into the cache, and can be used to monitor how efficient the memory allocated to the keycache is being used. A high number of keycache reads across a range of queries may indicate that the keycache is too small for size of data being accessed.

```

keycache-read-start(filepath, bytes, mem_used, mem_free)
keycache-read-block(bytes)

```

```
keycache-read-hit()  
keycache-read-miss()  
keycache-read-done(mem_used, mem_free)  
keycache-write-start(filepath, bytes, mem_used, mem_free)  
keycache-write-block(bytes)  
keycache-write-done(mem_used, mem_free)
```

When reading data from the index files into the keycache, the process first initializes the read operation (indicated by `keycache-read-start`), then loads blocks of data (`keycache-read-block`), and then the read block is either matches the data being identified (`keycache-read-hit`) or more data needs to be read (`keycache-read-miss`). Once the read operation has completed, reading stops with the `keycache-read-done`.

Data can be read from the index file into the keycache only when the specified key is not already within the keycache.

- `keycache-read-start`: Triggered when the keycache read operation is started. Data is read from the specified `filepath`, reading the specified number of `bytes`. The `mem_used` and `mem_avail` indicate memory currently used by the keycache and the amount of memory available within the keycache.
- `keycache-read-block`: Triggered when the keycache reads a block of data, of the specified number of `bytes`, from the index file into the keycache.
- `keycache-read-hit`: Triggered when the block of data read from the index file matches the key data requested.
- `keycache-read-miss`: Triggered when the block of data read from the index file does not match the key data needed.
- `keycache-read-done`: Triggered when the keycache read operation has completed. The `mem_used` and `mem_avail` indicate memory currently used by the keycache and the amount of memory available within the keycache.

Keycache writes occur when the index information is updated during an `INSERT`, `UPDATE`, or `DELETE` operation, and the cached key information is flushed back to the index file.

- `keycache-write-start`: Triggered when the keycache write operation is started. Data is written to the specified `filepath`, reading the specified number of `bytes`. The `mem_used` and `mem_avail` indicate memory currently used by the keycache and the amount of memory available within the keycache.
- `keycache-write-block`: Triggered when the keycache writes a block of data, of the specified number of `bytes`, to the index file from the keycache.
- `keycache-write-done`: Triggered when the keycache write operation has completed. The `mem_used` and `mem_avail` indicate memory currently used by the keycache and the amount of memory available within the keycache.



---

# Chapter 6 Security

## Table of Contents

6.1 General Security Issues .....	1076
6.1.1 Security Guidelines .....	1076
6.1.2 Keeping Passwords Secure .....	1078
6.1.3 Making MySQL Secure Against Attackers .....	1087
6.1.4 Security-Related mysqld Options and Variables .....	1088
6.1.5 How to Run MySQL as a Normal User .....	1089
6.1.6 Security Considerations for LOAD DATA LOCAL .....	1090
6.1.7 Client Programming Security Guidelines .....	1092
6.2 Access Control and Account Management .....	1094
6.2.1 Account User Names and Passwords .....	1095
6.2.2 Privileges Provided by MySQL .....	1097
6.2.3 Grant Tables .....	1104
6.2.4 Specifying Account Names .....	1111
6.2.5 Access Control, Stage 1: Connection Verification .....	1113
6.2.6 Access Control, Stage 2: Request Verification .....	1116
6.2.7 Adding Accounts, Assigning Privileges, and Dropping Accounts .....	1118
6.2.8 Reserved Accounts .....	1121
6.2.9 When Privilege Changes Take Effect .....	1121
6.2.10 Assigning Account Passwords .....	1122
6.2.11 Password Management .....	1123
6.2.12 Server Handling of Expired Passwords .....	1126
6.2.13 Pluggable Authentication .....	1128
6.2.14 Proxy Users .....	1132
6.2.15 Account Locking .....	1139
6.2.16 Setting Account Resource Limits .....	1140
6.2.17 Troubleshooting Problems Connecting to MySQL .....	1142
6.2.18 SQL-Based Account Activity Auditing .....	1147
6.3 Using Encrypted Connections .....	1148
6.3.1 Configuring MySQL to Use Encrypted Connections .....	1150
6.3.2 Encrypted Connection TLS Protocols and Ciphers .....	1155
6.3.3 Creating SSL and RSA Certificates and Keys .....	1162
6.3.4 SSL Library-Dependent Capabilities .....	1171
6.3.5 Connecting to MySQL Remotely from Windows with SSH .....	1173
6.4 Security Plugins .....	1173
6.4.1 Authentication Plugins .....	1174
6.4.2 Connection Control Plugins .....	1243
6.4.3 The Password Validation Plugin .....	1249
6.4.4 The MySQL Keyring .....	1257
6.4.5 MySQL Enterprise Audit .....	1294
6.4.6 MySQL Enterprise Firewall .....	1365
6.5 MySQL Enterprise Data Masking and De-Identification .....	1381
6.5.1 MySQL Enterprise Data Masking and De-Identification Elements .....	1383
6.5.2 Installing or Uninstalling MySQL Enterprise Data Masking and De-Identification .....	1383
6.5.3 Using MySQL Enterprise Data Masking and De-Identification .....	1384
6.5.4 MySQL Enterprise Data Masking and De-Identification Function Reference .....	1390
6.5.5 MySQL Enterprise Data Masking and De-Identification Function Descriptions .....	1390
6.6 MySQL Enterprise Encryption .....	1399
6.6.1 MySQL Enterprise Encryption Installation .....	1400

6.6.2 MySQL Enterprise Encryption Usage and Examples .....	1401
6.6.3 MySQL Enterprise Encryption Function Reference .....	1403
6.6.4 MySQL Enterprise Encryption Function Descriptions .....	1403
6.7 SELinux .....	1407
6.7.1 Check if SELinux is Enabled .....	1408
6.7.2 Changing the SELinux Mode .....	1409
6.7.3 MySQL Server SELinux Policies .....	1409
6.7.4 SELinux File Context .....	1409
6.7.5 SELinux TCP Port Context .....	1411
6.7.6 Troubleshooting SELinux .....	1412

When thinking about security within a MySQL installation, you should consider a wide range of possible topics and how they affect the security of your MySQL server and related applications:

- General factors that affect security. These include choosing good passwords, not granting unnecessary privileges to users, ensuring application security by preventing SQL injections and data corruption, and others. See [Section 6.1, “General Security Issues”](#).
- Security of the installation itself. The data files, log files, and the all the application files of your installation should be protected to ensure that they are not readable or writable by unauthorized parties. For more information, see [Section 2.9, “Postinstallation Setup and Testing”](#).
- Access control and security within the database system itself, including the users and databases granted with access to the databases, views and stored programs in use within the database. For more information, see [Section 6.2, “Access Control and Account Management”](#).
- The features offered by security-related plugins. See [Section 6.4, “Security Plugins”](#).
- Network security of MySQL and your system. The security is related to the grants for individual users, but you may also wish to restrict MySQL so that it is available only locally on the MySQL server host, or to a limited set of other hosts.
- Ensure that you have adequate and appropriate backups of your database files, configuration and log files. Also be sure that you have a recovery solution in place and test that you are able to successfully recover the information from your backups. See [Chapter 7, Backup and Recovery](#).



#### Note

Several topics in this chapter are also addressed in the [Secure Deployment Guide](#), which provides procedures for deploying a generic binary distribution of MySQL Enterprise Edition Server with features for managing the security of your MySQL installation.

## 6.1 General Security Issues

This section describes general security issues to be aware of and what you can do to make your MySQL installation more secure against attack or misuse. For information specifically about the access control system that MySQL uses for setting up user accounts and checking database access, see [Section 2.9, “Postinstallation Setup and Testing”](#).

For answers to some questions that are often asked about MySQL Server security issues, see [Section A.9, “MySQL 5.7 FAQ: Security”](#).

### 6.1.1 Security Guidelines

Anyone using MySQL on a computer connected to the Internet should read this section to avoid the most common security mistakes.

In discussing security, it is necessary to consider fully protecting the entire server host (not just the MySQL server) against all types of applicable attacks: eavesdropping, altering, playback, and denial of service. We do not cover all aspects of availability and fault tolerance here.

MySQL uses security based on Access Control Lists (ACLs) for all connections, queries, and other operations that users can attempt to perform. There is also support for SSL-encrypted connections between MySQL clients and servers. Many of the concepts discussed here are not specific to MySQL at all; the same general ideas apply to almost all applications.

When running MySQL, follow these guidelines:

- **Do not ever give anyone (except MySQL `root` accounts) access to the `user` table in the `mysql` system database!** This is critical.
- Learn how the MySQL access privilege system works (see [Section 6.2, “Access Control and Account Management”](#)). Use the `GRANT` and `REVOKE` statements to control access to MySQL. Do not grant more privileges than necessary. Never grant privileges to all hosts.

Checklist:

- Try `mysql -u root`. If you are able to connect successfully to the server without being asked for a password, anyone can connect to your MySQL server as the MySQL `root` user with full privileges! Review the MySQL installation instructions, paying particular attention to the information about setting a `root` password. See [Section 2.9.4, “Securing the Initial MySQL Account”](#).
- Use the `SHOW GRANTS` statement to check which accounts have access to what. Then use the `REVOKE` statement to remove those privileges that are not necessary.
- Do not store cleartext passwords in your database. If your computer becomes compromised, the intruder can take the full list of passwords and use them. Instead, use `SHA2( )` or some other one-way hashing function and store the hash value.

To prevent password recovery using rainbow tables, do not use these functions on a plain password; instead, choose some string to be used as a salt, and use `hash(hash(password)+salt)` values.

- Assume that all passwords will be subject to automated cracking attempts using lists of known passwords, and also to targeted guessing using publicly available information about you, such as social media posts. Do not choose passwords that consist of easily cracked or guessed items such as a dictionary word, proper name, sports team name, acronym, or commonly known phrase, particularly if they are relevant to you. The use of upper case letters, number substitutions and additions, and special characters does not help if these are used in predictable ways. Also do not choose any password you have seen used as an example anywhere, or a variation on it, even if it was presented as an example of a strong password.

Instead, choose passwords that are as long and as unpredictable as possible. That does not mean the combination needs to be a random string of characters that is difficult to remember and reproduce, although this is a good approach if you have, for example, password manager software that can generate and fill such passwords and store them securely. A passphrase containing multiple words is easy to create, remember, and reproduce, and is much more secure than a typical user-selected password consisting of a single modified word or a predictable sequence of characters. To create a secure passphrase, ensure that the words and other items in it are not a known phrase or quotation, do not occur in a predictable order, and preferably have no previous relationship to each other at all.

- Invest in a firewall. This protects you from at least 50% of all types of exploits in any software. Put MySQL behind the firewall or in a demilitarized zone (DMZ).

Checklist:

- Try to scan your ports from the Internet using a tool such as `nmap`. MySQL uses port 3306 by default. This port should not be accessible from untrusted hosts. As a simple way to check whether your MySQL port is open, try the following command from some remote machine, where `server_host` is the host name or IP address of the host on which your MySQL server runs:

```
$> telnet server_host 3306
```

If `telnet` hangs or the connection is refused, the port is blocked, which is how you want it to be. If you get a connection and some garbage characters, the port is open, and should be closed on your firewall or router, unless you really have a good reason to keep it open.

- Applications that access MySQL should not trust any data entered by users, and should be written using proper defensive programming techniques. See [Section 6.1.7, “Client Programming Security Guidelines”](#).
- Do not transmit plain (unencrypted) data over the Internet. This information is accessible to everyone who has the time and ability to intercept it and use it for their own purposes. Instead, use an encrypted protocol such as SSL or SSH. MySQL supports internal SSL connections. Another technique is to use SSH port-forwarding to create an encrypted (and compressed) tunnel for the communication.
- Learn to use the `tcpdump` and `strings` utilities. In most cases, you can check whether MySQL data streams are unencrypted by issuing a command like the following:

```
$> tcpdump -l -i eth0 -w - src or dst port 3306 | strings
```

This works under Linux and should work with small modifications under other systems.



### Warning

If you do not see cleartext data, this does not always mean that the information actually is encrypted. If you need high security, consult with a security expert.

## 6.1.2 Keeping Passwords Secure

Passwords occur in several contexts within MySQL. The following sections provide guidelines that enable end users and administrators to keep these passwords secure and avoid exposing them. There is also a discussion of how MySQL uses password hashing internally and of a plugin that you can use to enforce stricter passwords.

### 6.1.2.1 End-User Guidelines for Password Security

MySQL users should use the following guidelines to keep passwords secure.

When you run a client program to connect to the MySQL server, it is inadvisable to specify your password in a way that exposes it to discovery by other users. The methods you can use to specify your password when you run client programs are listed here, along with an assessment of the risks of each method. In short, the safest methods are to have the client program prompt for the password or to specify the password in a properly protected option file.

- Use the `mysql_config_editor` utility, which enables you to store authentication credentials in an encrypted login path file named `.mylogin.cnf`. The file can be read later by MySQL client programs to obtain authentication credentials for connecting to MySQL Server. See [Section 4.6.6, “mysql\\_config\\_editor — MySQL Configuration Utility”](#).
- Use a `--password=password` or `-ppassword` option on the command line. For example:

```
$> mysql -u francis -pprank db_name
```



### Warning

This is convenient *but insecure*. On some systems, your password becomes visible to system status programs such as `ps` that may be invoked by other users to display command lines. MySQL clients typically overwrite the command-line password argument with zeros during their initialization sequence. However, there is still a brief interval during which the value is visible. Also, on some systems this overwriting strategy is ineffective and the password remains visible to `ps`. (SystemV Unix systems and perhaps others are subject to this problem.)

If your operating environment is set up to display your current command in the title bar of your terminal window, the password remains visible as long as the command is running, even if the command has scrolled out of view in the window content area.

- Use the `--password` or `-p` option on the command line with no password value specified. In this case, the client program solicits the password interactively:

```
$> mysql -u francis -p db_name
Enter password: *****
```

The `*` characters indicate where you enter your password. The password is not displayed as you enter it.

It is more secure to enter your password this way than to specify it on the command line because it is not visible to other users. However, this method of entering a password is suitable only for programs that you run interactively. If you want to invoke a client from a script that runs noninteractively, there is no opportunity to enter the password from the keyboard. On some systems, you may even find that the first line of your script is read and interpreted (incorrectly) as your password.

- Store your password in an option file. For example, on Unix, you can list your password in the `[client]` section of the `.my.cnf` file in your home directory:

```
[client]
password=password
```

To keep the password safe, the file should not be accessible to anyone but yourself. To ensure this, set the file access mode to `400` or `600`. For example:

```
$> chmod 600 .my.cnf
```

To name from the command line a specific option file containing the password, use the `--defaults-file=file_name` option, where `file_name` is the full path name to the file. For example:

```
$> mysql --defaults-file=/home/francis/mysql-opts
```

[Section 4.2.2.2, “Using Option Files”](#), discusses option files in more detail.

- Store your password in the `MYSQL_PWD` environment variable. See [Section 4.9, “Environment Variables”](#).

This method of specifying your MySQL password must be considered *extremely insecure* and should not be used. Some versions of `ps` include an option to display the environment of running processes. On some systems, if you set `MYSQL_PWD`, your password is exposed to any other user who runs `ps`. Even on systems without such a version of `ps`, it is unwise to assume that there are no other methods by which users can examine process environments.

On Unix, the `mysql` client writes a record of executed statements to a history file (see [Section 4.5.1.3, “mysql Client Logging”](#)). By default, this file is named `.mysql_history` and is created in your home

directory. Passwords can be written as plain text in SQL statements such as `CREATE USER` and `ALTER USER`, so if you use these statements, they are logged in the history file. To keep this file safe, use a restrictive access mode, the same way as described earlier for the `.my.cnf` file.

If your command interpreter is configured to maintain a history, any file in which the commands are saved contains MySQL passwords entered on the command line. For example, `bash` uses `~/.bash_history`. Any such file should have a restrictive access mode.

### 6.1.2.2 Administrator Guidelines for Password Security

Database administrators should use the following guidelines to keep passwords secure.

MySQL stores passwords for user accounts in the `mysql.user` system table. Access to this table should never be granted to any nonadministrative accounts.

Account passwords can be expired so that users must reset them. See [Section 6.2.11, “Password Management”](#), and [Section 6.2.12, “Server Handling of Expired Passwords”](#).

The `validate_password` plugin can be used to enforce a policy on acceptable password. See [Section 6.4.3, “The Password Validation Plugin”](#).

A user who has access to modify the plugin directory (the value of the `plugin_dir` system variable) or the `my.cnf` file that specifies the plugin directory location can replace plugins and modify the capabilities provided by plugins, including authentication plugins.

Files such as log files to which passwords might be written should be protected. See [Section 6.1.2.3, “Passwords and Logging”](#).

### 6.1.2.3 Passwords and Logging

Passwords can be written as plain text in SQL statements such as `CREATE USER`, `GRANT`, `SET PASSWORD`, and statements that invoke the `PASSWORD()` function. If such statements are logged by the MySQL server as written, passwords in them become visible to anyone with access to the logs.

Statement logging avoids writing passwords as cleartext for the following statements:

```
CREATE USER ... IDENTIFIED BY ...
ALTER USER ... IDENTIFIED BY ...
GRANT ... IDENTIFIED BY ...
SET PASSWORD ...
SLAVE START ... PASSWORD = ...
CREATE SERVER ... OPTIONS(... PASSWORD ...)
ALTER SERVER ... OPTIONS(... PASSWORD ...)
```

Passwords in those statements are rewritten to not appear literally in statement text written to the general query log, slow query log, and binary log. Rewriting does not apply to other statements. In particular, `INSERT` or `UPDATE` statements for the `mysql.user` system table that refer to literal passwords are logged as is, so you should avoid such statements. (Direct modification of grant tables is discouraged, anyway.)

For the general query log, password rewriting can be suppressed by starting the server with the `--log-raw` option. For security reasons, this option is not recommended for production use. For diagnostic purposes, it may be useful to see the exact text of statements as received by the server.

Contents of the audit log file produced by the audit log plugin are not encrypted. For security reasons, this file should be written to a directory accessible only to the MySQL server and users with a legitimate reason to view the log. See [Section 6.4.5.3, “MySQL Enterprise Audit Security Considerations”](#).

Statements received by the server may be rewritten if a query rewrite plugin is installed (see [Query Rewrite Plugins](#)). In this case, the `--log-raw` option affects statement logging as follows:

- Without `--log-raw`, the server logs the statement returned by the query rewrite plugin. This may differ from the statement as received.
- With `--log-raw`, the server logs the original statement as received.

An implication of password rewriting is that statements that cannot be parsed (due, for example, to syntax errors) are not written to the general query log because they cannot be known to be password free. Use cases that require logging of all statements including those with errors should use the `--log-raw` option, bearing in mind that this also bypasses password rewriting.

Password rewriting occurs only when plain text passwords are expected. For statements with syntax that expect a password hash value, no rewriting occurs. If a plain text password is supplied erroneously for such syntax, the password is logged as given, without rewriting. For example, the following statement is logged as shown because a password hash value is expected:

```
CREATE USER 'user1'@'localhost' IDENTIFIED BY PASSWORD 'not-so-secret';
```

To guard log files against unwarranted exposure, locate them in a directory that restricts access to the server and the database administrator. If the server logs to tables in the `mysql` database, grant access to those tables only to the database administrator.

Replicas store the password for the replication source in the source info repository, which can be either a file or a table (see [Section 16.2.4, “Relay Log and Replication Metadata Repositories”](#)). Ensure that the repository can be accessed only by the database administrator. An alternative to storing the password in a file is to use the `START SLAVE` statement to specify credentials for connecting to the source.

Use a restricted access mode to protect database backups that include log tables or log files containing passwords.

### 6.1.2.4 Password Hashing in MySQL



#### Note

The information in this section applies fully only before MySQL 5.7.5, and only for accounts that use the `mysql_native_password` or `mysql_old_password` authentication plugins. Support for pre-4.1 password hashes was removed in MySQL 5.7.5. This includes removal of the `mysql_old_password` authentication plugin and the `OLD_PASSWORD()` function. Also, `secure_auth` cannot be disabled, and `old_passwords` cannot be set to 1.

As of MySQL 5.7.5, only the information about 4.1 password hashes and the `mysql_native_password` authentication plugin remains relevant.

MySQL lists user accounts in the `user` table of the `mysql` database. Each MySQL account can be assigned a password, although the `user` table does not store the cleartext version of the password, but a hash value computed from it.

MySQL uses passwords in two phases of client/server communication:

- When a client attempts to connect to the server, there is an initial authentication step in which the client must present a password that has a hash value matching the hash value stored in the `user` table for the account the client wants to use.
- After the client connects, it can (if it has sufficient privileges) set or change the password hash for accounts listed in the `user` table. The client can do this by using the `PASSWORD()` function to generate

a password hash, or by using a password-generating statement (`CREATE USER`, `GRANT`, or `SET PASSWORD`).

In other words, the server *checks* hash values during authentication when a client first attempts to connect. The server *generates* hash values if a connected client invokes the `PASSWORD()` function or uses a password-generating statement to set or change a password.

Password hashing methods in MySQL have the history described following. These changes are illustrated by changes in the result from the `PASSWORD()` function that computes password hash values and in the structure of the `user` table where passwords are stored.

## The Original (Pre-4.1) Hashing Method

The original hashing method produced a 16-byte string. Such hashes look like this:

```
mysql> SELECT PASSWORD('mypass');
+-----+
| PASSWORD('mypass') |
+-----+
| 6f8c114b58f2ce9e   |
+-----+
```

To store account passwords, the `Password` column of the `user` table was at this point 16 bytes long.

## The 4.1 Hashing Method

MySQL 4.1 introduced password hashing that provided better security and reduced the risk of passwords being intercepted. There were several aspects to this change:

- Different format of password values produced by the `PASSWORD()` function
- Widening of the `Password` column
- Control over the default hashing method
- Control over the permitted hashing methods for clients attempting to connect to the server

The changes in MySQL 4.1 took place in two stages:

- MySQL 4.1.0 used a preliminary version of the 4.1 hashing method. This method was short lived and the following discussion says nothing more about it.
- In MySQL 4.1.1, the hashing method was modified to produce a longer 41-byte hash value:

```
mysql> SELECT PASSWORD('mypass');
+-----+
| PASSWORD('mypass') |
+-----+
| *6C8989366EAF75BB670AD8EA7A7FC1176A95CEF4 |
+-----+
```

The longer password hash format has better cryptographic properties, and client authentication based on long hashes is more secure than that based on the older short hashes.

To accommodate longer password hashes, the `Password` column in the `user` table was changed at this point to be 41 bytes, its current length.

A widened `Password` column can store password hashes in both the pre-4.1 and 4.1 formats. The format of any given hash value can be determined two ways:



- The length: 4.1 and pre-4.1 hashes are 41 and 16 bytes, respectively.
- Password hashes in the 4.1 format always begin with a `*` character, whereas passwords in the pre-4.1 format never do.

To permit explicit generation of pre-4.1 password hashes, two additional changes were made:

- The `OLD_PASSWORD()` function was added, which returns hash values in the 16-byte format.
- For compatibility purposes, the `old_passwords` system variable was added, to enable DBAs and applications control over the hashing method. The default `old_passwords` value of 0 causes hashing to use the 4.1 method (41-byte hash values), but setting `old_passwords=1` causes hashing to use the pre-4.1 method. In this case, `PASSWORD()` produces 16-byte values and is equivalent to `OLD_PASSWORD()`

To permit DBAs control over how clients are permitted to connect, the `secure_auth` system variable was added. Starting the server with this variable disabled or enabled permits or prohibits clients to connect using the older pre-4.1 password hashing method. Before MySQL 5.6.5, `secure_auth` is disabled by default. As of 5.6.5, `secure_auth` is enabled by default to promote a more secure default configuration DBAs can disable it at their discretion, but this is not recommended, and pre-4.1 password hashes are deprecated and should be avoided. (For account upgrade instructions, see [Section 6.4.1.3, “Migrating Away from Pre-4.1 Password Hashing and the `mysql\_old\_password` Plugin”](#).)

In addition, the `mysql` client supports a `--secure-auth` option that is analogous to `secure_auth`, but from the client side. It can be used to prevent connections to less secure accounts that use pre-4.1 password hashing. This option is disabled by default before MySQL 5.6.7, enabled thereafter.

## Compatibility Issues Related to Hashing Methods

The widening of the `Password` column in MySQL 4.1 from 16 bytes to 41 bytes affects installation or upgrade operations as follows:

- If you perform a new installation of MySQL, the `Password` column is made 41 bytes long automatically.
- Upgrades from MySQL 4.1 or later to current versions of MySQL should not give rise to any issues in regard to the `Password` column because both versions use the same column length and password hashing method.
- For upgrades from a pre-4.1 release to 4.1 or later, you must upgrade the system tables after upgrading. (See [Section 4.4.7, “`mysql\_upgrade` — Check and Upgrade MySQL Tables”](#).)

The 4.1 hashing method is understood only by MySQL 4.1 (and higher) servers and clients, which can result in some compatibility problems. A 4.1 or higher client can connect to a pre-4.1 server, because the client understands both the pre-4.1 and 4.1 password hashing methods. However, a pre-4.1 client that attempts to connect to a 4.1 or higher server may run into difficulties. For example, a 4.0 `mysql` client may fail with the following error message:

```
$> mysql -h localhost -u root
Client does not support authentication protocol requested
by server; consider upgrading MySQL client
```

The following discussion describes the differences between the pre-4.1 and 4.1 hashing methods, and what you should do if you upgrade your server but need to maintain backward compatibility with pre-4.1 clients. (However, permitting connections by old clients is not recommended and should be avoided if possible.) This information is of particular importance to PHP programmers migrating MySQL databases from versions older than 4.1 to 4.1 or higher.

The differences between short and long password hashes are relevant both for how the server uses passwords during authentication and for how it generates password hashes for connected clients that perform password-changing operations.

The way in which the server uses password hashes during authentication is affected by the width of the `Password` column:

- If the column is short, only short-hash authentication is used.
- If the column is long, it can hold either short or long hashes, and the server can use either format:
  - Pre-4.1 clients can connect, but because they know only about the pre-4.1 hashing method, they can authenticate only using accounts that have short hashes.
  - 4.1 and later clients can authenticate using accounts that have short or long hashes.

Even for short-hash accounts, the authentication process is actually a bit more secure for 4.1 and later clients than for older clients. In terms of security, the gradient from least to most secure is:

- Pre-4.1 client authenticating with short password hash
- 4.1 or later client authenticating with short password hash
- 4.1 or later client authenticating with long password hash

The way in which the server generates password hashes for connected clients is affected by the width of the `Password` column and by the `old_passwords` system variable. A 4.1 or later server generates long hashes only if certain conditions are met: The `Password` column must be wide enough to hold long values and `old_passwords` must not be set to 1.

Those conditions apply as follows:

- The `Password` column must be wide enough to hold long hashes (41 bytes). If the column has not been updated and still has the pre-4.1 width of 16 bytes, the server notices that long hashes cannot fit into it and generates only short hashes when a client performs password-changing operations using the `PASSWORD()` function or a password-generating statement. This is the behavior that occurs if you have upgraded from a version of MySQL older than 4.1 to 4.1 or later but have not yet run the `mysql_upgrade` program to widen the `Password` column.
- If the `Password` column is wide, it can store either short or long password hashes. In this case, the `PASSWORD()` function and password-generating statements generate long hashes unless the server was started with the `old_passwords` system variable set to 1 to force the server to generate short password hashes instead.

The purpose of the `old_passwords` system variable is to permit backward compatibility with pre-4.1 clients under circumstances where the server would otherwise generate long password hashes. The option does not affect authentication (4.1 and later clients can still use accounts that have long password hashes), but it does prevent creation of a long password hash in the `user` table as the result of a password-changing operation. Were that permitted to occur, the account could no longer be used by pre-4.1 clients. With `old_passwords` disabled, the following undesirable scenario is possible:

- An old pre-4.1 client connects to an account that has a short password hash.
- The client changes its own password. With `old_passwords` disabled, this results in the account having a long password hash.
- The next time the old client attempts to connect to the account, it cannot, because the account has a long password hash that requires the 4.1 hashing method during authentication. (Once an account has

a long password hash in the user table, only 4.1 and later clients can authenticate for it because pre-4.1 clients do not understand long hashes.)

This scenario illustrates that, if you must support older pre-4.1 clients, it is problematic to run a 4.1 or higher server without `old_passwords` set to 1. By running the server with `old_passwords=1`, password-changing operations do not generate long password hashes and thus do not cause accounts to become inaccessible to older clients. (Those clients cannot inadvertently lock themselves out by changing their password and ending up with a long password hash.)

The downside of `old_passwords=1` is that any passwords created or changed use short hashes, even for 4.1 or later clients. Thus, you lose the additional security provided by long password hashes. To create an account that has a long hash (for example, for use by 4.1 clients) or to change an existing account to use a long password hash, an administrator can set the session value of `old_passwords` set to 0 while leaving the global value set to 1:

```
mysql> SET @@SESSION.old_passwords = 0;
Query OK, 0 rows affected (0.00 sec)

mysql> SELECT @@SESSION.old_passwords, @@GLOBAL.old_passwords;
+-----+-----+
| @@SESSION.old_passwords | @@GLOBAL.old_passwords |
+-----+-----+
| 0 | 1 |
+-----+-----+
1 row in set (0.00 sec)

mysql> CREATE USER 'newuser'@'localhost' IDENTIFIED BY 'newpass';
Query OK, 0 rows affected (0.03 sec)

mysql> SET PASSWORD FOR 'existinguser'@'localhost' = PASSWORD('existingpass');
Query OK, 0 rows affected (0.00 sec)
```

The following scenarios are possible in MySQL 4.1 or later. The factors are whether the `Password` column is short or long, and, if long, whether the server is started with `old_passwords` enabled or disabled.

**Scenario 1:** Short `Password` column in user table:

- Only short hashes can be stored in the `Password` column.
- The server uses only short hashes during client authentication.
- For connected clients, password hash-generating operations involving the `PASSWORD()` function or password-generating statements use short hashes exclusively. Any change to an account's password results in that account having a short password hash.
- The value of `old_passwords` is irrelevant because with a short `Password` column, the server generates only short password hashes anyway.

This scenario occurs when a pre-4.1 MySQL installation has been upgraded to 4.1 or later but `mysql_upgrade` has not been run to upgrade the system tables in the `mysql` database. (This is not a recommended configuration because it does not permit use of more secure 4.1 password hashing.)

**Scenario 2:** Long `Password` column; server started with `old_passwords=1`:

- Short or long hashes can be stored in the `Password` column.
- 4.1 and later clients can authenticate for accounts that have short or long hashes.
- Pre-4.1 clients can authenticate only for accounts that have short hashes.

- For connected clients, password hash-generating operations involving the `PASSWORD()` function or password-generating statements use short hashes exclusively. Any change to an account's password results in that account having a short password hash.

In this scenario, newly created accounts have short password hashes because `old_passwords=1` prevents generation of long hashes. Also, if you create an account with a long hash before setting `old_passwords` to 1, changing the account's password while `old_passwords=1` results in the account being given a short password, causing it to lose the security benefits of a longer hash.

To create a new account that has a long password hash, or to change the password of any existing account to use a long hash, first set the session value of `old_passwords` set to 0 while leaving the global value set to 1, as described previously.

In this scenario, the server has an up to date `Password` column, but is running with the default password hashing method set to generate pre-4.1 hash values. This is not a recommended configuration but may be useful during a transitional period in which pre-4.1 clients and passwords are upgraded to 4.1 or later. When that has been done, it is preferable to run the server with `old_passwords=0` and `secure_auth=1`.

**Scenario 3:** Long `Password` column; server started with `old_passwords=0`:

- Short or long hashes can be stored in the `Password` column.
- 4.1 and later clients can authenticate using accounts that have short or long hashes.
- Pre-4.1 clients can authenticate only using accounts that have short hashes.
- For connected clients, password hash-generating operations involving the `PASSWORD()` function or password-generating statements use long hashes exclusively. A change to an account's password results in that account having a long password hash.

As indicated earlier, a danger in this scenario is that it is possible for accounts that have a short password hash to become inaccessible to pre-4.1 clients. A change to such an account's password made using the `PASSWORD()` function or a password-generating statement results in the account being given a long password hash. From that point on, no pre-4.1 client can connect to the server using that account. The client must upgrade to 4.1 or later.

If this is a problem, you can change a password in a special way. For example, normally you use `SET PASSWORD` as follows to change an account password:

```
SET PASSWORD FOR 'some_user'@'some_host' = PASSWORD('password');
```

To change the password but create a short hash, use the `OLD_PASSWORD()` function instead:

```
SET PASSWORD FOR 'some_user'@'some_host' = OLD_PASSWORD('password');
```

`OLD_PASSWORD()` is useful for situations in which you explicitly want to generate a short hash.

The disadvantages for each of the preceding scenarios may be summarized as follows:

In scenario 1, you cannot take advantage of longer hashes that provide more secure authentication.

In scenario 2, `old_passwords=1` prevents accounts with short hashes from becoming inaccessible, but password-changing operations cause accounts with long hashes to revert to short hashes unless you take care to change the session value of `old_passwords` to 0 first.

In scenario 3, accounts with short hashes become inaccessible to pre-4.1 clients if you change their passwords without explicitly using `OLD_PASSWORD()`.

The best way to avoid compatibility problems related to short password hashes is to not use them:

- Upgrade all client programs to MySQL 4.1 or later.
- Run the server with `old_passwords=0`.
- Reset the password for any account with a short password hash to use a long password hash.
- For additional security, run the server with `secure_auth=1`.

### 6.1.3 Making MySQL Secure Against Attackers

When you connect to a MySQL server, you should use a password. The password is not transmitted as cleartext over the connection. Password handling during the client connection sequence was upgraded in MySQL 4.1.1 to be very secure. If you are still using pre-4.1.1-style passwords, the encryption algorithm is not as strong as the newer algorithm. With some effort, a clever attacker who can sniff the traffic between the client and the server can crack the password. (See [Section 6.1.2.4, “Password Hashing in MySQL”](#), for a discussion of the different password handling methods.)

All other information is transferred as text, and can be read by anyone who is able to watch the connection. If the connection between the client and the server goes through an untrusted network, and you are concerned about this, you can use the compressed protocol to make traffic much more difficult to decipher. You can also use MySQL's internal SSL support to make the connection even more secure. See [Section 6.3, “Using Encrypted Connections”](#). Alternatively, use SSH to get an encrypted TCP/IP connection between a MySQL server and a MySQL client. You can find an Open Source SSH client at <http://www.openssh.org/>, and a comparison of both Open Source and Commercial SSH clients at [http://en.wikipedia.org/wiki/Comparison\\_of\\_SSH\\_clients](http://en.wikipedia.org/wiki/Comparison_of_SSH_clients).

To make a MySQL system secure, you should strongly consider the following suggestions:

- Require all MySQL accounts to have a password. A client program does not necessarily know the identity of the person running it. It is common for client/server applications that the user can specify any user name to the client program. For example, anyone can use the `mysql` program to connect as any other person simply by invoking it as `mysql -u other_user db_name` if `other_user` has no password. If all accounts have a password, connecting using another user's account becomes much more difficult.

For a discussion of methods for setting passwords, see [Section 6.2.10, “Assigning Account Passwords”](#).

- Make sure that the only Unix user account with read or write privileges in the database directories is the account that is used for running `mysqld`.
- Never run the MySQL server as the Unix `root` user. This is extremely dangerous, because any user with the `FILE` privilege is able to cause the server to create files as `root` (for example, `~root/.bashrc`). To prevent this, `mysqld` refuses to run as `root` unless that is specified explicitly using the `--user=root` option.

`mysqld` can (and should) be run as an ordinary, unprivileged user instead. You can create a separate Unix account named `mysql` to make everything even more secure. Use this account only for administering MySQL. To start `mysqld` as a different Unix user, add a `user` option that specifies the user name in the `[mysqld]` group of the `my.cnf` option file where you specify server options. For example:

```
[mysqld]
user=mysql
```

This causes the server to start as the designated user whether you start it manually or by using `mysqld_safe` or `mysql.server`. For more details, see [Section 6.1.5, “How to Run MySQL as a Normal User”](#).

Running `mysqld` as a Unix user other than `root` does not mean that you need to change the `root` user name in the `user` table. *User names for MySQL accounts have nothing to do with user names for Unix accounts.*

- Do not grant the `FILE` privilege to nonadministrative users. Any user that has this privilege can write a file anywhere in the file system with the privileges of the `mysqld` daemon. This includes the server's data directory containing the files that implement the privilege tables. To make `FILE`-privilege operations a bit safer, files generated with `SELECT ... INTO OUTFILE` do not overwrite existing files and are writable by everyone.

The `FILE` privilege may also be used to read any file that is world-readable or accessible to the Unix user that the server runs as. With this privilege, you can read any file into a database table. This could be abused, for example, by using `LOAD DATA` to load `/etc/passwd` into a table, which then can be displayed with `SELECT`.

To limit the location in which files can be read and written, set the `secure_file_priv` system variable to a specific directory. See [Section 5.1.7, “Server System Variables”](#).

- Do not grant the `PROCESS` or `SUPER` privilege to nonadministrative users. The output of `mysqladmin processlist` and `SHOW PROCESSLIST` shows the text of any statements currently being executed, so any user who is permitted to see the server process list might be able to see statements issued by other users such as `UPDATE user SET password=PASSWORD('not_secure')`.

`mysqld` reserves an extra connection for users who have the `SUPER` privilege, so that a MySQL `root` user can log in and check server activity even if all normal connections are in use.

The `SUPER` privilege can be used to terminate client connections, change server operation by changing the value of system variables, and control replication servers.

- Do not permit the use of symlinks to tables. (This capability can be disabled with the `--skip-symbolic-links` option.) This is especially important if you run `mysqld` as `root`, because anyone that has write access to the server's data directory then could delete any file in the system! See [Section 8.12.3.2, “Using Symbolic Links for MyISAM Tables on Unix”](#).
- Stored programs and views should be written using the security guidelines discussed in [Section 23.6, “Stored Object Access Control”](#).
- If you do not trust your DNS, you should use IP addresses rather than host names in the grant tables. In any case, you should be very careful about creating grant table entries using host name values that contain wildcards.
- If you want to restrict the number of connections permitted to a single account, you can do so by setting the `max_user_connections` variable in `mysqld`. The `CREATE USER` and `ALTER USER` statements also support resource control options for limiting the extent of server use permitted to an account. See [Section 13.7.1.2, “CREATE USER Statement”](#), and [Section 13.7.1.1, “ALTER USER Statement”](#).
- If the plugin directory is writable by the server, it may be possible for a user to write executable code to a file in the directory using `SELECT ... INTO DUMPFILE`. This can be prevented by making `plugin_dir` read only to the server or by setting `secure_file_priv` to a directory where `SELECT` writes can be made safely.

## 6.1.4 Security-Related `mysqld` Options and Variables

The following table shows `mysqld` options and system variables that affect security. For descriptions of each of these, see [Section 5.1.6, “Server Command Options”](#), and [Section 5.1.7, “Server System Variables”](#).

**Table 6.1 Security Option and Variable Summary**

Name	Cmd-Line	Option File	System Var	Status Var	Var Scope	Dynamic
<a href="#">allow-suspicious-udfs</a>	Yes	Yes				
<a href="#">automatic_sp_privileges</a>	Yes	Yes	Yes		Global	Yes
<a href="#">chroot</a>	Yes	Yes				
<a href="#">des-key-file</a>	Yes	Yes				
<a href="#">local_infile</a>	Yes	Yes	Yes		Global	Yes
<a href="#">old_passwords</a>	Yes	Yes	Yes		Both	Yes
<a href="#">safe-user-create</a>	Yes	Yes				
<a href="#">secure_auth</a>	Yes	Yes	Yes		Global	Yes
<a href="#">secure_file_priv</a>	Yes	Yes	Yes		Global	No
<a href="#">skip-grant-tables</a>	Yes	Yes				
<a href="#">skip_name_resolve</a>	Yes	Yes	Yes		Global	No
<a href="#">skip_networking</a>	Yes	Yes	Yes		Global	No
<a href="#">skip_show_database</a>	Yes	Yes	Yes		Global	No

## 6.1.5 How to Run MySQL as a Normal User

On Windows, you can run the server as a Windows service using a normal user account.

On Linux, for installations performed using a MySQL repository, RPM packages, or Debian packages, the MySQL server `mysqld` should be started by the local `mysql` operating system user. Starting by another operating system user is not supported by the init scripts that are included as part of the installation.

On Unix (or Linux for installations performed using `tar` or `tar.gz` packages), the MySQL server `mysqld` can be started and run by any user. However, you should avoid running the server as the Unix `root` user for security reasons. To change `mysqld` to run as a normal unprivileged Unix user `user_name`, you must do the following:

1. Stop the server if it is running (use `mysqladmin shutdown`).
2. Change the database directories and files so that `user_name` has privileges to read and write files in them (you might need to do this as the Unix `root` user):

```
$> chown -R user_name /path/to/mysql/datadir
```

If you do not do this, the server is unable to access databases or tables when it runs as `user_name`.

If directories or files within the MySQL data directory are symbolic links, `chown -R` might not follow symbolic links for you. If it does not, you must also follow those links and change the directories and files they point to.

3. Start the server as user `user_name`. Another alternative is to start `mysqld` as the Unix `root` user and use the `--user=user_name` option. `mysqld` starts, then switches to run as the Unix user `user_name` before accepting any connections.

4. To start the server as the given user automatically at system startup time, specify the user name by adding a `user` option to the `[mysqld]` group of the `/etc/my.cnf` option file or the `my.cnf` option file in the server's data directory. For example:

```
[mysqld]
user=user_name
```

If your Unix machine itself is not secured, you should assign passwords to the MySQL `root` account in the grant tables. Otherwise, any user with a login account on that machine can run the `mysql` client with a `--user=root` option and perform any operation. (It is a good idea to assign passwords to MySQL accounts in any case, but especially so when other login accounts exist on the server host.) See [Section 2.9.4, "Securing the Initial MySQL Account"](#).

## 6.1.6 Security Considerations for LOAD DATA LOCAL

The `LOAD DATA` statement loads a data file into a table. The statement can load a file located on the server host, or, if the `LOCAL` keyword is specified, on the client host.

The `LOCAL` version of `LOAD DATA` has two potential security issues:

- Because `LOAD DATA LOCAL` is an SQL statement, parsing occurs on the server side, and transfer of the file from the client host to the server host is initiated by the MySQL server, which tells the client the file named in the statement. In theory, a patched server could tell the client program to transfer a file of the server's choosing rather than the file named in the statement. Such a server could access any file on the client host to which the client user has read access. (A patched server could in fact reply with a file-transfer request to any statement, not just `LOAD DATA LOCAL`, so a more fundamental issue is that clients should not connect to untrusted servers.)
- In a Web environment where the clients are connecting from a Web server, a user could use `LOAD DATA LOCAL` to read any files that the Web server process has read access to (assuming that a user could run any statement against the SQL server). In this environment, the client with respect to the MySQL server actually is the Web server, not a remote program being run by users who connect to the Web server.

To avoid connecting to untrusted servers, clients can establish a secure connection and verify the server identity by connecting using the `--ssl-mode=VERIFY_IDENTITY` option and the appropriate CA certificate. To implement this level of verification, you must first ensure that the CA certificate for the server is reliably available to the replica, otherwise availability issues will result. For more information, see [Command Options for Encrypted Connections](#).

To avoid `LOAD DATA` issues, clients should avoid using `LOCAL`.

Administrators and applications can configure whether to permit local data loading as follows:

- On the server side:
  - The `local_infile` system variable controls server-side `LOCAL` capability. Depending on the `local_infile` setting, the server refuses or permits local data loading by clients that request local data loading.
  - By default, `local_infile` is enabled. To cause the server to refuse or permit `LOAD DATA LOCAL` statements explicitly (regardless of how client programs and libraries are configured at build time or runtime), start `mysqld` with `local_infile` disabled or enabled. `local_infile` can also be set at runtime.
- On the client side:



- The `ENABLED_LOCAL_INFILE` CMake option controls the compiled-in default `LOCAL` capability for the MySQL client library (see [Section 2.8.7, “MySQL Source-Configuration Options”](#)). Clients that make no explicit arrangements therefore have `LOCAL` capability disabled or enabled according to the `ENABLED_LOCAL_INFILE` setting specified at MySQL build time.
- By default, the client library in MySQL binary distributions is compiled with `ENABLED_LOCAL_INFILE` enabled. If you compile MySQL from source, configure it with `ENABLED_LOCAL_INFILE` disabled or enabled based on whether clients that make no explicit arrangements should have `LOCAL` capability disabled or enabled.
- For client programs that use the C API, local data loading capability is determined by the default compiled into the MySQL client library. To enable or disable it explicitly, invoke the `mysql_options()` C API function to disable or enable the `MYSQL_OPT_LOCAL_INFILE` option. See [mysql\\_options\(\)](#).
- For the `mysql` client, local data loading capability is determined by the default compiled into the MySQL client library. To disable or enable it explicitly, use the `--local-infile=0` or `--local-infile=[1]` option.
- For the `mysqlimport` client, local data loading is not used by default. To disable or enable it explicitly, use the `--local=0` or `--local=[1]` option.
- If you use `LOAD DATA LOCAL` in Perl scripts or other programs that read the `[client]` group from option files, you can add a `local-infile` option setting to that group. To prevent problems for programs that do not understand this option, specify it using the `loose-` prefix:

```
[client]
loose-local-infile=0
```

or:

```
[client]
loose-local-infile=1
```

- In all cases, successful use of a `LOCAL` load operation by a client also requires that the server permits local loading.

If `LOCAL` capability is disabled, on either the server or client side, a client that attempts to issue a `LOAD DATA LOCAL` statement receives the following error message:

```
ERROR 1148: The used command is not allowed with this MySQL version
```

## MySQL Shell and Local Data Loading

MySQL Shell provides a number of utilities to dump tables, schemas, or server instances and load them into other instances. When you use these utilities to handle the data, MySQL Shell provides additional functions such as input preprocessing, multithreaded parallel loading, file compression and decompression, and handling access to Oracle Cloud Infrastructure Object Storage buckets. To get the best functionality, always use the most recent version available of MySQL Shell's dump and dump loading utilities.

MySQL Shell's data upload utilities use `LOAD DATA LOCAL INFILE` statements to upload data, so the `local_infile` system variable must be set to `ON` on the target server instance. You can do this before uploading the data, and remove it again afterwards. The utilities handle the file transfer requests safely to deal with the security considerations discussed in this topic.

MySQL Shell includes these dump and dump loading utilities:

Table export utility <code>util.exportTable()</code>	Exports a MySQL relational table into a data file, which can be uploaded to a MySQL server instance using MySQL Shell's parallel table import utility, imported to a different application, or used as a logical backup. The utility has preset options and customization options to produce different output formats.
Parallel table import utility <code>util.importTable()</code>	Imports a data file to a MySQL relational table. The data file can be the output from MySQL Shell's table export utility or another format supported by the utility's preset and customization options. The utility can carry out input preprocessing before adding the data to the table. It can accept multiple data files to merge into a single relational table, and automatically decompresses compressed files.
Instance dump utility <code>util.dumpInstance()</code> , schema dump utility <code>util.dumpSchemas()</code> , and table dump utility <code>util.dumpTables()</code>	Export an instance, schema, or table to a set of dump files, which can then be uploaded to a MySQL instance using MySQL Shell's dump loading utility. The utilities provide Oracle Cloud Infrastructure Object Storage streaming, MySQL HeatWave Service compatibility checks and modifications, and the ability to carry out a dry run to identify issues before proceeding with the dump.
Dump loading utility <code>util.loadDump()</code>	Import dump files created using MySQL Shell's instance, schema, or table dump utility into a MySQL HeatWave Service DB System or a MySQL Server instance. The utility manages the upload process and provides data streaming from remote storage, parallel loading of tables or table chunks, progress state tracking, resume and reset capability, and the option of concurrent loading while the dump is still taking place. MySQL Shell's parallel table import utility can be used in combination with the dump loading utility to modify data before uploading it to the target MySQL instance.

For details of the utilities, see [MySQL Shell Utilities](#).

## 6.1.7 Client Programming Security Guidelines

Client applications that access MySQL should use the following guidelines to avoid interpreting external data incorrectly or exposing sensitive information.

- [Handle External Data Properly](#)
- [Handle MySQL Error Messages Properly](#)

### Handle External Data Properly

Applications that access MySQL should not trust any data entered by users, who can try to trick your code by entering special or escaped character sequences in Web forms, URLs, or whatever application you have built. Be sure that your application remains secure if a user tries to perform SQL injection by entering something like  `; DROP DATABASE mysql ;` into a form. This is an extreme example, but large security leaks and data loss might occur as a result of hackers using similar techniques, if you do not prepare for them.

A common mistake is to protect only string data values. Remember to check numeric data as well. If an application generates a query such as `SELECT * FROM table WHERE ID=234` when a user enters the value `234`, the user can enter the value `234 OR 1=1` to cause the application to generate the query `SELECT * FROM table WHERE ID=234 OR 1=1`. As a result, the server retrieves every row in the

table. This exposes every row and causes excessive server load. The simplest way to protect from this type of attack is to use single quotation marks around the numeric constants: `SELECT * FROM table WHERE ID='234'`. If the user enters extra information, it all becomes part of the string. In a numeric context, MySQL automatically converts this string to a number and strips any trailing nonnumeric characters from it.

Sometimes people think that if a database contains only publicly available data, it need not be protected. This is incorrect. Even if it is permissible to display any row in the database, you should still protect against denial of service attacks (for example, those that are based on the technique in the preceding paragraph that causes the server to waste resources). Otherwise, your server becomes unresponsive to legitimate users.

Checklist:

- Enable strict SQL mode to tell the server to be more restrictive of what data values it accepts. See [Section 5.1.10, “Server SQL Modes”](#).
- Try to enter single and double quotation marks ( ' and " ) in all of your Web forms. If you get any kind of MySQL error, investigate the problem right away.
- Try to modify dynamic URLs by adding `%22 ("`, `%23 (#)`, and `%27 ('` to them.
- Try to modify data types in dynamic URLs from numeric to character types using the characters shown in the previous examples. Your application should be safe against these and similar attacks.
- Try to enter characters, spaces, and special symbols rather than numbers in numeric fields. Your application should remove them before passing them to MySQL or else generate an error. Passing unchecked values to MySQL is very dangerous!
- Check the size of data before passing it to MySQL.
- Have your application connect to the database using a user name different from the one you use for administrative purposes. Do not give your applications any access privileges they do not need.

Many application programming interfaces provide a means of escaping special characters in data values. Properly used, this prevents application users from entering values that cause the application to generate statements that have a different effect than you intend:

- MySQL SQL statements: Use SQL prepared statements and accept data values only by means of placeholders; see [Section 13.5, “Prepared Statements”](#).
- MySQL C API: Use the `mysql_real_escape_string_quote()` API call. Alternatively, use the C API prepared statement interface and accept data values only by means of placeholders; see [C API Prepared Statement Interface](#).
- MySQL++: Use the `escape` and `quote` modifiers for query streams.
- PHP: Use either the `mysqli` or `pdo_mysql` extensions, and not the older `ext/mysql` extension. The preferred API's support the improved MySQL authentication protocol and passwords, as well as prepared statements with placeholders. See also [MySQL and PHP](#).

If the older `ext/mysql` extension must be used, then for escaping use the `mysql_real_escape_string_quote()` function and not `mysql_escape_string()` or `addslashes()` because only `mysql_real_escape_string_quote()` is character set-aware; the other functions can be “bypassed” when using (invalid) multibyte character sets.

- Perl DBI: Use placeholders or the `quote()` method.

- Java JDBC: Use a `PreparedStatement` object and placeholders.

Other programming interfaces might have similar capabilities.

## Handle MySQL Error Messages Properly

It is the application's responsibility to intercept errors that occur as a result of executing SQL statements with the MySQL database server and handle them appropriately.

The information returned in a MySQL error is not gratuitous because that information is key in debugging MySQL using applications. It would be nearly impossible, for example, to debug a common 10-way join `SELECT` statement without providing information regarding which databases, tables, and other objects are involved with problems. Thus, MySQL errors must sometimes necessarily contain references to the names of those objects.

A simple but insecure approach for an application when it receives such an error from MySQL is to intercept it and display it verbatim to the client. However, revealing error information is a known application vulnerability type ([CVE-209](#)) and the application developer must ensure the application does not have this vulnerability.

For example, an application that displays a message such as this exposes both a database name and a table name to clients, which is information a client might attempt to exploit:

```
ERROR 1146 (42S02): Table 'mydb.mytable' does not exist
```

Instead, the proper behavior for an application when it receives such an error from MySQL is to log appropriate information, including the error information, to a secure audit location only accessible to trusted personnel. The application can return something more generic such as “Internal Error” to the user.

## 6.2 Access Control and Account Management

MySQL enables the creation of accounts that permit client users to connect to the server and access data managed by the server. The primary function of the MySQL privilege system is to authenticate a user who connects from a given host and to associate that user with privileges on a database such as `SELECT`, `INSERT`, `UPDATE`, and `DELETE`. Additional functionality includes the ability to grant privileges for administrative operations.

To control which users can connect, each account can be assigned authentication credentials such as a password. The user interface to MySQL accounts consists of SQL statements such as `CREATE USER`, `GRANT`, and `REVOKE`. See [Section 13.7.1, “Account Management Statements”](#).

The MySQL privilege system ensures that all users may perform only the operations permitted to them. As a user, when you connect to a MySQL server, your identity is determined by *the host from which you connect* and *the user name you specify*. When you issue requests after connecting, the system grants privileges according to your identity and *what you want to do*.

MySQL considers both your host name and user name in identifying you because there is no reason to assume that a given user name belongs to the same person on all hosts. For example, the user `joe` who connects from `office.example.com` need not be the same person as the user `joe` who connects from `home.example.com`. MySQL handles this by enabling you to distinguish users on different hosts that happen to have the same name: You can grant one set of privileges for connections by `joe` from `office.example.com`, and a different set of privileges for connections by `joe` from `home.example.com`. To see what privileges a given account has, use the `SHOW GRANTS` statement. For example:

```
SHOW GRANTS FOR 'joe'@'office.example.com';
```

```
SHOW GRANTS FOR 'joe'@'home.example.com';
```

Internally, the server stores privilege information in the grant tables of the `mysql` system database. The MySQL server reads the contents of these tables into memory when it starts and bases access-control decisions on the in-memory copies of the grant tables.

MySQL access control involves two stages when you run a client program that connects to the server:

**Stage 1:** The server accepts or rejects the connection based on your identity and whether you can verify your identity by supplying the correct password.

**Stage 2:** Assuming that you can connect, the server checks each statement you issue to determine whether you have sufficient privileges to perform it. For example, if you try to select rows from a table in a database or drop a table from the database, the server verifies that you have the `SELECT` privilege for the table or the `DROP` privilege for the database.

For a more detailed description of what happens during each stage, see [Section 6.2.5, “Access Control, Stage 1: Connection Verification”](#), and [Section 6.2.6, “Access Control, Stage 2: Request Verification”](#). For help in diagnosing privilege-related problems, see [Section 6.2.17, “Troubleshooting Problems Connecting to MySQL”](#).

If your privileges are changed (either by yourself or someone else) while you are connected, those changes do not necessarily take effect immediately for the next statement that you issue. For details about the conditions under which the server reloads the grant tables, see [Section 6.2.9, “When Privilege Changes Take Effect”](#).

There are some things that you cannot do with the MySQL privilege system:

- You cannot explicitly specify that a given user should be denied access. That is, you cannot explicitly match a user and then refuse the connection.
- You cannot specify that a user has privileges to create or drop tables in a database but not to create or drop the database itself.
- A password applies globally to an account. You cannot associate a password with a specific object such as a database, table, or routine.

## 6.2.1 Account User Names and Passwords

MySQL stores accounts in the `user` table of the `mysql` system database. An account is defined in terms of a user name and the client host or hosts from which the user can connect to the server. For information about account representation in the `user` table, see [Section 6.2.3, “Grant Tables”](#).

An account may also have authentication credentials such as a password. The credentials are handled by the account authentication plugin. MySQL supports multiple authentication plugins. Some of them use built-in authentication methods, whereas others enable authentication using external authentication methods. See [Section 6.2.13, “Pluggable Authentication”](#).

There are several distinctions between the way user names and passwords are used by MySQL and your operating system:

- User names, as used by MySQL for authentication purposes, have nothing to do with user names (login names) as used by Windows or Unix. On Unix, most MySQL clients by default try to log in using the current Unix user name as the MySQL user name, but that is for convenience only. The default can be overridden easily, because client programs permit any user name to be specified with a `-u` or `--`

`user` option. This means that anyone can attempt to connect to the server using any user name, so you cannot make a database secure in any way unless all MySQL accounts have passwords. Anyone who specifies a user name for an account that has no password can connect successfully to the server.

- MySQL user names are up to 32 characters long. Operating system user names may have a different maximum length.



### Warning

The MySQL user name length limit is hardcoded in MySQL servers and clients, and trying to circumvent it by modifying the definitions of the tables in the `mysql` database *does not work*.

You should never alter the structure of tables in the `mysql` database in any manner whatsoever except by means of the procedure that is described in [Section 2.10, “Upgrading MySQL”](#). Attempting to redefine the MySQL system tables in any other fashion results in undefined and unsupported behavior. The server is free to ignore rows that become malformed as a result of such modifications.

- To authenticate client connections for accounts that use built-in authentication methods, the server uses passwords stored in the `user` table. These passwords are distinct from passwords for logging in to your operating system. There is no necessary connection between the “external” password you use to log in to a Windows or Unix machine and the password you use to access the MySQL server on that machine.

If the server authenticates a client using some other plugin, the authentication method that the plugin implements may or may not use a password stored in the `user` table. In this case, it is possible that an external password is also used to authenticate to the MySQL server.

- Passwords stored in the `user` table are encrypted using plugin-specific algorithms. For information about MySQL native password hashing, see [Section 6.1.2.4, “Password Hashing in MySQL”](#).
- If the user name and password contain only ASCII characters, it is possible to connect to the server regardless of character set settings. To enable connections when the user name or password contain non-ASCII characters, client applications should call the `mysql_options()` C API function with the `MYSQL_SET_CHARSET_NAME` option and appropriate character set name as arguments. This causes authentication to take place using the specified character set. Otherwise, authentication fails unless the server default character set is the same as the encoding in the authentication defaults.

Standard MySQL client programs support a `--default-character-set` option that causes `mysql_options()` to be called as just described. In addition, character set autodetection is supported as described in [Section 10.4, “Connection Character Sets and Collations”](#). For programs that use a connector that is not based on the C API, the connector may provide an equivalent to `mysql_options()` that can be used instead. Check the connector documentation.

The preceding notes do not apply for `ucs2`, `utf16`, and `utf32`, which are not permitted as client character sets.

The MySQL installation process populates the grant tables with an initial `root` account, as described in [Section 2.9.4, “Securing the Initial MySQL Account”](#), which also discusses how to assign a password to it. Thereafter, you normally set up, modify, and remove MySQL accounts using statements such as `CREATE USER`, `DROP USER`, `GRANT`, and `REVOKE`. See [Section 6.2.7, “Adding Accounts, Assigning Privileges, and Dropping Accounts”](#), and [Section 13.7.1, “Account Management Statements”](#).

To connect to a MySQL server with a command-line client, specify user name and password options as necessary for the account that you want to use:

```
$> mysql --user=finley --password db_name
```

If you prefer short options, the command looks like this:

```
$> mysql -u finley -p db_name
```

If you omit the password value following the `--password` or `-p` option on the command line (as just shown), the client prompts for one. Alternatively, the password can be specified on the command line:

```
$> mysql --user=finley --password=password db_name
$> mysql -u finley -ppassword db_name
```

If you use the `-p` option, there must be *no space* between `-p` and the following password value.

Specifying a password on the command line should be considered insecure. See [Section 6.1.2.1, “End-User Guidelines for Password Security”](#). To avoid giving the password on the command line, use an option file or a login path file. See [Section 4.2.2.2, “Using Option Files”](#), and [Section 4.6.6, “mysql\\_config\\_editor — MySQL Configuration Utility”](#).

For additional information about specifying user names, passwords, and other connection parameters, see [Section 4.2.4, “Connecting to the MySQL Server Using Command Options”](#).

## 6.2.2 Privileges Provided by MySQL

The privileges granted to a MySQL account determine which operations the account can perform. MySQL privileges differ in the contexts in which they apply and at different levels of operation:

- Administrative privileges enable users to manage operation of the MySQL server. These privileges are global because they are not specific to a particular database.
- Database privileges apply to a database and to all objects within it. These privileges can be granted for specific databases, or globally so that they apply to all databases.
- Privileges for database objects such as tables, indexes, views, and stored routines can be granted for specific objects within a database, for all objects of a given type within a database (for example, all tables in a database), or globally for all objects of a given type in all databases.

Information about account privileges is stored in the grant tables in the `mysql` system database. For a description of the structure and contents of these tables, see [Section 6.2.3, “Grant Tables”](#). The MySQL server reads the contents of the grant tables into memory when it starts, and reloads them under the circumstances indicated in [Section 6.2.9, “When Privilege Changes Take Effect”](#). The server bases access-control decisions on the in-memory copies of the grant tables.



### Important

Some MySQL releases introduce changes to the grant tables to add new privileges or features. To make sure that you can take advantage of any new capabilities, update your grant tables to the current structure whenever you upgrade MySQL. See [Section 2.10, “Upgrading MySQL”](#).

The following sections summarize the available privileges, provide more detailed descriptions of each privilege, and offer usage guidelines.

- [Summary of Available Privileges](#)
- [Privilege Descriptions](#)

- [Privilege-Granting Guidelines](#)

## Summary of Available Privileges

The following table shows the privilege names used in [GRANT](#) and [REVOKE](#) statements, along with the column name associated with each privilege in the grant tables and the context in which the privilege applies.

**Table 6.2 Permissible Privileges for GRANT and REVOKE**

Privilege	Grant Table Column	Context
ALL [PRIVILEGES]	Synonym for “all privileges”	Server administration
ALTER	Alter_priv	Tables
ALTER ROUTINE	Alter_routine_priv	Stored routines
CREATE	Create_priv	Databases, tables, or indexes
CREATE ROUTINE	Create_routine_priv	Stored routines
CREATE TABLESPACE	Create_tablespace_priv	Server administration
CREATE TEMPORARY TABLES	Create_tmp_table_priv	Tables
CREATE USER	Create_user_priv	Server administration
CREATE VIEW	Create_view_priv	Views
DELETE	Delete_priv	Tables
DROP	Drop_priv	Databases, tables, or views
EVENT	Event_priv	Databases
EXECUTE	Execute_priv	Stored routines
FILE	File_priv	File access on server host
GRANT OPTION	Grant_priv	Databases, tables, or stored routines
INDEX	Index_priv	Tables
INSERT	Insert_priv	Tables or columns
LOCK TABLES	Lock_tables_priv	Databases
PROCESS	Process_priv	Server administration
PROXY	See <a href="#">proxies_priv</a> table	Server administration
REFERENCES	References_priv	Databases or tables
RELOAD	Reload_priv	Server administration
REPLICATION CLIENT	Repl_client_priv	Server administration
REPLICATION SLAVE	Repl_slave_priv	Server administration
SELECT	Select_priv	Tables or columns
SHOW DATABASES	Show_db_priv	Server administration
SHOW VIEW	Show_view_priv	Views
SHUTDOWN	Shutdown_priv	Server administration
SUPER	Super_priv	Server administration
TRIGGER	Trigger_priv	Tables



Privilege	Grant Table Column	Context
UPDATE	Update_priv	Tables or columns
USAGE	Synonym for “no privileges”	Server administration

## Privilege Descriptions

The following list provides general descriptions of each privilege available in MySQL. Particular SQL statements might have more specific privilege requirements than indicated here. If so, the description for the statement in question provides the details.

- [ALL, ALL PRIVILEGES](#)

These privilege specifiers are shorthand for “all privileges available at a given privilege level” (except [GRANT OPTION](#)). For example, granting [ALL](#) at the global or table level grants all global privileges or all table-level privileges, respectively.

- [ALTER](#)

Enables use of the [ALTER TABLE](#) statement to change the structure of tables. [ALTER TABLE](#) also requires the [CREATE](#) and [INSERT](#) privileges. Renaming a table requires [ALTER](#) and [DROP](#) on the old table, [CREATE](#), and [INSERT](#) on the new table.

- [ALTER ROUTINE](#)

Enables use of statements that alter or drop stored routines (stored procedures and functions).

- [CREATE](#)

Enables use of statements that create new databases and tables.

- [CREATE ROUTINE](#)

Enables use of statements that create stored routines (stored procedures and functions).

- [CREATE TABLESPACE](#)

Enables use of statements that create, alter, or drop tablespaces and log file groups.

- [CREATE TEMPORARY TABLES](#)

Enables the creation of temporary tables using the [CREATE TEMPORARY TABLE](#) statement.

After a session has created a temporary table, the server performs no further privilege checks on the table. The creating session can perform any operation on the table, such as [DROP TABLE](#), [INSERT](#), [UPDATE](#), or [SELECT](#). For more information, see [Section 13.1.18.2, “CREATE TEMPORARY TABLE Statement”](#).

- [CREATE USER](#)

Enables use of the [ALTER USER](#), [CREATE USER](#), [DROP USER](#), [RENAME USER](#), and [REVOKE ALL PRIVILEGES](#) statements.

- [CREATE VIEW](#)

Enables use of the [CREATE VIEW](#) statement.

- [DELETE](#)

Enables rows to be deleted from tables in a database.

- [DROP](#)

Enables use of statements that drop (remove) existing databases, tables, and views. The [DROP](#) privilege is required to use the [ALTER TABLE ... DROP PARTITION](#) statement on a partitioned table. The [DROP](#) privilege is also required for [TRUNCATE TABLE](#).

- [EVENT](#)

Enables use of statements that create, alter, drop, or display events for the Event Scheduler.

- [EXECUTE](#)

Enables use of statements that execute stored routines (stored procedures and functions).

- [FILE](#)

Affects the following operations and server behaviors:

- Enables reading and writing files on the server host using the [LOAD DATA](#) and [SELECT ... INTO OUTFILE](#) statements and the [LOAD\\_FILE\(\)](#) function. A user who has the [FILE](#) privilege can read any file on the server host that is either world-readable or readable by the MySQL server. (This implies the user can read any file in any database directory, because the server can access any of those files.)
- Enables creating new files in any directory where the MySQL server has write access. This includes the server's data directory containing the files that implement the privilege tables.
- As of MySQL 5.7.17, enables use of the [DATA DIRECTORY](#) or [INDEX DIRECTORY](#) table option for the [CREATE TABLE](#) statement.

As a security measure, the server does not overwrite existing files.

To limit the location in which files can be read and written, set the [secure\\_file\\_priv](#) system variable to a specific directory. See [Section 5.1.7, "Server System Variables"](#).

- [GRANT OPTION](#)

Enables you to grant to or revoke from other users those privileges that you yourself possess.

- [INDEX](#)

Enables use of statements that create or drop (remove) indexes. [INDEX](#) applies to existing tables. If you have the [CREATE](#) privilege for a table, you can include index definitions in the [CREATE TABLE](#) statement.

- [INSERT](#)

Enables rows to be inserted into tables in a database. [INSERT](#) is also required for the [ANALYZE TABLE](#), [OPTIMIZE TABLE](#), and [REPAIR TABLE](#) table-maintenance statements.

- [LOCK TABLES](#)

Enables use of explicit [LOCK TABLES](#) statements to lock tables for which you have the [SELECT](#) privilege. This includes use of write locks, which prevents other sessions from reading the locked table.

- [PROCESS](#)

The `PROCESS` privilege controls access to information about threads executing within the server (that is, information about statements being executed by sessions). Thread information available using the `SHOW PROCESSLIST` statement, the `mysqladmin processlist` command, the `INFORMATION_SCHEMA.PROCESSLIST` table, and the Performance Schema `processlist` table is accessible as follows:

- With the `PROCESS` privilege, a user has access to information about all threads, even those belonging to other users.
- Without the `PROCESS` privilege, nonanonymous users have access to information about their own threads but not threads for other users, and anonymous users have no access to thread information.



#### Note

The Performance Schema `threads` table also provides thread information, but table access uses a different privilege model. See [Section 25.12.16.4, “The threads Table”](#).

The `PROCESS` privilege also enables use of the `SHOW ENGINE` statement, access to the `INFORMATION_SCHEMA.InnoDB` tables (tables with names that begin with `INNODB_`), and (as of MySQL 5.7.31) access to the `INFORMATION_SCHEMA.FILES` table.

- `PROXY`

Enables one user to impersonate or become known as another user. See [Section 6.2.14, “Proxy Users”](#).

- `REFERENCES`

Creation of a foreign key constraint requires the `REFERENCES` privilege for the parent table.

- `RELOAD`

The `RELOAD` enables the following operations:

- Use of the `FLUSH` statement.
- Use of `mysqladmin` commands that are equivalent to `FLUSH` operations: `flush-hosts`, `flush-logs`, `flush-privileges`, `flush-status`, `flush-tables`, `flush-threads`, `refresh`, and `reload`.

The `reload` command tells the server to reload the grant tables into memory. `flush-privileges` is a synonym for `reload`. The `refresh` command closes and reopens the log files and flushes all tables. The other `flush-xxx` commands perform functions similar to `refresh`, but are more specific and may be preferable in some instances. For example, if you want to flush just the log files, `flush-logs` is a better choice than `refresh`.

- Use of `mysqldump` options that perform various `FLUSH` operations: `--flush-logs` and `--master-data`.
- Use of the `RESET` statement.

- `REPLICATION CLIENT`

Enables use of the `SHOW MASTER STATUS`, `SHOW SLAVE STATUS`, and `SHOW BINARY LOGS` statements.

- `REPLICATION SLAVE`

Enables the account to request updates that have been made to databases on the source server, using the `SHOW SLAVE HOSTS`, `SHOW RELAYLOG EVENTS`, and `SHOW BINLOG EVENTS` statements. This privilege is also required to use the `mysqlbinlog` options `--read-from-remote-server (-R)` and `--read-from-remote-master`. Grant this privilege to accounts that are used by replica servers to connect to the current server as their source.

- `SELECT`

Enables rows to be selected from tables in a database. `SELECT` statements require the `SELECT` privilege only if they actually access tables. Some `SELECT` statements do not access tables and can be executed without permission for any database. For example, you can use `SELECT` as a simple calculator to evaluate expressions that make no reference to tables:

```
SELECT 1+1;
SELECT PI()*2;
```

The `SELECT` privilege is also needed for other statements that read column values. For example, `SELECT` is needed for columns referenced on the right hand side of `col_name=expr` assignment in `UPDATE` statements or for columns named in the `WHERE` clause of `DELETE` or `UPDATE` statements.

The `SELECT` privilege is needed for tables or views used with `EXPLAIN`, including any underlying tables in view definitions.

- `SHOW DATABASES`

Enables the account to see database names by issuing the `SHOW DATABASE` statement. Accounts that do not have this privilege see only databases for which they have some privileges, and cannot use the statement at all if the server was started with the `--skip-show-database` option.



#### Caution

Because a global privilege is considered a privilege for all databases, *any* global privilege enables a user to see all database names with `SHOW DATABASES` or by examining the `INFORMATION_SCHEMA SCHEMATA` table.

- `SHOW VIEW`

Enables use of the `SHOW CREATE VIEW` statement. This privilege is also needed for views used with `EXPLAIN`.

- `SHUTDOWN`

Enables use of the `SHUTDOWN` statement, the `mysqladmin shutdown` command, and the `mysql_shutdown()` C API function.

- `SUPER`

Affects the following operations and server behaviors:

- Enables server configuration changes by modifying global system variables. For some system variables, setting the session value also requires the `SUPER` privilege. If a system variable is restricted and requires a special privilege to set the session value, the variable description indicates that restriction. Examples include `binlog_format`, `sql_log_bin`, and `sql_log_off`. See also [Section 5.1.8.1, “System Variable Privileges”](#).
- Enables changes to global transaction characteristics (see [Section 13.3.6, “SET TRANSACTION Statement”](#)).

- Enables the account to start and stop replication, including Group Replication.
- Enables use of the `CHANGE MASTER TO` and `CHANGE REPLICATION FILTER` statements.
- Enables binary log control by means of the `PURGE BINARY LOGS` and `BINLOG` statements.
- Enables setting the effective authorization ID when executing a view or stored program. A user with this privilege can specify any account in the `DEFINER` attribute of a view or stored program.
- Enables use of the `CREATE SERVER`, `ALTER SERVER`, and `DROP SERVER` statements.
- Enables use of the `mysqladmin debug` command.
- Enables `InnoDB` encryption key rotation.
- Enables reading the DES key file by the `DES_ENCRYPT()` function.
- Enables execution of Version Tokens functions.
- Enables control over client connections not permitted to non-`SUPER` accounts:
  - Enables use of the `KILL` statement or `mysqladmin kill` command to kill threads belonging to other accounts. (An account can always kill its own threads.)
  - The server does not execute `init_connect` system variable content when `SUPER` clients connect.
  - The server accepts one connection from a `SUPER` client even if the connection limit configured by the `max_connections` system variable is reached.
  - A server in offline mode (`offline_mode` enabled) does not terminate `SUPER` client connections at the next client request, and accepts new connections from `SUPER` clients.
  - Updates can be performed even when the `read_only` system variable is enabled. This applies to explicit table updates, and to use of account-management statements such as `GRANT` and `REVOKE` that update tables implicitly.

You may also need the `SUPER` privilege to create or alter stored functions if binary logging is enabled, as described in [Section 23.7, “Stored Program Binary Logging”](#).

- `TRIGGER`

Enables trigger operations. You must have this privilege for a table to create, drop, execute, or display triggers for that table.

When a trigger is activated (by a user who has privileges to execute `INSERT`, `UPDATE`, or `DELETE` statements for the table associated with the trigger), trigger execution requires that the user who defined the trigger still have the `TRIGGER` privilege for the table.

- `UPDATE`

Enables rows to be updated in tables in a database.

- `USAGE`

This privilege specifier stands for “no privileges.” It is used at the global level with `GRANT` to modify account attributes such as resource limits or SSL characteristics without naming specific account

privileges in the privilege list. `SHOW GRANTS` displays `USAGE` to indicate that an account has no privileges at a privilege level.

## Privilege-Granting Guidelines

It is a good idea to grant to an account only those privileges that it needs. You should exercise particular caution in granting the `FILE` and administrative privileges:

- `FILE` can be abused to read into a database table any files that the MySQL server can read on the server host. This includes all world-readable files and files in the server's data directory. The table can then be accessed using `SELECT` to transfer its contents to the client host.
- `GRANT OPTION` enables users to give their privileges to other users. Two users that have different privileges and with the `GRANT OPTION` privilege are able to combine privileges.
- `ALTER` may be used to subvert the privilege system by renaming tables.
- `SHUTDOWN` can be abused to deny service to other users entirely by terminating the server.
- `PROCESS` can be used to view the plain text of currently executing statements, including statements that set or change passwords.
- `SUPER` can be used to terminate other sessions or change how the server operates.
- Privileges granted for the `mysql` system database itself can be used to change passwords and other access privilege information:
  - Passwords are stored encrypted, so a malicious user cannot simply read them to know the plain text password. However, a user with write access to the `mysql.user` system table `authentication_string` column can change an account's password, and then connect to the MySQL server using that account.
  - `INSERT` or `UPDATE` granted for the `mysql` system database enable a user to add privileges or modify existing privileges, respectively.
  - `DROP` for the `mysql` system database enables a user to remove privilege tables, or even the database itself.

### 6.2.3 Grant Tables

The `mysql` system database includes several grant tables that contain information about user accounts and the privileges held by them. This section describes those tables. For information about other tables in the system database, see [Section 5.3, "The mysql System Database"](#).

The discussion here describes the underlying structure of the grant tables and how the server uses their contents when interacting with clients. However, normally you do not modify the grant tables directly. Modifications occur indirectly when you use account-management statements such as `CREATE USER`, `GRANT`, and `REVOKE` to set up accounts and control the privileges available to each one. See [Section 13.7.1, "Account Management Statements"](#). When you use such statements to perform account manipulations, the server modifies the grant tables on your behalf.



#### Note

Direct modification of grant tables using statements such as `INSERT`, `UPDATE`, or `DELETE` is discouraged and done at your own risk. The server is free to ignore rows that become malformed as a result of such modifications.

As of MySQL 5.7.18, for any operation that modifies a grant table, the server checks whether the table has the expected structure and produces an error if not. To update the tables to the expected structure, perform the MySQL upgrade procedure. See [Section 2.10, “Upgrading MySQL”](#).

- [Grant Table Overview](#)
- [The user and db Grant Tables](#)
- [The tables\\_priv and columns\\_priv Grant Tables](#)
- [The procs\\_priv Grant Table](#)
- [The proxies\\_priv Grant Table](#)
- [Grant Table Scope Column Properties](#)
- [Grant Table Privilege Column Properties](#)

## Grant Table Overview

These `mysql` database tables contain grant information:

- `user`: User accounts, global privileges, and other nonprivilege columns.
- `db`: Database-level privileges.
- `tables_priv`: Table-level privileges.
- `columns_priv`: Column-level privileges.
- `procs_priv`: Stored procedure and function privileges.
- `proxies_priv`: Proxy-user privileges.

Each grant table contains scope columns and privilege columns:

- Scope columns determine the scope of each row in the tables; that is, the context in which the row applies. For example, a `user` table row with `Host` and `User` values of `'h1.example.net'` and `'bob'` applies to authenticating connections made to the server from the host `h1.example.net` by a client that specifies a user name of `bob`. Similarly, a `db` table row with `Host`, `User`, and `Db` column values of `'h1.example.net'`, `'bob'` and `'reports'` applies when `bob` connects from the host `h1.example.net` to access the `reports` database. The `tables_priv` and `columns_priv` tables contain scope columns indicating tables or table/column combinations to which each row applies. The `procs_priv` scope columns indicate the stored routine to which each row applies.
- Privilege columns indicate which privileges a table row grants; that is, which operations it permits to be performed. The server combines the information in the various grant tables to form a complete description of a user's privileges. [Section 6.2.6, “Access Control, Stage 2: Request Verification”](#), describes the rules for this.

In addition, a grant table may contain columns used for purposes other than scope or privilege assessment.

The server uses the grant tables in the following manner:

- The `user` table scope columns determine whether to reject or permit incoming connections. For permitted connections, any privileges granted in the `user` table indicate the user's global privileges. Any privileges granted in this table apply to *all* databases on the server.



### Caution

Because a global privilege is considered a privilege for all databases, *any* global privilege enables a user to see all database names with `SHOW DATABASES` or by examining the `INFORMATION_SCHEMA SCHEMATA` table.

- The `db` table scope columns determine which users can access which databases from which hosts. The privilege columns determine the permitted operations. A privilege granted at the database level applies to the database and to all objects in the database, such as tables and stored programs.
- The `tables_priv` and `columns_priv` tables are similar to the `db` table, but are more fine-grained: They apply at the table and column levels rather than at the database level. A privilege granted at the table level applies to the table and to all its columns. A privilege granted at the column level applies only to a specific column.
- The `procs_priv` table applies to stored routines (stored procedures and functions). A privilege granted at the routine level applies only to a single procedure or function.
- The `proxies_priv` table indicates which users can act as proxies for other users and whether a user can grant the `PROXY` privilege to other users.

The server reads the contents of the grant tables into memory when it starts. You can tell it to reload the tables by issuing a `FLUSH PRIVILEGES` statement or executing a `mysqladmin flush-privileges` or `mysqladmin reload` command. Changes to the grant tables take effect as indicated in [Section 6.2.9, “When Privilege Changes Take Effect”](#).

When you modify an account, it is a good idea to verify that your changes have the intended effect. To check the privileges for a given account, use the `SHOW GRANTS` statement. For example, to determine the privileges that are granted to an account with user name and host name values of `bob` and `pc84.example.com`, use this statement:

```
SHOW GRANTS FOR 'bob'@'pc84.example.com' ;
```

To display nonprivilege properties of an account, use `SHOW CREATE USER`:

```
SHOW CREATE USER 'bob'@'pc84.example.com' ;
```

## The user and db Grant Tables

The server uses the `user` and `db` tables in the `mysql` database at both the first and second stages of access control (see [Section 6.2, “Access Control and Account Management”](#)). The columns in the `user` and `db` tables are shown here.

**Table 6.3 user and db Table Columns**

Table Name	<code>user</code>	<code>db</code>
<b>Scope columns</b>	<code>Host</code>	<code>Host</code>
	<code>User</code>	<code>Db</code>
		<code>User</code>
<b>Privilege columns</b>	<code>Select_priv</code>	<code>Select_priv</code>
	<code>Insert_priv</code>	<code>Insert_priv</code>
	<code>Update_priv</code>	<code>Update_priv</code>
	<code>Delete_priv</code>	<code>Delete_priv</code>
	<code>Index_priv</code>	<code>Index_priv</code>



## Grant Tables

<b>Table Name</b>	<b>user</b>	<b>db</b>
	Alter_priv	Alter_priv
	Create_priv	Create_priv
	Drop_priv	Drop_priv
	Grant_priv	Grant_priv
	Create_view_priv	Create_view_priv
	Show_view_priv	Show_view_priv
	Create_routine_priv	Create_routine_priv
	Alter_routine_priv	Alter_routine_priv
	Execute_priv	Execute_priv
	Trigger_priv	Trigger_priv
	Event_priv	Event_priv
	Create_tmp_table_priv	Create_tmp_table_priv
	Lock_tables_priv	Lock_tables_priv
	References_priv	References_priv
	Reload_priv	
	Shutdown_priv	
	Process_priv	
	File_priv	
	Show_db_priv	
	Super_priv	
	Repl_slave_priv	
	Repl_client_priv	
	Create_user_priv	
	Create_tablespace_priv	
<b>Security columns</b>	ssl_type	
	ssl_cipher	
	x509_issuer	
	x509_subject	
	plugin	
	authentication_string	
	password_expired	
	password_last_changed	
	password_lifetime	
	account_locked	
<b>Resource control columns</b>	max_questions	
	max_updates	
	max_connections	
	max_user_connections	

The `user` table `plugin` and `authentication_string` columns store authentication plugin and credential information.

The server uses the plugin named in the `plugin` column of an account row to authenticate connection attempts for the account.

The `plugin` column must be nonempty. At startup, and at runtime when `FLUSH PRIVILEGES` is executed, the server checks `user` table rows. For any row with an empty `plugin` column, the server writes a warning to the error log of this form:

```
[Warning] User entry 'user_name'@'host_name' has an empty plugin
value. The user will be ignored and no one can login with this user
anymore.
```

To address this problem, see [Section 6.4.1.3, “Migrating Away from Pre-4.1 Password Hashing and the `mysql\_old\_password` Plugin”](#).

The `password_expired` column permits DBAs to expire account passwords and require users to reset their password. The default `password_expired` value is 'N', but can be set to 'Y' with the `ALTER USER` statement. After an account's password has been expired, all operations performed by the account in subsequent connections to the server result in an error until the user issues an `ALTER USER` statement to establish a new account password.



#### Note

Although it is possible to “reset” an expired password by setting it to its current value, it is preferable, as a matter of good policy, to choose a different password.

`password_last_changed` is a `TIMESTAMP` column indicating when the password was last changed. The value is non-`NULL` only for accounts that use MySQL built-in authentication methods (accounts that use an authentication plugin of `mysql_native_password` or `sha256_password`). The value is `NULL` for other accounts, such as those authenticated using an external authentication system.

`password_last_changed` is updated by the `CREATE USER`, `ALTER USER`, and `SET PASSWORD` statements, and by `GRANT` statements that create an account or change an account password.

`password_lifetime` indicates the account password lifetime, in days. If the password is past its lifetime (assessed using the `password_last_changed` column), the server considers the password expired when clients connect using the account. A value of `N` greater than zero means that the password must be changed every `N` days. A value of 0 disables automatic password expiration. If the value is `NULL` (the default), the global expiration policy applies, as defined by the `default_password_lifetime` system variable.

`account_locked` indicates whether the account is locked (see [Section 6.2.15, “Account Locking”](#)).

## The `tables_priv` and `columns_priv` Grant Tables

During the second stage of access control, the server performs request verification to ensure that each client has sufficient privileges for each request that it issues. In addition to the `user` and `db` grant tables, the server may also consult the `tables_priv` and `columns_priv` tables for requests that involve tables. The latter tables provide finer privilege control at the table and column levels. They have the columns shown in the following table.

**Table 6.4 `tables_priv` and `columns_priv` Table Columns**

Table Name	<code>tables_priv</code>	<code>columns_priv</code>
Scope columns	Host	Host

Table Name	<code>tables_priv</code>	<code>columns_priv</code>
	<code>Db</code>	<code>Db</code>
	<code>User</code>	<code>User</code>
	<code>Table_name</code>	<code>Table_name</code>
		<code>Column_name</code>
<b>Privilege columns</b>	<code>Table_priv</code>	<code>Column_priv</code>
	<code>Column_priv</code>	
<b>Other columns</b>	<code>Timestamp</code>	<code>Timestamp</code>
	<code>Grantor</code>	

The `Timestamp` and `Grantor` columns are set to the current timestamp and the `CURRENT_USER` value, respectively, but are otherwise unused.

### The `procs_priv` Grant Table

For verification of requests that involve stored routines, the server may consult the `procs_priv` table, which has the columns shown in the following table.

**Table 6.5** `procs_priv` Table Columns

Table Name	<code>procs_priv</code>
<b>Scope columns</b>	<code>Host</code>
	<code>Db</code>
	<code>User</code>
	<code>Routine_name</code>
	<code>Routine_type</code>
<b>Privilege columns</b>	<code>Proc_priv</code>
<b>Other columns</b>	<code>Timestamp</code>
	<code>Grantor</code>

The `Routine_type` column is an `ENUM` column with values of `'FUNCTION'` or `'PROCEDURE'` to indicate the type of routine the row refers to. This column enables privileges to be granted separately for a function and a procedure with the same name.

The `Timestamp` and `Grantor` columns are unused.

### The `proxies_priv` Grant Table

The `proxies_priv` table records information about proxy accounts. It has these columns:

- `Host`, `User`: The proxy account; that is, the account that has the `PROXY` privilege for the proxied account.
- `Proxied_host`, `Proxied_user`: The proxied account.
- `Grantor`, `Timestamp`: Unused.
- `With_grant`: Whether the proxy account can grant the `PROXY` privilege to other accounts.

For an account to be able to grant the `PROXY` privilege to other accounts, it must have a row in the `proxies_priv` table with `With_grant` set to 1 and `Proxied_host` and `Proxied_user` set to indicate

the account or accounts for which the privilege can be granted. For example, the `'root'@'localhost'` account created during MySQL installation has a row in the `proxies_priv` table that enables granting the `PROXY` privilege for `'@'`, that is, for all users and all hosts. This enables `root` to set up proxy users, as well as to delegate to other accounts the authority to set up proxy users. See [Section 6.2.14, “Proxy Users”](#).

## Grant Table Scope Column Properties

Scope columns in the grant tables contain strings. The default value for each is the empty string. The following table shows the number of characters permitted in each column.

**Table 6.6 Grant Table Scope Column Lengths**

Column Name	Maximum Permitted Characters
<code>Host, Proxied_host</code>	60
<code>User, Proxied_user</code>	32
<code>Password</code>	41
<code>Db</code>	64
<code>Table_name</code>	64
<code>Column_name</code>	64
<code>Routine_name</code>	64

`Host` and `Proxied_host` values are converted to lowercase before being stored in the grant tables.

For access-checking purposes, comparisons of `User`, `Proxied_user`, `Password`, `authentication_string`, `Db`, and `Table_name` values are case-sensitive. Comparisons of `Host`, `Proxied_host`, `Column_name`, and `Routine_name` values are not case-sensitive.

## Grant Table Privilege Column Properties

The `user` and `db` tables list each privilege in a separate column that is declared as `ENUM('N','Y') DEFAULT 'N'`. In other words, each privilege can be disabled or enabled, with the default being disabled.

The `tables_priv`, `columns_priv`, and `procs_priv` tables declare the privilege columns as `SET` columns. Values in these columns can contain any combination of the privileges controlled by the table. Only those privileges listed in the column value are enabled.

**Table 6.7 Set-Type Privilege Column Values**

Table Name	Column Name	Possible Set Elements
<code>tables_priv</code>	<code>Table_priv</code>	<code>'Select', 'Insert', 'Update', 'Delete', 'Create', 'Drop', 'Grant', 'References', 'Index', 'Alter', 'Create View', 'Show view', 'Trigger'</code>
<code>tables_priv</code>	<code>Column_priv</code>	<code>'Select', 'Insert', 'Update', 'References'</code>
<code>columns_priv</code>	<code>Column_priv</code>	<code>'Select', 'Insert', 'Update', 'References'</code>

Table Name	Column Name	Possible Set Elements
<code>procs_priv</code>	<code>Proc_priv</code>	'Execute', 'Alter Routine', 'Grant'

Only the `user` table specifies administrative privileges, such as `RELOAD` and `SHUTDOWN`. Administrative operations are operations on the server itself and are not database-specific, so there is no reason to list these privileges in the other grant tables. Consequently, the server need consult only the `user` table to determine whether a user can perform an administrative operation.

The `FILE` privilege also is specified only in the `user` table. It is not an administrative privilege as such, but a user's ability to read or write files on the server host is independent of the database being accessed.

## 6.2.4 Specifying Account Names

MySQL account names consist of a user name and a host name, which enables creation of distinct accounts for users with the same user name who connect from different hosts. This section describes the syntax for account names, including special values and wildcard rules.

Account names appear in SQL statements such as `CREATE USER`, `GRANT`, and `SET PASSWORD` and follow these rules:

- Account name syntax is `'user_name'@'host_name'`.
- The `@'host_name'` part is optional. An account name consisting only of a user name is equivalent to `'user_name'@'%'`. For example, `'me'` is equivalent to `'me'@'%'`.
- The user name and host name need not be quoted if they are legal as unquoted identifiers. Quotes must be used if a `user_name` string contains special characters (such as space or `-`), or a `host_name` string contains special characters or wildcard characters (such as `.` or `%`). For example, in the account name `'test-user'@'%.com'`, both the user name and host name parts require quotes.
- Quote user names and host names as identifiers or as strings, using either backticks (```), single quotation marks (`'`), or double quotation marks (`"`). For string-quoting and identifier-quoting guidelines, see [Section 9.1.1, “String Literals”](#), and [Section 9.2, “Schema Object Names”](#).
- The user name and host name parts, if quoted, must be quoted separately. That is, write `'me'@'localhost'`, not `'me@localhost'`. The latter is actually equivalent to `'me@localhost'@'%'`.
- A reference to the `CURRENT_USER` or `CURRENT_USER()` function is equivalent to specifying the current client's user name and host name literally.

MySQL stores account names in grant tables in the `mysql` system database using separate columns for the user name and host name parts:

- The `user` table contains one row for each account. The `User` and `Host` columns store the user name and host name. This table also indicates which global privileges the account has.
- Other grant tables indicate privileges an account has for databases and objects within databases. These tables have `User` and `Host` columns to store the account name. Each row in these tables associates with the account in the `user` table that has the same `User` and `Host` values.
- For access-checking purposes, comparisons of `User` values are case-sensitive. Comparisons of `Host` values are not case-sensitive.

For additional detail about the properties of user names and host names as stored in the grant tables, such as maximum length, see [Grant Table Scope Column Properties](#).

User names and host names have certain special values or wildcard conventions, as described following.

The user name part of an account name is either a nonblank value that literally matches the user name for incoming connection attempts, or a blank value (the empty string) that matches any user name. An account with a blank user name is an anonymous user. To specify an anonymous user in SQL statements, use a quoted empty user name part, such as `'@'localhost'`.

The host name part of an account name can take many forms, and wildcards are permitted:

- A host value can be a host name or an IP address (IPv4 or IPv6). The name `'localhost'` indicates the local host. The IP address `'127.0.0.1'` indicates the IPv4 loopback interface. The IP address `:::1` indicates the IPv6 loopback interface.
- The `%` and `_` wildcard characters are permitted in host name or IP address values. These have the same meaning as for pattern-matching operations performed with the `LIKE` operator. For example, a host value of `'%'` matches any host name, whereas a value of `'%.mysql.com'` matches any host in the `mysql.com` domain. `'198.51.100.%'` matches any host in the 198.51.100 class C network.

Because IP wildcard values are permitted in host values (for example, `'198.51.100.%'` to match every host on a subnet), someone could try to exploit this capability by naming a host `198.51.100.somewhere.com`. To foil such attempts, MySQL does not perform matching on host names that start with digits and a dot. For example, if a host is named `1.2.example.com`, its name never matches the host part of account names. An IP wildcard value can match only IP addresses, not host names.

- For a host value specified as an IPv4 address, a netmask can be given to indicate how many address bits to use for the network number. Netmask notation cannot be used for IPv6 addresses.

The syntax is `host_ip/netmask`. For example:

```
CREATE USER 'david'@'198.51.100.0/255.255.255.0';
```

This enables `david` to connect from any client host having an IP address `client_ip` for which the following condition is true:

```
client_ip & netmask = host_ip
```

That is, for the `CREATE USER` statement just shown:

```
client_ip & 255.255.255.0 = 198.51.100.0
```

IP addresses that satisfy this condition range from `198.51.100.0` to `198.51.100.255`.

A netmask typically begins with bits set to 1, followed by bits set to 0. Examples:

- `198.0.0.0/255.0.0.0`: Any host on the 198 class A network
- `198.51.0.0/255.255.0.0`: Any host on the 198.51 class B network
- `198.51.100.0/255.255.255.0`: Any host on the 198.51.100 class C network
- `198.51.100.1`: Only the host with this specific IP address

The server performs matching of host values in account names against the client host using the value returned by the system DNS resolver for the client host name or IP address. Except in the case that the account host value is specified using netmask notation, the server performs this comparison as a string match, even for an account host value given as an IP address. This means that you should specify account host values in the same format used by DNS. Here are examples of problems to watch out for:

- Suppose that a host on the local network has a fully qualified name of `host1.example.com`. If DNS returns name lookups for this host as `host1.example.com`, use that name in account host values. If DNS returns just `host1`, use `host1` instead.
- If DNS returns the IP address for a given host as `198.51.100.2`, that matches an account host value of `198.51.100.2` but not `198.051.100.2`. Similarly, it matches an account host pattern like `198.51.100.%` but not `198.051.100.%`.

To avoid problems like these, it is advisable to check the format in which your DNS returns host names and addresses. Use values in the same format in MySQL account names.

## 6.2.5 Access Control, Stage 1: Connection Verification

When you attempt to connect to a MySQL server, the server accepts or rejects the connection based on these conditions:

- Your identity and whether you can verify it by supplying the proper credentials.
- Whether your account is locked or unlocked.

The server checks credentials first, then account locking state. A failure at either step causes the server to deny access to you completely. Otherwise, the server accepts the connection, and then enters Stage 2 and waits for requests.

The server performs identity and credentials checking using columns in the `user` table, accepting the connection only if these conditions are satisfied:

- The client host name and user name match the `Host` and `User` columns in some `user` table row. For the rules governing permissible `Host` and `User` values, see [Section 6.2.4, “Specifying Account Names”](#).
- The client supplies the credentials specified in the row (for example, a password), as indicated by the `authentication_string` column. Credentials are interpreted using the authentication plugin named in the `plugin` column.
- The row indicates that the account is unlocked. Locking state is recorded in the `account_locked` column, which must have a value of `'N'`. Account locking can be set or changed with the `CREATE USER` or `ALTER USER` statement.

Your identity is based on two pieces of information:

- Your MySQL user name.
- The client host from which you connect.

If the `User` column value is nonblank, the user name in an incoming connection must match exactly. If the `User` value is blank, it matches any user name. If the `user` table row that matches an incoming connection has a blank user name, the user is considered to be an anonymous user with no name, not a user with the name that the client actually specified. This means that a blank user name is used for all further access checking for the duration of the connection (that is, during Stage 2).

The `authentication_string` column can be blank. This is not a wildcard and does not mean that any password matches. It means that the user must connect without specifying a password. The authentication method implemented by the plugin that authenticates the client may or may not use the password in the `authentication_string` column. In this case, it is possible that an external password is also used to authenticate to the MySQL server.

Nonblank password values stored in the `authentication_string` column of the `user` table are encrypted. MySQL does not store passwords as cleartext for anyone to see. Rather, the password supplied by a user who is attempting to connect is encrypted (using the password hashing method implemented by the account authentication plugin). The encrypted password then is used during the connection process when checking whether the password is correct. This is done without the encrypted password ever traveling over the connection. See [Section 6.2.1, “Account User Names and Passwords”](#).

From the MySQL server's point of view, the encrypted password is the *real* password, so you should never give anyone access to it. In particular, *do not give nonadministrative users read access to tables in the `mysql` system database.*

The following table shows how various combinations of `User` and `Host` values in the `user` table apply to incoming connections.

User Value	Host Value	Permissible Connections
'fred'	'h1.example.net'	fred, connecting from h1.example.net
' '	'h1.example.net'	Any user, connecting from h1.example.net
'fred'	'%'	fred, connecting from any host
' '	'%'	Any user, connecting from any host
'fred'	'%.example.net'	fred, connecting from any host in the example.net domain
'fred'	'x.example.%'	fred, connecting from x.example.net, x.example.com, x.example.edu, and so on; this is probably not useful
'fred'	'198.51.100.177'	fred, connecting from the host with IP address 198.51.100.177
'fred'	'198.51.100.%'	fred, connecting from any host in the 198.51.100 class C subnet
'fred'	'198.51.100.0/255.255.255.'	Same as previous example

It is possible for the client host name and user name of an incoming connection to match more than one row in the `user` table. The preceding set of examples demonstrates this: Several of the entries shown match a connection from `h1.example.net` by `fred`.

When multiple matches are possible, the server must determine which of them to use. It resolves this issue as follows:

- Whenever the server reads the `user` table into memory, it sorts the rows.
- When a client attempts to connect, the server looks through the rows in sorted order.
- The server uses the first row that matches the client host name and user name.

The server uses sorting rules that order rows with the most-specific `Host` values first:

- Literal IP addresses and host names are the most specific.



- The specificity of a literal IP address is not affected by whether it has a netmask, so `198.51.100.13` and `198.51.100.0/255.255.255.0` are considered equally specific.
- The pattern `'%'` means “any host” and is least specific.
- The empty string `''` also means “any host” but sorts after `'%'`.

Non-TCP (socket file, named pipe, and shared memory) connections are treated as local connections and match a host part of `localhost` if there are any such accounts, or host parts with wildcards that match `localhost` otherwise (for example, `local%`, `l%`, `%`).

Rows with the same `Host` value are ordered with the most-specific `User` values first. A blank `User` value means “any user” and is least specific, so for rows with the same `Host` value, nonanonymous users sort before anonymous users.

For rows with equally-specific `Host` and `User` values, the order is nondeterministic.

To see how this works, suppose that the `user` table looks like this:

```
+-----+-----+
| Host   | User   | ...
+-----+-----+
| %      | root   | ...
| %      | jeffrey | ...
| localhost | root   | ...
| localhost |      | ...
+-----+-----+
```

When the server reads the table into memory, it sorts the rows using the rules just described. The result after sorting looks like this:

```
+-----+-----+
| Host   | User   | ...
+-----+-----+
| localhost | root   | ...
| localhost |      | ...
| %      | jeffrey | ...
| %      | root   | ...
+-----+-----+
```

When a client attempts to connect, the server looks through the sorted rows and uses the first match found. For a connection from `localhost` by `jeffrey`, two of the rows from the table match: the one with `Host` and `User` values of `'localhost'` and `''`, and the one with values of `'%'` and `'jeffrey'`. The `'localhost'` row appears first in sorted order, so that is the one the server uses.

Here is another example. Suppose that the `user` table looks like this:

```
+-----+-----+
| Host           | User   | ...
+-----+-----+
| %              | jeffrey | ...
| h1.example.net |      | ...
+-----+-----+
```

The sorted table looks like this:

```
+-----+-----+
| Host           | User   | ...
+-----+-----+
| h1.example.net |      | ...
| %              | jeffrey | ...
+-----+-----+
```

The first row matches a connection by any user from `h1.example.net`, whereas the second row matches a connection by `jeffrey` from any host.



#### Note

It is a common misconception to think that, for a given user name, all rows that explicitly name that user are used first when the server attempts to find a match for the connection. This is not true. The preceding example illustrates this, where a connection from `h1.example.net` by `jeffrey` is first matched not by the row containing `'jeffrey'` as the `User` column value, but by the row with no user name. As a result, `jeffrey` is authenticated as an anonymous user, even though he specified a user name when connecting.

If you are able to connect to the server, but your privileges are not what you expect, you probably are being authenticated as some other account. To find out what account the server used to authenticate you, use the `CURRENT_USER()` function. (See [Section 12.15, “Information Functions”](#).) It returns a value in `user_name@host_name` format that indicates the `User` and `Host` values from the matching `user` table row. Suppose that `jeffrey` connects and issues the following query:

```
mysql> SELECT CURRENT_USER();
+-----+
| CURRENT_USER() |
+-----+
| @localhost     |
+-----+
```

The result shown here indicates that the matching `user` table row had a blank `User` column value. In other words, the server is treating `jeffrey` as an anonymous user.

Another way to diagnose authentication problems is to print out the `user` table and sort it by hand to see where the first match is being made.

## 6.2.6 Access Control, Stage 2: Request Verification

After the server accepts a connection, it enters Stage 2 of access control. For each request that you issue through the connection, the server determines what operation you want to perform, then checks whether your privileges are sufficient. This is where the privilege columns in the grant tables come into play. These privileges can come from any of the `user`, `db`, `tables_priv`, `columns_priv`, or `procs_priv` tables. (You may find it helpful to refer to [Section 6.2.3, “Grant Tables”](#), which lists the columns present in each grant table.)

The `user` table grants global privileges. The `user` table row for an account indicates the account privileges that apply on a global basis no matter what the default database is. For example, if the `user` table grants you the `DELETE` privilege, you can delete rows from any table in any database on the server host. It is wise to grant privileges in the `user` table only to people who need them, such as database administrators. For other users, leave all privileges in the `user` table set to `'N'` and grant privileges at more specific levels only (for particular databases, tables, columns, or routines).

The `db` table grants database-specific privileges. Values in the scope columns of this table can take the following forms:

- A blank `User` value matches the anonymous user. A nonblank value matches literally; there are no wildcards in user names.
- The wildcard characters `%` and `_` can be used in the `Host` and `Db` columns. These have the same meaning as for pattern-matching operations performed with the `LIKE` operator. If you want to use either

character literally when granting privileges, you must escape it with a backslash. For example, to include the underscore character (`_`) as part of a database name, specify it as `\_` in the `GRANT` statement.

- A `'%'` or blank `Host` value means “any host.”
- A `'%'` or blank `Db` value means “any database.”

The server reads the `db` table into memory and sorts it at the same time that it reads the `user` table. The server sorts the `db` table based on the `Host`, `Db`, and `User` scope columns. As with the `user` table, sorting puts the most-specific values first and least-specific values last, and when the server looks for matching rows, it uses the first match that it finds.

The `tables_priv`, `columns_priv`, and `procs_priv` tables grant table-specific, column-specific, and routine-specific privileges. Values in the scope columns of these tables can take the following forms:

- The wildcard characters `%` and `_` can be used in the `Host` column. These have the same meaning as for pattern-matching operations performed with the `LIKE` operator.
- A `'%'` or blank `Host` value means “any host.”
- The `Db`, `Table_name`, `Column_name`, and `Routine_name` columns cannot contain wildcards or be blank.

The server sorts the `tables_priv`, `columns_priv`, and `procs_priv` tables based on the `Host`, `Db`, and `User` columns. This is similar to `db` table sorting, but simpler because only the `Host` column can contain wildcards.

The server uses the sorted tables to verify each request that it receives. For requests that require administrative privileges such as `SHUTDOWN` or `RELOAD`, the server checks only the `user` table row because that is the only table that specifies administrative privileges. The server grants access if the row permits the requested operation and denies access otherwise. For example, if you want to execute `mysqladmin shutdown` but your `user` table row does not grant the `SHUTDOWN` privilege to you, the server denies access without even checking the `db` table. (The latter table contains no `Shutdown_priv` column, so there is no need to check it.)

For database-related requests (`INSERT`, `UPDATE`, and so on), the server first checks the user's global privileges in the `user` table row. If the row permits the requested operation, access is granted. If the global privileges in the `user` table are insufficient, the server determines the user's database-specific privileges from the `db` table:

- The server looks in the `db` table for a match on the `Host`, `Db`, and `User` columns.
- The `Host` and `User` columns are matched to the connecting user's host name and MySQL user name.
- The `Db` column is matched to the database that the user wants to access.
- If there is no row for the `Host` and `User`, access is denied.

After determining the database-specific privileges granted by the `db` table rows, the server adds them to the global privileges granted by the `user` table. If the result permits the requested operation, access is granted. Otherwise, the server successively checks the user's table and column privileges in the `tables_priv` and `columns_priv` tables, adds those to the user's privileges, and permits or denies access based on the result. For stored-routine operations, the server uses the `procs_priv` table rather than `tables_priv` and `columns_priv`.

Expressed in boolean terms, the preceding description of how a user's privileges are calculated may be summarized like this:

```
global privileges
OR database privileges
OR table privileges
OR column privileges
OR routine privileges
```

It may not be apparent why, if the global privileges are initially found to be insufficient for the requested operation, the server adds those privileges to the database, table, and column privileges later. The reason is that a request might require more than one type of privilege. For example, if you execute an `INSERT INTO ... SELECT` statement, you need both the `INSERT` and the `SELECT` privileges. Your privileges might be such that the `user` table row grants one privilege global and the `db` table row grants the other specifically for the relevant database. In this case, you have the necessary privileges to perform the request, but the server cannot tell that from either your global or database privileges alone. It must make an access-control decision based on the combined privileges.

## 6.2.7 Adding Accounts, Assigning Privileges, and Dropping Accounts

To manage MySQL accounts, use the SQL statements intended for that purpose:

- `CREATE USER` and `DROP USER` create and remove accounts.
- `GRANT` and `REVOKE` assign privileges to and revoke privileges from accounts.
- `SHOW GRANTS` displays account privilege assignments.

Account-management statements cause the server to make appropriate modifications to the underlying grant tables, which are discussed in [Section 6.2.3, “Grant Tables”](#).



### Note

Direct modification of grant tables using statements such as `INSERT`, `UPDATE`, or `DELETE` is discouraged and done at your own risk. The server is free to ignore rows that become malformed as a result of such modifications.

As of MySQL 5.7.18, for any operation that modifies a grant table, the server checks whether the table has the expected structure and produces an error if not. `mysql_upgrade` must be run to update the tables to the expected structure.

Another option for creating accounts is to use the GUI tool MySQL Workbench. Also, several third-party programs offer capabilities for MySQL account administration. [phpMyAdmin](#) is one such program.

This section discusses the following topics:

- [Creating Accounts and Granting Privileges](#)
- [Checking Account Privileges and Properties](#)
- [Revoking Account Privileges](#)
- [Dropping Accounts](#)

For additional information about the statements discussed here, see [Section 13.7.1, “Account Management Statements”](#).

### Creating Accounts and Granting Privileges

The following examples show how to use the `mysql` client program to set up new accounts. These examples assume that the MySQL `root` account has the `CREATE USER` privilege and all privileges that it grants to other accounts.

At the command line, connect to the server as the MySQL `root` user, supplying the appropriate password at the password prompt:

```
$> mysql -u root -p
Enter password: (enter root password here)
```

After connecting to the server, you can add new accounts. The following example uses `CREATE USER` and `GRANT` statements to set up four accounts (where you see `'password'`, substitute an appropriate password):

```
CREATE USER 'finley'@'localhost'
  IDENTIFIED BY 'password';
GRANT ALL
  ON *.*
  TO 'finley'@'localhost'
  WITH GRANT OPTION;

CREATE USER 'finley'@'%.example.com'
  IDENTIFIED BY 'password';
GRANT ALL
  ON *.*
  TO 'finley'@'%.example.com'
  WITH GRANT OPTION;

CREATE USER 'admin'@'localhost'
  IDENTIFIED BY 'password';
GRANT RELOAD,PROCESS
  ON *.*
  TO 'admin'@'localhost';

CREATE USER 'dummy'@'localhost';
```

The accounts created by those statements have the following properties:

- Two accounts have a user name of `finley`. Both are superuser accounts with full global privileges to do anything. The `'finley'@'localhost'` account can be used only when connecting from the local host. The `'finley'@'%.example.com'` account uses the `'%'` wildcard in the host part, so it can be used to connect from any host in the `example.com` domain.

The `'finley'@'localhost'` account is necessary if there is an anonymous-user account for `localhost`. Without the `'finley'@'localhost'` account, that anonymous-user account takes precedence when `finley` connects from the local host and `finley` is treated as an anonymous user. The reason for this is that the anonymous-user account has a more specific `Host` column value than the `'finley'@'%'` account and thus comes earlier in the `user` table sort order. (For information about `user` table sorting, see [Section 6.2.5, “Access Control, Stage 1: Connection Verification”](#).)

- The `'admin'@'localhost'` account can be used only by `admin` to connect from the local host. It is granted the global `RELOAD` and `PROCESS` administrative privileges. These privileges enable the `admin` user to execute the `mysqladmin reload`, `mysqladmin refresh`, and `mysqladmin flush-xxx` commands, as well as `mysqladmin processlist`. No privileges are granted for accessing any databases. You could add such privileges using `GRANT` statements.
- The `'dummy'@'localhost'` account has no password (which is insecure and not recommended). This account can be used only to connect from the local host. No privileges are granted. It is assumed that you grant specific privileges to the account using `GRANT` statements.

The previous example grants privileges at the global level. The next example creates three accounts and grants them access at lower levels; that is, to specific databases or objects within databases. Each account has a user name of `custom`, but the host name parts differ:

```
CREATE USER 'custom'@'localhost'
```

```

IDENTIFIED BY 'password';
GRANT ALL
  ON bankaccount.*
  TO 'custom'@'localhost';

CREATE USER 'custom'@'host47.example.com'
  IDENTIFIED BY 'password';
GRANT SELECT,INSERT,UPDATE,DELETE,CREATE,DROP
  ON expenses.*
  TO 'custom'@'host47.example.com';

CREATE USER 'custom'@'%.example.com'
  IDENTIFIED BY 'password';
GRANT SELECT,INSERT,UPDATE,DELETE,CREATE,DROP
  ON customer.addresses
  TO 'custom'@'%.example.com';

```

The three accounts can be used as follows:

- The `'custom'@'localhost'` account has all database-level privileges to access the `bankaccount` database. The account can be used to connect to the server only from the local host.
- The `'custom'@'host47.example.com'` account has specific database-level privileges to access the `expenses` database. The account can be used to connect to the server only from the host `host47.example.com`.
- The `'custom'@'%.example.com'` account has specific table-level privileges to access the `addresses` table in the `customer` database, from any host in the `example.com` domain. The account can be used to connect to the server from all machines in the domain due to use of the `%` wildcard character in the host part of the account name.

## Checking Account Privileges and Properties

To see the privileges for an account, use `SHOW GRANTS`:

```

mysql> SHOW GRANTS FOR 'admin'@'localhost';
+-----+
| Grants for admin@localhost |
+-----+
| GRANT RELOAD, PROCESS ON *.* TO 'admin'@'localhost' |
+-----+

```

To see nonprivilege properties for an account, use `SHOW CREATE USER`:

```

mysql> SHOW CREATE USER 'admin'@'localhost'\G
***** 1. row *****
CREATE USER for admin@localhost: CREATE USER 'admin'@'localhost'
IDENTIFIED WITH 'mysql_native_password'
AS '*67ACDEBDAB923990001F0FFB017EB8ED41861105'
REQUIRE NONE PASSWORD EXPIRE DEFAULT ACCOUNT UNLOCK

```

## Revoking Account Privileges

To revoke account privileges, use the `REVOKE` statement. Privileges can be revoked at different levels, just as they can be granted at different levels.

Revoke global privileges:

```

REVOKE ALL
  ON *.*
  FROM 'finley'@'%.example.com';

```

```
REVOKE RELOAD
ON *.*
FROM 'admin'@'localhost';
```

Revoke database-level privileges:

```
REVOKE CREATE,DROP
ON expenses.*
FROM 'custom'@'host47.example.com';
```

Revoke table-level privileges:

```
REVOKE INSERT,UPDATE,DELETE
ON customer.addresses
FROM 'custom'@'%example.com';
```

To check the effect of privilege revocation, use `SHOW GRANTS`:

```
mysql> SHOW GRANTS FOR 'admin'@'localhost';
+-----+
| Grants for admin@localhost          |
+-----+
| GRANT PROCESS ON *.* TO 'admin'@'localhost' |
+-----+
```

## Dropping Accounts

To remove an account, use the `DROP USER` statement. For example, to drop some of the accounts created previously:

```
DROP USER 'finley'@'localhost';
DROP USER 'finley'@'%example.com';
DROP USER 'admin'@'localhost';
DROP USER 'dummy'@'localhost';
```

### 6.2.8 Reserved Accounts

One part of the MySQL installation process is data directory initialization (see [Section 2.9.1, “Initializing the Data Directory”](#)). During data directory initialization, MySQL creates user accounts that should be considered reserved:

- `'root'@'localhost'`: Used for administrative purposes. This account has all privileges and can perform any operation.

Strictly speaking, this account name is not reserved, in the sense that some installations rename the `root` account to something else to avoid exposing a highly privileged account with a well-known name.

- `'mysql.sys'@'localhost'`: Used as the `DEFINER` for `sys` schema objects. Use of the `mysql.sys` account avoids problems that occur if a DBA renames or removes the `root` account. This account is locked so that it cannot be used for client connections.
- `'mysql.session'@'localhost'`: Used internally by plugins to access the server. This account is locked so that it cannot be used for client connections.

### 6.2.9 When Privilege Changes Take Effect

If the `mysqld` server is started without the `--skip-grant-tables` option, it reads all grant table contents into memory during its startup sequence. The in-memory tables become effective for access control at that point.

If you modify the grant tables indirectly using an account-management statement, the server notices these changes and loads the grant tables into memory again immediately. Account-management statements are described in [Section 13.7.1, “Account Management Statements”](#). Examples include `GRANT`, `REVOKE`, `SET PASSWORD`, and `RENAME USER`.

If you modify the grant tables directly using statements such as `INSERT`, `UPDATE`, or `DELETE` (which is not recommended), the changes have no effect on privilege checking until you either tell the server to reload the tables or restart it. Thus, if you change the grant tables directly but forget to reload them, the changes have *no effect* until you restart the server. This may leave you wondering why your changes seem to make no difference!

To tell the server to reload the grant tables, perform a flush-privileges operation. This can be done by issuing a `FLUSH PRIVILEGES` statement or by executing a `mysqladmin flush-privileges` or `mysqladmin reload` command.

A grant table reload affects privileges for each existing client session as follows:

- Table and column privilege changes take effect with the client's next request.
- Database privilege changes take effect the next time the client executes a `USE db_name` statement.

**Note**

Client applications may cache the database name; thus, this effect may not be visible to them without actually changing to a different database.

- Global privileges and passwords are unaffected for a connected client. These changes take effect only in sessions for subsequent connections.

If the server is started with the `--skip-grant-tables` option, it does not read the grant tables or implement any access control. Any user can connect and perform any operation, *which is insecure*. To cause a server thus started to read the tables and enable access checking, flush the privileges.

## 6.2.10 Assigning Account Passwords

Required credentials for clients that connect to the MySQL server can include a password. This section describes how to assign passwords for MySQL accounts.

MySQL stores credentials in the `user` table in the `mysql` system database. Operations that assign or modify passwords are permitted only to users with the `CREATE USER` privilege, or, alternatively, privileges for the `mysql` database (`INSERT` privilege to create new accounts, `UPDATE` privilege to modify existing accounts). If the `read_only` system variable is enabled, use of account-modification statements such as `CREATE USER` or `ALTER USER` additionally requires the `SUPER` privilege.

The discussion here summarizes syntax only for the most common password-assignment statements. For complete details on other possibilities, see [Section 13.7.1.2, “CREATE USER Statement”](#), [Section 13.7.1.1, “ALTER USER Statement”](#), [Section 13.7.1.4, “GRANT Statement”](#), and [Section 13.7.1.7, “SET PASSWORD Statement”](#).

MySQL uses plugins to perform client authentication; see [Section 6.2.13, “Pluggable Authentication”](#). In password-assigning statements, the authentication plugin associated with an account performs any hashing required of a cleartext password specified. This enables MySQL to obfuscate passwords prior to storing them in the `mysql.user` system table. For the statements described here, MySQL automatically hashes the password specified. There are also syntax for `CREATE USER` and `ALTER USER` that permits hashed values to be specified literally. For details, see the descriptions of those statements.



To assign a password when you create a new account, use `CREATE USER` and include an `IDENTIFIED BY` clause:

```
CREATE USER 'jeffrey'@'localhost' IDENTIFIED BY 'password';
```

`CREATE USER` also supports syntax for specifying the account authentication plugin. See [Section 13.7.1.2, “CREATE USER Statement”](#).

To assign or change a password for an existing account, use the `ALTER USER` statement with an `IDENTIFIED BY` clause:

```
ALTER USER 'jeffrey'@'localhost' IDENTIFIED BY 'password';
```

If you are not connected as an anonymous user, you can change your own password without naming your own account literally:

```
ALTER USER USER() IDENTIFIED BY 'password';
```

To change an account password from the command line, use the `mysqladmin` command:

```
mysqladmin -u user_name -h host_name password "password"
```

The account for which this command sets the password is the one with a row in the `mysql.user` system table that matches `user_name` in the `User` column and the client host *from which you connect* in the `Host` column.



### Warning

Setting a password using `mysqladmin` should be considered *insecure*. On some systems, your password becomes visible to system status programs such as `ps` that may be invoked by other users to display command lines. MySQL clients typically overwrite the command-line password argument with zeros during their initialization sequence. However, there is still a brief interval during which the value is visible. Also, on some systems this overwriting strategy is ineffective and the password remains visible to `ps`. (SystemV Unix systems and perhaps others are subject to this problem.)

If you are using MySQL Replication, be aware that, currently, a password used by a replica as part of a `CHANGE MASTER TO` statement is effectively limited to 32 characters in length; if the password is longer, any excess characters are truncated. This is not due to any limit imposed by the MySQL Server generally, but rather is an issue specific to MySQL Replication. (For more information, see Bug #43439.)

## 6.2.11 Password Management

MySQL enables database administrators to expire account passwords manually, and to establish a policy for automatic password expiration. Expiration policy can be established globally, and individual accounts can be set to either defer to the global policy or override the global policy with specific per-account behavior.

- [Internal Versus External Credentials Storage](#)
- [Password Expiration Policy](#)

### Internal Versus External Credentials Storage

Some authentication plugins store account credentials internally to MySQL, in the `mysql.user` system table:

- `mysql_native_password`
- `sha256_password`

The discussion in this section applies to such authentication plugins because the password-management capabilities described here are based on internal credentials storage handled by MySQL itself.

Other authentication plugins store account credentials externally to MySQL. For accounts that use plugins that perform authentication against an external credentials system, password management must be handled externally against that system as well.

For information about individual authentication plugins, see [Section 6.4.1, “Authentication Plugins”](#).

## Password Expiration Policy

To expire an account password manually, use the `ALTER USER` statement:

```
ALTER USER 'jeffrey'@'localhost' PASSWORD EXPIRE;
```

This operation marks the password expired in the corresponding `mysql.user` system table row.

Password expiration according to policy is automatic and is based on password age, which for a given account is assessed from the date and time of its most recent password change. The `mysql.user` system table indicates for each account when its password was last changed, and the server automatically treats the password as expired at client connection time if its age is greater than its permitted lifetime. This works with no explicit manual password expiration.

To establish automatic password-expiration policy globally, use the `default_password_lifetime` system variable. Its default value is 0, which disables automatic password expiration. If the value of `default_password_lifetime` is a positive integer  $N$ , it indicates the permitted password lifetime, such that passwords must be changed every  $N$  days.



### Note

Prior to 5.7.11, the default `default_password_lifetime` value is 360 (passwords must be changed approximately once per year). For such versions, be aware that, if you make no changes to the `default_password_lifetime` variable or to individual user accounts, each user password expires after 360 days and the account starts running in restricted mode. Clients that connect to the server using the account then get an error indicating that the password must be changed: `ERROR 1820 (HY000): You must reset your password using ALTER USER statement before executing this statement.`

However, this is easy to miss for clients that automatically connect to the server, such as connections made from scripts. To avoid having such clients suddenly stop working due to a password expiring, make sure to change the password expiration settings for those clients, like this:

```
ALTER USER 'script'@'localhost' PASSWORD EXPIRE NEVER
```

Alternatively, set the `default_password_lifetime` variable to 0, thus disabling automatic password expiration for all users.

Examples:

- To establish a global policy that passwords have a lifetime of approximately six months, start the server with these lines in a server `my.cnf` file:

```
[mysqld]
default_password_lifetime=180
```

- To establish a global policy such that passwords never expire, set `default_password_lifetime` to 0:

```
[mysqld]
default_password_lifetime=0
```

- `default_password_lifetime` can also be changed at runtime:

```
SET GLOBAL default_password_lifetime = 180;
SET GLOBAL default_password_lifetime = 0;
```

The global password-expiration policy applies to all accounts that have not been set to override it. To establish policy for individual accounts, use the `PASSWORD EXPIRE` options of the `CREATE USER` and `ALTER USER` statements. See [Section 13.7.1.2, “CREATE USER Statement”](#), and [Section 13.7.1.1, “ALTER USER Statement”](#).

Example account-specific statements:

- Require the password to be changed every 90 days:

```
CREATE USER 'jeffrey'@'localhost' PASSWORD EXPIRE INTERVAL 90 DAY;
ALTER USER 'jeffrey'@'localhost' PASSWORD EXPIRE INTERVAL 90 DAY;
```

This expiration option overrides the global policy for all accounts named by the statement.

- Disable password expiration:

```
CREATE USER 'jeffrey'@'localhost' PASSWORD EXPIRE NEVER;
ALTER USER 'jeffrey'@'localhost' PASSWORD EXPIRE NEVER;
```

This expiration option overrides the global policy for all accounts named by the statement.

- Defer to the global expiration policy for all accounts named by the statement:

```
CREATE USER 'jeffrey'@'localhost' PASSWORD EXPIRE DEFAULT;
ALTER USER 'jeffrey'@'localhost' PASSWORD EXPIRE DEFAULT;
```

When a client successfully connects, the server determines whether the account password has expired:

- The server checks whether the password has been manually expired.
- Otherwise, the server checks whether the password age is greater than its permitted lifetime according to the automatic password expiration policy. If so, the server considers the password expired.

If the password is expired (whether manually or automatically), the server either disconnects the client or restricts the operations permitted to it (see [Section 6.2.12, “Server Handling of Expired Passwords”](#)). Operations performed by a restricted client result in an error until the user establishes a new account password:

```
mysql> SELECT 1;
ERROR 1820 (HY000): You must reset your password using ALTER USER
statement before executing this statement.

mysql> ALTER USER USER() IDENTIFIED BY 'password';
Query OK, 0 rows affected (0.01 sec)

mysql> SELECT 1;
```

```
+----+
| 1 |
+----+
| 1 |
+----+
1 row in set (0.00 sec)
```

This restricted mode of operation permits `SET` statements, which is useful before MySQL 5.7.6 if `SET PASSWORD` must be used instead of `ALTER USER` and the account password has a hashing format that requires `old_passwords` to be set to a value different from its default.

After the client resets the password, the server restores normal access for the session, as well as for subsequent connections that use the account. It is also possible for an administrative user to reset the account password, but any existing restricted sessions for that account remain restricted. A client using the account must disconnect and reconnect before statements can be executed successfully.



#### Note

Although it is possible to “reset” an expired password by setting it to its current value, it is preferable, as a matter of good policy, to choose a different password.

## 6.2.12 Server Handling of Expired Passwords

MySQL provides password-expiration capability, which enables database administrators to require that users reset their password. Passwords can be expired manually, and on the basis of a policy for automatic expiration (see [Section 6.2.11](#), “Password Management”).

The `ALTER USER` statement enables account password expiration. For example:

```
ALTER USER 'myuser'@'localhost' PASSWORD EXPIRE;
```

For each connection that uses an account with an expired password, the server either disconnects the client or restricts the client to “sandbox mode,” in which the server permits the client to perform only those operations necessary to reset the expired password. Which action is taken by the server depends on both client and server settings, as discussed later.

If the server disconnects the client, it returns an `ER_MUST_CHANGE_PASSWORD_LOGIN` error:

```
$> mysql -u myuser -p
Password: *****
ERROR 1862 (HY000): Your password has expired. To log in you must
change it using a client that supports expired passwords.
```

If the server restricts the client to sandbox mode, these operations are permitted within the client session:

- The client can reset the account password with `ALTER USER` or `SET PASSWORD`. After that has been done, the server restores normal access for the session, as well as for subsequent connections that use the account.



#### Note

Although it is possible to “reset” an expired password by setting it to its current value, it is preferable, as a matter of good policy, to choose a different password.

- The client can use the `SET` statement, which is useful before MySQL 5.7.6 if `SET PASSWORD` must be used instead of `ALTER USER` and the account uses an authentication plugin for which the `old_passwords` system variable must first be set to a nondefault value to perform password hashing in a specific way.

For any operation not permitted within the session, the server returns an `ER_MUST_CHANGE_PASSWORD` error:

```
mysql> USE performance_schema;
ERROR 1820 (HY000): You must reset your password using ALTER USER
statement before executing this statement.

mysql> SELECT 1;
ERROR 1820 (HY000): You must reset your password using ALTER USER
statement before executing this statement.
```

That is what normally happens for interactive invocations of the `mysql` client because by default such invocations are put in sandbox mode. To resume normal functioning, select a new password.

For noninteractive invocations of the `mysql` client (for example, in batch mode), the server normally disconnects the client if the password is expired. To permit noninteractive `mysql` invocations to stay connected so that the password can be changed (using the statements permitted in sandbox mode), add the `--connect-expired-password` option to the `mysql` command.

As mentioned previously, whether the server disconnects an expired-password client or restricts it to sandbox mode depends on a combination of client and server settings. The following discussion describes the relevant settings and how they interact.



#### Note

This discussion applies only for accounts with expired passwords. If a client connects using a nonexpired password, the server handles the client normally.

On the client side, a given client indicates whether it can handle sandbox mode for expired passwords. For clients that use the C client library, there are two ways to do this:

- Pass the `MYSQL_OPT_CAN_HANDLE_EXPIRED_PASSWORDS` flag to `mysql_options()` prior to connecting:

```
my_bool arg = 1;
mysql_options(mysql,
               MYSQL_OPT_CAN_HANDLE_EXPIRED_PASSWORDS,
               &arg);
```

This is the technique used within the `mysql` client, which enables `MYSQL_OPT_CAN_HANDLE_EXPIRED_PASSWORDS` if invoked interactively or with the `--connect-expired-password` option.

- Pass the `CLIENT_CAN_HANDLE_EXPIRED_PASSWORDS` flag to `mysql_real_connect()` at connect time:

```
MYSQL mysql;
mysql_init(&mysql);
if (!mysql_real_connect(&mysql,
                       host, user, password, db,
                       port, unix_socket,
                       CLIENT_CAN_HANDLE_EXPIRED_PASSWORDS))
{
    ... handle error ...
}
```

Other MySQL Connectors have their own conventions for indicating readiness to handle sandbox mode. See the documentation for the Connector in which you are interested.

On the server side, if a client indicates that it can handle expired passwords, the server puts it in sandbox mode.

If a client does not indicate that it can handle expired passwords (or uses an older version of the client library that cannot so indicate), the server action depends on the value of the `disconnect_on_expired_password` system variable:

- If `disconnect_on_expired_password` is enabled (the default), the server disconnects the client with an `ER_MUST_CHANGE_PASSWORD_LOGIN` error.
- If `disconnect_on_expired_password` is disabled, the server puts the client in sandbox mode.

## 6.2.13 Pluggable Authentication

When a client connects to the MySQL server, the server uses the user name provided by the client and the client host to select the appropriate account row from the `mysql.user` system table. The server then authenticates the client, determining from the account row which authentication plugin applies to the client:

- If the server cannot find the plugin, an error occurs and the connection attempt is rejected.
- Otherwise, the server invokes that plugin to authenticate the user, and the plugin returns a status to the server indicating whether the user provided the correct password and is permitted to connect.

Pluggable authentication enables these important capabilities:

- **Choice of authentication methods.** Pluggable authentication makes it easy for DBAs to choose and change the authentication method used for individual MySQL accounts.
- **External authentication.** Pluggable authentication makes it possible for clients to connect to the MySQL server with credentials appropriate for authentication methods that store credentials elsewhere than in the `mysql.user` system table. For example, plugins can be created to use external authentication methods such as PAM, Windows login IDs, LDAP, or Kerberos.
- **Proxy users:** If a user is permitted to connect, an authentication plugin can return to the server a user name different from the name of the connecting user, to indicate that the connecting user is a proxy for another user (the proxied user). While the connection lasts, the proxy user is treated, for purposes of access control, as having the privileges of the proxied user. In effect, one user impersonates another. For more information, see [Section 6.2.14, “Proxy Users”](#).



### Note

If you start the server with the `--skip-grant-tables` option, authentication plugins are not used even if loaded because the server performs no client authentication and permits any client to connect. Because this is insecure, you might want to use `--skip-grant-tables` in conjunction with enabling the `skip_networking` system variable to prevent remote clients from connecting.

- [Available Authentication Plugins](#)
- [Authentication Plugin Usage](#)
- [Restrictions on Pluggable Authentication](#)

## Available Authentication Plugins

MySQL 5.7 provides these authentication plugins:

- Plugins that perform native authentication; that is, authentication based on the password hashing methods in use from before the introduction of pluggable authentication in MySQL. The `mysql_native_password` plugin implements authentication based on the native password

hashing method. The `mysql_old_password` plugin implements native authentication based on the older (pre-4.1) password hashing method (and is deprecated and removed in MySQL 5.7.5). See [Section 6.4.1.1, “Native Pluggable Authentication”](#), and [Section 6.4.1.2, “Old Native Pluggable Authentication”](#).

- Plugins that perform authentication using SHA-256 password hashing. This is stronger encryption than that available with native authentication. See [Section 6.4.1.5, “SHA-256 Pluggable Authentication”](#), and [Section 6.4.1.4, “Caching SHA-2 Pluggable Authentication”](#).
- A client-side plugin that sends the password to the server without hashing or encryption. This plugin is used in conjunction with server-side plugins that require access to the password exactly as provided by the client user. See [Section 6.4.1.6, “Client-Side Cleartext Pluggable Authentication”](#).
- A plugin that performs external authentication using PAM (Pluggable Authentication Modules), enabling MySQL Server to use PAM to authenticate MySQL users. This plugin supports proxy users as well. See [Section 6.4.1.7, “PAM Pluggable Authentication”](#).
- A plugin that performs external authentication on Windows, enabling MySQL Server to use native Windows services to authenticate client connections. Users who have logged in to Windows can connect from MySQL client programs to the server based on the information in their environment without specifying an additional password. This plugin supports proxy users as well. See [Section 6.4.1.8, “Windows Pluggable Authentication”](#).
- Plugins that perform authentication using LDAP (Lightweight Directory Access Protocol) to authenticate MySQL users by accessing directory services such as X.500. These plugins support proxy users as well. See [Section 6.4.1.9, “LDAP Pluggable Authentication”](#).
- A plugin that prevents all client connections to any account that uses it. Use cases for this plugin include proxied accounts that should never permit direct login but are accessed only through proxy accounts and accounts that must be able to execute stored programs and views with elevated privileges without exposing those privileges to ordinary users. See [Section 6.4.1.10, “No-Login Pluggable Authentication”](#).
- A plugin that authenticates clients that connect from the local host through the Unix socket file. See [Section 6.4.1.11, “Socket Peer-Credential Pluggable Authentication”](#).
- A test plugin that checks account credentials and logs success or failure to the server error log. This plugin is intended for testing and development purposes, and as an example of how to write an authentication plugin. See [Section 6.4.1.12, “Test Pluggable Authentication”](#).

**Note**

For information about current restrictions on the use of pluggable authentication, including which connectors support which plugins, see [Restrictions on Pluggable Authentication](#).

Third-party connector developers should read that section to determine the extent to which a connector can take advantage of pluggable authentication capabilities and what steps to take to become more compliant.

If you are interested in writing your own authentication plugins, see [Writing Authentication Plugins](#).

## Authentication Plugin Usage

This section provides general instructions for installing and using authentication plugins. For instructions specific to a given plugin, see the section that describes that plugin under [Section 6.4.1, “Authentication Plugins”](#).

In general, pluggable authentication uses a pair of corresponding plugins on the server and client sides, so you use a given authentication method like this:

- If necessary, install the plugin library or libraries containing the appropriate plugins. On the server host, install the library containing the server-side plugin, so that the server can use it to authenticate client connections. Similarly, on each client host, install the library containing the client-side plugin for use by client programs. Authentication plugins that are built in need not be installed.
- For each MySQL account that you create, specify the appropriate server-side plugin to use for authentication. If the account is to use the default authentication plugin, the account-creation statement need not specify the plugin explicitly. The `default_authentication_plugin` system variable configures the default authentication plugin.
- When a client connects, the server-side plugin tells the client program which client-side plugin to use for authentication.

In the case that an account uses an authentication method that is the default for both the server and the client program, the server need not communicate to the client which client-side plugin to use, and a round trip in client/server negotiation can be avoided. This is true for accounts that use native MySQL authentication.

For standard MySQL clients such as `mysql` and `mysqladmin`, the `--default-auth=plugin_name` option can be specified on the command line as a hint about which client-side plugin the program can expect to use, although the server overrides this if the server-side plugin associated with the user account requires a different client-side plugin.

If the client program does not find the client-side plugin library file, specify a `--plugin-dir=dir_name` option to indicate the plugin library directory location.

## Restrictions on Pluggable Authentication

The first part of this section describes general restrictions on the applicability of the pluggable authentication framework described at [Section 6.2.13, “Pluggable Authentication”](#). The second part describes how third-party connector developers can determine the extent to which a connector can take advantage of pluggable authentication capabilities and what steps to take to become more compliant.

The term “native authentication” used here refers to authentication against passwords stored in the `mysql.user` system table. This is the same authentication method provided by older MySQL servers, before pluggable authentication was implemented. “Windows native authentication” refers to authentication using the credentials of a user who has already logged in to Windows, as implemented by the Windows Native Authentication plugin (“Windows plugin” for short).

- [General Pluggable Authentication Restrictions](#)
- [Pluggable Authentication and Third-Party Connectors](#)

## General Pluggable Authentication Restrictions

- **Connector/C++:** Clients that use this connector can connect to the server only through accounts that use native authentication.

Exception: A connector supports pluggable authentication if it was built to link to `libmysqlclient` dynamically (rather than statically) and it loads the current version of `libmysqlclient` if that version is installed, or if the connector is recompiled from source to link against the current `libmysqlclient`.

- **Connector/NET:** Clients that use Connector/NET can connect to the server through accounts that use native authentication or Windows native authentication.



- **Connector/PHP:** Clients that use this connector can connect to the server only through accounts that use native authentication, when compiled using the MySQL native driver for PHP (`mysqlnd`).
- **Windows native authentication:** Connecting through an account that uses the Windows plugin requires Windows Domain setup. Without it, NTLM authentication is used and then only local connections are possible; that is, the client and server must run on the same computer.
- **Proxy users:** Proxy user support is available to the extent that clients can connect through accounts authenticated with plugins that implement proxy user capability (that is, plugins that can return a user name different from that of the connecting user). For example, the PAM and Windows plugins support proxy users. The `mysql_native_password` and `sha256_password` authentication plugins do not support proxy users by default, but can be configured to do so; see [Server Support for Proxy User Mapping](#).
- **Replication:** Replicas can employ not only source accounts using native authentication, but can also connect through source accounts that use nonnative authentication if the required client-side plugin is available. If the plugin is built into `libmysqlclient`, it is available by default. Otherwise, the plugin must be installed on the replica side in the directory named by the replica `plugin_dir` system variable.
- **FEDERATED tables:** A `FEDERATED` table can access the remote table only through accounts on the remote server that use native authentication.

## Pluggable Authentication and Third-Party Connectors

Third-party connector developers can use the following guidelines to determine readiness of a connector to take advantage of pluggable authentication capabilities and what steps to take to become more compliant:

- An existing connector to which no changes have been made uses native authentication and clients that use the connector can connect to the server only through accounts that use native authentication. *However, you should test the connector against a recent version of the server to verify that such connections still work without problem.*

Exception: A connector might work with pluggable authentication without any changes if it links to `libmysqlclient` dynamically (rather than statically) and it loads the current version of `libmysqlclient` if that version is installed.

- To take advantage of pluggable authentication capabilities, a connector that is `libmysqlclient`-based should be relinked against the current version of `libmysqlclient`. This enables the connector to support connections through accounts that require client-side plugins now built into `libmysqlclient` (such as the cleartext plugin needed for PAM authentication and the Windows plugin needed for Windows native authentication). Linking with a current `libmysqlclient` also enables the connector to access client-side plugins installed in the default MySQL plugin directory (typically the directory named by the default value of the local server's `plugin_dir` system variable).

If a connector links to `libmysqlclient` dynamically, it must be ensured that the newer version of `libmysqlclient` is installed on the client host and that the connector loads it at runtime.

- Another way for a connector to support a given authentication method is to implement it directly in the client/server protocol. Connector/NET uses this approach to provide support for Windows native authentication.
- If a connector should be able to load client-side plugins from a directory different from the default plugin directory, it must implement some means for client users to specify the directory. Possibilities for this include a command-line option or environment variable from which the connector can obtain the directory name. Standard MySQL client programs such as `mysql` and `mysqladmin` implement a `--plugin-dir` option. See also [C API Client Plugin Interface](#).

- Proxy user support by a connector depends, as described earlier in this section, on whether the authentication methods that it supports permit proxy users.

## 6.2.14 Proxy Users

The MySQL server authenticates client connections using authentication plugins. The plugin that authenticates a given connection may request that the connecting (external) user be treated as a different user for privilege-checking purposes. This enables the external user to be a proxy for the second user; that is, to assume the privileges of the second user:

- The external user is a “proxy user” (a user who can impersonate or become known as another user).
- The second user is a “proxied user” (a user whose identity and privileges can be assumed by a proxy user).

This section describes how the proxy user capability works. For general information about authentication plugins, see [Section 6.2.13, “Pluggable Authentication”](#). For information about specific plugins, see [Section 6.4.1, “Authentication Plugins”](#). For information about writing authentication plugins that support proxy users, see [Implementing Proxy User Support in Authentication Plugins](#).

- [Requirements for Proxy User Support](#)
- [Simple Proxy User Example](#)
- [Preventing Direct Login to Proxied Accounts](#)
- [Granting and Revoking the PROXY Privilege](#)
- [Default Proxy Users](#)
- [Default Proxy User and Anonymous User Conflicts](#)
- [Server Support for Proxy User Mapping](#)
- [Proxy User System Variables](#)

### Requirements for Proxy User Support

For proxying to occur for a given authentication plugin, these conditions must be satisfied:

- Proxying must be supported, either by the plugin itself, or by the MySQL server on behalf of the plugin. In the latter case, server support may need to be enabled explicitly; see [Server Support for Proxy User Mapping](#).
- The account for the external proxy user must be set up to be authenticated by the plugin. Use the `CREATE USER` statement to associate an account with an authentication plugin, or `ALTER USER` to change its plugin.
- The account for the proxied user must exist and be granted the privileges to be assumed by the proxy user. Use the `CREATE USER` and `GRANT` statements for this.
- Normally, the proxied user is configured so that it can be used only in proxying scenarios and not for direct logins.
- The proxy user account must have the `PROXY` privilege for the proxied account. Use the `GRANT` statement for this.

- For a client connecting to the proxy account to be treated as a proxy user, the authentication plugin must return a user name different from the client user name, to indicate the user name of the proxied account that defines the privileges to be assumed by the proxy user.

Alternatively, for plugins that are provided proxy mapping by the server, the proxied user is determined from the `PROXY` privilege held by the proxy user.

The proxy mechanism permits mapping only the external client user name to the proxied user name. There is no provision for mapping host names:

- When a client connects to the server, the server determines the proper account based on the user name passed by the client program and the host from which the client connects.
- If that account is a proxy account, the server attempts to determine the appropriate proxied account by finding a match for a proxied account using the user name returned by the authentication plugin and the host name of the proxy account. The host name in the proxied account is ignored.

## Simple Proxy User Example

Consider the following account definitions:

```
-- create proxy account
CREATE USER 'employee_ext'@'localhost'
  IDENTIFIED WITH my_auth_plugin
  AS 'my_auth_string';

-- create proxied account and grant its privileges;
-- use mysql_no_login plugin to prevent direct login
CREATE USER 'employee'@'localhost'
  IDENTIFIED WITH mysql_no_login;
GRANT ALL
  ON employees.*
  TO 'employee'@'localhost';

-- grant to proxy account the
-- PROXY privilege for proxied account
GRANT PROXY
  ON 'employee'@'localhost'
  TO 'employee_ext'@'localhost';
```

When a client connects as `employee_ext` from the local host, MySQL uses the plugin named `my_auth_plugin` to perform authentication. Suppose that `my_auth_plugin` returns a user name of `employee` to the server, based on the content of `'my_auth_string'` and perhaps by consulting some external authentication system. The name `employee` differs from `employee_ext`, so returning `employee` serves as a request to the server to treat the `employee_ext` external user, for purposes of privilege checking, as the `employee` local user.

In this case, `employee_ext` is the proxy user and `employee` is the proxied user.

The server verifies that proxy authentication for `employee` is possible for the `employee_ext` user by checking whether `employee_ext` (the proxy user) has the `PROXY` privilege for `employee` (the proxied user). If this privilege has not been granted, an error occurs. Otherwise, `employee_ext` assumes the privileges of `employee`. The server checks statements executed during the client session by `employee_ext` against the privileges granted to `employee`. In this case, `employee_ext` can access tables in the `employees` database.

The proxied account, `employee`, uses the `mysql_no_login` authentication plugin to prevent clients from using the account to log in directly. (This assumes that the plugin is installed. For instructions, see [Section 6.4.1.10, “No-Login Pluggable Authentication”](#).) For alternative methods of protecting proxied accounts against direct use, see [Preventing Direct Login to Proxied Accounts](#).

When proxying occurs, the `USER()` and `CURRENT_USER()` functions can be used to see the difference between the connecting user (the proxy user) and the account whose privileges apply during the current session (the proxied user). For the example just described, those functions return these values:

```
mysql> SELECT USER(), CURRENT_USER();
+-----+-----+
| USER()           | CURRENT_USER() |
+-----+-----+
| employee_ext@localhost | employee@localhost |
+-----+-----+
```

In the `CREATE USER` statement that creates the proxy user account, the `IDENTIFIED WITH` clause that names the proxy-supporting authentication plugin is optionally followed by an `AS 'auth_string'` clause specifying a string that the server passes to the plugin when the user connects. If present, the string provides information that helps the plugin determine how to map the proxy (external) client user name to a proxied user name. It is up to each plugin whether it requires the `AS` clause. If so, the format of the authentication string depends on how the plugin intends to use it. Consult the documentation for a given plugin for information about the authentication string values it accepts.

## Preventing Direct Login to Proxied Accounts

Proxied accounts generally are intended to be used only by means of proxy accounts. That is, clients connect using a proxy account, then are mapped onto and assume the privileges of the appropriate proxied user.

There are multiple ways to ensure that a proxied account cannot be used directly:

- Associate the account with the `mysql_no_login` authentication plugin. In this case, the account cannot be used for direct logins under any circumstances. This assumes that the plugin is installed. For instructions, see [Section 6.4.1.10, “No-Login Pluggable Authentication”](#).
- Include the `ACCOUNT LOCK` option when you create the account. See [Section 13.7.1.2, “CREATE USER Statement”](#). With this method, also include a password so that if the account is unlocked later, it cannot be accessed with no password. (If the `validate_password` plugin is enabled, it does not permit creating an account without a password, even if the account is locked. See [Section 6.4.3, “The Password Validation Plugin”](#).)
- Create the account with a password but do not tell anyone else the password. If you do not let anyone know the password for the account, clients cannot use it to connect directly to the MySQL server.

## Granting and Revoking the PROXY Privilege

The `PROXY` privilege is needed to enable an external user to connect as and have the privileges of another user. To grant this privilege, use the `GRANT` statement. For example:

```
GRANT PROXY ON 'proxied_user' TO 'proxy_user';
```

The statement creates a row in the `mysql.proxies_priv` grant table.

At connect time, `proxy_user` must represent a valid externally authenticated MySQL user, and `proxied_user` must represent a valid locally authenticated user. Otherwise, the connection attempt fails.

The corresponding `REVOKE` syntax is:

```
REVOKE PROXY ON 'proxied_user' FROM 'proxy_user';
```

MySQL `GRANT` and `REVOKE` syntax extensions work as usual. Examples:

```
-- grant PROXY to multiple accounts
GRANT PROXY ON 'a' TO 'b', 'c', 'd';

-- revoke PROXY from multiple accounts
REVOKE PROXY ON 'a' FROM 'b', 'c', 'd';

-- grant PROXY to an account and enable the account to grant
-- PROXY to the proxied account
GRANT PROXY ON 'a' TO 'd' WITH GRANT OPTION;

-- grant PROXY to default proxy account
GRANT PROXY ON 'a' TO '@';
```

The `PROXY` privilege can be granted in these cases:

- By a user that has `GRANT PROXY ... WITH GRANT OPTION` for *proxied\_user*.
- By *proxied\_user* for itself: The value of `USER()` must exactly match `CURRENT_USER()` and *proxied\_user*, for both the user name and host name parts of the account name.

The initial `root` account created during MySQL installation has the `PROXY ... WITH GRANT OPTION` privilege for '@', that is, for all users and all hosts. This enables `root` to set up proxy users, as well as to delegate to other accounts the authority to set up proxy users. For example, `root` can do this:

```
CREATE USER 'admin'@'localhost'
  IDENTIFIED BY 'admin_password';
GRANT PROXY
  ON '@'
  TO 'admin'@'localhost'
  WITH GRANT OPTION;
```

Those statements create an `admin` user that can manage all `GRANT PROXY` mappings. For example, `admin` can do this:

```
GRANT PROXY ON sally TO joe;
```

## Default Proxy Users

To specify that some or all users should connect using a given authentication plugin, create a “blank” MySQL account with an empty user name and host name ('@'), associate it with that plugin, and let the plugin return the real authenticated user name (if different from the blank user). Suppose that there exists a plugin named `ldap_auth` that implements LDAP authentication and maps connecting users onto either a developer or manager account. To set up proxying of users onto these accounts, use the following statements:

```
-- create default proxy account
CREATE USER '@'
  IDENTIFIED WITH ldap_auth
  AS 'O=Oracle, OU=MySQL';

-- create proxied accounts; use
-- mysql_no_login plugin to prevent direct login
CREATE USER 'developer'@'localhost'
  IDENTIFIED WITH mysql_no_login;
CREATE USER 'manager'@'localhost'
  IDENTIFIED WITH mysql_no_login;

-- grant to default proxy account the
-- PROXY privilege for proxied accounts
GRANT PROXY
  ON 'manager'@'localhost'
  TO '@';
```

```
GRANT PROXY
ON 'developer'@'localhost'
TO '@';
```

Now assume that a client connects as follows:

```
$> mysql --user=myuser --password ...
Enter password: myuser_password
```

The server does not find `myuser` defined as a MySQL user, but because there is a blank user account (`'@'`) that matches the client user name and host name, the server authenticates the client against that account: The server invokes the `ldap_auth` authentication plugin and passes `myuser` and `myuser_password` to it as the user name and password.

If the `ldap_auth` plugin finds in the LDAP directory that `myuser_password` is not the correct password for `myuser`, authentication fails and the server rejects the connection.

If the password is correct and `ldap_auth` finds that `myuser` is a developer, it returns the user name `developer` to the MySQL server, rather than `myuser`. Returning a user name different from the client user name of `myuser` signals to the server that it should treat `myuser` as a proxy. The server verifies that `'@'` can authenticate as `developer` (because `'@'` has the `PROXY` privilege to do so) and accepts the connection. The session proceeds with `myuser` having the privileges of the `developer` proxied user. (These privileges should be set up by the DBA using `GRANT` statements, not shown.) The `USER()` and `CURRENT_USER()` functions return these values:

```
mysql> SELECT USER(), CURRENT_USER();
+-----+-----+
| USER()          | CURRENT_USER() |
+-----+-----+
| myuser@localhost | developer@localhost |
+-----+-----+
```

If the plugin instead finds in the LDAP directory that `myuser` is a manager, it returns `manager` as the user name and the session proceeds with `myuser` having the privileges of the `manager` proxied user.

```
mysql> SELECT USER(), CURRENT_USER();
+-----+-----+
| USER()          | CURRENT_USER() |
+-----+-----+
| myuser@localhost | manager@localhost |
+-----+-----+
```

For simplicity, external authentication cannot be multilevel: Neither the credentials for `developer` nor those for `manager` are taken into account in the preceding example. However, they are still used if a client tries to connect and authenticate directly as the `developer` or `manager` account, which is why those proxied accounts should be protected against direct login (see [Preventing Direct Login to Proxied Accounts](#)).

## Default Proxy User and Anonymous User Conflicts

If you intend to create a default proxy user, check for other existing “match any user” accounts that take precedence over the default proxy user because they can prevent that user from working as intended.

In the preceding discussion, the default proxy user account has `'@'` in the host part, which matches any host. If you set up a default proxy user, take care to also check whether nonproxy accounts exist with the same user part and `'%'` in the host part, because `'%'` also matches any host, but has precedence over `'@'` by the rules that the server uses to sort account rows internally (see [Section 6.2.5, “Access Control, Stage 1: Connection Verification”](#)).

Suppose that a MySQL installation includes these two accounts:

```
-- create default proxy account
CREATE USER '@'
  IDENTIFIED WITH some_plugin
  AS 'some_auth_string';
-- create anonymous account
CREATE USER '@%'
  IDENTIFIED BY 'anon_user_password';
```

The first account ('@') is intended as the default proxy user, used to authenticate connections for users who do not otherwise match a more-specific account. The second account ('@%') is an anonymous-user account, which might have been created, for example, to enable users without their own account to connect anonymously.

Both accounts have the same user part (''), which matches any user. And each account has a host part that matches any host. Nevertheless, there is a priority in account matching for connection attempts because the matching rules sort a host of '%' ahead of ''. For accounts that do not match any more-specific account, the server attempts to authenticate them against '@%' (the anonymous user) rather than '@' (the default proxy user). As a result, the default proxy account is never used.

To avoid this problem, use one of the following strategies:

- Remove the anonymous account so that it does not conflict with the default proxy user.
- Use a more-specific default proxy user that matches ahead of the anonymous user. For example, to permit only `localhost` proxy connections, use '@localhost':

```
CREATE USER '@localhost'
  IDENTIFIED WITH some_plugin
  AS 'some_auth_string';
```

In addition, modify any `GRANT PROXY` statements to name '@localhost' rather than '@' as the proxy user.

Be aware that this strategy prevents anonymous-user connections from `localhost`.

- Use a named default account rather than an anonymous default account. For an example of this technique, consult the instructions for using the `authentication_windows` plugin. See [Section 6.4.1.8, “Windows Pluggable Authentication”](#).
- Create multiple proxy users, one for local connections and one for “everything else” (remote connections). This can be useful particularly when local users should have different privileges from remote users.

Create the proxy users:

```
-- create proxy user for local connections
CREATE USER '@localhost'
  IDENTIFIED WITH some_plugin
  AS 'some_auth_string';
-- create proxy user for remote connections
CREATE USER '@%'
  IDENTIFIED WITH some_plugin
  AS 'some_auth_string';
```

Create the proxied users:

```
-- create proxied user for local connections
CREATE USER 'developer'@localhost
  IDENTIFIED WITH mysql_no_login;
```

```
-- create proxied user for remote connections
CREATE USER 'developer'@'%'
  IDENTIFIED WITH mysql_no_login;
```

Grant to each proxy account the `PROXY` privilege for the corresponding proxied account:

```
GRANT PROXY
  ON 'developer'@'localhost'
  TO '@'localhost';
GRANT PROXY
  ON 'developer'@'%'
  TO '@'%;
```

Finally, grant appropriate privileges to the local and remote proxied users (not shown).

Assume that the `some_plugin/'some_auth_string'` combination causes `some_plugin` to map the client user name to `developer`. Local connections match the `'@'localhost'` proxy user, which maps to the `'developer'@'localhost'` proxied user. Remote connections match the `'@'%'` proxy user, which maps to the `'developer'@'%'` proxied user.

## Server Support for Proxy User Mapping

Some authentication plugins implement proxy user mapping for themselves (for example, the PAM and Windows authentication plugins). Other authentication plugins do not support proxy users by default. Of these, some can request that the MySQL server itself map proxy users according to granted proxy privileges: `mysql_native_password`, `sha256_password`. If the `check_proxy_users` system variable is enabled, the server performs proxy user mapping for any authentication plugins that make such a request:

- By default, `check_proxy_users` is disabled, so the server performs no proxy user mapping even for authentication plugins that request server support for proxy users.
- If `check_proxy_users` is enabled, it may also be necessary to enable a plugin-specific system variable to take advantage of server proxy user mapping support:
  - For the `mysql_native_password` plugin, enable `mysql_native_password_proxy_users`.
  - For the `sha256_password` plugin, enable `sha256_password_proxy_users`.

For example, to enable all the preceding capabilities, start the server with these lines in the `my.cnf` file:

```
[mysqld]
check_proxy_users=ON
mysql_native_password_proxy_users=ON
sha256_password_proxy_users=ON
```

Assuming that the relevant system variables have been enabled, create the proxy user as usual using `CREATE USER`, then grant it the `PROXY` privilege to a single other account to be treated as the proxied user. When the server receives a successful connection request for the proxy user, it finds that the user has the `PROXY` privilege and uses it to determine the proper proxied user.

```
-- create proxy account
CREATE USER 'proxy_user'@'localhost'
  IDENTIFIED WITH mysql_native_password
  BY 'password';

-- create proxied account and grant its privileges;
-- use mysql_no_login plugin to prevent direct login
CREATE USER 'proxied_user'@'localhost'
  IDENTIFIED WITH mysql_no_login;
```



```
-- grant privileges to proxied account
GRANT ...
ON ...
TO 'proxied_user'@'localhost';

-- grant to proxy account the
-- PROXY privilege for proxied account
GRANT PROXY
ON 'proxied_user'@'localhost'
TO 'proxy_user'@'localhost';
```

To use the proxy account, connect to the server using its name and password:

```
$> mysql -u proxy_user -p
Enter password: (enter proxy_user password here)
```

Authentication succeeds, the server finds that `proxy_user` has the `PROXY` privilege for `proxied_user`, and the session proceeds with `proxy_user` having the privileges of `proxied_user`.

Proxy user mapping performed by the server is subject to these restrictions:

- The server does not proxy to or from an anonymous user, even if the associated `PROXY` privilege is granted.
- When a single account has been granted proxy privileges for more than one proxied account, server proxy user mapping is nondeterministic. Therefore, granting to a single account proxy privileges for multiple proxied accounts is discouraged.

## Proxy User System Variables

Two system variables help trace the proxy login process:

- `proxy_user`: This value is `NULL` if proxying is not used. Otherwise, it indicates the proxy user account. For example, if a client authenticates through the `' '@'` proxy account, this variable is set as follows:

```
mysql> SELECT @@proxy_user;
+-----+
| @@proxy_user |
+-----+
| ' '@'       |
+-----+
```

- `external_user`: Sometimes the authentication plugin may use an external user to authenticate to the MySQL server. For example, when using Windows native authentication, a plugin that authenticates using the windows API does not need the login ID passed to it. However, it still uses a Windows user ID to authenticate. The plugin may return this external user ID (or the first 512 UTF-8 bytes of it) to the server using the `external_user` read-only session variable. If the plugin does not set this variable, its value is `NULL`.

## 6.2.15 Account Locking

MySQL supports locking and unlocking user accounts using the `ACCOUNT LOCK` and `ACCOUNT UNLOCK` clauses for the `CREATE USER` and `ALTER USER` statements:

- When used with `CREATE USER`, these clauses specify the initial locking state for a new account. In the absence of either clause, the account is created in an unlocked state.

If the `validate_password` plugin is enabled, it does not permit creating an account without a password, even if the account is locked. See [Section 6.4.3, “The Password Validation Plugin”](#).

- When used with `ALTER USER`, these clauses specify the new locking state for an existing account. In the absence of either clause, the account locking state remains unchanged.

Account locking state is recorded in the `account_locked` column of the `mysql.user` system table. The output from `SHOW CREATE USER` indicates whether an account is locked or unlocked.

If a client attempts to connect to a locked account, the attempt fails. The server increments the `Locked_connects` status variable that indicates the number of attempts to connect to a locked account, returns an `ER_ACCOUNT_HAS_BEEN_LOCKED` error, and writes a message to the error log:

```
Access denied for user 'user_name'@'host_name'.
Account is locked.
```

Locking an account does not affect being able to connect using a proxy user that assumes the identity of the locked account. It also does not affect the ability to execute stored programs or views that have a `DEFINER` attribute naming the locked account. That is, the ability to use a proxied account or stored programs or views is not affected by locking the account.

The account-locking capability depends on the presence of the `account_locked` column in the `mysql.user` system table. For upgrades from MySQL versions older than 5.7.6, perform the MySQL upgrade procedure to ensure that this column exists. See [Section 2.10, “Upgrading MySQL”](#). For nonupgraded installations that have no `account_locked` column, the server treats all accounts as unlocked, and using the `ACCOUNT LOCK` or `ACCOUNT UNLOCK` clauses produces an error.

## 6.2.16 Setting Account Resource Limits

One means of restricting client use of MySQL server resources is to set the global `max_user_connections` system variable to a nonzero value. This limits the number of simultaneous connections that can be made by any given account, but places no limits on what a client can do once connected. In addition, setting `max_user_connections` does not enable management of individual accounts. Both types of control are of interest to MySQL administrators.

To address such concerns, MySQL permits limits for individual accounts on use of these server resources:

- The number of queries an account can issue per hour
- The number of updates an account can issue per hour
- The number of times an account can connect to the server per hour
- The number of simultaneous connections to the server by an account

Any statement that a client can issue counts against the query limit, unless its results are served from the query cache. Only statements that modify databases or tables count against the update limit.

An “account” in this context corresponds to a row in the `mysql.user` system table. That is, a connection is assessed against the `User` and `Host` values in the `user` table row that applies to the connection. For example, an account `'usera'@'%.example.com'` corresponds to a row in the `user` table that has `User` and `Host` values of `usera` and `%.example.com`, to permit `usera` to connect from any host in the `example.com` domain. In this case, the server applies resource limits in this row collectively to all connections by `usera` from any host in the `example.com` domain because all such connections use the same account.

Before MySQL 5.0, an “account” was assessed against the actual host from which a user connects. This older method of accounting may be selected by starting the server with the `--old-style-user-limits` option. In this case, if `usera` connects simultaneously from `host1.example.com` and `host2.example.com`, the server applies the account resource limits separately to each connection.

If `usera` connects again from `host1.example.com`, the server applies the limits for that connection together with the existing connection from that host.

To establish resource limits for an account at account-creation time, use the `CREATE USER` statement. To modify the limits for an existing account, use `ALTER USER`. Provide a `WITH` clause that names each resource to be limited. The default value for each limit is zero (no limit). For example, to create a new account that can access the `customer` database, but only in a limited fashion, issue these statements:

```
mysql> CREATE USER 'francis'@'localhost' IDENTIFIED BY 'frank'
->     WITH MAX_QUERIES_PER_HOUR 20
->         MAX_UPDATES_PER_HOUR 10
->         MAX_CONNECTIONS_PER_HOUR 5
->         MAX_USER_CONNECTIONS 2;
```

The limit types need not all be named in the `WITH` clause, but those named can be present in any order. The value for each per-hour limit should be an integer representing a count per hour. For `MAX_USER_CONNECTIONS`, the limit is an integer representing the maximum number of simultaneous connections by the account. If this limit is set to zero, the global `max_user_connections` system variable value determines the number of simultaneous connections. If `max_user_connections` is also zero, there is no limit for the account.

To modify limits for an existing account, use an `ALTER USER` statement. The following statement changes the query limit for `francis` to 100:

```
mysql> ALTER USER 'francis'@'localhost' WITH MAX_QUERIES_PER_HOUR 100;
```

The statement modifies only the limit value specified and leaves the account otherwise unchanged.

To remove a limit, set its value to zero. For example, to remove the limit on how many times per hour `francis` can connect, use this statement:

```
mysql> ALTER USER 'francis'@'localhost' WITH MAX_CONNECTIONS_PER_HOUR 0;
```

As mentioned previously, the simultaneous-connection limit for an account is determined from the `MAX_USER_CONNECTIONS` limit and the `max_user_connections` system variable. Suppose that the global `max_user_connections` value is 10 and three accounts have individual resource limits specified as follows:

```
ALTER USER 'user1'@'localhost' WITH MAX_USER_CONNECTIONS 0;
ALTER USER 'user2'@'localhost' WITH MAX_USER_CONNECTIONS 5;
ALTER USER 'user3'@'localhost' WITH MAX_USER_CONNECTIONS 20;
```

`user1` has a connection limit of 10 (the global `max_user_connections` value) because it has a `MAX_USER_CONNECTIONS` limit of zero. `user2` and `user3` have connection limits of 5 and 20, respectively, because they have nonzero `MAX_USER_CONNECTIONS` limits.

The server stores resource limits for an account in the `user` table row corresponding to the account. The `max_questions`, `max_updates`, and `max_connections` columns store the per-hour limits, and the `max_user_connections` column stores the `MAX_USER_CONNECTIONS` limit. (See [Section 6.2.3, “Grant Tables”](#).)

Resource-use counting takes place when any account has a nonzero limit placed on its use of any of the resources.

As the server runs, it counts the number of times each account uses resources. If an account reaches its limit on number of connections within the last hour, the server rejects further connections for the account until that hour is up. Similarly, if the account reaches its limit on the number of queries or updates, the server rejects further queries or updates until the hour is up. In all such cases, the server issues appropriate error messages.

Resource counting occurs per account, not per client. For example, if your account has a query limit of 50, you cannot increase your limit to 100 by making two simultaneous client connections to the server. Queries issued on both connections are counted together.

The current per-hour resource-use counts can be reset globally for all accounts, or individually for a given account:

- To reset the current counts to zero for all accounts, issue a `FLUSH USER_RESOURCES` statement. The counts also can be reset by reloading the grant tables (for example, with a `FLUSH PRIVILEGES` statement or a `mysqladmin reload` command).
- The counts for an individual account can be reset to zero by setting any of its limits again. Specify a limit value equal to the value currently assigned to the account.

Per-hour counter resets do not affect the `MAX_USER_CONNECTIONS` limit.

All counts begin at zero when the server starts. Counts do not carry over through server restarts.

For the `MAX_USER_CONNECTIONS` limit, an edge case can occur if the account currently has open the maximum number of connections permitted to it: A disconnect followed quickly by a connect can result in an error (`ER_TOO_MANY_USER_CONNECTIONS` or `ER_USER_LIMIT_REACHED`) if the server has not fully processed the disconnect by the time the connect occurs. When the server finishes disconnect processing, another connection is once more permitted.

## 6.2.17 Troubleshooting Problems Connecting to MySQL

If you encounter problems when you try to connect to the MySQL server, the following items describe some courses of action you can take to correct the problem.

- Make sure that the server is running. If it is not, clients cannot connect to it. For example, if an attempt to connect to the server fails with a message such as one of those following, one cause might be that the server is not running:

```
$> mysql
ERROR 2003: Can't connect to MySQL server on 'host_name' (111)
$> mysql
ERROR 2002: Can't connect to local MySQL server through socket
'/tmp/mysql.sock' (111)
```

- It might be that the server is running, but you are trying to connect using a TCP/IP port, named pipe, or Unix socket file different from the one on which the server is listening. To correct this when you invoke a client program, specify a `--port` option to indicate the proper port number, or a `--socket` option to indicate the proper named pipe or Unix socket file. To find out where the socket file is, you can use this command:

```
$> netstat -ln | grep mysql
```

- Make sure that the server has not been configured to ignore network connections or (if you are attempting to connect remotely) that it has not been configured to listen only locally on its network interfaces. If the server was started with the `skip_networking` system variable enabled, it does not accept TCP/IP connections at all. If the server was started with the `bind_address` system variable set to `127.0.0.1`, it listens for TCP/IP connections only locally on the loopback interface and does not accept remote connections.
- Check to make sure that there is no firewall blocking access to MySQL. Your firewall may be configured on the basis of the application being executed, or the port number used by MySQL for communication (3306 by default). Under Linux or Unix, check your IP tables (or similar) configuration to ensure that the

port has not been blocked. Under Windows, applications such as ZoneAlarm or Windows Firewall may need to be configured not to block the MySQL port.

- The grant tables must be properly set up so that the server can use them for access control. For some distribution types (such as binary distributions on Windows, or RPM and DEB distributions on Linux), the installation process initializes the MySQL data directory, including the `mysql` system database containing the grant tables. For distributions that do not do this, you must initialize the data directory manually. For details, see [Section 2.9, “Postinstallation Setup and Testing”](#).

To determine whether you need to initialize the grant tables, look for a `mysql` directory under the data directory. (The data directory normally is named `data` or `var` and is located under your MySQL installation directory.) Make sure that you have a file named `user.MYD` in the `mysql` database directory. If not, [initialize the data directory](#). After doing so and starting the server, you should be able to connect to the server.

- After a fresh installation, if you try to log on to the server as `root` without using a password, you might get the following error message.

```
$> mysql -u root
ERROR 1045 (28000): Access denied for user 'root'@'localhost' (using password: NO)
```

It means a root password has already been assigned during installation and it has to be supplied. See [Section 2.9.4, “Securing the Initial MySQL Account”](#) on the different ways the password could have been assigned and, in some cases, how to find it. If you need to reset the root password, see instructions in [Section B.3.3.2, “How to Reset the Root Password”](#). After you have found or reset your password, log on again as `root` using the `--password` (or `-p`) option:

```
$> mysql -u root -p
Enter password:
```

However, the server is going to let you connect as `root` without using a password if you have initialized MySQL using `mysqld --initialize-insecure` (see [Section 2.9.1, “Initializing the Data Directory”](#) for details). That is a security risk, so you should set a password for the `root` account; see [Section 2.9.4, “Securing the Initial MySQL Account”](#) for instructions.

- If you have updated an existing MySQL installation to a newer version, did you perform the MySQL upgrade procedure? If not, do so. The structure of the grant tables changes occasionally when new capabilities are added, so after an upgrade you should always make sure that your tables have the current structure. For instructions, see [Section 2.10, “Upgrading MySQL”](#).
- If a client program receives the following error message when it tries to connect, it means that the server expects passwords in a newer format than the client is capable of generating:

```
$> mysql
Client does not support authentication protocol requested
by server; consider upgrading MySQL client
```

For information on how to deal with this, see [Section 6.4.1.3, “Migrating Away from Pre-4.1 Password Hashing and the `mysql\_old\_password` Plugin”](#).

- Remember that client programs use connection parameters specified in option files or environment variables. If a client program seems to be sending incorrect default connection parameters when you have not specified them on the command line, check any applicable option files and your environment. For example, if you get `Access denied` when you run a client without any options, make sure that you have not specified an old password in any of your option files!

You can suppress the use of option files by a client program by invoking it with the `--no-defaults` option. For example:

```
$> mysqladmin --no-defaults -u root version
```

The option files that clients use are listed in [Section 4.2.2.2, “Using Option Files”](#). Environment variables are listed in [Section 4.9, “Environment Variables”](#).

- If you get the following error, it means that you are using an incorrect `root` password:

```
$> mysqladmin -u root -pXXXX ver
Access denied for user 'root'@'localhost' (using password: YES)
```

If the preceding error occurs even when you have not specified a password, it means that you have an incorrect password listed in some option file. Try the `--no-defaults` option as described in the previous item.

For information on changing passwords, see [Section 6.2.10, “Assigning Account Passwords”](#).

If you have lost or forgotten the `root` password, see [Section B.3.3.2, “How to Reset the Root Password”](#).

- `localhost` is a synonym for your local host name, and is also the default host to which clients try to connect if you specify no host explicitly.

You can use a `--host=127.0.0.1` option to name the server host explicitly. This makes a TCP/IP connection to the local `mysqld` server. You can also use TCP/IP by specifying a `--host` option that uses the actual host name of the local host. In this case, the host name must be specified in a `user` table row on the server host, even though you are running the client program on the same host as the server.

- The `Access denied` error message tells you who you are trying to log in as, the client host from which you are trying to connect, and whether you were using a password. Normally, you should have one row in the `user` table that exactly matches the host name and user name that were given in the error message. For example, if you get an error message that contains `using password: NO`, it means that you tried to log in without a password.
- If you get an `Access denied` error when trying to connect to the database with `mysql -u user_name`, you may have a problem with the `user` table. Check this by executing `mysql -u root mysql` and issuing this SQL statement:

```
SELECT * FROM user;
```

The result should include a row with the `Host` and `User` columns matching your client's host name and your MySQL user name.

- If the following error occurs when you try to connect from a host other than the one on which the MySQL server is running, it means that there is no row in the `user` table with a `Host` value that matches the client host:

```
Host ... is not allowed to connect to this MySQL server
```

You can fix this by setting up an account for the combination of client host name and user name that you are using when trying to connect.

If you do not know the IP address or host name of the machine from which you are connecting, you should put a row with `'%'` as the `Host` column value in the `user` table. After trying to connect from the client machine, use a `SELECT USER()` query to see how you really did connect. Then change the `'%'` in the `user` table row to the actual host name that shows up in the log. Otherwise, your system is left insecure because it permits connections from any host for the given user name.

On Linux, another reason that this error might occur is that you are using a binary MySQL version that is compiled with a different version of the `glibc` library than the one you are using. In this case, you should either upgrade your operating system or `glibc`, or download a source distribution of MySQL version and compile it yourself. A source RPM is normally trivial to compile and install, so this is not a big problem.

- If you specify a host name when trying to connect, but get an error message where the host name is not shown or is an IP address, it means that the MySQL server got an error when trying to resolve the IP address of the client host to a name:

```
$> mysqladmin -u root -pxxxx -h some_hostname ver
Access denied for user 'root'@'' (using password: YES)
```

If you try to connect as `root` and get the following error, it means that you do not have a row in the `user` table with a `User` column value of `'root'` and that `mysqld` cannot resolve the host name for your client:

```
Access denied for user ''@'unknown'
```

These errors indicate a DNS problem. To fix it, execute `mysqladmin flush-hosts` to reset the internal DNS host cache. See [Section 5.1.11.2, “DNS Lookups and the Host Cache”](#).

Some permanent solutions are:

- Determine what is wrong with your DNS server and fix it.
- Specify IP addresses rather than host names in the MySQL grant tables.
- Put an entry for the client machine name in `/etc/hosts` on Unix or `\windows\hosts` on Windows.
- Start `mysqld` with the `skip_name_resolve` system variable enabled.
- Start `mysqld` with the `--skip-host-cache` option.
- On Unix, if you are running the server and the client on the same machine, connect to `localhost`. For connections to `localhost`, MySQL programs attempt to connect to the local server by using a Unix socket file, unless there are connection parameters specified to ensure that the client makes a TCP/IP connection. For more information, see [Section 4.2.4, “Connecting to the MySQL Server Using Command Options”](#).
- On Windows, if you are running the server and the client on the same machine and the server supports named pipe connections, connect to the host name `.` (period). Connections to `.` use a named pipe rather than TCP/IP.
- If `mysql -u root` works but `mysql -h your_hostname -u root` results in `Access denied` (where `your_hostname` is the actual host name of the local host), you may not have the correct name for your host in the `user` table. A common problem here is that the `Host` value in the `user` table row specifies an unqualified host name, but your system's name resolution routines return a fully qualified domain name (or vice versa). For example, if you have a row with host `'pluto'` in the `user` table, but your DNS tells MySQL that your host name is `'pluto.example.com'`, the row does not work. Try adding a row to the `user` table that contains the IP address of your host as the `Host` column value. (Alternatively, you could add a row to the `user` table with a `Host` value that contains a wildcard (for example, `'pluto.%'`). However, use of `Host` values ending with `%` is *insecure* and is *not* recommended!)

- If `mysql -u user_name` works but `mysql -u user_name some_db` does not, you have not granted access to the given user for the database named `some_db`.
- If `mysql -u user_name` works when executed on the server host, but `mysql -h host_name -u user_name` does not work when executed on a remote client host, you have not enabled access to the server for the given user name from the remote host.
- If you cannot figure out why you get `Access denied`, remove from the `user` table all rows that have `Host` values containing wildcards (rows that contain `'%'` or `'_'` characters). A very common error is to insert a new row with `Host='%'` and `User='some_user'`, thinking that this enables you to specify `localhost` to connect from the same machine. The reason that this does not work is that the default privileges include a row with `Host='localhost'` and `User=''`. Because that row has a `Host` value `'localhost'` that is more specific than `'%'`, it is used in preference to the new row when connecting from `localhost`! The correct procedure is to insert a second row with `Host='localhost'` and `User='some_user'`, or to delete the row with `Host='localhost'` and `User=''`. After deleting the row, remember to issue a `FLUSH PRIVILEGES` statement to reload the grant tables. See also [Section 6.2.5, “Access Control, Stage 1: Connection Verification”](#).
- If you are able to connect to the MySQL server, but get an `Access denied` message whenever you issue a `SELECT ... INTO OUTFILE` or `LOAD DATA` statement, your row in the `user` table does not have the `FILE` privilege enabled.
- If you change the grant tables directly (for example, by using `INSERT`, `UPDATE`, or `DELETE` statements) and your changes seem to be ignored, remember that you must execute a `FLUSH PRIVILEGES` statement or a `mysqladmin flush-privileges` command to cause the server to reload the privilege tables. Otherwise, your changes have no effect until the next time the server is restarted. Remember that after you change the `root` password with an `UPDATE` statement, you do not need to specify the new password until after you flush the privileges, because the server does not yet know that you have changed the password.
- If your privileges seem to have changed in the middle of a session, it may be that a MySQL administrator has changed them. Reloading the grant tables affects new client connections, but it also affects existing connections as indicated in [Section 6.2.9, “When Privilege Changes Take Effect”](#).
- If you have access problems with a Perl, PHP, Python, or ODBC program, try to connect to the server with `mysql -u user_name db_name` or `mysql -u user_name -ppassword db_name`. If you are able to connect using the `mysql` client, the problem lies with your program, not with the access privileges. (There is no space between `-p` and the password; you can also use the `--password=password` syntax to specify the password. If you use the `-p` or `--password` option with no password value, MySQL prompts you for the password.)
- For testing purposes, start the `mysqld` server with the `--skip-grant-tables` option. Then you can change the MySQL grant tables and use the `SHOW GRANTS` statement to check whether your modifications have the desired effect. When you are satisfied with your changes, execute `mysqladmin flush-privileges` to tell the `mysqld` server to reload the privileges. This enables you to begin using the new grant table contents without stopping and restarting the server.
- If everything else fails, start the `mysqld` server with a debugging option (for example, `--debug=d,general,query`). This prints host and user information about attempted connections, as well as information about each command issued. See [Section 5.8.3, “The DEBUG Package”](#).
- If you have any other problems with the MySQL grant tables and ask on the [MySQL Community Slack](#), always provide a dump of the MySQL grant tables. You can dump the tables with the `mysqldump mysql` command. To file a bug report, see the instructions at [Section 1.5, “How to Report Bugs or Problems”](#). In some cases, you may need to restart `mysqld` with `--skip-grant-tables` to run `mysqldump`.



## 6.2.18 SQL-Based Account Activity Auditing

Applications can use the following guidelines to perform SQL-based auditing that ties database activity to MySQL accounts.

MySQL accounts correspond to rows in the `mysql.user` system table. When a client connects successfully, the server authenticates the client to a particular row in this table. The `User` and `Host` column values in this row uniquely identify the account and correspond to the `'user_name'@'host_name'` format in which account names are written in SQL statements.

The account used to authenticate a client determines which privileges the client has. Normally, the `CURRENT_USER()` function can be invoked to determine which account this is for the client user. Its value is constructed from the `User` and `Host` columns of the `user` table row for the account.

However, there are circumstances under which the `CURRENT_USER()` value corresponds not to the client user but to a different account. This occurs in contexts when privilege checking is not based the client's account:

- Stored routines (procedures and functions) defined with the `SQL SECURITY DEFINER` characteristic
- Views defined with the `SQL SECURITY DEFINER` characteristic
- Triggers and events

In those contexts, privilege checking is done against the `DEFINER` account and `CURRENT_USER()` refers to that account, not to the account for the client who invoked the stored routine or view or who caused the trigger to activate. To determine the invoking user, you can call the `USER()` function, which returns a value indicating the actual user name provided by the client and the host from which the client connected. However, this value does not necessarily correspond directly to an account in the `user` table, because the `USER()` value never contains wildcards, whereas account values (as returned by `CURRENT_USER()`) may contain user name and host name wildcards.

For example, a blank user name matches any user, so an account of `'@'localhost` enables clients to connect as an anonymous user from the local host with any user name. In this case, if a client connects as `user1` from the local host, `USER()` and `CURRENT_USER()` return different values:

```
mysql> SELECT USER(), CURRENT_USER();
+-----+-----+
| USER() | CURRENT_USER() |
+-----+-----+
| user1@localhost | @localhost |
+-----+-----+
```

The host name part of an account can contain wildcards, too. If the host name contains a `'%'` or `'_'` pattern character or uses netmask notation, the account can be used for clients connecting from multiple hosts and the `CURRENT_USER()` value does not indicate which one. For example, the account `'user2'@'%.example.com'` can be used by `user2` to connect from any host in the `example.com` domain. If `user2` connects from `remote.example.com`, `USER()` and `CURRENT_USER()` return different values:

```
mysql> SELECT USER(), CURRENT_USER();
+-----+-----+
| USER() | CURRENT_USER() |
+-----+-----+
| user2@remote.example.com | user2@%.example.com |
+-----+-----+
```

If an application must invoke `USER()` for user auditing (for example, if it does auditing from within triggers) but must also be able to associate the `USER()` value with an account in the `user` table, it is necessary

to avoid accounts that contain wildcards in the `User` or `Host` column. Specifically, do not permit `User` to be empty (which creates an anonymous-user account), and do not permit pattern characters or netmask notation in `Host` values. All accounts must have a nonempty `User` value and literal `Host` value.

With respect to the previous examples, the `'@'localhost'` and `'user2'@'%.example.com'` accounts should be changed not to use wildcards:

```
RENAME USER '@'localhost' TO 'user1'@'localhost';
RENAME USER 'user2'@'%.example.com' TO 'user2'@'remote.example.com';
```

If `user2` must be able to connect from several hosts in the `example.com` domain, there should be a separate account for each host.

To extract the user name or host name part from a `CURRENT_USER()` or `USER()` value, use the `SUBSTRING_INDEX()` function:

```
mysql> SELECT SUBSTRING_INDEX(CURRENT_USER(), '@', 1);
+-----+
| SUBSTRING_INDEX(CURRENT_USER(), '@', 1) |
+-----+
| user1                                     |
+-----+

mysql> SELECT SUBSTRING_INDEX(CURRENT_USER(), '@', -1);
+-----+
| SUBSTRING_INDEX(CURRENT_USER(), '@', -1) |
+-----+
| localhost                                 |
+-----+
```

## 6.3 Using Encrypted Connections

With an unencrypted connection between the MySQL client and the server, someone with access to the network could watch all your traffic and inspect the data being sent or received between client and server.

When you must move information over a network in a secure fashion, an unencrypted connection is unacceptable. To make any kind of data unreadable, use encryption. Encryption algorithms must include security elements to resist many kinds of known attacks such as changing the order of encrypted messages or replaying data twice.

MySQL supports encrypted connections between clients and the server using the TLS (Transport Layer Security) protocol. TLS is sometimes referred to as SSL (Secure Sockets Layer) but MySQL does not actually use the SSL protocol for encrypted connections because its encryption is weak (see [Section 6.3.2, “Encrypted Connection TLS Protocols and Ciphers”](#)).

TLS uses encryption algorithms to ensure that data received over a public network can be trusted. It has mechanisms to detect data change, loss, or replay. TLS also incorporates algorithms that provide identity verification using the X.509 standard.

X.509 makes it possible to identify someone on the Internet. In basic terms, there should be some entity called a “Certificate Authority” (or CA) that assigns electronic certificates to anyone who needs them. Certificates rely on asymmetric encryption algorithms that have two encryption keys (a public key and a secret key). A certificate owner can present the certificate to another party as proof of identity. A certificate consists of its owner's public key. Any data encrypted using this public key can be decrypted only using the corresponding secret key, which is held by the owner of the certificate.

MySQL can be compiled for encrypted-connection support using OpenSSL or yaSSL. For a comparison of the two packages, see [Section 6.3.4, “SSL Library-Dependent Capabilities”](#). For information about the encryption protocols and ciphers each package supports, see [Section 6.3.2, “Encrypted Connection TLS Protocols and Ciphers”](#).

**Note**

It is possible to compile MySQL using yaSSL as an alternative to OpenSSL only prior to MySQL 5.7.28. As of MySQL 5.7.28, support for yaSSL is removed and all MySQL builds use OpenSSL.

By default, MySQL programs attempt to connect using encryption if the server supports encrypted connections, falling back to an unencrypted connection if an encrypted connection cannot be established. For information about options that affect use of encrypted connections, see [Section 6.3.1, “Configuring MySQL to Use Encrypted Connections”](#) and [Command Options for Encrypted Connections](#).

MySQL performs encryption on a per-connection basis, and use of encryption for a given user can be optional or mandatory. This enables you to choose an encrypted or unencrypted connection according to the requirements of individual applications. For information on how to require users to use encrypted connections, see the discussion of the `REQUIRE` clause of the `CREATE USER` statement in [Section 13.7.1.2, “CREATE USER Statement”](#). See also the description of the `require_secure_transport` system variable at [Section 5.1.7, “Server System Variables”](#)

Encrypted connections can be used between source and replica servers. See [Section 16.3.8, “Setting Up Replication to Use Encrypted Connections”](#).

For information about using encrypted connections from the MySQL C API, see [Support for Encrypted Connections](#).

It is also possible to connect using encryption from within an SSH connection to the MySQL server host. For an example, see [Section 6.3.5, “Connecting to MySQL Remotely from Windows with SSH”](#).

Several improvements were made to encrypted-connection support in MySQL 5.7. The following timeline summarizes the changes:

- 5.7.3: On the client side, an explicit `--ssl` option is no longer advisory but prescriptive. Given a server enabled to support encrypted connections, a client program can require an encrypted connection by specifying only the `--ssl` option. (Previously, it was necessary for the client to specify either the `--ssl-ca` option, or all three of the `--ssl-ca`, `--ssl-key`, and `--ssl-cert` options.) The connection attempt fails if an encrypted connection cannot be established. Other `--ssl-xxx` options on the client side are advisory in the absence of `--ssl`: The client attempts to connect using encryption but falls back to an unencrypted connection if an encrypted connection cannot be established.
- 5.7.5: The server-side `--ssl` option value is enabled by default.

For servers compiled using OpenSSL, the `auto_generate_certs` and `sha256_password_auto_generate_rsa_keys` system variables are available to enable autogeneration and autodiscovery of SSL/RSA certificate and key files at startup. For certificate and key autodiscovery, if `--ssl` is enabled and other `--ssl-xxx` options are *not* given to configure encrypted connections explicitly, the server attempts to enable support for encrypted connections automatically at startup if it discovers the requisite certificate and key files in the data directory.

- 5.7.6: The `mysql_ssl_rsa_setup` utility is available to make it easier to manually generate SSL/RSA certificate and key files. Autodiscovery of SSL/RSA files at startup is expanded to apply to all servers, whether compiled using OpenSSL or yaSSL. (This means that `auto_generate_certs` need not be enabled for autodiscovery to occur.)

If the server discovers at startup that the CA certificate is self-signed, it writes a warning to the error log. (The certificate is self-signed if created automatically by the server, or manually using `mysql_ssl_rsa_setup`.)

- 5.7.7: The C client library attempts to establish an encrypted connection by default if the server supports encrypted connections. This affects client programs as follows:
  - In the absence of an `--ssl` option, clients attempt to connect using encryption, falling back to an unencrypted connection if an encrypted connection cannot be established.
  - The presence of an explicit `--ssl` option or a synonym (`--ssl=1`, `--enable-ssl`) is prescriptive: Clients require an encrypted connection and fail if one cannot be established.
  - With an `--ssl=0` option or a synonym (`--skip-ssl`, `--disable-ssl`), clients use an unencrypted connection.

This change also affects subsequent releases of MySQL Connectors that are based on the C client library: Connector/C++ and Connector/ODBC.

- 5.7.8: The `require_secure_transport` system variable is available to control whether client connections to the server must use some form of secure transport.
- 5.7.10: TLS protocol support is extended from TLSv1 to also include TLSv1.1 and TLSv1.2. The `tls_version` system variable on the server side and `--tls-version` option on the client side enable the level of support to be selected. See [Section 6.3.2, “Encrypted Connection TLS Protocols and Ciphers”](#).
- 5.7.11: MySQL client programs support an `--ssl-mode` option that enables you to specify the security state of the connection to the server. The `--ssl-mode` option comprises the capabilities of the client-side `--ssl` and `--ssl-verify-server-cert` options. Consequently, `--ssl` and `--ssl-verify-server-cert` are deprecated, and are removed in MySQL 8.0.
- 5.7.28: Support for yaSSL is removed. All MySQL builds use OpenSSL.
- 5.7.35: The TLSv1 and TLSv1.1 protocols are deprecated.

## 6.3.1 Configuring MySQL to Use Encrypted Connections

Several configuration parameters are available to indicate whether to use encrypted connections, and to specify the appropriate certificate and key files. This section provides general guidance about configuring the server and clients for encrypted connections:

- [Server-Side Startup Configuration for Encrypted Connections](#)
- [Client-Side Configuration for Encrypted Connections](#)
- [Configuring Encrypted Connections as Mandatory](#)

Encrypted connections also can be used in other contexts, as discussed in these additional sections:

- Between source and replica servers. See [Section 16.3.8, “Setting Up Replication to Use Encrypted Connections”](#).
- Among Group Replication servers. See [Section 17.6.2, “Group Replication Secure Socket Layer \(SSL\) Support”](#).
- By client programs that are based on the MySQL C API. See [Support for Encrypted Connections](#).

Instructions for creating any required certificate and key files are available in [Section 6.3.3, “Creating SSL and RSA Certificates and Keys”](#).

## Server-Side Startup Configuration for Encrypted Connections

On the server side, the `--ssl` option specifies that the server permits but does not require encrypted connections. This option is enabled by default, so it need not be specified explicitly.

To require that clients connect using encrypted connections, enable the `require_secure_transport` system variable. See [Configuring Encrypted Connections as Mandatory](#).

These system variables on the server side specify the certificate and key files the server uses when permitting clients to establish encrypted connections:

- `ssl_ca`: The path name of the Certificate Authority (CA) certificate file. (`ssl_capath` is similar but specifies the path name of a directory of CA certificate files.)
- `ssl_cert`: The path name of the server public key certificate file. This certificate can be sent to the client and authenticated against the CA certificate that it has.
- `ssl_key`: The path name of the server private key file.

For example, to enable the server for encrypted connections, start it with these lines in the `my.cnf` file, changing the file names as necessary:

```
[mysqld]
ssl_ca=ca.pem
ssl_cert=server-cert.pem
ssl_key=server-key.pem
```

To specify in addition that clients are required to use encrypted connections, enable the `require_secure_transport` system variable:

```
[mysqld]
ssl_ca=ca.pem
ssl_cert=server-cert.pem
ssl_key=server-key.pem
require_secure_transport=ON
```

Each certificate and key system variable names a file in PEM format. Should you need to create the required certificate and key files, see [Section 6.3.3, “Creating SSL and RSA Certificates and Keys”](#). MySQL servers compiled using OpenSSL can generate missing certificate and key files automatically at startup. See [Section 6.3.3.1, “Creating SSL and RSA Certificates and Keys using MySQL”](#). Alternatively, if you have a MySQL source distribution, you can test your setup using the demonstration certificate and key files in its `mysql-test/std_data` directory.

The server performs certificate and key file autodiscovery. If no explicit encrypted-connection options are given other than `--ssl` (possibly along with `ssl_cipher`) to configure encrypted connections, the server attempts to enable encrypted-connection support automatically at startup:

- If the server discovers valid certificate and key files named `ca.pem`, `server-cert.pem`, and `server-key.pem` in the data directory, it enables support for encrypted connections by clients. (The files need not have been generated automatically; what matters is that they have those names and are valid.)
- If the server does not find valid certificate and key files in the data directory, it continues executing but without support for encrypted connections.

If the server automatically enables encrypted connection support, it writes a note to the error log. If the server discovers that the CA certificate is self-signed, it writes a warning to the error log. (The certificate is self-signed if created automatically by the server or manually using `mysql_ssl_rsa_setup`.)

MySQL also provides these system variables for server-side encrypted-connection control:

- `ssl_cipher`: The list of permissible ciphers for connection encryption.
- `ssl_crl`: The path name of the file containing certificate revocation lists. (`ssl_crlpath` is similar but specifies the path name of a directory of certificate revocation-list files.)
- `tls_version`: Which encryption protocols the server permits for encrypted connections; see [Section 6.3.2, “Encrypted Connection TLS Protocols and Ciphers”](#). For example, you can configure `tls_version` to prevent clients from using less-secure protocols.

## Client-Side Configuration for Encrypted Connections

For a complete list of client options related to establishment of encrypted connections, see [Command Options for Encrypted Connections](#).

By default, MySQL client programs attempt to establish an encrypted connection if the server supports encrypted connections, with further control available through the `--ssl-mode` option:

- In the absence of an `--ssl-mode` option, clients attempt to connect using encryption, falling back to an unencrypted connection if an encrypted connection cannot be established. This is also the behavior with an explicit `--ssl-mode=PREFERRED` option.
- With `--ssl-mode=REQUIRED`, clients require an encrypted connection and fail if one cannot be established.
- With `--ssl-mode=DISABLED`, clients use an unencrypted connection.
- With `--ssl-mode=VERIFY_CA` or `--ssl-mode=VERIFY_IDENTITY`, clients require an encrypted connection, and also perform verification against the server CA certificate and (with `VERIFY_IDENTITY`) against the server host name in its certificate.



### Important

The default setting, `--ssl-mode=PREFERRED`, produces an encrypted connection if the other default settings are unchanged. However, to help prevent sophisticated man-in-the-middle attacks, it is important for the client to verify the server's identity. The settings `--ssl-mode=VERIFY_CA` and `--ssl-mode=VERIFY_IDENTITY` are a better choice than the default setting to help prevent this type of attack. `VERIFY_CA` makes the client check that the server's certificate is valid. `VERIFY_IDENTITY` makes the client check that the server's certificate is valid, and also makes the client check that the host name the client is using matches the identity in the server's certificate. To implement one of these settings, you must first ensure that the CA certificate for the server is reliably available to all the clients that use it in your environment, otherwise availability issues will result. For this reason, they are not the default setting.

Attempts to establish an unencrypted connection fail if the `require_secure_transport` system variable is enabled on the server side to cause the server to require encrypted connections. See [Configuring Encrypted Connections as Mandatory](#).

The following options on the client side identify the certificate and key files clients use when establishing encrypted connections to the server. They are similar to the `ssl_ca`, `ssl_cert`, and `ssl_key` system variables used on the server side, but `--ssl-cert` and `--ssl-key` identify the client public and private key:

- `--ssl-ca`: The path name of the Certificate Authority (CA) certificate file. This option, if used, must specify the same certificate used by the server. (`--ssl-capath` is similar but specifies the path name of a directory of CA certificate files.)

- `--ssl-cert`: The path name of the client public key certificate file.
- `--ssl-key`: The path name of the client private key file.

For additional security relative to that provided by the default encryption, clients can supply a CA certificate matching the one used by the server and enable host name identity verification. In this way, the server and client place their trust in the same CA certificate and the client verifies that the host to which it connected is the one intended:

- To specify the CA certificate, use `--ssl-ca` (or `--ssl-capath`), and specify `--ssl-mode=VERIFY_CA`.
- To enable host name identity verification as well, use `--ssl-mode=VERIFY_IDENTITY` rather than `--ssl-mode=VERIFY_CA`.



#### Note

Host name identity verification with `VERIFY_IDENTITY` does not work with self-signed certificates that are created automatically by the server or manually using `mysql_ssl_rsa_setup` (see [Section 6.3.3.1, “Creating SSL and RSA Certificates and Keys using MySQL”](#)). Such self-signed certificates do not contain the server name as the Common Name value.

Prior to MySQL 5.7.23, host name identity verification also does not work with certificates that specify the Common Name using wildcards because that name is compared verbatim to the server name.

MySQL also provides these options for client-side encrypted-connection control:

- `--ssl-cipher`: The list of permissible ciphers for connection encryption.
- `--ssl-crl`: The path name of the file containing certificate revocation lists. (`--ssl-crlpath` is similar but specifies the path name of a directory of certificate revocation-list files.)
- `--tls-version`: The permitted encryption protocols; see [Section 6.3.2, “Encrypted Connection TLS Protocols and Ciphers”](#).

Depending on the encryption requirements of the MySQL account used by a client, the client may be required to specify certain options to connect using encryption to the MySQL server.

Suppose that you want to connect using an account that has no special encryption requirements or that was created using a `CREATE USER` statement that included the `REQUIRE SSL` clause. Assuming that the server supports encrypted connections, a client can connect using encryption with no `--ssl-mode` option or with an explicit `--ssl-mode=PREFERRED` option:

```
mysql
```

Or:

```
mysql --ssl-mode=PREFERRED
```

For an account created with a `REQUIRE SSL` clause, the connection attempt fails if an encrypted connection cannot be established. For an account with no special encryption requirements, the attempt falls back to an unencrypted connection if an encrypted connection cannot be established. To prevent fallback and fail if an encrypted connection cannot be obtained, connect like this:

```
mysql --ssl-mode=REQUIRED
```

If the account has more stringent security requirements, other options must be specified to establish an encrypted connection:

- For accounts created with a `REQUIRE X509` clause, clients must specify at least `--ssl-cert` and `--ssl-key`. In addition, `--ssl-ca` (or `--ssl-capath`) is recommended so that the public certificate provided by the server can be verified. For example (enter the command on a single line):

```
mysql --ssl-ca=ca.pem
      --ssl-cert=client-cert.pem
      --ssl-key=client-key.pem
```

- For accounts created with a `REQUIRE ISSUER` or `REQUIRE SUBJECT` clause, the encryption requirements are the same as for `REQUIRE X509`, but the certificate must match the issue or subject, respectively, specified in the account definition.

For additional information about the `REQUIRE` clause, see [Section 13.7.1.2, “CREATE USER Statement”](#).

MySQL servers can generate client certificate and key files that clients can use to connect to MySQL server instances. See [Section 6.3.3, “Creating SSL and RSA Certificates and Keys”](#).



### Important

If a client connecting to a MySQL server instance uses an SSL certificate with the `extendedKeyUsage` extension (an X.509 v3 extension), the extended key usage must include client authentication (`clientAuth`). If the SSL certificate is only specified for server authentication (`serverAuth`) and other non-client certificate purposes, certificate verification fails and the client connection to the MySQL server instance fails. There is no `extendedKeyUsage` extension in SSL certificates generated by MySQL Server (as described in [Section 6.3.3.1, “Creating SSL and RSA Certificates and Keys using MySQL”](#)), and SSL certificates created using the `openssl` command following the instructions in [Section 6.3.3.2, “Creating SSL Certificates and Keys Using openssl”](#). If you use your own client certificate created in another way, ensure any `extendedKeyUsage` extension includes client authentication.

To prevent use of encryption and override other `--ssl-xxx` options, invoke the client program with `--ssl-mode=DISABLED`:

```
mysql --ssl-mode=DISABLED
```

To determine whether the current connection with the server uses encryption, check the session value of the `Ssl_cipher` status variable. If the value is empty, the connection is not encrypted. Otherwise, the connection is encrypted and the value indicates the encryption cipher. For example:

```
mysql> SHOW SESSION STATUS LIKE 'Ssl_cipher';
+-----+-----+
| Variable_name | Value                               |
+-----+-----+
| Ssl_cipher    | DHE-RSA-AES128-GCM-SHA256         |
+-----+-----+
```

For the `mysql` client, an alternative is to use the `STATUS` or `\s` command and check the `SSL` line:

```
mysql> \s
...
SSL: Not in use
...
```

Or:



```
mysql> \s
...
SSL: Cipher in use is DHE-RSA-AES128-GCM-SHA256
...
```

## Configuring Encrypted Connections as Mandatory

For some MySQL deployments it may be not only desirable but mandatory to use encrypted connections (for example, to satisfy regulatory requirements). This section discusses configuration settings that enable you to do this. These levels of control are available:

- You can configure the server to require that clients connect using encrypted connections.
- You can invoke individual client programs to require an encrypted connection, even if the server permits but does not require encryption.
- You can configure individual MySQL accounts to be usable only over encrypted connections.

To require that clients connect using encrypted connections, enable the `require_secure_transport` system variable. For example, put these lines in the server `my.cnf` file:

```
[mysqld]
require_secure_transport=ON
```

With `require_secure_transport` enabled, client connections to the server are required to use some form of secure transport, and the server permits only TCP/IP connections that use SSL, or connections that use a socket file (on Unix) or shared memory (on Windows). The server rejects nonsecure connection attempts, which fail with an `ER_SECURE_TRANSPORT_REQUIRED` error.

To invoke a client program such that it requires an encrypted connection whether or not the server requires encryption, use an `--ssl-mode` option value of `REQUIRED`, `VERIFY_CA`, or `VERIFY_IDENTITY`. For example:

```
mysql --ssl-mode=REQUIRED
mysqldump --ssl-mode=VERIFY_CA
mysqladmin --ssl-mode=VERIFY_IDENTITY
```

To configure a MySQL account to be usable only over encrypted connections, include a `REQUIRE` clause in the `CREATE USER` statement that creates the account, specifying in that clause the encryption characteristics you require. For example, to require an encrypted connection and the use of a valid X.509 certificate, use `REQUIRE X509`:

```
CREATE USER 'jeffrey'@'localhost' REQUIRE X509;
```

For additional information about the `REQUIRE` clause, see [Section 13.7.1.2, “CREATE USER Statement”](#).

To modify existing accounts that have no encryption requirements, use the `ALTER USER` statement.

## 6.3.2 Encrypted Connection TLS Protocols and Ciphers

MySQL supports multiple TLS protocols and ciphers, and enables configuring which protocols and ciphers to permit for encrypted connections. It is also possible to determine which protocol and cipher the current session uses.

- [Supported Connection TLS Protocols](#)
- [Connection TLS Protocol Configuration](#)

- [Deprecated TLS Protocols](#)
- [Connection Cipher Configuration](#)
- [Connection TLS Protocol Negotiation](#)
- [Monitoring Current Client Session TLS Protocol and Cipher](#)

## Supported Connection TLS Protocols

MySQL supports encrypted connections using the TLSv1, TLSv1.1, and TLSv1.2 protocols, listed in order from less secure to more secure. The set of protocols actually permitted for connections is subject to multiple factors:

- MySQL configuration. Permitted TLS protocols can be configured on both the server side and client side to include only a subset of the supported TLS protocols. The configuration on both sides must include at least one protocol in common or connection attempts cannot negotiate a protocol to use. For details, see [Connection TLS Protocol Negotiation](#).
- System-wide host configuration. The host system may permit only certain TLS protocols, which means that MySQL connections cannot use nonpermitted protocols even if MySQL itself permits them:
  - Suppose that MySQL configuration permits TLSv1, TLSv1.1, and TLSv1.2, but your host system configuration permits only connections that use TLSv1.2 or higher. In this case, you cannot establish MySQL connections that use TLSv1 or TLSv1.1, even though MySQL is configured to permit them, because the host system does not permit them.
  - If MySQL configuration permits TLSv1, TLSv1.1, and TLSv1.2, but your host system configuration permits only connections that use TLSv1.3 or higher, you cannot establish MySQL connections at all, because no protocol permitted by MySQL is permitted by the host system.

Workarounds for this issue include:

- Change the system-wide host configuration to permit additional TLS protocols. Consult your operating system documentation for instructions. For example, your system may have an `/etc/ssl/openssl.cnf` file that contains these lines to restrict TLS protocols to TLSv1.2 or higher:

```
[system_default_sect]
MinProtocol = TLSv1.2
```

Changing the value to a lower protocol version or `None` makes the system more permissive. This workaround has the disadvantage that permitting lower (less secure) protocols may have adverse security consequences.

- If you cannot or prefer not to change the host system TLS configuration, change MySQL applications to use higher (more secure) TLS protocols that are permitted by the host system. This may not be possible for older versions of MySQL that support only lower protocol versions. For example, TLSv1 is the only supported protocol prior to MySQL 5.6.46, so attempts to connect to a pre-5.6.46 server fail even if the client is from a newer MySQL version that supports higher protocol versions. In such cases, an upgrade to a version of MySQL that supports additional TLS versions may be required.
- The SSL library. If the SSL library does not support a particular protocol, neither does MySQL, and any parts of the following discussion that specify that protocol do not apply.
  - When compiled using OpenSSL 1.0.1 or higher, MySQL supports the TLSv1, TLSv1.1, and TLSv1.2 protocols.
  - When compiled using yaSSL, MySQL supports the TLSv1 and TLSv1.1 protocols.

**Note**

It is possible to compile MySQL using yaSSL as an alternative to OpenSSL only prior to MySQL 5.7.28. As of MySQL 5.7.28, support for yaSSL is removed and all MySQL builds use OpenSSL.

**Connection TLS Protocol Configuration**

On the server side, the value of the `tls_version` system variable determines which TLS protocols a MySQL server permits for encrypted connections. The `tls_version` value applies to connections from clients and from replica servers using regular source/replica replication. The variable value is a list of one or more comma-separated protocol versions from this list (not case-sensitive): TLSv1, TLSv1.1, TLSv1.2. By default, this variable lists all protocols supported by the SSL library used to compile MySQL (`TLSv1,TLSv1.1,TLSv1.2` for OpenSSL, `TLSv1,TLSv1.1` for yaSSL). To determine the value of `tls_version` at runtime, use this statement:

```
mysql> SHOW GLOBAL VARIABLES LIKE 'tls_version';
+-----+-----+
| Variable_name | Value                               |
+-----+-----+
| tls_version   | TLSv1,TLSv1.1,TLSv1.2             |
+-----+-----+
```

To change the value of `tls_version`, set it at server startup. For example, to permit connections that use the TLSv1.1 or TLSv1.2 protocol, but prohibit connections that use the less-secure TLSv1 protocol, use these lines in the server `my.cnf` file:

```
[mysqld]
tls_version=TLSv1.1,TLSv1.2
```

To be even more restrictive and permit only TLSv1.2 connections, set `tls_version` like this (assuming that your server is compiled using OpenSSL because yaSSL does not support TLSv1.2):

```
[mysqld]
tls_version=TLSv1.2
```

**Note**

As of MySQL 5.7.35, the TLSv1 and TLSv1.1 connection protocols are deprecated and support for them is subject to removal in a future version of MySQL. See [Deprecated TLS Protocols](#).

On the client side, the `--tls-version` option specifies which TLS protocols a client program permits for connections to the server. The format of the option value is the same as for the `tls_version` system variable described previously (a list of one or more comma-separated protocol versions).

For source/replica replication, the `MASTER_TLS_VERSION` option for the `CHANGE MASTER TO` statement specifies which TLS protocols a replica server permits for connections to the source. The format of the option value is the same as for the `tls_version` system variable described previously. See [Section 16.3.8, “Setting Up Replication to Use Encrypted Connections”](#).

The protocols that can be specified for `MASTER_TLS_VERSION` depend on the SSL library. This option is independent of and not affected by the server `tls_version` value. For example, a server that acts as a replica can be configured with `tls_version` set to TLSv1.2 to permit only incoming connections that use TLSv1.2, but also configured with `MASTER_TLS_VERSION` set to TLSv1.1 to permit only TLSv1.1 for outgoing replica connections to the source.

TLS protocol configuration affects which protocol a given connection uses, as described in [Connection TLS Protocol Negotiation](#).

Permitted protocols should be chosen such as not to leave “holes” in the list. For example, these server configuration values do not have holes:

```
tls_version=TLSv1,TLSv1.1,TLSv1.2
tls_version=TLSv1.1,TLSv1.2
tls_version=TLSv1.2
```

This value does have a hole and should not be used:

```
tls_version=TLSv1,TLSv1.2      (TLSv1.1 is missing)
```

The prohibition on holes also applies in other configuration contexts, such as for clients or replicas.

Unless you intend to disable encrypted connections, the list of permitted protocols should not be empty. If you set a TLS version parameter to the empty string, encrypted connections cannot be established:

- `tls_version`: The server does not permit encrypted incoming connections.
- `--tls-version`: The client does not permit encrypted outgoing connections to the server.
- `MASTER_TLS_VERSION`: The replica does not permit encrypted outgoing connections to the source.

## Deprecated TLS Protocols

As of MySQL 5.7.35, the TLSv1 and TLSv1.1 connection protocols are deprecated and support for them is subject to removal in a future MySQL version. (For background, refer to the IETF memo [Deprecating TLSv1.0 and TLSv1.1](#).) It is recommended that connections be made using the more-secure TLSv1.2 and TLSv1.3 protocols. TLSv1.3 requires that both the MySQL server and the client application be compiled with OpenSSL 1.1.1 or higher.

On the server side, this deprecation has the following effects:

- If the `tls_version` system variable is assigned a value containing a deprecated TLS protocol during server startup, the server writes a warning for each deprecated protocol to the error log.
- If a client successfully connects using a deprecated TLS protocol, the server writes a warning to the error log.

On the client side, the deprecation has no visible effect. Clients do not issue a warning if configured to permit a deprecated TLS protocol. This includes:

- Client programs that support a `--tls-version` option for specifying TLS protocols for connections to the MySQL server.
- Statements that enable replicas to specify TLS protocols for connections to the source server. ([CHANGE MASTER TO](#) has a `MASTER_TLS_VERSION` option.)

## Connection Cipher Configuration

A default set of ciphers applies to encrypted connections, which can be overridden by explicitly configuring the permitted ciphers. During connection establishment, both sides of a connection must permit some cipher in common or the connection fails. Of the permitted ciphers common to both sides, the SSL library chooses the one supported by the provided certificate that has the highest priority.

To specify a cipher or ciphers for encrypted connections, set the `ssl_cipher` system variable on the server side, and use the `--ssl-cipher` option for client programs.

For source/replica replication connections, where this server instance is the source, set the `ssl_cipher` system variable. Where this server instance is the replica, use the `MASTER_SSL_CIPHER` option for

the `CHANGE MASTER TO` statement. See [Section 16.3.8, “Setting Up Replication to Use Encrypted Connections”](#).

A given cipher may work only with particular TLS protocols, which affects the TLS protocol negotiation process. See [Connection TLS Protocol Negotiation](#).

To determine which ciphers a given server supports, check the session value of the `Ssl_cipher_list` status variable:

```
SHOW SESSION STATUS LIKE 'Ssl_cipher_list';
```

The `Ssl_cipher_list` status variable lists the possible SSL ciphers (empty for non-SSL connections). The set of available ciphers depends on your MySQL version and whether MySQL was compiled using OpenSSL or yaSSL, and (for OpenSSL) the library version used to compile MySQL.



#### Note

ECDSA ciphers only work in combination with an SSL certificate that uses ECDSA for the digital signature, and they do not work with certificates that use RSA. MySQL Server’s automatic generation process for SSL certificates does not generate ECDSA signed certificates, it generates only RSA signed certificates. Do not select ECDSA ciphers unless you have an ECDSA certificate available to you.

MySQL passes a default cipher list to the SSL library.

MySQL passes this default cipher list to OpenSSL:

```
ECDHE-ECDSA-AES128-GCM-SHA256
ECDHE-ECDSA-AES256-GCM-SHA384
ECDHE-RSA-AES128-GCM-SHA256
ECDHE-RSA-AES256-GCM-SHA384
ECDHE-ECDSA-AES128-SHA256
ECDHE-RSA-AES128-SHA256
ECDHE-ECDSA-AES256-SHA384
ECDHE-RSA-AES256-SHA384
DHE-RSA-AES128-GCM-SHA256
DHE-DSS-AES128-GCM-SHA256
DHE-RSA-AES128-SHA256
DHE-DSS-AES128-SHA256
DHE-DSS-AES256-GCM-SHA384
DHE-RSA-AES256-SHA256
DHE-DSS-AES256-SHA256
ECDHE-RSA-AES128-SHA
ECDHE-ECDSA-AES128-SHA
ECDHE-RSA-AES256-SHA
ECDHE-ECDSA-AES256-SHA
DHE-DSS-AES128-SHA
DHE-RSA-AES128-SHA
TLS_DHE_DSS_WITH_AES_256_CBC_SHA
DHE-RSA-AES256-SHA
AES128-GCM-SHA256
DH-DSS-AES128-GCM-SHA256
ECDH-ECDSA-AES128-GCM-SHA256
AES256-GCM-SHA384
DH-DSS-AES256-GCM-SHA384
ECDH-ECDSA-AES256-GCM-SHA384
AES128-SHA256
DH-DSS-AES128-SHA256
ECDH-ECDSA-AES128-SHA256
AES256-SHA256
DH-DSS-AES256-SHA256
ECDH-ECDSA-AES256-SHA384
AES128-SHA
DH-DSS-AES128-SHA
```

```

ECDH-ECDSA-AES128-SHA
AES256-SHA
DH-DSS-AES256-SHA
ECDH-ECDSA-AES256-SHA
DHE-RSA-AES256-GCM-SHA384
DH-RSA-AES128-GCM-SHA256
ECDH-RSA-AES128-GCM-SHA256
DH-RSA-AES256-GCM-SHA384
ECDH-RSA-AES256-GCM-SHA384
DH-RSA-AES128-SHA256
ECDH-RSA-AES128-SHA256
DH-RSA-AES256-SHA256
ECDH-RSA-AES256-SHA384
ECDHE-RSA-AES128-SHA
ECDHE-ECDSA-AES128-SHA
ECDHE-RSA-AES256-SHA
ECDHE-ECDSA-AES256-SHA
DHE-DSS-AES128-SHA
DHE-RSA-AES128-SHA
TLS_DHE_DSS_WITH_AES_256_CBC_SHA
DHE-RSA-AES256-SHA
AES128-SHA
DH-DSS-AES128-SHA
ECDH-ECDSA-AES128-SHA
AES256-SHA
DH-DSS-AES256-SHA
ECDH-ECDSA-AES256-SHA
DH-RSA-AES128-SHA
ECDH-RSA-AES128-SHA
DH-RSA-AES256-SHA
ECDH-RSA-AES256-SHA
DES-CBC3-SHA
    
```

MySQL passes this default cipher list to yaSSL:

```

DHE-RSA-AES256-SHA
DHE-RSA-AES128-SHA
AES128-RMD
DES-CBC3-RMD
DHE-RSA-AES256-RMD
DHE-RSA-AES128-RMD
DHE-RSA-DES-CBC3-RMD
AES256-SHA
RC4-SHA
RC4-MD5
DES-CBC3-SHA
DES-CBC-SHA
EDH-RSA-DES-CBC3-SHA
EDH-RSA-DES-CBC-SHA
AES128-SHA:AES256-RMD
    
```

As of MySQL 5.7.10, these cipher restrictions are in place:

- The following ciphers are permanently restricted:

```

!DHE-DSS-DES-CBC3-SHA
!DHE-RSA-DES-CBC3-SHA
!ECDH-RSA-DES-CBC3-SHA
!ECDH-ECDSA-DES-CBC3-SHA
!ECDHE-RSA-DES-CBC3-SHA
!ECDHE-ECDSA-DES-CBC3-SHA
    
```

- The following categories of ciphers are permanently restricted:

```

!aNULL
!eNULL
!EXPORT
    
```

```
!LOW
!MD5
!DES
!RC2
!RC4
!PSK
!SSLv3
```

If the server is started with the `ssl_cert` system variable set to a certificate that uses any of the preceding restricted ciphers or cipher categories, the server starts with support for encrypted connections disabled.

## Connection TLS Protocol Negotiation

Connection attempts in MySQL negotiate use of the highest TLS protocol version available on both sides for which a protocol-compatible encryption cipher is available on both sides. The negotiation process depends on factors such as the SSL library used to compile the server and client, the TLS protocol and encryption cipher configuration, and which key size is used:

- For a connection attempt to succeed, the server and client TLS protocol configuration must permit some protocol in common.
- Similarly, the server and client encryption cipher configuration must permit some cipher in common. A given cipher may work only with particular TLS protocols, so a protocol available to the negotiation process is not chosen unless there is also a compatible cipher.
- If the server and client are compiled using OpenSSL, TLSv1.2 is used if possible. If either or both the server and client are compiled using yaSSL, TLSv1.1 is used if possible. (“Possible” means that server and client configuration both must permit the indicated protocol, and both must also permit some protocol-compatible encryption cipher.) Otherwise, MySQL continues through the list of available protocols, proceeding from more secure protocols to less secure. Negotiation order is independent of the order in which protocols are configured. For example, negotiation order is the same regardless of whether `tls_version` has a value of `TLSv1`, `TLSv1.1`, `TLSv1.2` or `TLSv1.2`, `TLSv1.1`, `TLSv1`.



### Note

Prior to MySQL 5.7.10, MySQL supports only TLSv1, for both OpenSSL and yaSSL, and no system variable or client option exist for specifying which TLS protocols to permit.

- TLSv1.2 does not work with all ciphers that have a key size of 512 bits or less. To use this protocol with such a key, set the `ssl_cipher` system variable on the server side or use the `--ssl-cipher` client option to specify the cipher name explicitly:

```
AES128-SHA
AES128-SHA256
AES256-SHA
AES256-SHA256
CAMELLIA128-SHA
CAMELLIA256-SHA
DES-CBC3-SHA
DHE-RSA-AES256-SHA
RC4-MD5
RC4-SHA
SEED-SHA
```

- For better security, use a certificate with an RSA key size of at least 2048 bits.

If the server and client do not have a permitted protocol in common, and a protocol-compatible cipher in common, the server terminates the connection request. Examples:

- If the server is configured with `tls_version=TLSv1.1,TLSv1.2`:
  - Connection attempts fail for clients invoked with `--tls-version=TLSv1`, and for older clients that support only TLSv1.
  - Similarly, connection attempts fail for replicas configured with `MASTER_TLS_VERSION = 'TLSv1'`, and for older replicas that support only TLSv1.
- If the server is configured with `tls_version=TLSv1` or is an older server that supports only TLSv1:
  - Connection attempts fail for clients invoked with `--tls-version=TLSv1.1,TLSv1.2`.
  - Similarly, connection attempts fail for replicas configured with `MASTER_TLS_VERSION = 'TLSv1.1,TLSv1.2'`.

MySQL permits specifying a list of protocols to support. This list is passed directly down to the underlying SSL library and is ultimately up to that library what protocols it actually enables from the supplied list. Please refer to the MySQL source code and the OpenSSL `SSL_CTX_new()` documentation for information about how the SSL library handles this.

## Monitoring Current Client Session TLS Protocol and Cipher

To determine which encryption TLS protocol and cipher the current client session uses, check the session values of the `Ssl_version` and `Ssl_cipher` status variables:

```
mysql> SELECT * FROM performance_schema.session_status
      WHERE VARIABLE_NAME IN ('Ssl_version','Ssl_cipher');
```

VARIABLE_NAME	VARIABLE_VALUE
Ssl_cipher	DHE-RSA-AES128-GCM-SHA256
Ssl_version	TLSv1.2

If the connection is not encrypted, both variables have an empty value.

## 6.3.3 Creating SSL and RSA Certificates and Keys

The following discussion describes how to create the files required for SSL and RSA support in MySQL. File creation can be performed using facilities provided by MySQL itself, or by invoking the `openssl` command directly.

SSL certificate and key files enable MySQL to support encrypted connections using SSL. See [Section 6.3.1, “Configuring MySQL to Use Encrypted Connections”](#).

RSA key files enable MySQL to support secure password exchange over unencrypted connections for accounts authenticated by the `sha256_password` plugin. See [Section 6.4.1.5, “SHA-256 Pluggable Authentication”](#).

### 6.3.3.1 Creating SSL and RSA Certificates and Keys using MySQL

MySQL provides these ways to create the SSL certificate and key files and RSA key-pair files required to support encrypted connections using SSL and secure password exchange using RSA over unencrypted connections, if those files are missing:

- The server can autogenerate these files at startup, for MySQL distributions compiled using OpenSSL.
- Users can invoke the `mysql_ssl_rsa_setup` utility manually.



- For some distribution types, such as RPM and DEB packages, `mysql_ssl_rsa_setup` invocation occurs during data directory initialization. In this case, the MySQL distribution need not have been compiled using OpenSSL as long as the `openssl` command is available.



### Important

Server autogeneration and `mysql_ssl_rsa_setup` help lower the barrier to using SSL by making it easier to generate the required files. However, certificates generated by these methods are self-signed, which may not be very secure. After you gain experience using such files, consider obtaining certificate/key material from a registered certificate authority.



### Important

If a client connecting to a MySQL server instance uses an SSL certificate with the `extendedKeyUsage` extension (an X.509 v3 extension), the extended key usage must include client authentication (`clientAuth`). If the SSL certificate is only specified for server authentication (`serverAuth`) and other non-client certificate purposes, certificate verification fails and the client connection to the MySQL server instance fails. There is no `extendedKeyUsage` extension in SSL certificates generated by MySQL Server. If you use your own client certificate created in another way, ensure any `extendedKeyUsage` extension includes client authentication.

- [Automatic SSL and RSA File Generation](#)
- [Manual SSL and RSA File Generation Using `mysql\_ssl\_rsa\_setup`](#)
- [SSL and RSA File Characteristics](#)

## Automatic SSL and RSA File Generation

For MySQL distributions compiled using OpenSSL, the MySQL server has the capability of automatically generating missing SSL and RSA files at startup. The `auto_generate_certs` and `sha256_password_auto_generate_rsa_keys` system variables control automatic generation of these files. These variables are enabled by default. They can be enabled at startup and inspected but not set at runtime.

At startup, the server automatically generates server-side and client-side SSL certificate and key files in the data directory if the `auto_generate_certs` system variable is enabled, no SSL options other than `--ssl` are specified, and the server-side SSL files are missing from the data directory. These files enable encrypted client connections using SSL; see [Section 6.3.1, “Configuring MySQL to Use Encrypted Connections”](#).

1. The server checks the data directory for SSL files with the following names:

```
ca.pem
server-cert.pem
server-key.pem
```

2. If any of those files are present, the server creates no SSL files. Otherwise, it creates them, plus some additional files:

<code>ca.pem</code>	Self-signed CA certificate
<code>ca-key.pem</code>	CA private key
<code>server-cert.pem</code>	Server certificate
<code>server-key.pem</code>	Server private key
<code>client-cert.pem</code>	Client certificate
<code>client-key.pem</code>	Client private key

3. If the server autogenerates SSL files, it uses the names of the `ca.pem`, `server-cert.pem`, and `server-key.pem` files to set the corresponding system variables (`ssl_ca`, `ssl_cert`, `ssl_key`).

At startup, the server automatically generates RSA private/public key-pair files in the data directory if all of these conditions are true: The `sha256_password_auto_generate_rsa_keys` system variable is enabled; no RSA options are specified; the RSA files are missing from the data directory. These key-pair files enable secure password exchange using RSA over unencrypted connections for accounts authenticated by the `sha256_password` plugin; see [Section 6.4.1.5, “SHA-256 Pluggable Authentication”](#).

1. The server checks the data directory for RSA files with the following names:

```
private_key.pem      Private member of private/public key pair
public_key.pem      Public member of private/public key pair
```

2. If any of these files are present, the server creates no RSA files. Otherwise, it creates them.
3. If the server autogenerates the RSA files, it uses their names to set the corresponding system variables (`sha256_password_private_key_path`, `sha256_password_public_key_path`).

## Manual SSL and RSA File Generation Using `mysql_ssl_rsa_setup`

MySQL distributions include a `mysql_ssl_rsa_setup` utility that can be invoked manually to generate SSL and RSA files. This utility is included with all MySQL distributions, but it does require that the `openssl` command be available. For usage instructions, see [Section 4.4.5, “mysql\\_ssl\\_rsa\\_setup — Create SSL/RSA Files”](#).

## SSL and RSA File Characteristics

SSL and RSA files created automatically by the server or by invoking `mysql_ssl_rsa_setup` have these characteristics:

- SSL and RSA keys have a size of 2048 bits.
- The SSL CA certificate is self signed.
- The SSL server and client certificates are signed with the CA certificate and key, using the `sha256WithRSAEncryption` signature algorithm.
- SSL certificates use these Common Name (CN) values, with the appropriate certificate type (CA, Server, Client):

```
ca.pem:           MySQL_Server_suffix_Auto_Generated_CA_Certificate
server-cert.pm:  MySQL_Server_suffix_Auto_Generated_Server_Certificate
client-cert.pm:  MySQL_Server_suffix_Auto_Generated_Client_Certificate
```

The `suffix` value is based on the MySQL version number. For files generated by `mysql_ssl_rsa_setup`, the suffix can be specified explicitly using the `--suffix` option.

For files generated by the server, if the resulting CN values exceed 64 characters, the `_suffix` portion of the name is omitted.

- SSL files have blank values for Country (C), State or Province (ST), Organization (O), Organization Unit Name (OU) and email address.
- SSL files created by the server or by `mysql_ssl_rsa_setup` are valid for ten years from the time of generation.
- RSA files do not expire.
- SSL files have different serial numbers for each certificate/key pair (1 for CA, 2 for Server, 3 for Client).

- Files created automatically by the server are owned by the account that runs the server. Files created using `mysql_ssl_rsa_setup` are owned by the user who invoked that program. This can be changed on systems that support the `chown()` system call if the program is invoked by `root` and the `--uid` option is given to specify the user who should own the files.
- On Unix and Unix-like systems, the file access mode is 644 for certificate files (that is, world readable) and 600 for key files (that is, accessible only by the account that runs the server).

To see the contents of an SSL certificate (for example, to check the range of dates over which it is valid), invoke `openssl` directly:

```
openssl x509 -text -in ca.pem
openssl x509 -text -in server-cert.pem
openssl x509 -text -in client-cert.pem
```

It is also possible to check SSL certificate expiration information using this SQL statement:

```
mysql> SHOW STATUS LIKE 'Ssl_server_not%';
+-----+-----+
| Variable_name | Value |
+-----+-----+
| Ssl_server_not_after | Apr 28 14:16:39 2027 GMT |
| Ssl_server_not_before | May 1 14:16:39 2017 GMT |
+-----+-----+
```

### 6.3.3.2 Creating SSL Certificates and Keys Using openssl

This section describes how to use the `openssl` command to set up SSL certificate and key files for use by MySQL servers and clients. The first example shows a simplified procedure such as you might use from the command line. The second shows a script that contains more detail. The first two examples are intended for use on Unix and both use the `openssl` command that is part of OpenSSL. The third example describes how to set up SSL files on Windows.



#### Note

There are easier alternatives to generating the files required for SSL than the procedure described here: Let the server autogenerate them or use the `mysql_ssl_rsa_setup` program. See [Section 6.3.3.1, “Creating SSL and RSA Certificates and Keys using MySQL”](#).



#### Important

Whatever method you use to generate the certificate and key files, the Common Name value used for the server and client certificates/keys must each differ from the Common Name value used for the CA certificate. Otherwise, the certificate and key files do not work for servers compiled using OpenSSL. A typical error in this case is:

```
ERROR 2026 (HY000): SSL connection error:
error:00000001:lib(0):func(0):reason(1)
```



#### Important

If a client connecting to a MySQL server instance uses an SSL certificate with the `extendedKeyUsage` extension (an X.509 v3 extension), the extended key usage must include client authentication (`clientAuth`). If the SSL certificate is only specified for server authentication (`serverAuth`) and other non-client certificate purposes, certificate verification fails and the client connection to the MySQL server instance fails. There is no `extendedKeyUsage` extension in SSL

certificates created using the `openssl` command following the instructions in this topic. If you use your own client certificate created in another way, ensure any `extendedKeyUsage` extension includes client authentication.

- [Example 1: Creating SSL Files from the Command Line on Unix](#)
- [Example 2: Creating SSL Files Using a Script on Unix](#)
- [Example 3: Creating SSL Files on Windows](#)

### Example 1: Creating SSL Files from the Command Line on Unix

The following example shows a set of commands to create MySQL server and client certificate and key files. You must respond to several prompts by the `openssl` commands. To generate test files, you can press Enter to all prompts. To generate files for production use, you should provide nonempty responses.

```
# Create clean environment
rm -rf newcerts
mkdir newcerts && cd newcerts

# Create CA certificate
openssl genrsa 2048 > ca-key.pem
openssl req -new -x509 -nodes -days 3600 \
    -key ca-key.pem -out ca.pem

# Create server certificate, remove passphrase, and sign it
# server-cert.pem = public key, server-key.pem = private key
openssl req -newkey rsa:2048 -days 3600 \
    -nodes -keyout server-key.pem -out server-req.pem
openssl rsa -in server-key.pem -out server-key.pem
openssl x509 -req -in server-req.pem -days 3600 \
    -CA ca.pem -CAkey ca-key.pem -set_serial 01 -out server-cert.pem

# Create client certificate, remove passphrase, and sign it
# client-cert.pem = public key, client-key.pem = private key
openssl req -newkey rsa:2048 -days 3600 \
    -nodes -keyout client-key.pem -out client-req.pem
openssl rsa -in client-key.pem -out client-key.pem
openssl x509 -req -in client-req.pem -days 3600 \
    -CA ca.pem -CAkey ca-key.pem -set_serial 01 -out client-cert.pem
```

After generating the certificates, verify them:

```
openssl verify -CAfile ca.pem server-cert.pem client-cert.pem
```

You should see a response like this:

```
server-cert.pem: OK
client-cert.pem: OK
```

To see the contents of a certificate (for example, to check the range of dates over which a certificate is valid), invoke `openssl` like this:

```
openssl x509 -text -in ca.pem
openssl x509 -text -in server-cert.pem
openssl x509 -text -in client-cert.pem
```

Now you have a set of files that can be used as follows:

- `ca.pem`: Use this to set the `ssl_ca` system variable on the server side and the `--ssl-ca` option on the client side. (The CA certificate, if used, must be the same on both sides.)
- `server-cert.pem`, `server-key.pem`: Use these to set the `ssl_cert` and `ssl_key` system variables on the server side.

- `client-cert.pem`, `client-key.pem`: Use these as the arguments to the `--ssl-cert` and `--ssl-key` options on the client side.

For additional usage instructions, see [Section 6.3.1, “Configuring MySQL to Use Encrypted Connections”](#).

## Example 2: Creating SSL Files Using a Script on Unix

Here is an example script that shows how to set up SSL certificate and key files for MySQL. After executing the script, use the files for SSL connections as described in [Section 6.3.1, “Configuring MySQL to Use Encrypted Connections”](#).

```

DIR=`pwd`/openssl
PRIV=$DIR/private

mkdir $DIR $PRIV $DIR/newcerts
cp /usr/share/ssl/openssl.cnf $DIR
replace ./demoCA $DIR -- $DIR/openssl.cnf

# Create necessary files: $database, $serial and $new_certs_dir
# directory (optional)

touch $DIR/index.txt
echo "01" > $DIR/serial

#
# Generation of Certificate Authority(CA)
#

openssl req -new -x509 -keyout $PRIV/cakey.pem -out $DIR/ca.pem \
    -days 3600 -config $DIR/openssl.cnf

# Sample output:
# Using configuration from /home/finley/openssl/openssl.cnf
# Generating a 1024 bit RSA private key
# .....++++++
# .....++++++
# writing new private key to '/home/finley/openssl/private/cakey.pem'
# Enter PEM pass phrase:
# Verifying password - Enter PEM pass phrase:
# -----
# You are about to be asked to enter information that will be
# incorporated into your certificate request.
# What you are about to enter is what is called a Distinguished Name
# or a DN.
# There are quite a few fields but you can leave some blank
# For some fields there will be a default value,
# If you enter '.', the field will be left blank.
# -----
# Country Name (2 letter code) [AU]:FI
# State or Province Name (full name) [Some-State]:.
# Locality Name (eg, city) []:
# Organization Name (eg, company) [Internet Widgits Pty Ltd]:MySQL AB
# Organizational Unit Name (eg, section) []:
# Common Name (eg, YOUR name) []:MySQL admin
# Email Address []:

#
# Create server request and key
#

openssl req -new -keyout $DIR/server-key.pem -out \
    $DIR/server-req.pem -days 3600 -config $DIR/openssl.cnf

# Sample output:
# Using configuration from /home/finley/openssl/openssl.cnf
# Generating a 1024 bit RSA private key
# ..++++++

```

```

# .....+++++
# writing new private key to '/home/finley/openssl/server-key.pem'
# Enter PEM pass phrase:
# Verifying password - Enter PEM pass phrase:
# -----
# You are about to be asked to enter information that will be
# incorporated into your certificate request.
# What you are about to enter is what is called a Distinguished Name
# or a DN.
# There are quite a few fields but you can leave some blank
# For some fields there will be a default value,
# If you enter '.', the field will be left blank.
# -----
# Country Name (2 letter code) [AU]:FI
# State or Province Name (full name) [Some-State]:.
# Locality Name (eg, city) []:
# Organization Name (eg, company) [Internet Widgits Pty Ltd]:MySQL AB
# Organizational Unit Name (eg, section) []:
# Common Name (eg, YOUR name) []:MySQL server
# Email Address []:
#
# Please enter the following 'extra' attributes
# to be sent with your certificate request
# A challenge password []:
# An optional company name []:

#
# Remove the passphrase from the key
#
openssl rsa -in $DIR/server-key.pem -out $DIR/server-key.pem

#
# Sign server cert
#
openssl ca -cert $DIR/ca.pem -policy policy_anything \
  -out $DIR/server-cert.pem -config $DIR/openssl.cnf \
  -infile $DIR/server-req.pem

# Sample output:
# Using configuration from /home/finley/openssl/openssl.cnf
# Enter PEM pass phrase:
# Check that the request matches the signature
# Signature ok
# The Subjects Distinguished Name is as follows
# countryName           :PRINTABLE:'FI'
# organizationName      :PRINTABLE:'MySQL AB'
# commonName            :PRINTABLE:'MySQL admin'
# Certificate is to be certified until Sep 13 14:22:46 2003 GMT
# (365 days)
# Sign the certificate? [y/n]:y
#
#
# 1 out of 1 certificate requests certified, commit? [y/n]y
# Write out database with 1 new entries
# Data Base Updated

#
# Create client request and key
#
openssl req -new -keyout $DIR/client-key.pem -out \
  $DIR/client-req.pem -days 3600 -config $DIR/openssl.cnf

# Sample output:
# Using configuration from /home/finley/openssl/openssl.cnf
# Generating a 1024 bit RSA private key
# .....+++++
# .....+++++

```

```

# writing new private key to '/home/finley/openssl/client-key.pem'
# Enter PEM pass phrase:
# Verifying password - Enter PEM pass phrase:
# -----
# You are about to be asked to enter information that will be
# incorporated into your certificate request.
# What you are about to enter is what is called a Distinguished Name
# or a DN.
# There are quite a few fields but you can leave some blank
# For some fields there will be a default value,
# If you enter '.', the field will be left blank.
# -----
# Country Name (2 letter code) [AU]:FI
# State or Province Name (full name) [Some-State]:.
# Locality Name (eg, city) []:
# Organization Name (eg, company) [Internet Widgits Pty Ltd]:MySQL AB
# Organizational Unit Name (eg, section) []:
# Common Name (eg, YOUR name) []:MySQL user
# Email Address []:
#
# Please enter the following 'extra' attributes
# to be sent with your certificate request
# A challenge password []:
# An optional company name []:

#
# Remove the passphrase from the key
#
openssl rsa -in $DIR/client-key.pem -out $DIR/client-key.pem

#
# Sign client cert
#

openssl ca -cert $DIR/ca.pem -policy policy_anything \
    -out $DIR/client-cert.pem -config $DIR/openssl.cnf \
    -infile $DIR/client-req.pem

# Sample output:
# Using configuration from /home/finley/openssl/openssl.cnf
# Enter PEM pass phrase:
# Check that the request matches the signature
# Signature ok
# The Subjects Distinguished Name is as follows
# countryName             :PRINTABLE:'FI'
# organizationName        :PRINTABLE:'MySQL AB'
# commonName               :PRINTABLE:'MySQL user'
# Certificate is to be certified until Sep 13 16:45:17 2003 GMT
# (365 days)
# Sign the certificate? [y/n]:y
#
#
# 1 out of 1 certificate requests certified, commit? [y/n]y
# Write out database with 1 new entries
# Data Base Updated

#
# Create a my.cnf file that you can use to test the certificates
#

cat <<EOF > $DIR/my.cnf
[client]
ssl-ca=$DIR/ca.pem
ssl-cert=$DIR/client-cert.pem
ssl-key=$DIR/client-key.pem
[mysqld]
ssl_ca=$DIR/ca.pem

```

```
ssl_cert=$DIR/server-cert.pem
ssl_key=$DIR/server-key.pem
EOF
```

### Example 3: Creating SSL Files on Windows

Download OpenSSL for Windows if it is not installed on your system. An overview of available packages can be seen here:

<http://www.slproweb.com/products/Win32OpenSSL.html>

Choose the Win32 OpenSSL Light or Win64 OpenSSL Light package, depending on your architecture (32-bit or 64-bit). The default installation location is `C:\OpenSSL-Win32` or `C:\OpenSSL-Win64`, depending on which package you downloaded. The following instructions assume a default location of `C:\OpenSSL-Win32`. Modify this as necessary if you are using the 64-bit package.

If a message occurs during setup indicating '`...critical component is missing: Microsoft Visual C++ 2008 Redistributables`', cancel the setup and download one of the following packages as well, again depending on your architecture (32-bit or 64-bit):

- Visual C++ 2008 Redistributables (x86), available at:

<http://www.microsoft.com/downloads/details.aspx?familyid=9B2DA534-3E03-4391-8A4D-074B9F2BC1BF>

- Visual C++ 2008 Redistributables (x64), available at:

<http://www.microsoft.com/downloads/details.aspx?familyid=bd2a6171-e2d6-4230-b809-9a8d7548c1b6>

After installing the additional package, restart the OpenSSL setup procedure.

During installation, leave the default `C:\OpenSSL-Win32` as the install path, and also leave the default option '`Copy OpenSSL DLL files to the Windows system directory`' selected.

When the installation has finished, add `C:\OpenSSL-Win32\bin` to the Windows System Path variable of your server (depending on your version of Windows, the following path-setting instructions might differ slightly):

1. On the Windows desktop, right-click the **My Computer** icon, and select **Properties**.
2. Select the **Advanced** tab from the **System Properties** menu that appears, and click the **Environment Variables** button.
3. Under **System Variables**, select **Path**, then click the **Edit** button. The **Edit System Variable** dialogue should appear.
4. Add '`;C:\OpenSSL-Win32\bin`' to the end (notice the semicolon).
5. Press OK 3 times.
6. Check that OpenSSL was correctly integrated into the Path variable by opening a new command console (`Start>Run>cmd.exe`) and verifying that OpenSSL is available:

```
Microsoft Windows [Version ...]
Copyright (c) 2006 Microsoft Corporation. All rights reserved.

C:\Windows\system32>cd \

C:\>openssl
OpenSSL> exit <<< If you see the OpenSSL prompt, installation was successful.
```



```
C:\>
```

After OpenSSL has been installed, use instructions similar to those from Example 1 (shown earlier in this section), with the following changes:

- Change the following Unix commands:

```
# Create clean environment
rm -rf newcerts
mkdir newcerts && cd newcerts
```

On Windows, use these commands instead:

```
# Create clean environment
md c:\newcerts
cd c:\newcerts
```

- When a '\\' character is shown at the end of a command line, this '\\' character must be removed and the command lines entered all on a single line.

After generating the certificate and key files, to use them for SSL connections, see [Section 6.3.1](#), “Configuring MySQL to Use Encrypted Connections”.

### 6.3.3.3 Creating RSA Keys Using openssl

This section describes how to use the `openssl` command to set up the RSA key files that enable MySQL to support secure password exchange over unencrypted connections for accounts authenticated by the `sha256_password` plugin.



#### Note

There are easier alternatives to generating the files required for RSA than the procedure described here: Let the server autogenerate them or use the `mysql_ssl_rsa_setup` program. See [Section 6.3.3.1](#), “Creating SSL and RSA Certificates and Keys using MySQL”.

To create the RSA private and public key-pair files, run these commands while logged into the system account used to run the MySQL server so the files are owned by that account:

```
openssl genrsa -out private_key.pem 2048
openssl rsa -in private_key.pem -pubout -out public_key.pem
```

Those commands create 2,048-bit keys. To create stronger keys, use a larger value.

Then set the access modes for the key files. The private key should be readable only by the server, whereas the public key can be freely distributed to client users:

```
chmod 400 private_key.pem
chmod 444 public_key.pem
```

### 6.3.4 SSL Library-Dependent Capabilities

MySQL can be compiled using OpenSSL or yaSSL, both of which enable encrypted connections based on the OpenSSL API:

- MySQL Enterprise Edition binary distributions are compiled using OpenSSL. It is not possible to use yaSSL with MySQL Enterprise Edition.

- MySQL Community Edition binary distributions are compiled using yaSSL.
- MySQL Community Edition source distributions can be compiled using either OpenSSL or yaSSL (see [Section 2.8.6, “Configuring SSL Library Support”](#)).

**Note**

It is possible to compile MySQL using yaSSL as an alternative to OpenSSL only prior to MySQL 5.7.28. As of MySQL 5.7.28, support for yaSSL is removed and all MySQL builds use OpenSSL.

OpenSSL and yaSSL offer the same basic functionality, but MySQL distributions compiled using OpenSSL have additional features:

- OpenSSL supports TLSv1, TLSv1.1, and TLSv1.2 protocols. yaSSL supports only TLSv1 and TLSv1.1 protocols.
- OpenSSL supports a more flexible syntax for specifying ciphers (for the `ssl_cipher` system variable and `--ssl-cipher` client option), and supports a wider range of encryption ciphers from which to choose. See [Command Options for Encrypted Connections](#), and [Section 6.3.2, “Encrypted Connection TLS Protocols and Ciphers”](#).
- OpenSSL supports the `ssl_capath` system variable and `--ssl-capath` client option. MySQL distributions compiled using yaSSL do not because yaSSL does not look in any directory and do not follow a chained certificate tree. yaSSL requires that all components of the CA certificate tree be contained within a single CA certificate tree and that each certificate in the file has a unique SubjectName value. To work around this limitation, concatenate the individual certificate files comprising the certificate tree into a new file and specify that file as the value of the `ssl_ca` system variable and `--ssl-ca` option.
- OpenSSL supports certificate revocation-list capability (for the `ssl_crl` and `ssl_crlpath` system variables and `--ssl-crl` and `--ssl-crlpath` client options). Distributions compiled using yaSSL do not because revocation lists do not work with yaSSL. (yaSSL accepts these options but silently ignores them.)
- Accounts that authenticate using the `sha256_password` plugin can use RSA key files for secure password exchange over unencrypted connections. See [Section 6.4.1.5, “SHA-256 Pluggable Authentication”](#).
- The server can automatically generate missing SSL and RSA certificate and key files at startup. See [Section 6.3.3.1, “Creating SSL and RSA Certificates and Keys using MySQL”](#).
- OpenSSL supports more encryption modes for the `AES_ENCRYPT()` and `AES_DECRYPT()` functions. See [Section 12.13, “Encryption and Compression Functions”](#)

Certain OpenSSL-related system and status variables are present only if MySQL was compiled using OpenSSL:

- `auto_generate_certs`
- `sha256_password_auto_generate_rsa_keys`
- `sha256_password_private_key_path`
- `sha256_password_public_key_path`
- `Rsa_public_key`

To determine whether a server was compiled using OpenSSL, test the existence of any of those variables. For example, this statement returns a row if OpenSSL was used and an empty result if yaSSL was used:

```
SHOW STATUS LIKE 'Rsa_public_key';
```

### 6.3.5 Connecting to MySQL Remotely from Windows with SSH

This section describes how to get an encrypted connection to a remote MySQL server with SSH. The information was provided by David Carlson <[dcarlson@mplcomm.com](mailto:dcarlson@mplcomm.com)>.

1. Install an SSH client on your Windows machine. For a comparison of SSH clients, see [http://en.wikipedia.org/wiki/Comparison\\_of\\_SSH\\_clients](http://en.wikipedia.org/wiki/Comparison_of_SSH_clients).
2. Start your Windows SSH client. Set `Host_Name = yourmysqlserver_URL_or_IP`. Set `userid=your_userid` to log in to your server. This `userid` value might not be the same as the user name of your MySQL account.
3. Set up port forwarding. Either do a remote forward (Set `local_port: 3306, remote_host: yourmysqlservername_or_ip, remote_port: 3306`) or a local forward (Set `port: 3306, host: localhost, remote port: 3306`).
4. Save everything; otherwise you must to redo it the next time.
5. Log in to your server with the SSH session you just created.
6. On your Windows machine, start some ODBC application (such as Access).
7. Create a new file in Windows and link to MySQL using the ODBC driver the same way you normally do, except type in `localhost` for the MySQL host server, not `yourmysqlservername`.

At this point, you should have an ODBC connection to MySQL, encrypted using SSH.

## 6.4 Security Plugins

MySQL includes several plugins that implement security features:

- Plugins for authenticating attempts by clients to connect to MySQL Server. Plugins are available for several authentication protocols. For general discussion of the authentication process, see [Section 6.2.13, “Pluggable Authentication”](#). For characteristics of specific authentication plugins, see [Section 6.4.1, “Authentication Plugins”](#).
- A password-validation plugin for implementing password strength policies and assessing the strength of potential passwords. See [Section 6.4.3, “The Password Validation Plugin”](#).
- Keyring plugins that provide secure storage for sensitive information. See [Section 6.4.4, “The MySQL Keyring”](#).
- (MySQL Enterprise Edition only) MySQL Enterprise Audit, implemented using a server plugin, uses the open MySQL Audit API to enable standard, policy-based monitoring and logging of connection and query activity executed on specific MySQL servers. Designed to meet the Oracle audit specification, MySQL Enterprise Audit provides an out of box, easy to use auditing and compliance solution for applications that are governed by both internal and external regulatory guidelines. See [Section 6.4.5, “MySQL Enterprise Audit”](#).
- (MySQL Enterprise Edition only) MySQL Enterprise Firewall, an application-level firewall that enables database administrators to permit or deny SQL statement execution based on matching against lists of

accepted statement patterns. This helps harden MySQL Server against attacks such as SQL injection or attempts to exploit applications by using them outside of their legitimate query workload characteristics. See [Section 6.4.6, “MySQL Enterprise Firewall”](#).

- (MySQL Enterprise Edition only) MySQL Enterprise Data Masking and De-Identification, implemented as a plugin library containing a plugin and a set of functions. Data masking hides sensitive information by replacing real values with substitutes. MySQL Enterprise Data Masking and De-Identification functions enable masking existing data using several methods such as obfuscation (removing identifying characteristics), generation of formatted random data, and data replacement or substitution. See [Section 6.5, “MySQL Enterprise Data Masking and De-Identification”](#).

## 6.4.1 Authentication Plugins

The following sections describe pluggable authentication methods available in MySQL and the plugins that implement these methods. For general discussion of the authentication process, see [Section 6.2.13, “Pluggable Authentication”](#).

The default plugin is indicated by the value of the `default_authentication_plugin` system variable.

### 6.4.1.1 Native Pluggable Authentication

MySQL includes two plugins that implement native authentication; that is, authentication based on the password hashing methods in use from before the introduction of pluggable authentication. This section describes `mysql_native_password`, which implements authentication against the `mysql.user` system table using the native password hashing method. For information about `mysql_old_password`, which implements authentication using the older (pre-4.1) native password hashing method, see [Section 6.4.1.2, “Old Native Pluggable Authentication”](#). For information about these password hashing methods, see [Section 6.1.2.4, “Password Hashing in MySQL”](#).

The following table shows the plugin names on the server and client sides.

**Table 6.8 Plugin and Library Names for Native Password Authentication**

Plugin or File	Plugin or File Name
Server-side plugin	<code>mysql_native_password</code>
Client-side plugin	<code>mysql_native_password</code>
Library file	None (plugins are built in)

The following sections provide installation and usage information specific to native pluggable authentication:

- [Installing Native Pluggable Authentication](#)
- [Using Native Pluggable Authentication](#)

For general information about pluggable authentication in MySQL, see [Section 6.2.13, “Pluggable Authentication”](#).

### Installing Native Pluggable Authentication

The `mysql_native_password` plugin exists in server and client forms:

- The server-side plugin is built into the server, need not be loaded explicitly, and cannot be disabled by unloading it.

- The client-side plugin is built into the `libmysqlclient` client library and is available to any program linked against `libmysqlclient`.

## Using Native Pluggable Authentication

MySQL client programs use `mysql_native_password` by default. The `--default-auth` option can be used as a hint about which client-side plugin the program can expect to use:

```
$> mysql --default-auth=mysql_native_password ...
```

### 6.4.1.2 Old Native Pluggable Authentication

MySQL includes two plugins that implement native authentication; that is, authentication based on the password hashing methods in use from before the introduction of pluggable authentication. This section describes `mysql_old_password`, which implements authentication against the `mysql.user` system table using the older (pre-4.1) native password hashing method. For information about `mysql_native_password`, which implements authentication using the native password hashing method, see [Section 6.4.1.1, “Native Pluggable Authentication”](#). For information about these password hashing methods, see [Section 6.1.2.4, “Password Hashing in MySQL”](#).



#### Note

Passwords that use the pre-4.1 hashing method are less secure than passwordss that use the native password hashing method and should be avoided. Pre-4.1 passwordss are deprecated and support for them (including the `mysql_old_password` plugin) was removed in MySQL 5.7.5. For account upgrade instructions, see [Section 6.4.1.3, “Migrating Away from Pre-4.1 Password Hashing and the `mysql\_old\_password` Plugin”](#).

The following table shows the plugin names on the server and client sides.

**Table 6.9 Plugin and Library Names for Old Native Password Authentication**

Plugin or File	Plugin or File Name
Server-side plugin	<code>mysql_old_password</code>
Client-side plugin	<code>mysql_old_password</code>
Library file	None (plugins are built in)

The following sections provide installation and usage information specific to old native pluggable authentication:

- [Installing Old Native Pluggable Authentication](#)
- [Using Old Native Pluggable Authentication](#)

For general information about pluggable authentication in MySQL, see [Section 6.2.13, “Pluggable Authentication”](#).

## Installing Old Native Pluggable Authentication

The `mysql_old_password` plugin exists in server and client forms:

- The server-side plugin is built into the server, need not be loaded explicitly, and cannot be disabled by unloading it.

- The client-side plugin is built into the `libmysqlclient` client library and is available to any program linked against `libmysqlclient`.

## Using Old Native Pluggable Authentication

MySQL client programs can use the `--default-auth` option to specify the `mysql_old_password` plugin as a hint about which client-side plugin the program can expect to use:

```
$> mysql --default-auth=mysql_old_password ...
```

### 6.4.1.3 Migrating Away from Pre-4.1 Password Hashing and the `mysql_old_password` Plugin

The MySQL server authenticates connection attempts for each account listed in the `mysql.user` system table using the authentication plugin named in the `plugin` column. If the `plugin` column is empty, the server authenticates the account as follows:

- Before MySQL 5.7, the server uses the `mysql_native_password` or `mysql_old_password` plugin implicitly, depending on the format of the password hash in the `Password` column. If the `Password` value is empty or a 4.1 password hash (41 characters), the server uses `mysql_native_password`. If the password value is a pre-4.1 password hash (16 characters), the server uses `mysql_old_password`. (For additional information about these hash formats, see [Section 6.1.2.4, “Password Hashing in MySQL”](#).)
- As of MySQL 5.7, the server requires the `plugin` column to be nonempty and disables accounts that have an empty `plugin` value.

Pre-4.1 password hashes and the `mysql_old_password` plugin are deprecated in MySQL 5.6 and support for them is removed in MySQL 5.7. They provide a level of security inferior to that offered by 4.1 password hashing and the `mysql_native_password` plugin.

Given the requirement in MySQL 5.7 that the `plugin` column must be nonempty, coupled with removal of `mysql_old_password` support, DBAs are advised to upgrade accounts as follows:

- Upgrade accounts that use `mysql_native_password` implicitly to use it explicitly
- Upgrade accounts that use `mysql_old_password` (either implicitly or explicitly) to use `mysql_native_password` explicitly

The instructions in this section describe how to perform those upgrades. The result is that no account has an empty `plugin` value and no account uses pre-4.1 password hashing or the `mysql_old_password` plugin.

As a variant on these instructions, DBAs might offer users the choice to upgrade to the `sha256_password` plugin, which authenticates using SHA-256 password hashes. For information about this plugin, see [Section 6.4.1.5, “SHA-256 Pluggable Authentication”](#).

The following table lists the types of `mysql.user` accounts considered in this discussion.

<code>plugin</code> Column	<code>Password</code> Column	Authentication Result	Upgrade Action
Empty	Empty	Implicitly uses <code>mysql_native_password</code>	Assign plugin
Empty	4.1 hash	Implicitly uses <code>mysql_native_password</code>	Assign plugin

plugin Column	Password Column	Authentication Result	Upgrade Action
Empty	Pre-4.1 hash	Implicitly uses <code>mysql_old_password</code>	Assign plugin, rehash password
<code>mysql_native_password</code>	Empty	Explicitly uses <code>mysql_native_password</code>	None
<code>mysql_native_password</code>	4.1 hash	Explicitly uses <code>mysql_native_password</code>	None
<code>mysql_old_password</code>	Empty	Explicitly uses <code>mysql_old_password</code>	Upgrade plugin
<code>mysql_old_password</code>	Pre-4.1 hash	Explicitly uses <code>mysql_old_password</code>	Upgrade plugin, rehash password

Accounts corresponding to lines for the `mysql_native_password` plugin require no upgrade action (because no change of plugin or hash format is required). For accounts corresponding to lines for which the password is empty, consider asking the account owners to choose a password (or require it by using `ALTER USER` to expire empty account passwords).

### Upgrading Accounts from Implicit to Explicit `mysql_native_password` Use

Accounts that have an empty plugin and a 4.1 password hash use `mysql_native_password` implicitly. To upgrade these accounts to use `mysql_native_password` explicitly, execute these statements:

```
UPDATE mysql.user SET plugin = 'mysql_native_password'
WHERE plugin = '' AND (Password = '' OR LENGTH(Password) = 41);
FLUSH PRIVILEGES;
```

Before MySQL 5.7, you can execute those statements to upgrade accounts proactively. As of MySQL 5.7, you can run `mysql_upgrade`, which performs the same operation among its upgrade actions.

Notes:

- The upgrade operation just described is safe to execute at any time because it makes the `mysql_native_password` plugin explicit only for accounts that already use it implicitly.
- This operation requires no password changes, so it can be performed without affecting users or requiring their involvement in the upgrade process.

### Upgrading Accounts from `mysql_old_password` to `mysql_native_password`

Accounts that use `mysql_old_password` (either implicitly or explicitly) should be upgraded to use `mysql_native_password` explicitly. This requires changing the plugin *and* changing the password from pre-4.1 to 4.1 hash format.

For the accounts covered in this step that must be upgraded, one of these conditions is true:

- The account uses `mysql_old_password` implicitly because the `plugin` column is empty and the password has the pre-4.1 hash format (16 characters).
- The account uses `mysql_old_password` explicitly.

To identify such accounts, use this query:

```
SELECT User, Host, Password FROM mysql.user
WHERE (plugin = '' AND LENGTH(Password) = 16)
OR plugin = 'mysql_old_password';
```

The following discussion provides two methods for updating that set of accounts. They have differing characteristics, so read both and decide which is most suitable for a given MySQL installation.

### Method 1.

Characteristics of this method:

- It requires that server and clients be run with `secure_auth=0` until all users have been upgraded to `mysql_native_password`. (Otherwise, users cannot connect to the server using their old-format password hashes for the purpose of upgrading to a new-format hash.)
- It works for MySQL 5.5 and 5.6. In 5.7, it does not work because the server requires accounts to have a nonempty plugin and disables them otherwise. Therefore, if you have already upgraded to 5.7, choose Method 2, described later.

You should ensure that the server is running with `secure_auth=0`.

For all accounts that use `mysql_old_password` explicitly, set them to the empty plugin:

```
UPDATE mysql.user SET plugin = ''
WHERE plugin = 'mysql_old_password';
FLUSH PRIVILEGES;
```

To also expire the password for affected accounts, use these statements instead:

```
UPDATE mysql.user SET plugin = '', password_expired = 'Y'
WHERE plugin = 'mysql_old_password';
FLUSH PRIVILEGES;
```

Now affected users can reset their password to use 4.1 hashing. Ask each user who now has an empty plugin to connect to the server and execute these statements:

```
SET old_passwords = 0;
SET PASSWORD = PASSWORD('user-chosen-password');
```



#### Note

The client-side `--secure-auth` option is enabled by default, so remind users to disable it; otherwise, they cannot connect:

```
$> mysql -u user_name -p --secure-auth=0
```

After an affected user has executed those statements, you can set the corresponding account plugin to `mysql_native_password` to make the plugin explicit. Or you can periodically run these statements to find and fix any accounts for which affected users have reset their password:

```
UPDATE mysql.user SET plugin = 'mysql_native_password'
WHERE plugin = '' AND (Password = '' OR LENGTH(Password) = 41);
FLUSH PRIVILEGES;
```

When there are no more accounts with an empty plugin, this query returns an empty result:

```
SELECT User, Host, Password FROM mysql.user
WHERE plugin = '' AND LENGTH(Password) = 16;
```

At that point, all accounts have been migrated away from pre-4.1 password hashing and the server no longer need be run with `secure_auth=0`.

### Method 2.

Characteristics of this method:



- It assigns each affected account a new password, so you must tell each such user the new password and ask the user to choose a new one. Communication of passwords to users is outside the scope of MySQL, but should be done carefully.
- It does not require server or clients to be run with `secure_auth=0`.
- It works for any version of MySQL 5.5 or later (and for 5.7 has an easier variant).

With this method, you update each account separately due to the need to set passwords individually. *Choose a different password for each account.*

Suppose that `'user1'@'localhost'` is one of the accounts to be upgraded. Modify it as follows:

- In MySQL 5.7, `ALTER USER` provides the capability of modifying both the account password and its authentication plugin, so you need not modify the `mysql.user` system table directly:

```
ALTER USER 'user1'@'localhost'
IDENTIFIED WITH mysql_native_password BY 'DBA-chosen-password';
```

To also expire the account password, use this statement instead:

```
ALTER USER 'user1'@'localhost'
IDENTIFIED WITH mysql_native_password BY 'DBA-chosen-password'
PASSWORD EXPIRE;
```

Then tell the user the new password and ask the user to connect to the server with that password and execute this statement to choose a new password:

```
ALTER USER USER() IDENTIFIED BY 'user-chosen-password';
```

- Before MySQL 5.7, you must modify the `mysql.user` system table directly using these statements:

```
SET old_passwords = 0;
UPDATE mysql.user SET plugin = 'mysql_native_password',
Password = PASSWORD('DBA-chosen-password')
WHERE (User, Host) = ('user1', 'localhost');
FLUSH PRIVILEGES;
```

To also expire the account password, use these statements instead:

```
SET old_passwords = 0;
UPDATE mysql.user SET plugin = 'mysql_native_password',
Password = PASSWORD('DBA-chosen-password'), password_expired = 'Y'
WHERE (User, Host) = ('user1', 'localhost');
FLUSH PRIVILEGES;
```

Then tell the user the new password and ask the user to connect to the server with that password and execute these statements to choose a new password:

```
SET old_passwords = 0;
SET PASSWORD = PASSWORD('user-chosen-password');
```

Repeat for each account to be upgraded.

#### 6.4.1.4 Caching SHA-2 Pluggable Authentication

MySQL provides two authentication plugins that implement SHA-256 hashing for user account passwords:

- `sha256_password`: Implements basic SHA-256 authentication.
- `caching_sha2_password`: Implements SHA-256 authentication (like `sha256_password`), but uses caching on the server side for better performance and has additional features for wider applicability. (In

MySQL 5.7, `caching_sha2_password` is implemented only on the client side, as described later in this section.)

This section describes the caching SHA-2 authentication plugin, available as of MySQL 5.7.23. For information about the original basic (noncaching) plugin, see [Section 6.4.1.5, “SHA-256 Pluggable Authentication”](#).



### Important

In MySQL 5.7, the default authentication plugin is `mysql_native_password`. As of MySQL 8.0, the default authentication plugin is changed to `caching_sha2_password`. To enable MySQL 5.7 clients to connect to 8.0 and higher servers using accounts that authenticate with `caching_sha2_password`, the MySQL 5.7 client library and client programs support the `caching_sha2_password` client-side authentication plugin. This improves MySQL 5.7 client connect-capability compatibility with respect to MySQL 8.0 and higher servers, despite the differences in default authentication plugin.

Limiting `caching_sha2_password` support in MySQL 5.7 to the client-side plugin in the client library has these implications compared to MySQL 8.0:

- The `caching_sha2_password` server-side plugin is not implemented in MySQL 5.7.
- MySQL 5.7 servers do not support creating accounts that authenticate with `caching_sha2_password`.
- MySQL 5.7 servers do not implement system and status variables specific to `caching_sha2_password` server-side support: `caching_sha2_password_auto_generate_rsa_keys`, `caching_sha2_password_private_key_path`, `caching_sha2_password_public_key_path`, `Caching_sha2_password_rsa_public_key`.

In addition, there is no support for MySQL 5.7 replicas to connect to MySQL 8.0 replication source servers using accounts that authenticate with `caching_sha2_password`. That would involve a source replicating to a replica with a version number lower than the source version, whereas sources normally replicate to replicas having a version equal to or higher than the source version.



### Important

To connect to a MySQL 8.0 or higher server using an account that authenticates with the `caching_sha2_password` plugin, you must use either a secure connection or an unencrypted connection that supports password exchange using an RSA key pair, as described later in this section. Either way, the `caching_sha2_password` plugin uses MySQL's encryption capabilities. See [Section 6.3, “Using Encrypted Connections”](#).



### Note

In the name `sha256_password`, “sha256” refers to the 256-bit digest length the plugin uses for encryption. In the name `caching_sha2_password`, “sha2” refers more generally to the SHA-2 class of encryption algorithms, of which 256-bit encryption is one instance. The latter name choice leaves room for future expansion of possible digest lengths without changing the plugin name.

The `caching_sha2_password` plugin has these advantages, compared to `sha256_password`:

- On the server side, an in-memory cache enables faster reauthentication of users who have connected previously when they connect again. (This server-side behavior is implemented only in MySQL 8.0 and higher.)
- Support is provided for client connections that use the Unix socket-file and shared-memory protocols.

The following table shows the plugin name on the client side.

**Table 6.10 Plugin and Library Names for SHA-2 Authentication**

Plugin or File	Plugin or File Name
Client-side plugin	<code>caching_sha2_password</code>
Library file	None (plugin is built in)

The following sections provide installation and usage information specific to caching SHA-2 pluggable authentication:

- [Installing SHA-2 Pluggable Authentication](#)
- [Using SHA-2 Pluggable Authentication](#)
- [Cache Operation for SHA-2 Pluggable Authentication](#)

For general information about pluggable authentication in MySQL, see [Section 6.2.13, “Pluggable Authentication”](#).

## Installing SHA-2 Pluggable Authentication

In MySQL 5.7, the `caching_sha2_password` plugin exists in client form. The client-side plugin is built into the `libmysqlclient` client library and is available to any program linked against `libmysqlclient`.

## Using SHA-2 Pluggable Authentication

In MySQL 5.7, the `caching_sha2_password` client-side plugin enables connecting to MySQL 8.0 or higher servers using accounts that authenticate with the `caching_sha2_password` server-side plugin. The discussion here assumes that an account named `'sha2user'@'localhost'` exists on the MySQL 8.0 or higher server. For example, the following statement creates such an account, where `password` is the desired account password:

```
CREATE USER 'sha2user'@'localhost'
IDENTIFIED WITH caching_sha2_password BY 'password';
```

`caching_sha2_password` supports connections over secure transport. `caching_sha2_password` also supports encrypted password exchange using RSA over unencrypted connections if these conditions are satisfied:

- The MySQL 5.7 client library and client programs are compiled using OpenSSL, not yaSSL. `caching_sha2_password` works with distributions compiled using either package, but RSA support requires OpenSSL.



### Note

It is possible to compile MySQL using yaSSL as an alternative to OpenSSL only prior to MySQL 5.7.28. As of MySQL 5.7.28, support for yaSSL is removed and all MySQL builds use OpenSSL.

- The MySQL 8.0 or higher server to which you wish to connect is configured to support RSA (using the RSA configuration procedure given later in this section).

RSA support has these characteristics, where all aspects that pertain to the server side require a MySQL 8.0 or higher server:

- On the server side, two system variables name the RSA private and public key-pair files: `caching_sha2_password_private_key_path` and `caching_sha2_password_public_key_path`. The database administrator must set these variables at server startup if the key files to use have names that differ from the system variable default values.
- The server uses the `caching_sha2_password_auto_generate_rsa_keys` system variable to determine whether to automatically generate the RSA key-pair files. See [Section 6.3.3, “Creating SSL and RSA Certificates and Keys”](#).
- The `Caching_sha2_password_rsa_public_key` status variable displays the RSA public key value used by the `caching_sha2_password` authentication plugin.
- Clients that are in possession of the RSA public key can perform RSA key pair-based password exchange with the server during the connection process, as described later.
- For connections by accounts that authenticate with `caching_sha2_password` and RSA key pair-based password exchange, the server does not send the RSA public key to clients by default. Clients can use a client-side copy of the required public key, or request the public key from the server.

Use of a trusted local copy of the public key enables the client to avoid a round trip in the client/server protocol, and is more secure than requesting the public key from the server. On the other hand, requesting the public key from the server is more convenient (it requires no management of a client-side file) and may be acceptable in secure network environments.

- For command-line clients, use the `--server-public-key-path` option to specify the RSA public key file. Use the `--get-server-public-key` option to request the public key from the server. The following programs support the two options: `mysql`, `mysqladmin`, `mysqlbinlog`, `mysqlcheck`, `mysqldump`, `mysqlimport`, `mysqlpump`, `mysqlshow`, `mysqlslap`, `mysqltest`.
- For programs that use the C API, call `mysql_options()` to specify the RSA public key file by passing the `MYSQL_SERVER_PUBLIC_KEY` option and the name of the file, or request the public key from the server by passing the `MYSQL_OPT_GET_SERVER_PUBLIC_KEY` option.

In all cases, if the option is given to specify a valid public key file, it takes precedence over the option to request the public key from the server.

For clients that use the `caching_sha2_password` plugin, passwords are never exposed as cleartext when connecting to the MySQL 8.0 or higher server. How password transmission occurs depends on whether a secure connection or RSA encryption is used:

- If the connection is secure, an RSA key pair is unnecessary and is not used. This applies to TCP connections encrypted using TLS, as well as Unix socket-file and shared-memory connections. The password is sent as cleartext but cannot be snooped because the connection is secure.
- If the connection is not secure, an RSA key pair is used. This applies to TCP connections not encrypted using TLS and named-pipe connections. RSA is used only for password exchange between client and server, to prevent password snooping. When the server receives the encrypted password, it decrypts it. A scramble is used in the encryption to prevent repeat attacks.
- If a secure connection is not used and RSA encryption is not available, the connection attempt fails because the password cannot be sent without being exposed as cleartext.

As mentioned previously, RSA password encryption is available only if MySQL 5.7 was compiled using OpenSSL. The implication for clients from MySQL 5.7 distributions compiled using yaSSL is that, to use SHA-2 passwords, clients *must* use an encrypted connection to access the server. See [Section 6.3.1, “Configuring MySQL to Use Encrypted Connections”](#).

Assuming that MySQL 5.7 has been compiled using OpenSSL, use the following procedure to enable use of an RSA key pair for password exchange during the client connection process.



### Important

Aspects of this procedure that pertain to server configuration must be done on the MySQL 8.0 or higher server to which you wish to connect using MySQL 5.7 clients, *not* on your MySQL 5.7 server.

1. Create the RSA private and public key-pair files using the instructions in [Section 6.3.3, “Creating SSL and RSA Certificates and Keys”](#).
2. If the private and public key files are located in the data directory and are named `private_key.pem` and `public_key.pem` (the default values of the `caching_sha2_password_private_key_path` and `caching_sha2_password_public_key_path` system variables), the server uses them automatically at startup.

Otherwise, to name the key files explicitly, set the system variables to the key file names in the server option file. If the files are located in the server data directory, you need not specify their full path names:

```
[mysqld]
caching_sha2_password_private_key_path=myprivkey.pem
caching_sha2_password_public_key_path=myspubkey.pem
```

If the key files are not located in the data directory, or to make their locations explicit in the system variable values, use full path names:

```
[mysqld]
caching_sha2_password_private_key_path=/usr/local/mysql/myprivkey.pem
caching_sha2_password_public_key_path=/usr/local/mysql/mypubkey.pem
```

3. Restart the server, then connect to it and check the `Caching_sha2_password_rsa_public_key` status variable value. The actual value differs from that shown here, but should be nonempty:

```
mysql> SHOW STATUS LIKE 'Caching_sha2_password_rsa_public_key'\G
***** 1. row *****
Variable_name: Caching_sha2_password_rsa_public_key
Value: -----BEGIN PUBLIC KEY-----
MIGfMA0GCSqGSIb3DQEBAQUAA4GNADCBiQKBgQDO9nRUDd+KvSZgY7cNBZMNpwX6
MvE1PbJFXO7u18nJ9lwc99Du/E7lw6CVXw7VKrXPeHbVQUzGyUNkf45Nz/ckaaJa
aLgJOBcIDmNVnyU540T/1lcs2xiyfaDMe8fCJ64ZwTnKbY2gkt1IMjUAB5Ogd5kJ
g8aV7EtKwyhHb0c30QIDAQAB
-----END PUBLIC KEY-----
```

If the value is empty, the server found some problem with the key files. Check the error log for diagnostic information.

After the server has been configured with the RSA key files, accounts that authenticate with the `caching_sha2_password` plugin have the option of using those key files to connect to the server. As mentioned previously, such accounts can use either a secure connection (in which case RSA is not used) or an unencrypted connection that performs password exchange using RSA. Suppose that an unencrypted connection is used. For example:

```
$> mysql --ssl-mode=DISABLED -u sha2user -p
Enter password: password
```

For this connection attempt by `sha2user`, the server determines that `caching_sha2_password` is the appropriate authentication plugin and invokes it (because that was the plugin specified at `CREATE USER` time). The plugin finds that the connection is not encrypted and thus requires the password to be transmitted using RSA encryption. However, the server does not send the public key to the client, and the client provided no public key, so it cannot encrypt the password and the connection fails:

```
ERROR 2061 (HY000): Authentication plugin 'caching_sha2_password'
reported error: Authentication requires secure connection.
```

To request the RSA public key from the server, specify the `--get-server-public-key` option:

```
$> mysql --ssl-mode=DISABLED -u sha2user -p --get-server-public-key
Enter password: password
```

In this case, the server sends the RSA public key to the client, which uses it to encrypt the password and returns the result to the server. The plugin uses the RSA private key on the server side to decrypt the password and accepts or rejects the connection based on whether the password is correct.

Alternatively, if the client has a file containing a local copy of the RSA public key required by the server, it can specify the file using the `--server-public-key-path` option:

```
$> mysql --ssl-mode=DISABLED -u sha2user -p --server-public-key-path=file_name
Enter password: password
```

In this case, the client uses the public key to encrypt the password and returns the result to the server. The plugin uses the RSA private key on the server side to decrypt the password and accepts or rejects the connection based on whether the password is correct.

The public key value in the file named by the `--server-public-key-path` option should be the same as the key value in the server-side file named by the `caching_sha2_password_public_key_path` system variable. If the key file contains a valid public key value but the value is incorrect, an access-denied error occurs. If the key file does not contain a valid public key, the client program cannot use it.

Client users can obtain the RSA public key two ways:

- The database administrator can provide a copy of the public key file.
- A client user who can connect to the server some other way can use a `SHOW STATUS LIKE 'Caching_sha2_password_rsa_public_key'` statement and save the returned key value in a file.

## Cache Operation for SHA-2 Pluggable Authentication

On the server side, the `caching_sha2_password` plugin uses an in-memory cache for faster authentication of clients who have connected previously. For MySQL 5.7, which supports only the `caching_sha2_password` client-side plugin, this server-side caching thus takes place on the MySQL 8.0 or higher server to which you connect using MySQL 5.7 clients. For information about cache operation, see [Cache Operation for SHA-2 Pluggable Authentication](#), in the *MySQL 8.0 Reference Manual*.

### 6.4.1.5 SHA-256 Pluggable Authentication

MySQL provides two authentication plugins that implement SHA-256 hashing for user account passwords:

- `sha256_password`: Implements basic SHA-256 authentication.
- `caching_sha2_password`: Implements SHA-256 authentication (like `sha256_password`), but uses caching on the server side for better performance and has additional features for wider applicability.

This section describes the original noncaching SHA-2 authentication plugin. For information about the caching plugin, see [Section 6.4.1.4, “Caching SHA-2 Pluggable Authentication”](#).

**Important**

To connect to the server using an account that authenticates with the `sha256_password` plugin, you must use either a TLS connection or an unencrypted connection that supports password exchange using an RSA key pair, as described later in this section. Either way, the `sha256_password` plugin uses MySQL' encryption capabilities. See [Section 6.3, “Using Encrypted Connections”](#).

**Note**

In the name `sha256_password`, “sha256” refers to the 256-bit digest length the plugin uses for encryption. In the name `caching_sha2_password`, “sha2” refers more generally to the SHA-2 class of encryption algorithms, of which 256-bit encryption is one instance. The latter name choice leaves room for future expansion of possible digest lengths without changing the plugin name.

The following table shows the plugin names on the server and client sides.

**Table 6.11 Plugin and Library Names for SHA-256 Authentication**

Plugin or File	Plugin or File Name
Server-side plugin	<code>sha256_password</code>
Client-side plugin	<code>sha256_password</code>
Library file	None (plugins are built in)

The following sections provide installation and usage information specific to SHA-256 pluggable authentication:

- [Installing SHA-256 Pluggable Authentication](#)
- [Using SHA-256 Pluggable Authentication](#)

For general information about pluggable authentication in MySQL, see [Section 6.2.13, “Pluggable Authentication”](#).

## Installing SHA-256 Pluggable Authentication

The `sha256_password` plugin exists in server and client forms:

- The server-side plugin is built into the server, need not be loaded explicitly, and cannot be disabled by unloading it.
- The client-side plugin is built into the `libmysqlclient` client library and is available to any program linked against `libmysqlclient`.

## Using SHA-256 Pluggable Authentication

To set up an account that uses the `sha256_password` plugin for SHA-256 password hashing, use the following statement, where `password` is the desired account password:

```
CREATE USER 'sha256user'@'localhost'
IDENTIFIED WITH sha256_password BY 'password';
```

The server assigns the `sha256_password` plugin to the account and uses it to encrypt the password using SHA-256, storing those values in the `plugin` and `authentication_string` columns of the `mysql.user` system table.

The preceding instructions do not assume that `sha256_password` is the default authentication plugin. If `sha256_password` is the default authentication plugin, a simpler `CREATE USER` syntax can be used.

To start the server with the default authentication plugin set to `sha256_password`, put these lines in the server option file:

```
[mysqld]
default_authentication_plugin=sha256_password
```

That causes the `sha256_password` plugin to be used by default for new accounts. As a result, it is possible to create the account and set its password without naming the plugin explicitly:

```
CREATE USER 'sha256user'@'localhost' IDENTIFIED BY 'password';
```

Another consequence of setting `default_authentication_plugin` to `sha256_password` is that, to use some other plugin for account creation, you must specify that plugin explicitly. For example, to use the `mysql_native_password` plugin, use this statement:

```
CREATE USER 'nativeuser'@'localhost'
IDENTIFIED WITH mysql_native_password BY 'password';
```

`sha256_password` supports connections over secure transport. `sha256_password` also supports encrypted password exchange using RSA over unencrypted connections if these conditions are satisfied:

- MySQL is compiled using OpenSSL, not yaSSL. `sha256_password` works with distributions compiled using either package, but RSA support requires OpenSSL.



#### Note

It is possible to compile MySQL using yaSSL as an alternative to OpenSSL only prior to MySQL 5.7.28. As of MySQL 5.7.28, support for yaSSL is removed and all MySQL builds use OpenSSL.

- The MySQL server to which you wish to connect is configured to support RSA (using the RSA configuration procedure given later in this section).

RSA support has these characteristics:

- On the server side, two system variables name the RSA private and public key-pair files: `sha256_password_private_key_path` and `sha256_password_public_key_path`. The database administrator must set these variables at server startup if the key files to use have names that differ from the system variable default values.
- The server uses the `sha256_password_auto_generate_rsa_keys` system variable to determine whether to automatically generate the RSA key-pair files. See [Section 6.3.3, “Creating SSL and RSA Certificates and Keys”](#).
- The `Rsa_public_key` status variable displays the RSA public key value used by the `sha256_password` authentication plugin.
- Clients that are in possession of the RSA public key can perform RSA key pair-based password exchange with the server during the connection process, as described later.
- For connections by accounts that authenticate using `sha256_password` and RSA public key pair-based password exchange, the server sends the RSA public key to the client as needed. However, if a copy of the public key is available on the client host, the client can use it to save a round trip in the client/server protocol:



- For these command-line clients, use the `--server-public-key-path` option to specify the RSA public key file: `mysql`, `mysqltest`, and (as of MySQL 5.7.23) `mysqladmin`, `mysqlbinlog`, `mysqlcheck`, `mysqldump`, `mysqlimport`, `mysqlpump`, `mysqlshow`, `mysqlslap`, `mysqltest`.
- For programs that use the C API, call `mysql_options()` to specify the RSA public key file by passing the `MYSQL_SERVER_PUBLIC_KEY` option and the name of the file.
- For replicas, RSA key pair-based password exchange cannot be used to connect to source servers for accounts that authenticate with the `sha256_password` plugin. For such accounts, only secure connections can be used.

For clients that use the `sha256_password` plugin, passwords are never exposed as cleartext when connecting to the server. How password transmission occurs depends on whether a secure connection or RSA encryption is used:

- If the connection is secure, an RSA key pair is unnecessary and is not used. This applies to connections encrypted using TLS. The password is sent as cleartext but cannot be snooped because the connection is secure.



#### Note

Unlike `caching_sha2_password`, the `sha256_password` plugin does not treat shared-memory connections as secure, even though share-memory transport is secure by default.

- If the connection is not secure, and an RSA key pair is available, the connection remains unencrypted. This applies to connections not encrypted using TLS. RSA is used only for password exchange between client and server, to prevent password snooping. When the server receives the encrypted password, it decrypts it. A scramble is used in the encryption to prevent repeat attacks.
- If a secure connection is not used and RSA encryption is not available, the connection attempt fails because the password cannot be sent without being exposed as cleartext.

As mentioned previously, RSA password encryption is available only if MySQL was compiled using OpenSSL. The implication for MySQL distributions compiled using yaSSL is that, to use SHA-256 passwords, clients *must* use an encrypted connection to access the server. See [Section 6.3.1, “Configuring MySQL to Use Encrypted Connections”](#).



#### Note

To use RSA password encryption with `sha256_password`, the client and server both must be compiled using OpenSSL, not just one of them.

Assuming that MySQL has been compiled using OpenSSL, use the following procedure to enable use of an RSA key pair for password exchange during the client connection process:

1. Create the RSA private and public key-pair files using the instructions in [Section 6.3.3, “Creating SSL and RSA Certificates and Keys”](#).
2. If the private and public key files are located in the data directory and are named `private_key.pem` and `public_key.pem` (the default values of the `sha256_password_private_key_path` and `sha256_password_public_key_path` system variables), the server uses them automatically at startup.

Otherwise, to name the key files explicitly, set the system variables to the key file names in the server option file. If the files are located in the server data directory, you need not specify their full path names:

```
[mysqld]
sha256_password_private_key_path=myprivkey.pem
sha256_password_public_key_path=myspubkey.pem
```

If the key files are not located in the data directory, or to make their locations explicit in the system variable values, use full path names:

```
[mysqld]
sha256_password_private_key_path=/usr/local/mysql/myprivkey.pem
sha256_password_public_key_path=/usr/local/mysql/mypubkey.pem
```

- Restart the server, then connect to it and check the `Rsa_public_key` status variable value. The actual value differs from that shown here, but should be nonempty:

```
mysql> SHOW STATUS LIKE 'Rsa_public_key'\G
***** 1. row *****
Variable_name: Rsa_public_key
Value: -----BEGIN PUBLIC KEY-----
MIGfMA0GCsQGSIB3DQEBAQUAA4GNADCBiQKBgQDO9nRUDd+KvSZgY7cNBZMNpwX6
MvE1PbJFXO7u18nJ9lwc99Du/E7lw6CVXw7VKrXPeHbVQUzGyUNkf45Nz/ckaaJa
aLgJOBcIDmNVnyU540T/1lcs2xiyfaDMe8fCJ64ZwTnKbY2gkt1IMjUAB50gd5kJ
g8aV7EtKwyhHb0c30QIDAQAB
-----END PUBLIC KEY-----
```

If the value is empty, the server found some problem with the key files. Check the error log for diagnostic information.

After the server has been configured with the RSA key files, accounts that authenticate with the `sha256_password` plugin have the option of using those key files to connect to the server. As mentioned previously, such accounts can use either a secure connection (in which case RSA is not used) or an unencrypted connection that performs password exchange using RSA. Suppose that an unencrypted connection is used. For example:

```
$> mysql --ssl-mode=DISABLED -u sha256user -p
Enter password: password
```

For this connection attempt by `sha256user`, the server determines that `sha256_password` is the appropriate authentication plugin and invokes it (because that was the plugin specified at `CREATE USER` time). The plugin finds that the connection is not encrypted and thus requires the password to be transmitted using RSA encryption. In this case, the plugin sends the RSA public key to the client, which uses it to encrypt the password and returns the result to the server. The plugin uses the RSA private key on the server side to decrypt the password and accepts or rejects the connection based on whether the password is correct.

The server sends the RSA public key to the client as needed. However, if the client has a file containing a local copy of the RSA public key required by the server, it can specify the file using the `--server-public-key-path` option:

```
$> mysql --ssl-mode=DISABLED -u sha256user -p --server-public-key-path=file_name
Enter password: password
```

The public key value in the file named by the `--server-public-key-path` option should be the same as the key value in the server-side file named by the `sha256_password_public_key_path` system variable. If the key file contains a valid public key value but the value is incorrect, an access-denied error occurs. If the key file does not contain a valid public key, the client program cannot use it. In this case, the `sha256_password` plugin sends the public key to the client as if no `--server-public-key-path` option had been specified.

Client users can obtain the RSA public key two ways:

- The database administrator can provide a copy of the public key file.
- A client user who can connect to the server some other way can use a `SHOW STATUS LIKE 'Rsa_public_key'` statement and save the returned key value in a file.

### 6.4.1.6 Client-Side Cleartext Pluggable Authentication

A client-side authentication plugin is available that enables clients to send passwords to the server as cleartext, without hashing or encryption. This plugin is built into the MySQL client library.

The following table shows the plugin name.

**Table 6.12 Plugin and Library Names for Cleartext Authentication**

Plugin or File	Plugin or File Name
Server-side plugin	None, see discussion
Client-side plugin	<code>mysql_clear_password</code>
Library file	None (plugin is built in)

Many client-side authentication plugins perform hashing or encryption of a password before the client sends it to the server. This enables clients to avoid sending passwords as cleartext.

Hashing or encryption cannot be done for authentication schemes that require the server to receive the password as entered on the client side. In such cases, the client-side `mysql_clear_password` plugin is used, which enables the client to send the password to the server as cleartext. There is no corresponding server-side plugin. Rather, `mysql_clear_password` can be used on the client side in concert with any server-side plugin that needs a cleartext password. (Examples are the PAM and simple LDAP authentication plugins; see [Section 6.4.1.7, “PAM Pluggable Authentication”](#), and [Section 6.4.1.9, “LDAP Pluggable Authentication”](#).)

The following discussion provides usage information specific to cleartext pluggable authentication. For general information about pluggable authentication in MySQL, see [Section 6.2.13, “Pluggable Authentication”](#).



#### Note

Sending passwords as cleartext may be a security problem in some configurations. To avoid problems if there is any possibility that the password would be intercepted, clients should connect to MySQL Server using a method that protects the password. Possibilities include SSL (see [Section 6.3, “Using Encrypted Connections”](#)), IPsec, or a private network.

To make inadvertent use of the `mysql_clear_password` plugin less likely, MySQL clients must explicitly enable it. This can be done in several ways:

- Set the `LIBMYSQL_ENABLE_CLEARTEXT_PLUGIN` environment variable to a value that begins with `1`, `Y`, or `y`. This enables the plugin for all client connections.
- The `mysql`, `mysqladmin`, and `mysqlslap` client programs (also `mysqlcheck`, `mysqldump`, and `mysqlshow` for MySQL 5.7.10 and later) support an `--enable-cleartext-plugin` option that enables the plugin on a per-invocation basis.
- The `mysql_options()` C API function supports a `MYSQL_ENABLE_CLEARTEXT_PLUGIN` option that enables the plugin on a per-connection basis. Also, any program that uses `libmysqlclient` and reads option files can enable the plugin by including an `enable-cleartext-plugin` option in an option group read by the client library.

### 6.4.1.7 PAM Pluggable Authentication



#### Note

PAM pluggable authentication is an extension included in MySQL Enterprise Edition, a commercial product. To learn more about commercial products, see <https://www.mysql.com/products/>.

MySQL Enterprise Edition supports an authentication method that enables MySQL Server to use PAM (Pluggable Authentication Modules) to authenticate MySQL users. PAM enables a system to use a standard interface to access various kinds of authentication methods, such as traditional Unix passwords or an LDAP directory.

PAM pluggable authentication provides these capabilities:

- **External authentication:** PAM authentication enables MySQL Server to accept connections from users defined outside the MySQL grant tables and that authenticate using methods supported by PAM.
- **Proxy user support:** PAM authentication can return to MySQL a user name different from the external user name passed by the client program, based on the PAM groups the external user is a member of and the authentication string provided. This means that the plugin can return the MySQL user that defines the privileges the external PAM-authenticated user should have. For example, an operating system user named `joe` can connect and have the privileges of a MySQL user named `developer`.

PAM pluggable authentication has been tested on Linux and macOS.

The following table shows the plugin and library file names. The file name suffix might differ on your system. The file must be located in the directory named by the `plugin_dir` system variable. For installation information, see [Installing PAM Pluggable Authentication](#).

**Table 6.13 Plugin and Library Names for PAM Authentication**

Plugin or File	Plugin or File Name
Server-side plugin	<code>authentication_pam</code>
Client-side plugin	<code>mysql_clear_password</code>
Library file	<code>authentication_pam.so</code>

The client-side `mysql_clear_password` cleartext plugin that communicates with the server-side PAM plugin is built into the `libmysqlclient` client library and is included in all distributions, including community distributions. Inclusion of the client-side cleartext plugin in all MySQL distributions enables clients from any distribution to connect to a server that has the server-side PAM plugin loaded.

The following sections provide installation and usage information specific to PAM pluggable authentication:

- [How PAM Authentication of MySQL Users Works](#)
- [Installing PAM Pluggable Authentication](#)
- [Uninstalling PAM Pluggable Authentication](#)
- [Using PAM Pluggable Authentication](#)
- [PAM Unix Password Authentication without Proxy Users](#)
- [PAM LDAP Authentication without Proxy Users](#)
- [PAM Unix Password Authentication with Proxy Users and Group Mapping](#)

- [PAM Authentication Access to Unix Password Store](#)
- [PAM Authentication Debugging](#)

For general information about pluggable authentication in MySQL, see [Section 6.2.13, “Pluggable Authentication”](#). For information about the `mysql_clear_password` plugin, see [Section 6.4.1.6, “Client-Side Cleartext Pluggable Authentication”](#). For proxy user information, see [Section 6.2.14, “Proxy Users”](#).

## How PAM Authentication of MySQL Users Works

This section provides an overview of how MySQL and PAM work together to authenticate MySQL users. For examples showing how to set up MySQL accounts to use specific PAM services, see [Using PAM Pluggable Authentication](#).

1. The client program and the server communicate, with the client sending to the server the client user name (the operating system user name by default) and password:
  - The client user name is the external user name.
  - For accounts that use the PAM server-side authentication plugin, the corresponding client-side plugin is `mysql_clear_password`. This client-side plugin performs no password hashing, with the result that the client sends the password to the server as cleartext.
2. The server finds a matching MySQL account based on the external user name and the host from which the client connects. The PAM plugin uses the information passed to it by MySQL Server (such as user name, host name, password, and authentication string). When you define a MySQL account that authenticates using PAM, the authentication string contains:
  - A PAM service name, which is a name that the system administrator can use to refer to an authentication method for a particular application. There can be multiple applications associated with a single database server instance, so the choice of service name is left to the SQL application developer.
  - Optionally, if proxying is to be used, a mapping from PAM groups to MySQL user names.
3. The plugin uses the PAM service named in the authentication string to check the user credentials and returns `'Authentication succeeded, Username is user_name'` or `'Authentication failed'`. The password must be appropriate for the password store used by the PAM service. Examples:
  - For traditional Unix passwords, the service looks up passwords stored in the `/etc/shadow` file.
  - For LDAP, the service looks up passwords stored in an LDAP directory.

If the credentials check fails, the server refuses the connection.

4. Otherwise, the authentication string indicates whether proxying occurs. If the string contains no PAM group mapping, proxying does not occur. In this case, the MySQL user name is the same as the external user name.
5. Otherwise, proxying is indicated based on the PAM group mapping, with the MySQL user name determined based on the first matching group in the mapping list. The meaning of “PAM group” depends on the PAM service. Examples:
  - For traditional Unix passwords, groups are Unix groups defined in the `/etc/group` file, possibly supplemented with additional PAM information in a file such as `/etc/security/group.conf`.
  - For LDAP, groups are LDAP groups defined in an LDAP directory.

If the proxy user (the external user) has the `PROXY` privilege for the proxied MySQL user name, proxying occurs, with the proxy user assuming the privileges of the proxied user.

## Installing PAM Pluggable Authentication

This section describes how to install the server-side PAM authentication plugin. For general information about installing plugins, see [Section 5.5.1, “Installing and Uninstalling Plugins”](#).

To be usable by the server, the plugin library file must be located in the MySQL plugin directory (the directory named by the `plugin_dir` system variable). If necessary, configure the plugin directory location by setting the value of `plugin_dir` at server startup.

The plugin library file base name is `authentication_pam`. The file name suffix differs per platform (for example, `.so` for Unix and Unix-like systems, `.dll` for Windows).

To load the plugin at server startup, use the `--plugin-load-add` option to name the library file that contains it. With this plugin-loading method, the option must be given each time the server starts. For example, put these lines in the server `my.cnf` file, adjusting the `.so` suffix for your platform as necessary:

```
[mysqld]
plugin-load-add=authentication_pam.so
```

After modifying `my.cnf`, restart the server to cause the new settings to take effect.

Alternatively, to load the plugin at runtime, use this statement, adjusting the `.so` suffix for your platform as necessary:

```
INSTALL PLUGIN authentication_pam SONAME 'authentication_pam.so';
```

`INSTALL PLUGIN` loads the plugin immediately, and also registers it in the `mysql.plugins` system table to cause the server to load it for each subsequent normal startup without the need for `--plugin-load-add`.

To verify plugin installation, examine the Information Schema `PLUGINS` table or use the `SHOW PLUGINS` statement (see [Section 5.5.2, “Obtaining Server Plugin Information”](#)). For example:

```
mysql> SELECT PLUGIN_NAME, PLUGIN_STATUS
        FROM INFORMATION_SCHEMA.PLUGINS
        WHERE PLUGIN_NAME LIKE '%pam%';
+-----+-----+
| PLUGIN_NAME | PLUGIN_STATUS |
+-----+-----+
| authentication_pam | ACTIVE |
+-----+-----+
```

If the plugin fails to initialize, check the server error log for diagnostic messages.

To associate MySQL accounts with the PAM plugin, see [Using PAM Pluggable Authentication](#).

## Uninstalling PAM Pluggable Authentication

The method used to uninstall the PAM authentication plugin depends on how you installed it:

- If you installed the plugin at server startup using a `--plugin-load-add` option, restart the server without the option.
- If you installed the plugin at runtime using an `INSTALL PLUGIN` statement, it remains installed across server restarts. To uninstall it, use `UNINSTALL PLUGIN`:

```
UNINSTALL PLUGIN authentication_pam;
```

## Using PAM Pluggable Authentication

This section describes in general terms how to use the PAM authentication plugin to connect from MySQL client programs to the server. The following sections provide instructions for using PAM authentication in specific ways. It is assumed that the server is running with the server-side PAM plugin enabled, as described in [Installing PAM Pluggable Authentication](#).

To refer to the PAM authentication plugin in the `IDENTIFIED WITH` clause of a `CREATE USER` statement, use the name `authentication_pam`. For example:

```
CREATE USER user
  IDENTIFIED WITH authentication_pam
  AS 'auth_string';
```

The authentication string specifies the following types of information:

- The PAM service name (see [How PAM Authentication of MySQL Users Works](#)). Examples in the following discussion use a service name of `mysql-unix` for authentication using traditional Unix passwords, and `mysql-ldap` for authentication using LDAP.
- For proxy support, PAM provides a way for a PAM module to return to the server a MySQL user name other than the external user name passed by the client program when it connects to the server. Use the authentication string to control the mapping from external user names to MySQL user names. If you want to take advantage of proxy user capabilities, the authentication string must include this kind of mapping.

For example, if an account uses the `mysql-unix` PAM service name and should map operating system users in the `root` and `users` PAM groups to the `developer` and `data_entry` MySQL users, respectively, use a statement like this:

```
CREATE USER user
  IDENTIFIED WITH authentication_pam
  AS 'mysql-unix, root=developer, users=data_entry';
```

Authentication string syntax for the PAM authentication plugin follows these rules:

- The string consists of a PAM service name, optionally followed by a PAM group mapping list consisting of one or more keyword/value pairs each specifying a PAM group name and a MySQL user name:

```
pam_service_name[,pam_group_name=mysql_user_name]...
```

The plugin parses the authentication string for each connection attempt that uses the account. To minimize overhead, keep the string as short as possible.

- Each `pam_group_name=mysql_user_name` pair must be preceded by a comma.
- Leading and trailing spaces not inside double quotation marks are ignored.
- Unquoted `pam_service_name`, `pam_group_name`, and `mysql_user_name` values can contain anything except equal sign, comma, or space.
- If a `pam_service_name`, `pam_group_name`, or `mysql_user_name` value is quoted with double quotation marks, everything between the quotation marks is part of the value. This is necessary, for example, if the value contains space characters. All characters are legal except double quotation mark and backslash (`\`). To include either character, escape it with a backslash.

If the plugin successfully authenticates the external user name (the name passed by the client), it looks for a PAM group mapping list in the authentication string and, if present, uses it to return a different MySQL user name to the MySQL server based on which PAM groups the external user is a member of:

- If the authentication string contains no PAM group mapping list, the plugin returns the external name.

- If the authentication string does contain a PAM group mapping list, the plugin examines each `pam_group_name=mysql_user_name` pair in the list from left to right and tries to find a match for the `pam_group_name` value in a non-MySQL directory of the groups assigned to the authenticated user and returns `mysql_user_name` for the first match it finds. If the plugin finds no match for any PAM group, it returns the external name. If the plugin is not capable of looking up a group in a directory, it ignores the PAM group mapping list and returns the external name.

The following sections describe how to set up several authentication scenarios that use the PAM authentication plugin:

- No proxy users. This uses PAM only to check login names and passwords. Every external user permitted to connect to MySQL Server should have a matching MySQL account that is defined to use PAM authentication. (For a MySQL account of `'user_name'@'host_name'` to match the external user, `user_name` must be the external user name and `host_name` must match the host from which the client connects.) Authentication can be performed by various PAM-supported methods. Later discussion shows how to authenticate client credentials using traditional Unix passwords, and passwords in LDAP.

PAM authentication, when not done through proxy users or PAM groups, requires the MySQL user name to be same as the operating system user name. MySQL user names are limited to 32 characters (see [Section 6.2.3, “Grant Tables”](#)), which limits PAM nonproxy authentication to Unix accounts with names of at most 32 characters.

- Proxy users only, with PAM group mapping. For this scenario, create one or more MySQL accounts that define different sets of privileges. (Ideally, nobody should connect using those accounts directly.) Then define a default user authenticating through PAM that uses some mapping scheme (usually based on the external PAM groups the users are members of) to map all the external user names to the few MySQL accounts holding the privilege sets. Any client who connects and specifies an external user name as the client user name is mapped to one of the MySQL accounts and uses its privileges. The discussion shows how to set this up using traditional Unix passwords, but other PAM methods such as LDAP could be used instead.

Variations on these scenarios are possible:

- You can permit some users to log in directly (without proxying) but require others to connect through proxy accounts.
- You can use one PAM authentication method for some users, and another method for other users, by using differing PAM service names among your PAM-authenticated accounts. For example, you can use the `mysql-unix` PAM service for some users, and `mysql-ldap` for others.

The examples make the following assumptions. You might need to make some adjustments if your system is set up differently.

- The login name and password are `antonio` and `antonio_password`, respectively. Change these to correspond to the user you want to authenticate.
- The PAM configuration directory is `/etc/pam.d`.
- The PAM service name corresponds to the authentication method (`mysql-unix` or `mysql-ldap` in this discussion). To use a given PAM service, you must set up a PAM file with the same name in the PAM configuration directory (creating the file if it does not exist). In addition, you must name the PAM service in the authentication string of the `CREATE USER` statement for any account that authenticates using that PAM service.

The PAM authentication plugin checks at initialization time whether the `AUTHENTICATION_PAM_LOG` environment value is set in the server's startup environment. If so, the plugin enables logging of diagnostic



messages to the standard output. Depending on how your server is started, the message might appear on the console or in the error log. These messages can be helpful for debugging PAM-related issues that occur when the plugin performs authentication. For more information, see [PAM Authentication Debugging](#).

## PAM Unix Password Authentication without Proxy Users

This authentication scenario uses PAM to check external users defined in terms of operating system user names and Unix passwords, without proxying. Every such external user permitted to connect to MySQL Server should have a matching MySQL account that is defined to use PAM authentication through traditional Unix password store.



### Note

Traditional Unix passwords are checked using the `/etc/shadow` file. For information regarding possible issues related to this file, see [PAM Authentication Access to Unix Password Store](#).

1. Verify that Unix authentication permits logins to the operating system with the user name `antonio` and password `antonio_password`.
2. Set up PAM to authenticate MySQL connections using traditional Unix passwords by creating a `mysql-unix` PAM service file named `/etc/pam.d/mysql-unix`. The file contents are system dependent, so check existing login-related files in the `/etc/pam.d` directory to see what they look like. On Linux, the `mysql-unix` file might look like this:

```

#%PAM-1.0
auth            include            password-auth
account         include            password-auth

```

For macOS, use `login` rather than `password-auth`.

The PAM file format might differ on some systems. For example, on Ubuntu and other Debian-based systems, use these file contents instead:

```

@include common-auth
@include common-account
@include common-session-noninteractive

```

3. Create a MySQL account with the same user name as the operating system user name and define it to authenticate using the PAM plugin and the `mysql-unix` PAM service:

```

CREATE USER 'antonio'@'localhost'
  IDENTIFIED WITH authentication_pam
  AS 'mysql-unix';
GRANT ALL PRIVILEGES
  ON mydb.*
  TO 'antonio'@'localhost';

```

Here, the authentication string contains only the PAM service name, `mysql-unix`, which authenticates Unix passwords.

4. Use the `mysql` command-line client to connect to the MySQL server as `antonio`. For example:

```

$> mysql --user=antonio --password --enable-cleartext-plugin
Enter password: antonio_password

```

The server should permit the connection and the following query returns output as shown:

```

mysql> SELECT USER(), CURRENT_USER(), @@proxy_user;
+-----+-----+-----+

```

```

| USER()          | CURRENT_USER()  | @@proxy_user |
+-----+-----+-----+
| antonio@localhost | antonio@localhost | NULL         |
+-----+-----+-----+

```

This demonstrates that the `antonio` operating system user is authenticated to have the privileges granted to the `antonio` MySQL user, and that no proxying has occurred.



### Note

The client-side `mysql_clear_password` authentication plugin leaves the password untouched, so client programs send it to the MySQL server as cleartext. This enables the password to be passed as is to PAM. A cleartext password is necessary to use the server-side PAM library, but may be a security problem in some configurations. These measures minimize the risk:

- To make inadvertent use of the `mysql_clear_password` plugin less likely, MySQL clients must explicitly enable it (for example, with the `--enable-cleartext-plugin` option). See [Section 6.4.1.6, “Client-Side Cleartext Pluggable Authentication”](#).
- To avoid password exposure with the `mysql_clear_password` plugin enabled, MySQL clients should connect to the MySQL server using an encrypted connection. See [Section 6.3.1, “Configuring MySQL to Use Encrypted Connections”](#).

## PAM LDAP Authentication without Proxy Users

This authentication scenario uses PAM to check external users defined in terms of operating system user names and LDAP passwords, without proxying. Every such external user permitted to connect to MySQL Server should have a matching MySQL account that is defined to use PAM authentication through LDAP.

To use PAM LDAP pluggable authentication for MySQL, these prerequisites must be satisfied:

- An LDAP server must be available for the PAM LDAP service to communicate with.
- Each LDAP user to be authenticated by MySQL must be present in the directory managed by the LDAP server.



### Note

Another way to use LDAP for MySQL user authentication is to use the LDAP-specific authentication plugins. See [Section 6.4.1.9, “LDAP Pluggable Authentication”](#).

Configure MySQL for PAM LDAP authentication as follows:

1. Verify that Unix authentication permits logins to the operating system with the user name `antonio` and password `antonio_password`.
2. Set up PAM to authenticate MySQL connections using LDAP by creating a `mysql-ldap` PAM service file named `/etc/pam.d/mysql-ldap`. The file contents are system dependent, so check existing login-related files in the `/etc/pam.d` directory to see what they look like. On Linux, the `mysql-ldap` file might look like this:

```

#%PAM-1.0
auth        required    pam_ldap.so

```

```
account    required    pam_ldap.so
```

If PAM object files have a suffix different from `.so` on your system, substitute the correct suffix.

The PAM file format might differ on some systems.

3. Create a MySQL account with the same user name as the operating system user name and define it to authenticate using the PAM plugin and the `mysql-ldap` PAM service:

```
CREATE USER 'antonio'@'localhost'
  IDENTIFIED WITH authentication_pam
  AS 'mysql-ldap';
GRANT ALL PRIVILEGES
  ON mydb.*
  TO 'antonio'@'localhost';
```

Here, the authentication string contains only the PAM service name, `mysql-ldap`, which authenticates using LDAP.

4. Connecting to the server is the same as described in [PAM Unix Password Authentication without Proxy Users](#).

## PAM Unix Password Authentication with Proxy Users and Group Mapping

The authentication scheme described here uses proxying and PAM group mapping to map connecting MySQL users who authenticate using PAM onto other MySQL accounts that define different sets of privileges. Users do not connect directly through the accounts that define the privileges. Instead, they connect through a default proxy account authenticated using PAM, such that all the external users are mapped to the MySQL accounts that hold the privileges. Any user who connects using the proxy account is mapped to one of those MySQL accounts, the privileges for which determine the database operations permitted to the external user.

The procedure shown here uses Unix password authentication. To use LDAP instead, see the early steps of [PAM LDAP Authentication without Proxy Users](#).



### Note

Traditional Unix passwords are checked using the `/etc/shadow` file. For information regarding possible issues related to this file, see [PAM Authentication Access to Unix Password Store](#).

1. Verify that Unix authentication permits logins to the operating system with the user name `antonio` and password `antonio_password`.
2. Verify that `antonio` is a member of the `root` or `users` PAM group.
3. Set up PAM to authenticate the `mysql-unix` PAM service through operating system users by creating a file named `/etc/pam.d/mysql-unix`. The file contents are system dependent, so check existing login-related files in the `/etc/pam.d` directory to see what they look like. On Linux, the `mysql-unix` file might look like this:

```
##PAM-1.0
auth            include            password-auth
account         include            password-auth
```

For macOS, use `login` rather than `password-auth`.

The PAM file format might differ on some systems. For example, on Ubuntu and other Debian-based systems, use these file contents instead:

```
@include common-auth
@include common-account
@include common-session-noninteractive
```

4. Create a default proxy user ( ' '@' ) that maps external PAM users to the proxied accounts:

```
CREATE USER ' '@'
  IDENTIFIED WITH authentication_pam
  AS 'mysql-unix, root=developer, users=data_entry';
```

Here, the authentication string contains the PAM service name, `mysql-unix`, which authenticates Unix passwords. The authentication string also maps external users in the `root` and `users` PAM groups to the `developer` and `data_entry` MySQL user names, respectively.

The PAM group mapping list following the PAM service name is required when you set up proxy users. Otherwise, the plugin cannot tell how to perform mapping from external user names to the proper proxied MySQL user names.



#### Note

If your MySQL installation has anonymous users, they might conflict with the default proxy user. For more information about this issue, and ways of dealing with it, see [Default Proxy User and Anonymous User Conflicts](#).

5. Create the proxied accounts and grant to each one the privileges it should have:

```
CREATE USER 'developer'@'localhost'
  IDENTIFIED WITH mysql_no_login;
CREATE USER 'data_entry'@'localhost'
  IDENTIFIED WITH mysql_no_login;

GRANT ALL PRIVILEGES
  ON mydevdb.*
  TO 'developer'@'localhost';
GRANT ALL PRIVILEGES
  ON mydb.*
  TO 'data_entry'@'localhost';
```

The proxied accounts use the `mysql_no_login` authentication plugin to prevent clients from using the accounts to log in directly to the MySQL server. Instead, it is expected that users who authenticate using PAM use the `developer` or `data_entry` account by proxy based on their PAM group. (This assumes that the plugin is installed. For instructions, see [Section 6.4.1.10, “No-Login Pluggable Authentication”](#).) For alternative methods of protecting proxied accounts against direct use, see [Preventing Direct Login to Proxied Accounts](#).

6. Grant to the proxy account the `PROXY` privilege for each proxied account:

```
GRANT PROXY
  ON 'developer'@'localhost'
  TO ' '@';
GRANT PROXY
  ON 'data_entry'@'localhost'
  TO ' '@;
```

7. Use the `mysql` command-line client to connect to the MySQL server as `antonio`.

```
$> mysql --user=antonio --password --enable-cleartext-plugin
Enter password: antonio_password
```

The server authenticates the connection using the default ' '@' proxy account. The resulting privileges for `antonio` depend on which PAM groups `antonio` is a member of. If `antonio` is a

member of the `root` PAM group, the PAM plugin maps `root` to the `developer` MySQL user name and returns that name to the server. The server verifies that `'@'` has the `PROXY` privilege for `developer` and permits the connection. The following query returns output as shown:

```
mysql> SELECT USER(), CURRENT_USER(), @@proxy_user;
+-----+-----+-----+
| USER()          | CURRENT_USER()    | @@proxy_user |
+-----+-----+-----+
| antonio@localhost | developer@localhost | '@'         |
+-----+-----+-----+
```

This demonstrates that the `antonio` operating system user is authenticated to have the privileges granted to the `developer` MySQL user, and that proxying occurs through the default proxy account.

If `antonio` is not a member of the `root` PAM group but is a member of the `users` PAM group, a similar process occurs, but the plugin maps `user` PAM group membership to the `data_entry` MySQL user name and returns that name to the server:

```
mysql> SELECT USER(), CURRENT_USER(), @@proxy_user;
+-----+-----+-----+
| USER()          | CURRENT_USER()    | @@proxy_user |
+-----+-----+-----+
| antonio@localhost | data_entry@localhost | '@'         |
+-----+-----+-----+
```

This demonstrates that the `antonio` operating system user is authenticated to have the privileges of the `data_entry` MySQL user, and that proxying occurs through the default proxy account.



#### Note

The client-side `mysql_clear_password` authentication plugin leaves the password untouched, so client programs send it to the MySQL server as cleartext. This enables the password to be passed as is to PAM. A cleartext password is necessary to use the server-side PAM library, but may be a security problem in some configurations. These measures minimize the risk:

- To make inadvertent use of the `mysql_clear_password` plugin less likely, MySQL clients must explicitly enable it (for example, with the `--enable-cleartext-plugin` option). See [Section 6.4.1.6, “Client-Side Cleartext Pluggable Authentication”](#).
- To avoid password exposure with the `mysql_clear_password` plugin enabled, MySQL clients should connect to the MySQL server using an encrypted connection. See [Section 6.3.1, “Configuring MySQL to Use Encrypted Connections”](#).

## PAM Authentication Access to Unix Password Store

On some systems, Unix authentication uses a password store such as `/etc/shadow`, a file that typically has restricted access permissions. This can cause MySQL PAM-based authentication to fail. Unfortunately, the PAM implementation does not permit distinguishing “password could not be checked” (due, for example, to inability to read `/etc/shadow`) from “password does not match.” If you are using Unix password store for PAM authentication, you may be able to enable access to it from MySQL using one of the following methods:

- Assuming that the MySQL server is run from the `mysql` operating system account, put that account in the `shadow` group that has `/etc/shadow` access:
  1. Create a `shadow` group in `/etc/group`.

2. Add the `mysql` operating system user to the `shadow` group in `/etc/group`.
3. Assign `/etc/group` to the `shadow` group and enable the group read permission:

```
chgrp shadow /etc/shadow
chmod g+r /etc/shadow
```

4. Restart the MySQL server.

- If you are using the `pam_unix` module and the `unix_chkpwd` utility, enable password store access as follows:

```
chmod u-s /usr/sbin/unix_chkpwd
setcap cap_dac_read_search+ep /usr/sbin/unix_chkpwd
```

Adjust the path to `unix_chkpwd` as necessary for your platform.

## PAM Authentication Debugging

The PAM authentication plugin checks at initialization time whether the `AUTHENTICATION_PAM_LOG` environment value is set. In MySQL 5.7, and in MySQL NDB Cluster prior to NDB 7.5.33 and NDB 7.6.29, the value does not matter. The plugin enables logging of diagnostic messages to the standard output, including passwords. These messages may be helpful for debugging PAM-related issues that occur when the plugin performs authentication.

In MySQL NDB Cluster, beginning with versions 7.5.33 and 7.6.29, passwords are *not* included if you set `AUTHENTICATION_PAM_LOG=1` (or some other arbitrary value); you can enable logging of debugging messages, passwords included, by setting `AUTHENTICATION_PAM_LOG=PAM_LOG_WITH_SECRET_INFO`.

Some messages include reference to PAM plugin source files and line numbers, which enables plugin actions to be tied more closely to the location in the code where they occur.

Another technique for debugging connection failures and determining what is happening during connection attempts is to configure PAM authentication to permit all connections, then check the system log files. This technique should be used only on a *temporary* basis, and not on a production server.

Configure a PAM service file named `/etc/pam.d/mysql-any-password` with these contents (the format may differ on some systems):

```
##PAM-1.0
auth      required    pam_permit.so
account   required    pam_permit.so
```

Create an account that uses the PAM plugin and names the `mysql-any-password` PAM service:

```
CREATE USER 'testuser'@'localhost'
  IDENTIFIED WITH authentication_pam
  AS 'mysql-any-password';
```

The `mysql-any-password` service file causes any authentication attempt to return true, even for incorrect passwords. If an authentication attempt fails, that tells you the configuration problem is on the MySQL side. Otherwise, the problem is on the operating system/PAM side. To see what might be happening, check system log files such as `/var/log/secure`, `/var/log/audit.log`, `/var/log/syslog`, or `/var/log/messages`.

After determining what the problem is, remove the `mysql-any-password` PAM service file to disable any-password access.

### 6.4.1.8 Windows Pluggable Authentication



#### Note

Windows pluggable authentication is an extension included in MySQL Enterprise Edition, a commercial product. To learn more about commercial products, see <https://www.mysql.com/products/>.

MySQL Enterprise Edition for Windows supports an authentication method that performs external authentication on Windows, enabling MySQL Server to use native Windows services to authenticate client connections. Users who have logged in to Windows can connect from MySQL client programs to the server based on the information in their environment without specifying an additional password.

The client and server exchange data packets in the authentication handshake. As a result of this exchange, the server creates a security context object that represents the identity of the client in the Windows OS. This identity includes the name of the client account. Windows pluggable authentication uses the identity of the client to check whether it is a given account or a member of a group. By default, negotiation uses Kerberos to authenticate, then NTLM if Kerberos is unavailable.

Windows pluggable authentication provides these capabilities:

- **External authentication:** Windows authentication enables MySQL Server to accept connections from users defined outside the MySQL grant tables who have logged in to Windows.
- **Proxy user support:** Windows authentication can return to MySQL a user name different from the external user name passed by the client program. This means that the plugin can return the MySQL user that defines the privileges the external Windows-authenticated user should have. For example, a Windows user named `joe` can connect and have the privileges of a MySQL user named `developer`.

The following table shows the plugin and library file names. The file must be located in the directory named by the `plugin_dir` system variable.

**Table 6.14 Plugin and Library Names for Windows Authentication**

Plugin or File	Plugin or File Name
Server-side plugin	<code>authentication_windows</code>
Client-side plugin	<code>authentication_windows_client</code>
Library file	<code>authentication_windows.dll</code>

The library file includes only the server-side plugin. The client-side plugin is built into the `libmysqlclient` client library.

The server-side Windows authentication plugin is included only in MySQL Enterprise Edition. It is not included in MySQL community distributions. The client-side plugin is included in all distributions, including community distributions. This enables clients from any distribution to connect to a server that has the server-side plugin loaded.

The following sections provide installation and usage information specific to Windows pluggable authentication:

- [Installing Windows Pluggable Authentication](#)
- [Uninstalling Windows Pluggable Authentication](#)
- [Using Windows Pluggable Authentication](#)

For general information about pluggable authentication in MySQL, see [Section 6.2.13, “Pluggable Authentication”](#). For proxy user information, see [Section 6.2.14, “Proxy Users”](#).

## Installing Windows Pluggable Authentication

This section describes how to install the server-side Windows authentication plugin. For general information about installing plugins, see [Section 5.5.1, “Installing and Uninstalling Plugins”](#).

To be usable by the server, the plugin library file must be located in the MySQL plugin directory (the directory named by the `plugin_dir` system variable). If necessary, configure the plugin directory location by setting the value of `plugin_dir` at server startup.

To load the plugin at server startup, use the `--plugin-load-add` option to name the library file that contains it. With this plugin-loading method, the option must be given each time the server starts. For example, put these lines in the server `my.cnf` file:

```
[mysqld]
plugin-load-add=authentication_windows.dll
```

After modifying `my.cnf`, restart the server to cause the new settings to take effect.

Alternatively, to load the plugin at runtime, use this statement:

```
INSTALL PLUGIN authentication_windows SONAME 'authentication_windows.dll';
```

`INSTALL PLUGIN` loads the plugin immediately, and also registers it in the `mysql.plugins` system table to cause the server to load it for each subsequent normal startup without the need for `--plugin-load-add`.

To verify plugin installation, examine the Information Schema `PLUGINS` table or use the `SHOW PLUGINS` statement (see [Section 5.5.2, “Obtaining Server Plugin Information”](#)). For example:

```
mysql> SELECT PLUGIN_NAME, PLUGIN_STATUS
FROM INFORMATION_SCHEMA.PLUGINS
WHERE PLUGIN_NAME LIKE '%windows%';
+-----+-----+
| PLUGIN_NAME          | PLUGIN_STATUS |
+-----+-----+
| authentication_windows | ACTIVE        |
+-----+-----+
```

If the plugin fails to initialize, check the server error log for diagnostic messages.

To associate MySQL accounts with the Windows authentication plugin, see [Using Windows Pluggable Authentication](#). Additional plugin control is provided by the `authentication_windows_use_principal_name` and `authentication_windows_log_level` system variables. See [Section 5.1.7, “Server System Variables”](#).

## Uninstalling Windows Pluggable Authentication

The method used to uninstall the Windows authentication plugin depends on how you installed it:

- If you installed the plugin at server startup using a `--plugin-load-add` option, restart the server without the option.
- If you installed the plugin at runtime using an `INSTALL PLUGIN` statement, it remains installed across server restarts. To uninstall it, use `UNINSTALL PLUGIN`:



```
UNINSTALL PLUGIN authentication_windows;
```

In addition, remove any startup options that set Windows plugin-related system variables.

## Using Windows Pluggable Authentication

The Windows authentication plugin supports the use of MySQL accounts such that users who have logged in to Windows can connect to the MySQL server without having to specify an additional password. It is assumed that the server is running with the server-side plugin enabled, as described in [Installing Windows Pluggable Authentication](#). Once the DBA has enabled the server-side plugin and set up accounts to use it, clients can connect using those accounts with no other setup required on their part.

To refer to the Windows authentication plugin in the `IDENTIFIED WITH` clause of a `CREATE USER` statement, use the name `authentication_windows`. Suppose that the Windows users `Rafal` and `Tasha` should be permitted to connect to MySQL, as well as any users in the `Administrators` or `Power Users` group. To set this up, create a MySQL account named `sql_admin` that uses the Windows plugin for authentication:

```
CREATE USER sql_admin
  IDENTIFIED WITH authentication_windows
  AS 'Rafal, Tasha, Administrators, "Power Users"';
```

The plugin name is `authentication_windows`. The string following the `AS` keyword is the authentication string. It specifies that the Windows users named `Rafal` or `Tasha` are permitted to authenticate to the server as the MySQL user `sql_admin`, as are any Windows users in the `Administrators` or `Power Users` group. The latter group name contains a space, so it must be quoted with double quote characters.

After you create the `sql_admin` account, a user who has logged in to Windows can attempt to connect to the server using that account:

```
C:\> mysql --user=sql_admin
```

No password is required here. The `authentication_windows` plugin uses the Windows security API to check which Windows user is connecting. If that user is named `Rafal` or `Tasha`, or is a member of the `Administrators` or `Power Users` group, the server grants access and the client is authenticated as `sql_admin` and has whatever privileges are granted to the `sql_admin` account. Otherwise, the server denies access.

Authentication string syntax for the Windows authentication plugin follows these rules:

- The string consists of one or more user mappings separated by commas.
- Each user mapping associates a Windows user or group name with a MySQL user name:

```
win_user_or_group_name=mysql_user_name
win_user_or_group_name
```

For the latter syntax, with no `mysql_user_name` value given, the implicit value is the MySQL user created by the `CREATE USER` statement. Thus, these statements are equivalent:

```
CREATE USER sql_admin
  IDENTIFIED WITH authentication_windows
  AS 'Rafal, Tasha, Administrators, "Power Users"';

CREATE USER sql_admin
  IDENTIFIED WITH authentication_windows
  AS 'Rafal=sql_admin, Tasha=sql_admin, Administrators=sql_admin,
```

```
"Power Users"=sql_admin';
```

- Each backslash character (\) in a value must be doubled because backslash is the escape character in MySQL strings.
- Leading and trailing spaces not inside double quotation marks are ignored.
- Unquoted *win\_user\_or\_group\_name* and *mysql\_user\_name* values can contain anything except equal sign, comma, or space.
- If a *win\_user\_or\_group\_name* and or *mysql\_user\_name* value is quoted with double quotation marks, everything between the quotation marks is part of the value. This is necessary, for example, if the name contains space characters. All characters within double quotes are legal except double quotation mark and backslash. To include either character, escape it with a backslash.
- *win\_user\_or\_group\_name* values use conventional syntax for Windows principals, either local or in a domain. Examples (note the doubling of backslashes):

```
domain\\user
.\\user
domain\\group
.\\group
BUILTIN\\WellKnownGroup
```

When invoked by the server to authenticate a client, the plugin scans the authentication string left to right for a user or group match to the Windows user. If there is a match, the plugin returns the corresponding *mysql\_user\_name* to the MySQL server. If there is no match, authentication fails.

A user name match takes preference over a group name match. Suppose that the Windows user named *win\_user* is a member of *win\_group* and the authentication string looks like this:

```
'win_group = sql_user1, win_user = sql_user2'
```

When *win\_user* connects to the MySQL server, there is a match both to *win\_group* and to *win\_user*. The plugin authenticates the user as *sql\_user2* because the more-specific user match takes precedence over the group match, even though the group is listed first in the authentication string.

Windows authentication always works for connections from the same computer on which the server is running. For cross-computer connections, both computers must be registered with Microsoft Active Directory. If they are in the same Windows domain, it is unnecessary to specify a domain name. It is also possible to permit connections from a different domain, as in this example:

```
CREATE USER sql_accounting
  IDENTIFIED WITH authentication_windows
  AS 'SomeDomain\\Accounting';
```

Here *SomeDomain* is the name of the other domain. The backslash character is doubled because it is the MySQL escape character within strings.

MySQL supports the concept of proxy users whereby a client can connect and authenticate to the MySQL server using one account but while connected has the privileges of another account (see [Section 6.2.14, "Proxy Users"](#)). Suppose that you want Windows users to connect using a single user name but be mapped based on their Windows user and group names onto specific MySQL accounts as follows:

- The *local\_user* and *MyDomain\domain\_user* local and domain Windows users should map to the *local\_wlad* MySQL account.
- Users in the *MyDomain\Developers* domain group should map to the *local\_dev* MySQL account.

- Local machine administrators should map to the `local_admin` MySQL account.

To set this up, create a proxy account for Windows users to connect to, and configure this account so that users and groups map to the appropriate MySQL accounts (`local_wlad`, `local_dev`, `local_admin`). In addition, grant the MySQL accounts the privileges appropriate to the operations they need to perform. The following instructions use `win_proxy` as the proxy account, and `local_wlad`, `local_dev`, and `local_admin` as the proxied accounts.

1. Create the proxy MySQL account:

```
CREATE USER win_proxy
  IDENTIFIED WITH authentication_windows
  AS 'local_user = local_wlad,
     MyDomain\domain_user = local_wlad,
     MyDomain\Developers = local_dev,
     BUILTIN\Administrators = local_admin';
```

2. For proxying to work, the proxied accounts must exist, so create them:

```
CREATE USER local_wlad
  IDENTIFIED WITH mysql_no_login;
CREATE USER local_dev
  IDENTIFIED WITH mysql_no_login;
CREATE USER local_admin
  IDENTIFIED WITH mysql_no_login;
```

The proxied accounts use the `mysql_no_login` authentication plugin to prevent clients from using the accounts to log in directly to the MySQL server. Instead, it is expected that users who authenticate using Windows use the `win_proxy` proxy account. (This assumes that the plugin is installed. For instructions, see [Section 6.4.1.10, "No-Login Pluggable Authentication"](#).) For alternative methods of protecting proxied accounts against direct use, see [Preventing Direct Login to Proxied Accounts](#).

You should also execute `GRANT` statements (not shown) that grant each proxied account the privileges required for MySQL access.

3. Grant to the proxy account the `PROXY` privilege for each proxied account:

```
GRANT PROXY ON local_wlad TO win_proxy;
GRANT PROXY ON local_dev TO win_proxy;
GRANT PROXY ON local_admin TO win_proxy;
```

Now the Windows users `local_user` and `MyDomain\domain_user` can connect to the MySQL server as `win_proxy` and when authenticated have the privileges of the account given in the authentication string (in this case, `local_wlad`). A user in the `MyDomain\Developers` group who connects as `win_proxy` has the privileges of the `local_dev` account. A user in the `BUILTIN\Administrators` group has the privileges of the `local_admin` account.

To configure authentication so that all Windows users who do not have their own MySQL account go through a proxy account, substitute the default proxy account (`'@'`) for `win_proxy` in the preceding instructions. For information about default proxy accounts, see [Section 6.2.14, "Proxy Users"](#).



#### Note

If your MySQL installation has anonymous users, they might conflict with the default proxy user. For more information about this issue, and ways of dealing with it, see [Default Proxy User and Anonymous User Conflicts](#).

To use the Windows authentication plugin with Connector/NET connection strings in Connector/NET 8.0 and higher, see [Connector/NET Authentication](#).

### 6.4.1.9 LDAP Pluggable Authentication



#### Note

LDAP pluggable authentication is an extension included in MySQL Enterprise Edition, a commercial product. To learn more about commercial products, see <https://www.mysql.com/products/>.

As of MySQL 5.7.19, MySQL Enterprise Edition supports an authentication method that enables MySQL Server to use LDAP (Lightweight Directory Access Protocol) to authenticate MySQL users by accessing directory services such as X.500. MySQL uses LDAP to fetch user, credential, and group information.

LDAP pluggable authentication provides these capabilities:

- **External authentication:** LDAP authentication enables MySQL Server to accept connections from users defined outside the MySQL grant tables in LDAP directories.
- **Proxy user support:** LDAP authentication can return to MySQL a user name different from the external user name passed by the client program, based on the LDAP groups the external user is a member of. This means that an LDAP plugin can return the MySQL user that defines the privileges the external LDAP-authenticated user should have. For example, an LDAP user named `joe` can connect and have the privileges of a MySQL user named `developer`, if the LDAP group for `joe` is `developer`.
- **Security:** Using TLS, connections to the LDAP server can be secure.

The following tables show the plugin and library file names for simple and SASL-based LDAP authentication. The file name suffix might differ on your system. The files must be located in the directory named by the `plugin_dir` system variable.

**Table 6.15 Plugin and Library Names for Simple LDAP Authentication**

Plugin or File	Plugin or File Name
Server-side plugin name	<code>authentication_ldap_simple</code>
Client-side plugin name	<code>mysql_clear_password</code>
Library file name	<code>authentication_ldap_simple.so</code>

**Table 6.16 Plugin and Library Names for SASL-Based LDAP Authentication**

Plugin or File	Plugin or File Name
Server-side plugin name	<code>authentication_ldap_sasl</code>
Client-side plugin name	<code>authentication_ldap_sasl_client</code>
Library file names	<code>authentication_ldap_sasl.so</code> , <code>authentication_ldap_sasl_client.so</code>

The library files include only the `authentication_ldap_XXX` authentication plugins. The client-side `mysql_clear_password` plugin is built into the `libmysqlclient` client library.

Each server-side LDAP plugin works with a specific client-side plugin:

- The server-side `authentication_ldap_simple` plugin performs simple LDAP authentication. For connections by accounts that use this plugin, client programs use the client-side `mysql_clear_password` plugin, which sends the password to the server as cleartext. No password

hashing or encryption is used, so a secure connection between the MySQL client and server is recommended to prevent password exposure.

- The server-side `authentication_ldap_sasl` plugin performs SASL-based LDAP authentication. For connections by accounts that use this plugin, client programs use the client-side `authentication_ldap_sasl_client` plugin. The client-side and server-side SASL LDAP plugins use SASL messages for secure transmission of credentials within the LDAP protocol, to avoid sending the cleartext password between the MySQL client and server.

The server-side LDAP authentication plugins are included only in MySQL Enterprise Edition. They are not included in MySQL community distributions. The client-side SASL LDAP plugin is included in all distributions, including community distributions, and, as mentioned previously, the client-side `mysql_clear_password` plugin is built into the `libmysqlclient` client library, which also is included in all distributions. This enables clients from any distribution to connect to a server that has the appropriate server-side plugin loaded.

The following sections provide installation and usage information specific to LDAP pluggable authentication:

- [Prerequisites for LDAP Pluggable Authentication](#)
- [How LDAP Authentication of MySQL Users Works](#)
- [Installing LDAP Pluggable Authentication](#)
- [Uninstalling LDAP Pluggable Authentication](#)
- [LDAP Pluggable Authentication and `ldap.conf`](#)
- [Using LDAP Pluggable Authentication](#)
- [Simple LDAP Authentication \(Without Proxying\)](#)
- [SASL-Based LDAP Authentication \(Without Proxying\)](#)
- [LDAP Authentication with Proxying](#)
- [LDAP Authentication Group Preference and Mapping Specification](#)
- [LDAP Authentication User DN Suffixes](#)
- [LDAP Authentication Methods](#)

For general information about pluggable authentication in MySQL, see [Section 6.2.13, “Pluggable Authentication”](#). For information about the `mysql_clear_password` plugin, see [Section 6.4.1.6, “Client-Side Cleartext Pluggable Authentication”](#). For proxy user information, see [Section 6.2.14, “Proxy Users”](#).

**Note**

If your system supports PAM and permits LDAP as a PAM authentication method, another way to use LDAP for MySQL user authentication is to use the server-side `authentication_pam` plugin. See [Section 6.4.1.7, “PAM Pluggable Authentication”](#).

## Prerequisites for LDAP Pluggable Authentication

To use LDAP pluggable authentication for MySQL, these prerequisites must be satisfied:

- An LDAP server must be available for the LDAP authentication plugins to communicate with.
- LDAP users to be authenticated by MySQL must be present in the directory managed by the LDAP server.
- An LDAP client library must be available on systems where the server-side `authentication_ldap_sasl` or `authentication_ldap_simple` plugin is used. Currently, supported libraries are the Windows native LDAP library, or the OpenLDAP library on non-Windows systems.
- To use SASL-based LDAP authentication:
  - The LDAP server must be configured to communicate with a SASL server.
  - A SASL client library must be available on systems where the client-side `authentication_ldap_sasl_client` plugin is used. Currently, the only supported library is the Cyrus SASL library.

### How LDAP Authentication of MySQL Users Works

This section provides a general overview of how MySQL and LDAP work together to authenticate MySQL users. For examples showing how to set up MySQL accounts to use specific LDAP authentication plugins, see [Using LDAP Pluggable Authentication](#).

The client connects to the MySQL server, providing the MySQL client user name and the LDAP password:

- For simple LDAP authentication, the client-side and server-side plugins communicate the password as cleartext. A secure connection between the MySQL client and server is recommended to prevent password exposure.
- For SASL-based LDAP authentication, the client-side and server-side plugins avoid sending the cleartext password between the MySQL client and server. For example, the plugins might use SASL messages for secure transmission of credentials within the LDAP protocol.

If the client user name and host name match no MySQL account, the connection is rejected.

If there is a matching MySQL account, authentication against LDAP occurs. The LDAP server looks for an entry matching the user and authenticates the entry against the LDAP password:

- If the MySQL account names an LDAP user distinguished name (DN), LDAP authentication uses that value and the LDAP password provided by the client. (To associate an LDAP user DN with a MySQL account, include a `BY` clause that specifies an authentication string in the `CREATE USER` statement that creates the account.)
- If the MySQL account names no LDAP user DN, LDAP authentication uses the user name and LDAP password provided by the client. In this case, the authentication plugin first binds to the LDAP server using the root DN and password as credentials to find the user DN based on the client user name, then authenticates that user DN against the LDAP password. This bind using the root credentials fails if the root DN and password are set to incorrect values, or are empty (not set) and the LDAP server does not permit anonymous connections.

If the LDAP server finds no match or multiple matches, authentication fails and the client connection is rejected.

If the LDAP server finds a single match, LDAP authentication succeeds (assuming that the password is correct), the LDAP server returns the LDAP entry, and the authentication plugin determines the name of the authenticated user based on that entry:

- If the LDAP entry has a group attribute (by default, the `cn` attribute), the plugin returns its value as the authenticated user name.
- If the LDAP entry has no group attribute, the authentication plugin returns the client user name as the authenticated user name.

The MySQL server compares the client user name with the authenticated user name to determine whether proxying occurs for the client session:

- If the names are the same, no proxying occurs: The MySQL account matching the client user name is used for privilege checking.
- If the names differ, proxying occurs: MySQL looks for an account matching the authenticated user name. That account becomes the proxied user, which is used for privilege checking. The MySQL account that matched the client user name is treated as the external proxy user.

## Installing LDAP Pluggable Authentication

This section describes how to install the server-side LDAP authentication plugins. For general information about installing plugins, see [Section 5.5.1, “Installing and Uninstalling Plugins”](#).

To be usable by the server, the plugin library files must be located in the MySQL plugin directory (the directory named by the `plugin_dir` system variable). If necessary, configure the plugin directory location by setting the value of `plugin_dir` at server startup.

The server-side plugin library file base names are `authentication_ldap_simple` and `authentication_ldap_sasl`. The file name suffix differs per platform (for example, `.so` for Unix and Unix-like systems, `.dll` for Windows).

To load the plugins at server startup, use `--plugin-load-add` options to name the library files that contain them. With this plugin-loading method, the options must be given each time the server starts. Also, specify values for any plugin-provided system variables you wish to configure.

Each server-side LDAP plugin exposes a set of system variables that enable its operation to be configured. Setting most of these is optional, but you must set the variables that specify the LDAP server host (so the plugin knows where to connect) and base distinguished name for LDAP bind operations (to limit the scope of searches and obtain faster searches). For details about all LDAP system variables, see [Section 6.4.1.13, “Pluggable Authentication System Variables”](#).

To load the plugins and set the LDAP server host and base distinguished name for LDAP bind operations, put lines such as these in your `my.cnf` file, adjusting the `.so` suffix for your platform as necessary:

```
[mysqld]
plugin-load-add=authentication_ldap_simple.so
authentication_ldap_simple_server_host=127.0.0.1
authentication_ldap_simple_bind_base_dn="dc=example,dc=com"
plugin-load-add=authentication_ldap_sasl.so
authentication_ldap_sasl_server_host=127.0.0.1
authentication_ldap_sasl_bind_base_dn="dc=example,dc=com"
```

After modifying `my.cnf`, restart the server to cause the new settings to take effect.

Alternatively, to load the plugins at runtime, use these statements, adjusting the `.so` suffix for your platform as necessary:

```
INSTALL PLUGIN authentication_ldap_simple
  SONAME 'authentication_ldap_simple.so';
INSTALL PLUGIN authentication_ldap_sasl
```

```
SONAME 'authentication_ldap_sasl.so';
```

`INSTALL PLUGIN` loads the plugin immediately, and also registers it in the `mysql.plugins` system table to cause the server to load it for each subsequent normal startup without the need for `--plugin-load-add`.

After installing the plugins at runtime, their system variables become available and you can add settings for them to your `my.cnf` file to configure the plugins for subsequent restarts. For example:

```
[mysqld]
authentication_ldap_simple_server_host=127.0.0.1
authentication_ldap_simple_bind_base_dn="dc=example,dc=com"
authentication_ldap_sasl_server_host=127.0.0.1
authentication_ldap_sasl_bind_base_dn="dc=example,dc=com"
```

After modifying `my.cnf`, restart the server to cause the new settings to take effect.

To verify plugin installation, examine the Information Schema `PLUGINS` table or use the `SHOW PLUGINS` statement (see [Section 5.5.2, “Obtaining Server Plugin Information”](#)). For example:

```
mysql> SELECT PLUGIN_NAME, PLUGIN_STATUS
FROM INFORMATION_SCHEMA.PLUGINS
WHERE PLUGIN_NAME LIKE '%ldap%';
+-----+-----+
| PLUGIN_NAME | PLUGIN_STATUS |
+-----+-----+
| authentication_ldap_sasl | ACTIVE |
| authentication_ldap_simple | ACTIVE |
+-----+-----+
```

If a plugin fails to initialize, check the server error log for diagnostic messages.

To associate MySQL accounts with an LDAP plugin, see [Using LDAP Pluggable Authentication](#).



### Additional Notes for SELinux

On systems running EL6 or EL that have SELinux enabled, changes to the SELinux policy are required to enable the MySQL LDAP plugins to communicate with the LDAP service:

1. Create a file `mysqlldap.te` with these contents:

```
module mysqlldap 1.0;

require {
    type ldap_port_t;
    type mysqld_t;
    class tcp_socket name_connect;
}

#===== mysqld_t =====

allow mysqld_t ldap_port_t:tcp_socket name_connect;
```

2. Compile the security policy module into a binary representation:

```
checkmodule -M -m mysqlldap.te -o mysqlldap.mod
```

3. Create an SELinux policy module package:

```
semodule_package -m mysqlldap.mod -o mysqlldap.pp
```

4. Install the module package:



```
semodule -i mysqlldap.pp
```

5. When the SELinux policy changes have been made, restart the MySQL server:

```
service mysqld restart
```

## Uninstalling LDAP Pluggable Authentication

The method used to uninstall the LDAP authentication plugins depends on how you installed them:

- If you installed the plugins at server startup using `--plugin-load-add` options, restart the server without those options.
- If you installed the plugins at runtime using `INSTALL PLUGIN`, they remain installed across server restarts. To uninstall them, use `UNINSTALL PLUGIN`:

```
UNINSTALL PLUGIN authentication_ldap_simple;  
UNINSTALL PLUGIN authentication_ldap_sasl;
```

In addition, remove from your `my.cnf` file any startup options that set LDAP plugin-related system variables.

## LDAP Pluggable Authentication and `ldap.conf`

For installations that use OpenLDAP, the `ldap.conf` file provides global defaults for LDAP clients. Options can be set in this file to affect LDAP clients, including the LDAP authentication plugins. OpenLDAP uses configuration options in this order of precedence:

- Configuration specified by the LDAP client.
- Configuration specified in the `ldap.conf` file. To disable use of this file, set the `LDAPNOINIT` environment variable.
- OpenLDAP library built-in defaults.

If the library defaults or `ldap.conf` values do not yield appropriate option values, an LDAP authentication plugin may be able to set related variables to affect the LDAP configuration directly. For example, LDAP plugins can override `ldap.conf` parameters for TLS configuration: System variables are available to enable TLS and control CA configuration, such as `authentication_ldap_simple_tls` and `authentication_ldap_simple_ca_path` for simple LDAP authentication, and `authentication_ldap_sasl_tls` and `authentication_ldap_sasl_ca_path` for SASL LDAP authentication.

For more information about `ldap.conf` consult the `ldap.conf(5)` man page.

## Using LDAP Pluggable Authentication

This section describes how to enable MySQL accounts to connect to the MySQL server using LDAP pluggable authentication. It is assumed that the server is running with the appropriate server-side plugins enabled, as described in [Installing LDAP Pluggable Authentication](#), and that the appropriate client-side plugins are available on the client host.

This section does not describe LDAP configuration or administration. You are assumed to be familiar with those topics.

The two server-side LDAP plugins each work with a specific client-side plugin:

- The server-side `authentication_ldap_simple` plugin performs simple LDAP authentication. For connections by accounts that use this plugin, client programs use the client-side `mysql_clear_password` plugin, which sends the password to the server as cleartext. No password hashing or encryption is used, so a secure connection between the MySQL client and server is recommended to prevent password exposure.
- The server-side `authentication_ldap_sasl` plugin performs SASL-based LDAP authentication. For connections by accounts that use this plugin, client programs use the client-side `authentication_ldap_sasl_client` plugin. The client-side and server-side SASL LDAP plugins use SASL messages for secure transmission of credentials within the LDAP protocol, to avoid sending the cleartext password between the MySQL client and server.

Overall requirements for LDAP authentication of MySQL users:

- There must be an LDAP directory entry for each user to be authenticated.
- There must be a MySQL user account that specifies a server-side LDAP authentication plugin and optionally names the associated LDAP user distinguished name (DN). (To associate an LDAP user DN with a MySQL account, include a `BY` clause in the `CREATE USER` statement that creates the account.) If an account names no LDAP string, LDAP authentication uses the user name specified by the client to find the LDAP entry.
- Client programs connect using the connection method appropriate for the server-side authentication plugin the MySQL account uses. For LDAP authentication, connections require the MySQL user name and LDAP password. In addition, for accounts that use the server-side `authentication_ldap_simple` plugin, invoke client programs with the `--enable-cleartext-plugin` option to enable the client-side `mysql_clear_password` plugin.

The instructions here assume the following scenario:

- MySQL users `betsy` and `boris` authenticate to the LDAP entries for `betsy_ldap` and `boris_ldap`, respectively. (It is not necessary that the MySQL and LDAP user names differ. The use of different names in this discussion helps clarify whether an operation context is MySQL or LDAP.)
- LDAP entries use the `uid` attribute to specify user names. This may vary depending on LDAP server. Some LDAP servers use the `cn` attribute for user names rather than `uid`. To change the attribute, modify the `authentication_ldap_simple_user_search_attr` or `authentication_ldap_sasl_user_search_attr` system variable appropriately.
- These LDAP entries are available in the directory managed by the LDAP server, to provide distinguished name values that uniquely identify each user:

```
uid=betsy_ldap,ou=People,dc=example,dc=com
uid=boris_ldap,ou=People,dc=example,dc=com
```

- `CREATE USER` statements that create MySQL accounts name an LDAP user in the `BY` clause, to indicate which LDAP entry the MySQL account authenticates against.

The instructions for setting up an account that uses LDAP authentication depend on which server-side LDAP plugin is used. The following sections describe several usage scenarios.

## Simple LDAP Authentication (Without Proxying)

The procedure outlined in this section requires that `authentication_ldap_simple_group_search_attr` be set to an empty string, like this:

```
SET GLOBAL.authentication_ldap_simple_group_search_attr='';
```

Otherwise, proxying is used by default.

To set up a MySQL account for simple LDAP authentication, use a `CREATE USER` statement to specify the `authentication_ldap_simple` plugin, optionally including the LDAP user distinguished name (DN), as shown here:

```
CREATE USER user
  IDENTIFIED WITH authentication_ldap_simple
  [BY 'LDAP user DN'];
```

Suppose that MySQL user `betsy` has this entry in the LDAP directory:

```
uid=betsy_ldap,ou=People,dc=example,dc=com
```

Then the statement to create the MySQL account for `betsy` looks like this:

```
CREATE USER 'betsy'@'localhost'
  IDENTIFIED WITH authentication_ldap_simple
  AS 'uid=betsy_ldap,ou=People,dc=example,dc=com';
```

The authentication string specified in the `BY` clause does not include the LDAP password. That must be provided by the client user at connect time.

Clients connect to the MySQL server by providing the MySQL user name and LDAP password, and by enabling the client-side `mysql_clear_password` plugin:

```
$> mysql --user=betsy --password --enable-cleartext-plugin
Enter password: betsy_ldap_password
```



#### Note

The client-side `mysql_clear_password` authentication plugin leaves the password untouched, so client programs send it to the MySQL server as cleartext. This enables the password to be passed as is to the LDAP server. A cleartext password is necessary to use the server-side LDAP library without SASL, but may be a security problem in some configurations. These measures minimize the risk:

- To make inadvertent use of the `mysql_clear_password` plugin less likely, MySQL clients must explicitly enable it (for example, with the `--enable-cleartext-plugin` option). See [Section 6.4.1.6, “Client-Side Cleartext Pluggable Authentication”](#).
- To avoid password exposure with the `mysql_clear_password` plugin enabled, MySQL clients should connect to the MySQL server using an encrypted connection. See [Section 6.3.1, “Configuring MySQL to Use Encrypted Connections”](#).

The authentication process occurs as follows:

1. The client-side plugin sends `betsy` and `betsy_password` as the client user name and LDAP password to the MySQL server.
2. The connection attempt matches the `'betsy'@'localhost'` account. The server-side LDAP plugin finds that this account has an authentication string of `'uid=betsy_ldap,ou=People,dc=example,dc=com'` to name the LDAP user DN. The plugin sends this string and the LDAP password to the LDAP server.
3. The LDAP server finds the LDAP entry for `betsy_ldap` and the password matches, so LDAP authentication succeeds.

- The LDAP entry has no group attribute, so the server-side plugin returns the client user name (`betsy`) as the authenticated user. This is the same user name supplied by the client, so no proxying occurs and the client session uses the `'betsy'@'localhost'` account for privilege checking.

Had the `CREATE USER` statement contained no `BY` clause to specify the `betsy_ldap` LDAP distinguished name, authentication attempts would use the user name provided by the client (in this case, `betsy`). In the absence of an LDAP entry for `betsy`, authentication would fail.

## SASL-Based LDAP Authentication (Without Proxying)

The procedure outlined in this section requires that `authentication_ldap_sasl_group_search_attr` be set to an empty string, like this:

```
SET GLOBAL.authentication_ldap_sasl_group_search_attr='';
```

Otherwise, proxying is used by default.

To set up a MySQL account for SASL LDAP authentication, use a `CREATE USER` statement to specify the `authentication_ldap_sasl` plugin, optionally including the LDAP user distinguished name (DN), as shown here:

```
CREATE USER user
  IDENTIFIED WITH authentication_ldap_sasl
  [BY 'LDAP user DN'];
```

Suppose that MySQL user `boris` has this entry in the LDAP directory:

```
uid=boris_ldap,ou=People,dc=example,dc=com
```

Then the statement to create the MySQL account for `boris` looks like this:

```
CREATE USER 'boris'@'localhost'
  IDENTIFIED WITH authentication_ldap_sasl
  AS 'uid=boris_ldap,ou=People,dc=example,dc=com';
```

The authentication string specified in the `BY` clause does not include the LDAP password. That must be provided by the client user at connect time.

Clients connect to the MySQL server by providing the MySQL user name and LDAP password:

```
$> mysql --user=boris --password
Enter password: boris_ldap_password
```

For the server-side `authentication_ldap_sasl` plugin, clients use the client-side `authentication_ldap_sasl_client` plugin. If a client program does not find the client-side plugin, specify a `--plugin-dir` option that names the directory where the plugin library file is installed.

The authentication process for `boris` is similar to that previously described for `betsy` with simple LDAP authentication, except that the client-side and server-side SASL LDAP plugins use SASL messages for secure transmission of credentials within the LDAP protocol, to avoid sending the cleartext password between the MySQL client and server.

## LDAP Authentication with Proxying

LDAP authentication plugins support proxying, enabling a user to connect to the MySQL server as one user but assume the privileges of a different user. This section describes basic LDAP plugin proxy support. The LDAP plugins also support specification of group preference and proxy user mapping; see [LDAP Authentication Group Preference and Mapping Specification](#).

The proxying implementation described here is based on use of LDAP group attribute values to map connecting MySQL users who authenticate using LDAP onto other MySQL accounts that define different sets of privileges. Users do not connect directly through the accounts that define the privileges. Instead, they connect through a default proxy account authenticated with LDAP, such that all external logins are mapped to the proxied MySQL accounts that hold the privileges. Any user who connects using the proxy account is mapped to one of those proxied MySQL accounts, the privileges for which determine the database operations permitted to the external user.

The instructions here assume the following scenario:

- LDAP entries use the `uid` and `cn` attributes to specify user name and group values, respectively. To use different user and group attribute names, set the appropriate plugin-specific system variables:
  - For the `authentication_ldap_simple` plugin: Set `authentication_ldap_simple_user_search_attr` and `authentication_ldap_simple_group_search_attr`.
  - For the `authentication_ldap_sasl` plugin: Set `authentication_ldap_sasl_user_search_attr` and `authentication_ldap_sasl_group_search_attr`.
- These LDAP entries are available in the directory managed by the LDAP server, to provide distinguished name values that uniquely identify each user:

```
uid=basha,ou=People,dc=example,dc=com,cn=accounting
uid=basil,ou=People,dc=example,dc=com,cn=front_office
```

At connect time, the group attribute values become the authenticated user names, so they name the `accounting` and `front_office` proxied accounts.

- The examples assume use of SASL LDAP authentication. Make the appropriate adjustments for simple LDAP authentication.

Create the default proxy MySQL account:

```
CREATE USER ''@%'
  IDENTIFIED WITH authentication_ldap_sasl;
```

The proxy account definition has no `AS 'auth_string'` clause to name an LDAP user DN. Thus:

- When a client connects, the client user name becomes the LDAP user name to search for.
- The matching LDAP entry is expected to include a group attribute naming the proxied MySQL account that defines the privileges the client should have.



#### Note

If your MySQL installation has anonymous users, they might conflict with the default proxy user. For more information about this issue, and ways of dealing with it, see [Default Proxy User and Anonymous User Conflicts](#).

Create the proxied accounts and grant to each one the privileges it should have:

```
CREATE USER 'accounting'@'localhost'
  IDENTIFIED WITH mysql_no_login;
CREATE USER 'front_office'@'localhost'
  IDENTIFIED WITH mysql_no_login;

GRANT ALL PRIVILEGES
  ON accountingdb.*
```

```
TO 'accounting'@'localhost';
GRANT ALL PRIVILEGES
ON frontdb.*
TO 'front_office'@'localhost';
```

The proxied accounts use the `mysql_no_login` authentication plugin to prevent clients from using the accounts to log in directly to the MySQL server. Instead, users who authenticate using LDAP are expected to use the default `'@'%'` proxy account. (This assumes that the `mysql_no_login` plugin is installed. For instructions, see [Section 6.4.1.10, “No-Login Pluggable Authentication”](#).) For alternative methods of protecting proxied accounts against direct use, see [Preventing Direct Login to Proxied Accounts](#).

Grant to the proxy account the `PROXY` privilege for each proxied account:

```
GRANT PROXY
ON 'accounting'@'localhost'
TO '@'%;
GRANT PROXY
ON 'front_office'@'localhost'
TO '@'%;
```

Use the `mysql` command-line client to connect to the MySQL server as `basha`.

```
$> mysql --user=basha --password
Enter password: basha_password (basha LDAP password)
```

Authentication occurs as follows:

1. The server authenticates the connection using the default `'@'%'` proxy account, for client user `basha`.
2. The matching LDAP entry is:

```
uid=basha,ou=People,dc=example,dc=com,cn=accounting
```

3. The matching LDAP entry has group attribute `cn=accounting`, so `accounting` becomes the authenticated proxied user.
4. The authenticated user differs from the client user name `basha`, with the result that `basha` is treated as a proxy for `accounting`, and `basha` assumes the privileges of the proxied `accounting` account. The following query returns output as shown:

```
mysql> SELECT USER(), CURRENT_USER(), @@proxy_user;
+-----+-----+-----+
| USER()          | CURRENT_USER()    | @@proxy_user |
+-----+-----+-----+
| basha@localhost | accounting@localhost | '@'%'        |
+-----+-----+-----+
```

This demonstrates that `basha` uses the privileges granted to the proxied `accounting` MySQL account, and that proxying occurs through the default proxy user account.

Now connect as `basil` instead:

```
$> mysql --user=basil --password
Enter password: basil_password (basil LDAP password)
```

The authentication process for `basil` is similar to that previously described for `basha`:

1. The server authenticates the connection using the default `'@'%'` proxy account, for client user `basil`.
2. The matching LDAP entry is:

```
uid=basil,ou=People,dc=example,dc=com,cn=front_office
```

3. The matching LDAP entry has group attribute `cn=front_office`, so `front_office` becomes the authenticated proxied user.
4. The authenticated user differs from the client user name `basil`, with the result that `basil` is treated as a proxy for `front_office`, and `basil` assumes the privileges of the proxied `front_office` account. The following query returns output as shown:

```
mysql> SELECT USER(), CURRENT_USER(), @@proxy_user;
+-----+-----+-----+
| USER()          | CURRENT_USER()      | @@proxy_user |
+-----+-----+-----+
| basil@localhost | front_office@localhost | '@'%'       |
+-----+-----+-----+
```

This demonstrates that `basil` uses the privileges granted to the proxied `front_office` MySQL account, and that proxying occurs through the default proxy user account.

### LDAP Authentication Group Preference and Mapping Specification

As described in [LDAP Authentication with Proxying](#), basic LDAP authentication proxying works by the principle that the plugin uses the first group name returned by the LDAP server as the MySQL proxied user account name. This simple capability does not enable specifying any preference about which group name to use if the LDAP server returns multiple group names, or specifying any name other than the group name as the proxied user name.

As of MySQL 5.7.25, for MySQL accounts that use LDAP authentication, the authentication string can specify the following information to enable greater proxying flexibility:

- A list of groups in preference order, such that the plugin uses the first group name in the list that matches a group returned by the LDAP server.
- A mapping from group names to proxied user names, such that a group name when matched can provide a specified name to use as the proxied user. This provides an alternative to using the group name as the proxied user.

Consider the following MySQL proxy account definition:

```
CREATE USER '@'%'
  IDENTIFIED WITH authentication_ldap_sasl
  AS '+ou=People,dc=example,dc=com#grp1=usera,grp2,grp3=userc';
```

The authentication string has a user DN suffix `ou=People,dc=example,dc=com` prefixed by the `+` character. Thus, as described in [LDAP Authentication User DN Suffixes](#), the full user DN is constructed from the user DN suffix as specified, plus the client user name as the `uid` attribute.

The remaining part of the authentication string begins with `#`, which signifies the beginning of group preference and mapping information. This part of the authentication string lists group names in the order `grp1`, `grp2`, `grp3`. The LDAP plugin compares that list with the set of group names returned by the LDAP server, looking in list order for a match against the returned names. The plugin uses the first match, or if there is no match, authentication fails.

Suppose that the LDAP server returns groups `grp3`, `grp2`, and `grp7`. The LDAP plugin uses `grp2` because it is the first group in the authentication string that matches, even though it is not the first group returned by the LDAP server. If the LDAP server returns `grp4`, `grp2`, and `grp1`, the plugin uses `grp1` even though `grp2` also matches. `grp1` has a precedence higher than `grp2` because it is listed earlier in the authentication string.

Assuming that the plugin finds a group name match, it performs mapping from that group name to the MySQL proxied user name, if there is one. For the example proxy account, mapping occurs as follows:

- If the matching group name is `grp1` or `grp3`, those are associated in the authentication string with user names `usera` and `userc`, respectively. The plugin uses the corresponding associated user name as the proxied user name.
- If the matching group name is `grp2`, there is no associated user name in the authentication string. The plugin uses `grp2` as the proxied user name.

If the LDAP server returns a group in DN format, the LDAP plugin parses the group DN to extract the group name from it.

To specify LDAP group preference and mapping information, these principles apply:

- Begin the group preference and mapping part of the authentication string with a `#` prefix character.
- The group preference and mapping specification is a list of one or more items, separated by commas. Each item has the form `group_name=user_name` or `group_name`. Items should be listed in group name preference order. For a group name selected by the plugin as a match from set of group names returned by the LDAP server, the two syntaxes differ in effect as follows:
  - For an item specified as `group_name=user_name` (with a user name), the group name maps to the user name, which is used as the MySQL proxied user name.
  - For an item specified as `group_name` (with no user name), the group name is used as the MySQL proxied user name.
- To quote a group or user name that contains special characters such as space, surround it by double quote (") characters. For example, if an item has group and user names of `my group name` and `my user name`, it must be written in a group mapping using quotes:

```
"my group name"="my user name"
```

If an item has group and user names of `my_group_name` and `my_user_name` (which contain no special characters), it may but need not be written using quotes. Any of the following are valid:

```
my_group_name=my_user_name
my_group_name="my_user_name"
"my_group_name"=my_user_name
"my_group_name"="my_user_name"
```

- To escape a character, precede it by a backslash (`\`). This is useful particularly to include a literal double quote or backslash, which are otherwise not included literally.
- A user DN need not be present in the authentication string, but if present, it must precede the group preference and mapping part. A user DN can be given as a full user DN, or as a user DN suffix with a `+` prefix character. (See [LDAP Authentication User DN Suffixes](#).)

## LDAP Authentication User DN Suffixes

As of MySQL 5.7.21, LDAP authentication plugins permit the authentication string that provides user DN information to begin with a `+` prefix character:

- In the absence of a `+` character, the authentication string value is treated as is without modification.
- If the authentication string begins with `+`, the plugin constructs the full user DN value from the user name sent by the client, together with the DN specified in the authentication string (with the `+` removed). In the constructed DN, the client user name becomes the value of the attribute



that specifies LDAP user names. This is `uid` by default; to change the attribute, modify the appropriate system variable (`authentication_ldap_simple_user_search_attr` or `authentication_ldap_sasl_user_search_attr`). The authentication string is stored as given in the `mysql.user` system table, with the full user DN constructed on the fly before authentication.

This account authentication string does not have `+` at the beginning, so it is taken as the full user DN:

```
CREATE USER 'baldwin'
  IDENTIFIED WITH authentication_ldap_simple
  AS 'uid=admin,ou=People,dc=example,dc=com';
```

The client connects with the user name specified in the account (`baldwin`). In this case, that name is not used because the authentication string has no prefix and thus fully specifies the user DN.

This account authentication string does have `+` at the beginning, so it is taken as just part of the user DN:

```
CREATE USER 'accounting'
  IDENTIFIED WITH authentication_ldap_simple
  AS '+ou=People,dc=example,dc=com';
```

The client connects with the user name specified in the account (`accounting`), which in this case is used as the `uid` attribute together with the authentication string to construct the user DN: `uid=accounting,ou=People,dc=example,dc=com`

The accounts in the preceding examples have a nonempty user name, so the client always connects to the MySQL server using the same name as specified in the account definition. If an account has an empty user name, such as the default anonymous `'@'%'` proxy account described in [LDAP Authentication with Proxying](#), clients might connect to the MySQL server with varying user names. But the principle is the same: If the authentication string begins with `+`, the plugin uses the user name sent by the client together with the authentication string to construct the user DN.

## LDAP Authentication Methods

The LDAP authentication plugins use a configurable authentication method. The appropriate system variable and available method choices are plugin-specific:

- For the `authentication_ldap_simple` plugin: Configure the method by setting the `authentication_ldap_simple_auth_method_name` system variable. The permitted choices are `SIMPLE` and `AD-FOREST`.
- For the `authentication_ldap_sasl` plugin: Configure the method by setting the `authentication_ldap_sasl_auth_method_name` system variable. The only permitted choice is `SCRAM-SHA-1`.

See the system variable descriptions for information about each permitted method.

### 6.4.1.10 No-Login Pluggable Authentication

The `mysql_no_login` server-side authentication plugin prevents all client connections to any account that uses it. Use cases for this plugin include:

- Accounts that must be able to execute stored programs and views with elevated privileges without exposing those privileges to ordinary users.
- Proxied accounts that should never permit direct login but are intended to be accessed only through proxy accounts.

The following table shows the plugin and library file names. The file name suffix might differ on your system. The file must be located in the directory named by the `plugin_dir` system variable.

**Table 6.17 Plugin and Library Names for No-Login Authentication**

Plugin or File	Plugin or File Name
Server-side plugin	<code>mysql_no_login</code>
Client-side plugin	None
Library file	<code>mysql_no_login.so</code>

The following sections provide installation and usage information specific to no-login pluggable authentication:

- [Installing No-Login Pluggable Authentication](#)
- [Uninstalling No-Login Pluggable Authentication](#)
- [Using No-Login Pluggable Authentication](#)

For general information about pluggable authentication in MySQL, see [Section 6.2.13, “Pluggable Authentication”](#). For proxy user information, see [Section 6.2.14, “Proxy Users”](#).

## Installing No-Login Pluggable Authentication

This section describes how to install the no-login authentication plugin. For general information about installing plugins, see [Section 5.5.1, “Installing and Uninstalling Plugins”](#).

To be usable by the server, the plugin library file must be located in the MySQL plugin directory (the directory named by the `plugin_dir` system variable). If necessary, configure the plugin directory location by setting the value of `plugin_dir` at server startup.

The plugin library file base name is `mysql_no_login`. The file name suffix differs per platform (for example, `.so` for Unix and Unix-like systems, `.dll` for Windows).

To load the plugin at server startup, use the `--plugin-load-add` option to name the library file that contains it. With this plugin-loading method, the option must be given each time the server starts. For example, put these lines in the server `my.cnf` file, adjusting the `.so` suffix for your platform as necessary:

```
[mysqld]
plugin-load-add=mysql_no_login.so
```

After modifying `my.cnf`, restart the server to cause the new settings to take effect.

Alternatively, to load the plugin at runtime, use this statement, adjusting the `.so` suffix for your platform as necessary:

```
INSTALL PLUGIN mysql_no_login SONAME 'mysql_no_login.so';
```

`INSTALL PLUGIN` loads the plugin immediately, and also registers it in the `mysql.plugins` system table to cause the server to load it for each subsequent normal startup without the need for `--plugin-load-add`.

To verify plugin installation, examine the Information Schema `PLUGINS` table or use the `SHOW PLUGINS` statement (see [Section 5.5.2, “Obtaining Server Plugin Information”](#)). For example:

```
mysql> SELECT PLUGIN_NAME, PLUGIN_STATUS
FROM INFORMATION_SCHEMA.PLUGINS
WHERE PLUGIN_NAME LIKE '%login%';
+-----+-----+
| PLUGIN_NAME | PLUGIN_STATUS |
+-----+-----+
```

```
| mysql_no_login | ACTIVE |
+-----+-----+
```

If the plugin fails to initialize, check the server error log for diagnostic messages.

To associate MySQL accounts with the no-login plugin, see [Using No-Login Pluggable Authentication](#).

## Uninstalling No-Login Pluggable Authentication

The method used to uninstall the no-login authentication plugin depends on how you installed it:

- If you installed the plugin at server startup using a `--plugin-load-add` option, restart the server without the option.
- If you installed the plugin at runtime using an `INSTALL PLUGIN` statement, it remains installed across server restarts. To uninstall it, use `UNINSTALL PLUGIN`:

```
UNINSTALL PLUGIN mysql_no_login;
```

## Using No-Login Pluggable Authentication

This section describes how to use the no-login authentication plugin to prevent accounts from being used for connecting from MySQL client programs to the server. It is assumed that the server is running with the no-login plugin enabled, as described in [Installing No-Login Pluggable Authentication](#).

To refer to the no-login authentication plugin in the `IDENTIFIED WITH` clause of a `CREATE USER` statement, use the name `mysql_no_login`.

An account that authenticates using `mysql_no_login` may be used as the `DEFINER` for stored program and view objects. If such an object definition also includes `SQL SECURITY DEFINER`, it executes with that account's privileges. DBAs can use this behavior to provide access to confidential or sensitive data that is exposed only through well-controlled interfaces.

The following example illustrates these principles. It defines an account that does not permit client connections, and associates with it a view that exposes only certain columns of the `mysql.user` system table:

```
CREATE DATABASE nologindb;
CREATE USER 'nologin'@'localhost'
  IDENTIFIED WITH mysql_no_login;
GRANT ALL ON nologindb.*
  TO 'nologin'@'localhost';
GRANT SELECT ON mysql.user
  TO 'nologin'@'localhost';
CREATE DEFINER = 'nologin'@'localhost'
  SQL SECURITY DEFINER
  VIEW nologindb.myview
  AS SELECT User, Host FROM mysql.user;
```

To provide protected access to the view to an ordinary user, do this:

```
GRANT SELECT ON nologindb.myview
  TO 'ordinaryuser'@'localhost';
```

Now the ordinary user can use the view to access the limited information it presents:

```
SELECT * FROM nologindb.myview;
```

Attempts by the user to access columns other than those exposed by the view result in an error, as do attempts to select from the view by users not granted access to it.

**Note**

Because the `nologin` account cannot be used directly, the operations required to set up objects that it uses must be performed by `root` or similar account that has the privileges required to create the objects and set `DEFINER` values.

The `mysql_no_login` plugin is also useful in proxying scenarios. (For a discussion of concepts involved in proxying, see [Section 6.2.14, “Proxy Users”](#).) An account that authenticates using `mysql_no_login` may be used as a proxied user for proxy accounts:

```
-- create proxied account
CREATE USER 'proxied_user'@'localhost'
  IDENTIFIED WITH mysql_no_login;
-- grant privileges to proxied account
GRANT ...
  ON ...
  TO 'proxied_user'@'localhost';
-- permit proxy_user to be a proxy account for proxied account
GRANT PROXY
  ON 'proxied_user'@'localhost'
  TO 'proxy_user'@'localhost';
```

This enables clients to access MySQL through the proxy account (`proxy_user`) but not to bypass the proxy mechanism by connecting directly as the proxied user (`proxied_user`). A client who connects using the `proxy_user` account has the privileges of the `proxied_user` account, but `proxied_user` itself cannot be used to connect.

For alternative methods of protecting proxied accounts against direct use, see [Preventing Direct Login to Proxied Accounts](#).

### 6.4.1.11 Socket Peer-Credential Pluggable Authentication

The server-side `auth_socket` authentication plugin authenticates clients that connect from the local host through the Unix socket file. The plugin uses the `SO_PEERCREC` socket option to obtain information about the user running the client program. Thus, the plugin can be used only on systems that support the `SO_PEERCREC` option, such as Linux.

The source code for this plugin can be examined as a relatively simple example demonstrating how to write a loadable authentication plugin.

The following table shows the plugin and library file names. The file must be located in the directory named by the `plugin_dir` system variable.

**Table 6.18 Plugin and Library Names for Socket Peer-Credential Authentication**

Plugin or File	Plugin or File Name
Server-side plugin	<code>auth_socket</code>
Client-side plugin	None, see discussion
Library file	<code>auth_socket.so</code>

The following sections provide installation and usage information specific to socket pluggable authentication:

- [Installing Socket Pluggable Authentication](#)
- [Uninstalling Socket Pluggable Authentication](#)
- [Using Socket Pluggable Authentication](#)

For general information about pluggable authentication in MySQL, see [Section 6.2.13, “Pluggable Authentication”](#).

## Installing Socket Pluggable Authentication

This section describes how to install the socket authentication plugin. For general information about installing plugins, see [Section 5.5.1, “Installing and Uninstalling Plugins”](#).

To be usable by the server, the plugin library file must be located in the MySQL plugin directory (the directory named by the `plugin_dir` system variable). If necessary, configure the plugin directory location by setting the value of `plugin_dir` at server startup.

To load the plugin at server startup, use the `--plugin-load-add` option to name the library file that contains it. With this plugin-loading method, the option must be given each time the server starts. For example, put these lines in the server `my.cnf` file:

```
[mysqld]
plugin-load-add=auth_socket.so
```

After modifying `my.cnf`, restart the server to cause the new settings to take effect.

Alternatively, to load the plugin at runtime, use this statement:

```
INSTALL PLUGIN auth_socket SONAME 'auth_socket.so';
```

`INSTALL PLUGIN` loads the plugin immediately, and also registers it in the `mysql.plugins` system table to cause the server to load it for each subsequent normal startup without the need for `--plugin-load-add`.

To verify plugin installation, examine the Information Schema `PLUGINS` table or use the `SHOW PLUGINS` statement (see [Section 5.5.2, “Obtaining Server Plugin Information”](#)). For example:

```
mysql> SELECT PLUGIN_NAME, PLUGIN_STATUS
        FROM INFORMATION_SCHEMA.PLUGINS
        WHERE PLUGIN_NAME LIKE '%socket%';
+-----+-----+
| PLUGIN_NAME | PLUGIN_STATUS |
+-----+-----+
| auth_socket | ACTIVE        |
+-----+-----+
```

If the plugin fails to initialize, check the server error log for diagnostic messages.

To associate MySQL accounts with the socket plugin, see [Using Socket Pluggable Authentication](#).

## Uninstalling Socket Pluggable Authentication

The method used to uninstall the socket authentication plugin depends on how you installed it:

- If you installed the plugin at server startup using a `--plugin-load-add` option, restart the server without the option.
- If you installed the plugin at runtime using an `INSTALL PLUGIN` statement, it remains installed across server restarts. To uninstall it, use `UNINSTALL PLUGIN`:

```
UNINSTALL PLUGIN auth_socket;
```

## Using Socket Pluggable Authentication

The socket plugin checks whether the socket user name (the operating system user name) matches the MySQL user name specified by the client program to the server. If the names do not match, the plugin

checks whether the socket user name matches the name specified in the `authentication_string` column of the `mysql.user` system table row. If a match is found, the plugin permits the connection. The `authentication_string` value can be specified using an `IDENTIFIED ...AS` clause with `CREATE USER` or `ALTER USER`.

Suppose that a MySQL account is created for an operating system user named `valerie` who is to be authenticated by the `auth_socket` plugin for connections from the local host through the socket file:

```
CREATE USER 'valerie'@'localhost' IDENTIFIED WITH auth_socket;
```

If a user on the local host with a login name of `stefanie` invokes `mysql` with the option `--user=valerie` to connect through the socket file, the server uses `auth_socket` to authenticate the client. The plugin determines that the `--user` option value (`valerie`) differs from the client user's name (`stefanie`) and refuses the connection. If a user named `valerie` tries the same thing, the plugin finds that the user name and the MySQL user name are both `valerie` and permits the connection. However, the plugin refuses the connection even for `valerie` if the connection is made using a different protocol, such as TCP/IP.

To permit both the `valerie` and `stefanie` operating system users to access MySQL through socket file connections that use the account, this can be done two ways:

- Name both users at account-creation time, one following `CREATE USER`, and the other in the authentication string:

```
CREATE USER 'valerie'@'localhost' IDENTIFIED WITH auth_socket AS 'stefanie';
```

- If you have already used `CREATE USER` to create the account for a single user, use `ALTER USER` to add the second user:

```
CREATE USER 'valerie'@'localhost' IDENTIFIED WITH auth_socket;
ALTER USER 'valerie'@'localhost' IDENTIFIED WITH auth_socket AS 'stefanie';
```

To access the account, both `valerie` and `stefanie` specify `--user=valerie` at connect time.

### 6.4.1.12 Test Pluggable Authentication

MySQL includes a test plugin that checks account credentials and logs success or failure to the server error log. This is a loadable plugin (not built in) and must be installed prior to use.

The test plugin source code is separate from the server source, unlike the built-in native plugin, so it can be examined as a relatively simple example demonstrating how to write a loadable authentication plugin.



#### Note

This plugin is intended for testing and development purposes, and is not for use in production environments or on servers that are exposed to public networks.

The following table shows the plugin and library file names. The file name suffix might differ on your system. The file must be located in the directory named by the `plugin_dir` system variable.

**Table 6.19 Plugin and Library Names for Test Authentication**

Plugin or File	Plugin or File Name
Server-side plugin	<code>test_plugin_server</code>
Client-side plugin	<code>auth_test_plugin</code>
Library file	<code>auth_test_plugin.so</code>

The following sections provide installation and usage information specific to test pluggable authentication:

- [Installing Test Pluggable Authentication](#)
- [Uninstalling Test Pluggable Authentication](#)
- [Using Test Pluggable Authentication](#)

For general information about pluggable authentication in MySQL, see [Section 6.2.13, “Pluggable Authentication”](#).

## Installing Test Pluggable Authentication

This section describes how to install the server-side test authentication plugin. For general information about installing plugins, see [Section 5.5.1, “Installing and Uninstalling Plugins”](#).

To be usable by the server, the plugin library file must be located in the MySQL plugin directory (the directory named by the `plugin_dir` system variable). If necessary, configure the plugin directory location by setting the value of `plugin_dir` at server startup.

To load the plugin at server startup, use the `--plugin-load-add` option to name the library file that contains it. With this plugin-loading method, the option must be given each time the server starts. For example, put these lines in the server `my.cnf` file, adjusting the `.so` suffix for your platform as necessary:

```
[mysqld]
plugin-load-add=auth_test_plugin.so
```

After modifying `my.cnf`, restart the server to cause the new settings to take effect.

Alternatively, to load the plugin at runtime, use this statement, adjusting the `.so` suffix for your platform as necessary:

```
INSTALL PLUGIN test_plugin_server SONAME 'auth_test_plugin.so';
```

`INSTALL PLUGIN` loads the plugin immediately, and also registers it in the `mysql.plugins` system table to cause the server to load it for each subsequent normal startup without the need for `--plugin-load-add`.

To verify plugin installation, examine the Information Schema `PLUGINS` table or use the `SHOW PLUGINS` statement (see [Section 5.5.2, “Obtaining Server Plugin Information”](#)). For example:

```
mysql> SELECT PLUGIN_NAME, PLUGIN_STATUS
FROM INFORMATION_SCHEMA.PLUGINS
WHERE PLUGIN_NAME LIKE '%test_plugin%';
+-----+-----+
| PLUGIN_NAME          | PLUGIN_STATUS |
+-----+-----+
| test_plugin_server   | ACTIVE        |
+-----+-----+
```

If the plugin fails to initialize, check the server error log for diagnostic messages.

To associate MySQL accounts with the test plugin, see [Using Test Pluggable Authentication](#).

## Uninstalling Test Pluggable Authentication

The method used to uninstall the test authentication plugin depends on how you installed it:

- If you installed the plugin at server startup using a `--plugin-load-add` option, restart the server without the option.
- If you installed the plugin at runtime using an `INSTALL PLUGIN` statement, it remains installed across server restarts. To uninstall it, use `UNINSTALL PLUGIN`:

```
UNINSTALL PLUGIN test_plugin_server;
```

## Using Test Pluggable Authentication

To use the test authentication plugin, create an account and name that plugin in the `IDENTIFIED WITH` clause:

```
CREATE USER 'testuser'@'localhost'
IDENTIFIED WITH test_plugin_server
BY 'testpassword';
```

Then provide the `--user` and `--password` options for that account when you connect to the server. For example:

```
$> mysql --user=testuser --password
Enter password: testpassword
```

The plugin fetches the password as received from the client and compares it with the value stored in the `authentication_string` column of the account row in the `mysql.user` system table. If the two values match, the plugin returns the `authentication_string` value as the new effective user ID.

You can look in the server error log for a message indicating whether authentication succeeded (notice that the password is reported as the “user”):

```
[Note] Plugin test_plugin_server reported:
'successfully authenticated user testpassword'
```

### 6.4.1.13 Pluggable Authentication System Variables

These variables are unavailable unless the appropriate server-side plugin is installed:

- `authentication_ldap_sasl` for system variables with names of the form `authentication_ldap_sasl_XXX`
- `authentication_ldap_simple` for system variables with names of the form `authentication_ldap_simple_XXX`

**Table 6.20 Authentication Plugin System Variable Summary**

Name	Cmd-Line	Option File	System Var	Status Var	Var Scope	Dynamic
<code>authentication_ldap_sasl_auth_method_name</code>	Yes	Yes	Yes		Global	Yes
<code>authentication_ldap_sasl_bind_use_dn</code>	Yes	Yes	Yes		Global	Yes
<code>authentication_ldap_sasl_bind_use_dn</code>	Yes	Yes	Yes		Global	Yes
<code>authentication_ldap_sasl_bind_use_pwd</code>	Yes	Yes	Yes		Global	Yes
<code>authentication_ldap_sasl_ca_path</code>	Yes	Yes	Yes		Global	Yes
<code>authentication_ldap_sasl_group_search_attr</code>	Yes	Yes	Yes		Global	Yes
<code>authentication_ldap_sasl_group_search_filter</code>	Yes	Yes	Yes		Global	Yes
<code>authentication_ldap_sasl_init_page_size</code>	Yes	Yes	Yes		Global	Yes
<code>authentication_ldap_sasl_log_level</code>	Yes	Yes	Yes		Global	Yes
<code>authentication_ldap_sasl_max_page_size</code>	Yes	Yes	Yes		Global	Yes
<code>authentication_ldap_sasl_server_host</code>	Yes	Yes	Yes		Global	Yes
<code>authentication_ldap_sasl_server_port</code>	Yes	Yes	Yes		Global	Yes



Name	Cmd-Line	Option File	System Var	Status Var	Var Scope	Dynamic
authentication	Yes_sasl_tls	Yes	Yes		Global	Yes
authentication	Yes_sasl_user	Yes_search_attr	Yes		Global	Yes
authentication	Yes_simple_auth	Yes_method_name	Yes		Global	Yes
authentication	Yes_simple_bind	Yes_base_dn	Yes		Global	Yes
authentication	Yes_simple_bind	Yes_root_dn	Yes		Global	Yes
authentication	Yes_simple_bind	Yes_root_pwd	Yes		Global	Yes
authentication	Yes_simple_cert	Yes_path	Yes		Global	Yes
authentication	Yes_simple_group	Yes_search_attr	Yes		Global	Yes
authentication	Yes_simple_group	Yes_search_filter	Yes		Global	Yes
authentication	Yes_simple_init	Yes_pool_size	Yes		Global	Yes
authentication	Yes_simple_log	Yes_status	Yes		Global	Yes
authentication	Yes_simple_max	Yes_pool_size	Yes		Global	Yes
authentication	Yes_simple_server	Yes_host	Yes		Global	Yes
authentication	Yes_simple_server	Yes_port	Yes		Global	Yes
authentication	Yes_simple_tls	Yes	Yes		Global	Yes
authentication	Yes_simple_user	Yes_search_attr	Yes		Global	Yes
authentication	Yes_logs_log_level	Yes	Yes		Global	No
authentication	Yes_logs_use_principal_name	Yes	Yes		Global	No

- `authentication_ldap_sasl_auth_method_name`

Command-Line Format	<code>--authentication-ldap-sasl-auth-method-name=value</code>
Introduced	5.7.19
System Variable	<code>authentication_ldap_sasl_auth_method_name</code>
Scope	Global
Dynamic	Yes
Type	String
Default Value	<code>SCRAM-SHA-1</code>
Valid Values	<code>SCRAM-SHA-1</code>

For SASL LDAP authentication, the authentication method name. Communication between the authentication plugin and the LDAP server occurs according to this authentication method to ensure password security.

These authentication method values are permitted:

- `SCRAM-SHA-1`: Use a SASL challenge-response mechanism.

The client-side `authentication_ldap_sasl_client` plugin communicates with the SASL server, using the password to create a challenge and obtain a SASL request buffer, then passes this buffer to the server-side `authentication_ldap_sasl` plugin. The client-side and server-side SASL LDAP plugins use SASL messages for secure transmission of credentials within the LDAP protocol, to avoid sending the cleartext password between the MySQL client and server.

- `authentication_ldap_sasl_bind_base_dn`

Command-Line Format	<code>--authentication-ldap-sasl-bind-base-dn=value</code>
Introduced	5.7.19
System Variable	<code>authentication_ldap_sasl_bind_base_dn</code>
Scope	Global
Dynamic	Yes
Type	String
Default Value	<code>NULL</code>

For SASL LDAP authentication, the base distinguished name (DN). This variable can be used to limit the scope of searches by anchoring them at a certain location (the “base”) within the search tree.

Suppose that members of one set of LDAP user entries each have this form:

```
uid=user_name,ou=People,dc=example,dc=com
```

And that members of another set of LDAP user entries each have this form:

```
uid=user_name,ou=Admin,dc=example,dc=com
```

Then searches work like this for different base DN values:

- If the base DN is `ou=People,dc=example,dc=com`: Searches find user entries only in the first set.
- If the base DN is `ou=Admin,dc=example,dc=com`: Searches find user entries only in the second set.
- If the base DN is `ou=dc=example,dc=com`: Searches find user entries in the first or second set.

In general, more specific base DN values result in faster searches because they limit the search scope more.

- `authentication_ldap_sasl_bind_root_dn`

Command-Line Format	<code>--authentication-ldap-sasl-bind-root-dn=value</code>
Introduced	5.7.19
System Variable	<code>authentication_ldap_sasl_bind_root_dn</code>
Scope	Global
Dynamic	Yes
Type	String
Default Value	<code>NULL</code>

For SASL LDAP authentication, the root distinguished name (DN). This variable is used in conjunction with `authentication_ldap_sasl_bind_root_pwd` as the credentials for authenticating to the

LDAP server for the purpose of performing searches. Authentication uses either one or two LDAP bind operations, depending on whether the MySQL account names an LDAP user DN:

- If the account does not name a user DN: `authentication_ldap_sasl` performs an initial LDAP binding using `authentication_ldap_sasl_bind_root_dn` and `authentication_ldap_sasl_bind_root_pwd`. (These are both empty by default, so if they are not set, the LDAP server must permit anonymous connections.) The resulting bind LDAP handle is used to search for the user DN, based on the client user name. `authentication_ldap_sasl` performs a second bind using the user DN and client-supplied password.
  - If the account does name a user DN: The first bind operation is unnecessary in this case. `authentication_ldap_sasl` performs a single bind using the user DN and client-supplied password. This is faster than if the MySQL account does not specify an LDAP user DN.
- `authentication_ldap_sasl_bind_root_pwd`

Command-Line Format	<code>--authentication-ldap-sasl-bind-root-pwd=value</code>
Introduced	5.7.19
System Variable	<code>authentication_ldap_sasl_bind_root_pwd</code>
Scope	Global
Dynamic	Yes
Type	String
Default Value	NULL

For SASL LDAP authentication, the password for the root distinguished name. This variable is used in conjunction with `authentication_ldap_sasl_bind_root_dn`. See the description of that variable.

- `authentication_ldap_sasl_ca_path`

Command-Line Format	<code>--authentication-ldap-sasl-ca-path=value</code>
Introduced	5.7.19
System Variable	<code>authentication_ldap_sasl_ca_path</code>
Scope	Global
Dynamic	Yes
Type	String
Default Value	NULL

For SASL LDAP authentication, the absolute path of the certificate authority file. Specify this file if it is desired that the authentication plugin perform verification of the LDAP server certificate.



**Note**

In addition to setting the `authentication_ldap_sasl_ca_path` variable to the file name, you must add the appropriate certificate authority certificates to the file and enable the `authentication_ldap_sasl_tls` system variable. These variables can be set to override the default OpenLDAP TLS configuration; see [LDAP Pluggable Authentication and ldap.conf](#)

- `authentication_ldap_sasl_group_search_attr`

Command-Line Format	<code>--authentication-ldap-sasl-group-search-attr=value</code>
Introduced	5.7.19
System Variable	<code>authentication_ldap_sasl_group_search_attr</code>
Scope	Global
Dynamic	Yes
Type	String
Default Value	<code>cn</code>

For SASL LDAP authentication, the name of the attribute that specifies group names in LDAP directory entries. If `authentication_ldap_sasl_group_search_attr` has its default value of `cn`, searches return the `cn` value as the group name. For example, if an LDAP entry with a `uid` value of `user1` has a `cn` attribute of `mygroup`, searches for `user1` return `mygroup` as the group name.

This variable should be the empty string if you want no group or proxy authentication.

As of MySQL 5.7.21, if the group search attribute is `isMemberOf`, LDAP authentication directly retrieves the user attribute `isMemberOf` value and assigns it as group information. If the group search attribute is not `isMemberOf`, LDAP authentication searches for all groups where the user is a member. (The latter is the default behavior.) This behavior is based on how LDAP group information can be stored two ways:

- 1) A group entry can have an attribute named `memberUid` or `member` with a value that is a user name;
- 2) A user entry can have an attribute named `isMemberOf` with values that are group names.

- `authentication_ldap_sasl_group_search_filter`

Command-Line Format	<code>--authentication-ldap-sasl-group-search-filter=value</code>
Introduced	5.7.21
System Variable	<code>authentication_ldap_sasl_group_search_filter</code>
Scope	Global
Dynamic	Yes
Type	String
Default Value	<code>(   (&amp;(objectClass=posixGroup)(memberUid={s})) (&amp;(objectClass=group)(member={s})) )</code>

For SASL LDAP authentication, the custom group search filter.

As of MySQL 5.7.22, the search filter value can contain `{UA}` and `{UD}` notation to represent the user name and the full user DN. For example, `{UA}` is replaced with a user name such as `"admin"`, whereas `{UD}` is replaced with a use full DN such as `"uid=admin,ou=People,dc=example,dc=com"`. The following value is the default, which supports both OpenLDAP and Active Directory:

```
( | (&(objectClass=posixGroup)(memberUid={UA})) (&(objectClass=group)(member={UD})) )
```

Previously, if the group search attribute was `isMemberOf` or `memberOf`, it was treated as a user attribute that has group information. However, in some cases for the user scenario, `memberOf` was a simple user attribute that held no group information. For additional flexibility, an optional `{GA}` prefix

now can be used with the group search attribute. (Previously, it was assumed that if the group search attribute is `isMemberOf`, it is treated differently. Now any group attribute with a `{GA}` prefix is treated as a user attribute having group names.) For example, with a value of `{GA}MemberOf`, if the group value is the DN, the first attribute value from the group DN is returned as the group name.

In MySQL 5.7.21, the search filter used `%s` notation, expanding it to the user name for OpenLDAP (`(&(objectClass=posixGroup)(memberUid=%s))`) and to the full user DN for Active Directory (`(&(objectClass=group)(member=%s))`).

- `authentication_ldap_sasl_init_pool_size`

Command-Line Format	<code>--authentication-ldap-sasl-init-pool-size=#</code>
Introduced	5.7.19
System Variable	<code>authentication_ldap_sasl_init_pool_size</code>
Scope	Global
Dynamic	Yes
Type	Integer
Default Value	10
Minimum Value	0
Maximum Value	32767
Unit	connections

For SASL LDAP authentication, the initial size of the pool of connections to the LDAP server. Choose the value for this variable based on the average number of concurrent authentication requests to the LDAP server.

The plugin uses `authentication_ldap_sasl_init_pool_size` and `authentication_ldap_sasl_max_pool_size` together for connection-pool management:

- When the authentication plugin initializes, it creates `authentication_ldap_sasl_init_pool_size` connections, unless `authentication_ldap_sasl_max_pool_size=0` to disable pooling.
- If the plugin receives an authentication request when there are no free connections in the current connection pool, the plugin can create a new connection, up to the maximum connection pool size given by `authentication_ldap_sasl_max_pool_size`.
- If the plugin receives a request when the pool size is already at its maximum and there are no free connections, authentication fails.
- When the plugin unloads, it closes all pooled connections.

Changes to plugin system variable settings may have no effect on connections already in the pool. For example, modifying the LDAP server host, port, or TLS settings does not affect existing connections. However, if the original variable values were invalid and the connection pool could not be initialized, the plugin attempts to reinitialize the pool for the next LDAP request. In this case, the new system variable values are used for the reinitialization attempt.

If `authentication_ldap_sasl_max_pool_size=0` to disable pooling, each LDAP connection opened by the plugin uses the values the system variables have at that time.

- `authentication_ldap_sasl_log_status`

Command-Line Format	<code>--authentication-ldap-sasl-log-status=#</code>
Introduced	5.7.19
System Variable	<code>authentication_ldap_sasl_log_status</code>
Scope	Global
Dynamic	Yes
Type	Integer
Default Value	1
Minimum Value	1
Maximum Value	5

For SASL LDAP authentication, the logging level for messages written to the error log. The following table shows the permitted level values and their meanings.

**Table 6.21 Log Levels for `authentication_ldap_sasl_log_status`**

Option Value	Types of Messages Logged
1	No messages
2	Error messages
3	Error and warning messages
4	Error, warning, and information messages
5	Same as previous level plus debugging messages from MySQL

On the client side, messages can be logged to the standard output by setting the `AUTHENTICATION_LDAP_CLIENT_LOG` environment variable. The permitted and default values are the same as for `authentication_ldap_sasl_log_status`.

The `AUTHENTICATION_LDAP_CLIENT_LOG` environment variable applies only to SASL LDAP authentication. It has no effect for simple LDAP authentication because the client plugin in that case is `mysql_clear_password`, which knows nothing about LDAP operations.

- `authentication_ldap_sasl_max_pool_size`

Command-Line Format	<code>--authentication-ldap-sasl-max-pool-size=#</code>
Introduced	5.7.19
System Variable	<code>authentication_ldap_sasl_max_pool_size</code>
Scope	Global
Dynamic	Yes
Type	Integer
Default Value	1000
Minimum Value	0

Maximum Value	32767
Unit	connections

For SASL LDAP authentication, the maximum size of the pool of connections to the LDAP server. To disable connection pooling, set this variable to 0.

This variable is used in conjunction with `authentication_ldap_sasl_init_pool_size`. See the description of that variable.

- `authentication_ldap_sasl_server_host`

Command-Line Format	<code>--authentication-ldap-sasl-server-host=host_name</code>
Introduced	5.7.19
System Variable	<code>authentication_ldap_sasl_server_host</code>
Scope	Global
Dynamic	Yes
Type	String

The LDAP server host for SASL LDAP authentication; this can be a host name or IP address.

- `authentication_ldap_sasl_server_port`

Command-Line Format	<code>--authentication-ldap-sasl-server-port=port_num</code>
Introduced	5.7.19
System Variable	<code>authentication_ldap_sasl_server_port</code>
Scope	Global
Dynamic	Yes
Type	Integer
Default Value	389
Minimum Value	1
Maximum Value	32376

For SASL LDAP authentication, the LDAP server TCP/IP port number.

As of MySQL 5.7.25, if the LDAP port number is configured as 636 or 3269, the plugin uses LDAPS (LDAP over SSL) instead of LDAP. (LDAPS differs from `startTLS`.)

- `authentication_ldap_sasl_tls`

Command-Line Format	<code>--authentication-ldap-sasl-tls[={OFF ON} ]</code>
Introduced	5.7.19
System Variable	<code>authentication_ldap_sasl_tls</code>
Scope	Global
Dynamic	Yes

Type	Boolean
Default Value	OFF

For SASL LDAP authentication, whether connections by the plugin to the LDAP server are secure. If this variable is enabled, the plugin uses TLS to connect securely to the LDAP server. This variable can be set to override the default OpenLDAP TLS configuration; see [LDAP Pluggable Authentication and ldap.conf](#) If you enable this variable, you may also wish to set the `authentication_ldap_sasl_ca_path` variable.

MySQL LDAP plugins support the StartTLS method, which initializes TLS on top of a plain LDAP connection.

As of MySQL 5.7.25, LDAPS can be used by setting the `authentication_ldap_sasl_server_port` system variable.

- `authentication_ldap_sasl_user_search_attr`

Command-Line Format	<code>--authentication-ldap-sasl-user-search-attr=value</code>
Introduced	5.7.19
System Variable	<code>authentication_ldap_sasl_user_search_attr</code>
Scope	Global
Dynamic	Yes
Type	String
Default Value	<code>uid</code>

For SASL LDAP authentication, the name of the attribute that specifies user names in LDAP directory entries. If a user distinguished name is not provided, the authentication plugin searches for the name using this attribute. For example, if the `authentication_ldap_sasl_user_search_attr` value is `uid`, a search for the user name `user1` finds entries with a `uid` value of `user1`.

- `authentication_ldap_simple_auth_method_name`

Command-Line Format	<code>--authentication-ldap-simple-auth-method-name=value</code>
Introduced	5.7.19
System Variable	<code>authentication_ldap_simple_auth_method_name</code>
Scope	Global
Dynamic	Yes
Type	String
Default Value	<code>SIMPLE</code>
Valid Values	<code>SIMPLE</code>



For simple LDAP authentication, the authentication method name. Communication between the authentication plugin and the LDAP server occurs according to this authentication method.



### Note

For all simple LDAP authentication methods, it is recommended to also set TLS parameters to require that communication with the LDAP server take place over secure connections.

These authentication method values are permitted:

- **SIMPLE**: Use simple LDAP authentication. This method uses either one or two LDAP bind operations, depending on whether the MySQL account names an LDAP user distinguished name. See the description of [authentication\\_ldap\\_simple\\_bind\\_root\\_dn](#).
- **AD-FOREST**: A variation on **SIMPLE**, such that authentication searches all domains in the Active Directory forest, performing an LDAP bind to each Active Directory domain until the user is found in some domain.
- [authentication\\_ldap\\_simple\\_bind\\_base\\_dn](#)

Command-Line Format	<code>--authentication-ldap-simple-bind-base-dn=value</code>
Introduced	5.7.19
System Variable	<a href="#">authentication_ldap_simple_bind_base_dn</a>
Scope	Global
Dynamic	Yes
Type	String

Default Value	NULL
---------------	------

For simple LDAP authentication, the base distinguished name (DN). This variable can be used to limit the scope of searches by anchoring them at a certain location (the “base”) within the search tree.

Suppose that members of one set of LDAP user entries each have this form:

```
uid=user_name,ou=People,dc=example,dc=com
```

And that members of another set of LDAP user entries each have this form:

```
uid=user_name,ou=Admin,dc=example,dc=com
```

Then searches work like this for different base DN values:

- If the base DN is `ou=People,dc=example,dc=com`: Searches find user entries only in the first set.
- If the base DN is `ou=Admin,dc=example,dc=com`: Searches find user entries only in the second set.
- If the base DN is `ou=dc=example,dc=com`: Searches find user entries in the first or second set.

In general, more specific base DN values result in faster searches because they limit the search scope more.

- `authentication_ldap_simple_bind_root_dn`

Command-Line Format	<code>--authentication-ldap-simple-bind-root-dn=value</code>
Introduced	5.7.19
System Variable	<code>authentication_ldap_simple_bind_root_dn</code>
Scope	Global
Dynamic	Yes
Type	String
Default Value	NULL

For simple LDAP authentication, the root distinguished name (DN). This variable is used in conjunction with `authentication_ldap_simple_bind_root_pwd` as the credentials for authenticating to the LDAP server for the purpose of performing searches. Authentication uses either one or two LDAP bind operations, depending on whether the MySQL account names an LDAP user DN:

- If the account does not name a user DN: `authentication_ldap_simple` performs an initial LDAP binding using `authentication_ldap_simple_bind_root_dn` and `authentication_ldap_simple_bind_root_pwd`. (These are both empty by default, so if they are not set, the LDAP server must permit anonymous connections.) The resulting bind LDAP handle is used to search for the user DN, based on the client user name. `authentication_ldap_simple` performs a second bind using the user DN and client-supplied password.
- If the account does name a user DN: The first bind operation is unnecessary in this case. `authentication_ldap_simple` performs a single bind using the user DN and client-supplied password. This is faster than if the MySQL account does not specify an LDAP user DN.

- `authentication_ldap_simple_bind_root_pwd`

Command-Line Format	<code>--authentication-ldap-simple-bind-root-pwd=value</code>
Introduced	5.7.19
System Variable	<code>authentication_ldap_simple_bind_root_pwd</code>
Scope	Global
Dynamic	Yes
Type	String
Default Value	<code>NULL</code>

For simple LDAP authentication, the password for the root distinguished name. This variable is used in conjunction with `authentication_ldap_simple_bind_root_dn`. See the description of that variable.

- `authentication_ldap_simple_ca_path`

Command-Line Format	<code>--authentication-ldap-simple-ca-path=value</code>
Introduced	5.7.19
System Variable	<code>authentication_ldap_simple_ca_path</code>
Scope	Global
Dynamic	Yes
Type	String
Default Value	<code>NULL</code>

For simple LDAP authentication, the absolute path of the certificate authority file. Specify this file if it is desired that the authentication plugin perform verification of the LDAP server certificate.



**Note**

In addition to setting the `authentication_ldap_simple_ca_path` variable to the file name, you must add the appropriate certificate authority certificates to the file and enable the `authentication_ldap_simple_tls` system variable. These variables can be set to override the default OpenLDAP TLS configuration; see [LDAP Pluggable Authentication and ldap.conf](#)

- `authentication_ldap_simple_group_search_attr`

Command-Line Format	<code>--authentication-ldap-simple-group-search-attr=value</code>
Introduced	5.7.19
System Variable	<code>authentication_ldap_simple_group_search_attr</code>
Scope	Global
Dynamic	Yes
Type	String

Default Value	cn
---------------	----

For simple LDAP authentication, the name of the attribute that specifies group names in LDAP directory entries. If `authentication_ldap_simple_group_search_attr` has its default value of `cn`, searches return the `cn` value as the group name. For example, if an LDAP entry with a `uid` value of `user1` has a `cn` attribute of `mygroup`, searches for `user1` return `mygroup` as the group name.

As of MySQL 5.7.21, if the group search attribute is `isMemberOf`, LDAP authentication directly retrieves the user attribute `isMemberOf` value and assigns it as group information. If the group search attribute is not `isMemberOf`, LDAP authentication searches for all groups where the user is a member. (The latter is the default behavior.) This behavior is based on how LDAP group information can be stored two ways: 1) A group entry can have an attribute named `memberUid` or `member` with a value that is a user name; 2) A user entry can have an attribute named `isMemberOf` with values that are group names.

- `authentication_ldap_simple_group_search_filter`

Command-Line Format	<code>--authentication-ldap-simple-group-search-filter=value</code>
Introduced	5.7.21
System Variable	<code>authentication_ldap_simple_group_search_filter</code>
Scope	Global
Dynamic	Yes
Type	String
Default Value	<code>(   (&amp;(objectClass=posixGroup)(memberUid=%s)) (&amp;(objectClass=group)(member=%s)) )</code>

For simple LDAP authentication, the custom group search filter.

As of MySQL 5.7.22, the search filter value can contain `{UA}` and `{UD}` notation to represent the user name and the full user DN. For example, `{UA}` is replaced with a user name such as `"admin"`, whereas `{UD}` is replaced with a use full DN such as `"uid=admin,ou=People,dc=example,dc=com"`. The following value is the default, which supports both OpenLDAP and Active Directory:

```
( | (&(objectClass=posixGroup)(memberUid={UA})) (&(objectClass=group)(member={UD})) )
```

Previously, if the group search attribute was `isMemberOf` or `memberOf`, it was treated as a user attribute that has group information. However, in some cases for the user scenario, `memberOf` was a simple user attribute that held no group information. For additional flexibility, an optional `{GA}` prefix now can be used with the group search attribute. (Previously, it was assumed that if the group search attribute is `isMemberOf`, it is treated differently. Now any group attribute with a `{GA}` prefix is treated as a user attribute having group names.) For example, with a value of `{GA}memberOf`, if the group value is the DN, the first attribute value from the group DN is returned as the group name.

In MySQL 5.7.21, the search filter used `%s` notation, expanding it to the user name for OpenLDAP `(&(objectClass=posixGroup)(memberUid=%s))` and to the full user DN for Active Directory `(&(objectClass=group)(member=%s))`.

- `authentication_ldap_simple_init_pool_size`

Command-Line Format	<code>--authentication-ldap-simple-init-pool-size=#</code>
---------------------	--

Introduced	5.7.19
System Variable	<a href="#">authentication_ldap_simple_init_pool_size</a>
Scope	Global
Dynamic	Yes
Type	Integer
Default Value	10
Minimum Value	0
Maximum Value	32767
Unit	connections

For simple LDAP authentication, the initial size of the pool of connections to the LDAP server. Choose the value for this variable based on the average number of concurrent authentication requests to the LDAP server.

The plugin uses [authentication\\_ldap\\_simple\\_init\\_pool\\_size](#) and [authentication\\_ldap\\_simple\\_max\\_pool\\_size](#) together for connection-pool management:

- When the authentication plugin initializes, it creates [authentication\\_ldap\\_simple\\_init\\_pool\\_size](#) connections, unless [authentication\\_ldap\\_simple\\_max\\_pool\\_size=0](#) to disable pooling.
- If the plugin receives an authentication request when there are no free connections in the current connection pool, the plugin can create a new connection, up to the maximum connection pool size given by [authentication\\_ldap\\_simple\\_max\\_pool\\_size](#).
- If the plugin receives a request when the pool size is already at its maximum and there are no free connections, authentication fails.
- When the plugin unloads, it closes all pooled connections.

Changes to plugin system variable settings may have no effect on connections already in the pool. For example, modifying the LDAP server host, port, or TLS settings does not affect existing connections. However, if the original variable values were invalid and the connection pool could not be initialized, the plugin attempts to reinitialize the pool for the next LDAP request. In this case, the new system variable values are used for the reinitialization attempt.

If [authentication\\_ldap\\_simple\\_max\\_pool\\_size=0](#) to disable pooling, each LDAP connection opened by the plugin uses the values the system variables have at that time.

- [authentication\\_ldap\\_simple\\_log\\_status](#)

Command-Line Format	<code>--authentication-ldap-simple-log-status=#</code>
Introduced	5.7.19
System Variable	<a href="#">authentication_ldap_simple_log_status</a>
Scope	Global
Dynamic	Yes
Type	Integer
Default Value	1

Minimum Value	1
Maximum Value	5

For simple LDAP authentication, the logging level for messages written to the error log. The following table shows the permitted level values and their meanings.

**Table 6.22 Log Levels for authentication\_ldap\_simple\_log\_status**

Option Value	Types of Messages Logged
1	No messages
2	Error messages
3	Error and warning messages
4	Error, warning, and information messages
5	Same as previous level plus debugging messages from MySQL

- [authentication\\_ldap\\_simple\\_max\\_pool\\_size](#)

Command-Line Format	<code>--authentication-ldap-simple-max-pool-size=#</code>
Introduced	5.7.19
System Variable	<a href="#">authentication_ldap_simple_max_pool_size</a>
Scope	Global
Dynamic	Yes
Type	Integer
Default Value	1000
Minimum Value	0
Maximum Value	32767
Unit	connections

For simple LDAP authentication, the maximum size of the pool of connections to the LDAP server. To disable connection pooling, set this variable to 0.

This variable is used in conjunction with [authentication\\_ldap\\_simple\\_init\\_pool\\_size](#). See the description of that variable.

- [authentication\\_ldap\\_simple\\_server\\_host](#)

Command-Line Format	<code>--authentication-ldap-simple-server-host=host_name</code>
Introduced	5.7.19
System Variable	<a href="#">authentication_ldap_simple_server_host</a>
Scope	Global
Dynamic	Yes

Type	String
------	--------

For simple LDAP authentication, the LDAP server host. The permitted values for this variable depend on the authentication method:

- For `authentication_ldap_simple_auth_method_name=SIMPLE`: The LDAP server host can be a host name or IP address.
- For `authentication_ldap_simple_auth_method_name=AD-FOREST`. The LDAP server host can be an Active Directory domain name. For example, for an LDAP server URL of `ldap://example.mem.local:389`, the domain name can be `mem.local`.

An Active Directory forest setup can have multiple domains (LDAP server IPs), which can be discovered using DNS. On Unix and Unix-like systems, some additional setup may be required to configure your DNS server with SRV records that specify the LDAP servers for the Active Directory domain. For information about DNS SRV, see [RFC 2782](#).

Suppose that your configuration has these properties:

- The name server that provides information about Active Directory domains has IP address `10.172.166.100`.
- The LDAP servers have names `ldap1.mem.local` through `ldap3.mem.local` and IP addresses `10.172.166.101` through `10.172.166.103`.

You want the LDAP servers to be discoverable using SRV searches. For example, at the command line, a command like this should list the LDAP servers:

```
host -t SRV _ldap._tcp.mem.local
```

Perform the DNS configuration as follows:

1. Add a line to `/etc/resolv.conf` to specify the name server that provides information about Active Directory domains:

```
nameserver 10.172.166.100
```

2. Configure the appropriate zone file for the name server with SRV records for the LDAP servers:

```
_ldap._tcp.mem.local. 86400 IN SRV 0 100 389 ldap1.mem.local.
_ldap._tcp.mem.local. 86400 IN SRV 0 100 389 ldap2.mem.local.
_ldap._tcp.mem.local. 86400 IN SRV 0 100 389 ldap3.mem.local.
```

3. It may also be necessary to specify the IP address for the LDAP servers in `/etc/hosts` if the server host cannot be resolved. For example, add lines like this to the file:

```
10.172.166.101 ldap1.mem.local
10.172.166.102 ldap2.mem.local
10.172.166.103 ldap3.mem.local
```

With the DNS configured as just described, the server-side LDAP plugin can discover the LDAP servers and tries to authenticate in all domains until authentication succeeds or there are no more servers.

Windows needs no such settings as just described. Given the LDAP server host in the `authentication_ldap_simple_server_host` value, the Windows LDAP library searches all domains and attempts to authenticate.

- `authentication_ldap_simple_server_port`

Command-Line Format	<code>--authentication-ldap-simple-server-port=port_num</code>
Introduced	5.7.19
System Variable	<code>authentication_ldap_simple_server_port</code>
Scope	Global
Dynamic	Yes
Type	Integer
Default Value	389
Minimum Value	1
Maximum Value	32376

For simple LDAP authentication, the LDAP server TCP/IP port number.

As of MySQL 5.7.25, if the LDAP port number is configured as 636 or 3269, the plugin uses LDAPS (LDAP over SSL) instead of LDAP. (LDAPS differs from `startTLS`.)

- `authentication_ldap_simple_tls`

Command-Line Format	<code>--authentication-ldap-simple-tls[={OFF ON}]</code>
Introduced	5.7.19
System Variable	<code>authentication_ldap_simple_tls</code>
Scope	Global
Dynamic	Yes
Type	Boolean
Default Value	OFF

For simple LDAP authentication, whether connections by the plugin to the LDAP server are secure. If this variable is enabled, the plugin uses TLS to connect securely to the LDAP server. This variable can be set to override the default OpenLDAP TLS configuration; see [LDAP Pluggable Authentication and ldap.conf](#). If you enable this variable, you may also wish to set the `authentication_ldap_simple_ca_path` variable.

MySQL LDAP plugins support the StartTLS method, which initializes TLS on top of a plain LDAP connection.

As of MySQL 5.7.25, LDAPS can be used by setting the `authentication_ldap_simple_server_port` system variable.

- `authentication_ldap_simple_user_search_attr`

Command-Line Format	<code>--authentication-ldap-simple-user-search-attr=value</code>
Introduced	5.7.19
System Variable	<code>authentication_ldap_simple_user_search_attr</code>
Scope	Global



Dynamic	Yes
Type	String
Default Value	<code>uid</code>

For simple LDAP authentication, the name of the attribute that specifies user names in LDAP directory entries. If a user distinguished name is not provided, the authentication plugin searches for the name using this attribute. For example, if the `authentication_ldap_simple_user_search_attr` value is `uid`, a search for the user name `user1` finds entries with a `uid` value of `user1`.

## 6.4.2 Connection Control Plugins

As of MySQL 5.7.17, MySQL Server includes a plugin library that enables administrators to introduce an increasing delay in server response to connection attempts after a configurable number of consecutive failed attempts. This capability provides a deterrent that slows down brute force attacks against MySQL user accounts. The plugin library contains two plugins:

- `CONNECTION_CONTROL` checks incoming connection attempts and adds a delay to server responses as necessary. This plugin also exposes system variables that enable its operation to be configured and a status variable that provides rudimentary monitoring information.

The `CONNECTION_CONTROL` plugin uses the audit plugin interface (see [Writing Audit Plugins](#)). To collect information, it subscribes to the `MYSQL_AUDIT_CONNECTION_CLASSMASK` event class, and processes `MYSQL_AUDIT_CONNECTION_CONNECT` and `MYSQL_AUDIT_CONNECTION_CHANGE_USER` subevents to check whether the server should introduce a delay before responding to connection attempts.

- `CONNECTION_CONTROL_FAILED_LOGIN_ATTEMPTS` implements an `INFORMATION_SCHEMA` table that exposes more detailed monitoring information for failed connection attempts. For more information about this table, see [Section 24.6.2, “The INFORMATION\\_SCHEMA CONNECTION\\_CONTROL\\_FAILED\\_LOGIN\\_ATTEMPTS Table”](#).

The following sections provide information about connection control plugin installation and configuration.

### 6.4.2.1 Connection Control Plugin Installation

This section describes how to install the connection control plugins, `CONNECTION_CONTROL` and `CONNECTION_CONTROL_FAILED_LOGIN_ATTEMPTS`. For general information about installing plugins, see [Section 5.5.1, “Installing and Uninstalling Plugins”](#).

To be usable by the server, the plugin library file must be located in the MySQL plugin directory (the directory named by the `plugin_dir` system variable). If necessary, configure the plugin directory location by setting the value of `plugin_dir` at server startup.

The plugin library file base name is `connection_control`. The file name suffix differs per platform (for example, `.so` for Unix and Unix-like systems, `.dll` for Windows).

To load the plugins at server startup, use the `--plugin-load-add` option to name the library file that contains them. With this plugin-loading method, the option must be given each time the server starts. For example, put these lines in the server `my.cnf` file, adjusting the `.so` suffix for your platform as necessary:

```
[mysqld]
plugin-load-add=connection_control.so
```

After modifying `my.cnf`, restart the server to cause the new settings to take effect.

Alternatively, to load the plugins at runtime, use these statements, adjusting the `.so` suffix for your platform as necessary:

```
INSTALL PLUGIN CONNECTION_CONTROL
  SONAME 'connection_control.so';
INSTALL PLUGIN CONNECTION_CONTROL_FAILED_LOGIN_ATTEMPTS
  SONAME 'connection_control.so';
```

`INSTALL PLUGIN` loads the plugin immediately, and also registers it in the `mysql.plugins` system table to cause the server to load it for each subsequent normal startup without the need for `--plugin-load-add`.

To verify plugin installation, examine the Information Schema `PLUGINS` table or use the `SHOW PLUGINS` statement (see [Section 5.5.2, “Obtaining Server Plugin Information”](#)). For example:

```
mysql> SELECT PLUGIN_NAME, PLUGIN_STATUS
  FROM INFORMATION_SCHEMA.PLUGINS
  WHERE PLUGIN_NAME LIKE 'connection%';
```

PLUGIN_NAME	PLUGIN_STATUS
CONNECTION_CONTROL	ACTIVE
CONNECTION_CONTROL_FAILED_LOGIN_ATTEMPTS	ACTIVE

If a plugin fails to initialize, check the server error log for diagnostic messages.

If the plugins have been previously registered with `INSTALL PLUGIN` or are loaded with `--plugin-load-add`, you can use the `--connection-control` and `--connection-control-failed-login-attempts` options at server startup to control plugin activation. For example, to load the plugins at startup and prevent them from being removed at runtime, use these options:

```
[mysqld]
plugin-load-add=connection_control.so
connection-control=FORCE_PLUS_PERMANENT
connection-control-failed-login-attempts=FORCE_PLUS_PERMANENT
```

If it is desired to prevent the server from running without a given connection control plugin, use an option value of `FORCE` or `FORCE_PLUS_PERMANENT` to force server startup to fail if the plugin does not initialize successfully.



**Note**

It is possible to install one plugin without the other, but both must be installed for full connection control capability. In particular, installing only the `CONNECTION_CONTROL_FAILED_LOGIN_ATTEMPTS` plugin is of little use because, without the `CONNECTION_CONTROL` plugin to provide the data that populates the `CONNECTION_CONTROL_FAILED_LOGIN_ATTEMPTS` table, the table is always empty.

- [Connection Delay Configuration](#)
- [Connection Failure Assessment](#)
- [Connection Failure Monitoring](#)

**Connection Delay Configuration**

To enable configuring its operation, the `CONNECTION_CONTROL` plugin exposes these system variables:

- `connection_control_failed_connections_threshold`: The number of consecutive failed connection attempts permitted to accounts before the server adds a delay for subsequent connection attempts. To disable failed-connection counting, set `connection_control_failed_connections_threshold` to zero.

- `connection_control_min_connection_delay`: The minimum delay in milliseconds for connection failures above the threshold.
- `connection_control_max_connection_delay`: The maximum delay in milliseconds for connection failures above the threshold.

If `connection_control_failed_connections_threshold` is nonzero, failed-connection counting is enabled and has these properties:

- The delay is zero up through `connection_control_failed_connections_threshold` consecutive failed connection attempts.
- Thereafter, the server adds an increasing delay for subsequent consecutive attempts, until a successful connection occurs. The initial unadjusted delays begin at 1000 milliseconds (1 second) and increase by 1000 milliseconds per attempt. That is, once delay has been activated for an account, the unadjusted delays for subsequent failed attempts are 1000 milliseconds, 2000 milliseconds, 3000 milliseconds, and so forth.
- The actual delay experienced by a client is the unadjusted delay, adjusted to lie within the values of the `connection_control_min_connection_delay` and `connection_control_max_connection_delay` system variables, inclusive.
- Once delay has been activated for an account, the first successful connection thereafter by the account also experiences a delay, but failure counting is reset for subsequent connections.

For example, with the default `connection_control_failed_connections_threshold` value of 3, there is no delay for the first three consecutive failed connection attempts by an account. The actual adjusted delays experienced by the account for the fourth and subsequent failed connections depend on the `connection_control_min_connection_delay` and `connection_control_max_connection_delay` values:

- If `connection_control_min_connection_delay` and `connection_control_max_connection_delay` are 1000 and 20000, the adjusted delays are the same as the unadjusted delays, up to a maximum of 20000 milliseconds. The fourth and subsequent failed connections are delayed by 1000 milliseconds, 2000 milliseconds, 3000 milliseconds, and so forth.
- If `connection_control_min_connection_delay` and `connection_control_max_connection_delay` are 1500 and 20000, the adjusted delays for the fourth and subsequent failed connections are 1500 milliseconds, 2000 milliseconds, 3000 milliseconds, and so forth, up to a maximum of 20000 milliseconds.
- If `connection_control_min_connection_delay` and `connection_control_max_connection_delay` are 2000 and 3000, the adjusted delays for the fourth and subsequent failed connections are 2000 milliseconds, 2000 milliseconds, and 3000 milliseconds, with all subsequent failed connections also delayed by 3000 milliseconds.

You can set the `CONNECTION_CONTROL` system variables at server startup or runtime. Suppose that you want to permit four consecutive failed connection attempts before the server starts delaying its responses, with a minimum delay of 2000 milliseconds. To set the relevant variables at server startup, put these lines in the server `my.cnf` file:

```
[mysqld]
plugin-load-add=connection_control.so
connection-control-failed-connections-threshold=4
connection-control-min-connection-delay=2000
```

To set the variables at runtime, use these statements:

```
SET GLOBAL connection_control_failed_connections_threshold = 4;
```

```
SET GLOBAL connection_control_min_connection_delay = 1500;
```

`SET GLOBAL` sets the value for the running MySQL instance. To make the change permanent, add a line in your `my.cnf` file, as shown previously.

The `connection_control_min_connection_delay` and `connection_control_max_connection_delay` system variables both have minimum and maximum values of 1000 and 2147483647. In addition, the permitted range of values of each variable also depends on the current value of the other:

- `connection_control_min_connection_delay` cannot be set greater than the current value of `connection_control_max_connection_delay`.
- `connection_control_max_connection_delay` cannot be set less than the current value of `connection_control_min_connection_delay`.

Thus, to make the changes required for some configurations, you might need to set the variables in a specific order. Suppose that the current minimum and maximum delays are 1000 and 2000, and that you want to set them to 3000 and 5000. You cannot first set `connection_control_min_connection_delay` to 3000 because that is greater than the current `connection_control_max_connection_delay` value of 2000. Instead, set `connection_control_max_connection_delay` to 5000, then set `connection_control_min_connection_delay` to 3000.

## Connection Failure Assessment

When the `CONNECTION_CONTROL` plugin is installed, it checks connection attempts and tracks whether they fail or succeed. For this purpose, a failed connection attempt is one for which the client user and host match a known MySQL account but the provided credentials are incorrect, or do not match any known account.

Failed-connection counting is based on the user/host combination for each connection attempt. Determination of the applicable user name and host name takes proxying into account and occurs as follows:

- If the client user proxies another user, the account for failed-connection counting is the proxying user, not the proxied user. For example, if `external_user@example.com` proxies `proxy_user@example.com`, connection counting uses the proxying user, `external_user@example.com`, rather than the proxied user, `proxy_user@example.com`. Both `external_user@example.com` and `proxy_user@example.com` must have valid entries in the `mysql.user` system table and a proxy relationship between them must be defined in the `mysql.proxies_priv` system table (see [Section 6.2.14](#), “Proxy Users”).
- If the client user does not proxy another user, but does match a `mysql.user` entry, counting uses the `CURRENT_USER()` value corresponding to that entry. For example, if a user `user1` connecting from a host `host1.example.com` matches a `user1@host1.example.com` entry, counting uses `user1@host1.example.com`. If the user matches a `user1@%.example.com`, `user1@%.com`, or `user1@%` entry instead, counting uses `user1@%.example.com`, `user1@%.com`, or `user1@%`, respectively.

For the cases just described, the connection attempt matches some `mysql.user` entry, and whether the request succeeds or fails depends on whether the client provides the correct authentication credentials. For example, if the client presents an incorrect password, the connection attempt fails.

If the connection attempt matches no `mysql.user` entry, the attempt fails. In this case, no `CURRENT_USER()` value is available and connection-failure counting uses the user name provided by the client and the client host as determined by the server. For example, if a client attempts to connect as user `user2` from host `host2.example.com`, the user name part is available in the client

request and the server determines the host information. The user/host combination used for counting is `user2@host2.example.com`.



**Note**

The server maintains information about which client hosts can possibly connect to the server (essentially the union of host values for `mysql.user` entries). If a client attempts to connect from any other host, the server rejects the attempt at an early stage of connection setup:

```
ERROR 1130 (HY000): Host 'host_name' is not
allowed to connect to this MySQL server
```

Because this type of rejection occurs so early, `CONNECTION_CONTROL` does not see it, and does not count it.

**Connection Failure Monitoring**

To monitor failed connections, use these information sources:

- The `connection_control_delay_generated` status variable indicates the number of times the server added a delay to its response to a failed connection attempt. This does not count attempts that occur before reaching the threshold defined by the `connection_control_failed_connections_threshold` system variable.
- The `INFORMATION_SCHEMA.CONNECTION_CONTROL_FAILED_LOGIN_ATTEMPTS` table provides information about the current number of consecutive failed connection attempts per account (user/host combination). This counts all failed attempts, regardless of whether they were delayed.

Assigning a value to `connection_control_failed_connections_threshold` at runtime has these effects:

- All accumulated failed-connection counters are reset to zero.
- The `connection_control_delay_generated` status variable is reset to zero.
- The `CONNECTION_CONTROL_FAILED_LOGIN_ATTEMPTS` table becomes empty.

**6.4.2.2 Connection Control Plugin System and Status Variables**

This section describes the system and status variables that the `CONNECTION_CONTROL` plugin provides to enable its operation to be configured and monitored.

- [Connection Control Plugin System Variables](#)
- [Connection Control Plugin Status Variables](#)

**Connection Control Plugin System Variables**

If the `CONNECTION_CONTROL` plugin is installed, it exposes these system variables:

- `connection_control_failed_connections_threshold`

Command-Line Format	<code>--connection-control-failed-connections-threshold=#</code>
Introduced	5.7.17
System Variable	<code>connection_control_failed_connections_threshold</code>
Scope	Global

Dynamic	Yes
Type	Integer
Default Value	3
Minimum Value	0
Maximum Value	2147483647

The number of consecutive failed connection attempts permitted to accounts before the server adds a delay for subsequent connection attempts:

- If the variable has a nonzero value  $N$ , the server adds a delay beginning with consecutive failed attempt  $N+1$ . If an account has reached the point where connection responses are delayed, a delay also occurs for the next subsequent successful connection.
- Setting this variable to zero disables failed-connection counting. In this case, the server never adds delays.

For information about how `connection_control_failed_connections_threshold` interacts with other connection control system and status variables, see [Section 6.4.2.1, “Connection Control Plugin Installation”](#).

- `connection_control_max_connection_delay`

Command-Line Format	<code>--connection-control-max-connection-delay=#</code>
Introduced	5.7.17
System Variable	<code>connection_control_max_connection_delay</code>
Scope	Global
Dynamic	Yes
Type	Integer
Default Value	2147483647
Minimum Value	1000
Maximum Value	2147483647
Unit	milliseconds

The maximum delay in milliseconds for server response to failed connection attempts, if `connection_control_failed_connections_threshold` is greater than zero.

For information about how `connection_control_max_connection_delay` interacts with other connection control system and status variables, see [Section 6.4.2.1, “Connection Control Plugin Installation”](#).

- `connection_control_min_connection_delay`

Command-Line Format	<code>--connection-control-min-connection-delay=#</code>
Introduced	5.7.17
System Variable	<code>connection_control_min_connection_delay</code>
Scope	Global

Dynamic	Yes
Type	Integer
Default Value	1000
Minimum Value	1000
Maximum Value	2147483647
Unit	milliseconds

The minimum delay in milliseconds for server response to failed connection attempts, if `connection_control_failed_connections_threshold` is greater than zero.

For information about how `connection_control_min_connection_delay` interacts with other connection control system and status variables, see [Section 6.4.2.1, “Connection Control Plugin Installation”](#).

### Connection Control Plugin Status Variables

If the `CONNECTION_CONTROL` plugin is installed, it exposes this status variable:

- `connection_control_delay_generated`

The number of times the server added a delay to its response to a failed connection attempt. This does not count attempts that occur before reaching the threshold defined by the `connection_control_failed_connections_threshold` system variable.

This variable provides a simple counter. For more detailed connection control monitoring information, examine the `INFORMATION_SCHEMA CONNECTION_CONTROL_FAILED_LOGIN_ATTEMPTS` table; see [Section 24.6.2, “The INFORMATION\\_SCHEMA CONNECTION\\_CONTROL\\_FAILED\\_LOGIN\\_ATTEMPTS Table”](#).

Assigning a value to `connection_control_failed_connections_threshold` at runtime resets `connection_control_delay_generated` to zero.

This variable was added in MySQL 5.7.17.

### 6.4.3 The Password Validation Plugin

The `validate_password` plugin serves to improve security by requiring account passwords and enabling strength testing of potential passwords. This plugin exposes a set of system variables that enable you to configure password policy.

The `validate_password` plugin implements these capabilities:

- For SQL statements that assign a password supplied as a cleartext value, `validate_password` checks the password against the current password policy and rejects the password if it is weak (the statement returns an `ER_NOT_VALID_PASSWORD` error). This applies to the `ALTER USER`, `CREATE USER`, `GRANT`, and `SET PASSWORD` statements, and passwords given as arguments to the `PASSWORD()` function.
- For `CREATE USER` statements, `validate_password` requires that a password be given, and that it satisfies the password policy. This is true even if an account is locked initially because otherwise unlocking the account later would cause it to become accessible without a password that satisfies the policy.

- `validate_password` implements a `VALIDATE_PASSWORD_STRENGTH()` SQL function that assesses the strength of potential passwords. This function takes a password argument and returns an integer from 0 (weak) to 100 (strong).



**Note**

For statements that assign, modify, or generate account passwords (`ALTER USER`, `CREATE USER`, `GRANT`, and `SET PASSWORD`; statements that use `PASSWORD()`, the `validate_password` capabilities described here apply only to accounts that use an authentication plugin that stores credentials internally to MySQL. For accounts that use plugins that perform authentication against a credentials system external to MySQL, password management must be handled externally against that system as well. For more information about internal credentials storage, see [Section 6.2.11, “Password Management”](#).

The preceding restriction does not apply to use of the `VALIDATE_PASSWORD_STRENGTH()` function because it does not affect accounts directly.

Examples:

- `validate_password` checks the cleartext password in the following statement. Under the default password policy, which requires passwords to be at least 8 characters long, the password is weak and the statement produces an error:

```
mysql> ALTER USER USER() IDENTIFIED BY 'abc';
ERROR 1819 (HY000): Your password does not satisfy the current
policy requirements
```

- Passwords specified as hashed values are not checked because the original password value is not available for checking:

```
mysql> ALTER USER 'jeffrey'@'localhost'
IDENTIFIED WITH mysql_native_password
AS '*0D3CED9BEC10A777AEC23CCC353A8C08A633045E';
Query OK, 0 rows affected (0.01 sec)
```

- This account-creation statement fails, even though the account is locked initially, because it does not include a password that satisfies the current password policy:

```
mysql> CREATE USER 'juanita'@'localhost' ACCOUNT LOCK;
ERROR 1819 (HY000): Your password does not satisfy the current
policy requirements
```

- To check a password, use the `VALIDATE_PASSWORD_STRENGTH()` function:

```
mysql> SELECT VALIDATE_PASSWORD_STRENGTH('weak');
+-----+
| VALIDATE_PASSWORD_STRENGTH('weak') |
+-----+
|                                     25 |
+-----+
mysql> SELECT VALIDATE_PASSWORD_STRENGTH('lessweak$_@123');
+-----+
| VALIDATE_PASSWORD_STRENGTH('lessweak$_@123') |
+-----+
|                                               50 |
+-----+
mysql> SELECT VALIDATE_PASSWORD_STRENGTH('N0Tweak$_@123!');
+-----+
| VALIDATE_PASSWORD_STRENGTH('N0Tweak$_@123!') |
+-----+
```



```
|-----100-----|
+-----+-----+
```

To configure password checking, modify the system variables having names of the form `validate_password_xxx`; these are the parameters that control password policy. See [Section 6.4.3.2, “Password Validation Plugin Options and Variables”](#).

If `validate_password` is not installed, the `validate_password_xxx` system variables are not available, passwords in statements are not checked, and the `VALIDATE_PASSWORD_STRENGTH()` function always returns 0. For example, without the plugin installed, accounts can be assigned passwords shorter than 8 characters, or no password at all.

Assuming that `validate_password` is installed, it implements three levels of password checking: `LOW`, `MEDIUM`, and `STRONG`. The default is `MEDIUM`; to change this, modify the value of `validate_password_policy`. The policies implement increasingly strict password tests. The following descriptions refer to default parameter values, which can be modified by changing the appropriate system variables.

- `LOW` policy tests password length only. Passwords must be at least 8 characters long. To change this length, modify `validate_password_length`.
- `MEDIUM` policy adds the conditions that passwords must contain at least 1 numeric character, 1 lowercase character, 1 uppercase character, and 1 special (nonalphanumeric) character. To change these values, modify `validate_password_number_count`, `validate_password_mixed_case_count`, and `validate_password_special_char_count`.
- `STRONG` policy adds the condition that password substrings of length 4 or longer must not match words in the dictionary file, if one has been specified. To specify the dictionary file, modify `validate_password_dictionary_file`.

In addition, as of MySQL 5.7.15, `validate_password` supports the capability of rejecting passwords that match the user name part of the effective user account for the current session, either forward or in reverse. To provide control over this capability, `validate_password` exposes a `validate_password_check_user_name` system variable, which is enabled by default.

### 6.4.3.1 Password Validation Plugin Installation

This section describes how to install the `validate_password` password-validation plugin. For general information about installing plugins, see [Section 5.5.1, “Installing and Uninstalling Plugins”](#).



#### Note

If you installed MySQL 5.7 using the [MySQL Yum repository](#), [MySQL SLES Repository](#), or [RPM packages provided by Oracle](#), `validate_password` is enabled by default after you start your MySQL Server for the first time.

To be usable by the server, the plugin library file must be located in the MySQL plugin directory (the directory named by the `plugin_dir` system variable). If necessary, configure the plugin directory location by setting the value of `plugin_dir` at server startup.

The plugin library file base name is `validate_password`. The file name suffix differs per platform (for example, `.so` for Unix and Unix-like systems, `.dll` for Windows).

To load the plugin at server startup, use the `--plugin-load-add` option to name the library file that contains it. With this plugin-loading method, the option must be given each time the server starts. For example, put these lines in the server `my.cnf` file, adjusting the `.so` suffix for your platform as necessary:

```
[mysqld]
plugin-load-add=validate_password.so
```

After modifying `my.cnf`, restart the server to cause the new settings to take effect.

Alternatively, to load the plugin at runtime, use this statement, adjusting the `.so` suffix for your platform as necessary:

```
INSTALL PLUGIN validate_password SONAME 'validate_password.so';
```

`INSTALL PLUGIN` loads the plugin, and also registers it in the `mysql.plugins` system table to cause the plugin to be loaded for each subsequent normal server startup without the need for `--plugin-load-add`.

To verify plugin installation, examine the Information Schema `PLUGINS` table or use the `SHOW PLUGINS` statement (see Section 5.5.2, “Obtaining Server Plugin Information”). For example:

```
mysql> SELECT PLUGIN_NAME, PLUGIN_STATUS
        FROM INFORMATION_SCHEMA.PLUGINS
        WHERE PLUGIN_NAME LIKE 'validate%';
+-----+-----+
| PLUGIN_NAME | PLUGIN_STATUS |
+-----+-----+
| validate_password | ACTIVE |
+-----+-----+
```

If the plugin fails to initialize, check the server error log for diagnostic messages.

If the plugin has been previously registered with `INSTALL PLUGIN` or is loaded with `--plugin-load-add`, you can use the `--validate-password` option at server startup to control plugin activation. For example, to load the plugin at startup and prevent it from being removed at runtime, use these options:

```
[mysqld]
plugin-load-add=validate_password.so
validate-password=FORCE_PLUS_PERMANENT
```

If it is desired to prevent the server from running without the password-validation plugin, use `--validate-password` with a value of `FORCE` or `FORCE_PLUS_PERMANENT` to force server startup to fail if the plugin does not initialize successfully.

### 6.4.3.2 Password Validation Plugin Options and Variables

This section describes the options, system variables, and status variables that `validate_password` provides to enable its operation to be configured and monitored.

- [Password Validation Plugin Options](#)
- [Password Validation Plugin System Variables](#)
- [Password Validation Plugin Status Variables](#)

#### Password Validation Plugin Options

To control activation of the `validate_password` plugin, use this option:

- `--validate-password[=value]`

Command-Line Format	<code>--validate-password[=<i>value</i>]</code>
Type	Enumeration
Default Value	ON
Valid Values	ON OFF

	FORCE
	FORCE_PLUS_PERMANENT

This option controls how the server loads the `validate_password` plugin at startup. The value should be one of those available for plugin-loading options, as described in [Section 5.5.1, “Installing and Uninstalling Plugins”](#). For example, `--validate-password=FORCE_PLUS_PERMANENT` tells the server to load the plugin at startup and prevents it from being removed while the server is running.

This option is available only if the `validate_password` plugin has been previously registered with `INSTALL PLUGIN` or is loaded with `--plugin-load-add`. See [Section 6.4.3.1, “Password Validation Plugin Installation”](#).

## Password Validation Plugin System Variables

If the `validate_password` plugin is enabled, it exposes several system variables that enable configuration of password checking:

```
mysql> SHOW VARIABLES LIKE 'validate_password%';
+-----+-----+
| Variable_name | Value |
+-----+-----+
| validate_password_check_user_name | OFF |
| validate_password_dictionary_file | |
| validate_password_length | 8 |
| validate_password_mixed_case_count | 1 |
| validate_password_number_count | 1 |
| validate_password_policy | MEDIUM |
| validate_password_special_char_count | 1 |
+-----+-----+
```

To change how passwords are checked, you can set these system variables at server startup or at runtime. The following list describes the meaning of each variable.

- `validate_password_check_user_name`

Command-Line Format	<code>--validate-password-check-user-name[={OFF ON}]</code>
Introduced	5.7.15
System Variable	<code>validate_password_check_user_name</code>
Scope	Global
Dynamic	Yes
Type	Boolean
Default Value	OFF

Whether `validate_password` compares passwords to the user name part of the effective user account for the current session and rejects them if they match. This variable is unavailable unless `validate_password` is installed.

By default, `validate_password_check_user_name` is disabled. This variable controls user name matching independent of the value of `validate_password_policy`.

When `validate_password_check_user_name` is enabled, it has these effects:

- Checking occurs in all contexts for which `validate_password` is invoked, which includes use of statements such as `ALTER USER` or `SET PASSWORD` to change the current user's password, and invocation of functions such as `PASSWORD()` and `VALIDATE_PASSWORD_STRENGTH()`.
- The user names used for comparison are taken from the values of the `USER()` and `CURRENT_USER()` functions for the current session. An implication is that a user who has sufficient privileges to set another user's password can set the password to that user's name, and cannot set that user's password to the name of the user executing the statement. For example, `'root'@'localhost'` can set the password for `'jeffrey'@'localhost'` to `'jeffrey'`, but cannot set the password to `'root'`.
- Only the user name part of the `USER()` and `CURRENT_USER()` function values is used, not the host name part. If a user name is empty, no comparison occurs.
- If a password is the same as the user name or its reverse, a match occurs and the password is rejected.
- User-name matching is case-sensitive. The password and user name values are compared as binary strings on a byte-by-byte basis.
- If a password matches the user name, `VALIDATE_PASSWORD_STRENGTH()` returns 0 regardless of how other `validate_password` system variables are set.
- `validate_password_dictionary_file`

Command-Line Format	<code>--validate-password-dictionary-file=file_name</code>
System Variable	<code>validate_password_dictionary_file</code>
Scope	Global
Dynamic	Yes
Type	File name

The path name of the dictionary file that `validate_password` uses for checking passwords. This variable is unavailable unless `validate_password` is installed.

By default, this variable has an empty value and dictionary checks are not performed. For dictionary checks to occur, the variable value must be nonempty. If the file is named as a relative path, it is interpreted relative to the server data directory. File contents should be lowercase, one word per line. Contents are treated as having a character set of `utf8`. The maximum permitted file size is 1MB.

For the dictionary file to be used during password checking, the password policy must be set to 2 (`STRONG`); see the description of the `validate_password_policy` system variable. Assuming that is true, each substring of the password of length 4 up to 100 is compared to the words in the dictionary file. Any match causes the password to be rejected. Comparisons are not case-sensitive.

For `VALIDATE_PASSWORD_STRENGTH()`, the password is checked against all policies, including `STRONG`, so the strength assessment includes the dictionary check regardless of the `validate_password_policy` value.

`validate_password_dictionary_file` can be set at runtime and assigning a value causes the named file to be read without a server restart.

- `validate_password_length`

Command-Line Format	<code>--validate-password-length=#</code>
System Variable	<code>validate_password_length</code>
Scope	Global
Dynamic	Yes
Type	Integer
Default Value	8
Minimum Value	0

The minimum number of characters that `validate_password` requires passwords to have. This variable is unavailable unless `validate_password` is installed.

The `validate_password_length` minimum value is a function of several other related system variables. The value cannot be set less than the value of this expression:

```
validate_password_number_count
+ validate_password_special_char_count
+ ( 2 * validate_password_mixed_case_count )
```

If `validate_password` adjusts the value of `validate_password_length` due to the preceding constraint, it writes a message to the error log.

- `validate_password_mixed_case_count`

Command-Line Format	<code>--validate-password-mixed-case-count=#</code>
System Variable	<code>validate_password_mixed_case_count</code>
Scope	Global
Dynamic	Yes
Type	Integer
Default Value	1
Minimum Value	0

The minimum number of lowercase and uppercase characters that `validate_password` requires passwords to have if the password policy is `MEDIUM` or stronger. This variable is unavailable unless `validate_password` is installed.

For a given `validate_password_mixed_case_count` value, the password must have that many lowercase characters, and that many uppercase characters.

- `validate_password_number_count`

Command-Line Format	<code>--validate-password-number-count=#</code>
System Variable	<code>validate_password_number_count</code>
Scope	Global
Dynamic	Yes
Type	Integer
Default Value	1

Minimum Value	0
---------------	---

The minimum number of numeric (digit) characters that `validate_password` requires passwords to have if the password policy is `MEDIUM` or stronger. This variable is unavailable unless `validate_password` is installed.

- `validate_password_policy`

Command-Line Format	<code>--validate-password-policy=value</code>
System Variable	<code>validate_password_policy</code>
Scope	Global
Dynamic	Yes
Type	Enumeration
Default Value	1
Valid Values	0 1 2

The password policy enforced by `validate_password`. This variable is unavailable unless `validate_password` is installed.

`validate_password_policy` affects how `validate_password` uses its other policy-setting system variables, except for checking passwords against user names, which is controlled independently by `validate_password_check_user_name`.

The `validate_password_policy` value can be specified using numeric values 0, 1, 2, or the corresponding symbolic values `LOW`, `MEDIUM`, `STRONG`. The following table describes the tests performed for each policy. For the length test, the required length is the value of the `validate_password_length` system variable. Similarly, the required values for the other tests are given by other `validate_password_xxx` variables.

Policy	Tests Performed
0 or <code>LOW</code>	Length
1 or <code>MEDIUM</code>	Length; numeric, lowercase/uppercase, and special characters
2 or <code>STRONG</code>	Length; numeric, lowercase/uppercase, and special characters; dictionary file

- `validate_password_special_char_count`

Command-Line Format	<code>--validate-password-special-char-count=#</code>
System Variable	<code>validate_password_special_char_count</code>
Scope	Global
Dynamic	Yes
Type	Integer
Default Value	1

Minimum Value	0
---------------	---

The minimum number of nonalphanumeric characters that `validate_password` requires passwords to have if the password policy is `MEDIUM` or stronger. This variable is unavailable unless `validate_password` is installed.

## Password Validation Plugin Status Variables

If the `validate_password` plugin is enabled, it exposes status variables that provide operational information:

```
mysql> SHOW STATUS LIKE 'validate_password%';
+-----+-----+
| Variable_name | Value |
+-----+-----+
| validate_password.dictionary_file_last_parsed | 2019-10-03 08:33:49 |
| validate_password_dictionary_file_words_count | 1902 |
+-----+-----+
```

The following list describes the meaning of each status variable.

- `validate_password_dictionary_file_last_parsed`  
When the dictionary file was last parsed.
- `validate_password_dictionary_file_words_count`  
The number of words read from the dictionary file.

## 6.4.4 The MySQL Keyring

MySQL Server supports a keyring that enables internal server components and plugins to securely store sensitive information for later retrieval. The implementation comprises these elements:

- Keyring plugins that manage a backing store or communicate with a storage back end. These keyring plugins are available:
  - `keyring_file`: Stores keyring data in a file local to the server host. Available in MySQL Community Edition and MySQL Enterprise Edition distributions as of MySQL 5.7.11. See [Section 6.4.4.2, “Using the keyring\\_file File-Based Keyring Plugin”](#).
  - `keyring_encrypted_file`: Stores keyring data in an encrypted, password-protected file local to the server host. Available in MySQL Enterprise Edition distributions as of MySQL 5.7.21. See [Section 6.4.4.3, “Using the keyring\\_encrypted\\_file Encrypted File-Based Keyring Plugin”](#).
  - `keyring_okv`: A KMIP 1.1 plugin for use with KMIP-compatible back end keyring storage products such as Oracle Key Vault and Gemalto SafeNet KeySecure Appliance. Available in MySQL Enterprise Edition distributions as of MySQL 5.7.12. See [Section 6.4.4.4, “Using the keyring\\_okv KMIP Plugin”](#).
  - `keyring_aws`: Communicates with the Amazon Web Services Key Management Service for key generation and uses a local file for key storage. Available in MySQL Enterprise Edition distributions as of MySQL 5.7.19. See [Section 6.4.4.5, “Using the keyring\\_aws Amazon Web Services Keyring Plugin”](#).
- A keyring service interface for keyring key management (MySQL 5.7.13 and higher). This service is accessible at two levels:
  - SQL interface: In SQL statements, call the functions described in [Section 6.4.4.8, “General-Purpose Keyring Key-Management Functions”](#).

- C interface: In C-language code, call the keyring service functions described in [Section 5.5.6.2, “The Keyring Service”](#).
- A key migration capability. MySQL 5.7.21 and higher supports migration of keys between keystores, enabling DBAs to switch a MySQL installation from one keystore to another. See [Section 6.4.4.7, “Migrating Keys Between Keyring Keystores”](#).



### Warning

For encryption key management, the `keyring_file` and `keyring_encrypted_file` plugins are not intended as a regulatory compliance solution. Security standards such as PCI, FIPS, and others require use of key management systems to secure, manage, and protect encryption keys in key vaults or hardware security modules (HSMs).

Within MySQL, keyring service consumers include:

- The `InnoDB` storage engine uses the keyring to store its key for tablespace encryption. See [Section 14.14, “InnoDB Data-at-Rest Encryption”](#).
- MySQL Enterprise Audit uses the keyring to store the audit log file encryption password. See [Encrypting Audit Log Files](#).

For general keyring installation instructions, see [Section 6.4.4.1, “Keyring Plugin Installation”](#). For installation and configuration information specific to a given keyring plugin, see the section describing that plugin.

For information about using the keyring functions, see [Section 6.4.4.8, “General-Purpose Keyring Key-Management Functions”](#).

Keyring plugins and functions access a keyring service that provides the interface to the keyring. For information about accessing this service and writing keyring plugins, see [Section 5.5.6.2, “The Keyring Service”](#), and [Writing Keyring Plugins](#).

## 6.4.4.1 Keyring Plugin Installation

Keyring service consumers require that a keyring plugin be installed. This section describes how to install the keyring plugin of your choosing. Also, for general information about installing plugins, see [Section 5.5.1, “Installing and Uninstalling Plugins”](#).

If you intend to use keyring functions in conjunction with the chosen keyring plugin, install the functions after installing that plugin, using the instructions in [Section 6.4.4.8, “General-Purpose Keyring Key-Management Functions”](#).



### Note

Only one keyring plugin should be enabled at a time. Enabling multiple keyring plugins is unsupported and results may not be as anticipated.

MySQL provides these keyring plugin choices:

- `keyring_file`: Stores keyring data in a file local to the server host. Available in MySQL Community Edition and MySQL Enterprise Edition distributions.
- `keyring_encrypted_file`: Stores keyring data in an encrypted, password-protected file local to the server host. Available in MySQL Enterprise Edition distributions.



- `keyring_okv`: A KMIP 1.1 plugin for use with KMIP-compatible back end keyring storage products such as Oracle Key Vault and Gemalto SafeNet KeySecure Appliance. Available in MySQL Enterprise Edition distributions.
- `keyring_aws`: Communicates with the Amazon Web Services Key Management Service as a back end for key generation and uses a local file for key storage. Available in MySQL Enterprise Edition distributions.

To be usable by the server, the plugin library file must be located in the MySQL plugin directory (the directory named by the `plugin_dir` system variable). If necessary, configure the plugin directory location by setting the value of `plugin_dir` at server startup.

The keyring plugin must be loaded early during the server startup sequence so that components can access it as necessary during their own initialization. For example, the `InnoDB` storage engine uses the keyring for tablespace encryption, so the keyring plugin must be loaded and available prior to `InnoDB` initialization.

Installation for each keyring plugin is similar. The following instructions describe how to install `keyring_file`. To use a different keyring plugin, substitute its name for `keyring_file`.

The `keyring_file` plugin library file base name is `keyring_file`. The file name suffix differs per platform (for example, `.so` for Unix and Unix-like systems, `.dll` for Windows).

To load the plugin, use the `--early-plugin-load` option to name the plugin library file that contains it. For example, on platforms where the plugin library file suffix is `.so`, use these lines in the server `my.cnf` file, adjusting the `.so` suffix for your platform as necessary:

```
[mysqld]
early-plugin-load=keyring_file.so
```



### Important

In MySQL 5.7.11, the default `--early-plugin-load` value is the name of the `keyring_file` plugin library file, causing that plugin to be loaded by default. In MySQL 5.7.12 and higher, the default `--early-plugin-load` value is empty; to load the `keyring_file` plugin, you must explicitly specify the option with a value naming the `keyring_file` plugin library file.

`InnoDB` tablespace encryption requires that the keyring plugin to be used be loaded prior to `InnoDB` initialization, so this change of default `--early-plugin-load` value introduces an incompatibility for upgrades from 5.7.11 to 5.7.12 or higher. Administrators who have encrypted `InnoDB` tablespaces must take explicit action to ensure continued loading of the keyring plugin: Start the server with an `--early-plugin-load` option that names the plugin library file.

Before starting the server, check the notes for your chosen keyring plugin for configuration instructions specific to that plugin:

- `keyring_file`: [Section 6.4.4.2, “Using the keyring\\_file File-Based Keyring Plugin”](#).
- `keyring_encrypted_file`: [Section 6.4.4.3, “Using the keyring\\_encrypted\\_file Encrypted File-Based Keyring Plugin”](#).
- `keyring_okv`: [Section 6.4.4.4, “Using the keyring\\_okv KMIP Plugin”](#).
- `keyring_aws`: [Section 6.4.4.5, “Using the keyring\\_aws Amazon Web Services Keyring Plugin”](#)

After performing any plugin-specific configuration, start the server. Verify plugin installation by examining the Information Schema `PLUGINS` table or use the `SHOW PLUGINS` statement (see [Section 5.5.2, “Obtaining Server Plugin Information”](#)). For example:

```
mysql> SELECT PLUGIN_NAME, PLUGIN_STATUS
        FROM INFORMATION_SCHEMA.PLUGINS
        WHERE PLUGIN_NAME LIKE 'keyring%';
+-----+-----+
| PLUGIN_NAME | PLUGIN_STATUS |
+-----+-----+
| keyring_file | ACTIVE        |
+-----+-----+
```

If the plugin fails to initialize, check the server error log for diagnostic messages.

Plugins can be loaded by methods other than `--early-plugin-load`, such as the `--plugin-load` or `--plugin-load-add` option or the `INSTALL PLUGIN` statement. However, keyring plugins loaded using those methods may be available too late in the server startup sequence for certain components that use the keyring, such as `InnoDB`:

- Plugin loading using `--plugin-load` or `--plugin-load-add` occurs after `InnoDB` initialization.
- Plugins installed using `INSTALL PLUGIN` are registered in the `mysql.plugin` system table and loaded automatically for subsequent server restarts. However, because `mysql.plugin` is an `InnoDB` table, any plugins named in it can be loaded during startup only after `InnoDB` initialization.

If no keyring plugin is available when a component tries to access the keyring service, the service cannot be used by that component. As a result, the component may fail to initialize or may initialize with limited functionality. For example, if `InnoDB` finds that there are encrypted tablespaces when it initializes, it attempts to access the keyring. If the keyring is unavailable, `InnoDB` can access only unencrypted tablespaces. To ensure that `InnoDB` can access encrypted tablespaces as well, use `--early-plugin-load` to load the keyring plugin.

#### 6.4.4.2 Using the `keyring_file` File-Based Keyring Plugin

The `keyring_file` keyring plugin stores keyring data in a file local to the server host.



#### Warning

For encryption key management, the `keyring_file` plugin is not intended as a regulatory compliance solution. Security standards such as PCI, FIPS, and others require use of key management systems to secure, manage, and protect encryption keys in key vaults or hardware security modules (HSMs).

To install `keyring_file`, use the general instructions found in [Section 6.4.4.1, “Keyring Plugin Installation”](#), together with the configuration information specific to `keyring_file` found here.

To be usable during the server startup process, `keyring_file` must be loaded using the `--early-plugin-load` option. The `keyring_file_data` system variable optionally configures the location of the file used by the `keyring_file` plugin for data storage. The default value is platform specific. To configure the file location explicitly, set the variable value at startup. For example, use these lines in the server `my.cnf` file, adjusting the `.so` suffix and file location for your platform as necessary:

```
[mysqld]
early-plugin-load=keyring_file.so
keyring_file_data=/usr/local/mysql/mysql-keyring/keyring
```

If `keyring_file_data` is set to a new location, the keyring plugin creates a new, empty file containing no keys; this means that any existing encrypted tables can no longer be accessed.

Keyring operations are transactional: The `keyring_file` plugin uses a backup file during write operations to ensure that it can roll back to the original file if an operation fails. The backup file has the same name as the value of the `keyring_file_data` system variable with a suffix of `.backup`.

For additional information about `keyring_file_data`, see [Section 6.4.4.12, “Keyring System Variables”](#).

As of MySQL 5.7.17, to ensure that keys are flushed only when the correct keyring storage file exists, `keyring_file` stores a SHA-256 checksum of the keyring in the file. Before updating the file, the plugin verifies that it contains the expected checksum.

The `keyring_file` plugin supports the functions that comprise the standard MySQL Keyring service interface. Keyring operations performed by those functions are accessible at two levels:

- SQL interface: In SQL statements, call the functions described in [Section 6.4.4.8, “General-Purpose Keyring Key-Management Functions”](#).
- C interface: In C-language code, call the keyring service functions described in [Section 5.5.6.2, “The Keyring Service”](#).

Example (using the SQL interface):

```
SELECT keyring_key_generate('MyKey', 'AES', 32);
SELECT keyring_key_remove('MyKey');
```

For information about the characteristics of key values permitted by `keyring_file`, see [Section 6.4.4.6, “Supported Keyring Key Types and Lengths”](#).

### 6.4.4.3 Using the `keyring_encrypted_file` Encrypted File-Based Keyring Plugin



#### Note

The `keyring_encrypted_file` plugin is an extension included in MySQL Enterprise Edition, a commercial product. To learn more about commercial products, see <https://www.mysql.com/products/>.

The `keyring_encrypted_file` keyring plugin stores keyring data in an encrypted, password-protected file local to the server host. A password must be specified for the file. This plugin is available as of MySQL 5.7.21.



#### Warning

For encryption key management, the `keyring_encrypted_file` plugin is not intended as a regulatory compliance solution. Security standards such as PCI, FIPS, and others require use of key management systems to secure, manage, and protect encryption keys in key vaults or hardware security modules (HSMs).

To install `keyring_encrypted_file`, use the general instructions found in [Section 6.4.4.1, “Keyring Plugin Installation”](#), together with the configuration information specific to `keyring_encrypted_file` found here.

To be usable during the server startup process, `keyring_encrypted_file` must be loaded using the `--early-plugin-load` option. To specify the password for encrypting the keyring data file, set the `keyring_encrypted_file_password` system variable. (The password is mandatory; if not specified at server startup, `keyring_encrypted_file` initialization fails.) The `keyring_encrypted_file_data` system variable optionally configures the location of the file used by the `keyring_encrypted_file` plugin for data storage. The default value is platform specific. To configure the file location explicitly, set the

variable value at startup. For example, use these lines in the server `my.cnf` file, adjusting the `.so` suffix and file location for your platform as necessary and substituting your chosen password:

```
[mysqld]
early-plugin-load=keyring_encrypted_file.so
keyring_encrypted_file_data=/usr/local/mysql/mysql-keyring/keyring-encrypted
keyring_encrypted_file_password=password
```

Because the `my.cnf` file stores a password when written as shown, it should have a restrictive mode and be accessible only to the account used to run the MySQL server.

Keyring operations are transactional: The `keyring_encrypted_file` plugin uses a backup file during write operations to ensure that it can roll back to the original file if an operation fails. The backup file has the same name as the value of the `keyring_encrypted_file_data` system variable with a suffix of `.backup`.

For additional information about the system variables used to configure the `keyring_encrypted_file` plugin, see [Section 6.4.4.12, “Keyring System Variables”](#).

To ensure that keys are flushed only when the correct keyring storage file exists, `keyring_encrypted_file` stores a SHA-256 checksum of the keyring in the file. Before updating the file, the plugin verifies that it contains the expected checksum. In addition, `keyring_encrypted_file` encrypts file contents using AES before writing the file, and decrypts file contents after reading the file.

The `keyring_encrypted_file` plugin supports the functions that comprise the standard MySQL Keyring service interface. Keyring operations performed by those functions are accessible at two levels:

- SQL interface: In SQL statements, call the functions described in [Section 6.4.4.8, “General-Purpose Keyring Key-Management Functions”](#).
- C interface: In C-language code, call the keyring service functions described in [Section 5.5.6.2, “The Keyring Service”](#).

Example (using the SQL interface):

```
SELECT keyring_key_generate('MyKey', 'AES', 32);
SELECT keyring_key_remove('MyKey');
```

For information about the characteristics of key values permitted by `keyring_encrypted_file`, see [Section 6.4.4.6, “Supported Keyring Key Types and Lengths”](#).

#### 6.4.4.4 Using the `keyring_okv` KMIP Plugin



##### Note

The `keyring_okv` plugin is an extension included in MySQL Enterprise Edition, a commercial product. To learn more about commercial products, see <https://www.mysql.com/products/>.

The Key Management Interoperability Protocol (KMIP) enables communication of cryptographic keys between a key management server and its clients. The `keyring_okv` keyring plugin uses the KMIP 1.1 protocol to communicate securely as a client of a KMIP back end. Keyring material is generated exclusively by the back end, not by `keyring_okv`. The plugin works with these KMIP-compatible products:

- Oracle Key Vault
- Gemalto SafeNet KeySecure Appliance
- Townsend Alliance Key Manager

Each MySQL Server instance must be registered separately as a client for KMIP. If two or more MySQL Server instances use the same set of credentials, they can interfere with each other's functioning.

The `keyring_okv` plugin supports the functions that comprise the standard MySQL Keyring service interface. Keyring operations performed by those functions are accessible at two levels:

- SQL interface: In SQL statements, call the functions described in [Section 6.4.4.8, “General-Purpose Keyring Key-Management Functions”](#).
- C interface: In C-language code, call the keyring service functions described in [Section 5.5.6.2, “The Keyring Service”](#).

Example (using the SQL interface):

```
SELECT keyring_key_generate('MyKey', 'AES', 32);
SELECT keyring_key_remove('MyKey');
```

For information about the characteristics of key values permitted by `keyring_okv`, [Section 6.4.4.6, “Supported Keyring Key Types and Lengths”](#).

To install `keyring_okv`, use the general instructions found in [Section 6.4.4.1, “Keyring Plugin Installation”](#), together with the configuration information specific to `keyring_okv` found here.

- [General keyring\\_okv Configuration](#)
- [Configuring keyring\\_okv for Oracle Key Vault](#)
- [Configuring keyring\\_okv for Gemalto SafeNet KeySecure Appliance](#)
- [Configuring keyring\\_okv for Townsend Alliance Key Manager](#)
- [Password-Protecting the keyring\\_okv Key File](#)

## General keyring\_okv Configuration

Regardless of which KMIP back end the `keyring_okv` plugin uses for keyring storage, the `keyring_okv_conf_dir` system variable configures the location of the directory used by `keyring_okv` for its support files. The default value is empty, so you must set the variable to name a properly configured directory before the plugin can communicate with the KMIP back end. Unless you do so, `keyring_okv` writes a message to the error log during server startup that it cannot communicate:

```
[Warning] Plugin keyring_okv reported: 'For keyring_okv to be
initialized, please point the keyring_okv_conf_dir variable to a directory
containing Oracle Key Vault configuration file and ssl materials'
```

The `keyring_okv_conf_dir` variable must name a directory that contains the following items:

- `okvclient.ora`: A file that contains details of the KMIP back end with which `keyring_okv` communicates.
- `ssl`: A directory that contains the certificate and key files required to establish a secure connection with the KMIP back end: `CA.pem`, `cert.pem`, and `key.pem`. As of MySQL 5.7.20, if the key file is password-protected, the `ssl` directory can contain a single-line text file named `password.txt` containing the password needed to decrypt the key file.

Both the `okvclient.ora` file and `ssl` directory with the certificate and key files are required for `keyring_okv` to work properly. The procedure used to populate the configuration directory with these files depends on the KMIP back end used with `keyring_okv`, as described elsewhere.

The configuration directory used by `keyring_okv` as the location for its support files should have a restrictive mode and be accessible only to the account used to run the MySQL server. For example, on Unix and Unix-like systems, to use the `/usr/local/mysql/mysql-keyring-okv` directory, the following commands (executed as `root`) create the directory and set its mode and ownership:

```
cd /usr/local/mysql
mkdir mysql-keyring-okv
chmod 750 mysql-keyring-okv
chown mysql mysql-keyring-okv
chgrp mysql mysql-keyring-okv
```

To be usable during the server startup process, `keyring_okv` must be loaded using the `--early-plugin-load` option. Also, set the `keyring_okv_conf_dir` system variable to tell `keyring_okv` where to find its configuration directory. For example, use these lines in the server `my.cnf` file, adjusting the `.so` suffix and directory location for your platform as necessary:

```
[mysqld]
early-plugin-load=keyring_okv.so
keyring_okv_conf_dir=/usr/local/mysql/mysql-keyring-okv
```

For additional information about `keyring_okv_conf_dir`, see [Section 6.4.4.12, “Keyring System Variables”](#).

## Configuring `keyring_okv` for Oracle Key Vault

The discussion here assumes that you are familiar with Oracle Key Vault. Some pertinent information sources:

- [Oracle Key Vault site](#)
- [Oracle Key Vault documentation](#)

In Oracle Key Vault terminology, clients that use Oracle Key Vault to store and retrieve security objects are called endpoints. To communicate with Oracle Key Vault, it is necessary to register as an endpoint and enroll by downloading and installing endpoint support files. Note that you must register a separate endpoint for each MySQL Server instance. If two or more MySQL Server instances use the same endpoint, they can interfere with each other's functioning.

The following procedure briefly summarizes the process of setting up `keyring_okv` for use with Oracle Key Vault:

1. Create the configuration directory for the `keyring_okv` plugin to use.
2. Register an endpoint with Oracle Key Vault to obtain an enrollment token.
3. Use the enrollment token to obtain the `okvclient.jar` client software download.
4. Install the client software to populate the `keyring_okv` configuration directory that contains the Oracle Key Vault support files.

Use the following procedure to configure `keyring_okv` and Oracle Key Vault to work together. This description only summarizes how to interact with Oracle Key Vault. For details, visit the [Oracle Key Vault site](#) and consult the *Oracle Key Vault Administrator's Guide*.

1. Create the configuration directory that contains the Oracle Key Vault support files, and make sure that the `keyring_okv_conf_dir` system variable is set to name that directory (for details, see [General `keyring\_okv` Configuration](#)).

2. Log in to the Oracle Key Vault management console as a user who has the System Administrator role.
3. Select the Endpoints tab to arrive at the Endpoints page. On the Endpoints page, click Add.
4. Provide the required endpoint information and click Register. The endpoint type should be Other. Successful registration results in an enrollment token.
5. Log out from the Oracle Key Vault server.
6. Connect again to the Oracle Key Vault server, this time without logging in. Use the endpoint enrollment token to enroll and request the `okvclient.jar` software download. Save this file to your system.
7. Install the `okvclient.jar` file using the following command (you must have JDK 1.4 or higher):

```
java -jar okvclient.jar -d dir_name [-v]
```

The directory name following the `-d` option is the location in which to install extracted files. The `-v` option, if given, causes log information to be produced that may be useful if the command fails.

When the command asks for an Oracle Key Vault endpoint password, do not provide one. Instead, press **Enter**. (The result is that no password is required when the endpoint connects to Oracle Key Vault.)

The preceding command produces an `okvclient.ora` file, which should be in this location under the directory named by the `-d` option in the preceding `java -jar` command:

```
install_dir/conf/okvclient.ora
```

The expected file contents include lines that look like this:

```
SERVER=host_ip:port_num
STANDBY_SERVER=host_ip:port_num
```



#### Note

If the existing file is not in this format, then create a new file with the lines shown in the previous example. Also, consider backing up the `okvclient.ora` file before you run the `okvutil` command. Restore the file as needed.

The `keyring_okv` plugin attempts to communicate with the server running on the host named by the `SERVER` variable and falls back to `STANDBY_SERVER` if that fails:

- For the `SERVER` variable, a setting in the `okvclient.ora` file is mandatory.
- For the `STANDBY_SERVER` variable, a setting in the `okvclient.ora` file is optional, as of MySQL 5.7.19. Prior to MySQL 5.7.19, a setting for `STANDBY_SERVER` is mandatory; if `okvclient.ora` is generated with no setting for `STANDBY_SERVER`, `keyring_okv` fails to initialize. The workaround is to check `oraclient.ora` and add a “dummy” setting for `STANDBY_SERVER`, if one is missing. For example:

```
STANDBY_SERVER=127.0.0.1:5696
```

8. Go to the Oracle Key Vault installer directory and test the setup by running this command:

```
okvutil/bin/okvutil list
```

The output should look something like this:

Unique ID	Type	Identifier
255AB8DE-C97F-482C-E053-0100007F28B9	Symmetric Key	-

```
264BF6E0-A20E-7C42-E053-0100007FB29C Symmetric Key -
```

For a fresh Oracle Key Vault server (a server without any key in it), the output looks like this instead, to indicate that there are no keys in the vault:

```
no objects found
```

9. Use this command to extract the `ssl` directory containing SSL materials from the `okvclient.jar` file:

```
jar xf okvclient.jar ssl
```

10. Copy the Oracle Key Vault support files (the `okvclient.ora` file and the `ssl` directory) into the configuration directory.
11. (Optional) If you wish to password-protect the key file, use the instructions in [Password-Protecting the keyring\\_okv Key File](#).

After completing the preceding procedure, restart the MySQL server. It loads the `keyring_okv` plugin and `keyring_okv` uses the files in its configuration directory to communicate with Oracle Key Vault.

### Configuring `keyring_okv` for Gemalto SafeNet KeySecure Appliance

Gemalto SafeNet KeySecure Appliance uses the KMIP protocol (version 1.1 or 1.2). As of MySQL 5.7.18, the `keyring_okv` keyring plugin (which supports KMIP 1.1) can use KeySecure as its KMIP back end for keyring storage.

Use the following procedure to configure `keyring_okv` and KeySecure to work together. The description only summarizes how to interact with KeySecure. For details, consult the section named Add a KMIP Server in the [KeySecure User Guide](#).

1. Create the configuration directory that contains the KeySecure support files, and make sure that the `keyring_okv_conf_dir` system variable is set to name that directory (for details, see [General keyring\\_okv Configuration](#)).
2. In the configuration directory, create a subdirectory named `ssl` to use for storing the required SSL certificate and key files.
3. In the configuration directory, create a file named `okvclient.ora`. It should have following format:

```
SERVER=host_ip:port_num  
STANDBY_SERVER=host_ip:port_num
```

For example, if KeySecure is running on host 198.51.100.20 and listening on port 9002, the `okvclient.ora` file looks like this:

```
SERVER=198.51.100.20:9002  
STANDBY_SERVER=198.51.100.20:9002
```

4. Connect to the KeySecure Management Console as an administrator with credentials for Certificate Authorities access.
5. Navigate to Security >> Local CAs and create a local certificate authority (CA).
6. Go to Trusted CA Lists. Select Default and click on Properties. Then select Edit for Trusted Certificate Authority List and add the CA just created.
7. Download the CA and save it in the `ssl` directory as a file named `CA.pem`.
8. Navigate to Security >> Certificate Requests and create a certificate. Then you can download a compressed `tar` file containing certificate PEM files.



9. Extract the PEM files from in the downloaded file. For example, if the file name is `csr_w_pk_pkcs8.gz`, decompress and unpack it using this command:

```
tar zxvf csr_w_pk_pkcs8.gz
```

Two files result from the extraction operation: `certificate_request.pem` and `private_key_pkcs8.pem`.

10. Use this `openssl` command to decrypt the private key and create a file named `key.pem`:

```
openssl pkcs8 -in private_key_pkcs8.pem -out key.pem
```

11. Copy the `key.pem` file into the `ssl` directory.
12. Copy the certificate request in `certificate_request.pem` into the clipboard.
13. Navigate to Security >> Local CAs. Select the same CA that you created earlier (the one you downloaded to create the `CA.pem` file), and click Sign Request. Paste the Certificate Request from the clipboard, choose a certificate purpose of Client (the keyring is a client of KeySecure), and click Sign Request. The result is a certificate signed with the selected CA in a new page.
14. Copy the signed certificate to the clipboard, then save the clipboard contents as a file named `cert.pem` in the `ssl` directory.
15. (Optional) If you wish to password-protect the key file, use the instructions in [Password-Protecting the keyring\\_okv Key File](#).

After completing the preceding procedure, restart the MySQL server. It loads the `keyring_okv` plugin and `keyring_okv` uses the files in its configuration directory to communicate with KeySecure.

## Configuring `keyring_okv` for Townsend Alliance Key Manager

Townsend Alliance Key Manager uses the KMIP protocol. The `keyring_okv` keyring plugin can use Alliance Key Manager as its KMIP back end for keyring storage. For additional information, see [Alliance Key Manager for MySQL](#).

## Password-Protecting the `keyring_okv` Key File

As of MySQL 5.7.20, you can optionally protect the key file with a password and supply a file containing the password to enable the key file to be decrypted. To so do, change location to the `ssl` directory and perform these steps:

1. Encrypt the `key.pem` key file. For example, use a command like this, and enter the encryption password at the prompts:

```
$> openssl rsa -des3 -in key.pem -out key.pem.new
Enter PEM pass phrase:
Verifying - Enter PEM pass phrase:
```

2. Save the encryption password in a single-line text file named `password.txt` in the `ssl` directory.
3. Verify that the encrypted key file can be decrypted using the following command. The decrypted file should display on the console:

```
$> openssl rsa -in key.pem.new -passin file:password.txt
```

4. Remove the original `key.pem` file and rename `key.pem.new` to `key.pem`.
5. Change the ownership and access mode of new `key.pem` file and `password.txt` file as necessary to ensure that they have the same restrictions as other files in the `ssl` directory.

### 6.4.4.5 Using the `keyring_aws` Amazon Web Services Keyring Plugin

**Note**

The `keyring_aws` plugin is an extension included in MySQL Enterprise Edition, a commercial product. To learn more about commercial products, see <https://www.mysql.com/products/>.

The `keyring_aws` keyring plugin communicates with the Amazon Web Services Key Management Service (AWS KMS) as a back end for key generation and uses a local file for key storage. All keyring material is generated exclusively by the AWS server, not by `keyring_aws`.

MySQL Enterprise Edition can work with `keyring_aws` on Red Hat Enterprise Linux, SUSE Linux Enterprise Server, Debian, Ubuntu, macOS, and Windows. MySQL Enterprise Edition does not support the use of `keyring_aws` on these platforms:

- EL6
- Generic Linux (glibc2.12)
- Solaris

The discussion here assumes that you are familiar with AWS in general and KMS in particular. Some pertinent information sources:

- [AWS site](#)
- [KMS documentation](#)

The following sections provide configuration and usage information for the `keyring_aws` keyring plugin:

- [keyring\\_aws Configuration](#)
- [keyring\\_aws Operation](#)
- [keyring\\_aws Credential Changes](#)

#### `keyring_aws` Configuration

To install `keyring_aws`, use the general instructions found in [Section 6.4.4.1, “Keyring Plugin Installation”](#), together with the plugin-specific configuration information found here.

The plugin library file contains the `keyring_aws` plugin and two loadable functions, `keyring_aws_rotate_cmk()` and `keyring_aws_rotate_keys()`.

To configure `keyring_aws`, you must obtain a secret access key that provides credentials for communicating with AWS KMS and write it to a configuration file:

1. Create an AWS KMS account.
2. Use AWS KMS to create a secret access key ID and secret access key. The access key serves to verify your identity and that of your applications.
3. Use the AWS KMS account to create a customer master key (CMK) ID. At MySQL startup, set the `keyring_aws_cmk_id` system variable to the CMK ID value. This variable is mandatory and there is no default. (Its value can be changed at runtime if desired using `SET GLOBAL`.)
4. If necessary, create the directory in which the configuration file should be located. The directory should have a restrictive mode and be accessible only to the account used to run the MySQL server. For

example, on many Unix and Unix-like systems, such as Oracle Enterprise Linux, to use `/usr/local/mysql/mysql-keyring/keyring_aws_conf` as the file name, the following commands (executed as `root`) create its parent directory and set the directory mode and ownership:

```
$> cd /usr/local/mysql
$> mkdir mysql-keyring
$> chmod 750 mysql-keyring
$> chown mysql mysql-keyring
$> chgrp mysql mysql-keyring
```

At MySQL startup, set the `keyring_aws_conf_file` system variable to `/usr/local/mysql/mysql-keyring/keyring_aws_conf` to indicate the configuration file location to the server.

The location of the configuration file may vary according to Linux distribution; the directory for this file may also already be provided by a system module or other application such as AppArmor. For example, under AppArmor on recent editions of Ubuntu Linux, the keyring directory is specified as `/var/lib/mysql-keyring`. See [Ubuntu Server: AppArmor](#) for more information about using AppArmor on Ubuntu systems; see also [this example MySQL configuration file](#). For other operating platforms, see the system documentation for guidance.

5. Prepare the `keyring_aws` configuration file, which should contain two lines:

- Line 1: The secret access key ID
- Line 2: The secret access key

For example, if the key ID is `wwwwwwwwwwwwEXAMPLE` and the key is `xxxxxxxxxxxxx/yyyyyy/zzzzzzzEXAMPLEKEY`, the configuration file looks like this:

```
wwwwwwwwwwwwEXAMPLE
xxxxxxxxxxxxx/yyyyyy/zzzzzzzEXAMPLEKEY
```

To be usable during the server startup process, `keyring_aws` must be loaded using the `--early-plugin-load` option. The `keyring_aws_cmk_id` system variable is mandatory and configures the customer master key (CMK) ID obtained from the AWS KMS server. The `keyring_aws_conf_file` and `keyring_aws_data_file` system variables optionally configure the locations of the files used by the `keyring_aws` plugin for configuration information and data storage. The file location variable default values are platform specific. To configure the locations explicitly, set the variable values at startup. For example, use these lines in the server `my.cnf` file, adjusting the `.so` suffix and file locations for your platform as necessary:

```
[mysqld]
early-plugin-load=keyring_aws.so
keyring_aws_cmk_id='arn:aws:kms:us-west-2:111122223333:key/abcd1234-ef56-ab12-cd34-ef56abcd1234'
keyring_aws_conf_file=/usr/local/mysql/mysql-keyring/keyring_aws_conf
keyring_aws_data_file=/usr/local/mysql/mysql-keyring/keyring_aws_data
```

For the `keyring_aws` plugin to start successfully, the configuration file must exist and contain valid secret access key information, initialized as described previously. The storage file need not exist. If it does not, `keyring_aws` attempts to create it (as well as its parent directory, if necessary).



### Important

The default AWS region is `us-east-1`. For any other region, you must also set `keyring_aws_region` explicitly in `my.cnf`.

For additional information about the system variables used to configure the `keyring_aws` plugin, see [Section 6.4.4.12, “Keyring System Variables”](#).

Start the MySQL server and install the functions associated with the `keyring_aws` plugin. This is a one-time operation, performed by executing the following statements, adjusting the `.so` suffix for your platform as necessary:

```
CREATE FUNCTION keyring_aws_rotate_cmk RETURNS INTEGER
  SONAME 'keyring_aws.so';
CREATE FUNCTION keyring_aws_rotate_keys RETURNS INTEGER
  SONAME 'keyring_aws.so';
```

For additional information about the `keyring_aws` functions, see [Section 6.4.4.9, “Plugin-Specific Keyring Key-Management Functions”](#).

## keyring\_aws Operation

At plugin startup, the `keyring_aws` plugin reads the AWS secret access key ID and key from its configuration file. It also reads any encrypted keys contained in its storage file into its in-memory cache.

During operation, `keyring_aws` maintains encrypted keys in the in-memory cache and uses the storage file as local persistent storage. Each keyring operation is transactional: `keyring_aws` either successfully changes both the in-memory key cache and the keyring storage file, or the operation fails and the keyring state remains unchanged.

To ensure that keys are flushed only when the correct keyring storage file exists, `keyring_aws` stores a SHA-256 checksum of the keyring in the file. Before updating the file, the plugin verifies that it contains the expected checksum.

The `keyring_aws` plugin supports the functions that comprise the standard MySQL Keyring service interface. Keyring operations performed by these functions are accessible at two levels:

- SQL interface: In SQL statements, call the functions described in [Section 6.4.4.8, “General-Purpose Keyring Key-Management Functions”](#).
- C interface: In C-language code, call the keyring service functions described in [Section 5.5.6.2, “The Keyring Service”](#).

Example (using the SQL interface):

```
SELECT keyring_key_generate('MyKey', 'AES', 32);
SELECT keyring_key_remove('MyKey');
```

In addition, the `keyring_aws_rotate_cmk()` and `keyring_aws_rotate_keys()` functions “extend” the keyring plugin interface to provide AWS-related capabilities not covered by the standard keyring service interface. These capabilities are accessible only by calling these functions using SQL. There are no corresponding C-language key service functions.

For information about the characteristics of key values permitted by `keyring_aws`, see [Section 6.4.4.6, “Supported Keyring Key Types and Lengths”](#).

## keyring\_aws Credential Changes

Assuming that the `keyring_aws` plugin has initialized properly at server startup, it is possible to change the credentials used for communicating with AWS KMS:

1. Use AWS KMS to create a new secret access key ID and secret access key.
2. Store the new credentials in the configuration file (the file named by the `keyring_aws_conf_file` system variable). The file format is as described previously.

3. Reinitialize the `keyring_aws` plugin so that it re-reads the configuration file. Assuming that the new credentials are valid, the plugin should initialize successfully.

There are two ways to reinitialize the plugin:

- Restart the server. This is simpler and has no side effects, but is not suitable for installations that require minimal server downtime with as few restarts as possible.
- Reinitialize the plugin without restarting the server by executing the following statements, adjusting the `.so` suffix for your platform as necessary:

```
UNINSTALL PLUGIN keyring_aws;
INSTALL PLUGIN keyring_aws SONAME 'keyring_aws.so';
```



#### Note

In addition to loading a plugin at runtime, `INSTALL PLUGIN` has the side effect of registering the plugin in the `mysql.plugin` system table. Because of this, if you decide to stop using `keyring_aws`, it is not sufficient to remove the `--early-plugin-load` option from the set of options used to start the server. That stops the plugin from loading early, but the server still attempts to load it when it gets to the point in the startup sequence where it loads the plugins registered in `mysql.plugin`.

Consequently, if you execute the `UNINSTALL PLUGIN` plus `INSTALL PLUGIN` sequence just described to change the AWS KMS credentials, then to stop using `keyring_aws`, it is necessary to execute `UNINSTALL PLUGIN` again to unregister the plugin in addition to removing the `--early-plugin-load` option.

### 6.4.4.6 Supported Keyring Key Types and Lengths

MySQL Keyring supports keys of different types (encryption algorithms) and lengths:

- The available key types depend on which keyring plugin is installed.
- The permitted key lengths are subject to multiple factors:
  - General keyring loadable-function interface limits (for keys managed using one of the keyring functions described in [Section 6.4.4.8, “General-Purpose Keyring Key-Management Functions”](#)), or limits from back end implementations. These length limits can vary by key operation type.
  - In addition to the general limits, individual keyring plugins may impose restrictions on key lengths per key type.

[Table 6.23, “General Keyring Key Length Limits”](#) shows the general key-length limits. (The lower limits for `keyring_aws` are imposed by the AWS KMS interface, not the keyring functions.) [Table 6.24, “Keyring Plugin Key Types and Lengths”](#) shows the key types each keyring plugin permits, as well as any plugin-specific key-length restrictions.

**Table 6.23 General Keyring Key Length Limits**

Key Operation	Maximum Key Length
Generate key	2,048 bytes; 1,024 for <code>keyring_aws</code>
Store key	2,048 bytes

Key Operation	Maximum Key Length
Fetch key	2,048 bytes

**Table 6.24 Keyring Plugin Key Types and Lengths**

Plugin Name	Permitted Key Type	Plugin-Specific Length Restrictions
<code>keyring_aws</code>	AES	16, 24, or 32 bytes
<code>keyring_encrypted_file</code>	AES	None
	DSA	None
	RSA	None
<code>keyring_file</code>	AES	None
	DSA	None
	RSA	None
<code>keyring_okv</code>	AES	16, 24, or 32 bytes

#### 6.4.4.7 Migrating Keys Between Keyring Keystores

A keyring migration copies keys from one keystore to another, enabling a DBA to switch a MySQL installation to a different keystore. A successful migration operation has this result:

- The destination keystore contains the keys it had prior to the migration, plus the keys from the source keystore.
- The source keystore remains the same before and after the migration (because keys are copied, not moved).

If a key to be copied already exists in the destination keystore, an error occurs and the destination keystore is restored to its premigration state.

The following sections discuss the characteristics of offline and online migrations and describe how to perform migrations.

- [Offline and Online Key Migrations](#)
- [Key Migration Using a Migration Server](#)
- [Key Migration Involving Multiple Running Servers](#)

#### Offline and Online Key Migrations

A key migration is either offline or online:

- **Offline migration:** For use when you are sure that no running server on the local host is using the source or destination keystore. In this case, the migration operation can copy keys from the source keystore to the destination without the possibility of a running server modifying keystore content during the operation.
- **Online migration:** For use when a running server on the local host is using the source or destination keystore. In this case, care must be taken to prevent that server from updating keystores during the migration. This involves connecting to the running server and instructing it to pause keyring operations

so that keys can be copied safely from the source keystore to the destination. When key copying is complete, the running server is permitted to resume keyring operations.

When you plan a key migration, use these points to decide whether it should be offline or online:

- Do not perform offline migration involving a keystore that is in use by a running server.
- Pausing keyring operations during an online migration is accomplished by connecting to the running server and setting its global `keyring_operations` system variable to `OFF` before key copying and `ON` after key copying. This has several implications:
  - `keyring_operations` was introduced in MySQL 5.7.21, so online migration is possible only if the running server is from MySQL 5.7.21 or higher. If the running server is older, you must stop it, perform an offline migration, and restart it. All migration instructions elsewhere that refer to `keyring_operations` are subject to this condition.
  - The account used to connect to the running server must have the `SUPER` privilege required to modify `keyring_operations`.
  - For an online migration, the migration operation takes care of enabling and disabling `keyring_operations` on the running server. If the migration operation exits abnormally (for example, if it is forcibly terminated), it is possible for `keyring_operations` to remain disabled on the running server, leaving it unable to perform keyring operations. In this case, it may be necessary to connect to the running server and enable `keyring_operations` manually using this statement:

```
SET GLOBAL keyring_operations = ON;
```
- Online key migration provides for pausing keyring operations on a single running server. To perform a migration if multiple running servers are using the keystores involved, use the procedure described at [Key Migration Involving Multiple Running Servers](#).

## Key Migration Using a Migration Server

As of MySQL 5.7.21, a MySQL server becomes a migration server if invoked in a special operational mode that supports key migration. A migration server does not accept client connections. Instead, it runs only long enough to migrate keys, then exits. A migration server reports errors to the console (the standard error output).

To perform a key migration operation using a migration server, determine the key migration options required to specify which keyring plugins or components are involved, and whether the migration is offline or online:

- To indicate the source and destination keyring plugins, specify these options:
  - `--keyring-migration-source`: The source keyring plugin that manages the keys to be migrated.
  - `--keyring-migration-destination`: The destination keyring plugin to which the migrated keys are to be copied.

These options tell the server to run in key migration mode. For key migration operations, both options are mandatory. The source and destination plugins must differ, and the migration server must support both plugins.

- For an offline migration, no additional key migration options are needed.
- For an online migration, some running server currently is using the source or destination keystore. To invoke the migration server, specify additional key migration options that indicate how to connect to the

running server. This is necessary so that the migration server can connect to the running server and tell it to pause keyring use during the migration operation.

Use of any of the following options signifies an online migration:

- `--keyring-migration-host`: The host where the running server is located. This is always the local host because the migration server can migrate keys only between keystores managed by local plugins.
- `--keyring-migration-user`, `--keyring-migration-password`: The account credentials to use to connect to the running server.
- `--keyring-migration-port`: For TCP/IP connections, the port number to connect to on the running server.
- `--keyring-migration-socket`: For Unix socket file or Windows named pipe connections, the socket file or named pipe to connect to on the running server.

For additional details about the key migration options, see [Section 6.4.4.11, “Keyring Command Options”](#).

Start the migration server with key migration options indicating the source and destination keystores and whether the migration is offline or online, possibly with other options. Keep the following considerations in mind:

- Other server options might be required, such as configuration parameters for the two keyring plugins. For example, if `keyring_file` is the source or destination, you must set the `keyring_file_data` system variable if the keyring data file location is not the default location. Other non-keyring options may be required as well. One way to specify these options is by using `--defaults-file` to name an option file that contains the required options.
- The migration server expects path name option values to be full paths. Relative path names may not be resolved as you expect.
- The user who invokes a server in key-migration mode must not be the `root` operating system user, unless the `--user` option is specified with a non-`root` user name to run the server as that user.
- The user a server in key-migration mode runs as must have permission to read and write any local keyring files, such as the data file for a file-based plugin.

If you invoke the migration server from a system account different from that normally used to run MySQL, it might create keyring directories or files that are inaccessible to the server during normal operation. Suppose that `mysqld` normally runs as the `mysql` operating system user, but you invoke the migration server while logged in as `isabel`. Any new directories or files created by the migration server are owned by `isabel`. Subsequent startup fails when a server run as the `mysql` operating system user attempts to access file system objects owned by `isabel`.

To avoid this issue, start the migration server as the `root` operating system user and provide a `--user=user_name` option, where `user_name` is the system account normally used to run MySQL. Alternatively, after the migration, examine the keyring-related file system objects and change their ownership and permissions if necessary using `chown`, `chmod`, or similar commands, so that the objects are accessible to the running server.

Example command line for offline migration (enter the command on a single line):

```
mysqld --defaults-file=/usr/local/mysql/etc/my.cnf
--keyring-migration-source=keyring_file.so
--keyring-migration-destination=keyring_encrypted_file.so
--keyring_encrypted_file_password=password
```



Example command line for online migration:

```
mysqld --defaults-file=/usr/local/mysql/etc/my.cnf
--keyring-migration-source=keyring_file.so
--keyring-migration-destination=keyring_encrypted_file.so
--keyring_encrypted_file_password=password
--keyring-migration-host=127.0.0.1
--keyring-migration-user=root
--keyring-migration-password=root_password
```

The key migration server performs a migration operation as follows:

1. (Online migration only) Connect to the running server using the connection options.
2. (Online migration only) Disable `keyring_operations` on the running server.
3. Load the source and destination keyring plugins.
4. Copy keys from the source keystore to the destination.
5. Unload the keyring plugins.
6. (Online migration only) Enable `keyring_operations` on the running server.
7. (Online migration only) Disconnect from the running server.

If an error occurs during key migration, the destination keystore is restored to its premigration state.



#### Important

For an online migration operation, the migration server takes care of enabling and disabling `keyring_operations` on the running server. If the migration server exits abnormally (for example, if it is forcibly terminated), it is possible for `keyring_operations` to remain disabled on the running server, leaving it unable to perform keyring operations. In this case, it may be necessary to connect to the running server and enable `keyring_operations` manually using this statement:

```
SET GLOBAL keyring_operations = ON;
```

After a successful online key migration operation, the running server might need to be restarted:

- If the running server was using the source keystore before the migration and should continue to use it after the migration, it need not be restarted after the migration.
- If the running server was using the destination keystore before the migration and should continue to use it after the migration, it should be restarted after the migration to load all keys migrated into the destination keystore.
- If the running server was using the source keystore before the migration but should use the destination keystore after the migration, it must be reconfigured to use the destination keystore and restarted. In this case, be aware that although the running server is paused from modifying the source keystore during the migration itself, it is not paused during the interval between the migration and the subsequent restart. Care should be taken that the server does not modify the source keystore during this interval because any such changes will not be reflected in the destination keystore.

## Key Migration Involving Multiple Running Servers

Online key migration provides for pausing keyring operations on a single running server. To perform a migration if multiple running servers are using the keystores involved, use this procedure:

1. Connect to each running server manually and set `keyring_operations=OFF`. This ensures that no running server is using the source or destination keystore and satisfies the required condition for offline migration.
2. Use a migration server to perform an offline key migration for each paused server.
3. Connect to each running server manually and set `keyring_operations=ON`.

All running servers must support the `keyring_operations` system variable. Any server that does not must be stopped before the migration and restarted after.

#### 6.4.4.8 General-Purpose Keyring Key-Management Functions

MySQL Server supports a keyring service that enables internal server components and plugins to store sensitive information securely for later retrieval.

As of MySQL 5.7.13, MySQL Server includes an SQL interface for keyring key management, implemented as a set of general-purpose functions that access the capabilities provided by the internal keyring service. The keyring functions are contained in a plugin library file, which also contains a `keyring_udf` plugin that must be enabled prior to function invocation. For these functions to be used, a keyring plugin such as `keyring_file` or `keyring_okv` must be enabled.

The functions described here are general-purpose and intended for use with any keyring component or plugin. A given keyring component or plugin may also provide functions of its own that are intended for use only with that component or plugin; see [Section 6.4.4.9, “Plugin-Specific Keyring Key-Management Functions”](#).

The following sections provide installation instructions for the keyring functions and demonstrate how to use them. For information about the keyring service functions invoked by these functions, see [Section 5.5.6.2, “The Keyring Service”](#). For general keyring information, see [Section 6.4.4, “The MySQL Keyring”](#).

- [Installing or Uninstalling General-Purpose Keyring Functions](#)
- [Using General-Purpose Keyring Functions](#)
- [General-Purpose Keyring Function Reference](#)

#### Installing or Uninstalling General-Purpose Keyring Functions

This section describes how to install or uninstall the keyring functions, which are implemented in a plugin library file that also contains a `keyring_udf` plugin. For general information about installing or uninstalling plugins and loadable functions, see [Section 5.5.1, “Installing and Uninstalling Plugins”](#), and [Section 5.6.1, “Installing and Uninstalling Loadable Functions”](#).

The keyring functions enable keyring key management operations, but the `keyring_udf` plugin must also be installed because the functions do not work correctly without it. Attempts to use the functions without the `keyring_udf` plugin result in an error.

To be usable by the server, the plugin library file must be located in the MySQL plugin directory (the directory named by the `plugin_dir` system variable). If necessary, configure the plugin directory location by setting the value of `plugin_dir` at server startup.

The plugin library file base name is `keyring_udf`. The file name suffix differs per platform (for example, `.so` for Unix and Unix-like systems, `.dll` for Windows).

To install the `keyring_udf` plugin and the keyring functions, use the `INSTALL PLUGIN` and `CREATE FUNCTION` statements, adjusting the `.so` suffix for your platform as necessary:

```
INSTALL PLUGIN keyring_udf SONAME 'keyring_udf.so';
CREATE FUNCTION keyring_key_generate RETURNS INTEGER
  SONAME 'keyring_udf.so';
CREATE FUNCTION keyring_key_fetch RETURNS STRING
  SONAME 'keyring_udf.so';
CREATE FUNCTION keyring_key_length_fetch RETURNS INTEGER
  SONAME 'keyring_udf.so';
CREATE FUNCTION keyring_key_type_fetch RETURNS STRING
  SONAME 'keyring_udf.so';
CREATE FUNCTION keyring_key_store RETURNS INTEGER
  SONAME 'keyring_udf.so';
CREATE FUNCTION keyring_key_remove RETURNS INTEGER
  SONAME 'keyring_udf.so';
```

If the plugin and functions are used on a source replication server, install them on all replicas as well to avoid replication issues.

Once installed as just described, the plugin and functions remain installed until uninstalled. To remove them, use the `UNINSTALL PLUGIN` and `DROP FUNCTION` statements:

```
UNINSTALL PLUGIN keyring_udf;
DROP FUNCTION keyring_key_generate;
DROP FUNCTION keyring_key_fetch;
DROP FUNCTION keyring_key_length_fetch;
DROP FUNCTION keyring_key_type_fetch;
DROP FUNCTION keyring_key_store;
DROP FUNCTION keyring_key_remove;
```

## Using General-Purpose Keyring Functions

Before using the keyring general-purpose functions, install them according to the instructions provided in [Installing or Uninstalling General-Purpose Keyring Functions](#).

The keyring functions are subject to these constraints:

- To use any keyring function, the `keyring_udf` plugin must be enabled. Otherwise, an error occurs:

```
ERROR 1123 (HY000): Can't initialize function 'keyring_key_generate';
This function requires keyring_udf plugin which is not installed.
Please install
```

To install the `keyring_udf` plugin, see [Installing or Uninstalling General-Purpose Keyring Functions](#).

- The keyring functions invoke keyring service functions (see [Section 5.5.6.2, “The Keyring Service”](#)). The service functions in turn use whatever keyring plugin is installed (for example, `keyring_file` or `keyring_okv`). Therefore, to use any keyring function, some underlying keyring plugin must be enabled. Otherwise, an error occurs:

```
ERROR 3188 (HY000): Function 'keyring_key_generate' failed because
underlying keyring service returned an error. Please check if a
keyring plugin is installed and that provided arguments are valid
for the keyring you are using.
```

To install a keyring plugin, see [Section 6.4.4.1, “Keyring Plugin Installation”](#).

- A user must possess the global `EXECUTE` privilege to use any keyring function. Otherwise, an error occurs:

```
ERROR 1123 (HY000): Can't initialize function 'keyring_key_generate';
```

The user is not privileged to execute this function. User needs to have EXECUTE

To grant the global EXECUTE privilege to a user, use this statement:

```
GRANT EXECUTE ON *.* TO user;
```

Alternatively, should you prefer to avoid granting the global EXECUTE privilege while still permitting users to access specific key-management operations, “wrapper” stored programs can be defined (a technique described later in this section).

- A key stored in the keyring by a given user can be manipulated later only by the same user. That is, the value of the CURRENT\_USER() function at the time of key manipulation must have the same value as when the key was stored in the keyring. (This constraint rules out the use of the keyring functions for manipulation of instance-wide keys, such as those created by InnoDB to support tablespace encryption.)

To enable multiple users to perform operations on the same key, “wrapper” stored programs can be defined (a technique described later in this section).

- Keyring functions support the key types and lengths supported by the underlying keyring plugin. For information about keys specific to a particular keyring plugin, see Section 6.4.4.6, “Supported Keyring Key Types and Lengths”.

To create a new random key and store it in the keyring, call keyring\_key\_generate(), passing to it an ID for the key, along with the key type (encryption method) and its length in bytes. The following call creates a 2,048-bit DSA-encrypted key named MyKey:

```
mysql> SELECT keyring_key_generate('MyKey', 'DSA', 256);
+-----+
| keyring_key_generate('MyKey', 'DSA', 256) |
+-----+
| 1 |
+-----+
```

A return value of 1 indicates success. If the key cannot be created, the return value is NULL and an error occurs. One reason this might be is that the underlying keyring plugin does not support the specified combination of key type and key length; see Section 6.4.4.6, “Supported Keyring Key Types and Lengths”.

To be able to check the return type regardless of whether an error occurs, use SELECT ... INTO @var\_name and test the variable value:

```
mysql> SELECT keyring_key_generate('', '', -1) INTO @x;
ERROR 3188 (HY000): Function 'keyring_key_generate' failed because
underlying keyring service returned an error. Please check if a
keyring plugin is installed and that provided arguments are valid
for the keyring you are using.
mysql> SELECT @x;
+-----+
| @x |
+-----+
| NULL |
+-----+
mysql> SELECT keyring_key_generate('x', 'AES', 16) INTO @x;
mysql> SELECT @x;
+-----+
| @x |
+-----+
| 1 |
+-----+
```

This technique also applies to other keyring functions that for failure return a value and an error.

The ID passed to `keyring_key_generate()` provides a means by which to refer to the key in subsequent function calls. For example, use the key ID to retrieve its type as a string or its length in bytes as an integer:

```
mysql> SELECT keyring_key_type_fetch('MyKey');
+-----+
| keyring_key_type_fetch('MyKey') |
+-----+
| DSA                               |
+-----+
mysql> SELECT keyring_key_length_fetch('MyKey');
+-----+
| keyring_key_length_fetch('MyKey') |
+-----+
|                               256 |
+-----+
```

To retrieve a key value, pass the key ID to `keyring_key_fetch()`. The following example uses `HEX()` to display the key value because it may contain nonprintable characters. The example also uses a short key for brevity, but be aware that longer keys provide better security:

```
mysql> SELECT keyring_key_generate('MyShortKey', 'DSA', 8);
+-----+
| keyring_key_generate('MyShortKey', 'DSA', 8) |
+-----+
|                               1 |
+-----+
mysql> SELECT HEX(keyring_key_fetch('MyShortKey'));
+-----+
| HEX(keyring_key_fetch('MyShortKey')) |
+-----+
| 1DB3B0FC3328A24C                    |
+-----+
```

Keyring functions treat key IDs, types, and values as binary strings, so comparisons are case-sensitive. For example, IDs of `MyKey` and `mykey` refer to different keys.

To remove a key, pass the key ID to `keyring_key_remove()`:

```
mysql> SELECT keyring_key_remove('MyKey');
+-----+
| keyring_key_remove('MyKey') |
+-----+
|                               1 |
+-----+
```

To obfuscate and store a key that you provide, pass the key ID, type, and value to `keyring_key_store()`:

```
mysql> SELECT keyring_key_store('AES_key', 'AES', 'Secret string');
+-----+
| keyring_key_store('AES_key', 'AES', 'Secret string') |
+-----+
|                               1 |
+-----+
```

As indicated previously, a user must have the global `EXECUTE` privilege to call keyring functions, and the user who stores a key in the keyring initially must be the same user who performs subsequent operations on the key later, as determined from the `CURRENT_USER()` value in effect for each function call. To permit key operations to users who do not have the global `EXECUTE` privilege or who may not be the key “owner,” use this technique:

1. Define “wrapper” stored programs that encapsulate the required key operations and have a `DEFINER` value equal to the key owner.

2. Grant the `EXECUTE` privilege for specific stored programs to the individual users who should be able to invoke them.
3. If the operations implemented by the wrapper stored programs do not include key creation, create any necessary keys in advance, using the account named as the `DEFINER` in the stored program definitions.

This technique enables keys to be shared among users and provides to DBAs more fine-grained control over who can do what with keys, without having to grant global privileges.

The following example shows how to set up a shared key named `SharedKey` that is owned by the DBA, and a `get_shared_key()` stored function that provides access to the current key value. The value can be retrieved by any user with the `EXECUTE` privilege for that function, which is created in the `key_schema` schema.

From a MySQL administrative account (`'root'@'localhost'` in this example), create the administrative schema and the stored function to access the key:

```
mysql> CREATE SCHEMA key_schema;

mysql> CREATE DEFINER = 'root'@'localhost'
        FUNCTION key_schema.get_shared_key()
        RETURNS BLOB READS SQL DATA
        RETURN keyring_key_fetch('SharedKey');
```

From the administrative account, ensure that the shared key exists:

```
mysql> SELECT keyring_key_generate('SharedKey', 'DSA', 8);
+-----+
| keyring_key_generate('SharedKey', 'DSA', 8) |
+-----+
|                                           1 |
+-----+
```

From the administrative account, create an ordinary user account to which key access is to be granted:

```
mysql> CREATE USER 'key_user'@'localhost'
        IDENTIFIED BY 'key_user_pwd';
```

From the `key_user` account, verify that, without the proper `EXECUTE` privilege, the new account cannot access the shared key:

```
mysql> SELECT HEX(key_schema.get_shared_key());
ERROR 1370 (42000): execute command denied to user 'key_user'@'localhost'
for routine 'key_schema.get_shared_key'
```

From the administrative account, grant `EXECUTE` to `key_user` for the stored function:

```
mysql> GRANT EXECUTE ON FUNCTION key_schema.get_shared_key
        TO 'key_user'@'localhost';
```

From the `key_user` account, verify that the key is now accessible:

```
mysql> SELECT HEX(key_schema.get_shared_key());
+-----+
| HEX(key_schema.get_shared_key()) |
+-----+
| 9BAFB9E75CEEB013                |
+-----+
```

+-----+

## General-Purpose Keyring Function Reference

For each general-purpose keyring function, this section describes its purpose, calling sequence, and return value. For information about the conditions under which these functions can be invoked, see [Using General-Purpose Keyring Functions](#).

- `keyring_key_fetch(key_id)`

Given a key ID, deobfuscates and returns the key value.

Arguments:

- `key_id`: A string that specifies the key ID.

Return value:

Returns the key value as a string for success, `NULL` if the key does not exist, or `NULL` and an error for failure.



### Note

Key values retrieved using `keyring_key_fetch()` are subject to the general keyring function limits described in [Section 6.4.4.6, “Supported Keyring Key Types and Lengths”](#). A key value longer than that length can be stored using a keyring service function (see [Section 5.5.6.2, “The Keyring Service”](#)), but if retrieved using `keyring_key_fetch()` is truncated to the general keyring function limit.

Example:

```
mysql> SELECT keyring_key_generate('RSA_key', 'RSA', 16);
+-----+
| keyring_key_generate('RSA_key', 'RSA', 16) |
+-----+
|                                           1 |
+-----+
mysql> SELECT HEX(keyring_key_fetch('RSA_key'));
+-----+
| HEX(keyring_key_fetch('RSA_key')) |
+-----+
| 91C2253B696064D3556984B6630F891A |
+-----+
mysql> SELECT keyring_key_type_fetch('RSA_key');
+-----+
| keyring_key_type_fetch('RSA_key') |
+-----+
| RSA                                |
+-----+
mysql> SELECT keyring_key_length_fetch('RSA_key');
+-----+
| keyring_key_length_fetch('RSA_key') |
+-----+
|                                           16 |
+-----+
```

The example uses `HEX()` to display the key value because it may contain nonprintable characters. The example also uses a short key for brevity, but be aware that longer keys provide better security.

- `keyring_key_generate(key_id, key_type, key_length)`

Generates a new random key with a given ID, type, and length, and stores it in the keyring. The type and length values must be consistent with the values supported by the underlying keyring plugin. See [Section 6.4.4.6, “Supported Keyring Key Types and Lengths”](#).

Arguments:

- *key\_id*: A string that specifies the key ID.
- *key\_type*: A string that specifies the key type.
- *key\_length*: An integer that specifies the key length in bytes.

Return value:

Returns 1 for success, or `NULL` and an error for failure.

Example:

```
mysql> SELECT keyring_key_generate('RSA_key', 'RSA', 384);
+-----+
| keyring_key_generate('RSA_key', 'RSA', 384) |
+-----+
|                                     1 |
+-----+
```

- `keyring_key_length_fetch(key_id)`

Given a key ID, returns the key length.

Arguments:

- *key\_id*: A string that specifies the key ID.

Return value:

Returns the key length in bytes as an integer for success, `NULL` if the key does not exist, or `NULL` and an error for failure.

Example:

See the description of `keyring_key_fetch()`.

- `keyring_key_remove(key_id)`

Removes the key with a given ID from the keyring.

Arguments:

- *key\_id*: A string that specifies the key ID.

Return value:

Returns 1 for success, or `NULL` for failure.

Example:

```
mysql> SELECT keyring_key_remove('AES_key');
+-----+
| keyring_key_remove('AES_key') |
+-----+
```



```
+-----+
|              1 |
+-----+
```

- `keyring_key_store(key_id, key_type, key)`

Obfuscates and stores a key in the keyring.

Arguments:

- `key_id`: A string that specifies the key ID.
- `key_type`: A string that specifies the key type.
- `key`: A string that specifies the key value.

Return value:

Returns 1 for success, or `NULL` and an error for failure.

Example:

```
mysql> SELECT keyring_key_store('new key', 'DSA', 'My key value');
+-----+
| keyring_key_store('new key', 'DSA', 'My key value') |
+-----+
|              1 |
+-----+
```

- `keyring_key_type_fetch(key_id)`

Given a key ID, returns the key type.

Arguments:

- `key_id`: A string that specifies the key ID.

Return value:

Returns the key type as a string for success, `NULL` if the key does not exist, or `NULL` and an error for failure.

Example:

See the description of `keyring_key_fetch()`.

#### 6.4.4.9 Plugin-Specific Keyring Key-Management Functions

For each keyring plugin-specific function, this section describes its purpose, calling sequence, and return value. For information about general-purpose keyring functions, see [Section 6.4.4.8, “General-Purpose Keyring Key-Management Functions”](#).

- `keyring_aws_rotate_cmk()`

Associated keyring plugin: `keyring_aws`

`keyring_aws_rotate_cmk()` rotates the customer master key (CMK). Rotation changes only the key that AWS KMS uses for subsequent data key-encryption operations. AWS KMS maintains previous CMK versions, so keys generated using previous CMKs remain decryptable after rotation.

Rotation changes the CMK value used inside AWS KMS but does not change the ID used to refer to it, so there is no need to change the `keyring_aws_cmk_id` system variable after calling `keyring_aws_rotate_cmk()`.

This function requires the `SUPER` privilege.

Arguments:

None.

Return value:

Returns 1 for success, or `NULL` and an error for failure.

- `keyring_aws_rotate_keys()`

Associated keyring plugin: `keyring_aws`

`keyring_aws_rotate_keys()` rotates keys stored in the `keyring_aws` storage file named by the `keyring_aws_data_file` system variable. Rotation sends each key stored in the file to AWS KMS for re-encryption using the value of the `keyring_aws_cmk_id` system variable as the CMK value, and stores the new encrypted keys in the file.

`keyring_aws_rotate_keys()` is useful for key re-encryption under these circumstances:

- After rotating the CMK; that is, after invoking the `keyring_aws_rotate_cmk()` function.
- After changing the `keyring_aws_cmk_id` system variable to a different key value.

This function requires the `SUPER` privilege.

Arguments:

None.

Return value:

Returns 1 for success, or `NULL` and an error for failure.

#### 6.4.4.10 Keyring Metadata

To see whether a keyring plugin is loaded, check the Information Schema `PLUGINS` table or use the `SHOW PLUGINS` statement (see Section 5.5.2, “Obtaining Server Plugin Information”). For example:

```
mysql> SELECT PLUGIN_NAME, PLUGIN_STATUS
       FROM INFORMATION_SCHEMA.PLUGINS
       WHERE PLUGIN_NAME LIKE 'keyring%';
+-----+-----+
| PLUGIN_NAME | PLUGIN_STATUS |
+-----+-----+
| keyring_file | ACTIVE        |
+-----+-----+
```

#### 6.4.4.11 Keyring Command Options

MySQL supports the following keyring-related command-line options:

- `--keyring-migration-destination=plugin`

Command-Line Format	<code>--keyring-migration-destination=plugin_name</code>
Introduced	5.7.21
Type	String

The destination keyring plugin for key migration. See [Section 6.4.4.7, “Migrating Keys Between Keyring Keystores”](#). The format and interpretation of the option value is the same as described for the `--keyring-migration-source` option.

**Note**

`--keyring-migration-source` and `--keyring-migration-destination` are mandatory for all keyring migration operations. The source and destination plugins must differ, and the migration server must support both plugins.

- `--keyring-migration-host=host_name`

Command-Line Format	<code>--keyring-migration-host=host_name</code>
Introduced	5.7.21
Type	String
Default Value	<code>localhost</code>

The host location of the running server that is currently using one of the key migration keystores. See [Section 6.4.4.7, “Migrating Keys Between Keyring Keystores”](#). Migration always occurs on the local host, so the option always specifies a value for connecting to a local server, such as `localhost`, `127.0.0.1`, `:::1`, or the local host IP address or host name.

- `--keyring-migration-password[=password]`

Command-Line Format	<code>--keyring-migration-password[=password]</code>
Introduced	5.7.21
Type	String

The password of the MySQL account used for connecting to the running server that is currently using one of the key migration keystores. See [Section 6.4.4.7, “Migrating Keys Between Keyring Keystores”](#).

The password value is optional. If not given, the server prompts for one. If given, there must be *no space* between `--keyring-migration-password=` and the password following it. If no password option is specified, the default is to send no password.

Specifying a password on the command line should be considered insecure. See [Section 6.1.2.1, “End-User Guidelines for Password Security”](#). You can use an option file to avoid giving the password on the command line. In this case, the file should have a restrictive mode and be accessible only to the account used to run the migration server.

- `--keyring-migration-port=port_num`

Command-Line Format	<code>--keyring-migration-port=port_num</code>
Introduced	5.7.21

Type	Numeric
Default Value	3306

For TCP/IP connections, the port number for connecting to the running server that is currently using one of the key migration keystores. See [Section 6.4.4.7, “Migrating Keys Between Keyring Keystores”](#).

- `--keyring-migration-socket=path`

Command-Line Format	<code>--keyring-migration-socket={file_name pipe_name}</code>
Introduced	5.7.21
Type	String

For Unix socket file or Windows named pipe connections, the socket file or named pipe for connecting to the running server that is currently using one of the key migration keystores. See [Section 6.4.4.7, “Migrating Keys Between Keyring Keystores”](#).

- `--keyring-migration-source=plugin`

Command-Line Format	<code>--keyring-migration-source=plugin_name</code>
Introduced	5.7.21
Type	String

The source keyring plugin for key migration. See [Section 6.4.4.7, “Migrating Keys Between Keyring Keystores”](#).

The option value is similar to that for `--plugin-load`, except that only one plugin library can be specified. The value is given as `plugin_library` or `name=plugin_library`, where `plugin_library` is the name of a library file that contains plugin code, and `name` is the name of a plugin to load. If a plugin library is named without any preceding plugin name, the server loads all plugins in the library. With a preceding plugin name, the server loads only the named plugin from the library. The server looks for plugin library files in the directory named by the `plugin_dir` system variable.



#### Note

`--keyring-migration-source` and `--keyring-migration-destination` are mandatory for all keyring migration operations. The source and destination plugins must differ, and the migration server must support both plugins.

- `--keyring-migration-user=user_name`

Command-Line Format	<code>--keyring-migration-user=user_name</code>
Introduced	5.7.21
Type	String

The user name of the MySQL account used for connecting to the running server that is currently using one of the key migration keystores. See [Section 6.4.4.7, “Migrating Keys Between Keyring Keystores”](#).

MySQL Keyring plugins support the following system variables. Use them to configure keyring plugin operation. These variables are unavailable unless the appropriate keyring plugin is installed (see [Section 6.4.4.1, “Keyring Plugin Installation”](#)).

- `keyring_aws_cmk_id`

Command-Line Format	<code>--keyring-aws-cmk-id=value</code>
Introduced	5.7.19
System Variable	<code>keyring_aws_cmk_id</code>
Scope	Global
Dynamic	Yes
Type	String

The customer master key (CMK) ID obtained from the AWS KMS server and used by the `keyring_aws` plugin. This variable is unavailable unless that plugin is installed.

This variable is mandatory. If not specified, `keyring_aws` initialization fails.

- `keyring_aws_conf_file`

Command-Line Format	<code>--keyring-aws-conf-file=file_name</code>
Introduced	5.7.19
System Variable	<code>keyring_aws_conf_file</code>
Scope	Global
Dynamic	No
Type	File name
Default Value	<code>platform specific</code>

The location of the configuration file for the `keyring_aws` plugin. This variable is unavailable unless that plugin is installed.

At plugin startup, `keyring_aws` reads the AWS secret access key ID and key from the configuration file. For the `keyring_aws` plugin to start successfully, the configuration file must exist and contain valid secret access key information, initialized as described in [Section 6.4.4.5, “Using the keyring\\_aws Amazon Web Services Keyring Plugin”](#).

The default file name is `keyring_aws_conf`, located in the default keyring file directory. The location of this default directory is the same as for the `keyring_file_data` system variable. See the description of that variable for details, as well as for considerations to take into account if you create the directory manually.

- `keyring_aws_data_file`

Command-Line Format	<code>--keyring-aws-data-file</code>
Introduced	5.7.19
System Variable	<code>keyring_aws_data_file</code>
Scope	Global
Dynamic	No
Type	File name

Default Value	<code>platform specific</code>
---------------	--------------------------------

The location of the storage file for the `keyring_aws` plugin. This variable is unavailable unless that plugin is installed.

At plugin startup, if the value assigned to `keyring_aws_data_file` specifies a file that does not exist, the `keyring_aws` plugin attempts to create it (as well as its parent directory, if necessary). If the file does exist, `keyring_aws` reads any encrypted keys contained in the file into its in-memory cache. `keyring_aws` does not cache unencrypted keys in memory.

The default file name is `keyring_aws_data`, located in the default keyring file directory. The location of this default directory is the same as for the `keyring_file_data` system variable. See the description of that variable for details, as well as for considerations to take into account if you create the directory manually.

- `keyring_aws_region`

Command-Line Format	<code>--keyring-aws-region=value</code>
Introduced	5.7.19
System Variable	<code>keyring_aws_region</code>
Scope	Global
Dynamic	Yes
Type	Enumeration
Default Value	<code>us-east-1</code>
Valid Values (≥ 5.7.39)	<code>af-south-1</code> <code>ap-east-1</code> <code>ap-northeast-1</code> <code>ap-northeast-2</code> <code>ap-northeast-3</code> <code>ap-south-1</code> <code>ap-southeast-1</code> <code>ap-southeast-2</code> <code>ca-central-1</code> <code>cn-north-1</code> <code>cn-northwest-1</code> <code>eu-central-1</code> <code>eu-north-1</code> <code>eu-south-1</code> <code>eu-west-1</code>

	<p>eu-west-2</p> <p>eu-west-3</p> <p>me-south-1</p> <p>sa-east-1</p> <p>us-east-1</p> <p>us-east-2</p> <p>us-gov-east-1</p> <p>us-iso-east-1</p> <p>us-iso-west-1</p> <p>us-isob-east-1</p> <p>us-west-1</p> <p>us-west-2</p>
Valid Values ( $\geq 5.7.27, \leq 5.7.38$ )	<p>ap-northeast-1</p> <p>ap-northeast-2</p> <p>ap-south-1</p> <p>ap-southeast-1</p> <p>ap-southeast-2</p> <p>ca-central-1</p> <p>cn-north-1</p> <p>cn-northwest-1</p> <p>eu-central-1</p> <p>eu-west-1</p> <p>eu-west-2</p> <p>eu-west-3</p> <p>sa-east-1</p> <p>us-east-1</p> <p>us-east-2</p> <p>us-west-1</p> <p>us-west-2</p>

Valid Values (≥ 5.7.19, ≤ 5.7.26)	<pre>ap-northeast-1 ap-northeast-2 ap-south-1 ap-southeast-1 ap-southeast-2 eu-central-1 eu-west-1 sa-east-1 us-east-1 us-west-1 us-west-2</pre>
-----------------------------------	--

The AWS region for the `keyring_aws` plugin. This variable is unavailable unless that plugin is installed.

If not set, the AWS region defaults to `us-east-1`. Thus, for any other region, this variable must be set explicitly.

- `keyring_encrypted_file_data`

Command-Line Format	<code>--keyring-encrypted-file-data=file_name</code>
Introduced	5.7.21
System Variable	<code>keyring_encrypted_file_data</code>
Scope	Global
Dynamic	Yes
Type	File name
Default Value	<code>platform specific</code>

The path name of the data file used for secure data storage by the `keyring_encrypted_file` plugin. This variable is unavailable unless that plugin is installed. The file location should be in a directory considered for use only by keyring plugins. For example, do not locate the file under the data directory.

Keyring operations are transactional: The `keyring_encrypted_file` plugin uses a backup file during write operations to ensure that it can roll back to the original file if an operation fails. The backup file has the same name as the value of the `keyring_encrypted_file_data` system variable with a suffix of `.backup`.

Do not use the same `keyring_encrypted_file` data file for multiple MySQL instances. Each instance should have its own unique data file.

The default file name is `keyring_encrypted`, located in a directory that is platform specific and depends on the value of the `INSTALL_LAYOUT CMake` option, as shown in the following table. To specify the default directory for the file explicitly if you are building from source, use the `INSTALL_MYSQLKEYRINGDIR CMake` option.



<code>INSTALL_LAYOUT</code> Value	Default <code>keyring_encrypted_file_data</code> Value
DEB, RPM, SLES, SVR4	<code>/var/lib/mysql-keyring/keyring_encrypted</code>
Otherwise	<code>keyring/keyring_encrypted</code> under the <code>CMAKE_INSTALL_PREFIX</code> value

At plugin startup, if the value assigned to `keyring_encrypted_file_data` specifies a file that does not exist, the `keyring_encrypted_file` plugin attempts to create it (as well as its parent directory, if necessary).

If you create the directory manually, it should have a restrictive mode and be accessible only to the account used to run the MySQL server. For example, on Unix and Unix-like systems, to use the `/usr/local/mysql/mysql-keyring` directory, the following commands (executed as `root`) create the directory and set its mode and ownership:

```
cd /usr/local/mysql
mkdir mysql-keyring
chmod 750 mysql-keyring
chown mysql mysql-keyring
chgrp mysql mysql-keyring
```

If the `keyring_encrypted_file` plugin cannot create or access its data file, it writes an error message to the error log. If an attempted runtime assignment to `keyring_encrypted_file_data` results in an error, the variable value remains unchanged.



### Important

Once the `keyring_encrypted_file` plugin has created its data file and started to use it, it is important not to remove the file. Loss of the file causes data encrypted using its keys to become inaccessible. (It is permissible to rename or move the file, as long as you change the value of `keyring_encrypted_file_data` to match.)

- `keyring_encrypted_file_password`

Command-Line Format	<code>--keyring-encrypted-file-password=password</code>
Introduced	5.7.21
System Variable	<code>keyring_encrypted_file_password</code>
Scope	Global
Dynamic	Yes

Type	String
------	--------

The password used by the `keyring_encrypted_file` plugin. This variable is unavailable unless that plugin is installed.

This variable is mandatory. If not specified, `keyring_encrypted_file` initialization fails.

If this variable is specified in an option file, the file should have a restrictive mode and be accessible only to the account used to run the MySQL server.



### Important

Once the `keyring_encrypted_file_password` value has been set, changing it does not rotate the keyring password and could make the server inaccessible. If an incorrect password is provided, the `keyring_encrypted_file` plugin cannot load keys from the encrypted keyring file.

The password value cannot be displayed at runtime with `SHOW VARIABLES` or the Performance Schema `global_variables` table because the display value is obfuscated.

- `keyring_file_data`

Command-Line Format	<code>--keyring-file-data=file_name</code>
Introduced	5.7.11
System Variable	<code>keyring_file_data</code>
Scope	Global
Dynamic	Yes
Type	File name
Default Value	<code>platform specific</code>

The path name of the data file used for secure data storage by the `keyring_file` plugin. This variable is unavailable unless that plugin is installed. The file location should be in a directory considered for use only by keyring plugins. For example, do not locate the file under the data directory.

Keyring operations are transactional: The `keyring_file` plugin uses a backup file during write operations to ensure that it can roll back to the original file if an operation fails. The backup file has the same name as the value of the `keyring_file_data` system variable with a suffix of `.backup`.

Do not use the same `keyring_file` data file for multiple MySQL instances. Each instance should have its own unique data file.

The default file name is `keyring`, located in a directory that is platform specific and depends on the value of the `INSTALL_LAYOUT` CMake option, as shown in the following table. To specify the default directory for the file explicitly if you are building from source, use the `INSTALL_MYSQLKEYRINGDIR` CMake option.

<code>INSTALL_LAYOUT</code> Value	Default <code>keyring_file_data</code> Value
DEB, RPM, SLES, SVR4	<code>/var/lib/mysql-keyring/keyring</code>

<code>INSTALL_LAYOUT</code> Value	Default <code>keyring_file_data</code> Value
Otherwise	<code>keyring/keyring</code> under the <code>CMAKE_INSTALL_PREFIX</code> value

At plugin startup, if the value assigned to `keyring_file_data` specifies a file that does not exist, the `keyring_file` plugin attempts to create it (as well as its parent directory, if necessary).

If you create the directory manually, it should have a restrictive mode and be accessible only to the account used to run the MySQL server. For example, on Unix and Unix-like systems, to use the `/usr/local/mysql/mysql-keyring` directory, the following commands (executed as `root`) create the directory and set its mode and ownership:

```
cd /usr/local/mysql
mkdir mysql-keyring
chmod 750 mysql-keyring
chown mysql mysql-keyring
chgrp mysql mysql-keyring
```

If the `keyring_file` plugin cannot create or access its data file, it writes an error message to the error log. If an attempted runtime assignment to `keyring_file_data` results in an error, the variable value remains unchanged.



### Important

Once the `keyring_file` plugin has created its data file and started to use it, it is important not to remove the file. For example, `InnoDB` uses the file to store the master key used to decrypt the data in tables that use `InnoDB` tablespace encryption; see [Section 14.14, “InnoDB Data-at-Rest Encryption”](#). Loss of the file causes data in such tables to become inaccessible. (It is permissible to rename or move the file, as long as you change the value of `keyring_file_data` to match.) It is recommended that you create a separate backup of the keyring data file immediately after you create the first encrypted table and before and after master key rotation.

- `keyring_okv_conf_dir`

Command-Line Format	<code>--keyring-okv-conf-dir=dir_name</code>
Introduced	5.7.12
System Variable	<code>keyring_okv_conf_dir</code>
Scope	Global
Dynamic	Yes
Type	Directory name
Default Value	<code>empty string</code>

The path name of the directory that stores configuration information used by the `keyring_okv` plugin. This variable is unavailable unless that plugin is installed. The location should be a directory considered for use only by the `keyring_okv` plugin. For example, do not locate the directory under the data directory.

The default `keyring_okv_conf_dir` value is empty. For the `keyring_okv` plugin to be able to access Oracle Key Vault, the value must be set to a directory that contains Oracle Key Vault

configuration and SSL materials. For instructions on setting up this directory, see [Section 6.4.4.4, “Using the keyring\\_okv KMIP Plugin”](#).

The directory should have a restrictive mode and be accessible only to the account used to run the MySQL server. For example, on Unix and Unix-like systems, to use the `/usr/local/mysql/mysql-keyring-okv` directory, the following commands (executed as `root`) create the directory and set its mode and ownership:

```
cd /usr/local/mysql
mkdir mysql-keyring-okv
chmod 750 mysql-keyring-okv
chown mysql:mysql mysql-keyring-okv
chgrp mysql:mysql mysql-keyring-okv
```

If the value assigned to `keyring_okv_conf_dir` specifies a directory that does not exist, or that does not contain configuration information that enables a connection to Oracle Key Vault to be established, `keyring_okv` writes an error message to the error log. If an attempted runtime assignment to `keyring_okv_conf_dir` results in an error, the variable value and keyring operation remain unchanged.

- `keyring_operations`

Introduced	5.7.21
System Variable	<code>keyring_operations</code>
Scope	Global
Dynamic	Yes
Type	Boolean
Default Value	ON

Whether keyring operations are enabled. This variable is used during key migration operations. See [Section 6.4.4.7, “Migrating Keys Between Keyring Keystores”](#).

## 6.4.5 MySQL Enterprise Audit



### Note

MySQL Enterprise Audit is an extension included in MySQL Enterprise Edition, a commercial product. To learn more about commercial products, see <https://www.mysql.com/products/>.

MySQL Enterprise Edition includes MySQL Enterprise Audit, implemented using a server plugin named `audit_log`. MySQL Enterprise Audit uses the open MySQL Audit API to enable standard, policy-based monitoring, logging, and blocking of connection and query activity executed on specific MySQL servers. Designed to meet the Oracle audit specification, MySQL Enterprise Audit provides an out of box, easy to use auditing and compliance solution for applications that are governed by both internal and external regulatory guidelines.

When installed, the audit plugin enables MySQL Server to produce a log file containing an audit record of server activity. The log contents include when clients connect and disconnect, and what actions they perform while connected, such as which databases and tables they access.

After you install the audit plugin (see [Section 6.4.5.2, “Installing or Uninstalling MySQL Enterprise Audit”](#)), it writes an audit log file. By default, the file is named `audit.log` in the server data directory. To change the name of the file, set the `audit_log_file` system variable at server startup.

By default, audit log file contents are written in new-style XML format, without compression or encryption. To select the file format, set the `audit_log_format` system variable at server startup. For details on file format and contents, see [Section 6.4.5.4, “Audit Log File Formats”](#).

For more information about controlling how logging occurs, including audit log file naming and format selection, see [Section 6.4.5.5, “Configuring Audit Logging Characteristics”](#). To perform filtering of audited events, see [Section 6.4.5.7, “Audit Log Filtering”](#). For descriptions of the parameters used to configure the audit log plugin, see [Audit Log Options and Variables](#).

If the audit log plugin is enabled, the Performance Schema (see [Chapter 25, MySQL Performance Schema](#)) has instrumentation for it. To identify the relevant instruments, use this query:

```
SELECT NAME FROM performance_schema.setup_instruments
WHERE NAME LIKE '%/alog/%';
```

### 6.4.5.1 Elements of MySQL Enterprise Audit

MySQL Enterprise Audit is based on the audit log plugin and related elements:

- A server-side plugin named `audit_log` examines auditable events and determines whether to write them to the audit log.
- A set of functions enables manipulation of filtering definitions that control logging behavior, the encryption password, and log file reading.
- Tables in the `mysql` system database provide persistent storage of filter and user account data.
- System variables enable audit log configuration and status variables provide runtime operational information.



#### Note

Prior to MySQL 5.7.13, MySQL Enterprise Audit consists only of the `audit_log` plugin and operates in legacy mode. See [Section 6.4.5.10, “Legacy Mode Audit Log Filtering”](#).

### 6.4.5.2 Installing or Uninstalling MySQL Enterprise Audit

This section describes how to install or uninstall MySQL Enterprise Audit, which is implemented using the audit log plugin and related elements described in [Section 6.4.5.1, “Elements of MySQL Enterprise Audit”](#). For general information about installing plugins, see [Section 5.5.1, “Installing and Uninstalling Plugins”](#).



#### Important

Read this entire section before following its instructions. Parts of the procedure differ depending on your environment.



#### Note

If installed, the `audit_log` plugin involves some minimal overhead even when disabled. To avoid this overhead, do not install MySQL Enterprise Audit unless you plan to use it.

To be usable by the server, the plugin library file must be located in the MySQL plugin directory (the directory named by the `plugin_dir` system variable). If necessary, configure the plugin directory location by setting the value of `plugin_dir` at server startup.

**Note**

The instructions here apply to MySQL 5.7.13 and later.

Also, prior to MySQL 5.7.13, MySQL Enterprise Audit consists only of the `audit_log` plugin and includes none of the other elements described in [Section 6.4.5.1, “Elements of MySQL Enterprise Audit”](#). As of MySQL 5.7.13, if the `audit_log` plugin is already installed from a version of MySQL prior to 5.7.13, uninstall it using the following statement and restart the server before installing the current version:

```
UNINSTALL PLUGIN audit_log;
```

To install MySQL Enterprise Audit, look in the `share` directory of your MySQL installation and choose the script that is appropriate for your platform. The available scripts differ in the suffix used to refer to the plugin library file:

- `audit_log_filter_win_install.sql`: Choose this script for Windows systems that use `.dll` as the file name suffix.
- `audit_log_filter_linux_install.sql`: Choose this script for Linux and similar systems that use `.so` as the file name suffix.

Run the script as follows. The example here uses the Linux installation script. Make the appropriate substitution for your system.

```
$> mysql -u root -p < audit_log_filter_linux_install.sql
Enter password: (enter root password here)
```

**Note**

Some MySQL versions have introduced changes to the structure of the MySQL Enterprise Audit tables. To ensure that your tables are up to date for upgrades from earlier versions of MySQL 5.7, run `mysql_upgrade --force` (which also performs any other needed updates). If you prefer to run the update statements only for the MySQL Enterprise Audit tables, see the following discussion.

As of MySQL 5.7.23, for new MySQL installations, the `USER` and `HOST` columns in the `audit_log_user` table used by MySQL Enterprise Audit have definitions that better correspond to the definitions of the `User` and `Host` columns in the `mysql.user` system table. For upgrades to 5.7.23 or higher of an installation for which MySQL Enterprise Audit is already installed, it is recommended that you alter the table definitions as follows:

```
ALTER TABLE mysql.audit_log_user
  DROP FOREIGN KEY audit_log_user_ibfk_1;
ALTER TABLE mysql.audit_log_filter
  ENGINE=InnoDB;
ALTER TABLE mysql.audit_log_filter
  CONVERT TO CHARACTER SET utf8 COLLATE utf8_bin;
ALTER TABLE mysql.audit_log_user
  ENGINE=InnoDB;
ALTER TABLE mysql.audit_log_user
  CONVERT TO CHARACTER SET utf8 COLLATE utf8_bin;
ALTER TABLE mysql.audit_log_user
  MODIFY COLUMN USER VARCHAR(32);
ALTER TABLE mysql.audit_log_user
  ADD FOREIGN KEY (FILTERNAME) REFERENCES mysql.audit_log_filter(NAME);
```

As of MySQL 5.7.21, for a new installation of MySQL Enterprise Audit, [InnoDB](#) is used instead of [MyISAM](#) for the audit log tables. For upgrades to 5.7.21 or higher of an installation for which MySQL Enterprise Audit is already installed, it is recommended that you alter the audit log tables to use [InnoDB](#):

```
ALTER TABLE mysql.audit_log_user ENGINE=InnoDB;
ALTER TABLE mysql.audit_log_filter ENGINE=InnoDB;
```



### Note

To use MySQL Enterprise Audit in the context of source/replica replication, Group Replication, or InnoDB Cluster, you must use MySQL 5.7.21 or higher, and ensure that the audit log tables use [InnoDB](#) as just described. Then you must prepare the replica nodes prior to running the installation script on the source node. This is necessary because the [INSTALL PLUGIN](#) statement in the script is not replicated.

1. On each replica node, extract the [INSTALL PLUGIN](#) statement from the installation script and execute it manually.
2. On the source node, run the installation script as described previously.

To verify plugin installation, examine the Information Schema [PLUGINS](#) table or use the [SHOW PLUGINS](#) statement (see [Section 5.5.2, “Obtaining Server Plugin Information”](#)). For example:

```
mysql> SELECT PLUGIN_NAME, PLUGIN_STATUS
FROM INFORMATION_SCHEMA.PLUGINS
WHERE PLUGIN_NAME LIKE 'audit%';
```

PLUGIN_NAME	PLUGIN_STATUS
audit_log	ACTIVE

If the plugin fails to initialize, check the server error log for diagnostic messages.

After MySQL Enterprise Audit is installed, you can use the `--audit-log` option for subsequent server startups to control `audit_log` plugin activation. For example, to prevent the plugin from being removed at runtime, use this option:

```
[mysqld]
audit-log=FORCE_PLUS_PERMANENT
```

If it is desired to prevent the server from running without the audit plugin, use `--audit-log` with a value of `FORCE` or `FORCE_PLUS_PERMANENT` to force server startup to fail if the plugin does not initialize successfully.



### Important

By default, rule-based audit log filtering logs no auditable events for any users. This differs from legacy audit log behavior (prior to MySQL 5.7.13), which logs all auditable events for all users (see [Section 6.4.5.10, “Legacy Mode Audit Log Filtering”](#)). Should you wish to produce log-everything behavior with rule-based filtering, create a simple filter to enable logging and assign it to the default account:

```
SELECT audit_log_filter_set_filter('log_all', '{ "filter": { "log": true } }');
SELECT audit_log_filter_set_user('%', 'log_all');
```

The filter assigned to `%` is used for connections from any account that has no explicitly assigned filter (which initially is true for all accounts).

Once installed as just described, MySQL Enterprise Audit remains installed until uninstalled. To remove it, execute the following statements:

```
DROP TABLE IF EXISTS mysql.audit_log_user;
DROP TABLE IF EXISTS mysql.audit_log_filter;
UNINSTALL PLUGIN audit_log;
DROP FUNCTION audit_log_filter_set_filter;
DROP FUNCTION audit_log_filter_remove_filter;
DROP FUNCTION audit_log_filter_set_user;
DROP FUNCTION audit_log_filter_remove_user;
DROP FUNCTION audit_log_filter_flush;
DROP FUNCTION audit_log_encryption_password_get;
DROP FUNCTION audit_log_encryption_password_set;
DROP FUNCTION audit_log_read;
DROP FUNCTION audit_log_read_bookmark;
```

### 6.4.5.3 MySQL Enterprise Audit Security Considerations

By default, contents of audit log files produced by the audit log plugin are not encrypted and may contain sensitive information, such as the text of SQL statements. For security reasons, audit log files should be written to a directory accessible only to the MySQL server and to users with a legitimate reason to view the log. The default file name is `audit.log` in the data directory. This can be changed by setting the `audit_log_file` system variable at server startup. Other audit log files may exist due to log rotation.

For additional security, enable audit log file encryption. See [Encrypting Audit Log Files](#).

### 6.4.5.4 Audit Log File Formats

The MySQL server calls the audit log plugin to write an audit record to its log file whenever an auditable event occurs. Typically the first audit record written after plugin startup contains the server description and startup options. Elements following that one represent events such as client connect and disconnect events, executed SQL statements, and so forth. Only top-level statements are logged, not statements within stored programs such as triggers or stored procedures. Contents of files referenced by statements such as `LOAD DATA` are not logged.

To select the log format that the audit log plugin uses to write its log file, set the `audit_log_format` system variable at server startup. These formats are available:

- New-style XML format (`audit_log_format=NEW`): An XML format that has better compatibility with Oracle Audit Vault than old-style XML format. MySQL 5.7 uses new-style XML format by default.
- Old-style XML format (`audit_log_format=OLD`): The original audit log format used by default in older MySQL series.
- JSON format (`audit_log_format=JSON`)

By default, audit log file contents are written in new-style XML format, without compression or encryption.



#### Note

For information about issues to consider when changing the log format, see [Selecting Audit Log File Format](#).

The following sections describe the available audit logging formats:

- [New-Style XML Audit Log File Format](#)
- [Old-Style XML Audit Log File Format](#)
- [JSON Audit Log File Format](#)



## New-Style XML Audit Log File Format

Here is a sample log file in new-style XML format (`audit_log_format=NEW`), reformatted slightly for readability:

```
<?xml version="1.0" encoding="utf-8"?>
<AUDIT>
  <AUDIT_RECORD>
    <TIMESTAMP>2019-10-03T14:06:33 UTC</TIMESTAMP>
    <RECORD_ID>1_2019-10-03T14:06:33</RECORD_ID>
    <NAME>Audit</NAME>
    <SERVER_ID>1</SERVER_ID>
    <VERSION>1</VERSION>
    <STARTUP_OPTIONS>/usr/local/mysql/bin/mysqld
      --socket=/usr/local/mysql/mysql.sock
      --port=3306</STARTUP_OPTIONS>
    <OS_VERSION>i686-Linux</OS_VERSION>
    <MYSQL_VERSION>5.7.21-log</MYSQL_VERSION>
  </AUDIT_RECORD>
  <AUDIT_RECORD>
    <TIMESTAMP>2019-10-03T14:09:38 UTC</TIMESTAMP>
    <RECORD_ID>2_2019-10-03T14:06:33</RECORD_ID>
    <NAME>Connect</NAME>
    <CONNECTION_ID>5</CONNECTION_ID>
    <STATUS>0</STATUS>
    <STATUS_CODE>0</STATUS_CODE>
    <USER>root</USER>
    <OS_LOGIN/>
    <HOST>localhost</HOST>
    <IP>127.0.0.1</IP>
    <COMMAND_CLASS>connect</COMMAND_CLASS>
    <CONNECTION_TYPE>SSL/TLS</CONNECTION_TYPE>
    <PRIV_USER>root</PRIV_USER>
    <PROXY_USER/>
    <DB>test</DB>
  </AUDIT_RECORD>
  ...

  <AUDIT_RECORD>
    <TIMESTAMP>2019-10-03T14:09:38 UTC</TIMESTAMP>
    <RECORD_ID>6_2019-10-03T14:06:33</RECORD_ID>
    <NAME>Query</NAME>
    <CONNECTION_ID>5</CONNECTION_ID>
    <STATUS>0</STATUS>
    <STATUS_CODE>0</STATUS_CODE>
    <USER>root[root] @ localhost [127.0.0.1]</USER>
    <OS_LOGIN/>
    <HOST>localhost</HOST>
    <IP>127.0.0.1</IP>
    <COMMAND_CLASS>drop_table</COMMAND_CLASS>
    <SQLTEXT>DROP TABLE IF EXISTS t</SQLTEXT>
  </AUDIT_RECORD>
  ...

  <AUDIT_RECORD>
    <TIMESTAMP>2019-10-03T14:09:39 UTC</TIMESTAMP>
    <RECORD_ID>8_2019-10-03T14:06:33</RECORD_ID>
    <NAME>Quit</NAME>
    <CONNECTION_ID>5</CONNECTION_ID>
    <STATUS>0</STATUS>
    <STATUS_CODE>0</STATUS_CODE>
    <USER>root</USER>
    <OS_LOGIN/>
    <HOST>localhost</HOST>
    <IP>127.0.0.1</IP>
```

```

<COMMAND_CLASS>connect</COMMAND_CLASS>
<CONNECTION_TYPE>SSL/TLS</CONNECTION_TYPE>
</AUDIT_RECORD>

...

<AUDIT_RECORD>
<TIMESTAMP>2019-10-03T14:09:43 UTC</TIMESTAMP>
<RECORD_ID>11_2019-10-03T14:06:33</RECORD_ID>
<NAME>Quit</NAME>
<CONNECTION_ID>6</CONNECTION_ID>
<STATUS>0</STATUS>
<STATUS_CODE>0</STATUS_CODE>
<USER>root</USER>
<OS_LOGIN/>
<HOST>localhost</HOST>
<IP>127.0.0.1</IP>
<COMMAND_CLASS>connect</COMMAND_CLASS>
<CONNECTION_TYPE>SSL/TLS</CONNECTION_TYPE>
</AUDIT_RECORD>
<AUDIT_RECORD>
<TIMESTAMP>2019-10-03T14:09:45 UTC</TIMESTAMP>
<RECORD_ID>12_2019-10-03T14:06:33</RECORD_ID>
<NAME>NoAudit</NAME>
<SERVER_ID>1</SERVER_ID>
</AUDIT_RECORD>
</AUDIT>

```

The audit log file is written as XML, using UTF-8 (up to 4 bytes per character). The root element is `<AUDIT>`. The root element contains `<AUDIT_RECORD>` elements, each of which provides information about an audited event. When the audit log plugin begins writing a new log file, it writes the XML declaration and opening `<AUDIT>` root element tag. When the plugin closes a log file, it writes the closing `</AUDIT>` root element tag. The closing tag is not present while the file is open.

Elements within `<AUDIT_RECORD>` elements have these characteristics:

- Some elements appear in every `<AUDIT_RECORD>` element. Others are optional and may appear depending on the audit record type.
- Order of elements within an `<AUDIT_RECORD>` element is not guaranteed.
- Element values are not fixed length. Long values may be truncated as indicated in the element descriptions given later.
- The `<`, `>`, `"`, and `&` characters are encoded as `&lt;`, `&gt;`, `&quot;`, and `&amp;`, respectively. NUL bytes (U+00) are encoded as the `?` character.
- Characters not valid as XML characters are encoded using numeric character references. Valid XML characters are:

```
#x9 | #xA | #xD | [#x20-#xD7FF] | [#xE000-#xFFFF] | [#x10000-#x10FFFF]
```

The following elements are mandatory in every `<AUDIT_RECORD>` element:

- `<NAME>`

A string representing the type of instruction that generated the audit event, such as a command that the server received from a client.

Example:

```
<NAME>Query</NAME>
```

Some common `<NAME>` values:

Audit	When auditing starts, which may be server startup time
Connect	When a client connects, also known as logging in
Query	An SQL statement (executed directly)
Prepare	Preparation of an SQL statement; usually followed by Execute
Execute	Execution of an SQL statement; usually follows Prepare
Shutdown	Server shutdown
Quit	When a client disconnects
NoAudit	Auditing has been turned off

The possible values are `Audit`, `Binlog Dump`, `Change user`, `Close stmt`, `Connect Out`, `Connect`, `Create DB`, `Daemon`, `Debug`, `Delayed insert`, `Drop DB`, `Execute`, `Fetch`, `Field List`, `Init DB`, `Kill`, `Long Data`, `NoAudit`, `Ping`, `Prepare`, `Processlist`, `Query`, `Quit`, `Refresh`, `Register Slave`, `Reset stmt`, `Set option`, `Shutdown`, `Sleep`, `Statistics`, `Table Dump`, `TableDelete`, `TableInsert`, `TableRead`, `TableUpdate`, `Time`.

Many of these values correspond to the `COM_xxx` command values listed in the `my_command.h` header file. For example, `Create DB` and `Change user` correspond to `COM_CREATE_DB` and `COM_CHANGE_USER`, respectively.

Events having `<NAME>` values of `TableXXX` accompany `Query` events. For example, the following statement generates one `Query` event, two `TableRead` events, and a `TableInsert` events:

```
INSERT INTO t3 SELECT t1.* FROM t1 JOIN t2;
```

Each `TableXXX` event contains `<TABLE>` and `<DB>` elements to identify the table to which the event refers and the database that contains the table.

- `<RECORD_ID>`

A unique identifier for the audit record. The value is composed from a sequence number and timestamp, in the format `SEQ_TIMESTAMP`. When the audit log plugin opens the audit log file, it initializes the sequence number to the size of the audit log file, then increments the sequence by 1 for each record logged. The timestamp is a UTC value in `YYYY-MM-DDThh:mm:ss` format indicating the date and time when the audit log plugin opened the file.

Example:

```
<RECORD_ID>12_2019-10-03T14:06:33</RECORD_ID>
```

- `<TIMESTAMP>`

A string representing a UTC value in `YYYY-MM-DDThh:mm:ss UTC` format indicating the date and time when the audit event was generated. For example, the event corresponding to execution of an SQL statement received from a client has a `<TIMESTAMP>` value occurring after the statement finishes, not when it was received.

Example:

```
<TIMESTAMP>2019-10-03T14:09:45 UTC</TIMESTAMP>
```

The following elements are optional in `<AUDIT_RECORD>` elements. Many of them occur only with specific `<NAME>` element values.

- `<COMMAND_CLASS>`

A string that indicates the type of action performed.

Example:

```
<COMMAND_CLASS>drop_table</COMMAND_CLASS>
```

The values correspond to the `statement/sql/xxx` command counters. For example, `xxx` is `drop_table` and `select` for `DROP TABLE` and `SELECT` statements, respectively. The following statement displays the possible names:

```
SELECT REPLACE(EVENT_NAME, 'statement/sql/', '') AS name
FROM performance_schema.events_statements_summary_global_by_event_name
WHERE EVENT_NAME LIKE 'statement/sql/%'
ORDER BY name;
```

- `<CONNECTION_ID>`

An unsigned integer representing the client connection identifier. This is the same as the value returned by the `CONNECTION_ID()` function within the session.

Example:

```
<CONNECTION_ID>127</CONNECTION_ID>
```

- `<CONNECTION_TYPE>`

The security state of the connection to the server. Permitted values are `TCP/IP` (TCP/IP connection established without encryption), `SSL/TLS` (TCP/IP connection established with encryption), `Socket` (Unix socket file connection), `Named Pipe` (Windows named pipe connection), and `Shared Memory` (Windows shared memory connection).

Example:

```
<CONNECTION_TYPE>SSL/TLS</CONNECTION_TYPE>
```

- `<DB>`

A string representing a database name.

Example:

```
<DB>test</DB>
```

For connect events, this element indicates the default database; the element is empty if there is no default database. For table-access events, the element indicates the database to which the accessed table belongs.

- `<HOST>`

A string representing the client host name.

Example:

```
<HOST>localhost</HOST>
```

- `<IP>`

A string representing the client IP address.

Example:

```
<IP>127.0.0.1</IP>
```

- `<MYSQL_VERSION>`

A string representing the MySQL server version. This is the same as the value of the `VERSION()` function or `version` system variable.

Example:

```
<MYSQL_VERSION>5.7.21-log</MYSQL_VERSION>
```

- `<OS_LOGIN>`

A string representing the external user name used during the authentication process, as set by the plugin used to authenticate the client. With native (built-in) MySQL authentication, or if the plugin does not set the value, this element is empty. The value is the same as that of the `external_user` system variable (see [Section 6.2.14, "Proxy Users"](#)).

Example:

```
<OS_LOGIN>jeffrey</OS_LOGIN>
```

- `<OS_VERSION>`

A string representing the operating system on which the server was built or is running.

Example:

```
<OS_VERSION>x86_64-Linux</OS_VERSION>
```

- `<PRIV_USER>`

A string representing the user that the server authenticated the client as. This is the user name that the server uses for privilege checking, and may differ from the `<USER>` value.

Example:

```
<PRIV_USER>jeffrey</PRIV_USER>
```

- `<PROXY_USER>`

A string representing the proxy user (see [Section 6.2.14, "Proxy Users"](#)). The value is empty if user proxying is not in effect.

Example:

```
<PROXY_USER>developer</PROXY_USER>
```

- `<SERVER_ID>`

An unsigned integer representing the server ID. This is the same as the value of the `server_id` system variable.

Example:

```
<SERVER_ID>1</SERVER_ID>
```

- `<SQLTEXT>`

A string representing the text of an SQL statement. The value can be empty. Long values may be truncated. The string, like the audit log file itself, is written using UTF-8 (up to 4 bytes per character), so

the value may be the result of conversion. For example, the original statement might have been received from the client as an SJIS string.

Example:

```
<SQLTEXT>DELETE FROM t1</SQLTEXT>
```

- [<STARTUP\\_OPTIONS>](#)

A string representing the options that were given on the command line or in option files when the MySQL server was started. The first option is the path to the server executable.

Example:

```
<STARTUP_OPTIONS>/usr/local/mysql/bin/mysqld
--port=3306 --log_output=FILE</STARTUP_OPTIONS>
```

- [<STATUS>](#)

An unsigned integer representing the command status: 0 for success, nonzero if an error occurred. This is the same as the value of the `mysql_errno()` C API function. See the description for [<STATUS\\_CODE>](#) for information about how it differs from [<STATUS>](#).

The audit log does not contain the SQLSTATE value or error message. To see the associations between error codes, SQLSTATE values, and messages, see [Server Error Message Reference](#).

Warnings are not logged.

Example:

```
<STATUS>1051</STATUS>
```

- [<STATUS\\_CODE>](#)

An unsigned integer representing the command status: 0 for success, 1 if an error occurred.

The `STATUS_CODE` value differs from the `STATUS` value: `STATUS_CODE` is 0 for success and 1 for error, which is compatible with the EZ\_collector consumer for Audit Vault. `STATUS` is the value of the `mysql_errno()` C API function. This is 0 for success and nonzero for error, and thus is not necessarily 1 for error.

Example:

```
<STATUS_CODE>0</STATUS_CODE>
```

- [<TABLE>](#)

A string representing a table name.

Example:

```
<TABLE>t3</TABLE>
```

- [<USER>](#)

A string representing the user name sent by the client. This may differ from the [<PRIV\\_USER>](#) value.

Example:

```
<USER>root[root] @ localhost [127.0.0.1]</USER>
```

- `<VERSION>`

An unsigned integer representing the version of the audit log file format.

Example:

```
<VERSION>1</VERSION>
```

## Old-Style XML Audit Log File Format

Here is a sample log file in old-style XML format (`audit_log_format=OLD`), reformatted slightly for readability:

```
<?xml version="1.0" encoding="utf-8"?>
<AUDIT>
  <AUDIT_RECORD
    TIMESTAMP="2019-10-03T14:25:00 UTC"
    RECORD_ID="1_2019-10-03T14:25:00"
    NAME="Audit"
    SERVER_ID="1"
    VERSION="1"
    STARTUP_OPTIONS="--port=3306"
    OS_VERSION="i686-Linux"
    MYSQL_VERSION="5.7.21-log" />
  <AUDIT_RECORD
    TIMESTAMP="2019-10-03T14:25:24 UTC"
    RECORD_ID="2_2019-10-03T14:25:00"
    NAME="Connect"
    CONNECTION_ID="4"
    STATUS="0"
    STATUS_CODE="0"
    USER="root"
    OS_LOGIN=""
    HOST="localhost"
    IP="127.0.0.1"
    COMMAND_CLASS="connect"
    CONNECTION_TYPE="SSL/TLS"
    PRIV_USER="root"
    PROXY_USER=""
    DB="test" />
  ...
  <AUDIT_RECORD
    TIMESTAMP="2019-10-03T14:25:24 UTC"
    RECORD_ID="6_2019-10-03T14:25:00"
    NAME="Query"
    CONNECTION_ID="4"
    STATUS="0"
    STATUS_CODE="0"
    USER="root[root] @ localhost [127.0.0.1]"
    OS_LOGIN=""
    HOST="localhost"
    IP="127.0.0.1"
    COMMAND_CLASS="drop_table"
    SQLTEXT="DROP TABLE IF EXISTS t"/>
  ...
  <AUDIT_RECORD
    TIMESTAMP="2019-10-03T14:25:24 UTC"
    RECORD_ID="8_2019-10-03T14:25:00"
    NAME="Quit"
    CONNECTION_ID="4"
    STATUS="0"
    STATUS_CODE="0"
```

```

USER="root"
OS_LOGIN=""
HOST="localhost"
IP="127.0.0.1"
COMMAND_CLASS="connect"
CONNECTION_TYPE="SSL/TLS" />
<AUDIT_RECORD
TIMESTAMP="2019-10-03T14:25:32 UTC"
RECORD_ID="12_2019-10-03T14:25:00"
NAME="NoAudit"
SERVER_ID="1" />
</AUDIT>

```

The audit log file is written as XML, using UTF-8 (up to 4 bytes per character). The root element is `<AUDIT>`. The root element contains `<AUDIT_RECORD>` elements, each of which provides information about an audited event. When the audit log plugin begins writing a new log file, it writes the XML declaration and opening `<AUDIT>` root element tag. When the plugin closes a log file, it writes the closing `</AUDIT>` root element tag. The closing tag is not present while the file is open.

Attributes of `<AUDIT_RECORD>` elements have these characteristics:

- Some attributes appear in every `<AUDIT_RECORD>` element. Others are optional and may appear depending on the audit record type.
- Order of attributes within an `<AUDIT_RECORD>` element is not guaranteed.
- Attribute values are not fixed length. Long values may be truncated as indicated in the attribute descriptions given later.
- The `<`, `>`, `"`, and `&` characters are encoded as `&lt;`, `&gt;`, `&quot;`, and `&amp;`, respectively. NUL bytes (U+00) are encoded as the `?` character.
- Characters not valid as XML characters are encoded using numeric character references. Valid XML characters are:

```
#x9 | #xA | #xD | [#x20-#xD7FF] | [#xE000-#xFFFD] | [#x10000-#x10FFFF]
```

The following attributes are mandatory in every `<AUDIT_RECORD>` element:

- **NAME**

A string representing the type of instruction that generated the audit event, such as a command that the server received from a client.

Example: `NAME="Query"`

Some common **NAME** values:

Audit	When auditing starts, which may be server startup time
Connect	When a client connects, also known as logging in
Query	An SQL statement (executed directly)
Prepare	Preparation of an SQL statement; usually followed by Execute
Execute	Execution of an SQL statement; usually follows Prepare
Shutdown	Server shutdown
Quit	When a client disconnects
NoAudit	Auditing has been turned off

The possible values are `Audit`, `Binlog Dump`, `Change user`, `Close stmt`, `Connect Out`, `Connect`, `Create DB`, `Daemon`, `Debug`, `Delayed insert`, `Drop DB`, `Execute`, `Fetch`, `Field List`, `Init DB`, `Kill`, `Long Data`, `NoAudit`, `Ping`, `Prepare`, `Processlist`, `Query`, `Quit`, `Refresh`, `Register Slave`, `Reset stmt`, `Set option`, `Shutdown`, `Sleep`, `Statistics`, `Table Dump`, `TableDelete`, `TableInsert`, `TableRead`, `TableUpdate`, `Time`.



Many of these values correspond to the `COM_xxx` command values listed in the `my_command.h` header file. For example, "Create DB" and "Change user" correspond to `COM_CREATE_DB` and `COM_CHANGE_USER`, respectively.

Events having `NAME` values of `TableXXX` accompany `Query` events. For example, the following statement generates one `Query` event, two `TableRead` events, and a `TableInsert` events:

```
INSERT INTO t3 SELECT t1.* FROM t1 JOIN t2;
```

Each `TableXXX` event has `TABLE` and `DB` attributes to identify the table to which the event refers and the database that contains the table.

- `RECORD_ID`

A unique identifier for the audit record. The value is composed from a sequence number and timestamp, in the format `SEQ_TIMESTAMP`. When the audit log plugin opens the audit log file, it initializes the sequence number to the size of the audit log file, then increments the sequence by 1 for each record logged. The timestamp is a UTC value in `YYYY-MM-DDThh:mm:ss` format indicating the date and time when the audit log plugin opened the file.

Example: `RECORD_ID="12_2019-10-03T14:25:00"`

- `TIMESTAMP`

A string representing a UTC value in `YYYY-MM-DDThh:mm:ss UTC` format indicating the date and time when the audit event was generated. For example, the event corresponding to execution of an SQL statement received from a client has a `TIMESTAMP` value occurring after the statement finishes, not when it was received.

Example: `TIMESTAMP="2019-10-03T14:25:32 UTC"`

The following attributes are optional in `<AUDIT_RECORD>` elements. Many of them occur only for elements with specific values of the `NAME` attribute.

- `COMMAND_CLASS`

A string that indicates the type of action performed.

Example: `COMMAND_CLASS="drop_table"`

The values correspond to the `statement/sql/xxx` command counters. For example, `xxx` is `drop_table` and `select` for `DROP TABLE` and `SELECT` statements, respectively. The following statement displays the possible names:

```
SELECT REPLACE(EVENT_NAME, 'statement/sql/', '') AS name
FROM performance_schema.events_statements_summary_global_by_event_name
WHERE EVENT_NAME LIKE 'statement/sql/%'
ORDER BY name;
```

- `CONNECTION_ID`

An unsigned integer representing the client connection identifier. This is the same as the value returned by the `CONNECTION_ID()` function within the session.

Example: `CONNECTION_ID="127"`

- `CONNECTION_TYPE`

The security state of the connection to the server. Permitted values are [TCP/IP](#) (TCP/IP connection established without encryption), [SSL/TLS](#) (TCP/IP connection established with encryption), [Socket](#) (Unix socket file connection), [Named Pipe](#) (Windows named pipe connection), and [Shared Memory](#) (Windows shared memory connection).

Example: `CONNECTION_TYPE="SSL/TLS"`

- [DB](#)

A string representing a database name.

Example: `DB="test"`

For connect events, this attribute indicates the default database; the attribute is empty if there is no default database. For table-access events, the attribute indicates the database to which the accessed table belongs.

- [HOST](#)

A string representing the client host name.

Example: `HOST="localhost"`

- [IP](#)

A string representing the client IP address.

Example: `IP="127.0.0.1"`

- [MYSQL\\_VERSION](#)

A string representing the MySQL server version. This is the same as the value of the `VERSION()` function or `version` system variable.

Example: `MYSQL_VERSION="5.7.21-log"`

- [OS\\_LOGIN](#)

A string representing the external user name used during the authentication process, as set by the plugin used to authenticate the client. With native (built-in) MySQL authentication, or if the plugin does not set the value, this attribute is empty. The value is the same as that of the `external_user` system variable (see [Section 6.2.14, "Proxy Users"](#)).

Example: `OS_LOGIN="jeffrey"`

- [OS\\_VERSION](#)

A string representing the operating system on which the server was built or is running.

Example: `OS_VERSION="x86_64-Linux"`

- [PRIV\\_USER](#)

A string representing the user that the server authenticated the client as. This is the user name that the server uses for privilege checking, and it may differ from the `USER` value.

Example: `PRIV_USER="jeffrey"`

- `PROXY_USER`

A string representing the proxy user (see [Section 6.2.14, "Proxy Users"](#)). The value is empty if user proxying is not in effect.

Example: `PROXY_USER="developer"`

- `SERVER_ID`

An unsigned integer representing the server ID. This is the same as the value of the `server_id` system variable.

Example: `SERVER_ID="1"`

- `SQLTEXT`

A string representing the text of an SQL statement. The value can be empty. Long values may be truncated. The string, like the audit log file itself, is written using UTF-8 (up to 4 bytes per character), so the value may be the result of conversion. For example, the original statement might have been received from the client as an SJIS string.

Example: `SQLTEXT="DELETE FROM t1"`

- `STARTUP_OPTIONS`

A string representing the options that were given on the command line or in option files when the MySQL server was started.

Example: `STARTUP_OPTIONS="--port=3306 --log_output=FILE"`

- `STATUS`

An unsigned integer representing the command status: 0 for success, nonzero if an error occurred. This is the same as the value of the `mysql_errno()` C API function. See the description for `STATUS_CODE` for information about how it differs from `STATUS`.

The audit log does not contain the `SQLSTATE` value or error message. To see the associations between error codes, `SQLSTATE` values, and messages, see [Server Error Message Reference](#).

Warnings are not logged.

Example: `STATUS="1051"`

- `STATUS_CODE`

An unsigned integer representing the command status: 0 for success, 1 if an error occurred.

The `STATUS_CODE` value differs from the `STATUS` value: `STATUS_CODE` is 0 for success and 1 for error, which is compatible with the `EZ_collector` consumer for Audit Vault. `STATUS` is the value of the `mysql_errno()` C API function. This is 0 for success and nonzero for error, and thus is not necessarily 1 for error.

Example: `STATUS_CODE="0"`

- **TABLE**

A string representing a table name.

Example: `TABLE="t3"`

- **USER**

A string representing the user name sent by the client. This may differ from the `PRIV_USER` value.

- **VERSION**

An unsigned integer representing the version of the audit log file format.

Example: `VERSION="1"`

## JSON Audit Log File Format

For JSON-format audit logging (`audit_log_format=JSON`), the log file contents form a **JSON** array with each array element representing an audited event as a **JSON** hash of key-value pairs. Examples of complete event records appear later in this section. The following is an excerpt of partial events:

```
[
  {
    "timestamp": "2019-10-03 13:50:01",
    "id": 0,
    "class": "audit",
    "event": "startup",
    ...
  },
  {
    "timestamp": "2019-10-03 15:02:32",
    "id": 0,
    "class": "connection",
    "event": "connect",
    ...
  },
  ...
  {
    "timestamp": "2019-10-03 17:37:26",
    "id": 0,
    "class": "table_access",
    "event": "insert",
    ...
  }
  ...
]
```

The audit log file is written using UTF-8 (up to 4 bytes per character). When the audit log plugin begins writing a new log file, it writes the opening `[` array marker. When the plugin closes a log file, it writes the closing `]` array marker. The closing marker is not present while the file is open.

Items within audit records have these characteristics:

- Some items appear in every audit record. Others are optional and may appear depending on the audit record type.
- Order of items within an audit record is not guaranteed.
- Item values are not fixed length. Long values may be truncated as indicated in the item descriptions given later.

- The " and \ characters are encoded as \" and \\, respectively.

The following examples show the JSON object formats for different event types (as indicated by the `class` and `event` items), reformatted slightly for readability:

#### Auditing startup event:

```
{ "timestamp": "2019-10-03 14:21:56",
  "id": 0,
  "class": "audit",
  "event": "startup",
  "connection_id": 0,
  "startup_data": { "server_id": 1,
                    "os_version": "i686-Linux",
                    "mysql_version": "5.7.21-log",
                    "args": ["/usr/local/mysql/bin/mysqld",
                             "--loose-audit-log-format=JSON",
                             "--log-error=log.err",
                             "--pid-file=mysqld.pid",
                             "--port=3306" ] } }
```

When the audit log plugin starts as a result of server startup (as opposed to being enabled at runtime), `connection_id` is set to 0, and `account` and `login` are not present.

#### Auditing shutdown event:

```
{ "timestamp": "2019-10-03 14:28:20",
  "id": 3,
  "class": "audit",
  "event": "shutdown",
  "connection_id": 0,
  "shutdown_data": { "server_id": 1 } }
```

When the audit log plugin is uninstalled as a result of server shutdown (as opposed to being disabled at runtime), `connection_id` is set to 0, and `account` and `login` are not present.

#### Connect or change-user event:

```
{ "timestamp": "2019-10-03 14:23:18",
  "id": 1,
  "class": "connection",
  "event": "connect",
  "connection_id": 5,
  "account": { "user": "root", "host": "localhost" },
  "login": { "user": "root", "os": "", "ip": "::1", "proxy": "" },
  "connection_data": { "connection_type": "ssl",
                       "status": 0,
                       "db": "test" } }
```

#### Disconnect event:

```
{ "timestamp": "2019-10-03 14:24:45",
  "id": 3,
  "class": "connection",
  "event": "disconnect",
  "connection_id": 5,
  "account": { "user": "root", "host": "localhost" },
  "login": { "user": "root", "os": "", "ip": "::1", "proxy": "" },
  "connection_data": { "connection_type": "ssl" } }
```

#### Query event:

```
{ "timestamp": "2019-10-03 14:23:35",
  "id": 2,
  "class": "general",
```

```
"event": "status",
"connection_id": 5,
"account": { "user": "root", "host": "localhost" },
"login": { "user": "root", "os": "", "ip": "::1", "proxy": "" },
"general_data": { "command": "Query",
                  "sql_command": "show_variables",
                  "query": "SHOW VARIABLES",
                  "status": 0 } }
```

Table access event (read, delete, insert, update):

```
{ "timestamp": "2019-10-03 14:23:41",
  "id": 0,
  "class": "table_access",
  "event": "insert",
  "connection_id": 5,
  "account": { "user": "root", "host": "localhost" },
  "login": { "user": "root", "os": "", "ip": "127.0.0.1", "proxy": "" },
  "table_access_data": { "db": "test",
                        "table": "t1",
                        "query": "INSERT INTO t1 (i) VALUES(1),(2),(3)",
                        "sql_command": "insert" } }
```

The items in the following list appear at the top level of JSON-format audit records: Each item value is either a scalar or a [JSON](#) hash. For items that have a hash value, the description lists only the item names within that hash. For more complete descriptions of second-level hash items, see later in this section.

- [account](#)

The MySQL account associated with the event. The value is a hash containing these items equivalent to the value of the [CURRENT\\_USER\(\)](#) function within the section: [user](#), [host](#).

Example:

```
"account": { "user": "root", "host": "localhost" }
```

- [class](#)

A string representing the event class. The class defines the type of event, when taken together with the [event](#) item that specifies the event subclass.

Example:

```
"class": "connection"
```

The following table shows the permitted combinations of [class](#) and [event](#) values.

**Table 6.25 Audit Log Class and Event Combinations**

Class Value	Permitted Event Values
<a href="#">audit</a>	<a href="#">startup</a> , <a href="#">shutdown</a>
<a href="#">connection</a>	<a href="#">connect</a> , <a href="#">change_user</a> , <a href="#">disconnect</a>
<a href="#">general</a>	<a href="#">status</a>
<a href="#">table_access_data</a>	<a href="#">read</a> , <a href="#">delete</a> , <a href="#">insert</a> , <a href="#">update</a>

- [connection\\_data](#)

Information about a client connection. The value is a hash containing these items: [connection\\_type](#), [status](#), [db](#). This item occurs only for audit records with a [class](#) value of [connection](#).

Example:

```
"connection_data": { "connection_type": "ssl",
                    "status": 0,
                    "db": "test" }
```

- `connection_id`

An unsigned integer representing the client connection identifier. This is the same as the value returned by the `CONNECTION_ID()` function within the session.

Example:

```
"connection_id": 5
```

- `event`

A string representing the subclass of the event class. The subclass defines the type of event, when taken together with the `class` item that specifies the event class. For more information, see the `class` item description.

Example:

```
"event": "connect"
```

- `general_data`

Information about an executed statement or command. The value is a hash containing these items: `command`, `sql_command`, `query`, `status`. This item occurs only for audit records with a `class` value of `general`.

Example:

```
"general_data": { "command": "Query",
                 "sql_command": "show_variables",
                 "query": "SHOW VARIABLES",
                 "status": 0 }
```

- `id`

An unsigned integer representing an event ID.

Example:

```
"id": 2
```

For audit records that have the same `timestamp` value, their `id` values distinguish them and form a sequence. Within the audit log, `timestamp/id` pairs are unique. These pairs are bookmarks that identify event locations within the log.

- `login`

Information indicating how a client connected to the server. The value is a hash containing these items: `user`, `os`, `ip`, `proxy`.

Example:

```
"login": { "user": "root", "os": "", "ip": ":::1", "proxy": "" }
```

- `shutdown_data`

Information pertaining to audit log plugin termination. The value is a hash containing these items: `server_id`. This item occurs only for audit records with `class` and `event` values of `audit` and `shutdown`, respectively.

Example:

```
"shutdown_data": { "server_id": 1 }
```

- `startup_data`

Information pertaining to audit log plugin initialization. The value is a hash containing these items: `server_id`, `os_version`, `mysql_version`, `args`. This item occurs only for audit records with `class` and `event` values of `audit` and `startup`, respectively.

Example:

```
"startup_data": { "server_id": 1,
                  "os_version": "i686-Linux",
                  "mysql_version": "5.7.21-log",
                  "args": [ "/usr/local/mysql/bin/mysqld",
                            "--loose-audit-log-format=JSON",
                            "--log-error=log.err",
                            "--pid-file=mysqld.pid",
                            "--port=3306" ] }
```

- `table_access_data`

Information about an access to a table. The value is a hash containing these items: `db`, `table`, `query`, `sql_command`. This item occurs only for audit records with a `class` value of `table_access`.

Example:

```
"table_access_data": { "db": "test",
                      "table": "t1",
                      "query": "INSERT INTO t1 (i) VALUES(1),(2),(3)",
                      "sql_command": "insert" }
```

- `time`

This field is similar to that in the `timestamp` field, but the value is an integer and represents the UNIX timestamp value indicating the date and time when the audit event was generated.

Example:

```
"time" : 1618498687
```

The `time` field occurs in JSON-format log files only if the `audit_log_format_unix_timestamp` system variable is enabled.

- `timestamp`

A string representing a UTC value in `YYYY-MM-DD hh:mm:ss` format indicating the date and time when the audit event was generated. For example, the event corresponding to execution of an SQL statement



received from a client has a `timestamp` value occurring after the statement finishes, not when it was received.

Example:

```
"timestamp": "2019-10-03 13:50:01"
```

For audit records that have the same `timestamp` value, their `id` values distinguish them and form a sequence. Within the audit log, `timestamp/id` pairs are unique. These pairs are bookmarks that identify event locations within the log.

These items appear within hash values associated with top-level items of JSON-format audit records:

- `args`

An array of options that were given on the command line or in option files when the MySQL server was started. The first option is the path to the server executable.

Example:

```
"args": [ "/usr/local/mysql/bin/mysqld",  
          "--loose-audit-log-format=JSON",  
          "--log-error=log.err",  
          "--pid-file=mysqld.pid",  
          "--port=3306" ]
```

- `command`

A string representing the type of instruction that generated the audit event, such as a command that the server received from a client.

Example:

```
"command": "Query"
```

- `connection_type`

The security state of the connection to the server. Permitted values are `tcp/ip` (TCP/IP connection established without encryption), `ssl` (TCP/IP connection established with encryption), `socket` (Unix socket file connection), `named_pipe` (Windows named pipe connection), and `shared_memory` (Windows shared memory connection).

Example:

```
"connection_type": "tcp/tcp"
```

- `db`

A string representing a database name. For `connection_data`, it is the default database. For `table_access_data`, it is the table database.

Example:

```
"db": "test"
```

- `host`

A string representing the client host name.

Example:

```
"host": "localhost"
```

- `ip`

A string representing the client IP address.

Example:

```
"ip": ":::1"
```

- `mysql_version`

A string representing the MySQL server version. This is the same as the value of the `VERSION()` function or `version` system variable.

Example:

```
"mysql_version": "5.7.21-log"
```

- `os`

A string representing the external user name used during the authentication process, as set by the plugin used to authenticate the client. With native (built-in) MySQL authentication, or if the plugin does not set the value, this attribute is empty. The value is the same as that of the `external_user` system variable. See [Section 6.2.14, “Proxy Users”](#).

Example:

```
"os": "jeffrey"
```

- `os_version`

A string representing the operating system on which the server was built or is running.

Example:

```
"os_version": "i686-Linux"
```

- `proxy`

A string representing the proxy user (see [Section 6.2.14, “Proxy Users”](#)). The value is empty if user proxying is not in effect.

Example:

```
"proxy": "developer"
```

- `query`

A string representing the text of an SQL statement. The value can be empty. Long values may be truncated. The string, like the audit log file itself, is written using UTF-8 (up to 4 bytes per character), so the value may be the result of conversion. For example, the original statement might have been received from the client as an SJIS string.

Example:

```
"query": "DELETE FROM t1"
```

- `server_id`

An unsigned integer representing the server ID. This is the same as the value of the `server_id` system variable.

Example:

```
"server_id": 1
```

- `sql_command`

A string that indicates the SQL statement type.

Example:

```
"sql_command": "insert"
```

The values correspond to the `statement/sql/xxx` command counters. For example, `xxx` is `drop_table` and `select` for `DROP TABLE` and `SELECT` statements, respectively. The following statement displays the possible names:

```
SELECT REPLACE(EVENT_NAME, 'statement/sql/', '') AS name
FROM performance_schema.events_statements_summary_global_by_event_name
WHERE EVENT_NAME LIKE 'statement/sql/%'
ORDER BY name;
```

- `status`

An unsigned integer representing the command status: 0 for success, nonzero if an error occurred. This is the same as the value of the `mysql_errno()` C API function.

The audit log does not contain the SQLSTATE value or error message. To see the associations between error codes, SQLSTATE values, and messages, see [Server Error Message Reference](#).

Warnings are not logged.

Example:

```
"status": 1051
```

- `table`

A string representing a table name.

Example:

```
"table": "t1"
```

- `user`

A string representing a user name. The meaning differs depending on the item within which `user` occurs:

- Within `account` items, `user` is a string representing the user that the server authenticated the client as. This is the user name that the server uses for privilege checking.
- Within `login` items, `user` is a string representing the user name sent by the client.

Example:

```
"user": "root"
```

### 6.4.5.5 Configuring Audit Logging Characteristics

This section describes how to configure audit logging characteristics, such as the file to which the audit log plugin writes events, the format of written events, whether to enable log file compression and encryption, and space management.

- [Naming Conventions for Audit Log Files](#)
- [Selecting Audit Log File Format](#)
- [Compressing Audit Log Files](#)
- [Encrypting Audit Log Files](#)
- [Manually Uncompressing and Decrypting Audit Log Files](#)
- [Space Management of Audit Log Files](#)
- [Write Strategies for Audit Logging](#)

For additional information about the functions and system variables that affect audit logging, see [Audit Log Functions](#), and [Audit Log Options and Variables](#).

The audit log plugin can also control which audited events are written to the audit log file, based on event content or the account from which events originate. See [Section 6.4.5.7, “Audit Log Filtering”](#).

#### Naming Conventions for Audit Log Files

To configure the audit log file name, set the `audit_log_file` system variable at server startup. The default name is `audit.log` in the server data directory. For best security, write the audit log to a directory accessible only to the MySQL server and to users with a legitimate reason to view the log.

As of MySQL 5.7.21, the plugin interprets the `audit_log_file` value as composed of an optional leading directory name, a base name, and an optional suffix. If compression or encryption are enabled, the effective file name (the name actually used to create the log file) differs from the configured file name because it has additional suffixes:

- If compression is enabled, the plugin adds a suffix of `.gz`.
- If encryption is enabled, the plugin adds a suffix of `.enc`. The audit log plugin stores the encryption password in the keyring (see [Encrypting Audit Log Files](#)).

The effective audit log file name is the name resulting from the addition of applicable compression and encryption suffixes to the configured file name. For example, if the configured `audit_log_file` value is `audit.log`, the effective file name is one of the values shown in the following table.

Enabled Features	Effective File Name
No compression or encryption	<code>audit.log</code>
Compression	<code>audit.log.gz</code>
Encryption	<code>audit.log.enc</code>
Compression, encryption	<code>audit.log.gz.enc</code>

Prior to MySQL 5.7.21, the configured and effective log file names are the same. For example, if the configured `audit_log_file` value is `audit.log`, the audit log plugin writes to `audit.log`.

The audit log plugin performs certain actions during initialization and termination based on the effective audit log file name:

As of MySQL 5.7.21:

- During initialization, the plugin checks whether a file with the audit log file name already exists and renames it if so. (In this case, the plugin assumes that the previous server invocation exited unexpectedly with the audit log plugin running.) The plugin then writes to a new empty audit log file.
- During termination, the plugin renames the audit log file.
- File renaming (whether during plugin initialization or termination) occurs according to the usual rules for automatic size-based log file rotation; see [Manual Audit Log File Rotation](#).

Prior to MySQL 5.7.21, only the XML log formats are available and the plugin performs rudimentary integrity checking:

- During initialization, the plugin checks whether the file ends with an `</AUDIT>` tag and truncates the tag before writing any `<AUDIT_RECORD>` elements. If the log file exists but does not end with `</AUDIT>` or the `</AUDIT>` tag cannot be truncated, the plugin considers the file malformed and renames it. (Such renaming can occur if the server exits unexpectedly with the audit log plugin running.) The plugin then writes to a new empty audit log file.
- At termination, no file renaming occurs.
- When renaming occurs at plugin initialization, the renamed file has `.corrupted`, a timestamp, and `.xml` added to the end. For example, if the file name is `audit.log`, the plugin renames it to a value such as `audit.log.corrupted.15081807937726520.xml`. The timestamp value is similar to a Unix timestamp, with the last 7 digits representing the fractional second part. For information about interpreting the timestamp, see [Space Management of Audit Log Files](#).

## Selecting Audit Log File Format

To configure the audit log file format, set the `audit_log_format` system variable at server startup. These formats are available:

- **NEW**: New-style XML format. This is the default.
- **OLD**: Old-style XML format.
- **JSON**: JSON format.

For details about each format, see [Section 6.4.5.4, “Audit Log File Formats”](#).

If you change `audit_log_format`, it is recommended that you also change `audit_log_file`. For example, if you set `audit_log_format` to `JSON`, set `audit_log_file` to `audit.json`. Otherwise, newer log files will have a different format than older files, but they will all have the same base name with nothing to indicate when the format changed.



### Note

Prior to MySQL 5.7.21, changing the value of `audit_log_format` can result in writing log entries in one format to an existing log file that contains entries in a different format. To avoid this issue, use the following procedure:

1. Stop the server.
2. Either change the value of the `audit_log_file` system variable so the plugin writes to a different file, or rename the current audit log file manually.

3. Restart the server with the new value of `audit_log_format`. The audit log plugin creates a new log file and writes entries to it in the selected format.

## Compressing Audit Log Files

Audit log file compression is available as of MySQL 5.7.21. Compression can be enabled for any log format.

To configure audit log file compression, set the `audit_log_compression` system variable at server startup. Permitted values are `NONE` (no compression; the default) and `GZIP` (GNU Zip compression).

If both compression and encryption are enabled, compression occurs before encryption. To recover the original file manually, first decrypt it, then uncompress it. See [Manually Uncompressing and Decrypting Audit Log Files](#).

## Encrypting Audit Log Files

Audit log file encryption is available as of MySQL 5.7.21. Encryption can be enabled for any log format. Encryption is based on a user-defined password (with the exception of the initial password, which the audit log plugin generates). To use this feature, the MySQL keyring must be enabled because audit logging uses it for password storage. Any keyring plugin can be used; for instructions, see [Section 6.4.4, “The MySQL Keyring”](#).

To configure audit log file encryption, set the `audit_log_encryption` system variable at server startup. Permitted values are `NONE` (no encryption; the default) and `AES` (AES-256-CBC cipher encryption).

To set or get an encryption password at runtime, use these audit log functions:

- To set the current encryption password, invoke `audit_log_encryption_password_set()`. This function stores the new password in the keyring. If encryption is enabled, it also performs a log file rotation operation that renames the current log file, and begins a new log file encrypted with the password. File renaming occurs according to the usual rules for automatic size-based log file rotation; see [Manual Audit Log File Rotation](#).

Previously written audit log files are not re-encrypted with the new password. Keep a record of the previous password should you need to decrypt those files manually.

- To get the current encryption password, invoke `audit_log_encryption_password_get()`, which retrieves the password from the keyring.

For additional information about audit log encryption functions, see [Audit Log Functions](#).

When the audit log plugin initializes, if it finds that log file encryption is enabled, it checks whether the keyring contains an audit log encryption password. If not, the plugin automatically generates a random initial encryption password and stores it in the keyring. To discover this password, invoke `audit_log_encryption_password_get()`.

If both compression and encryption are enabled, compression occurs before encryption. To recover the original file manually, first decrypt it, then uncompress it. See [Manually Uncompressing and Decrypting Audit Log Files](#).

## Manually Uncompressing and Decrypting Audit Log Files

Audit log files can be uncompressed and decrypted using standard tools. This should be done only for log files that have been closed (archived) and are no longer in use, not for the log file that the audit log plugin

is currently writing. You can recognize archived log files because they have been renamed by the audit log plugin to include a timestamp in the file name just after the base name.

For this discussion, assume that `audit_log_file` is set to `audit.log`. In that case, an archived audit log file has one of the names shown in the following table.

Enabled Features	Archived File Name
No compression or encryption	<code>audit.timestamp.log</code>
Compression	<code>audit.timestamp.log.gz</code>
Encryption	<code>audit.timestamp.log.enc</code>
Compression, encryption	<code>audit.timestamp.log.gz.enc</code>

To uncompress a compressed log file manually, use `gunzip`, `gzip -d`, or equivalent command. For example:

```
gunzip -c audit.timestamp.log.gz > audit.timestamp.log
```

To decrypt an encrypted log file manually, use the `openssl` command. For example:

```
openssl enc -d -aes-256-cbc -pass pass:password -md sha256
  -in audit.timestamp.log.enc
  -out audit.timestamp.log
```

If both compression and encryption are enabled for audit logging, compression occurs before encryption. In this case, the file name has `.gz` and `.enc` suffixes added, corresponding to the order in which those operations occur. To recover the original file manually, perform the operations in reverse. That is, first decrypt the file, then uncompress it:

```
openssl enc -d -aes-256-cbc -pass pass:password -md sha256
  -in audit.timestamp.log.gz.enc
  -out audit.timestamp.log.gz
gunzip -c audit.timestamp.log.gz > audit.timestamp.log
```

## Space Management of Audit Log Files

The audit log file has the potential to grow quite large and consume a great deal of disk space. To manage the space used, log rotation can be employed. This involves rotating the current log file by renaming it, then opening a new current log file using the original name. Rotation can be performed manually, or configured to occur automatically.

To configure audit log file space management, use the following system variables:

- If `audit_log_rotate_on_size` is 0 (the default), automatic log file rotation is disabled:
  - No rotation occurs unless performed manually.
  - To rotate the current file, manually rename it, then enable `audit_log_flush` to close it and open a new current log file using the original name; see [Manual Audit Log File Rotation](#).
- If `audit_log_rotate_on_size` is greater than 0, automatic audit log file rotation is enabled:
  - Automatic rotation occurs when a write to the current log file causes its size to exceed the `audit_log_rotate_on_size` value, as well as under certain other conditions; see [Automatic Audit Log File Rotation](#). When rotation occurs, the audit log plugin renames the current log file and opens a new current log file using the original name.
  - With automatic rotation enabled, `audit_log_flush` has no effect.

**Note**

For JSON-format log files, rotation also occurs when the value of the `audit_log_format_unix_timestamp` system variable is changed at runtime. However, this does not occur for space-management purposes, but rather so that, for a given JSON-format log file, all records in the file either do or do not include the `time` field.

**Note**

Rotated (renamed) log files are not removed automatically. For example, with size-based log file rotation, renamed log files have unique names and accumulate indefinitely. They do not rotate off the end of the name sequence. To avoid excessive use of space, remove old files periodically, backing them up first as necessary.

The following sections describe log file rotation in greater detail.

- [Manual Audit Log File Rotation](#)
- [Automatic Audit Log File Rotation](#)

**Manual Audit Log File Rotation**

If `audit_log_rotate_on_size` is 0 (the default), no log rotation occurs unless performed manually. In this case, the audit log plugin closes and reopens the log file when the `audit_log_flush` value changes from disabled to enabled. Log file renaming must be done externally to the server. Suppose that the log file name is `audit.log` and you want to maintain the three most recent log files, cycling through the names `audit.log.1` through `audit.log.3`. On Unix, perform rotation manually like this:

1. From the command line, rename the current log files:

```
mv audit.log.2 audit.log.3
mv audit.log.1 audit.log.2
mv audit.log audit.log.1
```

This strategy overwrites the current `audit.log.3` contents, placing a bound on the number of archived log files and the space they use.

2. At this point, the plugin is still writing to the current log file, which has been renamed to `audit.log.1`. Connect to the server and flush the log file so the plugin closes it and reopens a new `audit.log` file:

```
SET GLOBAL audit_log_flush = ON;
```

`audit_log_flush` is special in that its value remains `OFF` so that you need not disable it explicitly before enabling it again to perform another flush.

**Note**

For JSON-format logging, renaming audit log files manually makes them unavailable to the log-reading functions because the audit log plugin can no longer determine that they are part of the log file sequence (see [Section 6.4.5.6, “Reading Audit Log Files”](#)). Consider setting `audit_log_rotate_on_size` greater than 0 to use size-based rotation instead.

**Automatic Audit Log File Rotation**

If `audit_log_rotate_on_size` is greater than 0, setting `audit_log_flush` has no effect. Instead, whenever a write to the current log file causes its size to exceed the `audit_log_rotate_on_size`



value, the audit log plugin automatically renames the current log file and opens a new current log file using the original name.

Automatic size-based rotation also occurs under these conditions:

- During plugin initialization, if a file with the audit log file name already exists (see [Naming Conventions for Audit Log Files](#)).
- During plugin termination.
- When the `audit_log_encryption_password_set()` function is called to set the encryption password.

The plugin renames the original file as follows:

- As of MySQL 5.7.21, the renamed file has a timestamp inserted after its base name and before its suffix. For example, if the file name is `audit.log`, the plugin renames it to a value such as `audit.20180115T140633.log`. The timestamp is a UTC value in `YYYYMMDDThhmmss` format. For XML logging, the timestamp indicates rotation time. For JSON logging, the timestamp is that of the last event written to the file.

If log files are encrypted, the original file name already contains a timestamp indicating the encryption password creation time (see [Naming Conventions for Audit Log Files](#)). In this case, the file name after rotation contains two timestamps. For example, an encrypted log file named `audit.log.20180110T130749-1.enc` is renamed to a value such as `audit.20180115T140633.log.20180110T130749-1.enc`.

- Prior to MySQL 5.7.21, the renamed file has a timestamp and `.xml` added to the end. For example, if the file name is `audit.log`, the plugin renames it to a value such as `audit.log.1515934443.7726520.xml`. The timestamp value is similar to a Unix timestamp, with the last 7 digits representing the fractional second part. By inserting a decimal point, the value can be interpreted using the `FROM_UNIXTIME()` function:

```
mysql> SELECT FROM_UNIXTIME(1515934443.7726520);
+-----+
| FROM_UNIXTIME(1515934443.7726520) |
+-----+
| 2018-01-14 06:54:03.772652 |
+-----+
```

## Write Strategies for Audit Logging

The audit log plugin can use any of several strategies for log writes. Regardless of strategy, logging occurs on a best-effort basis, with no guarantee of consistency.

To specify a write strategy, set the `audit_log_strategy` system variable at server startup. By default, the strategy value is `ASYNCHRONOUS` and the plugin logs asynchronously to a buffer, waiting if the buffer is full. You can tell the plugin not to wait (`PERFORMANCE`) or to log synchronously, either using file system caching (`SEMISYNCHRONOUS`) or forcing output with a `sync()` call after each write request (`SYNCHRONOUS`).

For asynchronous write strategy, the `audit_log_buffer_size` system variable is the buffer size in bytes. Set this variable at server startup to change the buffer size. The plugin uses a single buffer, which it allocates when it initializes and removes when it terminates. The plugin does not allocate this buffer for nonasynchronous write strategies.

Asynchronous logging strategy has these characteristics:

- Minimal impact on server performance and scalability.
- Blocking of threads that generate audit events for the shortest possible time; that is, time to allocate the buffer plus time to copy the event to the buffer.
- Output goes to the buffer. A separate thread handles writes from the buffer to the log file.

With asynchronous logging, the integrity of the log file may be compromised if a problem occurs during a write to the file or if the plugin does not shut down cleanly (for example, in the event that the server host exits unexpectedly). To reduce this risk, set `audit_log_strategy` to use synchronous logging.

A disadvantage of `PERFORMANCE` strategy is that it drops events when the buffer is full. For a heavily loaded server, the audit log may have events missing.

### 6.4.5.6 Reading Audit Log Files

The audit log plugin supports functions that provide an SQL interface for reading JSON-format audit log files. (This capability does not apply to log files written in other formats.)

When the audit log plugin initializes and is configured for JSON logging, it uses the directory containing the current audit log file as the location to search for readable audit log files. The plugin determines the file location, base name, and suffix from the value of the `audit_log_file` system variable, then looks for files with names that match the following pattern, where `[...]` indicates optional file name parts:

```
basename[.timestamp].suffix[.gz][.enc]
```

If a file name ends with `.enc`, the file is encrypted and reading its unencrypted contents requires a decryption password obtained from the keyring. For more information about encrypted audit log files, see [Encrypting Audit Log Files](#).

The plugin ignores files that have been renamed manually and do not match the pattern, and files that were encrypted with a password no longer available in the keyring. The plugin opens each remaining candidate file, verifies that the file actually contains `JSON` audit events, and sorts the files using the timestamps from the first event of each file. The result is a sequence of files that are subject to access using the log-reading functions:

- `audit_log_read()` reads events from the audit log or closes the reading process.
- `audit_log_read_bookmark()` returns a bookmark for the most recently written audit log event. This bookmark is suitable for passing to `audit_log_read()` to indicate where to begin reading.

`audit_log_read()` takes an optional `JSON` string argument, and the result returned from a successful call to either function is a `JSON` string.

To use the functions to read the audit log, follow these principles:

- Call `audit_log_read()` to read events beginning from a given position or the current position, or to close reading:
  - To initialize an audit log read sequence, pass an argument that indicates the position at which to begin. One way to do so is to pass the bookmark returned by `audit_log_read_bookmark()`:

```
SELECT audit_log_read(audit_log_read_bookmark());
```

- To continue reading from the current position in the sequence, call `audit_log_read()` with no position specified:

```
SELECT audit_log_read();
```

- To explicitly close the read sequence, pass a `JSON null` argument:

```
SELECT audit_log_read('null');
```

It is unnecessary to close reading explicitly. Reading is closed implicitly when the session ends or a new read sequence is initialized by calling `audit_log_read()` with an argument that indicates the position at which to begin.

- A successful call to `audit_log_read()` to read events returns a `JSON` string containing an array of audit events:
  - If the final value of the returned array is not a `JSON null` value, there are more events following those just read and `audit_log_read()` can be called again to read more of them.
  - If the final value of the returned array is a `JSON null` value, there are no more events left to be read in the current read sequence.

Each non-`null` array element is an event represented as a `JSON` hash. For example:

```
[
  {
    "timestamp": "2020-05-18 13:39:33", "id": 0,
    "class": "connection", "event": "connect",
    ...
  },
  {
    "timestamp": "2020-05-18 13:39:33", "id": 1,
    "class": "general", "event": "status",
    ...
  },
  {
    "timestamp": "2020-05-18 13:39:33", "id": 2,
    "class": "connection", "event": "disconnect",
    ...
  },
  null
]
```

For more information about the content of `JSON`-format audit events, see [JSON Audit Log File Format](#).

- An `audit_log_read()` call to read events that does not specify a position produces an error under any of these conditions:
  - A read sequence has not yet been initialized by passing a position to `audit_log_read()`.
  - There are no more events left to be read in the current read sequence; that is, `audit_log_read()` previously returned an array ending with a `JSON null` value.
  - The most recent read sequence has been closed by passing a `JSON null` value to `audit_log_read()`.

To read events under those conditions, it is necessary to first initialize a read sequence by calling `audit_log_read()` with an argument that specifies a position.

To specify a position to `audit_log_read()`, pass a bookmark, which is a `JSON` hash containing `timestamp` and `id` elements that uniquely identify a particular event. Here is an example bookmark, obtained by calling the `audit_log_read_bookmark()` function:

```
mysql> SELECT audit_log_read_bookmark();
+-----+
```

```
| audit_log_read_bookmark() |
+-----+
| { "timestamp": "2020-05-18 21:03:44", "id": 0 } |
+-----+
```

Passing the current bookmark to `audit_log_read()` initializes event reading beginning at the bookmark position:

```
mysql> SELECT audit_log_read(audit_log_read_bookmark());
+-----+
| audit_log_read(audit_log_read_bookmark()) |
+-----+
| [ { "timestamp": "2020-05-18 22:41:24", "id": 0, "class": "connection", ... } |
+-----+
```

The argument to `audit_log_read()` is optional. If present, it can be a `JSON null` value to close the read sequence, or a `JSON` hash.

Within a hash argument to `audit_log_read()`, items are optional and control aspects of the read operation such as the position at which to begin reading or how many events to read. The following items are significant (other items are ignored):

- `timestamp, id`: The position within the audit log of the first event to read. If the position is omitted from the argument, reading continues from the current position. The `timestamp` and `id` items together comprise a bookmark that uniquely identify a particular event. If an `audit_log_read()` argument includes either item, it must include both to completely specify a position or an error occurs.
- `max_array_length`: The maximum number of events to read from the log. If this item is omitted, the default is to read to the end of the log or until the read buffer is full, whichever comes first.

Example arguments accepted by `audit_log_read()`:

- Read events starting with the event that has the exact timestamp and event ID:

```
audit_log_read('{ "timestamp": "2020-05-24 12:30:00", "id": 0 }')
```

- Like the previous example, but read at most 3 events:

```
audit_log_read('{ "timestamp": "2020-05-24 12:30:00", "id": 0, "max_array_length": 3 }')
```

- Read events from the current position in the read sequence:

```
audit_log_read()
```

- Read at most 5 events beginning at the current position in the read sequence:

```
audit_log_read('{ "max_array_length": 5 }')
```

- Close the current read sequence:

```
audit_log_read('null')
```

To use the binary `JSON` string with functions that require a nonbinary string (such as functions that manipulate `JSON` values), perform a conversion to `utf8mb4`. Suppose that a call to obtain a bookmark produces this value:

```
mysql> SET @mark := audit_log_read_bookmark();
mysql> SELECT @mark;
+-----+
| @mark |
+-----+
| { "timestamp": "2020-05-18 16:10:28", "id": 2 } |
+-----+
```

Calling `audit_log_read()` with that argument can return multiple events. To limit `audit_log_read()` to reading at most *N* events, convert the string to `utf8mb4`, then add to it a `max_array_length` item with that value. For example, to read a single event, modify the string as follows:

```
mysql> SET @mark = CONVERT(@mark USING utf8mb4);
mysql> SET @mark := JSON_SET(@mark, '$.max_array_length', 1);
mysql> SELECT @mark;
+-----+
| @mark |
+-----+
| {"id": 2, "timestamp": "2020-05-18 16:10:28", "max_array_length": 1} |
+-----+
```

The modified string, when passed to `audit_log_read()`, produces a result containing at most one event, no matter how many are available.

To read a specific number of events beginning at the current position, pass a `JSON` hash that includes a `max_array_length` value but no position. This statement invoked repeatedly returns five events each time until no more events are available:

```
SELECT audit_log_read({'max_array_length': 5});
```

To set a limit on the number of bytes that `audit_log_read()` reads, set the `audit_log_read_buffer_size` system variable. As of MySQL 5.7.23, this variable has a default of 32KB and can be set at runtime. Each client should set its session value of `audit_log_read_buffer_size` appropriately for its use of `audit_log_read()`. Prior to MySQL 5.7.23, `audit_log_read_buffer_size` has a default of 1MB, affects all clients, and can be changed only at server startup.

For additional information about audit log-reading functions, see [Audit Log Functions](#).

### 6.4.5.7 Audit Log Filtering



#### Note

As of MySQL 5.7.13, for audit log filtering to work as described here, the audit log plugin *and the accompanying audit tables and functions* must be installed. If the plugin is installed without the accompanying audit tables and functions needed for rule-based filtering, the plugin operates in legacy filtering mode, described in [Section 6.4.5.10, “Legacy Mode Audit Log Filtering”](#). Legacy mode is filtering behavior as it was prior to MySQL 5.7.13; that is, before the introduction of rule-based filtering.

- [Properties of Audit Log Filtering](#)
- [Constraints on Audit Log Filtering Functions](#)
- [Using Audit Log Filtering Functions](#)

#### Properties of Audit Log Filtering

The audit log plugin has the capability of controlling logging of audited events by filtering them:

- Audited events can be filtered using these characteristics:
  - User account
  - Audit event class

- Audit event subclass
- Audit event fields such as those that indicate operation status or SQL statement executed
- Audit filtering is rule based:
  - A filter definition creates a set of auditing rules. Definitions can be configured to include or exclude events for logging based on the characteristics just described.
  - As of MySQL 5.7.20, filter rules have the capability of blocking (aborting) execution of qualifying events, in addition to existing capabilities for event logging.
  - Multiple filters can be defined, and any given filter can be assigned to any number of user accounts.
  - It is possible to define a default filter to use with any user account that has no explicitly assigned filter.

For information about writing filtering rules, see [Section 6.4.5.8, “Writing Audit Log Filter Definitions”](#).

- Audit log filters can be defined and modified using an SQL interface based on function calls. By default, audit log filter definitions are stored in the `mysql` system database, and you can display audit filters by querying the `mysql.audit_log_filter` table. It is possible to use a different database for this purpose, in which case you should query the `database_name.audit_log_filter` table instead. See [Section 6.4.5.2, “Installing or Uninstalling MySQL Enterprise Audit”](#), for more information.
- Within a given session, the value of the read-only `audit_log_filter_id` system variable indicates whether a filter is assigned to the session.



#### Note

By default, rule-based audit log filtering logs no auditable events for any users. To log all auditable events for all users, use the following statements, which create a simple filter to enable logging and assign it to the default account:

```
SELECT audit_log_filter_set_filter('log_all', '{ "filter": { "log": true } }');
SELECT audit_log_filter_set_user('%', 'log_all');
```

The filter assigned to `%` is used for connections from any account that has no explicitly assigned filter (which initially is true for all accounts).

As previously mentioned, the SQL interface for audit filtering control is function based. The following list briefly summarizes these functions:

- `audit_log_filter_set_filter()`: Define a filter.
- `audit_log_filter_remove_filter()`: Remove a filter.
- `audit_log_filter_set_user()`: Start filtering a user account.
- `audit_log_filter_remove_user()`: Stop filtering a user account.
- `audit_log_filter_flush()`: Flush manual changes to the filter tables to affect ongoing filtering.

For usage examples and complete details about the filtering functions, see [Using Audit Log Filtering Functions](#), and [Audit Log Functions](#).

## Constraints on Audit Log Filtering Functions

Audit log filtering functions are subject to these constraints:

- To use any filtering function, the `audit_log` plugin must be enabled or an error occurs. In addition, the audit tables must exist or an error occurs. To install the `audit_log` plugin and its accompanying functions and tables, see [Section 6.4.5.2, “Installing or Uninstalling MySQL Enterprise Audit”](#).
- To use any filtering function, a user must possess the `SUPER` privilege or an error occurs. To grant the `SUPER` privilege to a user account, use this statement:

```
GRANT SUPER ON *.* TO user;
```

Alternatively, should you prefer to avoid granting the `SUPER` privilege while still permitting users to access specific filtering functions, “wrapper” stored programs can be defined. This technique is described in the context of keyring functions in [Using General-Purpose Keyring Functions](#); it can be adapted for use with filtering functions.

- The `audit_log` plugin operates in legacy mode if it is installed but the accompanying audit tables and functions are not created. The plugin writes these messages to the error log at server startup:

```
[Warning] Plugin audit_log reported: 'Failed to open the audit log filter tables.'
[Warning] Plugin audit_log reported: 'Audit Log plugin supports a filtering,
which has not been installed yet. Audit Log plugin will run in the legacy
mode, which will be disabled in the next release.'
```

In legacy mode, filtering can be done based only on event account or status. For details, see [Section 6.4.5.10, “Legacy Mode Audit Log Filtering”](#).

## Using Audit Log Filtering Functions

Before using the audit log functions, install them according to the instructions provided in [Section 6.4.5.2, “Installing or Uninstalling MySQL Enterprise Audit”](#). The `SUPER` privilege is required to use any of these functions.

The audit log filtering functions enable filtering control by providing an interface to create, modify, and remove filter definitions and assign filters to user accounts.

Filter definitions are `JSON` values. For information about using `JSON` data in MySQL, see [Section 11.5, “The JSON Data Type”](#). This section shows some simple filter definitions. For more information about filter definitions, see [Section 6.4.5.8, “Writing Audit Log Filter Definitions”](#).

When a connection arrives, the audit log plugin determines which filter to use for the new session by searching for the user account name in the current filter assignments:

- If a filter is assigned to the user, the audit log uses that filter.
- Otherwise, if no user-specific filter assignment exists, but there is a filter assigned to the default account (`%`), the audit log uses the default filter.
- Otherwise, the audit log selects no audit events from the session for processing.

If a change-user operation occurs during a session (see `mysql_change_user()`), filter assignment for the session is updated using the same rules but for the new user.

By default, no accounts have a filter assigned, so no processing of auditable events occurs for any account.

Suppose that you want to change the default to be to log only connection-related activity (for example, to see connect, change-user, and disconnect events, but not the SQL statements users execute while connected). To achieve this, define a filter (shown here named `log_conn_events`) that enables logging

only of events in the `connection` class, and assign that filter to the default account, represented by the `%` account name:

```
SET @f = '{ "filter": { "class": { "name": "connection" } } }';
SELECT audit_log_filter_set_filter('log_conn_events', @f);
SELECT audit_log_filter_set_user('%', 'log_conn_events');
```

Now the audit log uses this default account filter for connections from any account that has no explicitly defined filter.

To assign a filter explicitly to a particular user account or accounts, define the filter, then assign it to the relevant accounts:

```
SELECT audit_log_filter_set_filter('log_all', '{ "filter": { "log": true } }');
SELECT audit_log_filter_set_user('user1@localhost', 'log_all');
SELECT audit_log_filter_set_user('user2@localhost', 'log_all');
```

Now full logging is enabled for `user1@localhost` and `user2@localhost`. Connections from other accounts continue to be filtered using the default account filter.

To disassociate a user account from its current filter, either unassign the filter or assign a different filter:

- To unassign the filter from the user account:

```
SELECT audit_log_filter_remove_user('user1@localhost');
```

Filtering of current sessions for the account remains unaffected. Subsequent connections from the account are filtered using the default account filter if there is one, and are not logged otherwise.

- To assign a different filter to the user account:

```
SELECT audit_log_filter_set_filter('log_nothing', '{ "filter": { "log": false } }');
SELECT audit_log_filter_set_user('user1@localhost', 'log_nothing');
```

Filtering of current sessions for the account remains unaffected. Subsequent connections from the account are filtered using the new filter. For the filter shown here, that means no logging for new connections from `user1@localhost`.

For audit log filtering, user name and host name comparisons are case-sensitive. This differs from comparisons for privilege checking, for which host name comparisons are not case-sensitive.

To remove a filter, do this:

```
SELECT audit_log_filter_remove_filter('log_nothing');
```

Removing a filter also unassigns it from any users to whom it is assigned, including any current sessions for those users.

The filtering functions just described affect audit filtering immediately and update the audit log tables in the `mysql` system database that store filters and user accounts (see [Audit Log Tables](#)). It is also possible to modify the audit log tables directly using statements such as `INSERT`, `UPDATE`, and `DELETE`, but such changes do not affect filtering immediately. To flush your changes and make them operational, call `audit_log_filter_flush()`:

```
SELECT audit_log_filter_flush();
```



### Warning

`audit_log_filter_flush()` should be used only after modifying the audit tables directly, to force reloading all filters. Otherwise, this function should



be avoided. It is, in effect, a simplified version of unloading and reloading the `audit_log` plugin with `UNINSTALL PLUGIN` plus `INSTALL PLUGIN`.

`audit_log_filter_flush()` affects all current sessions and detaches them from their previous filters. Current sessions are no longer logged unless they disconnect and reconnect, or execute a change-user operation.

To determine whether a filter is assigned to the current session, check the session value of the read-only `audit_log_filter_id` system variable. If the value is 0, no filter is assigned. A nonzero value indicates the internally maintained ID of the assigned filter:

```
mysql> SELECT @@audit_log_filter_id;
+-----+
| @@audit_log_filter_id |
+-----+
|                      2 |
+-----+
```

### 6.4.5.8 Writing Audit Log Filter Definitions

Filter definitions are `JSON` values. For information about using `JSON` data in MySQL, see [Section 11.5, “The JSON Data Type”](#).

Filter definitions have this form, where *actions* indicates how filtering takes place:

```
{ "filter": actions }
```

The following discussion describes permitted constructs in filter definitions.

- [Logging All Events](#)
- [Logging Specific Event Classes](#)
- [Logging Specific Event Subclasses](#)
- [Inclusive and Exclusive Logging](#)
- [Testing Event Field Values](#)
- [Blocking Execution of Specific Events](#)
- [Logical Operators](#)
- [Referencing Predefined Variables](#)
- [Referencing Predefined Functions](#)
- [Replacing a User Filter](#)

#### Logging All Events

To explicitly enable or disable logging of all events, use a `log` item in the filter:

```
{
  "filter": { "log": true }
}
```

The `log` value can be either `true` or `false`.

The preceding filter enables logging of all events. It is equivalent to:

```
{
  "filter": { }
}
```

Logging behavior depends on the `log` value and whether `class` or `event` items are specified:

- With `log` specified, its given value is used.
- Without `log` specified, logging is `true` if no `class` or `event` item is specified, and `false` otherwise (in which case, `class` or `event` can include their own `log` item).

## Logging Specific Event Classes

To log events of a specific class, use a `class` item in the filter, with its `name` field denoting the name of the class to log:

```
{
  "filter": {
    "class": { "name": "connection" }
  }
}
```

The `name` value can be `connection`, `general`, or `table_access` to log connection, general, or table-access events, respectively.

The preceding filter enables logging of events in the `connection` class. It is equivalent to the following filter with `log` items made explicit:

```
{
  "filter": {
    "log": false,
    "class": { "log": true,
              "name": "connection" }
  }
}
```

To enable logging of multiple classes, define the `class` value as a `JSON` array element that names the classes:

```
{
  "filter": {
    "class": [
      { "name": "connection" },
      { "name": "general" },
      { "name": "table_access" }
    ]
  }
}
```



### Note

When multiple instances of a given item appear at the same level within a filter definition, the item values can be combined into a single instance of that item within an array value. The preceding definition can be written like this:

```
{
  "filter": {
    "class": [
      { "name": [ "connection", "general", "table_access" ] }
    ]
  }
}
```

## Logging Specific Event Subclasses

To select specific event subclasses, use an `event` item containing a `name` item that names the subclasses. The default action for events selected by an `event` item is to log them. For example, this filter enables logging for the named event subclasses:

```
{
  "filter": {
    "class": [
      {
        "name": "connection",
        "event": [
          { "name": "connect" },
          { "name": "disconnect" }
        ]
      },
      { "name": "general" },
      {
        "name": "table_access",
        "event": [
          { "name": "insert" },
          { "name": "delete" },
          { "name": "update" }
        ]
      }
    ]
  }
}
```

The `event` item can also contain explicit `log` items to indicate whether to log qualifying events. This `event` item selects multiple events and explicitly indicates logging behavior for them:

```
"event": [
  { "name": "read", "log": false },
  { "name": "insert", "log": true },
  { "name": "delete", "log": true },
  { "name": "update", "log": true }
]
```

As of MySQL 5.7.20, the `event` item can also indicate whether to block qualifying events, if it contains an `abort` item. For details, see [Blocking Execution of Specific Events](#).

[Table 6.26, “Event Class and Subclass Combinations”](#) describes the permitted subclass values for each event class.

**Table 6.26 Event Class and Subclass Combinations**

Event Class	Event Subclass	Description
<code>connection</code>	<code>connect</code>	Connection initiation (successful or unsuccessful)
<code>connection</code>	<code>change_user</code>	User re-authentication with different user/password during session
<code>connection</code>	<code>disconnect</code>	Connection termination
<code>general</code>	<code>status</code>	General operation information
<code>table_access</code>	<code>read</code>	Table read statements, such as <code>SELECT</code> or <code>INSERT INTO ... SELECT</code>

Event Class	Event Subclass	Description
table_access	delete	Table delete statements, such as <code>DELETE</code> or <code>TRUNCATE TABLE</code>
table_access	insert	Table insert statements, such as <code>INSERT</code> or <code>REPLACE</code>
table_access	update	Table update statements, such as <code>UPDATE</code>

Table 6.27, “Log and Abort Characteristics Per Event Class and Subclass Combination” describes for each event subclass whether it can be logged or aborted.

**Table 6.27 Log and Abort Characteristics Per Event Class and Subclass Combination**

Event Class	Event Subclass	Can be Logged	Can be Aborted
connection	connect	Yes	No
connection	change_user	Yes	No
connection	disconnect	Yes	No
general	status	Yes	No
table_access	read	Yes	Yes
table_access	delete	Yes	Yes
table_access	insert	Yes	Yes
table_access	update	Yes	Yes

## Inclusive and Exclusive Logging

A filter can be defined in inclusive or exclusive mode:

- Inclusive mode logs only explicitly specified items.
- Exclusive mode logs everything but explicitly specified items.

To perform inclusive logging, disable logging globally and enable logging for specific classes. This filter logs `connect` and `disconnect` events in the `connection` class, and events in the `general` class:

```
{
  "filter": {
    "log": false,
    "class": [
      {
        "name": "connection",
        "event": [
          { "name": "connect", "log": true },
          { "name": "disconnect", "log": true }
        ]
      },
      { "name": "general", "log": true }
    ]
  }
}
```

To perform exclusive logging, enable logging globally and disable logging for specific classes. This filter logs everything except events in the `general` class:

```
{
```

```

"filter": {
  "log": true,
  "class":
    { "name": "general", "log": false }
}

```

This filter logs `change_user` events in the `connection` class, and `table_access` events, by virtue of *not* logging everything else:

```

{
  "filter": {
    "log": true,
    "class": [
      {
        "name": "connection",
        "event": [
          { "name": "connect", "log": false },
          { "name": "disconnect", "log": false }
        ]
      },
      { "name": "general", "log": false }
    ]
  }
}

```

## Testing Event Field Values

To enable logging based on specific event field values, specify a `field` item within the `log` item that indicates the field name and its expected value:

```

{
  "filter": {
    "class": {
      "name": "general",
      "event": {
        "name": "status",
        "log": {
          "field": { "name": "general_command.str", "value": "Query" }
        }
      }
    }
  }
}

```

Each event contains event class-specific fields that can be accessed from within a filter to perform custom filtering.

An event in the `connection` class indicates when a connection-related activity occurs during a session, such as a user connecting to or disconnecting from the server. [Table 6.28, “Connection Event Fields”](#) indicates the permitted fields for `connection` events.

**Table 6.28 Connection Event Fields**

Field Name	Field Type	Description
<code>status</code>	integer	Event status: 0: OK Otherwise: Failed
<code>connection_id</code>	unsigned integer	Connection ID

Field Name	Field Type	Description
<code>user.str</code>	string	User name specified during authentication
<code>user.length</code>	unsigned integer	User name length
<code>priv_user.str</code>	string	Authenticated user name (account user name)
<code>priv_user.length</code>	unsigned integer	Authenticated user name length
<code>external_user.str</code>	string	External user name (provided by third-party authentication plugin)
<code>external_user.length</code>	unsigned integer	External user name length
<code>proxy_user.str</code>	string	Proxy user name
<code>proxy_user.length</code>	unsigned integer	Proxy user name length
<code>host.str</code>	string	Connected user host
<code>host.length</code>	unsigned integer	Connected user host length
<code>ip.str</code>	string	Connected user IP address
<code>ip.length</code>	unsigned integer	Connected user IP address length
<code>database.str</code>	string	Database name specified at connect time
<code>database.length</code>	unsigned integer	Database name length
<code>connection_type</code>	integer	Connection type: 0 or <code>:::undefined</code> : Undefined 1 or <code>:::tcp/ip</code> : TCP/IP 2 or <code>:::socket</code> : Socket 3 or <code>:::named_pipe</code> : Named pipe 4 or <code>:::ssl</code> : TCP/IP with encryption 5 or <code>:::shared_memory</code> : Shared memory

The `:::xxx` values are symbolic pseudo-constants that may be given instead of the literal numeric values. They must be quoted as strings and are case-sensitive.

An event in the `general` class indicates the status code of an operation and its details. [Table 6.29, "General Event Fields"](#) indicates the permitted fields for `general` events.

**Table 6.29 General Event Fields**

Field Name	Field Type	Description
<code>general_error_code</code>	integer	Event status: 0: OK Otherwise: Failed

Field Name	Field Type	Description
<code>general_thread_id</code>	unsigned integer	Connection/thread ID
<code>general_user.str</code>	string	User name specified during authentication
<code>general_user.length</code>	unsigned integer	User name length
<code>general_command.str</code>	string	Command name
<code>general_command.length</code>	unsigned integer	Command name length
<code>general_query.str</code>	string	SQL statement text
<code>general_query.length</code>	unsigned integer	SQL statement text length
<code>general_host.str</code>	string	Host name
<code>general_host.length</code>	unsigned integer	Host name length
<code>general_sql_command.str</code>	string	SQL command type name
<code>general_sql_command.length</code>	unsigned integer	SQL command type name length
<code>general_external_user.str</code>	string	External user name (provided by third-party authentication plugin)
<code>general_external_user.length</code>	unsigned integer	External user name length
<code>general_ip.str</code>	string	Connected user IP address
<code>general_ip.length</code>	unsigned integer	Connection user IP address length

`general_command.str` indicates a command name: `Query`, `Execute`, `Quit`, or `Change user`.

A `general` event with the `general_command.str` field set to `Query` or `Execute` contains `general_sql_command.str` set to a value that specifies the type of SQL command: `alter_db`, `alter_db_upgrade`, `admin_commands`, and so forth. The available `general_sql_command.str` values can be seen as the last components of the Performance Schema instruments displayed by this statement:

```
mysql> SELECT NAME FROM performance_schema.setup_instruments
        WHERE NAME LIKE 'statement/sql/%' ORDER BY NAME;
+-----+
| NAME                                     |
+-----+
| statement/sql/alter_db                   |
| statement/sql/alter_db_upgrade           |
| statement/sql/alter_event                |
| statement/sql/alter_function             |
| statement/sql/alter_instance             |
| statement/sql/alter_procedure            |
| statement/sql/alter_server                |
| ...
```

An event in the `table_access` class provides information about a specific type of access to a table. [Table 6.30, “Table-Access Event Fields”](#) indicates the permitted fields for `table_access` events.

**Table 6.30 Table-Access Event Fields**

Field Name	Field Type	Description
<code>connection_id</code>	unsigned integer	Event connection ID
<code>sql_command_id</code>	integer	SQL command ID
<code>query.str</code>	string	SQL statement text

Field Name	Field Type	Description
<code>query.length</code>	unsigned integer	SQL statement text length
<code>table_database.str</code>	string	Database name associated with event
<code>table_database.length</code>	unsigned integer	Database name length
<code>table_name.str</code>	string	Table name associated with event
<code>table_name.length</code>	unsigned integer	Table name length

The following list shows which statements produce which table-access events:

- `read` event:
  - `SELECT`
  - `INSERT ... SELECT` (for tables referenced in `SELECT` clause)
  - `REPLACE ... SELECT` (for tables referenced in `SELECT` clause)
  - `UPDATE ... WHERE` (for tables referenced in `WHERE` clause)
  - `HANDLER ... READ`
- `delete` event:
  - `DELETE`
  - `TRUNCATE TABLE`
- `insert` event:
  - `INSERT`
  - `INSERT ... SELECT` (for table referenced in `INSERT` clause)
  - `REPLACE`
  - `REPLACE ... SELECT` (for table referenced in `REPLACE` clause)
  - `LOAD DATA`
  - `LOAD XML`
- `update` event:
  - `UPDATE`
  - `UPDATE ... WHERE` (for tables referenced in `UPDATE` clause)

## Blocking Execution of Specific Events

As of MySQL 5.7.20, `event` items can include an `abort` item that indicates whether to prevent qualifying events from executing. `abort` enables rules to be written that block execution of specific SQL statements.

The `abort` item must appear within an `event` item. For example:

```
"event": {
```



```
"name": qualifying event subclass names
"abort": condition
}
```

For event subclasses selected by the `name` item, the `abort` action is true or false, depending on `condition` evaluation. If the condition evaluates to true, the event is blocked. Otherwise, the event continues executing.

The `condition` specification can be as simple as `true` or `false`, or it can be more complex such that evaluation depends on event characteristics.

This filter blocks `INSERT`, `UPDATE`, and `DELETE` statements:

```
{
  "filter": {
    "class": {
      "name": "table_access",
      "event": {
        "name": [ "insert", "update", "delete" ],
        "abort": true
      }
    }
  }
}
```

This more complex filter blocks the same statements, but only for a specific table (`finances.bank_account`):

```
{
  "filter": {
    "class": {
      "name": "table_access",
      "event": {
        "name": [ "insert", "update", "delete" ],
        "abort": {
          "and": [
            { "field": { "name": "table_database.str", "value": "finances" } },
            { "field": { "name": "table_name.str", "value": "bank_account" } }
          ]
        }
      }
    }
  }
}
```

Statements matched and blocked by the filter return an error to the client:

```
ERROR 1045 (28000): Statement was aborted by an audit log filter
```

Not all events can be blocked (see [Table 6.27, “Log and Abort Characteristics Per Event Class and Subclass Combination”](#)). For an event that cannot be blocked, the audit log writes a warning to the error log rather than blocking it.

For attempts to define a filter in which the `abort` item appears elsewhere than in an `event` item, an error occurs.

## Logical Operators

Logical operators (`and`, `or`, `not`) permit construction of complex conditions, enabling more advanced filtering configurations to be written. The following `log` item logs only `general` events with `general_command` fields having a specific value and length:

```

{
  "filter": {
    "class": {
      "name": "general",
      "event": {
        "name": "status",
        "log": {
          "or": [
            {
              "and": [
                { "field": { "name": "general_command.str", "value": "Query" } },
                { "field": { "name": "general_command.length", "value": 5 } }
              ]
            },
            {
              "and": [
                { "field": { "name": "general_command.str", "value": "Execute" } },
                { "field": { "name": "general_command.length", "value": 7 } }
              ]
            }
          ]
        }
      }
    }
  }
}

```

## Referencing Predefined Variables

To refer to a predefined variable in a `log` condition, use a `variable` item, which takes `name` and `value` items and tests equality of the named variable against a given value:

```

"variable": {
  "name": "variable_name",
  "value": comparison_value
}

```

This is true if `variable_name` has the value `comparison_value`, false otherwise.

Example:

```

{
  "filter": {
    "class": {
      "name": "general",
      "event": {
        "name": "status",
        "log": {
          "variable": {
            "name": "audit_log_connection_policy_value",
            "value": "::none"
          }
        }
      }
    }
  }
}

```

Each predefined variable corresponds to a system variable. By writing a filter that tests a predefined variable, you can modify filter operation by setting the corresponding system variable, without having to redefine the filter. For example, by writing a filter that tests the value of the `audit_log_connection_policy_value` predefined variable, you can modify filter operation by changing the value of the `audit_log_connection_policy` system variable.

The `audit_log_xxx_policy` system variables are used for the legacy mode audit log (see [Section 6.4.5.10, “Legacy Mode Audit Log Filtering”](#)). With rule-based audit log filtering, those variables remain visible (for example, using `SHOW VARIABLES`), but changes to them have no effect unless you write filters containing constructs that refer to them.

The following list describes the permitted predefined variables for `variable` items:

- `audit_log_connection_policy_value`

This variable corresponds to the value of the `audit_log_connection_policy` system variable. The value is an unsigned integer. [Table 6.31, “audit\\_log\\_connection\\_policy\\_value Values”](#) shows the permitted values and the corresponding `audit_log_connection_policy` values.

**Table 6.31 audit\_log\_connection\_policy\_value Values**

Value	Corresponding audit_log_connection_policy Value
0 or ":: <none"< td=""> <td>NONE</td> </none"<>	NONE
1 or ":: <errors"< td=""> <td>ERRORS</td> </errors"<>	ERRORS
2 or ":: <all"< td=""> <td>ALL</td> </all"<>	ALL

The "::

- `audit_log_policy_value`

This variable corresponds to the value of the `audit_log_policy` system variable. The value is an unsigned integer. [Table 6.32, “audit\\_log\\_policy\\_value Values”](#) shows the permitted values and the corresponding `audit_log_policy` values.

**Table 6.32 audit\_log\_policy\_value Values**

Value	Corresponding audit_log_policy Value
0 or ":: <none"< td=""> <td>NONE</td> </none"<>	NONE
1 or ":: <logins"< td=""> <td>LOGINS</td> </logins"<>	LOGINS
2 or ":: <all"< td=""> <td>ALL</td> </all"<>	ALL
3 or ":: <queries"< td=""> <td>QUERIES</td> </queries"<>	QUERIES

The "::

- `audit_log_statement_policy_value`

This variable corresponds to the value of the `audit_log_statement_policy` system variable. The value is an unsigned integer. [Table 6.33, “audit\\_log\\_statement\\_policy\\_value Values”](#) shows the permitted values and the corresponding `audit_log_statement_policy` values.

**Table 6.33 audit\_log\_statement\_policy\_value Values**

Value	Corresponding audit_log_statement_policy Value
0 or ":: <none"< td=""> <td>NONE</td> </none"<>	NONE
1 or ":: <errors"< td=""> <td>ERRORS</td> </errors"<>	ERRORS

Value	Corresponding audit_log_statement_policy Value
2 or "::all"	ALL

The "::xxx" values are symbolic pseudo-constants that may be given instead of the literal numeric values. They must be quoted as strings and are case-sensitive.

## Referencing Predefined Functions

To refer to a predefined function in a `log` condition, use a `function` item, which takes `name` and `args` items to specify the function name and its arguments, respectively:

```
"function": {
  "name": "function_name",
  "args": arguments
}
```

The `name` item should specify the function name only, without parentheses or the argument list.

The `args` item must satisfy these conditions:

- If the function takes no arguments, no `args` item should be given.
- If the function does take arguments, an `args` item is needed, and the arguments must be given in the order listed in the function description. Arguments can refer to predefined variables, event fields, or string or numeric constants.

If the number of arguments is incorrect or the arguments are not of the correct data types required by the function an error occurs.

Example:

```
{
  "filter": {
    "class": {
      "name": "general",
      "event": {
        "name": "status",
        "log": {
          "function": {
            "name": "find_in_include_list",
            "args": [ { "string": [ { "field": "user.str" },
                                { "string": "@",
                                { "field": "host.str" } ] } ] ]
          }
        }
      }
    }
  }
}
```

The preceding filter determines whether to log `general` class `status` events depending on whether the current user is found in the `audit_log_include_accounts` system variable. That user is constructed using fields in the event.

The following list describes the permitted predefined functions for `function` items:

- `audit_log_exclude_accounts_is_null()`

Checks whether the `audit_log_exclude_accounts` system variable is `NULL`. This function can be helpful when defining filters that correspond to the legacy audit log implementation.

Arguments:

None.

- `audit_log_include_accounts_is_null()`

Checks whether the `audit_log_include_accounts` system variable is `NULL`. This function can be helpful when defining filters that correspond to the legacy audit log implementation.

Arguments:

None.

- `debug_sleep(millisecond)`

Sleeps for the given number of milliseconds. This function is used during performance measurement.

`debug_sleep()` is available for debug builds only.

Arguments:

- `millisecond`: An unsigned integer that specifies the number of milliseconds to sleep.

- `find_in_exclude_list(account)`

Checks whether an account string exists in the audit log exclude list (the value of the `audit_log_exclude_accounts` system variable).

Arguments:

- `account`: A string that specifies the user account name.

- `find_in_include_list(account)`

Checks whether an account string exists in the audit log include list (the value of the `audit_log_include_accounts` system variable).

Arguments:

- `account`: A string that specifies the user account name.

- `string_find(text, substr)`

Checks whether the `substr` value is contained in the `text` value. This search is case-sensitive.

Arguments:

- `text`: The text string to search.
- `substr`: The substring to search for in `text`.

## Replacing a User Filter

In some cases, the filter definition can be changed dynamically. To do this, define a `filter` configuration within an existing `filter`. For example:

```
{  
  "filter": {
```

```

    "id": "main",
    "class": {
      "name": "table_access",
      "event": {
        "name": [ "update", "delete" ],
        "log": false,
        "filter": {
          "class": {
            "name": "general",
            "event": { "name": "status",
                      "filter": { "ref": "main" } }
          },
          "activate": {
            "or": [
              { "field": { "name": "table_name.str", "value": "temp_1" } },
              { "field": { "name": "table_name.str", "value": "temp_2" } }
            ]
          }
        }
      }
    }
  }
}

```

A new filter is activated when the `activate` item within a subfilter evaluates to `true`. Using `activate` in a top-level `filter` is not permitted.

A new filter can be replaced with the original one by using a `ref` item inside the subfilter to refer to the original filter `id`.

The filter shown operates like this:

- The `main` filter waits for `table_access` events, either `update` or `delete`.
- If the `update` or `delete table_access` event occurs on the `temp_1` or `temp_2` table, the filter is replaced with the internal one (without an `id`, since there is no need to refer to it explicitly).
- If the end of the command is signalled (`general` / `status` event), an entry is written to the audit log file and the filter is replaced with the `main` filter.

The filter is useful to log statements that update or delete anything from the `temp_1` or `temp_2` tables, such as this one:

```
UPDATE temp_1, temp_3 SET temp_1.a=21, temp_3.a=23;
```

The statement generates multiple `table_access` events, but the audit log file contains only `general` or `status` entries.



#### Note

Any `id` values used in the definition are evaluated with respect only to that definition. They have nothing to do with the value of the `audit_log_filter_id` system variable.

### 6.4.5.9 Disabling Audit Logging

The `audit_log_disable` variable, introduced in MySQL 5.7.37, permits disabling audit logging for all connecting and connected sessions. The `audit_log_disable` variable can be set in a MySQL Server option file, in a command-line startup string, or at runtime using a `SET` statement; for example:

```
SET GLOBAL audit_log_disable = true;
```

Setting `audit_log_disable` to true disables the audit log plugin. The plugin is re-enabled when `audit_log_disable` is set back to `false`, which is the default setting.

Starting the audit log plugin with `audit_log_disable = true` generates a warning (`ER_WARN_AUDIT_LOG_DISABLED`) with the following message: `Audit Log is disabled. Enable it with audit_log_disable = false.` Setting `audit_log_disable` to false also generates a warning. When `audit_log_disable` is set to true, audit log function calls and variable changes generate a session warning.

Setting the runtime value of `audit_log_disable` requires the `SUPER` privilege.

### 6.4.5.10 Legacy Mode Audit Log Filtering



#### Note

This section describes legacy audit log filtering, which applies under either of these circumstances:

- Before MySQL 5.7.13, that is, prior to the introduction of rule-based audit log filtering described in [Section 6.4.5.7, “Audit Log Filtering”](#).
- As of MySQL 5.7.13, if the `audit_log` plugin is installed without the accompanying audit tables and functions needed for rule-based filtering.

The audit log plugin can filter audited events. This enables you to control whether audited events are written to the audit log file based on the account from which events originate or event status. Status filtering occurs separately for connection events and statement events.

- [Legacy Event Filtering by Account](#)
- [Legacy Event Filtering by Status](#)

#### Legacy Event Filtering by Account

To filter audited events based on the originating account, set one (not both) of the following system variables at server startup or runtime. These variables apply only for legacy audit log filtering.

- `audit_log_include_accounts`: The accounts to include in audit logging. If this variable is set, only these accounts are audited.
- `audit_log_exclude_accounts`: The accounts to exclude from audit logging. If this variable is set, all but these accounts are audited.

The value for either variable can be `NULL` or a string containing one or more comma-separated account names, each in `user_name@host_name` format. By default, both variables are `NULL`, in which case, no account filtering is done and auditing occurs for all accounts.

Modifications to `audit_log_include_accounts` or `audit_log_exclude_accounts` affect only connections created subsequent to the modification, not existing connections.

Example: To enable audit logging only for the `user1` and `user2` local host accounts, set the `audit_log_include_accounts` system variable like this:

```
SET GLOBAL audit_log_include_accounts = 'user1@localhost,user2@localhost';
```

Only one of `audit_log_include_accounts` or `audit_log_exclude_accounts` can be non-`NULL` at a time:

- If you set `audit_log_include_accounts`, the server sets `audit_log_exclude_accounts` to `NULL`.
- If you attempt to set `audit_log_exclude_accounts`, an error occurs unless `audit_log_include_accounts` is `NULL`. In this case, you must first clear `audit_log_include_accounts` by setting it to `NULL`.

```
-- This sets audit_log_exclude_accounts to NULL
SET GLOBAL audit_log_include_accounts = value;

-- This fails because audit_log_include_accounts is not NULL
SET GLOBAL audit_log_exclude_accounts = value;

-- To set audit_log_exclude_accounts, first set
-- audit_log_include_accounts to NULL
SET GLOBAL audit_log_include_accounts = NULL;
SET GLOBAL audit_log_exclude_accounts = value;
```

If you inspect the value of either variable, be aware that `SHOW VARIABLES` displays `NULL` as an empty string. To display `NULL` as `NULL`, use `SELECT` instead:

```
mysql> SHOW VARIABLES LIKE 'audit_log_include_accounts';
+-----+-----+
| Variable_name | Value |
+-----+-----+
| audit_log_include_accounts |      |
+-----+-----+
mysql> SELECT @@audit_log_include_accounts;
+-----+
| @@audit_log_include_accounts |
+-----+
| NULL                          |
+-----+
```

If a user name or host name requires quoting because it contains a comma, space, or other special character, quote it using single quotes. If the variable value itself is quoted with single quotes, double each inner single quote or escape it with a backslash. The following statements each enable audit logging for the local `root` account and are equivalent, even though the quoting styles differ:

```
SET GLOBAL audit_log_include_accounts = 'root@localhost';
SET GLOBAL audit_log_include_accounts = ''root''@''localhost'';
SET GLOBAL audit_log_include_accounts = '\root\'@\localhost\';
SET GLOBAL audit_log_include_accounts = "'root'@'localhost'";
```

The last statement does not work if the `ANSI_QUOTES` SQL mode is enabled because in that mode double quotes signify identifier quoting, not string quoting.

## Legacy Event Filtering by Status

To filter audited events based on status, set the following system variables at server startup or runtime. These variables apply only for legacy audit log filtering. For JSON audit log filtering, different status variables apply; see [Audit Log Options and Variables](#).

- `audit_log_connection_policy`: Logging policy for connection events
- `audit_log_statement_policy`: Logging policy for statement events

Each variable takes a value of `ALL` (log all associated events; this is the default), `ERRORS` (log only failed events), or `NONE` (do not log events). For example, to log all statement events but only failed connection events, use these settings:

```
SET GLOBAL audit_log_statement_policy = ALL;
```



```
SET GLOBAL audit_log_connection_policy = ERRORS;
```

Another policy system variable, `audit_log_policy`, is available but does not afford as much control as `audit_log_connection_policy` and `audit_log_statement_policy`. It can be set only at server startup. At runtime, it is a read-only variable. It takes a value of `ALL` (log all events; this is the default), `LOGINS` (log connection events), `QUERIES` (log statement events), or `NONE` (do not log events). For any of those values, the audit log plugin logs all selected events without distinction as to success or failure. Use of `audit_log_policy` at startup works as follows:

- If you do not set `audit_log_policy` or set it to its default of `ALL`, any explicit settings for `audit_log_connection_policy` or `audit_log_statement_policy` apply as specified. If not specified, they default to `ALL`.
- If you set `audit_log_policy` to a non-`ALL` value, that value takes precedence over and is used to set `audit_log_connection_policy` and `audit_log_statement_policy`, as indicated in the following table. If you also set either of those variables to a value other than their default of `ALL`, the server writes a message to the error log to indicate that their values are being overridden.

Startup <code>audit_log_policy</code> Value	Resulting <code>audit_log_connection_policy</code> Value	Resulting <code>audit_log_statement_policy</code> Value
<code>LOGINS</code>	<code>ALL</code>	<code>NONE</code>
<code>QUERIES</code>	<code>NONE</code>	<code>ALL</code>
<code>NONE</code>	<code>NONE</code>	<code>NONE</code>

### 6.4.5.11 Audit Log Reference

The following sections provide a reference to MySQL Enterprise Audit elements:

- [Audit Log Tables](#)
- [Audit Log Functions](#)
- [Audit Log Option and Variable Reference](#)
- [Audit Log Options and Variables](#)
- [Audit Log Status Variables](#)

To install the audit log tables and functions, use the instructions provided in [Section 6.4.5.2, “Installing or Uninstalling MySQL Enterprise Audit”](#). Unless those objects are installed, the `audit_log` plugin operates in legacy mode. See [Section 6.4.5.10, “Legacy Mode Audit Log Filtering”](#).

#### Audit Log Tables

MySQL Enterprise Audit uses tables in the `mysql` system database for persistent storage of filter and user account data. The tables can be accessed only by users who have privileges for that database. The tables use the `InnoDB` storage engine (`MyISAM` prior to MySQL 5.7.21).

If these tables are missing, the `audit_log` plugin operates in legacy mode. See [Section 6.4.5.10, “Legacy Mode Audit Log Filtering”](#).

The `audit_log_filter` table stores filter definitions. The table has these columns:

- `NAME`

The filter name.

- `FILTER`

The filter definition associated with the filter name. Definitions are stored as `JSON` values.

The `audit_log_user` table stores user account information. The table has these columns:

- `USER`

The user name part of an account. For an account `user1@localhost`, the `USER` part is `user1`.

- `HOST`

The host name part of an account. For an account `user1@localhost`, the `HOST` part is `localhost`.

- `FILTERNAME`

The name of the filter assigned to the account. The filter name associates the account with a filter defined in the `audit_log_filter` table.

## Audit Log Functions

This section describes, for each audit log function, its purpose, calling sequence, and return value. For information about the conditions under which these functions can be invoked, see [Section 6.4.5.7, “Audit Log Filtering”](#).

Each audit log function returns a string that indicates whether the operation succeeded. `OK` indicates success. `ERROR: message` indicates failure.

Audit log functions treat string arguments as binary strings (which means they do not distinguish lettercase), and string return values are binary strings.

If an audit log function is invoked from within the `mysql` client, binary string results display using hexadecimal notation, depending on the value of the `--binary-as-hex`. For more information about that option, see [Section 4.5.1, “mysql — The MySQL Command-Line Client”](#).

These audit log functions are available:

- `audit_log_encryption_password_get()`

Retrieves the current audit log encryption password as a binary string. The password is fetched from the MySQL keyring, which must be enabled or an error occurs. Any keyring plugin can be used; for instructions, see [Section 6.4.4, “The MySQL Keyring”](#).

For additional information about audit log encryption, see [Encrypting Audit Log Files](#).

Arguments:

None.

Return value:

The password string for success (up to 766 bytes), or `NULL` and an error for failure.

Example:

```
mysql> SELECT audit_log_encryption_password_get();
+-----+
| audit_log_encryption_password_get() |
```

```
+-----+
| secret |
+-----+
```

- `audit_log_encryption_password_set(password)`

Sets the audit log encryption password to the argument, stores the password in the MySQL keyring. If encryption is enabled, the function performs a log file rotation operation that renames the current log file, and begins a new log file encrypted with the password. The keyring must be enabled or an error occurs. Any keyring plugin can be used; for instructions, see [Section 6.4.4, “The MySQL Keyring”](#).

For additional information about audit log encryption, see [Encrypting Audit Log Files](#).

Arguments:

*password*: The password string. The maximum permitted length is 766 bytes.

Return value:

1 for success, 0 for failure.

Example:

```
mysql> SELECT audit_log_encryption_password_set(password);
+-----+
| audit_log_encryption_password_set(password) |
+-----+
| 1 |
+-----+
```

- `audit_log_filter_flush()`

Calling any of the other filtering functions affects operational audit log filtering immediately and updates the audit log tables. If instead you modify the contents of those tables directly using statements such as [INSERT](#), [UPDATE](#), and [DELETE](#), the changes do not affect filtering immediately. To flush your changes and make them operational, call `audit_log_filter_flush()`.



### Warning

`audit_log_filter_flush()` should be used only after modifying the audit tables directly, to force reloading all filters. Otherwise, this function should be avoided. It is, in effect, a simplified version of unloading and reloading the `audit_log` plugin with `UNINSTALL PLUGIN` plus `INSTALL PLUGIN`.

`audit_log_filter_flush()` affects all current sessions and detaches them from their previous filters. Current sessions are no longer logged unless they disconnect and reconnect, or execute a change-user operation.

If this function fails, an error message is returned and the audit log is disabled until the next successful call to `audit_log_filter_flush()`.

Arguments:

None.

Return value:

A string that indicates whether the operation succeeded. `OK` indicates success. `ERROR: message` indicates failure.

Example:

```
mysql> SELECT audit_log_filter_flush();
+-----+
| audit_log_filter_flush() |
+-----+
| OK                        |
+-----+
```

- `audit_log_filter_remove_filter(filter_name)`

Given a filter name, removes the filter from the current set of filters. It is not an error for the filter not to exist.

If a removed filter is assigned to any user accounts, those users stop being filtered (they are removed from the `audit_log_user` table). Termination of filtering includes any current sessions for those users: They are detached from the filter and no longer logged.

Arguments:

- `filter_name`: A string that specifies the filter name.

Return value:

A string that indicates whether the operation succeeded. `OK` indicates success. `ERROR: message` indicates failure.

Example:

```
mysql> SELECT audit_log_filter_remove_filter('SomeFilter');
+-----+
| audit_log_filter_remove_filter('SomeFilter') |
+-----+
| OK                                            |
+-----+
```

- `audit_log_filter_remove_user(user_name)`

Given a user account name, cause the user to be no longer assigned to a filter. It is not an error if the user has no filter assigned. Filtering of current sessions for the user remains unaffected. New connections for the user are filtered using the default account filter if there is one, and are not logged otherwise.

If the name is `%`, the function removes the default account filter that is used for any user account that has no explicitly assigned filter.

Arguments:

- `user_name`: The user account name as a string in `user_name@host_name` format, or `%` to represent the default account.

Return value:

A string that indicates whether the operation succeeded. `OK` indicates success. `ERROR: message` indicates failure.

Example:

```
mysql> SELECT audit_log_filter_remove_user('user1@localhost');
```

```

+-----+
| audit_log_filter_remove_user('user1@localhost') |
+-----+
| OK |
+-----+

```

- `audit_log_filter_set_filter(filter_name, definition)`

Given a filter name and definition, adds the filter to the current set of filters. If the filter already exists and is used by any current sessions, those sessions are detached from the filter and are no longer logged. This occurs because the new filter definition has a new filter ID that differs from its previous ID.

Arguments:

- `filter_name`: A string that specifies the filter name.
- `definition`: A `JSON` value that specifies the filter definition.

Return value:

A string that indicates whether the operation succeeded. `OK` indicates success. `ERROR: message` indicates failure.

Example:

```

mysql> SET @f = '{ "filter": { "log": false } }';
mysql> SELECT audit_log_filter_set_filter('SomeFilter', @f);
+-----+
| audit_log_filter_set_filter('SomeFilter', @f) |
+-----+
| OK |
+-----+

```

- `audit_log_filter_set_user(user_name, filter_name)`

Given a user account name and a filter name, assigns the filter to the user. A user can be assigned only one filter, so if the user was already assigned a filter, the assignment is replaced. Filtering of current sessions for the user remains unaffected. New connections are filtered using the new filter.

As a special case, the name `%` represents the default account. The filter is used for connections from any user account that has no explicitly assigned filter.

Arguments:

- `user_name`: The user account name as a string in `user_name@host_name` format, or `%` to represent the default account.
- `filter_name`: A string that specifies the filter name.

Return value:

A string that indicates whether the operation succeeded. `OK` indicates success. `ERROR: message` indicates failure.

Example:

```

mysql> SELECT audit_log_filter_set_user('user1@localhost', 'SomeFilter');
+-----+
| audit_log_filter_set_user('user1@localhost', 'SomeFilter') |
+-----+

```

```
| OK |
+-----+
```

- `audit_log_read([arg])`

Reads the audit log and returns a binary `JSON` string result. If the audit log format is not `JSON`, an error occurs.

With no argument or a `JSON` hash argument, `audit_log_read()` reads events from the audit log and returns a `JSON` string containing an array of audit events. Items in the hash argument influence how reading occurs, as described later. Each element in the returned array is an event represented as a `JSON` hash, with the exception that the last element may be a `JSON null` value to indicate no following events are available to read.

With an argument consisting of a `JSON null` value, `audit_log_read()` closes the current read sequence.

For additional details about the audit log-reading process, see [Section 6.4.5.6, “Reading Audit Log Files”](#).

Arguments:

`arg`: The argument is optional. If omitted, the function reads events from the current position. If present, the argument can be a `JSON null` value to close the read sequence, or a `JSON` hash. Within a hash argument, items are optional and control aspects of the read operation such as the position at which to begin reading or how many events to read. The following items are significant (other items are ignored):

- `timestamp`, `id`: The position within the audit log of the first event to read. If the position is omitted from the argument, reading continues from the current position. The `timestamp` and `id` items together comprise a bookmark that uniquely identify a particular event. If an `audit_log_read()` argument includes either item, it must include both to completely specify a position or an error occurs.

To obtain a bookmark for the most recently written event, call `audit_log_read_bookmark()`.

- `max_array_length`: The maximum number of events to read from the log. If this item is omitted, the default is to read to the end of the log or until the read buffer is full, whichever comes first.

Return value:

If the call succeeds, the return value is a binary `JSON` string containing an array of audit events, or a `JSON null` value if that was passed as the argument to close the read sequence. If the call fails, the return value is `NULL` and an error occurs.

Example:

```
mysql> SELECT audit_log_read(audit_log_read_bookmark());
+-----+
| audit_log_read(audit_log_read_bookmark()) |
+-----+
| [ {"timestamp":"2020-05-18 22:41:24","id":0,"class":"connection", ... |
+-----+
mysql> SELECT audit_log_read('null');
+-----+
| audit_log_read('null') |
+-----+
| null |
+-----+
```

- `audit_log_read_bookmark()`

Returns a binary `JSON` string representing a bookmark for the most recently written audit log event. If the audit log format is not `JSON`, an error occurs.

The bookmark is a `JSON` hash with `timestamp` and `id` items that uniquely identify the position of an event within the audit log. It is suitable for passing to `audit_log_read()` to indicate to that function the position at which to begin reading.

For additional details about the audit log-reading process, see [Section 6.4.5.6, “Reading Audit Log Files”](#).

Arguments:

None.

Return value:

A binary `JSON` string containing a bookmark for success, or `NULL` and an error for failure.

Example:

```
mysql> SELECT audit_log_read_bookmark();
+-----+
| audit_log_read_bookmark() |
+-----+
| { "timestamp": "2019-10-03 21:03:44", "id": 0 } |
+-----+
```

## Audit Log Option and Variable Reference

**Table 6.34 Audit Log Option and Variable Reference**

Name	Cmd-Line	Option File	System Var	Status Var	Var Scope	Dynamic
<a href="#">audit-log</a>	Yes	Yes				
<a href="#">audit_log_buffer_size</a>	Yes	Yes	Yes		Global	No
<a href="#">audit_log_compression</a>	Yes	Yes	Yes		Global	No
<a href="#">audit_log_connection_policy</a>	Yes	Yes	Yes		Global	Yes
<a href="#">audit_log_current_session</a>			Yes		Both	No
<a href="#">Audit_log_current_size</a>				Yes	Global	No
<a href="#">audit_log_disable</a>	Yes	Yes	Yes		Global	Yes
<a href="#">audit_log_encrypt</a>	Yes	Yes	Yes		Global	No
<a href="#">Audit_log_event_max_drop_size</a>				Yes	Global	No
<a href="#">Audit_log_events</a>				Yes	Global	No
<a href="#">Audit_log_events_filtered</a>				Yes	Global	No
<a href="#">Audit_log_events_lost</a>				Yes	Global	No
<a href="#">Audit_log_events_written</a>				Yes	Global	No
<a href="#">audit_log_exclude_accounts</a>	Yes	Yes	Yes		Global	Yes
<a href="#">audit_log_file</a>	Yes	Yes	Yes		Global	No
<a href="#">audit_log_filter_id</a>			Yes		Both	No

Name	Cmd-Line	Option File	System Var	Status Var	Var Scope	Dynamic
<a href="#">audit_log_flush</a>			Yes		Global	Yes
<a href="#">audit_log_format</a>	Yes	Yes	Yes		Global	No
<a href="#">audit_log_include_accounts</a>	Yes	Yes	Yes		Global	Yes
<a href="#">audit_log_policy</a>	Yes	Yes	Yes		Global	No
<a href="#">audit_log_read_buffer_size</a>	Yes	Yes	Yes		Varies	Varies
<a href="#">audit_log_rotate_size</a>	Yes	Yes	Yes		Global	Yes
<a href="#">audit_log_statement_policy</a>	Yes	Yes	Yes		Global	Yes
<a href="#">audit_log_strategy</a>	Yes	Yes	Yes		Global	No
<a href="#">Audit_log_total_size</a>				Yes	Global	No
<a href="#">Audit_log_write_waits</a>				Yes	Global	No

## Audit Log Options and Variables

This section describes the command options and system variables that configure operation of MySQL Enterprise Audit. If values specified at startup time are incorrect, the `audit_log` plugin may fail to initialize properly and the server does not load it. In this case, the server may also produce error messages for other audit log settings because it does not recognize them.

To configure activation of the audit log plugin, use this option:

- `--audit-log[=value]`

Command-Line Format	<code>--audit-log[=value]</code>
Type	Enumeration
Default Value	ON
Valid Values	ON OFF FORCE FORCE_PLUS_PERMANENT

This option controls how the server loads the `audit_log` plugin at startup. It is available only if the plugin has been previously registered with `INSTALL PLUGIN` or is loaded with `--plugin-load` or `--plugin-load-add`. See [Section 6.4.5.2, “Installing or Uninstalling MySQL Enterprise Audit”](#).

The option value should be one of those available for plugin-loading options, as described in [Section 5.5.1, “Installing and Uninstalling Plugins”](#). For example, `--audit-log=FORCE_PLUS_PERMANENT` tells the server to load the plugin and prevent it from being removed while the server is running.

If the audit log plugin is enabled, it exposes several system variables that permit control over logging:

```
mysql> SHOW VARIABLES LIKE 'audit_log%';
+-----+-----+
| Variable_name | Value |
+-----+-----+
| audit_log_buffer_size | 1048576 |
| audit_log_compression | NONE |
| audit_log_connection_policy | ALL |
+-----+-----+
```



audit_log_current_session	OFF
audit_log_disable	OFF
audit_log_encryption	NONE
audit_log_exclude_accounts	
audit_log_file	audit.log
audit_log_filter_id	0
audit_log_flush	OFF
audit_log_format	NEW
audit_log_format_unix_timestamp	OFF
audit_log_include_accounts	
audit_log_policy	ALL
audit_log_read_buffer_size	32768
audit_log_rotate_on_size	0
audit_log_statement_policy	ALL
audit_log_strategy	ASYNCHRONOUS

You can set any of these variables at server startup, and some of them at runtime. Those that are available only for legacy mode audit log filtering are so noted.

- [audit\\_log\\_buffer\\_size](#)

Command-Line Format	<code>--audit-log-buffer-size=#</code>
System Variable	<code>audit_log_buffer_size</code>
Scope	Global
Dynamic	No
Type	Integer
Default Value	1048576
Minimum Value	4096
Maximum Value (64-bit platforms)	18446744073709547520
Maximum Value (32-bit platforms)	4294967295
Unit	bytes
Block Size	4096

When the audit log plugin writes events to the log asynchronously, it uses a buffer to store event contents prior to writing them. This variable controls the size of that buffer, in bytes. The server adjusts the value to a multiple of 4096. The plugin uses a single buffer, which it allocates when it initializes and removes when it terminates. The plugin allocates this buffer only if logging is asynchronous.

- [audit\\_log\\_compression](#)

Command-Line Format	<code>--audit-log-compression=value</code>
Introduced	5.7.21
System Variable	<code>audit_log_compression</code>
Scope	Global
Dynamic	No
Type	Enumeration
Default Value	NONE
Valid Values	NONE GZIP

The type of compression for the audit log file. Permitted values are `NONE` (no compression; the default) and `GZIP` (GNU Zip compression). For more information, see [Compressing Audit Log Files](#).

- `audit_log_connection_policy`

Command-Line Format	<code>--audit-log-connection-policy=value</code>
System Variable	<code>audit_log_connection_policy</code>
Scope	Global
Dynamic	Yes
Type	Enumeration
Default Value	<code>ALL</code>
Valid Values	<code>ALL</code> <code>ERRORS</code> <code>NONE</code>



#### Note

This variable applies only to legacy mode audit log filtering (see [Section 6.4.5.10, “Legacy Mode Audit Log Filtering”](#)).

The policy controlling how the audit log plugin writes connection events to its log file. The following table shows the permitted values.

Value	Description
<code>ALL</code>	Log all connection events
<code>ERRORS</code>	Log only failed connection events
<code>NONE</code>	Do not log connection events



#### Note

At server startup, any explicit value given for `audit_log_connection_policy` may be overridden if `audit_log_policy` is also specified, as described in [Section 6.4.5.5, “Configuring Audit Logging Characteristics”](#).

- `audit_log_current_session`

System Variable	<code>audit_log_current_session</code>
Scope	Global, Session
Dynamic	No
Type	Boolean
Default Value	<code>depends on filtering policy</code>

Whether audit logging is enabled for the current session. The session value of this variable is read only. It is set when the session begins based on the values of the `audit_log_include_accounts` and `audit_log_exclude_accounts` system variables. The audit log plugin uses the session value to determine whether to audit events for the session. (There is a global value, but the plugin does not use it.)

- `audit_log_disable`

Command-Line Format	<code>--audit-log-disable[={OFF ON}]</code>
Introduced	5.7.37
System Variable	<code>audit_log_disable</code>
Scope	Global
Dynamic	Yes
Type	Boolean
Default Value	<code>OFF</code>

Permits disabling audit logging for all connecting and connected sessions. Disabling audit logging requires the `SUPER` privilege. See [Section 6.4.5.9, “Disabling Audit Logging”](#).

- `audit_log_encryption`

Command-Line Format	<code>--audit-log-encryption=value</code>
Introduced	5.7.21
System Variable	<code>audit_log_encryption</code>
Scope	Global
Dynamic	No
Type	Enumeration
Default Value	<code>NONE</code>
Valid Values	<code>NONE</code> <code>AES</code>

The type of encryption for the audit log file. Permitted values are `NONE` (no encryption; the default) and `AES` (AES-256-CBC cipher encryption). For more information, see [Encrypting Audit Log Files](#).

- `audit_log_exclude_accounts`

Command-Line Format	<code>--audit-log-exclude-accounts=value</code>
System Variable	<code>audit_log_exclude_accounts</code>
Scope	Global
Dynamic	Yes
Type	String

Default Value	NULL
---------------	------

**Note**

This variable applies only to legacy mode audit log filtering (see [Section 6.4.5.10, “Legacy Mode Audit Log Filtering”](#)).

The accounts for which events should not be logged. The value should be `NULL` or a string containing a list of one or more comma-separated account names. For more information, see [Section 6.4.5.7, “Audit Log Filtering”](#).

Modifications to `audit_log_exclude_accounts` affect only connections created subsequent to the modification, not existing connections.

- `audit_log_file`

Command-Line Format	<code>--audit-log-file=file_name</code>
System Variable	<code>audit_log_file</code>
Scope	Global
Dynamic	No
Type	File name
Default Value	<code>audit.log</code>

The base name and suffix of the file to which the audit log plugin writes events. The default value is `audit.log`, regardless of logging format. To have the name suffix correspond to the format, set the name explicitly, choosing a different suffix (for example, `audit.xml` for XML format, `audit.json` for JSON format).

If the value of `audit_log_file` is a relative path name, the plugin interprets it relative to the data directory. If the value is a full path name, the plugin uses the value as is. A full path name may be useful if it is desirable to locate audit files on a separate file system or directory. For security reasons, write the audit log file to a directory accessible only to the MySQL server and to users with a legitimate reason to view the log.

For details about how the audit log plugin interprets the `audit_log_file` value and the rules for file renaming that occurs at plugin initialization and termination, see [Naming Conventions for Audit Log Files](#).

As of MySQL 5.7.21, the audit log plugin uses the directory containing the audit log file (determined from the `audit_log_file` value) as the location to search for readable audit log files. From these log files and the current file, the plugin constructs a list of the ones that are subject to use with the audit log bookmarking and reading functions. See [Section 6.4.5.6, “Reading Audit Log Files”](#).

- `audit_log_filter_id`

Introduced	5.7.13
System Variable	<code>audit_log_filter_id</code>
Scope	Global, Session
Dynamic	No
Type	Integer
Default Value	1
Minimum Value	0

Maximum Value	4294967295
---------------	------------

The session value of this variable indicates the internally maintained ID of the audit filter for the current session. A value of 0 means that the session has no filter assigned.

- `audit_log_flush`

System Variable	<code>audit_log_flush</code>
Scope	Global
Dynamic	Yes
Type	Boolean
Default Value	<code>OFF</code>

If `audit_log_rotate_on_size` is 0, automatic audit log file rotation is disabled and rotation occurs only when performed manually. In that case, enabling `audit_log_flush` by setting it to 1 or `ON` causes the audit log plugin to close and reopen its log file to flush it. (The variable value remains `OFF` so that you need not disable it explicitly before enabling it again to perform another flush.) For more information, see [Section 6.4.5.5, “Configuring Audit Logging Characteristics”](#).

- `audit_log_format`

Command-Line Format	<code>--audit-log-format=value</code>
System Variable	<code>audit_log_format</code>
Scope	Global
Dynamic	No
Type	Enumeration
Default Value	<code>NEW</code>
Valid Values (≥ 5.7.21)	<code>OLD</code> <code>NEW</code> <code>JSON</code>
Valid Values (≤ 5.7.20)	<code>OLD</code> <code>NEW</code>

The audit log file format. Permitted values are `OLD` (old-style XML), `NEW` (new-style XML; the default), and (as of MySQL 5.7.21) `JSON`. For details about each format, see [Section 6.4.5.4, “Audit Log File Formats”](#).



**Note**

For information about issues to consider when changing the log format, see [Selecting Audit Log File Format](#).

- `audit_log_format_unix_timestamp`

Command-Line Format	<code>--audit-log-format-unix-timestamp[={OFF ON}]</code>
Introduced	5.7.35

System Variable	<code>audit_log_format_unix_timestamp</code>
Scope	Global
Dynamic	Yes
Type	Boolean
Default Value	OFF

This variable applies only for JSON-format audit log output. When that is true, enabling this variable causes each log file record to include a `time` field. The field value is an integer that represents the UNIX timestamp value indicating the date and time when the audit event was generated.

Changing the value of this variable at runtime causes log file rotation so that, for a given JSON-format log file, all records in the file either do or do not include the `time` field.

- `audit_log_include_accounts`

Command-Line Format	<code>--audit-log-include-accounts=value</code>
System Variable	<code>audit_log_include_accounts</code>
Scope	Global
Dynamic	Yes
Type	String
Default Value	NULL



**Note**

This variable applies only to legacy mode audit log filtering (see [Section 6.4.5.10, “Legacy Mode Audit Log Filtering”](#)).

The accounts for which events should be logged. The value should be `NULL` or a string containing a list of one or more comma-separated account names. For more information, see [Section 6.4.5.7, “Audit Log Filtering”](#).

Modifications to `audit_log_include_accounts` affect only connections created subsequent to the modification, not existing connections.

- `audit_log_policy`

Command-Line Format	<code>--audit-log-policy=value</code>
System Variable	<code>audit_log_policy</code>
Scope	Global
Dynamic	No
Type	Enumeration
Default Value	ALL
Valid Values	ALL LOGINS QUERIES

NONE

**Note**

This variable applies only to legacy mode audit log filtering (see [Section 6.4.5.10](#), “Legacy Mode Audit Log Filtering”).

The policy controlling how the audit log plugin writes events to its log file. The following table shows the permitted values.

Value	Description
ALL	Log all events
LOGINS	Log only login events
QUERIES	Log only query events
NONE	Log nothing (disable the audit stream)

`audit_log_policy` can be set only at server startup. At runtime, it is a read-only variable. Two other system variables, `audit_log_connection_policy` and `audit_log_statement_policy`, provide finer control over logging policy and can be set either at startup or at runtime. If you use `audit_log_policy` at startup instead of the other two variables, the server uses its value to set those variables. For more information about the policy variables and their interaction, see [Section 6.4.5.5](#), “Configuring Audit Logging Characteristics”.

- `audit_log_read_buffer_size`

Command-Line Format	<code>--audit-log-read-buffer-size=#</code>
Introduced	5.7.21
System Variable	<code>audit_log_read_buffer_size</code>
Scope (≥ 5.7.23)	Global, Session
Scope (≤ 5.7.22)	Global
Dynamic (≥ 5.7.23)	Yes
Dynamic (≤ 5.7.22)	No
Type	Integer
Default Value (≥ 5.7.23)	32768
Default Value (≤ 5.7.22)	1048576
Minimum Value (≥ 5.7.23)	32768
Minimum Value (≤ 5.7.22)	1024
Maximum Value	4194304
Unit	bytes

The buffer size for reading from the audit log file, in bytes. The `audit_log_read()` function reads no more than this many bytes. Log file reading is supported only for JSON log format. For more information, see [Section 6.4.5.6](#), “Reading Audit Log Files”.

As of MySQL 5.7.23, this variable has a default of 32KB and can be set at runtime. Each client should set its session value of `audit_log_read_buffer_size` appropriately for its use of

`audit_log_read()`. Prior to MySQL 5.7.23, `audit_log_read_buffer_size` has a default of 1MB, affects all clients, and can be changed only at server startup.

- `audit_log_rotate_on_size`

Command-Line Format	<code>--audit-log-rotate-on-size=#</code>
System Variable	<code>audit_log_rotate_on_size</code>
Scope	Global
Dynamic	Yes
Type	Integer
Default Value	0
Minimum Value	0
Maximum Value	18446744073709551615
Unit	bytes
Block Size	4096

If `audit_log_rotate_on_size` is 0, the audit log plugin does not perform automatic size-based log file rotation. If rotation is to occur, you must perform it manually; see [Manual Audit Log File Rotation](#).

If `audit_log_rotate_on_size` is greater than 0, automatic size-based log file rotation occurs. Whenever a write to the log file causes its size to exceed the `audit_log_rotate_on_size` value, the audit log plugin renames the current log file and opens a new current log file using the original name.

If you set `audit_log_rotate_on_size` to a value that is not a multiple of 4096, it is truncated to the nearest multiple. In particular, setting it to a value less than 4096 sets it to 0 and no rotation occurs, except manually.

For more information about audit log file rotation, see [Space Management of Audit Log Files](#).

- `audit_log_statement_policy`

Command-Line Format	<code>--audit-log-statement-policy=value</code>
System Variable	<code>audit_log_statement_policy</code>
Scope	Global
Dynamic	Yes
Type	Enumeration
Default Value	ALL
Valid Values	ALL ERRORS NONE



#### Note

This variable applies only to legacy mode audit log filtering (see [Section 6.4.5.10, “Legacy Mode Audit Log Filtering”](#)).

The policy controlling how the audit log plugin writes statement events to its log file. The following table shows the permitted values.



Value	Description
<a href="#">ALL</a>	Log all statement events
<a href="#">ERRORS</a>	Log only failed statement events
<a href="#">NONE</a>	Do not log statement events

**Note**

At server startup, any explicit value given for `audit_log_statement_policy` may be overridden if `audit_log_policy` is also specified, as described in [Section 6.4.5.5, “Configuring Audit Logging Characteristics”](#).

- `audit_log_strategy`

Command-Line Format	<code>--audit-log-strategy=value</code>
System Variable	<code>audit_log_strategy</code>
Scope	Global
Dynamic	No
Type	Enumeration
Default Value	<code>ASYNCHRONOUS</code>
Valid Values	<code>ASYNCHRONOUS</code> <code>PERFORMANCE</code> <code>SEMISYNCHRONOUS</code> <code>SYNCHRONOUS</code>

The logging method used by the audit log plugin. These strategy values are permitted:

- `ASYNCHRONOUS`: Log asynchronously. Wait for space in the output buffer.
- `PERFORMANCE`: Log asynchronously. Drop requests for which there is insufficient space in the output buffer.
- `SEMISYNCHRONOUS`: Log synchronously. Permit caching by the operating system.
- `SYNCHRONOUS`: Log synchronously. Call `sync()` after each request.

## Audit Log Status Variables

If the audit log plugin is enabled, it exposes several status variables that provide operational information. These variables are available for legacy mode audit filtering and JSON mode audit filtering.

- `Audit_log_current_size`

The size of the current audit log file. The value increases when an event is written to the log and is reset to 0 when the log is rotated.

- `Audit_log_event_max_drop_size`

The size of the largest dropped event in performance logging mode. For a description of logging modes, see [Section 6.4.5.5, “Configuring Audit Logging Characteristics”](#).

- `Audit_log_events`

The number of events handled by the audit log plugin, whether or not they were written to the log based on filtering policy (see [Section 6.4.5.5, “Configuring Audit Logging Characteristics”](#)).

- `Audit_log_events_filtered`

The number of events handled by the audit log plugin that were filtered (not written to the log) based on filtering policy (see [Section 6.4.5.5, “Configuring Audit Logging Characteristics”](#)).

- `Audit_log_events_lost`

The number of events lost in performance logging mode because an event was larger than the available audit log buffer space. This value may be useful for assessing how to set `audit_log_buffer_size` to size the buffer for performance mode. For a description of logging modes, see [Section 6.4.5.5, “Configuring Audit Logging Characteristics”](#).

- `Audit_log_events_written`

The number of events written to the audit log.

- `Audit_log_total_size`

The total size of events written to all audit log files. Unlike `Audit_log_current_size`, the value of `Audit_log_total_size` increases even when the log is rotated.

- `Audit_log_write_waits`

The number of times an event had to wait for space in the audit log buffer in asynchronous logging mode. For a description of logging modes, see [Section 6.4.5.5, “Configuring Audit Logging Characteristics”](#).

### 6.4.5.12 Audit Log Restrictions

MySQL Enterprise Audit is subject to these general restrictions:

- Only SQL statements are logged. Changes made by no-SQL APIs, such as memcached, Node.JS, and the NDB API, are not logged.
- Only top-level statements are logged, not statements within stored programs such as triggers or stored procedures.
- Contents of files referenced by statements such as `LOAD DATA` are not logged.
- Prior to MySQL 5.7.21, MySQL Enterprise Audit uses `MyISAM` tables in the `mysql` system database. Group Replication does not support `MyISAM` tables. Consequently, MySQL Enterprise Audit and Group Replication cannot be used together.

**NDB Cluster.** It is possible to use MySQL Enterprise Audit with MySQL NDB Cluster, subject to the following conditions:

- All changes to be logged must be done using the SQL interface. Changes using no-SQL interfaces, such as those provided by the NDB API, memcached, or ClusterJ, are not logged.
- The plugin must be installed on each MySQL server that is used to execute SQL on the cluster.
- Audit plugin data must be aggregated amongst all MySQL servers used with the cluster. This aggregation is the responsibility of the application or user.

## 6.4.6 MySQL Enterprise Firewall

**Note**

MySQL Enterprise Firewall is an extension included in MySQL Enterprise Edition, a commercial product. To learn more about commercial products, see <https://www.mysql.com/products/>.

MySQL Enterprise Edition includes MySQL Enterprise Firewall, an application-level firewall that enables database administrators to permit or deny SQL statement execution based on matching against lists of accepted statement patterns. This helps harden MySQL Server against attacks such as SQL injection or attempts to exploit applications by using them outside of their legitimate query workload characteristics.

Each MySQL account registered with the firewall has its own statement allowlist, enabling protection to be tailored per account. For a given account, the firewall can operate in recording, protecting, or detecting mode, for training in the accepted statement patterns, active protection against unacceptable statements, or passive detection of unacceptable statements. The diagram illustrates how the firewall processes incoming statements in each mode.

Figure 6.1 MySQL Enterprise Firewall Operation

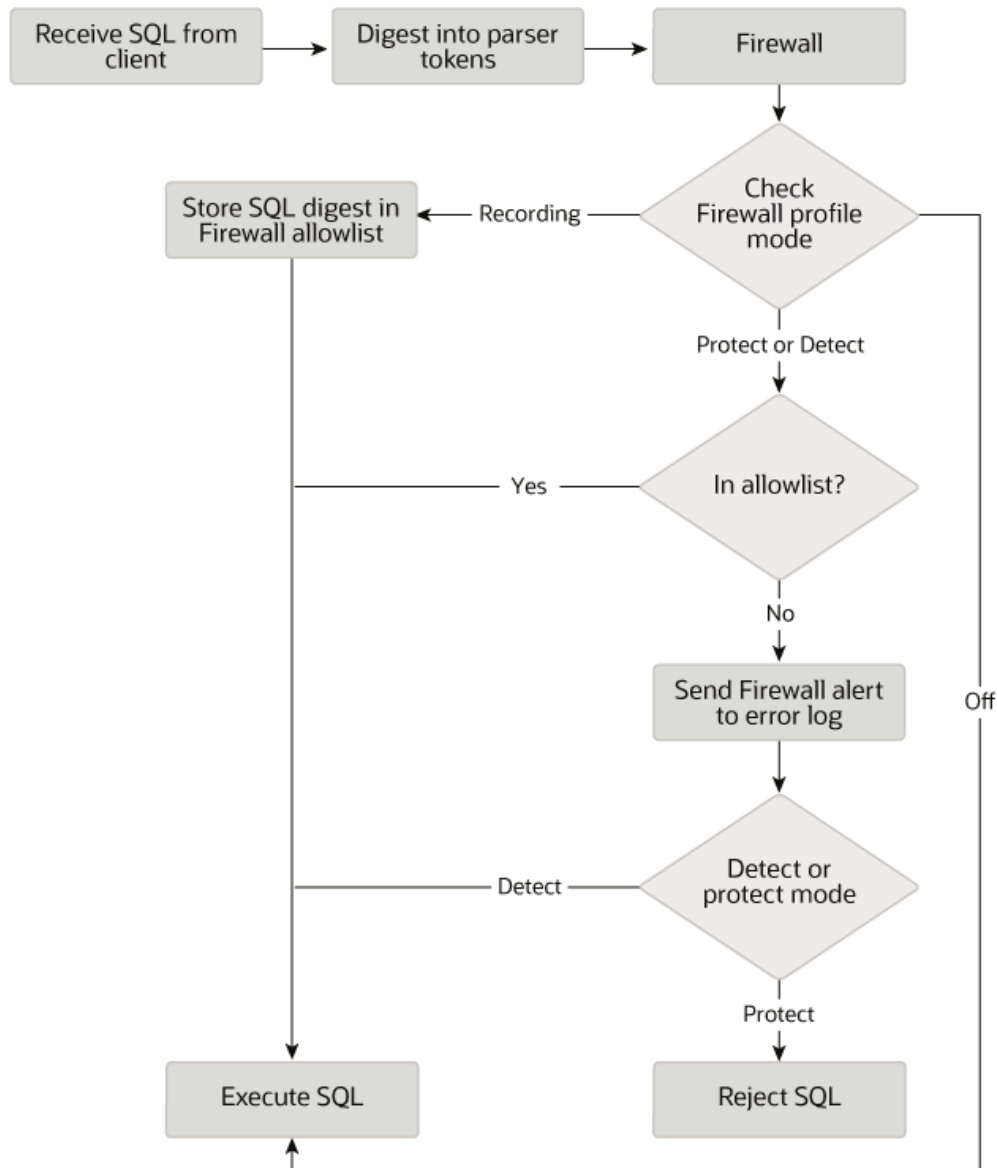

The following sections describe the elements of MySQL Enterprise Firewall, discuss how to install and use it, and provide reference information for its elements.

#### 6.4.6.1 Elements of MySQL Enterprise Firewall

MySQL Enterprise Firewall is based on a plugin library that includes these elements:

- A server-side plugin named `MYSQL_FIREWALL` examines SQL statements before they execute and, based on the registered firewall profiles, renders a decision whether to execute or reject each statement.
- Server-side plugins named `MYSQL_FIREWALL_USERS` and `MYSQL_FIREWALL_WHITELIST` implement `INFORMATION_SCHEMA` tables that provide views into the registered profiles.
- Profiles are cached in memory for better performance. Tables in the `mysql` system database provide persistent backing storage of firewall data.

- Stored procedures perform tasks such as registering firewall profiles, establishing their operational mode, and managing transfer of firewall data between the in-memory cache and persistent storage.
- Administrative functions provide an API for lower-level tasks such as synchronizing the cache with persistent storage.
- System variables enable firewall configuration and status variables provide runtime operational information.

### 6.4.6.2 Installing or Uninstalling MySQL Enterprise Firewall

MySQL Enterprise Firewall installation is a one-time operation that installs the elements described in [Section 6.4.6.1, “Elements of MySQL Enterprise Firewall”](#). Installation can be performed using a graphical interface or manually:

- On Windows, MySQL Installer includes an option to enable MySQL Enterprise Firewall for you.
- MySQL Workbench 6.3.4 or higher can install MySQL Enterprise Firewall, enable or disable an installed firewall, or uninstall the firewall.
- Manual MySQL Enterprise Firewall installation involves running a script located in the `share` directory of your MySQL installation.



#### Important

Read this entire section before following its instructions. Parts of the procedure differ depending on your environment.



#### Note

If installed, MySQL Enterprise Firewall involves some minimal overhead even when disabled. To avoid this overhead, do not install the firewall unless you plan to use it.



#### Note

MySQL Enterprise Firewall does not work together with the query cache. If the query cache is enabled, disable it before installing the firewall (see [Section 8.10.3.3, “Query Cache Configuration”](#)).

For usage instructions, see [Section 6.4.6.3, “Using MySQL Enterprise Firewall”](#). For reference information, see [Section 6.4.6.4, “MySQL Enterprise Firewall Reference”](#).

- [Installing MySQL Enterprise Firewall](#)
- [Uninstalling MySQL Enterprise Firewall](#)

### Installing MySQL Enterprise Firewall

If MySQL Enterprise Firewall is already installed from an older version of MySQL, uninstall it using the instructions given later in this section and then restart your server before installing the current version. In this case, it is also necessary to register your configuration again.

On Windows, you can use MySQL Installer to install MySQL Enterprise Firewall, as shown in [Figure 6.2, “MySQL Enterprise Firewall Installation on Windows”](#). Check the **Enable MySQL Enterprise Firewall** check box. (**Open Firewall port for network access** has a different purpose. It refers to Windows Firewall and controls whether Windows blocks the TCP/IP port on which the MySQL server listens for client connections.)

Figure 6.2 MySQL Enterprise Firewall Installation on Windows

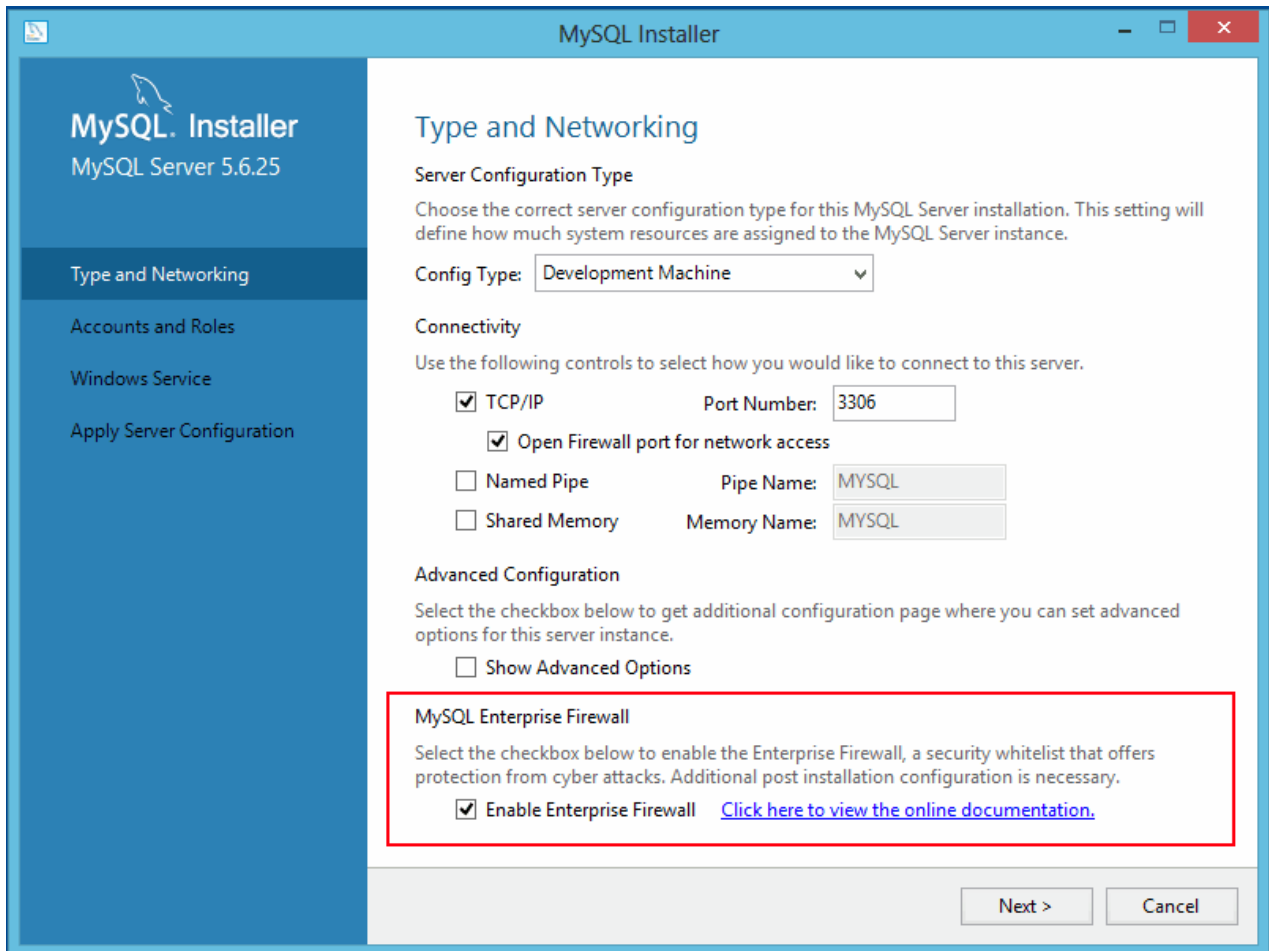

To install MySQL Enterprise Firewall using MySQL Workbench 6.3.4 or higher, see [MySQL Enterprise Firewall Interface](#).

To install MySQL Enterprise Firewall manually, look in the `share` directory of your MySQL installation and choose the script that is appropriate for your platform. The available scripts differ in the suffix used to refer to the plugin library file:

- `win_install_firewall.sql`: Choose this script for Windows systems that use `.dll` as the file name suffix.
- `linux_install_firewall.sql`: Choose this script for Linux and similar systems that use `.so` as the file name suffix.

The installation script creates stored procedures in the default database, `mysql`. Run the script as follows on the command line. The example here uses the Linux installation script. Make the appropriate substitutions for your system.

```
$> mysql -u root -p < linux_install_firewall.sql
Enter password: (enter root password here)
```



#### Note

As of MySQL 5.7.21, for a new installation of MySQL Enterprise Firewall, `InnoDB` is used instead of `MyISAM` for the firewall tables. For upgrades to 5.7.21 or higher

of an installation for which MySQL Enterprise Firewall is already installed, it is recommended that you alter the firewall tables to use [InnoDB](#):

```
ALTER TABLE mysql.firewall_users ENGINE=InnoDB;
ALTER TABLE mysql.firewall_whitelist ENGINE=InnoDB;
```



### Note

To use MySQL Enterprise Firewall in the context of source/replica replication, Group Replication, or InnoDB Cluster, you must use MySQL 5.7.21 or higher, and ensure that the firewall tables use [InnoDB](#) as just described. Then you must prepare the replica nodes prior to running the installation script on the source node. This is necessary because the `INSTALL PLUGIN` statements in the script are not replicated.

1. On each replica node, extract the `INSTALL PLUGIN` statements from the installation script and execute them manually.
2. On the source node, run the installation script as described previously.

Installing MySQL Enterprise Firewall either using a graphical interface or manually should enable the firewall. To verify that, connect to the server and execute this statement:

```
mysql> SHOW GLOBAL VARIABLES LIKE 'mysql_firewall_mode';
+-----+-----+
| Variable_name | Value |
+-----+-----+
| mysql_firewall_mode | ON |
+-----+-----+
```

If the plugin fails to initialize, check the server error log for diagnostic messages.

## Uninstalling MySQL Enterprise Firewall

MySQL Enterprise Firewall can be uninstalled using MySQL Workbench or manually.

To uninstall MySQL Enterprise Firewall using MySQL Workbench 6.3.4 or higher, see [MySQL Enterprise Firewall Interface](#), in [Chapter 29, MySQL Workbench](#).

To uninstall MySQL Enterprise Firewall manually, execute the following statements. Statements use `IF EXISTS` because, depending on the previously installed firewall version, some objects might not exist.

```
DROP TABLE IF EXISTS mysql.firewall_users;
DROP TABLE IF EXISTS mysql.firewall_whitelist;

UNINSTALL PLUGIN MYSQL_FIREWALL;
UNINSTALL PLUGIN MYSQL_FIREWALL_USERS;
UNINSTALL PLUGIN MYSQL_FIREWALL_WHITELIST;

DROP FUNCTION IF EXISTS mysql_firewall_flush_status;
DROP FUNCTION IF EXISTS normalize_statement;
DROP FUNCTION IF EXISTS read_firewall_users;
DROP FUNCTION IF EXISTS read_firewall_whitelist;
DROP FUNCTION IF EXISTS set_firewall_mode;

DROP PROCEDURE IF EXISTS mysql.sp_reload_firewall_rules;
DROP PROCEDURE IF EXISTS mysql.sp_set_firewall_mode;
```

### 6.4.6.3 Using MySQL Enterprise Firewall

Before using MySQL Enterprise Firewall, install it according to the instructions provided in [Section 6.4.6.2, “Installing or Uninstalling MySQL Enterprise Firewall”](#). Also, MySQL Enterprise Firewall does not work

together with the query cache; disable the query cache if it is enabled (see [Section 8.10.3.3, “Query Cache Configuration”](#)).

This section describes how to configure MySQL Enterprise Firewall using SQL statements. Alternatively, MySQL Workbench 6.3.4 or higher provides a graphical interface for firewall control. See [MySQL Enterprise Firewall Interface](#).

- [Enabling or Disabling the Firewall](#)
- [Assigning Firewall Privileges](#)
- [Firewall Concepts](#)
- [Registering Firewall Account Profiles](#)
- [Monitoring the Firewall](#)

## Enabling or Disabling the Firewall

To enable or disable the firewall, set the `mysql_firewall_mode` system variable. By default, this variable is enabled when the firewall is installed. To control the initial firewall state explicitly, you can set the variable at server startup. For example, to enable the firewall in an option file, use these lines:

```
[mysqld]
mysql_firewall_mode=ON
```

After modifying `my.cnf`, restart the server to cause the new setting to take effect.

It is also possible to disable or enable the firewall at runtime:

```
SET GLOBAL mysql_firewall_mode = OFF;
SET GLOBAL mysql_firewall_mode = ON;
```

## Assigning Firewall Privileges

With the firewall installed, grant the appropriate privileges to the MySQL account or accounts to be used for administering it:

- Grant the `EXECUTE` privilege for the firewall stored procedures in the `mysql` system database. These may invoke administrative functions, so stored procedure access also requires the privileges needed for those functions.
- Grant the `SUPER` privilege so that the firewall administrative functions can be executed.

## Firewall Concepts

The MySQL server permits clients to connect and receives from them SQL statements to be executed. If the firewall is enabled, the server passes to it each incoming statement that does not immediately fail with a syntax error. Based on whether the firewall accepts the statement, the server executes it or returns an error to the client. This section describes how the firewall accomplishes the task of accepting or rejecting statements.

- [Firewall Profiles](#)
- [Firewall Statement Matching](#)
- [Profile Operational Modes](#)

## Firewall Profiles

The firewall uses a registry of profiles that determine whether to permit statement execution. Profiles have these attributes:



- An allowlist. The allowlist is the set of rules that defines which statements are acceptable to the profile.
- A current operational mode. The mode enables the profile to be used in different ways. For example: the profile can be placed in training mode to establish the allowlist; the allowlist can be used for restricting statement execution or intrusion detection; the profile can be disabled entirely.
- A scope of applicability. The scope indicates which client connections the profile applies to.

The firewall supports account-based profiles such that each profile matches a particular client account (client user name and host name combination). For example, you can register one account profile for which the allowlist applies to connections originating from `admin@localhost` and another account profile for which the allowlist applies to connections originating from `myapp@apphost.example.com`.

Initially, no profiles exist, so by default, the firewall accepts all statements and has no effect on which statements MySQL accounts can execute. To apply firewall protective capabilities, explicit action is required:

- Register one or more profiles with the firewall.
- Train the firewall by establishing the allowlist for each profile; that is, the types of statements the profile permits clients to execute.
- Place the trained profiles in protecting mode to harden MySQL against unauthorized statement execution:
  - MySQL associates each client session with a specific user name and host name combination. This combination is the *session account*.
  - For each client connection, the firewall uses the session account to determine which profile applies to handling incoming statements from the client.

The firewall accepts only statements permitted by the applicable profile allowlist.

The profile-based protection afforded by the firewall enables implementation of strategies such as these:

- If an application has unique protection requirements, configure it to use an account not used for any other purpose and set up a profile for that account.
- If related applications share protection requirements, configure them all to use the same account (and thus the same account profile).

## Firewall Statement Matching

Statement matching performed by the firewall does not use SQL statements as received from clients. Instead, the server converts incoming statements to normalized digest form and firewall operation uses these digests. The benefit of statement normalization is that it enables similar statements to be grouped and recognized using a single pattern. For example, these statements are distinct from each other:

```
SELECT first_name, last_name FROM customer WHERE customer_id = 1;
select first_name, last_name from customer where customer_id = 99;
SELECT first_name, last_name FROM customer WHERE customer_id = 143;
```

But all of them have the same normalized digest form:

```
SELECT `first_name`, `last_name` FROM `customer` WHERE `customer_id` = ?
```

By using normalization, firewall allowlists can store digests that each match many different statements received from clients. For more information about normalization and digests, see [Section 25.10, “Performance Schema Statement Digests”](#).

**Warning**

Setting the `max_digest_length` system variable to zero disables digest production, which also disables server functionality that requires digests, such as MySQL Enterprise Firewall.

**Profile Operational Modes**

Each profile registered with the firewall has its own operational mode, chosen from these values:

- **OFF**: This mode disables the profile. The firewall considers it inactive and ignores it.
- **RECORDING**: This is the firewall training mode. Incoming statements received from a client that matches the profile are considered acceptable for the profile and become part of its “fingerprint.” The firewall records the normalized digest form of each statement to learn the acceptable statement patterns for the profile. Each pattern is a rule, and the union of the rules is the profile allowlist.
- **PROTECTING**: In this mode, the profile allows or prevents statement execution. The firewall matches incoming statements against the profile allowlist, accepting only statements that match and rejecting those that do not. After training a profile in **RECORDING** mode, switch it to **PROTECTING** mode to harden MySQL against access by statements that deviate from the allowlist. If the `mysql_firewall_trace` system variable is enabled, the firewall also writes rejected statements to the error log.
- **DETECTING**: This mode detects but does not block intrusions (statements that are suspicious because they match nothing in the profile allowlist). In **DETECTING** mode, the firewall writes suspicious statements to the error log but accepts them without denying access.

When a profile is assigned any of the preceding mode values, the firewall stores the mode in the profile. Firewall mode-setting operations also permit a mode value of **RESET**, but this value is not stored: setting a profile to **RESET** mode causes the firewall to delete all rules for the profile and set its mode to **OFF**.

**Note**

Messages written to the error log in **DETECTING** mode or because `mysql_firewall_trace` is enabled are written as Notes, which are information messages. To ensure that such messages appear in the error log and are not discarded, set the `log_error_verbosity` system variable to a value of 3.

As previously mentioned, MySQL associates each client session with a specific user name and host name combination known as the *session account*. The firewall matches the session account against registered profiles to determine which profile applies to handling incoming statements from the session:

- The firewall ignores inactive profiles (profiles with a mode of **OFF**).
- The session account matches an active account profile having the same user and host, if there is one. There is at most one such account profile.

After matching the session account to registered profiles, the firewall handles each incoming statement as follows:

- If there is no applicable profile, the firewall imposes no restrictions and accepts the statement.
- If there is an applicable profile, its mode determines statement handling:
  - In **RECORDING** mode, the firewall adds the statement to the profile allowlist rules and accepts it.
  - In **PROTECTING** mode, the firewall compares the statement to the rules in the profile allowlist. The firewall accepts the statement if there is a match, and rejects it otherwise. If the

`mysql_firewall_trace` system variable is enabled, the firewall also writes rejected statements to the error log.

- In `DETECTING` mode, the firewall detects intrusions without denying access. The firewall accepts the statement, but also matches it to the profile allowlist, as in `PROTECTING` mode. If the statement is suspicious (nonmatching), the firewall writes it to the error log.

## Registering Firewall Account Profiles

MySQL Enterprise Firewall enables profiles to be registered that correspond to individual accounts. To use a firewall account profile to protect MySQL against incoming statements from a given account, follow these steps:

1. Register the account profile and put it in `RECORDING` mode.
2. Connect to the MySQL server using the account and execute statements to be learned. This trains the account profile and establishes the rules that form the profile allowlist.
3. Switch the account profile to `PROTECTING` mode. When a client connects to the server using the account, the account profile allowlist restricts statement execution.
4. Should additional training be necessary, switch the account profile to `RECORDING` mode again, update its allowlist with new statement patterns, then switch it back to `PROTECTING` mode.

Observe these guidelines for firewall-related account references:

- Take note of the context in which account references occur. To name an account for firewall operations, specify it as a single quoted string (`'user_name@host_name'`). This differs from the usual MySQL convention for statements such as `CREATE USER` and `GRANT`, for which you quote the user and host parts of an account name separately (`'user_name'@'host_name'`).

The requirement for naming accounts as a single quoted string for firewall operations means that you cannot use accounts that have embedded `@` characters in the user name.

- The firewall assesses statements against accounts represented by actual user and host names as authenticated by the server. When registering accounts in profiles, do not use wildcard characters or netmasks:
  - Suppose that an account named `me@%.example.org` exists and a client uses it to connect to the server from the host `abc.example.org`.
  - The account name contains a `%` wildcard character, but the server authenticates the client as having a user name of `me` and host name of `abc.example.com`, and that is what the firewall sees.
  - Consequently, the account name to use for firewall operations is `me@abc.example.org` rather than `me@%.example.org`.

The following procedure shows how to register an account profile with the firewall, train the firewall to know the acceptable statements for that profile (its allowlist), and use the profile to protect MySQL against execution of unacceptable statements by the account. The example account, `fwuser@localhost`, is presumed for use by an application that accesses tables in the `sakila` database (available at <https://dev.mysql.com/doc/index-other.html>).

Use an administrative MySQL account to perform the steps in this procedure, except those steps designated for execution by the `fwuser@localhost` account that corresponds to the account profile registered with the firewall. For statements executed using this account, the default database should be `sakila`. (You can use a different database by adjusting the instructions accordingly.)

1. If necessary, create the account to use for executing statements (choose an appropriate password) and grant it privileges for the `sakila` database:

```
CREATE USER 'fwuser'@'localhost' IDENTIFIED BY 'password';
GRANT ALL ON sakila.* TO 'fwuser'@'localhost';
```

2. Use the `sp_set_firewall_mode()` stored procedure to register the account profile with the firewall and place the profile in `RECORDING` (training) mode:

```
CALL mysql.sp_set_firewall_mode('fwuser@localhost', 'RECORDING');
```

3. To train the registered account profile, connect to the server as `fwuser` from the server host so that the firewall sees a session account of `fwuser@localhost`. Then use the account to execute some statements to be considered legitimate for the profile. For example:

```
SELECT first_name, last_name FROM customer WHERE customer_id = 1;
UPDATE rental SET return_date = NOW() WHERE rental_id = 1;
SELECT get_customer_balance(1, NOW());
```

Because the profile is in `RECORDING` mode, the firewall records the normalized digest form of the statements as rules in the profile allowlist.



#### Note

Until the `fwuser@localhost` account profile receives statements in `RECORDING` mode, its allowlist is empty, which is equivalent to “deny all.” No statement can match an empty allowlist, which has these implications:

- The account profile cannot be switched to `PROTECTING` mode. It would reject every statement, effectively prohibiting the account from executing any statement.
- The account profile can be switched to `DETECTING` mode. In this case, the profile accepts every statement but logs it as suspicious.

4. At this point, the account profile information is cached. To see this information, query the `INFORMATION_SCHEMA` firewall tables:

```
mysql> SELECT MODE FROM INFORMATION_SCHEMA.MYSQL_FIREWALL_USERS
      WHERE USERHOST = 'fwuser@localhost';
+-----+
| MODE |
+-----+
| RECORDING |
+-----+
mysql> SELECT RULE FROM INFORMATION_SCHEMA.MYSQL_FIREWALL_WHITELIST
      WHERE USERHOST = 'fwuser@localhost';
+-----+
| RULE |
+-----+
| SELECT `first_name` , `last_name` FROM `customer` WHERE `customer_id` = ? |
| SELECT `get_customer_balance` ( ? , NOW ( ) ) |
| UPDATE `rental` SET `return_date` = NOW ( ) WHERE `rental_id` = ? |
| SELECT @@`version_comment` LIMIT ? |
+-----+
```

**Note**

The `@@version_comment` rule comes from a statement sent automatically by the `mysql` client when you connect to the server.

**Important**

Train the firewall under conditions matching application use. For example, to determine server characteristics and capabilities, a given MySQL connector might send statements to the server at the beginning of each session. If an application normally is used through that connector, train the firewall using the connector, too. That enables those initial statements to become part of the allowlist for the account profile associated with the application.

- Invoke `sp_set_firewall_mode()` again, this time switching the account profile to `PROTECTING` mode:

```
CALL mysql.sp_set_firewall_mode('fwuser@localhost', 'PROTECTING');
```

**Important**

Switching the account profile out of `RECORDING` mode synchronizes its cached data to the `mysql` system database tables that provide persistent underlying storage. If you do not switch the mode for a profile that is being recorded, the cached data is not written to persistent storage and is lost when the server is restarted.

- Test the account profile by using the account to execute some acceptable and unacceptable statements. The firewall matches each statement from the account against the profile allowlist and accepts or rejects it:
  - This statement is not identical to a training statement but produces the same normalized statement as one of them, so the firewall accepts it:

```
mysql> SELECT first_name, last_name FROM customer WHERE customer_id = '48';
+-----+-----+
| first_name | last_name |
+-----+-----+
| ANN       | EVANS    |
+-----+-----+
```

- These statements match nothing in the allowlist, so the firewall rejects each with an error:

```
mysql> SELECT first_name, last_name FROM customer WHERE customer_id = 1 OR TRUE;
ERROR 1045 (28000): Statement was blocked by Firewall
mysql> SHOW TABLES LIKE 'customer%';
ERROR 1045 (28000): Statement was blocked by Firewall
mysql> TRUNCATE TABLE mysql.slow_log;
ERROR 1045 (28000): Statement was blocked by Firewall
```

- If the `mysql_firewall_trace` system variable is enabled, the firewall also writes rejected statements to the error log. For example:

```
[Note] Plugin MYSQL_FIREWALL reported:
'ACCESS DENIED for fwuser@localhost. Reason: No match in whitelist.
Statement: TRUNCATE TABLE `mysql` . `slow_log` '
```

These log messages may be helpful in identifying the source of attacks, should that be necessary.

The firewall account profile now is trained for the `fwuser@localhost` account. When clients connect using that account and attempt to execute statements, the profile protects MySQL against statements not matched by the profile allowlist.

It is possible to detect intrusions by logging nonmatching statements as suspicious without denying access. First, put the account profile in `DETECTING` mode:

```
CALL mysql.sp_set_firewall_mode('fwuser@localhost', 'DETECTING');
```

Then, using the account, execute a statement that does not match the account profile allowlist. In `DETECTING` mode, the firewall permits the nonmatching statement to execute:

```
mysql> SHOW TABLES LIKE 'customer%';
+-----+
| Tables_in_sakila (customer%) |
+-----+
| customer                      |
| customer_list                 |
+-----+
```

In addition, the firewall writes a message to the error log:

```
[Note] Plugin MYSQL_FIREWALL reported:
'SUSPICIOUS STATEMENT from 'fwuser@localhost'. Reason: No match in whitelist.
Statement: SHOW TABLES LIKE ? '
```

To disable an account profile, change its mode to `OFF`:

```
CALL mysql.sp_set_firewall_mode(user, 'OFF');
```

To forget all training for a profile and disable it, reset it:

```
CALL mysql.sp_set_firewall_mode(user, 'RESET');
```

The reset operation causes the firewall to delete all rules for the profile and set its mode to `OFF`.

## Monitoring the Firewall

To assess firewall activity, examine its status variables. For example, after performing the procedure shown earlier to train and protect the `fwuser@localhost` account, the variables look like this:

```
mysql> SHOW GLOBAL STATUS LIKE 'Firewall%';
+-----+
| Variable_name          | Value |
+-----+
| Firewall_access_denied | 3     |
| Firewall_access_granted | 4     |
| Firewall_access_suspicious | 1     |
| Firewall_cached_entries | 4     |
+-----+
```

The variables indicate the number of statements rejected, accepted, logged as suspicious, and added to the cache, respectively. The `Firewall_access_granted` count is 4 because of the `@@version_comment` statement sent by the `mysql` client each of the three times you connected using the registered account, plus the `SHOW TABLES` statement that was not blocked in `DETECTING` mode.

### 6.4.6.4 MySQL Enterprise Firewall Reference

The following sections provide a reference to MySQL Enterprise Firewall elements:

- [MySQL Enterprise Firewall Tables](#)
- [MySQL Enterprise Firewall Stored Procedures](#)

- [MySQL Enterprise Firewall Administrative Functions](#)
- [MySQL Enterprise Firewall System Variables](#)
- [MySQL Enterprise Firewall Status Variables](#)

## MySQL Enterprise Firewall Tables

MySQL Enterprise Firewall maintains profile information on a per-group and per-account basis, using tables in the firewall database for persistent storage and Information Schema tables to provide views into in-memory cached data. When enabled, the firewall bases operational decisions on the cached data. The firewall database can be the `mysql` system database or a custom schema (see [Installing MySQL Enterprise Firewall](#)).

Tables in the firewall database are covered in this section. For information about MySQL Enterprise Firewall Information Schema tables, see [Section 24.7, “INFORMATION\\_SCHEMA MySQL Enterprise Firewall Tables”](#).

Each `mysql` system database table is accessible only by accounts that have the `SELECT` privilege for it. The `INFORMATION_SCHEMA` tables are accessible by anyone.

The `mysql.firewall_users` table lists names and operational modes of registered firewall account profiles. The table has the following columns (with the corresponding Information Schema `MYSQL_FIREWALL_USERS` table having similar but not necessarily identical columns):

- `USERHOST`

The account profile name. Each account name has the format `user_name@host_name`.

- `MODE`

The current operational mode for the profile. Permitted mode values are `OFF`, `DETECTING`, `PROTECTING`, `RECORDING`, and `RESET`. For details about their meanings, see [Firewall Concepts](#).

The `mysql.firewall_whitelist` table lists allowlist rules of registered firewall account profiles. The table has the following columns (with the corresponding Information Schema `MYSQL_FIREWALL_WHITELIST` table having similar but not necessarily identical columns):

- `USERHOST`

The account profile name. Each account name has the format `user_name@host_name`.

- `RULE`

A normalized statement indicating an acceptable statement pattern for the profile. A profile allowlist is the union of its rules.

- `ID`

An integer column that is a primary key for the table. This column was added in MySQL 5.7.23.

## MySQL Enterprise Firewall Stored Procedures

MySQL Enterprise Firewall stored procedures perform tasks such as registering profiles with the firewall, establishing their operational mode, and managing transfer of firewall data between the cache and persistent storage. These procedures invoke administrative functions that provide an API for lower-level tasks.

Firewall stored procedures are created in the `mysql` system database. To invoke a firewall stored procedure, either do so while `mysql` is the default database, or qualify the procedure name with the database name. For example:

```
CALL mysql.sp_set_firewall_mode(user, mode);
```

The following list describes each firewall stored procedure:

- `sp_reload_firewall_rules(user)`

This stored procedure provides control over firewall operation for individual account profiles. The procedure uses firewall administrative functions to reload the in-memory rules for an account profile from the rules stored in the `mysql.firewall_whitelist` table.

Arguments:

- *user*: The name of the affected account profile, as a string in `user_name@host_name` format.

Example:

```
CALL mysql.sp_reload_firewall_rules('fwuser@localhost');
```



### Warning

This procedure clears the account profile in-memory allowlist rules before reloading them from persistent storage, and sets the profile mode to `OFF`. If the profile mode was not `OFF` prior to the `sp_reload_firewall_rules()` call, use `sp_set_firewall_mode()` to restore its previous mode after reloading the rules. For example, if the profile was in `PROTECTING` mode, that is no longer true after calling `sp_reload_firewall_rules()` and you must set it to `PROTECTING` again explicitly.

- `sp_set_firewall_mode(user, mode)`

This stored procedure establishes the operational mode for a firewall account profile, after registering the profile with the firewall if it was not already registered. The procedure also invokes firewall administrative functions as necessary to transfer firewall data between the cache and persistent storage. This procedure may be called even if the `mysql_firewall_mode` system variable is `OFF`, although setting the mode for a profile has no operational effect until the firewall is enabled.

Arguments:

- *user*: The name of the affected account profile, as a string in `user_name@host_name` format.
- *mode*: The operational mode for the profile, as a string. Permitted mode values are `OFF`, `DETECTING`, `PROTECTING`, `RECORDING`, and `RESET`. For details about their meanings, see [Firewall Concepts](#).

Switching an account profile to any mode but `RECORDING` synchronizes its firewall cache data to the `mysql` system database tables that provide persistent underlying storage. Switching the mode from `OFF` to `RECORDING` reloads the allowlist from the `mysql.firewall_whitelist` table into the cache.

If an account profile has an empty allowlist, its mode cannot be set to `PROTECTING` because the profile would reject every statement, effectively prohibiting the account from executing statements. In response to such a mode-setting attempt, the firewall produces a diagnostic message that is returned as a result set rather than as an SQL error:

```
mysql> CALL mysql.sp_set_firewall_mode('a@b','PROTECTING');
```

```
+-----+
```



```

| set_firewall_mode(arg_userhost, arg_mode) |
+-----+-----+
| ERROR: PROTECTING mode requested for a@b but the whitelist is empty. |
+-----+-----+
1 row in set (0.02 sec)

Query OK, 0 rows affected (0.02 sec)

```

## MySQL Enterprise Firewall Administrative Functions

MySQL Enterprise Firewall administrative functions provide an API for lower-level tasks such as synchronizing the firewall cache with the underlying system tables.

*Under normal operation, these functions are invoked by the firewall stored procedures, not directly by users.* For that reason, these function descriptions do not include details such as information about their arguments and return types.

- [Firewall Account Profile Functions](#)
- [Firewall Miscellaneous Functions](#)

### Firewall Account Profile Functions

These functions perform management operations on firewall account profiles:

- `read_firewall_users(user, mode)`

This aggregate function updates the firewall account profile cache through a `SELECT` statement on the `mysql.firewall_users` table. It requires the `SUPER` privilege.

Example:

```

SELECT read_firewall_users('fwuser@localhost', 'RECORDING')
FROM mysql.firewall_users;

```

- `read_firewall_whitelist(user, rule)`

This aggregate function updates the recorded-statement cache for the named account profile through a `SELECT` statement on the `mysql.firewall_whitelist` table. It requires the `SUPER` privilege.

Example:

```

SELECT read_firewall_whitelist('fwuser@localhost', fw.rule)
FROM mysql.firewall_whitelist AS fw
WHERE USERHOST = 'fwuser@localhost';

```

- `set_firewall_mode(user, mode)`

This function manages the account profile cache and establishes the profile operational mode. It requires the `SUPER` privilege.

Example:

```

SELECT set_firewall_mode('fwuser@localhost', 'RECORDING');

```

### Firewall Miscellaneous Functions

These functions perform miscellaneous firewall operations:

- `mysql_firewall_flush_status()`

This function resets several firewall status variables to 0:

- `Firewall_access_denied`
- `Firewall_access_granted`
- `Firewall_access_suspicious`

This function requires the `SUPER` privilege.

Example:

```
SELECT mysql_firewall_flush_status();
```

- `normalize_statement(stmt)`

This function normalizes an SQL statement into the digest form used for allowlist rules. It requires the `SUPER` privilege.

Example:

```
SELECT normalize_statement('SELECT * FROM t1 WHERE c1 > 2');
```

## MySQL Enterprise Firewall System Variables

MySQL Enterprise Firewall supports the following system variables. Use them to configure firewall operation. These variables are unavailable unless the firewall is installed (see [Section 6.4.6.2, “Installing or Uninstalling MySQL Enterprise Firewall”](#)).

- `mysql_firewall_mode`

Command-Line Format	<code>--mysql-firewall-mode[={OFF ON}]</code>
System Variable	<code>mysql_firewall_mode</code>
Scope	Global
Dynamic	Yes
Type	Boolean
Default Value	ON

Whether MySQL Enterprise Firewall is enabled (the default) or disabled.

- `mysql_firewall_trace`

Command-Line Format	<code>--mysql-firewall-trace[={OFF ON}]</code>
System Variable	<code>mysql_firewall_trace</code>
Scope	Global
Dynamic	Yes
Type	Boolean
Default Value	OFF

Whether the MySQL Enterprise Firewall trace is enabled or disabled (the default). When `mysql_firewall_trace` is enabled, for `PROTECTING` mode, the firewall writes rejected statements to the error log.

## MySQL Enterprise Firewall Status Variables

MySQL Enterprise Firewall supports the following status variables. Use them to obtain information about firewall operational status. These variables are unavailable unless the firewall is installed (see [Section 6.4.6.2, “Installing or Uninstalling MySQL Enterprise Firewall”](#)). Firewall status variables are set to 0 whenever the `MYSQL_FIREWALL` plugin is installed or the server is started. Many of them are reset to zero by the `mysql_firewall_flush_status()` function (see [MySQL Enterprise Firewall Administrative Functions](#)).

- `Firewall_access_denied`

The number of statements rejected by MySQL Enterprise Firewall.

- `Firewall_access_granted`

The number of statements accepted by MySQL Enterprise Firewall.

- `Firewall_access_suspicious`

The number of statements logged by MySQL Enterprise Firewall as suspicious for users who are in `DETECTING` mode.

- `Firewall_cached_entries`

The number of statements recorded by MySQL Enterprise Firewall, including duplicates.

## 6.5 MySQL Enterprise Data Masking and De-Identification



### Note

MySQL Enterprise Data Masking and De-Identification is an extension included in MySQL Enterprise Edition, a commercial product. To learn more about commercial products, <https://www.mysql.com/products/>.

As of MySQL 5.7.24, MySQL Enterprise Edition provides data masking and de-identification capabilities:

- Transformation of existing data to mask it and remove identifying characteristics, such as changing all digits of a credit card number but the last four to 'X' characters.
- Generation of random data, such as email addresses and payment card numbers.

The way that applications use these capabilities depends on the purpose for which the data is used and who accesses it:

- Applications that use sensitive data may protect it by performing data masking and permitting use of partially masked data for client identification. Example: A call center may ask for clients to provide their last four Social Security number digits.
- Applications that require properly formatted data, but not necessarily the original data, can synthesize sample data. Example: An application developer who is testing data validators but has no access to original data may synthesize random data with the same format.

Example 1:

Medical research facilities can hold patient data that comprises a mix of personal and medical data. This may include genetic sequences (long strings), test results stored in JSON format, and other data types. Although the data may be used mostly by automated analysis software, access to genome data or test

results of particular patients is still possible. In such cases, data masking should be used to render this information not personally identifiable.

Example 2:

A credit card processor company provides a set of services using sensitive data, such as:

- Processing a large number of financial transactions per second.
- Storing a large amount of transaction-related data.
- Protecting transaction-related data with strict requirements for personal data.
- Handling client complaints about transactions using reversible or partially masked data.

A typical transaction may include many types of sensitive information, including:

- Credit card number.
- Transaction type and amount.
- Merchant type.
- Transaction cryptogram (to confirm transaction legitimacy).
- Geolocation of GPS-equipped terminal (for fraud detection).

Those types of information may then be joined within a bank or other card-issuing financial institution with client personal data, such as:

- Full client name (either person or company).
- Address.
- Date of birth.
- Social Security number.
- Email address.
- Phone number.

Various employee roles within both the card processing company and the financial institution require access to that data. Some of these roles may require access only to masked data. Other roles may require access to the original data on a case-to-case basis, which is recorded in audit logs.

Masking and de-identification are core to regulatory compliance, so MySQL Enterprise Data Masking and De-Identification can help application developers satisfy privacy requirements:

- PCI – DSS: Payment Card Data.
- HIPAA: Privacy of Health Data, Health Information Technology for Economic and Clinical Health Act (HITECH Act).
- EU General Data Protection Directive (GDPR): Protection of Personal Data.
- Data Protection Act (UK): Protection of Personal Data.
- Sarbanes Oxley, GLBA, The USA Patriot Act, Identity Theft and Assumption Deterrence Act of 1998.
- FERPA – Student Data, NASD, CA SB1386 and AB 1950, State Data Protection Laws, Basel II.

The following sections describe the elements of MySQL Enterprise Data Masking and De-Identification, discuss how to install and use it, and provide reference information for its elements.

## 6.5.1 MySQL Enterprise Data Masking and De-Identification Elements

MySQL Enterprise Data Masking and De-Identification is based on a plugin library that implements these elements:

- A server-side plugin named `data_masking`.
- A set of loadable functions provides an SQL-level API for performing masking and de-identification operations. Some of these functions require the `SUPER` privilege.

## 6.5.2 Installing or Uninstalling MySQL Enterprise Data Masking and De-Identification

This section describes how to install or uninstall MySQL Enterprise Data Masking and De-Identification, which is implemented as a plugin library file containing a plugin and several loadable functions. For general information about installing or uninstalling plugins and loadable functions, see [Section 5.5.1, “Installing and Uninstalling Plugins”](#), and [Section 5.6.1, “Installing and Uninstalling Loadable Functions”](#).

To be usable by the server, the plugin library file must be located in the MySQL plugin directory (the directory named by the `plugin_dir` system variable). If necessary, configure the plugin directory location by setting the value of `plugin_dir` at server startup.

The plugin library file base name is `data_masking`. The file name suffix differs per platform (for example, `.so` for Unix and Unix-like systems, `.dll` for Windows).

To install the MySQL Enterprise Data Masking and De-Identification plugin and functions, use the `INSTALL PLUGIN` and `CREATE FUNCTION` statements, adjusting the `.so` suffix for your platform as necessary:

```
INSTALL PLUGIN data_masking SONAME 'data_masking.so';
CREATE FUNCTION gen_blacklist RETURNS STRING
  SONAME 'data_masking.so';
CREATE FUNCTION gen_dictionary RETURNS STRING
  SONAME 'data_masking.so';
CREATE FUNCTION gen_dictionary_drop RETURNS STRING
  SONAME 'data_masking.so';
CREATE FUNCTION gen_dictionary_load RETURNS STRING
  SONAME 'data_masking.so';
CREATE FUNCTION gen_range RETURNS INTEGER
  SONAME 'data_masking.so';
CREATE FUNCTION gen_rnd_email RETURNS STRING
  SONAME 'data_masking.so';
CREATE FUNCTION gen_rnd_pan RETURNS STRING
  SONAME 'data_masking.so';
CREATE FUNCTION gen_rnd_ssn RETURNS STRING
  SONAME 'data_masking.so';
CREATE FUNCTION gen_rnd_us_phone RETURNS STRING
  SONAME 'data_masking.so';
CREATE FUNCTION mask_inner RETURNS STRING
  SONAME 'data_masking.so';
CREATE FUNCTION mask_outer RETURNS STRING
  SONAME 'data_masking.so';
CREATE FUNCTION mask_pan RETURNS STRING
  SONAME 'data_masking.so';
CREATE FUNCTION mask_pan_relaxed RETURNS STRING
  SONAME 'data_masking.so';
CREATE FUNCTION mask_ssn RETURNS STRING
  SONAME 'data_masking.so';
```

If the plugin and functions are used on a replication source server, install them on all replica servers as well to avoid replication issues.

Once installed as just described, the plugin and functions remain installed until uninstalled. To remove them, use the `UNINSTALL PLUGIN` and `DROP FUNCTION` statements:

```
UNINSTALL PLUGIN data_masking;
DROP FUNCTION gen_blacklist;
DROP FUNCTION gen_dictionary;
DROP FUNCTION gen_dictionary_drop;
DROP FUNCTION gen_dictionary_load;
DROP FUNCTION gen_range;
DROP FUNCTION gen_rnd_email;
DROP FUNCTION gen_rnd_pan;
DROP FUNCTION gen_rnd_ssn;
DROP FUNCTION gen_rnd_us_phone;
DROP FUNCTION mask_inner;
DROP FUNCTION mask_outer;
DROP FUNCTION mask_pan;
DROP FUNCTION mask_pan_relaxed;
DROP FUNCTION mask_ssn;
```

### 6.5.3 Using MySQL Enterprise Data Masking and De-Identification

Before using MySQL Enterprise Data Masking and De-Identification, install it according to the instructions provided at [Section 6.5.2, “Installing or Uninstalling MySQL Enterprise Data Masking and De-Identification”](#).

To use MySQL Enterprise Data Masking and De-Identification in applications, invoke the functions that are appropriate for the operations you wish to perform. For detailed function descriptions, see [Section 6.5.5, “MySQL Enterprise Data Masking and De-Identification Function Descriptions”](#). This section demonstrates how to use the functions to carry out some representative tasks. It first presents an overview of the available functions, followed by some examples of how the functions might be used in real-world context:

- [Masking Data to Remove Identifying Characteristics](#)
- [Generating Random Data with Specific Characteristics](#)
- [Generating Random Data Using Dictionaries](#)
- [Using Masked Data for Customer Identification](#)
- [Creating Views that Display Masked Data](#)

#### Masking Data to Remove Identifying Characteristics

MySQL provides general-purpose masking functions that mask arbitrary strings, and special-purpose masking functions that mask specific types of values.

#### General-Purpose Masking Functions

`mask_inner()` and `mask_outer()` are general-purpose functions that mask parts of arbitrary strings based on position within the string:

- `mask_inner()` masks the interior of its string argument, leaving the ends unmasked. Other arguments specify the sizes of the unmasked ends.

```
mysql> SELECT mask_inner('This is a string', 5, 1);
+-----+
| mask_inner('This is a string', 5, 1) |
```

```

+-----+
| This XXXXXXXXXXXg |
+-----+
mysql> SELECT mask_inner('This is a string', 1, 5);
+-----+
| mask_inner('This is a string', 1, 5) |
+-----+
| TXXXXXXXXXtring |
+-----+

```

- `mask_outer()` does the reverse, masking the ends of its string argument, leaving the interior unmasked. Other arguments specify the sizes of the masked ends.

```

mysql> SELECT mask_outer('This is a string', 5, 1);
+-----+
| mask_outer('This is a string', 5, 1) |
+-----+
| XXXXXis a strinX |
+-----+
mysql> SELECT mask_outer('This is a string', 1, 5);
+-----+
| mask_outer('This is a string', 1, 5) |
+-----+
| Xhis is a sXXXXX |
+-----+

```

By default, `mask_inner()` and `mask_outer()` use 'X' as the masking character, but permit an optional masking-character argument:

```

mysql> SELECT mask_inner('This is a string', 5, 1, '*');
+-----+
| mask_inner('This is a string', 5, 1, '*') |
+-----+
| This *****g |
+-----+
mysql> SELECT mask_outer('This is a string', 5, 1, '#');
+-----+
| mask_outer('This is a string', 5, 1, '#') |
+-----+
| #####is a strin# |
+-----+

```

## Special-Purpose Masking Functions

Other masking functions expect a string argument representing a specific type of value and mask it to remove identifying characteristics.



### Note

The examples here supply function arguments using the random value generation functions that return the appropriate type of value. For more information about generation functions, see [Generating Random Data with Specific Characteristics](#).

**Payment card Primary Account Number masking.** Masking functions provide strict and relaxed masking of Primary Account Numbers.

- `mask_pan()` masks all but the last four digits of the number:

```

mysql> SELECT mask_pan(gen_rnd_pan());
+-----+
| mask_pan(gen_rnd_pan()) |
+-----+
| XXXXXXXXXXXX2461 |
+-----+

```

- `mask_pan_relaxed()` is similar but does not mask the first six digits that indicate the payment card issuer unmasked:

```
mysql> SELECT mask_pan_relaxed(gen_rnd_pan());
+-----+
| mask_pan_relaxed(gen_rnd_pan()) |
+-----+
| 770630XXXXXX0807                |
+-----+
```

**US Social Security number masking.** `mask_ssn()` masks all but the last four digits of the number:

```
mysql> SELECT mask_ssn(gen_rnd_ssn());
+-----+
| mask_ssn(gen_rnd_ssn()) |
+-----+
| XXX-XX-1723             |
+-----+
```

## Generating Random Data with Specific Characteristics

Several functions generate random values. These values can be used for testing, simulation, and so forth.

`gen_range()` returns a random integer selected from a given range:

```
mysql> SELECT gen_range(1, 10);
+-----+
| gen_range(1, 10) |
+-----+
| 6                 |
+-----+
```

`gen_rnd_email()` returns a random email address in the `example.com` domain:

```
mysql> SELECT gen_rnd_email();
+-----+
| gen_rnd_email() |
+-----+
| ayxnq.xmkpvvy@example.com |
+-----+
```

`gen_rnd_pan()` returns a random payment card Primary Account Number (PAN).

Because it cannot be guaranteed that the number generated is not assigned to a legitimate payment account, the result of `gen_rnd_pan()` should never be displayed, other than for testing purposes. For display in applications, always employ a masking function such as `mask_pan()` or `mask_pan_relaxed()`. We show such use of the latter function with `gen_rnd_pan()` here:

```
mysql> SELECT mask_pan_relaxed( gen_rnd_pan() );
+-----+
| mask_pan_relaxed( gen_rnd_pan() ) |
+-----+
| 707064XXXXXX4850                |
+-----+
```

`gen_rnd_ssn()` returns a random US Social Security number whose first and second parts are each chosen from a range not used for legitimate numbers:

```
mysql> SELECT gen_rnd_ssn();
+-----+
| gen_rnd_ssn() |
+-----+
| 912-45-1615   |
+-----+
```



`gen_rnd_us_phone()` returns a random US phone number in the 555 area code not used for legitimate numbers:

```
mysql> SELECT gen_rnd_us_phone();
+-----+
| gen_rnd_us_phone() |
+-----+
| 1-555-747-5627     |
+-----+
```

## Generating Random Data Using Dictionaries

MySQL Enterprise Data Masking and De-Identification enables dictionaries to be used as sources of random values. To use a dictionary, it must first be loaded from a file and given a name. Each loaded dictionary becomes part of the dictionary registry. Items then can be selected from registered dictionaries and used as random values or as replacements for other values.

A valid dictionary file has these characteristics:

- The file contents are plain text, one term per line.
- Empty lines are ignored.
- The file must contain at least one term.

Suppose that a file named `de_cities.txt` contains these city names in Germany:

```
Berlin
Munich
Bremen
```

Also suppose that a file named `us_cities.txt` contains these city names in the United States:

```
Chicago
Houston
Phoenix
El Paso
Detroit
```

Assume that the `secure_file_priv` system variable is set to `/usr/local/mysql/mysql-files`. In that case, copy the dictionary files to that directory so that the MySQL server can access them. Then use `gen_dictionary_load()` to load the dictionaries into the dictionary registry and assign them names:

```
mysql> SELECT gen_dictionary_load('/usr/local/mysql/mysql-files/de_cities.txt', 'DE_Cities');
+-----+
| gen_dictionary_load('/usr/local/mysql/mysql-files/de_cities.txt', 'DE_Cities') |
+-----+
| Dictionary load success                                                         |
+-----+
mysql> SELECT gen_dictionary_load('/usr/local/mysql/mysql-files/us_cities.txt', 'US_Cities');
+-----+
| gen_dictionary_load('/usr/local/mysql/mysql-files/us_cities.txt', 'US_Cities') |
+-----+
| Dictionary load success                                                         |
+-----+
```

To select a random term from a dictionary, use `gen_dictionary()`:

```
mysql> SELECT gen_dictionary('DE_Cities');
+-----+
| gen_dictionary('DE_Cities') |
+-----+
| Berlin                       |
+-----+
```

```

+-----+
mysql> SELECT gen_dictionary('US_Cities');
+-----+
| gen_dictionary('US_Cities') |
+-----+
| Phoenix                      |
+-----+

```

To select a random term from multiple dictionaries, randomly select one of the dictionaries, then select a term from it:

```

mysql> SELECT gen_dictionary(ELT(gen_range(1,2), 'DE_Cities', 'US_Cities'));
+-----+
| gen_dictionary(ELT(gen_range(1,2), 'DE_Cities', 'US_Cities')) |
+-----+
| Detroit                                                            |
+-----+
mysql> SELECT gen_dictionary(ELT(gen_range(1,2), 'DE_Cities', 'US_Cities'));
+-----+
| gen_dictionary(ELT(gen_range(1,2), 'DE_Cities', 'US_Cities')) |
+-----+
| Bremen                                                            |
+-----+

```

The `gen_blacklist()` function enables a term from one dictionary to be replaced by a term from another dictionary, which effects masking by substitution. Its arguments are the term to replace, the dictionary in which the term appears, and the dictionary from which to choose a replacement. For example, to substitute a US city for a German city, or vice versa, use `gen_blacklist()` like this:

```

mysql> SELECT gen_blacklist('Munich', 'DE_Cities', 'US_Cities');
+-----+
| gen_blacklist('Munich', 'DE_Cities', 'US_Cities') |
+-----+
| Houston                                            |
+-----+
mysql> SELECT gen_blacklist('El Paso', 'US_Cities', 'DE_Cities');
+-----+
| gen_blacklist('El Paso', 'US_Cities', 'DE_Cities') |
+-----+
| Bremen                                            |
+-----+

```

If the term to replace is not in the first dictionary, `gen_blacklist()` returns it unchanged:

```

mysql> SELECT gen_blacklist('Moscow', 'DE_Cities', 'US_Cities');
+-----+
| gen_blacklist('Moscow', 'DE_Cities', 'US_Cities') |
+-----+
| Moscow                                             |
+-----+

```

## Using Masked Data for Customer Identification

At customer-service call centers, one common identity verification technique is to ask customers to provide their last four Social Security number (SSN) digits. For example, a customer might say her name is Joanna Bond and that her last four SSN digits are 0007.

Suppose that a `customer` table containing customer records has these columns:

- `id`: Customer ID number.
- `first_name`: Customer first name.
- `last_name`: Customer last name.

- `ssn`: Customer Social Security number.

For example, the table might be defined as follows:

```
CREATE TABLE customer
(
  id          BIGINT NOT NULL AUTO_INCREMENT PRIMARY KEY,
  first_name  VARCHAR(40),
  last_name   VARCHAR(40),
  ssn        VARCHAR(11)
);
```

The application used by customer-service representatives to check the customer SSN might execute a query like this:

```
mysql> SELECT id, ssn
-> FROM customer
-> WHERE first_name = 'Joanna' AND last_name = 'Bond';
+-----+-----+
| id | ssn |
+-----+-----+
| 786 | 906-39-0007 |
+-----+-----+
```

However, that exposes the SSN to the customer-service representative, who has no need to see anything but the last four digits. Instead, the application can use this query to display only the masked SSN:

```
mysql> SELECT id, mask_ssn(CONVERT(ssn USING binary)) AS masked_ssn
-> FROM customer
-> WHERE first_name = 'Joanna' AND last_name = 'Bond';
+-----+-----+
| id | masked_ssn |
+-----+-----+
| 786 | XXX-XX-0007 |
+-----+-----+
```

Now the representative sees only what is necessary, and customer privacy is preserved.

Why was the `CONVERT()` function used for the argument to `mask_ssn()`? Because `mask_ssn()` requires an argument of length 11. Thus, even though `ssn` is defined as `VARCHAR(11)`, if the `ssn` column has a multibyte character set, it may appear to be longer than 11 bytes when passed to a loadable function, and an error occurs. Converting the value to a binary string ensures that the function sees an argument of length 11.

A similar technique may be needed for other data masking functions when string arguments do not have a single-byte character set.

## Creating Views that Display Masked Data

If masked data from a table is used for multiple queries, it may be convenient to define a view that produces masked data. That way, applications can select from the view without performing masking in individual queries.

For example, a masking view on the `customer` table from the previous section can be defined like this:

```
CREATE VIEW masked_customer AS
SELECT id, first_name, last_name,
mask_ssn(CONVERT(ssn USING binary)) AS masked_ssn
FROM customer;
```

Then the query to look up a customer becomes simpler but still returns masked data:

```
mysql> SELECT id, masked_ssn
mysql> FROM masked_customer
mysql> WHERE first_name = 'Joanna' AND last_name = 'Bond';
+-----+-----+
| id | masked_ssn |
+-----+-----+
| 786 | XXX-XX-0007 |
+-----+-----+
```

## 6.5.4 MySQL Enterprise Data Masking and De-Identification Function Reference

Table 6.35 MySQL Enterprise Data Masking and De-Identification Functions

Name	Description
<code>gen_blacklist()</code>	Perform dictionary term replacement
<code>gen_dictionary_drop()</code>	Remove dictionary from registry
<code>gen_dictionary_load()</code>	Load dictionary into registry
<code>gen_dictionary()</code>	Return random term from dictionary
<code>gen_range()</code>	Generate random number within range
<code>gen_rnd_email()</code>	Generate random email address
<code>gen_rnd_pan()</code>	Generate random payment card Primary Account Number
<code>gen_rnd_ssn()</code>	Generate random US Social Security Number
<code>gen_rnd_us_phone()</code>	Generate random US phone number
<code>mask_inner()</code>	Mask interior part of string
<code>mask_outer()</code>	Mask left and right parts of string
<code>mask_pan()</code>	Mask payment card Primary Account Number part of string
<code>mask_pan_relaxed()</code>	Mask payment card Primary Account Number part of string
<code>mask_ssn()</code>	Mask US Social Security Number

## 6.5.5 MySQL Enterprise Data Masking and De-Identification Function Descriptions

The MySQL Enterprise Data Masking and De-Identification plugin library includes several functions, which may be grouped into these categories:

- [Data Masking Functions](#)
- [Random Data Generation Functions](#)
- [Random Data Dictionary-Based Functions](#)

These functions treat string arguments as binary strings (which means they do not distinguish lettercase), and string return values are binary strings. If a string return value should be in a different character set, convert it. The following example shows how to convert the result of `gen_rnd_email()` to the `utf8mb4` character set:

```
SET @email = CONVERT(gen_rnd_email() USING utf8mb4);
```

It may also be necessary to convert string arguments, as illustrated in [Using Masked Data for Customer Identification](#).

If a MySQL Enterprise Data Masking and De-Identification function is invoked from within the `mysql` client, binary string results display using hexadecimal notation, depending on the value of the `--binary-as-hex`. For more information about that option, see [Section 4.5.1, “mysql — The MySQL Command-Line Client”](#).

## Data Masking Functions

Each function in this section performs a masking operation on its string argument and returns the masked result.

- `mask_inner(str, margin1, margin2 [, mask_char])`

Masks the interior part of a string, leaving the ends untouched, and returns the result. An optional masking character can be specified.

Arguments:

- `str`: The string to mask.
- `margin1`: A nonnegative integer that specifies the number of characters on the left end of the string to remain unmasked. If the value is 0, no left end characters remain unmasked.
- `margin2`: A nonnegative integer that specifies the number of characters on the right end of the string to remain unmasked. If the value is 0, no right end characters remain unmasked.
- `mask_char`: (Optional) The single character to use for masking. The default is 'X' if `mask_char` is not given.

The masking character must be a single-byte character. Attempts to use a multibyte character produce an error.

Return value:

The masked string, or `NULL` if either margin is negative.

If the sum of the margin values is larger than the argument length, no masking occurs and the argument is returned unchanged.

Example:

```
mysql> SELECT mask_inner('abcdef', 1, 2), mask_inner('abcdef',0, 5);
+-----+-----+
| mask_inner('abcdef', 1, 2) | mask_inner('abcdef',0, 5) |
+-----+-----+
| aXXXef                    | Xbcdef                    |
+-----+-----+
mysql> SELECT mask_inner('abcdef', 1, 2, '*'), mask_inner('abcdef',0, 5, '#');
+-----+-----+
| mask_inner('abcdef', 1, 2, '*') | mask_inner('abcdef',0, 5, '#') |
+-----+-----+
| a***ef                        | #bcdef                      |
+-----+-----+
```

- `mask_outer(str, margin1, margin2 [, mask_char])`

Masks the left and right ends of a string, leaving the interior unmasked, and returns the result. An optional masking character can be specified.

## Arguments:

- *str*: The string to mask.
- *margin1*: A nonnegative integer that specifies the number of characters on the left end of the string to mask. If the value is 0, no left end characters are masked.
- *margin2*: A nonnegative integer that specifies the number of characters on the right end of the string to mask. If the value is 0, no right end characters are masked.
- *mask\_char*: (Optional) The single character to use for masking. The default is 'X' if *mask\_char* is not given.

The masking character must be a single-byte character. Attempts to use a multibyte character produce an error.

## Return value:

The masked string, or `NULL` if either margin is negative.

If the sum of the margin values is larger than the argument length, the entire argument is masked.

## Example:

```
mysql> SELECT mask_outer('abcdef', 1, 2), mask_outer('abcdef',0, 5);
+-----+-----+
| mask_outer('abcdef', 1, 2) | mask_outer('abcdef',0, 5) |
+-----+-----+
| XbcdXX                    | aXXXXX                    |
+-----+-----+
mysql> SELECT mask_outer('abcdef', 1, 2, '*'), mask_outer('abcdef',0, 5, '#');
+-----+-----+
| mask_outer('abcdef', 1, 2, '*') | mask_outer('abcdef',0, 5, '#') |
+-----+-----+
| *bcd**                        | a#####                  |
+-----+-----+
```

- `mask_pan(str)`

Masks a payment card Primary Account Number and returns the number with all but the last four digits replaced by 'X' characters.

## Arguments:

- *str*: The string to mask. The string must be a suitable length for the Primary Account Number, but is not otherwise checked.

## Return value:

The masked payment number as a string. If the argument is shorter than required, it is returned unchanged.

## Example:

```
mysql> SELECT mask_pan(gen_rnd_pan());
+-----+
| mask_pan(gen_rnd_pan()) |
+-----+
| XXXXXXXXXXXXX9102     |
+-----+
```

```
mysql> SELECT mask_pan(gen_rnd_pan(19));
+-----+
| mask_pan(gen_rnd_pan(19)) |
+-----+
| XXXXXXXXXXXXXXX8268      |
+-----+
mysql> SELECT mask_pan('a*Z');
+-----+
| mask_pan('a*Z') |
+-----+
| a*Z              |
+-----+
```

- `mask_pan_relaxed(str)`

Masks a payment card Primary Account Number and returns the number with all but the first six and last four digits replaced by 'X' characters. The first six digits indicate the payment card issuer.

Arguments:

- `str`: The string to mask. The string must be a suitable length for the Primary Account Number, but is not otherwise checked.

Return value:

The masked payment number as a string. If the argument is shorter than required, it is returned unchanged.

Example:

```
mysql> SELECT mask_pan_relaxed(gen_rnd_pan());
+-----+
| mask_pan_relaxed(gen_rnd_pan()) |
+-----+
| 551279XXXXXX3108              |
+-----+
mysql> SELECT mask_pan_relaxed(gen_rnd_pan(19));
+-----+
| mask_pan_relaxed(gen_rnd_pan(19)) |
+-----+
| 462634XXXXXX6739              |
+-----+
mysql> SELECT mask_pan_relaxed('a*Z');
+-----+
| mask_pan_relaxed('a*Z') |
+-----+
| a*Z                      |
+-----+
```

- `mask_ssn(str)`

Masks a US Social Security number and returns the number with all but the last four digits replaced by 'X' characters.

Arguments:

- `str`: The string to mask. The string must be 11 characters long, but is not otherwise checked.

Return value:

The masked Social Security number as a string, or `NULL` if the argument is not the correct length.

Example:

```
mysql> SELECT mask_ssn('909-63-6922'), mask_ssn('abcdefghijk');
+-----+-----+
| mask_ssn('909-63-6922') | mask_ssn('abcdefghijk') |
+-----+-----+
| XXX-XX-6922           | XXX-XX-hijk           |
+-----+-----+
mysql> SELECT mask_ssn('909');
+-----+
| mask_ssn('909') |
+-----+
| NULL           |
+-----+
```

## Random Data Generation Functions

The functions in this section generate random values for different types of data. When possible, generated values have characteristics reserved for demonstration or test values, to avoid having them mistaken for legitimate data. For example, `gen_rnd_us_phone()` returns a US phone number that uses the 555 area code, which is not assigned to phone numbers in actual use. Individual function descriptions describe any exceptions to this principle.

- `gen_range(lower, upper)`

Generates a random number chosen from a specified range.

Arguments:

- `lower`: An integer that specifies the lower boundary of the range.
- `upper`: An integer that specifies the upper boundary of the range, which must not be less than the lower boundary.

Return value:

A random integer in the range from `lower` to `upper`, inclusive, or `NULL` if the `upper` argument is less than `lower`.

Example:

```
mysql> SELECT gen_range(100, 200), gen_range(-1000, -800);
+-----+-----+
| gen_range(100, 200) | gen_range(-1000, -800) |
+-----+-----+
| 177                 | -917                 |
+-----+-----+
mysql> SELECT gen_range(1, 0);
```



```

+-----+
| gen_range(1, 0) |
+-----+
|                |
|                |
|                |
|                |
+-----+

```

- `gen_rnd_email()`

Generates a random email address in the `example.com` domain.

Arguments:

None.

Return value:

A random email address as a string.

Example:

```

mysql> SELECT gen_rnd_email();
+-----+
| gen_rnd_email() |
+-----+
| ijocv.mwvhuf@example.com |
+-----+

```

- `gen_rnd_pan([size])`

Generates a random payment card Primary Account Number. The number passes the Luhn check (an algorithm that performs a checksum verification against a check digit).



### Warning

Values returned from `gen_rnd_pan()` should be used only for test purposes, and are not suitable for publication. There is no way to guarantee that a given return value is not assigned to a legitimate payment account. Should it be necessary to publish a `gen_rnd_pan()` result, consider masking it with `mask_pan()` or `mask_pan_relaxed()`.

Arguments:

- `size`: (Optional) An integer that specifies the size of the result. The default is 16 if `size` is not given. If given, `size` must be an integer in the range from 12 to 19.

Return value:

A random payment number as a string, or `NULL` if a `size` argument outside the permitted range is given.

Example:

```

mysql> SELECT mask_pan(gen_rnd_pan());
+-----+
| mask_pan(gen_rnd_pan()) |
+-----+
| XXXXXXXXXXXXX5805 |
+-----+
mysql> SELECT mask_pan(gen_rnd_pan(19));
+-----+
| mask_pan(gen_rnd_pan(19)) |
+-----+

```

```

| XXXXXXXXXXXXXXX5067 |
+-----+
mysql> SELECT mask_pan_relaxed(gen_rnd_pan());
+-----+
| mask_pan_relaxed(gen_rnd_pan()) |
+-----+
| 398403XXXXXX9547 |
+-----+
mysql> SELECT mask_pan_relaxed(gen_rnd_pan(19));
+-----+
| mask_pan_relaxed(gen_rnd_pan(19)) |
+-----+
| 578416XXXXXXXXX6509 |
+-----+
mysql> SELECT gen_rnd_pan(11), gen_rnd_pan(20);
+-----+-----+
| gen_rnd_pan(11) | gen_rnd_pan(20) |
+-----+-----+
| NULL | NULL |
+-----+-----+

```

- `gen_rnd_ssn()`

Generates a random US Social Security number in `AAA-BB-CCCC` format. The `AAA` part is greater than 900 and the `BB` part is less than 70; these values are outside the ranges used for legitimate Social Security numbers.

Arguments:

None.

Return value:

A random Social Security number as a string.

Example:

```

mysql> SELECT gen_rnd_ssn();
+-----+
| gen_rnd_ssn() |
+-----+
| 951-26-0058 |
+-----+

```

- `gen_rnd_us_phone()`

Generates a random US phone number in `1-555-AAA-BBBB` format. The 555 area code is not used for legitimate phone numbers.

Arguments:

None.

Return value:

A random US phone number as a string.

Example:

```

mysql> SELECT gen_rnd_us_phone();
+-----+
| gen_rnd_us_phone() |
+-----+

```

```
| 1-555-682-5423 |
+-----+
```

## Random Data Dictionary-Based Functions

The functions in this section manipulate dictionaries of terms and perform generation and masking operations based on them. Some of these functions require the `SUPER` privilege.

When a dictionary is loaded, it becomes part of the dictionary registry and is assigned a name to be used by other dictionary functions. Dictionaries are loaded from plain text files containing one term per line. Empty lines are ignored. To be valid, a dictionary file must contain at least one nonempty line.

- `gen_blacklist(str, dictionary_name, replacement_dictionary_name)`

Replaces a term present in one dictionary with a term from a second dictionary and returns the replacement term. This masks the original term by substitution.

Arguments:

- `str`: A string that indicates the term to replace.
- `dictionary_name`: A string that names the dictionary containing the term to replace.
- `replacement_dictionary_name`: A string that names the dictionary from which to choose the replacement term.

Return value:

A string randomly chosen from `replacement_dictionary_name` as a replacement for `str`, or `str` if it does not appear in `dictionary_name`, or `NULL` if either dictionary name is not in the dictionary registry.

If the term to replace appears in both dictionaries, it is possible for the return value to be the same term.

Example:

```
mysql> SELECT gen_blacklist('Berlin', 'DE_Cities', 'US_Cities');
+-----+
| gen_blacklist('Berlin', 'DE_Cities', 'US_Cities') |
+-----+
| Phoenix |
+-----+
```

- `gen_dictionary(dictionary_name)`

Returns a random term from a dictionary.

Arguments:

- `dictionary_name`: A string that names the dictionary from which to choose the term.

Return value:

A random term from the dictionary as a string, or `NULL` if the dictionary name is not in the dictionary registry.

Example:

```
mysql> SELECT gen_dictionary('mydict');
+-----+
```

```

| gen_dictionary('mydict') |
+-----+
| My term                  |
+-----+
mysql> SELECT gen_dictionary('no-such-dict');
+-----+
| gen_dictionary('no-such-dict') |
+-----+
| NULL                            |
+-----+

```

- `gen_dictionary_drop(dictionary_name)`

Removes a dictionary from the dictionary registry.

This function requires the `SUPER` privilege.

Arguments:

- `dictionary_name`: A string that names the dictionary to remove from the dictionary registry.

Return value:

A string that indicates whether the drop operation succeeded. `Dictionary removed` indicates success. `Dictionary removal error` indicates failure.

Example:

```

mysql> SELECT gen_dictionary_drop('mydict');
+-----+
| gen_dictionary_drop('mydict') |
+-----+
| Dictionary removed            |
+-----+
mysql> SELECT gen_dictionary_drop('no-such-dict');
+-----+
| gen_dictionary_drop('no-such-dict') |
+-----+
| Dictionary removal error        |
+-----+

```

- `gen_dictionary_load(dictionary_path, dictionary_name)`

Loads a file into the dictionary registry and assigns the dictionary a name to be used with other functions that require a dictionary name argument.

This function requires the `SUPER` privilege.



### Important

Dictionaries are not persistent. Any dictionary used by applications must be loaded for each server startup.

Once loaded into the registry, a dictionary is used as is, even if the underlying dictionary file changes. To reload a dictionary, first drop it with `gen_dictionary_drop()`, then load it again with `gen_dictionary_load()`.

Arguments:

- `dictionary_path`: A string that specifies the path name of the dictionary file.
- `dictionary_name`: A string that provides a name for the dictionary.

Return value:

A string that indicates whether the load operation succeeded. `Dictionary load success` indicates success. `Dictionary load error` indicates failure. Dictionary load failure can occur for several reasons, including:

- A dictionary with the given name is already loaded.
- The dictionary file is not found.
- The dictionary file contains no terms.
- The `secure_file_priv` system variable is set and the dictionary file is not located in the directory named by the variable.

Example:

```
mysql> SELECT gen_dictionary_load('/usr/local/mysql/mysql-files/mydict','mydict');
+-----+
| gen_dictionary_load('/usr/local/mysql/mysql-files/mydict','mydict') |
+-----+
| Dictionary load success                                             |
+-----+
mysql> SELECT gen_dictionary_load('/dev/null','null');
+-----+
| gen_dictionary_load('/dev/null','null') |
+-----+
| Dictionary load error                                               |
+-----+
```

## 6.6 MySQL Enterprise Encryption



### Note

MySQL Enterprise Encryption is an extension included in MySQL Enterprise Edition, a commercial product. To learn more about commercial products, <https://www.mysql.com/products/>.

MySQL Enterprise Edition includes a set of encryption functions based on the OpenSSL library that expose OpenSSL capabilities at the SQL level. These functions enable Enterprise applications to perform the following operations:

- Implement added data protection using public-key asymmetric cryptography
- Create public and private keys and digital signatures
- Perform asymmetric encryption and decryption
- Use cryptographic hashing for digital signing and data verification and validation

MySQL Enterprise Encryption supports the RSA, DSA, and DH cryptographic algorithms.

MySQL Enterprise Encryption is supplied as a library of loadable functions, from which individual functions can be installed individually.

## 6.6.1 MySQL Enterprise Encryption Installation

MySQL Enterprise Encryption functions are located in a loadable function library file installed in the plugin directory (the directory named by the `plugin_dir` system variable). The function library base name is `openssl_udf` and the suffix is platform dependent. For example, the file name on Linux or Windows is `openssl_udf.so` or `openssl_udf.dll`, respectively.

To install functions from the library file, use the `CREATE FUNCTION` statement. To load all functions from the library, use this set of statements, adjusting the file name suffix as necessary:

```
CREATE FUNCTION asymmetric_decrypt RETURNS STRING
  SONAME 'openssl_udf.so';
CREATE FUNCTION asymmetric_derive RETURNS STRING
  SONAME 'openssl_udf.so';
CREATE FUNCTION asymmetric_encrypt RETURNS STRING
  SONAME 'openssl_udf.so';
CREATE FUNCTION asymmetric_sign RETURNS STRING
  SONAME 'openssl_udf.so';
CREATE FUNCTION asymmetric_verify RETURNS INTEGER
  SONAME 'openssl_udf.so';
CREATE FUNCTION create_asymmetric_priv_key RETURNS STRING
  SONAME 'openssl_udf.so';
CREATE FUNCTION create_asymmetric_pub_key RETURNS STRING
  SONAME 'openssl_udf.so';
CREATE FUNCTION create_dh_parameters RETURNS STRING
  SONAME 'openssl_udf.so';
CREATE FUNCTION create_digest RETURNS STRING
  SONAME 'openssl_udf.so';
```

Once installed, the functions remain installed across server restarts. To unload the functions, use the `DROP FUNCTION` statement:

```
DROP FUNCTION asymmetric_decrypt;
DROP FUNCTION asymmetric_derive;
DROP FUNCTION asymmetric_encrypt;
DROP FUNCTION asymmetric_sign;
DROP FUNCTION asymmetric_verify;
DROP FUNCTION create_asymmetric_priv_key;
DROP FUNCTION create_asymmetric_pub_key;
DROP FUNCTION create_dh_parameters;
DROP FUNCTION create_digest;
```

In the `CREATE FUNCTION` and `DROP FUNCTION` statements, the function names must be specified in lowercase. This differs from their use at function invocation time, for which you can use any lettercase.

The `CREATE FUNCTION` and `DROP FUNCTION` statements require the `INSERT` and `DROP` privilege, respectively, for the `mysql` database.

## 6.6.2 MySQL Enterprise Encryption Usage and Examples

To use MySQL Enterprise Encryption in applications, invoke the functions that are appropriate for the operations you wish to perform. This section demonstrates how to carry out some representative tasks:

- [Create a private/public key pair using RSA encryption](#)
- [Use the private key to encrypt data and the public key to decrypt it](#)
- [Generate a digest from a string](#)
- [Use the digest with a key pair](#)
- [Create a symmetric key](#)
- [Limit CPU usage by key-generation operations](#)

### Create a private/public key pair using RSA encryption

```
-- Encryption algorithm; can be 'DSA' or 'DH' instead
SET @algo = 'RSA';
-- Key length in bits; make larger for stronger keys
SET @key_len = 1024;

-- Create private key
SET @priv = create_asymmetric_priv_key(@algo, @key_len);
-- Derive corresponding public key from private key, using same algorithm
SET @pub = create_asymmetric_pub_key(@algo, @priv);
```

Now you can use the key pair to encrypt and decrypt data, sign and verify data, or generate symmetric keys.

### Use the private key to encrypt data and the public key to decrypt it

This requires that the members of the key pair be RSA keys.

```
SET @ciphertext = asymmetric_encrypt(@algo, 'My secret text', @priv);
SET @plaintext = asymmetric_decrypt(@algo, @ciphertext, @pub);
```

Conversely, you can encrypt using the public key and decrypt using the private key.

```
SET @ciphertext = asymmetric_encrypt(@algo, 'My secret text', @pub);
SET @plaintext = asymmetric_decrypt(@algo, @ciphertext, @priv);
```

In either case, the algorithm specified for the encryption and decryption functions must match that used to generate the keys.

### Generate a digest from a string

```
-- Digest type; can be 'SHA256', 'SHA384', or 'SHA512' instead
SET @dig_type = 'SHA224';

-- Generate digest string
SET @dig = create_digest(@dig_type, 'My text to digest');
```

### Use the digest with a key pair

The key pair can be used to sign data, then verify that the signature matches the digest.

```
-- Encryption algorithm; could be 'DSA' instead; keys must
-- have been created using same algorithm
```

```
SET @algo = 'RSA';

-- Generate signature for digest and verify signature against digest
SET @sig = asymmetric_sign(@algo, @dig, @priv, @dig_type);
-- Verify signature against digest
SET @verf = asymmetric_verify(@algo, @dig, @sig, @pub, @dig_type);
```

## Create a symmetric key

This requires DH private/public keys as inputs, created using a shared symmetric secret. Create the secret by passing the key length to `create_dh_parameters()`, then pass the secret as the “key length” to `create_asymmetric_priv_key()`.

```
-- Generate DH shared symmetric secret
SET @dhp = create_dh_parameters(1024);
-- Generate DH key pairs
SET @algo = 'DH';
SET @priv1 = create_asymmetric_priv_key(@algo, @dhp);
SET @pub1 = create_asymmetric_pub_key(@algo, @priv1);
SET @priv2 = create_asymmetric_priv_key(@algo, @dhp);
SET @pub2 = create_asymmetric_pub_key(@algo, @priv2);

-- Generate symmetric key using public key of first party,
-- private key of second party
SET @sym1 = asymmetric_derive(@pub1, @priv2);

-- Or use public key of second party, private key of first party
SET @sym2 = asymmetric_derive(@pub2, @priv1);
```

Key string values can be created at runtime and stored into a variable or table using `SET`, `SELECT`, or `INSERT`:

```
SET @priv1 = create_asymmetric_priv_key('RSA', 1024);
SELECT create_asymmetric_priv_key('RSA', 1024) INTO @priv2;
INSERT INTO t (key_col) VALUES(create_asymmetric_priv_key('RSA', 1024));
```

Key string values stored in files can be read using the `LOAD_FILE()` function by users who have the `FILE` privilege.

Digest and signature strings can be handled similarly.

## Limit CPU usage by key-generation operations

The `create_asymmetric_priv_key()` and `create_dh_parameters()` encryption functions take a key-length parameter, and the amount of CPU resources required by these functions increases as the key length increases. For some installations, this might result in unacceptable CPU usage if applications frequently generate excessively long keys.

OpenSSL imposes a minimum key length of 1,024 bits for all keys. OpenSSL also imposes a maximum key length of 10,000 bits and 16,384 bits for DSA and RSA keys, respectively, for `create_asymmetric_priv_key()`, and a maximum key length of 10,000 bits for `create_dh_parameters()`. If those maximum values are too high, three environment variables are available as of MySQL 5.7.17 to enable MySQL server administrators to set lower maximum lengths for key generation, and thereby to limit CPU usage:

- `MYSQL_OPENSSL_UDF_DSA_BITS_THRESHOLD`: Maximum DSA key length in bits for `create_asymmetric_priv_key()`. The minimum and maximum values for this variable are 1,024 and 10,000.
- `MYSQL_OPENSSL_UDF_RSA_BITS_THRESHOLD`: Maximum RSA key length in bits for `create_asymmetric_priv_key()`. The minimum and maximum values for this variable are 1,024 and 16,384.



- `MYSQL_OPENSSL_UDF_DH_BITS_THRESHOLD`: Maximum key length in bits for `create_dh_parameters()`. The minimum and maximum values for this variable are 1,024 and 10,000.

To use any of these environment variables, set them in the environment of the process that starts the server. If set, their values take precedence over the maximum key lengths imposed by OpenSSL. For example, to set a maximum key length of 4,096 bits for DSA and RSA keys for `create_asymmetric_priv_key()`, set these variables:

```
export MYSQL_OPENSSL_UDF_DSA_BITS_THRESHOLD=4096
export MYSQL_OPENSSL_UDF_RSA_BITS_THRESHOLD=4096
```

The example uses Bourne shell syntax. The syntax for other shells may differ.

## 6.6.3 MySQL Enterprise Encryption Function Reference

**Table 6.36 MySQL Enterprise Encryption Functions**

Name	Description
<code>asymmetric_decrypt()</code>	Decrypt ciphertext using private or public key
<code>asymmetric_derive()</code>	Derive symmetric key from asymmetric keys
<code>asymmetric_encrypt()</code>	Encrypt cleartext using private or public key
<code>asymmetric_sign()</code>	Generate signature from digest
<code>asymmetric_verify()</code>	Verify that signature matches digest
<code>create_asymmetric_priv_key()</code>	Create private key
<code>create_asymmetric_pub_key()</code>	Create public key
<code>create_dh_parameters()</code>	Generate shared DH secret
<code>create_digest()</code>	Generate digest from string

## 6.6.4 MySQL Enterprise Encryption Function Descriptions

MySQL Enterprise Encryption functions have these general characteristics:

- For arguments of the wrong type or an incorrect number of arguments, each function returns an error.
- If the arguments are not suitable to permit a function to perform the requested operation, it returns `NULL` or 0 as appropriate. This occurs, for example, if a function does not support a specified algorithm, a key length is too short or long, or a string expected to be a key string in PEM format is not a valid key. (OpenSSL imposes its own key-length limits, and server administrators can impose additional limits on maximum key length by setting environment variables. See [Section 6.6.2, “MySQL Enterprise Encryption Usage and Examples”](#).)
- The underlying SSL library takes care of randomness initialization.

Several of the functions take an encryption algorithm argument. The following table summarizes the supported algorithms by function.

**Table 6.37 Supported Algorithms by Function**

Function	Supported Algorithms
<code>asymmetric_decrypt()</code>	RSA
<code>asymmetric_derive()</code>	DH
<code>asymmetric_encrypt()</code>	RSA

Function	Supported Algorithms
<code>asymmetric_sign()</code>	RSA, DSA
<code>asymmetric_verify()</code>	RSA, DSA
<code>create_asymmetric_priv_key()</code>	RSA, DSA, DH
<code>create_asymmetric_pub_key()</code>	RSA, DSA, DH
<code>create_dh_parameters()</code>	DH



### Note

Although you can create keys using any of the RSA, DSA, or DH encryption algorithms, other functions that take key arguments might accept only certain types of keys. For example, `asymmetric_encrypt()` and `asymmetric_decrypt()` accept only RSA keys.

The following descriptions describe the calling sequences for MySQL Enterprise Encryption functions. For additional examples and discussion, see [Section 6.6.2, “MySQL Enterprise Encryption Usage and Examples”](#).

- `asymmetric_decrypt(algorithm, crypt_str, key_str)`

Decrypts an encrypted string using the given algorithm and key string, and returns the resulting plaintext as a binary string. If decryption fails, the result is `NULL`.

*key\_str* must be a valid key string in PEM format. For successful decryption, it must be the public or private key string corresponding to the private or public key string used with `asymmetric_encrypt()` to produce the encrypted string. *algorithm* indicates the encryption algorithm used to create the key.

Supported *algorithm* values: 'RSA'

For a usage example, see the description of `asymmetric_encrypt()`.

- `asymmetric_derive(pub_key_str, priv_key_str)`

Derives a symmetric key using the private key of one party and the public key of another, and returns the resulting key as a binary string. If key derivation fails, the result is `NULL`.

*pub\_key\_str* and *priv\_key\_str* must be valid key strings in PEM format. They must be created using the DH algorithm.

Suppose that you have two pairs of public and private keys:

```
SET @dhp = create_dh_parameters(1024);
SET @priv1 = create_asymmetric_priv_key('DH', @dhp);
SET @pub1 = create_asymmetric_pub_key('DH', @priv1);
SET @priv2 = create_asymmetric_priv_key('DH', @dhp);
SET @pub2 = create_asymmetric_pub_key('DH', @priv2);
```

Suppose further that you use the private key from one pair and the public key from the other pair to create a symmetric key string. Then this symmetric key identity relationship holds:

```
asymmetric_derive(@pub1, @priv2) = asymmetric_derive(@pub2, @priv1)
```

- `asymmetric_encrypt(algorithm, str, key_str)`

Encrypts a string using the given algorithm and key string, and returns the resulting ciphertext as a binary string. If encryption fails, the result is `NULL`.

The *str* length cannot be greater than the *key\_str* length – 11, in bytes

*key\_str* must be a valid key string in PEM format. *algorithm* indicates the encryption algorithm used to create the key.

Supported *algorithm* values: 'RSA'

To encrypt a string, pass a private or public key string to `asymmetric_encrypt()`. To recover the original unencrypted string, pass the encrypted string to `asymmetric_decrypt()`, along with the public or private key string corresponding to the private or public key string used for encryption.

```
-- Generate private/public key pair
SET @priv = create_asymmetric_priv_key('RSA', 1024);
SET @pub = create_asymmetric_pub_key('RSA', @priv);

-- Encrypt using private key, decrypt using public key
SET @ciphertext = asymmetric_encrypt('RSA', 'The quick brown fox', @priv);
SET @plaintext = asymmetric_decrypt('RSA', @ciphertext, @pub);

-- Encrypt using public key, decrypt using private key
SET @ciphertext = asymmetric_encrypt('RSA', 'The quick brown fox', @pub);
SET @plaintext = asymmetric_decrypt('RSA', @ciphertext, @priv);
```

Suppose that:

```
SET @s = a string to be encrypted
SET @priv = a valid private RSA key string in PEM format
SET @pub = the corresponding public RSA key string in PEM format
```

Then these identity relationships hold:

```
asymmetric_decrypt('RSA', asymmetric_encrypt('RSA', @s, @priv), @pub) = @s
asymmetric_decrypt('RSA', asymmetric_encrypt('RSA', @s, @pub), @priv) = @s
```

- `asymmetric_sign(algorithm, digest_str, priv_key_str, digest_type)`

Signs a digest string using a private key string, and returns the signature as a binary string. If signing fails, the result is `NULL`.

*digest\_str* is the digest string. It can be generated by calling `create_digest()`. *digest\_type* indicates the digest algorithm used to generate the digest string.

*priv\_key\_str* is the private key string to use for signing the digest string. It must be a valid key string in PEM format. *algorithm* indicates the encryption algorithm used to create the key.

Supported *algorithm* values: 'RSA', 'DSA'

Supported *digest\_type* values: 'SHA224', 'SHA256', 'SHA384', 'SHA512'

For a usage example, see the description of `asymmetric_verify()`.

- `asymmetric_verify(algorithm, digest_str, sig_str, pub_key_str, digest_type)`

Verifies whether the signature string matches the digest string, and returns 1 or 0 to indicate whether verification succeeded or failed.

*digest\_str* is the digest string. It can be generated by calling `create_digest()`. *digest\_type* indicates the digest algorithm used to generate the digest string.

*sig\_str* is the signature string. It can be generated by calling `asymmetric_sign()`.

*pub\_key\_str* is the public key string of the signer. It corresponds to the private key passed to `asymmetric_sign()` to generate the signature string and must be a valid key string in PEM format. *algorithm* indicates the encryption algorithm used to create the key.

Supported *algorithm* values: 'RSA', 'DSA'

Supported *digest\_type* values: 'SHA224', 'SHA256', 'SHA384', 'SHA512'

```
-- Set the encryption algorithm and digest type
SET @algo = 'RSA';
SET @dig_type = 'SHA224';

-- Create private/public key pair
SET @priv = create_asymmetric_priv_key(@algo, 1024);
SET @pub = create_asymmetric_pub_key(@algo, @priv);

-- Generate digest from string
SET @dig = create_digest(@dig_type, 'The quick brown fox');

-- Generate signature for digest and verify signature against digest
SET @sig = asymmetric_sign(@algo, @dig, @priv, @dig_type);
SET @verf = asymmetric_verify(@algo, @dig, @sig, @pub, @dig_type);
```

- `create_asymmetric_priv_key(algorithm, {key_len|dh_secret})`

Creates a private key using the given algorithm and key length or DH secret, and returns the key as a binary string in PEM format. If key generation fails, the result is `NULL`.

Supported *algorithm* values: 'RSA', 'DSA', 'DH'

Supported *key\_len* values: The minimum key length in bits is 1,024. The maximum key length depends on the algorithm: 16,384 for RSA and 10,000 for DSA. These key-length limits are constraints imposed by OpenSSL. Server administrators can impose additional limits on maximum key length by setting environment variables. See [Section 6.6.2, “MySQL Enterprise Encryption Usage and Examples”](#).

For DH keys, pass a shared DH secret instead of a key length. To create the secret, pass the key length to `create_dh_parameters()`.

This example creates a 2,048-bit DSA private key, then derives a public key from the private key:

```
SET @priv = create_asymmetric_priv_key('DSA', 2048);
```

```
SET @pub = create_asymmetric_pub_key('DSA', @priv);
```

For an example showing DH key generation, see the description of [asymmetric\\_derive\(\)](#).

Some general considerations in choosing key lengths and encryption algorithms:

- The strength of encryption for private and public keys increases with the key size, but the time for key generation increases as well.
- Generation of DH keys takes much longer than RSA or RSA keys.
- Asymmetric encryption functions are slower than symmetric functions. If performance is an important factor and the functions are to be used very frequently, you are better off using symmetric encryption. For example, consider using [AES\\_ENCRYPT\(\)](#) and [AES\\_DECRYPT\(\)](#).
- [create\\_asymmetric\\_pub\\_key\(\*algorithm\*, \*priv\\_key\\_str\*\)](#)

Derives a public key from the given private key using the given algorithm, and returns the key as a binary string in PEM format. If key derivation fails, the result is `NULL`.

*priv\_key\_str* must be a valid key string in PEM format. *algorithm* indicates the encryption algorithm used to create the key.

Supported *algorithm* values: 'RSA', 'DSA', 'DH'

For a usage example, see the description of [create\\_asymmetric\\_priv\\_key\(\)](#).

- [create\\_dh\\_parameters\(\*key\\_len\*\)](#)

Creates a shared secret for generating a DH private/public key pair and returns a binary string that can be passed to [create\\_asymmetric\\_priv\\_key\(\)](#). If secret generation fails, the result is null.

Supported *key\_len* values: The minimum and maximum key lengths in bits are 1,024 and 10,000. These key-length limits are constraints imposed by OpenSSL. Server administrators can impose additional limits on maximum key length by setting environment variables. See [Section 6.6.2, “MySQL Enterprise Encryption Usage and Examples”](#).

For an example showing how to use the return value for generating symmetric keys, see the description of [asymmetric\\_derive\(\)](#).

```
SET @dhp = create_dh_parameters(1024);
```

- [create\\_digest\(\*digest\\_type\*, \*str\*\)](#)

Creates a digest from the given string using the given digest type, and returns the digest as a binary string. If digest generation fails, the result is `NULL`.

Supported *digest\_type* values: 'SHA224', 'SHA256', 'SHA384', 'SHA512'

```
SET @dig = create_digest('SHA512', 'The quick brown fox');
```

The resulting digest string is suitable for use with [asymmetric\\_sign\(\)](#) and [asymmetric\\_verify\(\)](#).

## 6.7 SELinux

Security-Enhanced Linux (SELinux) is a mandatory access control (MAC) system that implements access rights by applying a security label referred to as an *SELinux context* to each system object. SELinux policy

modules use SELinux contexts to define rules for how processes, files, ports, and other system objects interact with each other. Interaction between system objects is only permitted if a policy rule allows it.

An SELinux context (the label applied to a system object) has the following fields: `user`, `role`, `type`, and `security level`. Type information rather than the entire SELinux context is used most commonly to define rules for how processes interact with other system objects. MySQL SELinux policy modules, for example, define policy rules using `type` information.

You can view SELinux contexts using operating system commands such as `ls` and `ps` with the `-Z` option. Assuming that SELinux is enabled and a MySQL Server is running, the following commands show the SELinux context for the `mysqld` process and MySQL data directory:

`mysqld` process:

```
$> ps -eZ | grep mysqld
system_u:system_r:mysqld_t:s0      5924 ?          00:00:03 mysqld
```

MySQL data directory:

```
$> cd /var/lib
$> ls -Z | grep mysql
system_u:object_r:mysqld_db_t:s0 mysql
```

where:

- `system_u` is an SELinux user identity for system processes and objects.
- `system_r` is an SELinux role used for system processes.
- `objects_r` is an SELinux role used for system objects.
- `mysqld_t` is the type associated with the `mysqld` process.
- `mysqld_db_t` is the type associated with the MySQL data directory and its files.
- `s0` is the security level.

For more information about interpreting SELinux contexts, refer to your distribution's SELinux documentation.

## 6.7.1 Check if SELinux is Enabled

SELinux is enabled by default on some Linux distributions including Oracle Linux, RHEL, CentOS, and Fedora. Use the `sestatus` command to determine if SELinux is enabled on your distribution:

```
$> sestatus
SELinux status:                enabled
SELinuxfs mount:              /sys/fs/selinux
SELinux root directory:      /etc/selinux
Loaded policy name:           targeted
Current mode:                 enforcing
Mode from config file:       enforcing
Policy MLS status:           enabled
Policy deny_unknown status:  allowed
Memory protection checking:   actual (secure)
Max kernel policy version:    31
```

If SELinux is disabled or the `sestatus` command is not found, refer to your distribution's SELinux documentation for guidance before enabling SELinux.

## 6.7.2 Changing the SELinux Mode

SELinux supports enforcing, permissive, and disabled modes. Enforcing mode is the default. Permissive mode allows operations that are not permitted in enforcing mode and logs those operations to the SELinux audit log. Permissive mode is typically used when developing policies or troubleshooting. In disabled mode, polices are not enforced, and contexts are not applied to system objects, which makes it difficult to enable SELinux later.

To view the current SELinux mode, use the `sestatus` command mentioned previously or the `getenforce` utility.

```
$> getenforce
Enforcing
```

To change the SELinux mode, use the `setenforce` utility:

```
$> setenforce 0
$> getenforce
Permissive
```

```
$> setenforce 1
$> getenforce
Enforcing
```

Changes made with `setenforce` are lost when you restart the system. To permanently change the SELinux mode, edit the `/etc/selinux/config` file and restart the system.

## 6.7.3 MySQL Server SELinux Policies

MySQL Server SELinux policy modules are typically installed by default. You can view installed modules using the `semodule -l` command. MySQL Server SELinux policy modules include:

- `mysqld_selinux`
- `mysqld_safe_selinux`

For information about MySQL Server SELinux policy modules, refer to the SELinux manual pages. The manual pages provide information about types and Booleans associated with the MySQL service. Manual pages are named in the `service-name_selinux` format.

```
man mysqld_selinux
```

If SELinux manual pages are not available, refer to your distribution's SELinux documentation for information about how to generate manual pages using the `sepolicy manpage` utility.

## 6.7.4 SELinux File Context

The MySQL Server reads from and writes to many files. If the SELinux context is not set correctly for these files, access to the files could be denied.

The instructions that follow use the `semanage` binary to manage file context; on RHEL, it's part of the `policycoreutils-python-utils` package:

```
yum install -y policycoreutils-python-utils
```

After installing the `semanage` binary, you can list MySQL file contexts using `semanage` with the `fcontext` option.

```
semanage fcontext -l | grep -i mysql
```

## Setting the MySQL Data Directory Context

The default data directory location is `/var/lib/mysql/`; and the SELinux context used is `mysqld_db_t`.

If you edit the configuration file to use a different location for the data directory, or for any of the files normally in the data directory (such as the binary logs), you may need to set the context for the new location. For example:

```
semanage fcontext -a -t mysqld_db_t "/path/to/my/custom/datadir(/.*)?"
restorecon -Rv /path/to/my/custom/datadir

semanage fcontext -a -t mysqld_db_t "/path/to/my/custom/logdir(/.*)?"
restorecon -Rv /path/to/my/custom/logdir
```

## Setting the MySQL Error Log File Context

The default location for RedHat RPMs is `/var/log/mysqld.log`; and the SELinux context type used is `mysqld_log_t`.

If you edit the configuration file to use a different location, you may need to set the context for the new location. For example:

```
semanage fcontext -a -t mysqld_log_t "/path/to/my/custom/error.log"
restorecon -Rv /path/to/my/custom/error.log
```

## Setting the PID File Context

The default location for the PID file is `/var/run/mysqld/mysqld.pid`; and the SELinux context type used is `mysqld_var_run_t`.

If you edit the configuration file to use a different location, you may need to set the context for the new location. For example:

```
semanage fcontext -a -t mysqld_var_run_t "/path/to/my/custom/pidfile/directory/.*?"
restorecon -Rv /path/to/my/custom/pidfile/directory
```

## Setting the Unix Domain Socket Context

The default location for the Unix domain socket is `/var/lib/mysql/mysql.sock`; and the SELinux context type used is `mysqld_var_run_t`.

If you edit the configuration file to use a different location, you may need to set the context for the new location. For example:

```
semanage fcontext -a -t mysqld_var_run_t "/path/to/my/custom/mysql\.sock"
restorecon -Rv /path/to/my/custom/mysql.sock
```

## Setting the `secure_file_priv` Directory Context

For MySQL versions since 5.6.34, 5.7.16, and 8.0.11.

Installing the MySQL Server RPM creates a `/var/lib/mysql-files/` directory but does not set the SELinux context for it. The `/var/lib/mysql-files/` directory is intended to be used for operations such as `SELECT ... INTO OUTFILE`.

If you enabled the use of this directory by setting `secure_file_priv`, you may need to set the context like so:

```
semanage fcontext -a -t mysqld_db_t "/var/lib/mysql-files(/.*)?"
```



```
restorecon -Rv /var/lib/mysql-files
```

Edit this path if you used a different location. For security purposes, this directory should never be within the data directory.

For more information about this variable, see the [secure\\_file\\_priv](#) documentation.

## 6.7.5 SELinux TCP Port Context

The instructions that follow use the `semanage` binary to manage port context; on RHEL, it's part of the `policycoreutils-python-utils` package:

```
yum install -y policycoreutils-python-utils
```

After installing the `semanage` binary, you can list ports defined with the `mysqld_port_t` context using `semanage` with the `port` option.

```
$> semanage port -l | grep mysqld
mysqld_port_t          tcp          1186, 3306, 63132-63164
```

### 6.7.5.1 Setting the TCP Port Context for mysqld

The default TCP port for `mysqld` is `3306`; and the SELinux context type used is `mysqld_port_t`.

If you configure `mysqld` to use a different TCP `port`, you may need to set the context for the new port. For example to define the SELinux context for a non-default port such as port `3307`:

```
semanage port -a -t mysqld_port_t -p tcp 3307
```

To confirm that the port is added:

```
$> semanage port -l | grep mysqld
mysqld_port_t          tcp          3307, 1186, 3306, 63132-63164
```

### 6.7.5.2 Setting the TCP Port Context for MySQL Features

If you enable certain MySQL features, you might need to set the SELinux TCP port context for additional ports used by those features. If ports used by MySQL features do not have the correct SELinux context, the features might not function correctly.

The following sections describe how to set port contexts for MySQL features. Generally, the same method can be used to set the port context for any MySQL features. For information about ports used by MySQL features, refer to the [MySQL Port Reference](#).

#### Setting the TCP Port Context for Group Replication

If SELinux is enabled, you must set the port context for the Group Replication communication port, which is defined by the `group_replication_local_address` variable. `mysqld` must be able to bind to the Group Replication communication port and listen there. InnoDB Cluster relies on Group Replication so this applies equally to instances used in a cluster. To view ports currently used by MySQL, issue:

```
semanage port -l | grep mysqld
```

Assuming the Group Replication communication port is `33061`, set the port context by issuing:

```
semanage port -a -t mysqld_port_t -p tcp 33061
```

#### Setting the TCP Port Context for Document Store

If SELinux is enabled, you must set the port context for the communication port used by X Plugin, which is defined by the `mysqlx_port` variable. `mysqld` must be able to bind to the X Plugin communication port and listen there.

Assuming the X Plugin communication port is 33060, set the port context by issuing:

```
semanage port -a -t mysqld_port_t -p tcp 33060
```

## 6.7.6 Troubleshooting SELinux

Troubleshooting SELinux typically involves placing SELinux into permissive mode, rerunning problematic operations, checking for access denial messages in the SELinux audit log, and placing SELinux back into enforcing mode after problems are resolved.

To avoid placing the entire system into permissive mode using `setenforce`, you can permit only the MySQL service to run permissively by placing its SELinux domain (`mysqld_t`) into permissive mode using the `semanage` command:

```
semanage permissive -a mysqld_t
```

When you are finished troubleshooting, use this command to place the `mysqld_t` domain back into enforcing mode:

```
semanage permissive -d mysqld_t
```

SELinux writes logs for denied operations to `/var/log/audit/audit.log`. You can check for denials by searching for “denied” messages.

```
grep "denied" /var/log/audit/audit.log
```

The following sections describes a few common areas where SELinux-related issues may be encountered.

### File Contexts

If a MySQL directory or file has an incorrect SELinux context, access may be denied. This issue can occur if MySQL is configured to read from or write to a non-default directory or file. For example, if you configure MySQL to use a non-default data directory, the directory may not have the expected SELinux context.

Attempting to start the MySQL service on a non-default data directory with an invalid SELinux context causes the following startup failure.

```
$> systemctl start mysql.service
Job for mysqld.service failed because the control process exited with error code.
See "systemctl status mysqld.service" and "journalctl -xe" for details.
```

In this case, a “denial” message is logged to `/var/log/audit/audit.log`:

```
$> grep "denied" /var/log/audit/audit.log
type=AVC msg=audit(1587133719.786:194): avc: denied { write } for pid=7133 comm="mysqld"
name="mysql" dev="dm-0" ino=51347078 scontext=system_u:system_r:mysqld_t:s0
tcontext=unconfined_u:object_r:default_t:s0 tclass=dir permissive=0
```

For information about setting the proper SELinux context for MySQL directories and files, see [Section 6.7.4, “SELinux File Context”](#).

### Port Access

SELinux expects services such as MySQL Server to use specific ports. Changing ports without updating the SELinux policies may cause a service failure.

The `mysqld_port_t` port type defines the ports that the MySQL listens on. If you configure the MySQL Server to use a non-default port, such as port 3307, and do not update the policy to reflect the change, the MySQL service fails to start:

```
$> systemctl start mysqld.service
Job for mysqld.service failed because the control process exited with error code.
See "systemctl status mysqld.service" and "journalctl -xe" for details.
```

In this case, a denial message is logged to `/var/log/audit/audit.log`:

```
$> grep "denied" /var/log/audit/audit.log
type=AVC msg=audit(1587134375.845:198): avc: denied { name_bind } for pid=7340
comm="mysqld" src=3307 scontext=system_u:system_r:mysqld_t:s0
tcontext=system_u:object_r:unreserved_port_t:s0 tclass=tcp_socket permissive=0
```

For information about setting the proper SELinux port context for MySQL, see [Section 6.7.5, “SELinux TCP Port Context”](#). Similar port access issues can occur when enabling MySQL features that use ports that are not defined with the required context. For more information, see [Section 6.7.5.2, “Setting the TCP Port Context for MySQL Features”](#).

## Application Changes

SELinux may not be aware of application changes. For example, a new release, an application extension, or a new feature may access system resources in a way that is not permitted by SELinux, resulting in access denials. In such cases, you can use the `audit2allow` utility to create custom policies to permit access where it is required. The typical method for creating custom policies is to change the SELinux mode to permissive, identify access denial messages in the SELinux audit log, and use the `audit2allow` utility to create custom policies to permit access.

For information about using the `audit2allow` utility, refer to your distribution's SELinux documentation.

If you encounter access issues for MySQL that you believe should be handled by standard MySQL SELinux policy modules, please open a bug report in your distribution's bug tracking system.



---

# Chapter 7 Backup and Recovery

## Table of Contents

7.1 Backup and Recovery Types .....	1416
7.2 Database Backup Methods .....	1419
7.3 Example Backup and Recovery Strategy .....	1421
7.3.1 Establishing a Backup Policy .....	1422
7.3.2 Using Backups for Recovery .....	1424
7.3.3 Backup Strategy Summary .....	1424
7.4 Using mysqldump for Backups .....	1424
7.4.1 Dumping Data in SQL Format with mysqldump .....	1425
7.4.2 Reloading SQL-Format Backups .....	1426
7.4.3 Dumping Data in Delimited-Text Format with mysqldump .....	1427
7.4.4 Reloading Delimited-Text Format Backups .....	1428
7.4.5 mysqldump Tips .....	1428
7.5 Point-in-Time (Incremental) Recovery .....	1430
7.5.1 Point-in-Time Recovery Using Binary Log .....	1431
7.5.2 Point-in-Time Recovery Using Event Positions .....	1432
7.6 MyISAM Table Maintenance and Crash Recovery .....	1433
7.6.1 Using myisamchk for Crash Recovery .....	1434
7.6.2 How to Check MyISAM Tables for Errors .....	1435
7.6.3 How to Repair MyISAM Tables .....	1435
7.6.4 MyISAM Table Optimization .....	1438
7.6.5 Setting Up a MyISAM Table Maintenance Schedule .....	1438

It is important to back up your databases so that you can recover your data and be up and running again in case problems occur, such as system crashes, hardware failures, or users deleting data by mistake. Backups are also essential as a safeguard before upgrading a MySQL installation, and they can be used to transfer a MySQL installation to another system or to set up replica servers.

MySQL offers a variety of backup strategies from which you can choose the methods that best suit the requirements for your installation. This chapter discusses several backup and recovery topics with which you should be familiar:

- Types of backups: Logical versus physical, full versus incremental, and so forth.
- Methods for creating backups.
- Recovery methods, including point-in-time recovery.
- Backup scheduling, compression, and encryption.
- Table maintenance, to enable recovery of corrupt tables.

## Additional Resources

Resources related to backup or to maintaining data availability include the following:

- Customers of MySQL Enterprise Edition can use the MySQL Enterprise Backup product for backups. For an overview of the MySQL Enterprise Backup product, see [Section 28.1, “MySQL Enterprise Backup Overview”](#).

- A forum dedicated to backup issues is available at <https://forums.mysql.com/list.php?28>.
- Details for `mysqldump` can be found in [Chapter 4, MySQL Programs](#).
- The syntax of the SQL statements described here is given in [Chapter 13, SQL Statements](#).
- For additional information about `InnoDB` backup procedures, see [Section 14.19.1, “InnoDB Backup”](#).
- Replication enables you to maintain identical data on multiple servers. This has several benefits, such as enabling client query load to be distributed over servers, availability of data even if a given server is taken offline or fails, and the ability to make backups with no impact on the source by using a replica server. See [Chapter 16, Replication](#).
- MySQL InnoDB Cluster is a collection of products that work together to provide a high availability solution. A group of MySQL servers can be configured to create a cluster using MySQL Shell. The cluster of servers has a single source, called the primary, which acts as the read-write source. Multiple secondary servers are replicas of the source. A minimum of three servers are required to create a high availability cluster. A client application is connected to the primary via MySQL Router. If the primary fails, a secondary is automatically promoted to the role of primary, and MySQL Router routes requests to the new primary.
- NDB Cluster provides a high-availability, high-redundancy version of MySQL adapted for the distributed computing environment. See [Chapter 21, MySQL NDB Cluster 7.5 and NDB Cluster 7.6](#), which provides information about MySQL NDB Cluster 7.5 (based on MySQL 5.7 but containing the latest improvements and fixes for the `NDB` storage engine).

## 7.1 Backup and Recovery Types

This section describes the characteristics of different types of backups.

### Physical (Raw) Versus Logical Backups

Physical backups consist of raw copies of the directories and files that store database contents. This type of backup is suitable for large, important databases that need to be recovered quickly when problems occur.

Logical backups save information represented as logical database structure (`CREATE DATABASE`, `CREATE TABLE` statements) and content (`INSERT` statements or delimited-text files). This type of backup is suitable for smaller amounts of data where you might edit the data values or table structure, or recreate the data on a different machine architecture.

Physical backup methods have these characteristics:

- The backup consists of exact copies of database directories and files. Typically this is a copy of all or part of the MySQL data directory.
- Physical backup methods are faster than logical because they involve only file copying without conversion.
- Output is more compact than for logical backup.
- Because backup speed and compactness are important for busy, important databases, the MySQL Enterprise Backup product performs physical backups. For an overview of the MySQL Enterprise Backup product, see [Section 28.1, “MySQL Enterprise Backup Overview”](#).
- Backup and restore granularity ranges from the level of the entire data directory down to the level of individual files. This may or may not provide for table-level granularity, depending on storage engine. For

example, [InnoDB](#) tables can each be in a separate file, or share file storage with other [InnoDB](#) tables; each [MyISAM](#) table corresponds uniquely to a set of files.

- In addition to databases, the backup can include any related files such as log or configuration files.
- Data from [MEMORY](#) tables is tricky to back up this way because their contents are not stored on disk. (The MySQL Enterprise Backup product has a feature where you can retrieve data from [MEMORY](#) tables during a backup.)
- Backups are portable only to other machines that have identical or similar hardware characteristics.
- Backups can be performed while the MySQL server is not running. If the server is running, it is necessary to perform appropriate locking so that the server does not change database contents during the backup. MySQL Enterprise Backup does this locking automatically for tables that require it.
- Physical backup tools include the [mysqlbackup](#) of MySQL Enterprise Backup for [InnoDB](#) or any other tables, or file system-level commands (such as [cp](#), [scp](#), [tar](#), [rsync](#)) for [MyISAM](#) tables.
- For restore:
  - MySQL Enterprise Backup restores [InnoDB](#) and other tables that it backed up.
  - [ndb\\_restore](#) restores [NDB](#) tables.
  - Files copied at the file system level can be copied back to their original locations with file system commands.

Logical backup methods have these characteristics:

- The backup is done by querying the MySQL server to obtain database structure and content information.
- Backup is slower than physical methods because the server must access database information and convert it to logical format. If the output is written on the client side, the server must also send it to the backup program.
- Output is larger than for physical backup, particularly when saved in text format.
- Backup and restore granularity is available at the server level (all databases), database level (all tables in a particular database), or table level. This is true regardless of storage engine.
- The backup does not include log or configuration files, or other database-related files that are not part of databases.
- Backups stored in logical format are machine independent and highly portable.
- Logical backups are performed with the MySQL server running. The server is not taken offline.
- Logical backup tools include the [mysqldump](#) program and the [SELECT ... INTO OUTFILE](#) statement. These work for any storage engine, even [MEMORY](#).
- To restore logical backups, SQL-format dump files can be processed using the [mysql](#) client. To load delimited-text files, use the [LOAD DATA](#) statement or the [mysqlimport](#) client.

## Online Versus Offline Backups

Online backups take place while the MySQL server is running so that the database information can be obtained from the server. Offline backups take place while the server is stopped. This distinction can also

be described as “hot” versus “cold” backups; a “warm” backup is one where the server remains running but locked against modifying data while you access database files externally.

Online backup methods have these characteristics:

- The backup is less intrusive to other clients, which can connect to the MySQL server during the backup and may be able to access data depending on what operations they need to perform.
- Care must be taken to impose appropriate locking so that data modifications do not take place that would compromise backup integrity. The MySQL Enterprise Backup product does such locking automatically.

Offline backup methods have these characteristics:

- Clients can be affected adversely because the server is unavailable during backup. For that reason, such backups are often taken from a replica server that can be taken offline without harming availability.
- The backup procedure is simpler because there is no possibility of interference from client activity.

A similar distinction between online and offline applies for recovery operations, and similar characteristics apply. However, it is more likely for clients to be affected for online recovery than for online backup because recovery requires stronger locking. During backup, clients might be able to read data while it is being backed up. Recovery modifies data and does not just read it, so clients must be prevented from accessing data while it is being restored.

## Local Versus Remote Backups

A local backup is performed on the same host where the MySQL server runs, whereas a remote backup is done from a different host. For some types of backups, the backup can be initiated from a remote host even if the output is written locally on the server host.

- `mysqldump` can connect to local or remote servers. For SQL output (`CREATE` and `INSERT` statements), local or remote dumps can be done and generate output on the client. For delimited-text output (with the `--tab` option), data files are created on the server host.
- `SELECT ... INTO OUTFILE` can be initiated from a local or remote client host, but the output file is created on the server host.
- Physical backup methods typically are initiated locally on the MySQL server host so that the server can be taken offline, although the destination for copied files might be remote.

## Snapshot Backups

Some file system implementations enable “snapshots” to be taken. These provide logical copies of the file system at a given point in time, without requiring a physical copy of the entire file system. (For example, the implementation may use copy-on-write techniques so that only parts of the file system modified after the snapshot time need be copied.) MySQL itself does not provide the capability for taking file system snapshots. It is available through third-party solutions such as Veritas, LVM, or ZFS.

## Full Versus Incremental Backups

A full backup includes all data managed by a MySQL server at a given point in time. An incremental backup consists of the changes made to the data during a given time span (from one point in time to another). MySQL has different ways to perform full backups, such as those described earlier in this section. Incremental backups are made possible by enabling the server's binary log, which the server uses to record data changes.



## Full Versus Point-in-Time (Incremental) Recovery

A full recovery restores all data from a full backup. This restores the server instance to the state that it had when the backup was made. If that state is not sufficiently current, a full recovery can be followed by recovery of incremental backups made since the full backup, to bring the server to a more up-to-date state.

Incremental recovery is recovery of changes made during a given time span. This is also called point-in-time recovery because it makes a server's state current up to a given time. Point-in-time recovery is based on the binary log and typically follows a full recovery from the backup files that restores the server to its state when the backup was made. Then the data changes written in the binary log files are applied as incremental recovery to redo data modifications and bring the server up to the desired point in time.

## Table Maintenance

Data integrity can be compromised if tables become corrupt. For [InnoDB](#) tables, this is not a typical issue. For programs to check [MyISAM](#) tables and repair them if problems are found, see [Section 7.6, “MyISAM Table Maintenance and Crash Recovery”](#).

## Backup Scheduling, Compression, and Encryption

Backup scheduling is valuable for automating backup procedures. Compression of backup output reduces space requirements, and encryption of the output provides better security against unauthorized access of backed-up data. MySQL itself does not provide these capabilities. The MySQL Enterprise Backup product can compress [InnoDB](#) backups, and compression or encryption of backup output can be achieved using file system utilities. Other third-party solutions may be available.

## 7.2 Database Backup Methods

This section summarizes some general methods for making backups.

### Making a Hot Backup with MySQL Enterprise Backup

Customers of MySQL Enterprise Edition can use the [MySQL Enterprise Backup](#) product to do [physical](#) backups of entire instances or selected databases, tables, or both. This product includes features for [incremental](#) and [compressed](#) backups. Backing up the physical database files makes restore much faster than logical techniques such as the `mysqldump` command. [InnoDB](#) tables are copied using a [hot backup](#) mechanism. (Ideally, the [InnoDB](#) tables should represent a substantial majority of the data.) Tables from other storage engines are copied using a [warm backup](#) mechanism. For an overview of the MySQL Enterprise Backup product, see [Section 28.1, “MySQL Enterprise Backup Overview”](#).

### Making Backups with `mysqldump`

The `mysqldump` program can make backups. It can back up all kinds of tables. (See [Section 7.4, “Using `mysqldump` for Backups”](#).)

For [InnoDB](#) tables, it is possible to perform an online backup that takes no locks on tables using the `--single-transaction` option to `mysqldump`. See [Section 7.3.1, “Establishing a Backup Policy”](#).

### Making Backups by Copying Table Files

For storage engines that represent each table using its own files, tables can be backed up by copying those files. For example, [MyISAM](#) tables are stored as files, so it is easy to do a backup by copying files

(\* .frm, \* .MYD, and \* .MYI files). To get a consistent backup, stop the server or lock and flush the relevant tables:

```
FLUSH TABLES tbl_list WITH READ LOCK;
```

You need only a read lock; this enables other clients to continue to query the tables while you are making a copy of the files in the database directory. The flush is needed to ensure that the all active index pages are written to disk before you start the backup. See [Section 13.3.5, “LOCK TABLES and UNLOCK TABLES Statements”](#), and [Section 13.7.6.3, “FLUSH Statement”](#).

You can also create a binary backup simply by copying all table files, as long as the server is not updating anything. (But note that table file copying methods do not work if your database contains [InnoDB](#) tables. Also, even if the server is not actively updating data, [InnoDB](#) may still have modified data cached in memory and not flushed to disk.)

## Making Delimited-Text File Backups

To create a text file containing a table's data, you can use `SELECT * INTO OUTFILE 'file_name' FROM tbl_name`. The file is created on the MySQL server host, not the client host. For this statement, the output file cannot already exist because permitting files to be overwritten constitutes a security risk. See [Section 13.2.9, “SELECT Statement”](#). This method works for any kind of data file, but saves only table data, not the table structure.

Another way to create text data files (along with files containing `CREATE TABLE` statements for the backed up tables) is to use `mysqldump` with the `--tab` option. See [Section 7.4.3, “Dumping Data in Delimited-Text Format with mysqldump”](#).

To reload a delimited-text data file, use `LOAD DATA` or `mysqlimport`.

## Making Incremental Backups by Enabling the Binary Log

MySQL supports incremental backups: You must start the server with the `--log-bin` option to enable binary logging; see [Section 5.4.4, “The Binary Log”](#). The binary log files provide you with the information you need to replicate changes to the database that are made subsequent to the point at which you performed a backup. At the moment you want to make an incremental backup (containing all changes that happened since the last full or incremental backup), you should rotate the binary log by using `FLUSH LOGS`. This done, you need to copy to the backup location all binary logs which range from the one of the moment of the last full or incremental backup to the last but one. These binary logs are the incremental backup; at restore time, you apply them as explained in [Section 7.5, “Point-in-Time \(Incremental\) Recovery”](#). The next time you do a full backup, you should also rotate the binary log using `FLUSH LOGS` or `mysqldump --flush-logs`. See [Section 4.5.4, “mysqldump — A Database Backup Program”](#).

## Making Backups Using Replicas

If you have performance problems with your source server while making backups, one strategy that can help is to set up replication and perform backups on the replica rather than on the source. See [Section 16.3.1, “Using Replication for Backups”](#).

If you are backing up a replica server, you should back up its source info and relay log info repositories (see [Section 16.2.4, “Relay Log and Replication Metadata Repositories”](#)) when you back up the replica's databases, regardless of the backup method you choose. These information files are always needed to resume replication after you restore the replica's data. If your replica is replicating `LOAD DATA` statements, you should also back up any `SQL_LOAD-*` files that exist in the directory that the replica uses for this purpose. The replica needs these files to resume replication of any interrupted `LOAD DATA` operations.

The location of this directory is the value of the `slave_load_tmpdir` system variable. If the server was not started with that variable set, the directory location is the value of the `tmpdir` system variable.

## Recovering Corrupt Tables

If you have to restore `MyISAM` tables that have become corrupt, try to recover them using `REPAIR TABLE` or `myisamchk -r` first. That should work in 99.9% of all cases. If `myisamchk` fails, see [Section 7.6, “MyISAM Table Maintenance and Crash Recovery”](#).

## Making Backups Using a File System Snapshot

If you are using a Veritas file system, you can make a backup like this:

1. From a client program, execute `FLUSH TABLES WITH READ LOCK`.
2. From another shell, execute `mount vxfs snapshot`.
3. From the first client, execute `UNLOCK TABLES`.
4. Copy files from the snapshot.
5. Unmount the snapshot.

Similar snapshot capabilities may be available in other file systems, such as LVM or ZFS.

## 7.3 Example Backup and Recovery Strategy

This section discusses a procedure for performing backups that enables you to recover data after several types of crashes:

- Operating system crash
- Power failure
- File system crash
- Hardware problem (hard drive, motherboard, and so forth)

The example commands do not include options such as `--user` and `--password` for the `mysqldump` and `mysql` client programs. You should include such options as necessary to enable client programs to connect to the MySQL server.

Assume that data is stored in the `InnoDB` storage engine, which has support for transactions and automatic crash recovery. Assume also that the MySQL server is under load at the time of the crash. If it were not, no recovery would ever be needed.

For cases of operating system crashes or power failures, we can assume that MySQL's disk data is available after a restart. The `InnoDB` data files might not contain consistent data due to the crash, but `InnoDB` reads its logs and finds in them the list of pending committed and noncommitted transactions that have not been flushed to the data files. `InnoDB` automatically rolls back those transactions that were not committed, and flushes to its data files those that were committed. Information about this recovery process is conveyed to the user through the MySQL error log. The following is an example log excerpt:

```
InnoDB: Database was not shut down normally.
InnoDB: Starting recovery from log files...
InnoDB: Starting log scan based on checkpoint at
InnoDB: log sequence number 0 13674004
```

```

InnoDB: Doing recovery: scanned up to log sequence number 0 13739520
InnoDB: Doing recovery: scanned up to log sequence number 0 13805056
InnoDB: Doing recovery: scanned up to log sequence number 0 13870592
InnoDB: Doing recovery: scanned up to log sequence number 0 13936128
...
InnoDB: Doing recovery: scanned up to log sequence number 0 20555264
InnoDB: Doing recovery: scanned up to log sequence number 0 20620800
InnoDB: Doing recovery: scanned up to log sequence number 0 20664692
InnoDB: 1 uncommitted transaction(s) which must be rolled back
InnoDB: Starting rollback of uncommitted transactions
InnoDB: Rolling back trx no 16745
InnoDB: Rolling back of trx no 16745 completed
InnoDB: Rollback of uncommitted transactions completed
InnoDB: Starting an apply batch of log records to the database...
InnoDB: Apply batch completed
InnoDB: Started
mysqld: ready for connections

```

For the cases of file system crashes or hardware problems, we can assume that the MySQL disk data is *not* available after a restart. This means that MySQL fails to start successfully because some blocks of disk data are no longer readable. In this case, it is necessary to reformat the disk, install a new one, or otherwise correct the underlying problem. Then it is necessary to recover our MySQL data from backups, which means that backups must already have been made. To make sure that is the case, design and implement a backup policy.

### 7.3.1 Establishing a Backup Policy

To be useful, backups must be scheduled regularly. A full backup (a snapshot of the data at a point in time) can be done in MySQL with several tools. For example, [MySQL Enterprise Backup](#) can perform a [physical backup](#) of an entire instance, with optimizations to minimize overhead and avoid disruption when backing up [InnoDB](#) data files; [mysqldump](#) provides online [logical backup](#). This discussion uses [mysqldump](#).

Assume that we make a full backup of all our [InnoDB](#) tables in all databases using the following command on Sunday at 1 p.m., when load is low:

```
$> mysqldump --all-databases --master-data --single-transaction > backup_sunday_1_PM.sql
```

The resulting `.sql` file produced by [mysqldump](#) contains a set of SQL `INSERT` statements that can be used to reload the dumped tables at a later time.

This backup operation acquires a global read lock on all tables at the beginning of the dump (using `FLUSH TABLES WITH READ LOCK`). As soon as this lock has been acquired, the binary log coordinates are read and the lock is released. If long updating statements are running when the `FLUSH` statement is issued, the backup operation may stall until those statements finish. After that, the dump becomes lock-free and does not disturb reads and writes on the tables.

It was assumed earlier that the tables to back up are [InnoDB](#) tables, so `--single-transaction` uses a consistent read and guarantees that data seen by [mysqldump](#) does not change. (Changes made by other clients to [InnoDB](#) tables are not seen by the [mysqldump](#) process.) If the backup operation includes nontransactional tables, consistency requires that they do not change during the backup. For example, for the [MyISAM](#) tables in the `mysql` database, there must be no administrative changes to MySQL accounts during the backup.

Full backups are necessary, but it is not always convenient to create them. They produce large backup files and take time to generate. They are not optimal in the sense that each successive full backup includes all data, even that part that has not changed since the previous full backup. It is more efficient to make an initial full backup, and then to make incremental backups. The incremental backups are smaller and take less time to produce. The tradeoff is that, at recovery time, you cannot restore your data just by reloading the full backup. You must also process the incremental backups to recover the incremental changes.

To make incremental backups, we need to save the incremental changes. In MySQL, these changes are represented in the binary log, so the MySQL server should always be started with the `--log-bin` option to enable that log. With binary logging enabled, the server writes each data change into a file while it updates data. Looking at the data directory of a MySQL server that was started with the `--log-bin` option and that has been running for some days, we find these MySQL binary log files:

```
-rw-rw---- 1 guilhem guilhem 1277324 Nov 10 23:59 gbichot2-bin.000001
-rw-rw---- 1 guilhem guilhem      4 Nov 10 23:59 gbichot2-bin.000002
-rw-rw---- 1 guilhem guilhem      79 Nov 11 11:06 gbichot2-bin.000003
-rw-rw---- 1 guilhem guilhem     508 Nov 11 11:08 gbichot2-bin.000004
-rw-rw---- 1 guilhem guilhem 220047446 Nov 12 16:47 gbichot2-bin.000005
-rw-rw---- 1 guilhem guilhem  998412 Nov 14 10:08 gbichot2-bin.000006
-rw-rw---- 1 guilhem guilhem     361 Nov 14 10:07 gbichot2-bin.index
```

Each time it restarts, the MySQL server creates a new binary log file using the next number in the sequence. While the server is running, you can also tell it to close the current binary log file and begin a new one manually by issuing a `FLUSH LOGS` SQL statement or with a `mysqladmin flush-logs` command. `mysqldump` also has an option to flush the logs. The `.index` file in the data directory contains the list of all MySQL binary logs in the directory.

The MySQL binary logs are important for recovery because they form the set of incremental backups. If you make sure to flush the logs when you make your full backup, the binary log files created afterward contain all the data changes made since the backup. Let's modify the previous `mysqldump` command a bit so that it flushes the MySQL binary logs at the moment of the full backup, and so that the dump file contains the name of the new current binary log:

```
$> mysqldump --single-transaction --flush-logs --master-data=2 \
      --all-databases > backup_sunday_1_PM.sql
```

After executing this command, the data directory contains a new binary log file, `gbichot2-bin.000007`, because the `--flush-logs` option causes the server to flush its logs. The `--master-data` option causes `mysqldump` to write binary log information to its output, so the resulting `.sql` dump file includes these lines:

```
-- Position to start replication or point-in-time recovery from
-- CHANGE MASTER TO MASTER_LOG_FILE='gbichot2-bin.000007',MASTER_LOG_POS=4;
```

Because the `mysqldump` command made a full backup, those lines mean two things:

- The dump file contains all changes made before any changes written to the `gbichot2-bin.000007` binary log file or higher.
- All data changes logged after the backup are not present in the dump file, but are present in the `gbichot2-bin.000007` binary log file or higher.

On Monday at 1 p.m., we can create an incremental backup by flushing the logs to begin a new binary log file. For example, executing a `mysqladmin flush-logs` command creates `gbichot2-bin.000008`. All changes between the Sunday 1 p.m. full backup and Monday 1 p.m. are in the `gbichot2-bin.000007` file. This incremental backup is important, so it is a good idea to copy it to a safe place. (For example, back it up on tape or DVD, or copy it to another machine.) On Tuesday at 1 p.m., execute another `mysqladmin flush-logs` command. All changes between Monday 1 p.m. and Tuesday 1 p.m. are in the `gbichot2-bin.000008` file (which also should be copied somewhere safe).

The MySQL binary logs take up disk space. To free up space, purge them from time to time. One way to do this is by deleting the binary logs that are no longer needed, such as when we make a full backup:

```
$> mysqldump --single-transaction --flush-logs --master-data=2 \
      --all-databases --delete-master-logs > backup_sunday_1_PM.sql
```

**Note**

Deleting the MySQL binary logs with `mysqldump --delete-master-logs` can be dangerous if your server is a replication source server, because replica servers might not yet fully have processed the contents of the binary log. The description for the `PURGE BINARY LOGS` statement explains what should be verified before deleting the MySQL binary logs. See [Section 13.4.1.1, “PURGE BINARY LOGS Statement”](#).

## 7.3.2 Using Backups for Recovery

Now, suppose that we have a catastrophic unexpected exit on Wednesday at 8 a.m. that requires recovery from backups. To recover, first we restore the last full backup we have (the one from Sunday 1 p.m.). The full backup file is just a set of SQL statements, so restoring it is very easy:

```
$> mysql < backup_sunday_1_PM.sql
```

At this point, the data is restored to its state as of Sunday 1 p.m.. To restore the changes made since then, we must use the incremental backups; that is, the `gbichot2-bin.000007` and `gbichot2-bin.000008` binary log files. Fetch the files if necessary from where they were backed up, and then process their contents like this:

```
$> mysqlbinlog gbichot2-bin.000007 gbichot2-bin.000008 | mysql
```

We now have recovered the data to its state as of Tuesday 1 p.m., but still are missing the changes from that date to the date of the crash. To not lose them, we would have needed to have the MySQL server store its MySQL binary logs into a safe location (RAID disks, SAN, ...) different from the place where it stores its data files, so that these logs were not on the destroyed disk. (That is, we can start the server with a `--log-bin` option that specifies a location on a different physical device from the one on which the data directory resides. That way, the logs are safe even if the device containing the directory is lost.) If we had done this, we would have the `gbichot2-bin.000009` file (and any subsequent files) at hand, and we could apply them using `mysqlbinlog` and `mysql` to restore the most recent data changes with no loss up to the moment of the crash:

```
$> mysqlbinlog gbichot2-bin.000009 ... | mysql
```

For more information about using `mysqlbinlog` to process binary log files, see [Section 7.5, “Point-in-Time \(Incremental\) Recovery”](#).

## 7.3.3 Backup Strategy Summary

In case of an operating system crash or power failure, `InnoDB` itself does all the job of recovering data. But to make sure that you can sleep well, observe the following guidelines:

- Always run the MySQL server with the `--log-bin` option, or even `--log-bin=log_name`, where the log file name is located on some safe media different from the drive on which the data directory is located. If you have such safe media, this technique can also be good for disk load balancing (which results in a performance improvement).
- Make periodic full backups, using the `mysqldump` command shown earlier in [Section 7.3.1, “Establishing a Backup Policy”](#), that makes an online, nonblocking backup.
- Make periodic incremental backups by flushing the logs with `FLUSH LOGS` or `mysqladmin flush-logs`.

## 7.4 Using `mysqldump` for Backups

This section describes how to use `mysqldump` to produce dump files, and how to reload dump files. A dump file can be used in several ways:

- As a backup to enable data recovery in case of data loss.
- As a source of data for setting up replicas.
- As a source of data for experimentation:
  - To make a copy of a database that you can use without changing the original data.
  - To test potential upgrade incompatibilities.

`mysqldump` produces two types of output, depending on whether the `--tab` option is given:

- Without `--tab`, `mysqldump` writes SQL statements to the standard output. This output consists of `CREATE` statements to create dumped objects (databases, tables, stored routines, and so forth), and `INSERT` statements to load data into tables. The output can be saved in a file and reloaded later using `mysql` to recreate the dumped objects. Options are available to modify the format of the SQL statements, and to control which objects are dumped.
- With `--tab`, `mysqldump` produces two output files for each dumped table. The server writes one file as tab-delimited text, one line per table row. This file is named `tbl_name.txt` in the output directory. The server also sends a `CREATE TABLE` statement for the table to `mysqldump`, which writes it as a file named `tbl_name.sql` in the output directory.

## 7.4.1 Dumping Data in SQL Format with mysqldump

This section describes how to use `mysqldump` to create SQL-format dump files. For information about reloading such dump files, see [Section 7.4.2, “Reloading SQL-Format Backups”](#).

By default, `mysqldump` writes information as SQL statements to the standard output. You can save the output in a file:

```
$> mysqldump [arguments] > file_name
```

To dump all databases, invoke `mysqldump` with the `--all-databases` option:

```
$> mysqldump --all-databases > dump.sql
```

To dump only specific databases, name them on the command line and use the `--databases` option:

```
$> mysqldump --databases db1 db2 db3 > dump.sql
```

The `--databases` option causes all names on the command line to be treated as database names. Without this option, `mysqldump` treats the first name as a database name and those following as table names.

With `--all-databases` or `--databases`, `mysqldump` writes `CREATE DATABASE` and `USE` statements prior to the dump output for each database. This ensures that when the dump file is reloaded, it creates each database if it does not exist and makes it the default database so database contents are loaded into the same database from which they came. If you want to cause the dump file to force a drop of each database before recreating it, use the `--add-drop-database` option as well. In this case, `mysqldump` writes a `DROP DATABASE` statement preceding each `CREATE DATABASE` statement.

To dump a single database, name it on the command line:

```
$> mysqldump --databases test > dump.sql
```

In the single-database case, it is permissible to omit the `--databases` option:

```
$> mysqldump test > dump.sql
```

The difference between the two preceding commands is that without `--databases`, the dump output contains no `CREATE DATABASE` or `USE` statements. This has several implications:

- When you reload the dump file, you must specify a default database name so that the server knows which database to reload.
- For reloading, you can specify a database name different from the original name, which enables you to reload the data into a different database.
- If the database to be reloaded does not exist, you must create it first.
- Because the output contains no `CREATE DATABASE` statement, the `--add-drop-database` option has no effect. If you use it, it produces no `DROP DATABASE` statement.

To dump only specific tables from a database, name them on the command line following the database name:

```
$> mysqldump test t1 t3 t7 > dump.sql
```

## 7.4.2 Reloading SQL-Format Backups

To reload a dump file written by `mysqldump` that consists of SQL statements, use it as input to the `mysql` client. If the dump file was created by `mysqldump` with the `--all-databases` or `--databases` option, it contains `CREATE DATABASE` and `USE` statements and it is not necessary to specify a default database into which to load the data:

```
$> mysql < dump.sql
```

Alternatively, from within `mysql`, use a `source` command:

```
mysql> source dump.sql
```

If the file is a single-database dump not containing `CREATE DATABASE` and `USE` statements, create the database first (if necessary):

```
$> mysqladmin create db1
```

Then specify the database name when you load the dump file:

```
$> mysql db1 < dump.sql
```

Alternatively, from within `mysql`, create the database, select it as the default database, and load the dump file:

```
mysql> CREATE DATABASE IF NOT EXISTS db1;
mysql> USE db1;
mysql> source dump.sql
```



### Note

For Windows PowerShell users: Because the "<" character is reserved for future use in PowerShell, an alternative approach is required, such as using quotes `cmd.exe /c "mysql < dump.sql"`.



## 7.4.3 Dumping Data in Delimited-Text Format with mysqldump

This section describes how to use `mysqldump` to create delimited-text dump files. For information about reloading such dump files, see [Section 7.4.4, “Reloading Delimited-Text Format Backups”](#).

If you invoke `mysqldump` with the `--tab=dir_name` option, it uses `dir_name` as the output directory and dumps tables individually in that directory using two files for each table. The table name is the base name for these files. For a table named `t1`, the files are named `t1.sql` and `t1.txt`. The `.sql` file contains a `CREATE TABLE` statement for the table. The `.txt` file contains the table data, one line per table row.

The following command dumps the contents of the `db1` database to files in the `/tmp` database:

```
$> mysqldump --tab=/tmp db1
```

The `.txt` files containing table data are written by the server, so they are owned by the system account used for running the server. The server uses `SELECT ... INTO OUTFILE` to write the files, so you must have the `FILE` privilege to perform this operation, and an error occurs if a given `.txt` file already exists.

The server sends the `CREATE` definitions for dumped tables to `mysqldump`, which writes them to `.sql` files. These files therefore are owned by the user who executes `mysqldump`.

It is best that `--tab` be used only for dumping a local server. If you use it with a remote server, the `--tab` directory must exist on both the local and remote hosts, and the `.txt` files are written by the server in the remote directory (on the server host), whereas the `.sql` files are written by `mysqldump` in the local directory (on the client host).

For `mysqldump --tab`, the server by default writes table data to `.txt` files one line per row with tabs between column values, no quotation marks around column values, and newline as the line terminator. (These are the same defaults as for `SELECT ... INTO OUTFILE`.)

To enable data files to be written using a different format, `mysqldump` supports these options:

- `--fields-terminated-by=str`

The string for separating column values (default: tab).

- `--fields-enclosed-by=char`

The character within which to enclose column values (default: no character).

- `--fields-optionally-enclosed-by=char`

The character within which to enclose non-numeric column values (default: no character).

- `--fields-escaped-by=char`

The character for escaping special characters (default: no escaping).

- `--lines-terminated-by=str`

The line-termination string (default: newline).

Depending on the value you specify for any of these options, it might be necessary on the command line to quote or escape the value appropriately for your command interpreter. Alternatively, specify the value using hex notation. Suppose that you want `mysqldump` to quote column values within double quotation marks. To do so, specify double quote as the value for the `--fields-enclosed-by` option. But this

character is often special to command interpreters and must be treated specially. For example, on Unix, you can quote the double quote like this:

```
--fields-enclosed-by='''
```

On any platform, you can specify the value in hex:

```
--fields-enclosed-by=0x22
```

It is common to use several of the data-formatting options together. For example, to dump tables in comma-separated values format with lines terminated by carriage-return/newline pairs (`\r\n`), use this command (enter it on a single line):

```
$> mysqldump --tab=/tmp --fields-terminated-by=,
      --fields-enclosed-by=''' --lines-terminated-by=0x0d0a db1
```

Should you use any of the data-formatting options to dump table data, you must specify the same format when you reload data files later, to ensure proper interpretation of the file contents.

## 7.4.4 Reloading Delimited-Text Format Backups

For backups produced with `mysqldump --tab`, each table is represented in the output directory by an `.sql` file containing the `CREATE TABLE` statement for the table, and a `.txt` file containing the table data. To reload a table, first change location into the output directory. Then process the `.sql` file with `mysql` to create an empty table and process the `.txt` file to load the data into the table:

```
$> mysql db1 < t1.sql
$> mysqlimport db1 t1.txt
```

An alternative to using `mysqlimport` to load the data file is to use the `LOAD DATA` statement from within the `mysql` client:

```
mysql> USE db1;
mysql> LOAD DATA INFILE 't1.txt' INTO TABLE t1;
```

If you used any data-formatting options with `mysqldump` when you initially dumped the table, you must use the same options with `mysqlimport` or `LOAD DATA` to ensure proper interpretation of the data file contents:

```
$> mysqlimport --fields-terminated-by=,
      --fields-enclosed-by=''' --lines-terminated-by=0x0d0a db1 t1.txt
```

Or:

```
mysql> USE db1;
mysql> LOAD DATA INFILE 't1.txt' INTO TABLE t1
      FIELDS TERMINATED BY ',' FIELDS ENCLOSED BY ''''
      LINES TERMINATED BY '\r\n';
```

## 7.4.5 mysqldump Tips

This section surveys techniques that enable you to use `mysqldump` to solve specific problems:

- How to make a copy a database
- How to copy a database from one server to another
- How to dump stored programs (stored procedures and functions, triggers, and events)

- How to dump definitions and data separately

### 7.4.5.1 Making a Copy of a Database

```
$> mysqldump db1 > dump.sql
$> mysqladmin create db2
$> mysql db2 < dump.sql
```

Do not use `--databases` on the `mysqldump` command line because that causes `USE db1` to be included in the dump file, which overrides the effect of naming `db2` on the `mysql` command line.

### 7.4.5.2 Copy a Database from one Server to Another

On Server 1:

```
$> mysqldump --databases db1 > dump.sql
```

Copy the dump file from Server 1 to Server 2.

On Server 2:

```
$> mysql < dump.sql
```

Use of `--databases` with the `mysqldump` command line causes the dump file to include `CREATE DATABASE` and `USE` statements that create the database if it does exist and make it the default database for the reloaded data.

Alternatively, you can omit `--databases` from the `mysqldump` command. Then you need to create the database on Server 2 (if necessary) and to specify it as the default database when you reload the dump file.

On Server 1:

```
$> mysqldump db1 > dump.sql
```

On Server 2:

```
$> mysqladmin create db1
$> mysql db1 < dump.sql
```

You can specify a different database name in this case, so omitting `--databases` from the `mysqldump` command enables you to dump data from one database and load it into another.

### 7.4.5.3 Dumping Stored Programs

Several options control how `mysqldump` handles stored programs (stored procedures and functions, triggers, and events):

- `--events`: Dump Event Scheduler events
- `--routines`: Dump stored procedures and functions
- `--triggers`: Dump triggers for tables

The `--triggers` option is enabled by default so that when tables are dumped, they are accompanied by any triggers they have. The other options are disabled by default and must be specified explicitly to dump the corresponding objects. To disable any of these options explicitly, use its skip form: `--skip-events`, `--skip-routines`, or `--skip-triggers`.

### 7.4.5.4 Dumping Table Definitions and Content Separately

The `--no-data` option tells `mysqldump` not to dump table data, resulting in the dump file containing only statements to create the tables. Conversely, the `--no-create-info` option tells `mysqldump` to suppress `CREATE` statements from the output, so that the dump file contains only table data.

For example, to dump table definitions and data separately for the `test` database, use these commands:

```
$> mysqldump --no-data test > dump-defs.sql
$> mysqldump --no-create-info test > dump-data.sql
```

For a definition-only dump, add the `--routines` and `--events` options to also include stored routine and event definitions:

```
$> mysqldump --no-data --routines --events test > dump-defs.sql
```

### 7.4.5.5 Using `mysqldump` to Test for Upgrade Incompatibilities

When contemplating a MySQL upgrade, it is prudent to install the newer version separately from your current production version. Then you can dump the database and database object definitions from the production server and load them into the new server to verify that they are handled properly. (This is also useful for testing downgrades.)

On the production server:

```
$> mysqldump --all-databases --no-data --routines --events > dump-defs.sql
```

On the upgraded server:

```
$> mysql < dump-defs.sql
```

Because the dump file does not contain table data, it can be processed quickly. This enables you to spot potential incompatibilities without waiting for lengthy data-loading operations. Look for warnings or errors while the dump file is being processed.

After you have verified that the definitions are handled properly, dump the data and try to load it into the upgraded server.

On the production server:

```
$> mysqldump --all-databases --no-create-info > dump-data.sql
```

On the upgraded server:

```
$> mysql < dump-data.sql
```

Now check the table contents and run some test queries.

## 7.5 Point-in-Time (Incremental) Recovery

Point-in-time recovery refers to recovery of data changes up to a given point in time. Typically, this type of recovery is performed after restoring a full backup that brings the server to its state as of the time the backup was made. (The full backup can be made in several ways, such as those listed in [Section 7.2, “Database Backup Methods”](#).) Point-in-time recovery then brings the server up to date incrementally from the time of the full backup to a more recent time.

## 7.5.1 Point-in-Time Recovery Using Binary Log

This section explains the general idea of using the binary log to perform a point-in-time-recovery. The next section, [Section 7.5.2, “Point-in-Time Recovery Using Event Positions”](#), explains the operation in details with an example.



### Note

Many of the examples in this and the next section use the `mysql` client to process binary log output produced by `mysqlbinlog`. If your binary log contains `\0` (null) characters, that output cannot be parsed by `mysql` unless you invoke it with the `--binary-mode` option.

The source of information for point-in-time recovery is the set of binary log files generated subsequent to the full backup operation. Therefore, to allow a server to be restored to a point-in-time, binary logging must be enabled on it (see [Section 5.4.4, “The Binary Log”](#) for details).

To restore data from the binary log, you must know the name and location of the current binary log files. By default, the server creates binary log files in the data directory, but a path name can be specified with the `--log-bin` option to place the files in a different location. To see a listing of all binary log files, use this statement:

```
mysql> SHOW BINARY LOGS;
```

To determine the name of the current binary log file, issue the following statement:

```
mysql> SHOW MASTER STATUS;
```

The `mysqlbinlog` utility converts the events in the binary log files from binary format to text so that they can be viewed or applied. `mysqlbinlog` has options for selecting sections of the binary log based on event times or position of events within the log. See [Section 4.6.7, “mysqlbinlog — Utility for Processing Binary Log Files”](#).

Applying events from the binary log causes the data modifications they represent to be reexecuted. This enables recovery of data changes for a given span of time. To apply events from the binary log, process `mysqlbinlog` output using the `mysql` client:

```
$> mysqlbinlog binlog_files | mysql -u root -p
```

Viewing log contents can be useful when you need to determine event times or positions to select partial log contents prior to executing events. To view events from the log, send `mysqlbinlog` output into a paging program:

```
$> mysqlbinlog binlog_files | more
```

Alternatively, save the output in a file and view the file in a text editor:

```
$> mysqlbinlog binlog_files > tmpfile
$> ... edit tmpfile ...
```

After editing the file, apply the contents as follows:

```
$> mysql -u root -p < tmpfile
```

If you have more than one binary log to apply on the MySQL server, use a single connection to apply the contents of all binary log files that you want to process. Here is one way to do so:

```
$> mysqlbinlog binlog.000001 binlog.000002 | mysql -u root -p
```

Another approach is to write the whole log to a single file and then process the file:

```
$> mysqlbinlog binlog.000001 > /tmp/statements.sql
$> mysqlbinlog binlog.000002 >> /tmp/statements.sql
$> mysql -u root -p -e "source /tmp/statements.sql"
```

## 7.5.2 Point-in-Time Recovery Using Event Positions

The last section, [Section 7.5.1, “Point-in-Time Recovery Using Binary Log”](#), explains the general idea of using the binary log to perform a point-in-time-recovery. The section explains the operation in details with an example.

As an example, suppose that around 13:00:00 on May 27, 2020, an SQL statement was executed that deleted a table. You can perform a point-in-time recovery to restore the server up to its state right before the table deletion. These are some sample steps to achieve that:

1. Restore the last full backup created before the point-in-time of interest (call it  $t_p$ , which is 13:00:00 on May 27, 2020 in our example). When finished, note the binary log position up to which you have restored the server for later use, and restart the server.



### Note

While the last binary log position recovered is also displayed by InnoDB after the restore and server restart, that is *not* a reliable means for obtaining the ending log position of your restore, as there could be DDL events and non-InnoDB changes that have taken place after the time reflected by the displayed position. Your backup and restore tool should provide you with the last binary log position for your recovery: for example, if you are using `mysqlbinlog` for the task, check the stop position of the binary log replay; if you are using MySQL Enterprise Backup, the last binary log position has been saved in your backup. See [Point-in-Time Recovery](#).

2. Find the precise binary log event position corresponding to the point in time up to which you want to restore your database. In our example, given that we know the rough time where the table deletion took place ( $t_p$ ), we can find the log position by checking the log contents around that time using the `mysqlbinlog` utility. Use the `--start-datetime` and `--stop-datetime` options to specify a short time period around  $t_p$ , and then look for the event in the output. For example:

```
$> mysqlbinlog --start-datetime="2020-05-27 12:59:00" --stop-datetime="2020-05-27 13:06:00" \
--verbose /var/lib/mysql/bin.123456 | grep -C 12 "DROP TABLE"
# at 1868
#200527 13:00:30 server id 2 end_log_pos 1985 CRC32 0x8b894489 Query thread_id=8 exec_time=0 error_code=0
use `pets`/*!*/;
SET TIMESTAMP=1590598830/*!*/;
SET @@session.pseudo_thread_id=8/*!*/;
SET @@session.foreign_key_checks=1, @@session.sql_auto_is_null=0, @@session.unique_checks=1, @@session.auto_c
SET @@session.sql_mode=1436549152/*!80005 &~0x1003ff00/*!*/;
SET @@session.auto_increment_increment=1, @@session.auto_increment_offset=1/*!*/;
/*!\C latin1 *//*!*/;
SET @@session.character_set_client=8,@@session.collation_connection=8,@@session.collation_server=8/*!*/;
SET @@session.lc_time_names=0/*!*/;
SET @@session.collation_database=DEFAULT/*!*/;
DROP TABLE `cats` /* generated by server */
/*!*/;
# at 1985
#200527 13:05:06 server id 2 end_log_pos 2050 CRC32 0x2f8d0249 Anonymous_GTID last_committed=6 sequence_r
/*!50718 SET TRANSACTION ISOLATION LEVEL READ COMMITTED/*!*/;
# original_commit_timestamp=0 (1969-12-31 19:00:00.000000 EST)
# immediate_commit_timestamp=0 (1969-12-31 19:00:00.000000 EST)
/*!80001 SET @@session.original_commit_timestamp=0/*!*/;
```

```

/*!80014 SET @@session.original_server_version=0/*!*/;
/*!80014 SET @@session.immediate_server_version=0/*!*/;
SET @@SESSION.GTID_NEXT= 'ANONYMOUS'/*!*/;
# at 2050
#200527 13:05:06 server id 2  end_log_pos 2122 CRC32 0x56280bb1  Query thread_id=8  exec_time=0  error_co

```

From the output of `mysqlbinlog`, the `DROP TABLE `pets`.`cats`` statement can be found in the segment of the binary log between the line `# at 1868` and `# at 1985`, which means the statement takes place *after* the log position 1868, and the log is at position 1985 after the `DROP TABLE` statement.



### Note

Only use the `--start-datetime` and `--stop-datetime` options to help you find the actual event positions of interest. Using the two options to specify the range of binary log segment to apply is not recommended: there is a higher risk of missing binary log events when using the options. Use `--start-position` and `--stop-position` instead.

- Apply the events in binary log file to the server, starting with the log position you found in step 1 (assume it is 1006) and ending at the position you have found in step 2 that is *before* your point-in-time of interest (which is 1868):

```

$> mysqlbinlog --start-position=1006 --stop-position=1868 /var/lib/mysql/bin.123456 \
| mysql -u root -p

```

The command recovers all the transactions from the starting position until just before the stop position. Because the output of `mysqlbinlog` includes `SET TIMESTAMP` statements before each SQL statement recorded, the recovered data and related MySQL logs reflect the original times at which the transactions were executed.

Your database has now been restored to the point-in-time of interest,  $t_p$ , right before the table `pets.cats` was dropped.

- Beyond the point-in-time recovery that has been finished, if you also want to reexecute all the statements *after* your point-in-time of interest, use `mysqlbinlog` again to apply all the events after  $t_p$  to the server. We noted in step 2 that after the statement we wanted to skip, the log is at position 1985; we can use it for the `--start-position` option, so that any statements after the position are included:

```

$> mysqlbinlog --start-position=1985 /var/lib/mysql/bin.123456 \
| mysql -u root -p

```

Your database has been restored the latest statement recorded in the binary log file, but with the selected event skipped.

## 7.6 MyISAM Table Maintenance and Crash Recovery

This section discusses how to use `myisamchk` to check or repair MyISAM tables (tables that have `.MYD` and `.MYI` files for storing data and indexes). For general `myisamchk` background, see [Section 4.6.3, “myisamchk — MyISAM Table-Maintenance Utility”](#). Other table-repair information can be found at [Section 2.10.12, “Rebuilding or Repairing Tables or Indexes”](#).

You can use `myisamchk` to check, repair, or optimize database tables. The following sections describe how to perform these operations and how to set up a table maintenance schedule. For information about using `myisamchk` to get information about your tables, see [Section 4.6.3.5, “Obtaining Table Information with myisamchk”](#).

Even though table repair with `myisamchk` is quite secure, it is always a good idea to make a backup *before* doing a repair or any maintenance operation that could make a lot of changes to a table.

`myisamchk` operations that affect indexes can cause `MyISAM FULLTEXT` indexes to be rebuilt with full-text parameters that are incompatible with the values used by the MySQL server. To avoid this problem, follow the guidelines in [Section 4.6.3.1, “myisamchk General Options”](#).

`MyISAM` table maintenance can also be done using the SQL statements that perform operations similar to what `myisamchk` can do:

- To check `MyISAM` tables, use `CHECK TABLE`.
- To repair `MyISAM` tables, use `REPAIR TABLE`.
- To optimize `MyISAM` tables, use `OPTIMIZE TABLE`.
- To analyze `MyISAM` tables, use `ANALYZE TABLE`.

For additional information about these statements, see [Section 13.7.2, “Table Maintenance Statements”](#).

These statements can be used directly or by means of the `mysqlcheck` client program. One advantage of these statements over `myisamchk` is that the server does all the work. With `myisamchk`, you must make sure that the server does not use the tables at the same time so that there is no unwanted interaction between `myisamchk` and the server.

## 7.6.1 Using myisamchk for Crash Recovery

This section describes how to check for and deal with data corruption in MySQL databases. If your tables become corrupted frequently, you should try to find the reason why. See [Section B.3.3.3, “What to Do If MySQL Keeps Crashing”](#).

For an explanation of how `MyISAM` tables can become corrupted, see [Section 15.2.4, “MyISAM Table Problems”](#).

If you run `mysqld` with external locking disabled (which is the default), you cannot reliably use `myisamchk` to check a table when `mysqld` is using the same table. If you can be certain that no one can access the tables through `mysqld` while you run `myisamchk`, you have only to execute `mysqladmin flush-tables` before you start checking the tables. If you cannot guarantee this, you must stop `mysqld` while you check the tables. If you run `myisamchk` to check tables that `mysqld` is updating at the same time, you may get a warning that a table is corrupt even when it is not.

If the server is run with external locking enabled, you can use `myisamchk` to check tables at any time. In this case, if the server tries to update a table that `myisamchk` is using, the server waits for `myisamchk` to finish before it continues.

If you use `myisamchk` to repair or optimize tables, you *must* always ensure that the `mysqld` server is not using the table (this also applies if external locking is disabled). If you do not stop `mysqld`, you should at least do a `mysqladmin flush-tables` before you run `myisamchk`. Your tables *may become corrupted* if the server and `myisamchk` access the tables simultaneously.

When performing crash recovery, it is important to understand that each `MyISAM` table `tbl_name` in a database corresponds to the three files in the database directory shown in the following table.

File	Purpose
<code>tbl_name.frm</code>	Definition (format) file
<code>tbl_name.MYD</code>	Data file



File	Purpose
<code>tbl_name.MYI</code>	Index file

Each of these three file types is subject to corruption in various ways, but problems occur most often in data files and index files.

`myisamchk` works by creating a copy of the `.MYD` data file row by row. It ends the repair stage by removing the old `.MYD` file and renaming the new file to the original file name. If you use `--quick`, `myisamchk` does not create a temporary `.MYD` file, but instead assumes that the `.MYD` file is correct and generates only a new index file without touching the `.MYD` file. This is safe, because `myisamchk` automatically detects whether the `.MYD` file is corrupt and aborts the repair if it is. You can also specify the `--quick` option twice to `myisamchk`. In this case, `myisamchk` does not abort on some errors (such as duplicate-key errors) but instead tries to resolve them by modifying the `.MYD` file. Normally the use of two `--quick` options is useful only if you have too little free disk space to perform a normal repair. In this case, you should at least make a backup of the table before running `myisamchk`.

## 7.6.2 How to Check MyISAM Tables for Errors

To check a `MyISAM` table, use the following commands:

- `myisamchk tbl_name`

This finds 99.99% of all errors. What it cannot find is corruption that involves *only* the data file (which is very unusual). If you want to check a table, you should normally run `myisamchk` without options or with the `-s` (silent) option.

- `myisamchk -m tbl_name`

This finds 99.999% of all errors. It first checks all index entries for errors and then reads through all rows. It calculates a checksum for all key values in the rows and verifies that the checksum matches the checksum for the keys in the index tree.

- `myisamchk -e tbl_name`

This does a complete and thorough check of all data (`-e` means “extended check”). It does a check-read of every key for each row to verify that they indeed point to the correct row. This may take a long time for a large table that has many indexes. Normally, `myisamchk` stops after the first error it finds. If you want to obtain more information, you can add the `-v` (verbose) option. This causes `myisamchk` to keep going, up through a maximum of 20 errors.

- `myisamchk -e -i tbl_name`

This is like the previous command, but the `-i` option tells `myisamchk` to print additional statistical information.

In most cases, a simple `myisamchk` command with no arguments other than the table name is sufficient to check a table.

## 7.6.3 How to Repair MyISAM Tables

The discussion in this section describes how to use `myisamchk` on `MyISAM` tables (extensions `.MYI` and `.MYD`).

You can also use the `CHECK TABLE` and `REPAIR TABLE` statements to check and repair `MyISAM` tables. See [Section 13.7.2.2, “CHECK TABLE Statement”](#), and [Section 13.7.2.5, “REPAIR TABLE Statement”](#).

Symptoms of corrupted tables include queries that abort unexpectedly and observable errors such as these:

- `tbl_name.frm` is locked against change
- Can't find file `tbl_name.MYI` (Errcode: `nnn`)
- Unexpected end of file
- Record file is crashed
- Got error `nnn` from table handler

To get more information about the error, run `pererror nnn`, where `nnn` is the error number. The following example shows how to use `pererror` to find the meanings for the most common error numbers that indicate a problem with a table:

```
$> pererror 126 127 132 134 135 136 141 144 145
MySQL error code 126 = Index file is crashed
MySQL error code 127 = Record-file is crashed
MySQL error code 132 = Old database file
MySQL error code 134 = Record was already deleted (or record file crashed)
MySQL error code 135 = No more room in record file
MySQL error code 136 = No more room in index file
MySQL error code 141 = Duplicate unique key or constraint on write or update
MySQL error code 144 = Table is crashed and last repair failed
MySQL error code 145 = Table was marked as crashed and should be repaired
```

Note that error 135 (no more room in record file) and error 136 (no more room in index file) are not errors that can be fixed by a simple repair. In this case, you must use `ALTER TABLE` to increase the `MAX_ROWS` and `AVG_ROW_LENGTH` table option values:

```
ALTER TABLE tbl_name MAX_ROWS=xxx AVG_ROW_LENGTH=yyy;
```

If you do not know the current table option values, use `SHOW CREATE TABLE`.

For the other errors, you must repair your tables. `myisamchk` can usually detect and fix most problems that occur.

The repair process involves up to four stages, described here. Before you begin, you should change location to the database directory and check the permissions of the table files. On Unix, make sure that they are readable by the user that `mysqld` runs as (and to you, because you need to access the files you are checking). If it turns out you need to modify files, they must also be writable by you.

This section is for the cases where a table check fails (such as those described in [Section 7.6.2, “How to Check MyISAM Tables for Errors”](#)), or you want to use the extended features that `myisamchk` provides.

The `myisamchk` options used for table maintenance with are described in [Section 4.6.3, “myisamchk — MyISAM Table-Maintenance Utility”](#). `myisamchk` also has variables that you can set to control memory allocation that may improve performance. See [Section 4.6.3.6, “myisamchk Memory Usage”](#).

If you are going to repair a table from the command line, you must first stop the `mysqld` server. Note that when you do `mysqladmin shutdown` on a remote server, the `mysqld` server is still available for a while after `mysqladmin` returns, until all statement-processing has stopped and all index changes have been flushed to disk.

### Stage 1: Checking your tables

Run `myisamchk *.MYI` or `myisamchk -e *.MYI` if you have more time. Use the `-s` (silent) option to suppress unnecessary information.

If the `mysqld` server is stopped, you should use the `--update-state` option to tell `myisamchk` to mark the table as “checked.”

You have to repair only those tables for which `myisamchk` announces an error. For such tables, proceed to Stage 2.

If you get unexpected errors when checking (such as `out of memory` errors), or if `myisamchk` crashes, go to Stage 3.

### Stage 2: Easy safe repair

First, try `myisamchk -r -q tbl_name` (`-r -q` means “quick recovery mode”). This attempts to repair the index file without touching the data file. If the data file contains everything that it should and the delete links point at the correct locations within the data file, this should work, and the table is fixed. Start repairing the next table. Otherwise, use the following procedure:

1. Make a backup of the data file before continuing.
2. Use `myisamchk -r tbl_name` (`-r` means “recovery mode”). This removes incorrect rows and deleted rows from the data file and reconstructs the index file.
3. If the preceding step fails, use `myisamchk --safe-recover tbl_name`. Safe recovery mode uses an old recovery method that handles a few cases that regular recovery mode does not (but is slower).



#### Note

If you want a repair operation to go much faster, you should set the values of the `sort_buffer_size` and `key_buffer_size` variables each to about 25% of your available memory when running `myisamchk`.

If you get unexpected errors when repairing (such as `out of memory` errors), or if `myisamchk` crashes, go to Stage 3.

### Stage 3: Difficult repair

You should reach this stage only if the first 16KB block in the index file is destroyed or contains incorrect information, or if the index file is missing. In this case, it is necessary to create a new index file. Do so as follows:

1. Move the data file to a safe place.
2. Use the table description file to create new (empty) data and index files:

```
$> mysql db_name
```

```
mysql> SET autocommit=1;
mysql> TRUNCATE TABLE tbl_name;
mysql> quit
```

3. Copy the old data file back onto the newly created data file. (Do not just move the old file back onto the new file. You want to retain a copy in case something goes wrong.)



#### Important

If you are using replication, you should stop it prior to performing the above procedure, since it involves file system operations, and these are not logged by MySQL.

Go back to Stage 2. `myisamchk -r -q` should work. (This should not be an endless loop.)

You can also use the `REPAIR TABLE tbl_name USE_FRM` SQL statement, which performs the whole procedure automatically. There is also no possibility of unwanted interaction between a utility and the server, because the server does all the work when you use `REPAIR TABLE`. See [Section 13.7.2.5, “REPAIR TABLE Statement”](#).

#### Stage 4: Very difficult repair

You should reach this stage only if the `.frm` description file has also crashed. That should never happen, because the description file is not changed after the table is created:

1. Restore the description file from a backup and go back to Stage 3. You can also restore the index file and go back to Stage 2. In the latter case, you should start with `myisamchk -r`.
2. If you do not have a backup but know exactly how the table was created, create a copy of the table in another database. Remove the new data file, and then move the `.frm` description and `.MYI` index files from the other database to your crashed database. This gives you new description and index files, but leaves the `.MYD` data file alone. Go back to Stage 2 and attempt to reconstruct the index file.

## 7.6.4 MyISAM Table Optimization

To coalesce fragmented rows and eliminate wasted space that results from deleting or updating rows, run `myisamchk` in recovery mode:

```
$> myisamchk -r tbl_name
```

You can optimize a table in the same way by using the `OPTIMIZE TABLE` SQL statement. `OPTIMIZE TABLE` does a table repair and a key analysis, and also sorts the index tree so that key lookups are faster. There is also no possibility of unwanted interaction between a utility and the server, because the server does all the work when you use `OPTIMIZE TABLE`. See [Section 13.7.2.4, “OPTIMIZE TABLE Statement”](#).

`myisamchk` has a number of other options that you can use to improve the performance of a table:

- `--analyze` or `-a`: Perform key distribution analysis. This improves join performance by enabling the join optimizer to better choose the order in which to join the tables and which indexes it should use.
- `--sort-index` or `-S`: Sort the index blocks. This optimizes seeks and makes table scans that use indexes faster.
- `--sort-records=index_num` or `-R index_num`: Sort data rows according to a given index. This makes your data much more localized and may speed up range-based `SELECT` and `ORDER BY` operations that use this index.

For a full description of all available options, see [Section 4.6.3, “myisamchk — MyISAM Table-Maintenance Utility”](#).

## 7.6.5 Setting Up a MyISAM Table Maintenance Schedule

It is a good idea to perform table checks on a regular basis rather than waiting for problems to occur. One way to check and repair MyISAM tables is with the `CHECK TABLE` and `REPAIR TABLE` statements. See [Section 13.7.2, “Table Maintenance Statements”](#).

Another way to check tables is to use `myisamchk`. For maintenance purposes, you can use `myisamchk -s`. The `-s` option (short for `--silent`) causes `myisamchk` to run in silent mode, printing messages only when errors occur.

It is also a good idea to enable automatic MyISAM table checking. For example, whenever the machine has done a restart in the middle of an update, you usually need to check each table that could have been

affected before it is used further. (These are “expected crashed tables.”) To cause the server to check MyISAM tables automatically, start it with the `myisam_recover_options` system variable set. See [Section 5.1.7, “Server System Variables”](#).

You should also check your tables regularly during normal system operation. For example, you can run a `cron` job to check important tables once a week, using a line like this in a `crontab` file:

```
35 0 * * 0 /path/to/myisamchk --fast --silent /path/to/datadir/*/*.MYI
```

This prints out information about crashed tables so that you can examine and repair them as necessary.

To start with, execute `myisamchk -s` each night on all tables that have been updated during the last 24 hours. As you see that problems occur infrequently, you can back off the checking frequency to once a week or so.

Normally, MySQL tables need little maintenance. If you are performing many updates to MyISAM tables with dynamic-sized rows (tables with `VARCHAR`, `BLOB`, or `TEXT` columns) or have tables with many deleted rows you may want to defragment/reclaim space from the tables from time to time. You can do this by using `OPTIMIZE TABLE` on the tables in question. Alternatively, if you can stop the `mysqld` server for a while, change location into the data directory and use this command while the server is stopped:

```
$> myisamchk -r -s --sort-index --myisam_sort_buffer_size=16M */*.MYI
```



---

# Chapter 8 Optimization

## Table of Contents

8.1 Optimization Overview .....	1443
8.2 Optimizing SQL Statements .....	1444
8.2.1 Optimizing SELECT Statements .....	1444
8.2.2 Optimizing Subqueries, Derived Tables, and View References .....	1489
8.2.3 Optimizing INFORMATION_SCHEMA Queries .....	1500
8.2.4 Optimizing Data Change Statements .....	1505
8.2.5 Optimizing Database Privileges .....	1506
8.2.6 Other Optimization Tips .....	1507
8.3 Optimization and Indexes .....	1507
8.3.1 How MySQL Uses Indexes .....	1507
8.3.2 Primary Key Optimization .....	1509
8.3.3 Foreign Key Optimization .....	1509
8.3.4 Column Indexes .....	1509
8.3.5 Multiple-Column Indexes .....	1511
8.3.6 Verifying Index Usage .....	1512
8.3.7 InnoDB and MyISAM Index Statistics Collection .....	1512
8.3.8 Comparison of B-Tree and Hash Indexes .....	1514
8.3.9 Use of Index Extensions .....	1515
8.3.10 Optimizer Use of Generated Column Indexes .....	1517
8.3.11 Indexed Lookups from TIMESTAMP Columns .....	1519
8.4 Optimizing Database Structure .....	1521
8.4.1 Optimizing Data Size .....	1521
8.4.2 Optimizing MySQL Data Types .....	1523
8.4.3 Optimizing for Many Tables .....	1525
8.4.4 Internal Temporary Table Use in MySQL .....	1526
8.4.5 Limits on Number of Databases and Tables .....	1528
8.4.6 Limits on Table Size .....	1528
8.4.7 Limits on Table Column Count and Row Size .....	1530
8.5 Optimizing for InnoDB Tables .....	1532
8.5.1 Optimizing Storage Layout for InnoDB Tables .....	1532
8.5.2 Optimizing InnoDB Transaction Management .....	1533
8.5.3 Optimizing InnoDB Read-Only Transactions .....	1534
8.5.4 Optimizing InnoDB Redo Logging .....	1535
8.5.5 Bulk Data Loading for InnoDB Tables .....	1536
8.5.6 Optimizing InnoDB Queries .....	1537
8.5.7 Optimizing InnoDB DDL Operations .....	1537
8.5.8 Optimizing InnoDB Disk I/O .....	1538
8.5.9 Optimizing InnoDB Configuration Variables .....	1541
8.5.10 Optimizing InnoDB for Systems with Many Tables .....	1543
8.6 Optimizing for MyISAM Tables .....	1543
8.6.1 Optimizing MyISAM Queries .....	1543
8.6.2 Bulk Data Loading for MyISAM Tables .....	1544
8.6.3 Optimizing REPAIR TABLE Statements .....	1545
8.7 Optimizing for MEMORY Tables .....	1547
8.8 Understanding the Query Execution Plan .....	1547
8.8.1 Optimizing Queries with EXPLAIN .....	1547
8.8.2 EXPLAIN Output Format .....	1548
8.8.3 Extended EXPLAIN Output Format .....	1562

8.8.4	Obtaining Execution Plan Information for a Named Connection .....	1564
8.8.5	Estimating Query Performance .....	1565
8.9	Controlling the Query Optimizer .....	1566
8.9.1	Controlling Query Plan Evaluation .....	1566
8.9.2	Switchable Optimizations .....	1566
8.9.3	Optimizer Hints .....	1571
8.9.4	Index Hints .....	1577
8.9.5	The Optimizer Cost Model .....	1580
8.10	Buffering and Caching .....	1583
8.10.1	InnoDB Buffer Pool Optimization .....	1583
8.10.2	The MyISAM Key Cache .....	1584
8.10.3	The MySQL Query Cache .....	1588
8.10.4	Caching of Prepared Statements and Stored Programs .....	1595
8.11	Optimizing Locking Operations .....	1597
8.11.1	Internal Locking Methods .....	1597
8.11.2	Table Locking Issues .....	1599
8.11.3	Concurrent Inserts .....	1601
8.11.4	Metadata Locking .....	1601
8.11.5	External Locking .....	1604
8.12	Optimizing the MySQL Server .....	1606
8.12.1	System Factors .....	1606
8.12.2	Optimizing Disk I/O .....	1606
8.12.3	Using Symbolic Links .....	1608
8.12.4	Optimizing Memory Use .....	1611
8.13	Measuring Performance (Benchmarking) .....	1617
8.13.1	Measuring the Speed of Expressions and Functions .....	1618
8.13.2	Using Your Own Benchmarks .....	1618
8.13.3	Measuring Performance with performance_schema .....	1619
8.14	Examining Server Thread (Process) Information .....	1619
8.14.1	Accessing the Process List .....	1619
8.14.2	Thread Command Values .....	1621
8.14.3	General Thread States .....	1623
8.14.4	Query Cache Thread States .....	1629
8.14.5	Replication Source Thread States .....	1630
8.14.6	Replication Replica I/O Thread States .....	1630
8.14.7	Replication Replica SQL Thread States .....	1632
8.14.8	Replication Replica Connection Thread States .....	1632
8.14.9	NDB Cluster Thread States .....	1633
8.14.10	Event Scheduler Thread States .....	1634
8.15	Tracing the Optimizer .....	1634
8.15.1	Typical Usage .....	1634
8.15.2	System Variables Controlling Tracing .....	1634
8.15.3	Traceable Statements .....	1635
8.15.4	Tuning Trace Purging .....	1636
8.15.5	Tracing Memory Usage .....	1637
8.15.6	Privilege Checking .....	1637
8.15.7	Interaction with the --debug Option .....	1637
8.15.8	The optimizer_trace System Variable .....	1637
8.15.9	The end_markers_in_json System Variable .....	1637
8.15.10	Selecting Optimizer Features to Trace .....	1637
8.15.11	Trace General Structure .....	1638
8.15.12	Example .....	1638
8.15.13	Displaying Traces in Other Applications .....	1649
8.15.14	Preventing the Use of Optimizer Trace .....	1649



8.15.15 Testing Optimizer Trace ..... 1649  
 8.15.16 Optimizer Trace Implementation ..... 1650

This chapter explains how to optimize MySQL performance and provides examples. Optimization involves configuring, tuning, and measuring performance, at several levels. Depending on your job role (developer, DBA, or a combination of both), you might optimize at the level of individual SQL statements, entire applications, a single database server, or multiple networked database servers. Sometimes you can be proactive and plan in advance for performance, while other times you might troubleshoot a configuration or code issue after a problem occurs. Optimizing CPU and memory usage can also improve scalability, allowing the database to handle more load without slowing down.

## 8.1 Optimization Overview

Database performance depends on several factors at the database level, such as tables, queries, and configuration settings. These software constructs result in CPU and I/O operations at the hardware level, which you must minimize and make as efficient as possible. As you work on database performance, you start by learning the high-level rules and guidelines for the software side, and measuring performance using wall-clock time. As you become an expert, you learn more about what happens internally, and start measuring things such as CPU cycles and I/O operations.

Typical users aim to get the best database performance out of their existing software and hardware configurations. Advanced users look for opportunities to improve the MySQL software itself, or develop their own storage engines and hardware appliances to expand the MySQL ecosystem.

- [Optimizing at the Database Level](#)
- [Optimizing at the Hardware Level](#)
- [Balancing Portability and Performance](#)

### Optimizing at the Database Level

The most important factor in making a database application fast is its basic design:

- Are the tables structured properly? In particular, do the columns have the right data types, and does each table have the appropriate columns for the type of work? For example, applications that perform frequent updates often have many tables with few columns, while applications that analyze large amounts of data often have few tables with many columns.
- Are the right [indexes](#) in place to make queries efficient?
- Are you using the appropriate storage engine for each table, and taking advantage of the strengths and features of each storage engine you use? In particular, the choice of a transactional storage engine such as [InnoDB](#) or a nontransactional one such as [MyISAM](#) can be very important for performance and scalability.



**Note**

[InnoDB](#) is the default storage engine for new tables. In practice, the advanced [InnoDB](#) performance features mean that [InnoDB](#) tables often outperform the simpler [MyISAM](#) tables, especially for a busy database.

- Does each table use an appropriate row format? This choice also depends on the storage engine used for the table. In particular, compressed tables use less disk space and so require less disk I/O to read

and write the data. Compression is available for all kinds of workloads with [InnoDB](#) tables, and for read-only [MyISAM](#) tables.

- Does the application use an appropriate [locking strategy](#)? For example, by allowing shared access when possible so that database operations can run concurrently, and requesting exclusive access when appropriate so that critical operations get top priority. Again, the choice of storage engine is significant. The [InnoDB](#) storage engine handles most locking issues without involvement from you, allowing for better concurrency in the database and reducing the amount of experimentation and tuning for your code.
- Are all [memory areas used for caching](#) sized correctly? That is, large enough to hold frequently accessed data, but not so large that they overload physical memory and cause paging. The main memory areas to configure are the [InnoDB](#) buffer pool, the [MyISAM](#) key cache, and the MySQL query cache.

## Optimizing at the Hardware Level

Any database application eventually hits hardware limits as the database becomes more and more busy. A DBA must evaluate whether it is possible to tune the application or reconfigure the server to avoid these [bottlenecks](#), or whether more hardware resources are required. System bottlenecks typically arise from these sources:

- Disk seeks. It takes time for the disk to find a piece of data. With modern disks, the mean time for this is usually lower than 10ms, so we can in theory do about 100 seeks a second. This time improves slowly with new disks and is very hard to optimize for a single table. The way to optimize seek time is to distribute the data onto more than one disk.
- Disk reading and writing. When the disk is at the correct position, we need to read or write the data. With modern disks, one disk delivers at least 10–20MB/s throughput. This is easier to optimize than seeks because you can read in parallel from multiple disks.
- CPU cycles. When the data is in main memory, we must process it to get our result. Having large tables compared to the amount of memory is the most common limiting factor. But with small tables, speed is usually not the problem.
- Memory bandwidth. When the CPU needs more data than can fit in the CPU cache, main memory bandwidth becomes a bottleneck. This is an uncommon bottleneck for most systems, but one to be aware of.

## Balancing Portability and Performance

To use performance-oriented SQL extensions in a portable MySQL program, you can wrap MySQL-specific keywords in a statement within `/*! */` comment delimiters. Other SQL servers ignore the commented keywords. For information about writing comments, see [Section 9.6, “Comments”](#).

## 8.2 Optimizing SQL Statements

The core logic of a database application is performed through SQL statements, whether issued directly through an interpreter or submitted behind the scenes through an API. The tuning guidelines in this section help to speed up all kinds of MySQL applications. The guidelines cover SQL operations that read and write data, the behind-the-scenes overhead for SQL operations in general, and operations used in specific scenarios such as database monitoring.

### 8.2.1 Optimizing SELECT Statements

Queries, in the form of `SELECT` statements, perform all the lookup operations in the database. Tuning these statements is a top priority, whether to achieve sub-second response times for dynamic web pages, or to chop hours off the time to generate huge overnight reports.

Besides `SELECT` statements, the tuning techniques for queries also apply to constructs such as `CREATE TABLE...AS SELECT`, `INSERT INTO...SELECT`, and `WHERE` clauses in `DELETE` statements. Those statements have additional performance considerations because they combine write operations with the read-oriented query operations.

NDB Cluster supports a join pushdown optimization whereby a qualifying join is sent in its entirety to NDB Cluster data nodes, where it can be distributed among them and executed in parallel. For more information about this optimization, see [Conditions for NDB pushdown joins](#).

The main considerations for optimizing queries are:

- To make a slow `SELECT ... WHERE` query faster, the first thing to check is whether you can add an [index](#). Set up indexes on columns used in the `WHERE` clause, to speed up evaluation, filtering, and the final retrieval of results. To avoid wasted disk space, construct a small set of indexes that speed up many related queries used in your application.

Indexes are especially important for queries that reference different tables, using features such as [joins](#) and [foreign keys](#). You can use the `EXPLAIN` statement to determine which indexes are used for a `SELECT`. See [Section 8.3.1, “How MySQL Uses Indexes”](#) and [Section 8.8.1, “Optimizing Queries with EXPLAIN”](#).

- Isolate and tune any part of the query, such as a function call, that takes excessive time. Depending on how the query is structured, a function could be called once for every row in the result set, or even once for every row in the table, greatly magnifying any inefficiency.
- Minimize the number of [full table scans](#) in your queries, particularly for big tables.
- Keep table statistics up to date by using the `ANALYZE TABLE` statement periodically, so the optimizer has the information needed to construct an efficient execution plan.
- Learn the tuning techniques, indexing techniques, and configuration parameters that are specific to the storage engine for each table. Both [InnoDB](#) and [MyISAM](#) have sets of guidelines for enabling and sustaining high performance in queries. For details, see [Section 8.5.6, “Optimizing InnoDB Queries”](#) and [Section 8.6.1, “Optimizing MyISAM Queries”](#).
- You can optimize single-query transactions for [InnoDB](#) tables, using the technique in [Section 8.5.3, “Optimizing InnoDB Read-Only Transactions”](#).
- Avoid transforming the query in ways that make it hard to understand, especially if the optimizer does some of the same transformations automatically.
- If a performance issue is not easily solved by one of the basic guidelines, investigate the internal details of the specific query by reading the `EXPLAIN` plan and adjusting your indexes, `WHERE` clauses, join clauses, and so on. (When you reach a certain level of expertise, reading the `EXPLAIN` plan might be your first step for every query.)
- Adjust the size and properties of the memory areas that MySQL uses for caching. With efficient use of the [InnoDB buffer pool](#), [MyISAM key cache](#), and the MySQL query cache, repeated queries run faster because the results are retrieved from memory the second and subsequent times.
- Even for a query that runs fast using the cache memory areas, you might still optimize further so that they require less cache memory, making your application more scalable. Scalability means that your

application can handle more simultaneous users, larger requests, and so on without experiencing a big drop in performance.

- Deal with locking issues, where the speed of your query might be affected by other sessions accessing the tables at the same time.

### 8.2.1.1 WHERE Clause Optimization

This section discusses optimizations that can be made for processing [WHERE](#) clauses. The examples use [SELECT](#) statements, but the same optimizations apply for [WHERE](#) clauses in [DELETE](#) and [UPDATE](#) statements.



#### Note

Because work on the MySQL optimizer is ongoing, not all of the optimizations that MySQL performs are documented here.

You might be tempted to rewrite your queries to make arithmetic operations faster, while sacrificing readability. Because MySQL does similar optimizations automatically, you can often avoid this work, and leave the query in a more understandable and maintainable form. Some of the optimizations performed by MySQL follow:

- Removal of unnecessary parentheses:

```
((a AND b) AND c OR ((a AND b) AND (c AND d)))
-> (a AND b AND c) OR (a AND b AND c AND d)
```

- Constant folding:

```
(a<b AND b=c) AND a=5
-> b>5 AND b=c AND a=5
```

- Constant condition removal:

```
(b>=5 AND b=5) OR (b=6 AND 5=5) OR (b=7 AND 5=6)
-> b=5 OR b=6
```

- Constant expressions used by indexes are evaluated only once.
- [COUNT\(\\*\)](#) on a single table without a [WHERE](#) is retrieved directly from the table information for [MyISAM](#) and [MEMORY](#) tables. This is also done for any [NOT NULL](#) expression when used with only one table.
- Early detection of invalid constant expressions. MySQL quickly detects that some [SELECT](#) statements are impossible and returns no rows.
- [HAVING](#) is merged with [WHERE](#) if you do not use [GROUP BY](#) or aggregate functions ([COUNT\(\)](#), [MIN\(\)](#), and so on).
- For each table in a join, a simpler [WHERE](#) is constructed to get a fast [WHERE](#) evaluation for the table and also to skip rows as soon as possible.
- All constant tables are read first before any other tables in the query. A constant table is any of the following:
  - An empty table or a table with one row.
  - A table that is used with a [WHERE](#) clause on a [PRIMARY KEY](#) or a [UNIQUE](#) index, where all index parts are compared to constant expressions and are defined as [NOT NULL](#).

All of the following tables are used as constant tables:

```
SELECT * FROM t WHERE primary_key=1;
SELECT * FROM t1,t2
WHERE t1.primary_key=1 AND t2.primary_key=t1.id;
```

- The best join combination for joining the tables is found by trying all possibilities. If all columns in `ORDER BY` and `GROUP BY` clauses come from the same table, that table is preferred first when joining.
- If there is an `ORDER BY` clause and a different `GROUP BY` clause, or if the `ORDER BY` or `GROUP BY` contains columns from tables other than the first table in the join queue, a temporary table is created.
- If you use the `SQL_SMALL_RESULT` modifier, MySQL uses an in-memory temporary table.
- Each table index is queried, and the best index is used unless the optimizer believes that it is more efficient to use a table scan. At one time, a scan was used based on whether the best index spanned more than 30% of the table, but a fixed percentage no longer determines the choice between using an index or a scan. The optimizer now is more complex and bases its estimate on additional factors such as table size, number of rows, and I/O block size.
- In some cases, MySQL can read rows from the index without even consulting the data file. If all columns used from the index are numeric, only the index tree is used to resolve the query.
- Before each row is output, those that do not match the `HAVING` clause are skipped.

Some examples of queries that are very fast:

```
SELECT COUNT(*) FROM tbl_name;

SELECT MIN(key_part1),MAX(key_part1) FROM tbl_name;

SELECT MAX(key_part2) FROM tbl_name
WHERE key_part1=constant;

SELECT ... FROM tbl_name
ORDER BY key_part1,key_part2,... LIMIT 10;

SELECT ... FROM tbl_name
ORDER BY key_part1 DESC, key_part2 DESC, ... LIMIT 10;
```

MySQL resolves the following queries using only the index tree, assuming that the indexed columns are numeric:

```
SELECT key_part1,key_part2 FROM tbl_name WHERE key_part1=val;

SELECT COUNT(*) FROM tbl_name
WHERE key_part1=val1 AND key_part2=val2;

SELECT MAX(key_part2) FROM tbl_name GROUP BY key_part1;
```

The following queries use indexing to retrieve the rows in sorted order without a separate sorting pass:

```
SELECT ... FROM tbl_name
ORDER BY key_part1,key_part2,... ;

SELECT ... FROM tbl_name
ORDER BY key_part1 DESC, key_part2 DESC, ... ;
```

### 8.2.1.2 Range Optimization

The `range` access method uses a single index to retrieve a subset of table rows that are contained within one or several index value intervals. It can be used for a single-part or multiple-part index. The following sections describe conditions under which the optimizer uses range access.

- [Range Access Method for Single-Part Indexes](#)
- [Range Access Method for Multiple-Part Indexes](#)
- [Equality Range Optimization of Many-Valued Comparisons](#)
- [Range Optimization of Row Constructor Expressions](#)
- [Limiting Memory Use for Range Optimization](#)

## Range Access Method for Single-Part Indexes

For a single-part index, index value intervals can be conveniently represented by corresponding conditions in the `WHERE` clause, denoted as *range conditions* rather than “intervals.”

The definition of a range condition for a single-part index is as follows:

- For both `BTREE` and `HASH` indexes, comparison of a key part with a constant value is a range condition when using the `=`, `<=>`, `IN()`, `IS NULL`, or `IS NOT NULL` operators.
- Additionally, for `BTREE` indexes, comparison of a key part with a constant value is a range condition when using the `>`, `<`, `>=`, `<=`, `BETWEEN`, `!=`, or `<>` operators, or `LIKE` comparisons if the argument to `LIKE` is a constant string that does not start with a wildcard character.
- For all index types, multiple range conditions combined with `OR` or `AND` form a range condition.

“Constant value” in the preceding descriptions means one of the following:

- A constant from the query string
- A column of a `const` or `system` table from the same join
- The result of an uncorrelated subquery
- Any expression composed entirely from subexpressions of the preceding types

Here are some examples of queries with range conditions in the `WHERE` clause:

```
SELECT * FROM t1
  WHERE key_col > 1
     AND key_col < 10;

SELECT * FROM t1
  WHERE key_col = 1
     OR key_col IN (15,18,20);

SELECT * FROM t1
  WHERE key_col LIKE 'ab%'
     OR key_col BETWEEN 'bar' AND 'foo';
```

Some nonconstant values may be converted to constants during the optimizer constant propagation phase.

MySQL tries to extract range conditions from the `WHERE` clause for each of the possible indexes. During the extraction process, conditions that cannot be used for constructing the range condition are dropped, conditions that produce overlapping ranges are combined, and conditions that produce empty ranges are removed.

Consider the following statement, where `key1` is an indexed column and `nonkey` is not indexed:

```
SELECT * FROM t1 WHERE
  (key1 < 'abc' AND (key1 LIKE 'abcde%' OR key1 LIKE '%b')) OR
```

```
(key1 < 'bar' AND nonkey = 4) OR
(key1 < 'uux' AND key1 > 'z');
```

The extraction process for key `key1` is as follows:

1. Start with original `WHERE` clause:

```
(key1 < 'abc' AND (key1 LIKE 'abcde%' OR key1 LIKE '%b')) OR
(key1 < 'bar' AND nonkey = 4) OR
(key1 < 'uux' AND key1 > 'z')
```

2. Remove `nonkey = 4` and `key1 LIKE '%b'` because they cannot be used for a range scan. The correct way to remove them is to replace them with `TRUE`, so that we do not miss any matching rows when doing the range scan. Replacing them with `TRUE` yields:

```
(key1 < 'abc' AND (key1 LIKE 'abcde%' OR TRUE)) OR
(key1 < 'bar' AND TRUE) OR
(key1 < 'uux' AND key1 > 'z')
```

3. Collapse conditions that are always true or false:

- `(key1 LIKE 'abcde%' OR TRUE)` is always true
- `(key1 < 'uux' AND key1 > 'z')` is always false

Replacing these conditions with constants yields:

```
(key1 < 'abc' AND TRUE) OR (key1 < 'bar' AND TRUE) OR (FALSE)
```

Removing unnecessary `TRUE` and `FALSE` constants yields:

```
(key1 < 'abc') OR (key1 < 'bar')
```

4. Combining overlapping intervals into one yields the final condition to be used for the range scan:

```
(key1 < 'bar')
```

In general (and as demonstrated by the preceding example), the condition used for a range scan is less restrictive than the `WHERE` clause. MySQL performs an additional check to filter out rows that satisfy the range condition but not the full `WHERE` clause.

The range condition extraction algorithm can handle nested `AND/OR` constructs of arbitrary depth, and its output does not depend on the order in which conditions appear in `WHERE` clause.

MySQL does not support merging multiple ranges for the `range` access method for spatial indexes. To work around this limitation, you can use a `UNION` with identical `SELECT` statements, except that you put each spatial predicate in a different `SELECT`.

## Range Access Method for Multiple-Part Indexes

Range conditions on a multiple-part index are an extension of range conditions for a single-part index. A range condition on a multiple-part index restricts index rows to lie within one or several key tuple intervals. Key tuple intervals are defined over a set of key tuples, using ordering from the index.

For example, consider a multiple-part index defined as `key1(key_part1, key_part2, key_part3)`, and the following set of key tuples listed in key order:

<code>key_part1</code>	<code>key_part2</code>	<code>key_part3</code>
NULL	1	'abc'
NULL	1	'xyz'
NULL	2	'foo'

1	1	'abc'
1	1	'xyz'
1	2	'abc'
2	1	'aaa'

The condition `key_part1 = 1` defines this interval:

```
(1,-inf,-inf) <= (key_part1,key_part2,key_part3) < (1,+inf,+inf)
```

The interval covers the 4th, 5th, and 6th tuples in the preceding data set and can be used by the range access method.

By contrast, the condition `key_part3 = 'abc'` does not define a single interval and cannot be used by the range access method.

The following descriptions indicate how range conditions work for multiple-part indexes in greater detail.

- For [HASH](#) indexes, each interval containing identical values can be used. This means that the interval can be produced only for conditions in the following form:

```
key_part1 cmp const1
AND key_part2 cmp const2
AND ...
AND key_partN cmp constN;
```

Here, `const1`, `const2`, ... are constants, `cmp` is one of the `=`, `<=>`, or `IS NULL` comparison operators, and the conditions cover all index parts. (That is, there are `N` conditions, one for each part of an `N`-part index.) For example, the following is a range condition for a three-part [HASH](#) index:

```
key_part1 = 1 AND key_part2 IS NULL AND key_part3 = 'foo'
```

For the definition of what is considered to be a constant, see [Range Access Method for Single-Part Indexes](#).

- For a [BTREE](#) index, an interval might be usable for conditions combined with `AND`, where each condition compares a key part with a constant value using `=`, `<=>`, `IS NULL`, `>`, `<`, `>=`, `<=`, `!=`, `<>`, `BETWEEN`, or `LIKE 'pattern'` (where `'pattern'` does not start with a wildcard). An interval can be used as long as it is possible to determine a single key tuple containing all rows that match the condition (or two intervals if `<>` or `!=` is used).

The optimizer attempts to use additional key parts to determine the interval as long as the comparison operator is `=`, `<=>`, or `IS NULL`. If the operator is `>`, `<`, `>=`, `<=`, `!=`, `<>`, `BETWEEN`, or `LIKE`, the optimizer uses it but considers no more key parts. For the following expression, the optimizer uses `=` from the first comparison. It also uses `>=` from the second comparison but considers no further key parts and does not use the third comparison for interval construction:

```
key_part1 = 'foo' AND key_part2 >= 10 AND key_part3 > 10
```

The single interval is:

```
('foo',10,-inf) < (key_part1,key_part2,key_part3) < ('foo',+inf,+inf)
```

It is possible that the created interval contains more rows than the initial condition. For example, the preceding interval includes the value `('foo', 11, 0)`, which does not satisfy the original condition.

- If conditions that cover sets of rows contained within intervals are combined with `OR`, they form a condition that covers a set of rows contained within the union of their intervals. If the conditions are combined with `AND`, they form a condition that covers a set of rows contained within the intersection of their intervals. For example, for this condition on a two-part index:



```
(key_part1 = 1 AND key_part2 < 2) OR (key_part1 > 5)
```

The intervals are:

```
(1,-inf) < (key_part1,key_part2) < (1,2)
(5,-inf) < (key_part1,key_part2)
```

In this example, the interval on the first line uses one key part for the left bound and two key parts for the right bound. The interval on the second line uses only one key part. The `key_len` column in the `EXPLAIN` output indicates the maximum length of the key prefix used.

In some cases, `key_len` may indicate that a key part was used, but that might be not what you would expect. Suppose that `key_part1` and `key_part2` can be `NULL`. Then the `key_len` column displays two key part lengths for the following condition:

```
key_part1 >= 1 AND key_part2 < 2
```

But, in fact, the condition is converted to this:

```
key_part1 >= 1 AND key_part2 IS NOT NULL
```

For a description of how optimizations are performed to combine or eliminate intervals for range conditions on a single-part index, see [Range Access Method for Single-Part Indexes](#). Analogous steps are performed for range conditions on multiple-part indexes.

## Equality Range Optimization of Many-Valued Comparisons

Consider these expressions, where `col_name` is an indexed column:

```
col_name IN(val1, ..., valN)
col_name = val1 OR ... OR col_name = valN
```

Each expression is true if `col_name` is equal to any of several values. These comparisons are equality range comparisons (where the “range” is a single value). The optimizer estimates the cost of reading qualifying rows for equality range comparisons as follows:

- If there is a unique index on `col_name`, the row estimate for each range is 1 because at most one row can have the given value.
- Otherwise, any index on `col_name` is nonunique and the optimizer can estimate the row count for each range using dives into the index or index statistics.

With index dives, the optimizer makes a dive at each end of a range and uses the number of rows in the range as the estimate. For example, the expression `col_name IN (10, 20, 30)` has three equality ranges and the optimizer makes two dives per range to generate a row estimate. Each pair of dives yields an estimate of the number of rows that have the given value.

Index dives provide accurate row estimates, but as the number of comparison values in the expression increases, the optimizer takes longer to generate a row estimate. Use of index statistics is less accurate than index dives but permits faster row estimation for large value lists.

The `eq_range_index_dive_limit` system variable enables you to configure the number of values at which the optimizer switches from one row estimation strategy to the other. To permit use of index dives for comparisons of up to  $N$  equality ranges, set `eq_range_index_dive_limit` to  $N + 1$ . To disable use of statistics and always use index dives regardless of  $N$ , set `eq_range_index_dive_limit` to 0.

To update table index statistics for best estimates, use `ANALYZE TABLE`.

Even under conditions when index dives would otherwise be used, they are skipped for queries that satisfy all these conditions:

- A single-index `FORCE INDEX` index hint is present. The idea is that if index use is forced, there is nothing to be gained from the additional overhead of performing dives into the index.
- The index is nonunique and not a `FULLTEXT` index.
- No subquery is present.
- No `DISTINCT`, `GROUP BY`, or `ORDER BY` clause is present.

Those dive-skipping conditions apply only for single-table queries. Index dives are not skipped for multiple-table queries (joins).

## Range Optimization of Row Constructor Expressions

The optimizer is able to apply the range scan access method to queries of this form:

```
SELECT ... FROM t1 WHERE ( col_1, col_2 ) IN ( ( 'a', 'b' ), ( 'c', 'd' ) );
```

Previously, for range scans to be used, it was necessary to write the query as:

```
SELECT ... FROM t1 WHERE ( col_1 = 'a' AND col_2 = 'b' )
OR ( col_1 = 'c' AND col_2 = 'd' );
```

For the optimizer to use a range scan, queries must satisfy these conditions:

- Only `IN()` predicates are used, not `NOT IN()`.
- On the left side of the `IN()` predicate, the row constructor contains only column references.
- On the right side of the `IN()` predicate, row constructors contain only runtime constants, which are either literals or local column references that are bound to constants during execution.
- On the right side of the `IN()` predicate, there is more than one row constructor.

For more information about the optimizer and row constructors, see [Section 8.2.1.19, “Row Constructor Expression Optimization”](#)

## Limiting Memory Use for Range Optimization

To control the memory available to the range optimizer, use the `range_optimizer_max_mem_size` system variable:

- A value of 0 means “no limit.”
- With a value greater than 0, the optimizer tracks the memory consumed when considering the range access method. If the specified limit is about to be exceeded, the range access method is abandoned and other methods, including a full table scan, are considered instead. This could be less optimal. If this happens, the following warning occurs (where *N* is the current `range_optimizer_max_mem_size` value):

```
Warning      3170      Memory capacity of N bytes for
              'range_optimizer_max_mem_size' exceeded. Range
              optimization was not done for this query.
```

- For `UPDATE` and `DELETE` statements, if the optimizer falls back to a full table scan and the `sql_safe_updates` system variable is enabled, an error occurs rather than a warning because, in

effect, no key is used to determine which rows to modify. For more information, see [Using Safe-Updates Mode \(--safe-updates\)](#).

For individual queries that exceed the available range optimization memory and for which the optimizer falls back to less optimal plans, increasing the `range_optimizer_max_mem_size` value may improve performance.

To estimate the amount of memory needed to process a range expression, use these guidelines:

- For a simple query such as the following, where there is one candidate key for the range access method, each predicate combined with `OR` uses approximately 230 bytes:

```
SELECT COUNT(*) FROM t
WHERE a=1 OR a=2 OR a=3 OR ... a=N;
```

- Similarly for a query such as the following, each predicate combined with `AND` uses approximately 125 bytes:

```
SELECT COUNT(*) FROM t
WHERE a=1 AND b=1 AND c=1 ... N;
```

- For a query with `IN()` predicates:

```
SELECT COUNT(*) FROM t
WHERE a IN (1,2, ..., M) AND b IN (1,2, ..., N);
```

Each literal value in an `IN()` list counts as a predicate combined with `OR`. If there are two `IN()` lists, the number of predicates combined with `OR` is the product of the number of literal values in each list. Thus, the number of predicates combined with `OR` in the preceding case is  $M \times N$ .

Before 5.7.11, the number of bytes per predicate combined with `OR` was higher, approximately 700 bytes.

### 8.2.1.3 Index Merge Optimization

The *Index Merge* access method retrieves rows with multiple `range` scans and merges their results into one. This access method merges index scans from a single table only, not scans across multiple tables. The merge can produce unions, intersections, or unions-of-intersections of its underlying scans.

Example queries for which Index Merge may be used:

```
SELECT * FROM tbl_name WHERE key1 = 10 OR key2 = 20;

SELECT * FROM tbl_name
WHERE (key1 = 10 OR key2 = 20) AND non_key = 30;

SELECT * FROM t1, t2
WHERE (t1.key1 IN (1,2) OR t1.key2 LIKE 'value%')
AND t2.key1 = t1.some_col;

SELECT * FROM t1, t2
WHERE t1.key1 = 1
AND (t2.key1 = t1.some_col OR t2.key2 = t1.some_col2);
```



#### Note

The Index Merge optimization algorithm has the following known limitations:

- If your query has a complex `WHERE` clause with deep `AND/OR` nesting and MySQL does not choose the optimal plan, try distributing terms using the following identity transformations:

```
(x AND y) OR z => (x OR z) AND (y OR z)
(x OR y) AND z => (x AND z) OR (y AND z)
```

- Index Merge is not applicable to full-text indexes.

In `EXPLAIN` output, the Index Merge method appears as `index_merge` in the `type` column. In this case, the `key` column contains a list of indexes used, and `key_len` contains a list of the longest key parts for those indexes.

The Index Merge access method has several algorithms, which are displayed in the `Extra` field of `EXPLAIN` output:

- Using `intersect(...)`
- Using `union(...)`
- Using `sort_union(...)`

The following sections describe these algorithms in greater detail. The optimizer chooses between different possible Index Merge algorithms and other access methods based on cost estimates of the various available options.

Use of Index Merge is subject to the value of the `index_merge`, `index_merge_intersection`, `index_merge_union`, and `index_merge_sort_union` flags of the `optimizer_switch` system variable. See [Section 8.9.2, “Switchable Optimizations”](#). By default, all those flags are `on`. To enable only certain algorithms, set `index_merge` to `off`, and enable only such of the others as should be permitted.

- [Index Merge Intersection Access Algorithm](#)
- [Index Merge Union Access Algorithm](#)
- [Index Merge Sort-Union Access Algorithm](#)

## Index Merge Intersection Access Algorithm

This access algorithm is applicable when a `WHERE` clause is converted to several range conditions on different keys combined with `AND`, and each condition is one of the following:

- An  $N$ -part expression of this form, where the index has exactly  $N$  parts (that is, all index parts are covered):

```
key_part1 = const1 AND key_part2 = const2 ... AND key_partN = constN
```

- Any range condition over the primary key of an `InnoDB` table.

Examples:

```
SELECT * FROM innodb_table
WHERE primary_key < 10 AND key_coll = 20;

SELECT * FROM tbl_name
WHERE key1_part1 = 1 AND key1_part2 = 2 AND key2 = 2;
```

The Index Merge intersection algorithm performs simultaneous scans on all used indexes and produces the intersection of row sequences that it receives from the merged index scans.

If all columns used in the query are covered by the used indexes, full table rows are not retrieved (`EXPLAIN` output contains `Using index` in `Extra` field in this case). Here is an example of such a query:

```
SELECT COUNT(*) FROM t1 WHERE key1 = 1 AND key2 = 1;
```

If the used indexes do not cover all columns used in the query, full rows are retrieved only when the range conditions for all used keys are satisfied.

If one of the merged conditions is a condition over the primary key of an [InnoDB](#) table, it is not used for row retrieval, but is used to filter out rows retrieved using other conditions.

## Index Merge Union Access Algorithm

The criteria for this algorithm are similar to those for the Index Merge intersection algorithm. The algorithm is applicable when the table's `WHERE` clause is converted to several range conditions on different keys combined with `OR`, and each condition is one of the following:

- An  $N$ -part expression of this form, where the index has exactly  $N$  parts (that is, all index parts are covered):

```
key_part1 = const1 OR key_part2 = const2 ... OR key_partN = constN
```

- Any range condition over a primary key of an [InnoDB](#) table.
- A condition for which the Index Merge intersection algorithm is applicable.

Examples:

```
SELECT * FROM t1
  WHERE key1 = 1 OR key2 = 2 OR key3 = 3;

SELECT * FROM innodb_table
  WHERE (key1 = 1 AND key2 = 2)
  OR (key3 = 'foo' AND key4 = 'bar') AND key5 = 5;
```

## Index Merge Sort-Union Access Algorithm

This access algorithm is applicable when the `WHERE` clause is converted to several range conditions combined by `OR`, but the Index Merge union algorithm is not applicable.

Examples:

```
SELECT * FROM tbl_name
  WHERE key_col1 < 10 OR key_col2 < 20;

SELECT * FROM tbl_name
  WHERE (key_col1 > 10 OR key_col2 = 20) AND nonkey_col = 30;
```

The difference between the sort-union algorithm and the union algorithm is that the sort-union algorithm must first fetch row IDs for all rows and sort them before returning any rows.

### 8.2.1.4 Engine Condition Pushdown Optimization

This optimization improves the efficiency of direct comparisons between a nonindexed column and a constant. In such cases, the condition is “pushed down” to the storage engine for evaluation. This optimization can be used only by the [NDB](#) storage engine.

For NDB Cluster, this optimization can eliminate the need to send nonmatching rows over the network between the cluster's data nodes and the MySQL server that issued the query, and can speed up queries where it is used by a factor of 5 to 10 times over cases where condition pushdown could be but is not used.

Suppose that an NDB Cluster table is defined as follows:

```
CREATE TABLE t1 (
  a INT,
  b INT,
  KEY(a)
) ENGINE=NDB;
```

Engine condition pushdown can be used with queries such as the one shown here, which includes a comparison between a nonindexed column and a constant:

```
SELECT a, b FROM t1 WHERE b = 10;
```

The use of engine condition pushdown can be seen in the output of [EXPLAIN](#):

```
mysql> EXPLAIN SELECT a,b FROM t1 WHERE b = 10\G
***** 1. row *****
      id: 1
    select_type: SIMPLE
      table: t1
       type: ALL
possible_keys: NULL
         key: NULL
      key_len: NULL
         ref: NULL
        rows: 10
     Extra: Using where with pushed condition
```

However, engine condition pushdown *cannot* be used with either of these two queries:

```
SELECT a,b FROM t1 WHERE a = 10;
SELECT a,b FROM t1 WHERE b + 1 = 10;
```

Engine condition pushdown is not applicable to the first query because an index exists on column `a`. (An index access method would be more efficient and so would be chosen in preference to condition pushdown.) Engine condition pushdown cannot be employed for the second query because the comparison involving the nonindexed column `b` is indirect. (However, engine condition pushdown could be applied if you were to reduce `b + 1 = 10` to `b = 9` in the `WHERE` clause.)

Engine condition pushdown may also be employed when an indexed column is compared with a constant using a `>` or `<` operator:

```
mysql> EXPLAIN SELECT a, b FROM t1 WHERE a < 2\G
***** 1. row *****
      id: 1
    select_type: SIMPLE
      table: t1
       type: range
possible_keys: a
         key: a
      key_len: 5
         ref: NULL
        rows: 2
     Extra: Using where with pushed condition
```

Other supported comparisons for engine condition pushdown include the following:

- `column [NOT] LIKE pattern`  
`pattern` must be a string literal containing the pattern to be matched; for syntax, see [Section 12.8.1, “String Comparison Functions and Operators”](#).
- `column IS [NOT] NULL`
- `column IN (value_list)`

Each item in the *value\_list* must be a constant, literal value.

- *column BETWEEN constant1 AND constant2*

*constant1* and *constant2* must each be a constant, literal value.

In all of the cases in the preceding list, it is possible for the condition to be converted into the form of one or more direct comparisons between a column and a constant.

Engine condition pushdown is enabled by default. To disable it at server startup, set the `optimizer_switch` system variable's `engine_condition_pushdown` flag to `off`. For example, in a `my.cnf` file, use these lines:

```
[mysqld]
optimizer_switch=engine_condition_pushdown=off
```

At runtime, disable condition pushdown like this:

```
SET optimizer_switch='engine_condition_pushdown=off';
```

**Limitations.** Engine condition pushdown is subject to the following limitations:

- Engine condition pushdown is supported only by the `NDB` storage engine.
- Columns may be compared with constants only; however, this includes expressions which evaluate to constant values.
- Columns used in comparisons cannot be of any of the `BLOB` or `TEXT` types. This exclusion extends to `JSON`, `BIT`, and `ENUM` columns as well.
- A string value to be compared with a column must use the same collation as the column.
- Joins are not directly supported; conditions involving multiple tables are pushed separately where possible. Use extended `EXPLAIN` output to determine which conditions are actually pushed down. See [Section 8.8.3, “Extended EXPLAIN Output Format”](#).

### 8.2.1.5 Index Condition Pushdown Optimization

Index Condition Pushdown (ICP) is an optimization for the case where MySQL retrieves rows from a table using an index. Without ICP, the storage engine traverses the index to locate rows in the base table and returns them to the MySQL server which evaluates the `WHERE` condition for the rows. With ICP enabled, and if parts of the `WHERE` condition can be evaluated by using only columns from the index, the MySQL server pushes this part of the `WHERE` condition down to the storage engine. The storage engine then evaluates the pushed index condition by using the index entry and only if this is satisfied is the row read from the table. ICP can reduce the number of times the storage engine must access the base table and the number of times the MySQL server must access the storage engine.

Applicability of the Index Condition Pushdown optimization is subject to these conditions:

- ICP is used for the `range`, `ref`, `eq_ref`, and `ref_or_null` access methods when there is a need to access full table rows.
- ICP can be used for `InnoDB` and `MyISAM` tables, including partitioned `InnoDB` and `MyISAM` tables.
- For `InnoDB` tables, ICP is used only for secondary indexes. The goal of ICP is to reduce the number of full-row reads and thereby reduce I/O operations. For `InnoDB` clustered indexes, the complete record is already read into the `InnoDB` buffer. Using ICP in this case does not reduce I/O.

- ICP is not supported with secondary indexes created on virtual generated columns. [InnoDB](#) supports secondary indexes on virtual generated columns.
- Conditions that refer to subqueries cannot be pushed down.
- Conditions that refer to stored functions cannot be pushed down. Storage engines cannot invoke stored functions.
- Triggered conditions cannot be pushed down. (For information about triggered conditions, see [Section 8.2.2.3, “Optimizing Subqueries with the EXISTS Strategy”](#).)

To understand how this optimization works, first consider how an index scan proceeds when Index Condition Pushdown is not used:

1. Get the next row, first by reading the index tuple, and then by using the index tuple to locate and read the full table row.
2. Test the part of the `WHERE` condition that applies to this table. Accept or reject the row based on the test result.

Using Index Condition Pushdown, the scan proceeds like this instead:

1. Get the next row's index tuple (but not the full table row).
2. Test the part of the `WHERE` condition that applies to this table and can be checked using only index columns. If the condition is not satisfied, proceed to the index tuple for the next row.
3. If the condition is satisfied, use the index tuple to locate and read the full table row.
4. Test the remaining part of the `WHERE` condition that applies to this table. Accept or reject the row based on the test result.

`EXPLAIN` output shows `Using index condition` in the `Extra` column when Index Condition Pushdown is used. It does not show `Using index` because that does not apply when full table rows must be read.

Suppose that a table contains information about people and their addresses and that the table has an index defined as `INDEX (zipcode, lastname, firstname)`. If we know a person's `zipcode` value but are not sure about the last name, we can search like this:

```
SELECT * FROM people
WHERE zipcode='95054'
AND lastname LIKE '%etrunia%'
AND address LIKE '%Main Street%';
```

MySQL can use the index to scan through people with `zipcode='95054'`. The second part (`lastname LIKE '%etrunia%'`) cannot be used to limit the number of rows that must be scanned, so without Index Condition Pushdown, this query must retrieve full table rows for all people who have `zipcode='95054'`.

With Index Condition Pushdown, MySQL checks the `lastname LIKE '%etrunia%'` part before reading the full table row. This avoids reading full rows corresponding to index tuples that match the `zipcode` condition but not the `lastname` condition.

Index Condition Pushdown is enabled by default. It can be controlled with the `optimizer_switch` system variable by setting the `index_condition_pushdown` flag:

```
SET optimizer_switch = 'index_condition_pushdown=off';
SET optimizer_switch = 'index_condition_pushdown=on';
```



See [Section 8.9.2, “Switchable Optimizations”](#).

### 8.2.1.6 Nested-Loop Join Algorithms

MySQL executes joins between tables using a nested-loop algorithm or variations on it.

- [Nested-Loop Join Algorithm](#)
- [Block Nested-Loop Join Algorithm](#)

#### Nested-Loop Join Algorithm

A simple nested-loop join (NLJ) algorithm reads rows from the first table in a loop one at a time, passing each row to a nested loop that processes the next table in the join. This process is repeated as many times as there remain tables to be joined.

Assume that a join between three tables `t1`, `t2`, and `t3` is to be executed using the following join types:

Table	Join Type
<code>t1</code>	<code>range</code>
<code>t2</code>	<code>ref</code>
<code>t3</code>	<code>ALL</code>

If a simple NLJ algorithm is used, the join is processed like this:

```
for each row in t1 matching range {
  for each row in t2 matching reference key {
    for each row in t3 {
      if row satisfies join conditions, send to client
    }
  }
}
```

Because the NLJ algorithm passes rows one at a time from outer loops to inner loops, it typically reads tables processed in the inner loops many times.

#### Block Nested-Loop Join Algorithm

A Block Nested-Loop (BNL) join algorithm uses buffering of rows read in outer loops to reduce the number of times that tables in inner loops must be read. For example, if 10 rows are read into a buffer and the buffer is passed to the next inner loop, each row read in the inner loop can be compared against all 10 rows in the buffer. This reduces by an order of magnitude the number of times the inner table must be read.

MySQL join buffering has these characteristics:

- Join buffering can be used when the join is of type `ALL` or `index` (in other words, when no possible keys can be used, and a full scan is done, of either the data or index rows, respectively), or `range`. Use of buffering is also applicable to outer joins, as described in [Section 8.2.1.11, “Block Nested-Loop and Batched Key Access Joins”](#).
- A join buffer is never allocated for the first nonconstant table, even if it would be of type `ALL` or `index`.
- Only columns of interest to a join are stored in its join buffer, not whole rows.
- The `join_buffer_size` system variable determines the size of each join buffer used to process a query.
- One buffer is allocated for each join that can be buffered, so a given query might be processed using multiple join buffers.

- A join buffer is allocated prior to executing the join and freed after the query is done.

For the example join described previously for the NLJ algorithm (without buffering), the join is done as follows using join buffering:

```

for each row in t1 matching range {
  for each row in t2 matching reference key {
    store used columns from t1, t2 in join buffer
    if buffer is full {
      for each row in t3 {
        for each t1, t2 combination in join buffer {
          if row satisfies join conditions, send to client
        }
      }
      empty join buffer
    }
  }
}

if buffer is not empty {
  for each row in t3 {
    for each t1, t2 combination in join buffer {
      if row satisfies join conditions, send to client
    }
  }
}

```

If  $S$  is the size of each stored  $t1$ ,  $t2$  combination in the join buffer and  $C$  is the number of combinations in the buffer, the number of times table  $t3$  is scanned is:

$$(S * C) / \text{join\_buffer\_size} + 1$$

The number of  $t3$  scans decreases as the value of `join_buffer_size` increases, up to the point when `join_buffer_size` is large enough to hold all previous row combinations. At that point, no speed is gained by making it larger.

### 8.2.1.7 Nested Join Optimization

The syntax for expressing joins permits nested joins. The following discussion refers to the join syntax described in [Section 13.2.9.2, “JOIN Clause”](#).

The syntax of `table_factor` is extended in comparison with the SQL Standard. The latter accepts only `table_reference`, not a list of them inside a pair of parentheses. This is a conservative extension if we consider each comma in a list of `table_reference` items as equivalent to an inner join. For example:

```

SELECT * FROM t1 LEFT JOIN (t2, t3, t4)
      ON (t2.a=t1.a AND t3.b=t1.b AND t4.c=t1.c)

```

Is equivalent to:

```

SELECT * FROM t1 LEFT JOIN (t2 CROSS JOIN t3 CROSS JOIN t4)
      ON (t2.a=t1.a AND t3.b=t1.b AND t4.c=t1.c)

```

In MySQL, `CROSS JOIN` is syntactically equivalent to `INNER JOIN`; they can replace each other. In standard SQL, they are not equivalent. `INNER JOIN` is used with an `ON` clause; `CROSS JOIN` is used otherwise.

In general, parentheses can be ignored in join expressions containing only inner join operations. Consider this join expression:

```

t1 LEFT JOIN (t2 LEFT JOIN t3 ON t2.b=t3.b OR t2.b IS NULL)

```

```
ON t1.a=t2.a
```

After removing parentheses and grouping operations to the left, that join expression transforms into this expression:

```
(t1 LEFT JOIN t2 ON t1.a=t2.a) LEFT JOIN t3
ON t2.b=t3.b OR t2.b IS NULL
```

Yet, the two expressions are not equivalent. To see this, suppose that the tables `t1`, `t2`, and `t3` have the following state:

- Table `t1` contains rows (1), (2)
- Table `t2` contains row (1,101)
- Table `t3` contains row (101)

In this case, the first expression returns a result set including the rows (1,1,101,101), (2,NULL,NULL,NULL), whereas the second expression returns the rows (1,1,101,101), (2,NULL,NULL,101):

```
mysql> SELECT *
FROM t1
LEFT JOIN
(t2 LEFT JOIN t3 ON t2.b=t3.b OR t2.b IS NULL)
ON t1.a=t2.a;
```

a	a	b	b
1	1	101	101
2	NULL	NULL	NULL

```
mysql> SELECT *
FROM (t1 LEFT JOIN t2 ON t1.a=t2.a)
LEFT JOIN t3
ON t2.b=t3.b OR t2.b IS NULL;
```

a	a	b	b
1	1	101	101
2	NULL	NULL	101

In the following example, an outer join operation is used together with an inner join operation:

```
t1 LEFT JOIN (t2, t3) ON t1.a=t2.a
```

That expression cannot be transformed into the following expression:

```
t1 LEFT JOIN t2 ON t1.a=t2.a, t3
```

For the given table states, the two expressions return different sets of rows:

```
mysql> SELECT *
FROM t1 LEFT JOIN (t2, t3) ON t1.a=t2.a;
```

a	a	b	b
1	1	101	101
2	NULL	NULL	NULL

```
mysql> SELECT *
```

```
FROM t1 LEFT JOIN t2 ON t1.a=t2.a, t3;
```

a	a	b	b
1	1	101	101
2	NULL	NULL	101

Therefore, if we omit parentheses in a join expression with outer join operators, we might change the result set for the original expression.

More exactly, we cannot ignore parentheses in the right operand of the left outer join operation and in the left operand of a right join operation. In other words, we cannot ignore parentheses for the inner table expressions of outer join operations. Parentheses for the other operand (operand for the outer table) can be ignored.

The following expression:

```
(t1,t2) LEFT JOIN t3 ON P(t2.b,t3.b)
```

Is equivalent to this expression for any tables `t1,t2,t3` and any condition `P` over attributes `t2.b` and `t3.b`:

```
t1, t2 LEFT JOIN t3 ON P(t2.b,t3.b)
```

Whenever the order of execution of join operations in a join expression (*joined\_table*) is not from left to right, we talk about nested joins. Consider the following queries:

```
SELECT * FROM t1 LEFT JOIN (t2 LEFT JOIN t3 ON t2.b=t3.b) ON t1.a=t2.a
WHERE t1.a > 1

SELECT * FROM t1 LEFT JOIN (t2, t3) ON t1.a=t2.a
WHERE (t2.b=t3.b OR t2.b IS NULL) AND t1.a > 1
```

Those queries are considered to contain these nested joins:

```
t2 LEFT JOIN t3 ON t2.b=t3.b
t2, t3
```

In the first query, the nested join is formed with a left join operation. In the second query, it is formed with an inner join operation.

In the first query, the parentheses can be omitted: The grammatical structure of the join expression dictates the same order of execution for join operations. For the second query, the parentheses cannot be omitted, although the join expression here can be interpreted unambiguously without them. In our extended syntax, the parentheses in `(t2, t3)` of the second query are required, although theoretically the query could be parsed without them: We still would have unambiguous syntactical structure for the query because `LEFT JOIN` and `ON` play the role of the left and right delimiters for the expression `(t2,t3)`.

The preceding examples demonstrate these points:

- For join expressions involving only inner joins (and not outer joins), parentheses can be removed and joins evaluated left to right. In fact, tables can be evaluated in any order.
- The same is not true, in general, for outer joins or for outer joins mixed with inner joins. Removal of parentheses may change the result.

Queries with nested outer joins are executed in the same pipeline manner as queries with inner joins. More exactly, a variation of the nested-loop join algorithm is exploited. Recall the algorithm by which the nested-

loop join executes a query (see [Section 8.2.1.6, “Nested-Loop Join Algorithms”](#)). Suppose that a join query over 3 tables **T1**, **T2**, **T3** has this form:

```
SELECT * FROM T1 INNER JOIN T2 ON P1(T1,T2)
          INNER JOIN T3 ON P2(T2,T3)
WHERE P(T1,T2,T3)
```

Here, **P1(T1, T2)** and **P2(T2, T3)** are some join conditions (on expressions), whereas **P(T1, T2, T3)** is a condition over columns of tables **T1**, **T2**, **T3**.

The nested-loop join algorithm would execute this query in the following manner:

```
FOR each row t1 in T1 {
  FOR each row t2 in T2 such that P1(t1,t2) {
    FOR each row t3 in T3 such that P2(t2,t3) {
      IF P(t1,t2,t3) {
        t:=t1||t2||t3; OUTPUT t;
      }
    }
  }
}
```

The notation **t1 || t2 || t3** indicates a row constructed by concatenating the columns of rows **t1**, **t2**, and **t3**. In some of the following examples, **NULL** where a table name appears means a row in which **NULL** is used for each column of that table. For example, **t1 || t2 || NULL** indicates a row constructed by concatenating the columns of rows **t1** and **t2**, and **NULL** for each column of **t3**. Such a row is said to be **NULL-complemented**.

Now consider a query with nested outer joins:

```
SELECT * FROM T1 LEFT JOIN
          (T2 LEFT JOIN T3 ON P2(T2,T3))
          ON P1(T1,T2)
WHERE P(T1,T2,T3)
```

For this query, modify the nested-loop pattern to obtain:

```
FOR each row t1 in T1 {
  BOOL f1:=FALSE;
  FOR each row t2 in T2 such that P1(t1,t2) {
    BOOL f2:=FALSE;
    FOR each row t3 in T3 such that P2(t2,t3) {
      IF P(t1,t2,t3) {
        t:=t1||t2||t3; OUTPUT t;
      }
      f2=TRUE;
    }
    f1=TRUE;
  }
  IF (!f2) {
    IF P(t1,t2,NULL) {
      t:=t1||t2||NULL; OUTPUT t;
    }
    f1=TRUE;
  }
}
IF (!f1) {
  IF P(t1,NULL,NULL) {
    t:=t1||NULL||NULL; OUTPUT t;
  }
}
```

In general, for any nested loop for the first inner table in an outer join operation, a flag is introduced that is turned off before the loop and is checked after the loop. The flag is turned on when for the current row

from the outer table a match from the table representing the inner operand is found. If at the end of the loop cycle the flag is still off, no match has been found for the current row of the outer table. In this case, the row is complemented by `NULL` values for the columns of the inner tables. The result row is passed to the final check for the output or into the next nested loop, but only if the row satisfies the join condition of all embedded outer joins.

In the example, the outer join table expressed by the following expression is embedded:

```
(T2 LEFT JOIN T3 ON P2(T2,T3))
```

For the query with inner joins, the optimizer could choose a different order of nested loops, such as this one:

```
FOR each row t3 in T3 {
  FOR each row t2 in T2 such that P2(t2,t3) {
    FOR each row t1 in T1 such that P1(t1,t2) {
      IF P(t1,t2,t3) {
        t:=t1||t2||t3; OUTPUT t;
      }
    }
  }
}
```

For queries with outer joins, the optimizer can choose only such an order where loops for outer tables precede loops for inner tables. Thus, for our query with outer joins, only one nesting order is possible. For the following query, the optimizer evaluates two different nestings. In both nestings, `T1` must be processed in the outer loop because it is used in an outer join. `T2` and `T3` are used in an inner join, so that join must be processed in the inner loop. However, because the join is an inner join, `T2` and `T3` can be processed in either order.

```
SELECT * T1 LEFT JOIN (T2,T3) ON P1(T1,T2) AND P2(T1,T3)
WHERE P(T1,T2,T3)
```

One nesting evaluates `T2`, then `T3`:

```
FOR each row t1 in T1 {
  BOOL f1:=FALSE;
  FOR each row t2 in T2 such that P1(t1,t2) {
    FOR each row t3 in T3 such that P2(t1,t3) {
      IF P(t1,t2,t3) {
        t:=t1||t2||t3; OUTPUT t;
      }
    }
    f1:=TRUE
  }
  IF (!f1) {
    IF P(t1,NULL,NULL) {
      t:=t1||NULL||NULL; OUTPUT t;
    }
  }
}
```

The other nesting evaluates `T3`, then `T2`:

```
FOR each row t1 in T1 {
  BOOL f1:=FALSE;
  FOR each row t3 in T3 such that P2(t1,t3) {
    FOR each row t2 in T2 such that P1(t1,t2) {
      IF P(t1,t2,t3) {
        t:=t1||t2||t3; OUTPUT t;
      }
    }
    f1:=TRUE
  }
}
```

```

}
IF (!f1) {
  IF P(t1,NULL,NULL) {
    t:=t1||NULL||NULL; OUTPUT t;
  }
}
}

```

When discussing the nested-loop algorithm for inner joins, we omitted some details whose impact on the performance of query execution may be huge. We did not mention so-called “pushed-down” conditions. Suppose that our `WHERE` condition `P(T1, T2, T3)` can be represented by a conjunctive formula:

```
P(T1,T2,T2) = C1(T1) AND C2(T2) AND C3(T3).
```

In this case, MySQL actually uses the following nested-loop algorithm for the execution of the query with inner joins:

```

FOR each row t1 in T1 such that C1(t1) {
  FOR each row t2 in T2 such that P1(t1,t2) AND C2(t2) {
    FOR each row t3 in T3 such that P2(t2,t3) AND C3(t3) {
      IF P(t1,t2,t3) {
        t:=t1||t2||t3; OUTPUT t;
      }
    }
  }
}

```

You see that each of the conjuncts `C1(T1)`, `C2(T2)`, `C3(T3)` are pushed out of the most inner loop to the most outer loop where it can be evaluated. If `C1(T1)` is a very restrictive condition, this condition pushdown may greatly reduce the number of rows from table `T1` passed to the inner loops. As a result, the execution time for the query may improve immensely.

For a query with outer joins, the `WHERE` condition is to be checked only after it has been found that the current row from the outer table has a match in the inner tables. Thus, the optimization of pushing conditions out of the inner nested loops cannot be applied directly to queries with outer joins. Here we must introduce conditional pushed-down predicates guarded by the flags that are turned on when a match has been encountered.

Recall this example with outer joins:

```
P(T1,T2,T3)=C1(T1) AND C(T2) AND C3(T3)
```

For that example, the nested-loop algorithm using guarded pushed-down conditions looks like this:

```

FOR each row t1 in T1 such that C1(t1) {
  BOOL f1:=FALSE;
  FOR each row t2 in T2
    such that P1(t1,t2) AND (f1?C2(t2):TRUE) {
    BOOL f2:=FALSE;
    FOR each row t3 in T3
      such that P2(t2,t3) AND (f1&&f2?C3(t3):TRUE) {
      IF (f1&&f2?TRUE:(C2(t2) AND C3(t3))) {
        t:=t1||t2||t3; OUTPUT t;
      }
      f2=TRUE;
      f1=TRUE;
    }
  }
  IF (!f2) {
    IF (f1?TRUE:C2(t2) && P(t1,t2,NULL)) {
      t:=t1||t2||NULL; OUTPUT t;
    }
    f1=TRUE;
  }
}

```

```

    }
    IF (!f1 && P(t1,NULL,NULL)) {
        t:=t1|NULL|NULL; OUTPUT t;
    }
}

```

In general, pushed-down predicates can be extracted from join conditions such as `P1(T1,T2)` and `P(T2,T3)`. In this case, a pushed-down predicate is guarded also by a flag that prevents checking the predicate for the `NULL`-complemented row generated by the corresponding outer join operation.

Access by key from one inner table to another in the same nested join is prohibited if it is induced by a predicate from the `WHERE` condition.

### 8.2.1.8 Outer Join Optimization

Outer joins include `LEFT JOIN` and `RIGHT JOIN`.

MySQL implements an `A LEFT JOIN B join_specification` as follows:

- Table `B` is set to depend on table `A` and all tables on which `A` depends.
- Table `A` is set to depend on all tables (except `B`) that are used in the `LEFT JOIN` condition.
- The `LEFT JOIN` condition is used to decide how to retrieve rows from table `B`. (In other words, any condition in the `WHERE` clause is not used.)
- All standard join optimizations are performed, with the exception that a table is always read after all tables on which it depends. If there is a circular dependency, an error occurs.
- All standard `WHERE` optimizations are performed.
- If there is a row in `A` that matches the `WHERE` clause, but there is no row in `B` that matches the `ON` condition, an extra `B` row is generated with all columns set to `NULL`.
- If you use `LEFT JOIN` to find rows that do not exist in some table and you have the following test: `col_name IS NULL` in the `WHERE` part, where `col_name` is a column that is declared as `NOT NULL`, MySQL stops searching for more rows (for a particular key combination) after it has found one row that matches the `LEFT JOIN` condition.

The `RIGHT JOIN` implementation is analogous to that of `LEFT JOIN` with the table roles reversed. Right joins are converted to equivalent left joins, as described in [Section 8.2.1.9, “Outer Join Simplification”](#).

For a `LEFT JOIN`, if the `WHERE` condition is always false for the generated `NULL` row, the `LEFT JOIN` is changed to an inner join. For example, the `WHERE` clause would be false in the following query if `t2.column1` were `NULL`:

```
SELECT * FROM t1 LEFT JOIN t2 ON (column1) WHERE t2.column2=5;
```

Therefore, it is safe to convert the query to an inner join:

```
SELECT * FROM t1, t2 WHERE t2.column2=5 AND t1.column1=t2.column1;
```

Now the optimizer can use table `t2` before table `t1` if doing so would result in a better query plan. To provide a hint about the table join order, use `STRAIGHT_JOIN`; see [Section 13.2.9, “SELECT Statement”](#). However, `STRAIGHT_JOIN` may prevent indexes from being used because it disables semijoin transformations; see [Section 8.2.2.1, “Optimizing Subqueries, Derived Tables, and View References with Semijoin Transformations”](#).



### 8.2.1.9 Outer Join Simplification

Table expressions in the `FROM` clause of a query are simplified in many cases.

At the parser stage, queries with right outer join operations are converted to equivalent queries containing only left join operations. In the general case, the conversion is performed such that this right join:

```
(T1, ...) RIGHT JOIN (T2, ...) ON P(T1, ..., T2, ...)
```

Becomes this equivalent left join:

```
(T2, ...) LEFT JOIN (T1, ...) ON P(T1, ..., T2, ...)
```

All inner join expressions of the form `T1 INNER JOIN T2 ON P(T1, T2)` are replaced by the list `T1, T2, P(T1, T2)` being joined as a conjunct to the `WHERE` condition (or to the join condition of the embedding join, if there is any).

When the optimizer evaluates plans for outer join operations, it takes into consideration only plans where, for each such operation, the outer tables are accessed before the inner tables. The optimizer choices are limited because only such plans enable outer joins to be executed using the nested-loop algorithm.

Consider a query of this form, where `R(T2)` greatly narrows the number of matching rows from table `T2`:

```
SELECT * T1 FROM T1
  LEFT JOIN T2 ON P1(T1, T2)
 WHERE P(T1, T2) AND R(T2)
```

If the query is executed as written, the optimizer has no choice but to access the less-restricted table `T1` before the more-restricted table `T2`, which may produce a very inefficient execution plan.

Instead, MySQL converts the query to a query with no outer join operation if the `WHERE` condition is null-rejected. (That is, it converts the outer join to an inner join.) A condition is said to be null-rejected for an outer join operation if it evaluates to `FALSE` or `UNKNOWN` for any `NULL`-complemented row generated for the operation.

Thus, for this outer join:

```
T1 LEFT JOIN T2 ON T1.A=T2.A
```

Conditions such as these are null-rejected because they cannot be true for any `NULL`-complemented row (with `T2` columns set to `NULL`):

```
T2.B IS NOT NULL
T2.B > 3
T2.C <= T1.C
T2.B < 2 OR T2.C > 1
```

Conditions such as these are not null-rejected because they might be true for a `NULL`-complemented row:

```
T2.B IS NULL
T1.B < 3 OR T2.B IS NOT NULL
T1.B < 3 OR T2.B > 3
```

The general rules for checking whether a condition is null-rejected for an outer join operation are simple:

- It is of the form `A IS NOT NULL`, where `A` is an attribute of any of the inner tables
- It is a predicate containing a reference to an inner table that evaluates to `UNKNOWN` when one of its arguments is `NULL`

- It is a conjunction containing a null-rejected condition as a conjunct
- It is a disjunction of null-rejected conditions

A condition can be null-rejected for one outer join operation in a query and not null-rejected for another. In this query, the `WHERE` condition is null-rejected for the second outer join operation but is not null-rejected for the first one:

```
SELECT * FROM T1 LEFT JOIN T2 ON T2.A=T1.A
           LEFT JOIN T3 ON T3.B=T1.B
WHERE T3.C > 0
```

If the `WHERE` condition is null-rejected for an outer join operation in a query, the outer join operation is replaced by an inner join operation.

For example, in the preceding query, the second outer join is null-rejected and can be replaced by an inner join:

```
SELECT * FROM T1 LEFT JOIN T2 ON T2.A=T1.A
           INNER JOIN T3 ON T3.B=T1.B
WHERE T3.C > 0
```

For the original query, the optimizer evaluates only plans compatible with the single table-access order `T1, T2, T3`. For the rewritten query, it additionally considers the access order `T3, T1, T2`.

A conversion of one outer join operation may trigger a conversion of another. Thus, the query:

```
SELECT * FROM T1 LEFT JOIN T2 ON T2.A=T1.A
           LEFT JOIN T3 ON T3.B=T2.B
WHERE T3.C > 0
```

Is first converted to the query:

```
SELECT * FROM T1 LEFT JOIN T2 ON T2.A=T1.A
           INNER JOIN T3 ON T3.B=T2.B
WHERE T3.C > 0
```

Which is equivalent to the query:

```
SELECT * FROM (T1 LEFT JOIN T2 ON T2.A=T1.A), T3
WHERE T3.C > 0 AND T3.B=T2.B
```

The remaining outer join operation can also be replaced by an inner join because the condition `T3.B=T2.B` is null-rejected. This results in a query with no outer joins at all:

```
SELECT * FROM (T1 INNER JOIN T2 ON T2.A=T1.A), T3
WHERE T3.C > 0 AND T3.B=T2.B
```

Sometimes the optimizer succeeds in replacing an embedded outer join operation, but cannot convert the embedding outer join. The following query:

```
SELECT * FROM T1 LEFT JOIN
           (T2 LEFT JOIN T3 ON T3.B=T2.B)
           ON T2.A=T1.A
WHERE T3.C > 0
```

Is converted to:

```
SELECT * FROM T1 LEFT JOIN
           (T2 INNER JOIN T3 ON T3.B=T2.B)
           ON T2.A=T1.A
WHERE T3.C > 0
```

That can be rewritten only to the form still containing the embedding outer join operation:

```
SELECT * FROM T1 LEFT JOIN
      (T2,T3)
      ON (T2.A=T1.A AND T3.B=T2.B)
WHERE T3.C > 0
```

Any attempt to convert an embedded outer join operation in a query must take into account the join condition for the embedding outer join together with the [WHERE](#) condition. In this query, the [WHERE](#) condition is not null-rejected for the embedded outer join, but the join condition of the embedding outer join [T2.A=T1.A AND T3.C=T1.C](#) is null-rejected:

```
SELECT * FROM T1 LEFT JOIN
      (T2 LEFT JOIN T3 ON T3.B=T2.B)
      ON T2.A=T1.A AND T3.C=T1.C
WHERE T3.D > 0 OR T1.D > 0
```

Consequently, the query can be converted to:

```
SELECT * FROM T1 LEFT JOIN
      (T2, T3)
      ON T2.A=T1.A AND T3.C=T1.C AND T3.B=T2.B
WHERE T3.D > 0 OR T1.D > 0
```

### 8.2.1.10 Multi-Range Read Optimization

Reading rows using a range scan on a secondary index can result in many random disk accesses to the base table when the table is large and not stored in the storage engine's cache. With the Disk-Sweep Multi-Range Read (MRR) optimization, MySQL tries to reduce the number of random disk access for range scans by first scanning the index only and collecting the keys for the relevant rows. Then the keys are sorted and finally the rows are retrieved from the base table using the order of the primary key. The motivation for Disk-sweep MRR is to reduce the number of random disk accesses and instead achieve a more sequential scan of the base table data.

The Multi-Range Read optimization provides these benefits:

- MRR enables data rows to be accessed sequentially rather than in random order, based on index tuples. The server obtains a set of index tuples that satisfy the query conditions, sorts them according to data row ID order, and uses the sorted tuples to retrieve data rows in order. This makes data access more efficient and less expensive.
- MRR enables batch processing of requests for key access for operations that require access to data rows through index tuples, such as range index scans and equi-joins that use an index for the join attribute. MRR iterates over a sequence of index ranges to obtain qualifying index tuples. As these results accumulate, they are used to access the corresponding data rows. It is not necessary to acquire all index tuples before starting to read data rows.

The MRR optimization is not supported with secondary indexes created on virtual generated columns. [InnoDB](#) supports secondary indexes on virtual generated columns.

The following scenarios illustrate when MRR optimization can be advantageous:

Scenario A: MRR can be used for [InnoDB](#) and [MyISAM](#) tables for index range scans and equi-join operations.

1. A portion of the index tuples are accumulated in a buffer.
2. The tuples in the buffer are sorted by their data row ID.

3. Data rows are accessed according to the sorted index tuple sequence.

Scenario B: MRR can be used for [NDB](#) tables for multiple-range index scans or when performing an equi-join by an attribute.

1. A portion of ranges, possibly single-key ranges, is accumulated in a buffer on the central node where the query is submitted.
2. The ranges are sent to the execution nodes that access data rows.
3. The accessed rows are packed into packages and sent back to the central node.
4. The received packages with data rows are placed in a buffer.
5. Data rows are read from the buffer.

When MRR is used, the [Extra](#) column in [EXPLAIN](#) output shows [Using MRR](#).

[InnoDB](#) and [MyISAM](#) do not use MRR if full table rows need not be accessed to produce the query result. This is the case if results can be produced entirely on the basis on information in the index tuples (through a [covering index](#)); MRR provides no benefit.

Two [optimizer\\_switch](#) system variable flags provide an interface to the use of MRR optimization. The [mrr](#) flag controls whether MRR is enabled. If [mrr](#) is enabled ([on](#)), the [mrr\\_cost\\_based](#) flag controls whether the optimizer attempts to make a cost-based choice between using and not using MRR ([on](#)) or uses MRR whenever possible ([off](#)). By default, [mrr](#) is [on](#) and [mrr\\_cost\\_based](#) is [on](#). See [Section 8.9.2, “Switchable Optimizations”](#).

For MRR, a storage engine uses the value of the [read\\_rnd\\_buffer\\_size](#) system variable as a guideline for how much memory it can allocate for its buffer. The engine uses up to [read\\_rnd\\_buffer\\_size](#) bytes and determines the number of ranges to process in a single pass.

### 8.2.1.11 Block Nested-Loop and Batched Key Access Joins

In MySQL, a Batched Key Access (BKA) Join algorithm is available that uses both index access to the joined table and a join buffer. The BKA algorithm supports inner join, outer join, and semijoin operations, including nested outer joins. Benefits of BKA include improved join performance due to more efficient table scanning. Also, the Block Nested-Loop (BNL) Join algorithm previously used only for inner joins is extended and can be employed for outer join and semijoin operations, including nested outer joins.

The following sections discuss the join buffer management that underlies the extension of the original BNL algorithm, the extended BNL algorithm, and the BKA algorithm. For information about semijoin strategies, see [Section 8.2.2.1, “Optimizing Subqueries, Derived Tables, and View References with Semijoin Transformations”](#)

- [Join Buffer Management for Block Nested-Loop and Batched Key Access Algorithms](#)
- [Block Nested-Loop Algorithm for Outer Joins and Semijoins](#)
- [Batched Key Access Joins](#)
- [Optimizer Hints for Block Nested-Loop and Batched Key Access Algorithms](#)

### Join Buffer Management for Block Nested-Loop and Batched Key Access Algorithms

MySQL can employ join buffers to execute not only inner joins without index access to the inner table, but also outer joins and semijoins that appear after subquery flattening. Moreover, a join buffer can be effectively used when there is an index access to the inner table.

The join buffer management code slightly more efficiently utilizes join buffer space when storing the values of the interesting row columns: No additional bytes are allocated in buffers for a row column if its value is `NULL`, and the minimum number of bytes is allocated for any value of the `VARCHAR` type.

The code supports two types of buffers, regular and incremental. Suppose that join buffer `B1` is employed to join tables `t1` and `t2` and the result of this operation is joined with table `t3` using join buffer `B2`:

- A regular join buffer contains columns from each join operand. If `B2` is a regular join buffer, each row `r` put into `B2` is composed of the columns of a row `r1` from `B1` and the interesting columns of a matching row `r2` from table `t3`.
- An incremental join buffer contains only columns from rows of the table produced by the second join operand. That is, it is incremental to a row from the first operand buffer. If `B2` is an incremental join buffer, it contains the interesting columns of the row `r2` together with a link to the row `r1` from `B1`.

Incremental join buffers are always incremental relative to a join buffer from an earlier join operation, so the buffer from the first join operation is always a regular buffer. In the example just given, the buffer `B1` used to join tables `t1` and `t2` must be a regular buffer.

Each row of the incremental buffer used for a join operation contains only the interesting columns of a row from the table to be joined. These columns are augmented with a reference to the interesting columns of the matched row from the table produced by the first join operand. Several rows in the incremental buffer can refer to the same row `r` whose columns are stored in the previous join buffers insofar as all these rows match row `r`.

Incremental buffers enable less frequent copying of columns from buffers used for previous join operations. This provides a savings in buffer space because in the general case a row produced by the first join operand can be matched by several rows produced by the second join operand. It is unnecessary to make several copies of a row from the first operand. Incremental buffers also provide a savings in processing time due to the reduction in copying time.

The `block_nested_loop` and `batched_key_access` flags of the `optimizer_switch` system variable control how the optimizer uses the Block Nested-Loop and Batched Key Access join algorithms. By default, `block_nested_loop` is `on` and `batched_key_access` is `off`. See [Section 8.9.2, “Switchable Optimizations”](#). Optimizer hints may also be applied; see [Optimizer Hints for Block Nested-Loop and Batched Key Access Algorithms](#).

For information about semijoin strategies, see [Section 8.2.2.1, “Optimizing Subqueries, Derived Tables, and View References with Semijoin Transformations”](#)

## Block Nested-Loop Algorithm for Outer Joins and Semijoins

The original implementation of the MySQL BNL algorithm is extended to support outer join and semijoin operations.

When these operations are executed with a join buffer, each row put into the buffer is supplied with a match flag.

If an outer join operation is executed using a join buffer, each row of the table produced by the second operand is checked for a match against each row in the join buffer. When a match is found, a new extended row is formed (the original row plus columns from the second operand) and sent for further extensions by the remaining join operations. In addition, the match flag of the matched row in the buffer is enabled. After all rows of the table to be joined have been examined, the join buffer is scanned. Each row from the buffer that does not have its match flag enabled is extended by `NULL` complements (`NULL` values for each column in the second operand) and sent for further extensions by the remaining join operations.

The `block_nested_loop` flag of the `optimizer_switch` system variable controls how the optimizer uses the Block Nested-Loop algorithm. By default, `block_nested_loop` is `on`. See [Section 8.9.2, “Switchable Optimizations”](#). Optimizer hints may also be applied; see [Optimizer Hints for Block Nested-Loop and Batched Key Access Algorithms](#).

In `EXPLAIN` output, use of BNL for a table is signified when the `Extra` value contains `Using join buffer (Block Nested Loop)` and the `type` value is `ALL`, `index`, or `range`.

Some cases involving the combination of one or more subqueries with one or more left joins, particularly those returning many rows, may use BNL even though it is not ideal in such instances. This is a known issue which is fixed in MySQL 8.0. If upgrading MySQL is not immediately feasible for you, you may wish to disable BNL in the meantime by setting `optimizer_switch='block_nested_loop=off'` or employing the `NO_BNL` optimizer hint to let the optimizer choose a better plan, using one or more index hints (see [Section 8.9.4, “Index Hints”](#)), or some combination of these, to improve the performance of such queries.

For information about semijoin strategies, see [Section 8.2.2.1, “Optimizing Subqueries, Derived Tables, and View References with Semijoin Transformations”](#)

## Batched Key Access Joins

MySQL implements a method of joining tables called the Batched Key Access (BKA) join algorithm. BKA can be applied when there is an index access to the table produced by the second join operand. Like the BNL join algorithm, the BKA join algorithm employs a join buffer to accumulate the interesting columns of the rows produced by the first operand of the join operation. Then the BKA algorithm builds keys to access the table to be joined for all rows in the buffer and submits these keys in a batch to the database engine for index lookups. The keys are submitted to the engine through the Multi-Range Read (MRR) interface (see [Section 8.2.1.10, “Multi-Range Read Optimization”](#)). After submission of the keys, the MRR engine functions perform lookups in the index in an optimal way, fetching the rows of the joined table found by these keys, and starts feeding the BKA join algorithm with matching rows. Each matching row is coupled with a reference to a row in the join buffer.

When BKA is used, the value of `join_buffer_size` defines how large the batch of keys is in each request to the storage engine. The larger the buffer, the more sequential access is made to the right hand table of a join operation, which can significantly improve performance.

For BKA to be used, the `batched_key_access` flag of the `optimizer_switch` system variable must be set to `on`. BKA uses MRR, so the `mrr` flag must also be `on`. Currently, the cost estimation for MRR is too pessimistic. Hence, it is also necessary for `mrr_cost_based` to be `off` for BKA to be used. The following setting enables BKA:

```
mysql> SET optimizer_switch='mrr=on,mrr_cost_based=off,batched_key_access=on';
```

There are two scenarios by which MRR functions execute:

- The first scenario is used for conventional disk-based storage engines such as [InnoDB](#) and [MyISAM](#). For these engines, usually the keys for all rows from the join buffer are submitted to the MRR interface at once. Engine-specific MRR functions perform index lookups for the submitted keys, get row IDs (or primary keys) from them, and then fetch rows for all these selected row IDs one by one by request from BKA algorithm. Every row is returned with an association reference that enables access to the matched row in the join buffer. The rows are fetched by the MRR functions in an optimal way: They are fetched in the row ID (primary key) order. This improves performance because reads are in disk order rather than random order.
- The second scenario is used for remote storage engines such as [NDB](#). A package of keys for a portion of rows from the join buffer, together with their associations, is sent by a MySQL Server (SQL node) to

NDB Cluster data nodes. In return, the SQL node receives a package (or several packages) of matching rows coupled with corresponding associations. The BKA join algorithm takes these rows and builds new joined rows. Then a new set of keys is sent to the data nodes and the rows from the returned packages are used to build new joined rows. The process continues until the last keys from the join buffer are sent to the data nodes, and the SQL node has received and joined all rows matching these keys. This improves performance because fewer key-bearing packages sent by the SQL node to the data nodes means fewer round trips between it and the data nodes to perform the join operation.

With the first scenario, a portion of the join buffer is reserved to store row IDs (primary keys) selected by index lookups and passed as a parameter to the MRR functions.

There is no special buffer to store keys built for rows from the join buffer. Instead, a function that builds the key for the next row in the buffer is passed as a parameter to the MRR functions.

In `EXPLAIN` output, use of BKA for a table is signified when the `Extra` value contains `Using join buffer (Batched Key Access)` and the `type` value is `ref` or `eq_ref`.

## Optimizer Hints for Block Nested-Loop and Batched Key Access Algorithms

In addition to using the `optimizer_switch` system variable to control optimizer use of the BNL and BKA algorithms session-wide, MySQL supports optimizer hints to influence the optimizer on a per-statement basis. See [Section 8.9.3, “Optimizer Hints”](#).

To use a BNL or BKA hint to enable join buffering for any inner table of an outer join, join buffering must be enabled for all inner tables of the outer join.

### 8.2.1.12 Condition Filtering

In join processing, prefix rows are those rows passed from one table in a join to the next. In general, the optimizer attempts to put tables with low prefix counts early in the join order to keep the number of row combinations from increasing rapidly. To the extent that the optimizer can use information about conditions on rows selected from one table and passed to the next, the more accurately it can compute row estimates and choose the best execution plan.

Without condition filtering, the prefix row count for a table is based on the estimated number of rows selected by the `WHERE` clause according to whichever access method the optimizer chooses. Condition filtering enables the optimizer to use other relevant conditions in the `WHERE` clause not taken into account by the access method, and thus improve its prefix row count estimates. For example, even though there might be an index-based access method that can be used to select rows from the current table in a join, there might also be additional conditions for the table in the `WHERE` clause that can filter (further restrict) the estimate for qualifying rows passed to the next table.

A condition contributes to the filtering estimate only if:

- It refers to the current table.
- It depends on a constant value or values from earlier tables in the join sequence.
- It was not already taken into account by the access method.

In `EXPLAIN` output, the `rows` column indicates the row estimate for the chosen access method, and the `filtered` column reflects the effect of condition filtering. `filtered` values are expressed as percentages. The maximum value is 100, which means no filtering of rows occurred. Values decreasing from 100 indicate increasing amounts of filtering.

The prefix row count (the number of rows estimated to be passed from the current table in a join to the next) is the product of the `rows` and `filtered` values. That is, the prefix row count is the estimated row

count, reduced by the estimated filtering effect. For example, if `rows` is 1000 and `filtered` is 20%, condition filtering reduces the estimated row count of 1000 to a prefix row count of  $1000 \times 20\% = 1000 \times .2 = 200$ .

Consider the following query:

```
SELECT *
FROM employee JOIN department ON employee.dept_no = department.dept_no
WHERE employee.first_name = 'John'
AND employee.hire_date BETWEEN '2018-01-01' AND '2018-06-01';
```

Suppose that the data set has these characteristics:

- The `employee` table has 1024 rows.
- The `department` table has 12 rows.
- Both tables have an index on `dept_no`.
- The `employee` table has an index on `first_name`.
- 8 rows satisfy this condition on `employee.first_name`:

```
employee.first_name = 'John'
```

- 150 rows satisfy this condition on `employee.hire_date`:

```
employee.hire_date BETWEEN '2018-01-01' AND '2018-06-01'
```

- 1 row satisfies both conditions:

```
employee.first_name = 'John'
AND employee.hire_date BETWEEN '2018-01-01' AND '2018-06-01'
```

Without condition filtering, `EXPLAIN` produces output like this:

id	table	type	possible_keys	key	ref	rows	filtered
1	employee	ref	name,h_date,dept	name	const	8	100.00
1	department	eq_ref	PRIMARY	PRIMARY	dept_no	1	100.00

For `employee`, the access method on the `name` index picks up the 8 rows that match a name of `'John'`. No filtering is done (`filtered` is 100%), so all rows are prefix rows for the next table: The prefix row count is  $rows \times filtered = 8 \times 100\% = 8$ .

With condition filtering, the optimizer additionally takes into account conditions from the `WHERE` clause not taken into account by the access method. In this case, the optimizer uses heuristics to estimate a filtering effect of 16.31% for the `BETWEEN` condition on `employee.hire_date`. As a result, `EXPLAIN` produces output like this:

id	table	type	possible_keys	key	ref	rows	filtered
1	employee	ref	name,h_date,dept	name	const	8	16.31
1	department	eq_ref	PRIMARY	PRIMARY	dept_no	1	100.00

Now the prefix row count is  $rows \times filtered = 8 \times 16.31\% = 1.3$ , which more closely reflects actual data set.



Normally, the optimizer does not calculate the condition filtering effect (prefix row count reduction) for the last joined table because there is no next table to pass rows to. An exception occurs for `EXPLAIN`: To provide more information, the filtering effect is calculated for all joined tables, including the last one.

To control whether the optimizer considers additional filtering conditions, use the `condition_fanout_filter` flag of the `optimizer_switch` system variable (see [Section 8.9.2, “Switchable Optimizations”](#)). This flag is enabled by default but can be disabled to suppress condition filtering (for example, if a particular query is found to yield better performance without it).

If the optimizer overestimates the effect of condition filtering, performance may be worse than if condition filtering is not used. In such cases, these techniques may help:

- If a column is not indexed, index it so that the optimizer has some information about the distribution of column values and can improve its row estimates.
- Change the join order. Ways to accomplish this include join-order optimizer hints (see [Section 8.9.3, “Optimizer Hints”](#)), `STRAIGHT_JOIN` immediately following the `SELECT`, and the `STRAIGHT_JOIN` join operator.
- Disable condition filtering for the session:

```
SET optimizer_switch = 'condition_fanout_filter=off';
```

### 8.2.1.13 IS NULL Optimization

MySQL can perform the same optimization on `col_name IS NULL` that it can use for `col_name = constant_value`. For example, MySQL can use indexes and ranges to search for `NULL` with `IS NULL`.

Examples:

```
SELECT * FROM tbl_name WHERE key_col IS NULL;

SELECT * FROM tbl_name WHERE key_col <=> NULL;

SELECT * FROM tbl_name
WHERE key_col=const1 OR key_col=const2 OR key_col IS NULL;
```

If a `WHERE` clause includes a `col_name IS NULL` condition for a column that is declared as `NOT NULL`, that expression is optimized away. This optimization does not occur in cases when the column might produce `NULL` anyway (for example, if it comes from a table on the right side of a `LEFT JOIN`).

MySQL can also optimize the combination `col_name = expr OR col_name IS NULL`, a form that is common in resolved subqueries. `EXPLAIN` shows `ref_or_null` when this optimization is used.

This optimization can handle one `IS NULL` for any key part.

Some examples of queries that are optimized, assuming that there is an index on columns `a` and `b` of table `t2`:

```
SELECT * FROM t1 WHERE t1.a=expr OR t1.a IS NULL;

SELECT * FROM t1, t2 WHERE t1.a=t2.a OR t2.a IS NULL;

SELECT * FROM t1, t2
WHERE (t1.a=t2.a OR t2.a IS NULL) AND t2.b=t1.b;

SELECT * FROM t1, t2
WHERE t1.a=t2.a AND (t2.b=t1.b OR t2.b IS NULL);

SELECT * FROM t1, t2
WHERE (t1.a=t2.a AND t2.a IS NULL AND ...)
```

```
OR (t1.a=t2.a AND t2.a IS NULL AND ...);
```

`ref_or_null` works by first doing a read on the reference key, and then a separate search for rows with a `NULL` key value.

The optimization can handle only one `IS NULL` level. In the following query, MySQL uses key lookups only on the expression `(t1.a=t2.a AND t2.a IS NULL)` and is not able to use the key part on `b`:

```
SELECT * FROM t1, t2
WHERE (t1.a=t2.a AND t2.a IS NULL)
OR (t1.b=t2.b AND t2.b IS NULL);
```

### 8.2.1.14 ORDER BY Optimization

This section describes when MySQL can use an index to satisfy an `ORDER BY` clause, the `filesort` operation used when an index cannot be used, and execution plan information available from the optimizer about `ORDER BY`.

An `ORDER BY` with and without `LIMIT` may return rows in different orders, as discussed in [Section 8.2.1.17, “LIMIT Query Optimization”](#).

- [Use of Indexes to Satisfy ORDER BY](#)
- [Use of filesort to Satisfy ORDER BY](#)
- [Influencing ORDER BY Optimization](#)
- [ORDER BY Execution Plan Information Available](#)

#### Use of Indexes to Satisfy ORDER BY

In some cases, MySQL may use an index to satisfy an `ORDER BY` clause and avoid the extra sorting involved in performing a `filesort` operation.

The index may also be used even if the `ORDER BY` does not match the index exactly, as long as all unused portions of the index and all extra `ORDER BY` columns are constants in the `WHERE` clause. If the index does not contain all columns accessed by the query, the index is used only if index access is cheaper than other access methods.

Assuming that there is an index on `(key_part1, key_part2)`, the following queries may use the index to resolve the `ORDER BY` part. Whether the optimizer actually does so depends on whether reading the index is more efficient than a table scan if columns not in the index must also be read.

- In this query, the index on `(key_part1, key_part2)` enables the optimizer to avoid sorting:

```
SELECT * FROM t1
ORDER BY key_part1, key_part2;
```

However, the query uses `SELECT *`, which may select more columns than `key_part1` and `key_part2`. In that case, scanning an entire index and looking up table rows to find columns not in the index may be more expensive than scanning the table and sorting the results. If so, the optimizer is not likely to use the index. If `SELECT *` selects only the index columns, the index is used and sorting avoided.

If `t1` is an `InnoDB` table, the table primary key is implicitly part of the index, and the index can be used to resolve the `ORDER BY` for this query:

```
SELECT pk, key_part1, key_part2 FROM t1
ORDER BY key_part1, key_part2;
```

- In this query, `key_part1` is constant, so all rows accessed through the index are in `key_part2` order, and an index on `(key_part1, key_part2)` avoids sorting if the `WHERE` clause is selective enough to make an index range scan cheaper than a table scan:

```
SELECT * FROM t1
WHERE key_part1 = constant
ORDER BY key_part2;
```

- In the next two queries, whether the index is used is similar to the same queries without `DESC` shown previously:

```
SELECT * FROM t1
ORDER BY key_part1 DESC, key_part2 DESC;

SELECT * FROM t1
WHERE key_part1 = constant
ORDER BY key_part2 DESC;
```

- In the next two queries, `key_part1` is compared to a constant. The index is used if the `WHERE` clause is selective enough to make an index range scan cheaper than a table scan:

```
SELECT * FROM t1
WHERE key_part1 > constant
ORDER BY key_part1 ASC;

SELECT * FROM t1
WHERE key_part1 < constant
ORDER BY key_part1 DESC;
```

- In the next query, the `ORDER BY` does not name `key_part1`, but all rows selected have a constant `key_part1` value, so the index can still be used:

```
SELECT * FROM t1
WHERE key_part1 = constant1 AND key_part2 > constant2
ORDER BY key_part2;
```

In some cases, MySQL *cannot* use indexes to resolve the `ORDER BY`, although it may still use indexes to find the rows that match the `WHERE` clause. Examples:

- The query uses `ORDER BY` on different indexes:

```
SELECT * FROM t1 ORDER BY key1, key2;
```

- The query uses `ORDER BY` on nonconsecutive parts of an index:

```
SELECT * FROM t1 WHERE key2=constant ORDER BY key1_part1, key1_part3;
```

- The query mixes `ASC` and `DESC`:

```
SELECT * FROM t1 ORDER BY key_part1 DESC, key_part2 ASC;
```

- The index used to fetch the rows differs from the one used in the `ORDER BY`:

```
SELECT * FROM t1 WHERE key2=constant ORDER BY key1;
```

- The query uses `ORDER BY` with an expression that includes terms other than the index column name:

```
SELECT * FROM t1 ORDER BY ABS(key);
SELECT * FROM t1 ORDER BY -key;
```

- The query joins many tables, and the columns in the `ORDER BY` are not all from the first nonconstant table that is used to retrieve rows. (This is the first table in the `EXPLAIN` output that does not have a `const` join type.)

- The query has different `ORDER BY` and `GROUP BY` expressions.
- There is an index on only a prefix of a column named in the `ORDER BY` clause. In this case, the index cannot be used to fully resolve the sort order. For example, if only the first 10 bytes of a `CHAR(20)` column are indexed, the index cannot distinguish values past the 10th byte and a `filesort` is needed.
- The index does not store rows in order. For example, this is true for a `HASH` index in a `MEMORY` table.

Availability of an index for sorting may be affected by the use of column aliases. Suppose that the column `t1.a` is indexed. In this statement, the name of the column in the select list is `a`. It refers to `t1.a`, as does the reference to `a` in the `ORDER BY`, so the index on `t1.a` can be used:

```
SELECT a FROM t1 ORDER BY a;
```

In this statement, the name of the column in the select list is also `a`, but it is the alias name. It refers to `ABS(a)`, as does the reference to `a` in the `ORDER BY`, so the index on `t1.a` cannot be used:

```
SELECT ABS(a) AS a FROM t1 ORDER BY a;
```

In the following statement, the `ORDER BY` refers to a name that is not the name of a column in the select list. But there is a column in `t1` named `a`, so the `ORDER BY` refers to `t1.a` and the index on `t1.a` can be used. (The resulting sort order may be completely different from the order for `ABS(a)`, of course.)

```
SELECT ABS(a) AS b FROM t1 ORDER BY a;
```

By default, MySQL sorts `GROUP BY col1, col2, ...` queries as if you also included `ORDER BY col1, col2, ...` in the query. If you include an explicit `ORDER BY` clause that contains the same column list, MySQL optimizes it away without any speed penalty, although the sorting still occurs.

If a query includes `GROUP BY` but you want to avoid the overhead of sorting the result, you can suppress sorting by specifying `ORDER BY NULL`. For example:

```
INSERT INTO foo
SELECT a, COUNT(*) FROM bar GROUP BY a ORDER BY NULL;
```

The optimizer may still choose to use sorting to implement grouping operations. `ORDER BY NULL` suppresses sorting of the result, not prior sorting done by grouping operations to determine the result.



### Note

`GROUP BY` implicitly sorts by default (that is, in the absence of `ASC` or `DESC` designators for `GROUP BY` columns). However, relying on implicit `GROUP BY` sorting (that is, sorting in the absence of `ASC` or `DESC` designators) or explicit sorting for `GROUP BY` (that is, by using explicit `ASC` or `DESC` designators for `GROUP BY` columns) is deprecated. To produce a given sort order, provide an `ORDER BY` clause.

## Use of filesort to Satisfy ORDER BY

If an index cannot be used to satisfy an `ORDER BY` clause, MySQL performs a `filesort` operation that reads table rows and sorts them. A `filesort` constitutes an extra sorting phase in query execution.

To obtain memory for `filesort` operations, the optimizer allocates a fixed amount of `sort_buffer_size` bytes up front. Individual sessions can change the session value of this variable as desired to avoid excessive memory use, or to allocate more memory as necessary.

A `filesort` operation uses temporary disk files as necessary if the result set is too large to fit in memory. Some types of queries are particularly suited to completely in-memory `filesort` operations. For example,

the optimizer can use `filesort` to efficiently handle in memory, without temporary files, the `ORDER BY` operation for queries (and subqueries) of the following form:

```
SELECT ... FROM single_table ... ORDER BY non_index_column [DESC] LIMIT [M,]N;
```

Such queries are common in web applications that display only a few rows from a larger result set. Examples:

```
SELECT coll, ... FROM t1 ... ORDER BY name LIMIT 10;
SELECT coll, ... FROM t1 ... ORDER BY RAND() LIMIT 15;
```

## Influencing ORDER BY Optimization

For slow `ORDER BY` queries for which `filesort` is not used, try lowering the `max_length_for_sort_data` system variable to a value that is appropriate to trigger a `filesort`. (A symptom of setting the value of this variable too high is a combination of high disk activity and low CPU activity.)

To increase `ORDER BY` speed, check whether you can get MySQL to use indexes rather than an extra sorting phase. If this is not possible, try the following strategies:

- Increase the `sort_buffer_size` variable value. Ideally, the value should be large enough for the entire result set to fit in the sort buffer (to avoid writes to disk and merge passes), but at minimum the value must be large enough to accommodate 15 tuples. (Up to 15 temporary disk files are merged and there must be room in memory for at least one tuple per file.)

Take into account that the size of column values stored in the sort buffer is affected by the `max_sort_length` system variable value. For example, if tuples store values of long string columns and you increase the value of `max_sort_length`, the size of sort buffer tuples increases as well and may require you to increase `sort_buffer_size`. For column values calculated as a result of string expressions (such as those that invoke a string-valued function), the `filesort` algorithm cannot tell the maximum length of expression values, so it must allocate `max_sort_length` bytes for each tuple.

To monitor the number of merge passes (to merge temporary files), check the `Sort_merge_passes` status variable.

- Increase the `read_rnd_buffer_size` variable value so that more rows are read at a time.
- Change the `tmpdir` system variable to point to a dedicated file system with large amounts of free space. The variable value can list several paths that are used in round-robin fashion; you can use this feature to spread the load across several directories. Separate the paths by colon characters (`:`) on Unix and semicolon characters (`;`) on Windows. The paths should name directories in file systems located on different *physical* disks, not different partitions on the same disk.

## ORDER BY Execution Plan Information Available

With `EXPLAIN` (see [Section 8.8.1, “Optimizing Queries with EXPLAIN”](#)), you can check whether MySQL can use indexes to resolve an `ORDER BY` clause:

- If the `Extra` column of `EXPLAIN` output does not contain `Using filesort`, the index is used and a `filesort` is not performed.
- If the `Extra` column of `EXPLAIN` output contains `Using filesort`, the index is not used and a `filesort` is performed.

In addition, if a `filesort` is performed, optimizer trace output includes a `filesort_summary` block. For example:

```

"filesort_summary": {
  "rows": 100,
  "examined_rows": 100,
  "number_of_tmp_files": 0,
  "sort_buffer_size": 25192,
  "sort_mode": "<sort_key, packed_additional_fields>"
}

```

The `sort_mode` value provides information about the contents of tuples in the sort buffer:

- `<sort_key, rowid>`: This indicates that sort buffer tuples are pairs that contain the sort key value and row ID of the original table row. Tuples are sorted by sort key value and the row ID is used to read the row from the table.
- `<sort_key, additional_fields>`: This indicates that sort buffer tuples contain the sort key value and columns referenced by the query. Tuples are sorted by sort key value and column values are read directly from the tuple.
- `<sort_key, packed_additional_fields>`: Like the previous variant, but the additional columns are packed tightly together instead of using a fixed-length encoding.

`EXPLAIN` does not distinguish whether the optimizer does or does not perform a `filesort` in memory. Use of an in-memory `filesort` can be seen in optimizer trace output. Look for `filesort_priority_queue_optimization`. For information about the optimizer trace, see [Section 8.15, “Tracing the Optimizer”](#).

### 8.2.1.15 GROUP BY Optimization

The most general way to satisfy a `GROUP BY` clause is to scan the whole table and create a new temporary table where all rows from each group are consecutive, and then use this temporary table to discover groups and apply aggregate functions (if any). In some cases, MySQL is able to do much better than that and avoid creation of temporary tables by using index access.

The most important preconditions for using indexes for `GROUP BY` are that all `GROUP BY` columns reference attributes from the same index, and that the index stores its keys in order (as is true, for example, for a `BTREE` index, but not for a `HASH` index). Whether use of temporary tables can be replaced by index access also depends on which parts of an index are used in a query, the conditions specified for these parts, and the selected aggregate functions.

There are two ways to execute a `GROUP BY` query through index access, as detailed in the following sections. The first method applies the grouping operation together with all range predicates (if any). The second method first performs a range scan, and then groups the resulting tuples.

In MySQL, `GROUP BY` is used for sorting, so the server may also apply `ORDER BY` optimizations to grouping. However, relying on implicit or explicit `GROUP BY` sorting is deprecated. See [Section 8.2.1.14, “ORDER BY Optimization”](#).

- [Loose Index Scan](#)
- [Tight Index Scan](#)

#### Loose Index Scan

The most efficient way to process `GROUP BY` is when an index is used to directly retrieve the grouping columns. With this access method, MySQL uses the property of some index types that the keys are ordered (for example, `BTREE`). This property enables use of lookup groups in an index without having to consider all keys in the index that satisfy all `WHERE` conditions. This access method considers only a fraction of the keys in an index, so it is called a *Loose Index Scan*. When there is no `WHERE` clause, a

Loose Index Scan reads as many keys as the number of groups, which may be a much smaller number than that of all keys. If the `WHERE` clause contains range predicates (see the discussion of the `range` join type in [Section 8.8.1, “Optimizing Queries with EXPLAIN”](#)), a Loose Index Scan looks up the first key of each group that satisfies the range conditions, and again reads the smallest possible number of keys. This is possible under the following conditions:

- The query is over a single table.
- The `GROUP BY` names only columns that form a leftmost prefix of the index and no other columns. (If, instead of `GROUP BY`, the query has a `DISTINCT` clause, all distinct attributes refer to columns that form a leftmost prefix of the index.) For example, if a table `t1` has an index on `(c1,c2,c3)`, Loose Index Scan is applicable if the query has `GROUP BY c1, c2`. It is not applicable if the query has `GROUP BY c2, c3` (the columns are not a leftmost prefix) or `GROUP BY c1, c2, c4` (`c4` is not in the index).
- The only aggregate functions used in the select list (if any) are `MIN()` and `MAX()`, and all of them refer to the same column. The column must be in the index and must immediately follow the columns in the `GROUP BY`.
- Any other parts of the index than those from the `GROUP BY` referenced in the query must be constants (that is, they must be referenced in equalities with constants), except for the argument of `MIN()` or `MAX()` functions.
- For columns in the index, full column values must be indexed, not just a prefix. For example, with `c1 VARCHAR(20)`, `INDEX (c1(10))`, the index uses only a prefix of `c1` values and cannot be used for Loose Index Scan.

If Loose Index Scan is applicable to a query, the `EXPLAIN` output shows `Using index for group-by` in the `Extra` column.

Assume that there is an index `idx(c1,c2,c3)` on table `t1(c1,c2,c3,c4)`. The Loose Index Scan access method can be used for the following queries:

```
SELECT c1, c2 FROM t1 GROUP BY c1, c2;
SELECT DISTINCT c1, c2 FROM t1;
SELECT c1, MIN(c2) FROM t1 GROUP BY c1;
SELECT c1, c2 FROM t1 WHERE c1 < const GROUP BY c1, c2;
SELECT MAX(c3), MIN(c3), c1, c2 FROM t1 WHERE c2 > const GROUP BY c1, c2;
SELECT c2 FROM t1 WHERE c1 < const GROUP BY c1, c2;
SELECT c1, c2 FROM t1 WHERE c3 = const GROUP BY c1, c2;
```

The following queries cannot be executed with this quick select method, for the reasons given:

- There are aggregate functions other than `MIN()` or `MAX()`:

```
SELECT c1, SUM(c2) FROM t1 GROUP BY c1;
```

- The columns in the `GROUP BY` clause do not form a leftmost prefix of the index:

```
SELECT c1, c2 FROM t1 GROUP BY c2, c3;
```

- The query refers to a part of a key that comes after the `GROUP BY` part, and for which there is no equality with a constant:

```
SELECT c1, c3 FROM t1 GROUP BY c1, c2;
```

Were the query to include `WHERE c3 = const`, Loose Index Scan could be used.

The Loose Index Scan access method can be applied to other forms of aggregate function references in the select list, in addition to the `MIN()` and `MAX()` references already supported:

- `AVG(DISTINCT)`, `SUM(DISTINCT)`, and `COUNT(DISTINCT)` are supported. `AVG(DISTINCT)` and `SUM(DISTINCT)` take a single argument. `COUNT(DISTINCT)` can have more than one column argument.
- There must be no `GROUP BY` or `DISTINCT` clause in the query.
- The Loose Index Scan limitations described previously still apply.

Assume that there is an index `idx(c1, c2, c3)` on table `t1(c1, c2, c3, c4)`. The Loose Index Scan access method can be used for the following queries:

```
SELECT COUNT(DISTINCT c1), SUM(DISTINCT c1) FROM t1;
SELECT COUNT(DISTINCT c1, c2), COUNT(DISTINCT c2, c1) FROM t1;
```

## Tight Index Scan

A Tight Index Scan may be either a full index scan or a range index scan, depending on the query conditions.

When the conditions for a Loose Index Scan are not met, it still may be possible to avoid creation of temporary tables for `GROUP BY` queries. If there are range conditions in the `WHERE` clause, this method reads only the keys that satisfy these conditions. Otherwise, it performs an index scan. Because this method reads all keys in each range defined by the `WHERE` clause, or scans the whole index if there are no range conditions, it is called a *Tight Index Scan*. With a Tight Index Scan, the grouping operation is performed only after all keys that satisfy the range conditions have been found.

For this method to work, it is sufficient that there be a constant equality condition for all columns in a query referring to parts of the key coming before or in between parts of the `GROUP BY` key. The constants from the equality conditions fill in any “gaps” in the search keys so that it is possible to form complete prefixes of the index. These index prefixes then can be used for index lookups. If the `GROUP BY` result requires sorting, and it is possible to form search keys that are prefixes of the index, MySQL also avoids extra sorting operations because searching with prefixes in an ordered index already retrieves all the keys in order.

Assume that there is an index `idx(c1, c2, c3)` on table `t1(c1, c2, c3, c4)`. The following queries do not work with the Loose Index Scan access method described previously, but still work with the Tight Index Scan access method.

- There is a gap in the `GROUP BY`, but it is covered by the condition `c2 = 'a'`:

```
SELECT c1, c2, c3 FROM t1 WHERE c2 = 'a' GROUP BY c1, c3;
```

- The `GROUP BY` does not begin with the first part of the key, but there is a condition that provides a constant for that part:

```
SELECT c1, c2, c3 FROM t1 WHERE c1 = 'a' GROUP BY c2, c3;
```

### 8.2.1.16 DISTINCT Optimization

`DISTINCT` combined with `ORDER BY` needs a temporary table in many cases.

Because `DISTINCT` may use `GROUP BY`, learn how MySQL works with columns in `ORDER BY` or `HAVING` clauses that are not part of the selected columns. See [Section 12.19.3, “MySQL Handling of GROUP BY”](#).

In most cases, a `DISTINCT` clause can be considered as a special case of `GROUP BY`. For example, the following two queries are equivalent:



```
SELECT DISTINCT c1, c2, c3 FROM t1
WHERE c1 > const;

SELECT c1, c2, c3 FROM t1
WHERE c1 > const GROUP BY c1, c2, c3;
```

Due to this equivalence, the optimizations applicable to `GROUP BY` queries can be also applied to queries with a `DISTINCT` clause. Thus, for more details on the optimization possibilities for `DISTINCT` queries, see [Section 8.2.1.15, “GROUP BY Optimization”](#).

When combining `LIMIT row_count` with `DISTINCT`, MySQL stops as soon as it finds `row_count` unique rows.

If you do not use columns from all tables named in a query, MySQL stops scanning any unused tables as soon as it finds the first match. In the following case, assuming that `t1` is used before `t2` (which you can check with `EXPLAIN`), MySQL stops reading from `t2` (for any particular row in `t1`) when it finds the first row in `t2`:

```
SELECT DISTINCT t1.a FROM t1, t2 where t1.a=t2.a;
```

### 8.2.1.17 LIMIT Query Optimization

If you need only a specified number of rows from a result set, use a `LIMIT` clause in the query, rather than fetching the whole result set and throwing away the extra data.

MySQL sometimes optimizes a query that has a `LIMIT row_count` clause and no `HAVING` clause:

- If you select only a few rows with `LIMIT`, MySQL uses indexes in some cases when normally it would prefer to do a full table scan.
- If you combine `LIMIT row_count` with `ORDER BY`, MySQL stops sorting as soon as it has found the first `row_count` rows of the sorted result, rather than sorting the entire result. If ordering is done by using an index, this is very fast. If a filesort must be done, all rows that match the query without the `LIMIT` clause are selected, and most or all of them are sorted, before the first `row_count` are found. After the initial rows have been found, MySQL does not sort any remainder of the result set.

One manifestation of this behavior is that an `ORDER BY` query with and without `LIMIT` may return rows in different order, as described later in this section.

- If you combine `LIMIT row_count` with `DISTINCT`, MySQL stops as soon as it finds `row_count` unique rows.
- In some cases, a `GROUP BY` can be resolved by reading the index in order (or doing a sort on the index), then calculating summaries until the index value changes. In this case, `LIMIT row_count` does not calculate any unnecessary `GROUP BY` values.
- As soon as MySQL has sent the required number of rows to the client, it aborts the query unless you are using `SQL_CALC_FOUND_ROWS`. In that case, the number of rows can be retrieved with `SELECT FOUND_ROWS()`. See [Section 12.15, “Information Functions”](#).
- `LIMIT 0` quickly returns an empty set. This can be useful for checking the validity of a query. It can also be employed to obtain the types of the result columns within applications that use a MySQL API that makes result set metadata available. With the `mysql` client program, you can use the `--column-type-info` option to display result column types.
- If the server uses temporary tables to resolve a query, it uses the `LIMIT row_count` clause to calculate how much space is required.

- If an index is not used for `ORDER BY` but a `LIMIT` clause is also present, the optimizer may be able to avoid using a merge file and sort the rows in memory using an in-memory `filesort` operation.

If multiple rows have identical values in the `ORDER BY` columns, the server is free to return those rows in any order, and may do so differently depending on the overall execution plan. In other words, the sort order of those rows is nondeterministic with respect to the nonordered columns.

One factor that affects the execution plan is `LIMIT`, so an `ORDER BY` query with and without `LIMIT` may return rows in different orders. Consider this query, which is sorted by the `category` column but nondeterministic with respect to the `id` and `rating` columns:

```
mysql> SELECT * FROM ratings ORDER BY category;
```

id	category	rating
1	1	4.5
5	1	3.2
3	2	3.7
4	2	3.5
6	2	3.5
2	3	5.0
7	3	2.7

Including `LIMIT` may affect order of rows within each `category` value. For example, this is a valid query result:

```
mysql> SELECT * FROM ratings ORDER BY category LIMIT 5;
```

id	category	rating
1	1	4.5
5	1	3.2
4	2	3.5
3	2	3.7
6	2	3.5

In each case, the rows are sorted by the `ORDER BY` column, which is all that is required by the SQL standard.

If it is important to ensure the same row order with and without `LIMIT`, include additional columns in the `ORDER BY` clause to make the order deterministic. For example, if `id` values are unique, you can make rows for a given `category` value appear in `id` order by sorting like this:

```
mysql> SELECT * FROM ratings ORDER BY category, id;
```

id	category	rating
1	1	4.5
5	1	3.2
3	2	3.7
4	2	3.5
6	2	3.5
2	3	5.0
7	3	2.7

```
mysql> SELECT * FROM ratings ORDER BY category, id LIMIT 5;
```

id	category	rating
1	1	4.5
5	1	3.2

3	2	3.7
4	2	3.5
6	2	3.5

For a query with an `ORDER BY` or `GROUP BY` and a `LIMIT` clause, the optimizer tries to choose an ordered index by default when it appears doing so would speed up query execution. Prior to MySQL 5.7.33, there was no way to override this behavior, even in cases where using some other optimization might be faster. Beginning with MySQL 5.7.33, it is possible to turn off this optimization by setting the `optimizer_switch` system variable's `prefer_ordering_index` flag to `off`.

*Example:* First we create and populate a table `t` as shown here:

```
# Create and populate a table t:

mysql> CREATE TABLE t (
  ->   id1 BIGINT NOT NULL,
  ->   id2 BIGINT NOT NULL,
  ->   c1 VARCHAR(50) NOT NULL,
  ->   c2 VARCHAR(50) NOT NULL,
  ->   PRIMARY KEY (id1),
  ->   INDEX i (id2, c1)
  -> );

# [Insert some rows into table t - not shown]
```

Verify that the `prefer_ordering_index` flag is enabled:

```
mysql> SELECT @@optimizer_switch LIKE '%prefer_ordering_index=on%';
+-----+
| @@optimizer_switch LIKE '%prefer_ordering_index=on%' |
+-----+
| 1 |
+-----+
```

Since the following query has a `LIMIT` clause, we expect it to use an ordered index, if possible. In this case, as we can see from the `EXPLAIN` output, it uses the table's primary key.

```
mysql> EXPLAIN SELECT c2 FROM t
  ->   WHERE id2 > 3
  ->   ORDER BY id1 ASC LIMIT 2\G
***** 1. row *****
   id: 1
  select_type: SIMPLE
    table: t
  partitions: NULL
    type: index
possible_keys: i
    key: PRIMARY
   key_len: 8
    ref: NULL
    rows: 2
  filtered: 70.00
  Extra: Using where
```

Now we disable the `prefer_ordering_index` flag, and re-run the same query; this time it uses the index `i` (which includes the `id2` column used in the `WHERE` clause), and a filesort:

```
mysql> SET optimizer_switch = "prefer_ordering_index=off";

mysql> EXPLAIN SELECT c2 FROM t
  ->   WHERE id2 > 3
  ->   ORDER BY id1 ASC LIMIT 2\G
***** 1. row *****
   id: 1
```

```

select_type: SIMPLE
  table: t
  partitions: NULL
    type: range
possible_keys: i
  key: i
  key_len: 8
  ref: NULL
  rows: 14
  filtered: 100.00
  Extra: Using index condition; Using filesort
    
```

See also [Section 8.9.2, “Switchable Optimizations”](#).

### 8.2.1.18 Function Call Optimization

MySQL functions are tagged internally as deterministic or nondeterministic. A function is nondeterministic if, given fixed values for its arguments, it can return different results for different invocations. Examples of nondeterministic functions: [RAND\(\)](#), [UUID\(\)](#).

If a function is tagged nondeterministic, a reference to it in a [WHERE](#) clause is evaluated for every row (when selecting from one table) or combination of rows (when selecting from a multiple-table join).

MySQL also determines when to evaluate functions based on types of arguments, whether the arguments are table columns or constant values. A deterministic function that takes a table column as argument must be evaluated whenever that column changes value.

Nondeterministic functions may affect query performance. For example, some optimizations may not be available, or more locking might be required. The following discussion uses [RAND\(\)](#) but applies to other nondeterministic functions as well.

Suppose that a table `t` has this definition:

```
CREATE TABLE t (id INT NOT NULL PRIMARY KEY, col_a VARCHAR(100));
```

Consider these two queries:

```

SELECT * FROM t WHERE id = POW(1,2);
SELECT * FROM t WHERE id = FLOOR(1 + RAND() * 49);
    
```

Both queries appear to use a primary key lookup because of the equality comparison against the primary key, but that is true only for the first of them:

- The first query always produces a maximum of one row because [POW\(\)](#) with constant arguments is a constant value and is used for index lookup.
- The second query contains an expression that uses the nondeterministic function [RAND\(\)](#), which is not constant in the query but in fact has a new value for every row of table `t`. Consequently, the query reads every row of the table, evaluates the predicate for each row, and outputs all rows for which the primary key matches the random value. This might be zero, one, or multiple rows, depending on the `id` column values and the values in the [RAND\(\)](#) sequence.

The effects of nondeterminism are not limited to [SELECT](#) statements. This [UPDATE](#) statement uses a nondeterministic function to select rows to be modified:

```
UPDATE t SET col_a = some_expr WHERE id = FLOOR(1 + RAND() * 49);
```

Presumably the intent is to update at most a single row for which the primary key matches the expression. However, it might update zero, one, or multiple rows, depending on the `id` column values and the values in the [RAND\(\)](#) sequence.

The behavior just described has implications for performance and replication:

- Because a nondeterministic function does not produce a constant value, the optimizer cannot use strategies that might otherwise be applicable, such as index lookups. The result may be a table scan.
- [InnoDB](#) might escalate to a range-key lock rather than taking a single row lock for one matching row.
- Updates that do not execute deterministically are unsafe for replication.

The difficulties stem from the fact that the `RAND()` function is evaluated once for every row of the table. To avoid multiple function evaluations, use one of these techniques:

- Move the expression containing the nondeterministic function to a separate statement, saving the value in a variable. In the original statement, replace the expression with a reference to the variable, which the optimizer can treat as a constant value:

```
SET @keyval = FLOOR(1 + RAND() * 49);
UPDATE t SET col_a = some_expr WHERE id = @keyval;
```

- Assign the random value to a variable in a derived table. This technique causes the variable to be assigned a value, once, prior to its use in the comparison in the `WHERE` clause:

```
SET optimizer_switch = 'derived_merge=off';
UPDATE t, (SELECT @keyval := FLOOR(1 + RAND() * 49)) AS dt
SET col_a = some_expr WHERE id = @keyval;
```

As mentioned previously, a nondeterministic expression in the `WHERE` clause might prevent optimizations and result in a table scan. However, it may be possible to partially optimize the `WHERE` clause if other expressions are deterministic. For example:

```
SELECT * FROM t WHERE partial_key=5 AND some_column=RAND();
```

If the optimizer can use `partial_key` to reduce the set of rows selected, `RAND()` is executed fewer times, which diminishes the effect of nondeterminism on optimization.

### 8.2.1.19 Row Constructor Expression Optimization

Row constructors permit simultaneous comparisons of multiple values. For example, these two statements are semantically equivalent:

```
SELECT * FROM t1 WHERE (column1,column2) = (1,1);
SELECT * FROM t1 WHERE column1 = 1 AND column2 = 1;
```

In addition, the optimizer handles both expressions the same way.

The optimizer is less likely to use available indexes if the row constructor columns do not cover the prefix of an index. Consider the following table, which has a primary key on `(c1, c2, c3)`:

```
CREATE TABLE t1 (
  c1 INT, c2 INT, c3 INT, c4 CHAR(100),
  PRIMARY KEY(c1,c2,c3)
);
```

In this query, the `WHERE` clause uses all columns in the index. However, the row constructor itself does not cover an index prefix, with the result that the optimizer uses only `c1` (`key_len=4`, the size of `c1`):

```
mysql> EXPLAIN SELECT * FROM t1
  WHERE c1=1 AND (c2,c3) > (1,1)\G
***** 1. row *****
      id: 1
  select_type: SIMPLE
```

```

table: t1
partitions: NULL
type: ref
possible_keys: PRIMARY
key: PRIMARY
key_len: 4
ref: const
rows: 3
filtered: 100.00
Extra: Using where

```

In such cases, rewriting the row constructor expression using an equivalent nonconstructor expression may result in more complete index use. For the given query, the row constructor and equivalent nonconstructor expressions are:

```

(c2,c3) > (1,1)
c2 > 1 OR ((c2 = 1) AND (c3 > 1))

```

Rewriting the query to use the nonconstructor expression results in the optimizer using all three columns in the index (`key_len=12`):

```

mysql> EXPLAIN SELECT * FROM t1
      WHERE c1 = 1 AND (c2 > 1 OR ((c2 = 1) AND (c3 > 1)))\G
***** 1. row *****
      id: 1
      select_type: SIMPLE
      table: t1
      partitions: NULL
      type: range
      possible_keys: PRIMARY
      key: PRIMARY
      key_len: 12
      ref: NULL
      rows: 3
      filtered: 100.00
      Extra: Using where

```

Thus, for better results, avoid mixing row constructors with [AND/OR](#) expressions. Use one or the other.

Under certain conditions, the optimizer can apply the range access method to [IN\(\)](#) expressions that have row constructor arguments. See [Range Optimization of Row Constructor Expressions](#).

### 8.2.1.20 Avoiding Full Table Scans

The output from [EXPLAIN](#) shows `ALL` in the `type` column when MySQL uses a [full table scan](#) to resolve a query. This usually happens under the following conditions:

- The table is so small that it is faster to perform a table scan than to bother with a key lookup. This is common for tables with fewer than 10 rows and a short row length.
- There are no usable restrictions in the `ON` or `WHERE` clause for indexed columns.
- You are comparing indexed columns with constant values and MySQL has calculated (based on the index tree) that the constants cover too large a part of the table and that a table scan would be faster. See [Section 8.2.1.1, “WHERE Clause Optimization”](#).
- You are using a key with low cardinality (many rows match the key value) through another column. In this case, MySQL assumes that by using the key it is likely to perform many key lookups and that a table scan would be faster.

For small tables, a table scan often is appropriate and the performance impact is negligible. For large tables, try the following techniques to avoid having the optimizer incorrectly choose a table scan:

- Use `ANALYZE TABLE tbl_name` to update the key distributions for the scanned table. See [Section 13.7.2.1, “ANALYZE TABLE Statement”](#).
- Use `FORCE INDEX` for the scanned table to tell MySQL that table scans are very expensive compared to using the given index:

```
SELECT * FROM t1, t2 FORCE INDEX (index_for_column)
WHERE t1.col_name=t2.col_name;
```

See [Section 8.9.4, “Index Hints”](#).

- Start `mysqld` with the `--max-seeks-for-key=1000` option or use `SET max_seeks_for_key=1000` to tell the optimizer to assume that no key scan causes more than 1,000 key seeks. See [Section 5.1.7, “Server System Variables”](#).

## 8.2.2 Optimizing Subqueries, Derived Tables, and View References

The MySQL query optimizer has different strategies available to evaluate subqueries:

- For `IN` (or `=ANY`) subqueries, the optimizer has these choices:
  - Semijoin
  - Materialization
  - `EXISTS` strategy
- For `NOT IN` (or `<>ALL`) subqueries, the optimizer has these choices:
  - Materialization
  - `EXISTS` strategy

For derived tables, the optimizer has these choices (which also apply to view references):

- Merge the derived table into the outer query block
- Materialize the derived table to an internal temporary table

The following discussion provides more information about the preceding optimization strategies.



### Note

A limitation on `UPDATE` and `DELETE` statements that use a subquery to modify a single table is that the optimizer does not use semijoin or materialization subquery optimizations. As a workaround, try rewriting them as multiple-table `UPDATE` and `DELETE` statements that use a join rather than a subquery.

### 8.2.2.1 Optimizing Subqueries, Derived Tables, and View References with Semijoin Transformations

A semijoin is a preparation-time transformation that enables multiple execution strategies such as table pullout, duplicate weedout, first match, loose scan, and materialization. The optimizer uses semijoin strategies to improve subquery execution, as described in this section.

For an inner join between two tables, the join returns a row from one table as many times as there are matches in the other table. But for some questions, the only information that matters is whether there is

a match, not the number of matches. Suppose that there are tables named `class` and `roster` that list classes in a course curriculum and class rosters (students enrolled in each class), respectively. To list the classes that actually have students enrolled, you could use this join:

```
SELECT class.class_num, class.class_name
FROM class INNER JOIN roster
WHERE class.class_num = roster.class_num;
```

However, the result lists each class once for each enrolled student. For the question being asked, this is unnecessary duplication of information.

Assuming that `class_num` is a primary key in the `class` table, duplicate suppression is possible by using `SELECT DISTINCT`, but it is inefficient to generate all matching rows first only to eliminate duplicates later.

The same duplicate-free result can be obtained by using a subquery:

```
SELECT class_num, class_name
FROM class
WHERE class_num IN (SELECT class_num FROM roster);
```

Here, the optimizer can recognize that the `IN` clause requires the subquery to return only one instance of each class number from the `roster` table. In this case, the query can use a *semijoin*; that is, an operation that returns only one instance of each row in `class` that is matched by rows in `roster`.

Outer join and inner join syntax is permitted in the outer query specification, and table references may be base tables, derived tables, or view references.

In MySQL, a subquery must satisfy these criteria to be handled as a semijoin:

- It must be an `IN` (or `=ANY`) subquery that appears at the top level of the `WHERE` or `ON` clause, possibly as a term in an `AND` expression. For example:

```
SELECT ...
FROM ot1, ...
WHERE (oe1, ...) IN (SELECT ie1, ... FROM it1, ... WHERE ...);
```

Here, `oti` and `iti` represent tables in the outer and inner parts of the query, and `oei` and `iei` represent expressions that refer to columns in the outer and inner tables.

- It must be a single `SELECT` without `UNION` constructs.
- It must not contain a `GROUP BY` or `HAVING` clause.
- It must not be implicitly grouped (it must contain no aggregate functions).
- It must not have `ORDER BY` with `LIMIT`.
- The statement must not use the `STRAIGHT_JOIN` join type in the outer query.
- The `STRAIGHT_JOIN` modifier must not be present.
- The number of outer and inner tables together must be less than the maximum number of tables permitted in a join.

The subquery may be correlated or uncorrelated. `DISTINCT` is permitted, as is `LIMIT` unless `ORDER BY` is also used.

If a subquery meets the preceding criteria, MySQL converts it to a semijoin and makes a cost-based choice from these strategies:



- Convert the subquery to a join, or use table pullout and run the query as an inner join between subquery tables and outer tables. Table pullout pulls a table out from the subquery to the outer query.
- Duplicate Weedout: Run the semijoin as if it was a join and remove duplicate records using a temporary table.
- FirstMatch: When scanning the inner tables for row combinations and there are multiple instances of a given value group, choose one rather than returning them all. This "shortcuts" scanning and eliminates production of unnecessary rows.
- LooseScan: Scan a subquery table using an index that enables a single value to be chosen from each subquery's value group.
- Materialize the subquery into an indexed temporary table that is used to perform a join, where the index is used to remove duplicates. The index might also be used later for lookups when joining the temporary table with the outer tables; if not, the table is scanned. For more information about materialization, see [Section 8.2.2.2, "Optimizing Subqueries with Materialization"](#).

Each of these strategies can be enabled or disabled using the following `optimizer_switch` system variable flags:

- The `semijoin` flag controls whether semijoins are used.
- If `semijoin` is enabled, the `firstmatch`, `loosescan`, `duplicateweedout`, and `materialization` flags enable finer control over the permitted semijoin strategies.
- If the `duplicateweedout` semijoin strategy is disabled, it is not used unless all other applicable strategies are also disabled.
- If `duplicateweedout` is disabled, on occasion the optimizer may generate a query plan that is far from optimal. This occurs due to heuristic pruning during greedy search, which can be avoided by setting `optimizer_prune_level=0`.

These flags are enabled by default. See [Section 8.9.2, "Switchable Optimizations"](#).

The optimizer minimizes differences in handling of views and derived tables. This affects queries that use the `STRAIGHT_JOIN` modifier and a view with an `IN` subquery that can be converted to a semijoin. The following query illustrates this because the change in processing causes a change in transformation, and thus a different execution strategy:

```
CREATE VIEW v AS
SELECT *
FROM t1
WHERE a IN (SELECT b
            FROM t2);

SELECT STRAIGHT_JOIN *
FROM t3 JOIN v ON t3.x = v.a;
```

The optimizer first looks at the view and converts the `IN` subquery to a semijoin, then checks whether it is possible to merge the view into the outer query. Because the `STRAIGHT_JOIN` modifier in the outer query prevents semijoin, the optimizer refuses the merge, causing derived table evaluation using a materialized table.

`EXPLAIN` output indicates the use of semijoin strategies as follows:

- Semijoin tables show up in the outer select. For extended `EXPLAIN` output, the text displayed by a following `SHOW WARNINGS` shows the rewritten query, which displays the semijoin structure. (See [Section 8.8.3, "Extended EXPLAIN Output Format"](#).) From this you can get an idea about which

tables were pulled out of the semijoin. If a subquery was converted to a semijoin, you can see that the subquery predicate is gone and its tables and `WHERE` clause were merged into the outer query join list and `WHERE` clause.

- Temporary table use for Duplicate Weedout is indicated by `Start temporary` and `End temporary` in the `Extra` column. Tables that were not pulled out and are in the range of `EXPLAIN` output rows covered by `Start temporary` and `End temporary` have their `rowid` in the temporary table.
- `FirstMatch(tbl_name)` in the `Extra` column indicates join shortcutting.
- `LooseScan(m..n)` in the `Extra` column indicates use of the LooseScan strategy. `m` and `n` are key part numbers.
- Temporary table use for materialization is indicated by rows with a `select_type` value of `MATERIALIZED` and rows with a `table` value of `<subqueryN>`.

### 8.2.2.2 Optimizing Subqueries with Materialization

The optimizer uses materialization to enable more efficient subquery processing. Materialization speeds up query execution by generating a subquery result as a temporary table, normally in memory. The first time MySQL needs the subquery result, it materializes that result into a temporary table. Any subsequent time the result is needed, MySQL refers again to the temporary table. The optimizer may index the table with a hash index to make lookups fast and inexpensive. The index contains unique values to eliminate duplicates and make the table smaller.

Subquery materialization uses an in-memory temporary table when possible, falling back to on-disk storage if the table becomes too large. See [Section 8.4.4, “Internal Temporary Table Use in MySQL”](#).

If materialization is not used, the optimizer sometimes rewrites a noncorrelated subquery as a correlated subquery. For example, the following `IN` subquery is noncorrelated (`where_condition` involves only columns from `t2` and not `t1`):

```
SELECT * FROM t1
WHERE t1.a IN (SELECT t2.b FROM t2 WHERE where_condition);
```

The optimizer might rewrite this as an `EXISTS` correlated subquery:

```
SELECT * FROM t1
WHERE EXISTS (SELECT t2.b FROM t2 WHERE where_condition AND t1.a=t2.b);
```

Subquery materialization using a temporary table avoids such rewrites and makes it possible to execute the subquery only once rather than once per row of the outer query.

For subquery materialization to be used in MySQL, the `optimizer_switch` system variable `materialization` flag must be enabled. (See [Section 8.9.2, “Switchable Optimizations”](#).) With the `materialization` flag enabled, materialization applies to subquery predicates that appear anywhere (in the select list, `WHERE`, `ON`, `GROUP BY`, `HAVING`, or `ORDER BY`), for predicates that fall into any of these use cases:

- The predicate has this form, when no outer expression `oe_i` or inner expression `ie_i` is nullable. `N` is 1 or larger.

```
(oe_1, oe_2, ..., oe_N) [NOT] IN (SELECT ie_1, ie_2, ..., ie_N ...)
```

- The predicate has this form, when there is a single outer expression `oe` and inner expression `ie`. The expressions can be nullable.

```
oe [NOT] IN (SELECT ie ...)
```

- The predicate is `IN` or `NOT IN` and a result of `UNKNOWN (NULL)` has the same meaning as a result of `FALSE`.

The following examples illustrate how the requirement for equivalence of `UNKNOWN` and `FALSE` predicate evaluation affects whether subquery materialization can be used. Assume that `where_condition` involves columns only from `t2` and not `t1` so that the subquery is noncorrelated.

This query is subject to materialization:

```
SELECT * FROM t1
WHERE t1.a IN (SELECT t2.b FROM t2 WHERE where_condition);
```

Here, it does not matter whether the `IN` predicate returns `UNKNOWN` or `FALSE`. Either way, the row from `t1` is not included in the query result.

An example where subquery materialization is not used is the following query, where `t2.b` is a nullable column:

```
SELECT * FROM t1
WHERE (t1.a,t1.b) NOT IN (SELECT t2.a,t2.b FROM t2
                        WHERE where_condition);
```

The following restrictions apply to the use of subquery materialization:

- The types of the inner and outer expressions must match. For example, the optimizer might be able to use materialization if both expressions are integer or both are decimal, but cannot if one expression is integer and the other is decimal.
- The inner expression cannot be a `BLOB`.

Use of `EXPLAIN` with a query provides some indication of whether the optimizer uses subquery materialization:

- Compared to query execution that does not use materialization, `select_type` may change from `DEPENDENT SUBQUERY` to `SUBQUERY`. This indicates that, for a subquery that would be executed once per outer row, materialization enables the subquery to be executed just once.
- For extended `EXPLAIN` output, the text displayed by a following `SHOW WARNINGS` includes `materialize` and `materialized-subquery`.

### 8.2.2.3 Optimizing Subqueries with the EXISTS Strategy

Certain optimizations are applicable to comparisons that use the `IN` (or `=ANY`) operator to test subquery results. This section discusses these optimizations, particularly with regard to the challenges that `NULL` values present. The last part of the discussion suggests how you can help the optimizer.

Consider the following subquery comparison:

```
outer_expr IN (SELECT inner_expr FROM ... WHERE subquery_where)
```

MySQL evaluates queries “from outside to inside.” That is, it first obtains the value of the outer expression `outer_expr`, and then runs the subquery and captures the rows that it produces.

A very useful optimization is to “inform” the subquery that the only rows of interest are those where the inner expression `inner_expr` is equal to `outer_expr`. This is done by pushing down an appropriate equality into the subquery’s `WHERE` clause to make it more restrictive. The converted comparison looks like this:

```
EXISTS (SELECT 1 FROM ... WHERE subquery_where AND outer_expr=inner_expr)
```

After the conversion, MySQL can use the pushed-down equality to limit the number of rows it must examine to evaluate the subquery.

More generally, a comparison of  $N$  values to a subquery that returns  $N$ -value rows is subject to the same conversion. If  $oe_i$  and  $ie_i$  represent corresponding outer and inner expression values, this subquery comparison:

```
(oe_1, ..., oe_N) IN
  (SELECT ie_1, ..., ie_N FROM ... WHERE subquery_where)
```

Becomes:

```
EXISTS (SELECT 1 FROM ... WHERE subquery_where
        AND oe_1 = ie_1
        AND ...
        AND oe_N = ie_N)
```

For simplicity, the following discussion assumes a single pair of outer and inner expression values.

The conversion just described has its limitations. It is valid only if we ignore possible `NULL` values. That is, the “pushdown” strategy works as long as both of these conditions are true:

- `outer_expr` and `inner_expr` cannot be `NULL`.
- You need not distinguish `NULL` from `FALSE` subquery results. If the subquery is a part of an `OR` or `AND` expression in the `WHERE` clause, MySQL assumes that you do not care. Another instance where the optimizer notices that `NULL` and `FALSE` subquery results need not be distinguished is this construct:

```
... WHERE outer_expr IN (subquery)
```

In this case, the `WHERE` clause rejects the row whether `IN (subquery)` returns `NULL` or `FALSE`.

When either or both of those conditions do not hold, optimization is more complex.

Suppose that `outer_expr` is known to be a non-`NULL` value but the subquery does not produce a row such that `outer_expr = inner_expr`. Then `outer_expr IN (SELECT ...)` evaluates as follows:

- `NULL`, if the `SELECT` produces any row where `inner_expr` is `NULL`
- `FALSE`, if the `SELECT` produces only non-`NULL` values or produces nothing

In this situation, the approach of looking for rows with `outer_expr = inner_expr` is no longer valid. It is necessary to look for such rows, but if none are found, also look for rows where `inner_expr` is `NULL`. Roughly speaking, the subquery can be converted to something like this:

```
EXISTS (SELECT 1 FROM ... WHERE subquery_where AND
        (outer_expr=inner_expr OR inner_expr IS NULL))
```

The need to evaluate the extra `IS NULL` condition is why MySQL has the `ref_or_null` access method:

```
mysql> EXPLAIN
        SELECT outer_expr IN (SELECT t2.maybe_null_key
                             FROM t2, t3 WHERE ...)
        FROM t1;
***** 1. row *****
      id: 1
  select_type: PRIMARY
      table: t1
  ...
***** 2. row *****
      id: 2
  select_type: DEPENDENT SUBQUERY
      table: t2
```

```

        type: ref_or_null
possible_keys: maybe_null_key
        key: maybe_null_key
        key_len: 5
        ref: func
        rows: 2
        Extra: Using where; Using index
...
    
```

The `unique_subquery` and `index_subquery` subquery-specific access methods also have “or `NULL`” variants.

The additional `OR ... IS NULL` condition makes query execution slightly more complicated (and some optimizations within the subquery become inapplicable), but generally this is tolerable.

The situation is much worse when `outer_expr` can be `NULL`. According to the SQL interpretation of `NULL` as “unknown value,” `NULL IN (SELECT inner_expr ...)` should evaluate to:

- `NULL`, if the `SELECT` produces any rows
- `FALSE`, if the `SELECT` produces no rows

For proper evaluation, it is necessary to be able to check whether the `SELECT` has produced any rows at all, so `outer_expr = inner_expr` cannot be pushed down into the subquery. This is a problem because many real world subqueries become very slow unless the equality can be pushed down.

Essentially, there must be different ways to execute the subquery depending on the value of `outer_expr`.

The optimizer chooses SQL compliance over speed, so it accounts for the possibility that `outer_expr` might be `NULL`:

- If `outer_expr` is `NULL`, to evaluate the following expression, it is necessary to execute the `SELECT` to determine whether it produces any rows:

```
NULL IN (SELECT inner_expr FROM ... WHERE subquery_where)
```

It is necessary to execute the original `SELECT` here, without any pushed-down equalities of the kind mentioned previously.

- On the other hand, when `outer_expr` is not `NULL`, it is absolutely essential that this comparison:

```
outer_expr IN (SELECT inner_expr FROM ... WHERE subquery_where)
```

Be converted to this expression that uses a pushed-down condition:

```
EXISTS (SELECT 1 FROM ... WHERE subquery_where AND outer_expr=inner_expr)
```

Without this conversion, subqueries are slow.

To solve the dilemma of whether or not to push down conditions into the subquery, the conditions are wrapped within “trigger” functions. Thus, an expression of the following form:

```
outer_expr IN (SELECT inner_expr FROM ... WHERE subquery_where)
```

Is converted into:

```
EXISTS (SELECT 1 FROM ... WHERE subquery_where
        AND trigcond(outer_expr=inner_expr))
```

More generally, if the subquery comparison is based on several pairs of outer and inner expressions, the conversion takes this comparison:

```
(oe_1, ..., oe_N) IN (SELECT ie_1, ..., ie_N FROM ... WHERE subquery_where)
```

And converts it to this expression:

```
EXISTS (SELECT 1 FROM ... WHERE subquery_where
        AND trigcond(oe_1=ie_1)
        AND ...
        AND trigcond(oe_N=ie_N)
    )
```

Each `trigcond(X)` is a special function that evaluates to the following values:

- `X` when the “linked” outer expression `oe_i` is not `NULL`
- `TRUE` when the “linked” outer expression `oe_i` is `NULL`



#### Note

Trigger functions are *not* triggers of the kind that you create with `CREATE TRIGGER`.

Equalities that are wrapped within `trigcond()` functions are not first class predicates for the query optimizer. Most optimizations cannot deal with predicates that may be turned on and off at query execution time, so they assume any `trigcond(X)` to be an unknown function and ignore it. Triggered equalities can be used by those optimizations:

- Reference optimizations: `trigcond(X=Y [OR Y IS NULL])` can be used to construct `ref`, `eq_ref`, or `ref_or_null` table accesses.
- Index lookup-based subquery execution engines: `trigcond(X=Y)` can be used to construct `unique_subquery` or `index_subquery` accesses.
- Table-condition generator: If the subquery is a join of several tables, the triggered condition is checked as soon as possible.

When the optimizer uses a triggered condition to create some kind of index lookup-based access (as for the first two items of the preceding list), it must have a fallback strategy for the case when the condition is turned off. This fallback strategy is always the same: Do a full table scan. In `EXPLAIN` output, the fallback shows up as `Full scan on NULL key` in the `Extra` column:

```
mysql> EXPLAIN SELECT t1.col1,
        t1.col1 IN (SELECT t2.key1 FROM t2 WHERE t2.col2=t1.col2) FROM t1\G
***** 1. row *****
      id: 1
  select_type: PRIMARY
     table: t1
        ...
***** 2. row *****
      id: 2
  select_type: DEPENDENT SUBQUERY
     table: t2
        type: index_subquery
possible_keys: key1
           key: key1
        key_len: 5
           ref: func
           rows: 2
        Extra: Using where; Full scan on NULL key
```

If you run `EXPLAIN` followed by `SHOW WARNINGS`, you can see the triggered condition:

```
***** 1. row *****
```

```

Level: Note
Code: 1003
Message: select `test`.`t1`.`col1` AS `col1`,
         <in_optimizer>(`test`.`t1`.`col1`,
         <exists>(<index_lookup>(<cache>(`test`.`t1`.`col1`) in t2
         on key1 checking NULL
         where (`test`.`t2`.`col2` = `test`.`t1`.`col2`) having
         trigcond(<is_not_null_test>(`test`.`t2`.`key1`)))) AS
         `t1.col1 IN (select t2.key1 from t2 where t2.col2=t1.col2)`
         from `test`.`t1`

```

The use of triggered conditions has some performance implications. A `NULL IN (SELECT ...)` expression now may cause a full table scan (which is slow) when it previously did not. This is the price paid for correct results (the goal of the trigger-condition strategy is to improve compliance, not speed).

For multiple-table subqueries, execution of `NULL IN (SELECT ...)` is particularly slow because the join optimizer does not optimize for the case where the outer expression is `NULL`. It assumes that subquery evaluations with `NULL` on the left side are very rare, even if there are statistics that indicate otherwise. On the other hand, if the outer expression might be `NULL` but never actually is, there is no performance penalty.

To help the query optimizer better execute your queries, use these suggestions:

- Declare a column as `NOT NULL` if it really is. This also helps other aspects of the optimizer by simplifying condition testing for the column.
- If you need not distinguish a `NULL` from `FALSE` subquery result, you can easily avoid the slow execution path. Replace a comparison that looks like this:

```
outer_expr IN (SELECT inner_expr FROM ...)
```

with this expression:

```
(outer_expr IS NOT NULL) AND (outer_expr IN (SELECT inner_expr FROM ...))
```

Then `NULL IN (SELECT ...)` is never evaluated because MySQL stops evaluating `AND` parts as soon as the expression result is clear.

Another possible rewrite:

```
EXISTS (SELECT inner_expr FROM ...
        WHERE inner_expr=outer_expr)
```

This would apply when you need not distinguish `NULL` from `FALSE` subquery results, in which case you may actually want `EXISTS`.

The `subquery_materialization_cost_based` flag of the `optimizer_switch` system variable enables control over the choice between subquery materialization and `IN-to-EXISTS` subquery transformation. See [Section 8.9.2, “Switchable Optimizations”](#).

### 8.2.2.4 Optimizing Derived Tables and View References with Merging or Materialization

The optimizer can handle derived table references using two strategies (which also apply to view references):

- Merge the derived table into the outer query block
- Materialize the derived table to an internal temporary table

Example 1:

```
SELECT * FROM (SELECT * FROM t1) AS derived_t1;
```

With merging of the derived table `derived_t1`, that query is executed similar to:

```
SELECT * FROM t1;
```

Example 2:

```
SELECT *
FROM t1 JOIN (SELECT t2.f1 FROM t2) AS derived_t2 ON t1.f2=derived_t2.f1
WHERE t1.f1 > 0;
```

With merging of the derived table `derived_t2`, that query is executed similar to:

```
SELECT t1.*, t2.f1
FROM t1 JOIN t2 ON t1.f2=t2.f1
WHERE t1.f1 > 0;
```

With materialization, `derived_t1` and `derived_t2` are each treated as a separate table within their respective queries.

The optimizer handles derived tables and view references the same way: It avoids unnecessary materialization whenever possible, which enables pushing down conditions from the outer query to derived tables and produces more efficient execution plans. (For an example, see [Section 8.2.2.2, “Optimizing Subqueries with Materialization”](#).)

If merging would result in an outer query block that references more than 61 base tables, the optimizer chooses materialization instead.

The optimizer propagates an `ORDER BY` clause in a derived table or view reference to the outer query block if these conditions are all true:

- The outer query is not grouped or aggregated.
- The outer query does not specify `DISTINCT`, `HAVING`, or `ORDER BY`.
- The outer query has this derived table or view reference as the only source in the `FROM` clause.

Otherwise, the optimizer ignores the `ORDER BY` clause.

The following means are available to influence whether the optimizer attempts to merge derived tables and view references into the outer query block:

- The `derived_merge` flag of the `optimizer_switch` system variable can be used, assuming that no other rule prevents merging. See [Section 8.9.2, “Switchable Optimizations”](#). By default, the flag is enabled to permit merging. Disabling the flag prevents merging and avoids `ER_UPDATE_TABLE_USED` errors.

The `derived_merge` flag also applies to views that contain no `ALGORITHM` clause. Thus, if an `ER_UPDATE_TABLE_USED` error occurs for a view reference that uses an expression equivalent to the subquery, adding `ALGORITHM=TEMPTABLE` to the view definition prevents merging and takes precedence over the `derived_merge` value.

- It is possible to disable merging by using in the subquery any constructs that prevent merging, although these are not as explicit in their effect on materialization. Constructs that prevent merging are the same for derived tables and view references:
  - Aggregate functions (`SUM()`, `MIN()`, `MAX()`, `COUNT()`, and so forth)
  - `DISTINCT`



- `GROUP BY`
- `HAVING`
- `LIMIT`
- `UNION` or `UNION ALL`
- Subqueries in the select list
- Assignments to user variables
- References only to literal values (in this case, there is no underlying table)

The `derived_merge` flag also applies to views that contain no `ALGORITHM` clause. Thus, if an `ER_UPDATE_TABLE_USED` error occurs for a view reference that uses an expression equivalent to the subquery, adding `ALGORITHM=TEMPTABLE` to the view definition prevents merging and takes precedence over the current `derived_merge` value.

If the optimizer chooses the materialization strategy rather than merging for a derived table, it handles the query as follows:

- The optimizer postpones derived table materialization until its contents are needed during query execution. This improves performance because delaying materialization may result in not having to do it at all. Consider a query that joins the result of a derived table to another table: If the optimizer processes that other table first and finds that it returns no rows, the join need not be carried out further and the optimizer can completely skip materializing the derived table.
- During query execution, the optimizer may add an index to a derived table to speed up row retrieval from it.

Consider the following `EXPLAIN` statement, for a `SELECT` query that contains a derived table:

```
EXPLAIN SELECT * FROM (SELECT * FROM t1) AS derived_t1;
```

The optimizer avoids materializing the derived table by delaying it until the result is needed during `SELECT` execution. In this case, the query is not executed (because it occurs in an `EXPLAIN` statement), so the result is never needed.

Even for queries that are executed, delay of derived table materialization may enable the optimizer to avoid materialization entirely. When this happens, query execution is quicker by the time needed to perform materialization. Consider the following query, which joins the result of a derived table to another table:

```
SELECT *
FROM t1 JOIN (SELECT t2.f1 FROM t2) AS derived_t2
      ON t1.f2=derived_t2.f1
WHERE t1.f1 > 0;
```

If the optimization processes `t1` first and the `WHERE` clause produces an empty result, the join must necessarily be empty and the derived table need not be materialized.

For cases when a derived table requires materialization, the optimizer may add an index to the materialized table to speed up access to it. If such an index enables `ref` access to the table, it can greatly reduce amount of data read during query execution. Consider the following query:

```
SELECT *
FROM t1 JOIN (SELECT DISTINCT f1 FROM t2) AS derived_t2
      ON t1.f1=derived_t2.f1;
```

The optimizer constructs an index over column `f1` from `derived_t2` if doing so would enable use of `ref` access for the lowest cost execution plan. After adding the index, the optimizer can treat the materialized derived table the same as a regular table with an index, and it benefits similarly from the generated index. The overhead of index creation is negligible compared to the cost of query execution without the index. If `ref` access would result in higher cost than some other access method, the optimizer creates no index and loses nothing.

For optimizer trace output, a merged derived table or view reference is not shown as a node. Only its underlying tables appear in the top query's plan.

### 8.2.3 Optimizing INFORMATION\_SCHEMA Queries

Applications that monitor databases may make frequent use of `INFORMATION_SCHEMA` tables. Certain types of queries for `INFORMATION_SCHEMA` tables can be optimized to execute more quickly. The goal is to minimize file operations (for example, scanning a directory or opening a table file) to collect the information that makes up these dynamic tables.



**Note**

Comparison behavior for database and table names in `INFORMATION_SCHEMA` queries might differ from what you expect. For details, see [Section 10.8.7, “Using Collation in INFORMATION\\_SCHEMA Searches”](#).

**1) Try to use constant lookup values for database and table names in the `WHERE` clause**

You can take advantage of this principle as follows:

- To look up databases or tables, use expressions that evaluate to a constant, such as literal values, functions that return a constant, or scalar subqueries.
- Avoid queries that use a nonconstant database name lookup value (or no lookup value) because they require a scan of the data directory to find matching database directory names.
- Within a database, avoid queries that use a nonconstant table name lookup value (or no lookup value) because they require a scan of the database directory to find matching table files.

This principle applies to the `INFORMATION_SCHEMA` tables shown in the following table, which shows the columns for which a constant lookup value enables the server to avoid a directory scan. For example, if you are selecting from `TABLES`, using a constant lookup value for `TABLE_SCHEMA` in the `WHERE` clause enables a data directory scan to be avoided.

Table	Column to specify to avoid data directory scan	Column to specify to avoid database directory scan
<code>COLUMNS</code>	<code>TABLE_SCHEMA</code>	<code>TABLE_NAME</code>
<code>KEY_COLUMN_USAGE</code>	<code>TABLE_SCHEMA</code>	<code>TABLE_NAME</code>
<code>PARTITIONS</code>	<code>TABLE_SCHEMA</code>	<code>TABLE_NAME</code>
<code>REFERENTIAL_CONSTRAINTS</code>	<code>CONSTRAINT_SCHEMA</code>	<code>TABLE_NAME</code>
<code>STATISTICS</code>	<code>TABLE_SCHEMA</code>	<code>TABLE_NAME</code>
<code>TABLES</code>	<code>TABLE_SCHEMA</code>	<code>TABLE_NAME</code>
<code>TABLE_CONSTRAINTS</code>	<code>TABLE_SCHEMA</code>	<code>TABLE_NAME</code>
<code>TRIGGERS</code>	<code>EVENT_OBJECT_SCHEMA</code>	<code>EVENT_OBJECT_TABLE</code>
<code>VIEWS</code>	<code>TABLE_SCHEMA</code>	<code>TABLE_NAME</code>

The benefit of a query that is limited to a specific constant database name is that checks need be made only for the named database directory. Example:

```
SELECT TABLE_NAME FROM INFORMATION_SCHEMA.TABLES
WHERE TABLE_SCHEMA = 'test';
```

Use of the literal database name `test` enables the server to check only the `test` database directory, regardless of how many databases there might be. By contrast, the following query is less efficient because it requires a scan of the data directory to determine which database names match the pattern `'test%'`:

```
SELECT TABLE_NAME FROM INFORMATION_SCHEMA.TABLES
WHERE TABLE_SCHEMA LIKE 'test%';
```

For a query that is limited to a specific constant table name, checks need be made only for the named table within the corresponding database directory. Example:

```
SELECT TABLE_NAME FROM INFORMATION_SCHEMA.TABLES
WHERE TABLE_SCHEMA = 'test' AND TABLE_NAME = 't1';
```

Use of the literal table name `t1` enables the server to check only the files for the `t1` table, regardless of how many tables there might be in the `test` database. By contrast, the following query requires a scan of the `test` database directory to determine which table names match the pattern `'t%'`:

```
SELECT TABLE_NAME FROM INFORMATION_SCHEMA.TABLES
WHERE TABLE_SCHEMA = 'test' AND TABLE_NAME LIKE 't%';
```

The following query requires a scan of the database directory to determine matching database names for the pattern `'test%'`, and for each matching database, it requires a scan of the database directory to determine matching table names for the pattern `'t%'`:

```
SELECT TABLE_NAME FROM INFORMATION_SCHEMA.TABLES
WHERE TABLE_SCHEMA = 'test%' AND TABLE_NAME LIKE 't%';
```

## 2) Write queries that minimize the number of table files that must be opened

For queries that refer to certain `INFORMATION_SCHEMA` table columns, several optimizations are available that minimize the number of table files that must be opened. Example:

```
SELECT TABLE_NAME, ENGINE FROM INFORMATION_SCHEMA.TABLES
WHERE TABLE_SCHEMA = 'test';
```

In this case, after the server has scanned the database directory to determine the names of the tables in the database, those names become available with no further file system lookups. Thus, `TABLE_NAME` requires no files to be opened. The `ENGINE` (storage engine) value can be determined by opening the table's `.frm` file, without touching other table files such as the `.MYD` or `.MYI` file.

Some values, such as `INDEX_LENGTH` for `MyISAM` tables, require opening the `.MYD` or `.MYI` file as well.

The file-opening optimization types are denoted thus:

- `SKIP_OPEN_TABLE`: Table files do not need to be opened. The information has already become available within the query by scanning the database directory.
- `OPEN_FRM_ONLY`: Only the table's `.frm` file need be opened.
- `OPEN_TRIGGER_ONLY`: Only the table's `.TRG` file need be opened.
- `OPEN_FULL_TABLE`: The unoptimized information lookup. The `.frm`, `.MYD`, and `.MYI` files must be opened.

The following list indicates how the preceding optimization types apply to `INFORMATION_SCHEMA` table columns. For tables and columns not named, none of the optimizations apply.

- `COLUMNS`: `OPEN_FRM_ONLY` applies to all columns
- `KEY_COLUMN_USAGE`: `OPEN_FULL_TABLE` applies to all columns
- `PARTITIONS`: `OPEN_FULL_TABLE` applies to all columns
- `REFERENTIAL_CONSTRAINTS`: `OPEN_FULL_TABLE` applies to all columns
- `STATISTICS`:

Column	Optimization type
TABLE_CATALOG	OPEN_FRM_ONLY
TABLE_SCHEMA	OPEN_FRM_ONLY
TABLE_NAME	OPEN_FRM_ONLY
NON_UNIQUE	OPEN_FRM_ONLY
INDEX_SCHEMA	OPEN_FRM_ONLY
INDEX_NAME	OPEN_FRM_ONLY
SEQ_IN_INDEX	OPEN_FRM_ONLY
COLUMN_NAME	OPEN_FRM_ONLY
COLLATION	OPEN_FRM_ONLY
CARDINALITY	OPEN_FULL_TABLE
SUB_PART	OPEN_FRM_ONLY
PACKED	OPEN_FRM_ONLY
NULLABLE	OPEN_FRM_ONLY
INDEX_TYPE	OPEN_FULL_TABLE
COMMENT	OPEN_FRM_ONLY

- `TABLES`:

Column	Optimization type
TABLE_CATALOG	SKIP_OPEN_TABLE
TABLE_SCHEMA	SKIP_OPEN_TABLE
TABLE_NAME	SKIP_OPEN_TABLE
TABLE_TYPE	OPEN_FRM_ONLY
ENGINE	OPEN_FRM_ONLY
VERSION	OPEN_FRM_ONLY
ROW_FORMAT	OPEN_FULL_TABLE
TABLE_ROWS	OPEN_FULL_TABLE
AVG_ROW_LENGTH	OPEN_FULL_TABLE
DATA_LENGTH	OPEN_FULL_TABLE
MAX_DATA_LENGTH	OPEN_FULL_TABLE

Column	Optimization type
INDEX_LENGTH	OPEN_FULL_TABLE
DATA_FREE	OPEN_FULL_TABLE
AUTO_INCREMENT	OPEN_FULL_TABLE
CREATE_TIME	OPEN_FULL_TABLE
UPDATE_TIME	OPEN_FULL_TABLE
CHECK_TIME	OPEN_FULL_TABLE
TABLE_COLLATION	OPEN_FRM_ONLY
CHECKSUM	OPEN_FULL_TABLE
CREATE_OPTIONS	OPEN_FRM_ONLY
TABLE_COMMENT	OPEN_FRM_ONLY

- TABLE\_CONSTRAINTS: OPEN\_FULL\_TABLE applies to all columns
- TRIGGERS: OPEN\_TRIGGER\_ONLY applies to all columns
- VIEWS:

Column	Optimization type
TABLE_CATALOG	OPEN_FRM_ONLY
TABLE_SCHEMA	OPEN_FRM_ONLY
TABLE_NAME	OPEN_FRM_ONLY
VIEW_DEFINITION	OPEN_FRM_ONLY
CHECK_OPTION	OPEN_FRM_ONLY
IS_UPDATABLE	OPEN_FULL_TABLE
DEFINER	OPEN_FRM_ONLY
SECURITY_TYPE	OPEN_FRM_ONLY
CHARACTER_SET_CLIENT	OPEN_FRM_ONLY
COLLATION_CONNECTION	OPEN_FRM_ONLY

**3) Use EXPLAIN to determine whether the server can use INFORMATION\_SCHEMA optimizations for a query**

This applies particularly for INFORMATION\_SCHEMA queries that search for information from more than one database, which might take a long time and impact performance. The Extra value in EXPLAIN output indicates which, if any, of the optimizations described earlier the server can use to evaluate INFORMATION\_SCHEMA queries. The following examples demonstrate the kinds of information you can expect to see in the Extra value.

```
mysql> EXPLAIN SELECT TABLE_NAME FROM INFORMATION_SCHEMA.VIEWS WHERE
      TABLE_SCHEMA = 'test' AND TABLE_NAME = 'v1'\G
***** 1. row *****
      id: 1
      select_type: SIMPLE
      table: VIEWS
      type: ALL
possible_keys: NULL
      key: TABLE_SCHEMA, TABLE_NAME
      key_len: NULL
```

```

        ref: NULL
        rows: NULL
        Extra: Using where; Open_frm_only; Scanned 0 databases
    
```

Use of constant database and table lookup values enables the server to avoid directory scans. For references to `VIEWS.TABLE_NAME`, only the `.frm` file need be opened.

```

mysql> EXPLAIN SELECT TABLE_NAME, ROW_FORMAT FROM INFORMATION_SCHEMA.TABLES\G
***** 1. row *****
        id: 1
        select_type: SIMPLE
        table: TABLES
        type: ALL
possible_keys: NULL
        key: NULL
        key_len: NULL
        ref: NULL
        rows: NULL
        Extra: Open_full_table; Scanned all databases
    
```

No lookup values are provided (there is no `WHERE` clause), so the server must scan the data directory and each database directory. For each table thus identified, the table name and row format are selected. `TABLE_NAME` requires no further table files to be opened (the `SKIP_OPEN_TABLE` optimization applies). `ROW_FORMAT` requires all table files to be opened (`OPEN_FULL_TABLE` applies). `EXPLAIN` reports `OPEN_FULL_TABLE` because it is more expensive than `SKIP_OPEN_TABLE`.

```

mysql> EXPLAIN SELECT TABLE_NAME, TABLE_TYPE FROM INFORMATION_SCHEMA.TABLES
        WHERE TABLE_SCHEMA = 'test'\G
***** 1. row *****
        id: 1
        select_type: SIMPLE
        table: TABLES
        type: ALL
possible_keys: NULL
        key: TABLE_SCHEMA
        key_len: NULL
        ref: NULL
        rows: NULL
        Extra: Using where; Open_frm_only; Scanned 1 database
    
```

No table name lookup value is provided, so the server must scan the `test` database directory. For the `TABLE_NAME` and `TABLE_TYPE` columns, the `SKIP_OPEN_TABLE` and `OPEN_FRM_ONLY` optimizations apply, respectively. `EXPLAIN` reports `OPEN_FRM_ONLY` because it is more expensive.

```

mysql> EXPLAIN SELECT B.TABLE_NAME
        FROM INFORMATION_SCHEMA.TABLES AS A, INFORMATION_SCHEMA.COLUMNS AS B
        WHERE A.TABLE_SCHEMA = 'test'
        AND A.TABLE_NAME = 't1'
        AND B.TABLE_NAME = A.TABLE_NAME\G
***** 1. row *****
        id: 1
        select_type: SIMPLE
        table: A
        type: ALL
possible_keys: NULL
        key: TABLE_SCHEMA, TABLE_NAME
        key_len: NULL
        ref: NULL
        rows: NULL
        Extra: Using where; Skip_open_table; Scanned 0 databases
***** 2. row *****
        id: 1
        select_type: SIMPLE
        table: B
        type: ALL
    
```

```
possible_keys: NULL
  key: NULL
  key_len: NULL
  ref: NULL
  rows: NULL
  Extra: Using where; Open_frm_only; Scanned all databases;
        Using join buffer
```

For the first `EXPLAIN` output row: Constant database and table lookup values enable the server to avoid directory scans for `TABLES` values. References to `TABLES . TABLE_NAME` require no further table files.

For the second `EXPLAIN` output row: All `COLUMNS` table values are `OPEN_FRM_ONLY` lookups, so `COLUMNS . TABLE_NAME` requires the `.frm` file to be opened.

```
mysql> EXPLAIN SELECT * FROM INFORMATION_SCHEMA.COLLATIONS\G
***** 1. row *****
      id: 1
  select_type: SIMPLE
        table: COLLATIONS
        type: ALL
possible_keys: NULL
  key: NULL
  key_len: NULL
  ref: NULL
  rows: NULL
  Extra:
```

In this case, no optimizations apply because `COLLATIONS` is not one of the `INFORMATION_SCHEMA` tables for which optimizations are available.

## 8.2.4 Optimizing Data Change Statements

This section explains how to speed up data change statements: `INSERT`, `UPDATE`, and `DELETE`. Traditional OLTP applications and modern web applications typically do many small data change operations, where concurrency is vital. Data analysis and reporting applications typically run data change operations that affect many rows at once, where the main considerations is the I/O to write large amounts of data and keep indexes up-to-date. For inserting and updating large volumes of data (known in the industry as ETL, for “extract-transform-load”), sometimes you use other SQL statements or external commands, that mimic the effects of `INSERT`, `UPDATE`, and `DELETE` statements.

### 8.2.4.1 Optimizing INSERT Statements

To optimize insert speed, combine many small operations into a single large operation. Ideally, you make a single connection, send the data for many new rows at once, and delay all index updates and consistency checking until the very end.

The time required for inserting a row is determined by the following factors, where the numbers indicate approximate proportions:

- Connecting: (3)
- Sending query to server: (2)
- Parsing query: (2)
- Inserting row: (1 × size of row)
- Inserting indexes: (1 × number of indexes)
- Closing: (1)

This does not take into consideration the initial overhead to open tables, which is done once for each concurrently running query.

The size of the table slows down the insertion of indexes by  $\log N$ , assuming B-tree indexes.

You can use the following methods to speed up inserts:

- If you are inserting many rows from the same client at the same time, use `INSERT` statements with multiple `VALUES` lists to insert several rows at a time. This is considerably faster (many times faster in some cases) than using separate single-row `INSERT` statements. If you are adding data to a nonempty table, you can tune the `bulk_insert_buffer_size` variable to make data insertion even faster. See [Section 5.1.7, “Server System Variables”](#).
- When loading a table from a text file, use `LOAD DATA`. This is usually 20 times faster than using `INSERT` statements. See [Section 13.2.6, “LOAD DATA Statement”](#).
- Take advantage of the fact that columns have default values. Insert values explicitly only when the value to be inserted differs from the default. This reduces the parsing that MySQL must do and improves the insert speed.
- See [Section 8.5.5, “Bulk Data Loading for InnoDB Tables”](#) for tips specific to `InnoDB` tables.
- See [Section 8.6.2, “Bulk Data Loading for MyISAM Tables”](#) for tips specific to `MyISAM` tables.

### 8.2.4.2 Optimizing UPDATE Statements

An update statement is optimized like a `SELECT` query with the additional overhead of a write. The speed of the write depends on the amount of data being updated and the number of indexes that are updated. Indexes that are not changed do not get updated.

Another way to get fast updates is to delay updates and then do many updates in a row later. Performing multiple updates together is much quicker than doing one at a time if you lock the table.

For a `MyISAM` table that uses dynamic row format, updating a row to a longer total length may split the row. If you do this often, it is very important to use `OPTIMIZE TABLE` occasionally. See [Section 13.7.2.4, “OPTIMIZE TABLE Statement”](#).

### 8.2.4.3 Optimizing DELETE Statements

The time required to delete individual rows in a `MyISAM` table is exactly proportional to the number of indexes. To delete rows more quickly, you can increase the size of the key cache by increasing the `key_buffer_size` system variable. See [Section 5.1.1, “Configuring the Server”](#).

To delete all rows from a `MyISAM` table, `TRUNCATE TABLE tbl_name` is faster than `DELETE FROM tbl_name`. Truncate operations are not transaction-safe; an error occurs when attempting one in the course of an active transaction or active table lock. See [Section 13.1.34, “TRUNCATE TABLE Statement”](#).

## 8.2.5 Optimizing Database Privileges

The more complex your privilege setup, the more overhead applies to all SQL statements. Simplifying the privileges established by `GRANT` statements enables MySQL to reduce permission-checking overhead when clients execute statements. For example, if you do not grant any table-level or column-level privileges, the server need not ever check the contents of the `tables_priv` and `columns_priv` tables. Similarly, if you place no resource limits on any accounts, the server does not have to perform resource counting. If you have a very high statement-processing load, consider using a simplified grant structure to reduce permission-checking overhead.



## 8.2.6 Other Optimization Tips

This section lists a number of miscellaneous tips for improving query processing speed:

- If your application makes several database requests to perform related updates, combining the statements into a stored routine can help performance. Similarly, if your application computes a single result based on several column values or large volumes of data, combining the computation into a loadable function can help performance. The resulting fast database operations are then available to be reused by other queries, applications, and even code written in different programming languages. See [Section 23.2, “Using Stored Routines”](#) and [Adding Functions to MySQL](#) for more information.
- To fix any compression issues that occur with [ARCHIVE](#) tables, use [OPTIMIZE TABLE](#). See [Section 15.5, “The ARCHIVE Storage Engine”](#).
- If possible, classify reports as “live” or as “statistical”, where data needed for statistical reports is created only from summary tables that are generated periodically from the live data.
- If you have data that does not conform well to a rows-and-columns table structure, you can pack and store data into a [BLOB](#) column. In this case, you must provide code in your application to pack and unpack information, but this might save I/O operations to read and write the sets of related values.
- With Web servers, store images and other binary assets as files, with the path name stored in the database rather than the file itself. Most Web servers are better at caching files than database contents, so using files is generally faster. (Although you must handle backups and storage issues yourself in this case.)
- If you need really high speed, look at the low-level MySQL interfaces. For example, by accessing the MySQL [InnoDB](#) or [MyISAM](#) storage engine directly, you could get a substantial speed increase compared to using the SQL interface.

Similarly, for databases using the [NDBCLUSTER](#) storage engine, you may wish to investigate possible use of the NDB API (see [MySQL NDB Cluster API Developer Guide](#)).

- Replication can provide a performance benefit for some operations. You can distribute client retrievals among replicas to split up the load. To avoid slowing down the source while making backups, you can make backups using a replica. See [Chapter 16, Replication](#).

## 8.3 Optimization and Indexes

The best way to improve the performance of [SELECT](#) operations is to create indexes on one or more of the columns that are tested in the query. The index entries act like pointers to the table rows, allowing the query to quickly determine which rows match a condition in the [WHERE](#) clause, and retrieve the other column values for those rows. All MySQL data types can be indexed.

Although it can be tempting to create an indexes for every possible column used in a query, unnecessary indexes waste space and waste time for MySQL to determine which indexes to use. Indexes also add to the cost of inserts, updates, and deletes because each index must be updated. You must find the right balance to achieve fast queries using the optimal set of indexes.

### 8.3.1 How MySQL Uses Indexes

Indexes are used to find rows with specific column values quickly. Without an index, MySQL must begin with the first row and then read through the entire table to find the relevant rows. The larger the table, the more this costs. If the table has an index for the columns in question, MySQL can quickly determine the position to seek to in the middle of the data file without having to look at all the data. This is much faster than reading every row sequentially.

Most MySQL indexes ([PRIMARY KEY](#), [UNIQUE](#), [INDEX](#), and [FULLTEXT](#)) are stored in [B-trees](#). Exceptions: Indexes on spatial data types use R-trees; [MEMORY](#) tables also support [hash indexes](#); [InnoDB](#) uses inverted lists for [FULLTEXT](#) indexes.

In general, indexes are used as described in the following discussion. Characteristics specific to hash indexes (as used in [MEMORY](#) tables) are described in [Section 8.3.8, “Comparison of B-Tree and Hash Indexes”](#).

MySQL uses indexes for these operations:

- To find the rows matching a [WHERE](#) clause quickly.
- To eliminate rows from consideration. If there is a choice between multiple indexes, MySQL normally uses the index that finds the smallest number of rows (the most [selective](#) index).
- If the table has a multiple-column index, any leftmost prefix of the index can be used by the optimizer to look up rows. For example, if you have a three-column index on `(col1, col2, col3)`, you have indexed search capabilities on `(col1)`, `(col1, col2)`, and `(col1, col2, col3)`. For more information, see [Section 8.3.5, “Multiple-Column Indexes”](#).
- To retrieve rows from other tables when performing joins. MySQL can use indexes on columns more efficiently if they are declared as the same type and size. In this context, [VARCHAR](#) and [CHAR](#) are considered the same if they are declared as the same size. For example, `VARCHAR(10)` and `CHAR(10)` are the same size, but `VARCHAR(10)` and `CHAR(15)` are not.

For comparisons between nonbinary string columns, both columns should use the same character set. For example, comparing a `utf8` column with a `latin1` column precludes use of an index.

Comparison of dissimilar columns (comparing a string column to a temporal or numeric column, for example) may prevent use of indexes if values cannot be compared directly without conversion. For a given value such as `1` in the numeric column, it might compare equal to any number of values in the string column such as `'1'`, `' 1'`, `'00001'`, or `'01.e1'`. This rules out use of any indexes for the string column.

- To find the `MIN()` or `MAX()` value for a specific indexed column `key_col`. This is optimized by a preprocessor that checks whether you are using `WHERE key_part_N = constant` on all key parts that occur before `key_col` in the index. In this case, MySQL does a single key lookup for each `MIN()` or `MAX()` expression and replaces it with a constant. If all expressions are replaced with constants, the query returns at once. For example:

```
SELECT MIN(key_part2),MAX(key_part2)
FROM tbl_name WHERE key_part1=10;
```

- To sort or group a table if the sorting or grouping is done on a leftmost prefix of a usable index (for example, `ORDER BY key_part1, key_part2`). If all key parts are followed by `DESC`, the key is read in reverse order. See [Section 8.2.1.14, “ORDER BY Optimization”](#), and [Section 8.2.1.15, “GROUP BY Optimization”](#).
- In some cases, a query can be optimized to retrieve values without consulting the data rows. (An index that provides all the necessary results for a query is called a [covering index](#).) If a query uses from a table only columns that are included in some index, the selected values can be retrieved from the index tree for greater speed:

```
SELECT key_part3 FROM tbl_name
WHERE key_part1=1
```

Indexes are less important for queries on small tables, or big tables where report queries process most or all of the rows. When a query needs to access most of the rows, reading sequentially is faster than working

through an index. Sequential reads minimize disk seeks, even if not all the rows are needed for the query. See [Section 8.2.1.20, “Avoiding Full Table Scans”](#) for details.

### 8.3.2 Primary Key Optimization

The primary key for a table represents the column or set of columns that you use in your most vital queries. It has an associated index, for fast query performance. Query performance benefits from the [NOT NULL](#) optimization, because it cannot include any [NULL](#) values. With the [InnoDB](#) storage engine, the table data is physically organized to do ultra-fast lookups and sorts based on the primary key column or columns.

If your table is big and important, but does not have an obvious column or set of columns to use as a primary key, you might create a separate column with auto-increment values to use as the primary key. These unique IDs can serve as pointers to corresponding rows in other tables when you join tables using foreign keys.

### 8.3.3 Foreign Key Optimization

If a table has many columns, and you query many different combinations of columns, it might be efficient to split the less-frequently used data into separate tables with a few columns each, and relate them back to the main table by duplicating the numeric ID column from the main table. That way, each small table can have a primary key for fast lookups of its data, and you can query just the set of columns that you need using a join operation. Depending on how the data is distributed, the queries might perform less I/O and take up less cache memory because the relevant columns are packed together on disk. (To maximize performance, queries try to read as few data blocks as possible from disk; tables with only a few columns can fit more rows in each data block.)

### 8.3.4 Column Indexes

The most common type of index involves a single column, storing copies of the values from that column in a data structure, allowing fast lookups for the rows with the corresponding column values. The B-tree data structure lets the index quickly find a specific value, a set of values, or a range of values, corresponding to operators such as `=`, `>`, `≤`, [BETWEEN](#), [IN](#), and so on, in a [WHERE](#) clause.

The maximum number of indexes per table and the maximum index length is defined per storage engine. See [Chapter 14, \*The InnoDB Storage Engine\*](#), and [Chapter 15, \*Alternative Storage Engines\*](#). All storage engines support at least 16 indexes per table and a total index length of at least 256 bytes. Most storage engines have higher limits.

For additional information about column indexes, see [Section 13.1.14, “CREATE INDEX Statement”](#).

- [Index Prefixes](#)
- [FULLTEXT Indexes](#)
- [Spatial Indexes](#)
- [Indexes in the MEMORY Storage Engine](#)

#### Index Prefixes

With `col_name(N)` syntax in an index specification for a string column, you can create an index that uses only the first `N` characters of the column. Indexing only a prefix of column values in this way can make the index file much smaller. When you index a [BLOB](#) or [TEXT](#) column, you *must* specify a prefix length for the index. For example:

```
CREATE TABLE test (blob_col BLOB, INDEX(blob_col(10)));
```

Prefixes can be up to 1000 bytes long (767 bytes for [InnoDB](#) tables, unless you have `innodb_large_prefix` set).

**Note**

Prefix limits are measured in bytes, whereas the prefix length in `CREATE TABLE`, `ALTER TABLE`, and `CREATE INDEX` statements is interpreted as number of characters for nonbinary string types (`CHAR`, `VARCHAR`, `TEXT`) and number of bytes for binary string types (`BINARY`, `VARBINARY`, `BLOB`). Take this into account when specifying a prefix length for a nonbinary string column that uses a multibyte character set.

If a search term exceeds the index prefix length, the index is used to exclude non-matching rows, and the remaining rows are examined for possible matches.

For additional information about index prefixes, see [Section 13.1.14, “CREATE INDEX Statement”](#).

## FULLTEXT Indexes

`FULLTEXT` indexes are used for full-text searches. Only the [InnoDB](#) and [MyISAM](#) storage engines support `FULLTEXT` indexes and only for `CHAR`, `VARCHAR`, and `TEXT` columns. Indexing always takes place over the entire column and column prefix indexing is not supported. For details, see [Section 12.9, “Full-Text Search Functions”](#).

Optimizations are applied to certain kinds of `FULLTEXT` queries against single [InnoDB](#) tables. Queries with these characteristics are particularly efficient:

- `FULLTEXT` queries that only return the document ID, or the document ID and the search rank.
- `FULLTEXT` queries that sort the matching rows in descending order of score and apply a `LIMIT` clause to take the top N matching rows. For this optimization to apply, there must be no `WHERE` clauses and only a single `ORDER BY` clause in descending order.
- `FULLTEXT` queries that retrieve only the `COUNT(*)` value of rows matching a search term, with no additional `WHERE` clauses. Code the `WHERE` clause as `WHERE MATCH(text) AGAINST ('other_text')`, without any `> 0` comparison operator.

For queries that contain full-text expressions, MySQL evaluates those expressions during the optimization phase of query execution. The optimizer does not just look at full-text expressions and make estimates, it actually evaluates them in the process of developing an execution plan.

An implication of this behavior is that `EXPLAIN` for full-text queries is typically slower than for non-full-text queries for which no expression evaluation occurs during the optimization phase.

`EXPLAIN` for full-text queries may show `Select tables optimized away` in the `Extra` column due to matching occurring during optimization; in this case, no table access need occur during later execution.

## Spatial Indexes

You can create indexes on spatial data types. [MyISAM](#) and [InnoDB](#) support R-tree indexes on spatial types. Other storage engines use B-trees for indexing spatial types (except for `ARCHIVE`, which does not support spatial type indexing).

## Indexes in the MEMORY Storage Engine

The `MEMORY` storage engine uses `HASH` indexes by default, but also supports `BTREE` indexes.

## 8.3.5 Multiple-Column Indexes

MySQL can create composite indexes (that is, indexes on multiple columns). An index may consist of up to 16 columns. For certain data types, you can index a prefix of the column (see [Section 8.3.4, “Column Indexes”](#)).

MySQL can use multiple-column indexes for queries that test all the columns in the index, or queries that test just the first column, the first two columns, the first three columns, and so on. If you specify the columns in the right order in the index definition, a single composite index can speed up several kinds of queries on the same table.

A multiple-column index can be considered a sorted array, the rows of which contain values that are created by concatenating the values of the indexed columns.



### Note

As an alternative to a composite index, you can introduce a column that is “hashed” based on information from other columns. If this column is short, reasonably unique, and indexed, it might be faster than a “wide” index on many columns. In MySQL, it is very easy to use this extra column:

```
SELECT * FROM tbl_name
WHERE hash_col=MD5(CONCAT(val1,val2))
AND col1=val1 AND col2=val2;
```

Suppose that a table has the following specification:

```
CREATE TABLE test (
  id          INT NOT NULL,
  last_name   CHAR(30) NOT NULL,
  first_name  CHAR(30) NOT NULL,
  PRIMARY KEY (id),
  INDEX name (last_name,first_name)
);
```

The `name` index is an index over the `last_name` and `first_name` columns. The index can be used for lookups in queries that specify values in a known range for combinations of `last_name` and `first_name` values. It can also be used for queries that specify just a `last_name` value because that column is a leftmost prefix of the index (as described later in this section). Therefore, the `name` index is used for lookups in the following queries:

```
SELECT * FROM test WHERE last_name='Jones';

SELECT * FROM test
  WHERE last_name='Jones' AND first_name='John';

SELECT * FROM test
  WHERE last_name='Jones'
  AND (first_name='John' OR first_name='Jon');

SELECT * FROM test
  WHERE last_name='Jones'
  AND first_name >='M' AND first_name < 'N';
```

However, the `name` index is *not* used for lookups in the following queries:

```
SELECT * FROM test WHERE first_name='John';

SELECT * FROM test
  WHERE last_name='Jones' OR first_name='John';
```

Suppose that you issue the following `SELECT` statement:

```
SELECT * FROM tbl_name
WHERE col1=val1 AND col2=val2;
```

If a multiple-column index exists on `col1` and `col2`, the appropriate rows can be fetched directly. If separate single-column indexes exist on `col1` and `col2`, the optimizer attempts to use the Index Merge optimization (see [Section 8.2.1.3, “Index Merge Optimization”](#)), or attempts to find the most restrictive index by deciding which index excludes more rows and using that index to fetch the rows.

If the table has a multiple-column index, any leftmost prefix of the index can be used by the optimizer to look up rows. For example, if you have a three-column index on `(col1, col2, col3)`, you have indexed search capabilities on `(col1)`, `(col1, col2)`, and `(col1, col2, col3)`.

MySQL cannot use the index to perform lookups if the columns do not form a leftmost prefix of the index. Suppose that you have the `SELECT` statements shown here:

```
SELECT * FROM tbl_name WHERE col1=val1;
SELECT * FROM tbl_name WHERE col1=val1 AND col2=val2;

SELECT * FROM tbl_name WHERE col2=val2;
SELECT * FROM tbl_name WHERE col2=val2 AND col3=val3;
```

If an index exists on `(col1, col2, col3)`, only the first two queries use the index. The third and fourth queries do involve indexed columns, but do not use an index to perform lookups because `(col2)` and `(col2, col3)` are not leftmost prefixes of `(col1, col2, col3)`.

### 8.3.6 Verifying Index Usage

Always check whether all your queries really use the indexes that you have created in the tables. Use the `EXPLAIN` statement, as described in [Section 8.8.1, “Optimizing Queries with EXPLAIN”](#).

### 8.3.7 InnoDB and MyISAM Index Statistics Collection

Storage engines collect statistics about tables for use by the optimizer. Table statistics are based on value groups, where a value group is a set of rows with the same key prefix value. For optimizer purposes, an important statistic is the average value group size.

MySQL uses the average value group size in the following ways:

- To estimate how many rows must be read for each `ref` access
- To estimate how many rows a partial join produces; that is, the number of rows that an operation of this form produces:

```
(...) JOIN tbl_name ON tbl_name.key = expr
```

As the average value group size for an index increases, the index is less useful for those two purposes because the average number of rows per lookup increases: For the index to be good for optimization purposes, it is best that each index value target a small number of rows in the table. When a given index value yields a large number of rows, the index is less useful and MySQL is less likely to use it.

The average value group size is related to table cardinality, which is the number of value groups. The `SHOW INDEX` statement displays a cardinality value based on  $N/S$ , where  $N$  is the number of rows in the table and  $S$  is the average value group size. That ratio yields an approximate number of value groups in the table.

For a join based on the `<=>` comparison operator, `NULL` is not treated differently from any other value: `NULL <=> NULL`, just as `N <=> N` for any other  $N$ .

However, for a join based on the = operator, `NULL` is different from non-`NULL` values: `expr1 = expr2` is not true when `expr1` or `expr2` (or both) are `NULL`. This affects `ref` accesses for comparisons of the form `tbl_name.key = expr`: MySQL does not access the table if the current value of `expr` is `NULL`, because the comparison cannot be true.

For = comparisons, it does not matter how many `NULL` values are in the table. For optimization purposes, the relevant value is the average size of the non-`NULL` value groups. However, MySQL does not currently enable that average size to be collected or used.

For InnoDB and MyISAM tables, you have some control over collection of table statistics by means of the `innodb_stats_method` and `myisam_stats_method` system variables, respectively. These variables have three possible values, which differ as follows:

- When the variable is set to `nulls_equal`, all `NULL` values are treated as identical (that is, they all form a single value group).

If the `NULL` value group size is much higher than the average non-`NULL` value group size, this method skews the average value group size upward. This makes index appear to the optimizer to be less useful than it really is for joins that look for non-`NULL` values. Consequently, the `nulls_equal` method may cause the optimizer not to use the index for `ref` accesses when it should.

- When the variable is set to `nulls_unequal`, `NULL` values are not considered the same. Instead, each `NULL` value forms a separate value group of size 1.

If you have many `NULL` values, this method skews the average value group size downward. If the average non-`NULL` value group size is large, counting `NULL` values each as a group of size 1 causes the optimizer to overestimate the value of the index for joins that look for non-`NULL` values. Consequently, the `nulls_unequal` method may cause the optimizer to use this index for `ref` lookups when other methods may be better.

- When the variable is set to `nulls_ignored`, `NULL` values are ignored.

If you tend to use many joins that use `<=>` rather than `=`, `NULL` values are not special in comparisons and one `NULL` is equal to another. In this case, `nulls_equal` is the appropriate statistics method.

The `innodb_stats_method` system variable has a global value; the `myisam_stats_method` system variable has both global and session values. Setting the global value affects statistics collection for tables from the corresponding storage engine. Setting the session value affects statistics collection only for the current client connection. This means that you can force a table's statistics to be regenerated with a given method without affecting other clients by setting the session value of `myisam_stats_method`.

To regenerate MyISAM table statistics, you can use any of the following methods:

- Execute `myisamchk --stats_method=method_name --analyze`
- Change the table to cause its statistics to go out of date (for example, insert a row and then delete it), and then set `myisam_stats_method` and issue an `ANALYZE TABLE` statement

Some caveats regarding the use of `innodb_stats_method` and `myisam_stats_method`:

- You can force table statistics to be collected explicitly, as just described. However, MySQL may also collect statistics automatically. For example, if during the course of executing statements for a table, some of those statements modify the table, MySQL may collect statistics. (This may occur for bulk inserts or deletes, or some `ALTER TABLE` statements, for example.) If this happens, the statistics are collected using whatever value `innodb_stats_method` or `myisam_stats_method` has at the time. Thus, if you collect statistics using one method, but the system variable is set to the other method when a table's statistics are collected automatically later, the other method is used.

- There is no way to tell which method was used to generate statistics for a given table.
- These variables apply only to [InnoDB](#) and [MyISAM](#) tables. Other storage engines have only one method for collecting table statistics. Usually it is closer to the [nulls\\_equal](#) method.

### 8.3.8 Comparison of B-Tree and Hash Indexes

Understanding the B-tree and hash data structures can help predict how different queries perform on different storage engines that use these data structures in their indexes, particularly for the [MEMORY](#) storage engine that lets you choose B-tree or hash indexes.

- [B-Tree Index Characteristics](#)
- [Hash Index Characteristics](#)

#### B-Tree Index Characteristics

A B-tree index can be used for column comparisons in expressions that use the `=`, `>`, `>=`, `<`, `<=`, or [BETWEEN](#) operators. The index also can be used for [LIKE](#) comparisons if the argument to [LIKE](#) is a constant string that does not start with a wildcard character. For example, the following [SELECT](#) statements use indexes:

```
SELECT * FROM tbl_name WHERE key_col LIKE 'Patrick%';
SELECT * FROM tbl_name WHERE key_col LIKE 'Pat%_ck%';
```

In the first statement, only rows with `'Patrick' <= key_col < 'Patricl'` are considered. In the second statement, only rows with `'Pat' <= key_col < 'Pau'` are considered.

The following [SELECT](#) statements do not use indexes:

```
SELECT * FROM tbl_name WHERE key_col LIKE '%Patrick%';
SELECT * FROM tbl_name WHERE key_col LIKE other_col;
```

In the first statement, the [LIKE](#) value begins with a wildcard character. In the second statement, the [LIKE](#) value is not a constant.

If you use `... LIKE '%string%'` and `string` is longer than three characters, MySQL uses the *Turbo Boyer-Moore algorithm* to initialize the pattern for the string and then uses this pattern to perform the search more quickly.

A search using `col_name IS NULL` employs indexes if `col_name` is indexed.

Any index that does not span all [AND](#) levels in the [WHERE](#) clause is not used to optimize the query. In other words, to be able to use an index, a prefix of the index must be used in every [AND](#) group.

The following [WHERE](#) clauses use indexes:

```
... WHERE index_part1=1 AND index_part2=2 AND other_column=3

/* index = 1 OR index = 2 */
... WHERE index=1 OR A=10 AND index=2

/* optimized like "index_part1='hello'" */
... WHERE index_part1='hello' AND index_part3=5

/* Can use index on index1 but not on index2 or index3 */
... WHERE index1=1 AND index2=2 OR index1=3 AND index3=3;
```

These [WHERE](#) clauses do *not* use indexes:

```
/* index_part1 is not used */
... WHERE index_part2=1 AND index_part3=2
```



```

/* Index is not used in both parts of the WHERE clause */
... WHERE index=1 OR A=10

/* No index spans all rows */
... WHERE index_part1=1 OR index_part2=10

```

Sometimes MySQL does not use an index, even if one is available. One circumstance under which this occurs is when the optimizer estimates that using the index would require MySQL to access a very large percentage of the rows in the table. (In this case, a table scan is likely to be much faster because it requires fewer seeks.) However, if such a query uses [LIMIT](#) to retrieve only some of the rows, MySQL uses an index anyway, because it can much more quickly find the few rows to return in the result.

## Hash Index Characteristics

Hash indexes have somewhat different characteristics from those just discussed:

- They are used only for equality comparisons that use the = or <=> operators (but are *very* fast). They are not used for comparison operators such as < that find a range of values. Systems that rely on this type of single-value lookup are known as “key-value stores”; to use MySQL for such applications, use hash indexes wherever possible.
- The optimizer cannot use a hash index to speed up [ORDER BY](#) operations. (This type of index cannot be used to search for the next entry in order.)
- MySQL cannot determine approximately how many rows there are between two values (this is used by the range optimizer to decide which index to use). This may affect some queries if you change a [MyISAM](#) or [InnoDB](#) table to a hash-indexed [MEMORY](#) table.
- Only whole keys can be used to search for a row. (With a B-tree index, any leftmost prefix of the key can be used to find rows.)

### 8.3.9 Use of Index Extensions

[InnoDB](#) automatically extends each secondary index by appending the primary key columns to it. Consider this table definition:

```

CREATE TABLE t1 (
  i1 INT NOT NULL DEFAULT 0,
  i2 INT NOT NULL DEFAULT 0,
  d DATE DEFAULT NULL,
  PRIMARY KEY (i1, i2),
  INDEX k_d (d)
) ENGINE = InnoDB;

```

This table defines the primary key on columns ([i1](#), [i2](#)). It also defines a secondary index [k\\_d](#) on column ([d](#)), but internally [InnoDB](#) extends this index and treats it as columns ([d](#), [i1](#), [i2](#)).

The optimizer takes into account the primary key columns of the extended secondary index when determining how and whether to use that index. This can result in more efficient query execution plans and better performance.

The optimizer can use extended secondary indexes for [ref](#), [range](#), and [index\\_merge](#) index access, for Loose Index Scan access, for join and sorting optimization, and for [MIN\(\)](#)/[MAX\(\)](#) optimization.

The following example shows how execution plans are affected by whether the optimizer uses extended secondary indexes. Suppose that [t1](#) is populated with these rows:

```

INSERT INTO t1 VALUES
(1, 1, '1998-01-01'), (1, 2, '1999-01-01'),

```

```
(1, 3, '2000-01-01'), (1, 4, '2001-01-01'),
(1, 5, '2002-01-01'), (2, 1, '1998-01-01'),
(2, 2, '1999-01-01'), (2, 3, '2000-01-01'),
(2, 4, '2001-01-01'), (2, 5, '2002-01-01'),
(3, 1, '1998-01-01'), (3, 2, '1999-01-01'),
(3, 3, '2000-01-01'), (3, 4, '2001-01-01'),
(3, 5, '2002-01-01'), (4, 1, '1998-01-01'),
(4, 2, '1999-01-01'), (4, 3, '2000-01-01'),
(4, 4, '2001-01-01'), (4, 5, '2002-01-01'),
(5, 1, '1998-01-01'), (5, 2, '1999-01-01'),
(5, 3, '2000-01-01'), (5, 4, '2001-01-01'),
(5, 5, '2002-01-01');
```

Now consider this query:

```
EXPLAIN SELECT COUNT(*) FROM t1 WHERE i1 = 3 AND d = '2000-01-01'
```

The execution plan depends on whether the extended index is used.

When the optimizer does not consider index extensions, it treats the index `k_d` as only `(d)`. `EXPLAIN` for the query produces this result:

```
mysql> EXPLAIN SELECT COUNT(*) FROM t1 WHERE i1 = 3 AND d = '2000-01-01'\G
***** 1. row *****
      id: 1
    select_type: SIMPLE
      table: t1
       type: ref
possible_keys: PRIMARY,k_d
         key: k_d
        key_len: 4
         ref: const
         rows: 5
      Extra: Using where; Using index
```

When the optimizer takes index extensions into account, it treats `k_d` as `(d, i1, i2)`. In this case, it can use the leftmost index prefix `(d, i1)` to produce a better execution plan:

```
mysql> EXPLAIN SELECT COUNT(*) FROM t1 WHERE i1 = 3 AND d = '2000-01-01'\G
***** 1. row *****
      id: 1
    select_type: SIMPLE
      table: t1
       type: ref
possible_keys: PRIMARY,k_d
         key: k_d
        key_len: 8
         ref: const,const
         rows: 1
      Extra: Using index
```

In both cases, `key` indicates that the optimizer uses secondary index `k_d` but the `EXPLAIN` output shows these improvements from using the extended index:

- `key_len` goes from 4 bytes to 8 bytes, indicating that key lookups use columns `d` and `i1`, not just `d`.
- The `ref` value changes from `const` to `const,const` because the key lookup uses two key parts, not one.
- The `rows` count decreases from 5 to 1, indicating that `InnoDB` should need to examine fewer rows to produce the result.
- The `Extra` value changes from `Using where; Using index` to `Using index`. This means that rows can be read using only the index, without consulting columns in the data row.

Differences in optimizer behavior for use of extended indexes can also be seen with `SHOW STATUS`:

```
FLUSH TABLE t1;
FLUSH STATUS;
SELECT COUNT(*) FROM t1 WHERE i1 = 3 AND d = '2000-01-01';
SHOW STATUS LIKE 'handler_read%'
```

The preceding statements include `FLUSH TABLES` and `FLUSH STATUS` to flush the table cache and clear the status counters.

Without index extensions, `SHOW STATUS` produces this result:

Variable_name	Value
Handler_read_first	0
Handler_read_key	1
Handler_read_last	0
Handler_read_next	5
Handler_read_prev	0
Handler_read_rnd	0
Handler_read_rnd_next	0

With index extensions, `SHOW STATUS` produces this result. The `Handler_read_next` value decreases from 5 to 1, indicating more efficient use of the index:

Variable_name	Value
Handler_read_first	0
Handler_read_key	1
Handler_read_last	0
Handler_read_next	1
Handler_read_prev	0
Handler_read_rnd	0
Handler_read_rnd_next	0

The `use_index_extensions` flag of the `optimizer_switch` system variable permits control over whether the optimizer takes the primary key columns into account when determining how to use an `InnoDB` table's secondary indexes. By default, `use_index_extensions` is enabled. To check whether disabling use of index extensions improves performance, use this statement:

```
SET optimizer_switch = 'use_index_extensions=off';
```

Use of index extensions by the optimizer is subject to the usual limits on the number of key parts in an index (16) and the maximum key length (3072 bytes).

### 8.3.10 Optimizer Use of Generated Column Indexes

MySQL supports indexes on generated columns. For example:

```
CREATE TABLE t1 (f1 INT, gc INT AS (f1 + 1) STORED, INDEX (gc));
```

The generated column, `gc`, is defined as the expression `f1 + 1`. The column is also indexed and the optimizer can take that index into account during execution plan construction. In the following query, the `WHERE` clause refers to `gc` and the optimizer considers whether the index on that column yields a more efficient plan:

```
SELECT * FROM t1 WHERE gc > 9;
```

The optimizer can use indexes on generated columns to generate execution plans, even in the absence of direct references in queries to those columns by name. This occurs if the `WHERE`, `ORDER BY`, or `GROUP BY` clause refers to an expression that matches the definition of some indexed generated column. The following query does not refer directly to `gc` but does use an expression that matches the definition of `gc`:

```
SELECT * FROM t1 WHERE f1 + 1 > 9;
```

The optimizer recognizes that the expression `f1 + 1` matches the definition of `gc` and that `gc` is indexed, so it considers that index during execution plan construction. You can see this using `EXPLAIN`:

```
mysql> EXPLAIN SELECT * FROM t1 WHERE f1 + 1 > 9\G
***** 1. row *****
      id: 1
    select_type: SIMPLE
      table: t1
    partitions: NULL
       type: range
possible_keys: gc
          key: gc
        key_len: 5
         ref: NULL
        rows: 1
   filtered: 100.00
      Extra: Using index condition
```

In effect, the optimizer has replaced the expression `f1 + 1` with the name of the generated column that matches the expression. That is also apparent in the rewritten query available in the extended `EXPLAIN` information displayed by `SHOW WARNINGS`:

```
mysql> SHOW WARNINGS\G
***** 1. row *****
      Level: Note
        Code: 1003
    Message: /* select#1 */ select `test`.`t1`.`f1` AS `f1`,`test`.`t1`.`gc`
           AS `gc` from `test`.`t1` where (`test`.`t1`.`gc` > 9)
```

The following restrictions and conditions apply to the optimizer's use of generated column indexes:

- For a query expression to match a generated column definition, the expression must be identical and it must have the same result type. For example, if the generated column expression is `f1 + 1`, the optimizer does not recognize a match if the query uses `1 + f1`, or if `f1 + 1` (an integer expression) is compared with a string.
- The optimization applies to these operators: `=`, `<`, `<=`, `>`, `>=`, `BETWEEN`, and `IN()`.

For operators other than `BETWEEN` and `IN()`, either operand can be replaced by a matching generated column. For `BETWEEN` and `IN()`, only the first argument can be replaced by a matching generated column, and the other arguments must have the same result type. `BETWEEN` and `IN()` are not yet supported for comparisons involving JSON values.

- The generated column must be defined as an expression that contains at least a function call or one of the operators mentioned in the preceding item. The expression cannot consist of a simple reference to another column. For example, `gc INT AS (f1) STORED` consists only of a column reference, so indexes on `gc` are not considered.
- For comparisons of strings to indexed generated columns that compute a value from a JSON function that returns a quoted string, `JSON_UNQUOTE()` is needed in the column definition to remove the extra quotes from the function value. (For direct comparison of a string to the function result, the JSON comparator handles quote removal, but this does not occur for index lookups.) For example, instead of writing a column definition like this:

```
doc_name TEXT AS (JSON_EXTRACT(jdoc, '$.name')) STORED
```

Write it like this:

```
doc_name TEXT AS (JSON_UNQUOTE(JSON_EXTRACT(jdoc, '$.name'))) STORED
```

With the latter definition, the optimizer can detect a match for both of these comparisons:

```
... WHERE JSON_EXTRACT(jdoc, '$.name') = 'some_string' ...
... WHERE JSON_UNQUOTE(JSON_EXTRACT(jdoc, '$.name')) = 'some_string' ...
```

Without `JSON_UNQUOTE()` in the column definition, the optimizer detects a match only for the first of those comparisons.

- If the optimizer fails to choose the desired index, an index hint can be used to force the optimizer to make a different choice.

### 8.3.11 Indexed Lookups from `TIMESTAMP` Columns

Temporal values are stored in `TIMESTAMP` columns as UTC values, and values inserted into and retrieved from `TIMESTAMP` columns are converted between the session time zone and UTC. (This is the same type of conversion performed by the `CONVERT_TZ()` function. If the session time zone is UTC, there is effectively no time zone conversion.)

Due to conventions for local time zone changes such as Daylight Saving Time (DST), conversions between UTC and non-UTC time zones are not one-to-one in both directions. UTC values that are distinct may not be distinct in another time zone. The following example shows distinct UTC values that become identical in a non-UTC time zone:

```
mysql> CREATE TABLE tstable (ts TIMESTAMP);
mysql> SET time_zone = 'UTC'; -- insert UTC values
mysql> INSERT INTO tstable VALUES
      ('2018-10-28 00:30:00'),
      ('2018-10-28 01:30:00');
mysql> SELECT ts FROM tstable;
+-----+
| ts                |
+-----+
| 2018-10-28 00:30:00 |
| 2018-10-28 01:30:00 |
+-----+
mysql> SET time_zone = 'MET'; -- retrieve non-UTC values
mysql> SELECT ts FROM tstable;
+-----+
| ts                |
+-----+
| 2018-10-28 02:30:00 |
| 2018-10-28 02:30:00 |
+-----+
```



#### Note

To use named time zones such as `'MET'` or `'Europe/Amsterdam'`, the time zone tables must be properly set up. For instructions, see [Section 5.1.13, “MySQL Server Time Zone Support”](#).

You can see that the two distinct UTC values are the same when converted to the `'MET'` time zone. This phenomenon can lead to different results for a given `TIMESTAMP` column query, depending on whether the optimizer uses an index to execute the query.

Suppose that a query selects values from the table shown earlier using a `WHERE` clause to search the `ts` column for a single specific value such as a user-provided timestamp literal:

```
SELECT ts FROM tstable
WHERE ts = 'literal';
```

Suppose further that the query executes under these conditions:

- The session time zone is not UTC and has a DST shift. For example:

```
SET time_zone = 'MET';
```

- Unique UTC values stored in the `TIMESTAMP` column are not unique in the session time zone due to DST shifts. (The example shown earlier illustrates how this can occur.)
- The query specifies a search value that is within the hour of entry into DST in the session time zone.

Under those conditions, the comparison in the `WHERE` clause occurs in different ways for nonindexed and indexed lookups and leads to different results:

- If there is no index or the optimizer cannot use it, comparisons occur in the session time zone. The optimizer performs a table scan in which it retrieves each `ts` column value, converts it from UTC to the session time zone, and compares it to the search value (also interpreted in the session time zone):

```
mysql> SELECT ts FROM tstable
        WHERE ts = '2018-10-28 02:30:00';
+-----+
| ts                |
+-----+
| 2018-10-28 02:30:00 |
| 2018-10-28 02:30:00 |
+-----+
```

Because the stored `ts` values are converted to the session time zone, it is possible for the query to return two timestamp values that are distinct as UTC values but equal in the session time zone: One value that occurs before the DST shift when clocks are changed, and one value that was occurs after the DST shift.

- If there is a usable index, comparisons occur in UTC. The optimizer performs an index scan, first converting the search value from the session time zone to UTC, then comparing the result to the UTC index entries:

```
mysql> ALTER TABLE tstable ADD INDEX (ts);
mysql> SELECT ts FROM tstable
        WHERE ts = '2018-10-28 02:30:00';
+-----+
| ts                |
+-----+
| 2018-10-28 02:30:00 |
+-----+
```

In this case, the (converted) search value is matched only to index entries, and because the index entries for the distinct stored UTC values are also distinct, the search value can match only one of them.

Due to different optimizer operation for nonindexed and indexed lookups, the query produces different results in each case. The result from the nonindexed lookup returns all values that match in the session time zone. The indexed lookup cannot do so:

- It is performed within the storage engine, which knows only about UTC values.
- For the two distinct session time zone values that map to the same UTC value, the indexed lookup matches only the corresponding UTC index entry and returns only a single row.

In the preceding discussion, the data set stored in `tstable` happens to consist of distinct UTC values. In such cases, all index-using queries of the form shown match at most one index entry.

If the index is not `UNIQUE`, it is possible for the table (and the index) to store multiple instances of a given UTC value. For example, the `ts` column might contain multiple instances of the UTC value `'2018-10-28 00:30:00'`. In this case, the index-using query would return each of them (converted to the MET value `'2018-10-28 02:30:00'` in the result set). It remains true that index-using queries match the converted search value to a single value in the UTC index entries, rather than matching multiple UTC values that convert to the search value in the session time zone.

If it is important to return all `ts` values that match in the session time zone, the workaround is to suppress use of the index with an `IGNORE INDEX` hint:

```
mysql> SELECT ts FROM tstable
        IGNORE INDEX (ts)
        WHERE ts = '2018-10-28 02:30:00';
```

ts
2018-10-28 02:30:00
2018-10-28 02:30:00

The same lack of one-to-one mapping for time zone conversions in both directions occurs in other contexts as well, such as conversions performed with the `FROM_UNIXTIME()` and `UNIX_TIMESTAMP()` functions. See [Section 12.7, “Date and Time Functions”](#).

## 8.4 Optimizing Database Structure

In your role as a database designer, look for the most efficient way to organize your schemas, tables, and columns. As when tuning application code, you minimize I/O, keep related items together, and plan ahead so that performance stays high as the data volume increases. Starting with an efficient database design makes it easier for team members to write high-performing application code, and makes the database likely to endure as applications evolve and are rewritten.

### 8.4.1 Optimizing Data Size

Design your tables to minimize their space on the disk. This can result in huge improvements by reducing the amount of data written to and read from disk. Smaller tables normally require less main memory while their contents are being actively processed during query execution. Any space reduction for table data also results in smaller indexes that can be processed faster.

MySQL supports many different storage engines (table types) and row formats. For each table, you can decide which storage and indexing method to use. Choosing the proper table format for your application can give you a big performance gain. See [Chapter 14, \*The InnoDB Storage Engine\*](#), and [Chapter 15, \*Alternative Storage Engines\*](#).

You can get better performance for a table and minimize storage space by using the techniques listed here:

- [Table Columns](#)
- [Row Format](#)
- [Indexes](#)
- [Joins](#)
- [Normalization](#)

---

## Table Columns

- Use the most efficient (smallest) data types possible. MySQL has many specialized types that save disk space and memory. For example, use the smaller integer types if possible to get smaller tables. `MEDIUMINT` is often a better choice than `INT` because a `MEDIUMINT` column uses 25% less space.
- Declare columns to be `NOT NULL` if possible. It makes SQL operations faster, by enabling better use of indexes and eliminating overhead for testing whether each value is `NULL`. You also save some storage space, one bit per column. If you really need `NULL` values in your tables, use them. Just avoid the default setting that allows `NULL` values in every column.

## Row Format

- `InnoDB` tables are created using the `DYNAMIC` row format by default. To use a row format other than `DYNAMIC`, configure `innodb_default_row_format`, or specify the `ROW_FORMAT` option explicitly in a `CREATE TABLE` or `ALTER TABLE` statement.

The compact family of row formats, which includes `COMPACT`, `DYNAMIC`, and `COMPRESSED`, decreases row storage space at the cost of increasing CPU use for some operations. If your workload is a typical one that is limited by cache hit rates and disk speed it is likely to be faster. If it is a rare case that is limited by CPU speed, it might be slower.

The compact family of row formats also optimizes `CHAR` column storage when using a variable-length character set such as `utf8mb3` or `utf8mb4`. With `ROW_FORMAT=REDUNDANT`, `CHAR(N)` occupies  $N \times$  the maximum byte length of the character set. Many languages can be written primarily using single-byte `utf8` characters, so a fixed storage length often wastes space. With the compact family of rows formats, `InnoDB` allocates a variable amount of storage in the range of  $N$  to  $N \times$  the maximum byte length of the character set for these columns by stripping trailing spaces. The minimum storage length is  $N$  bytes to facilitate in-place updates in typical cases. For more information, see [Section 14.11, “InnoDB Row Formats”](#).

- To minimize space even further by storing table data in compressed form, specify `ROW_FORMAT=COMPRESSED` when creating `InnoDB` tables, or run the `mysampack` command on an existing `MyISAM` table. (`InnoDB` compressed tables are readable and writable, while `MyISAM` compressed tables are read-only.)
- For `MyISAM` tables, if you do not have any variable-length columns (`VARCHAR`, `TEXT`, or `BLOB` columns), a fixed-size row format is used. This is faster but may waste some space. See [Section 15.2.3, “MyISAM Table Storage Formats”](#). You can hint that you want to have fixed length rows even if you have `VARCHAR` columns with the `CREATE TABLE` option `ROW_FORMAT=FIXED`.

## Indexes

- The primary index of a table should be as short as possible. This makes identification of each row easy and efficient. For `InnoDB` tables, the primary key columns are duplicated in each secondary index entry, so a short primary key saves considerable space if you have many secondary indexes.
- Create only the indexes that you need to improve query performance. Indexes are good for retrieval, but slow down insert and update operations. If you access a table mostly by searching on a combination of columns, create a single composite index on them rather than a separate index for each column. The first part of the index should be the column most used. If you *always* use many columns when selecting from the table, the first column in the index should be the one with the most duplicates, to obtain better compression of the index.
- If it is very likely that a long string column has a unique prefix on the first number of characters, it is better to index only this prefix, using MySQL's support for creating an index on the leftmost part of



the column (see [Section 13.1.14, “CREATE INDEX Statement”](#)). Shorter indexes are faster, not only because they require less disk space, but because they also give you more hits in the index cache, and thus fewer disk seeks. See [Section 5.1.1, “Configuring the Server”](#).

## Joins

- In some circumstances, it can be beneficial to split into two a table that is scanned very often. This is especially true if it is a dynamic-format table and it is possible to use a smaller static format table that can be used to find the relevant rows when scanning the table.
- Declare columns with identical information in different tables with identical data types, to speed up joins based on the corresponding columns.
- Keep column names simple, so that you can use the same name across different tables and simplify join queries. For example, in a table named `customer`, use a column name of `name` instead of `customer_name`. To make your names portable to other SQL servers, consider keeping them shorter than 18 characters.

## Normalization

- Normally, try to keep all data nonredundant (observing what is referred to in database theory as *third normal form*). Instead of repeating lengthy values such as names and addresses, assign them unique IDs, repeat these IDs as needed across multiple smaller tables, and join the tables in queries by referencing the IDs in the join clause.
- If speed is more important than disk space and the maintenance costs of keeping multiple copies of data, for example in a business intelligence scenario where you analyze all the data from large tables, you can relax the normalization rules, duplicating information or creating summary tables to gain more speed.

## 8.4.2 Optimizing MySQL Data Types

### 8.4.2.1 Optimizing for Numeric Data

- For unique IDs or other values that can be represented as either strings or numbers, prefer numeric columns to string columns. Since large numeric values can be stored in fewer bytes than the corresponding strings, it is faster and takes less memory to transfer and compare them.
- If you are using numeric data, it is faster in many cases to access information from a database (using a live connection) than to access a text file. Information in the database is likely to be stored in a more compact format than in the text file, so accessing it involves fewer disk accesses. You also save code in your application because you can avoid parsing the text file to find line and column boundaries.

### 8.4.2.2 Optimizing for Character and String Types

For character and string columns, follow these guidelines:

- Use binary collation order for fast comparison and sort operations, when you do not need language-specific collation features. You can use the `BINARY` operator to use binary collation within a particular query.
- When comparing values from different columns, declare those columns with the same character set and collation wherever possible, to avoid string conversions while running the query.
- For column values less than 8KB in size, use binary `VARCHAR` instead of `BLOB`. The `GROUP BY` and `ORDER BY` clauses can generate temporary tables, and these temporary tables can use the `MEMORY` storage engine if the original table does not contain any `BLOB` columns.

- If a table contains string columns such as name and address, but many queries do not retrieve those columns, consider splitting the string columns into a separate table and using join queries with a foreign key when necessary. When MySQL retrieves any value from a row, it reads a data block containing all the columns of that row (and possibly other adjacent rows). Keeping each row small, with only the most frequently used columns, allows more rows to fit in each data block. Such compact tables reduce disk I/O and memory usage for common queries.
- When you use a randomly generated value as a primary key in an [InnoDB](#) table, prefix it with an ascending value such as the current date and time if possible. When consecutive primary values are physically stored near each other, [InnoDB](#) can insert and retrieve them faster.
- See [Section 8.4.2.1, “Optimizing for Numeric Data”](#) for reasons why a numeric column is usually preferable to an equivalent string column.

### 8.4.2.3 Optimizing for BLOB Types

- When storing a large blob containing textual data, consider compressing it first. Do not use this technique when the entire table is compressed by [InnoDB](#) or [MyISAM](#).
- For a table with several columns, to reduce memory requirements for queries that do not use the BLOB column, consider splitting the BLOB column into a separate table and referencing it with a join query when needed.
- Since the performance requirements to retrieve and display a BLOB value might be very different from other data types, you could put the BLOB-specific table on a different storage device or even a separate database instance. For example, to retrieve a BLOB might require a large sequential disk read that is better suited to a traditional hard drive than to an [SSD device](#).
- See [Section 8.4.2.2, “Optimizing for Character and String Types”](#) for reasons why a binary [VARCHAR](#) column is sometimes preferable to an equivalent BLOB column.
- Rather than testing for equality against a very long text string, you can store a hash of the column value in a separate column, index that column, and test the hashed value in queries. (Use the [MD5\(\)](#) or [CRC32\(\)](#) function to produce the hash value.) Since hash functions can produce duplicate results for different inputs, you still include a clause `AND blob_column = long_string_value` in the query to guard against false matches; the performance benefit comes from the smaller, easily scanned index for the hashed values.

### 8.4.2.4 Using PROCEDURE ANALYSE

```
ANALYSE([max_elements[,max_memory]])
```



#### Note

`PROCEDURE ANALYSE()` is deprecated as of MySQL 5.7.18, and is removed in MySQL 8.0.

`ANALYSE()` examines the result from a query and returns an analysis of the results that suggests optimal data types for each column that may help reduce table sizes. To obtain this analysis, append `PROCEDURE ANALYSE` to the end of a `SELECT` statement:

```
SELECT ... FROM ... WHERE ... PROCEDURE ANALYSE([max_elements,[max_memory]])
```

For example:

```
SELECT col1, col2 FROM table1 PROCEDURE ANALYSE(10, 2000);
```

The results show some statistics for the values returned by the query, and propose an optimal data type for the columns. This can be helpful for checking your existing tables, or after importing new data. You may need to try different settings for the arguments so that `PROCEDURE ANALYSE()` does not suggest the `ENUM` data type when it is not appropriate.

The arguments are optional and are used as follows:

- `max_elements` (default 256) is the maximum number of distinct values that `ANALYSE()` notices per column. This is used by `ANALYSE()` to check whether the optimal data type should be of type `ENUM`; if there are more than `max_elements` distinct values, then `ENUM` is not a suggested type.
- `max_memory` (default 8192) is the maximum amount of memory that `ANALYSE()` should allocate per column while trying to find all distinct values.

A `PROCEDURE` clause is not permitted in a `UNION` statement.

### 8.4.3 Optimizing for Many Tables

Some techniques for keeping individual queries fast involve splitting data across many tables. When the number of tables runs into the thousands or even millions, the overhead of dealing with all these tables becomes a new performance consideration.

#### 8.4.3.1 How MySQL Opens and Closes Tables

When you execute a `mysqladmin status` command, you should see something like this:

```
Uptime: 426 Running threads: 1 Questions: 11082
Reloads: 1 Open tables: 12
```

The `Open tables` value of 12 can be somewhat puzzling if you have fewer than 12 tables.

MySQL is multithreaded, so there may be many clients issuing queries for a given table simultaneously. To minimize the problem with multiple client sessions having different states on the same table, the table is opened independently by each concurrent session. This uses additional memory but normally increases performance. With `MyISAM` tables, one extra file descriptor is required for the data file for each client that has the table open. (By contrast, the index file descriptor is shared between all sessions.)

The `table_open_cache` and `max_connections` system variables affect the maximum number of files the server keeps open. If you increase one or both of these values, you may run up against a limit imposed by your operating system on the per-process number of open file descriptors. Many operating systems permit you to increase the open-files limit, although the method varies widely from system to system. Consult your operating system documentation to determine whether it is possible to increase the limit and how to do so.

`table_open_cache` is related to `max_connections`. For example, for 200 concurrent running connections, specify a table cache size of at least  $200 * N$ , where  $N$  is the maximum number of tables per join in any of the queries which you execute. You must also reserve some extra file descriptors for temporary tables and files.

Make sure that your operating system can handle the number of open file descriptors implied by the `table_open_cache` setting. If `table_open_cache` is set too high, MySQL may run out of file descriptors and exhibit symptoms such as refusing connections or failing to perform queries.

Also take into account that the `MyISAM` storage engine needs two file descriptors for each unique open table. For a partitioned `MyISAM` table, two file descriptors are required for each partition of the opened table. (When `MyISAM` opens a partitioned table, it opens every partition of this table, whether or not a given partition is actually used. See [MyISAM and partition file descriptor usage](#).) To increase the number of file

descriptors available to MySQL, set the `open_files_limit` system variable. See [Section B.3.2.16, “File Not Found and Similar Errors”](#).

The cache of open tables is kept at a level of `table_open_cache` entries. The server autosizes the cache size at startup. To set the size explicitly, set the `table_open_cache` system variable at startup. MySQL may temporarily open more tables than this to execute queries, as described later in this section.

MySQL closes an unused table and removes it from the table cache under the following circumstances:

- When the cache is full and a thread tries to open a table that is not in the cache.
- When the cache contains more than `table_open_cache` entries and a table in the cache is no longer being used by any threads.
- When a table-flushing operation occurs. This happens when someone issues a `FLUSH TABLES` statement or executes a `mysqladmin flush-tables` or `mysqladmin refresh` command.

When the table cache fills up, the server uses the following procedure to locate a cache entry to use:

- Tables not currently in use are released, beginning with the table least recently used.
- If a new table must be opened, but the cache is full and no tables can be released, the cache is temporarily extended as necessary. When the cache is in a temporarily extended state and a table goes from a used to unused state, the table is closed and released from the cache.

A `MyISAM` table is opened for each concurrent access. This means the table needs to be opened twice if two threads access the same table or if a thread accesses the table twice in the same query (for example, by joining the table to itself). Each concurrent open requires an entry in the table cache. The first open of any `MyISAM` table takes two file descriptors: one for the data file and one for the index file. Each additional use of the table takes only one file descriptor for the data file. The index file descriptor is shared among all threads.

If you are opening a table with the `HANDLER tbl_name OPEN` statement, a dedicated table object is allocated for the thread. This table object is not shared by other threads and is not closed until the thread calls `HANDLER tbl_name CLOSE` or the thread terminates. When this happens, the table is put back in the table cache (if the cache is not full). See [Section 13.2.4, “HANDLER Statement”](#).

To determine whether your table cache is too small, check the `Opened_tables` status variable, which indicates the number of table-opening operations since the server started:

```
mysql> SHOW GLOBAL STATUS LIKE 'Opened_tables';
+-----+-----+
| Variable_name | Value |
+-----+-----+
| Opened_tables | 2741  |
+-----+-----+
```

If the value is very large or increases rapidly, even when you have not issued many `FLUSH TABLES` statements, increase the `table_open_cache` value at server startup.

### 8.4.3.2 Disadvantages of Creating Many Tables in the Same Database

If you have many `MyISAM` tables in the same database directory, open, close, and create operations are slow. If you execute `SELECT` statements on many different tables, there is a little overhead when the table cache is full, because for every table that has to be opened, another must be closed. You can reduce this overhead by increasing the number of entries permitted in the table cache.

## 8.4.4 Internal Temporary Table Use in MySQL

In some cases, the server creates internal temporary tables while processing statements. Users have no direct control over when this occurs.

The server creates temporary tables under conditions such as these:

- Evaluation of `UNION` statements, with some exceptions described later.
- Evaluation of some views, such those that use the `TEMPTABLE` algorithm, `UNION`, or aggregation.
- Evaluation of derived tables (see [Section 13.2.10.8, “Derived Tables”](#)).
- Tables created for subquery or semijoin materialization (see [Section 8.2.2, “Optimizing Subqueries, Derived Tables, and View References”](#)).
- Evaluation of statements that contain an `ORDER BY` clause and a different `GROUP BY` clause, or for which the `ORDER BY` or `GROUP BY` contains columns from tables other than the first table in the join queue.
- Evaluation of `DISTINCT` combined with `ORDER BY` may require a temporary table.
- For queries that use the `SQL_SMALL_RESULT` modifier, MySQL uses an in-memory temporary table, unless the query also contains elements (described later) that require on-disk storage.
- To evaluate `INSERT ... SELECT` statements that select from and insert into the same table, MySQL creates an internal temporary table to hold the rows from the `SELECT`, then inserts those rows into the target table. See [Section 13.2.5.1, “INSERT ... SELECT Statement”](#).
- Evaluation of multiple-table `UPDATE` statements.
- Evaluation of `GROUP_CONCAT()` or `COUNT(DISTINCT)` expressions.

To determine whether a statement requires a temporary table, use `EXPLAIN` and check the `Extra` column to see whether it says `Using temporary` (see [Section 8.8.1, “Optimizing Queries with EXPLAIN”](#)). `EXPLAIN` does not necessarily say `Using temporary` for derived or materialized temporary tables.

Some query conditions prevent the use of an in-memory temporary table, in which case the server uses an on-disk table instead:

- Presence of a `BLOB` or `TEXT` column in the table. This includes user-defined variables having a string value because they are treated as `BLOB` or `TEXT` columns, depending on whether their value is a binary or nonbinary string, respectively.
- Presence of any string column with a maximum length larger than 512 (bytes for binary strings, characters for nonbinary strings) in the `SELECT` list, if `UNION` or `UNION ALL` is used.
- The `SHOW COLUMNS` and `DESCRIBE` statements use `BLOB` as the type for some columns, thus the temporary table used for the results is an on-disk table.

The server does not use a temporary table for `UNION` statements that meet certain qualifications. Instead, it retains from temporary table creation only the data structures necessary to perform result column typecasting. The table is not fully instantiated and no rows are written to or read from it; rows are sent directly to the client. The result is reduced memory and disk requirements, and smaller delay before the first row is sent to the client because the server need not wait until the last query block is executed. `EXPLAIN` and optimizer trace output reflects this execution strategy: The `UNION RESULT` query block is not present because that block corresponds to the part that reads from the temporary table.

These conditions qualify a `UNION` for evaluation without a temporary table:

- The union is `UNION ALL`, not `UNION` or `UNION DISTINCT`.
- There is no global `ORDER BY` clause.
- The union is not the top-level query block of an `{INSERT | REPLACE} ... SELECT ...` statement.

## Internal Temporary Table Storage Engine

An internal temporary table can be held in memory and processed by the `MEMORY` storage engine, or stored on disk by the `InnoDB` or `MyISAM` storage engine.

If an internal temporary table is created as an in-memory table but becomes too large, MySQL automatically converts it to an on-disk table. The maximum size for in-memory temporary tables is defined by the `tmp_table_size` or `max_heap_table_size` value, whichever is smaller. This differs from `MEMORY` tables explicitly created with `CREATE TABLE`. For such tables, only the `max_heap_table_size` variable determines how large a table can grow, and there is no conversion to on-disk format.

The `internal_tmp_disk_storage_engine` variable defines the storage engine the server uses to manage on-disk internal temporary tables. Permitted values are `INNODB` (the default) and `MYISAM`.



### Note

When using `internal_tmp_disk_storage_engine=INNODB`, queries that generate on-disk internal temporary tables that exceed `InnoDB row or column limits` return `Row size too large` or `Too many columns` errors. The workaround is to set `internal_tmp_disk_storage_engine` to `MYISAM`.

When an internal temporary table is created in memory or on disk, the server increments the `Created_tmp_tables` value. When an internal temporary table is created on disk, the server increments the `Created_tmp_disk_tables` value. If too many internal temporary tables are created on disk, consider increasing the `tmp_table_size` and `max_heap_table_size` settings.

## Internal Temporary Table Storage Format

In-memory temporary tables are managed by the `MEMORY` storage engine, which uses fixed-length row format. `VARCHAR` and `VARBINARY` column values are padded to the maximum column length, in effect storing them as `CHAR` and `BINARY` columns.

On-disk temporary tables are managed by the `InnoDB` or `MyISAM` storage engine (depending on the `internal_tmp_disk_storage_engine` setting). Both engines store temporary tables using dynamic-width row format. Columns take only as much storage as needed, which reduces disk I/O, space requirements, and processing time compared to on-disk tables that use fixed-length rows.

For statements that initially create an internal temporary table in memory, then convert it to an on-disk table, better performance might be achieved by skipping the conversion step and creating the table on disk to begin with. The `big_tables` variable can be used to force disk storage of internal temporary tables.

## 8.4.5 Limits on Number of Databases and Tables

MySQL has no limit on the number of databases. The underlying file system may have a limit on the number of directories.

MySQL has no limit on the number of tables. The underlying file system may have a limit on the number of files that represent tables. Individual storage engines may impose engine-specific constraints. `InnoDB` permits up to 4 billion tables.

## 8.4.6 Limits on Table Size

The effective maximum table size for MySQL databases is usually determined by operating system constraints on file sizes, not by MySQL internal limits. For up-to-date information operating system file size limits, refer to the documentation specific to your operating system.

Windows users, please note that FAT and VFAT (FAT32) are *not* considered suitable for production use with MySQL. Use NTFS instead.

If you encounter a full-table error, there are several reasons why it might have occurred:

- The disk might be full.
- You are using [InnoDB](#) tables and have run out of room in an [InnoDB](#) tablespace file. The maximum tablespace size is also the maximum size for a table. For tablespace size limits, see [Section 14.23, “InnoDB Limits”](#).

Generally, partitioning of tables into multiple tablespace files is recommended for tables larger than 1TB in size.

- You have hit an operating system file size limit. For example, you are using [MyISAM](#) tables on an operating system that supports files only up to 2GB in size and you have hit this limit for the data file or index file.
- You are using a [MyISAM](#) table and the space required for the table exceeds what is permitted by the internal pointer size. [MyISAM](#) permits data and index files to grow up to 256TB by default, but this limit can be changed up to the maximum permissible size of 65,536TB ( $256^7 - 1$  bytes).

If you need a [MyISAM](#) table that is larger than the default limit and your operating system supports large files, the [CREATE TABLE](#) statement supports [AVG\\_ROW\\_LENGTH](#) and [MAX\\_ROWS](#) options. See [Section 13.1.18, “CREATE TABLE Statement”](#). The server uses these options to determine how large a table to permit.

If the pointer size is too small for an existing table, you can change the options with [ALTER TABLE](#) to increase a table's maximum permissible size. See [Section 13.1.8, “ALTER TABLE Statement”](#).

```
ALTER TABLE tbl_name MAX_ROWS=1000000000 AVG_ROW_LENGTH=nnn;
```

You have to specify [AVG\\_ROW\\_LENGTH](#) only for tables with [BLOB](#) or [TEXT](#) columns; in this case, MySQL cannot optimize the space required based only on the number of rows.

To change the default size limit for [MyISAM](#) tables, set the [myisam\\_data\\_pointer\\_size](#), which sets the number of bytes used for internal row pointers. The value is used to set the pointer size for new tables if you do not specify the [MAX\\_ROWS](#) option. The value of [myisam\\_data\\_pointer\\_size](#) can be from 2 to 7. For example, for tables that use the dynamic storage format, a value of 4 permits tables up to 4GB; a value of 6 permits tables up to 256TB. Tables that use the fixed storage format have a larger maximum data length. For storage format characteristics, see [Section 15.2.3, “MyISAM Table Storage Formats”](#).

You can check the maximum data and index sizes by using this statement:

```
SHOW TABLE STATUS FROM db_name LIKE 'tbl_name';
```

You also can use [myisamchk -dv /path/to/table-index-file](#). See [Section 13.7.5, “SHOW Statements”](#), or [Section 4.6.3, “myisamchk — MyISAM Table-Maintenance Utility”](#).

Other ways to work around file-size limits for [MyISAM](#) tables are as follows:

- If your large table is read only, you can use [myisampack](#) to compress it. [myisampack](#) usually compresses a table by at least 50%, so you can have, in effect, much bigger tables. [myisampack](#)

also can merge multiple tables into a single table. See [Section 4.6.5, “myisampack — Generate Compressed, Read-Only MyISAM Tables”](#).

- MySQL includes a [MERGE](#) library that enables you to handle a collection of [MyISAM](#) tables that have identical structure as a single [MERGE](#) table. See [Section 15.7, “The MERGE Storage Engine”](#).
- You are using the [MEMORY \(HEAP\)](#) storage engine; in this case you need to increase the value of the [max\\_heap\\_table\\_size](#) system variable. See [Section 5.1.7, “Server System Variables”](#).

## 8.4.7 Limits on Table Column Count and Row Size

This section describes limits on the number of columns in tables and the size of individual rows.

- [Column Count Limits](#)
- [Row Size Limits](#)

### Column Count Limits

MySQL has hard limit of 4096 columns per table, but the effective maximum may be less for a given table. The exact column limit depends on several factors:

- The maximum row size for a table constrains the number (and possibly size) of columns because the total length of all columns cannot exceed this size. See [Row Size Limits](#).
- The storage requirements of individual columns constrain the number of columns that fit within a given maximum row size. Storage requirements for some data types depend on factors such as storage engine, storage format, and character set. See [Section 11.7, “Data Type Storage Requirements”](#).
- Storage engines may impose additional restrictions that limit table column count. For example, [InnoDB](#) has a limit of 1017 columns per table. See [Section 14.23, “InnoDB Limits”](#). For information about other storage engines, see [Chapter 15, \*Alternative Storage Engines\*](#).
- Each table has an [.frm](#) file that contains the table definition. The definition affects the content of this file in ways that may affect the number of columns permitted in the table. See [Limits Imposed by .frm File Structure](#).

### Row Size Limits

The maximum row size for a given table is determined by several factors:

- The internal representation of a MySQL table has a maximum row size limit of 65,535 bytes, even if the storage engine is capable of supporting larger rows. [BLOB](#) and [TEXT](#) columns only contribute 9 to 12 bytes toward the row size limit because their contents are stored separately from the rest of the row.
- The maximum row size for an [InnoDB](#) table, which applies to data stored locally within a database page, is slightly less than half a page for 4KB, 8KB, 16KB, and 32KB [innodb\\_page\\_size](#) settings. For example, the maximum row size is slightly less than 8KB for the default 16KB [InnoDB](#) page size. For 64KB pages, the maximum row size is slightly less than 16KB. See [Section 14.23, “InnoDB Limits”](#).

If a row containing [variable-length columns](#) exceeds the [InnoDB](#) maximum row size, [InnoDB](#) selects variable-length columns for external off-page storage until the row fits within the [InnoDB](#) row size limit. The amount of data stored locally for variable-length columns that are stored off-page differs by row format. For more information, see [Section 14.11, “InnoDB Row Formats”](#).

- Different storage formats use different amounts of page header and trailer data, which affects the amount of storage available for rows.



- For information about [InnoDB](#) row formats, see [Section 14.11, “InnoDB Row Formats”](#).
- For information about [MyISAM](#) storage formats, see [Section 15.2.3, “MyISAM Table Storage Formats”](#).

## Row Size Limit Examples

- The MySQL maximum row size limit of 65,535 bytes is demonstrated in the following [InnoDB](#) and [MyISAM](#) examples. The limit is enforced regardless of storage engine, even though the storage engine may be capable of supporting larger rows.

```
mysql> CREATE TABLE t (a VARCHAR(10000), b VARCHAR(10000),
  c VARCHAR(10000), d VARCHAR(10000), e VARCHAR(10000),
  f VARCHAR(10000), g VARCHAR(6000)) ENGINE=InnoDB CHARACTER SET latin1;
ERROR 1118 (42000): Row size too large. The maximum row size for the used
table type, not counting BLOBs, is 65535. This includes storage overhead,
check the manual. You have to change some columns to TEXT or BLOBs
```

```
mysql> CREATE TABLE t (a VARCHAR(10000), b VARCHAR(10000),
  c VARCHAR(10000), d VARCHAR(10000), e VARCHAR(10000),
  f VARCHAR(10000), g VARCHAR(6000)) ENGINE=MyISAM CHARACTER SET latin1;
ERROR 1118 (42000): Row size too large. The maximum row size for the used
table type, not counting BLOBs, is 65535. This includes storage overhead,
check the manual. You have to change some columns to TEXT or BLOBs
```

In the following [MyISAM](#) example, changing a column to [TEXT](#) avoids the 65,535-byte row size limit and permits the operation to succeed because [BLOB](#) and [TEXT](#) columns only contribute 9 to 12 bytes toward the row size.

```
mysql> CREATE TABLE t (a VARCHAR(10000), b VARCHAR(10000),
  c VARCHAR(10000), d VARCHAR(10000), e VARCHAR(10000),
  f VARCHAR(10000), g TEXT(6000)) ENGINE=MyISAM CHARACTER SET latin1;
Query OK, 0 rows affected (0.02 sec)
```

The operation succeeds for an [InnoDB](#) table because changing a column to [TEXT](#) avoids the MySQL 65,535-byte row size limit, and [InnoDB](#) off-page storage of variable-length columns avoids the [InnoDB](#) row size limit.

```
mysql> CREATE TABLE t (a VARCHAR(10000), b VARCHAR(10000),
  c VARCHAR(10000), d VARCHAR(10000), e VARCHAR(10000),
  f VARCHAR(10000), g TEXT(6000)) ENGINE=InnoDB CHARACTER SET latin1;
Query OK, 0 rows affected (0.02 sec)
```

- Storage for variable-length columns includes length bytes, which are counted toward the row size. For example, a [VARCHAR\(255\) CHARACTER SET utf8mb3](#) column takes two bytes to store the length of the value, so each value can take up to 767 bytes.

The statement to create table `t1` succeeds because the columns require 32,765 + 2 bytes and 32,766 + 2 bytes, which falls within the maximum row size of 65,535 bytes:

```
mysql> CREATE TABLE t1
  (c1 VARCHAR(32765) NOT NULL, c2 VARCHAR(32766) NOT NULL)
  ENGINE = InnoDB CHARACTER SET latin1;
Query OK, 0 rows affected (0.02 sec)
```

The statement to create table `t2` fails because, although the column length is within the maximum length of 65,535 bytes, two additional bytes are required to record the length, which causes the row size to exceed 65,535 bytes:

```
mysql> CREATE TABLE t2
  (c1 VARCHAR(65535) NOT NULL)
  ENGINE = InnoDB CHARACTER SET latin1;
```

```
ERROR 1118 (42000): Row size too large. The maximum row size for the used
table type, not counting BLOBs, is 65535. This includes storage overhead,
check the manual. You have to change some columns to TEXT or BLOBs
```

Reducing the column length to 65,533 or less permits the statement to succeed.

```
mysql> CREATE TABLE t2
  (c1 VARCHAR(65533) NOT NULL)
  ENGINE = InnoDB CHARACTER SET latin1;
Query OK, 0 rows affected (0.01 sec)
```

- For **MyISAM** tables, **NULL** columns require additional space in the row to record whether their values are **NULL**. Each **NULL** column takes one bit extra, rounded up to the nearest byte.

The statement to create table `t3` fails because **MyISAM** requires space for **NULL** columns in addition to the space required for variable-length column length bytes, causing the row size to exceed 65,535 bytes:

```
mysql> CREATE TABLE t3
  (c1 VARCHAR(32765) NULL, c2 VARCHAR(32766) NULL)
  ENGINE = MyISAM CHARACTER SET latin1;
ERROR 1118 (42000): Row size too large. The maximum row size for the used
table type, not counting BLOBs, is 65535. This includes storage overhead,
check the manual. You have to change some columns to TEXT or BLOBs
```

For information about **InnoDB NULL** column storage, see [Section 14.11, “InnoDB Row Formats”](#).

- **InnoDB** restricts row size (for data stored locally within the database page) to slightly less than half a database page for 4KB, 8KB, 16KB, and 32KB `innodb_page_size` settings, and to slightly less than 16KB for 64KB pages.

The statement to create table `t4` fails because the defined columns exceed the row size limit for a 16KB **InnoDB** page.

```
mysql> CREATE TABLE t4 (
  c1 CHAR(255),c2 CHAR(255),c3 CHAR(255),
  c4 CHAR(255),c5 CHAR(255),c6 CHAR(255),
  c7 CHAR(255),c8 CHAR(255),c9 CHAR(255),
  c10 CHAR(255),c11 CHAR(255),c12 CHAR(255),
  c13 CHAR(255),c14 CHAR(255),c15 CHAR(255),
  c16 CHAR(255),c17 CHAR(255),c18 CHAR(255),
  c19 CHAR(255),c20 CHAR(255),c21 CHAR(255),
  c22 CHAR(255),c23 CHAR(255),c24 CHAR(255),
  c25 CHAR(255),c26 CHAR(255),c27 CHAR(255),
  c28 CHAR(255),c29 CHAR(255),c30 CHAR(255),
  c31 CHAR(255),c32 CHAR(255),c33 CHAR(255)
) ENGINE=InnoDB ROW_FORMAT=COMPACT DEFAULT CHARSET latin1;
ERROR 1118 (42000): Row size too large (> 8126). Changing some columns to TEXT or BLOB or using
ROW_FORMAT=DYNAMIC or ROW_FORMAT=COMPRESSED may help. In current row format, BLOB prefix of 768
bytes is stored inline.
```

## 8.5 Optimizing for InnoDB Tables

**InnoDB** is the storage engine that MySQL customers typically use in production databases where reliability and concurrency are important. **InnoDB** is the default storage engine in MySQL. This section explains how to optimize database operations for **InnoDB** tables.

### 8.5.1 Optimizing Storage Layout for InnoDB Tables

- Once your data reaches a stable size, or a growing table has increased by tens or some hundreds of megabytes, consider using the `OPTIMIZE TABLE` statement to reorganize the table and compact any wasted space. The reorganized tables require less disk I/O to perform full table scans. This is a

straightforward technique that can improve performance when other techniques such as improving index usage or tuning application code are not practical.

`OPTIMIZE TABLE` copies the data part of the table and rebuilds the indexes. The benefits come from improved packing of data within indexes, and reduced fragmentation within the tablespaces and on disk. The benefits vary depending on the data in each table. You may find that there are significant gains for some and not for others, or that the gains decrease over time until you next optimize the table. This operation can be slow if the table is large or if the indexes being rebuilt do not fit into the buffer pool. The first run after adding a lot of data to a table is often much slower than later runs.

- In `InnoDB`, having a long `PRIMARY KEY` (either a single column with a lengthy value, or several columns that form a long composite value) wastes a lot of disk space. The primary key value for a row is duplicated in all the secondary index records that point to the same row. (See [Section 14.6.2.1, “Clustered and Secondary Indexes”](#).) Create an `AUTO_INCREMENT` column as the primary key if your primary key is long, or index a prefix of a long `VARCHAR` column instead of the entire column.
- Use the `VARCHAR` data type instead of `CHAR` to store variable-length strings or for columns with many `NULL` values. A `CHAR(N)` column always takes `N` characters to store data, even if the string is shorter or its value is `NULL`. Smaller tables fit better in the buffer pool and reduce disk I/O.

When using `COMPACT` row format (the default `InnoDB` format) and variable-length character sets, such as `utf8` or `sjis`, `CHAR(N)` columns occupy a variable amount of space, but still at least `N` bytes.

- For tables that are big, or contain lots of repetitive text or numeric data, consider using `COMPRESSED` row format. Less disk I/O is required to bring data into the buffer pool, or to perform full table scans. Before making a permanent decision, measure the amount of compression you can achieve by using `COMPRESSED` versus `COMPACT` row format.

## 8.5.2 Optimizing InnoDB Transaction Management

To optimize `InnoDB` transaction processing, find the ideal balance between the performance overhead of transactional features and the workload of your server. For example, an application might encounter performance issues if it commits thousands of times per second, and different performance issues if it commits only every 2-3 hours.

- The default MySQL setting `AUTOCOMMIT=1` can impose performance limitations on a busy database server. Where practical, wrap several related data change operations into a single transaction, by issuing `SET AUTOCOMMIT=0` or a `START TRANSACTION` statement, followed by a `COMMIT` statement after making all the changes.

`InnoDB` must flush the log to disk at each transaction commit if that transaction made modifications to the database. When each change is followed by a commit (as with the default autocommit setting), the I/O throughput of the storage device puts a cap on the number of potential operations per second.

- Alternatively, for transactions that consist only of a single `SELECT` statement, turning on `AUTOCOMMIT` helps `InnoDB` to recognize read-only transactions and optimize them. See [Section 8.5.3, “Optimizing InnoDB Read-Only Transactions”](#) for requirements.
- Avoid performing rollbacks after inserting, updating, or deleting huge numbers of rows. If a big transaction is slowing down server performance, rolling it back can make the problem worse, potentially taking several times as long to perform as the original data change operations. Killing the database process does not help, because the rollback starts again on server startup.

To minimize the chance of this issue occurring:

- Increase the size of the `buffer pool` so that all the data change changes can be cached rather than immediately written to disk.

- Set `innodb_change_buffering=all` so that update and delete operations are buffered in addition to inserts.
- Consider issuing `COMMIT` statements periodically during the big data change operation, possibly breaking a single delete or update into multiple statements that operate on smaller numbers of rows.

To get rid of a runaway rollback once it occurs, increase the buffer pool so that the rollback becomes CPU-bound and runs fast, or kill the server and restart with `innodb_force_recovery=3`, as explained in [Section 14.19.2, “InnoDB Recovery”](#).

This issue is expected to be infrequent with the default setting `innodb_change_buffering=all`, which allows update and delete operations to be cached in memory, making them faster to perform in the first place, and also faster to roll back if needed. Make sure to use this parameter setting on servers that process long-running transactions with many inserts, updates, or deletes.

- If you can afford the loss of some of the latest committed transactions if an unexpected exit occurs, you can set the `innodb_flush_log_at_trx_commit` parameter to 0. InnoDB tries to flush the log once per second anyway, although the flush is not guaranteed. Also, set the value of `innodb_support_xa` to 0, which reduces the number of disk flushes due to synchronizing on disk data and the binary log.



**Note**

`innodb_support_xa` is deprecated; expect it to be removed in a future release. As of MySQL 5.7.10, InnoDB support for two-phase commit in XA transactions is always enabled and disabling `innodb_support_xa` is no longer permitted.

- When rows are modified or deleted, the rows and associated [undo logs](#) are not physically removed immediately, or even immediately after the transaction commits. The old data is preserved until transactions that started earlier or concurrently are finished, so that those transactions can access the previous state of modified or deleted rows. Thus, a long-running transaction can prevent InnoDB from purging data that was changed by a different transaction.
- When rows are modified or deleted within a long-running transaction, other transactions using the `READ COMMITTED` and `REPEATABLE READ` isolation levels have to do more work to reconstruct the older data if they read those same rows.
- When a long-running transaction modifies a table, queries against that table from other transactions do not make use of the [covering index](#) technique. Queries that normally could retrieve all the result columns from a secondary index, instead look up the appropriate values from the table data.

If secondary index pages are found to have a `PAGE_MAX_TRX_ID` that is too new, or if records in the secondary index are delete-marked, InnoDB may need to look up records using a clustered index.

### 8.5.3 Optimizing InnoDB Read-Only Transactions

InnoDB can avoid the overhead associated with setting up the [transaction ID](#) (`TRX_ID` field) for transactions that are known to be read-only. A transaction ID is only needed for a [transaction](#) that might perform write operations or [locking reads](#) such as `SELECT ... FOR UPDATE`. Eliminating unnecessary transaction IDs reduces the size of internal data structures that are consulted each time a query or data change statement constructs a [read view](#).

InnoDB detects read-only transactions when:

- The transaction is started with the `START TRANSACTION READ ONLY` statement. In this case, attempting to make changes to the database (for InnoDB, MyISAM, or other types of tables) causes an error, and the transaction continues in read-only state:

```
ERROR 1792 (25006): Cannot execute statement in a READ ONLY transaction.
```

You can still make changes to session-specific temporary tables in a read-only transaction, or issue locking queries for them, because those changes and locks are not visible to any other transaction.

- The `autocommit` setting is turned on, so that the transaction is guaranteed to be a single statement, and the single statement making up the transaction is a “non-locking” `SELECT` statement. That is, a `SELECT` that does not use a `FOR UPDATE` or `LOCK IN SHARED MODE` clause.
- The transaction is started without the `READ ONLY` option, but no updates or statements that explicitly lock rows have been executed yet. Until updates or explicit locks are required, a transaction stays in read-only mode.

Thus, for a read-intensive application such as a report generator, you can tune a sequence of InnoDB queries by grouping them inside `START TRANSACTION READ ONLY` and `COMMIT`, or by turning on the `autocommit` setting before running the `SELECT` statements, or simply by avoiding any data change statements interspersed with the queries.

For information about `START TRANSACTION` and `autocommit`, see [Section 13.3.1, “START TRANSACTION, COMMIT, and ROLLBACK Statements”](#).



**Note**

Transactions that qualify as auto-commit, non-locking, and read-only (AC-NL-RO) are kept out of certain internal InnoDB data structures and are therefore not listed in `SHOW ENGINE INNODB STATUS` output.

## 8.5.4 Optimizing InnoDB Redo Logging

Consider the following guidelines for optimizing redo logging:

- Make your redo log files big, even as big as the [buffer pool](#). When InnoDB has written the redo log files full, it must write the modified contents of the buffer pool to disk in a [checkpoint](#). Small redo log files cause many unnecessary disk writes. Although historically big redo log files caused lengthy recovery times, recovery is now much faster and you can confidently use large redo log files.

The size and number of redo log files are configured using the `innodb_log_file_size` and `innodb_log_files_in_group` configuration options. For information about modifying an existing redo log file configuration, see [Changing the Number or Size of InnoDB Redo Log Files](#).

- Consider increasing the size of the [log buffer](#). A large log buffer enables large [transactions](#) to run without a need to write the log to disk before the transactions [commit](#). Thus, if you have transactions that update, insert, or delete many rows, making the log buffer larger saves disk I/O. Log buffer size is configured using the `innodb_log_buffer_size` configuration option.
- Configure the `innodb_log_write_ahead_size` configuration option to avoid “read-on-write”. This option defines the write-ahead block size for the redo log. Set `innodb_log_write_ahead_size` to match the operating system or file system cache block size. Read-on-write occurs when redo log blocks are not entirely cached to the operating system or file system due to a mismatch between write-ahead block size for the redo log and operating system or file system cache block size.

Valid values for `innodb_log_write_ahead_size` are multiples of the InnoDB log file block size ( $2^n$ ). The minimum value is the InnoDB log file block size (512). Write-ahead does not occur when the minimum value is specified. The maximum value is equal to the `innodb_page_size` value. If you specify a value for `innodb_log_write_ahead_size` that is larger than the `innodb_page_size` value, the `innodb_log_write_ahead_size` setting is truncated to the `innodb_page_size` value.

Setting the `innodb_log_write_ahead_size` value too low in relation to the operating system or file system cache block size results in read-on-write. Setting the value too high may have a slight impact on `fsync` performance for log file writes due to several blocks being written at once.

## 8.5.5 Bulk Data Loading for InnoDB Tables

These performance tips supplement the general guidelines for fast inserts in [Section 8.2.4.1, “Optimizing INSERT Statements”](#).

- When importing data into `InnoDB`, turn off autocommit mode, because it performs a log flush to disk for every insert. To disable autocommit during your import operation, surround it with `SET autocommit` and `COMMIT` statements:

```
SET autocommit=0;
... SQL import statements ...
COMMIT;
```

The `mysqldump` option `--opt` creates dump files that are fast to import into an `InnoDB` table, even without wrapping them with the `SET autocommit` and `COMMIT` statements.

- If you have `UNIQUE` constraints on secondary keys, you can speed up table imports by temporarily turning off the uniqueness checks during the import session:

```
SET unique_checks=0;
... SQL import statements ...
SET unique_checks=1;
```

For big tables, this saves a lot of disk I/O because `InnoDB` can use its change buffer to write secondary index records in a batch. Be certain that the data contains no duplicate keys.

- If you have `FOREIGN KEY` constraints in your tables, you can speed up table imports by turning off the foreign key checks for the duration of the import session:

```
SET foreign_key_checks=0;
... SQL import statements ...
SET foreign_key_checks=1;
```

For big tables, this can save a lot of disk I/O.

- Use the multiple-row `INSERT` syntax to reduce communication overhead between the client and the server if you need to insert many rows:

```
INSERT INTO yourtable VALUES (1,2), (5,5), ...;
```

This tip is valid for inserts into any table, not just `InnoDB` tables.

- When doing bulk inserts into tables with auto-increment columns, set `innodb_autoinc_lock_mode` to 2 instead of the default value 1. See [Section 14.6.1.6, “AUTO\\_INCREMENT Handling in InnoDB”](#) for details.
- When performing bulk inserts, it is faster to insert rows in `PRIMARY KEY` order. `InnoDB` tables use a `clustered index`, which makes it relatively fast to use data in the order of the `PRIMARY KEY`. Performing bulk inserts in `PRIMARY KEY` order is particularly important for tables that do not fit entirely within the buffer pool.
- For optimal performance when loading data into an `InnoDB FULLTEXT` index, follow this set of steps:
  1. Define a column `FTS_DOC_ID` at table creation time, of type `BIGINT UNSIGNED NOT NULL`, with a unique index named `FTS_DOC_ID_INDEX`. For example:

```
CREATE TABLE t1 (
  FTS_DOC_ID BIGINT unsigned NOT NULL AUTO_INCREMENT,
  title varchar(255) NOT NULL DEFAULT '',
  text mediumtext NOT NULL,
  PRIMARY KEY (`FTS_DOC_ID`)
) ENGINE=InnoDB DEFAULT CHARSET=latin1;
CREATE UNIQUE INDEX FTS_DOC_ID_INDEX on t1(FTS_DOC_ID);
```

2. Load the data into the table.
3. Create the `FULLTEXT` index after the data is loaded.



#### Note

When adding `FTS_DOC_ID` column at table creation time, ensure that the `FTS_DOC_ID` column is updated when the `FULLTEXT` indexed column is updated, as the `FTS_DOC_ID` must increase monotonically with each `INSERT` or `UPDATE`. If you choose not to add the `FTS_DOC_ID` at table creation time and have `InnoDB` manage DOC IDs for you, `InnoDB` adds the `FTS_DOC_ID` as a hidden column with the next `CREATE FULLTEXT INDEX` call. This approach, however, requires a table rebuild which can impact performance.

## 8.5.6 Optimizing InnoDB Queries

To tune queries for `InnoDB` tables, create an appropriate set of indexes on each table. See [Section 8.3.1, “How MySQL Uses Indexes”](#) for details. Follow these guidelines for `InnoDB` indexes:

- Because each `InnoDB` table has a `primary key` (whether you request one or not), specify a set of primary key columns for each table, columns that are used in the most important and time-critical queries.
- Do not specify too many or too long columns in the primary key, because these column values are duplicated in each secondary index. When an index contains unnecessary data, the I/O to read this data and memory to cache it reduce the performance and scalability of the server.
- Do not create a separate `secondary index` for each column, because each query can only make use of one index. Indexes on rarely tested columns or columns with only a few different values might not be helpful for any queries. If you have many queries for the same table, testing different combinations of columns, try to create a small number of `concatenated indexes` rather than a large number of single-column indexes. If an index contains all the columns needed for the result set (known as a `covering index`), the query might be able to avoid reading the table data at all.
- If an indexed column cannot contain any `NULL` values, declare it as `NOT NULL` when you create the table. The optimizer can better determine which index is most effective to use for a query, when it knows whether each column contains `NULL` values.
- You can optimize single-query transactions for `InnoDB` tables, using the technique in [Section 8.5.3, “Optimizing InnoDB Read-Only Transactions”](#).

## 8.5.7 Optimizing InnoDB DDL Operations

- Many DDL operations on tables and indexes (`CREATE`, `ALTER`, and `DROP` statements) can be performed online. See [Section 14.13, “InnoDB and Online DDL”](#) for details.
- Online DDL support for adding secondary indexes means that you can generally speed up the process of creating and loading a table and associated indexes by creating the table without secondary indexes, then adding secondary indexes after the data is loaded.

- Use `TRUNCATE TABLE` to empty a table, not `DELETE FROM tbl_name`. Foreign key constraints can make a `TRUNCATE` statement work like a regular `DELETE` statement, in which case a sequence of commands like `DROP TABLE` and `CREATE TABLE` might be fastest.
- Because the primary key is integral to the storage layout of each InnoDB table, and changing the definition of the primary key involves reorganizing the whole table, always set up the primary key as part of the `CREATE TABLE` statement, and plan ahead so that you do not need to `ALTER` or `DROP` the primary key afterward.

## 8.5.8 Optimizing InnoDB Disk I/O

If you follow best practices for database design and tuning techniques for SQL operations, but your database is still slow due to heavy disk I/O activity, consider these disk I/O optimizations. If the Unix `top` tool or the Windows Task Manager shows that the CPU usage percentage with your workload is less than 70%, your workload is probably disk-bound.

- Increase buffer pool size

When table data is cached in the InnoDB buffer pool, it can be accessed repeatedly by queries without requiring any disk I/O. Specify the size of the buffer pool with the `innodb_buffer_pool_size` option. This memory area is important enough that it is typically recommended that `innodb_buffer_pool_size` is configured to 50 to 75 percent of system memory. For more information see, [Section 8.12.4.1, “How MySQL Uses Memory”](#).

- Adjust the flush method

In some versions of GNU/Linux and Unix, flushing files to disk with the Unix `fsync()` call (which InnoDB uses by default) and similar methods is surprisingly slow. If database write performance is an issue, conduct benchmarks with the `innodb_flush_method` parameter set to `O_DSYNC`.

- Use a noop or deadline I/O scheduler with native AIO on Linux

InnoDB uses the asynchronous I/O subsystem (native AIO) on Linux to perform read-ahead and write requests for data file pages. This behavior is controlled by the `innodb_use_native_aio` configuration option, which is enabled by default. With native AIO, the type of I/O scheduler has greater influence on I/O performance. Generally, noop and deadline I/O schedulers are recommended. Conduct benchmarks to determine which I/O scheduler provides the best results for your workload and environment. For more information, see [Section 14.8.7, “Using Asynchronous I/O on Linux”](#).

- Use direct I/O on Solaris 10 for x86\_64 architecture

When using the InnoDB storage engine on Solaris 10 for x86\_64 architecture (AMD Opteron), use direct I/O for InnoDB-related files to avoid degradation of InnoDB performance. To use direct I/O for an entire UFS file system used for storing InnoDB-related files, mount it with the `forcedirectio` option; see `mount_ufs(1M)`. (The default on Solaris 10/x86\_64 is *not* to use this option.) To apply direct I/O only to InnoDB file operations rather than the whole file system, set `innodb_flush_method = O_DIRECT`. With this setting, InnoDB calls `directio()` instead of `fcntl()` for I/O to data files (not for I/O to log files).

- Use raw storage for data and log files with Solaris 2.6 or later

When using the InnoDB storage engine with a large `innodb_buffer_pool_size` value on any release of Solaris 2.6 and up and any platform (sparc/x86/x64/amd64), conduct benchmarks with InnoDB data files and log files on raw devices or on a separate direct I/O UFS file system, using the `forcedirectio` mount option as described previously. (It is necessary to use the mount option rather than setting `innodb_flush_method` if you want direct I/O for the log files.) Users of the Veritas file system VxFS should use the `convosync=direct` mount option.



Do not place other MySQL data files, such as those for [MyISAM](#) tables, on a direct I/O file system. Executables or libraries *must not* be placed on a direct I/O file system.

- Use additional storage devices

Additional storage devices could be used to set up a RAID configuration. For related information, see [Section 8.12.2, “Optimizing Disk I/O”](#).

Alternatively, [InnoDB](#) tablespace data files and log files can be placed on different physical disks. For more information, refer to the following sections:

- [Section 14.8.1, “InnoDB Startup Configuration”](#)
  - [Section 14.6.1.2, “Creating Tables Externally”](#)
  - [Creating a General Tablespace](#)
  - [Section 14.6.1.4, “Moving or Copying InnoDB Tables”](#)
- Consider non-rotational storage

Non-rotational storage generally provides better performance for random I/O operations; and rotational storage for sequential I/O operations. When distributing data and log files across rotational and non-rotational storage devices, consider the type of I/O operations that are predominantly performed on each file.

Random I/O-oriented files typically include [file-per-table](#) and [general tablespace](#) data files, [undo tablespace](#) files, and [temporary tablespace](#) files. Sequential I/O-oriented files include [InnoDB system](#)

[tablespace](#) files (due to [doublewrite buffering](#) and [change buffering](#)) and log files such as [binary log](#) files and [redo log](#) files.

Review settings for the following configuration options when using non-rotational storage:

- [innodb\\_checksum\\_algorithm](#)

The [crc32](#) option uses a faster checksum algorithm and is recommended for fast storage systems.

- [innodb\\_flush\\_neighbors](#)

Optimizes I/O for rotational storage devices. Disable it for non-rotational storage or a mix of rotational and non-rotational storage.

- [innodb\\_io\\_capacity](#)

The default setting of 200 is generally sufficient for a lower-end non-rotational storage device. For higher-end, bus-attached devices, consider a higher setting such as 1000.

- [innodb\\_io\\_capacity\\_max](#)

The default value of 2000 is intended for workloads that use non-rotational storage. For a high-end, bus-attached non-rotational storage device, consider a higher setting such as 2500.

- [innodb\\_log\\_compressed\\_pages](#)

If redo logs are on non-rotational storage, consider disabling this option to reduce logging. See [Disable logging of compressed pages](#).

- [innodb\\_log\\_file\\_size](#)

If redo logs are on non-rotational storage, configure this option to maximize caching and write combining.

- [innodb\\_page\\_size](#)

Consider using a page size that matches the internal sector size of the disk. Early-generation SSD devices often have a 4KB sector size. Some newer devices have a 16KB sector size. The default [InnoDB](#) page size is 16KB. Keeping the page size close to the storage device block size minimizes the amount of unchanged data that is rewritten to disk.

- [binlog\\_row\\_image](#)

If binary logs are on non-rotational storage and all tables have primary keys, consider setting this option to [minimal](#) to reduce logging.

Ensure that TRIM support is enabled for your operating system. It is typically enabled by default.

- Increase I/O capacity to avoid backlogs

If throughput drops periodically because of [InnoDB checkpoint](#) operations, consider increasing the value of the [innodb\\_io\\_capacity](#) configuration option. Higher values cause more frequent [flushing](#), avoiding the backlog of work that can cause dips in throughput.

- Lower I/O capacity if flushing does not fall behind

If the system is not falling behind with [InnoDB flushing](#) operations, consider lowering the value of the [innodb\\_io\\_capacity](#) configuration option. Typically, you keep this option value as low as practical,

but not so low that it causes periodic drops in throughput as mentioned in the preceding bullet. In a typical scenario where you could lower the option value, you might see a combination like this in the output from `SHOW ENGINE INNODB STATUS`:

- History list length low, below a few thousand.
- Insert buffer merges close to rows inserted.
- Modified pages in buffer pool consistently well below `innodb_max_dirty_pages_pct` of the buffer pool. (Measure at a time when the server is not doing bulk inserts; it is normal during bulk inserts for the modified pages percentage to rise significantly.)
- `Log sequence number - Last checkpoint` is at less than 7/8 or ideally less than 6/8 of the total size of the InnoDB log files.
- Store system tablespace files on Fusion-io devices

You can take advantage of a doublewrite buffer-related I/O optimization by storing system tablespace files (“ibdata files”) on Fusion-io devices that support atomic writes. In this case, doublewrite buffering (`innodb_doublewrite`) is automatically disabled and Fusion-io atomic writes are used for all data files. This feature is only supported on Fusion-io hardware and is only enabled for Fusion-io NVMFS on Linux. To take full advantage of this feature, an `innodb_flush_method` setting of `O_DIRECT` is recommended.



**Note**

Because the doublewrite buffer setting is global, doublewrite buffering is also disabled for data files residing on non-Fusion-io hardware.

- Disable logging of compressed pages

When using the InnoDB table `compression` feature, images of re-compressed pages are written to the redo log when changes are made to compressed data. This behavior is controlled by `innodb_log_compressed_pages`, which is enabled by default to prevent corruption that can occur if a different version of the `zlib` compression algorithm is used during recovery. If you are certain that the `zlib` version is not subject to change, disable `innodb_log_compressed_pages` to reduce redo log generation for workloads that modify compressed data.

## 8.5.9 Optimizing InnoDB Configuration Variables

Different settings work best for servers with light, predictable loads, versus servers that are running near full capacity all the time, or that experience spikes of high activity.

Because the InnoDB storage engine performs many of its optimizations automatically, many performance-tuning tasks involve monitoring to ensure that the database is performing well, and changing configuration options when performance drops. See [Section 14.17, “InnoDB Integration with MySQL Performance Schema”](#) for information about detailed InnoDB performance monitoring.

The main configuration steps you can perform include:

- Enabling InnoDB to use high-performance memory allocators on systems that include them. See [Section 14.8.4, “Configuring the Memory Allocator for InnoDB”](#).
- Controlling the types of data change operations for which InnoDB buffers the changed data, to avoid frequent small disk writes. See [Configuring Change Buffering](#). Because the default is to buffer all types of data change operations, only change this setting if you need to reduce the amount of buffering.

- Turning the adaptive hash indexing feature on and off using the `innodb_adaptive_hash_index` option. See [Section 14.5.3, “Adaptive Hash Index”](#) for more information. You might change this setting during periods of unusual activity, then restore it to its original setting.
- Setting a limit on the number of concurrent threads that InnoDB processes, if context switching is a bottleneck. See [Section 14.8.5, “Configuring Thread Concurrency for InnoDB”](#).
- Controlling the amount of prefetching that InnoDB does with its read-ahead operations. When the system has unused I/O capacity, more read-ahead can improve the performance of queries. Too much read-ahead can cause periodic drops in performance on a heavily loaded system. See [Section 14.8.3.4, “Configuring InnoDB Buffer Pool Prefetching \(Read-Ahead\)”](#).
- Increasing the number of background threads for read or write operations, if you have a high-end I/O subsystem that is not fully utilized by the default values. See [Section 14.8.6, “Configuring the Number of Background InnoDB I/O Threads”](#).
- Controlling how much I/O InnoDB performs in the background. See [Section 14.8.8, “Configuring InnoDB I/O Capacity”](#). You might scale back this setting if you observe periodic drops in performance.
- Controlling the algorithm that determines when InnoDB performs certain types of background writes. See [Section 14.8.3.5, “Configuring Buffer Pool Flushing”](#). The algorithm works for some types of workloads but not others, so might turn off this setting if you observe periodic drops in performance.
- Taking advantage of multicore processors and their cache memory configuration, to minimize delays in context switching. See [Section 14.8.9, “Configuring Spin Lock Polling”](#).
- Preventing one-time operations such as table scans from interfering with the frequently accessed data stored in the InnoDB buffer cache. See [Section 14.8.3.3, “Making the Buffer Pool Scan Resistant”](#).
- Adjusting log files to a size that makes sense for reliability and crash recovery. InnoDB log files have often been kept small to avoid long startup times after a crash. Optimizations introduced in MySQL 5.5 speed up certain steps of the crash [recovery](#) process. In particular, scanning the [redo log](#) and applying the redo log are faster due to improved algorithms for memory management. If you have kept your log files artificially small to avoid long startup times, you can now consider increasing log file size to reduce the I/O that occurs due recycling of redo log records.
- Configuring the size and number of instances for the InnoDB buffer pool, especially important for systems with multi-gigabyte buffer pools. See [Section 14.8.3.2, “Configuring Multiple Buffer Pool Instances”](#).
- Increasing the maximum number of concurrent transactions, which dramatically improves scalability for the busiest databases. See [Section 14.6.7, “Undo Logs”](#).
- Moving purge operations (a type of garbage collection) into a background thread. See [Section 14.8.10, “Purge Configuration”](#). To effectively measure the results of this setting, tune the other I/O-related and thread-related configuration settings first.
- Reducing the amount of switching that InnoDB does between concurrent threads, so that SQL operations on a busy server do not queue up and form a “traffic jam”. Set a value for the `innodb_thread_concurrency` option, up to approximately 32 for a high-powered modern system. Increase the value for the `innodb_concurrency_tickets` option, typically to 5000 or so. This combination of options sets a cap on the number of threads that InnoDB processes at any one time, and allows each thread to do substantial work before being swapped out, so that the number of waiting threads stays low and operations can complete without excessive context switching.

## 8.5.10 Optimizing InnoDB for Systems with Many Tables

- If you have configured [non-persistent optimizer statistics](#) (a non-default configuration), InnoDB computes index [cardinality](#) values for a table the first time that table is accessed after startup, instead of storing such values in the table. This step can take significant time on systems that partition the data into many tables. Since this overhead only applies to the initial table open operation, to “warm up” a table for later use, access it immediately after startup by issuing a statement such as `SELECT 1 FROM tbl_name LIMIT 1`.

Optimizer statistics are persisted to disk by default, enabled by the `innodb_stats_persistent` configuration option. For information about persistent optimizer statistics, see [Section 14.8.11.1](#), “Configuring Persistent Optimizer Statistics Parameters”.

## 8.6 Optimizing for MyISAM Tables

The [MyISAM](#) storage engine performs best with read-mostly data or with low-concurrency operations, because table locks limit the ability to perform simultaneous updates. In MySQL, InnoDB is the default storage engine rather than [MyISAM](#).

### 8.6.1 Optimizing MyISAM Queries

Some general tips for speeding up queries on [MyISAM](#) tables:

- To help MySQL better optimize queries, use `ANALYZE TABLE` or run `myisamchk --analyze` on a table after it has been loaded with data. This updates a value for each index part that indicates the average number of rows that have the same value. (For unique indexes, this is always 1.) MySQL uses this to decide which index to choose when you join two tables based on a nonconstant expression. You can check the result from the table analysis by using `SHOW INDEX FROM tbl_name` and examining the [Cardinality](#) value. `myisamchk --description --verbose` shows index distribution information.
- To sort an index and data according to an index, use `myisamchk --sort-index --sort-records=1` (assuming that you want to sort on index 1). This is a good way to make queries faster if you have a unique index from which you want to read all rows in order according to the index. The first time you sort a large table this way, it may take a long time.
- Try to avoid complex `SELECT` queries on [MyISAM](#) tables that are updated frequently, to avoid problems with table locking that occur due to contention between readers and writers.
- [MyISAM](#) supports concurrent inserts: If a table has no free blocks in the middle of the data file, you can `INSERT` new rows into it at the same time that other threads are reading from the table. If it is important to be able to do this, consider using the table in ways that avoid deleting rows. Another possibility is to run `OPTIMIZE TABLE` to defragment the table after you have deleted a lot of rows from it. This behavior is altered by setting the `concurrent_insert` variable. You can force new rows to be appended (and therefore permit concurrent inserts), even in tables that have deleted rows. See [Section 8.11.3](#), “Concurrent Inserts”.
- For [MyISAM](#) tables that change frequently, try to avoid all variable-length columns (`VARCHAR`, `BLOB`, and `TEXT`). The table uses dynamic row format if it includes even a single variable-length column. See [Chapter 15, Alternative Storage Engines](#).
- It is normally not useful to split a table into different tables just because the rows become large. In accessing a row, the biggest performance hit is the disk seek needed to find the first byte of the row. After finding the data, most modern disks can read the entire row fast enough for most applications. The only cases where splitting up a table makes an appreciable difference is if it is a [MyISAM](#) table using

dynamic row format that you can change to a fixed row size, or if you very often need to scan the table but do not need most of the columns. See [Chapter 15, Alternative Storage Engines](#).

- Use `ALTER TABLE ... ORDER BY expr1, expr2, ...` if you usually retrieve rows in *expr1*, *expr2*, ... order. By using this option after extensive changes to the table, you may be able to get higher performance.
- If you often need to calculate results such as counts based on information from a lot of rows, it may be preferable to introduce a new table and update the counter in real time. An update of the following form is very fast:

```
UPDATE tbl_name SET count_col=count_col+1 WHERE key_col=constant;
```

This is very important when you use MySQL storage engines such as `MyISAM` that has only table-level locking (multiple readers with single writers). This also gives better performance with most database systems, because the row locking manager in this case has less to do.

- Use `OPTIMIZE TABLE` periodically to avoid fragmentation with dynamic-format `MyISAM` tables. See [Section 15.2.3, “MyISAM Table Storage Formats”](#).
- Declaring a `MyISAM` table with the `DELAY_KEY_WRITE=1` table option makes index updates faster because they are not flushed to disk until the table is closed. The downside is that if something kills the server while such a table is open, you must ensure that the table is okay by running the server with the `myisam_recover_options` system variable set, or by running `myisamchk` before restarting the server. (However, even in this case, you should not lose anything by using `DELAY_KEY_WRITE`, because the key information can always be generated from the data rows.)
- Strings are automatically prefix- and end-space compressed in `MyISAM` indexes. See [Section 13.1.14, “CREATE INDEX Statement”](#).
- You can increase performance by caching queries or answers in your application and then executing many inserts or updates together. Locking the table during this operation ensures that the index cache is only flushed once after all updates. You can also take advantage of MySQL's query cache to achieve similar results; see [Section 8.10.3, “The MySQL Query Cache”](#).

## 8.6.2 Bulk Data Loading for MyISAM Tables

These performance tips supplement the general guidelines for fast inserts in [Section 8.2.4.1, “Optimizing INSERT Statements”](#).

- For a `MyISAM` table, you can use concurrent inserts to add rows at the same time that `SELECT` statements are running, if there are no deleted rows in middle of the data file. See [Section 8.11.3, “Concurrent Inserts”](#).
- With some extra work, it is possible to make `LOAD DATA` run even faster for a `MyISAM` table when the table has many indexes. Use the following procedure:
  1. Execute a `FLUSH TABLES` statement or a `mysqladmin flush-tables` command.
  2. Use `myisamchk --keys-used=0 -rq /path/to/db/tbl_name` to remove all use of indexes for the table.
  3. Insert data into the table with `LOAD DATA`. This does not update any indexes and therefore is very fast.
  4. If you intend only to read from the table in the future, use `myisampack` to compress it. See [Section 15.2.3.3, “Compressed Table Characteristics”](#).

5. Re-create the indexes with `myisamchk -rq /path/to/db/tbl_name`. This creates the index tree in memory before writing it to disk, which is much faster than updating the index during `LOAD DATA` because it avoids lots of disk seeks. The resulting index tree is also perfectly balanced.
6. Execute a `FLUSH TABLES` statement or a `mysqladmin flush-tables` command.

`LOAD DATA` performs the preceding optimization automatically if the `MyISAM` table into which you insert data is empty. The main difference between automatic optimization and using the procedure explicitly is that you can let `myisamchk` allocate much more temporary memory for the index creation than you might want the server to allocate for index re-creation when it executes the `LOAD DATA` statement.

You can also disable or enable the nonunique indexes for a `MyISAM` table by using the following statements rather than `myisamchk`. If you use these statements, you can skip the `FLUSH TABLES` operations:

```
ALTER TABLE tbl_name DISABLE KEYS;
ALTER TABLE tbl_name ENABLE KEYS;
```

- To speed up `INSERT` operations that are performed with multiple statements for nontransactional tables, lock your tables:

```
LOCK TABLES a WRITE;
INSERT INTO a VALUES (1,23),(2,34),(4,33);
INSERT INTO a VALUES (8,26),(6,29);
...
UNLOCK TABLES;
```

This benefits performance because the index buffer is flushed to disk only once, after all `INSERT` statements have completed. Normally, there would be as many index buffer flushes as there are `INSERT` statements. Explicit locking statements are not needed if you can insert all rows with a single `INSERT`.

Locking also lowers the total time for multiple-connection tests, although the maximum wait time for individual connections might go up because they wait for locks. Suppose that five clients attempt to perform inserts simultaneously as follows:

- Connection 1 does 1000 inserts
- Connections 2, 3, and 4 do 1 insert
- Connection 5 does 1000 inserts

If you do not use locking, connections 2, 3, and 4 finish before 1 and 5. If you use locking, connections 2, 3, and 4 probably do not finish before 1 or 5, but the total time should be about 40% faster.

`INSERT`, `UPDATE`, and `DELETE` operations are very fast in MySQL, but you can obtain better overall performance by adding locks around everything that does more than about five successive inserts or updates. If you do very many successive inserts, you could do a `LOCK TABLES` followed by an `UNLOCK TABLES` once in a while (each 1,000 rows or so) to permit other threads to access table. This would still result in a nice performance gain.

`INSERT` is still much slower for loading data than `LOAD DATA`, even when using the strategies just outlined.

- To increase performance for `MyISAM` tables, for both `LOAD DATA` and `INSERT`, enlarge the key cache by increasing the `key_buffer_size` system variable. See [Section 5.1.1, “Configuring the Server”](#).

## 8.6.3 Optimizing REPAIR TABLE Statements

`REPAIR TABLE` for `MyISAM` tables is similar to using `myisamchk` for repair operations, and some of the same performance optimizations apply:

- `myisamchk` has variables that control memory allocation. You may be able to improve its performance by setting these variables, as described in [Section 4.6.3.6, “myisamchk Memory Usage”](#).
- For `REPAIR TABLE`, the same principle applies, but because the repair is done by the server, you set server system variables instead of `myisamchk` variables. Also, in addition to setting memory-allocation variables, increasing the `myisam_max_sort_file_size` system variable increases the likelihood that the repair uses the faster filesort method and avoids the slower repair by key cache method. Set the variable to the maximum file size for your system, after checking to be sure that there is enough free space to hold a copy of the table files. The free space must be available in the file system containing the original table files.

Suppose that a `myisamchk` table-repair operation is done using the following options to set its memory-allocation variables:

```
--key_buffer_size=128M --myisam_sort_buffer_size=256M
--read_buffer_size=64M --write_buffer_size=64M
```

Some of those `myisamchk` variables correspond to server system variables:

<code>myisamchk</code> Variable	System Variable
<code>key_buffer_size</code>	<code>key_buffer_size</code>
<code>myisam_sort_buffer_size</code>	<code>myisam_sort_buffer_size</code>
<code>read_buffer_size</code>	<code>read_buffer_size</code>
<code>write_buffer_size</code>	none

Each of the server system variables can be set at runtime, and some of them (`myisam_sort_buffer_size`, `read_buffer_size`) have a session value in addition to a global value. Setting a session value limits the effect of the change to your current session and does not affect other users. Changing a global-only variable (`key_buffer_size`, `myisam_max_sort_file_size`) affects other users as well. For `key_buffer_size`, you must take into account that the buffer is shared with those users. For example, if you set the `myisamchk key_buffer_size` variable to 128MB, you could set the corresponding `key_buffer_size` system variable larger than that (if it is not already set larger), to permit key buffer use by activity in other sessions. However, changing the global key buffer size invalidates the buffer, causing increased disk I/O and slowdown for other sessions. An alternative that avoids this problem is to use a separate key cache, assign to it the indexes from the table to be repaired, and deallocate it when the repair is complete. See [Section 8.10.2.2, “Multiple Key Caches”](#).

Based on the preceding remarks, a `REPAIR TABLE` operation can be done as follows to use settings similar to the `myisamchk` command. Here a separate 128MB key buffer is allocated and the file system is assumed to permit a file size of at least 100GB.

```
SET SESSION myisam_sort_buffer_size = 256*1024*1024;
SET SESSION read_buffer_size = 64*1024*1024;
SET GLOBAL myisam_max_sort_file_size = 100*1024*1024*1024;
SET GLOBAL repair_cache.key_buffer_size = 128*1024*1024;
CACHE INDEX tbl_name IN repair_cache;
LOAD INDEX INTO CACHE tbl_name;
REPAIR TABLE tbl_name ;
SET GLOBAL repair_cache.key_buffer_size = 0;
```

If you intend to change a global variable but want to do so only for the duration of a `REPAIR TABLE` operation to minimally affect other users, save its value in a user variable and restore it afterward. For example:

```
SET @old_myisam_sort_buffer_size = @@GLOBAL.myisam_max_sort_file_size;
```



```
SET GLOBAL myisam_max_sort_file_size = 100*1024*1024*1024;
REPAIR TABLE tbl_name ;
SET GLOBAL myisam_max_sort_file_size = @old_myisam_max_sort_file_size;
```

The system variables that affect `REPAIR TABLE` can be set globally at server startup if you want the values to be in effect by default. For example, add these lines to the server `my.cnf` file:

```
[mysqld]
myisam_sort_buffer_size=256M
key_buffer_size=1G
myisam_max_sort_file_size=100G
```

These settings do not include `read_buffer_size`. Setting `read_buffer_size` globally to a large value does so for all sessions and can cause performance to suffer due to excessive memory allocation for a server with many simultaneous sessions.

## 8.7 Optimizing for MEMORY Tables

Consider using `MEMORY` tables for noncritical data that is accessed often, and is read-only or rarely updated. Benchmark your application against equivalent `InnoDB` or `MyISAM` tables under a realistic workload, to confirm that any additional performance is worth the risk of losing data, or the overhead of copying data from a disk-based table at application start.

For best performance with `MEMORY` tables, examine the kinds of queries against each table, and specify the type to use for each associated index, either a B-tree index or a hash index. On the `CREATE INDEX` statement, use the clause `USING BTREE` or `USING HASH`. B-tree indexes are fast for queries that do greater-than or less-than comparisons through operators such as `>` or `BETWEEN`. Hash indexes are only fast for queries that look up single values through the `=` operator, or a restricted set of values through the `IN` operator. For why `USING BTREE` is often a better choice than the default `USING HASH`, see [Section 8.2.1.20, “Avoiding Full Table Scans”](#). For implementation details of the different types of `MEMORY` indexes, see [Section 8.3.8, “Comparison of B-Tree and Hash Indexes”](#).

## 8.8 Understanding the Query Execution Plan

Depending on the details of your tables, columns, indexes, and the conditions in your `WHERE` clause, the MySQL optimizer considers many techniques to efficiently perform the lookups involved in an SQL query. A query on a huge table can be performed without reading all the rows; a join involving several tables can be performed without comparing every combination of rows. The set of operations that the optimizer chooses to perform the most efficient query is called the “query execution plan”, also known as the `EXPLAIN` plan. Your goals are to recognize the aspects of the `EXPLAIN` plan that indicate a query is optimized well, and to learn the SQL syntax and indexing techniques to improve the plan if you see some inefficient operations.

### 8.8.1 Optimizing Queries with EXPLAIN

The `EXPLAIN` statement provides information about how MySQL executes statements:

- `EXPLAIN` works with `SELECT`, `DELETE`, `INSERT`, `REPLACE`, and `UPDATE` statements.
- When `EXPLAIN` is used with an explainable statement, MySQL displays information from the optimizer about the statement execution plan. That is, MySQL explains how it would process the statement, including information about how tables are joined and in which order. For information about using `EXPLAIN` to obtain execution plan information, see [Section 8.8.2, “EXPLAIN Output Format”](#).
- When `EXPLAIN` is used with `FOR CONNECTION connection_id` rather than an explainable statement, it displays the execution plan for the statement executing in the named connection. See [Section 8.8.4, “Obtaining Execution Plan Information for a Named Connection”](#).

- For `SELECT` statements, `EXPLAIN` produces additional execution plan information that can be displayed using `SHOW WARNINGS`. See [Section 8.8.3, “Extended EXPLAIN Output Format”](#).
- `EXPLAIN` is useful for examining queries involving partitioned tables. See [Section 22.3.5, “Obtaining Information About Partitions”](#).
- The `FORMAT` option can be used to select the output format. `TRADITIONAL` presents the output in tabular format. This is the default if no `FORMAT` option is present. `JSON` format displays the information in JSON format.

With the help of `EXPLAIN`, you can see where you should add indexes to tables so that the statement executes faster by using indexes to find rows. You can also use `EXPLAIN` to check whether the optimizer joins the tables in an optimal order. To give a hint to the optimizer to use a join order corresponding to the order in which the tables are named in a `SELECT` statement, begin the statement with `SELECT STRAIGHT_JOIN` rather than just `SELECT`. (See [Section 13.2.9, “SELECT Statement”](#).) However, `STRAIGHT_JOIN` may prevent indexes from being used because it disables semijoin transformations. See [Section 8.2.2.1, “Optimizing Subqueries, Derived Tables, and View References with Semijoin Transformations”](#).

The optimizer trace may sometimes provide information complementary to that of `EXPLAIN`. However, the optimizer trace format and content are subject to change between versions. For details, see [Section 8.15, “Tracing the Optimizer”](#).

If you have a problem with indexes not being used when you believe that they should be, run `ANALYZE TABLE` to update table statistics, such as cardinality of keys, that can affect the choices the optimizer makes. See [Section 13.7.2.1, “ANALYZE TABLE Statement”](#).



#### Note

`EXPLAIN` can also be used to obtain information about the columns in a table. `EXPLAIN tbl_name` is synonymous with `DESCRIBE tbl_name` and `SHOW COLUMNS FROM tbl_name`. For more information, see [Section 13.8.1, “DESCRIBE Statement”](#), and [Section 13.7.5.5, “SHOW COLUMNS Statement”](#).

## 8.8.2 EXPLAIN Output Format

The `EXPLAIN` statement provides information about how MySQL executes statements. `EXPLAIN` works with `SELECT`, `DELETE`, `INSERT`, `REPLACE`, and `UPDATE` statements.

`EXPLAIN` returns a row of information for each table used in the `SELECT` statement. It lists the tables in the output in the order that MySQL would read them while processing the statement. MySQL resolves all joins using a nested-loop join method. This means that MySQL reads a row from the first table, and then finds a matching row in the second table, the third table, and so on. When all tables are processed, MySQL outputs the selected columns and backtracks through the table list until a table is found for which there are more matching rows. The next row is read from this table and the process continues with the next table.

`EXPLAIN` output includes partition information. Also, for `SELECT` statements, `EXPLAIN` generates extended information that can be displayed with `SHOW WARNINGS` following the `EXPLAIN` (see [Section 8.8.3, “Extended EXPLAIN Output Format”](#)).



#### Note

In older MySQL releases, partition and extended information was produced using `EXPLAIN PARTITIONS` and `EXPLAIN EXTENDED`. Those syntaxes are still recognized for backward compatibility but partition and extended output is now enabled by default, so the `PARTITIONS` and `EXTENDED` keywords are superfluous

and deprecated. Their use results in a warning; expect them to be removed from `EXPLAIN` syntax in a future MySQL release.

You cannot use the deprecated `PARTITIONS` and `EXTENDED` keywords together in the same `EXPLAIN` statement. In addition, neither of these keywords can be used together with the `FORMAT` option.



#### Note

MySQL Workbench has a Visual Explain capability that provides a visual representation of `EXPLAIN` output. See [Tutorial: Using Explain to Improve Query Performance](#).

- [EXPLAIN Output Columns](#)
- [EXPLAIN Join Types](#)
- [EXPLAIN Extra Information](#)
- [EXPLAIN Output Interpretation](#)

## EXPLAIN Output Columns

This section describes the output columns produced by `EXPLAIN`. Later sections provide additional information about the `type` and `Extra` columns.

Each output row from `EXPLAIN` provides information about one table. Each row contains the values summarized in [Table 8.1, “EXPLAIN Output Columns”](#), and described in more detail following the table. Column names are shown in the table’s first column; the second column provides the equivalent property name shown in the output when `FORMAT=JSON` is used.

**Table 8.1 EXPLAIN Output Columns**

Column	JSON Name	Meaning
<code>id</code>	<code>select_id</code>	The <code>SELECT</code> identifier
<code>select_type</code>	None	The <code>SELECT</code> type
<code>table</code>	<code>table_name</code>	The table for the output row
<code>partitions</code>	<code>partitions</code>	The matching partitions
<code>type</code>	<code>access_type</code>	The join type
<code>possible_keys</code>	<code>possible_keys</code>	The possible indexes to choose
<code>key</code>	<code>key</code>	The index actually chosen
<code>key_len</code>	<code>key_length</code>	The length of the chosen key
<code>ref</code>	<code>ref</code>	The columns compared to the index
<code>rows</code>	<code>rows</code>	Estimate of rows to be examined
<code>filtered</code>	<code>filtered</code>	Percentage of rows filtered by table condition
<code>Extra</code>	None	Additional information



#### Note

JSON properties which are `NULL` are not displayed in JSON-formatted `EXPLAIN` output.

- `id` (JSON name: `select_id`)

The `SELECT` identifier. This is the sequential number of the `SELECT` within the query. The value can be `NULL` if the row refers to the union result of other rows. In this case, the `table` column shows a value like `<unionM,N>` to indicate that the row refers to the union of the rows with `id` values of `M` and `N`.

- `select_type` (JSON name: none)

The type of `SELECT`, which can be any of those shown in the following table. A JSON-formatted `EXPLAIN` exposes the `SELECT` type as a property of a `query_block`, unless it is `SIMPLE` or `PRIMARY`. The JSON names (where applicable) are also shown in the table.

<code>select_type</code> Value	JSON Name	Meaning
<code>SIMPLE</code>	None	Simple <code>SELECT</code> (not using <code>UNION</code> or subqueries)
<code>PRIMARY</code>	None	Outermost <code>SELECT</code>
<code>UNION</code>	None	Second or later <code>SELECT</code> statement in a <code>UNION</code>
<code>DEPENDENT UNION</code>	<code>dependent (true)</code>	Second or later <code>SELECT</code> statement in a <code>UNION</code> , dependent on outer query
<code>UNION RESULT</code>	<code>union_result</code>	Result of a <code>UNION</code> .
<code>SUBQUERY</code>	None	First <code>SELECT</code> in subquery
<code>DEPENDENT SUBQUERY</code>	<code>dependent (true)</code>	First <code>SELECT</code> in subquery, dependent on outer query
<code>DERIVED</code>	None	Derived table
<code>MATERIALIZED</code>	<code>materialized_from_subquery</code>	Materialized subquery
<code>UNCACHEABLE SUBQUERY</code>	<code>cacheable (false)</code>	A subquery for which the result cannot be cached and must be re-evaluated for each row of the outer query
<code>UNCACHEABLE UNION</code>	<code>cacheable (false)</code>	The second or later select in a <code>UNION</code> that belongs to an uncacheable subquery (see <code>UNCACHEABLE SUBQUERY</code> )

`DEPENDENT` typically signifies the use of a correlated subquery. See [Section 13.2.10.7, “Correlated Subqueries”](#).

`DEPENDENT SUBQUERY` evaluation differs from `UNCACHEABLE SUBQUERY` evaluation. For `DEPENDENT SUBQUERY`, the subquery is re-evaluated only once for each set of different values of the variables from its outer context. For `UNCACHEABLE SUBQUERY`, the subquery is re-evaluated for each row of the outer context.

Cacheability of subqueries differs from caching of query results in the query cache (which is described in [Section 8.10.3.1, “How the Query Cache Operates”](#)). Subquery caching occurs during query execution, whereas the query cache is used to store results only after query execution finishes.

When you specify `FORMAT=JSON` with `EXPLAIN`, the output has no single property directly equivalent to `select_type`; the `query_block` property corresponds to a given `SELECT`. Properties equivalent to most of the `SELECT` subquery types just shown are available (an example being

`materialized_from_subquery` for `MATERIALIZED`), and are displayed when appropriate. There are no JSON equivalents for `SIMPLE` or `PRIMARY`.

The `select_type` value for non-`SELECT` statements displays the statement type for affected tables. For example, `select_type` is `DELETE` for `DELETE` statements.

- `table` (JSON name: `table_name`)

The name of the table to which the row of output refers. This can also be one of the following values:

- `<unionM,N>`: The row refers to the union of the rows with `id` values of `M` and `N`.
- `<derivedN>`: The row refers to the derived table result for the row with an `id` value of `N`. A derived table may result, for example, from a subquery in the `FROM` clause.
- `<subqueryN>`: The row refers to the result of a materialized subquery for the row with an `id` value of `N`. See [Section 8.2.2.2, “Optimizing Subqueries with Materialization”](#).

- `partitions` (JSON name: `partitions`)

The partitions from which records would be matched by the query. The value is `NULL` for nonpartitioned tables. See [Section 22.3.5, “Obtaining Information About Partitions”](#).

- `type` (JSON name: `access_type`)

The join type. For descriptions of the different types, see [EXPLAIN Join Types](#).

- `possible_keys` (JSON name: `possible_keys`)

The `possible_keys` column indicates the indexes from which MySQL can choose to find the rows in this table. Note that this column is totally independent of the order of the tables as displayed in the output from `EXPLAIN`. That means that some of the keys in `possible_keys` might not be usable in practice with the generated table order.

If this column is `NULL` (or undefined in JSON-formatted output), there are no relevant indexes. In this case, you may be able to improve the performance of your query by examining the `WHERE` clause to check whether it refers to some column or columns that would be suitable for indexing. If so, create an appropriate index and check the query with `EXPLAIN` again. See [Section 13.1.8, “ALTER TABLE Statement”](#).

To see what indexes a table has, use `SHOW INDEX FROM tbl_name`.

- `key` (JSON name: `key`)

The `key` column indicates the key (index) that MySQL actually decided to use. If MySQL decides to use one of the `possible_keys` indexes to look up rows, that index is listed as the key value.

It is possible for `key` to name an index that is not present in the `possible_keys` value. This can happen if none of the `possible_keys` indexes are suitable for looking up rows, but all the columns selected by the query are columns of some other index. That is, the named index covers the selected

columns, so although it is not used to determine which rows to retrieve, an index scan is more efficient than a data row scan.

For `InnoDB`, a secondary index might cover the selected columns even if the query also selects the primary key because `InnoDB` stores the primary key value with each secondary index. If `key` is `NULL`, MySQL found no index to use for executing the query more efficiently.

To force MySQL to use or ignore an index listed in the `possible_keys` column, use `FORCE INDEX`, `USE INDEX`, or `IGNORE INDEX` in your query. See [Section 8.9.4, “Index Hints”](#).

For `MyISAM` tables, running `ANALYZE TABLE` helps the optimizer choose better indexes. For `MyISAM` tables, `myisamchk --analyze` does the same. See [Section 13.7.2.1, “ANALYZE TABLE Statement”](#), and [Section 7.6, “MyISAM Table Maintenance and Crash Recovery”](#).

- `key_len` (JSON name: `key_length`)

The `key_len` column indicates the length of the key that MySQL decided to use. The value of `key_len` enables you to determine how many parts of a multiple-part key MySQL actually uses. If the `key` column says `NULL`, the `key_len` column also says `NULL`.

Due to the key storage format, the key length is one greater for a column that can be `NULL` than for a `NOT NULL` column.

- `ref` (JSON name: `ref`)

The `ref` column shows which columns or constants are compared to the index named in the `key` column to select rows from the table.

If the value is `func`, the value used is the result of some function. To see which function, use `SHOW WARNINGS` following `EXPLAIN` to see the extended `EXPLAIN` output. The function might actually be an operator such as an arithmetic operator.

- `rows` (JSON name: `rows`)

The `rows` column indicates the number of rows MySQL believes it must examine to execute the query.

For `InnoDB` tables, this number is an estimate, and may not always be exact.

- `filtered` (JSON name: `filtered`)

The `filtered` column indicates an estimated percentage of table rows filtered by the table condition. The maximum value is 100, which means no filtering of rows occurred. Values decreasing from 100 indicate increasing amounts of filtering. `rows` shows the estimated number of rows examined and `rows × filtered` shows the number of rows joined with the following table. For example, if `rows` is 1000 and `filtered` is 50.00 (50%), the number of rows to be joined with the following table is  $1000 \times 50\% = 500$ .

- `Extra` (JSON name: `none`)

This column contains additional information about how MySQL resolves the query. For descriptions of the different values, see [EXPLAIN Extra Information](#).

There is no single JSON property corresponding to the `Extra` column; however, values that can occur in this column are exposed as JSON properties, or as the text of the `message` property.

## EXPLAIN Join Types

The `type` column of `EXPLAIN` output describes how tables are joined. In JSON-formatted output, these are found as values of the `access_type` property. The following list describes the join types, ordered from the best type to the worst:

- `system`

The table has only one row (= system table). This is a special case of the `const` join type.

- `const`

The table has at most one matching row, which is read at the start of the query. Because there is only one row, values from the column in this row can be regarded as constants by the rest of the optimizer. `const` tables are very fast because they are read only once.

`const` is used when you compare all parts of a `PRIMARY KEY` or `UNIQUE` index to constant values. In the following queries, `tbl_name` can be used as a `const` table:

```
SELECT * FROM tbl_name WHERE primary_key=1;

SELECT * FROM tbl_name
WHERE primary_key_part1=1 AND primary_key_part2=2;
```

- `eq_ref`

One row is read from this table for each combination of rows from the previous tables. Other than the `system` and `const` types, this is the best possible join type. It is used when all parts of an index are used by the join and the index is a `PRIMARY KEY` or `UNIQUE NOT NULL` index.

`eq_ref` can be used for indexed columns that are compared using the `=` operator. The comparison value can be a constant or an expression that uses columns from tables that are read before this table. In the following examples, MySQL can use an `eq_ref` join to process `ref_table`:

```
SELECT * FROM ref_table,other_table
WHERE ref_table.key_column=other_table.column;

SELECT * FROM ref_table,other_table
WHERE ref_table.key_column_part1=other_table.column
AND ref_table.key_column_part2=1;
```

- `ref`

All rows with matching index values are read from this table for each combination of rows from the previous tables. `ref` is used if the join uses only a leftmost prefix of the key or if the key is not a `PRIMARY KEY` or `UNIQUE` index (in other words, if the join cannot select a single row based on the key value). If the key that is used matches only a few rows, this is a good join type.

`ref` can be used for indexed columns that are compared using the `=` or `<=>` operator. In the following examples, MySQL can use a `ref` join to process `ref_table`:

```
SELECT * FROM ref_table WHERE key_column=expr;

SELECT * FROM ref_table,other_table
WHERE ref_table.key_column=other_table.column;

SELECT * FROM ref_table,other_table
WHERE ref_table.key_column_part1=other_table.column
AND ref_table.key_column_part2=1;
```

- `fulltext`

The join is performed using a `FULLTEXT` index.

- `ref_or_null`

This join type is like `ref`, but with the addition that MySQL does an extra search for rows that contain `NULL` values. This join type optimization is used most often in resolving subqueries. In the following examples, MySQL can use a `ref_or_null` join to process `ref_table`:

```
SELECT * FROM ref_table
WHERE key_column=expr OR key_column IS NULL;
```

See [Section 8.2.1.13, “IS NULL Optimization”](#).

- `index_merge`

This join type indicates that the Index Merge optimization is used. In this case, the `key` column in the output row contains a list of indexes used, and `key_len` contains a list of the longest key parts for the indexes used. For more information, see [Section 8.2.1.3, “Index Merge Optimization”](#).

- `unique_subquery`

This type replaces `eq_ref` for some `IN` subqueries of the following form:

```
value IN (SELECT primary_key FROM single_table WHERE some_expr)
```

`unique_subquery` is just an index lookup function that replaces the subquery completely for better efficiency.

- `index_subquery`

This join type is similar to `unique_subquery`. It replaces `IN` subqueries, but it works for nonunique indexes in subqueries of the following form:

```
value IN (SELECT key_column FROM single_table WHERE some_expr)
```

- `range`

Only rows that are in a given range are retrieved, using an index to select the rows. The `key` column in the output row indicates which index is used. The `key_len` contains the longest key part that was used. The `ref` column is `NULL` for this type.

`range` can be used when a key column is compared to a constant using any of the `=`, `<>`, `>`, `>=`, `<`, `<=`, `IS NULL`, `<=>`, `BETWEEN`, `LIKE`, or `IN()` operators:

```
SELECT * FROM tbl_name
WHERE key_column = 10;

SELECT * FROM tbl_name
WHERE key_column BETWEEN 10 and 20;

SELECT * FROM tbl_name
WHERE key_column IN (10,20,30);

SELECT * FROM tbl_name
WHERE key_part1 = 10 AND key_part2 IN (10,20,30);
```



- `index`

The `index` join type is the same as `ALL`, except that the index tree is scanned. This occurs two ways:

- If the index is a covering index for the queries and can be used to satisfy all data required from the table, only the index tree is scanned. In this case, the `Extra` column says `Using index`. An index-only scan usually is faster than `ALL` because the size of the index usually is smaller than the table data.
- A full table scan is performed using reads from the index to look up data rows in index order. `Uses index` does not appear in the `Extra` column.

MySQL can use this join type when the query uses only columns that are part of a single index.

- `ALL`

A full table scan is done for each combination of rows from the previous tables. This is normally not good if the table is the first table not marked `const`, and usually *very bad* in all other cases. Normally, you can avoid `ALL` by adding indexes that enable row retrieval from the table based on constant values or column values from earlier tables.

## EXPLAIN Extra Information

The `Extra` column of `EXPLAIN` output contains additional information about how MySQL resolves the query. The following list explains the values that can appear in this column. Each item also indicates for JSON-formatted output which property displays the `Extra` value. For some of these, there is a specific property. The others display as the text of the `message` property.

If you want to make your queries as fast as possible, look out for `Extra` column values of `Using filesort` and `Using temporary`, or, in JSON-formatted `EXPLAIN` output, for `using_filesort` and `using_temporary_table` properties equal to `true`.

- `Child of 'table' pushed join@1` (JSON: `message` text)

This table is referenced as the child of `table` in a join that can be pushed down to the NDB kernel. Applies only in NDB Cluster, when pushed-down joins are enabled. See the description of the `ndb_join_pushdown` server system variable for more information and examples.

- `const row not found` (JSON property: `const_row_not_found`)

For a query such as `SELECT ... FROM tbl_name`, the table was empty.

- `Deleting all rows` (JSON property: `message`)

For `DELETE`, some storage engines (such as `MyISAM`) support a handler method that removes all table rows in a simple and fast way. This `Extra` value is displayed if the engine uses this optimization.

- `Distinct` (JSON property: `distinct`)

MySQL is looking for distinct values, so it stops searching for more rows for the current row combination after it has found the first matching row.

- `FirstMatch(tbl_name)` (JSON property: `first_match`)

The semijoin FirstMatch join shortcutting strategy is used for `tbl_name`.

- `Full scan on NULL key` (JSON property: `message`)

This occurs for subquery optimization as a fallback strategy when the optimizer cannot use an index-lookup access method.

- `Impossible HAVING` (JSON property: `message`)

The `HAVING` clause is always false and cannot select any rows.

- `Impossible WHERE` (JSON property: `message`)

The `WHERE` clause is always false and cannot select any rows.

- `Impossible WHERE noticed after reading const tables` (JSON property: `message`)

MySQL has read all `const` (and `system`) tables and notice that the `WHERE` clause is always false.

- `LooseScan(m..n)` (JSON property: `message`)

The semijoin LooseScan strategy is used. `m` and `n` are key part numbers.

- `No matching min/max row` (JSON property: `message`)

No row satisfies the condition for a query such as `SELECT MIN(...) FROM ... WHERE condition`.

- `no matching row in const table` (JSON property: `message`)

For a query with a join, there was an empty table or a table with no rows satisfying a unique index condition.

- `No matching rows after partition pruning` (JSON property: `message`)

For `DELETE` or `UPDATE`, the optimizer found nothing to delete or update after partition pruning. It is similar in meaning to `Impossible WHERE` for `SELECT` statements.

- `No tables used` (JSON property: `message`)

The query has no `FROM` clause, or has a `FROM DUAL` clause.

For `INSERT` or `REPLACE` statements, `EXPLAIN` displays this value when there is no `SELECT` part. For example, it appears for `EXPLAIN INSERT INTO t VALUES(10)` because that is equivalent to `EXPLAIN INSERT INTO t SELECT 10 FROM DUAL`.

- `Not exists` (JSON property: `message`)

MySQL was able to do a `LEFT JOIN` optimization on the query and does not examine more rows in this table for the previous row combination after it finds one row that matches the `LEFT JOIN` criteria. Here is an example of the type of query that can be optimized this way:

```
SELECT * FROM t1 LEFT JOIN t2 ON t1.id=t2.id
WHERE t2.id IS NULL;
```

Assume that `t2.id` is defined as `NOT NULL`. In this case, MySQL scans `t1` and looks up the rows in `t2` using the values of `t1.id`. If MySQL finds a matching row in `t2`, it knows that `t2.id` can never be `NULL`, and does not scan through the rest of the rows in `t2` that have the same `id` value. In other words, for each row in `t1`, MySQL needs to do only a single lookup in `t2`, regardless of how many rows actually match in `t2`.

- `Plan isn't ready yet` (JSON property: `none`)

This value occurs with `EXPLAIN FOR CONNECTION` when the optimizer has not finished creating the execution plan for the statement executing in the named connection. If execution plan output comprises multiple lines, any or all of them could have this `Extra` value, depending on the progress of the optimizer in determining the full execution plan.

- `Range checked for each record (index map: N)` (JSON property: `message`)

MySQL found no good index to use, but found that some of indexes might be used after column values from preceding tables are known. For each row combination in the preceding tables, MySQL checks whether it is possible to use a `range` or `index_merge` access method to retrieve rows. This is not very fast, but is faster than performing a join with no index at all. The applicability criteria are as described in [Section 8.2.1.2, “Range Optimization”](#), and [Section 8.2.1.3, “Index Merge Optimization”](#), with the exception that all column values for the preceding table are known and considered to be constants.

Indexes are numbered beginning with 1, in the same order as shown by `SHOW INDEX` for the table. The index map value `N` is a bitmask value that indicates which indexes are candidates. For example, a value of `0x19` (binary 11001) means that indexes 1, 4, and 5 are considered.

- `Scanned N databases` (JSON property: `message`)

This indicates how many directory scans the server performs when processing a query for `INFORMATION_SCHEMA` tables, as described in [Section 8.2.3, “Optimizing INFORMATION\\_SCHEMA Queries”](#). The value of `N` can be 0, 1, or `all`.

- `Select tables optimized away` (JSON property: `message`)

The optimizer determined 1) that at most one row should be returned, and 2) that to produce this row, a deterministic set of rows must be read. When the rows to be read can be read during the optimization phase (for example, by reading index rows), there is no need to read any tables during query execution.

The first condition is fulfilled when the query is implicitly grouped (contains an aggregate function but no `GROUP BY` clause). The second condition is fulfilled when one row lookup is performed per index used. The number of indexes read determines the number of rows to read.

Consider the following implicitly grouped query:

```
SELECT MIN(c1), MIN(c2) FROM t1;
```

Suppose that `MIN(c1)` can be retrieved by reading one index row and `MIN(c2)` can be retrieved by reading one row from a different index. That is, for each column `c1` and `c2`, there exists an index where

the column is the first column of the index. In this case, one row is returned, produced by reading two deterministic rows.

This `Extra` value does not occur if the rows to read are not deterministic. Consider this query:

```
SELECT MIN(c2) FROM t1 WHERE c1 <= 10;
```

Suppose that `(c1, c2)` is a covering index. Using this index, all rows with `c1 <= 10` must be scanned to find the minimum `c2` value. By contrast, consider this query:

```
SELECT MIN(c2) FROM t1 WHERE c1 = 10;
```

In this case, the first index row with `c1 = 10` contains the minimum `c2` value. Only one row must be read to produce the returned row.

For storage engines that maintain an exact row count per table (such as `MyISAM`, but not `InnoDB`), this `Extra` value can occur for `COUNT(*)` queries for which the `WHERE` clause is missing or always true and there is no `GROUP BY` clause. (This is an instance of an implicitly grouped query where the storage engine influences whether a deterministic number of rows can be read.)

- `Skip_open_table`, `Open_frm_only`, `Open_full_table` (JSON property: `message`)

These values indicate file-opening optimizations that apply to queries for `INFORMATION_SCHEMA` tables, as described in [Section 8.2.3, “Optimizing INFORMATION\\_SCHEMA Queries”](#).

- `Skip_open_table`: Table files do not need to be opened. The information has already become available within the query by scanning the database directory.
- `Open_frm_only`: Only the table's `.frm` file need be opened.
- `Open_full_table`: The unoptimized information lookup. The `.frm`, `.MYD`, and `.MYI` files must be opened.
- `Start temporary`, `End temporary` (JSON property: `message`)

This indicates temporary table use for the semijoin Duplicate Weedout strategy.

- `unique row not found` (JSON property: `message`)

For a query such as `SELECT ... FROM tbl_name`, no rows satisfy the condition for a `UNIQUE` index or `PRIMARY KEY` on the table.

- `Using filesort` (JSON property: `using_filesort`)

MySQL must do an extra pass to find out how to retrieve the rows in sorted order. The sort is done by going through all rows according to the join type and storing the sort key and pointer to the row for all rows that match the `WHERE` clause. The keys then are sorted and the rows are retrieved in sorted order. See [Section 8.2.1.14, “ORDER BY Optimization”](#).

- `Using index` (JSON property: `using_index`)

The column information is retrieved from the table using only information in the index tree without having to do an additional seek to read the actual row. This strategy can be used when the query uses only columns that are part of a single index.

For `InnoDB` tables that have a user-defined clustered index, that index can be used even when `Using index` is absent from the `Extra` column. This is the case if `type` is `index` and `key` is `PRIMARY`.

- `Using index condition` (JSON property: `using_index_condition`)

Tables are read by accessing index tuples and testing them first to determine whether to read full table rows. In this way, index information is used to defer (“push down”) reading full table rows unless it is necessary. See [Section 8.2.1.5, “Index Condition Pushdown Optimization”](#).

- `Using index for group-by` (JSON property: `using_index_for_group_by`)

Similar to the `Using index` table access method, `Using index for group-by` indicates that MySQL found an index that can be used to retrieve all columns of a `GROUP BY` or `DISTINCT` query without any extra disk access to the actual table. Additionally, the index is used in the most efficient way so that for each group, only a few index entries are read. For details, see [Section 8.2.1.15, “GROUP BY Optimization”](#).

- `Using join buffer (Block Nested Loop)`, `Using join buffer (Batched Key Access)` (JSON property: `using_join_buffer`)

Tables from earlier joins are read in portions into the join buffer, and then their rows are used from the buffer to perform the join with the current table. (`Block Nested Loop`) indicates use of the Block Nested-Loop algorithm and (`Batched Key Access`) indicates use of the Batched Key Access algorithm. That is, the keys from the table on the preceding line of the `EXPLAIN` output are buffered, and the matching rows are fetched in batches from the table represented by the line in which `Using join buffer` appears.

In JSON-formatted output, the value of `using_join_buffer` is always either one of `Block Nested Loop` or `Batched Key Access`.

For more information about these algorithms, see [Block Nested-Loop Join Algorithm](#), and [Batched Key Access Joins](#).

- `Using MRR` (JSON property: `message`)

Tables are read using the Multi-Range Read optimization strategy. See [Section 8.2.1.10, “Multi-Range Read Optimization”](#).

- `Using sort_union(...)`, `Using union(...)`, `Using intersect(...)` (JSON property: `message`)

These indicate the particular algorithm showing how index scans are merged for the `index_merge` join type. See [Section 8.2.1.3, “Index Merge Optimization”](#).

- `Using temporary` (JSON property: `using_temporary_table`)

To resolve the query, MySQL needs to create a temporary table to hold the result. This typically happens if the query contains `GROUP BY` and `ORDER BY` clauses that list columns differently.

- `Using where` (JSON property: `attached_condition`)

A `WHERE` clause is used to restrict which rows to match against the next table or send to the client. Unless you specifically intend to fetch or examine all rows from the table, you may have something wrong in your query if the `Extra` value is not `Using where` and the table join type is `ALL` or `index`.

`Using where` has no direct counterpart in JSON-formatted output; the `attached_condition` property contains any `WHERE` condition used.

- `Using where with pushed condition` (JSON property: `message`)

This item applies to [NDB tables](#) *only*. It means that NDB Cluster is using the Condition Pushdown optimization to improve the efficiency of a direct comparison between a nonindexed column and a constant. In such cases, the condition is “pushed down” to the cluster’s data nodes and is evaluated on all data nodes simultaneously. This eliminates the need to send nonmatching rows over the network, and can speed up such queries by a factor of 5 to 10 times over cases where Condition Pushdown could be but is not used. For more information, see [Section 8.2.1.4, “Engine Condition Pushdown Optimization”](#).

- `Zero limit` (JSON property: `message`)

The query had a `LIMIT 0` clause and cannot select any rows.

## EXPLAIN Output Interpretation

You can get a good indication of how good a join is by taking the product of the values in the `rows` column of the `EXPLAIN` output. This should tell you roughly how many rows MySQL must examine to execute the query. If you restrict queries with the `max_join_size` system variable, this row product also is used to determine which multiple-table `SELECT` statements to execute and which to abort. See [Section 5.1.1, “Configuring the Server”](#).

The following example shows how a multiple-table join can be optimized progressively based on the information provided by `EXPLAIN`.

Suppose that you have the `SELECT` statement shown here and that you plan to examine it using `EXPLAIN`:

```
EXPLAIN SELECT tt.TicketNumber, tt.TimeIn,
             tt.ProjectReference, tt.EstimatedShipDate,
             tt.ActualShipDate, tt.ClientID,
             tt.ServiceCodes, tt.RepetitiveID,
             tt.CurrentProcess, tt.CurrentDPPerson,
             tt.RecordVolume, tt.DPPrinted, et.COUNTRY,
             et_1.COUNTRY, do.CUSTNAME
FROM tt, et, et AS et_1, do
WHERE tt.SubmitTime IS NULL
      AND tt.ActualPC = et.EMPLOYID
      AND tt.AssignedPC = et_1.EMPLOYID
      AND tt.ClientID = do.CUSTNMBR;
```

For this example, make the following assumptions:

- The columns being compared have been declared as follows.

Table	Column	Data Type
tt	ActualPC	CHAR(10)
tt	AssignedPC	CHAR(10)
tt	ClientID	CHAR(10)
et	EMPLOYID	CHAR(15)
do	CUSTNMBR	CHAR(15)

- The tables have the following indexes.

Table	Index
tt	ActualPC
tt	AssignedPC

Table	Index
tt	ClientID
et	EMPLOYID (primary key)
do	CUSTNMBR (primary key)

- The `tt.ActualPC` values are not evenly distributed.

Initially, before any optimizations have been performed, the `EXPLAIN` statement produces the following information:

```
table type possible_keys key key_len ref rows Extra
et ALL PRIMARY NULL NULL NULL 74
do ALL PRIMARY NULL NULL NULL 2135
et_1 ALL PRIMARY NULL NULL NULL 74
tt ALL AssignedPC, NULL NULL NULL 3872
      ClientID,
      ActualPC
      Range checked for each record (index map: 0x23)
```

Because `type` is `ALL` for each table, this output indicates that MySQL is generating a Cartesian product of all the tables; that is, every combination of rows. This takes quite a long time, because the product of the number of rows in each table must be examined. For the case at hand, this product is  $74 \times 2135 \times 74 \times 3872 = 45,268,558,720$  rows. If the tables were bigger, you can only imagine how long it would take.

One problem here is that MySQL can use indexes on columns more efficiently if they are declared as the same type and size. In this context, `VARCHAR` and `CHAR` are considered the same if they are declared as the same size. `tt.ActualPC` is declared as `CHAR(10)` and `et.EMPLOYID` is `CHAR(15)`, so there is a length mismatch.

To fix this disparity between column lengths, use `ALTER TABLE` to lengthen `ActualPC` from 10 characters to 15 characters:

```
mysql> ALTER TABLE tt MODIFY ActualPC VARCHAR(15);
```

Now `tt.ActualPC` and `et.EMPLOYID` are both `VARCHAR(15)`. Executing the `EXPLAIN` statement again produces this result:

```
table type possible_keys key key_len ref rows Extra
tt ALL AssignedPC, NULL NULL NULL 3872 Using
      ClientID, where
      ActualPC
do ALL PRIMARY NULL NULL NULL 2135
      Range checked for each record (index map: 0x1)
et_1 ALL PRIMARY NULL NULL NULL 74
      Range checked for each record (index map: 0x1)
et eq_ref PRIMARY PRIMARY 15 tt.ActualPC 1
```

This is not perfect, but is much better: The product of the `rows` values is less by a factor of 74. This version executes in a couple of seconds.

A second alteration can be made to eliminate the column length mismatches for the `tt.AssignedPC = et_1.EMPLOYID` and `tt.ClientID = do.CUSTNMBR` comparisons:

```
mysql> ALTER TABLE tt MODIFY AssignedPC VARCHAR(15),
      MODIFY ClientID VARCHAR(15);
```

After that modification, `EXPLAIN` produces the output shown here:

```
table type possible_keys key key_len ref rows Extra
```

## Extended EXPLAIN Output Format

```
et  ALL  PRIMARY  NULL  NULL  NULL  74
tt  ref   AssignedPC,  ActualPC 15  et.EMPLOYID  52  Using
      ClientID,
      ActualPC
et_1 eq_ref PRIMARY  PRIMARY 15  tt.AssignedPC 1
do  eq_ref PRIMARY  PRIMARY 15  tt.ClientID 1
```

At this point, the query is optimized almost as well as possible. The remaining problem is that, by default, MySQL assumes that values in the `tt.ActualPC` column are evenly distributed, and that is not the case for the `tt` table. Fortunately, it is easy to tell MySQL to analyze the key distribution:

```
mysql> ANALYZE TABLE tt;
```

With the additional index information, the join is perfect and `EXPLAIN` produces this result:

```
table type  possible_keys  key  key_len  ref  rows  Extra
tt  ALL  AssignedPC,  NULL  NULL  NULL  3872  Using
      ClientID,
      ActualPC
et  eq_ref PRIMARY  PRIMARY 15  tt.ActualPC 1
et_1 eq_ref PRIMARY  PRIMARY 15  tt.AssignedPC 1
do  eq_ref PRIMARY  PRIMARY 15  tt.ClientID 1
```

The `rows` column in the output from `EXPLAIN` is an educated guess from the MySQL join optimizer. Check whether the numbers are even close to the truth by comparing the `rows` product with the actual number of rows that the query returns. If the numbers are quite different, you might get better performance by using `STRAIGHT_JOIN` in your `SELECT` statement and trying to list the tables in a different order in the `FROM` clause. (However, `STRAIGHT_JOIN` may prevent indexes from being used because it disables semijoin transformations. See [Section 8.2.2.1, “Optimizing Subqueries, Derived Tables, and View References with Semijoin Transformations”](#).)

It is possible in some cases to execute statements that modify data when `EXPLAIN SELECT` is used with a subquery; for more information, see [Section 13.2.10.8, “Derived Tables”](#).

### 8.8.3 Extended EXPLAIN Output Format

For `SELECT` statements, the `EXPLAIN` statement produces extra (“extended”) information that is not part of `EXPLAIN` output but can be viewed by issuing a `SHOW WARNINGS` statement following `EXPLAIN`. The `Message` value in `SHOW WARNINGS` output displays how the optimizer qualifies table and column names in the `SELECT` statement, what the `SELECT` looks like after the application of rewriting and optimization rules, and possibly other notes about the optimization process.

The extended information displayable with a `SHOW WARNINGS` statement following `EXPLAIN` is produced only for `SELECT` statements. `SHOW WARNINGS` displays an empty result for other explainable statements (`DELETE`, `INSERT`, `REPLACE`, and `UPDATE`).



#### Note

In older MySQL releases, extended information was produced using `EXPLAIN EXTENDED`. That syntax is still recognized for backward compatibility but extended output is now enabled by default, so the `EXTENDED` keyword is superfluous and deprecated. Its use results in a warning; expect it to be removed from `EXPLAIN` syntax in a future MySQL release.

Here is an example of extended `EXPLAIN` output:

```
mysql> EXPLAIN
      SELECT t1.a, t1.a IN (SELECT t2.a FROM t2) FROM t1\G
***** 1. row *****
```



```

        id: 1
    select_type: PRIMARY
        table: t1
        type: index
possible_keys: NULL
        key: PRIMARY
        key_len: 4
        ref: NULL
        rows: 4
    filtered: 100.00
    Extra: Using index
***** 2. row *****
        id: 2
    select_type: SUBQUERY
        table: t2
        type: index
possible_keys: a
        key: a
        key_len: 5
        ref: NULL
        rows: 3
    filtered: 100.00
    Extra: Using index
2 rows in set, 1 warning (0.00 sec)

mysql> SHOW WARNINGS\G
***** 1. row *****
    Level: Note
    Code: 1003
Message: /* select#1 */ select `test`.`t1`.`a` AS `a`,
        <in_optimizer>(`test`.`t1`.`a`,`test`.`t1`.`a` in
        ( <materialize> (/* select#2 */ select `test`.`t2`.`a`
        from `test`.`t2` where 1 having 1 ),
        <primary_index_lookup>(`test`.`t1`.`a` in
        <temporary table> on <auto_key>
        where ((`test`.`t1`.`a` = `materialized-subquery`.`a`)))) AS `t1.a`
        IN (SELECT t2.a FROM t2)` from `test`.`t1`
1 row in set (0.00 sec)

```

Because the statement displayed by [SHOW WARNINGS](#) may contain special markers to provide information about query rewriting or optimizer actions, the statement is not necessarily valid SQL and is not intended to be executed. The output may also include rows with [Message](#) values that provide additional non-SQL explanatory notes about actions taken by the optimizer.

The following list describes special markers that can appear in the extended output displayed by [SHOW WARNINGS](#):

- [<auto\\_key>](#)

An automatically generated key for a temporary table.

- [<cache>\(expr\)](#)

The expression (such as a scalar subquery) is executed once and the resulting value is saved in memory for later use. For results consisting of multiple values, a temporary table may be created and you might see [<temporary table>](#) instead.

- [<exists>\(query fragment\)](#)

The subquery predicate is converted to an [EXISTS](#) predicate and the subquery is transformed so that it can be used together with the [EXISTS](#) predicate.

- [<in\\_optimizer>\(query fragment\)](#)

This is an internal optimizer object with no user significance.

- `<index_lookup>(query fragment)`

The query fragment is processed using an index lookup to find qualifying rows.

- `<if>(condition, expr1, expr2)`

If the condition is true, evaluate to `expr1`, otherwise `expr2`.

- `<is_not_null_test>(expr)`

A test to verify that the expression does not evaluate to `NULL`.

- `<materialize>(query fragment)`

Subquery materialization is used.

- ``materialized-subquery`.col_name`

A reference to the column `col_name` in an internal temporary table materialized to hold the result from evaluating a subquery.

- `<primary_index_lookup>(query fragment)`

The query fragment is processed using a primary key lookup to find qualifying rows.

- `<ref_null_helper>(expr)`

This is an internal optimizer object with no user significance.

- `/* select#N */ select_stmt`

The `SELECT` is associated with the row in non-extended `EXPLAIN` output that has an `id` value of `N`.

- `outer_tables semi join (inner_tables)`

A semijoin operation. `inner_tables` shows the tables that were not pulled out. See [Section 8.2.2.1, “Optimizing Subqueries, Derived Tables, and View References with Semijoin Transformations”](#).

- `<temporary table>`

This represents an internal temporary table created to cache an intermediate result.

When some tables are of `const` or `system` type, expressions involving columns from these tables are evaluated early by the optimizer and are not part of the displayed statement. However, with `FORMAT=JSON`, some `const` table accesses are displayed as a `ref` access that uses a `const` value.

## 8.8.4 Obtaining Execution Plan Information for a Named Connection

To obtain the execution plan for an explainable statement executing in a named connection, use this statement:

```
EXPLAIN [options] FOR CONNECTION connection_id;
```

`EXPLAIN FOR CONNECTION` returns the `EXPLAIN` information that is currently being used to execute a query in a given connection. Because of changes to data (and supporting statistics) it may produce a different result from running `EXPLAIN` on the equivalent query text. This difference in behavior can be

useful in diagnosing more transient performance problems. For example, if you are running a statement in one session that is taking a long time to complete, using `EXPLAIN FOR CONNECTION` in another session may yield useful information about the cause of the delay.

`connection_id` is the connection identifier, as obtained from the `INFORMATION_SCHEMA.PROCESSLIST` table or the `SHOW PROCESSLIST` statement. If you have the `PROCESS` privilege, you can specify the identifier for any connection. Otherwise, you can specify the identifier only for your own connections.

If the named connection is not executing a statement, the result is empty. Otherwise, `EXPLAIN FOR CONNECTION` applies only if the statement being executed in the named connection is explainable. This includes `SELECT`, `DELETE`, `INSERT`, `REPLACE`, and `UPDATE`. (However, `EXPLAIN FOR CONNECTION` does not work for prepared statements, even prepared statements of those types.)

If the named connection is executing an explainable statement, the output is what you would obtain by using `EXPLAIN` on the statement itself.

If the named connection is executing a statement that is not explainable, an error occurs. For example, you cannot name the connection identifier for your current session because `EXPLAIN` is not explainable:

```
mysql> SELECT CONNECTION_ID();
+-----+
| CONNECTION_ID() |
+-----+
|           373 |
+-----+
1 row in set (0.00 sec)

mysql> EXPLAIN FOR CONNECTION 373;
ERROR 1889 (HY000): EXPLAIN FOR CONNECTION command is supported
only for SELECT/UPDATE/INSERT/DELETE/REPLACE
```

The `Com_explain_other` status variable indicates the number of `EXPLAIN FOR CONNECTION` statements executed.

## 8.8.5 Estimating Query Performance

In most cases, you can estimate query performance by counting disk seeks. For small tables, you can usually find a row in one disk seek (because the index is probably cached). For bigger tables, you can estimate that, using B-tree indexes, you need this many seeks to find a row:  $\log(\text{row\_count}) / \log(\text{index\_block\_length} / 3 * 2 / (\text{index\_length} + \text{data\_pointer\_length})) + 1$ .

In MySQL, an index block is usually 1,024 bytes and the data pointer is usually four bytes. For a 500,000-row table with a key value length of three bytes (the size of `MEDIUMINT`), the formula indicates  $\log(500,000) / \log(1024/3*2/(3+4)) + 1 = 4$  seeks.

This index would require storage of about  $500,000 * 7 * 3/2 = 5.2\text{MB}$  (assuming a typical index buffer fill ratio of  $2/3$ ), so you probably have much of the index in memory and so need only one or two calls to read data to find the row.

For writes, however, you need four seek requests to find where to place a new index value and normally two seeks to update the index and write the row.

The preceding discussion does not mean that your application performance slowly degenerates by  $\log N$ . As long as everything is cached by the OS or the MySQL server, things become only marginally slower as the table gets bigger. After the data gets too big to be cached, things start to go much slower until your applications are bound only by disk seeks (which increase by  $\log N$ ). To avoid this, increase the key cache size as the data grows. For `MyISAM` tables, the key cache size is controlled by the `key_buffer_size` system variable. See [Section 5.1.1, “Configuring the Server”](#).

## 8.9 Controlling the Query Optimizer

MySQL provides optimizer control through system variables that affect how query plans are evaluated, switchable optimizations, optimizer and index hints, and the optimizer cost model.

### 8.9.1 Controlling Query Plan Evaluation

The task of the query optimizer is to find an optimal plan for executing an SQL query. Because the difference in performance between “good” and “bad” plans can be orders of magnitude (that is, seconds versus hours or even days), most query optimizers, including that of MySQL, perform a more or less exhaustive search for an optimal plan among all possible query evaluation plans. For join queries, the number of possible plans investigated by the MySQL optimizer grows exponentially with the number of tables referenced in a query. For small numbers of tables (typically less than 7 to 10) this is not a problem. However, when larger queries are submitted, the time spent in query optimization may easily become the major bottleneck in the server’s performance.

A more flexible method for query optimization enables the user to control how exhaustive the optimizer is in its search for an optimal query evaluation plan. The general idea is that the fewer plans that are investigated by the optimizer, the less time it spends in compiling a query. On the other hand, because the optimizer skips some plans, it may miss finding an optimal plan.

The behavior of the optimizer with respect to the number of plans it evaluates can be controlled using two system variables:

- The `optimizer_prune_level` variable tells the optimizer to skip certain plans based on estimates of the number of rows accessed for each table. Our experience shows that this kind of “educated guess” rarely misses optimal plans, and may dramatically reduce query compilation times. That is why this option is on (`optimizer_prune_level=1`) by default. However, if you believe that the optimizer missed a better query plan, this option can be switched off (`optimizer_prune_level=0`) with the risk that query compilation may take much longer. Note that, even with the use of this heuristic, the optimizer still explores a roughly exponential number of plans.
- The `optimizer_search_depth` variable tells how far into the “future” of each incomplete plan the optimizer should look to evaluate whether it should be expanded further. Smaller values of `optimizer_search_depth` may result in orders of magnitude smaller query compilation times. For example, queries with 12, 13, or more tables may easily require hours and even days to compile if `optimizer_search_depth` is close to the number of tables in the query. At the same time, if compiled with `optimizer_search_depth` equal to 3 or 4, the optimizer may compile in less than a minute for the same query. If you are unsure of what a reasonable value is for `optimizer_search_depth`, this variable can be set to 0 to tell the optimizer to determine the value automatically.

### 8.9.2 Switchable Optimizations

The `optimizer_switch` system variable enables control over optimizer behavior. Its value is a set of flags, each of which has a value of `on` or `off` to indicate whether the corresponding optimizer behavior is enabled or disabled. This variable has global and session values and can be changed at runtime. The global default can be set at server startup.

To see the current set of optimizer flags, select the variable value:

```
mysql> SELECT @@optimizer_switch\G
***** 1. row *****
@@optimizer_switch:  index_merge=on,index_merge_union=on,
                    index_merge_sort_union=on,
                    index_merge_intersection=on,
                    engine_condition_pushdown=on,
```

```

index_condition_pushdown=on,
mrr=on,mrr_cost_based=on,
block_nested_loop=on,batched_key_access=off,
materialization=on,semi_join=on,loosescan=on,
firstmatch=on,duplicateweedout=on,
subquery_materialization_cost_based=on,
use_index_extensions=on,
condition_fanout_filter=on,derived_merge=on,
prefer_ordering_index=on

```

To change the value of `optimizer_switch`, assign a value consisting of a comma-separated list of one or more commands:

```
SET [GLOBAL|SESSION] optimizer_switch='command[,command]...';
```

Each `command` value should have one of the forms shown in the following table.

Command Syntax	Meaning
<code>default</code>	Reset every optimization to its default value
<code>opt_name=default</code>	Set the named optimization to its default value
<code>opt_name=off</code>	Disable the named optimization
<code>opt_name=on</code>	Enable the named optimization

The order of the commands in the value does not matter, although the `default` command is executed first if present. Setting an `opt_name` flag to `default` sets it to whichever of `on` or `off` is its default value. Specifying any given `opt_name` more than once in the value is not permitted and causes an error. Any errors in the value cause the assignment to fail with an error, leaving the value of `optimizer_switch` unchanged.

The following list describes the permissible `opt_name` flag names, grouped by optimization strategy:

- Batched Key Access Flags

- `batched_key_access` (default `off`)

Controls use of BKA join algorithm.

For `batched_key_access` to have any effect when set to `on`, the `mrr` flag must also be `on`. Currently, the cost estimation for MRR is too pessimistic. Hence, it is also necessary for `mrr_cost_based` to be `off` for BKA to be used.

For more information, see [Section 8.2.1.11, “Block Nested-Loop and Batched Key Access Joins”](#).

- Block Nested-Loop Flags

- `block_nested_loop` (default `on`)

Controls use of BNL join algorithm.

For more information, see [Section 8.2.1.11, “Block Nested-Loop and Batched Key Access Joins”](#).

- Condition Filtering Flags

- `condition_fanout_filter` (default `on`)

Controls use of condition filtering.

For more information, see [Section 8.2.1.12, “Condition Filtering”](#).

- Derived Table Merging Flags

- `derived_merge` (default `on`)

Controls merging of derived tables and views into outer query block.

The `derived_merge` flag controls whether the optimizer attempts to merge derived tables and view references into the outer query block, assuming that no other rule prevents merging; for example, an `ALGORITHM` directive for a view takes precedence over the `derived_merge` setting. By default, the flag is `on` to enable merging.

For more information, see [Section 8.2.2.4, “Optimizing Derived Tables and View References with Merging or Materialization”](#).

- Engine Condition Pushdown Flags

- `engine_condition_pushdown` (default `on`)

Controls engine condition pushdown.

For more information, see [Section 8.2.1.4, “Engine Condition Pushdown Optimization”](#).

- Index Condition Pushdown Flags

- `index_condition_pushdown` (default `on`)

Controls index condition pushdown.

For more information, see [Section 8.2.1.5, “Index Condition Pushdown Optimization”](#).

- Index Extensions Flags

- `use_index_extensions` (default `on`)

Controls use of index extensions.

For more information, see [Section 8.3.9, “Use of Index Extensions”](#).

- Index Merge Flags

- `index_merge` (default `on`)

Controls all Index Merge optimizations.

- `index_merge_intersection` (default `on`)

Controls the Index Merge Intersection Access optimization.

- `index_merge_sort_union` (default `on`)

Controls the Index Merge Sort-Union Access optimization.

- `index_merge_union` (default `on`)

Controls the Index Merge Union Access optimization.

For more information, see [Section 8.2.1.3, “Index Merge Optimization”](#).

- Limit Optimization Flags

- `prefer_ordering_index` (default `on`)

Controls whether, in the case of a query having an `ORDER BY` or `GROUP BY` with a `LIMIT` clause, the optimizer tries to use an ordered index instead of an unordered index, a filesort, or some other optimization. This optimization is performed by default whenever the optimizer determines that using it would allow for faster execution of the query.

Because the algorithm that makes this determination cannot handle every conceivable case (due in part to the assumption that the distribution of data is always more or less uniform), there are cases in which this optimization may not be desirable. Prior to MySQL 5.7.33, it was not possible to disable this optimization, but in MySQL 5.7.33 and later, while it remains the default behavior, it can be disabled by setting the `prefer_ordering_index` flag to `off`.

For more information and examples, see [Section 8.2.1.17, “LIMIT Query Optimization”](#).

- Multi-Range Read Flags

- `mrr` (default `on`)

Controls the Multi-Range Read strategy.

- `mrr_cost_based` (default `on`)

Controls use of cost-based MRR if `mrr=on`.

For more information, see [Section 8.2.1.10, “Multi-Range Read Optimization”](#).

- Semijoin Flags

- `duplicateweedout` (default `on`)

Controls the semijoin Duplicate Weedout strategy.

- `firstmatch` (default `on`)

Controls the semijoin FirstMatch strategy.

- `loosescan` (default `on`)

Controls the semijoin LooseScan strategy (not to be confused with Loose Index Scan for `GROUP BY`).

- `semijoin` (default `on`)

Controls all semijoin strategies.

The `semijoin`, `firstmatch`, `loosescan`, and `duplicateweedout` flags enable control over semijoin strategies. The `semijoin` flag controls whether semijoins are used. If it is set to `on`, the `firstmatch` and `loosescan` flags enable finer control over the permitted semijoin strategies.

If the `duplicateweedout` semijoin strategy is disabled, it is not used unless all other applicable strategies are also disabled.

If `semijoin` and `materialization` are both `on`, semijoins also use materialization where applicable. These flags are `on` by default.

For more information, see [Section 8.2.2.1, “Optimizing Subqueries, Derived Tables, and View References with Semijoin Transformations”](#).

- Subquery Materialization Flags
  - `materialization` (default `on`)  
Controls materialization (including semijoin materialization).
  - `subquery_materialization_cost_based` (default `on`)  
Use cost-based materialization choice.

The `materialization` flag controls whether subquery materialization is used. If `semi join` and `materialization` are both `on`, semijoins also use materialization where applicable. These flags are `on` by default.

The `subquery_materialization_cost_based` flag enables control over the choice between subquery materialization and `IN-to-EXISTS` subquery transformation. If the flag is `on` (the default), the optimizer performs a cost-based choice between subquery materialization and `IN-to-EXISTS` subquery transformation if either method could be used. If the flag is `off`, the optimizer chooses subquery materialization over `IN-to-EXISTS` subquery transformation.

For more information, see [Section 8.2.2, “Optimizing Subqueries, Derived Tables, and View References”](#).

When you assign a value to `optimizer_switch`, flags that are not mentioned keep their current values. This makes it possible to enable or disable specific optimizer behaviors in a single statement without affecting other behaviors. The statement does not depend on what other optimizer flags exist and what their values are. Suppose that all Index Merge optimizations are enabled:

```
mysql> SELECT @@optimizer_switch\G
***** 1. row *****
@@optimizer_switch: index_merge=on,index_merge_union=on,
                    index_merge_sort_union=on,
                    index_merge_intersection=on,
                    engine_condition_pushdown=on,
                    index_condition_pushdown=on,
                    mrr=on,mrr_cost_based=on,
                    block_nested_loop=on,batched_key_access=off,
                    materialization=on,semi join=on,loosescan=on,
                    firstmatch=on,duplicateweedout=on,
                    subquery_materialization_cost_based=on,
                    use_index_extensions=on,
                    condition_fanout_filter=on,derived_merge=on,
                    prefer_ordering_index=on
```

If the server is using the Index Merge Union or Index Merge Sort-Union access methods for certain queries and you want to check whether the optimizer performs better without them, set the variable value like this:

```
mysql> SET optimizer_switch='index_merge_union=off,index_merge_sort_union=off';

mysql> SELECT @@optimizer_switch\G
***** 1. row *****
@@optimizer_switch: index_merge=on,index_merge_union=off,
                    index_merge_sort_union=off,
                    index_merge_intersection=on,
                    engine_condition_pushdown=on,
                    index_condition_pushdown=on,
                    mrr=on,mrr_cost_based=on,
                    block_nested_loop=on,batched_key_access=off,
                    materialization=on,semi join=on,loosescan=on,
                    firstmatch=on,duplicateweedout=on,
                    subquery_materialization_cost_based=on,
                    use_index_extensions=on,
```



```
condition_fanout_filter=on,derived_merge=on,
prefer_ordering_index=on
```

### 8.9.3 Optimizer Hints

One means of control over optimizer strategies is to set the `optimizer_switch` system variable (see [Section 8.9.2, “Switchable Optimizations”](#)). Changes to this variable affect execution of all subsequent queries; to affect one query differently from another, it is necessary to change `optimizer_switch` before each one.

another way to control the optimizer is by using optimizer hints, which can be specified within individual statements. Because optimizer hints apply on a per-statement basis, they provide finer control over statement execution plans than can be achieved using `optimizer_switch`. For example, you can enable an optimization for one table in a statement and disable the optimization for a different table. Hints within a statement take precedence over `optimizer_switch` flags.

Examples:

```
SELECT /*+ NO_RANGE_OPTIMIZATION(t3 PRIMARY, f2_idx) */ f1
  FROM t3 WHERE f1 > 30 AND f1 < 33;
SELECT /*+ BKA(t1) NO_BKA(t2) */ * FROM t1 INNER JOIN t2 WHERE ...;
SELECT /*+ NO_ICP(t1, t2) */ * FROM t1 INNER JOIN t2 WHERE ...;
SELECT /*+ SEMIJOIN(FIRSTMATCH, LOOSESCAN) */ * FROM t1 ...;
EXPLAIN SELECT /*+ NO_ICP(t1) */ * FROM t1 WHERE ...;
```



#### Note

The `mysql` client by default strips comments from SQL statements sent to the server (including optimizer hints) until MySQL 5.7.7, when it was changed to pass optimizer hints to the server. To ensure that optimizer hints are not stripped if you are using an older version of the `mysql` client with a version of the server that understands optimizer hints, invoke `mysql` with the `--comments` option.

Optimizer hints, described here, differ from index hints, described in [Section 8.9.4, “Index Hints”](#). Optimizer and index hints may be used separately or together.

- [Optimizer Hint Overview](#)
- [Optimizer Hint Syntax](#)
- [Table-Level Optimizer Hints](#)
- [Index-Level Optimizer Hints](#)
- [Subquery Optimizer Hints](#)
- [Statement Execution Time Optimizer Hints](#)
- [Optimizer Hints for Naming Query Blocks](#)

### Optimizer Hint Overview

Optimizer hints apply at different scope levels:

- Global: The hint affects the entire statement
- Query block: The hint affects a particular query block within a statement
- Table-level: The hint affects a particular table within a query block

- Index-level: The hint affects a particular index within a table

The following table summarizes the available optimizer hints, the optimizer strategies they affect, and the scope or scopes at which they apply. More details are given later.

**Table 8.2 Optimizer Hints Available**

Hint Name	Description	Applicable Scopes
<code>BKA, NO_BKA</code>	Affects Batched Key Access join processing	Query block, table
<code>BNL, NO_BNL</code>	Affects Block Nested-Loop join processing	Query block, table
<code>MAX_EXECUTION_TIME</code>	Limits statement execution time	Global
<code>MRR, NO_MRR</code>	Affects Multi-Range Read optimization	Table, index
<code>NO_ICP</code>	Affects Index Condition Pushdown optimization	Table, index
<code>NO_RANGE_OPTIMIZATION</code>	Affects range optimization	Table, index
<code>QB_NAME</code>	Assigns name to query block	Query block
<code>SEMIJOIN, NO_SEMIJOIN</code>	semijoin strategies	Query block
<code>SUBQUERY</code>	Affects materialization, <code>IN-to-EXISTS</code> subquery strategies	Query block

Disabling an optimization prevents the optimizer from using it. Enabling an optimization means the optimizer is free to use the strategy if it applies to statement execution, not that the optimizer necessarily uses it.

## Optimizer Hint Syntax

MySQL supports comments in SQL statements as described in [Section 9.6, “Comments”](#). Optimizer hints must be specified within `/*+ ... */` comments. That is, optimizer hints use a variant of `/* ... */` C-style comment syntax, with a `+` character following the `/*` comment opening sequence. Examples:

```
/*+ BKA(t1) */
/*+ BNL(t1, t2) */
/*+ NO_RANGE_OPTIMIZATION(t4 PRIMARY) */
/*+ QB_NAME(qb2) */
```

Whitespace is permitted after the `+` character.

The parser recognizes optimizer hint comments after the initial keyword of `SELECT`, `UPDATE`, `INSERT`, `REPLACE`, and `DELETE` statements. Hints are permitted in these contexts:

- At the beginning of query and data change statements:

```
SELECT /*+ ... */ ...
INSERT /*+ ... */ ...
REPLACE /*+ ... */ ...
UPDATE /*+ ... */ ...
DELETE /*+ ... */ ...
```

- At the beginning of query blocks:

```
(SELECT /*+ ... */ ... )
```

```
(SELECT ... ) UNION (SELECT /*+ ... */ ... )
(SELECT /*+ ... */ ... ) UNION (SELECT /*+ ... */ ... )
UPDATE ... WHERE x IN (SELECT /*+ ... */ ...)
INSERT ... SELECT /*+ ... */ ...
```

- In hintable statements prefaced by `EXPLAIN`. For example:

```
EXPLAIN SELECT /*+ ... */ ...
EXPLAIN UPDATE ... WHERE x IN (SELECT /*+ ... */ ...)
```

The implication is that you can use `EXPLAIN` to see how optimizer hints affect execution plans. Use `SHOW WARNINGS` immediately after `EXPLAIN` to see how hints are used. The extended `EXPLAIN` output displayed by a following `SHOW WARNINGS` indicates which hints were used. Ignored hints are not displayed.

A hint comment may contain multiple hints, but a query block cannot contain multiple hint comments. This is valid:

```
SELECT /*+ BNL(t1) BKA(t2) */ ...
```

But this is invalid:

```
SELECT /*+ BNL(t1) */ /* BKA(t2) */ ...
```

When a hint comment contains multiple hints, the possibility of duplicates and conflicts exists. The following general guidelines apply. For specific hint types, additional rules may apply, as indicated in the hint descriptions.

- Duplicate hints: For a hint such as `/*+ MRR(idx1) MRR(idx1) */`, MySQL uses the first hint and issues a warning about the duplicate hint.
- Conflicting hints: For a hint such as `/*+ MRR(idx1) NO_MRR(idx1) */`, MySQL uses the first hint and issues a warning about the second conflicting hint.

Query block names are identifiers and follow the usual rules about what names are valid and how to quote them (see [Section 9.2, “Schema Object Names”](#)).

Hint names, query block names, and strategy names are not case-sensitive. References to table and index names follow the usual identifier case sensitivity rules (see [Section 9.2.3, “Identifier Case Sensitivity”](#)).

## Table-Level Optimizer Hints

Table-level hints affect use of the Block Nested-Loop (BNL) and Batched Key Access (BKA) join-processing algorithms (see [Section 8.2.1.11, “Block Nested-Loop and Batched Key Access Joins”](#)). These hint types apply to specific tables, or all tables in a query block.

Syntax of table-level hints:

```
hint_name([@query_block_name] [tbl_name [, tbl_name] ...])
hint_name([tbl_name@query_block_name [, tbl_name@query_block_name] ...])
```

The syntax refers to these terms:

- `hint_name`: These hint names are permitted:
  - `BKA`, `NO_BKA`: Enable or disable BKA for the specified tables.
  - `BNL`, `NO_BNL`: Enable or disable BNL for the specified tables.

**Note**

To use a BNL or BKA hint to enable join buffering for any inner table of an outer join, join buffering must be enabled for all inner tables of the outer join.

- *tbl\_name*: The name of a table used in the statement. The hint applies to all tables that it names. If the hint names no tables, it applies to all tables of the query block in which it occurs.

If a table has an alias, hints must refer to the alias, not the table name.

Table names in hints cannot be qualified with schema names.

- *query\_block\_name*: The query block to which the hint applies. If the hint includes no leading *@query\_block\_name*, the hint applies to the query block in which it occurs. For *tbl\_name@query\_block\_name* syntax, the hint applies to the named table in the named query block. To assign a name to a query block, see [Optimizer Hints for Naming Query Blocks](#).

Examples:

```
SELECT /*+ NO_BKA(t1, t2) */ t1.* FROM t1 INNER JOIN t2 INNER JOIN t3;
SELECT /*+ NO_BNL() BKA(t1) */ t1.* FROM t1 INNER JOIN t2 INNER JOIN t3;
```

A table-level hint applies to tables that receive records from previous tables, not sender tables. Consider this statement:

```
SELECT /*+ BNL(t2) */ FROM t1, t2;
```

If the optimizer chooses to process *t1* first, it applies a Block Nested-Loop join to *t2* by buffering the rows from *t1* before starting to read from *t2*. If the optimizer instead chooses to process *t2* first, the hint has no effect because *t2* is a sender table.

## Index-Level Optimizer Hints

Index-level hints affect which index-processing strategies the optimizer uses for particular tables or indexes. These hint types affect use of Index Condition Pushdown (ICP), Multi-Range Read (MRR), and range optimizations (see [Section 8.2.1, “Optimizing SELECT Statements”](#)).

Syntax of index-level hints:

```
hint_name([@query_block_name] tbl_name [index_name [, index_name] ...])
hint_name(tbl_name@query_block_name [index_name [, index_name] ...])
```

The syntax refers to these terms:

- *hint\_name*: These hint names are permitted:
  - **MRR, NO\_MRR**: Enable or disable MRR for the specified table or indexes. MRR hints apply only to **InnoDB** and **MyISAM** tables.
  - **NO\_ICP**: Disable ICP for the specified table or indexes. By default, ICP is a candidate optimization strategy, so there is no hint for enabling it.
  - **NO\_RANGE\_OPTIMIZATION**: Disable index range access for the specified table or indexes. This hint also disables Index Merge and Loose Index Scan for the table or indexes. By default, range access is a candidate optimization strategy, so there is no hint for enabling it.

This hint may be useful when the number of ranges may be high and range optimization would require many resources.

- *tbl\_name*: The table to which the hint applies.
- *index\_name*: The name of an index in the named table. The hint applies to all indexes that it names. If the hint names no indexes, it applies to all indexes in the table.

To refer to a primary key, use the name `PRIMARY`. To see the index names for a table, use `SHOW INDEX`.

- *query\_block\_name*: The query block to which the hint applies. If the hint includes no leading `@query_block_name`, the hint applies to the query block in which it occurs. For `tbl_name@query_block_name` syntax, the hint applies to the named table in the named query block. To assign a name to a query block, see [Optimizer Hints for Naming Query Blocks](#).

Examples:

```
SELECT /*+ MRR(t1) */ * FROM t1 WHERE f2 <= 3 AND 3 <= f3;
SELECT /*+ NO_RANGE_OPTIMIZATION(t3 PRIMARY, f2_idx) */ f1
FROM t3 WHERE f1 > 30 AND f1 < 33;
INSERT INTO t3(f1, f2, f3)
(SELECT /*+ NO_ICP(t2) */ t2.f1, t2.f2, t2.f3 FROM t1,t2
WHERE t1.f1=t2.f1 AND t2.f2 BETWEEN t1.f1
AND t1.f2 AND t2.f2 + 1 >= t1.f1 + 1);
```

## Subquery Optimizer Hints

Subquery hints affect whether to use semijoin transformations and which semijoin strategies to permit, and, when semijoins are not used, whether to use subquery materialization or `IN-to-EXISTS` transformations. For more information about these optimizations, see [Section 8.2.2, “Optimizing Subqueries, Derived Tables, and View References”](#).

Syntax of hints that affect semijoin strategies:

```
hint_name([@query_block_name] [strategy [, strategy] ...])
```

The syntax refers to these terms:

- *hint\_name*: These hint names are permitted:
  - `SEMIJOIN`, `NO_SEMIJOIN`: Enable or disable the named semijoin strategies.
- *strategy*: A semijoin strategy to be enabled or disabled. These strategy names are permitted: `DUPSWEEDOUT`, `FIRSTMATCH`, `LOOESCAN`, `MATERIALIZATION`.

For `SEMIJOIN` hints, if no strategies are named, semijoin is used if possible based on the strategies enabled according to the `optimizer_switch` system variable. If strategies are named but inapplicable for the statement, `DUPSWEEDOUT` is used.

For `NO_SEMIJOIN` hints, if no strategies are named, semijoin is not used. If strategies are named that rule out all applicable strategies for the statement, `DUPSWEEDOUT` is used.

If one subquery is nested within another and both are merged into a semijoin of an outer query, any specification of semijoin strategies for the innermost query are ignored. `SEMIJOIN` and `NO_SEMIJOIN` hints can still be used to enable or disable semijoin transformations for such nested subqueries.

If `DUPSWEEDOUT` is disabled, on occasion the optimizer may generate a query plan that is far from optimal. This occurs due to heuristic pruning during greedy search, which can be avoided by setting `optimizer_prune_level=0`.

Examples:

```
SELECT /*+ NO_SEMIJOIN(@subq1 FIRSTMATCH, LOOSESCAN) */ * FROM t2
WHERE t2.a IN (SELECT /*+ QB_NAME(subq1) */ a FROM t3);
SELECT /*+ SEMIJOIN(@subq1 MATERIALIZATION, DUPSWEEDOUT) */ * FROM t2
WHERE t2.a IN (SELECT /*+ QB_NAME(subq1) */ a FROM t3);
```

Syntax of hints that affect whether to use subquery materialization or [IN-to-EXISTS](#) transformations:

```
SUBQUERY([@query_block_name] strategy)
```

The hint name is always [SUBQUERY](#).

For [SUBQUERY](#) hints, these *strategy* values are permitted: [INTOEXISTS](#), [MATERIALIZATION](#).

Examples:

```
SELECT id, a IN (SELECT /*+ SUBQUERY(MATERIALIZATION) */ a FROM t1) FROM t2;
SELECT * FROM t2 WHERE t2.a IN (SELECT /*+ SUBQUERY(INTOEXISTS) */ a FROM t1);
```

For semijoin and [SUBQUERY](#) hints, a leading [@query\\_block\\_name](#) specifies the query block to which the hint applies. If the hint includes no leading [@query\\_block\\_name](#), the hint applies to the query block in which it occurs. To assign a name to a query block, see [Optimizer Hints for Naming Query Blocks](#).

If a hint comment contains multiple subquery hints, the first is used. If there are other following hints of that type, they produce a warning. Following hints of other types are silently ignored.

## Statement Execution Time Optimizer Hints

The [MAX\\_EXECUTION\\_TIME](#) hint is permitted only for [SELECT](#) statements. It places a limit *N* (a timeout value in milliseconds) on how long a statement is permitted to execute before the server terminates it:

```
MAX_EXECUTION_TIME(N)
```

Example with a timeout of 1 second (1000 milliseconds):

```
SELECT /*+ MAX_EXECUTION_TIME(1000) */ * FROM t1 INNER JOIN t2 WHERE ...
```

The [MAX\\_EXECUTION\\_TIME\(\*N\*\)](#) hint sets a statement execution timeout of *N* milliseconds. If this option is absent or *N* is 0, the statement timeout established by the [max\\_execution\\_time](#) system variable applies.

The [MAX\\_EXECUTION\\_TIME](#) hint is applicable as follows:

- For statements with multiple [SELECT](#) keywords, such as unions or statements with subqueries, [MAX\\_EXECUTION\\_TIME](#) applies to the entire statement and must appear after the first [SELECT](#).
- It applies to read-only [SELECT](#) statements. Statements that are not read only are those that invoke a stored function that modifies data as a side effect.
- It does not apply to [SELECT](#) statements in stored programs and is ignored.

## Optimizer Hints for Naming Query Blocks

Table-level, index-level, and subquery optimizer hints permit specific query blocks to be named as part of their argument syntax. To create these names, use the [QB\\_NAME](#) hint, which assigns a name to the query block in which it occurs:

```
QB_NAME(name)
```

[QB\\_NAME](#) hints can be used to make explicit in a clear way which query blocks other hints apply to. They also permit all non-query block name hints to be specified within a single hint comment for easier understanding of complex statements. Consider the following statement:

```
SELECT ...
FROM (SELECT ...
FROM (SELECT ... FROM ...)) ...
```

`QB_NAME` hints assign names to query blocks in the statement:

```
SELECT /*+ QB_NAME(qb1) */ ...
FROM (SELECT /*+ QB_NAME(qb2) */ ...
FROM (SELECT /*+ QB_NAME(qb3) */ ... FROM ...)) ...
```

Then other hints can use those names to refer to the appropriate query blocks:

```
SELECT /*+ QB_NAME(qb1) MRR(@qb1 t1) BKA(@qb2) NO_MRR(@qb3t1 idx1, id2) */ ...
FROM (SELECT /*+ QB_NAME(qb2) */ ...
FROM (SELECT /*+ QB_NAME(qb3) */ ... FROM ...)) ...
```

The resulting effect is as follows:

- `MRR(@qb1 t1)` applies to table `t1` in query block `qb1`.
- `BKA(@qb2)` applies to query block `qb2`.
- `NO_MRR(@qb3 t1 idx1, id2)` applies to indexes `idx1` and `idx2` in table `t1` in query block `qb3`.

Query block names are identifiers and follow the usual rules about what names are valid and how to quote them (see [Section 9.2, “Schema Object Names”](#)). For example, a query block name that contains spaces must be quoted, which can be done using backticks:

```
SELECT /*+ BKA(@`my hint name`) */ ...
FROM (SELECT /*+ QB_NAME(`my hint name`) */ ...) ...
```

If the `ANSI_QUOTES` SQL mode is enabled, it is also possible to quote query block names within double quotation marks:

```
SELECT /*+ BKA(@"my hint name") */ ...
FROM (SELECT /*+ QB_NAME("my hint name") */ ...) ...
```

## 8.9.4 Index Hints

Index hints give the optimizer information about how to choose indexes during query processing. Index hints, described here, differ from optimizer hints, described in [Section 8.9.3, “Optimizer Hints”](#). Index and optimizer hints may be used separately or together.

Index hints apply to `SELECT` and `UPDATE` statements. They also work with multi-table `DELETE` statements, but not with single-table `DELETE`, as shown later in this section.

Index hints are specified following a table name. (For the general syntax for specifying tables in a `SELECT` statement, see [Section 13.2.9.2, “JOIN Clause”](#).) The syntax for referring to an individual table, including index hints, looks like this:

```
tbl_name [[AS] alias] [index_hint_list]

index_hint_list:
    index_hint [index_hint] ...

index_hint:
    USE {INDEX|KEY}
      [FOR {JOIN|ORDER BY|GROUP BY}] ([index_list])
    | {IGNORE|FORCE} {INDEX|KEY}
      [FOR {JOIN|ORDER BY|GROUP BY}] (index_list)
```

```
index_list:
  index_name [, index_name] ...
```

The `USE INDEX (index_list)` hint tells MySQL to use only one of the named indexes to find rows in the table. The alternative syntax `IGNORE INDEX (index_list)` tells MySQL to not use some particular index or indexes. These hints are useful if `EXPLAIN` shows that MySQL is using the wrong index from the list of possible indexes.

The `FORCE INDEX` hint acts like `USE INDEX (index_list)`, with the addition that a table scan is assumed to be *very* expensive. In other words, a table scan is used only if there is no way to use one of the named indexes to find rows in the table.

Each hint requires index names, not column names. To refer to a primary key, use the name `PRIMARY`. To see the index names for a table, use the `SHOW INDEX` statement or the Information Schema `STATISTICS` table.

An `index_name` value need not be a full index name. It can be an unambiguous prefix of an index name. If a prefix is ambiguous, an error occurs.

Examples:

```
SELECT * FROM table1 USE INDEX (col1_index,col2_index)
  WHERE col1=1 AND col2=2 AND col3=3;

SELECT * FROM table1 IGNORE INDEX (col3_index)
  WHERE col1=1 AND col2=2 AND col3=3;
```

The syntax for index hints has the following characteristics:

- It is syntactically valid to omit `index_list` for `USE INDEX`, which means “use no indexes.” Omitting `index_list` for `FORCE INDEX` or `IGNORE INDEX` is a syntax error.
- You can specify the scope of an index hint by adding a `FOR` clause to the hint. This provides more fine-grained control over optimizer selection of an execution plan for various phases of query processing. To affect only the indexes used when MySQL decides how to find rows in the table and how to process joins, use `FOR JOIN`. To influence index usage for sorting or grouping rows, use `FOR ORDER BY` or `FOR GROUP BY`.
- You can specify multiple index hints:

```
SELECT * FROM t1 USE INDEX (i1) IGNORE INDEX FOR ORDER BY (i2) ORDER BY a;
```

It is not an error to name the same index in several hints (even within the same hint):

```
SELECT * FROM t1 USE INDEX (i1) USE INDEX (i1,i1);
```

However, it is an error to mix `USE INDEX` and `FORCE INDEX` for the same table:

```
SELECT * FROM t1 USE INDEX FOR JOIN (i1) FORCE INDEX FOR JOIN (i2);
```

If an index hint includes no `FOR` clause, the scope of the hint is to apply to all parts of the statement. For example, this hint:

```
IGNORE INDEX (i1)
```

is equivalent to this combination of hints:

```
IGNORE INDEX FOR JOIN (i1)
IGNORE INDEX FOR ORDER BY (i1)
IGNORE INDEX FOR GROUP BY (i1)
```



In MySQL 5.0, hint scope with no `FOR` clause was to apply only to row retrieval. To cause the server to use this older behavior when no `FOR` clause is present, enable the `old` system variable at server startup. Take care about enabling this variable in a replication setup. With statement-based binary logging, having different modes for the source and replicas might lead to replication errors.

When index hints are processed, they are collected in a single list by type (`USE`, `FORCE`, `IGNORE`) and by scope (`FOR JOIN`, `FOR ORDER BY`, `FOR GROUP BY`). For example:

```
SELECT * FROM t1
  USE INDEX () IGNORE INDEX (i2) USE INDEX (i1) USE INDEX (i2);
```

is equivalent to:

```
SELECT * FROM t1
  USE INDEX (i1,i2) IGNORE INDEX (i2);
```

The index hints then are applied for each scope in the following order:

1. `{USE|FORCE} INDEX` is applied if present. (If not, the optimizer-determined set of indexes is used.)
2. `IGNORE INDEX` is applied over the result of the previous step. For example, the following two queries are equivalent:

```
SELECT * FROM t1 USE INDEX (i1) IGNORE INDEX (i2) USE INDEX (i2);
SELECT * FROM t1 USE INDEX (i1);
```

For `FULLTEXT` searches, index hints work as follows:

- For natural language mode searches, index hints are silently ignored. For example, `IGNORE INDEX(i1)` is ignored with no warning and the index is still used.
- For boolean mode searches, index hints with `FOR ORDER BY` or `FOR GROUP BY` are silently ignored. Index hints with `FOR JOIN` or no `FOR` modifier are honored. In contrast to how hints apply for non-`FULLTEXT` searches, the hint is used for all phases of query execution (finding rows and retrieval, grouping, and ordering). This is true even if the hint is given for a non-`FULLTEXT` index.

For example, the following two queries are equivalent:

```
SELECT * FROM t
  USE INDEX (index1)
  IGNORE INDEX FOR ORDER BY (index1)
  IGNORE INDEX FOR GROUP BY (index1)
  WHERE ... IN BOOLEAN MODE ... ;

SELECT * FROM t
  USE INDEX (index1)
  WHERE ... IN BOOLEAN MODE ... ;
```

Index hints work with `DELETE` statements, but only if you use multi-table `DELETE` syntax, as shown here:

```
mysql> EXPLAIN DELETE FROM t1 USE INDEX(col2)
-> WHERE col1 BETWEEN 1 AND 100 AND COL2 BETWEEN 1 AND 100\G
ERROR 1064 (42000): You have an error in your SQL syntax; check the manual that
corresponds to your MySQL server version for the right syntax to use near 'use
index(col2) where col1 between 1 and 100 and col2 between 1 and 100' at line 1

mysql> EXPLAIN DELETE t1.* FROM t1 USE INDEX(col2)
-> WHERE col1 BETWEEN 1 AND 100 AND COL2 BETWEEN 1 AND 100\G
***** 1. row *****
      id: 1
select_type: DELETE
```

```
table: t1
partitions: NULL
type: range
possible_keys: col2
key: col2
key_len: 5
ref: NULL
rows: 72
filtered: 11.11
Extra: Using where
1 row in set, 1 warning (0.00 sec)
```

### 8.9.5 The Optimizer Cost Model

To generate execution plans, the optimizer uses a cost model that is based on estimates of the cost of various operations that occur during query execution. The optimizer has a set of compiled-in default “cost constants” available to it to make decisions regarding execution plans.

The optimizer also has a database of cost estimates to use during execution plan construction. These estimates are stored in the `server_cost` and `engine_cost` tables in the `mysql` system database and are configurable at any time. The intent of these tables is to make it possible to easily adjust the cost estimates that the optimizer uses when it attempts to arrive at query execution plans.

- [Cost Model General Operation](#)
- [The Cost Model Database](#)
- [Making Changes to the Cost Model Database](#)

#### Cost Model General Operation

The configurable optimizer cost model works like this:

- The server reads the cost model tables into memory at startup and uses the in-memory values at runtime. Any non-`NULL` cost estimate specified in the tables takes precedence over the corresponding compiled-in default cost constant. Any `NULL` estimate indicates to the optimizer to use the compiled-in default.
- At runtime, the server may re-read the cost tables. This occurs when a storage engine is dynamically loaded or when a `FLUSH OPTIMIZER_COSTS` statement is executed.
- Cost tables enable server administrators to easily adjust cost estimates by changing entries in the tables. It is also easy to revert to a default by setting an entry's cost to `NULL`. The optimizer uses the in-memory cost values, so changes to the tables should be followed by `FLUSH OPTIMIZER_COSTS` to take effect.
- The in-memory cost estimates that are current when a client session begins apply throughout that session until it ends. In particular, if the server re-reads the cost tables, any changed estimates apply only to subsequently started sessions. Existing sessions are unaffected.
- Cost tables are specific to a given server instance. The server does not replicate cost table changes to replicas.

#### The Cost Model Database

The optimizer cost model database consists of two tables in the `mysql` system database that contain cost estimate information for operations that occur during query execution:

- `server_cost`: Optimizer cost estimates for general server operations

- `engine_cost`: Optimizer cost estimates for operations specific to particular storage engines

The `server_cost` table contains these columns:

- `cost_name`

The name of a cost estimate used in the cost model. The name is not case-sensitive. If the server does not recognize the cost name when it reads this table, it writes a warning to the error log.

- `cost_value`

The cost estimate value. If the value is non-`NULL`, the server uses it as the cost. Otherwise, it uses the default estimate (the compiled-in value). DBAs can change a cost estimate by updating this column. If the server finds that the cost value is invalid (nonpositive) when it reads this table, it writes a warning to the error log.

To override a default cost estimate (for an entry that specifies `NULL`), set the cost to a non-`NULL` value. To revert to the default, set the value to `NULL`. Then execute `FLUSH OPTIMIZER_COSTS` to tell the server to re-read the cost tables.

- `last_update`

The time of the last row update.

- `comment`

A descriptive comment associated with the cost estimate. DBAs can use this column to provide information about why a cost estimate row stores a particular value.

The primary key for the `server_cost` table is the `cost_name` column, so it is not possible to create multiple entries for any cost estimate.

The server recognizes these `cost_name` values for the `server_cost` table:

- `disk temptable create cost` (default 40.0), `disk temptable row cost` (default 1.0)

The cost estimates for internally created temporary tables stored in a disk-based storage engine (either `InnoDB` or `MyISAM`). Increasing these values increases the cost estimate of using internal temporary tables and makes the optimizer prefer query plans with less use of them. For information about such tables, see [Section 8.4.4, “Internal Temporary Table Use in MySQL”](#).

The larger default values for these disk parameters compared to the default values for the corresponding memory parameters (`memory temptable create cost`, `memory temptable row cost`) reflects the greater cost of processing disk-based tables.

- `key compare cost` (default 0.1)

The cost of comparing record keys. Increasing this value causes a query plan that compares many keys to become more expensive. For example, a query plan that performs a `filesort` becomes relatively more expensive compared to a query plan that avoids sorting by using an index.

- `memory temptable create cost` (default 2.0), `memory temptable row cost` (default 0.2)

The cost estimates for internally created temporary tables stored in the `MEMORY` storage engine. Increasing these values increases the cost estimate of using internal temporary tables and makes the optimizer prefer query plans with less use of them. For information about such tables, see [Section 8.4.4, “Internal Temporary Table Use in MySQL”](#).

The smaller default values for these memory parameters compared to the default values for the corresponding disk parameters (`disk temptable create cost`, `disk temptable row cost`) reflects the lesser cost of processing memory-based tables.

- `row_evaluate_cost` (default 0.2)

The cost of evaluating record conditions. Increasing this value causes a query plan that examines many rows to become more expensive compared to a query plan that examines fewer rows. For example, a table scan becomes relatively more expensive compared to a range scan that reads fewer rows.

The `engine_cost` table contains these columns:

- `engine_name`

The name of the storage engine to which this cost estimate applies. The name is not case-sensitive. If the value is `default`, it applies to all storage engines that have no named entry of their own. If the server does not recognize the engine name when it reads this table, it writes a warning to the error log.

- `device_type`

The device type to which this cost estimate applies. The column is intended for specifying different cost estimates for different storage device types, such as hard disk drives versus solid state drives. Currently, this information is not used and 0 is the only permitted value.

- `cost_name`

Same as in the `server_cost` table.

- `cost_value`

Same as in the `server_cost` table.

- `last_update`

Same as in the `server_cost` table.

- `comment`

Same as in the `server_cost` table.

The primary key for the `engine_cost` table is a tuple comprising the (`cost_name`, `engine_name`, `device_type`) columns, so it is not possible to create multiple entries for any combination of values in those columns.

The server recognizes these `cost_name` values for the `engine_cost` table:

- `io_block_read_cost` (default 1.0)

The cost of reading an index or data block from disk. Increasing this value causes a query plan that reads many disk blocks to become more expensive compared to a query plan that reads fewer disk blocks. For example, a table scan becomes relatively more expensive compared to a range scan that reads fewer blocks.

- `memory_block_read_cost` (default 1.0)

Similar to `io_block_read_cost`, but represents the cost of reading an index or data block from an in-memory database buffer.

If the `io_block_read_cost` and `memory_block_read_cost` values differ, the execution plan may change between two runs of the same query. Suppose that the cost for memory access is less than the cost for disk access. In that case, at server startup before data has been read into the buffer pool, you may get a different plan than after the query has been run because then the data is in memory.

## Making Changes to the Cost Model Database

For DBAs who wish to change the cost model parameters from their defaults, try doubling or halving the value and measuring the effect.

Changes to the `io_block_read_cost` and `memory_block_read_cost` parameters are most likely to yield worthwhile results. These parameter values enable cost models for data access methods to take into account the costs of reading information from different sources; that is, the cost of reading information from disk versus reading information already in a memory buffer. For example, all other things being equal, setting `io_block_read_cost` to a value larger than `memory_block_read_cost` causes the optimizer to prefer query plans that read information already held in memory to plans that must read from disk.

This example shows how to change the default value for `io_block_read_cost`:

```
UPDATE mysql.engine_cost
SET cost_value = 2.0
WHERE cost_name = 'io_block_read_cost';
FLUSH OPTIMIZER_COSTS;
```

This example shows how to change the value of `io_block_read_cost` only for the `InnoDB` storage engine:

```
INSERT INTO mysql.engine_cost
VALUES ('InnoDB', 0, 'io_block_read_cost', 3.0,
CURRENT_TIMESTAMP, 'Using a slower disk for InnoDB');
FLUSH OPTIMIZER_COSTS;
```

## 8.10 Buffering and Caching

MySQL uses several strategies that cache information in memory buffers to increase performance.

### 8.10.1 InnoDB Buffer Pool Optimization

`InnoDB` maintains a storage area called the `buffer pool` for caching data and indexes in memory. Knowing how the `InnoDB` buffer pool works, and taking advantage of it to keep frequently accessed data in memory, is an important aspect of MySQL tuning.

For an explanation of the inner workings of the `InnoDB` buffer pool, an overview of its LRU replacement algorithm, and general configuration information, see [Section 14.5.1, “Buffer Pool”](#).

For additional `InnoDB` buffer pool configuration and tuning information, see these sections:

- [Section 14.8.3.4, “Configuring InnoDB Buffer Pool Prefetching \(Read-Ahead\)”](#)
- [Section 14.8.3.5, “Configuring Buffer Pool Flushing”](#)
- [Section 14.8.3.3, “Making the Buffer Pool Scan Resistant”](#)
- [Section 14.8.3.2, “Configuring Multiple Buffer Pool Instances”](#)
- [Section 14.8.3.6, “Saving and Restoring the Buffer Pool State”](#)
- [Section 14.8.3.1, “Configuring InnoDB Buffer Pool Size”](#)

## 8.10.2 The MyISAM Key Cache

To minimize disk I/O, the [MyISAM](#) storage engine exploits a strategy that is used by many database management systems. It employs a cache mechanism to keep the most frequently accessed table blocks in memory:

- For index blocks, a special structure called the *key cache* (or *key buffer*) is maintained. The structure contains a number of block buffers where the most-used index blocks are placed.
- For data blocks, MySQL uses no special cache. Instead it relies on the native operating system file system cache.

This section first describes the basic operation of the [MyISAM](#) key cache. Then it discusses features that improve key cache performance and that enable you to better control cache operation:

- Multiple sessions can access the cache concurrently.
- You can set up multiple key caches and assign table indexes to specific caches.

To control the size of the key cache, use the [key\\_buffer\\_size](#) system variable. If this variable is set equal to zero, no key cache is used. The key cache also is not used if the [key\\_buffer\\_size](#) value is too small to allocate the minimal number of block buffers (8).

When the key cache is not operational, index files are accessed using only the native file system buffering provided by the operating system. (In other words, table index blocks are accessed using the same strategy as that employed for table data blocks.)

An index block is a contiguous unit of access to the [MyISAM](#) index files. Usually the size of an index block is equal to the size of nodes of the index B-tree. (Indexes are represented on disk using a B-tree data structure. Nodes at the bottom of the tree are leaf nodes. Nodes above the leaf nodes are nonleaf nodes.)

All block buffers in a key cache structure are the same size. This size can be equal to, greater than, or less than the size of a table index block. Usually one these two values is a multiple of the other.

When data from any table index block must be accessed, the server first checks whether it is available in some block buffer of the key cache. If it is, the server accesses data in the key cache rather than on disk. That is, it reads from the cache or writes into it rather than reading from or writing to disk. Otherwise, the server chooses a cache block buffer containing a different table index block (or blocks) and replaces the data there by a copy of required table index block. As soon as the new index block is in the cache, the index data can be accessed.

If it happens that a block selected for replacement has been modified, the block is considered “dirty.” In this case, prior to being replaced, its contents are flushed to the table index from which it came.

Usually the server follows an *LRU* (*Least Recently Used*) strategy: When choosing a block for replacement, it selects the least recently used index block. To make this choice easier, the key cache module maintains all used blocks in a special list (*LRU chain*) ordered by time of use. When a block is accessed, it is the most recently used and is placed at the end of the list. When blocks need to be replaced, blocks at the beginning of the list are the least recently used and become the first candidates for eviction.

The [InnoDB](#) storage engine also uses an LRU algorithm, to manage its buffer pool. See [Section 14.5.1](#), “[Buffer Pool](#)”.

### 8.10.2.1 Shared Key Cache Access

Threads can access key cache buffers simultaneously, subject to the following conditions:

- A buffer that is not being updated can be accessed by multiple sessions.
- A buffer that is being updated causes sessions that need to use it to wait until the update is complete.
- Multiple sessions can initiate requests that result in cache block replacements, as long as they do not interfere with each other (that is, as long as they need different index blocks, and thus cause different cache blocks to be replaced).

Shared access to the key cache enables the server to improve throughput significantly.

### 8.10.2.2 Multiple Key Caches

Shared access to the key cache improves performance but does not eliminate contention among sessions entirely. They still compete for control structures that manage access to the key cache buffers. To reduce key cache access contention further, MySQL also provides multiple key caches. This feature enables you to assign different table indexes to different key caches.

Where there are multiple key caches, the server must know which cache to use when processing queries for a given [MyISAM](#) table. By default, all [MyISAM](#) table indexes are cached in the default key cache. To assign table indexes to a specific key cache, use the [CACHE INDEX](#) statement (see [Section 13.7.6.2, “CACHE INDEX Statement”](#)). For example, the following statement assigns indexes from the tables `t1`, `t2`, and `t3` to the key cache named `hot_cache`:

```
mysql> CACHE INDEX t1, t2, t3 IN hot_cache;
```

Table	Op	Msg_type	Msg_text
test.t1	assign_to_keycache	status	OK
test.t2	assign_to_keycache	status	OK
test.t3	assign_to_keycache	status	OK

The key cache referred to in a [CACHE INDEX](#) statement can be created by setting its size with a [SET GLOBAL](#) parameter setting statement or by using server startup options. For example:

```
mysql> SET GLOBAL keycache1.key_buffer_size=128*1024;
```

To destroy a key cache, set its size to zero:

```
mysql> SET GLOBAL keycache1.key_buffer_size=0;
```

You cannot destroy the default key cache. Any attempt to do this is ignored:

```
mysql> SET GLOBAL key_buffer_size = 0;
```

```
mysql> SHOW VARIABLES LIKE 'key_buffer_size';
```

Variable_name	Value
key_buffer_size	8384512

Key cache variables are structured system variables that have a name and components. For `keycache1.key_buffer_size`, `keycache1` is the cache variable name and `key_buffer_size` is the cache component. See [Section 5.1.8.3, “Structured System Variables”](#), for a description of the syntax used for referring to structured key cache system variables.

By default, table indexes are assigned to the main (default) key cache created at the server startup. When a key cache is destroyed, all indexes assigned to it are reassigned to the default key cache.

For a busy server, you can use a strategy that involves three key caches:

- A “hot” key cache that takes up 20% of the space allocated for all key caches. Use this for tables that are heavily used for searches but that are not updated.
- A “cold” key cache that takes up 20% of the space allocated for all key caches. Use this cache for medium-sized, intensively modified tables, such as temporary tables.
- A “warm” key cache that takes up 60% of the key cache space. Employ this as the default key cache, to be used by default for all other tables.

One reason the use of three key caches is beneficial is that access to one key cache structure does not block access to the others. Statements that access tables assigned to one cache do not compete with statements that access tables assigned to another cache. Performance gains occur for other reasons as well:

- The hot cache is used only for retrieval queries, so its contents are never modified. Consequently, whenever an index block needs to be pulled in from disk, the contents of the cache block chosen for replacement need not be flushed first.
- For an index assigned to the hot cache, if there are no queries requiring an index scan, there is a high probability that the index blocks corresponding to nonleaf nodes of the index B-tree remain in the cache.
- An update operation most frequently executed for temporary tables is performed much faster when the updated node is in the cache and need not be read from disk first. If the size of the indexes of the temporary tables are comparable with the size of cold key cache, the probability is very high that the updated node is in the cache.

The `CACHE INDEX` statement sets up an association between a table and a key cache, but the association is lost each time the server restarts. If you want the association to take effect each time the server starts, one way to accomplish this is to use an option file: Include variable settings that configure your key caches, and an `init_file` system variable that names a file containing `CACHE INDEX` statements to be executed. For example:

```
key_buffer_size = 4G
hot_cache.key_buffer_size = 2G
cold_cache.key_buffer_size = 2G
init_file=/path/to/data-directory/mysql_d_init.sql
```

The statements in `mysql_d_init.sql` are executed each time the server starts. The file should contain one SQL statement per line. The following example assigns several tables each to `hot_cache` and `cold_cache`:

```
CACHE INDEX db1.t1, db1.t2, db2.t3 IN hot_cache
CACHE INDEX db1.t4, db2.t5, db2.t6 IN cold_cache
```

### 8.10.2.3 Midpoint Insertion Strategy

By default, the key cache management system uses a simple LRU strategy for choosing key cache blocks to be evicted, but it also supports a more sophisticated method called the *midpoint insertion strategy*.

When using the midpoint insertion strategy, the LRU chain is divided into two parts: a hot sublist and a warm sublist. The division point between two parts is not fixed, but the key cache management system takes care that the warm part is not “too short,” always containing at least `key_cache_division_limit` percent of the key cache blocks. `key_cache_division_limit` is a component of structured key cache variables, so its value is a parameter that can be set per cache.

When an index block is read from a table into the key cache, it is placed at the end of the warm sublist. After a certain number of hits (accesses of the block), it is promoted to the hot sublist. At present, the number of hits required to promote a block (3) is the same for all index blocks.



A block promoted into the hot sublist is placed at the end of the list. The block then circulates within this sublist. If the block stays at the beginning of the sublist for a long enough time, it is demoted to the warm sublist. This time is determined by the value of the `key_cache_age_threshold` component of the key cache.

The threshold value prescribes that, for a key cache containing  $N$  blocks, the block at the beginning of the hot sublist not accessed within the last  $N * \text{key\_cache\_age\_threshold} / 100$  hits is to be moved to the beginning of the warm sublist. It then becomes the first candidate for eviction, because blocks for replacement always are taken from the beginning of the warm sublist.

The midpoint insertion strategy enables you to keep more-valued blocks always in the cache. If you prefer to use the plain LRU strategy, leave the `key_cache_division_limit` value set to its default of 100.

The midpoint insertion strategy helps to improve performance when execution of a query that requires an index scan effectively pushes out of the cache all the index blocks corresponding to valuable high-level B-tree nodes. To avoid this, you must use a midpoint insertion strategy with the `key_cache_division_limit` set to much less than 100. Then valuable frequently hit nodes are preserved in the hot sublist during an index scan operation as well.

### 8.10.2.4 Index Preloading

If there are enough blocks in a key cache to hold blocks of an entire index, or at least the blocks corresponding to its nonleaf nodes, it makes sense to preload the key cache with index blocks before starting to use it. Preloading enables you to put the table index blocks into a key cache buffer in the most efficient way: by reading the index blocks from disk sequentially.

Without preloading, the blocks are still placed into the key cache as needed by queries. Although the blocks stay in the cache, because there are enough buffers for all of them, they are fetched from disk in random order, and not sequentially.

To preload an index into a cache, use the `LOAD INDEX INTO CACHE` statement. For example, the following statement preloads nodes (index blocks) of indexes of the tables `t1` and `t2`:

```
mysql> LOAD INDEX INTO CACHE t1, t2 IGNORE LEAVES;
+-----+-----+-----+-----+
| Table | Op          | Msg_type | Msg_text |
+-----+-----+-----+-----+
| test.t1 | preload_keys | status   | OK       |
| test.t2 | preload_keys | status   | OK       |
+-----+-----+-----+-----+
```

The `IGNORE LEAVES` modifier causes only blocks for the nonleaf nodes of the index to be preloaded. Thus, the statement shown preloads all index blocks from `t1`, but only blocks for the nonleaf nodes from `t2`.

If an index has been assigned to a key cache using a `CACHE INDEX` statement, preloading places index blocks into that cache. Otherwise, the index is loaded into the default key cache.

### 8.10.2.5 Key Cache Block Size

It is possible to specify the size of the block buffers for an individual key cache using the `key_cache_block_size` variable. This permits tuning of the performance of I/O operations for index files.

The best performance for I/O operations is achieved when the size of read buffers is equal to the size of the native operating system I/O buffers. But setting the size of key nodes equal to the size of the I/O buffer does not always ensure the best overall performance. When reading the big leaf nodes, the server pulls in a lot of unnecessary data, effectively preventing reading other leaf nodes.

To control the size of blocks in the `.MYI` index file of `MyISAM` tables, use the `--myisam-block-size` option at server startup.

### 8.10.2.6 Restructuring a Key Cache

A key cache can be restructured at any time by updating its parameter values. For example:

```
mysql> SET GLOBAL cold_cache.key_buffer_size=4*1024*1024;
```

If you assign to either the `key_buffer_size` or `key_cache_block_size` key cache component a value that differs from the component's current value, the server destroys the cache's old structure and creates a new one based on the new values. If the cache contains any dirty blocks, the server saves them to disk before destroying and re-creating the cache. Restructuring does not occur if you change other key cache parameters.

When restructuring a key cache, the server first flushes the contents of any dirty buffers to disk. After that, the cache contents become unavailable. However, restructuring does not block queries that need to use indexes assigned to the cache. Instead, the server directly accesses the table indexes using native file system caching. File system caching is not as efficient as using a key cache, so although queries execute, a slowdown can be anticipated. After the cache has been restructured, it becomes available again for caching indexes assigned to it, and the use of file system caching for the indexes ceases.

### 8.10.3 The MySQL Query Cache



#### Note

The query cache is deprecated as of MySQL 5.7.20, and is removed in MySQL 8.0.

The query cache stores the text of a `SELECT` statement together with the corresponding result that was sent to the client. If an identical statement is received later, the server retrieves the results from the query cache rather than parsing and executing the statement again. The query cache is shared among sessions, so a result set generated by one client can be sent in response to the same query issued by another client.

The query cache can be useful in an environment where you have tables that do not change very often and for which the server receives many identical queries. This is a typical situation for many Web servers that generate many dynamic pages based on database content.

The query cache does not return stale data. When tables are modified, any relevant entries in the query cache are flushed.



#### Note

The query cache does not work in an environment where you have multiple `mysqld` servers updating the same `MyISAM` tables.

The query cache is used for prepared statements under the conditions described in [Section 8.10.3.1, "How the Query Cache Operates"](#).



#### Note

The query cache is not supported for partitioned tables, and is automatically disabled for queries involving partitioned tables. The query cache cannot be enabled for such queries.

Some performance data for the query cache follows. These results were generated by running the MySQL benchmark suite on a Linux Alpha 2x500MHz system with 2GB RAM and a 64MB query cache.

- If all the queries you are performing are simple (such as selecting a row from a table with one row), but still differ so that the queries cannot be cached, the overhead for having the query cache active is 13%. This could be regarded as the worst case scenario. In real life, queries tend to be much more complicated, so the overhead normally is significantly lower.
- Searches for a single row in a single-row table are 238% faster with the query cache than without it. This can be regarded as close to the minimum speedup to be expected for a query that is cached.

To disable the query cache at server startup, set the `query_cache_size` system variable to 0. By disabling the query cache code, there is no noticeable overhead.

The query cache offers the potential for substantial performance improvement, but do not assume that it does so under all circumstances. With some query cache configurations or server workloads, you might actually see a performance decrease:

- Be cautious about sizing the query cache excessively large, which increases the overhead required to maintain the cache, possibly beyond the benefit of enabling it. Sizes in tens of megabytes are usually beneficial. Sizes in the hundreds of megabytes might not be.
- Server workload has a significant effect on query cache efficiency. A query mix consisting almost entirely of a fixed set of `SELECT` statements is much more likely to benefit from enabling the cache than a mix in which frequent `INSERT` statements cause continual invalidation of results in the cache. In some cases, a workaround is to use the `SQL_NO_CACHE` option to prevent results from even entering the cache for `SELECT` statements that use frequently modified tables. (See [Section 8.10.3.2, “Query Cache SELECT Options”](#).)

To verify that enabling the query cache is beneficial, test the operation of your MySQL server with the cache enabled and disabled. Then retest periodically because query cache efficiency may change as server workload changes.

### 8.10.3.1 How the Query Cache Operates



#### Note

The query cache is deprecated as of MySQL 5.7.20, and is removed in MySQL 8.0.

This section describes how the query cache works when it is operational. [Section 8.10.3.3, “Query Cache Configuration”](#), describes how to control whether it is operational.

Incoming queries are compared to those in the query cache before parsing, so the following two queries are regarded as different by the query cache:

```
SELECT * FROM tbl_name
Select * from tbl_name
```

Queries must be *exactly* the same (byte for byte) to be seen as identical. In addition, query strings that are identical may be treated as different for other reasons. Queries that use different databases, different protocol versions, or different default character sets are considered different queries and are cached separately.

The cache is not used for queries of the following types:

- Queries that are a subquery of an outer query
- Queries executed within the body of a stored function, trigger, or event

Before a query result is fetched from the query cache, MySQL checks whether the user has `SELECT` privilege for all databases and tables involved. If this is not the case, the cached result is not used.

If a query result is returned from query cache, the server increments the `Qcache_hits` status variable, not `Com_select`. See [Section 8.10.3.4, “Query Cache Status and Maintenance”](#).

If a table changes, all cached queries that use the table become invalid and are removed from the cache. This includes queries that use `MERGE` tables that map to the changed table. A table can be changed by many types of statements, such as `INSERT`, `UPDATE`, `DELETE`, `TRUNCATE TABLE`, `ALTER TABLE`, `DROP TABLE`, or `DROP DATABASE`.

The query cache also works within transactions when using `InnoDB` tables.

The result from a `SELECT` query on a view is cached.

The query cache works for `SELECT SQL_CALC_FOUND_ROWS . . .` queries and stores a value that is returned by a following `SELECT FOUND_ROWS()` query. `FOUND_ROWS()` returns the correct value even if the preceding query was fetched from the cache because the number of found rows is also stored in the cache. The `SELECT FOUND_ROWS()` query itself cannot be cached.

Prepared statements that are issued using the binary protocol using `mysql_stmt_prepare()` and `mysql_stmt_execute()` (see [C API Prepared Statement Interface](#)), are subject to limitations on caching. Comparison with statements in the query cache is based on the text of the statement after expansion of `?` parameter markers. The statement is compared only with other cached statements that were executed using the binary protocol. That is, for query cache purposes, prepared statements issued using the binary protocol are distinct from prepared statements issued using the text protocol (see [Section 13.5, “Prepared Statements”](#)).

A query cannot be cached if it uses any of the following functions:

- `AES_DECRYPT()`
- `AES_ENCRYPT()`
- `BENCHMARK()`
- `CONNECTION_ID()`
- `CONVERT_TZ()`
- `CURDATE()`
- `CURRENT_DATE()`
- `CURRENT_TIME()`
- `CURRENT_TIMESTAMP()`
- `CURRENT_USER()`
- `CURTIME()`
- `DATABASE()`
- `ENCRYPT()` with one parameter
- `FOUND_ROWS()`
- `GET_LOCK()`
- `IS_FREE_LOCK()`
- `IS_USED_LOCK()`

- `LAST_INSERT_ID()`
- `LOAD_FILE()`
- `MASTER_POS_WAIT()`
- `NOW()`
- `PASSWORD()`
- `RAND()`
- `RANDOM_BYTES()`
- `RELEASE_ALL_LOCKS()`
- `RELEASE_LOCK()`
- `SLEEP()`
- `SYSDATE()`
- `UNIX_TIMESTAMP()` with no parameters
- `USER()`
- `UUID()`
- `UUID_SHORT()`

A query also is not cached under these conditions:

- It refers to loadable functions or stored functions.
- It refers to user variables or local stored program variables.
- It refers to tables in the `mysql`, `INFORMATION_SCHEMA`, or `performance_schema` database.
- It refers to any partitioned tables.
- It is of any of the following forms:

```
SELECT ... LOCK IN SHARE MODE
SELECT ... FOR UPDATE
SELECT ... INTO OUTFILE ...
SELECT ... INTO DUMPFILE ...
SELECT * FROM ... WHERE autoincrement_col IS NULL
```

The last form is not cached because it is used as the ODBC workaround for obtaining the last insert ID value. See the Connector/ODBC section of [Chapter 27, Connectors and APIs](#).

Statements within transactions that use `SERIALIZABLE` isolation level also cannot be cached because they use `LOCK IN SHARE MODE` locking.

- It uses `TEMPORARY` tables.
- It does not use any tables.
- It generates warnings.
- The user has a column-level privilege for any of the involved tables.

### 8.10.3.2 Query Cache SELECT Options



#### Note

The query cache is deprecated as of MySQL 5.7.20, and is removed in MySQL 8.0.

Two query cache-related options may be specified in `SELECT` statements:

- `SQL_CACHE`

The query result is cached if it is cacheable and the value of the `query_cache_type` system variable is `ON` or `DEMAND`.

- `SQL_NO_CACHE`

The server does not use the query cache. It neither checks the query cache to see whether the result is already cached, nor does it cache the query result.

Examples:

```
SELECT SQL_CACHE id, name FROM customer;
SELECT SQL_NO_CACHE id, name FROM customer;
```

### 8.10.3.3 Query Cache Configuration



#### Note

The query cache is deprecated as of MySQL 5.7.20, and is removed in MySQL 8.0.

The `have_query_cache` server system variable indicates whether the query cache is available:

```
mysql> SHOW VARIABLES LIKE 'have_query_cache';
+-----+-----+
| Variable_name | Value |
+-----+-----+
| have_query_cache | YES  |
+-----+-----+
```

When using a standard MySQL binary, this value is always `YES`, even if query caching is disabled.

Several other system variables control query cache operation. These can be set in an option file or on the command line when starting `mysqld`. The query cache system variables all have names that begin with `query_cache_`. They are described briefly in [Section 5.1.7, “Server System Variables”](#), with additional configuration information given here.

To set the size of the query cache, set the `query_cache_size` system variable. Setting it to 0 disables the query cache, as does setting `query_cache_type=0`. By default, the query cache is disabled. This is achieved using a default size of 1M, with a default for `query_cache_type` of 0.

To reduce overhead significantly, start the server with `query_cache_type=0` if you do not intend to use the query cache.



#### Note

When using the Windows Configuration Wizard to install or configure MySQL, the default value for `query_cache_size` is configured automatically for you based on the different configuration types available. When using the Windows Configuration

Wizard, the query cache may be enabled (that is, set to a nonzero value) due to the selected configuration. The query cache is also controlled by the setting of the `query_cache_type` variable. Check the values of these variables as set in your `my.ini` file after configuration has taken place.

When you set `query_cache_size` to a nonzero value, keep in mind that the query cache needs a minimum size of about 40KB to allocate its structures. (The exact size depends on system architecture.) If you set the value too small, you'll get a warning, as in this example:

```
mysql> SET GLOBAL query_cache_size = 40000;
Query OK, 0 rows affected, 1 warning (0.00 sec)

mysql> SHOW WARNINGS\G
***** 1. row *****
Level: Warning
Code: 1282
Message: Query cache failed to set size 39936;
        new query cache size is 0

mysql> SET GLOBAL query_cache_size = 41984;
Query OK, 0 rows affected (0.00 sec)

mysql> SHOW VARIABLES LIKE 'query_cache_size';
+-----+-----+
| Variable_name | Value |
+-----+-----+
| query_cache_size | 41984 |
+-----+-----+
```

For the query cache to actually be able to hold any query results, its size must be set larger:

```
mysql> SET GLOBAL query_cache_size = 1000000;
Query OK, 0 rows affected (0.04 sec)

mysql> SHOW VARIABLES LIKE 'query_cache_size';
+-----+-----+
| Variable_name | Value |
+-----+-----+
| query_cache_size | 999424 |
+-----+-----+
1 row in set (0.00 sec)
```

The `query_cache_size` value is aligned to the nearest 1024 byte block. The value reported may therefore be different from the value that you assign.

If the query cache size is greater than 0, the `query_cache_type` variable influences how it works. This variable can be set to the following values:

- A value of `0` or `OFF` prevents caching or retrieval of cached results.
- A value of `1` or `ON` enables caching except of those statements that begin with `SELECT SQL_NO_CACHE`.
- A value of `2` or `DEMAND` causes caching of only those statements that begin with `SELECT SQL_CACHE`.

If `query_cache_size` is 0, you should also set `query_cache_type` variable to 0. In this case, the server does not acquire the query cache mutex at all, which means that the query cache cannot be enabled at runtime and there is reduced overhead in query execution.

Setting the `GLOBAL query_cache_type` value determines query cache behavior for all clients that connect after the change is made. Individual clients can control cache behavior for their own connection by setting the `SESSION query_cache_type` value. For example, a client can disable use of the query cache for its own queries like this:

```
mysql> SET SESSION query_cache_type = OFF;
```

If you set `query_cache_type` at server startup (rather than at runtime with a `SET` statement), only the numeric values are permitted.

To control the maximum size of individual query results that can be cached, set the `query_cache_limit` system variable. The default value is 1MB.

Be careful not to set the size of the cache too large. Due to the need for threads to lock the cache during updates, you may see lock contention issues with a very large cache.



#### Note

You can set the maximum size that can be specified for the query cache at runtime with the `SET` statement by using the `--maximum-query_cache_size=32M` option on the command line or in the configuration file.

When a query is to be cached, its result (the data sent to the client) is stored in the query cache during result retrieval. Therefore the data usually is not handled in one big chunk. The query cache allocates blocks for storing this data on demand, so when one block is filled, a new block is allocated. Because memory allocation operation is costly (timewise), the query cache allocates blocks with a minimum size given by the `query_cache_min_res_unit` system variable. When a query is executed, the last result block is trimmed to the actual data size so that unused memory is freed. Depending on the types of queries your server executes, you might find it helpful to tune the value of `query_cache_min_res_unit`:

- The default value of `query_cache_min_res_unit` is 4KB. This should be adequate for most cases.
- If you have a lot of queries with small results, the default block size may lead to memory fragmentation, as indicated by a large number of free blocks. Fragmentation can force the query cache to prune (delete) queries from the cache due to lack of memory. In this case, decrease the value of `query_cache_min_res_unit`. The number of free blocks and queries removed due to pruning are given by the values of the `Qcache_free_blocks` and `Qcache_lowmem_prunes` status variables.
- If most of your queries have large results (check the `Qcache_total_blocks` and `Qcache_queries_in_cache` status variables), you can increase performance by increasing `query_cache_min_res_unit`. However, be careful to not make it too large (see the previous item).

### 8.10.3.4 Query Cache Status and Maintenance



#### Note

The query cache is deprecated as of MySQL 5.7.20, and is removed in MySQL 8.0.

To check whether the query cache is present in your MySQL server, use the following statement:

```
mysql> SHOW VARIABLES LIKE 'have_query_cache';
+-----+-----+
| Variable_name | Value |
+-----+-----+
| have_query_cache | YES  |
+-----+-----+
```

You can defragment the query cache to better utilize its memory with the `FLUSH QUERY CACHE` statement. The statement does not remove any queries from the cache.

The `RESET QUERY CACHE` statement removes all query results from the query cache. The `FLUSH TABLES` statement also does this.



To monitor query cache performance, use `SHOW STATUS` to view the cache status variables:

```
mysql> SHOW STATUS LIKE 'Qcache%';
+-----+-----+
| Variable_name | Value |
+-----+-----+
| Qcache_free_blocks | 36 |
| Qcache_free_memory | 138488 |
| Qcache_hits | 79570 |
| Qcache_inserts | 27087 |
| Qcache_lowmem_prunes | 3114 |
| Qcache_not_cached | 22989 |
| Qcache_queries_in_cache | 415 |
| Qcache_total_blocks | 912 |
+-----+-----+
```

Descriptions of each of these variables are given in [Section 5.1.9, “Server Status Variables”](#). Some uses for them are described here.

The total number of `SELECT` queries is given by this formula:

```
Com_select
+ Qcache_hits
+ queries with errors found by parser
```

The `Com_select` value is given by this formula:

```
Qcache_inserts
+ Qcache_not_cached
+ queries with errors found during the column-privileges check
```

The query cache uses variable-length blocks, so `Qcache_total_blocks` and `Qcache_free_blocks` may indicate query cache memory fragmentation. After `FLUSH QUERY CACHE`, only a single free block remains.

Every cached query requires a minimum of two blocks (one for the query text and one or more for the query results). Also, every table that is used by a query requires one block. However, if two or more queries use the same table, only one table block needs to be allocated.

The information provided by the `Qcache_lowmem_prunes` status variable can help you tune the query cache size. It counts the number of queries that have been removed from the cache to free up memory for caching new queries. The query cache uses a least recently used (LRU) strategy to decide which queries to remove from the cache. Tuning information is given in [Section 8.10.3.3, “Query Cache Configuration”](#).

## 8.10.4 Caching of Prepared Statements and Stored Programs

For certain statements that a client might execute multiple times during a session, the server converts the statement to an internal structure and caches that structure to be used during execution. Caching enables the server to perform more efficiently because it avoids the overhead of reconvertng the statement should it be needed again during the session. Conversion and caching occurs for these statements:

- Prepared statements, both those processed at the SQL level (using the `PREPARE` statement) and those processed using the binary client/server protocol (using the `mysql_stmt_prepare()` C API function). The `max_prepared_stmt_count` system variable controls the total number of statements the server caches. (The sum of the number of prepared statements across all sessions.)
- Stored programs (stored procedures and functions, triggers, and events). In this case, the server converts and caches the entire program body. The `stored_program_cache` system variable indicates the approximate number of stored programs the server caches per session.

The server maintains caches for prepared statements and stored programs on a per-session basis. Statements cached for one session are not accessible to other sessions. When a session ends, the server discards any statements cached for it.

When the server uses a cached internal statement structure, it must take care that the structure does not go out of date. Metadata changes can occur for an object used by the statement, causing a mismatch between the current object definition and the definition as represented in the internal statement structure. Metadata changes occur for DDL statements such as those that create, drop, alter, rename, or truncate tables, or that analyze, optimize, or repair tables. Table content changes (for example, with [INSERT](#) or [UPDATE](#)) do not change metadata, nor do [SELECT](#) statements.

Here is an illustration of the problem. Suppose that a client prepares this statement:

```
PREPARE s1 FROM 'SELECT * FROM t1';
```

The [SELECT \\*](#) expands in the internal structure to the list of columns in the table. If the set of columns in the table is modified with [ALTER TABLE](#), the prepared statement goes out of date. If the server does not detect this change the next time the client executes `s1`, the prepared statement returns incorrect results.

To avoid problems caused by metadata changes to tables or views referred to by the prepared statement, the server detects these changes and automatically reprepares the statement when it is next executed. That is, the server reparses the statement and rebuilds the internal structure. Reparsing also occurs after referenced tables or views are flushed from the table definition cache, either implicitly to make room for new entries in the cache, or explicitly due to [FLUSH TABLES](#).

Similarly, if changes occur to objects used by a stored program, the server reparses affected statements within the program.

The server also detects metadata changes for objects in expressions. These might be used in statements specific to stored programs, such as [DECLARE CURSOR](#) or flow-control statements such as [IF](#), [CASE](#), and [RETURN](#).

To avoid reparsing entire stored programs, the server reparses affected statements or expressions within a program only as needed. Examples:

- Suppose that metadata for a table or view is changed. Reparsing occurs for a [SELECT \\*](#) within the program that accesses the table or view, but not for a [SELECT \\*](#) that does not access the table or view.
- When a statement is affected, the server reparses it only partially if possible. Consider this [CASE](#) statement:

```
CASE case_expr
  WHEN when_expr1 ...
  WHEN when_expr2 ...
  WHEN when_expr3 ...
  ...
END CASE
```

If a metadata change affects only `WHEN when_expr3`, that expression is reparsed. `case_expr` and the other `WHEN` expressions are not reparsed.

Reparsing uses the default database and SQL mode that were in effect for the original conversion to internal form.

The server attempts reparsing up to three times. An error occurs if all attempts fail.

Reparsing is automatic, but to the extent that it occurs, diminishes prepared statement and stored program performance.

For prepared statements, the `Com_stmt_reprepare` status variable tracks the number of re Preparations.

## 8.11 Optimizing Locking Operations

MySQL manages contention for table contents using [locking](#):

- Internal locking is performed within the MySQL server itself to manage contention for table contents by multiple threads. This type of locking is internal because it is performed entirely by the server and involves no other programs. See [Section 8.11.1, “Internal Locking Methods”](#).
- External locking occurs when the server and other programs lock `MyISAM` table files to coordinate among themselves which program can access the tables at which time. See [Section 8.11.5, “External Locking”](#).

### 8.11.1 Internal Locking Methods

This section discusses internal locking; that is, locking performed within the MySQL server itself to manage contention for table contents by multiple sessions. This type of locking is internal because it is performed entirely by the server and involves no other programs. For locking performed on MySQL files by other programs, see [Section 8.11.5, “External Locking”](#).

- [Row-Level Locking](#)
- [Table-Level Locking](#)
- [Choosing the Type of Locking](#)

#### Row-Level Locking

MySQL uses [row-level locking](#) for `InnoDB` tables to support simultaneous write access by multiple sessions, making them suitable for multi-user, highly concurrent, and OLTP applications.

To avoid [deadlocks](#) when performing multiple concurrent write operations on a single `InnoDB` table, acquire necessary locks at the start of the transaction by issuing a `SELECT ... FOR UPDATE` statement for each group of rows expected to be modified, even if the data change statements come later in the transaction. If transactions modify or lock more than one table, issue the applicable statements in the same order within each transaction. Deadlocks affect performance rather than representing a serious error, because `InnoDB` automatically [detects](#) deadlock conditions and rolls back one of the affected transactions.

On high concurrency systems, deadlock detection can cause a slowdown when numerous threads wait for the same lock. At times, it may be more efficient to disable deadlock detection and rely on the `innodb_lock_wait_timeout` setting for transaction rollback when a deadlock occurs. Deadlock detection can be disabled using the `innodb_deadlock_detect` configuration option.

Advantages of row-level locking:

- Fewer lock conflicts when different sessions access different rows.
- Fewer changes for rollbacks.
- Possible to lock a single row for a long time.

#### Table-Level Locking

MySQL uses [table-level locking](#) for `MyISAM`, `MEMORY`, and `MERGE` tables, permitting only one session to update those tables at a time. This locking level makes these storage engines more suitable for read-only, read-mostly, or single-user applications.

These storage engines avoid [deadlocks](#) by always requesting all needed locks at once at the beginning of a query and always locking the tables in the same order. The tradeoff is that this strategy reduces concurrency; other sessions that want to modify the table must wait until the current data change statement finishes.

Advantages of table-level locking:

- Relatively little memory required (row locking requires memory per row or group of rows locked)
- Fast when used on a large part of the table because only a single lock is involved.
- Fast if you often do [GROUP BY](#) operations on a large part of the data or must scan the entire table frequently.

MySQL grants table write locks as follows:

1. If there are no locks on the table, put a write lock on it.
2. Otherwise, put the lock request in the write lock queue.

MySQL grants table read locks as follows:

1. If there are no write locks on the table, put a read lock on it.
2. Otherwise, put the lock request in the read lock queue.

Table updates are given higher priority than table retrievals. Therefore, when a lock is released, the lock is made available to the requests in the write lock queue and then to the requests in the read lock queue. This ensures that updates to a table are not “starved” even when there is heavy [SELECT](#) activity for the table. However, if there are many updates for a table, [SELECT](#) statements wait until there are no more updates.

For information on altering the priority of reads and writes, see [Section 8.11.2, “Table Locking Issues”](#).

You can analyze the table lock contention on your system by checking the [Table\\_locks\\_immediate](#) and [Table\\_locks\\_waited](#) status variables, which indicate the number of times that requests for table locks could be granted immediately and the number that had to wait, respectively:

```
mysql> SHOW STATUS LIKE 'Table%';
+-----+-----+
| Variable_name | Value |
+-----+-----+
| Table_locks_immediate | 1151552 |
| Table_locks_waited | 15324 |
+-----+-----+
```

The Performance Schema lock tables also provide locking information. See [Section 25.12.12, “Performance Schema Lock Tables”](#).

The [MyISAM](#) storage engine supports concurrent inserts to reduce contention between readers and writers for a given table: If a [MyISAM](#) table has no free blocks in the middle of the data file, rows are always inserted at the end of the data file. In this case, you can freely mix concurrent [INSERT](#) and [SELECT](#) statements for a [MyISAM](#) table without locks. That is, you can insert rows into a [MyISAM](#) table at the same time other clients are reading from it. Holes can result from rows having been deleted from or updated in the middle of the table. If there are holes, concurrent inserts are disabled but are enabled again automatically when all holes have been filled with new data. To control this behavior, use the [concurrent\\_insert](#) system variable. See [Section 8.11.3, “Concurrent Inserts”](#).

If you acquire a table lock explicitly with [LOCK TABLES](#), you can request a [READ LOCAL](#) lock rather than a [READ](#) lock to enable other sessions to perform concurrent inserts while you have the table locked.

To perform many `INSERT` and `SELECT` operations on a table `t1` when concurrent inserts are not possible, you can insert rows into a temporary table `temp_t1` and update the real table with the rows from the temporary table:

```
mysql> LOCK TABLES t1 WRITE, temp_t1 WRITE;
mysql> INSERT INTO t1 SELECT * FROM temp_t1;
mysql> DELETE FROM temp_t1;
mysql> UNLOCK TABLES;
```

## Choosing the Type of Locking

Generally, table locks are superior to row-level locks in the following cases:

- Most statements for the table are reads.
- Statements for the table are a mix of reads and writes, where writes are updates or deletes for a single row that can be fetched with one key read:

```
UPDATE tbl_name SET column=value WHERE unique_key_col=key_value;
DELETE FROM tbl_name WHERE unique_key_col=key_value;
```

- `SELECT` combined with concurrent `INSERT` statements, and very few `UPDATE` or `DELETE` statements.
- Many scans or `GROUP BY` operations on the entire table without any writers.

With higher-level locks, you can more easily tune applications by supporting locks of different types, because the lock overhead is less than for row-level locks.

Options other than row-level locking:

- Versioning (such as that used in MySQL for concurrent inserts) where it is possible to have one writer at the same time as many readers. This means that the database or table supports different views for the data depending on when access begins. Other common terms for this are “time travel,” “copy on write,” or “copy on demand.”
- Copy on demand is in many cases superior to row-level locking. However, in the worst case, it can use much more memory than using normal locks.
- Instead of using row-level locks, you can employ application-level locks, such as those provided by `GET_LOCK()` and `RELEASE_LOCK()` in MySQL. These are advisory locks, so they work only with applications that cooperate with each other. See [Section 12.14, “Locking Functions”](#).

### 8.11.2 Table Locking Issues

`InnoDB` tables use row-level locking so that multiple sessions and applications can read from and write to the same table simultaneously, without making each other wait or producing inconsistent results. For this storage engine, avoid using the `LOCK TABLES` statement, because it does not offer any extra protection, but instead reduces concurrency. The automatic row-level locking makes these tables suitable for your busiest databases with your most important data, while also simplifying application logic since you do not need to lock and unlock tables. Consequently, the `InnoDB` storage engine is the default in MySQL.

MySQL uses table locking (instead of page, row, or column locking) for all storage engines except `InnoDB`. The locking operations themselves do not have much overhead. But because only one session can write to a table at any one time, for best performance with these other storage engines, use them primarily for tables that are queried often and rarely inserted into or updated.

- [Performance Considerations Favoring InnoDB](#)
- [Workarounds for Locking Performance Issues](#)

---

## Performance Considerations Favoring InnoDB

When choosing whether to create a table using `InnoDB` or a different storage engine, keep in mind the following disadvantages of table locking:

- Table locking enables many sessions to read from a table at the same time, but if a session wants to write to a table, it must first get exclusive access, meaning it might have to wait for other sessions to finish with the table first. During the update, all other sessions that want to access this particular table must wait until the update is done.
- Table locking causes problems when a session is waiting because the disk is full and free space needs to become available before the session can proceed. In this case, all sessions that want to access the problem table are also put in a waiting state until more disk space is made available.
- A `SELECT` statement that takes a long time to run prevents other sessions from updating the table in the meantime, making the other sessions appear slow or unresponsive. While a session is waiting to get exclusive access to the table for updates, other sessions that issue `SELECT` statements queue up behind it, reducing concurrency even for read-only sessions.

## Workarounds for Locking Performance Issues

The following items describe some ways to avoid or reduce contention caused by table locking:

- Consider switching the table to the `InnoDB` storage engine, either using `CREATE TABLE ... ENGINE=INNODB` during setup, or using `ALTER TABLE ... ENGINE=INNODB` for an existing table. See [Chapter 14, The InnoDB Storage Engine](#) for more details about this storage engine.
- Optimize `SELECT` statements to run faster so that they lock tables for a shorter time. You might have to create some summary tables to do this.
- Start `mysqld` with `--low-priority-updates`. For storage engines that use only table-level locking (such as `MyISAM`, `MEMORY`, and `MERGE`), this gives all statements that update (modify) a table lower priority than `SELECT` statements. In this case, the second `SELECT` statement in the preceding scenario would execute before the `UPDATE` statement, and would not wait for the first `SELECT` to finish.
- To specify that all updates issued in a specific connection should be done with low priority, set the `low_priority_updates` server system variable equal to 1.
- To give a specific `INSERT`, `UPDATE`, or `DELETE` statement lower priority, use the `LOW_PRIORITY` attribute.
- To give a specific `SELECT` statement higher priority, use the `HIGH_PRIORITY` attribute. See [Section 13.2.9, “SELECT Statement”](#).
- Start `mysqld` with a low value for the `max_write_lock_count` system variable to force MySQL to temporarily elevate the priority of all `SELECT` statements that are waiting for a table after a specific number of write locks to the table occur (for example, for insert operations). This permits read locks after a certain number of write locks.
- If you have problems with mixed `SELECT` and `DELETE` statements, the `LIMIT` option to `DELETE` may help. See [Section 13.2.2, “DELETE Statement”](#).
- Using `SQL_BUFFER_RESULT` with `SELECT` statements can help to make the duration of table locks shorter. See [Section 13.2.9, “SELECT Statement”](#).
- Splitting table contents into separate tables may help, by allowing queries to run against columns in one table, while updates are confined to columns in a different table.

- You could change the locking code in `mysys/thr_lock.c` to use a single queue. In this case, write locks and read locks would have the same priority, which might help some applications.

### 8.11.3 Concurrent Inserts

The `MyISAM` storage engine supports concurrent inserts to reduce contention between readers and writers for a given table: If a `MyISAM` table has no holes in the data file (deleted rows in the middle), an `INSERT` statement can be executed to add rows to the end of the table at the same time that `SELECT` statements are reading rows from the table. If there are multiple `INSERT` statements, they are queued and performed in sequence, concurrently with the `SELECT` statements. The results of a concurrent `INSERT` may not be visible immediately.

The `concurrent_insert` system variable can be set to modify the concurrent-insert processing. By default, the variable is set to `AUTO` (or 1) and concurrent inserts are handled as just described. If `concurrent_insert` is set to `NEVER` (or 0), concurrent inserts are disabled. If the variable is set to `ALWAYS` (or 2), concurrent inserts at the end of the table are permitted even for tables that have deleted rows. See also the description of the `concurrent_insert` system variable.

If you are using the binary log, concurrent inserts are converted to normal inserts for `CREATE ... SELECT` or `INSERT ... SELECT` statements. This is done to ensure that you can re-create an exact copy of your tables by applying the log during a backup operation. See [Section 5.4.4, “The Binary Log”](#). In addition, for those statements a read lock is placed on the selected-from table such that inserts into that table are blocked. The effect is that concurrent inserts for that table must wait as well.

With `LOAD DATA`, if you specify `CONCURRENT` with a `MyISAM` table that satisfies the condition for concurrent inserts (that is, it contains no free blocks in the middle), other sessions can retrieve data from the table while `LOAD DATA` is executing. Use of the `CONCURRENT` option affects the performance of `LOAD DATA` a bit, even if no other session is using the table at the same time.

If you specify `HIGH_PRIORITY`, it overrides the effect of the `--low-priority-updates` option if the server was started with that option. It also causes concurrent inserts not to be used.

For `LOCK TABLE`, the difference between `READ LOCAL` and `READ` is that `READ LOCAL` permits nonconflicting `INSERT` statements (concurrent inserts) to execute while the lock is held. However, this cannot be used if you are going to manipulate the database using processes external to the server while you hold the lock.

### 8.11.4 Metadata Locking

MySQL uses metadata locking to manage concurrent access to database objects and to ensure data consistency. Metadata locking applies not just to tables, but also to schemas, stored programs (procedures, functions, triggers, scheduled events), tablespaces, user locks acquired with the `GET_LOCK()` function (see [Section 12.14, “Locking Functions”](#)), and locks acquired with the locking service described in [Section 5.5.6.1, “The Locking Service”](#).

The Performance Schema `metadata_locks` table exposes metadata lock information, which can be useful for seeing which sessions hold locks, are blocked waiting for locks, and so forth. For details, see [Section 25.12.12.1, “The metadata\\_locks Table”](#).

Metadata locking does involve some overhead, which increases as query volume increases. Metadata contention increases the more that multiple queries attempt to access the same objects.

Metadata locking is not a replacement for the table definition cache, and its mutexes and locks differ from the `LOCK_open` mutex. The following discussion provides some information about how metadata locking works.

- [Metadata Lock Acquisition](#)
- [Metadata Lock Release](#)

## Metadata Lock Acquisition

If there are multiple waiters for a given lock, the highest-priority lock request is satisfied first, with an exception related to the `max_write_lock_count` system variable. Write lock requests have higher priority than read lock requests. However, if `max_write_lock_count` is set to some low value (say, 10), read lock requests may be preferred over pending write lock requests if the read lock requests have already been passed over in favor of 10 write lock requests. Normally this behavior does not occur because `max_write_lock_count` by default has a very large value.

Statements acquire metadata locks one by one, not simultaneously, and perform deadlock detection in the process.

DML statements normally acquire locks in the order in which tables are mentioned in the statement.

DDL statements, `LOCK TABLES`, and other similar statements try to reduce the number of possible deadlocks between concurrent DDL statements by acquiring locks on explicitly named tables in name order. Locks might be acquired in a different order for implicitly used tables (such as tables in foreign key relationships that also must be locked).

For example, `RENAME TABLE` is a DDL statement that acquires locks in name order:

- This `RENAME TABLE` statement renames `tbla` to something else, and renames `tblc` to `tbla`:

```
RENAME TABLE tbla TO tbld, tblc TO tbla;
```

The statement acquires metadata locks, in order, on `tbla`, `tblc`, and `tbld` (because `tbld` follows `tblc` in name order):

- This slightly different statement also renames `tbla` to something else, and renames `tblc` to `tbla`:

```
RENAME TABLE tbla TO tblb, tblc TO tbla;
```

In this case, the statement acquires metadata locks, in order, on `tbla`, `tblb`, and `tblc` (because `tblb` precedes `tblc` in name order):

Both statements acquire locks on `tbla` and `tblc`, in that order, but differ in whether the lock on the remaining table name is acquired before or after `tblc`.

Metadata lock acquisition order can make a difference in operation outcome when multiple transactions execute concurrently, as the following example illustrates.

Begin with two tables `x` and `x_new` that have identical structure. Three clients issue statements that involve these tables:

Client 1:

```
LOCK TABLE x WRITE, x_new WRITE;
```

The statement requests and acquires write locks in name order on `x` and `x_new`.

Client 2:

```
INSERT INTO x VALUES(1);
```

The statement requests and blocks waiting for a write lock on `x`.



Client 3:

```
RENAME TABLE x TO x_old, x_new TO x;
```

The statement requests exclusive locks in name order on `x`, `x_new`, and `x_old`, but blocks waiting for the lock on `x`.

Client 1:

```
UNLOCK TABLES;
```

The statement releases the write locks on `x` and `x_new`. The exclusive lock request for `x` by Client 3 has higher priority than the write lock request by Client 2, so Client 3 acquires its lock on `x`, then also on `x_new` and `x_old`, performs the renaming, and releases its locks. Client 2 then acquires its lock on `x`, performs the insert, and releases its lock.

Lock acquisition order results in the `RENAME TABLE` executing before the `INSERT`. The `x` into which the insert occurs is the table that was named `x_new` when Client 2 issued the insert and was renamed to `x` by Client 3:

```
mysql> SELECT * FROM x;
+-----+
| i     |
+-----+
|     1 |
+-----+

mysql> SELECT * FROM x_old;
Empty set (0.01 sec)
```

Now begin instead with tables named `x` and `new_x` that have identical structure. Again, three clients issue statements that involve these tables:

Client 1:

```
LOCK TABLE x WRITE, new_x WRITE;
```

The statement requests and acquires write locks in name order on `new_x` and `x`.

Client 2:

```
INSERT INTO x VALUES(1);
```

The statement requests and blocks waiting for a write lock on `x`.

Client 3:

```
RENAME TABLE x TO old_x, new_x TO x;
```

The statement requests exclusive locks in name order on `new_x`, `old_x`, and `x`, but blocks waiting for the lock on `new_x`.

Client 1:

```
UNLOCK TABLES;
```

The statement releases the write locks on `x` and `new_x`. For `x`, the only pending request is by Client 2, so Client 2 acquires its lock, performs the insert, and releases the lock. For `new_x`, the only pending request is by Client 3, which is permitted to acquire that lock (and also the lock on `old_x`). The rename operation still blocks for the lock on `x` until the Client 2 insert finishes and releases its lock. Then Client 3 acquires the lock on `x`, performs the rename, and releases its lock.

In this case, lock acquisition order results in the `INSERT` executing before the `RENAME TABLE`. The `x` into which the insert occurs is the original `x`, now renamed to `old_x` by the rename operation:

```
mysql> SELECT * FROM x;
Empty set (0.01 sec)

mysql> SELECT * FROM old_x;
+-----+
| i     |
+-----+
|     1 |
+-----+
```

If order of lock acquisition in concurrent statements makes a difference to an application in operation outcome, as in the preceding example, you may be able to adjust the table names to affect the order of lock acquisition.

## Metadata Lock Release

To ensure transaction serializability, the server must not permit one session to perform a data definition language (DDL) statement on a table that is used in an uncompleted explicitly or implicitly started transaction in another session. The server achieves this by acquiring metadata locks on tables used within a transaction and deferring release of those locks until the transaction ends. A metadata lock on a table prevents changes to the table's structure. This locking approach has the implication that a table that is being used by a transaction within one session cannot be used in DDL statements by other sessions until the transaction ends.

This principle applies not only to transactional tables, but also to nontransactional tables. Suppose that a session begins a transaction that uses transactional table `t` and nontransactional table `nt` as follows:

```
START TRANSACTION;
SELECT * FROM t;
SELECT * FROM nt;
```

The server holds metadata locks on both `t` and `nt` until the transaction ends. If another session attempts a DDL or write lock operation on either table, it blocks until metadata lock release at transaction end. For example, a second session blocks if it attempts any of these operations:

```
DROP TABLE t;
ALTER TABLE t ...;
DROP TABLE nt;
ALTER TABLE nt ...;
LOCK TABLE t ... WRITE;
```

The same behavior applies for The `LOCK TABLES ... READ`. That is, explicitly or implicitly started transactions that update any table (transactional or nontransactional) block and are blocked by `LOCK TABLES ... READ` for that table.

If the server acquires metadata locks for a statement that is syntactically valid but fails during execution, it does not release the locks early. Lock release is still deferred to the end of the transaction because the failed statement is written to the binary log and the locks protect log consistency.

In autocommit mode, each statement is in effect a complete transaction, so metadata locks acquired for the statement are held only to the end of the statement.

Metadata locks acquired during a `PREPARE` statement are released once the statement has been prepared, even if preparation occurs within a multiple-statement transaction.

## 8.11.5 External Locking

External locking is the use of file system locking to manage contention for [MyISAM](#) database tables by multiple processes. External locking is used in situations where a single process such as the MySQL server cannot be assumed to be the only process that requires access to tables. Here are some examples:

- If you run multiple servers that use the same database directory (not recommended), each server must have external locking enabled.
- If you use [myisamchk](#) to perform table maintenance operations on [MyISAM](#) tables, you must either ensure that the server is not running, or that the server has external locking enabled so that it locks table files as necessary to coordinate with [myisamchk](#) for access to the tables. The same is true for use of [myisampack](#) to pack [MyISAM](#) tables.

If the server is run with external locking enabled, you can use [myisamchk](#) at any time for read operations such as checking tables. In this case, if the server tries to update a table that [myisamchk](#) is using, the server waits for [myisamchk](#) to finish before it continues.

If you use [myisamchk](#) for write operations such as repairing or optimizing tables, or if you use [myisampack](#) to pack tables, you *must* always ensure that the [mysqld](#) server is not using the table. If you do not stop [mysqld](#), at least do a [mysqladmin flush-tables](#) before you run [myisamchk](#). Your tables *may become corrupted* if the server and [myisamchk](#) access the tables simultaneously.

With external locking in effect, each process that requires access to a table acquires a file system lock for the table files before proceeding to access the table. If all necessary locks cannot be acquired, the process is blocked from accessing the table until the locks can be obtained (after the process that currently holds the locks releases them).

External locking affects server performance because the server must sometimes wait for other processes before it can access tables.

External locking is unnecessary if you run a single server to access a given data directory (which is the usual case) and if no other programs such as [myisamchk](#) need to modify tables while the server is running. If you only *read* tables with other programs, external locking is not required, although [myisamchk](#) might report warnings if the server changes tables while [myisamchk](#) is reading them.

With external locking disabled, to use [myisamchk](#), you must either stop the server while [myisamchk](#) executes or else lock and flush the tables before running [myisamchk](#). (See [Section 8.12.1, “System Factors”](#).) To avoid this requirement, use the [CHECK TABLE](#) and [REPAIR TABLE](#) statements to check and repair [MyISAM](#) tables.

For [mysqld](#), external locking is controlled by the value of the [skip\\_external\\_locking](#) system variable. When this variable is enabled, external locking is disabled, and vice versa. External locking is disabled by default.

Use of external locking can be controlled at server startup by using the [--external-locking](#) or [--skip-external-locking](#) option.

If you do use external locking option to enable updates to [MyISAM](#) tables from many MySQL processes, you must ensure that the following conditions are satisfied:

- Do not use the query cache for queries that use tables that are updated by another process.
- Do not start the server with the [delay\\_key\\_write](#) system variable set to [ALL](#) or use the [DELAY\\_KEY\\_WRITE=1](#) table option for any shared tables. Otherwise, index corruption can occur.

The easiest way to satisfy these conditions is to always use [--external-locking](#) together with [--delay-key-write=OFF](#) and [--query-cache-size=0](#). (This is not done by default because in many setups it is useful to have a mixture of the preceding options.)

## 8.12 Optimizing the MySQL Server

This section discusses optimization techniques for the database server, primarily dealing with system configuration rather than tuning SQL statements. The information in this section is appropriate for DBAs who want to ensure performance and scalability across the servers they manage; for developers constructing installation scripts that include setting up the database; and people running MySQL themselves for development, testing, and so on who want to maximize their own productivity.

### 8.12.1 System Factors

Some system-level factors can affect performance in a major way:

- If you have enough RAM, you could remove all swap devices. Some operating systems use a swap device in some contexts even if you have free memory.
- Avoid external locking for [MyISAM](#) tables. The default is for external locking to be disabled. The `--external-locking` and `--skip-external-locking` options explicitly enable and disable external locking.

Disabling external locking does not affect MySQL's functionality as long as you run only one server. Just remember to take down the server (or lock and flush the relevant tables) before you run `myisamchk`. On some systems it is mandatory to disable external locking because it does not work, anyway.

The only case in which you cannot disable external locking is when you run multiple MySQL *servers* (not clients) on the same data, or if you run `myisamchk` to check (not repair) a table without telling the server to flush and lock the tables first. Note that using multiple MySQL servers to access the same data concurrently is generally *not* recommended, except when using NDB Cluster.

The `LOCK TABLES` and `UNLOCK TABLES` statements use internal locking, so you can use them even if external locking is disabled.

### 8.12.2 Optimizing Disk I/O

This section describes ways to configure storage devices when you can devote more and faster storage hardware to the database server. For information about optimizing an [InnoDB](#) configuration to improve I/O performance, see [Section 8.5.8, "Optimizing InnoDB Disk I/O"](#).

- Disk seeks are a huge performance bottleneck. This problem becomes more apparent when the amount of data starts to grow so large that effective caching becomes impossible. For large databases where you access data more or less randomly, you can be sure that you need at least one disk seek to read and a couple of disk seeks to write things. To minimize this problem, use disks with low seek times.
- Increase the number of available disk spindles (and thereby reduce the seek overhead) by either symlinking files to different disks or striping the disks:
  - Using symbolic links

This means that, for [MyISAM](#) tables, you symlink the index file and data files from their usual location in the data directory to another disk (that may also be striped). This makes both the seek and read times better, assuming that the disk is not used for other purposes as well. See [Section 8.12.3, "Using Symbolic Links"](#).

Symbolic links are not supported for use with [InnoDB](#) tables. However, it is possible to place [InnoDB](#) data and log files on different physical disks. For more information, see [Section 8.5.8, "Optimizing InnoDB Disk I/O"](#).

- **Striping**

Striping means that you have many disks and put the first block on the first disk, the second block on the second disk, and the  $N$ -th block on the  $(N \text{ MOD } \textit{number\_of\_disks})$  disk, and so on. This means if your normal data size is less than the stripe size (or perfectly aligned), you get much better performance. Striping is very dependent on the operating system and the stripe size, so benchmark your application with different stripe sizes. See [Section 8.13.2, “Using Your Own Benchmarks”](#).

The speed difference for striping is *very* dependent on the parameters. Depending on how you set the striping parameters and number of disks, you may get differences measured in orders of magnitude. You have to choose to optimize for random or sequential access.

- For reliability, you may want to use RAID 0+1 (striping plus mirroring), but in this case, you need  $2 \times N$  drives to hold  $N$  drives of data. This is probably the best option if you have the money for it. However, you may also have to invest in some volume-management software to handle it efficiently.
- A good option is to vary the RAID level according to how critical a type of data is. For example, store semi-important data that can be regenerated on a RAID 0 disk, but store really important data such as host information and logs on a RAID 0+1 or RAID  $N$  disk. RAID  $N$  can be a problem if you have many writes, due to the time required to update the parity bits.
- You can also set the parameters for the file system that the database uses:

If you do not need to know when files were last accessed (which is not really useful on a database server), you can mount your file systems with the `-o noatime` option. That skips updates to the last access time in inodes on the file system, which avoids some disk seeks.

On many operating systems, you can set a file system to be updated asynchronously by mounting it with the `-o async` option. If your computer is reasonably stable, this should give you better performance without sacrificing too much reliability. (This flag is on by default on Linux.)

## Using NFS with MySQL

You should be cautious when considering whether to use NFS with MySQL. Potential issues, which vary by operating system and NFS version, include the following:

- MySQL data and log files placed on NFS volumes becoming locked and unavailable for use. Locking issues may occur in cases where multiple instances of MySQL access the same data directory or where MySQL is shut down improperly, due to a power outage, for example. NFS version 4 addresses underlying locking issues with the introduction of advisory and lease-based locking. However, sharing a data directory among MySQL instances is not recommended.
- Data inconsistencies introduced due to messages received out of order or lost network traffic. To avoid this issue, use TCP with `hard` and `intr` mount options.
- Maximum file size limitations. NFS Version 2 clients can only access the lowest 2GB of a file (signed 32 bit offset). NFS Version 3 clients support larger files (up to 64 bit offsets). The maximum supported file size also depends on the local file system of the NFS server.

Using NFS within a professional SAN environment or other storage system tends to offer greater reliability than using NFS outside of such an environment. However, NFS within a SAN environment may be slower than directly attached or bus-attached non-rotational storage.

If you choose to use NFS, NFS Version 4 or later is recommended, as is testing your NFS setup thoroughly before deploying into a production environment.

## 8.12.3 Using Symbolic Links

You can move databases or tables from the database directory to other locations and replace them with symbolic links to the new locations. You might want to do this, for example, to move a database to a file system with more free space or increase the speed of your system by spreading your tables to different disks.

For [InnoDB](#) tables, use the `DATA DIRECTORY` clause of the `CREATE TABLE` statement instead of symbolic links, as explained in [Section 14.6.1.2, “Creating Tables Externally”](#). This new feature is a supported, cross-platform technique.

The recommended way to do this is to symlink entire database directories to a different disk. Symlink [MyISAM](#) tables only as a last resort.

To determine the location of your data directory, use this statement:

```
SHOW VARIABLES LIKE 'datadir';
```

### 8.12.3.1 Using Symbolic Links for Databases on Unix

On Unix, the way to symlink a database is first to create a directory on some disk where you have free space and then to create a soft link to it from the MySQL data directory.

```
$> mkdir /drl/databases/test
$> ln -s /drl/databases/test /path/to/datadir
```

MySQL does not support linking one directory to multiple databases. Replacing a database directory with a symbolic link works as long as you do not make a symbolic link between databases. Suppose that you have a database `db1` under the MySQL data directory, and then make a symlink `db2` that points to `db1`:

```
$> cd /path/to/datadir
$> ln -s db1 db2
```

The result is that, for any table `tbl_a` in `db1`, there also appears to be a table `tbl_a` in `db2`. If one client updates `db1.tbl_a` and another client updates `db2.tbl_a`, problems are likely to occur.

### 8.12.3.2 Using Symbolic Links for MyISAM Tables on Unix

Symlinks are fully supported only for [MyISAM](#) tables. For files used by tables for other storage engines, you may get strange problems if you try to use symbolic links. For [InnoDB](#) tables, use the alternative technique explained in [Section 14.6.1.2, “Creating Tables Externally”](#) instead.

Do not symlink tables on systems that do not have a fully operational `realpath()` call. (Linux and Solaris support `realpath()`). To determine whether your system supports symbolic links, check the value of the `have_symlink` system variable using this statement:

```
SHOW VARIABLES LIKE 'have_symlink';
```

The handling of symbolic links for [MyISAM](#) tables works as follows:

- In the data directory, you always have the table format (`.frm`) file, the data (`.MYD`) file, and the index (`.MYI`) file. The data file and index file can be moved elsewhere and replaced in the data directory by symlinks. The format file cannot.
- You can symlink the data file and the index file independently to different directories.
- To instruct a running MySQL server to perform the symlinking, use the `DATA DIRECTORY` and `INDEX DIRECTORY` options to `CREATE TABLE`. See [Section 13.1.18, “CREATE TABLE Statement”](#). Alternatively, if `mysqld` is not running, symlinking can be accomplished manually using `ln -s` from the command line.

**Note**

The path used with either or both of the `DATA DIRECTORY` and `INDEX DIRECTORY` options may not include the MySQL `data` directory. (Bug #32167)

- `myisamchk` does not replace a symlink with the data file or index file. It works directly on the file to which the symlink points. Any temporary files are created in the directory where the data file or index file is located. The same is true for the `ALTER TABLE`, `OPTIMIZE TABLE`, and `REPAIR TABLE` statements.

**Note**

When you drop a table that is using symlinks, *both the symlink and the file to which the symlink points are dropped*. This is an extremely good reason *not* to run `mysqld` as the `root` operating system user or permit operating system users to have write access to MySQL database directories.

- If you rename a table with `ALTER TABLE ... RENAME` or `RENAME TABLE` and you do not move the table to another database, the symlinks in the database directory are renamed to the new names and the data file and index file are renamed accordingly.
- If you use `ALTER TABLE ... RENAME` or `RENAME TABLE` to move a table to another database, the table is moved to the other database directory. If the table name changed, the symlinks in the new database directory are renamed to the new names and the data file and index file are renamed accordingly.
- If you are not using symlinks, start `mysqld` with the `--skip-symbolic-links` option to ensure that no one can use `mysqld` to drop or rename a file outside of the data directory.

These table symlink operations are not supported:

- `ALTER TABLE` ignores the `DATA DIRECTORY` and `INDEX DIRECTORY` table options.
- As indicated previously, only the data and index files can be symbolic links. The `.frm` file must *never* be a symbolic link. Attempting to do this (for example, to make one table name a synonym for another) produces incorrect results. Suppose that you have a database `db1` under the MySQL data directory, a table `tbl1` in this database, and in the `db1` directory you make a symlink `tbl2` that points to `tbl1`:

```
$> cd /path/to/datadir/db1
$> ln -s tbl1.frm tbl2.frm
$> ln -s tbl1.MYD tbl2.MYD
$> ln -s tbl1.MYI tbl2.MYI
```

Problems result if one thread reads `db1.tbl1` and another thread updates `db1.tbl2`:

- The query cache is “fooled” (it has no way of knowing that `tbl1` has not been updated, so it returns outdated results).
- `ALTER` statements on `tbl2` fail.

### 8.12.3.3 Using Symbolic Links for Databases on Windows

On Windows, symbolic links can be used for database directories. This enables you to put a database directory at a different location (for example, on a different disk) by setting up a symbolic link to it. Use of database symlinks on Windows is similar to their use on Unix, although the procedure for setting up the link differs.

Suppose that you want to place the database directory for a database named `mydb` at `D:\data\mydb`. To do this, create a symbolic link in the MySQL data directory that points to `D:\data\mydb`. However, before

creating the symbolic link, make sure that the `D:\data\mydb` directory exists by creating it if necessary. If you already have a database directory named `mydb` in the data directory, move it to `D:\data`. Otherwise, the symbolic link is ineffective. To avoid problems, make sure that the server is not running when you move the database directory.

On Windows, you can create a symlink using the `mklink` command. This command requires administrative privileges.

1. Make sure that the desired path to the database exists. For this example, we use `D:\data\mydb`, and a database named `mydb`.
2. If the database does not already exist, issue `CREATE DATABASE mydb` in the `mysql` client to create it.
3. Stop the MySQL service.
4. Using Windows Explorer or the command line, move the directory `mydb` from the data directory to `D:\data`, replacing the directory of the same name.
5. If you are not already using the command prompt, open it, and change location to the data directory, like this:

```
C:\> cd \path\to\datadir
```

If your MySQL installation is in the default location, you can use this:

```
C:\> cd C:\ProgramData\MySQL\MySQL Server 5.7\Data
```

6. In the data directory, create a symlink named `mydb` that points to the location of the database directory:

```
C:\> mklink /d mydb D:\data\mydb
```

7. Start the MySQL service.

After this, all tables created in the database `mydb` are created in `D:\data\mydb`.

Alternatively, on any version of Windows supported by MySQL, you can create a symbolic link to a MySQL database by creating a `.sym` file in the data directory that contains the path to the destination directory. The file should be named `db_name.sym`, where `db_name` is the database name.

Support for database symbolic links on Windows using `.sym` files is enabled by default. If you do not need `.sym` file symbolic links, you can disable support for them by starting `mysqld` with the `--skip-symbolic-links` option. To determine whether your system supports `.sym` file symbolic links, check the value of the `have_symlink` system variable using this statement:

```
SHOW VARIABLES LIKE 'have_symlink';
```

To create a `.sym` file symlink, use this procedure:

1. Change location into the data directory:

```
C:\> cd \path\to\datadir
```

2. In the data directory, create a text file named `mydb.sym` that contains this path name: `D:\data\mydb`



### Note

The path name to the new database and tables should be absolute. If you specify a relative path, the location is relative to the `mydb.sym` file.



After this, all tables created in the database `mydb` are created in `D:\data\mydb`.



#### Note

Because support for `.sym` files is redundant with native symlink support available using `mklink`, use of `.sym` files is deprecated; expect support for them to be removed in a future MySQL release.

The following limitations apply to the use of `.sym` files for database symbolic linking on Windows. These limitations do not apply for symlinks created using `mklink`.

- The symbolic link is not used if a directory with the same name as the database exists in the MySQL data directory.
- The `--innodb_file_per_table` option cannot be used.
- If you run `mysqld` as a service, you cannot use a mapped drive to a remote server as the destination of the symbolic link. As a workaround, you can use the full path (`\\servername\path\`).

## 8.12.4 Optimizing Memory Use

### 8.12.4.1 How MySQL Uses Memory

MySQL allocates buffers and caches to improve performance of database operations. The default configuration is designed to permit a MySQL server to start on a virtual machine that has approximately 512MB of RAM. You can improve MySQL performance by increasing the values of certain cache and buffer-related system variables. You can also modify the default configuration to run MySQL on systems with limited memory.

The following list describes some of the ways that MySQL uses memory. Where applicable, relevant system variables are referenced. Some items are storage engine or feature specific.

- The `InnoDB` buffer pool is a memory area that holds cached `InnoDB` data for tables, indexes, and other auxiliary buffers. For efficiency of high-volume read operations, the buffer pool is divided into `pages` that can potentially hold multiple rows. For efficiency of cache management, the buffer pool is implemented as a linked list of pages; data that is rarely used is aged out of the cache, using a variation of the `LRU` algorithm. For more information, see [Section 14.5.1, “Buffer Pool”](#).

The size of the buffer pool is important for system performance:

- `InnoDB` allocates memory for the entire buffer pool at server startup, using `malloc()` operations. The `innodb_buffer_pool_size` system variable defines the buffer pool size. Typically, a recommended `innodb_buffer_pool_size` value is 50 to 75 percent of system memory. `innodb_buffer_pool_size` can be configured dynamically, while the server is running. For more information, see [Section 14.8.3.1, “Configuring InnoDB Buffer Pool Size”](#).
- On systems with a large amount of memory, you can improve concurrency by dividing the buffer pool into multiple `buffer pool instances`. The `innodb_buffer_pool_instances` system variable defines the number of buffer pool instances.
- A buffer pool that is too small may cause excessive churning as pages are flushed from the buffer pool only to be required again a short time later.
- A buffer pool that is too large may cause swapping due to competition for memory.
- All threads share the `MyISAM` key buffer. The `key_buffer_size` system variable determines its size.

For each `MyISAM` table the server opens, the index file is opened once; the data file is opened once for each concurrently running thread that accesses the table. For each concurrent thread, a table structure, column structures for each column, and a buffer of size  $3 * N$  are allocated (where  $N$  is the maximum row length, not counting `BLOB` columns). A `BLOB` column requires five to eight bytes plus the length of the `BLOB` data. The `MyISAM` storage engine maintains one extra row buffer for internal use.

- The `myisam_use_mmap` system variable can be set to 1 to enable memory-mapping for all `MyISAM` tables.
- If an internal in-memory temporary table becomes too large (as determined using the `tmp_table_size` and `max_heap_table_size` system variables), MySQL automatically converts the table from in-memory to on-disk format. On-disk temporary tables use the storage engine defined by the `internal_tmp_disk_storage_engine` system variable. You can increase the permissible temporary table size as described in [Section 8.4.4, “Internal Temporary Table Use in MySQL”](#).

For `MEMORY` tables explicitly created with `CREATE TABLE`, only the `max_heap_table_size` system variable determines how large a table can grow, and there is no conversion to on-disk format.

- The [MySQL Performance Schema](#) is a feature for monitoring MySQL server execution at a low level. The Performance Schema dynamically allocates memory incrementally, scaling its memory use to actual server load, instead of allocating required memory during server startup. Once memory is allocated, it is not freed until the server is restarted. For more information, see [Section 25.17, “The Performance Schema Memory-Allocation Model”](#).
- Each thread that the server uses to manage client connections requires some thread-specific space. The following list indicates these and which system variables control their size:
  - A stack (`thread_stack`)
  - A connection buffer (`net_buffer_length`)
  - A result buffer (`net_buffer_length`)

The connection buffer and result buffer each begin with a size equal to `net_buffer_length` bytes, but are dynamically enlarged up to `max_allowed_packet` bytes as needed. The result buffer shrinks to `net_buffer_length` bytes after each SQL statement. While a statement is running, a copy of the current statement string is also allocated.

Each connection thread uses memory for computing statement digests. The server allocates `max_digest_length` bytes per session. See [Section 25.10, “Performance Schema Statement Digests”](#).

- All threads share the same base memory.
- When a thread is no longer needed, the memory allocated to it is released and returned to the system unless the thread goes back into the thread cache. In that case, the memory remains allocated.
- Each request that performs a sequential scan of a table allocates a *read buffer*. The `read_buffer_size` system variable determines the buffer size.
- When reading rows in an arbitrary sequence (for example, following a sort), a *random-read buffer* may be allocated to avoid disk seeks. The `read_rnd_buffer_size` system variable determines the buffer size.
- All joins are executed in a single pass, and most joins can be done without even using a temporary table. Most temporary tables are memory-based hash tables. Temporary tables with a large row length (calculated as the sum of all column lengths) or that contain `BLOB` columns are stored on disk.

- Most requests that perform a sort allocate a sort buffer and zero to two temporary files depending on the result set size. See [Section B.3.3.5, “Where MySQL Stores Temporary Files”](#).
- Almost all parsing and calculating is done in thread-local and reusable memory pools. No memory overhead is needed for small items, thus avoiding the normal slow memory allocation and freeing. Memory is allocated only for unexpectedly large strings.
- For each table having `BLOB` columns, a buffer is enlarged dynamically to read in larger `BLOB` values. If you scan a table, the buffer grows as large as the largest `BLOB` value.
- MySQL requires memory and descriptors for the table cache. Handler structures for all in-use tables are saved in the table cache and managed as “First In, First Out” (FIFO). The `table_open_cache` system variable defines the initial table cache size; see [Section 8.4.3.1, “How MySQL Opens and Closes Tables”](#).

MySQL also requires memory for the table definition cache. The `table_definition_cache` system variable defines the number of table definitions (from `.frm` files) that can be stored in the table definition cache. If you use a large number of tables, you can create a large table definition cache to speed up the opening of tables. The table definition cache takes less space and does not use file descriptors, unlike the table cache.

- A `FLUSH TABLES` statement or `mysqladmin flush-tables` command closes all tables that are not in use at once and marks all in-use tables to be closed when the currently executing thread finishes. This effectively frees most in-use memory. `FLUSH TABLES` does not return until all tables have been closed.
- The server caches information in memory as a result of `GRANT`, `CREATE USER`, `CREATE SERVER`, and `INSTALL PLUGIN` statements. This memory is not released by the corresponding `REVOKE`, `DROP USER`, `DROP SERVER`, and `UNINSTALL PLUGIN` statements, so for a server that executes many instances of the statements that cause caching, cached memory use is very likely to increase unless it is freed with `FLUSH PRIVILEGES`.

`ps` and other system status programs may report that `mysqld` uses a lot of memory. This may be caused by thread stacks on different memory addresses. For example, the Solaris version of `ps` counts the unused memory between stacks as used memory. To verify this, check available swap with `swap -s`. We test `mysqld` with several memory-leakage detectors (both commercial and Open Source), so there should be no memory leaks.

### 8.12.4.2 Monitoring MySQL Memory Usage

The following example demonstrates how to use [Performance Schema](#) and `sys schema` to monitor MySQL memory usage.

Most Performance Schema memory instrumentation is disabled by default. Instruments can be enabled by updating the `ENABLED` column of the Performance Schema `setup_instruments` table. Memory instruments have names in the form of `memory/code_area/instrument_name`, where `code_area` is a value such as `sql` or `innodb`, and `instrument_name` is the instrument detail.

1. To view available MySQL memory instruments, query the Performance Schema `setup_instruments` table. The following query returns hundreds of memory instruments for all code areas.

```
mysql> SELECT * FROM performance_schema.setup_instruments
      WHERE NAME LIKE '%memory%';
```

You can narrow results by specifying a code area. For example, you can limit results to `InnoDB` memory instruments by specifying `innodb` as the code area.

```
mysql> SELECT * FROM performance_schema.setup_instruments
      WHERE NAME LIKE '%memory/innodb%';
```

NAME	ENABLED	TIMED
memory/innodb/adaptive hash index	NO	NO
memory/innodb/buf_buf_pool	NO	NO
memory/innodb/dict_stats_bg_recalc_pool_t	NO	NO
memory/innodb/dict_stats_index_map_t	NO	NO
memory/innodb/dict_stats_n_diff_on_level	NO	NO
memory/innodb/other	NO	NO
memory/innodb/row_log_buf	NO	NO
memory/innodb/row_merge_sort	NO	NO
memory/innodb/std	NO	NO
memory/innodb/trx_sys_t::rw_trx_ids	NO	NO
...		

Depending on your MySQL installation, code areas may include [performance\\_schema](#), [sql](#), [client](#), [innodb](#), [myisam](#), [csv](#), [memory](#), [blackhole](#), [archive](#), [partition](#), and others.

- To enable memory instruments, add a [performance-schema-instrument](#) rule to your MySQL configuration file. For example, to enable all memory instruments, add this rule to your configuration file and restart the server:

```
performance-schema-instrument='memory/%=COUNTED'
```



### Note

Enabling memory instruments at startup ensures that memory allocations that occur at startup are counted.

After restarting the server, the [ENABLED](#) column of the Performance Schema [setup\\_instruments](#) table should report [YES](#) for memory instruments that you enabled. The [TIMED](#) column in the [setup\\_instruments](#) table is ignored for memory instruments because memory operations are not timed.

```
mysql> SELECT * FROM performance_schema.setup_instruments
      WHERE NAME LIKE '%memory/innodb%';
```

NAME	ENABLED	TIMED
memory/innodb/adaptive hash index	NO	NO
memory/innodb/buf_buf_pool	NO	NO
memory/innodb/dict_stats_bg_recalc_pool_t	NO	NO
memory/innodb/dict_stats_index_map_t	NO	NO
memory/innodb/dict_stats_n_diff_on_level	NO	NO
memory/innodb/other	NO	NO
memory/innodb/row_log_buf	NO	NO
memory/innodb/row_merge_sort	NO	NO
memory/innodb/std	NO	NO
memory/innodb/trx_sys_t::rw_trx_ids	NO	NO
...		

- Query memory instrument data. In this example, memory instrument data is queried in the Performance Schema [memory\\_summary\\_global\\_by\\_event\\_name](#) table, which summarizes data by [EVENT\\_NAME](#). The [EVENT\\_NAME](#) is the name of the instrument.

The following query returns memory data for the [InnoDB](#) buffer pool. For column descriptions, see [Section 25.12.15.9, "Memory Summary Tables"](#).

```
mysql> SELECT * FROM performance_schema.memory_summary_global_by_event_name
      WHERE EVENT_NAME LIKE 'memory/innodb/buf_buf_pool'\G
      EVENT_NAME: memory/innodb/buf_buf_pool
      COUNT_ALLOC: 1
      COUNT_FREE: 0
```

```
SUM_NUMBER_OF_BYTES_ALLOC: 137428992
SUM_NUMBER_OF_BYTES_FREE: 0
LOW_COUNT_USED: 0
CURRENT_COUNT_USED: 1
HIGH_COUNT_USED: 1
LOW_NUMBER_OF_BYTES_USED: 0
CURRENT_NUMBER_OF_BYTES_USED: 137428992
HIGH_NUMBER_OF_BYTES_USED: 137428992
```

The same underlying data can be queried using the `sys` schema `memory_global_by_current_bytes` table, which shows current memory usage within the server globally, broken down by allocation type.

```
mysql> SELECT * FROM sys.memory_global_by_current_bytes
WHERE event_name LIKE 'memory/innodb/buf_buf_pool'\G
***** 1. row *****
event_name: memory/innodb/buf_buf_pool
current_count: 1
current_alloc: 131.06 MiB
current_avg_alloc: 131.06 MiB
high_count: 1
high_alloc: 131.06 MiB
high_avg_alloc: 131.06 MiB
```

This `sys` schema query aggregates currently allocated memory (`current_alloc`) by code area:

```
mysql> SELECT SUBSTRING_INDEX(event_name,'/',2) AS
code_area, sys.format_bytes(SUM(current_alloc))
AS current_alloc
FROM sys.x$memory_global_by_current_bytes
GROUP BY SUBSTRING_INDEX(event_name,'/',2)
ORDER BY SUM(current_alloc) DESC;
```

code_area	current_alloc
memory/innodb	843.24 MiB
memory/performance_schema	81.29 MiB
memory/mysys	8.20 MiB
memory/sql	2.47 MiB
memory/memory	174.01 KiB
memory/myisam	46.53 KiB
memory/blackhole	512 bytes
memory/federated	512 bytes
memory/csv	512 bytes
memory/vio	496 bytes

For more information about `sys` schema, see [Chapter 26, MySQL sys Schema](#).

### 8.12.4.3 Enabling Large Page Support

Some hardware and operating system architectures support memory pages greater than the default (usually 4KB). The actual implementation of this support depends on the underlying hardware and operating system. Applications that perform a lot of memory accesses may obtain performance improvements by using large pages due to reduced Translation Lookaside Buffer (TLB) misses.

In MySQL, large pages can be used by `InnoDB`, to allocate memory for its buffer pool and additional memory pool.

Standard use of large pages in MySQL attempts to use the largest size supported, up to 4MB. Under Solaris, a “super large pages” feature enables uses of pages up to 256MB. This feature is available for recent SPARC platforms. It can be enabled or disabled by using the `--super-large-pages` or `--skip-super-large-pages` option.

MySQL also supports the Linux implementation of large page support (which is called HugeTLB in Linux).

Before large pages can be used on Linux, the kernel must be enabled to support them and it is necessary to configure the HugeTLB memory pool. For reference, the HugeTBL API is documented in the [Documentation/vm/hugetlbpage.txt](#) file of your Linux sources.

The kernels for some recent systems such as Red Hat Enterprise Linux may have the large pages feature enabled by default. To check whether this is true for your kernel, use the following command and look for output lines containing “huge”:

```
$> grep -i huge /proc/meminfo
AnonHugePages:    2658304 kB
ShmemHugePages:      0 kB
HugePages_Total:    0
HugePages_Free:      0
HugePages_Rsvd:      0
HugePages_Surp:      0
Hugepagesize:       2048 kB
Hugetlb:            0 kB
```

The nonempty command output indicates that large page support is present, but the zero values indicate that no pages are configured for use.

If your kernel needs to be reconfigured to support large pages, consult the [hugetlbpage.txt](#) file for instructions.

Assuming that your Linux kernel has large page support enabled, configure it for use by MySQL using the following steps:

1. Determine the number of large pages needed. This is the size of the InnoDB buffer pool divided by the large page size, which we can calculate as `innodb_buffer_pool_size / Hugepagesize`. Assuming the default value for the `innodb_buffer_pool_size` (128MB) and using the `Hugepagesize` value obtained from `/proc/meminfo` (2MB), this is 128MB / 2MB, or 64 Huge Pages. We call this value *P*.
2. As system root, open the file `/etc/sysctl.conf` in a text editor, and add the line shown here, where *P* is the number of large pages obtained in the previous step:

```
vm.nr_hugepages=P
```

Using the actual value obtained previously, the additional line should look like this:

```
vm.nr_hugepages=66
```

Save the updated file.

3. As system root, run the following command:

```
$> sudo sysctl -p
```



#### Note

On some systems the large pages file may be named slightly differently; for example, some distributions call it `nr_hugepages`. In the event `sysctl` returns an error relating to the file name, check the name of the corresponding file in `/proc/sys/vm` and use that instead.

To verify the large page configuration, check `/proc/meminfo` again as described previously. Now you should see some additional nonzero values in the output, similar to this:

```
$> grep -i huge /proc/meminfo
AnonHugePages: 2686976 kB
ShmemHugePages: 0 kB
HugePages_Total: 233
HugePages_Free: 233
HugePages_Rsvd: 0
HugePages_Surp: 0
Hugepagesize: 2048 kB
Hugetlb: 477184 kB
```

- Optionally, you may wish to compact the Linux VM. You can do this using a sequence of commands, possibly in a script file, similar to what is shown here:

```
sync
sync
sync
echo 3 > /proc/sys/vm/drop_caches
echo 1 > /proc/sys/vm/compact_memory
```

See your operating platform documentation for more information about how to do this.

- Check any configuration files such as `my.cnf` used by the server, and make sure that `innodb_buffer_pool_chunk_size` is set larger than the huge page size. The default for this variable is 128M.
- Large page support in the MySQL server is disabled by default. To enable it, start the server with `--large-pages`. You can also do so by adding the following line to the `[mysqld]` section of the server `my.cnf` file:

```
large-pages=ON
```

With this option enabled, `InnoDB` uses large pages automatically for its buffer pool and additional memory pool. If `InnoDB` cannot do this, it falls back to use of traditional memory and writes a warning to the error log: `Warning: Using conventional memory pool`.

You can verify that MySQL is now using large pages by checking `/proc/meminfo` again after restarting `mysqld`, like this:

```
$> grep -i huge /proc/meminfo
AnonHugePages: 2516992 kB
ShmemHugePages: 0 kB
HugePages_Total: 233
HugePages_Free: 222
HugePages_Rsvd: 55
HugePages_Surp: 0
Hugepagesize: 2048 kB
Hugetlb: 477184 kB
```

## 8.13 Measuring Performance (Benchmarking)

To measure performance, consider the following factors:

- Whether you are measuring the speed of a single operation on a quiet system, or how a set of operations (a “workload”) works over a period of time. With simple tests, you usually test how changing one aspect (a configuration setting, the set of indexes on a table, the SQL clauses in a query) affects performance. Benchmarks are typically long-running and elaborate performance tests, where the results could dictate high-level choices such as hardware and storage configuration, or how soon to upgrade to a new MySQL version.
- For benchmarking, sometimes you must simulate a heavy database workload to get an accurate picture.

- Performance can vary depending on so many different factors that a difference of a few percentage points might not be a decisive victory. The results might shift the opposite way when you test in a different environment.
- Certain MySQL features help or do not help performance depending on the workload. For completeness, always test performance with those features turned on and turned off. The two most important features to try with each workload are the [MySQL query cache](#), and the [adaptive hash index](#) for [InnoDB](#) tables.

This section progresses from simple and direct measurement techniques that a single developer can do, to more complicated ones that require additional expertise to perform and interpret the results.

### 8.13.1 Measuring the Speed of Expressions and Functions

To measure the speed of a specific MySQL expression or function, invoke the `BENCHMARK()` function using the `mysql` client program. Its syntax is `BENCHMARK(loop_count,expr)`. The return value is always zero, but `mysql` prints a line displaying approximately how long the statement took to execute. For example:

```
mysql> SELECT BENCHMARK(1000000,1+1);
+-----+
| BENCHMARK(1000000,1+1) |
+-----+
|                          0 |
+-----+
1 row in set (0.32 sec)
```

This result was obtained on a Pentium II 400MHz system. It shows that MySQL can execute 1,000,000 simple addition expressions in 0.32 seconds on that system.

The built-in MySQL functions are typically highly optimized, but there may be some exceptions. `BENCHMARK()` is an excellent tool for finding out if some function is a problem for your queries.

### 8.13.2 Using Your Own Benchmarks

Benchmark your application and database to find out where the bottlenecks are. After fixing one bottleneck (or by replacing it with a “dummy” module), you can proceed to identify the next bottleneck. Even if the overall performance for your application currently is acceptable, you should at least make a plan for each bottleneck and decide how to solve it if someday you really need the extra performance.

A free benchmark suite is the Open Source Database Benchmark, available at <http://osdb.sourceforge.net/>.

It is very common for a problem to occur only when the system is very heavily loaded. We have had many customers who contact us when they have a (tested) system in production and have encountered load problems. In most cases, performance problems turn out to be due to issues of basic database design (for example, table scans are not good under high load) or problems with the operating system or libraries. Most of the time, these problems would be much easier to fix if the systems were not already in production.

To avoid problems like this, benchmark your whole application under the worst possible load:

- The `mysqlslap` program can be helpful for simulating a high load produced by multiple clients issuing queries simultaneously. See [Section 4.5.8, “mysqlslap — A Load Emulation Client”](#).
- You can also try benchmarking packages such as SysBench and DBT2, available at <https://launchpad.net/sysbench>, and <http://osdbt.sourceforge.net/#dbt2>.

These programs or packages can bring a system to its knees, so be sure to use them only on your development systems.



### 8.13.3 Measuring Performance with performance\_schema

You can query the tables in the `performance_schema` database to see real-time information about the performance characteristics of your server and the applications it is running. See [Chapter 25, MySQL Performance Schema](#) for details.

## 8.14 Examining Server Thread (Process) Information

To ascertain what your MySQL server is doing, it can be helpful to examine the process list, which indicates the operations currently being performed by the set of threads executing within the server. For example:

```
mysql> SHOW PROCESSLIST\G
***** 1. row *****
  Id: 1
  User: event_scheduler
  Host: localhost
  db: NULL
  Command: Daemon
  Time: 2756681
  State: Waiting on empty queue
  Info: NULL
***** 2. row *****
  Id: 20
  User: me
  Host: localhost:52943
  db: test
  Command: Query
  Time: 0
  State: starting
  Info: SHOW PROCESSLIST
```

Threads can be killed with the `KILL` statement. See [Section 13.7.6.4, “KILL Statement”](#).

### 8.14.1 Accessing the Process List

The following discussion enumerates the sources of process information, the privileges required to see process information, and describes the content of process list entries.

- [Sources of Process Information](#)
- [Privileges Required to Access the Process List](#)
- [Content of Process List Entries](#)

#### Sources of Process Information

Process information is available from these sources:

- The `SHOW PROCESSLIST` statement: [Section 13.7.5.29, “SHOW PROCESSLIST Statement”](#)
- The `mysqladmin processlist` command: [Section 4.5.2, “mysqladmin — A MySQL Server Administration Program”](#)
- The `INFORMATION_SCHEMA.PROCESSLIST` table: [Section 24.3.18, “The INFORMATION\\_SCHEMA PROCESSLIST Table”](#)
- The Performance Schema `processlist` table: [Section 25.12.16.3, “The processlist Table”](#)
- The Performance Schema `threads` table columns with names having a prefix of `PROCESSLIST_`: [Section 25.12.16.4, “The threads Table”](#)

- The `sys` schema `processlist` and `session` views: [Section 26.4.3.22, “The processlist and x\\$processlist Views”](#), and [Section 26.4.3.33, “The session and x\\$session Views”](#)

The `threads` table compares to `SHOW PROCESSLIST`, `INFORMATION_SCHEMA.PROCESSLIST`, and `mysqladmin processlist` as follows:

- Access to the `threads` table does not require a mutex and has minimal impact on server performance. The other sources have negative performance consequences because they require a mutex.



#### Note

As of MySQL 5.7.39, an alternative implementation for `SHOW PROCESSLIST` is available based on the Performance Schema `processlist` table, which, like the `threads` table, does not require a mutex and has better performance characteristics. For details, see [Section 25.12.16.3, “The processlist Table”](#).

- The `threads` table displays background threads, which the other sources do not. It also provides additional information for each thread that the other sources do not, such as whether the thread is a foreground or background thread, and the location within the server associated with the thread. This means that the `threads` table can be used to monitor thread activity the other sources cannot.
- You can enable or disable Performance Schema thread monitoring, as described in [Section 25.12.16.4, “The threads Table”](#).

For these reasons, DBAs who perform server monitoring using one of the other thread information sources may wish to monitor using the `threads` table instead.

The `sys` schema `processlist` view presents information from the Performance Schema `threads` table in a more accessible format. The `sys` schema `session` view presents information about user sessions like the `sys` schema `processlist` view, but with background processes filtered out.

## Privileges Required to Access the Process List

For most sources of process information, if you have the `PROCESS` privilege, you can see all threads, even those belonging to other users. Otherwise (without the `PROCESS` privilege), nonanonymous users have access to information about their own threads but not threads for other users, and anonymous users have no access to thread information.

The Performance Schema `threads` table also provides thread information, but table access uses a different privilege model. See [Section 25.12.16.4, “The threads Table”](#).

## Content of Process List Entries

Each process list entry contains several pieces of information. The following list describes them using the labels from `SHOW PROCESSLIST` output. Other process information sources use similar labels.

- `Id` is the connection identifier for the client associated with the thread.
- `User` and `Host` indicate the account associated with the thread.
- `db` is the default database for the thread, or `NULL` if none has been selected.
- `Command` and `State` indicate what the thread is doing.

Most states correspond to very quick operations. If a thread stays in a given state for many seconds, there might be a problem that needs to be investigated.

The following sections list the possible `Command` values, and `State` values grouped by category. The meaning for some of these values is self-evident. For others, additional description is provided.

**Note**

Applications that examine process list information should be aware that the commands and states are subject to change.

- `Time` indicates how long the thread has been in its current state. The thread's notion of the current time may be altered in some cases: The thread can change the time with `SET TIMESTAMP = value`. For a replica SQL thread, the value is the number of seconds between the timestamp of the last replicated event and the real time of the replica host. See [Section 16.2.3, “Replication Threads”](#).
- `Info` indicates the statement the thread is executing, or `NULL` if it is executing no statement. For `SHOW PROCESSLIST`, this value contains only the first 100 characters of the statement. To see complete statements, use `SHOW FULL PROCESSLIST` (or query a different process information source).

## 8.14.2 Thread Command Values

A thread can have any of the following `Command` values:

- `Binlog Dump`  
This is a thread on a replication source for sending binary log contents to a replica.
- `Change user`  
The thread is executing a change user operation.
- `Close stmt`  
The thread is closing a prepared statement.
- `Connect`  
A replica is connected to its source.
- `Connect Out`  
A replica is connecting to its source.
- `Create DB`  
The thread is executing a create database operation.
- `Daemon`  
This thread is internal to the server, not a thread that services a client connection.
- `Debug`  
The thread is generating debugging information.
- `Delayed insert`  
The thread is a delayed insert handler.
- `Drop DB`  
The thread is executing a drop database operation.
- `Error`

- `Execute`  
The thread is executing a prepared statement.
- `Fetch`  
The thread is fetching the results from executing a prepared statement.
- `Field List`  
The thread is retrieving information for table columns.
- `Init DB`  
The thread is selecting a default database.
- `Kill`  
The thread is killing another thread.
- `Long Data`  
The thread is retrieving long data in the result of executing a prepared statement.
- `Ping`  
The thread is handling a server ping request.
- `Prepare`  
The thread is preparing a prepared statement.
- `Processlist`  
The thread is producing information about server threads.
- `Query`  
The thread is executing a statement.
- `Quit`  
The thread is terminating.
- `Refresh`  
The thread is flushing table, logs, or caches, or resetting status variable or replication server information.
- `Register Slave`  
The thread is registering a replica server.
- `Reset stmt`  
The thread is resetting a prepared statement.
- `Set option`  
The thread is setting or resetting a client statement execution option.

- `Shutdown`

The thread is shutting down the server.

- `Sleep`

The thread is waiting for the client to send a new statement to it.

- `Statistics`

The thread is producing server status information.

- `Time`

Unused.

### 8.14.3 General Thread States

The following list describes thread `State` values that are associated with general query processing and not more specialized activities such as replication. Many of these are useful only for finding bugs in the server.

- `After create`

This occurs when the thread creates a table (including internal temporary tables), at the end of the function that creates the table. This state is used even if the table could not be created due to some error.

- `altering table`

The server is in the process of executing an in-place `ALTER TABLE`.

- `Analyzing`

The thread is calculating a `MyISAM` table key distributions (for example, for `ANALYZE TABLE`).

- `checking permissions`

The thread is checking whether the server has the required privileges to execute the statement.

- `Checking table`

The thread is performing a table check operation.

- `cleaning up`

The thread has processed one command and is preparing to free memory and reset certain state variables.

- `committing alter table to storage engine`

The server has finished an in-place `ALTER TABLE` and is committing the result.

- `closing tables`

The thread is flushing the changed table data to disk and closing the used tables. This should be a fast operation. If not, verify that you do not have a full disk and that the disk is not in very heavy use.

- `converting HEAP to ondisk`

The thread is converting an internal temporary table from a `MEMORY` table to an on-disk table.

- `copy to tmp table`

The thread is processing an `ALTER TABLE` statement. This state occurs after the table with the new structure has been created but before rows are copied into it.

For a thread in this state, the Performance Schema can be used to obtain about the progress of the copy operation. See [Section 25.12.5, “Performance Schema Stage Event Tables”](#).

- `Copying to group table`

If a statement has different `ORDER BY` and `GROUP BY` criteria, the rows are sorted by group and copied to a temporary table.

- `Copying to tmp table`

The server is copying to a temporary table in memory.

- `Copying to tmp table on disk`

The server is copying to a temporary table on disk. The temporary result set has become too large (see [Section 8.4.4, “Internal Temporary Table Use in MySQL”](#)). Consequently, the thread is changing the temporary table from in-memory to disk-based format to save memory.

- `Creating index`

The thread is processing `ALTER TABLE ... ENABLE KEYS` for a `MyISAM` table.

- `Creating sort index`

The thread is processing a `SELECT` that is resolved using an internal temporary table.

- `creating table`

The thread is creating a table. This includes creation of temporary tables.

- `Creating tmp table`

The thread is creating a temporary table in memory or on disk. If the table is created in memory but later is converted to an on-disk table, the state during that operation is `Copying to tmp table on disk`.

- `deleting from main table`

The server is executing the first part of a multiple-table delete. It is deleting only from the first table, and saving columns and offsets to be used for deleting from the other (reference) tables.

- `deleting from reference tables`

The server is executing the second part of a multiple-table delete and deleting the matched rows from the other tables.

- `discard_or_import_tablespace`

The thread is processing an `ALTER TABLE ... DISCARD TABLESPACE` or `ALTER TABLE ... IMPORT TABLESPACE` statement.

- `end`

This occurs at the end but before the cleanup of `ALTER TABLE`, `CREATE VIEW`, `DELETE`, `INSERT`, `SELECT`, or `UPDATE` statements.

For the `end` state, the following operations could be happening:

- Removing query cache entries after data in a table is changed
- Writing an event to the binary log
- Freeing memory buffers, including for blobs
- `executing`

The thread has begun executing a statement.

- `Execution of init_command`

The thread is executing statements in the value of the `init_command` system variable.

- `freeing items`

The thread has executed a command. Some freeing of items done during this state involves the query cache. This state is usually followed by `cleaning up`.

- `FULLTEXT initialization`

The server is preparing to perform a natural-language full-text search.

- `init`

This occurs before the initialization of `ALTER TABLE`, `DELETE`, `INSERT`, `SELECT`, or `UPDATE` statements. Actions taken by the server in this state include flushing the binary log, the `InnoDB` log, and some query cache cleanup operations.

- `Killed`

Someone has sent a `KILL` statement to the thread and it should abort next time it checks the kill flag. The flag is checked in each major loop in MySQL, but in some cases it might still take a short time for the thread to die. If the thread is locked by some other thread, the kill takes effect as soon as the other thread releases its lock.

- `logging slow query`

The thread is writing a statement to the slow-query log.

- `login`

The initial state for a connection thread until the client has been authenticated successfully.

- `manage keys`

The server is enabling or disabling a table index.

- `Opening tables`

The thread is trying to open a table. This should be a very fast procedure, unless something prevents opening. For example, an `ALTER TABLE` or a `LOCK TABLE` statement can prevent opening a table until the statement is finished. It is also worth checking that your `table_open_cache` value is large enough.

- `optimizing`

The server is performing initial optimizations for a query.

- `preparing`

This state occurs during query optimization.

- `preparing for alter table`

The server is preparing to execute an in-place `ALTER TABLE`.

- `Purging old relay logs`

The thread is removing unneeded relay log files.

- `query end`

This state occurs after processing a query but before the `freeing items` state.

- `Receiving from client`

The server is reading a packet from the client. This state is called `Reading from net` prior to MySQL 5.7.8.

- `Removing duplicates`

The query was using `SELECT DISTINCT` in such a way that MySQL could not optimize away the distinct operation at an early stage. Because of this, MySQL requires an extra stage to remove all duplicated rows before sending the result to the client.

- `removing tmp table`

The thread is removing an internal temporary table after processing a `SELECT` statement. This state is not used if no temporary table was created.

- `rename`

The thread is renaming a table.

- `rename result table`

The thread is processing an `ALTER TABLE` statement, has created the new table, and is renaming it to replace the original table.

- `Reopen tables`

The thread got a lock for the table, but noticed after getting the lock that the underlying table structure changed. It has freed the lock, closed the table, and is trying to reopen it.

- `Repair by sorting`

The repair code is using a sort to create indexes.

- `Repair done`

The thread has completed a multithreaded repair for a `MyISAM` table.

- `Repair with keycache`



The repair code is using creating keys one by one through the key cache. This is much slower than `Repair by sorting`.

- `Rolling back`

The thread is rolling back a transaction.

- `Saving state`

For `MyISAM` table operations such as repair or analysis, the thread is saving the new table state to the `.MYI` file header. State includes information such as number of rows, the `AUTO_INCREMENT` counter, and key distributions.

- `Searching rows for update`

The thread is doing a first phase to find all matching rows before updating them. This has to be done if the `UPDATE` is changing the index that is used to find the involved rows.

- `Sending data`

The thread is reading and processing rows for a `SELECT` statement, and sending data to the client. Because operations occurring during this state tend to perform large amounts of disk access (reads), it is often the longest-running state over the lifetime of a given query.

- `Sending to client`

The server is writing a packet to the client. This state is called `Writing to net` prior to MySQL 5.7.8.

- `setup`

The thread is beginning an `ALTER TABLE` operation.

- `Sorting for group`

The thread is doing a sort to satisfy a `GROUP BY`.

- `Sorting for order`

The thread is doing a sort to satisfy an `ORDER BY`.

- `Sorting index`

The thread is sorting index pages for more efficient access during a `MyISAM` table optimization operation.

- `Sorting result`

For a `SELECT` statement, this is similar to `Creating sort index`, but for nontemporary tables.

- `starting`

The first stage at the beginning of statement execution.

- `statistics`

The server is calculating statistics to develop a query execution plan. If a thread is in this state for a long time, the server is probably disk-bound performing other work.

- `System lock`

The thread has called `mysql_lock_tables()` and the thread state has not been updated since. This is a very general state that can occur for many reasons.

For example, the thread is going to request or is waiting for an internal or external system lock for the table. This can occur when `InnoDB` waits for a table-level lock during execution of `LOCK TABLES`. If this state is being caused by requests for external locks and you are not using multiple `mysqld` servers that are accessing the same `MyISAM` tables, you can disable external system locks with the `--skip-external-locking` option. However, external locking is disabled by default, so it is likely that this option has no effect. For `SHOW PROFILE`, this state means the thread is requesting the lock (not waiting for it).

- `update`

The thread is getting ready to start updating the table.

- `Updating`

The thread is searching for rows to update and is updating them.

- `updating main table`

The server is executing the first part of a multiple-table update. It is updating only the first table, and saving columns and offsets to be used for updating the other (reference) tables.

- `updating reference tables`

The server is executing the second part of a multiple-table update and updating the matched rows from the other tables.

- `User lock`

The thread is going to request or is waiting for an advisory lock requested with a `GET_LOCK()` call. For `SHOW PROFILE`, this state means the thread is requesting the lock (not waiting for it).

- `User sleep`

The thread has invoked a `SLEEP()` call.

- `Waiting for commit lock`

`FLUSH TABLES WITH READ LOCK` is waiting for a commit lock.

- `Waiting for global read lock`

`FLUSH TABLES WITH READ LOCK` is waiting for a global read lock or the global `read_only` system variable is being set.

- `Waiting for tables`

The thread got a notification that the underlying structure for a table has changed and it needs to reopen the table to get the new structure. However, to reopen the table, it must wait until all other threads have closed the table in question.

This notification takes place if another thread has used `FLUSH TABLES` or one of the following statements on the table in question: `FLUSH TABLES tbl_name`, `ALTER TABLE`, `RENAME TABLE`, `REPAIR TABLE`, `ANALYZE TABLE`, or `OPTIMIZE TABLE`.

- `Waiting for table flush`

The thread is executing `FLUSH TABLES` and is waiting for all threads to close their tables, or the thread got a notification that the underlying structure for a table has changed and it needs to reopen the table to get the new structure. However, to reopen the table, it must wait until all other threads have closed the table in question.

This notification takes place if another thread has used `FLUSH TABLES` or one of the following statements on the table in question: `FLUSH TABLES tbl_name`, `ALTER TABLE`, `RENAME TABLE`, `REPAIR TABLE`, `ANALYZE TABLE`, or `OPTIMIZE TABLE`.

- `Waiting for lock_type lock`

The server is waiting to acquire a `THR_LOCK` lock or a lock from the metadata locking subsystem, where `lock_type` indicates the type of lock.

This state indicates a wait for a `THR_LOCK`:

- `Waiting for table level lock`

These states indicate a wait for a metadata lock:

- `Waiting for event metadata lock`
- `Waiting for global read lock`
- `Waiting for schema metadata lock`
- `Waiting for stored function metadata lock`
- `Waiting for stored procedure metadata lock`
- `Waiting for table metadata lock`
- `Waiting for trigger metadata lock`

For information about table lock indicators, see [Section 8.11.1, “Internal Locking Methods”](#). For information about metadata locking, see [Section 8.11.4, “Metadata Locking”](#). To see which locks are blocking lock requests, use the Performance Schema lock tables described at [Section 25.12.12, “Performance Schema Lock Tables”](#).

- `Waiting on cond`

A generic state in which the thread is waiting for a condition to become true. No specific state information is available.

- `Writing to net`

The server is writing a packet to the network. This state is called `Sending to client` as of MySQL 5.7.8.

## 8.14.4 Query Cache Thread States

These thread states are associated with the query cache (see [Section 8.10.3, “The MySQL Query Cache”](#)).

- `checking privileges on cached query`

The server is checking whether the user has privileges to access a cached query result.

- `checking query cache for query`

The server is checking whether the current query is present in the query cache.

- `invalidating query cache entries`

Query cache entries are being marked invalid because the underlying tables have changed.

- `sending cached result to client`

The server is taking the result of a query from the query cache and sending it to the client.

- `storing result in query cache`

The server is storing the result of a query in the query cache.

- `Waiting for query cache lock`

This state occurs while a session is waiting to take the query cache lock. This can happen for any statement that needs to perform some query cache operation, such as an `INSERT` or `DELETE` that invalidates the query cache, a `SELECT` that looks for a cached entry, `RESET QUERY CACHE`, and so forth.

### 8.14.5 Replication Source Thread States

The following list shows the most common states you may see in the `State` column for the `Binlog Dump` thread of the replication source. If you see no `Binlog Dump` threads on a source, this means that replication is not running; that is, that no replicas are currently connected.

- `Finished reading one binlog; switching to next binlog`

The thread has finished reading a binary log file and is opening the next one to send to the replica.

- `Master has sent all binlog to slave; waiting for more updates`

The thread has read all remaining updates from the binary logs and sent them to the replica. The thread is now idle, waiting for new events to appear in the binary log resulting from new updates occurring on the source.

- `Sending binlog event to slave`

Binary logs consist of *events*, where an event is usually an update plus some other information. The thread has read an event from the binary log and is now sending it to the replica.

- `Waiting to finalize termination`

A very brief state that occurs as the thread is stopping.

### 8.14.6 Replication Replica I/O Thread States

The following list shows the most common states you see in the `State` column for a replica server I/O thread. This state also appears in the `Slave_IO_State` column displayed by `SHOW SLAVE STATUS`, so you can get a good view of what is happening by using that statement.

- `Checking master version`

A state that occurs very briefly, after the connection to the source is established.

- `Connecting to master`

The thread is attempting to connect to the source.
- `Queueing master event to the relay log`

The thread has read an event and is copying it to the relay log so that the SQL thread can process it.
- `Reconnecting after a failed binlog dump request`

The thread is trying to reconnect to the source.
- `Reconnecting after a failed master event read`

The thread is trying to reconnect to the source. When connection is established again, the state becomes `Waiting for master to send event`.
- `Registering slave on master`

A state that occurs very briefly after the connection to the source is established.
- `Requesting binlog dump`

A state that occurs very briefly, after the connection to the source is established. The thread sends to the source a request for the contents of its binary logs, starting from the requested binary log file name and position.
- `Waiting for its turn to commit`

A state that occurs when the replica thread is waiting for older worker threads to commit if `slave_preserve_commit_order` is enabled.
- `Waiting for master to send event`

The thread has connected to the source and is waiting for binary log events to arrive. This can last for a long time if the source is idle. If the wait lasts for `slave_net_timeout` seconds, a timeout occurs. At that point, the thread considers the connection to be broken and makes an attempt to reconnect.
- `Waiting for master update`

The initial state before `Connecting to master`.
- `Waiting for slave mutex on exit`

A state that occurs briefly as the thread is stopping.
- `Waiting for the slave SQL thread to free enough relay log space`

You are using a nonzero `relay_log_space_limit` value, and the relay logs have grown large enough that their combined size exceeds this value. The I/O thread is waiting until the SQL thread frees enough space by processing relay log contents so that it can delete some relay log files.
- `Waiting to reconnect after a failed binlog dump request`

If the binary log dump request failed (due to disconnection), the thread goes into this state while it sleeps, then tries to reconnect periodically. The interval between retries can be specified using the `CHANGE MASTER TO` statement.
- `Waiting to reconnect after a failed master event read`

---

An error occurred while reading (due to disconnection). The thread is sleeping for the number of seconds set by the `CHANGE MASTER TO` statement (default 60) before attempting to reconnect.

## 8.14.7 Replication Replica SQL Thread States

The following list shows the most common states you may see in the `State` column for a replica server SQL thread:

- `Making temporary file (append) before replaying LOAD DATA INFILE`

The thread is executing a `LOAD DATA` statement and is appending the data to a temporary file containing the data from which the replica reads rows.

- `Making temporary file (create) before replaying LOAD DATA INFILE`

The thread is executing a `LOAD DATA` statement and is creating a temporary file containing the data from which the replica reads rows. This state can only be encountered if the original `LOAD DATA` statement was logged by a source running a version of MySQL lower than MySQL 5.0.3.

- `Reading event from the relay log`

The thread has read an event from the relay log so that the event can be processed.

- `Slave has read all relay log; waiting for more updates`

The thread has processed all events in the relay log files, and is now waiting for the I/O thread to write new events to the relay log.

- `Waiting for an event from Coordinator`

Using the multithreaded replica (`slave_parallel_workers` is greater than 1), one of the replica worker threads is waiting for an event from the coordinator thread.

- `Waiting for slave mutex on exit`

A very brief state that occurs as the thread is stopping.

- `Waiting for Slave Workers to free pending events`

This waiting action occurs when the total size of events being processed by Workers exceeds the size of the `slave_pending_jobs_size_max` system variable. The Coordinator resumes scheduling when the size drops below this limit. This state occurs only when `slave_parallel_workers` is set greater than 0.

- `Waiting for the next event in relay log`

The initial state before `Reading event from the relay log`.

- `Waiting until MASTER_DELAY seconds after master executed event`

The SQL thread has read an event but is waiting for the replica delay to lapse. This delay is set with the `MASTER_DELAY` option of `CHANGE MASTER TO`.

The `Info` column for the SQL thread may also show the text of a statement. This indicates that the thread has read an event from the relay log, extracted the statement from it, and may be executing it.

## 8.14.8 Replication Replica Connection Thread States

These thread states occur on a replica server but are associated with connection threads, not with the I/O or SQL threads.

- `Changing master`

The thread is processing a `CHANGE MASTER TO` statement.

- `Killing slave`

The thread is processing a `STOP SLAVE` statement.

- `Opening master dump table`

This state occurs after `Creating table from master dump`.

- `Reading master dump table data`

This state occurs after `Opening master dump table`.

- `Rebuilding the index on master dump table`

This state occurs after `Reading master dump table data`.

### 8.14.9 NDB Cluster Thread States

- `Committing events to binlog`

- `Opening mysql.ndb_apply_status`

- `Processing events`

The thread is processing events for binary logging.

- `Processing events from schema table`

The thread is doing the work of schema replication.

- `Shutting down`

- `Syncing ndb table schema operation and binlog`

This is used to have a correct binary log of schema operations for NDB.

- `Waiting for allowed to take ndbcluster global schema lock`

The thread is waiting for permission to take a global schema lock.

- `Waiting for event from ndbcluster`

The server is acting as an SQL node in an NDB Cluster, and is connected to a cluster management node.

- `Waiting for first event from ndbcluster`

- `Waiting for ndbcluster binlog update to reach current position`

- `Waiting for ndbcluster global schema lock`

The thread is waiting for a global schema lock held by another thread to be released.

- `Waiting for ndbcluster to start`

- `Waiting for schema epoch`

The thread is waiting for a schema epoch (that is, a global checkpoint).

## 8.14.10 Event Scheduler Thread States

These states occur for the Event Scheduler thread, threads that are created to execute scheduled events, or threads that terminate the scheduler.

- `Clearing`

The scheduler thread or a thread that was executing an event is terminating and is about to end.

- `Initialized`

The scheduler thread or a thread that executes an event has been initialized.

- `Waiting for next activation`

The scheduler has a nonempty event queue but the next activation is in the future.

- `Waiting for scheduler to stop`

The thread issued `SET GLOBAL event_scheduler=OFF` and is waiting for the scheduler to stop.

- `Waiting on empty queue`

The scheduler's event queue is empty and it is sleeping.

## 8.15 Tracing the Optimizer

The MySQL optimizer includes the capability to perform tracing; the interface is provided by a set of `optimizer_trace_xxx` system variables and the `INFORMATION_SCHEMA.OPTIMIZER_TRACE` table.

### 8.15.1 Typical Usage

To perform optimizer tracing entails the following steps:

1. Enable tracing by executing `SET optimizer_trace="enabled=ON"`.
2. Execute the statement to be traced. See [Section 8.15.3, "Traceable Statements"](#), for a listing of statements which can be traced.
3. Examine the contents of the `INFORMATION_SCHEMA.OPTIMIZER_TRACE` table.
4. To examine traces for multiple queries, repeat the previous two steps as needed.
5. To disable tracing after you have finished, execute `SET optimizer_trace="enabled=OFF"`.

You can trace only statements which are executed within the current session; you cannot see traces from other sessions.

### 8.15.2 System Variables Controlling Tracing

The following system variables affect optimizer tracing:

- `optimizer_trace`: Enables or disables optimizer tracing. See [Section 8.15.8, "The optimizer\\_trace System Variable"](#).



- `optimizer_trace_features`: Enables or disables selected features of the MySQL Optimizer, using the syntax shown here:

```
SET optimizer_trace_features=option=value[,option=value][,...]

option:
  {greedy_search | range_optimizer | dynamic_range | repeated_subselect}

value:
  {on | off | default}
```

See [Section 8.15.10, “Selecting Optimizer Features to Trace”](#), for more information on the effects of these.

- `optimizer_trace_max_mem_size`: Maximum amount of memory that can be used for storing all traces.
- `optimizer_trace_limit`: The maximum number of optimizer traces to be shown. See [Section 8.15.4, “Tuning Trace Purging”](#), for more information.
- `optimizer_trace_offset`: Offset of the first trace shown. See [Section 8.15.4, “Tuning Trace Purging”](#).
- `end_markers_in_json`: If set to `1`, causes the trace to repeat the key (if present) near the closing bracket. This also affects the output of `EXPLAIN FORMAT=JSON` in those versions of MySQL which support this statement. See [Section 8.15.9, “The `end\_markers\_in\_json` System Variable”](#).

### 8.15.3 Traceable Statements

Statements which are traceable are listed here:

- `SELECT`
- `INSERT`
- `REPLACE`
- `UPDATE`
- `DELETE`
- `EXPLAIN` with any of the preceding statements
- `SET`
- `DO`
- `DECLARE`, `CASE`, `IF`, and `RETURN` as used in stored routines
- `CALL`

Tracing is supported for both `INSERT` and `REPLACE` statements using `VALUES`, `VALUES ROW`, or `SELECT`.

Traces of multi-table `UPDATE` and `DELETE` statements are supported.

Tracing of `SET optimizer_trace` is not supported.

For statements which are prepared and executed in separate steps, preparation and execution are traced separately.

## 8.15.4 Tuning Trace Purging

By default, each new trace overwrites the previous trace. Thus, if a statement contains substatements (such as invoking stored procedures, stored functions, or triggers), the topmost statement and substatements each generate one trace, but at the end of execution, the trace for only the last substatement is visible.

A user who wants to see the trace of a different substatement can enable or disable tracing for the desired substatement, but this requires editing the routine code, which may not always be possible. Another solution is to tune trace purging. This is done by setting the `optimizer_trace_offset` and `optimizer_trace_limit` system variables, like this:

```
SET optimizer_trace_offset=offset, optimizer_trace_limit=limit;
```

*offset* is a signed integer (default `-1`); *limit* is a positive integer (default `1`). Such a `SET` statement has the following effects:

- All traces previously stored are cleared from memory.
- A subsequent `SELECT` from the `OPTIMIZER_TRACE` table returns the first *limit* traces of the *offset* oldest stored traces (if *offset*  $\geq$  0), or the first *limit* traces of the *-offset* newest stored traces (if *offset*  $<$  0).

Examples:

- `SET optimizer_trace_offset=-1, optimizer_trace_limit=1`: The most recent trace is shown (the default).
- `SET optimizer_trace_offset=-2, optimizer_trace_limit=1`: The next-to-last trace is shown.
- `SET optimizer_trace_offset=-5, optimizer_trace_limit=5`: The last five traces are shown.

Negative values for *offset* can thus prove useful when the substatements of interest are the last few in a stored routine. For example:

```
SET optimizer_trace_offset=-5, optimizer_trace_limit=5;

CALL stored_routine(); # more than 5 substatements in this routine

SELECT * FROM information_schema.OPTIMIZER_TRACE; # see only the last 5 traces
```

A positive *offset* can be useful when one knows that the interesting substatements are the first few in a stored routine.

The more accurately these two variables are set, the less memory is used. For example, `SET optimizer_trace_offset=0, optimizer_trace_limit=5` requires sufficient memory to store five traces, so if only the three first are needed, it is better to use `SET optimizer_trace_offset=0, optimizer_trace_limit=3`, since tracing stops after *limit* traces. A stored routine may have a loop which executes many substatements and thus generates many traces, which can use a lot of memory; in such cases, choosing appropriate values for *offset* and *limit* can restrict tracing to, for example, a single iteration of the loop. This also decreases the impact of tracing on execution speed.

If *offset* is greater than or equal to 0, only *limit* traces are kept in memory. If *offset* is less than 0, that is not true: instead, *-offset* traces are kept in memory. Even if *limit* is smaller than *-offset*, excluding the last statement, the last statement must still be traced because it will be within the limit after

executing one more statement. Since an offset less than 0 is counted from the end, the “window” moves as more statements execute.

Using `optimizer_trace_offset` and `optimizer_trace_limit`, which are restrictions at the trace producer level, provide better (greater) speed and (less) memory usage than setting offsets or limits at the trace consumer (SQL) level with `SELECT * FROM OPTIMIZER_TRACE LIMIT limit OFFSET offset`, which saves almost nothing.

### 8.15.5 Tracing Memory Usage

Each stored trace is a string, which is extended (using `realloc()`) as optimization progresses by appending more data to it. The `optimizer_trace_max_mem_size` server system variable sets a limit on the total amount of memory used by all traces currently being stored. If this limit is reached, the current trace is not extended, which means the trace is incomplete; in this case the `MISSING_BYTES_BEYOND_MAX_MEM_SIZE` column shows the number of bytes missing from the trace.

### 8.15.6 Privilege Checking

In complex scenarios where the query uses SQL SECURITY DEFINER views or stored routines, it may be that a user is denied from seeing the trace of its query because it lacks some extra privileges on those objects. In that case, the trace will be shown as empty and the `INSUFFICIENT_PRIVILEGES` column will show "1".

### 8.15.7 Interaction with the `--debug` Option

Anything written to the trace is automatically written to the debug file.

### 8.15.8 The `optimizer_trace` System Variable

The `optimizer_trace` system variable has these on/off switches:

- `enabled`: Enables (`ON`) or disables (`OFF`) tracing
- `one_line`: If set to `ON`, the trace contains no whitespace, thus conserving space. This renders the trace difficult to read for humans, still usable by JSON parsers, since they ignore whitespace.

### 8.15.9 The `end_markers_in_json` System Variable

When reading a very large JSON document, it can be difficult to pair its closing bracket and opening brackets; setting `end_markers_in_json=ON` repeats the structure's key, if it has one, near the closing bracket. This variable affects both optimizer traces and the output of `EXPLAIN FORMAT=JSON`.



#### Note

If `end_markers_in_json` is enabled, the repetition of the key means the result is not a valid JSON document, and causes JSON parsers to throw an error.

### 8.15.10 Selecting Optimizer Features to Trace

Some features in the optimizer can be invoked many times during statement optimization and execution, and thus can make the trace grow beyond reason. They are:

- *Greedy search*: With an  $N$ -table join, this could explore factorial( $N$ ) plans.
- *Range optimizer*
- *Dynamic range optimization*: Shown as `range checked for each record` in `EXPLAIN` output; each outer row causes a re-run of the range optimizer.

- *Subqueries*: A subquery in which the `WHERE` clause may be executed once per row.

Those features can be excluded from tracing by setting one or more switches of the `optimizer_trace_features` system variable to `OFF`. These switches are listed here:

- `greedy_search`: Greedy search is not traced.
- `range_optimizer`: The range optimizer is not traced.
- `dynamic_range`: Only the first call to the range optimizer on this `JOIN_TAB::SQL_SELECT` is traced.
- `repeated_subselect`: Only the first execution of this `Item_subselect` is traced.

## 8.15.11 Trace General Structure

A trace follows the actual execution path very closely; for each join, there is a join preparation object, a join optimization object, and a join execution object. Query transformations (`IN` to `EXISTS`, outer join to inner join, and so on), simplifications (elimination of clauses), and equality propagation are shown in subobjects. Calls to the range optimizer, cost evaluations, reasons why an access path is chosen over another one, or why a sorting method is chosen over another one, are shown as well.

## 8.15.12 Example

Here we take an example from the test suite.

```
#
# Tracing of ORDER BY & GROUP BY simplification.
#
SET optimizer_trace="enabled=on",end_markers_in_json=on; # make readable
SET optimizer_trace_max_mem_size=1000000; # avoid small default

CREATE TABLE t1 (
  pk INT, col_int_key INT,
  col_varchar_key VARCHAR(1),
  col_varchar_nokey VARCHAR(1)
);

INSERT INTO t1 VALUES
  (10,7,'v','v'),(11,0,'s','s'),(12,9,'l','l'),(13,3,'y','y'),(14,4,'c','c'),
  (15,2,'i','i'),(16,5,'h','h'),(17,3,'q','q'),(18,1,'a','a'),(19,3,'v','v'),
  (20,6,'u','u'),(21,7,'s','s'),(22,5,'y','y'),(23,1,'z','z'),(24,204,'h','h'),
  (25,224,'p','p'),(26,9,'e','e'),(27,5,'i','i'),(28,0,'y','y'),(29,3,'w','w');

CREATE TABLE t2 (
  pk INT, col_int_key INT,
  col_varchar_key VARCHAR(1),
  col_varchar_nokey VARCHAR(1),
  PRIMARY KEY (pk)
);

INSERT INTO t2 VALUES
  (1,4,'b','b'),(2,8,'y','y'),(3,0,'p','p'),(4,0,'f','f'),(5,0,'p','p'),
  (6,7,'d','d'),(7,7,'f','f'),(8,5,'j','j'),(9,3,'e','e'),(10,188,'u','u'),
  (11,4,'v','v'),(12,9,'u','u'),(13,6,'i','i'),(14,1,'x','x'),(15,5,'l','l'),
  (16,6,'q','q'),(17,2,'n','n'),(18,4,'r','r'),(19,231,'c','c'),(20,4,'h','h'),
  (21,3,'k','k'),(22,3,'t','t'),(23,7,'t','t'),(24,6,'k','k'),(25,7,'g','g'),
  (26,9,'z','z'),(27,4,'n','n'),(28,4,'j','j'),(29,2,'l','l'),(30,1,'d','d'),
  (31,2,'t','t'),(32,194,'y','y'),(33,2,'i','i'),(34,3,'j','j'),(35,8,'r','r'),
  (36,4,'b','b'),(37,9,'o','o'),(38,4,'k','k'),(39,5,'a','a'),(40,5,'f','f'),
  (41,9,'t','t'),(42,3,'c','c'),(43,8,'c','c'),(44,0,'r','r'),(45,98,'k','k'),
  (46,3,'l','l'),(47,1,'o','o'),(48,0,'t','t'),(49,189,'v','v'),(50,8,'x','x'),
  (51,3,'j','j'),(52,3,'x','x'),(53,9,'k','k'),(54,6,'o','o'),(55,8,'z','z'),
  (56,3,'n','n'),(57,9,'c','c'),(58,5,'d','d'),(59,9,'s','s'),(60,2,'j','j');
```

```
(61,2,'w','w'),(62,5,'f','f'),(63,8,'p','p'),(64,6,'o','o'),(65,9,'f','f'),
(66,0,'x','x'),(67,3,'q','q'),(68,6,'g','g'),(69,5,'x','x'),(70,8,'p','p'),
(71,2,'q','q'),(72,120,'q','q'),(73,25,'v','v'),(74,1,'g','g'),(75,3,'l','l'),
(76,1,'w','w'),(77,3,'h','h'),(78,153,'c','c'),(79,5,'o','o'),(80,9,'o','o'),
(81,1,'v','v'),(82,8,'y','y'),(83,7,'d','d'),(84,6,'p','p'),(85,2,'z','z'),
(86,4,'t','t'),(87,7,'b','b'),(88,3,'y','y'),(89,8,'k','k'),(90,4,'c','c'),
(91,6,'z','z'),(92,1,'t','t'),(93,7,'o','o'),(94,1,'u','u'),(95,0,'t','t'),
(96,2,'k','k'),(97,7,'u','u'),(98,2,'b','b'),(99,1,'m','m'),(100,5,'o','o');

SELECT SUM(alias2.col_varchar_nokey) AS c1, alias2.pk AS c2
  FROM t1 AS alias1
  STRAIGHT_JOIN t2 AS alias2
  ON alias2.pk = alias1.col_int_key
  WHERE alias1.pk
  GROUP BY c2
  ORDER BY alias1.col_int_key, alias2.pk;
```

c1	c2
0	1
0	2
0	3
0	4
0	5
0	6
0	7
0	9



### Note

For reference, the complete trace is shown uninterrupted at the end of this section.

Now we can examine the trace, whose first column ([QUERY](#)), containing the original statement to be traced, is shown here:

```
SELECT * FROM INFORMATION_SCHEMA.OPTIMIZER_TRACE\G
***** 1. row *****
QUERY: SELECT SUM(alias2.col_varchar_nokey) AS c1, alias2.pk AS c2
  FROM t1 AS alias1
  STRAIGHT_JOIN t2 AS alias2
  ON alias2.pk = alias1.col_int_key
  WHERE alias1.pk
  GROUP BY c2
  ORDER BY alias1.col_int_key, alias2.pk
```

This can be useful mark when several traces are stored.

The [TRACE](#) column begins by showing that execution of the statement is made up of discrete steps, like this:

```
"steps": [
  {
```

This is followed by the preparation of the join for the first (and only) [SELECT](#) in the statement being traced, as shown here:

```
"steps": [
  {
    "expanded_query": "/* select#1 */ select \
      sum(`test`.`alias2`.`col_varchar_nokey`) AS \
        `SUM(alias2.col_varchar_nokey)`, `test`.`alias2`.`pk` AS `field2` \
      from (`test`.`t1` `alias1` straight_join `test`.`t2` `alias2` \
        on((`test`.`alias2`.`pk` = `test`.`alias1`.`col_int_key`))) \
```

## Example

```
where `test`.`alias1`.`pk` \
group by `test`.`alias2`.`pk` \
order by `test`.`alias1`.`col_int_key`,`test`.`alias2`.`pk`"
}
] /* steps */
} /* join_preparation */
},
```

The output just shown displays the query as it is used for preparing the join; all columns (fields) have been resolved to their databases and tables, and each `SELECT` is annotated with a sequence number, which can be useful when studying subqueries.

The next portion of the trace shows how the join is optimized, starting with condition processing:

```
{
  "join_optimization": {
    "select#": 1,
    "steps": [
      {
        "condition_processing": {
          "condition": "WHERE",
          "original_condition": "(`test`.`alias1`.`pk` and \
(`test`.`alias2`.`pk` = `test`.`alias1`.`col_int_key`))",
          "steps": [
            {
              "transformation": "equality_propagation",
              "resulting_condition": "(`test`.`alias1`.`pk` and \
multiple equal(`test`.`alias2`.`pk`, \
`test`.`alias1`.`col_int_key`))"
            },
            {
              "transformation": "constant_propagation",
              "resulting_condition": "(`test`.`alias1`.`pk` and \
multiple equal(`test`.`alias2`.`pk`, \
`test`.`alias1`.`col_int_key`))"
            },
            {
              "transformation": "trivial_condition_removal",
              "resulting_condition": "(`test`.`alias1`.`pk` and \
multiple equal(`test`.`alias2`.`pk`, \
`test`.`alias1`.`col_int_key`))"
            }
          ] /* steps */
        } /* condition_processing */
      },

```

Next, the optimizer checks for possible `ref` accesses, and identifies one:

```
{
  "ref_optimizer_key_uses": [
    {
      "database": "test",
      "table": "alias2",
      "field": "pk",
      "equals": "`test`.`alias1`.`col_int_key`",
      "null_rejecting": true
    }
  ] /* ref_optimizer_key_uses */
},
```

A `ref` access which rejects `NULL` has been identified: no `NULL` in `test.alias1.col_int_key` can have a match. (Observe that it could have a match, were the operator a null-safe equals `<=>`).

Next, for every table in the query, we estimate the cost of, and number of records returned by, a table scan or a range access.

We need to find an optimal order for the tables. Normally, greedy search is used, but since the statement uses a straight join, only the requested order is explored, and one or more access methods are selected. As shown in this portion of the trace, we can choose a table scan:

```
{
  "records_estimation": [
    {
      "database": "test",
      "table": "alias1",
      "const_keys_added": {
        "keys": [
          ] /* keys */,
        "cause": "group_by"
      } /* const_keys_added */,
      "range_analysis": {
        "table_scan": {
          "records": 20,
          "cost": 8.1977
        } /* table_scan */
      } /* range_analysis */
    },
    {
      "database": "test",
      "table": "alias2",
      "const_keys_added": {
        "keys": [
          "PRIMARY"
        ] /* keys */,
        "cause": "group_by"
      } /* const_keys_added */,
      "range_analysis": {
        "table_scan": {
          "records": 100,
          "cost": 24.588
        } /* table_scan */,
        "potential_range_indices": [
          {
            "index": "PRIMARY",
            "usable": true,
            "key_parts": [
              "pk"
            ] /* key_parts */
          }
        ] /* potential_range_indices */,
        "setup_range_conditions": [
          ] /* setup_range_conditions */,
        "group_index_range": {
          "chosen": false,
          "cause": "not_single_table"
        } /* group_index_range */
      } /* range_analysis */
    }
  ] /* records_estimation */
},
```

As just shown in the second portion of the range analysis, it is not possible to use `GROUP_MIN_MAX` because it accepts only one table, and we have two in the join. This means that no range access is possible.

The optimizer estimates that reading the first table, and applying any required conditions to it, yields 20 rows:

```
{
  "considered_execution_plans": [
    {
      "database": "test",
```

## Example

```
"table": "alias1",
"best_access_path": {
  "considered_access_paths": [
    {
      "access_type": "scan",
      "records": 20,
      "cost": 2.0977,
      "chosen": true
    }
  ] /* considered_access_paths */
} /* best_access_path */,
"cost_for_plan": 6.0977,
"records_for_plan": 20,
```

For `alias2`, we choose `ref` access on the primary key rather than a table scan, because the number of records returned by the latter (75) is far greater than that returned by `ref` access (1), as shown here:

```
"rest_of_plan": [
  {
    "database": "test",
    "table": "alias2",
    "best_access_path": {
      "considered_access_paths": [
        {
          "access_type": "ref",
          "index": "PRIMARY",
          "records": 1,
          "cost": 20.2,
          "chosen": true
        },
        {
          "access_type": "scan",
          "using_join_cache": true,
          "records": 75,
          "cost": 7.4917,
          "chosen": false
        }
      ] /* considered_access_paths */
    } /* best_access_path */,
    "cost_for_plan": 30.098,
    "records_for_plan": 20,
    "chosen": true
  }
] /* rest_of_plan */
} /* considered_execution_plans */
},
```

Now that the order of tables is fixed, we can split the `WHERE` condition into chunks which can be tested early (pushdown of conditions down the join tree):

```
{
  "attaching_conditions_to_tables": {
    "original_condition": "(`test`.`alias2`.`pk` = \
`test`.`alias1`.`col_int_key`) and `test`.`alias1`.`pk`)",
    "attached_conditions_computation": [
      ] /* attached_conditions_computation */,
    "attached_conditions_summary": [
      {
        "database": "test",
        "table": "alias1",
        "attached": "(`test`.`alias1`.`pk` and \
(`test`.`alias1`.`col_int_key` is not null))"
      }
    ]
  }
},
```

This condition can be tested on rows of `alias1` without reading rows from `alias2`.



```

        {
          "database": "test",
          "table": "alias2",
          "attached": null
        }
      ] /* attached_conditions_summary */
    } /* attaching_conditions_to_tables */
  },
  {

```

Now we try to simplify the [ORDER BY](#):

```

    "clause_processing": {
      "clause": "ORDER BY",
      "original_clause": "`test`.`alias1`.`col_int_key`,`test`.`alias2`.`pk`",
      "items": [
        {
          "item": "`test`.`alias1`.`col_int_key`"
        },
        {
          "item": "`test`.`alias2`.`pk`",
          "eq_ref_to_preceding_items": true
        }
      ] /* items */,

```

Because the [WHERE](#) clause contains `alias2.pk=alias1.col_int_key`, ordering by both columns is unnecessary; we can order by the first column alone, since the second column is always equal to it.

```

      "resulting_clause_is_simple": true,
      "resulting_clause": "`test`.`alias1`.`col_int_key`"
    } /* clause_processing */
  },

```

The shorter [ORDER BY](#) clause (which is not visible in the output of [EXPLAIN](#)) can be implemented as an index scan, since it uses only a single column of one table.

```

    {
      "clause_processing": {
        "clause": "GROUP BY",
        "original_clause": "`test`.`alias2`.`pk`",
        "items": [
          {
            "item": "`test`.`alias2`.`pk`"
          }
        ] /* items */,
        "resulting_clause_is_simple": false,
        "resulting_clause": "`test`.`alias2`.`pk`"
      } /* clause_processing */
    },
    {
      "refine_plan": [
        {
          "database": "test",
          "table": "alias1",
          "scan_type": "table"
        },
        {
          "database": "test",
          "table": "alias2"
        }
      ] /* refine_plan */
    }
  ] /* steps */
} /* join_optimization */
},
{

```

## Example

Now the join is executed:

```
"join_execution": {
  "select#": 1,
  "steps": [
    ] /* steps */
  } /* join_execution */
}
] /* steps */
} 0 0
```

All traces have the same basic structure. If a statement uses subqueries, there can be multiple preparations, optimizations, and executions, as well as subquery-specific transformations.

The complete trace is shown here:

```
mysql> SELECT * FROM INFORMATION_SCHEMA.OPTIMIZER_TRACE\G
***** 1. row *****
QUERY: SELECT SUM(alias2.col_varchar_nokey) AS c1, alias2.pk AS c2
FROM t1 AS alias1
STRAIGHT_JOIN t2 AS alias2
ON alias2.pk = alias1.col_int_key
WHERE alias1.pk
GROUP BY c2
ORDER BY alias1.col_int_key, alias2.pk
TRACE: {
  "steps": [
    {
      "join_preparation": {
        "select#": 1,
        "steps": [
          {
            "expanded_query": "/* select#1 */ select sum(`alias2`.`col_varchar_nokey`) AS `c1`,`alias2`.`pk` AS `c2`",
          },
          {
            "transformations_to_nested_joins": {
              "transformations": [
                "JOIN_condition_to_WHERE",
                "parenthesis_removal"
              ] /* transformations */,
              "expanded_query": "/* select#1 */ select sum(`alias2`.`col_varchar_nokey`) AS `c1`,`alias2`.`pk` AS `c2`",
            } /* transformations_to_nested_joins */
          },
          {
            "functional_dependencies_of_GROUP_columns": {
              "all_columns_of_table_map_bits": [
                1
              ] /* all_columns_of_table_map_bits */,
              "columns": [
                "test.alias2.pk",
                "test.alias1.col_int_key"
              ] /* columns */
            } /* functional_dependencies_of_GROUP_columns */
          }
        ] /* steps */
      } /* join_preparation */
    },
    {
      "join_optimization": {
        "select#": 1,
        "steps": [
          {
            "condition_processing": {
              "condition": "WHERE",
              "original_condition": "((0 <> `alias1`.`pk`) and (`alias2`.`pk` = `alias1`.`col_int_key`))",
              "steps": [
            
```

## Example

```
        "transformation": "equality_propagation",
        "resulting_condition": "((0 <> `alias1`.`pk`) and multiple equal(`alias2`.`pk`, `alias1`
    },
    {
        "transformation": "constant_propagation",
        "resulting_condition": "((0 <> `alias1`.`pk`) and multiple equal(`alias2`.`pk`, `alias1`
    },
    {
        "transformation": "trivial_condition_removal",
        "resulting_condition": "((0 <> `alias1`.`pk`) and multiple equal(`alias2`.`pk`, `alias1`
    }
] /* steps */
} /* condition_processing */
},
{
    "substitute_generated_columns": {
    } /* substitute_generated_columns */
},
{
    "table_dependencies": [
        {
            "table": "`t1` `alias1`",
            "row_may_be_null": false,
            "map_bit": 0,
            "depends_on_map_bits": [
            ] /* depends_on_map_bits */
        },
        {
            "table": "`t2` `alias2`",
            "row_may_be_null": false,
            "map_bit": 1,
            "depends_on_map_bits": [
                0
            ] /* depends_on_map_bits */
        }
    ] /* table_dependencies */
},
{
    "ref_optimizer_key_uses": [
        {
            "table": "`t2` `alias2`",
            "field": "pk",
            "equals": "`alias1`.`col_int_key`",
            "null_rejecting": true
        }
    ] /* ref_optimizer_key_uses */
},
{
    "rows_estimation": [
        {
            "table": "`t1` `alias1`",
            "table_scan": {
                "rows": 20,
                "cost": 0.25
            } /* table_scan */
        },
        {
            "table": "`t2` `alias2`",
            "const_keys_added": {
                "keys": [
                    "PRIMARY"
                ] /* keys */,
                "cause": "group_by"
            } /* const_keys_added */,
            "range_analysis": {
                "table_scan": {
                    "rows": 100,
```

## Example

```
    "cost": 12.35
  } /* table_scan */,
  "potential_range_indexes": [
    {
      "index": "PRIMARY",
      "usable": true,
      "key_parts": [
        "pk"
      ] /* key_parts */
    }
  ] /* potential_range_indexes */,
  "setup_range_conditions": [
  ] /* setup_range_conditions */,
  "group_index_skip_scan": {
    "chosen": false,
    "cause": "not_single_table"
  } /* group_index_skip_scan */,
  "skip_scan_range": {
    "chosen": false,
    "cause": "not_single_table"
  } /* skip_scan_range */
} /* range_analysis */
}
] /* rows_estimation */
},
{
  "considered_execution_plans": [
    {
      "plan_prefix": [
      ] /* plan_prefix */,
      "table": "`t1` `alias1`",
      "best_access_path": {
        "considered_access_paths": [
          {
            "rows_to_scan": 20,
            "filtering_effect": [
            ] /* filtering_effect */,
            "final_filtering_effect": 0.9,
            "access_type": "scan",
            "resulting_rows": 18,
            "cost": 2.25,
            "chosen": true
          }
        ] /* considered_access_paths */
      } /* best_access_path */,
      "condition_filtering_pct": 100,
      "rows_for_plan": 18,
      "cost_for_plan": 2.25,
      "rest_of_plan": [
        {
          "plan_prefix": [
            "`t1` `alias1`"
          ] /* plan_prefix */,
          "table": "`t2` `alias2`",
          "best_access_path": {
            "considered_access_paths": [
              {
                "access_type": "eq_ref",
                "index": "PRIMARY",
                "rows": 1,
                "cost": 6.3,
                "chosen": true,
                "cause": "clustered_pk_chosen_by_heuristics"
              },
              {
                "rows_to_scan": 100,
                "filtering_effect": [
```

## Example

```
        ] /* filtering_effect */,
        "final_filtering_effect": 1,
        "access_type": "scan",
        "using_join_cache": true,
        "buffers_needed": 1,
        "resulting_rows": 100,
        "cost": 180.25,
        "chosen": false
    }
    ] /* considered_access_paths */
    } /* best_access_path */,
    "condition_filtering_pct": 100,
    "rows_for_plan": 18,
    "cost_for_plan": 8.55,
    "chosen": true
    }
    ] /* rest_of_plan */
    }
} /* considered_execution_plans */
},
{
    "attaching_conditions_to_tables": {
        "original_condition": "((`alias2`.`pk` = `alias1`.`col_int_key`) and (0 <> `alias1`.`pk`))",
        "attached_conditions_computation": [
            ] /* attached_conditions_computation */,
        "attached_conditions_summary": [
            {
                "table": "`t1` `alias1`",
                "attached": "((0 <> `alias1`.`pk`) and (`alias1`.`col_int_key` is not null))"
            },
            {
                "table": "`t2` `alias2`",
                "attached": "(`alias2`.`pk` = `alias1`.`col_int_key`)"
            }
        ] /* attached_conditions_summary */
    } /* attaching_conditions_to_tables */
},
{
    "optimizing_distinct_group_by_order_by": {
        "simplifying_order_by": {
            "original_clause": "`alias1`.`col_int_key`,`alias2`.`pk`",
            "items": [
                {
                    "item": "`alias1`.`col_int_key`"
                },
                {
                    "item": "`alias2`.`pk`",
                    "eq_ref_to_preceding_items": true
                }
            ] /* items */,
            "resulting_clause_is_simple": true,
            "resulting_clause": "`alias1`.`col_int_key`"
        } /* simplifying_order_by */,
        "simplifying_group_by": {
            "original_clause": "`c2`",
            "items": [
                {
                    "item": "`alias2`.`pk`"
                }
            ] /* items */,
            "resulting_clause_is_simple": false,
            "resulting_clause": "`c2`"
        } /* simplifying_group_by */
    } /* optimizing_distinct_group_by_order_by */
},
{
    "finalizing_table_conditions": [
```

## Example

```
{
  "table": "`t1` `alias1`",
  "original_table_condition": "((0 <> `alias1`.`pk`) and (`alias1`.`col_int_key` is not null))",
  "final_table_condition": "((0 <> `alias1`.`pk`) and (`alias1`.`col_int_key` is not null))",
},
{
  "table": "`t2` `alias2`",
  "original_table_condition": "(`alias2`.`pk` = `alias1`.`col_int_key`)",
  "final_table_condition": null
}
] /* finalizing_table_conditions */
},
{
  "refine_plan": [
    {
      "table": "`t1` `alias1`"
    },
    {
      "table": "`t2` `alias2`"
    }
  ] /* refine_plan */
},
{
  "considering_tmp_tables": [
    {
      "adding_tmp_table_in_plan_at_position": 2,
      "write_method": "continuously_update_group_row"
    },
    {
      "adding_sort_to_table": ""
    } /* filesort */
  ] /* considering_tmp_tables */
}
] /* steps */
} /* join_optimization */
},
{
  "join_execution": {
    "select#": 1,
    "steps": [
      {
        "temp_table_aggregate": {
          "select#": 1,
          "steps": [
            {
              "creating_tmp_table": {
                "tmp_table_info": {
                  "table": "<temporary>",
                  "in_plan_at_position": 2,
                  "columns": 3,
                  "row_length": 18,
                  "key_length": 4,
                  "unique_constraint": false,
                  "makes_grouped_rows": true,
                  "cannot_insert_duplicates": false,
                  "location": "TempTable"
                } /* tmp_table_info */
              } /* creating_tmp_table */
            }
          ] /* steps */
        } /* temp_table_aggregate */
      },
      {
        "sorting_table": "<temporary>",
        "filesort_information": [
          {
            "direction": "asc",
```

```

        "expression": "`alias1`.`col_int_key`"
    }
] /* filesort_information */,
"filesort_priority_queue_optimization": {
  "usable": false,
  "cause": "not applicable (no LIMIT)"
} /* filesort_priority_queue_optimization */,
"filesort_execution": [
] /* filesort_execution */,
"filesort_summary": {
  "memory_available": 262144,
  "key_size": 9,
  "row_size": 26,
  "max_rows_per_buffer": 7710,
  "num_rows_estimate": 18446744073709551615,
  "num_rows_found": 8,
  "num_initial_chunks_spilled_to_disk": 0,
  "peak_memory_used": 32832,
  "sort_algorithm": "std:sort",
  "unpacked_addon_fields": "skip_heuristic",
  "sort_mode": "<fixed_sort_key, additional_fields>"
} /* filesort_summary */
}
] /* steps */
} /* join_execution */
}
] /* steps */
}
MISSING_BYTES_BEYOND_MAX_MEM_SIZE: 0
INSUFFICIENT_PRIVILEGES: 0
    
```

### 8.15.13 Displaying Traces in Other Applications

Examining a trace in the `mysql` command-line client can be made less difficult using the `pager less` command (or your operating platform's equivalent). An alternative can be to send the trace to a file, similarly to what is shown here:

```

SELECT TRACE INTO DUMPFILE file
FROM INFORMATION_SCHEMA.OPTIMIZER_TRACE;
    
```

You can then pass this file to a JSON-aware text editor or other viewer, such as the [JsonView add-on for Firefox and Chrome](#), which shows objects in color and allows objects to be expanded or collapsed.

`INTO DUMPFILE` is preferable to `INTO OUTFILE` for this purpose, since the latter escapes newlines. As noted previously, you should ensure that `end_markers_in_json` is `OFF` when executing the `SELECT INTO` statement, so that the output is valid JSON.

### 8.15.14 Preventing the Use of Optimizer Trace

If, for some reason, you wish to prevent users from seeing traces of their queries, start the server with the options shown here:

```

--maximum-optimizer-trace-max-mem-size=0 --optimizer-trace-max-mem-size=0
    
```

This sets the maximum size to 0 and prevents users from changing this limit, thus truncating all traces to 0 bytes.

### 8.15.15 Testing Optimizer Trace

This feature is tested in `mysql-test/suite/opt_trace` and `unittest/gunit/opt_trace-t`.

## 8.15.16 Optimizer Trace Implementation

See the files `sql/opt_trace*`, starting with `sql/opt_trace.h`. A trace is started by creating an instance of `Opt_trace_start`; information is added to this trace by creating instances of `Opt_trace_object` and `Opt_trace_array`, and by using the `add()` methods of these classes.



---

# Chapter 9 Language Structure

## Table of Contents

9.1 Literal Values .....	1651
9.1.1 String Literals .....	1651
9.1.2 Numeric Literals .....	1654
9.1.3 Date and Time Literals .....	1654
9.1.4 Hexadecimal Literals .....	1657
9.1.5 Bit-Value Literals .....	1659
9.1.6 Boolean Literals .....	1660
9.1.7 NULL Values .....	1660
9.2 Schema Object Names .....	1660
9.2.1 Identifier Length Limits .....	1662
9.2.2 Identifier Qualifiers .....	1663
9.2.3 Identifier Case Sensitivity .....	1665
9.2.4 Mapping of Identifiers to File Names .....	1667
9.2.5 Function Name Parsing and Resolution .....	1669
9.3 Keywords and Reserved Words .....	1673
9.4 User-Defined Variables .....	1697
9.5 Expressions .....	1701
9.6 Comments .....	1705

This chapter discusses the rules for writing the following elements of [SQL](#) statements when using MySQL:

- Literal values such as strings and numbers
- Identifiers such as database, table, and column names
- Keywords and reserved words
- User-defined and system variables
- Expressions
- Comments

## 9.1 Literal Values

This section describes how to write literal values in MySQL. These include strings, numbers, hexadecimal and bit values, boolean values, and [NULL](#). The section also covers various nuances that you may encounter when dealing with these basic types in MySQL.

### 9.1.1 String Literals

A string is a sequence of bytes or characters, enclosed within either single quote ( `'` ) or double quote ( `"` ) characters. Examples:

```
'a string'  
"another string"
```

Quoted strings placed next to each other are concatenated to a single string. The following lines are equivalent:

```
'a string'
'a' ' ' 'string'
```

If the [ANSI\\_QUOTES](#) SQL mode is enabled, string literals can be quoted only within single quotation marks because a string quoted within double quotation marks is interpreted as an identifier.

A *binary string* is a string of bytes. Every binary string has a character set and collation named [binary](#). A *nonbinary string* is a string of characters. It has a character set other than [binary](#) and a collation that is compatible with the character set.

For both types of strings, comparisons are based on the numeric values of the string unit. For binary strings, the unit is the byte; comparisons use numeric byte values. For nonbinary strings, the unit is the character and some character sets support multibyte characters; comparisons use numeric character code values. Character code ordering is a function of the string collation. (For more information, see [Section 10.8.5, “The binary Collation Compared to `\_bin` Collations”](#).)



#### Note

Within the `mysql` client, binary strings display using hexadecimal notation, depending on the value of the `--binary-as-hex`. For more information about that option, see [Section 4.5.1, “mysql — The MySQL Command-Line Client”](#).

A character string literal may have an optional character set introducer and [COLLATE](#) clause, to designate it as a string that uses a particular character set and collation:

```
[_charset_name]'string' [COLLATE collation_name]
```

Examples:

```
SELECT _latin1'string';
SELECT _binary'string';
SELECT _utf8'string' COLLATE utf8_danish_ci;
```

You can use `N'literal'` (or `n'literal'`) to create a string in the national character set. These statements are equivalent:

```
SELECT N'some text';
SELECT n'some text';
SELECT _utf8'some text';
```

For information about these forms of string syntax, see [Section 10.3.7, “The National Character Set”](#), and [Section 10.3.8, “Character Set Introducers”](#).

Within a string, certain sequences have special meaning unless the [NO\\_BACKSLASH\\_ESCAPES](#) SQL mode is enabled. Each of these sequences begins with a backslash (`\`), known as the *escape character*. MySQL recognizes the escape sequences shown in [Table 9.1, “Special Character Escape Sequences”](#). For all other escape sequences, backslash is ignored. That is, the escaped character is interpreted as if it was not escaped. For example, `\x` is just `x`. These sequences are case-sensitive. For example, `\b` is interpreted as a backspace, but `\B` is interpreted as `B`. Escape processing is done according to the character set indicated by the `character_set_connection` system variable. This is true even for strings that are preceded by an introducer that indicates a different character set, as discussed in [Section 10.3.6, “Character String Literal Character Set and Collation”](#).

**Table 9.1 Special Character Escape Sequences**

Escape Sequence	Character Represented by Sequence
<code>\0</code>	An ASCII NUL ( <code>x'00'</code> ) character

Escape Sequence	Character Represented by Sequence
\'	A single quote ( ' ) character
\"	A double quote ( " ) character
\b	A backspace character
\n	A newline (linefeed) character
\r	A carriage return character
\t	A tab character
\z	ASCII 26 (Control+Z); see note following the table
\\	A backslash ( \ ) character
\%	A % character; see note following the table
\_	A _ character; see note following the table

The ASCII 26 character can be encoded as `\z` to enable you to work around the problem that ASCII 26 stands for END-OF-FILE on Windows. ASCII 26 within a file causes problems if you try to use `mysql db_name < file_name`.

The `\%` and `\_` sequences are used to search for literal instances of `%` and `_` in pattern-matching contexts where they would otherwise be interpreted as wildcard characters. See the description of the `LIKE` operator in [Section 12.8.1, “String Comparison Functions and Operators”](#). If you use `\%` or `\_` outside of pattern-matching contexts, they evaluate to the strings `\%` and `\_`, not to `%` and `_`.

There are several ways to include quote characters within a string:

- A ' inside a string quoted with ' may be written as ''.
- A " inside a string quoted with " may be written as "".
- Precede the quote character by an escape character (\).
- A ' inside a string quoted with " needs no special treatment and need not be doubled or escaped. In the same way, " inside a string quoted with ' needs no special treatment.

The following `SELECT` statements demonstrate how quoting and escaping work:

```
mysql> SELECT 'hello', "hello", ""hello"", 'hel'lo', '\hello';
+-----+-----+-----+-----+
| hello | "hello" | ""hello"" | hel'lo | 'hello |
+-----+-----+-----+-----+

mysql> SELECT "hello", "'hello'", ""'hello'"" , "hel"lo", "\"hello";
+-----+-----+-----+-----+
| hello | 'hello' | ""'hello'"" | hel"lo | "hello |
+-----+-----+-----+-----+

mysql> SELECT 'This\nIs\nFour\nLines';
+-----+
| This
Is
Four
Lines |
+-----+

mysql> SELECT 'disappearing\ backslash';
+-----+
| disappearing backslash |
+-----+
```

To insert binary data into a string column (such as a `BLOB` column), you should represent certain characters by escape sequences. Backslash (`\`) and the quote character used to quote the string must be escaped. In certain client environments, it may also be necessary to escape `NUL` or Control+Z. The `mysql` client truncates quoted strings containing `NUL` characters if they are not escaped, and Control+Z may be taken for END-OF-FILE on Windows if not escaped. For the escape sequences that represent each of these characters, see [Table 9.1, “Special Character Escape Sequences”](#).

When writing application programs, any string that might contain any of these special characters must be properly escaped before the string is used as a data value in an SQL statement that is sent to the MySQL server. You can do this in two ways:

- Process the string with a function that escapes the special characters. In a C program, you can use the `mysql_real_escape_string_quote()` C API function to escape characters. See [mysql\\_real\\_escape\\_string\\_quote\(\)](#). Within SQL statements that construct other SQL statements, you can use the `QUOTE()` function. The Perl DBI interface provides a `quote` method to convert special characters to the proper escape sequences. See [Section 27.9, “MySQL Perl API”](#). Other language interfaces may provide a similar capability.
- As an alternative to explicitly escaping special characters, many MySQL APIs provide a placeholder capability that enables you to insert special markers into a statement string, and then bind data values to them when you issue the statement. In this case, the API takes care of escaping special characters in the values for you.

## 9.1.2 Numeric Literals

Number literals include exact-value (integer and `DECIMAL`) literals and approximate-value (floating-point) literals.

Integers are represented as a sequence of digits. Numbers may include `.` as a decimal separator. Numbers may be preceded by `-` or `+` to indicate a negative or positive value, respectively. Numbers represented in scientific notation with a mantissa and exponent are approximate-value numbers.

Exact-value numeric literals have an integer part or fractional part, or both. They may be signed. Examples: `1`, `.2`, `3.4`, `-5`, `-6.78`, `+9.10`.

Approximate-value numeric literals are represented in scientific notation with a mantissa and exponent. Either or both parts may be signed. Examples: `1.2E3`, `1.2E-3`, `-1.2E3`, `-1.2E-3`.

Two numbers that look similar may be treated differently. For example, `2.34` is an exact-value (fixed-point) number, whereas `2.34E0` is an approximate-value (floating-point) number.

The `DECIMAL` data type is a fixed-point type and calculations are exact. In MySQL, the `DECIMAL` type has several synonyms: `NUMERIC`, `DEC`, `FIXED`. The integer types also are exact-value types. For more information about exact-value calculations, see [Section 12.21, “Precision Math”](#).

The `FLOAT` and `DOUBLE` data types are floating-point types and calculations are approximate. In MySQL, types that are synonymous with `FLOAT` or `DOUBLE` are `DOUBLE PRECISION` and `REAL`.

An integer may be used in floating-point context; it is interpreted as the equivalent floating-point number.

## 9.1.3 Date and Time Literals

- [Standard SQL and ODBC Date and Time Literals](#)
- [String and Numeric Literals in Date and Time Context](#)

Date and time values can be represented in several formats, such as quoted strings or as numbers, depending on the exact type of the value and other factors. For example, in contexts where MySQL expects a date, it interprets any of '2015-07-21', '20150721', and 20150721 as a date.

This section describes the acceptable formats for date and time literals. For more information about the temporal data types, such as the range of permitted values, see [Section 11.2, “Date and Time Data Types”](#).

## Standard SQL and ODBC Date and Time Literals

Standard SQL requires temporal literals to be specified using a type keyword and a string. The space between the keyword and string is optional.

```
DATE 'str'
TIME 'str'
TIMESTAMP 'str'
```

MySQL recognizes but, unlike standard SQL, does not require the type keyword. Applications that are to be standard-compliant should include the type keyword for temporal literals.

MySQL also recognizes the ODBC syntax corresponding to the standard SQL syntax:

```
{ d 'str' }
{ t 'str' }
{ ts 'str' }
```

MySQL uses the type keywords and the ODBC constructions to produce `DATE`, `TIME`, and `DATETIME` values, respectively, including a trailing fractional seconds part if specified. The `TIMESTAMP` syntax produces a `DATETIME` value in MySQL because `DATETIME` has a range that more closely corresponds to the standard SQL `TIMESTAMP` type, which has a year range from 0001 to 9999. (The MySQL `TIMESTAMP` year range is 1970 to 2038.)

## String and Numeric Literals in Date and Time Context

MySQL recognizes `DATE` values in these formats:

- As a string in either 'YYYY-MM-DD' or 'YY-MM-DD' format. A “relaxed” syntax is permitted: Any punctuation character may be used as the delimiter between date parts. For example, '2012-12-31', '2012/12/31', '2012^12^31', and '2012@12@31' are equivalent.
- As a string with no delimiters in either 'YYYYMMDD' or 'YYMMDD' format, provided that the string makes sense as a date. For example, '20070523' and '070523' are interpreted as '2007-05-23', but '071332' is illegal (it has nonsensical month and day parts) and becomes '0000-00-00'.
- As a number in either 'YYYYMMDD' or 'YYMMDD' format, provided that the number makes sense as a date. For example, 19830905 and 830905 are interpreted as '1983-09-05'.

MySQL recognizes `DATETIME` and `TIMESTAMP` values in these formats:

- As a string in either 'YYYY-MM-DD hh:mm:ss' or 'YY-MM-DD hh:mm:ss' format. A “relaxed” syntax is permitted here, too: Any punctuation character may be used as the delimiter between date parts or time parts. For example, '2012-12-31 11:30:45', '2012^12^31 11+30+45', '2012/12/31 11\*30\*45', and '2012@12@31 11^30^45' are equivalent.

The only delimiter recognized between a date and time part and a fractional seconds part is the decimal point.

The date and time parts can be separated by `T` rather than a space. For example, `'2012-12-31 11:30:45'` and `'2012-12-31T11:30:45'` are equivalent.

- As a string with no delimiters in either `'YYYYMMDDhhmmss'` or `'YYMMDDhhmmss'` format, provided that the string makes sense as a date. For example, `'20070523091528'` and `'070523091528'` are interpreted as `'2007-05-23 09:15:28'`, but `'071122129015'` is illegal (it has a nonsensical minute part) and becomes `'0000-00-00 00:00:00'`.
- As a number in either `YYYYMMDDhhmmss` or `YYMMDDhhmmss` format, provided that the number makes sense as a date. For example, `19830905132800` and `830905132800` are interpreted as `'1983-09-05 13:28:00'`.

A `DATETIME` or `TIMESTAMP` value can include a trailing fractional seconds part in up to microseconds (6 digits) precision. The fractional part should always be separated from the rest of the time by a decimal point; no other fractional seconds delimiter is recognized. For information about fractional seconds support in MySQL, see [Section 11.2.7, “Fractional Seconds in Time Values”](#).

Dates containing two-digit year values are ambiguous because the century is unknown. MySQL interprets two-digit year values using these rules:

- Year values in the range `70-99` become `1970-1999`.
- Year values in the range `00-69` become `2000-2069`.

See also [Section 11.2.10, “2-Digit Years in Dates”](#).

For values specified as strings that include date part delimiters, it is unnecessary to specify two digits for month or day values that are less than `10`. `'2015-6-9'` is the same as `'2015-06-09'`. Similarly, for values specified as strings that include time part delimiters, it is unnecessary to specify two digits for hour, minute, or second values that are less than `10`. `'2015-10-30 1:2:3'` is the same as `'2015-10-30 01:02:03'`.

Values specified as numbers should be 6, 8, 12, or 14 digits long. If a number is 8 or 14 digits long, it is assumed to be in `YYYYMMDD` or `YYYYMMDDhhmmss` format and that the year is given by the first 4 digits. If the number is 6 or 12 digits long, it is assumed to be in `YYMMDD` or `YYMMDDhhmmss` format and that the year is given by the first 2 digits. Numbers that are not one of these lengths are interpreted as though padded with leading zeros to the closest length.

Values specified as nondelimited strings are interpreted according to their length. For a string 8 or 14 characters long, the year is assumed to be given by the first 4 characters. Otherwise, the year is assumed to be given by the first 2 characters. The string is interpreted from left to right to find year, month, day, hour, minute, and second values, for as many parts as are present in the string. This means you should not use strings that have fewer than 6 characters. For example, if you specify `'9903'`, thinking that represents March, 1999, MySQL converts it to the “zero” date value. This occurs because the year and month values are `99` and `03`, but the day part is completely missing. However, you can explicitly specify a value of zero to represent missing month or day parts. For example, to insert the value `'1999-03-00'`, use `'990300'`.

MySQL recognizes `TIME` values in these formats:

- As a string in `'D hh:mm:ss'` format. You can also use one of the following “relaxed” syntaxes: `'hh:mm:ss'`, `'hh:mm'`, `'D hh:mm'`, `'D hh'`, or `'ss'`. Here `D` represents days and can have a value from 0 to 34.
- As a string with no delimiters in `'hhmmss'` format, provided that it makes sense as a time. For example, `'101112'` is understood as `'10:11:12'`, but `'109712'` is illegal (it has a nonsensical minute part) and becomes `'00:00:00'`.

- As a number in *hhmmss* format, provided that it makes sense as a time. For example, 101112 is understood as '10:11:12'. The following alternative formats are also understood: *ss*, *mmss*, or *hhmmss*.

A trailing fractional seconds part is recognized in the '*D hh:mm:ss.fraction*', '*hh:mm:ss.fraction*', '*hhmmss.fraction*', and *hhmmss.fraction* time formats, where *fraction* is the fractional part in up to microseconds (6 digits) precision. The fractional part should always be separated from the rest of the time by a decimal point; no other fractional seconds delimiter is recognized. For information about fractional seconds support in MySQL, see [Section 11.2.7, "Fractional Seconds in Time Values"](#).

For **TIME** values specified as strings that include a time part delimiter, it is unnecessary to specify two digits for hours, minutes, or seconds values that are less than 10. '8:3:2' is the same as '08:03:02'.

## 9.1.4 Hexadecimal Literals

Hexadecimal literal values are written using `X'val'` or `0xval` notation, where *val* contains hexadecimal digits (0..9, A..F). Lettercase of the digits and of any leading `x` does not matter. A leading `0x` is case-sensitive and cannot be written as `0X`.

Legal hexadecimal literals:

```
X'01AF'
X'01af'
x'01AF'
x'01af'
0x01AF
0x01af
```

Illegal hexadecimal literals:

```
X'0G'   (G is not a hexadecimal digit)
0X01AF (0X must be written as 0x)
```

Values written using `X'val'` notation must contain an even number of digits or a syntax error occurs. To correct the problem, pad the value with a leading zero:

```
mysql> SET @s = X'FFF';
ERROR 1064 (42000): You have an error in your SQL syntax;
check the manual that corresponds to your MySQL server
version for the right syntax to use near 'X'FFF''

mysql> SET @s = X'0FFF';
Query OK, 0 rows affected (0.00 sec)
```

Values written using `0xval` notation that contain an odd number of digits are treated as having an extra leading 0. For example, `0xaaa` is interpreted as `0x0aaa`.

By default, a hexadecimal literal is a binary string, where each pair of hexadecimal digits represents a character:

```
mysql> SELECT X'4D7953514C', CHARSET(X'4D7953514C');
+-----+-----+
| X'4D7953514C' | CHARSET(X'4D7953514C') |
+-----+-----+
| MySQL         | binary                  |
+-----+-----+
mysql> SELECT 0x5461626c65, CHARSET(0x5461626c65);
+-----+-----+
| 0x5461626c65 | CHARSET(0x5461626c65) |
+-----+-----+
```

Table	binary
-------	--------

A hexadecimal literal may have an optional character set introducer and `COLLATE` clause, to designate it as a string that uses a particular character set and collation:

```
[_charset_name] X'val' [COLLATE collation_name]
```

Examples:

```
SELECT _latin1 X'4D7953514C';
SELECT _utf8 0x4D7953514C COLLATE utf8_danish_ci;
```

The examples use `X'val'` notation, but `0xval` notation permits introducers as well. For information about introducers, see [Section 10.3.8, “Character Set Introducers”](#).

In numeric contexts, MySQL treats a hexadecimal literal like a `BIGINT UNSIGNED` (64-bit unsigned integer). To ensure numeric treatment of a hexadecimal literal, use it in numeric context. Ways to do this include adding 0 or using `CAST(... AS UNSIGNED)`. For example, a hexadecimal literal assigned to a user-defined variable is a binary string by default. To assign the value as a number, use it in numeric context:

```
mysql> SET @v1 = X'41';
mysql> SET @v2 = X'41'+0;
mysql> SET @v3 = CAST(X'41' AS UNSIGNED);
mysql> SELECT @v1, @v2, @v3;
+-----+-----+-----+
| @v1  | @v2  | @v3  |
+-----+-----+-----+
| A    | 65   | 65   |
+-----+-----+-----+
```

An empty hexadecimal value (`X''`) evaluates to a zero-length binary string. Converted to a number, it produces 0:

```
mysql> SELECT CHARSET(X''), LENGTH(X'');
+-----+-----+
| CHARSET(X'') | LENGTH(X'') |
+-----+-----+
| binary      | 0           |
+-----+-----+
mysql> SELECT X''+0;
+-----+
| X''+0      |
+-----+
| 0          |
+-----+
```

The `X'val'` notation is based on standard SQL. The `0x` notation is based on ODBC, for which hexadecimal strings are often used to supply values for `BLOB` columns.

To convert a string or a number to a string in hexadecimal format, use the `HEX()` function:

```
mysql> SELECT HEX('cat');
+-----+
| HEX('cat') |
+-----+
| 636174     |
+-----+
mysql> SELECT X'636174';
+-----+
| X'636174'  |
+-----+
```



```
| cat |
+-----+
```

## 9.1.5 Bit-Value Literals

Bit-value literals are written using `b'val'` or `0bval` notation. `val` is a binary value written using zeros and ones. Lettercase of any leading `b` does not matter. A leading `0b` is case-sensitive and cannot be written as `0B`.

Legal bit-value literals:

```
b'01'
B'01'
0b01
```

Illegal bit-value literals:

```
b'2'      (2 is not a binary digit)
0B01     (0B must be written as 0b)
```

By default, a bit-value literal is a binary string:

```
mysql> SELECT b'1000001', CHARSET(b'1000001');
+-----+-----+
| b'1000001' | CHARSET(b'1000001') |
+-----+-----+
| A          | binary              |
+-----+-----+
mysql> SELECT 0b1100001, CHARSET(0b1100001);
+-----+-----+
| 0b1100001 | CHARSET(0b1100001) |
+-----+-----+
| a          | binary              |
+-----+-----+
```

A bit-value literal may have an optional character set introducer and `COLLATE` clause, to designate it as a string that uses a particular character set and collation:

```
[_charset_name] b'val' [COLLATE collation_name]
```

Examples:

```
SELECT _latin1 b'1000001';
SELECT _utf8 0b1000001 COLLATE utf8_danish_ci;
```

The examples use `b'val'` notation, but `0bval` notation permits introducers as well. For information about introducers, see [Section 10.3.8, “Character Set Introducers”](#).

In numeric contexts, MySQL treats a bit literal like an integer. To ensure numeric treatment of a bit literal, use it in numeric context. Ways to do this include adding `0` or using `CAST(... AS UNSIGNED)`. For example, a bit literal assigned to a user-defined variable is a binary string by default. To assign the value as a number, use it in numeric context:

```
mysql> SET @v1 = b'1100001';
mysql> SET @v2 = b'1100001'+0;
mysql> SET @v3 = CAST(b'1100001' AS UNSIGNED);
mysql> SELECT @v1, @v2, @v3;
+-----+-----+-----+
| @v1 | @v2 | @v3 |
+-----+-----+-----+
| a   | 97  | 97  |
+-----+-----+-----+
```

An empty bit value (`b''`) evaluates to a zero-length binary string. Converted to a number, it produces 0:

```
mysql> SELECT CHARSET(b''), LENGTH(b'');
+-----+-----+
| CHARSET(b'') | LENGTH(b'') |
+-----+-----+
| binary       | 0           |
+-----+-----+
mysql> SELECT b''+0;
+-----+
| b''+0 |
+-----+
| 0     |
+-----+
```

Bit-value notation is convenient for specifying values to be assigned to `BIT` columns:

```
mysql> CREATE TABLE t (b BIT(8));
mysql> INSERT INTO t SET b = b'11111111';
mysql> INSERT INTO t SET b = b'1010';
mysql> INSERT INTO t SET b = b'0101';
```

Bit values in result sets are returned as binary values, which may not display well. To convert a bit value to printable form, use it in numeric context or use a conversion function such as `BIN()` or `HEX()`. High-order 0 digits are not displayed in the converted value.

```
mysql> SELECT b+0, BIN(b), OCT(b), HEX(b) FROM t;
+-----+-----+-----+-----+
| b+0 | BIN(b) | OCT(b) | HEX(b) |
+-----+-----+-----+-----+
| 255 | 11111111 | 377   | FF     |
| 10  | 1010    | 12    | A      |
| 5   | 101     | 5     | 5      |
+-----+-----+-----+-----+
```

## 9.1.6 Boolean Literals

The constants `TRUE` and `FALSE` evaluate to `1` and `0`, respectively. The constant names can be written in any lettercase.

```
mysql> SELECT TRUE, true, FALSE, false;
-> 1, 1, 0, 0
```

## 9.1.7 NULL Values

The `NULL` value means “no data.” `NULL` can be written in any lettercase. A synonym is `\N` (case-sensitive). Treatment of `\N` as a synonym for `NULL` in SQL statements is deprecated as of MySQL 5.7.18 and is removed in MySQL 8.0; use `NULL` instead.

Be aware that the `NULL` value is different from values such as `0` for numeric types or the empty string for string types. For more information, see [Section B.3.4.3, “Problems with NULL Values”](#).

For text file import or export operations performed with `LOAD DATA` or `SELECT ... INTO OUTFILE`, `NULL` is represented by the `\N` sequence. See [Section 13.2.6, “LOAD DATA Statement”](#). Use of `\N` in text files is unaffected by the deprecation of `\N` in SQL statements.

For sorting with `ORDER BY`, `NULL` values sort before other values for ascending sorts, after other values for descending sorts.

## 9.2 Schema Object Names

Certain objects within MySQL, including database, table, index, column, alias, view, stored procedure, partition, tablespace, and other object names are known as identifiers. This section describes the permissible syntax for identifiers in MySQL. [Section 9.2.1, “Identifier Length Limits”](#), indicates the maximum length of each type of identifier. [Section 9.2.3, “Identifier Case Sensitivity”](#), describes which types of identifiers are case-sensitive and under what conditions.

An identifier may be quoted or unquoted. If an identifier contains special characters or is a reserved word, you *must* quote it whenever you refer to it. (Exception: A reserved word that follows a period in a qualified name must be an identifier, so it need not be quoted.) Reserved words are listed at [Section 9.3, “Keywords and Reserved Words”](#).

Internally, identifiers are converted to and are stored as Unicode (UTF-8). The permissible Unicode characters in identifiers are those in the Basic Multilingual Plane (BMP). Supplementary characters are not permitted. Identifiers thus may contain these characters:

- Permitted characters in unquoted identifiers:
  - ASCII: [0-9,a-z,A-Z\$\_] (basic Latin letters, digits 0-9, dollar, underscore)
  - Extended: U+0080 .. U+FFFF
- Permitted characters in quoted identifiers include the full Unicode Basic Multilingual Plane (BMP), except U+0000:
  - ASCII: U+0001 .. U+007F
  - Extended: U+0080 .. U+FFFF
- ASCII NUL (U+0000) and supplementary characters (U+10000 and higher) are not permitted in quoted or unquoted identifiers.
- Identifiers may begin with a digit but unless quoted may not consist solely of digits.
- Database, table, and column names cannot end with space characters.

The identifier quote character is the backtick (`):

```
mysql> SELECT * FROM `select` WHERE `select`.id > 100;
```

If the `ANSI_QUOTES` SQL mode is enabled, it is also permissible to quote identifiers within double quotation marks:

```
mysql> CREATE TABLE "test" (col INT);
ERROR 1064: You have an error in your SQL syntax...
mysql> SET sql_mode='ANSI_QUOTES';
mysql> CREATE TABLE "test" (col INT);
Query OK, 0 rows affected (0.00 sec)
```

The `ANSI_QUOTES` mode causes the server to interpret double-quoted strings as identifiers. Consequently, when this mode is enabled, string literals must be enclosed within single quotation marks. They cannot be enclosed within double quotation marks. The server SQL mode is controlled as described in [Section 5.1.10, “Server SQL Modes”](#).

Identifier quote characters can be included within an identifier if you quote the identifier. If the character to be included within the identifier is the same as that used to quote the identifier itself, then you need to double the character. The following statement creates a table named `a`b`` that contains a column named `c`d``:

```
mysql> CREATE TABLE `a``b` (`c`d` INT);
```

In the select list of a query, a quoted column alias can be specified using identifier or string quoting characters:

```
mysql> SELECT 1 AS `one`, 2 AS 'two';
+-----+-----+
| one | two |
+-----+-----+
| 1 | 2 |
+-----+-----+
```

Elsewhere in the statement, quoted references to the alias must use identifier quoting or the reference is treated as a string literal.

It is recommended that you do not use names that begin with *Me* or *MeN*, where *M* and *N* are integers. For example, avoid using `1e` as an identifier, because an expression such as `1e+3` is ambiguous. Depending on context, it might be interpreted as the expression `1e + 3` or as the number `1e+3`.

Be careful when using `MD5()` to produce table names because it can produce names in illegal or ambiguous formats such as those just described.

A user variable cannot be used directly in an SQL statement as an identifier or as part of an identifier. See [Section 9.4, “User-Defined Variables”](#), for more information and examples of workarounds.

Special characters in database and table names are encoded in the corresponding file system names as described in [Section 9.2.4, “Mapping of Identifiers to File Names”](#). If you have databases or tables from an older version of MySQL that contain special characters and for which the underlying directory names or file names have not been updated to use the new encoding, the server displays their names with a prefix of `#mysql150#`. For information about referring to such names or converting them to the newer encoding, see that section.

## 9.2.1 Identifier Length Limits

The following table describes the maximum length for each type of identifier.

Identifier Type	Maximum Length (characters)
Database	64 (NDB storage engine: 63)
Table	64 (NDB storage engine: 63)
Column	64
Index	64
Constraint	64
Stored Program	64
View	64
Tablespace	64
Server	64
Log File Group	64
Alias	256 (see exception following table)
Compound Statement Label	16
User-Defined Variable	64

Aliases for column names in `CREATE VIEW` statements are checked against the maximum column length of 64 characters (not the maximum alias length of 256 characters).

For constraint definitions that include no constraint name, the server internally generates a name derived from the associated table name. For example, internally generated foreign key constraint names consist of the table name plus `_ibfk_` and a number. If the table name is close to the length limit for constraint names, the additional characters required for the constraint name may cause that name to exceed the limit, resulting in an error.

Identifiers are stored using Unicode (UTF-8). This applies to identifiers in table definitions that are stored in `.frm` files and to identifiers stored in the grant tables in the `mysql` database. The sizes of the identifier string columns in the grant tables are measured in characters. You can use multibyte characters without reducing the number of characters permitted for values stored in these columns.

NDB Cluster imposes a maximum length of 63 characters for names of databases and tables. See [Section 21.2.7.5, “Limits Associated with Database Objects in NDB Cluster”](#).

Values such as user name and host names in MySQL account names are strings rather than identifiers. For information about the maximum length of such values as stored in grant tables, see [Grant Table Scope Column Properties](#).

## 9.2.2 Identifier Qualifiers

Object names may be unqualified or qualified. An unqualified name is permitted in contexts where interpretation of the name is unambiguous. A qualified name includes at least one qualifier to clarify the interpretive context by overriding a default context or providing missing context.

For example, this statement creates a table using the unqualified name `t1`:

```
CREATE TABLE t1 (i INT);
```

Because `t1` includes no qualifier to specify a database, the statement creates the table in the default database. If there is no default database, an error occurs.

This statement creates a table using the qualified name `db1.t1`:

```
CREATE TABLE db1.t1 (i INT);
```

Because `db1.t1` includes a database qualifier `db1`, the statement creates `t1` in the database named `db1`, regardless of the default database. The qualifier *must* be specified if there is no default database. The qualifier *may* be specified if there is a default database, to specify a database different from the default, or to make the database explicit if the default is the same as the one specified.

Qualifiers have these characteristics:

- An unqualified name consists of a single identifier. A qualified name consists of multiple identifiers.
- The components of a multiple-part name must be separated by period (`.`) characters. The initial parts of a multiple-part name act as qualifiers that affect the context within which to interpret the final identifier.
- The qualifier character is a separate token and need not be contiguous with the associated identifiers. For example, `tbl_name.col_name` and `tbl_name . col_name` are equivalent.
- If any components of a multiple-part name require quoting, quote them individually rather than quoting the name as a whole. For example, write ``my-table`.`my-column``, not ``my-table.my-column``.
- A reserved word that follows a period in a qualified name must be an identifier, so in that context it need not be quoted.
- The syntax `.tbl_name` means the table `tbl_name` in the default database.

**Note**

This syntax is deprecated as of MySQL 5.7.20; expect it to be removed in a future version of MySQL.

The permitted qualifiers for object names depend on the object type:

- A database name is fully qualified and takes no qualifier:

```
CREATE DATABASE db1;
```

- A table, view, or stored program name may be given a database-name qualifier. Examples of unqualified and qualified names in `CREATE` statements:

```
CREATE TABLE mytable ...;
CREATE VIEW myview ...;
CREATE PROCEDURE myproc ...;
CREATE FUNCTION myfunc ...;
CREATE EVENT myevent ...;

CREATE TABLE mydb.mytable ...;
CREATE VIEW mydb.myview ...;
CREATE PROCEDURE mydb.myproc ...;
CREATE FUNCTION mydb.myfunc ...;
CREATE EVENT mydb.myevent ...;
```

- A trigger is associated with a table, so any qualifier applies to the table name:

```
CREATE TRIGGER mytrigger ... ON mytable ...;

CREATE TRIGGER mytrigger ... ON mydb.mytable ...;
```

- A column name may be given multiple qualifiers to indicate context in statements that reference it, as shown in the following table.

Column Reference	Meaning
<i>col_name</i>	Column <i>col_name</i> from whichever table used in the statement contains a column of that name
<i>tbl_name.col_name</i>	Column <i>col_name</i> from table <i>tbl_name</i> of the default database
<i>db_name.tbl_name.col_name</i>	Column <i>col_name</i> from table <i>tbl_name</i> of the database <i>db_name</i>

In other words, a column name may be given a table-name qualifier, which itself may be given a database-name qualifier. Examples of unqualified and qualified column references in `SELECT` statements:

```
SELECT c1 FROM mytable
WHERE c2 > 100;

SELECT mytable.c1 FROM mytable
WHERE mytable.c2 > 100;

SELECT mydb.mytable.c1 FROM mydb.mytable
WHERE mydb.mytable.c2 > 100;
```

You need not specify a qualifier for an object reference in a statement unless the unqualified reference is ambiguous. Suppose that column `c1` occurs only in table `t1`, `c2` only in `t2`, and `c` in both `t1` and `t2`. Any

unqualified reference to `c` is ambiguous in a statement that refers to both tables and must be qualified as `t1.c` or `t2.c` to indicate which table you mean:

```
SELECT c1, c2, t1.c FROM t1 INNER JOIN t2
WHERE t2.c > 100;
```

Similarly, to retrieve from a table `t` in database `db1` and from a table `t` in database `db2` in the same statement, you must qualify the table references: For references to columns in those tables, qualifiers are required only for column names that appear in both tables. Suppose that column `c1` occurs only in table `db1.t`, `c2` only in `db2.t`, and `c` in both `db1.t` and `db2.t`. In this case, `c` is ambiguous and must be qualified but `c1` and `c2` need not be:

```
SELECT c1, c2, db1.t.c FROM db1.t INNER JOIN db2.t
WHERE db2.t.c > 100;
```

Table aliases enable qualified column references to be written more simply:

```
SELECT c1, c2, t1.c FROM db1.t AS t1 INNER JOIN db2.t AS t2
WHERE t2.c > 100;
```

## 9.2.3 Identifier Case Sensitivity

In MySQL, databases correspond to directories within the data directory. Each table within a database corresponds to at least one file within the database directory (and possibly more, depending on the storage engine). Triggers also correspond to files. Consequently, the case sensitivity of the underlying operating system plays a part in the case sensitivity of database, table, and trigger names. This means such names are not case-sensitive in Windows, but are case-sensitive in most varieties of Unix. One notable exception is macOS, which is Unix-based but uses a default file system type (HFS+) that is not case-sensitive. However, macOS also supports UFS volumes, which are case-sensitive just as on any Unix. See [Section 1.6.1, “MySQL Extensions to Standard SQL”](#). The `lower_case_table_names` system variable also affects how the server handles identifier case sensitivity, as described later in this section.



### Note

Although database, table, and trigger names are not case-sensitive on some platforms, you should not refer to one of these using different cases within the same statement. The following statement would not work because it refers to a table both as `my_table` and as `MY_TABLE`:

```
mysql> SELECT * FROM my_table WHERE MY_TABLE.col=1;
```

Column, index, stored routine, and event names are not case-sensitive on any platform, nor are column aliases.

However, names of logfile groups are case-sensitive. This differs from standard SQL.

By default, table aliases are case-sensitive on Unix, but not so on Windows or macOS. The following statement would not work on Unix, because it refers to the alias both as `a` and as `A`:

```
mysql> SELECT col_name FROM tbl_name AS a
WHERE a.col_name = 1 OR A.col_name = 2;
```

However, this same statement is permitted on Windows. To avoid problems caused by such differences, it is best to adopt a consistent convention, such as always creating and referring to databases and tables using lowercase names. This convention is recommended for maximum portability and ease of use.

How table and database names are stored on disk and used in MySQL is affected by the `lower_case_table_names` system variable, which you can set when starting `mysqld`.

`lower_case_table_names` can take the values shown in the following table. This variable does *not* affect case sensitivity of trigger identifiers. On Unix, the default value of `lower_case_table_names` is 0. On Windows, the default value is 1. On macOS, the default value is 2.

Value	Meaning
0	Table and database names are stored on disk using the lettercase specified in the <code>CREATE TABLE</code> or <code>CREATE DATABASE</code> statement. Name comparisons are case-sensitive. You should <i>not</i> set this variable to 0 if you are running MySQL on a system that has case-insensitive file names (such as Windows or macOS). If you force this variable to 0 with <code>--lower-case-table-names=0</code> on a case-insensitive file system and access <code>MyISAM</code> table names using different lettercases, index corruption may result.
1	Table names are stored in lowercase on disk and name comparisons are not case-sensitive. MySQL converts all table names to lowercase on storage and lookup. This behavior also applies to database names and table aliases.
2	Table and database names are stored on disk using the lettercase specified in the <code>CREATE TABLE</code> or <code>CREATE DATABASE</code> statement, but MySQL converts them to lowercase on lookup. Name comparisons are not case-sensitive. This works <i>only</i> on file systems that are not case-sensitive! <code>InnoDB</code> table names and view names are stored in lowercase, as for <code>lower_case_table_names=1</code> .

If you are using MySQL on only one platform, you do not normally have to change the `lower_case_table_names` variable from its default value. However, you may encounter difficulties if you want to transfer tables between platforms that differ in file system case sensitivity. For example, on Unix, you can have two different tables named `my_table` and `MY_TABLE`, but on Windows these two names are considered identical. To avoid data transfer problems arising from lettercase of database or table names, you have two options:

- Use `lower_case_table_names=1` on all systems. The main disadvantage with this is that when you use `SHOW TABLES` or `SHOW DATABASES`, you do not see the names in their original lettercase.
- Use `lower_case_table_names=0` on Unix and `lower_case_table_names=2` on Windows. This preserves the lettercase of database and table names. The disadvantage of this is that you must ensure that your statements always refer to your database and table names with the correct lettercase on Windows. If you transfer your statements to Unix, where lettercase is significant, they do not work if the lettercase is incorrect.

**Exception:** If you are using `InnoDB` tables and you are trying to avoid these data transfer problems, you should set `lower_case_table_names` to 1 on all platforms to force names to be converted to lowercase.

If you plan to set the `lower_case_table_names` system variable to 1 on Unix, you must first convert your old database and table names to lowercase before stopping `mysqld` and restarting it with the new variable setting. To do this for an individual table, use `RENAME TABLE`:



```
RENAME TABLE T1 TO t1;
```

To convert one or more entire databases, dump them before setting `lower_case_table_names`, then drop the databases, and reload them after setting `lower_case_table_names`:

1. Use `mysqldump` to dump each database:

```
mysqldump --databases db1 > db1.sql
mysqldump --databases db2 > db2.sql
...
```

Do this for each database that must be recreated.

2. Use `DROP DATABASE` to drop each database.
3. Stop the server, set `lower_case_table_names`, and restart the server.
4. Reload the dump file for each database. Because `lower_case_table_names` is set, each database and table name is converted to lowercase as it is re-created:

```
mysql < db1.sql
mysql < db2.sql
...
```

Object names may be considered duplicates if their uppercase forms are equal according to a binary collation. That is true for names of cursors, conditions, procedures, functions, savepoints, stored routine parameters, stored program local variables, and plugins. It is not true for names of columns, constraints, databases, partitions, statements prepared with `PREPARE`, tables, triggers, users, and user-defined variables.

File system case sensitivity can affect searches in string columns of `INFORMATION_SCHEMA` tables. For more information, see [Section 10.8.7, “Using Collation in INFORMATION\\_SCHEMA Searches”](#).

## 9.2.4 Mapping of Identifiers to File Names

There is a correspondence between database and table identifiers and names in the file system. For the basic structure, MySQL represents each database as a directory in the data directory, and each table by one or more files in the appropriate database directory. For the table format files (`.FRM`), the data is always stored in this structure and location.

For the data and index files, the exact representation on disk is storage engine specific. These files may be stored in the same location as the `FRM` files, or the information may be stored in a separate file. `InnoDB` data is stored in the `InnoDB` data files. If you are using tablespaces with `InnoDB`, then the specific tablespace files you create are used instead.

Any character is legal in database or table identifiers except ASCII NUL (`x'00'`). MySQL encodes any characters that are problematic in the corresponding file system objects when it creates database directories or table files:

- Basic Latin letters (`a..zA..Z`), digits (`0..9`) and underscore (`_`) are encoded as is. Consequently, their case sensitivity directly depends on file system features.
- All other national letters from alphabets that have uppercase/lowercase mapping are encoded as shown in the following table. Values in the Code Range column are UCS-2 values.

Code Range	Pattern	Number	Used	Unused	Blocks
00C0..017F	[@][0..4][g..z]	5*20= 100	97	3	Latin-1 Supplement +

Code Range	Pattern	Number	Used	Unused	Blocks
					Latin Extended-A
0370..03FF	[@][5..9][g..z]	5*20= 100	88	12	Greek and Coptic
0400..052F	[@][g..z][0..6]	20*7= 140	137	3	Cyrillic + Cyrillic Supplement
0530..058F	[@][g..z][7..8]	20*2= 40	38	2	Armenian
2160..217F	[@][g..z][9]	20*1= 20	16	4	Number Forms
0180..02AF	[@][g..z][a..k]	20*11=220	203	17	Latin Extended-B + IPA Extensions
1E00..1EFF	[@][g..z][l..r]	20*7= 140	136	4	Latin Extended Additional
1F00..1FFF	[@][g..z][s..z]	20*8= 160	144	16	Greek Extended
.... ....	[@][a..f][g..z]	6*20= 120	0	120	RESERVED
24B6..24E9	[@][@][a..z]	26	26	0	Enclosed Alphanumerics
FF21..FF5A	[@][a..z][@]	26	26	0	Halfwidth and Fullwidth forms

One of the bytes in the sequence encodes lettercase. For example: [LATIN CAPITAL LETTER A WITH GRAVE](#) is encoded as @0G, whereas [LATIN SMALL LETTER A WITH GRAVE](#) is encoded as @0g. Here the third byte (G or g) indicates lettercase. (On a case-insensitive file system, both letters are treated as the same.)

For some blocks, such as Cyrillic, the second byte determines lettercase. For other blocks, such as Latin1 Supplement, the third byte determines lettercase. If two bytes in the sequence are letters (as in Greek Extended), the leftmost letter character stands for lettercase. All other letter bytes must be in lowercase.

- All nonletter characters except underscore (`_`), as well as letters from alphabets that do not have uppercase/lowercase mapping (such as Hebrew) are encoded using hexadecimal representation using lowercase letters for hexadecimal digits `a..f`:

```
0x003F -> @003f
0xFFFF -> @ffff
```

The hexadecimal values correspond to character values in the `ucs2` double-byte character set.

On Windows, some names such as `nul`, `prn`, and `aux` are encoded by appending `@@@` to the name when the server creates the corresponding file or directory. This occurs on all platforms for portability of the corresponding database object between platforms.

If you have databases or tables from a version of MySQL older than 5.1.6 that contain special characters and for which the underlying directory names or file names have not been updated to use the new encoding, the server displays their names with a prefix of `#mysql50#` in the output from `INFORMATION_SCHEMA` tables or `SHOW` statements. For example, if you have a table named `a@b` and its name encoding has not been updated, `SHOW TABLES` displays it like this:

```
mysql> SHOW TABLES;
+-----+
```

```
| Tables_in_test |
+-----+
| #mysql50#a@b |
+-----+
```

To refer to such a name for which the encoding has not been updated, you must supply the `#mysql50#` prefix:

```
mysql> SHOW COLUMNS FROM `a@b`;
ERROR 1146 (42S02): Table 'test.a@b' doesn't exist

mysql> SHOW COLUMNS FROM `#mysql50#a@b`;
+-----+-----+-----+-----+-----+-----+
| Field | Type   | Null | Key | Default | Extra |
+-----+-----+-----+-----+-----+-----+
| i     | int(11)| YES  |     | NULL    |      |
+-----+-----+-----+-----+-----+-----+
```

To update old names to eliminate the need to use the special prefix to refer to them, re-encode them with `mysqlcheck`. The following commands update all names to the new encoding:

```
mysqlcheck --check-upgrade --all-databases
mysqlcheck --fix-db-names --fix-table-names --all-databases
```

To check only specific databases or tables, omit `--all-databases` and provide the appropriate database or table arguments. For information about `mysqlcheck` invocation syntax, see [Section 4.5.3, “mysqlcheck — A Table Maintenance Program”](#).



#### Note

The `#mysql50#` prefix is intended only to be used internally by the server. You should not create databases or tables with names that use this prefix.

Also, `mysqlcheck` cannot fix names that contain literal instances of the `@` character that is used for encoding special characters. If you have databases or tables that contain this character, use `mysqldump` to dump them before upgrading to MySQL 5.1.6 or later, and then reload the dump file after upgrading.



#### Note

Conversion of pre-MySQL 5.1 database names containing special characters to 5.1 format with the addition of a `#mysql50#` prefix is deprecated; expect it to be removed in a future version of MySQL. Because such conversions are deprecated, the `--fix-db-names` and `--fix-table-names` options for `mysqlcheck` and the `UPGRADE DATA DIRECTORY NAME` clause for the `ALTER DATABASE` statement are also deprecated.

Upgrades are supported only from one release series to another (for example, 5.0 to 5.1, or 5.1 to 5.5), so there should be little remaining need for conversion of older 5.0 database names to current versions of MySQL. As a workaround, upgrade a MySQL 5.0 installation to MySQL 5.1 before upgrading to a more recent release.

## 9.2.5 Function Name Parsing and Resolution

MySQL supports built-in (native) functions, loadable functions, and stored functions. This section describes how the server recognizes whether the name of a built-in function is used as a function call or as an identifier, and how the server determines which function to use in cases when functions of different types exist with a given name.

- [Built-In Function Name Parsing](#)
- [Function Name Resolution](#)

## Built-In Function Name Parsing

The parser uses default rules for parsing names of built-in functions. These rules can be changed by enabling the `IGNORE_SPACE` SQL mode.

When the parser encounters a word that is the name of a built-in function, it must determine whether the name signifies a function call or is instead a nonexpression reference to an identifier such as a table or column name. For example, in the following statements, the first reference to `count` is a function call, whereas the second reference is a table name:

```
SELECT COUNT(*) FROM mytable;  
CREATE TABLE count (i INT);
```

The parser should recognize the name of a built-in function as indicating a function call only when parsing what is expected to be an expression. That is, in nonexpression context, function names are permitted as identifiers.

However, some built-in functions have special parsing or implementation considerations, so the parser uses the following rules by default to distinguish whether their names are being used as function calls or as identifiers in nonexpression context:

- To use the name as a function call in an expression, there must be no whitespace between the name and the following ( parenthesis character.
- Conversely, to use the function name as an identifier, it must not be followed immediately by a parenthesis.

The requirement that function calls be written with no whitespace between the name and the parenthesis applies only to the built-in functions that have special considerations. `COUNT` is one such name. The `sql/lex.h` source file lists the names of these special functions for which following whitespace determines their interpretation: names defined by the `SYM_FN()` macro in the `symbols[]` array.

The following list names the functions in MySQL 5.7 that are affected by the `IGNORE_SPACE` setting and listed as special in the `sql/lex.h` source file. You may find it easiest to treat the no-whitespace requirement as applying to all function calls.

- `ADDDATE`
- `BIT_AND`
- `BIT_OR`
- `BIT_XOR`
- `CAST`
- `COUNT`
- `CURDATE`
- `CURTIME`
- `DATE_ADD`
- `DATE_SUB`

- `EXTRACT`
- `GROUP_CONCAT`
- `MAX`
- `MID`
- `MIN`
- `NOW`
- `POSITION`
- `SESSION_USER`
- `STD`
- `STDDEV`
- `STDDEV_POP`
- `STDDEV_SAMP`
- `SUBDATE`
- `SUBSTR`
- `SUBSTRING`
- `SUM`
- `SYSDATE`
- `SYSTEM_USER`
- `TRIM`
- `VARIANCE`
- `VAR_POP`
- `VAR_SAMP`

For functions not listed as special in `sql/lex.h`, whitespace does not matter. They are interpreted as function calls only when used in expression context and may be used freely as identifiers otherwise. `ASCII` is one such name. However, for these nonaffected function names, interpretation may vary in expression context: `func_name ()` is interpreted as a built-in function if there is one with the given name; if not, `func_name ()` is interpreted as a loadable function or stored function if one exists with that name.

The `IGNORE_SPACE` SQL mode can be used to modify how the parser treats function names that are whitespace-sensitive:

- With `IGNORE_SPACE` disabled, the parser interprets the name as a function call when there is no whitespace between the name and the following parenthesis. This occurs even when the function name is used in nonexpression context:

```
mysql> CREATE TABLE count(i INT);
ERROR 1064 (42000): You have an error in your SQL syntax ...
near 'count(i INT)'
```

To eliminate the error and cause the name to be treated as an identifier, either use whitespace following the name or write it as a quoted identifier (or both):

```
CREATE TABLE count (i INT);
CREATE TABLE `count` (i INT);
CREATE TABLE `count` (i INT);
```

- With `IGNORE_SPACE` enabled, the parser loosens the requirement that there be no whitespace between the function name and the following parenthesis. This provides more flexibility in writing function calls. For example, either of the following function calls are legal:

```
SELECT COUNT(*) FROM mytable;
SELECT COUNT (*) FROM mytable;
```

However, enabling `IGNORE_SPACE` also has the side effect that the parser treats the affected function names as reserved words (see [Section 9.3, “Keywords and Reserved Words”](#)). This means that a space following the name no longer signifies its use as an identifier. The name can be used in function calls with or without following whitespace, but causes a syntax error in nonexpression context unless it is quoted. For example, with `IGNORE_SPACE` enabled, both of the following statements fail with a syntax error because the parser interprets `count` as a reserved word:

```
CREATE TABLE count(i INT);
CREATE TABLE count (i INT);
```

To use the function name in nonexpression context, write it as a quoted identifier:

```
CREATE TABLE `count` (i INT);
CREATE TABLE `count` (i INT);
```

To enable the `IGNORE_SPACE` SQL mode, use this statement:

```
SET sql_mode = 'IGNORE_SPACE';
```

`IGNORE_SPACE` is also enabled by certain other composite modes such as `ANSI` that include it in their value:

```
SET sql_mode = 'ANSI';
```

Check [Section 5.1.10, “Server SQL Modes”](#), to see which composite modes enable `IGNORE_SPACE`.

To minimize the dependency of SQL code on the `IGNORE_SPACE` setting, use these guidelines:

- Avoid creating loadable functions or stored functions that have the same name as a built-in function.
- Avoid using function names in nonexpression context. For example, these statements use `count` (one of the affected function names affected by `IGNORE_SPACE`), so they fail with or without whitespace following the name if `IGNORE_SPACE` is enabled:

```
CREATE TABLE count(i INT);
CREATE TABLE count (i INT);
```

If you must use a function name in nonexpression context, write it as a quoted identifier:

```
CREATE TABLE `count` (i INT);
CREATE TABLE `count` (i INT);
```

## Function Name Resolution

The following rules describe how the server resolves references to function names for function creation and invocation:

- Built-in functions and loadable functions

An error occurs if you try to create a loadable function with the same name as a built-in function.

- Built-in functions and stored functions

It is possible to create a stored function with the same name as a built-in function, but to invoke the stored function it is necessary to qualify it with a schema name. For example, if you create a stored function named `PI` in the `test` schema, invoke it as `test.PI()` because the server resolves `PI()` without a qualifier as a reference to the built-in function. The server generates a warning if the stored function name collides with a built-in function name. The warning can be displayed with `SHOW WARNINGS`.

- Loadable functions and stored functions

Loadable functions and stored functions share the same namespace, so you cannot create a loadable function and a stored function with the same name.

The preceding function name resolution rules have implications for upgrading to versions of MySQL that implement new built-in functions:

- If you have already created a loadable function with a given name and upgrade MySQL to a version that implements a new built-in function with the same name, the loadable function becomes inaccessible. To correct this, use `DROP FUNCTION` to drop the loadable function and `CREATE FUNCTION` to re-create the loadable function with a different nonconflicting name. Then modify any affected code to use the new name.
- If a new version of MySQL implements a built-in function with the same name as an existing stored function, you have two choices: Rename the stored function to use a nonconflicting name, or change calls to the function so that they use a schema qualifier (that is, use `schema_name.func_name()` syntax). In either case, modify any affected code accordingly.

## 9.3 Keywords and Reserved Words

Keywords are words that have significance in SQL. Certain keywords, such as `SELECT`, `DELETE`, or `BIGINT`, are reserved and require special treatment for use as identifiers such as table and column names. This may also be true for the names of built-in functions.

Nonreserved keywords are permitted as identifiers without quoting. Reserved words are permitted as identifiers if you quote them as described in [Section 9.2, “Schema Object Names”](#):

```
mysql> CREATE TABLE interval (begin INT, end INT);
ERROR 1064 (42000): You have an error in your SQL syntax ...
near 'interval (begin INT, end INT)'
```

`BEGIN` and `END` are keywords but not reserved, so their use as identifiers does not require quoting. `INTERVAL` is a reserved keyword and must be quoted to be used as an identifier:

```
mysql> CREATE TABLE `interval` (begin INT, end INT);
Query OK, 0 rows affected (0.01 sec)
```

Exception: A word that follows a period in a qualified name must be an identifier, so it need not be quoted even if it is reserved:

```
mysql> CREATE TABLE mydb.interval (begin INT, end INT);
Query OK, 0 rows affected (0.01 sec)
```

Names of built-in functions are permitted as identifiers but may require care to be used as such. For example, `COUNT` is acceptable as a column name. However, by default, no whitespace is permitted in

function invocations between the function name and the following ( character. This requirement enables the parser to distinguish whether the name is used in a function call or in nonfunction context. For further details on recognition of function names, see [Section 9.2.5, “Function Name Parsing and Resolution”](#).

- [MySQL 5.7 Keywords and Reserved Words](#)
- [MySQL 5.7 New Keywords and Reserved Words](#)
- [MySQL 5.7 Removed Keywords and Reserved Words](#)

## MySQL 5.7 Keywords and Reserved Words

The following list shows the keywords and reserved words in MySQL 5.7, along with changes to individual words from version to version. Reserved keywords are marked with (R). In addition, `_FILENAME` is reserved.

At some point, you might upgrade to a higher version, so it is a good idea to have a look at future reserved words, too. You can find these in the manuals that cover higher versions of MySQL. Most of the reserved words in the list are forbidden by standard SQL as column or table names (for example, `GROUP`). A few are reserved because MySQL needs them and uses a `yacc` parser.

A | B | C | D | E | F | G | H | I | J | K | L | M | N | O | P | Q | R | S | T | U | V | W | X | Y | Z

A

- `ACCESSIBLE` (R)
- `ACCOUNT`; added in 5.7.6 (nonreserved)
- `ACTION`
- `ADD` (R)
- `AFTER`
- `AGAINST`
- `AGGREGATE`
- `ALGORITHM`
- `ALL` (R)
- `ALTER` (R)
- `ALWAYS`; added in 5.7.6 (nonreserved)
- `ANALYSE`
- `ANALYZE` (R)
- `AND` (R)
- `ANY`
- `AS` (R)
- `ASC` (R)



- ASCII
- ASENSITIVE (R)
- AT
- AUTOEXTEND\_SIZE
- AUTO\_INCREMENT
- AVG
- AVG\_ROW\_LENGTH

## B

- BACKUP
- BEFORE (R)
- BEGIN
- BETWEEN (R)
- BIGINT (R)
- BINARY (R)
- BINLOG
- BIT
- BLOB (R)
- BLOCK
- BOOL
- BOOLEAN
- BOTH (R)
- BTREE
- BY (R)
- BYTE

## C

- CACHE
- CALL (R)
- CASCADE (R)
- CASCADED
- CASE (R)

- CATALOG\_NAME
- CHAIN
- CHANGE (R)
- CHANGED
- CHANNEL; added in 5.7.6 (nonreserved)
- CHAR (R)
- CHARACTER (R)
- CHARSET
- CHECK (R)
- CHECKSUM
- CIPHER
- CLASS\_ORIGIN
- CLIENT
- CLOSE
- COALESCE
- CODE
- COLLATE (R)
- COLLATION
- COLUMN (R)
- COLUMNS
- COLUMN\_FORMAT
- COLUMN\_NAME
- COMMENT
- COMMIT
- COMMITTED
- COMPACT
- COMPLETION
- COMPRESSED
- COMPRESSION; added in 5.7.8 (nonreserved)
- CONCURRENT

- `CONDITION (R)`
- `CONNECTION`
- `CONSISTENT`
- `CONSTRAINT (R)`
- `CONSTRAINT_CATALOG`
- `CONSTRAINT_NAME`
- `CONSTRAINT_SCHEMA`
- `CONTAINS`
- `CONTEXT`
- `CONTINUE (R)`
- `CONVERT (R)`
- `CPU`
- `CREATE (R)`
- `CROSS (R)`
- `CUBE`
- `CURRENT`
- `CURRENT_DATE (R)`
- `CURRENT_TIME (R)`
- `CURRENT_TIMESTAMP (R)`
- `CURRENT_USER (R)`
- `CURSOR (R)`
- `CURSOR_NAME`

## D

- `DATA`
- `DATABASE (R)`
- `DATABASES (R)`
- `DATAFILE`
- `DATE`
- `DATETIME`
- `DAY`

- DAY\_HOUR (R)
- DAY\_MICROSECOND (R)
- DAY\_MINUTE (R)
- DAY\_SECOND (R)
- DEALLOCATE
- DEC (R)
- DECIMAL (R)
- DECLARE (R)
- DEFAULT (R)
- DEFAULT\_AUTH
- DEFINER
- DELAYED (R)
- DELAY\_KEY\_WRITE
- DELETE (R)
- DESC (R)
- DESCRIBE (R)
- DES\_KEY\_FILE
- DETERMINISTIC (R)
- DIAGNOSTICS
- DIRECTORY
- DISABLE
- DISCARD
- DISK
- DISTINCT (R)
- DISTINCTROW (R)
- DIV (R)
- DO
- DOUBLE (R)
- DROP (R)
- DUAL (R)

- DUMPFILE
- DUPLICATE
- DYNAMIC

## E

- EACH (R)
- ELSE (R)
- ELSEIF (R)
- ENABLE
- ENCLOSED (R)
- ENCRYPTION; added in 5.7.11 (nonreserved)
- END
- ENDS
- ENGINE
- ENGINES
- ENUM
- ERROR
- ERRORS
- ESCAPE
- ESCAPED (R)
- EVENT
- EVENTS
- EVERY
- EXCHANGE
- EXECUTE
- EXISTS (R)
- EXIT (R)
- EXPANSION
- EXPIRE
- EXPLAIN (R)
- EXPORT

- EXTENDED
- EXTENT\_SIZE

## F

- FALSE (R)
- FAST
- FAULTS
- FETCH (R)
- FIELDS
- FILE
- FILE\_BLOCK\_SIZE; added in 5.7.6 (nonreserved)
- FILTER; added in 5.7.3 (nonreserved)
- FIRST
- FIXED
- FLOAT (R)
- FLOAT4 (R)
- FLOAT8 (R)
- FLUSH
- FOLLOWS; added in 5.7.2 (nonreserved)
- FOR (R)
- FORCE (R)
- FOREIGN (R)
- FORMAT
- FOUND
- FROM (R)
- FULL
- FULLTEXT (R)
- FUNCTION

## G

- GENERAL
- GENERATED (R); added in 5.7.6 (reserved)

- GEOMETRY
- GEOMETRYCOLLECTION
- GET (R)
- GET\_FORMAT
- GLOBAL
- GRANT (R)
- GRANTS
- GROUP (R)
- GROUP\_REPLICATION; added in 5.7.6 (nonreserved)

## H

- HANDLER
- HASH
- HAVING (R)
- HELP
- HIGH\_PRIORITY (R)
- HOST
- HOSTS
- HOUR
- HOUR\_MICROSECOND (R)
- HOUR\_MINUTE (R)
- HOUR\_SECOND (R)

## I

- IDENTIFIED
- IF (R)
- IGNORE (R)
- IGNORE\_SERVER\_IDS
- IMPORT
- IN (R)
- INDEX (R)
- INDEXES

- `INFILE` (R)
  - `INITIAL_SIZE`
  - `INNER` (R)
  - `INOUT` (R)
  - `INSENSITIVE` (R)
  - `INSERT` (R)
  - `INSERT_METHOD`
  - `INSTALL`
  - `INSTANCE`; added in 5.7.11 (nonreserved)
  - `INT` (R)
  - `INT1` (R)
  - `INT2` (R)
  - `INT3` (R)
  - `INT4` (R)
  - `INT8` (R)
  - `INTEGER` (R)
  - `INTERVAL` (R)
  - `INTO` (R)
  - `INVOKER`
  - `IO`
  - `IO_AFTER_GTIDS` (R)
  - `IO_BEFORE_GTIDS` (R)
  - `IO_THREAD`
  - `IPC`
  - `IS` (R)
  - `ISOLATION`
  - `ISSUER`
  - `ITERATE` (R)
- J
- `JOIN` (R)



- `JSON`; added in 5.7.8 (nonreserved)

## K

- `KEY` (R)
- `KEYS` (R)
- `KEY_BLOCK_SIZE`
- `KILL` (R)

## L

- `LANGUAGE`
- `LAST`
- `LEADING` (R)
- `LEAVE` (R)
- `LEAVES`
- `LEFT` (R)
- `LESS`
- `LEVEL`
- `LIKE` (R)
- `LIMIT` (R)
- `LINEAR` (R)
- `LINES` (R)
- `LINestring`
- `LIST`
- `LOAD` (R)
- `LOCAL`
- `LOCALTIME` (R)
- `LOCALTIMESTAMP` (R)
- `LOCK` (R)
- `LOCKS`
- `LOGFILE`
- `LOGS`
- `LONG` (R)

- `LOBLOB (R)`
- `LONGTEXT (R)`
- `LOOP (R)`
- `LOW_PRIORITY (R)`

## M

- `MASTER`
- `MASTER_AUTO_POSITION`
- `MASTER_BIND (R)`
- `MASTER_CONNECT_RETRY`
- `MASTER_DELAY`
- `MASTER_HEARTBEAT_PERIOD`
- `MASTER_HOST`
- `MASTER_LOG_FILE`
- `MASTER_LOG_POS`
- `MASTER_PASSWORD`
- `MASTER_PORT`
- `MASTER_RETRY_COUNT`
- `MASTER_SERVER_ID`
- `MASTER_SSL`
- `MASTER_SSL_CA`
- `MASTER_SSL_CAPATH`
- `MASTER_SSL_CERT`
- `MASTER_SSL_CIPHER`
- `MASTER_SSL_CRL`
- `MASTER_SSL_CRLPATH`
- `MASTER_SSL_KEY`
- `MASTER_SSL_VERIFY_SERVER_CERT (R)`
- `MASTER_TLS_VERSION`; added in 5.7.10 (nonreserved)
- `MASTER_USER`
- `MATCH (R)`

- MAXVALUE (R)
- MAX\_CONNECTIONS\_PER\_HOUR
- MAX\_QUERIES\_PER\_HOUR
- MAX\_ROWS
- MAX\_SIZE
- MAX\_STATEMENT\_TIME; added in 5.7.4 (nonreserved); removed in 5.7.8
- MAX\_UPDATES\_PER\_HOUR
- MAX\_USER\_CONNECTIONS
- MEDIUM
- MEDIUMBLOB (R)
- MEDIUMINT (R)
- MEDIUMTEXT (R)
- MEMORY
- MERGE
- MESSAGE\_TEXT
- MICROSECOND
- MIDDLEINT (R)
- MIGRATE
- MINUTE
- MINUTE\_MICROSECOND (R)
- MINUTE\_SECOND (R)
- MIN\_ROWS
- MOD (R)
- MODE
- MODIFIES (R)
- MODIFY
- MONTH
- MULTILINESTRING
- MULTIPOINT
- MULTIPOLYGON

- MUTEX
- MYSQL\_ERRNO

## N

- NAME
- NAMES
- NATIONAL
- NATURAL (R)
- NCHAR
- NDB
- NDBCLUSTER
- NEVER; added in 5.7.4 (nonreserved)
- NEW
- NEXT
- NO
- NODEGROUP
- NONBLOCKING; removed in 5.7.6
- NONE
- NOT (R)
- NO\_WAIT
- NO\_WRITE\_TO\_BINLOG (R)
- NULL (R)
- NUMBER
- NUMERIC (R)
- NVARCHAR

## O

- OFFSET
- OLD\_PASSWORD; removed in 5.7.5
- ON (R)
- ONE
- ONLY

- OPEN
- OPTIMIZE (R)
- OPTIMIZER\_COSTS (R); added in 5.7.5 (reserved)
- OPTION (R)
- OPTIONALLY (R)
- OPTIONS
- OR (R)
- ORDER (R)
- OUT (R)
- OUTER (R)
- OUTFILE (R)
- OWNER

## P

- PACK\_KEYS
- PAGE
- PARSER
- PARSE\_GCOL\_EXPR; added in 5.7.6 (reserved); became nonreserved in 5.7.8
- PARTIAL
- PARTITION (R)
- PARTITIONING
- PARTITIONS
- PASSWORD
- PHASE
- PLUGIN
- PLUGINS
- PLUGIN\_DIR
- POINT
- POLYGON
- PORT
- PRECEDES; added in 5.7.2 (nonreserved)

- `PRECISION` (R)
- `PREPARE`
- `PRESERVE`
- `PREV`
- `PRIMARY` (R)
- `PRIVILEGES`
- `PROCEDURE` (R)
- `PROCESSLIST`
- `PROFILE`
- `PROFILES`
- `PROXY`
- `PURGE` (R)

## Q

- `QUARTER`
- `QUERY`
- `QUICK`

## R

- `RANGE` (R)
- `READ` (R)
- `READS` (R)
- `READ_ONLY`
- `READ_WRITE` (R)
- `REAL` (R)
- `REBUILD`
- `RECOVER`
- `REDOFILE`
- `REDO_BUFFER_SIZE`
- `REDUNDANT`
- `REFERENCES` (R)
- `REGEXP` (R)

- RELAY
- RELAYLOG
- RELAY\_LOG\_FILE
- RELAY\_LOG\_POS
- RELAY\_THREAD
- RELEASE (R)
- RELOAD
- REMOVE
- RENAME (R)
- REORGANIZE
- REPAIR
- REPEAT (R)
- REPEATABLE
- REPLACE (R)
- REPLICATE\_DO\_DB; added in 5.7.3 (nonreserved)
- REPLICATE\_DO\_TABLE; added in 5.7.3 (nonreserved)
- REPLICATE\_IGNORE\_DB; added in 5.7.3 (nonreserved)
- REPLICATE\_IGNORE\_TABLE; added in 5.7.3 (nonreserved)
- REPLICATE\_REWRITE\_DB; added in 5.7.3 (nonreserved)
- REPLICATE\_WILD\_DO\_TABLE; added in 5.7.3 (nonreserved)
- REPLICATE\_WILD\_IGNORE\_TABLE; added in 5.7.3 (nonreserved)
- REPLICATION
- REQUIRE (R)
- RESET
- RESIGNAL (R)
- RESTORE
- RESTRICT (R)
- RESUME
- RETURN (R)
- RETURNED\_SQLSTATE

- RETURNS
- REVERSE
- REVOKE (R)
- RIGHT (R)
- RLIKE (R)
- ROLLBACK
- ROLLUP
- ROTATE; added in 5.7.11 (nonreserved)
- ROUTINE
- ROW
- ROWS
- ROW\_COUNT
- ROW\_FORMAT
- RTREE

## S

- SAVEPOINT
- SCHEDULE
- SCHEMA (R)
- SCHEMAS (R)
- SCHEMA\_NAME
- SECOND
- SECOND\_MICROSECOND (R)
- SECURITY
- SELECT (R)
- SENSITIVE (R)
- SEPARATOR (R)
- SERIAL
- SERIALIZABLE
- SERVER
- SESSION



- SET (R)
- SHARE
- SHOW (R)
- SHUTDOWN
- SIGNAL (R)
- SIGNED
- SIMPLE
- SLAVE
- SLOW
- SMALLINT (R)
- SNAPSHOT
- SOCKET
- SOME
- SONAME
- SOUNDS
- SOURCE
- SPATIAL (R)
- SPECIFIC (R)
- SQL (R)
- SQLEXCEPTION (R)
- SQLSTATE (R)
- SQLWARNING (R)
- SQL\_AFTER\_GTIDS
- SQL\_AFTER\_MTS\_GAPS
- SQL\_BEFORE\_GTIDS
- SQL\_BIG\_RESULT (R)
- SQL\_BUFFER\_RESULT
- SQL\_CACHE
- SQL\_CALC\_FOUND\_ROWS (R)
- SQL\_NO\_CACHE

- `SQL_SMALL_RESULT (R)`
- `SQL_THREAD`
- `SQL_TSI_DAY`
- `SQL_TSI_HOUR`
- `SQL_TSI_MINUTE`
- `SQL_TSI_MONTH`
- `SQL_TSI_QUARTER`
- `SQL_TSI_SECOND`
- `SQL_TSI_WEEK`
- `SQL_TSI_YEAR`
- `SSL (R)`
- `STACKED`
- `START`
- `STARTING (R)`
- `STARTS`
- `STATS_AUTO_RECALC`
- `STATS_PERSISTENT`
- `STATS_SAMPLE_PAGES`
- `STATUS`
- `STOP`
- `STORAGE`
- `STORED (R)`; added in 5.7.6 (reserved)
- `STRAIGHT_JOIN (R)`
- `STRING`
- `SUBCLASS_ORIGIN`
- `SUBJECT`
- `SUBPARTITION`
- `SUBPARTITIONS`
- `SUPER`
- `SUSPEND`

- SWAPS
- SWITCHES

## T

- TABLE (R)
- TABLES
- TABLESPACE
- TABLE\_CHECKSUM
- TABLE\_NAME
- TEMPORARY
- TEMPTABLE
- TERMINATED (R)
- TEXT
- THAN
- THEN (R)
- TIME
- TIMESTAMP
- TIMESTAMPADD
- TIMESTAMPDIF
- TINYBLOB (R)
- TINYINT (R)
- TINYTEXT (R)
- TO (R)
- TRAILING (R)
- TRANSACTION
- TRIGGER (R)
- TRIGGERS
- TRUE (R)
- TRUNCATE
- TYPE
- TYPES

## U

- `UNCOMMITTED`
- `UNDEFINED`
- `UNDO (R)`
- `UNDOFILE`
- `UNDO_BUFFER_SIZE`
- `UNICODE`
- `UNINSTALL`
- `UNION (R)`
- `UNIQUE (R)`
- `UNKNOWN`
- `UNLOCK (R)`
- `UNSIGNED (R)`
- `UNTIL`
- `UPDATE (R)`
- `UPGRADE`
- `USAGE (R)`
- `USE (R)`
- `USER`
- `USER_RESOURCES`
- `USE_FRM`
- `USING (R)`
- `UTC_DATE (R)`
- `UTC_TIME (R)`
- `UTC_TIMESTAMP (R)`

## V

- `VALIDATION`; added in 5.7.5 (nonreserved)
- `VALUE`
- `VALUES (R)`
- `VARBINARY (R)`

- `VARCHAR` (R)
- `VARCHARACTER` (R)
- `VARIABLES`
- `VARYING` (R)
- `VIEW`
- `VIRTUAL` (R); added in 5.7.6 (reserved)

## W

- `WAIT`
- `WARNINGS`
- `WEEK`
- `WEIGHT_STRING`
- `WHEN` (R)
- `WHERE` (R)
- `WHILE` (R)
- `WITH` (R)
- `WITHOUT`; added in 5.7.5 (nonreserved)
- `WORK`
- `WRAPPER`
- `WRITE` (R)

## X

- `X509`
- `XA`
- `XID`; added in 5.7.5 (nonreserved)
- `XML`
- `XOR` (R)

## Y

- `YEAR`
- `YEAR_MONTH` (R)

## Z

- `ZEROFILL` (R)

## MySQL 5.7 New Keywords and Reserved Words

The following list shows the keywords and reserved words that are added in MySQL 5.7, compared to MySQL 5.6. Reserved keywords are marked with (R).

A | C | E | F | G | I | J | M | N | O | P | R | S | V | W | X

A

- ACCOUNT
- ALWAYS

C

- CHANNEL
- COMPRESSION

E

- ENCRYPTION

F

- FILE\_BLOCK\_SIZE
- FILTER
- FOLLOWS

G

- GENERATED (R)
- GROUP\_REPLICATION

I

- INSTANCE

J

- JSON

M

- MASTER\_TLS\_VERSION

N

- NEVER

O

- OPTIMIZER\_COSTS (R)

P

- PARSE\_GCOL\_EXPR

- PRECEDES

## R

- REPLICATE\_DO\_DB
- REPLICATE\_DO\_TABLE
- REPLICATE\_IGNORE\_DB
- REPLICATE\_IGNORE\_TABLE
- REPLICATE\_REWRITE\_DB
- REPLICATE\_WILD\_DO\_TABLE
- REPLICATE\_WILD\_IGNORE\_TABLE
- ROTATE

## S

- STACKED
- STORED (R)

## V

- VALIDATION
- VIRTUAL (R)

## W

- WITHOUT

## X

- XID

## MySQL 5.7 Removed Keywords and Reserved Words

The following list shows the keywords and reserved words that are removed in MySQL 5.7, compared to MySQL 5.6. Reserved keywords are marked with (R).

- OLD\_PASSWORD

## 9.4 User-Defined Variables

You can store a value in a user-defined variable in one statement and refer to it later in another statement. This enables you to pass values from one statement to another.

User variables are written as `@var_name`, where the variable name `var_name` consists of alphanumeric characters, `.`, `_`, and `$`. A user variable name can contain other characters if you quote it as a string or identifier (for example, `@'my-var'`, `@"my-var"`, or `@`my-var``).

User-defined variables are session specific. A user variable defined by one client cannot be seen or used by other clients. (Exception: A user with access to the Performance Schema

`user_variables_by_thread` table can see all user variables for all sessions.) All variables for a given client session are automatically freed when that client exits.

User variable names are not case-sensitive. Names have a maximum length of 64 characters.

One way to set a user-defined variable is by issuing a `SET` statement:

```
SET @var_name = expr [, @var_name = expr] ...
```

For `SET`, either `=` or `:=` can be used as the assignment operator.

User variables can be assigned a value from a limited set of data types: integer, decimal, floating-point, binary or nonbinary string, or `NULL` value. Assignment of decimal and real values does not preserve the precision or scale of the value. A value of a type other than one of the permissible types is converted to a permissible type. For example, a value having a temporal or spatial data type is converted to a binary string. A value having the `JSON` data type is converted to a string with a character set of `utf8mb4` and a collation of `utf8mb4_bin`.

If a user variable is assigned a nonbinary (character) string value, it has the same character set and collation as the string. The coercibility of user variables is implicit. (This is the same coercibility as for table column values.)

Hexadecimal or bit values assigned to user variables are treated as binary strings. To assign a hexadecimal or bit value as a number to a user variable, use it in numeric context. For example, add 0 or use `CAST(... AS UNSIGNED)`:

```
mysql> SET @v1 = X'41';
mysql> SET @v2 = X'41'+0;
mysql> SET @v3 = CAST(X'41' AS UNSIGNED);
mysql> SELECT @v1, @v2, @v3;
+-----+-----+-----+
| @v1 | @v2 | @v3 |
+-----+-----+-----+
| A   | 65  | 65  |
+-----+-----+-----+
mysql> SET @v1 = b'1000001';
mysql> SET @v2 = b'1000001'+0;
mysql> SET @v3 = CAST(b'1000001' AS UNSIGNED);
mysql> SELECT @v1, @v2, @v3;
+-----+-----+-----+
| @v1 | @v2 | @v3 |
+-----+-----+-----+
| A   | 65  | 65  |
+-----+-----+-----+
```

If the value of a user variable is selected in a result set, it is returned to the client as a string.

If you refer to a variable that has not been initialized, it has a value of `NULL` and a type of string.

User variables may be used in most contexts where expressions are permitted. This does not currently include contexts that explicitly require a literal value, such as in the `LIMIT` clause of a `SELECT` statement, or the `IGNORE N LINES` clause of a `LOAD DATA` statement.

It is also possible to assign a value to a user variable in statements other than `SET`. (This functionality is deprecated in MySQL 8.0 and subject to removal in a subsequent release.) When making an assignment in this way, the assignment operator must be `:=` and not `=` because the latter is treated as the comparison operator `=` in statements other than `SET`:

```
mysql> SET @t1=1, @t2=2, @t3:=4;
mysql> SELECT @t1, @t2, @t3, @t4 := @t1+@t2+@t3;
```



```
+-----+-----+-----+-----+
| @t1 | @t2 | @t3 | @t4 := @t1+@t2+@t3 |
+-----+-----+-----+-----+
| 1 | 2 | 4 | 7 |
+-----+-----+-----+-----+
```

As a general rule, other than in `SET` statements, you should never assign a value to a user variable and read the value within the same statement. For example, to increment a variable, this is okay:

```
SET @a = @a + 1;
```

For other statements, such as `SELECT`, you might get the results you expect, but this is not guaranteed. In the following statement, you might think that MySQL evaluates `@a` first and then does an assignment second:

```
SELECT @a, @a:=@a+1, ...;
```

However, the order of evaluation for expressions involving user variables is undefined.

Another issue with assigning a value to a variable and reading the value within the same non-`SET` statement is that the default result type of a variable is based on its type at the start of the statement. The following example illustrates this:

```
mysql> SET @a='test';
mysql> SELECT @a,(@a:=20) FROM tbl_name;
```

For this `SELECT` statement, MySQL reports to the client that column one is a string and converts all accesses of `@a` to strings, even though `@a` is set to a number for the second row. After the `SELECT` statement executes, `@a` is regarded as a number for the next statement.

To avoid problems with this behavior, either do not assign a value to and read the value of the same variable within a single statement, or else set the variable to `0`, `0.0`, or `' '` to define its type before you use it.

In a `SELECT` statement, each select expression is evaluated only when sent to the client. This means that in a `HAVING`, `GROUP BY`, or `ORDER BY` clause, referring to a variable that is assigned a value in the select expression list does *not* work as expected:

```
mysql> SELECT (@aa:=id) AS a, (@aa+3) AS b FROM tbl_name HAVING b=5;
```

The reference to `b` in the `HAVING` clause refers to an alias for an expression in the select list that uses `@aa`. This does not work as expected: `@aa` contains the value of `id` from the previous selected row, not from the current row.

User variables are intended to provide data values. They cannot be used directly in an SQL statement as an identifier or as part of an identifier, such as in contexts where a table or database name is expected, or as a reserved word such as `SELECT`. This is true even if the variable is quoted, as shown in the following example:

```
mysql> SELECT c1 FROM t;
+----+
| c1 |
+----+
| 0 |
+----+
| 1 |
+----+
2 rows in set (0.00 sec)

mysql> SET @col = "c1";
```

```

Query OK, 0 rows affected (0.00 sec)

mysql> SELECT @col FROM t;
+-----+
| @col |
+-----+
| c1   |
+-----+
1 row in set (0.00 sec)

mysql> SELECT `@col` FROM t;
ERROR 1054 (42S22): Unknown column '@col' in 'field list'

mysql> SET @col = "`c1`";
Query OK, 0 rows affected (0.00 sec)

mysql> SELECT @col FROM t;
+-----+
| @col |
+-----+
| `c1` |
+-----+
1 row in set (0.00 sec)

```

An exception to this principle that user variables cannot be used to provide identifiers, is when you are constructing a string for use as a prepared statement to execute later. In this case, user variables can be used to provide any part of the statement. The following example illustrates how this can be done:

```

mysql> SET @c = "c1";
Query OK, 0 rows affected (0.00 sec)

mysql> SET @s = CONCAT("SELECT ", @c, " FROM t");
Query OK, 0 rows affected (0.00 sec)

mysql> PREPARE stmt FROM @s;
Query OK, 0 rows affected (0.04 sec)
Statement prepared

mysql> EXECUTE stmt;
+-----+
| c1 |
+-----+
| 0 |
+-----+
| 1 |
+-----+
2 rows in set (0.00 sec)

mysql> DEALLOCATE PREPARE stmt;
Query OK, 0 rows affected (0.00 sec)

```

See [Section 13.5, “Prepared Statements”](#), for more information.

A similar technique can be used in application programs to construct SQL statements using program variables, as shown here using PHP 5:

```

<?php
    $mysqli = new mysqli("localhost", "user", "pass", "test");

    if( mysqli_connect_errno() )
        die("Connection failed: %s\n", mysqli_connect_error());

    $col = "c1";

    $query = "SELECT $col FROM t";

```

```

$result = $mysqli->query($query);

while($row = $result->fetch_assoc())
{
    echo "<p>" . $row["$col"] . "</p>\n";
}

$result->close();

$mysqli->close();

?>

```

Assembling an SQL statement in this fashion is sometimes known as “Dynamic SQL”.

## 9.5 Expressions

This section lists the grammar rules that expressions must follow in MySQL and provides additional information about the types of terms that may appear in expressions.

- [Expression Syntax](#)
- [Expression Term Notes](#)
- [Temporal Intervals](#)

### Expression Syntax

The following grammar rules define expression syntax in MySQL. The grammar shown here is based on that given in the `sql/sql_yacc.yy` file of MySQL source distributions. For additional information about some of the expression terms, see [Expression Term Notes](#).

```

expr:
    expr OR expr
  | expr || expr
  | expr XOR expr
  | expr AND expr
  | expr && expr
  | NOT expr
  | ! expr
  | boolean_primary IS [NOT] {TRUE | FALSE | UNKNOWN}
  | boolean_primary

boolean_primary:
    boolean_primary IS [NOT] NULL
  | boolean_primary <=> predicate
  | boolean_primary comparison_operator predicate
  | boolean_primary comparison_operator {ALL | ANY} (subquery)
  | predicate

comparison_operator: = | >= | > | <= | < | <> | !=

predicate:
    bit_expr [NOT] IN (subquery)
  | bit_expr [NOT] IN (expr [, expr] ...)
  | bit_expr [NOT] BETWEEN bit_expr AND predicate
  | bit_expr SOUNDS LIKE bit_expr
  | bit_expr [NOT] LIKE simple_expr [ESCAPE simple_expr]
  | bit_expr [NOT] REGEXP bit_expr
  | bit_expr

bit_expr:
    bit_expr | bit_expr
  | bit_expr & bit_expr

```

```

| bit_expr << bit_expr
| bit_expr >> bit_expr
| bit_expr + bit_expr
| bit_expr - bit_expr
| bit_expr * bit_expr
| bit_expr / bit_expr
| bit_expr DIV bit_expr
| bit_expr MOD bit_expr
| bit_expr % bit_expr
| bit_expr ^ bit_expr
| bit_expr + interval_expr
| bit_expr - interval_expr
| simple_expr

simple_expr:
  literal
| identifier
| function_call
| simple_expr COLLATE collation_name
| param_marker
| variable
| simple_expr || simple_expr
| + simple_expr
| - simple_expr
| ~ simple_expr
| ! simple_expr
| BINARY simple_expr
| (expr [, expr] ...)
| ROW (expr, expr [, expr] ...)
| (subquery)
| EXISTS (subquery)
| {identifier expr}
| match_expr
| case_expr
| interval_expr

```

For operator precedence, see [Section 12.4.1, “Operator Precedence”](#). The precedence and meaning of some operators depends on the SQL mode:

- By default, `||` is a logical `OR` operator. With `PIPES_AS_CONCAT` enabled, `||` is string concatenation, with a precedence between `^` and the unary operators.
- By default, `!` has a higher precedence than `NOT`. With `HIGH_NOT_PRECEDENCE` enabled, `!` and `NOT` have the same precedence.

See [Section 5.1.10, “Server SQL Modes”](#).

## Expression Term Notes

For literal value syntax, see [Section 9.1, “Literal Values”](#).

For identifier syntax, see [Section 9.2, “Schema Object Names”](#).

Variables can be user variables, system variables, or stored program local variables or parameters:

- User variables: [Section 9.4, “User-Defined Variables”](#)
- System variables: [Section 5.1.8, “Using System Variables”](#)
- Stored program local variables: [Section 13.6.4.1, “Local Variable DECLARE Statement”](#)
- Stored program parameters: [Section 13.1.16, “CREATE PROCEDURE and CREATE FUNCTION Statements”](#)

*param\_marker* is ? as used in prepared statements for placeholders. See [Section 13.5.1, “PREPARE Statement”](#).

(*subquery*) indicates a subquery that returns a single value; that is, a scalar subquery. See [Section 13.2.10.1, “The Subquery as Scalar Operand”](#).

{*identifier expr*} is ODBC escape syntax and is accepted for ODBC compatibility. The value is *expr*. The { and } curly braces in the syntax should be written literally; they are not metasyntax as used elsewhere in syntax descriptions.

*match\_expr* indicates a `MATCH` expression. See [Section 12.9, “Full-Text Search Functions”](#).

*case\_expr* indicates a `CASE` expression. See [Section 12.5, “Flow Control Functions”](#).

*interval\_expr* represents a temporal interval. See [Temporal Intervals](#).

## Temporal Intervals

*interval\_expr* in expressions represents a temporal interval. Intervals have this syntax:

```
INTERVAL expr unit
```

*expr* represents a quantity. *unit* represents the unit for interpreting the quantity; it is a specifier such as `HOUR`, `DAY`, or `WEEK`. The `INTERVAL` keyword and the *unit* specifier are not case-sensitive.

The following table shows the expected form of the *expr* argument for each *unit* value.

**Table 9.2 Temporal Interval Expression and Unit Arguments**

<i>unit</i> Value	Expected <i>expr</i> Format
MICROSECOND	MICROSECONDS
SECOND	SECONDS
MINUTE	MINUTES
HOUR	HOURS
DAY	DAYS
WEEK	WEEKS
MONTH	MONTHS
QUARTER	QUARTERS
YEAR	YEARS
SECOND_MICROSECOND	' SECONDS . MICROSECONDS '
MINUTE_MICROSECOND	' MINUTES : SECONDS . MICROSECONDS '
MINUTE_SECOND	' MINUTES : SECONDS '
HOUR_MICROSECOND	' HOURS : MINUTES : SECONDS . MICROSECONDS '
HOUR_SECOND	' HOURS : MINUTES : SECONDS '
HOUR_MINUTE	' HOURS : MINUTES '
DAY_MICROSECOND	' DAYS HOURS : MINUTES : SECONDS . MICROSECONDS '
DAY_SECOND	' DAYS HOURS : MINUTES : SECONDS '
DAY_MINUTE	' DAYS HOURS : MINUTES '

<i>unit</i> Value	Expected <i>expr</i> Format
DAY_HOUR	'DAYS HOURS'
YEAR_MONTH	'YEARS-MONTHS'

MySQL permits any punctuation delimiter in the *expr* format. Those shown in the table are the suggested delimiters.

Temporal intervals are used for certain functions, such as `DATE_ADD()` and `DATE_SUB()`:

```
mysql> SELECT DATE_ADD('2018-05-01',INTERVAL 1 DAY);
-> '2018-05-02'
mysql> SELECT DATE_SUB('2018-05-01',INTERVAL 1 YEAR);
-> '2017-05-01'
mysql> SELECT DATE_ADD('2020-12-31 23:59:59',
-> INTERVAL 1 SECOND);
-> '2021-01-01 00:00:00'
mysql> SELECT DATE_ADD('2018-12-31 23:59:59',
-> INTERVAL 1 DAY);
-> '2019-01-01 23:59:59'
mysql> SELECT DATE_ADD('2100-12-31 23:59:59',
-> INTERVAL '1:1' MINUTE_SECOND);
-> '2101-01-01 00:01:00'
mysql> SELECT DATE_SUB('2025-01-01 00:00:00',
-> INTERVAL '1 1:1:1' DAY_SECOND);
-> '2024-12-30 22:58:59'
mysql> SELECT DATE_ADD('1900-01-01 00:00:00',
-> INTERVAL '-1 10' DAY_HOUR);
-> '1899-12-30 14:00:00'
mysql> SELECT DATE_SUB('1998-01-02', INTERVAL 31 DAY);
-> '1997-12-02'
mysql> SELECT DATE_ADD('1992-12-31 23:59:59.000002',
-> INTERVAL '1.999999' SECOND_MICROSECOND);
-> '1993-01-01 00:00:01.000001'
```

Temporal arithmetic also can be performed in expressions using `INTERVAL` together with the `+` or `-` operator:

```
date + INTERVAL expr unit
date - INTERVAL expr unit
```

`INTERVAL expr unit` is permitted on either side of the `+` operator if the expression on the other side is a date or datetime value. For the `-` operator, `INTERVAL expr unit` is permitted only on the right side, because it makes no sense to subtract a date or datetime value from an interval.

```
mysql> SELECT '2018-12-31 23:59:59' + INTERVAL 1 SECOND;
-> '2019-01-01 00:00:00'
mysql> SELECT INTERVAL 1 DAY + '2018-12-31';
-> '2019-01-01'
mysql> SELECT '2025-01-01' - INTERVAL 1 SECOND;
-> '2024-12-31 23:59:59'
```

The `EXTRACT()` function uses the same kinds of *unit* specifiers as `DATE_ADD()` or `DATE_SUB()`, but extracts parts from the date rather than performing date arithmetic:

```
mysql> SELECT EXTRACT(YEAR FROM '2019-07-02');
-> 2019
mysql> SELECT EXTRACT(YEAR_MONTH FROM '2019-07-02 01:02:03');
-> 201907
```

Temporal intervals can be used in `CREATE EVENT` statements:

```
CREATE EVENT myevent
```

```
ON SCHEDULE AT CURRENT_TIMESTAMP + INTERVAL 1 HOUR
DO
  UPDATE myschema.mytable SET mycol = mycol + 1;
```

If you specify an interval value that is too short (does not include all the interval parts that would be expected from the *unit* keyword), MySQL assumes that you have left out the leftmost parts of the interval value. For example, if you specify a *unit* of `DAY_SECOND`, the value of *expr* is expected to have days, hours, minutes, and seconds parts. If you specify a value like `'1:10'`, MySQL assumes that the days and hours parts are missing and the value represents minutes and seconds. In other words, `'1:10' DAY_SECOND` is interpreted in such a way that it is equivalent to `'1:10' MINUTE_SECOND`. This is analogous to the way that MySQL interprets `TIME` values as representing elapsed time rather than as a time of day.

*expr* is treated as a string, so be careful if you specify a nonstring value with `INTERVAL`. For example, with an interval specifier of `HOURL_MINUTE`, `'6/4'` is treated as 6 hours, four minutes, whereas `6/4` evaluates to `1.5000` and is treated as 1 hour, 5000 minutes:

```
mysql> SELECT '6/4', 6/4;
      -> 1.5000
mysql> SELECT DATE_ADD('2019-01-01', INTERVAL '6/4' HOUR_MINUTE);
      -> '2019-01-01 06:04:00'
mysql> SELECT DATE_ADD('2019-01-01', INTERVAL 6/4 HOUR_MINUTE);
      -> '2019-01-04 12:20:00'
```

To ensure interpretation of the interval value as you expect, a `CAST()` operation may be used. To treat `6/4` as 1 hour, 5 minutes, cast it to a `DECIMAL` value with a single fractional digit:

```
mysql> SELECT CAST(6/4 AS DECIMAL(3,1));
      -> 1.5
mysql> SELECT DATE_ADD('1970-01-01 12:00:00',
      ->           INTERVAL CAST(6/4 AS DECIMAL(3,1)) HOUR_MINUTE);
      -> '1970-01-01 13:05:00'
```

If you add to or subtract from a date value something that contains a time part, the result is automatically converted to a datetime value:

```
mysql> SELECT DATE_ADD('2023-01-01', INTERVAL 1 DAY);
      -> '2023-01-02'
mysql> SELECT DATE_ADD('2023-01-01', INTERVAL 1 HOUR);
      -> '2023-01-01 01:00:00'
```

If you add `MONTH`, `YEAR_MONTH`, or `YEAR` and the resulting date has a day that is larger than the maximum day for the new month, the day is adjusted to the maximum days in the new month:

```
mysql> SELECT DATE_ADD('2019-01-30', INTERVAL 1 MONTH);
      -> '2019-02-28'
```

Date arithmetic operations require complete dates and do not work with incomplete dates such as `'2016-07-00'` or badly malformed dates:

```
mysql> SELECT DATE_ADD('2016-07-00', INTERVAL 1 DAY);
      -> NULL
mysql> SELECT '2005-03-32' + INTERVAL 1 MONTH;
      -> NULL
```

## 9.6 Comments

MySQL Server supports three comment styles:

- From a `#` character to the end of the line.

- From a `--` sequence to the end of the line. In MySQL, the `--` (double-dash) comment style requires the second dash to be followed by at least one whitespace or control character, such as a space or tab. This syntax differs slightly from standard SQL comment syntax, as discussed in [Section 1.6.2.4, “--' as the Start of a Comment”](#).
- From a `/*` sequence to the following `*/` sequence, as in the C programming language. This syntax enables a comment to extend over multiple lines because the beginning and closing sequences need not be on the same line.

The following example demonstrates all three comment styles:

```
mysql> SELECT 1+1;      # This comment continues to the end of line
mysql> SELECT 1+1;      -- This comment continues to the end of line
mysql> SELECT 1 /* this is an in-line comment */ + 1;
mysql> SELECT 1+
/*
this is a
multiple-line comment
*/
1;
```

Nested comments are not supported. (Under some conditions, nested comments might be permitted, but usually are not, and users should avoid them.)

MySQL Server supports certain variants of C-style comments. These enable you to write code that includes MySQL extensions, but is still portable, by using comments of the following form:

```
/*! MySQL-specific code */
```

In this case, MySQL Server parses and executes the code within the comment as it would any other SQL statement, but other SQL servers ignore the extensions. For example, MySQL Server recognizes the `STRAIGHT_JOIN` keyword in the following statement, but other servers do not:

```
SELECT /*! STRAIGHT_JOIN */ col1 FROM table1,table2 WHERE ...
```

If you add a version number after the `!` character, the syntax within the comment is executed only if the MySQL version is greater than or equal to the specified version number. The `KEY_BLOCK_SIZE` keyword in the following comment is executed only by servers from MySQL 5.1.10 or higher:

```
CREATE TABLE t1(a INT, KEY (a)) /*!50110 KEY_BLOCK_SIZE=1024 */;
```

The version number uses the format `Mmmrrr`, where `M` is a major version, `mm` is a two-digit minor version, and `rr` is a two-digit release number. For example: In a statement to be run only by a MySQL server version 5.7.31 or later, use `50731` in the comment.

The comment syntax just described applies to how the `mysqld` server parses SQL statements. The `mysql` client program also performs some parsing of statements before sending them to the server. (It does this to determine statement boundaries within a multiple-statement input line.) For information about differences between the server and `mysql` client parsers, see [Section 4.5.1.6, “mysql Client Tips”](#).

Comments in `/*!12345 ... */` format are not stored on the server. If this format is used to comment stored programs, the comments are not retained in the program body.

Another variant of C-style comment syntax is used to specify optimizer hints. Hint comments include a `+` character following the `/*` comment opening sequence. Example:

```
SELECT /*+ BKA(t1) */ FROM ... ;
```

For more information, see [Section 8.9.3, “Optimizer Hints”](#).



The use of short-form `mysql` commands such as `\C` within multiple-line `/* ... */` comments is not supported. Short-form commands do work within single-line `/*! ... */` version comments, as do `/*+ ... */` optimizer-hint comments, which are stored in object definitions. If there is a concern that optimizer-hint comments may be stored in object definitions so that dump files when reloaded with `mysql` would result in execution of such commands, either invoke `mysql` with the `--binary-mode` option or use a reload client other than `mysql`.



---

# Chapter 10 Character Sets, Collations, Unicode

## Table of Contents

10.1 Character Sets and Collations in General .....	1710
10.2 Character Sets and Collations in MySQL .....	1711
10.2.1 Character Set Repertoire .....	1713
10.2.2 UTF-8 for Metadata .....	1714
10.3 Specifying Character Sets and Collations .....	1716
10.3.1 Collation Naming Conventions .....	1716
10.3.2 Server Character Set and Collation .....	1717
10.3.3 Database Character Set and Collation .....	1718
10.3.4 Table Character Set and Collation .....	1719
10.3.5 Column Character Set and Collation .....	1719
10.3.6 Character String Literal Character Set and Collation .....	1721
10.3.7 The National Character Set .....	1723
10.3.8 Character Set Introducers .....	1723
10.3.9 Examples of Character Set and Collation Assignment .....	1725
10.3.10 Compatibility with Other DBMSs .....	1726
10.4 Connection Character Sets and Collations .....	1726
10.5 Configuring Application Character Set and Collation .....	1732
10.6 Error Message Character Set .....	1734
10.7 Column Character Set Conversion .....	1735
10.8 Collation Issues .....	1736
10.8.1 Using COLLATE in SQL Statements .....	1736
10.8.2 COLLATE Clause Precedence .....	1737
10.8.3 Character Set and Collation Compatibility .....	1737
10.8.4 Collation Coercibility in Expressions .....	1737
10.8.5 The binary Collation Compared to <code>_bin</code> Collations .....	1739
10.8.6 Examples of the Effect of Collation .....	1741
10.8.7 Using Collation in <code>INFORMATION_SCHEMA</code> Searches .....	1742
10.9 Unicode Support .....	1744
10.9.1 The <code>utf8mb4</code> Character Set (4-Byte UTF-8 Unicode Encoding) .....	1746
10.9.2 The <code>utf8mb3</code> Character Set (3-Byte UTF-8 Unicode Encoding) .....	1747
10.9.3 The <code>utf8</code> Character Set (Alias for <code>utf8mb3</code> ) .....	1747
10.9.4 The <code>ucs2</code> Character Set (UCS-2 Unicode Encoding) .....	1747
10.9.5 The <code>utf16</code> Character Set (UTF-16 Unicode Encoding) .....	1748
10.9.6 The <code>utf16le</code> Character Set (UTF-16LE Unicode Encoding) .....	1748
10.9.7 The <code>utf32</code> Character Set (UTF-32 Unicode Encoding) .....	1748
10.9.8 Converting Between 3-Byte and 4-Byte Unicode Character Sets .....	1749
10.10 Supported Character Sets and Collations .....	1751
10.10.1 Unicode Character Sets .....	1752
10.10.2 West European Character Sets .....	1758
10.10.3 Central European Character Sets .....	1759
10.10.4 South European and Middle East Character Sets .....	1760
10.10.5 Baltic Character Sets .....	1761
10.10.6 Cyrillic Character Sets .....	1761
10.10.7 Asian Character Sets .....	1762
10.10.8 The Binary Character Set .....	1766
10.11 Restrictions on Character Sets .....	1767
10.12 Setting the Error Message Language .....	1768

10.13 Adding a Character Set .....	1768
10.13.1 Character Definition Arrays .....	1770
10.13.2 String Collating Support for Complex Character Sets .....	1771
10.13.3 Multi-Byte Character Support for Complex Character Sets .....	1771
10.14 Adding a Collation to a Character Set .....	1772
10.14.1 Collation Implementation Types .....	1773
10.14.2 Choosing a Collation ID .....	1776
10.14.3 Adding a Simple Collation to an 8-Bit Character Set .....	1777
10.14.4 Adding a UCA Collation to a Unicode Character Set .....	1778
10.15 Character Set Configuration .....	1785
10.16 MySQL Server Locale Support .....	1786

MySQL includes character set support that enables you to store data using a variety of character sets and perform comparisons according to a variety of collations. The default MySQL server character set and collation are `latin1` and `latin1_swedish_ci`, but you can specify character sets at the server, database, table, column, and string literal levels.

This chapter discusses the following topics:

- What are character sets and collations?
- The multiple-level default system for character set assignment.
- Syntax for specifying character sets and collations.
- Affected functions and operations.
- Unicode support.
- The character sets and collations that are available, with notes.
- Selecting the language for error messages.
- Selecting the locale for day and month names.

Character set issues affect not only data storage, but also communication between client programs and the MySQL server. If you want the client program to communicate with the server using a character set different from the default, you'll need to indicate which one. For example, to use the `utf8` Unicode character set, issue this statement after connecting to the server:

```
SET NAMES 'utf8';
```

For more information about configuring character sets for application use and character set-related issues in client/server communication, see [Section 10.5, “Configuring Application Character Set and Collation”](#), and [Section 10.4, “Connection Character Sets and Collations”](#).

## 10.1 Character Sets and Collations in General

A *character set* is a set of symbols and encodings. A *collation* is a set of rules for comparing characters in a character set. Let's make the distinction clear with an example of an imaginary character set.

Suppose that we have an alphabet with four letters: `A`, `B`, `a`, `b`. We give each letter a number: `A` = 0, `B` = 1, `a` = 2, `b` = 3. The letter `A` is a symbol, the number 0 is the *encoding* for `A`, and the combination of all four letters and their encodings is a *character set*.

Suppose that we want to compare two string values, `A` and `B`. The simplest way to do this is to look at the encodings: 0 for `A` and 1 for `B`. Because 0 is less than 1, we say `A` is less than `B`. What we've just done is apply a collation to our character set. The collation is a set of rules (only one rule in this case): “compare the encodings.” We call this simplest of all possible collations a *binary* collation.

But what if we want to say that the lowercase and uppercase letters are equivalent? Then we would have at least two rules: (1) treat the lowercase letters `a` and `b` as equivalent to `A` and `B`; (2) then compare the encodings. We call this a *case-insensitive* collation. It is a little more complex than a binary collation.

In real life, most character sets have many characters: not just `A` and `B` but whole alphabets, sometimes multiple alphabets or eastern writing systems with thousands of characters, along with many special symbols and punctuation marks. Also in real life, most collations have many rules, not just for whether to distinguish lettercase, but also for whether to distinguish accents (an “accent” is a mark attached to a character as in German `Ö`), and for multiple-character mappings (such as the rule that `Ö = OE` in one of the two German collations).

MySQL can do these things for you:

- Store strings using a variety of character sets.
- Compare strings using a variety of collations.
- Mix strings with different character sets or collations in the same server, the same database, or even the same table.
- Enable specification of character set and collation at any level.

To use these features effectively, you must know what character sets and collations are available, how to change the defaults, and how they affect the behavior of string operators and functions.

## 10.2 Character Sets and Collations in MySQL

MySQL Server supports multiple character sets. To display the available character sets, use the `INFORMATION_SCHEMA.CHARACTER_SETS` table or the `SHOW CHARACTER SET` statement. A partial listing follows. For more complete information, see [Section 10.10, “Supported Character Sets and Collations”](#).

```
mysql> SHOW CHARACTER SET;
```

Charset	Description	Default collation	Maxlen
big5	Big5 Traditional Chinese	big5_chinese_ci	2
...			
latin1	cp1252 West European	latin1_swedish_ci	1
latin2	ISO 8859-2 Central European	latin2_general_ci	1
...			
utf8	UTF-8 Unicode	utf8_general_ci	3
ucs2	UCS-2 Unicode	ucs2_general_ci	2
...			
utf8mb4	UTF-8 Unicode	utf8mb4_general_ci	4
...			
binary	Binary pseudo charset	binary	1
...			

By default, the `SHOW CHARACTER SET` statement displays all available character sets. It takes an optional `LIKE` or `WHERE` clause that indicates which character set names to match. For example:

```
mysql> SHOW CHARACTER SET LIKE 'latin%';
```

Charset	Description	Default collation	Maxlen
latin1	cp1252 West European	latin1_swedish_ci	1
latin2	ISO 8859-2 Central European	latin2_general_ci	1

Charset	Description	Default collation	Maxlen
latin1	cp1252 West European	latin1_swedish_ci	1
latin2	ISO 8859-2 Central European	latin2_general_ci	1
latin5	ISO 8859-9 Turkish	latin5_turkish_ci	1
latin7	ISO 8859-13 Baltic	latin7_general_ci	1

A given character set always has at least one collation, and most character sets have several. To list the display collations for a character set, use the `INFORMATION_SCHEMA.COLLATIONS` table or the `SHOW COLLATION` statement.

By default, the `SHOW COLLATION` statement displays all available collations. It takes an optional `LIKE` or `WHERE` clause that indicates which collation names to display. For example, to see the collations for the default character set, `latin1` (cp1252 West European), use this statement:

```
mysql> SHOW COLLATION WHERE Charset = 'latin1';
```

Collation	Charset	Id	Default	Compiled	Sortlen
latin1_german1_ci	latin1	5		Yes	1
latin1_swedish_ci	latin1	8	Yes	Yes	1
latin1_danish_ci	latin1	15		Yes	1
latin1_german2_ci	latin1	31		Yes	2
latin1_bin	latin1	47		Yes	1
latin1_general_ci	latin1	48		Yes	1
latin1_general_cs	latin1	49		Yes	1
latin1_spanish_ci	latin1	94		Yes	1

The `latin1` collations have the following meanings.

Collation	Meaning
<code>latin1_bin</code>	Binary according to <code>latin1</code> encoding
<code>latin1_danish_ci</code>	Danish/Norwegian
<code>latin1_general_ci</code>	Multilingual (Western European)
<code>latin1_general_cs</code>	Multilingual (ISO Western European), case-sensitive
<code>latin1_german1_ci</code>	German DIN-1 (dictionary order)
<code>latin1_german2_ci</code>	German DIN-2 (phone book order)
<code>latin1_spanish_ci</code>	Modern Spanish
<code>latin1_swedish_ci</code>	Swedish/Finnish

Collations have these general characteristics:

- Two different character sets cannot have the same collation.
- Each character set has a *default collation*. For example, the default collations for `latin1` and `utf8` are `latin1_swedish_ci` and `utf8_general_ci`, respectively. The `INFORMATION_SCHEMA.CHARACTER_SETS` table and the `SHOW CHARACTER SET` statement indicate the default collation for each character set. The `INFORMATION_SCHEMA.COLLATIONS` table and the `SHOW COLLATION` statement have a column that indicates for each collation whether it is the default for its character set (`Yes` if so, empty if not).
- Collation names start with the name of the character set with which they are associated, generally followed by one or more suffixes indicating other collation characteristics. For additional information about naming conventions, see [Section 10.3.1, “Collation Naming Conventions”](#).

When a character set has multiple collations, it might not be clear which collation is most suitable for a given application. To avoid choosing an inappropriate collation, perform some comparisons with representative data values to make sure that a given collation sorts values the way you expect.

## 10.2.1 Character Set Repertoire

The *repertoire* of a character set is the collection of characters in the set.

String expressions have a repertoire attribute, which can have two values:

- **ASCII**: The expression can contain only ASCII characters; that is, characters in the Unicode range `U+0000` to `U+007F`.
- **UNICODE**: The expression can contain characters in the Unicode range `U+0000` to `U+10FFFF`. This includes characters in the Basic Multilingual Plane (BMP) range (`U+0000` to `U+FFFF`) and supplementary characters outside the BMP range (`U+10000` to `U+10FFFF`).

The **ASCII** range is a subset of **UNICODE** range, so a string with **ASCII** repertoire can be converted safely without loss of information to the character set of any string with **UNICODE** repertoire. It can also be converted safely to any character set that is a superset of the `ascii` character set. (All MySQL character sets are supersets of `ascii` with the exception of `swe7`, which reuses some punctuation characters for Swedish accented characters.)

The use of repertoire enables character set conversion in expressions for many cases where MySQL would otherwise return an “illegal mix of collations” error when the rules for collation coercibility are insufficient to resolve ambiguities. (For information about coercibility, see [Section 10.8.4, “Collation Coercibility in Expressions”](#).)

The following discussion provides examples of expressions and their repertoires, and describes how the use of repertoire changes string expression evaluation:

- The repertoire for a string constant depends on string content and may differ from the repertoire of the string character set. Consider these statements:

```
SET NAMES utf8; SELECT 'abc';
SELECT _utf8'def';
SELECT N'MySQL';
```

Although the character set is `utf8` in each of the preceding cases, the strings do not actually contain any characters outside the ASCII range, so their repertoire is **ASCII** rather than **UNICODE**.

- A column having the `ascii` character set has **ASCII** repertoire because of its character set. In the following table, `c1` has **ASCII** repertoire:

```
CREATE TABLE t1 (c1 CHAR(1) CHARACTER SET ascii);
```

The following example illustrates how repertoire enables a result to be determined in a case where an error occurs without repertoire:

```
CREATE TABLE t1 (
  c1 CHAR(1) CHARACTER SET latin1,
  c2 CHAR(1) CHARACTER SET ascii
);
INSERT INTO t1 VALUES ('a','b');
SELECT CONCAT(c1,c2) FROM t1;
```

Without repertoire, this error occurs:

```
ERROR 1267 (HY000): Illegal mix of collations (latin1_swedish_ci,IMPLICIT)
and (ascii_general_ci,IMPLICIT) for operation 'concat'
```

Using repertoire, subset to superset ([ascii](#) to [latin1](#)) conversion can occur and a result is returned:

```
+-----+
| CONCAT(c1,c2) |
+-----+
| ab           |
+-----+
```

- Functions with one string argument inherit the repertoire of their argument. The result of `UPPER(_utf8'abc')` has [ASCII](#) repertoire because its argument has [ASCII](#) repertoire. (Despite the `_utf8` introducer, the string `'abc'` contains no characters outside the ASCII range.)
- For functions that return a string but do not have string arguments and use `character_set_connection` as the result character set, the result repertoire is [ASCII](#) if `character_set_connection` is `ascii`, and [UNICODE](#) otherwise:

```
FORMAT(numeric_column, 4);
```

Use of repertoire changes how MySQL evaluates the following example:

```
SET NAMES ascii;
CREATE TABLE t1 (a INT, b VARCHAR(10) CHARACTER SET latin1);
INSERT INTO t1 VALUES (1,'b');
SELECT CONCAT(FORMAT(a, 4), b) FROM t1;
```

Without repertoire, this error occurs:

```
ERROR 1267 (HY000): Illegal mix of collations (ascii_general_ci,COERCIBLE)
and (latin1_swedish_ci,IMPLICIT) for operation 'concat'
```

With repertoire, a result is returned:

```
+-----+
| CONCAT(FORMAT(a, 4), b) |
+-----+
| 1.0000b                |
+-----+
```

- Functions with two or more string arguments use the “widest” argument repertoire for the result repertoire, where [UNICODE](#) is wider than [ASCII](#). Consider the following `CONCAT()` calls:

```
CONCAT(_ucs2 X'0041', _ucs2 X'0042')
CONCAT(_ucs2 X'0041', _ucs2 X'00C2')
```

For the first call, the repertoire is [ASCII](#) because both arguments are within the ASCII range. For the second call, the repertoire is [UNICODE](#) because the second argument is outside the ASCII range.

- The repertoire for function return values is determined based on the repertoire of only those arguments that affect the result's character set and collation.

```
IF(column1 < column2, 'smaller', 'greater')
```

The result repertoire is [ASCII](#) because the two string arguments (the second argument and the third argument) both have [ASCII](#) repertoire. The first argument does not matter for the result repertoire, even if the expression uses string values.

## 10.2.2 UTF-8 for Metadata

*Metadata* is “the data about the data.” Anything that *describes* the database—as opposed to being the *contents* of the database—is metadata. Thus column names, database names, user names, version



names, and most of the string results from `SHOW` are metadata. This is also true of the contents of tables in `INFORMATION_SCHEMA` because those tables by definition contain information about database objects.

Representation of metadata must satisfy these requirements:

- All metadata must be in the same character set. Otherwise, neither the `SHOW` statements nor `SELECT` statements for tables in `INFORMATION_SCHEMA` would work properly because different rows in the same column of the results of these operations would be in different character sets.
- Metadata must include all characters in all languages. Otherwise, users would not be able to name columns and tables using their own languages.

To satisfy both requirements, MySQL stores metadata in a Unicode character set, namely UTF-8. This does not cause any disruption if you never use accented or non-Latin characters. But if you do, you should be aware that metadata is in UTF-8.

The metadata requirements mean that the return values of the `USER()`, `CURRENT_USER()`, `SESSION_USER()`, `SYSTEM_USER()`, `DATABASE()`, and `VERSION()` functions have the UTF-8 character set by default.

The server sets the `character_set_system` system variable to the name of the metadata character set:

```
mysql> SHOW VARIABLES LIKE 'character_set_system';
+-----+-----+
| Variable_name | Value |
+-----+-----+
| character_set_system | utf8 |
+-----+-----+
```

Storage of metadata using Unicode does *not* mean that the server returns headers of columns and the results of `DESCRIBE` functions in the `character_set_system` character set by default. When you use `SELECT column1 FROM t`, the name `column1` itself is returned from the server to the client in the character set determined by the value of the `character_set_results` system variable, which has a default value of `utf8`. If you want the server to pass metadata results back in a different character set, use the `SET NAMES` statement to force the server to perform character set conversion. `SET NAMES` sets the `character_set_results` and other related system variables. (See [Section 10.4, “Connection Character Sets and Collations”](#).) Alternatively, a client program can perform the conversion after receiving the result from the server. It is more efficient for the client to perform the conversion, but this option is not always available for all clients.

If `character_set_results` is set to `NULL`, no conversion is performed and the server returns metadata using its original character set (the set indicated by `character_set_system`).

Error messages returned from the server to the client are converted to the client character set automatically, as with metadata.

If you are using (for example) the `USER()` function for comparison or assignment within a single statement, don't worry. MySQL performs some automatic conversion for you.

```
SELECT * FROM t1 WHERE USER() = latin1_column;
```

This works because the contents of `latin1_column` are automatically converted to UTF-8 before the comparison.

```
INSERT INTO t1 (latin1_column) SELECT USER();
```

This works because the contents of `USER()` are automatically converted to `latin1` before the assignment.

Although automatic conversion is not in the SQL standard, the standard does say that every character set is (in terms of supported characters) a “subset” of Unicode. Because it is a well-known principle that “what applies to a superset can apply to a subset,” we believe that a collation for Unicode can apply for comparisons with non-Unicode strings. For more information about coercion of strings, see [Section 10.8.4, “Collation Coercibility in Expressions”](#).

## 10.3 Specifying Character Sets and Collations

There are default settings for character sets and collations at four levels: server, database, table, and column. The description in the following sections may appear complex, but it has been found in practice that multiple-level defaulting leads to natural and obvious results.

`CHARACTER SET` is used in clauses that specify a character set. `CHARSET` can be used as a synonym for `CHARACTER SET`.

Character set issues affect not only data storage, but also communication between client programs and the MySQL server. If you want the client program to communicate with the server using a character set different from the default, you'll need to indicate which one. For example, to use the `utf8` Unicode character set, issue this statement after connecting to the server:

```
SET NAMES 'utf8';
```

For more information about character set-related issues in client/server communication, see [Section 10.4, “Connection Character Sets and Collations”](#).

### 10.3.1 Collation Naming Conventions

MySQL collation names follow these conventions:

- A collation name starts with the name of the character set with which it is associated, generally followed by one or more suffixes indicating other collation characteristics. For example, `utf8_general_ci` and `latin1_swedish_ci` are collations for the `utf8` and `latin1` character sets, respectively. The `binary` character set has a single collation, also named `binary`, with no suffixes.
- A language-specific collation includes a language name. For example, `utf8_turkish_ci` and `utf8_hungarian_ci` sort characters for the `utf8` character set using the rules of Turkish and Hungarian, respectively.
- Collation suffixes indicate whether a collation is case-sensitive, accent-sensitive, or kana-sensitive (or some combination thereof), or binary. The following table shows the suffixes used to indicate these characteristics.

**Table 10.1 Collation Suffix Meanings**

Suffix	Meaning
<code>_ai</code>	Accent-insensitive
<code>_as</code>	Accent-sensitive
<code>_ci</code>	Case-insensitive
<code>_cs</code>	Case-sensitive
<code>_bin</code>	Binary

For nonbinary collation names that do not specify accent sensitivity, it is determined by case sensitivity. If a collation name does not contain `_ai` or `_as`, `_ci` in the name implies `_ai` and `_cs` in the name

implies `_as`. For example, `latin1_general_ci` is explicitly case-insensitive and implicitly accent-insensitive, and `latin1_general_cs` is explicitly case-sensitive and implicitly accent-sensitive.

For the `binary` collation of the `binary` character set, comparisons are based on numeric byte values. For the `_bin` collation of a nonbinary character set, comparisons are based on numeric character code values, which differ from byte values for multibyte characters. For information about the differences between the `binary` collation of the `binary` character set and the `_bin` collations of nonbinary character sets, see [Section 10.8.5, “The binary Collation Compared to `\_bin` Collations”](#).

- Collation names for Unicode character sets may include a version number to indicate the version of the Unicode Collation Algorithm (UCA) on which the collation is based. UCA-based collations without a version number in the name use the version-4.0.0 UCA weight keys. For example:
  - `utf8_unicode_520_ci` is based on UCA 5.2.0 weight keys (<http://www.unicode.org/Public/UCD/5.2.0/allkeys.txt>).
  - `utf8_unicode_ci` (with no version named) is based on UCA 4.0.0 weight keys (<http://www.unicode.org/Public/UCD/4.0.0/allkeys-4.0.0.txt>).
- For Unicode character sets, the `xxx_general_mysql500_ci` collations preserve the pre-5.1.24 ordering of the original `xxx_general_ci` collations and permit upgrades for tables created before MySQL 5.1.24 (Bug #27877).

## 10.3.2 Server Character Set and Collation

MySQL Server has a server character set and a server collation. By default, these are `latin1` and `latin1_swedish_ci`, but they can be set explicitly at server startup on the command line or in an option file and changed at runtime.

Initially, the server character set and collation depend on the options that you use when you start `mysqld`. You can use `--character-set-server` for the character set. Along with it, you can add `--collation-server` for the collation. If you don't specify a character set, that is the same as saying `--character-set-server=latin1`. If you specify only a character set (for example, `latin1`) but not a collation, that is the same as saying `--character-set-server=latin1 --collation-server=latin1_swedish_ci` because `latin1_swedish_ci` is the default collation for `latin1`. Therefore, the following three commands all have the same effect:

```
mysqld
mysqld --character-set-server=latin1
mysqld --character-set-server=latin1 \
  --collation-server=latin1_swedish_ci
```

One way to change the settings is by recompiling. To change the default server character set and collation when building from sources, use the `DEFAULT_CHARSET` and `DEFAULT_COLLATION` options for `CMake`. For example:

```
cmake . -DDEFAULT_CHARSET=latin1
```

Or:

```
cmake . -DDEFAULT_CHARSET=latin1 \
  -DDEFAULT_COLLATION=latin1_german1_ci
```

Both `mysqld` and `CMake` verify that the character set/collation combination is valid. If not, each program displays an error message and terminates.

The server character set and collation are used as default values if the database character set and collation are not specified in `CREATE DATABASE` statements. They have no other purpose.

The current server character set and collation can be determined from the values of the `character_set_server` and `collation_server` system variables. These variables can be changed at runtime.

### 10.3.3 Database Character Set and Collation

Every database has a database character set and a database collation. The `CREATE DATABASE` and `ALTER DATABASE` statements have optional clauses for specifying the database character set and collation:

```
CREATE DATABASE db_name
  [[DEFAULT] CHARACTER SET charset_name]
  [[DEFAULT] COLLATE collation_name]

ALTER DATABASE db_name
  [[DEFAULT] CHARACTER SET charset_name]
  [[DEFAULT] COLLATE collation_name]
```

The keyword `SCHEMA` can be used instead of `DATABASE`.

All database options are stored in a text file named `db.opt` that can be found in the database directory.

The `CHARACTER SET` and `COLLATE` clauses make it possible to create databases with different character sets and collations on the same MySQL server.

Example:

```
CREATE DATABASE db_name CHARACTER SET latin1 COLLATE latin1_swedish_ci;
```

MySQL chooses the database character set and database collation in the following manner:

- If both `CHARACTER SET charset_name` and `COLLATE collation_name` are specified, character set `charset_name` and collation `collation_name` are used.
- If `CHARACTER SET charset_name` is specified without `COLLATE`, character set `charset_name` and its default collation are used. To see the default collation for each character set, use the `SHOW CHARACTER SET` statement or query the `INFORMATION_SCHEMA.CHARACTER_SETS` table.
- If `COLLATE collation_name` is specified without `CHARACTER SET`, the character set associated with `collation_name` and collation `collation_name` are used.
- Otherwise (neither `CHARACTER SET` nor `COLLATE` is specified), the server character set and server collation are used.

The character set and collation for the default database can be determined from the values of the `character_set_database` and `collation_database` system variables. The server sets these variables whenever the default database changes. If there is no default database, the variables have the same value as the corresponding server-level system variables, `character_set_server` and `collation_server`.

To see the default character set and collation for a given database, use these statements:

```
USE db_name;
SELECT @@character_set_database, @@collation_database;
```

Alternatively, to display the values without changing the default database:

```
SELECT DEFAULT_CHARACTER_SET_NAME, DEFAULT_COLLATION_NAME
FROM INFORMATION_SCHEMA.SCHEMATA WHERE SCHEMA_NAME = 'db_name';
```

The database character set and collation affect these aspects of server operation:

- For `CREATE TABLE` statements, the database character set and collation are used as default values for table definitions if the table character set and collation are not specified. To override this, provide explicit `CHARACTER SET` and `COLLATE` table options.
- For `LOAD DATA` statements that include no `CHARACTER SET` clause, the server uses the character set indicated by the `character_set_database` system variable to interpret the information in the file. To override this, provide an explicit `CHARACTER SET` clause.
- For stored routines (procedures and functions), the database character set and collation in effect at routine creation time are used as the character set and collation of character data parameters for which the declaration includes no `CHARACTER SET` or a `COLLATE` attribute. To override this, provide `CHARACTER SET` and `COLLATE` explicitly.

### 10.3.4 Table Character Set and Collation

Every table has a table character set and a table collation. The `CREATE TABLE` and `ALTER TABLE` statements have optional clauses for specifying the table character set and collation:

```
CREATE TABLE tbl_name (column_list)
  [[DEFAULT] CHARACTER SET charset_name]
  [COLLATE collation_name]]

ALTER TABLE tbl_name
  [[DEFAULT] CHARACTER SET charset_name]
  [COLLATE collation_name]
```

Example:

```
CREATE TABLE t1 ( ... )
CHARACTER SET latin1 COLLATE latin1_danish_ci;
```

MySQL chooses the table character set and collation in the following manner:

- If both `CHARACTER SET charset_name` and `COLLATE collation_name` are specified, character set `charset_name` and collation `collation_name` are used.
- If `CHARACTER SET charset_name` is specified without `COLLATE`, character set `charset_name` and its default collation are used. To see the default collation for each character set, use the `SHOW CHARACTER SET` statement or query the `INFORMATION_SCHEMA.CHARACTER_SETS` table.
- If `COLLATE collation_name` is specified without `CHARACTER SET`, the character set associated with `collation_name` and collation `collation_name` are used.
- Otherwise (neither `CHARACTER SET` nor `COLLATE` is specified), the database character set and collation are used.

The table character set and collation are used as default values for column definitions if the column character set and collation are not specified in individual column definitions. The table character set and collation are MySQL extensions; there are no such things in standard SQL.

### 10.3.5 Column Character Set and Collation

Every “character” column (that is, a column of type `CHAR`, `VARCHAR`, a `TEXT` type, or any synonym) has a column character set and a column collation. Column definition syntax for `CREATE TABLE` and `ALTER TABLE` has optional clauses for specifying the column character set and collation:

```
col_name {CHAR | VARCHAR | TEXT} (col_length)
```

```
[CHARACTER SET charset_name]  
[COLLATE collation_name]
```

These clauses can also be used for [ENUM](#) and [SET](#) columns:

```
col_name {ENUM | SET} (val_list)  
[CHARACTER SET charset_name]  
[COLLATE collation_name]
```

Examples:

```
CREATE TABLE t1  
(  
  col1 VARCHAR(5)  
    CHARACTER SET latin1  
    COLLATE latin1_german1_ci  
);  
  
ALTER TABLE t1 MODIFY  
  col1 VARCHAR(5)  
    CHARACTER SET latin1  
    COLLATE latin1_swedish_ci;
```

MySQL chooses the column character set and collation in the following manner:

- If both [CHARACTER SET \*charset\\_name\*](#) and [COLLATE \*collation\\_name\*](#) are specified, character set *charset\_name* and collation *collation\_name* are used.

```
CREATE TABLE t1  
(  
  col1 CHAR(10) CHARACTER SET utf8 COLLATE utf8_unicode_ci  
) CHARACTER SET latin1 COLLATE latin1_bin;
```

The character set and collation are specified for the column, so they are used. The column has character set [utf8](#) and collation [utf8\\_unicode\\_ci](#).

- If [CHARACTER SET \*charset\\_name\*](#) is specified without [COLLATE](#), character set *charset\_name* and its default collation are used.

```
CREATE TABLE t1  
(  
  col1 CHAR(10) CHARACTER SET utf8  
) CHARACTER SET latin1 COLLATE latin1_bin;
```

The character set is specified for the column, but the collation is not. The column has character set [utf8](#) and the default collation for [utf8](#), which is [utf8\\_general\\_ci](#). To see the default collation for each character set, use the [SHOW CHARACTER SET](#) statement or query the [INFORMATION\\_SCHEMA.CHARACTER\\_SETS](#) table.

- If [COLLATE \*collation\\_name\*](#) is specified without [CHARACTER SET](#), the character set associated with *collation\_name* and collation *collation\_name* are used.

```
CREATE TABLE t1  
(  
  col1 CHAR(10) COLLATE utf8_polish_ci  
) CHARACTER SET latin1 COLLATE latin1_bin;
```

The collation is specified for the column, but the character set is not. The column has collation [utf8\\_polish\\_ci](#) and the character set is the one associated with the collation, which is [utf8](#).

- Otherwise (neither [CHARACTER SET](#) nor [COLLATE](#) is specified), the table character set and collation are used.

```
CREATE TABLE t1
(
  coll CHAR(10)
) CHARACTER SET latin1 COLLATE latin1_bin;
```

Neither the character set nor collation is specified for the column, so the table defaults are used. The column has character set `latin1` and collation `latin1_bin`.

The `CHARACTER SET` and `COLLATE` clauses are standard SQL.

If you use `ALTER TABLE` to convert a column from one character set to another, MySQL attempts to map the data values, but if the character sets are incompatible, there may be data loss.

### 10.3.6 Character String Literal Character Set and Collation

Every character string literal has a character set and a collation.

For the simple statement `SELECT 'string'`, the string has the connection default character set and collation defined by the `character_set_connection` and `collation_connection` system variables.

A character string literal may have an optional character set introducer and `COLLATE` clause, to designate it as a string that uses a particular character set and collation:

```
[_charset_name]'string' [COLLATE collation_name]
```

The `_charset_name` expression is formally called an *introducer*. It tells the parser, “the string that follows uses character set `charset_name`.” An introducer does not change the string to the introducer character set like `CONVERT()` would do. It does not change the string value, although padding may occur. The introducer is just a signal. See [Section 10.3.8, “Character Set Introducers”](#).

Examples:

```
SELECT 'abc';
SELECT _latin1'abc';
SELECT _binary'abc';
SELECT _utf8'abc' COLLATE utf8_danish_ci;
```

Character set introducers and the `COLLATE` clause are implemented according to standard SQL specifications.

MySQL determines the character set and collation of a character string literal in the following manner:

- If both `_charset_name` and `COLLATE collation_name` are specified, character set `charset_name` and collation `collation_name` are used. `collation_name` must be a permitted collation for `charset_name`.
- If `_charset_name` is specified but `COLLATE` is not specified, character set `charset_name` and its default collation are used. To see the default collation for each character set, use the `SHOW CHARACTER SET` statement or query the `INFORMATION_SCHEMA.CHARACTER_SETS` table.
- If `_charset_name` is not specified but `COLLATE collation_name` is specified, the connection default character set given by the `character_set_connection` system variable and collation `collation_name` are used. `collation_name` must be a permitted collation for the connection default character set.
- Otherwise (neither `_charset_name` nor `COLLATE collation_name` is specified), the connection default character set and collation given by the `character_set_connection` and `collation_connection` system variables are used.

Examples:

- A nonbinary string with `latin1` character set and `latin1_german1_ci` collation:

```
SELECT _latin1'Müller' COLLATE latin1_german1_ci;
```

- A nonbinary string with `utf8` character set and its default collation (that is, `utf8_general_ci`):

```
SELECT _utf8'Müller';
```

- A binary string with `binary` character set and its default collation (that is, `binary`):

```
SELECT _binary'Müller';
```

- A nonbinary string with the connection default character set and `utf8_general_ci` collation (fails if the connection character set is not `utf8`):

```
SELECT 'Müller' COLLATE utf8_general_ci;
```

- A string with the connection default character set and collation:

```
SELECT 'Müller';
```

An introducer indicates the character set for the following string, but does not change how the parser performs escape processing within the string. Escapes are always interpreted by the parser according to the character set given by `character_set_connection`.

The following examples show that escape processing occurs using `character_set_connection` even in the presence of an introducer. The examples use `SET NAMES` (which changes `character_set_connection`, as discussed in [Section 10.4, “Connection Character Sets and Collations”](#)), and display the resulting strings using the `HEX()` function so that the exact string contents can be seen.

Example 1:

```
mysql> SET NAMES latin1;
mysql> SELECT HEX('à\n'), HEX(_sjis'à\n');
+-----+-----+
| HEX('à\n') | HEX(_sjis'à\n') |
+-----+-----+
| E00A      | E00A              |
+-----+-----+
```

Here, `à` (hexadecimal value `E0`) is followed by `\n`, the escape sequence for newline. The escape sequence is interpreted using the `character_set_connection` value of `latin1` to produce a literal newline (hexadecimal value `0A`). This happens even for the second string. That is, the `_sjis` introducer does not affect the parser's escape processing.

Example 2:

```
mysql> SET NAMES sjis;
mysql> SELECT HEX('à\n'), HEX(_latin1'à\n');
+-----+-----+
| HEX('à\n') | HEX(_latin1'à\n') |
+-----+-----+
| E05C6E     | E05C6E             |
+-----+-----+
```

Here, `character_set_connection` is `sjis`, a character set in which the sequence of `à` followed by `\` (hexadecimal values `05` and `5C`) is a valid multibyte character. Hence, the first two bytes of the string are interpreted as a single `sjis` character, and the `\` is not interpreted as an escape character. The



following `n` (hexadecimal value `6E`) is not interpreted as part of an escape sequence. This is true even for the second string; the `_latin1` introducer does not affect escape processing.

### 10.3.7 The National Character Set

Standard SQL defines `NCHAR` or `NATIONAL CHAR` as a way to indicate that a `CHAR` column should use some predefined character set. MySQL uses `utf8` as this predefined character set. For example, these data type declarations are equivalent:

```
CHAR(10) CHARACTER SET utf8
NATIONAL CHARACTER(10)
NCHAR(10)
```

As are these:

```
VARCHAR(10) CHARACTER SET utf8
NATIONAL VARCHAR(10)
NVARCHAR(10)
NCHAR VARCHAR(10)
NATIONAL CHARACTER VARYING(10)
NATIONAL CHAR VARYING(10)
```

You can use `N'literal'` (or `n'literal'`) to create a string in the national character set. These statements are equivalent:

```
SELECT N'some text';
SELECT n'some text';
SELECT _utf8'some text';
```

### 10.3.8 Character Set Introducers

A character string literal, hexadecimal literal, or bit-value literal may have an optional character set introducer and `COLLATE` clause, to designate it as a string that uses a particular character set and collation:

```
[_charset_name] literal [COLLATE collation_name]
```

The `_charset_name` expression is formally called an *introducer*. It tells the parser, “the string that follows uses character set `charset_name`.” An introducer does not change the string to the introducer character set like `CONVERT()` would do. It does not change the string value, although padding may occur. The introducer is just a signal.

For character string literals, space between the introducer and the string is permitted but optional.

For character set literals, an introducer indicates the character set for the following string, but does not change how the parser performs escape processing within the string. Escapes are always interpreted by the parser according to the character set given by `character_set_connection`. For additional discussion and examples, see [Section 10.3.6, “Character String Literal Character Set and Collation”](#).

Examples:

```
SELECT 'abc';
SELECT _latin1'abc';
SELECT _binary'abc';
SELECT _utf8'abc' COLLATE utf8_danish_ci;

SELECT _latin1 X'4D7953514C';
SELECT _utf8 0x4D7953514C COLLATE utf8_danish_ci;
```

```
SELECT _latin1 b'1000001';
SELECT _utf8 0b1000001 COLLATE utf8_danish_ci;
```

Character set introducers and the `COLLATE` clause are implemented according to standard SQL specifications.

Character string literals can be designated as binary strings by using the `_binary` introducer. Hexadecimal literals and bit-value literals are binary strings by default, so `_binary` is permitted, but unnecessary.

MySQL determines the character set and collation of a character string literal, hexadecimal literal, or bit-value literal in the following manner:

- If both `_charset_name` and `COLLATE collation_name` are specified, character set `charset_name` and collation `collation_name` are used. `collation_name` must be a permitted collation for `charset_name`.
- If `_charset_name` is specified but `COLLATE` is not specified, character set `charset_name` and its default collation are used. To see the default collation for each character set, use the `SHOW CHARACTER SET` statement or query the `INFORMATION_SCHEMA.CHARACTER_SETS` table.
- If `_charset_name` is not specified but `COLLATE collation_name` is specified:
  - For a character string literal, the connection default character set given by the `character_set_connection` system variable and collation `collation_name` are used. `collation_name` must be a permitted collation for the connection default character set.
  - For a hexadecimal literal or bit-value literal, the only permitted collation is `binary` because these types of literals are binary strings by default.
- Otherwise (neither `_charset_name` nor `COLLATE collation_name` is specified):
  - For a character string literal, the connection default character set and collation given by the `character_set_connection` and `collation_connection` system variables are used.
  - For a hexadecimal literal or bit-value literal, the character set and collation are `binary`.

Examples:

- Nonbinary strings with `latin1` character set and `latin1_german1_ci` collation:

```
SELECT _latin1'Müller' COLLATE latin1_german1_ci;
SELECT _latin1 X'0A0D' COLLATE latin1_german1_ci;
SELECT _latin1 b'0110' COLLATE latin1_german1_ci;
```

- Nonbinary strings with `utf8` character set and its default collation (that is, `utf8_general_ci`):

```
SELECT _utf8'Müller';
SELECT _utf8 X'0A0D';
SELECT _utf8 b'0110';
```

- Binary strings with `binary` character set and its default collation (that is, `binary`):

```
SELECT _binary'Müller';
SELECT X'0A0D';
SELECT b'0110';
```

The hexadecimal literal and bit-value literal need no introducer because they are binary strings by default.

- A nonbinary string with the connection default character set and `utf8_general_ci` collation (fails if the connection character set is not `utf8`):

```
SELECT 'Müller' COLLATE utf8_general_ci;
```

This construction (`COLLATE` only) does not work for hexadecimal literals or bit literals because their character set is `binary` no matter the connection character set, and `binary` is not compatible with the `utf8_general_ci` collation. The only permitted `COLLATE` clause in the absence of an introducer is `COLLATE binary`.

- A string with the connection default character set and collation:

```
SELECT 'Müller';
```

### 10.3.9 Examples of Character Set and Collation Assignment

The following examples show how MySQL determines default character set and collation values.

#### Example 1: Table and Column Definition

```
CREATE TABLE t1
(
  c1 CHAR(10) CHARACTER SET latin1 COLLATE latin1_german1_ci
) DEFAULT CHARACTER SET latin2 COLLATE latin2_bin;
```

Here we have a column with a `latin1` character set and a `latin1_german1_ci` collation. The definition is explicit, so that is straightforward. Notice that there is no problem with storing a `latin1` column in a `latin2` table.

#### Example 2: Table and Column Definition

```
CREATE TABLE t1
(
  c1 CHAR(10) CHARACTER SET latin1
) DEFAULT CHARACTER SET latin1 COLLATE latin1_danish_ci;
```

This time we have a column with a `latin1` character set and a default collation. Although it might seem natural, the default collation is not taken from the table level. Instead, because the default collation for `latin1` is always `latin1_swedish_ci`, column `c1` has a collation of `latin1_swedish_ci` (not `latin1_danish_ci`).

#### Example 3: Table and Column Definition

```
CREATE TABLE t1
(
  c1 CHAR(10)
) DEFAULT CHARACTER SET latin1 COLLATE latin1_danish_ci;
```

We have a column with a default character set and a default collation. In this circumstance, MySQL checks the table level to determine the column character set and collation. Consequently, the character set for column `c1` is `latin1` and its collation is `latin1_danish_ci`.

#### Example 4: Database, Table, and Column Definition

```
CREATE DATABASE d1
  DEFAULT CHARACTER SET latin2 COLLATE latin2_czech_cs;
USE d1;
CREATE TABLE t1
(
```

```
c1 CHAR(10)
);
```

We create a column without specifying its character set and collation. We're also not specifying a character set and a collation at the table level. In this circumstance, MySQL checks the database level to determine the table settings, which thereafter become the column settings.) Consequently, the character set for column `c1` is `latin2` and its collation is `latin2_czech_cs`.

### 10.3.10 Compatibility with Other DBMSs

For MaxDB compatibility these two statements are the same:

```
CREATE TABLE t1 (f1 CHAR(N) UNICODE);
CREATE TABLE t1 (f1 CHAR(N) CHARACTER SET ucs2);
```

## 10.4 Connection Character Sets and Collations

A “connection” is what a client program makes when it connects to the server, to begin a session within which it interacts with the server. The client sends SQL statements, such as queries, over the session connection. The server sends responses, such as result sets or error messages, over the connection back to the client.

- [Connection Character Set and Collation System Variables](#)
- [Impermissible Client Character Sets](#)
- [Client Program Connection Character Set Configuration](#)
- [SQL Statements for Connection Character Set Configuration](#)
- [Connection Character Set Error Handling](#)

### Connection Character Set and Collation System Variables

Several character set and collation system variables relate to a client's interaction with the server. Some of these have been mentioned in earlier sections:

- The `character_set_server` and `collation_server` system variables indicate the server character set and collation. See [Section 10.3.2, “Server Character Set and Collation”](#).
- The `character_set_database` and `collation_database` system variables indicate the character set and collation of the default database. See [Section 10.3.3, “Database Character Set and Collation”](#).

Additional character set and collation system variables are involved in handling traffic for the connection between a client and the server. Every client has session-specific connection-related character set and collation system variables. These session system variable values are initialized at connect time, but can be changed within the session.

Several questions about character set and collation handling for client connections can be answered in terms of system variables:

- What character set are statements in when they leave the client?

The server takes the `character_set_client` system variable to be the character set in which statements are sent by the client.

**Note**

Some character sets cannot be used as the client character set. See [Impermissible Client Character Sets](#).

- What character set should the server translate statements to after receiving them?

To determine this, the server uses the `character_set_connection` and `collation_connection` system variables:

- The server converts statements sent by the client from `character_set_client` to `character_set_connection`. Exception: For string literals that have an introducer such as `_utf8mb4` or `_latin2`, the introducer determines the character set. See [Section 10.3.8, “Character Set Introducers”](#).
- `collation_connection` is important for comparisons of literal strings. For comparisons of strings with column values, `collation_connection` does not matter because columns have their own collation, which has a higher collation precedence (see [Section 10.8.4, “Collation Coercibility in Expressions”](#)).

- What character set should the server translate query results to before shipping them back to the client?

The `character_set_results` system variable indicates the character set in which the server returns query results to the client. This includes result data such as column values, result metadata such as column names, and error messages.

To tell the server to perform no conversion of result sets or error messages, set `character_set_results` to `NULL` or `binary`:

```
SET character_set_results = NULL;
SET character_set_results = binary;
```

For more information about character sets and error messages, see [Section 10.6, “Error Message Character Set”](#).

To see the values of the character set and collation system variables that apply to the current session, use this statement:

```
SELECT * FROM performance_schema.session_variables
WHERE VARIABLE_NAME IN (
'character_set_client', 'character_set_connection',
'character_set_results', 'collation_connection'
) ORDER BY VARIABLE_NAME;
```

The following simpler statements also display the connection variables, but include other related variables as well. They can be useful to see *all* character set and collation system variables:

```
SHOW SESSION VARIABLES LIKE 'character\_set\_%';
SHOW SESSION VARIABLES LIKE 'collation\_%';
```

Clients can fine-tune the settings for these variables, or depend on the defaults (in which case, you can skip the rest of this section). If you do not use the defaults, you must change the character settings *for each connection to the server*.

## Impermissible Client Character Sets

The `character_set_client` system variable cannot be set to certain character sets:

```
ucs2
utf16
utf16le
utf32
```

Attempting to use any of those character sets as the client character set produces an error:

```
mysql> SET character_set_client = 'ucs2';
ERROR 1231 (42000): Variable 'character_set_client'
can't be set to the value of 'ucs2'
```

The same error occurs if any of those character sets are used in the following contexts, all of which result in an attempt to set `character_set_client` to the named character set:

- The `--default-character-set=charset_name` command option used by MySQL client programs such as `mysql` and `mysqladmin`.
- The `SET NAMES 'charset_name'` statement.
- The `SET CHARACTER SET 'charset_name'` statement.

## Client Program Connection Character Set Configuration

When a client connects to the server, it indicates which character set it wants to use for communication with the server. (Actually, the client indicates the default collation for that character set, from which the server can determine the character set.) The server uses this information to set the `character_set_client`, `character_set_results`, `character_set_connection` system variables to the character set, and `collation_connection` to the character set default collation. In effect, the server performs the equivalent of a `SET NAMES` operation.

If the server does not support the requested character set or collation, it falls back to using the server character set and collation to configure the connection. For additional detail about this fallback behavior, see [Connection Character Set Error Handling](#).

The `mysql`, `mysqladmin`, `mysqlcheck`, `mysqlimport`, and `mysqlshow` client programs determine the default character set to use as follows:

- In the absence of other information, each client uses the compiled-in default character set, usually `latin1`.
- Each client can autodetect which character set to use based on the operating system setting, such as the value of the `LANG` or `LC_ALL` locale environment variable on Unix systems or the code page setting on Windows systems. For systems on which the locale is available from the OS, the client uses it to set the default character set rather than using the compiled-in default. For example, setting `LANG` to `ru_RU.KOI8-R` causes the `koi8r` character set to be used. Thus, users can configure the locale in their environment for use by MySQL clients.

The OS character set is mapped to the closest MySQL character set if there is no exact match. If the client does not support the matching character set, it uses the compiled-in default. For example, `ucs2` is not supported as a connection character set, so it maps to the compiled-in default.

C applications can use character set autodetection based on the OS setting by invoking `mysql_options()` as follows before connecting to the server:

```
mysql_options(mysql,
              MYSQL_SET_CHARSET_NAME,
              MYSQL_AUTODETECT_CHARSET_NAME);
```

- Each client supports a `--default-character-set` option, which enables users to specify the character set explicitly to override whatever default the client otherwise determines.

**Note**

Some character sets cannot be used as the client character set. Attempting to use them with `--default-character-set` produces an error. See [Impermissible Client Character Sets](#).

With the `mysql` client, to use a character set different from the default, you could explicitly execute a `SET NAMES` statement every time you connect to the server (see [Client Program Connection Character Set Configuration](#)). To accomplish the same result more easily, specify the character set in your option file. For example, the following option file setting changes the three connection-related character set system variables set to `koi8r` each time you invoke `mysql`:

```
[mysql]
default-character-set=koi8r
```

If you are using the `mysql` client with auto-reconnect enabled (which is not recommended), it is preferable to use the `charset` command rather than `SET NAMES`. For example:

```
mysql> charset koi8r
Charset changed
```

The `charset` command issues a `SET NAMES` statement, and also changes the default character set that `mysql` uses when it reconnects after the connection has dropped.

When configuring client programs, you must also consider the environment within which they execute. See [Section 10.5, “Configuring Application Character Set and Collation”](#).

## SQL Statements for Connection Character Set Configuration

After a connection has been established, clients can change the character set and collation system variables for the current session. These variables can be changed individually using `SET` statements, but two more convenient statements affect the connection-related character set system variables as a group:

- `SET NAMES 'charset_name' [COLLATE 'collation_name']`

`SET NAMES` indicates what character set the client uses to send SQL statements to the server. Thus, `SET NAMES 'cp1251'` tells the server, “future incoming messages from this client are in character set `cp1251`.” It also specifies the character set that the server should use for sending results back to the client. (For example, it indicates what character set to use for column values if you use a `SELECT` statement that produces a result set.)

A `SET NAMES 'charset_name'` statement is equivalent to these three statements:

```
SET character_set_client = charset_name;
SET character_set_results = charset_name;
SET character_set_connection = charset_name;
```

Setting `character_set_connection` to `charset_name` also implicitly sets `collation_connection` to the default collation for `charset_name`. It is unnecessary to set that collation explicitly. To specify a particular collation to use for `collation_connection`, add a `COLLATE` clause:

```
SET NAMES 'charset_name' COLLATE 'collation_name'
```

- `SET CHARACTER SET 'charset_name'`

`SET CHARACTER SET` is similar to `SET NAMES` but sets `character_set_connection` and `collation_connection` to `character_set_database` and `collation_database` (which, as mentioned previously, indicate the character set and collation of the default database).

A `SET CHARACTER SET charset_name` statement is equivalent to these three statements:

```
SET character_set_client = charset_name;
SET character_set_results = charset_name;
SET collation_connection = @@collation_database;
```

Setting `collation_connection` also implicitly sets `character_set_connection` to the character set associated with the collation (equivalent to executing `SET character_set_connection = @@character_set_database`). It is unnecessary to set `character_set_connection` explicitly.



### Note

Some character sets cannot be used as the client character set. Attempting to use them with `SET NAMES` or `SET CHARACTER SET` produces an error. See [Impermissible Client Character Sets](#).

Example: Suppose that `column1` is defined as `CHAR(5) CHARACTER SET latin2`. If you do not say `SET NAMES` or `SET CHARACTER SET`, then for `SELECT column1 FROM t`, the server sends back all the values for `column1` using the character set that the client specified when it connected. On the other hand, if you say `SET NAMES 'latin1'` or `SET CHARACTER SET 'latin1'` before issuing the `SELECT` statement, the server converts the `latin2` values to `latin1` just before sending results back. Conversion may be lossy for characters that are not in both character sets.

## Connection Character Set Error Handling

Attempts to use an inappropriate connection character set or collation can produce an error, or cause the server to fall back to its default character set and collation for a given connection. This section describes problems that can occur when configuring the connection character set. These problems can occur when establishing a connection or when changing the character set within an established connection.

- [Connect-Time Error Handling](#)
- [Runtime Error Handling](#)

### Connect-Time Error Handling

Some character sets cannot be used as the client character set; see [Impermissible Client Character Sets](#). If you specify a character set that is valid but not permitted as a client character set, the server returns an error:

```
$> mysql --default-character-set=ucs2
ERROR 1231 (42000): Variable 'character_set_client' can't be set to
the value of 'ucs2'
```

If you specify a character set that the client does not recognize, it produces an error:

```
$> mysql --default-character-set=bogus
mysql: Character set 'bogus' is not a compiled character set and is
not specified in the '/usr/local/mysql/share/charsets/Index.xml' file
ERROR 2019 (HY000): Can't initialize character set bogus
(path: /usr/local/mysql/share/charsets/)
```

If you specify a character set that the client recognizes but the server does not, the server falls back to its default character set and collation. Suppose that the server is configured to use `latin1` and `latin1_swedish_ci` as its defaults, and that it does not recognize `gb18030` as a valid character set.



A client that specifies `--default-character-set=gb18030` is able to connect to the server, but the resulting character set is not what the client wants:

```
mysql> SHOW SESSION VARIABLES LIKE 'character\_set\__%';
+-----+-----+
| Variable_name      | Value |
+-----+-----+
| character_set_client | latin1 |
| character_set_connection | latin1 |
| ...                |      |
| character_set_results  | latin1 |
| ...                |      |
+-----+-----+
mysql> SHOW SESSION VARIABLES LIKE 'collation\_connection';
+-----+-----+
| Variable_name      | Value |
+-----+-----+
| collation_connection | latin1_swedish_ci |
+-----+-----+
```

You can see that the connection system variables have been set to reflect a character set and collation of `latin1` and `latin1_swedish_ci`. This occurs because the server cannot satisfy the client character set request and falls back to its defaults.

In this case, the client cannot use the character set that it wants because the server does not support it. The client must either be willing to use a different character set, or connect to a different server that supports the desired character set.

The same problem occurs in a more subtle context: When the client tells the server to use a character set that the server recognizes, but the default collation for that character set on the client side is not known on the server side. This occurs, for example, when a MySQL 8.0 client wants to connect to a MySQL 5.7 server using `utf8mb4` as the client character set. A client that specifies `--default-character-set=utf8mb4` is able to connect to the server. However, as in the previous example, the server falls back to its default character set and collation, not what the client requested:

```
mysql> SHOW SESSION VARIABLES LIKE 'character\_set\__%';
+-----+-----+
| Variable_name      | Value |
+-----+-----+
| character_set_client | latin1 |
| character_set_connection | latin1 |
| ...                |      |
| character_set_results  | latin1 |
| ...                |      |
+-----+-----+
mysql> SHOW SESSION VARIABLES LIKE 'collation\_connection';
+-----+-----+
| Variable_name      | Value |
+-----+-----+
| collation_connection | latin1_swedish_ci |
+-----+-----+
```

Why does this occur? After all, `utf8mb4` is known to the 8.0 client and the 5.7 server, so both of them recognize it. To understand this behavior, it is necessary to understand that when the client tells the server which character set it wants to use, it really tells the server the default collation for that character set. Therefore, the aforementioned behavior occurs due to a combination of factors:

- The default collation for `utf8mb4` differs between MySQL 5.7 and 8.0 (`utf8mb4_general_ci` for 5.7, `utf8mb4_0900_ai_ci` for 8.0).
- When the 8.0 client requests a character set of `utf8mb4`, what it sends to the server is the default 8.0 `utf8mb4` collation; that is, the `utf8mb4_0900_ai_ci`.

- `utf8mb4_0900_ai_ci` is implemented only as of MySQL 8.0, so the 5.7 server does not recognize it.
- Because the 5.7 server does not recognize `utf8mb4_0900_ai_ci`, it cannot satisfy the client character set request, and falls back to its default character set and collation (`latin1` and `latin1_swedish_ci`).

In this case, the client can still use `utf8mb4` by issuing a `SET NAMES 'utf8mb4'` statement after connecting. The resulting collation is the 5.7 default `utf8mb4` collation; that is, `utf8mb4_general_ci`. If the client additionally wants a collation of `utf8mb4_0900_ai_ci`, it cannot achieve that because the server does not recognize that collation. The client must either be willing to use a different `utf8mb4` collation, or connect to a server from MySQL 8.0 or higher.

## Runtime Error Handling

Within an established connection, the client can request a change of connection character set and collation with `SET NAMES` or `SET CHARACTER SET`.

Some character sets cannot be used as the client character set; see [Impermissible Client Character Sets](#). If you specify a character set that is valid but not permitted as a client character set, the server returns an error:

```
mysql> SET NAMES 'ucs2';
ERROR 1231 (42000): Variable 'character_set_client' can't be set to
the value of 'ucs2'
```

If the server does not recognize the character set (or the collation), it produces an error:

```
mysql> SET NAMES 'bogus';
ERROR 1115 (42000): Unknown character set: 'bogus'

mysql> SET NAMES 'utf8mb4' COLLATE 'bogus';
ERROR 1273 (HY000): Unknown collation: 'bogus'
```



### Tip

A client that wants to verify whether its requested character set was honored by the server can execute the following statement after connecting and checking that the result is the expected character set:

```
SELECT @@character_set_client;
```

## 10.5 Configuring Application Character Set and Collation

For applications that store data using the default MySQL character set and collation (`latin1`, `latin1_swedish_ci`), no special configuration should be needed. If applications require data storage using a different character set or collation, you can configure character set information several ways:

- Specify character settings per database. For example, applications that use one database might use the default of `latin1`, whereas applications that use another database might use `sjis`.
- Specify character settings at server startup. This causes the server to use the given settings for all applications that do not make other arrangements.
- Specify character settings at configuration time, if you build MySQL from source. This causes the server to use the given settings as the defaults for all applications, without having to specify them at server startup.

When different applications require different character settings, the per-database technique provides a good deal of flexibility. If most or all applications use the same character set, specifying character settings at server startup or configuration time may be most convenient.

For the per-database or server-startup techniques, the settings control the character set for data storage. Applications must also tell the server which character set to use for client/server communications, as described in the following instructions.

The examples shown here assume use of the `utf8` character set and `utf8_general_ci` collation in particular contexts as an alternative to the defaults of `latin1` and `latin1_swedish_ci`.

- **Specify character settings per database.** To create a database such that its tables use a given default character set and collation for data storage, use a `CREATE DATABASE` statement like this:

```
CREATE DATABASE mydb
  CHARACTER SET utf8
  COLLATE utf8_general_ci;
```

Tables created in the database use `utf8` and `utf8_general_ci` by default for any character columns.

Applications that use the database should also configure their connection to the server each time they connect. This can be done by executing a `SET NAMES 'utf8'` statement after connecting. The statement can be used regardless of connection method (the `mysql` client, PHP scripts, and so forth).

In some cases, it may be possible to configure the connection to use the desired character set some other way. For example, to connect using `mysql`, you can specify the `--default-character-set=utf8` command-line option to achieve the same effect as `SET NAMES 'utf8'`.

For more information about configuring client connections, see [Section 10.4, “Connection Character Sets and Collations”](#).



#### Note

If you use `ALTER DATABASE` to change the database default character set or collation, existing stored routines in the database that use those defaults must be dropped and recreated so that they use the new defaults. (In a stored routine, variables with character data types use the database defaults if the character set or collation are not specified explicitly. See [Section 13.1.16, “CREATE PROCEDURE and CREATE FUNCTION Statements”](#).)

- **Specify character settings at server startup.** To select a character set and collation at server startup, use the `--character-set-server` and `--collation-server` options. For example, to specify the options in an option file, include these lines:

```
[mysqld]
character-set-server=utf8
collation-server=utf8_general_ci
```

These settings apply server-wide and apply as the defaults for databases created by any application, and for tables created in those databases.

It is still necessary for applications to configure their connection using `SET NAMES` or equivalent after they connect, as described previously. You might be tempted to start the server with the `--init_connect="SET NAMES 'utf8'"` option to cause `SET NAMES` to be executed automatically for each client that connects. However, this may yield inconsistent results because the `init_connect` value is not executed for users who have the `SUPER` privilege.

- **Specify character settings at MySQL configuration time.** To select a character set and collation if you configure and build MySQL from source, use the `DEFAULT_CHARSET` and `DEFAULT_COLLATION` `CMake` options:

```
cmake . -DDEFAULT_CHARSET=utf8 \
```

```
-DDEFAULT_COLLATION=utf8_general_ci
```

The resulting server uses `utf8` and `utf8_general_ci` as the default for databases and tables and for client connections. It is unnecessary to use `--character-set-server` and `--collation-server` to specify those defaults at server startup. It is also unnecessary for applications to configure their connection using `SET NAMES` or equivalent after they connect to the server.

Regardless of how you configure the MySQL character set for application use, you must also consider the environment within which those applications execute. For example, if you send statements using UTF-8 text taken from a file that you create in an editor, you should edit the file with the locale of your environment set to UTF-8 so that the file encoding is correct and so that the operating system handles it correctly. If you use the `mysql` client from within a terminal window, the window must be configured to use UTF-8 or characters may not display properly. For a script that executes in a Web environment, the script must handle character encoding properly for its interaction with the MySQL server, and it must generate pages that correctly indicate the encoding so that browsers know how to display the content of the pages. For example, you can include this `<meta>` tag within your `<head>` element:

```
<meta http-equiv="Content-Type" content="text/html; charset=utf-8" />
```

## 10.6 Error Message Character Set

This section describes how the MySQL server uses character sets for constructing error messages. For information about the language of error messages (rather than the character set), see [Section 10.12, “Setting the Error Message Language”](#). For general information about configuring error logging, see [Section 5.4.2, “The Error Log”](#).

- [Character Set for Error Message Construction](#)
- [Character Set for Error Message Disposition](#)

### Character Set for Error Message Construction

The server constructs error messages as follows:

- The message template uses UTF-8 (`utf8mb3`).
- Parameters in the message template are replaced with values that apply to a specific error occurrence:
  - Identifiers such as table or column names use UTF-8 internally so they are copied as is.
  - Character (nonbinary) string values are converted from their character set to UTF-8.
  - Binary string values are copied as is for bytes in the range `0x20` to `0x7E`, and using `\x` hexadecimal encoding for bytes outside that range. For example, if a duplicate-key error occurs for an attempt to insert `0x41CF9F` into a `VARBINARY` unique column, the resulting error message uses UTF-8 with some bytes hexadecimal encoded:

```
Duplicate entry 'A\xCF\x9F' for key 1
```

### Character Set for Error Message Disposition

An error message, once constructed, can be written by the server to the error log or sent to clients:

- If the server writes the error message to the error log, it writes it in UTF-8, as constructed, without conversion to another character set.
- If the server sends the error message to a client program, the server converts it from UTF-8 to the character set specified by the `character_set_results` system variable. If

`character_set_results` has a value of `NULL` or `binary`, no conversion occurs. No conversion occurs if the variable value is `utf8mb3` or `utf8mb4`, either, because those character sets have a repertoire that includes all UTF-8 characters used in message construction.

If characters cannot be represented in `character_set_results`, some encoding may occur during the conversion. The encoding uses Unicode code point values:

- Characters in the Basic Multilingual Plane (BMP) range (`0x0000` to `0xFFFF`) are written using `\nnnn` notation.
- Characters outside the BMP range (`0x10000` to `0x10FFFF`) are written using `\+nnnnnn` notation.

Clients can set `character_set_results` to control the character set in which they receive error messages. The variable can be set directly, or indirectly by means such as `SET NAMES`. For more information about `character_set_results`, see [Section 10.4, “Connection Character Sets and Collations”](#).

## 10.7 Column Character Set Conversion

To convert a binary or nonbinary string column to use a particular character set, use `ALTER TABLE`. For successful conversion to occur, one of the following conditions must apply:

- If the column has a binary data type (`BINARY`, `VARBINARY`, `BLOB`), all the values that it contains must be encoded using a single character set (the character set you’re converting the column to). If you use a binary column to store information in multiple character sets, MySQL has no way to know which values use which character set and cannot convert the data properly.
- If the column has a nonbinary data type (`CHAR`, `VARCHAR`, `TEXT`), its contents should be encoded in the column character set, not some other character set. If the contents are encoded in a different character set, you can convert the column to use a binary data type first, and then to a nonbinary column with the desired character set.

Suppose that a table `t` has a binary column named `col1` defined as `VARBINARY(50)`. Assuming that the information in the column is encoded using a single character set, you can convert it to a nonbinary column that has that character set. For example, if `col1` contains binary data representing characters in the `greek` character set, you can convert it as follows:

```
ALTER TABLE t MODIFY col1 VARCHAR(50) CHARACTER SET greek;
```

If your original column has a type of `BINARY(50)`, you could convert it to `CHAR(50)`, but the resulting values are padded with `0x00` bytes at the end, which may be undesirable. To remove these bytes, use the `TRIM()` function:

```
UPDATE t SET col1 = TRIM(TRAILING 0x00 FROM col1);
```

Suppose that table `t` has a nonbinary column named `col1` defined as `CHAR(50) CHARACTER SET latin1` but you want to convert it to use `utf8` so that you can store values from many languages. The following statement accomplishes this:

```
ALTER TABLE t MODIFY col1 CHAR(50) CHARACTER SET utf8;
```

Conversion may be lossy if the column contains characters that are not in both character sets.

A special case occurs if you have old tables from before MySQL 4.1 where a nonbinary column contains values that actually are encoded in a character set different from the server's default character set. For example, an application might have stored `sjis` values in a column, even though MySQL's default character set was different. It is possible to convert the column to use the proper character set but an

additional step is required. Suppose that the server's default character set was `latin1` and `coll` is defined as `CHAR(50)` but its contents are `sjis` values. The first step is to convert the column to a binary data type, which removes the existing character set information without performing any character conversion:

```
ALTER TABLE t MODIFY coll BLOB;
```

The next step is to convert the column to a nonbinary data type with the proper character set:

```
ALTER TABLE t MODIFY coll CHAR(50) CHARACTER SET sjis;
```

This procedure requires that the table not have been modified already with statements such as `INSERT` or `UPDATE` after an upgrade to MySQL 4.1 or higher. In that case, MySQL stores new values in the column using `latin1`, and the column contains a mix of `sjis` and `latin1` values and cannot be converted properly.

If you specified attributes when creating a column initially, you should also specify them when altering the table with `ALTER TABLE`. For example, if you specified `NOT NULL` and an explicit `DEFAULT` value, you should also provide them in the `ALTER TABLE` statement. Otherwise, the resulting column definition does not include those attributes.

To convert all character columns in a table, the `ALTER TABLE ... CONVERT TO CHARACTER SET charset` statement may be useful. See [Section 13.1.8, "ALTER TABLE Statement"](#).



#### Note

`ALTER TABLE` statements which make changes in table or column character sets or collations must be performed using `ALGORITHM=COPY`. For more information, see [Section 14.13.1, "Online DDL Operations"](#).

## 10.8 Collation Issues

The following sections discuss various aspects of character set collations.

### 10.8.1 Using COLLATE in SQL Statements

With the `COLLATE` clause, you can override whatever the default collation is for a comparison. `COLLATE` may be used in various parts of SQL statements. Here are some examples:

- With `ORDER BY`:

```
SELECT k
FROM t1
ORDER BY k COLLATE latin1_german2_ci;
```

- With `AS`:

```
SELECT k COLLATE latin1_german2_ci AS k1
FROM t1
ORDER BY k1;
```

- With `GROUP BY`:

```
SELECT k
FROM t1
GROUP BY k COLLATE latin1_german2_ci;
```

- With aggregate functions:

```
SELECT MAX(k COLLATE latin1_german2_ci)
```

```
FROM t1;
```

- With `DISTINCT`:

```
SELECT DISTINCT k COLLATE latin1_german2_ci
FROM t1;
```

- With `WHERE`:

```
SELECT *
FROM t1
WHERE _latin1 'Müller' COLLATE latin1_german2_ci = k;
```

```
SELECT *
FROM t1
WHERE k LIKE _latin1 'Müller' COLLATE latin1_german2_ci;
```

- With `HAVING`:

```
SELECT k
FROM t1
GROUP BY k
HAVING k = _latin1 'Müller' COLLATE latin1_german2_ci;
```

## 10.8.2 COLLATE Clause Precedence

The `COLLATE` clause has high precedence (higher than `||`), so the following two expressions are equivalent:

```
x || y COLLATE z
x || (y COLLATE z)
```

## 10.8.3 Character Set and Collation Compatibility

Each character set has one or more collations, but each collation is associated with one and only one character set. Therefore, the following statement causes an error message because the `latin2_bin` collation is not legal with the `latin1` character set:

```
mysql> SELECT _latin1 'x' COLLATE latin2_bin;
ERROR 1253 (42000): COLLATION 'latin2_bin' is not valid
for CHARACTER SET 'latin1'
```

## 10.8.4 Collation Coercibility in Expressions

In the great majority of statements, it is obvious what collation MySQL uses to resolve a comparison operation. For example, in the following cases, it should be clear that the collation is the collation of column `x`:

```
SELECT x FROM T ORDER BY x;
SELECT x FROM T WHERE x = x;
SELECT DISTINCT x FROM T;
```

However, with multiple operands, there can be ambiguity. For example, this statement performs a comparison between the column `x` and the string literal `'Y'`:

```
SELECT x FROM T WHERE x = 'Y';
```

If `x` and `'Y'` have the same collation, there is no ambiguity about the collation to use for the comparison. But if they have different collations, should the comparison use the collation of `x`, or of `'Y'`? Both `x` and `'Y'` have collations, so which collation takes precedence?

A mix of collations may also occur in contexts other than comparison. For example, a multiple-argument concatenation operation such as `CONCAT(x, 'Y')` combines its arguments to produce a single string. What collation should the result have?

To resolve questions like these, MySQL checks whether the collation of one item can be coerced to the collation of the other. MySQL assigns coercibility values as follows:

- An explicit `COLLATE` clause has a coercibility of 0 (not coercible at all).
- The concatenation of two strings with different collations has a coercibility of 1.
- The collation of a column or a stored routine parameter or local variable has a coercibility of 2.
- A “system constant” (the string returned by functions such as `USER()` or `VERSION()`) has a coercibility of 3.
- The collation of a literal has a coercibility of 4.
- The collation of a numeric or temporal value has a coercibility of 5.
- `NULL` or an expression that is derived from `NULL` has a coercibility of 6.

MySQL uses coercibility values with the following rules to resolve ambiguities:

- Use the collation with the lowest coercibility value.
- If both sides have the same coercibility, then:
  - If both sides are Unicode, or both sides are not Unicode, it is an error.
  - If one of the sides has a Unicode character set, and another side has a non-Unicode character set, the side with Unicode character set wins, and automatic character set conversion is applied to the non-Unicode side. For example, the following statement does not return an error:

```
SELECT CONCAT(utf8_column, latin1_column) FROM t1;
```

It returns a result that has a character set of `utf8` and the same collation as `utf8_column`. Values of `latin1_column` are automatically converted to `utf8` before concatenating.

- For an operation with operands from the same character set but that mix a `_bin` collation and a `_ci` or `_cs` collation, the `_bin` collation is used. This is similar to how operations that mix nonbinary and binary strings evaluate the operands as binary strings, applied to collations rather than data types.

Although automatic conversion is not in the SQL standard, the standard does say that every character set is (in terms of supported characters) a “subset” of Unicode. Because it is a well-known principle that “what applies to a superset can apply to a subset,” we believe that a collation for Unicode can apply for comparisons with non-Unicode strings. More generally, MySQL uses the concept of character set repertoire, which can sometimes be used to determine subset relationships among character sets and enable conversion of operands in operations that would otherwise produce an error. See [Section 10.2.1, “Character Set Repertoire”](#).

The following table illustrates some applications of the preceding rules.

Comparison	Collation Used
<code>column1 = 'A'</code>	Use collation of <code>column1</code>
<code>column1 = 'A' COLLATE x</code>	Use collation of <code>'A' COLLATE x</code>



Comparison	Collation Used
<code>column1 COLLATE x = 'A' COLLATE y</code>	Error

To determine the coercibility of a string expression, use the `COERCIBILITY()` function (see [Section 12.15, “Information Functions”](#)):

```
mysql> SELECT COERCIBILITY(_utf8'A' COLLATE utf8_bin);
-> 0
mysql> SELECT COERCIBILITY(VERSION());
-> 3
mysql> SELECT COERCIBILITY('A');
-> 4
mysql> SELECT COERCIBILITY(1000);
-> 5
mysql> SELECT COERCIBILITY(NULL);
-> 6
```

For implicit conversion of a numeric or temporal value to a string, such as occurs for the argument `1` in the expression `CONCAT(1, 'abc')`, the result is a character (nonbinary) string that has a character set and collation determined by the `character_set_connection` and `collation_connection` system variables. See [Section 12.3, “Type Conversion in Expression Evaluation”](#).

## 10.8.5 The binary Collation Compared to `_bin` Collations

This section describes how the `binary` collation for binary strings compares to `_bin` collations for nonbinary strings.

Binary strings (as stored using the `BINARY`, `VARBINARY`, and `BLOB` data types) have a character set and collation named `binary`. Binary strings are sequences of bytes and the numeric values of those bytes determine comparison and sort order. See [Section 10.10.8, “The Binary Character Set”](#).

Nonbinary strings (as stored using the `CHAR`, `VARCHAR`, and `TEXT` data types) have a character set and collation other than `binary`. A given nonbinary character set can have several collations, each of which defines a particular comparison and sort order for the characters in the set. One of these is the binary collation, indicated by a `_bin` suffix in the collation name. For example, the binary collation for `utf8` and `latin1` is named `utf8_bin` and `latin1_bin`, respectively.

The `binary` collation differs from `_bin` collations in several respects, discussed in the following sections:

- [The Unit for Comparison and Sorting](#)
- [Character Set Conversion](#)
- [Lettercase Conversion](#)
- [Trailing Space Handling in Comparisons](#)
- [Trailing Space Handling for Inserts and Retrievals](#)

### The Unit for Comparison and Sorting

Binary strings are sequences of bytes. For the `binary` collation, comparison and sorting are based on numeric byte values. Nonbinary strings are sequences of characters, which might be multibyte. Collations for nonbinary strings define an ordering of the character values for comparison and sorting. For `_bin` collations, this ordering is based on numeric character code values, which is similar to ordering for binary strings except that character code values might be multibyte.

## Character Set Conversion

A nonbinary string has a character set and is automatically converted to another character set in many cases, even when the string has a `_bin` collation:

- When assigning column values to another column that has a different character set:

```
UPDATE t1 SET utf8_bin_column=latin1_column;
INSERT INTO t1 (latin1_column) SELECT utf8_bin_column FROM t2;
```

- When assigning column values for `INSERT` or `UPDATE` using a string literal:

```
SET NAMES latin1;
INSERT INTO t1 (utf8_bin_column) VALUES ('string-in-latin1');
```

- When sending results from the server to a client:

```
SET NAMES latin1;
SELECT utf8_bin_column FROM t2;
```

For binary string columns, no conversion occurs. For cases similar to those preceding, the string value is copied byte-wise.

## Lettercase Conversion

Collations for nonbinary character sets provide information about lettercase of characters, so characters in a nonbinary string can be converted from one lettercase to another, even for `_bin` collations that ignore lettercase for ordering:

```
mysql> SET NAMES utf8mb4 COLLATE utf8mb4_bin;
mysql> SELECT LOWER('aA'), UPPER('zZ');
+-----+-----+
| LOWER('aA') | UPPER('zZ') |
+-----+-----+
| aa          | ZZ          |
+-----+-----+
```

The concept of lettercase does not apply to bytes in a binary string. To perform lettercase conversion, the string must first be converted to a nonbinary string using a character set appropriate for the data stored in the string:

```
mysql> SET NAMES binary;
mysql> SELECT LOWER('aA'), LOWER(CONVERT('aA' USING utf8mb4));
+-----+-----+
| LOWER('aA') | LOWER(CONVERT('aA' USING utf8mb4)) |
+-----+-----+
| aA          | aa          |
+-----+-----+
```

## Trailing Space Handling in Comparisons

Nonbinary strings have `PAD SPACE` behavior for all collations, including `_bin` collations. Trailing spaces are insignificant in comparisons:

```
mysql> SET NAMES utf8 COLLATE utf8_bin;
mysql> SELECT 'a ' = 'a';
+-----+
| 'a ' = 'a' |
+-----+
| 1           |
+-----+
```

For binary strings, all bytes are significant in comparisons, including trailing spaces:

```
mysql> SET NAMES binary;
mysql> SELECT 'a ' = 'a';
+-----+
| 'a ' = 'a' |
+-----+
|          0 |
+-----+
```

### Trailing Space Handling for Inserts and Retrievals

**CHAR(N)** columns store nonbinary strings *N* characters long. For inserts, values shorter than *N* characters are extended with spaces. For retrievals, trailing spaces are removed.

**BINARY(N)** columns store binary strings *N* bytes long. For inserts, values shorter than *N* bytes are extended with 0x00 bytes. For retrievals, nothing is removed; a value of the declared length is always returned.

```
mysql> CREATE TABLE t1 (
  a CHAR(10) CHARACTER SET utf8 COLLATE utf8_bin,
  b BINARY(10)
);
mysql> INSERT INTO t1 VALUES ('x','x');
mysql> INSERT INTO t1 VALUES ('x ','x ');
mysql> SELECT a, b, HEX(a), HEX(b) FROM t1;
+-----+-----+-----+-----+
| a      | b      | HEX(a) | HEX(b) |
+-----+-----+-----+-----+
| x      | x      | 78     | 78000000000000000000 |
| x      | x      | 78     | 78200000000000000000 |
+-----+-----+-----+-----+
```

## 10.8.6 Examples of the Effect of Collation

### Example 1: Sorting German Umlauts

Suppose that column *X* in table *T* has these `latin1` column values:

```
Muffler
Müller
MX Systems
MySQL
```

Suppose also that the column values are retrieved using the following statement:

```
SELECT X FROM T ORDER BY X COLLATE collation_name;
```

The following table shows the resulting order of the values if we use `ORDER BY` with different collations.

<code>latin1_swedish_ci</code>	<code>latin1_german1_ci</code>	<code>latin1_german2_ci</code>
Muffler	Muffler	Müller
MX Systems	Müller	Muffler
Müller	MX Systems	MX Systems
MySQL	MySQL	MySQL

The character that causes the different sort orders in this example is the U with two dots over it (ü), which the Germans call “U-umlaut.”

- The first column shows the result of the `SELECT` using the Swedish/Finnish collating rule, which says that U-umlaut sorts with Y.
- The second column shows the result of the `SELECT` using the German DIN-1 rule, which says that U-umlaut sorts with U.
- The third column shows the result of the `SELECT` using the German DIN-2 rule, which says that U-umlaut sorts with UE.

### Example 2: Searching for German Umlauts

Suppose that you have three tables that differ only by the character set and collation used:

```
mysql> SET NAMES utf8;
mysql> CREATE TABLE german1 (
    c CHAR(10)
) CHARACTER SET latin1 COLLATE latin1_german1_ci;
mysql> CREATE TABLE german2 (
    c CHAR(10)
) CHARACTER SET latin1 COLLATE latin1_german2_ci;
mysql> CREATE TABLE germanutf8 (
    c CHAR(10)
) CHARACTER SET utf8 COLLATE utf8_unicode_ci;
```

Each table contains two records:

```
mysql> INSERT INTO german1 VALUES ('Bar'), ('Bär');
mysql> INSERT INTO german2 VALUES ('Bar'), ('Bär');
mysql> INSERT INTO germanutf8 VALUES ('Bar'), ('Bär');
```

Two of the above collations have an `A = Ä` equality, and one has no such equality (`latin1_german2_ci`). For that reason, you'll get these results in comparisons:

```
mysql> SELECT * FROM german1 WHERE c = 'Bär';
+-----+
| c      |
+-----+
| Bar    |
| Bär    |
+-----+
mysql> SELECT * FROM german2 WHERE c = 'Bär';
+-----+
| c      |
+-----+
| Bär    |
+-----+
mysql> SELECT * FROM germanutf8 WHERE c = 'Bär';
+-----+
| c      |
+-----+
| Bar    |
| Bär    |
+-----+
```

This is not a bug but rather a consequence of the sorting properties of `latin1_german1_ci` and `utf8_unicode_ci` (the sorting shown is done according to the German DIN 5007 standard).

## 10.8.7 Using Collation in INFORMATION\_SCHEMA Searches

String columns in `INFORMATION_SCHEMA` tables have a collation of `utf8_general_ci`, which is case-insensitive. However, for values that correspond to objects that are represented in the file system, such

as databases and tables, searches in `INFORMATION_SCHEMA` string columns can be case-sensitive or case-insensitive, depending on the characteristics of the underlying file system and the value of the `lower_case_table_names` system variable. For example, searches may be case-sensitive if the file system is case-sensitive. This section describes this behavior and how to modify it if necessary; see also Bug #34921.

Suppose that a query searches the `SCHEMATA.SCHEMA_NAME` column for the `test` database. On Linux, file systems are case-sensitive, so comparisons of `SCHEMATA.SCHEMA_NAME` with `'test'` match, but comparisons with `'TEST'` do not:

```
mysql> SELECT SCHEMA_NAME FROM INFORMATION_SCHEMA.SCHEMATA
        WHERE SCHEMA_NAME = 'test';
+-----+
| SCHEMA_NAME |
+-----+
| test        |
+-----+

mysql> SELECT SCHEMA_NAME FROM INFORMATION_SCHEMA.SCHEMATA
        WHERE SCHEMA_NAME = 'TEST';
Empty set (0.00 sec)
```

These results occur with the `lower_case_table_names` system variable set to 0. Changing the value of `lower_case_table_names` to 1 or 2 causes the second query to return the same (nonempty) result as the first query.

On Windows or macOS, file systems are not case-sensitive, so comparisons match both `'test'` and `'TEST'`:

```
mysql> SELECT SCHEMA_NAME FROM INFORMATION_SCHEMA.SCHEMATA
        WHERE SCHEMA_NAME = 'test';
+-----+
| SCHEMA_NAME |
+-----+
| test        |
+-----+

mysql> SELECT SCHEMA_NAME FROM INFORMATION_SCHEMA.SCHEMATA
        WHERE SCHEMA_NAME = 'TEST';
+-----+
| SCHEMA_NAME |
+-----+
| TEST        |
+-----+
```

The value of `lower_case_table_names` makes no difference in this context.

The preceding behavior occurs because the `utf8_general_ci` collation is not used for `INFORMATION_SCHEMA` queries when searching for values that correspond to objects represented in the file system. It is a result of file system-scanning optimizations implemented for `INFORMATION_SCHEMA` searches. For information about these optimizations, see [Section 8.2.3, “Optimizing INFORMATION\\_SCHEMA Queries”](#).

If the result of a string operation on an `INFORMATION_SCHEMA` column differs from expectations, a workaround is to use an explicit `COLLATE` clause to force a suitable collation (see [Section 10.8.1, “Using COLLATE in SQL Statements”](#)). For example, to perform a case-insensitive search, use `COLLATE` with the `INFORMATION_SCHEMA` column name:

```
mysql> SELECT SCHEMA_NAME FROM INFORMATION_SCHEMA.SCHEMATA
        WHERE SCHEMA_NAME COLLATE utf8_general_ci = 'test';
+-----+
```

```

| SCHEMA_NAME |
+-----+
| test        |
+-----+

mysql> SELECT SCHEMA_NAME FROM INFORMATION_SCHEMA.SCHEMATA
       WHERE SCHEMA_NAME COLLATE utf8_general_ci = 'TEST';
+-----+
| SCHEMA_NAME |
+-----+
| test        |
+-----+

```

In the preceding queries, it is important to apply the `COLLATE` clause to the `INFORMATION_SCHEMA` column name. Applying `COLLATE` to the comparison value has no effect.

You can also use the `UPPER()` or `LOWER()` function:

```

WHERE UPPER(SCHEMA_NAME) = 'TEST'
WHERE LOWER(SCHEMA_NAME) = 'test'

```

Although a case-insensitive comparison can be performed even on platforms with case-sensitive file systems, as just shown, it is not necessarily always the right thing to do. On such platforms, it is possible to have multiple objects with names that differ only in lettercase. For example, tables named `city`, `CITY`, and `City` can all exist simultaneously. Consider whether a search should match all such names or just one and write queries accordingly. The first of the following comparisons (with `utf8_bin`) is case-sensitive; the others are not:

```

WHERE TABLE_NAME COLLATE utf8_bin = 'City'
WHERE TABLE_NAME COLLATE utf8_general_ci = 'city'
WHERE UPPER(TABLE_NAME) = 'CITY'
WHERE LOWER(TABLE_NAME) = 'city'

```

Searches in `INFORMATION_SCHEMA` string columns for values that refer to `INFORMATION_SCHEMA` itself do use the `utf8_general_ci` collation because `INFORMATION_SCHEMA` is a “virtual” database not represented in the file system. For example, comparisons with `SCHEMATA.SCHEMA_NAME` match `'information_schema'` or `'INFORMATION_SCHEMA'` regardless of platform:

```

mysql> SELECT SCHEMA_NAME FROM INFORMATION_SCHEMA.SCHEMATA
       WHERE SCHEMA_NAME = 'information_schema';
+-----+
| SCHEMA_NAME |
+-----+
| information_schema |
+-----+

mysql> SELECT SCHEMA_NAME FROM INFORMATION_SCHEMA.SCHEMATA
       WHERE SCHEMA_NAME = 'INFORMATION_SCHEMA';
+-----+
| SCHEMA_NAME |
+-----+
| information_schema |
+-----+

```

## 10.9 Unicode Support

The Unicode Standard includes characters from the Basic Multilingual Plane (BMP) and supplementary characters that lie outside the BMP. This section describes support for Unicode in MySQL. For information about the Unicode Standard itself, visit the [Unicode Consortium website](#).

BMP characters have these characteristics:

- Their code point values are between 0 and 65535 (or `U+0000` and `U+FFFF`).
- They can be encoded in a variable-length encoding using 8, 16, or 24 bits (1 to 3 bytes).
- They can be encoded in a fixed-length encoding using 16 bits (2 bytes).
- They are sufficient for almost all characters in major languages.

Supplementary characters lie outside the BMP:

- Their code point values are between `U+10000` and `U+10FFFF`.
- Unicode support for supplementary characters requires character sets that have a range outside BMP characters and therefore take more space than BMP characters (up to 4 bytes per character).

The UTF-8 (Unicode Transformation Format with 8-bit units) method for encoding Unicode data is implemented according to RFC 3629, which describes encoding sequences that take from one to four bytes. The idea of UTF-8 is that various Unicode characters are encoded using byte sequences of different lengths:

- Basic Latin letters, digits, and punctuation signs use one byte.
- Most European and Middle East script letters fit into a 2-byte sequence: extended Latin letters (with tilde, macron, acute, grave and other accents), Cyrillic, Greek, Armenian, Hebrew, Arabic, Syriac, and others.
- Korean, Chinese, and Japanese ideographs use 3-byte or 4-byte sequences.

MySQL supports these Unicode character sets:

- `utf8mb4`: A UTF-8 encoding of the Unicode character set using one to four bytes per character.
- `utf8mb3`: A UTF-8 encoding of the Unicode character set using one to three bytes per character.
- `utf8`: An alias for `utf8mb3`.
- `ucs2`: The UCS-2 encoding of the Unicode character set using two bytes per character.
- `utf16`: The UTF-16 encoding for the Unicode character set using two or four bytes per character. Like `ucs2` but with an extension for supplementary characters.
- `utf16le`: The UTF-16LE encoding for the Unicode character set. Like `utf16` but little-endian rather than big-endian.
- `utf32`: The UTF-32 encoding for the Unicode character set using four bytes per character.

Table 10.2, “Unicode Character Set General Characteristics”, summarizes the general characteristics of Unicode character sets supported by MySQL.

**Table 10.2 Unicode Character Set General Characteristics**

Character Set	Supported Characters	Required Storage Per Character
<code>utf8mb3</code> , <code>utf8</code>	BMP only	1, 2, or 3 bytes
<code>ucs2</code>	BMP only	2 bytes
<code>utf8mb4</code>	BMP and supplementary	1, 2, 3, or 4 bytes
<code>utf16</code>	BMP and supplementary	2 or 4 bytes
<code>utf16le</code>	BMP and supplementary	2 or 4 bytes

Character Set	Supported Characters	Required Storage Per Character
utf32	BMP and supplementary	4 bytes

Characters outside the BMP compare as REPLACEMENT CHARACTER and convert to '?' when converted to a Unicode character set that supports only BMP characters (utf8mb3 or ucs2).

If you use character sets that support supplementary characters and thus are “wider” than the BMP-only utf8mb3 and ucs2 character sets, there are potential incompatibility issues for your applications; see Section 10.9.8, “Converting Between 3-Byte and 4-Byte Unicode Character Sets”. That section also describes how to convert tables from the (3-byte) utf8mb3 to the (4-byte) utf8mb4, and what constraints may apply in doing so.

A similar set of collations is available for most Unicode character sets. For example, each has a Danish collation, the names of which are utf8mb4\_danish\_ci, utf8mb3\_danish\_ci, utf8\_danish\_ci, ucs2\_danish\_ci, utf16\_danish\_ci, and utf32\_danish\_ci. The exception is utf16le, which has only two collations. For information about Unicode collations and their differentiating properties, including collation properties for supplementary characters, see Section 10.10.1, “Unicode Character Sets”.

The MySQL implementation of UCS-2, UTF-16, and UTF-32 stores characters in big-endian byte order and does not use a byte order mark (BOM) at the beginning of values. Other database systems might use little-endian byte order or a BOM. In such cases, conversion of values must be performed when transferring data between those systems and MySQL. The implementation of UTF-16LE is little-endian.

MySQL uses no BOM for UTF-8 values.

Client applications that communicate with the server using Unicode should set the client character set accordingly (for example, by issuing a SET NAMES 'utf8mb4' statement). Some character sets cannot be used as the client character set. Attempting to use them with SET NAMES or SET CHARACTER SET produces an error. See Impermissible Client Character Sets.

The following sections provide additional detail on the Unicode character sets in MySQL.

## 10.9.1 The utf8mb4 Character Set (4-Byte UTF-8 Unicode Encoding)

The utf8mb4 character set has these characteristics:

- Supports BMP and supplementary characters.
- Requires a maximum of four bytes per multibyte character.

utf8mb4 contrasts with the utf8mb3 character set, which supports only BMP characters and uses a maximum of three bytes per character:

- For a BMP character, utf8mb4 and utf8mb3 have identical storage characteristics: same code values, same encoding, same length.
- For a supplementary character, utf8mb4 requires four bytes to store it, whereas utf8mb3 cannot store the character at all. When converting utf8mb3 columns to utf8mb4, you need not worry about converting supplementary characters because there are none.

utf8mb4 is a superset of utf8mb3, so for an operation such as the following concatenation, the result has character set utf8mb4 and the collation of utf8mb4\_col:

```
SELECT CONCAT(utf8mb3_col, utf8mb4_col);
```

Similarly, the following comparison in the WHERE clause works according to the collation of utf8mb4\_col:



```
SELECT * FROM utf8mb3_tbl, utf8mb4_tbl
WHERE utf8mb3_tbl.utf8mb3_col = utf8mb4_tbl.utf8mb4_col;
```

For information about data type storage as it relates to multibyte character sets, see [String Type Storage Requirements](#).

## 10.9.2 The utf8mb3 Character Set (3-Byte UTF-8 Unicode Encoding)

The `utf8mb3` character set has these characteristics:

- Supports BMP characters only (no support for supplementary characters)
- Requires a maximum of three bytes per multibyte character.

Applications that use UTF-8 data but require supplementary character support should use `utf8mb4` rather than `utf8mb3` (see [Section 10.9.1, “The utf8mb4 Character Set \(4-Byte UTF-8 Unicode Encoding\)”](#)).

Exactly the same set of characters is available in `utf8mb3` and `ucs2`. That is, they have the same [repertoire](#).

`utf8` is an alias for `utf8mb3`; the character limit is implicit, rather than explicit in the name.

`utf8mb3` can be used in `CHARACTER SET` clauses, and `utf8mb3_collation_substring` in `COLLATE` clauses, where `collation_substring` is `bin`, `czech_ci`, `danish_ci`, `esperanto_ci`, `estonian_ci`, and so forth. For example:

```
CREATE TABLE t (s1 CHAR(1)) CHARACTER SET utf8mb3;
SELECT * FROM t WHERE s1 COLLATE utf8mb3_general_ci = 'x';
DECLARE x VARCHAR(5) CHARACTER SET utf8mb3 COLLATE utf8mb3_danish_ci;
SELECT CAST('a' AS CHAR CHARACTER SET utf8) COLLATE utf8_czech_ci;
```

MySQL immediately converts instances of `utf8mb3` in statements to `utf8`, so in statements such as `SHOW CREATE TABLE` or `SELECT CHARACTER_SET_NAME FROM INFORMATION_SCHEMA.COLUMNS` or `SELECT COLLATION_NAME FROM INFORMATION_SCHEMA.COLUMNS`, users see the name `utf8` or `utf8_collation_substring`.

`utf8mb3` is also valid in contexts other than `CHARACTER SET` clauses. For example:

```
mysqld --character-set-server=utf8mb3
```

```
SET NAMES 'utf8mb3'; /* and other SET statements that have similar effect */
SELECT _utf8mb3 'a';
```

For information about data type storage as it relates to multibyte character sets, see [String Type Storage Requirements](#).

### 10.9.3 The utf8 Character Set (Alias for utf8mb3)

`utf8` is an alias for the `utf8mb3` character set. For more information, see [Section 10.9.2, “The utf8mb3 Character Set \(3-Byte UTF-8 Unicode Encoding\)”](#).

### 10.9.4 The ucs2 Character Set (UCS-2 Unicode Encoding)

In UCS-2, every character is represented by a 2-byte Unicode code with the most significant byte first. For example: `LATIN CAPITAL LETTER A` has the code `0x0041` and it is stored as a 2-byte sequence: `0x00 0x41`. `CYRILLIC SMALL LETTER YERU` (Unicode `0x044B`) is stored as a 2-byte sequence: `0x04 0x4B`. For Unicode characters and their codes, please refer to the [Unicode Consortium website](#).

The `ucs2` character set has these characteristics:

- Supports BMP characters only (no support for supplementary characters)
- Uses a fixed-length 16-bit encoding and requires two bytes per character.

## 10.9.5 The utf16 Character Set (UTF-16 Unicode Encoding)

The `utf16` character set is the `ucs2` character set with an extension that enables encoding of supplementary characters:

- For a BMP character, `utf16` and `ucs2` have identical storage characteristics: same code values, same encoding, same length.
- For a supplementary character, `utf16` has a special sequence for representing the character using 32 bits. This is called the “surrogate” mechanism: For a number greater than `0xffff`, take 10 bits and add them to `0xd800` and put them in the first 16-bit word, take 10 more bits and add them to `0xdc00` and put them in the next 16-bit word. Consequently, all supplementary characters require 32 bits, where the first 16 bits are a number between `0xd800` and `0xdbff`, and the last 16 bits are a number between `0xdc00` and `0xdfff`. Examples are in Section 15.5 [Surrogates Area](#) of the Unicode 4.0 document.

Because `utf16` supports surrogates and `ucs2` does not, there is a validity check that applies only in `utf16`: You cannot insert a top surrogate without a bottom surrogate, or vice versa. For example:

```
INSERT INTO t (ucs2_column) VALUES (0xd800); /* legal */
INSERT INTO t (utf16_column)VALUES (0xd800); /* illegal */
```

There is no validity check for characters that are technically valid but are not true Unicode (that is, characters that Unicode considers to be “unassigned code points” or “private use” characters or even “illegals” like `0xffff`). For example, since `U+F8FF` is the Apple Logo, this is legal:

```
INSERT INTO t (utf16_column)VALUES (0xf8ff); /* legal */
```

Such characters cannot be expected to mean the same thing to everyone.

Because MySQL must allow for the worst case (that one character requires four bytes) the maximum length of a `utf16` column or index is only half of the maximum length for a `ucs2` column or index. For example, the maximum length of a `MEMORY` table index key is 3072 bytes, so these statements create tables with the longest permitted indexes for `ucs2` and `utf16` columns:

```
CREATE TABLE tf (s1 VARCHAR(1536) CHARACTER SET ucs2) ENGINE=MEMORY;
CREATE INDEX i ON tf (s1);
CREATE TABLE tg (s1 VARCHAR(768) CHARACTER SET utf16) ENGINE=MEMORY;
CREATE INDEX i ON tg (s1);
```

## 10.9.6 The utf16le Character Set (UTF-16LE Unicode Encoding)

This is the same as `utf16` but is little-endian rather than big-endian.

## 10.9.7 The utf32 Character Set (UTF-32 Unicode Encoding)

The `utf32` character set is fixed length (like `ucs2` and unlike `utf16`). `utf32` uses 32 bits for every character, unlike `ucs2` (which uses 16 bits for every character), and unlike `utf16` (which uses 16 bits for some characters and 32 bits for others).

`utf32` takes twice as much space as `ucs2` and more space than `utf16`, but `utf32` has the same advantage as `ucs2` that it is predictable for storage: The required number of bytes for `utf32` equals the

number of characters times 4. Also, unlike `utf16`, there are no tricks for encoding in `utf32`, so the stored value equals the code value.

To demonstrate how the latter advantage is useful, here is an example that shows how to determine a `utf8mb4` value given the `utf32` code value:

```
/* Assume code value = 100cc LINEAR B WHEELED CHARIOT */
CREATE TABLE tmp (utf32_col CHAR(1) CHARACTER SET utf32,
                  utf8mb4_col CHAR(1) CHARACTER SET utf8mb4);
INSERT INTO tmp VALUES (0x000100cc,NULL);
UPDATE tmp SET utf8mb4_col = utf32_col;
SELECT HEX(utf32_col),HEX(utf8mb4_col) FROM tmp;
```

MySQL is very forgiving about additions of unassigned Unicode characters or private-use-area characters. There is in fact only one validity check for `utf32`: No code value may be greater than `0x10ffff`. For example, this is illegal:

```
INSERT INTO t (utf32_column) VALUES (0x110000); /* illegal */
```

## 10.9.8 Converting Between 3-Byte and 4-Byte Unicode Character Sets

This section describes issues that you may face when converting character data between the `utf8mb3` and `utf8mb4` character sets.



### Note

This discussion focuses primarily on converting between `utf8mb3` and `utf8mb4`, but similar principles apply to converting between the `ucs2` character set and character sets such as `utf16` or `utf32`.

The `utf8mb3` and `utf8mb4` character sets differ as follows:

- `utf8mb3` supports only characters in the Basic Multilingual Plane (BMP). `utf8mb4` additionally supports supplementary characters that lie outside the BMP.
- `utf8mb3` uses a maximum of three bytes per character. `utf8mb4` uses a maximum of four bytes per character.



### Note

This discussion refers to the `utf8mb3` and `utf8mb4` character set names to be explicit about referring to 3-byte and 4-byte UTF-8 character set data. The exception is that in table definitions, `utf8` is used because MySQL converts instances of `utf8mb3` specified in such definitions to `utf8`, which is an alias for `utf8mb3`.

One advantage of converting from `utf8mb3` to `utf8mb4` is that this enables applications to use supplementary characters. One tradeoff is that this may increase data storage space requirements.

In terms of table content, conversion from `utf8mb3` to `utf8mb4` presents no problems:

- For a BMP character, `utf8mb4` and `utf8mb3` have identical storage characteristics: same code values, same encoding, same length.
- For a supplementary character, `utf8mb4` requires four bytes to store it, whereas `utf8mb3` cannot store the character at all. When converting `utf8mb3` columns to `utf8mb4`, you need not worry about converting supplementary characters because there are none.

In terms of table structure, these are the primary potential incompatibilities:

- For the variable-length character data types ([VARCHAR](#) and the [TEXT](#) types), the maximum permitted length in characters is less for [utf8mb4](#) columns than for [utf8mb3](#) columns.
- For all character data types ([CHAR](#), [VARCHAR](#), and the [TEXT](#) types), the maximum number of characters that can be indexed is less for [utf8mb4](#) columns than for [utf8mb3](#) columns.

Consequently, to convert tables from [utf8mb3](#) to [utf8mb4](#), it may be necessary to change some column or index definitions.

Tables can be converted from [utf8mb3](#) to [utf8mb4](#) by using [ALTER TABLE](#). Suppose that a table has this definition:

```
CREATE TABLE t1 (  
  col1 CHAR(10) CHARACTER SET utf8 COLLATE utf8_unicode_ci NOT NULL,  
  col2 CHAR(10) CHARACTER SET utf8 COLLATE utf8_bin NOT NULL  
) CHARACTER SET utf8;
```

The following statement converts `t1` to use [utf8mb4](#):

```
ALTER TABLE t1  
  DEFAULT CHARACTER SET utf8mb4,  
  MODIFY col1 CHAR(10)  
    CHARACTER SET utf8mb4 COLLATE utf8mb4_unicode_ci NOT NULL,  
  MODIFY col2 CHAR(10)  
    CHARACTER SET utf8mb4 COLLATE utf8mb4_bin NOT NULL;
```

The catch when converting from [utf8mb3](#) to [utf8mb4](#) is that the maximum length of a column or index key is unchanged in terms of *bytes*. Therefore, it is smaller in terms of *characters* because the maximum length of a character is four bytes instead of three. For the [CHAR](#), [VARCHAR](#), and [TEXT](#) data types, watch for these issues when converting your MySQL tables:

- Check all definitions of [utf8mb3](#) columns and make sure they do not exceed the maximum length for the storage engine.
- Check all indexes on [utf8mb3](#) columns and make sure they do not exceed the maximum length for the storage engine. Sometimes the maximum can change due to storage engine enhancements.

If the preceding conditions apply, you must either reduce the defined length of columns or indexes, or continue to use [utf8mb3](#) rather than [utf8mb4](#).

Here are some examples where structural changes may be needed:

- A [TINYTEXT](#) column can hold up to 255 bytes, so it can hold up to 85 3-byte or 63 4-byte characters. Suppose that you have a [TINYTEXT](#) column that uses [utf8mb3](#) but must be able to contain more than 63 characters. You cannot convert it to [utf8mb4](#) unless you also change the data type to a longer type such as [TEXT](#).

Similarly, a very long [VARCHAR](#) column may need to be changed to one of the longer [TEXT](#) types if you want to convert it from [utf8mb3](#) to [utf8mb4](#).

- [InnoDB](#) has a maximum index length of 767 bytes for tables that use [COMPACT](#) or [REDUNDANT](#) row format, so for [utf8mb3](#) or [utf8mb4](#) columns, you can index a maximum of 255 or 191 characters, respectively. If you currently have [utf8mb3](#) columns with indexes longer than 191 characters, you must index a smaller number of characters.

In an [InnoDB](#) table that uses [COMPACT](#) or [REDUNDANT](#) row format, these column and index definitions are legal:

```
coll VARCHAR(500) CHARACTER SET utf8, INDEX (coll(255))
```

To use `utf8mb4` instead, the index must be smaller:

```
coll VARCHAR(500) CHARACTER SET utf8mb4, INDEX (coll(191))
```



### Note

For `InnoDB` tables that use `COMPRESSED` or `DYNAMIC` row format, you can enable the `innodb_large_prefix` option to permit [index key prefixes](#) longer than 767 bytes (up to 3072 bytes). Creating such tables also requires the option values `innodb_file_format=barracuda` and `innodb_file_per_table=true`.) In this case, enabling the `innodb_large_prefix` option enables you to index a maximum of 1024 or 768 characters for `utf8mb3` or `utf8mb4` columns, respectively. For related information, see [Section 14.23, “InnoDB Limits”](#).

The preceding types of changes are most likely to be required only if you have very long columns or indexes. Otherwise, you should be able to convert your tables from `utf8mb3` to `utf8mb4` without problems, using `ALTER TABLE` as described previously.

The following items summarize other potential incompatibilities:

- `SET NAMES 'utf8mb4'` causes use of the 4-byte character set for connection character sets. As long as no 4-byte characters are sent from the server, there should be no problems. Otherwise, applications that expect to receive a maximum of three bytes per character may have problems. Conversely, applications that expect to send 4-byte characters must ensure that the server understands them.
- For replication, if character sets that support supplementary characters are to be used on the source, all replicas must understand them as well.

Also, keep in mind the general principle that if a table has different definitions on the source and replica, this can lead to unexpected results. For example, the differences in maximum index key length make it risky to use `utf8mb3` on the source and `utf8mb4` on the replica.

If you have converted to `utf8mb4`, `utf16`, `utf16le`, or `utf32`, and then decide to convert back to `utf8mb3` or `ucs2` (for example, to downgrade to an older version of MySQL), these considerations apply:

- `utf8mb3` and `ucs2` data should present no problems.
- The server must be recent enough to recognize definitions referring to the character set from which you are converting.
- For object definitions that refer to the `utf8mb4` character set, you can dump them with `mysqldump` prior to downgrading, edit the dump file to change instances of `utf8mb4` to `utf8`, and reload the file in the older server, as long as there are no 4-byte characters in the data. The older server sees `utf8` in the dump file object definitions and creates new objects that use the (3-byte) `utf8` character set.

## 10.10 Supported Character Sets and Collations

This section indicates which character sets MySQL supports. There is one subsection for each group of related character sets. For each character set, the permissible collations are listed.

To list the available character sets and their default collations, use the `SHOW CHARACTER SET` statement or query the `INFORMATION_SCHEMA.CHARACTER_SETS` table. For example:

```
mysql> SHOW CHARACTER SET;
```

Charset	Description	Default collation	Maxlen
big5	Big5 Traditional Chinese	big5_chinese_ci	2
dec8	DEC West European	dec8_swedish_ci	1
cp850	DOS West European	cp850_general_ci	1
hp8	HP West European	hp8_english_ci	1
koi8r	KOI8-R Relcom Russian	koi8r_general_ci	1
latin1	cpl252 West European	latin1_swedish_ci	1
latin2	ISO 8859-2 Central European	latin2_general_ci	1
swe7	7bit Swedish	swe7_swedish_ci	1
ascii	US ASCII	ascii_general_ci	1
ujis	EUC-JP Japanese	ujis_japanese_ci	3
sjis	Shift-JIS Japanese	sjis_japanese_ci	2
hebrew	ISO 8859-8 Hebrew	hebrew_general_ci	1
tis620	TIS620 Thai	tis620_thai_ci	1
euckr	EUC-KR Korean	euckr_korean_ci	2
koi8u	KOI8-U Ukrainian	koi8u_general_ci	1
gb2312	GB2312 Simplified Chinese	gb2312_chinese_ci	2
greek	ISO 8859-7 Greek	greek_general_ci	1
cp1250	Windows Central European	cp1250_general_ci	1
gbk	GBK Simplified Chinese	gbk_chinese_ci	2
latin5	ISO 8859-9 Turkish	latin5_turkish_ci	1
armscii8	ARMScii8 Armenian	armscii8_general_ci	1
utf8	UTF-8 Unicode	utf8_general_ci	3
ucs2	UCS-2 Unicode	ucs2_general_ci	2
cp866	DOS Russian	cp866_general_ci	1
keybcs2	DOS Kamenicky Czech-Slovak	keybcs2_general_ci	1
macce	Mac Central European	macce_general_ci	1
macroman	Mac West European	macroman_general_ci	1
cp852	DOS Central European	cp852_general_ci	1
latin7	ISO 8859-13 Baltic	latin7_general_ci	1
utf8mb4	UTF-8 Unicode	utf8mb4_general_ci	4
cp1251	Windows Cyrillic	cp1251_general_ci	1
utf16	UTF-16 Unicode	utf16_general_ci	4
utf16le	UTF-16LE Unicode	utf16le_general_ci	4
cp1256	Windows Arabic	cp1256_general_ci	1
cp1257	Windows Baltic	cp1257_general_ci	1
utf32	UTF-32 Unicode	utf32_general_ci	4
binary	Binary pseudo charset	binary	1
geostd8	GEOSTD8 Georgian	geostd8_general_ci	1
cp932	SJIS for Windows Japanese	cp932_japanese_ci	2
eucjpms	UJIS for Windows Japanese	eucjpms_japanese_ci	3
gb18030	China National Standard GB18030	gb18030_chinese_ci	4

In cases where a character set has multiple collations, it might not be clear which collation is most suitable for a given application. To avoid choosing the wrong collation, it can be helpful to perform some comparisons with representative data values to make sure that a given collation sorts values the way you expect.

## 10.10.1 Unicode Character Sets

This section describes the collations available for Unicode character sets and their differentiating properties. For general information about Unicode, see [Section 10.9, “Unicode Support”](#).

MySQL supports multiple Unicode character sets:

- `utf8mb4`: A UTF-8 encoding of the Unicode character set using one to four bytes per character.
- `utf8mb3`: A UTF-8 encoding of the Unicode character set using one to three bytes per character.
- `utf8`: An alias for `utf8mb3`.

- `ucs2`: The UCS-2 encoding of the Unicode character set using two bytes per character.
- `utf16`: The UTF-16 encoding for the Unicode character set using two or four bytes per character. Like `ucs2` but with an extension for supplementary characters.
- `utf16le`: The UTF-16LE encoding for the Unicode character set. Like `utf16` but little-endian rather than big-endian.
- `utf32`: The UTF-32 encoding for the Unicode character set using four bytes per character.

`utf8mb4`, `utf16`, `utf16le`, and `utf32` support Basic Multilingual Plane (BMP) characters and supplementary characters that lie outside the BMP. `utf8` and `ucs2` support only BMP characters.

Most Unicode character sets have a general collation (indicated by `_general` in the name or by the absence of a language specifier), a binary collation (indicated by `_bin` in the name), and several language-specific collations (indicated by language specifiers). For example, for `utf8mb4`, `utf8mb4_general_ci` and `utf8mb4_bin` are its general and binary collations, and `utf8mb4_danish_ci` is one of its language-specific collations.

Collation support for `utf16le` is limited. The only collations available are `utf16le_general_ci` and `utf16le_bin`. These are similar to `utf16_general_ci` and `utf16_bin`.

- [Unicode Collation Algorithm \(UCA\) Versions](#)
- [Language-Specific Collations](#)
- [\\_general\\_ci Versus \\_unicode\\_ci Collations](#)
- [Character Collating Weights](#)
- [Miscellaneous Information](#)

## Unicode Collation Algorithm (UCA) Versions

MySQL implements the `xxx_unicode_ci` collations according to the Unicode Collation Algorithm (UCA) described at <http://www.unicode.org/reports/tr10/>. The collation uses the version-4.0.0 UCA weight keys: <http://www.unicode.org/Public/UCD/4.0.0/allkeys-4.0.0.txt>. The `xxx_unicode_ci` collations have only partial support for the Unicode Collation Algorithm. Some characters are not supported, and combining marks are not fully supported. This affects primarily Vietnamese, Yoruba, and some smaller languages such as Navajo. A combined character is considered different from the same character written with a single unicode character in string comparisons, and the two characters are considered to have a different length (for example, as returned by the `CHAR_LENGTH()` function or in result set metadata).

Unicode collations based on UCA versions higher than 4.0.0 include the version in the collation name. Thus, `utf8_unicode_520_ci` is based on UCA 5.2.0 weight keys (<http://www.unicode.org/Public/UCD/5.2.0/allkeys.txt>).

The `LOWER()` and `UPPER()` functions perform case folding according to the collation of their argument. A character that has uppercase and lowercase versions only in a Unicode version higher than 4.0.0 is converted by these functions only if the argument collation uses a high enough UCA version.

## Language-Specific Collations

MySQL implements language-specific Unicode collations if the ordering based only on the Unicode Collation Algorithm (UCA) does not work well for a language. Language-specific collations are UCA-based, with additional language tailoring rules. Examples of such rules appear later in this section. For questions

about particular language orderings, <http://unicode.org> provides Common Locale Data Repository (CLDR) collation charts at <http://www.unicode.org/cldr/charts/30/collation/index.html>.

A language name shown in the following table indicates a language-specific collation. Unicode character sets may include collations for one or more of these languages.

**Table 10.3 Unicode Collation Language Specifiers**

Language	Language Specifier
Classical Latin	<code>roman</code>
Croatian	<code>croatian</code>
Czech	<code>czech</code>
Danish	<code>danish</code>
Esperanto	<code>esperanto</code>
Estonian	<code>estonian</code>
German phone book order	<code>german2</code>
Hungarian	<code>hungarian</code>
Icelandic	<code>icelandic</code>
Latvian	<code>latvian</code>
Lithuanian	<code>lithuanian</code>
Persian	<code>persian</code>
Polish	<code>polish</code>
Romanian	<code>romanian</code>
Sinhala	<code>sinhala</code>
Slovak	<code>slovak</code>
Slovenian	<code>slovenian</code>
Modern Spanish	<code>spanish</code>
Traditional Spanish	<code>spanish2</code>
Swedish	<code>swedish</code>
Turkish	<code>turkish</code>
Vietnamese	<code>vietnamese</code>

Croatian collations are tailored for these Croatian letters: Č, Ć, Dž, Đ, Lj, Nj, Š, Ž.

Danish collations may also be used for Norwegian.

For Classical Latin collations, `I` and `J` compare as equal, and `U` and `V` compare as equal.

Spanish collations are available for modern and traditional Spanish. For both, `ñ` (n-tilde) is a separate letter between `n` and `o`. In addition, for traditional Spanish, `ch` is a separate letter between `c` and `d`, and `ll` is a separate letter between `l` and `m`.

Traditional Spanish collations may also be used for Asturian and Galician.

Swedish collations include Swedish rules. For example, in Swedish, the following relationship holds, which is not something expected by a German or French speaker:



```
Ü = Y < Ö
```

## `_general_ci` Versus `_unicode_ci` Collations

For any Unicode character set, operations performed using the `xxx_general_ci` collation are faster than those for the `xxx_unicode_ci` collation. For example, comparisons for the `utf8_general_ci` collation are faster, but slightly less correct, than comparisons for `utf8_unicode_ci`. The reason is that `utf8_unicode_ci` supports mappings such as expansions; that is, when one character compares as equal to combinations of other characters. For example, `ß` is equal to `ss` in German and some other languages. `utf8_unicode_ci` also supports contractions and ignorable characters. `utf8_general_ci` is a legacy collation that does not support expansions, contractions, or ignorable characters. It can make only one-to-one comparisons between characters.

To further illustrate, the following equalities hold in both `utf8_general_ci` and `utf8_unicode_ci` (for the effect of this in comparisons or searches, see [Section 10.8.6, “Examples of the Effect of Collation”](#)):

```
Ä = A
Ö = O
Ü = U
```

A difference between the collations is that this is true for `utf8_general_ci`:

```
ß = s
```

Whereas this is true for `utf8_unicode_ci`, which supports the German DIN-1 ordering (also known as dictionary order):

```
ß = ss
```

MySQL implements `utf8` language-specific collations if the ordering with `utf8_unicode_ci` does not work well for a language. For example, `utf8_unicode_ci` works fine for German dictionary order and French, so there is no need to create special `utf8` collations.

`utf8_general_ci` also is satisfactory for both German and French, except that `ß` is equal to `s`, and not to `ss`. If this is acceptable for your application, you should use `utf8_general_ci` because it is faster. If this is not acceptable (for example, if you require German dictionary order), use `utf8_unicode_ci` because it is more accurate.

If you require German DIN-2 (phone book) ordering, use the `utf8_german2_ci` collation, which compares the following sets of characters equal:

```
Ä = Æ = AE
Ö = Œ = OE
Ü = UE
ß = ss
```

`utf8_german2_ci` is similar to `latin1_german2_ci`, but the latter does not compare `Æ` equal to `AE` or `Œ` equal to `OE`. There is no `utf8_german_ci` corresponding to `latin1_german_ci` for German dictionary order because `utf8_general_ci` suffices.

## Character Collating Weights

A character's collating weight is determined as follows:

- For all Unicode collations except the `_bin` (binary) collations, MySQL performs a table lookup to find a character's collating weight.

- For `_bin` collations, the weight is based on the code point, possibly with leading zero bytes added.

Collating weights can be displayed using the `WEIGHT_STRING()` function. (See [Section 12.8, “String Functions and Operators”](#).) If a collation uses a weight lookup table, but a character is not in the table (for example, because it is a “new” character), collating weight determination becomes more complex:

- For BMP characters in general collations (`xxx_general_ci`), the weight is the code point.
- For BMP characters in UCA collations (for example, `xxx_unicode_ci` and language-specific collations), the following algorithm applies:

```
if (code >= 0x3400 && code <= 0x4DB5)
  base= 0xFB80; /* CJK Ideograph Extension */
else if (code >= 0x4E00 && code <= 0x9FA5)
  base= 0xFB40; /* CJK Ideograph */
else
  base= 0xFBC0; /* All other characters */
aaaa= base + (code >> 15);
bbbb= (code & 0x7FFF) | 0x8000;
```

The result is a sequence of two collating elements, `aaaa` followed by `bbbb`. For example:

```
mysql> SELECT HEX(WEIGHT_STRING(_ucs2 0x04CF COLLATE ucs2_unicode_ci));
+-----+
| HEX(WEIGHT_STRING(_ucs2 0x04CF COLLATE ucs2_unicode_ci)) |
+-----+
| FBC084CF |
+-----+
```

Thus, `U+04cf CYRILLIC SMALL LETTER PALOCHKA` is, with all UCA 4.0.0 collations, greater than `U+04c0 CYRILLIC LETTER PALOCHKA`. With UCA 5.2.0 collations, all palochkas sort together.

- For supplementary characters in general collations, the weight is the weight for `0xffff REPLACEMENT CHARACTER`. For supplementary characters in UCA 4.0.0 collations, their collating weight is `0xffff`. That is, to MySQL, all supplementary characters are equal to each other, and greater than almost all BMP characters.

An example with Deseret characters and `COUNT(DISTINCT)`:

```
CREATE TABLE t (s1 VARCHAR(5) CHARACTER SET utf32 COLLATE utf32_unicode_ci);
INSERT INTO t VALUES (0xffff); /* REPLACEMENT CHARACTER */
INSERT INTO t VALUES (0x010412); /* DESERET CAPITAL LETTER BEE */
INSERT INTO t VALUES (0x010413); /* DESERET CAPITAL LETTER TEE */
SELECT COUNT(DISTINCT s1) FROM t;
```

The result is 2 because in the MySQL `xxx_unicode_ci` collations, the replacement character has a weight of `0x0dc6`, whereas Deseret Bee and Deseret Tee both have a weight of `0xffff`. (Were the `utf32_general_ci` collation used instead, the result is 1 because all three characters have a weight of `0xffff` in that collation.)

An example with cuneiform characters and `WEIGHT_STRING()`:

```
/*
The four characters in the INSERT string are
00000041 # LATIN CAPITAL LETTER A
0001218F # CUNEIFORM SIGN KAB
000121A7 # CUNEIFORM SIGN KISH
00000042 # LATIN CAPITAL LETTER B
*/
CREATE TABLE t (s1 CHAR(4) CHARACTER SET utf32 COLLATE utf32_unicode_ci);
INSERT INTO t VALUES (0x000000410001218f000121a700000042);
SELECT HEX(WEIGHT_STRING(s1)) FROM t;
```

The result is:

```
0E33 FFFD FFFD 0E4A
```

[0E33](#) and [0E4A](#) are primary weights as in [UCA 4.0.0](#). [FFFD](#) is the weight for KAB and also for KISH.

The rule that all supplementary characters are equal to each other is nonoptimal but is not expected to cause trouble. These characters are very rare, so it is very rare that a multi-character string consists entirely of supplementary characters. In Japan, since the supplementary characters are obscure Kanji ideographs, the typical user does not care what order they are in, anyway. If you really want rows sorted by the MySQL rule and secondarily by code point value, it is easy:

```
ORDER BY s1 COLLATE utf32_unicode_ci, s1 COLLATE utf32_bin
```

- For supplementary characters based on UCA versions higher than 4.0.0 (for example, [xxx\\_unicode\\_520\\_ci](#)), supplementary characters do not necessarily all have the same collating weight. Some have explicit weights from the UCA [allkeys.txt](#) file. Others have weights calculated from this algorithm:

```
aaaa= base + (code >> 15);
bbbb= (code & 0x7FFF) | 0x8000;
```

There is a difference between “ordering by the character's code value” and “ordering by the character's binary representation,” a difference that appears only with [utf16\\_bin](#), because of surrogates.

Suppose that [utf16\\_bin](#) (the binary collation for [utf16](#)) was a binary comparison “byte by byte” rather than “character by character.” If that were so, the order of characters in [utf16\\_bin](#) would differ from the order in [utf8\\_bin](#). For example, the following chart shows two rare characters. The first character is in the range [E000-FFFF](#), so it is greater than a surrogate but less than a supplementary. The second character is a supplementary.

Code point	Character	utf8	utf16
0FF9D	HALFWIDTH KATAKANA LETTER N	EF BE 9D	FF 9D
10384	UGARITIC LETTER DELTA	F0 90 8E 84	D8 00 DF 84

The two characters in the chart are in order by code point value because  $0xff9d < 0x10384$ . And they are in order by [utf8](#) value because  $0xef < 0xf0$ . But they are not in order by [utf16](#) value, if we use byte-by-byte comparison, because  $0xff > 0xd8$ .

So MySQL's [utf16\\_bin](#) collation is not “byte by byte.” It is “by code point.” When MySQL sees a supplementary-character encoding in [utf16](#), it converts to the character's code-point value, and then compares. Therefore, [utf8\\_bin](#) and [utf16\\_bin](#) are the same ordering. This is consistent with the SQL:2008 standard requirement for a UCS\_BASIC collation: “UCS\_BASIC is a collation in which the ordering is determined entirely by the Unicode scalar values of the characters in the strings being sorted. It is applicable to the UCS character repertoire. Since every character repertoire is a subset of the UCS repertoire, the UCS\_BASIC collation is potentially applicable to every character set. NOTE 11: The Unicode scalar value of a character is its code point treated as an unsigned integer.”

If the character set is [ucs2](#), comparison is byte-by-byte, but [ucs2](#) strings should not contain surrogates, anyway.

## Miscellaneous Information

The [xxx\\_general\\_mysql500\\_ci](#) collations preserve the pre-5.1.24 ordering of the original [xxx\\_general\\_ci](#) collations and permit upgrades for tables created before MySQL 5.1.24 (Bug #27877).

## 10.10.2 West European Character Sets

Western European character sets cover most West European languages, such as French, Spanish, Catalan, Basque, Portuguese, Italian, Albanian, Dutch, German, Danish, Swedish, Norwegian, Finnish, Faroese, Icelandic, Irish, Scottish, and English.

- `ascii` (US ASCII) collations:
  - `ascii_bin`
  - `ascii_general_ci` (default)
- `cp850` (DOS West European) collations:
  - `cp850_bin`
  - `cp850_general_ci` (default)
- `dec8` (DEC Western European) collations:
  - `dec8_bin`
  - `dec8_swedish_ci` (default)
- `hp8` (HP Western European) collations:
  - `hp8_bin`
  - `hp8_english_ci` (default)
- `latin1` (cp1252 West European) collations:
  - `latin1_bin`
  - `latin1_danish_ci`
  - `latin1_general_ci`
  - `latin1_general_cs`
  - `latin1_german1_ci`
  - `latin1_german2_ci`
  - `latin1_spanish_ci`
  - `latin1_swedish_ci` (default)

`latin1` is the default character set. MySQL's `latin1` is the same as the Windows `cp1252` character set. This means it is the same as the official [ISO 8859-1](#) or IANA (Internet Assigned Numbers Authority) `latin1`, except that IANA `latin1` treats the code points between `0x80` and `0x9f` as “undefined,” whereas `cp1252`, and therefore MySQL's `latin1`, assign characters for those positions. For example, `0x80` is the Euro sign. For the “undefined” entries in `cp1252`, MySQL translates `0x81` to Unicode `0x0081`, `0x8d` to `0x008d`, `0x8f` to `0x008f`, `0x90` to `0x0090`, and `0x9d` to `0x009d`.

The `latin1_swedish_ci` collation is the default that probably is used by the majority of MySQL customers. Although it is frequently said that it is based on the Swedish/Finnish collation rules, there are Swedes and Finns who disagree with this statement.

The `latin1_german1_ci` and `latin1_german2_ci` collations are based on the DIN-1 and DIN-2 standards, where DIN stands for *Deutsches Institut für Normung* (the German equivalent of ANSI). DIN-1 is called the “dictionary collation” and DIN-2 is called the “phone book collation.” For an example of the effect this has in comparisons or when doing searches, see [Section 10.8.6, “Examples of the Effect of Collation”](#).

- `latin1_german1_ci` (dictionary) rules:

```
Ä = A
Ö = O
Ü = U
ß = s
```

- `latin1_german2_ci` (phone-book) rules:

```
Ä = AE
Ö = OE
Ü = UE
ß = ss
```

In the `latin1_spanish_ci` collation, ñ (n-tilde) is a separate letter between `n` and `o`.

- `macroman` (Mac West European) collations:
  - `macroman_bin`
  - `macroman_general_ci` (default)
- `swe7` (7bit Swedish) collations:
  - `swe7_bin`
  - `swe7_swedish_ci` (default)

### 10.10.3 Central European Character Sets

MySQL provides some support for character sets used in the Czech Republic, Slovakia, Hungary, Romania, Slovenia, Croatia, Poland, and Serbia (Latin).

- `cp1250` (Windows Central European) collations:
  - `cp1250_bin`
  - `cp1250_croatian_ci`
  - `cp1250_czech_cs`
  - `cp1250_general_ci` (default)
  - `cp1250_polish_ci`
- `cp852` (DOS Central European) collations:
  - `cp852_bin`
  - `cp852_general_ci` (default)
- `keybcs2` (DOS Kamenicky Czech-Slovak) collations:

- `keybcs2_bin`
- `keybcs2_general_ci` (default)
- `latin2` (ISO 8859-2 Central European) collations:
  - `latin2_bin`
  - `latin2_croatian_ci`
  - `latin2_czech_cs`
  - `latin2_general_ci` (default)
  - `latin2_hungarian_ci`
- `macce` (Mac Central European) collations:
  - `macce_bin`
  - `macce_general_ci` (default)

#### 10.10.4 South European and Middle East Character Sets

South European and Middle Eastern character sets supported by MySQL include Armenian, Arabic, Georgian, Greek, Hebrew, and Turkish.

- `armscii8` (ARMScii8 Armenian) collations:
  - `armscii8_bin`
  - `armscii8_general_ci` (default)
- `cp1256` (Windows Arabic) collations:
  - `cp1256_bin`
  - `cp1256_general_ci` (default)
- `geostd8` (GEOSTD8 Georgian) collations:
  - `geostd8_bin`
  - `geostd8_general_ci` (default)
- `greek` (ISO 8859-7 Greek) collations:
  - `greek_bin`
  - `greek_general_ci` (default)
- `hebrew` (ISO 8859-8 Hebrew) collations:
  - `hebrew_bin`
  - `hebrew_general_ci` (default)
- `latin5` (ISO 8859-9 Turkish) collations:

- `latin5_bin`
- `latin5_turkish_ci` (default)

### 10.10.5 Baltic Character Sets

The Baltic character sets cover Estonian, Latvian, and Lithuanian languages.

- `cp1257` (Windows Baltic) collations:
  - `cp1257_bin`
  - `cp1257_general_ci` (default)
  - `cp1257_lithuanian_ci`
- `latin7` (ISO 8859-13 Baltic) collations:
  - `latin7_bin`
  - `latin7_estonian_cs`
  - `latin7_general_ci` (default)
  - `latin7_general_cs`

### 10.10.6 Cyrillic Character Sets

The Cyrillic character sets and collations are for use with Belarusian, Bulgarian, Russian, Ukrainian, and Serbian (Cyrillic) languages.

- `cp1251` (Windows Cyrillic) collations:
  - `cp1251_bin`
  - `cp1251_bulgarian_ci`
  - `cp1251_general_ci` (default)
  - `cp1251_general_cs`
  - `cp1251_ukrainian_ci`
- `cp866` (DOS Russian) collations:
  - `cp866_bin`
  - `cp866_general_ci` (default)
- `koi8r` (KOI8-R Relcom Russian) collations:
  - `koi8r_bin`
  - `koi8r_general_ci` (default)
- `koi8u` (KOI8-U Ukrainian) collations:
  - `koi8u_bin`

- `koi8u_general_ci` (default)

## 10.10.7 Asian Character Sets

The Asian character sets that we support include Chinese, Japanese, Korean, and Thai. These can be complicated. For example, the Chinese sets must allow for thousands of different characters. See [Section 10.10.7.1, “The cp932 Character Set”](#), for additional information about the `cp932` and `sjis` character sets. See [Section 10.10.7.2, “The gb18030 Character Set”](#), for additional information about character set support for the Chinese National Standard GB 18030.

For answers to some common questions and problems relating support for Asian character sets in MySQL, see [Section A.11, “MySQL 5.7 FAQ: MySQL Chinese, Japanese, and Korean Character Sets”](#).

- `big5` (Big5 Traditional Chinese) collations:
  - `big5_bin`
  - `big5_chinese_ci` (default)
- `cp932` (SJIS for Windows Japanese) collations:
  - `cp932_bin`
  - `cp932_japanese_ci` (default)
- `ujis` (UJIS for Windows Japanese) collations:
  - `ujis_bin`
  - `ujis_japanese_ci` (default)
- `euckr` (EUC-KR Korean) collations:
  - `euckr_bin`
  - `euckr_korean_ci` (default)
- `gb2312` (GB2312 Simplified Chinese) collations:
  - `gb2312_bin`
  - `gb2312_chinese_ci` (default)
- `gbk` (GBK Simplified Chinese) collations:
  - `gbk_bin`
  - `gbk_chinese_ci` (default)
- `gb18030` (China National Standard GB18030) collations:
  - `gb18030_bin`
  - `gb18030_chinese_ci` (default)
  - `gb18030_unicode_520_ci`
- `sjis` (Shift-JIS Japanese) collations:



- `sjis_bin`
- `sjis_japanese_ci` (default)
- `tis620` (TIS620 Thai) collations:
  - `tis620_bin`
  - `tis620_thai_ci` (default)
- `ujis` (EUC-JP Japanese) collations:
  - `ujis_bin`
  - `ujis_japanese_ci` (default)

The `big5_chinese_ci` collation sorts on number of strokes.

### 10.10.7.1 The `cp932` Character Set

#### Why is `cp932` needed?

In MySQL, the `sjis` character set corresponds to the `Shift_JIS` character set defined by IANA, which supports JIS X0201 and JIS X0208 characters. (See <http://www.iana.org/assignments/character-sets>.)

However, the meaning of “SHIFT JIS” as a descriptive term has become very vague and it often includes the extensions to `Shift_JIS` that are defined by various vendors.

For example, “SHIFT JIS” used in Japanese Windows environments is a Microsoft extension of `Shift_JIS` and its exact name is `Microsoft Windows Codepage : 932` or `cp932`. In addition to the characters supported by `Shift_JIS`, `cp932` supports extension characters such as NEC special characters, NEC selected—IBM extended characters, and IBM selected characters.

Many Japanese users have experienced problems using these extension characters. These problems stem from the following factors:

- MySQL automatically converts character sets.
- Character sets are converted using Unicode (`ucs2`).
- The `sjis` character set does not support the conversion of these extension characters.
- There are several conversion rules from so-called “SHIFT JIS” to Unicode, and some characters are converted to Unicode differently depending on the conversion rule. MySQL supports only one of these rules (described later).

The MySQL `cp932` character set is designed to solve these problems.

Because MySQL supports character set conversion, it is important to separate IANA `Shift_JIS` and `cp932` into two different character sets because they provide different conversion rules.

#### How does `cp932` differ from `sjis`?

The `cp932` character set differs from `sjis` in the following ways:

- `cp932` supports NEC special characters, NEC selected—IBM extended characters, and IBM selected characters.

- Some `cp932` characters have two different code points, both of which convert to the same Unicode code point. When converting from Unicode back to `cp932`, one of the code points must be selected. For this “round trip conversion,” the rule recommended by Microsoft is used. (See <http://support.microsoft.com/kb/170559/EN-US/>.)

The conversion rule works like this:

- If the character is in both JIS X 0208 and NEC special characters, use the code point of JIS X 0208.
- If the character is in both NEC special characters and IBM selected characters, use the code point of NEC special characters.
- If the character is in both IBM selected characters and NEC selected—IBM extended characters, use the code point of IBM extended characters.

The table shown at <https://msdn.microsoft.com/en-us/goglobal/cc305152.aspx> provides information about the Unicode values of `cp932` characters. For `cp932` table entries with characters under which a four-digit number appears, the number represents the corresponding Unicode (`ucs2`) encoding. For table entries with an underlined two-digit value appears, there is a range of `cp932` character values that begin with those two digits. Clicking such a table entry takes you to a page that displays the Unicode value for each of the `cp932` characters that begin with those digits.

The following links are of special interest. They correspond to the encodings for the following sets of characters:

- NEC special characters (lead byte `0x87`):

<https://msdn.microsoft.com/en-us/goglobal/gg674964>

- NEC selected—IBM extended characters (lead byte `0xED` and `0xEE`):

<https://msdn.microsoft.com/en-us/goglobal/gg671837>  
<https://msdn.microsoft.com/en-us/goglobal/gg671838>

- IBM selected characters (lead byte `0xFA`, `0xFB`, `0xFC`):

<https://msdn.microsoft.com/en-us/goglobal/gg671839>  
<https://msdn.microsoft.com/en-us/goglobal/gg671840>  
<https://msdn.microsoft.com/en-us/goglobal/gg671841>

- `cp932` supports conversion of user-defined characters in combination with `eucjpms`, and solves the problems with `sjis/ujis` conversion. For details, please refer to <http://www.sjfaq.org/afaq/encodings.html>.

For some characters, conversion to and from `ucs2` is different for `sjis` and `cp932`. The following tables illustrate these differences.

Conversion to `ucs2`:

<code>sjis/cp932</code> Value	<code>sjis</code> -> <code>ucs2</code> Conversion	<code>cp932</code> -> <code>ucs2</code> Conversion
5C	005C	005C
7E	007E	007E
815C	2015	2015
815F	005C	FF3C
8160	301C	FF5E
8161	2016	2225

<a href="#">sjis/cp932 Value</a>	<a href="#">sjis -&gt; ucs2 Conversion</a>	<a href="#">cp932 -&gt; ucs2 Conversion</a>
817C	2212	FF0D
8191	00A2	FFE0
8192	00A3	FFE1
81CA	00AC	FFE2

Conversion from [ucs2](#):

<a href="#">ucs2 value</a>	<a href="#">ucs2 -&gt; sjis Conversion</a>	<a href="#">ucs2 -&gt; cp932 Conversion</a>
005C	815F	5C
007E	7E	7E
00A2	8191	3F
00A3	8192	3F
00AC	81CA	3F
2015	815C	815C
2016	8161	3F
2212	817C	3F
2225	3F	8161
301C	8160	3F
FF0D	3F	817C
FF3C	3F	815F
FF5E	3F	8160
FFE0	3F	8191
FFE1	3F	8192
FFE2	3F	81CA

Users of any Japanese character sets should be aware that using `--character-set-client-handshake` (or `--skip-character-set-client-handshake`) has an important effect. See [Section 5.1.6, “Server Command Options”](#).

### 10.10.7.2 The `gb18030` Character Set

In MySQL, the `gb18030` character set corresponds to the “Chinese National Standard GB 18030-2005: Information technology—Chinese coded character set”, which is the official character set of the People’s Republic of China (PRC).

#### Characteristics of the MySQL `gb18030` Character Set

- Supports all code points defined by the GB 18030-2005 standard. Unassigned code points in the ranges (GB+8431A439, GB+90308130) and (GB+E3329A36, GB+EF39EF39) are treated as '?' (0x3F). Conversion of unassigned code points return '?'.
- Supports UPPER and LOWER conversion for all GB18030 code points. Case folding defined by Unicode is also supported (based on [CaseFolding-6.3.0.txt](#)).
- Supports Conversion of data to and from other character sets.
- Supports SQL statements such as `SET NAMES`.

- Supports comparison between `gb18030` strings, and between `gb18030` strings and strings of other character sets. There is a conversion if strings have different character sets. Comparisons that include or ignore trailing spaces are also supported.
- The private use area (U+E000, U+F8FF) in Unicode is mapped to `gb18030`.
- There is no mapping between (U+D800, U+DFFF) and GB18030. Attempted conversion of code points in this range returns '?'.  
 If an incoming sequence is illegal, an error or warning is returned. If an illegal sequence is used in `CONVERT()`, an error is returned. Otherwise, a warning is returned.
- For consistency with `utf8` and `utf8mb4`, UPPER is not supported for ligatures.
- Searches for ligatures also match uppercase ligatures when using the `gb18030_unicode_520_ci` collation.
- If a character has more than one uppercase character, the chosen uppercase character is the one whose lowercase is the character itself.
- The minimum multibyte length is 1 and the maximum is 4. The character set determines the length of a sequence using the first 1 or 2 bytes.

## Supported Collations

- `gb18030_bin`: A binary collation.
- `gb18030_chinese_ci`: The default collation, which supports Pinyin. Sorting of non-Chinese characters is based on the order of the original sort key. The original sort key is `GB(UPPER(ch))` if `UPPER(ch)` exists. Otherwise, the original sort key is `GB(ch)`. Chinese characters are sorted according to the Pinyin collation defined in the Unicode Common Locale Data Repository (CLDR 24). Non-Chinese characters are sorted before Chinese characters with the exception of `GB+FE39FE39`, which is the code point maximum.
- `gb18030_unicode_520_ci`: A Unicode collation. Use this collation if you need to ensure that ligatures are sorted correctly.

## 10.10.8 The Binary Character Set

The `binary` character set is the character set for binary strings, which are sequences of bytes. The `binary` character set has one collation, also named `binary`. Comparison and sorting are based on numeric byte values, rather than on numeric character code values (which for multibyte characters differ from numeric byte values). For information about the differences between the `binary` collation of the `binary` character set and the `_bin` collations of nonbinary character sets, see [Section 10.8.5, “The binary Collation Compared to \\_bin Collations”](#).

For the `binary` character set, the concepts of lettercase and accent equivalence do not apply:

- For single-byte characters stored as binary strings, character and byte boundaries are the same, so lettercase and accent differences are significant in comparisons. That is, the `binary` collation is case-sensitive and accent-sensitive.

```
mysql> SET NAMES 'binary';
mysql> SELECT CHARSET('abc'), COLLATION('abc');
+-----+-----+
| CHARSET('abc') | COLLATION('abc') |
+-----+-----+
| binary         | binary           |
+-----+-----+
```

```
mysql> SELECT 'abc' = 'ABC', 'a' = 'ä';
+-----+-----+
| 'abc' = 'ABC' | 'a' = 'ä' |
+-----+-----+
| 0 | 0 |
+-----+-----+
```

- For multibyte characters stored as binary strings, character and byte boundaries differ. Character boundaries are lost, so comparisons that depend on them are not meaningful.

To perform lettercase conversion of a binary string, first convert it to a nonbinary string using a character set appropriate for the data stored in the string:

```
mysql> SET @str = BINARY 'New York';
mysql> SELECT LOWER(@str), LOWER(CONVERT(@str USING utf8mb4));
+-----+-----+
| LOWER(@str) | LOWER(CONVERT(@str USING utf8mb4)) |
+-----+-----+
| New York | new york |
+-----+-----+
```

To convert a string expression to a binary string, these constructs are equivalent:

```
BINARY expr
CAST(expr AS BINARY)
CONVERT(expr USING BINARY)
```

If a value is a character string literal, the `_binary` introducer may be used to designate it as a binary string. For example:

```
_binary 'a'
```

The `_binary` introducer is permitted for hexadecimal literals and bit-value literals as well, but unnecessary; such literals are binary strings by default.

For more information about introducers, see [Section 10.3.8, “Character Set Introducers”](#).



#### Note

Within the `mysql` client, binary strings display using hexadecimal notation, depending on the value of the `--binary-as-hex`. For more information about that option, see [Section 4.5.1, “mysql — The MySQL Command-Line Client”](#).

## 10.11 Restrictions on Character Sets

- Identifiers are stored in `mysql` database tables (`user`, `db`, and so forth) using `utf8`, but identifiers can contain only characters in the Basic Multilingual Plane (BMP). Supplementary characters are not permitted in identifiers.
- The `ucs2`, `utf16`, `utf16le`, and `utf32` character sets have the following restrictions:
  - None of them can be used as the client character set. See [Impermissible Client Character Sets](#).
  - It is currently not possible to use `LOAD DATA` to load data files that use these character sets.
  - `FULLTEXT` indexes cannot be created on a column that uses any of these character sets. However, you can perform `IN BOOLEAN MODE` searches on the column without an index.
  - The use of `ENCRYPT()` with these character sets is not recommended because the underlying system call expects a string terminated by a zero byte.

- The `REGEXP` and `RLIKE` operators work in byte-wise fashion, so they are not multibyte safe and may produce unexpected results with multibyte character sets. In addition, these operators compare characters by their byte values and accented characters may not compare as equal even if a given collation treats them as equal.

## 10.12 Setting the Error Message Language

By default, `mysqld` produces error messages in English, but they can be displayed instead in any of several other languages: Czech, Danish, Dutch, Estonian, French, German, Greek, Hungarian, Italian, Japanese, Korean, Norwegian, Norwegian-ny, Polish, Portuguese, Romanian, Russian, Slovak, Spanish, or Swedish. This applies to messages the server writes to the error log and sends to clients.

To select the language in which the server writes error messages, follow the instructions in this section. For information about changing the character set for error messages (rather than the language), see [Section 10.6, “Error Message Character Set”](#). For general information about configuring error logging, see [Section 5.4.2, “The Error Log”](#).

The server searches for the error message file using these rules:

- It looks for the file in a directory constructed from two system variable values, `lc_messages_dir` and `lc_messages`, with the latter converted to a language name. Suppose that you start the server using this command:

```
mysqld --lc_messages_dir=/usr/share/mysql --lc_messages=fr_FR
```

In this case, `mysqld` maps the locale `fr_FR` to the language `french` and looks for the error file in the `/usr/share/mysql/french` directory.

By default, the language files are located in the `share/mysql/LANGUAGE` directory under the MySQL base directory.

- If the message file cannot be found in the directory constructed as just described, the server ignores the `lc_messages` value and uses only the `lc_messages_dir` value as the location in which to look.

The `lc_messages_dir` system variable can be set only at server startup and has only a global read-only value at runtime. `lc_messages` can be set at server startup and has global and session values that can be modified at runtime. Thus, the error message language can be changed while the server is running, and each client can have its own error message language by setting its session `lc_messages` value to the desired locale name. For example, if the server is using the `fr_FR` locale for error messages, a client can execute this statement to receive error messages in English:

```
SET lc_messages = 'en_US';
```

## 10.13 Adding a Character Set

This section discusses the procedure for adding a character set to MySQL. The proper procedure depends on whether the character set is simple or complex:

- If the character set does not need special string collating routines for sorting and does not need multibyte character support, it is simple.
- If the character set needs either of those features, it is complex.

For example, `greek` and `swe7` are simple character sets, whereas `big5` and `czech` are complex character sets.

To use the following instructions, you must have a MySQL source distribution. In the instructions, *MYSET* represents the name of the character set that you want to add.

1. Add a `<charset>` element for *MYSET* to the `sql/share/charsets/Index.xml` file. Use the existing contents in the file as a guide to adding new contents. A partial listing for the `latin1` `<charset>` element follows:

```
<charset name="latin1">
  <family>Western</family>
  <description>cp1252 West European</description>
  ...
  <collation name="latin1_swedish_ci" id="8" order="Finnish, Swedish">
    <flag>primary</flag>
    <flag>compiled</flag>
  </collation>
  <collation name="latin1_danish_ci" id="15" order="Danish"/>
  ...
  <collation name="latin1_bin" id="47" order="Binary">
    <flag>binary</flag>
    <flag>compiled</flag>
  </collation>
  ...
</charset>
```

The `<charset>` element must list all the collations for the character set. These must include at least a binary collation and a default (primary) collation. The default collation is often named using a suffix of `general_ci` (general, case-insensitive). It is possible for the binary collation to be the default collation, but usually they are different. The default collation should have a `primary` flag. The binary collation should have a `binary` flag.

You must assign a unique ID number to each collation. The range of IDs from 1024 to 2047 is reserved for user-defined collations. To find the maximum of the currently used collation IDs, use this query:

```
SELECT MAX(ID) FROM INFORMATION_SCHEMA.COLLATIONS;
```

2. This step depends on whether you are adding a simple or complex character set. A simple character set requires only a configuration file, whereas a complex character set requires C source file that defines collation functions, multibyte functions, or both.

For a simple character set, create a configuration file, *MYSET.xml*, that describes the character set properties. Create this file in the `sql/share/charsets` directory. You can use a copy of `latin1.xml` as the basis for this file. The syntax for the file is very simple:

- Comments are written as ordinary XML comments (`<!-- text -->`).
- Words within `<map>` array elements are separated by arbitrary amounts of whitespace.
- Each word within `<map>` array elements must be a number in hexadecimal format.
- The `<map>` array element for the `<ctype>` element has 257 words. The other `<map>` array elements after that have 256 words. See [Section 10.13.1, "Character Definition Arrays"](#).
- For each collation listed in the `<charset>` element for the character set in `Index.xml`, *MYSET.xml* must contain a `<collation>` element that defines the character ordering.

For a complex character set, create a C source file that describes the character set properties and defines the support routines necessary to properly perform operations on the character set:

- Create the file `ctype-MYSET.c` in the `strings` directory. Look at one of the existing `ctype-*.c` files (such as `ctype-big5.c`) to see what needs to be defined. The arrays in your file must have

names like `ctype_MYSET`, `to_lower_MYSET`, and so on. These correspond to the arrays for a simple character set. See [Section 10.13.1, “Character Definition Arrays”](#).

- For each `<collation>` element listed in the `<charset>` element for the character set in `Index.xml`, the `ctype-MYSET.c` file must provide an implementation of the collation.
  - If the character set requires string collating functions, see [Section 10.13.2, “String Collating Support for Complex Character Sets”](#).
  - If the character set requires multibyte character support, see [Section 10.13.3, “Multi-Byte Character Support for Complex Character Sets”](#).
3. Modify the configuration information. Use the existing configuration information as a guide to adding information for `MYSYS`. The example here assumes that the character set has default and binary collations, but more lines are needed if `MYSET` has additional collations.
    - a. Edit `mysys/charset-def.c`, and “register” the collations for the new character set.

Add these lines to the “declaration” section:

```
#ifdef HAVE_CHARSET_MYSET
extern CHARSET_INFO my_charset_MYSET_general_ci;
extern CHARSET_INFO my_charset_MYSET_bin;
#endif
```

Add these lines to the “registration” section:

```
#ifdef HAVE_CHARSET_MYSET
    add_compiled_collation(&my_charset_MYSET_general_ci);
    add_compiled_collation(&my_charset_MYSET_bin);
#endif
```

- b. If the character set uses `ctype-MYSET.c`, edit `strings/CMakeLists.txt` and add `ctype-MYSET.c` to the definition of the `STRINGS_SOURCES` variable.
  - c. Edit `cmake/character_sets.cmake`:
    - i. Add `MYSET` to the value of with `CHARSETS_AVAILABLE` in alphabetic order.
    - ii. Add `MYSET` to the value of `CHARSETS_COMPLEX` in alphabetic order. This is needed even for simple character sets, or `CMake` does not recognize `-DDEFAULT_CHARSET=MYSET`.
4. Reconfigure, recompile, and test.

### 10.13.1 Character Definition Arrays

Each simple character set has a configuration file located in the `sql/share/charsets` directory. For a character set named `MYSYS`, the file is named `MYSET.xml`. It uses `<map>` array elements to list character set properties. `<map>` elements appear within these elements:

- `<ctype>` defines attributes for each character.
- `<lower>` and `<upper>` list the lowercase and uppercase characters.
- `<unicode>` maps 8-bit character values to Unicode values.
- `<collation>` elements indicate character ordering for comparison and sorting, one element per collation. Binary collations need no `<map>` element because the character codes themselves provide the ordering.



For a complex character set as implemented in a `ctype-MYSET.c` file in the `strings` directory, there are corresponding arrays: `ctype_MYSET[]`, `to_lower_MYSET[]`, and so forth. Not every complex character set has all of the arrays. See also the existing `ctype-*.c` files for examples. See the `CHARSET_INFO.txt` file in the `strings` directory for additional information.

Most of the arrays are indexed by character value and have 256 elements. The `<ctype>` array is indexed by character value + 1 and has 257 elements. This is a legacy convention for handling EOF.

`<ctype>` array elements are bit values. Each element describes the attributes of a single character in the character set. Each attribute is associated with a bitmask, as defined in `include/m_ctype.h`:

```
#define _MY_U 01 /* Upper case */
#define _MY_L 02 /* Lower case */
#define _MY_NMR 04 /* Numeral (digit) */
#define _MY_SPC 010 /* Spacing character */
#define _MY_PNT 020 /* Punctuation */
#define _MY_CTR 040 /* Control character */
#define _MY_B 0100 /* Blank */
#define _MY_X 0200 /* hexadecimal digit */
```

The `<ctype>` value for a given character should be the union of the applicable bitmask values that describe the character. For example, 'A' is an uppercase character (`_MY_U`) as well as a hexadecimal digit (`_MY_X`), so its `ctype` value should be defined like this:

```
ctype['A'+1] = _MY_U | _MY_X = 01 | 0200 = 0201
```

The bitmask values in `m_ctype.h` are octal values, but the elements of the `<ctype>` array in `MYSET.xml` should be written as hexadecimal values.

The `<lower>` and `<upper>` arrays hold the lowercase and uppercase characters corresponding to each member of the character set. For example:

```
lower['A'] should contain 'a'
upper['a'] should contain 'A'
```

Each `<collation>` array indicates how characters should be ordered for comparison and sorting purposes. MySQL sorts characters based on the values of this information. In some cases, this is the same as the `<upper>` array, which means that sorting is case-insensitive. For more complicated sorting rules (for complex character sets), see the discussion of string collating in [Section 10.13.2, "String Collating Support for Complex Character Sets"](#).

## 10.13.2 String Collating Support for Complex Character Sets

For a simple character set named `MYSET`, sorting rules are specified in the `MYSET.xml` configuration file using `<map>` array elements within `<collation>` elements. If the sorting rules for your language are too complex to be handled with simple arrays, you must define string collating functions in the `ctype-MYSET.c` source file in the `strings` directory.

The existing character sets provide the best documentation and examples to show how these functions are implemented. Look at the `ctype-*.c` files in the `strings` directory, such as the files for the `big5`, `czech`, `gbk`, `sjis`, and `tis160` character sets. Take a look at the `MY_COLLATION_HANDLER` structures to see how they are used. See also the `CHARSET_INFO.txt` file in the `strings` directory for additional information.

## 10.13.3 Multi-Byte Character Support for Complex Character Sets

If you want to add support for a new character set named `MYSET` that includes multibyte characters, you must use multibyte character functions in the `ctype-MYSET.c` source file in the `strings` directory.

The existing character sets provide the best documentation and examples to show how these functions are implemented. Look at the `ctype-*.c` files in the `strings` directory, such as the files for the `euc_kr`, `gb2312`, `gbk`, `sjis`, and `ujis` character sets. Take a look at the `MY_CHARSET_HANDLER` structures to see how they are used. See also the `CHARSET_INFO.txt` file in the `strings` directory for additional information.

## 10.14 Adding a Collation to a Character Set

A collation is a set of rules that defines how to compare and sort character strings. Each collation in MySQL belongs to a single character set. Every character set has at least one collation, and most have two or more collations.

A collation orders characters based on weights. Each character in a character set maps to a weight. Characters with equal weights compare as equal, and characters with unequal weights compare according to the relative magnitude of their weights.

The `WEIGHT_STRING()` function can be used to see the weights for the characters in a string. The value that it returns to indicate weights is a binary string, so it is convenient to use `HEX(WEIGHT_STRING(str))` to display the weights in printable form. The following example shows that weights do not differ for lettercase for the letters in `'AaBb'` if it is a nonbinary case-insensitive string, but do differ if it is a binary string:

```
mysql> SELECT HEX(WEIGHT_STRING('AaBb' COLLATE latin1_swedish_ci));
+-----+
| HEX(WEIGHT_STRING('AaBb' COLLATE latin1_swedish_ci)) |
+-----+
| 41414242                                             |
+-----+
mysql> SELECT HEX(WEIGHT_STRING(BINARY 'AaBb'));
+-----+
| HEX(WEIGHT_STRING(BINARY 'AaBb')) |
+-----+
| 41614262                                             |
+-----+
```

MySQL supports several collation implementations, as discussed in [Section 10.14.1, “Collation Implementation Types”](#). Some of these can be added to MySQL without recompiling:

- Simple collations for 8-bit character sets.
- UCA-based collations for Unicode character sets.
- Binary (`xxx_bin`) collations.

The following sections describe how to add user-defined collations of the first two types to existing character sets. All existing character sets already have a binary collation, so there is no need here to describe how to add one.

Summary of the procedure for adding a new user-defined collation:

1. Choose a collation ID.
2. Add configuration information that names the collation and describes the character-ordering rules.
3. Restart the server.
4. Verify that the server recognizes the collation.

The instructions here cover only user-defined collations that can be added without recompiling MySQL. To add a collation that does require recompiling (as implemented by means of functions in a C source file), use the instructions in [Section 10.13, “Adding a Character Set”](#). However, instead of adding all the information required for a complete character set, just modify the appropriate files for an existing character set. That is, based on what is already present for the character set’s current collations, add data structures, functions, and configuration information for the new collation.



### Note

If you modify an existing user-defined collation, that may affect the ordering of rows for indexes on columns that use the collation. In this case, rebuild any such indexes to avoid problems such as incorrect query results. See [Section 2.10.12, “Rebuilding or Repairing Tables or Indexes”](#).

## Additional Resources

- Example showing how to add a collation for full-text searches: [Section 12.9.7, “Adding a User-Defined Collation for Full-Text Indexing”](#)
- The Unicode Collation Algorithm (UCA) specification: <http://www.unicode.org/reports/tr10/>
- The Locale Data Markup Language (LDML) specification: <http://www.unicode.org/reports/tr35/>

### 10.14.1 Collation Implementation Types

MySQL implements several types of collations:

#### Simple collations for 8-bit character sets

This kind of collation is implemented using an array of 256 weights that defines a one-to-one mapping from character codes to weights. `latin1_swedish_ci` is an example. It is a case-insensitive collation, so the uppercase and lowercase versions of a character have the same weights and they compare as equal.

```
mysql> SET NAMES 'latin1' COLLATE 'latin1_swedish_ci';
Query OK, 0 rows affected (0.01 sec)

mysql> SELECT HEX(WEIGHT_STRING('a')), HEX(WEIGHT_STRING('A'));
+-----+-----+
| HEX(WEIGHT_STRING('a')) | HEX(WEIGHT_STRING('A')) |
+-----+-----+
| 41                        | 41                        |
+-----+-----+
1 row in set (0.01 sec)

mysql> SELECT 'a' = 'A';
+-----+
| 'a' = 'A' |
+-----+
|          1 |
+-----+
1 row in set (0.12 sec)
```

For implementation instructions, see [Section 10.14.3, “Adding a Simple Collation to an 8-Bit Character Set”](#).

#### Complex collations for 8-bit character sets

This kind of collation is implemented using functions in a C source file that define how to order characters, as described in [Section 10.13, “Adding a Character Set”](#).

### Collations for non-Unicode multibyte character sets

For this type of collation, 8-bit (single-byte) and multibyte characters are handled differently. For 8-bit characters, character codes map to weights in case-insensitive fashion. (For example, the single-byte characters 'a' and 'A' both have a weight of 0x41.) For multibyte characters, there are two types of relationship between character codes and weights:

- Weights equal character codes. `sjis_japanese_ci` is an example of this kind of collation. The multibyte character 'ぢ' has a character code of 0x82C0, and the weight is also 0x82C0.

```
mysql> CREATE TABLE t1
      (c1 VARCHAR(2) CHARACTER SET sjis COLLATE sjis_japanese_ci);
Query OK, 0 rows affected (0.01 sec)

mysql> INSERT INTO t1 VALUES ('a'),('A'),(0x82C0);
Query OK, 3 rows affected (0.00 sec)
Records: 3 Duplicates: 0 Warnings: 0

mysql> SELECT c1, HEX(c1), HEX(WEIGHT_STRING(c1)) FROM t1;
+-----+-----+-----+
| c1   | HEX(c1) | HEX(WEIGHT_STRING(c1)) |
+-----+-----+-----+
| a    | 61      | 41                      |
| A    | 41      | 41                      |
| ぢ    | 82C0    | 82C0                   |
+-----+-----+-----+
3 rows in set (0.00 sec)
```

- Character codes map one-to-one to weights, but a code is not necessarily equal to the weight. `gbk_chinese_ci` is an example of this kind of collation. The multibyte character '臚' has a character code of 0x81B0 but a weight of 0xC286.

```
mysql> CREATE TABLE t1
      (c1 VARCHAR(2) CHARACTER SET gbk COLLATE gbk_chinese_ci);
Query OK, 0 rows affected (0.33 sec)

mysql> INSERT INTO t1 VALUES ('a'),('A'),(0x81B0);
Query OK, 3 rows affected (0.00 sec)
Records: 3 Duplicates: 0 Warnings: 0

mysql> SELECT c1, HEX(c1), HEX(WEIGHT_STRING(c1)) FROM t1;
+-----+-----+-----+
| c1   | HEX(c1) | HEX(WEIGHT_STRING(c1)) |
+-----+-----+-----+
| a    | 61      | 41                      |
| A    | 41      | 41                      |
| 臚    | 81B0    | C286                   |
+-----+-----+-----+
3 rows in set (0.00 sec)
```

For implementation instructions, see [Section 10.13, “Adding a Character Set”](#).

### Collations for Unicode multibyte character sets

Some of these collations are based on the Unicode Collation Algorithm (UCA), others are not.

Non-UCA collations have a one-to-one mapping from character code to weight. In MySQL, such collations are case-insensitive and accent-insensitive. `utf8_general_ci` is an example: 'a', 'A', 'À', and 'á' each have different character codes but all have a weight of 0x0041 and compare as equal.

```
mysql> SET NAMES 'utf8' COLLATE 'utf8_general_ci';
Query OK, 0 rows affected (0.00 sec)
```

```
mysql> CREATE TABLE t1
  (c1 CHAR(1) CHARACTER SET UTF8 COLLATE utf8_general_ci);
Query OK, 0 rows affected (0.01 sec)

mysql> INSERT INTO t1 VALUES ('a'),('A'),('À'),('á');
Query OK, 4 rows affected (0.00 sec)
Records: 4 Duplicates: 0 Warnings: 0

mysql> SELECT c1, HEX(c1), HEX(WEIGHT_STRING(c1)) FROM t1;
+-----+-----+-----+
| c1   | HEX(c1) | HEX(WEIGHT_STRING(c1)) |
+-----+-----+-----+
| a    | 61      | 0041                    |
| A    | 41      | 0041                    |
| À    | C380    | 0041                    |
| á    | C3A1    | 0041                    |
+-----+-----+-----+
4 rows in set (0.00 sec)
```

UCA-based collations in MySQL have these properties:

- If a character has weights, each weight uses 2 bytes (16 bits).
- A character may have zero weights (or an empty weight). In this case, the character is ignorable. Example: "U+0000 NULL" does not have a weight and is ignorable.
- A character may have one weight. Example: 'a' has a weight of 0x0E33.

```
mysql> SET NAMES 'utf8' COLLATE 'utf8_unicode_ci';
Query OK, 0 rows affected (0.05 sec)

mysql> SELECT HEX('a'), HEX(WEIGHT_STRING('a'));
+-----+-----+
| HEX('a') | HEX(WEIGHT_STRING('a')) |
+-----+-----+
| 61       | 0E33                     |
+-----+-----+
1 row in set (0.02 sec)
```

- A character may have many weights. This is an expansion. Example: The German letter 'ß' (SZ ligature, or SHARP S) has a weight of 0x0FEA0FEA.

```
mysql> SET NAMES 'utf8' COLLATE 'utf8_unicode_ci';
Query OK, 0 rows affected (0.11 sec)

mysql> SELECT HEX('ß'), HEX(WEIGHT_STRING('ß'));
+-----+-----+
| HEX('ß') | HEX(WEIGHT_STRING('ß')) |
+-----+-----+
| C39F     | 0FEA0FEA                 |
+-----+-----+
1 row in set (0.00 sec)
```

- Many characters may have one weight. This is a contraction. Example: 'ch' is a single letter in Czech and has a weight of 0x0EE2.

```
mysql> SET NAMES 'utf8' COLLATE 'utf8_czech_ci';
Query OK, 0 rows affected (0.09 sec)

mysql> SELECT HEX('ch'), HEX(WEIGHT_STRING('ch'));
+-----+-----+
| HEX('ch') | HEX(WEIGHT_STRING('ch')) |
+-----+-----+
| 6368     | 0EE2                     |
+-----+-----+
```

```
+-----+
1 row in set (0.00 sec)
```

A many-characters-to-many-weights mapping is also possible (this is contraction with expansion), but is not supported by MySQL.

For implementation instructions, for a non-UCA collation, see [Section 10.13, “Adding a Character Set”](#). For a UCA collation, see [Section 10.14.4, “Adding a UCA Collation to a Unicode Character Set”](#).

### Miscellaneous collations

There are also a few collations that do not fall into any of the previous categories.

## 10.14.2 Choosing a Collation ID

Each collation must have a unique ID. To add a collation, you must choose an ID value that is not currently used. MySQL supports two-byte collation IDs. The range of IDs from 1024 to 2047 is reserved for user-defined collations.

The collation ID that you choose appears in these contexts:

- The `ID` column of the Information Schema `COLLATIONS` table.
- The `Id` column of `SHOW COLLATION` output.
- The `charsetnr` member of the `MYSQL_FIELD` C API data structure.
- The `number` member of the `MY_CHARSET_INFO` data structure returned by the `mysql_get_character_set_info()` C API function.

To determine the largest currently used ID, issue the following statement:

```
mysql> SELECT MAX(ID) FROM INFORMATION_SCHEMA.COLLATIONS;
+-----+
| MAX(ID) |
+-----+
|      247 |
+-----+
```

To display a list of all currently used IDs, issue this statement:

```
mysql> SELECT ID FROM INFORMATION_SCHEMA.COLLATIONS ORDER BY ID;
+-----+
| ID |
+-----+
|  1 |
|  2 |
| ... |
| 52 |
| 53 |
| 57 |
| 58 |
| ... |
| 98 |
| 99 |
|128 |
|129 |
| ... |
|247 |
+-----+
```

**Warning**

Before upgrading, you should save the configuration files that you change. If you upgrade in place, the process replaces the modified files.

### 10.14.3 Adding a Simple Collation to an 8-Bit Character Set

This section describes how to add a simple collation for an 8-bit character set by writing the `<collation>` elements associated with a `<charset>` character set description in the MySQL `Index.xml` file. The procedure described here does not require recompiling MySQL. The example adds a collation named `latin1_test_ci` to the `latin1` character set.

1. Choose a collation ID, as shown in [Section 10.14.2, “Choosing a Collation ID”](#). The following steps use an ID of 1024.
2. Modify the `Index.xml` and `latin1.xml` configuration files. These files are located in the directory named by the `character_sets_dir` system variable. You can check the variable value as follows, although the path name might be different on your system:

```
mysql> SHOW VARIABLES LIKE 'character_sets_dir';
+-----+-----+
| Variable_name | Value                               |
+-----+-----+
| character_sets_dir | /user/local/mysql/share/mysql/charsets/ |
+-----+-----+
```

3. Choose a name for the collation and list it in the `Index.xml` file. Find the `<charset>` element for the character set to which the collation is being added, and add a `<collation>` element that indicates the collation name and ID, to associate the name with the ID. For example:

```
<charset name="latin1">
...
  <collation name="latin1_test_ci" id="1024"/>
...
</charset>
```

4. In the `latin1.xml` configuration file, add a `<collation>` element that names the collation and that contains a `<map>` element that defines a character code-to-weight mapping table for character codes 0 to 255. Each value within the `<map>` element must be a number in hexadecimal format.

```
<collation name="latin1_test_ci">
<map>
00 01 02 03 04 05 06 07 08 09 0A 0B 0C 0D 0E 0F
10 11 12 13 14 15 16 17 18 19 1A 1B 1C 1D 1E 1F
20 21 22 23 24 25 26 27 28 29 2A 2B 2C 2D 2E 2F
30 31 32 33 34 35 36 37 38 39 3A 3B 3C 3D 3E 3F
40 41 42 43 44 45 46 47 48 49 4A 4B 4C 4D 4E 4F
50 51 52 53 54 55 56 57 58 59 5A 5B 5C 5D 5E 5F
60 41 42 43 44 45 46 47 48 49 4A 4B 4C 4D 4E 4F
50 51 52 53 54 55 56 57 58 59 5A 7B 7C 7D 7E 7F
80 81 82 83 84 85 86 87 88 89 8A 8B 8C 8D 8E 8F
90 91 92 93 94 95 96 97 98 99 9A 9B 9C 9D 9E 9F
A0 A1 A2 A3 A4 A5 A6 A7 A8 A9 AA AB AC AD AE AF
B0 B1 B2 B3 B4 B5 B6 B7 B8 B9 BA BB BC BD BE BF
41 41 41 41 5B 5D 5B 43 45 45 45 45 49 49 49 49
44 4E 4F 4F 4F 4F 5C D7 5C 55 55 55 59 59 DE DF
41 41 41 41 5B 5D 5B 43 45 45 45 45 49 49 49 49
44 4E 4F 4F 4F 4F 5C F7 5C 55 55 55 59 59 DE FF
</map>
</collation>
```

5. Restart the server and use this statement to verify that the collation is present:

```
mysql> SHOW COLLATION WHERE Collation = 'latin1_test_ci';
+-----+-----+-----+-----+-----+-----+
| Collation | Charset | Id   | Default | Compiled | Sortlen |
+-----+-----+-----+-----+-----+-----+
| latin1_test_ci | latin1 | 1024 |         |          | 1       |
+-----+-----+-----+-----+-----+-----+
```

## 10.14.4 Adding a UCA Collation to a Unicode Character Set

This section describes how to add a UCA collation for a Unicode character set by writing the `<collation>` element within a `<charset>` character set description in the MySQL `Index.xml` file. The procedure described here does not require recompiling MySQL. It uses a subset of the Locale Data Markup Language (LDML) specification, which is available at <http://www.unicode.org/reports/tr35/>. With this method, you need not define the entire collation. Instead, you begin with an existing “base” collation and describe the new collation in terms of how it differs from the base collation. The following table lists the base collations of the Unicode character sets for which UCA collations can be defined. It is not possible to create user-defined UCA collations for `utf16le`; there is no `utf16le_unicode_ci` collation that would serve as the basis for such collations.

**Table 10.4 MySQL Character Sets Available for User-Defined UCA Collations**

Character Set	Base Collation
<code>utf8</code>	<code>utf8_unicode_ci</code>
<code>ucs2</code>	<code>ucs2_unicode_ci</code>
<code>utf16</code>	<code>utf16_unicode_ci</code>
<code>utf32</code>	<code>utf32_unicode_ci</code>

The following sections show how to add a collation that is defined using LDML syntax, and provide a summary of LDML rules supported in MySQL.

### 10.14.4.1 Defining a UCA Collation Using LDML Syntax

To add a UCA collation for a Unicode character set without recompiling MySQL, use the following procedure. If you are unfamiliar with the LDML rules used to describe the collation's sort characteristics, see [Section 10.14.4.2, “LDML Syntax Supported in MySQL”](#).

The example adds a collation named `utf8_phone_ci` to the `utf8` character set. The collation is designed for a scenario involving a Web application for which users post their names and phone numbers. Phone numbers can be given in very different formats:

```
+7-12345-67
+7-12-345-67
+7 12 345 67
+7 (12) 345 67
+71234567
```

The problem raised by dealing with these kinds of values is that the varying permissible formats make searching for a specific phone number very difficult. The solution is to define a new collation that reorders punctuation characters, making them ignorable.

1. Choose a collation ID, as shown in [Section 10.14.2, “Choosing a Collation ID”](#). The following steps use an ID of 1029.
2. To modify the `Index.xml` configuration file. This file is located in the directory named by the `character_sets_dir` system variable. You can check the variable value as follows, although the path name might be different on your system:



```
mysql> SHOW VARIABLES LIKE 'character_sets_dir';
+-----+-----+
| Variable_name | Value                                     |
+-----+-----+
| character_sets_dir | /user/local/mysql/share/mysql/charsets/ |
+-----+-----+
```

3. Choose a name for the collation and list it in the `Index.xml` file. In addition, you'll need to provide the collation ordering rules. Find the `<charset>` element for the character set to which the collation is being added, and add a `<collation>` element that indicates the collation name and ID, to associate the name with the ID. Within the `<collation>` element, provide a `<rules>` element containing the ordering rules:

```
<charset name="utf8">
...
<collation name="utf8_phone_ci" id="1029">
  <rules>
    <reset>\u0000</reset>
    <i>\u0020</i> <!-- space -->
    <i>\u0028</i> <!-- left parenthesis -->
    <i>\u0029</i> <!-- right parenthesis -->
    <i>\u002B</i> <!-- plus -->
    <i>\u002D</i> <!-- hyphen -->
  </rules>
</collation>
...
</charset>
```

4. If you want a similar collation for other Unicode character sets, add other `<collation>` elements. For example, to define `ucs2_phone_ci`, add a `<collation>` element to the `<charset name="ucs2">` element. Remember that each collation must have its own unique ID.
5. Restart the server and use this statement to verify that the collation is present:

```
mysql> SHOW COLLATION WHERE Collation = 'utf8_phone_ci';
+-----+-----+-----+-----+-----+-----+
| Collation      | Charset | Id    | Default | Compiled | Sortlen |
+-----+-----+-----+-----+-----+-----+
| utf8_phone_ci | utf8    | 1029 |         |          | 8       |
+-----+-----+-----+-----+-----+-----+
```

Now test the collation to make sure that it has the desired properties.

Create a table containing some sample phone numbers using the new collation:

```
mysql> CREATE TABLE phonebook (
  name VARCHAR(64),
  phone VARCHAR(64) CHARACTER SET utf8 COLLATE utf8_phone_ci
);
Query OK, 0 rows affected (0.09 sec)

mysql> INSERT INTO phonebook VALUES ('Svoj','+7 912 800 80 02');
Query OK, 1 row affected (0.00 sec)

mysql> INSERT INTO phonebook VALUES ('Hf','+7 (912) 800 80 04');
Query OK, 1 row affected (0.00 sec)

mysql> INSERT INTO phonebook VALUES ('Bar','+7-912-800-80-01');
Query OK, 1 row affected (0.00 sec)

mysql> INSERT INTO phonebook VALUES ('Ramil','(7912) 800 80 03');
Query OK, 1 row affected (0.00 sec)

mysql> INSERT INTO phonebook VALUES ('Sanja','+380 (912) 8008005');
```

```
Query OK, 1 row affected (0.00 sec)
```

Run some queries to see whether the ignored punctuation characters are in fact ignored for comparison and sorting:

```
mysql> SELECT * FROM phonebook ORDER BY phone;
+-----+-----+
| name | phone                |
+-----+-----+
| Sanja | +380 (912) 8008005   |
| Bar   | +7-912-800-80-01    |
| Svoj  | +7 912 800 80 02    |
| Ramil | (7912) 800 80 03    |
| Hf    | +7 (912) 800 80 04  |
+-----+-----+
5 rows in set (0.00 sec)

mysql> SELECT * FROM phonebook WHERE phone='+7(912)800-80-01';
+-----+-----+
| name | phone                |
+-----+-----+
| Bar   | +7-912-800-80-01    |
+-----+-----+
1 row in set (0.00 sec)

mysql> SELECT * FROM phonebook WHERE phone='79128008001';
+-----+-----+
| name | phone                |
+-----+-----+
| Bar   | +7-912-800-80-01    |
+-----+-----+
1 row in set (0.00 sec)

mysql> SELECT * FROM phonebook WHERE phone='7 9 1 2 8 0 0 8 0 0 1';
+-----+-----+
| name | phone                |
+-----+-----+
| Bar   | +7-912-800-80-01    |
+-----+-----+
1 row in set (0.00 sec)
```

#### 10.14.4.2 LDML Syntax Supported in MySQL

This section describes the LDML syntax that MySQL recognizes. This is a subset of the syntax described in the LDML specification available at <http://www.unicode.org/reports/tr35/>, which should be consulted for further information. MySQL recognizes a large enough subset of the syntax that, in many cases, it is possible to download a collation definition from the Unicode Common Locale Data Repository and paste the relevant part (that is, the part between the `<rules>` and `</rules>` tags) into the MySQL `Index.xml` file. The rules described here are all supported except that character sorting occurs only at the primary level. Rules that specify differences at secondary or higher sort levels are recognized (and thus can be included in collation definitions) but are treated as equality at the primary level.

The MySQL server generates diagnostics when it finds problems while parsing the `Index.xml` file. See [Section 10.14.4.3, “Diagnostics During Index.xml Parsing”](#).

##### Character Representation

Characters named in LDML rules can be written literally or in `\unnnn` format, where `nnnn` is the hexadecimal Unicode code point value. For example, `A` and `á` can be written literally or as `\u0041` and `\u00E1`. Within hexadecimal values, the digits `A` through `F` are not case-sensitive; `\u00E1` and `\u00e1` are equivalent. For UCA 4.0.0 collations, hexadecimal notation can be used only for characters in the Basic Multilingual Plane, not for characters outside the BMP range of `0000` to `FFFF`. For UCA 5.2.0 collations, hexadecimal notation can be used for any character.

The `Index.xml` file itself should be written using UTF-8 encoding.

### Syntax Rules

LDML has reset rules and shift rules to specify character ordering. Orderings are given as a set of rules that begin with a reset rule that establishes an anchor point, followed by shift rules that indicate how characters sort relative to the anchor point.

- A `<reset>` rule does not specify any ordering in and of itself. Instead, it “resets” the ordering for subsequent shift rules to cause them to be taken in relation to a given character. Either of the following rules resets subsequent shift rules to be taken in relation to the letter 'A':

```
<reset>A</reset>
<reset>\u0041</reset>
```

- The `<p>`, `<s>`, and `<t>` shift rules define primary, secondary, and tertiary differences of a character from another character:
  - Use primary differences to distinguish separate letters.
  - Use secondary differences to distinguish accent variations.
  - Use tertiary differences to distinguish lettercase variations.

Either of these rules specifies a primary shift rule for the 'G' character:

```
<p>G</p>
<p>\u0047</p>
```

- The `<i>` shift rule indicates that one character sorts identically to another. The following rules cause 'b' to sort the same as 'a':

```
<reset>a</reset>
<i>b</i>
```

- Abbreviated shift syntax specifies multiple shift rules using a single pair of tags. The following table shows the correspondence between abbreviated syntax rules and the equivalent nonabbreviated rules.

**Table 10.5 Abbreviated Shift Syntax**

Abbreviated Syntax	Nonabbreviated Syntax
<code>&lt;pc&gt;xyz&lt;/pc&gt;</code>	<code>&lt;p&gt;x&lt;/p&gt;&lt;p&gt;y&lt;/p&gt;&lt;p&gt;z&lt;/p&gt;</code>
<code>&lt;sc&gt;xyz&lt;/sc&gt;</code>	<code>&lt;s&gt;x&lt;/s&gt;&lt;s&gt;y&lt;/s&gt;&lt;s&gt;z&lt;/s&gt;</code>
<code>&lt;tc&gt;xyz&lt;/tc&gt;</code>	<code>&lt;t&gt;x&lt;/t&gt;&lt;t&gt;y&lt;/t&gt;&lt;t&gt;z&lt;/t&gt;</code>
<code>&lt;ic&gt;xyz&lt;/ic&gt;</code>	<code>&lt;i&gt;x&lt;/i&gt;&lt;i&gt;y&lt;/i&gt;&lt;i&gt;z&lt;/i&gt;</code>

- An expansion is a reset rule that establishes an anchor point for a multiple-character sequence. MySQL supports expansions 2 to 6 characters long. The following rules put 'z' greater at the primary level than the sequence of three characters 'abc':

```
<reset>abc</reset>
<p>z</p>
```

- A contraction is a shift rule that sorts a multiple-character sequence. MySQL supports contractions 2 to 6 characters long. The following rules put the sequence of three characters 'xyz' greater at the primary level than 'a':

```
<reset>a</reset>
<p>xyz</p>
```

- Long expansions and long contractions can be used together. These rules put the sequence of three characters 'xyz' greater at the primary level than the sequence of three characters 'abc':

```
<reset>abc</reset>
<p>xyz</p>
```

- Normal expansion syntax uses `<x>` plus `<extend>` elements to specify an expansion. The following rules put the character 'k' greater at the secondary level than the sequence 'ch'. That is, 'k' behaves as if it expands to a character after 'c' followed by 'h':

```
<reset>c</reset>
<x><s>k</s><extend>h</extend></x>
```

This syntax permits long sequences. These rules sort the sequence 'ccs' greater at the tertiary level than the sequence 'cscs':

```
<reset>cs</reset>
<x><t>ccs</t><extend>cs</extend></x>
```

The LDML specification describes normal expansion syntax as “tricky.” See that specification for details.

- Previous context syntax uses `<x>` plus `<context>` elements to specify that the context before a character affects how it sorts. The following rules put '-' greater at the secondary level than 'a', but only when '-' occurs after 'b':

```
<reset>a</reset>
<x><context>b</context><s>-</s></x>
```

- Previous context syntax can include the `<extend>` element. These rules put 'def' greater at the primary level than 'aghi', but only when 'def' comes after 'abc':

```
<reset>a</reset>
<x><context>abc</context><p>def</p><extend>ghi</extend></x>
```

- Reset rules permit a `before` attribute. Normally, shift rules after a reset rule indicate characters that sort after the reset character. Shift rules after a reset rule that has the `before` attribute indicate characters that sort before the reset character. The following rules put the character 'b' immediately before 'a' at the primary level:

```
<reset before="primary">a</reset>
<p>b</p>
```

Permissible `before` attribute values specify the sort level by name or the equivalent numeric value:

```
<reset before="primary">
<reset before="1">

<reset before="secondary">
<reset before="2">

<reset before="tertiary">
<reset before="3">
```

- A reset rule can name a logical reset position rather than a literal character:

```
<first_tertiary_ignorable/>
<last_tertiary_ignorable/>
<first_secondary_ignorable/>
<last_secondary_ignorable/>
```

```
<first_primary_ignorable/>
<last_primary_ignorable/>
<first_variable/>
<last_variable/>
<first_non_ignorable/>
<last_non_ignorable/>
<first_trailing/>
<last_trailing/>
```

These rules put 'z' greater at the primary level than nonignorable characters that have a Default Unicode Collation Element Table (DUCET) entry and that are not CJK:

```
<reset><last_non_ignorable/></reset>
<p>z</p>
```

Logical positions have the code points shown in the following table.

**Table 10.6 Logical Reset Position Code Points**

Logical Position	Unicode 4.0.0 Code Point	Unicode 5.2.0 Code Point
<code>&lt;first_non_ignorable/&gt;</code>	U+02D0	U+02D0
<code>&lt;last_non_ignorable/&gt;</code>	U+A48C	U+1342E
<code>&lt;first_primary_ignorable/&gt;</code>	U+0332	U+0332
<code>&lt;last_primary_ignorable/&gt;</code>	U+20EA	U+101FD
<code>&lt;first_secondary_ignorable/&gt;</code>	U+0000	U+0000
<code>&lt;last_secondary_ignorable/&gt;</code>	U+FE73	U+FE73
<code>&lt;first_tertiary_ignorable/&gt;</code>	U+0000	U+0000
<code>&lt;last_tertiary_ignorable/&gt;</code>	U+FE73	U+FE73
<code>&lt;first_trailing/&gt;</code>	U+0000	U+0000
<code>&lt;last_trailing/&gt;</code>	U+0000	U+0000
<code>&lt;first_variable/&gt;</code>	U+0009	U+0009
<code>&lt;last_variable/&gt;</code>	U+2183	U+1D371

- The `<collation>` element permits a `shift-after-method` attribute that affects character weight calculation for shift rules. The attribute has these permitted values:
  - `simple`: Calculate character weights as for reset rules that do not have a `before` attribute. This is the default if the attribute is not given.
  - `expand`: Use expansions for shifts after reset rules.

Suppose that '0' and '1' have weights of 0E29 and 0E2A and we want to put all basic Latin letters between '0' and '1':

```
<reset>0</reset>
```

```
<pc>abcdefghi jklmnopqrstuvwxyz</pc>
```

For simple shift mode, weights are calculated as follows:

```
'a' has weight 0E29+1
'b' has weight 0E29+2
'c' has weight 0E29+3
...
```

However, there are not enough vacant positions to put 26 characters between '0' and '1'. The result is that digits and letters are intermixed.

To solve this, use `shift-after-method="expand"`. Then weights are calculated like this:

```
'a' has weight [0E29][233D+1]
'b' has weight [0E29][233D+2]
'c' has weight [0E29][233D+3]
...
```

233D is the UCA 4.0.0 weight for character 0xA48C, which is the last nonignorable character (a sort of the greatest character in the collation, excluding CJK). UCA 5.2.0 is similar but uses 3ACA, for character 0x1342E.

### MySQL-Specific LDML Extensions

An extension to LDML rules permits the `<collation>` element to include an optional `version` attribute in `<collation>` tags to indicate the UCA version on which the collation is based. If the `version` attribute is omitted, its default value is 4.0.0. For example, this specification indicates a collation that is based on UCA 5.2.0:

```
<collation id="nnn" name="utf8_XXX_ci" version="5.2.0">
...
</collation>
```

## 10.14.4.3 Diagnostics During Index.xml Parsing

The MySQL server generates diagnostics when it finds problems while parsing the `Index.xml` file:

- Unknown tags are written to the error log. For example, the following message results if a collation definition contains a `<aaa>` tag:

```
[Warning] Buffered warning: Unknown LDML tag:
'charsets/charset/collation/rules/aaa'
```

- If collation initialization is not possible, the server reports an “Unknown collation” error, and also generates warnings explaining the problems, such as in the previous example. In other cases, when a collation description is generally correct but contains some unknown tags, the collation is initialized and is available for use. The unknown parts are ignored, but a warning is generated in the error log.
- Problems with collations generate warnings that clients can display with `SHOW WARNINGS`. Suppose that a reset rule contains an expansion longer than the maximum supported length of 6 characters:

```
<reset>abcdefghi</reset>
<i>x</i>
```

An attempt to use the collation produces warnings:

```
mysql> SELECT _utf8'test' COLLATE utf8_test_ci;
ERROR 1273 (HY000): Unknown collation: 'utf8_test_ci'
mysql> SHOW WARNINGS;
+-----+-----+-----+-----+-----+-----+
+-----+-----+-----+-----+-----+-----+
```

Level	Code	Message
Error	1273	Unknown collation: 'utf8_test_ci'
Warning	1273	Expansion is too long at 'abcdefghi=x'

## 10.15 Character Set Configuration

The MySQL server has a compiled-in default character set and collation. To change these defaults, use the `--character-set-server` and `--collation-server` options when you start the server. See [Section 5.1.6, “Server Command Options”](#). The collation must be a legal collation for the default character set. To determine which collations are available for each character set, use the `SHOW COLLATION` statement or query the `INFORMATION_SCHEMA.COLLATIONS` table.

If you try to use a character set that is not compiled into your binary, you might run into the following problems:

- If your program uses an incorrect path to determine where the character sets are stored (which is typically the `share/mysql/charsets` or `share/charsets` directory under the MySQL installation directory), this can be fixed by using the `--character-sets-dir` option when you run the program. For example, to specify a directory to be used by MySQL client programs, list it in the `[client]` group of your option file. The examples given here show what the setting might look like for Unix or Windows, respectively:

```
[client]
character-sets-dir=/usr/local/mysql/share/mysql/charsets

[client]
character-sets-dir="C:/Program Files/MySQL/MySQL Server 5.7/share/charsets"
```

- If the character set is a complex character set that cannot be loaded dynamically, you must recompile the program with support for the character set.

For Unicode character sets, you can define collations without recompiling by using LDML notation. See [Section 10.14.4, “Adding a UCA Collation to a Unicode Character Set”](#).

- If the character set is a dynamic character set, but you do not have a configuration file for it, you should install the configuration file for the character set from a new MySQL distribution.
- If your character set index file (`Index.xml`) does not contain the name for the character set, your program displays an error message:

```
Character set 'charset_name' is not a compiled character set and is not
specified in the '/usr/share/mysql/charsets/Index.xml' file
```

To solve this problem, you should either get a new index file or manually add the name of any missing character sets to the current file.

You can force client programs to use specific character set as follows:

```
[client]
default-character-set=charset_name
```

This is normally unnecessary. However, when `character_set_system` differs from `character_set_server` or `character_set_client`, and you input characters manually (as database object identifiers, column values, or both), these may be displayed incorrectly in output from the client or the output itself may be formatted incorrectly. In such cases, starting the mysql client with `--default-character-set=system_character_set`—that is, setting the client character set to match the system character set—should fix the problem.

## 10.16 MySQL Server Locale Support

The locale indicated by the `lc_time_names` system variable controls the language used to display day and month names and abbreviations. This variable affects the output from the `DATE_FORMAT()`, `DAYNAME()`, and `MONTHNAME()` functions.

`lc_time_names` does not affect the `STR_TO_DATE()` or `GET_FORMAT()` function.

The `lc_time_names` value does not affect the result from `FORMAT()`, but this function takes an optional third parameter that enables a locale to be specified to be used for the result number's decimal point, thousands separator, and grouping between separators. Permissible locale values are the same as the legal values for the `lc_time_names` system variable.

Locale names have language and region subtags listed by IANA (<http://www.iana.org/assignments/language-subtag-registry>) such as `'ja_JP'` or `'pt_BR'`. The default value is `'en_US'` regardless of your system's locale setting, but you can set the value at server startup, or set the `GLOBAL` value at runtime if you have privileges sufficient to set global system variables; see [Section 5.1.8.1, “System Variable Privileges”](#). Any client can examine the value of `lc_time_names` or set its `SESSION` value to affect the locale for its own connection.

```
mysql> SET NAMES 'utf8';
Query OK, 0 rows affected (0.09 sec)

mysql> SELECT @@lc_time_names;
+-----+
| @@lc_time_names |
+-----+
| en_US           |
+-----+
1 row in set (0.00 sec)

mysql> SELECT DAYNAME('2010-01-01'), MONTHNAME('2010-01-01');
+-----+-----+
| DAYNAME('2010-01-01') | MONTHNAME('2010-01-01') |
+-----+-----+
| Friday                | January                  |
+-----+-----+
1 row in set (0.00 sec)

mysql> SELECT DATE_FORMAT('2010-01-01','%W %a %M %b');
+-----+
| DATE_FORMAT('2010-01-01','%W %a %M %b') |
+-----+
| Friday Fri January Jan                  |
+-----+
1 row in set (0.00 sec)

mysql> SET lc_time_names = 'es_MX';
Query OK, 0 rows affected (0.00 sec)

mysql> SELECT @@lc_time_names;
+-----+
| @@lc_time_names |
+-----+
| es_MX           |
+-----+
1 row in set (0.00 sec)

mysql> SELECT DAYNAME('2010-01-01'), MONTHNAME('2010-01-01');
+-----+-----+
| DAYNAME('2010-01-01') | MONTHNAME('2010-01-01') |
+-----+-----+
| viernes               | enero                    |
+-----+-----+
```



```

+-----+-----+
1 row in set (0.00 sec)

mysql> SELECT DATE_FORMAT('2010-01-01','%W %a %M %b');
+-----+-----+
| DATE_FORMAT('2010-01-01','%W %a %M %b') |
+-----+-----+
| viernes vie enero ene                    |
+-----+-----+
1 row in set (0.00 sec)

```

The day or month name for each of the affected functions is converted from `utf8` to the character set indicated by the `character_set_connection` system variable.

`lc_time_names` may be set to any of the following locale values. The set of locales supported by MySQL may differ from those supported by your operating system.

Locale Value	Meaning
<code>ar_AE</code>	Arabic - United Arab Emirates
<code>ar_BH</code>	Arabic - Bahrain
<code>ar_DZ</code>	Arabic - Algeria
<code>ar_EG</code>	Arabic - Egypt
<code>ar_IN</code>	Arabic - India
<code>ar_IQ</code>	Arabic - Iraq
<code>ar_JO</code>	Arabic - Jordan
<code>ar_KW</code>	Arabic - Kuwait
<code>ar_LB</code>	Arabic - Lebanon
<code>ar_LY</code>	Arabic - Libya
<code>ar_MA</code>	Arabic - Morocco
<code>ar_OM</code>	Arabic - Oman
<code>ar_QA</code>	Arabic - Qatar
<code>ar_SA</code>	Arabic - Saudi Arabia
<code>ar_SD</code>	Arabic - Sudan
<code>ar_SY</code>	Arabic - Syria
<code>ar_TN</code>	Arabic - Tunisia
<code>ar_YE</code>	Arabic - Yemen
<code>be_BY</code>	Belarusian - Belarus
<code>bg_BG</code>	Bulgarian - Bulgaria
<code>ca_ES</code>	Catalan - Spain
<code>cs_CZ</code>	Czech - Czech Republic
<code>da_DK</code>	Danish - Denmark
<code>de_AT</code>	German - Austria
<code>de_BE</code>	German - Belgium
<code>de_CH</code>	German - Switzerland
<code>de_DE</code>	German - Germany
<code>de_LU</code>	German - Luxembourg

<b>Locale Value</b>	<b>Meaning</b>
el_GR	Greek - Greece
en_AU	English - Australia
en_CA	English - Canada
en_GB	English - United Kingdom
en_IN	English - India
en_NZ	English - New Zealand
en_PH	English - Philippines
en_US	English - United States
en_ZA	English - South Africa
en_ZW	English - Zimbabwe
es_AR	Spanish - Argentina
es_BO	Spanish - Bolivia
es_CL	Spanish - Chile
es_CO	Spanish - Colombia
es_CR	Spanish - Costa Rica
es_DO	Spanish - Dominican Republic
es_EC	Spanish - Ecuador
es_ES	Spanish - Spain
es_GT	Spanish - Guatemala
es_HN	Spanish - Honduras
es_MX	Spanish - Mexico
es_NI	Spanish - Nicaragua
es_PA	Spanish - Panama
es_PE	Spanish - Peru
es_PR	Spanish - Puerto Rico
es_PY	Spanish - Paraguay
es_SV	Spanish - El Salvador
es_US	Spanish - United States
es_UY	Spanish - Uruguay
es_VE	Spanish - Venezuela
et_EE	Estonian - Estonia
eu_ES	Basque - Spain
fi_FI	Finnish - Finland
fo_FO	Faroese - Faroe Islands
fr_BE	French - Belgium
fr_CA	French - Canada
fr_CH	French - Switzerland
fr_FR	French - France

<b>Locale Value</b>	<b>Meaning</b>
fr_LU	French - Luxembourg
gl_ES	Galician - Spain
gu_IN	Gujarati - India
he_IL	Hebrew - Israel
hi_IN	Hindi - India
hr_HR	Croatian - Croatia
hu_HU	Hungarian - Hungary
id_ID	Indonesian - Indonesia
is_IS	Icelandic - Iceland
it_CH	Italian - Switzerland
it_IT	Italian - Italy
ja_JP	Japanese - Japan
ko_KR	Korean - Republic of Korea
lt_LT	Lithuanian - Lithuania
lv_LV	Latvian - Latvia
mk_MK	Macedonian - North Macedonia
mn_MN	Mongolia - Mongolian
ms_MY	Malay - Malaysia
nb_NO	Norwegian(Bokmål) - Norway
nl_BE	Dutch - Belgium
nl_NL	Dutch - The Netherlands
no_NO	Norwegian - Norway
pl_PL	Polish - Poland
pt_BR	Portugese - Brazil
pt_PT	Portugese - Portugal
rm_CH	Romansh - Switzerland
ro_RO	Romanian - Romania
ru_RU	Russian - Russia
ru_UA	Russian - Ukraine
sk_SK	Slovak - Slovakia
sl_SI	Slovenian - Slovenia
sq_AL	Albanian - Albania
sr_RS	Serbian - Serbia
sv_FI	Swedish - Finland
sv_SE	Swedish - Sweden
ta_IN	Tamil - India
te_IN	Telugu - India
th_TH	Thai - Thailand

<b>Locale Value</b>	<b>Meaning</b>
tr_TR	Turkish - Turkey
uk_UA	Ukrainian - Ukraine
ur_PK	Urdu - Pakistan
vi_VN	Vietnamese - Vietnam
zh_CN	Chinese - China
zh_HK	Chinese - Hong Kong
zh_TW	Chinese - Taiwan

---

# Chapter 11 Data Types

## Table of Contents

11.1	Numeric Data Types .....	1792
11.1.1	Numeric Data Type Syntax .....	1792
11.1.2	Integer Types (Exact Value) - INTEGER, INT, SMALLINT, TINYINT, MEDIUMINT, BIGINT .....	1796
11.1.3	Fixed-Point Types (Exact Value) - DECIMAL, NUMERIC .....	1796
11.1.4	Floating-Point Types (Approximate Value) - FLOAT, DOUBLE .....	1797
11.1.5	Bit-Value Type - BIT .....	1797
11.1.6	Numeric Type Attributes .....	1797
11.1.7	Out-of-Range and Overflow Handling .....	1798
11.2	Date and Time Data Types .....	1800
11.2.1	Date and Time Data Type Syntax .....	1801
11.2.2	The DATE, DATETIME, and TIMESTAMP Types .....	1803
11.2.3	The TIME Type .....	1805
11.2.4	The YEAR Type .....	1806
11.2.5	2-Digit YEAR(2) Limitations and Migrating to 4-Digit YEAR .....	1806
11.2.6	Automatic Initialization and Updating for TIMESTAMP and DATETIME .....	1809
11.2.7	Fractional Seconds in Time Values .....	1813
11.2.8	What Calendar Is Used By MySQL? .....	1813
11.2.9	Conversion Between Date and Time Types .....	1814
11.2.10	2-Digit Years in Dates .....	1815
11.3	String Data Types .....	1815
11.3.1	String Data Type Syntax .....	1815
11.3.2	The CHAR and VARCHAR Types .....	1819
11.3.3	The BINARY and VARBINARY Types .....	1821
11.3.4	The BLOB and TEXT Types .....	1822
11.3.5	The ENUM Type .....	1824
11.3.6	The SET Type .....	1827
11.4	Spatial Data Types .....	1829
11.4.1	Spatial Data Types .....	1831
11.4.2	The OpenGIS Geometry Model .....	1832
11.4.3	Supported Spatial Data Formats .....	1838
11.4.4	Geometry Well-Formedness and Validity .....	1841
11.4.5	Creating Spatial Columns .....	1841
11.4.6	Populating Spatial Columns .....	1842
11.4.7	Fetching Spatial Data .....	1843
11.4.8	Optimizing Spatial Analysis .....	1843
11.4.9	Creating Spatial Indexes .....	1843
11.4.10	Using Spatial Indexes .....	1844
11.5	The JSON Data Type .....	1846
11.6	Data Type Default Values .....	1860
11.7	Data Type Storage Requirements .....	1862
11.8	Choosing the Right Type for a Column .....	1866
11.9	Using Data Types from Other Database Engines .....	1867

MySQL supports [SQL](#) data types in several categories: numeric types, date and time types, string (character and byte) types, spatial types, and the [JSON](#) data type. This chapter provides an overview and more detailed description of the properties of the types in each category, and a summary of the data type storage requirements. The initial overviews are intentionally brief. Consult the more detailed descriptions

for additional information about particular data types, such as the permissible formats in which you can specify values.

Data type descriptions use these conventions:

- For integer types, *M* indicates the maximum display width. For floating-point and fixed-point types, *M* is the total number of digits that can be stored (the precision). For string types, *M* is the maximum length. The maximum permissible value of *M* depends on the data type.
- *D* applies to floating-point and fixed-point types and indicates the number of digits following the decimal point (the scale). The maximum possible value is 30, but should be no greater than *M*-2.
- *fsp* applies to the `TIME`, `DATETIME`, and `TIMESTAMP` types and represents fractional seconds precision; that is, the number of digits following the decimal point for fractional parts of seconds. The *fsp* value, if given, must be in the range 0 to 6. A value of 0 signifies that there is no fractional part. If omitted, the default precision is 0. (This differs from the standard SQL default of 6, for compatibility with previous MySQL versions.)
- Square brackets ( [ and ] ) indicate optional parts of type definitions.

## 11.1 Numeric Data Types

MySQL supports all standard SQL numeric data types. These types include the exact numeric data types (`INTEGER`, `SMALLINT`, `DECIMAL`, and `NUMERIC`), as well as the approximate numeric data types (`FLOAT`, `REAL`, and `DOUBLE PRECISION`). The keyword `INT` is a synonym for `INTEGER`, and the keywords `DEC` and `FIXED` are synonyms for `DECIMAL`. MySQL treats `DOUBLE` as a synonym for `DOUBLE PRECISION` (a nonstandard extension). MySQL also treats `REAL` as a synonym for `DOUBLE PRECISION` (a nonstandard variation), unless the `REAL_AS_FLOAT` SQL mode is enabled.

The `BIT` data type stores bit values and is supported for `MyISAM`, `MEMORY`, `InnoDB`, and `NDB` tables.

For information about how MySQL handles assignment of out-of-range values to columns and overflow during expression evaluation, see [Section 11.1.7, “Out-of-Range and Overflow Handling”](#).

For information about storage requirements of the numeric data types, see [Section 11.7, “Data Type Storage Requirements”](#).

For descriptions of functions that operate on numeric values, see [Section 12.6, “Numeric Functions and Operators”](#). The data type used for the result of a calculation on numeric operands depends on the types of the operands and the operations performed on them. For more information, see [Section 12.6.1, “Arithmetic Operators”](#).

### 11.1.1 Numeric Data Type Syntax

For integer data types, *M* indicates the minimum display width. The maximum display width is 255. Display width is unrelated to the range of values a type can store, as described in [Section 11.1.6, “Numeric Type Attributes”](#).

For floating-point and fixed-point data types, *M* is the total number of digits that can be stored.

If you specify `ZEROFILL` for a numeric column, MySQL automatically adds the `UNSIGNED` attribute to the column.

Numeric data types that permit the `UNSIGNED` attribute also permit `SIGNED`. However, these data types are signed by default, so the `SIGNED` attribute has no effect.

`SERIAL` is an alias for `BIGINT UNSIGNED NOT NULL AUTO_INCREMENT UNIQUE`.

`SERIAL` `DEFAULT VALUE` in the definition of an integer column is an alias for `NOT NULL` `AUTO_INCREMENT` `UNIQUE`.



**Warning**

When you use subtraction between integer values where one is of type `UNSIGNED`, the result is unsigned unless the `NO_UNSIGNED_SUBTRACTION` SQL mode is enabled. See [Section 12.10, “Cast Functions and Operators”](#).

- `BIT[(M)]`

A bit-value type. `M` indicates the number of bits per value, from 1 to 64. The default is 1 if `M` is omitted.

- `TINYINT[(M)] [UNSIGNED] [ZEROFILL]`

A very small integer. The signed range is `-128` to `127`. The unsigned range is `0` to `255`.

- `BOOL`, `BOOLEAN`

These types are synonyms for `TINYINT(1)`. A value of zero is considered false. Nonzero values are considered true:

```
mysql> SELECT IF(0, 'true', 'false');
+-----+
| IF(0, 'true', 'false') |
+-----+
| false                  |
+-----+

mysql> SELECT IF(1, 'true', 'false');
+-----+
| IF(1, 'true', 'false') |
+-----+
| true                   |
+-----+

mysql> SELECT IF(2, 'true', 'false');
+-----+
| IF(2, 'true', 'false') |
+-----+
| true                   |
+-----+
```

However, the values `TRUE` and `FALSE` are merely aliases for `1` and `0`, respectively, as shown here:

```
mysql> SELECT IF(0 = FALSE, 'true', 'false');
+-----+
| IF(0 = FALSE, 'true', 'false') |
+-----+
| true                            |
+-----+

mysql> SELECT IF(1 = TRUE, 'true', 'false');
+-----+
| IF(1 = TRUE, 'true', 'false') |
+-----+
| true                            |
+-----+

mysql> SELECT IF(2 = TRUE, 'true', 'false');
+-----+
| IF(2 = TRUE, 'true', 'false') |
+-----+
| false                           |
+-----+
```

```

+-----+
mysql> SELECT IF(2 = FALSE, 'true', 'false');
+-----+
| IF(2 = FALSE, 'true', 'false') |
+-----+
| false                          |
+-----+

```

The last two statements display the results shown because 2 is equal to neither 1 nor 0.

- `SMALLINT[(M)] [UNSIGNED] [ZEROFILL]`

A small integer. The signed range is -32768 to 32767. The unsigned range is 0 to 65535.

- `MEDIUMINT[(M)] [UNSIGNED] [ZEROFILL]`

A medium-sized integer. The signed range is -8388608 to 8388607. The unsigned range is 0 to 16777215.

- `INT[(M)] [UNSIGNED] [ZEROFILL]`

A normal-size integer. The signed range is -2147483648 to 2147483647. The unsigned range is 0 to 4294967295.

- `INTEGER[(M)] [UNSIGNED] [ZEROFILL]`

This type is a synonym for `INT`.

- `BIGINT[(M)] [UNSIGNED] [ZEROFILL]`

A large integer. The signed range is -9223372036854775808 to 9223372036854775807. The unsigned range is 0 to 18446744073709551615.

`SERIAL` is an alias for `BIGINT UNSIGNED NOT NULL AUTO_INCREMENT UNIQUE`.

Some things you should be aware of with respect to `BIGINT` columns:

- All arithmetic is done using signed `BIGINT` or `DOUBLE` values, so you should not use unsigned big integers larger than 9223372036854775807 (63 bits) except with bit functions! If you do that, some of the last digits in the result may be wrong because of rounding errors when converting a `BIGINT` value to a `DOUBLE`.

MySQL can handle `BIGINT` in the following cases:

- When using integers to store large unsigned values in a `BIGINT` column.
- In `MIN(col_name)` or `MAX(col_name)`, where `col_name` refers to a `BIGINT` column.
- When using operators (+, -, \*, and so on) where both operands are integers.
- You can always store an exact integer value in a `BIGINT` column by storing it using a string. In this case, MySQL performs a string-to-number conversion that involves no intermediate double-precision representation.
- The -, +, and \* operators use `BIGINT` arithmetic when both operands are integer values. This means that if you multiply two big integers (or results from functions that return integers), you may get unexpected results when the result is larger than 9223372036854775807.
- `DECIMAL[(M[,D])] [UNSIGNED] [ZEROFILL]`



A packed “exact” fixed-point number. *M* is the total number of digits (the precision) and *D* is the number of digits after the decimal point (the scale). The decimal point and (for negative numbers) the  $-$  sign are not counted in *M*. If *D* is 0, values have no decimal point or fractional part. The maximum number of digits (*M*) for `DECIMAL` is 65. The maximum number of supported decimals (*D*) is 30. If *D* is omitted, the default is 0. If *M* is omitted, the default is 10. (There is also a limit on how long the text of `DECIMAL` literals can be; see [Section 12.21.3, “Expression Handling”](#).)

`UNSIGNED`, if specified, disallows negative values.

All basic calculations ( $+$ ,  $-$ ,  $*$ ,  $/$ ) with `DECIMAL` columns are done with a precision of 65 digits.

- `DEC[(M[,D])] [UNSIGNED] [ZEROFILL]`, `NUMERIC[(M[,D])] [UNSIGNED] [ZEROFILL]`, `FIXED[(M[,D])] [UNSIGNED] [ZEROFILL]`

These types are synonyms for `DECIMAL`. The `FIXED` synonym is available for compatibility with other database systems.

- `FLOAT(M,D) [UNSIGNED] [ZEROFILL]`

A small (single-precision) floating-point number. Permissible values are  $-3.402823466E+38$  to  $-1.175494351E-38$ , 0, and  $1.175494351E-38$  to  $3.402823466E+38$ . These are the theoretical limits, based on the IEEE standard. The actual range might be slightly smaller depending on your hardware or operating system.

*M* is the total number of digits and *D* is the number of digits following the decimal point. If *M* and *D* are omitted, values are stored to the limits permitted by the hardware. A single-precision floating-point number is accurate to approximately 7 decimal places.

`FLOAT(M,D)` is a nonstandard MySQL extension.

`UNSIGNED`, if specified, disallows negative values.

Using `FLOAT` might give you some unexpected problems because all calculations in MySQL are done with double precision. See [Section B.3.4.7, “Solving Problems with No Matching Rows”](#).

- `FLOAT(p) [UNSIGNED] [ZEROFILL]`

A floating-point number. *p* represents the precision in bits, but MySQL uses this value only to determine whether to use `FLOAT` or `DOUBLE` for the resulting data type. If *p* is from 0 to 24, the data type becomes `FLOAT` with no *M* or *D* values. If *p* is from 25 to 53, the data type becomes `DOUBLE` with no *M* or *D* values. The range of the resulting column is the same as for the single-precision `FLOAT` or double-precision `DOUBLE` data types described earlier in this section.

`FLOAT(p)` syntax is provided for ODBC compatibility.

- `DOUBLE(M,D) [UNSIGNED] [ZEROFILL]`

A normal-size (double-precision) floating-point number. Permissible values are  $-1.7976931348623157E+308$  to  $-2.2250738585072014E-308$ , 0, and  $2.2250738585072014E-308$  to  $1.7976931348623157E+308$ . These are the theoretical limits, based on the IEEE standard. The actual range might be slightly smaller depending on your hardware or operating system.

*M* is the total number of digits and *D* is the number of digits following the decimal point. If *M* and *D* are omitted, values are stored to the limits permitted by the hardware. A double-precision floating-point number is accurate to approximately 15 decimal places.

`DOUBLE(M,D)` is a nonstandard MySQL extension.

`UNSIGNED`, if specified, disallows negative values.

- `DOUBLE PRECISION[(M,D)] [UNSIGNED] [ZEROFILL]`, `REAL[(M,D)] [UNSIGNED] [ZEROFILL]`

These types are synonyms for `DOUBLE`. Exception: If the `REAL_AS_FLOAT` SQL mode is enabled, `REAL` is a synonym for `FLOAT` rather than `DOUBLE`.

## 11.1.2 Integer Types (Exact Value) - INTEGER, INT, SMALLINT, TINYINT, MEDIUMINT, BIGINT

MySQL supports the SQL standard integer types `INTEGER` (or `INT`) and `SMALLINT`. As an extension to the standard, MySQL also supports the integer types `TINYINT`, `MEDIUMINT`, and `BIGINT`. The following table shows the required storage and range for each integer type.

**Table 11.1 Required Storage and Range for Integer Types Supported by MySQL**

Type	Storage (Bytes)	Minimum Value Signed	Minimum Value Unsigned	Maximum Value Signed	Maximum Value Unsigned
<code>TINYINT</code>	1	-128	0	127	255
<code>SMALLINT</code>	2	-32768	0	32767	65535
<code>MEDIUMINT</code>	3	-8388608	0	8388607	16777215
<code>INT</code>	4	-2147483648	0	2147483647	4294967295
<code>BIGINT</code>	8	$-2^{63}$	0	$2^{63}-1$	$2^{64}-1$

## 11.1.3 Fixed-Point Types (Exact Value) - DECIMAL, NUMERIC

The `DECIMAL` and `NUMERIC` types store exact numeric data values. These types are used when it is important to preserve exact precision, for example with monetary data. In MySQL, `NUMERIC` is implemented as `DECIMAL`, so the following remarks about `DECIMAL` apply equally to `NUMERIC`.

MySQL stores `DECIMAL` values in binary format. See [Section 12.21, “Precision Math”](#).

In a `DECIMAL` column declaration, the precision and scale can be (and usually is) specified. For example:

```
salary DECIMAL(5,2)
```

In this example, `5` is the precision and `2` is the scale. The precision represents the number of significant digits that are stored for values, and the scale represents the number of digits that can be stored following the decimal point.

Standard SQL requires that `DECIMAL(5,2)` be able to store any value with five digits and two decimals, so values that can be stored in the `salary` column range from `-999.99` to `999.99`.

In standard SQL, the syntax `DECIMAL(M)` is equivalent to `DECIMAL(M,0)`. Similarly, the syntax `DECIMAL` is equivalent to `DECIMAL(M,0)`, where the implementation is permitted to decide the value of `M`. MySQL supports both of these variant forms of `DECIMAL` syntax. The default value of `M` is 10.

If the scale is 0, `DECIMAL` values contain no decimal point or fractional part.

The maximum number of digits for `DECIMAL` is 65, but the actual range for a given `DECIMAL` column can be constrained by the precision or scale for a given column. When such a column is assigned a value with

more digits following the decimal point than are permitted by the specified scale, the value is converted to that scale. (The precise behavior is operating system-specific, but generally the effect is truncation to the permissible number of digits.)

### 11.1.4 Floating-Point Types (Approximate Value) - FLOAT, DOUBLE

The `FLOAT` and `DOUBLE` types represent approximate numeric data values. MySQL uses four bytes for single-precision values and eight bytes for double-precision values.

For `FLOAT`, the SQL standard permits an optional specification of the precision (but not the range of the exponent) in bits following the keyword `FLOAT` in parentheses, that is, `FLOAT(p)`. MySQL also supports this optional precision specification, but the precision value in `FLOAT(p)` is used only to determine storage size. A precision from 0 to 23 results in a 4-byte single-precision `FLOAT` column. A precision from 24 to 53 results in an 8-byte double-precision `DOUBLE` column.

MySQL permits a nonstandard syntax: `FLOAT(M,D)` or `REAL(M,D)` or `DOUBLE PRECISION(M,D)`. Here, (*M*,*D*) means that values can be stored with up to *M* digits in total, of which *D* digits may be after the decimal point. For example, a column defined as `FLOAT(7,4)` looks like `-999.9999` when displayed. MySQL performs rounding when storing values, so if you insert `999.00009` into a `FLOAT(7,4)` column, the approximate result is `999.0001`.

Because floating-point values are approximate and not stored as exact values, attempts to treat them as exact in comparisons may lead to problems. They are also subject to platform or implementation dependencies. For more information, see [Section B.3.4.8, “Problems with Floating-Point Values”](#).

For maximum portability, code requiring storage of approximate numeric data values should use `FLOAT` or `DOUBLE PRECISION` with no specification of precision or number of digits.

### 11.1.5 Bit-Value Type - BIT

The `BIT` data type is used to store bit values. A type of `BIT(M)` enables storage of *M*-bit values. *M* can range from 1 to 64.

To specify bit values, `b'value'` notation can be used. *value* is a binary value written using zeros and ones. For example, `b'111'` and `b'10000000'` represent 7 and 128, respectively. See [Section 9.1.5, “Bit-Value Literals”](#).

If you assign a value to a `BIT(M)` column that is less than *M* bits long, the value is padded on the left with zeros. For example, assigning a value of `b'101'` to a `BIT(6)` column is, in effect, the same as assigning `b'000101'`.

**NDB Cluster.** The maximum combined size of all `BIT` columns used in a given `NDB` table must not exceed 4096 bits.

### 11.1.6 Numeric Type Attributes

MySQL supports an extension for optionally specifying the display width of integer data types in parentheses following the base keyword for the type. For example, `INT(4)` specifies an `INT` with a display width of four digits. This optional display width may be used by applications to display integer values having a width less than the width specified for the column by left-padding them with spaces. (That is, this width is present in the metadata returned with result sets. Whether it is used is up to the application.)

The display width does *not* constrain the range of values that can be stored in the column. Nor does it prevent values wider than the column display width from being displayed correctly. For example, a column specified as `SMALLINT(3)` has the usual `SMALLINT` range of `-32768` to `32767`, and values outside the range permitted by three digits are displayed in full using more than three digits.

When used in conjunction with the optional (nonstandard) `ZEROFILL` attribute, the default padding of spaces is replaced with zeros. For example, for a column declared as `INT(4) ZEROFILL`, a value of 5 is retrieved as `0005`.



#### Note

The `ZEROFILL` attribute is ignored for columns involved in expressions or `UNION` queries.

If you store values larger than the display width in an integer column that has the `ZEROFILL` attribute, you may experience problems when MySQL generates temporary tables for some complicated joins. In these cases, MySQL assumes that the data values fit within the column display width.

All integer types can have an optional (nonstandard) `UNSIGNED` attribute. An unsigned type can be used to permit only nonnegative numbers in a column or when you need a larger upper numeric range for the column. For example, if an `INT` column is `UNSIGNED`, the size of the column's range is the same but its endpoints shift up, from `-2147483648` and `2147483647` to `0` and `4294967295`.

Floating-point and fixed-point types also can be `UNSIGNED`. As with integer types, this attribute prevents negative values from being stored in the column. Unlike the integer types, the upper range of column values remains the same.

If you specify `ZEROFILL` for a numeric column, MySQL automatically adds the `UNSIGNED` attribute.

Integer or floating-point data types can have the `AUTO_INCREMENT` attribute. When you insert a value of `NULL` into an indexed `AUTO_INCREMENT` column, the column is set to the next sequence value. Typically this is `value+1`, where `value` is the largest value for the column currently in the table. (`AUTO_INCREMENT` sequences begin with 1.)

Storing 0 into an `AUTO_INCREMENT` column has the same effect as storing `NULL`, unless the `NO_AUTO_VALUE_ON_ZERO` SQL mode is enabled.

Inserting `NULL` to generate `AUTO_INCREMENT` values requires that the column be declared `NOT NULL`. If the column is declared `NULL`, inserting `NULL` stores a `NULL`. When you insert any other value into an `AUTO_INCREMENT` column, the column is set to that value and the sequence is reset so that the next automatically generated value follows sequentially from the inserted value.

Negative values for `AUTO_INCREMENT` columns are not supported.

## 11.1.7 Out-of-Range and Overflow Handling

When MySQL stores a value in a numeric column that is outside the permissible range of the column data type, the result depends on the SQL mode in effect at the time:

- If strict SQL mode is enabled, MySQL rejects the out-of-range value with an error, and the insert fails, in accordance with the SQL standard.
- If no restrictive modes are enabled, MySQL clips the value to the appropriate endpoint of the column data type range and stores the resulting value instead.

When an out-of-range value is assigned to an integer column, MySQL stores the value representing the corresponding endpoint of the column data type range.

When a floating-point or fixed-point column is assigned a value that exceeds the range implied by the specified (or default) precision and scale, MySQL stores the value representing the corresponding endpoint of that range.

Suppose that a table `t1` has this definition:

```
CREATE TABLE t1 (i1 TINYINT, i2 TINYINT UNSIGNED);
```

With strict SQL mode enabled, an out of range error occurs:

```
mysql> SET sql_mode = 'TRADITIONAL';
mysql> INSERT INTO t1 (i1, i2) VALUES(256, 256);
ERROR 1264 (22003): Out of range value for column 'i1' at row 1
mysql> SELECT * FROM t1;
Empty set (0.00 sec)
```

With strict SQL mode not enabled, clipping with warnings occurs:

```
mysql> SET sql_mode = '';
mysql> INSERT INTO t1 (i1, i2) VALUES(256, 256);
mysql> SHOW WARNINGS;
+-----+-----+-----+
| Level | Code | Message |
+-----+-----+-----+
| Warning | 1264 | Out of range value for column 'i1' at row 1 |
| Warning | 1264 | Out of range value for column 'i2' at row 1 |
+-----+-----+-----+
mysql> SELECT * FROM t1;
+-----+-----+
| i1 | i2 |
+-----+-----+
| 127 | 255 |
+-----+-----+
```

When strict SQL mode is not enabled, column-assignment conversions that occur due to clipping are reported as warnings for `ALTER TABLE`, `LOAD DATA`, `UPDATE`, and multiple-row `INSERT` statements. In strict mode, these statements fail, and some or all the values are not inserted or changed, depending on whether the table is a transactional table and other factors. For details, see [Section 5.1.10, “Server SQL Modes”](#).

Overflow during numeric expression evaluation results in an error. For example, the largest signed `BIGINT` value is 9223372036854775807, so the following expression produces an error:

```
mysql> SELECT 9223372036854775807 + 1;
ERROR 1690 (22003): BIGINT value is out of range in '(9223372036854775807 + 1)'
```

To enable the operation to succeed in this case, convert the value to unsigned;

```
mysql> SELECT CAST(9223372036854775807 AS UNSIGNED) + 1;
+-----+
| CAST(9223372036854775807 AS UNSIGNED) + 1 |
+-----+
| 9223372036854775808 |
+-----+
```

Whether overflow occurs depends on the range of the operands, so another way to handle the preceding expression is to use exact-value arithmetic because `DECIMAL` values have a larger range than integers:

```
mysql> SELECT 9223372036854775807.0 + 1;
+-----+
| 9223372036854775807.0 + 1 |
+-----+
| 9223372036854775808.0 |
+-----+
```

Subtraction between integer values, where one is of type `UNSIGNED`, produces an unsigned result by default. If the result would otherwise have been negative, an error results:

```
mysql> SET sql_mode = '';
Query OK, 0 rows affected (0.00 sec)

mysql> SELECT CAST(0 AS UNSIGNED) - 1;
ERROR 1690 (22003): BIGINT UNSIGNED value is out of range in '(cast(0 as unsigned) - 1)'
```

If the `NO_UNSIGNED_SUBTRACTION` SQL mode is enabled, the result is negative:

```
mysql> SET sql_mode = 'NO_UNSIGNED_SUBTRACTION';
mysql> SELECT CAST(0 AS UNSIGNED) - 1;
+-----+
| CAST(0 AS UNSIGNED) - 1 |
+-----+
|                          -1 |
+-----+
```

If the result of such an operation is used to update an `UNSIGNED` integer column, the result is clipped to the maximum value for the column type, or clipped to 0 if `NO_UNSIGNED_SUBTRACTION` is enabled. If strict SQL mode is enabled, an error occurs and the column remains unchanged.

## 11.2 Date and Time Data Types

The date and time data types for representing temporal values are `DATE`, `TIME`, `DATETIME`, `TIMESTAMP`, and `YEAR`. Each temporal type has a range of valid values, as well as a “zero” value that may be used when you specify an invalid value that MySQL cannot represent. The `TIMESTAMP` and `DATETIME` types have special automatic updating behavior, described in [Section 11.2.6, “Automatic Initialization and Updating for `TIMESTAMP` and `DATETIME`”](#).

For information about storage requirements of the temporal data types, see [Section 11.7, “Data Type Storage Requirements”](#).

For descriptions of functions that operate on temporal values, see [Section 12.7, “Date and Time Functions”](#).

Keep in mind these general considerations when working with date and time types:

- MySQL retrieves values for a given date or time type in a standard output format, but it attempts to interpret a variety of formats for input values that you supply (for example, when you specify a value to be assigned to or compared to a date or time type). For a description of the permitted formats for date and time types, see [Section 9.1.3, “Date and Time Literals”](#). It is expected that you supply valid values. Unpredictable results may occur if you use values in other formats.
- Although MySQL tries to interpret values in several formats, date parts must always be given in year-month-day order (for example, `'98-09-04'`), rather than in the month-day-year or day-month-year orders commonly used elsewhere (for example, `'09-04-98'`, `'04-09-98'`). To convert strings in other orders to year-month-day order, the `STR_TO_DATE()` function may be useful.
- Dates containing 2-digit year values are ambiguous because the century is unknown. MySQL interprets 2-digit year values using these rules:
  - Year values in the range `70-99` become `1970-1999`.
  - Year values in the range `00-69` become `2000-2069`.

See also [Section 11.2.10, “2-Digit Years in Dates”](#).

- Conversion of values from one temporal type to another occurs according to the rules in [Section 11.2.9, “Conversion Between Date and Time Types”](#).

- MySQL automatically converts a date or time value to a number if the value is used in numeric context and vice versa.
- By default, when MySQL encounters a value for a date or time type that is out of range or otherwise invalid for the type, it converts the value to the “zero” value for that type. The exception is that out-of-range `TIME` values are clipped to the appropriate endpoint of the `TIME` range.
- By setting the SQL mode to the appropriate value, you can specify more exactly what kind of dates you want MySQL to support. (See [Section 5.1.10, “Server SQL Modes”](#).) You can get MySQL to accept certain dates, such as `'2009-11-31'`, by enabling the `ALLOW_INVALID_DATES` SQL mode. This is useful when you want to store a “possibly wrong” value which the user has specified (for example, in a web form) in the database for future processing. Under this mode, MySQL verifies only that the month is in the range from 1 to 12 and that the day is in the range from 1 to 31.
- MySQL permits you to store dates where the day or month and day are zero in a `DATE` or `DATETIME` column. This is useful for applications that need to store birthdates for which you may not know the exact date. In this case, you simply store the date as `'2009-00-00'` or `'2009-01-00'`. However, with dates such as these, you should not expect to get correct results for functions such as `DATE_SUB()` or `DATE_ADD()` that require complete dates. To disallow zero month or day parts in dates, enable the `NO_ZERO_IN_DATE` mode.
- MySQL permits you to store a “zero” value of `'0000-00-00'` as a “dummy date.” In some cases, this is more convenient than using `NULL` values, and uses less data and index space. To disallow `'0000-00-00'`, enable the `NO_ZERO_DATE` mode.
- “Zero” date or time values used through Connector/ODBC are converted automatically to `NULL` because ODBC cannot handle such values.

The following table shows the format of the “zero” value for each type. The “zero” values are special, but you can store or refer to them explicitly using the values shown in the table. You can also do this using the values `'0'` or `0`, which are easier to write. For temporal types that include a date part (`DATE`, `DATETIME`, and `TIMESTAMP`), use of these values may produce warning or errors. The precise behavior depends on which, if any, of the strict and `NO_ZERO_DATE` SQL modes are enabled; see [Section 5.1.10, “Server SQL Modes”](#).

Data Type	“Zero” Value
<code>DATE</code>	<code>'0000-00-00'</code>
<code>TIME</code>	<code>'00:00:00'</code>
<code>DATETIME</code>	<code>'0000-00-00 00:00:00'</code>
<code>TIMESTAMP</code>	<code>'0000-00-00 00:00:00'</code>
<code>YEAR</code>	<code>0000</code>

## 11.2.1 Date and Time Data Type Syntax

The date and time data types for representing temporal values are `DATE`, `TIME`, `DATETIME`, `TIMESTAMP`, and `YEAR`.

For the `DATE` and `DATETIME` range descriptions, “supported” means that although earlier values might work, there is no guarantee.

MySQL permits fractional seconds for `TIME`, `DATETIME`, and `TIMESTAMP` values, with up to microseconds (6 digits) precision. To define a column that includes a fractional seconds part, use the syntax

*type\_name*(*fsp*), where *type\_name* is `TIME`, `DATETIME`, or `TIMESTAMP`, and *fsp* is the fractional seconds precision. For example:

```
CREATE TABLE t1 (t TIME(3), dt DATETIME(6), ts TIMESTAMP(0));
```

The *fsp* value, if given, must be in the range 0 to 6. A value of 0 signifies that there is no fractional part. If omitted, the default precision is 0. (This differs from the standard SQL default of 6, for compatibility with previous MySQL versions.)

Any `TIMESTAMP` or `DATETIME` column in a table can have automatic initialization and updating properties; see [Section 11.2.6, “Automatic Initialization and Updating for `TIMESTAMP` and `DATETIME`”](#).

- `DATE`

A date. The supported range is '1000-01-01' to '9999-12-31'. MySQL displays `DATE` values in 'YYYY-MM-DD' format, but permits assignment of values to `DATE` columns using either strings or numbers.

- `DATETIME`(*fsp*)

A date and time combination. The supported range is '1000-01-01 00:00:00.000000' to '9999-12-31 23:59:59.499999'. MySQL displays `DATETIME` values in 'YYYY-MM-DD hh:mm:ss[.fraction]' format, but permits assignment of values to `DATETIME` columns using either strings or numbers.

An optional *fsp* value in the range from 0 to 6 may be given to specify fractional seconds precision. A value of 0 signifies that there is no fractional part. If omitted, the default precision is 0.

Automatic initialization and updating to the current date and time for `DATETIME` columns can be specified using `DEFAULT` and `ON UPDATE` column definition clauses, as described in [Section 11.2.6, “Automatic Initialization and Updating for `TIMESTAMP` and `DATETIME`”](#).

- `TIMESTAMP`(*fsp*)

A timestamp. The range is '1970-01-01 00:00:01.000000' UTC to '2038-01-19 03:14:07.499999' UTC. `TIMESTAMP` values are stored as the number of seconds since the epoch ('1970-01-01 00:00:00' UTC). A `TIMESTAMP` cannot represent the value '1970-01-01 00:00:00' because that is equivalent to 0 seconds from the epoch and the value 0 is reserved for representing '0000-00-00 00:00:00', the “zero” `TIMESTAMP` value.

An optional *fsp* value in the range from 0 to 6 may be given to specify fractional seconds precision. A value of 0 signifies that there is no fractional part. If omitted, the default precision is 0.

The way the server handles `TIMESTAMP` definitions depends on the value of the `explicit_defaults_for_timestamp` system variable (see [Section 5.1.7, “Server System Variables”](#)).

If `explicit_defaults_for_timestamp` is enabled, there is no automatic assignment of the `DEFAULT CURRENT_TIMESTAMP` or `ON UPDATE CURRENT_TIMESTAMP` attributes to any `TIMESTAMP` column. They must be included explicitly in the column definition. Also, any `TIMESTAMP` not explicitly declared as `NOT NULL` permits `NULL` values.

If `explicit_defaults_for_timestamp` is disabled, the server handles `TIMESTAMP` as follows:

Unless specified otherwise, the first `TIMESTAMP` column in a table is defined to be automatically set to the date and time of the most recent modification if not explicitly assigned a value. This makes `TIMESTAMP` useful for recording the timestamp of an `INSERT` or `UPDATE` operation. You can also set



any `TIMESTAMP` column to the current date and time by assigning it a `NULL` value, unless it has been defined with the `NULL` attribute to permit `NULL` values.

Automatic initialization and updating to the current date and time can be specified using `DEFAULT CURRENT_TIMESTAMP` and `ON UPDATE CURRENT_TIMESTAMP` column definition clauses. By default, the first `TIMESTAMP` column has these properties, as previously noted. However, any `TIMESTAMP` column in a table can be defined to have these properties.

- `TIME[ (fsp) ]`

A time. The range is `'-838:59:59.000000'` to `'838:59:59.000000'`. MySQL displays `TIME` values in `'hh:mm:ss[.fraction]'` format, but permits assignment of values to `TIME` columns using either strings or numbers.

An optional `fsp` value in the range from 0 to 6 may be given to specify fractional seconds precision. A value of 0 signifies that there is no fractional part. If omitted, the default precision is 0.

- `YEAR[ (4) ]`

A year in 4-digit format. MySQL displays `YEAR` values in `YYYY` format, but permits assignment of values to `YEAR` columns using either strings or numbers. Values display as `1901` to `2155`, or `0000`.



#### Note

The `YEAR(2)` data type is deprecated and support for it is removed in MySQL 5.7.5. To convert 2-digit `YEAR(2)` columns to 4-digit `YEAR` columns, see [Section 11.2.5, “2-Digit YEAR\(2\) Limitations and Migrating to 4-Digit YEAR”](#).

For additional information about `YEAR` display format and interpretation of input values, see [Section 11.2.4, “The YEAR Type”](#).

The `SUM()` and `AVG()` aggregate functions do not work with temporal values. (They convert the values to numbers, losing everything after the first nonnumeric character.) To work around this problem, convert to numeric units, perform the aggregate operation, and convert back to a temporal value. Examples:

```
SELECT SEC_TO_TIME(SUM(TIME_TO_SEC(time_col))) FROM tbl_name;
SELECT FROM_DAYS(SUM(TO_DAYS(date_col))) FROM tbl_name;
```



#### Note

The MySQL server can be run with the `MAXDB` SQL mode enabled. In this case, `TIMESTAMP` is identical with `DATETIME`. If this mode is enabled at the time that a table is created, `TIMESTAMP` columns are created as `DATETIME` columns. As a result, such columns use `DATETIME` display format, have the same range of values, and there is no automatic initialization or updating to the current date and time. See [Section 5.1.10, “Server SQL Modes”](#).



#### Note

As of MySQL 5.7.22, `MAXDB` is deprecated; expect it to be removed in a future version of MySQL.

## 11.2.2 The DATE, DATETIME, and TIMESTAMP Types

The `DATE`, `DATETIME`, and `TIMESTAMP` types are related. This section describes their characteristics, how they are similar, and how they differ. MySQL recognizes `DATE`, `DATETIME`, and `TIMESTAMP` values in

several formats, described in [Section 9.1.3, “Date and Time Literals”](#). For the `DATE` and `DATETIME` range descriptions, “supported” means that although earlier values might work, there is no guarantee.

The `DATE` type is used for values with a date part but no time part. MySQL retrieves and displays `DATE` values in `'YYYY-MM-DD'` format. The supported range is `'1000-01-01'` to `'9999-12-31'`.

The `DATETIME` type is used for values that contain both date and time parts. MySQL retrieves and displays `DATETIME` values in `'YYYY-MM-DD hh:mm:ss'` format. The supported range is `'1000-01-01 00:00:00'` to `'9999-12-31 23:59:59'`.

The `TIMESTAMP` data type is used for values that contain both date and time parts. `TIMESTAMP` has a range of `'1970-01-01 00:00:01'` UTC to `'2038-01-19 03:14:07'` UTC.

A `DATETIME` or `TIMESTAMP` value can include a trailing fractional seconds part in up to microseconds (6 digits) precision. In particular, any fractional part in a value inserted into a `DATETIME` or `TIMESTAMP` column is stored rather than discarded. With the fractional part included, the format for these values is `'YYYY-MM-DD hh:mm:ss[.fraction]'`, the range for `DATETIME` values is `'1000-01-01 00:00:00.000000'` to `'9999-12-31 23:59:59.499999'`, and the range for `TIMESTAMP` values is `'1970-01-01 00:00:01.000000'` to `'2038-01-19 03:14:07.499999'`. The fractional part should always be separated from the rest of the time by a decimal point; no other fractional seconds delimiter is recognized. For information about fractional seconds support in MySQL, see [Section 11.2.7, “Fractional Seconds in Time Values”](#).

The `TIMESTAMP` and `DATETIME` data types offer automatic initialization and updating to the current date and time. For more information, see [Section 11.2.6, “Automatic Initialization and Updating for TIMESTAMP and DATETIME”](#).

MySQL converts `TIMESTAMP` values from the current time zone to UTC for storage, and back from UTC to the current time zone for retrieval. (This does not occur for other types such as `DATETIME`.) By default, the current time zone for each connection is the server's time. The time zone can be set on a per-connection basis. As long as the time zone setting remains constant, you get back the same value you store. If you store a `TIMESTAMP` value, and then change the time zone and retrieve the value, the retrieved value is different from the value you stored. This occurs because the same time zone was not used for conversion in both directions. The current time zone is available as the value of the `time_zone` system variable. For more information, see [Section 5.1.13, “MySQL Server Time Zone Support”](#).

Invalid `DATE`, `DATETIME`, or `TIMESTAMP` values are converted to the “zero” value of the appropriate type (`'0000-00-00'` or `'0000-00-00 00:00:00'`), if the SQL mode permits this conversion. The precise behavior depends on which if any of strict SQL mode and the `NO_ZERO_DATE` SQL mode are enabled; see [Section 5.1.10, “Server SQL Modes”](#).

Be aware of certain properties of date value interpretation in MySQL:

- MySQL permits a “relaxed” format for values specified as strings, in which any punctuation character may be used as the delimiter between date parts or time parts. In some cases, this syntax can be deceiving. For example, a value such as `'10:11:12'` might look like a time value because of the `:`, but is interpreted as the year `'2010-11-12'` if used in date context. The value `'10:45:15'` is converted to `'0000-00-00'` because `'45'` is not a valid month.

The only delimiter recognized between a date and time part and a fractional seconds part is the decimal point.

- The server requires that month and day values be valid, and not merely in the range 1 to 12 and 1 to 31, respectively. With strict mode disabled, invalid dates such as `'2004-04-31'` are converted to `'0000-00-00'` and a warning is generated. With strict mode enabled, invalid dates generate an error. To permit such dates, enable `ALLOW_INVALID_DATES`. See [Section 5.1.10, “Server SQL Modes”](#), for more information.

- MySQL does not accept `TIMESTAMP` values that include a zero in the day or month column or values that are not a valid date. The sole exception to this rule is the special “zero” value `'0000-00-00 00:00:00'`, if the SQL mode permits this value. The precise behavior depends on which if any of strict SQL mode and the `NO_ZERO_DATE` SQL mode are enabled; see [Section 5.1.10, “Server SQL Modes”](#).
- Dates containing 2-digit year values are ambiguous because the century is unknown. MySQL interprets 2-digit year values using these rules:
  - Year values in the range `00-69` become `2000-2069`.
  - Year values in the range `70-99` become `1970-1999`.

See also [Section 11.2.10, “2-Digit Years in Dates”](#).



#### Note

The MySQL server can be run with the `MAXDB` SQL mode enabled. In this case, `TIMESTAMP` is identical with `DATETIME`. If this mode is enabled at the time that a table is created, `TIMESTAMP` columns are created as `DATETIME` columns. As a result, such columns use `DATETIME` display format, have the same range of values, and there is no automatic initialization or updating to the current date and time. See [Section 5.1.10, “Server SQL Modes”](#).



#### Note

As of MySQL 5.7.22, `MAXDB` is deprecated; expect it to be removed in a future version of MySQL.

## 11.2.3 The TIME Type

MySQL retrieves and displays `TIME` values in `'hh:mm:ss'` format (or `'hhh:mm:ss'` format for large hours values). `TIME` values may range from `'-838:59:59'` to `'838:59:59'`. The hours part may be so large because the `TIME` type can be used not only to represent a time of day (which must be less than 24 hours), but also elapsed time or a time interval between two events (which may be much greater than 24 hours, or even negative).

MySQL recognizes `TIME` values in several formats, some of which can include a trailing fractional seconds part in up to microseconds (6 digits) precision. See [Section 9.1.3, “Date and Time Literals”](#). For information about fractional seconds support in MySQL, see [Section 11.2.7, “Fractional Seconds in Time Values”](#). In particular, any fractional part in a value inserted into a `TIME` column is stored rather than discarded. With the fractional part included, the range for `TIME` values is `'-838:59:59.000000'` to `'838:59:59.000000'`.

Be careful about assigning abbreviated values to a `TIME` column. MySQL interprets abbreviated `TIME` values with colons as time of the day. That is, `'11:12'` means `'11:12:00'`, not `'00:11:12'`. MySQL interprets abbreviated values without colons using the assumption that the two rightmost digits represent seconds (that is, as elapsed time rather than as time of day). For example, you might think of `'1112'` and `1112` as meaning `'11:12:00'` (12 minutes after 11 o'clock), but MySQL interprets them as `'00:11:12'` (11 minutes, 12 seconds). Similarly, `'12'` and `12` are interpreted as `'00:00:12'`.

The only delimiter recognized between a time part and a fractional seconds part is the decimal point.

By default, values that lie outside the `TIME` range but are otherwise valid are clipped to the closest endpoint of the range. For example, `'-850:00:00'` and `'850:00:00'` are converted to `'-838:59:59'` and `'838:59:59'`. Invalid `TIME` values are converted to `'00:00:00'`. Note that because `'00:00:00'` is itself a valid `TIME` value, there is no way to tell, from a value of `'00:00:00'` stored in a table, whether the original value was specified as `'00:00:00'` or whether it was invalid.

For more restrictive treatment of invalid `TIME` values, enable strict SQL mode to cause errors to occur. See [Section 5.1.10, “Server SQL Modes”](#).

## 11.2.4 The YEAR Type

The `YEAR` type is a 1-byte type used to represent year values. It can be declared as `YEAR` with an implicit display width of 4 characters, or equivalently as `YEAR(4)` with an explicit display width.



### Note

The 2-digit `YEAR(2)` data type is deprecated and support for it is removed in MySQL 5.7.5. To convert 2-digit `YEAR(2)` columns to 4-digit `YEAR` columns, see [Section 11.2.5, “2-Digit YEAR\(2\) Limitations and Migrating to 4-Digit YEAR”](#).

MySQL displays `YEAR` values in `YYYY` format, with a range of 1901 to 2155, and 0000.

`YEAR` accepts input values in a variety of formats:

- As 4-digit strings in the range '1901' to '2155'.
- As 4-digit numbers in the range 1901 to 2155.
- As 1- or 2-digit strings in the range '0' to '99'. MySQL converts values in the ranges '0' to '69' and '70' to '99' to `YEAR` values in the ranges 2000 to 2069 and 1970 to 1999.
- As 1- or 2-digit numbers in the range 0 to 99. MySQL converts values in the ranges 1 to 69 and 70 to 99 to `YEAR` values in the ranges 2001 to 2069 and 1970 to 1999.

The result of inserting a numeric 0 has a display value of 0000 and an internal value of 0000. To insert zero and have it be interpreted as 2000, specify it as a string '0' or '00'.

- As the result of functions that return a value that is acceptable in `YEAR` context, such as `NOW()`.

If strict SQL mode is not enabled, MySQL converts invalid `YEAR` values to 0000. In strict SQL mode, attempting to insert an invalid `YEAR` value produces an error.

See also [Section 11.2.10, “2-Digit Years in Dates”](#).

## 11.2.5 2-Digit YEAR(2) Limitations and Migrating to 4-Digit YEAR

This section describes problems that can occur when using the 2-digit `YEAR(2)` data type and provides information about converting existing `YEAR(2)` columns to 4-digit year-valued columns, which can be declared as `YEAR` with an implicit display width of 4 characters, or equivalently as `YEAR(4)` with an explicit display width.

Although the internal range of values for `YEAR/YEAR(4)` and the deprecated `YEAR(2)` type is the same (1901 to 2155, and 0000), the display width for `YEAR(2)` makes that type inherently ambiguous because displayed values indicate only the last two digits of the internal values and omit the century digits. The result can be a loss of information under certain circumstances. For this reason, avoid using `YEAR(2)` in your applications and use `YEAR/YEAR(4)` wherever you need a year-valued data type. As of MySQL 5.7.5, support for `YEAR(2)` is removed and existing 2-digit `YEAR(2)` columns must be converted to 4-digit `YEAR` columns to become usable again.

### YEAR(2) Limitations

Issues with the `YEAR(2)` data type include ambiguity of displayed values, and possible loss of information when values are dumped and reloaded or converted to strings.

- Displayed `YEAR(2)` values can be ambiguous. It is possible for up to three `YEAR(2)` values that have different internal values to have the same displayed value, as the following example demonstrates:

```
mysql> CREATE TABLE t (y2 YEAR(2), y4 YEAR);
Query OK, 0 rows affected, 1 warning (0.01 sec)

mysql> INSERT INTO t (y2) VALUES(1912),(2012),(2112);
Query OK, 3 rows affected (0.00 sec)
Records: 3 Duplicates: 0 Warnings: 0

mysql> UPDATE t SET y4 = y2;
Query OK, 3 rows affected (0.00 sec)
Rows matched: 3 Changed: 3 Warnings: 0

mysql> SELECT * FROM t;
+-----+-----+
| y2   | y4   |
+-----+-----+
| 12   | 1912 |
| 12   | 2012 |
| 12   | 2112 |
+-----+-----+
3 rows in set (0.00 sec)
```

- If you use `mysqldump` to dump the table created in the preceding example, the dump file represents all `y2` values using the same 2-digit representation (12). If you reload the table from the dump file, all resulting rows have internal value 2012 and display value 12, thus losing the distinctions between them.
- Conversion of a 2-digit or 4-digit `YEAR` data value to string form uses the data type display width. Suppose that a `YEAR(2)` column and a `YEAR/YEAR(4)` column both contain the value 1970. Assigning each column to a string results in a value of '70' or '1970', respectively. That is, loss of information occurs for conversion from `YEAR(2)` to string.
- Values outside the range from 1970 to 2069 are stored incorrectly when inserted into a `YEAR(2)` column in a `CSV` table. For example, inserting 2211 results in a display value of 11 but an internal value of 2011.

To avoid these problems, use the 4-digit `YEAR` or `YEAR(4)` data type rather than the 2-digit `YEAR(2)` data type. Suggestions regarding migration strategies appear later in this section.

## Reduced/Removed YEAR(2) Support in MySQL 5.7

Before MySQL 5.7.5, support for `YEAR(2)` is diminished. As of MySQL 5.7.5, support for `YEAR(2)` is removed.

- `YEAR(2)` column definitions for new tables produce warnings or errors:
  - Before MySQL 5.7.5, `YEAR(2)` column definitions for new tables are converted (with an `ER_INVALID_YEAR_COLUMN_LENGTH` warning) to 4-digit `YEAR` columns:

```
mysql> CREATE TABLE t1 (y YEAR(2));
Query OK, 0 rows affected, 1 warning (0.04 sec)

mysql> SHOW WARNINGS\G
***** 1. row *****
Level: Warning
Code: 1818
Message: YEAR(2) column type is deprecated. Creating YEAR(4) column instead.
1 row in set (0.00 sec)

mysql> SHOW CREATE TABLE t1\G
***** 1. row *****
```

```

Table: t1
Create Table: CREATE TABLE `t1` (
  `y` year(4) DEFAULT NULL
) ENGINE=InnoDB DEFAULT CHARSET=latin1
1 row in set (0.00 sec)

```

- As of MySQL 5.7.5, `YEAR(2)` column definitions for new tables produce an `ER_INVALID_YEAR_COLUMN_LENGTH` error:

```

mysql> CREATE TABLE t1 (y YEAR(2));
ERROR 1818 (HY000): Supports only YEAR or YEAR(4) column.

```

- `YEAR(2)` column in existing tables remain as `YEAR(2)`:
  - Before MySQL 5.7.5, `YEAR(2)` is processed in queries as in older versions of MySQL.
  - As of MySQL 5.7.5, `YEAR(2)` columns in queries produce warnings or errors.
- Several programs or statements convert `YEAR(2)` columns to 4-digit `YEAR` columns automatically:
  - `ALTER TABLE` statements that result in a table rebuild.
  - `REPAIR TABLE` (which `CHECK TABLE` recommends you use, if it finds a table that contains `YEAR(2)` columns).
  - `mysql_upgrade` (which uses `REPAIR TABLE`).
  - Dumping with `mysqldump` and reloading the dump file. Unlike the conversions performed by the preceding three items, a dump and reload has the potential to change data values.

A MySQL upgrade usually involves at least one of the last two items. However, with respect to `YEAR(2)`, `mysql_upgrade` is preferable to `mysqldump`, which, as noted, can change data values.

## Migrating from YEAR(2) to 4-Digit YEAR

To convert 2-digit `YEAR(2)` columns to 4-digit `YEAR` columns, you can do so manually at any time without upgrading. Alternatively, you can upgrade to a version of MySQL with reduced or removed support for `YEAR(2)` (MySQL 5.6.6 or later), then have MySQL convert `YEAR(2)` columns automatically. In the latter case, avoid upgrading by dumping and reloading your data because that can change data values. In addition, if you use replication, there are upgrade considerations you must take into account.

To convert 2-digit `YEAR(2)` columns to 4-digit `YEAR` manually, use `ALTER TABLE` or `REPAIR TABLE`. Suppose that a table `t1` has this definition:

```
CREATE TABLE t1 (ycol YEAR(2) NOT NULL DEFAULT '70');
```

Modify the column using `ALTER TABLE` as follows:

```
ALTER TABLE t1 FORCE;
```

The `ALTER TABLE` statement converts the table without changing `YEAR(2)` values. If the server is a replication source, the `ALTER TABLE` statement replicates to replicas and makes the corresponding table change on each one.

Another migration method is to perform a binary upgrade: Upgrade MySQL in place without dumping and reloading your data. Then run `mysql_upgrade`, which uses `REPAIR TABLE` to convert 2-digit `YEAR(2)` columns to 4-digit `YEAR` columns without changing data values. If the server is a replication source, the `REPAIR TABLE` statements replicate to replicas and make the corresponding table changes on each one, unless you invoke `mysql_upgrade` with the `--skip-write-binlog` option.

Upgrades to replication servers usually involve upgrading replicas to a newer version of MySQL, then upgrading the source. For example, if a source and replica both run MySQL 5.5, a typical upgrade sequence involves upgrading the replica to 5.6, then upgrading the source to 5.6. With regard to the different treatment of `YEAR(2)` as of MySQL 5.6.6, that upgrade sequence results in a problem: Suppose that the replica has been upgraded but not yet the source. Then creating a table containing a 2-digit `YEAR(2)` column on the source results in a table containing a 4-digit `YEAR` column on the replica. Consequently, the following operations have a different result on the source and replica, if you use statement-based replication:

- Inserting numeric 0. The resulting value has an internal value of 2000 on the source but 0000 on the replica.
- Converting `YEAR(2)` to string. This operation uses the display value of `YEAR(2)` on the source but `YEAR(4)` on the replica.

To avoid such problems, modify all 2-digit `YEAR(2)` columns on the source to 4-digit `YEAR` columns before upgrading. (Use `ALTER TABLE`, as described previously.) That makes it possible to upgrade normally (replica first, then source) without introducing any `YEAR(2)` to `YEAR(4)` differences between the source and replica.

One migration method should be avoided: Do not dump your data with `mysqldump` and reload the dump file after upgrading. That has the potential to change `YEAR(2)` values, as described previously.

A migration from 2-digit `YEAR(2)` columns to 4-digit `YEAR` columns should also involve examining application code for the possibility of changed behavior under conditions such as these:

- Code that expects selecting a `YEAR` column to produce exactly two digits.
- Code that does not account for different handling for inserts of numeric 0: Inserting 0 into `YEAR(2)` or `YEAR(4)` results in an internal value of 2000 or 0000, respectively.

## 11.2.6 Automatic Initialization and Updating for `TIMESTAMP` and `DATETIME`

`TIMESTAMP` and `DATETIME` columns can be automatically initialized and updated to the current date and time (that is, the current timestamp).

For any `TIMESTAMP` or `DATETIME` column in a table, you can assign the current timestamp as the default value, the auto-update value, or both:

- An auto-initialized column is set to the current timestamp for inserted rows that specify no value for the column.
- An auto-updated column is automatically updated to the current timestamp when the value of any other column in the row is changed from its current value. An auto-updated column remains unchanged if all other columns are set to their current values. To prevent an auto-updated column from updating when other columns change, explicitly set it to its current value. To update an auto-updated column even when other columns do not change, explicitly set it to the value it should have (for example, set it to `CURRENT_TIMESTAMP`).

In addition, if the `explicit_defaults_for_timestamp` system variable is disabled, you can initialize or update any `TIMESTAMP` (but not `DATETIME`) column to the current date and time by assigning it a `NULL` value, unless it has been defined with the `NULL` attribute to permit `NULL` values.

To specify automatic properties, use the `DEFAULT CURRENT_TIMESTAMP` and `ON UPDATE CURRENT_TIMESTAMP` clauses in column definitions. The order of the clauses does not matter. If both are present in a column definition, either can occur first. Any of the synonyms for `CURRENT_TIMESTAMP` have

the same meaning as `CURRENT_TIMESTAMP`. These are `CURRENT_TIMESTAMP()`, `NOW()`, `LOCALTIME`, `LOCALTIME()`, `LOCALTIMESTAMP`, and `LOCALTIMESTAMP()`.

Use of `DEFAULT CURRENT_TIMESTAMP` and `ON UPDATE CURRENT_TIMESTAMP` is specific to `TIMESTAMP` and `DATETIME`. The `DEFAULT` clause also can be used to specify a constant (nonautomatic) default value (for example, `DEFAULT 0` or `DEFAULT '2000-01-01 00:00:00'`).



### Note

The following examples use `DEFAULT 0`, a default that can produce warnings or errors depending on whether strict SQL mode or the `NO_ZERO_DATE` SQL mode is enabled. Be aware that the `TRADITIONAL` SQL mode includes strict mode and `NO_ZERO_DATE`. See [Section 5.1.10, “Server SQL Modes”](#).

`TIMESTAMP` or `DATETIME` column definitions can specify the current timestamp for both the default and auto-update values, for one but not the other, or for neither. Different columns can have different combinations of automatic properties. The following rules describe the possibilities:

- With both `DEFAULT CURRENT_TIMESTAMP` and `ON UPDATE CURRENT_TIMESTAMP`, the column has the current timestamp for its default value and is automatically updated to the current timestamp.

```
CREATE TABLE t1 (
  ts TIMESTAMP DEFAULT CURRENT_TIMESTAMP ON UPDATE CURRENT_TIMESTAMP,
  dt DATETIME DEFAULT CURRENT_TIMESTAMP ON UPDATE CURRENT_TIMESTAMP
);
```

- With a `DEFAULT` clause but no `ON UPDATE CURRENT_TIMESTAMP` clause, the column has the given default value and is not automatically updated to the current timestamp.

The default depends on whether the `DEFAULT` clause specifies `CURRENT_TIMESTAMP` or a constant value. With `CURRENT_TIMESTAMP`, the default is the current timestamp.

```
CREATE TABLE t1 (
  ts TIMESTAMP DEFAULT CURRENT_TIMESTAMP,
  dt DATETIME DEFAULT CURRENT_TIMESTAMP
);
```

With a constant, the default is the given value. In this case, the column has no automatic properties at all.

```
CREATE TABLE t1 (
  ts TIMESTAMP DEFAULT 0,
  dt DATETIME DEFAULT 0
);
```

- With an `ON UPDATE CURRENT_TIMESTAMP` clause and a constant `DEFAULT` clause, the column is automatically updated to the current timestamp and has the given constant default value.

```
CREATE TABLE t1 (
  ts TIMESTAMP DEFAULT 0 ON UPDATE CURRENT_TIMESTAMP,
  dt DATETIME DEFAULT 0 ON UPDATE CURRENT_TIMESTAMP
);
```

- With an `ON UPDATE CURRENT_TIMESTAMP` clause but no `DEFAULT` clause, the column is automatically updated to the current timestamp but does not have the current timestamp for its default value.

The default in this case is type dependent. `TIMESTAMP` has a default of 0 unless defined with the `NULL` attribute, in which case the default is `NULL`.

```
CREATE TABLE t1 (
  ts1 TIMESTAMP ON UPDATE CURRENT_TIMESTAMP,      -- default 0
```



```
ts2 TIMESTAMP NULL ON UPDATE CURRENT_TIMESTAMP -- default NULL
);
```

`DATETIME` has a default of `NULL` unless defined with the `NOT NULL` attribute, in which case the default is `0`.

```
CREATE TABLE t1 (
  dt1 DATETIME ON UPDATE CURRENT_TIMESTAMP,          -- default NULL
  dt2 DATETIME NOT NULL ON UPDATE CURRENT_TIMESTAMP -- default 0
);
```

`TIMESTAMP` and `DATETIME` columns have no automatic properties unless they are specified explicitly, with this exception: If the `explicit_defaults_for_timestamp` system variable is disabled, the *first* `TIMESTAMP` column has both `DEFAULT CURRENT_TIMESTAMP` and `ON UPDATE CURRENT_TIMESTAMP` if neither is specified explicitly. To suppress automatic properties for the first `TIMESTAMP` column, use one of these strategies:

- Enable the `explicit_defaults_for_timestamp` system variable. In this case, the `DEFAULT CURRENT_TIMESTAMP` and `ON UPDATE CURRENT_TIMESTAMP` clauses that specify automatic initialization and updating are available, but are not assigned to any `TIMESTAMP` column unless explicitly included in the column definition.
- Alternatively, if `explicit_defaults_for_timestamp` is disabled, do either of the following:
  - Define the column with a `DEFAULT` clause that specifies a constant default value.
  - Specify the `NULL` attribute. This also causes the column to permit `NULL` values, which means that you cannot assign the current timestamp by setting the column to `NULL`. Assigning `NULL` sets the column to `NULL`, not the current timestamp. To assign the current timestamp, set the column to `CURRENT_TIMESTAMP` or a synonym such as `NOW()`.

Consider these table definitions:

```
CREATE TABLE t1 (
  ts1 TIMESTAMP DEFAULT 0,
  ts2 TIMESTAMP DEFAULT CURRENT_TIMESTAMP
      ON UPDATE CURRENT_TIMESTAMP);
CREATE TABLE t2 (
  ts1 TIMESTAMP NULL,
  ts2 TIMESTAMP DEFAULT CURRENT_TIMESTAMP
      ON UPDATE CURRENT_TIMESTAMP);
CREATE TABLE t3 (
  ts1 TIMESTAMP NULL DEFAULT 0,
  ts2 TIMESTAMP DEFAULT CURRENT_TIMESTAMP
      ON UPDATE CURRENT_TIMESTAMP);
```

The tables have these properties:

- In each table definition, the first `TIMESTAMP` column has no automatic initialization or updating.
- The tables differ in how the `ts1` column handles `NULL` values. For `t1`, `ts1` is `NOT NULL` and assigning it a value of `NULL` sets it to the current timestamp. For `t2` and `t3`, `ts1` permits `NULL` and assigning it a value of `NULL` sets it to `NULL`.
- `t2` and `t3` differ in the default value for `ts1`. For `t2`, `ts1` is defined to permit `NULL`, so the default is also `NULL` in the absence of an explicit `DEFAULT` clause. For `t3`, `ts1` permits `NULL` but has an explicit default of `0`.

If a `TIMESTAMP` or `DATETIME` column definition includes an explicit fractional seconds precision value anywhere, the same value must be used throughout the column definition. This is permitted:

```
CREATE TABLE t1 (
  ts TIMESTAMP(6) DEFAULT CURRENT_TIMESTAMP(6) ON UPDATE CURRENT_TIMESTAMP(6)
);
```

This is not permitted:

```
CREATE TABLE t1 (
  ts TIMESTAMP(6) DEFAULT CURRENT_TIMESTAMP ON UPDATE CURRENT_TIMESTAMP(3)
);
```

## TIMESTAMP Initialization and the NULL Attribute

If the `explicit_defaults_for_timestamp` system variable is disabled, `TIMESTAMP` columns by default are `NOT NULL`, cannot contain `NULL` values, and assigning `NULL` assigns the current timestamp. To permit a `TIMESTAMP` column to contain `NULL`, explicitly declare it with the `NULL` attribute. In this case, the default value also becomes `NULL` unless overridden with a `DEFAULT` clause that specifies a different default value. `DEFAULT NULL` can be used to explicitly specify `NULL` as the default value. (For a `TIMESTAMP` column not declared with the `NULL` attribute, `DEFAULT NULL` is invalid.) If a `TIMESTAMP` column permits `NULL` values, assigning `NULL` sets it to `NULL`, not to the current timestamp.

The following table contains several `TIMESTAMP` columns that permit `NULL` values:

```
CREATE TABLE t
(
  ts1 TIMESTAMP NULL DEFAULT NULL,
  ts2 TIMESTAMP NULL DEFAULT 0,
  ts3 TIMESTAMP NULL DEFAULT CURRENT_TIMESTAMP
);
```

A `TIMESTAMP` column that permits `NULL` values does *not* take on the current timestamp at insert time except under one of the following conditions:

- Its default value is defined as `CURRENT_TIMESTAMP` and no value is specified for the column
- `CURRENT_TIMESTAMP` or any of its synonyms such as `NOW()` is explicitly inserted into the column

In other words, a `TIMESTAMP` column defined to permit `NULL` values auto-initializes only if its definition includes `DEFAULT CURRENT_TIMESTAMP`:

```
CREATE TABLE t (ts TIMESTAMP NULL DEFAULT CURRENT_TIMESTAMP);
```

If the `TIMESTAMP` column permits `NULL` values but its definition does not include `DEFAULT CURRENT_TIMESTAMP`, you must explicitly insert a value corresponding to the current date and time. Suppose that tables `t1` and `t2` have these definitions:

```
CREATE TABLE t1 (ts TIMESTAMP NULL DEFAULT '0000-00-00 00:00:00');
CREATE TABLE t2 (ts TIMESTAMP NULL DEFAULT NULL);
```

To set the `TIMESTAMP` column in either table to the current timestamp at insert time, explicitly assign it that value. For example:

```
INSERT INTO t2 VALUES (CURRENT_TIMESTAMP);
INSERT INTO t1 VALUES (NOW());
```

If the `explicit_defaults_for_timestamp` system variable is enabled, `TIMESTAMP` columns permit `NULL` values only if declared with the `NULL` attribute. Also, `TIMESTAMP` columns do not permit assigning `NULL` to assign the current timestamp, whether declared with the `NULL` or `NOT NULL` attribute. To assign the current timestamp, set the column to `CURRENT_TIMESTAMP` or a synonym such as `NOW()`.

## 11.2.7 Fractional Seconds in Time Values

MySQL has fractional seconds support for `TIME`, `DATETIME`, and `TIMESTAMP` values, with up to microseconds (6 digits) precision:

- To define a column that includes a fractional seconds part, use the syntax `type_name(fsp)`, where `type_name` is `TIME`, `DATETIME`, or `TIMESTAMP`, and `fsp` is the fractional seconds precision. For example:

```
CREATE TABLE t1 (t TIME(3), dt DATETIME(6));
```

The `fsp` value, if given, must be in the range 0 to 6. A value of 0 signifies that there is no fractional part. If omitted, the default precision is 0. (This differs from the standard SQL default of 6, for compatibility with previous MySQL versions.)

- Inserting a `TIME`, `DATE`, or `TIMESTAMP` value with a fractional seconds part into a column of the same type but having fewer fractional digits results in rounding. Consider a table created and populated as follows:

```
CREATE TABLE fractest( c1 TIME(2), c2 DATETIME(2), c3 TIMESTAMP(2) );
INSERT INTO fractest VALUES
('17:51:04.777', '2018-09-08 17:51:04.777', '2018-09-08 17:51:04.777');
```

The temporal values are inserted into the table with rounding:

```
mysql> SELECT * FROM fractest;
+-----+-----+-----+
| c1          | c2          | c3          |
+-----+-----+-----+
| 17:51:04.78 | 2018-09-08 17:51:04.78 | 2018-09-08 17:51:04.78 |
+-----+-----+-----+
```

No warning or error is given when such rounding occurs. This behavior follows the SQL standard, and is not affected by the server `sql_mode` setting.

- Functions that take temporal arguments accept values with fractional seconds. Return values from temporal functions include fractional seconds as appropriate. For example, `NOW()` with no argument returns the current date and time with no fractional part, but takes an optional argument from 0 to 6 to specify that the return value includes a fractional seconds part of that many digits.
- Syntax for temporal literals produces temporal values: `DATE 'str'`, `TIME 'str'`, and `TIMESTAMP 'str'`, and the ODBC-syntax equivalents. The resulting value includes a trailing fractional seconds part if specified. Previously, the temporal type keyword was ignored and these constructs produced the string value. See [Standard SQL and ODBC Date and Time Literals](#)

## 11.2.8 What Calendar Is Used By MySQL?

MySQL uses what is known as a *proleptic Gregorian calendar*.

Every country that has switched from the Julian to the Gregorian calendar has had to discard at least ten days during the switch. To see how this works, consider the month of October 1582, when the first Julian-to-Gregorian switch occurred.

Monday	Tuesday	Wednesday	Thursday	Friday	Saturday	Sunday
1	2	3	4	15	16	17
18	19	20	21	22	23	24
25	26	27	28	29	30	31

There are no dates between October 4 and October 15. This discontinuity is called the *cutover*. Any dates before the cutover are Julian, and any dates following the cutover are Gregorian. Dates during a cutover are nonexistent.

A calendar applied to dates when it was not actually in use is called *proleptic*. Thus, if we assume there was never a cutover and Gregorian rules always rule, we have a proleptic Gregorian calendar. This is what is used by MySQL, as is required by standard SQL. For this reason, dates prior to the cutover stored as MySQL `DATE` or `DATETIME` values must be adjusted to compensate for the difference. It is important to realize that the cutover did not occur at the same time in all countries, and that the later it happened, the more days were lost. For example, in Great Britain, it took place in 1752, when Wednesday September 2 was followed by Thursday September 14. Russia remained on the Julian calendar until 1918, losing 13 days in the process, and what is popularly referred to as its “October Revolution” occurred in November according to the Gregorian calendar.

## 11.2.9 Conversion Between Date and Time Types

To some extent, you can convert a value from one temporal type to another. However, there may be some alteration of the value or loss of information. In all cases, conversion between temporal types is subject to the range of valid values for the resulting type. For example, although `DATE`, `DATETIME`, and `TIMESTAMP` values all can be specified using the same set of formats, the types do not all have the same range of values. `TIMESTAMP` values cannot be earlier than 1970 UTC or later than '2038-01-19 03:14:07' UTC. This means that a date such as '1968-01-01', while valid as a `DATE` or `DATETIME` value, is not valid as a `TIMESTAMP` value and is converted to 0.

Conversion of `DATE` values:

- Conversion to a `DATETIME` or `TIMESTAMP` value adds a time part of '00:00:00' because the `DATE` value contains no time information.
- Conversion to a `TIME` value is not useful; the result is '00:00:00'.

Conversion of `DATETIME` and `TIMESTAMP` values:

- Conversion to a `DATE` value takes fractional seconds into account and rounds the time part. For example, '1999-12-31 23:59:59.499' becomes '1999-12-31', whereas '1999-12-31 23:59:59.500' becomes '2000-01-01'.
- Conversion to a `TIME` value discards the date part because the `TIME` type contains no date information.

For conversion of `TIME` values to other temporal types, the value of `CURRENT_DATE()` is used for the date part. The `TIME` is interpreted as elapsed time (not time of day) and added to the date. This means that the date part of the result differs from the current date if the time value is outside the range from '00:00:00' to '23:59:59'.

Suppose that the current date is '2012-01-01'. `TIME` values of '12:00:00', '24:00:00', and '-12:00:00', when converted to `DATETIME` or `TIMESTAMP` values, result in '2012-01-01 12:00:00', '2012-01-02 00:00:00', and '2011-12-31 12:00:00', respectively.

Conversion of `TIME` to `DATE` is similar but discards the time part from the result: '2012-01-01', '2012-01-02', and '2011-12-31', respectively.

Explicit conversion can be used to override implicit conversion. For example, in comparison of `DATE` and `DATETIME` values, the `DATE` value is coerced to the `DATETIME` type by adding a time part of '00:00:00'. To perform the comparison by ignoring the time part of the `DATETIME` value instead, use the `CAST()` function in the following way:

```
date_col = CAST(datetime_col AS DATE)
```

Conversion of `TIME` and `DATETIME` values to numeric form (for example, by adding `+0`) depends on whether the value contains a fractional seconds part. `TIME(N)` or `DATETIME(N)` is converted to integer when `N` is 0 (or omitted) and to a `DECIMAL` value with `N` decimal digits when `N` is greater than 0:

```
mysql> SELECT CURTIME(), CURTIME()+0, CURTIME(3)+0;
+-----+-----+-----+
| CURTIME() | CURTIME()+0 | CURTIME(3)+0 |
+-----+-----+-----+
| 09:28:00 |          92800 | 92800.887 |
+-----+-----+-----+
mysql> SELECT NOW(), NOW()+0, NOW(3)+0;
+-----+-----+-----+
| NOW() | NOW()+0 | NOW(3)+0 |
+-----+-----+-----+
| 2012-08-15 09:28:00 | 20120815092800 | 20120815092800.889 |
+-----+-----+-----+
```

## 11.2.10 2-Digit Years in Dates

Date values with 2-digit years are ambiguous because the century is unknown. Such values must be interpreted into 4-digit form because MySQL stores years internally using 4 digits.

For `DATETIME`, `DATE`, and `TIMESTAMP` types, MySQL interprets dates specified with ambiguous year values using these rules:

- Year values in the range `00–69` become `2000–2069`.
- Year values in the range `70–99` become `1970–1999`.

For `YEAR`, the rules are the same, with this exception: A numeric `00` inserted into `YEAR` results in `0000` rather than `2000`. To specify zero for `YEAR` and have it be interpreted as `2000`, specify it as a string `'0'` or `'00'`.

Remember that these rules are only heuristics that provide reasonable guesses as to what your data values mean. If the rules used by MySQL do not produce the values you require, you must provide unambiguous input containing 4-digit year values.

`ORDER BY` properly sorts `YEAR` values that have 2-digit years.

Some functions like `MIN()` and `MAX()` convert a `YEAR` to a number. This means that a value with a 2-digit year does not work properly with these functions. The fix in this case is to convert the `YEAR` to 4-digit year format.

## 11.3 String Data Types

The string data types are `CHAR`, `VARCHAR`, `BINARY`, `VARBINARY`, `BLOB`, `TEXT`, `ENUM`, and `SET`.

For information about storage requirements of the string data types, see [Section 11.7, “Data Type Storage Requirements”](#).

For descriptions of functions that operate on string values, see [Section 12.8, “String Functions and Operators”](#).

### 11.3.1 String Data Type Syntax

The string data types are `CHAR`, `VARCHAR`, `BINARY`, `VARBINARY`, `BLOB`, `TEXT`, `ENUM`, and `SET`.

In some cases, MySQL may change a string column to a type different from that given in a `CREATE TABLE` or `ALTER TABLE` statement. See [Section 13.1.18.6, “Silent Column Specification Changes”](#).

For definitions of character string columns ([CHAR](#), [VARCHAR](#), and the [TEXT](#) types), MySQL interprets length specifications in character units. For definitions of binary string columns ([BINARY](#), [VARBINARY](#), and the [BLOB](#) types), MySQL interprets length specifications in byte units.

Column definitions for character string data types [CHAR](#), [VARCHAR](#), the [TEXT](#) types, [ENUM](#), [SET](#), and any synonyms) can specify the column character set and collation:

- [CHARACTER SET](#) specifies the character set. If desired, a collation for the character set can be specified with the [COLLATE](#) attribute, along with any other attributes. For example:

```
CREATE TABLE t
(
  c1 VARCHAR(20) CHARACTER SET utf8,
  c2 TEXT CHARACTER SET latin1 COLLATE latin1_general_cs
);
```

This table definition creates a column named `c1` that has a character set of `utf8` with the default collation for that character set, and a column named `c2` that has a character set of `latin1` and a case-sensitive (`_cs`) collation.

The rules for assigning the character set and collation when either or both of [CHARACTER SET](#) and the [COLLATE](#) attribute are missing are described in [Section 10.3.5, “Column Character Set and Collation”](#).

[CHARSET](#) is a synonym for [CHARACTER SET](#).

- Specifying the [CHARACTER SET binary](#) attribute for a character string data type causes the column to be created as the corresponding binary string data type: [CHAR](#) becomes [BINARY](#), [VARCHAR](#) becomes [VARBINARY](#), and [TEXT](#) becomes [BLOB](#). For the [ENUM](#) and [SET](#) data types, this does not occur; they are created as declared. Suppose that you specify a table using this definition:

```
CREATE TABLE t
(
  c1 VARCHAR(10) CHARACTER SET binary,
  c2 TEXT CHARACTER SET binary,
  c3 ENUM('a','b','c') CHARACTER SET binary
);
```

The resulting table has this definition:

```
CREATE TABLE t
(
  c1 VARBINARY(10),
  c2 BLOB,
  c3 ENUM('a','b','c') CHARACTER SET binary
);
```

- The [BINARY](#) attribute is a nonstandard MySQL extension that is shorthand for specifying the binary (`_bin`) collation of the column character set (or of the table default character set if no column character set is specified). In this case, comparison and sorting are based on numeric character code values. Suppose that you specify a table using this definition:

```
CREATE TABLE t
(
  c1 VARCHAR(10) CHARACTER SET latin1 BINARY,
  c2 TEXT BINARY
) CHARACTER SET utf8mb4;
```

The resulting table has this definition:

```
CREATE TABLE t (
  c1 VARCHAR(10) CHARACTER SET latin1 COLLATE latin1_bin,
  c2 TEXT CHARACTER SET utf8mb4 COLLATE utf8mb4_bin
```

```
) CHARACTER SET utf8mb4;
```

- The `ASCII` attribute is shorthand for `CHARACTER SET latin1`.
- The `UNICODE` attribute is shorthand for `CHARACTER SET ucs2`.

Character column comparison and sorting are based on the collation assigned to the column. For the `CHAR`, `VARCHAR`, `TEXT`, `ENUM`, and `SET` data types, you can declare a column with a binary (`_bin`) collation or the `BINARY` attribute to cause comparison and sorting to use the underlying character code values rather than a lexical ordering.

For additional information about use of character sets in MySQL, see [Chapter 10, Character Sets, Collations, Unicode](#).

- `[NATIONAL] CHAR[(M)] [CHARACTER SET charset_name] [COLLATE collation_name]`

A fixed-length string that is always right-padded with spaces to the specified length when stored. *M* represents the column length in characters. The range of *M* is 0 to 255. If *M* is omitted, the length is 1.



#### Note

Trailing spaces are removed when `CHAR` values are retrieved unless the `PAD_CHAR_TO_FULL_LENGTH` SQL mode is enabled.

`CHAR` is shorthand for `CHARACTER`. `NATIONAL CHAR` (or its equivalent short form, `NCHAR`) is the standard SQL way to define that a `CHAR` column should use some predefined character set. MySQL uses `utf8` as this predefined character set. [Section 10.3.7, “The National Character Set”](#).

The `CHAR BYTE` data type is an alias for the `BINARY` data type. This is a compatibility feature.

MySQL permits you to create a column of type `CHAR(0)`. This is useful primarily when you must be compliant with old applications that depend on the existence of a column but that do not actually use its value. `CHAR(0)` is also quite nice when you need a column that can take only two values: A column that is defined as `CHAR(0) NULL` occupies only one bit and can take only the values `NULL` and `'` (the empty string).

- `[NATIONAL] VARCHAR(M) [CHARACTER SET charset_name] [COLLATE collation_name]`

A variable-length string. *M* represents the maximum column length in characters. The range of *M* is 0 to 65,535. The effective maximum length of a `VARCHAR` is subject to the maximum row size (65,535 bytes, which is shared among all columns) and the character set used. For example, `utf8` characters can require up to three bytes per character, so a `VARCHAR` column that uses the `utf8` character set can be declared to be a maximum of 21,844 characters. See [Section 8.4.7, “Limits on Table Column Count and Row Size”](#).

MySQL stores `VARCHAR` values as a 1-byte or 2-byte length prefix plus data. The length prefix indicates the number of bytes in the value. A `VARCHAR` column uses one length byte if values require no more than 255 bytes, two length bytes if values may require more than 255 bytes.



#### Note

MySQL follows the standard SQL specification, and does *not* remove trailing spaces from `VARCHAR` values.

`VARCHAR` is shorthand for `CHARACTER VARYING`. `NATIONAL VARCHAR` is the standard SQL way to define that a `VARCHAR` column should use some predefined character set. MySQL uses `utf8` as this predefined character set. [Section 10.3.7, “The National Character Set”](#). `NVARCHAR` is shorthand for `NATIONAL VARCHAR`.

- `BINARY[ (M) ]`

The `BINARY` type is similar to the `CHAR` type, but stores binary byte strings rather than nonbinary character strings. An optional length `M` represents the column length in bytes. If omitted, `M` defaults to 1.

- `VARBINARY(M)`

The `VARBINARY` type is similar to the `VARCHAR` type, but stores binary byte strings rather than nonbinary character strings. `M` represents the maximum column length in bytes.

- `TINYBLOB`

A `BLOB` column with a maximum length of 255 ( $2^8 - 1$ ) bytes. Each `TINYBLOB` value is stored using a 1-byte length prefix that indicates the number of bytes in the value.

- `TINYTEXT [CHARACTER SET charset_name] [COLLATE collation_name]`

A `TEXT` column with a maximum length of 255 ( $2^8 - 1$ ) characters. The effective maximum length is less if the value contains multibyte characters. Each `TINYTEXT` value is stored using a 1-byte length prefix that indicates the number of bytes in the value.

- `BLOB[ (M) ]`

A `BLOB` column with a maximum length of 65,535 ( $2^{16} - 1$ ) bytes. Each `BLOB` value is stored using a 2-byte length prefix that indicates the number of bytes in the value.

An optional length `M` can be given for this type. If this is done, MySQL creates the column as the smallest `BLOB` type large enough to hold values `M` bytes long.

- `TEXT[ (M) ] [CHARACTER SET charset_name] [COLLATE collation_name]`

A `TEXT` column with a maximum length of 65,535 ( $2^{16} - 1$ ) bytes. The effective maximum length is less if the value contains multibyte characters. Each `TEXT` value is stored using a 2-byte length prefix that indicates the number of bytes in the value.

An optional length `M` can be given for this type. If this is done, MySQL creates the column as the smallest `TEXT` type large enough to hold values `M` characters long.

- `MEDIUMBLOB`

A `BLOB` column with a maximum length of 16,777,215 ( $2^{24} - 1$ ) bytes. Each `MEDIUMBLOB` value is stored using a 3-byte length prefix that indicates the number of bytes in the value.

- `MEDIUMTEXT [CHARACTER SET charset_name] [COLLATE collation_name]`

A `TEXT` column with a maximum length of 16,777,215 ( $2^{24} - 1$ ) characters. The effective maximum length is less if the value contains multibyte characters. Each `MEDIUMTEXT` value is stored using a 3-byte length prefix that indicates the number of bytes in the value.



- `LONGBLOB`

A `BLOB` column with a maximum length of 4,294,967,295 or 4GB ( $2^{32} - 1$ ) bytes. The effective maximum length of `LONGBLOB` columns depends on the configured maximum packet size in the client/server protocol and available memory. Each `LONGBLOB` value is stored using a 4-byte length prefix that indicates the number of bytes in the value.

- `LONGTEXT [CHARACTER SET charset_name] [COLLATE collation_name]`

A `TEXT` column with a maximum length of 4,294,967,295 or 4GB ( $2^{32} - 1$ ) characters. The effective maximum length is less if the value contains multibyte characters. The effective maximum length of `LONGTEXT` columns also depends on the configured maximum packet size in the client/server protocol and available memory. Each `LONGTEXT` value is stored using a 4-byte length prefix that indicates the number of bytes in the value.

- `ENUM('value1','value2',...) [CHARACTER SET charset_name] [COLLATE collation_name]`

An enumeration. A string object that can have only one value, chosen from the list of values `'value1'`, `'value2'`, ..., `NULL` or the special `''` error value. `ENUM` values are represented internally as integers.

An `ENUM` column can have a maximum of 65,535 distinct elements. (The practical limit is less than 3000.) A table can have no more than 255 unique element list definitions among its `ENUM` and `SET` columns considered as a group. For more information on these limits, see [Limits Imposed by .frm File Structure](#).

- `SET('value1','value2',...) [CHARACTER SET charset_name] [COLLATE collation_name]`

A set. A string object that can have zero or more values, each of which must be chosen from the list of values `'value1'`, `'value2'`, ... `SET` values are represented internally as integers.

A `SET` column can have a maximum of 64 distinct members. A table can have no more than 255 unique element list definitions among its `ENUM` and `SET` columns considered as a group. For more information on this limit, see [Limits Imposed by .frm File Structure](#).

## 11.3.2 The CHAR and VARCHAR Types

The `CHAR` and `VARCHAR` types are similar, but differ in the way they are stored and retrieved. They also differ in maximum length and in whether trailing spaces are retained.

The `CHAR` and `VARCHAR` types are declared with a length that indicates the maximum number of characters you want to store. For example, `CHAR(30)` can hold up to 30 characters.

The length of a `CHAR` column is fixed to the length that you declare when you create the table. The length can be any value from 0 to 255. When `CHAR` values are stored, they are right-padded with spaces to the specified length. When `CHAR` values are retrieved, trailing spaces are removed unless the `PAD_CHAR_TO_FULL_LENGTH` SQL mode is enabled.

Values in `VARCHAR` columns are variable-length strings. The length can be specified as a value from 0 to 65,535. The effective maximum length of a `VARCHAR` is subject to the maximum row size (65,535 bytes, which is shared among all columns) and the character set used. See [Section 8.4.7, "Limits on Table Column Count and Row Size"](#).

In contrast to `CHAR`, `VARCHAR` values are stored as a 1-byte or 2-byte length prefix plus data. The length prefix indicates the number of bytes in the value. A column uses one length byte if values require no more than 255 bytes, two length bytes if values may require more than 255 bytes.

If strict SQL mode is not enabled and you assign a value to a [CHAR](#) or [VARCHAR](#) column that exceeds the column's maximum length, the value is truncated to fit and a warning is generated. For truncation of nonspace characters, you can cause an error to occur (rather than a warning) and suppress insertion of the value by using strict SQL mode. See [Section 5.1.10, “Server SQL Modes”](#).

For [VARCHAR](#) columns, trailing spaces in excess of the column length are truncated prior to insertion and a warning is generated, regardless of the SQL mode in use. For [CHAR](#) columns, truncation of excess trailing spaces from inserted values is performed silently regardless of the SQL mode.

[VARCHAR](#) values are not padded when they are stored. Trailing spaces are retained when values are stored and retrieved, in conformance with standard SQL.

The following table illustrates the differences between [CHAR](#) and [VARCHAR](#) by showing the result of storing various string values into [CHAR\(4\)](#) and [VARCHAR\(4\)](#) columns (assuming that the column uses a single-byte character set such as [latin1](#)).

Value	CHAR(4)	Storage Required	VARCHAR(4)	Storage Required
' '	' '	4 bytes	' '	1 byte
'ab'	'ab '	4 bytes	'ab'	3 bytes
'abcd'	'abcd'	4 bytes	'abcd'	5 bytes
'abcdefgh'	'abcd'	4 bytes	'abcd'	5 bytes

The values shown as stored in the last row of the table apply *only when not using strict SQL mode*; if strict mode is enabled, values that exceed the column length are *not stored*, and an error results.

[InnoDB](#) encodes fixed-length fields greater than or equal to 768 bytes in length as variable-length fields, which can be stored off-page. For example, a [CHAR\(255\)](#) column can exceed 768 bytes if the maximum byte length of the character set is greater than 3, as it is with [utf8mb4](#).

If a given value is stored into the [CHAR\(4\)](#) and [VARCHAR\(4\)](#) columns, the values retrieved from the columns are not always the same because trailing spaces are removed from [CHAR](#) columns upon retrieval. The following example illustrates this difference:

```
mysql> CREATE TABLE vc (v VARCHAR(4), c CHAR(4));
Query OK, 0 rows affected (0.01 sec)

mysql> INSERT INTO vc VALUES ('ab ', 'ab ');
Query OK, 1 row affected (0.00 sec)

mysql> SELECT CONCAT('(', v, ')'), CONCAT('(', c, ')') FROM vc;
+-----+-----+
| CONCAT('(', v, ')') | CONCAT('(', c, ')') |
+-----+-----+
| (ab )              | (ab)                 |
+-----+-----+
1 row in set (0.06 sec)
```

Values in [CHAR](#), [VARCHAR](#), and [TEXT](#) columns are sorted and compared according to the character set collation assigned to the column.

All MySQL collations are of type [PAD SPACE](#). This means that all [CHAR](#), [VARCHAR](#), and [TEXT](#) values are compared without regard to any trailing spaces. “Comparison” in this context does not include the [LIKE](#) pattern-matching operator, for which trailing spaces are significant. For example:

```
mysql> CREATE TABLE names (myname CHAR(10));
Query OK, 0 rows affected (0.03 sec)

mysql> INSERT INTO names VALUES ('Jones');
```

```

Query OK, 1 row affected (0.00 sec)

mysql> SELECT myname = 'Jones', myname = 'Jones ' FROM names;
+-----+-----+
| myname = 'Jones' | myname = 'Jones ' |
+-----+-----+
| 1 | 1 |
+-----+-----+
1 row in set (0.00 sec)

mysql> SELECT myname LIKE 'Jones', myname LIKE 'Jones ' FROM names;
+-----+-----+
| myname LIKE 'Jones' | myname LIKE 'Jones ' |
+-----+-----+
| 1 | 0 |
+-----+-----+
1 row in set (0.00 sec)

```

This is not affected by the server SQL mode.



#### Note

For more information about MySQL character sets and collations, see [Chapter 10, Character Sets, Collations, Unicode](#). For additional information about storage requirements, see [Section 11.7, “Data Type Storage Requirements”](#).

For those cases where trailing pad characters are stripped or comparisons ignore them, if a column has an index that requires unique values, inserting into the column values that differ only in number of trailing pad characters results in a duplicate-key error. For example, if a table contains 'a', an attempt to store 'a ' causes a duplicate-key error.

### 11.3.3 The BINARY and VARBINARY Types

The [BINARY](#) and [VARBINARY](#) types are similar to [CHAR](#) and [VARCHAR](#), except that they store binary strings rather than nonbinary strings. That is, they store byte strings rather than character strings. This means they have the [binary](#) character set and collation, and comparison and sorting are based on the numeric values of the bytes in the values.

The permissible maximum length is the same for [BINARY](#) and [VARBINARY](#) as it is for [CHAR](#) and [VARCHAR](#), except that the length for [BINARY](#) and [VARBINARY](#) is measured in bytes rather than characters.

The [BINARY](#) and [VARBINARY](#) data types are distinct from the [CHAR BINARY](#) and [VARCHAR BINARY](#) data types. For the latter types, the [BINARY](#) attribute does not cause the column to be treated as a binary string column. Instead, it causes the binary ([\\_bin](#)) collation for the column character set (or the table default character set if no column character set is specified) to be used, and the column itself stores nonbinary character strings rather than binary byte strings. For example, if the default character set is [latin1](#), [CHAR\(5\) BINARY](#) is treated as [CHAR\(5\) CHARACTER SET latin1 COLLATE latin1\\_bin](#). This differs from [BINARY\(5\)](#), which stores 5-byte binary strings that have the [binary](#) character set and collation. For information about the differences between the [binary](#) collation of the [binary](#) character set and the [\\_bin](#) collations of nonbinary character sets, see [Section 10.8.5, “The binary Collation Compared to \\_bin Collations”](#).

If strict SQL mode is not enabled and you assign a value to a [BINARY](#) or [VARBINARY](#) column that exceeds the column's maximum length, the value is truncated to fit and a warning is generated. For cases of truncation, to cause an error to occur (rather than a warning) and suppress insertion of the value, use strict SQL mode. See [Section 5.1.10, “Server SQL Modes”](#).

When [BINARY](#) values are stored, they are right-padded with the pad value to the specified length. The pad value is `0x00` (the zero byte). Values are right-padded with `0x00` for inserts, and no trailing bytes

are removed for retrievals. All bytes are significant in comparisons, including `ORDER BY` and `DISTINCT` operations. `0x00` and space differ in comparisons, with `0x00` sorting before space.

Example: For a `BINARY(3)` column, `'a '` becomes `'a \0'` when inserted. `'a\0'` becomes `'a\0\0'` when inserted. Both inserted values remain unchanged for retrievals.

For `VARBINARY`, there is no padding for inserts and no bytes are stripped for retrievals. All bytes are significant in comparisons, including `ORDER BY` and `DISTINCT` operations. `0x00` and space differ in comparisons, with `0x00` sorting before space.

For those cases where trailing pad bytes are stripped or comparisons ignore them, if a column has an index that requires unique values, inserting values into the column that differ only in number of trailing pad bytes results in a duplicate-key error. For example, if a table contains `'a'`, an attempt to store `'a\0'` causes a duplicate-key error.

You should consider the preceding padding and stripping characteristics carefully if you plan to use the `BINARY` data type for storing binary data and you require that the value retrieved be exactly the same as the value stored. The following example illustrates how `0x00`-padding of `BINARY` values affects column value comparisons:

```
mysql> CREATE TABLE t (c BINARY(3));
Query OK, 0 rows affected (0.01 sec)

mysql> INSERT INTO t SET c = 'a';
Query OK, 1 row affected (0.01 sec)

mysql> SELECT HEX(c), c = 'a', c = 'a\0' from t;
+-----+-----+-----+
| HEX(c) | c = 'a' | c = 'a\0' |
+-----+-----+-----+
| 610000 |      0 |          1 |
+-----+-----+-----+
1 row in set (0.09 sec)
```

If the value retrieved must be the same as the value specified for storage with no padding, it might be preferable to use `VARBINARY` or one of the `BLOB` data types instead.



#### Note

Within the `mysql` client, binary strings display using hexadecimal notation, depending on the value of the `--binary-as-hex`. For more information about that option, see [Section 4.5.1, “mysql — The MySQL Command-Line Client”](#).

## 11.3.4 The BLOB and TEXT Types

A `BLOB` is a binary large object that can hold a variable amount of data. The four `BLOB` types are `TINYBLOB`, `BLOB`, `MEDIUMBLOB`, and `LONGBLOB`. These differ only in the maximum length of the values they can hold. The four `TEXT` types are `TINYTEXT`, `TEXT`, `MEDIUMTEXT`, and `LONGTEXT`. These correspond to the four `BLOB` types and have the same maximum lengths and storage requirements. See [Section 11.7, “Data Type Storage Requirements”](#).

`BLOB` values are treated as binary strings (byte strings). They have the `binary` character set and collation, and comparison and sorting are based on the numeric values of the bytes in column values. `TEXT` values are treated as nonbinary strings (character strings). They have a character set other than `binary`, and values are sorted and compared based on the collation of the character set.

If strict SQL mode is not enabled and you assign a value to a `BLOB` or `TEXT` column that exceeds the column's maximum length, the value is truncated to fit and a warning is generated. For truncation of

nonspace characters, you can cause an error to occur (rather than a warning) and suppress insertion of the value by using strict SQL mode. See [Section 5.1.10, “Server SQL Modes”](#).

Truncation of excess trailing spaces from values to be inserted into `TEXT` columns always generates a warning, regardless of the SQL mode.

For `TEXT` and `BLOB` columns, there is no padding on insert and no bytes are stripped on select.

If a `TEXT` column is indexed, index entry comparisons are space-padded at the end. This means that, if the index requires unique values, duplicate-key errors occur for values that differ only in the number of trailing spaces. For example, if a table contains 'a', an attempt to store 'a ' causes a duplicate-key error. This is not true for `BLOB` columns.

In most respects, you can regard a `BLOB` column as a `VARBINARY` column that can be as large as you like. Similarly, you can regard a `TEXT` column as a `VARCHAR` column. `BLOB` and `TEXT` differ from `VARBINARY` and `VARCHAR` in the following ways:

- For indexes on `BLOB` and `TEXT` columns, you must specify an index prefix length. For `CHAR` and `VARCHAR`, a prefix length is optional. See [Section 8.3.4, “Column Indexes”](#).
- `BLOB` and `TEXT` columns cannot have `DEFAULT` values.

If you use the `BINARY` attribute with a `TEXT` data type, the column is assigned the binary (`_bin`) collation of the column character set.

`LONG` and `LONG VARCHAR` map to the `MEDIUMTEXT` data type. This is a compatibility feature.

MySQL Connector/ODBC defines `BLOB` values as `LONGVARBINARY` and `TEXT` values as `LONGVARCHAR`.

Because `BLOB` and `TEXT` values can be extremely long, you might encounter some constraints in using them:

- Only the first `max_sort_length` bytes of the column are used when sorting. The default value of `max_sort_length` is 1024. You can make more bytes significant in sorting or grouping by increasing the value of `max_sort_length` at server startup or runtime. Any client can change the value of its session `max_sort_length` variable:

```
mysql> SET max_sort_length = 2000;
mysql> SELECT id, comment FROM t
-> ORDER BY comment;
```

- Instances of `BLOB` or `TEXT` columns in the result of a query that is processed using a temporary table causes the server to use a table on disk rather than in memory because the `MEMORY` storage engine does not support those data types (see [Section 8.4.4, “Internal Temporary Table Use in MySQL”](#)). Use of disk incurs a performance penalty, so include `BLOB` or `TEXT` columns in the query result only if they are really needed. For example, avoid using `SELECT *`, which selects all columns.
- The maximum size of a `BLOB` or `TEXT` object is determined by its type, but the largest value you actually can transmit between the client and server is determined by the amount of available memory and the size of the communications buffers. You can change the message buffer size by changing the value of the `max_allowed_packet` variable, but you must do so for both the server and your client program. For example, both `mysql` and `mysqldump` enable you to change the client-side `max_allowed_packet` value. See [Section 5.1.1, “Configuring the Server”](#), [Section 4.5.1, “mysql — The MySQL Command-Line Client”](#), and [Section 4.5.4, “mysqldump — A Database Backup Program”](#). You may also want to compare the packet sizes and the size of the data objects you are storing with the storage requirements, see [Section 11.7, “Data Type Storage Requirements”](#)

Each `BLOB` or `TEXT` value is represented internally by a separately allocated object. This is in contrast to all other data types, for which storage is allocated once per column when the table is opened.

In some cases, it may be desirable to store binary data such as media files in `BLOB` or `TEXT` columns. You may find MySQL's string handling functions useful for working with such data. See [Section 12.8, “String Functions and Operators”](#). For security and other reasons, it is usually preferable to do so using application code rather than giving application users the `FILE` privilege. You can discuss specifics for various languages and platforms in the MySQL Forums (<http://forums.mysql.com/>).



#### Note

Within the `mysql` client, binary strings display using hexadecimal notation, depending on the value of the `--binary-as-hex`. For more information about that option, see [Section 4.5.1, “mysql — The MySQL Command-Line Client”](#).

## 11.3.5 The ENUM Type

An `ENUM` is a string object with a value chosen from a list of permitted values that are enumerated explicitly in the column specification at table creation time.

See [Section 11.3.1, “String Data Type Syntax”](#) for `ENUM` type syntax and length limits.

The `ENUM` type has these advantages:

- Compact data storage in situations where a column has a limited set of possible values. The strings you specify as input values are automatically encoded as numbers. See [Section 11.7, “Data Type Storage Requirements”](#) for storage requirements for the `ENUM` type.
- Readable queries and output. The numbers are translated back to the corresponding strings in query results.

and these potential issues to consider:

- If you make enumeration values that look like numbers, it is easy to mix up the literal values with their internal index numbers, as explained in [Enumeration Limitations](#).
- Using `ENUM` columns in `ORDER BY` clauses requires extra care, as explained in [Enumeration Sorting](#).
- [Creating and Using ENUM Columns](#)
- [Index Values for Enumeration Literals](#)
- [Handling of Enumeration Literals](#)
- [Empty or NULL Enumeration Values](#)
- [Enumeration Sorting](#)
- [Enumeration Limitations](#)

## Creating and Using ENUM Columns

An enumeration value must be a quoted string literal. For example, you can create a table with an `ENUM` column like this:

```
CREATE TABLE shirts (
  name VARCHAR(40),
  size ENUM('x-small', 'small', 'medium', 'large', 'x-large')
```

```
);
INSERT INTO shirts (name, size) VALUES ('dress shirt','large'), ('t-shirt','medium'),
 ('polo shirt','small');
SELECT name, size FROM shirts WHERE size = 'medium';
+-----+-----+
| name   | size   |
+-----+-----+
| t-shirt| medium|
+-----+-----+
UPDATE shirts SET size = 'small' WHERE size = 'large';
COMMIT;
```

Inserting 1 million rows into this table with a value of 'medium' would require 1 million bytes of storage, as opposed to 6 million bytes if you stored the actual string 'medium' in a VARCHAR column.

## Index Values for Enumeration Literals

Each enumeration value has an index:

- The elements listed in the column specification are assigned index numbers, beginning with 1.
- The index value of the empty string error value is 0. This means that you can use the following SELECT statement to find rows into which invalid ENUM values were assigned:

```
mysql> SELECT * FROM tbl_name WHERE enum_col=0;
```

- The index of the NULL value is NULL.
- The term “index” here refers to a position within the list of enumeration values. It has nothing to do with table indexes.

For example, a column specified as ENUM('Mercury', 'Venus', 'Earth') can have any of the values shown here. The index of each value is also shown.

Value	Index
NULL	NULL
' '	0
'Mercury'	1
'Venus'	2
'Earth'	3

An ENUM column can have a maximum of 65,535 distinct elements. (The practical limit is less than 3000.) A table can have no more than 255 unique element list definitions among its ENUM and SET columns considered as a group. For more information on these limits, see [Limits Imposed by .frm File Structure](#).

If you retrieve an ENUM value in a numeric context, the column value's index is returned. For example, you can retrieve numeric values from an ENUM column like this:

```
mysql> SELECT enum_col+0 FROM tbl_name;
```

Functions such as SUM() or AVG() that expect a numeric argument cast the argument to a number if necessary. For ENUM values, the index number is used in the calculation.

## Handling of Enumeration Literals

Trailing spaces are automatically deleted from ENUM member values in the table definition when a table is created.

When retrieved, values stored into an [ENUM](#) column are displayed using the lettercase that was used in the column definition. Note that [ENUM](#) columns can be assigned a character set and collation. For binary or case-sensitive collations, lettercase is taken into account when assigning values to the column.

If you store a number into an [ENUM](#) column, the number is treated as the index into the possible values, and the value stored is the enumeration member with that index. (However, this does *not* work with [LOAD DATA](#), which treats all input as strings.) If the numeric value is quoted, it is still interpreted as an index if there is no matching string in the list of enumeration values. For these reasons, it is not advisable to define an [ENUM](#) column with enumeration values that look like numbers, because this can easily become confusing. For example, the following column has enumeration members with string values of '0', '1', and '2', but numeric index values of 1, 2, and 3:

```
numbers ENUM('0','1','2')
```

If you store 2, it is interpreted as an index value, and becomes '1' (the value with index 2). If you store '2', it matches an enumeration value, so it is stored as '2'. If you store '3', it does not match any enumeration value, so it is treated as an index and becomes '2' (the value with index 3).

```
mysql> INSERT INTO t (numbers) VALUES(2),('2'),('3');
mysql> SELECT * FROM t;
```

```
+-----+
| numbers |
+-----+
| 1       |
| 2       |
| 2       |
+-----+
```

To determine all possible values for an [ENUM](#) column, use [SHOW COLUMNS FROM tbl\\_name LIKE 'enum\\_col'](#) and parse the [ENUM](#) definition in the [Type](#) column of the output.

In the C API, [ENUM](#) values are returned as strings. For information about using result set metadata to distinguish them from other strings, see [C API Basic Data Structures](#).

## Empty or NULL Enumeration Values

An enumeration value can also be the empty string ('') or [NULL](#) under certain circumstances:

- If you insert an invalid value into an [ENUM](#) (that is, a string not present in the list of permitted values), the empty string is inserted instead as a special error value. This string can be distinguished from a “normal” empty string by the fact that this string has the numeric value 0. See [Index Values for Enumeration Literals](#) for details about the numeric indexes for the enumeration values.

If strict SQL mode is enabled, attempts to insert invalid [ENUM](#) values result in an error.

- If an [ENUM](#) column is declared to permit [NULL](#), the [NULL](#) value is a valid value for the column, and the default value is [NULL](#). If an [ENUM](#) column is declared [NOT NULL](#), its default value is the first element of the list of permitted values.

## Enumeration Sorting

[ENUM](#) values are sorted based on their index numbers, which depend on the order in which the enumeration members were listed in the column specification. For example, 'b' sorts before 'a' for [ENUM\('b','a'\)](#). The empty string sorts before nonempty strings, and [NULL](#) values sort before all other enumeration values.

To prevent unexpected results when using the [ORDER BY](#) clause on an [ENUM](#) column, use one of these techniques:



- Specify the [ENUM](#) list in alphabetic order.
- Make sure that the column is sorted lexically rather than by index number by coding `ORDER BY CAST(col AS CHAR)` or `ORDER BY CONCAT(col)`.

## Enumeration Limitations

An enumeration value cannot be an expression, even one that evaluates to a string value.

For example, this `CREATE TABLE` statement does *not* work because the `CONCAT` function cannot be used to construct an enumeration value:

```
CREATE TABLE sizes (
  size ENUM('small', CONCAT('med','ium'), 'large')
);
```

You also cannot employ a user variable as an enumeration value. This pair of statements do *not* work:

```
SET @mysize = 'medium';

CREATE TABLE sizes (
  size ENUM('small', @mysize, 'large')
);
```

We strongly recommend that you do *not* use numbers as enumeration values, because it does not save on storage over the appropriate [TINYINT](#) or [SMALLINT](#) type, and it is easy to mix up the strings and the underlying number values (which might not be the same) if you quote the [ENUM](#) values incorrectly. If you do use a number as an enumeration value, always enclose it in quotation marks. If the quotation marks are omitted, the number is regarded as an index. See [Handling of Enumeration Literals](#) to see how even a quoted number could be mistakenly used as a numeric index value.

Duplicate values in the definition cause a warning, or an error if strict SQL mode is enabled.

### 11.3.6 The SET Type

A [SET](#) is a string object that can have zero or more values, each of which must be chosen from a list of permitted values specified when the table is created. [SET](#) column values that consist of multiple set members are specified with members separated by commas (,). A consequence of this is that [SET](#) member values should not themselves contain commas.

For example, a column specified as `SET('one', 'two') NOT NULL` can have any of these values:

```
' '
'one'
'two'
'one,two'
```

A [SET](#) column can have a maximum of 64 distinct members. A table can have no more than 255 unique element list definitions among its [ENUM](#) and [SET](#) columns considered as a group. For more information on this limit, see [Limits Imposed by .frm File Structure](#).

Duplicate values in the definition cause a warning, or an error if strict SQL mode is enabled.

Trailing spaces are automatically deleted from [SET](#) member values in the table definition when a table is created.

See [String Type Storage Requirements](#) for storage requirements for the [SET](#) type.

See [Section 11.3.1, “String Data Type Syntax”](#) for [SET](#) type syntax and length limits.

When retrieved, values stored in a `SET` column are displayed using the lettercase that was used in the column definition. Note that `SET` columns can be assigned a character set and collation. For binary or case-sensitive collations, lettercase is taken into account when assigning values to the column.

MySQL stores `SET` values numerically, with the low-order bit of the stored value corresponding to the first set member. If you retrieve a `SET` value in a numeric context, the value retrieved has bits set corresponding to the set members that make up the column value. For example, you can retrieve numeric values from a `SET` column like this:

```
mysql> SELECT set_col+0 FROM tbl_name;
```

If a number is stored into a `SET` column, the bits that are set in the binary representation of the number determine the set members in the column value. For a column specified as `SET('a','b','c','d')`, the members have the following decimal and binary values.

SET Member	Decimal Value	Binary Value
'a'	1	0001
'b'	2	0010
'c'	4	0100
'd'	8	1000

If you assign a value of 9 to this column, that is 1001 in binary, so the first and fourth `SET` value members 'a' and 'd' are selected and the resulting value is 'a,d'.

For a value containing more than one `SET` element, it does not matter what order the elements are listed in when you insert the value. It also does not matter how many times a given element is listed in the value. When the value is retrieved later, each element in the value appears once, with elements listed according to the order in which they were specified at table creation time. Suppose that a column is specified as `SET('a','b','c','d')`:

```
mysql> CREATE TABLE myset (col SET('a', 'b', 'c', 'd'));
```

If you insert the values 'a,d', 'd,a', 'a,d,d', 'a,d,a', and 'd,a,d':

```
mysql> INSERT INTO myset (col) VALUES
-> ('a,d'), ('d,a'), ('a,d,a'), ('a,d,d'), ('d,a,d');
Query OK, 5 rows affected (0.01 sec)
Records: 5 Duplicates: 0 Warnings: 0
```

Then all these values appear as 'a,d' when retrieved:

```
mysql> SELECT col FROM myset;
+-----+
| col |
+-----+
| a,d |
| a,d |
| a,d |
| a,d |
| a,d |
+-----+
5 rows in set (0.04 sec)
```

If you set a `SET` column to an unsupported value, the value is ignored and a warning is issued:

```
mysql> INSERT INTO myset (col) VALUES ('a,d,d,s');
Query OK, 1 row affected, 1 warning (0.03 sec)

mysql> SHOW WARNINGS;
```

```

| Level | Code | Message |
+-----+-----+-----+
| Warning | 1265 | Data truncated for column 'col' at row 1 |
+-----+-----+-----+
1 row in set (0.04 sec)

mysql> SELECT col FROM myset;
+-----+
| col |
+-----+
| a,d |
| a,d |
| a,d |
| a,d |
| a,d |
| a,d |
+-----+
6 rows in set (0.01 sec)

```

If strict SQL mode is enabled, attempts to insert invalid `SET` values result in an error.

`SET` values are sorted numerically. `NULL` values sort before non-`NULL` `SET` values.

Functions such as `SUM()` or `AVG()` that expect a numeric argument cast the argument to a number if necessary. For `SET` values, the cast operation causes the numeric value to be used.

Normally, you search for `SET` values using the `FIND_IN_SET()` function or the `LIKE` operator:

```

mysql> SELECT * FROM tbl_name WHERE FIND_IN_SET('value',set_col)>0;
mysql> SELECT * FROM tbl_name WHERE set_col LIKE '%value%';

```

The first statement finds rows where `set_col` contains the `value` set member. The second is similar, but not the same: It finds rows where `set_col` contains `value` anywhere, even as a substring of another set member.

The following statements also are permitted:

```

mysql> SELECT * FROM tbl_name WHERE set_col & 1;
mysql> SELECT * FROM tbl_name WHERE set_col = 'val1,val2';

```

The first of these statements looks for values containing the first set member. The second looks for an exact match. Be careful with comparisons of the second type. Comparing set values to `'val1,val2'` returns different results than comparing values to `'val2,val1'`. You should specify the values in the same order they are listed in the column definition.

To determine all possible values for a `SET` column, use `SHOW COLUMNS FROM tbl_name LIKE set_col` and parse the `SET` definition in the `Type` column of the output.

In the C API, `SET` values are returned as strings. For information about using result set metadata to distinguish them from other strings, see [C API Basic Data Structures](#).

## 11.4 Spatial Data Types

The [Open Geospatial Consortium](#) (OGC) is an international consortium of more than 250 companies, agencies, and universities participating in the development of publicly available conceptual solutions that can be useful with all kinds of applications that manage spatial data.

The Open Geospatial Consortium publishes the *OpenGIS® Implementation Standard for Geographic information - Simple Feature Access - Part 2: SQL Option*, a document that proposes several conceptual ways for extending an SQL RDBMS to support spatial data. This specification is available from the OGC website at <http://www.opengeospatial.org/standards/sfs>.

Following the OGC specification, MySQL implements spatial extensions as a subset of the **SQL with Geometry Types** environment. This term refers to an SQL environment that has been extended with a set of geometry types. A geometry-valued SQL column is implemented as a column that has a geometry type. The specification describes a set of SQL geometry types, as well as functions on those types to create and analyze geometry values.

MySQL spatial extensions enable the generation, storage, and analysis of geographic features:

- Data types for representing spatial values
- Functions for manipulating spatial values
- Spatial indexing for improved access times to spatial columns

The spatial data types and functions are available for [MyISAM](#), [InnoDB](#), [NDB](#), and [ARCHIVE](#) tables. For indexing spatial columns, [MyISAM](#) and [InnoDB](#) support both [SPATIAL](#) and non-[SPATIAL](#) indexes. The other storage engines support non-[SPATIAL](#) indexes, as described in [Section 13.1.14, “CREATE INDEX Statement”](#).

A **geographic feature** is anything in the world that has a location. A feature can be:

- An entity. For example, a mountain, a pond, a city.
- A space. For example, town district, the tropics.
- A definable location. For example, a crossroad, as a particular place where two streets intersect.

Some documents use the term **geospatial feature** to refer to geographic features.

**Geometry** is another word that denotes a geographic feature. Originally the word **geometry** meant measurement of the earth. Another meaning comes from cartography, referring to the geometric features that cartographers use to map the world.

The discussion here considers these terms synonymous: **geographic feature**, **geospatial feature**, **feature**, or **geometry**. The term most commonly used is **geometry**, defined as *a point or an aggregate of points representing anything in the world that has a location*.

The following material covers these topics:

- The spatial data types implemented in MySQL model
- The basis of the spatial extensions in the OpenGIS geometry model
- Data formats for representing spatial data
- How to use spatial data in MySQL
- Use of indexing for spatial data
- MySQL differences from the OpenGIS specification

For information about functions that operate on spatial data, see [Section 12.16, “Spatial Analysis Functions”](#).

## MySQL GIS Conformance and Compatibility

MySQL does not implement the following GIS features:

- Additional Metadata Views

OpenGIS specifications propose several additional metadata views. For example, a system view named `GEOMETRY_COLUMNS` contains a description of geometry columns, one row for each geometry column in the database.

- The OpenGIS function `Length()` on `LineString` and `MultiLineString` should be called in MySQL as `ST_Length()`

The problem is that there is an existing SQL function `Length()` that calculates the length of string values, and sometimes it is not possible to distinguish whether the function is called in a textual or spatial context.

## Additional Resources

The Open Geospatial Consortium publishes the *OpenGIS® Implementation Standard for Geographic information - Simple feature access - Part 2: SQL option*, a document that proposes several conceptual ways for extending an SQL RDBMS to support spatial data. The Open Geospatial Consortium (OGC) maintains a website at <http://www.opengeospatial.org/>. The specification is available there at <http://www.opengeospatial.org/standards/sfs>. It contains additional information relevant to the material here.

If you have questions or concerns about the use of the spatial extensions to MySQL, you can discuss them in the GIS forum: <https://forums.mysql.com/list.php?23>.

### 11.4.1 Spatial Data Types

MySQL has spatial data types that correspond to OpenGIS classes. The basis for these types is described in [Section 11.4.2, “The OpenGIS Geometry Model”](#).

Some spatial data types hold single geometry values:

- `GEOMETRY`
- `POINT`
- `LINestring`
- `POLYGON`

`GEOMETRY` can store geometry values of any type. The other single-value types (`POINT`, `LINestring`, and `POLYGON`) restrict their values to a particular geometry type.

The other spatial data types hold collections of values:

- `MULTIPOINT`
- `MULTILINestring`
- `MULTIPOLYGON`
- `GEOMETRYCOLLECTION`

`GEOMETRYCOLLECTION` can store a collection of objects of any type. The other collection types (`MULTIPOINT`, `MULTILINestring`, and `MULTIPOLYGON`) restrict collection members to those having a particular geometry type.

Example: To create a table named `geom` that has a column named `g` that can store values of any geometry type, use this statement:

```
CREATE TABLE geom (g GEOMETRY);
```

[SPATIAL](#) indexes can be created on [NOT NULL](#) spatial columns, so if you plan to index the column, declare it [NOT NULL](#):

```
CREATE TABLE geom (g GEOMETRY NOT NULL);
```

For other examples showing how to use spatial data types in MySQL, see [Section 11.4.5, “Creating Spatial Columns”](#).

## 11.4.2 The OpenGIS Geometry Model

The set of geometry types proposed by OGC's **SQL with Geometry Types** environment is based on the **OpenGIS Geometry Model**. In this model, each geometric object has the following general properties:

- It is associated with a spatial reference system, which describes the coordinate space in which the object is defined.
- It belongs to some geometry class.

### 11.4.2.1 The Geometry Class Hierarchy

The geometry classes define a hierarchy as follows:

- [Geometry](#) (noninstantiable)
  - [Point](#) (instantiable)
  - [Curve](#) (noninstantiable)
    - [LineString](#) (instantiable)
      - [Line](#)
      - [LinearRing](#)
  - [Surface](#) (noninstantiable)
    - [Polygon](#) (instantiable)
- [GeometryCollection](#) (instantiable)
  - [MultiPoint](#) (instantiable)
  - [MultiCurve](#) (noninstantiable)
    - [MultiLineString](#) (instantiable)
  - [MultiSurface](#) (noninstantiable)
    - [MultiPolygon](#) (instantiable)

It is not possible to create objects in noninstantiable classes. It is possible to create objects in instantiable classes. All classes have properties, and instantiable classes may also have assertions (rules that define valid class instances).

[Geometry](#) is the base class. It is an abstract class. The instantiable subclasses of [Geometry](#) are restricted to zero-, one-, and two-dimensional geometric objects that exist in two-dimensional coordinate

space. All instantiable geometry classes are defined so that valid instances of a geometry class are topologically closed (that is, all defined geometries include their boundary).

The base `Geometry` class has subclasses for `Point`, `Curve`, `Surface`, and `GeometryCollection`:

- `Point` represents zero-dimensional objects.
- `Curve` represents one-dimensional objects, and has subclass `LineString`, with sub-subclasses `Line` and `LinearRing`.
- `Surface` is designed for two-dimensional objects and has subclass `Polygon`.
- `GeometryCollection` has specialized zero-, one-, and two-dimensional collection classes named `MultiPoint`, `MultiLineString`, and `MultiPolygon` for modeling geometries corresponding to collections of `Points`, `LineStrings`, and `Polygons`, respectively. `MultiCurve` and `MultiSurface` are introduced as abstract superclasses that generalize the collection interfaces to handle `Curves` and `Surfaces`.

`Geometry`, `Curve`, `Surface`, `MultiCurve`, and `MultiSurface` are defined as noninstantiable classes. They define a common set of methods for their subclasses and are included for extensibility.

`Point`, `LineString`, `Polygon`, `GeometryCollection`, `MultiPoint`, `MultiLineString`, and `MultiPolygon` are instantiable classes.

### 11.4.2.2 Geometry Class

`Geometry` is the root class of the hierarchy. It is a noninstantiable class but has a number of properties, described in the following list, that are common to all geometry values created from any of the `Geometry` subclasses. Particular subclasses have their own specific properties, described later.

#### Geometry Properties

A geometry value has the following properties:

- Its **type**. Each geometry belongs to one of the instantiable classes in the hierarchy.
- Its **SRID**, or spatial reference identifier. This value identifies the geometry's associated spatial reference system that describes the coordinate space in which the geometry object is defined.

In MySQL, the SRID value is an integer associated with the geometry value. The maximum usable SRID value is  $2^{32}-1$ . If a larger value is given, only the lower 32 bits are used. All computations are done assuming SRID 0, regardless of the actual SRID value. SRID 0 represents an infinite flat Cartesian plane with no units assigned to its axes.

- Its **coordinates** in its spatial reference system, represented as double-precision (8-byte) numbers. All nonempty geometries include at least one pair of (X,Y) coordinates. Empty geometries contain no coordinates.

Coordinates are related to the SRID. For example, in different coordinate systems, the distance between two objects may differ even when objects have the same coordinates, because the distance on the **planar** coordinate system and the distance on the **geodetic** system (coordinates on the Earth's surface) are different things.

- Its **interior**, **boundary**, and **exterior**.

Every geometry occupies some position in space. The exterior of a geometry is all space not occupied by the geometry. The interior is the space occupied by the geometry. The boundary is the interface between the geometry's interior and exterior.

- Its **MBR** (minimum bounding rectangle), or envelope. This is the bounding geometry, formed by the minimum and maximum (X,Y) coordinates:

```
(( (MINX MINY, MAXX MINY, MAXX MAXY, MINX MAXY, MINX MINY))
```

- Whether the value is **simple** or **nonsimple**. Geometry values of types ([LineString](#), [MultiPoint](#), [MultiLineString](#)) are either simple or nonsimple. Each type determines its own assertions for being simple or nonsimple.
- Whether the value is **closed** or **not closed**. Geometry values of types ([LineString](#), [MultiString](#)) are either closed or not closed. Each type determines its own assertions for being closed or not closed.
- Whether the value is **empty** or **nonempty**. A geometry is empty if it does not have any points. Exterior, interior, and boundary of an empty geometry are not defined (that is, they are represented by a [NULL](#) value). An empty geometry is defined to be always simple and has an area of 0.
- Its **dimension**. A geometry can have a dimension of -1, 0, 1, or 2:
  - -1 for an empty geometry.
  - 0 for a geometry with no length and no area.
  - 1 for a geometry with nonzero length and zero area.
  - 2 for a geometry with nonzero area.

[Point](#) objects have a dimension of zero. [LineString](#) objects have a dimension of 1. [Polygon](#) objects have a dimension of 2. The dimensions of [MultiPoint](#), [MultiLineString](#), and [MultiPolygon](#) objects are the same as the dimensions of the elements they consist of.

### 11.4.2.3 Point Class

A [Point](#) is a geometry that represents a single location in coordinate space.

#### [Point](#) Examples

- Imagine a large-scale map of the world with many cities. A [Point](#) object could represent each city.
- On a city map, a [Point](#) object could represent a bus stop.

#### [Point](#) Properties

- X-coordinate value.
- Y-coordinate value.
- [Point](#) is defined as a zero-dimensional geometry.
- The boundary of a [Point](#) is the empty set.

### 11.4.2.4 Curve Class

A [Curve](#) is a one-dimensional geometry, usually represented by a sequence of points. Particular subclasses of [Curve](#) define the type of interpolation between points. [Curve](#) is a noninstantiable class.

#### [Curve](#) Properties

- A [Curve](#) has the coordinates of its points.
- A [Curve](#) is defined as a one-dimensional geometry.



- A [Curve](#) is simple if it does not pass through the same point twice, with the exception that a curve can still be simple if the start and end points are the same.
- A [Curve](#) is closed if its start point is equal to its endpoint.
- The boundary of a closed [Curve](#) is empty.
- The boundary of a nonclosed [Curve](#) consists of its two endpoints.
- A [Curve](#) that is simple and closed is a [LinearRing](#).

### 11.4.2.5 LineString Class

A [LineString](#) is a [Curve](#) with linear interpolation between points.

#### [LineString](#) Examples

- On a world map, [LineString](#) objects could represent rivers.
- In a city map, [LineString](#) objects could represent streets.

#### [LineString](#) Properties

- A [LineString](#) has coordinates of segments, defined by each consecutive pair of points.
- A [LineString](#) is a [Line](#) if it consists of exactly two points.
- A [LineString](#) is a [LinearRing](#) if it is both closed and simple.

### 11.4.2.6 Surface Class

A [Surface](#) is a two-dimensional geometry. It is a noninstantiable class. Its only instantiable subclass is [Polygon](#).

Simple surfaces in three-dimensional space are isomorphic to planar surfaces.

Polyhedral surfaces are formed by “stitching” together simple surfaces along their boundaries, polyhedral surfaces in three-dimensional space may not be planar as a whole.

#### [Surface](#) Properties

- A [Surface](#) is defined as a two-dimensional geometry.
- The OpenGIS specification defines a simple [Surface](#) as a geometry that consists of a single “patch” that is associated with a single exterior boundary and zero or more interior boundaries.
- The boundary of a simple [Surface](#) is the set of closed curves corresponding to its exterior and interior boundaries.

### 11.4.2.7 Polygon Class

A [Polygon](#) is a planar [Surface](#) representing a multisided geometry. It is defined by a single exterior boundary and zero or more interior boundaries, where each interior boundary defines a hole in the [Polygon](#).

#### [Polygon](#) Examples

- On a region map, [Polygon](#) objects could represent forests, districts, and so on.

#### [Polygon](#) Assertions

- The boundary of a `Polygon` consists of a set of `LinearRing` objects (that is, `LineString` objects that are both simple and closed) that make up its exterior and interior boundaries.
- A `Polygon` has no rings that cross. The rings in the boundary of a `Polygon` may intersect at a `Point`, but only as a tangent.
- A `Polygon` has no lines, spikes, or punctures.
- A `Polygon` has an interior that is a connected point set.
- A `Polygon` may have holes. The exterior of a `Polygon` with holes is not connected. Each hole defines a connected component of the exterior.

The preceding assertions make a `Polygon` a simple geometry.

### 11.4.2.8 GeometryCollection Class

A `GeometryCollection` is a geometry that is a collection of zero or more geometries of any class.

All the elements in a geometry collection must be in the same spatial reference system (that is, in the same coordinate system). There are no other constraints on the elements of a geometry collection, although the subclasses of `GeometryCollection` described in the following sections may restrict membership. Restrictions may be based on:

- Element type (for example, a `MultiPoint` may contain only `Point` elements)
- Dimension
- Constraints on the degree of spatial overlap between elements

### 11.4.2.9 MultiPoint Class

A `MultiPoint` is a geometry collection composed of `Point` elements. The points are not connected or ordered in any way.

#### MultiPoint Examples

- On a world map, a `MultiPoint` could represent a chain of small islands.
- On a city map, a `MultiPoint` could represent the outlets for a ticket office.

#### MultiPoint Properties

- A `MultiPoint` is a zero-dimensional geometry.
- A `MultiPoint` is simple if no two of its `Point` values are equal (have identical coordinate values).
- The boundary of a `MultiPoint` is the empty set.

### 11.4.2.10 MultiCurve Class

A `MultiCurve` is a geometry collection composed of `Curve` elements. `MultiCurve` is a noninstantiable class.

#### MultiCurve Properties

- A `MultiCurve` is a one-dimensional geometry.
- A `MultiCurve` is simple if and only if all of its elements are simple; the only intersections between any two elements occur at points that are on the boundaries of both elements.

- A `MultiCurve` boundary is obtained by applying the “mod 2 union rule” (also known as the “odd-even rule”): A point is in the boundary of a `MultiCurve` if it is in the boundaries of an odd number of `Curve` elements.
- A `MultiCurve` is closed if all of its elements are closed.
- The boundary of a closed `MultiCurve` is always empty.

#### 11.4.2.11 MultiLineString Class

A `MultiLineString` is a `MultiCurve` geometry collection composed of `LineString` elements.

##### `MultiLineString` Examples

- On a region map, a `MultiLineString` could represent a river system or a highway system.

#### 11.4.2.12 MultiSurface Class

A `MultiSurface` is a geometry collection composed of surface elements. `MultiSurface` is a noninstantiable class. Its only instantiable subclass is `MultiPolygon`.

##### `MultiSurface` Assertions

- Surfaces within a `MultiSurface` have no interiors that intersect.
- Surfaces within a `MultiSurface` have boundaries that intersect at most at a finite number of points.

#### 11.4.2.13 MultiPolygon Class

A `MultiPolygon` is a `MultiSurface` object composed of `Polygon` elements.

##### `MultiPolygon` Examples

- On a region map, a `MultiPolygon` could represent a system of lakes.

##### `MultiPolygon` Assertions

- A `MultiPolygon` has no two `Polygon` elements with interiors that intersect.
- A `MultiPolygon` has no two `Polygon` elements that cross (crossing is also forbidden by the previous assertion), or that touch at an infinite number of points.
- A `MultiPolygon` may not have cut lines, spikes, or punctures. A `MultiPolygon` is a regular, closed point set.
- A `MultiPolygon` that has more than one `Polygon` has an interior that is not connected. The number of connected components of the interior of a `MultiPolygon` is equal to the number of `Polygon` values in the `MultiPolygon`.

##### `MultiPolygon` Properties

- A `MultiPolygon` is a two-dimensional geometry.
- A `MultiPolygon` boundary is a set of closed curves (`LineString` values) corresponding to the boundaries of its `Polygon` elements.
- Each `Curve` in the boundary of the `MultiPolygon` is in the boundary of exactly one `Polygon` element.
- Every `Curve` in the boundary of an `Polygon` element is in the boundary of the `MultiPolygon`.

### 11.4.3 Supported Spatial Data Formats

Two standard spatial data formats are used to represent geometry objects in queries:

- Well-Known Text (WKT) format
- Well-Known Binary (WKB) format

Internally, MySQL stores geometry values in a format that is not identical to either WKT or WKB format. (Internal format is like WKB but with an initial 4 bytes to indicate the SRID.)

There are functions available to convert between different data formats; see [Section 12.16.6, “Geometry Format Conversion Functions”](#).

The following sections describe the spatial data formats MySQL uses:

- [Well-Known Text \(WKT\) Format](#)
- [Well-Known Binary \(WKB\) Format](#)
- [Internal Geometry Storage Format](#)

#### Well-Known Text (WKT) Format

The Well-Known Text (WKT) representation of geometry values is designed for exchanging geometry data in ASCII form. The OpenGIS specification provides a Backus-Naur grammar that specifies the formal production rules for writing WKT values (see [Section 11.4, “Spatial Data Types”](#)).

Examples of WKT representations of geometry objects:

- A [Point](#):

```
POINT(15 20)
```

The point coordinates are specified with no separating comma. This differs from the syntax for the SQL [Point\(\)](#) function, which requires a comma between the coordinates. Take care to use the syntax appropriate to the context of a given spatial operation. For example, the following statements both use [ST\\_X\(\)](#) to extract the X-coordinate from a [Point](#) object. The first produces the object directly using the [Point\(\)](#) function. The second uses a WKT representation converted to a [Point](#) with [ST\\_GeomFromText\(\)](#).

```
mysql> SELECT ST_X(Point(15, 20));
+-----+
| ST_X(Point(15, 20)) |
+-----+
|                    15 |
+-----+

mysql> SELECT ST_X(ST_GeomFromText('POINT(15 20)'));
+-----+
| ST_X(ST_GeomFromText('POINT(15 20)')) |
+-----+
|                    15 |
+-----+
```

- A [LineString](#) with four points:

```
LINestring(0 0, 10 10, 20 25, 50 60)
```

The point coordinate pairs are separated by commas.

- A [Polygon](#) with one exterior ring and one interior ring:

```
POLYGON((0 0,10 0,10 10,0 10,0 0),(5 5,7 5,7 7,5 7, 5 5))
```

- A [MultiPoint](#) with three [Point](#) values:

```
MULTIPOINT(0 0, 20 20, 60 60)
```

As of MySQL 5.7.9, spatial functions such as `ST_MPointFromText()` and `ST_GeomFromText()` that accept WKT-format representations of [MultiPoint](#) values permit individual points within values to be surrounded by parentheses. For example, both of the following function calls are valid, whereas before MySQL 5.7.9 the second one produces an error:

```
ST_MPointFromText('MULTIPOINT (1 1, 2 2, 3 3)')
ST_MPointFromText('MULTIPOINT ((1 1), (2 2), (3 3))')
```

As of MySQL 5.7.9, output for [MultiPoint](#) values includes parentheses around each point. For example:

```
mysql> SET @mp = 'MULTIPOINT(1 1, 2 2, 3 3)';
mysql> SELECT ST_AsText(ST_GeomFromText(@mp));
+-----+
| ST_AsText(ST_GeomFromText(@mp)) |
+-----+
| MULTIPOINT((1 1),(2 2),(3 3))   |
+-----+
```

Before MySQL 5.7.9, output for the same value does not include parentheses around each point:

```
mysql> SET @mp = 'MULTIPOINT(1 1, 2 2, 3 3)';
mysql> SELECT ST_AsText(ST_GeomFromText(@mp));
+-----+
| ST_AsText(ST_GeomFromText(@mp)) |
+-----+
| MULTIPOINT(1 1,2 2,3 3)         |
+-----+
```

- A [MultiLineString](#) with two [LineString](#) values:

```
MULTILINESTRING((10 10, 20 20), (15 15, 30 15))
```

- A [MultiPolygon](#) with two [Polygon](#) values:

```
MULTIPOLYGON(((0 0,10 0,10 10,0 10,0 0)),((5 5,7 5,7 7,5 7, 5 5)))
```

- A [GeometryCollection](#) consisting of two [Point](#) values and one [LineString](#):

```
GEOMETRYCOLLECTION(POINT(10 10), POINT(30 30), LINESTRING(15 15, 20 20))
```

## Well-Known Binary (WKB) Format

The Well-Known Binary (WKB) representation of geometric values is used for exchanging geometry data as binary streams represented by [BLOB](#) values containing geometric WKB information. This format is defined by the OpenGIS specification (see [Section 11.4, “Spatial Data Types”](#)). It is also defined in the ISO *SQL/MM Part 3: Spatial* standard.

WKB uses 1-byte unsigned integers, 4-byte unsigned integers, and 8-byte double-precision numbers (IEEE 754 format). A byte is eight bits.

For example, a WKB value that corresponds to `POINT(1 -1)` consists of this sequence of 21 bytes, each represented by two hexadecimal digits:

```
010100000000000000000000F03F000000000000F0BF
```

The sequence consists of the components shown in the following table.

**Table 11.2 WKB Components Example**

Component	Size	Value
Byte order	1 byte	01
WKB type	4 bytes	01000000
X coordinate	8 bytes	00000000000000F03F
Y coordinate	8 bytes	00000000000000F0BF

Component representation is as follows:

- The byte order indicator is either 1 or 0 to signify little-endian or big-endian storage. The little-endian and big-endian byte orders are also known as Network Data Representation (NDR) and External Data Representation (XDR), respectively.
- The WKB type is a code that indicates the geometry type. MySQL uses values from 1 through 7 to indicate [Point](#), [LineString](#), [Polygon](#), [MultiPoint](#), [MultiLineString](#), [MultiPolygon](#), and [GeometryCollection](#).
- A [Point](#) value has X and Y coordinates, each represented as a double-precision value.

WKB values for more complex geometry values have more complex data structures, as detailed in the OpenGIS specification.

## Internal Geometry Storage Format

MySQL stores geometry values using 4 bytes to indicate the SRID followed by the WKB representation of the value. For a description of WKB format, see [Well-Known Binary \(WKB\) Format](#).

For the WKB part, these MySQL-specific considerations apply:

- The byte-order indicator byte is 1 because MySQL stores geometries as little-endian values.
- MySQL supports geometry types of [Point](#), [LineString](#), [Polygon](#), [MultiPoint](#), [MultiLineString](#), [MultiPolygon](#), and [GeometryCollection](#). Other geometry types are not supported.

The `LENGTH()` function returns the space in bytes required for value storage. Example:

```
mysql> SET @g = ST_GeomFromText('POINT(1 -1)');
mysql> SELECT LENGTH(@g);
+-----+
| LENGTH(@g) |
+-----+
|          25 |
+-----+
mysql> SELECT HEX(@g);
+-----+
| HEX(@g) |
+-----+
| 00000000010100000000000000000000F03F000000000000F0BF |
+-----+
```

The value length is 25 bytes, made up of these components (as can be seen from the hexadecimal value):

- 4 bytes for integer SRID (0)

- 1 byte for integer byte order (1 = little-endian)
- 4 bytes for integer type information (1 = `Point`)
- 8 bytes for double-precision X coordinate (1)
- 8 bytes for double-precision Y coordinate (-1)

### 11.4.4 Geometry Well-Formedness and Validity

For geometry values, MySQL distinguishes between the concepts of syntactically well-formed and geometrically valid.

A geometry is syntactically well-formed if it satisfies conditions such as those in this (nonexhaustive) list:

- Linestrings have at least two points
- Polygons have at least one ring
- Polygon rings are closed (first and last points the same)
- Polygon rings have at least 4 points (minimum polygon is a triangle with first and last points the same)
- Collections are not empty (except `GeometryCollection`)

A geometry is geometrically valid if it is syntactically well-formed and satisfies conditions such as those in this (nonexhaustive) list:

- Polygons are not self-intersecting
- Polygon interior rings are inside the exterior ring
- Multipolygons do not have overlapping polygons

Spatial functions fail if a geometry is not syntactically well-formed. Spatial import functions that parse WKT or WKB values raise an error for attempts to create a geometry that is not syntactically well-formed. Syntactic well-formedness is also checked for attempts to store geometries into tables.

It is permitted to insert, select, and update geometrically invalid geometries, but they must be syntactically well-formed. Due to the computational expense, MySQL does not check explicitly for geometric validity. Spatial computations may detect some cases of invalid geometries and raise an error, but they may also return an undefined result without detecting the invalidity. Applications that require geometrically valid geometries should check them using the `ST_IsValid()` function.

### 11.4.5 Creating Spatial Columns

MySQL provides a standard way of creating spatial columns for geometry types, for example, with `CREATE TABLE` or `ALTER TABLE`. Spatial columns are supported for `MyISAM`, `InnoDB`, `NDB`, and `ARCHIVE` tables. See also the notes about spatial indexes under [Section 11.4.9, “Creating Spatial Indexes”](#).

- Use the `CREATE TABLE` statement to create a table with a spatial column:

```
CREATE TABLE geom (g GEOMETRY);
```

- Use the `ALTER TABLE` statement to add or drop a spatial column to or from an existing table:

```
ALTER TABLE geom ADD pt POINT;
ALTER TABLE geom DROP pt;
```

## 11.4.6 Populating Spatial Columns

After you have created spatial columns, you can populate them with spatial data.

Values should be stored in internal geometry format, but you can convert them to that format from either Well-Known Text (WKT) or Well-Known Binary (WKB) format. The following examples demonstrate how to insert geometry values into a table by converting WKT values to internal geometry format:

- Perform the conversion directly in the `INSERT` statement:

```
INSERT INTO geom VALUES (ST_GeomFromText('POINT(1 1)'));

SET @g = 'POINT(1 1)';
INSERT INTO geom VALUES (ST_GeomFromText(@g));
```

- Perform the conversion prior to the `INSERT`:

```
SET @g = ST_GeomFromText('POINT(1 1)');
INSERT INTO geom VALUES (@g);
```

The following examples insert more complex geometries into the table:

```
SET @g = 'LINESTRING(0 0,1 1,2 2)';
INSERT INTO geom VALUES (ST_GeomFromText(@g));

SET @g = 'POLYGON((0 0,10 0,10 10,0 10,0 0),(5 5,7 5,7 7,5 7, 5 5))';
INSERT INTO geom VALUES (ST_GeomFromText(@g));

SET @g =
'GEOMETRYCOLLECTION(POINT(1 1),LINESTRING(0 0,1 1,2 2,3 3,4 4))';
INSERT INTO geom VALUES (ST_GeomFromText(@g));
```

The preceding examples use `ST_GeomFromText()` to create geometry values. You can also use type-specific functions:

```
SET @g = 'POINT(1 1)';
INSERT INTO geom VALUES (ST_PointFromText(@g));

SET @g = 'LINESTRING(0 0,1 1,2 2)';
INSERT INTO geom VALUES (ST_LineStringFromText(@g));

SET @g = 'POLYGON((0 0,10 0,10 10,0 10,0 0),(5 5,7 5,7 7,5 7, 5 5))';
INSERT INTO geom VALUES (ST_PolygonFromText(@g));

SET @g =
'GEOMETRYCOLLECTION(POINT(1 1),LINESTRING(0 0,1 1,2 2,3 3,4 4))';
INSERT INTO geom VALUES (ST_GeomCollFromText(@g));
```

A client application program that wants to use WKB representations of geometry values is responsible for sending correctly formed WKB in queries to the server. There are several ways to satisfy this requirement. For example:

- Inserting a `POINT(1 1)` value with hex literal syntax:

```
INSERT INTO geom VALUES
(ST_GeomFromWKB('X'01010000000000000000000000F03F000000000000F03F'));
```

- An ODBC application can send a WKB representation, binding it to a placeholder using an argument of `BLOB` type:

```
INSERT INTO geom VALUES (ST_GeomFromWKB(?))
```

Other programming interfaces may support a similar placeholder mechanism.



- In a C program, you can escape a binary value using `mysql_real_escape_string_quote()` and include the result in a query string that is sent to the server. See `mysql_real_escape_string_quote()`.

### 11.4.7 Fetching Spatial Data

Geometry values stored in a table can be fetched in internal format. You can also convert them to WKT or WKB format.

- Fetching spatial data in internal format:

Fetching geometry values using internal format can be useful in table-to-table transfers:

```
CREATE TABLE geom2 (g GEOMETRY) SELECT g FROM geom;
```

- Fetching spatial data in WKT format:

The `ST_AsText()` function converts a geometry from internal format to a WKT string.

```
SELECT ST_AsText(g) FROM geom;
```

- Fetching spatial data in WKB format:

The `ST_AsBinary()` function converts a geometry from internal format to a `BLOB` containing the WKB value.

```
SELECT ST_AsBinary(g) FROM geom;
```

### 11.4.8 Optimizing Spatial Analysis

For `MyISAM` and `InnoDB` tables, search operations in columns containing spatial data can be optimized using `SPATIAL` indexes. The most typical operations are:

- Point queries that search for all objects that contain a given point
- Region queries that search for all objects that overlap a given region

MySQL uses **R-Trees with quadratic splitting** for `SPATIAL` indexes on spatial columns. A `SPATIAL` index is built using the minimum bounding rectangle (MBR) of a geometry. For most geometries, the MBR is a minimum rectangle that surrounds the geometries. For a horizontal or a vertical linestring, the MBR is a rectangle degenerated into the linestring. For a point, the MBR is a rectangle degenerated into the point.

It is also possible to create normal indexes on spatial columns. In a non-`SPATIAL` index, you must declare a prefix for any spatial column except for `POINT` columns.

`MyISAM` and `InnoDB` support both `SPATIAL` and non-`SPATIAL` indexes. Other storage engines support non-`SPATIAL` indexes, as described in [Section 13.1.14, “CREATE INDEX Statement”](#).

### 11.4.9 Creating Spatial Indexes

For `InnoDB` and `MyISAM` tables, MySQL can create spatial indexes using syntax similar to that for creating regular indexes, but using the `SPATIAL` keyword. Columns in spatial indexes must be declared `NOT NULL`. The following examples demonstrate how to create spatial indexes:

- With `CREATE TABLE`:

```
CREATE TABLE geom (g GEOMETRY NOT NULL, SPATIAL INDEX(g));
```

- With `ALTER TABLE`:

```
CREATE TABLE geom (g GEOMETRY NOT NULL);
ALTER TABLE geom ADD SPATIAL INDEX(g);
```

- With `CREATE INDEX`:

```
CREATE TABLE geom (g GEOMETRY NOT NULL);
CREATE SPATIAL INDEX g ON geom (g);
```

`SPATIAL INDEX` creates an R-tree index. For storage engines that support nonspatial indexing of spatial columns, the engine creates a B-tree index. A B-tree index on spatial values is useful for exact-value lookups, but not for range scans.

For more information on indexing spatial columns, see [Section 13.1.14, “CREATE INDEX Statement”](#).

To drop spatial indexes, use `ALTER TABLE` or `DROP INDEX`:

- With `ALTER TABLE`:

```
ALTER TABLE geom DROP INDEX g;
```

- With `DROP INDEX`:

```
DROP INDEX g ON geom;
```

Example: Suppose that a table `geom` contains more than 32,000 geometries, which are stored in the column `g` of type `GEOMETRY`. The table also has an `AUTO_INCREMENT` column `fid` for storing object ID values.

```
mysql> DESCRIBE geom;
+-----+-----+-----+-----+-----+-----+
| Field | Type      | Null | Key | Default | Extra          |
+-----+-----+-----+-----+-----+-----+
| fid   | int(11)   |      | PRI | NULL    | auto_increment |
| g     | geometry  |      |     |         |                |
+-----+-----+-----+-----+-----+-----+
2 rows in set (0.00 sec)

mysql> SELECT COUNT(*) FROM geom;
+-----+
| count(*) |
+-----+
|      32376 |
+-----+
1 row in set (0.00 sec)
```

To add a spatial index on the column `g`, use this statement:

```
mysql> ALTER TABLE geom ADD SPATIAL INDEX(g);
Query OK, 32376 rows affected (4.05 sec)
Records: 32376 Duplicates: 0 Warnings: 0
```

## 11.4.10 Using Spatial Indexes

The optimizer investigates whether available spatial indexes can be involved in the search for queries that use a function such as `MBRContains()` or `MBRWithin()` in the `WHERE` clause. The following query finds all objects that are in the given rectangle:

```
mysql> SET @poly =
-> 'Polygon((30000 15000,
           31000 15000,
           31000 16000,
           30000 16000,
```

```

          30000 15000)');
mysql> SELECT fid,ST_AsText(g) FROM geom WHERE
-> MBRContains(ST_GeomFromText(@poly),g);
+-----+
| fid | ST_AsText(g) |
+-----+
| 21 | LINESTRING(30350.4 15828.8,30350.6 15845,30333.8 15845,30 ... |
| 22 | LINESTRING(30350.6 15871.4,30350.6 15887.8,30334 15887.8, ... |
| 23 | LINESTRING(30350.6 15914.2,30350.6 15930.4,30334 15930.4, ... |
| 24 | LINESTRING(30290.2 15823,30290.2 15839.4,30273.4 15839.4, ... |
| 25 | LINESTRING(30291.4 15866.2,30291.6 15882.4,30274.8 15882. ... |
| 26 | LINESTRING(30291.6 15918.2,30291.6 15934.4,30275 15934.4, ... |
| 249 | LINESTRING(30337.8 15938.6,30337.8 15946.8,30320.4 15946. ... |
| 1 | LINESTRING(30250.4 15129.2,30248.8 15138.4,30238.2 15136. ... |
| 2 | LINESTRING(30220.2 15122.8,30217.2 15137.8,30207.6 15136, ... |
| 3 | LINESTRING(30179 15114.4,30176.6 15129.4,30167 15128,3016 ... |
| 4 | LINESTRING(30155.2 15121.4,30140.4 15118.6,30142 15109,30 ... |
| 5 | LINESTRING(30192.4 15085,30177.6 15082.2,30179.2 15072.4, ... |
| 6 | LINESTRING(30244 15087,30229 15086.2,30229.4 15076.4,3024 ... |
| 7 | LINESTRING(30200.6 15059.4,30185.6 15058.6,30186 15048.8, ... |
| 10 | LINESTRING(30179.6 15017.8,30181 15002.8,30190.8 15003.6, ... |
| 11 | LINESTRING(30154.2 15000.4,30168.6 15004.8,30166 15014.2, ... |
| 13 | LINESTRING(30105 15065.8,30108.4 15050.8,30118 15053,3011 ... |
| 154 | LINESTRING(30276.2 15143.8,30261.4 15141,30263 15131.4,30 ... |
| 155 | LINESTRING(30269.8 15084,30269.4 15093.4,30258.6 15093,30 ... |
| 157 | LINESTRING(30128.2 15011,30113.2 15010.2,30113.6 15000.4, ... |
+-----+
20 rows in set (0.00 sec)

```

Use [EXPLAIN](#) to check the way this query is executed:

```

mysql> SET @poly =
-> 'Polygon((30000 15000,
          31000 15000,
          31000 16000,
          30000 16000,
          30000 15000)');
mysql> EXPLAIN SELECT fid,ST_AsText(g) FROM geom WHERE
-> MBRContains(ST_GeomFromText(@poly),g)\G
***** 1. row *****
      id: 1
  select_type: SIMPLE
        table: geom
         type: range
possible_keys: g
         key: g
        key_len: 32
         ref: NULL
         rows: 50
      Extra: Using where
1 row in set (0.00 sec)

```

Check what would happen without a spatial index:

```

mysql> SET @poly =
-> 'Polygon((30000 15000,
          31000 15000,
          31000 16000,
          30000 16000,
          30000 15000)');
mysql> EXPLAIN SELECT fid,ST_AsText(g) FROM g IGNORE INDEX (g) WHERE
-> MBRContains(ST_GeomFromText(@poly),g)\G
***** 1. row *****
      id: 1
  select_type: SIMPLE
        table: geom
         type: ALL

```

```
possible_keys: NULL
  key: NULL
  key_len: NULL
  ref: NULL
  rows: 32376
  Extra: Using where
1 row in set (0.00 sec)
```

Executing the `SELECT` statement without the spatial index yields the same result but causes the execution time to rise from 0.00 seconds to 0.46 seconds:

```
mysql> SET @poly =
-> 'Polygon((30000 15000,
           31000 15000,
           31000 16000,
           30000 16000,
           30000 15000))';
mysql> SELECT fid,ST_AsText(g) FROM geom IGNORE INDEX (g) WHERE
-> MBRContains(ST_GeomFromText(@poly),g);
+-----+-----+
| fid | ST_AsText(g) |
+-----+-----+
| 1 | LINESTRING(30250.4 15129.2,30248.8 15138.4,30238.2 15136. ... |
| 2 | LINESTRING(30220.2 15122.8,30217.2 15137.8,30207.6 15136, ... |
| 3 | LINESTRING(30179 15114.4,30176.6 15129.4,30167 15128,3016 ... |
| 4 | LINESTRING(30155.2 15121.4,30140.4 15118.6,30142 15109,30 ... |
| 5 | LINESTRING(30192.4 15085,30177.6 15082.2,30179.2 15072.4, ... |
| 6 | LINESTRING(30244 15087,30229 15086.2,30229.4 15076.4,3024 ... |
| 7 | LINESTRING(30200.6 15059.4,30185.6 15058.6,30186 15048.8, ... |
| 10 | LINESTRING(30179.6 15017.8,30181 15002.8,30190.8 15003.6, ... |
| 11 | LINESTRING(30154.2 15000.4,30168.6 15004.8,30166 15014.2, ... |
| 13 | LINESTRING(30105 15065.8,30108.4 15050.8,30118 15053,3011 ... |
| 21 | LINESTRING(30350.4 15828.8,30350.6 15845,30333.8 15845,30 ... |
| 22 | LINESTRING(30350.6 15871.4,30350.6 15887.8,30334 15887.8, ... |
| 23 | LINESTRING(30350.6 15914.2,30350.6 15930.4,30334 15930.4, ... |
| 24 | LINESTRING(30290.2 15823,30290.2 15839.4,30273.4 15839.4, ... |
| 25 | LINESTRING(30291.4 15866.2,30291.6 15882.4,30274.8 15882. ... |
| 26 | LINESTRING(30291.6 15918.2,30291.6 15934.4,30275 15934.4, ... |
| 154 | LINESTRING(30276.2 15143.8,30261.4 15141,30263 15131.4,30 ... |
| 155 | LINESTRING(30269.8 15084,30269.4 15093.4,30258.6 15093,30 ... |
| 157 | LINESTRING(30128.2 15011,30113.2 15010.2,30113.6 15000.4, ... |
| 249 | LINESTRING(30337.8 15938.6,30337.8 15946.8,30320.4 15946. ... |
+-----+-----+
20 rows in set (0.46 sec)
```

## 11.5 The JSON Data Type

- [Creating JSON Values](#)
- [Normalization, Merging, and Autowrapping of JSON Values](#)
- [Searching and Modifying JSON Values](#)
- [JSON Path Syntax](#)
- [Comparison and Ordering of JSON Values](#)
- [Converting between JSON and non-JSON values](#)
- [Aggregation of JSON Values](#)

As of MySQL 5.7.8, MySQL supports a native `JSON` (JavaScript Object Notation) data type defined by [RFC 8259](#) that enables efficient access to data in JSON documents. The `JSON` data type provides these advantages over storing JSON-format strings in a string column:

- Automatic validation of JSON documents stored in `JSON` columns. Invalid documents produce an error.
- Optimized storage format. JSON documents stored in `JSON` columns are converted to an internal format that permits quick read access to document elements. When the server later must read a JSON value stored in this binary format, the value need not be parsed from a text representation. The binary format is structured to enable the server to look up subobjects or nested values directly by key or array index without reading all values before or after them in the document.



### Note

This discussion uses `JSON` in monospace to indicate specifically the JSON data type and “JSON” in regular font to indicate JSON data in general.

The space required to store a `JSON` document is roughly the same as for `LONGBLOB` or `LONGTEXT`; see [Section 11.7, “Data Type Storage Requirements”](#), for more information. It is important to keep in mind that the size of any JSON document stored in a `JSON` column is limited to the value of the `max_allowed_packet` system variable. (When the server is manipulating a JSON value internally in memory, it can be larger than this; the limit applies when the server stores it.)

A `JSON` column cannot have a non-`NULL` default value.

Along with the `JSON` data type, a set of SQL functions is available to enable operations on JSON values, such as creation, manipulation, and searching. The following discussion shows examples of these operations. For details about individual functions, see [Section 12.17, “JSON Functions”](#).

A set of spatial functions for operating on GeoJSON values is also available. See [Section 12.16.11, “Spatial GeoJSON Functions”](#).

`JSON` columns, like columns of other binary types, are not indexed directly; instead, you can create an index on a generated column that extracts a scalar value from the `JSON` column. See [Indexing a Generated Column to Provide a JSON Column Index](#), for a detailed example.

The MySQL optimizer also looks for compatible indexes on virtual columns that match JSON expressions.

MySQL NDB Cluster 7.5 (7.5.2 and later) supports `JSON` columns and MySQL JSON functions, including creation of an index on a column generated from a `JSON` column as a workaround for being unable to index a `JSON` column. A maximum of 3 `JSON` columns per `NDB` table is supported.

The next few sections provide basic information regarding the creation and manipulation of JSON values.

## Creating JSON Values

A JSON array contains a list of values separated by commas and enclosed within `[` and `]` characters:

```
["abc", 10, null, true, false]
```

A JSON object contains a set of key-value pairs separated by commas and enclosed within `{` and `}` characters:

```
{"k1": "value", "k2": 10}
```

As the examples illustrate, JSON arrays and objects can contain scalar values that are strings or numbers, the JSON null literal, or the JSON boolean `true` or `false` literals. Keys in JSON objects must be strings. Temporal (date, time, or datetime) scalar values are also permitted:

```
["12:18:29.000000", "2015-07-29", "2015-07-29 12:18:29.000000"]
```

Nesting is permitted within JSON array elements and JSON object key values:

```
[99, {"id": "HK500", "cost": 75.99}, ["hot", "cold"]]
{"k1": "value", "k2": [10, 20]}
```

You can also obtain JSON values from a number of functions supplied by MySQL for this purpose (see [Section 12.17.2, “Functions That Create JSON Values”](#)) as well as by casting values of other types to the `JSON` type using `CAST(value AS JSON)` (see [Converting between JSON and non-JSON values](#)). The next several paragraphs describe how MySQL handles JSON values provided as input.

In MySQL, JSON values are written as strings. MySQL parses any string used in a context that requires a JSON value, and produces an error if it is not valid as JSON. These contexts include inserting a value into a column that has the `JSON` data type and passing an argument to a function that expects a JSON value (usually shown as `json_doc` or `json_val` in the documentation for MySQL JSON functions), as the following examples demonstrate:

- Attempting to insert a value into a `JSON` column succeeds if the value is a valid JSON value, but fails if it is not:

```
mysql> CREATE TABLE t1 (jdoc JSON);
Query OK, 0 rows affected (0.20 sec)

mysql> INSERT INTO t1 VALUES('{"key1": "value1", "key2": "value2"}');
Query OK, 1 row affected (0.01 sec)

mysql> INSERT INTO t1 VALUES('[1, 2,');
ERROR 3140 (22032) at line 2: Invalid JSON text:
"Invalid value." at position 6 in value (or column) '[1, 2,'.
```

Positions for “at position *N*” in such error messages are 0-based, but should be considered rough indications of where the problem in a value actually occurs.

- The `JSON_TYPE()` function expects a JSON argument and attempts to parse it into a JSON value. It returns the value's JSON type if it is valid and produces an error otherwise:

```
mysql> SELECT JSON_TYPE('["a", "b", 1]');
+-----+
| JSON_TYPE('["a", "b", 1]') |
+-----+
| ARRAY                        |
+-----+

mysql> SELECT JSON_TYPE('"hello"');
+-----+
| JSON_TYPE('"hello"') |
+-----+
| STRING                |
+-----+

mysql> SELECT JSON_TYPE('hello');
ERROR 3146 (22032): Invalid data type for JSON data in argument 1
to function json_type; a JSON string or JSON type is required.
```

MySQL handles strings used in JSON context using the `utf8mb4` character set and `utf8mb4_bin` collation. Strings in other character sets are converted to `utf8mb4` as necessary. (For strings in the `ascii` or `utf8` character sets, no conversion is needed because `ascii` and `utf8` are subsets of `utf8mb4`.)

As an alternative to writing JSON values using literal strings, functions exist for composing JSON values from component elements. `JSON_ARRAY()` takes a (possibly empty) list of values and returns a JSON array containing those values:

```
mysql> SELECT JSON_ARRAY('a', 1, NOW());
+-----+
| JSON_ARRAY('a', 1, NOW()) |
```

```
+-----+
| ["a", 1, "2015-07-27 09:43:47.000000"] |
+-----+
```

`JSON_OBJECT()` takes a (possibly empty) list of key-value pairs and returns a JSON object containing those pairs:

```
mysql> SELECT JSON_OBJECT('key1', 1, 'key2', 'abc');
+-----+
| JSON_OBJECT('key1', 1, 'key2', 'abc') |
+-----+
| {"key1": 1, "key2": "abc"}           |
+-----+
```

`JSON_MERGE()` takes two or more JSON documents and returns the combined result:

```
mysql> SELECT JSON_MERGE('["a", 1]', '{"key": "value"}');
+-----+
| JSON_MERGE('["a", 1]', '{"key": "value"}') |
+-----+
| ["a", 1, {"key": "value"}]                 |
+-----+
```

For information about the merging rules, see [Normalization, Merging, and Autowrapping of JSON Values](#).

JSON values can be assigned to user-defined variables:

```
mysql> SET @j = JSON_OBJECT('key', 'value');
mysql> SELECT @j;
+-----+
| @j          |
+-----+
| {"key": "value"} |
+-----+
```

However, user-defined variables cannot be of `JSON` data type, so although `@j` in the preceding example looks like a JSON value and has the same character set and collation as a JSON value, it does *not* have the `JSON` data type. Instead, the result from `JSON_OBJECT()` is converted to a string when assigned to the variable.

Strings produced by converting JSON values have a character set of `utf8mb4` and a collation of `utf8mb4_bin`:

```
mysql> SELECT CHARSET(@j), COLLATION(@j);
+-----+
| CHARSET(@j) | COLLATION(@j) |
+-----+
| utf8mb4     | utf8mb4_bin   |
+-----+
```

Because `utf8mb4_bin` is a binary collation, comparison of JSON values is case-sensitive.

```
mysql> SELECT JSON_ARRAY('x') = JSON_ARRAY('X');
+-----+
| JSON_ARRAY('x') = JSON_ARRAY('X') |
+-----+
|                                     0 |
+-----+
```

Case sensitivity also applies to the JSON `null`, `true`, and `false` literals, which always must be written in lowercase:

```
mysql> SELECT JSON_VALID('null'), JSON_VALID('Null'), JSON_VALID('NULL');
```

```
+-----+-----+-----+
| JSON_VALID('null') | JSON_VALID('Null') | JSON_VALID('NULL') |
+-----+-----+-----+
|          1          |          0          |          0          |
+-----+-----+-----+
```

```
mysql> SELECT CAST('null' AS JSON);
```

```
+-----+
| CAST('null' AS JSON) |
+-----+
| null                 |
+-----+
1 row in set (0.00 sec)
```

```
mysql> SELECT CAST('NULL' AS JSON);
```

```
ERROR 3141 (22032): Invalid JSON text in argument 1 to function cast_as_json:
"Invalid value." at position 0 in 'NULL'.
```

Case sensitivity of the JSON literals differs from that of the SQL `NULL`, `TRUE`, and `FALSE` literals, which can be written in any lettercase:

```
mysql> SELECT ISNULL(null), ISNULL(Null), ISNULL(NULL);
```

```
+-----+-----+-----+
| ISNULL(null) | ISNULL(Null) | ISNULL(NULL) |
+-----+-----+-----+
|          1   |          1   |          1   |
+-----+-----+-----+
```

Sometimes it may be necessary or desirable to insert quote characters ( " or ' ) into a JSON document. Assume for this example that you want to insert some JSON objects containing strings representing sentences that state some facts about MySQL, each paired with an appropriate keyword, into a table created using the SQL statement shown here:

```
mysql> CREATE TABLE facts (sentence JSON);
```

Among these keyword-sentence pairs is this one:

```
mascot: The MySQL mascot is a dolphin named "Sakila".
```

One way to insert this as a JSON object into the `facts` table is to use the MySQL `JSON_OBJECT()` function. In this case, you must escape each quote character using a backslash, as shown here:

```
mysql> INSERT INTO facts VALUES
> (JSON_OBJECT("mascot", "Our mascot is a dolphin named \"Sakila\"."));
```

This does not work in the same way if you insert the value as a JSON object literal, in which case, you must use the double backslash escape sequence, like this:

```
mysql> INSERT INTO facts VALUES
> ('{"mascot": "Our mascot is a dolphin named \\\"Sakila\\\"."}');
```

Using the double backslash keeps MySQL from performing escape sequence processing, and instead causes it to pass the string literal to the storage engine for processing. After inserting the JSON object in either of the ways just shown, you can see that the backslashes are present in the JSON column value by doing a simple `SELECT`, like this:

```
mysql> SELECT sentence FROM facts;
```

```
+-----+
| sentence |
+-----+
| {"mascot": "Our mascot is a dolphin named \"Sakila\"."} |
+-----+
```



To look up this particular sentence employing `mascot` as the key, you can use the column-path operator `->`, as shown here:

```
mysql> SELECT col->"$.mascot" FROM qtest;
+-----+
| col->"$.mascot" |
+-----+
| "Our mascot is a dolphin named \"Sakila\"." |
+-----+
1 row in set (0.00 sec)
```

This leaves the backslashes intact, along with the surrounding quote marks. To display the desired value using `mascot` as the key, but without including the surrounding quote marks or any escapes, use the inline path operator `->>`, like this:

```
mysql> SELECT sentence->>"$.mascot" FROM facts;
+-----+
| sentence->>"$.mascot" |
+-----+
| Our mascot is a dolphin named "Sakila". |
+-----+
```



### Note

The previous example does not work as shown if the `NO_BACKSLASH_ESCAPES` server SQL mode is enabled. If this mode is set, a single backslash instead of double backslashes can be used to insert the JSON object literal, and the backslashes are preserved. If you use the `JSON_OBJECT()` function when performing the insert and this mode is set, you must alternate single and double quotes, like this:

```
mysql> INSERT INTO facts VALUES
> (JSON_OBJECT('mascot', 'Our mascot is a dolphin named "Sakila".'));
```

See the description of the `JSON_UNQUOTE()` function for more information about the effects of this mode on escaped characters in JSON values.

## Normalization, Merging, and Autowrapping of JSON Values

When a string is parsed and found to be a valid JSON document, it is also normalized: Members with keys that duplicate a key found earlier in the document are discarded (even if the values differ). The object value produced by the following `JSON_OBJECT()` call does not include the second `key1` element because that key name occurs earlier in the value:

```
mysql> SELECT JSON_OBJECT('key1', 1, 'key2', 'abc', 'key1', 'def');
+-----+
| JSON_OBJECT('key1', 1, 'key2', 'abc', 'key1', 'def') |
+-----+
| {"key1": 1, "key2": "abc"} |
+-----+
```



### Note

This “first key wins” handling of duplicate keys is not consistent with [RFC 7159](#). This is a known issue in MySQL 5.7, which is fixed in MySQL 8.0. (Bug #86866, Bug #26369555)

MySQL also discards extra whitespace between keys, values, or elements in the original JSON document, and leaves (or inserts, when necessary) a single space following each comma (,) or colon (:) when displaying it. This is done to enhance readability.

MySQL functions that produce JSON values (see [Section 12.17.2, “Functions That Create JSON Values”](#)) always return normalized values.

To make lookups more efficient, it also sorts the keys of a JSON object. *You should be aware that the result of this ordering is subject to change and not guaranteed to be consistent across releases.*

## Merging JSON Values

In contexts that combine multiple arrays, the arrays are merged into a single array by concatenating arrays named later to the end of the first array. In the following example, `JSON_MERGE()` merges its arguments into a single array:

```
mysql> SELECT JSON_MERGE('[1, 2]', '["a", "b"]', '[true, false]');
+-----+
| JSON_MERGE('[1, 2]', '["a", "b"]', '[true, false]') |
+-----+
| [1, 2, "a", "b", true, false] |
+-----+
```

Normalization is also performed when values are inserted into JSON columns, as shown here:

```
mysql> CREATE TABLE t1 (c1 JSON);

mysql> INSERT INTO t1 VALUES
  >   ( '{"x": 17, "x": "red"}' ),
  >   ( '{"x": 17, "x": "red", "x": [3, 5, 7]}' );

mysql> SELECT c1 FROM t1;
+-----+
| c1 |
+-----+
| {"x": 17} |
| {"x": 17} |
+-----+
```

Multiple objects when merged produce a single object. If multiple objects have the same key, the value for that key in the resulting merged object is an array containing the key values:

```
mysql> SELECT JSON_MERGE('{ "a": 1, "b": 2 }', '{ "c": 3, "a": 4 }');
+-----+
| JSON_MERGE('{ "a": 1, "b": 2 }', '{ "c": 3, "a": 4 }') |
+-----+
| { "a": [1, 4], "b": 2, "c": 3 } |
+-----+
```

Nonarray values used in a context that requires an array value are autowrapped: The value is surrounded by `[` and `]` characters to convert it to an array. In the following statement, each argument is autowrapped as an array (`[1]`, `[2]`). These are then merged to produce a single result array:

```
mysql> SELECT JSON_MERGE('1', '2');
+-----+
| JSON_MERGE('1', '2') |
+-----+
| [1, 2] |
+-----+
```

Array and object values are merged by autowrapping the object as an array and merging the two arrays:

```
mysql> SELECT JSON_MERGE('[10, 20]', '{ "a": "x", "b": "y" }');
+-----+
| JSON_MERGE('[10, 20]', '{ "a": "x", "b": "y" }') |
+-----+
| [10, 20, { "a": "x", "b": "y" }] |
+-----+
```

## Searching and Modifying JSON Values

A JSON path expression selects a value within a JSON document.

Path expressions are useful with functions that extract parts of or modify a JSON document, to specify where within that document to operate. For example, the following query extracts from a JSON document the value of the member with the `name` key:

```
mysql> SELECT JSON_EXTRACT('{ "id": 14, "name": "Aztalan" }', '$.name');
+-----+
| JSON_EXTRACT('{ "id": 14, "name": "Aztalan" }', '$.name') |
+-----+
| "Aztalan" |
+-----+
```

Path syntax uses a leading `$` character to represent the JSON document under consideration, optionally followed by selectors that indicate successively more specific parts of the document:

- A period followed by a key name names the member in an object with the given key. The key name must be specified within double quotation marks if the name without quotes is not legal within path expressions (for example, if it contains a space).
- `[N]` appended to a `path` that selects an array names the value at position `N` within the array. Array positions are integers beginning with zero. If `path` does not select an array value, `path[0]` evaluates to the same value as `path`:

```
mysql> SELECT JSON_SET('"x"', '$[0]', 'a');
+-----+
| JSON_SET('"x"', '$[0]', 'a') |
+-----+
| "a" |
+-----+
1 row in set (0.00 sec)
```

- Paths can contain `*` or `**` wildcards:
  - `.[*]` evaluates to the values of all members in a JSON object.
  - `[*]` evaluates to the values of all elements in a JSON array.
  - `prefix**suffix` evaluates to all paths that begin with the named prefix and end with the named suffix.
- A path that does not exist in the document (evaluates to nonexistent data) evaluates to `NULL`.

Let `$` refer to this JSON array with three elements:

```
[3, {"a": [5, 6], "b": 10}, [99, 100]]
```

Then:

- `$.0` evaluates to `3`.
- `$.1` evaluates to `{"a": [5, 6], "b": 10}`.
- `$.2` evaluates to `[99, 100]`.
- `$.3` evaluates to `NULL` (it refers to the fourth array element, which does not exist).

Because `$(1)` and `$(2)` evaluate to nonscalar values, they can be used as the basis for more-specific path expressions that select nested values. Examples:

- `$(1).a` evaluates to `[5, 6]`.
- `$(1).a[1]` evaluates to `6`.
- `$(1).b` evaluates to `10`.
- `$(2)[0]` evaluates to `99`.

As mentioned previously, path components that name keys must be quoted if the unquoted key name is not legal in path expressions. Let `$` refer to this value:

```
{"a fish": "shark", "a bird": "sparrow"}
```

The keys both contain a space and must be quoted:

- `$. "a fish"` evaluates to `shark`.
- `$. "a bird"` evaluates to `sparrow`.

Paths that use wildcards evaluate to an array that can contain multiple values:

```
mysql> SELECT JSON_EXTRACT('{ "a": 1, "b": 2, "c": [3, 4, 5] }', '$.*');
+-----+
| JSON_EXTRACT('{ "a": 1, "b": 2, "c": [3, 4, 5] }', '$.*') |
+-----+
| [1, 2, [3, 4, 5]] |
+-----+
mysql> SELECT JSON_EXTRACT('{ "a": 1, "b": 2, "c": [3, 4, 5] }', '$.c[*]');
+-----+
| JSON_EXTRACT('{ "a": 1, "b": 2, "c": [3, 4, 5] }', '$.c[*]') |
+-----+
| [3, 4, 5] |
+-----+
```

In the following example, the path `$$$ .b` evaluates to multiple paths (`$.a.b` and `$.c.b`) and produces an array of the matching path values:

```
mysql> SELECT JSON_EXTRACT('{ "a": { "b": 1 }, "c": { "b": 2 } }', '$$.b');
+-----+
| JSON_EXTRACT('{ "a": { "b": 1 }, "c": { "b": 2 } }', '$$.b') |
+-----+
| [1, 2] |
+-----+
```

In MySQL 5.7.9 and later, you can use `column->path` with a JSON column identifier and JSON path expression as a synonym for `JSON_EXTRACT(column, path)`. See [Section 12.17.3, “Functions That Search JSON Values”](#), for more information. See also [Indexing a Generated Column to Provide a JSON Column Index](#).

Some functions take an existing JSON document, modify it in some way, and return the resulting modified document. Path expressions indicate where in the document to make changes. For example, the `JSON_SET()`, `JSON_INSERT()`, and `JSON_REPLACE()` functions each take a JSON document, plus one or more path/value pairs that describe where to modify the document and the values to use. The functions differ in how they handle existing and nonexisting values within the document.

Consider this document:

```
mysql> SET @j = '{"a", {"b": [true, false]}, [10, 20]}';
```

`JSON_SET()` replaces values for paths that exist and adds values for paths that do not exist.

```
mysql> SELECT JSON_SET(@j, '$[1].b[0]', 1, '$[2][2]', 2);
+-----+
| JSON_SET(@j, '$[1].b[0]', 1, '$[2][2]', 2) |
+-----+
| [{"a", {"b": [1, false]}, [10, 20, 2]}] |
+-----+
```

In this case, the path `[$[1].b[0]` selects an existing value (`true`), which is replaced with the value following the path argument (1). The path `[$[2][2]` does not exist, so the corresponding value (2) is added to the value selected by `[$[2]`.

`JSON_INSERT()` adds new values but does not replace existing values:

```
mysql> SELECT JSON_INSERT(@j, '$[1].b[0]', 1, '$[2][2]', 2);
+-----+
| JSON_INSERT(@j, '$[1].b[0]', 1, '$[2][2]', 2) |
+-----+
| [{"a", {"b": [true, false]}, [10, 20, 2]}] |
+-----+
```

`JSON_REPLACE()` replaces existing values and ignores new values:

```
mysql> SELECT JSON_REPLACE(@j, '$[1].b[0]', 1, '$[2][2]', 2);
+-----+
| JSON_REPLACE(@j, '$[1].b[0]', 1, '$[2][2]', 2) |
+-----+
| [{"a", {"b": [1, false]}, [10, 20]}] |
+-----+
```

The path/value pairs are evaluated left to right. The document produced by evaluating one pair becomes the new value against which the next pair is evaluated.

`JSON_REMOVE()` takes a JSON document and one or more paths that specify values to be removed from the document. The return value is the original document minus the values selected by paths that exist within the document:

```
mysql> SELECT JSON_REMOVE(@j, '$[2]', '$[1].b[1]', '$[1].b[1]');
+-----+
| JSON_REMOVE(@j, '$[2]', '$[1].b[1]', '$[1].b[1]') |
+-----+
| [{"a", {"b": [true]}}] |
+-----+
```

The paths have these effects:

- `[$[2]` matches `[10, 20]` and removes it.
- The first instance of `[$[1].b[1]` matches `false` in the `b` element and removes it.
- The second instance of `[$[1].b[1]` matches nothing: That element has already been removed, the path no longer exists, and has no effect.

## JSON Path Syntax

Many of the JSON functions supported by MySQL and described elsewhere in this Manual (see [Section 12.17, “JSON Functions”](#)) require a path expression in order to identify a specific element in a JSON document. A path consists of the path's scope followed by one or more path legs. For paths used in MySQL JSON functions, the scope is always the document being searched or otherwise operated on, represented by a leading `$` character. Path legs are separated by period characters (`.`). Cells in arrays

are represented by `[N]`, where `N` is a non-negative integer. Names of keys must be double-quoted strings or valid ECMAScript identifiers (see <http://www.ecma-international.org/ecma-262/5.1/#sec-7.6>). Path expressions, like JSON text, should be encoded using the `ascii`, `utf8`, or `utf8mb4` character set. Other character encodings are implicitly coerced to `utf8mb4`. The complete syntax is shown here:

```
pathExpression:
    scope[ (pathLeg)* ]

pathLeg:
    member | arrayLocation | doubleAsterisk

member:
    period ( keyName | asterisk )

arrayLocation:
    leftBracket ( nonNegativeInteger | asterisk ) rightBracket

keyName:
    ESIdentifier | doubleQuotedString

doubleAsterisk:
    '***'

period:
    '.'

asterisk:
    '*'

leftBracket:
    '['

rightBracket:
    ']'
```

As noted previously, in MySQL, the scope of the path is always the document being operated on, represented as `$`. You can use `'$'` as a synonym for the document in JSON path expressions.



**Note**

Some implementations support column references for scopes of JSON paths; currently, MySQL does not support these.

The wildcard `*` and `**` tokens are used as follows:

- `.*` represents the values of all members in the object.
- `[*]` represents the values of all cells in the array.
- `[prefix]**suffix` represents all paths beginning with `prefix` and ending with `suffix`. `prefix` is optional, while `suffix` is required; in other words, a path may not end in `**`.

In addition, a path may not contain the sequence `***`.

For path syntax examples, see the descriptions of the various JSON functions that take paths as arguments, such as `JSON_CONTAINS_PATH()`, `JSON_SET()`, and `JSON_REPLACE()`. For examples which include the use of the `*` and `**` wildcards, see the description of the `JSON_SEARCH()` function.

## Comparison and Ordering of JSON Values

JSON values can be compared using the `=`, `<`, `<=`, `>`, `>=`, `<>`, `!=`, and `<=>` operators.

The following comparison operators and functions are not yet supported with JSON values:

- `BETWEEN`
- `IN( )`
- `GREATEST( )`
- `LEAST( )`

A workaround for the comparison operators and functions just listed is to cast JSON values to a native MySQL numeric or string data type so they have a consistent non-JSON scalar type.

Comparison of JSON values takes place at two levels. The first level of comparison is based on the JSON types of the compared values. If the types differ, the comparison result is determined solely by which type has higher precedence. If the two values have the same JSON type, a second level of comparison occurs using type-specific rules.

The following list shows the precedences of JSON types, from highest precedence to the lowest. (The type names are those returned by the `JSON_TYPE( )` function.) Types shown together on a line have the same precedence. Any value having a JSON type listed earlier in the list compares greater than any value having a JSON type listed later in the list.

```
BLOB
BIT
OPAQUE
DATETIME
TIME
DATE
BOOLEAN
ARRAY
OBJECT
STRING
INTEGER, DOUBLE
NULL
```

For JSON values of the same precedence, the comparison rules are type specific:

- `BLOB`

The first *N* bytes of the two values are compared, where *N* is the number of bytes in the shorter value. If the first *N* bytes of the two values are identical, the shorter value is ordered before the longer value.

- `BIT`

Same rules as for `BLOB`.

- `OPAQUE`

Same rules as for `BLOB`. `OPAQUE` values are values that are not classified as one of the other types.

- `DATETIME`

A value that represents an earlier point in time is ordered before a value that represents a later point in time. If two values originally come from the MySQL `DATETIME` and `TIMESTAMP` types, respectively, they are equal if they represent the same point in time.

- `TIME`

The smaller of two time values is ordered before the larger one.

- **DATE**

The earlier date is ordered before the more recent date.

- **ARRAY**

Two JSON arrays are equal if they have the same length and values in corresponding positions in the arrays are equal.

If the arrays are not equal, their order is determined by the elements in the first position where there is a difference. The array with the smaller value in that position is ordered first. If all values of the shorter array are equal to the corresponding values in the longer array, the shorter array is ordered first.

Example:

```
[ ] < [ "a" ] < [ "ab" ] < [ "ab", "cd", "ef" ] < [ "ab", "ef" ]
```

- **BOOLEAN**

The JSON false literal is less than the JSON true literal.

- **OBJECT**

Two JSON objects are equal if they have the same set of keys, and each key has the same value in both objects.

Example:

```
{ "a": 1, "b": 2 } = { "b": 2, "a": 1 }
```

The order of two objects that are not equal is unspecified but deterministic.

- **STRING**

Strings are ordered lexically on the first *N* bytes of the `utf8mb4` representation of the two strings being compared, where *N* is the length of the shorter string. If the first *N* bytes of the two strings are identical, the shorter string is considered smaller than the longer string.

Example:

```
"a" < "ab" < "b" < "bc"
```

This ordering is equivalent to the ordering of SQL strings with collation `utf8mb4_bin`. Because `utf8mb4_bin` is a binary collation, comparison of JSON values is case-sensitive:

```
"A" < "a"
```

- **INTEGER, DOUBLE**

JSON values can contain exact-value numbers and approximate-value numbers. For a general discussion of these types of numbers, see [Section 9.1.2, “Numeric Literals”](#).

The rules for comparing native MySQL numeric types are discussed in [Section 12.3, “Type Conversion in Expression Evaluation”](#), but the rules for comparing numbers within JSON values differ somewhat:

- In a comparison between two columns that use the native MySQL `INT` and `DOUBLE` numeric types, respectively, it is known that all comparisons involve an integer and a double, so the integer is converted to double for all rows. That is, exact-value numbers are converted to approximate-value numbers.



- On the other hand, if the query compares two JSON columns containing numbers, it cannot be known in advance whether numbers are integer or double. To provide the most consistent behavior across all rows, MySQL converts approximate-value numbers to exact-value numbers. The resulting ordering is consistent and does not lose precision for the exact-value numbers. For example, given the scalars 9223372036854775805, 9223372036854775806, 9223372036854775807 and 9.223372036854776e18, the order is such as this:

```
9223372036854775805 < 9223372036854775806 < 9223372036854775807
< 9.223372036854776e18 = 9223372036854776000 < 9223372036854776001
```

Were JSON comparisons to use the non-JSON numeric comparison rules, inconsistent ordering could occur. The usual MySQL comparison rules for numbers yield these orderings:

- Integer comparison:

```
9223372036854775805 < 9223372036854775806 < 9223372036854775807
```

(not defined for 9.223372036854776e18)

- Double comparison:

```
9223372036854775805 = 9223372036854775806 = 9223372036854775807 = 9.223372036854776e18
```

For comparison of any JSON value to SQL `NULL`, the result is `UNKNOWN`.

For comparison of JSON and non-JSON values, the non-JSON value is converted to JSON according to the rules in the following table, then the values compared as described previously.

## Converting between JSON and non-JSON values

The following table provides a summary of the rules that MySQL follows when casting between JSON values and values of other types:

**Table 11.3 JSON Conversion Rules**

other type	CAST(other type AS JSON)	CAST(JSON AS other type)
JSON	No change	No change
utf8 character type ( <code>utf8mb4</code> , <code>utf8</code> , <code>ascii</code> )	The string is parsed into a JSON value.	The JSON value is serialized into a <code>utf8mb4</code> string.
Other character types	Other character encodings are implicitly converted to <code>utf8mb4</code> and treated as described for utf8 character type.	The JSON value is serialized into a <code>utf8mb4</code> string, then cast to the other character encoding. The result may not be meaningful.
<code>NULL</code>	Results in a <code>NULL</code> value of type JSON.	Not applicable.
Geometry types	The geometry value is converted into a JSON document by calling <code>ST_AsGeoJSON()</code> .	Illegal operation. Workaround: Pass the result of <code>CAST(json_val AS CHAR)</code> to <code>ST_GeomFromGeoJSON()</code> .
All other types	Results in a JSON document consisting of a single scalar value.	Succeeds if the JSON document consists of a single scalar value of the target type and that scalar value can be cast to the target

other type	CAST(other type AS JSON)	CAST(JSON AS other type)
		type. Otherwise, returns <code>NULL</code> and produces a warning.

`ORDER BY` and `GROUP BY` for JSON values works according to these principles:

- Ordering of scalar JSON values uses the same rules as in the preceding discussion.
- For ascending sorts, SQL `NULL` orders before all JSON values, including the JSON null literal; for descending sorts, SQL `NULL` orders after all JSON values, including the JSON null literal.
- Sort keys for JSON values are bound by the value of the `max_sort_length` system variable, so keys that differ only after the first `max_sort_length` bytes compare as equal.
- Sorting of nonscalar values is not currently supported and a warning occurs.

For sorting, it can be beneficial to cast a JSON scalar to some other native MySQL type. For example, if a column named `jdoc` contains JSON objects having a member consisting of an `id` key and a nonnegative value, use this expression to sort by `id` values:

```
ORDER BY CAST(JSON_EXTRACT(jdoc, '$.id') AS UNSIGNED)
```

If there happens to be a generated column defined to use the same expression as in the `ORDER BY`, the MySQL optimizer recognizes that and considers using the index for the query execution plan. See [Section 8.3.10, “Optimizer Use of Generated Column Indexes”](#).

## Aggregation of JSON Values

For aggregation of JSON values, SQL `NULL` values are ignored as for other data types. Non-`NULL` values are converted to a numeric type and aggregated, except for `MIN()`, `MAX()`, and `GROUP_CONCAT()`.

The conversion to number should produce a meaningful result for JSON values that are numeric scalars, although (depending on the values) truncation and loss of precision may occur. Conversion to number of other JSON values may not produce a meaningful result.

## 11.6 Data Type Default Values

Data type specifications can have explicit or implicit default values.

- [Explicit Default Handling](#)
- [Implicit Default Handling](#)

### Explicit Default Handling

A `DEFAULT value` clause in a data type specification explicitly indicates a default value for a column. Examples:

```
CREATE TABLE t1 (
  i      INT DEFAULT -1,
  c      VARCHAR(10) DEFAULT '',
  price DOUBLE(16,2) DEFAULT '0.00'
);
```

`SERIAL DEFAULT VALUE` is a special case. In the definition of an integer column, it is an alias for `NOT NULL AUTO_INCREMENT UNIQUE`.

With one exception, the default value specified in a `DEFAULT` clause must be a literal constant; it cannot be a function or an expression. This means, for example, that you cannot set the default for a date column to be the value of a function such as `NOW()` or `CURRENT_DATE`. The exception is that, for `TIMESTAMP` and `DATETIME` columns, you can specify `CURRENT_TIMESTAMP` as the default. See [Section 11.2.6, “Automatic Initialization and Updating for `TIMESTAMP` and `DATETIME`”](#).

The `BLOB`, `TEXT`, `GEOMETRY`, and `JSON` data types cannot be assigned a default value.

## Implicit Default Handling

If a data type specification includes no explicit `DEFAULT` value, MySQL determines the default value as follows:

If the column can take `NULL` as a value, the column is defined with an explicit `DEFAULT NULL` clause.

If the column cannot take `NULL` as a value, MySQL defines the column with no explicit `DEFAULT` clause.

For data entry into a `NOT NULL` column that has no explicit `DEFAULT` clause, if an `INSERT` or `REPLACE` statement includes no value for the column, or an `UPDATE` statement sets the column to `NULL`, MySQL handles the column according to the SQL mode in effect at the time:

- If strict SQL mode is enabled, an error occurs for transactional tables and the statement is rolled back. For nontransactional tables, an error occurs, but if this happens for the second or subsequent row of a multiple-row statement, any rows preceding the error have already been inserted.
- If strict mode is not enabled, MySQL sets the column to the implicit default value for the column data type.

Suppose that a table `t` is defined as follows:

```
CREATE TABLE t (i INT NOT NULL);
```

In this case, `i` has no explicit default, so in strict mode each of the following statements produce an error and no row is inserted. When not using strict mode, only the third statement produces an error; the implicit default is inserted for the first two statements, but the third fails because `DEFAULT(i)` cannot produce a value:

```
INSERT INTO t VALUES();
INSERT INTO t VALUES(DEFAULT);
INSERT INTO t VALUES(DEFAULT(i));
```

See [Section 5.1.10, “Server SQL Modes”](#).

For a given table, the `SHOW CREATE TABLE` statement displays which columns have an explicit `DEFAULT` clause.

Implicit defaults are defined as follows:

- For numeric types, the default is `0`, with the exception that for integer or floating-point types declared with the `AUTO_INCREMENT` attribute, the default is the next value in the sequence.
- For date and time types other than `TIMESTAMP`, the default is the appropriate “zero” value for the type. This is also true for `TIMESTAMP` if the `explicit_defaults_for_timestamp` system variable is enabled (see [Section 5.1.7, “Server System Variables”](#)). Otherwise, for the first `TIMESTAMP` column in a table, the default value is the current date and time. See [Section 11.2, “Date and Time Data Types”](#).
- For string types other than `ENUM`, the default value is the empty string. For `ENUM`, the default is the first enumeration value.

## 11.7 Data Type Storage Requirements

- [InnoDB Table Storage Requirements](#)
- [NDB Table Storage Requirements](#)
- [Numeric Type Storage Requirements](#)
- [Date and Time Type Storage Requirements](#)
- [String Type Storage Requirements](#)
- [Spatial Type Storage Requirements](#)
- [JSON Storage Requirements](#)

The storage requirements for table data on disk depend on several factors. Different storage engines represent data types and store raw data differently. Table data might be compressed, either for a column or an entire row, complicating the calculation of storage requirements for a table or column.

Despite differences in storage layout on disk, the internal MySQL APIs that communicate and exchange information about table rows use a consistent data structure that applies across all storage engines.

This section includes guidelines and information for the storage requirements for each data type supported by MySQL, including the internal format and size for storage engines that use a fixed-size representation for data types. Information is listed by category or storage engine.

The internal representation of a table has a maximum row size of 65,535 bytes, even if the storage engine is capable of supporting larger rows. This figure excludes `BLOB` or `TEXT` columns, which contribute only 9 to 12 bytes toward this size. For `BLOB` and `TEXT` data, the information is stored internally in a different area of memory than the row buffer. Different storage engines handle the allocation and storage of this data in different ways, according to the method they use for handling the corresponding types. For more information, see [Chapter 15, \*Alternative Storage Engines\*](#), and [Section 8.4.7, “Limits on Table Column Count and Row Size”](#).

### InnoDB Table Storage Requirements

See [Section 14.11, “InnoDB Row Formats”](#) for information about storage requirements for `InnoDB` tables.

### NDB Table Storage Requirements



#### Important

`NDB` tables use *4-byte alignment*; all `NDB` data storage is done in multiples of 4 bytes. Thus, a column value that would typically take 15 bytes requires 16 bytes in an `NDB` table. For example, in `NDB` tables, the `TINYINT`, `SMALLINT`, `MEDIUMINT`, and `INTEGER (INT)` column types each require 4 bytes storage per record due to the alignment factor.

Each `BIT(M)` column takes  $M$  bits of storage space. Although an individual `BIT` column is *not* 4-byte aligned, `NDB` reserves 4 bytes (32 bits) per row for the first 1-32 bits needed for `BIT` columns, then another 4 bytes for bits 33-64, and so on.

While a `NULL` itself does not require any storage space, `NDB` reserves 4 bytes per row if the table definition contains any columns defined as `NULL`, up to 32 `NULL`

columns. (If an NDB Cluster table is defined with more than 32 `NULL` columns up to 64 `NULL` columns, then 8 bytes per row are reserved.)

Every table using the `NDB` storage engine requires a primary key; if you do not define a primary key, a “hidden” primary key is created by `NDB`. This hidden primary key consumes 31-35 bytes per table record.

You can use the `ndb_size.pl` Perl script to estimate `NDB` storage requirements. It connects to a current MySQL (not NDB Cluster) database and creates a report on how much space that database would require if it used the `NDB` storage engine. See [Section 21.5.28, “ndb\\_size.pl — NDBCLUSTER Size Requirement Estimator”](#) for more information.

## Numeric Type Storage Requirements

Data Type	Storage Required
<code>TINYINT</code>	1 byte
<code>SMALLINT</code>	2 bytes
<code>MEDIUMINT</code>	3 bytes
<code>INT</code> , <code>INTEGER</code>	4 bytes
<code>BIGINT</code>	8 bytes
<code>FLOAT(p)</code>	4 bytes if $0 \leq p \leq 24$ , 8 bytes if $25 \leq p \leq 53$
<code>FLOAT</code>	4 bytes
<code>DOUBLE [PRECISION]</code> , <code>REAL</code>	8 bytes
<code>DECIMAL(M,D)</code> , <code>NUMERIC(M,D)</code>	Varies; see following discussion
<code>BIT(M)</code>	approximately $(M+7)/8$ bytes

Values for `DECIMAL` (and `NUMERIC`) columns are represented using a binary format that packs nine decimal (base 10) digits into four bytes. Storage for the integer and fractional parts of each value are determined separately. Each multiple of nine digits requires four bytes, and the “leftover” digits require some fraction of four bytes. The storage required for excess digits is given by the following table.

Leftover Digits	Number of Bytes
0	0
1	1
2	1
3	2
4	2
5	3
6	3
7	4
8	4

## Date and Time Type Storage Requirements

For `TIME`, `DATETIME`, and `TIMESTAMP` columns, the storage required for tables created before MySQL 5.6.4 differs from tables created from 5.6.4 on. This is due to a change in 5.6.4 that permits these types to have a fractional part, which requires from 0 to 3 bytes.

Data Type	Storage Required Before MySQL 5.6.4	Storage Required as of MySQL 5.6.4
<a href="#">YEAR</a>	1 byte	1 byte
<a href="#">DATE</a>	3 bytes	3 bytes
<a href="#">TIME</a>	3 bytes	3 bytes + fractional seconds storage
<a href="#">DATETIME</a>	8 bytes	5 bytes + fractional seconds storage
<a href="#">TIMESTAMP</a>	4 bytes	4 bytes + fractional seconds storage

As of MySQL 5.6.4, storage for [YEAR](#) and [DATE](#) remains unchanged. However, [TIME](#), [DATETIME](#), and [TIMESTAMP](#) are represented differently. [DATETIME](#) is packed more efficiently, requiring 5 rather than 8 bytes for the nonfractional part, and all three parts have a fractional part that requires from 0 to 3 bytes, depending on the fractional seconds precision of stored values.

Fractional Seconds Precision	Storage Required
0	0 bytes
1, 2	1 byte
3, 4	2 bytes
5, 6	3 bytes

For example, [TIME\(0\)](#), [TIME\(2\)](#), [TIME\(4\)](#), and [TIME\(6\)](#) use 3, 4, 5, and 6 bytes, respectively. [TIME](#) and [TIME\(0\)](#) are equivalent and require the same storage.

For details about internal representation of temporal values, see [MySQL Internals: Important Algorithms and Structures](#).

## String Type Storage Requirements

In the following table, *M* represents the declared column length in characters for nonbinary string types and bytes for binary string types. *L* represents the actual length in bytes of a given string value.

Data Type	Storage Required
<a href="#">CHAR(M)</a>	The compact family of InnoDB row formats optimize storage for variable-length character sets. See <a href="#">COMPACT Row Format Storage Characteristics</a> . Otherwise, $M \times w$ bytes, $0 \leq M \leq 255$ , where <i>w</i> is the number of bytes required for the maximum-length character in the character set.
<a href="#">BINARY(M)</a>	<i>M</i> bytes, $0 \leq M \leq 255$
<a href="#">VARCHAR(M)</a> , <a href="#">VARBINARY(M)</a>	<i>L</i> + 1 bytes if column values require 0 – 255 bytes, <i>L</i> + 2 bytes if values may require more than 255 bytes
<a href="#">TINYBLOB</a> , <a href="#">TINYTEXT</a>	<i>L</i> + 1 bytes, where $L < 2^8$
<a href="#">BLOB</a> , <a href="#">TEXT</a>	<i>L</i> + 2 bytes, where $L < 2^{16}$
<a href="#">MEDIUMBLOB</a> , <a href="#">MEDIUMTEXT</a>	<i>L</i> + 3 bytes, where $L < 2^{24}$

Data Type	Storage Required
<code>LONGBLOB</code> , <code>LONGTEXT</code>	$L + 4$ bytes, where $L < 2^{32}$
<code>ENUM('value1', 'value2', ...)</code>	1 or 2 bytes, depending on the number of enumeration values (65,535 values maximum)
<code>SET('value1', 'value2', ...)</code>	1, 2, 3, 4, or 8 bytes, depending on the number of set members (64 members maximum)

Variable-length string types are stored using a length prefix plus data. The length prefix requires from one to four bytes depending on the data type, and the value of the prefix is  $L$  (the byte length of the string). For example, storage for a `MEDIUMTEXT` value requires  $L$  bytes to store the value plus three bytes to store the length of the value.

To calculate the number of bytes used to store a particular `CHAR`, `VARCHAR`, or `TEXT` column value, you must take into account the character set used for that column and whether the value contains multibyte characters. In particular, when using a `utf8` Unicode character set, you must keep in mind that not all characters use the same number of bytes. `utf8mb3` and `utf8mb4` character sets can require up to three and four bytes per character, respectively. For a breakdown of the storage used for different categories of `utf8mb3` or `utf8mb4` characters, see [Section 10.9, “Unicode Support”](#).

`VARCHAR`, `VARBINARY`, and the `BLOB` and `TEXT` types are variable-length types. For each, the storage requirements depend on these factors:

- The actual length of the column value
- The column's maximum possible length
- The character set used for the column, because some character sets contain multibyte characters

For example, a `VARCHAR(255)` column can hold a string with a maximum length of 255 characters. Assuming that the column uses the `latin1` character set (one byte per character), the actual storage required is the length of the string ( $L$ ), plus one byte to record the length of the string. For the string `'abcd'`,  $L$  is 4 and the storage requirement is five bytes. If the same column is instead declared to use the `ucs2` double-byte character set, the storage requirement is 10 bytes: The length of `'abcd'` is eight bytes and the column requires two bytes to store lengths because the maximum length is greater than 255 (up to 510 bytes).

The effective maximum number of *bytes* that can be stored in a `VARCHAR` or `VARBINARY` column is subject to the maximum row size of 65,535 bytes, which is shared among all columns. For a `VARCHAR` column that stores multibyte characters, the effective maximum number of *characters* is less. For example, `utf8mb3` characters can require up to three bytes per character, so a `VARCHAR` column that uses the `utf8mb3` character set can be declared to be a maximum of 21,844 characters. See [Section 8.4.7, “Limits on Table Column Count and Row Size”](#).

`InnoDB` encodes fixed-length fields greater than or equal to 768 bytes in length as variable-length fields, which can be stored off-page. For example, a `CHAR(255)` column can exceed 768 bytes if the maximum byte length of the character set is greater than 3, as it is with `utf8mb4`.

The `NDB` storage engine supports variable-width columns. This means that a `VARCHAR` column in an `NDB` Cluster table requires the same amount of storage as would any other storage engine, with the exception that such values are 4-byte aligned. Thus, the string `'abcd'` stored in a `VARCHAR(50)` column using the `latin1` character set requires 8 bytes (rather than 5 bytes for the same column value in a `MyISAM` table).

`TEXT`, `BLOB`, and `JSON` columns are implemented differently in the `NDB` storage engine, wherein each row in the column is made up of two separate parts. One of these is of fixed size (256 bytes for `TEXT` and

[BLOB](#), 4000 bytes for [JSON](#)), and is actually stored in the original table. The other consists of any data in excess of 256 bytes, which is stored in a hidden blob parts table. The size of the rows in this second table are determined by the exact type of the column, as shown in the following table:

Type	Blob Part Size
<a href="#">BLOB</a> , <a href="#">TEXT</a>	2000
<a href="#">MEDIUMBLOB</a> , <a href="#">MEDIUMTEXT</a>	4000
<a href="#">LONGBLOB</a> , <a href="#">LONGTEXT</a>	13948
<a href="#">JSON</a>	8100

This means that the size of a [TEXT](#) column is 256 if  $size \leq 256$  (where  $size$  represents the size of the row); otherwise, the size is  $256 + size + (2000 \times (size - 256) \% 2000)$ .

No blob parts are stored separately by [NDB](#) for [TINYBLOB](#) or [TINYTEXT](#) column values.

You can increase the size of an [NDB](#) blob column's blob part to the maximum of 13948 using [NDB\\_COLUMN](#) in a column comment when creating or altering the parent table. See [NDB\\_COLUMN Options](#), for more information.

The size of an [ENUM](#) object is determined by the number of different enumeration values. One byte is used for enumerations with up to 255 possible values. Two bytes are used for enumerations having between 256 and 65,535 possible values. See [Section 11.3.5, "The ENUM Type"](#).

The size of a [SET](#) object is determined by the number of different set members. If the set size is  $N$ , the object occupies  $(N+7) / 8$  bytes, rounded up to 1, 2, 3, 4, or 8 bytes. A [SET](#) can have a maximum of 64 members. See [Section 11.3.6, "The SET Type"](#).

## Spatial Type Storage Requirements

MySQL stores geometry values using 4 bytes to indicate the SRID followed by the WKB representation of the value. The [LENGTH\(\)](#) function returns the space in bytes required for value storage.

For descriptions of WKB and internal storage formats for spatial values, see [Section 11.4.3, "Supported Spatial Data Formats"](#).

## JSON Storage Requirements

In general, the storage requirement for a [JSON](#) column is approximately the same as for a [LONGBLOB](#) or [LONGTEXT](#) column; that is, the space consumed by a JSON document is roughly the same as it would be for the document's string representation stored in a column of one of these types. However, there is an overhead imposed by the binary encoding, including metadata and dictionaries needed for lookup, of the individual values stored in the JSON document. For example, a string stored in a JSON document requires 4 to 10 bytes additional storage, depending on the length of the string and the size of the object or array in which it is stored.

In addition, MySQL imposes a limit on the size of any JSON document stored in a [JSON](#) column such that it cannot be any larger than the value of [max\\_allowed\\_packet](#).

## 11.8 Choosing the Right Type for a Column

For optimum storage, you should try to use the most precise type in all cases. For example, if an integer column is used for values in the range from 1 to 99999, [MEDIUMINT UNSIGNED](#) is the best type. Of the types that represent all the required values, this type uses the least amount of storage.



All basic calculations (+, -, \*, and /) with `DECIMAL` columns are done with precision of 65 decimal (base 10) digits. See [Section 11.1.1, “Numeric Data Type Syntax”](#).

If accuracy is not too important or if speed is the highest priority, the `DOUBLE` type may be good enough. For high precision, you can always convert to a fixed-point type stored in a `BIGINT`. This enables you to do all calculations with 64-bit integers and then convert results back to floating-point values as necessary.

## 11.9 Using Data Types from Other Database Engines

To facilitate the use of code written for SQL implementations from other vendors, MySQL maps data types as shown in the following table. These mappings make it easier to import table definitions from other database systems into MySQL.

Other Vendor Type	MySQL Type
<code>BOOL</code>	<code>TINYINT</code>
<code>BOOLEAN</code>	<code>TINYINT</code>
<code>CHARACTER VARYING(M)</code>	<code>VARCHAR(M)</code>
<code>FIXED</code>	<code>DECIMAL</code>
<code>FLOAT4</code>	<code>FLOAT</code>
<code>FLOAT8</code>	<code>DOUBLE</code>
<code>INT1</code>	<code>TINYINT</code>
<code>INT2</code>	<code>SMALLINT</code>
<code>INT3</code>	<code>MEDIUMINT</code>
<code>INT4</code>	<code>INT</code>
<code>INT8</code>	<code>BIGINT</code>
<code>LONG VARBINARY</code>	<code>MEDIUMBLOB</code>
<code>LONG VARCHAR</code>	<code>MEDIUMTEXT</code>
<code>LONG</code>	<code>MEDIUMTEXT</code>
<code>MIDDLEINT</code>	<code>MEDIUMINT</code>
<code>NUMERIC</code>	<code>DECIMAL</code>

Data type mapping occurs at table creation time, after which the original type specifications are discarded. If you create a table with types used by other vendors and then issue a `DESCRIBE tbl_name` statement, MySQL reports the table structure using the equivalent MySQL types. For example:

```
mysql> CREATE TABLE t (a BOOL, b FLOAT8, c LONG VARCHAR, d NUMERIC);
Query OK, 0 rows affected (0.00 sec)

mysql> DESCRIBE t;
+-----+-----+-----+-----+-----+-----+
| Field | Type          | Null | Key | Default | Extra |
+-----+-----+-----+-----+-----+-----+
| a     | tinyint(1)   | YES  |     | NULL    |       |
| b     | double       | YES  |     | NULL    |       |
| c     | mediumtext   | YES  |     | NULL    |       |
| d     | decimal(10,0)| YES  |     | NULL    |       |
+-----+-----+-----+-----+-----+-----+
4 rows in set (0.01 sec)
```



---

# Chapter 12 Functions and Operators

## Table of Contents

12.1 Built-In Function and Operator Reference .....	1871
12.2 Loadable Function Reference .....	1891
12.3 Type Conversion in Expression Evaluation .....	1893
12.4 Operators .....	1896
12.4.1 Operator Precedence .....	1898
12.4.2 Comparison Functions and Operators .....	1899
12.4.3 Logical Operators .....	1905
12.4.4 Assignment Operators .....	1907
12.5 Flow Control Functions .....	1908
12.6 Numeric Functions and Operators .....	1910
12.6.1 Arithmetic Operators .....	1911
12.6.2 Mathematical Functions .....	1913
12.7 Date and Time Functions .....	1922
12.8 String Functions and Operators .....	1944
12.8.1 String Comparison Functions and Operators .....	1962
12.8.2 Regular Expressions .....	1965
12.8.3 Character Set and Collation of Function Results .....	1971
12.9 Full-Text Search Functions .....	1972
12.9.1 Natural Language Full-Text Searches .....	1973
12.9.2 Boolean Full-Text Searches .....	1977
12.9.3 Full-Text Searches with Query Expansion .....	1983
12.9.4 Full-Text Stopwords .....	1984
12.9.5 Full-Text Restrictions .....	1988
12.9.6 Fine-Tuning MySQL Full-Text Search .....	1989
12.9.7 Adding a User-Defined Collation for Full-Text Indexing .....	1992
12.9.8 ngram Full-Text Parser .....	1993
12.9.9 MeCab Full-Text Parser Plugin .....	1996
12.10 Cast Functions and Operators .....	2000
12.11 XML Functions .....	2007
12.12 Bit Functions and Operators .....	2018
12.13 Encryption and Compression Functions .....	2021
12.14 Locking Functions .....	2033
12.15 Information Functions .....	2035
12.16 Spatial Analysis Functions .....	2045
12.16.1 Spatial Function Reference .....	2045
12.16.2 Argument Handling by Spatial Functions .....	2051
12.16.3 Functions That Create Geometry Values from WKT Values .....	2052
12.16.4 Functions That Create Geometry Values from WKB Values .....	2055
12.16.5 MySQL-Specific Functions That Create Geometry Values .....	2058
12.16.6 Geometry Format Conversion Functions .....	2059
12.16.7 Geometry Property Functions .....	2060
12.16.8 Spatial Operator Functions .....	2069
12.16.9 Functions That Test Spatial Relations Between Geometry Objects .....	2072
12.16.10 Spatial Geohash Functions .....	2078
12.16.11 Spatial GeoJSON Functions .....	2080
12.16.12 Spatial Convenience Functions .....	2082
12.17 JSON Functions .....	2085
12.17.1 JSON Function Reference .....	2085

12.17.2 Functions That Create JSON Values .....	2087
12.17.3 Functions That Search JSON Values .....	2088
12.17.4 Functions That Modify JSON Values .....	2097
12.17.5 Functions That Return JSON Value Attributes .....	2107
12.17.6 JSON Utility Functions .....	2110
12.18 Functions Used with Global Transaction Identifiers (GTIDs) .....	2113
12.19 Aggregate Functions .....	2115
12.19.1 Aggregate Function Descriptions .....	2115
12.19.2 GROUP BY Modifiers .....	2122
12.19.3 MySQL Handling of GROUP BY .....	2126
12.19.4 Detection of Functional Dependence .....	2130
12.20 Miscellaneous Functions .....	2133
12.21 Precision Math .....	2141
12.21.1 Types of Numeric Values .....	2142
12.21.2 DECIMAL Data Type Characteristics .....	2142
12.21.3 Expression Handling .....	2143
12.21.4 Rounding Behavior .....	2145
12.21.5 Precision Math Examples .....	2146

Expressions can be used at several points in [SQL](#) statements, such as in the [ORDER BY](#) or [HAVING](#) clauses of [SELECT](#) statements, in the [WHERE](#) clause of a [SELECT](#), [DELETE](#), or [UPDATE](#) statement, or in [SET](#) statements. Expressions can be written using values from several sources, such as literal values, column values, [NULL](#), variables, built-in functions and operators, loadable functions, and stored functions (a type of stored object).

This chapter describes the built-in functions and operators that are permitted for writing expressions in MySQL. For information about loadable functions and stored functions, see [Section 5.6, “MySQL Server Loadable Functions”](#), and [Section 23.2, “Using Stored Routines”](#). For the rules describing how the server interprets references to different kinds of functions, see [Section 9.2.5, “Function Name Parsing and Resolution”](#).

An expression that contains [NULL](#) always produces a [NULL](#) value unless otherwise indicated in the documentation for a particular function or operator.



### Note

By default, there must be no whitespace between a function name and the parenthesis following it. This helps the MySQL parser distinguish between function calls and references to tables or columns that happen to have the same name as a function. However, spaces around function arguments are permitted.

To tell the MySQL server to accept spaces after function names by starting it with the `--sql-mode=IGNORE_SPACE` option. (See [Section 5.1.10, “Server SQL Modes”](#).) Individual client programs can request this behavior by using the `CLIENT_IGNORE_SPACE` option for `mysql_real_connect()`. In either case, all function names become reserved words.

For the sake of brevity, some examples in this chapter display the output from the `mysql` program in abbreviated form. Rather than showing examples in this format:

```
mysql> SELECT MOD(29,9);
+-----+
| mod(29,9) |
+-----+
|          2 |
+-----+
1 rows in set (0.00 sec)
```

This format is used instead:

```
mysql> SELECT MOD(29,9);
-> 2
```

## 12.1 Built-In Function and Operator Reference

The following table lists each built-in (native) function and operator and provides a short description of each one. For a table listing functions that are loadable at runtime, see [Section 12.2, “Loadable Function Reference”](#).

**Table 12.1 Built-In Functions and Operators**

Name	Description	Introduced	Deprecated
&	Bitwise AND		
>	Greater than operator		
>>	Right shift		
>=	Greater than or equal operator		
<	Less than operator		
<>, !=	Not equal operator		
<<	Left shift		
<=	Less than or equal operator		
<=>	NULL-safe equal to operator		
%, MOD	Modulo operator		
*	Multiplication operator		
+	Addition operator		
-	Minus operator		
-	Change the sign of the argument		
->	Return value from JSON column after evaluating path; equivalent to <code>JSON_EXTRACT()</code> .		
->>	Return value from JSON column after evaluating path and unquoting the result; equivalent to <code>JSON_UNQUOTE(JSON_EXTRACT())</code> .	5.7.13	
/	Division operator		
:=	Assign a value		
=	Assign a value (as part of a <code>SET</code> statement, or as part of the <code>SET</code> clause in an <code>UPDATE</code> statement)		
=	Equal operator		

Name	Description	Introduced	Deprecated
<code>^</code>	Bitwise XOR		
<code>ABS()</code>	Return the absolute value		
<code>ACOS()</code>	Return the arc cosine		
<code>ADDDATE()</code>	Add time values (intervals) to a date value		
<code>ADDTIME()</code>	Add time		
<code>AES_DECRYPT()</code>	Decrypt using AES		
<code>AES_ENCRYPT()</code>	Encrypt using AES		
<code>AND, &amp;&amp;</code>	Logical AND		
<code>ANY_VALUE()</code>	Suppress ONLY_FULL_GROUP_BY value rejection		
<code>Area()</code>	Return Polygon or MultiPolygon area		Yes
<code>AsBinary(), AsWKB()</code>	Convert from internal geometry format to WKB		Yes
<code>ASCII()</code>	Return numeric value of left-most character		
<code>ASIN()</code>	Return the arc sine		
<code>AsText(), AsWKT()</code>	Convert from internal geometry format to WKT		Yes
<code>ATAN()</code>	Return the arc tangent		
<code>ATAN2(), ATAN()</code>	Return the arc tangent of the two arguments		
<code>AVG()</code>	Return the average value of the argument		
<code>BENCHMARK()</code>	Repeatedly execute an expression		
<code>BETWEEN ... AND ...</code>	Whether a value is within a range of values		
<code>BIN()</code>	Return a string containing binary representation of a number		
<code>BINARY</code>	Cast a string to a binary string		
<code>BIT_AND()</code>	Return bitwise AND		
<code>BIT_COUNT()</code>	Return the number of bits that are set		
<code>BIT_LENGTH()</code>	Return length of argument in bits		
<code>BIT_OR()</code>	Return bitwise OR		
<code>BIT_XOR()</code>	Return bitwise XOR		

Name	Description	Introduced	Deprecated
<code>Buffer()</code>	Return geometry of points within given distance from geometry		Yes
<code>CASE</code>	Case operator		
<code>CAST()</code>	Cast a value as a certain type		
<code>CEIL()</code>	Return the smallest integer value not less than the argument		
<code>CEILING()</code>	Return the smallest integer value not less than the argument		
<code>Centroid()</code>	Return centroid as a point		Yes
<code>CHAR()</code>	Return the character for each integer passed		
<code>CHAR_LENGTH()</code>	Return number of characters in argument		
<code>CHARACTER_LENGTH()</code>	Synonym for <code>CHAR_LENGTH()</code>		
<code>CHARSET()</code>	Return the character set of the argument		
<code>COALESCE()</code>	Return the first non-NULL argument		
<code>COERCIBILITY()</code>	Return the collation coercibility value of the string argument		
<code>COLLATION()</code>	Return the collation of the string argument		
<code>COMPRESS()</code>	Return result as a binary string		
<code>CONCAT()</code>	Return concatenated string		
<code>CONCAT_WS()</code>	Return concatenate with separator		
<code>CONNECTION_ID()</code>	Return the connection ID (thread ID) for the connection		
<code>Contains()</code>	Whether MBR of one geometry contains MBR of another		Yes
<code>CONV()</code>	Convert numbers between different number bases		

Name	Description	Introduced	Deprecated
<code>CONVERT()</code>	Cast a value as a certain type		
<code>CONVERT_TZ()</code>	Convert from one time zone to another		
<code>ConvexHull()</code>	Return convex hull of geometry		Yes
<code>COS()</code>	Return the cosine		
<code>COT()</code>	Return the cotangent		
<code>COUNT()</code>	Return a count of the number of rows returned		
<code>COUNT(DISTINCT)</code>	Return the count of a number of different values		
<code>CRC32()</code>	Compute a cyclic redundancy check value		
<code>Crosses()</code>	Whether one geometry crosses another		Yes
<code>CURDATE()</code>	Return the current date		
<code>CURRENT_DATE()</code> , <code>CURRENT_DATE</code>	Synonyms for <code>CURDATE()</code>		
<code>CURRENT_TIME()</code> , <code>CURRENT_TIME</code>	Synonyms for <code>CURTIME()</code>		
<code>CURRENT_TIMESTAMP()</code> , <code>CURRENT_TIMESTAMP</code>	Synonyms for <code>NOW()</code>		
<code>CURRENT_USER()</code> , <code>CURRENT_USER</code>	The authenticated user name and host name		
<code>CURTIME()</code>	Return the current time		
<code>DATABASE()</code>	Return the default (current) database name		
<code>DATE()</code>	Extract the date part of a date or datetime expression		
<code>DATE_ADD()</code>	Add time values (intervals) to a date value		
<code>DATE_FORMAT()</code>	Format date as specified		
<code>DATE_SUB()</code>	Subtract a time value (interval) from a date		
<code>DATEDIFF()</code>	Subtract two dates		
<code>DAY()</code>	Synonym for <code>DAYOFMONTH()</code>		
<code>DAYNAME()</code>	Return the name of the weekday		



<b>Name</b>	<b>Description</b>	<b>Introduced</b>	<b>Deprecated</b>
<code>DAYOFMONTH()</code>	Return the day of the month (0-31)		
<code>DAYOFWEEK()</code>	Return the weekday index of the argument		
<code>DAYOFYEAR()</code>	Return the day of the year (1-366)		
<code>DECODE()</code>	Decode a string encrypted using <code>ENCODE()</code>		Yes
<code>DEFAULT()</code>	Return the default value for a table column		
<code>DEGREES()</code>	Convert radians to degrees		
<code>DES_DECRYPT()</code>	Decrypt a string		Yes
<code>DES_ENCRYPT()</code>	Encrypt a string		Yes
<code>Dimension()</code>	Dimension of geometry		Yes
<code>Disjoint()</code>	Whether MBRs of two geometries are disjoint		Yes
<code>DIV</code>	Integer division		
<code>ELT()</code>	Return string at index number		
<code>ENCODE()</code>	Encode a string		Yes
<code>ENCRYPT()</code>	Encrypt a string		Yes
<code>EndPoint()</code>	End Point of LineString		Yes
<code>Envelope()</code>	Return MBR of geometry		Yes
<code>Equals()</code>	Whether MBRs of two geometries are equal		Yes
<code>EXISTS()</code>	Whether the result of a query contains any rows		
<code>EXP()</code>	Raise to the power of		
<code>EXPORT_SET()</code>	Return a string such that for every bit set in the value bits, you get an on string and for every unset bit, you get an off string		
<code>ExteriorRing()</code>	Return exterior ring of Polygon		Yes
<code>EXTRACT()</code>	Extract part of a date		
<code>ExtractValue()</code>	Extract a value from an XML string using XPath notation		

Name	Description	Introduced	Deprecated
<code>FIELD()</code>	Index (position) of first argument in subsequent arguments		
<code>FIND_IN_SET()</code>	Index (position) of first argument within second argument		
<code>FLOOR()</code>	Return the largest integer value not greater than the argument		
<code>FORMAT()</code>	Return a number formatted to specified number of decimal places		
<code>FOUND_ROWS()</code>	For a SELECT with a LIMIT clause, the number of rows that would be returned were there no LIMIT clause		
<code>FROM_BASE64()</code>	Decode base64 encoded string and return result		
<code>FROM_DAYS()</code>	Convert a day number to a date		
<code>FROM_UNIXTIME()</code>	Format Unix timestamp as a date		
<code>GeomCollFromText()</code> , <code>GeometryCollectionFromText()</code>	Return geometry collection from WKT		Yes
<code>GeomCollFromWKB()</code> , <code>GeometryCollectionFromWKB()</code>	Return geometry collection from WKB		Yes
<code>GeometryCollection()</code>	Construct geometry collection from geometries		
<code>GeometryN()</code>	Return N-th geometry from geometry collection		Yes
<code>GeometryType()</code>	Return name of geometry type		Yes
<code>GeomFromText()</code> , <code>GeometryFromText()</code>	Return geometry from WKT		Yes
<code>GeomFromWKB()</code> , <code>GeometryFromWKB()</code>	Return geometry from WKB		Yes
<code>GET_FORMAT()</code>	Return a date format string		
<code>GET_LOCK()</code>	Get a named lock		
<code>GLength()</code>	Return length of LineString		Yes
<code>GREATEST()</code>	Return the largest argument		

Name	Description	Introduced	Deprecated
GROUP_CONCAT()	Return a concatenated string		
GTID_SUBSET()	Return true if all GTIDs in subset are also in set; otherwise false.		
GTID_SUBTRACT()	Return all GTIDs in set that are not in subset.		
HEX()	Hexadecimal representation of decimal or string value		
HOUR()	Extract the hour		
IF()	If/else construct		
IFNULL()	Null if/else construct		
IN()	Whether a value is within a set of values		
INET_ATON()	Return the numeric value of an IP address		
INET_NTOA()	Return the IP address from a numeric value		
INET6_ATON()	Return the numeric value of an IPv6 address		
INET6_NTOA()	Return the IPv6 address from a numeric value		
INSERT()	Insert substring at specified position up to specified number of characters		
INSTR()	Return the index of the first occurrence of substring		
InteriorRingN()	Return N-th interior ring of Polygon		Yes
Intersects()	Whether MBRs of two geometries intersect		Yes
INTERVAL()	Return the index of the argument that is less than the first argument		
IS	Test a value against a boolean		
IS_FREE_LOCK()	Whether the named lock is free		
IS_IPV4()	Whether argument is an IPv4 address		

Name	Description	Introduced	Deprecated
<code>IS_IPV4_COMPAT()</code>	Whether argument is an IPv4-compatible address		
<code>IS_IPV4_MAPPED()</code>	Whether argument is an IPv4-mapped address		
<code>IS_IPV6()</code>	Whether argument is an IPv6 address		
<code>IS NOT</code>	Test a value against a boolean		
<code>IS NOT NULL</code>	NOT NULL value test		
<code>IS NULL</code>	NULL value test		
<code>IS_USED_LOCK()</code>	Whether the named lock is in use; return connection identifier if true		
<code>IsClosed()</code>	Whether a geometry is closed and simple		Yes
<code>IsEmpty()</code>	Whether a geometry is empty		Yes
<code>ISNULL()</code>	Test whether the argument is NULL		
<code>IsSimple()</code>	Whether a geometry is simple		Yes
<code>JSON_APPEND()</code>	Append data to JSON document		Yes
<code>JSON_ARRAY()</code>	Create JSON array		
<code>JSON_ARRAY_APPEND()</code>	Append data to JSON document		
<code>JSON_ARRAY_INSERT()</code>	Insert into JSON array		
<code>JSON_ARRAYAGG()</code>	Return result set as a single JSON array	5.7.22	
<code>JSON_CONTAINS()</code>	Whether JSON document contains specific object at path		
<code>JSON_CONTAINS_PATH()</code>	Whether JSON document contains any data at path		
<code>JSON_DEPTH()</code>	Maximum depth of JSON document		
<code>JSON_EXTRACT()</code>	Return data from JSON document		
<code>JSON_INSERT()</code>	Insert data into JSON document		
<code>JSON_KEYS()</code>	Array of keys from JSON document		

Name	Description	Introduced	Deprecated
<code>JSON_LENGTH()</code>	Number of elements in JSON document		
<code>JSON_MERGE()</code>	Merge JSON documents, preserving duplicate keys. Deprecated synonym for <code>JSON_MERGE_PRESERVE()</code>		5.7.22
<code>JSON_MERGE_PATCH()</code>	Merge JSON documents, replacing values of duplicate keys	5.7.22	
<code>JSON_MERGE_PRESERVE()</code>	Merge JSON documents, preserving duplicate keys	5.7.22	
<code>JSON_OBJECT()</code>	Create JSON object		
<code>JSON_OBJECTAGG()</code>	Return result set as a single JSON object	5.7.22	
<code>JSON_PRETTY()</code>	Print a JSON document in human-readable format	5.7.22	
<code>JSON_QUOTE()</code>	Quote JSON document		
<code>JSON_REMOVE()</code>	Remove data from JSON document		
<code>JSON_REPLACE()</code>	Replace values in JSON document		
<code>JSON_SEARCH()</code>	Path to value within JSON document		
<code>JSON_SET()</code>	Insert data into JSON document		
<code>JSON_STORAGE_SIZE()</code>	Space used for storage of binary representation of a JSON document	5.7.22	
<code>JSON_TYPE()</code>	Type of JSON value		
<code>JSON_UNQUOTE()</code>	Unquote JSON value		
<code>JSON_VALID()</code>	Whether JSON value is valid		
<code>LAST_DAY</code>	Return the last day of the month for the argument		
<code>LAST_INSERT_ID()</code>	Value of the AUTOINCREMENT column for the last INSERT		
<code>LCASE()</code>	Synonym for <code>LOWER()</code>		
<code>LEAST()</code>	Return the smallest argument		

Name	Description	Introduced	Deprecated
<code>LEFT()</code>	Return the leftmost number of characters as specified		
<code>LENGTH()</code>	Return the length of a string in bytes		
<code>LIKE</code>	Simple pattern matching		
<code>LineFromText()</code> , <code>LineStringFromText()</code>	Construct LineString from WKT		Yes
<code>LineFromWKB()</code> , <code>LineStringFromWKB()</code>	Construct LineString from WKB		Yes
<code>LineString()</code>	Construct LineString from Point values		
<code>LN()</code>	Return the natural logarithm of the argument		
<code>LOAD_FILE()</code>	Load the named file		
<code>LOCALTIME()</code> , <code>LOCALTIME</code>	Synonym for NOW()		
<code>LOCALTIMESTAMP()</code> , <code>LOCALTIMESTAMP()</code>	Synonym for NOW()		
<code>LOCATE()</code>	Return the position of the first occurrence of substring		
<code>LOG()</code>	Return the natural logarithm of the first argument		
<code>LOG10()</code>	Return the base-10 logarithm of the argument		
<code>LOG2()</code>	Return the base-2 logarithm of the argument		
<code>LOWER()</code>	Return the argument in lowercase		
<code>LPAD()</code>	Return the string argument, left-padded with the specified string		
<code>LTRIM()</code>	Remove leading spaces		
<code>MAKE_SET()</code>	Return a set of comma-separated strings that have the corresponding bit in bits set		
<code>MAKEDATE()</code>	Create a date from the year and day of year		
<code>MAKETIME()</code>	Create time from hour, minute, second		

Name	Description	Introduced	Deprecated
<code>MASTER_POS_WAIT()</code>	Block until the replica has read and applied all updates up to the specified position		
<code>MATCH()</code>	Perform full-text search		
<code>MAX()</code>	Return the maximum value		
<code>MBRContains()</code>	Whether MBR of one geometry contains MBR of another		
<code>MBRCoveredBy()</code>	Whether one MBR is covered by another		
<code>MBRCovers()</code>	Whether one MBR covers another		
<code>MBRDisjoint()</code>	Whether MBRs of two geometries are disjoint		
<code>MBREqual()</code>	Whether MBRs of two geometries are equal		Yes
<code>MBREquals()</code>	Whether MBRs of two geometries are equal		
<code>MBRIntersects()</code>	Whether MBRs of two geometries intersect		
<code>MBROverlaps()</code>	Whether MBRs of two geometries overlap		
<code>MBRTouches()</code>	Whether MBRs of two geometries touch		
<code>MBRWithin()</code>	Whether MBR of one geometry is within MBR of another		
<code>MD5()</code>	Calculate MD5 checksum		
<code>MICROSECOND()</code>	Return the microseconds from argument		
<code>MID()</code>	Return a substring starting from the specified position		
<code>MIN()</code>	Return the minimum value		
<code>MINUTE()</code>	Return the minute from the argument		
<code>MLineFromText(), MultiLineStringFromText()</code>	Construct MultiLineString from WKT		Yes
<code>MLineFromWKB(), MultiLineStringFromWKB()</code>	Construct MultiLineString from WKB		Yes
<code>MOD()</code>	Return the remainder		

Name	Description	Introduced	Deprecated
<code>MONTH()</code>	Return the month from the date passed		
<code>MONTHNAME()</code>	Return the name of the month		
<code>MPointFromText()</code> , <code>MultiPointFromText()</code>	Construct MultiPoint from WKT		Yes
<code>MPointFromWKB()</code> , <code>MultiPointFromWKB()</code>	Construct MultiPoint from WKB		Yes
<code>MPolyFromText()</code> , <code>MultiPolygonFromText()</code>	Construct MultiPolygon from WKT		Yes
<code>MPolyFromWKB()</code> , <code>MultiPolygonFromWKB()</code>	Construct MultiPolygon from WKB		Yes
<code>MultiLineString()</code>	Construct MultiLineString from LineString values		
<code>MultiPoint()</code>	Construct MultiPoint from Point values		
<code>MultiPolygon()</code>	Construct MultiPolygon from Polygon values		
<code>NAME_CONST()</code>	Cause the column to have the given name		
<code>NOT, !</code>	Negates value		
<code>NOT BETWEEN ... AND ...</code>	Whether a value is not within a range of values		
<code>NOT EXISTS()</code>	Whether the result of a query contains no rows		
<code>NOT IN()</code>	Whether a value is not within a set of values		
<code>NOT LIKE</code>	Negation of simple pattern matching		
<code>NOT REGEXP</code>	Negation of REGEXP		
<code>NOW()</code>	Return the current date and time		
<code>NULLIF()</code>	Return NULL if expr1 = expr2		
<code>NumGeometries()</code>	Return number of geometries in geometry collection		Yes
<code>NumInteriorRings()</code>	Return number of interior rings in Polygon		Yes
<code>NumPoints()</code>	Return number of points in LineString		Yes
<code>OCT()</code>	Return a string containing octal representation of a number		



Name	Description	Introduced	Deprecated
<code>OCTET_LENGTH()</code>	Synonym for <code>LENGTH()</code>		
<code>OR,   </code>	Logical OR		
<code>ORD()</code>	Return character code for leftmost character of the argument		
<code>Overlaps()</code>	Whether MBRs of two geometries overlap		Yes
<code>PASSWORD()</code>	Calculate and return a password string		Yes
<code>PERIOD_ADD()</code>	Add a period to a year-month		
<code>PERIOD_DIFF()</code>	Return the number of months between periods		
<code>PI()</code>	Return the value of pi		
<code>Point()</code>	Construct Point from coordinates		
<code>PointFromText()</code>	Construct Point from WKT		Yes
<code>PointFromWKB()</code>	Construct Point from WKB		Yes
<code>PointN()</code>	Return N-th point from LineString		Yes
<code>PolyFromText()</code> , <code>PolygonFromText()</code>	Construct Polygon from WKT		Yes
<code>PolyFromWKB()</code> , <code>PolygonFromWKB()</code>	Construct Polygon from WKB		Yes
<code>Polygon()</code>	Construct Polygon from LineString arguments		
<code>POSITION()</code>	Synonym for <code>LOCATE()</code>		
<code>POW()</code>	Return the argument raised to the specified power		
<code>POWER()</code>	Return the argument raised to the specified power		
<code>PROCEDURE ANALYSE()</code>	Analyze the results of a query		5.7.18
<code>QUARTER()</code>	Return the quarter from a date argument		
<code>QUOTE()</code>	Escape the argument for use in an SQL statement		
<code>RADIANS()</code>	Return argument converted to radians		

Name	Description	Introduced	Deprecated
<code>RAND()</code>	Return a random floating-point value		
<code>RANDOM_BYTES()</code>	Return a random byte vector		
<code>REGEXP</code>	Whether string matches regular expression		
<code>RELEASE_ALL_LOCKS()</code>	Release all current named locks		
<code>RELEASE_LOCK()</code>	Release the named lock		
<code>REPEAT()</code>	Repeat a string the specified number of times		
<code>REPLACE()</code>	Replace occurrences of a specified string		
<code>REVERSE()</code>	Reverse the characters in a string		
<code>RIGHT()</code>	Return the specified rightmost number of characters		
<code>RLIKE</code>	Whether string matches regular expression		
<code>ROUND()</code>	Round the argument		
<code>ROW_COUNT()</code>	The number of rows updated		
<code>RPAD()</code>	Append string the specified number of times		
<code>RTRIM()</code>	Remove trailing spaces		
<code>SCHEMA()</code>	Synonym for <code>DATABASE()</code>		
<code>SEC_TO_TIME()</code>	Converts seconds to 'hh:mm:ss' format		
<code>SECOND()</code>	Return the second (0-59)		
<code>SESSION_USER()</code>	Synonym for <code>USER()</code>		
<code>SHA1()</code> , <code>SHA()</code>	Calculate an SHA-1 160-bit checksum		
<code>SHA2()</code>	Calculate an SHA-2 checksum		
<code>SIGN()</code>	Return the sign of the argument		
<code>SIN()</code>	Return the sine of the argument		
<code>SLEEP()</code>	Sleep for a number of seconds		
<code>SOUNDEX()</code>	Return a soundex string		

Name	Description	Introduced	Deprecated
<code>SOUNDS LIKE</code>	Compare sounds		
<code>SPACE()</code>	Return a string of the specified number of spaces		
<code>Distance()</code>	The distance of one geometry from another		Yes
<code>SQRT()</code>	Return the square root of the argument		
<code>SRID()</code>	Return spatial reference system ID for geometry		Yes
<code>ST_Area()</code>	Return Polygon or MultiPolygon area		
<code>ST_AsBinary()</code> , <code>ST_AsWKB()</code>	Convert from internal geometry format to WKB		
<code>ST_AsGeoJSON()</code>	Generate GeoJSON object from geometry		
<code>ST_AsText()</code> , <code>ST_AsWKT()</code>	Convert from internal geometry format to WKT		
<code>ST_Buffer()</code>	Return geometry of points within given distance from geometry		
<code>ST_Buffer_Strategy()</code>	Produce strategy option for <code>ST_Buffer()</code>		
<code>ST_Centroid()</code>	Return centroid as a point		
<code>ST_Contains()</code>	Whether one geometry contains another		
<code>ST_ConvexHull()</code>	Return convex hull of geometry		
<code>ST_Crosses()</code>	Whether one geometry crosses another		
<code>ST_Difference()</code>	Return point set difference of two geometries		
<code>ST_Dimension()</code>	Dimension of geometry		
<code>ST_Disjoint()</code>	Whether one geometry is disjoint from another		
<code>ST_Distance()</code>	The distance of one geometry from another		
<code>ST_Distance_Sphere()</code>	Minimum distance on earth between two geometries		
<code>ST_EndPoint()</code>	End Point of LineString		
<code>ST_Envelope()</code>	Return MBR of geometry		

Name	Description	Introduced	Deprecated
<code>ST_Equals()</code>	Whether one geometry is equal to another		
<code>ST_ExteriorRing()</code>	Return exterior ring of Polygon		
<code>ST_GeoHash()</code>	Produce a geohash value		
<code>ST_GeomCollFromText()</code> , <code>ST_GeometryCollectionFromWKT()</code> , <code>ST_GeomCollFromText()</code>	Return geometry collection from WKT		
<code>ST_GeomCollFromWKB()</code> , <code>ST_GeometryCollectionFromWKB()</code>	Return geometry collection from WKB		
<code>ST_GeometryN()</code>	Return N-th geometry from geometry collection		
<code>ST_GeometryType()</code>	Return name of geometry type		
<code>ST_GeomFromGeoJSON()</code>	Generate geometry from GeoJSON object		
<code>ST_GeomFromText()</code> , <code>ST_GeometryFromText()</code>	Return geometry from WKT		
<code>ST_GeomFromWKB()</code> , <code>ST_GeometryFromWKB()</code>	Return geometry from WKB		
<code>ST_InteriorRingN()</code>	Return N-th interior ring of Polygon		
<code>ST_Intersection()</code>	Return point set intersection of two geometries		
<code>ST_Intersects()</code>	Whether one geometry intersects another		
<code>ST_IsClosed()</code>	Whether a geometry is closed and simple		
<code>ST_IsEmpty()</code>	Whether a geometry is empty		
<code>ST_IsSimple()</code>	Whether a geometry is simple		
<code>ST_IsValid()</code>	Whether a geometry is valid		
<code>ST_LatFromGeoHash()</code>	Return latitude from geohash value		
<code>ST_Length()</code>	Return length of LineString		
<code>ST_LineFromText()</code> , <code>ST_LineStringFromText()</code>	Construct LineString from WKT		
<code>ST_LineFromWKB()</code> , <code>ST_LineStringFromWKB()</code>	Construct LineString from WKB		

Name	Description	Introduced	Deprecated
<code>ST_LongFromGeoHash()</code>	Return longitude from geohash value		
<code>ST_MakeEnvelope()</code>	Rectangle around two points		
<code>ST_MLineFromText()</code> , <code>ST_MultiLineStringFromWKT()</code>	Construct MultiLineString from WKT		
<code>ST_MLineFromWKB()</code> , <code>ST_MultiLineStringFromWKB()</code>	Construct MultiLineString from WKB		
<code>ST_MPointFromText()</code> , <code>ST_MultiPointFromText()</code>	Construct MultiPoint from WKT		
<code>ST_MPointFromWKB()</code> , <code>ST_MultiPointFromWKB()</code>	Construct MultiPoint from WKB		
<code>ST_MPolyFromText()</code> , <code>ST_MultiPolygonFromText()</code>	Construct MultiPolygon from WKT		
<code>ST_MPolyFromWKB()</code> , <code>ST_MultiPolygonFromWKB()</code>	Construct MultiPolygon from WKB		
<code>ST_NumGeometries()</code>	Return number of geometries in geometry collection		
<code>ST_NumInteriorRing()</code> , <code>ST_NumInteriorRings()</code>	Return number of interior rings in Polygon		
<code>ST_NumPoints()</code>	Return number of points in LineString		
<code>ST_Overlaps()</code>	Whether one geometry overlaps another		
<code>ST_PointFromGeoHash()</code>	Convert geohash value to POINT value		
<code>ST_PointFromText()</code>	Construct Point from WKT		
<code>ST_PointFromWKB()</code>	Construct Point from WKB		
<code>ST_PointN()</code>	Return N-th point from LineString		
<code>ST_PolyFromText()</code> , <code>ST_PolygonFromText()</code>	Construct Polygon from WKT		
<code>ST_PolyFromWKB()</code> , <code>ST_PolygonFromWKB()</code>	Construct Polygon from WKB		
<code>ST_Simplify()</code>	Return simplified geometry		
<code>ST_SRID()</code>	Return spatial reference system ID for geometry		
<code>ST_StartPoint()</code>	Start Point of LineString		

Name	Description	Introduced	Deprecated
<code>ST_SymDifference()</code>	Return point set symmetric difference of two geometries		
<code>ST_Touches()</code>	Whether one geometry touches another		
<code>ST_Union()</code>	Return point set union of two geometries		
<code>ST_Validate()</code>	Return validated geometry		
<code>ST_Within()</code>	Whether one geometry is within another		
<code>ST_X()</code>	Return X coordinate of Point		
<code>ST_Y()</code>	Return Y coordinate of Point		
<code>StartPoint()</code>	Start Point of LineString		Yes
<code>STD()</code>	Return the population standard deviation		
<code>STDDEV()</code>	Return the population standard deviation		
<code>STDDEV_POP()</code>	Return the population standard deviation		
<code>STDDEV_SAMP()</code>	Return the sample standard deviation		
<code>STR_TO_DATE()</code>	Convert a string to a date		
<code>STRCMP()</code>	Compare two strings		
<code>SUBDATE()</code>	Synonym for <code>DATE_SUB()</code> when invoked with three arguments		
<code>SUBSTR()</code>	Return the substring as specified		
<code>SUBSTRING()</code>	Return the substring as specified		
<code>SUBSTRING_INDEX()</code>	Return a substring from a string before the specified number of occurrences of the delimiter		
<code>SUBTIME()</code>	Subtract times		
<code>SUM()</code>	Return the sum		
<code>SYSDATE()</code>	Return the time at which the function executes		
<code>SYSTEM_USER()</code>	Synonym for <code>USER()</code>		

Name	Description	Introduced	Deprecated
<code>TAN()</code>	Return the tangent of the argument		
<code>TIME()</code>	Extract the time portion of the expression passed		
<code>TIME_FORMAT()</code>	Format as time		
<code>TIME_TO_SEC()</code>	Return the argument converted to seconds		
<code>TIMEDIFF()</code>	Subtract time		
<code>TIMESTAMP()</code>	With a single argument, this function returns the date or datetime expression; with two arguments, the sum of the arguments		
<code>TIMESTAMPADD()</code>	Add an interval to a datetime expression		
<code>TIMESTAMPDIFF()</code>	Return the difference of two datetime expressions, using the units specified		
<code>TO_BASE64()</code>	Return the argument converted to a base-64 string		
<code>TO_DAYS()</code>	Return the date argument converted to days		
<code>TO_SECONDS()</code>	Return the date or datetime argument converted to seconds since Year 0		
<code>Touches()</code>	Whether one geometry touches another		Yes
<code>TRIM()</code>	Remove leading and trailing spaces		
<code>TRUNCATE()</code>	Truncate to specified number of decimal places		
<code>UCASE()</code>	Synonym for UPPER()		
<code>UNCOMPRESS()</code>	Uncompress a string compressed		
<code>UNCOMPRESSED_LENGTH()</code>	Return the length of a string before compression		
<code>UNHEX()</code>	Return a string containing hex representation of a number		
<code>UNIX_TIMESTAMP()</code>	Return a Unix timestamp		

Name	Description	Introduced	Deprecated
<code>UpdateXML()</code>	Return replaced XML fragment		
<code>UPPER()</code>	Convert to uppercase		
<code>USER()</code>	The user name and host name provided by the client		
<code>UTC_DATE()</code>	Return the current UTC date		
<code>UTC_TIME()</code>	Return the current UTC time		
<code>UTC_TIMESTAMP()</code>	Return the current UTC date and time		
<code>UUID()</code>	Return a Universal Unique Identifier (UUID)		
<code>UUID_SHORT()</code>	Return an integer-valued universal identifier		
<code>VALIDATE_PASSWORD_STRENGTH()</code>	Determine strength of password		
<code>VALUES()</code>	Define the values to be used during an INSERT		
<code>VAR_POP()</code>	Return the population standard variance		
<code>VAR_SAMP()</code>	Return the sample variance		
<code>VARIANCE()</code>	Return the population standard variance		
<code>VERSION()</code>	Return a string that indicates the MySQL server version		
<code>WAIT_FOR_EXECUTED_GTIDS()</code>	Wait until the given GTIDs have executed on the replica.		
<code>WAIT_UNTIL_SQL_THREAD_AFTER_GTIDS()</code>	Use <code>WAIT_FOR_EXECUTED_GTID_SET()</code> .		
<code>WEEK()</code>	Return the week number		
<code>WEEKDAY()</code>	Return the weekday index		
<code>WEEKOFYEAR()</code>	Return the calendar week of the date (1-53)		
<code>WEIGHT_STRING()</code>	Return the weight string for a string		
<code>Within()</code>	Whether MBR of one geometry is within MBR of another		Yes



Name	Description	Introduced	Deprecated
<code>X()</code>	Return X coordinate of Point		Yes
<code>XOR</code>	Logical XOR		
<code>Y()</code>	Return Y coordinate of Point		Yes
<code>YEAR()</code>	Return the year		
<code>YEARWEEK()</code>	Return the year and week		
<code> </code>	Bitwise OR		
<code>~</code>	Bitwise inversion		

## 12.2 Loadable Function Reference

The following table lists each function that is loadable at runtime and provides a short description of each one. For a table listing built-in functions and operators, see [Section 12.1, “Built-In Function and Operator Reference”](#)

For general information about loadable functions, see [Section 5.6, “MySQL Server Loadable Functions”](#).

**Table 12.2 Loadable Functions**

Name	Description
<code>asymmetric_decrypt()</code>	Decrypt ciphertext using private or public key
<code>asymmetric_derive()</code>	Derive symmetric key from asymmetric keys
<code>asymmetric_encrypt()</code>	Encrypt cleartext using private or public key
<code>asymmetric_sign()</code>	Generate signature from digest
<code>asymmetric_verify()</code>	Verify that signature matches digest
<code>audit_log_encryption_password_get()</code>	Fetch audit log encryption password
<code>audit_log_encryption_password_set()</code>	Set audit log encryption password
<code>audit_log_filter_flush()</code>	Flush audit log filter tables
<code>audit_log_filter_remove_filter()</code>	Remove audit log filter
<code>audit_log_filter_remove_user()</code>	Unassign audit log filter from user
<code>audit_log_filter_set_filter()</code>	Define audit log filter
<code>audit_log_filter_set_user()</code>	Assign audit log filter to user
<code>audit_log_read()</code>	Return audit log records
<code>audit_log_read_bookmark()</code>	Bookmark for most recent audit log event
<code>create_asymmetric_priv_key()</code>	Create private key
<code>create_asymmetric_pub_key()</code>	Create public key
<code>create_dh_parameters()</code>	Generate shared DH secret
<code>create_digest()</code>	Generate digest from string
<code>flush_rewrite_rules()</code>	Load <code>rewrite_rules</code> table into Rewriter cache
<code>gen_blacklist()</code>	Perform dictionary term replacement
<code>gen_dictionary_drop()</code>	Remove dictionary from registry

## Loadable Function Reference

Name	Description
<code>gen_dictionary_load()</code>	Load dictionary into registry
<code>gen_dictionary()</code>	Return random term from dictionary
<code>gen_range()</code>	Generate random number within range
<code>gen_rnd_email()</code>	Generate random email address
<code>gen_rnd_pan()</code>	Generate random payment card Primary Account Number
<code>gen_rnd_ssn()</code>	Generate random US Social Security Number
<code>gen_rnd_us_phone()</code>	Generate random US phone number
<code>keyring_aws_rotate_cmk()</code>	Rotate AWS customer master key
<code>keyring_aws_rotate_keys()</code>	Rotate keys in keyring_aws storage file
<code>keyring_key_fetch()</code>	Fetch keyring key value
<code>keyring_key_generate()</code>	Generate random keyring key
<code>keyring_key_length_fetch()</code>	Return keyring key length
<code>keyring_key_remove()</code>	Remove keyring key
<code>keyring_key_store()</code>	Store key in keyring
<code>keyring_key_type_fetch()</code>	Return keyring key type
<code>load_rewrite_rules()</code>	Rewriter plugin helper routine
<code>mask_inner()</code>	Mask interior part of string
<code>mask_outer()</code>	Mask left and right parts of string
<code>mask_pan()</code>	Mask payment card Primary Account Number part of string
<code>mask_pan_relaxed()</code>	Mask payment card Primary Account Number part of string
<code>mask_ssn()</code>	Mask US Social Security Number
<code>mysql_firewall_flush_status()</code>	Reset firewall status variables
<code>normalize_statement()</code>	Normalize SQL statement to digest form
<code>read_firewall_users()</code>	Update firewall account profile cache
<code>read_firewall_whitelist()</code>	Update firewall account profile recorded-statement cache
<code>service_get_read_locks()</code>	Acquire locking service shared locks
<code>service_get_write_locks()</code>	Acquire locking service exclusive locks
<code>service_release_locks()</code>	Release locking service locks
<code>set_firewall_mode()</code>	Establish firewall account profile operational mode
<code>version_tokens_delete()</code>	Delete tokens from version tokens list
<code>version_tokens_edit()</code>	Modify version tokens list
<code>version_tokens_lock_exclusive()</code>	Acquire exclusive locks on version tokens
<code>version_tokens_lock_shared()</code>	Acquire shared locks on version tokens
<code>version_tokens_set()</code>	Set version tokens list
<code>version_tokens_show()</code>	Return version tokens list

Name	Description
<code>version_tokens_unlock()</code>	Release version tokens locks

## 12.3 Type Conversion in Expression Evaluation

When an operator is used with operands of different types, type conversion occurs to make the operands compatible. Some conversions occur implicitly. For example, MySQL automatically converts strings to numbers as necessary, and vice versa.

```
mysql> SELECT 1+'1';
-> 2
mysql> SELECT CONCAT(2,' test');
-> '2 test'
```

It is also possible to convert a number to a string explicitly using the `CAST()` function. Conversion occurs implicitly with the `CONCAT()` function because it expects string arguments.

```
mysql> SELECT 38.8, CAST(38.8 AS CHAR);
-> 38.8, '38.8'
mysql> SELECT 38.8, CONCAT(38.8);
-> 38.8, '38.8'
```

See later in this section for information about the character set of implicit number-to-string conversions, and for modified rules that apply to `CREATE TABLE ... SELECT` statements.

The following rules describe how conversion occurs for comparison operations:

- If one or both arguments are `NULL`, the result of the comparison is `NULL`, except for the `NULL`-safe `<=>` equality comparison operator. For `NULL <=> NULL`, the result is true. No conversion is needed.
- If both arguments in a comparison operation are strings, they are compared as strings.
- If both arguments are integers, they are compared as integers.
- Hexadecimal values are treated as binary strings if not compared to a number.
- If one of the arguments is a `TIMESTAMP` or `DATETIME` column and the other argument is a constant, the constant is converted to a timestamp before the comparison is performed. This is done to be more ODBC-friendly. This is not done for the arguments to `IN()`. To be safe, always use complete datetime, date, or time strings when doing comparisons. For example, to achieve best results when using `BETWEEN` with date or time values, use `CAST()` to explicitly convert the values to the desired data type.

A single-row subquery from a table or tables is not considered a constant. For example, if a subquery returns an integer to be compared to a `DATETIME` value, the comparison is done as two integers. The integer is not converted to a temporal value. To compare the operands as `DATETIME` values, use `CAST()` to explicitly convert the subquery value to `DATETIME`.

- If one of the arguments is a decimal value, comparison depends on the other argument. The arguments are compared as decimal values if the other argument is a decimal or integer value, or as floating-point values if the other argument is a floating-point value.
- In all other cases, the arguments are compared as floating-point (double-precision) numbers. For example, a comparison of string and numeric operands takes place as a comparison of floating-point numbers.

For information about conversion of values from one temporal type to another, see [Section 11.2.9, “Conversion Between Date and Time Types”](#).

Comparison of JSON values takes place at two levels. The first level of comparison is based on the JSON types of the compared values. If the types differ, the comparison result is determined solely by which type has higher precedence. If the two values have the same JSON type, a second level of comparison occurs using type-specific rules. For comparison of JSON and non-JSON values, the non-JSON value is converted to JSON and the values compared as JSON values. For details, see [Comparison and Ordering of JSON Values](#).

The following examples illustrate conversion of strings to numbers for comparison operations:

```
mysql> SELECT 1 > '6x';
-> 0
mysql> SELECT 7 > '6x';
-> 1
mysql> SELECT 0 > 'x6';
-> 0
mysql> SELECT 0 = 'x6';
-> 1
```

For comparisons of a string column with a number, MySQL cannot use an index on the column to look up the value quickly. If `str_col` is an indexed string column, the index cannot be used when performing the lookup in the following statement:

```
SELECT * FROM tbl_name WHERE str_col=1;
```

The reason for this is that there are many different strings that may convert to the value 1, such as '1', '1 ', or '1a'.

Another issue can arise when comparing a string column with integer 0. Consider table `t1` created and populated as shown here:

```
mysql> CREATE TABLE t1 (
->   c1 INT NOT NULL AUTO_INCREMENT,
->   c2 INT DEFAULT NULL,
->   c3 VARCHAR(25) DEFAULT NULL,
->   PRIMARY KEY (c1)
-> );
Query OK, 0 rows affected (0.03 sec)

mysql> INSERT INTO t1 VALUES ROW(1, 52, 'grape'), ROW(2, 139, 'apple'),
->                               ROW(3, 37, 'peach'), ROW(4, 221, 'watermelon'),
->                               ROW(5, 83, 'pear');
Query OK, 5 rows affected (0.01 sec)
Records: 5  Duplicates: 0  Warnings: 0
```

Observe the result when selecting from this table and comparing `c3`, which is a `VARCHAR` column, with integer 0:

```
mysql> SELECT * FROM t1 WHERE c3 = 0;
+-----+
| c1 | c2 | c3 |
+-----+
| 1 | 52 | grape |
| 2 | 139 | apple |
| 3 | 37 | peach |
| 4 | 221 | watermelon |
| 5 | 83 | pear |
+-----+
5 rows in set, 5 warnings (0.00 sec)
```

*This occurs even when using strict SQL mode.* To prevent this from happening, quote the value, as shown here:

```
mysql> SELECT * FROM t1 WHERE c3 = '0';
Empty set (0.00 sec)
```

This does *not* occur when `SELECT` is part of a data definition statement such as `CREATE TABLE ... SELECT`; in strict mode, the statement fails due to the invalid comparison:

```
mysql> CREATE TABLE t2 SELECT * FROM t1 WHERE c3 = 0;
ERROR 1292 (22007): Truncated incorrect DOUBLE value: 'grape'
```

When the `0` is quoted, the statement succeeds, but the table created contains no rows because there were none matching `'0'`, as shown here:

```
mysql> CREATE TABLE t2 SELECT * FROM t1 WHERE c3 = '0';
Query OK, 0 rows affected (0.03 sec)
Records: 0 Duplicates: 0 Warnings: 0

mysql> SELECT * FROM t2;
Empty set (0.00 sec)
```

This is a known issue, which is due to the fact that strict mode is not applied when processing `SELECT`. See also [Strict SQL Mode](#).

Comparisons between floating-point numbers and large integer values are approximate because the integer is converted to double-precision floating point before comparison, which is not capable of representing all 64-bit integers exactly. For example, the integer value  $2^{53} + 1$  is not representable as a float, and is rounded to  $2^{53}$  or  $2^{53} + 2$  before a float comparison, depending on the platform.

To illustrate, only the first of the following comparisons compares equal values, but both comparisons return true (1):

```
mysql> SELECT '9223372036854775807' = 9223372036854775807;
-> 1
mysql> SELECT '9223372036854775807' = 9223372036854775806;
-> 1
```

When conversions from string to floating-point and from integer to floating-point occur, they do not necessarily occur the same way. The integer may be converted to floating-point by the CPU, whereas the string is converted digit by digit in an operation that involves floating-point multiplications. Also, results can be affected by factors such as computer architecture or the compiler version or optimization level. One way to avoid such problems is to use `CAST()` so that a value is not converted implicitly to a float-point number:

```
mysql> SELECT CAST('9223372036854775807' AS UNSIGNED) = 9223372036854775806;
-> 0
```

For more information about floating-point comparisons, see [Section B.3.4.8, “Problems with Floating-Point Values”](#).

The server includes `dtoa`, a conversion library that provides the basis for improved conversion between string or `DECIMAL` values and approximate-value (`FLOAT/DOUBLE`) numbers:

- Consistent conversion results across platforms, which eliminates, for example, Unix versus Windows conversion differences.
- Accurate representation of values in cases where results previously did not provide sufficient precision, such as for values close to IEEE limits.
- Conversion of numbers to string format with the best possible precision. The precision of `dtoa` is always the same or better than that of the standard C library functions.

Because the conversions produced by this library differ in some cases from non-`dtoa` results, the potential exists for incompatibilities in applications that rely on previous results. For example, applications that depend on a specific exact result from previous conversions might need adjustment to accommodate additional precision.

The `dtoa` library provides conversions with the following properties. `D` represents a value with a `DECIMAL` or string representation, and `F` represents a floating-point number in native binary (IEEE) format.

- `F` -> `D` conversion is done with the best possible precision, returning `D` as the shortest string that yields `F` when read back in and rounded to the nearest value in native binary format as specified by IEEE.
- `D` -> `F` conversion is done such that `F` is the nearest native binary number to the input decimal string `D`.

These properties imply that `F` -> `D` -> `F` conversions are lossless unless `F` is `-inf`, `+inf`, or `NaN`. The latter values are not supported because the SQL standard defines them as invalid values for `FLOAT` or `DOUBLE`.

For `D` -> `F` -> `D` conversions, a sufficient condition for losslessness is that `D` uses 15 or fewer digits of precision, is not a denormal value, `-inf`, `+inf`, or `NaN`. In some cases, the conversion is lossless even if `D` has more than 15 digits of precision, but this is not always the case.

Implicit conversion of a numeric or temporal value to string produces a value that has a character set and collation determined by the `character_set_connection` and `collation_connection` system variables. (These variables commonly are set with `SET NAMES`. For information about connection character sets, see [Section 10.4, "Connection Character Sets and Collations"](#).)

This means that such a conversion results in a character (nonbinary) string (a `CHAR`, `VARCHAR`, or `LONGTEXT` value), except in the case that the connection character set is set to `binary`. In that case, the conversion result is a binary string (a `BINARY`, `VARBINARY`, or `LONGBLOB` value).

For integer expressions, the preceding remarks about expression *evaluation* apply somewhat differently for expression *assignment*; for example, in a statement such as this:

```
CREATE TABLE t SELECT integer_expr;
```

In this case, the table in the column resulting from the expression has type `INT` or `BIGINT` depending on the length of the integer expression. If the maximum length of the expression does not fit in an `INT`, `BIGINT` is used instead. The length is taken from the `max_length` value of the `SELECT` result set metadata (see [C API Basic Data Structures](#)). This means that you can force a `BIGINT` rather than `INT` by use of a sufficiently long expression:

```
CREATE TABLE t SELECT 0000000000000000000000000000000000;
```

## 12.4 Operators

Table 12.3 Operators

Name	Description	Introduced
&	Bitwise AND	
>	Greater than operator	
>>	Right shift	
>=	Greater than or equal operator	
<	Less than operator	
<>, !=	Not equal operator	
<<	Left shift	
<=	Less than or equal operator	
<=>	NULL-safe equal to operator	
%, MOD	Modulo operator	
*	Multiplication operator	

## Operators

Name	Description	Introduced
+	Addition operator	
-	Minus operator	
-	Change the sign of the argument	
->	Return value from JSON column after evaluating path; equivalent to JSON_EXTRACT().	
->>	Return value from JSON column after evaluating path and unquoting the result; equivalent to JSON_UNQUOTE(JSON_EXTRACT()).	5.7.13
/	Division operator	
:=	Assign a value	
=	Assign a value (as part of a <a href="#">SET</a> statement, or as part of the <a href="#">SET</a> clause in an <a href="#">UPDATE</a> statement)	
=	Equal operator	
^	Bitwise XOR	
AND, &&	Logical AND	
BETWEEN ... AND ...	Whether a value is within a range of values	
BINARY	Cast a string to a binary string	
CASE	Case operator	
DIV	Integer division	
EXISTS()	Whether the result of a query contains any rows	
IN()	Whether a value is within a set of values	
IS	Test a value against a boolean	
IS NOT	Test a value against a boolean	
IS NOT NULL	NOT NULL value test	
IS NULL	NULL value test	
LIKE	Simple pattern matching	
NOT, !	Negates value	
NOT BETWEEN ... AND ...	Whether a value is not within a range of values	
NOT EXISTS()	Whether the result of a query contains no rows	
NOT IN()	Whether a value is not within a set of values	
NOT LIKE	Negation of simple pattern matching	
NOT REGEXP	Negation of REGEXP	

Name	Description	Introduced
OR,	Logical OR	
REGEXP	Whether string matches regular expression	
RLIKE	Whether string matches regular expression	
SOUNDS LIKE	Compare sounds	
XOR	Logical XOR	
	Bitwise OR	
~	Bitwise inversion	

## 12.4.1 Operator Precedence

Operator precedences are shown in the following list, from highest precedence to the lowest. Operators that are shown together on a line have the same precedence.

```

INTERVAL
BINARY, COLLATE
!
- (unary minus), ~ (unary bit inversion)
^
*, /, DIV, %, MOD
-, +
<<, >>
&
|
= (comparison), <=>, >=, >, <=, <, <>, !=, IS, LIKE, REGEXP, IN
BETWEEN, CASE, WHEN, THEN, ELSE
NOT
AND, &&
XOR
OR, ||
= (assignment), :=

```

The precedence of = depends on whether it is used as a comparison operator (=) or as an assignment operator (:=). When used as a comparison operator, it has the same precedence as <=>, >=, >, <=, <, <>, !=, IS, LIKE, REGEXP, and IN(). When used as an assignment operator, it has the same precedence as :=. [Section 13.7.4.1, “SET Syntax for Variable Assignment”](#), and [Section 9.4, “User-Defined Variables”](#), explain how MySQL determines which interpretation of = should apply.

For operators that occur at the same precedence level within an expression, evaluation proceeds left to right, with the exception that assignments evaluate right to left.

The precedence and meaning of some operators depends on the SQL mode:

- By default, || is a logical OR operator. With `PIPES_AS_CONCAT` enabled, || is string concatenation, with a precedence between ^ and the unary operators.
- By default, ! has a higher precedence than NOT. With `HIGH_NOT_PRECEDENCE` enabled, ! and NOT have the same precedence.

See [Section 5.1.10, “Server SQL Modes”](#).

The precedence of operators determines the order of evaluation of terms in an expression. To override this order and group terms explicitly, use parentheses. For example:



```
mysql> SELECT 1+2*3;
-> 7
mysql> SELECT (1+2)*3;
-> 9
```

## 12.4.2 Comparison Functions and Operators

Table 12.4 Comparison Operators

Name	Description
>	Greater than operator
>=	Greater than or equal operator
<	Less than operator
<>, !=	Not equal operator
<=	Less than or equal operator
<=>	NULL-safe equal to operator
=	Equal operator
BETWEEN ... AND ...	Whether a value is within a range of values
COALESCE()	Return the first non-NULL argument
EXISTS()	Whether the result of a query contains any rows
GREATEST()	Return the largest argument
IN()	Whether a value is within a set of values
INTERVAL()	Return the index of the argument that is less than the first argument
IS	Test a value against a boolean
IS NOT	Test a value against a boolean
IS NOT NULL	NOT NULL value test
IS NULL	NULL value test
ISNULL()	Test whether the argument is NULL
LEAST()	Return the smallest argument
LIKE	Simple pattern matching
NOT BETWEEN ... AND ...	Whether a value is not within a range of values
NOT EXISTS()	Whether the result of a query contains no rows
NOT IN()	Whether a value is not within a set of values
NOT LIKE	Negation of simple pattern matching
STRCMP()	Compare two strings

Comparison operations result in a value of 1 (TRUE), 0 (FALSE), or NULL. These operations work for both numbers and strings. Strings are automatically converted to numbers and numbers to strings as necessary.

The following relational comparison operators can be used to compare not only scalar operands, but row operands:

```
= > < >= <= <> !=
```

The descriptions for those operators later in this section detail how they work with row operands. For additional examples of row comparisons in the context of row subqueries, see [Section 13.2.10.5, “Row Subqueries”](#).

Some of the functions in this section return values other than 1 (TRUE), 0 (FALSE), or NULL. `LEAST()` and `GREATEST()` are examples of such functions; [Section 12.3, “Type Conversion in Expression Evaluation”](#), describes the rules for comparison operations performed by these and similar functions for determining their return values.

To convert a value to a specific type for comparison purposes, you can use the `CAST()` function. String values can be converted to a different character set using `CONVERT()`. See [Section 12.10, “Cast Functions and Operators”](#).

By default, string comparisons are not case-sensitive and use the current character set. The default is `latin1` (cp1252 West European), which also works well for English.

- =

Equal:

```
mysql> SELECT 1 = 0;
-> 0
mysql> SELECT '0' = 0;
-> 1
mysql> SELECT '0.0' = 0;
-> 1
mysql> SELECT '0.01' = 0;
-> 0
mysql> SELECT '.01' = 0.01;
-> 1
```

For row comparisons,  $(a, b) = (x, y)$  is equivalent to:

```
(a = x) AND (b = y)
```

- <=>

NULL-safe equal. This operator performs an equality comparison like the `=` operator, but returns 1 rather than NULL if both operands are NULL, and 0 rather than NULL if one operand is NULL.

The `<=>` operator is equivalent to the standard SQL `IS NOT DISTINCT FROM` operator.

```
mysql> SELECT 1 <=> 1, NULL <=> NULL, 1 <=> NULL;
-> 1, 1, 0
mysql> SELECT 1 = 1, NULL = NULL, 1 = NULL;
-> 1, NULL, NULL
```

For row comparisons,  $(a, b) <=> (x, y)$  is equivalent to:

```
(a <=> x) AND (b <=> y)
```

- <>, !=

Not equal:

```
mysql> SELECT '.01' <> '0.01';
-> 1
mysql> SELECT .01 <> '0.01';
-> 0
mysql> SELECT 'zapp' <> 'zappp';
```

```
-> 1
```

For row comparisons,  $(a, b) <> (x, y)$  and  $(a, b) \neq (x, y)$  are equivalent to:

```
(a <> x) OR (b <> y)
```

- `<=`

Less than or equal:

```
mysql> SELECT 0.1 <= 2;
-> 1
```

For row comparisons,  $(a, b) \leq (x, y)$  is equivalent to:

```
(a < x) OR ((a = x) AND (b <= y))
```

- `<`

Less than:

```
mysql> SELECT 2 < 2;
-> 0
```

For row comparisons,  $(a, b) < (x, y)$  is equivalent to:

```
(a < x) OR ((a = x) AND (b < y))
```

- `>=`

Greater than or equal:

```
mysql> SELECT 2 >= 2;
-> 1
```

For row comparisons,  $(a, b) \geq (x, y)$  is equivalent to:

```
(a > x) OR ((a = x) AND (b >= y))
```

- `>`

Greater than:

```
mysql> SELECT 2 > 2;
-> 0
```

For row comparisons,  $(a, b) > (x, y)$  is equivalent to:

```
(a > x) OR ((a = x) AND (b > y))
```

- `expr BETWEEN min AND max`

If `expr` is greater than or equal to `min` and `expr` is less than or equal to `max`, `BETWEEN` returns 1, otherwise it returns 0. This is equivalent to the expression `(min <= expr AND expr <= max)` if all the arguments are of the same type. Otherwise type conversion takes place according to the rules described in [Section 12.3, “Type Conversion in Expression Evaluation”](#), but applied to all the three arguments.

```
mysql> SELECT 2 BETWEEN 1 AND 3, 2 BETWEEN 3 and 1;
-> 1, 0
mysql> SELECT 1 BETWEEN 2 AND 3;
-> 0
```

```
mysql> SELECT 'b' BETWEEN 'a' AND 'c';
-> 1
mysql> SELECT 2 BETWEEN 2 AND '3';
-> 1
mysql> SELECT 2 BETWEEN 2 AND 'x-3';
-> 0
```

For best results when using `BETWEEN` with date or time values, use `CAST()` to explicitly convert the values to the desired data type. Examples: If you compare a `DATETIME` to two `DATE` values, convert the `DATE` values to `DATETIME` values. If you use a string constant such as `'2001-1-1'` in a comparison to a `DATE`, cast the string to a `DATE`.

- `expr NOT BETWEEN min AND max`

This is the same as `NOT (expr BETWEEN min AND max)`.

- `COALESCE(value, ...)`

Returns the first non-`NULL` value in the list, or `NULL` if there are no non-`NULL` values.

The return type of `COALESCE()` is the aggregated type of the argument types.

```
mysql> SELECT COALESCE(NULL,1);
-> 1
mysql> SELECT COALESCE(NULL,NULL,NULL);
-> NULL
```

- `EXISTS(query)`

Whether the result of a query contains any rows.

```
CREATE TABLE t (col VARCHAR(3));
INSERT INTO t VALUES ('aaa', 'bbb', 'ccc', 'eee');

SELECT EXISTS (SELECT * FROM t WHERE col LIKE 'c%');
-> 1

SELECT EXISTS (SELECT * FROM t WHERE col LIKE 'd%');
-> 0
```

- `NOT EXISTS(query)`

Whether the result of a query contains no rows:

```
SELECT NOT EXISTS (SELECT * FROM t WHERE col LIKE 'c%');
-> 0

SELECT NOT EXISTS (SELECT * FROM t WHERE col LIKE 'd%');
-> 1
```

- `GREATEST(value1,value2,...)`

With two or more arguments, returns the largest (maximum-valued) argument. The arguments are compared using the same rules as for `LEAST()`.

```
mysql> SELECT GREATEST(2,0);
-> 2
mysql> SELECT GREATEST(34.0,3.0,5.0,767.0);
-> 767.0
mysql> SELECT GREATEST('B','A','C');
-> 'C'
```

`GREATEST()` returns `NULL` if any argument is `NULL`.

- `expr IN (value, ...)`

Returns 1 (true) if `expr` is equal to any of the values in the `IN()` list, else returns 0 (false).

Type conversion takes place according to the rules described in [Section 12.3, “Type Conversion in Expression Evaluation”](#), applied to all the arguments. If no type conversion is needed for the values in the `IN()` list, they are all constants of the same type, and `expr` can be compared to each of them as a value of the same type (possibly after type conversion), an optimization takes place. The values the list are sorted and the search for `expr` is done using a binary search, which makes the `IN()` operation very quick.

```
mysql> SELECT 2 IN (0,3,5,7);
-> 0
mysql> SELECT 'wefwf' IN ('wee','wefwf','weg');
-> 1
```

`IN()` can be used to compare row constructors:

```
mysql> SELECT (3,4) IN ((1,2), (3,4));
-> 1
mysql> SELECT (3,4) IN ((1,2), (3,5));
-> 0
```

You should never mix quoted and unquoted values in an `IN()` list because the comparison rules for quoted values (such as strings) and unquoted values (such as numbers) differ. Mixing types may therefore lead to inconsistent results. For example, do not write an `IN()` expression like this:

```
SELECT val1 FROM tbl1 WHERE val1 IN (1,2,'a');
```

Instead, write it like this:

```
SELECT val1 FROM tbl1 WHERE val1 IN ('1','2','a');
```

Implicit type conversion may produce nonintuitive results:

```
mysql> SELECT 'a' IN (0), 0 IN ('b');
-> 1, 1
```

In both cases, the comparison values are converted to floating-point values, yielding 0.0 in each case, and a comparison result of 1 (true).

The number of values in the `IN()` list is only limited by the `max_allowed_packet` value.

To comply with the SQL standard, `IN()` returns `NULL` not only if the expression on the left hand side is `NULL`, but also if no match is found in the list and one of the expressions in the list is `NULL`.

`IN()` syntax can also be used to write certain types of subqueries. See [Section 13.2.10.3, “Subqueries with ANY, IN, or SOME”](#).

- `expr NOT IN (value, ...)`

This is the same as `NOT (expr IN (value, ...))`.

- `INTERVAL(N,N1,N2,N3,...)`

Returns 0 if  $N \leq N1$ , 1 if  $N \leq N2$  and so on, or -1 if  $N$  is `NULL`. All arguments are treated as integers. It is required that  $N1 \leq N2 \leq N3 \leq \dots \leq Nn$  for this function to work correctly. This is because a binary search is used (very fast).

```
mysql> SELECT INTERVAL(23, 1, 15, 17, 30, 44, 200);
```

```

-> 3
mysql> SELECT INTERVAL(10, 1, 10, 100, 1000);
-> 2
mysql> SELECT INTERVAL(22, 23, 30, 44, 200);
-> 0

```

- `IS boolean_value`

Tests a value against a boolean value, where `boolean_value` can be `TRUE`, `FALSE`, or `UNKNOWN`.

```

mysql> SELECT 1 IS TRUE, 0 IS FALSE, NULL IS UNKNOWN;
-> 1, 1, 1

```

- `IS NOT boolean_value`

Tests a value against a boolean value, where `boolean_value` can be `TRUE`, `FALSE`, or `UNKNOWN`.

```

mysql> SELECT 1 IS NOT UNKNOWN, 0 IS NOT UNKNOWN, NULL IS NOT UNKNOWN;
-> 1, 1, 0

```

- `IS NULL`

Tests whether a value is `NULL`.

```

mysql> SELECT 1 IS NULL, 0 IS NULL, NULL IS NULL;
-> 0, 0, 1

```

To work well with ODBC programs, MySQL supports the following extra features when using `IS NULL`:

- If `sql_auto_is_null` variable is set to 1, then after a statement that successfully inserts an automatically generated `AUTO_INCREMENT` value, you can find that value by issuing a statement of the following form:

```
SELECT * FROM tbl_name WHERE auto_col IS NULL
```

If the statement returns a row, the value returned is the same as if you invoked the `LAST_INSERT_ID()` function. For details, including the return value after a multiple-row insert, see [Section 12.15, “Information Functions”](#). If no `AUTO_INCREMENT` value was successfully inserted, the `SELECT` statement returns no row.

The behavior of retrieving an `AUTO_INCREMENT` value by using an `IS NULL` comparison can be disabled by setting `sql_auto_is_null = 0`. See [Section 5.1.7, “Server System Variables”](#).

The default value of `sql_auto_is_null` is 0.

- For `DATE` and `DATETIME` columns that are declared as `NOT NULL`, you can find the special date `'0000-00-00'` by using a statement like this:

```
SELECT * FROM tbl_name WHERE date_column IS NULL
```

This is needed to get some ODBC applications to work because ODBC does not support a `'0000-00-00'` date value.

See [Obtaining Auto-Increment Values](#), and the description for the `FLAG_AUTO_IS_NULL` option at [Connector/ODBC Connection Parameters](#).

- `IS NOT NULL`

Tests whether a value is not `NULL`.

```
mysql> SELECT 1 IS NOT NULL, 0 IS NOT NULL, NULL IS NOT NULL;
```

```
-> 1, 1, 0
```

- `ISNULL(expr)`

If `expr` is `NULL`, `ISNULL()` returns 1, otherwise it returns 0.

```
mysql> SELECT ISNULL(1+1);
-> 0
mysql> SELECT ISNULL(1/0);
-> 1
```

`ISNULL()` can be used instead of `=` to test whether a value is `NULL`. (Comparing a value to `NULL` using `=` always yields `NULL`.)

The `ISNULL()` function shares some special behaviors with the `IS NULL` comparison operator. See the description of `IS NULL`.

- `LEAST(value1,value2,...)`

With two or more arguments, returns the smallest (minimum-valued) argument. The arguments are compared using the following rules:

- If any argument is `NULL`, the result is `NULL`. No comparison is needed.
- If all arguments are integer-valued, they are compared as integers.
- If at least one argument is double precision, they are compared as double-precision values. Otherwise, if at least one argument is a `DECIMAL` value, they are compared as `DECIMAL` values.
- If the arguments comprise a mix of numbers and strings, they are compared as numbers.
- If any argument is a nonbinary (character) string, the arguments are compared as nonbinary strings.
- In all other cases, the arguments are compared as binary strings.

The return type of `LEAST()` is the aggregated type of the comparison argument types.

```
mysql> SELECT LEAST(2,0);
-> 0
mysql> SELECT LEAST(34.0,3.0,5.0,767.0);
-> 3.0
mysql> SELECT LEAST('B','A','C');
-> 'A'
```

## 12.4.3 Logical Operators

**Table 12.5 Logical Operators**

Name	Description
<code>AND, &amp;&amp;</code>	Logical AND
<code>NOT, !</code>	Negates value
<code>OR,   </code>	Logical OR
<code>XOR</code>	Logical XOR

In SQL, all logical operators evaluate to `TRUE`, `FALSE`, or `NULL` (`UNKNOWN`). In MySQL, these are implemented as 1 (`TRUE`), 0 (`FALSE`), and `NULL`. Most of this is common to different SQL database servers, although some servers may return any nonzero value for `TRUE`.

MySQL evaluates any nonzero, non-NULL value to `TRUE`. For example, the following statements all assess to `TRUE`:

```
mysql> SELECT 10 IS TRUE;
-> 1
mysql> SELECT -10 IS TRUE;
-> 1
mysql> SELECT 'string' IS NOT NULL;
-> 1
```

- `NOT, !`

Logical NOT. Evaluates to `1` if the operand is `0`, to `0` if the operand is nonzero, and `NOT NULL` returns `NULL`.

```
mysql> SELECT NOT 10;
-> 0
mysql> SELECT NOT 0;
-> 1
mysql> SELECT NOT NULL;
-> NULL
mysql> SELECT ! (1+1);
-> 0
mysql> SELECT ! 1+1;
-> 1
```

The last example produces `1` because the expression evaluates the same way as `(!1)+1`.

- `AND, &&`

Logical AND. Evaluates to `1` if all operands are nonzero and not `NULL`, to `0` if one or more operands are `0`, otherwise `NULL` is returned.

```
mysql> SELECT 1 AND 1;
-> 1
mysql> SELECT 1 AND 0;
-> 0
mysql> SELECT 1 AND NULL;
-> NULL
mysql> SELECT 0 AND NULL;
-> 0
mysql> SELECT NULL AND 0;
-> 0
```

- `OR, ||`

Logical OR. When both operands are non-NULL, the result is `1` if any operand is nonzero, and `0` otherwise. With a `NULL` operand, the result is `1` if the other operand is nonzero, and `NULL` otherwise. If both operands are `NULL`, the result is `NULL`.

```
mysql> SELECT 1 OR 1;
-> 1
mysql> SELECT 1 OR 0;
-> 1
mysql> SELECT 0 OR 0;
-> 0
mysql> SELECT 0 OR NULL;
-> NULL
mysql> SELECT 1 OR NULL;
-> 1
```



**Note**

If the `PIPES_AS_CONCAT` SQL mode is enabled, `||` signifies the SQL-standard string concatenation operator (like `CONCAT()`).

- `XOR`

Logical XOR. Returns `NULL` if either operand is `NULL`. For non-`NULL` operands, evaluates to `1` if an odd number of operands is nonzero, otherwise `0` is returned.

```
mysql> SELECT 1 XOR 1;
-> 0
mysql> SELECT 1 XOR 0;
-> 1
mysql> SELECT 1 XOR NULL;
-> NULL
mysql> SELECT 1 XOR 1 XOR 1;
-> 1
```

`a XOR b` is mathematically equal to `(a AND (NOT b)) OR ((NOT a) and b)`.

## 12.4.4 Assignment Operators

**Table 12.6 Assignment Operators**

Name	Description
<code>:=</code>	Assign a value
<code>=</code>	Assign a value (as part of a <code>SET</code> statement, or as part of the <code>SET</code> clause in an <code>UPDATE</code> statement)

- `:=`

Assignment operator. Causes the user variable on the left hand side of the operator to take on the value to its right. The value on the right hand side may be a literal value, another variable storing a value, or any legal expression that yields a scalar value, including the result of a query (provided that this value is a scalar value). You can perform multiple assignments in the same `SET` statement. You can perform multiple assignments in the same statement.

Unlike `=`, the `:=` operator is never interpreted as a comparison operator. This means you can use `:=` in any valid SQL statement (not just in `SET` statements) to assign a value to a variable.

```
mysql> SELECT @var1, @var2;
-> NULL, NULL
mysql> SELECT @var1 := 1, @var2;
-> 1, NULL
mysql> SELECT @var1, @var2;
-> 1, NULL
mysql> SELECT @var1, @var2 := @var1;
-> 1, 1
mysql> SELECT @var1, @var2;
-> 1, 1

mysql> SELECT @var1:=COUNT(*) FROM t1;
-> 4
mysql> SELECT @var1;
-> 4
```

You can make value assignments using `:=` in other statements besides `SELECT`, such as `UPDATE`, as shown here:

```
mysql> SELECT @var1;
-> 4
mysql> SELECT * FROM t1;
-> 1, 3, 5, 7

mysql> UPDATE t1 SET c1 = 2 WHERE c1 = @var1:= 1;
Query OK, 1 row affected (0.00 sec)
Rows matched: 1 Changed: 1 Warnings: 0

mysql> SELECT @var1;
-> 1
mysql> SELECT * FROM t1;
-> 2, 3, 5, 7
```

While it is also possible both to set and to read the value of the same variable in a single SQL statement using the `:=` operator, this is not recommended. [Section 9.4, “User-Defined Variables”](#), explains why you should avoid doing this.

- =

This operator is used to perform value assignments in two cases, described in the next two paragraphs.

Within a `SET` statement, `=` is treated as an assignment operator that causes the user variable on the left hand side of the operator to take on the value to its right. (In other words, when used in a `SET` statement, `=` is treated identically to `:=`.) The value on the right hand side may be a literal value, another variable storing a value, or any legal expression that yields a scalar value, including the result of a query (provided that this value is a scalar value). You can perform multiple assignments in the same `SET` statement.

In the `SET` clause of an `UPDATE` statement, `=` also acts as an assignment operator; in this case, however, it causes the column named on the left hand side of the operator to assume the value given to the right, provided any `WHERE` conditions that are part of the `UPDATE` are met. You can make multiple assignments in the same `SET` clause of an `UPDATE` statement.

In any other context, `=` is treated as a [comparison operator](#).

```
mysql> SELECT @var1, @var2;
-> NULL, NULL
mysql> SELECT @var1 := 1, @var2;
-> 1, NULL
mysql> SELECT @var1, @var2;
-> 1, NULL
mysql> SELECT @var1, @var2 := @var1;
-> 1, 1
mysql> SELECT @var1, @var2;
-> 1, 1
```

For more information, see [Section 13.7.4.1, “SET Syntax for Variable Assignment”](#), [Section 13.2.11, “UPDATE Statement”](#), and [Section 13.2.10, “Subqueries”](#).

## 12.5 Flow Control Functions

**Table 12.7 Flow Control Operators**

Name	Description
<code>CASE</code>	Case operator
<code>IF()</code>	If/else construct
<code>IFNULL()</code>	Null if/else construct

Name	Description
NULLIF()	Return NULL if <code>expr1 = expr2</code>

- `CASE value WHEN compare_value THEN result [WHEN compare_value THEN result ...] [ELSE result] END`

`CASE WHEN condition THEN result [WHEN condition THEN result ...] [ELSE result] END`

The first `CASE` syntax returns the `result` for the first `value=compare_value` comparison that is true. The second syntax returns the result for the first condition that is true. If no comparison or condition is true, the result after `ELSE` is returned, or `NULL` if there is no `ELSE` part.



#### Note

The syntax of the `CASE operator` described here differs slightly from that of the SQL `CASE statement` described in [Section 13.6.5.1, “CASE Statement”](#), for use inside stored programs. The `CASE` statement cannot have an `ELSE NULL` clause, and it is terminated with `END CASE` instead of `END`.

The return type of a `CASE` expression result is the aggregated type of all result values.

```
mysql> SELECT CASE 1 WHEN 1 THEN 'one'
->      WHEN 2 THEN 'two' ELSE 'more' END;
-> 'one'
mysql> SELECT CASE WHEN 1>0 THEN 'true' ELSE 'false' END;
-> 'true'
mysql> SELECT CASE BINARY 'B'
->      WHEN 'a' THEN 1 WHEN 'b' THEN 2 END;
-> NULL
```

- `IF(expr1,expr2,expr3)`

If `expr1` is `TRUE` (`expr1 <> 0` and `expr1 IS NOT NULL`), `IF()` returns `expr2`. Otherwise, it returns `expr3`.



#### Note

There is also an `IF statement`, which differs from the `IF()` function described here. See [Section 13.6.5.2, “IF Statement”](#).

If only one of `expr2` or `expr3` is explicitly `NULL`, the result type of the `IF()` function is the type of the non-`NULL` expression.

The default return type of `IF()` (which may matter when it is stored into a temporary table) is calculated as follows:

- If `expr2` or `expr3` produce a string, the result is a string.
  - If `expr2` and `expr3` are both strings, the result is case-sensitive if either string is case-sensitive.
- If `expr2` or `expr3` produce a floating-point value, the result is a floating-point value.
- If `expr2` or `expr3` produce an integer, the result is an integer.

```
mysql> SELECT IF(1>2,2,3);
-> 3
mysql> SELECT IF(1<2,'yes','no');
-> 'yes'
```

```
mysql> SELECT IF(STRCMP('test','test1'),'no','yes');
-> 'no'
```

- `IFNULL(expr1,expr2)`

If `expr1` is not `NULL`, `IFNULL()` returns `expr1`; otherwise it returns `expr2`.

```
mysql> SELECT IFNULL(1,0);
-> 1
mysql> SELECT IFNULL(NULL,10);
-> 10
mysql> SELECT IFNULL(1/0,10);
-> 10
mysql> SELECT IFNULL(1/0,'yes');
-> 'yes'
```

The default return type of `IFNULL(expr1,expr2)` is the more “general” of the two expressions, in the order `STRING`, `REAL`, or `INTEGER`. Consider the case of a table based on expressions or where MySQL must internally store a value returned by `IFNULL()` in a temporary table:

```
mysql> CREATE TABLE tmp SELECT IFNULL(1,'test') AS test;
mysql> DESCRIBE tmp;
+-----+-----+-----+-----+-----+-----+
| Field | Type          | Null | Key | Default | Extra |
+-----+-----+-----+-----+-----+-----+
| test  | varbinary(4) | NO   |     |         |       |
+-----+-----+-----+-----+-----+-----+
```

In this example, the type of the `test` column is `VARBINARY(4)` (a string type).

- `NULLIF(expr1,expr2)`

Returns `NULL` if `expr1 = expr2` is true, otherwise returns `expr1`. This is the same as `CASE WHEN expr1 = expr2 THEN NULL ELSE expr1 END`.

The return value has the same type as the first argument.

```
mysql> SELECT NULLIF(1,1);
-> NULL
mysql> SELECT NULLIF(1,2);
-> 1
```



**Note**

MySQL evaluates `expr1` twice if the arguments are not equal.

## 12.6 Numeric Functions and Operators

Table 12.8 Numeric Functions and Operators

Name	Description
<code>%</code> , <code>MOD</code>	Modulo operator
<code>*</code>	Multiplication operator
<code>+</code>	Addition operator
<code>-</code>	Minus operator
<code>-</code>	Change the sign of the argument
<code>/</code>	Division operator

Name	Description
ABS ( )	Return the absolute value
ACOS ( )	Return the arc cosine
ASIN ( )	Return the arc sine
ATAN ( )	Return the arc tangent
ATAN2 ( ), ATAN ( )	Return the arc tangent of the two arguments
CEIL ( )	Return the smallest integer value not less than the argument
CEILING ( )	Return the smallest integer value not less than the argument
CONV ( )	Convert numbers between different number bases
COS ( )	Return the cosine
COT ( )	Return the cotangent
CRC32 ( )	Compute a cyclic redundancy check value
DEGREES ( )	Convert radians to degrees
DIV	Integer division
EXP ( )	Raise to the power of
FLOOR ( )	Return the largest integer value not greater than the argument
LN ( )	Return the natural logarithm of the argument
LOG ( )	Return the natural logarithm of the first argument
LOG10 ( )	Return the base-10 logarithm of the argument
LOG2 ( )	Return the base-2 logarithm of the argument
MOD ( )	Return the remainder
PI ( )	Return the value of pi
POW ( )	Return the argument raised to the specified power
POWER ( )	Return the argument raised to the specified power
RADIANS ( )	Return argument converted to radians
RAND ( )	Return a random floating-point value
ROUND ( )	Round the argument
SIGN ( )	Return the sign of the argument
SIN ( )	Return the sine of the argument
SQRT ( )	Return the square root of the argument
TAN ( )	Return the tangent of the argument
TRUNCATE ( )	Truncate to specified number of decimal places

## 12.6.1 Arithmetic Operators

Table 12.9 Arithmetic Operators

Name	Description
%, MOD	Modulo operator

Name	Description
*	Multiplication operator
+	Addition operator
-	Minus operator
-	Change the sign of the argument
/	Division operator
DIV	Integer division

The usual arithmetic operators are available. The result is determined according to the following rules:

- In the case of `-`, `+`, and `*`, the result is calculated with `BIGINT` (64-bit) precision if both operands are integers.
- If both operands are integers and any of them are unsigned, the result is an unsigned integer. For subtraction, if the `NO_UNSIGNED_SUBTRACTION` SQL mode is enabled, the result is signed even if any operand is unsigned.
- If any of the operands of a `+`, `-`, `/`, `*`, `%` is a real or string value, the precision of the result is the precision of the operand with the maximum precision.
- In division performed with `/`, the scale of the result when using two exact-value operands is the scale of the first operand plus the value of the `div_precision_increment` system variable (which is 4 by default). For example, the result of the expression `5.05 / 0.014` has a scale of six decimal places (`360.714286`).

These rules are applied for each operation, such that nested calculations imply the precision of each component. Hence, `(14620 / 9432456) / (24250 / 9432456)`, resolves first to `(0.0014) / (0.0026)`, with the final result having 8 decimal places (`0.60288653`).

Because of these rules and the way they are applied, care should be taken to ensure that components and subcomponents of a calculation use the appropriate level of precision. See [Section 12.10, “Cast Functions and Operators”](#).

For information about handling of overflow in numeric expression evaluation, see [Section 11.1.7, “Out-of-Range and Overflow Handling”](#).

Arithmetic operators apply to numbers. For other types of values, alternative operations may be available. For example, to add date values, use `DATE_ADD()`; see [Section 12.7, “Date and Time Functions”](#).

- `+`

Addition:

```
mysql> SELECT 3+5;
-> 8
```

- `-`

Subtraction:

```
mysql> SELECT 3-5;
-> -2
```

- `-`

Unary minus. This operator changes the sign of the operand.

```
mysql> SELECT - 2;
-> -2
```



**Note**

If this operator is used with a `BIGINT`, the return value is also a `BIGINT`. This means that you should avoid using `-` on integers that may have the value of  $-2^{63}$ .

- `*`

Multiplication:

```
mysql> SELECT 3*5;
-> 15
mysql> SELECT 18014398509481984*18014398509481984.0;
-> 324518553658426726783156020576256.0
mysql> SELECT 18014398509481984*18014398509481984;
-> out-of-range error
```

The last expression produces an error because the result of the integer multiplication exceeds the 64-bit range of `BIGINT` calculations. (See [Section 11.1, “Numeric Data Types”](#).)

- `/`

Division:

```
mysql> SELECT 3/5;
-> 0.60
```

Division by zero produces a `NULL` result:

```
mysql> SELECT 102/(1-1);
-> NULL
```

A division is calculated with `BIGINT` arithmetic only if performed in a context where its result is converted to an integer.

- `DIV`

Integer division. Discards from the division result any fractional part to the right of the decimal point.

If either operand has a noninteger type, the operands are converted to `DECIMAL` and divided using `DECIMAL` arithmetic before converting the result to `BIGINT`. If the result exceeds `BIGINT` range, an error occurs.

```
mysql> SELECT 5 DIV 2, -5 DIV 2, 5 DIV -2, -5 DIV -2;
-> 2, -2, -2, 2
```

- `N % M, N MOD M`

Modulo operation. Returns the remainder of `N` divided by `M`. For more information, see the description for the `MOD()` function in [Section 12.6.2, “Mathematical Functions”](#).

## 12.6.2 Mathematical Functions

**Table 12.10 Mathematical Functions**

Name	Description
<code>ABS()</code>	Return the absolute value

Name	Description
ACOS ( )	Return the arc cosine
ASIN ( )	Return the arc sine
ATAN ( )	Return the arc tangent
ATAN2 ( ), ATAN ( )	Return the arc tangent of the two arguments
CEIL ( )	Return the smallest integer value not less than the argument
CEILING ( )	Return the smallest integer value not less than the argument
CONV ( )	Convert numbers between different number bases
COS ( )	Return the cosine
COT ( )	Return the cotangent
CRC32 ( )	Compute a cyclic redundancy check value
DEGREES ( )	Convert radians to degrees
EXP ( )	Raise to the power of
FLOOR ( )	Return the largest integer value not greater than the argument
LN ( )	Return the natural logarithm of the argument
LOG ( )	Return the natural logarithm of the first argument
LOG10 ( )	Return the base-10 logarithm of the argument
LOG2 ( )	Return the base-2 logarithm of the argument
MOD ( )	Return the remainder
PI ( )	Return the value of pi
POW ( )	Return the argument raised to the specified power
POWER ( )	Return the argument raised to the specified power
RADIANS ( )	Return argument converted to radians
RAND ( )	Return a random floating-point value
ROUND ( )	Round the argument
SIGN ( )	Return the sign of the argument
SIN ( )	Return the sine of the argument
SQRT ( )	Return the square root of the argument
TAN ( )	Return the tangent of the argument
TRUNCATE ( )	Truncate to specified number of decimal places

All mathematical functions return `NULL` in the event of an error.

- `ABS ( X )`

Returns the absolute value of `X`, or `NULL` if `X` is `NULL`.

The result type is derived from the argument type. An implication of this is that `ABS ( -9223372036854775808 )` produces an error because the result cannot be stored in a signed `BIGINT` value.



```
mysql> SELECT ABS(2);
-> 2
mysql> SELECT ABS(-32);
-> 32
```

This function is safe to use with `BIGINT` values.

- `ACOS(X)`

Returns the arc cosine of `X`, that is, the value whose cosine is `X`. Returns `NULL` if `X` is not in the range `-1` to `1`.

```
mysql> SELECT ACOS(1);
-> 0
mysql> SELECT ACOS(1.0001);
-> NULL
mysql> SELECT ACOS(0);
-> 1.5707963267949
```

- `ASIN(X)`

Returns the arc sine of `X`, that is, the value whose sine is `X`. Returns `NULL` if `X` is not in the range `-1` to `1`.

```
mysql> SELECT ASIN(0.2);
-> 0.20135792079033
mysql> SELECT ASIN('foo');
```

ASIN('foo')
0

```
1 row in set, 1 warning (0.00 sec)

mysql> SHOW WARNINGS;
```

Level	Code	Message
Warning	1292	Truncated incorrect DOUBLE value: 'foo'

- `ATAN(X)`

Returns the arc tangent of `X`, that is, the value whose tangent is `X`.

```
mysql> SELECT ATAN(2);
-> 1.1071487177941
mysql> SELECT ATAN(-2);
-> -1.1071487177941
```

- `ATAN(Y, X)`, `ATAN2(Y, X)`

Returns the arc tangent of the two variables `X` and `Y`. It is similar to calculating the arc tangent of `Y / X`, except that the signs of both arguments are used to determine the quadrant of the result.

```
mysql> SELECT ATAN(-2, 2);
-> -0.78539816339745
mysql> SELECT ATAN2(PI(), 0);
-> 1.5707963267949
```

- `CEIL(X)`

`CEIL()` is a synonym for `CEILING()`.

- `CEILING(X)`

Returns the smallest integer value not less than  $X$ .

```
mysql> SELECT CEILING(1.23);
-> 2
mysql> SELECT CEILING(-1.23);
-> -1
```

For exact-value numeric arguments, the return value has an exact-value numeric type. For string or floating-point arguments, the return value has a floating-point type.

- `CONV(N, from_base, to_base)`

Converts numbers between different number bases. Returns a string representation of the number  $N$ , converted from base  $from\_base$  to base  $to\_base$ . Returns `NULL` if any argument is `NULL`. The argument  $N$  is interpreted as an integer, but may be specified as an integer or a string. The minimum base is 2 and the maximum base is 36. If  $from\_base$  is a negative number,  $N$  is regarded as a signed number. Otherwise,  $N$  is treated as unsigned. `CONV()` works with 64-bit precision.

```
mysql> SELECT CONV('a',16,2);
-> '1010'
mysql> SELECT CONV('6E',18,8);
-> '172'
mysql> SELECT CONV(-17,10,-18);
-> '-H'
mysql> SELECT CONV(10+'10'+ '10'+X'0a',10,10);
-> '40'
```

- `COS(X)`

Returns the cosine of  $X$ , where  $X$  is given in radians.

```
mysql> SELECT COS(PI());
-> -1
```

- `COT(X)`

Returns the cotangent of  $X$ .

```
mysql> SELECT COT(12);
-> -1.5726734063977
mysql> SELECT COT(0);
-> out-of-range error
```

- `CRC32(expr)`

Computes a cyclic redundancy check value and returns a 32-bit unsigned value. The result is `NULL` if the argument is `NULL`. The argument is expected to be a string and (if possible) is treated as one if it is not.

```
mysql> SELECT CRC32('MySQL');
-> 3259397556
mysql> SELECT CRC32('mysql');
-> 2501908538
```

- `DEGREES(X)`

Returns the argument  $X$ , converted from radians to degrees.

```
mysql> SELECT DEGREES(PI());
-> 180
mysql> SELECT DEGREES(PI() / 2);
-> 90
```

- `EXP(X)`

Returns the value of  $e$  (the base of natural logarithms) raised to the power of  $X$ . The inverse of this function is `LOG()` (using a single argument only) or `LN()`.

```
mysql> SELECT EXP(2);
      -> 7.3890560989307
mysql> SELECT EXP(-2);
      -> 0.13533528323661
mysql> SELECT EXP(0);
      -> 1
```

- `FLOOR(X)`

Returns the largest integer value not greater than  $X$ .

```
mysql> SELECT FLOOR(1.23), FLOOR(-1.23);
      -> 1, -2
```

For exact-value numeric arguments, the return value has an exact-value numeric type. For string or floating-point arguments, the return value has a floating-point type.

- `FORMAT(X,D)`

Formats the number  $X$  to a format like ' $\#,###,###.##$ ', rounded to  $D$  decimal places, and returns the result as a string. For details, see [Section 12.8, "String Functions and Operators"](#).

- `HEX(N_or_S)`

This function can be used to obtain a hexadecimal representation of a decimal number or a string; the manner in which it does so varies according to the argument's type. See this function's description in [Section 12.8, "String Functions and Operators"](#), for details.

- `LN(X)`

Returns the natural logarithm of  $X$ ; that is, the base- $e$  logarithm of  $X$ . If  $X$  is less than or equal to  $0.0E0$ , the function returns `NULL` and a warning "Invalid argument for logarithm" is reported.

```
mysql> SELECT LN(2);
      -> 0.69314718055995
mysql> SELECT LN(-2);
      -> NULL
```

This function is synonymous with `LOG(X)`. The inverse of this function is the `EXP()` function.

- `LOG(X), LOG(B,X)`

If called with one parameter, this function returns the natural logarithm of  $X$ . If  $X$  is less than or equal to  $0.0E0$ , the function returns `NULL` and a warning "Invalid argument for logarithm" is reported.

The inverse of this function (when called with a single argument) is the `EXP()` function.

```
mysql> SELECT LOG(2);
      -> 0.69314718055995
mysql> SELECT LOG(-2);
      -> NULL
```

If called with two parameters, this function returns the logarithm of  $X$  to the base  $B$ . If  $X$  is less than or equal to 0, or if  $B$  is less than or equal to 1, then `NULL` is returned.

```
mysql> SELECT LOG(2,65536);
```

```
mysql> SELECT LOG(10,100);
-> 2
mysql> SELECT LOG(1,100);
-> NULL
```

$\text{LOG}(B, X)$  is equivalent to  $\text{LOG}(X) / \text{LOG}(B)$ .

- $\text{LOG2}(X)$

Returns the base-2 logarithm of  $X$ . If  $X$  is less than or equal to 0.0E0, the function returns `NULL` and a warning “Invalid argument for logarithm” is reported.

```
mysql> SELECT LOG2(65536);
-> 16
mysql> SELECT LOG2(-100);
-> NULL
```

$\text{LOG2}()$  is useful for finding out how many bits a number requires for storage. This function is approximately equivalent to the expression  $\text{LOG}(X) / \text{LOG}(2)$ .

- $\text{LOG10}(X)$

Returns the base-10 logarithm of  $X$ . If  $X$  is less than or equal to 0.0E0, the function returns `NULL` and a warning “Invalid argument for logarithm” is reported.

```
mysql> SELECT LOG10(2);
-> 0.30102999566398
mysql> SELECT LOG10(100);
-> 2
mysql> SELECT LOG10(-100);
-> NULL
```

$\text{LOG10}(X)$  is approximately equivalent to  $\text{LOG}(10, X)$ .

- $\text{MOD}(N, M), N \% M, N \text{ MOD } M$

Modulo operation. Returns the remainder of  $N$  divided by  $M$ .

```
mysql> SELECT MOD(234, 10);
-> 4
mysql> SELECT 253 \% 7;
-> 1
mysql> SELECT MOD(29, 9);
-> 2
mysql> SELECT 29 MOD 9;
-> 2
```

This function is safe to use with `BIGINT` values.

$\text{MOD}()$  also works on values that have a fractional part and returns the exact remainder after division:

```
mysql> SELECT MOD(34.5, 3);
-> 1.5
```

$\text{MOD}(N, 0)$  returns `NULL`.

- `PI()`

Returns the value of  $\pi$  (pi). The default number of decimal places displayed is seven, but MySQL uses the full double-precision value internally.

Because the return value of this function is a double-precision value, its exact representation may vary between platforms or implementations. This also applies to any expressions making use of `PI()`. See [Section 11.1.4, “Floating-Point Types \(Approximate Value\) - FLOAT, DOUBLE”](#).

```
mysql> SELECT PI();
-> 3.141593
mysql> SELECT PI()+0.00000000000000000000;
-> 3.141592653589793000
```

- `POW(X,Y)`

Returns the value of  $X$  raised to the power of  $Y$ .

```
mysql> SELECT POW(2,2);
-> 4
mysql> SELECT POW(2,-2);
-> 0.25
```

- `POWER(X,Y)`

This is a synonym for `POW()`.

- `RADIANS(X)`

Returns the argument  $X$ , converted from degrees to radians. (Note that  $\pi$  radians equals 180 degrees.)

```
mysql> SELECT RADIANS(90);
-> 1.5707963267949
```

- `RAND([N])`

Returns a random floating-point value  $v$  in the range  $0 \leq v < 1.0$ . To obtain a random integer  $R$  in the range  $i \leq R < j$ , use the expression `FLOOR(i + RAND() * (j - i))`. For example, to obtain a random integer in the range the range  $7 \leq R < 12$ , use the following statement:

```
SELECT FLOOR(7 + (RAND() * 5));
```

If an integer argument  $N$  is specified, it is used as the seed value:

- With a constant initializer argument, the seed is initialized once when the statement is prepared, prior to execution.
- With a nonconstant initializer argument (such as a column name), the seed is initialized with the value for each invocation of `RAND()`.

One implication of this behavior is that for equal argument values, `RAND(N)` returns the same value each time, and thus produces a repeatable sequence of column values. In the following example, the sequence of values produced by `RAND(3)` is the same both places it occurs.

```
mysql> CREATE TABLE t (i INT);
Query OK, 0 rows affected (0.42 sec)

mysql> INSERT INTO t VALUES(1),(2),(3);
Query OK, 3 rows affected (0.00 sec)
Records: 3 Duplicates: 0 Warnings: 0
```

```
mysql> SELECT i, RAND() FROM t;
+-----+-----+
| i     | RAND() |
+-----+-----+
| 1     | 0.61914388706828 |
| 2     | 0.93845168309142 |
| 3     | 0.83482678498591 |
+-----+-----+
3 rows in set (0.00 sec)

mysql> SELECT i, RAND(3) FROM t;
+-----+-----+
| i     | RAND(3) |
+-----+-----+
| 1     | 0.90576975597606 |
| 2     | 0.37307905813035 |
| 3     | 0.14808605345719 |
+-----+-----+
3 rows in set (0.00 sec)

mysql> SELECT i, RAND() FROM t;
+-----+-----+
| i     | RAND() |
+-----+-----+
| 1     | 0.35877890638893 |
| 2     | 0.28941420772058 |
| 3     | 0.37073435016976 |
+-----+-----+
3 rows in set (0.00 sec)

mysql> SELECT i, RAND(3) FROM t;
+-----+-----+
| i     | RAND(3) |
+-----+-----+
| 1     | 0.90576975597606 |
| 2     | 0.37307905813035 |
| 3     | 0.14808605345719 |
+-----+-----+
3 rows in set (0.01 sec)
```

`RAND()` in a `WHERE` clause is evaluated for every row (when selecting from one table) or combination of rows (when selecting from a multiple-table join). Thus, for optimizer purposes, `RAND()` is not a constant value and cannot be used for index optimizations. For more information, see [Section 8.2.1.18, “Function Call Optimization”](#).

Use of a column with `RAND()` values in an `ORDER BY` or `GROUP BY` clause may yield unexpected results because for either clause a `RAND()` expression can be evaluated multiple times for the same row, each time returning a different result. If the goal is to retrieve rows in random order, you can use a statement like this:

```
SELECT * FROM tbl_name ORDER BY RAND();
```

To select a random sample from a set of rows, combine `ORDER BY RAND()` with `LIMIT`:

```
SELECT * FROM table1, table2 WHERE a=b AND c<d ORDER BY RAND() LIMIT 1000;
```

`RAND()` is not meant to be a perfect random generator. It is a fast way to generate random numbers on demand that is portable between platforms for the same MySQL version.

This function is unsafe for statement-based replication. A warning is logged if you use this function when `binlog_format` is set to `STATEMENT`.

- `ROUND(X)`, `ROUND(X,D)`

Rounds the argument `X` to `D` decimal places. The rounding algorithm depends on the data type of `X`. `D` defaults to 0 if not specified. `D` can be negative to cause `D` digits left of the decimal point of the value `X` to become zero. The maximum absolute value for `D` is 30; any digits in excess of 30 (or -30) are truncated.

```
mysql> SELECT ROUND(-1.23);
-> -1
mysql> SELECT ROUND(-1.58);
-> -2
mysql> SELECT ROUND(1.58);
-> 2
mysql> SELECT ROUND(1.298, 1);
-> 1.3
mysql> SELECT ROUND(1.298, 0);
-> 1
mysql> SELECT ROUND(23.298, -1);
-> 20
mysql> SELECT ROUND(.12345678901234567890123456789012345, 35);
-> 0.123456789012345678901234567890
```

The return value has the same type as the first argument (assuming that it is integer, double, or decimal). This means that for an integer argument, the result is an integer (no decimal places):

```
mysql> SELECT ROUND(150.000,2), ROUND(150,2);
+-----+-----+
| ROUND(150.000,2) | ROUND(150,2) |
+-----+-----+
|          150.00 |          150 |
+-----+-----+
```

`ROUND()` uses the following rules depending on the type of the first argument:

- For exact-value numbers, `ROUND()` uses the “round half away from zero” or “round toward nearest” rule: A value with a fractional part of .5 or greater is rounded up to the next integer if positive or down to the next integer if negative. (In other words, it is rounded away from zero.) A value with a fractional part less than .5 is rounded down to the next integer if positive or up to the next integer if negative.
- For approximate-value numbers, the result depends on the C library. On many systems, this means that `ROUND()` uses the “round to nearest even” rule: A value with a fractional part exactly halfway between two integers is rounded to the nearest even integer.

The following example shows how rounding differs for exact and approximate values:

```
mysql> SELECT ROUND(2.5), ROUND(25E-1);
+-----+-----+
| ROUND(2.5) | ROUND(25E-1) |
+-----+-----+
| 3         | 2           |
+-----+-----+
```

For more information, see [Section 12.21, “Precision Math”](#).

- `SIGN(X)`

Returns the sign of the argument as `-1`, `0`, or `1`, depending on whether `X` is negative, zero, or positive.

```
mysql> SELECT SIGN(-32);
-> -1
mysql> SELECT SIGN(0);
-> 0
mysql> SELECT SIGN(234);
```

```
-> 1
```

- `SIN(X)`

Returns the sine of  $X$ , where  $X$  is given in radians.

```
mysql> SELECT SIN(PI());
-> 1.2246063538224e-16
mysql> SELECT ROUND(SIN(PI()));
-> 0
```

- `SQRT(X)`

Returns the square root of a nonnegative number  $X$ .

```
mysql> SELECT SQRT(4);
-> 2
mysql> SELECT SQRT(20);
-> 4.4721359549996
mysql> SELECT SQRT(-16);
-> NULL
```

- `TAN(X)`

Returns the tangent of  $X$ , where  $X$  is given in radians.

```
mysql> SELECT TAN(PI());
-> -1.2246063538224e-16
mysql> SELECT TAN(PI()+1);
-> 1.5574077246549
```

- `TRUNCATE(X,D)`

Returns the number  $X$ , truncated to  $D$  decimal places. If  $D$  is 0, the result has no decimal point or fractional part.  $D$  can be negative to cause  $D$  digits left of the decimal point of the value  $X$  to become zero.

```
mysql> SELECT TRUNCATE(1.223,1);
-> 1.2
mysql> SELECT TRUNCATE(1.999,1);
-> 1.9
mysql> SELECT TRUNCATE(1.999,0);
-> 1
mysql> SELECT TRUNCATE(-1.999,1);
-> -1.9
mysql> SELECT TRUNCATE(122,-2);
-> 100
mysql> SELECT TRUNCATE(10.28*100,0);
-> 1028
```

All numbers are rounded toward zero.

## 12.7 Date and Time Functions

This section describes the functions that can be used to manipulate temporal values. See [Section 11.2, “Date and Time Data Types”](#), for a description of the range of values each date and time type has and the valid formats in which values may be specified.

**Table 12.11 Date and Time Functions**

Name	Description
<code>ADDDATE()</code>	Add time values (intervals) to a date value



Name	Description
ADDTIME ( )	Add time
CONVERT_TZ ( )	Convert from one time zone to another
CURDATE ( )	Return the current date
CURRENT_DATE ( ), CURRENT_DATE	Synonyms for CURDATE()
CURRENT_TIME ( ), CURRENT_TIME	Synonyms for CURTIME()
CURRENT_TIMESTAMP ( ), CURRENT_TIMESTAMP	Synonyms for NOW()
CURTIME ( )	Return the current time
DATE ( )	Extract the date part of a date or datetime expression
DATE_ADD ( )	Add time values (intervals) to a date value
DATE_FORMAT ( )	Format date as specified
DATE_SUB ( )	Subtract a time value (interval) from a date
DATEDIFF ( )	Subtract two dates
DAY ( )	Synonym for DAYOFMONTH()
DAYNAME ( )	Return the name of the weekday
DAYOFMONTH ( )	Return the day of the month (0-31)
DAYOFWEEK ( )	Return the weekday index of the argument
DAYOFYEAR ( )	Return the day of the year (1-366)
EXTRACT ( )	Extract part of a date
FROM_DAYS ( )	Convert a day number to a date
FROM_UNIXTIME ( )	Format Unix timestamp as a date
GET_FORMAT ( )	Return a date format string
HOUR ( )	Extract the hour
LAST_DAY	Return the last day of the month for the argument
LOCALTIME ( ), LOCALTIME	Synonym for NOW()
LOCALTIMESTAMP, LOCALTIMESTAMP ( )	Synonym for NOW()
MAKEDATE ( )	Create a date from the year and day of year
MAKETIME ( )	Create time from hour, minute, second
MICROSECOND ( )	Return the microseconds from argument
MINUTE ( )	Return the minute from the argument
MONTH ( )	Return the month from the date passed
MONTHNAME ( )	Return the name of the month
NOW ( )	Return the current date and time
PERIOD_ADD ( )	Add a period to a year-month
PERIOD_DIFF ( )	Return the number of months between periods
QUARTER ( )	Return the quarter from a date argument
SEC_TO_TIME ( )	Converts seconds to 'hh:mm:ss' format
SECOND ( )	Return the second (0-59)

Name	Description
<code>STR_TO_DATE()</code>	Convert a string to a date
<code>SUBDATE()</code>	Synonym for <code>DATE_SUB()</code> when invoked with three arguments
<code>SUBTIME()</code>	Subtract times
<code>SYSDATE()</code>	Return the time at which the function executes
<code>TIME()</code>	Extract the time portion of the expression passed
<code>TIME_FORMAT()</code>	Format as time
<code>TIME_TO_SEC()</code>	Return the argument converted to seconds
<code>TIMEDIFF()</code>	Subtract time
<code>TIMESTAMP()</code>	With a single argument, this function returns the date or datetime expression; with two arguments, the sum of the arguments
<code>TIMESTAMPADD()</code>	Add an interval to a datetime expression
<code>TIMESTAMPDIFF()</code>	Return the difference of two datetime expressions, using the units specified
<code>TO_DAYS()</code>	Return the date argument converted to days
<code>TO_SECONDS()</code>	Return the date or datetime argument converted to seconds since Year 0
<code>UNIX_TIMESTAMP()</code>	Return a Unix timestamp
<code>UTC_DATE()</code>	Return the current UTC date
<code>UTC_TIME()</code>	Return the current UTC time
<code>UTC_TIMESTAMP()</code>	Return the current UTC date and time
<code>WEEK()</code>	Return the week number
<code>WEEKDAY()</code>	Return the weekday index
<code>WEEKOFYEAR()</code>	Return the calendar week of the date (1-53)
<code>YEAR()</code>	Return the year
<code>YEARWEEK()</code>	Return the year and week

Here is an example that uses date functions. The following query selects all rows with a `date_col` value from within the last 30 days:

```
mysql> SELECT something FROM tbl_name
-> WHERE DATE_SUB(CURDATE(),INTERVAL 30 DAY) <= date_col;
```

The query also selects rows with dates that lie in the future.

Functions that expect date values usually accept datetime values and ignore the time part. Functions that expect time values usually accept datetime values and ignore the date part.

Functions that return the current date or time each are evaluated only once per query at the start of query execution. This means that multiple references to a function such as `NOW()` within a single query always produce the same result. (For our purposes, a single query also includes a call to a stored program (stored routine, trigger, or event) and all subprograms called by that program.) This principle also applies to `CURDATE()`, `CURTIME()`, `UTC_DATE()`, `UTC_TIME()`, `UTC_TIMESTAMP()`, and to any of their synonyms.

The `CURRENT_TIMESTAMP()`, `CURRENT_TIME()`, `CURRENT_DATE()`, and `FROM_UNIXTIME()` functions return values in the current session time zone, which is available as the session value of the `time_zone` system variable. In addition, `UNIX_TIMESTAMP()` assumes that its argument is a datetime value in the session time zone. See [Section 5.1.13, “MySQL Server Time Zone Support”](#).

Some date functions can be used with “zero” dates or incomplete dates such as `'2001-11-00'`, whereas others cannot. Functions that extract parts of dates typically work with incomplete dates and thus can return 0 when you might otherwise expect a nonzero value. For example:

```
mysql> SELECT DAYOFMONTH('2001-11-00'), MONTH('2005-00-00');
-> 0, 0
```

Other functions expect complete dates and return `NULL` for incomplete dates. These include functions that perform date arithmetic or that map parts of dates to names. For example:

```
mysql> SELECT DATE_ADD('2006-05-00',INTERVAL 1 DAY);
-> NULL
mysql> SELECT DAYNAME('2006-05-00');
-> NULL
```

Several functions are strict when passed a `DATE()` function value as their argument and reject incomplete dates with a day part of zero: `CONVERT_TZ()`, `DATE_ADD()`, `DATE_SUB()`, `DAYOFYEAR()`, `TIMESTAMPDIFF()`, `TO_DAYS()`, `TO_SECONDS()`, `WEEK()`, `WEEKDAY()`, `WEEKOFYEAR()`, `YEARWEEK()`.

Fractional seconds for `TIME`, `DATETIME`, and `TIMESTAMP` values are supported, with up to microsecond precision. Functions that take temporal arguments accept values with fractional seconds. Return values from temporal functions include fractional seconds as appropriate.

- `ADDDATE(date,INTERVAL expr unit),ADDDATE(expr,days)`

When invoked with the `INTERVAL` form of the second argument, `ADDDATE()` is a synonym for `DATE_ADD()`. The related function `SUBDATE()` is a synonym for `DATE_SUB()`. For information on the `INTERVAL unit` argument, see [Temporal Intervals](#).

```
mysql> SELECT DATE_ADD('2008-01-02', INTERVAL 31 DAY);
-> '2008-02-02'
mysql> SELECT ADDDATE('2008-01-02', INTERVAL 31 DAY);
-> '2008-02-02'
```

When invoked with the `days` form of the second argument, MySQL treats it as an integer number of days to be added to `expr`.

```
mysql> SELECT ADDDATE('2008-01-02', 31);
-> '2008-02-02'
```

- `ADDTIME(expr1,expr2)`

`ADDTIME()` adds `expr2` to `expr1` and returns the result. `expr1` is a time or datetime expression, and `expr2` is a time expression.

```
mysql> SELECT ADDTIME('2007-12-31 23:59:59.999999', '1 1:1:1.000002');
-> '2008-01-02 01:01:01.000001'
mysql> SELECT ADDTIME('01:00:00.999999', '02:00:00.999998');
-> '03:00:01.999997'
```

- `CONVERT_TZ(dt,from_tz,to_tz)`

`CONVERT_TZ()` converts a datetime value `dt` from the time zone given by `from_tz` to the time zone given by `to_tz` and returns the resulting value. Time zones are specified as described in [Section 5.1.13, “MySQL Server Time Zone Support”](#). This function returns `NULL` if the arguments are invalid.

If the value falls out of the supported range of the `TIMESTAMP` type when converted from `from_tz` to UTC, no conversion occurs. The `TIMESTAMP` range is described in [Section 11.2.1, “Date and Time Data Type Syntax”](#).

```
mysql> SELECT CONVERT_TZ('2004-01-01 12:00:00','GMT','MET');
-> '2004-01-01 13:00:00'
mysql> SELECT CONVERT_TZ('2004-01-01 12:00:00','+00:00','+10:00');
-> '2004-01-01 22:00:00'
```



### Note

To use named time zones such as `'MET'` or `'Europe/Amsterdam'`, the time zone tables must be properly set up. For instructions, see [Section 5.1.13, “MySQL Server Time Zone Support”](#).

- `CURDATE()`

Returns the current date as a value in `'YYYY-MM-DD'` or `YYYYMMDD` format, depending on whether the function is used in string or numeric context.

```
mysql> SELECT CURDATE();
-> '2008-06-13'
mysql> SELECT CURDATE() + 0;
-> 20080613
```

- `CURRENT_DATE`, `CURRENT_DATE()`

`CURRENT_DATE` and `CURRENT_DATE()` are synonyms for `CURDATE()`.

- `CURRENT_TIME`, `CURRENT_TIME([fsp])`

`CURRENT_TIME` and `CURRENT_TIME()` are synonyms for `CURTIME()`.

- `CURRENT_TIMESTAMP`, `CURRENT_TIMESTAMP([fsp])`

`CURRENT_TIMESTAMP` and `CURRENT_TIMESTAMP()` are synonyms for `NOW()`.

- `CURTIME([fsp])`

Returns the current time as a value in `'hh:mm:ss'` or `hhmmss` format, depending on whether the function is used in string or numeric context. The value is expressed in the session time zone.

If the `fsp` argument is given to specify a fractional seconds precision from 0 to 6, the return value includes a fractional seconds part of that many digits.

```
mysql> SELECT CURTIME();
-> '23:50:26'
mysql> SELECT CURTIME() + 0;
-> 235026.000000
```

- `DATE(expr)`

Extracts the date part of the date or datetime expression `expr`.

```
mysql> SELECT DATE('2003-12-31 01:02:03');
-> '2003-12-31'
```

- `DATEDIFF(expr1,expr2)`

`DATEDIFF()` returns  $expr1 - expr2$  expressed as a value in days from one date to the other. *expr1* and *expr2* are date or date-and-time expressions. Only the date parts of the values are used in the calculation.

```
mysql> SELECT DATEDIFF('2007-12-31 23:59:59','2007-12-30');
-> 1
mysql> SELECT DATEDIFF('2010-11-30 23:59:59','2010-12-31');
-> -31
```

- `DATE_ADD(date,INTERVAL expr unit),DATE_SUB(date,INTERVAL expr unit)`

These functions perform date arithmetic. The *date* argument specifies the starting date or datetime value. *expr* is an expression specifying the interval value to be added or subtracted from the starting date. *expr* is evaluated as a string; it may start with a `-` for negative intervals. *unit* is a keyword indicating the units in which the expression should be interpreted.

For more information about temporal interval syntax, including a full list of *unit* specifiers, the expected form of the *expr* argument for each *unit* value, and rules for operand interpretation in temporal arithmetic, see [Temporal Intervals](#).

The return value depends on the arguments:

- `DATE` if the *date* argument is a `DATE` value and your calculations involve only `YEAR`, `MONTH`, and `DAY` parts (that is, no time parts).
- `DATETIME` if the first argument is a `DATETIME` (or `TIMESTAMP`) value, or if the first argument is a `DATE` and the *unit* value uses `HOURS`, `MINUTES`, or `SECONDS`.
- String otherwise.

To ensure that the result is `DATETIME`, you can use `CAST()` to convert the first argument to `DATETIME`.

```
mysql> SELECT DATE_ADD('2018-05-01',INTERVAL 1 DAY);
-> '2018-05-02'
mysql> SELECT DATE_SUB('2018-05-01',INTERVAL 1 YEAR);
-> '2017-05-01'
mysql> SELECT DATE_ADD('2020-12-31 23:59:59',
-> INTERVAL 1 SECOND);
-> '2021-01-01 00:00:00'
mysql> SELECT DATE_ADD('2018-12-31 23:59:59',
-> INTERVAL 1 DAY);
-> '2019-01-01 23:59:59'
mysql> SELECT DATE_ADD('2100-12-31 23:59:59',
-> INTERVAL '1:1' MINUTE_SECOND);
-> '2101-01-01 00:01:00'
mysql> SELECT DATE_SUB('2025-01-01 00:00:00',
-> INTERVAL '1 1:1:1' DAY_SECOND);
-> '2024-12-30 22:58:59'
mysql> SELECT DATE_ADD('1900-01-01 00:00:00',
-> INTERVAL '-1 10' DAY_HOUR);
-> '1899-12-30 14:00:00'
mysql> SELECT DATE_SUB('1998-01-02', INTERVAL 31 DAY);
-> '1997-12-02'
mysql> SELECT DATE_ADD('1992-12-31 23:59:59.000002',
-> INTERVAL '1.999999' SECOND_MICROSECOND);
```

## Date and Time Functions

```
-> '1993-01-01 00:00:01.000001'
```

When adding a `MONTH` interval to a `DATE` or `DATETIME` value, and the resulting date includes a day that does not exist in the given month, the day is adjusted to the last day of the month, as shown here:

```
mysql> SELECT DATE_ADD('2024-03-30', INTERVAL 1 MONTH) AS d1,
>         DATE_ADD('2024-03-31', INTERVAL 1 MONTH) AS d2;
+-----+-----+
| d1      | d2      |
+-----+-----+
| 2024-04-30 | 2024-04-30 |
+-----+-----+
1 row in set (0.00 sec)
```

- `DATE_FORMAT(date, format)`

Formats the `date` value according to the `format` string.

The specifiers shown in the following table may be used in the `format` string. The `%` character is required before format specifier characters. The specifiers apply to other functions as well: `STR_TO_DATE()`, `TIME_FORMAT()`, `UNIX_TIMESTAMP()`.

Specifier	Description
<code>%a</code>	Abbreviated weekday name ( <code>Sun..Sat</code> )
<code>%b</code>	Abbreviated month name ( <code>Jan..Dec</code> )
<code>%c</code>	Month, numeric ( <code>0..12</code> )
<code>%D</code>	Day of the month with English suffix ( <code>0th, 1st, 2nd, 3rd, ...</code> )
<code>%d</code>	Day of the month, numeric ( <code>00..31</code> )
<code>%e</code>	Day of the month, numeric ( <code>0..31</code> )
<code>%f</code>	Microseconds ( <code>000000..999999</code> )
<code>%H</code>	Hour ( <code>00..23</code> )
<code>%h</code>	Hour ( <code>01..12</code> )
<code>%I</code>	Hour ( <code>01..12</code> )
<code>%i</code>	Minutes, numeric ( <code>00..59</code> )
<code>%j</code>	Day of year ( <code>001..366</code> )
<code>%k</code>	Hour ( <code>0..23</code> )
<code>%l</code>	Hour ( <code>1..12</code> )
<code>%M</code>	Month name ( <code>January..December</code> )
<code>%m</code>	Month, numeric ( <code>00..12</code> )
<code>%p</code>	AM or PM
<code>%r</code>	Time, 12-hour ( <code>hh:mm:ss</code> followed by AM or PM)
<code>%S</code>	Seconds ( <code>00..59</code> )
<code>%s</code>	Seconds ( <code>00..59</code> )
<code>%T</code>	Time, 24-hour ( <code>hh:mm:ss</code> )
<code>%U</code>	Week ( <code>00..53</code> ), where Sunday is the first day of the week; <code>WEEK()</code> mode 0

Specifier	Description
<code>%u</code>	Week (00..53), where Monday is the first day of the week; <code>WEEK()</code> mode 1
<code>%V</code>	Week (01..53), where Sunday is the first day of the week; <code>WEEK()</code> mode 2; used with <code>%X</code>
<code>%v</code>	Week (01..53), where Monday is the first day of the week; <code>WEEK()</code> mode 3; used with <code>%x</code>
<code>%W</code>	Weekday name (Sunday..Saturday)
<code>%w</code>	Day of the week (0=Sunday..6=Saturday)
<code>%X</code>	Year for the week where Sunday is the first day of the week, numeric, four digits; used with <code>%V</code>
<code>%x</code>	Year for the week, where Monday is the first day of the week, numeric, four digits; used with <code>%v</code>
<code>%Y</code>	Year, numeric, four digits
<code>%y</code>	Year, numeric (two digits)
<code>%%</code>	A literal <code>%</code> character
<code>%x</code>	<code>x</code> , for any “ <code>x</code> ” not listed above

Ranges for the month and day specifiers begin with zero due to the fact that MySQL permits the storing of incomplete dates such as '2014-00-00'.

The language used for day and month names and abbreviations is controlled by the value of the `lc_time_names` system variable (Section 10.16, “MySQL Server Locale Support”).

For the `%U`, `%u`, `%V`, and `%v` specifiers, see the description of the `WEEK()` function for information about the mode values. The mode affects how week numbering occurs.

`DATE_FORMAT()` returns a string with a character set and collation given by `character_set_connection` and `collation_connection` so that it can return month and weekday names containing non-ASCII characters.

```
mysql> SELECT DATE_FORMAT('2009-10-04 22:23:00', '%W %M %Y');
-> 'Sunday October 2009'
mysql> SELECT DATE_FORMAT('2007-10-04 22:23:00', '%H:%i:%s');
-> '22:23:00'
mysql> SELECT DATE_FORMAT('1900-10-04 22:23:00',
->      '%D %y %a %d %m %b %j');
-> '4th 00 Thu 04 10 Oct 277'
mysql> SELECT DATE_FORMAT('1997-10-04 22:23:00',
->      '%H %k %I %r %T %S %w');
-> '22 22 10 10:23:00 PM 22:23:00 00 6'
mysql> SELECT DATE_FORMAT('1999-01-01', '%X %V');
-> '1998 52'
mysql> SELECT DATE_FORMAT('2006-06-00', '%d');
-> '00'
```

- `DATE_SUB(date, INTERVAL expr unit)`

See the description for `DATE_ADD()`.

- `DAY(date)`

`DAY()` is a synonym for `DAYOFMONTH()`.

- `DAYNAME(date)`

Returns the name of the weekday for *date*. The language used for the name is controlled by the value of the `lc_time_names` system variable (Section 10.16, “MySQL Server Locale Support”).

```
mysql> SELECT DAYNAME('2007-02-03');
-> 'Saturday'
```

- `DAYOFMONTH(date)`

Returns the day of the month for *date*, in the range 1 to 31, or 0 for dates such as '0000-00-00' or '2008-00-00' that have a zero day part.

```
mysql> SELECT DAYOFMONTH('2007-02-03');
-> 3
```

- `DAYOFWEEK(date)`

Returns the weekday index for *date* (1 = Sunday, 2 = Monday, ..., 7 = Saturday). These index values correspond to the ODBC standard.

```
mysql> SELECT DAYOFWEEK('2007-02-03');
-> 7
```

- `DAYOFYEAR(date)`

Returns the day of the year for *date*, in the range 1 to 366.

```
mysql> SELECT DAYOFYEAR('2007-02-03');
-> 34
```

- `EXTRACT(unit FROM date)`

The `EXTRACT()` function uses the same kinds of *unit* specifiers as `DATE_ADD()` or `DATE_SUB()`, but extracts parts from the date rather than performing date arithmetic. For information on the *unit* argument, see [Temporal Intervals](#).

```
mysql> SELECT EXTRACT(YEAR FROM '2019-07-02');
-> 2019
mysql> SELECT EXTRACT(YEAR_MONTH FROM '2019-07-02 01:02:03');
-> 201907
mysql> SELECT EXTRACT(DAY_MINUTE FROM '2019-07-02 01:02:03');
-> 20102
mysql> SELECT EXTRACT(MICROSECOND
-> FROM '2003-01-02 10:30:00.000123');
-> 123
```

- `FROM_DAYS(N)`

Given a day number *N*, returns a `DATE` value.

```
mysql> SELECT FROM_DAYS(730669);
-> '2000-07-03'
```

Use `FROM_DAYS()` with caution on old dates. It is not intended for use with values that precede the advent of the Gregorian calendar (1582). See [Section 11.2.8, “What Calendar Is Used By MySQL?”](#).

- `FROM_UNIXTIME(unix_timestamp[,format])`

Returns a representation of *unix\_timestamp* as a datetime or character string value. The value returned is expressed using the session time zone. (Clients can set the session time zone as described in [Section 5.1.13, “MySQL Server Time Zone Support”](#).) *unix\_timestamp* is an internal timestamp



value representing seconds since '1970-01-01 00:00:00' UTC, such as produced by the `UNIX_TIMESTAMP()` function.

If *format* is omitted, this function returns a `DATETIME` value.

If *unix\_timestamp* is an integer, the fractional seconds precision of the `DATETIME` is zero. When *unix\_timestamp* is a decimal value, the fractional seconds precision of the `DATETIME` is the same as the precision of the decimal value, up to a maximum of 6. When *unix\_timestamp* is a floating point number, the fractional seconds precision of the datetime is 6.

*format* is used to format the result in the same way as the format string used for the `DATE_FORMAT()` function. If *format* is supplied, the value returned is a `VARCHAR`.

```
mysql> SELECT FROM_UNIXTIME(1447430881);
-> '2015-11-13 10:08:01'
mysql> SELECT FROM_UNIXTIME(1447430881) + 0;
-> 20151113100801
mysql> SELECT FROM_UNIXTIME(1447430881,
->                                '%Y %D %M %h:%i:%s %x');
-> '2015 13th November 10:08:01 2015'
```



#### Note

If you use `UNIX_TIMESTAMP()` and `FROM_UNIXTIME()` to convert between values in a non-UTC time zone and Unix timestamp values, the conversion is lossy because the mapping is not one-to-one in both directions. For details, see the description of the `UNIX_TIMESTAMP()` function.

- `GET_FORMAT({DATE|TIME|DATETIME}, {'EUR'|'USA'|'JIS'|'ISO'|'INTERNAL'})`

Returns a format string. This function is useful in combination with the `DATE_FORMAT()` and the `STR_TO_DATE()` functions.

The possible values for the first and second arguments result in several possible format strings (for the specifiers used, see the table in the `DATE_FORMAT()` function description). ISO format refers to ISO 9075, not ISO 8601.

Function Call	Result
<code>GET_FORMAT(DATE, 'USA')</code>	'%m.%d.%Y'
<code>GET_FORMAT(DATE, 'JIS')</code>	'%Y-%m-%d'
<code>GET_FORMAT(DATE, 'ISO')</code>	'%Y-%m-%d'
<code>GET_FORMAT(DATE, 'EUR')</code>	'%d.%m.%Y'
<code>GET_FORMAT(DATE, 'INTERNAL')</code>	'%Y%m%d'
<code>GET_FORMAT(DATETIME, 'USA')</code>	'%Y-%m-%d %H.%i.%s'
<code>GET_FORMAT(DATETIME, 'JIS')</code>	'%Y-%m-%d %H:%i:%s'
<code>GET_FORMAT(DATETIME, 'ISO')</code>	'%Y-%m-%d %H:%i:%s'
<code>GET_FORMAT(DATETIME, 'EUR')</code>	'%Y-%m-%d %H.%i.%s'
<code>GET_FORMAT(DATETIME, 'INTERNAL')</code>	'%Y%m%d%H%i%s'
<code>GET_FORMAT(TIME, 'USA')</code>	'%h:%i:%s %p'
<code>GET_FORMAT(TIME, 'JIS')</code>	'%H:%i:%s'
<code>GET_FORMAT(TIME, 'ISO')</code>	'%H:%i:%s'

Function Call	Result
<code>GET_FORMAT(TIME, 'EUR')</code>	<code>'%H.%i.%s'</code>
<code>GET_FORMAT(TIME, 'INTERNAL')</code>	<code>'%H%i%s'</code>

`TIMESTAMP` can also be used as the first argument to `GET_FORMAT()`, in which case the function returns the same values as for `DATETIME`.

```
mysql> SELECT DATE_FORMAT('2003-10-03',GET_FORMAT(DATE,'EUR'));
      -> '03.10.2003'
mysql> SELECT STR_TO_DATE('10.31.2003',GET_FORMAT(DATE,'USA'));
      -> '2003-10-31'
```

- `HOUR(time)`

Returns the hour for *time*. The range of the return value is 0 to 23 for time-of-day values. However, the range of `TIME` values actually is much larger, so `HOUR` can return values greater than 23.

```
mysql> SELECT HOUR('10:05:03');
      -> 10
mysql> SELECT HOUR('272:59:59');
      -> 272
```

- `LAST_DAY(date)`

Takes a date or datetime value and returns the corresponding value for the last day of the month. Returns `NULL` if the argument is invalid.

```
mysql> SELECT LAST_DAY('2003-02-05');
      -> '2003-02-28'
mysql> SELECT LAST_DAY('2004-02-05');
      -> '2004-02-29'
mysql> SELECT LAST_DAY('2004-01-01 01:01:01');
      -> '2004-01-31'
mysql> SELECT LAST_DAY('2003-03-32');
      -> NULL
```

- `LOCALTIME, LOCALTIME([fsp])`

`LOCALTIME` and `LOCALTIME()` are synonyms for `NOW()`.

- `LOCALTIMESTAMP, LOCALTIMESTAMP([fsp])`

`LOCALTIMESTAMP` and `LOCALTIMESTAMP()` are synonyms for `NOW()`.

- `MAKEDATE(year,dayofyear)`

Returns a date, given year and day-of-year values. *dayofyear* must be greater than 0 or the result is `NULL`.

```
mysql> SELECT MAKEDATE(2011,31), MAKEDATE(2011,32);
      -> '2011-01-31', '2011-02-01'
mysql> SELECT MAKEDATE(2011,365), MAKEDATE(2014,365);
      -> '2011-12-31', '2014-12-31'
mysql> SELECT MAKEDATE(2011,0);
      -> NULL
```

- `MAKETIME(hour,minute,second)`

Returns a time value calculated from the *hour*, *minute*, and *second* arguments.

The *second* argument can have a fractional part.

```
mysql> SELECT MAKETIME(12,15,30);
-> '12:15:30'
```

- `MICROSECOND(expr)`

Returns the microseconds from the time or datetime expression *expr* as a number in the range from 0 to 999999.

```
mysql> SELECT MICROSECOND('12:00:00.123456');
-> 123456
mysql> SELECT MICROSECOND('2019-12-31 23:59:59.000010');
-> 10
```

- `MINUTE(time)`

Returns the minute for *time*, in the range 0 to 59.

```
mysql> SELECT MINUTE('2008-02-03 10:05:03');
-> 5
```

- `MONTH(date)`

Returns the month for *date*, in the range 1 to 12 for January to December, or 0 for dates such as '0000-00-00' or '2008-00-00' that have a zero month part.

```
mysql> SELECT MONTH('2008-02-03');
-> 2
```

- `MONTHNAME(date)`

Returns the full name of the month for *date*. The language used for the name is controlled by the value of the `lc_time_names` system variable (Section 10.16, “MySQL Server Locale Support”).

```
mysql> SELECT MONTHNAME('2008-02-03');
-> 'February'
```

- `NOW([fsp])`

Returns the current date and time as a value in '*YYYY-MM-DD hh:mm:ss*' or *YYYYMMDDhhmmss* format, depending on whether the function is used in string or numeric context. The value is expressed in the session time zone.

If the *fsp* argument is given to specify a fractional seconds precision from 0 to 6, the return value includes a fractional seconds part of that many digits.

```
mysql> SELECT NOW();
-> '2007-12-15 23:50:26'
mysql> SELECT NOW() + 0;
-> 20071215235026.000000
```

`NOW()` returns a constant time that indicates the time at which the statement began to execute. (Within a stored function or trigger, `NOW()` returns the time at which the function or triggering statement began to execute.) This differs from the behavior for `SYSDATE()`, which returns the exact time at which it executes.

```
mysql> SELECT NOW(), SLEEP(2), NOW();
+-----+-----+-----+
| NOW()          | SLEEP(2) | NOW()          |
+-----+-----+-----+
| 2006-04-12 13:47:36 |          0 | 2006-04-12 13:47:36 |
+-----+-----+-----+
```

```
mysql> SELECT SYSDATE(), SLEEP(2), SYSDATE();
+-----+-----+-----+
| SYSDATE()          | SLEEP(2) | SYSDATE()          |
+-----+-----+-----+
| 2006-04-12 13:47:44 |          0 | 2006-04-12 13:47:46 |
+-----+-----+-----+
```

In addition, the `SET TIMESTAMP` statement affects the value returned by `NOW()` but not by `SYSDATE()`. This means that timestamp settings in the binary log have no effect on invocations of `SYSDATE()`. Setting the timestamp to a nonzero value causes each subsequent invocation of `NOW()` to return that value. Setting the timestamp to zero cancels this effect so that `NOW()` once again returns the current date and time.

See the description for `SYSDATE()` for additional information about the differences between the two functions.

- `PERIOD_ADD(P,N)`

Adds *N* months to period *P* (in the format `YYMM` or `YYYYMM`). Returns a value in the format `YYYYMM`.



#### Note

The period argument *P* is *not* a date value.

```
mysql> SELECT PERIOD_ADD(200801,2);
-> 200803
```

- `PERIOD_DIFF(P1,P2)`

Returns the number of months between periods *P1* and *P2*. *P1* and *P2* should be in the format `YYMM` or `YYYYMM`. Note that the period arguments *P1* and *P2* are *not* date values.

```
mysql> SELECT PERIOD_DIFF(200802,200703);
-> 11
```

- `QUARTER(date)`

Returns the quarter of the year for *date*, in the range 1 to 4.

```
mysql> SELECT QUARTER('2008-04-01');
-> 2
```

- `SECOND(time)`

Returns the second for *time*, in the range 0 to 59.

```
mysql> SELECT SECOND('10:05:03');
-> 3
```

- `SEC_TO_TIME(seconds)`

Returns the *seconds* argument, converted to hours, minutes, and seconds, as a `TIME` value. The range of the result is constrained to that of the `TIME` data type. A warning occurs if the argument corresponds to a value outside that range.

```
mysql> SELECT SEC_TO_TIME(2378);
-> '00:39:38'
mysql> SELECT SEC_TO_TIME(2378) + 0;
-> 3938
```

- `STR_TO_DATE(str, format)`

This is the inverse of the `DATE_FORMAT()` function. It takes a string `str` and a format string `format`. `STR_TO_DATE()` returns a `DATETIME` value if the format string contains both date and time parts, or a `DATE` or `TIME` value if the string contains only date or time parts. If `str` or `format` is `NULL`, the function returns `NULL`. If the date, time, or datetime value extracted from `str` cannot be parsed according to the rules followed by the server, `STR_TO_DATE()` returns `NULL` and produces a warning.

The server scans `str` attempting to match `format` to it. The format string can contain literal characters and format specifiers beginning with `%`. Literal characters in `format` must match literally in `str`. Format specifiers in `format` must match a date or time part in `str`. For the specifiers that can be used in `format`, see the `DATE_FORMAT()` function description.

```
mysql> SELECT STR_TO_DATE('01,5,2013','%d,%m,%Y');
-> '2013-05-01'
mysql> SELECT STR_TO_DATE('May 1, 2013','%M %d,%Y');
-> '2013-05-01'
```

Scanning starts at the beginning of `str` and fails if `format` is found not to match. Extra characters at the end of `str` are ignored.

```
mysql> SELECT STR_TO_DATE('a09:30:17','%a%h:%i:%s');
-> '09:30:17'
mysql> SELECT STR_TO_DATE('a09:30:17','%h:%i:%s');
-> NULL
mysql> SELECT STR_TO_DATE('09:30:17a','%h:%i:%s');
-> '09:30:17'
```

Unspecified date or time parts have a value of 0, so incompletely specified values in `str` produce a result with some or all parts set to 0:

```
mysql> SELECT STR_TO_DATE('abc','abc');
-> '0000-00-00'
mysql> SELECT STR_TO_DATE('9','%m');
-> '0000-09-00'
mysql> SELECT STR_TO_DATE('9','%s');
-> '00:00:09'
```

Range checking on the parts of date values is as described in [Section 11.2.2, “The DATE, DATETIME, and TIMESTAMP Types”](#). This means, for example, that “zero” dates or dates with part values of 0 are permitted unless the SQL mode is set to disallow such values.

```
mysql> SELECT STR_TO_DATE('00/00/0000','%m/%d/%Y');
-> '0000-00-00'
mysql> SELECT STR_TO_DATE('04/31/2004','%m/%d/%Y');
-> '2004-04-31'
```

If the `NO_ZERO_DATE` SQL mode is enabled, zero dates are disallowed. In that case, `STR_TO_DATE()` returns `NULL` and generates a warning:

```
mysql> SET sql_mode = '';
mysql> SELECT STR_TO_DATE('00/00/0000','%m/%d/%Y');
+-----+
| STR_TO_DATE('00/00/0000','%m/%d/%Y') |
+-----+
| 0000-00-00 |
+-----+
mysql> SET sql_mode = 'NO_ZERO_DATE';
mysql> SELECT STR_TO_DATE('00/00/0000','%m/%d/%Y');
+-----+
| STR_TO_DATE('00/00/0000','%m/%d/%Y') |
+-----+
```

```

| NULL |
+-----+
mysql> SHOW WARNINGS\G
***** 1. row *****
Level: Warning
Code: 1411
Message: Incorrect datetime value: '00/00/0000' for function str_to_date

```

Prior to MySQL 5.7.44, it was possible to pass an invalid date string such as '2021-11-31' to this function. In MySQL 5.7.44 and later, `STR_TO_DATE()` performs complete range checking and raises an error if the date after conversion would be invalid.



### Note

You cannot use format "`%X%V`" to convert a year-week string to a date because the combination of a year and week does not uniquely identify a year and month if the week crosses a month boundary. To convert a year-week to a date, you should also specify the weekday:

```

mysql> SELECT STR_TO_DATE('200442 Monday', '%X%V %W');
-> '2004-10-18'

```

You should also be aware that, for dates and the date portions of datetime values, `STR_TO_DATE()` checks (only) the individual year, month, and day of month values for validity. More precisely, this means that the year is checked to be sure that it is in the range 0-9999 inclusive, the month is checked to ensure that it is in the range 1-12 inclusive, and the day of month is checked to make sure that it is in the range 1-31 inclusive, but the server does not check the values in combination. For example, `SELECT STR_TO_DATE('23-2-31', '%Y-%m-%d')` returns `2023-02-31`. Enabling or disabling the `ALLOW_INVALID_DATES` server SQL mode has no effect on this behavior. See [Section 11.2.2, "The DATE, DATETIME, and TIMESTAMP Types"](#), for more information.

- `SUBDATE(date, INTERVAL expr unit), SUBDATE(expr, days)`

When invoked with the `INTERVAL` form of the second argument, `SUBDATE()` is a synonym for `DATE_SUB()`. For information on the `INTERVAL unit` argument, see the discussion for `DATE_ADD()`.

```

mysql> SELECT DATE_SUB('2008-01-02', INTERVAL 31 DAY);
-> '2007-12-02'
mysql> SELECT SUBDATE('2008-01-02', INTERVAL 31 DAY);
-> '2007-12-02'

```

The second form enables the use of an integer value for `days`. In such cases, it is interpreted as the number of days to be subtracted from the date or datetime expression `expr`.

```

mysql> SELECT SUBDATE('2008-01-02 12:00:00', 31);
-> '2007-12-02 12:00:00'

```

- `SUBTIME(expr1, expr2)`

`SUBTIME()` returns `expr1 - expr2` expressed as a value in the same format as `expr1`. `expr1` is a time or datetime expression, and `expr2` is a time expression.

```

mysql> SELECT SUBTIME('2007-12-31 23:59:59.999999', '1 1:1:1.000002');
-> '2007-12-30 22:58:58.999997'
mysql> SELECT SUBTIME('01:00:00.999999', '02:00:00.999998');
-> '-00:59:59.999999'

```

- `SYSDATE([fsp])`

Returns the current date and time as a value in `'YYYY-MM-DD hh:mm:ss'` or `YYYYMMDDhhmmss` format, depending on whether the function is used in string or numeric context.

If the `fsp` argument is given to specify a fractional seconds precision from 0 to 6, the return value includes a fractional seconds part of that many digits.

`SYSDATE()` returns the time at which it executes. This differs from the behavior for `NOW()`, which returns a constant time that indicates the time at which the statement began to execute. (Within a stored function or trigger, `NOW()` returns the time at which the function or triggering statement began to execute.)

```
mysql> SELECT NOW(), SLEEP(2), NOW();
+-----+-----+-----+
| NOW()          | SLEEP(2) | NOW()          |
+-----+-----+-----+
| 2006-04-12 13:47:36 |          0 | 2006-04-12 13:47:36 |
+-----+-----+-----+

mysql> SELECT SYSDATE(), SLEEP(2), SYSDATE();
+-----+-----+-----+
| SYSDATE()      | SLEEP(2) | SYSDATE()      |
+-----+-----+-----+
| 2006-04-12 13:47:44 |          0 | 2006-04-12 13:47:46 |
+-----+-----+-----+
```

In addition, the `SET TIMESTAMP` statement affects the value returned by `NOW()` but not by `SYSDATE()`. This means that timestamp settings in the binary log have no effect on invocations of `SYSDATE()`.

Because `SYSDATE()` can return different values even within the same statement, and is not affected by `SET TIMESTAMP`, it is nondeterministic and therefore unsafe for replication if statement-based binary logging is used. If that is a problem, you can use row-based logging.

Alternatively, you can use the `--sysdate-is-now` option to cause `SYSDATE()` to be an alias for `NOW()`. This works if the option is used on both the source and the replica.

The nondeterministic nature of `SYSDATE()` also means that indexes cannot be used for evaluating expressions that refer to it.

- `TIME(expr)`

Extracts the time part of the time or datetime expression `expr` and returns it as a string.

This function is unsafe for statement-based replication. A warning is logged if you use this function when `binlog_format` is set to `STATEMENT`.

```
mysql> SELECT TIME('2003-12-31 01:02:03');
-> '01:02:03'
mysql> SELECT TIME('2003-12-31 01:02:03.000123');
-> '01:02:03.000123'
```

- `TIMEDIFF(expr1,expr2)`

`TIMEDIFF()` returns  $expr1 - expr2$  expressed as a time value. *expr1* and *expr2* are strings which are converted to `TIME` or `DATETIME` expressions; these must be of the same type following conversion.

The result returned by `TIMEDIFF()` is limited to the range allowed for `TIME` values. Alternatively, you can use either of the functions `TIMESTAMPDIFF()` and `UNIX_TIMESTAMP()`, both of which return integers.

```
mysql> SELECT TIMEDIFF('2000:01:01 00:00:00',
->                    '2000:01:01 00:00:00.000001');
->      '-00:00:00.000001'
mysql> SELECT TIMEDIFF('2008-12-31 23:59:59.000001',
->                    '2008-12-30 01:01:01.000002');
->      '46:58:57.999999'
```

- `TIMESTAMP(expr)`, `TIMESTAMP(expr1,expr2)`

With a single argument, this function returns the date or datetime expression *expr* as a datetime value. With two arguments, it adds the time expression *expr2* to the date or datetime expression *expr1* and returns the result as a datetime value.

```
mysql> SELECT TIMESTAMP('2003-12-31');
->      '2003-12-31 00:00:00'
mysql> SELECT TIMESTAMP('2003-12-31 12:00:00','12:00:00');
->      '2004-01-01 00:00:00'
```

- `TIMESTAMPADD(unit,interval,datetime_expr)`

Adds the integer expression *interval* to the date or datetime expression *datetime\_expr*. The unit for *interval* is given by the *unit* argument, which should be one of the following values: `MICROSECOND` (microseconds), `SECOND`, `MINUTE`, `HOURL`, `DAY`, `WEEK`, `MONTH`, `QUARTER`, or `YEAR`.

The *unit* value may be specified using one of keywords as shown, or with a prefix of `SQL_TSI_`. For example, `DAY` and `SQL_TSI_DAY` both are legal.

```
mysql> SELECT TIMESTAMPADD(MINUTE,1,'2003-01-02');
->      '2003-01-02 00:01:00'
mysql> SELECT TIMESTAMPADD(WEEK,1,'2003-01-02');
->      '2003-01-09'
```

When adding a `MONTH` interval to a `DATE` or `DATETIME` value, and the resulting date includes a day that does not exist in the given month, the day is adjusted to the last day of the month, as shown here:

```
mysql> SELECT TIMESTAMPADD(MONTH, 1, DATE '2024-03-30') AS t1,
->        TIMESTAMPADD(MONTH, 1, DATE '2024-03-31') AS t2;
+-----+-----+
| t1      | t2      |
+-----+-----+
| 2024-04-30 | 2024-04-30 |
+-----+-----+
1 row in set (0.00 sec)
```

- `TIMESTAMPDIFF(unit,datetime_expr1,datetime_expr2)`

Returns  $datetime\_expr2 - datetime\_expr1$ , where *datetime\_expr1* and *datetime\_expr2* are date or datetime expressions. One expression may be a date and the other a datetime; a date value is treated as a datetime having the time part `'00:00:00'` where necessary. The unit for the result (an



integer) is given by the *unit* argument. The legal values for *unit* are the same as those listed in the description of the `TIMESTAMPADD()` function.

```
mysql> SELECT TIMESTAMPDIFF(MONTH,'2003-02-01','2003-05-01');
-> 3
mysql> SELECT TIMESTAMPDIFF(YEAR,'2002-05-01','2001-01-01');
-> -1
mysql> SELECT TIMESTAMPDIFF(MINUTE,'2003-02-01','2003-05-01 12:05:55');
-> 128885
```



#### Note

The order of the date or datetime arguments for this function is the opposite of that used with the `TIMESTAMP()` function when invoked with 2 arguments.

- `TIME_FORMAT(time,format)`

This is used like the `DATE_FORMAT()` function, but the *format* string may contain format specifiers only for hours, minutes, seconds, and microseconds. Other specifiers produce a `NULL` value or `0`.

If the *time* value contains an hour part that is greater than `23`, the `%H` and `%k` hour format specifiers produce a value larger than the usual range of `0..23`. The other hour format specifiers produce the hour value modulo 12.

```
mysql> SELECT TIME_FORMAT('100:00:00', '%H %k %h %I %l');
-> '100 100 04 04 4'
```

- `TIME_TO_SEC(time)`

Returns the *time* argument, converted to seconds.

```
mysql> SELECT TIME_TO_SEC('22:23:00');
-> 80580
mysql> SELECT TIME_TO_SEC('00:39:38');
-> 2378
```

- `TO_DAYS(date)`

Given a date *date*, returns a day number (the number of days since year 0).

```
mysql> SELECT TO_DAYS(950501);
-> 728779
mysql> SELECT TO_DAYS('2007-10-07');
-> 733321
```

`TO_DAYS()` is not intended for use with values that precede the advent of the Gregorian calendar (1582), because it does not take into account the days that were lost when the calendar was changed. For dates before 1582 (and possibly a later year in other locales), results from this function are not reliable. See [Section 11.2.8, “What Calendar Is Used By MySQL?”](#), for details.

Remember that MySQL converts two-digit year values in dates to four-digit form using the rules in [Section 11.2, “Date and Time Data Types”](#). For example, `'2008-10-07'` and `'08-10-07'` are seen as identical dates:

```
mysql> SELECT TO_DAYS('2008-10-07'), TO_DAYS('08-10-07');
-> 733687, 733687
```

In MySQL, the zero date is defined as `'0000-00-00'`, even though this date is itself considered invalid. This means that, for `'0000-00-00'` and `'0000-01-01'`, `TO_DAYS()` returns the values shown here:

```
mysql> SELECT TO_DAYS('0000-00-00');
```

```

+-----+
| to_days('0000-00-00') |
+-----+
|                NULL |
+-----+
1 row in set, 1 warning (0.00 sec)

mysql> SHOW WARNINGS;
+-----+-----+-----+
| Level | Code | Message |
+-----+-----+-----+
| Warning | 1292 | Incorrect datetime value: '0000-00-00' |
+-----+-----+-----+
1 row in set (0.00 sec)

mysql> SELECT TO_DAYS('0000-01-01');
+-----+
| to_days('0000-01-01') |
+-----+
|                1 |
+-----+
1 row in set (0.00 sec)

```

This is true whether or not the `ALLOW_INVALID_DATES` SQL server mode is enabled.

- `TO_SECONDS(expr)`

Given a date or datetime *expr*, returns the number of seconds since the year 0. If *expr* is not a valid date or datetime value, returns `NULL`.

```

mysql> SELECT TO_SECONDS(950501);
-> 62966505600
mysql> SELECT TO_SECONDS('2009-11-29');
-> 63426672000
mysql> SELECT TO_SECONDS('2009-11-29 13:43:32');
-> 63426721412
mysql> SELECT TO_SECONDS( NOW() );
-> 63426721458

```

Like `TO_DAYS()`, `TO_SECONDS()` is not intended for use with values that precede the advent of the Gregorian calendar (1582), because it does not take into account the days that were lost when the calendar was changed. For dates before 1582 (and possibly a later year in other locales), results from this function are not reliable. See [Section 11.2.8, “What Calendar Is Used By MySQL?”](#), for details.

Like `TO_DAYS()`, `TO_SECONDS()`, converts two-digit year values in dates to four-digit form using the rules in [Section 11.2, “Date and Time Data Types”](#).

In MySQL, the zero date is defined as `'0000-00-00'`, even though this date is itself considered invalid. This means that, for `'0000-00-00'` and `'0000-01-01'`, `TO_SECONDS()` returns the values shown here:

```

mysql> SELECT TO_SECONDS('0000-00-00');
+-----+
| TO_SECONDS('0000-00-00') |
+-----+
|                NULL |
+-----+
1 row in set, 1 warning (0.00 sec)

mysql> SHOW WARNINGS;
+-----+-----+-----+
| Level | Code | Message |
+-----+-----+-----+

```

```

| Warning | 1292 | Incorrect datetime value: '0000-00-00' |
+-----+-----+-----+
1 row in set (0.00 sec)

mysql> SELECT TO_SECONDS('0000-01-01');
+-----+
| TO_SECONDS('0000-01-01') |
+-----+
|                86400 |
+-----+
1 row in set (0.00 sec)

```

This is true whether or not the `ALLOW_INVALID_DATES` SQL server mode is enabled.

- `UNIX_TIMESTAMP([date])`

If `UNIX_TIMESTAMP()` is called with no `date` argument, it returns a Unix timestamp representing seconds since '1970-01-01 00:00:00' UTC.

If `UNIX_TIMESTAMP()` is called with a `date` argument, it returns the value of the argument as seconds since '1970-01-01 00:00:00' UTC. The server interprets `date` as a value in the session time zone and converts it to an internal Unix timestamp value in UTC. (Clients can set the session time zone as described in [Section 5.1.13, "MySQL Server Time Zone Support"](#).) The `date` argument may be a `DATE`, `DATETIME`, or `TIMESTAMP` string, or a number in `YYMMDD`, `YYMMDDhhmmss`, `YYYYMMDD`, or `YYYYMMDDhhmmss` format. If the argument includes a time part, it may optionally include a fractional seconds part.

The return value is an integer if no argument is given or the argument does not include a fractional seconds part, or `DECIMAL` if an argument is given that includes a fractional seconds part.

When the `date` argument is a `TIMESTAMP` column, `UNIX_TIMESTAMP()` returns the internal timestamp value directly, with no implicit "string-to-Unix-timestamp" conversion.

The valid range of argument values is the same as for the `TIMESTAMP` data type: '1970-01-01 00:00:01.000000' UTC to '2038-01-19 03:14:07.999999' UTC. If you pass an out-of-range date to `UNIX_TIMESTAMP()`, it returns 0.

```

mysql> SELECT UNIX_TIMESTAMP();
-> 1447431666
mysql> SELECT UNIX_TIMESTAMP('2015-11-13 10:20:19');
-> 1447431619
mysql> SELECT UNIX_TIMESTAMP('2015-11-13 10:20:19.012');
-> 1447431619.012

```

If you use `UNIX_TIMESTAMP()` and `FROM_UNIXTIME()` to convert between values in a non-UTC time zone and Unix timestamp values, the conversion is lossy because the mapping is not one-to-one in both directions. For example, due to conventions for local time zone changes such as Daylight Saving Time (DST), it is possible for `UNIX_TIMESTAMP()` to map two values that are distinct in a non-UTC time zone to the same Unix timestamp value. `FROM_UNIXTIME()` maps that value back to only one of the original values. Here is an example, using values that are distinct in the `MET` time zone:

```

mysql> SET time_zone = 'MET';
mysql> SELECT UNIX_TIMESTAMP('2005-03-27 03:00:00');
+-----+
| UNIX_TIMESTAMP('2005-03-27 03:00:00') |
+-----+
|                1111885200 |
+-----+
mysql> SELECT UNIX_TIMESTAMP('2005-03-27 02:00:00');

```

```

+-----+
| UNIX_TIMESTAMP('2005-03-27 02:00:00') |
+-----+
|                                     1111885200 |
+-----+
mysql> SELECT FROM_UNIXTIME(1111885200);
+-----+
| FROM_UNIXTIME(1111885200) |
+-----+
| 2005-03-27 03:00:00      |
+-----+

```

**Note**

To use named time zones such as 'MET' or 'Europe/Amsterdam', the time zone tables must be properly set up. For instructions, see [Section 5.1.13, “MySQL Server Time Zone Support”](#).

If you want to subtract `UNIX_TIMESTAMP()` columns, you might want to cast them to signed integers. See [Section 12.10, “Cast Functions and Operators”](#).

- `UTC_DATE`, `UTC_DATE()`

Returns the current UTC date as a value in 'YYYY-MM-DD' or YYYYMMDD format, depending on whether the function is used in string or numeric context.

```
mysql> SELECT UTC_DATE(), UTC_DATE() + 0;
-> '2003-08-14', 20030814
```

- `UTC_TIME`, `UTC_TIME([fsp])`

Returns the current UTC time as a value in 'hh:mm:ss' or hhmmss format, depending on whether the function is used in string or numeric context.

If the `fsp` argument is given to specify a fractional seconds precision from 0 to 6, the return value includes a fractional seconds part of that many digits.

```
mysql> SELECT UTC_TIME(), UTC_TIME() + 0;
-> '18:07:53', 180753.000000
```

- `UTC_TIMESTAMP`, `UTC_TIMESTAMP([fsp])`

Returns the current UTC date and time as a value in 'YYYY-MM-DD hh:mm:ss' or YYYYMMDDhhmmss format, depending on whether the function is used in string or numeric context.

If the `fsp` argument is given to specify a fractional seconds precision from 0 to 6, the return value includes a fractional seconds part of that many digits.

```
mysql> SELECT UTC_TIMESTAMP(), UTC_TIMESTAMP() + 0;
-> '2003-08-14 18:08:04', 20030814180804.000000
```

- `WEEK(date[, mode])`

This function returns the week number for `date`. The two-argument form of `WEEK()` enables you to specify whether the week starts on Sunday or Monday and whether the return value should

be in the range from 0 to 53 or from 1 to 53. If the *mode* argument is omitted, the value of the `default_week_format` system variable is used. See [Section 5.1.7, “Server System Variables”](#).

The following table describes how the *mode* argument works.

Mode	First day of week	Range	Week 1 is the first week ...
0	Sunday	0-53	with a Sunday in this year
1	Monday	0-53	with 4 or more days this year
2	Sunday	1-53	with a Sunday in this year
3	Monday	1-53	with 4 or more days this year
4	Sunday	0-53	with 4 or more days this year
5	Monday	0-53	with a Monday in this year
6	Sunday	1-53	with 4 or more days this year
7	Monday	1-53	with a Monday in this year

For *mode* values with a meaning of “with 4 or more days this year,” weeks are numbered according to ISO 8601:1988:

- If the week containing January 1 has 4 or more days in the new year, it is week 1.
- Otherwise, it is the last week of the previous year, and the next week is week 1.

```
mysql> SELECT WEEK('2008-02-20');
-> 7
mysql> SELECT WEEK('2008-02-20',0);
-> 7
mysql> SELECT WEEK('2008-02-20',1);
-> 8
mysql> SELECT WEEK('2008-12-31',1);
-> 53
```

If a date falls in the last week of the previous year, MySQL returns 0 if you do not use 2, 3, 6, or 7 as the optional *mode* argument:

```
mysql> SELECT YEAR('2000-01-01'), WEEK('2000-01-01',0);
-> 2000, 0
```

One might argue that `WEEK()` should return 52 because the given date actually occurs in the 52nd week of 1999. `WEEK()` returns 0 instead so that the return value is “the week number in the given year.” This

makes use of the `WEEK()` function reliable when combined with other functions that extract a date part from a date.

If you prefer a result evaluated with respect to the year that contains the first day of the week for the given date, use `0`, `2`, `5`, or `7` as the optional *mode* argument.

```
mysql> SELECT WEEK('2000-01-01',2);
-> 52
```

Alternatively, use the `YEARWEEK()` function:

```
mysql> SELECT YEARWEEK('2000-01-01');
-> 199952
mysql> SELECT MID(YEARWEEK('2000-01-01'),5,2);
-> '52'
```

- `WEEKDAY(date)`

Returns the weekday index for *date* (`0` = Monday, `1` = Tuesday, ... `6` = Sunday).

```
mysql> SELECT WEEKDAY('2008-02-03 22:23:00');
-> 6
mysql> SELECT WEEKDAY('2007-11-06');
-> 1
```

- `WEEKOFYEAR(date)`

Returns the calendar week of the date as a number in the range from `1` to `53`. `WEEKOFYEAR()` is a compatibility function that is equivalent to `WEEK(date,3)`.

```
mysql> SELECT WEEKOFYEAR('2008-02-20');
-> 8
```

- `YEAR(date)`

Returns the year for *date*, in the range `1000` to `9999`, or `0` for the “zero” date.

```
mysql> SELECT YEAR('1987-01-01');
-> 1987
```

- `YEARWEEK(date)`, `YEARWEEK(date,mode)`

Returns year and week for a date. The year in the result may be different from the year in the date argument for the first and the last week of the year.

The *mode* argument works exactly like the *mode* argument to `WEEK()`. For the single-argument syntax, a *mode* value of `0` is used. Unlike `WEEK()`, the value of `default_week_format` does not influence `YEARWEEK()`.

```
mysql> SELECT YEARWEEK('1987-01-01');
-> 198652
```

The week number is different from what the `WEEK()` function would return (`0`) for optional arguments `0` or `1`, as `WEEK()` then returns the week in the context of the given year.

## 12.8 String Functions and Operators

Table 12.12 String Functions and Operators

Name	Description
<code>ASCII()</code>	Return numeric value of left-most character

Name	Description
<code>BIN()</code>	Return a string containing binary representation of a number
<code>BIT_LENGTH()</code>	Return length of argument in bits
<code>CHAR()</code>	Return the character for each integer passed
<code>CHAR_LENGTH()</code>	Return number of characters in argument
<code>CHARACTER_LENGTH()</code>	Synonym for <code>CHAR_LENGTH()</code>
<code>CONCAT()</code>	Return concatenated string
<code>CONCAT_WS()</code>	Return concatenate with separator
<code>ELT()</code>	Return string at index number
<code>EXPORT_SET()</code>	Return a string such that for every bit set in the value bits, you get an on string and for every unset bit, you get an off string
<code>FIELD()</code>	Index (position) of first argument in subsequent arguments
<code>FIND_IN_SET()</code>	Index (position) of first argument within second argument
<code>FORMAT()</code>	Return a number formatted to specified number of decimal places
<code>FROM_BASE64()</code>	Decode base64 encoded string and return result
<code>HEX()</code>	Hexadecimal representation of decimal or string value
<code>INSERT()</code>	Insert substring at specified position up to specified number of characters
<code>INSTR()</code>	Return the index of the first occurrence of substring
<code>LCASE()</code>	Synonym for <code>LOWER()</code>
<code>LEFT()</code>	Return the leftmost number of characters as specified
<code>LENGTH()</code>	Return the length of a string in bytes
<code>LIKE</code>	Simple pattern matching
<code>LOAD_FILE()</code>	Load the named file
<code>LOCATE()</code>	Return the position of the first occurrence of substring
<code>LOWER()</code>	Return the argument in lowercase
<code>LPAD()</code>	Return the string argument, left-padded with the specified string
<code>LTRIM()</code>	Remove leading spaces
<code>MAKE_SET()</code>	Return a set of comma-separated strings that have the corresponding bit in bits set
<code>MATCH()</code>	Perform full-text search
<code>MID()</code>	Return a substring starting from the specified position

Name	Description
NOT LIKE	Negation of simple pattern matching
NOT REGEXP	Negation of REGEXP
OCT()	Return a string containing octal representation of a number
OCTET_LENGTH()	Synonym for LENGTH()
ORD()	Return character code for leftmost character of the argument
POSITION()	Synonym for LOCATE()
QUOTE()	Escape the argument for use in an SQL statement
REGEXP	Whether string matches regular expression
REPEAT()	Repeat a string the specified number of times
REPLACE()	Replace occurrences of a specified string
REVERSE()	Reverse the characters in a string
RIGHT()	Return the specified rightmost number of characters
RLIKE	Whether string matches regular expression
RPAD()	Append string the specified number of times
RTRIM()	Remove trailing spaces
SOUNDEX()	Return a soundex string
SOUNDS LIKE	Compare sounds
SPACE()	Return a string of the specified number of spaces
STRCMP()	Compare two strings
SUBSTR()	Return the substring as specified
SUBSTRING()	Return the substring as specified
SUBSTRING_INDEX()	Return a substring from a string before the specified number of occurrences of the delimiter
TO_BASE64()	Return the argument converted to a base-64 string
TRIM()	Remove leading and trailing spaces
UCASE()	Synonym for UPPER()
UNHEX()	Return a string containing hex representation of a number
UPPER()	Convert to uppercase
WEIGHT_STRING()	Return the weight string for a string

String-valued functions return `NULL` if the length of the result would be greater than the value of the `max_allowed_packet` system variable. See [Section 5.1.1, “Configuring the Server”](#).

For functions that operate on string positions, the first position is numbered 1.

For functions that take length arguments, noninteger arguments are rounded to the nearest integer.

- `ASCII(str)`



Returns the numeric value of the leftmost character of the string *str*. Returns 0 if *str* is the empty string. Returns *NULL* if *str* is *NULL*. `ASCII()` works for 8-bit characters.

```
mysql> SELECT ASCII('2');
-> 50
mysql> SELECT ASCII(2);
-> 50
mysql> SELECT ASCII('dx');
-> 100
```

See also the `ORD()` function.

- `BIN(N)`

Returns a string representation of the binary value of *N*, where *N* is a longlong (`BIGINT`) number. This is equivalent to `CONV(N, 10, 2)`. Returns *NULL* if *N* is *NULL*.

```
mysql> SELECT BIN(12);
-> '1100'
```

- `BIT_LENGTH(str)`

Returns the length of the string *str* in bits.

```
mysql> SELECT BIT_LENGTH('text');
-> 32
```

- `CHAR(N, ... [USING charset_name])`

`CHAR()` interprets each argument *N* as an integer and returns a string consisting of the characters given by the code values of those integers. *NULL* values are skipped.

```
mysql> SELECT CHAR(77,121,83,81,'76');
-> 'MySQL'
mysql> SELECT CHAR(77,77.3,'77.3');
-> 'MMM'
```

`CHAR()` arguments larger than 255 are converted into multiple result bytes. For example, `CHAR(256)` is equivalent to `CHAR(1,0)`, and `CHAR(256*256)` is equivalent to `CHAR(1,0,0)`:

```
mysql> SELECT HEX(CHAR(1,0)), HEX(CHAR(256));
+-----+-----+
| HEX(CHAR(1,0)) | HEX(CHAR(256)) |
+-----+-----+
| 0100          | 0100          |
+-----+-----+
mysql> SELECT HEX(CHAR(1,0,0)), HEX(CHAR(256*256));
+-----+-----+
| HEX(CHAR(1,0,0)) | HEX(CHAR(256*256)) |
+-----+-----+
| 010000         | 010000         |
+-----+-----+
```

By default, `CHAR()` returns a binary string. To produce a string in a given character set, use the optional `USING` clause:

```
mysql> SELECT CHARSET(CHAR(X'65')), CHARSET(CHAR(X'65' USING utf8));
+-----+-----+
| CHARSET(CHAR(X'65')) | CHARSET(CHAR(X'65' USING utf8)) |
+-----+-----+
| binary              | utf8                            |
+-----+-----+
```

If `USING` is given and the result string is illegal for the given character set, a warning is issued. Also, if strict SQL mode is enabled, the result from `CHAR()` becomes `NULL`.

If `CHAR()` is invoked from within the `mysql` client, binary strings display using hexadecimal notation, depending on the value of the `--binary-as-hex`. For more information about that option, see [Section 4.5.1, “mysql — The MySQL Command-Line Client”](#).

- `CHAR_LENGTH(str)`

Returns the length of the string `str`, measured in code points. A multibyte character counts as a single code point. This means that, for a string containing two 3-byte characters, `LENGTH()` returns 6, whereas `CHAR_LENGTH()` returns 2, as shown here:

```
mysql> SET @dolphin:='海豚';
Query OK, 0 rows affected (0.01 sec)

mysql> SELECT LENGTH(@dolphin), CHAR_LENGTH(@dolphin);
+-----+-----+
| LENGTH(@dolphin) | CHAR_LENGTH(@dolphin) |
+-----+-----+
|                6 |                      2 |
+-----+-----+
1 row in set (0.00 sec)
```

- `CHARACTER_LENGTH(str)`

`CHARACTER_LENGTH()` is a synonym for `CHAR_LENGTH()`.

- `CONCAT(str1, str2, ...)`

Returns the string that results from concatenating the arguments. May have one or more arguments. If all arguments are nonbinary strings, the result is a nonbinary string. If the arguments include any binary strings, the result is a binary string. A numeric argument is converted to its equivalent nonbinary string form.

`CONCAT()` returns `NULL` if any argument is `NULL`.

```
mysql> SELECT CONCAT('My', 'S', 'QL');
-> 'MySQL'
mysql> SELECT CONCAT('My', NULL, 'QL');
-> NULL
mysql> SELECT CONCAT(14.3);
-> '14.3'
```

For quoted strings, concatenation can be performed by placing the strings next to each other:

```
mysql> SELECT 'My' 'S' 'QL';
-> 'MySQL'
```

If `CONCAT()` is invoked from within the `mysql` client, binary string results display using hexadecimal notation, depending on the value of the `--binary-as-hex`. For more information about that option, see [Section 4.5.1, “mysql — The MySQL Command-Line Client”](#).

- `CONCAT_WS(separator, str1, str2, ...)`

`CONCAT_WS()` stands for Concatenate With Separator and is a special form of `CONCAT()`. The first argument is the separator for the rest of the arguments. The separator is added between the strings to

be concatenated. The separator can be a string, as can the rest of the arguments. If the separator is `NULL`, the result is `NULL`.

```
mysql> SELECT CONCAT_WS(',', 'First name', 'Second name', 'Last Name');
-> 'First name,Second name,Last Name'
mysql> SELECT CONCAT_WS(',', 'First name', NULL, 'Last Name');
-> 'First name,Last Name'
```

`CONCAT_WS()` does not skip empty strings. However, it does skip any `NULL` values after the separator argument.

- `ELT(N, str1, str2, str3, ...)`

`ELT()` returns the *N*th element of the list of strings: `str1` if *N* = 1, `str2` if *N* = 2, and so on. Returns `NULL` if *N* is less than 1 or greater than the number of arguments. `ELT()` is the complement of `FIELD()`.

```
mysql> SELECT ELT(1, 'Aa', 'Bb', 'Cc', 'Dd');
-> 'Aa'
mysql> SELECT ELT(4, 'Aa', 'Bb', 'Cc', 'Dd');
-> 'Dd'
```

- `EXPORT_SET(bits, on, off[, separator[, number_of_bits]])`

Returns a string such that for every bit set in the value `bits`, you get an `on` string and for every bit not set in the value, you get an `off` string. Bits in `bits` are examined from right to left (from low-order to high-order bits). Strings are added to the result from left to right, separated by the `separator` string (the default being the comma character `,`). The number of bits examined is given by `number_of_bits`, which has a default of 64 if not specified. `number_of_bits` is silently clipped to 64 if larger than 64. It is treated as an unsigned integer, so a value of `-1` is effectively the same as 64.

```
mysql> SELECT EXPORT_SET(5, 'Y', 'N', ',', '4');
-> 'Y,N,Y,N'
mysql> SELECT EXPORT_SET(6, '1', '0', ',', '10');
-> '0,1,1,0,0,0,0,0,0,0'
```

- `FIELD(str, str1, str2, str3, ...)`

Returns the index (position) of `str` in the `str1, str2, str3, ...` list. Returns 0 if `str` is not found.

If all arguments to `FIELD()` are strings, all arguments are compared as strings. If all arguments are numbers, they are compared as numbers. Otherwise, the arguments are compared as double.

If `str` is `NULL`, the return value is 0 because `NULL` fails equality comparison with any value. `FIELD()` is the complement of `ELT()`.

```
mysql> SELECT FIELD('Bb', 'Aa', 'Bb', 'Cc', 'Dd', 'Ff');
-> 2
mysql> SELECT FIELD('Gg', 'Aa', 'Bb', 'Cc', 'Dd', 'Ff');
-> 0
```

- `FIND_IN_SET(str, strlist)`

Returns a value in the range of 1 to *N* if the string `str` is in the string list `strlist` consisting of *N* substrings. A string list is a string composed of substrings separated by `,` characters. If the first argument is a constant string and the second is a column of type `SET`, the `FIND_IN_SET()` function is optimized to use bit arithmetic. Returns 0 if `str` is not in `strlist` or if `strlist` is the empty string. Returns `NULL` if either argument is `NULL`. This function does not work properly if the first argument contains a comma (`,`) character.

```
mysql> SELECT FIND_IN_SET('b', 'a,b,c,d');
```

```
-> 2
```

- `FORMAT(X,D[,locale])`

Formats the number *X* to a format like '#,###,###.##', rounded to *D* decimal places, and returns the result as a string. If *D* is 0, the result has no decimal point or fractional part.

The optional third parameter enables a locale to be specified to be used for the result number's decimal point, thousands separator, and grouping between separators. Permissible locale values are the same as the legal values for the `lc_time_names` system variable (see [Section 10.16, “MySQL Server Locale Support”](#)). If no locale is specified, the default is 'en\_US'.

```
mysql> SELECT FORMAT(12332.123456, 4);
-> '12,332.1235'
mysql> SELECT FORMAT(12332.1,4);
-> '12,332.1000'
mysql> SELECT FORMAT(12332.2,0);
-> '12,332'
mysql> SELECT FORMAT(12332.2,2,'de_DE');
-> '12.332,20'
```

- `FROM_BASE64(str)`

Takes a string encoded with the base-64 encoded rules used by `TO_BASE64()` and returns the decoded result as a binary string. The result is `NULL` if the argument is `NULL` or not a valid base-64 string. See the description of `TO_BASE64()` for details about the encoding and decoding rules.

```
mysql> SELECT TO_BASE64('abc'), FROM_BASE64(TO_BASE64('abc'));
-> 'JWJj', 'abc'
```

If `FROM_BASE64()` is invoked from within the `mysql` client, binary strings display using hexadecimal notation, depending on the value of the `--binary-as-hex`. For more information about that option, see [Section 4.5.1, “mysql — The MySQL Command-Line Client”](#).

- `HEX(str)`, `HEX(N)`

For a string argument *str*, `HEX()` returns a hexadecimal string representation of *str* where each byte of each character in *str* is converted to two hexadecimal digits. (Multibyte characters therefore become more than two digits.) The inverse of this operation is performed by the `UNHEX()` function.

For a numeric argument *N*, `HEX()` returns a hexadecimal string representation of the value of *N* treated as a longlong (`BIGINT`) number. This is equivalent to `CONV(N,10,16)`. The inverse of this operation is performed by `CONV(HEX(N),16,10)`.

```
mysql> SELECT X'616263', HEX('abc'), UNHEX(HEX('abc'));
-> 'abc', 616263, 'abc'
mysql> SELECT HEX(255), CONV(HEX(255),16,10);
-> 'FF', 255
```

- `INSERT(str,pos,len,newstr)`

Returns the string *str*, with the substring beginning at position *pos* and *len* characters long replaced by the string *newstr*. Returns the original string if *pos* is not within the length of the string. Replaces the rest of the string from position *pos* if *len* is not within the length of the rest of the string. Returns `NULL` if any argument is `NULL`.

```
mysql> SELECT INSERT('Quadratic', 3, 4, 'What');
-> 'QuWhattic'
mysql> SELECT INSERT('Quadratic', -1, 4, 'What');
-> 'Quadratic'
mysql> SELECT INSERT('Quadratic', 3, 100, 'What');
```

```
-> 'QuWhat'
```

This function is multibyte safe.

- `INSTR(str, substr)`

Returns the position of the first occurrence of substring `substr` in string `str`. This is the same as the two-argument form of `LOCATE()`, except that the order of the arguments is reversed.

```
mysql> SELECT INSTR('foobarbar', 'bar');
-> 4
mysql> SELECT INSTR('xbar', 'foobar');
-> 0
```

This function is multibyte safe, and is case-sensitive only if at least one argument is a binary string.

- `LCASE(str)`

`LCASE()` is a synonym for `LOWER()`.

`LCASE()` used in a view is rewritten as `LOWER()` when storing the view's definition. (Bug #12844279)

- `LEFT(str, len)`

Returns the leftmost `len` characters from the string `str`, or `NULL` if any argument is `NULL`.

```
mysql> SELECT LEFT('foobarbar', 5);
-> 'fooba'
```

This function is multibyte safe.

- `LENGTH(str)`

Returns the length of the string `str`, measured in bytes. A multibyte character counts as multiple bytes. This means that for a string containing five 2-byte characters, `LENGTH()` returns 10, whereas `CHAR_LENGTH()` returns 5.

```
mysql> SELECT LENGTH('text');
-> 4
```



#### Note

The `Length()` OpenGIS spatial function is named `ST_Length()` in MySQL.

- `LOAD_FILE(file_name)`

Reads the file and returns the file contents as a string. To use this function, the file must be located on the server host, you must specify the full path name to the file, and you must have the `FILE` privilege. The file must be readable by all and its size less than `max_allowed_packet` bytes. If the `secure_file_priv` system variable is set to a nonempty directory name, the file to be loaded must be located in that directory.

If the file does not exist or cannot be read because one of the preceding conditions is not satisfied, the function returns `NULL`.

The `character_set_filesystem` system variable controls interpretation of file names that are given as literal strings.

```
mysql> UPDATE t
      SET blob_col=LOAD_FILE('/tmp/picture')
```

```
WHERE id=1;
```

- `LOCATE(substr, str)`, `LOCATE(substr, str, pos)`

The first syntax returns the position of the first occurrence of substring `substr` in string `str`. The second syntax returns the position of the first occurrence of substring `substr` in string `str`, starting at position `pos`. Returns 0 if `substr` is not in `str`. Returns `NULL` if `substr` or `str` is `NULL`.

```
mysql> SELECT LOCATE('bar', 'foobarbar');
-> 4
mysql> SELECT LOCATE('xbar', 'foobar');
-> 0
mysql> SELECT LOCATE('bar', 'foobarbar', 5);
-> 7
```

This function is multibyte safe, and is case-sensitive only if at least one argument is a binary string.

- `LOWER(str)`

Returns the string `str` with all characters changed to lowercase according to the current character set mapping. The default is `latin1` (cp1252 West European).

```
mysql> SELECT LOWER('QUADRATICALLY');
-> 'quadratically'
```

`LOWER()` (and `UPPER()`) are ineffective when applied to binary strings (`BINARY`, `VARBINARY`, `BLOB`). To perform lettercase conversion of a binary string, first convert it to a nonbinary string using a character set appropriate for the data stored in the string:

```
mysql> SET @str = BINARY 'New York';
mysql> SELECT LOWER(@str), LOWER(CONVERT(@str USING latin1));
+-----+-----+
| LOWER(@str) | LOWER(CONVERT(@str USING latin1)) |
+-----+-----+
| New York   | new york                           |
+-----+-----+
```

For collations of Unicode character sets, `LOWER()` and `UPPER()` work according to the Unicode Collation Algorithm (UCA) version in the collation name, if there is one, and UCA 4.0.0 if no version is specified. For example, `utf8_unicode_520_ci` works according to UCA 5.2.0, whereas `utf8_unicode_ci` works according to UCA 4.0.0. See [Section 10.10.1, “Unicode Character Sets”](#).

This function is multibyte safe.

In previous versions of MySQL, `LOWER()` used within a view was rewritten as `LCASE()` when storing the view's definition. In MySQL 5.7, `LOWER()` is never rewritten in such cases, but `LCASE()` used within views is instead rewritten as `LOWER()`. (Bug #12844279)

- `LPAD(str, len, padstr)`

Returns the string `str`, left-padded with the string `padstr` to a length of `len` characters. If `str` is longer than `len`, the return value is shortened to `len` characters.

```
mysql> SELECT LPAD('hi', 4, '??');
-> '??hi'
mysql> SELECT LPAD('hi', 1, '??');
-> 'h'
```

- `LTRIM(str)`

Returns the string `str` with leading space characters removed.

```
mysql> SELECT LTRIM('  barbar');
-> 'barbar'
```

This function is multibyte safe.

- `MAKE_SET(bits, str1, str2, ...)`

Returns a set value (a string containing substrings separated by `,` characters) consisting of the strings that have the corresponding bit in `bits` set. `str1` corresponds to bit 0, `str2` to bit 1, and so on. `NULL` values in `str1, str2, ...` are not appended to the result.

```
mysql> SELECT MAKE_SET(1, 'a', 'b', 'c');
-> 'a'
mysql> SELECT MAKE_SET(1 | 4, 'hello', 'nice', 'world');
-> 'hello,world'
mysql> SELECT MAKE_SET(1 | 4, 'hello', 'nice', NULL, 'world');
-> 'hello'
mysql> SELECT MAKE_SET(0, 'a', 'b', 'c');
-> ''
```

- `MID(str, pos)`, `MID(str FROM pos)`, `MID(str, pos, len)`, `MID(str FROM pos FOR len)`

`MID(str, pos, len)` is a synonym for `SUBSTRING(str, pos, len)`.

- `OCT(N)`

Returns a string representation of the octal value of `N`, where `N` is a longlong (`BIGINT`) number. This is equivalent to `CONV(N, 10, 8)`. Returns `NULL` if `N` is `NULL`.

```
mysql> SELECT OCT(12);
-> '14'
```

- `OCTET_LENGTH(str)`

`OCTET_LENGTH()` is a synonym for `LENGTH()`.

- `ORD(str)`

If the leftmost character of the string `str` is a multibyte character, returns the code for that character, calculated from the numeric values of its constituent bytes using this formula:

```
(1st byte code)
+ (2nd byte code * 256)
+ (3rd byte code * 256^2) ...
```

If the leftmost character is not a multibyte character, `ORD()` returns the same value as the `ASCII()` function.

```
mysql> SELECT ORD('2');
-> 50
```

- `POSITION(substr IN str)`

`POSITION(substr IN str)` is a synonym for `LOCATE(substr, str)`.

- `QUOTE(str)`

Quotes a string to produce a result that can be used as a properly escaped data value in an SQL statement. The string is returned enclosed by single quotation marks and with each instance of backslash (`\`), single quote (`'`), ASCII `NUL`, and Control+Z preceded by a backslash. If the argument is `NULL`, the return value is the word "NULL" without enclosing single quotation marks.

```
mysql> SELECT QUOTE('Don\'t!');
-> 'Don\'t!'
mysql> SELECT QUOTE(NULL);
-> NULL
```

For comparison, see the quoting rules for literal strings and within the C API in [Section 9.1.1](#), “String Literals”, and `mysql_real_escape_string_quote()`.

- `REPEAT(str, count)`

Returns a string consisting of the string `str` repeated `count` times. If `count` is less than 1, returns an empty string. Returns `NULL` if `str` or `count` are `NULL`.

```
mysql> SELECT REPEAT('MySQL', 3);
-> 'MySQLMySQLMySQL'
```

- `REPLACE(str, from_str, to_str)`

Returns the string `str` with all occurrences of the string `from_str` replaced by the string `to_str`. `REPLACE()` performs a case-sensitive match when searching for `from_str`.

```
mysql> SELECT REPLACE('www.mysql.com', 'w', 'Ww');
-> 'WwWwWw.mysql.com'
```

This function is multibyte safe.

- `REVERSE(str)`

Returns the string `str` with the order of the characters reversed.

```
mysql> SELECT REVERSE('abc');
-> 'cba'
```

This function is multibyte safe.

- `RIGHT(str, len)`

Returns the rightmost `len` characters from the string `str`, or `NULL` if any argument is `NULL`.

```
mysql> SELECT RIGHT('foobarbar', 4);
-> 'rbar'
```

This function is multibyte safe.

- `RPAD(str, len, padstr)`

Returns the string `str`, right-padded with the string `padstr` to a length of `len` characters. If `str` is longer than `len`, the return value is shortened to `len` characters.

```
mysql> SELECT RPAD('hi', 5, '?');
-> 'hi???'
mysql> SELECT RPAD('hi', 1, '?');
-> 'h'
```

This function is multibyte safe.



- `RTRIM(str)`

Returns the string *str* with trailing space characters removed.

```
mysql> SELECT RTRIM('barbar ');
-> 'barbar'
```

This function is multibyte safe.

- `SOUNDEX(str)`

Returns a soundex string from *str*. Two strings that sound almost the same should have identical soundex strings. A standard soundex string is four characters long, but the `SOUNDEX()` function returns an arbitrarily long string. You can use `SUBSTRING()` on the result to get a standard soundex string. All nonalphabetic characters in *str* are ignored. All international alphabetic characters outside the A-Z range are treated as vowels.



### Important

When using `SOUNDEX()`, you should be aware of the following limitations:

- This function, as currently implemented, is intended to work well with strings that are in the English language only. Strings in other languages may not produce reliable results.
- This function is not guaranteed to provide consistent results with strings that use multibyte character sets, including `utf-8`. See Bug #22638 for more information.

```
mysql> SELECT SOUNDEX('Hello');
-> 'H400'
mysql> SELECT SOUNDEX('Quadratically');
-> 'Q36324'
```



### Note

This function implements the original Soundex algorithm, not the more popular enhanced version (also described by D. Knuth). The difference is that original version discards vowels first and duplicates second, whereas the enhanced version discards duplicates first and vowels second.

- `expr1 SOUNDS LIKE expr2`

This is the same as `SOUNDEX(expr1) = SOUNDEX(expr2)`.

- `SPACE(N)`

Returns a string consisting of *N* space characters.

```
mysql> SELECT SPACE(6);
-> '      '
```

- `SUBSTR(str,pos)`, `SUBSTR(str FROM pos)`, `SUBSTR(str,pos,len)`, `SUBSTR(str FROM pos FOR len)`

`SUBSTR()` is a synonym for `SUBSTRING()`.

- `SUBSTRING(str,pos)`, `SUBSTRING(str FROM pos)`, `SUBSTRING(str,pos,len)`, `SUBSTRING(str FROM pos FOR len)`

The forms without a `len` argument return a substring from string `str` starting at position `pos`. The forms with a `len` argument return a substring `len` characters long from string `str`, starting at position `pos`. The forms that use `FROM` are standard SQL syntax. It is also possible to use a negative value for `pos`. In this case, the beginning of the substring is `pos` characters from the end of the string, rather than the beginning. A negative value may be used for `pos` in any of the forms of this function. A value of 0 for `pos` returns an empty string.

For all forms of `SUBSTRING()`, the position of the first character in the string from which the substring is to be extracted is reckoned as 1.

```
mysql> SELECT SUBSTRING('Quadratically',5);
-> 'ratically'
mysql> SELECT SUBSTRING('foobarbar' FROM 4);
-> 'barbar'
mysql> SELECT SUBSTRING('Quadratically',5,6);
-> 'ratika'
mysql> SELECT SUBSTRING('Sakila', -3);
-> 'ila'
mysql> SELECT SUBSTRING('Sakila', -5, 3);
-> 'aki'
mysql> SELECT SUBSTRING('Sakila' FROM -4 FOR 2);
-> 'ki'
```

This function is multibyte safe.

If `len` is less than 1, the result is the empty string.

- `SUBSTRING_INDEX(str,delim,count)`

Returns the substring from string `str` before `count` occurrences of the delimiter `delim`. If `count` is positive, everything to the left of the final delimiter (counting from the left) is returned. If `count` is negative, everything to the right of the final delimiter (counting from the right) is returned. `SUBSTRING_INDEX()` performs a case-sensitive match when searching for `delim`.

```
mysql> SELECT SUBSTRING_INDEX('www.mysql.com', '.', 2);
-> 'www.mysql'
mysql> SELECT SUBSTRING_INDEX('www.mysql.com', '.', -2);
-> 'mysql.com'
```

This function is multibyte safe.

- `TO_BASE64(str)`

Converts the string argument to base-64 encoded form and returns the result as a character string with the connection character set and collation. If the argument is not a string, it is converted to a string before conversion takes place. The result is `NULL` if the argument is `NULL`. Base-64 encoded strings can be decoded using the `FROM_BASE64()` function.

```
mysql> SELECT TO_BASE64('abc'), FROM_BASE64(TO_BASE64('abc'));
```

```
-> 'JWJj', 'abc'
```

Different base-64 encoding schemes exist. These are the encoding and decoding rules used by `TO_BASE64()` and `FROM_BASE64()`:

- The encoding for alphabet value 62 is '+'.
  - The encoding for alphabet value 63 is '/'.
  - Encoded output consists of groups of 4 printable characters. Each 3 bytes of the input data are encoded using 4 characters. If the last group is incomplete, it is padded with '=' characters to a length of 4.
  - A newline is added after each 76 characters of encoded output to divide long output into multiple lines.
  - Decoding recognizes and ignores newline, carriage return, tab, and space.
- `TRIM([{BOTH | LEADING | TRAILING} [remstr] FROM] str), TRIM([remstr FROM] str)`

Returns the string `str` with all `remstr` prefixes or suffixes removed. If none of the specifiers `BOTH`, `LEADING`, or `TRAILING` is given, `BOTH` is assumed. `remstr` is optional and, if not specified, spaces are removed.

```
mysql> SELECT TRIM(' bar ');
-> 'bar'
mysql> SELECT TRIM(LEADING 'x' FROM 'xxxbarxxx');
-> 'barxxx'
mysql> SELECT TRIM(BOTH 'x' FROM 'xxxbarxxx');
-> 'bar'
mysql> SELECT TRIM(TRAILING 'xyz' FROM 'barxyz');
-> 'barx'
```

This function is multibyte safe.

- `UCASE(str)`

`UCASE()` is a synonym for `UPPER()`.

In MySQL 5.7, `UCASE()` used in a view is rewritten as `UPPER()` when storing the view's definition. (Bug #12844279)

- `UNHEX(str)`

For a string argument `str`, `UNHEX(str)` interprets each pair of characters in the argument as a hexadecimal number and converts it to the byte represented by the number. The return value is a binary string.

```
mysql> SELECT UNHEX('4D7953514C');
-> 'MySQL'
mysql> SELECT X'4D7953514C';
-> 'MySQL'
mysql> SELECT UNHEX(HEX('string'));
-> 'string'
mysql> SELECT HEX(UNHEX('1267'));
-> '1267'
```

The characters in the argument string must be legal hexadecimal digits: '0' .. '9', 'A' .. 'F', 'a' .. 'f'. If the argument contains any nonhexadecimal digits, the result is `NULL`:

```
mysql> SELECT UNHEX('GG');
+-----+
```

```
| UNHEX('GG') |
+-----+
| NULL        |
+-----+
```

A `NULL` result can occur if the argument to `UNHEX()` is a `BINARY` column, because values are padded with `0x00` bytes when stored but those bytes are not stripped on retrieval. For example, `'41'` is stored into a `CHAR(3)` column as `'41 '` and retrieved as `'41'` (with the trailing pad space stripped), so `UNHEX()` for the column value returns `X'41'`. By contrast, `'41'` is stored into a `BINARY(3)` column as `'41\0'` and retrieved as `'41\0'` (with the trailing pad `0x00` byte not stripped). `'\0'` is not a legal hexadecimal digit, so `UNHEX()` for the column value returns `NULL`.

For a numeric argument `N`, the inverse of `HEX(N)` is not performed by `UNHEX()`. Use `CONV(HEX(N), 16, 10)` instead. See the description of `HEX()`.

If `UNHEX()` is invoked from within the `mysql` client, binary strings display using hexadecimal notation, depending on the value of the `--binary-as-hex`. For more information about that option, see [Section 4.5.1, “mysql — The MySQL Command-Line Client”](#).

- `UPPER(str)`

Returns the string `str` with all characters changed to uppercase according to the current character set mapping. The default is `latin1` (cp1252 West European).

```
mysql> SELECT UPPER('Hej');
-> 'HEJ'
```

See the description of `LOWER()` for information that also applies to `UPPER()`. This included information about how to perform lettercase conversion of binary strings (`BINARY`, `VARBINARY`, `BLOB`) for which these functions are ineffective, and information about case folding for Unicode character sets.

This function is multibyte safe.

In previous versions of MySQL, `UPPER()` used within a view was rewritten as `UCASE()` when storing the view's definition. In MySQL 5.7, `UPPER()` is never rewritten in such cases, but `UCASE()` used within views is instead rewritten as `UPPER()`. (Bug #12844279)

- `WEIGHT_STRING(str [AS {CHAR|BINARY}(N)] [LEVEL levels] [flags])`

`levels: N [ASC|DESC|REVERSE] [, N [ASC|DESC|REVERSE]] ...`

This function returns the weight string for the input string. The return value is a binary string that represents the comparison and sorting value of the string. It has these properties:

- If `WEIGHT_STRING(str1) = WEIGHT_STRING(str2)`, then `str1 = str2` (`str1` and `str2` are considered equal)
- If `WEIGHT_STRING(str1) < WEIGHT_STRING(str2)`, then `str1 < str2` (`str1` sorts before `str2`)

`WEIGHT_STRING()` is a debugging function intended for internal use. Its behavior can change without notice between MySQL versions. It can be used for testing and debugging of collations, especially if you are adding a new collation. See [Section 10.14, “Adding a Collation to a Character Set”](#).

This list briefly summarizes the arguments. More details are given in the discussion following the list.

- `str`: The input string expression.
- `AS` clause: Optional; cast the input string to a given type and length.
- `LEVEL` clause: Optional; specify weight levels for the return value.
- `flags`: Optional; unused.

The input string, `str`, is a string expression. If the input is a nonbinary (character) string such as a `CHAR`, `VARCHAR`, or `TEXT` value, the return value contains the collation weights for the string. If the input is a binary (byte) string such as a `BINARY`, `VARBINARY`, or `BLOB` value, the return value is the same as the input (the weight for each byte in a binary string is the byte value). If the input is `NULL`, `WEIGHT_STRING()` returns `NULL`.

Examples:

```
mysql> SET @s = _latin1 'AB' COLLATE latin1_swedish_ci;
mysql> SELECT @s, HEX(@s), HEX(WEIGHT_STRING(@s));
+-----+-----+-----+
| @s    | HEX(@s) | HEX(WEIGHT_STRING(@s)) |
+-----+-----+-----+
| AB    | 4142    | 4142                    |
+-----+-----+-----+
```

```
mysql> SET @s = _latin1 'ab' COLLATE latin1_swedish_ci;
mysql> SELECT @s, HEX(@s), HEX(WEIGHT_STRING(@s));
+-----+-----+-----+
| @s    | HEX(@s) | HEX(WEIGHT_STRING(@s)) |
+-----+-----+-----+
| ab    | 6162    | 4142                    |
+-----+-----+-----+
```

```
mysql> SET @s = CAST('AB' AS BINARY);
mysql> SELECT @s, HEX(@s), HEX(WEIGHT_STRING(@s));
+-----+-----+-----+
| @s    | HEX(@s) | HEX(WEIGHT_STRING(@s)) |
+-----+-----+-----+
| AB    | 4142    | 4142                    |
+-----+-----+-----+
```

```
mysql> SET @s = CAST('ab' AS BINARY);
mysql> SELECT @s, HEX(@s), HEX(WEIGHT_STRING(@s));
```

```

+-----+-----+-----+
| @s    | HEX(@s) | HEX(WEIGHT_STRING(@s)) |
+-----+-----+-----+
| ab    | 6162    | 6162                    |
+-----+-----+-----+

```

The preceding examples use `HEX()` to display the `WEIGHT_STRING()` result. Because the result is a binary value, `HEX()` can be especially useful when the result contains nonprinting values, to display it in printable form:

```

mysql> SET @s = CONVERT(X'C39F' USING utf8) COLLATE utf8_czech_ci;
mysql> SELECT HEX(WEIGHT_STRING(@s));
+-----+
| HEX(WEIGHT_STRING(@s)) |
+-----+
| 0FEA0FEA              |
+-----+

```

For non-`NULL` return values, the data type of the value is `VARBINARY` if its length is within the maximum length for `VARBINARY`, otherwise the data type is `BLOB`.

The `AS` clause may be given to cast the input string to a nonbinary or binary string and to force it to a given length:

- `AS CHAR(N)` casts the string to a nonbinary string and pads it on the right with spaces to a length of `N` characters. `N` must be at least 1. If `N` is less than the length of the input string, the string is truncated to `N` characters. No warning occurs for truncation.
- `AS BINARY(N)` is similar but casts the string to a binary string, `N` is measured in bytes (not characters), and padding uses `0x00` bytes (not spaces).

```

mysql> SET NAMES 'latin1';
mysql> SELECT HEX(WEIGHT_STRING('ab' AS CHAR(4)));
+-----+
| HEX(WEIGHT_STRING('ab' AS CHAR(4))) |
+-----+
| 41422020                            |
+-----+
mysql> SET NAMES 'utf8';
mysql> SELECT HEX(WEIGHT_STRING('ab' AS CHAR(4)));
+-----+
| HEX(WEIGHT_STRING('ab' AS CHAR(4))) |
+-----+
| 0041004200200020                    |
+-----+

```

```

mysql> SELECT HEX(WEIGHT_STRING('ab' AS BINARY(4)));
+-----+
| HEX(WEIGHT_STRING('ab' AS BINARY(4))) |
+-----+
| 61620000                             |
+-----+

```

The `LEVEL` clause may be given to specify that the return value should contain weights for specific collation levels.

The `levels` specifier following the `LEVEL` keyword may be given either as a list of one or more integers separated by commas, or as a range of two integers separated by a dash. Whitespace around the punctuation characters does not matter.

Examples:

```
LEVEL 1
LEVEL 2, 3, 5
LEVEL 1-3
```

Any level less than 1 is treated as 1. Any level greater than the maximum for the input string collation is treated as maximum for the collation. The maximum varies per collation, but is never greater than 6.

In a list of levels, levels must be given in increasing order. In a range of levels, if the second number is less than the first, it is treated as the first number (for example, 4-2 is the same as 4-4).

If the `LEVEL` clause is omitted, MySQL assumes `LEVEL 1 - max`, where `max` is the maximum level for the collation.

If `LEVEL` is specified using list syntax (not range syntax), any level number can be followed by these modifiers:

- `ASC`: Return the weights without modification. This is the default.
- `DESC`: Return bitwise-inverted weights (for example, `0x78f0 DESC = 0x870f`).
- `REVERSE`: Return the weights in reverse order (that is, the weights for the reversed string, with the first character last and the last first).

Examples:

```
mysql> SELECT HEX(WEIGHT_STRING(0x007fff LEVEL 1));
+-----+
| HEX(WEIGHT_STRING(0x007fff LEVEL 1)) |
+-----+
| 007FFF                                |
+-----+
```

```
mysql> SELECT HEX(WEIGHT_STRING(0x007fff LEVEL 1 DESC));
+-----+
| HEX(WEIGHT_STRING(0x007fff LEVEL 1 DESC)) |
+-----+
| FF8000                                    |
+-----+
```

```
mysql> SELECT HEX(WEIGHT_STRING(0x007fff LEVEL 1 REVERSE));
+-----+
| HEX(WEIGHT_STRING(0x007fff LEVEL 1 REVERSE)) |
+-----+
| FF7F00                                    |
+-----+
```

```
mysql> SELECT HEX(WEIGHT_STRING(0x007fff LEVEL 1 DESC REVERSE));
+-----+
| HEX(WEIGHT_STRING(0x007fff LEVEL 1 DESC REVERSE)) |
+-----+
| 0080FF                                |
+-----+
```

The *flags* clause currently is unused.

If `WEIGHT_STRING()` is invoked from within the `mysql` client, binary strings display using hexadecimal notation, depending on the value of the `--binary-as-hex`. For more information about that option, see [Section 4.5.1, “mysql — The MySQL Command-Line Client”](#).

## 12.8.1 String Comparison Functions and Operators

**Table 12.13** String Comparison Functions and Operators

Name	Description
<code>LIKE</code>	Simple pattern matching
<code>NOT LIKE</code>	Negation of simple pattern matching
<code>STRCMP()</code>	Compare two strings

If a string function is given a binary string as an argument, the resulting string is also a binary string. A number converted to a string is treated as a binary string. This affects only comparisons.

Normally, if any expression in a string comparison is case-sensitive, the comparison is performed in case-sensitive fashion.

If a string function is invoked from within the `mysql` client, binary strings display using hexadecimal notation, depending on the value of the `--binary-as-hex`. For more information about that option, see [Section 4.5.1, “mysql — The MySQL Command-Line Client”](#).

- `expr LIKE pat [ESCAPE 'escape_char']`

Pattern matching using an SQL pattern. Returns 1 (`TRUE`) or 0 (`FALSE`). If either *expr* or *pat* is `NULL`, the result is `NULL`.

The pattern need not be a literal string. For example, it can be specified as a string expression or table column. In the latter case, the column must be defined as one of the MySQL string types (see [Section 11.3, “String Data Types”](#)).

Per the SQL standard, `LIKE` performs matching on a per-character basis, thus it can produce results different from the `=` comparison operator:

```
mysql> SELECT 'ä' LIKE 'ae' COLLATE latin1_german2_ci;
+-----+
| 'ä' LIKE 'ae' COLLATE latin1_german2_ci |
+-----+
|                                           0 |
+-----+
mysql> SELECT 'ä' = 'ae' COLLATE latin1_german2_ci;
+-----+
| 'ä' = 'ae' COLLATE latin1_german2_ci |
+-----+
|                                           1 |
+-----+
```

In particular, trailing spaces are significant, which is not true for comparisons of nonbinary strings (`CHAR`, `VARCHAR`, and `TEXT` values) performed with the `=` operator:

```
mysql> SELECT 'a' = 'a ', 'a' LIKE 'a ';
+-----+
| 'a' = 'a ' | 'a' LIKE 'a ' |
+-----+
```



```
|          1 |          0 |
+-----+-----+
1 row in set (0.00 sec)
```

With `LIKE` you can use the following two wildcard characters in the pattern:

- `%` matches any number of characters, even zero characters.
- `_` matches exactly one character.

```
mysql> SELECT 'David!' LIKE 'David_';
-> 1
mysql> SELECT 'David!' LIKE '%D%v%';
-> 1
```

To test for literal instances of a wildcard character, precede it by the escape character. If you do not specify the `ESCAPE` character, `\` is assumed, unless the `NO_BACKSLASH_ESCAPES` SQL mode is enabled. In that case, no escape character is used.

- `\%` matches one `%` character.
- `\_` matches one `_` character.

```
mysql> SELECT 'David!' LIKE 'David\%';
-> 0
mysql> SELECT 'David_' LIKE 'David\_';
-> 1
```

To specify a different escape character, use the `ESCAPE` clause:

```
mysql> SELECT 'David_' LIKE 'David|_' ESCAPE '|';
-> 1
```

The escape sequence should be one character long to specify the escape character, or empty to specify that no escape character is used. The expression must evaluate as a constant at execution time. If the `NO_BACKSLASH_ESCAPES` SQL mode is enabled, the sequence cannot be empty.

The following statements illustrate that string comparisons are not case-sensitive unless one of the operands is case-sensitive (uses a case-sensitive collation or is a binary string):

```
mysql> SELECT 'abc' LIKE 'ABC';
-> 1
mysql> SELECT 'abc' LIKE _latin1 'ABC' COLLATE latin1_general_cs;
-> 0
mysql> SELECT 'abc' LIKE _latin1 'ABC' COLLATE latin1_bin;
-> 0
mysql> SELECT 'abc' LIKE BINARY 'ABC';
-> 0
```

As an extension to standard SQL, MySQL permits `LIKE` on numeric expressions.

```
mysql> SELECT 10 LIKE '1%';
-> 1
```

MySQL attempts in such cases to perform implicit conversion of the expression to a string. See [Section 12.3, “Type Conversion in Expression Evaluation”](#).



#### Note

MySQL uses C escape syntax in strings (for example, `\n` to represent the newline character). If you want a `LIKE` string to contain a literal `\`, you must

double it. (Unless the `NO_BACKSLASH_ESCAPES` SQL mode is enabled, in which case no escape character is used.) For example, to search for `\n`, specify it as `\\n`. To search for `\`, specify it as `\\`; this is because the backslashes are stripped once by the parser and again when the pattern match is made, leaving a single backslash to be matched against.

Exception: At the end of the pattern string, backslash can be specified as `\\`. At the end of the string, backslash stands for itself because there is nothing following to escape. Suppose that a table contains the following values:

```
mysql> SELECT filename FROM t1;
```

filename
C:
C:\
C:\Programs
C:\Programs\

To test for values that end with backslash, you can match the values using either of the following patterns:

```
mysql> SELECT filename, filename LIKE '%\\' FROM t1;
```

filename	filename LIKE '%\\'
C:	0
C:\	1
C:\Programs	0
C:\Programs\	1

```
mysql> SELECT filename, filename LIKE '%\\\\' FROM t1;
```

filename	filename LIKE '%\\\\'
C:	0
C:\	1
C:\Programs	0
C:\Programs\	1

- `expr NOT LIKE pat [ESCAPE 'escape_char']`

This is the same as `NOT (expr LIKE pat [ESCAPE 'escape_char'])`.



### Note

Aggregate queries involving `NOT LIKE` comparisons with columns containing `NULL` may yield unexpected results. For example, consider the following table and data:

```
CREATE TABLE foo (bar VARCHAR(10));
INSERT INTO foo VALUES (NULL), (NULL);
```

The query `SELECT COUNT(*) FROM foo WHERE bar LIKE '%baz%';` returns 0. You might assume that `SELECT COUNT(*) FROM foo WHERE bar NOT LIKE '%baz%';` would return 2. However, this is not the case: The second query returns 0. This is because `NULL NOT LIKE expr` always returns `NULL`, regardless of the value of `expr`. The same is true for aggregate queries involving

`NULL` and comparisons using `NOT RLIKE` or `NOT REGEXP`. In such cases, you must test explicitly for `NOT NULL` using `OR` (and not `AND`), as shown here:

```
SELECT COUNT(*) FROM foo WHERE bar NOT LIKE '%baz%' OR bar IS NULL;
```

- `STRCMP(expr1,expr2)`

`STRCMP()` returns 0 if the strings are the same, -1 if the first argument is smaller than the second according to the current sort order, and 1 otherwise.

```
mysql> SELECT STRCMP('text', 'text2');
-> -1
mysql> SELECT STRCMP('text2', 'text');
-> 1
mysql> SELECT STRCMP('text', 'text');
-> 0
```

`STRCMP()` performs the comparison using the collation of the arguments.

```
mysql> SET @s1 = _latin1 'x' COLLATE latin1_general_ci;
mysql> SET @s2 = _latin1 'X' COLLATE latin1_general_ci;
mysql> SET @s3 = _latin1 'x' COLLATE latin1_general_cs;
mysql> SET @s4 = _latin1 'X' COLLATE latin1_general_cs;
mysql> SELECT STRCMP(@s1, @s2), STRCMP(@s3, @s4);
+-----+-----+
| STRCMP(@s1, @s2) | STRCMP(@s3, @s4) |
+-----+-----+
| 0 | 1 |
+-----+-----+
```

If the collations are incompatible, one of the arguments must be converted to be compatible with the other. See [Section 10.8.4, “Collation Coercibility in Expressions”](#).

```
mysql> SELECT STRCMP(@s1, @s3);
ERROR 1267 (HY000): Illegal mix of collations (latin1_general_ci,IMPLICIT)
and (latin1_general_cs,IMPLICIT) for operation 'strcmp'
mysql> SELECT STRCMP(@s1, @s3 COLLATE latin1_general_ci);
+-----+
| STRCMP(@s1, @s3 COLLATE latin1_general_ci) |
+-----+
| 0 |
+-----+
```

## 12.8.2 Regular Expressions

**Table 12.14 Regular Expression Functions and Operators**

Name	Description
<code>NOT REGEXP</code>	Negation of <code>REGEXP</code>
<code>REGEXP</code>	Whether string matches regular expression
<code>RLIKE</code>	Whether string matches regular expression

A regular expression is a powerful way of specifying a pattern for a complex search. This section discusses the operators available for regular expression matching and illustrates, with examples, some of the special characters and constructs that can be used for regular expression operations. See also [Section 3.3.4.7, “Pattern Matching”](#).

MySQL uses Henry Spencer's implementation of regular expressions, which is aimed at conformance with POSIX 1003.2. MySQL uses the extended version to support regular expression pattern-matching operations in SQL statements. This section does not contain all the details that can be found in Henry

Spencer's [`regex\(7\)`](#) manual page. That manual page is included in MySQL source distributions, in the `regex.7` file under the `regex` directory.

- [Regular Expression Function and Operator Descriptions](#)
- [Regular Expression Syntax](#)

## Regular Expression Function and Operator Descriptions

- `expr NOT REGEXP pat, expr NOT RLIKE pat`

This is the same as `NOT (expr REGEXP pat)`.

- `expr REGEXP pat, expr RLIKE pat`

Returns 1 if the string `expr` matches the regular expression specified by the pattern `pat`, 0 otherwise. If either `expr` or `pat` is `NULL`, the return value is `NULL`.

`RLIKE` is a synonym for `REGEXP`.

The pattern can be an extended regular expression, the syntax for which is discussed in [Regular Expression Syntax](#). The pattern need not be a literal string. For example, it can be specified as a string expression or table column.



### Note

MySQL uses C escape syntax in strings (for example, `\n` to represent the newline character). If you want your `expr` or `pat` argument to contain a literal `\`, you must double it. (Unless the `NO_BACKSLASH_ESCAPES` SQL mode is enabled, in which case no escape character is used.)

Regular expression operations use the character set and collation of the string expression and pattern arguments when deciding the type of a character and performing the comparison. If the arguments have different character sets or collations, coercibility rules apply as described in [Section 10.8.4, "Collation Coercibility in Expressions"](#). If either argument is a binary string, the arguments are handled in case-sensitive fashion as binary strings.

```
mysql> SELECT 'Michael!' REGEXP '.*';
+-----+
| 'Michael!' REGEXP '.*' |
+-----+
|                          1 |
+-----+
mysql> SELECT 'new*\n*line' REGEXP 'new\\*.*\\*line';
+-----+
| 'new*\n*line' REGEXP 'new\\*.*\\*line' |
+-----+
|                                          0 |
+-----+
mysql> SELECT 'a' REGEXP '^[a-d]';
+-----+
| 'a' REGEXP '^[a-d]' |
+-----+
|                          1 |
+-----+
```



### Warning

The `REGEXP` and `RLIKE` operators work in byte-wise fashion, so they are not multibyte safe and may produce unexpected results with multibyte character

sets. In addition, these operators compare characters by their byte values and accented characters may not compare as equal even if a given collation treats them as equal.

## Regular Expression Syntax

A regular expression describes a set of strings. The simplest regular expression is one that has no special characters in it. For example, the regular expression `hello` matches `hello` and nothing else.

Nontrivial regular expressions use certain special constructs so that they can match more than one string. For example, the regular expression `hello|world` contains the `|` alternation operator and matches either the `hello` or `world`.

As a more complex example, the regular expression `B[an]*s` matches any of the strings `Bananas`, `Baaaaas`, `Bs`, and any other string starting with a `B`, ending with an `s`, and containing any number of `a` or `n` characters in between.

A regular expression for the `REGEXP` operator may use any of the following special characters and constructs:

- `^`

Match the beginning of a string.

```
mysql> SELECT 'fo\ngo' REGEXP '^fo$';      -> 0
mysql> SELECT 'fofo' REGEXP '^fo';        -> 1
```

- `$`

Match the end of a string.

```
mysql> SELECT 'fo\ngo' REGEXP '^fo\ngo$';  -> 1
mysql> SELECT 'fo\ngo' REGEXP '^fo$';      -> 0
```

- `.`

Match any character (including carriage return and newline).

```
mysql> SELECT 'fofo' REGEXP '^f.*$';        -> 1
mysql> SELECT 'fo\r\ngo' REGEXP '^f.*$';    -> 1
```

- `a*`

Match any sequence of zero or more `a` characters.

```
mysql> SELECT 'Ban' REGEXP '^Ba*n';         -> 1
mysql> SELECT 'Baaan' REGEXP '^Ba*n';      -> 1
mysql> SELECT 'Bn' REGEXP '^Ba*n';         -> 1
```

- `a+`

Match any sequence of one or more `a` characters.

```
mysql> SELECT 'Ban' REGEXP '^Ba+n';         -> 1
mysql> SELECT 'Bn' REGEXP '^Ba+n';         -> 0
```

- `a?`

Match either zero or one `a` character.

```
mysql> SELECT 'Bn' REGEXP '^Ba?n';         -> 1
mysql> SELECT 'Ban' REGEXP '^Ba?n';        -> 1
```

```
mysql> SELECT 'Baan' REGEXP '^Ba?n';          -> 0
```

- `de|abc`

Alternation; match either of the sequences `de` or `abc`.

```
mysql> SELECT 'pi' REGEXP 'pi|apa';          -> 1
mysql> SELECT 'axe' REGEXP 'pi|apa';         -> 0
mysql> SELECT 'apa' REGEXP 'pi|apa';         -> 1
mysql> SELECT 'apa' REGEXP '^ (pi|apa) $';   -> 1
mysql> SELECT 'pi' REGEXP '^ (pi|apa) $';   -> 1
mysql> SELECT 'pix' REGEXP '^ (pi|apa) $';   -> 0
```

- `(abc)*`

Match zero or more instances of the sequence `abc`.

```
mysql> SELECT 'pi' REGEXP '^ (pi) * $';     -> 1
mysql> SELECT 'pip' REGEXP '^ (pi) * $';    -> 0
mysql> SELECT 'pipi' REGEXP '^ (pi) * $';   -> 1
```

- `{1}, {2,3}`

Repetition; `{n}` and `{m,n}` notation provide a more general way of writing regular expressions that match many occurrences of the previous atom (or “piece”) of the pattern. `m` and `n` are integers.

- `a*`

Can be written as `a{0,}`.

- `a+`

Can be written as `a{1,}`.

- `a?`

Can be written as `a{0,1}`.

To be more precise, `a{n}` matches exactly `n` instances of `a`. `a{n,}` matches `n` or more instances of `a`. `a{m,n}` matches `m` through `n` instances of `a`, inclusive. If both `m` and `n` are given, `m` must be less than or equal to `n`.

`m` and `n` must be in the range from 0 to `RE_DUP_MAX` (default 255), inclusive.

```
mysql> SELECT 'abcde' REGEXP 'a[bcd]{2}e';  -> 0
mysql> SELECT 'abcde' REGEXP 'a[bcd]{3}e';  -> 1
mysql> SELECT 'abcde' REGEXP 'a[bcd]{1,10}e'; -> 1
```

- `[a-dX], [^a-dX]`

Matches any character that is (or is not, if `^` is used) either `a`, `b`, `c`, `d` or `X`. A `-` character between two other characters forms a range that matches all characters from the first character to the second. For example, `[0-9]` matches any decimal digit. To include a literal `]` character, it must immediately follow the opening bracket `[`. To include a literal `-` character, it must be written first or last. Any character that does not have a defined special meaning inside a `[ ]` pair matches only itself.

```
mysql> SELECT 'aXbc' REGEXP '[a-dXYZ]';     -> 1
mysql> SELECT 'aXbc' REGEXP '^ [a-dXYZ] $'; -> 0
mysql> SELECT 'aXbc' REGEXP '^ [a-dXYZ] + $'; -> 1
mysql> SELECT 'aXbc' REGEXP '^ [^a-dXYZ] + $'; -> 0
mysql> SELECT 'gheis' REGEXP '^ [^a-dXYZ] + $'; -> 1
```

```
mysql> SELECT 'gheisa' REGEXP '^[^a-dXYZ]+$';          -> 0
```

- [.characters.]

Within a bracket expression (written using [ and ]), matches the sequence of characters of that collating element. `characters` is either a single character or a character name like `newline`. The following table lists the permissible character names.

The following table shows the permissible character names and the characters that they match. For characters given as numeric values, the values are represented in octal.

Name	Character	Name	Character
NUL	0	SOH	001
STX	002	ETX	003
EOT	004	ENQ	005
ACK	006	BEL	007
alert	007	BS	010
backspace	'\b'	HT	011
tab	'\t'	LF	012
newline	'\n'	VT	013
vertical-tab	'\v'	FF	014
form-feed	'\f'	CR	015
carriage-return	'\r'	SO	016
SI	017	DLE	020
DC1	021	DC2	022
DC3	023	DC4	024
NAK	025	SYN	026
ETB	027	CAN	030
EM	031	SUB	032
ESC	033	IS4	034
FS	034	IS3	035
GS	035	IS2	036
RS	036	IS1	037
US	037	space	' '
exclamation-mark	'!'	quotation-mark	'\"'
number-sign	'#'	dollar-sign	'\$'
percent-sign	'%'	ampersand	'&'
apostrophe	'\''	left-parenthesis	'('
right-parenthesis	')'	asterisk	'*'
plus-sign	'+'	comma	','
hyphen	'-'	hyphen-minus	'-'
period	'.'	full-stop	'.'

## Regular Expressions

Name	Character	Name	Character
slash	'/'	solidus	'/'
zero	'0'	one	'1'
two	'2'	three	'3'
four	'4'	five	'5'
six	'6'	seven	'7'
eight	'8'	nine	'9'
colon	':'	semicolon	';'
less-than-sign	'<'	equals-sign	'='
greater-than-sign	'>'	question-mark	'?'
commercial-at	'@'	left-square-bracket	'['
backslash	'\'	reverse-solidus	'\'
right-square-bracket	']'	circumflex	'^'
circumflex-accent	'^'	underscore	'_'
low-line	'_'	grave-accent	'`'
left-brace	'{'	left-curly-bracket	'{'
vertical-line	' '	right-brace	'}'
right-curly-bracket	'}'	tilde	'~'
DEL	177		

```
mysql> SELECT '~' REGEXP '[[.~.]]';           -> 1
mysql> SELECT '~' REGEXP '[[.tilde.]]';      -> 1
```

- `[=character_class=]`

Within a bracket expression (written using `[` and `]`), `[=character_class=]` represents an equivalence class. It matches all characters with the same collation value, including itself. For example, if `o` and `(+)` are the members of an equivalence class, `[[=o=]]`, `[[=(+)=]]`, and `[o(+)]` are all synonymous. An equivalence class may not be used as an endpoint of a range.

- `[:character_class:]`

Within a bracket expression (written using `[` and `]`), `[:character_class:]` represents a character class that matches all characters belonging to that class. The following table lists the standard class names. These names stand for the character classes defined in the `ctype(3)` manual page. A particular locale may provide other class names. A character class may not be used as an endpoint of a range.

Character Class Name	Meaning
<code>alnum</code>	Alphanumeric characters
<code>alpha</code>	Alphabetic characters
<code>blank</code>	Whitespace characters
<code>cntrl</code>	Control characters



Character Class Name	Meaning
<code>digit</code>	Digit characters
<code>graph</code>	Graphic characters
<code>lower</code>	Lowercase alphabetic characters
<code>print</code>	Graphic or space characters
<code>punct</code>	Punctuation characters
<code>space</code>	Space, tab, newline, and carriage return
<code>upper</code>	Uppercase alphabetic characters
<code>xdigit</code>	Hexadecimal digit characters

```
mysql> SELECT 'justalnums' REGEXP '[:alnum:]+';      -> 1
mysql> SELECT '!' REGEXP '[:alnum:]+';            -> 0
```

- `[:<:]`, `[:>:]`

These markers stand for word boundaries. They match the beginning and end of words, respectively. A word is a sequence of word characters that is not preceded by or followed by word characters. A word character is an alphanumeric character in the `alnum` class or an underscore (`_`).

```
mysql> SELECT 'a word a' REGEXP '[:<:]word[:>:]';  -> 1
mysql> SELECT 'a xword a' REGEXP '[:<:]word[:>:]'; -> 0
```

To use a literal instance of a special character in a regular expression, precede it by two backslash (`\`) characters. The MySQL parser interprets one of the backslashes, and the regular expression library interprets the other. For example, to match the string `1+2` that contains the special `+` character, only the last of the following regular expressions is the correct one:

```
mysql> SELECT '1+2' REGEXP '1+2';                 -> 0
mysql> SELECT '1+2' REGEXP '1\+2';                -> 0
mysql> SELECT '1+2' REGEXP '1\\+2';                -> 1
```

### 12.8.3 Character Set and Collation of Function Results

MySQL has many operators and functions that return a string. This section answers the question: What is the character set and collation of such a string?

For simple functions that take string input and return a string result as output, the output's character set and collation are the same as those of the principal input value. For example, `UPPER(X)` returns a string with the same character string and collation as `X`. The same applies for `INSTR()`, `LCASE()`, `LOWER()`, `LTRIM()`, `MID()`, `REPEAT()`, `REPLACE()`, `REVERSE()`, `RIGHT()`, `RPAD()`, `RTRIM()`, `SOUNDEX()`, `SUBSTRING()`, `TRIM()`, `UCASE()`, and `UPPER()`.



#### Note

The `REPLACE()` function, unlike all other functions, always ignores the collation of the string input and performs a case-sensitive comparison.

If a string input or function result is a binary string, the string has the `binary` character set and collation. This can be checked by using the `CHARSET()` and `COLLATION()` functions, both of which return `binary` for a binary string argument:

```
mysql> SELECT CHARSET(BINARY 'a'), COLLATION(BINARY 'a');
+-----+-----+
| CHARSET(BINARY 'a') | COLLATION(BINARY 'a') |
```

```
+-----+-----+
| binary | binary |
+-----+-----+
```

For operations that combine multiple string inputs and return a single string output, the “aggregation rules” of standard SQL apply for determining the collation of the result:

- If an explicit `COLLATE Y` occurs, use `Y`.
- If explicit `COLLATE Y` and `COLLATE Z` occur, raise an error.
- Otherwise, if all collations are `Y`, use `Y`.
- Otherwise, the result has no collation.

For example, with `CASE ... WHEN a THEN b WHEN b THEN c COLLATE X END`, the resulting collation is `X`. The same applies for `UNION`, `|`, `CONCAT()`, `ELT()`, `GREATEST()`, `IF()`, and `LEAST()`.

For operations that convert to character data, the character set and collation of the strings that result from the operations are defined by the `character_set_connection` and `collation_connection` system variables that determine the default connection character set and collation (see [Section 10.4, “Connection Character Sets and Collations”](#)). This applies only to `CAST()`, `CONV()`, `FORMAT()`, `HEX()`, and `SPACE()`.

As of MySQL 5.7.19, an exception to the preceding principle occurs for expressions for virtual generated columns. In such expressions, the table character set is used for `CONV()` or `HEX()` results, regardless of connection character set.

If there is any question about the character set or collation of the result returned by a string function, use the `CHARSET()` or `COLLATION()` function to find out:

```
mysql> SELECT USER(), CHARSET(USER()), COLLATION(USER());
+-----+-----+-----+
| USER()          | CHARSET(USER()) | COLLATION(USER()) |
+-----+-----+-----+
| test@localhost | utf8            | utf8_general_ci   |
+-----+-----+-----+
mysql> SELECT CHARSET(COMPRESS('abc')), COLLATION(COMPRESS('abc'));
+-----+-----+
| CHARSET(COMPRESS('abc')) | COLLATION(COMPRESS('abc')) |
+-----+-----+
| binary                   | binary                     |
+-----+-----+
```

## 12.9 Full-Text Search Functions

`MATCH (col1,col2,...) AGAINST (expr [search_modifier])`

```
search_modifier:
{
    IN NATURAL LANGUAGE MODE
  | IN NATURAL LANGUAGE MODE WITH QUERY EXPANSION
  | IN BOOLEAN MODE
  | WITH QUERY EXPANSION
}
```

MySQL has support for full-text indexing and searching:

- A full-text index in MySQL is an index of type `FULLTEXT`.
- Full-text indexes can be used only with `InnoDB` or `MyISAM` tables, and can be created only for `CHAR`, `VARCHAR`, or `TEXT` columns.

- MySQL provides a built-in full-text ngram parser that supports Chinese, Japanese, and Korean (CJK), and an installable MeCab full-text parser plugin for Japanese. Parsing differences are outlined in [Section 12.9.8, “ngram Full-Text Parser”](#), and [Section 12.9.9, “MeCab Full-Text Parser Plugin”](#).
- A `FULLTEXT` index definition can be given in the `CREATE TABLE` statement when a table is created, or added later using `ALTER TABLE` or `CREATE INDEX`.
- For large data sets, it is much faster to load your data into a table that has no `FULLTEXT` index and then create the index after that, than to load data into a table that has an existing `FULLTEXT` index.

Full-text searching is performed using `MATCH() AGAINST()` syntax. `MATCH()` takes a comma-separated list that names the columns to be searched. `AGAINST` takes a string to search for, and an optional modifier that indicates what type of search to perform. The search string must be a string value that is constant during query evaluation. This rules out, for example, a table column because that can differ for each row.

There are three types of full-text searches:

- A natural language search interprets the search string as a phrase in natural human language (a phrase in free text). There are no special operators, with the exception of double quote (") characters. The stopwords list applies. For more information about stopwords lists, see [Section 12.9.4, “Full-Text Stopwords”](#).

Full-text searches are natural language searches if the `IN NATURAL LANGUAGE MODE` modifier is given or if no modifier is given. For more information, see [Section 12.9.1, “Natural Language Full-Text Searches”](#).

- A boolean search interprets the search string using the rules of a special query language. The string contains the words to search for. It can also contain operators that specify requirements such that a word must be present or absent in matching rows, or that it should be weighted higher or lower than usual. Certain common words (stopwords) are omitted from the search index and do not match if present in the search string. The `IN BOOLEAN MODE` modifier specifies a boolean search. For more information, see [Section 12.9.2, “Boolean Full-Text Searches”](#).
- A query expansion search is a modification of a natural language search. The search string is used to perform a natural language search. Then words from the most relevant rows returned by the search are added to the search string and the search is done again. The query returns the rows from the second search. The `IN NATURAL LANGUAGE MODE WITH QUERY EXPANSION` or `WITH QUERY EXPANSION` modifier specifies a query expansion search. For more information, see [Section 12.9.3, “Full-Text Searches with Query Expansion”](#).

For information about `FULLTEXT` query performance, see [Section 8.3.4, “Column Indexes”](#).

For more information about `InnoDB FULLTEXT` indexes, see [Section 14.6.2.4, “InnoDB Full-Text Indexes”](#).

Constraints on full-text searching are listed in [Section 12.9.5, “Full-Text Restrictions”](#).

The `myisam_ftdump` utility dumps the contents of a `MyISAM` full-text index. This may be helpful for debugging full-text queries. See [Section 4.6.2, “myisam\\_ftdump — Display Full-Text Index information”](#).

## 12.9.1 Natural Language Full-Text Searches

By default or with the `IN NATURAL LANGUAGE MODE` modifier, the `MATCH()` function performs a natural language search for a string against a *text collection*. A collection is a set of one or more columns included in a `FULLTEXT` index. The search string is given as the argument to `AGAINST()`. For each row in the table, `MATCH()` returns a relevance value; that is, a similarity measure between the search string and the text in that row in the columns named in the `MATCH()` list.

```
mysql> CREATE TABLE articles (
->   id INT UNSIGNED AUTO_INCREMENT NOT NULL PRIMARY KEY,
->   title VARCHAR(200),
->   body TEXT,
->   FULLTEXT (title,body)
-> ) ENGINE=InnoDB;
Query OK, 0 rows affected (0.08 sec)

mysql> INSERT INTO articles (title,body) VALUES
->   ('MySQL Tutorial','DBMS stands for DataBase ...'),
->   ('How To Use MySQL Well','After you went through a ...'),
->   ('Optimizing MySQL','In this tutorial, we show ...'),
->   ('1001 MySQL Tricks','1. Never run mysqld as root. 2. ...'),
->   ('MySQL vs. YourSQL','In the following database comparison ...'),
->   ('MySQL Security','When configured properly, MySQL ...');
Query OK, 6 rows affected (0.01 sec)
Records: 6  Duplicates: 0  Warnings: 0

mysql> SELECT * FROM articles
-> WHERE MATCH (title,body)
-> AGAINST ('database' IN NATURAL LANGUAGE MODE);
+-----+-----+-----+
| id | title                | body                |
+-----+-----+-----+
| 1 | MySQL Tutorial       | DBMS stands for DataBase ... |
| 5 | MySQL vs. YourSQL   | In the following database comparison ... |
+-----+-----+-----+
2 rows in set (0.00 sec)
```

By default, the search is performed in case-insensitive fashion. To perform a case-sensitive full-text search, use a binary collation for the indexed columns. For example, a column that uses the `latin1` character set of can be assigned a collation of `latin1_bin` to make it case-sensitive for full-text searches.

When `MATCH()` is used in a `WHERE` clause, as in the example shown earlier, the rows returned are automatically sorted with the highest relevance first as long as the following conditions are met:

- There must be no explicit `ORDER BY` clause.
- The search must be performed using a full-text index scan rather than a table scan.
- If the query joins tables, the full-text index scan must be the leftmost non-constant table in the join.

Given the conditions just listed, it is usually less effort to specify using `ORDER BY` an explicit sort order when one is necessary or desired.

Relevance values are nonnegative floating-point numbers. Zero relevance means no similarity. Relevance is computed based on the number of words in the row (document), the number of unique words in the row, the total number of words in the collection, and the number of rows that contain a particular word.



#### Note

The term “document” may be used interchangeably with the term “row”, and both terms refer to the indexed part of the row. The term “collection” refers to the indexed columns and encompasses all rows.

To simply count matches, you could use a query like this:

```
mysql> SELECT COUNT(*) FROM articles
-> WHERE MATCH (title,body)
-> AGAINST ('database' IN NATURAL LANGUAGE MODE);
+-----+
| COUNT(*) |
+-----+
```

```

+-----+
|      2 |
+-----+
1 row in set (0.00 sec)

```

You might find it quicker to rewrite the query as follows:

```

mysql> SELECT
-> COUNT(IF(MATCH (title,body) AGAINST ('database' IN NATURAL LANGUAGE MODE), 1, NULL))
-> AS count
-> FROM articles;
+-----+
| count |
+-----+
|      2 |
+-----+
1 row in set (0.03 sec)

```

The first query does some extra work (sorting the results by relevance) but also can use an index lookup based on the `WHERE` clause. The index lookup might make the first query faster if the search matches few rows. The second query performs a full table scan, which might be faster than the index lookup if the search term was present in most rows.

For natural-language full-text searches, the columns named in the `MATCH()` function must be the same columns included in some `FULLTEXT` index in your table. For the preceding query, the columns named in the `MATCH()` function (`title` and `body`) are the same as those named in the definition of the `article` table's `FULLTEXT` index. To search the `title` or `body` separately, you would create separate `FULLTEXT` indexes for each column.

You can also perform a boolean search or a search with query expansion. These search types are described in [Section 12.9.2, "Boolean Full-Text Searches"](#), and [Section 12.9.3, "Full-Text Searches with Query Expansion"](#).

A full-text search that uses an index can name columns only from a single table in the `MATCH()` clause because an index cannot span multiple tables. For `MyISAM` tables, a boolean search can be done in the absence of an index (albeit more slowly), in which case it is possible to name columns from multiple tables.

The preceding example is a basic illustration that shows how to use the `MATCH()` function where rows are returned in order of decreasing relevance. The next example shows how to retrieve the relevance values explicitly. Returned rows are not ordered because the `SELECT` statement includes neither `WHERE` nor `ORDER BY` clauses:

```

mysql> SELECT id, MATCH (title,body)
-> AGAINST ('Tutorial' IN NATURAL LANGUAGE MODE) AS score
-> FROM articles;
+-----+
| id | score |
+-----+
| 1 | 0.22764469683170319 |
| 2 | 0 |
| 3 | 0.22764469683170319 |
| 4 | 0 |
| 5 | 0 |
| 6 | 0 |
+-----+
6 rows in set (0.00 sec)

```

The following example is more complex. The query returns the relevance values and it also sorts the rows in order of decreasing relevance. To achieve this result, specify `MATCH()` twice: once in the `SELECT` list and once in the `WHERE` clause. This causes no additional overhead, because the MySQL optimizer notices that the two `MATCH()` calls are identical and invokes the full-text search code only once.

```
mysql> SELECT id, body, MATCH (title,body)
-> AGAINST ('Security implications of running MySQL as root'
-> IN NATURAL LANGUAGE MODE) AS score
-> FROM articles
-> WHERE MATCH (title,body)
-> AGAINST('Security implications of running MySQL as root'
-> IN NATURAL LANGUAGE MODE);
```

id	body	score
4	1. Never run mysqld as root. 2. ...	1.5219271183014
6	When configured properly, MySQL ...	1.3114095926285

2 rows in set (0.00 sec)

A phrase that is enclosed within double quote (") characters matches only rows that contain the phrase *literally, as it was typed*. The full-text engine splits the phrase into words and performs a search in the `FULLTEXT` index for the words. Nonword characters need not be matched exactly: Phrase searching requires only that matches contain exactly the same words as the phrase and in the same order. For example, "test phrase" matches "test, phrase". If the phrase contains no words that are in the index, the result is empty. For example, if all words are either stopwords or shorter than the minimum length of indexed words, the result is empty.

The MySQL `FULLTEXT` implementation regards any sequence of true word characters (letters, digits, and underscores) as a word. That sequence may also contain apostrophes ('), but not more than one in a row. This means that `aaa 'bbb` is regarded as one word, but `aaa ' 'bbb` is regarded as two words. Apostrophes at the beginning or the end of a word are stripped by the `FULLTEXT` parser; `'aaa 'bbb'` would be parsed as `aaa 'bbb`.

The built-in `FULLTEXT` parser determines where words start and end by looking for certain delimiter characters; for example, (space), , (comma), and . (period). If words are not separated by delimiters (as in, for example, Chinese), the built-in `FULLTEXT` parser cannot determine where a word begins or ends. To be able to add words or other indexed terms in such languages to a `FULLTEXT` index that uses the built-in `FULLTEXT` parser, you must preprocess them so that they are separated by some arbitrary delimiter. Alternatively, you can create `FULLTEXT` indexes using the ngram parser plugin (for Chinese, Japanese, or Korean) or the MeCab parser plugin (for Japanese).

It is possible to write a plugin that replaces the built-in full-text parser. For details, see [The MySQL Plugin API](#). For example parser plugin source code, see the `plugin/fulltext` directory of a MySQL source distribution.

Some words are ignored in full-text searches:

- Any word that is too short is ignored. The default minimum length of words that are found by full-text searches is three characters for `InnoDB` search indexes, or four characters for `MyISAM`. You can control the cutoff by setting a configuration option before creating the index: `innodb_ft_min_token_size` configuration option for `InnoDB` search indexes, or `ft_min_word_len` for `MyISAM`.



#### Note

This behavior does not apply to `FULLTEXT` indexes that use the ngram parser. For the ngram parser, token length is defined by the `ngram_token_size` option.

- Words in the stopwords list are ignored. A stopword is a word such as "the" or "some" that is so common that it is considered to have zero semantic value. There is a built-in stopwords list, but it can be overridden by a user-defined list. The stopwords lists and related configuration options are different for `InnoDB` search indexes and `MyISAM` ones. Stopword processing is controlled by the configuration options `innodb_ft_enable_stopword`, `innodb_ft_server_stopword_table`,

and `innodb_ft_user_stopword_table` for InnoDB search indexes, and `ft_stopword_file` for MyISAM ones.

See [Section 12.9.4, “Full-Text Stopwords”](#) to view default stopwords lists and how to change them. The default minimum word length can be changed as described in [Section 12.9.6, “Fine-Tuning MySQL Full-Text Search”](#).

Every correct word in the collection and in the query is weighted according to its significance in the collection or query. Thus, a word that is present in many documents has a lower weight, because it has lower semantic value in this particular collection. Conversely, if the word is rare, it receives a higher weight. The weights of the words are combined to compute the relevance of the row. This technique works best with large collections.



### MyISAM Limitation

For very small tables, word distribution does not adequately reflect their semantic value, and this model may sometimes produce bizarre results for search indexes on MyISAM tables. For example, although the word “MySQL” is present in every row of the `articles` table shown earlier, a search for the word in a MyISAM search index produces no results:

```
mysql> SELECT * FROM articles
-> WHERE MATCH (title,body)
-> AGAINST ('MySQL' IN NATURAL LANGUAGE MODE);
Empty set (0.00 sec)
```

The search result is empty because the word “MySQL” is present in at least 50% of the rows, and so is effectively treated as a stopword. This filtering technique is more suitable for large data sets, where you might not want the result set to return every second row from a 1GB table, than for small data sets where it might cause poor results for popular terms.

The 50% threshold can surprise you when you first try full-text searching to see how it works, and makes InnoDB tables more suited to experimentation with full-text searches. If you create a MyISAM table and insert only one or two rows of text into it, every word in the text occurs in at least 50% of the rows. As a result, no search returns any results until the table contains more rows. Users who need to bypass the 50% limitation can build search indexes on InnoDB tables, or use the boolean search mode explained in [Section 12.9.2, “Boolean Full-Text Searches”](#).

## 12.9.2 Boolean Full-Text Searches

MySQL can perform boolean full-text searches using the `IN BOOLEAN MODE` modifier. With this modifier, certain characters have special meaning at the beginning or end of words in the search string. In the following query, the `+` and `-` operators indicate that a word must be present or absent, respectively, for a match to occur. Thus, the query retrieves all the rows that contain the word “MySQL” but that do *not* contain the word “YourSQL”:

```
mysql> SELECT * FROM articles WHERE MATCH (title,body)
-> AGAINST ('+MySQL -YourSQL' IN BOOLEAN MODE);
+-----+-----+-----+
| id | title | body |
+-----+-----+-----+
| 1 | MySQL Tutorial | DBMS stands for DataBase ... |
| 2 | How To Use MySQL Well | After you went through a ... |
| 3 | Optimizing MySQL | In this tutorial, we show ... |
| 4 | 1001 MySQL Tricks | 1. Never run mysqld as root. 2. ... |
| 6 | MySQL Security | When configured properly, MySQL ... |
```



**Note**

In implementing this feature, MySQL uses what is sometimes referred to as *implied Boolean logic*, in which

- + stands for **AND**
- - stands for **NOT**
- [no operator] implies **OR**

Boolean full-text searches have these characteristics:

- They do not automatically sort rows in order of decreasing relevance.
- **InnoDB** tables require a **FULLTEXT** index on all columns of the **MATCH( )** expression to perform boolean queries. Boolean queries against a **MyISAM** search index can work even without a **FULLTEXT** index, although a search executed in this fashion would be quite slow.
- The minimum and maximum word length full-text parameters apply to **FULLTEXT** indexes created using the built-in **FULLTEXT** parser and MeCab parser plugin. **innodb\_ft\_min\_token\_size** and **innodb\_ft\_max\_token\_size** are used for **InnoDB** search indexes. **ft\_min\_word\_len** and **ft\_max\_word\_len** are used for **MyISAM** search indexes.

Minimum and maximum word length full-text parameters do not apply to **FULLTEXT** indexes created using the ngram parser. ngram token size is defined by the **ngram\_token\_size** option.

- The stopword list applies, controlled by **innodb\_ft\_enable\_stopword**, **innodb\_ft\_server\_stopword\_table**, and **innodb\_ft\_user\_stopword\_table** for **InnoDB** search indexes, and **ft\_stopword\_file** for **MyISAM** ones.
- **InnoDB** full-text search does not support the use of multiple operators on a single search word, as in this example: **'++apple'**. Use of multiple operators on a single search word returns a syntax error to standard out. **MyISAM** full-text search successfully processes the same search, ignoring all operators except for the operator immediately adjacent to the search word.
- **InnoDB** full-text search only supports leading plus or minus signs. For example, **InnoDB** supports **'+apple'** but does not support **'apple+'**. Specifying a trailing plus or minus sign causes **InnoDB** to report a syntax error.
- **InnoDB** full-text search does not support the use of a leading plus sign with wildcard (**'+\*'**), a plus and minus sign combination (**'+-'**), or leading a plus and minus sign combination (**'+-apple'**). These invalid queries return a syntax error.
- **InnoDB** full-text search does not support the use of the **@** symbol in boolean full-text searches. The **@** symbol is reserved for use by the **@distance** proximity search operator.
- They do not use the 50% threshold that applies to **MyISAM** search indexes.

The boolean full-text search capability supports the following operators:

- +

A leading or trailing plus sign indicates that this word *must* be present in each row that is returned. **InnoDB** only supports leading plus signs.

- -



A leading or trailing minus sign indicates that this word must *not* be present in any of the rows that are returned. `InnoDB` only supports leading minus signs.

Note: The `-` operator acts only to exclude rows that are otherwise matched by other search terms. Thus, a boolean-mode search that contains only terms preceded by `-` returns an empty result. It does not return “all rows except those containing any of the excluded terms.”

- (no operator)

By default (when neither `+` nor `-` is specified), the word is optional, but the rows that contain it are rated higher. This mimics the behavior of `MATCH() AGAINST()` without the `IN BOOLEAN MODE` modifier.

- `@distance`

This operator works on `InnoDB` tables only. It tests whether two or more words all start within a specified distance from each other, measured in words. Specify the search words within a double-quoted string immediately before the `@distance` operator, for example, `MATCH(col1) AGAINST('"word1 word2 word3" @8' IN BOOLEAN MODE)`

- `>` `<`

These two operators are used to change a word's contribution to the relevance value that is assigned to a row. The `>` operator increases the contribution and the `<` operator decreases it. See the example following this list.

- `( )`

Parentheses group words into subexpressions. Parenthesized groups can be nested.

- `~`

A leading tilde acts as a negation operator, causing the word's contribution to the row's relevance to be negative. This is useful for marking “noise” words. A row containing such a word is rated lower than others, but is not excluded altogether, as it would be with the `-` operator.

- `*`

The asterisk serves as the truncation (or wildcard) operator. Unlike the other operators, it is *appended* to the word to be affected. Words match if they begin with the word preceding the `*` operator.

If a word is specified with the truncation operator, it is not stripped from a boolean query, even if it is too short or a stopword. Whether a word is too short is determined from the `innodb_ft_min_token_size` setting for `InnoDB` tables, or `ft_min_word_len` for `MyISAM` tables. These options are not applicable to `FULLTEXT` indexes that use the ngram parser.

The wildcarded word is considered as a prefix that must be present at the start of one or more words. If the minimum word length is 4, a search for `'+word +the*'` could return fewer rows than a search for `'+word +the'`, because the second query ignores the too-short search term `the`.

- `"`

A phrase that is enclosed within double quote (`"`) characters matches only rows that contain the phrase *literally, as it was typed*. The full-text engine splits the phrase into words and performs a search in the `FULLTEXT` index for the words. Nonword characters need not be matched exactly: Phrase searching requires only that matches contain exactly the same words as the phrase and in the same order. For example, `"test phrase"` matches `"test, phrase"`.

If the phrase contains no words that are in the index, the result is empty. The words might not be in the index because of a combination of factors: if they do not exist in the text, are stopwords, or are shorter than the minimum length of indexed words.

The following examples demonstrate some search strings that use boolean full-text operators:

- `'apple banana'`

Find rows that contain at least one of the two words.

- `'+apple +juice'`

Find rows that contain both words.

- `'+apple macintosh'`

Find rows that contain the word “apple”, but rank rows higher if they also contain “macintosh”.

- `'+apple -macintosh'`

Find rows that contain the word “apple” but not “macintosh”.

- `'+apple ~macintosh'`

Find rows that contain the word “apple”, but if the row also contains the word “macintosh”, rate it lower than if row does not. This is “softer” than a search for `'+apple -macintosh'`, for which the presence of “macintosh” causes the row not to be returned at all.

- `'+apple +(>turnover <strudel)'`

Find rows that contain the words “apple” and “turnover”, or “apple” and “strudel” (in any order), but rank “apple turnover” higher than “apple strudel”.

- `'apple*'`

Find rows that contain words such as “apple”, “apples”, “applesauce”, or “applet”.

- `'"some words"'`

Find rows that contain the exact phrase “some words” (for example, rows that contain “some words of wisdom” but not “some noise words”). Note that the `"` characters that enclose the phrase are operator characters that delimit the phrase. They are not the quotation marks that enclose the search string itself.

## Relevancy Rankings for InnoDB Boolean Mode Search

InnoDB full-text search is modeled on the [Sphinx](#) full-text search engine, and the algorithms used are based on [BM25](#) and [TF-IDF](#) ranking algorithms. For these reasons, relevancy rankings for InnoDB boolean full-text search may differ from [MyISAM](#) relevancy rankings.

InnoDB uses a variation of the “term frequency-inverse document frequency” ([TF-IDF](#)) weighting system to rank a document's relevance for a given full-text search query. The [TF-IDF](#) weighting is based on how frequently a word appears in a document, offset by how frequently the word appears in all documents in the collection. In other words, the more frequently a word appears in a document, and the less frequently the word appears in the document collection, the higher the document is ranked.

## How Relevancy Ranking is Calculated

The term frequency (**TF**) value is the number of times that a word appears in a document. The inverse document frequency (**IDF**) value of a word is calculated using the following formula, where `total_records` is the number of records in the collection, and `matching_records` is the number of records that the search term appears in.

$$\{IDF\} = \log_{10}(\{total\_records\} / \{matching\_records\})$$

When a document contains a word multiple times, the IDF value is multiplied by the TF value:

$$\{TF\} * \{IDF\}$$

Using the **TF** and **IDF** values, the relevancy ranking for a document is calculated using this formula:

$$\{rank\} = \{TF\} * \{IDF\} * \{IDF\}$$

The formula is demonstrated in the following examples.

## Relevancy Ranking for a Single Word Search

This example demonstrates the relevancy ranking calculation for a single-word search.

```
mysql> CREATE TABLE articles (
->   id INT UNSIGNED AUTO_INCREMENT NOT NULL PRIMARY KEY,
->   title VARCHAR(200),
->   body TEXT,
->   FULLTEXT (title,body)
->) ENGINE=InnoDB;
Query OK, 0 rows affected (1.04 sec)

mysql> INSERT INTO articles (title,body) VALUES
->   ('MySQL Tutorial','This database tutorial ...'),
->   ('How To Use MySQL','After you went through a ...'),
->   ('Optimizing Your Database','In this database tutorial ...'),
->   ('MySQL vs. YourSQL','When comparing databases ...'),
->   ('MySQL Security','When configured properly, MySQL ...'),
->   ('Database, Database, Database','database database database'),
->   ('1001 MySQL Tricks','1. Never run mysqld as root. 2. ...'),
->   ('MySQL Full-Text Indexes','MySQL fulltext indexes use a ...');
Query OK, 8 rows affected (0.06 sec)
Records: 8 Duplicates: 0 Warnings: 0

mysql> SELECT id, title, body,
->   MATCH (title,body) AGAINST ('database' IN BOOLEAN MODE) AS score
->   FROM articles ORDER BY score DESC;
+-----+-----+-----+-----+
| id | title | body | score |
+-----+-----+-----+-----+
| 6 | Database, Database, Database | database database database | 1.0886961221694946 |
| 3 | Optimizing Your Database | In this database tutorial ... | 0.36289870738983154 |
| 1 | MySQL Tutorial | This database tutorial ... | 0.18144935369491577 |
| 2 | How To Use MySQL | After you went through a ... | 0 |
| 4 | MySQL vs. YourSQL | When comparing databases ... | 0 |
| 5 | MySQL Security | When configured properly, MySQL ... | 0 |
| 7 | 1001 MySQL Tricks | 1. Never run mysqld as root. 2. ... | 0 |
| 8 | MySQL Full-Text Indexes | MySQL fulltext indexes use a .. | 0 |
+-----+-----+-----+-----+
8 rows in set (0.00 sec)
```

There are 8 records in total, with 3 that match the “database” search term. The first record (`id 6`) contains the search term 6 times and has a relevancy ranking of `1.0886961221694946`. This ranking value is calculated using a **TF** value of 6 (the “database” search term appears 6 times in record `id 6`) and an **IDF** value of `0.42596873216370745`, which is calculated as follows (where 8 is the total number of records and 3 is the number of records that the search term appears in):

```
 $\${IDF} = \text{LOG}_{10}(8 / 3) = 0.42596873216370745$ 
```

The **TF** and **IDF** values are then entered into the ranking formula:

```
 $\${rank} = \${TF} * \${IDF} * \${IDF}$ 
```

Performing the calculation in the MySQL command-line client returns a ranking value of 1.088696164686938.

```
mysql> SELECT 6*LOG10(8/3)*LOG10(8/3);
+-----+
| 6*LOG10(8/3)*LOG10(8/3) |
+-----+
|          1.088696164686938 |
+-----+
1 row in set (0.00 sec)
```



**Note**

You may notice a slight difference in the ranking values returned by the `SELECT ... MATCH ... AGAINST` statement and the MySQL command-line client (1.0886961221694946 versus 1.088696164686938). The difference is due to how the casts between integers and floats/doubles are performed internally by **InnoDB** (along with related precision and rounding decisions), and how they are performed elsewhere, such as in the MySQL command-line client or other types of calculators.

**Relevancy Ranking for a Multiple Word Search**

This example demonstrates the relevancy ranking calculation for a multiple-word full-text search based on the `articles` table and data used in the previous example.

If you search on more than one word, the relevancy ranking value is a sum of the relevancy ranking value for each word, as shown in this formula:

```
 $\${rank} = \${TF} * \${IDF} * \${IDF} + \${TF} * \${IDF} * \${IDF}$ 
```

Performing a search on two terms ('mysql tutorial') returns the following results:

```
mysql> SELECT id, title, body, MATCH (title,body)
-> AGAINST ('mysql tutorial' IN BOOLEAN MODE) AS score
-> FROM articles ORDER BY score DESC;
+-----+-----+-----+-----+
| id | title | body | score |
+-----+-----+-----+-----+
| 1 | MySQL Tutorial | This database tutorial ... | 0.7405621409416199 |
| 3 | Optimizing Your Database | In this database tutorial ... | 0.3624762296676636 |
| 5 | MySQL Security | When configured properly, MySQL ... | 0.031219376251101494 |
| 8 | MySQL Full-Text Indexes | MySQL fulltext indexes use a .. | 0.031219376251101494 |
| 2 | How To Use MySQL | After you went through a ... | 0.015609688125550747 |
| 4 | MySQL vs. YourSQL | When comparing databases ... | 0.015609688125550747 |
| 7 | 1001 MySQL Tricks | 1. Never run mysqld as root. 2. ... | 0.015609688125550747 |
| 6 | Database, Database, Database | database database database | 0 |
+-----+-----+-----+-----+
8 rows in set (0.00 sec)
```

In the first record (`id 8`), 'mysql' appears once and 'tutorial' appears twice. There are six matching records for 'mysql' and two matching records for 'tutorial'. The MySQL command-line client returns the expected ranking value when inserting these values into the ranking formula for a multiple word search:

```
mysql> SELECT (1*log10(8/6)*log10(8/6)) + (2*log10(8/2)*log10(8/2));
+-----+
| (1*log10(8/6)*log10(8/6)) + (2*log10(8/2)*log10(8/2)) |
+-----+
```

```

| 0.7405621541938003 |
+-----+
1 row in set (0.00 sec)

```

**Note**

The slight difference in the ranking values returned by the `SELECT ... MATCH ... AGAINST` statement and the MySQL command-line client is explained in the preceding example.

### 12.9.3 Full-Text Searches with Query Expansion

Full-text search supports query expansion (and in particular, its variant “blind query expansion”). This is generally useful when a search phrase is too short, which often means that the user is relying on implied knowledge that the full-text search engine lacks. For example, a user searching for “database” may really mean that “MySQL”, “Oracle”, “DB2”, and “RDBMS” all are phrases that should match “databases” and should be returned, too. This is implied knowledge.

Blind query expansion (also known as automatic relevance feedback) is enabled by adding `WITH QUERY EXPANSION` or `IN NATURAL LANGUAGE MODE WITH QUERY EXPANSION` following the search phrase. It works by performing the search twice, where the search phrase for the second search is the original search phrase concatenated with the few most highly relevant documents from the first search. Thus, if one of these documents contains the word “databases” and the word “MySQL”, the second search finds the documents that contain the word “MySQL” even if they do not contain the word “database”. The following example shows this difference:

```

mysql> SELECT * FROM articles
      WHERE MATCH (title,body)
      AGAINST ('database' IN NATURAL LANGUAGE MODE);
+-----+
| id | title                | body                |
+-----+
| 1  | MySQL Tutorial       | DBMS stands for DataBase ...
| 5  | MySQL vs. YourSQL    | In the following database comparison ...
+-----+
2 rows in set (0.00 sec)

mysql> SELECT * FROM articles
      WHERE MATCH (title,body)
      AGAINST ('database' WITH QUERY EXPANSION);
+-----+
| id | title                | body                |
+-----+
| 5  | MySQL vs. YourSQL    | In the following database comparison ...
| 1  | MySQL Tutorial       | DBMS stands for DataBase ...
| 3  | Optimizing MySQL     | In this tutorial we show ...
| 6  | MySQL Security       | When configured properly, MySQL ...
| 2  | How To Use MySQL Well | After you went through a ...
| 4  | 1001 MySQL Tricks    | 1. Never run mysqld as root. 2. ...
+-----+
6 rows in set (0.00 sec)

```

Another example could be searching for books by Georges Simenon about Maigret, when a user is not sure how to spell “Maigret”. A search for “Megre and the reluctant witnesses” finds only “Maigret and the Reluctant Witnesses” without query expansion. A search with query expansion finds all books with the word “Maigret” on the second pass.

**Note**

Because blind query expansion tends to increase noise significantly by returning nonrelevant documents, use it only when a search phrase is short.

## 12.9.4 Full-Text Stopwords

The stopwords list is loaded and searched for full-text queries using the server character set and collation (the values of the `character_set_server` and `collation_server` system variables). False hits or misses might occur for stopwords lookups if the stopwords file or columns used for full-text indexing or searches have a character set or collation different from `character_set_server` or `collation_server`.

Case sensitivity of stopwords lookups depends on the server collation. For example, lookups are case-insensitive if the collation is `latin1_swedish_ci`, whereas lookups are case-sensitive if the collation is `latin1_general_cs` or `latin1_bin`.

- [Stopwords for InnoDB Search Indexes](#)
- [Stopwords for MyISAM Search Indexes](#)

### Stopwords for InnoDB Search Indexes

`InnoDB` has a relatively short list of default stopwords, because documents from technical, literary, and other sources often use short words as keywords or in significant phrases. For example, you might search for “to be or not to be” and expect to get a sensible result, rather than having all those words ignored.

To see the default `InnoDB` stopwords list, query the Information Schema `INNODB_FT_DEFAULT_STOPWORD` table.

```
mysql> SELECT * FROM INFORMATION_SCHEMA.INNODB_FT_DEFAULT_STOPWORD;
+-----+
| value |
+-----+
| a     |
| about |
| an    |
| are   |
| as    |
| at    |
| be    |
| by    |
| com   |
| de    |
| en    |
| for   |
| from  |
| how   |
| i     |
| in    |
| is    |
| it    |
| la    |
| of    |
| on    |
| or    |
| that  |
| the   |
| this  |
| to    |
| was   |
| what  |
| when  |
| where |
| who   |
| will  |
| with  |
| und   |
```

```
| the |
| www |
+-----+
36 rows in set (0.00 sec)
```

To define your own stopwords list for all [InnoDB](#) tables, define a table with the same structure as the [INNODB\\_FT\\_DEFAULT\\_STOPWORD](#) table, populate it with stopwords, and set the value of the [innodb\\_ft\\_server\\_stopword\\_table](#) option to a value in the form *db\_name/table\_name* before creating the full-text index. The stopwords table must have a single [VARCHAR](#) column named *value*. The following example demonstrates creating and configuring a new global stopwords table for [InnoDB](#).

```
-- Create a new stopwords table

mysql> CREATE TABLE my_stopwords(value VARCHAR(30)) ENGINE = INNODB;
Query OK, 0 rows affected (0.01 sec)

-- Insert stopwords (for simplicity, a single stopwords is used in this example)

mysql> INSERT INTO my_stopwords(value) VALUES ('Ishmael');
Query OK, 1 row affected (0.00 sec)

-- Create the table

mysql> CREATE TABLE opening_lines (
  id INT UNSIGNED AUTO_INCREMENT NOT NULL PRIMARY KEY,
  opening_line TEXT(500),
  author VARCHAR(200),
  title VARCHAR(200)
) ENGINE=InnoDB;
Query OK, 0 rows affected (0.01 sec)

-- Insert data into the table

mysql> INSERT INTO opening_lines(opening_line,author,title) VALUES
('Call me Ishmael.','Herman Melville','Moby-Dick'),
('A screaming comes across the sky.','Thomas Pynchon','Gravity\'s Rainbow'),
('I am an invisible man.','Ralph Ellison','Invisible Man'),
('Where now? Who now? When now?','Samuel Beckett','The Unnamable'),
('It was love at first sight.','Joseph Heller','Catch-22'),
('All this happened, more or less.','Kurt Vonnegut','Slaughterhouse-Five'),
('Mrs. Dalloway said she would buy the flowers herself.','Virginia Woolf','Mrs. Dalloway'),
('It was a pleasure to burn.','Ray Bradbury','Fahrenheit 451');
Query OK, 8 rows affected (0.00 sec)
Records: 8 Duplicates: 0 Warnings: 0

-- Set the innodb_ft_server_stopword_table option to the new stopwords table

mysql> SET GLOBAL innodb_ft_server_stopword_table = 'test/my_stopwords';
Query OK, 0 rows affected (0.00 sec)

-- Create the full-text index (which rebuilds the table if no FTS_DOC_ID column is defined)

mysql> CREATE FULLTEXT INDEX idx ON opening_lines(opening_line);
Query OK, 0 rows affected, 1 warning (1.17 sec)
Records: 0 Duplicates: 0 Warnings: 1
```

Verify that the specified stopwords ('Ishmael') does not appear by querying the Information Schema [INNODB\\_FT\\_INDEX\\_TABLE](#) table.



### Note

By default, words less than 3 characters in length or greater than 84 characters in length do not appear in an [InnoDB](#) full-text search index. Maximum and minimum word length values are configurable using the [innodb\\_ft\\_max\\_token\\_size](#) and

`innodb_ft_min_token_size` variables. This default behavior does not apply to the ngram parser plugin. ngram token size is defined by the `ngram_token_size` option.

```
mysql> SET GLOBAL innodb_ft_aux_table='test/opening_lines';
Query OK, 0 rows affected (0.00 sec)

mysql> SELECT word FROM INFORMATION_SCHEMA.INNODB_FT_INDEX_TABLE LIMIT 15;
+-----+
| word |
+-----+
| across |
| all |
| burn |
| buy |
| call |
| comes |
| dalloway |
| first |
| flowers |
| happened |
| herself |
| invisible |
| less |
| love |
| man |
+-----+
15 rows in set (0.00 sec)
```

To create stopwords lists on a table-by-table basis, create other stopwords tables and use the `innodb_ft_user_stopword_table` option to specify the stopwords table that you want to use before you create the full-text index.

## Stopwords for MyISAM Search Indexes

The stopwords file is loaded and searched using `latin1` if `character_set_server` is `ucs2`, `utf16`, `utf16le`, or `utf32`.

To override the default stopwords list for MyISAM tables, set the `ft_stopword_file` system variable. (See [Section 5.1.7, “Server System Variables”](#).) The variable value should be the path name of the file containing the stopwords list, or the empty string to disable stopwords filtering. The server looks for the file in the data directory unless an absolute path name is given to specify a different directory. After changing the value of this variable or the contents of the stopwords file, restart the server and rebuild your `FULLTEXT` indexes.

The stopwords list is free-form, separating stopwords with any nonalphanumeric character such as newline, space, or comma. Exceptions are the underscore character (`_`) and a single apostrophe (`'`) which are treated as part of a word. The character set of the stopwords list is the server's default character set; see [Section 10.3.2, “Server Character Set and Collation”](#).

The following list shows the default stopwords for MyISAM search indexes. In a MySQL source distribution, you can find this list in the `storage/myisam/ft_static.c` file.

a's	able	about	above	according
accordingly	across	actually	after	afterwards
again	against	ain't	all	allow
allows	almost	alone	along	already
also	although	always	am	among
amongst	an	and	another	any
anybody	anyhow	anyone	anything	anyway
anyways	anywhere	apart	appear	appreciate
appropriate	are	aren't	around	as
aside	ask	asking	associated	at



## Full-Text Stopwords

available	away	awfully	be	became
because	become	becomes	becoming	been
before	beforehand	behind	being	believe
below	beside	besides	best	better
between	beyond	both	brief	but
by	c'mon	c's	came	can
can't	cannot	cant	cause	causes
certain	certainly	changes	clearly	co
com	come	comes	concerning	consequently
consider	considering	contain	containing	contains
corresponding	could	couldn't	course	currently
definitely	described	despite	did	didn't
different	do	does	doesn't	doing
don't	done	down	downwards	during
each	edu	eg	eight	either
else	elsewhere	enough	entirely	especially
et	etc	even	ever	every
everybody	everyone	everything	everywhere	ex
exactly	example	except	far	few
fifth	first	five	followed	following
follows	for	former	formerly	forth
four	from	further	furthermore	get
gets	getting	given	gives	go
goes	going	gone	got	gotten
greetings	had	hadn't	happens	hardly
has	hasn't	have	haven't	having
he	he's	hello	help	hence
her	here	here's	hereafter	hereby
herein	hereupon	hers	herself	hi
him	himself	his	hither	hopefully
how	howbeit	however	i'd	i'll
i'm	i've	ie	if	ignored
immediate	in	inasmuch	inc	indeed
indicate	indicated	indicates	inner	insofar
instead	into	inward	is	isn't
it	it'd	it'll	it's	its
itself	just	keep	keeps	kept
know	known	knows	last	lately
later	latter	latterly	least	less
lest	let	let's	like	liked
likely	little	look	looking	looks
ltd	mainly	many	may	maybe
me	mean	meanwhile	merely	might
more	moreover	most	mostly	much
must	my	myself	name	namely
nd	near	nearly	necessary	need
needs	neither	never	nevertheless	new
next	nine	no	nobody	non
none	noone	nor	normally	not
nothing	novel	now	nowhere	obviously
of	off	often	oh	ok
okay	old	on	once	one
ones	only	onto	or	other
others	otherwise	ought	our	ours
ourselves	out	outside	over	overall
own	particular	particularly	per	perhaps
placed	please	plus	possible	presumably
probably	provides	que	quite	qv
rather	rd	re	really	reasonably
regarding	regardless	regards	relatively	respectively
right	said	same	saw	say
saying	says	second	secondly	see
seeing	seem	seemed	seeming	seems
seen	self	selves	sensible	sent
serious	seriously	seven	several	shall
she	should	shouldn't	since	six
so	some	somebody	somehow	someone

## Full-Text Restrictions

something	sometime	sometimes	somewhat	somewhere
soon	sorry	specified	specify	specifying
still	sub	such	sup	sure
t's	take	taken	tell	tends
th	than	thank	thanks	thanx
that	that's	thats	the	their
theirs	them	themselves	then	thence
there	there's	thereafter	thereby	therefore
therein	theres	thereupon	these	they
they'd	they'll	they're	they've	think
third	this	thorough	thoroughly	those
though	three	through	throughout	thru
thus	to	together	too	took
toward	towards	tried	tries	truly
try	trying	twice	two	un
under	unfortunately	unless	unlikely	until
unto	up	upon	us	use
used	useful	uses	using	usually
value	various	very	via	viz
vs	want	wants	was	wasn't
way	we	we'd	we'll	we're
we've	welcome	well	went	were
weren't	what	what's	whatever	when
whence	whenever	where	where's	whereafter
whereas	whereby	wherein	whereupon	wherever
whether	which	while	whither	who
who's	whoever	whole	whom	whose
why	will	willing	wish	with
within	without	won't	wonder	would
wouldn't	yes	yet	you	you'd
you'll	you're	you've	your	yours
yourself	yourselves	zero		

### 12.9.5 Full-Text Restrictions

- Full-text searches are supported for [InnoDB](#) and [MyISAM](#) tables only.
- Full-text searches are not supported for partitioned tables. See [Section 22.6, “Restrictions and Limitations on Partitioning”](#).
- Full-text searches can be used with most multibyte character sets. The exception is that for Unicode, the [utf8](#) character set can be used, but not the [ucs2](#) character set. Although [FULLTEXT](#) indexes on [ucs2](#) columns cannot be used, you can perform [IN BOOLEAN MODE](#) searches on a [ucs2](#) column that has no such index.

The remarks for [utf8](#) also apply to [utf8mb4](#), and the remarks for [ucs2](#) also apply to [utf16](#), [utf16le](#), and [utf32](#).

- Ideographic languages such as Chinese and Japanese do not have word delimiters. Therefore, the built-in full-text parser *cannot determine where words begin and end in these and other such languages*.

A character-based ngram full-text parser that supports Chinese, Japanese, and Korean (CJK), and a word-based MeCab parser plugin that supports Japanese are provided for use with [InnoDB](#) and [MyISAM](#) tables.

- Although the use of multiple character sets within a single table is supported, all columns in a [FULLTEXT](#) index must use the same character set and collation.
- The [MATCH\(\)](#) column list must match exactly the column list in some [FULLTEXT](#) index definition for the table, unless this [MATCH\(\)](#) is [IN BOOLEAN MODE](#) on a [MyISAM](#) table. For [MyISAM](#) tables, boolean-mode searches can be done on nonindexed columns, although they are likely to be slow.

- The argument to `AGAINST()` must be a string value that is constant during query evaluation. This rules out, for example, a table column because that can differ for each row.
- Index hints are more limited for `FULLTEXT` searches than for non-`FULLTEXT` searches. See [Section 8.9.4, “Index Hints”](#).
- For `InnoDB`, all DML operations (`INSERT`, `UPDATE`, `DELETE`) involving columns with full-text indexes are processed at transaction commit time. For example, for an `INSERT` operation, an inserted string is tokenized and decomposed into individual words. The individual words are then added to full-text index tables when the transaction is committed. As a result, full-text searches only return committed data.
- The `%` character is not a supported wildcard character for full-text searches.

## 12.9.6 Fine-Tuning MySQL Full-Text Search

MySQL's full-text search capability has few user-tunable parameters. You can exert more control over full-text searching behavior if you have a MySQL source distribution because some changes require source code modifications. See [Section 2.8, “Installing MySQL from Source”](#).

Full-text search is carefully tuned for effectiveness. Modifying the default behavior in most cases can actually decrease effectiveness. *Do not alter the MySQL sources unless you know what you are doing.*

Most full-text variables described in this section must be set at server startup time. A server restart is required to change them; they cannot be modified while the server is running.

Some variable changes require that you rebuild the `FULLTEXT` indexes in your tables. Instructions for doing so are given later in this section.

- [Configuring Minimum and Maximum Word Length](#)
- [Configuring the Natural Language Search Threshold](#)
- [Modifying Boolean Full-Text Search Operators](#)
- [Character Set Modifications](#)
- [Rebuilding InnoDB Full-Text Indexes](#)
- [Optimizing InnoDB Full-Text Indexes](#)
- [Rebuilding MyISAM Full-Text Indexes](#)

### Configuring Minimum and Maximum Word Length

The minimum and maximum lengths of words to be indexed are defined by the `innodb_ft_min_token_size` and `innodb_ft_max_token_size` for `InnoDB` search indexes, and `ft_min_word_len` and `ft_max_word_len` for `MyISAM` ones.



#### Note

Minimum and maximum word length full-text parameters do not apply to `FULLTEXT` indexes created using the ngram parser. ngram token size is defined by the `ngram_token_size` option.

After changing any of these options, rebuild your `FULLTEXT` indexes for the change to take effect. For example, to make two-character words searchable, you could put the following lines in an option file:

```
[mysqld]
```

```
innodb_ft_min_token_size=2
ft_min_word_len=2
```

Then restart the server and rebuild your `FULLTEXT` indexes. For `MyISAM` tables, note the remarks regarding `myisamchk` in the instructions that follow for rebuilding `MyISAM` full-text indexes.

## Configuring the Natural Language Search Threshold

For `MyISAM` search indexes, the 50% threshold for natural language searches is determined by the particular weighting scheme chosen. To disable it, look for the following line in `storage/myisam/ftdefs.h`:

```
#define GWS_IN_USE GWS_PROB
```

Change that line to this:

```
#define GWS_IN_USE GWS_FREQ
```

Then recompile MySQL. There is no need to rebuild the indexes in this case.



### Note

By making this change, you *severely* decrease MySQL's ability to provide adequate relevance values for the `MATCH()` function. If you really need to search for such common words, it would be better to search using `IN BOOLEAN MODE` instead, which does not observe the 50% threshold.

## Modifying Boolean Full-Text Search Operators

To change the operators used for boolean full-text searches on `MyISAM` tables, set the `ft_boolean_syntax` system variable. (`InnoDB` does not have an equivalent setting.) This variable can be changed while the server is running, but you must have privileges sufficient to set global system variables (see [Section 5.1.8.1, “System Variable Privileges”](#)). No rebuilding of indexes is necessary in this case.

## Character Set Modifications

For the built-in full-text parser, you can change the set of characters that are considered word characters in several ways, as described in the following list. After making the modification, rebuild the indexes for each table that contains any `FULLTEXT` indexes. Suppose that you want to treat the hyphen character ('-') as a word character. Use one of these methods:

- Modify the MySQL source: In `storage/innobase/handler/ha_innodb.cc` (for `InnoDB`), or in `storage/myisam/ftdefs.h` (for `MyISAM`), see the `true_word_char()` and `misc_word_char()` macros. Add '-' to one of those macros and recompile MySQL.
- Modify a character set file: This requires no recompilation. The `true_word_char()` macro uses a “character type” table to distinguish letters and numbers from other characters. You can edit the contents of the `<ctype><map>` array in one of the character set XML files to specify that '-' is a “letter.” Then use the given character set for your `FULLTEXT` indexes. For information about the `<ctype><map>` array format, see [Section 10.13.1, “Character Definition Arrays”](#).
- Add a new collation for the character set used by the indexed columns, and alter the columns to use that collation. For general information about adding collations, see [Section 10.14, “Adding a Collation to a Character Set”](#). For an example specific to full-text indexing, see [Section 12.9.7, “Adding a User-Defined Collation for Full-Text Indexing”](#).

## Rebuilding InnoDB Full-Text Indexes

For the changes to take effect, `FULLTEXT` indexes must be rebuilt after modifying any of the following full-text index variables: `innodb_ft_min_token_size`; `innodb_ft_max_token_size`; `innodb_ft_server_stopword_table`; `innodb_ft_user_stopword_table`; `innodb_ft_enable_stopword`; `ngram_token_size`. Modifying `innodb_ft_min_token_size`, `innodb_ft_max_token_size`, or `ngram_token_size` requires restarting the server.

To rebuild `FULLTEXT` indexes for an `InnoDB` table, use `ALTER TABLE` with the `DROP INDEX` and `ADD INDEX` options to drop and re-create each index.

## Optimizing InnoDB Full-Text Indexes

Running `OPTIMIZE TABLE` on a table with a full-text index rebuilds the full-text index, removing deleted Document IDs and consolidating multiple entries for the same word, where possible.

To optimize a full-text index, enable `innodb_optimize_fulltext_only` and run `OPTIMIZE TABLE`.

```
mysql> set GLOBAL innodb_optimize_fulltext_only=ON;
Query OK, 0 rows affected (0.01 sec)

mysql> OPTIMIZE TABLE opening_lines;
+-----+-----+-----+-----+
| Table                | Op      | Msg_type | Msg_text |
+-----+-----+-----+-----+
| test.opening_lines   | optimize | status   | OK       |
+-----+-----+-----+-----+
1 row in set (0.01 sec)
```

To avoid lengthy rebuild times for full-text indexes on large tables, you can use the `innodb_ft_num_word_optimize` option to perform the optimization in stages. The `innodb_ft_num_word_optimize` option defines the number of words that are optimized each time `OPTIMIZE TABLE` is run. The default setting is 2000, which means that 2000 words are optimized each time `OPTIMIZE TABLE` is run. Subsequent `OPTIMIZE TABLE` operations continue from where the preceding `OPTIMIZE TABLE` operation ended.

## Rebuilding MyISAM Full-Text Indexes

If you modify full-text variables that affect indexing (`ft_min_word_len`, `ft_max_word_len`, or `ft_stopword_file`), or if you change the stopword file itself, you must rebuild your `FULLTEXT` indexes after making the changes and restarting the server.

To rebuild the `FULLTEXT` indexes for a `MyISAM` table, it is sufficient to do a `QUICK` repair operation:

```
mysql> REPAIR TABLE tbl_name QUICK;
```

Alternatively, use `ALTER TABLE` as just described. In some cases, this may be faster than a repair operation.

Each table that contains any `FULLTEXT` index must be repaired as just shown. Otherwise, queries for the table may yield incorrect results, and modifications to the table cause the server to see the table as corrupt and in need of repair.

If you use `myisamchk` to perform an operation that modifies `MyISAM` table indexes (such as repair or analyze), the `FULLTEXT` indexes are rebuilt using the *default* full-text parameter values for minimum word length, maximum word length, and stopword file unless you specify otherwise. This can result in queries failing.

The problem occurs because these parameters are known only by the server. They are not stored in `MyISAM` index files. To avoid the problem if you have modified the minimum or maximum word length or

stopword file values used by the server, specify the same `ft_min_word_len`, `ft_max_word_len`, and `ft_stopword_file` values for `myisamchk` that you use for `mysqld`. For example, if you have set the minimum word length to 3, you can repair a table with `myisamchk` like this:

```
myisamchk --recover --ft_min_word_len=3 tbl_name.MYI
```

To ensure that `myisamchk` and the server use the same values for full-text parameters, place each one in both the `[mysqld]` and `[myisamchk]` sections of an option file:

```
[mysqld]
ft_min_word_len=3

[myisamchk]
ft_min_word_len=3
```

An alternative to using `myisamchk` for `MyISAM` table index modification is to use the `REPAIR TABLE`, `ANALYZE TABLE`, `OPTIMIZE TABLE`, or `ALTER TABLE` statements. These statements are performed by the server, which knows the proper full-text parameter values to use.

## 12.9.7 Adding a User-Defined Collation for Full-Text Indexing

This section describes how to add a user-defined collation for full-text searches using the built-in full-text parser. The sample collation is like `latin1_swedish_ci` but treats the `' - '` character as a letter rather than as a punctuation character so that it can be indexed as a word character. General information about adding collations is given in [Section 10.14, “Adding a Collation to a Character Set”](#); it is assumed that you have read it and are familiar with the files involved.

To add a collation for full-text indexing, use the following procedure. The instructions here add a collation for a simple character set, which as discussed in [Section 10.14, “Adding a Collation to a Character Set”](#), can be created using a configuration file that describes the character set properties. For a complex character set such as Unicode, create collations using C source files that describe the character set properties.

1. Add a collation to the `Index.xml` file. The permitted range of IDs for user-defined collations is given in [Section 10.14.2, “Choosing a Collation ID”](#). The ID must be unused, so choose a value different from 1025 if that ID is already taken on your system.

```
<charset name="latin1">
...
<collation name="latin1_fulltext_ci" id="1025"/>
</charset>
```

2. Declare the sort order for the collation in the `latin1.xml` file. In this case, the order can be copied from `latin1_swedish_ci`:

```
<collation name="latin1_fulltext_ci">
<map>
00 01 02 03 04 05 06 07 08 09 0A 0B 0C 0D 0E 0F
10 11 12 13 14 15 16 17 18 19 1A 1B 1C 1D 1E 1F
20 21 22 23 24 25 26 27 28 29 2A 2B 2C 2D 2E 2F
30 31 32 33 34 35 36 37 38 39 3A 3B 3C 3D 3E 3F
40 41 42 43 44 45 46 47 48 49 4A 4B 4C 4D 4E 4F
50 51 52 53 54 55 56 57 58 59 5A 5B 5C 5D 5E 5F
60 41 42 43 44 45 46 47 48 49 4A 4B 4C 4D 4E 4F
50 51 52 53 54 55 56 57 58 59 5A 7B 7C 7D 7E 7F
80 81 82 83 84 85 86 87 88 89 8A 8B 8C 8D 8E 8F
90 91 92 93 94 95 96 97 98 99 9A 9B 9C 9D 9E 9F
A0 A1 A2 A3 A4 A5 A6 A7 A8 A9 AA AB AC AD AE AF
B0 B1 B2 B3 B4 B5 B6 B7 B8 B9 BA BB BC BD BE BF
41 41 41 41 5C 5B 5C 43 45 45 45 45 49 49 49
44 4E 4F 4F 4F 4F 5D D7 D8 55 55 55 59 59 DE DF
```

```

41 41 41 41 5C 5B 5C 43 45 45 45 45 49 49 49 49
44 4E 4F 4F 4F 4F 5D F7 D8 55 55 55 59 59 DE FF
</map>
</collation>

```

- Modify the `ctype` array in `latin1.xml`. Change the value corresponding to 0x2D (which is the code for the '-' character) from 10 (punctuation) to 01 (uppercase letter). In the following array, this is the element in the fourth row down, third value from the end.

```

<ctype>
<map>
00
20 20 20 20 20 20 20 20 20 28 28 28 28 28 20 20
20 20 20 20 20 20 20 20 20 20 20 20 20 20 20 20
48 10 10 10 10 10 10 10 10 10 10 10 10 01 10 10
84 84 84 84 84 84 84 84 84 84 84 10 10 10 10 10
10 81 81 81 81 81 81 01 01 01 01 01 01 01 01 01
01 01 01 01 01 01 01 01 01 01 01 10 10 10 10 10
10 82 82 82 82 82 82 02 02 02 02 02 02 02 02 02
02 02 02 02 02 02 02 02 02 02 02 10 10 10 10 20
10 00 10 02 10 10 10 10 10 10 10 01 10 01 00 01 00
00 10 10 10 10 10 10 10 10 10 10 02 10 02 00 02 01
48 10 10 10 10 10 10 10 10 10 10 10 10 10 10 10
10 10 10 10 10 10 10 10 10 10 10 10 10 10 10
01 01 01 01 01 01 01 01 01 01 01 01 01 01 01 01
01 01 01 01 01 01 01 10 01 01 01 01 01 01 01 02
02 02 02 02 02 02 02 02 02 02 02 02 02 02 02 02
02 02 02 02 02 02 02 10 02 02 02 02 02 02 02 02
</map>
</ctype>

```

- Restart the server.
- To employ the new collation, include it in the definition of columns that are to use it:

```

mysql> DROP TABLE IF EXISTS t1;
Query OK, 0 rows affected (0.13 sec)

mysql> CREATE TABLE t1 (
  a TEXT CHARACTER SET latin1 COLLATE latin1_fulltext_ci,
  FULLTEXT INDEX(a)
) ENGINE=InnoDB;
Query OK, 0 rows affected (0.47 sec)

```

- Test the collation to verify that hyphen is considered as a word character:

```

mysql> INSERT INTO t1 VALUES ('----'),('....'),('abcd');
Query OK, 3 rows affected (0.22 sec)
Records: 3 Duplicates: 0 Warnings: 0

mysql> SELECT * FROM t1 WHERE MATCH a AGAINST ('----' IN BOOLEAN MODE);
+-----+
| a      |
+-----+
| ----  |
+-----+
1 row in set (0.00 sec)

```

## 12.9.8 ngram Full-Text Parser

The built-in MySQL full-text parser uses the white space between words as a delimiter to determine where words begin and end, which is a limitation when working with ideographic languages that do not use word delimiters. To address this limitation, MySQL provides an ngram full-text parser that supports Chinese, Japanese, and Korean (CJK). The ngram full-text parser is supported for use with [InnoDB](#) and [MyISAM](#).

**Note**

MySQL also provides a MeCab full-text parser plugin for Japanese, which tokenizes documents into meaningful words. For more information, see [Section 12.9.9, “MeCab Full-Text Parser Plugin”](#).

An ngram is a contiguous sequence of  $n$  characters from a given sequence of text. The ngram parser tokenizes a sequence of text into a contiguous sequence of  $n$  characters. For example, you can tokenize “abcd” for different values of  $n$  using the ngram full-text parser.

```
n=1: 'a', 'b', 'c', 'd'
n=2: 'ab', 'bc', 'cd'
n=3: 'abc', 'bcd'
n=4: 'abcd'
```

The ngram full-text parser is a built-in server plugin. As with other built-in server plugins, it is automatically loaded when the server is started.

The full-text search syntax described in [Section 12.9, “Full-Text Search Functions”](#) applies to the ngram parser plugin. Differences in parsing behavior are described in this section. Full-text-related configuration options, except for minimum and maximum word length options (`innodb_ft_min_token_size`, `innodb_ft_max_token_size`, `ft_min_word_len`, `ft_max_word_len`) are also applicable.

## Configuring ngram Token Size

The ngram parser has a default ngram token size of 2 (bigram). For example, with a token size of 2, the ngram parser parses the string “abc def” into four tokens: “ab”, “bc”, “de” and “ef”.

ngram token size is configurable using the `ngram_token_size` configuration option, which has a minimum value of 1 and maximum value of 10.

Typically, `ngram_token_size` is set to the size of the largest token that you want to search for. If you only intend to search for single characters, set `ngram_token_size` to 1. A smaller token size produces a smaller full-text search index, and faster searches. If you need to search for words comprised of more than one character, set `ngram_token_size` accordingly. For example, “Happy Birthday” is “生日快乐” in simplified Chinese, where “生日” is “birthday”, and “快乐” translates as “happy”. To search on two-character words such as these, set `ngram_token_size` to a value of 2 or higher.

As a read-only variable, `ngram_token_size` may only be set as part of a startup string or in a configuration file:

- Startup string:

```
mysqld --ngram_token_size=2
```

- Configuration file:

```
[mysqld]
ngram_token_size=2
```

**Note**

The following minimum and maximum word length configuration options are ignored for `FULLTEXT` indexes that use the ngram parser: `innodb_ft_min_token_size`, `innodb_ft_max_token_size`, `ft_min_word_len`, and `ft_max_word_len`.

## Creating a FULLTEXT Index that Uses the ngram Parser

To create a `FULLTEXT` index that uses the ngram parser, specify `WITH PARSE` `ngram` with `CREATE TABLE`, `ALTER TABLE`, or `CREATE INDEX`.



The following example demonstrates creating a table with an `ngram FULLTEXT` index, inserting sample data (Simplified Chinese text), and viewing tokenized data in the Information Schema `INNODB_FT_INDEX_CACHE` table.

```
mysql> USE test;

mysql> CREATE TABLE articles (
    id INT UNSIGNED AUTO_INCREMENT NOT NULL PRIMARY KEY,
    title VARCHAR(200),
    body TEXT,
    FULLTEXT (title,body) WITH PARSER ngram
) ENGINE=InnoDB CHARACTER SET utf8mb4;

mysql> SET NAMES utf8mb4;

INSERT INTO articles (title,body) VALUES
('数据库管理','在本教程中我将向你展示如何管理数据库'),
('数据库应用开发','学习开发数据库应用程序');

mysql> SET GLOBAL innodb_ft_aux_table="test/articles";

mysql> SELECT * FROM INFORMATION_SCHEMA.INNODB_FT_INDEX_CACHE ORDER BY doc_id, position;
```

To add a `FULLTEXT` index to an existing table, you can use `ALTER TABLE` or `CREATE INDEX`. For example:

```
CREATE TABLE articles (
    id INT UNSIGNED AUTO_INCREMENT NOT NULL PRIMARY KEY,
    title VARCHAR(200),
    body TEXT
) ENGINE=InnoDB CHARACTER SET utf8;

ALTER TABLE articles ADD FULLTEXT INDEX ft_index (title,body) WITH PARSER ngram;

# Or:

CREATE FULLTEXT INDEX ft_index ON articles (title,body) WITH PARSER ngram;
```

## ngram Parser Space Handling

The ngram parser eliminates spaces when parsing. For example:

- “ab cd” is parsed to “ab”, “cd”
- “a bc” is parsed to “bc”

## ngram Parser Stopword Handling

The built-in MySQL full-text parser compares words to entries in the stopwords list. If a word is equal to an entry in the stopwords list, the word is excluded from the index. For the ngram parser, stopwords handling is performed differently. Instead of excluding tokens that are equal to entries in the stopwords list, the ngram parser excludes tokens that *contain* stopwords. For example, assuming `ngram_token_size=2`, a document that contains “a,b” is parsed to “a,” and “,b”. If a comma (“,”) is defined as a stopwords, both “a,” and “,b” are excluded from the index because they contain a comma.

By default, the ngram parser uses the default stopwords list, which contains a list of English stopwords. For a stopwords list applicable to Chinese, Japanese, or Korean, you must create your own. For information about creating a stopwords list, see [Section 12.9.4, “Full-Text Stopwords”](#).

Stopwords greater in length than `ngram_token_size` are ignored.

## ngram Parser Term Search

For *natural language mode* search, the search term is converted to a union of ngram terms. For example, the string “abc” (assuming `ngram_token_size=2`) is converted to “ab bc”. Given two documents, one containing “ab” and the other containing “abc”, the search term “ab bc” matches both documents.

For *boolean mode* search, the search term is converted to an ngram phrase search. For example, the string 'abc' (assuming `ngram_token_size=2`) is converted to “ab bc”. Given two documents, one containing 'ab' and the other containing 'abc', the search phrase “ab bc” only matches the document containing 'abc'.

## ngram Parser Wildcard Search

Because an ngram `FULLTEXT` index contains only ngrams, and does not contain information about the beginning of terms, wildcard searches may return unexpected results. The following behaviors apply to wildcard searches using ngram `FULLTEXT` search indexes:

- If the prefix term of a wildcard search is shorter than ngram token size, the query returns all indexed rows that contain ngram tokens starting with the prefix term. For example, assuming `ngram_token_size=2`, a search on “a\*” returns all rows starting with “a”.
- If the prefix term of a wildcard search is longer than ngram token size, the prefix term is converted to an ngram phrase and the wildcard operator is ignored. For example, assuming `ngram_token_size=2`, an “abc\*” wildcard search is converted to “ab bc”.

## ngram Parser Phrase Search

Phrase searches are converted to ngram phrase searches. For example, The search phrase “abc” is converted to “ab bc”, which returns documents containing “abc” and “ab bc”.

The search phrase “abc def” is converted to “ab bc de ef”, which returns documents containing “abc def” and “ab bc de ef”. A document that contains “abcdef” is not returned.

## 12.9.9 MeCab Full-Text Parser Plugin

The built-in MySQL full-text parser uses the white space between words as a delimiter to determine where words begin and end, which is a limitation when working with ideographic languages that do not use word delimiters. To address this limitation for Japanese, MySQL provides a MeCab full-text parser plugin. The MeCab full-text parser plugin is supported for use with `InnoDB` and `MyISAM`.



### Note

MySQL also provides an ngram full-text parser plugin that supports Japanese. For more information, see [Section 12.9.8, “ngram Full-Text Parser”](#).

The MeCab full-text parser plugin is a full-text parser plugin for Japanese that tokenizes a sequence of text into meaningful words. For example, MeCab tokenizes “データベース管理” (“Database Management”) into “データベース” (“Database”) and “管理” (“Management”). By comparison, the `ngram` full-text parser tokenizes text into a contiguous sequence of  $n$  characters, where  $n$  represents a number between 1 and 10.

In addition to tokenizing text into meaningful words, MeCab indexes are typically smaller than ngram indexes, and MeCab full-text searches are generally faster. One drawback is that it may take longer for the MeCab full-text parser to tokenize documents, compared to the ngram full-text parser.

The full-text search syntax described in [Section 12.9, “Full-Text Search Functions”](#) applies to the MeCab parser plugin. Differences in parsing behavior are described in this section. Full-text related configuration options are also applicable.

For additional information about the MeCab parser, refer to the [MeCab: Yet Another Part-of-Speech and Morphological Analyzer](#) project on Github.

## Installing the MeCab Parser Plugin

The MeCab parser plugin requires `mecab` and `mecab-ipadic`.

On supported Fedora, Debian and Ubuntu platforms (except Ubuntu 12.04 where the system `mecab` version is too old), MySQL dynamically links to the system `mecab` installation if it is installed to the default location. On other supported Unix-like platforms, `libmecab.so` is statically linked in `libpluginmecab.so`, which is located in the MySQL plugin directory. `mecab-ipadic` is included in MySQL binaries and is located in `MYSQL_HOME/lib/mecab`.

You can install `mecab` and `mecab-ipadic` using a native package management utility (on Fedora, Debian, and Ubuntu), or you can build `mecab` and `mecab-ipadic` from source. For information about installing `mecab` and `mecab-ipadic` using a native package management utility, see [Installing MeCab From a Binary Distribution \(Optional\)](#). If you want to build `mecab` and `mecab-ipadic` from source, see [Building MeCab From Source \(Optional\)](#).

On Windows, `libmecab.dll` is found in the MySQL `bin` directory. `mecab-ipadic` is located in `MYSQL_HOME/lib/mecab`.

To install and configure the MeCab parser plugin, perform the following steps:

1. In the MySQL configuration file, set the `mecab_rc_file` configuration option to the location of the `mecabrc` configuration file, which is the configuration file for MeCab. If you are using the MeCab package distributed with MySQL, the `mecabrc` file is located in `MYSQL_HOME/lib/mecab/etc/`.

```
[mysqld]
loose-mecab-rc-file=MYSQL_HOME/lib/mecab/etc/mecabrc
```

The `loose` prefix is an [option modifier](#). The `mecab_rc_file` option is not recognized by MySQL until the MeCab parser plugin is installed but it must be set before attempting to install the MeCab parser plugin. The `loose` prefix allows you restart MySQL without encountering an error due to an unrecognized variable.

If you use your own MeCab installation, or build MeCab from source, the location of the `mecabrc` configuration file may differ.

For information about the MySQL configuration file and its location, see [Section 4.2.2.2, “Using Option Files”](#).

2. Also in the MySQL configuration file, set the minimum token size to 1 or 2, which are the values recommended for use with the MeCab parser. For `InnoDB` tables, minimum token size is defined by the `innodb_ft_min_token_size` configuration option, which has a default value of 3. For `MyISAM` tables, minimum token size is defined by `ft_min_word_len`, which has a default value of 4.

```
[mysqld]
innodb_ft_min_token_size=1
```

3. Modify the `mecabrc` configuration file to specify the dictionary you want to use. The `mecab-ipadic` package distributed with MySQL binaries includes three dictionaries (`ipadic_euc-jp`, `ipadic_sjis`, and `ipadic_utf-8`). The `mecabrc` configuration file packaged with MySQL contains an entry similar to the following:

```
dicdir = /path/to/mysql/lib/mecab/lib/mecab/dic/ipadic_euc-jp
```

To use the `ipadic_utf-8` dictionary, for example, modify the entry as follows:

```
dicdir=MYSQL_HOME/lib/mecab/dic/ipadic_utf-8
```

If you are using your own MeCab installation or have built MeCab from source, the default `dicdir` entry in the `mecabrc` file differs, as do the dictionaries and their location.



#### Note

After the MeCab parser plugin is installed, you can use the `mecab_charset` status variable to view the character set used with MeCab. The three MeCab dictionaries provided with the MySQL binary support the following character sets.

- The `ipadic_euc-jp` dictionary supports the `ujis` and `eucjpms` character sets.
- The `ipadic_sjis` dictionary supports the `sjis` and `cp932` character sets.
- The `ipadic_utf-8` dictionary supports the `utf8` and `utf8mb4` character sets.

`mecab_charset` only reports the first supported character set. For example, the `ipadic_utf-8` dictionary supports both `utf8` and `utf8mb4`. `mecab_charset` always reports `utf8` when this dictionary is in use.

4. Restart MySQL.
5. Install the MeCab parser plugin:

The MeCab parser plugin is installed using `INSTALL PLUGIN`. The plugin name is `mecab`, and the shared library name is `libpluginmecab.so`. For additional information about installing plugins, see [Section 5.5.1, “Installing and Uninstalling Plugins”](#).

```
INSTALL PLUGIN mecab SONAME 'libpluginmecab.so';
```

Once installed, the MeCab parser plugin loads at every normal MySQL restart.

6. Verify that the MeCab parser plugin is loaded using the `SHOW PLUGINS` statement.

```
mysql> SHOW PLUGINS;
```

A `mecab` plugin should appear in the list of plugins.

## Creating a FULLTEXT Index that uses the MeCab Parser

To create a `FULLTEXT` index that uses the mecab parser, specify `WITH PARSE ngram` with `CREATE TABLE`, `ALTER TABLE`, or `CREATE INDEX`.

This example demonstrates creating a table with a `mecab FULLTEXT` index, inserting sample data, and viewing tokenized data in the Information Schema `INNODB_FT_INDEX_CACHE` table:

```
mysql> USE test;
mysql> CREATE TABLE articles (
  id INT UNSIGNED AUTO_INCREMENT NOT NULL PRIMARY KEY,
```

```

    title VARCHAR(200),
    body TEXT,
    FULLTEXT (title,body) WITH PARSER mecab
  ) ENGINE=InnoDB CHARACTER SET utf8;

mysql> SET NAMES utf8;

mysql> INSERT INTO articles (title,body) VALUES
  ('データベース管理','このチュートリアルでは、私はどのようにデータベースを管理する方法を紹介します'),
  ('データベースアプリケーション開発','データベースアプリケーションを開発することを学ぶ');

mysql> SET GLOBAL innodb_ft_aux_table="test/articles";

mysql> SELECT * FROM INFORMATION_SCHEMA.INNODB_FT_INDEX_CACHE ORDER BY doc_id, position;

```

To add a [FULLTEXT](#) index to an existing table, you can use [ALTER TABLE](#) or [CREATE INDEX](#). For example:

```

CREATE TABLE articles (
  id INT UNSIGNED AUTO_INCREMENT NOT NULL PRIMARY KEY,
  title VARCHAR(200),
  body TEXT
) ENGINE=InnoDB CHARACTER SET utf8;

ALTER TABLE articles ADD FULLTEXT INDEX ft_index (title,body) WITH PARSER mecab;

# Or:

CREATE FULLTEXT INDEX ft_index ON articles (title,body) WITH PARSER mecab;

```

## MeCab Parser Space Handling

The MeCab parser uses spaces as separators in query strings. For example, the MeCab parser tokenizes データベース管理 as データベース and 管理.

## MeCab Parser Stopword Handling

By default, the MeCab parser uses the default stopword list, which contains a short list of English stopwords. For a stopword list applicable to Japanese, you must create your own. For information about creating stopword lists, see [Section 12.9.4, "Full-Text Stopwords"](#).

## MeCab Parser Term Search

For natural language mode search, the search term is converted to a union of tokens. For example, データベース管理 is converted to データベース 管理.

```
SELECT COUNT(*) FROM articles WHERE MATCH(title,body) AGAINST('データベース管理' IN NATURAL LANGUAGE MODE);
```

For boolean mode search, the search term is converted to a search phrase. For example, データベース管理 is converted to データベース 管理.

```
SELECT COUNT(*) FROM articles WHERE MATCH(title,body) AGAINST('データベース管理' IN BOOLEAN MODE);
```

## MeCab Parser Wildcard Search

Wildcard search terms are not tokenized. A search on データベース管理\* is performed on the prefix, データベース管理.

```
SELECT COUNT(*) FROM articles WHERE MATCH(title,body) AGAINST('データベース*' IN BOOLEAN MODE);
```

## MeCab Parser Phrase Search

Phrases are tokenized. For example, データベース管理 is tokenized as データベース 管理.

```
SELECT COUNT(*) FROM articles WHERE MATCH(title,body) AGAINST('データベース管理' IN BOOLEAN MODE);
```

## Installing MeCab From a Binary Distribution (Optional)

This section describes how to install `mecab` and `mecab-ipadic` from a binary distribution using a native package management utility. For example, on Fedora, you can use Yum to perform the installation:

```
yum mecab-devel
```

On Debian or Ubuntu, you can perform an APT installation:

```
apt-get install mecab
apt-get install mecab-ipadic
```

## Installing MeCab From Source (Optional)

If you want to build `mecab` and `mecab-ipadic` from source, basic installation steps are provided below. For additional information, refer to the MeCab documentation.

1. Download the tar.gz packages for `mecab` and `mecab-ipadic` from <http://taku910.github.io/mecab/#download>. As of February, 2016, the latest available packages are `mecab-0.996.tar.gz` and `mecab-ipadic-2.7.0-20070801.tar.gz`.

2. Install `mecab`:

```
tar zxvf mecab-0.996.tar
cd mecab-0.996
./configure
make
make check
su
make install
```

3. Install `mecab-ipadic`:

```
tar zxvf mecab-ipadic-2.7.0-20070801.tar
cd mecab-ipadic-2.7.0-20070801
./configure
make
su
make install
```

4. Compile MySQL using the `WITH_MECAB` CMake option. Set the `WITH_MECAB` option to `system` if you have installed `mecab` and `mecab-ipadic` to the default location.

```
-DWITH_MECAB=system
```

If you defined a custom installation directory, set `WITH_MECAB` to the custom directory. For example:

```
-DWITH_MECAB=/path/to/mecab
```

## 12.10 Cast Functions and Operators

Table 12.15 Cast Functions and Operators

Name	Description
<code>BINARY</code>	Cast a string to a binary string

Name	Description
<code>CAST()</code>	Cast a value as a certain type
<code>CONVERT()</code>	Cast a value as a certain type

Cast functions and operators enable conversion of values from one data type to another.

- [Cast Function and Operator Descriptions](#)
- [Character Set Conversions](#)
- [Character Set Conversions for String Comparisons](#)
- [Other Uses for Cast Operations](#)

## Cast Function and Operator Descriptions

- `BINARY expr`

The `BINARY` operator converts the expression to a binary string (a string that has the `binary` character set and `binary` collation). A common use for `BINARY` is to force a character string comparison to be done byte by byte using numeric byte values rather than character by character. The `BINARY` operator also causes trailing spaces in comparisons to be significant. For information about the differences between the `binary` collation of the `binary` character set and the `_bin` collations of nonbinary character sets, see [Section 10.8.5, “The binary Collation Compared to `\_bin` Collations”](#).

```
mysql> SELECT 'a' = 'A';
-> 1
mysql> SELECT BINARY 'a' = 'A';
-> 0
mysql> SELECT 'a' = 'a ';
-> 1
mysql> SELECT BINARY 'a' = 'a ';
-> 0
```

In a comparison, `BINARY` affects the entire operation; it can be given before either operand with the same result.

To convert a string expression to a binary string, these constructs are equivalent:

```
CONVERT(expr USING BINARY)
CAST(expr AS BINARY)
BINARY expr
```

If a value is a string literal, it can be designated as a binary string without converting it by using the `_binary` character set introducer:

```
mysql> SELECT 'a' = 'A';
-> 1
mysql> SELECT _binary 'a' = 'A';
-> 0
```

For information about introducers, see [Section 10.3.8, “Character Set Introducers”](#).

The `BINARY` operator in expressions differs in effect from the `BINARY` attribute in character column definitions. For a character column defined with the `BINARY` attribute, MySQL assigns the table default character set and the binary (`_bin`) collation of that character set. Every nonbinary character set has a `_bin` collation. For example, if the table default character set is `utf8`, these two column definitions are equivalent:

```
CHAR(10) BINARY
CHAR(10) CHARACTER SET utf8 COLLATE utf8_bin
```

The use of `CHARACTER SET binary` in the definition of a `CHAR`, `VARCHAR`, or `TEXT` column causes the column to be treated as the corresponding binary string data type. For example, the following pairs of definitions are equivalent:

```
CHAR(10) CHARACTER SET binary
BINARY(10)

VARCHAR(10) CHARACTER SET binary
VARBINARY(10)

TEXT CHARACTER SET binary
BLOB
```

If `BINARY` is invoked from within the `mysql` client, binary strings display using hexadecimal notation, depending on the value of the `--binary-as-hex`. For more information about that option, see [Section 4.5.1, “mysql — The MySQL Command-Line Client”](#).

- `CAST(expr AS type)`

`CAST(expr AS type)` takes an expression of any type and produces a result value of the specified type. This operation may also be expressed as `CONVERT(expr, type)`, which is equivalent.

These *type* values are permitted:

- `BINARY[ (N) ]`

Produces a string with the `VARBINARY` data type, except that when the expression *expr* is empty (zero length), the result type is `BINARY(0)`. If the optional length *N* is given, `BINARY(N)` causes the cast to use no more than *N* bytes of the argument. Values shorter than *N* bytes are padded with `0x00` bytes to a length of *N*. If the optional length *N* is not given, MySQL calculates the maximum length from the expression. If the supplied or calculated length is greater than an internal threshold, the result type is `BLOB`. If the length is still too long, the result type is `LOB`.

For a description of how casting to `BINARY` affects comparisons, see [Section 11.3.3, “The BINARY and VARBINARY Types”](#).

- `CHAR[ (N) ] [ charset_info ]`

Produces a string with the `VARCHAR` data type, unless the expression *expr* is empty (zero length), in which case the result type is `CHAR(0)`. If the optional length *N* is given, `CHAR(N)` causes the cast to use no more than *N* characters of the argument. No padding occurs for values shorter than *N* characters. If the optional length *N* is not given, MySQL calculates the maximum length from the expression. If the supplied or calculated length is greater than an internal threshold, the result type is `TEXT`. If the length is still too long, the result type is `LONGTEXT`.

With no *charset\_info* clause, `CHAR` produces a string with the default character set. To specify the character set explicitly, these *charset\_info* values are permitted:

- `CHARACTER SET charset_name`: Produces a string with the given character set.
- `ASCII`: Shorthand for `CHARACTER SET latin1`.
- `UNICODE`: Shorthand for `CHARACTER SET ucs2`.

In all cases, the string has the character set default collation.



- `DATE`

Produces a `DATE` value.

- `DATETIME[ (M) ]`

Produces a `DATETIME` value. If the optional `M` value is given, it specifies the fractional seconds precision.

- `DECIMAL[ (M[ ,D] ) ]`

Produces a `DECIMAL` value. If the optional `M` and `D` values are given, they specify the maximum number of digits (the precision) and the number of digits following the decimal point (the scale). If `D` is omitted, 0 is assumed. If `M` is omitted, 10 is assumed.

- `JSON`

Produces a `JSON` value. For details on the rules for conversion of values between `JSON` and other types, see [Comparison and Ordering of JSON Values](#).

- `NCHAR[ (N) ]`

Like `CHAR`, but produces a string with the national character set. See [Section 10.3.7, “The National Character Set”](#).

Unlike `CHAR`, `NCHAR` does not permit trailing character set information to be specified.

- `SIGNED [ INTEGER ]`

Produces a signed `BIGINT` value.

- `TIME[ (M) ]`

Produces a `TIME` value. If the optional `M` value is given, it specifies the fractional seconds precision.

- `UNSIGNED [ INTEGER ]`

Produces an unsigned `BIGINT` value.

- `CONVERT(expr USING transcoding_name)`

`CONVERT(expr, type)`

`CONVERT(expr USING transcoding_name)` is standard SQL syntax. The non-`USING` form of `CONVERT()` is ODBC syntax.

`CONVERT(expr USING transcoding_name)` converts data between different character sets. In MySQL, transcoding names are the same as the corresponding character set names. For example, this statement converts the string `'abc'` in the default character set to the corresponding string in the `utf8` character set:

```
SELECT CONVERT('abc' USING utf8);
```

`CONVERT(expr, type)` syntax (without `USING`) takes an expression and a `type` value specifying a result type, and produces a result value of the specified type. This operation may also be expressed as `CAST(expr AS type)`, which is equivalent. For more information, see the description of `CAST()`.

## Character Set Conversions

`CONVERT()` with a `USING` clause converts data between character sets:

```
CONVERT(expr USING transcoding_name)
```

In MySQL, transcoding names are the same as the corresponding character set names.

Examples:

```
SELECT CONVERT('test' USING utf8);
SELECT CONVERT(_latin1'Müller' USING utf8);
INSERT INTO utf8_table (utf8_column)
  SELECT CONVERT(latin1_column USING utf8) FROM latin1_table;
```

To convert strings between character sets, you can also use `CONVERT(expr, type)` syntax (without `USING`), or `CAST(expr AS type)`, which is equivalent:

```
CONVERT(string, CHAR[(N)] CHARACTER SET charset_name)
CAST(string AS CHAR[(N)] CHARACTER SET charset_name)
```

Examples:

```
SELECT CONVERT('test', CHAR CHARACTER SET utf8);
SELECT CAST('test' AS CHAR CHARACTER SET utf8);
```

If you specify `CHARACTER SET charset_name` as just shown, the character set and collation of the result are `charset_name` and the default collation of `charset_name`. If you omit `CHARACTER SET charset_name`, the character set and collation of the result are defined by the `character_set_connection` and `collation_connection` system variables that determine the default connection character set and collation (see [Section 10.4, “Connection Character Sets and Collations”](#)).

A `COLLATE` clause is not permitted within a `CONVERT()` or `CAST()` call, but you can apply it to the function result. For example, these are legal:

```
SELECT CONVERT('test' USING utf8) COLLATE utf8_bin;
SELECT CONVERT('test', CHAR CHARACTER SET utf8) COLLATE utf8_bin;
SELECT CAST('test' AS CHAR CHARACTER SET utf8) COLLATE utf8_bin;
```

But these are illegal:

```
SELECT CONVERT('test' USING utf8 COLLATE utf8_bin);
SELECT CONVERT('test', CHAR CHARACTER SET utf8 COLLATE utf8_bin);
SELECT CAST('test' AS CHAR CHARACTER SET utf8 COLLATE utf8_bin);
```

For string literals, another way to specify the character set is to use a character set introducer. `_latin1` and `_latin2` in the preceding example are instances of introducers. Unlike conversion functions such as `CAST()`, or `CONVERT()`, which convert a string from one character set to another, an introducer designates a string literal as having a particular character set, with no conversion involved. For more information, see [Section 10.3.8, “Character Set Introducers”](#).

## Character Set Conversions for String Comparisons

Normally, you cannot compare a `BLOB` value or other binary string in case-insensitive fashion because binary strings use the `binary` character set, which has no collation with the concept of lettercase. To perform a case-insensitive comparison, first use the `CONVERT()` or `CAST()` function to convert the value to a nonbinary string. Comparisons of the resulting string use its collation. For example, if the conversion

result collation is not case-sensitive, a `LIKE` operation is not case-sensitive. That is true for the following operation because the default `latin1` collation (`latin1_swedish_ci`) is not case-sensitive:

```
SELECT 'A' LIKE CONVERT(blob_col USING latin1)
FROM tbl_name;
```

To specify a particular collation for the converted string, use a `COLLATE` clause following the `CONVERT()` call:

```
SELECT 'A' LIKE CONVERT(blob_col USING latin1) COLLATE latin1_german1_ci
FROM tbl_name;
```

To use a different character set, substitute its name for `latin1` in the preceding statements (and similarly to use a different collation).

`CONVERT()` and `CAST()` can be used more generally for comparing strings represented in different character sets. For example, a comparison of these strings results in an error because they have different character sets:

```
mysql> SET @s1 = _latin1 'abc', @s2 = _latin2 'abc';
mysql> SELECT @s1 = @s2;
ERROR 1267 (HY000): Illegal mix of collations (latin1_swedish_ci,IMPLICIT)
and (latin2_general_ci,IMPLICIT) for operation '='

```

Converting one of the strings to a character set compatible with the other enables the comparison to occur without error:

```
mysql> SELECT @s1 = CONVERT(@s2 USING latin1);
+-----+
| @s1 = CONVERT(@s2 USING latin1) |
+-----+
|                                1 |
+-----+
```

Character set conversion is also useful preceding lettercase conversion of binary strings. `LOWER()` and `UPPER()` are ineffective when applied directly to binary strings because the concept of lettercase does not apply. To perform lettercase conversion of a binary string, first convert it to a nonbinary string using a character set appropriate for the data stored in the string:

```
mysql> SET @str = BINARY 'New York';
mysql> SELECT LOWER(@str), LOWER(CONVERT(@str USING latin1));
+-----+-----+
| LOWER(@str) | LOWER(CONVERT(@str USING latin1)) |
+-----+-----+
| New York   | new york                           |
+-----+-----+
```

Be aware that if you apply `BINARY`, `CAST()`, or `CONVERT()` to an indexed column, MySQL may not be able to use the index efficiently.

## Other Uses for Cast Operations

The cast functions are useful for creating a column with a specific type in a `CREATE TABLE ... SELECT` statement:

```
mysql> CREATE TABLE new_table SELECT CAST('2000-01-01' AS DATE) AS c1;
mysql> SHOW CREATE TABLE new_table\G
***** 1. row *****
      Table: new_table
Create Table: CREATE TABLE `new_table` (
  `c1` date DEFAULT NULL
) ENGINE=InnoDB DEFAULT CHARSET=latin1
```

The cast functions are useful for sorting [ENUM](#) columns in lexical order. Normally, sorting of [ENUM](#) columns occurs using the internal numeric values. Casting the values to [CHAR](#) results in a lexical sort:

```
SELECT enum_col FROM tbl_name ORDER BY CAST(enum_col AS CHAR);
```

[CAST\(\)](#) also changes the result if you use it as part of a more complex expression such as [CONCAT\('Date: ',CAST\(NOW\(\) AS DATE\)\)](#).

For temporal values, there is little need to use [CAST\(\)](#) to extract data in different formats. Instead, use a function such as [EXTRACT\(\)](#), [DATE\\_FORMAT\(\)](#), or [TIME\\_FORMAT\(\)](#). See [Section 12.7, “Date and Time Functions”](#).

To cast a string to a number, it normally suffices to use the string value in numeric context:

```
mysql> SELECT 1+'1';
-> 2
```

That is also true for hexadecimal and bit literals, which are binary strings by default:

```
mysql> SELECT X'41', X'41'+0;
-> 'A', 65
mysql> SELECT b'1100001', b'1100001'+0;
-> 'a', 97
```

A string used in an arithmetic operation is converted to a floating-point number during expression evaluation.

A number used in string context is converted to a string:

```
mysql> SELECT CONCAT('hello you ',2);
-> 'hello you 2'
```

For information about implicit conversion of numbers to strings, see [Section 12.3, “Type Conversion in Expression Evaluation”](#).

MySQL supports arithmetic with both signed and unsigned 64-bit values. For numeric operators (such as + or -) where one of the operands is an unsigned integer, the result is unsigned by default (see [Section 12.6.1, “Arithmetic Operators”](#)). To override this, use the [SIGNED](#) or [UNSIGNED](#) cast operator to cast a value to a signed or unsigned 64-bit integer, respectively.

```
mysql> SELECT 1 - 2;
-> -1
mysql> SELECT CAST(1 - 2 AS UNSIGNED);
-> 18446744073709551615
mysql> SELECT CAST(CAST(1 - 2 AS UNSIGNED) AS SIGNED);
-> -1
```

If either operand is a floating-point value, the result is a floating-point value and is not affected by the preceding rule. (In this context, [DECIMAL](#) column values are regarded as floating-point values.)

```
mysql> SELECT CAST(1 AS UNSIGNED) - 2.0;
-> -1.0
```

The SQL mode affects the result of conversion operations (see [Section 5.1.10, “Server SQL Modes”](#)). Examples:

- For conversion of a “zero” date string to a date, [CONVERT\(\)](#) and [CAST\(\)](#) return [NULL](#) and produce a warning when the [NO\\_ZERO\\_DATE](#) SQL mode is enabled.
- For integer subtraction, if the [NO\\_UNSIGNED\\_SUBTRACTION](#) SQL mode is enabled, the subtraction result is signed even if any operand is unsigned.

## 12.11 XML Functions

**Table 12.16 XML Functions**

Name	Description
<code>ExtractValue()</code>	Extract a value from an XML string using XPath notation
<code>UpdateXML()</code>	Return replaced XML fragment

This section discusses XML and related functionality in MySQL.



### Note

It is possible to obtain XML-formatted output from MySQL in the `mysql` and `mysqldump` clients by invoking them with the `--xml` option. See [Section 4.5.1](#), “`mysql` — The MySQL Command-Line Client”, and [Section 4.5.4](#), “`mysqldump` — A Database Backup Program”.

Two functions providing basic XPath 1.0 (XML Path Language, version 1.0) capabilities are available. Some basic information about XPath syntax and usage is provided later in this section; however, an in-depth discussion of these topics is beyond the scope of this manual, and you should refer to the [XML Path Language \(XPath\) 1.0 standard](#) for definitive information. A useful resource for those new to XPath or who desire a refresher in the basics is the [Zvon.org XPath Tutorial](#), which is available in several languages.



### Note

These functions remain under development. We continue to improve these and other aspects of XML and XPath functionality in MySQL 5.7 and onwards. You may discuss these, ask questions about them, and obtain help from other users with them in the [MySQL XML User Forum](#).

XPath expressions used with these functions support user variables and local stored program variables. User variables are weakly checked; variables local to stored programs are strongly checked (see also Bug #26518):

- **User variables (weak checking).** Variables using the syntax ``${variable_name}` (that is, user variables) are not checked. No warnings or errors are issued by the server if a variable has the wrong type or has previously not been assigned a value. This also means the user is fully responsible for any typographical errors, since no warnings are given if (for example) ``${myvairable}` is used where ``${myvariable}` was intended.

Example:

```
mysql> SET @xml = '<a><b>X</b><b>Y</b></a>';
Query OK, 0 rows affected (0.00 sec)

mysql> SET @i =1, @j = 2;
Query OK, 0 rows affected (0.00 sec)

mysql> SELECT @i, ExtractValue(@xml, '//b[${i}]');
+-----+-----+
| @i    | ExtractValue(@xml, '//b[${i}]') |
+-----+-----+
| 1    | X                               |
+-----+-----+
1 row in set (0.00 sec)

mysql> SELECT @j, ExtractValue(@xml, '//b[${j}]');
+-----+-----+
| @j    | ExtractValue(@xml, '//b[${j}]') |
+-----+-----+
```

```

| @j | ExtractValue(@xml, '//b[$@j]') |
+-----+-----+-----+
| 2 | Y | |
+-----+-----+-----+
1 row in set (0.00 sec)

mysql> SELECT @k, ExtractValue(@xml, '//b[$@k]');
+-----+-----+-----+
| @k | ExtractValue(@xml, '//b[$@k]') |
+-----+-----+-----+
| NULL | |
+-----+-----+-----+
1 row in set (0.00 sec)

```

- **Variables in stored programs (strong checking).** Variables using the syntax `$variable_name` can be declared and used with these functions when they are called inside stored programs. Such variables are local to the stored program in which they are defined, and are strongly checked for type and value.

Example:

```

mysql> DELIMITER |

mysql> CREATE PROCEDURE myproc ()
-> BEGIN
-> DECLARE i INT DEFAULT 1;
-> DECLARE xml VARCHAR(25) DEFAULT '<a>X</a><a>Y</a><a>Z</a>';
->
-> WHILE i < 4 DO
-> SELECT xml, i, ExtractValue(xml, '//a[$i]');
-> SET i = i+1;
-> END WHILE;
-> END |
Query OK, 0 rows affected (0.01 sec)

mysql> DELIMITER ;

mysql> CALL myproc();
+-----+-----+-----+
| xml | i | ExtractValue(xml, '//a[$i]') |
+-----+-----+-----+
| <a>X</a><a>Y</a><a>Z</a> | 1 | X |
+-----+-----+-----+
1 row in set (0.00 sec)

+-----+-----+-----+
| xml | i | ExtractValue(xml, '//a[$i]') |
+-----+-----+-----+
| <a>X</a><a>Y</a><a>Z</a> | 2 | Y |
+-----+-----+-----+
1 row in set (0.01 sec)

+-----+-----+-----+
| xml | i | ExtractValue(xml, '//a[$i]') |
+-----+-----+-----+
| <a>X</a><a>Y</a><a>Z</a> | 3 | Z |
+-----+-----+-----+
1 row in set (0.01 sec)

```

**Parameters.** Variables used in XPath expressions inside stored routines that are passed in as parameters are also subject to strong checking.

Expressions containing user variables or variables local to stored programs must otherwise (except for notation) conform to the rules for XPath expressions containing variables as given in the XPath 1.0 specification.

**Note**

A user variable used to store an XPath expression is treated as an empty string. Because of this, it is not possible to store an XPath expression as a user variable. (Bug #32911)

- `ExtractValue(xml_frag, xpath_expr)`

`ExtractValue()` takes two string arguments, a fragment of XML markup `xml_frag` and an XPath expression `xpath_expr` (also known as a *locator*); it returns the text (CDATA) of the first text node which is a child of the element or elements matched by the XPath expression.

Using this function is the equivalent of performing a match using the `xpath_expr` after appending `/text()`. In other words, `ExtractValue('<a><b>Sakila</b></a>', '/a/b')` and `ExtractValue('<a><b>Sakila</b></a>', '/a/b/text()')` produce the same result.

If multiple matches are found, the content of the first child text node of each matching element is returned (in the order matched) as a single, space-delimited string.

If no matching text node is found for the expression (including the implicit `/text()`)—for whatever reason, as long as `xpath_expr` is valid, and `xml_frag` consists of elements which are properly nested and closed—an empty string is returned. No distinction is made between a match on an empty element and no match at all. This is by design.

If you need to determine whether no matching element was found in `xml_frag` or such an element was found but contained no child text nodes, you should test the result of an expression that uses the XPath `count()` function. For example, both of these statements return an empty string, as shown here:

```
mysql> SELECT ExtractValue('<a><b/></a>', '/a/b');
+-----+
| ExtractValue('<a><b/></a>', '/a/b') |
+-----+
|                                     |
+-----+
1 row in set (0.00 sec)

mysql> SELECT ExtractValue('<a><c/></a>', '/a/b');
+-----+
| ExtractValue('<a><c/></a>', '/a/b') |
+-----+
|                                     |
+-----+
1 row in set (0.00 sec)
```

However, you can determine whether there was actually a matching element using the following:

```
mysql> SELECT ExtractValue('<a><b/></a>', 'count(/a/b)');
+-----+
| ExtractValue('<a><b/></a>', 'count(/a/b)') |
+-----+
| 1                                           |
+-----+
1 row in set (0.00 sec)

mysql> SELECT ExtractValue('<a><c/></a>', 'count(/a/b)');
+-----+
| ExtractValue('<a><c/></a>', 'count(/a/b)') |
+-----+
| 0                                           |
+-----+
```

1 row in set (0.01 sec)



### Important

`ExtractValue()` returns only `CDATA`, and does not return any tags that might be contained within a matching tag, nor any of their content (see the result returned as `val1` in the following example).

```
mysql> SELECT
->   ExtractValue('<a>ccc<b>ddd</b></a>', '/a') AS val1,
->   ExtractValue('<a>ccc<b>ddd</b></a>', '/a/b') AS val2,
->   ExtractValue('<a>ccc<b>ddd</b></a>', '//b') AS val3,
->   ExtractValue('<a>ccc<b>ddd</b></a>', '/b') AS val4,
->   ExtractValue('<a>ccc<b>ddd</b><b>eee</b></a>', '//b') AS val5;
```

val1	val2	val3	val4	val5
ccc	ddd	ddd		ddd eee

This function uses the current SQL collation for making comparisons with `contains()`, performing the same collation aggregation as other string functions (such as `CONCAT()`), in taking into account the collation coercibility of their arguments; see [Section 10.8.4, “Collation Coercibility in Expressions”](#), for an explanation of the rules governing this behavior.

(Previously, binary—that is, case-sensitive—comparison was always used.)

`NULL` is returned if `xml_frag` contains elements which are not properly nested or closed, and a warning is generated, as shown in this example:

```
mysql> SELECT ExtractValue('<a>c</a><b', '//a');
+-----+
| ExtractValue('<a>c</a><b', '//a') |
+-----+
| NULL |
+-----+
1 row in set, 1 warning (0.00 sec)

mysql> SHOW WARNINGS\G
***** 1. row *****
Level: Warning
Code: 1525
Message: Incorrect XML value: 'parse error at line 1 pos 11:
        END-OF-INPUT unexpected ('>' wanted)'
1 row in set (0.00 sec)

mysql> SELECT ExtractValue('<a>c</a><b/>', '//a');
+-----+
| ExtractValue('<a>c</a><b/>', '//a') |
+-----+
| c |
+-----+
1 row in set (0.00 sec)
```



- `UpdateXML(xml_target, xpath_expr, new_xml)`

This function replaces a single portion of a given fragment of XML markup `xml_target` with a new XML fragment `new_xml`, and then returns the changed XML. The portion of `xml_target` that is replaced matches an XPath expression `xpath_expr` supplied by the user.

If no expression matching `xpath_expr` is found, or if multiple matches are found, the function returns the original `xml_target` XML fragment. All three arguments should be strings.

```
mysql> SELECT
->   UpdateXML('<a><b>ccc</b><d></d></a>', '/a', '<e>fff</e>') AS val1,
->   UpdateXML('<a><b>ccc</b><d></d></a>', '/b', '<e>fff</e>') AS val2,
->   UpdateXML('<a><b>ccc</b><d></d></a>', '//b', '<e>fff</e>') AS val3,
->   UpdateXML('<a><b>ccc</b><d></d></a>', '/a/d', '<e>fff</e>') AS val4,
->   UpdateXML('<a><d></d><b>ccc</b><d></d></a>', '/a/d', '<e>fff</e>') AS val5
-> \G

***** 1. row *****
val1: <e>fff</e>
val2: <a><b>ccc</b><d></d></a>
val3: <a><e>fff</e><d></d></a>
val4: <a><b>ccc</b><e>fff</e></a>
val5: <a><d></d><b>ccc</b><d></d></a>
```



### Note

A discussion in depth of XPath syntax and usage are beyond the scope of this manual. Please see the [XML Path Language \(XPath\) 1.0 specification](#) for definitive information. A useful resource for those new to XPath or who are wishing a refresher in the basics is the [Zvon.org XPath Tutorial](#), which is available in several languages.

Descriptions and examples of some basic XPath expressions follow:

- `/tag`

Matches `<tag/>` if and only if `<tag/>` is the root element.

Example: `/a` has a match in `<a><b/></a>` because it matches the outermost (root) tag. It does not match the inner `a` element in `<b><a/></b>` because in this instance it is the child of another element.

- `/tag1/tag2`

Matches `<tag2/>` if and only if it is a child of `<tag1/>`, and `<tag1/>` is the root element.

Example: `/a/b` matches the `b` element in the XML fragment `<a><b/></a>` because it is a child of the root element `a`. It does not have a match in `<b><a/></b>` because in this case, `b` is the root element (and hence the child of no other element). Nor does the XPath expression have a match in `<a><c><b/></c></a>`; here, `b` is a descendant of `a`, but not actually a child of `a`.

This construct is extendable to three or more elements. For example, the XPath expression `/a/b/c` matches the `c` element in the fragment `<a><b><c/></b></a>`.

- `//tag`

Matches any instance of `<tag>`.

Example: `//a` matches the `a` element in any of the following: `<a><b><c/></b></a>`; `<c><a><b/></c></a>`; `<c><b><a/></b></c>`.

// can be combined with /. For example, //a/b matches the *b* element in either of the fragments <a><b/></a> or <c><a><b/></a></c>.



### Note

//tag is the equivalent of /descendant-or-self::\* /tag. A common error is to confuse this with /descendant-or-self::tag, although the latter expression can actually lead to very different results, as can be seen here:

```
mysql> SET @xml = '<a><b><c>w</c><b>x</b><d>y</d>z</b></a>';
Query OK, 0 rows affected (0.00 sec)

mysql> SELECT @xml;
+-----+
| @xml                                     |
+-----+
| <a><b><c>w</c><b>x</b><d>y</d>z</b></a>      |
+-----+
1 row in set (0.00 sec)

mysql> SELECT ExtractValue(@xml, '//b[1]');
+-----+
| ExtractValue(@xml, '//b[1]')           |
+-----+
| x z                                     |
+-----+
1 row in set (0.00 sec)

mysql> SELECT ExtractValue(@xml, '//b[2]');
+-----+
| ExtractValue(@xml, '//b[2]')           |
+-----+
|                                         |
+-----+
1 row in set (0.01 sec)

mysql> SELECT ExtractValue(@xml, '/descendant-or-self::*b[1]');
+-----+
| ExtractValue(@xml, '/descendant-or-self::*b[1]') |
+-----+
| x z                                     |
+-----+
1 row in set (0.06 sec)

mysql> SELECT ExtractValue(@xml, '/descendant-or-self::*b[2]');
+-----+
| ExtractValue(@xml, '/descendant-or-self::*b[2]') |
+-----+
|                                         |
+-----+
1 row in set (0.00 sec)

mysql> SELECT ExtractValue(@xml, '/descendant-or-self::b[1]');
+-----+
| ExtractValue(@xml, '/descendant-or-self::b[1]') |
+-----+
| z                                               |
+-----+
1 row in set (0.00 sec)

mysql> SELECT ExtractValue(@xml, '/descendant-or-self::b[2]');
+-----+
| ExtractValue(@xml, '/descendant-or-self::b[2]') |
```

```

+-----+
| x      |
+-----+
1 row in set (0.00 sec)

```

- The `*` operator acts as a “wildcard” that matches any element. For example, the expression `/*/b` matches the `b` element in either of the XML fragments `<a><b/></a>` or `<c><b/></c>`. However, the expression does not produce a match in the fragment `<b><a/></b>` because `b` must be a child of some other element. The wildcard may be used in any position: The expression `/*/b/*` matches any child of a `b` element that is itself not the root element.
- You can match any of several locators using the `|` (UNION) operator. For example, the expression `//b|//c` matches all `b` and `c` elements in the XML target.
- It is also possible to match an element based on the value of one or more of its attributes. This done using the syntax `tag[@attribute="value"]`. For example, the expression `//b[@id="idB"]` matches the second `b` element in the fragment `<a><b id="idA"/><c/><b id="idB"/></a>`. To match against *any* element having `attribute="value"`, use the XPath expression `//*[@attribute="value"]`.

To filter multiple attribute values, simply use multiple attribute-comparison clauses in succession. For example, the expression `//b[@c="x"][@d="y"]` matches the element `<b c="x" d="y"/>` occurring anywhere in a given XML fragment.

To find elements for which the same attribute matches any of several values, you can use multiple locators joined by the `|` operator. For example, to match all `b` elements whose `c` attributes have either of the values 23 or 17, use the expression `//b[@c="23"]|//b[@c="17"]`. You can also use the logical `or` operator for this purpose: `//b[@c="23" or @c="17"]`.



#### Note

The difference between `or` and `|` is that `or` joins conditions, while `|` joins result sets.

**XPath Limitations.** The XPath syntax supported by these functions is currently subject to the following limitations:

- Nodeset-to-nodeset comparison (such as `'/a/b[@c=@d]'`) is not supported.
- All of the standard XPath comparison operators are supported. (Bug #22823)
- Relative locator expressions are resolved in the context of the root node. For example, consider the following query and result:

```

mysql> SELECT ExtractValue(
->   '<a><b c="1">X</b><b c="2">Y</b></a>',
->   'a/b'
-> ) AS result;
+-----+
| result |
+-----+
| X Y    |
+-----+
1 row in set (0.03 sec)

```

In this case, the locator `a/b` resolves to `/a/b`.

Relative locators are also supported within predicates. In the following example, `d[../@c="1"]` is resolved as `/a/b[@c="1"]/d`:

```
mysql> SELECT ExtractValue(
->     '<a>
->         <b c="1"><d>X</d></b>
->         <b c="2"><d>X</d></b>
->     </a>',
->     'a/b/d[../@c="1"]')
-> AS result;
+-----+
| result |
+-----+
| X      |
+-----+
1 row in set (0.00 sec)
```

- Locators prefixed with expressions that evaluate as scalar values—including variable references, literals, numbers, and scalar function calls—are not permitted, and their use results in an error.
- The `::` operator is not supported in combination with node types such as the following:
  - `axis::comment()`
  - `axis::text()`
  - `axis::processing-instructions()`
  - `axis::node()`

However, name tests (such as `axis::name` and `axis::*`) are supported, as shown in these examples:

```
mysql> SELECT ExtractValue('<a><b>x</b><c>y</c></a>', '/a/child:b');
+-----+
| ExtractValue('<a><b>x</b><c>y</c></a>', '/a/child:b') |
+-----+
| x |
+-----+
1 row in set (0.02 sec)

mysql> SELECT ExtractValue('<a><b>x</b><c>y</c></a>', '/a/child::*');
+-----+
| ExtractValue('<a><b>x</b><c>y</c></a>', '/a/child::*') |
+-----+
| x y |
+-----+
1 row in set (0.01 sec)
```

- “Up-and-down” navigation is not supported in cases where the path would lead “above” the root element. That is, you cannot use expressions which match on descendants of ancestors of a given element, where one or more of the ancestors of the current element is also an ancestor of the root element (see Bug #16321).

- The following XPath functions are not supported, or have known issues as indicated:

- `id()`
- `lang()`
- `local-name()`
- `name()`
- `namespace-uri()`
- `normalize-space()`
- `starts-with()`
- `string()`
- `substring-after()`
- `substring-before()`
- `translate()`

- The following axes are not supported:

- `following-sibling`
- `following`
- `preceding-sibling`
- `preceding`

XPath expressions passed as arguments to `ExtractValue()` and `UpdateXML()` may contain the colon character (:) in element selectors, which enables their use with markup employing XML namespaces notation. For example:

```
mysql> SET @xml = '<a>111<b:c>222<d>333</d><e:f>444</e:f></b:c></a>';
Query OK, 0 rows affected (0.00 sec)

mysql> SELECT ExtractValue(@xml, '//e:f');
+-----+
| ExtractValue(@xml, '//e:f') |
+-----+
| 444                          |
+-----+
1 row in set (0.00 sec)

mysql> SELECT UpdateXML(@xml, '//b:c', '<g:h>555</g:h>');
+-----+
| UpdateXML(@xml, '//b:c', '<g:h>555</g:h>') |
+-----+
| <a>111<g:h>555</g:h></a>                    |
+-----+
1 row in set (0.00 sec)
```

This is similar in some respects to what is permitted by [Apache Xalan](#) and some other parsers, and is much simpler than requiring namespace declarations or the use of the `namespace-uri()` and `local-name()` functions.

**Error handling.** For both `ExtractValue()` and `UpdateXML()`, the XPath locator used must be valid and the XML to be searched must consist of elements which are properly nested and closed. If the locator is invalid, an error is generated:

```
mysql> SELECT ExtractValue('<a>c</a><b/>', '&a');
ERROR 1105 (HY000): XPATH syntax error: '&a'
```

If `xml_frag` does not consist of elements which are properly nested and closed, `NULL` is returned and a warning is generated, as shown in this example:

```
mysql> SELECT ExtractValue('<a>c</a><b', '//a');
+-----+
| ExtractValue('<a>c</a><b', '//a') |
+-----+
| NULL |
+-----+
1 row in set, 1 warning (0.00 sec)

mysql> SHOW WARNINGS\G
***** 1. row *****
Level: Warning
Code: 1525
Message: Incorrect XML value: 'parse error at line 1 pos 11:
        END-OF-INPUT unexpected ('>' wanted)'
1 row in set (0.00 sec)

mysql> SELECT ExtractValue('<a>c</a><b/>', '//a');
+-----+
| ExtractValue('<a>c</a><b/>', '//a') |
+-----+
| c |
+-----+
1 row in set (0.00 sec)
```



### Important

The replacement XML used as the third argument to `UpdateXML()` is *not* checked to determine whether it consists solely of elements which are properly nested and closed.

**XPath Injection.** *code injection* occurs when malicious code is introduced into the system to gain unauthorized access to privileges and data. It is based on exploiting assumptions made by developers about the type and content of data input from users. XPath is no exception in this regard.

A common scenario in which this can happen is the case of application which handles authorization by matching the combination of a login name and password with those found in an XML file, using an XPath expression like this one:

```
//user[login/text()='neapolitan' and password/text()='1c3cr34m']/attribute::id
```

This is the XPath equivalent of an SQL statement like this one:

```
SELECT id FROM users WHERE login='neapolitan' AND password='1c3cr34m';
```

A PHP application employing XPath might handle the login process like this:

```
<?php
    $file      = "users.xml";

    $login     = $POST["login"];
    $password  = $POST["password"];
```

```

$xmlpath = "//user[login/text()=$login and password/text()=$password]/attribute::id";

if( file_exists($file) )
{
    $xml = simplexml_load_file($file);

    if($result = $xml->xpath($xmlpath))
        echo "You are now logged in as user $result[0].";
    else
        echo "Invalid login name or password.";
}
else
    exit("Failed to open $file.");

?>

```

No checks are performed on the input. This means that a malevolent user can “short-circuit” the test by entering ' or 1=1 for both the login name and password, resulting in `$xmlpath` being evaluated as shown here:

```
//user[login/text()=' or 1=1 and password/text()=' or 1=1]/attribute::id
```

Since the expression inside the square brackets always evaluates as `true`, it is effectively the same as this one, which matches the `id` attribute of every `user` element in the XML document:

```
//user/attribute::id
```

One way in which this particular attack can be circumvented is simply by quoting the variable names to be interpolated in the definition of `$xmlpath`, forcing the values passed from a Web form to be converted to strings:

```
$xmlpath = "//user[login/text()=' $login' and password/text()=' $password']/attribute::id";
```

This is the same strategy that is often recommended for preventing SQL injection attacks. In general, the practices you should follow for preventing XPath injection attacks are the same as for preventing SQL injection:

- Never accepted untested data from users in your application.
- Check all user-submitted data for type; reject or convert data that is of the wrong type
- Test numeric data for out of range values; truncate, round, or reject values that are out of range. Test strings for illegal characters and either strip them out or reject input containing them.
- Do not output explicit error messages that might provide an unauthorized user with clues that could be used to compromise the system; log these to a file or database table instead.

Just as SQL injection attacks can be used to obtain information about database schemas, so can XPath injection be used to traverse XML files to uncover their structure, as discussed in Amit Klein's paper [Blind XPath Injection](#) (PDF file, 46KB).

It is also important to check the output being sent back to the client. Consider what can happen when we use the MySQL `ExtractValue()` function:

```

mysql> SELECT ExtractValue(
->     LOAD_FILE('users.xml'),
->     '//user[login/text()=' or 1=1 and password/text()=' or 1=1]/attribute::id'
-> ) AS id;
+-----+
| id    |
+-----+
| 00327 13579 02403 42354 28570 |

```

```
+-----+
1 row in set (0.01 sec)
```

Because `ExtractValue()` returns multiple matches as a single space-delimited string, this injection attack provides every valid ID contained within `users.xml` to the user as a single row of output. As an extra safeguard, you should also test output before returning it to the user. Here is a simple example:

```
mysql> SELECT @id = ExtractValue(
->   LOAD_FILE('users.xml'),
->   '//#user[login/text()="" or 1=1 and password/text()="" or 1=1]/attribute::id'
-> );
Query OK, 0 rows affected (0.00 sec)

mysql> SELECT IF(
->   INSTR(@id, ' ') = 0,
->   @id,
->   'Unable to retrieve user ID')
-> AS singleID;
+-----+
| singleID |
+-----+
| Unable to retrieve user ID |
+-----+
1 row in set (0.00 sec)
```

In general, the guidelines for returning data to users securely are the same as for accepting user input. These can be summed up as:

- Always test outgoing data for type and permissible values.
- Never permit unauthorized users to view error messages that might provide information about the application that could be used to exploit it.

## 12.12 Bit Functions and Operators

Table 12.17 Bit Functions and Operators

Name	Description
<code>&amp;</code>	Bitwise AND
<code>&gt;&gt;</code>	Right shift
<code>&lt;&lt;</code>	Left shift
<code>^</code>	Bitwise XOR
<code>BIT_COUNT()</code>	Return the number of bits that are set
<code> </code>	Bitwise OR
<code>~</code>	Bitwise inversion

The following list describes available bit functions and operators:

- `|`  
Bitwise OR.

The result is an unsigned 64-bit integer.

```
mysql> SELECT 29 | 15;
-> 31
```

- `&`



Bitwise AND.

The result is an unsigned 64-bit integer.

```
mysql> SELECT 29 & 15;
-> 13
```

- ^

Bitwise XOR.

The result is an unsigned 64-bit integer.

```
mysql> SELECT 1 ^ 1;
-> 0
mysql> SELECT 1 ^ 0;
-> 1
mysql> SELECT 11 ^ 3;
-> 8
```

- <<

Shifts a longlong (**BIGINT**) number to the left.

The result is an unsigned 64-bit integer. The value is truncated to 64 bits. In particular, if the shift count is greater or equal to the width of an unsigned 64-bit number, the result is zero.

```
mysql> SELECT 1 << 2;
-> 4
```

- >>

Shifts a longlong (**BIGINT**) number to the right.

The result is an unsigned 64-bit integer. The value is truncated to 64 bits. In particular, if the shift count is greater or equal to the width of an unsigned 64-bit number, the result is zero.

```
mysql> SELECT 4 >> 2;
-> 1
```

- ~

Invert all bits.

The result is an unsigned 64-bit integer.

```
mysql> SELECT 5 & ~1;
-> 4
```

- **BIT\_COUNT(N)**

Returns the number of bits that are set in the argument *N* as an unsigned 64-bit integer, or **NULL** if the argument is **NULL**.

```
mysql> SELECT BIT_COUNT(29), BIT_COUNT(b'101010');
-> 4, 3
```

Bit functions and operators comprise **BIT\_COUNT()**, **BIT\_AND()**, **BIT\_OR()**, **BIT\_XOR()**, **&**, **|**, **^**, **~**, **<<**, and **>>**. (The **BIT\_AND()**, **BIT\_OR()**, and **BIT\_XOR()** functions are aggregate functions described at [Section 12.19.1, “Aggregate Function Descriptions”](#).) Currently, bit functions and operators require

**BIGINT** (64-bit integer) arguments and return **BIGINT** values, so they have a maximum range of 64 bits. Arguments of other types are converted to **BIGINT** and truncation might occur.

An extension for MySQL 8.0 changes this cast-to-**BIGINT** behavior: Bit functions and operators permit binary string type arguments (**BINARY**, **VARBINARY**, and the **BLOB** types), enabling them to take arguments and produce return values larger than 64 bits. Consequently, bit operations on binary arguments in MySQL 5.7 might produce different results in MySQL 8.0. To provide advance notice about this potential change in behavior, the server produces warnings as of MySQL 5.7.11 for bit operations for which binary arguments are not converted to integer in MySQL 8.0. These warnings afford an opportunity to rewrite affected statements. To produce MySQL 5.7 behavior explicitly in a way that does not change after an upgrade to 8.0, cast bit-operation binary arguments to convert them to integer.

The five problematic expression types to watch out for are:

```
nonliteral_binary { & | ^ } binary
binary { & | ^ } nonliteral_binary
nonliteral_binary { << >> } anything
~ nonliteral_binary
AGGR_BIT_FUNC(nonliteral_binary)
```

Those expressions return **BIGINT** in MySQL 5.7, binary string in 8.0.

Explanation of notation:

- { *op1 op2 ...* }: List of operators that apply to the given expression type.
- *binary*: Any kind of binary string argument, including a hexadecimal literal, bit literal, or **NULL** literal.
- *nonliteral\_binary*: An argument that is a binary string value other than a hexadecimal literal, bit literal, or **NULL** literal.
- *AGGR\_BIT\_FUNC*: An aggregate function that takes bit-value arguments: **BIT\_AND()**, **BIT\_OR()**, **BIT\_XOR()**.

The server produces a single warning for each problematic expression in a statement, not a warning for each row processed. Suppose that a statement containing two problematic expressions selects three rows from a table. The number of warnings per statement execution is two, not six. The following example illustrates this.

```
mysql> CREATE TABLE t(vbin1 VARBINARY(32), vbin2 VARBINARY(32));
Query OK, 0 rows affected (0.03 sec)

mysql> INSERT INTO t VALUES (3,1),(3,2),(3,3);
Query OK, 3 rows affected (0.01 sec)
Records: 3 Duplicates: 0 Warnings: 0

mysql> SELECT HEX(vbin1 & vbin2) AS op1,
-> HEX(vbin1 | vbin2) AS op2
-> FROM t;
+-----+-----+
| op1  | op2  |
+-----+-----+
| 1    | 3    |
| 2    | 3    |
| 3    | 3    |
+-----+-----+
3 rows in set, 2 warnings (0.00 sec)

mysql> SHOW WARNINGS\G
***** 1. row *****
Level: Warning
```

```
Code: 1287
Message: Bitwise operations on BINARY will change behavior in a future
version, check the 'Bit functions' section in the manual.
***** 2. row *****
Level: Warning
Code: 1287
Message: Bitwise operations on BINARY will change behavior in a future
version, check the 'Bit functions' section in the manual.
2 rows in set (0.00 sec)
```

To avoid having an affected statement produce a different result after an upgrade to MySQL 8.0, rewrite it so that it generates no bit-operation warnings. To do this, cast at least one binary argument to `BIGINT` with `CAST(... AS UNSIGNED)`. This makes the MySQL 5.7 implicit binary-to-integer cast explicit:

```
mysql> SELECT HEX(CAST(vbin1 AS UNSIGNED) & CAST(vbin2 AS UNSIGNED)) AS op1,
-> HEX(CAST(vbin1 AS UNSIGNED) | CAST(vbin2 AS UNSIGNED)) AS op2
-> FROM t;
+-----+-----+
| op1   | op2   |
+-----+-----+
| 1     | 3     |
| 2     | 3     |
| 3     | 3     |
+-----+-----+
3 rows in set (0.01 sec)

mysql> SHOW WARNINGS\G
Empty set (0.00 sec)
```

With the statement rewritten as shown, MySQL 8.0 respects the intention to treat the binary arguments as integers and produces the same result as in 5.7. Also, replicating the statement from MySQL 5.7 to 8.0 does not produce different results on different servers.

An affected statement that cannot be rewritten is subject to these potential problems with respect to upgrades and replication:

- The statement might return a different result after an upgrade to MySQL 8.0.
- Replication to MySQL 8.0 from older versions might fail for statement-based and mixed-format binary logging. This is also true for replaying older binary logs on an 8.0 server (for example, using `mysqlbinlog`). To avoid this, switch to row-based binary logging on the older source server.

## 12.13 Encryption and Compression Functions

Table 12.18 Encryption Functions

Name	Description	Deprecated
<code>AES_DECRYPT()</code>	Decrypt using AES	
<code>AES_ENCRYPT()</code>	Encrypt using AES	
<code>COMPRESS()</code>	Return result as a binary string	
<code>DECODE()</code>	Decode a string encrypted using <code>ENCODE()</code>	Yes
<code>DES_DECRYPT()</code>	Decrypt a string	Yes
<code>DES_ENCRYPT()</code>	Encrypt a string	Yes
<code>ENCODE()</code>	Encode a string	Yes
<code>ENCRYPT()</code>	Encrypt a string	Yes
<code>MD5()</code>	Calculate MD5 checksum	

Name	Description	Deprecated
<a href="#">PASSWORD()</a>	Calculate and return a password string	Yes
<a href="#">RANDOM_BYTES()</a>	Return a random byte vector	
<a href="#">SHA1()</a> , <a href="#">SHA()</a>	Calculate an SHA-1 160-bit checksum	
<a href="#">SHA2()</a>	Calculate an SHA-2 checksum	
<a href="#">UNCOMPRESS()</a>	Uncompress a string compressed	
<a href="#">UNCOMPRESSED_LENGTH()</a>	Return the length of a string before compression	
<a href="#">VALIDATE_PASSWORD_STRENGTH()</a>	Determine strength of password	

Many encryption and compression functions return strings for which the result might contain arbitrary byte values. If you want to store these results, use a column with a [VARBINARY](#) or [BLOB](#) binary string data type. This avoids potential problems with trailing space removal or character set conversion that would change data values, such as may occur if you use a nonbinary string data type ([CHAR](#), [VARCHAR](#), [TEXT](#)).

Some encryption functions return strings of ASCII characters: [MD5\(\)](#), [PASSWORD\(\)](#), [SHA\(\)](#), [SHA1\(\)](#), [SHA2\(\)](#). Their return value is a string that has a character set and collation determined by the [character\\_set\\_connection](#) and [collation\\_connection](#) system variables. This is a nonbinary string unless the character set is [binary](#).

If an application stores values from a function such as [MD5\(\)](#) or [SHA1\(\)](#) that returns a string of hex digits, more efficient storage and comparisons can be obtained by converting the hex representation to binary using [UNHEX\(\)](#) and storing the result in a [BINARY\(N\)](#) column. Each pair of hexadecimal digits requires one byte in binary form, so the value of *N* depends on the length of the hex string. *N* is 16 for an [MD5\(\)](#) value and 20 for a [SHA1\(\)](#) value. For [SHA2\(\)](#), *N* ranges from 28 to 32 depending on the argument specifying the desired bit length of the result.

The size penalty for storing the hex string in a [CHAR](#) column is at least two times, up to eight times if the value is stored in a column that uses the [utf8](#) character set (where each character uses 4 bytes). Storing the string also results in slower comparisons because of the larger values and the need to take character set collation rules into account.

Suppose that an application stores [MD5\(\)](#) string values in a [CHAR\(32\)](#) column:

```
CREATE TABLE md5_tbl (md5_val CHAR(32), ...);
INSERT INTO md5_tbl (md5_val, ...) VALUES(MD5('abcdef'), ...);
```

To convert hex strings to more compact form, modify the application to use [UNHEX\(\)](#) and [BINARY\(16\)](#) instead as follows:

```
CREATE TABLE md5_tbl (md5_val BINARY(16), ...);
INSERT INTO md5_tbl (md5_val, ...) VALUES(UNHEX(MD5('abcdef')), ...);
```

Applications should be prepared to handle the very rare case that a hashing function produces the same value for two different input values. One way to make collisions detectable is to make the hash column a primary key.



#### Note

Exploits for the MD5 and SHA-1 algorithms have become known. You may wish to consider using another one-way encryption function described in this section instead, such as [SHA2\(\)](#).



### Caution

Passwords or other sensitive values supplied as arguments to encryption functions are sent as cleartext to the MySQL server unless an SSL connection is used. Also, such values appear in any MySQL logs to which they are written. To avoid these types of exposure, applications can encrypt sensitive values on the client side before sending them to the server. The same considerations apply to encryption keys. To avoid exposing these, applications can use stored procedures to encrypt and decrypt values on the server side.

- `AES_DECRYPT(crypt_str,key_str [, init_vector] [, kdf_name] [, salt] [, info / iterations])`

This function decrypts data using the official AES (Advanced Encryption Standard) algorithm. For more information, see the description of `AES_ENCRYPT()`.

Statements that use `AES_DECRYPT()` are unsafe for statement-based replication.

- `AES_ENCRYPT(str,key_str [, init_vector] [, kdf_name] [, salt] [, info / iterations])`

`AES_ENCRYPT()` and `AES_DECRYPT()` implement encryption and decryption of data using the official AES (Advanced Encryption Standard) algorithm, previously known as “Rijndael.” The AES standard permits various key lengths. By default these functions implement AES with a 128-bit key length. Key lengths of 196 or 256 bits can be used, as described later. The key length is a trade off between performance and security.

`AES_ENCRYPT()` encrypts the string *str* using the key string *key\_str*, and returns a binary string containing the encrypted output. `AES_DECRYPT()` decrypts the encrypted string *crypt\_str* using the key string *key\_str*, and returns the original plaintext string. If either function argument is `NULL`, the function returns `NULL`. If `AES_DECRYPT()` detects invalid data or incorrect padding, it returns `NULL`. However, it is possible for `AES_DECRYPT()` to return a non-`NULL` value (possibly garbage) if the input data or the key is invalid.

As of MySQL 5.7.40, these functions support the use of a key derivation function (KDF) to create a cryptographically strong secret key from the information passed in *key\_str*. The derived key is used to encrypt and decrypt the data, and it remains in the MySQL Server instance and is not accessible to users. Using a KDF is highly recommended, as it provides better security than specifying your own premade key or deriving it by a simpler method as you use the function. The functions support HKDF (available from OpenSSL 1.1.0), for which you can specify an optional salt and context-specific information to include in the keying material, and PBKDF2 (available from OpenSSL 1.0.2), for which you can specify an optional salt and set the number of iterations used to produce the key.

`AES_ENCRYPT()` and `AES_DECRYPT()` permit control of the block encryption mode. The `block_encryption_mode` system variable controls the mode for block-based encryption algorithms. Its default value is `aes-128-ecb`, which signifies encryption using a key length of 128 bits and ECB mode. For a description of the permitted values of this variable, see [Section 5.1.7, “Server System Variables”](#). The optional *init\_vector* argument is used to provide an initialization vector for block encryption modes that require it.

Statements that use `AES_ENCRYPT()` or `AES_DECRYPT()` are unsafe for statement-based replication.

If `AES_ENCRYPT()` is invoked from within the `mysql` client, binary strings display using hexadecimal notation, depending on the value of the `--binary-as-hex`. For more information about that option, see [Section 4.5.1, “mysql — The MySQL Command-Line Client”](#).

The arguments for the `AES_ENCRYPT()` and `AES_DECRYPT()` functions are as follows:

<i>str</i>	<p>The string for <code>AES_ENCRYPT()</code> to encrypt using the key string <i>key_str</i>, or (as of MySQL 5.7.40) the key derived from it by the specified KDF. The string can be any length. Padding is automatically added to <i>str</i> so it is a multiple of a block as required by block-based algorithms such as AES. This padding is automatically removed by the <code>AES_DECRYPT()</code> function.</p>
<i>crypt_str</i>	<p>The encrypted string for <code>AES_DECRYPT()</code> to decrypt using the key string <i>key_str</i>, or (from MySQL 5.7.40) the key derived from it by the specified KDF. The string can be any length. The length of <i>crypt_str</i> can be calculated from the length of the original string using this formula:</p> <pre>16 * (trunc(string_length / 16) + 1)</pre>
<i>key_str</i>	<p>The encryption key, or the input keying material that is used as the basis for deriving a key using a key derivation function (KDF). For the same instance of data, use the same value of <i>key_str</i> for encryption with <code>AES_ENCRYPT()</code> and decryption with <code>AES_DECRYPT()</code>.</p> <p>If you are using a KDF, which you can from MySQL 5.7.40, <i>key_str</i> can be any arbitrary information such as a password or passphrase. In the further arguments for the function, you specify the KDF name, then add further options to increase the security as appropriate for the KDF.</p> <p>When you use a KDF, the function creates a cryptographically strong secret key from the information passed in <i>key_str</i> and any salt or additional information that you provide in the other arguments. The derived key is used to encrypt and decrypt the data, and it remains in the MySQL Server instance and is not accessible to users. Using a KDF is highly recommended, as it provides better security than specifying your own premade key or deriving it by a simpler method as you use the function.</p> <p>If you are not using a KDF, for a key length of 128 bits, the most secure way to pass a key to the <i>key_str</i> argument is to create a truly random 128-bit value and pass it as a binary value. For example:</p> <pre>INSERT INTO t VALUES (1,AES_ENCRYPT('text',UNHEX('F3229A0B371ED2D9441B830D21A390C3')));</pre> <p>A passphrase can be used to generate an AES key by hashing the passphrase. For example:</p> <pre>INSERT INTO t VALUES (1,AES_ENCRYPT('text', UNHEX(SHA2('My secret passphrase',512)))));</pre> <p>If you exceed the maximum key length of 128 bits, a warning is returned. If you are not using a KDF, do not pass a password or passphrase directly to <i>key_str</i>, hash it first. Previous versions of this documentation suggested the former approach, but it is no longer recommended as the examples shown here are more secure.</p>
<i>init_vector</i>	<p>An initialization vector, for block encryption modes that require it. The <code>block_encryption_mode</code> system variable controls</p>

the mode. For the same instance of data, use the same value of *init\_vector* for encryption with `AES_ENCRYPT()` and decryption with `AES_DECRYPT()`.



#### Note

If you are using a KDF, you must specify an initialization vector or a null string for this argument, in order to access the later arguments to define the KDF.

For modes that require an initialization vector, it must be 16 bytes or longer (bytes in excess of 16 are ignored). An error occurs if *init\_vector* is missing. For modes that do not require an initialization vector, it is ignored and a warning is generated if *init\_vector* is specified, unless you are using a KDF.

The default value for the `block_encryption_mode` system variable is `aes-128-ecb`, or ECB mode, which does not require an initialization vector. The alternative permitted block encryption modes CBC, CFB1, CFB8, CFB128, and OFB all require an initialization vector.

A random string of bytes to use for the initialization vector can be produced by calling `RANDOM_BYTES(16)`.

*kdf\_name*

The name of the key derivation function (KDF) to create a key from the input keying material passed in *key\_str*, and other arguments as appropriate for the KDF. This optional argument is available from MySQL 5.7.40.

For the same instance of data, use the same value of *kdf\_name* for encryption with `AES_ENCRYPT()` and decryption with `AES_DECRYPT()`. When you specify *kdf\_name*, you must specify *init\_vector*, using either a valid initialization vector, or a null string if the encryption mode does not require an initialization vector.

The following values are supported:

`hkdf`

HKDF, which is available from OpenSSL 1.1.0. HKDF extracts a pseudorandom key from the keying material then expands it into additional keys. With HKDF, you can specify an optional salt (*salt*) and context-specific information such as application details (*info*) to include in the keying material.

`pbkdf2_hmac`

PBKDF2, which is available from OpenSSL 1.0.2. PBKDF2 applies a pseudorandom function to the keying material, and repeats this process a large number of times

to produce the key. With PBKDF2, you can specify an optional salt (*salt*) to include in the keying material, and set the number of iterations used to produce the key (*iterations*).

In this example, HKDF is specified as the key derivation function, and a salt and context information are provided. The argument for the initialization vector is included but is the empty string:

```
SELECT AES_ENCRYPT('mytext','mykeystring', '', 'hkdf', 'salt', 'info');
```

In this example, PBKDF2 is specified as the key derivation function, a salt is provided, and the number of iterations is doubled from the recommended minimum:

```
SELECT AES_ENCRYPT('mytext','mykeystring', '', 'pbkdf2_hmac','salt', '2000');
```

*salt*

A salt to be passed to the key derivation function (KDF). This optional argument is available from MySQL 5.7.40. Both HKDF and PBKDF2 can use salts, and their use is recommended to help prevent attacks based on dictionaries of common passwords or rainbow tables.

A salt consists of random data, which for security must be different for each encryption operation. A random string of bytes to use for the salt can be produced by calling `RANDOM_BYTES()`. This example produces a 64-bit salt:

```
SET @salt = RANDOM_BYTES(8);
```

For the same instance of data, use the same value of *salt* for encryption with `AES_ENCRYPT()` and decryption with `AES_DECRYPT()`. The salt can safely be stored along with the encrypted data.

*info*

Context-specific information for HKDF to include in the keying material, such as information about the application. This optional argument is available from MySQL 5.7.40 when you specify `hkdf` as the KDF name. HKDF adds this information to the keying material specified in *key\_str* and the salt specified in *salt* to produce the key.

For the same instance of data, use the same value of *info* for encryption with `AES_ENCRYPT()` and decryption with `AES_DECRYPT()`.

*iterations*

The iteration count for PBKDF2 to use when producing the key. This optional argument is available from MySQL 5.7.40 when you specify `pbkdf2_hmac` as the KDF name. A higher count gives greater resistance to brute-force attacks because it has a greater computational cost for the attacker, but the same is necessarily true for the key derivation process. The default if you do not specify



this argument is 1000, which is the minimum recommended by the OpenSSL standard.

For the same instance of data, use the same value of *iterations* for encryption with `AES_ENCRYPT()` and decryption with `AES_DECRYPT()`.

```
mysql> SET block_encryption_mode = 'aes-256-cbc';
mysql> SET @key_str = SHA2('My secret passphrase',512);
mysql> SET @init_vector = RANDOM_BYTES(16);
mysql> SET @crypt_str = AES_ENCRYPT('text',@key_str,@init_vector);
mysql> SELECT AES_DECRYPT(@crypt_str,@key_str,@init_vector);
+-----+
| AES_DECRYPT(@crypt_str,@key_str,@init_vector) |
+-----+
| text |
+-----+
```

- `COMPRESS(string_to_compress)`

Compresses a string and returns the result as a binary string. This function requires MySQL to have been compiled with a compression library such as `zlib`. Otherwise, the return value is always `NULL`. The compressed string can be uncompressed with `UNCOMPRESS()`.

```
mysql> SELECT LENGTH(COMPRESS(REPEAT('a',1000)));
-> 21
mysql> SELECT LENGTH(COMPRESS(''));
-> 0
mysql> SELECT LENGTH(COMPRESS('a'));
-> 13
mysql> SELECT LENGTH(COMPRESS(REPEAT('a',16)));
-> 15
```

The compressed string contents are stored the following way:

- Empty strings are stored as empty strings.
- Nonempty strings are stored as a 4-byte length of the uncompressed string (low byte first), followed by the compressed string. If the string ends with space, an extra `.` character is added to avoid problems with endspace trimming should the result be stored in a `CHAR` or `VARCHAR` column. (However, use of nonbinary string data types such as `CHAR` or `VARCHAR` to store compressed strings is not recommended anyway because character set conversion may occur. Use a `VARBINARY` or `BLOB` binary string column instead.)

If `COMPRESS()` is invoked from within the `mysql` client, binary strings display using hexadecimal notation, depending on the value of the `--binary-as-hex`. For more information about that option, see [Section 4.5.1, “mysql — The MySQL Command-Line Client”](#).

- `DECODE(crypt_str,pass_str)`

`DECODE()` decrypts the encrypted string `crypt_str` using `pass_str` as the password. `crypt_str` should be a string returned from `ENCODE()`.



#### Note

The `ENCODE()` and `DECODE()` functions are deprecated in MySQL 5.7, and should no longer be used. Expect them to be removed in a future MySQL release. Consider using `AES_ENCRYPT()` and `AES_DECRYPT()` instead.

- `DES_DECRYPT(crypt_str[, key_str])`

Decrypts a string encrypted with `DES_ENCRYPT()`. If an error occurs, this function returns `NULL`.

This function works only if MySQL has been configured with SSL support. See [Section 6.3, “Using Encrypted Connections”](#).

If no *key\_str* argument is given, `DES_DECRYPT()` examines the first byte of the encrypted string to determine the DES key number that was used to encrypt the original string, and then reads the key from the DES key file to decrypt the message. For this to work, the user must have the `SUPER` privilege. The key file can be specified with the `--des-key-file` server option.

If you pass this function a *key\_str* argument, that string is used as the key for decrypting the message.

If the *crypt\_str* argument does not appear to be an encrypted string, MySQL returns the given *crypt\_str*.



#### Note

The `DES_ENCRYPT()` and `DES_DECRYPT()` functions are deprecated in MySQL 5.7, are removed in MySQL 8.0, and should no longer be used. Consider using `AES_ENCRYPT()` and `AES_DECRYPT()` instead.

- `DES_ENCRYPT(str[, {key_num|key_str}])`

Encrypts the string with the given key using the Triple-DES algorithm.

This function works only if MySQL has been configured with SSL support. See [Section 6.3, “Using Encrypted Connections”](#).

The encryption key to use is chosen based on the second argument to `DES_ENCRYPT()`, if one was given. With no argument, the first key from the DES key file is used. With a *key\_num* argument, the given key number (0 to 9) from the DES key file is used. With a *key\_str* argument, the given key string is used to encrypt *str*.

The key file can be specified with the `--des-key-file` server option.

The return string is a binary string where the first character is `CHAR(128 | key_num)`. If an error occurs, `DES_ENCRYPT()` returns `NULL`.

The 128 is added to make it easier to recognize an encrypted key. If you use a string key, *key\_num* is 127.

The string length for the result is given by this formula:

```
new_len = orig_len + (8 - (orig_len % 8)) + 1
```

Each line in the DES key file has the following format:

```
key_num des_key_str
```

Each *key\_num* value must be a number in the range from 0 to 9. Lines in the file may be in any order. *des\_key\_str* is the string that is used to encrypt the message. There should be at least one space

between the number and the key. The first key is the default key that is used if you do not specify any key argument to `DES_ENCRYPT()`.

You can tell MySQL to read new key values from the key file with the `FLUSH DES_KEY_FILE` statement. This requires the `RELOAD` privilege.

One benefit of having a set of default keys is that it gives applications a way to check for the existence of encrypted column values, without giving the end user the right to decrypt those values.



#### Note

The `DES_ENCRYPT()` and `DES_DECRYPT()` functions are deprecated in MySQL 5.7, are removed in MySQL 8.0, and should no longer be used. Consider using `AES_ENCRYPT()` and `AES_DECRYPT()` instead.

```
mysql> SELECT customer_address FROM customer_table
> WHERE crypted_credit_card = DES_ENCRYPT('credit_card_number');
```

If `DES_ENCRYPT()` is invoked from within the `mysql` client, binary strings display using hexadecimal notation, depending on the value of the `--binary-as-hex`. For more information about that option, see [Section 4.5.1, “mysql — The MySQL Command-Line Client”](#).

- `ENCODE(str, pass_str)`

`ENCODE()` encrypts `str` using `pass_str` as the password. The result is a binary string of the same length as `str`. To decrypt the result, use `DECODE()`.



#### Note

The `ENCODE()` and `DECODE()` functions are deprecated in MySQL 5.7, and should no longer be used. Expect them to be removed in a future MySQL release.

If you still need to use `ENCODE()`, a salt value must be used with it to reduce risk. For example:

```
ENCODE('cleartext', CONCAT('my_random_salt', 'my_secret_password'))
```

A new random salt value must be used whenever a password is updated.

If `ENCODE()` is invoked from within the `mysql` client, binary strings display using hexadecimal notation, depending on the value of the `--binary-as-hex`. For more information about that option, see [Section 4.5.1, “mysql — The MySQL Command-Line Client”](#).

- `ENCRYPT(str[, salt])`

Encrypts `str` using the Unix `crypt()` system call and returns a binary string. The `salt` argument must be a string with at least two characters or else the result is `NULL`. If no `salt` argument is given, a random value is used.



#### Note

The `ENCRYPT()` function is deprecated in MySQL 5.7, are removed in MySQL 8.0, and should no longer be used. For one-way hashing, consider using `SHA2()` instead.

```
mysql> SELECT ENCRYPT('hello');
```

```
-> 'VxuFAJXVARROc'
```

`ENCRYPT()` ignores all but the first eight characters of `str`, at least on some systems. This behavior is determined by the implementation of the underlying `crypt()` system call.

The use of `ENCRYPT()` with the `ucs2`, `utf16`, `utf16le`, or `utf32` multibyte character sets is not recommended because the system call expects a string terminated by a zero byte.

If `crypt()` is not available on your system (as is the case with Windows), `ENCRYPT()` always returns `NULL`.

If `ENCRYPT()` is invoked from within the `mysql` client, binary strings display using hexadecimal notation, depending on the value of the `--binary-as-hex`. For more information about that option, see [Section 4.5.1, “mysql — The MySQL Command-Line Client”](#).

- `MD5(str)`

Calculates an MD5 128-bit checksum for the string. The value is returned as a string of 32 hexadecimal digits, or `NULL` if the argument was `NULL`. The return value can, for example, be used as a hash key. See the notes at the beginning of this section about storing hash values efficiently.

The return value is a string in the connection character set.

```
mysql> SELECT MD5('testing');
-> 'ae2b1fca515949e5d54fb22b8ed95575'
```

This is the “RSA Data Security, Inc. MD5 Message-Digest Algorithm.”

See the note regarding the MD5 algorithm at the beginning this section.

- `PASSWORD(str)`



#### Note

This function is deprecated in MySQL 5.7 and is removed in MySQL 8.0.

Returns a hashed password string calculated from the cleartext password `str`. The return value is a string in the connection character set, or `NULL` if the argument is `NULL`. This function is the SQL interface to the algorithm used by the server to encrypt MySQL passwords for storage in the `mysql.user` grant table.

The `old_passwords` system variable controls the password hashing method used by the `PASSWORD()` function. It also influences password hashing performed by `CREATE USER` and `GRANT` statements that specify a password using an `IDENTIFIED BY` clause.

The following table shows, for each password hashing method, the permitted value of `old_passwords` and which authentication plugins use the hashing method.

Password Hashing Method	old_passwords Value	Associated Authentication Plugin
MySQL 4.1 native hashing	0	<code>mysql_native_password</code>
SHA-256 hashing	2	<code>sha256_password</code>

SHA-256 password hashing (`old_passwords=2`) uses a random salt value, which makes the result from `PASSWORD()` nondeterministic. Consequently, statements that use this function are not safe for statement-based replication and cannot be stored in the query cache.

Encryption performed by `PASSWORD()` is one-way (not reversible), but it is not the same type of encryption used for Unix passwords.



#### Note

`PASSWORD()` is used by the authentication system in MySQL Server; you should *not* use it in your own applications. For that purpose, consider a more secure function such as `SHA2()` instead. Also see [RFC 2195, section 2 \(Challenge-Response Authentication Mechanism \(CRAM\)\)](#), for more information about handling passwords and authentication securely in your applications.



#### Caution

Under some circumstances, statements that invoke `PASSWORD()` may be recorded in server logs or on the client side in a history file such as `~/.mysql_history`, which means that cleartext passwords may be read by anyone having read access to that information. For information about the conditions under which this occurs for the server logs and how to control it, see [Section 6.1.2.3, “Passwords and Logging”](#). For similar information about client-side logging, see [Section 4.5.1.3, “mysql Client Logging”](#).

- `RANDOM_BYTES(len)`

This function returns a binary string of `len` random bytes generated using the random number generator of the SSL library. Permitted values of `len` range from 1 to 1024. For values outside that range, an error occurs.

`RANDOM_BYTES()` can be used to provide the initialization vector for the `AES_DECRYPT()` and `AES_ENCRYPT()` functions. For use in that context, `len` must be at least 16. Larger values are permitted, but bytes in excess of 16 are ignored.

`RANDOM_BYTES()` generates a random value, which makes its result nondeterministic. Consequently, statements that use this function are unsafe for statement-based replication and cannot be stored in the query cache.

If `RANDOM_BYTES()` is invoked from within the `mysql` client, binary strings display using hexadecimal notation, depending on the value of the `--binary-as-hex`. For more information about that option, see [Section 4.5.1, “mysql — The MySQL Command-Line Client”](#).

- `SHA1(str)`, `SHA(str)`

Calculates an SHA-1 160-bit checksum for the string, as described in RFC 3174 (Secure Hash Algorithm). The value is returned as a string of 40 hexadecimal digits, or `NULL` if the argument was `NULL`. One of the possible uses for this function is as a hash key. See the notes at the beginning of this section about storing hash values efficiently. `SHA()` is synonymous with `SHA1()`.

The return value is a string in the connection character set.

```
mysql> SELECT SHA1('abc');
-> 'a9993e364706816aba3e25717850c26c9cd0d89d'
```

`SHA1()` can be considered a cryptographically more secure equivalent of `MD5()`. However, see the note regarding the MD5 and SHA-1 algorithms at the beginning this section.

- `SHA2(str, hash_length)`

Calculates the SHA-2 family of hash functions (SHA-224, SHA-256, SHA-384, and SHA-512). The first argument is the plaintext string to be hashed. The second argument indicates the desired bit length of the result, which must have a value of 224, 256, 384, 512, or 0 (which is equivalent to 256). If either argument is `NULL` or the hash length is not one of the permitted values, the return value is `NULL`. Otherwise, the function result is a hash value containing the desired number of bits. See the notes at the beginning of this section about storing hash values efficiently.

The return value is a string in the connection character set.

```
mysql> SELECT SHA2('abc', 224);
-> '23097d223405d8228642a477bda255b32aadfce4bda0b3f7e36c9da7'
```

This function works only if MySQL has been configured with SSL support. See [Section 6.3, “Using Encrypted Connections”](#).

`SHA2()` can be considered cryptographically more secure than `MD5()` or `SHA1()`.

- `UNCOMPRESS(string_to_uncompress)`

Uncompresses a string compressed by the `COMPRESS()` function. If the argument is not a compressed value, the result is `NULL`. This function requires MySQL to have been compiled with a compression library such as `zlib`. Otherwise, the return value is always `NULL`.

```
mysql> SELECT UNCOMPRESS(COMPRESS('any string'));
-> 'any string'
mysql> SELECT UNCOMPRESS('any string');
-> NULL
```

- `UNCOMPRESSED_LENGTH(compressed_string)`

Returns the length that the compressed string had before being compressed.

```
mysql> SELECT UNCOMPRESSED_LENGTH(COMPRESS(REPEAT('a',30)));
-> 30
```

- `VALIDATE_PASSWORD_STRENGTH(str)`

Given an argument representing a plaintext password, this function returns an integer to indicate how strong the password is. The return value ranges from 0 (weak) to 100 (strong).

Password assessment by `VALIDATE_PASSWORD_STRENGTH()` is done by the `validate_password` plugin. If that plugin is not installed, the function always returns 0. For information about installing `validate_password`, see [Section 6.4.3, “The Password Validation Plugin”](#). To examine or configure the parameters that affect password testing, check or set the system variables implemented by `validate_password`. See [Section 6.4.3.2, “Password Validation Plugin Options and Variables”](#).

The password is subjected to increasingly strict tests and the return value reflects which tests were satisfied, as shown in the following table. In addition, if the `validate_password_check_user_name` system variable is enabled and the password matches the user name, `VALIDATE_PASSWORD_STRENGTH()` returns 0 regardless of how other `validate_password` system variables are set.

Password Test	Return Value
Length < 4	0
Length ≥ 4 and < <code>validate_password_length</code>	25

Password Test	Return Value
Satisfies policy 1 ( <b>LOW</b> )	50
Satisfies policy 2 ( <b>MEDIUM</b> )	75
Satisfies policy 3 ( <b>STRONG</b> )	100

## 12.14 Locking Functions

This section describes functions used to manipulate user-level locks.

**Table 12.19 Locking Functions**

Name	Description
<code>GET_LOCK()</code>	Get a named lock
<code>IS_FREE_LOCK()</code>	Whether the named lock is free
<code>IS_USED_LOCK()</code>	Whether the named lock is in use; return connection identifier if true
<code>RELEASE_ALL_LOCKS()</code>	Release all current named locks
<code>RELEASE_LOCK()</code>	Release the named lock

- `GET_LOCK(str, timeout)`

Tries to obtain a lock with a name given by the string *str*, using a timeout of *timeout* seconds. A negative *timeout* value means infinite timeout. The lock is exclusive. While held by one session, other sessions cannot obtain a lock of the same name.

Returns `1` if the lock was obtained successfully, `0` if the attempt timed out (for example, because another client has previously locked the name), or `NULL` if an error occurred (such as running out of memory or the thread was killed with `mysqladmin kill`).

A lock obtained with `GET_LOCK()` is released explicitly by executing `RELEASE_LOCK()` or implicitly when your session terminates (either normally or abnormally). Locks obtained with `GET_LOCK()` are not released when transactions commit or roll back.

In MySQL 5.7, `GET_LOCK()` was reimplemented using the metadata locking (MDL) subsystem and its capabilities were extended. Multiple simultaneous locks can be acquired and `GET_LOCK()` does not release any existing locks.

It is even possible for a given session to acquire multiple locks for the same name. Other sessions cannot acquire a lock with that name until the acquiring session releases all its locks for the name.

As a result of the MDL reimplementation, uniquely named locks acquired with `GET_LOCK()` appear in the Performance Schema `metadata_locks` table. The `OBJECT_TYPE` column says `USER_LEVEL_LOCK` and the `OBJECT_NAME` column indicates the lock name. In the case that multiple locks are acquired for the *same* name, only the first lock for the name registers a row in the `metadata_locks` table. Subsequent locks for the name increment a counter in the lock but do not acquire additional metadata locks. The `metadata_locks` row for the lock is deleted when the last lock instance on the name is released.

The capability of acquiring multiple locks means there is the possibility of deadlock among clients. When this happens, the server chooses a caller and terminates its lock-acquisition request with an `ER_USER_LOCK_DEADLOCK` error. This error does not cause transactions to roll back.

Before MySQL 5.7, only a single simultaneous lock can be acquired and `GET_LOCK()` releases any existing lock. The difference in lock acquisition behavior as of MySQL 5.7 can be seen by the following example. Suppose that you execute these statements:

```
SELECT GET_LOCK('lock1',10);
SELECT GET_LOCK('lock2',10);
SELECT RELEASE_LOCK('lock2');
SELECT RELEASE_LOCK('lock1');
```

In MySQL 5.7 or later, the second `GET_LOCK()` acquires a second lock and both `RELEASE_LOCK()` calls return 1 (success). Before MySQL 5.7, the second `GET_LOCK()` releases the first lock ('lock1') and the second `RELEASE_LOCK()` returns `NULL` (failure) because there is no 'lock1' to release.

MySQL 5.7 and later enforces a maximum length on lock names of 64 characters. Previously, no limit was enforced.

`GET_LOCK()` can be used to implement application locks or to simulate record locks. Names are locked on a server-wide basis. If a name has been locked within one session, `GET_LOCK()` blocks any request by another session for a lock with the same name. This enables clients that agree on a given lock name to use the name to perform cooperative advisory locking. But be aware that it also enables a client that is not among the set of cooperating clients to lock a name, either inadvertently or deliberately, and thus prevent any of the cooperating clients from locking that name. One way to reduce the likelihood of this is to use lock names that are database-specific or application-specific. For example, use lock names of the form `db_name.str` or `app_name.str`.

If multiple clients are waiting for a lock, the order in which they acquire it is undefined. Applications should not assume that clients acquire the lock in the same order that they issued the lock requests.

`GET_LOCK()` is unsafe for statement-based replication. A warning is logged if you use this function when `binlog_format` is set to `STATEMENT`.

Since `GET_LOCK()` establishes a lock only on a single `mysqld`, it is not suitable for use with NDB Cluster, which has no way of enforcing an SQL lock across multiple MySQL servers. See [Section 21.2.7.10, "Limitations Relating to Multiple NDB Cluster Nodes"](#), for more information.



### Caution

With the capability of acquiring multiple named locks, it is possible for a single statement to acquire a large number of locks. For example:

```
INSERT INTO ... SELECT GET_LOCK(t1.col_name) FROM t1;
```

These types of statements may have certain adverse effects. For example, if the statement fails part way through and rolls back, locks acquired up to the point of failure still exist. If the intent is for there to be a correspondence between rows inserted and locks acquired, that intent is not satisfied. Also, if it is important that locks are granted in a certain order, be aware that result set order may differ depending on which execution plan the optimizer chooses. For these reasons, it may be best to limit applications to a single lock-acquisition call per statement.

A different locking interface is available as either a plugin service or a set of loadable functions. This interface provides lock namespaces and distinct read and write locks, unlike the interface provided by `GET_LOCK()` and related functions. For details, see [Section 5.5.6.1, "The Locking Service"](#).



- `IS_FREE_LOCK(str)`

Checks whether the lock named `str` is free to use (that is, not locked). Returns `1` if the lock is free (no one is using the lock), `0` if the lock is in use, and `NULL` if an error occurs (such as an incorrect argument).

This function is unsafe for statement-based replication. A warning is logged if you use this function when `binlog_format` is set to `STATEMENT`.

- `IS_USED_LOCK(str)`

Checks whether the lock named `str` is in use (that is, locked). If so, it returns the connection identifier of the client session that holds the lock. Otherwise, it returns `NULL`.

This function is unsafe for statement-based replication. A warning is logged if you use this function when `binlog_format` is set to `STATEMENT`.

- `RELEASE_ALL_LOCKS()`

Releases all named locks held by the current session and returns the number of locks released (0 if there were none)

This function is unsafe for statement-based replication. A warning is logged if you use this function when `binlog_format` is set to `STATEMENT`.

- `RELEASE_LOCK(str)`

Releases the lock named by the string `str` that was obtained with `GET_LOCK()`. Returns `1` if the lock was released, `0` if the lock was not established by this thread (in which case the lock is not released), and `NULL` if the named lock did not exist. The lock does not exist if it was never obtained by a call to `GET_LOCK()` or if it has previously been released.

The `DO` statement is convenient to use with `RELEASE_LOCK()`. See [Section 13.2.3, “DO Statement”](#).

This function is unsafe for statement-based replication. A warning is logged if you use this function when `binlog_format` is set to `STATEMENT`.

## 12.15 Information Functions

**Table 12.20 Information Functions**

Name	Description
<code>BENCHMARK()</code>	Repeatedly execute an expression
<code>CHARSET()</code>	Return the character set of the argument
<code>COERCIBILITY()</code>	Return the collation coercibility value of the string argument
<code>COLLATION()</code>	Return the collation of the string argument
<code>CONNECTION_ID()</code>	Return the connection ID (thread ID) for the connection
<code>CURRENT_USER()</code> , <code>CURRENT_USER</code>	The authenticated user name and host name
<code>DATABASE()</code>	Return the default (current) database name
<code>FOUND_ROWS()</code>	For a <code>SELECT</code> with a <code>LIMIT</code> clause, the number of rows that would be returned were there no <code>LIMIT</code> clause

Name	Description
<code>LAST_INSERT_ID()</code>	Value of the AUTOINCREMENT column for the last INSERT
<code>ROW_COUNT()</code>	The number of rows updated
<code>SCHEMA()</code>	Synonym for DATABASE()
<code>SESSION_USER()</code>	Synonym for USER()
<code>SYSTEM_USER()</code>	Synonym for USER()
<code>USER()</code>	The user name and host name provided by the client
<code>VERSION()</code>	Return a string that indicates the MySQL server version

- `BENCHMARK(count, expr)`

The `BENCHMARK()` function executes the expression `expr` repeatedly `count` times. It may be used to time how quickly MySQL processes the expression. The result value is 0, or `NULL` for inappropriate arguments such as a `NULL` or negative repeat count.

The intended use is from within the `mysql` client, which reports query execution times:

```
mysql> SELECT BENCHMARK(1000000,AES_ENCRYPT('hello','goodbye'));
+-----+
| BENCHMARK(1000000,AES_ENCRYPT('hello','goodbye')) |
+-----+
|                                0 |
+-----+
1 row in set (4.74 sec)
```

The time reported is elapsed time on the client end, not CPU time on the server end. It is advisable to execute `BENCHMARK()` several times, and to interpret the result with regard to how heavily loaded the server machine is.

`BENCHMARK()` is intended for measuring the runtime performance of scalar expressions, which has some significant implications for the way that you use it and interpret the results:

- Only scalar expressions can be used. Although the expression can be a subquery, it must return a single column and at most a single row. For example, `BENCHMARK(10, (SELECT * FROM t))` fails if the table `t` has more than one column or more than one row.
- Executing a `SELECT expr` statement `N` times differs from executing `SELECT BENCHMARK(N, expr)` in terms of the amount of overhead involved. The two have very different execution profiles and you should not expect them to take the same amount of time. The former involves the parser, optimizer, table locking, and runtime evaluation `N` times each. The latter involves only runtime evaluation `N` times, and all the other components just once. Memory structures already allocated are reused, and runtime optimizations such as local caching of results already evaluated for aggregate functions can alter the results. Use of `BENCHMARK()` thus measures performance of the runtime component by giving more weight to that component and removing the “noise” introduced by the network, parser, optimizer, and so forth.
- `CHARSET(str)`

Returns the character set of the string argument.

```
mysql> SELECT CHARSET('abc');
-> 'latin1'
```

```
mysql> SELECT CHARSET(CONVERT('abc' USING utf8));
-> 'utf8'
mysql> SELECT CHARSET(USER());
-> 'utf8'
```

- `COERCIBILITY(str)`

Returns the collation coercibility value of the string argument.

```
mysql> SELECT COERCIBILITY('abc' COLLATE latin1_swedish_ci);
-> 0
mysql> SELECT COERCIBILITY(USER());
-> 3
mysql> SELECT COERCIBILITY('abc');
-> 4
mysql> SELECT COERCIBILITY(1000);
-> 5
```

The return values have the meanings shown in the following table. Lower values have higher precedence.

Coercibility	Meaning	Example
0	Explicit collation	Value with <code>COLLATE</code> clause
1	No collation	Concatenation of strings with different collations
2	Implicit collation	Column value, stored routine parameter or local variable
3	System constant	<code>USER()</code> return value
4	Coercible	Literal string
5	Numeric	Numeric or temporal value
6	Ignorable	<code>NULL</code> or an expression derived from <code>NULL</code>

For more information, see [Section 10.8.4, “Collation Coercibility in Expressions”](#).

- `COLLATION(str)`

Returns the collation of the string argument.

```
mysql> SELECT COLLATION('abc');
-> 'latin1_swedish_ci'
mysql> SELECT COLLATION(_utf8'abc');
-> 'utf8_general_ci'
```

- `CONNECTION_ID()`

Returns the connection ID (thread ID) for the connection. Every connection has an ID that is unique among the set of currently connected clients.

The value returned by `CONNECTION_ID()` is the same type of value as displayed in the `ID` column of the Information Schema `PROCESSLIST` table, the `Id` column of `SHOW PROCESSLIST` output, and the `PROCESSLIST_ID` column of the Performance Schema `threads` table.

```
mysql> SELECT CONNECTION_ID();
```

-&gt; 23786

**Warning**

Changing the session value of the `pseudo_thread_id` system variable changes the value returned by the `CONNECTION_ID()` function.

- `CURRENT_USER, CURRENT_USER()`

Returns the user name and host name combination for the MySQL account that the server used to authenticate the current client. This account determines your access privileges. The return value is a string in the `utf8` character set.

The value of `CURRENT_USER()` can differ from the value of `USER()`.

```
mysql> SELECT USER();
-> 'davida@localhost'
mysql> SELECT * FROM mysql.user;
ERROR 1044: Access denied for user ''@'localhost' to
database 'mysql'
mysql> SELECT CURRENT_USER();
-> '@localhost'
```

The example illustrates that although the client specified a user name of `davida` (as indicated by the value of the `USER()` function), the server authenticated the client using an anonymous user account (as seen by the empty user name part of the `CURRENT_USER()` value). One way this might occur is that there is no account listed in the grant tables for `davida`.

Within a stored program or view, `CURRENT_USER()` returns the account for the user who defined the object (as given by its `DEFINER` value) unless defined with the `SQL SECURITY INVOKER` characteristic. In the latter case, `CURRENT_USER()` returns the object's invoker.

Triggers and events have no option to define the `SQL SECURITY` characteristic, so for these objects, `CURRENT_USER()` returns the account for the user who defined the object. To return the invoker, use `USER()` or `SESSION_USER()`.

The following statements support use of the `CURRENT_USER()` function to take the place of the name of (and, possibly, a host for) an affected user or a definer; in such cases, `CURRENT_USER()` is expanded where and as needed:

- `DROP USER`
- `RENAME USER`
- `GRANT`
- `REVOKE`
- `CREATE FUNCTION`
- `CREATE PROCEDURE`
- `CREATE TRIGGER`
- `CREATE EVENT`
- `CREATE VIEW`
- `ALTER EVENT`

- `ALTER VIEW`
- `SET PASSWORD`

For information about the implications that this expansion of `CURRENT_USER()` has for replication, see [Section 16.4.1.8, “Replication of `CURRENT\_USER\(\)`”](#).

- `DATABASE()`

Returns the default (current) database name as a string in the `utf8` character set. If there is no default database, `DATABASE()` returns `NULL`. Within a stored routine, the default database is the database that the routine is associated with, which is not necessarily the same as the database that is the default in the calling context.

```
mysql> SELECT DATABASE();
-> 'test'
```

If there is no default database, `DATABASE()` returns `NULL`.

- `FOUND_ROWS()`

A `SELECT` statement may include a `LIMIT` clause to restrict the number of rows the server returns to the client. In some cases, it is desirable to know how many rows the statement would have returned without the `LIMIT`, but without running the statement again. To obtain this row count, include an `SQL_CALC_FOUND_ROWS` option in the `SELECT` statement, and then invoke `FOUND_ROWS()` afterward:

```
mysql> SELECT SQL_CALC_FOUND_ROWS * FROM tbl_name
-> WHERE id > 100 LIMIT 10;
mysql> SELECT FOUND_ROWS();
```

The second `SELECT` returns a number indicating how many rows the first `SELECT` would have returned had it been written without the `LIMIT` clause.

In the absence of the `SQL_CALC_FOUND_ROWS` option in the most recent successful `SELECT` statement, `FOUND_ROWS()` returns the number of rows in the result set returned by that statement. If the statement includes a `LIMIT` clause, `FOUND_ROWS()` returns the number of rows up to the limit. For example, `FOUND_ROWS()` returns 10 or 60, respectively, if the statement includes `LIMIT 10` or `LIMIT 50, 10`.

The row count available through `FOUND_ROWS()` is transient and not intended to be available past the statement following the `SELECT SQL_CALC_FOUND_ROWS` statement. If you need to refer to the value later, save it:

```
mysql> SELECT SQL_CALC_FOUND_ROWS * FROM ... ;
mysql> SET @rows = FOUND_ROWS();
```

If you are using `SELECT SQL_CALC_FOUND_ROWS`, MySQL must calculate how many rows are in the full result set. However, this is faster than running the query again without `LIMIT`, because the result set need not be sent to the client.

`SQL_CALC_FOUND_ROWS` and `FOUND_ROWS()` can be useful in situations when you want to restrict the number of rows that a query returns, but also determine the number of rows in the full result set without running the query again. An example is a Web script that presents a paged display containing links to

the pages that show other sections of a search result. Using `FOUND_ROWS()` enables you to determine how many other pages are needed for the rest of the result.

The use of `SQL_CALC_FOUND_ROWS` and `FOUND_ROWS()` is more complex for `UNION` statements than for simple `SELECT` statements, because `LIMIT` may occur at multiple places in a `UNION`. It may be applied to individual `SELECT` statements in the `UNION`, or global to the `UNION` result as a whole.

The intent of `SQL_CALC_FOUND_ROWS` for `UNION` is that it should return the row count that would be returned without a global `LIMIT`. The conditions for use of `SQL_CALC_FOUND_ROWS` with `UNION` are:

- The `SQL_CALC_FOUND_ROWS` keyword must appear in the first `SELECT` of the `UNION`.
- The value of `FOUND_ROWS()` is exact only if `UNION ALL` is used. If `UNION` without `ALL` is used, duplicate removal occurs and the value of `FOUND_ROWS()` is only approximate.
- If no `LIMIT` is present in the `UNION`, `SQL_CALC_FOUND_ROWS` is ignored and returns the number of rows in the temporary table that is created to process the `UNION`.

Beyond the cases described here, the behavior of `FOUND_ROWS()` is undefined (for example, its value following a `SELECT` statement that fails with an error).



### Important

`FOUND_ROWS()` is not replicated reliably using statement-based replication. This function is automatically replicated using row-based replication.

- `LAST_INSERT_ID()`, `LAST_INSERT_ID(expr)`

With no argument, `LAST_INSERT_ID()` returns a `BIGINT UNSIGNED` (64-bit) value representing the first automatically generated value successfully inserted for an `AUTO_INCREMENT` column as a result of the most recently executed `INSERT` statement. The value of `LAST_INSERT_ID()` remains unchanged if no rows are successfully inserted.

With an argument, `LAST_INSERT_ID()` returns an unsigned integer.

For example, after inserting a row that generates an `AUTO_INCREMENT` value, you can get the value like this:

```
mysql> SELECT LAST_INSERT_ID();
-> 195
```

The currently executing statement does not affect the value of `LAST_INSERT_ID()`. Suppose that you generate an `AUTO_INCREMENT` value with one statement, and then refer to `LAST_INSERT_ID()` in a multiple-row `INSERT` statement that inserts rows into a table with its own `AUTO_INCREMENT` column. The value of `LAST_INSERT_ID()` remains stable in the second statement; its value for the second and later rows is not affected by the earlier row insertions. (However, if you mix references to `LAST_INSERT_ID()` and `LAST_INSERT_ID(expr)`, the effect is undefined.)

If the previous statement returned an error, the value of `LAST_INSERT_ID()` is undefined. For transactional tables, if the statement is rolled back due to an error, the value of `LAST_INSERT_ID()` is left undefined. For manual `ROLLBACK`, the value of `LAST_INSERT_ID()` is not restored to that before the transaction; it remains as it was at the point of the `ROLLBACK`.

Within the body of a stored routine (procedure or function) or a trigger, the value of `LAST_INSERT_ID()` changes the same way as for statements executed outside the body of these kinds of objects. The effect

of a stored routine or trigger upon the value of `LAST_INSERT_ID()` that is seen by following statements depends on the kind of routine:

- If a stored procedure executes statements that change the value of `LAST_INSERT_ID()`, the changed value is seen by statements that follow the procedure call.
- For stored functions and triggers that change the value, the value is restored when the function or trigger ends, so statements following them do not see a changed value.

The ID that was generated is maintained in the server on a *per-connection basis*. This means that the value returned by the function to a given client is the first `AUTO_INCREMENT` value generated for most recent statement affecting an `AUTO_INCREMENT` column *by that client*. This value cannot be affected by other clients, even if they generate `AUTO_INCREMENT` values of their own. This behavior ensures that each client can retrieve its own ID without concern for the activity of other clients, and without the need for locks or transactions.

The value of `LAST_INSERT_ID()` is not changed if you set the `AUTO_INCREMENT` column of a row to a non-“magic” value (that is, a value that is not `NULL` and not `0`).



### Important

If you insert multiple rows using a single `INSERT` statement, `LAST_INSERT_ID()` returns the value generated for the *first* inserted row *only*. The reason for this is to make it possible to reproduce easily the same `INSERT` statement against some other server.

For example:

```
mysql> USE test;

mysql> CREATE TABLE t (
  id INT AUTO_INCREMENT NOT NULL PRIMARY KEY,
  name VARCHAR(10) NOT NULL
);

mysql> INSERT INTO t VALUES (NULL, 'Bob');

mysql> SELECT * FROM t;
+----+-----+
| id | name |
+----+-----+
|  1 | Bob  |
+----+-----+

mysql> SELECT LAST_INSERT_ID();
+-----+
| LAST_INSERT_ID() |
+-----+
|                  1 |
+-----+

mysql> INSERT INTO t VALUES
  (NULL, 'Mary'), (NULL, 'Jane'), (NULL, 'Lisa');

mysql> SELECT * FROM t;
+----+-----+
| id | name |
+----+-----+
|  1 | Bob  |
|  2 | Mary |
|  3 | Jane |
|  4 | Lisa |
+----+-----+
```

```

+----+-----+
mysql> SELECT LAST_INSERT_ID();
+-----+
| LAST_INSERT_ID() |
+-----+
|                2 |
+-----+

```

Although the second `INSERT` statement inserted three new rows into `t`, the ID generated for the first of these rows was `2`, and it is this value that is returned by `LAST_INSERT_ID()` for the following `SELECT` statement.

If you use `INSERT IGNORE` and the row is ignored, the `LAST_INSERT_ID()` remains unchanged from the current value (or 0 is returned if the connection has not yet performed a successful `INSERT`) and, for non-transactional tables, the `AUTO_INCREMENT` counter is not incremented. For `InnoDB` tables, the `AUTO_INCREMENT` counter is incremented if `innodb_autoinc_lock_mode` is set to 1 or 2, as demonstrated in the following example:

```

mysql> USE test;

mysql> SELECT @@innodb_autoinc_lock_mode;
+-----+
| @@innodb_autoinc_lock_mode |
+-----+
|                1 |
+-----+

mysql> CREATE TABLE `t` (
  `id` INT(11) NOT NULL AUTO_INCREMENT,
  `val` INT(11) DEFAULT NULL,
  PRIMARY KEY (`id`),
  UNIQUE KEY `i1` (`val`)
) ENGINE=InnoDB DEFAULT CHARSET=latin1;

# Insert two rows

mysql> INSERT INTO t (val) VALUES (1),(2);

# With auto_increment_offset=1, the inserted rows
# result in an AUTO_INCREMENT value of 3

mysql> SHOW CREATE TABLE t\G
***** 1. row *****
      Table: t
Create Table: CREATE TABLE `t` (
  `id` int(11) NOT NULL AUTO_INCREMENT,
  `val` int(11) DEFAULT NULL,
  PRIMARY KEY (`id`),
  UNIQUE KEY `i1` (`val`)
) ENGINE=InnoDB AUTO_INCREMENT=3 DEFAULT CHARSET=latin1

# LAST_INSERT_ID() returns the first automatically generated
# value that is successfully inserted for the AUTO_INCREMENT column

mysql> SELECT LAST_INSERT_ID();
+-----+
| LAST_INSERT_ID() |
+-----+
|                1 |
+-----+

# The attempted insertion of duplicate rows fail but errors are ignored

mysql> INSERT IGNORE INTO t (val) VALUES (1),(2);

```



```

Query OK, 0 rows affected (0.00 sec)
Records: 2 Duplicates: 2 Warnings: 0

# With innodb_autoinc_lock_mode=1, the AUTO_INCREMENT counter
# is incremented for the ignored rows

mysql> SHOW CREATE TABLE t\G
***** 1. row *****
      Table: t
Create Table: CREATE TABLE `t` (
  `id` int(11) NOT NULL AUTO_INCREMENT,
  `val` int(11) DEFAULT NULL,
  PRIMARY KEY (`id`),
  UNIQUE KEY `i1` (`val`)
) ENGINE=InnoDB AUTO_INCREMENT=5 DEFAULT CHARSET=latin1

# The LAST_INSERT_ID is unchanged because the previous insert was unsuccessful

mysql> SELECT LAST_INSERT_ID();
+-----+
| LAST_INSERT_ID() |
+-----+
|                1 |
+-----+

```

For more information, see [Section 14.6.1.6, “AUTO\\_INCREMENT Handling in InnoDB”](#).

If *expr* is given as an argument to `LAST_INSERT_ID()`, the value of the argument is returned by the function and is remembered as the next value to be returned by `LAST_INSERT_ID()`. This can be used to simulate sequences:

1. Create a table to hold the sequence counter and initialize it:

```

mysql> CREATE TABLE sequence (id INT NOT NULL);
mysql> INSERT INTO sequence VALUES (0);

```

2. Use the table to generate sequence numbers like this:

```

mysql> UPDATE sequence SET id=LAST_INSERT_ID(id+1);
mysql> SELECT LAST_INSERT_ID();

```

The `UPDATE` statement increments the sequence counter and causes the next call to `LAST_INSERT_ID()` to return the updated value. The `SELECT` statement retrieves that value. The `mysql_insert_id()` C API function can also be used to get the value. See [mysql\\_insert\\_id\(\)](#).

You can generate sequences without calling `LAST_INSERT_ID()`, but the utility of using the function this way is that the ID value is maintained in the server as the last automatically generated value. It is multi-user safe because multiple clients can issue the `UPDATE` statement and get their own sequence value with the `SELECT` statement (or `mysql_insert_id()`), without affecting or being affected by other clients that generate their own sequence values.

Note that `mysql_insert_id()` is only updated after `INSERT` and `UPDATE` statements, so you cannot use the C API function to retrieve the value for `LAST_INSERT_ID(expr)` after executing other SQL statements like `SELECT` or `SET`.

- `ROW_COUNT()`

`ROW_COUNT()` returns a value as follows:

- DDL statements: 0. This applies to statements such as `CREATE TABLE` or `DROP TABLE`.
- DML statements other than `SELECT`: The number of affected rows. This applies to statements such as `UPDATE`, `INSERT`, or `DELETE` (as before), but now also to statements such as `ALTER TABLE` and `LOAD DATA`.
- `SELECT`: -1 if the statement returns a result set, or the number of rows “affected” if it does not. For example, for `SELECT * FROM t1`, `ROW_COUNT()` returns -1. For `SELECT * FROM t1 INTO OUTFILE 'file_name'`, `ROW_COUNT()` returns the number of rows written to the file.
- `SIGNAL` statements: 0.

For `UPDATE` statements, the affected-rows value by default is the number of rows actually changed. If you specify the `CLIENT_FOUND_ROWS` flag to `mysql_real_connect()` when connecting to `mysqld`, the affected-rows value is the number of rows “found”; that is, matched by the `WHERE` clause.

For `REPLACE` statements, the affected-rows value is 2 if the new row replaced an old row, because in this case, one row was inserted after the duplicate was deleted.

For `INSERT ... ON DUPLICATE KEY UPDATE` statements, the affected-rows value per row is 1 if the row is inserted as a new row, 2 if an existing row is updated, and 0 if an existing row is set to its current values. If you specify the `CLIENT_FOUND_ROWS` flag, the affected-rows value is 1 (not 0) if an existing row is set to its current values.

The `ROW_COUNT()` value is similar to the value from the `mysql_affected_rows()` C API function and the row count that the `mysql` client displays following statement execution.

```
mysql> INSERT INTO t VALUES(1),(2),(3);
Query OK, 3 rows affected (0.00 sec)
Records: 3 Duplicates: 0 Warnings: 0

mysql> SELECT ROW_COUNT();
+-----+
| ROW_COUNT() |
+-----+
|          3 |
+-----+
1 row in set (0.00 sec)

mysql> DELETE FROM t WHERE i IN(1,2);
Query OK, 2 rows affected (0.00 sec)

mysql> SELECT ROW_COUNT();
+-----+
| ROW_COUNT() |
+-----+
|          2 |
+-----+
1 row in set (0.00 sec)
```



### Important

`ROW_COUNT()` is not replicated reliably using statement-based replication. This function is automatically replicated using row-based replication.

- [SCHEMA\(\)](#)

This function is a synonym for [DATABASE\(\)](#).

- [SESSION\\_USER\(\)](#)

[SESSION\\_USER\(\)](#) is a synonym for [USER\(\)](#).

- [SYSTEM\\_USER\(\)](#)

[SYSTEM\\_USER\(\)](#) is a synonym for [USER\(\)](#).

- [USER\(\)](#)

Returns the current MySQL user name and host name as a string in the `utf8` character set.

```
mysql> SELECT USER();
-> 'davida@localhost'
```

The value indicates the user name you specified when connecting to the server, and the client host from which you connected. The value can be different from that of [CURRENT\\_USER\(\)](#).

- [VERSION\(\)](#)

Returns a string that indicates the MySQL server version. The string uses the `utf8` character set. The value might have a suffix in addition to the version number. See the description of the `version` system variable in [Section 5.1.7, “Server System Variables”](#).

This function is unsafe for statement-based replication. A warning is logged if you use this function when `binlog_format` is set to `STATEMENT`.

```
mysql> SELECT VERSION();
-> '5.7.44-standard'
```

## 12.16 Spatial Analysis Functions

MySQL provides functions to perform various operations on spatial data. These functions can be grouped into several major categories according to the type of operation they perform:

- Functions that create geometries in various formats (WKT, WKB, internal)
- Functions that convert geometries between formats
- Functions that access qualitative or quantitative properties of a geometry
- Functions that describe relations between two geometries
- Functions that create new geometries from existing ones

For general background about MySQL support for using spatial data, see [Section 11.4, “Spatial Data Types”](#).

### 12.16.1 Spatial Function Reference

The following table lists each spatial function and provides a short description of each one.

Table 12.21 Spatial Functions

Name	Description	Deprecated
<code>Area()</code>	Return Polygon or MultiPolygon area	Yes
<code>AsBinary(), AsWKB()</code>	Convert from internal geometry format to WKB	Yes
<code>AsText(), AsWKT()</code>	Convert from internal geometry format to WKT	Yes
<code>Buffer()</code>	Return geometry of points within given distance from geometry	Yes
<code>Centroid()</code>	Return centroid as a point	Yes
<code>Contains()</code>	Whether MBR of one geometry contains MBR of another	Yes
<code>ConvexHull()</code>	Return convex hull of geometry	Yes
<code>Crosses()</code>	Whether one geometry crosses another	Yes
<code>Dimension()</code>	Dimension of geometry	Yes
<code>Disjoint()</code>	Whether MBRs of two geometries are disjoint	Yes
<code>EndPoint()</code>	End Point of LineString	Yes
<code>Envelope()</code>	Return MBR of geometry	Yes
<code>Equals()</code>	Whether MBRs of two geometries are equal	Yes
<code>ExteriorRing()</code>	Return exterior ring of Polygon	Yes
<code>GeomCollFromText(), GeometryCollectionFromText()</code>	Return geometry collection from WKT	Yes
<code>GeomCollFromWKB(), GeometryCollectionFromWKB()</code>	Return geometry collection from WKB	Yes
<code>GeometryCollection()</code>	Construct geometry collection from geometries	
<code>GeometryN()</code>	Return N-th geometry from geometry collection	Yes
<code>GeometryType()</code>	Return name of geometry type	Yes
<code>GeomFromText(), GeometryFromText()</code>	Return geometry from WKT	Yes
<code>GeomFromWKB(), GeometryFromWKB()</code>	Return geometry from WKB	Yes
<code>GLength()</code>	Return length of LineString	Yes
<code>InteriorRingN()</code>	Return N-th interior ring of Polygon	Yes
<code>Intersects()</code>	Whether MBRs of two geometries intersect	Yes

Name	Description	Deprecated
<code>IsClosed()</code>	Whether a geometry is closed and simple	Yes
<code>IsEmpty()</code>	Whether a geometry is empty	Yes
<code>IsSimple()</code>	Whether a geometry is simple	Yes
<code>LineFromText()</code> , <code>LineStringFromText()</code>	Construct LineString from WKT	Yes
<code>LineFromWKB()</code> , <code>LineStringFromWKB()</code>	Construct LineString from WKB	Yes
<code>LineString()</code>	Construct LineString from Point values	
<code>MBRContains()</code>	Whether MBR of one geometry contains MBR of another	
<code>MBRCoveredBy()</code>	Whether one MBR is covered by another	
<code>MBRCovers()</code>	Whether one MBR covers another	
<code>MBRDisjoint()</code>	Whether MBRs of two geometries are disjoint	
<code>MBREqual()</code>	Whether MBRs of two geometries are equal	Yes
<code>MBREquals()</code>	Whether MBRs of two geometries are equal	
<code>MBRIntersects()</code>	Whether MBRs of two geometries intersect	
<code>MBROverlaps()</code>	Whether MBRs of two geometries overlap	
<code>MBRTouches()</code>	Whether MBRs of two geometries touch	
<code>MBRWithin()</code>	Whether MBR of one geometry is within MBR of another	
<code>MLineFromText()</code> , <code>MultiLineStringFromText()</code>	Construct MultiLineString from WKT	Yes
<code>MLineFromWKB()</code> , <code>MultiLineStringFromWKB()</code>	Construct MultiLineString from WKB	Yes
<code>MPointFromText()</code> , <code>MultiPointFromText()</code>	Construct MultiPoint from WKT	Yes
<code>MPointFromWKB()</code> , <code>MultiPointFromWKB()</code>	Construct MultiPoint from WKB	Yes
<code>MPolyFromText()</code> , <code>MultiPolygonFromText()</code>	Construct MultiPolygon from WKT	Yes
<code>MPolyFromWKB()</code> , <code>MultiPolygonFromWKB()</code>	Construct MultiPolygon from WKB	Yes
<code>MultiLineString()</code>	Construct MultiLineString from LineString values	

## Spatial Function Reference

Name	Description	Deprecated
<code>MultiPoint()</code>	Construct MultiPoint from Point values	
<code>MultiPolygon()</code>	Construct MultiPolygon from Polygon values	
<code>NumGeometries()</code>	Return number of geometries in geometry collection	Yes
<code>NumInteriorRings()</code>	Return number of interior rings in Polygon	Yes
<code>NumPoints()</code>	Return number of points in LineString	Yes
<code>Overlaps()</code>	Whether MBRs of two geometries overlap	Yes
<code>Point()</code>	Construct Point from coordinates	
<code>PointFromText()</code>	Construct Point from WKT	Yes
<code>PointFromWKB()</code>	Construct Point from WKB	Yes
<code>PointN()</code>	Return N-th point from LineString	Yes
<code>PolyFromText()</code> , <code>PolygonFromText()</code>	Construct Polygon from WKT	Yes
<code>PolyFromWKB()</code> , <code>PolygonFromWKB()</code>	Construct Polygon from WKB	Yes
<code>Polygon()</code>	Construct Polygon from LineString arguments	
<code>Distance()</code>	The distance of one geometry from another	Yes
<code>SRID()</code>	Return spatial reference system ID for geometry	Yes
<code>ST_Area()</code>	Return Polygon or MultiPolygon area	
<code>ST_AsBinary()</code> , <code>ST_AsWKB()</code>	Convert from internal geometry format to WKB	
<code>ST_AsGeoJSON()</code>	Generate GeoJSON object from geometry	
<code>ST_AsText()</code> , <code>ST_AsWKT()</code>	Convert from internal geometry format to WKT	
<code>ST_Buffer()</code>	Return geometry of points within given distance from geometry	
<code>ST_Buffer_Strategy()</code>	Produce strategy option for <code>ST_Buffer()</code>	
<code>ST_Centroid()</code>	Return centroid as a point	
<code>ST_Contains()</code>	Whether one geometry contains another	
<code>ST_ConvexHull()</code>	Return convex hull of geometry	

Name	Description	Deprecated
<code>ST_Crosses()</code>	Whether one geometry crosses another	
<code>ST_Difference()</code>	Return point set difference of two geometries	
<code>ST_Dimension()</code>	Dimension of geometry	
<code>ST_Disjoint()</code>	Whether one geometry is disjoint from another	
<code>ST_Distance()</code>	The distance of one geometry from another	
<code>ST_Distance_Sphere()</code>	Minimum distance on earth between two geometries	
<code>ST_EndPoint()</code>	End Point of LineString	
<code>ST_Envelope()</code>	Return MBR of geometry	
<code>ST_Equals()</code>	Whether one geometry is equal to another	
<code>ST_ExteriorRing()</code>	Return exterior ring of Polygon	
<code>ST_GeoHash()</code>	Produce a geohash value	
<code>ST_GeomCollFromText()</code> , <code>ST_GeometryCollectionFromText()</code> , <code>ST_GeomCollFromTxt()</code>	Return geometry collection from WKT)	
<code>ST_GeomCollFromWKB()</code> , <code>ST_GeometryCollectionFromWKB()</code>	Return geometry collection from WKB	
<code>ST_GeometryN()</code>	Return N-th geometry from geometry collection	
<code>ST_GeometryType()</code>	Return name of geometry type	
<code>ST_GeomFromGeoJSON()</code>	Generate geometry from GeoJSON object	
<code>ST_GeomFromText()</code> , <code>ST_GeometryFromText()</code>	Return geometry from WKT	
<code>ST_GeomFromWKB()</code> , <code>ST_GeometryFromWKB()</code>	Return geometry from WKB	
<code>ST_InteriorRingN()</code>	Return N-th interior ring of Polygon	
<code>ST_Intersection()</code>	Return point set intersection of two geometries	
<code>ST_Intersects()</code>	Whether one geometry intersects another	
<code>ST_IsClosed()</code>	Whether a geometry is closed and simple	
<code>ST_IsEmpty()</code>	Whether a geometry is empty	
<code>ST_IsSimple()</code>	Whether a geometry is simple	
<code>ST_IsValid()</code>	Whether a geometry is valid	

## Spatial Function Reference

Name	Description	Deprecated
<code>ST_LatFromGeoHash()</code>	Return latitude from geohash value	
<code>ST_Length()</code>	Return length of LineString	
<code>ST_LineFromText()</code> , <code>ST_LineStringFromText()</code>	Construct LineString from WKT	
<code>ST_LineFromWKB()</code> , <code>ST_LineStringFromWKB()</code>	Construct LineString from WKB	
<code>ST_LongFromGeoHash()</code>	Return longitude from geohash value	
<code>ST_MakeEnvelope()</code>	Rectangle around two points	
<code>ST_MLineFromText()</code> , <code>ST_MultiLineStringFromText()</code>	Construct MultiLineString from WKT	
<code>ST_MLineFromWKB()</code> , <code>ST_MultiLineStringFromWKB()</code>	Construct MultiLineString from WKB	
<code>ST_MPointFromText()</code> , <code>ST_MultiPointFromText()</code>	Construct MultiPoint from WKT	
<code>ST_MPointFromWKB()</code> , <code>ST_MultiPointFromWKB()</code>	Construct MultiPoint from WKB	
<code>ST_MPolyFromText()</code> , <code>ST_MultiPolygonFromText()</code>	Construct MultiPolygon from WKT	
<code>ST_MPolyFromWKB()</code> , <code>ST_MultiPolygonFromWKB()</code>	Construct MultiPolygon from WKB	
<code>ST_NumGeometries()</code>	Return number of geometries in geometry collection	
<code>ST_NumInteriorRing()</code> , <code>ST_NumInteriorRings()</code>	Return number of interior rings in Polygon	
<code>ST_NumPoints()</code>	Return number of points in LineString	
<code>ST_Overlaps()</code>	Whether one geometry overlaps another	
<code>ST_PointFromGeoHash()</code>	Convert geohash value to POINT value	
<code>ST_PointFromText()</code>	Construct Point from WKT	
<code>ST_PointFromWKB()</code>	Construct Point from WKB	
<code>ST_PointN()</code>	Return N-th point from LineString	
<code>ST_PolyFromText()</code> , <code>ST_PolygonFromText()</code>	Construct Polygon from WKT	
<code>ST_PolyFromWKB()</code> , <code>ST_PolygonFromWKB()</code>	Construct Polygon from WKB	
<code>ST_Simplify()</code>	Return simplified geometry	
<code>ST_SRID()</code>	Return spatial reference system ID for geometry	
<code>ST_StartPoint()</code>	Start Point of LineString	



Name	Description	Deprecated
<code>ST_SymDifference()</code>	Return point set symmetric difference of two geometries	
<code>ST_Touches()</code>	Whether one geometry touches another	
<code>ST_Union()</code>	Return point set union of two geometries	
<code>ST_Validate()</code>	Return validated geometry	
<code>ST_Within()</code>	Whether one geometry is within another	
<code>ST_X()</code>	Return X coordinate of Point	
<code>ST_Y()</code>	Return Y coordinate of Point	
<code>StartPoint()</code>	Start Point of LineString	Yes
<code>Touches()</code>	Whether one geometry touches another	Yes
<code>Within()</code>	Whether MBR of one geometry is within MBR of another	Yes
<code>X()</code>	Return X coordinate of Point	Yes
<code>Y()</code>	Return Y coordinate of Point	Yes

## 12.16.2 Argument Handling by Spatial Functions

Spatial values, or geometries, have the properties described in [Section 11.4.2.2, “Geometry Class”](#). The following discussion lists general spatial function argument-handling characteristics. Specific functions or groups of functions may have additional or different argument-handling characteristics, as discussed in the sections where those function descriptions occur. Where that is true, those descriptions take precedence over the general discussion here.

Spatial functions are defined only for valid geometry values. See [Section 11.4.4, “Geometry Well-Formedness and Validity”](#).

The spatial reference identifier (SRID) of a geometry identifies the coordinate space in which the geometry is defined. In MySQL, the SRID value is an integer associated with the geometry value. The maximum usable SRID value is  $2^{32}-1$ . If a larger value is given, only the lower 32 bits are used.

In MySQL, all computations are done assuming SRID 0, regardless of the actual SRID value. SRID 0 represents an infinite flat Cartesian plane with no units assigned to its axes. In the future, computations may use the specified SRID values. To ensure SRID 0 behavior, create geometry values using SRID 0. SRID 0 is the default for new geometry values if no SRID is specified.

Geometry values produced by any spatial function inherit the SRID of the geometry arguments.

The [Open Geospatial Consortium](#) guidelines require that input polygons already be closed, so unclosed polygons are rejected as invalid rather than being closed.

Empty geometry-collection handling is as follows: An empty WKT input geometry collection may be specified as `'GEOMETRYCOLLECTION()'`. This is also the output WKT resulting from a spatial operation that produces an empty geometry collection.

During parsing of a nested geometry collection, the collection is flattened and its basic components are used in various GIS operations to compute results. This provides additional flexibility to users because it is

unnecessary to be concerned about the uniqueness of geometry data. Nested geometry collections may be produced from nested GIS function calls without having to be explicitly flattened first.

### 12.16.3 Functions That Create Geometry Values from WKT Values

These functions take as arguments a Well-Known Text (WKT) representation and, optionally, a spatial reference system identifier (SRID). They return the corresponding geometry.

`ST_GeomFromText()` accepts a WKT value of any geometry type as its first argument. Other functions provide type-specific construction functions for construction of geometry values of each geometry type.

For a description of WKT format, see [Well-Known Text \(WKT\) Format](#).

- `GeomCollFromText(wkt [, srid]), GeometryCollectionFromText(wkt [, srid])`

`ST_GeomCollFromText()`, `ST_GeometryCollectionFromText()`, `ST_GeomCollFromText()`, `GeomCollFromText()`, and `GeometryCollectionFromText()` are synonyms. For more information, see the description of `ST_GeomCollFromText()`.

`GeomCollFromText()` and `GeometryCollectionFromText()` are deprecated; expect them to be removed in a future MySQL release. Use `ST_GeomCollFromText()` and `ST_GeometryCollectionFromText()` instead.

- `GeomFromText(wkt [, srid]), GeometryFromText(wkt [, srid])`

`ST_GeomFromText()`, `ST_GeometryFromText()`, `GeomFromText()`, and `GeometryFromText()` are synonyms. For more information, see the description of `ST_GeomFromText()`.

`GeomFromText()` and `GeometryFromText()` are deprecated; expect them to be removed in a future MySQL release. Use `ST_GeomFromText()` and `ST_GeometryFromText()` instead.

- `LineFromText(wkt [, srid]), LineStringFromText(wkt [, srid])`

`ST_LineFromText()`, `ST_LineStringFromText()`, `LineFromText()`, and `LineStringFromText()` are synonyms. For more information, see the description of `ST_LineFromText()`.

`LineFromText()` and `LineStringFromText()` are deprecated; expect them to be removed in a future MySQL release. Use `ST_LineFromText()` and `ST_LineStringFromText()` instead.

- `MLineFromText(wkt [, srid]), MultiLineStringFromText(wkt [, srid])`

`ST_MLineFromText()`, `ST_MultiLineStringFromText()`, `MLineFromText()`, and `MultiLineStringFromText()` are synonyms. For more information, see the description of `ST_MLineFromText()`.

`MLineFromText()` and `MultiLineStringFromText()` are deprecated; expect them to be removed in a future MySQL release. Use `ST_MLineFromText()` and `ST_MultiLineStringFromText()` instead.

- `MPointFromText(wkt [, srid]), MultiPointFromText(wkt [, srid])`

`ST_MPointFromText()`, `ST_MultiPointFromText()`, `MPointFromText()`, and `MultiPointFromText()` are synonyms. For more information, see the description of `ST_MPointFromText()`.

`MPointFromText()` and `MultiPointFromText()` are deprecated; expect them to be removed in a future MySQL release. Use `ST_MPointFromText()` and `ST_MultiPointFromText()` instead.

- `MPolyFromText(wkt [, srid]), MultiPolygonFromText(wkt [, srid])`

`ST_MPolyFromText()`, `ST_MultiPolygonFromText()`, `MPolyFromText()`, and `MultiPolygonFromText()` are synonyms. For more information, see the description of `ST_MPolyFromText()`.

`MPolyFromText()` and `MultiPolygonFromText()` are deprecated; expect them to be removed in a future MySQL release. Use `ST_MPolyFromText()` and `ST_MultiPolygonFromText()` instead.

- `PointFromText(wkt [, srid])`

`ST_PointFromText()` and `PointFromText()` are synonyms. For more information, see the description of `ST_PointFromText()`.

`PointFromText()` is deprecated; expect it to be removed in a future MySQL release. Use `ST_PointFromText()` instead.

- `PolyFromText(wkt [, srid]), PolygonFromText(wkt [, srid])`

`ST_PolyFromText()`, `ST_PolygonFromText()`, `PolyFromText()`, and `PolygonFromText()` are synonyms. For more information, see the description of `ST_PolyFromText()`.

`PolyFromText()` and `PolygonFromText()` are deprecated; expect them to be removed in a future MySQL release. Use `ST_PolyFromText()` and `ST_PolygonFromText()` instead.

- `ST_GeomCollFromText(wkt [, srid]), ST_GeometryCollectionFromText(wkt [, srid]), ST_GeomCollFromTtxt(wkt [, srid])`

Constructs a `GeometryCollection` value using its WKT representation and SRID.

If the geometry argument is `NULL` or not a syntactically well-formed geometry, or if the SRID argument is `NULL`, the return value is `NULL`.

```
mysql> SET @g = "MULTILINESTRING((10 10, 11 11), (9 9, 10 10));"
mysql> SELECT ST_AsText(ST_GeomCollFromText(@g));
+-----+
| ST_AsText(ST_GeomCollFromText(@g)) |
+-----+
| MULTILINESTRING((10 10,11 11),(9 9,10 10)) |
+-----+
```

`ST_GeomCollFromText()`, `ST_GeometryCollectionFromText()`, `ST_GeomCollFromTtxt()`, `GeomCollFromText()`, and `GeometryCollectionFromText()` are synonyms.

- `ST_GeomFromText(wkt [, srid]), ST_GeometryFromText(wkt [, srid])`

Constructs a geometry value of any type using its WKT representation and SRID.

If the geometry argument is `NULL` or not a syntactically well-formed geometry, or if the SRID argument is `NULL`, the return value is `NULL`.

`ST_GeomFromText()`, `ST_GeometryFromText()`, `GeomFromText()`, and `GeometryFromText()` are synonyms.

- `ST_LineFromText(wkt [, srid]), ST_LineStringFromText(wkt [, srid])`

Constructs a `LineString` value using its WKT representation and SRID.

If the geometry argument is `NULL` or not a syntactically well-formed geometry, or if the SRID argument is `NULL`, the return value is `NULL`.

`ST_LineFromText()`, `ST_LineStringFromText()`, `LineFromText()`, and `LineStringFromText()` are synonyms.

- `ST_MLineFromText(wkt [, srid]), ST_MultiLineStringFromText(wkt [, srid])`

Constructs a `MultiLineString` value using its WKT representation and SRID.

If the geometry argument is `NULL` or not a syntactically well-formed geometry, or if the SRID argument is `NULL`, the return value is `NULL`.

`ST_MLineFromText()`, `ST_MultiLineStringFromText()`, `MLineFromText()`, and `MultiLineStringFromText()` are synonyms.

- `ST_MPointFromText(wkt [, srid]), ST_MultiPointFromText(wkt [, srid])`

Constructs a `MultiPoint` value using its WKT representation and SRID.

If the geometry argument is `NULL` or not a syntactically well-formed geometry, or if the SRID argument is `NULL`, the return value is `NULL`.

Functions such as `ST_MPointFromText()` and `ST_GeomFromText()` that accept WKT-format representations of `MultiPoint` values permit individual points within values to be surrounded by parentheses. For example, both of the following function calls are valid:

```
ST_MPointFromText('MULTIPOINT (1 1, 2 2, 3 3)')
ST_MPointFromText('MULTIPOINT ((1 1), (2 2), (3 3))')
```

`ST_MPointFromText()`, `ST_MultiPointFromText()`, `MPointFromText()`, and `MultiPointFromText()` are synonyms.

- `ST_MPolyFromText(wkt [, srid]), ST_MultiPolygonFromText(wkt [, srid])`

Constructs a `MultiPolygon` value using its WKT representation and SRID.

If the geometry argument is `NULL` or not a syntactically well-formed geometry, or if the SRID argument is `NULL`, the return value is `NULL`.

`ST_MPolyFromText()`, `ST_MultiPolygonFromText()`, `MPolyFromText()`, and `MultiPolygonFromText()` are synonyms.

- `ST_PointFromText(wkt [, srid])`

Constructs a `Point` value using its WKT representation and SRID.

If the geometry argument is `NULL` or not a syntactically well-formed geometry, or if the SRID argument is `NULL`, the return value is `NULL`.

`ST_PointFromText()` and `PointFromText()` are synonyms.

- `ST_PolyFromText(wkt [, srid]), ST_PolygonFromText(wkt [, srid])`

Constructs a `Polygon` value using its WKT representation and SRID.

If the geometry argument is `NULL` or not a syntactically well-formed geometry, or if the SRID argument is `NULL`, the return value is `NULL`.

`ST_PolyFromText()`, `ST_PolygonFromText()`, `PolyFromText()`, and `PolygonFromText()` are synonyms.

## 12.16.4 Functions That Create Geometry Values from WKB Values

These functions take as arguments a `BLOB` containing a Well-Known Binary (WKB) representation and, optionally, a spatial reference system identifier (SRID). They return the corresponding geometry.

`ST_GeomFromWKB()` accepts a WKB value of any geometry type as its first argument. Other functions provide type-specific construction functions for construction of geometry values of each geometry type.

These functions also accept geometry objects as returned by the functions in [Section 12.16.5, “MySQL-Specific Functions That Create Geometry Values”](#). Thus, those functions may be used to provide the first argument to the functions in this section. However, as of MySQL 5.7.19, use of geometry arguments is deprecated and generates a warning. Geometry arguments are not accepted in MySQL 8.0. To migrate calls from using geometry arguments to using WKB arguments, follow these guidelines:

For a description of WKB format, see [Well-Known Binary \(WKB\) Format](#).

- Rewrite constructs such as `ST_GeomFromWKB(Point(0, 0))` as `Point(0, 0)`.
- Rewrite constructs such as `ST_GeomFromWKB(Point(0, 0), 4326)` as `ST_GeomFromWKB(ST_AsWKB(Point(0, 0)), 4326)`. (Alternatively, in MySQL 8.0, you can use `ST_SRID(Point(0, 0), 4326)`.)
- `GeomCollFromWKB(wkb [, srid])`, `GeometryCollectionFromWKB(wkb [, srid])`

`ST_GeomCollFromWKB()`, `ST_GeometryCollectionFromWKB()`, `GeomCollFromWKB()`, and `GeometryCollectionFromWKB()` are synonyms. For more information, see the description of `ST_GeomCollFromWKB()`.

`GeomCollFromWKB()` and `GeometryCollectionFromWKB()` are deprecated; expect them to be removed in a future MySQL release. Use `ST_GeomCollFromWKB()` and `ST_GeometryCollectionFromWKB()` instead.

- `GeomFromWKB(wkb [, srid])`, `GeometryFromWKB(wkb [, srid])`

`ST_GeomFromWKB()`, `ST_GeometryFromWKB()`, `GeomFromWKB()`, and `GeometryFromWKB()` are synonyms. For more information, see the description of `ST_GeomFromWKB()`.

`GeomFromWKB()` and `GeometryFromWKB()` are deprecated; expect them to be removed in a future MySQL release. Use `ST_GeomFromWKB()` and `ST_GeometryFromWKB()` instead.

- `LineFromWKB(wkb [, srid])`, `LineStringFromWKB(wkb [, srid])`

`ST_LineFromWKB()`, `ST_LineStringFromWKB()`, `LineFromWKB()`, and `LineStringFromWKB()` are synonyms. For more information, see the description of `ST_LineFromWKB()`.

`LineFromWKB()` and `LineStringFromWKB()` are deprecated; expect them to be removed in a future MySQL release. Use `ST_LineFromWKB()` and `ST_LineStringFromWKB()` instead.

- `MLineFromWKB(wkb [, srid])`, `MultiLineStringFromWKB(wkb [, srid])`

`ST_MLineFromWKB()`, `ST_MultiLineStringFromWKB()`, `MLineFromWKB()`, and `MultiLineStringFromWKB()` are synonyms. For more information, see the description of `ST_MLineFromWKB()`.

`MLineFromWKB()` and `MultiLineStringFromWKB()` are deprecated; expect them to be removed in a future MySQL release. Use `ST_MLineFromWKB()` and `ST_MultiLineStringFromWKB()` instead.

- `MPointFromWKB(wkb [, srid])`, `MultiPointFromWKB(wkb [, srid])`

`ST_MPointFromWKB()`, `ST_MultiPointFromWKB()`, `MPointFromWKB()`, and `MultiPointFromWKB()` are synonyms. For more information, see the description of `ST_MPointFromWKB()`.

`MPointFromWKB()` and `MultiPointFromWKB()` are deprecated; expect them to be removed in a future MySQL release. Use `ST_MPointFromWKB()` and `ST_MultiPointFromWKB()` instead.

- `MPolyFromWKB(wkb [, srid])`, `MultiPolygonFromWKB(wkb [, srid])`

`ST_MPolyFromWKB()`, `ST_MultiPolygonFromWKB()`, `MPolyFromWKB()`, and `MultiPolygonFromWKB()` are synonyms. For more information, see the description of `ST_MPolyFromWKB()`.

`MPolyFromWKB()` and `MultiPolygonFromWKB()` are deprecated; expect them to be removed in a future MySQL release. Use `ST_MPolyFromWKB()` and `ST_MultiPolygonFromWKB()` instead.

- `PointFromWKB(wkb [, srid])`

`ST_PointFromWKB()` and `PointFromWKB()` are synonyms. For more information, see the description of `ST_PointFromWKB()`.

`PointFromWKB()` is deprecated; expect it to be removed in a future MySQL release. Use `ST_PointFromWKB()` instead.

- `PolyFromWKB(wkb [, srid])`, `PolygonFromWKB(wkb [, srid])`

`ST_PolyFromWKB()`, `ST_PolygonFromWKB()`, `PolyFromWKB()`, and `PolygonFromWKB()` are synonyms. For more information, see the description of `ST_PolyFromWKB()`.

`PolyFromWKB()` and `PolygonFromWKB()` are deprecated; expect them to be removed in a future MySQL release. Use `ST_PolyFromWKB()` and `ST_PolygonFromWKB()` instead.

- `ST_GeomCollFromWKB(wkb [, srid])`, `ST_GeometryCollectionFromWKB(wkb [, srid])`

Constructs a `GeometryCollection` value using its WKB representation and SRID.

The result is `NULL` if the WKB or SRID argument is `NULL`.

`ST_GeomCollFromWKB()`, `ST_GeometryCollectionFromWKB()`, `GeomCollFromWKB()`, and `GeometryCollectionFromWKB()` are synonyms.

- `ST_GeomFromWKB(wkb [, srid]), ST_GeometryFromWKB(wkb [, srid])`

Constructs a geometry value of any type using its WKB representation and SRID.

The result is `NULL` if the WKB or SRID argument is `NULL`.

`ST_GeomFromWKB()`, `ST_GeometryFromWKB()`, `GeomFromWKB()`, and `GeometryFromWKB()` are synonyms.

- `ST_LineFromWKB(wkb [, srid]), ST_LineStringFromWKB(wkb [, srid])`

Constructs a `LineString` value using its WKB representation and SRID.

The result is `NULL` if the WKB or SRID argument is `NULL`.

`ST_LineFromWKB()`, `ST_LineStringFromWKB()`, `LineFromWKB()`, and `LineStringFromWKB()` are synonyms.

- `ST_MLineFromWKB(wkb [, srid]), ST_MultiLineStringFromWKB(wkb [, srid])`

Constructs a `MultiLineString` value using its WKB representation and SRID.

The result is `NULL` if the WKB or SRID argument is `NULL`.

`ST_MLineFromWKB()`, `ST_MultiLineStringFromWKB()`, `MLineFromWKB()`, and `MultiLineStringFromWKB()` are synonyms.

- `ST_MPointFromWKB(wkb [, srid]), ST_MultiPointFromWKB(wkb [, srid])`

Constructs a `MultiPoint` value using its WKB representation and SRID.

The result is `NULL` if the WKB or SRID argument is `NULL`.

`ST_MPointFromWKB()`, `ST_MultiPointFromWKB()`, `MPointFromWKB()`, and `MultiPointFromWKB()` are synonyms.

- `ST_MPolyFromWKB(wkb [, srid]), ST_MultiPolygonFromWKB(wkb [, srid])`

Constructs a `MultiPolygon` value using its WKB representation and SRID.

The result is `NULL` if the WKB or SRID argument is `NULL`.

`ST_MPolyFromWKB()`, `ST_MultiPolygonFromWKB()`, `MPolyFromWKB()`, and `MultiPolygonFromWKB()` are synonyms.

- `ST_PointFromWKB(wkb [, srid])`

Constructs a `Point` value using its WKB representation and SRID.

The result is `NULL` if the WKB or SRID argument is `NULL`.

`ST_PointFromWKB()` and `PointFromWKB()` are synonyms.

- `ST_PolyFromWKB(wkb [, srid]), ST_PolygonFromWKB(wkb [, srid])`

Constructs a `Polygon` value using its WKB representation and SRID.

The result is `NULL` if the WKB or SRID argument is `NULL`.

`ST_PolyFromWKB()`, `ST_PolygonFromWKB()`, `PolyFromWKB()`, and `PolygonFromWKB()` are synonyms.

## 12.16.5 MySQL-Specific Functions That Create Geometry Values

MySQL provides a set of useful nonstandard functions for creating geometry values. The functions described in this section are MySQL extensions to the OpenGIS specification.

These functions produce geometry objects from either WKB values or geometry objects as arguments. If any argument is not a proper WKB or geometry representation of the proper object type, the return value is `NULL`.

For example, you can insert the geometry return value from `Point()` directly into a `POINT` column:

```
INSERT INTO t1 (pt_col) VALUES(Point(1,2));
```

- `GeometryCollection(g [, g] ...)`

Constructs a `GeometryCollection` value from the geometry arguments.

`GeometryCollection()` returns all the proper geometries contained in the arguments even if a nonsupported geometry is present.

`GeometryCollection()` with no arguments is permitted as a way to create an empty geometry.

- `LineString(pt [, pt] ...)`

Constructs a `LineString` value from a number of `Point` or WKB `Point` arguments. If the number of arguments is less than two, the return value is `NULL`.

- `MultiLineString(ls [, ls] ...)`

Constructs a `MultiLineString` value using `LineString` or WKB `LineString` arguments.

- `MultiPoint(pt [, pt2] ...)`

Constructs a `MultiPoint` value using `Point` or WKB `Point` arguments.

- `MultiPolygon(poly [, poly] ...)`

Constructs a `MultiPolygon` value from a set of `Polygon` or WKB `Polygon` arguments.

- `Point(x, y)`

Constructs a `Point` using its coordinates.

- `Polygon(ls [, ls] ...)`

Constructs a `Polygon` value from a number of `LineString` or WKB `LineString` arguments. If any argument does not represent a `LinearRing` (that is, not a closed and simple `LineString`), the return value is `NULL`.



## 12.16.6 Geometry Format Conversion Functions

MySQL supports the functions listed in this section for converting geometry values from internal geometry format to WKT or WKB format.

There are also functions to convert a string from WKT or WKB format to internal geometry format. See [Section 12.16.3, “Functions That Create Geometry Values from WKT Values”](#), and [Section 12.16.4, “Functions That Create Geometry Values from WKB Values”](#).

- `AsBinary(g)`, `AsWKB(g)`

`ST_AsBinary()`, `ST_AsWKB()`, `AsBinary()`, and `AsWKB()` are synonyms. For more information, see the description of `ST_AsBinary()`.

`AsBinary()` and `AsWKB()` are deprecated; expect them to be removed in a future MySQL release. Use `ST_AsBinary()` and `ST_AsWKB()` instead.

- `AsText(g)`, `AsWKT(g)`

`ST_AsText()`, `ST_AsWKT()`, `AsText()`, and `AsWKT()` are synonyms. For more information, see the description of `ST_AsText()`.

`AsText()` and `AsWKT()` are deprecated; expect them to be removed in a future MySQL release. Use `ST_AsText()` and `ST_AsWKT()` instead.

- `ST_AsBinary(g)`, `ST_AsWKB(g)`

Converts a value in internal geometry format to its WKB representation and returns the binary result.

If the argument is `NULL`, the return value is `NULL`. If the argument is not a syntactically well-formed geometry, an `ER_GIS_INVALID_DATA` error occurs.

```
SELECT ST_AsBinary(g) FROM geom;
```

`ST_AsBinary()`, `ST_AsWKB()`, `AsBinary()`, and `AsWKB()` are synonyms.

- `ST_AsText(g)`, `ST_AsWKT(g)`

Converts a value in internal geometry format to its WKT representation and returns the string result.

If the argument is `NULL`, the return value is `NULL`. If the argument is not a syntactically well-formed geometry, an `ER_GIS_INVALID_DATA` error occurs.

```
mysql> SET @g = 'LineString(1 1,2 2,3 3)';
mysql> SELECT ST_AsText(ST_GeomFromText(@g));
+-----+
| ST_AsText(ST_GeomFromText(@g)) |
+-----+
| LINESTRING(1 1,2 2,3 3)         |
+-----+
```

`ST_AsText()`, `ST_AsWKT()`, `AsText()`, and `AsWKT()` are synonyms.

Output for `MultiPoint` values includes parentheses around each point. For example:

```
mysql> SET @mp = 'MULTIPOINT(1 1, 2 2, 3 3)';
mysql> SELECT ST_AsText(ST_GeomFromText(@mp));
+-----+
| ST_AsText(ST_GeomFromText(@mp)) |
+-----+
```

```
| MULTIPOINT((1 1),(2 2),(3 3)) |  
+-----+  
+-----+
```

## 12.16.7 Geometry Property Functions

Each function that belongs to this group takes a geometry value as its argument and returns some quantitative or qualitative property of the geometry. Some functions restrict their argument type. Such functions return `NULL` if the argument is of an incorrect geometry type. For example, the `ST_Area()` polygon function returns `NULL` if the object type is neither `Polygon` nor `MultiPolygon`.

### 12.16.7.1 General Geometry Property Functions

The functions listed in this section do not restrict their argument and accept a geometry value of any type.

- `Dimension(g)`

`ST_Dimension()` and `Dimension()` are synonyms. For more information, see the description of `ST_Dimension()`.

`Dimension()` is deprecated; expect it to be removed in a future MySQL release. Use `ST_Dimension()` instead.

- `Envelope(g)`

`ST_Envelope()` and `Envelope()` are synonyms. For more information, see the description of `ST_Envelope()`.

`Envelope()` is deprecated; expect it to be removed in a future MySQL release. Use `ST_Envelope()` instead.

- `GeometryType(g)`

`ST_GeometryType()` and `GeometryType()` are synonyms. For more information, see the description of `ST_GeometryType()`.

`GeometryType()` is deprecated; expect it to be removed in a future MySQL release. Use `ST_GeometryType()` instead.

- `IsEmpty(g)`

`ST_IsEmpty()` and `IsEmpty()` are synonyms. For more information, see the description of `ST_IsEmpty()`.

`IsEmpty()` is deprecated; expect it to be removed in a future MySQL release. Use `ST_IsEmpty()` instead.

- `IsSimple(g)`

`ST_IsSimple()` and `IsSimple()` are synonyms. For more information, see the description of `ST_IsSimple()`.

`IsSimple()` is deprecated; expect it to be removed in a future MySQL release. Use `ST_IsSimple()` instead.

- `SRID(g)`

`ST_SRID()` and `SRID()` are synonyms. For more information, see the description of `ST_SRID()`.

`SRID()` is deprecated; expect it to be removed in a future MySQL release. Use `ST_SRID()` instead.

- `ST_Dimension(g)`

Returns the inherent dimension of the geometry value *g*, or `NULL` if the argument is `NULL`. The dimension can be `-1`, `0`, `1`, or `2`. The meaning of these values is given in [Section 11.4.2.2, “Geometry Class”](#).

```
mysql> SELECT ST_Dimension(ST_GeomFromText('LineString(1 1,2 2)'));
+-----+
| ST_Dimension(ST_GeomFromText('LineString(1 1,2 2)')) |
+-----+
| 1 |
+-----+
```

`ST_Dimension()` and `Dimension()` are synonyms.

- `ST_Envelope(g)`

Returns the minimum bounding rectangle (MBR) for the geometry value *g*, or `NULL` if the argument is `NULL`. The result is returned as a `Polygon` value that is defined by the corner points of the bounding box:

```
POLYGON((MINX MINY, MAXX MINY, MAXX MAXY, MINX MAXY, MINX MINY))
```

```
mysql> SELECT ST_AsText(ST_Envelope(ST_GeomFromText('LineString(1 1,2 2)')));
+-----+
| ST_AsText(ST_Envelope(ST_GeomFromText('LineString(1 1,2 2)')) |
+-----+
| POLYGON((1 1,2 1,2 2,1 2,1 1)) |
+-----+
```

If the argument is a point or a vertical or horizontal line segment, `ST_Envelope()` returns the point or the line segment as its MBR rather than returning an invalid polygon:

```
mysql> SELECT ST_AsText(ST_Envelope(ST_GeomFromText('LineString(1 1,1 2)')));
+-----+
| ST_AsText(ST_Envelope(ST_GeomFromText('LineString(1 1,1 2)')) |
+-----+
| LINESTRING(1 1,1 2) |
+-----+
```

`ST_Envelope()` and `Envelope()` are synonyms.

- `ST_GeometryType(g)`

Returns a binary string indicating the name of the geometry type of which the geometry instance *g* is a member, or `NULL` if the argument is `NULL`. The name corresponds to one of the instantiable `Geometry` subclasses.

```
mysql> SELECT ST_GeometryType(ST_GeomFromText('POINT(1 1)'));
+-----+
| ST_GeometryType(ST_GeomFromText('POINT(1 1)')) |
+-----+
| POINT |
+-----+
```

`ST_GeometryType()` and `GeometryType()` are synonyms.

- `ST_IsEmpty(g)`

This function is a placeholder that returns 0 for any valid geometry value, 1 for any invalid geometry value, or `NULL` if the argument is `NULL`.

MySQL does not support GIS `EMPTY` values such as `POINT EMPTY`.

`ST_IsEmpty()` and `IsEmpty()` are synonyms.

- `ST_IsSimple(g)`

Returns 1 if the geometry value *g* has no anomalous geometric points, such as self-intersection or self-tangency. `ST_IsSimple()` returns 0 if the argument is not simple, and `NULL` if the argument is `NULL`.

The descriptions of the instantiable geometric classes given under [Section 11.4.2, “The OpenGIS Geometry Model”](#) includes the specific conditions that cause class instances to be classified as not simple.

`ST_IsSimple()` and `IsSimple()` are synonyms.

- `ST_SRID(g)`

Returns an integer indicating the spatial reference system ID associated with the geometry value *g*, or `NULL` if the argument is `NULL`.

```
mysql> SELECT ST_SRID(ST_GeomFromText('LineString(1 1,2 2)',101));
+-----+
| ST_SRID(ST_GeomFromText('LineString(1 1,2 2)',101)) |
+-----+
|                               101 |
+-----+
```

`ST_SRID()` and `SRID()` are synonyms.

### 12.16.7.2 Point Property Functions

A `Point` consists of X and Y coordinates, which may be obtained using the following functions:

- `ST_X(p)`

Returns the X-coordinate value for the `Point` object *p* as a double-precision number.

```
mysql> SELECT ST_X(Point(56.7, 53.34));
+-----+
| ST_X(Point(56.7, 53.34)) |
+-----+
|                56.7 |
+-----+
```

`ST_X()` and `X()` are synonyms.

- `ST_Y(p)`

Returns the Y-coordinate value for the `Point` object *p* as a double-precision number.

```
mysql> SELECT ST_Y(Point(56.7, 53.34));
+-----+
| ST_Y(Point(56.7, 53.34)) |
+-----+
|                53.34 |
+-----+
```

`ST_Y()` and `Y()` are synonyms.

- `X(p)`

`ST_X()` and `X()` are synonyms. For more information, see the description of `ST_X()`.

`X()` is deprecated; expect it to be removed in a future MySQL release. Use `ST_X()` instead.

- `Y(p)`

`ST_Y()` and `Y()` are synonyms. For more information, see the description of `ST_Y()`.

`Y()` is deprecated; expect it to be removed in a future MySQL release. Use `ST_Y()` instead.

### 12.16.7.3 LineString and MultiLineString Property Functions

A `LineString` consists of `Point` values. You can extract particular points of a `LineString`, count the number of points that it contains, or obtain its length.

Some functions in this section also work for `MultiLineString` values.

- `EndPoint(ls)`

`ST_EndPoint()` and `EndPoint()` are synonyms. For more information, see the description of `ST_EndPoint()`.

`EndPoint()` is deprecated; expect it to be removed in a future MySQL release. Use `ST_EndPoint()` instead.

- `GLength(ls)`

`GLength()` is a nonstandard name. It corresponds to the OpenGIS `ST_Length()` function. (There is an existing SQL function `Length()` that calculates the length of string values.)

`GLength()` is deprecated; expect it to be removed in a future MySQL release. Use `ST_Length()` instead.

- `IsClosed(ls)`

`ST_IsClosed()` and `IsClosed()` are synonyms. For more information, see the description of `ST_IsClosed()`.

`IsClosed()` is deprecated; expect it to be removed in a future MySQL release. Use `ST_IsClosed()` instead.

- `NumPoints(ls)`

`ST_NumPoints()` and `NumPoints()` are synonyms. For more information, see the description of `ST_NumPoints()`.

`NumPoints()` is deprecated; expect it to be removed in a future MySQL release. Use `ST_NumPoints()` instead.

- `PointN(ls, N)`

`ST_PointN()` and `PointN()` are synonyms. For more information, see the description of `ST_PointN()`.

`PointN()` is deprecated; expect it to be removed in a future MySQL release. Use `ST_PointN()` instead.

- `ST_EndPoint(ls)`

Returns the `Point` that is the endpoint of the `LineString` value `ls`. If the argument is `NULL` or an empty geometry, the return value is `NULL`.

```
mysql> SET @ls = 'LineString(1 1,2 2,3 3)';
mysql> SELECT ST_AsText(ST_EndPoint(ST_GeomFromText(@ls)));
+-----+
| ST_AsText(ST_EndPoint(ST_GeomFromText(@ls))) |
+-----+
| POINT(3 3) |
+-----+
```

`ST_EndPoint()` and `EndPoint()` are synonyms.

- `ST_IsClosed(ls)`

For a `LineString` value `ls`, `ST_IsClosed()` returns 1 if `ls` is closed (that is, its `ST_StartPoint()` and `ST_EndPoint()` values are the same). If the argument is `NULL` or an empty geometry, the return value is `NULL`.

For a `MultiLineString` value `ls`, `ST_IsClosed()` returns 1 if `ls` is closed (that is, the `ST_StartPoint()` and `ST_EndPoint()` values are the same for each `LineString` in `ls`).

`ST_IsClosed()` returns 0 if `ls` is not closed.

```
mysql> SET @ls1 = 'LineString(1 1,2 2,3 3,2 2)';
mysql> SET @ls2 = 'LineString(1 1,2 2,3 3,1 1)';

mysql> SELECT ST_IsClosed(ST_GeomFromText(@ls1));
+-----+
| ST_IsClosed(ST_GeomFromText(@ls1)) |
+-----+
| 0 |
+-----+

mysql> SELECT ST_IsClosed(ST_GeomFromText(@ls2));
+-----+
| ST_IsClosed(ST_GeomFromText(@ls2)) |
+-----+
| 1 |
+-----+

mysql> SET @ls3 = 'MultiLineString((1 1,2 2,3 3),(4 4,5 5))';

mysql> SELECT ST_IsClosed(ST_GeomFromText(@ls3));
+-----+
| ST_IsClosed(ST_GeomFromText(@ls3)) |
+-----+
| 0 |
+-----+
```

`ST_IsClosed()` and `IsClosed()` are synonyms.

- `ST_Length(ls)`

Returns a double-precision number indicating the length of the `LineString` or `MultiLineString` value `ls` in its associated spatial reference system. The length of a `MultiLineString` value is equal to

the sum of the lengths of its elements. If the argument is `NULL` or an empty geometry, the return value is `NULL`.

```
mysql> SET @ls = 'LineString(1 1,2 2,3 3)';
mysql> SELECT ST_Length(ST_GeomFromText(@ls));
+-----+
| ST_Length(ST_GeomFromText(@ls)) |
+-----+
|                2.8284271247461903 |
+-----+

mysql> SET @mls = 'MultiLineString((1 1,2 2,3 3),(4 4,5 5))';
mysql> SELECT ST_Length(ST_GeomFromText(@mls));
+-----+
| ST_Length(ST_GeomFromText(@mls)) |
+-----+
|                4.242640687119286 |
+-----+
```

`ST_Length()` should be used in preference to `GLength()`, which has a nonstandard name.

- `ST_NumPoints(ls)`

Returns the number of `Point` objects in the `LineString` value `ls`. If the argument is `NULL` or an empty geometry, the return value is `NULL`.

```
mysql> SET @ls = 'LineString(1 1,2 2,3 3)';
mysql> SELECT ST_NumPoints(ST_GeomFromText(@ls));
+-----+
| ST_NumPoints(ST_GeomFromText(@ls)) |
+-----+
|                3 |
+-----+
```

`ST_NumPoints()` and `NumPoints()` are synonyms.

- `ST_PointN(ls, N)`

Returns the `N`-th `Point` in the `LineString` value `ls`. Points are numbered beginning with 1. If any argument is `NULL` or the geometry argument is an empty geometry, the return value is `NULL`.

```
mysql> SET @ls = 'LineString(1 1,2 2,3 3)';
mysql> SELECT ST_AsText(ST_PointN(ST_GeomFromText(@ls),2));
+-----+
| ST_AsText(ST_PointN(ST_GeomFromText(@ls),2)) |
+-----+
| POINT(2 2) |
+-----+
```

`ST_PointN()` and `PointN()` are synonyms.

- `ST_StartPoint(ls)`

Returns the `Point` that is the start point of the `LineString` value `ls`. If the argument is `NULL` or an empty geometry, the return value is `NULL`.

```
mysql> SET @ls = 'LineString(1 1,2 2,3 3)';
mysql> SELECT ST_AsText(ST_StartPoint(ST_GeomFromText(@ls)));
+-----+
| ST_AsText(ST_StartPoint(ST_GeomFromText(@ls))) |
+-----+
| POINT(1 1) |
+-----+
```

---

`ST_StartPoint()` and `StartPoint()` are synonyms.

- `StartPoint(ls)`

`ST_StartPoint()` and `StartPoint()` are synonyms. For more information, see the description of `ST_StartPoint()`.

`StartPoint()` is deprecated; expect it to be removed in a future MySQL release. Use `ST_StartPoint()` instead.

### 12.16.7.4 Polygon and MultiPolygon Property Functions

Functions in this section return properties of `Polygon` or `MultiPolygon` values.

- `Area({poly|mpoly})`

`ST_Area()` and `Area()` are synonyms. For more information, see the description of `ST_Area()`.

`Area()` is deprecated; expect it to be removed in a future MySQL release. Use `ST_Area()` instead.

- `Centroid({poly|mpoly})`

`ST_Centroid()` and `Centroid()` are synonyms. For more information, see the description of `ST_Centroid()`.

`Centroid()` is deprecated; expect it to be removed in a future MySQL release. Use `ST_Centroid()` instead.

- `ExteriorRing(poly)`

`ST_ExteriorRing()` and `ExteriorRing()` are synonyms. For more information, see the description of `ST_ExteriorRing()`.

`ExteriorRing()` is deprecated; expect it to be removed in a future MySQL release. Use `ST_ExteriorRing()` instead.

- `InteriorRingN(poly, N)`

`ST_InteriorRingN()` and `InteriorRingN()` are synonyms. For more information, see the description of `ST_InteriorRingN()`.

`InteriorRingN()` is deprecated; expect it to be removed in a future MySQL release. Use `ST_InteriorRingN()` instead.

- `NumInteriorRings(poly)`

`ST_NumInteriorRings()` and `NumInteriorRings()` are synonyms. For more information, see the description of `ST_NumInteriorRings()`.

`NumInteriorRings()` is deprecated; expect it to be removed in a future MySQL release. Use `ST_NumInteriorRings()` instead.

- `ST_Area({poly|mpoly})`

Returns a double-precision number indicating the area of the `Polygon` or `MultiPolygon` argument, as measured in its spatial reference system. For arguments of dimension 0 or 1, the result is 0. If the argument is an empty geometry the return value is 0. If the argument is `NULL` the return value is `NULL`.



The result is the sum of the area values of all components for a geometry collection. If a geometry collection is empty, its area is returned as 0.

```
mysql> SET @poly =
      'Polygon((0 0,0 3,3 0,0 0),(1 1,1 2,2 1,1 1))';
mysql> SELECT ST_Area(ST_GeomFromText(@poly));
+-----+
| ST_Area(ST_GeomFromText(@poly)) |
+-----+
|                                4 |
+-----+

mysql> SET @mpoly =
      'MultiPolygon(((0 0,0 3,3 3,3 0,0 0),(1 1,1 2,2 2,2 1,1 1)))';
mysql> SELECT ST_Area(ST_GeomFromText(@mpoly));
+-----+
| ST_Area(ST_GeomFromText(@mpoly)) |
+-----+
|                                8 |
+-----+
```

`ST_Area()` and `Area()` are synonyms.

- `ST_Centroid({poly|mpoly})`

Returns the mathematical centroid for the `Polygon` or `MultiPolygon` argument as a `Point`. The result is not guaranteed to be on the `MultiPolygon`. If the argument is `NULL` or an empty geometry, the return value is `NULL`.

This function processes geometry collections by computing the centroid point for components of highest dimension in the collection. Such components are extracted and made into a single `MultiPolygon`, `MultiLineString`, or `MultiPoint` for centroid computation. If the argument is an empty geometry collection, the return value is `NULL`.

```
mysql> SET @poly =
      ST_GeomFromText('POLYGON((0 0,10 0,10 10,0 10,0 0),(5 5,7 5,7 7,5 7,5 5))');
mysql> SELECT ST_GeometryType(@poly),ST_AsText(ST_Centroid(@poly));
+-----+-----+
| ST_GeometryType(@poly) | ST_AsText(ST_Centroid(@poly)) |
+-----+-----+
| POLYGON                | POINT(4.958333333333333 4.958333333333333) |
+-----+-----+
```

`ST_Centroid()` and `Centroid()` are synonyms.

- `ST_ExteriorRing(poly)`

Returns the exterior ring of the `Polygon` value `poly` as a `LineString`. If the argument is `NULL` or an empty geometry, the return value is `NULL`.

```
mysql> SET @poly =
      'Polygon((0 0,0 3,3 3,3 0,0 0),(1 1,1 2,2 2,2 1,1 1))';
mysql> SELECT ST_AsText(ST_ExteriorRing(ST_GeomFromText(@poly)));
+-----+
| ST_AsText(ST_ExteriorRing(ST_GeomFromText(@poly))) |
+-----+
| LINESTRING(0 0,0 3,3 3,3 0,0 0) |
+-----+
```

`ST_ExteriorRing()` and `ExteriorRing()` are synonyms.

- `ST_InteriorRingN(poly, N)`

Returns the *N*-th interior ring for the [Polygon](#) value *poly* as a [LineString](#). Rings are numbered beginning with 1. If the argument is [NULL](#) or an empty geometry, the return value is [NULL](#).

```
mysql> SET @poly =
      'Polygon((0 0,0 3,3 3,3 0,0 0),(1 1,1 2,2 2,2 1,1 1))';
mysql> SELECT ST_AsText(ST_InteriorRingN(ST_GeomFromText(@poly),1));
+-----+
| ST_AsText(ST_InteriorRingN(ST_GeomFromText(@poly),1)) |
+-----+
| LINESTRING(1 1,1 2,2 2,2 1,1 1) |
+-----+
```

[ST\\_InteriorRingN\(\)](#) and [InteriorRingN\(\)](#) are synonyms.

- [ST\\_NumInteriorRing\(\*poly\*\)](#), [ST\\_NumInteriorRings\(\*poly\*\)](#)

Returns the number of interior rings in the [Polygon](#) value *poly*. If the argument is [NULL](#) or an empty geometry, the return value is [NULL](#).

```
mysql> SET @poly =
      'Polygon((0 0,0 3,3 3,3 0,0 0),(1 1,1 2,2 2,2 1,1 1))';
mysql> SELECT ST_NumInteriorRings(ST_GeomFromText(@poly));
+-----+
| ST_NumInteriorRings(ST_GeomFromText(@poly)) |
+-----+
| 1 |
+-----+
```

[ST\\_NumInteriorRing\(\)](#), [ST\\_NumInteriorRings\(\)](#), and [NumInteriorRings\(\)](#) are synonyms.

### 12.16.7.5 GeometryCollection Property Functions

These functions return properties of [GeometryCollection](#) values.

- [GeometryN\(\*gc\*, \*N\*\)](#)

[ST\\_GeometryN\(\)](#) and [GeometryN\(\)](#) are synonyms. For more information, see the description of [ST\\_GeometryN\(\)](#).

[GeometryN\(\)](#) is deprecated; expect it to be removed in a future MySQL release. Use [ST\\_GeometryN\(\)](#) instead.

- [NumGeometries\(\*gc\*\)](#)

[ST\\_NumGeometries\(\)](#) and [NumGeometries\(\)](#) are synonyms. For more information, see the description of [ST\\_NumGeometries\(\)](#).

[NumGeometries\(\)](#) is deprecated; expect it to be removed in a future MySQL release. Use [ST\\_NumGeometries\(\)](#) instead.

- [ST\\_GeometryN\(\*gc\*, \*N\*\)](#)

Returns the *N*-th geometry in the [GeometryCollection](#) value *gc*. Geometries are numbered beginning with 1. If any argument is [NULL](#) or the geometry argument is an empty geometry, the return value is [NULL](#).

```
mysql> SET @gc = 'GeometryCollection(Point(1 1),LineString(2 2, 3 3))';
mysql> SELECT ST_AsText(ST_GeometryN(ST_GeomFromText(@gc),1));
+-----+
| ST_AsText(ST_GeometryN(ST_GeomFromText(@gc),1)) |
+-----+
```

```
+-----+
| POINT(1 1) |
+-----+
```

`ST_GeometryN()` and `GeometryN()` are synonyms.

- `ST_NumGeometries(gc)`

Returns the number of geometries in the `GeometryCollection` value `gc`. If the argument is `NULL` or an empty geometry, the return value is `NULL`.

```
mysql> SET @gc = 'GeometryCollection(Point(1 1),LineString(2 2, 3 3))';
mysql> SELECT ST_NumGeometries(ST_GeomFromText(@gc));
+-----+
| ST_NumGeometries(ST_GeomFromText(@gc)) |
+-----+
| 2 |
+-----+
```

`ST_NumGeometries()` and `NumGeometries()` are synonyms.

## 12.16.8 Spatial Operator Functions

OpenGIS proposes a number of functions that can produce geometries. They are designed to implement spatial operators.

These functions support all argument type combinations except those that are inapplicable according to the [Open Geospatial Consortium](#) specification.

In addition, [Section 12.16.7, “Geometry Property Functions”](#), discusses several functions that construct new geometries from existing ones. See that section for descriptions of these functions:

- `ST_Envelope(g)`
- `ST_StartPoint(ls)`
- `ST_EndPoint(ls)`
- `ST_PointN(ls, N)`
- `ST_ExteriorRing(poly)`
- `ST_InteriorRingN(poly, N)`
- `ST_GeometryN(gc, N)`

These spatial operator functions are available:

- `Buffer(g, d [, strategy1 [, strategy2 [, strategy3]])`

`ST_Buffer()` and `Buffer()` are synonyms. For more information, see the description of `ST_Buffer()`.

`Buffer()` is deprecated; expect it to be removed in a future MySQL release. Use `ST_Buffer()` instead.

- `ConvexHull(g)`

`ST_ConvexHull()` and `ConvexHull()` are synonyms. For more information, see the description of `ST_ConvexHull()`.

`ConvexHull()` is deprecated; expect it to be removed in a future MySQL release. Use `ST_ConvexHull()` instead.

- `ST_Buffer(g, d [, strategy1 [, strategy2 [, strategy3]]])`

Returns a geometry that represents all points whose distance from the geometry value *g* is less than or equal to a distance of *d*, or `NULL` if any argument is `NULL`. The SRID of the geometry argument must be 0 because `ST_Buffer()` supports only the Cartesian coordinate system. If any geometry argument is not a syntactically well-formed geometry, an `ER_GIS_INVALID_DATA` error occurs.

If the geometry argument is empty, `ST_Buffer()` returns an empty geometry.

If the distance is 0, `ST_Buffer()` returns the geometry argument unchanged:

```
mysql> SET @pt = ST_GeomFromText('POINT(0 0)');
mysql> SELECT ST_AsText(ST_Buffer(@pt, 0));
+-----+
| ST_AsText(ST_Buffer(@pt, 0)) |
+-----+
| POINT(0 0)                   |
+-----+
```

`ST_Buffer()` supports negative distances for `Polygon` and `MultiPolygon` values, and for geometry collections containing `Polygon` or `MultiPolygon` values. The result may be an empty geometry. An `ER_WRONG_ARGUMENTS` error occurs for `ST_Buffer()` with a negative distance for `Point`, `MultiPoint`, `LineString`, and `MultiLineString` values, and for geometry collections not containing any `Polygon` or `MultiPolygon` values.

`ST_Buffer()` permits up to three optional strategy arguments following the distance argument. Strategies influence buffer computation. These arguments are byte string values produced by the `ST_Buffer_Strategy()` function, to be used for point, join, and end strategies:

- Point strategies apply to `Point` and `MultiPoint` geometries. If no point strategy is specified, the default is `ST_Buffer_Strategy('point_circle', 32)`.
- Join strategies apply to `LineString`, `MultiLineString`, `Polygon`, and `MultiPolygon` geometries. If no join strategy is specified, the default is `ST_Buffer_Strategy('join_round', 32)`.
- End strategies apply to `LineString` and `MultiLineString` geometries. If no end strategy is specified, the default is `ST_Buffer_Strategy('end_round', 32)`.

Up to one strategy of each type may be specified, and they may be given in any order. If multiple strategies of a given type are specified, an `ER_WRONG_ARGUMENTS` error occurs.

```
mysql> SET @pt = ST_GeomFromText('POINT(0 0)');
mysql> SET @pt_strategy = ST_Buffer_Strategy('point_square');
mysql> SELECT ST_AsText(ST_Buffer(@pt, 2, @pt_strategy));
+-----+
| ST_AsText(ST_Buffer(@pt, 2, @pt_strategy)) |
+-----+
| POLYGON((-2 -2,2 -2,2 2,-2 2,-2 -2))      |
+-----+
```

```
mysql> SET @ls = ST_GeomFromText('LINESTRING(0 0,0 5,5 5)');
mysql> SET @end_strategy = ST_Buffer_Strategy('end_flat');
mysql> SET @join_strategy = ST_Buffer_Strategy('join_round', 10);
mysql> SELECT ST_AsText(ST_Buffer(@ls, 5, @end_strategy, @join_strategy))
+-----+
```

```
| ST_AsText(ST_Buffer(@ls, 5, @end_strategy, @join_strategy)) |
+-----+
| POLYGON((5 5,5 10,0 10,-3.5355339059327373 8.535533905932738, |
| -5 5,-5 0,0 0,5 0,5 5)) |
+-----+
```

`ST_Buffer()` and `Buffer()` are synonyms.

- `ST_Buffer_Strategy(strategy [, points_per_circle])`

This function returns a strategy byte string for use with `ST_Buffer()` to influence buffer computation. If any argument is `NULL`, the return value is `NULL`. If any argument is invalid, an `ER_WRONG_ARGUMENTS` error occurs.

Information about strategies is available at [Boost.org](http://Boost.org).

The first argument must be a string indicating a strategy option:

- For point strategies, permitted values are `'point_circle'` and `'point_square'`.
- For join strategies, permitted values are `'join_round'` and `'join_miter'`.
- For end strategies, permitted values are `'end_round'` and `'end_flat'`.

If the first argument is `'point_circle'`, `'join_round'`, `'join_miter'`, or `'end_round'`, the `points_per_circle` argument must be given as a positive numeric value. The maximum `points_per_circle` value is the value of the `max_points_in_geometry` system variable. If the first argument is `'point_square'` or `'end_flat'`, the `points_per_circle` argument must not be given or an `ER_WRONG_ARGUMENTS` error occurs.

For examples, see the description of `ST_Buffer()`.

- `ST_ConvexHull(g)`

Returns a geometry that represents the convex hull of the geometry value `g`. If the argument is `NULL`, the return value is `NULL`.

This function computes a geometry's convex hull by first checking whether its vertex points are colinear. The function returns a linear hull if so, a polygon hull otherwise. This function processes geometry collections by extracting all vertex points of all components of the collection, creating a `MultiPoint` value from them, and computing its convex hull. If the argument is an empty geometry collection, the return value is `NULL`.

```
mysql> SET @g = 'MULTIPOINT(5 0,25 0,15 10,15 25)';
mysql> SELECT ST_AsText(ST_ConvexHull(ST_GeomFromText(@g)));
+-----+
| ST_AsText(ST_ConvexHull(ST_GeomFromText(@g))) |
+-----+
| POLYGON((5 0,25 0,15 25,5 0)) |
+-----+
```

`ST_ConvexHull()` and `ConvexHull()` are synonyms.

- `ST_Difference(g1, g2)`

Returns a geometry that represents the point set difference of the geometry values `g1` and `g2`. If any argument is `NULL`, the return value is `NULL`.

```
mysql> SET @g1 = Point(1,1), @g2 = Point(2,2);
mysql> SELECT ST_AsText(ST_Difference(@g1, @g2));
```

```

+-----+
| ST_AsText(ST_Difference(@g1, @g2)) |
+-----+
| POINT(1 1) |
+-----+
    
```

- `ST_Intersection(g1, g2)`

Returns a geometry that represents the point set intersection of the geometry values *g1* and *g2*. If any argument is `NULL`, the return value is `NULL`.

```

mysql> SET @g1 = ST_GeomFromText('LineString(1 1, 3 3)');
mysql> SET @g2 = ST_GeomFromText('LineString(1 3, 3 1)');
mysql> SELECT ST_AsText(ST_Intersection(@g1, @g2));
+-----+
| ST_AsText(ST_Intersection(@g1, @g2)) |
+-----+
| POINT(2 2) |
+-----+
    
```

- `ST_SymDifference(g1, g2)`

Returns a geometry that represents the point set symmetric difference of the geometry values *g1* and *g2*, which is defined as:

```
g1 symdifference g2 := (g1 union g2) difference (g1 intersection g2)
```

Or, in function call notation:

```
ST_SymDifference(g1, g2) = ST_Difference(ST_Union(g1, g2), ST_Intersection(g1, g2))
```

If any argument is `NULL`, the return value is `NULL`.

```

mysql> SET @g1 = ST_GeomFromText('MULTIPOINT(5 0,15 10,15 25)');
mysql> SET @g2 = ST_GeomFromText('MULTIPOINT(1 1,15 10,15 25)');
mysql> SELECT ST_AsText(ST_SymDifference(@g1, @g2));
+-----+
| ST_AsText(ST_SymDifference(@g1, @g2)) |
+-----+
| MULTIPOINT((1 1),(5 0)) |
+-----+
    
```

- `ST_Union(g1, g2)`

Returns a geometry that represents the point set union of the geometry values *g1* and *g2*. If any argument is `NULL`, the return value is `NULL`.

```

mysql> SET @g1 = ST_GeomFromText('LineString(1 1, 3 3)');
mysql> SET @g2 = ST_GeomFromText('LineString(1 3, 3 1)');
mysql> SELECT ST_AsText(ST_Union(@g1, @g2));
+-----+
| ST_AsText(ST_Union(@g1, @g2)) |
+-----+
| MULTILINESTRING((1 1,3 3),(1 3,3 1)) |
+-----+
    
```

## 12.16.9 Functions That Test Spatial Relations Between Geometry Objects

The functions described in this section take two geometries as arguments and return a qualitative or quantitative relation between them.

MySQL implements two sets of functions using function names defined by the OpenGIS specification. One set tests the relationship between two geometry values using precise object shapes, the other set uses object minimum bounding rectangles (MBRs).

There is also a MySQL-specific set of MBR-based functions available to test the relationship between two geometry values.

### 12.16.9.1 Spatial Relation Functions That Use Object Shapes

The OpenGIS specification defines the following functions to test the relationship between two geometry values *g1* and *g2*, using precise object shapes. The return values 1 and 0 indicate true and false, respectively, except for `ST_Distance()` and `Distance()`, which return distance values.

These functions support all argument type combinations except those that are inapplicable according to the Open Geospatial Consortium specification.

- `Crosses(g1, g2)`

`ST_Crosses()` and `Crosses()` are synonyms. For more information, see the description of `ST_Crosses()`.

`Crosses()` is deprecated; expect it to be removed in a future MySQL release. Use `ST_Crosses()` instead.

- `Distance(g1, g2)`

`ST_Distance()` and `Distance()` are synonyms. For more information, see the description of `ST_Distance()`.

`Distance()` is deprecated; expect it to be removed in a future MySQL release. Use `ST_Distance()` instead.

- `ST_Contains(g1, g2)`

Returns 1 or 0 to indicate whether *g1* completely contains *g2*. This tests the opposite relationship as `ST_Within()`.

- `ST_Crosses(g1, g2)`

The term *spatially crosses* denotes a spatial relation between two given geometries that has the following properties:

- The two geometries intersect.
- Their intersection results in a geometry that has a dimension that is one less than the maximum dimension of the two given geometries.
- Their intersection is not equal to either of the two given geometries.

This function returns 1 or 0 to indicate whether *g1* spatially crosses *g2*. If *g1* is a `Polygon` or a `MultiPolygon`, or if *g2* is a `Point` or a `MultiPoint`, the return value is `NULL`.

This function returns 0 if called with an inapplicable geometry argument type combination. For example, it returns 0 if the first argument is a `Polygon` or `MultiPolygon` and/or the second argument is a `Point` or `MultiPoint`.

Returns 1 if *g1* spatially crosses *g2*. Returns `NULL` if *g1* is a `Polygon` or a `MultiPolygon`, or if *g2* is a `Point` or a `MultiPoint`. Otherwise, returns 0.

This function returns 0 if called with an inapplicable geometry argument type combination. For example, it returns 0 if the first argument is a [Polygon](#) or [MultiPolygon](#) and/or the second argument is a [Point](#) or [MultiPoint](#).

`ST_Crosses()` and `Crosses()` are synonyms.

- `ST_Disjoint(g1, g2)`

Returns 1 or 0 to indicate whether `g1` is spatially disjoint from (does not intersect) `g2`.

- `ST_Distance(g1, g2)`

Returns the distance between `g1` and `g2`. If either argument is `NULL` or an empty geometry, the return value is `NULL`.

This function processes geometry collections by returning the shortest distance among all combinations of the components of the two geometry arguments.

If an intermediate or final result produces NaN or a negative number, an `ER_GIS_INVALID_DATA` error occurs.

```
mysql> SET @g1 = Point(1,1);
mysql> SET @g2 = Point(2,2);
mysql> SELECT ST_Distance(@g1, @g2);
+-----+
| ST_Distance(@g1, @g2) |
+-----+
| 1.4142135623730951 |
+-----+
```

`ST_Distance()` and `Distance()` are synonyms.

- `ST_Equals(g1, g2)`

Returns 1 or 0 to indicate whether `g1` is spatially equal to `g2`.

```
mysql> SET @g1 = Point(1,1), @g2 = Point(2,2);
mysql> SELECT ST_Equals(@g1, @g1), ST_Equals(@g1, @g2);
+-----+-----+
| ST_Equals(@g1, @g1) | ST_Equals(@g1, @g2) |
+-----+-----+
| 1 | 0 |
+-----+-----+
```

- `ST_Intersects(g1, g2)`

Returns 1 or 0 to indicate whether `g1` spatially intersects `g2`.

- `ST_Overlaps(g1, g2)`

Two geometries *spatially overlap* if they intersect and their intersection results in a geometry of the same dimension but not equal to either of the given geometries.

This function returns 1 or 0 to indicate whether `g1` spatially overlaps `g2`.

This function returns 0 if called with an inapplicable geometry argument type combination. For example, it returns 0 if called with geometries of different dimensions or any argument is a [Point](#).



- `ST_Touches(g1, g2)`

Two geometries *spatially touch* if their interiors do not intersect, but the boundary of one of the geometries intersects either the boundary or the interior of the other.

This function returns 1 or 0 to indicate whether `g1` spatially touches `g2`.

This function returns 0 if called with an inapplicable geometry argument type combination. For example, it returns 0 if either of the arguments is a `Point` or `MultiPoint`.

`ST_Touches()` and `Touches()` are synonyms.

- `ST_Within(g1, g2)`

Returns 1 or 0 to indicate whether `g1` is spatially within `g2`. This tests the opposite relationship as `ST_Contains()`.

- `Touches(g1, g2)`

`ST_Touches()` and `Touches()` are synonyms. For more information, see the description of `ST_Touches()`.

`Touches()` is deprecated; expect it to be removed in a future MySQL release. Use `ST_Touches()` instead.

### 12.16.9.2 Spatial Relation Functions That Use Minimum Bounding Rectangles

MySQL provides several MySQL-specific functions that test the relationship between minimum bounding rectangles (MBRs) of two geometries `g1` and `g2`. The return values 1 and 0 indicate true and false, respectively.

A corresponding set of MBR functions defined according to the OpenGIS specification is described later in this section.

- `MBRContains(g1, g2)`

Returns 1 or 0 to indicate whether the minimum bounding rectangle of `g1` contains the minimum bounding rectangle of `g2`. This tests the opposite relationship as `MBRWithin()`.

```
mysql> SET @g1 = ST_GeomFromText('Polygon((0 0,0 3,3 3,3 0,0 0))');
mysql> SET @g2 = ST_GeomFromText('Point(1 1)');
mysql> SELECT MBRContains(@g1,@g2), MBRWithin(@g2,@g1);
+-----+-----+
| MBRContains(@g1,@g2) | MBRWithin(@g2,@g1) |
+-----+-----+
| 1 | 1 |
+-----+-----+
```

`MBRContains()` and `Contains()` are synonyms.

- `MBRCoveredBy(g1, g2)`

Returns 1 or 0 to indicate whether the minimum bounding rectangle of `g1` is covered by the minimum bounding rectangle of `g2`. This tests the opposite relationship as `MBRCovers()`.

`MBRCoveredBy()` handles its arguments as follows:

- If either argument is `NULL` or an empty geometry, the return value is `NULL`.

- If either argument is not a syntactically well-formed geometry byte string, an `ER_GIS_INVALID_DATA` error occurs.
- Otherwise, the return value is non-`NULL`.

```
mysql> SET @g1 = ST_GeomFromText('Polygon((0 0,0 3,3 3,3 0,0 0))');
mysql> SET @g2 = ST_GeomFromText('Point(1 1)');
mysql> SELECT MBR Covers(@g1,@g2), MBRCoveredby(@g1,@g2);
+-----+-----+
| MBR Covers(@g1,@g2) | MBRCoveredby(@g1,@g2) |
+-----+-----+
| 1 | 0 |
+-----+-----+
mysql> SELECT MBR Covers(@g2,@g1), MBRCoveredby(@g2,@g1);
+-----+-----+
| MBR Covers(@g2,@g1) | MBRCoveredby(@g2,@g1) |
+-----+-----+
| 0 | 1 |
+-----+-----+
```

- `MBRCovers(g1, g2)`

Returns 1 or 0 to indicate whether the minimum bounding rectangle of *g1* covers the minimum bounding rectangle of *g2*. This tests the opposite relationship as `MBRCoveredBy()`. See the description of `MBRCoveredBy()` for examples.

`MBRCovers()` handles its arguments as follows:

- If either argument is `NULL` or an empty geometry, the return value is `NULL`.
  - If either argument is not a syntactically well-formed geometry byte string, an `ER_GIS_INVALID_DATA` error occurs.
  - Otherwise, the return value is non-`NULL`.
- `MBRDisjoint(g1, g2)`

Returns 1 or 0 to indicate whether the minimum bounding rectangles of the two geometries *g1* and *g2* are disjoint (do not intersect).

`MBRDisjoint()` and `Disjoint()` are synonyms.

- `MBREqual(g1, g2)`

Returns 1 or 0 to indicate whether the minimum bounding rectangles of the two geometries *g1* and *g2* are the same.

`MBREqual()` is deprecated; expect it to be removed in a future MySQL release. Use `MBREquals()` instead.

- `MBREquals(g1, g2)`

Returns 1 or 0 to indicate whether the minimum bounding rectangles of the two geometries *g1* and *g2* are the same.

`MBREquals()`, `MBREqual()`, and `Equals()` are synonyms.

- `MBRIntersects(g1, g2)`

Returns 1 or 0 to indicate whether the minimum bounding rectangles of the two geometries *g1* and *g2* intersect.

`MBRIntersects()` and `Intersects()` are synonyms.

- `MBROverlaps(g1, g2)`

Two geometries *spatially overlap* if they intersect and their intersection results in a geometry of the same dimension but not equal to either of the given geometries.

This function returns 1 or 0 to indicate whether the minimum bounding rectangles of the two geometries *g1* and *g2* overlap.

`MBROverlaps()` and `Overlaps()` are synonyms.

- `MBRTouches(g1, g2)`

Two geometries *spatially touch* if their interiors do not intersect, but the boundary of one of the geometries intersects either the boundary or the interior of the other.

This function returns 1 or 0 to indicate whether the minimum bounding rectangles of the two geometries *g1* and *g2* touch.

- `MBRWithin(g1, g2)`

Returns 1 or 0 to indicate whether the minimum bounding rectangle of *g1* is within the minimum bounding rectangle of *g2*. This tests the opposite relationship as `MBRContains()`.

```
mysql> SET @g1 = ST_GeomFromText('Polygon((0 0,0 3,3 3,3 0,0 0))');
mysql> SET @g2 = ST_GeomFromText('Polygon((0 0,0 5,5 5,5 0,0 0))');
mysql> SELECT MBRWithin(@g1,@g2), MBRWithin(@g2,@g1);
+-----+-----+
| MBRWithin(@g1,@g2) | MBRWithin(@g2,@g1) |
+-----+-----+
| 1 | 0 |
+-----+-----+
```

`MBRWithin()` and `Within()` are synonyms.

The OpenGIS specification defines the following functions that test the relationship between two geometry values *g1* and *g2*. The MySQL implementation uses minimum bounding rectangles, so these functions return the same result as the corresponding MBR-based functions described earlier in this section. The return values 1 and 0 indicate true and false, respectively.

These functions support all argument type combinations except those that are inapplicable according to the Open Geospatial Consortium specification.

- `Contains(g1, g2)`

`MBRContains()` and `Contains()` are synonyms. For more information, see the description of `MBRContains()`.

`Contains()` is deprecated; expect it to be removed in a future MySQL release. Use `MBRContains()` instead.

- `Disjoint(g1, g2)`

`MBRDisjoint()` and `Disjoint()` are synonyms. For more information, see the description of `MBRDisjoint()`.

`Disjoint()` is deprecated; expect it to be removed in a future MySQL release. Use `MBRDisjoint()` instead.

- `Equals(g1, g2)`

`MBREquals()` and `Equals()` are synonyms. For more information, see the description of `MBREquals()`.

`Equals()` is deprecated; expect it to be removed in a future MySQL release. Use `MBREquals()` instead.

- `Intersects(g1, g2)`

`MBRIntersects()` and `Intersects()` are synonyms. For more information, see the description of `MBRIntersects()`.

`Intersects()` is deprecated; expect it to be removed in a future MySQL release. Use `MBRIntersects()` instead.

- `Overlaps(g1, g2)`

`MBROverlaps()` and `Overlaps()` are synonyms. For more information, see the description of `MBROverlaps()`.

`Overlaps()` is deprecated; expect it to be removed in a future MySQL release. Use `MBROverlaps()` instead.

- `Within(g1, g2)`

`MBRWithin()` and `Within()` are synonyms. For more information, see the description of `MBRWithin()`.

`Within()` is deprecated; expect it to be removed in a future MySQL release. Use `MBRWithin()` instead.

## 12.16.10 Spatial Geohash Functions

Geohash is a system for encoding latitude and longitude coordinates of arbitrary precision into a text string. Geohash values are strings that contain only characters chosen from "0123456789bcdefghjkmnpqrstuvwxy".

The functions in this section enable manipulation of geohash values, which provides applications the capabilities of importing and exporting geohash data, and of indexing and searching geohash values.

- `ST_GeoHash(longitude, latitude, max_length)`, `ST_GeoHash(point, max_length)`

Returns a geohash string in the connection character set and collation.

If any argument is `NULL`, the return value is `NULL`. If any argument is invalid, an error occurs.

For the first syntax, the *longitude* must be a number in the range [-180, 180], and the *latitude* must be a number in the range [-90, 90]. For the second syntax, a `POINT` value is required, where the X and Y coordinates are in the valid ranges for longitude and latitude, respectively.

The resulting string is no longer than *max\_length* characters, which has an upper limit of 100. The string might be shorter than *max\_length* characters because the algorithm that creates the geohash value continues until it has created a string that is either an exact representation of the location or *max\_length* characters, whichever comes first.

```
mysql> SELECT ST_GeoHash(180,0,10), ST_GeoHash(-180,-90,15);
+-----+-----+
| ST_GeoHash(180,0,10) | ST_GeoHash(-180,-90,15) |
+-----+-----+
| xbpbbpbpbpb       | 0000000000000000       |
+-----+-----+
```

- `ST_LatFromGeoHash(geohash_str)`

Returns the latitude from a geohash string value, as a `DOUBLE` value in the range [-90, 90].

If the argument is `NULL`, the return value is `NULL`. If the argument is invalid, an error occurs.

The `ST_LatFromGeoHash()` decoding function reads no more than 433 characters from the *geohash\_str* argument. That represents the upper limit on information in the internal representation of coordinate values. Characters past the 433rd are ignored, even if they are otherwise illegal and produce an error.

```
mysql> SELECT ST_LatFromGeoHash(ST_GeoHash(45,-20,10));
+-----+
| ST_LatFromGeoHash(ST_GeoHash(45,-20,10)) |
+-----+
| -20 |
+-----+
```

- `ST_LongFromGeoHash(geohash_str)`

Returns the longitude from a geohash string value, as a `DOUBLE` value in the range [-180, 180].

If the argument is `NULL`, the return value is `NULL`. If the argument is invalid, an error occurs.

The remarks in the description of `ST_LatFromGeoHash()` regarding the maximum number of characters processed from the *geohash\_str* argument also apply to `ST_LongFromGeoHash()`.

```
mysql> SELECT ST_LongFromGeoHash(ST_GeoHash(45,-20,10));
+-----+
| ST_LongFromGeoHash(ST_GeoHash(45,-20,10)) |
+-----+
| 45 |
+-----+
```

- `ST_PointFromGeoHash(geohash_str, srid)`

Returns a `POINT` value containing the decoded geohash value, given a geohash string value.

The X and Y coordinates of the point are the longitude in the range [-180, 180] and the latitude in the range [-90, 90], respectively.

If any argument is `NULL`, the return value is `NULL`. If any argument is invalid, an error occurs.

The `srid` argument is an unsigned 32-bit integer.

The remarks in the description of `ST_LatFromGeoHash()` regarding the maximum number of characters processed from the `geohash_str` argument also apply to `ST_PointFromGeoHash()`.

```
mysql> SET @gh = ST_GeoHash(45,-20,10);
mysql> SELECT ST_AsText(ST_PointFromGeoHash(@gh,0));
+-----+
| ST_AsText(ST_PointFromGeoHash(@gh,0)) |
+-----+
| POINT(45 -20)                          |
+-----+
```

### 12.16.11 Spatial GeoJSON Functions

This section describes functions for converting between GeoJSON documents and spatial values. GeoJSON is an open standard for encoding geometric/geographical features. For more information, see <http://geojson.org>. The functions discussed here follow GeoJSON specification revision 1.0.

GeoJSON supports the same geometric/geographic data types that MySQL supports. Feature and FeatureCollection objects are not supported, except that geometry objects are extracted from them. CRS support is limited to values that identify an SRID.

MySQL also supports a native `JSON` data type and a set of SQL functions to enable operations on JSON values. For more information, see [Section 11.5, “The JSON Data Type”](#), and [Section 12.17, “JSON Functions”](#).

- `ST_AsGeoJSON(g [, max_dec_digits [, options]])`

Generates a GeoJSON object from the geometry `g`. The object string has the connection character set and collation.

If any argument is `NULL`, the return value is `NULL`. If any non-`NULL` argument is invalid, an error occurs.

`max_dec_digits`, if specified, limits the number of decimal digits for coordinates and causes rounding of output. If not specified, this argument defaults to its maximum value of  $2^{32} - 1$ . The minimum is 0.

`options`, if specified, is a bitmask. The following table shows the permitted flag values. If the geometry argument has an SRID of 0, no CRS object is produced even for those flag values that request one.

Flag Value	Meaning
0	No options. This is the default if <code>options</code> is not specified.
1	Add a bounding box to the output.
2	Add a short-format CRS URN to the output. The default format is a short format ( <code>EPSG:srid</code> ).

Flag Value	Meaning
4	Add a long-format CRS URN ( <code>urn:ogc:def:crs:EPSG::srid</code> ). This flag overrides flag 2. For example, option values of 5 and 7 mean the same (add a bounding box and a long-format CRS URN).

```
mysql> SELECT ST_AsGeoJSON(ST_GeomFromText('POINT(11.11111 12.22222)'),2);
+-----+
| ST_AsGeoJSON(ST_GeomFromText('POINT(11.11111 12.22222)'),2) |
+-----+
| {"type": "Point", "coordinates": [11.11, 12.22]} |
+-----+
```

- `ST_GeomFromGeoJSON(str [, options [, srid]])`

Parses a string *str* representing a GeoJSON object and returns a geometry.

If any argument is `NULL`, the return value is `NULL`. If any non-`NULL` argument is invalid, an error occurs.

*options*, if given, describes how to handle GeoJSON documents that contain geometries with coordinate dimensions higher than 2. The following table shows the permitted *options* values.

Option Value	Meaning
1	Reject the document and produce an error. This is the default if <i>options</i> is not specified.
2, 3, 4	Accept the document and strip off the coordinates for higher coordinate dimensions.

*options* values of 2, 3, and 4 currently produce the same effect. If geometries with coordinate dimensions higher than 2 are supported in the future, these values can be expected to produce different effects.

The *srid* argument, if given, must be a 32-bit unsigned integer. If not given, the geometry return value has an SRID of 4326.

GeoJSON geometry, feature, and feature collection objects may have a *crs* property. The parsing function parses named CRS URNs in the `urn:ogc:def:crs:EPSG::srid` and `EPSG:srid` namespaces, but not CRSs given as link objects. Also, `urn:ogc:def:crs:OGC:1.3:CRS84` is recognized as SRID 4326. If an object has a CRS that is not understood, an error occurs, with the exception that if the optional *srid* argument is given, any CRS is ignored even if it is invalid.

As specified in the GeoJSON specification, parsing is case-sensitive for the *type* member of the GeoJSON input (`Point`, `LineString`, and so forth). The specification is silent regarding case sensitivity for other parsing, which in MySQL is not case-sensitive.

This example shows the parsing result for a simple GeoJSON object:

```
mysql> SET @json = '{ "type": "Point", "coordinates": [102.0, 0.0] }';
mysql> SELECT ST_AsText(ST_GeomFromGeoJSON(@json));
+-----+
| ST_AsText(ST_GeomFromGeoJSON(@json)) |
+-----+
| POINT(102 0) |
+-----+
```

## 12.16.12 Spatial Convenience Functions

The functions in this section provide convenience operations on geometry values.

- `ST_Distance_Sphere(g1, g2 [, radius])`

Returns the minimum spherical distance between two points and/or multipoints on a sphere, in meters, or `NULL` if any geometry argument is `NULL` or empty.

Calculations use a spherical earth and a configurable radius. The optional `radius` argument should be given in meters. If omitted, the default radius is 6,370,986 meters. An `ER_WRONG_ARGUMENTS` error occurs if the `radius` argument is present but not positive.

The geometry arguments should consist of points that specify (longitude, latitude) coordinate values:

- Longitude and latitude are the first and second coordinates of the point, respectively.
- Both coordinates are in degrees.
- Longitude values must be in the range (-180, 180]. Positive values are east of the prime meridian.
- Latitude values must be in the range [-90, 90]. Positive values are north of the equator.

Supported argument combinations are (`Point`, `Point`), (`Point`, `MultiPoint`), and (`MultiPoint`, `Point`). An `ER_GIS_UNSUPPORTED_ARGUMENT` error occurs for other combinations.

If any geometry argument is not a syntactically well-formed geometry byte string, an `ER_GIS_INVALID_DATA` error occurs.

```
mysql> SET @pt1 = ST_GeomFromText('POINT(0 0)');
mysql> SET @pt2 = ST_GeomFromText('POINT(180 0)');
mysql> SELECT ST_Distance_Sphere(@pt1, @pt2);
+-----+
| ST_Distance_Sphere(@pt1, @pt2) |
+-----+
|                20015042.813723423 |
+-----+
```

- `ST_IsValid(g)`

Returns 1 if the argument is syntactically well-formed and is geometrically valid, 0 if the argument is not syntactically well-formed or is not geometrically valid. If the argument is `NULL`, the return value is `NULL`. Geometry validity is defined by the OGC specification.

The only valid empty geometry is represented in the form of an empty geometry collection value. `ST_IsValid()` returns 1 in this case.

`ST_IsValid()` works only for the Cartesian coordinate system and requires a geometry argument with an SRID of 0. An `ER_WRONG_ARGUMENTS` error occurs otherwise.

```
mysql> SET @ls1 = ST_GeomFromText('LINESTRING(0 0,-0.00 0,0.0 0)');
mysql> SET @ls2 = ST_GeomFromText('LINESTRING(0 0, 1 1)');
mysql> SELECT ST_IsValid(@ls1);
+-----+
| ST_IsValid(@ls1) |
+-----+
|                0 |
+-----+
mysql> SELECT ST_IsValid(@ls2);
+-----+
```



```
| ST_IsValid(@ls2) |
+-----+
|                1 |
+-----+
```

- `ST_MakeEnvelope(pt1, pt2)`

Returns the rectangle that forms the envelope around two points, as a [Point](#), [LineString](#), or [Polygon](#). If any argument is `NULL`, the return value is `NULL`.

Calculations are done using the Cartesian coordinate system rather than on a sphere, spheroid, or on earth.

Given two points `pt1` and `pt2`, `ST_MakeEnvelope()` creates the result geometry on an abstract plane like this:

- If `pt1` and `pt2` are equal, the result is the point `pt1`.
- Otherwise, if `(pt1, pt2)` is a vertical or horizontal line segment, the result is the line segment `(pt1, pt2)`.
- Otherwise, the result is a polygon using `pt1` and `pt2` as diagonal points.

The result geometry has an SRID of 0.

`ST_MakeEnvelope()` requires [Point](#) geometry arguments with an SRID of 0. An `ER_WRONG_ARGUMENTS` error occurs otherwise.

If any argument is not a syntactically well-formed geometry byte string, or if any coordinate value of the two points is infinite or `NaN`, an `ER_GIS_INVALID_DATA` error occurs.

```
mysql> SET @pt1 = ST_GeomFromText('POINT(0 0)');
mysql> SET @pt2 = ST_GeomFromText('POINT(1 1)');
mysql> SELECT ST_AsText(ST_MakeEnvelope(@pt1, @pt2));
+-----+
| ST_AsText(ST_MakeEnvelope(@pt1, @pt2)) |
+-----+
| POLYGON((0 0,1 0,1 1,0 1,0 0)) |
+-----+
```

- `ST_Simplify(g, max_distance)`

Simplifies a geometry using the Douglas-Peucker algorithm and returns a simplified value of the same type. If any argument is `NULL`, the return value is `NULL`.

The geometry may be any geometry type, although the Douglas-Peucker algorithm may not actually process every type. A geometry collection is processed by giving its components one by one to the simplification algorithm, and the returned geometries are put into a geometry collection as result.

The `max_distance` argument is the distance (in units of the input coordinates) of a vertex to other segments to be removed. Vertices within this distance of the simplified linestring are removed. If the `max_distance` argument is not positive, or is `NaN`, an `ER_WRONG_ARGUMENTS` error occurs.

According to Boost.Geometry, geometries might become invalid as a result of the simplification process, and the process might create self-intersections. To check the validity of the result, pass it to `ST_IsValid()`.

If the geometry argument is not a syntactically well-formed geometry byte string, an `ER_GIS_INVALID_DATA` error occurs.

```
mysql> SET @g = ST_GeomFromText('LINESTRING(0 0,0 1,1 1,1 2,2 2,2 3,3 3)');
mysql> SELECT ST_AsText(ST_Simplify(@g, 0.5));
+-----+
| ST_AsText(ST_Simplify(@g, 0.5)) |
+-----+
| LINESTRING(0 0,0 1,1 2 3,3 3) |
+-----+
mysql> SELECT ST_AsText(ST_Simplify(@g, 1.0));
+-----+
| ST_AsText(ST_Simplify(@g, 1.0)) |
+-----+
| LINESTRING(0 0,3 3) |
+-----+
```

- `ST_Validate(g)`

Validates a geometry according to the OGC specification. A geometry can be syntactically well-formed (WKB value plus SRID) but geometrically invalid. For example, this polygon is geometrically invalid: `POLYGON((0 0, 0 0, 0 0, 0 0, 0 0))`

`ST_Validate()` returns the geometry if it is syntactically well-formed and is geometrically valid, `NULL` if the argument is not syntactically well-formed or is not geometrically valid or is `NULL`.

`ST_Validate()` can be used to filter out invalid geometry data, although at a cost. For applications that require more precise results not tainted by invalid data, this penalty may be worthwhile.

If the geometry argument is valid, it is returned as is, except that if an input `Polygon` or `MultiPolygon` has clockwise rings, those rings are reversed before checking for validity. If the geometry is valid, the value with the reversed rings is returned.

The only valid empty geometry is represented in the form of an empty geometry collection value. `ST_Validate()` returns it directly without further checks in this case.

`ST_Validate()` works only for the Cartesian coordinate system and requires a geometry argument with an SRID of 0. An `ER_WRONG_ARGUMENTS` error occurs otherwise.

```
mysql> SET @ls1 = ST_GeomFromText('LINESTRING(0 0)');
mysql> SET @ls2 = ST_GeomFromText('LINESTRING(0 0, 1 1)');
mysql> SELECT ST_AsText(ST_Validate(@ls1));
```

```

+-----+
| ST_AsText(ST_Validate(@ls1)) |
+-----+
| NULL |
+-----+
mysql> SELECT ST_AsText(ST_Validate(@ls2));
+-----+
| ST_AsText(ST_Validate(@ls2)) |
+-----+
| LINESTRING(0 0,1 1) |
+-----+

```

## 12.17 JSON Functions

The functions described in this section perform operations on JSON values. For discussion of the `JSON` data type and additional examples showing how to use these functions, see [Section 11.5, “The JSON Data Type”](#).

For functions that take a JSON argument, an error occurs if the argument is not a valid JSON value. Arguments parsed as JSON are indicated by `json_doc`; arguments indicated by `val` are not parsed.

Functions that return JSON values always perform normalization of these values (see [Normalization, Merging, and Autowrapping of JSON Values](#)), and thus orders them. *The precise outcome of the sort is subject to change at any time; do not rely on it to be consistent between releases.*

Unless otherwise indicated, the JSON functions were added in MySQL 5.7.8.

A set of spatial functions for operating on GeoJSON values is also available. See [Section 12.16.11, “Spatial GeoJSON Functions”](#).

### 12.17.1 JSON Function Reference

**Table 12.22 JSON Functions**

Name	Description	Introduced	Deprecated
<code>-&gt;</code>	Return value from JSON column after evaluating path; equivalent to <code>JSON_EXTRACT()</code> .		
<code>-&gt;&gt;</code>	Return value from JSON column after evaluating path and unquoting the result; equivalent to <code>JSON_UNQUOTE(JSON_EXTRACT())</code> .	5.7.13	
<code>JSON_APPEND()</code>	Append data to JSON document		Yes
<code>JSON_ARRAY()</code>	Create JSON array		
<code>JSON_ARRAY_APPEND()</code>	Append data to JSON document		
<code>JSON_ARRAY_INSERT()</code>	Insert into JSON array		
<code>JSON_CONTAINS()</code>	Whether JSON document contains specific object at path		

## JSON Function Reference

Name	Description	Introduced	Deprecated
<code>JSON_CONTAINS_PATH()</code>	Whether JSON document contains any data at path		
<code>JSON_DEPTH()</code>	Maximum depth of JSON document		
<code>JSON_EXTRACT()</code>	Return data from JSON document		
<code>JSON_INSERT()</code>	Insert data into JSON document		
<code>JSON_KEYS()</code>	Array of keys from JSON document		
<code>JSON_LENGTH()</code>	Number of elements in JSON document		
<code>JSON_MERGE()</code>	Merge JSON documents, preserving duplicate keys. Deprecated synonym for <code>JSON_MERGE_PRESERVE()</code>		5.7.22
<code>JSON_MERGE_PATCH()</code>	Merge JSON documents, replacing values of duplicate keys	5.7.22	
<code>JSON_MERGE_PRESERVE()</code>	Merge JSON documents, preserving duplicate keys	5.7.22	
<code>JSON_OBJECT()</code>	Create JSON object		
<code>JSON_PRETTY()</code>	Print a JSON document in human-readable format	5.7.22	
<code>JSON_QUOTE()</code>	Quote JSON document		
<code>JSON_REMOVE()</code>	Remove data from JSON document		
<code>JSON_REPLACE()</code>	Replace values in JSON document		
<code>JSON_SEARCH()</code>	Path to value within JSON document		
<code>JSON_SET()</code>	Insert data into JSON document		
<code>JSON_STORAGE_SIZE()</code>	Space used for storage of binary representation of a JSON document	5.7.22	
<code>JSON_TYPE()</code>	Type of JSON value		
<code>JSON_UNQUOTE()</code>	Unquote JSON value		
<code>JSON_VALID()</code>	Whether JSON value is valid		

MySQL 5.7.22 and later supports two aggregate JSON functions `JSON_ARRAYAGG()` and `JSON_OBJECTAGG()`. See [Section 12.19, “Aggregate Functions”](#), for descriptions of these.

Also beginning with MySQL 5.7.22:

- “pretty-printing” of JSON values in an easy-to-read format can be obtained using the `JSON_PRETTY()` function.
- You can see how much storage space a given JSON value takes up using `JSON_STORAGE_SIZE()`.

For complete descriptions of these two functions, see [Section 12.17.6, “JSON Utility Functions”](#).

## 12.17.2 Functions That Create JSON Values

The functions listed in this section compose JSON values from component elements.

- `JSON_ARRAY([val[, val] ...])`

Evaluates a (possibly empty) list of values and returns a JSON array containing those values.

```
mysql> SELECT JSON_ARRAY(1, "abc", NULL, TRUE, CURTIME());
+-----+
| JSON_ARRAY(1, "abc", NULL, TRUE, CURTIME()) |
+-----+
| [1, "abc", null, true, "11:30:24.000000"] |
+-----+
```

- `JSON_OBJECT([key, val[, key, val] ...])`

Evaluates a (possibly empty) list of key-value pairs and returns a JSON object containing those pairs. An error occurs if any key name is `NULL` or the number of arguments is odd.

```
mysql> SELECT JSON_OBJECT('id', 87, 'name', 'carrot');
+-----+
| JSON_OBJECT('id', 87, 'name', 'carrot') |
+-----+
| {"id": 87, "name": "carrot"} |
+-----+
```

- `JSON_QUOTE(string)`

Quotes a string as a JSON value by wrapping it with double quote characters and escaping interior quote and other characters, then returning the result as a `utf8mb4` string. Returns `NULL` if the argument is `NULL`.

This function is typically used to produce a valid JSON string literal for inclusion within a JSON document.

Certain special characters are escaped with backslashes per the escape sequences shown in [Table 12.23, “JSON\\_UNQUOTE\(\) Special Character Escape Sequences”](#).

```
mysql> SELECT JSON_QUOTE('null'), JSON_QUOTE('"null"');
+-----+
| JSON_QUOTE('null') | JSON_QUOTE('"null"') |
+-----+
| "null" | "\"null\"" |
+-----+
mysql> SELECT JSON_QUOTE('[1, 2, 3]');
+-----+
| JSON_QUOTE('[1, 2, 3]') |
+-----+
| "[1, 2, 3]" |
+-----+
```

You can also obtain JSON values by casting values of other types to the `JSON` type using `CAST(value AS JSON)`; see [Converting between JSON and non-JSON values](#), for more information.

Two aggregate functions generating JSON values are available (MySQL 5.7.22 and later). `JSON_ARRAYAGG()` returns a result set as a single JSON array, and `JSON_OBJECTAGG()` returns a result set as a single JSON object. For more information, see [Section 12.19, “Aggregate Functions”](#).

### 12.17.3 Functions That Search JSON Values

The functions in this section perform search operations on JSON values to extract data from them, report whether data exists at a location within them, or report the path to data within them.

- `JSON_CONTAINS(target, candidate[, path])`

Indicates by returning 1 or 0 whether a given *candidate* JSON document is contained within a *target* JSON document, or—if a *path* argument was supplied—whether the candidate is found at a specific path within the target. Returns `NULL` if any argument is `NULL`, or if the path argument does not identify a section of the target document. An error occurs if *target* or *candidate* is not a valid JSON document, or if the *path* argument is not a valid path expression or contains a `*` or `**` wildcard.

To check only whether any data exists at the path, use `JSON_CONTAINS_PATH()` instead.

The following rules define containment:

- A candidate scalar is contained in a target scalar if and only if they are comparable and are equal. Two scalar values are comparable if they have the same `JSON_TYPE()` types, with the exception that values of types `INTEGER` and `DECIMAL` are also comparable to each other.
- A candidate array is contained in a target array if and only if every element in the candidate is contained in some element of the target.
- A candidate nonarray is contained in a target array if and only if the candidate is contained in some element of the target.
- A candidate object is contained in a target object if and only if for each key in the candidate there is a key with the same name in the target and the value associated with the candidate key is contained in the value associated with the target key.

Otherwise, the candidate value is not contained in the target document.

```
mysql> SET @j = '{"a": 1, "b": 2, "c": {"d": 4}}';
mysql> SET @j2 = '1';
mysql> SELECT JSON_CONTAINS(@j, @j2, '$.a');
+-----+
| JSON_CONTAINS(@j, @j2, '$.a') |
+-----+
|                               1 |
+-----+
mysql> SELECT JSON_CONTAINS(@j, @j2, '$.b');
+-----+
| JSON_CONTAINS(@j, @j2, '$.b') |
+-----+
|                               0 |
+-----+

mysql> SET @j2 = '{"d": 4}';
mysql> SELECT JSON_CONTAINS(@j, @j2, '$.a');
+-----+
| JSON_CONTAINS(@j, @j2, '$.a') |
+-----+
```

```

|          0 |
+-----+
mysql> SELECT JSON_CONTAINS(@j, @j2, '$.c');
+-----+
| JSON_CONTAINS(@j, @j2, '$.c') |
+-----+
|          1 |
+-----+
    
```

- `JSON_CONTAINS_PATH(json_doc, one_or_all, path[, path] ...)`

Returns 0 or 1 to indicate whether a JSON document contains data at a given path or paths. Returns `NULL` if any argument is `NULL`. An error occurs if the `json_doc` argument is not a valid JSON document, any `path` argument is not a valid path expression, or `one_or_all` is not 'one' or 'all'.

To check for a specific value at a path, use `JSON_CONTAINS()` instead.

The return value is 0 if no specified path exists within the document. Otherwise, the return value depends on the `one_or_all` argument:

- 'one': 1 if at least one path exists within the document, 0 otherwise.
- 'all': 1 if all paths exist within the document, 0 otherwise.

```

mysql> SET @j = '{"a": 1, "b": 2, "c": {"d": 4}}';
mysql> SELECT JSON_CONTAINS_PATH(@j, 'one', '$.a', '$.e');
+-----+
| JSON_CONTAINS_PATH(@j, 'one', '$.a', '$.e') |
+-----+
|          1 |
+-----+
mysql> SELECT JSON_CONTAINS_PATH(@j, 'all', '$.a', '$.e');
+-----+
| JSON_CONTAINS_PATH(@j, 'all', '$.a', '$.e') |
+-----+
|          0 |
+-----+
mysql> SELECT JSON_CONTAINS_PATH(@j, 'one', '$.c.d');
+-----+
| JSON_CONTAINS_PATH(@j, 'one', '$.c.d') |
+-----+
|          1 |
+-----+
mysql> SELECT JSON_CONTAINS_PATH(@j, 'one', '$.a.d');
+-----+
| JSON_CONTAINS_PATH(@j, 'one', '$.a.d') |
+-----+
|          0 |
+-----+
    
```

- `JSON_EXTRACT(json_doc, path[, path] ...)`

Returns data from a JSON document, selected from the parts of the document matched by the `path` arguments. Returns `NULL` if any argument is `NULL` or no paths locate a value in the document. An error occurs if the `json_doc` argument is not a valid JSON document or any `path` argument is not a valid path expression.

The return value consists of all values matched by the `path` arguments. If it is possible that those arguments could return multiple values, the matched values are autowrapped as an array, in the order corresponding to the paths that produced them. Otherwise, the return value is the single matched value.

```

mysql> SELECT JSON_EXTRACT('[10, 20, [30, 40]]', '$[1]');
+-----+
    
```

```

| JSON_EXTRACT('[10, 20, [30, 40]]', '$[1]') |
+-----+
| 20 |
+-----+
mysql> SELECT JSON_EXTRACT('[10, 20, [30, 40]]', '$[1]', '$[0]');
+-----+
| JSON_EXTRACT('[10, 20, [30, 40]]', '$[1]', '$[0]') |
+-----+
| [20, 10] |
+-----+
mysql> SELECT JSON_EXTRACT('[10, 20, [30, 40]]', '$[2][*]');
+-----+
| JSON_EXTRACT('[10, 20, [30, 40]]', '$[2][*]') |
+-----+
| [30, 40] |
+-----+

```

MySQL 5.7.9 and later supports the `->` operator as shorthand for this function as used with 2 arguments where the left hand side is a `JSON` column identifier (not an expression) and the right hand side is the JSON path to be matched within the column.

- `column->path`

In MySQL 5.7.9 and later, the `->` operator serves as an alias for the `JSON_EXTRACT()` function when used with two arguments, a column identifier on the left and a JSON path (a string literal) on the right that is evaluated against the JSON document (the column value). You can use such expressions in place of column references wherever they occur in SQL statements.

The two `SELECT` statements shown here produce the same output:

```

mysql> SELECT c, JSON_EXTRACT(c, "$.id"), g
> FROM jemp
> WHERE JSON_EXTRACT(c, "$.id") > 1
> ORDER BY JSON_EXTRACT(c, "$.name");
+-----+-----+-----+
| c | c->"$.id" | g |
+-----+-----+-----+
| {"id": "3", "name": "Barney"} | "3" | 3 |
| {"id": "4", "name": "Betty"} | "4" | 4 |
| {"id": "2", "name": "Wilma"} | "2" | 2 |
+-----+-----+-----+
3 rows in set (0.00 sec)

mysql> SELECT c, c->"$.id", g
> FROM jemp
> WHERE c->"$.id" > 1
> ORDER BY c->"$.name";
+-----+-----+-----+
| c | c->"$.id" | g |
+-----+-----+-----+
| {"id": "3", "name": "Barney"} | "3" | 3 |
| {"id": "4", "name": "Betty"} | "4" | 4 |
| {"id": "2", "name": "Wilma"} | "2" | 2 |
+-----+-----+-----+
3 rows in set (0.00 sec)

```

This functionality is not limited to `SELECT`, as shown here:

```

mysql> ALTER TABLE jemp ADD COLUMN n INT;
Query OK, 0 rows affected (0.68 sec)
Records: 0 Duplicates: 0 Warnings: 0

mysql> UPDATE jemp SET n=1 WHERE c->"$.id" = "4";
Query OK, 1 row affected (0.04 sec)

```



```

Rows matched: 1  Changed: 1  Warnings: 0

mysql> SELECT c, c->"$.id", g, n
> FROM jemp
> WHERE JSON_EXTRACT(c, "$.id") > 1
> ORDER BY c->"$.name";
+-----+-----+-----+-----+
| c                | c->"$.id" | g  | n  |
+-----+-----+-----+-----+
| {"id": "3", "name": "Barney"} | "3"      | 3  | NULL |
| {"id": "4", "name": "Betty"}   | "4"      | 4  | 1    |
| {"id": "2", "name": "Wilma"}   | "2"      | 2  | NULL |
+-----+-----+-----+-----+
3 rows in set (0.00 sec)

mysql> DELETE FROM jemp WHERE c->"$.id" = "4";
Query OK, 1 row affected (0.04 sec)

mysql> SELECT c, c->"$.id", g, n
> FROM jemp
> WHERE JSON_EXTRACT(c, "$.id") > 1
> ORDER BY c->"$.name";
+-----+-----+-----+-----+
| c                | c->"$.id" | g  | n  |
+-----+-----+-----+-----+
| {"id": "3", "name": "Barney"} | "3"      | 3  | NULL |
| {"id": "2", "name": "Wilma"}   | "2"      | 2  | NULL |
+-----+-----+-----+-----+
2 rows in set (0.00 sec)
    
```

(See [Indexing a Generated Column to Provide a JSON Column Index](#), for the statements used to create and populate the table just shown.)

This also works with JSON array values, as shown here:

```

mysql> CREATE TABLE tj10 (a JSON, b INT);
Query OK, 0 rows affected (0.26 sec)

mysql> INSERT INTO tj10
> VALUES ("[3,10,5,17,44]", 33), ("[3,10,5,17,[22,44,66]]", 0);
Query OK, 1 row affected (0.04 sec)

mysql> SELECT a->"$[4]" FROM tj10;
+-----+
| a->"$[4]" |
+-----+
| 44        |
| [22, 44, 66] |
+-----+
2 rows in set (0.00 sec)

mysql> SELECT * FROM tj10 WHERE a->"$[0]" = 3;
+-----+-----+
| a                | b  |
+-----+-----+
| [3, 10, 5, 17, 44] | 33 |
| [3, 10, 5, 17, [22, 44, 66]] | 0  |
+-----+-----+
2 rows in set (0.00 sec)
    
```

Nested arrays are supported. An expression using `->` evaluates as `NULL` if no matching key is found in the target JSON document, as shown here:

```

mysql> SELECT * FROM tj10 WHERE a->"$[4][1]" IS NOT NULL;
+-----+-----+
| a                | b  |
+-----+-----+
    
```

```

+-----+-----+
| [3, 10, 5, 17, [22, 44, 66]] | 0 |
+-----+-----+

mysql> SELECT a->"${4}[1]" FROM tj10;
+-----+
| a->"${4}[1]" |
+-----+
| NULL        |
| 44          |
+-----+
2 rows in set (0.00 sec)

```

This is the same behavior as seen in such cases when using `JSON_EXTRACT()`:

```

mysql> SELECT JSON_EXTRACT(a, "${4}[1]") FROM tj10;
+-----+
| JSON_EXTRACT(a, "${4}[1]") |
+-----+
| NULL                        |
| 44                          |
+-----+
2 rows in set (0.00 sec)

```

- `column->>path`

This is an improved, unquoting extraction operator available in MySQL 5.7.13 and later. Whereas the `->` operator simply extracts a value, the `->>` operator in addition unquotes the extracted result. In other words, given a `JSON` column value `column` and a path expression `path` (a string literal), the following three expressions return the same value:

- `JSON_UNQUOTE( JSON_EXTRACT(column, path) )`
- `JSON_UNQUOTE( column -> path )`
- `column->>path`

The `->>` operator can be used wherever `JSON_UNQUOTE( JSON_EXTRACT( ) )` would be allowed. This includes (but is not limited to) `SELECT` lists, `WHERE` and `HAVING` clauses, and `ORDER BY` and `GROUP BY` clauses.

The next few statements demonstrate some `->>` operator equivalences with other expressions in the `mysql` client:

```

mysql> SELECT * FROM jemp WHERE g > 2;
+-----+-----+
| c                | g |
+-----+-----+
| {"id": "3", "name": "Barney"} | 3 |
| {"id": "4", "name": "Betty"}  | 4 |
+-----+-----+
2 rows in set (0.01 sec)

mysql> SELECT c->'$.name' AS name
->      FROM jemp WHERE g > 2;
+-----+
| name      |
+-----+
| "Barney"  |
| "Betty"   |
+-----+
2 rows in set (0.00 sec)

```

```
mysql> SELECT JSON_UNQUOTE(c->'$.name') AS name
->      FROM jemp WHERE g > 2;
+-----+
| name  |
+-----+
| Barney|
| Betty |
+-----+
2 rows in set (0.00 sec)

mysql> SELECT c->>'$.name' AS name
->      FROM jemp WHERE g > 2;
+-----+
| name  |
+-----+
| Barney|
| Betty |
+-----+
2 rows in set (0.00 sec)
```

See [Indexing a Generated Column to Provide a JSON Column Index](#), for the SQL statements used to create and populate the `jemp` table in the set of examples just shown.

This operator can also be used with JSON arrays, as shown here:

```
mysql> CREATE TABLE tj10 (a JSON, b INT);
Query OK, 0 rows affected (0.26 sec)

mysql> INSERT INTO tj10 VALUES
->      ('[3,10,5,"x",44]', 33),
->      ('[3,10,5,17,[22,"y",66]]', 0);
Query OK, 2 rows affected (0.04 sec)
Records: 2 Duplicates: 0 Warnings: 0

mysql> SELECT a->"$[3]", a->"$[4][1]" FROM tj10;
+-----+-----+
| a->"$[3]" | a->"$[4][1]" |
+-----+-----+
| "x"      | NULL         |
| 17       | "y"         |
+-----+-----+
2 rows in set (0.00 sec)

mysql> SELECT a->>"$[3]", a->>"$[4][1]" FROM tj10;
+-----+-----+
| a->>"$[3]" | a->>"$[4][1]" |
+-----+-----+
| x         | NULL         |
| 17        | y           |
+-----+-----+
2 rows in set (0.00 sec)
```

As with `->`, the `->>` operator is always expanded in the output of `EXPLAIN`, as the following example demonstrates:

```
mysql> EXPLAIN SELECT c->>'$.name' AS name
->      FROM jemp WHERE g > 2\G
***** 1. row *****
      id: 1
  select_type: SIMPLE
        table: jemp
  partitions: NULL
         type: range
possible_keys: i
          key: i
         key_len: 5
```

```

        ref: NULL
        rows: 2
        filtered: 100.00
        Extra: Using where
1 row in set, 1 warning (0.00 sec)

mysql> SHOW WARNINGS\G
***** 1. row *****
Level: Note
Code: 1003
Message: /* select#1 */ select
json_unquote(json_extract(`jtest`.`jemp`.`c`, '$.name')) AS `name` from
`jtest`.`jemp` where (`jtest`.`jemp`.`g` > 2)
1 row in set (0.00 sec)

```

This is similar to how MySQL expands the `->` operator in the same circumstances.

The `->>` operator was added in MySQL 5.7.13.

- `JSON_KEYS(json_doc[, path])`

Returns the keys from the top-level value of a JSON object as a JSON array, or, if a `path` argument is given, the top-level keys from the selected path. Returns `NULL` if any argument is `NULL`, the `json_doc` argument is not an object, or `path`, if given, does not locate an object. An error occurs if the `json_doc` argument is not a valid JSON document or the `path` argument is not a valid path expression or contains a `*` or `**` wildcard.

The result array is empty if the selected object is empty. If the top-level value has nested subobjects, the return value does not include keys from those subobjects.

```

mysql> SELECT JSON_KEYS('{ "a": 1, "b": { "c": 30 } }');
+-----+
| JSON_KEYS('{ "a": 1, "b": { "c": 30 } }') |
+-----+
| ["a", "b"]                               |
+-----+
mysql> SELECT JSON_KEYS('{ "a": 1, "b": { "c": 30 } }', '$.b');
+-----+
| JSON_KEYS('{ "a": 1, "b": { "c": 30 } }', '$.b') |
+-----+
| ["c"]                                           |
+-----+

```

- `JSON_SEARCH(json_doc, one_or_all, search_str[, escape_char[, path] ...])`

Returns the path to the given string within a JSON document. Returns `NULL` if any of the `json_doc`, `search_str`, or `path` arguments are `NULL`; no `path` exists within the document; or `search_str` is not found. An error occurs if the `json_doc` argument is not a valid JSON document, any `path` argument is

not a valid path expression, `one_or_all` is not `'one'` or `'all'`, or `escape_char` is not a constant expression.

The `one_or_all` argument affects the search as follows:

- `'one'`: The search terminates after the first match and returns one path string. It is undefined which match is considered first.
- `'all'`: The search returns all matching path strings such that no duplicate paths are included. If there are multiple strings, they are autowrapped as an array. The order of the array elements is undefined.

Within the `search_str` search string argument, the `%` and `_` characters work as for the `LIKE` operator: `%` matches any number of characters (including zero characters), and `_` matches exactly one character.

To specify a literal `%` or `_` character in the search string, precede it by the escape character. The default is `\` if the `escape_char` argument is missing or `NULL`. Otherwise, `escape_char` must be a constant that is empty or one character.

For more information about matching and escape character behavior, see the description of `LIKE` in [Section 12.8.1, “String Comparison Functions and Operators”](#). For escape character handling, a difference from the `LIKE` behavior is that the escape character for `JSON_SEARCH()` must evaluate to a constant at compile time, not just at execution time. For example, if `JSON_SEARCH()` is used in a prepared statement and the `escape_char` argument is supplied using a `?` parameter, the parameter value might be constant at execution time, but is not at compile time.

`search_str` and `path` are always interpreted as utf8mb4 strings, regardless of their actual encoding. This is a known issue which is fixed in MySQL 8.0 ( Bug #32449181).

```
mysql> SET @j = '["abc", [{"k": "10"}, "def"], {"x": "abc"}, {"y": "bcd"}]';

mysql> SELECT JSON_SEARCH(@j, 'one', 'abc');
+-----+
| JSON_SEARCH(@j, 'one', 'abc') |
+-----+
| "$[0]"                          |
+-----+

mysql> SELECT JSON_SEARCH(@j, 'all', 'abc');
+-----+
| JSON_SEARCH(@j, 'all', 'abc') |
+-----+
| ["$[0]", "$[2].x"]           |
+-----+

mysql> SELECT JSON_SEARCH(@j, 'all', 'ghi');
+-----+
| JSON_SEARCH(@j, 'all', 'ghi') |
+-----+
| NULL                          |
+-----+

mysql> SELECT JSON_SEARCH(@j, 'all', '10');
+-----+
| JSON_SEARCH(@j, 'all', '10') |
+-----+
| "$[1][0].k"                  |
+-----+

mysql> SELECT JSON_SEARCH(@j, 'all', '10', NULL, '$');
+-----+
| JSON_SEARCH(@j, 'all', '10', NULL, '$') |
+-----+
```

## Functions That Search JSON Values

```
| "$[1][0].k" |
+-----+
mysql> SELECT JSON_SEARCH(@j, 'all', '10', NULL, '$[*]');
+-----+
| JSON_SEARCH(@j, 'all', '10', NULL, '$[*]') |
+-----+
| "$[1][0].k" |
+-----+

mysql> SELECT JSON_SEARCH(@j, 'all', '10', NULL, '$**.k');
+-----+
| JSON_SEARCH(@j, 'all', '10', NULL, '$**.k') |
+-----+
| "$[1][0].k" |
+-----+

mysql> SELECT JSON_SEARCH(@j, 'all', '10', NULL, '$[*][0].k');
+-----+
| JSON_SEARCH(@j, 'all', '10', NULL, '$[*][0].k') |
+-----+
| "$[1][0].k" |
+-----+

mysql> SELECT JSON_SEARCH(@j, 'all', '10', NULL, '$[1]');
+-----+
| JSON_SEARCH(@j, 'all', '10', NULL, '$[1]') |
+-----+
| "$[1][0].k" |
+-----+

mysql> SELECT JSON_SEARCH(@j, 'all', '10', NULL, '$[1][0]');
+-----+
| JSON_SEARCH(@j, 'all', '10', NULL, '$[1][0]') |
+-----+
| "$[1][0].k" |
+-----+

mysql> SELECT JSON_SEARCH(@j, 'all', 'abc', NULL, '$[2]');
+-----+
| JSON_SEARCH(@j, 'all', 'abc', NULL, '$[2]') |
+-----+
| "$[2].x" |
+-----+

mysql> SELECT JSON_SEARCH(@j, 'all', '%a%');
+-----+
| JSON_SEARCH(@j, 'all', '%a%') |
+-----+
| ["$[0]", "$[2].x"] |
+-----+

mysql> SELECT JSON_SEARCH(@j, 'all', '%b%');
+-----+
| JSON_SEARCH(@j, 'all', '%b%') |
+-----+
| ["$[0]", "$[2].x", "$[3].y"] |
+-----+

mysql> SELECT JSON_SEARCH(@j, 'all', '%b%', NULL, '$[0]');
+-----+
| JSON_SEARCH(@j, 'all', '%b%', NULL, '$[0]') |
+-----+
| "$[0]" |
+-----+

mysql> SELECT JSON_SEARCH(@j, 'all', '%b%', NULL, '$[2]');
```

```

+-----+
| JSON_SEARCH(@j, 'all', '%b%', NULL, '${2}') |
+-----+
| "${2}.x" |
+-----+

mysql> SELECT JSON_SEARCH(@j, 'all', '%b%', NULL, '${1}');
+-----+
| JSON_SEARCH(@j, 'all', '%b%', NULL, '${1}') |
+-----+
| NULL |
+-----+

mysql> SELECT JSON_SEARCH(@j, 'all', '%b%', '', '${1}');
+-----+
| JSON_SEARCH(@j, 'all', '%b%', '', '${1}') |
+-----+
| NULL |
+-----+

mysql> SELECT JSON_SEARCH(@j, 'all', '%b%', '', '${3}');
+-----+
| JSON_SEARCH(@j, 'all', '%b%', '', '${3}') |
+-----+
| "${3}.y" |
+-----+
    
```

For more information about the JSON path syntax supported by MySQL, including rules governing the wildcard operators `*` and `**`, see [JSON Path Syntax](#).

## 12.17.4 Functions That Modify JSON Values

The functions in this section modify JSON values and return the result.

- `JSON_APPEND(json_doc, path, val[, path, val] ...)`

Appends values to the end of the indicated arrays within a JSON document and returns the result. This function was renamed to `JSON_ARRAY_APPEND()` in MySQL 5.7.9; the alias `JSON_APPEND()` is now deprecated in MySQL 5.7, and is removed in MySQL 8.0.

- `JSON_ARRAY_APPEND(json_doc, path, val[, path, val] ...)`

Appends values to the end of the indicated arrays within a JSON document and returns the result. Returns `NULL` if any argument is `NULL`. An error occurs if the `json_doc` argument is not a valid JSON document or any `path` argument is not a valid path expression or contains a `*` or `**` wildcard.

The path-value pairs are evaluated left to right. The document produced by evaluating one pair becomes the new value against which the next pair is evaluated.

If a path selects a scalar or object value, that value is autowrapped within an array and the new value is added to that array. Pairs for which the path does not identify any value in the JSON document are ignored.

```

mysql> SET @j = '{"a", ["b", "c"], "d"}';
mysql> SELECT JSON_ARRAY_APPEND(@j, '${1}', 1);
+-----+
| JSON_ARRAY_APPEND(@j, '${1}', 1) |
+-----+
| [{"a", ["b", "c", 1], "d"} |
+-----+

mysql> SELECT JSON_ARRAY_APPEND(@j, '${0}', 2);
+-----+
| JSON_ARRAY_APPEND(@j, '${0}', 2) |
    
```

```

+-----+
| [{"a", 2}, {"b", "c"}, "d"] |
+-----+
mysql> SELECT JSON_ARRAY_APPEND(@j, '$[1][0]', 3);
+-----+
| JSON_ARRAY_APPEND(@j, '$[1][0]', 3) |
+-----+
| [{"a", [{"b", 3}, "c"], "d"} |
+-----+

mysql> SET @j = '{"a": 1, "b": [2, 3], "c": 4}';
mysql> SELECT JSON_ARRAY_APPEND(@j, '$.b', 'x');
+-----+
| JSON_ARRAY_APPEND(@j, '$.b', 'x') |
+-----+
| {"a": 1, "b": [2, 3, "x"], "c": 4} |
+-----+
mysql> SELECT JSON_ARRAY_APPEND(@j, '$.c', 'y');
+-----+
| JSON_ARRAY_APPEND(@j, '$.c', 'y') |
+-----+
| {"a": 1, "b": [2, 3], "c": [4, "y"]} |
+-----+

mysql> SET @j = '{"a": 1}';
mysql> SELECT JSON_ARRAY_APPEND(@j, '$', 'z');
+-----+
| JSON_ARRAY_APPEND(@j, '$', 'z') |
+-----+
| [{"a": 1}, "z"] |
+-----+
    
```

- `JSON_ARRAY_INSERT(json_doc, path, val[, path, val] ...)`

Updates a JSON document, inserting into an array within the document and returning the modified document. Returns `NULL` if any argument is `NULL`. An error occurs if the `json_doc` argument is not a valid JSON document or any `path` argument is not a valid path expression or contains a `*` or `**` wildcard or does not end with an array element identifier.

The path-value pairs are evaluated left to right. The document produced by evaluating one pair becomes the new value against which the next pair is evaluated.

Pairs for which the path does not identify any array in the JSON document are ignored. If a path identifies an array element, the corresponding value is inserted at that element position, shifting any following values to the right. If a path identifies an array position past the end of an array, the value is inserted at the end of the array.

```

mysql> SET @j = '{"a", {"b": [1, 2]}, [3, 4]}';
mysql> SELECT JSON_ARRAY_INSERT(@j, '$[1]', 'x');
+-----+
| JSON_ARRAY_INSERT(@j, '$[1]', 'x') |
+-----+
| [{"a", "x", {"b": [1, 2]}, [3, 4]} |
+-----+
mysql> SELECT JSON_ARRAY_INSERT(@j, '$[100]', 'x');
+-----+
| JSON_ARRAY_INSERT(@j, '$[100]', 'x') |
+-----+
| [{"a", {"b": [1, 2]}, [3, 4], "x"} |
+-----+
mysql> SELECT JSON_ARRAY_INSERT(@j, '$[1].b[0]', 'x');
+-----+
| JSON_ARRAY_INSERT(@j, '$[1].b[0]', 'x') |
+-----+
    
```



```

| ["a", {"b": ["x", 1, 2]}, [3, 4]] |
+-----+
mysql> SELECT JSON_ARRAY_INSERT(@j, '$[2][1]', 'y');
+-----+
| JSON_ARRAY_INSERT(@j, '$[2][1]', 'y') |
+-----+
| ["a", {"b": [1, 2]}, [3, "y", 4]] |
+-----+
mysql> SELECT JSON_ARRAY_INSERT(@j, '$[0]', 'x', '$[2][1]', 'y');
+-----+
| JSON_ARRAY_INSERT(@j, '$[0]', 'x', '$[2][1]', 'y') |
+-----+
| [{"x", "a", {"b": [1, 2]}, [3, 4]] |
+-----+
    
```

Earlier modifications affect the positions of the following elements in the array, so subsequent paths in the same `JSON_ARRAY_INSERT()` call should take this into account. In the final example, the second path inserts nothing because the path no longer matches anything after the first insert.

- `JSON_INSERT(json_doc, path, val[, path, val] ...)`

Inserts data into a JSON document and returns the result. Returns `NULL` if any argument is `NULL`. An error occurs if the `json_doc` argument is not a valid JSON document or any `path` argument is not a valid path expression or contains a `*` or `**` wildcard.

The path-value pairs are evaluated left to right. The document produced by evaluating one pair becomes the new value against which the next pair is evaluated.

A path-value pair for an existing path in the document is ignored and does not overwrite the existing document value. A path-value pair for a nonexisting path in the document adds the value to the document if the path identifies one of these types of values:

- A member not present in an existing object. The member is added to the object and associated with the new value.
- A position past the end of an existing array. The array is extended with the new value. If the existing value is not an array, it is autowrapped as an array, then extended with the new value.

Otherwise, a path-value pair for a nonexisting path in the document is ignored and has no effect.

For a comparison of `JSON_INSERT()`, `JSON_REPLACE()`, and `JSON_SET()`, see the discussion of `JSON_SET()`.

```

mysql> SET @j = '{ "a": 1, "b": [2, 3]}';
mysql> SELECT JSON_INSERT(@j, '$.a', 10, '$.c', '[true, false]');
+-----+
| JSON_INSERT(@j, '$.a', 10, '$.c', '[true, false]') |
+-----+
| {"a": 1, "b": [2, 3], "c": "[true, false]"} |
+-----+
    
```

The third and final value listed in the result is a quoted string and not an array like the second one (which is not quoted in the output); no casting of values to the JSON type is performed. To insert the array as an array, you must perform such casts explicitly, as shown here:

```

mysql> SELECT JSON_INSERT(@j, '$.a', 10, '$.c', CAST('[true, false]' AS JSON));
+-----+
| JSON_INSERT(@j, '$.a', 10, '$.c', CAST('[true, false]' AS JSON)) |
+-----+
| {"a": 1, "b": [2, 3], "c": [true, false]} |
+-----+
    
```

```
1 row in set (0.00 sec)
```

- [JSON\\_MERGE\(\*json\\_doc\*, \*json\\_doc\*\[, \*json\\_doc\*\] ...\)](#)

Merges two or more JSON documents. Synonym for [JSON\\_MERGE\\_PRESERVE\(\)](#); deprecated in MySQL 5.7.22 and subject to removal in a future release.

```
mysql> SELECT JSON_MERGE('[1, 2]', '[true, false]');
+-----+
| JSON_MERGE('[1, 2]', '[true, false]') |
+-----+
| [1, 2, true, false]                  |
+-----+
1 row in set, 1 warning (0.00 sec)

mysql> SHOW WARNINGS\G
***** 1. row *****
Level: Warning
Code: 1287
Message: 'JSON_MERGE' is deprecated and will be removed in a future release. \
Please use JSON_MERGE_PRESERVE/JSON_MERGE_PATCH instead
1 row in set (0.00 sec)
```

For additional examples, see the entry for [JSON\\_MERGE\\_PRESERVE\(\)](#).

- [JSON\\_MERGE\\_PATCH\(\*json\\_doc\*, \*json\\_doc\*\[, \*json\\_doc\*\] ...\)](#)

Performs an [RFC 7396](#) compliant merge of two or more JSON documents and returns the merged result, without preserving members having duplicate keys. Raises an error if at least one of the documents passed as arguments to this function is not valid.



### Note

For an explanation and example of the differences between this function and [JSON\\_MERGE\\_PRESERVE\(\)](#), see [JSON\\_MERGE\\_PATCH\(\) compared with JSON\\_MERGE\\_PRESERVE\(\)](#).

[JSON\\_MERGE\\_PATCH\(\)](#) performs a merge as follows:

1. If the first argument is not an object, the result of the merge is the same as if an empty object had been merged with the second argument.
2. If the second argument is not an object, the result of the merge is the second argument.
3. If both arguments are objects, the result of the merge is an object with the following members:
  - All members of the first object which do not have a corresponding member with the same key in the second object.
  - All members of the second object which do not have a corresponding key in the first object, and whose value is not the JSON `null` literal.
  - All members with a key that exists in both the first and the second object, and whose value in the second object is not the JSON `null` literal. The values of these members are the results of recursively merging the value in the first object with the value in the second object.

For additional information, see [Normalization, Merging, and Autowrapping of JSON Values](#).

```
mysql> SELECT JSON_MERGE_PATCH('[1, 2]', '[true, false]');
+-----+
| JSON_MERGE_PATCH('[1, 2]', '[true, false]') |
+-----+
```

```

| JSON_MERGE_PATCH('[1, 2]', '[true, false]') |
+-----+
| [true, false] |
+-----+

mysql> SELECT JSON_MERGE_PATCH('{ "name": "x" }', '{ "id": 47 }');
+-----+
| JSON_MERGE_PATCH('{ "name": "x" }', '{ "id": 47 }') |
+-----+
| { "id": 47, "name": "x" } |
+-----+

mysql> SELECT JSON_MERGE_PATCH('1', 'true');
+-----+
| JSON_MERGE_PATCH('1', 'true') |
+-----+
| true |
+-----+

mysql> SELECT JSON_MERGE_PATCH('[1, 2]', '{ "id": 47 }');
+-----+
| JSON_MERGE_PATCH('[1, 2]', '{ "id": 47 }') |
+-----+
| { "id": 47 } |
+-----+

mysql> SELECT JSON_MERGE_PATCH('{ "a": 1, "b":2 }',
>     '{ "a": 3, "c":4 }');
+-----+
| JSON_MERGE_PATCH('{ "a": 1, "b":2 }', '{ "a": 3, "c":4 }') |
+-----+
| { "a": 3, "b": 2, "c": 4 } |
+-----+

mysql> SELECT JSON_MERGE_PATCH('{ "a": 1, "b":2 }', '{ "a": 3, "c":4 }',
>     '{ "a": 5, "d":6 }');
+-----+
| JSON_MERGE_PATCH('{ "a": 1, "b":2 }', '{ "a": 3, "c":4 }', '{ "a": 5, "d":6 }') |
+-----+
| { "a": 5, "b": 2, "c": 4, "d": 6 } |
+-----+

```

You can use this function to remove a member by specifying `null` as the value of the same member in the second argument, as shown here:

```

mysql> SELECT JSON_MERGE_PATCH('{ "a":1, "b":2 }', '{ "b":null }');
+-----+
| JSON_MERGE_PATCH('{ "a":1, "b":2 }', '{ "b":null }') |
+-----+
| { "a": 1 } |
+-----+

```

This example shows that the function operates in a recursive fashion; that is, values of members are not limited to scalars, but rather can themselves be JSON documents:

```

mysql> SELECT JSON_MERGE_PATCH('{ "a":{ "x":1 } }', '{ "a":{ "y":2 } }');
+-----+
| JSON_MERGE_PATCH('{ "a":{ "x":1 } }', '{ "a":{ "y":2 } }') |
+-----+
| { "a": { "x": 1, "y": 2 } } |
+-----+

```

`JSON_MERGE_PATCH()` is supported in MySQL 5.7.22 and later.

**JSON\_MERGE\_PATCH() compared with JSON\_MERGE\_PRESERVE().** The behavior of `JSON_MERGE_PATCH()` is the same as that of `JSON_MERGE_PRESERVE()`, with the following two exceptions:

- `JSON_MERGE_PATCH()` removes any member in the first object with a matching key in the second object, provided that the value associated with the key in the second object is not `JSON null`.
- If the second object has a member with a key matching a member in the first object, `JSON_MERGE_PATCH()` *replaces* the value in the first object with the value in the second object, whereas `JSON_MERGE_PRESERVE()` *appends* the second value to the first value.

This example compares the results of merging the same 3 JSON objects, each having a matching key "a", with each of these two functions:

```
mysql> SET @x = '{ "a": 1, "b": 2 }',
> @y = '{ "a": 3, "c": 4 }',
> @z = '{ "a": 5, "d": 6 }';

mysql> SELECT JSON_MERGE_PATCH(@x, @y, @z) AS Patch,
-> JSON_MERGE_PRESERVE(@x, @y, @z) AS Preserve\G
***** 1. row *****
Patch: {"a": 5, "b": 2, "c": 4, "d": 6}
Preserve: {"a": [1, 3, 5], "b": 2, "c": 4, "d": 6}
```

- `JSON_MERGE_PRESERVE(json_doc, json_doc[, json_doc] ...)`

Merges two or more JSON documents and returns the merged result. Returns `NULL` if any argument is `NULL`. An error occurs if any argument is not a valid JSON document.

Merging takes place according to the following rules. For additional information, see [Normalization, Merging, and Autowrapping of JSON Values](#).

- Adjacent arrays are merged to a single array.
- Adjacent objects are merged to a single object.
- A scalar value is autowrapped as an array and merged as an array.
- An adjacent array and object are merged by autowrapping the object as an array and merging the two arrays.

```
mysql> SELECT JSON_MERGE_PRESERVE('[1, 2]', '[true, false]');
+-----+
| JSON_MERGE_PRESERVE('[1, 2]', '[true, false]') |
+-----+
| [1, 2, true, false] |
+-----+

mysql> SELECT JSON_MERGE_PRESERVE('{"name": "x"}', '{"id": 47}');
+-----+
| JSON_MERGE_PRESERVE('{"name": "x"}', '{"id": 47}') |
+-----+
| {"id": 47, "name": "x"} |
+-----+

mysql> SELECT JSON_MERGE_PRESERVE('1', 'true');
+-----+
```

```

| JSON_MERGE_PRESERVE('1', 'true') |
+-----+
| [1, true] |
+-----+

mysql> SELECT JSON_MERGE_PRESERVE('[1, 2]', '{"id": 47}');
+-----+
| JSON_MERGE_PRESERVE('[1, 2]', '{"id": 47}') |
+-----+
| [1, 2, {"id": 47}] |
+-----+

mysql> SELECT JSON_MERGE_PRESERVE('{ "a": 1, "b": 2 }',
>   '{ "a": 3, "c": 4 }');
+-----+
| JSON_MERGE_PRESERVE('{ "a": 1, "b": 2 }', '{ "a": 3, "c": 4 }') |
+-----+
| {"a": [1, 3], "b": 2, "c": 4} |
+-----+

mysql> SELECT JSON_MERGE_PRESERVE('{ "a": 1, "b": 2 }', '{ "a": 3, "c": 4 }',
>   '{ "a": 5, "d": 6 }');
+-----+
| JSON_MERGE_PRESERVE('{ "a": 1, "b": 2 }', '{ "a": 3, "c": 4 }', '{ "a": 5, "d": 6 }') |
+-----+
| {"a": [1, 3, 5], "b": 2, "c": 4, "d": 6} |
+-----+
    
```

This function was added in MySQL 5.7.22 as a synonym for `JSON_MERGE()`. The `JSON_MERGE()` function is now deprecated, and is subject to removal in a future release of MySQL.

This function is similar to but differs from `JSON_MERGE_PATCH()` in significant respects; see [JSON\\_MERGE\\_PATCH\(\) compared with JSON\\_MERGE\\_PRESERVE\(\)](#), for more information.

- `JSON_REMOVE(json_doc, path[, path] ...)`

Removes data from a JSON document and returns the result. Returns `NULL` if any argument is `NULL`. An error occurs if the `json_doc` argument is not a valid JSON document or any `path` argument is not a valid path expression or is `$` or contains a `*` or `**` wildcard.

The `path` arguments are evaluated left to right. The document produced by evaluating one path becomes the new value against which the next path is evaluated.

It is not an error if the element to be removed does not exist in the document; in that case, the path does not affect the document.

```

mysql> SET @j = '['a', ['b', 'c'], 'd'];
mysql> SELECT JSON_REMOVE(@j, '$[1]');
+-----+
| JSON_REMOVE(@j, '$[1]') |
+-----+
| ["a", "d"] |
+-----+
    
```

- `JSON_REPLACE(json_doc, path, val[, path, val] ...)`

Replaces existing values in a JSON document and returns the result. Returns `NULL` if *json\_doc* or any *path* argument is `NULL`. An error occurs if the *json\_doc* argument is not a valid JSON document or any *path* argument is not a valid path expression or contains a `*` or `**` wildcard.

The path-value pairs are evaluated left to right. The document produced by evaluating one pair becomes the new value against which the next pair is evaluated.

A path-value pair for an existing path in the document overwrites the existing document value with the new value. A path-value pair for a nonexisting path in the document is ignored and has no effect.

For a comparison of `JSON_INSERT()`, `JSON_REPLACE()`, and `JSON_SET()`, see the discussion of `JSON_SET()`.

```
mysql> SET @j = '{ "a": 1, "b": [2, 3]}';
mysql> SELECT JSON_REPLACE(@j, '$.a', 10, '$.c', '[true, false]');
+-----+
| JSON_REPLACE(@j, '$.a', 10, '$.c', '[true, false]') |
+-----+
| {"a": 10, "b": [2, 3]}                               |
+-----+

mysql> SELECT JSON_REPLACE(NULL, '$.a', 10, '$.c', '[true, false]');
+-----+
| JSON_REPLACE(NULL, '$.a', 10, '$.c', '[true, false]') |
+-----+
| NULL                                                  |
+-----+

mysql> SELECT JSON_REPLACE(@j, NULL, 10, '$.c', '[true, false]');
+-----+
| JSON_REPLACE(@j, NULL, 10, '$.c', '[true, false]') |
+-----+
| NULL                                               |
+-----+

mysql> SELECT JSON_REPLACE(@j, '$.a', NULL, '$.c', '[true, false]');
+-----+
| JSON_REPLACE(@j, '$.a', NULL, '$.c', '[true, false]') |
+-----+
| {"a": null, "b": [2, 3]}                             |
+-----+
```

- `JSON_SET(json_doc, path, val[, path, val] ...)`

Inserts or updates data in a JSON document and returns the result. Returns `NULL` if *json\_doc* or *path* is `NULL`, or if *path*, when given, does not locate an object. Otherwise, an error occurs if the *json\_doc*

argument is not a valid JSON document or any *path* argument is not a valid path expression or contains a *\** or *\*\** wildcard.

The path-value pairs are evaluated left to right. The document produced by evaluating one pair becomes the new value against which the next pair is evaluated.

A path-value pair for an existing path in the document overwrites the existing document value with the new value. A path-value pair for a nonexisting path in the document adds the value to the document if the path identifies one of these types of values:

- A member not present in an existing object. The member is added to the object and associated with the new value.
- A position past the end of an existing array. The array is extended with the new value. If the existing value is not an array, it is autowrapped as an array, then extended with the new value.

Otherwise, a path-value pair for a nonexisting path in the document is ignored and has no effect.

The `JSON_SET()`, `JSON_INSERT()`, and `JSON_REPLACE()` functions are related:

- `JSON_SET()` replaces existing values and adds nonexisting values.
- `JSON_INSERT()` inserts values without replacing existing values.
- `JSON_REPLACE()` replaces *only* existing values.

The following examples illustrate these differences, using one path that does exist in the document (`$.a`) and another that does not exist (`$.c`):

```
mysql> SET @j = '{ "a": 1, "b": [2, 3] }';
mysql> SELECT JSON_SET(@j, '$.a', 10, '$.c', '[true, false]');
+-----+
| JSON_SET(@j, '$.a', 10, '$.c', '[true, false]') |
+-----+
| {"a": 10, "b": [2, 3], "c": "[true, false]"}      |
+-----+
mysql> SELECT JSON_INSERT(@j, '$.a', 10, '$.c', '[true, false]');
+-----+
| JSON_INSERT(@j, '$.a', 10, '$.c', '[true, false]') |
+-----+
| {"a": 1, "b": [2, 3], "c": "[true, false]"}        |
+-----+
mysql> SELECT JSON_REPLACE(@j, '$.a', 10, '$.c', '[true, false]');
+-----+
| JSON_REPLACE(@j, '$.a', 10, '$.c', '[true, false]') |
+-----+
| {"a": 10, "b": [2, 3]}                               |
+-----+
```

- `JSON_UNQUOTE(json_val)`

Unquotes JSON value and returns the result as a `utf8mb4` string. Returns `NULL` if the argument is `NULL`. An error occurs if the value starts and ends with double quotes but is not a valid JSON string literal.

Within a string, certain sequences have special meaning unless the `NO_BACKSLASH_ESCAPES` SQL mode is enabled. Each of these sequences begins with a backslash (`\`), known as the *escape character*. MySQL recognizes the escape sequences shown in [Table 12.23, “JSON\\_UNQUOTE\(\) Special Character Escape Sequences”](#). For all other escape sequences, backslash is ignored. That is, the

escaped character is interpreted as if it was not escaped. For example, `\x` is just `x`. These sequences are case-sensitive. For example, `\b` is interpreted as a backspace, but `\B` is interpreted as `B`.

**Table 12.23 JSON\_UNQUOTE() Special Character Escape Sequences**

Escape Sequence	Character Represented by Sequence
<code>\"</code>	A double quote (") character
<code>\b</code>	A backspace character
<code>\f</code>	A formfeed character
<code>\n</code>	A newline (linefeed) character
<code>\r</code>	A carriage return character
<code>\t</code>	A tab character
<code>\\</code>	A backslash (\) character
<code>\uXXXX</code>	UTF-8 bytes for Unicode value <code>XXXX</code>

Two simple examples of the use of this function are shown here:

```
mysql> SET @j = '"abc"';
mysql> SELECT @j, JSON_UNQUOTE(@j);
+-----+-----+
| @j      | JSON_UNQUOTE(@j) |
+-----+-----+
| "abc"   | abc               |
+-----+-----+
mysql> SET @j = '[1, 2, 3]';
mysql> SELECT @j, JSON_UNQUOTE(@j);
+-----+-----+
| @j      | JSON_UNQUOTE(@j) |
+-----+-----+
| [1, 2, 3] | [1, 2, 3]       |
+-----+-----+
```

The following set of examples shows how `JSON_UNQUOTE` handles escapes with `NO_BACKSLASH_ESCAPES` disabled and enabled:

```
mysql> SELECT @@sql_mode;
+-----+
| @@sql_mode |
+-----+

mysql> SELECT JSON_UNQUOTE('\t\u0032');
+-----+
| JSON_UNQUOTE('\t\u0032') |
+-----+
| 2                          |
+-----+

mysql> SET @@sql_mode = 'NO_BACKSLASH_ESCAPES';
mysql> SELECT JSON_UNQUOTE('\t\u0032');
+-----+
| JSON_UNQUOTE('\t\u0032') |
+-----+
| \t\u0032                 |
+-----+

mysql> SELECT JSON_UNQUOTE('\t\u0032');
+-----+
```



```
| JSON_UNQUOTE('"\t\u0032"') |
+-----+
|          2          |
+-----+
```

## 12.17.5 Functions That Return JSON Value Attributes

The functions in this section return attributes of JSON values.

- `JSON_DEPTH(json_doc)`

Returns the maximum depth of a JSON document. Returns `NULL` if the argument is `NULL`. An error occurs if the argument is not a valid JSON document.

An empty array, empty object, or scalar value has depth 1. A nonempty array containing only elements of depth 1 or nonempty object containing only member values of depth 1 has depth 2. Otherwise, a JSON document has depth greater than 2.

```
mysql> SELECT JSON_DEPTH('{}'), JSON_DEPTH('[]'), JSON_DEPTH('true');
+-----+-----+-----+
| JSON_DEPTH('{}') | JSON_DEPTH('[]') | JSON_DEPTH('true') |
+-----+-----+-----+
|          1          |          1          |          1          |
+-----+-----+-----+
mysql> SELECT JSON_DEPTH('[10, 20]'), JSON_DEPTH('[[], {}]');
+-----+-----+
| JSON_DEPTH('[10, 20]') | JSON_DEPTH('[[], {}]') |
+-----+-----+
|          2          |          2          |
+-----+-----+
mysql> SELECT JSON_DEPTH('[10, {"a": 20}]');
+-----+
| JSON_DEPTH('[10, {"a": 20}]') |
+-----+
|          3          |
+-----+
```

- `JSON_LENGTH(json_doc[, path])`

Returns the length of a JSON document, or, if a `path` argument is given, the length of the value within the document identified by the path. Returns `NULL` if any argument is `NULL` or the `path` argument does not identify a value in the document. An error occurs if the `json_doc` argument is not a valid JSON document or the `path` argument is not a valid path expression or contains a `*` or `**` wildcard.

The length of a document is determined as follows:

- The length of a scalar is 1.
- The length of an array is the number of array elements.
- The length of an object is the number of object members.
- The length does not count the length of nested arrays or objects.

```
mysql> SELECT JSON_LENGTH('[1, 2, {"a": 3}]');
+-----+
| JSON_LENGTH('[1, 2, {"a": 3}]') |
+-----+
|          3          |
+-----+
mysql> SELECT JSON_LENGTH('{ "a": 1, "b": {"c": 30} }');
+-----+
```

```

+-----+
| JSON_LENGTH('{ "a": 1, "b": {"c": 30}}') |
+-----+
|                                     2 |
+-----+
mysql> SELECT JSON_LENGTH('{ "a": 1, "b": {"c": 30}}', '$.b');
+-----+
| JSON_LENGTH('{ "a": 1, "b": {"c": 30}}', '$.b') |
+-----+
|                                     1 |
+-----+

```

- `JSON_TYPE(json_val)`

Returns a `utf8mb4` string indicating the type of a JSON value. This can be an object, an array, or a scalar type, as shown here:

```

mysql> SET @j = '{"a": [10, true]}';
mysql> SELECT JSON_TYPE(@j);
+-----+
| JSON_TYPE(@j) |
+-----+
| OBJECT        |
+-----+
mysql> SELECT JSON_TYPE(JSON_EXTRACT(@j, '$.a'));
+-----+
| JSON_TYPE(JSON_EXTRACT(@j, '$.a')) |
+-----+
| ARRAY         |
+-----+
mysql> SELECT JSON_TYPE(JSON_EXTRACT(@j, '$.a[0]'));
+-----+
| JSON_TYPE(JSON_EXTRACT(@j, '$.a[0]')) |
+-----+
| INTEGER       |
+-----+
mysql> SELECT JSON_TYPE(JSON_EXTRACT(@j, '$.a[1]'));
+-----+
| JSON_TYPE(JSON_EXTRACT(@j, '$.a[1]')) |
+-----+
| BOOLEAN      |
+-----+

```

`JSON_TYPE()` returns `NULL` if the argument is `NULL`:

```

mysql> SELECT JSON_TYPE(NULL);
+-----+
| JSON_TYPE(NULL) |
+-----+
| NULL            |
+-----+

```

An error occurs if the argument is not a valid JSON value:

```

mysql> SELECT JSON_TYPE(1);
ERROR 3146 (22032): Invalid data type for JSON data in argument 1

```

to function `json_type`; a JSON string or JSON type is required.

For a non-`NULL`, non-error result, the following list describes the possible `JSON_TYPE()` return values:

- Purely JSON types:
  - `OBJECT`: JSON objects
  - `ARRAY`: JSON arrays
  - `BOOLEAN`: The JSON true and false literals
  - `NULL`: The JSON null literal
- Numeric types:
  - `INTEGER`: MySQL `TINYINT`, `SMALLINT`, `MEDIUMINT` and `INT` and `BIGINT` scalars
  - `DOUBLE`: MySQL `DOUBLE` `FLOAT` scalars
  - `DECIMAL`: MySQL `DECIMAL` and `NUMERIC` scalars
- Temporal types:
  - `DATETIME`: MySQL `DATETIME` and `TIMESTAMP` scalars
  - `DATE`: MySQL `DATE` scalars
  - `TIME`: MySQL `TIME` scalars
- String types:
  - `STRING`: MySQL `utf8` character type scalars: `CHAR`, `VARCHAR`, `TEXT`, `ENUM`, and `SET`
- Binary types:
  - `BLOB`: MySQL binary type scalars: `BINARY`, `VARBINARY`, `BLOB`
  - `BIT`: MySQL `BIT` scalars
- All other types:
  - `OPAQUE` (raw bits)
- `JSON_VALID(val)`

Returns 0 or 1 to indicate whether a value is valid JSON. Returns `NULL` if the argument is `NULL`.

```
mysql> SELECT JSON_VALID('{\"a\": 1}');
+-----+
| JSON_VALID('{\"a\": 1}') |
+-----+
| 1 |
+-----+
mysql> SELECT JSON_VALID('hello'), JSON_VALID('\"hello\"');
+-----+-----+
| JSON_VALID('hello') | JSON_VALID('\"hello\"') |
+-----+-----+
| 0 | 1 |
+-----+-----+
```

## 12.17.6 JSON Utility Functions

This section documents utility functions that act on JSON values, or strings that can be parsed as JSON values. `JSON_PRETTY()` prints out a JSON value in a format that is easy to read.

`JSON_STORAGE_SIZE()` shows the amount of storage space used by a given JSON value.

- `JSON_PRETTY(json_val)`

Provides pretty-printing of JSON values similar to that implemented in PHP and by other languages and database systems. The value supplied must be a JSON value or a valid string representation of a JSON value. Extraneous whitespaces and newlines present in this value have no effect on the output. For a `NULL` value, the function returns `NULL`. If the value is not a JSON document, or if it cannot be parsed as one, the function fails with an error.

Formatting of the output from this function adheres to the following rules:

- Each array element or object member appears on a separate line, indented by one additional level as compared to its parent.
- Each level of indentation adds two leading spaces.
- A comma separating individual array elements or object members is printed before the newline that separates the two elements or members.
- The key and the value of an object member are separated by a colon followed by a space (`' : '`).
- An empty object or array is printed on a single line. No space is printed between the opening and closing brace.
- Special characters in string scalars and key names are escaped employing the same rules used by the `JSON_QUOTE()` function.

```
mysql> SELECT JSON_PRETTY('123'); # scalar
+-----+
| JSON_PRETTY('123') |
+-----+
| 123                 |
+-----+

mysql> SELECT JSON_PRETTY("[1,3,5]"); # array
+-----+
| JSON_PRETTY("[1,3,5]") |
+-----+
| [                     |
| 1,                   |
| 3,                   |
| 5                     |
| ]                     |
+-----+

mysql> SELECT JSON_PRETTY('{ "a": "10", "b": "15", "x": "25" }'); # object
+-----+
| JSON_PRETTY('{ "a": "10", "b": "15", "x": "25" }') |
+-----+
| {                   |
|   "a": "10",       |
|   "b": "15",       |
|   "x": "25"       |
| }                   |
+-----+
```

```
mysql> SELECT JSON_PRETTY('["a",1,{"key1":
>   "value1"},"5",      "77" ,
>   {"key2":["value3","valueX",
>   "valueY"]},"j", "2"   ]')\G # nested arrays and objects
***** 1. row *****
JSON_PRETTY('["a",1,{"key1":
      "value1"},"5",      "77" ,
      {"key2":["value3","valuex",
      "valuey"]},"j", "2"   ]'): [
  "a",
  1,
  {
    "key1": "value1"
  },
  "5",
  "77",
  {
    "key2": [
      "value3",
      "valuex",
      "valuey"
    ]
  },
  "j",
  "2"
]
```

Added in MySQL 5.7.22.

- `JSON_STORAGE_SIZE(json_val)`

This function returns the number of bytes used to store the binary representation of a JSON document. When the argument is a `JSON` column, this is the space used to store the JSON document. `json_val` must be a valid JSON document or a string which can be parsed as one. In the case where it is string, the function returns the amount of storage space in the JSON binary representation that is created by parsing the string as JSON and converting it to binary. It returns `NULL` if the argument is `NULL`.

An error results when `json_val` is not `NULL`, and is not—or cannot be successfully parsed as—a JSON document.

To illustrate this function's behavior when used with a `JSON` column as its argument, we create a table named `jtable` containing a `JSON` column `jcol`, insert a JSON value into the table, then obtain the storage space used by this column with `JSON_STORAGE_SIZE()`, as shown here:

```
mysql> CREATE TABLE jtable (jcol JSON);
Query OK, 0 rows affected (0.42 sec)

mysql> INSERT INTO jtable VALUES
->   ('{"a": 1000, "b": "wxyz", "c": "[1, 3, 5, 7]"}');
Query OK, 1 row affected (0.04 sec)

mysql> SELECT
->   jcol,
->   JSON_STORAGE_SIZE(jcol) AS Size
-> FROM jtable;
+-----+-----+
| jcol                                     | Size |
+-----+-----+
| {"a": 1000, "b": "wxyz", "c": "[1, 3, 5, 7]"} | 47   |
+-----+-----+
```

## JSON Utility Functions

```
1 row in set (0.00 sec)
```

According to the output of `JSON_STORAGE_SIZE()`, the JSON document inserted into the column takes up 47 bytes. Following an update, the function shows the storage used for the newly-set value:

```
mysql> UPDATE jtable
mysql> SET jcol = '{"a": 4.55, "b": "wxyz", "c": "[true, false]"}';
Query OK, 1 row affected (0.04 sec)
Rows matched: 1 Changed: 1 Warnings: 0

mysql> SELECT
-> jcol,
-> JSON_STORAGE_SIZE(jcol) AS Size
-> FROM jtable;
+-----+-----+
| jcol | Size |
+-----+-----+
| {"a": 4.55, "b": "wxyz", "c": "[true, false]"} | 56 |
+-----+-----+
1 row in set (0.00 sec)
```

This function also shows the space currently used to store a JSON document in a user variable:

```
mysql> SET @j = '[100, "sakila", [1, 3, 5], 425.05]';
Query OK, 0 rows affected (0.00 sec)

mysql> SELECT @j, JSON_STORAGE_SIZE(@j) AS Size;
+-----+-----+
| @j | Size |
+-----+-----+
| [100, "sakila", [1, 3, 5], 425.05] | 45 |
+-----+-----+
1 row in set (0.00 sec)

mysql> SET @j = JSON_SET(@j, '$[1]', "json");
Query OK, 0 rows affected (0.00 sec)

mysql> SELECT @j, JSON_STORAGE_SIZE(@j) AS Size;
+-----+-----+
| @j | Size |
+-----+-----+
| [100, "json", [1, 3, 5], 425.05] | 43 |
+-----+-----+
1 row in set (0.00 sec)

mysql> SET @j = JSON_SET(@j, '$[2][0]', JSON_ARRAY(10, 20, 30));
Query OK, 0 rows affected (0.00 sec)

mysql> SELECT @j, JSON_STORAGE_SIZE(@j) AS Size;
+-----+-----+
| @j | Size |
+-----+-----+
| [100, "json", [[10, 20, 30], 3, 5], 425.05] | 56 |
+-----+-----+
1 row in set (0.00 sec)
```

For a JSON literal, this function also returns the current storage space used, as shown here:

```
mysql> SELECT
-> JSON_STORAGE_SIZE('[100, "sakila", [1, 3, 5], 425.05]') AS A,
-> JSON_STORAGE_SIZE('{ "a": 1000, "b": "a", "c": "[1, 3, 5, 7]" }') AS B,
-> JSON_STORAGE_SIZE('{ "a": 1000, "b": "wxyz", "c": "[1, 3, 5, 7]" }') AS C,
-> JSON_STORAGE_SIZE('[100, "json", [[10, 20, 30], 3, 5], 425.05]') AS D;
+-----+-----+
| A | B | C | D |
+-----+-----+
1 row in set (0.00 sec)
```

```
| 45 | 44 | 47 | 56 |
+----+----+----+----+
1 row in set (0.00 sec)
```

This function was added in MySQL 5.7.22.

## 12.18 Functions Used with Global Transaction Identifiers (GTIDs)

The functions described in this section are used with GTID-based replication. It is important to keep in mind that all of these functions take string representations of GTID sets as arguments. As such, the GTID sets must always be quoted when used with them. See [GTID Sets](#) for more information.

The union of two GTID sets is simply their representations as strings, joined together with an interposed comma. In other words, you can define a very simple function for obtaining the union of two GTID sets, similar to that created here:

```
CREATE FUNCTION GTID_UNION(g1 TEXT, g2 TEXT)
  RETURNS TEXT DETERMINISTIC
  RETURN CONCAT(g1, ',', g2);
```

For more information about GTIDs and how these GTID functions are used in practice, see [Section 16.1.3, “Replication with Global Transaction Identifiers”](#).

**Table 12.24 GTID Functions**

Name	Description
<code>GTID_SUBSET()</code>	Return true if all GTIDs in subset are also in set; otherwise false.
<code>GTID_SUBTRACT()</code>	Return all GTIDs in set that are not in subset.
<code>WAIT_FOR_EXECUTED_GTID_SET()</code>	Wait until the given GTIDs have executed on the replica.
<code>WAIT_UNTIL_SQL_THREAD_AFTER_GTIDS()</code>	Use <code>WAIT_FOR_EXECUTED_GTID_SET()</code> .

- `GTID_SUBSET(set1, set2)`

Given two sets of global transaction identifiers *set1* and *set2*, returns true if all GTIDs in *set1* are also in *set2*. Returns false otherwise.

The GTID sets used with this function are represented as strings, as shown in the following examples:

```
mysql> SELECT GTID_SUBSET('3E11FA47-71CA-11E1-9E33-C80AA9429562:23',
-> '3E11FA47-71CA-11E1-9E33-C80AA9429562:21-57')\G
***** 1. row *****
GTID_SUBSET('3E11FA47-71CA-11E1-9E33-C80AA9429562:23',
'3E11FA47-71CA-11E1-9E33-C80AA9429562:21-57'): 1
1 row in set (0.00 sec)

mysql> SELECT GTID_SUBSET('3E11FA47-71CA-11E1-9E33-C80AA9429562:23-25',
-> '3E11FA47-71CA-11E1-9E33-C80AA9429562:21-57')\G
***** 1. row *****
GTID_SUBSET('3E11FA47-71CA-11E1-9E33-C80AA9429562:23-25',
'3E11FA47-71CA-11E1-9E33-C80AA9429562:21-57'): 1
1 row in set (0.00 sec)

mysql> SELECT GTID_SUBSET('3E11FA47-71CA-11E1-9E33-C80AA9429562:20-25',
-> '3E11FA47-71CA-11E1-9E33-C80AA9429562:21-57')\G
***** 1. row *****
GTID_SUBSET('3E11FA47-71CA-11E1-9E33-C80AA9429562:20-25',
'3E11FA47-71CA-11E1-9E33-C80AA9429562:21-57'): 0
1 row in set (0.00 sec)
```

- `GTID_SUBTRACT(set1, set2)`

Given two sets of global transaction identifiers *set1* and *set2*, returns only those GTIDs from *set1* that are not in *set2*.

All GTID sets used with this function are represented as strings and must be quoted, as shown in these examples:

```
mysql> SELECT GTID_SUBTRACT('3E11FA47-71CA-11E1-9E33-C80AA9429562:21-57',
-> '3E11FA47-71CA-11E1-9E33-C80AA9429562:21')\G
***** 1. row *****
GTID_SUBTRACT('3E11FA47-71CA-11E1-9E33-C80AA9429562:21-57',
'3E11FA47-71CA-11E1-9E33-C80AA9429562:21'): 3e11fa47-71ca-11e1-9e33-c80aa9429562:22-57
1 row in set (0.00 sec)

mysql> SELECT GTID_SUBTRACT('3E11FA47-71CA-11E1-9E33-C80AA9429562:21-57',
-> '3E11FA47-71CA-11E1-9E33-C80AA9429562:20-25')\G
***** 1. row *****
GTID_SUBTRACT('3E11FA47-71CA-11E1-9E33-C80AA9429562:21-57',
'3E11FA47-71CA-11E1-9E33-C80AA9429562:20-25'): 3e11fa47-71ca-11e1-9e33-c80aa9429562:26-57
1 row in set (0.00 sec)

mysql> SELECT GTID_SUBTRACT('3E11FA47-71CA-11E1-9E33-C80AA9429562:21-57',
-> '3E11FA47-71CA-11E1-9E33-C80AA9429562:23-24')\G
***** 1. row *****
GTID_SUBTRACT('3E11FA47-71CA-11E1-9E33-C80AA9429562:21-57',
'3E11FA47-71CA-11E1-9E33-C80AA9429562:23-24'): 3e11fa47-71ca-11e1-9e33-c80aa9429562:21-22:25-57
1 row in set (0.01 sec)
```

Subtracting a GTID set from itself produces an empty set, as shown here:

```
mysql> SELECT GTID_SUBTRACT('3E11FA47-71CA-11E1-9E33-C80AA9429562:21-57',
-> '3E11FA47-71CA-11E1-9E33-C80AA9429562:21-57')\G
***** 1. row *****
GTID_SUBTRACT('3E11FA47-71CA-11E1-9E33-C80AA9429562:21-57',
'3E11FA47-71CA-11E1-9E33-C80AA9429562:21-57'):
1 row in set (0.00 sec)
```

- `WAIT_FOR_EXECUTED_GTID_SET(gtid_set[, timeout])`

Wait until the server has applied all of the transactions whose global transaction identifiers are contained in *gtid\_set*; that is, until the condition `GTID_SUBSET(gtid_subset, @@GLOBAL.gtid_executed)` holds. See [Section 16.1.3.1, “GTID Format and Storage”](#) for a definition of GTID sets.

If a timeout is specified, and *timeout* seconds elapse before all of the transactions in the GTID set have been applied, the function stops waiting. *timeout* is optional, and the default timeout is 0 seconds, in which case the function always waits until all of the transactions in the GTID set have been applied. *timeout* must be greater than or equal to 0; as of MySQL 5.7.18, when running in strict SQL mode, a negative *timeout* value is immediately rejected with an error; otherwise the function returns `NULL`, and raises a warning.

`WAIT_FOR_EXECUTED_GTID_SET()` monitors all the GTIDs that are applied on the server, including transactions that arrive from all replication channels and user clients. It does not take into account whether replication channels have been started or stopped.

For more information, see [Section 16.1.3, “Replication with Global Transaction Identifiers”](#).

GTID sets used with this function are represented as strings and so must be quoted as shown in the following example:

```
mysql> SELECT WAIT_FOR_EXECUTED_GTID_SET('3E11FA47-71CA-11E1-9E33-C80AA9429562:1-5');
```



-&gt; 0

For a syntax description for GTID sets, see [Section 16.1.3.1, “GTID Format and Storage”](#).

For `WAIT_FOR_EXECUTED_GTID_SET()`, the return value is the state of the query, where 0 represents success, and 1 represents timeout. Any other failures generate an error.

`gtid_mode` cannot be changed to OFF while any client is using this function to wait for GTIDs to be applied.

- `WAIT_UNTIL_SQL_THREAD_AFTER_GTIDS(gtid_set[, timeout][, channel])`

`WAIT_UNTIL_SQL_THREAD_AFTER_GTIDS()` is similar to `WAIT_FOR_EXECUTED_GTID_SET()` in that it waits until all of the transactions whose global transaction identifiers are contained in *gtid\_set* have been applied, or until *timeout* seconds have elapsed, whichever occurs first. However, `WAIT_UNTIL_SQL_THREAD_AFTER_GTIDS()` applies to a specific replication channel, and stops only after the transactions have been applied on the specified channel, for which the applier must be running. In contrast, `WAIT_FOR_EXECUTED_GTID_SET()` stops after the transactions have been applied, regardless of where they were applied (on any replication channel or any user client), and whether or not any replication channels are running.

*timeout* must be greater than or equal to 0; as of MySQL 5.7.18, when running in strict SQL mode, a negative *timeout* value is immediately rejected with an error (`ER_WRONG_ARGUMENTS`); otherwise `WAIT_UNTIL_SQL_THREAD_AFTER_GTIDS()` returns `NULL`, and raises a warning.

The *channel* option names which replication channel the function applies to. If no channel is named and no channels other than the default replication channel exist, the function applies to the default replication channel. If multiple replication channels exist, you must specify a channel as otherwise it is not known which replication channel the function applies to. See [Section 16.2.2, “Replication Channels”](#) for more information on replication channels.



#### Note

Because `WAIT_UNTIL_SQL_THREAD_AFTER_GTIDS()` applies to a specific replication channel, if an expected transaction arrives on a different replication channel or from a user client, for example in a failover or manual recovery situation, the function can hang indefinitely if no timeout is set. Use `WAIT_FOR_EXECUTED_GTID_SET()` instead to ensure correct handling of transactions in these situations.

GTID sets used with `WAIT_UNTIL_SQL_THREAD_AFTER_GTIDS()` are represented as strings and must be quoted in the same way as for `WAIT_FOR_EXECUTED_GTID_SET()`. For `WAIT_UNTIL_SQL_THREAD_AFTER_GTIDS()`, the return value for the function is an arbitrary positive number. If GTID-based replication is not active (that is, if the value of the `gtid_mode` variable is OFF), then this value is undefined and `WAIT_UNTIL_SQL_THREAD_AFTER_GTIDS()` returns `NULL`. If the replica is not running then the function also returns `NULL`.

`gtid_mode` cannot be changed to OFF while any client is using this function to wait for GTIDs to be applied.

## 12.19 Aggregate Functions

Aggregate functions operate on sets of values. They are often used with a `GROUP BY` clause to group values into subsets.

### 12.19.1 Aggregate Function Descriptions

This section describes aggregate functions that operate on sets of values. They are often used with a `GROUP BY` clause to group values into subsets.

**Table 12.25 Aggregate Functions**

Name	Description	Introduced
<code>AVG()</code>	Return the average value of the argument	
<code>BIT_AND()</code>	Return bitwise AND	
<code>BIT_OR()</code>	Return bitwise OR	
<code>BIT_XOR()</code>	Return bitwise XOR	
<code>COUNT()</code>	Return a count of the number of rows returned	
<code>COUNT(DISTINCT)</code>	Return the count of a number of different values	
<code>GROUP_CONCAT()</code>	Return a concatenated string	
<code>JSON_ARRAYAGG()</code>	Return result set as a single JSON array	5.7.22
<code>JSON_OBJECTAGG()</code>	Return result set as a single JSON object	5.7.22
<code>MAX()</code>	Return the maximum value	
<code>MIN()</code>	Return the minimum value	
<code>STD()</code>	Return the population standard deviation	
<code>STDDEV()</code>	Return the population standard deviation	
<code>STDDEV_POP()</code>	Return the population standard deviation	
<code>STDDEV_SAMP()</code>	Return the sample standard deviation	
<code>SUM()</code>	Return the sum	
<code>VAR_POP()</code>	Return the population standard variance	
<code>VAR_SAMP()</code>	Return the sample variance	
<code>VARIANCE()</code>	Return the population standard variance	

Unless otherwise stated, aggregate functions ignore `NULL` values.

If you use an aggregate function in a statement containing no `GROUP BY` clause, it is equivalent to grouping on all rows. For more information, see [Section 12.19.3, “MySQL Handling of GROUP BY”](#).

For numeric arguments, the variance and standard deviation functions return a `DOUBLE` value. The `SUM()` and `AVG()` functions return a `DECIMAL` value for exact-value arguments (integer or `DECIMAL`), and a `DOUBLE` value for approximate-value arguments (`FLOAT` or `DOUBLE`).

The `SUM()` and `AVG()` aggregate functions do not work with temporal values. (They convert the values to numbers, losing everything after the first nonnumeric character.) To work around this problem, convert to numeric units, perform the aggregate operation, and convert back to a temporal value. Examples:

```
SELECT SEC_TO_TIME(SUM(TIME_TO_SEC(time_col))) FROM tbl_name;
SELECT FROM_DAYS(SUM(TO_DAYS(date_col))) FROM tbl_name;
```

Functions such as `SUM()` or `AVG()` that expect a numeric argument cast the argument to a number if necessary. For `SET` or `ENUM` values, the cast operation causes the underlying numeric value to be used.

The `BIT_AND()`, `BIT_OR()`, and `BIT_XOR()` aggregate functions perform bit operations. They require `BIGINT` (64-bit integer) arguments and return `BIGINT` values. Arguments of other types are converted to `BIGINT` and truncation might occur. For information about a change in MySQL 8.0 that permits bit operations to take binary string type arguments (`BINARY`, `VARBINARY`, and the `BLOB` types), see [Section 12.12, “Bit Functions and Operators”](#).

- `AVG([DISTINCT] expr)`

Returns the average value of *expr*. The `DISTINCT` option can be used to return the average of the distinct values of *expr*.

If there are no matching rows, `AVG()` returns `NULL`.

```
mysql> SELECT student_name, AVG(test_score)
        FROM student
        GROUP BY student_name;
```

- `BIT_AND(expr)`

Returns the bitwise `AND` of all bits in *expr*. The calculation is performed with 64-bit (`BIGINT`) precision.

If there are no matching rows, `BIT_AND()` returns a neutral value (all bits set to 1).

- `BIT_OR(expr)`

Returns the bitwise `OR` of all bits in *expr*. The calculation is performed with 64-bit (`BIGINT`) precision.

If there are no matching rows, `BIT_OR()` returns a neutral value (all bits set to 0).

- `BIT_XOR(expr)`

Returns the bitwise `XOR` of all bits in *expr*. The calculation is performed with 64-bit (`BIGINT`) precision.

If there are no matching rows, `BIT_XOR()` returns a neutral value (all bits set to 0).

- `COUNT(expr)`

Returns a count of the number of non-`NULL` values of *expr* in the rows retrieved by a `SELECT` statement. The result is a `BIGINT` value.

If there are no matching rows, `COUNT()` returns 0.

```
mysql> SELECT student.student_name, COUNT(*)
        FROM student, course
        WHERE student.student_id=course.student_id
        GROUP BY student_name;
```

`COUNT(*)` is somewhat different in that it returns a count of the number of rows retrieved, whether or not they contain `NULL` values.

For transactional storage engines such as `InnoDB`, storing an exact row count is problematic. Multiple transactions may be occurring at the same time, each of which may affect the count.

**InnoDB** does not keep an internal count of rows in a table because concurrent transactions might “see” different numbers of rows at the same time. Consequently, `SELECT COUNT(*)` statements only count rows visible to the current transaction.

Prior to MySQL 5.7.18, **InnoDB** processes `SELECT COUNT(*)` statements by scanning the clustered index. As of MySQL 5.7.18, **InnoDB** processes `SELECT COUNT(*)` statements by traversing the smallest available secondary index unless an index or optimizer hint directs the optimizer to use a different index. If a secondary index is not present, the clustered index is scanned.

Processing `SELECT COUNT(*)` statements takes some time if index records are not entirely in the buffer pool. For a faster count, create a counter table and let your application update it according to the inserts and deletes it does. However, this method may not scale well in situations where thousands of concurrent transactions are initiating updates to the same counter table. If an approximate row count is sufficient, use `SHOW TABLE STATUS`.

**InnoDB** handles `SELECT COUNT(*)` and `SELECT COUNT(1)` operations in the same way. There is no performance difference.

For **MyISAM** tables, `COUNT(*)` is optimized to return very quickly if the `SELECT` retrieves from one table, no other columns are retrieved, and there is no `WHERE` clause. For example:

```
mysql> SELECT COUNT(*) FROM student;
```

This optimization only applies to **MyISAM** tables, because an exact row count is stored for this storage engine and can be accessed very quickly. `COUNT(1)` is only subject to the same optimization if the first column is defined as `NOT NULL`.

- `COUNT(DISTINCT expr, [expr...])`

Returns a count of the number of rows with different non-`NULL` `expr` values.

If there are no matching rows, `COUNT(DISTINCT)` returns 0.

```
mysql> SELECT COUNT(DISTINCT results) FROM student;
```

In MySQL, you can obtain the number of distinct expression combinations that do not contain `NULL` by giving a list of expressions. In standard SQL, you would have to do a concatenation of all expressions inside `COUNT(DISTINCT ...)`.

- `GROUP_CONCAT(expr)`

This function returns a string result with the concatenated non-`NULL` values from a group. It returns `NULL` if there are no non-`NULL` values. The full syntax is as follows:

```
GROUP_CONCAT([DISTINCT] expr [,expr ...]
             [ORDER BY {unsigned_integer | col_name | expr}
              [ASC | DESC] [,col_name ...]]
             [SEPARATOR str_val])
```

```
mysql> SELECT student_name,
           GROUP_CONCAT(test_score)
FROM student
GROUP BY student_name;
```

Or:

```
mysql> SELECT student_name,
           GROUP_CONCAT(DISTINCT test_score
                        ORDER BY test_score DESC SEPARATOR ' ')
```

```
FROM student
GROUP BY student_name;
```

In MySQL, you can get the concatenated values of expression combinations. To eliminate duplicate values, use the [DISTINCT](#) clause. To sort values in the result, use the [ORDER BY](#) clause. To sort in reverse order, add the [DESC](#) (descending) keyword to the name of the column you are sorting by in the [ORDER BY](#) clause. The default is ascending order; this may be specified explicitly using the [ASC](#) keyword. The default separator between values in a group is comma (,). To specify a separator explicitly, use [SEPARATOR](#) followed by the string literal value that should be inserted between group values. To eliminate the separator altogether, specify [SEPARATOR ''](#).

The result is truncated to the maximum length that is given by the [group\\_concat\\_max\\_len](#) system variable, which has a default value of 1024. The value can be set higher, although the effective maximum length of the return value is constrained by the value of [max\\_allowed\\_packet](#). The syntax to change the value of [group\\_concat\\_max\\_len](#) at runtime is as follows, where *val* is an unsigned integer:

```
SET [GLOBAL | SESSION] group_concat_max_len = val;
```

The return value is a nonbinary or binary string, depending on whether the arguments are nonbinary or binary strings. The result type is [TEXT](#) or [BLOB](#) unless [group\\_concat\\_max\\_len](#) is less than or equal to 512, in which case the result type is [VARCHAR](#) or [VARBINARY](#).

If [GROUP\\_CONCAT\(\)](#) is invoked from within the [mysql](#) client, binary string results display using hexadecimal notation, depending on the value of the [--binary-as-hex](#). For more information about that option, see [Section 4.5.1, “mysql — The MySQL Command-Line Client”](#).

See also [CONCAT\(\)](#) and [CONCAT\\_WS\(\)](#): [Section 12.8, “String Functions and Operators”](#).

- [JSON\\_ARRAYAGG\(\*col\\_or\\_expr\*\)](#)

Aggregates a result set as a single [JSON](#) array whose elements consist of the rows. The order of elements in this array is undefined. The function acts on a column or an expression that evaluates to a single value. Returns [NULL](#) if the result contains no rows, or in the event of an error.

```
mysql> SELECT o_id, attribute, value FROM t3;
+-----+-----+-----+
| o_id | attribute | value |
+-----+-----+-----+
| 2 | color | red |
| 2 | fabric | silk |
| 3 | color | green |
| 3 | shape | square |
+-----+-----+-----+
4 rows in set (0.00 sec)

mysql> SELECT o_id, JSON_ARRAYAGG(attribute) AS attributes
-> FROM t3 GROUP BY o_id;
+-----+-----+
| o_id | attributes |
+-----+-----+
| 2 | ["color", "fabric"] |
| 3 | ["color", "shape"] |
+-----+-----+
2 rows in set (0.00 sec)
```

Added in MySQL 5.7.22.

- `JSON_OBJECTAGG(key, value)`

Takes two column names or expressions as arguments, the first of these being used as a key and the second as a value, and returns a JSON object containing key-value pairs. Returns `NULL` if the result contains no rows, or in the event of an error. An error occurs if any key name is `NULL` or the number of arguments is not equal to 2.

```
mysql> SELECT o_id, attribute, value FROM t3;
+-----+-----+-----+
| o_id | attribute | value |
+-----+-----+-----+
| 2   | color    | red   |
| 2   | fabric   | silk  |
| 3   | color    | green |
| 3   | shape    | square|
+-----+-----+-----+
4 rows in set (0.00 sec)

mysql> SELECT o_id, JSON_OBJECTAGG(attribute, value)
-> FROM t3 GROUP BY o_id;
+-----+-----+
| o_id | JSON_OBJECTAGG(attribute, value) |
+-----+-----+
| 2   | {"color": "red", "fabric": "silk"} |
| 3   | {"color": "green", "shape": "square"} |
+-----+-----+
2 rows in set (0.00 sec)
```

**Duplicate key handling.** When the result of this function is normalized, values having duplicate keys are discarded. In keeping with the MySQL `JSON` data type specification that does not permit duplicate keys, only the last value encountered is used with that key in the returned object (“last duplicate key wins”). This means that the result of using this function on columns from a `SELECT` can depend on the order in which the rows are returned, which is not guaranteed.

Consider the following:

```
mysql> CREATE TABLE t(c VARCHAR(10), i INT);
Query OK, 0 rows affected (0.33 sec)

mysql> INSERT INTO t VALUES ('key', 3), ('key', 4), ('key', 5);
Query OK, 3 rows affected (0.10 sec)
Records: 3 Duplicates: 0 Warnings: 0

mysql> SELECT c, i FROM t;
+-----+-----+
| c   | i |
+-----+-----+
| key | 3 |
| key | 4 |
| key | 5 |
+-----+-----+
3 rows in set (0.00 sec)

mysql> SELECT JSON_OBJECTAGG(c, i) FROM t;
+-----+
| JSON_OBJECTAGG(c, i) |
+-----+
| {"key": 5}           |
+-----+
1 row in set (0.00 sec)

mysql> DELETE FROM t;
Query OK, 3 rows affected (0.08 sec)
```

```
mysql> INSERT INTO t VALUES ('key', 3), ('key', 5), ('key', 4);
Query OK, 3 rows affected (0.06 sec)
Records: 3 Duplicates: 0 Warnings: 0

mysql> SELECT c, i FROM t;
+-----+-----+
| c     | i     |
+-----+-----+
| key   | 3     |
| key   | 5     |
| key   | 4     |
+-----+-----+
3 rows in set (0.00 sec)

mysql> SELECT JSON_OBJECTAGG(c, i) FROM t;
+-----+
| JSON_OBJECTAGG(c, i) |
+-----+
| {"key": 4}           |
+-----+
1 row in set (0.00 sec)
```

See [Normalization, Merging, and Autowrapping of JSON Values](#), for additional information and examples.

Added in MySQL 5.7.22.

- `MAX([DISTINCT] expr)`

Returns the maximum value of *expr*. `MAX()` may take a string argument; in such cases, it returns the maximum string value. See [Section 8.3.1, “How MySQL Uses Indexes”](#). The `DISTINCT` keyword can be used to find the maximum of the distinct values of *expr*, however, this produces the same result as omitting `DISTINCT`.

If there are no matching rows, `MAX()` returns `NULL`.

```
mysql> SELECT student_name, MIN(test_score), MAX(test_score)
FROM student
GROUP BY student_name;
```

For `MAX()`, MySQL currently compares `ENUM` and `SET` columns by their string value rather than by the string's relative position in the set. This differs from how `ORDER BY` compares them.

- `MIN([DISTINCT] expr)`

Returns the minimum value of *expr*. `MIN()` may take a string argument; in such cases, it returns the minimum string value. See [Section 8.3.1, “How MySQL Uses Indexes”](#). The `DISTINCT` keyword can be used to find the minimum of the distinct values of *expr*, however, this produces the same result as omitting `DISTINCT`.

If there are no matching rows, `MIN()` returns `NULL`.

```
mysql> SELECT student_name, MIN(test_score), MAX(test_score)
FROM student
GROUP BY student_name;
```

For `MIN()`, MySQL currently compares `ENUM` and `SET` columns by their string value rather than by the string's relative position in the set. This differs from how `ORDER BY` compares them.

- `STD(expr)`

Returns the population standard deviation of *expr*. `STD()` is a synonym for the standard SQL function `STDDEV_POP()`, provided as a MySQL extension.

If there are no matching rows, `STD()` returns `NULL`.
- `STDDEV(expr)`

Returns the population standard deviation of *expr*. `STDDEV()` is a synonym for the standard SQL function `STDDEV_POP()`, provided for compatibility with Oracle.

If there are no matching rows, `STDDEV()` returns `NULL`.
- `STDDEV_POP(expr)`

Returns the population standard deviation of *expr* (the square root of `VAR_POP()`). You can also use `STD()` or `STDDEV()`, which are equivalent but not standard SQL.

If there are no matching rows, `STDDEV_POP()` returns `NULL`.
- `STDDEV_SAMP(expr)`

Returns the sample standard deviation of *expr* (the square root of `VAR_SAMP()`).

If there are no matching rows, `STDDEV_SAMP()` returns `NULL`.
- `SUM([DISTINCT] expr)`

Returns the sum of *expr*. If the return set has no rows, `SUM()` returns `NULL`. The `DISTINCT` keyword can be used to sum only the distinct values of *expr*.

If there are no matching rows, `SUM()` returns `NULL`.
- `VAR_POP(expr)`

Returns the population standard variance of *expr*. It considers rows as the whole population, not as a sample, so it has the number of rows as the denominator. You can also use `VARIANCE()`, which is equivalent but is not standard SQL.

If there are no matching rows, `VAR_POP()` returns `NULL`.
- `VAR_SAMP(expr)`

Returns the sample variance of *expr*. That is, the denominator is the number of rows minus one.

If there are no matching rows, `VAR_SAMP()` returns `NULL`.
- `VARIANCE(expr)`

Returns the population standard variance of *expr*. `VARIANCE()` is a synonym for the standard SQL function `VAR_POP()`, provided as a MySQL extension.

If there are no matching rows, `VARIANCE()` returns `NULL`.

## 12.19.2 GROUP BY Modifiers

The `GROUP BY` clause permits a `WITH ROLLUP` modifier that causes summary output to include extra rows that represent higher-level (that is, super-aggregate) summary operations. `ROLLUP` thus enables you to



answer questions at multiple levels of analysis with a single query. For example, [ROLLUP](#) can be used to provide support for OLAP (Online Analytical Processing) operations.

Suppose that a `sales` table has `year`, `country`, `product`, and `profit` columns for recording sales profitability:

```
CREATE TABLE sales
(
  year      INT,
  country   VARCHAR(20),
  product   VARCHAR(32),
  profit    INT
);
```

To summarize table contents per year, use a simple `GROUP BY` like this:

```
mysql> SELECT year, SUM(profit) AS profit
        FROM sales
        GROUP BY year;
```

```
+-----+-----+
| year | profit |
+-----+-----+
| 2000 |  4525 |
| 2001 |  3010 |
+-----+-----+
```

The output shows the total (aggregate) profit for each year. To also determine the total profit summed over all years, you must add up the individual values yourself or run an additional query. Or you can use [ROLLUP](#), which provides both levels of analysis with a single query. Adding a `WITH ROLLUP` modifier to the `GROUP BY` clause causes the query to produce another (super-aggregate) row that shows the grand total over all year values:

```
mysql> SELECT year, SUM(profit) AS profit
        FROM sales
        GROUP BY year WITH ROLLUP;
```

```
+-----+-----+
| year | profit |
+-----+-----+
| 2000 |  4525 |
| 2001 |  3010 |
| NULL |  7535 |
+-----+-----+
```

The `NULL` value in the `year` column identifies the grand total super-aggregate line.

[ROLLUP](#) has a more complex effect when there are multiple `GROUP BY` columns. In this case, each time there is a change in value in any but the last grouping column, the query produces an extra super-aggregate summary row.

For example, without [ROLLUP](#), a summary of the `sales` table based on `year`, `country`, and `product` might look like this, where the output indicates summary values only at the year/country/product level of analysis:

```
mysql> SELECT year, country, product, SUM(profit) AS profit
        FROM sales
        GROUP BY year, country, product;
```

```
+-----+-----+-----+-----+
| year | country | product  | profit |
+-----+-----+-----+-----+
| 2000 | Finland | Computer | 1500   |
| 2000 | Finland | Phone    | 100    |
| 2000 | India   | Calculator | 150    |
| 2000 | India   | Computer  | 1200   |
| 2000 | USA     | Calculator | 75     |
```

## GROUP BY Modifiers

2000	USA	Computer	1500
2001	Finland	Phone	10
2001	USA	Calculator	50
2001	USA	Computer	2700
2001	USA	TV	250

With `ROLLUP` added, the query produces several extra rows:

```
mysql> SELECT year, country, product, SUM(profit) AS profit
FROM sales
GROUP BY year, country, product WITH ROLLUP;
```

year	country	product	profit
2000	Finland	Computer	1500
2000	Finland	Phone	100
2000	Finland	NULL	1600
2000	India	Calculator	150
2000	India	Computer	1200
2000	India	NULL	1350
2000	USA	Calculator	75
2000	USA	Computer	1500
2000	USA	NULL	1575
2000	NULL	NULL	4525
2001	Finland	Phone	10
2001	Finland	NULL	10
2001	USA	Calculator	50
2001	USA	Computer	2700
2001	USA	TV	250
2001	USA	NULL	3000
2001	NULL	NULL	3010
NULL	NULL	NULL	7535

Now the output includes summary information at four levels of analysis, not just one:

- Following each set of product rows for a given year and country, an extra super-aggregate summary row appears showing the total for all products. These rows have the `product` column set to `NULL`.
- Following each set of rows for a given year, an extra super-aggregate summary row appears showing the total for all countries and products. These rows have the `country` and `products` columns set to `NULL`.
- Finally, following all other rows, an extra super-aggregate summary row appears showing the grand total for all years, countries, and products. This row has the `year`, `country`, and `products` columns set to `NULL`.

The `NULL` indicators in each super-aggregate row are produced when the row is sent to the client. The server looks at the columns named in the `GROUP BY` clause following the leftmost one that has changed value. For any column in the result set with a name that matches any of those names, its value is set to `NULL`. (If you specify grouping columns by column position, the server identifies which columns to set to `NULL` by position.)

Because the `NULL` values in the super-aggregate rows are placed into the result set at such a late stage in query processing, you can test them as `NULL` values only in the select list or `HAVING` clause. You cannot test them as `NULL` values in join conditions or the `WHERE` clause to determine which rows to select. For example, you cannot add `WHERE product IS NULL` to the query to eliminate from the output all but the super-aggregate rows.

The `NULL` values do appear as `NULL` on the client side and can be tested as such using any MySQL client programming interface. However, at this point, you cannot distinguish whether a `NULL` represents a regular

grouped value or a super-aggregate value. In MySQL 8.0, you can use the `GROUPING()` function to test the distinction.

## Other Considerations When using ROLLUP

The following discussion lists some behaviors specific to the MySQL implementation of `ROLLUP`.

When you use `ROLLUP`, you cannot also use an `ORDER BY` clause to sort the results. In other words, `ROLLUP` and `ORDER BY` are mutually exclusive in MySQL. However, you still have some control over sort order. To work around the restriction that prevents using `ROLLUP` with `ORDER BY` and achieve a specific sort order of grouped results, generate the grouped result set as a derived table and apply `ORDER BY` to it. For example:

```
mysql> SELECT * FROM
      (SELECT year, SUM(profit) AS profit
       FROM sales GROUP BY year WITH ROLLUP) AS dt
      ORDER BY year DESC;
+-----+-----+
| year | profit |
+-----+-----+
| 2001 | 3010   |
| 2000 | 4525   |
| NULL | 7535   |
+-----+-----+
```

In this case, the super-aggregate summary rows sort with the rows from which they are calculated, and their placement depends on sort order (at the beginning for ascending sort, at the end for descending sort).

`LIMIT` can be used to restrict the number of rows returned to the client. `LIMIT` is applied after `ROLLUP`, so the limit applies against the extra rows added by `ROLLUP`. For example:

```
mysql> SELECT year, country, product, SUM(profit) AS profit
      FROM sales
      GROUP BY year, country, product WITH ROLLUP
      LIMIT 5;
+-----+-----+-----+-----+
| year | country | product | profit |
+-----+-----+-----+-----+
| 2000 | Finland | Computer | 1500   |
| 2000 | Finland | Phone   | 100    |
| 2000 | Finland | NULL    | 1600   |
| 2000 | India   | Calculator | 150    |
| 2000 | India   | Computer | 1200   |
+-----+-----+-----+-----+
```

Using `LIMIT` with `ROLLUP` may produce results that are more difficult to interpret, because there is less context for understanding the super-aggregate rows.

A MySQL extension permits a column that does not appear in the `GROUP BY` list to be named in the select list. (For information about nonaggregated columns and `GROUP BY`, see [Section 12.19.3, “MySQL Handling of GROUP BY”](#).) In this case, the server is free to choose any value from this nonaggregated column in summary rows, and this includes the extra rows added by `WITH ROLLUP`. For example, in the following query, `country` is a nonaggregated column that does not appear in the `GROUP BY` list and values chosen for this column are nondeterministic:

```
mysql> SELECT year, country, SUM(profit) AS profit
      FROM sales
      GROUP BY year WITH ROLLUP;
+-----+-----+-----+
| year | country | profit |
+-----+-----+-----+
| 2000 | India   | 4525   |
| 2001 | USA     | 3010   |
+-----+-----+-----+
```

```
| NULL | USA      | 7535 |
+-----+-----+-----+
```

This behavior is permitted when the `ONLY_FULL_GROUP_BY` SQL mode is not enabled. If that mode is enabled, the server rejects the query as illegal because `country` is not listed in the `GROUP BY` clause. With `ONLY_FULL_GROUP_BY` enabled, you can still execute the query by using the `ANY_VALUE()` function for nondeterministic-value columns:

```
mysql> SELECT year, ANY_VALUE(country) AS country, SUM(profit) AS profit
        FROM sales
        GROUP BY year WITH ROLLUP;
+-----+-----+-----+
| year | country | profit |
+-----+-----+-----+
| 2000 | India   | 4525   |
| 2001 | USA     | 3010   |
| NULL | USA     | 7535   |
+-----+-----+-----+
```

### 12.19.3 MySQL Handling of GROUP BY

SQL-92 and earlier does not permit queries for which the select list, `HAVING` condition, or `ORDER BY` list refer to nonaggregated columns that are not named in the `GROUP BY` clause. For example, this query is illegal in standard SQL-92 because the nonaggregated `name` column in the select list does not appear in the `GROUP BY`:

```
SELECT o.custid, c.name, MAX(o.payment)
   FROM orders AS o, customers AS c
  WHERE o.custid = c.custid
   GROUP BY o.custid;
```

For the query to be legal in SQL-92, the `name` column must be omitted from the select list or named in the `GROUP BY` clause.

SQL:1999 and later permits such nonaggregates per optional feature T301 if they are functionally dependent on `GROUP BY` columns: If such a relationship exists between `name` and `custid`, the query is legal. This would be the case, for example, were `custid` a primary key of `customers`.

MySQL 5.7.5 and later implements detection of functional dependence. If the `ONLY_FULL_GROUP_BY` SQL mode is enabled (which it is by default), MySQL rejects queries for which the select list, `HAVING` condition, or `ORDER BY` list refer to nonaggregated columns that are neither named in the `GROUP BY` clause nor are functionally dependent on them. (Before 5.7.5, MySQL does not detect functional dependency and `ONLY_FULL_GROUP_BY` is not enabled by default.)

MySQL 5.7.5 and later also permits a nonaggregate column not named in a `GROUP BY` clause when `ONLY_FULL_GROUP_BY` SQL mode is enabled, provided that this column is limited to a single value, as shown in the following example:

```
mysql> CREATE TABLE mytable (
->   id INT UNSIGNED NOT NULL PRIMARY KEY,
->   a VARCHAR(10),
->   b INT
-> );

mysql> INSERT INTO mytable
-> VALUES (1, 'abc', 1000),
->        (2, 'abc', 2000),
->        (3, 'def', 4000);

mysql> SET SESSION sql_mode = sys.list_add(@@session.sql_mode, 'ONLY_FULL_GROUP_BY');

mysql> SELECT a, SUM(b) FROM mytable WHERE a = 'abc';
```

```

+-----+-----+
| a      | SUM(b) |
+-----+-----+
| abc    | 3000   |
+-----+-----+

```

It is also possible to have more than one nonaggregate column in the `SELECT` list when employing `ONLY_FULL_GROUP_BY`. In this case, every such column must be limited to a single value, and all such limiting conditions must be joined by logical `AND`, as shown here:

```

mysql> DROP TABLE IF EXISTS mytable;

mysql> CREATE TABLE mytable (
  ->   id INT UNSIGNED NOT NULL PRIMARY KEY,
  ->   a VARCHAR(10),
  ->   b VARCHAR(10),
  ->   c INT
  -> );

mysql> INSERT INTO mytable
  -> VALUES (1, 'abc', 'qrs', 1000),
  ->          (2, 'abc', 'tuv', 2000),
  ->          (3, 'def', 'qrs', 4000),
  ->          (4, 'def', 'tuv', 8000),
  ->          (5, 'abc', 'qrs', 16000),
  ->          (6, 'def', 'tuv', 32000);

mysql> SELECT @@session.sql_mode;
+-----+-----+
| @@session.sql_mode |
+-----+-----+
| ONLY_FULL_GROUP_BY,STRICT_TRANS_TABLES,NO_ENGINE_SUBSTITUTION |
+-----+-----+

mysql> SELECT a, b, SUM(c) FROM mytable
  ->   WHERE a = 'abc' AND b = 'qrs';
+-----+-----+-----+
| a      | b      | SUM(c) |
+-----+-----+-----+
| abc    | qrs    | 17000  |
+-----+-----+-----+

```

If `ONLY_FULL_GROUP_BY` is disabled, a MySQL extension to the standard SQL use of `GROUP BY` permits the select list, `HAVING` condition, or `ORDER BY` list to refer to nonaggregated columns even if the columns are not functionally dependent on `GROUP BY` columns. This causes MySQL to accept the preceding query. In this case, the server is free to choose any value from each group, so unless they are the same, the values chosen are nondeterministic, which is probably not what you want. Furthermore, the selection of values from each group cannot be influenced by adding an `ORDER BY` clause. Result set sorting occurs after values have been chosen, and `ORDER BY` does not affect which value within each group the server chooses. Disabling `ONLY_FULL_GROUP_BY` is useful primarily when you know that, due to some property of the data, all values in each nonaggregated column not named in the `GROUP BY` are the same for each group.

You can achieve the same effect without disabling `ONLY_FULL_GROUP_BY` by using `ANY_VALUE()` to refer to the nonaggregated column.

The following discussion demonstrates functional dependence, the error message MySQL produces when functional dependence is absent, and ways of causing MySQL to accept a query in the absence of functional dependence.

This query might be invalid with `ONLY_FULL_GROUP_BY` enabled because the nonaggregated `address` column in the select list is not named in the `GROUP BY` clause:

```
SELECT name, address, MAX(age) FROM t GROUP BY name;
```

The query is valid if `name` is a primary key of `t` or is a unique `NOT NULL` column. In such cases, MySQL recognizes that the selected column is functionally dependent on a grouping column. For example, if `name` is a primary key, its value determines the value of `address` because each group has only one value of the primary key and thus only one row. As a result, there is no randomness in the choice of `address` value in a group and no need to reject the query.

The query is invalid if `name` is not a primary key of `t` or a unique `NOT NULL` column. In this case, no functional dependency can be inferred and an error occurs:

```
mysql> SELECT name, address, MAX(age) FROM t GROUP BY name;
ERROR 1055 (42000): Expression #2 of SELECT list is not in GROUP
BY clause and contains nonaggregated column 'mydb.t.address' which
is not functionally dependent on columns in GROUP BY clause; this
is incompatible with sql_mode=only_full_group_by
```

If you know that, *for a given data set*, each `name` value in fact uniquely determines the `address` value, `address` is effectively functionally dependent on `name`. To tell MySQL to accept the query, you can use the `ANY_VALUE()` function:

```
SELECT name, ANY_VALUE(address), MAX(age) FROM t GROUP BY name;
```

Alternatively, disable `ONLY_FULL_GROUP_BY`.

The preceding example is quite simple, however. In particular, it is unlikely you would group on a single primary key column because every group would contain only one row. For additional examples demonstrating functional dependence in more complex queries, see [Section 12.19.4, “Detection of Functional Dependence”](#).

If a query has aggregate functions and no `GROUP BY` clause, it cannot have nonaggregated columns in the select list, `HAVING` condition, or `ORDER BY` list with `ONLY_FULL_GROUP_BY` enabled:

```
mysql> SELECT name, MAX(age) FROM t;
ERROR 1140 (42000): In aggregated query without GROUP BY, expression
#1 of SELECT list contains nonaggregated column 'mydb.t.name'; this
is incompatible with sql_mode=only_full_group_by
```

Without `GROUP BY`, there is a single group and it is nondeterministic which `name` value to choose for the group. Here, too, `ANY_VALUE()` can be used, if it is immaterial which `name` value MySQL chooses:

```
SELECT ANY_VALUE(name), MAX(age) FROM t;
```

In MySQL 5.7.5 and later, `ONLY_FULL_GROUP_BY` also affects handling of queries that use `DISTINCT` and `ORDER BY`. Consider the case of a table `t` with three columns `c1`, `c2`, and `c3` that contains these rows:

```
c1 c2 c3
1  2  A
3  4  B
1  2  C
```

Suppose that we execute the following query, expecting the results to be ordered by `c3`:

```
SELECT DISTINCT c1, c2 FROM t ORDER BY c3;
```

To order the result, duplicates must be eliminated first. But to do so, should we keep the first row or the third? This arbitrary choice influences the retained value of `c3`, which in turn influences ordering and makes it arbitrary as well. To prevent this problem, a query that has `DISTINCT` and `ORDER BY` is rejected as invalid if any `ORDER BY` expression does not satisfy at least one of these conditions:

- The expression is equal to one in the select list
- All columns referenced by the expression and belonging to the query's selected tables are elements of the select list

Another MySQL extension to standard SQL permits references in the `HAVING` clause to aliased expressions in the select list. For example, the following query returns `name` values that occur only once in table `orders`:

```
SELECT name, COUNT(name) FROM orders
GROUP BY name
HAVING COUNT(name) = 1;
```

The MySQL extension permits the use of an alias in the `HAVING` clause for the aggregated column:

```
SELECT name, COUNT(name) AS c FROM orders
GROUP BY name
HAVING c = 1;
```



### Note

Before MySQL 5.7.5, enabling `ONLY_FULL_GROUP_BY` disables this extension, thus requiring the `HAVING` clause to be written using unaliased expressions.

Standard SQL permits only column expressions in `GROUP BY` clauses, so a statement such as this is invalid because `FLOOR(value/100)` is a noncolumn expression:

```
SELECT id, FLOOR(value/100)
FROM tbl_name
GROUP BY id, FLOOR(value/100);
```

MySQL extends standard SQL to permit noncolumn expressions in `GROUP BY` clauses and considers the preceding statement valid.

Standard SQL also does not permit aliases in `GROUP BY` clauses. MySQL extends standard SQL to permit aliases, so another way to write the query is as follows:

```
SELECT id, FLOOR(value/100) AS val
FROM tbl_name
GROUP BY id, val;
```

The alias `val` is considered a column expression in the `GROUP BY` clause.

In the presence of a noncolumn expression in the `GROUP BY` clause, MySQL recognizes equality between that expression and expressions in the select list. This means that with `ONLY_FULL_GROUP_BY` SQL mode enabled, the query containing `GROUP BY id, FLOOR(value/100)` is valid because that same `FLOOR()` expression occurs in the select list. However, MySQL does not try to recognize functional dependence on `GROUP BY` noncolumn expressions, so the following query is invalid with `ONLY_FULL_GROUP_BY` enabled, even though the third selected expression is a simple formula of the `id` column and the `FLOOR()` expression in the `GROUP BY` clause:

```
SELECT id, FLOOR(value/100), id+FLOOR(value/100)
FROM tbl_name
GROUP BY id, FLOOR(value/100);
```

A workaround is to use a derived table:

```
SELECT id, F, id+F
FROM
  (SELECT id, FLOOR(value/100) AS F
   FROM tbl_name
   GROUP BY id, FLOOR(value/100)) AS dt;
```

## 12.19.4 Detection of Functional Dependence

The following discussion provides several examples of the ways in which MySQL detects functional dependencies. The examples use this notation:

```
{X} -> {Y}
```

Understand this as “*X* uniquely determines *Y*,” which also means that *Y* is functionally dependent on *X*.

The examples use the `world` database, which can be downloaded from <https://dev.mysql.com/doc/index-other.html>. You can find details on how to install the database on the same page.

- [Functional Dependencies Derived from Keys](#)
- [Functional Dependencies Derived from Multiple-Column Keys and from Equalities](#)
- [Functional Dependency Special Cases](#)
- [Functional Dependencies and Views](#)
- [Combinations of Functional Dependencies](#)

### Functional Dependencies Derived from Keys

The following query selects, for each country, a count of spoken languages:

```
SELECT co.Name, COUNT(*)
FROM countrylanguage cl, country co
WHERE cl.CountryCode = co.Code
GROUP BY co.Code;
```

`co.Code` is a primary key of `co`, so all columns of `co` are functionally dependent on it, as expressed using this notation:

```
{co.Code} -> {co.*}
```

Thus, `co.name` is functionally dependent on `GROUP BY` columns and the query is valid.

A `UNIQUE` index over a `NOT NULL` column could be used instead of a primary key and the same functional dependence would apply. (This is not true for a `UNIQUE` index that permits `NULL` values because it permits multiple `NULL` values and in that case uniqueness is lost.)

### Functional Dependencies Derived from Multiple-Column Keys and from Equalities

This query selects, for each country, a list of all spoken languages and how many people speak them:

```
SELECT co.Name, cl.Language,
cl.Percentage * co.Population / 100.0 AS SpokenBy
FROM countryLanguage cl, country co
WHERE cl.CountryCode = co.Code
GROUP BY cl.CountryCode, cl.Language;
```

The pair (`cl.CountryCode`, `cl.Language`) is a two-column composite primary key of `cl`, so that column pair uniquely determines all columns of `cl`:

```
{cl.CountryCode, cl.Language} -> {cl.*}
```

Moreover, because of the equality in the `WHERE` clause:

```
{cl.CountryCode} -> {co.Code}
```

And, because `co.Code` is primary key of `co`:



```
{co.Code} -> {co.*}
```

“Uniquely determines” relationships are transitive, therefore:

```
{cl.CountryCode, cl.Language} -> {cl.*,co.*}
```

As a result, the query is valid.

As with the previous example, a **UNIQUE** key over **NOT NULL** columns could be used instead of a primary key.

An **INNER JOIN** condition can be used instead of **WHERE**. The same functional dependencies apply:

```
SELECT co.Name, cl.Language,
cl.Percentage * co.Population/100.0 AS SpokenBy
FROM countrylanguage cl INNER JOIN country co
ON cl.CountryCode = co.Code
GROUP BY cl.CountryCode, cl.Language;
```

## Functional Dependency Special Cases

Whereas an equality test in a **WHERE** condition or **INNER JOIN** condition is symmetric, an equality test in an outer join condition is not, because tables play different roles.

Assume that referential integrity has been accidentally broken and there exists a row of **countrylanguage** without a corresponding row in **country**. Consider the same query as in the previous example, but with a **LEFT JOIN**:

```
SELECT co.Name, cl.Language,
cl.Percentage * co.Population/100.0 AS SpokenBy
FROM countrylanguage cl LEFT JOIN country co
ON cl.CountryCode = co.Code
GROUP BY cl.CountryCode, cl.Language;
```

For a given value of **cl.CountryCode**, the value of **co.Code** in the join result is either found in a matching row (determined by **cl.CountryCode**) or is **NULL**-complemented if there is no match (also determined by **cl.CountryCode**). In each case, this relationship applies:

```
{cl.CountryCode} -> {co.Code}
```

**cl.CountryCode** is itself functionally dependent on **{cl.CountryCode, cl.Language}** which is a primary key.

If in the join result **co.Code** is **NULL**-complemented, **co.Name** is as well. If **co.Code** is not **NULL**-complemented, then because **co.Code** is a primary key, it determines **co.Name**. Therefore, in all cases:

```
{co.Code} -> {co.Name}
```

Which yields:

```
{cl.CountryCode, cl.Language} -> {cl.*,co.*}
```

As a result, the query is valid.

However, suppose that the tables are swapped, as in this query:

```
SELECT co.Name, cl.Language,
cl.Percentage * co.Population/100.0 AS SpokenBy
FROM country co LEFT JOIN countrylanguage cl
ON cl.CountryCode = co.Code
GROUP BY cl.CountryCode, cl.Language;
```

Now this relationship does *not* apply:

```
{cl.CountryCode, cl.Language} -> {cl.*,co.*}
```

All `NULL`-complemented rows made for `cl` are put into a single group (they have both `GROUP BY` columns equal to `NULL`), and inside this group the value of `co.Name` can vary. The query is invalid and MySQL rejects it.

Functional dependence in outer joins is thus linked to whether determinant columns belong to the left or right side of the `LEFT JOIN`. Determination of functional dependence becomes more complex if there are nested outer joins or the join condition does not consist entirely of equality comparisons.

## Functional Dependencies and Views

Suppose that a view on countries produces their code, their name in uppercase, and how many different official languages they have:

```
CREATE VIEW country2 AS
SELECT co.Code, UPPER(co.Name) AS UpperName,
COUNT(cl.Language) AS OfficialLanguages
FROM country AS co JOIN countrylanguage AS cl
ON cl.CountryCode = co.Code
WHERE cl.isOfficial = 'T'
GROUP BY co.Code;
```

This definition is valid because:

```
{co.Code} -> {co.*}
```

In the view result, the first selected column is `co.Code`, which is also the group column and thus determines all other selected expressions:

```
{country2.Code} -> {country2.*}
```

MySQL understands this and uses this information, as described following.

This query displays countries, how many different official languages they have, and how many cities they have, by joining the view with the `city` table:

```
SELECT co2.Code, co2.UpperName, co2.OfficialLanguages,
COUNT(*) AS Cities
FROM country2 AS co2 JOIN city ci
ON ci.CountryCode = co2.Code
GROUP BY co2.Code;
```

This query is valid because, as seen previously:

```
{co2.Code} -> {co2.*}
```

MySQL is able to discover a functional dependency in the result of a view and use that to validate a query which uses the view. The same would be true if `country2` were a derived table, as in:

```
SELECT co2.Code, co2.UpperName, co2.OfficialLanguages,
COUNT(*) AS Cities
FROM
(
SELECT co.Code, UPPER(co.Name) AS UpperName,
COUNT(cl.Language) AS OfficialLanguages
FROM country AS co JOIN countrylanguage AS cl
ON cl.CountryCode=co.Code
WHERE cl.isOfficial='T'
GROUP BY co.Code
) AS co2
JOIN city ci ON ci.CountryCode = co2.Code
GROUP BY co2.Code;
```

## Combinations of Functional Dependencies

MySQL is able to combine all of the preceding types of functional dependencies (key based, equality based, view based) to validate more complex queries.

## 12.20 Miscellaneous Functions

**Table 12.26 Miscellaneous Functions**

Name	Description
<code>ANY_VALUE()</code>	Suppress <code>ONLY_FULL_GROUP_BY</code> value rejection
<code>DEFAULT()</code>	Return the default value for a table column
<code>INET_ATON()</code>	Return the numeric value of an IP address
<code>INET_NTOA()</code>	Return the IP address from a numeric value
<code>INET6_ATON()</code>	Return the numeric value of an IPv6 address
<code>INET6_NTOA()</code>	Return the IPv6 address from a numeric value
<code>IS_IPV4()</code>	Whether argument is an IPv4 address
<code>IS_IPV4_COMPAT()</code>	Whether argument is an IPv4-compatible address
<code>IS_IPV4_MAPPED()</code>	Whether argument is an IPv4-mapped address
<code>IS_IPV6()</code>	Whether argument is an IPv6 address
<code>NAME_CONST()</code>	Cause the column to have the given name
<code>SLEEP()</code>	Sleep for a number of seconds
<code>UUID()</code>	Return a Universal Unique Identifier (UUID)
<code>UUID_SHORT()</code>	Return an integer-valued universal identifier
<code>VALUES()</code>	Define the values to be used during an INSERT

- `ANY_VALUE(arg)`

This function is useful for `GROUP BY` queries when the `ONLY_FULL_GROUP_BY` SQL mode is enabled, for cases when MySQL rejects a query that you know is valid for reasons that MySQL cannot determine. The function return value and type are the same as the return value and type of its argument, but the function result is not checked for the `ONLY_FULL_GROUP_BY` SQL mode.

For example, if `name` is a nonindexed column, the following query fails with `ONLY_FULL_GROUP_BY` enabled:

```
mysql> SELECT name, address, MAX(age) FROM t GROUP BY name;
ERROR 1055 (42000): Expression #2 of SELECT list is not in GROUP
BY clause and contains nonaggregated column 'mydb.t.address' which
is not functionally dependent on columns in GROUP BY clause; this
is incompatible with sql_mode=only_full_group_by
```

The failure occurs because `address` is a nonaggregated column that is neither named among `GROUP BY` columns nor functionally dependent on them. As a result, the `address` value for rows within each `name` group is nondeterministic. There are multiple ways to cause MySQL to accept the query:

- Alter the table to make `name` a primary key or a unique `NOT NULL` column. This enables MySQL to determine that `address` is functionally dependent on `name`; that is, `address` is uniquely determined by `name`. (This technique is inapplicable if `NULL` must be permitted as a valid `name` value.)

- Use `ANY_VALUE()` to refer to `address`:

```
SELECT name, ANY_VALUE(address), MAX(age) FROM t GROUP BY name;
```

In this case, MySQL ignores the nondeterminism of `address` values within each `name` group and accepts the query. This may be useful if you simply do not care which value of a nonaggregated column is chosen for each group. `ANY_VALUE()` is not an aggregate function, unlike functions such as `SUM()` or `COUNT()`. It simply acts to suppress the test for nondeterminism.

- Disable `ONLY_FULL_GROUP_BY`. This is equivalent to using `ANY_VALUE()` with `ONLY_FULL_GROUP_BY` enabled, as described in the previous item.

`ANY_VALUE()` is also useful if functional dependence exists between columns but MySQL cannot determine it. The following query is valid because `age` is functionally dependent on the grouping column `age-1`, but MySQL cannot tell that and rejects the query with `ONLY_FULL_GROUP_BY` enabled:

```
SELECT age FROM t GROUP BY age-1;
```

To cause MySQL to accept the query, use `ANY_VALUE()`:

```
SELECT ANY_VALUE(age) FROM t GROUP BY age-1;
```

`ANY_VALUE()` can be used for queries that refer to aggregate functions in the absence of a `GROUP BY` clause:

```
mysql> SELECT name, MAX(age) FROM t;
ERROR 1140 (42000): In aggregated query without GROUP BY, expression
#1 of SELECT list contains nonaggregated column 'mydb.t.name'; this
is incompatible with sql_mode=only_full_group_by
```

Without `GROUP BY`, there is a single group and it is nondeterministic which `name` value to choose for the group. `ANY_VALUE()` tells MySQL to accept the query:

```
SELECT ANY_VALUE(name), MAX(age) FROM t;
```

It may be that, due to some property of a given data set, you know that a selected nonaggregated column is effectively functionally dependent on a `GROUP BY` column. For example, an application may enforce uniqueness of one column with respect to another. In this case, using `ANY_VALUE()` for the effectively functionally dependent column may make sense.

For additional discussion, see [Section 12.19.3, “MySQL Handling of GROUP BY”](#).

- `DEFAULT(col_name)`

Returns the default value for a table column. An error results if the column has no default value.

```
mysql> UPDATE t SET i = DEFAULT(i)+1 WHERE id < 100;
```

- `FORMAT(X,D)`

Formats the number `X` to a format like `'#,###,###.##'`, rounded to `D` decimal places, and returns the result as a string. For details, see [Section 12.8, “String Functions and Operators”](#).

- `INET_ATON(expr)`

Given the dotted-quad representation of an IPv4 network address as a string, returns an integer that represents the numeric value of the address in network byte order (big endian). `INET_ATON()` returns `NULL` if it does not understand its argument.

```
mysql> SELECT INET_ATON('10.0.5.9');
-> 167773449
```

For this example, the return value is calculated as  $10 \times 256^3 + 0 \times 256^2 + 5 \times 256 + 9$ .

`INET_ATON()` may or may not return a non-NULL result for short-form IP addresses (such as `'127.1'` as a representation of `'127.0.0.1'`). Because of this, `INET_ATON()` should not be used for such addresses.



#### Note

To store values generated by `INET_ATON()`, use an `INT UNSIGNED` column rather than `INT`, which is signed. If you use a signed column, values corresponding to IP addresses for which the first octet is greater than 127 cannot be stored correctly. See [Section 11.1.7, “Out-of-Range and Overflow Handling”](#).

- `INET_NTOA(expr)`

Given a numeric IPv4 network address in network byte order, returns the dotted-quad string representation of the address as a string in the connection character set. `INET_NTOA()` returns `NULL` if it does not understand its argument.

```
mysql> SELECT INET_NTOA(167773449);
-> '10.0.5.9'
```

- `INET6_ATON(expr)`

Given an IPv6 or IPv4 network address as a string, returns a binary string that represents the numeric value of the address in network byte order (big endian). Because numeric-format IPv6 addresses require more bytes than the largest integer type, the representation returned by this function has the `VARBINARY` data type: `VARBINARY(16)` for IPv6 addresses and `VARBINARY(4)` for IPv4 addresses. If the argument is not a valid address, `INET6_ATON()` returns `NULL`.

The following examples use `HEX()` to display the `INET6_ATON()` result in printable form:

```
mysql> SELECT HEX(INET6_ATON('fdfe::5a55:caff:fefa:9089'));
-> 'FDFE00000000000005A55CAFFFEFA9089'
mysql> SELECT HEX(INET6_ATON('10.0.5.9'));
-> '0A000509'
```

`INET6_ATON()` observes several constraints on valid arguments. These are given in the following list along with examples.

- A trailing zone ID is not permitted, as in `fe80::3%1` or `fe80::3%eth0`.
- A trailing network mask is not permitted, as in `2001:45f:3:ba::/64` or `198.51.100.0/24`.
- For values representing IPv4 addresses, only classless addresses are supported. Classful addresses such as `198.51.1` are rejected. A trailing port number is not permitted, as in `198.51.100.2:8080`. Hexadecimal numbers in address components are not permitted, as in `198.0xa0.1.2`. Octal numbers are not supported: `198.51.010.1` is treated as `198.51.10.1`, not `198.51.8.1`. These IPv4 constraints also apply to IPv6 addresses that have IPv4 address parts, such as IPv4-compatible or IPv4-mapped addresses.

To convert an IPv4 address `expr` represented in numeric form as an `INT` value to an IPv6 address represented in numeric form as a `VARBINARY` value, use this expression:

```
INET6_ATON(INET_NTOA(expr))
```

For example:

```
mysql> SELECT HEX(INET6_ATON(INET_NTOA(167773449)));
-> '0A000509'
```

If `INET6_ATON()` is invoked from within the `mysql` client, binary strings display using hexadecimal notation, depending on the value of the `--binary-as-hex`. For more information about that option, see [Section 4.5.1, “mysql — The MySQL Command-Line Client”](#).

- `INET6_NTOA(expr)`

Given an IPv6 or IPv4 network address represented in numeric form as a binary string, returns the string representation of the address as a string in the connection character set. If the argument is not a valid address, `INET6_NTOA()` returns `NULL`.

`INET6_NTOA()` has these properties:

- It does not use operating system functions to perform conversions, thus the output string is platform independent.
- The return string has a maximum length of 39 (4 x 8 + 7). Given this statement:

```
CREATE TABLE t AS SELECT INET6_NTOA(expr) AS c1;
```

The resulting table would have this definition:

```
CREATE TABLE t (c1 VARCHAR(39) CHARACTER SET utf8 DEFAULT NULL);
```

- The return string uses lowercase letters for IPv6 addresses.

```
mysql> SELECT INET6_NTOA(INET6_ATON('fdfe::5a55:caff:fefa:9089'));
-> 'fdfe::5a55:caff:fefa:9089'
mysql> SELECT INET6_NTOA(INET6_ATON('10.0.5.9'));
-> '10.0.5.9'
mysql> SELECT INET6_NTOA(UNHEX('FDFE0000000000005A55CAFFFEFA9089'));
-> 'fdfe::5a55:caff:fefa:9089'
mysql> SELECT INET6_NTOA(UNHEX('0A000509'));
-> '10.0.5.9'
```

If `INET6_NTOA()` is invoked from within the `mysql` client, binary strings display using hexadecimal notation, depending on the value of the `--binary-as-hex`. For more information about that option, see [Section 4.5.1, “mysql — The MySQL Command-Line Client”](#).

- `IS_IPV4(expr)`

Returns 1 if the argument is a valid IPv4 address specified as a string, 0 otherwise.

```
mysql> SELECT IS_IPV4('10.0.5.9'), IS_IPV4('10.0.5.256');
-> 1, 0
```

For a given argument, if `IS_IPV4()` returns 1, `INET_ATON()` (and `INET6_ATON()`) returns a value that is not `NULL`. The converse statement is not true: In some cases, `INET_ATON()` returns a value other than `NULL` when `IS_IPV4()` returns 0.

As implied by the preceding remarks, `IS_IPV4()` is more strict than `INET_ATON()` about what constitutes a valid IPv4 address, so it may be useful for applications that need to perform strong checks against invalid values. Alternatively, use `INET6_ATON()` to convert IPv4 addresses to internal form

and check for a `NULL` result (which indicates an invalid address). `INET6_ATON()` is equally strong as `IS_IPV4()` about checking IPv4 addresses.

- `IS_IPV4_COMPAT(expr)`

This function takes an IPv6 address represented in numeric form as a binary string, as returned by `INET6_ATON()`. It returns 1 if the argument is a valid IPv4-compatible IPv6 address, 0 otherwise. IPv4-compatible addresses have the form `::ipv4_address`.

```
mysql> SELECT IS_IPV4_COMPAT(INET6_ATON('::10.0.5.9'));
-> 1
mysql> SELECT IS_IPV4_COMPAT(INET6_ATON('::ffff:10.0.5.9'));
-> 0
```

The IPv4 part of an IPv4-compatible address can also be represented using hexadecimal notation. For example, `198.51.100.1` has this raw hexadecimal value:

```
mysql> SELECT HEX(INET6_ATON('198.51.100.1'));
-> 'C6336401'
```

Expressed in IPv4-compatible form, `::198.51.100.1` is equivalent to `::c0a8:0001` or (without leading zeros) `::c0a8:1`

```
mysql> SELECT
-> IS_IPV4_COMPAT(INET6_ATON('::198.51.100.1')),
-> IS_IPV4_COMPAT(INET6_ATON('::c0a8:0001')),
-> IS_IPV4_COMPAT(INET6_ATON('::c0a8:1'));
-> 1, 1, 1
```

- `IS_IPV4_MAPPED(expr)`

This function takes an IPv6 address represented in numeric form as a binary string, as returned by `INET6_ATON()`. It returns 1 if the argument is a valid IPv4-mapped IPv6 address, 0 otherwise. IPv4-mapped addresses have the form `::ffff:ipv4_address`.

```
mysql> SELECT IS_IPV4_MAPPED(INET6_ATON('::10.0.5.9'));
-> 0
mysql> SELECT IS_IPV4_MAPPED(INET6_ATON('::ffff:10.0.5.9'));
-> 1
```

As with `IS_IPV4_COMPAT()` the IPv4 part of an IPv4-mapped address can also be represented using hexadecimal notation:

```
mysql> SELECT
-> IS_IPV4_MAPPED(INET6_ATON('::ffff:198.51.100.1')),
-> IS_IPV4_MAPPED(INET6_ATON('::ffff:c0a8:0001')),
-> IS_IPV4_MAPPED(INET6_ATON('::ffff:c0a8:1'));
-> 1, 1, 1
```

- `IS_IPV6(expr)`

Returns 1 if the argument is a valid IPv6 address specified as a string, 0 otherwise. This function does not consider IPv4 addresses to be valid IPv6 addresses.

```
mysql> SELECT IS_IPV6('10.0.5.9'), IS_IPV6('::1');
-> 0, 1
```

For a given argument, if `IS_IPV6()` returns 1, `INET6_ATON()` returns a value that is not `NULL`.

- `MASTER_POS_WAIT(log_name, log_pos[, timeout][, channel])`

This function is useful for control of source-replica synchronization. It blocks until the replica has read and applied all updates up to the specified position in the source log. The return value is the number of log events the replica had to wait for to advance to the specified position. The function returns `NULL` if the replica SQL thread is not started, the replica's source information is not initialized, the arguments are incorrect, or an error occurs. It returns `-1` if the timeout has been exceeded. If the replica SQL thread stops while `MASTER_POS_WAIT()` is waiting, the function returns `NULL`. If the replica is past the specified position, the function returns immediately.

On a multithreaded replica, the function waits until expiry of the limit set by the `slave_checkpoint_group` or `slave_checkpoint_period` system variable, when the checkpoint operation is called to update the status of the replica. Depending on the setting for the system variables, the function might therefore return some time after the specified position was reached.

If a `timeout` value is specified, `MASTER_POS_WAIT()` stops waiting when `timeout` seconds have elapsed. `timeout` must be greater than or equal to 0. (As of MySQL 5.7.18, when the server is running in strict SQL mode, a negative `timeout` value is immediately rejected with `ER_WRONG_ARGUMENTS`; otherwise the function returns `NULL`, and raises a warning.)

The optional `channel` value enables you to name which replication channel the function applies to. See [Section 16.2.2, “Replication Channels”](#) for more information.

This function is unsafe for statement-based replication. A warning is logged if you use this function when `binlog_format` is set to `STATEMENT`.

- `NAME_CONST(name, value)`

Returns the given value. When used to produce a result set column, `NAME_CONST()` causes the column to have the given name. The arguments should be constants.

```
mysql> SELECT NAME_CONST('myname', 14);
+-----+
| myname |
+-----+
|      14 |
+-----+
```

This function is for internal use only. The server uses it when writing statements from stored programs that contain references to local program variables, as described in [Section 23.7, “Stored Program Binary Logging”](#). You might see this function in the output from `mysqlbinlog`.

For your applications, you can obtain exactly the same result as in the example just shown by using simple aliasing, like this:

```
mysql> SELECT 14 AS myname;
+-----+
| myname |
+-----+
|      14 |
+-----+
1 row in set (0.00 sec)
```

See [Section 13.2.9, “SELECT Statement”](#), for more information about column aliases.



- `SLEEP(duration)`

Sleeps (pauses) for the number of seconds given by the *duration* argument, then returns 0. The duration may have a fractional part. If the argument is `NULL` or negative, `SLEEP()` produces a warning, or an error in strict SQL mode.

When sleep returns normally (without interruption), it returns 0:

```
mysql> SELECT SLEEP(1000);
+-----+
| SLEEP(1000) |
+-----+
|           0 |
+-----+
```

When `SLEEP()` is the only thing invoked by a query that is interrupted, it returns 1 and the query itself returns no error. This is true whether the query is killed or times out:

- This statement is interrupted using `KILL QUERY` from another session:

```
mysql> SELECT SLEEP(1000);
+-----+
| SLEEP(1000) |
+-----+
|           1 |
+-----+
```

- This statement is interrupted by timing out:

```
mysql> SELECT /*+ MAX_EXECUTION_TIME(1) */ SLEEP(1000);
+-----+
| SLEEP(1000) |
+-----+
|           1 |
+-----+
```

When `SLEEP()` is only part of a query that is interrupted, the query returns an error:

- This statement is interrupted using `KILL QUERY` from another session:

```
mysql> SELECT 1 FROM t1 WHERE SLEEP(1000);
ERROR 1317 (70100): Query execution was interrupted
```

- This statement is interrupted by timing out:

```
mysql> SELECT /*+ MAX_EXECUTION_TIME(1000) */ 1 FROM t1 WHERE SLEEP(1000);
ERROR 3024 (HY000): Query execution was interrupted, maximum statement
execution time exceeded
```

This function is unsafe for statement-based replication. A warning is logged if you use this function when `binlog_format` is set to `STATEMENT`.

- `UUID()`

Returns a Universal Unique Identifier (UUID) generated according to RFC 4122, “A Universally Unique Identifier (UUID) URN Namespace” (<http://www.ietf.org/rfc/rfc4122.txt>).

A UUID is designed as a number that is globally unique in space and time. Two calls to `UUID()` are expected to generate two different values, even if these calls are performed on two separate devices not connected to each other.

**Warning**

Although `UUID()` values are intended to be unique, they are not necessarily unguessable or unpredictable. If unpredictability is required, UUID values should be generated some other way.

`UUID()` returns a value that conforms to UUID version 1 as described in RFC 4122. The value is a 128-bit number represented as a `utf8` string of five hexadecimal numbers in `aaaaaaaa-bbbb-cccc-dddd-eeeeeeeeeeee` format:

- The first three numbers are generated from the low, middle, and high parts of a timestamp. The high part also includes the UUID version number.
- The fourth number preserves temporal uniqueness in case the timestamp value loses monotonicity (for example, due to daylight saving time).
- The fifth number is an IEEE 802 node number that provides spatial uniqueness. A random number is substituted if the latter is not available (for example, because the host device has no Ethernet card, or it is unknown how to find the hardware address of an interface on the host operating system). In this case, spatial uniqueness cannot be guaranteed. Nevertheless, a collision should have very low probability.

The MAC address of an interface is taken into account only on FreeBSD, Linux, and Windows. On other operating systems, MySQL uses a randomly generated 48-bit number.

```
mysql> SELECT UUID();
-> '6ccd780c-baba-1026-9564-5b8c656024db'
```

This function is unsafe for statement-based replication. A warning is logged if you use this function when `binlog_format` is set to `STATEMENT`.

- `UUID_SHORT()`

Returns a “short” universal identifier as a 64-bit unsigned integer. Values returned by `UUID_SHORT()` differ from the string-format 128-bit identifiers returned by the `UUID()` function and have different

uniqueness properties. The value of `UUID_SHORT()` is guaranteed to be unique if the following conditions hold:

- The `server_id` value of the current server is between 0 and 255 and is unique among your set of source and replica servers
- You do not set back the system time for your server host between `mysqld` restarts
- You invoke `UUID_SHORT()` on average fewer than 16 million times per second between `mysqld` restarts

The `UUID_SHORT()` return value is constructed this way:

```
(server_id & 255) << 56
+ (server_startup_time_in_seconds << 24)
+ incremented_variable++;
```

```
mysql> SELECT UUID_SHORT();
-> 92395783831158784
```



### Note

`UUID_SHORT()` does not work with statement-based replication.

- `VALUES(col_name)`

In an `INSERT ... ON DUPLICATE KEY UPDATE` statement, you can use the `VALUES(col_name)` function in the `UPDATE` clause to refer to column values from the `INSERT` portion of the statement. In other words, `VALUES(col_name)` in the `UPDATE` clause refers to the value of `col_name` that would be inserted, had no duplicate-key conflict occurred. This function is especially useful in multiple-row inserts. The `VALUES()` function is meaningful only in the `ON DUPLICATE KEY UPDATE` clause of `INSERT` statements and returns `NULL` otherwise. See [Section 13.2.5.2, “INSERT ... ON DUPLICATE KEY UPDATE Statement”](#).

```
mysql> INSERT INTO table (a,b,c) VALUES (1,2,3),(4,5,6)
-> ON DUPLICATE KEY UPDATE c=VALUES(a)+VALUES(b);
```

## 12.21 Precision Math

MySQL provides support for precision math: numeric value handling that results in extremely accurate results and a high degree control over invalid values. Precision math is based on these two features:

- SQL modes that control how strict the server is about accepting or rejecting invalid data.
- The MySQL library for fixed-point arithmetic.

These features have several implications for numeric operations and provide a high degree of compliance with standard SQL:

- **Precise calculations:** For exact-value numbers, calculations do not introduce floating-point errors. Instead, exact precision is used. For example, MySQL treats a number such as `.0001` as an exact value rather than as an approximation, and summing it 10,000 times produces a result of exactly `1`, not a value that is merely “close” to 1.
- **Well-defined rounding behavior:** For exact-value numbers, the result of `ROUND()` depends on its argument, not on environmental factors such as how the underlying C library works.

- **Platform independence:** Operations on exact numeric values are the same across different platforms such as Windows and Unix.
- **Control over handling of invalid values:** Overflow and division by zero are detectable and can be treated as errors. For example, you can treat a value that is too large for a column as an error rather than having the value truncated to lie within the range of the column's data type. Similarly, you can treat division by zero as an error rather than as an operation that produces a result of `NULL`. The choice of which approach to take is determined by the setting of the server SQL mode.

The following discussion covers several aspects of how precision math works, including possible incompatibilities with older applications. At the end, some examples are given that demonstrate how MySQL handles numeric operations precisely. For information about controlling the SQL mode, see [Section 5.1.10, “Server SQL Modes”](#).

## 12.21.1 Types of Numeric Values

The scope of precision math for exact-value operations includes the exact-value data types (integer and `DECIMAL` types) and exact-value numeric literals. Approximate-value data types and numeric literals are handled as floating-point numbers.

Exact-value numeric literals have an integer part or fractional part, or both. They may be signed. Examples: `1`, `.2`, `3.4`, `-5`, `-6.78`, `+9.10`.

Approximate-value numeric literals are represented in scientific notation with a mantissa and exponent. Either or both parts may be signed. Examples: `1.2E3`, `1.2E-3`, `-1.2E3`, `-1.2E-3`.

Two numbers that look similar may be treated differently. For example, `2.34` is an exact-value (fixed-point) number, whereas `2.34E0` is an approximate-value (floating-point) number.

The `DECIMAL` data type is a fixed-point type and calculations are exact. In MySQL, the `DECIMAL` type has several synonyms: `NUMERIC`, `DEC`, `FIXED`. The integer types also are exact-value types.

The `FLOAT` and `DOUBLE` data types are floating-point types and calculations are approximate. In MySQL, types that are synonymous with `FLOAT` or `DOUBLE` are `DOUBLE PRECISION` and `REAL`.

## 12.21.2 DECIMAL Data Type Characteristics

This section discusses the characteristics of the `DECIMAL` data type (and its synonyms), with particular regard to the following topics:

- Maximum number of digits
- Storage format
- Storage requirements
- The nonstandard MySQL extension to the upper range of `DECIMAL` columns

The declaration syntax for a `DECIMAL` column is `DECIMAL(M,D)`. The ranges of values for the arguments are as follows:

- `M` is the maximum number of digits (the precision). It has a range of 1 to 65.
- `D` is the number of digits to the right of the decimal point (the scale). It has a range of 0 to 30 and must be no larger than `M`.

If `D` is omitted, the default is 0. If `M` is omitted, the default is 10.

The maximum value of 65 for *M* means that calculations on `DECIMAL` values are accurate up to 65 digits. This limit of 65 digits of precision also applies to exact-value numeric literals, so the maximum range of such literals differs from before. (There is also a limit on how long the text of `DECIMAL` literals can be; see [Section 12.21.3, “Expression Handling”](#).)

Values for `DECIMAL` columns are stored using a binary format that packs nine decimal digits into 4 bytes. The storage requirements for the integer and fractional parts of each value are determined separately. Each multiple of nine digits requires 4 bytes, and any remaining digits left over require some fraction of 4 bytes. The storage required for remaining digits is given by the following table.

Leftover Digits	Number of Bytes
0	0
1–2	1
3–4	2
5–6	3
7–9	4

For example, a `DECIMAL(18,9)` column has nine digits on either side of the decimal point, so the integer part and the fractional part each require 4 bytes. A `DECIMAL(20,6)` column has fourteen integer digits and six fractional digits. The integer digits require four bytes for nine of the digits and 3 bytes for the remaining five digits. The six fractional digits require 3 bytes.

`DECIMAL` columns do not store a leading `+` character or `-` character or leading `0` digits. If you insert `+0003.1` into a `DECIMAL(5,1)` column, it is stored as `3.1`. For negative numbers, a literal `-` character is not stored.

`DECIMAL` columns do not permit values larger than the range implied by the column definition. For example, a `DECIMAL(3,0)` column supports a range of `-999` to `999`. A `DECIMAL(M,D)` column permits up to  $M - D$  digits to the left of the decimal point.

The SQL standard requires that the precision of `NUMERIC(M,D)` be *exactly* *M* digits. For `DECIMAL(M,D)`, the standard requires a precision of at least *M* digits but permits more. In MySQL, `DECIMAL(M,D)` and `NUMERIC(M,D)` are the same, and both have a precision of exactly *M* digits.

For a full explanation of the internal format of `DECIMAL` values, see the file `strings/decimal.c` in a MySQL source distribution. The format is explained (with an example) in the `decimal2bin()` function.

## 12.21.3 Expression Handling

With precision math, exact-value numbers are used as given whenever possible. For example, numbers in comparisons are used exactly as given without a change in value. In strict SQL mode, for `INSERT` into a column with an exact data type (`DECIMAL` or integer), a number is inserted with its exact value if it is within the column range. When retrieved, the value should be the same as what was inserted. (If strict SQL mode is not enabled, truncation for `INSERT` is permissible.)

Handling of a numeric expression depends on what kind of values the expression contains:

- If any approximate values are present, the expression is approximate and is evaluated using floating-point arithmetic.
- If no approximate values are present, the expression contains only exact values. If any exact value contains a fractional part (a value following the decimal point), the expression is evaluated using



- A string that begins with a number can be converted, but the trailing nonnumeric portion is truncated. If the truncated portion contains anything other than spaces, this produces an error in strict mode, or a warning otherwise.

By default, division by zero produces a result of `NULL` and no warning. By setting the SQL mode appropriately, division by zero can be restricted.

With the `ERROR_FOR_DIVISION_BY_ZERO` SQL mode enabled, MySQL handles division by zero differently:

- If strict mode is not enabled, a warning occurs.
- If strict mode is enabled, inserts and updates involving division by zero are prohibited, and an error occurs.

In other words, inserts and updates involving expressions that perform division by zero can be treated as errors, but this requires `ERROR_FOR_DIVISION_BY_ZERO` in addition to strict mode.

Suppose that we have this statement:

```
INSERT INTO t SET i = 1/0;
```

This is what happens for combinations of strict and `ERROR_FOR_DIVISION_BY_ZERO` modes.

sql_mode Value	Result
' ' (Default)	No warning, no error; <code>i</code> is set to <code>NULL</code> .
strict	No warning, no error; <code>i</code> is set to <code>NULL</code> .
<code>ERROR_FOR_DIVISION_BY_ZERO</code>	Warning, no error; <code>i</code> is set to <code>NULL</code> .
strict, <code>ERROR_FOR_DIVISION_BY_ZERO</code>	Error condition; no row is inserted.

## 12.21.4 Rounding Behavior

This section discusses precision math rounding for the `ROUND()` function and for inserts into columns with exact-value types (`DECIMAL` and integer).

The `ROUND()` function rounds differently depending on whether its argument is exact or approximate:

- For exact-value numbers, `ROUND()` uses the “round half up” rule: A value with a fractional part of .5 or greater is rounded up to the next integer if positive or down to the next integer if negative. (In other words, it is rounded away from zero.) A value with a fractional part less than .5 is rounded down to the next integer if positive or up to the next integer if negative. (In other words, it is rounded toward zero.)
- For approximate-value numbers, the result depends on the C library. On many systems, this means that `ROUND()` uses the “round to nearest even” rule: A value with a fractional part exactly half way between two integers is rounded to the nearest even integer.

The following example shows how rounding differs for exact and approximate values:

```
mysql> SELECT ROUND(2.5), ROUND(25E-1);
+-----+-----+
| ROUND(2.5) | ROUND(25E-1) |
+-----+-----+
| 3         | 2           |
+-----+-----+
```

For inserts into a `DECIMAL` or integer column, the target is an exact data type, so rounding uses “round half away from zero,” regardless of whether the value to be inserted is exact or approximate:

```
mysql> CREATE TABLE t (d DECIMAL(10,0));
Query OK, 0 rows affected (0.00 sec)

mysql> INSERT INTO t VALUES(2.5),(2.5E0);
Query OK, 2 rows affected, 2 warnings (0.00 sec)
Records: 2 Duplicates: 0 Warnings: 2

mysql> SHOW WARNINGS;
+-----+-----+-----+
| Level | Code | Message                                     |
+-----+-----+-----+
| Note  | 1265 | Data truncated for column 'd' at row 1 |
| Note  | 1265 | Data truncated for column 'd' at row 2 |
+-----+-----+-----+
2 rows in set (0.00 sec)

mysql> SELECT d FROM t;
+-----+
| d     |
+-----+
| 3     |
| 3     |
+-----+
2 rows in set (0.00 sec)
```

The `SHOW WARNINGS` statement displays the notes that are generated by truncation due to rounding of the fractional part. Such truncation is not an error, even in strict SQL mode (see [Section 12.21.3, “Expression Handling”](#)).

## 12.21.5 Precision Math Examples

This section provides some examples that show precision math query results in MySQL. These examples demonstrate the principles described in [Section 12.21.3, “Expression Handling”](#), and [Section 12.21.4, “Rounding Behavior”](#).

**Example 1.** Numbers are used with their exact value as given when possible:

```
mysql> SELECT (.1 + .2) = .3;
+-----+
| (.1 + .2) = .3 |
+-----+
| 1 |
+-----+
```

For floating-point values, results are inexact:

```
mysql> SELECT (.1E0 + .2E0) = .3E0;
+-----+
| (.1E0 + .2E0) = .3E0 |
+-----+
| 0 |
+-----+
```

Another way to see the difference in exact and approximate value handling is to add a small number to a sum many times. Consider the following stored procedure, which adds `.0001` to a variable 1,000 times.

```
CREATE PROCEDURE p ()
BEGIN
  DECLARE i INT DEFAULT 0;
  DECLARE d DECIMAL(10,4) DEFAULT 0;
  DECLARE f FLOAT DEFAULT 0;
  WHILE i < 10000 DO
    SET d = d + .0001;
```



```

SET f = f + .0001E0;
SET i = i + 1;
END WHILE;
SELECT d, f;
END;

```

The sum for both `d` and `f` logically should be 1, but that is true only for the decimal calculation. The floating-point calculation introduces small errors:

```

+-----+-----+
| d      | f      |
+-----+-----+
| 1.0000 | 0.99999999999991 |
+-----+-----+

```

**Example 2.** Multiplication is performed with the scale required by standard SQL. That is, for two numbers `X1` and `X2` that have scale `S1` and `S2`, the scale of the result is `S1 + S2`:

```

mysql> SELECT .01 * .01;
+-----+
| .01 * .01 |
+-----+
| 0.0001    |
+-----+

```

**Example 3.** Rounding behavior for exact-value numbers is well-defined:

Rounding behavior (for example, with the `ROUND()` function) is independent of the implementation of the underlying C library, which means that results are consistent from platform to platform.

- Rounding for exact-value columns (`DECIMAL` and integer) and exact-valued numbers uses the “round half away from zero” rule. A value with a fractional part of .5 or greater is rounded away from zero to the nearest integer, as shown here:

```

mysql> SELECT ROUND(2.5), ROUND(-2.5);
+-----+-----+
| ROUND(2.5) | ROUND(-2.5) |
+-----+-----+
| 3          | -3          |
+-----+-----+

```

- Rounding for floating-point values uses the C library, which on many systems uses the “round to nearest even” rule. A value with a fractional part exactly half way between two integers is rounded to the nearest even integer:

```

mysql> SELECT ROUND(2.5E0), ROUND(-2.5E0);
+-----+-----+
| ROUND(2.5E0) | ROUND(-2.5E0) |
+-----+-----+
| 2            | -2            |
+-----+-----+

```

**Example 4.** In strict mode, inserting a value that is out of range for a column causes an error, rather than truncation to a legal value.

When MySQL is not running in strict mode, truncation to a legal value occurs:

```

mysql> SET sql_mode='';
Query OK, 0 rows affected (0.00 sec)

mysql> CREATE TABLE t (i TINYINT);
Query OK, 0 rows affected (0.01 sec)

```

```
mysql> INSERT INTO t SET i = 128;
Query OK, 1 row affected, 1 warning (0.00 sec)

mysql> SELECT i FROM t;
+-----+
| i     |
+-----+
| 127  |
+-----+
1 row in set (0.00 sec)
```

However, an error occurs if strict mode is in effect:

```
mysql> SET sql_mode='STRICT_ALL_TABLES';
Query OK, 0 rows affected (0.00 sec)

mysql> CREATE TABLE t (i TINYINT);
Query OK, 0 rows affected (0.00 sec)

mysql> INSERT INTO t SET i = 128;
ERROR 1264 (22003): Out of range value adjusted for column 'i' at row 1

mysql> SELECT i FROM t;
Empty set (0.00 sec)
```

**Example 5:** In strict mode and with `ERROR_FOR_DIVISION_BY_ZERO` set, division by zero causes an error, not a result of `NULL`.

In nonstrict mode, division by zero has a result of `NULL`:

```
mysql> SET sql_mode='';
Query OK, 0 rows affected (0.01 sec)

mysql> CREATE TABLE t (i TINYINT);
Query OK, 0 rows affected (0.00 sec)

mysql> INSERT INTO t SET i = 1 / 0;
Query OK, 1 row affected (0.00 sec)

mysql> SELECT i FROM t;
+-----+
| i     |
+-----+
| NULL  |
+-----+
1 row in set (0.03 sec)
```

However, division by zero is an error if the proper SQL modes are in effect:

```
mysql> SET sql_mode='STRICT_ALL_TABLES,ERROR_FOR_DIVISION_BY_ZERO';
Query OK, 0 rows affected (0.00 sec)

mysql> CREATE TABLE t (i TINYINT);
Query OK, 0 rows affected (0.00 sec)

mysql> INSERT INTO t SET i = 1 / 0;
ERROR 1365 (22012): Division by 0

mysql> SELECT i FROM t;
Empty set (0.01 sec)
```

**Example 6.** Exact-value literals are evaluated as exact values.

Approximate-value literals are evaluated using floating point, but exact-value literals are handled as `DECIMAL`:

```
mysql> CREATE TABLE t SELECT 2.5 AS a, 25E-1 AS b;
Query OK, 1 row affected (0.01 sec)
Records: 1 Duplicates: 0 Warnings: 0
```

```
mysql> DESCRIBE t;
```

Field	Type	Null	Key	Default	Extra
a	decimal(2,1) unsigned	NO		0.0	
b	double	NO		0	

```
2 rows in set (0.01 sec)
```

**Example 7.** If the argument to an aggregate function is an exact numeric type, the result is also an exact numeric type, with a scale at least that of the argument.

Consider these statements:

```
mysql> CREATE TABLE t (i INT, d DECIMAL, f FLOAT);
mysql> INSERT INTO t VALUES(1,1,1);
mysql> CREATE TABLE y SELECT AVG(i), AVG(d), AVG(f) FROM t;
```

The result is a double only for the floating-point argument. For exact type arguments, the result is also an exact type:

```
mysql> DESCRIBE y;
```

Field	Type	Null	Key	Default	Extra
AVG(i)	decimal(14,4)	YES		NULL	
AVG(d)	decimal(14,4)	YES		NULL	
AVG(f)	double	YES		NULL	

The result is a double only for the floating-point argument. For exact type arguments, the result is also an exact type.



---

# Chapter 13 SQL Statements

## Table of Contents

13.1 Data Definition Statements .....	2152
13.1.1 ALTER DATABASE Statement .....	2152
13.1.2 ALTER EVENT Statement .....	2154
13.1.3 ALTER FUNCTION Statement .....	2155
13.1.4 ALTER INSTANCE Statement .....	2155
13.1.5 ALTER LOGFILE GROUP Statement .....	2156
13.1.6 ALTER PROCEDURE Statement .....	2157
13.1.7 ALTER SERVER Statement .....	2157
13.1.8 ALTER TABLE Statement .....	2158
13.1.9 ALTER TABLESPACE Statement .....	2181
13.1.10 ALTER VIEW Statement .....	2183
13.1.11 CREATE DATABASE Statement .....	2183
13.1.12 CREATE EVENT Statement .....	2184
13.1.13 CREATE FUNCTION Statement .....	2188
13.1.14 CREATE INDEX Statement .....	2188
13.1.15 CREATE LOGFILE GROUP Statement .....	2194
13.1.16 CREATE PROCEDURE and CREATE FUNCTION Statements .....	2196
13.1.17 CREATE SERVER Statement .....	2201
13.1.18 CREATE TABLE Statement .....	2202
13.1.19 CREATE TABLESPACE Statement .....	2252
13.1.20 CREATE TRIGGER Statement .....	2258
13.1.21 CREATE VIEW Statement .....	2260
13.1.22 DROP DATABASE Statement .....	2265
13.1.23 DROP EVENT Statement .....	2266
13.1.24 DROP FUNCTION Statement .....	2266
13.1.25 DROP INDEX Statement .....	2266
13.1.26 DROP LOGFILE GROUP Statement .....	2267
13.1.27 DROP PROCEDURE and DROP FUNCTION Statements .....	2267
13.1.28 DROP SERVER Statement .....	2268
13.1.29 DROP TABLE Statement .....	2268
13.1.30 DROP TABLESPACE Statement .....	2269
13.1.31 DROP TRIGGER Statement .....	2270
13.1.32 DROP VIEW Statement .....	2270
13.1.33 RENAME TABLE Statement .....	2271
13.1.34 TRUNCATE TABLE Statement .....	2272
13.2 Data Manipulation Statements .....	2273
13.2.1 CALL Statement .....	2273
13.2.2 DELETE Statement .....	2274
13.2.3 DO Statement .....	2278
13.2.4 HANDLER Statement .....	2279
13.2.5 INSERT Statement .....	2280
13.2.6 LOAD DATA Statement .....	2289
13.2.7 LOAD XML Statement .....	2300
13.2.8 REPLACE Statement .....	2308
13.2.9 SELECT Statement .....	2310
13.2.10 Subqueries .....	2327
13.2.11 UPDATE Statement .....	2340
13.3 Transactional and Locking Statements .....	2344

13.3.1	START TRANSACTION, COMMIT, and ROLLBACK Statements .....	2344
13.3.2	Statements That Cannot Be Rolled Back .....	2347
13.3.3	Statements That Cause an Implicit Commit .....	2347
13.3.4	SAVEPOINT, ROLLBACK TO SAVEPOINT, and RELEASE SAVEPOINT Statements .....	2348
13.3.5	LOCK TABLES and UNLOCK TABLES Statements .....	2349
13.3.6	SET TRANSACTION Statement .....	2355
13.3.7	XA Transactions .....	2358
13.4	Replication Statements .....	2363
13.4.1	SQL Statements for Controlling Replication Source Servers .....	2363
13.4.2	SQL Statements for Controlling Replica Servers .....	2366
13.4.3	SQL Statements for Controlling Group Replication .....	2381
13.5	Prepared Statements .....	2382
13.5.1	PREPARE Statement .....	2386
13.5.2	EXECUTE Statement .....	2386
13.5.3	DEALLOCATE PREPARE Statement .....	2386
13.6	Compound Statements .....	2387
13.6.1	BEGIN ... END Compound Statement .....	2387
13.6.2	Statement Labels .....	2387
13.6.3	DECLARE Statement .....	2388
13.6.4	Variables in Stored Programs .....	2388
13.6.5	Flow Control Statements .....	2390
13.6.6	Cursors .....	2395
13.6.7	Condition Handling .....	2397
13.7	Database Administration Statements .....	2425
13.7.1	Account Management Statements .....	2425
13.7.2	Table Maintenance Statements .....	2454
13.7.3	Plugin and Loadable Function Statements .....	2465
13.7.4	SET Statements .....	2468
13.7.5	SHOW Statements .....	2473
13.7.6	Other Administrative Statements .....	2526
13.8	Utility Statements .....	2537
13.8.1	DESCRIBE Statement .....	2537
13.8.2	EXPLAIN Statement .....	2537
13.8.3	HELP Statement .....	2540
13.8.4	USE Statement .....	2542

This chapter describes the syntax for the [SQL](#) statements supported by MySQL.

## 13.1 Data Definition Statements

### 13.1.1 ALTER DATABASE Statement

```
ALTER {DATABASE | SCHEMA} [db_name]
    alter_option ...
ALTER {DATABASE | SCHEMA} db_name
    UPGRADE DATA DIRECTORY NAME

alter_option: {
    [DEFAULT] CHARACTER SET [=] charset_name
    | [DEFAULT] COLLATE [=] collation_name
}
```

[ALTER DATABASE](#) enables you to change the overall characteristics of a database. These characteristics are stored in the `db.opt` file in the database directory. This statement requires the [ALTER](#) privilege on the database. [ALTER SCHEMA](#) is a synonym for [ALTER DATABASE](#).

The database name can be omitted from the first syntax, in which case the statement applies to the default database. An error occurs if there is no default database.

- [Character Set and Collation Options](#)
- [Upgrading from Versions Older than MySQL 5.1](#)

## Character Set and Collation Options

The `CHARACTER SET` clause changes the default database character set. The `COLLATE` clause changes the default database collation. For information about character set and collation names, see [Chapter 10, Character Sets, Collations, Unicode](#).

To see the available character sets and collations, use the `SHOW CHARACTER SET` and `SHOW COLLATION` statements, respectively. See [Section 13.7.5.3, “SHOW CHARACTER SET Statement”](#), and [Section 13.7.5.4, “SHOW COLLATION Statement”](#).

A stored routine that uses the database defaults when the routine is created includes those defaults as part of its definition. (In a stored routine, variables with character data types use the database defaults if the character set or collation are not specified explicitly. See [Section 13.1.16, “CREATE PROCEDURE and CREATE FUNCTION Statements”](#).) If you change the default character set or collation for a database, any stored routines that are to use the new defaults must be dropped and recreated.

## Upgrading from Versions Older than MySQL 5.1

The syntax that includes the `UPGRADE DATA DIRECTORY NAME` clause updates the name of the directory associated with the database to use the encoding implemented in MySQL 5.1 for mapping database names to database directory names (see [Section 9.2.4, “Mapping of Identifiers to File Names”](#)). This clause is for use under these conditions:

- It is intended when upgrading MySQL to 5.1 or later from older versions.
- It is intended to update a database directory name to the current encoding format if the name contains special characters that need encoding.
- The statement is used by `mysqlcheck` (as invoked by `mysql_upgrade`).

For example, if a database in MySQL 5.0 has the name `a-b-c`, the name contains instances of the `-` (dash) character. In MySQL 5.0, the database directory is also named `a-b-c`, which is not necessarily safe for all file systems. In MySQL 5.1 and later, the same database name is encoded as `a@002db@002dc` to produce a file system-neutral directory name.

When a MySQL installation is upgraded to MySQL 5.1 or later from an older version, the server displays a name such as `a-b-c` (which is in the old format) as `#mysql50#a-b-c`, and you must refer to the name using the `#mysql50#` prefix. Use `UPGRADE DATA DIRECTORY NAME` in this case to explicitly tell the server to re-encode the database directory name to the current encoding format:

```
ALTER DATABASE `#mysql50#a-b-c` UPGRADE DATA DIRECTORY NAME;
```

After executing this statement, you can refer to the database as `a-b-c` without the special `#mysql50#` prefix.



### Note

The `UPGRADE DATA DIRECTORY NAME` clause is deprecated in MySQL 5.7 and removed in MySQL 8.0. If it is necessary to convert MySQL 5.0 database or table names, a workaround is to upgrade a MySQL 5.0 installation to MySQL 5.1 before upgrading to MySQL 8.0.

## 13.1.2 ALTER EVENT Statement

```
ALTER
  [DEFINER = user]
  EVENT event_name
  [ON SCHEDULE schedule]
  [ON COMPLETION [NOT] PRESERVE]
  [RENAME TO new_event_name]
  [ENABLE | DISABLE | DISABLE ON SLAVE]
  [COMMENT 'string']
  [DO event_body]
```

The `ALTER EVENT` statement changes one or more of the characteristics of an existing event without the need to drop and recreate it. The syntax for each of the `DEFINER`, `ON SCHEDULE`, `ON COMPLETION`, `COMMENT`, `ENABLE / DISABLE`, and `DO` clauses is exactly the same as when used with `CREATE EVENT`. (See [Section 13.1.12, “CREATE EVENT Statement”](#).)

Any user can alter an event defined on a database for which that user has the `EVENT` privilege. When a user executes a successful `ALTER EVENT` statement, that user becomes the definer for the affected event.

`ALTER EVENT` works only with an existing event:

```
mysql> ALTER EVENT no_such_event
>   ON SCHEDULE
>   EVERY '2:3' DAY_HOUR;
ERROR 1517 (HY000): Unknown event 'no_such_event'
```

In each of the following examples, assume that the event named `myevent` is defined as shown here:

```
CREATE EVENT myevent
  ON SCHEDULE
    EVERY 6 HOUR
  COMMENT 'A sample comment.'
  DO
    UPDATE myschema.mytable SET mycol = mycol + 1;
```

The following statement changes the schedule for `myevent` from once every six hours starting immediately to once every twelve hours, starting four hours from the time the statement is run:

```
ALTER EVENT myevent
  ON SCHEDULE
    EVERY 12 HOUR
  STARTS CURRENT_TIMESTAMP + INTERVAL 4 HOUR;
```

It is possible to change multiple characteristics of an event in a single statement. This example changes the SQL statement executed by `myevent` to one that deletes all records from `mytable`; it also changes the schedule for the event such that it executes once, one day after this `ALTER EVENT` statement is run.

```
ALTER EVENT myevent
  ON SCHEDULE
    AT CURRENT_TIMESTAMP + INTERVAL 1 DAY
  DO
    TRUNCATE TABLE myschema.mytable;
```

Specify the options in an `ALTER EVENT` statement only for those characteristics that you want to change; omitted options keep their existing values. This includes any default values for `CREATE EVENT` such as `ENABLE`.

To disable `myevent`, use this `ALTER EVENT` statement:

```
ALTER EVENT myevent
  DISABLE;
```



The `ON SCHEDULE` clause may use expressions involving built-in MySQL functions and user variables to obtain any of the `timestamp` or `interval` values which it contains. You cannot use stored routines or loadable functions in such expressions, and you cannot use any table references; however, you can use `SELECT FROM DUAL`. This is true for both `ALTER EVENT` and `CREATE EVENT` statements. References to stored routines, loadable functions, and tables in such cases are specifically not permitted, and fail with an error (see Bug #22830).

Although an `ALTER EVENT` statement that contains another `ALTER EVENT` statement in its `DO` clause appears to succeed, when the server attempts to execute the resulting scheduled event, the execution fails with an error.

To rename an event, use the `ALTER EVENT` statement's `RENAME TO` clause. This statement renames the event `myevent` to `yourevent`:

```
ALTER EVENT myevent
  RENAME TO yourevent;
```

You can also move an event to a different database using `ALTER EVENT ... RENAME TO ...` and `db_name.event_name` notation, as shown here:

```
ALTER EVENT olddb.myevent
  RENAME TO newdb.myevent;
```

To execute the previous statement, the user executing it must have the `EVENT` privilege on both the `olddb` and `newdb` databases.



#### Note

There is no `RENAME EVENT` statement.

The value `DISABLE ON SLAVE` is used on a replica instead of `ENABLE` or `DISABLE` to indicate an event that was created on the source and replicated to the replica, but that is not executed on the replica. Normally, `DISABLE ON SLAVE` is set automatically as required; however, there are some circumstances under which you may want or need to change it manually. See [Section 16.4.1.16, “Replication of Invoked Features”](#), for more information.

### 13.1.3 ALTER FUNCTION Statement

```
ALTER FUNCTION func_name [characteristic ...]

characteristic: {
  COMMENT 'string'
  | LANGUAGE SQL
  | { CONTAINS SQL | NO SQL | READS SQL DATA | MODIFIES SQL DATA }
  | SQL SECURITY { DEFINER | INVOKER }
}
```

This statement can be used to change the characteristics of a stored function. More than one change may be specified in an `ALTER FUNCTION` statement. However, you cannot change the parameters or body of a stored function using this statement; to make such changes, you must drop and re-create the function using `DROP FUNCTION` and `CREATE FUNCTION`.

You must have the `ALTER ROUTINE` privilege for the function. (That privilege is granted automatically to the function creator.) If binary logging is enabled, the `ALTER FUNCTION` statement might also require the `SUPER` privilege, as described in [Section 23.7, “Stored Program Binary Logging”](#).

### 13.1.4 ALTER INSTANCE Statement

```
ALTER INSTANCE ROTATE INNODB MASTER KEY
```

`ALTER INSTANCE`, introduced in MySQL 5.7.11, defines actions applicable to a MySQL server instance. The statement supports these actions:

- `ALTER INSTANCE ROTATE INNODB MASTER KEY`

This action rotates the master encryption key used for `InnoDB` tablespace encryption. Key rotation requires the `SUPER` privilege. To perform this action, a keyring plugin must be installed and configured. For instructions, see [Section 6.4.4, “The MySQL Keyring”](#).

`ALTER INSTANCE ROTATE INNODB MASTER KEY` supports concurrent DML. However, it cannot be run concurrently with `CREATE TABLE ... ENCRYPTION` or `ALTER TABLE ... ENCRYPTION` operations, and locks are taken to prevent conflicts that could arise from concurrent execution of these statements. If one of the conflicting statements is running, it must complete before another can proceed.

`ALTER INSTANCE` actions are written to the binary log so that they can be executed on replicated servers.

For additional `ALTER INSTANCE ROTATE INNODB MASTER KEY` usage information, see [Section 14.14, “InnoDB Data-at-Rest Encryption”](#). For information about keyring plugins, see [Section 6.4.4, “The MySQL Keyring”](#).

## 13.1.5 ALTER LOGFILE GROUP Statement

```
ALTER LOGFILE GROUP logfile_group
  ADD UNDOFILE 'file_name'
  [INITIAL_SIZE [=] size]
  [WAIT]
  ENGINE [=] engine_name
```

This statement adds an `UNDO` file named '*file\_name*' to an existing log file group *logfile\_group*. An `ALTER LOGFILE GROUP` statement has one and only one `ADD UNDOFILE` clause. No `DROP UNDOFILE` clause is currently supported.



### Note

All NDB Cluster Disk Data objects share the same namespace. This means that *each Disk Data object* must be uniquely named (and not merely each Disk Data object of a given type). For example, you cannot have a tablespace and an undo log file with the same name, or an undo log file and a data file with the same name.

The optional `INITIAL_SIZE` parameter sets the `UNDO` file's initial size in bytes; if not specified, the initial size defaults to 134217728 (128 MB). You may optionally follow *size* with a one-letter abbreviation for an order of magnitude, similar to those used in `my.cnf`. Generally, this is one of the letters `M` (megabytes) or `G` (gigabytes). (Bug #13116514, Bug #16104705, Bug #62858)

On 32-bit systems, the maximum supported value for `INITIAL_SIZE` is 4294967296 (4 GB). (Bug #29186)

The minimum allowed value for `INITIAL_SIZE` is 1048576 (1 MB). (Bug #29574)



### Note

`WAIT` is parsed but otherwise ignored. This keyword currently has no effect, and is intended for future expansion.

The `ENGINE` parameter (required) determines the storage engine which is used by this log file group, with *engine\_name* being the name of the storage engine. Currently, the only accepted values for *engine\_name* are `“NDBCLUSTER”` and `“NDB”`. The two values are equivalent.

Here is an example, which assumes that the log file group `lg_3` has already been created using `CREATE LOGFILE GROUP` (see [Section 13.1.15, “CREATE LOGFILE GROUP Statement”](#)):

```
ALTER LOGFILE GROUP lg_3
  ADD UNDOFILE 'undo_10.dat'
  INITIAL_SIZE=32M
  ENGINE=NDBCLUSTER;
```

When `ALTER LOGFILE GROUP` is used with `ENGINE = NDBCLUSTER` (alternatively, `ENGINE = NDB`), an `UNDO` log file is created on each NDB Cluster data node. You can verify that the `UNDO` files were created and obtain information about them by querying the Information Schema `FILES` table. For example:

```
mysql> SELECT FILE_NAME, LOGFILE_GROUP_NUMBER, EXTRA
  -> FROM INFORMATION_SCHEMA.FILES
  -> WHERE LOGFILE_GROUP_NAME = 'lg_3';
+-----+-----+-----+
| FILE_NAME      | LOGFILE_GROUP_NUMBER | EXTRA          |
+-----+-----+-----+
| newdata.dat    | 0                    | CLUSTER_NODE=3 |
| newdata.dat    | 0                    | CLUSTER_NODE=4 |
| undo_10.dat    | 11                   | CLUSTER_NODE=3 |
| undo_10.dat    | 11                   | CLUSTER_NODE=4 |
+-----+-----+-----+
4 rows in set (0.01 sec)
```

(See [Section 24.3.9, “The INFORMATION\\_SCHEMA FILES Table”](#).)

Memory used for `UNDO_BUFFER_SIZE` comes from the global pool whose size is determined by the value of the `SharedGlobalMemory` data node configuration parameter. This includes any default value implied for this option by the setting of the `InitialLogFileGroup` data node configuration parameter.

`ALTER LOGFILE GROUP` is useful only with Disk Data storage for NDB Cluster. For more information, see [Section 21.6.11, “NDB Cluster Disk Data Tables”](#).

## 13.1.6 ALTER PROCEDURE Statement

```
ALTER PROCEDURE proc_name [characteristic ...]

characteristic: {
  COMMENT 'string'
  | LANGUAGE SQL
  | { CONTAINS SQL | NO SQL | READS SQL DATA | MODIFIES SQL DATA }
  | SQL SECURITY { DEFINER | INVOKER }
}
```

This statement can be used to change the characteristics of a stored procedure. More than one change may be specified in an `ALTER PROCEDURE` statement. However, you cannot change the parameters or body of a stored procedure using this statement; to make such changes, you must drop and re-create the procedure using `DROP PROCEDURE` and `CREATE PROCEDURE`.

You must have the `ALTER ROUTINE` privilege for the procedure. By default, that privilege is granted automatically to the procedure creator. This behavior can be changed by disabling the `automatic_sp_privileges` system variable. See [Section 23.2.2, “Stored Routines and MySQL Privileges”](#).

## 13.1.7 ALTER SERVER Statement

```
ALTER SERVER server_name
  OPTIONS (option [, option] ...)
```

Alters the server information for *server\_name*, adjusting any of the options permitted in the `CREATE SERVER` statement. The corresponding fields in the `mysql.servers` table are updated accordingly. This statement requires the `SUPER` privilege.

For example, to update the `USER` option:

```
ALTER SERVER s OPTIONS (USER 'sally');
```

`ALTER SERVER` causes an implicit commit. See [Section 13.3.3, “Statements That Cause an Implicit Commit”](#).

`ALTER SERVER` is not written to the binary log, regardless of the logging format that is in use.

## 13.1.8 ALTER TABLE Statement

```
ALTER TABLE tbl_name
  [alter_option [, alter_option] ...]
  [partition_options]

alter_option: {
  table_options
| ADD [COLUMN] col_name column_definition
  [FIRST | AFTER col_name]
| ADD [COLUMN] (col_name column_definition,...)
| ADD {INDEX | KEY} [index_name]
  [index_type] (key_part,...) [index_option] ...
| ADD {FULLTEXT | SPATIAL} [INDEX | KEY] [index_name]
  (key_part,...) [index_option] ...
| ADD [CONSTRAINT [symbol]] PRIMARY KEY
  [index_type] (key_part,...)
  [index_option] ...
| ADD [CONSTRAINT [symbol]] UNIQUE [INDEX | KEY]
  [index_name] [index_type] (key_part,...)
  [index_option] ...
| ADD [CONSTRAINT [symbol]] FOREIGN KEY
  [index_name] (col_name,...)
  reference_definition
| ADD CHECK (expr)
| ALGORITHM [=] {DEFAULT | INPLACE | COPY}
| ALTER [COLUMN] col_name {
  SET DEFAULT {literal | (expr)}
  | DROP DEFAULT
}
| CHANGE [COLUMN] old_col_name new_col_name column_definition
  [FIRST | AFTER col_name]
| [DEFAULT] CHARACTER SET [=] charset_name [COLLATE [=] collation_name]
| CONVERT TO CHARACTER SET charset_name [COLLATE collation_name]
| {DISABLE | ENABLE} KEYS
| {DISCARD | IMPORT} TABLESPACE
| DROP [COLUMN] col_name
| DROP {INDEX | KEY} index_name
| DROP PRIMARY KEY
| DROP FOREIGN KEY fk_symbol
| FORCE
| LOCK [=] {DEFAULT | NONE | SHARED | EXCLUSIVE}
| MODIFY [COLUMN] col_name column_definition
  [FIRST | AFTER col_name]
| ORDER BY col_name [, col_name] ...
| RENAME {INDEX | KEY} old_index_name TO new_index_name
| RENAME [TO | AS] new_tbl_name
| {WITHOUT | WITH} VALIDATION
}

partition_options:
  partition_option [partition_option] ...
```

## ALTER TABLE Statement

```
partition_option: {
  ADD PARTITION (partition_definition)
| DROP PARTITION partition_names
| DISCARD PARTITION {partition_names | ALL} TABLESPACE
| IMPORT PARTITION {partition_names | ALL} TABLESPACE
| TRUNCATE PARTITION {partition_names | ALL}
| COALESCE PARTITION number
| REORGANIZE PARTITION partition_names INTO (partition_definitions)
| EXCHANGE PARTITION partition_name WITH TABLE tbl_name [{WITH | WITHOUT} VALIDATION]
| ANALYZE PARTITION {partition_names | ALL}
| CHECK PARTITION {partition_names | ALL}
| OPTIMIZE PARTITION {partition_names | ALL}
| REBUILD PARTITION {partition_names | ALL}
| REPAIR PARTITION {partition_names | ALL}
| REMOVE PARTITIONING
| UPGRADE PARTITIONING
}

key_part:
  col_name [(length)] [ASC | DESC]

index_type:
  USING {BTREE | HASH}

index_option: {
  KEY_BLOCK_SIZE [=] value
| index_type
| WITH PARSER parser_name
| COMMENT 'string'
}

table_options:
  table_option [,] table_option ...

table_option: {
  AUTO_INCREMENT [=] value
| AVG_ROW_LENGTH [=] value
| [DEFAULT] CHARACTER SET [=] charset_name
| CHECKSUM [=] {0 | 1}
| [DEFAULT] COLLATE [=] collation_name
| COMMENT [=] 'string'
| COMPRESSION [=] {'ZLIB' | 'LZ4' | 'NONE'}
| CONNECTION [=] 'connect_string'
| {DATA | INDEX} DIRECTORY [=] 'absolute path to directory'
| DELAY_KEY_WRITE [=] {0 | 1}
| ENCRYPTION [=] {'Y' | 'N'}
| ENGINE [=] engine_name
| INSERT_METHOD [=] { NO | FIRST | LAST }
| KEY_BLOCK_SIZE [=] value
| MAX_ROWS [=] value
| MIN_ROWS [=] value
| PACK_KEYS [=] {0 | 1 | DEFAULT}
| PASSWORD [=] 'string'
| ROW_FORMAT [=] {DEFAULT | DYNAMIC | FIXED | COMPRESSED | REDUNDANT | COMPACT}
| STATS_AUTO_RECALC [=] {DEFAULT | 0 | 1}
| STATS_PERSISTENT [=] {DEFAULT | 0 | 1}
| STATS_SAMPLE_PAGES [=] value
| TABLESPACE tablespace_name [STORAGE {DISK | MEMORY}]
| UNION [=] (tbl_name[,tbl_name]...)
}

partition_options:
  (see CREATE TABLE options)
```

`ALTER TABLE` changes the structure of a table. For example, you can add or delete columns, create or destroy indexes, change the type of existing columns, or rename columns or the table itself. You can also change characteristics such as the storage engine used for the table or the table comment.

- To use `ALTER TABLE`, you need `ALTER`, `CREATE`, and `INSERT` privileges for the table. Renaming a table requires `ALTER` and `DROP` on the old table, `ALTER`, `CREATE`, and `INSERT` on the new table.
- Following the table name, specify the alterations to be made. If none are given, `ALTER TABLE` does nothing.
- The syntax for many of the permissible alterations is similar to clauses of the `CREATE TABLE` statement. *column\_definition* clauses use the same syntax for `ADD` and `CHANGE` as for `CREATE TABLE`. For more information, see [Section 13.1.18, “CREATE TABLE Statement”](#).
- The word `COLUMN` is optional and can be omitted.
- Multiple `ADD`, `ALTER`, `DROP`, and `CHANGE` clauses are permitted in a single `ALTER TABLE` statement, separated by commas. This is a MySQL extension to standard SQL, which permits only one of each clause per `ALTER TABLE` statement. For example, to drop multiple columns in a single statement, do this:

```
ALTER TABLE t2 DROP COLUMN c, DROP COLUMN d;
```

- If a storage engine does not support an attempted `ALTER TABLE` operation, a warning may result. Such warnings can be displayed with `SHOW WARNINGS`. See [Section 13.7.5.40, “SHOW WARNINGS Statement”](#). For information on troubleshooting `ALTER TABLE`, see [Section B.3.6.1, “Problems with ALTER TABLE”](#).
- For information about generated columns, see [Section 13.1.8.2, “ALTER TABLE and Generated Columns”](#).
- For usage examples, see [Section 13.1.8.3, “ALTER TABLE Examples”](#).
- With the `mysql_info()` C API function, you can find out how many rows were copied by `ALTER TABLE`. See `mysql_info()`.

There are several additional aspects to the `ALTER TABLE` statement, described under the following topics in this section:

- [Table Options](#)
- [Performance and Space Requirements](#)
- [Concurrency Control](#)
- [Adding and Dropping Columns](#)
- [Renaming, Redefining, and Reordering Columns](#)
- [Primary Keys and Indexes](#)
- [Foreign Keys and Other Constraints](#)
- [Changing the Character Set](#)
- [Discarding and Importing InnoDB Tablespaces](#)
- [Row Order for MyISAM Tables](#)
- [Partitioning Options](#)

## Table Options

*table\_options* signifies table options of the kind that can be used in the `CREATE TABLE` statement, such as `ENGINE`, `AUTO_INCREMENT`, `AVG_ROW_LENGTH`, `MAX_ROWS`, `ROW_FORMAT`, or `TABLESPACE`.

For descriptions of all table options, see [Section 13.1.18, “CREATE TABLE Statement”](#). However, `ALTER TABLE` ignores `DATA DIRECTORY` and `INDEX DIRECTORY` when given as table options. `ALTER TABLE` permits them only as partitioning options, and, as of MySQL 5.7.17, requires that you have the `FILE` privilege.

Use of table options with `ALTER TABLE` provides a convenient way of altering single table characteristics. For example:

- If `t1` is currently not an `InnoDB` table, this statement changes its storage engine to `InnoDB`:

```
ALTER TABLE t1 ENGINE = InnoDB;
```

- See [Section 14.6.1.5, “Converting Tables from MyISAM to InnoDB”](#) for considerations when switching tables to the `InnoDB` storage engine.
- When you specify an `ENGINE` clause, `ALTER TABLE` rebuilds the table. This is true even if the table already has the specified storage engine.
- Running `ALTER TABLE tbl_name ENGINE=INNODB` on an existing `InnoDB` table performs a “null” `ALTER TABLE` operation, which can be used to defragment an `InnoDB` table, as described in [Section 14.12.4, “Defragmenting a Table”](#). Running `ALTER TABLE tbl_name FORCE` on an `InnoDB` table performs the same function.
- `ALTER TABLE tbl_name ENGINE=INNODB` and `ALTER TABLE tbl_name FORCE` use [online DDL](#). For more information, see [Section 14.13, “InnoDB and Online DDL”](#).
- The outcome of attempting to change the storage engine of a table is affected by whether the desired storage engine is available and the setting of the `NO_ENGINE_SUBSTITUTION` SQL mode, as described in [Section 5.1.10, “Server SQL Modes”](#).
- To prevent inadvertent loss of data, `ALTER TABLE` cannot be used to change the storage engine of a table to `MERGE` or `BLACKHOLE`.
- To change the `InnoDB` table to use compressed row-storage format:

```
ALTER TABLE t1 ROW_FORMAT = COMPRESSED;
```

- To enable or disable encryption for an `InnoDB` table in a file-per-table tablespace:

```
ALTER TABLE t1 ENCRYPTION='Y';
ALTER TABLE t1 ENCRYPTION='N';
```

A keyring plugin must be installed and configured to use the `ENCRYPTION` option. For more information, see [Section 14.14, “InnoDB Data-at-Rest Encryption”](#).

The `ENCRYPTION` option is supported only by the `InnoDB` storage engine; thus it works only if the table already uses `InnoDB` (and you do not change the table's storage engine), or if the `ALTER TABLE` statement also specifies `ENGINE=InnoDB`. Otherwise the statement is rejected with `ER_CHECK_NOT_IMPLEMENTED`.

- To reset the current auto-increment value:

```
ALTER TABLE t1 AUTO_INCREMENT = 13;
```

You cannot reset the counter to a value less than or equal to the value that is currently in use. For both [InnoDB](#) and [MyISAM](#), if the value is less than or equal to the maximum value currently in the [AUTO\\_INCREMENT](#) column, the value is reset to the current maximum [AUTO\\_INCREMENT](#) column value plus one.

- To change the default table character set:

```
ALTER TABLE t1 CHARACTER SET = utf8;
```

See also [Changing the Character Set](#).

- To add (or change) a table comment:

```
ALTER TABLE t1 COMMENT = 'New table comment';
```

- Use [ALTER TABLE](#) with the [TABLESPACE](#) option to move [InnoDB](#) tables between existing [general tablespaces](#), [file-per-table tablespaces](#), and the [system tablespace](#). See [Moving Tables Between Tablespaces Using ALTER TABLE](#).
  - [ALTER TABLE ... TABLESPACE](#) operations always cause a full table rebuild, even if the [TABLESPACE](#) attribute has not changed from its previous value.
  - [ALTER TABLE ... TABLESPACE](#) syntax does not support moving a table from a temporary tablespace to a persistent tablespace.
  - The [DATA DIRECTORY](#) clause, which is supported with [CREATE TABLE ... TABLESPACE](#), is not supported with [ALTER TABLE ... TABLESPACE](#), and is ignored if specified.
  - For more information about the capabilities and limitations of the [TABLESPACE](#) option, see [CREATE TABLE](#).
- MySQL NDB Cluster 7.5.2 and later supports setting [NDB\\_TABLE](#) options for controlling a table's partition balance (fragment count type), read-from-any-replica capability, full replication, or any combination of these, as part of the table comment for an [ALTER TABLE](#) statement in the same manner as for [CREATE TABLE](#), as shown in this example:

```
ALTER TABLE t1 COMMENT = "NDB_TABLE=READ_BACKUP=0,PARTITION_BALANCE=FOR_RA_BY_NODE";
```

It is also possible to set [NDB\\_COMMENT](#) options for columns of [NDB](#) tables as part of an [ALTER TABLE](#) statement, like this one:

```
ALTER TABLE t1
CHANGE COLUMN c1 c1 BLOB
COMMENT = 'NDB_COLUMN=MAX_BLOB_PART_SIZE';
```

Bear in mind that [ALTER TABLE ... COMMENT ...](#) discards any existing comment for the table. See [Setting NDB\\_TABLE options](#), for additional information and examples.

To verify that the table options were changed as intended, use [SHOW CREATE TABLE](#), or query the Information Schema [TABLES](#) table.

## Performance and Space Requirements

[ALTER TABLE](#) operations are processed using one of the following algorithms:

- **COPY:** Operations are performed on a copy of the original table, and table data is copied from the original table to the new table row by row. Concurrent DML is not permitted.



- **INPLACE**: Operations avoid copying table data but may rebuild the table in place. An exclusive metadata lock on the table may be taken briefly during preparation and execution phases of the operation. Typically, concurrent DML is supported.

For tables using the **NDB** storage engine, these algorithms work as follows:

- **COPY**: **NDB** creates a copy of the table and alters it; the **NDB** Cluster handler then copies the data between the old and new versions of the table. Subsequently, **NDB** deletes the old table and renames the new one.

This is sometimes also referred to as a “copying” or “offline” **ALTER TABLE**.

- **INPLACE**: The data nodes make the required changes; the **NDB** Cluster handler does not copy data or otherwise take part.

This is sometimes also referred to as a “non-copying” or “online” **ALTER TABLE**.

See [Section 21.6.12, “Online Operations with ALTER TABLE in NDB Cluster”](#), for more information.

The **ALGORITHM** clause is optional. If the **ALGORITHM** clause is omitted, MySQL uses **ALGORITHM=INPLACE** for storage engines and **ALTER TABLE** clauses that support it. Otherwise, **ALGORITHM=COPY** is used.

Specifying an **ALGORITHM** clause requires the operation to use the specified algorithm for clauses and storage engines that support it, or fail with an error otherwise. Specifying **ALGORITHM=DEFAULT** is the same as omitting the **ALGORITHM** clause.

**ALTER TABLE** operations that use the **COPY** algorithm wait for other operations that are modifying the table to complete. After alterations are applied to the table copy, data is copied over, the original table is deleted, and the table copy is renamed to the name of the original table. While the **ALTER TABLE** operation executes, the original table is readable by other sessions (with the exception noted shortly). Updates and writes to the table started after the **ALTER TABLE** operation begins are stalled until the new table is ready, then are automatically redirected to the new table. The temporary copy of the table is created in the database directory of the original table unless it is a **RENAME TO** operation that moves the table to a database that resides in a different directory.

The exception referred to earlier is that **ALTER TABLE** blocks reads (not just writes) at the point where it is ready to install a new version of the table **.frm** file, discard the old file, and clear outdated table structures from the table and table definition caches. At this point, it must acquire an exclusive lock. To do so, it waits for current readers to finish, and blocks new reads and writes.

An **ALTER TABLE** operation that uses the **COPY** algorithm prevents concurrent DML operations. Concurrent queries are still allowed. That is, a table-copying operation always includes at least the concurrency restrictions of **LOCK=SHARED** (allow queries but not DML). You can further restrict concurrency for operations that support the **LOCK** clause by specifying **LOCK=EXCLUSIVE**, which prevents DML and queries. For more information, see [Concurrency Control](#).

To force use of the **COPY** algorithm for an **ALTER TABLE** operation that would otherwise not use it, enable the **old\_alter\_table** system variable or specify **ALGORITHM=COPY**. If there is a conflict between the **old\_alter\_table** setting and an **ALGORITHM** clause with a value other than **DEFAULT**, the **ALGORITHM** clause takes precedence.

For **InnoDB** tables, an **ALTER TABLE** operation that uses the **COPY** algorithm on a table that resides in a **shared tablespace** can increase the amount of space used by the tablespace. Such operations require as much additional space as the data in the table plus indexes. For a table residing in a shared tablespace,

the additional space used during the operation is not released back to the operating system as it is for a table that resides in a [file-per-table](#) tablespace.

For information about space requirements for online DDL operations, see [Section 14.13.3, “Online DDL Space Requirements”](#).

`ALTER TABLE` operations that support the `INPLACE` algorithm include:

- `ALTER TABLE` operations supported by the [InnoDB online DDL](#) feature. See [Section 14.13.1, “Online DDL Operations”](#).
- Renaming a table. MySQL renames files that correspond to the table `tbl_name` without making a copy. (You can also use the `RENAME TABLE` statement to rename tables. See [Section 13.1.33, “RENAME TABLE Statement”](#).) Privileges granted specifically for the renamed table are not migrated to the new name. They must be changed manually.
- Operations that only modify table metadata. These operations are immediate because the server only alters the table `.frm` file, not touch table contents. Metadata-only operations include:
  - Renaming a column.
  - Changing the default value of a column (except for `NDB` tables).
  - Modifying the definition of an `ENUM` or `SET` column by adding new enumeration or set members to the *end* of the list of valid member values, as long as the storage size of the data type does not change. For example, adding a member to a `SET` column that has 8 members changes the required storage per value from 1 byte to 2 bytes; this requires a table copy. Adding members in the middle of the list causes renumbering of existing members, which requires a table copy.
- Renaming an index.
- Adding or dropping a secondary index, for `InnoDB` and `NDB` tables. See [Section 14.13, “InnoDB and Online DDL”](#).
- For `NDB` tables, operations that add and drop indexes on variable-width columns. These operations occur online, without table copying and without blocking concurrent DML actions for most of their duration. See [Section 21.6.12, “Online Operations with ALTER TABLE in NDB Cluster”](#).

`ALTER TABLE` upgrades MySQL 5.5 temporal columns to 5.6 format for `ADD COLUMN`, `CHANGE COLUMN`, `MODIFY COLUMN`, `ADD INDEX`, and `FORCE` operations. This conversion cannot be done using the `INPLACE` algorithm because the table must be rebuilt, so specifying `ALGORITHM=INPLACE` in these cases results in an error. Specify `ALGORITHM=COPY` if necessary.

If an `ALTER TABLE` operation on a multicolumn index used to partition a table by `KEY` changes the order of the columns, it can only be performed using `ALGORITHM=COPY`.

The `WITHOUT VALIDATION` and `WITH VALIDATION` clauses affect whether `ALTER TABLE` performs an in-place operation for [virtual generated column](#) modifications. See [Section 13.1.8.2, “ALTER TABLE and Generated Columns”](#).

`NDB Cluster` formerly supported online `ALTER TABLE` operations using the `ONLINE` and `OFFLINE` keywords. These keywords are no longer supported; their use causes a syntax error. MySQL `NDB Cluster` 7.5 (and later) supports online operations using the same `ALGORITHM=INPLACE` syntax used with the standard MySQL Server. `NDB` does not support changing a tablespace online. See [Section 21.6.12, “Online Operations with ALTER TABLE in NDB Cluster”](#), for more information.

`ALTER TABLE` with `DISCARD ... PARTITION ... TABLESPACE` or `IMPORT ... PARTITION ... TABLESPACE` does not create any temporary tables or temporary partition files.

`ALTER TABLE` with `ADD PARTITION`, `DROP PARTITION`, `COALESCE PARTITION`, `REBUILD PARTITION`, or `REORGANIZE PARTITION` does not create temporary tables (except when used with `NDB` tables); however, these operations can and do create temporary partition files.

`ADD` or `DROP` operations for `RANGE` or `LIST` partitions are immediate operations or nearly so. `ADD` or `COALESCE` operations for `HASH` or `KEY` partitions copy data between all partitions, unless `LINEAR HASH` or `LINEAR KEY` was used; this is effectively the same as creating a new table, although the `ADD` or `COALESCE` operation is performed partition by partition. `REORGANIZE` operations copy only changed partitions and do not touch unchanged ones.

For `MyISAM` tables, you can speed up index re-creation (the slowest part of the alteration process) by setting the `myisam_sort_buffer_size` system variable to a high value.

## Concurrency Control

For `ALTER TABLE` operations that support it, you can use the `LOCK` clause to control the level of concurrent reads and writes on a table while it is being altered. Specifying a non-default value for this clause enables you to require a certain amount of concurrent access or exclusivity during the alter operation, and halts the operation if the requested degree of locking is not available. The parameters for the `LOCK` clause are:

- `LOCK = DEFAULT`

Maximum level of concurrency for the given `ALGORITHM` clause (if any) and `ALTER TABLE` operation: Permit concurrent reads and writes if supported. If not, permit concurrent reads if supported. If not, enforce exclusive access.

- `LOCK = NONE`

If supported, permit concurrent reads and writes. Otherwise, an error occurs.

- `LOCK = SHARED`

If supported, permit concurrent reads but block writes. Writes are blocked even if concurrent writes are supported by the storage engine for the given `ALGORITHM` clause (if any) and `ALTER TABLE` operation. If concurrent reads are not supported, an error occurs.

- `LOCK = EXCLUSIVE`

Enforce exclusive access. This is done even if concurrent reads/writes are supported by the storage engine for the given `ALGORITHM` clause (if any) and `ALTER TABLE` operation.

## Adding and Dropping Columns

Use `ADD` to add new columns to a table, and `DROP` to remove existing columns. `DROP col_name` is a MySQL extension to standard SQL.

To add a column at a specific position within a table row, use `FIRST` or `AFTER col_name`. The default is to add the column last.

If a table contains only one column, the column cannot be dropped. If what you intend is to remove the table, use the `DROP TABLE` statement instead.

If columns are dropped from a table, the columns are also removed from any index of which they are a part. If all columns that make up an index are dropped, the index is dropped as well.

## Renaming, Redefining, and Reordering Columns

The `CHANGE`, `MODIFY`, and `ALTER` clauses enable the names and definitions of existing columns to be altered. They have these comparative characteristics:

- `CHANGE`:
  - Can rename a column and change its definition, or both.
  - Has more capability than `MODIFY`, but at the expense of convenience for some operations. `CHANGE` requires naming the column twice if not renaming it.
  - With `FIRST` or `AFTER`, can reorder columns.
- `MODIFY`:
  - Can change a column definition but not its name.
  - More convenient than `CHANGE` to change a column definition without renaming it.
  - With `FIRST` or `AFTER`, can reorder columns.
- `ALTER`: Used only to change a column default value.

`CHANGE` is a MySQL extension to standard SQL. `MODIFY` is a MySQL extension for Oracle compatibility.

To alter a column to change both its name and definition, use `CHANGE`, specifying the old and new names and the new definition. For example, to rename an `INT NOT NULL` column from `a` to `b` and change its definition to use the `BIGINT` data type while retaining the `NOT NULL` attribute, do this:

```
ALTER TABLE t1 CHANGE a b BIGINT NOT NULL;
```

To change a column definition but not its name, use `CHANGE` or `MODIFY`. With `CHANGE`, the syntax requires two column names, so you must specify the same name twice to leave the name unchanged. For example, to change the definition of column `b`, do this:

```
ALTER TABLE t1 CHANGE b b INT NOT NULL;
```

`MODIFY` is more convenient to change the definition without changing the name because it requires the column name only once:

```
ALTER TABLE t1 MODIFY b INT NOT NULL;
```

To change a column name but not its definition, use `CHANGE`. The syntax requires a column definition, so to leave the definition unchanged, you must respecify the definition the column currently has. For example, to rename an `INT NOT NULL` column from `b` to `a`, do this:

```
ALTER TABLE t1 CHANGE b a INT NOT NULL;
```

For column definition changes using `CHANGE` or `MODIFY`, the definition must include the data type and all attributes that should apply to the new column, other than index attributes such as `PRIMARY KEY` or `UNIQUE`. Attributes present in the original definition but not specified for the new definition are not carried forward. Suppose that a column `col1` is defined as `INT UNSIGNED DEFAULT 1 COMMENT 'my column'` and you modify the column as follows, intending to change only `INT` to `BIGINT`:

```
ALTER TABLE t1 MODIFY col1 BIGINT;
```

That statement changes the data type from `INT` to `BIGINT`, but it also drops the `UNSIGNED`, `DEFAULT`, and `COMMENT` attributes. To retain them, the statement must include them explicitly:

```
ALTER TABLE t1 MODIFY col1 BIGINT UNSIGNED DEFAULT 1 COMMENT 'my column';
```

For data type changes using [CHANGE](#) or [MODIFY](#), MySQL tries to convert existing column values to the new type as well as possible.



### Warning

This conversion may result in alteration of data. For example, if you shorten a string column, values may be truncated. To prevent the operation from succeeding if conversions to the new data type would result in loss of data, enable strict SQL mode before using [ALTER TABLE](#) (see [Section 5.1.10](#), “Server SQL Modes”).

If you use [CHANGE](#) or [MODIFY](#) to shorten a column for which an index exists on the column, and the resulting column length is less than the index length, MySQL shortens the index automatically.

For columns renamed by [CHANGE](#), MySQL automatically renames these references to the renamed column:

- Indexes that refer to the old column, including indexes and disabled [MyISAM](#) indexes.
- Foreign keys that refer to the old column.

For columns renamed by [CHANGE](#), MySQL does not automatically rename these references to the renamed column:

- Generated column and partition expressions that refer to the renamed column. You must use [CHANGE](#) to redefine such expressions in the same [ALTER TABLE](#) statement as the one that renames the column.
- Views and stored programs that refer to the renamed column. You must manually alter the definition of these objects to refer to the new column name.

To reorder columns within a table, use [FIRST](#) and [AFTER](#) in [CHANGE](#) or [MODIFY](#) operations.

[ALTER ... SET DEFAULT](#) or [ALTER ... DROP DEFAULT](#) specify a new default value for a column or remove the old default value, respectively. If the old default is removed and the column can be [NULL](#), the new default is [NULL](#). If the column cannot be [NULL](#), MySQL assigns a default value as described in [Section 11.6](#), “Data Type Default Values”.

[ALTER ... SET DEFAULT](#) cannot be used with the [CURRENT\\_TIMESTAMP](#) function.

## Primary Keys and Indexes

[DROP PRIMARY KEY](#) drops the [primary key](#). If there is no primary key, an error occurs. For information about the performance characteristics of primary keys, especially for [InnoDB](#) tables, see [Section 8.3.2](#), “Primary Key Optimization”.

If you add a [UNIQUE INDEX](#) or [PRIMARY KEY](#) to a table, MySQL stores it before any nonunique index to permit detection of duplicate keys as early as possible.

[DROP INDEX](#) removes an index. This is a MySQL extension to standard SQL. See [Section 13.1.25](#), “[DROP INDEX Statement](#)”. To determine index names, use [SHOW INDEX FROM tbl\\_name](#).

Some storage engines permit you to specify an index type when creating an index. The syntax for the [index\\_type](#) specifier is [USING type\\_name](#). For details about [USING](#), see [Section 13.1.14](#), “[CREATE INDEX Statement](#)”. The preferred position is after the column list. You should expect support for use of the option before the column list to be removed in a future MySQL release.

*index\_option* values specify additional options for an index. For details about permissible *index\_option* values, see [Section 13.1.14, “CREATE INDEX Statement”](#).

`RENAME INDEX old_index_name TO new_index_name` renames an index. This is a MySQL extension to standard SQL. The content of the table remains unchanged. *old\_index\_name* must be the name of an existing index in the table that is not dropped by the same `ALTER TABLE` statement. *new\_index\_name* is the new index name, which cannot duplicate the name of an index in the resulting table after changes have been applied. Neither index name can be `PRIMARY`.

If you use `ALTER TABLE` on a `MyISAM` table, all nonunique indexes are created in a separate batch (as for `REPAIR TABLE`). This should make `ALTER TABLE` much faster when you have many indexes.

For `MyISAM` tables, key updating can be controlled explicitly. Use `ALTER TABLE ... DISABLE KEYS` to tell MySQL to stop updating nonunique indexes. Then use `ALTER TABLE ... ENABLE KEYS` to re-create missing indexes. `MyISAM` does this with a special algorithm that is much faster than inserting keys one by one, so disabling keys before performing bulk insert operations should give a considerable speedup. Using `ALTER TABLE ... DISABLE KEYS` requires the `INDEX` privilege in addition to the privileges mentioned earlier.

While the nonunique indexes are disabled, they are ignored for statements such as `SELECT` and `EXPLAIN` that otherwise would use them.

After an `ALTER TABLE` statement, it may be necessary to run `ANALYZE TABLE` to update index cardinality information. See [Section 13.7.5.22, “SHOW INDEX Statement”](#).

## Foreign Keys and Other Constraints

The `FOREIGN KEY` and `REFERENCES` clauses are supported by the `InnoDB` and `NDB` storage engines, which implement `ADD [CONSTRAINT [symbol]] FOREIGN KEY [index_name] (...) REFERENCES ... (...)`. See [Section 1.6.3.2, “FOREIGN KEY Constraints”](#). For other storage engines, the clauses are parsed but ignored.

The `CHECK` constraint clause is parsed but ignored by all storage engines. See [Section 13.1.18, “CREATE TABLE Statement”](#). The reason for accepting but ignoring syntax clauses is for compatibility, to make it easier to port code from other SQL servers, and to run applications that create tables with references. See [Section 1.6.2, “MySQL Differences from Standard SQL”](#).

For `ALTER TABLE`, unlike `CREATE TABLE`, `ADD FOREIGN KEY` ignores *index\_name* if given and uses an automatically generated foreign key name. As a workaround, include the `CONSTRAINT` clause to specify the foreign key name:

```
ADD CONSTRAINT name FOREIGN KEY (...)
```



### Important

MySQL silently ignores inline `REFERENCES` specifications, where the references are defined as part of the column specification. MySQL accepts only `REFERENCES` clauses defined as part of a separate `FOREIGN KEY` specification.



### Note

Partitioned `InnoDB` tables do not support foreign keys. This restriction does not apply to `NDB` tables, including those explicitly partitioned by `[LINEAR] KEY`. For more information, see [Section 22.6.2, “Partitioning Limitations Relating to Storage Engines”](#).

MySQL Server and NDB Cluster both support the use of `ALTER TABLE` to drop foreign keys:

```
ALTER TABLE tbl_name DROP FOREIGN KEY fk_symbol;
```

Adding and dropping a foreign key in the same `ALTER TABLE` statement is supported for `ALTER TABLE ... ALGORITHM=INPLACE` but not for `ALTER TABLE ... ALGORITHM=COPY`.

The server prohibits changes to foreign key columns that have the potential to cause loss of referential integrity. A workaround is to use `ALTER TABLE ... DROP FOREIGN KEY` before changing the column definition and `ALTER TABLE ... ADD FOREIGN KEY` afterward. Examples of prohibited changes include:

- Changes to the data type of foreign key columns that may be unsafe. For example, changing `VARCHAR(20)` to `VARCHAR(30)` is permitted, but changing it to `VARCHAR(1024)` is not because that alters the number of length bytes required to store individual values.
- Changing a `NULL` column to `NOT NULL` in non-strict mode is prohibited to prevent converting `NULL` values to default non-`NULL` values, for which there are no corresponding values in the referenced table. The operation is permitted in strict mode, but an error is returned if any such conversion is required.

`ALTER TABLE tbl_name RENAME new_tbl_name` changes internally generated foreign key constraint names and user-defined foreign key constraint names that begin with the string “`tbl_name_ibfk_`” to reflect the new table name. `InnoDB` interprets foreign key constraint names that begin with the string “`tbl_name_ibfk_`” as internally generated names.

## Changing the Character Set

To change the table default character set and all character columns (`CHAR`, `VARCHAR`, `TEXT`) to a new character set, use a statement like this:

```
ALTER TABLE tbl_name CONVERT TO CHARACTER SET charset_name;
```

The statement also changes the collation of all character columns. If you specify no `COLLATE` clause to indicate which collation to use, the statement uses default collation for the character set. If this collation is inappropriate for the intended table use (for example, if it would change from a case-sensitive collation to a case-insensitive collation), specify a collation explicitly.

For a column that has a data type of `VARCHAR` or one of the `TEXT` types, `CONVERT TO CHARACTER SET` changes the data type as necessary to ensure that the new column is long enough to store as many characters as the original column. For example, a `TEXT` column has two length bytes, which store the byte-length of values in the column, up to a maximum of 65,535. For a `latin1 TEXT` column, each character requires a single byte, so the column can store up to 65,535 characters. If the column is converted to `utf8`, each character might require up to three bytes, for a maximum possible length of  $3 \times 65,535 = 196,605$  bytes. That length does not fit in a `TEXT` column's length bytes, so MySQL converts the data type to `MEDIUMTEXT`, which is the smallest string type for which the length bytes can record a value of 196,605. Similarly, a `VARCHAR` column might be converted to `MEDIUMTEXT`.

To avoid data type changes of the type just described, do not use `CONVERT TO CHARACTER SET`. Instead, use `MODIFY` to change individual columns. For example:

```
ALTER TABLE t MODIFY latin1_text_col TEXT CHARACTER SET utf8;
ALTER TABLE t MODIFY latin1_varchar_col VARCHAR(M) CHARACTER SET utf8;
```

If you specify `CONVERT TO CHARACTER SET binary`, the `CHAR`, `VARCHAR`, and `TEXT` columns are converted to their corresponding binary string types (`BINARY`, `VARBINARY`, `BLOB`). This means that the columns no longer have a character set and a subsequent `CONVERT TO` operation does not apply to them.

If `charset_name` is `DEFAULT` in a `CONVERT TO CHARACTER SET` operation, the character set named by the `character_set_database` system variable is used.

**Warning**

The `CONVERT TO` operation converts column values between the original and named character sets. This is *not* what you want if you have a column in one character set (like `latin1`) but the stored values actually use some other, incompatible character set (like `utf8`). In this case, you have to do the following for each such column:

```
ALTER TABLE t1 CHANGE c1 c1 BLOB;
ALTER TABLE t1 CHANGE c1 c1 TEXT CHARACTER SET utf8;
```

The reason this works is that there is no conversion when you convert to or from `BLOB` columns.

To change only the *default* character set for a table, use this statement:

```
ALTER TABLE tbl_name DEFAULT CHARACTER SET charset_name;
```

The word `DEFAULT` is optional. The default character set is the character set that is used if you do not specify the character set for columns that you add to a table later (for example, with `ALTER TABLE ... ADD column`).

When the `foreign_key_checks` system variable is enabled, which is the default setting, character set conversion is not permitted on tables that include a character string column used in a foreign key constraint. The workaround is to disable `foreign_key_checks` before performing the character set conversion. You must perform the conversion on both tables involved in the foreign key constraint before re-enabling `foreign_key_checks`. If you re-enable `foreign_key_checks` after converting only one of the tables, an `ON DELETE CASCADE` or `ON UPDATE CASCADE` operation could corrupt data in the referencing table due to implicit conversion that occurs during these operations (Bug #45290, Bug #74816).

## Discarding and Importing InnoDB Tablespaces

An `InnoDB` table created in its own `file-per-table` tablespace can be imported from a backup or from another MySQL server instance using `DISCARD TABLESPACE` and `IMPORT TABLESPACE` clauses. See [Section 14.6.1.3, “Importing InnoDB Tables”](#).

## Row Order for MyISAM Tables

`ORDER BY` enables you to create the new table with the rows in a specific order. This option is useful primarily when you know that you query the rows in a certain order most of the time. By using this option after major changes to the table, you might be able to get higher performance. In some cases, it might make sorting easier for MySQL if the table is in order by the column that you want to order it by later.

**Note**

The table does not remain in the specified order after inserts and deletes.

`ORDER BY` syntax permits one or more column names to be specified for sorting, each of which optionally can be followed by `ASC` or `DESC` to indicate ascending or descending sort order, respectively. The default is ascending order. Only column names are permitted as sort criteria; arbitrary expressions are not permitted. This clause should be given last after any other clauses.

`ORDER BY` does not make sense for `InnoDB` tables because `InnoDB` always orders table rows according to the `clustered index`.

When used on a partitioned table, `ALTER TABLE ... ORDER BY` orders rows within each partition only.



## Partitioning Options

*partition\_options* signifies options that can be used with partitioned tables for repartitioning, to add, drop, discard, import, merge, and split partitions, and to perform partitioning maintenance.

It is possible for an `ALTER TABLE` statement to contain a `PARTITION BY` or `REMOVE PARTITIONING` clause in an addition to other alter specifications, but the `PARTITION BY` or `REMOVE PARTITIONING` clause must be specified last after any other specifications. The `ADD PARTITION`, `DROP PARTITION`, `DISCARD PARTITION`, `IMPORT PARTITION`, `COALESCE PARTITION`, `REORGANIZE PARTITION`, `EXCHANGE PARTITION`, `ANALYZE PARTITION`, `CHECK PARTITION`, and `REPAIR PARTITION` options cannot be combined with other alter specifications in a single `ALTER TABLE`, since the options just listed act on individual partitions.

For more information about partition options, see [Section 13.1.18, “CREATE TABLE Statement”](#), and [Section 13.1.8.1, “ALTER TABLE Partition Operations”](#). For information about and examples of `ALTER TABLE ... EXCHANGE PARTITION` statements, see [Section 22.3.3, “Exchanging Partitions and Subpartitions with Tables”](#).

Prior to MySQL 5.7.6, partitioned `InnoDB` tables used the generic `ha_partition` partitioning handler employed by `MyISAM` and other storage engines not supplying their own partitioning handlers; in MySQL 5.7.6 and later, such tables are created using the `InnoDB` storage engine's own (or “native”) partitioning handler. Beginning with MySQL 5.7.9, you can upgrade an `InnoDB` table that was created in MySQL 5.7.6 or earlier (that is, created using `ha_partition`) to the `InnoDB` native partition handler using `ALTER TABLE ... UPGRADE PARTITIONING`. (Bug #76734, Bug #20727344) This `ALTER TABLE` syntax does not accept any other options and can be used only on a single table at a time. You can also use `mysql_upgrade` in MySQL 5.7.9 or later to upgrade older partitioned `InnoDB` tables to the native partitioning handler.

### 13.1.8.1 ALTER TABLE Partition Operations

Partitioning-related clauses for `ALTER TABLE` can be used with partitioned tables for repartitioning, to add, drop, discard, import, merge, and split partitions, and to perform partitioning maintenance.

- Simply using a *partition\_options* clause with `ALTER TABLE` on a partitioned table repartitions the table according to the partitioning scheme defined by the *partition\_options*. This clause always begins with `PARTITION BY`, and follows the same syntax and other rules as apply to the *partition\_options* clause for `CREATE TABLE` (for more detailed information, see [Section 13.1.18, “CREATE TABLE Statement”](#)), and can also be used to partition an existing table that is not already partitioned. For example, consider a (nonpartitioned) table defined as shown here:

```
CREATE TABLE t1 (
  id INT,
  year_col INT
);
```

This table can be partitioned by `HASH`, using the `id` column as the partitioning key, into 8 partitions by means of this statement:

```
ALTER TABLE t1
  PARTITION BY HASH(id)
  PARTITIONS 8;
```

MySQL supports an `ALGORITHM` option with `[SUB]PARTITION BY [LINEAR] KEY.ALGORITHM=1` causes the server to use the same key-hashing functions as MySQL 5.1 when computing the placement of rows in partitions; `ALGORITHM=2` means that the server employs the key-hashing functions implemented and used by default for new `KEY` partitioned tables in MySQL 5.5 and later. (Partitioned tables created with the key-hashing functions employed in MySQL 5.5 and later cannot be used by a MySQL 5.1 server.) Not specifying the option has the same effect as using `ALGORITHM=2`. This option

is intended for use chiefly when upgrading or downgrading [\[LINEAR\] KEY](#) partitioned tables between MySQL 5.1 and later MySQL versions, or for creating tables partitioned by [KEY](#) or [LINEAR KEY](#) on a MySQL 5.5 or later server which can be used on a MySQL 5.1 server.

To upgrade a [KEY](#) partitioned table that was created in MySQL 5.1, first execute [SHOW CREATE TABLE](#) and note the exact columns and number of partitions shown. Now execute an [ALTER TABLE](#) statement using exactly the same column list and number of partitions as in the [CREATE TABLE](#) statement, while adding [ALGORITHM=2](#) immediately following the [PARTITION BY](#) keywords. (You should also include the [LINEAR](#) keyword if it was used for the original table definition.) An example from a session in the `mysql` client is shown here:

```
mysql> SHOW CREATE TABLE p\G
***** 1. row *****
      Table: p
Create Table: CREATE TABLE `p` (
  `id` int(11) NOT NULL AUTO_INCREMENT,
  `cd` datetime NOT NULL,
  PRIMARY KEY (`id`)
) ENGINE=InnoDB DEFAULT CHARSET=latin1
/*!50100 PARTITION BY LINEAR KEY (id)
PARTITIONS 32 */
1 row in set (0.00 sec)

mysql> ALTER TABLE p PARTITION BY LINEAR KEY ALGORITHM=2 (id) PARTITIONS 32;
Query OK, 0 rows affected (5.34 sec)
Records: 0 Duplicates: 0 Warnings: 0

mysql> SHOW CREATE TABLE p\G
***** 1. row *****
      Table: p
Create Table: CREATE TABLE `p` (
  `id` int(11) NOT NULL AUTO_INCREMENT,
  `cd` datetime NOT NULL,
  PRIMARY KEY (`id`)
) ENGINE=InnoDB DEFAULT CHARSET=latin1
/*!50100 PARTITION BY LINEAR KEY (id)
PARTITIONS 32 */
1 row in set (0.00 sec)
```

Downgrading a table created using the default key-hashing used in MySQL 5.5 and later to enable its use by a MySQL 5.1 server is similar, except in this case you should use [ALGORITHM=1](#) to force the table's partitions to be rebuilt using the MySQL 5.1 key-hashing functions. It is recommended that you not do this except when necessary for compatibility with a MySQL 5.1 server, as the improved [KEY](#) hashing functions used by default in MySQL 5.5 and later provide fixes for a number of issues found in the older implementation.



#### Note

A table upgraded by means of [ALTER TABLE ... PARTITION BY ALGORITHM=2 \[LINEAR\] KEY ...](#) can no longer be used by a MySQL 5.1 server. (Such a table would need to be downgraded with [ALTER TABLE ... PARTITION BY ALGORITHM=1 \[LINEAR\] KEY ...](#) before it could be used again by a MySQL 5.1 server.)

The table that results from using an [ALTER TABLE ... PARTITION BY](#) statement must follow the same rules as one created using [CREATE TABLE ... PARTITION BY](#). This includes the rules governing the relationship between any unique keys (including any primary key) that the table might have, and the column or columns used in the partitioning expression, as discussed in [Section 22.6.1](#),

“Partitioning Keys, Primary Keys, and Unique Keys”. The `CREATE TABLE ... PARTITION BY` rules for specifying the number of partitions also apply to `ALTER TABLE ... PARTITION BY`.

The *partition\_definition* clause for `ALTER TABLE ADD PARTITION` supports the same options as the clause of the same name for the `CREATE TABLE` statement. (See [Section 13.1.18, “CREATE TABLE Statement”](#), for the syntax and description.) Suppose that you have the partitioned table created as shown here:

```
CREATE TABLE t1 (
  id INT,
  year_col INT
)
PARTITION BY RANGE (year_col) (
  PARTITION p0 VALUES LESS THAN (1991),
  PARTITION p1 VALUES LESS THAN (1995),
  PARTITION p2 VALUES LESS THAN (1999)
);
```

You can add a new partition `p3` to this table for storing values less than `2002` as follows:

```
ALTER TABLE t1 ADD PARTITION (PARTITION p3 VALUES LESS THAN (2002));
```

`DROP PARTITION` can be used to drop one or more `RANGE` or `LIST` partitions. This statement cannot be used with `HASH` or `KEY` partitions; instead, use `COALESCE PARTITION` (see below). Any data that was stored in the dropped partitions named in the *partition\_names* list is discarded. For example, given the table `t1` defined previously, you can drop the partitions named `p0` and `p1` as shown here:

```
ALTER TABLE t1 DROP PARTITION p0, p1;
```



#### Note

`DROP PARTITION` does not work with tables that use the `NDB` storage engine. See [Section 22.3.1, “Management of RANGE and LIST Partitions”](#), and [Section 21.2.7, “Known Limitations of NDB Cluster”](#).

`ADD PARTITION` and `DROP PARTITION` do not currently support `IF [NOT] EXISTS`.

`DISCARD PARTITION ... TABLESPACE` and `IMPORT PARTITION ... TABLESPACE` options extend the [Transportable Tablespace](#) feature to individual `InnoDB` table partitions. Each `InnoDB` table partition has its own tablespace file (`.ibd` file). The [Transportable Tablespace](#) feature makes it easy to copy the tablespaces from a running MySQL server instance to another running instance, or to perform a

restore on the same instance. Both options take a list of one or more comma-separated partition names. For example:

```
ALTER TABLE t1 DISCARD PARTITION p2, p3 TABLESPACE;
```

```
ALTER TABLE t1 IMPORT PARTITION p2, p3 TABLESPACE;
```

When running `DISCARD PARTITION ... TABLESPACE` and `IMPORT PARTITION ... TABLESPACE` on subpartitioned tables, both partition and subpartition names are allowed. When a partition name is specified, subpartitions of that partition are included.

The [Transportable Tablespace](#) feature also supports copying or restoring partitioned `InnoDB` tables. For more information, see [Section 14.6.1.3, "Importing InnoDB Tables"](#).

Renames of partitioned tables are supported. You can rename individual partitions indirectly using `ALTER TABLE ... REORGANIZE PARTITION`; however, this operation copies the partition's data.

To delete rows from selected partitions, use the `TRUNCATE PARTITION` option. This option takes a comma-separated list of one or more partition names. For example, consider the table `t1` as defined here:

```
CREATE TABLE t1 (
  id INT,
  year_col INT
)
PARTITION BY RANGE (year_col) (
  PARTITION p0 VALUES LESS THAN (1991),
  PARTITION p1 VALUES LESS THAN (1995),
  PARTITION p2 VALUES LESS THAN (1999),
  PARTITION p3 VALUES LESS THAN (2003),
  PARTITION p4 VALUES LESS THAN (2007)
);
```

To delete all rows from partition `p0`, use the following statement:

```
ALTER TABLE t1 TRUNCATE PARTITION p0;
```

The statement just shown has the same effect as the following `DELETE` statement:

```
DELETE FROM t1 WHERE year_col < 1991;
```

When truncating multiple partitions, the partitions do not have to be contiguous: This can greatly simplify delete operations on partitioned tables that would otherwise require very complex `WHERE` conditions if done with `DELETE` statements. For example, this statement deletes all rows from partitions `p1` and `p3`:

```
ALTER TABLE t1 TRUNCATE PARTITION p1, p3;
```

An equivalent `DELETE` statement is shown here:

```
DELETE FROM t1 WHERE
  (year_col >= 1991 AND year_col < 1995)
  OR
```

```
(year_col >= 2003 AND year_col < 2007);
```

If you use the [ALL](#) keyword in place of the list of partition names, the statement acts on all table partitions.

[TRUNCATE PARTITION](#) merely deletes rows; it does not alter the definition of the table itself, or of any of its partitions.

To verify that the rows were dropped, check the [INFORMATION\\_SCHEMA.PARTITIONS](#) table, using a query such as this one:

```
SELECT PARTITION_NAME, TABLE_ROWS
FROM INFORMATION_SCHEMA.PARTITIONS
WHERE TABLE_NAME = 't1';
```

[TRUNCATE PARTITION](#) is supported only for partitioned tables that use the [MyISAM](#), [InnoDB](#), or [MEMORY](#) storage engine. It also works on [BLACKHOLE](#) tables (but has no effect). It is not supported for [ARCHIVE](#) tables.

[COALESCE PARTITION](#) can be used with a table that is partitioned by [HASH](#) or [KEY](#) to reduce the number of partitions by *number*. Suppose that you have created table *t2* as follows:

```
CREATE TABLE t2 (
  name VARCHAR (30),
  started DATE
)
PARTITION BY HASH( YEAR(started) )
PARTITIONS 6;
```

To reduce the number of partitions used by *t2* from 6 to 4, use the following statement:

```
ALTER TABLE t2 COALESCE PARTITION 2;
```

The data contained in the last *number* partitions are merged into the remaining partitions. In this case, partitions 4 and 5 are merged into the first 4 partitions (the partitions numbered 0, 1, 2, and 3).

To change some but not all the partitions used by a partitioned table, you can use [REORGANIZE PARTITION](#). This statement can be used in several ways:

- To merge a set of partitions into a single partition. This is done by naming several partitions in the *partition\_names* list and supplying a single definition for *partition\_definition*.
- To split an existing partition into several partitions. Accomplish this by naming a single partition for *partition\_names* and providing multiple *partition\_definitions*.
- To change the ranges for a subset of partitions defined using [VALUES LESS THAN](#) or the value lists for a subset of partitions defined using [VALUES IN](#).
- This statement may also be used without the *partition\_names INTO (partition\_definitions)* option on tables that are automatically partitioned using [HASH](#) partitioning to force redistribution of data. (Currently, only [NDB](#) tables are automatically partitioned in this way.) This is useful in NDB Cluster where, after you have added new NDB Cluster data nodes online to an existing NDB Cluster, you wish to redistribute existing NDB Cluster table data to the new

data nodes. In such cases, you should invoke the statement with the `ALGORITHM=INPLACE` option; in other words, as shown here:

```
ALTER TABLE table ALGORITHM=INPLACE, REORGANIZE PARTITION;
```

You cannot perform other DDL concurrently with online table reorganization—that is, no other DDL statements can be issued while an `ALTER TABLE ... ALGORITHM=INPLACE, REORGANIZE PARTITION` statement is executing. For more information about adding NDB Cluster data nodes online, see [Section 21.6.7, “Adding NDB Cluster Data Nodes Online”](#).



#### Note

`ALTER TABLE ... ALGORITHM=INPLACE, REORGANIZE PARTITION` does not work with tables which were created using the `MAX_ROWS` option, because it uses the constant `MAX_ROWS` value specified in the original `CREATE TABLE` statement to determine the number of partitions required, so no new partitions are created. Instead, you can use `ALTER TABLE ... ALGORITHM=INPLACE, MAX_ROWS=rows` to increase the maximum number of rows for such a table; in this case, `ALTER TABLE ... ALGORITHM=INPLACE, REORGANIZE PARTITION` is not needed (and causes an error if executed). The value of `rows` must be greater than the value specified for `MAX_ROWS` in the original `CREATE TABLE` statement for this to work.

Employing `MAX_ROWS` to force the number of table partitions is deprecated in NDB 7.5.4 and later; use `PARTITION_BALANCE` instead (see [Setting NDB\\_TABLE options](#)).

Attempting to use `REORGANIZE PARTITION` without the `partition_names INTO (partition_definitions)` option on explicitly partitioned tables results in the error `REORGANIZE PARTITION without parameters can only be used on auto-partitioned tables using HASH partitioning`.



#### Note

For partitions that have not been explicitly named, MySQL automatically provides the default names `p0`, `p1`, `p2`, and so on. The same is true with regard to subpartitions.

For more detailed information about and examples of `ALTER TABLE ... REORGANIZE PARTITION` statements, see [Section 22.3.1, “Management of RANGE and LIST Partitions”](#).

- To exchange a table partition or subpartition with a table, use the `ALTER TABLE ... EXCHANGE PARTITION` statement—that is, to move any existing rows in the partition or subpartition to the nonpartitioned table, and any existing rows in the nonpartitioned table to the table partition or subpartition.

For usage information and examples, see [Section 22.3.3, “Exchanging Partitions and Subpartitions with Tables”](#).

- Several options provide partition maintenance and repair functionality analogous to that implemented for nonpartitioned tables by statements such as `CHECK TABLE` and `REPAIR TABLE` (which are also supported for partitioned tables; for more information, see [Section 13.7.2, “Table Maintenance Statements”](#)). These include `ANALYZE PARTITION`, `CHECK PARTITION`, `OPTIMIZE PARTITION`, `REBUILD PARTITION`, and `REPAIR PARTITION`. Each of these options takes a `partition_names` clause consisting of one or more names of partitions, separated by commas. The partitions must already

exist in the table to be altered. You can also use the `ALL` keyword in place of `partition_names`, in which case the statement acts on all table partitions. For more information and examples, see [Section 22.3.4, “Maintenance of Partitions”](#).

Some MySQL storage engines, such as `InnoDB`, do not support per-partition optimization. For a partitioned table using such a storage engine, `ALTER TABLE ... OPTIMIZE PARTITION` causes the entire table to be rebuilt and analyzed, and an appropriate warning to be issued. (Bug #11751825, Bug #42822)

To work around this problem, use the statements `ALTER TABLE ... REBUILD PARTITION` and `ALTER TABLE ... ANALYZE PARTITION` instead.

The `ANALYZE PARTITION`, `CHECK PARTITION`, `OPTIMIZE PARTITION`, and `REPAIR PARTITION` options are not permitted for tables which are not partitioned.

- In MySQL 5.7.9 and later, you can use `ALTER TABLE ... UPGRADE PARTITIONING` to upgrade a partitioned `InnoDB` table that was created with the old generic partitioning handler to the `InnoDB` native partitioning employed in MySQL 5.7.6 and later. Also beginning with MySQL 5.7.9, the `mysql_upgrade` utility checks for such partitioned `InnoDB` tables and attempts to upgrade them to native partitioning as part of its normal operations.



### Important

Partitioned `InnoDB` tables that do not use the `InnoDB` native partitioning handler cannot be used in MySQL 8.0 or later. `ALTER TABLE ... UPGRADE PARTITIONING` is not supported in MySQL 8.0 or later; therefore, any partitioned `InnoDB` tables that employ the generic handler *must* be upgraded to the `InnoDB` native handler *before* upgrading your MySQL installation to MySQL 8.0 or later.

- `REMOVE PARTITIONING` enables you to remove a table's partitioning without otherwise affecting the table or its data. This option can be combined with other `ALTER TABLE` options such as those used to add, drop, or rename columns or indexes.
- Using the `ENGINE` option with `ALTER TABLE` changes the storage engine used by the table without affecting the partitioning.

When `ALTER TABLE ... EXCHANGE PARTITION` or `ALTER TABLE ... TRUNCATE PARTITION` is run against a partitioned table that uses `MyISAM` (or another storage engine that makes use of table-level locking), only those partitions that are actually read from are locked. (This does not apply to partitioned tables using a storage engine that employs row-level locking, such as `InnoDB`.) See [Section 22.6.4, “Partitioning and Locking”](#).

It is possible for an `ALTER TABLE` statement to contain a `PARTITION BY` or `REMOVE PARTITIONING` clause in addition to other alter specifications, but the `PARTITION BY` or `REMOVE PARTITIONING` clause must be specified last after any other specifications.

The `ADD PARTITION`, `DROP PARTITION`, `COALESCE PARTITION`, `REORGANIZE PARTITION`, `ANALYZE PARTITION`, `CHECK PARTITION`, and `REPAIR PARTITION` options cannot be combined with other alter specifications in a single `ALTER TABLE`, since the options just listed act on individual partitions. For more information, see [Section 13.1.8.1, “ALTER TABLE Partition Operations”](#).

Only a single instance of any one of the following options can be used in a given `ALTER TABLE` statement: `PARTITION BY`, `ADD PARTITION`, `DROP PARTITION`, `TRUNCATE PARTITION`, `EXCHANGE PARTITION`, `REORGANIZE PARTITION`, or `COALESCE PARTITION`, `ANALYZE PARTITION`, `CHECK PARTITION`, `OPTIMIZE PARTITION`, `REBUILD PARTITION`, `REMOVE PARTITIONING`.

For example, the following two statements are invalid:

```
ALTER TABLE t1 ANALYZE PARTITION p1, ANALYZE PARTITION p2;
```

```
ALTER TABLE t1 ANALYZE PARTITION p1, CHECK PARTITION p2;
```

In the first case, you can analyze partitions `p1` and `p2` of table `t1` concurrently using a single statement with a single `ANALYZE PARTITION` option that lists both of the partitions to be analyzed, like this:

```
ALTER TABLE t1 ANALYZE PARTITION p1, p2;
```

In the second case, it is not possible to perform `ANALYZE` and `CHECK` operations on different partitions of the same table concurrently. Instead, you must issue two separate statements, like this:

```
ALTER TABLE t1 ANALYZE PARTITION p1;
ALTER TABLE t1 CHECK PARTITION p2;
```

`REBUILD` operations are currently unsupported for subpartitions. The `REBUILD` keyword is expressly disallowed with subpartitions, and causes `ALTER TABLE` to fail with an error if so used.

`CHECK PARTITION` and `REPAIR PARTITION` operations fail when the partition to be checked or repaired contains any duplicate key errors.

For more information about these statements, see [Section 22.3.4, "Maintenance of Partitions"](#).

### 13.1.8.2 ALTER TABLE and Generated Columns

`ALTER TABLE` operations permitted for generated columns are `ADD`, `MODIFY`, and `CHANGE`.

- Generated columns can be added.

```
CREATE TABLE t1 (c1 INT);
ALTER TABLE t1 ADD COLUMN c2 INT GENERATED ALWAYS AS (c1 + 1) STORED;
```

- The data type and expression of generated columns can be modified.

```
CREATE TABLE t1 (c1 INT, c2 INT GENERATED ALWAYS AS (c1 + 1) STORED);
ALTER TABLE t1 MODIFY COLUMN c2 TINYINT GENERATED ALWAYS AS (c1 + 5) STORED;
```

- Generated columns can be renamed or dropped, if no other column refers to them.

```
CREATE TABLE t1 (c1 INT, c2 INT GENERATED ALWAYS AS (c1 + 1) STORED);
ALTER TABLE t1 CHANGE c2 c3 INT GENERATED ALWAYS AS (c1 + 1) STORED;
ALTER TABLE t1 DROP COLUMN c3;
```

- Virtual generated columns cannot be altered to stored generated columns, or vice versa. To work around this, drop the column, then add it with the new definition.

```
CREATE TABLE t1 (c1 INT, c2 INT GENERATED ALWAYS AS (c1 + 1) VIRTUAL);
ALTER TABLE t1 DROP COLUMN c2;
ALTER TABLE t1 ADD COLUMN c2 INT GENERATED ALWAYS AS (c1 + 1) STORED;
```

- Nongenerated columns can be altered to stored but not virtual generated columns.

```
CREATE TABLE t1 (c1 INT, c2 INT);
ALTER TABLE t1 MODIFY COLUMN c2 INT GENERATED ALWAYS AS (c1 + 1) STORED;
```

- Stored but not virtual generated columns can be altered to nongenerated columns. The stored generated values become the values of the nongenerated column.

```
CREATE TABLE t1 (c1 INT, c2 INT GENERATED ALWAYS AS (c1 + 1) STORED);
ALTER TABLE t1 MODIFY COLUMN c2 INT;
```

- `ADD COLUMN` is not an in-place operation for stored columns (done without using a temporary table) because the expression must be evaluated by the server. For stored columns, indexing changes are



done in place, and expression changes are not done in place. Changes to column comments are done in place.

- For non-partitioned tables, [ADD COLUMN](#) and [DROP COLUMN](#) are in-place operations for virtual columns. However, adding or dropping a virtual column cannot be performed in place in combination with other [ALTER TABLE](#) operations.

For partitioned tables, [ADD COLUMN](#) and [DROP COLUMN](#) are not in-place operations for virtual columns.

- [InnoDB](#) supports secondary indexes on virtual generated columns. Adding or dropping a secondary index on a virtual generated column is an in-place operation. For more information, see [Section 13.1.18.8, “Secondary Indexes and Generated Columns”](#).
- When a [VIRTUAL](#) generated column is added to a table or modified, it is not ensured that values being calculated by the generated column expression are not out of range for the column. This can lead to inconsistent data being returned and unexpectedly failed statements. To permit control over whether validation occurs for such columns, [ALTER TABLE](#) supports [WITHOUT VALIDATION](#) and [WITH VALIDATION](#) clauses:
  - With [WITHOUT VALIDATION](#) (the default if neither clause is specified), an in-place operation is performed (if possible), data integrity is not checked, and the statement finishes more quickly. However, later reads from the table might report warnings or errors for the column if values are out of range.
  - With [WITH VALIDATION](#), [ALTER TABLE](#) copies the table. If an out-of-range or any other error occurs, the statement fails. Because a table copy is performed, the statement takes longer.

[WITHOUT VALIDATION](#) and [WITH VALIDATION](#) are permitted only with [ADD COLUMN](#), [CHANGE COLUMN](#), and [MODIFY COLUMN](#) operations. Otherwise, an [ER\\_WRONG\\_USAGE](#) error occurs.

- As of MySQL 5.7.10, if expression evaluation causes truncation or provides incorrect input to a function, the [ALTER TABLE](#) statement terminates with an error and the DDL operation is rejected.
- An [ALTER TABLE](#) statement that changes the default value of a column *col\_name* may also change the value of a generated column expression that refers to the column using [DEFAULT\(col\\_name\)](#). For this reason, as of MySQL 5.7.13, [ALTER TABLE](#) operations that change the definition of a column cause a table rebuild if any generated column expression uses [DEFAULT\(\)](#).

### 13.1.8.3 ALTER TABLE Examples

Begin with a table `t1` created as shown here:

```
CREATE TABLE t1 (a INTEGER, b CHAR(10));
```

To rename the table from `t1` to `t2`:

```
ALTER TABLE t1 RENAME t2;
```

To change column `a` from [INTEGER](#) to [TINYINT NOT NULL](#) (leaving the name the same), and to change column `b` from [CHAR\(10\)](#) to [CHAR\(20\)](#) as well as renaming it from `b` to `c`:

```
ALTER TABLE t2 MODIFY a TINYINT NOT NULL, CHANGE b c CHAR(20);
```

To add a new [TIMESTAMP](#) column named `d`:

```
ALTER TABLE t2 ADD d TIMESTAMP;
```

To add an index on column `d` and a [UNIQUE](#) index on column `a`:

```
ALTER TABLE t2 ADD INDEX (d), ADD UNIQUE (a);
```

To remove column `c`:

```
ALTER TABLE t2 DROP COLUMN c;
```

To add a new `AUTO_INCREMENT` integer column named `c`:

```
ALTER TABLE t2 ADD c INT UNSIGNED NOT NULL AUTO_INCREMENT,
  ADD PRIMARY KEY (c);
```

We indexed `c` (as a `PRIMARY KEY`) because `AUTO_INCREMENT` columns must be indexed, and we declare `c` as `NOT NULL` because primary key columns cannot be `NULL`.

For `NDB` tables, it is also possible to change the storage type used for a table or column. For example, consider an `NDB` table created as shown here:

```
mysql> CREATE TABLE t1 (c1 INT) TABLESPACE ts_1 ENGINE NDB;
Query OK, 0 rows affected (1.27 sec)
```

To convert this table to disk-based storage, you can use the following `ALTER TABLE` statement:

```
mysql> ALTER TABLE t1 TABLESPACE ts_1 STORAGE DISK;
Query OK, 0 rows affected (2.99 sec)
Records: 0 Duplicates: 0 Warnings: 0

mysql> SHOW CREATE TABLE t1\G
***** 1. row *****
      Table: t1
Create Table: CREATE TABLE `t1` (
  `c1` int(11) DEFAULT NULL
) /*!50100 TABLESPACE ts_1 STORAGE DISK */
ENGINE=ndbcluster DEFAULT CHARSET=latin1
1 row in set (0.01 sec)
```

It is not necessary that the tablespace was referenced when the table was originally created; however, the tablespace must be referenced by the `ALTER TABLE`:

```
mysql> CREATE TABLE t2 (c1 INT) ts_1 ENGINE NDB;
Query OK, 0 rows affected (1.00 sec)

mysql> ALTER TABLE t2 STORAGE DISK;
ERROR 1005 (HY000): Can't create table 'c.#sql-1750_3' (errno: 140)
mysql> ALTER TABLE t2 TABLESPACE ts_1 STORAGE DISK;
Query OK, 0 rows affected (3.42 sec)
Records: 0 Duplicates: 0 Warnings: 0
mysql> SHOW CREATE TABLE t2\G
***** 1. row *****
      Table: t1
Create Table: CREATE TABLE `t2` (
  `c1` int(11) DEFAULT NULL
) /*!50100 TABLESPACE ts_1 STORAGE DISK */
ENGINE=ndbcluster DEFAULT CHARSET=latin1
1 row in set (0.01 sec)
```

To change the storage type of an individual column, you can use `ALTER TABLE ... MODIFY [COLUMN]`. For example, suppose you create an `NDB Cluster Disk Data` table with two columns, using this `CREATE TABLE` statement:

```
mysql> CREATE TABLE t3 (c1 INT, c2 INT)
->   TABLESPACE ts_1 STORAGE DISK ENGINE NDB;
Query OK, 0 rows affected (1.34 sec)
```

To change column `c2` from disk-based to in-memory storage, include a `STORAGE MEMORY` clause in the column definition used by the `ALTER TABLE` statement, as shown here:

```
mysql> ALTER TABLE t3 MODIFY c2 INT STORAGE MEMORY;
Query OK, 0 rows affected (3.14 sec)
Records: 0 Duplicates: 0 Warnings: 0
```

You can make an in-memory column into a disk-based column by using `STORAGE DISK` in a similar fashion.

Column `c1` uses disk-based storage, since this is the default for the table (determined by the table-level `STORAGE DISK` clause in the `CREATE TABLE` statement). However, column `c2` uses in-memory storage, as can be seen here in the output of `SHOW CREATE TABLE`:

```
mysql> SHOW CREATE TABLE t3\G
***** 1. row *****
      Table: t3
Create Table: CREATE TABLE `t3` (
  `c1` int(11) DEFAULT NULL,
  `c2` int(11) /*!50120 STORAGE MEMORY */ DEFAULT NULL
) /*!50100 TABLESPACE ts_1 STORAGE DISK */ ENGINE=ndbcluster DEFAULT CHARSET=latin1
1 row in set (0.02 sec)
```

When you add an `AUTO_INCREMENT` column, column values are filled in with sequence numbers automatically. For `MyISAM` tables, you can set the first sequence number by executing `SET INSERT_ID=value` before `ALTER TABLE` or by using the `AUTO_INCREMENT=value` table option.

With `MyISAM` tables, if you do not change the `AUTO_INCREMENT` column, the sequence number is not affected. If you drop an `AUTO_INCREMENT` column and then add another `AUTO_INCREMENT` column, the numbers are resequenced beginning with 1.

When replication is used, adding an `AUTO_INCREMENT` column to a table might not produce the same ordering of the rows on the replica and the source. This occurs because the order in which the rows are numbered depends on the specific storage engine used for the table and the order in which the rows were inserted. If it is important to have the same order on the source and replica, the rows must be ordered before assigning an `AUTO_INCREMENT` number. Assuming that you want to add an `AUTO_INCREMENT` column to the table `t1`, the following statements produce a new table `t2` identical to `t1` but with an `AUTO_INCREMENT` column:

```
CREATE TABLE t2 (id INT AUTO_INCREMENT PRIMARY KEY)
SELECT * FROM t1 ORDER BY col1, col2;
```

This assumes that the table `t1` has columns `col1` and `col2`.

This set of statements also produces a new table `t2` identical to `t1`, with the addition of an `AUTO_INCREMENT` column:

```
CREATE TABLE t2 LIKE t1;
ALTER TABLE t2 ADD id INT AUTO_INCREMENT PRIMARY KEY;
INSERT INTO t2 SELECT * FROM t1 ORDER BY col1, col2;
```



### Important

To guarantee the same ordering on both source and replica, *all* columns of `t1` must be referenced in the `ORDER BY` clause.

Regardless of the method used to create and populate the copy having the `AUTO_INCREMENT` column, the final step is to drop the original table and then rename the copy:

```
DROP TABLE t1;
ALTER TABLE t2 RENAME t1;
```

## 13.1.9 ALTER TABLESPACE Statement

```
ALTER TABLESPACE tablespace_name
  {ADD | DROP} DATAFILE 'file_name'
  [INITIAL_SIZE [=] size]
  [WAIT]
  ENGINE [=] engine_name
```

This statement is used either to add a new data file, or to drop a data file from a tablespace.

The `ADD DATAFILE` variant enables you to specify an initial size using an `INITIAL_SIZE` clause, where `size` is measured in bytes; the default value is 134217728 (128 MB). You may optionally follow `size` with a one-letter abbreviation for an order of magnitude, similar to those used in `my.cnf`. Generally, this is one of the letters `M` (megabytes) or `G` (gigabytes).



#### Note

All NDB Cluster Disk Data objects share the same namespace. This means that *each Disk Data object* must be uniquely named (and not merely each Disk Data object of a given type). For example, you cannot have a tablespace and a data file with the same name, or an undo log file and a tablespace with the same name.

On 32-bit systems, the maximum supported value for `INITIAL_SIZE` is 4294967296 (4 GB). (Bug #29186)

`INITIAL_SIZE` is rounded, explicitly, as for `CREATE TABLESPACE`.

Once a data file has been created, its size cannot be changed; however, you can add more data files to the tablespace using additional `ALTER TABLESPACE ... ADD DATAFILE` statements.

Using `DROP DATAFILE` with `ALTER TABLESPACE` drops the data file '`file_name`' from the tablespace. You cannot drop a data file from a tablespace which is in use by any table; in other words, the data file must be empty (no extents used). See [Section 21.6.11.1, “NDB Cluster Disk Data Objects”](#). In addition, any data file to be dropped must previously have been added to the tablespace with `CREATE TABLESPACE` or `ALTER TABLESPACE`.

Both `ALTER TABLESPACE ... ADD DATAFILE` and `ALTER TABLESPACE ... DROP DATAFILE` require an `ENGINE` clause which specifies the storage engine used by the tablespace. Currently, the only accepted values for `engine_name` are `NDB` and `NDBCLUSTER`.

`WAIT` is parsed but otherwise ignored, and so has no effect in MySQL 5.7. It is intended for future expansion.

When `ALTER TABLESPACE ... ADD DATAFILE` is used with `ENGINE = NDB`, a data file is created on each Cluster data node. You can verify that the data files were created and obtain information about them by querying the Information Schema `FILES` table. For example, the following query shows all data files belonging to the tablespace named `newts`:

```
mysql> SELECT LOGFILE_GROUP_NAME, FILE_NAME, EXTRA
-> FROM INFORMATION_SCHEMA.FILES
-> WHERE TABLESPACE_NAME = 'newts' AND FILE_TYPE = 'DATAFILE';
+-----+-----+-----+
| LOGFILE_GROUP_NAME | FILE_NAME      | EXTRA                |
+-----+-----+-----+
| lg_3               | newdata.dat    | CLUSTER_NODE=3      |
| lg_3               | newdata.dat    | CLUSTER_NODE=4      |
| lg_3               | newdata2.dat   | CLUSTER_NODE=3      |
| lg_3               | newdata2.dat   | CLUSTER_NODE=4      |
+-----+-----+-----+
2 rows in set (0.03 sec)
```

See [Section 24.3.9, “The INFORMATION\\_SCHEMA FILES Table”](#).

`ALTER TABLESPACE` is useful only with Disk Data storage for NDB Cluster. See [Section 21.6.11, “NDB Cluster Disk Data Tables”](#).

### 13.1.10 ALTER VIEW Statement

```
ALTER
  [ALGORITHM = {UNDEFINED | MERGE | TEMPTABLE}]
  [DEFINER = user]
  [SQL SECURITY { DEFINER | INVOKER }]
  VIEW view_name [(column_list)]
  AS select_statement
  [WITH [CASCADED | LOCAL] CHECK OPTION]
```

This statement changes the definition of a view, which must exist. The syntax is similar to that for `CREATE VIEW` (see [Section 13.1.21, “CREATE VIEW Statement”](#)). This statement requires the `CREATE VIEW` and `DROP` privileges for the view, and some privilege for each column referred to in the `SELECT` statement. `ALTER VIEW` is permitted only to the definer or users with the `SUPER` privilege.

### 13.1.11 CREATE DATABASE Statement

```
CREATE {DATABASE | SCHEMA} [IF NOT EXISTS] db_name
  [create_option] ...

create_option: [DEFAULT] {
  CHARACTER SET [=] charset_name
  | COLLATE [=] collation_name
}
```

`CREATE DATABASE` creates a database with the given name. To use this statement, you need the `CREATE` privilege for the database. `CREATE SCHEMA` is a synonym for `CREATE DATABASE`.

An error occurs if the database exists and you did not specify `IF NOT EXISTS`.

`CREATE DATABASE` is not permitted within a session that has an active `LOCK TABLES` statement.

Each *create\_option* specifies a database characteristic. Database characteristics are stored in the `db.opt` file in the database directory. The `CHARACTER SET` option specifies the default database character set. The `COLLATE` option specifies the default database collation. For information about character set and collation names, see [Chapter 10, Character Sets, Collations, Unicode](#).

To see the available character sets and collations, use the `SHOW CHARACTER SET` and `SHOW COLLATION` statements, respectively. See [Section 13.7.5.3, “SHOW CHARACTER SET Statement”](#), and [Section 13.7.5.4, “SHOW COLLATION Statement”](#).

A database in MySQL is implemented as a directory containing files that correspond to tables in the database. Because there are no tables in a database when it is initially created, the `CREATE DATABASE` statement creates only a directory under the MySQL data directory and the `db.opt` file. Rules for permissible database names are given in [Section 9.2, “Schema Object Names”](#). If a database name contains special characters, the name for the database directory contains encoded versions of those characters as described in [Section 9.2.4, “Mapping of Identifiers to File Names”](#).

If you manually create a directory under the data directory (for example, with `mkdir`), the server considers it a database directory and it shows up in the output of `SHOW DATABASES`.

When you create a database, let the server manage the directory and the files in it. Manipulating database directories and files directly can cause inconsistencies and unexpected results.

MySQL has no limit on the number of databases. The underlying file system may have a limit on the number of directories.

You can also use the `mysqladmin` program to create databases. See [Section 4.5.2, “mysqladmin — A MySQL Server Administration Program”](#).

### 13.1.12 CREATE EVENT Statement

```
CREATE
  [DEFINER = user]
  EVENT
  [IF NOT EXISTS]
  event_name
  ON SCHEDULE schedule
  [ON COMPLETION [NOT] PRESERVE]
  [ENABLE | DISABLE | DISABLE ON SLAVE]
  [COMMENT 'string']
  DO event_body;

schedule: {
  AT timestamp [+ INTERVAL interval] ...
  | EVERY interval
  [STARTS timestamp [+ INTERVAL interval] ...]
  [ENDS timestamp [+ INTERVAL interval] ...]
}

interval:
  quantity {YEAR | QUARTER | MONTH | DAY | HOUR | MINUTE |
            WEEK | SECOND | YEAR_MONTH | DAY_HOUR | DAY_MINUTE |
            DAY_SECOND | HOUR_MINUTE | HOUR_SECOND | MINUTE_SECOND}
```

This statement creates and schedules a new event. The event does not run unless the Event Scheduler is enabled. For information about checking Event Scheduler status and enabling it if necessary, see [Section 23.4.2, “Event Scheduler Configuration”](#).

`CREATE EVENT` requires the `EVENT` privilege for the schema in which the event is to be created. If the `DEFINER` clause is present, the privileges required depend on the `user` value, as discussed in [Section 23.6, “Stored Object Access Control”](#).

The minimum requirements for a valid `CREATE EVENT` statement are as follows:

- The keywords `CREATE EVENT` plus an event name, which uniquely identifies the event in a database schema.
- An `ON SCHEDULE` clause, which determines when and how often the event executes.
- A `DO` clause, which contains the SQL statement to be executed by an event.

This is an example of a minimal `CREATE EVENT` statement:

```
CREATE EVENT myevent
  ON SCHEDULE AT CURRENT_TIMESTAMP + INTERVAL 1 HOUR
  DO
    UPDATE myschema.mytable SET mycol = mycol + 1;
```

The previous statement creates an event named `myevent`. This event executes once—one hour following its creation—by running an SQL statement that increments the value of the `myschema.mytable` table's `mycol` column by 1.

The `event_name` must be a valid MySQL identifier with a maximum length of 64 characters. Event names are not case-sensitive, so you cannot have two events named `myevent` and `MyEvent` in the same schema. In general, the rules governing event names are the same as those for names of stored routines. See [Section 9.2, “Schema Object Names”](#).

An event is associated with a schema. If no schema is indicated as part of *event\_name*, the default (current) schema is assumed. To create an event in a specific schema, qualify the event name with a schema using *schema\_name.event\_name* syntax.

The **DEFINER** clause specifies the MySQL account to be used when checking access privileges at event execution time. If the **DEFINER** clause is present, the *user* value should be a MySQL account specified as '*user\_name*'@'*host\_name*', `CURRENT_USER`, or `CURRENT_USER()`. The permitted *user* values depend on the privileges you hold, as discussed in [Section 23.6, “Stored Object Access Control”](#). Also see that section for additional information about event security.

If the **DEFINER** clause is omitted, the default definer is the user who executes the `CREATE EVENT` statement. This is the same as specifying `DEFINER = CURRENT_USER` explicitly.

Within an event body, the `CURRENT_USER` function returns the account used to check privileges at event execution time, which is the **DEFINER** user. For information about user auditing within events, see [Section 6.2.18, “SQL-Based Account Activity Auditing”](#).

`IF NOT EXISTS` has the same meaning for `CREATE EVENT` as for `CREATE TABLE`: If an event named *event\_name* already exists in the same schema, no action is taken, and no error results. (However, a warning is generated in such cases.)

The **ON SCHEDULE** clause determines when, how often, and for how long the *event\_body* defined for the event repeats. This clause takes one of two forms:

- `AT timestamp` is used for a one-time event. It specifies that the event executes one time only at the date and time given by *timestamp*, which must include both the date and time, or must be an expression that resolves to a datetime value. You may use a value of either the `DATETIME` or `TIMESTAMP` type for this purpose. If the date is in the past, a warning occurs, as shown here:

```
mysql> SELECT NOW();
+-----+
| NOW() |
+-----+
| 2006-02-10 23:59:01 |
+-----+
1 row in set (0.04 sec)

mysql> CREATE EVENT e_totals
-> ON SCHEDULE AT '2006-02-10 23:59:00'
-> DO INSERT INTO test.totals VALUES (NOW());
Query OK, 0 rows affected, 1 warning (0.00 sec)

mysql> SHOW WARNINGS\G
***** 1. row *****
Level: Note
Code: 1588
Message: Event execution time is in the past and ON COMPLETION NOT
PRESERVE is set. The event was dropped immediately after
creation.
```

`CREATE EVENT` statements which are themselves invalid—for whatever reason—fail with an error.

You may use `CURRENT_TIMESTAMP` to specify the current date and time. In such a case, the event acts as soon as it is created.

To create an event which occurs at some point in the future relative to the current date and time—such as that expressed by the phrase “three weeks from now”—you can use the optional clause `+ INTERVAL interval`. The *interval* portion consists of two parts, a quantity and a unit of time, and follows the syntax rules described in [Temporal Intervals](#), except that you cannot use any units keywords that involving microseconds when defining an event. With some interval types, complex time units may

be used. For example, “two minutes and ten seconds” can be expressed as `+ INTERVAL '2:10' MINUTE_SECOND`.

You can also combine intervals. For example, `AT CURRENT_TIMESTAMP + INTERVAL 3 WEEK + INTERVAL 2 DAY` is equivalent to “three weeks and two days from now”. Each portion of such a clause must begin with `+ INTERVAL`.

- To repeat actions at a regular interval, use an `EVERY` clause. The `EVERY` keyword is followed by an *interval* as described in the previous discussion of the `AT` keyword. (`+ INTERVAL` is *not* used with `EVERY`.) For example, `EVERY 6 WEEK` means “every six weeks”.

Although `+ INTERVAL` clauses are not permitted in an `EVERY` clause, you can use the same complex time units permitted in a `+ INTERVAL`.

An `EVERY` clause may contain an optional `STARTS` clause. `STARTS` is followed by a *timestamp* value that indicates when the action should begin repeating, and may also use `+ INTERVAL interval` to specify an amount of time “from now”. For example, `EVERY 3 MONTH STARTS CURRENT_TIMESTAMP + INTERVAL 1 WEEK` means “every three months, beginning one week from now”. Similarly, you can express “every two weeks, beginning six hours and fifteen minutes from now” as `EVERY 2 WEEK STARTS CURRENT_TIMESTAMP + INTERVAL '6:15' HOUR_MINUTE`. Not specifying `STARTS` is the same as using `STARTS CURRENT_TIMESTAMP`—that is, the action specified for the event begins repeating immediately upon creation of the event.

An `EVERY` clause may contain an optional `ENDS` clause. The `ENDS` keyword is followed by a *timestamp* value that tells MySQL when the event should stop repeating. You may also use `+ INTERVAL interval` with `ENDS`; for instance, `EVERY 12 HOUR STARTS CURRENT_TIMESTAMP + INTERVAL 30 MINUTE ENDS CURRENT_TIMESTAMP + INTERVAL 4 WEEK` is equivalent to “every twelve hours, beginning thirty minutes from now, and ending four weeks from now”. Not using `ENDS` means that the event continues executing indefinitely.

`ENDS` supports the same syntax for complex time units as `STARTS` does.

You may use `STARTS`, `ENDS`, both, or neither in an `EVERY` clause.

If a repeating event does not terminate within its scheduling interval, the result may be multiple instances of the event executing simultaneously. If this is undesirable, you should institute a mechanism to prevent simultaneous instances. For example, you could use the `GET_LOCK()` function, or row or table locking.

The `ON SCHEDULE` clause may use expressions involving built-in MySQL functions and user variables to obtain any of the *timestamp* or *interval* values which it contains. You may not use stored functions or loadable functions in such expressions, nor may you use any table references; however, you may use `SELECT FROM DUAL`. This is true for both `CREATE EVENT` and `ALTER EVENT` statements. References to stored functions, loadable functions, and tables in such cases are specifically not permitted, and fail with an error (see Bug #22830).

Times in the `ON SCHEDULE` clause are interpreted using the current session `time_zone` value. This becomes the event time zone; that is, the time zone that is used for event scheduling and is in effect within the event as it executes. These times are converted to UTC and stored along with the event time zone in the `mysql.event` table. This enables event execution to proceed as defined regardless of any subsequent changes to the server time zone or daylight saving time effects. For additional information about representation of event times, see [Section 23.4.4, “Event Metadata”](#). See also [Section 13.7.5.18, “SHOW EVENTS Statement”](#), and [Section 24.3.8, “The INFORMATION\\_SCHEMA EVENTS Table”](#).

Normally, once an event has expired, it is immediately dropped. You can override this behavior by specifying `ON COMPLETION PRESERVE`. Using `ON COMPLETION NOT PRESERVE` merely makes the default nonpersistent behavior explicit.



You can create an event but prevent it from being active using the `DISABLE` keyword. Alternatively, you can use `ENABLE` to make explicit the default status, which is active. This is most useful in conjunction with `ALTER EVENT` (see [Section 13.1.2, “ALTER EVENT Statement”](#)).

A third value may also appear in place of `ENABLE` or `DISABLE`; `DISABLE ON SLAVE` is set for the status of an event on a replica to indicate that the event was created on the source and replicated to the replica, but is not executed on the replica. See [Section 16.4.1.16, “Replication of Invoked Features”](#).

You may supply a comment for an event using a `COMMENT` clause. `comment` may be any string of up to 64 characters that you wish to use for describing the event. The comment text, being a string literal, must be surrounded by quotation marks.

The `DO` clause specifies an action carried by the event, and consists of an SQL statement. Nearly any valid MySQL statement that can be used in a stored routine can also be used as the action statement for a scheduled event. (See [Section 23.8, “Restrictions on Stored Programs”](#).) For example, the following event `e_hourly` deletes all rows from the `sessions` table once per hour, where this table is part of the `site_activity` schema:

```
CREATE EVENT e_hourly
ON SCHEDULE
  EVERY 1 HOUR
COMMENT 'Clears out sessions table each hour.'
DO
  DELETE FROM site_activity.sessions;
```

MySQL stores the `sql_mode` system variable setting in effect when an event is created or altered, and always executes the event with this setting in force, *regardless of the current server SQL mode when the event begins executing*.

A `CREATE EVENT` statement that contains an `ALTER EVENT` statement in its `DO` clause appears to succeed; however, when the server attempts to execute the resulting scheduled event, the execution fails with an error.



#### Note

Statements such as `SELECT` or `SHOW` that merely return a result set have no effect when used in an event; the output from these is not sent to the MySQL Monitor, nor is it stored anywhere. However, you can use statements such as `SELECT ... INTO` and `INSERT INTO ... SELECT` that store a result. (See the next example in this section for an instance of the latter.)

The schema to which an event belongs is the default schema for table references in the `DO` clause. Any references to tables in other schemas must be qualified with the proper schema name.

As with stored routines, you can use compound-statement syntax in the `DO` clause by using the `BEGIN` and `END` keywords, as shown here:

```
delimiter |

CREATE EVENT e_daily
ON SCHEDULE
  EVERY 1 DAY
COMMENT 'Saves total number of sessions then clears the table each day'
DO
  BEGIN
    INSERT INTO site_activity.totals (time, total)
      SELECT CURRENT_TIMESTAMP, COUNT(*)
        FROM site_activity.sessions;
    DELETE FROM site_activity.sessions;
  END |
```

```
delimiter ;
```

This example uses the `delimiter` command to change the statement delimiter. See [Section 23.1, “Defining Stored Programs”](#).

More complex compound statements, such as those used in stored routines, are possible in an event. This example uses local variables, an error handler, and a flow control construct:

```
delimiter |
CREATE EVENT e
  ON SCHEDULE
    EVERY 5 SECOND
  DO
    BEGIN
      DECLARE v INTEGER;
      DECLARE CONTINUE HANDLER FOR SQLEXCEPTION BEGIN END;

      SET v = 0;

      WHILE v < 5 DO
        INSERT INTO t1 VALUES (0);
        UPDATE t2 SET s1 = s1 + 1;
        SET v = v + 1;
      END WHILE;
    END |
delimiter ;
```

There is no way to pass parameters directly to or from events; however, it is possible to invoke a stored routine with parameters within an event:

```
CREATE EVENT e_call_myproc
  ON SCHEDULE
    AT CURRENT_TIMESTAMP + INTERVAL 1 DAY
  DO CALL myproc(5, 27);
```

If an event's definer has privileges sufficient to set global system variables (see [Section 5.1.8.1, “System Variable Privileges”](#)), the event can read and write global variables. As granting such privileges entails a potential for abuse, extreme care must be taken in doing so.

Generally, any statements that are valid in stored routines may be used for action statements executed by events. For more information about statements permissible within stored routines, see [Section 23.2.1, “Stored Routine Syntax”](#). You can create an event as part of a stored routine, but an event cannot be created by another event.

### 13.1.13 CREATE FUNCTION Statement

The `CREATE FUNCTION` statement is used to create stored functions and loadable functions:

- For information about creating stored functions, see [Section 13.1.16, “CREATE PROCEDURE and CREATE FUNCTION Statements”](#).
- For information about creating loadable functions, see [Section 13.7.3.1, “CREATE FUNCTION Statement for Loadable Functions”](#).

### 13.1.14 CREATE INDEX Statement

```
CREATE [UNIQUE | FULLTEXT | SPATIAL] INDEX index_name
  [index_type]
  ON tbl_name (key_part, ...)
  [index_option]
  [algorithm_option | lock_option] ...
```

```

key_part:
  col_name [(length)] [ASC | DESC]

index_option: {
  KEY_BLOCK_SIZE [=] value
  | index_type
  | WITH PARSER parser_name
  | COMMENT 'string'
}

index_type:
  USING {BTREE | HASH}

algorithm_option:
  ALGORITHM [=] {DEFAULT | INPLACE | COPY}

lock_option:
  LOCK [=] {DEFAULT | NONE | SHARED | EXCLUSIVE}

```

Normally, you create all indexes on a table at the time the table itself is created with `CREATE TABLE`. See [Section 13.1.18, “CREATE TABLE Statement”](#). This guideline is especially important for `InnoDB` tables, where the primary key determines the physical layout of rows in the data file. `CREATE INDEX` enables you to add indexes to existing tables.

`CREATE INDEX` is mapped to an `ALTER TABLE` statement to create indexes. See [Section 13.1.8, “ALTER TABLE Statement”](#). `CREATE INDEX` cannot be used to create a `PRIMARY KEY`; use `ALTER TABLE` instead. For more information about indexes, see [Section 8.3.1, “How MySQL Uses Indexes”](#).

`InnoDB` supports secondary indexes on virtual columns. For more information, see [Section 13.1.18.8, “Secondary Indexes and Generated Columns”](#).

When the `innodb_stats_persistent` setting is enabled, run the `ANALYZE TABLE` statement for an `InnoDB` table after creating an index on that table.

An index specification of the form `(key_part1, key_part2, ...)` creates an index with multiple key parts. Index key values are formed by concatenating the values of the given key parts. For example `(col1, col2, col3)` specifies a multiple-column index with index keys consisting of values from `col1`, `col2`, and `col3`.

A `key_part` specification can end with `ASC` or `DESC`. These keywords are permitted for future extensions for specifying ascending or descending index value storage. Currently, they are parsed but ignored; index values are always stored in ascending order.

The following sections describe different aspects of the `CREATE INDEX` statement:

- [Column Prefix Key Parts](#)
- [Unique Indexes](#)
- [Full-Text Indexes](#)
- [Spatial Indexes](#)
- [Index Options](#)
- [Table Copying and Locking Options](#)

## Column Prefix Key Parts

For string columns, indexes can be created that use only the leading part of column values, using `col_name(length)` syntax to specify an index prefix length:

- Prefixes can be specified for `CHAR`, `VARCHAR`, `BINARY`, and `VARBINARY` key parts.
- Prefixes *must* be specified for `BLOB` and `TEXT` key parts. Additionally, `BLOB` and `TEXT` columns can be indexed only for `InnoDB`, `MyISAM`, and `BLACKHOLE` tables.
- Prefix *limits* are measured in bytes. However, prefix *lengths* for index specifications in `CREATE TABLE`, `ALTER TABLE`, and `CREATE INDEX` statements are interpreted as number of characters for nonbinary string types (`CHAR`, `VARCHAR`, `TEXT`) and number of bytes for binary string types (`BINARY`, `VARBINARY`, `BLOB`). Take this into account when specifying a prefix length for a nonbinary string column that uses a multibyte character set.

Prefix support and lengths of prefixes (where supported) are storage engine dependent. For example, a prefix can be up to 767 bytes long for `InnoDB` tables or 3072 bytes if the `innodb_large_prefix` option is enabled. For `MyISAM` tables, the prefix length limit is 1000 bytes. The `NDB` storage engine does not support prefixes (see [Section 21.2.7.6, “Unsupported or Missing Features in NDB Cluster”](#)).

As of MySQL 5.7.17, if a specified index prefix exceeds the maximum column data type size, `CREATE INDEX` handles the index as follows:

- For a nonunique index, either an error occurs (if strict SQL mode is enabled), or the index length is reduced to lie within the maximum column data type size and a warning is produced (if strict SQL mode is not enabled).
- For a unique index, an error occurs regardless of SQL mode because reducing the index length might enable insertion of nonunique entries that do not meet the specified uniqueness requirement.

The statement shown here creates an index using the first 10 characters of the `name` column (assuming that `name` has a nonbinary string type):

```
CREATE INDEX part_of_name ON customer (name(10));
```

If names in the column usually differ in the first 10 characters, lookups performed using this index should not be much slower than using an index created from the entire `name` column. Also, using column prefixes for indexes can make the index file much smaller, which could save a lot of disk space and might also speed up `INSERT` operations.

## Unique Indexes

A `UNIQUE` index creates a constraint such that all values in the index must be distinct. An error occurs if you try to add a new row with a key value that matches an existing row. If you specify a prefix value for a column in a `UNIQUE` index, the column values must be unique within the prefix length. A `UNIQUE` index permits multiple `NULL` values for columns that can contain `NULL`.

If a table has a `PRIMARY KEY` or `UNIQUE NOT NULL` index that consists of a single column that has an integer type, you can use `_rowid` to refer to the indexed column in `SELECT` statements, as follows:

- `_rowid` refers to the `PRIMARY KEY` column if there is a `PRIMARY KEY` consisting of a single integer column. If there is a `PRIMARY KEY` but it does not consist of a single integer column, `_rowid` cannot be used.
- Otherwise, `_rowid` refers to the column in the first `UNIQUE NOT NULL` index if that index consists of a single integer column. If the first `UNIQUE NOT NULL` index does not consist of a single integer column, `_rowid` cannot be used.

## Full-Text Indexes

`FULLTEXT` indexes are supported only for `InnoDB` and `MyISAM` tables and can include only `CHAR`, `VARCHAR`, and `TEXT` columns. Indexing always happens over the entire column; column prefix indexing is

not supported and any prefix length is ignored if specified. See [Section 12.9, “Full-Text Search Functions”](#), for details of operation.

## Spatial Indexes

The [MyISAM](#), [InnoDB](#), [NDB](#), and [ARCHIVE](#) storage engines support spatial columns such as [POINT](#) and [GEOMETRY](#). ([Section 11.4, “Spatial Data Types”](#), describes the spatial data types.) However, support for spatial column indexing varies among engines. Spatial and nonspatial indexes on spatial columns are available according to the following rules.

Spatial indexes on spatial columns (created using [SPATIAL INDEX](#)) have these characteristics:

- Available only for [MyISAM](#) and [InnoDB](#) tables. Specifying [SPATIAL INDEX](#) for other storage engines results in an error.
- Indexed columns must be [NOT NULL](#).
- Column prefix lengths are prohibited. The full width of each column is indexed.

Nonspatial indexes on spatial columns (created with [INDEX](#), [UNIQUE](#), or [PRIMARY KEY](#)) have these characteristics:

- Permitted for any storage engine that supports spatial columns except [ARCHIVE](#).
- Columns can be [NULL](#) unless the index is a primary key.
- For each spatial column in a non-[SPATIAL](#) index except [POINT](#) columns, a column prefix length must be specified. (This is the same requirement as for indexed [BLOB](#) columns.) The prefix length is given in bytes.
- The index type for a non-[SPATIAL](#) index depends on the storage engine. Currently, B-tree is used.
- Permitted for a column that can have [NULL](#) values only for [InnoDB](#), [MyISAM](#), and [MEMORY](#) tables.

## Index Options

Following the key part list, index options can be given. An *index\_option* value can be any of the following:

- [KEY\\_BLOCK\\_SIZE \[=\] value](#)

For [MyISAM](#) tables, [KEY\\_BLOCK\\_SIZE](#) optionally specifies the size in bytes to use for index key blocks. The value is treated as a hint; a different size could be used if necessary. A [KEY\\_BLOCK\\_SIZE](#) value specified for an individual index definition overrides a table-level [KEY\\_BLOCK\\_SIZE](#) value.

[KEY\\_BLOCK\\_SIZE](#) is not supported at the index level for [InnoDB](#) tables. See [Section 13.1.18, “CREATE TABLE Statement”](#).

- *index\_type*

Some storage engines permit you to specify an index type when creating an index. For example:

```
CREATE TABLE lookup (id INT) ENGINE = MEMORY;
CREATE INDEX id_index ON lookup (id) USING BTREE;
```

[Table 13.1, “Index Types Per Storage Engine”](#) shows the permissible index type values supported by different storage engines. Where multiple index types are listed, the first one is the default when no index type specifier is given. Storage engines not listed in the table do not support an *index\_type* clause in index definitions.

**Table 13.1 Index Types Per Storage Engine**

Storage Engine	Permissible Index Types
InnoDB	BTREE
MyISAM	BTREE
MEMORY/HEAP	HASH, BTREE
NDB	HASH, BTREE (see note in text)

The *index\_type* clause cannot be used for `FULLTEXT INDEX` or `SPATIAL INDEX` specifications. Full-text index implementation is storage engine dependent. Spatial indexes are implemented as R-tree indexes.

`BTREE` indexes are implemented by the `NDB` storage engine as T-tree indexes.

**Note**

For indexes on `NDB` table columns, the `USING` option can be specified only for a unique index or primary key. `USING HASH` prevents the creation of an ordered index; otherwise, creating a unique index or primary key on an `NDB` table automatically results in the creation of both an ordered index and a hash index, each of which indexes the same set of columns.

For unique indexes that include one or more `NULL` columns of an `NDB` table, the hash index can be used only to look up literal values, which means that `IS [NOT] NULL` conditions require a full scan of the table. One workaround is to make sure that a unique index using one or more `NULL` columns on such a table is always created in such a way that it includes the ordered index; that is, avoid employing `USING HASH` when creating the index.

If you specify an index type that is not valid for a given storage engine, but another index type is available that the engine can use without affecting query results, the engine uses the available type. The parser recognizes `RTREE` as a type name, but currently this cannot be specified for any storage engine.

**Note**

Use of the *index\_type* option before the `ON tbl_name` clause is deprecated; you should expect support for use of the option in this position to be removed in a future MySQL release. If an *index\_type* option is given in both the earlier and later positions, the final option applies.

`TYPE type_name` is recognized as a synonym for `USING type_name`. However, `USING` is the preferred form.

The following tables show index characteristics for the storage engines that support the *index\_type* option.

**Table 13.2 InnoDB Storage Engine Index Characteristics**

Index Class	Index Type	Stores NULL VALUES	Permits Multiple NULL Values	IS NULL Scan Type	IS NOT NULL Scan Type
Primary key	BTREE	No	No	N/A	N/A
Unique	BTREE	Yes	Yes	Index	Index

Index Class	Index Type	Stores NULL VALUES	Permits Multiple NULL Values	IS NULL Scan Type	IS NOT NULL Scan Type
Key	<a href="#">BTREE</a>	Yes	Yes	Index	Index
<a href="#">FULLTEXT</a>	N/A	Yes	Yes	Table	Table
<a href="#">SPATIAL</a>	N/A	No	No	N/A	N/A

Table 13.3 MyISAM Storage Engine Index Characteristics

Index Class	Index Type	Stores NULL VALUES	Permits Multiple NULL Values	IS NULL Scan Type	IS NOT NULL Scan Type
Primary key	<a href="#">BTREE</a>	No	No	N/A	N/A
Unique	<a href="#">BTREE</a>	Yes	Yes	Index	Index
Key	<a href="#">BTREE</a>	Yes	Yes	Index	Index
<a href="#">FULLTEXT</a>	N/A	Yes	Yes	Table	Table
<a href="#">SPATIAL</a>	N/A	No	No	N/A	N/A

Table 13.4 MEMORY Storage Engine Index Characteristics

Index Class	Index Type	Stores NULL VALUES	Permits Multiple NULL Values	IS NULL Scan Type	IS NOT NULL Scan Type
Primary key	<a href="#">BTREE</a>	No	No	N/A	N/A
Unique	<a href="#">BTREE</a>	Yes	Yes	Index	Index
Key	<a href="#">BTREE</a>	Yes	Yes	Index	Index
Primary key	<a href="#">HASH</a>	No	No	N/A	N/A
Unique	<a href="#">HASH</a>	Yes	Yes	Index	Index
Key	<a href="#">HASH</a>	Yes	Yes	Index	Index

Table 13.5 NDB Storage Engine Index Characteristics

Index Class	Index Type	Stores NULL VALUES	Permits Multiple NULL Values	IS NULL Scan Type	IS NOT NULL Scan Type
Primary key	<a href="#">BTREE</a>	No	No	Index	Index
Unique	<a href="#">BTREE</a>	Yes	Yes	Index	Index
Key	<a href="#">BTREE</a>	Yes	Yes	Index	Index
Primary key	<a href="#">HASH</a>	No	No	Table (see note 1)	Table (see note 1)
Unique	<a href="#">HASH</a>	Yes	Yes	Table (see note 1)	Table (see note 1)

Index Class	Index Type	Stores NULL VALUES	Permits Multiple NULL Values	IS NULL Scan Type	IS NOT NULL Scan Type
Key	<a href="#">HASH</a>	Yes	Yes	Table (see note 1)	Table (see note 1)

Table note:

1. If [USING HASH](#) is specified that prevents creation of an implicit ordered index.

- [WITH PARSER \*parser\\_name\*](#)

This option can be used only with [FULLTEXT](#) indexes. It associates a parser plugin with the index if full-text indexing and searching operations need special handling. [InnoDB](#) and [MyISAM](#) support full-text parser plugins. If you have a [MyISAM](#) table with an associated full-text parser plugin, you can convert the table to [InnoDB](#) using [ALTER TABLE](#). See [Full-Text Parser Plugins](#) and [Writing Full-Text Parser Plugins](#) for more information.

- [COMMENT 'string'](#)

Index definitions can include an optional comment of up to 1024 characters.

The [MERGE\\_THRESHOLD](#) for index pages can be configured for individual indexes using the [index\\_option COMMENT](#) clause of the [CREATE INDEX](#) statement. For example:

```
CREATE TABLE t1 (id INT);
CREATE INDEX id_index ON t1 (id) COMMENT 'MERGE_THRESHOLD=40';
```

If the page-full percentage for an index page falls below the [MERGE\\_THRESHOLD](#) value when a row is deleted or when a row is shortened by an update operation, [InnoDB](#) attempts to merge the index page with a neighboring index page. The default [MERGE\\_THRESHOLD](#) value is 50, which is the previously hardcoded value.

[MERGE\\_THRESHOLD](#) can also be defined at the index level and table level using [CREATE TABLE](#) and [ALTER TABLE](#) statements. For more information, see [Section 14.8.12, “Configuring the Merge Threshold for Index Pages”](#).

## Table Copying and Locking Options

[ALGORITHM](#) and [LOCK](#) clauses may be given to influence the table copying method and level of concurrency for reading and writing the table while its indexes are being modified. They have the same meaning as for the [ALTER TABLE](#) statement. For more information, see [Section 13.1.8, “ALTER TABLE Statement”](#)

NDB Cluster formerly supported online [CREATE INDEX](#) operations using an alternative syntax that is no longer supported. NDB Cluster now supports online operations using the same [ALGORITHM=INPLACE](#) syntax used with the standard MySQL Server. See [Section 21.6.12, “Online Operations with ALTER TABLE in NDB Cluster”](#), for more information.

### 13.1.15 CREATE LOGFILE GROUP Statement

```
CREATE LOGFILE GROUP logfile_group
  ADD UNDOFILE 'undo_file'
  [INITIAL_SIZE [=] initial_size]
  [UNDO_BUFFER_SIZE [=] undo_buffer_size]
  [REDO_BUFFER_SIZE [=] redo_buffer_size]
  [NODEGROUP [=] nodegroup_id]
```



```
[WAIT]
[COMMENT [=] 'string']
ENGINE [=] engine_name
```

This statement creates a new log file group named *logfile\_group* having a single UNDO file named *'undo\_file'*. A `CREATE LOGFILE GROUP` statement has one and only one `ADD UNDOFILE` clause. For rules covering the naming of log file groups, see [Section 9.2, “Schema Object Names”](#).



### Note

All NDB Cluster Disk Data objects share the same namespace. This means that *each Disk Data object* must be uniquely named (and not merely each Disk Data object of a given type). For example, you cannot have a tablespace and a log file group with the same name, or a tablespace and a data file with the same name.

There can be only one log file group per NDB Cluster instance at any given time.

The optional `INITIAL_SIZE` parameter sets the UNDO file's initial size; if not specified, it defaults to `128M` (128 megabytes). The optional `UNDO_BUFFER_SIZE` parameter sets the size used by the UNDO buffer for the log file group; The default value for `UNDO_BUFFER_SIZE` is `8M` (eight megabytes); this value cannot exceed the amount of system memory available. Both of these parameters are specified in bytes. You may optionally follow either or both of these with a one-letter abbreviation for an order of magnitude, similar to those used in `my.cnf`. Generally, this is one of the letters `M` (for megabytes) or `G` (for gigabytes).

Memory used for `UNDO_BUFFER_SIZE` comes from the global pool whose size is determined by the value of the `SharedGlobalMemory` data node configuration parameter. This includes any default value implied for this option by the setting of the `InitialLogFileGroup` data node configuration parameter.

The maximum permitted for `UNDO_BUFFER_SIZE` is 629145600 (600 MB).

On 32-bit systems, the maximum supported value for `INITIAL_SIZE` is 4294967296 (4 GB). (Bug #29186)

The minimum allowed value for `INITIAL_SIZE` is 1048576 (1 MB).

The `ENGINE` option determines the storage engine to be used by this log file group, with *engine\_name* being the name of the storage engine. In MySQL 5.7, this must be `NDB` (or `NDBCLUSTER`). If `ENGINE` is not set, MySQL tries to use the engine specified by the `default_storage_engine` server system variable (formerly `storage_engine`). In any case, if the engine is not specified as `NDB` or `NDBCLUSTER`, the `CREATE LOGFILE GROUP` statement appears to succeed but actually fails to create the log file group, as shown here:

```
mysql> CREATE LOGFILE GROUP lg1
->     ADD UNDOFILE 'undo.dat' INITIAL_SIZE = 10M;
Query OK, 0 rows affected, 1 warning (0.00 sec)

mysql> SHOW WARNINGS;
+-----+-----+-----+
| Level | Code | Message
+-----+-----+-----+
| Error | 1478 | Table storage engine 'InnoDB' does not support the create option 'TABLESPACE or LOGFILE G
+-----+-----+-----+
1 row in set (0.00 sec)

mysql> DROP LOGFILE GROUP lg1 ENGINE = NDB;
ERROR 1529 (HY000): Failed to drop LOGFILE GROUP

mysql> CREATE LOGFILE GROUP lg1
->     ADD UNDOFILE 'undo.dat' INITIAL_SIZE = 10M
->     ENGINE = NDB;
Query OK, 0 rows affected (2.97 sec)
```

The fact that the `CREATE LOGFILE GROUP` statement does not actually return an error when a non-NDB storage engine is named, but rather appears to succeed, is a known issue which we hope to address in a future release of NDB Cluster.

`REDO_BUFFER_SIZE`, `NODEGROUP`, `WAIT`, and `COMMENT` are parsed but ignored, and so have no effect in MySQL 5.7. These options are intended for future expansion.

When used with `ENGINE [=] NDB`, a log file group and associated `UNDO` log file are created on each Cluster data node. You can verify that the `UNDO` files were created and obtain information about them by querying the Information Schema `FILES` table. For example:

```
mysql> SELECT LOGFILE_GROUP_NAME, LOGFILE_GROUP_NUMBER, EXTRA
-> FROM INFORMATION_SCHEMA.FILES
-> WHERE FILE_NAME = 'undo_10.dat';
+-----+-----+-----+
| LOGFILE_GROUP_NAME | LOGFILE_GROUP_NUMBER | EXTRA          |
+-----+-----+-----+
| lg_3               | 11                   | CLUSTER_NODE=3 |
| lg_3               | 11                   | CLUSTER_NODE=4 |
+-----+-----+-----+
2 rows in set (0.06 sec)
```

`CREATE LOGFILE GROUP` is useful only with Disk Data storage for NDB Cluster. See [Section 21.6.11, “NDB Cluster Disk Data Tables”](#).

## 13.1.16 CREATE PROCEDURE and CREATE FUNCTION Statements

```
CREATE
  [DEFINER = user]
  PROCEDURE sp_name ([proc_parameter[,...]]
  [characteristic ...] routine_body

CREATE
  [DEFINER = user]
  FUNCTION sp_name ([func_parameter[,...]])
  RETURNS type
  [characteristic ...] routine_body

proc_parameter:
  [ IN | OUT | INOUT ] param_name type

func_parameter:
  param_name type

type:
  Any valid MySQL data type

characteristic: {
  COMMENT 'string'
  | LANGUAGE SQL
  | [NOT] DETERMINISTIC
  | { CONTAINS SQL | NO SQL | READS SQL DATA | MODIFIES SQL DATA }
  | SQL SECURITY { DEFINER | INVOKER }
  }
```

```
routine_body:
  Valid SQL routine statement
```

These statements are used to create a stored routine (a stored procedure or function). That is, the specified routine becomes known to the server. By default, a stored routine is associated with the default database. To associate the routine explicitly with a given database, specify the name as `db_name.sp_name` when you create it.

The `CREATE FUNCTION` statement is also used in MySQL to support loadable functions. See [Section 13.7.3.1, “CREATE FUNCTION Statement for Loadable Functions”](#). A loadable function can be regarded as an external stored function. Stored functions share their namespace with loadable functions. See [Section 9.2.5, “Function Name Parsing and Resolution”](#), for the rules describing how the server interprets references to different kinds of functions.

To invoke a stored procedure, use the `CALL` statement (see [Section 13.2.1, “CALL Statement”](#)). To invoke a stored function, refer to it in an expression. The function returns a value during expression evaluation.

`CREATE PROCEDURE` and `CREATE FUNCTION` require the `CREATE ROUTINE` privilege. If the `DEFINER` clause is present, the privileges required depend on the `user` value, as discussed in [Section 23.6, “Stored Object Access Control”](#). If binary logging is enabled, `CREATE FUNCTION` might require the `SUPER` privilege, as discussed in [Section 23.7, “Stored Program Binary Logging”](#).

By default, MySQL automatically grants the `ALTER ROUTINE` and `EXECUTE` privileges to the routine creator. This behavior can be changed by disabling the `automatic_sp_privileges` system variable. See [Section 23.2.2, “Stored Routines and MySQL Privileges”](#).

The `DEFINER` and `SQL SECURITY` clauses specify the security context to be used when checking access privileges at routine execution time, as described later in this section.

If the routine name is the same as the name of a built-in SQL function, a syntax error occurs unless you use a space between the name and the following parenthesis when defining the routine or invoking it later. For this reason, avoid using the names of existing SQL functions for your own stored routines.

The `IGNORE_SPACE` SQL mode applies to built-in functions, not to stored routines. It is always permissible to have spaces after a stored routine name, regardless of whether `IGNORE_SPACE` is enabled.

The parameter list enclosed within parentheses must always be present. If there are no parameters, an empty parameter list of `()` should be used. Parameter names are not case-sensitive.

Each parameter is an `IN` parameter by default. To specify otherwise for a parameter, use the keyword `OUT` or `INOUT` before the parameter name.



#### Note

Specifying a parameter as `IN`, `OUT`, or `INOUT` is valid only for a `PROCEDURE`. For a `FUNCTION`, parameters are always regarded as `IN` parameters.

An `IN` parameter passes a value into a procedure. The procedure might modify the value, but the modification is not visible to the caller when the procedure returns. An `OUT` parameter passes a value from the procedure back to the caller. Its initial value is `NULL` within the procedure, and its value is visible to the caller when the procedure returns. An `INOUT` parameter is initialized by the caller, can be modified by the procedure, and any change made by the procedure is visible to the caller when the procedure returns.

For each `OUT` or `INOUT` parameter, pass a user-defined variable in the `CALL` statement that invokes the procedure so that you can obtain its value when the procedure returns. If you are calling the procedure from within another stored procedure or function, you can also pass a routine parameter or local routine variable as an `OUT` or `INOUT` parameter. If you are calling the procedure from within a trigger, you can also pass `NEW.col_name` as an `OUT` or `INOUT` parameter.

For information about the effect of unhandled conditions on procedure parameters, see [Section 13.6.7.8, “Condition Handling and OUT or INOUT Parameters”](#).

Routine parameters cannot be referenced in statements prepared within the routine; see [Section 23.8, “Restrictions on Stored Programs”](#).

The following example shows a simple stored procedure that, given a country code, counts the number of cities for that country that appear in the `city` table of the `world` database. The country code is passed using an `IN` parameter, and the city count is returned using an `OUT` parameter:

```
mysql> delimiter //

mysql> CREATE PROCEDURE citycount (IN country CHAR(3), OUT cities INT)
BEGIN
    SELECT COUNT(*) INTO cities FROM world.city
    WHERE CountryCode = country;
END//
Query OK, 0 rows affected (0.01 sec)

mysql> delimiter ;

mysql> CALL citycount('JPN', @cities); -- cities in Japan
Query OK, 1 row affected (0.00 sec)

mysql> SELECT @cities;
+-----+
| @cities |
+-----+
|      248 |
+-----+
1 row in set (0.00 sec)

mysql> CALL citycount('FRA', @cities); -- cities in France
Query OK, 1 row affected (0.00 sec)

mysql> SELECT @cities;
+-----+
| @cities |
+-----+
|       40 |
+-----+
1 row in set (0.00 sec)
```

The example uses the `mysql` client `delimiter` command to change the statement delimiter from `;` to `//` while the procedure is being defined. This enables the `;` delimiter used in the procedure body to be passed through to the server rather than being interpreted by `mysql` itself. See [Section 23.1, “Defining Stored Programs”](#).

The `RETURNS` clause may be specified only for a `FUNCTION`, for which it is mandatory. It indicates the return type of the function, and the function body must contain a `RETURN value` statement. If the `RETURN` statement returns a value of a different type, the value is coerced to the proper type. For example, if a function specifies an `ENUM` or `SET` value in the `RETURNS` clause, but the `RETURN` statement returns an integer, the value returned from the function is the string for the corresponding `ENUM` member of set of `SET` members.

The following example function takes a parameter, performs an operation using an SQL function, and returns the result. In this case, it is unnecessary to use `delimiter` because the function definition contains no internal `;` statement delimiters:

```
mysql> CREATE FUNCTION hello (s CHAR(20))
-> RETURNS CHAR(50) DETERMINISTIC
-> RETURN CONCAT('Hello, ',s,'!');
Query OK, 0 rows affected (0.00 sec)

mysql> SELECT hello('world');
+-----+
| hello('world') |
+-----+
| Hello, world! |
```

```
+-----+
1 row in set (0.00 sec)
```

Parameter types and function return types can be declared to use any valid data type. The `COLLATE` attribute can be used if preceded by a `CHARACTER SET` specification.

The `routine_body` consists of a valid SQL routine statement. This can be a simple statement such as `SELECT` or `INSERT`, or a compound statement written using `BEGIN` and `END`. Compound statements can contain declarations, loops, and other control structure statements. The syntax for these statements is described in [Section 13.6, “Compound Statements”](#). In practice, stored functions tend to use compound statements, unless the body consists of a single `RETURN` statement.

MySQL permits routines to contain DDL statements, such as `CREATE` and `DROP`. MySQL also permits stored procedures (but not stored functions) to contain SQL transaction statements such as `COMMIT`. Stored functions may not contain statements that perform explicit or implicit commit or rollback. Support for these statements is not required by the SQL standard, which states that each DBMS vendor may decide whether to permit them.

Statements that return a result set can be used within a stored procedure but not within a stored function. This prohibition includes `SELECT` statements that do not have an `INTO var_list` clause and other statements such as `SHOW`, `EXPLAIN`, and `CHECK TABLE`. For statements that can be determined at function definition time to return a result set, a `Not allowed to return a result set from a function` error occurs (`ER_SP_NO_RETSET`). For statements that can be determined only at runtime to return a result set, a `PROCEDURE %s can't return a result set in the given context` error occurs (`ER_SP_BADSELECT`).

`USE` statements within stored routines are not permitted. When a routine is invoked, an implicit `USE db_name` is performed (and undone when the routine terminates). This causes the routine to have the given default database while it executes. References to objects in databases other than the routine default database should be qualified with the appropriate database name.

For additional information about statements that are not permitted in stored routines, see [Section 23.8, “Restrictions on Stored Programs”](#).

For information about invoking stored procedures from within programs written in a language that has a MySQL interface, see [Section 13.2.1, “CALL Statement”](#).

MySQL stores the `sql_mode` system variable setting in effect when a routine is created or altered, and always executes the routine with this setting in force, *regardless of the current server SQL mode when the routine begins executing*.

The switch from the SQL mode of the invoker to that of the routine occurs after evaluation of arguments and assignment of the resulting values to routine parameters. If you define a routine in strict SQL mode but invoke it in nonstrict mode, assignment of arguments to routine parameters does not take place in strict mode. If you require that expressions passed to a routine be assigned in strict SQL mode, you should invoke the routine with strict mode in effect.

The `COMMENT` characteristic is a MySQL extension, and may be used to describe the stored routine. This information is displayed by the `SHOW CREATE PROCEDURE` and `SHOW CREATE FUNCTION` statements.

The `LANGUAGE` characteristic indicates the language in which the routine is written. The server ignores this characteristic; only SQL routines are supported.

A routine is considered “deterministic” if it always produces the same result for the same input parameters, and “not deterministic” otherwise. If neither `DETERMINISTIC` nor `NOT DETERMINISTIC` is given in the routine definition, the default is `NOT DETERMINISTIC`. To declare that a function is deterministic, you must specify `DETERMINISTIC` explicitly.

Assessment of the nature of a routine is based on the “honesty” of the creator: MySQL does not check that a routine declared `DETERMINISTIC` is free of statements that produce nondeterministic results. However, misdeclaring a routine might affect results or affect performance. Declaring a nondeterministic routine as `DETERMINISTIC` might lead to unexpected results by causing the optimizer to make incorrect execution plan choices. Declaring a deterministic routine as `NONDETERMINISTIC` might diminish performance by causing available optimizations not to be used.

If binary logging is enabled, the `DETERMINISTIC` characteristic affects which routine definitions MySQL accepts. See [Section 23.7, “Stored Program Binary Logging”](#).

A routine that contains the `NOW()` function (or its synonyms) or `RAND()` is nondeterministic, but it might still be replication-safe. For `NOW()`, the binary log includes the timestamp and replicates correctly. `RAND()` also replicates correctly as long as it is called only a single time during the execution of a routine. (You can consider the routine execution timestamp and random number seed as implicit inputs that are identical on the source and replica.)

Several characteristics provide information about the nature of data use by the routine. In MySQL, these characteristics are advisory only. The server does not use them to constrain what kinds of statements a routine is permitted to execute.

- `CONTAINS SQL` indicates that the routine does not contain statements that read or write data. This is the default if none of these characteristics is given explicitly. Examples of such statements are `SET @x = 1` or `DO RELEASE_LOCK('abc')`, which execute but neither read nor write data.
- `NO SQL` indicates that the routine contains no SQL statements.
- `READS SQL DATA` indicates that the routine contains statements that read data (for example, `SELECT`), but not statements that write data.
- `MODIFIES SQL DATA` indicates that the routine contains statements that may write data (for example, `INSERT` or `DELETE`).

The `SQL SECURITY` characteristic can be `DEFINER` or `INVOKER` to specify the security context; that is, whether the routine executes using the privileges of the account named in the routine `DEFINER` clause or the user who invokes it. This account must have permission to access the database with which the routine is associated. The default value is `DEFINER`. The user who invokes the routine must have the `EXECUTE` privilege for it, as must the `DEFINER` account if the routine executes in definer security context.

The `DEFINER` clause specifies the MySQL account to be used when checking access privileges at routine execution time for routines that have the `SQL SECURITY DEFINER` characteristic.

If the `DEFINER` clause is present, the `user` value should be a MySQL account specified as `'user_name'@'host_name'`, `CURRENT_USER`, or `CURRENT_USER()`. The permitted `user` values depend on the privileges you hold, as discussed in [Section 23.6, “Stored Object Access Control”](#). Also see that section for additional information about stored routine security.

If the `DEFINER` clause is omitted, the default definer is the user who executes the `CREATE PROCEDURE` or `CREATE FUNCTION` statement. This is the same as specifying `DEFINER = CURRENT_USER` explicitly.

Within the body of a stored routine that is defined with the `SQL SECURITY DEFINER` characteristic, the `CURRENT_USER` function returns the routine's `DEFINER` value. For information about user auditing within stored routines, see [Section 6.2.18, “SQL-Based Account Activity Auditing”](#).

Consider the following procedure, which displays a count of the number of MySQL accounts listed in the `mysql.user` system table:

```
CREATE DEFINER = 'admin'@'localhost' PROCEDURE account_count()
BEGIN
```

```
SELECT 'Number of accounts:', COUNT(*) FROM mysql.user;
END;
```

The procedure is assigned a `DEFINER` account of `'admin'@'localhost'` no matter which user defines it. It executes with the privileges of that account no matter which user invokes it (because the default security characteristic is `DEFINER`). The procedure succeeds or fails depending on whether invoker has the `EXECUTE` privilege for it and `'admin'@'localhost'` has the `SELECT` privilege for the `mysql.user` table.

Now suppose that the procedure is defined with the `SQL SECURITY INVOKER` characteristic:

```
CREATE DEFINER = 'admin'@'localhost' PROCEDURE account_count()
SQL SECURITY INVOKER
BEGIN
  SELECT 'Number of accounts:', COUNT(*) FROM mysql.user;
END;
```

The procedure still has a `DEFINER` of `'admin'@'localhost'`, but in this case, it executes with the privileges of the invoking user. Thus, the procedure succeeds or fails depending on whether the invoker has the `EXECUTE` privilege for it and the `SELECT` privilege for the `mysql.user` table.

The server handles the data type of a routine parameter, local routine variable created with `DECLARE`, or function return value as follows:

- Assignments are checked for data type mismatches and overflow. Conversion and overflow problems result in warnings, or errors in strict SQL mode.
- Only scalar values can be assigned. For example, a statement such as `SET x = (SELECT 1, 2)` is invalid.
- For character data types, if `CHARACTER SET` is included in the declaration, the specified character set and its default collation is used. If the `COLLATE` attribute is also present, that collation is used rather than the default collation.

If `CHARACTER SET` and `COLLATE` are not present, the database character set and collation in effect at routine creation time are used. To avoid having the server use the database character set and collation, provide an explicit `CHARACTER SET` and a `COLLATE` attribute for character data parameters.

If you alter the database default character set or collation, stored routines that are to use the new database defaults must be dropped and recreated.

The database character set and collation are given by the value of the `character_set_database` and `collation_database` system variables. For more information, see [Section 10.3.3, “Database Character Set and Collation”](#).

## 13.1.17 CREATE SERVER Statement

```
CREATE SERVER server_name
  FOREIGN DATA WRAPPER wrapper_name
  OPTIONS (option [, option] ...)

option: {
  HOST character-literal
  | DATABASE character-literal
  | USER character-literal
  | PASSWORD character-literal
  | SOCKET character-literal
  | OWNER character-literal
  | PORT numeric-literal
}
```

This statement creates the definition of a server for use with the [FEDERATED](#) storage engine. The [CREATE SERVER](#) statement creates a new row in the `servers` table in the `mysql` database. This statement requires the [SUPER](#) privilege.

The `server_name` should be a unique reference to the server. Server definitions are global within the scope of the server, it is not possible to qualify the server definition to a specific database. `server_name` has a maximum length of 64 characters (names longer than 64 characters are silently truncated), and is case-insensitive. You may specify the name as a quoted string.

The `wrapper_name` is an identifier and may be quoted with single quotation marks.

For each `option` you must specify either a character literal or numeric literal. Character literals are UTF-8, support a maximum length of 64 characters and default to a blank (empty) string. String literals are silently truncated to 64 characters. Numeric literals must be a number between 0 and 9999, default value is 0.



#### Note

The [OWNER](#) option is currently not applied, and has no effect on the ownership or operation of the server connection that is created.

The [CREATE SERVER](#) statement creates an entry in the `mysql.servers` table that can later be used with the [CREATE TABLE](#) statement when creating a [FEDERATED](#) table. The options that you specify are used to populate the columns in the `mysql.servers` table. The table columns are `Server_name`, `Host`, `Db`, `Username`, `Password`, `Port` and `Socket`.

For example:

```
CREATE SERVER s
FOREIGN DATA WRAPPER mysql
OPTIONS (USER 'Remote', HOST '198.51.100.106', DATABASE 'test');
```

Be sure to specify all options necessary to establish a connection to the server. The user name, host name, and database name are mandatory. Other options might be required as well, such as password.

The data stored in the table can be used when creating a connection to a [FEDERATED](#) table:

```
CREATE TABLE t (s1 INT) ENGINE=FEDERATED CONNECTION='s';
```

For more information, see [Section 15.8, “The FEDERATED Storage Engine”](#).

[CREATE SERVER](#) causes an implicit commit. See [Section 13.3.3, “Statements That Cause an Implicit Commit”](#).

[CREATE SERVER](#) is not written to the binary log, regardless of the logging format that is in use.

## 13.1.18 CREATE TABLE Statement

```
CREATE [TEMPORARY] TABLE [IF NOT EXISTS] tbl_name
(create_definition,...)
[table_options]
[partition_options]

CREATE [TEMPORARY] TABLE [IF NOT EXISTS] tbl_name
[(create_definition,...)]
[table_options]
[partition_options]
[IGNORE | REPLACE]
[AS] query_expression

CREATE [TEMPORARY] TABLE [IF NOT EXISTS] tbl_name
{ LIKE old_tbl_name | (LIKE old_tbl_name) }
```



```

create_definition: {
  col_name column_definition
  | {INDEX | KEY} [index_name] [index_type] (key_part,...)
    [index_option] ...
  | {FULLTEXT | SPATIAL} [INDEX | KEY] [index_name] (key_part,...)
    [index_option] ...
  | [CONSTRAINT [symbol]] PRIMARY KEY
    [index_type] (key_part,...)
    [index_option] ...
  | [CONSTRAINT [symbol]] UNIQUE [INDEX | KEY]
    [index_name] [index_type] (key_part,...)
    [index_option] ...
  | [CONSTRAINT [symbol]] FOREIGN KEY
    [index_name] (col_name,...)
    reference_definition
  | CHECK (expr)
}

column_definition: {
  data_type [NOT NULL | NULL] [DEFAULT default_value]
  [AUTO_INCREMENT] [UNIQUE [KEY]] [[PRIMARY] KEY]
  [COMMENT 'string']
  [COLLATE collation_name]
  [COLUMN_FORMAT {FIXED | DYNAMIC | DEFAULT}]
  [STORAGE {DISK | MEMORY}]
  [reference_definition]
  | data_type
  [COLLATE collation_name]
  [GENERATED ALWAYS] AS (expr)
  [VIRTUAL | STORED] [NOT NULL | NULL]
  [UNIQUE [KEY]] [[PRIMARY] KEY]
  [COMMENT 'string']
  [reference_definition]
}

data_type:
  (see Chapter 11, Data Types)

key_part:
  col_name [(length)] [ASC | DESC]

index_type:
  USING {BTREE | HASH}

index_option: {
  KEY_BLOCK_SIZE [=] value
  | index_type
  | WITH PARSER parser_name
  | COMMENT 'string'
}

reference_definition:
  REFERENCES tbl_name (key_part,...)
  [MATCH FULL | MATCH PARTIAL | MATCH SIMPLE]
  [ON DELETE reference_option]
  [ON UPDATE reference_option]

reference_option:
  RESTRICT | CASCADE | SET NULL | NO ACTION | SET DEFAULT

table_options:
  table_option [[,] table_option] ...

table_option: {
  AUTO_INCREMENT [=] value
  | AVG_ROW_LENGTH [=] value
  | [DEFAULT] CHARACTER SET [=] charset_name
}

```

## CREATE TABLE Statement

```
| CHECKSUM [=] {0 | 1}
| [DEFAULT] COLLATE [=] collation_name
| COMMENT [=] 'string'
| COMPRESSION [=] {'ZLIB' | 'LZ4' | 'NONE'}
| CONNECTION [=] 'connect_string'
| {DATA | INDEX} DIRECTORY [=] 'absolute path to directory'
| DELAY_KEY_WRITE [=] {0 | 1}
| ENCRYPTION [=] {'Y' | 'N'}
| ENGINE [=] engine_name
| INSERT_METHOD [=] { NO | FIRST | LAST }
| KEY_BLOCK_SIZE [=] value
| MAX_ROWS [=] value
| MIN_ROWS [=] value
| PACK_KEYS [=] {0 | 1 | DEFAULT}
| PASSWORD [=] 'string'
| ROW_FORMAT [=] {DEFAULT | DYNAMIC | FIXED | COMPRESSED | REDUNDANT | COMPACT}
| STATS_AUTO_RECALC [=] {DEFAULT | 0 | 1}
| STATS_PERSISTENT [=] {DEFAULT | 0 | 1}
| STATS_SAMPLE_PAGES [=] value
| tablespace_option
| UNION [=] (tbl_name [, tbl_name] ... )
}
```

### *partition\_options*:

```
PARTITION BY
  { [LINEAR] HASH(expr)
  | [LINEAR] KEY [ALGORITHM={1 | 2}] (column_list)
  | RANGE{(expr) | COLUMNS(column_list)}
  | LIST{(expr) | COLUMNS(column_list)} }
[PARTITIONS num]
[SUBPARTITION BY
  { [LINEAR] HASH(expr)
  | [LINEAR] KEY [ALGORITHM={1 | 2}] (column_list) }
[SUBPARTITIONS num]
]
[(partition_definition [, partition_definition] ...)]
```

### *partition\_definition*:

```
PARTITION partition_name
  [VALUES
    {LESS THAN {(expr | value_list) | MAXVALUE}
    |
    IN (value_list)}]
  [[STORAGE] ENGINE [=] engine_name]
  [COMMENT [=] 'string' ]
  [DATA DIRECTORY [=] 'data_dir']
  [INDEX DIRECTORY [=] 'index_dir']
  [MAX_ROWS [=] max_number_of_rows]
  [MIN_ROWS [=] min_number_of_rows]
  [TABLESPACE [=] tablespace_name]
  [(subpartition_definition [, subpartition_definition] ...)]
```

### *subpartition\_definition*:

```
SUBPARTITION logical_name
  [[STORAGE] ENGINE [=] engine_name]
  [COMMENT [=] 'string' ]
  [DATA DIRECTORY [=] 'data_dir']
  [INDEX DIRECTORY [=] 'index_dir']
  [MAX_ROWS [=] max_number_of_rows]
  [MIN_ROWS [=] min_number_of_rows]
  [TABLESPACE [=] tablespace_name]
```

### *tablespace\_option*:

```
TABLESPACE tablespace_name [STORAGE DISK]
| [TABLESPACE tablespace_name] STORAGE MEMORY
```

### *query\_expression*:

```
SELECT ... (Some valid select or union statement)
```

`CREATE TABLE` creates a table with the given name. You must have the `CREATE` privilege for the table.

By default, tables are created in the default database, using the `InnoDB` storage engine. An error occurs if the table exists, if there is no default database, or if the database does not exist.

MySQL has no limit on the number of tables. The underlying file system may have a limit on the number of files that represent tables. Individual storage engines may impose engine-specific constraints. `InnoDB` permits up to 4 billion tables.

For information about the physical representation of a table, see [Section 13.1.18.1, “Files Created by CREATE TABLE”](#).

There are several aspects to the `CREATE TABLE` statement, described under the following topics in this section:

- [Table Name](#)
- [Temporary Tables](#)
- [Table Cloning and Copying](#)
- [Column Data Types and Attributes](#)
- [Indexes and Foreign Keys](#)
- [Table Options](#)
- [Table Partitioning](#)

## Table Name

- `tbl_name`

The table name can be specified as `db_name.tbl_name` to create the table in a specific database. This works regardless of whether there is a default database, assuming that the database exists. If you use quoted identifiers, quote the database and table names separately. For example, write ``mydb`.`mytbl``, not ``mydb.mytbl``.

Rules for permissible table names are given in [Section 9.2, “Schema Object Names”](#).

- `IF NOT EXISTS`

Prevents an error from occurring if the table exists. However, there is no verification that the existing table has a structure identical to that indicated by the `CREATE TABLE` statement.

## Temporary Tables

You can use the `TEMPORARY` keyword when creating a table. A `TEMPORARY` table is visible only within the current session, and is dropped automatically when the session is closed. For more information, see [Section 13.1.18.2, “CREATE TEMPORARY TABLE Statement”](#).

## Table Cloning and Copying

- `LIKE`

Use `CREATE TABLE ... LIKE` to create an empty table based on the definition of another table, including any column attributes and indexes defined in the original table:

```
CREATE TABLE new_tbl LIKE orig_tbl;
```

For more information, see [Section 13.1.18.3, “CREATE TABLE ... LIKE Statement”](#).

- `[AS] query_expression`

To create one table from another, add a `SELECT` statement at the end of the `CREATE TABLE` statement:

```
CREATE TABLE new_tbl AS SELECT * FROM orig_tbl;
```

For more information, see [Section 13.1.18.4, “CREATE TABLE ... SELECT Statement”](#).

- `IGNORE` | `REPLACE`

The `IGNORE` and `REPLACE` options indicate how to handle rows that duplicate unique key values when copying a table using a `SELECT` statement.

For more information, see [Section 13.1.18.4, “CREATE TABLE ... SELECT Statement”](#).

## Column Data Types and Attributes

There is a hard limit of 4096 columns per table, but the effective maximum may be less for a given table and depends on the factors discussed in [Section 8.4.7, “Limits on Table Column Count and Row Size”](#).

- `data_type`

`data_type` represents the data type in a column definition. For a full description of the syntax available for specifying column data types, as well as information about the properties of each type, see [Chapter 11, Data Types](#).

- Some attributes do not apply to all data types. `AUTO_INCREMENT` applies only to integer and floating-point types. `DEFAULT` does not apply to the `BLOB`, `TEXT`, `GEOMETRY`, and `JSON` types.
- Character data types (`CHAR`, `VARCHAR`, the `TEXT` types, `ENUM`, `SET`, and any synonyms) can include `CHARACTER SET` to specify the character set for the column. `CHARSET` is a synonym for `CHARACTER SET`. A collation for the character set can be specified with the `COLLATE` attribute, along with any other attributes. For details, see [Chapter 10, Character Sets, Collations, Unicode](#). Example:

```
CREATE TABLE t (c CHAR(20) CHARACTER SET utf8 COLLATE utf8_bin);
```

MySQL 5.7 interprets length specifications in character column definitions in characters. Lengths for `BINARY` and `VARBINARY` are in bytes.

- For `CHAR`, `VARCHAR`, `BINARY`, and `VARBINARY` columns, indexes can be created that use only the leading part of column values, using `col_name(length)` syntax to specify an index prefix length. `BLOB` and `TEXT` columns also can be indexed, but a prefix length *must* be given. Prefix lengths are given in characters for nonbinary string types and in bytes for binary string types. That is, index entries consist of the first `length` characters of each column value for `CHAR`, `VARCHAR`, and `TEXT` columns, and the first `length` bytes of each column value for `BINARY`, `VARBINARY`, and `BLOB` columns. Indexing only a prefix of column values like this can make the index file much smaller. For additional information about index prefixes, see [Section 13.1.14, “CREATE INDEX Statement”](#).

Only the `InnoDB` and `MyISAM` storage engines support indexing on `BLOB` and `TEXT` columns. For example:

```
CREATE TABLE test (blob_col BLOB, INDEX(blob_col(10)));
```

As of MySQL 5.7.17, if a specified index prefix exceeds the maximum column data type size, `CREATE TABLE` handles the index as follows:

- For a nonunique index, either an error occurs (if strict SQL mode is enabled), or the index length is reduced to lie within the maximum column data type size and a warning is produced (if strict SQL mode is not enabled).
- For a unique index, an error occurs regardless of SQL mode because reducing the index length might enable insertion of nonunique entries that do not meet the specified uniqueness requirement.
- `JSON` columns cannot be indexed. You can work around this restriction by creating an index on a generated column that extracts a scalar value from the `JSON` column. See [Indexing a Generated Column to Provide a JSON Column Index](#), for a detailed example.
- `NOT NULL` | `NULL`

If neither `NULL` nor `NOT NULL` is specified, the column is treated as though `NULL` had been specified.

In MySQL 5.7, only the `InnoDB`, `MyISAM`, and `MEMORY` storage engines support indexes on columns that can have `NULL` values. In other cases, you must declare indexed columns as `NOT NULL` or an error results.

- `DEFAULT`

Specifies a default value for a column. For more information about default value handling, including the case that a column definition includes no explicit `DEFAULT` value, see [Section 11.6, “Data Type Default Values”](#).

If the `NO_ZERO_DATE` or `NO_ZERO_IN_DATE` SQL mode is enabled and a date-valued default is not correct according to that mode, `CREATE TABLE` produces a warning if strict SQL mode is not enabled and an error if strict mode is enabled. For example, with `NO_ZERO_IN_DATE` enabled, `c1 DATE DEFAULT '2010-00-00'` produces a warning.

- `AUTO_INCREMENT`

An integer or floating-point column can have the additional attribute `AUTO_INCREMENT`. When you insert a value of `NULL` (recommended) or `0` into an indexed `AUTO_INCREMENT` column, the column is set to the next sequence value. Typically this is `value+1`, where `value` is the largest value for the column currently in the table. `AUTO_INCREMENT` sequences begin with `1`.

To retrieve an `AUTO_INCREMENT` value after inserting a row, use the `LAST_INSERT_ID()` SQL function or the `mysql_insert_id()` C API function. See [Section 12.15, “Information Functions”](#), and [mysql\\_insert\\_id\(\)](#).

If the `NO_AUTO_VALUE_ON_ZERO` SQL mode is enabled, you can store `0` in `AUTO_INCREMENT` columns as `0` without generating a new sequence value. See [Section 5.1.10, “Server SQL Modes”](#).

There can be only one `AUTO_INCREMENT` column per table, it must be indexed, and it cannot have a `DEFAULT` value. An `AUTO_INCREMENT` column works properly only if it contains only positive values. Inserting a negative number is regarded as inserting a very large positive number. This is done to avoid

precision problems when numbers “wrap” over from positive to negative and also to ensure that you do not accidentally get an `AUTO_INCREMENT` column that contains 0.

For `MyISAM` tables, you can specify an `AUTO_INCREMENT` secondary column in a multiple-column key. See [Section 3.6.9, “Using AUTO\\_INCREMENT”](#).

To make MySQL compatible with some ODBC applications, you can find the `AUTO_INCREMENT` value for the last inserted row with the following query:

```
SELECT * FROM tbl_name WHERE auto_col IS NULL
```

This method requires that `sql_auto_is_null` variable is not set to 0. See [Section 5.1.7, “Server System Variables”](#).

For information about `InnoDB` and `AUTO_INCREMENT`, see [Section 14.6.1.6, “AUTO\\_INCREMENT Handling in InnoDB”](#). For information about `AUTO_INCREMENT` and MySQL Replication, see [Section 16.4.1.1, “Replication and AUTO\\_INCREMENT”](#).

- `COMMENT`

A comment for a column can be specified with the `COMMENT` option, up to 1024 characters long. The comment is displayed by the `SHOW CREATE TABLE` and `SHOW FULL COLUMNS` statements. It is also shown in the `COLUMN_COMMENT` column of the Information Schema `COLUMNS` table.

- `COLUMN_FORMAT`

In `NDB Cluster`, it is also possible to specify a data storage format for individual columns of `NDB` tables using `COLUMN_FORMAT`. Permissible column formats are `FIXED`, `DYNAMIC`, and `DEFAULT`. `FIXED` is used to specify fixed-width storage, `DYNAMIC` permits the column to be variable-width, and `DEFAULT` causes the column to use fixed-width or variable-width storage as determined by the column's data type (possibly overridden by a `ROW_FORMAT` specifier).

Beginning with MySQL `NDB Cluster` 7.5.4, for `NDB` tables, the default value for `COLUMN_FORMAT` is `FIXED`. (The default had been switched to `DYNAMIC` in MySQL `NDB Cluster` 7.5.1, but this change was reverted to maintain backwards compatibility with existing GA release series.) (Bug #24487363)

In `NDB Cluster`, the maximum possible offset for a column defined with `COLUMN_FORMAT=FIXED` is 8188 bytes. For more information and possible workarounds, see [Section 21.2.7.5, “Limits Associated with Database Objects in NDB Cluster”](#).

`COLUMN_FORMAT` currently has no effect on columns of tables using storage engines other than `NDB`. In MySQL 5.7 and later, `COLUMN_FORMAT` is silently ignored.

- `STORAGE`

For `NDB` tables, it is possible to specify whether the column is stored on disk or in memory by using a `STORAGE` clause. `STORAGE DISK` causes the column to be stored on disk, and `STORAGE MEMORY` causes in-memory storage to be used. The `CREATE TABLE` statement used must still include a `TABLESPACE` clause:

```
mysql> CREATE TABLE t1 (
->     c1 INT STORAGE DISK,
->     c2 INT STORAGE MEMORY
-> ) ENGINE NDB;
ERROR 1005 (HY000): Can't create table 'c.t1' (errno: 140)

mysql> CREATE TABLE t1 (
->     c1 INT STORAGE DISK,
->     c2 INT STORAGE MEMORY
```

```
-> ) TABLESPACE ts_1 ENGINE NDB;
Query OK, 0 rows affected (1.06 sec)
```

For NDB tables, `STORAGE DEFAULT` is equivalent to `STORAGE MEMORY`.

The `STORAGE` clause has no effect on tables using storage engines other than NDB. The `STORAGE` keyword is supported only in the build of `mysqld` that is supplied with NDB Cluster; it is not recognized in any other version of MySQL, where any attempt to use the `STORAGE` keyword causes a syntax error.

- `GENERATED ALWAYS`

Used to specify a generated column expression. For information about [generated columns](#), see [Section 13.1.18.7, “CREATE TABLE and Generated Columns”](#).

Stored [generated columns](#) can be indexed. InnoDB supports secondary indexes on [virtual generated columns](#). See [Section 13.1.18.8, “Secondary Indexes and Generated Columns”](#).

## Indexes and Foreign Keys

Several keywords apply to creation of indexes and foreign keys. For general background in addition to the following descriptions, see [Section 13.1.14, “CREATE INDEX Statement”](#), and [Section 13.1.18.5, “FOREIGN KEY Constraints”](#).

- `CONSTRAINT symbol`

The `CONSTRAINT symbol` clause may be given to name a constraint. If the clause is not given, or a *symbol* is not included following the `CONSTRAINT` keyword, MySQL automatically generates a constraint name, with the exception noted below. The *symbol* value, if used, must be unique per schema (database), per constraint type. A duplicate *symbol* results in an error. See also the discussion about length limits of generated constraint identifiers at [Section 9.2.1, “Identifier Length Limits”](#).



### Note

If the `CONSTRAINT symbol` clause is not given in a foreign key definition, or a *symbol* is not included following the `CONSTRAINT` keyword, NDB uses the foreign key index name.

The SQL standard specifies that all types of constraints (primary key, unique index, foreign key, check) belong to the same namespace. In MySQL, each constraint type has its own namespace per schema. Consequently, names for each type of constraint must be unique per schema.

- `PRIMARY KEY`

A unique index where all key columns must be defined as `NOT NULL`. If they are not explicitly declared as `NOT NULL`, MySQL declares them so implicitly (and silently). A table can have only one `PRIMARY KEY`. The name of a `PRIMARY KEY` is always `PRIMARY`, which thus cannot be used as the name for any other kind of index.

If you do not have a `PRIMARY KEY` and an application asks for the `PRIMARY KEY` in your tables, MySQL returns the first `UNIQUE` index that has no `NULL` columns as the `PRIMARY KEY`.

In InnoDB tables, keep the `PRIMARY KEY` short to minimize storage overhead for secondary indexes. Each secondary index entry contains a copy of the primary key columns for the corresponding row. (See [Section 14.6.2.1, “Clustered and Secondary Indexes”](#).)

In the created table, a [PRIMARY KEY](#) is placed first, followed by all [UNIQUE](#) indexes, and then the nonunique indexes. This helps the MySQL optimizer to prioritize which index to use and also more quickly to detect duplicated [UNIQUE](#) keys.

A [PRIMARY KEY](#) can be a multiple-column index. However, you cannot create a multiple-column index using the [PRIMARY KEY](#) key attribute in a column specification. Doing so only marks that single column as primary. You must use a separate [PRIMARY KEY\(key\\_part, ...\)](#) clause.

If a table has a [PRIMARY KEY](#) or [UNIQUE NOT NULL](#) index that consists of a single column that has an integer type, you can use `_rowid` to refer to the indexed column in [SELECT](#) statements, as described in [Unique Indexes](#).

In MySQL, the name of a [PRIMARY KEY](#) is [PRIMARY](#). For other indexes, if you do not assign a name, the index is assigned the same name as the first indexed column, with an optional suffix (`_2`, `_3`, ...) to make it unique. You can see index names for a table using [SHOW INDEX FROM tbl\\_name](#). See [Section 13.7.5.22, "SHOW INDEX Statement"](#).

- [KEY](#) | [INDEX](#)

[KEY](#) is normally a synonym for [INDEX](#). The key attribute [PRIMARY KEY](#) can also be specified as just [KEY](#) when given in a column definition. This was implemented for compatibility with other database systems.

- [UNIQUE](#)

A [UNIQUE](#) index creates a constraint such that all values in the index must be distinct. An error occurs if you try to add a new row with a key value that matches an existing row. For all engines, a [UNIQUE](#) index permits multiple [NULL](#) values for columns that can contain [NULL](#). If you specify a prefix value for a column in a [UNIQUE](#) index, the column values must be unique within the prefix length.

If a table has a [PRIMARY KEY](#) or [UNIQUE NOT NULL](#) index that consists of a single column that has an integer type, you can use `_rowid` to refer to the indexed column in [SELECT](#) statements, as described in [Unique Indexes](#).

- [FULLTEXT](#)

A [FULLTEXT](#) index is a special type of index used for full-text searches. Only the [InnoDB](#) and [MyISAM](#) storage engines support [FULLTEXT](#) indexes. They can be created only from [CHAR](#), [VARCHAR](#), and [TEXT](#) columns. Indexing always happens over the entire column; column prefix indexing is not supported and any prefix length is ignored if specified. See [Section 12.9, "Full-Text Search Functions"](#), for details of operation. A [WITH PARSER](#) clause can be specified as an *index\_option* value to associate a parser plugin with the index if full-text indexing and searching operations need special handling. This clause is valid only for [FULLTEXT](#) indexes. Both [InnoDB](#) and [MyISAM](#) support full-text parser plugins. See [Full-Text Parser Plugins](#) and [Writing Full-Text Parser Plugins](#) for more information.

- [SPATIAL](#)

You can create [SPATIAL](#) indexes on spatial data types. Spatial types are supported only for [MyISAM](#) and [InnoDB](#) tables, and indexed columns must be declared as [NOT NULL](#). See [Section 11.4, "Spatial Data Types"](#).

- [FOREIGN KEY](#)

MySQL supports foreign keys, which let you cross-reference related data across tables, and foreign key constraints, which help keep this spread-out data consistent. For definition and option information, see [reference\\_definition](#), and [reference\\_option](#).



Partitioned tables employing the [InnoDB](#) storage engine do not support foreign keys. See [Section 22.6, “Restrictions and Limitations on Partitioning”](#), for more information.

- `CHECK`

The `CHECK` clause is parsed but ignored by all storage engines.

- `key_part`

- A `key_part` specification can end with `ASC` or `DESC`. These keywords are permitted for future extensions for specifying ascending or descending index value storage. Currently, they are parsed but ignored; index values are always stored in ascending order.
- Prefixes, defined by the `length` attribute, can be up to 767 bytes long for [InnoDB](#) tables or 3072 bytes if the `innodb_large_prefix` option is enabled. For [MyISAM](#) tables, the prefix length limit is 1000 bytes.

Prefix *limits* are measured in bytes. However, prefix *lengths* for index specifications in `CREATE TABLE`, `ALTER TABLE`, and `CREATE INDEX` statements are interpreted as number of characters for nonbinary string types (`CHAR`, `VARCHAR`, `TEXT`) and number of bytes for binary string types (`BINARY`, `VARBINARY`, `BLOB`). Take this into account when specifying a prefix length for a nonbinary string column that uses a multibyte character set.

- `index_type`

Some storage engines permit you to specify an index type when creating an index. The syntax for the `index_type` specifier is `USING type_name`.

Example:

```
CREATE TABLE lookup
(id INT, INDEX USING BTREE (id))
ENGINE = MEMORY;
```

The preferred position for `USING` is after the index column list. It can be given before the column list, but support for use of the option in that position is deprecated; expect it to be removed in a future MySQL release.

- `index_option`

`index_option` values specify additional options for an index.

- `KEY_BLOCK_SIZE`

For [MyISAM](#) tables, `KEY_BLOCK_SIZE` optionally specifies the size in bytes to use for index key blocks. The value is treated as a hint; a different size could be used if necessary. A `KEY_BLOCK_SIZE` value specified for an individual index definition overrides the table-level `KEY_BLOCK_SIZE` value.

For information about the table-level `KEY_BLOCK_SIZE` attribute, see [Table Options](#).

- `WITH PARSER`

The `WITH PARSER` option can be used only with `FULLTEXT` indexes. It associates a parser plugin with the index if full-text indexing and searching operations need special handling. Both [InnoDB](#) and

`MyISAM` support full-text parser plugins. If you have a `MyISAM` table with an associated full-text parser plugin, you can convert the table to `InnoDB` using `ALTER TABLE`.

- `COMMENT`

Index definitions can include an optional comment of up to 1024 characters.

You can set the `InnoDB MERGE_THRESHOLD` value for an individual index using the `index_option COMMENT` clause. See [Section 14.8.12, “Configuring the Merge Threshold for Index Pages”](#).

For more information about permissible `index_option` values, see [Section 13.1.14, “CREATE INDEX Statement”](#). For more information about indexes, see [Section 8.3.1, “How MySQL Uses Indexes”](#).

- `reference_definition`

For `reference_definition` syntax details and examples, see [Section 13.1.18.5, “FOREIGN KEY Constraints”](#).

`InnoDB` and `NDB` tables support checking of foreign key constraints. The columns of the referenced table must always be explicitly named. Both `ON DELETE` and `ON UPDATE` actions on foreign keys are supported. For more detailed information and examples, see [Section 13.1.18.5, “FOREIGN KEY Constraints”](#).

For other storage engines, MySQL Server parses and ignores the `FOREIGN KEY` syntax in `CREATE TABLE` statements.



### Important

For users familiar with the ANSI/ISO SQL Standard, please note that no storage engine, including `InnoDB`, recognizes or enforces the `MATCH` clause used in referential integrity constraint definitions. Use of an explicit `MATCH` clause does not have the specified effect, and also causes `ON DELETE` and `ON UPDATE` clauses to be ignored. For these reasons, specifying `MATCH` should be avoided.

The `MATCH` clause in the SQL standard controls how `NULL` values in a composite (multiple-column) foreign key are handled when comparing to a primary key. `InnoDB` essentially implements the semantics defined by `MATCH SIMPLE`, which permit a foreign key to be all or partially `NULL`. In that case, the (child table) row containing such a foreign key is permitted to be inserted, and does not match any row in the referenced (parent) table. It is possible to implement other semantics using triggers.

Additionally, MySQL requires that the referenced columns be indexed for performance. However, `InnoDB` does not enforce any requirement that the referenced columns be declared `UNIQUE` or `NOT NULL`. The handling of foreign key references to nonunique keys or keys that contain `NULL` values is not well defined for operations such as `UPDATE` or `DELETE CASCADE`. You are advised to use foreign keys that reference only keys that are both `UNIQUE` (or `PRIMARY`) and `NOT NULL`.

MySQL parses but ignores “inline `REFERENCES` specifications” (as defined in the SQL standard) where the references are defined as part of the column specification. MySQL accepts `REFERENCES` clauses only when specified as part of a separate `FOREIGN KEY` specification. For more information, see [Section 1.6.2.3, “FOREIGN KEY Constraint Differences”](#).

- *reference\_option*

For information about the `RESTRICT`, `CASCADE`, `SET NULL`, `NO ACTION`, and `SET DEFAULT` options, see [Section 13.1.18.5, “FOREIGN KEY Constraints”](#).

## Table Options

Table options are used to optimize the behavior of the table. In most cases, you do not have to specify any of them. These options apply to all storage engines unless otherwise indicated. Options that do not apply to a given storage engine may be accepted and remembered as part of the table definition. Such options then apply if you later use `ALTER TABLE` to convert the table to use a different storage engine.

- `ENGINE`

Specifies the storage engine for the table, using one of the names shown in the following table. The engine name can be unquoted or quoted. The quoted name `'DEFAULT'` is recognized but ignored.

Storage Engine	Description
<code>InnoDB</code>	Transaction-safe tables with row locking and foreign keys. The default storage engine for new tables. See <a href="#">Chapter 14, <i>The InnoDB Storage Engine</i></a> , and in particular <a href="#">Section 14.1, “Introduction to InnoDB”</a> if you have MySQL experience but are new to <code>InnoDB</code> .
<code>MyISAM</code>	The binary portable storage engine that is primarily used for read-only or read-mostly workloads. See <a href="#">Section 15.2, “The MyISAM Storage Engine”</a> .
<code>MEMORY</code>	The data for this storage engine is stored only in memory. See <a href="#">Section 15.3, “The MEMORY Storage Engine”</a> .
<code>CSV</code>	Tables that store rows in comma-separated values format. See <a href="#">Section 15.4, “The CSV Storage Engine”</a> .
<code>ARCHIVE</code>	The archiving storage engine. See <a href="#">Section 15.5, “The ARCHIVE Storage Engine”</a> .
<code>EXAMPLE</code>	An example engine. See <a href="#">Section 15.9, “The EXAMPLE Storage Engine”</a> .
<code>FEDERATED</code>	Storage engine that accesses remote tables. See <a href="#">Section 15.8, “The FEDERATED Storage Engine”</a> .
<code>HEAP</code>	This is a synonym for <code>MEMORY</code> .
<code>MERGE</code>	A collection of <code>MyISAM</code> tables used as one table. Also known as <code>MRG_MyISAM</code> . See <a href="#">Section 15.7, “The MERGE Storage Engine”</a> .
<code>NDB</code>	Clustered, fault-tolerant, memory-based tables, supporting transactions and foreign keys. Also known as <code>NDBCLUSTER</code> . See <a href="#">Chapter 21, <i>MySQL NDB Cluster 7.5 and NDB Cluster 7.6</i></a> .

By default, if a storage engine is specified that is not available, the statement fails with an error. You can override this behavior by removing `NO_ENGINE_SUBSTITUTION` from the server SQL mode (see [Section 5.1.10, “Server SQL Modes”](#)) so that MySQL allows substitution of the specified engine with the

default storage engine instead. Normally in such cases, this is `InnoDB`, which is the default value for the `default_storage_engine` system variable. When `NO_ENGINE_SUBSTITUTION` is disabled, a warning occurs if the storage engine specification is not honored.

- `AUTO_INCREMENT`

The initial `AUTO_INCREMENT` value for the table. In MySQL 5.7, this works for `MyISAM`, `MEMORY`, `InnoDB`, and `ARCHIVE` tables. To set the first auto-increment value for engines that do not support the `AUTO_INCREMENT` table option, insert a “dummy” row with a value one less than the desired value after creating the table, and then delete the dummy row.

For engines that support the `AUTO_INCREMENT` table option in `CREATE TABLE` statements, you can also use `ALTER TABLE tbl_name AUTO_INCREMENT = N` to reset the `AUTO_INCREMENT` value. The value cannot be set lower than the maximum value currently in the column.

- `AVG_ROW_LENGTH`

An approximation of the average row length for your table. You need to set this only for large tables with variable-size rows.

When you create a `MyISAM` table, MySQL uses the product of the `MAX_ROWS` and `AVG_ROW_LENGTH` options to decide how big the resulting table is. If you don't specify either option, the maximum size for `MyISAM` data and index files is 256TB by default. (If your operating system does not support files that large, table sizes are constrained by the file size limit.) If you want to keep down the pointer sizes to make the index smaller and faster and you don't really need big files, you can decrease the default pointer size by setting the `myisam_data_pointer_size` system variable. (See [Section 5.1.7, “Server System Variables”](#).) If you want all your tables to be able to grow above the default limit and are willing to have your tables slightly slower and larger than necessary, you can increase the default pointer size by setting this variable. Setting the value to 7 permits table sizes up to 65,536TB.

- `[DEFAULT] CHARACTER SET`

Specifies a default character set for the table. `CHARSET` is a synonym for `CHARACTER SET`. If the character set name is `DEFAULT`, the database character set is used.

- `CHECKSUM`

Set this to 1 if you want MySQL to maintain a live checksum for all rows (that is, a checksum that MySQL updates automatically as the table changes). This makes the table a little slower to update, but also makes it easier to find corrupted tables. The `CHECKSUM TABLE` statement reports the checksum. (`MyISAM` only.)

- `[DEFAULT] COLLATE`

Specifies a default collation for the table.

- `COMMENT`

A comment for the table, up to 2048 characters long.

You can set the `InnoDB MERGE_THRESHOLD` value for a table using the `table_option COMMENT` clause. See [Section 14.8.12, “Configuring the Merge Threshold for Index Pages”](#).

**Setting NDB\_TABLE options.** In MySQL NDB Cluster 7.5.2 and later, the table comment in a `CREATE TABLE` or `ALTER TABLE` statement can also be used to specify one to four of the `NDB_TABLE` options `NOLOGGING`, `READ_BACKUP`, `PARTITION_BALANCE`, or `FULLY_REPLICATED` as a set of name-

value pairs, separated by commas if need be, immediately following the string `NDB_TABLE=` that begins the quoted comment text. An example statement using this syntax is shown here (emphasized text):

```
CREATE TABLE t1 (
  c1 INT NOT NULL AUTO_INCREMENT PRIMARY KEY,
  c2 VARCHAR(100),
  c3 VARCHAR(100) )
ENGINE=NDB
COMMENT="NDB_TABLE=READ_BACKUP=0, PARTITION_BALANCE=FOR_RP_BY_NODE" ;
```

Spaces are not permitted within the quoted string. The string is case-insensitive.

The comment is displayed as part of the output of `SHOW CREATE TABLE`. The text of the comment is also available as the `TABLE_COMMENT` column of the MySQL Information Schema `TABLES` table.

This comment syntax is also supported with `ALTER TABLE` statements for `NDB` tables. Keep in mind that a table comment used with `ALTER TABLE` replaces any existing comment which the table might have had perviously.

Setting the `MERGE_THRESHOLD` option in table comments is not supported for `NDB` tables (it is ignored).

For complete syntax information and examples, see [Section 13.1.18.9, "Setting NDB Comment Options"](#).

- `COMPRESSION`

The compression algorithm used for page level compression for `InnoDB` tables. Supported values include `Zlib`, `LZ4`, and `None`. The `COMPRESSION` attribute was introduced with the transparent page compression feature. Page compression is only supported with `InnoDB` tables that reside in `file-per-table` tablespaces, and is only available on Linux and Windows platforms that support sparse files and hole punching. For more information, see [Section 14.9.2, "InnoDB Page Compression"](#).

- `CONNECTION`

The connection string for a `FEDERATED` table.



#### Note

Older versions of MySQL used a `COMMENT` option for the connection string.

- `DATA DIRECTORY, INDEX DIRECTORY`

For `InnoDB`, the `DATA DIRECTORY='directory'` clause permits creating a table outside of the data directory. The `innodb_file_per_table` variable must be enabled to use the `DATA DIRECTORY` clause. The full directory path must be specified. For more information, see [Section 14.6.1.2, "Creating Tables Externally"](#).

When creating `MyISAM` tables, you can use the `DATA DIRECTORY='directory'` clause, the `INDEX DIRECTORY='directory'` clause, or both. They specify where to put a `MyISAM` table's data file and index file, respectively. Unlike `InnoDB` tables, MySQL does not create subdirectories that correspond

to the database name when creating a `MyISAM` table with a `DATA DIRECTORY` or `INDEX DIRECTORY` option. Files are created in the directory that is specified.

As of MySQL 5.7.17, you must have the `FILE` privilege to use the `DATA DIRECTORY` or `INDEX DIRECTORY` table option.



### Important

Table-level `DATA DIRECTORY` and `INDEX DIRECTORY` options are ignored for partitioned tables. (Bug #32091)

These options work only when you are not using the `--skip-symbolic-links` option. Your operating system must also have a working, thread-safe `realpath()` call. See [Section 8.12.3.2, “Using Symbolic Links for MyISAM Tables on Unix”](#), for more complete information.

If a `MyISAM` table is created with no `DATA DIRECTORY` option, the `.MYD` file is created in the database directory. By default, if `MyISAM` finds an existing `.MYD` file in this case, it overwrites it. The same applies to `.MYI` files for tables created with no `INDEX DIRECTORY` option. To suppress this behavior, start the server with the `--keep_files_on_create` option, in which case `MyISAM` does not overwrite existing files and returns an error instead.

If a `MyISAM` table is created with a `DATA DIRECTORY` or `INDEX DIRECTORY` option and an existing `.MYD` or `.MYI` file is found, `MyISAM` always returns an error. It does not overwrite a file in the specified directory.



### Important

You cannot use path names that contain the MySQL data directory with `DATA DIRECTORY` or `INDEX DIRECTORY`. This includes partitioned tables and individual table partitions. (See Bug #32167.)

- `DELAY_KEY_WRITE`

Set this to 1 if you want to delay key updates for the table until the table is closed. See the description of the `delay_key_write` system variable in [Section 5.1.7, “Server System Variables”](#). (`MyISAM` only.)

- `ENCRYPTION`

Set the `ENCRYPTION` option to `'Y'` to enable page-level data encryption for an `InnoDB` table created in a `file-per-table` tablespace. Option values are not case-sensitive. The `ENCRYPTION` option was introduced with the `InnoDB` tablespace encryption feature; see [Section 14.14, “InnoDB Data-at-Rest Encryption”](#). A `keyring` plugin must be installed and configured before encryption can be enabled.

The `ENCRYPTION` option is supported only by the `InnoDB` storage engine; thus it works only if the default storage engine is `InnoDB`, or if the `CREATE TABLE` statement also specifies `ENGINE=InnoDB`. Otherwise the statement is rejected with `ER_CHECK_NOT_IMPLEMENTED`.

- `INSERT_METHOD`

If you want to insert data into a `MERGE` table, you must specify with `INSERT_METHOD` the table into which the row should be inserted. `INSERT_METHOD` is an option useful for `MERGE` tables only. Use a value of `FIRST` or `LAST` to have inserts go to the first or last table, or a value of `NO` to prevent inserts. See [Section 15.7, “The MERGE Storage Engine”](#).

- [KEY\\_BLOCK\\_SIZE](#)

For [MyISAM](#) tables, [KEY\\_BLOCK\\_SIZE](#) optionally specifies the size in bytes to use for index key blocks. The value is treated as a hint; a different size could be used if necessary. A [KEY\\_BLOCK\\_SIZE](#) value specified for an individual index definition overrides the table-level [KEY\\_BLOCK\\_SIZE](#) value.

For [InnoDB](#) tables, [KEY\\_BLOCK\\_SIZE](#) specifies the [page](#) size in kilobytes to use for [compressed InnoDB](#) tables. The [KEY\\_BLOCK\\_SIZE](#) value is treated as a hint; a different size could be used by [InnoDB](#) if necessary. [KEY\\_BLOCK\\_SIZE](#) can only be less than or equal to the [innodb\\_page\\_size](#) value. A value of 0 represents the default compressed page size, which is half of the [innodb\\_page\\_size](#) value. Depending on [innodb\\_page\\_size](#), possible [KEY\\_BLOCK\\_SIZE](#) values include 0, 1, 2, 4, 8, and 16. See [Section 14.9.1, “InnoDB Table Compression”](#) for more information.

Oracle recommends enabling [innodb\\_strict\\_mode](#) when specifying [KEY\\_BLOCK\\_SIZE](#) for [InnoDB](#) tables. When [innodb\\_strict\\_mode](#) is enabled, specifying an invalid [KEY\\_BLOCK\\_SIZE](#) value returns an error. If [innodb\\_strict\\_mode](#) is disabled, an invalid [KEY\\_BLOCK\\_SIZE](#) value results in a warning, and the [KEY\\_BLOCK\\_SIZE](#) option is ignored.

The [Create\\_options](#) column in response to [SHOW TABLE STATUS](#) reports the originally specified [KEY\\_BLOCK\\_SIZE](#) option, as does [SHOW CREATE TABLE](#).

[InnoDB](#) only supports [KEY\\_BLOCK\\_SIZE](#) at the table level.

[KEY\\_BLOCK\\_SIZE](#) is not supported with 32KB and 64KB [innodb\\_page\\_size](#) values. [InnoDB](#) table compression does not support these pages sizes.

- [MAX\\_ROWS](#)

The maximum number of rows you plan to store in the table. This is not a hard limit, but rather a hint to the storage engine that the table must be able to store at least this many rows.



#### Important

The use of [MAX\\_ROWS](#) with [NDB](#) tables to control the number of table partitions is deprecated as of [NDB Cluster 7.5.4](#). It remains supported in later versions for backward compatibility, but is subject to removal in a future release. Use [PARTITION\\_BALANCE](#) instead; see [Setting NDB\\_TABLE options](#).

The [NDB](#) storage engine treats this value as a maximum. If you plan to create very large [NDB Cluster](#) tables (containing millions of rows), you should use this option to insure that [NDB](#) allocates sufficient number of index slots in the hash table used for storing hashes of the table's primary keys by setting [MAX\\_ROWS = 2 \\* rows](#), where [rows](#) is the number of rows that you expect to insert into the table.

The maximum [MAX\\_ROWS](#) value is 4294967295; larger values are truncated to this limit.

- [MIN\\_ROWS](#)

The minimum number of rows you plan to store in the table. The [MEMORY](#) storage engine uses this option as a hint about memory use.

- [PACK\\_KEYS](#)

Takes effect only with [MyISAM](#) tables. Set this option to 1 if you want to have smaller indexes. This usually makes updates slower and reads faster. Setting the option to 0 disables all packing of keys. Setting it to [DEFAULT](#) tells the storage engine to pack only long [CHAR](#), [VARCHAR](#), [BINARY](#), or [VARBINARY](#) columns.

If you do not use `PACK_KEYS`, the default is to pack strings, but not numbers. If you use `PACK_KEYS=1`, numbers are packed as well.

When packing binary number keys, MySQL uses prefix compression:

- Every key needs one extra byte to indicate how many bytes of the previous key are the same for the next key.
- The pointer to the row is stored in high-byte-first order directly after the key, to improve compression.

This means that if you have many equal keys on two consecutive rows, all following “same” keys usually only take two bytes (including the pointer to the row). Compare this to the ordinary case where the following keys takes `storage_size_for_key + pointer_size` (where the pointer size is usually 4). Conversely, you get a significant benefit from prefix compression only if you have many numbers that are the same. If all keys are totally different, you use one byte more per key, if the key is not a key that can have `NULL` values. (In this case, the packed key length is stored in the same byte that is used to mark if a key is `NULL`.)

- `PASSWORD`

This option is unused. If you have a need to scramble your `.frm` files and make them unusable to any other MySQL server, please contact our sales department.

- `ROW_FORMAT`

Defines the physical format in which the rows are stored.

When creating a table with `strict mode` disabled, the storage engine's default row format is used if the specified row format is not supported. The actual row format of the table is reported in the `Row_format` column in response to `SHOW TABLE STATUS`. The `Create_options` column shows the row format that was specified in the `CREATE TABLE` statement, as does `SHOW CREATE TABLE`.

Row format choices differ depending on the storage engine used for the table.

For `InnoDB` tables:

- The default row format is defined by `innodb_default_row_format`, which has a default setting of `DYNAMIC`. The default row format is used when the `ROW_FORMAT` option is not defined or when `ROW_FORMAT=DEFAULT` is used.

If the `ROW_FORMAT` option is not defined, or if `ROW_FORMAT=DEFAULT` is used, operations that rebuild a table also silently change the row format of the table to the default defined by `innodb_default_row_format`. For more information, see [Defining the Row Format of a Table](#).

- For more efficient `InnoDB` storage of data types, especially `BLOB` types, use the `DYNAMIC`. See [DYNAMIC Row Format](#) for requirements associated with the `DYNAMIC` row format.
- To enable compression for `InnoDB` tables, specify `ROW_FORMAT=COMPRESSED`. See [Section 14.9, “InnoDB Table and Page Compression”](#) for requirements associated with the `COMPRESSED` row format.
- The row format used in older versions of MySQL can still be requested by specifying the `REDUNDANT` row format.
- When you specify a non-default `ROW_FORMAT` clause, consider also enabling the `innodb_strict_mode` configuration option.



- `ROW_FORMAT=FIXED` is not supported. If `ROW_FORMAT=FIXED` is specified while `innodb_strict_mode` is disabled, InnoDB issues a warning and assumes `ROW_FORMAT=DYNAMIC`. If `ROW_FORMAT=FIXED` is specified while `innodb_strict_mode` is enabled, which is the default, InnoDB returns an error.
- For additional information about InnoDB row formats, see [Section 14.11, “InnoDB Row Formats”](#).

For MyISAM tables, the option value can be `FIXED` or `DYNAMIC` for static or variable-length row format. `myisampack` sets the type to `COMPRESSED`. See [Section 15.2.3, “MyISAM Table Storage Formats”](#).

For NDB tables, the default `ROW_FORMAT` in MySQL NDB Cluster 7.5.1 and later is `DYNAMIC`. (Previously, it was `FIXED`.)

- `STATS_AUTO_RECALC`

Specifies whether to automatically recalculate [persistent statistics](#) for an InnoDB table. The value `DEFAULT` causes the persistent statistics setting for the table to be determined by the `innodb_stats_auto_recalc` configuration option. The value `1` causes statistics to be recalculated when 10% of the data in the table has changed. The value `0` prevents automatic recalculation for this table; with this setting, issue an `ANALYZE TABLE` statement to recalculate the statistics after making substantial changes to the table. For more information about the persistent statistics feature, see [Section 14.8.11.1, “Configuring Persistent Optimizer Statistics Parameters”](#).

- `STATS_PERSISTENT`

Specifies whether to enable [persistent statistics](#) for an InnoDB table. The value `DEFAULT` causes the persistent statistics setting for the table to be determined by the `innodb_stats_persistent` configuration option. The value `1` enables persistent statistics for the table, while the value `0` turns off this feature. After enabling persistent statistics through a `CREATE TABLE` or `ALTER TABLE` statement, issue an `ANALYZE TABLE` statement to calculate the statistics, after loading representative data into the table. For more information about the persistent statistics feature, see [Section 14.8.11.1, “Configuring Persistent Optimizer Statistics Parameters”](#).

- `STATS_SAMPLE_PAGES`

The number of index pages to sample when estimating cardinality and other statistics for an indexed column, such as those calculated by `ANALYZE TABLE`. For more information, see [Section 14.8.11.1, “Configuring Persistent Optimizer Statistics Parameters”](#).

- **TABLESPACE**

The **TABLESPACE** clause can be used to create an **InnoDB** table in an existing general tablespace, a file-per-table tablespace, or the system tablespace.

```
CREATE TABLE tbl_name ... TABLESPACE [=] tablespace_name
```

The general tablespace that you specify must exist prior to using the **TABLESPACE** clause. For information about general tablespaces, see [Section 14.6.3.3, “General Tablespaces”](#).

The *tablespace\_name* is a case-sensitive identifier. It may be quoted or unquoted. The forward slash character (“/”) is not permitted. Names beginning with “innodb\_” are reserved for special use.

To create a table in the system tablespace, specify **innodb\_system** as the tablespace name.

```
CREATE TABLE tbl_name ... TABLESPACE [=] innodb_system
```

Using **TABLESPACE [=] innodb\_system**, you can place a table of any uncompressed row format in the system tablespace regardless of the **innodb\_file\_per\_table** setting. For example, you can add a table with **ROW\_FORMAT=DYNAMIC** to the system tablespace using **TABLESPACE [=] innodb\_system**.

To create a table in a file-per-table tablespace, specify **innodb\_file\_per\_table** as the tablespace name.

```
CREATE TABLE tbl_name ... TABLESPACE [=] innodb_file_per_table
```



### Note

If **innodb\_file\_per\_table** is enabled, you need not specify **TABLESPACE=innodb\_file\_per\_table** to create an **InnoDB** file-per-table

tablespace. InnoDB tables are created in file-per-table tablespaces by default when `innodb_file_per_table` is enabled.



#### Note

Support for creating table partitions in shared InnoDB tablespaces is deprecated in MySQL 5.7.24; expect it to be removed in a future version of MySQL. Shared tablespaces include the InnoDB system tablespace and general tablespaces.

The `DATA DIRECTORY` clause is permitted with `CREATE TABLE ... TABLESPACE=innodb_file_per_table` but is otherwise not supported for use in combination with the `TABLESPACE` option.



#### Note

Support for `TABLESPACE = innodb_file_per_table` and `TABLESPACE = innodb_temporary` clauses with `CREATE TEMPORARY TABLE` is deprecated as of MySQL 5.7.24; expect it to be removed in a future version of MySQL.

The `STORAGE` table option is employed only with NDB tables. `STORAGE` determines the type of storage used, and can be either of `DISK` or `MEMORY`.

`TABLESPACE ... STORAGE DISK` assigns a table to an NDB Cluster Disk Data tablespace. `STORAGE DISK` cannot be used in `CREATE TABLE` unless preceded by `TABLESPACE tablespace_name`.

For `STORAGE MEMORY`, the tablespace name is optional, thus, you can use `TABLESPACE tablespace_name STORAGE MEMORY` or simply `STORAGE MEMORY` to specify explicitly that the table is in-memory.

See [Section 21.6.11, “NDB Cluster Disk Data Tables”](#), for more information.

- `UNION`

Used to access a collection of identical MyISAM tables as one. This works only with `MERGE` tables. See [Section 15.7, “The MERGE Storage Engine”](#).

You must have `SELECT`, `UPDATE`, and `DELETE` privileges for the tables you map to a `MERGE` table.



#### Note

Formerly, all tables used had to be in the same database as the `MERGE` table itself. This restriction no longer applies.

## Table Partitioning

`partition_options` can be used to control partitioning of the table created with `CREATE TABLE`.

Not all options shown in the syntax for `partition_options` at the beginning of this section are available for all partitioning types. Please see the listings for the following individual types for information specific to each type, and see [Chapter 22, Partitioning](#), for more complete information about the workings of and uses for partitioning in MySQL, as well as additional examples of table creation and other statements relating to MySQL partitioning.

Partitions can be modified, merged, added to tables, and dropped from tables. For basic information about the MySQL statements to accomplish these tasks, see [Section 13.1.8, “ALTER TABLE Statement”](#). For more detailed descriptions and examples, see [Section 22.3, “Partition Management”](#).

- [PARTITION BY](#)

If used, a *partition\_options* clause begins with [PARTITION BY](#). This clause contains the function that is used to determine the partition; the function returns an integer value ranging from 1 to *num*, where *num* is the number of partitions. (The maximum number of user-defined partitions which a table may contain is 1024; the number of subpartitions—discussed later in this section—is included in this maximum.)



### Note

The expression (*expr*) used in a [PARTITION BY](#) clause cannot refer to any columns not in the table being created; such references are specifically not permitted and cause the statement to fail with an error. (Bug #29444)

- [HASH\(\*expr\*\)](#)

Hashes one or more columns to create a key for placing and locating rows. *expr* is an expression using one or more table columns. This can be any valid MySQL expression (including MySQL functions) that yields a single integer value. For example, these are both valid [CREATE TABLE](#) statements using [PARTITION BY HASH](#):

```
CREATE TABLE t1 (col1 INT, col2 CHAR(5))
  PARTITION BY HASH(col1);

CREATE TABLE t1 (col1 INT, col2 CHAR(5), col3 DATETIME)
  PARTITION BY HASH ( YEAR(col3) );
```

You may not use either [VALUES LESS THAN](#) or [VALUES IN](#) clauses with [PARTITION BY HASH](#).

[PARTITION BY HASH](#) uses the remainder of *expr* divided by the number of partitions (that is, the modulus). For examples and additional information, see [Section 22.2.4, “HASH Partitioning”](#).

The [LINEAR](#) keyword entails a somewhat different algorithm. In this case, the number of the partition in which a row is stored is calculated as the result of one or more logical [AND](#) operations. For discussion and examples of linear hashing, see [Section 22.2.4.1, “LINEAR HASH Partitioning”](#).

- [KEY\(\*column\\_list\*\)](#)

This is similar to [HASH](#), except that MySQL supplies the hashing function so as to guarantee an even data distribution. The *column\_list* argument is simply a list of 1 or more table columns (maximum: 16). This example shows a simple table partitioned by key, with 4 partitions:

```
CREATE TABLE tk (col1 INT, col2 CHAR(5), col3 DATE)
  PARTITION BY KEY(col3)
  PARTITIONS 4;
```

For tables that are partitioned by key, you can employ linear partitioning by using the [LINEAR](#) keyword. This has the same effect as with tables that are partitioned by [HASH](#). That is, the partition number is found using the [&](#) operator rather than the modulus (see [Section 22.2.4.1, “LINEAR HASH Partitioning”](#), and [Section 22.2.5, “KEY Partitioning”](#), for details). This example uses linear partitioning by key to distribute data between 5 partitions:

```
CREATE TABLE tk (col1 INT, col2 CHAR(5), col3 DATE)
  PARTITION BY LINEAR KEY(col3)
  PARTITIONS 5;
```

The `ALGORITHM={1 | 2}` option is supported with `[SUB]PARTITION BY [LINEAR] KEY`. `ALGORITHM=1` causes the server to use the same key-hashing functions as MySQL 5.1; `ALGORITHM=2` means that the server employs the key-hashing functions used by default for new [KEY](#) partitioned tables

in MySQL 5.7 and later. Not specifying the option has the same effect as using `ALGORITHM=2`. This option is intended for use chiefly when upgrading `[LINEAR] KEY` partitioned tables from MySQL 5.1 to later MySQL versions. For more information, see [Section 13.1.8.1, “ALTER TABLE Partition Operations”](#).

`mysqldump` writes this option encased in versioned comments, like this:

```
CREATE TABLE t1 (a INT)
/*!50100 PARTITION BY KEY */ /*!50611 ALGORITHM = 1 */ /*!50100 (
PARTITIONS 3 */
```

This causes MySQL 5.6.10 and earlier servers to ignore the option, which would otherwise cause a syntax error in those versions.

`ALGORITHM=1` is shown when necessary in the output of `SHOW CREATE TABLE` using versioned comments in the same manner as `mysqldump`. `ALGORITHM=2` is always omitted from `SHOW CREATE TABLE` output, even if this option was specified when creating the original table.

You may not use either `VALUES LESS THAN` or `VALUES IN` clauses with `PARTITION BY KEY`.

- `RANGE(expr)`

In this case, `expr` shows a range of values using a set of `VALUES LESS THAN` operators. When using range partitioning, you must define at least one partition using `VALUES LESS THAN`. You cannot use `VALUES IN` with range partitioning.



#### Note

For tables partitioned by `RANGE`, `VALUES LESS THAN` must be used with either an integer literal value or an expression that evaluates to a single integer value. In MySQL 5.7, you can overcome this limitation in a table that is defined using `PARTITION BY RANGE COLUMNS`, as described later in this section.

Suppose that you have a table that you wish to partition on a column containing year values, according to the following scheme.

Partition Number:	Years Range:
0	1990 and earlier
1	1991 to 1994
2	1995 to 1998
3	1999 to 2002
4	2003 to 2005
5	2006 and later

A table implementing such a partitioning scheme can be realized by the `CREATE TABLE` statement shown here:

```
CREATE TABLE t1 (
  year_col INT,
  some_data INT
)
PARTITION BY RANGE (year_col) (
  PARTITION p0 VALUES LESS THAN (1991),
  PARTITION p1 VALUES LESS THAN (1995),
  PARTITION p2 VALUES LESS THAN (1999),
  PARTITION p3 VALUES LESS THAN (2002),
  PARTITION p4 VALUES LESS THAN (2006),
```

```

PARTITION p5 VALUES LESS THAN MAXVALUE
);

```

`PARTITION ... VALUES LESS THAN ...` statements work in a consecutive fashion. `VALUES LESS THAN MAXVALUE` works to specify “leftover” values that are greater than the maximum value otherwise specified.

`VALUES LESS THAN` clauses work sequentially in a manner similar to that of the `case` portions of a `switch ... case` block (as found in many programming languages such as C, Java, and PHP). That is, the clauses must be arranged in such a way that the upper limit specified in each successive `VALUES LESS THAN` is greater than that of the previous one, with the one referencing `MAXVALUE` coming last of all in the list.

- `RANGE COLUMNS(column_list)`

This variant on `RANGE` facilitates partition pruning for queries using range conditions on multiple columns (that is, having conditions such as `WHERE a = 1 AND b < 10` or `WHERE a = 1 AND b = 10 AND c < 10`). It enables you to specify value ranges in multiple columns by using a list of columns in the `COLUMNS` clause and a set of column values in each `PARTITION ... VALUES LESS THAN (value_list)` partition definition clause. (In the simplest case, this set consists of a single column.) The maximum number of columns that can be referenced in the `column_list` and `value_list` is 16.

The `column_list` used in the `COLUMNS` clause may contain only names of columns; each column in the list must be one of the following MySQL data types: the integer types; the string types; and time or date column types. Columns using `BLOB`, `TEXT`, `SET`, `ENUM`, `BIT`, or spatial data types are not permitted; columns that use floating-point number types are also not permitted. You also may not use functions or arithmetic expressions in the `COLUMNS` clause.

The `VALUES LESS THAN` clause used in a partition definition must specify a literal value for each column that appears in the `COLUMNS()` clause; that is, the list of values used for each `VALUES LESS THAN` clause must contain the same number of values as there are columns listed in the `COLUMNS` clause. An attempt to use more or fewer values in a `VALUES LESS THAN` clause than there are in the `COLUMNS` clause causes the statement to fail with the error `Inconsistency in usage of column lists for partitioning...` You cannot use `NULL` for any value appearing in `VALUES LESS THAN`. It is possible to use `MAXVALUE` more than once for a given column other than the first, as shown in this example:

```

CREATE TABLE rc (
  a INT NOT NULL,
  b INT NOT NULL
)
PARTITION BY RANGE COLUMNS(a,b) (
  PARTITION p0 VALUES LESS THAN (10,5),
  PARTITION p1 VALUES LESS THAN (20,10),
  PARTITION p2 VALUES LESS THAN (50,MAXVALUE),
  PARTITION p3 VALUES LESS THAN (65,MAXVALUE),
  PARTITION p4 VALUES LESS THAN (MAXVALUE,MAXVALUE)
);

```

Each value used in a `VALUES LESS THAN` value list must match the type of the corresponding column exactly; no conversion is made. For example, you cannot use the string `'1'` for a value that matches a column that uses an integer type (you must use the numeral `1` instead), nor can you use the numeral `1` for a value that matches a column that uses a string type (in such a case, you must use a quoted string: `'1'`).

For more information, see [Section 22.2.1, “RANGE Partitioning”](#), and [Section 22.4, “Partition Pruning”](#).

- `LIST(expr)`

This is useful when assigning partitions based on a table column with a restricted set of possible values, such as a state or country code. In such a case, all rows pertaining to a certain state or country can be assigned to a single partition, or a partition can be reserved for a certain set of states or countries. It is similar to `RANGE`, except that only `VALUES IN` may be used to specify permissible values for each partition.

`VALUES IN` is used with a list of values to be matched. For instance, you could create a partitioning scheme such as the following:

```
CREATE TABLE client_firms (
  id INT,
  name VARCHAR(35)
)
PARTITION BY LIST (id) (
  PARTITION r0 VALUES IN (1, 5, 9, 13, 17, 21),
  PARTITION r1 VALUES IN (2, 6, 10, 14, 18, 22),
  PARTITION r2 VALUES IN (3, 7, 11, 15, 19, 23),
  PARTITION r3 VALUES IN (4, 8, 12, 16, 20, 24)
);
```

When using list partitioning, you must define at least one partition using `VALUES IN`. You cannot use `VALUES LESS THAN` with `PARTITION BY LIST`.



#### Note

For tables partitioned by `LIST`, the value list used with `VALUES IN` must consist of integer values only. In MySQL 5.7, you can overcome this limitation using partitioning by `LIST COLUMNS`, which is described later in this section.

- `LIST COLUMNS(column_list)`

This variant on `LIST` facilitates partition pruning for queries using comparison conditions on multiple columns (that is, having conditions such as `WHERE a = 5 AND b = 5` or `WHERE a = 1 AND b = 10 AND c = 5`). It enables you to specify values in multiple columns by using a list of columns in the `COLUMNS` clause and a set of column values in each `PARTITION ... VALUES IN (value_list)` partition definition clause.

The rules governing regarding data types for the column list used in `LIST COLUMNS(column_list)` and the value list used in `VALUES IN(value_list)` are the same as those for the column list used in `RANGE COLUMNS(column_list)` and the value list used in `VALUES LESS THAN(value_list)`, respectively, except that in the `VALUES IN` clause, `MAXVALUE` is not permitted, and you may use `NULL`.

There is one important difference between the list of values used for `VALUES IN` with `PARTITION BY LIST COLUMNS` as opposed to when it is used with `PARTITION BY LIST`. When used with `PARTITION BY LIST COLUMNS`, each element in the `VALUES IN` clause must be a set of column values; the number of values in each set must be the same as the number of columns used in the `COLUMNS` clause, and the data types of these values must match those of the columns (and occur in the same order). In the simplest case, the set consists of a single column. The maximum number of columns that can be used in the `column_list` and in the elements making up the `value_list` is 16.

The table defined by the following `CREATE TABLE` statement provides an example of a table using `LIST COLUMNS` partitioning:

```
CREATE TABLE lc (
  a INT NULL,
  b INT NULL
)
```

```

PARTITION BY LIST COLUMNS(a,b) (
  PARTITION p0 VALUES IN( (0,0), (NULL,NULL) ),
  PARTITION p1 VALUES IN( (0,1), (0,2), (0,3), (1,1), (1,2) ),
  PARTITION p2 VALUES IN( (1,0), (2,0), (2,1), (3,0), (3,1) ),
  PARTITION p3 VALUES IN( (1,3), (2,2), (2,3), (3,2), (3,3) )
);

```

- `PARTITIONS num`

The number of partitions may optionally be specified with a `PARTITIONS num` clause, where `num` is the number of partitions. If both this clause *and* any `PARTITION` clauses are used, `num` must be equal to the total number of any partitions that are declared using `PARTITION` clauses.



#### Note

Whether or not you use a `PARTITIONS` clause in creating a table that is partitioned by `RANGE` or `LIST`, you must still include at least one `PARTITION VALUES` clause in the table definition (see below).

- `SUBPARTITION BY`

A partition may optionally be divided into a number of subpartitions. This can be indicated by using the optional `SUBPARTITION BY` clause. Subpartitioning may be done by `HASH` or `KEY`. Either of these may be `LINEAR`. These work in the same way as previously described for the equivalent partitioning types. (It is not possible to subpartition by `LIST` or `RANGE`.)

The number of subpartitions can be indicated using the `SUBPARTITIONS` keyword followed by an integer value.

- Rigorous checking of the value used in `PARTITIONS` or `SUBPARTITIONS` clauses is applied and this value must adhere to the following rules:
  - The value must be a positive, nonzero integer.
  - No leading zeros are permitted.
  - The value must be an integer literal, and cannot not be an expression. For example, `PARTITIONS 0.2E+01` is not permitted, even though `0.2E+01` evaluates to `2`. (Bug #15890)
- `partition_definition`

Each partition may be individually defined using a `partition_definition` clause. The individual parts making up this clause are as follows:

- `PARTITION partition_name`

Specifies a logical name for the partition.

- `VALUES`

For range partitioning, each partition must include a `VALUES LESS THAN` clause; for list partitioning, you must specify a `VALUES IN` clause for each partition. This is used to determine which rows are



to be stored in this partition. See the discussions of partitioning types in [Chapter 22, Partitioning](#), for syntax examples.

- `[STORAGE] ENGINE`

The partitioning handler accepts a `[STORAGE] ENGINE` option for both `PARTITION` and `SUBPARTITION`. Currently, the only way in which this can be used is to set all partitions or all subpartitions to the same storage engine, and an attempt to set different storage engines for partitions or subpartitions in the same table raises the error `ERROR 1469 (HY000): The mix of handlers in the partitions is not permitted in this version of MySQL`. We expect to lift this restriction on partitioning in a future MySQL release.

- `COMMENT`

An optional `COMMENT` clause may be used to specify a string that describes the partition. Example:

```
COMMENT = 'Data for the years previous to 1999'
```

The maximum length for a partition comment is 1024 characters.

- `DATA DIRECTORY` and `INDEX DIRECTORY`

`DATA DIRECTORY` and `INDEX DIRECTORY` may be used to indicate the directory where, respectively, the data and indexes for this partition are to be stored. Both the `data_dir` and the `index_dir` must be absolute system path names.

As of MySQL 5.7.17, you must have the `FILE` privilege to use the `DATA DIRECTORY` or `INDEX DIRECTORY` partition option.

Example:

```
CREATE TABLE th (id INT, name VARCHAR(30), adate DATE)
PARTITION BY LIST(YEAR(adate))
(
  PARTITION p1999 VALUES IN (1995, 1999, 2003)
    DATA DIRECTORY = '/var/appdata/95/data'
    INDEX DIRECTORY = '/var/appdata/95/idx',
  PARTITION p2000 VALUES IN (1996, 2000, 2004)
    DATA DIRECTORY = '/var/appdata/96/data'
    INDEX DIRECTORY = '/var/appdata/96/idx',
  PARTITION p2001 VALUES IN (1997, 2001, 2005)
    DATA DIRECTORY = '/var/appdata/97/data'
    INDEX DIRECTORY = '/var/appdata/97/idx',
  PARTITION p2002 VALUES IN (1998, 2002, 2006)
    DATA DIRECTORY = '/var/appdata/98/data'
    INDEX DIRECTORY = '/var/appdata/98/idx'
);
```

`DATA DIRECTORY` and `INDEX DIRECTORY` behave in the same way as in the `CREATE TABLE` statement's `table_option` clause as used for `MyISAM` tables.

One data directory and one index directory may be specified per partition. If left unspecified, the data and indexes are stored by default in the table's database directory.

On Windows, the `DATA DIRECTORY` and `INDEX DIRECTORY` options are not supported for individual partitions or subpartitions of `MyISAM` tables, and the `INDEX DIRECTORY` option is not supported for

individual partitions or subpartitions of [InnoDB](#) tables. These options are ignored on Windows, except that a warning is generated. (Bug #30459)



#### Note

The [DATA DIRECTORY](#) and [INDEX DIRECTORY](#) options are ignored for creating partitioned tables if [NO\\_DIR\\_IN\\_CREATE](#) is in effect. (Bug #24633)

- [MAX\\_ROWS](#) and [MIN\\_ROWS](#)

May be used to specify, respectively, the maximum and minimum number of rows to be stored in the partition. The values for *max\_number\_of\_rows* and *min\_number\_of\_rows* must be positive integers. As with the table-level options with the same names, these act only as “suggestions” to the server and are not hard limits.

- [TABLESPACE](#)

May be used to designate a tablespace for the partition. Supported by NDB Cluster. For [InnoDB](#) tables, it may be used to designate a file-per-table tablespace for the partition by specifying `TABLESPACE `innodb_file_per_table``. All partitions must belong to the same storage engine.



#### Note

Support for placing [InnoDB](#) table partitions in shared [InnoDB](#) tablespaces is deprecated in MySQL 5.7.24; expect it to be removed in a future MySQL version. Shared tablespaces include the [InnoDB](#) system tablespace and general tablespaces.

- *subpartition\_definition*

The partition definition may optionally contain one or more *subpartition\_definition* clauses. Each of these consists at a minimum of the `SUBPARTITION name`, where *name* is an identifier for the subpartition. Except for the replacement of the `PARTITION` keyword with `SUBPARTITION`, the syntax for a subpartition definition is identical to that for a partition definition.

Subpartitioning must be done by [HASH](#) or [KEY](#), and can be done only on [RANGE](#) or [LIST](#) partitions. See [Section 22.2.6](#), “Subpartitioning”.

### Partitioning by Generated Columns

Partitioning by generated columns is permitted. For example:

```
CREATE TABLE t1 (
  s1 INT,
  s2 INT AS (EXP(s1)) STORED
)
PARTITION BY LIST (s2) (
  PARTITION p1 VALUES IN (1)
);
```

Partitioning sees a generated column as a regular column, which enables workarounds for limitations on functions that are not permitted for partitioning (see [Section 22.6.3](#), “Partitioning Limitations Relating to Functions”). The preceding example demonstrates this technique: `EXP()` cannot be used directly in the `PARTITION BY` clause, but a generated column defined using `EXP()` is permitted.

### 13.1.18.1 Files Created by CREATE TABLE

MySQL represents each table by an `.frm` table format (definition) file in the database directory. The storage engine for the table might create other files as well.

For an [InnoDB](#) table created in a file-per-table tablespace or general tablespace, table data and associated indexes are stored in a [.ibd file](#) in the database directory. When an [InnoDB](#) table is created in the system tablespace, table data and indexes are stored in the [ibdata\\* files](#) that represent the system tablespace. The [innodb\\_file\\_per\\_table](#) option controls whether tables are created in file-per-table tablespaces or the system tablespace, by default. The [TABLESPACE](#) option can be used to place a table in a file-per-table tablespace, general tablespace, or the system tablespace, regardless of the [innodb\\_file\\_per\\_table](#) setting.

For [MyISAM](#) tables, the storage engine creates data and index files. Thus, for each [MyISAM](#) table *tbl\_name*, there are three disk files.

File	Purpose
<i>tbl_name.frm</i>	Table format (definition) file
<i>tbl_name.MYD</i>	Data file
<i>tbl_name.MYI</i>	Index file

[Chapter 15, Alternative Storage Engines](#), describes what files each storage engine creates to represent tables. If a table name contains special characters, the names for the table files contain encoded versions of those characters as described in [Section 9.2.4, “Mapping of Identifiers to File Names”](#).

### Limits Imposed by .frm File Structure

As described previously, each table has an [.frm](#) file that contains the table definition. The server uses the following expression to check some of the table information stored in the file against an upper limit of 64KB:

```
if (info_length+(ulong) create_fields.elements*FCOMP+288+
    n_length+int_length+com_length > 65535L || int_count > 255)
```

The portion of the information stored in the [.frm](#) file that is checked against the expression cannot grow beyond the 64KB limit, so if the table definition reaches this size, no more columns can be added.

The relevant factors in the expression are:

- [info\\_length](#) is space needed for “screens.” This is related to MySQL's Unireg heritage.
- [create\\_fields.elements](#) is the number of columns.
- [FCOMP](#) is 17.
- [n\\_length](#) is the total length of all column names, including one byte per name as a separator.
- [int\\_length](#) is related to the list of values for [ENUM](#) and [SET](#) columns. In this context, “int” does not mean “integer.” It means “interval,” a term that refers collectively to [ENUM](#) and [SET](#) columns.
- [int\\_count](#) is the number of unique [ENUM](#) and [SET](#) definitions.
- [com\\_length](#) is the total length of column comments.

The expression just described has several implications for permitted table definitions:

- Using long column names can reduce the maximum number of columns, as can the inclusion of [ENUM](#) or [SET](#) columns, or use of column comments.
- A table can have no more than 255 unique [ENUM](#) and [SET](#) definitions. Columns with identical element lists are considered the same against this limit. For example, if a table contains these two columns, they count as one (not two) toward this limit because the definitions are identical:

```
e1 ENUM('a','b','c')
```

```
e2 ENUM('a','b','c')
```

- The sum of the length of element names in the unique `ENUM` and `SET` definitions counts toward the 64KB limit, so although the theoretical limit on number of elements in a given `ENUM` column is 65,535, the practical limit is less than 3000.

### 13.1.18.2 CREATE TEMPORARY TABLE Statement

You can use the `TEMPORARY` keyword when creating a table. A `TEMPORARY` table is visible only within the current session, and is dropped automatically when the session is closed. This means that two different sessions can use the same temporary table name without conflicting with each other or with an existing non-`TEMPORARY` table of the same name. (The existing table is hidden until the temporary table is dropped.)

`CREATE TABLE` causes an implicit commit, except when used with the `TEMPORARY` keyword. See [Section 13.3.3, “Statements That Cause an Implicit Commit”](#).

`TEMPORARY` tables have a very loose relationship with databases (schemas). Dropping a database does not automatically drop any `TEMPORARY` tables created within that database. Also, you can create a `TEMPORARY` table in a nonexistent database if you qualify the table name with the database name in the `CREATE TABLE` statement. In this case, all subsequent references to the table must be qualified with the database name.

To create a temporary table, you must have the `CREATE TEMPORARY TABLES` privilege. After a session has created a temporary table, the server performs no further privilege checks on the table. The creating session can perform any operation on the table, such as `DROP TABLE`, `INSERT`, `UPDATE`, or `SELECT`.

One implication of this behavior is that a session can manipulate its temporary tables even if the current user has no privilege to create them. Suppose that the current user does not have the `CREATE TEMPORARY TABLES` privilege but is able to execute a definer-context stored procedure that executes with the privileges of a user who does have `CREATE TEMPORARY TABLES` and that creates a temporary table. While the procedure executes, the session uses the privileges of the defining user. After the procedure returns, the effective privileges revert to those of the current user, which can still see the temporary table and perform any operation on it.



#### Note

Support for `TABLESPACE = innodb_file_per_table` and `TABLESPACE = innodb_temporary` clauses with `CREATE TEMPORARY TABLE` is deprecated as of MySQL 5.7.24; expect it to be removed in a future version of MySQL.

### 13.1.18.3 CREATE TABLE ... LIKE Statement

Use `CREATE TABLE ... LIKE` to create an empty table based on the definition of another table, including any column attributes and indexes defined in the original table:

```
CREATE TABLE new_tbl LIKE orig_tbl;
```

The copy is created using the same version of the table storage format as the original table. The `SELECT` privilege is required on the original table.

`LIKE` works only for base tables, not for views.



#### Important

You cannot execute `CREATE TABLE` or `CREATE TABLE ... LIKE` while a `LOCK TABLES` statement is in effect.

`CREATE TABLE ... LIKE` makes the same checks as `CREATE TABLE` and does not just copy the `.frm` file. This means that, if the current SQL mode is different from the mode in effect when the original table was created, the table definition might be considered invalid for the new mode, and the statement fails.

For `CREATE TABLE ... LIKE`, the destination table preserves generated column information from the original table.

`CREATE TABLE ... LIKE` does not preserve any `DATA DIRECTORY` or `INDEX DIRECTORY` table options that were specified for the original table, or any foreign key definitions.

If the original table is a `TEMPORARY` table, `CREATE TABLE ... LIKE` does not preserve `TEMPORARY`. To create a `TEMPORARY` destination table, use `CREATE TEMPORARY TABLE ... LIKE`.

### 13.1.18.4 CREATE TABLE ... SELECT Statement

You can create one table from another by adding a `SELECT` statement at the end of the `CREATE TABLE` statement:

```
CREATE TABLE new_tbl [AS] SELECT * FROM orig_tbl;
```

MySQL creates new columns for all elements in the `SELECT`. For example:

```
mysql> CREATE TABLE test (a INT NOT NULL AUTO_INCREMENT,
->     PRIMARY KEY (a), KEY(b))
->     ENGINE=InnoDB SELECT b,c FROM test2;
```

This creates an `InnoDB` table with three columns, `a`, `b`, and `c`. The `ENGINE` option is part of the `CREATE TABLE` statement, and should not be used following the `SELECT`; this would result in a syntax error. The same is true for other `CREATE TABLE` options such as `CHARSET`.

Notice that the columns from the `SELECT` statement are appended to the right side of the table, not overlapped onto it. Take the following example:

```
mysql> SELECT * FROM foo;
+----+
| n |
+----+
| 1 |
+----+

mysql> CREATE TABLE bar (m INT) SELECT n FROM foo;
Query OK, 1 row affected (0.02 sec)
Records: 1 Duplicates: 0 Warnings: 0

mysql> SELECT * FROM bar;
+-----+-----+
| m     | n |
+-----+-----+
| NULL  | 1 |
+-----+-----+
1 row in set (0.00 sec)
```

For each row in table `foo`, a row is inserted in `bar` with the values from `foo` and default values for the new columns.

In a table resulting from `CREATE TABLE ... SELECT`, columns named only in the `CREATE TABLE` part come first. Columns named in both parts or only in the `SELECT` part come after that. The data type of `SELECT` columns can be overridden by also specifying the column in the `CREATE TABLE` part.

If any errors occur while copying the data to the table, it is automatically dropped and not created.

You can precede the `SELECT` by `IGNORE` or `REPLACE` to indicate how to handle rows that duplicate unique key values. With `IGNORE`, rows that duplicate an existing row on a unique key value are discarded. With `REPLACE`, new rows replace rows that have the same unique key value. If neither `IGNORE` nor `REPLACE` is specified, duplicate unique key values result in an error. For more information, see [The Effect of IGNORE on Statement Execution](#).

Because the ordering of the rows in the underlying `SELECT` statements cannot always be determined, `CREATE TABLE ... IGNORE SELECT` and `CREATE TABLE ... REPLACE SELECT` statements are flagged as unsafe for statement-based replication. Such statements produce a warning in the error log when using statement-based mode and are written to the binary log using the row-based format when using `MIXED` mode. See also [Section 16.2.1.1, “Advantages and Disadvantages of Statement-Based and Row-Based Replication”](#).

`CREATE TABLE ... SELECT` does not automatically create any indexes for you. This is done intentionally to make the statement as flexible as possible. If you want to have indexes in the created table, you should specify these before the `SELECT` statement:

```
mysql> CREATE TABLE bar (UNIQUE (n)) SELECT n FROM foo;
```

For `CREATE TABLE ... SELECT`, the destination table does not preserve information about whether columns in the selected-from table are generated columns. The `SELECT` part of the statement cannot assign values to generated columns in the destination table.

Some conversion of data types might occur. For example, the `AUTO_INCREMENT` attribute is not preserved, and `VARCHAR` columns can become `CHAR` columns. Retrained attributes are `NULL` (or `NOT NULL`) and, for those columns that have them, `CHARACTER SET`, `COLLATION`, `COMMENT`, and the `DEFAULT` clause.

When creating a table with `CREATE TABLE ... SELECT`, make sure to alias any function calls or expressions in the query. If you do not, the `CREATE` statement might fail or result in undesirable column names.

```
CREATE TABLE artists_and_works
  SELECT artist.name, COUNT(work.artist_id) AS number_of_works
  FROM artist LEFT JOIN work ON artist.id = work.artist_id
  GROUP BY artist.id;
```

You can also explicitly specify the data type for a column in the created table:

```
CREATE TABLE foo (a TINYINT NOT NULL) SELECT b+1 AS a FROM bar;
```

For `CREATE TABLE ... SELECT`, if `IF NOT EXISTS` is given and the target table exists, nothing is inserted into the destination table, and the statement is not logged.

To ensure that the binary log can be used to re-create the original tables, MySQL does not permit concurrent inserts during `CREATE TABLE ... SELECT`.

You cannot use `FOR UPDATE` as part of the `SELECT` in a statement such as `CREATE TABLE new_table SELECT ... FROM old_table ...`. If you attempt to do so, the statement fails.

### 13.1.18.5 FOREIGN KEY Constraints

MySQL supports foreign keys, which permit cross-referencing related data across tables, and foreign key constraints, which help keep the related data consistent.

A foreign key relationship involves a parent table that holds the initial column values, and a child table with column values that reference the parent column values. A foreign key constraint is defined on the child table.

The essential syntax for defining a foreign key constraint in a `CREATE TABLE` or `ALTER TABLE` statement includes the following:

```
[CONSTRAINT [symbol]] FOREIGN KEY
  [index_name] (col_name, ...)
  REFERENCES tbl_name (col_name,...)
  [ON DELETE reference_option]
  [ON UPDATE reference_option]

reference_option:
  RESTRICT | CASCADE | SET NULL | NO ACTION | SET DEFAULT
```

Foreign key constraint usage is described under the following topics in this section:

- [Identifiers](#)
- [Conditions and Restrictions](#)
- [Referential Actions](#)
- [Foreign Key Constraint Examples](#)
- [Adding Foreign Key Constraints](#)
- [Dropping Foreign Key Constraints](#)
- [Foreign Key Checks](#)
- [Foreign Key Definitions and Metadata](#)
- [Foreign Key Errors](#)

## Identifiers

Foreign key constraint naming is governed by the following rules:

- The `CONSTRAINT symbol` value is used, if defined.
- If the `CONSTRAINT symbol` clause is not defined, or a symbol is not included following the `CONSTRAINT` keyword:
  - For `InnoDB` tables, a constraint name is generated automatically.
  - For `NDB` tables, the `FOREIGN KEY index_name` value is used, if defined. Otherwise, a constraint name is generated automatically.
- The `CONSTRAINT symbol` value, if defined, must be unique in the database. A duplicate `symbol` results in an error similar to: `ERROR 1005 (HY000): Can't create table 'test.fk1' (errno: 121)`.

Table and column identifiers in a `FOREIGN KEY ... REFERENCES` clause can be quoted within backticks (```). Alternatively, double quotation marks (`"`) can be used if the `ANSI_QUOTES` SQL mode is enabled. The `lower_case_table_names` system variable setting is also taken into account.

## Conditions and Restrictions

Foreign key constraints are subject to the following conditions and restrictions:

- Parent and child tables must use the same storage engine, and they cannot be defined as temporary tables.

- Creating a foreign key constraint requires the [REFERENCES](#) privilege on the parent table.
- Corresponding columns in the foreign key and the referenced key must have similar data types. *The size and sign of fixed precision types such as [INTEGER](#) and [DECIMAL](#) must be the same.* The length of string types need not be the same. For nonbinary (character) string columns, the character set and collation must be the same.
- MySQL supports foreign key references between one column and another within a table. (A column cannot have a foreign key reference to itself.) In these cases, a “child table record” refers to a dependent record within the same table.
- MySQL requires indexes on foreign keys and referenced keys so that foreign key checks can be fast and not require a table scan. In the referencing table, there must be an index where the foreign key columns are listed as the *first* columns in the same order. Such an index is created on the referencing table automatically if it does not exist. This index might be silently dropped later if you create another index that can be used to enforce the foreign key constraint. *index\_name*, if given, is used as described previously.
- [InnoDB](#) permits a foreign key to reference any index column or group of columns. However, in the referenced table, there must be an index where the referenced columns are the *first* columns in the same order. Hidden columns that [InnoDB](#) adds to an index are also considered (see [Section 14.6.2.1, “Clustered and Secondary Indexes”](#)).

[NDB](#) requires an explicit unique key (or primary key) on any column referenced as a foreign key. [InnoDB](#) does not, which is an extension of standard SQL.

- Index prefixes on foreign key columns are not supported. Consequently, [BLOB](#) and [TEXT](#) columns cannot be included in a foreign key because indexes on those columns must always include a prefix length.
- [InnoDB](#) does not currently support foreign keys for tables with user-defined partitioning. This includes both parent and child tables.

This restriction does not apply for [NDB](#) tables that are partitioned by [KEY](#) or [LINEAR KEY](#) (the only user partitioning types supported by the [NDB](#) storage engine); these may have foreign key references or be the targets of such references.

- A table in a foreign key relationship cannot be altered to use another storage engine. To change the storage engine, you must drop any foreign key constraints first.
- A foreign key constraint cannot reference a virtual generated column.
- Prior to 5.7.16, a foreign key constraint cannot reference a secondary index defined on a virtual generated column.

For information about how the MySQL implementation of foreign key constraints differs from the SQL standard, see [Section 1.6.2.3, “FOREIGN KEY Constraint Differences”](#).

## Referential Actions

When an [UPDATE](#) or [DELETE](#) operation affects a key value in the parent table that has matching rows in the child table, the result depends on the *referential action* specified by [ON UPDATE](#) and [ON DELETE](#) subclauses of the [FOREIGN KEY](#) clause. Referential actions include:

- [CASCADE](#): Delete or update the row from the parent table and automatically delete or update the matching rows in the child table. Both [ON DELETE CASCADE](#) and [ON UPDATE CASCADE](#) are supported.



Between two tables, do not define several `ON UPDATE CASCADE` clauses that act on the same column in the parent table or in the child table.

If a `FOREIGN KEY` clause is defined on both tables in a foreign key relationship, making both tables a parent and child, an `ON UPDATE CASCADE` or `ON DELETE CASCADE` subclause defined for one `FOREIGN KEY` clause must be defined for the other in order for cascading operations to succeed. If an `ON UPDATE CASCADE` or `ON DELETE CASCADE` subclause is only defined for one `FOREIGN KEY` clause, cascading operations fail with an error.



#### Note

Cascaded foreign key actions do not activate triggers.

- `SET NULL`: Delete or update the row from the parent table and set the foreign key column or columns in the child table to `NULL`. Both `ON DELETE SET NULL` and `ON UPDATE SET NULL` clauses are supported.

If you specify a `SET NULL` action, *make sure that you have not declared the columns in the child table as `NOT NULL`.*

- `RESTRICT`: Rejects the delete or update operation for the parent table. Specifying `RESTRICT` (or `NO ACTION`) is the same as omitting the `ON DELETE` or `ON UPDATE` clause.
- `NO ACTION`: A keyword from standard SQL. For `InnoDB`, this is equivalent to `RESTRICT`; the delete or update operation for the parent table is immediately rejected if there is a related foreign key value in the referenced table. `NDB` supports deferred checks, and `NO ACTION` specifies a deferred check; when this is used, constraint checks are not performed until commit time. Note that for `NDB` tables, this causes all foreign key checks made for both parent and child tables to be deferred.
- `SET DEFAULT`: This action is recognized by the MySQL parser, but both `InnoDB` and `NDB` reject table definitions containing `ON DELETE SET DEFAULT` or `ON UPDATE SET DEFAULT` clauses.

For storage engines that support foreign keys, MySQL rejects any `INSERT` or `UPDATE` operation that attempts to create a foreign key value in a child table if there is no matching candidate key value in the parent table.

For an `ON DELETE` or `ON UPDATE` that is not specified, the default action is always `RESTRICT`.

For `NDB` tables, `ON UPDATE CASCADE` is not supported where the reference is to the parent table's primary key.

As of `NDB 7.5.14` and `NDB 7.6.10`: For `NDB` tables, `ON DELETE CASCADE` is not supported where the child table contains one or more columns of any of the `TEXT` or `BLOB` types. (Bug #89511, Bug #27484882)

`InnoDB` performs cascading operations using a depth-first search algorithm on the records of the index that corresponds to the foreign key constraint.

A foreign key constraint on a stored generated column cannot use `CASCADE`, `SET NULL`, or `SET DEFAULT` as `ON UPDATE` referential actions, nor can it use `SET NULL` or `SET DEFAULT` as `ON DELETE` referential actions.

A foreign key constraint on the base column of a stored generated column cannot use `CASCADE`, `SET NULL`, or `SET DEFAULT` as `ON UPDATE` or `ON DELETE` referential actions.

In MySQL 5.7.13 and earlier, `InnoDB` does not permit defining a foreign key constraint with a cascading referential action on the `base column` of an indexed virtual generated column. This restriction is lifted in MySQL 5.7.14.

In MySQL 5.7.13 and earlier, [InnoDB](#) does not permit defining cascading referential actions on non-virtual foreign key columns that are explicitly included in a [virtual index](#). This restriction is lifted in MySQL 5.7.14.

## Foreign Key Constraint Examples

This simple example relates [parent](#) and [child](#) tables through a single-column foreign key:

```
CREATE TABLE parent (  
  id INT NOT NULL,  
  PRIMARY KEY (id)  
) ENGINE=INNODB;  
  
CREATE TABLE child (  
  id INT,  
  parent_id INT,  
  INDEX par_ind (parent_id),  
  FOREIGN KEY (parent_id)  
    REFERENCES parent(id)  
    ON DELETE CASCADE  
) ENGINE=INNODB;
```

This is a more complex example in which a [product\\_order](#) table has foreign keys for two other tables. One foreign key references a two-column index in the [product](#) table. The other references a single-column index in the [customer](#) table:

```
CREATE TABLE product (  
  category INT NOT NULL, id INT NOT NULL,  
  price DECIMAL,  
  PRIMARY KEY(category, id)  
) ENGINE=INNODB;  
  
CREATE TABLE customer (  
  id INT NOT NULL,  
  PRIMARY KEY (id)  
) ENGINE=INNODB;  
  
CREATE TABLE product_order (  
  no INT NOT NULL AUTO_INCREMENT,  
  product_category INT NOT NULL,  
  product_id INT NOT NULL,  
  customer_id INT NOT NULL,  
  
  PRIMARY KEY(no),  
  INDEX (product_category, product_id),  
  INDEX (customer_id),  
  
  FOREIGN KEY (product_category, product_id)  
    REFERENCES product(category, id)  
    ON UPDATE CASCADE ON DELETE RESTRICT,  
  
  FOREIGN KEY (customer_id)  
    REFERENCES customer(id)  
) ENGINE=INNODB;
```

## Adding Foreign Key Constraints

You can add a foreign key constraint to an existing table using the following [ALTER TABLE](#) syntax:

```
ALTER TABLE tbl_name  
  ADD [CONSTRAINT [symbol]] FOREIGN KEY  
  [index_name] (col_name, ...)  
  REFERENCES tbl_name (col_name,...)  
  [ON DELETE reference_option]  
  [ON UPDATE reference_option]
```

The foreign key can be self referential (referring to the same table). When you add a foreign key constraint to a table using `ALTER TABLE`, remember to first create an index on the column(s) referenced by the foreign key.

## Dropping Foreign Key Constraints

You can drop a foreign key constraint using the following `ALTER TABLE` syntax:

```
ALTER TABLE tbl_name DROP FOREIGN KEY fk_symbol;
```

If the `FOREIGN KEY` clause defined a `CONSTRAINT` name when you created the constraint, you can refer to that name to drop the foreign key constraint. Otherwise, a constraint name was generated internally, and you must use that value. To determine the foreign key constraint name, use `SHOW CREATE TABLE`:

```
mysql> SHOW CREATE TABLE child\G
***** 1. row *****
      Table: child
Create Table: CREATE TABLE `child` (
  `id` int(11) DEFAULT NULL,
  `parent_id` int(11) DEFAULT NULL,
  KEY `par_ind` (`parent_id`),
  CONSTRAINT `child_ibfk_1` FOREIGN KEY (`parent_id`)
  REFERENCES `parent` (`id`) ON DELETE CASCADE
) ENGINE=InnoDB DEFAULT CHARSET=latin1

mysql> ALTER TABLE child DROP FOREIGN KEY `child_ibfk_1`;
```

Adding and dropping a foreign key in the same `ALTER TABLE` statement is supported for `ALTER TABLE ... ALGORITHM=INPLACE`. It is not supported for `ALTER TABLE ... ALGORITHM=COPY`.

## Foreign Key Checks

In MySQL, InnoDB and NDB tables support checking of foreign key constraints. Foreign key checking is controlled by the `foreign_key_checks` variable, which is enabled by default. Typically, you leave this variable enabled during normal operation to enforce referential integrity. The `foreign_key_checks` variable has the same effect on NDB tables as it does for InnoDB tables.

The `foreign_key_checks` variable is dynamic and supports both global and session scopes. For information about using system variables, see [Section 5.1.8, “Using System Variables”](#).

Disabling foreign key checking is useful when:

- Dropping a table that is referenced by a foreign key constraint. A referenced table can only be dropped after `foreign_key_checks` is disabled. When you drop a table, constraints defined on the table are also dropped.
- Reloading tables in different order than required by their foreign key relationships. For example, `mysqldump` produces correct definitions of tables in the dump file, including foreign key constraints for child tables. To make it easier to reload dump files for tables with foreign key relationships, `mysqldump` automatically includes a statement in the dump output that disables `foreign_key_checks`. This enables you to import the tables in any order in case the dump file contains tables that are not correctly ordered for foreign keys. Disabling `foreign_key_checks` also speeds up the import operation by avoiding foreign key checks.
- Executing `LOAD DATA` operations, to avoid foreign key checking.
- Performing an `ALTER TABLE` operation on a table that has a foreign key relationship.

When `foreign_key_checks` is disabled, foreign key constraints are ignored, with the following exceptions:

- Recreating a table that was previously dropped returns an error if the table definition does not conform to the foreign key constraints that reference the table. The table must have the correct column names and types. It must also have indexes on the referenced keys. If these requirements are not satisfied, MySQL returns Error 1005 that refers to errno: 150 in the error message, which means that a foreign key constraint was not correctly formed.
- Altering a table returns an error (errno: 150) if a foreign key definition is incorrectly formed for the altered table.
- Dropping an index required by a foreign key constraint. The foreign key constraint must be removed before dropping the index.
- Creating a foreign key constraint where a column references a nonmatching column type.

Disabling `foreign_key_checks` has these additional implications:

- It is permitted to drop a database that contains tables with foreign keys that are referenced by tables outside the database.
- It is permitted to drop a table with foreign keys referenced by other tables.
- Enabling `foreign_key_checks` does not trigger a scan of table data, which means that rows added to a table while `foreign_key_checks` is disabled are not checked for consistency when `foreign_key_checks` is re-enabled.

## Foreign Key Definitions and Metadata

To view a foreign key definition, use `SHOW CREATE TABLE`:

```
mysql> SHOW CREATE TABLE child\G
***** 1. row *****
      Table: child
Create Table: CREATE TABLE `child` (
  `id` int(11) DEFAULT NULL,
  `parent_id` int(11) DEFAULT NULL,
  KEY `par_ind` (`parent_id`),
  CONSTRAINT `child_ibfk_1` FOREIGN KEY (`parent_id`)
    REFERENCES `parent` (`id`) ON DELETE CASCADE
) ENGINE=InnoDB DEFAULT CHARSET=latin1
```

You can obtain information about foreign keys from the Information Schema `KEY_COLUMN_USAGE` table. An example of a query against this table is shown here:

```
mysql> SELECT TABLE_SCHEMA, TABLE_NAME, COLUMN_NAME, CONSTRAINT_NAME
FROM INFORMATION_SCHEMA.KEY_COLUMN_USAGE
WHERE REFERENCED_TABLE_SCHEMA IS NOT NULL;
+-----+-----+-----+-----+
| TABLE_SCHEMA | TABLE_NAME | COLUMN_NAME | CONSTRAINT_NAME |
+-----+-----+-----+-----+
| test          | child       | parent_id   | child_ibfk_1    |
+-----+-----+-----+-----+
```

You can obtain information specific to InnoDB foreign keys from the `INNODB_SYS_FOREIGN` and `INNODB_SYS_FOREIGN_COLS` tables. Example queries are show here:

```
mysql> SELECT * FROM INFORMATION_SCHEMA.INNODB_SYS_FOREIGN \G
***** 1. row *****
      ID: test/child_ibfk_1
FOR_NAME: test/child
REF_NAME: test/parent
```

```

N_COLS: 1
TYPE: 1

mysql> SELECT * FROM INFORMATION_SCHEMA.INNO_DB_SYS_FOREIGN_COLS \G
***** 1. row *****
          ID: test/child_ibfk_1
FOR_COL_NAME: parent_id
REF_COL_NAME: id
          POS: 0

```

## Foreign Key Errors

In the event of a foreign key error involving [InnoDB](#) tables (usually Error 150 in the MySQL Server), information about the latest foreign key error can be obtained by checking [SHOW ENGINE INNODB STATUS](#) output.

```

mysql> SHOW ENGINE INNODB STATUS\G
...
-----
LATEST FOREIGN KEY ERROR
-----
2014-10-16 18:35:18 0x7fc2a95c1700 Transaction:
TRANSACTION 1814, ACTIVE 0 sec inserting
mysql tables in use 1, locked 1
4 lock struct(s), heap size 1136, 3 row lock(s), undo log entries 3
MySQL thread id 2, OS thread handle 140474041767680, query id 74 localhost
root update
INSERT INTO child VALUES
  (NULL, 1)
  , (NULL, 2)
  , (NULL, 3)
  , (NULL, 4)
  , (NULL, 5)
  , (NULL, 6)
Foreign key constraint fails for table `mysql`.`child`:
'
  CONSTRAINT `child_ibfk_1` FOREIGN KEY (`parent_id`) REFERENCES `parent`
  (`id`) ON DELETE CASCADE ON UPDATE CASCADE
Trying to add in child table, in index par_ind tuple:
DATA TUPLE: 2 fields;
  0: len 4; hex 80000003; asc      ;;
  1: len 4; hex 80000003; asc      ;;

But in parent table `mysql`.`parent`, in index PRIMARY,
the closest match we can find is record:
PHYSICAL RECORD: n_fields 3; compact format; info bits 0
  0: len 4; hex 80000004; asc      ;;
  1: len 6; hex 00000000070a; asc    ;;
  2: len 7; hex aa0000011d0134; asc    4;;
...

```



### Warning

[ER\\_NO\\_REFERENCED\\_ROW\\_2](#) and [ER\\_ROW\\_IS\\_REFERENCED\\_2](#) error messages for foreign key operations expose information about parent tables, even if the user has no parent table access privileges. To hide information about parent tables, include the appropriate condition handlers in application code and stored programs.

## 13.1.18.6 Silent Column Specification Changes

In some cases, MySQL silently changes column specifications from those given in a [CREATE TABLE](#) or [ALTER TABLE](#) statement. These might be changes to a data type, to attributes associated with a data type, or to an index specification.

All changes are subject to the internal row-size limit of 65,535 bytes, which may cause some attempts at data type changes to fail. See [Section 8.4.7, “Limits on Table Column Count and Row Size”](#).

- Columns that are part of a [PRIMARY KEY](#) are made [NOT NULL](#) even if not declared that way.
- Trailing spaces are automatically deleted from [ENUM](#) and [SET](#) member values when the table is created.
- MySQL maps certain data types used by other SQL database vendors to MySQL types. See [Section 11.9, “Using Data Types from Other Database Engines”](#).
- If you include a [USING](#) clause to specify an index type that is not permitted for a given storage engine, but there is another index type available that the engine can use without affecting query results, the engine uses the available type.
- If strict SQL mode is not enabled, a [VARCHAR](#) column with a length specification greater than 65535 is converted to [TEXT](#), and a [VARBINARY](#) column with a length specification greater than 65535 is converted to [BLOB](#). Otherwise, an error occurs in either of these cases.
- Specifying the [CHARACTER SET binary](#) attribute for a character data type causes the column to be created as the corresponding binary data type: [CHAR](#) becomes [BINARY](#), [VARCHAR](#) becomes [VARBINARY](#), and [TEXT](#) becomes [BLOB](#). For the [ENUM](#) and [SET](#) data types, this does not occur; they are created as declared. Suppose that you specify a table using this definition:

```
CREATE TABLE t
(
  c1 VARCHAR(10) CHARACTER SET binary,
  c2 TEXT CHARACTER SET binary,
  c3 ENUM('a','b','c') CHARACTER SET binary
);
```

The resulting table has this definition:

```
CREATE TABLE t
(
  c1 VARBINARY(10),
  c2 BLOB,
  c3 ENUM('a','b','c') CHARACTER SET binary
);
```

To see whether MySQL used a data type other than the one you specified, issue a [DESCRIBE](#) or [SHOW CREATE TABLE](#) statement after creating or altering the table.

Certain other data type changes can occur if you compress a table using [myisampack](#). See [Section 15.2.3.3, “Compressed Table Characteristics”](#).

### 13.1.18.7 CREATE TABLE and Generated Columns

[CREATE TABLE](#) supports the specification of generated columns. Values of a generated column are computed from an expression included in the column definition.

Generated columns are supported by the [NDB](#) storage engine beginning with MySQL NDB Cluster 7.5.3.

The following simple example shows a table that stores the lengths of the sides of right triangles in the [sidea](#) and [sideb](#) columns, and computes the length of the hypotenuse in [sidec](#) (the square root of the sums of the squares of the other sides):

```
CREATE TABLE triangle (
  sidea DOUBLE,
  sideb DOUBLE,
```

```

    sidec DOUBLE AS (SQRT(sidea * sidea + sideb * sideb))
  );
INSERT INTO triangle (sidea, sideb) VALUES(1,1),(3,4),(6,8);

```

Selecting from the table yields this result:

```

mysql> SELECT * FROM triangle;
+-----+-----+-----+
| sidea | sideb | sidec |
+-----+-----+-----+
| 1     | 1     | 1.4142135623730951 |
| 3     | 4     | 5 |
| 6     | 8     | 10 |
+-----+-----+-----+

```

Any application that uses the `triangle` table has access to the hypotenuse values without having to specify the expression that calculates them.

Generated column definitions have this syntax:

```

col_name data_type [GENERATED ALWAYS] AS (expr)
  [VIRTUAL | STORED] [NOT NULL | NULL]
  [UNIQUE [KEY]] [[PRIMARY] KEY]
  [COMMENT 'string']

```

`AS (expr)` indicates that the column is generated and defines the expression used to compute column values. `AS` may be preceded by `GENERATED ALWAYS` to make the generated nature of the column more explicit. Constructs that are permitted or prohibited in the expression are discussed later.

The `VIRTUAL` or `STORED` keyword indicates how column values are stored, which has implications for column use:

- **VIRTUAL:** Column values are not stored, but are evaluated when rows are read, immediately after any `BEFORE` triggers. A virtual column takes no storage.

`InnoDB` supports secondary indexes on virtual columns. See [Section 13.1.18.8, “Secondary Indexes and Generated Columns”](#).

- **STORED:** Column values are evaluated and stored when rows are inserted or updated. A stored column does require storage space and can be indexed.

The default is `VIRTUAL` if neither keyword is specified.

It is permitted to mix `VIRTUAL` and `STORED` columns within a table.

Other attributes may be given to indicate whether the column is indexed or can be `NULL`, or provide a comment.

Generated column expressions must adhere to the following rules. An error occurs if an expression contains disallowed constructs.

- Literals, deterministic built-in functions, and operators are permitted. A function is deterministic if, given the same data in tables, multiple invocations produce the same result, independently of the connected user. Examples of functions that are nondeterministic and fail this definition: `CONNECTION_ID()`, `CURRENT_USER()`, `NOW()`.
- Stored functions and loadable functions are not permitted.
- Stored procedure and function parameters are not permitted.

- Variables (system variables, user-defined variables, and stored program local variables) are not permitted.
- Subqueries are not permitted.
- A generated column definition can refer to other generated columns, but only those occurring earlier in the table definition. A generated column definition can refer to any base (nongenerated) column in the table whether its definition occurs earlier or later.
- The `AUTO_INCREMENT` attribute cannot be used in a generated column definition.
- An `AUTO_INCREMENT` column cannot be used as a base column in a generated column definition.
- As of MySQL 5.7.10, if expression evaluation causes truncation or provides incorrect input to a function, the `CREATE TABLE` statement terminates with an error and the DDL operation is rejected.

If the expression evaluates to a data type that differs from the declared column type, implicit coercion to the declared type occurs according to the usual MySQL type-conversion rules. See [Section 12.3, “Type Conversion in Expression Evaluation”](#).



#### Note

If any component of the expression depends on the SQL mode, different results may occur for different uses of the table unless the SQL mode is the same during all uses.

For `CREATE TABLE ... LIKE`, the destination table preserves generated column information from the original table.

For `CREATE TABLE ... SELECT`, the destination table does not preserve information about whether columns in the selected-from table are generated columns. The `SELECT` part of the statement cannot assign values to generated columns in the destination table.

Partitioning by generated columns is permitted. See [Table Partitioning](#).

A foreign key constraint on a stored generated column cannot use `CASCADE`, `SET NULL`, or `SET DEFAULT` as `ON UPDATE` referential actions, nor can it use `SET NULL` or `SET DEFAULT` as `ON DELETE` referential actions.

A foreign key constraint on the base column of a stored generated column cannot use `CASCADE`, `SET NULL`, or `SET DEFAULT` as `ON UPDATE` or `ON DELETE` referential actions.

A foreign key constraint cannot reference a virtual generated column.

Triggers cannot use `NEW.col_name` or use `OLD.col_name` to refer to generated columns.

For `INSERT`, `REPLACE`, and `UPDATE`, if a generated column is inserted into, replaced, or updated explicitly, the only permitted value is `DEFAULT`.

A generated column in a view is considered updatable because it is possible to assign to it. However, if such a column is updated explicitly, the only permitted value is `DEFAULT`.

Generated columns have several use cases, such as these:

- Virtual generated columns can be used as a way to simplify and unify queries. A complicated condition can be defined as a generated column and referred to from multiple queries on the table to ensure that all of them use exactly the same condition.



- Stored generated columns can be used as a materialized cache for complicated conditions that are costly to calculate on the fly.
- Generated columns can simulate functional indexes: Use a generated column to define a functional expression and index it. This can be useful for working with columns of types that cannot be indexed directly, such as [JSON](#) columns; see [Indexing a Generated Column to Provide a JSON Column Index](#), for a detailed example.

For stored generated columns, the disadvantage of this approach is that values are stored twice; once as the value of the generated column and once in the index.

- If a generated column is indexed, the optimizer recognizes query expressions that match the column definition and uses indexes from the column as appropriate during query execution, even if a query does not refer to the column directly by name. For details, see [Section 8.3.10, “Optimizer Use of Generated Column Indexes”](#).

Example:

Suppose that a table `t1` contains `first_name` and `last_name` columns and that applications frequently construct the full name using an expression like this:

```
SELECT CONCAT(first_name, ' ', last_name) AS full_name FROM t1;
```

One way to avoid writing out the expression is to create a view `v1` on `t1`, which simplifies applications by enabling them to select `full_name` directly without using an expression:

```
CREATE VIEW v1 AS
SELECT *, CONCAT(first_name, ' ', last_name) AS full_name FROM t1;

SELECT full_name FROM v1;
```

A generated column also enables applications to select `full_name` directly without the need to define a view:

```
CREATE TABLE t1 (
  first_name VARCHAR(10),
  last_name VARCHAR(10),
  full_name VARCHAR(255) AS (CONCAT(first_name, ' ', last_name))
);

SELECT full_name FROM t1;
```

### 13.1.18.8 Secondary Indexes and Generated Columns

[InnoDB](#) supports secondary indexes on virtual generated columns. Other index types are not supported. A secondary index defined on a virtual column is sometimes referred to as a “virtual index”.

A secondary index may be created on one or more virtual columns or on a combination of virtual columns and regular columns or stored generated columns. Secondary indexes that include virtual columns may be defined as [UNIQUE](#).

When a secondary index is created on a virtual generated column, generated column values are materialized in the records of the index. If the index is a [covering index](#) (one that includes all the columns retrieved by a query), generated column values are retrieved from materialized values in the index structure instead of computed “on the fly”.

There are additional write costs to consider when using a secondary index on a virtual column due to computation performed when materializing virtual column values in secondary index records during [INSERT](#) and [UPDATE](#) operations. Even with additional write costs, secondary indexes on virtual columns

may be preferable to generated *stored* columns, which are materialized in the clustered index, resulting in larger tables that require more disk space and memory. If a secondary index is not defined on a virtual column, there are additional costs for reads, as virtual column values must be computed each time the column's row is examined.

Values of an indexed virtual column are MVCC-logged to avoid unnecessary recomputation of generated column values during rollback or during a purge operation. The data length of logged values is limited by the index key limit of 767 bytes for **COMPACT** and **REDUNDANT** row formats, and 3072 bytes for **DYNAMIC** and **COMPRESSED** row formats.

Adding or dropping a secondary index on a virtual column is an in-place operation.

Prior to 5.7.16, a foreign key constraint cannot reference a secondary index defined on a virtual generated column.

In MySQL 5.7.13 and earlier, **InnoDB** does not permit defining a foreign key constraint with a cascading referential action on the base column of an indexed generated virtual column. This restriction is lifted in MySQL 5.7.14.

## Indexing a Generated Column to Provide a JSON Column Index

As noted elsewhere, **JSON** columns cannot be indexed directly. To create an index that references such a column indirectly, you can define a generated column that extracts the information that should be indexed, then create an index on the generated column, as shown in this example:

```
mysql> CREATE TABLE jemp (
->   c JSON,
->   g INT GENERATED ALWAYS AS (c->"$.id"),
->   INDEX i (g)
-> );
Query OK, 0 rows affected (0.28 sec)

mysql> INSERT INTO jemp (c) VALUES
>   ('{"id": "1", "name": "Fred"}'), ('{"id": "2", "name": "Wilma"}'),
>   ('{"id": "3", "name": "Barney"}'), ('{"id": "4", "name": "Betty"}');
Query OK, 4 rows affected (0.04 sec)
Records: 4 Duplicates: 0 Warnings: 0

mysql> SELECT c->>"$.name" AS name
>   FROM jemp WHERE g > 2;
+-----+
| name  |
+-----+
| Barney|
| Betty |
+-----+
2 rows in set (0.00 sec)

mysql> EXPLAIN SELECT c->>"$.name" AS name
>   FROM jemp WHERE g > 2\G
***** 1. row *****
      id: 1
select_type: SIMPLE
      table: jemp
  partitions: NULL
      type: range
possible_keys: i
      key: i
      key_len: 5
      ref: NULL
      rows: 2
  filtered: 100.00
  Extra: Using where
```

```

1 row in set, 1 warning (0.00 sec)

mysql> SHOW WARNINGS\G
***** 1. row *****
Level: Note
Code: 1003
Message: /* select#1 */ select json_unquote(json_extract(`test`.`jemp`.`c`, '$.name'))
AS `name` from `test`.`jemp` where (`test`.`jemp`.`g` > 2)
1 row in set (0.00 sec)

```

(We have wrapped the output from the last statement in this example to fit the viewing area.)

The `->` operator is supported in MySQL 5.7.9 and later. The `->>` operator is supported beginning with MySQL 5.7.13.

When you use `EXPLAIN` on a `SELECT` or other SQL statement containing one or more expressions that use the `->` or `->>` operator, these expressions are translated into their equivalents using `JSON_EXTRACT()` and (if needed) `JSON_UNQUOTE()` instead, as shown here in the output from `SHOW WARNINGS` immediately following this `EXPLAIN` statement:

```

mysql> EXPLAIN SELECT c->>"$.name"
> FROM jemp WHERE g > 2 ORDER BY c->"$.name"\G
***** 1. row *****
id: 1
select_type: SIMPLE
table: jemp
partitions: NULL
type: range
possible_keys: i
key: i
key_len: 5
ref: NULL
rows: 2
filtered: 100.00
Extra: Using where; Using filesort
1 row in set, 1 warning (0.00 sec)

mysql> SHOW WARNINGS\G
***** 1. row *****
Level: Note
Code: 1003
Message: /* select#1 */ select json_unquote(json_extract(`test`.`jemp`.`c`, '$.name')) AS
`c->>"$.name"` from `test`.`jemp` where (`test`.`jemp`.`g` > 2) order by
json_extract(`test`.`jemp`.`c`, '$.name')
1 row in set (0.00 sec)

```

See the descriptions of the `->` and `->>` operators, as well as those of the `JSON_EXTRACT()` and `JSON_UNQUOTE()` functions, for additional information and examples.

This technique also can be used to provide indexes that indirectly reference columns of other types that cannot be indexed directly, such as `GEOMETRY` columns.

## JSON columns and indirect indexing in NDB Cluster

It is also possible to use indirect indexing of JSON columns in MySQL NDB Cluster, subject to the following conditions:

1. NDB handles a JSON column value internally as a BLOB. This means that any NDB table having one or more JSON columns must have a primary key, else it cannot be recorded in the binary log.
2. The NDB storage engine does not support indexing of virtual columns. Since the default for generated columns is `VIRTUAL`, you must specify explicitly the generated column to which to apply the indirect index as `STORED`.

The **CREATE TABLE** statement used to create the table `jempn` shown here is a version of the `jemp` table shown previously, with modifications making it compatible with **NDB**:

```
CREATE TABLE jempn (
  a BIGINT(20) NOT NULL AUTO_INCREMENT PRIMARY KEY,
  c JSON DEFAULT NULL,
  g INT GENERATED ALWAYS AS (c->"$.name") STORED,
  INDEX i (g)
) ENGINE=NDB;
```

We can populate this table using the following **INSERT** statement:

```
INSERT INTO jempn (a, c) VALUES
(NULL, '{"id": "1", "name": "Fred"}'),
(NULL, '{"id": "2", "name": "Wilma"}'),
(NULL, '{"id": "3", "name": "Barney"}'),
(NULL, '{"id": "4", "name": "Betty"}');
```

Now **NDB** can use index `i`, as shown here:

```
mysql> EXPLAIN SELECT c->"$.name" AS name
      FROM jempn WHERE g > 2\G
***** 1. row *****
      id: 1
      select_type: SIMPLE
      table: jempn
      partitions: p0,p1
      type: range
possible_keys: i
      key: i
      key_len: 5
      ref: NULL
      rows: 3
      filtered: 100.00
      Extra: Using where with pushed condition (`test`.`jempn`.`g` > 2)
1 row in set, 1 warning (0.00 sec)

mysql> SHOW WARNINGS\G
***** 1. row *****
      Level: Note
      Code: 1003
      Message: /* select#1 */ select
      json_unquote(json_extract(`test`.`jempn`.`c`, '$.name')) AS `name` from
      `test`.`jempn` where (`test`.`jempn`.`g` > 2)
1 row in set (0.00 sec)
```

You should keep in mind that a stored generated column, as well as any index on such a column, uses **DataMemory**. In **NDB 7.5**, an index on a stored generated column also uses **IndexMemory**.

### 13.1.18.9 Setting NDB Comment Options

- [NDB\\_COLUMN Options](#)
- [NDB\\_TABLE Options](#)

It is possible to set a number of options specific to **NDB Cluster** in the table comment or column comments of an **NDB** table. Table-level options for controlling read from any replica and partition balance can be embedded in a table comment using **NDB\_TABLE**.

**NDB\_COLUMN** can be used in a column comment to set the size of the blob parts table column used for storing parts of blob values by **NDB** to its maximum. This works for **BLOB**, **MEDIUMBLOB**, **LONGBLOB**, **TEXT**, **MEDIUMTEXT**, **LONGTEXT**, and **JSON** columns.

`NDB_TABLE` can be used in a table comment to set options relating to partition balance and whether the table is fully replicated, among others.

The remainder of this section describes these options and their use.

## NDB\_COLUMN Options

In NDB Cluster, a column comment in a `CREATE TABLE` or `ALTER TABLE` statement can also be used to specify an `NDB_COLUMN` option. NDB 7.5 and 7.6 support a single column comment option `MAX_BLOB_PART_SIZE`; syntax for this option is shown here:

```
COMMENT 'NDB_COLUMN=MAX_BLOB_PART_SIZE[={0|1}]'
```

The `=` sign and the value following it are optional. Using any value other than 0 or 1 results in a syntax error.

The effect of using `MAX_BLOB_PART_SIZE` in a column comment is to set the blob part size of a `TEXT` or `BLOB` column to the maximum number of bytes supported for this by NDB (13948). This option can be applied to any blob column type supported by MySQL except `TINYBLOB` or `TINYTEXT` (`BLOB`, `MEDIUMBLOB`, `LONGBLOB`, `TEXT`, `MEDIUMTEXT`, `LONGTEXT`). `MAX_BLOB_PART_SIZE` has no effect on `JSON` columns.

You should also keep in mind, especially when working with `TEXT` columns, that the value set by `MAX_BLOB_PART_SIZE` represents column size in bytes. It does not indicate the number of characters, which varies according to the character set and collation used by the column.

To see the effects of this option, we first run the following SQL statement in the `mysql` client to create a table with two `BLOB` columns, one (`c1`) with no extra options, and another (`c2`) with `MAX_BLOB_PART_SIZE`:

```
mysql> CREATE TABLE test.t (
->   p INT PRIMARY KEY,
->   c1 BLOB,
->   c2 BLOB COMMENT 'NDB_COLUMN=MAX_BLOB_PART_SIZE'
-> ) ENGINE NDB;
Query OK, 0 rows affected (0.32 sec)
```

From the system shell, run the `ndb_desc` utility to obtain information about the table just created, as shown in this example:

```
$> ndb_desc -d test t
-- t --
Version: 1
Fragment type: HashMapPartition
K Value: 6
Min load factor: 78
Max load factor: 80
Temporary table: no
Number of attributes: 3
Number of primary keys: 1
Length of frm data: 324
Row Checksum: 1
Row GCI: 1
SingleUserMode: 0
ForceVarPart: 1
FragmentCount: 2
ExtraRowGciBits: 0
ExtraRowAuthorBits: 0
TableStatus: Retrieved
HashMap: DEFAULT-HASHMAP-3840-2
-- Attributes --
```

## CREATE TABLE Statement

```
p Int PRIMARY KEY DISTRIBUTION KEY AT=FIXED ST=MEMORY
c1 Blob(256,2000,0) NULL AT=MEDIUM_VAR ST=MEMORY BV=2 BT=NDB$BLOB_22_1
c2 Blob(256,13948,0) NULL AT=MEDIUM_VAR ST=MEMORY BV=2 BT=NDB$BLOB_22_2
-- Indexes --
PRIMARY KEY(p) - UniqueHashIndex
PRIMARY(p) - OrderedIndex
```

Column information in the output is listed under [Attributes](#); for columns `c1` and `c2` it is displayed here in emphasized text. For `c1`, the blob part size is 2000, the default value; for `c2`, it is 13948, as set by [MAX\\_BLOB\\_PART\\_SIZE](#).

You can change the blob part size for a given blob column of an [NDB](#) table using an [ALTER TABLE](#) statement such as this one, and verifying the changes afterwards using [SHOW CREATE TABLE](#):

```
mysql> ALTER TABLE test.t
-> DROP COLUMN c1,
-> ADD COLUMN c1 BLOB COMMENT 'NDB_COLUMN=MAX_BLOB_PART_SIZE',
-> CHANGE COLUMN c2 c2 BLOB AFTER c1;
Query OK, 0 rows affected (0.47 sec)
Records: 0 Duplicates: 0 Warnings: 0

mysql> SHOW CREATE TABLE test.t\G
***** 1. row *****
      Table: t
Create Table: CREATE TABLE `t` (
  `p` int(11) NOT NULL,
  `c1` blob COMMENT 'NDB_COLUMN=MAX_BLOB_PART_SIZE',
  `c2` blob,
  PRIMARY KEY (`p`)
) ENGINE=ndbcluster DEFAULT CHARSET=latin1
1 row in set (0.00 sec)

mysql> EXIT
Bye
```

The output of `ndb_desc` shows that the blob part sizes of the columns have been changed as expected:

```
$> ndb_desc -d test t
-- t --
Version: 16777220
Fragment type: HashMapPartition
K Value: 6
Min load factor: 78
Max load factor: 80
Temporary table: no
Number of attributes: 3
Number of primary keys: 1
Length of frm data: 324
Row Checksum: 1
Row GCI: 1
SingleUserMode: 0
ForceVarPart: 1
FragmentCount: 2
ExtraRowGciBits: 0
ExtraRowAuthorBits: 0
TableStatus: Retrieved
HashMap: DEFAULT-HASHMAP-3840-2
-- Attributes --
p Int PRIMARY KEY DISTRIBUTION KEY AT=FIXED ST=MEMORY
c1 Blob(256,13948,0) NULL AT=MEDIUM_VAR ST=MEMORY BV=2 BT=NDB$BLOB_26_1
c2 Blob(256,2000,0) NULL AT=MEDIUM_VAR ST=MEMORY BV=2 BT=NDB$BLOB_26_2
-- Indexes --
PRIMARY KEY(p) - UniqueHashIndex
PRIMARY(p) - OrderedIndex

NDBT_ProgramExit: 0 - OK
```

Changing a column's blob part size must be done using a copying `ALTER TABLE`; this operation cannot be performed online (see [Section 21.6.12, “Online Operations with ALTER TABLE in NDB Cluster”](#)).

For more information about how NDB stores columns of blob types, see [String Type Storage Requirements](#).

## NDB\_TABLE Options

For an NDB Cluster table, the table comment in a `CREATE TABLE` or `ALTER TABLE` statement can also be used to specify an `NDB_TABLE` option, which consists of one or more name-value pairs, separated by commas if need be, following the string `NDB_TABLE=`. Complete syntax for names and values syntax is shown here:

```
COMMENT="NDB_TABLE=ndb_table_option[,ndb_table_option[,...]]"

ndb_table_option: {
  NOLOGGING={1 | 0}
  | READ_BACKUP={1 | 0}
  | PARTITION_BALANCE={FOR_RP_BY_NODE | FOR_RA_BY_NODE | FOR_RP_BY_LDM
                       | FOR_RA_BY_LDM | FOR_RA_BY_LDM_X_2
                       | FOR_RA_BY_LDM_X_3 | FOR_RA_BY_LDM_X_4}
  | FULLY_REPLICATED={1 | 0}
}
```

Spaces are not permitted within the quoted string. The string is case-insensitive.

The four NDB table options that can be set as part of a comment in this way are described in more detail in the next few paragraphs.

**NOLOGGING:** By default, NDB tables are logged, and checkpointed. This makes them durable to whole cluster failures. Using `NOLOGGING` when creating or altering a table means that this table is not redo logged or included in local checkpoints. In this case, the table is still replicated across the data nodes for high availability, and updated using transactions, but changes made to it are not recorded in the data node's redo logs, and its content is not checkpointed to disk; when recovering from a cluster failure, the cluster retains the table definition, but none of its rows—that is, the table is empty.

Using such nonlogging tables reduces the data node's demands on disk I/O and storage, as well as CPU for checkpointing CPU. This may be suitable for short-lived data which is frequently updated, and where the loss of all data in the unlikely event of a total cluster failure is acceptable.

It is also possible to use the `ndb_table_no_logging` system variable to cause any NDB tables created or altered while this variable is in effect to behave as though it had been created with the `NOLOGGING` comment. Unlike when using the comment directly, there is nothing in this case in the output of `SHOW CREATE TABLE` to indicate that it is a nonlogging table. Using the table comment approach is recommended since it offers per-table control of the feature, and this aspect of the table schema is embedded in the table creation statement where it can be found easily by SQL-based tools.

**READ\_BACKUP:** Setting this option to 1 has the same effect as though `ndb_read_backup` were enabled; enables reading from any replica. Doing so greatly improves the performance of reads from the table at a relatively small cost to write performance.

Starting with MySQL NDB Cluster 7.5.3, you can set `READ_BACKUP` for an existing table online (Bug #80858, Bug #23001617), using an `ALTER TABLE` statement similar to one of those shown here:

```
ALTER TABLE ... ALGORITHM=INPLACE, COMMENT="NDB_TABLE=READ_BACKUP=1";
ALTER TABLE ... ALGORITHM=INPLACE, COMMENT="NDB_TABLE=READ_BACKUP=0";
```

Prior to MySQL NDB Cluster 7.5.4, setting `READ_BACKUP` to 1 also caused `FRAGMENT_COUNT_TYPE` to be set to `ONE_PER_LDM_PER_NODE_GROUP`.

For more information about the `ALGORITHM` option for `ALTER TABLE`, see [Section 21.6.12, “Online Operations with ALTER TABLE in NDB Cluster”](#).

`PARTITION_BALANCE`: Provides additional control over assignment and placement of partitions. The following four schemes are supported:

1. `FOR_RP_BY_NODE`: One partition per node.

Only one LDM on each node stores a primary partition. Each partition is stored in the same LDM (same ID) on all nodes.

2. `FOR_RA_BY_NODE`: One partition per node group.

Each node stores a single partition, which can be either a primary replica or a backup replica. Each partition is stored in the same LDM on all nodes.

3. `FOR_RP_BY_LDM`: One partition for each LDM on each node; the default.

This is the same behavior as prior to MySQL NDB Cluster 7.5.2, except for a slightly different mapping of partitions to LDMs, starting with LDM 0 and placing one partition per node group, then moving on to the next LDM.

In MySQL NDB Cluster 7.5.4 and later, this is the setting used if `READ_BACKUP` is set to 1. (Bug #82634, Bug #24482114)

4. `FOR_RA_BY_LDM`: One partition per LDM in each node group.

These partitions can be primary or backup partitions.

Prior to MySQL NDB Cluster 7.5.4, this was the setting used if `READ_BACKUP` was set to 1.

5. `FOR_RA_BY_LDM_X_2`: Two partitions per LDM in each node group.

These partitions can be primary or backup partitions.

This setting was added in NDB 7.5.4.

6. `FOR_RA_BY_LDM_X_3`: Three partitions per LDM in each node group.

These partitions can be primary or backup partitions.

This setting was added in NDB 7.5.4.

7. `FOR_RA_BY_LDM_X_4`: Four partitions per LDM in each node group.

These partitions can be primary or backup partitions.

This setting was added in NDB 7.5.4.

Beginning with NDB 7.5.4, `PARTITION_BALANCE` is the preferred interface for setting the number of partitions per table. Using `MAX_ROWS` to force the number of partitions is deprecated as of NDB 7.5.4, continues to be supported in NDB 7.6 for backward compatibility, but is subject to removal in a future release of MySQL NDB Cluster. (Bug #81759, Bug #23544301)

Prior to MySQL NDB Cluster 7.5.4, `PARTITION_BALANCE` was named `FRAGMENT_COUNT_TYPE`, and accepted as its value one of (in the same order as that of the listing just shown) `ONE_PER_NODE`, `ONE_PER_NODE_GROUP`, `ONE_PER_LDM_PER_NODE`, or `ONE_PER_LDM_PER_NODE_GROUP`. (Bug #81761, Bug #23547525)



`FULLY_REPLICATED` controls whether the table is fully replicated, that is, whether each data node has a complete copy of the table. To enable full replication of the table, use `FULLY_REPLICATED=1`.

This setting can also be controlled using the `ndb_fully_replicated` system variable. Setting it to `ON` enables the option by default for all new `NDB` tables; the default is `OFF`, which maintains the previous behavior (as in MySQL NDB Cluster 7.5.1 and earlier, before support for fully replicated tables was introduced). The `ndb_data_node_neighbour` system variable is also used for fully replicated tables, to ensure that when a fully replicated table is accessed, we access the data node which is local to this MySQL Server.

An example of a `CREATE TABLE` statement using such a comment when creating an `NDB` table is shown here:

```
mysql> CREATE TABLE t1 (
>   c1 INT NOT NULL AUTO_INCREMENT PRIMARY KEY,
>   c2 VARCHAR(100),
>   c3 VARCHAR(100) )
> ENGINE=NDB
>
COMMENT="NDB_TABLE=READ_BACKUP=0,PARTITION_BALANCE=FOR_RP_BY_NODE";
```

The comment is displayed as part of the output of `SHOW CREATE TABLE`. The text of the comment is also available from querying the MySQL Information Schema `TABLES` table, as in this example:

```
mysql> SELECT TABLE_NAME, TABLE_SCHEMA, TABLE_COMMENT
> FROM INFORMATION_SCHEMA.TABLES WHERE TABLE_NAME="t1"\G
***** 1. row *****
TABLE_NAME: t1
TABLE_SCHEMA: test
TABLE_COMMENT: NDB_TABLE=READ_BACKUP=0,PARTITION_BALANCE=FOR_RP_BY_NODE
1 row in set (0.01 sec)
```

This comment syntax is also supported with `ALTER TABLE` statements for `NDB` tables, as shown here:

```
mysql> ALTER TABLE t1 COMMENT="NDB_TABLE=PARTITION_BALANCE=FOR_RA_BY_NODE";
Query OK, 0 rows affected (0.40 sec)
Records: 0 Duplicates: 0 Warnings: 0
```

Beginning with `NDB 7.6.15`, the `TABLE_COMMENT` column displays the comment that is required to re-create the table as it is following the `ALTER TABLE` statement, like this:

```
mysql> SELECT TABLE_NAME, TABLE_SCHEMA, TABLE_COMMENT
-> FROM INFORMATION_SCHEMA.TABLES WHERE TABLE_NAME="t1"\G
***** 1. row *****
TABLE_NAME: t1
TABLE_SCHEMA: test
TABLE_COMMENT: NDB_TABLE=READ_BACKUP=0,PARTITION_BALANCE=FOR_RP_BY_NODE
1 row in set (0.01 sec)
```

```
mysql> SELECT TABLE_NAME, TABLE_SCHEMA, TABLE_COMMENT
> FROM INFORMATION_SCHEMA.TABLES WHERE TABLE_NAME="t1";
+-----+-----+-----+
| TABLE_NAME | TABLE_SCHEMA | TABLE_COMMENT |
+-----+-----+-----+
| t1          | c              | NDB_TABLE=PARTITION_BALANCE=FOR_RA_BY_NODE |
| t1          | d              | |
+-----+-----+-----+
2 rows in set (0.01 sec)
```

Keep in mind that a table comment used with `ALTER TABLE` replaces any existing comment which the table might have.

```
mysql> ALTER TABLE t1 COMMENT="NDB_TABLE=PARTITION_BALANCE=FOR_RA_BY_NODE";
Query OK, 0 rows affected (0.40 sec)
```

```
Records: 0 Duplicates: 0 Warnings: 0
```

```
mysql> SELECT TABLE_NAME, TABLE_SCHEMA, TABLE_COMMENT
> FROM INFORMATION_SCHEMA.TABLES WHERE TABLE_NAME="t1";
```

TABLE_NAME	TABLE_SCHEMA	TABLE_COMMENT
t1	c	NDB_TABLE=PARTITION_BALANCE=FOR_RA_BY_NODE
t1	d	

2 rows in set (0.01 sec)

Prior to NDB 7.6.15, the table comment used with `ALTER TABLE` replaced any existing comment which the table might have had. This meant that (for example) the `READ_BACKUP` value was not carried over to the new comment set by the `ALTER TABLE` statement, and that any unspecified values reverted to their defaults. (BUG#30428829) There was thus no longer any way using SQL to retrieve the value previously set for the comment. To keep comment values from reverting to their defaults, it was necessary to preserve any such values from the existing comment string and include them in the comment passed to `ALTER TABLE`.

You can also see the value of the `PARTITION_BALANCE` option in the output of `ndb_desc`. `ndb_desc` also shows whether the `READ_BACKUP` and `FULLY_REPLICATED` options are set for the table. See the description of this program for more information.

### 13.1.19 CREATE TABLESPACE Statement

```
CREATE TABLESPACE tablespace_name

InnoDB and NDB:
  ADD DATAFILE 'file_name'

InnoDB only:
  [FILE_BLOCK_SIZE = value]

NDB only:
  USE LOGFILE GROUP logfile_group
  [EXTENT_SIZE [=] extent_size]
  [INITIAL_SIZE [=] initial_size]
  [AUTOEXTEND_SIZE [=] autoextend_size]
  [MAX_SIZE [=] max_size]
  [NODEGROUP [=] nodegroup_id]
  [WAIT]
  [COMMENT [=] 'string']

InnoDB and NDB:
  [ENGINE [=] engine_name]
```

This statement is used to create a tablespace. The precise syntax and semantics depend on the storage engine used. In standard MySQL 5.7 releases, this is always an `InnoDB` tablespace. MySQL NDB Cluster 7.5 also supports tablespaces using the `NDB` storage engine in addition to those using `InnoDB`.

- [Considerations for InnoDB](#)
- [Considerations for NDB Cluster](#)
- [Options](#)
- [Notes](#)
- [InnoDB Examples](#)
- [NDB Example](#)

## Considerations for InnoDB

`CREATE TABLESPACE` syntax is used to create general tablespaces. A general tablespace is a shared tablespace. It can hold multiple tables, and supports all table row formats. General tablespaces can be created in a location relative to or independent of the data directory.

After creating an InnoDB general tablespace, you can use `CREATE TABLE tbl_name ... TABLESPACE [=] tablespace_name` or `ALTER TABLE tbl_name TABLESPACE [=] tablespace_name` to add tables to the tablespace. For more information, see [Section 14.6.3.3, “General Tablespaces”](#).

## Considerations for NDB Cluster

This statement is used to create a tablespace, which can contain one or more data files, providing storage space for NDB Cluster Disk Data tables (see [Section 21.6.11, “NDB Cluster Disk Data Tables”](#)). One data file is created and added to the tablespace using this statement. Additional data files may be added to the tablespace by using the `ALTER TABLESPACE` statement (see [Section 13.1.9, “ALTER TABLESPACE Statement”](#)).



### Note

All NDB Cluster Disk Data objects share the same namespace. This means that *each Disk Data object* must be uniquely named (and not merely each Disk Data object of a given type). For example, you cannot have a tablespace and a log file group with the same name, or a tablespace and a data file with the same name.

A log file group of one or more `UNDO` log files must be assigned to the tablespace to be created with the `USE LOGFILE GROUP` clause. `logfile_group` must be an existing log file group created with `CREATE LOGFILE GROUP` (see [Section 13.1.15, “CREATE LOGFILE GROUP Statement”](#)). Multiple tablespaces may use the same log file group for `UNDO` logging.

When setting `EXTENT_SIZE` or `INITIAL_SIZE`, you may optionally follow the number with a one-letter abbreviation for an order of magnitude, similar to those used in `my.cnf`. Generally, this is one of the letters `M` (for megabytes) or `G` (for gigabytes).

`INITIAL_SIZE` and `EXTENT_SIZE` are subject to rounding as follows:

- `EXTENT_SIZE` is rounded up to the nearest whole multiple of 32K.
- `INITIAL_SIZE` is rounded *down* to the nearest whole multiple of 32K; this result is rounded up to the nearest whole multiple of `EXTENT_SIZE` (after any rounding).



### Note

NDB reserves 4% of a tablespace for data node restart operations. This reserved space cannot be used for data storage. This restriction applies beginning with NDB 7.6.

The rounding just described is done explicitly, and a warning is issued by the MySQL Server when any such rounding is performed. The rounded values are also used by the NDB kernel for calculating Information Schema `FILES` column values and other purposes. However, to avoid an unexpected result, we suggest that you always use whole multiples of 32K in specifying these options.

When `CREATE TABLESPACE` is used with `ENGINE [=] NDB`, a tablespace and associated data file are created on each Cluster data node. You can verify that the data files were created and obtain information about them by querying the Information Schema `FILES` table. (See the example later in this section.)

(See [Section 24.3.9, “The INFORMATION\\_SCHEMA FILES Table”](#).)

## Options

- **ADD DATAFILE:** Defines the name of a tablespace data file; this option is always required. The *file\_name*, including any specified path, must be quoted with single or double quotation marks. File names (not counting the file extension) and directory names must be at least one byte in length. Zero length file names and directory names are not supported.

Because there are considerable differences in how **InnoDB** and **NDB** treat data files, the two storage engines are covered separately in the discussion that follows.

**InnoDB data files.** An **InnoDB** tablespace supports only a single data file, whose name must include a `.ibd` extension.

For an **InnoDB** tablespace, the data file is created by default in the MySQL data directory (`datadir`). To place the data file in a location other than the default, include an absolute directory path or a path relative to the default location.

When an **InnoDB** tablespace is created outside of the data directory, an `isl` file is created in the data directory. To avoid conflicts with implicitly created file-per-table tablespaces, creating an **InnoDB** general tablespace in a subdirectory under the data directory is not supported. When creating an **InnoDB** general tablespace outside of the data directory, the directory must exist prior to creating the tablespace.



### Note

In MySQL 5.7, `ALTER TABLESPACE` is not supported by **InnoDB**.

**NDB data files.** An **NDB** tablespace supports multiple data files which can have any legal file names; more data files can be added to an **NDB** Cluster tablespace following its creation by using an `ALTER TABLESPACE` statement.

An **NDB** tablespace data file is created by default in the data node file system directory—that is, the directory named `ndb_nodeid_fs/TS` under the data node's data directory (`DataDir`), where *nodeid* is the data node's `NodeId`. To place the data file in a location other than the default, include an absolute directory path or a path relative to the default location. If the directory specified does not exist, **NDB** attempts to create it; the system user account under which the data node process is running must have the appropriate permissions to do so.



### Note

When determining the path used for a data file, **NDB** does not expand the `~` (tilde) character.

When multiple data nodes are run on the same physical host, the following considerations apply:

- You cannot specify an absolute path when creating a data file.
- It is not possible to create tablespace data files outside the data node file system directory, unless each data node has a separate data directory.
- If each data node has its own data directory, data files can be created anywhere within this directory.
- If each data node has its own data directory, it may also be possible to create a data file outside the node's data directory using a relative path, as long as this path resolves to a unique location on the host file system for each data node running on that host.

- **FILE\_BLOCK\_SIZE**: This option—which is specific to **InnoDB**, and is ignored by **NDB**—defines the block size for the tablespace data file. Values can be specified in bytes or kilobytes. For example, an 8 kilobyte file block size can be specified as 8192 or 8K. If you do not specify this option, **FILE\_BLOCK\_SIZE** defaults to the **innodb\_page\_size** value. **FILE\_BLOCK\_SIZE** is required when you intend to use the tablespace for storing compressed **InnoDB** tables (**ROW\_FORMAT=COMPRESSED**). In this case, you must define the tablespace **FILE\_BLOCK\_SIZE** when creating the tablespace.

If **FILE\_BLOCK\_SIZE** is equal the **innodb\_page\_size** value, the tablespace can contain only tables having an uncompressed row format (**COMPACT**, **REDUNDANT**, and **DYNAMIC**). Tables with a **COMPRESSED** row format have a different physical page size than uncompressed tables. Therefore, compressed tables cannot coexist in the same tablespace as uncompressed tables.

For a general tablespace to contain compressed tables, **FILE\_BLOCK\_SIZE** must be specified, and the **FILE\_BLOCK\_SIZE** value must be a valid compressed page size in relation to the **innodb\_page\_size** value. Also, the physical page size of the compressed table (**KEY\_BLOCK\_SIZE**) must be equal to **FILE\_BLOCK\_SIZE/1024**. For example, if **innodb\_page\_size=16K**, and **FILE\_BLOCK\_SIZE=8K**, the **KEY\_BLOCK\_SIZE** of the table must be 8. For more information, see [Section 14.6.3.3, “General Tablespaces”](#).

- **USE LOGFILE GROUP**: Required for **NDB**, this is the name of a log file group previously created using **CREATE LOGFILE GROUP**. Not supported for **InnoDB**, where it fails with an error.
- **EXTENT\_SIZE**: This option is specific to **NDB**, and is not supported by **InnoDB**, where it fails with an error. **EXTENT\_SIZE** sets the size, in bytes, of the extents used by any files belonging to the tablespace. The default value is 1M. The minimum size is 32K, and theoretical maximum is 2G, although the practical maximum size depends on a number of factors. In most cases, changing the extent size does not have any measurable effect on performance, and the default value is recommended for all but the most unusual situations.

An *extent* is a unit of disk space allocation. One extent is filled with as much data as that extent can contain before another extent is used. In theory, up to 65,535 (64K) extents may be used per data file; however, the recommended maximum is 32,768 (32K). The recommended maximum size for a single data file is 32G—that is, 32K extents × 1 MB per extent. In addition, once an extent is allocated to a given partition, it cannot be used to store data from a different partition; an extent cannot store data from more than one partition. This means, for example that a tablespace having a single datafile whose **INITIAL\_SIZE** (described in the following item) is 256 MB and whose **EXTENT\_SIZE** is 128M has just two extents, and so can be used to store data from at most two different disk data table partitions.

You can see how many extents remain free in a given data file by querying the Information Schema **FILES** table, and so derive an estimate for how much space remains free in the file. For further discussion and examples, see [Section 24.3.9, “The INFORMATION\\_SCHEMA FILES Table”](#).

- **INITIAL\_SIZE**: This option is specific to **NDB**, and is not supported by **InnoDB**, where it fails with an error.

The **INITIAL\_SIZE** parameter sets the total size in bytes of the data file that was specifically using **ADD DATAFILE**. Once this file has been created, its size cannot be changed; however, you can add more data files to the tablespace using **ALTER TABLESPACE ... ADD DATAFILE**.

**INITIAL\_SIZE** is optional; its default value is 134217728 (128 MB).

On 32-bit systems, the maximum supported value for **INITIAL\_SIZE** is 4294967296 (4 GB).

- **AUTOEXTEND\_SIZE**: Currently ignored by MySQL; reserved for possible future use. Has no effect in any release of MySQL 5.7 or MySQL NDB Cluster 7.5, regardless of the storage engine used.

- **MAX\_SIZE**: Currently ignored by MySQL; reserved for possible future use. Has no effect in any release of MySQL 5.7 or MySQL NDB Cluster 7.5, regardless of the storage engine used.
- **NODEGROUP**: Currently ignored by MySQL; reserved for possible future use. Has no effect in any release of MySQL 5.7 or MySQL NDB Cluster 7.5, regardless of the storage engine used.
- **WAIT**: Currently ignored by MySQL; reserved for possible future use. Has no effect in any release of MySQL 5.7 or MySQL NDB Cluster 7.5, regardless of the storage engine used.
- **COMMENT**: Currently ignored by MySQL; reserved for possible future use. Has no effect in any release of MySQL 5.7 or MySQL NDB Cluster 7.5, regardless of the storage engine used.
- **ENGINE**: Defines the storage engine which uses the tablespace, where *engine\_name* is the name of the storage engine. Currently, only the **InnoDB** storage engine is supported by standard MySQL 5.7 releases. MySQL NDB Cluster 7.5 supports both **NDB** and **InnoDB** tablespaces. The value of the `default_storage_engine` system variable is used for **ENGINE** if the option is not specified.

## Notes

- For the rules covering the naming of MySQL tablespaces, see [Section 9.2, “Schema Object Names”](#). In addition to these rules, the slash character (“/”) is not permitted, nor can you use names beginning with `innodb_`, as this prefix is reserved for system use.
- Tablespaces do not support temporary tables.
- `innodb_file_per_table`, `innodb_file_format`, and `innodb_file_format_max` settings have no influence on `CREATE TABLESPACE` operations. `innodb_file_per_table` does not need to be enabled. General tablespaces support all table row formats regardless of file format settings. Likewise, general tablespaces support the addition of tables of any row format using `CREATE TABLE ... TABLESPACE`, regardless of file format settings.
- `innodb_strict_mode` is not applicable to general tablespaces. Tablespace management rules are strictly enforced independently of `innodb_strict_mode`. If `CREATE TABLESPACE` parameters are incorrect or incompatible, the operation fails regardless of the `innodb_strict_mode` setting. When a table is added to a general tablespace using `CREATE TABLE ... TABLESPACE` or `ALTER TABLE ... TABLESPACE`, `innodb_strict_mode` is ignored but the statement is evaluated as if `innodb_strict_mode` is enabled.
- Use `DROP TABLESPACE` to remove a tablespace. All tables must be dropped from a tablespace using `DROP TABLE` prior to dropping the tablespace. Before dropping an NDB Cluster tablespace you must also remove all its data files using one or more `ALTER TABLESPACE ... DROP DATATFILE` statements. See [Section 21.6.11.1, “NDB Cluster Disk Data Objects”](#).
- All parts of an **InnoDB** table added to an **InnoDB** general tablespace reside in the general tablespace, including indexes and **BLOB** pages.

For an **NDB** table assigned to a tablespace, only those columns which are not indexed are stored on disk, and actually use the tablespace data files. Indexes and indexed columns for all **NDB** tables are always kept in memory.

- Similar to the system tablespace, truncating or dropping tables stored in a general tablespace creates free space internally in the general tablespace `.ibd data file` which can only be used for new **InnoDB** data. Space is not released back to the operating system as it is for file-per-table tablespaces.
- A general tablespace is not associated with any database or schema.
- `ALTER TABLE ... DISCARD TABLESPACE` and `ALTER TABLE ... IMPORT TABLESPACE` are not supported for tables that belong to a general tablespace.

- The server uses tablespace-level metadata locking for DDL that references general tablespaces. By comparison, the server uses table-level metadata locking for DDL that references file-per-table tablespaces.
- A generated or existing tablespace cannot be changed to a general tablespace.
- Tables stored in a general tablespace can only be opened in MySQL 5.7.6 or later due to the addition of new table flags.
- There is no conflict between general tablespace names and file-per-table tablespace names. The “/” character, which is present in file-per-table tablespace names, is not permitted in general tablespace names.
- `mysqldump` and `mysqlpump` do not dump `InnoDB CREATE TABLESPACE` statements.

## InnoDB Examples

This example demonstrates creating a general tablespace and adding three uncompressed tables of different row formats.

```
mysql> CREATE TABLESPACE `ts1` ADD DATAFILE 'ts1.ibd' ENGINE=INNODB;
mysql> CREATE TABLE t1 (c1 INT PRIMARY KEY) TABLESPACE ts1 ROW_FORMAT=REDUNDANT;
mysql> CREATE TABLE t2 (c1 INT PRIMARY KEY) TABLESPACE ts1 ROW_FORMAT=COMPACT;
mysql> CREATE TABLE t3 (c1 INT PRIMARY KEY) TABLESPACE ts1 ROW_FORMAT=DYNAMIC;
```

This example demonstrates creating a general tablespace and adding a compressed table. The example assumes a default `innodb_page_size` value of 16K. The `FILE_BLOCK_SIZE` of 8192 requires that the compressed table have a `KEY_BLOCK_SIZE` of 8.

```
mysql> CREATE TABLESPACE `ts2` ADD DATAFILE 'ts2.ibd' FILE_BLOCK_SIZE = 8192 Engine=InnoDB;
mysql> CREATE TABLE t4 (c1 INT PRIMARY KEY) TABLESPACE ts2 ROW_FORMAT=COMPRESSED KEY_BLOCK_SIZE=8;
```

## NDB Example

Suppose that you wish to create an NDB Cluster Disk Data tablespace named `myts` using a datafile named `mydata-1.dat`. An NDB tablespace always requires the use of a log file group consisting of one or more undo log files. For this example, we first create a log file group named `mylg` that contains one undo log file named `myundo-1.dat`, using the `CREATE LOGFILE GROUP` statement shown here:

```
mysql> CREATE LOGFILE GROUP mylg
->   ADD UNDOFILE 'myundo-1.dat'
->   ENGINE=NDB;
Query OK, 0 rows affected (3.29 sec)
```

Now you can create the tablespace previously described using the following statement:

```
mysql> CREATE TABLESPACE myts
->   ADD DATAFILE 'mydata-1.dat'
->   USE LOGFILE GROUP mylg
->   ENGINE=NDB;
Query OK, 0 rows affected (2.98 sec)
```

You can now create a Disk Data table using a `CREATE TABLE` statement with the `TABLESPACE` and `STORAGE DISK` options, similar to what is shown here:

```
mysql> CREATE TABLE mytable (
->   id INT UNSIGNED NOT NULL AUTO_INCREMENT PRIMARY KEY,
```

```

->   lname VARCHAR(50) NOT NULL,
->   fname VARCHAR(50) NOT NULL,
->   dob DATE NOT NULL,
->   joined DATE NOT NULL,
->   INDEX(last_name, first_name)
-> )
->   TABLESPACE myts STORAGE DISK
->   ENGINE=NDB;

```

Query OK, 0 rows affected (1.41 sec)

It is important to note that only the `dob` and `joined` columns from `mytable` are actually stored on disk, due to the fact that the `id`, `lname`, and `fname` columns are all indexed.

As mentioned previously, when `CREATE TABLESPACE` is used with `ENGINE [=] NDB`, a tablespace and associated data file are created on each NDB Cluster data node. You can verify that the data files were created and obtain information about them by querying the Information Schema `FILES` table, as shown here:

```

mysql> SELECT FILE_NAME, FILE_TYPE, LOGFILE_GROUP_NAME, STATUS, EXTRA
->   FROM INFORMATION_SCHEMA.FILES
->   WHERE TABLESPACE_NAME = 'myts';

```

file_name	file_type	logfile_group_name	status	extra
mydata-1.dat	DATAFILE	mylg	NORMAL	CLUSTER_NODE=5
mydata-1.dat	DATAFILE	mylg	NORMAL	CLUSTER_NODE=6
NULL	TABLESPACE	mylg	NORMAL	NULL

3 rows in set (0.01 sec)

For additional information and examples, see [Section 21.6.11.1, “NDB Cluster Disk Data Objects”](#).

## 13.1.20 CREATE TRIGGER Statement

```

CREATE
  [DEFINER = user]
  TRIGGER trigger_name
  trigger_time trigger_event
  ON tbl_name FOR EACH ROW
  [trigger_order]
  trigger_body

trigger_time: { BEFORE | AFTER }

trigger_event: { INSERT | UPDATE | DELETE }

trigger_order: { FOLLOWS | PRECEDES } other_trigger_name

```

This statement creates a new trigger. A trigger is a named database object that is associated with a table, and that activates when a particular event occurs for the table. The trigger becomes associated with the table named `tbl_name`, which must refer to a permanent table. You cannot associate a trigger with a `TEMPORARY` table or a view.

Trigger names exist in the schema namespace, meaning that all triggers must have unique names within a schema. Triggers in different schemas can have the same name.

This section describes `CREATE TRIGGER` syntax. For additional discussion, see [Section 23.3.1, “Trigger Syntax and Examples”](#).

`CREATE TRIGGER` requires the `TRIGGER` privilege for the table associated with the trigger. If the `DEFINER` clause is present, the privileges required depend on the `user` value, as discussed in [Section 23.6, “Stored](#)



**Object Access Control**". If binary logging is enabled, `CREATE TRIGGER` might require the `SUPER` privilege, as discussed in [Section 23.7, "Stored Program Binary Logging"](#).

The `DEFINER` clause determines the security context to be used when checking access privileges at trigger activation time, as described later in this section.

`trigger_time` is the trigger action time. It can be `BEFORE` or `AFTER` to indicate that the trigger activates before or after each row to be modified.

Basic column value checks occur prior to trigger activation, so you cannot use `BEFORE` triggers to convert values inappropriate for the column type to valid values.

`trigger_event` indicates the kind of operation that activates the trigger. These `trigger_event` values are permitted:

- `INSERT`: The trigger activates whenever a new row is inserted into the table (for example, through `INSERT`, `LOAD DATA`, and `REPLACE` statements).
- `UPDATE`: The trigger activates whenever a row is modified (for example, through `UPDATE` statements).
- `DELETE`: The trigger activates whenever a row is deleted from the table (for example, through `DELETE` and `REPLACE` statements). `DROP TABLE` and `TRUNCATE TABLE` statements on the table do *not* activate this trigger, because they do not use `DELETE`. Dropping a partition does not activate `DELETE` triggers, either.

The `trigger_event` does not represent a literal type of SQL statement that activates the trigger so much as it represents a type of table operation. For example, an `INSERT` trigger activates not only for `INSERT` statements but also `LOAD DATA` statements because both statements insert rows into a table.

A potentially confusing example of this is the `INSERT INTO ... ON DUPLICATE KEY UPDATE ...` syntax: a `BEFORE INSERT` trigger activates for every row, followed by either an `AFTER INSERT` trigger or both the `BEFORE UPDATE` and `AFTER UPDATE` triggers, depending on whether there was a duplicate key for the row.

**Note**

Cascaded foreign key actions do not activate triggers.

It is possible to define multiple triggers for a given table that have the same trigger event and action time. For example, you can have two `BEFORE UPDATE` triggers for a table. By default, triggers that have the same trigger event and action time activate in the order they were created. To affect trigger order, specify a `trigger_order` clause that indicates `FOLLOWS` or `PRECEDES` and the name of an existing trigger that also has the same trigger event and action time. With `FOLLOWS`, the new trigger activates after the existing trigger. With `PRECEDES`, the new trigger activates before the existing trigger.

`trigger_body` is the statement to execute when the trigger activates. To execute multiple statements, use the `BEGIN ... END` compound statement construct. This also enables you to use the same statements that are permitted within stored routines. See [Section 13.6.1, "BEGIN ... END Compound Statement"](#). Some statements are not permitted in triggers; see [Section 23.8, "Restrictions on Stored Programs"](#).

Within the trigger body, you can refer to columns in the subject table (the table associated with the trigger) by using the aliases `OLD` and `NEW`. `OLD.col_name` refers to a column of an existing row before it is updated or deleted. `NEW.col_name` refers to the column of a new row to be inserted or an existing row after it is updated.

Triggers cannot use `NEW.col_name` or use `OLD.col_name` to refer to generated columns. For information about generated columns, see [Section 13.1.18.7, “CREATE TABLE and Generated Columns”](#).

MySQL stores the `sql_mode` system variable setting in effect when a trigger is created, and always executes the trigger body with this setting in force, *regardless of the current server SQL mode when the trigger begins executing*.

The `DEFINER` clause specifies the MySQL account to be used when checking access privileges at trigger activation time. If the `DEFINER` clause is present, the `user` value should be a MySQL account specified as `'user_name'@'host_name'`, `CURRENT_USER`, or `CURRENT_USER()`. The permitted `user` values depend on the privileges you hold, as discussed in [Section 23.6, “Stored Object Access Control”](#). Also see that section for additional information about trigger security.

If the `DEFINER` clause is omitted, the default definer is the user who executes the `CREATE TRIGGER` statement. This is the same as specifying `DEFINER = CURRENT_USER` explicitly.

MySQL takes the `DEFINER` user into account when checking trigger privileges as follows:

- At `CREATE TRIGGER` time, the user who issues the statement must have the `TRIGGER` privilege.
- At trigger activation time, privileges are checked against the `DEFINER` user. This user must have these privileges:
  - The `TRIGGER` privilege for the subject table.
  - The `SELECT` privilege for the subject table if references to table columns occur using `OLD.col_name` or `NEW.col_name` in the trigger body.
  - The `UPDATE` privilege for the subject table if table columns are targets of `SET NEW.col_name = value` assignments in the trigger body.
  - Whatever other privileges normally are required for the statements executed by the trigger.

Within a trigger body, the `CURRENT_USER` function returns the account used to check privileges at trigger activation time. This is the `DEFINER` user, not the user whose actions caused the trigger to be activated. For information about user auditing within triggers, see [Section 6.2.18, “SQL-Based Account Activity Auditing”](#).

If you use `LOCK TABLES` to lock a table that has triggers, the tables used within the trigger are also locked, as described in [LOCK TABLES and Triggers](#).

For additional discussion of trigger use, see [Section 23.3.1, “Trigger Syntax and Examples”](#).

## 13.1.21 CREATE VIEW Statement

```
CREATE
  [OR REPLACE]
  [ALGORITHM = {UNDEFINED | MERGE | TEMPTABLE}]
  [DEFINER = user]
  [SQL SECURITY { DEFINER | INVOKER }]
  VIEW view_name [(column_list)]
  AS select_statement
  [WITH [CASCADED | LOCAL] CHECK OPTION]
```

The `CREATE VIEW` statement creates a new view, or replaces an existing view if the `OR REPLACE` clause is given. If the view does not exist, `CREATE OR REPLACE VIEW` is the same as `CREATE VIEW`. If the view does exist, `CREATE OR REPLACE VIEW` replaces it.

For information about restrictions on view use, see [Section 23.9, “Restrictions on Views”](#).

The *select\_statement* is a `SELECT` statement that provides the definition of the view. (Selecting from the view selects, in effect, using the `SELECT` statement.) The *select\_statement* can select from base tables or from other views.

The view definition is “frozen” at creation time and is not affected by subsequent changes to the definitions of the underlying tables. For example, if a view is defined as `SELECT *` on a table, new columns added to the table later do not become part of the view, and columns dropped from the table result in an error when selecting from the view.

The `ALGORITHM` clause affects how MySQL processes the view. The `DEFINER` and `SQL SECURITY` clauses specify the security context to be used when checking access privileges at view invocation time. The `WITH CHECK OPTION` clause can be given to constrain inserts or updates to rows in tables referenced by the view. These clauses are described later in this section.

The `CREATE VIEW` statement requires the `CREATE VIEW` privilege for the view, and some privilege for each column selected by the `SELECT` statement. For columns used elsewhere in the `SELECT` statement, you must have the `SELECT` privilege. If the `OR REPLACE` clause is present, you must also have the `DROP` privilege for the view. If the `DEFINER` clause is present, the privileges required depend on the *user* value, as discussed in [Section 23.6, “Stored Object Access Control”](#).

When a view is referenced, privilege checking occurs as described later in this section.

A view belongs to a database. By default, a new view is created in the default database. To create the view explicitly in a given database, use *db\_name.view\_name* syntax to qualify the view name with the database name:

```
CREATE VIEW test.v AS SELECT * FROM t;
```

Unqualified table or view names in the `SELECT` statement are also interpreted with respect to the default database. A view can refer to tables or views in other databases by qualifying the table or view name with the appropriate database name.

Within a database, base tables and views share the same namespace, so a base table and a view cannot have the same name.

Columns retrieved by the `SELECT` statement can be simple references to table columns, or expressions that use functions, constant values, operators, and so forth.

A view must have unique column names with no duplicates, just like a base table. By default, the names of the columns retrieved by the `SELECT` statement are used for the view column names. To define explicit names for the view columns, specify the optional *column\_list* clause as a list of comma-separated identifiers. The number of names in *column\_list* must be the same as the number of columns retrieved by the `SELECT` statement.

A view can be created from many kinds of `SELECT` statements. It can refer to base tables or other views. It can use joins, `UNION`, and subqueries. The `SELECT` need not even refer to any tables:

```
CREATE VIEW v_today (today) AS SELECT CURRENT_DATE;
```

The following example defines a view that selects two columns from another table as well as an expression calculated from those columns:

```
mysql> CREATE TABLE t (qty INT, price INT);
mysql> INSERT INTO t VALUES(3, 50);
mysql> CREATE VIEW v AS SELECT qty, price, qty*price AS value FROM t;
mysql> SELECT * FROM v;
+-----+-----+-----+
| qty  | price | value |
+-----+-----+-----+
```

```
| 3 | 50 | 150 |
+-----+-----+-----+
```

A view definition is subject to the following restrictions:

- The `SELECT` statement cannot refer to system variables or user-defined variables.
- Within a stored program, the `SELECT` statement cannot refer to program parameters or local variables.
- The `SELECT` statement cannot refer to prepared statement parameters.
- Any table or view referred to in the definition must exist. If, after the view has been created, a table or view that the definition refers to is dropped, use of the view results in an error. To check a view definition for problems of this kind, use the `CHECK TABLE` statement.
- The definition cannot refer to a `TEMPORARY` table, and you cannot create a `TEMPORARY` view.
- You cannot associate a trigger with a view.
- Aliases for column names in the `SELECT` statement are checked against the maximum column length of 64 characters (not the maximum alias length of 256 characters).

`ORDER BY` is permitted in a view definition, but it is ignored if you select from a view using a statement that has its own `ORDER BY`.

For other options or clauses in the definition, they are added to the options or clauses of the statement that references the view, but the effect is undefined. For example, if a view definition includes a `LIMIT` clause, and you select from the view using a statement that has its own `LIMIT` clause, it is undefined which limit applies. This same principle applies to options such as `ALL`, `DISTINCT`, or `SQL_SMALL_RESULT` that follow the `SELECT` keyword, and to clauses such as `INTO`, `FOR UPDATE`, `LOCK IN SHARE MODE`, and `PROCEDURE`.

The results obtained from a view may be affected if you change the query processing environment by changing system variables:

```
mysql> CREATE VIEW v (mycol) AS SELECT 'abc';
Query OK, 0 rows affected (0.01 sec)

mysql> SET sql_mode = '';
Query OK, 0 rows affected (0.00 sec)

mysql> SELECT "mycol" FROM v;
+-----+
| mycol |
+-----+
| mycol |
+-----+
1 row in set (0.01 sec)

mysql> SET sql_mode = 'ANSI_QUOTES';
Query OK, 0 rows affected (0.00 sec)

mysql> SELECT "mycol" FROM v;
+-----+
| mycol |
+-----+
| abc   |
+-----+
1 row in set (0.00 sec)
```

The `DEFINER` and `SQL SECURITY` clauses determine which MySQL account to use when checking access privileges for the view when a statement is executed that references the view. The valid `SQL`

`SECURITY` characteristic values are `DEFINER` (the default) and `INVOKER`. These indicate that the required privileges must be held by the user who defined or invoked the view, respectively.

If the `DEFINER` clause is present, the `user` value should be a MySQL account specified as `'user_name'@'host_name'`, `CURRENT_USER`, or `CURRENT_USER()`. The permitted `user` values depend on the privileges you hold, as discussed in [Section 23.6, “Stored Object Access Control”](#). Also see that section for additional information about view security.

If the `DEFINER` clause is omitted, the default definer is the user who executes the `CREATE VIEW` statement. This is the same as specifying `DEFINER = CURRENT_USER` explicitly.

Within a view definition, the `CURRENT_USER` function returns the view's `DEFINER` value by default. For views defined with the `SQL SECURITY INVOKER` characteristic, `CURRENT_USER` returns the account for the view's invoker. For information about user auditing within views, see [Section 6.2.18, “SQL-Based Account Activity Auditing”](#).

Within a stored routine that is defined with the `SQL SECURITY DEFINER` characteristic, `CURRENT_USER` returns the routine's `DEFINER` value. This also affects a view defined within such a routine, if the view definition contains a `DEFINER` value of `CURRENT_USER`.

MySQL checks view privileges like this:

- At view definition time, the view creator must have the privileges needed to use the top-level objects accessed by the view. For example, if the view definition refers to table columns, the creator must have some privilege for each column in the select list of the definition, and the `SELECT` privilege for each column used elsewhere in the definition. If the definition refers to a stored function, only the privileges needed to invoke the function can be checked. The privileges required at function invocation time can be checked only as it executes: For different invocations, different execution paths within the function might be taken.
- The user who references a view must have appropriate privileges to access it (`SELECT` to select from it, `INSERT` to insert into it, and so forth.)
- When a view has been referenced, privileges for objects accessed by the view are checked against the privileges held by the view `DEFINER` account or invoker, depending on whether the `SQL SECURITY` characteristic is `DEFINER` or `INVOKER`, respectively.
- If reference to a view causes execution of a stored function, privilege checking for statements executed within the function depend on whether the function `SQL SECURITY` characteristic is `DEFINER` or `INVOKER`. If the security characteristic is `DEFINER`, the function runs with the privileges of the `DEFINER` account. If the characteristic is `INVOKER`, the function runs with the privileges determined by the view's `SQL SECURITY` characteristic.

Example: A view might depend on a stored function, and that function might invoke other stored routines. For example, the following view invokes a stored function `f()`:

```
CREATE VIEW v AS SELECT * FROM t WHERE t.id = f(t.name);
```

Suppose that `f()` contains a statement such as this:

```
IF name IS NULL then
  CALL p1();
ELSE
  CALL p2();
END IF;
```

The privileges required for executing statements within `f()` need to be checked when `f()` executes. This might mean that privileges are needed for `p1()` or `p2()`, depending on the execution path within `f()`.

Those privileges must be checked at runtime, and the user who must possess the privileges is determined by the [SQL SECURITY](#) values of the view `v` and the function `f()`.

The [DEFINER](#) and [SQL SECURITY](#) clauses for views are extensions to standard SQL. In standard SQL, views are handled using the rules for [SQL SECURITY DEFINER](#). The standard says that the definer of the view, which is the same as the owner of the view's schema, gets applicable privileges on the view (for example, [SELECT](#)) and may grant them. MySQL has no concept of a schema “owner”, so MySQL adds a clause to identify the definer. The [DEFINER](#) clause is an extension where the intent is to have what the standard has; that is, a permanent record of who defined the view. This is why the default [DEFINER](#) value is the account of the view creator.

The optional [ALGORITHM](#) clause is a MySQL extension to standard SQL. It affects how MySQL processes the view. [ALGORITHM](#) takes three values: [MERGE](#), [TEMPTABLE](#), or [UNDEFINED](#). For more information, see [Section 23.5.2, “View Processing Algorithms”](#), as well as [Section 8.2.2.4, “Optimizing Derived Tables and View References with Merging or Materialization”](#).

Some views are updatable. That is, you can use them in statements such as [UPDATE](#), [DELETE](#), or [INSERT](#) to update the contents of the underlying table. For a view to be updatable, there must be a one-to-one relationship between the rows in the view and the rows in the underlying table. There are also certain other constructs that make a view nonupdatable.

A generated column in a view is considered updatable because it is possible to assign to it. However, if such a column is updated explicitly, the only permitted value is [DEFAULT](#). For information about generated columns, see [Section 13.1.18.7, “CREATE TABLE and Generated Columns”](#).

The [WITH CHECK OPTION](#) clause can be given for an updatable view to prevent inserts or updates to rows except those for which the [WHERE](#) clause in the *select\_statement* is true.

In a [WITH CHECK OPTION](#) clause for an updatable view, the [LOCAL](#) and [CASCADED](#) keywords determine the scope of check testing when the view is defined in terms of another view. The [LOCAL](#) keyword restricts the [CHECK OPTION](#) only to the view being defined. [CASCADED](#) causes the checks for underlying views to be evaluated as well. When neither keyword is given, the default is [CASCADED](#).

For more information about updatable views and the [WITH CHECK OPTION](#) clause, see [Section 23.5.3, “Updatable and Insertable Views”](#), and [Section 23.5.4, “The View WITH CHECK OPTION Clause”](#).

Views created before MySQL 5.7.3 containing [ORDER BY integer](#) can result in errors at view evaluation time. Consider these view definitions, which use [ORDER BY](#) with an ordinal number:

```
CREATE VIEW v1 AS SELECT x, y, z FROM t ORDER BY 2;
CREATE VIEW v2 AS SELECT x, 1, z FROM t ORDER BY 2;
```

In the first case, [ORDER BY 2](#) refers to a named column `y`. In the second case, it refers to a constant 1. For queries that select from either view fewer than 2 columns (the number named in the [ORDER BY](#) clause), an error occurs if the server evaluates the view using the [MERGE](#) algorithm. Examples:

```
mysql> SELECT x FROM v1;
ERROR 1054 (42S22): Unknown column '2' in 'order clause'
mysql> SELECT x FROM v2;
ERROR 1054 (42S22): Unknown column '2' in 'order clause'
```

As of MySQL 5.7.3, to handle view definitions like this, the server writes them differently into the `.frm` file that stores the view definition. This difference is visible with [SHOW CREATE VIEW](#). Previously, the `.frm` file contained this for the [ORDER BY 2](#) clause:

```
For v1: ORDER BY 2
For v2: ORDER BY 2
```

As of 5.7.3, the `.frm` file contains this:

```
For v1: ORDER BY `t`.`y`
For v2: ORDER BY ''
```

That is, for `v1`, 2 is replaced by a reference to the name of the column referred to. For `v2`, 2 is replaced by a constant string expression (ordering by a constant has no effect, so ordering by any constant works).

If you experience view-evaluation errors such as just described, drop and recreate the view so that the `.frm` file contains the updated view representation. Alternatively, for views like `v2` that order by a constant value, drop and recreate the view with no `ORDER BY` clause.

## 13.1.22 DROP DATABASE Statement

```
DROP {DATABASE | SCHEMA} [IF EXISTS] db_name
```

`DROP DATABASE` drops all tables in the database and deletes the database. Be *very* careful with this statement! To use `DROP DATABASE`, you need the `DROP` privilege on the database. `DROP SCHEMA` is a synonym for `DROP DATABASE`.



### Important

When a database is dropped, privileges granted specifically for the database are *not* automatically dropped. They must be dropped manually. See [Section 13.7.1.4, “GRANT Statement”](#).

`IF EXISTS` is used to prevent an error from occurring if the database does not exist.

If the default database is dropped, the default database is unset (the `DATABASE()` function returns `NULL`).

If you use `DROP DATABASE` on a symbolically linked database, both the link and the original database are deleted.

`DROP DATABASE` returns the number of tables that were removed. This corresponds to the number of `.frm` files removed.

The `DROP DATABASE` statement removes from the given database directory those files and directories that MySQL itself may create during normal operation:

- All files with the following extensions:

- `.BAK`
- `.DAT`
- `.HSH`
- `.MRG`
- `.MYD`
- `.MYI`
- `.TRG`
- `.TRN`
- `.cfg`
- `.db`

- `.frm`
- `.ibd`
- `.ndb`
- `.par`
- The `db.opt` file, if it exists.

If other files or directories remain in the database directory after MySQL removes those just listed, the database directory cannot be removed. In this case, you must remove any remaining files or directories manually and issue the `DROP DATABASE` statement again.

Dropping a database does not remove any `TEMPORARY` tables that were created in that database. `TEMPORARY` tables are automatically removed when the session that created them ends. See [Section 13.1.18.2, “CREATE TEMPORARY TABLE Statement”](#).

You can also drop databases with `mysqladmin`. See [Section 4.5.2, “mysqladmin — A MySQL Server Administration Program”](#).

### 13.1.23 DROP EVENT Statement

```
DROP EVENT [IF EXISTS] event_name
```

This statement drops the event named `event_name`. The event immediately ceases being active, and is deleted completely from the server.

If the event does not exist, the error `ERROR 1517 (HY000): Unknown event 'event_name'` results. You can override this and cause the statement to generate a warning for nonexistent events instead using `IF EXISTS`.

This statement requires the `EVENT` privilege for the schema to which the event to be dropped belongs.

### 13.1.24 DROP FUNCTION Statement

The `DROP FUNCTION` statement is used to drop stored functions and loadable functions:

- For information about dropping stored functions, see [Section 13.1.27, “DROP PROCEDURE and DROP FUNCTION Statements”](#).
- For information about dropping loadable functions, see [Section 13.7.3.2, “DROP FUNCTION Statement for Loadable Functions”](#).

### 13.1.25 DROP INDEX Statement

```
DROP INDEX index_name ON tbl_name
      [algorithm_option | lock_option] ...

algorithm_option:
  ALGORITHM [=] {DEFAULT | INPLACE | COPY}

lock_option:
  LOCK [=] {DEFAULT | NONE | SHARED | EXCLUSIVE}
```

`DROP INDEX` drops the index named `index_name` from the table `tbl_name`. This statement is mapped to an `ALTER TABLE` statement to drop the index. See [Section 13.1.8, “ALTER TABLE Statement”](#).



To drop a primary key, the index name is always `PRIMARY`, which must be specified as a quoted identifier because `PRIMARY` is a reserved word:

```
DROP INDEX `PRIMARY` ON t;
```

Indexes on variable-width columns of `NDB` tables are dropped online; that is, without any table copying. The table is not locked against access from other `NDB` Cluster API nodes, although it is locked against other operations on the *same* API node for the duration of the operation. This is done automatically by the server whenever it determines that it is possible to do so; you do not have to use any special SQL syntax or server options to cause it to happen.

`ALGORITHM` and `LOCK` clauses may be given to influence the table copying method and level of concurrency for reading and writing the table while its indexes are being modified. They have the same meaning as for the `ALTER TABLE` statement. For more information, see [Section 13.1.8, “ALTER TABLE Statement”](#)

`NDB` Cluster formerly supported online `DROP INDEX` operations using the `ONLINE` and `OFFLINE` keywords. These keywords are no longer supported in MySQL `NDB` Cluster 7.5 and later, and their use causes a syntax error. Instead, MySQL `NDB` Cluster 7.5 and later support online operations using the same `ALGORITHM=INPLACE` syntax used with the standard MySQL Server. See [Section 21.6.12, “Online Operations with ALTER TABLE in NDB Cluster”](#), for more information.

### 13.1.26 DROP LOGFILE GROUP Statement

```
DROP LOGFILE GROUP logfile_group
ENGINE [=] engine_name
```

This statement drops the log file group named `logfile_group`. The log file group must already exist or an error results. (For information on creating log file groups, see [Section 13.1.15, “CREATE LOGFILE GROUP Statement”](#).)



#### Important

Before dropping a log file group, you must drop all tablespaces that use that log file group for `UNDO` logging.

The required `ENGINE` clause provides the name of the storage engine used by the log file group to be dropped. Currently, the only permitted values for `engine_name` are `NDB` and `NDBCLUSTER`.

`DROP LOGFILE GROUP` is useful only with Disk Data storage for `NDB` Cluster. See [Section 21.6.11, “NDB Cluster Disk Data Tables”](#).

### 13.1.27 DROP PROCEDURE and DROP FUNCTION Statements

```
DROP {PROCEDURE | FUNCTION} [IF EXISTS] sp_name
```

These statements are used to drop a stored routine (a stored procedure or function). That is, the specified routine is removed from the server. (`DROP FUNCTION` is also used to drop loadable functions; see [Section 13.7.3.2, “DROP FUNCTION Statement for Loadable Functions”](#).)

To drop a stored routine, you must have the `ALTER ROUTINE` privilege for it. (If the `automatic_sp_privileges` system variable is enabled, that privilege and `EXECUTE` are granted automatically to the routine creator when the routine is created and dropped from the creator when the routine is dropped. See [Section 23.2.2, “Stored Routines and MySQL Privileges”](#).)

The `IF EXISTS` clause is a MySQL extension. It prevents an error from occurring if the procedure or function does not exist. A warning is produced that can be viewed with `SHOW WARNINGS`.

`DROP FUNCTION` is also used to drop loadable functions (see [Section 13.7.3.2, “DROP FUNCTION Statement for Loadable Functions”](#)).

## 13.1.28 DROP SERVER Statement

```
DROP SERVER [ IF EXISTS ] server_name
```

Drops the server definition for the server named *server\_name*. The corresponding row in the `mysql.servers` table is deleted. This statement requires the `SUPER` privilege.

Dropping a server for a table does not affect any `FEDERATED` tables that used this connection information when they were created. See [Section 13.1.17, “CREATE SERVER Statement”](#).

`DROP SERVER` causes an implicit commit. See [Section 13.3.3, “Statements That Cause an Implicit Commit”](#).

`DROP SERVER` is not written to the binary log, regardless of the logging format that is in use.

## 13.1.29 DROP TABLE Statement

```
DROP [TEMPORARY] TABLE [IF EXISTS]
  tbl_name [, tbl_name] ...
[RESTRICT | CASCADE]
```

`DROP TABLE` removes one or more tables. You must have the `DROP` privilege for each table.

*Be careful* with this statement! For each table, it removes the table definition and all table data. If the table is partitioned, the statement removes the table definition, all its partitions, all data stored in those partitions, and all partition definitions associated with the dropped table.

Dropping a table also drops any triggers for the table.

`DROP TABLE` causes an implicit commit, except when used with the `TEMPORARY` keyword. See [Section 13.3.3, “Statements That Cause an Implicit Commit”](#).



### Important

When a table is dropped, privileges granted specifically for the table are *not* automatically dropped. They must be dropped manually. See [Section 13.7.1.4, “GRANT Statement”](#).

If any tables named in the argument list do not exist, `DROP TABLE` behavior depends on whether the `IF EXISTS` clause is given:

- Without `IF EXISTS`, the statement drops all named tables that do exist, and returns an error indicating which nonexistent tables it was unable to drop.
- With `IF EXISTS`, no error occurs for nonexistent tables. The statement drops all named tables that do exist, and generates a `NOTE` diagnostic for each nonexistent table. These notes can be displayed with `SHOW WARNINGS`. See [Section 13.7.5.40, “SHOW WARNINGS Statement”](#).

`IF EXISTS` can also be useful for dropping tables in unusual circumstances under which there is an `.frm` file but no table managed by the storage engine. (For example, if an abnormal server exit occurs after removal of the table from the storage engine but before `.frm` file removal.)

The `TEMPORARY` keyword has the following effects:

- The statement drops only `TEMPORARY` tables.
- The statement does not cause an implicit commit.

- No access rights are checked. A `TEMPORARY` table is visible only with the session that created it, so no check is necessary.

Including the `TEMPORARY` keyword is a good way to prevent accidentally dropping non-`TEMPORARY` tables.

The `RESTRICT` and `CASCADE` keywords do nothing. They are permitted to make porting easier from other database systems.

`DROP TABLE` is not supported with all `innodb_force_recovery` settings. See [Section 14.22.2, “Forcing InnoDB Recovery”](#).

### 13.1.30 DROP TABLESPACE Statement

```
DROP TABLESPACE tablespace_name
[ENGINE [=] engine_name]
```

This statement drops a tablespace that was previously created using `CREATE TABLESPACE`. It is supported with all MySQL NDB Cluster 7.5 releases, and with `InnoDB` in the standard MySQL Server as well.

`ENGINE` sets the storage engine that uses the tablespace, where `engine_name` is the name of the storage engine. Currently, the values `InnoDB` and `NDB` are supported. If not set, the value of `default_storage_engine` is used. If it is not the same as the storage engine used to create the tablespace, the `DROP TABLESPACE` statement fails.

For an `InnoDB` tablespace, all tables must be dropped from the tablespace prior to a `DROP TABLESPACE` operation. If the tablespace is not empty, `DROP TABLESPACE` returns an error.

As with the `InnoDB` system tablespace, truncating or dropping `InnoDB` tables stored in a general tablespace creates free space in the tablespace `.ibd data file`, which can only be used for new `InnoDB` data. Space is not released back to the operating system by such operations as it is for file-per-table tablespaces.

An `NDB` tablespace to be dropped must not contain any data files; in other words, before you can drop an `NDB` tablespace, you must first drop each of its data files using `ALTER TABLESPACE ... DROP DATAFILE`.

#### Notes

- Tablespaces are not deleted automatically. A tablespace must be dropped explicitly using `DROP TABLESPACE`. `DROP DATABASE` has no effect in this regard, even if the operation drops all tables belonging to the tablespace.
- A `DROP DATABASE` operation can drop tables that belong to a general tablespace but it cannot drop the tablespace, even if the operation drops all tables that belong to the tablespace. The tablespace must be dropped explicitly using `DROP TABLESPACE tablespace_name`.
- Similar to the system tablespace, truncating or dropping tables stored in a general tablespace creates free space internally in the general tablespace `.ibd data file` which can only be used for new `InnoDB` data. Space is not released back to the operating system as it is for file-per-table tablespaces.

#### InnoDB Example

This example demonstrates how to drop an `InnoDB` general tablespace. The general tablespace `ts1` is created with a single table. Before dropping the tablespace, the table must be dropped.

```
mysql> CREATE TABLESPACE `ts1` ADD DATAFILE 'ts1.ibd' Engine=InnoDB;
mysql> CREATE TABLE t1 (c1 INT PRIMARY KEY) TABLESPACE ts1 Engine=InnoDB;
```

```
mysql> DROP TABLE t1;

mysql> DROP TABLESPACE ts1;
```

## NDB Example

This example shows how to drop an NDB tablespace `myts` having a data file named `mydata-1.dat` after first creating the tablespace, and assumes the existence of a log file group named `mylg` (see [Section 13.1.15, “CREATE LOGFILE GROUP Statement”](#)).

```
mysql> CREATE TABLESPACE myts
->     ADD DATAFILE 'mydata-1.dat'
->     USE LOGFILE GROUP mylg
->     ENGINE=NDB;
```

You must remove all data files from the tablespace using `ALTER TABLESPACE`, as shown here, before it can be dropped:

```
mysql> ALTER TABLESPACE myts
->     DROP DATAFILE 'mydata-1.dat'
->     ENGINE=NDB;

mysql> DROP TABLESPACE myts;
```

## 13.1.31 DROP TRIGGER Statement

```
DROP TRIGGER [IF EXISTS] [schema_name.]trigger_name
```

This statement drops a trigger. The schema (database) name is optional. If the schema is omitted, the trigger is dropped from the default schema. `DROP TRIGGER` requires the `TRIGGER` privilege for the table associated with the trigger.

Use `IF EXISTS` to prevent an error from occurring for a trigger that does not exist. A `NOTE` is generated for a nonexistent trigger when using `IF EXISTS`. See [Section 13.7.5.40, “SHOW WARNINGS Statement”](#).

Triggers for a table are also dropped if you drop the table.

## 13.1.32 DROP VIEW Statement

```
DROP VIEW [IF EXISTS]
  view_name [, view_name] ...
  [RESTRICT | CASCADE]
```

`DROP VIEW` removes one or more views. You must have the `DROP` privilege for each view.

If any views named in the argument list do not exist, the statement returns an error indicating by name which nonexistent views it was unable to drop, but also drops all views in the list that do exist.



### Note

In MySQL 8.0, `DROP VIEW` fails if any views named in the argument list do not exist. Due to the change in behavior, a partially completed `DROP VIEW` operation on a MySQL 5.7 source fails when replicated to a MySQL 8.0 replica. To avoid this failure scenario, use `IF EXISTS` syntax in `DROP VIEW` statements to prevent an error from occurring for views that do not exist. For more information, see [Atomic Data Definition Statement Support](#).

The `IF EXISTS` clause prevents an error from occurring for views that don't exist. When this clause is given, a `NOTE` is generated for each nonexistent view. See [Section 13.7.5.40, “SHOW WARNINGS Statement”](#).

`RESTRICT` and `CASCADE`, if given, are parsed and ignored.

### 13.1.33 RENAME TABLE Statement

```
RENAME TABLE
    tbl_name TO new_tbl_name
    [, tbl_name2 TO new_tbl_name2] ...
```

`RENAME TABLE` renames one or more tables. You must have `ALTER` and `DROP` privileges for the original table, and `CREATE` and `INSERT` privileges for the new table.

For example, to rename a table named `old_table` to `new_table`, use this statement:

```
RENAME TABLE old_table TO new_table;
```

That statement is equivalent to the following `ALTER TABLE` statement:

```
ALTER TABLE old_table RENAME new_table;
```

`RENAME TABLE`, unlike `ALTER TABLE`, can rename multiple tables within a single statement:

```
RENAME TABLE old_table1 TO new_table1,
               old_table2 TO new_table2,
               old_table3 TO new_table3;
```

Renaming operations are performed left to right. Thus, to swap two table names, do this (assuming that a table with the intermediary name `tmp_table` does not already exist):

```
RENAME TABLE old_table TO tmp_table,
               new_table TO old_table,
               tmp_table TO new_table;
```

Metadata locks on tables are acquired in name order, which in some cases can make a difference in operation outcome when multiple transactions execute concurrently. See [Section 8.11.4, “Metadata Locking”](#).

To execute `RENAME TABLE`, there must be no active transactions or tables locked with `LOCK TABLES`. With the transaction table locking conditions satisfied, the rename operation is done atomically; no other session can access any of the tables while the rename is in progress.

If any errors occur during a `RENAME TABLE`, the statement fails and no changes are made.

You can use `RENAME TABLE` to move a table from one database to another:

```
RENAME TABLE current_db.tbl_name TO other_db.tbl_name;
```

Using this method to move all tables from one database to a different one in effect renames the database (an operation for which MySQL has no single statement), except that the original database continues to exist, albeit with no tables.

Like `RENAME TABLE`, `ALTER TABLE ... RENAME` can also be used to move a table to a different database. Regardless of the statement used, if the rename operation would move the table to a database located on a different file system, the success of the outcome is platform specific and depends on the underlying operating system calls used to move table files.

If a table has triggers, attempts to rename the table into a different database fail with a `Trigger in wrong schema (ER_TRG_IN_WRONG_SCHEMA)` error.

To rename `TEMPORARY` tables, `RENAME TABLE` does not work. Use `ALTER TABLE` instead.

`RENAME TABLE` works for views, except that views cannot be renamed into a different database.

Any privileges granted specifically for a renamed table or view are not migrated to the new name. They must be changed manually.

`RENAME TABLE tbl_name TO new_tbl_name` changes internally generated foreign key constraint names and user-defined foreign key constraint names that begin with the string “*tbl\_name\_ibfk\_*” to reflect the new table name. `InnoDB` interprets foreign key constraint names that begin with the string “*tbl\_name\_ibfk\_*” as internally generated names.

Foreign key constraint names that point to the renamed table are automatically updated unless there is a conflict, in which case the statement fails with an error. A conflict occurs if the renamed constraint name already exists. In such cases, you must drop and re-create the foreign keys for them to function properly.

### 13.1.34 TRUNCATE TABLE Statement

```
TRUNCATE [TABLE] tbl_name
```

`TRUNCATE TABLE` empties a table completely. It requires the `DROP` privilege.

Logically, `TRUNCATE TABLE` is similar to a `DELETE` statement that deletes all rows, or a sequence of `DROP TABLE` and `CREATE TABLE` statements. To achieve high performance, it bypasses the DML method of deleting data. Thus, it cannot be rolled back, it does not cause `ON DELETE` triggers to fire, and it cannot be performed for `InnoDB` tables with parent-child foreign key relationships.

Although `TRUNCATE TABLE` is similar to `DELETE`, it is classified as a DDL statement rather than a DML statement. It differs from `DELETE` in the following ways:

- Truncate operations drop and re-create the table, which is much faster than deleting rows one by one, particularly for large tables.
- Truncate operations cause an implicit commit, and so cannot be rolled back. See [Section 13.3.3, “Statements That Cause an Implicit Commit”](#).
- Truncation operations cannot be performed if the session holds an active table lock.
- `TRUNCATE TABLE` fails for an `InnoDB` table or `NDB` table if there are any `FOREIGN KEY` constraints from other tables that reference the table. Foreign key constraints between columns of the same table are permitted.
- Truncation operations do not return a meaningful value for the number of deleted rows. The usual result is “0 rows affected,” which should be interpreted as “no information.”
- As long as the table format file *tbl\_name.frm* is valid, the table can be re-created as an empty table with `TRUNCATE TABLE`, even if the data or index files have become corrupted.
- Any `AUTO_INCREMENT` value is reset to its start value. This is true even for `MyISAM` and `InnoDB`, which normally do not reuse sequence values.
- When used with partitioned tables, `TRUNCATE TABLE` preserves the partitioning; that is, the data and index files are dropped and re-created, while the partition definitions (*.par*) file is unaffected.
- The `TRUNCATE TABLE` statement does not invoke `ON DELETE` triggers.

`TRUNCATE TABLE` is treated for purposes of binary logging and replication as DDL rather than DML, and is always logged as a statement.

`TRUNCATE TABLE` for a table closes all handlers for the table that were opened with `HANDLER OPEN`.

On a system with a large `InnoDB` buffer pool and `innodb_adaptive_hash_index` enabled, `TRUNCATE TABLE` operations may cause a temporary drop in system performance due to an LRU scan that occurs when removing an `InnoDB` table's adaptive hash index entries. The problem was addressed for `DROP TABLE` in MySQL 5.5.23 (Bug #13704145, Bug #64284) but remains a known issue for `TRUNCATE TABLE` (Bug #68184).

`TRUNCATE TABLE` can be used with Performance Schema summary tables, but the effect is to reset the summary columns to 0 or `NULL`, not to remove rows. See [Section 25.12.15, “Performance Schema Summary Tables”](#).

## 13.2 Data Manipulation Statements

### 13.2.1 CALL Statement

```
CALL sp_name([parameter[,...]])
CALL sp_name[()]
```

The `CALL` statement invokes a stored procedure that was defined previously with `CREATE PROCEDURE`.

Stored procedures that take no arguments can be invoked without parentheses. That is, `CALL p()` and `CALL p` are equivalent.

`CALL` can pass back values to its caller using parameters that are declared as `OUT` or `INOUT` parameters. When the procedure returns, a client program can also obtain the number of rows affected for the final statement executed within the routine: At the SQL level, call the `ROW_COUNT()` function; from the C API, call the `mysql_affected_rows()` function.

For information about the effect of unhandled conditions on procedure parameters, see [Section 13.6.7.8, “Condition Handling and OUT or INOUT Parameters”](#).

To get back a value from a procedure using an `OUT` or `INOUT` parameter, pass the parameter by means of a user variable, and then check the value of the variable after the procedure returns. (If you are calling the procedure from within another stored procedure or function, you can also pass a routine parameter or local routine variable as an `IN` or `INOUT` parameter.) For an `INOUT` parameter, initialize its value before passing it to the procedure. The following procedure has an `OUT` parameter that the procedure sets to the current server version, and an `INOUT` value that the procedure increments by one from its current value:

```
DELIMITER //

CREATE PROCEDURE p (OUT ver_param VARCHAR(25), INOUT incr_param INT)
BEGIN
  # Set value of OUT parameter
  SELECT VERSION() INTO ver_param;
  # Increment value of INOUT parameter
  SET incr_param = incr_param + 1;
END //

DELIMITER ;
```

Before calling the procedure, initialize the variable to be passed as the `INOUT` parameter. After calling the procedure, the values of the two variables have been set or modified:

```
mysql> SET @increment = 10;
mysql> CALL p(@version, @increment);
mysql> SELECT @version, @increment;
+-----+-----+
| @version | @increment |
+-----+-----+
| 5.7.44  |          11 |
+-----+-----+
```

In prepared `CALL` statements used with `PREPARE` and `EXECUTE`, placeholders can be used for `IN` parameters, `OUT`, and `INOUT` parameters. These types of parameters can be used as follows:

```
mysql> SET @increment = 10;
mysql> PREPARE s FROM 'CALL p(?, ?)';
mysql> EXECUTE s USING @version, @increment;
mysql> SELECT @version, @increment;
+-----+-----+
| @version | @increment |
+-----+-----+
| 5.7.44  |          11 |
+-----+-----+
```

To write C programs that use the `CALL` SQL statement to execute stored procedures that produce result sets, the `CLIENT_MULTI_RESULTS` flag must be enabled. This is because each `CALL` returns a result to indicate the call status, in addition to any result sets that might be returned by statements executed within the procedure. `CLIENT_MULTI_RESULTS` must also be enabled if `CALL` is used to execute any stored procedure that contains prepared statements. It cannot be determined when such a procedure is loaded whether those statements produce result sets, so it is necessary to assume that they do so.

`CLIENT_MULTI_RESULTS` can be enabled when you call `mysql_real_connect()`, either explicitly by passing the `CLIENT_MULTI_RESULTS` flag itself, or implicitly by passing `CLIENT_MULTI_STATEMENTS` (which also enables `CLIENT_MULTI_RESULTS`). `CLIENT_MULTI_RESULTS` is enabled by default.

To process the result of a `CALL` statement executed using `mysql_query()` or `mysql_real_query()`, use a loop that calls `mysql_next_result()` to determine whether there are more results. For an example, see [Multiple Statement Execution Support](#).

C programs can use the prepared-statement interface to execute `CALL` statements and access `OUT` and `INOUT` parameters. This is done by processing the result of a `CALL` statement using a loop that calls `mysql_stmt_next_result()` to determine whether there are more results. For an example, see [Prepared CALL Statement Support](#). Languages that provide a MySQL interface can use prepared `CALL` statements to directly retrieve `OUT` and `INOUT` procedure parameters.

Metadata changes to objects referred to by stored programs are detected and cause automatic reparsing of the affected statements when the program is next executed. For more information, see [Section 8.10.4, “Caching of Prepared Statements and Stored Programs”](#).

## 13.2.2 DELETE Statement

`DELETE` is a DML statement that removes rows from a table.

### Single-Table Syntax

```
DELETE [LOW_PRIORITY] [QUICK] [IGNORE] FROM tbl_name
  [PARTITION (partition_name [, partition_name] ...)]
  [WHERE where_condition]
  [ORDER BY ...]
  [LIMIT row_count]
```

The `DELETE` statement deletes rows from `tbl_name` and returns the number of deleted rows. To check the number of deleted rows, call the `ROW_COUNT()` function described in [Section 12.15, “Information Functions”](#).

### Main Clauses

The conditions in the optional `WHERE` clause identify which rows to delete. With no `WHERE` clause, all rows are deleted.



*where\_condition* is an expression that evaluates to true for each row to be deleted. It is specified as described in [Section 13.2.9, “SELECT Statement”](#).

If the `ORDER BY` clause is specified, the rows are deleted in the order that is specified. The `LIMIT` clause places a limit on the number of rows that can be deleted. These clauses apply to single-table deletes, but not multi-table deletes.

## Multiple-Table Syntax

```
DELETE [LOW_PRIORITY] [QUICK] [IGNORE]
      tbl_name[.*] [, tbl_name[.*]] ...
FROM table_references
[WHERE where_condition]

DELETE [LOW_PRIORITY] [QUICK] [IGNORE]
      FROM tbl_name[.*] [, tbl_name[.*]] ...
      USING table_references
[WHERE where_condition]
```

## Privileges

You need the `DELETE` privilege on a table to delete rows from it. You need only the `SELECT` privilege for any columns that are only read, such as those named in the `WHERE` clause.

## Performance

When you do not need to know the number of deleted rows, the `TRUNCATE TABLE` statement is a faster way to empty a table than a `DELETE` statement with no `WHERE` clause. Unlike `DELETE`, `TRUNCATE TABLE` cannot be used within a transaction or if you have a lock on the table. See [Section 13.1.34, “TRUNCATE TABLE Statement”](#) and [Section 13.3.5, “LOCK TABLES and UNLOCK TABLES Statements”](#).

The speed of delete operations may also be affected by factors discussed in [Section 8.2.4.3, “Optimizing DELETE Statements”](#).

To ensure that a given `DELETE` statement does not take too much time, the MySQL-specific `LIMIT row_count` clause for `DELETE` specifies the maximum number of rows to be deleted. If the number of rows to delete is larger than the limit, repeat the `DELETE` statement until the number of affected rows is less than the `LIMIT` value.

## Subqueries

You cannot delete from a table and select from the same table in a subquery.

## Partitioned Table Support

`DELETE` supports explicit partition selection using the `PARTITION` clause, which takes a list of the comma-separated names of one or more partitions or subpartitions (or both) from which to select rows to be dropped. Partitions not included in the list are ignored. Given a partitioned table `t` with a partition named `p0`, executing the statement `DELETE FROM t PARTITION (p0)` has the same effect on the table as executing `ALTER TABLE t TRUNCATE PARTITION (p0)`; in both cases, all rows in partition `p0` are dropped.

`PARTITION` can be used along with a `WHERE` condition, in which case the condition is tested only on rows in the listed partitions. For example, `DELETE FROM t PARTITION (p0) WHERE c < 5` deletes rows only from partition `p0` for which the condition `c < 5` is true; rows in any other partitions are not checked and thus not affected by the `DELETE`.

The `PARTITION` clause can also be used in multiple-table `DELETE` statements. You can use up to one such option per table named in the `FROM` option.

For more information and examples, see [Section 22.5, “Partition Selection”](#).

## Auto-Increment Columns

If you delete the row containing the maximum value for an `AUTO_INCREMENT` column, the value is not reused for a `MyISAM` or `InnoDB` table. If you delete all rows in the table with `DELETE FROM tbl_name` (without a `WHERE` clause) in `autocommit` mode, the sequence starts over for all storage engines except `InnoDB` and `MyISAM`. There are some exceptions to this behavior for `InnoDB` tables, as discussed in [Section 14.6.1.6, “AUTO\\_INCREMENT Handling in InnoDB”](#).

For `MyISAM` tables, you can specify an `AUTO_INCREMENT` secondary column in a multiple-column key. In this case, reuse of values deleted from the top of the sequence occurs even for `MyISAM` tables. See [Section 3.6.9, “Using AUTO\\_INCREMENT”](#).

## Modifiers

The `DELETE` statement supports the following modifiers:

- If you specify the `LOW_PRIORITY` modifier, the server delays execution of the `DELETE` until no other clients are reading from the table. This affects only storage engines that use only table-level locking (such as `MyISAM`, `MEMORY`, and `MERGE`).
- For `MyISAM` tables, if you use the `QUICK` modifier, the storage engine does not merge index leaves during delete, which may speed up some kinds of delete operations.
- The `IGNORE` modifier causes MySQL to ignore ignorable errors during the process of deleting rows. (Errors encountered during the parsing stage are processed in the usual manner.) Errors that are ignored due to the use of `IGNORE` are returned as warnings. For more information, see [The Effect of IGNORE on Statement Execution](#).

## Order of Deletion

If the `DELETE` statement includes an `ORDER BY` clause, rows are deleted in the order specified by the clause. This is useful primarily in conjunction with `LIMIT`. For example, the following statement finds rows matching the `WHERE` clause, sorts them by `timestamp_column`, and deletes the first (oldest) one:

```
DELETE FROM somelog WHERE user = 'jcole'  
ORDER BY timestamp_column LIMIT 1;
```

`ORDER BY` also helps to delete rows in an order required to avoid referential integrity violations.

## InnoDB Tables

If you are deleting many rows from a large table, you may exceed the lock table size for an `InnoDB` table. To avoid this problem, or simply to minimize the time that the table remains locked, the following strategy (which does not use `DELETE` at all) might be helpful:

1. Select the rows *not* to be deleted into an empty table that has the same structure as the original table:

```
INSERT INTO t_copy SELECT * FROM t WHERE ... ;
```

2. Use `RENAME TABLE` to atomically move the original table out of the way and rename the copy to the original name:

```
RENAME TABLE t TO t_old, t_copy TO t;
```

3. Drop the original table:

```
DROP TABLE t_old;
```

No other sessions can access the tables involved while `RENAME TABLE` executes, so the rename operation is not subject to concurrency problems. See [Section 13.1.33, “RENAME TABLE Statement”](#).

## MyISAM Tables

In `MyISAM` tables, deleted rows are maintained in a linked list and subsequent `INSERT` operations reuse old row positions. To reclaim unused space and reduce file sizes, use the `OPTIMIZE TABLE` statement or the `myisamchk` utility to reorganize tables. `OPTIMIZE TABLE` is easier to use, but `myisamchk` is faster. See [Section 13.7.2.4, “OPTIMIZE TABLE Statement”](#), and [Section 4.6.3, “myisamchk — MyISAM Table-Maintenance Utility”](#).

The `QUICK` modifier affects whether index leaves are merged for delete operations. `DELETE QUICK` is most useful for applications where index values for deleted rows are replaced by similar index values from rows inserted later. In this case, the holes left by deleted values are reused.

`DELETE QUICK` is not useful when deleted values lead to underfilled index blocks spanning a range of index values for which new inserts occur again. In this case, use of `QUICK` can lead to wasted space in the index that remains unreclaimed. Here is an example of such a scenario:

1. Create a table that contains an indexed `AUTO_INCREMENT` column.
2. Insert many rows into the table. Each insert results in an index value that is added to the high end of the index.
3. Delete a block of rows at the low end of the column range using `DELETE QUICK`.

In this scenario, the index blocks associated with the deleted index values become underfilled but are not merged with other index blocks due to the use of `QUICK`. They remain underfilled when new inserts occur, because new rows do not have index values in the deleted range. Furthermore, they remain underfilled even if you later use `DELETE` without `QUICK`, unless some of the deleted index values happen to lie in index blocks within or adjacent to the underfilled blocks. To reclaim unused index space under these circumstances, use `OPTIMIZE TABLE`.

If you are going to delete many rows from a table, it might be faster to use `DELETE QUICK` followed by `OPTIMIZE TABLE`. This rebuilds the index rather than performing many index block merge operations.

## Multi-Table Deletes

You can specify multiple tables in a `DELETE` statement to delete rows from one or more tables depending on the condition in the `WHERE` clause. You cannot use `ORDER BY` or `LIMIT` in a multiple-table `DELETE`. The `table_references` clause lists the tables involved in the join, as described in [Section 13.2.9.2, “JOIN Clause”](#).

For the first multiple-table syntax, only matching rows from the tables listed before the `FROM` clause are deleted. For the second multiple-table syntax, only matching rows from the tables listed in the `FROM` clause (before the `USING` clause) are deleted. The effect is that you can delete rows from many tables at the same time and have additional tables that are used only for searching:

```
DELETE t1, t2 FROM t1 INNER JOIN t2 INNER JOIN t3
WHERE t1.id=t2.id AND t2.id=t3.id;
```

Or:

```
DELETE FROM t1, t2 USING t1 INNER JOIN t2 INNER JOIN t3
WHERE t1.id=t2.id AND t2.id=t3.id;
```

These statements use all three tables when searching for rows to delete, but delete matching rows only from tables `t1` and `t2`.

The preceding examples use `INNER JOIN`, but multiple-table `DELETE` statements can use other types of join permitted in `SELECT` statements, such as `LEFT JOIN`. For example, to delete rows that exist in `t1` that have no match in `t2`, use a `LEFT JOIN`:

```
DELETE t1 FROM t1 LEFT JOIN t2 ON t1.id=t2.id WHERE t2.id IS NULL;
```

The syntax permits `.*` after each `tbl_name` for compatibility with `Access`.

If you use a multiple-table `DELETE` statement involving `InnoDB` tables for which there are foreign key constraints, the MySQL optimizer might process tables in an order that differs from that of their parent/child relationship. In this case, the statement fails and rolls back. Instead, you should delete from a single table and rely on the `ON DELETE` capabilities that `InnoDB` provides to cause the other tables to be modified accordingly.



### Note

If you declare an alias for a table, you must use the alias when referring to the table:

```
DELETE t1 FROM test AS t1, test2 WHERE ...
```

Table aliases in a multiple-table `DELETE` should be declared only in the `table_references` part of the statement. Elsewhere, alias references are permitted but not alias declarations.

Correct:

```
DELETE a1, a2 FROM t1 AS a1 INNER JOIN t2 AS a2
WHERE a1.id=a2.id;

DELETE FROM a1, a2 USING t1 AS a1 INNER JOIN t2 AS a2
WHERE a1.id=a2.id;
```

Incorrect:

```
DELETE t1 AS a1, t2 AS a2 FROM t1 INNER JOIN t2
WHERE a1.id=a2.id;

DELETE FROM t1 AS a1, t2 AS a2 USING t1 INNER JOIN t2
WHERE a1.id=a2.id;
```

## 13.2.3 DO Statement

```
DO expr [, expr] ...
```

`DO` executes the expressions but does not return any results. In most respects, `DO` is shorthand for `SELECT expr, ...`, but has the advantage that it is slightly faster when you do not care about the result.

`DO` is useful primarily with functions that have side effects, such as `RELEASE_LOCK()`.

Example: This `SELECT` statement pauses, but also produces a result set:

```
mysql> SELECT SLEEP(5);
+-----+
| SLEEP(5) |
+-----+
|          0 |
+-----+
1 row in set (5.02 sec)
```

`DO`, on the other hand, pauses without producing a result set.:

```
mysql> DO SLEEP(5);
Query OK, 0 rows affected (4.99 sec)
```

This could be useful, for example in a stored function or trigger, which prohibit statements that produce result sets.

`DO` only executes expressions. It cannot be used in all cases where `SELECT` can be used. For example, `DO id FROM t1` is invalid because it references a table.

## 13.2.4 HANDLER Statement

```
HANDLER tbl_name OPEN [ [AS] alias ]

HANDLER tbl_name READ index_name { = | <= | >= | < | > } (value1,value2,...)
  [ WHERE where_condition ] [LIMIT ... ]
HANDLER tbl_name READ index_name { FIRST | NEXT | PREV | LAST }
  [ WHERE where_condition ] [LIMIT ... ]
HANDLER tbl_name READ { FIRST | NEXT }
  [ WHERE where_condition ] [LIMIT ... ]

HANDLER tbl_name CLOSE
```

The `HANDLER` statement provides direct access to table storage engine interfaces. It is available for `InnoDB` and `MyISAM` tables.

The `HANDLER ... OPEN` statement opens a table, making it accessible using subsequent `HANDLER ... READ` statements. This table object is not shared by other sessions and is not closed until the session calls `HANDLER ... CLOSE` or the session terminates.

If you open the table using an alias, further references to the open table with other `HANDLER` statements must use the alias rather than the table name. If you do not use an alias, but open the table using a table name qualified by the database name, further references must use the unqualified table name. For example, for a table opened using `mydb.mytable`, further references must use `mytable`.

The first `HANDLER ... READ` syntax fetches a row where the index specified satisfies the given values and the `WHERE` condition is met. If you have a multiple-column index, specify the index column values as a comma-separated list. Either specify values for all the columns in the index, or specify values for a leftmost prefix of the index columns. Suppose that an index `my_idx` includes three columns named `col_a`, `col_b`, and `col_c`, in that order. The `HANDLER` statement can specify values for all three columns in the index, or for the columns in a leftmost prefix. For example:

```
HANDLER ... READ my_idx = (col_a_val,col_b_val,col_c_val) ...
HANDLER ... READ my_idx = (col_a_val,col_b_val) ...
HANDLER ... READ my_idx = (col_a_val) ...
```

To employ the `HANDLER` interface to refer to a table's `PRIMARY KEY`, use the quoted identifier ``PRIMARY``:

```
HANDLER tbl_name READ `PRIMARY` ...
```

The second `HANDLER ... READ` syntax fetches a row from the table in index order that matches the `WHERE` condition.

The third `HANDLER ... READ` syntax fetches a row from the table in natural row order that matches the `WHERE` condition. It is faster than `HANDLER tbl_name READ index_name` when a full table scan is desired. Natural row order is the order in which rows are stored in a `MyISAM` table data file. This statement works for `InnoDB` tables as well, but there is no such concept because there is no separate data file.

Without a `LIMIT` clause, all forms of `HANDLER ... READ` fetch a single row if one is available. To return a specific number of rows, include a `LIMIT` clause. It has the same syntax as for the `SELECT` statement. See [Section 13.2.9, “SELECT Statement”](#).

`HANDLER ... CLOSE` closes a table that was opened with `HANDLER ... OPEN`.

There are several reasons to use the `HANDLER` interface instead of normal `SELECT` statements:

- `HANDLER` is faster than `SELECT`:
  - A designated storage engine handler object is allocated for the `HANDLER ... OPEN`. The object is reused for subsequent `HANDLER` statements for that table; it need not be reinitialized for each one.
  - There is less parsing involved.
  - There is no optimizer or query-checking overhead.
  - The handler interface does not have to provide a consistent look of the data (for example, `dirty reads` are permitted), so the storage engine can use optimizations that `SELECT` does not normally permit.
- `HANDLER` makes it easier to port to MySQL applications that use a low-level `ISAM`-like interface. (See [Section 14.21, “InnoDB memcached Plugin”](#) for an alternative way to adapt applications that use the key-value store paradigm.)
- `HANDLER` enables you to traverse a database in a manner that is difficult (or even impossible) to accomplish with `SELECT`. The `HANDLER` interface is a more natural way to look at data when working with applications that provide an interactive user interface to the database.

`HANDLER` is a somewhat low-level statement. For example, it does not provide consistency. That is, `HANDLER ... OPEN` does *not* take a snapshot of the table, and does *not* lock the table. This means that after a `HANDLER ... OPEN` statement is issued, table data can be modified (by the current session or other sessions) and these modifications might be only partially visible to `HANDLER ... NEXT` or `HANDLER ... PREV` scans.

An open handler can be closed and marked for reopen, in which case the handler loses its position in the table. This occurs when both of the following circumstances are true:

- Any session executes `FLUSH TABLES` or DDL statements on the handler's table.
- The session in which the handler is open executes non-`HANDLER` statements that use tables.

`TRUNCATE TABLE` for a table closes all handlers for the table that were opened with `HANDLER OPEN`.

If a table is flushed with `FLUSH TABLES tbl_name WITH READ LOCK` was opened with `HANDLER`, the handler is implicitly flushed and loses its position.

## 13.2.5 INSERT Statement

```
INSERT [LOW_PRIORITY | DELAYED | HIGH_PRIORITY] [IGNORE]
  [INTO] tbl_name
  [PARTITION (partition_name [, partition_name] ...)]
  [(col_name [, col_name] ...)]
  {VALUES | VALUE} (value_list) [, (value_list)] ...
  [ON DUPLICATE KEY UPDATE assignment_list]

INSERT [LOW_PRIORITY | DELAYED | HIGH_PRIORITY] [IGNORE]
  [INTO] tbl_name
  [PARTITION (partition_name [, partition_name] ...)]
  SET assignment_list
  [ON DUPLICATE KEY UPDATE assignment_list]

INSERT [LOW_PRIORITY | HIGH_PRIORITY] [IGNORE]
  [INTO] tbl_name
  [PARTITION (partition_name [, partition_name] ...)]
  [(col_name [, col_name] ...)]
  SELECT ...
```

```
[ON DUPLICATE KEY UPDATE assignment_list]

value:
  {expr | DEFAULT}

value_list:
  value [, value] ...

assignment:
  col_name = value

assignment_list:
  assignment [, assignment] ...
```

INSERT inserts new rows into an existing table. The `INSERT ... VALUES` and `INSERT ... SET` forms of the statement insert rows based on explicitly specified values. The `INSERT ... SELECT` form inserts rows selected from another table or tables. `INSERT` with an `ON DUPLICATE KEY UPDATE` clause enables existing rows to be updated if a row to be inserted would cause a duplicate value in a `UNIQUE` index or `PRIMARY KEY`.

For additional information about `INSERT ... SELECT` and `INSERT ... ON DUPLICATE KEY UPDATE`, see [Section 13.2.5.1, “INSERT ... SELECT Statement”](#), and [Section 13.2.5.2, “INSERT ... ON DUPLICATE KEY UPDATE Statement”](#).

In MySQL 5.7, the `DELAYED` keyword is accepted but ignored by the server. For the reasons for this, see [Section 13.2.5.3, “INSERT DELAYED Statement”](#),

Inserting into a table requires the `INSERT` privilege for the table. If the `ON DUPLICATE KEY UPDATE` clause is used and a duplicate key causes an `UPDATE` to be performed instead, the statement requires the `UPDATE` privilege for the columns to be updated. For columns that are read but not modified you need only the `SELECT` privilege (such as for a column referenced only on the right hand side of an `col_name=expr` assignment in an `ON DUPLICATE KEY UPDATE` clause).

When inserting into a partitioned table, you can control which partitions and subpartitions accept new rows. The `PARTITION` clause takes a list of the comma-separated names of one or more partitions or subpartitions (or both) of the table. If any of the rows to be inserted by a given `INSERT` statement do not match one of the partitions listed, the `INSERT` statement fails with the error `Found a row not matching the given partition set`. For more information and examples, see [Section 22.5, “Partition Selection”](#).

`tbl_name` is the table into which rows should be inserted. Specify the columns for which the statement provides values as follows:

- Provide a parenthesized list of comma-separated column names following the table name. In this case, a value for each named column must be provided by the `VALUES` list or the `SELECT` statement.
- If you do not specify a list of column names for `INSERT ... VALUES` or `INSERT ... SELECT`, values for every column in the table must be provided by the `VALUES` list or the `SELECT` statement. If you do not know the order of the columns in the table, use `DESCRIBE tbl_name` to find out.
- A `SET` clause indicates columns explicitly by name, together with the value to assign each one.

Column values can be given in several ways:

- If strict SQL mode is not enabled, any column not explicitly given a value is set to its default (explicit or implicit) value. For example, if you specify a column list that does not name all the columns in the table, unnamed columns are set to their default values. Default value assignment is described in [Section 11.6, “Data Type Default Values”](#). See also [Section 1.6.3.3, “Constraints on Invalid Data”](#).

If strict SQL mode is enabled, an `INSERT` statement generates an error if it does not specify an explicit value for every column that has no default value. See [Section 5.1.10, “Server SQL Modes”](#).

- If both the column list and the `VALUES` list are empty, `INSERT` creates a row with each column set to its default value:

```
INSERT INTO tbl_name () VALUES();
```

If strict mode is not enabled, MySQL uses the implicit default value for any column that has no explicitly defined default. If strict mode is enabled, an error occurs if any column has no default value.

- Use the keyword `DEFAULT` to set a column explicitly to its default value. This makes it easier to write `INSERT` statements that assign values to all but a few columns, because it enables you to avoid writing an incomplete `VALUES` list that does not include a value for each column in the table. Otherwise, you must provide the list of column names corresponding to each value in the `VALUES` list.
- If a generated column is inserted into explicitly, the only permitted value is `DEFAULT`. For information about generated columns, see [Section 13.1.18.7, “CREATE TABLE and Generated Columns”](#).
- In expressions, you can use `DEFAULT(col_name)` to produce the default value for column *col\_name*.
- Type conversion of an expression *expr* that provides a column value might occur if the expression data type does not match the column data type. Conversion of a given value can result in different inserted values depending on the column type. For example, inserting the string `'1999.0e-2'` into an `INT`, `FLOAT`, `DECIMAL(10,6)`, or `YEAR` column inserts the value `1999`, `19.9921`, `19.992100`, or `1999`, respectively. The value stored in the `INT` and `YEAR` columns is `1999` because the string-to-number conversion looks only at as much of the initial part of the string as may be considered a valid integer or year. For the `FLOAT` and `DECIMAL` columns, the string-to-number conversion considers the entire string a valid numeric value.
- An expression *expr* can refer to any column that was set earlier in a value list. For example, you can do this because the value for `col2` refers to `col1`, which has previously been assigned:

```
INSERT INTO tbl_name (col1,col2) VALUES(15,col1*2);
```

But the following is not legal, because the value for `col1` refers to `col2`, which is assigned after `col1`:

```
INSERT INTO tbl_name (col1,col2) VALUES(col2*2,15);
```

An exception occurs for columns that contain `AUTO_INCREMENT` values. Because `AUTO_INCREMENT` values are generated after other value assignments, any reference to an `AUTO_INCREMENT` column in the assignment returns a `0`.

`INSERT` statements that use `VALUES` syntax can insert multiple rows. To do this, include multiple lists of comma-separated column values, with lists enclosed within parentheses and separated by commas. Example:

```
INSERT INTO tbl_name (a,b,c) VALUES(1,2,3),(4,5,6),(7,8,9);
```

Each values list must contain exactly as many values as are to be inserted per row. The following statement is invalid because it contains one list of nine values, rather than three lists of three values each:

```
INSERT INTO tbl_name (a,b,c) VALUES(1,2,3,4,5,6,7,8,9);
```

`VALUE` is a synonym for `VALUES` in this context. Neither implies anything about the number of values lists, nor about the number of values per list. Either may be used whether there is a single values list or multiple lists, and regardless of the number of values per list.



The affected-rows value for an `INSERT` can be obtained using the `ROW_COUNT()` SQL function or the `mysql_affected_rows()` C API function. See [Section 12.15, “Information Functions”](#), and `mysql_affected_rows()`.

If you use an `INSERT ... VALUES` statement with multiple value lists or `INSERT ... SELECT`, the statement returns an information string in this format:

```
Records: N1 Duplicates: N2 Warnings: N3
```

If you are using the C API, the information string can be obtained by invoking the `mysql_info()` function. See `mysql_info()`.

`Records` indicates the number of rows processed by the statement. (This is not necessarily the number of rows actually inserted because `Duplicates` can be nonzero.) `Duplicates` indicates the number of rows that could not be inserted because they would duplicate some existing unique index value. `Warnings` indicates the number of attempts to insert column values that were problematic in some way. Warnings can occur under any of the following conditions:

- Inserting `NULL` into a column that has been declared `NOT NULL`. For multiple-row `INSERT` statements or `INSERT INTO ... SELECT` statements, the column is set to the implicit default value for the column data type. This is `0` for numeric types, the empty string (`' '`) for string types, and the “zero” value for date and time types. `INSERT INTO ... SELECT` statements are handled the same way as multiple-row inserts because the server does not examine the result set from the `SELECT` to see whether it returns a single row. (For a single-row `INSERT`, no warning occurs when `NULL` is inserted into a `NOT NULL` column. Instead, the statement fails with an error.)
- Setting a numeric column to a value that lies outside the column range. The value is clipped to the closest endpoint of the range.
- Assigning a value such as `'10.34 a'` to a numeric column. The trailing nonnumeric text is stripped off and the remaining numeric part is inserted. If the string value has no leading numeric part, the column is set to `0`.
- Inserting a string into a string column (`CHAR`, `VARCHAR`, `TEXT`, or `BLOB`) that exceeds the column maximum length. The value is truncated to the column maximum length.
- Inserting a value into a date or time column that is illegal for the data type. The column is set to the appropriate zero value for the type.
- For `INSERT` examples involving `AUTO_INCREMENT` column values, see [Section 3.6.9, “Using AUTO\\_INCREMENT”](#).

If `INSERT` inserts a row into a table that has an `AUTO_INCREMENT` column, you can find the value used for that column by using the `LAST_INSERT_ID()` SQL function or the `mysql_insert_id()` C API function.



#### Note

These two functions do not always behave identically. The behavior of `INSERT` statements with respect to `AUTO_INCREMENT` columns is discussed further in [Section 12.15, “Information Functions”](#), and `mysql_insert_id()`.

The `INSERT` statement supports the following modifiers:

- If you use the `LOW_PRIORITY` modifier, execution of the `INSERT` is delayed until no other clients are reading from the table. This includes other clients that began reading while existing clients are reading,

and while the `INSERT LOW_PRIORITY` statement is waiting. It is possible, therefore, for a client that issues an `INSERT LOW_PRIORITY` statement to wait for a very long time.

`LOW_PRIORITY` affects only storage engines that use only table-level locking (such as `MyISAM`, `MEMORY`, and `MERGE`).



#### Note

`LOW_PRIORITY` should normally not be used with `MyISAM` tables because doing so disables concurrent inserts. See [Section 8.11.3, “Concurrent Inserts”](#).

- If you specify `HIGH_PRIORITY`, it overrides the effect of the `--low-priority-updates` option if the server was started with that option. It also causes concurrent inserts not to be used. See [Section 8.11.3, “Concurrent Inserts”](#).

`HIGH_PRIORITY` affects only storage engines that use only table-level locking (such as `MyISAM`, `MEMORY`, and `MERGE`).

- If you use the `IGNORE` modifier, ignorable errors that occur while executing the `INSERT` statement are ignored. For example, without `IGNORE`, a row that duplicates an existing `UNIQUE` index or `PRIMARY KEY` value in the table causes a duplicate-key error and the statement is aborted. With `IGNORE`, the row is discarded and no error occurs. Ignored errors generate warnings instead.

`IGNORE` has a similar effect on inserts into partitioned tables where no partition matching a given value is found. Without `IGNORE`, such `INSERT` statements are aborted with an error. When `INSERT IGNORE` is used, the insert operation fails silently for rows containing the unmatched value, but inserts rows that are matched. For an example, see [Section 22.2.2, “LIST Partitioning”](#).

Data conversions that would trigger errors abort the statement if `IGNORE` is not specified. With `IGNORE`, invalid values are adjusted to the closest values and inserted; warnings are produced but the statement does not abort. You can determine with the `mysql_info()` C API function how many rows were actually inserted into the table.

For more information, see [The Effect of IGNORE on Statement Execution](#).

You can use `REPLACE` instead of `INSERT` to overwrite old rows. `REPLACE` is the counterpart to `INSERT IGNORE` in the treatment of new rows that contain unique key values that duplicate old rows: The new rows replace the old rows rather than being discarded. See [Section 13.2.8, “REPLACE Statement”](#).

- If you specify `ON DUPLICATE KEY UPDATE`, and a row is inserted that would cause a duplicate value in a `UNIQUE` index or `PRIMARY KEY`, an `UPDATE` of the old row occurs. The affected-rows value per row is 1 if the row is inserted as a new row, 2 if an existing row is updated, and 0 if an existing row is set to its current values. If you specify the `CLIENT_FOUND_ROWS` flag to the `mysql_real_connect()` C API function when connecting to `mysqld`, the affected-rows value is 1 (not 0) if an existing row is set to its current values. See [Section 13.2.5.2, “INSERT ... ON DUPLICATE KEY UPDATE Statement”](#).
- `INSERT DELAYED` was deprecated in MySQL 5.6, and is scheduled for eventual removal. In MySQL 5.7, the `DELAYED` modifier is accepted but ignored. Use `INSERT` (without `DELAYED`) instead. See [Section 13.2.5.3, “INSERT DELAYED Statement”](#).

An `INSERT` statement affecting a partitioned table using a storage engine such as `MyISAM` that employs table-level locks locks only those partitions into which rows are actually inserted. (For storage engines such as `InnoDB` that employ row-level locking, no locking of partitions takes place.) For more information, see [Section 22.6.4, “Partitioning and Locking”](#).

### 13.2.5.1 INSERT ... SELECT Statement

```

INSERT [LOW_PRIORITY | HIGH_PRIORITY] [IGNORE]
  [INTO] tbl_name
  [PARTITION (partition_name [, partition_name] ...)]
  [(col_name [, col_name] ...)]
  SELECT ...
  [ON DUPLICATE KEY UPDATE assignment_list]

value:
  {expr | DEFAULT}

assignment:
  col_name = value

assignment_list:
  assignment [, assignment] ...

```

With `INSERT ... SELECT`, you can quickly insert many rows into a table from the result of a `SELECT` statement, which can select from one or many tables. For example:

```

INSERT INTO tbl_temp2 (fld_id)
  SELECT tbl_temp1.fld_order_id
  FROM tbl_temp1 WHERE tbl_temp1.fld_order_id > 100;

```

The following conditions hold for `INSERT ... SELECT` statements:

- Specify `IGNORE` to ignore rows that would cause duplicate-key violations.
- The target table of the `INSERT` statement may appear in the `FROM` clause of the `SELECT` part of the query. However, you cannot insert into a table and select from the same table in a subquery.

When selecting from and inserting into the same table, MySQL creates an internal temporary table to hold the rows from the `SELECT` and then inserts those rows into the target table. However, you cannot use `INSERT INTO t ... SELECT ... FROM t` when `t` is a `TEMPORARY` table, because `TEMPORARY` tables cannot be referred to twice in the same statement. See [Section 8.4.4, “Internal Temporary Table Use in MySQL”](#), and [Section B.3.6.2, “TEMPORARY Table Problems”](#).

- `AUTO_INCREMENT` columns work as usual.
- To ensure that the binary log can be used to re-create the original tables, MySQL does not permit concurrent inserts for `INSERT ... SELECT` statements (see [Section 8.11.3, “Concurrent Inserts”](#)).
- To avoid ambiguous column reference problems when the `SELECT` and the `INSERT` refer to the same table, provide a unique alias for each table used in the `SELECT` part, and qualify column names in that part with the appropriate alias.

You can explicitly select which partitions or subpartitions (or both) of the source or target table (or both) are to be used with a `PARTITION` clause following the name of the table. When `PARTITION` is used with the name of the source table in the `SELECT` portion of the statement, rows are selected only from the partitions or subpartitions named in its partition list. When `PARTITION` is used with the name of the target table for the `INSERT` portion of the statement, it must be possible to insert all rows selected into the partitions or subpartitions named in the partition list following the option. Otherwise, the `INSERT ... SELECT` statement fails. For more information and examples, see [Section 22.5, “Partition Selection”](#).

For `INSERT ... SELECT` statements, see [Section 13.2.5.2, “INSERT ... ON DUPLICATE KEY UPDATE Statement”](#) for conditions under which the `SELECT` columns can be referred to in an `ON DUPLICATE KEY UPDATE` clause.

The order in which a `SELECT` statement with no `ORDER BY` clause returns rows is nondeterministic. This means that, when using replication, there is no guarantee that such a `SELECT` returns rows in the same order on the source and the replica, which can lead to inconsistencies between them. To prevent this

from occurring, always write `INSERT ... SELECT` statements that are to be replicated using an `ORDER BY` clause that produces the same row order on the source and the replica. See also [Section 16.4.1.17, “Replication and LIMIT”](#).

Due to this issue, `INSERT ... SELECT ON DUPLICATE KEY UPDATE` and `INSERT IGNORE ... SELECT` statements are flagged as unsafe for statement-based replication. Such statements produce a warning in the error log when using statement-based mode and are written to the binary log using the row-based format when using `MIXED` mode. (Bug #11758262, Bug #50439)

See also [Section 16.2.1.1, “Advantages and Disadvantages of Statement-Based and Row-Based Replication”](#).

An `INSERT ... SELECT` statement affecting partitioned tables using a storage engine such as `MyISAM` that employs table-level locks locks all partitions of the target table; however, only those partitions that are actually read from the source table are locked. (This does not occur with tables using storage engines such as `InnoDB` that employ row-level locking.) For more information, see [Section 22.6.4, “Partitioning and Locking”](#).

### 13.2.5.2 INSERT ... ON DUPLICATE KEY UPDATE Statement

If you specify an `ON DUPLICATE KEY UPDATE` clause and a row to be inserted would cause a duplicate value in a `UNIQUE` index or `PRIMARY KEY`, an `UPDATE` of the old row occurs. For example, if column `a` is declared as `UNIQUE` and contains the value `1`, the following two statements have similar effect:

```
INSERT INTO t1 (a,b,c) VALUES (1,2,3)
ON DUPLICATE KEY UPDATE c=c+1;

UPDATE t1 SET c=c+1 WHERE a=1;
```

The effects are not quite identical: For an `InnoDB` table where `a` is an auto-increment column, the `INSERT` statement increases the auto-increment value but the `UPDATE` does not.

If column `b` is also unique, the `INSERT` is equivalent to this `UPDATE` statement instead:

```
UPDATE t1 SET c=c+1 WHERE a=1 OR b=2 LIMIT 1;
```

If `a=1 OR b=2` matches several rows, only *one* row is updated. In general, you should try to avoid using an `ON DUPLICATE KEY UPDATE` clause on tables with multiple unique indexes.

With `ON DUPLICATE KEY UPDATE`, the affected-rows value per row is 1 if the row is inserted as a new row, 2 if an existing row is updated, and 0 if an existing row is set to its current values. If you specify the `CLIENT_FOUND_ROWS` flag to the `mysql_real_connect()` C API function when connecting to `mysqld`, the affected-rows value is 1 (not 0) if an existing row is set to its current values.

If a table contains an `AUTO_INCREMENT` column and `INSERT ... ON DUPLICATE KEY UPDATE` inserts or updates a row, the `LAST_INSERT_ID()` function returns the `AUTO_INCREMENT` value.

The `ON DUPLICATE KEY UPDATE` clause can contain multiple column assignments, separated by commas.

It is possible to use `IGNORE` with `ON DUPLICATE KEY UPDATE` in an `INSERT` statement, but this may not behave as you expect when inserting multiple rows into a table that has multiple unique keys. This becomes apparent when an updated value is itself a duplicate key value. Consider the table `t`, created and populated by the statements shown here:

```
mysql> CREATE TABLE t (a SERIAL, b BIGINT NOT NULL, UNIQUE KEY (b));;
Query OK, 0 rows affected (0.03 sec)

mysql> INSERT INTO t VALUES (1,1), (2,2);
```

```
Query OK, 2 rows affected (0.01 sec)
Records: 2 Duplicates: 0 Warnings: 0
```

```
mysql> SELECT * FROM t;
+----+----+
| a | b |
+----+----+
| 1 | 1 |
| 2 | 2 |
+----+----+
2 rows in set (0.00 sec)
```

Now we attempt to insert two rows, one of which contains a duplicate key value, using `ON DUPLICATE KEY UPDATE`, where the `UPDATE` clause itself results in a duplicate key value:

```
mysql> INSERT INTO t VALUES (2,3), (3,3) ON DUPLICATE KEY UPDATE a=a+1, b=b-1;
ERROR 1062 (23000): Duplicate entry '1' for key 't.b'
mysql> SELECT * FROM t;
+----+----+
| a | b |
+----+----+
| 1 | 1 |
| 2 | 2 |
+----+----+
2 rows in set (0.00 sec)
```

The first row contains a duplicate value for one of the table's unique keys (column `a`), but `b=b+1` in the `UPDATE` clause results in a unique key violation for column `b`; the statement is immediately rejected with an error, and no rows are updated. Let us repeat the statement, this time adding the `IGNORE` keyword, like this:

```
mysql> INSERT IGNORE INTO t VALUES (2,3), (3,3)
      -> ON DUPLICATE KEY UPDATE a=a+1, b=b-1;
Query OK, 1 row affected, 1 warning (0.00 sec)
Records: 2 Duplicates: 1 Warnings: 1
```

This time, the previous error is demoted to a warning, as shown here:

```
mysql> SHOW WARNINGS;
+-----+-----+-----+
| Level | Code | Message |
+-----+-----+-----+
| Warning | 1062 | Duplicate entry '1' for key 't.b' |
+-----+-----+-----+
1 row in set (0.00 sec)
```

Because the statement was not rejected, execution continues. This means that the second row is inserted into `t`, as we can see here:

```
mysql> SELECT * FROM t;
+----+----+
| a | b |
+----+----+
| 1 | 1 |
| 2 | 2 |
| 3 | 3 |
+----+----+
3 rows in set (0.00 sec)
```

In assignment value expressions in the `ON DUPLICATE KEY UPDATE` clause, you can use the `VALUES(col_name)` function to refer to column values from the `INSERT` portion of the `INSERT ... ON DUPLICATE KEY UPDATE` statement. In other words, `VALUES(col_name)` in the `ON DUPLICATE KEY UPDATE` clause refers to the value of `col_name` that would be inserted, had no duplicate-key conflict occurred. This function is especially useful in multiple-row inserts. The `VALUES()` function is meaningful

only as an introducer for `INSERT` statement value lists, or in the `ON DUPLICATE KEY UPDATE` clause of an `INSERT` statement, and returns `NULL` otherwise. For example:

```
INSERT INTO t1 (a,b,c) VALUES (1,2,3),(4,5,6)
ON DUPLICATE KEY UPDATE c=VALUES(a)+VALUES(b);
```

That statement is identical to the following two statements:

```
INSERT INTO t1 (a,b,c) VALUES (1,2,3)
ON DUPLICATE KEY UPDATE c=3;
INSERT INTO t1 (a,b,c) VALUES (4,5,6)
ON DUPLICATE KEY UPDATE c=9;
```

For `INSERT ... SELECT` statements, these rules apply regarding acceptable forms of `SELECT` query expressions that you can refer to in an `ON DUPLICATE KEY UPDATE` clause:

- References to columns from queries on a single table, which may be a derived table.
- References to columns from queries on a join over multiple tables.
- References to columns from `DISTINCT` queries.
- References to columns in other tables, as long as the `SELECT` does not use `GROUP BY`. One side effect is that you must qualify references to nonunique column names.

References to columns from a `UNION` do not work reliably. To work around this restriction, rewrite the `UNION` as a derived table so that its rows can be treated as a single-table result set. For example, this statement can produce incorrect results:

```
INSERT INTO t1 (a, b)
SELECT c, d FROM t2
UNION
SELECT e, f FROM t3
ON DUPLICATE KEY UPDATE b = b + c;
```

Instead, use an equivalent statement that rewrites the `UNION` as a derived table:

```
INSERT INTO t1 (a, b)
SELECT * FROM
(SELECT c, d FROM t2
UNION
SELECT e, f FROM t3) AS dt
ON DUPLICATE KEY UPDATE b = b + c;
```

The technique of rewriting a query as a derived table also enables references to columns from `GROUP BY` queries.

Because the results of `INSERT ... SELECT` statements depend on the ordering of rows from the `SELECT` and this order cannot always be guaranteed, it is possible when logging `INSERT ... SELECT ON DUPLICATE KEY UPDATE` statements for the source and the replica to diverge. Thus, `INSERT ... SELECT ON DUPLICATE KEY UPDATE` statements are flagged as unsafe for statement-based replication. Such statements produce a warning in the error log when using statement-based mode and are written to the binary log using the row-based format when using `MIXED` mode. An `INSERT ... ON DUPLICATE KEY UPDATE` statement against a table having more than one unique or primary key is also marked as unsafe. (Bug #11765650, Bug #58637)

See also [Section 16.2.1.1, “Advantages and Disadvantages of Statement-Based and Row-Based Replication”](#).

An `INSERT ... ON DUPLICATE KEY UPDATE` on a partitioned table using a storage engine such as `MyISAM` that employs table-level locks locks any partitions of the table in which a partitioning key column

is updated. (This does not occur with tables using storage engines such as [InnoDB](#) that employ row-level locking.) For more information, see [Section 22.6.4, “Partitioning and Locking”](#).

### 13.2.5.3 INSERT DELAYED Statement

```
INSERT DELAYED ...
```

The `DELAYED` option for the `INSERT` statement is a MySQL extension to standard SQL. In previous versions of MySQL, it can be used for certain kinds of tables (such as `MyISAM`), such that when a client uses `INSERT DELAYED`, it gets an okay from the server at once, and the row is queued to be inserted when the table is not in use by any other thread.

`DELAYED` inserts and replaces were deprecated in MySQL 5.6. In MySQL 5.7, `DELAYED` is not supported. The server recognizes but ignores the `DELAYED` keyword, handles the insert as a nondelayed insert, and generates an `ER_WARN_LEGACY_SYNTAX_CONVERTED` warning: `INSERT DELAYED is no longer supported. The statement was converted to INSERT`. The `DELAYED` keyword is scheduled for removal in a future release.

### 13.2.6 LOAD DATA Statement

```
LOAD DATA
  [LOW_PRIORITY | CONCURRENT] [LOCAL]
  INFILE 'file_name'
  [REPLACE | IGNORE]
  INTO TABLE tbl_name
  [PARTITION (partition_name [, partition_name] ...)]
  [CHARACTER SET charset_name]
  [{FIELDS | COLUMNS}
   [TERMINATED BY 'string']
   [[OPTIONALLY] ENCLOSED BY 'char']
   [ESCAPED BY 'char']
  ]
  [LINES
   [STARTING BY 'string']
   [TERMINATED BY 'string']
  ]
  [IGNORE number {LINES | ROWS}]
  [(col_name_or_user_var
   [, col_name_or_user_var] ...)]
  [SET col_name={expr | DEFAULT}
   [, col_name={expr | DEFAULT}] ...]
```

The `LOAD DATA` statement reads rows from a text file into a table at a very high speed. The file can be read from the server host or the client host, depending on whether the `LOCAL` modifier is given. `LOCAL` also affects data interpretation and error handling.

`LOAD DATA` is the complement of `SELECT ... INTO OUTFILE`. (See [Section 13.2.9.1, “SELECT ... INTO Statement”](#).) To write data from a table to a file, use `SELECT ... INTO OUTFILE`. To read the file back into a table, use `LOAD DATA`. The syntax of the `FIELDS` and `LINES` clauses is the same for both statements.

The `mysqlimport` utility provides another way to load data files; it operates by sending a `LOAD DATA` statement to the server. See [Section 4.5.5, “mysqlimport — A Data Import Program”](#).

For information about the efficiency of `INSERT` versus `LOAD DATA` and speeding up `LOAD DATA`, see [Section 8.2.4.1, “Optimizing INSERT Statements”](#).

- [Non-LOCAL Versus LOCAL Operation](#)
- [Input File Character Set](#)

- [Input File Location](#)
- [Security Requirements](#)
- [Duplicate-Key and Error Handling](#)
- [Index Handling](#)
- [Field and Line Handling](#)
- [Column List Specification](#)
- [Input Preprocessing](#)
- [Column Value Assignment](#)
- [Partitioned Table Support](#)
- [Concurrency Considerations](#)
- [Statement Result Information](#)
- [Replication Considerations](#)
- [Miscellaneous Topics](#)

## Non-LOCAL Versus LOCAL Operation

The `LOCAL` modifier affects these aspects of `LOAD DATA`, compared to non-`LOCAL` operation:

- It changes the expected location of the input file; see [Input File Location](#).
- It changes the statement security requirements; see [Security Requirements](#).
- Unless `REPLACE` is also specified, `LOCAL` has the same effect as the `IGNORE` modifier on the interpretation of input file contents and error handling; see [Duplicate-Key and Error Handling](#), and [Column Value Assignment](#).

`LOCAL` works only if the server and your client both have been configured to permit it. For example, if `mysqld` was started with the `local_infile` system variable disabled, `LOCAL` produces an error. See [Section 6.1.6, “Security Considerations for LOAD DATA LOCAL”](#).

## Input File Character Set

The file name must be given as a literal string. On Windows, specify backslashes in path names as forward slashes or doubled backslashes. The server interprets the file name using the character set indicated by the `character_set_filesystem` system variable.

By default, the server interprets the file contents using the character set indicated by the `character_set_database` system variable. If the file contents use a character set different from this default, it is a good idea to specify that character set by using the `CHARACTER SET` clause. A character set of `binary` specifies “no conversion.”

`SET NAMES` and the setting of `character_set_client` do not affect interpretation of file contents.

`LOAD DATA` interprets all fields in the file as having the same character set, regardless of the data types of the columns into which field values are loaded. For proper interpretation of the file, you must ensure that it was written with the correct character set. For example, if you write a data file with `mysqldump -T` or by issuing a `SELECT ... INTO OUTFILE` statement in `mysql`, be sure to use a `--default-character-set` option to write output in the character set to be used when the file is loaded with `LOAD DATA`.



**Note**

It is not possible to load data files that use the `ucs2`, `utf16`, `utf16le`, or `utf32` character set.

## Input File Location

These rules determine the `LOAD DATA` input file location:

- If `LOCAL` is not specified, the file must be located on the server host. The server reads the file directly, locating it as follows:
  - If the file name is an absolute path name, the server uses it as given.
  - If the file name is a relative path name with leading components, the server looks for the file relative to its data directory.
  - If the file name has no leading components, the server looks for the file in the database directory of the default database.
- If `LOCAL` is specified, the file must be located on the client host. The client program reads the file, locating it as follows:
  - If the file name is an absolute path name, the client program uses it as given.
  - If the file name is a relative path name, the client program looks for the file relative to its invocation directory.

When `LOCAL` is used, the client program reads the file and sends its contents to the server. The server creates a copy of the file in the directory where it stores temporary files. See [Section B.3.3.5, “Where MySQL Stores Temporary Files”](#). Lack of sufficient space for the copy in this directory can cause the `LOAD DATA LOCAL` statement to fail.

The non-`LOCAL` rules mean that the server reads a file named as `./myfile.txt` relative to its data directory, whereas it reads a file named as `myfile.txt` from the database directory of the default database. For example, if the following `LOAD DATA` statement is executed while `db1` is the default database, the server reads the file `data.txt` from the database directory for `db1`, even though the statement explicitly loads the file into a table in the `db2` database:

```
LOAD DATA INFILE 'data.txt' INTO TABLE db2.my_table;
```

## Security Requirements

For a non-`LOCAL` load operation, the server reads a text file located on the server host, so these security requirements must be satisfied:

- You must have the `FILE` privilege. See [Section 6.2.2, “Privileges Provided by MySQL”](#).
- The operation is subject to the `secure_file_priv` system variable setting:
  - If the variable value is a nonempty directory name, the file must be located in that directory.
  - If the variable value is empty (which is `insecure`), the file need only be readable by the server.

For a `LOCAL` load operation, the client program reads a text file located on the client host. Because the file contents are sent over the connection by the client to the server, using `LOCAL` is a bit slower than when the server accesses the file directly. On the other hand, you do not need the `FILE` privilege, and the file can be located in any directory the client program can access.

## Duplicate-Key and Error Handling

The `REPLACE` and `IGNORE` modifiers control handling of new (input) rows that duplicate existing table rows on unique key values (`PRIMARY KEY` or `UNIQUE` index values):

- With `REPLACE`, new rows that have the same value as a unique key value in an existing row replace the existing row. See [Section 13.2.8, “REPLACE Statement”](#).
- With `IGNORE`, new rows that duplicate an existing row on a unique key value are discarded. For more information, see [The Effect of IGNORE on Statement Execution](#).

Unless `REPLACE` is also specified, the `LOCAL` modifier has the same effect as `IGNORE`. This occurs because the server has no way to stop transmission of the file in the middle of the operation.

If none of `REPLACE`, `IGNORE`, or `LOCAL` is specified, an error occurs when a duplicate key value is found, and the rest of the text file is ignored.

In addition to affecting duplicate-key handling as just described, `IGNORE` and `LOCAL` also affect error handling:

- When neither `IGNORE` nor `LOCAL` is specified, data-interpretation errors terminate the operation.
- When `IGNORE`—or `LOCAL` without `REPLACE`—is specified, data interpretation errors become warnings and the load operation continues, even if the SQL mode is restrictive. For examples, see [Column Value Assignment](#).

## Index Handling

To ignore foreign key constraints during the load operation, execute a `SET foreign_key_checks = 0` statement before executing `LOAD DATA`.

If you use `LOAD DATA` on an empty `MyISAM` table, all nonunique indexes are created in a separate batch (as for `REPAIR TABLE`). Normally, this makes `LOAD DATA` much faster when you have many indexes. In some extreme cases, you can create the indexes even faster by turning them off with `ALTER TABLE ... DISABLE KEYS` before loading the file into the table and re-creating the indexes with `ALTER TABLE ... ENABLE KEYS` after loading the file. See [Section 8.2.4.1, “Optimizing INSERT Statements”](#).

## Field and Line Handling

For both the `LOAD DATA` and `SELECT ... INTO OUTFILE` statements, the syntax of the `FIELDS` and `LINES` clauses is the same. Both clauses are optional, but `FIELDS` must precede `LINES` if both are specified.

If you specify a `FIELDS` clause, each of its subclauses (`TERMINATED BY`, `[OPTIONALLY] ENCLOSED BY`, and `ESCAPED BY`) is also optional, except that you must specify at least one of them. Arguments to these clauses are permitted to contain only ASCII characters.

If you specify no `FIELDS` or `LINES` clause, the defaults are the same as if you had written this:

```
FIELDS TERMINATED BY '\t' ENCLOSED BY '' ESCAPED BY '\\'  
LINES TERMINATED BY '\n' STARTING BY ''
```

Backslash is the MySQL escape character within strings in SQL statements. Thus, to specify a literal backslash, you must specify two backslashes for the value to be interpreted as a single backslash. The escape sequences `'\t'` and `'\n'` specify tab and newline characters, respectively.

In other words, the defaults cause `LOAD DATA` to act as follows when reading input:

- Look for line boundaries at newlines.

- Do not skip any line prefix.
- Break lines into fields at tabs.
- Do not expect fields to be enclosed within any quoting characters.
- Interpret characters preceded by the escape character `\` as escape sequences. For example, `\t`, `\n`, and `\\` signify tab, newline, and backslash, respectively. See the discussion of `FIELDS ESCAPED BY` later for the full list of escape sequences.

Conversely, the defaults cause `SELECT ... INTO OUTFILE` to act as follows when writing output:

- Write tabs between fields.
- Do not enclose fields within any quoting characters.
- Use `\` to escape instances of tab, newline, or `\` that occur within field values.
- Write newlines at the ends of lines.



### Note

For a text file generated on a Windows system, proper file reading might require `LINES TERMINATED BY '\r\n'` because Windows programs typically use two characters as a line terminator. Some programs, such as `WordPad`, might use `\r` as a line terminator when writing files. To read such files, use `LINES TERMINATED BY '\r'`.

If all the input lines have a common prefix that you want to ignore, you can use `LINES STARTING BY 'prefix_string'` to skip the prefix *and anything before it*. If a line does not include the prefix, the entire line is skipped. Suppose that you issue the following statement:

```
LOAD DATA INFILE '/tmp/test.txt' INTO TABLE test
  FIELDS TERMINATED BY ',' LINES STARTING BY 'xxx';
```

If the data file looks like this:

```
xxx"abc",1
something xxx"def",2
"ghi",3
```

The resulting rows are `("abc",1)` and `("def",2)`. The third row in the file is skipped because it does not contain the prefix.

The `IGNORE number LINES` clause can be used to ignore lines at the start of the file. For example, you can use `IGNORE 1 LINES` to skip an initial header line containing column names:

```
LOAD DATA INFILE '/tmp/test.txt' INTO TABLE test IGNORE 1 LINES;
```

When you use `SELECT ... INTO OUTFILE` in tandem with `LOAD DATA` to write data from a database into a file and then read the file back into the database later, the field- and line-handling options for both statements must match. Otherwise, `LOAD DATA` does not interpret the contents of the file properly. Suppose that you use `SELECT ... INTO OUTFILE` to write a file with fields delimited by commas:

```
SELECT * INTO OUTFILE 'data.txt'
  FIELDS TERMINATED BY ','
  FROM table2;
```

To read the comma-delimited file, the correct statement is:

```
LOAD DATA INFILE 'data.txt' INTO TABLE table2
  FIELDS TERMINATED BY ',';
```

If instead you tried to read the file with the statement shown following, it would not work because it instructs `LOAD DATA` to look for tabs between fields:

```
LOAD DATA INFILE 'data.txt' INTO TABLE table2
  FIELDS TERMINATED BY '\t';
```

The likely result is that each input line would be interpreted as a single field.

`LOAD DATA` can be used to read files obtained from external sources. For example, many programs can export data in comma-separated values (CSV) format, such that lines have fields separated by commas and enclosed within double quotation marks, with an initial line of column names. If the lines in such a file are terminated by carriage return/newline pairs, the statement shown here illustrates the field- and line-handling options you would use to load the file:

```
LOAD DATA INFILE 'data.txt' INTO TABLE tbl_name
  FIELDS TERMINATED BY ',' ENCLOSED BY '"'
  LINES TERMINATED BY '\r\n'
  IGNORE 1 LINES;
```

If the input values are not necessarily enclosed within quotation marks, use `OPTIONALLY` before the `ENCLOSED BY` option.

Any of the field- or line-handling options can specify an empty string (' '). If not empty, the `FIELDS [OPTIONALLY] ENCLOSED BY` and `FIELDS ESCAPED BY` values must be a single character. The `FIELDS TERMINATED BY`, `LINES STARTING BY`, and `LINES TERMINATED BY` values can be more than one character. For example, to write lines that are terminated by carriage return/linefeed pairs, or to read a file containing such lines, specify a `LINES TERMINATED BY '\r\n'` clause.

To read a file containing jokes that are separated by lines consisting of `%%`, you can do this

```
CREATE TABLE jokes
  (a INT NOT NULL AUTO_INCREMENT PRIMARY KEY,
  joke TEXT NOT NULL);
LOAD DATA INFILE '/tmp/jokes.txt' INTO TABLE jokes
  FIELDS TERMINATED BY ''
  LINES TERMINATED BY '\n%%\n' (joke);
```

`FIELDS [OPTIONALLY] ENCLOSED BY` controls quoting of fields. For output (`SELECT ... INTO OUTFILE`), if you omit the word `OPTIONALLY`, all fields are enclosed by the `ENCLOSED BY` character. An example of such output (using a comma as the field delimiter) is shown here:

```
"1","a string","100.20"
"2","a string containing a , comma","102.20"
"3","a string containing a \" quote","102.20"
"4","a string containing a \", quote and comma","102.20"
```

If you specify `OPTIONALLY`, the `ENCLOSED BY` character is used only to enclose values from columns that have a string data type (such as `CHAR`, `BINARY`, `TEXT`, or `ENUM`):

```
1,"a string",100.20
2,"a string containing a , comma",102.20
3,"a string containing a \" quote",102.20
4,"a string containing a \", quote and comma",102.20
```

Occurrences of the `ENCLOSED BY` character within a field value are escaped by prefixing them with the `ESCAPED BY` character. Also, if you specify an empty `ESCAPED BY` value, it is possible to inadvertently generate output that cannot be read properly by `LOAD DATA`. For example, the preceding output just shown would appear as follows if the escape character is empty. Observe that the second field in the fourth line contains a comma following the quote, which (erroneously) appears to terminate the field:

```
1,"a string",100.20
2,"a string containing a , comma",102.20
```

```
3,"a string containing a " quote",102.20
4,"a string containing a ", quote and comma",102.20
```

For input, the **ENCLOSED BY** character, if present, is stripped from the ends of field values. (This is true regardless of whether **OPTIONALLY** is specified; **OPTIONALLY** has no effect on input interpretation.) Occurrences of the **ENCLOSED BY** character preceded by the **ESCAPED BY** character are interpreted as part of the current field value.

If the field begins with the **ENCLOSED BY** character, instances of that character are recognized as terminating a field value only if followed by the field or line **TERMINATED BY** sequence. To avoid ambiguity, occurrences of the **ENCLOSED BY** character within a field value can be doubled and are interpreted as a single instance of the character. For example, if **ENCLOSED BY ' '** is specified, quotation marks are handled as shown here:

```
"The ""BIG"" boss"  -> The "BIG" boss
The "BIG" boss      -> The "BIG" boss
The ""BIG"" boss    -> The ""BIG"" boss
```

**FIELDS ESCAPED BY** controls how to read or write special characters:

- For input, if the **FIELDS ESCAPED BY** character is not empty, occurrences of that character are stripped and the following character is taken literally as part of a field value. Some two-character sequences that are exceptions, where the first character is the escape character. These sequences are shown in the following table (using **\** for the escape character). The rules for **NULL** handling are described later in this section.

Character	Escape Sequence
<b>\0</b>	An ASCII NUL ( <b>x'00'</b> ) character
<b>\b</b>	A backspace character
<b>\n</b>	A newline (linefeed) character
<b>\r</b>	A carriage return character
<b>\t</b>	A tab character.
<b>\z</b>	ASCII 26 (Control+Z)
<b>\N</b>	NULL

For more information about **\**-escape syntax, see [Section 9.1.1, "String Literals"](#).

If the **FIELDS ESCAPED BY** character is empty, escape-sequence interpretation does not occur.

- For output, if the **FIELDS ESCAPED BY** character is not empty, it is used to prefix the following characters on output:
  - The **FIELDS ESCAPED BY** character.
  - The **FIELDS [OPTIONALLY] ENCLOSED BY** character.
  - The first character of the **FIELDS TERMINATED BY** and **LINES TERMINATED BY** values, if the **ENCLOSED BY** character is empty or unspecified.
  - ASCII 0 (what is actually written following the escape character is ASCII 0, not a zero-valued byte).

If the **FIELDS ESCAPED BY** character is empty, no characters are escaped and **NULL** is output as **NULL**, not **\N**. It is probably not a good idea to specify an empty escape character, particularly if field values in your data contain any of the characters in the list just given.

In certain cases, field- and line-handling options interact:

- If `LINES TERMINATED BY` is an empty string and `FIELDS TERMINATED BY` is nonempty, lines are also terminated with `FIELDS TERMINATED BY`.
- If the `FIELDS TERMINATED BY` and `FIELDS ENCLOSED BY` values are both empty ( `' '` ), a fixed-row (nondelimited) format is used. With fixed-row format, no delimiters are used between fields (but you can still have a line terminator). Instead, column values are read and written using a field width wide enough to hold all values in the field. For `TINYINT`, `SMALLINT`, `MEDIUMINT`, `INT`, and `BIGINT`, the field widths are 4, 6, 8, 11, and 20, respectively, no matter what the declared display width is.

`LINES TERMINATED BY` is still used to separate lines. If a line does not contain all fields, the rest of the columns are set to their default values. If you do not have a line terminator, you should set this to `' '`. In this case, the text file must contain all fields for each row.

Fixed-row format also affects handling of `NULL` values, as described later.



#### Note

Fixed-size format does not work if you are using a multibyte character set.

Handling of `NULL` values varies according to the `FIELDS` and `LINES` options in use:

- For the default `FIELDS` and `LINES` values, `NULL` is written as a field value of `\N` for output, and a field value of `\N` is read as `NULL` for input (assuming that the `ESCAPED BY` character is `\`).
- If `FIELDS ENCLOSED BY` is not empty, a field containing the literal word `NULL` as its value is read as a `NULL` value. This differs from the word `NULL` enclosed within `FIELDS ENCLOSED BY` characters, which is read as the string `'NULL'`.
- If `FIELDS ESCAPED BY` is empty, `NULL` is written as the word `NULL`.
- With fixed-row format (which is used when `FIELDS TERMINATED BY` and `FIELDS ENCLOSED BY` are both empty), `NULL` is written as an empty string. This causes both `NULL` values and empty strings in the table to be indistinguishable when written to the file because both are written as empty strings. If you need to be able to tell the two apart when reading the file back in, you should not use fixed-row format.

An attempt to load `NULL` into a `NOT NULL` column produces either a warning or an error according to the rules described in [Column Value Assignment](#).

Some cases are not supported by `LOAD DATA`:

- Fixed-size rows (`FIELDS TERMINATED BY` and `FIELDS ENCLOSED BY` both empty) and `BLOB` or `TEXT` columns.
- If you specify one separator that is the same as or a prefix of another, `LOAD DATA` cannot interpret the input properly. For example, the following `FIELDS` clause would cause problems:

```
FIELDS TERMINATED BY ''' ENCLOSED BY '''
```

- If `FIELDS ESCAPED BY` is empty, a field value that contains an occurrence of `FIELDS ENCLOSED BY` or `LINES TERMINATED BY` followed by the `FIELDS TERMINATED BY` value causes `LOAD DATA` to stop reading a field or line too early. This happens because `LOAD DATA` cannot properly determine where the field or line value ends.

## Column List Specification

The following example loads all columns of the `persondata` table:

```
LOAD DATA INFILE 'persondata.txt' INTO TABLE persondata;
```

By default, when no column list is provided at the end of the `LOAD DATA` statement, input lines are expected to contain a field for each table column. If you want to load only some of a table's columns, specify a column list:

```
LOAD DATA INFILE 'persondata.txt' INTO TABLE persondata
(col_name_or_user_var [, col_name_or_user_var] ...);
```

You must also specify a column list if the order of the fields in the input file differs from the order of the columns in the table. Otherwise, MySQL cannot tell how to match input fields with table columns.

## Input Preprocessing

Each instance of `col_name_or_user_var` in `LOAD DATA` syntax is either a column name or a user variable. With user variables, the `SET` clause enables you to perform preprocessing transformations on their values before assigning the result to columns.

User variables in the `SET` clause can be used in several ways. The following example uses the first input column directly for the value of `t1.column1`, and assigns the second input column to a user variable that is subjected to a division operation before being used for the value of `t1.column2`:

```
LOAD DATA INFILE 'file.txt'
INTO TABLE t1
(column1, @var1)
SET column2 = @var1/100;
```

The `SET` clause can be used to supply values not derived from the input file. The following statement sets `column3` to the current date and time:

```
LOAD DATA INFILE 'file.txt'
INTO TABLE t1
(column1, column2)
SET column3 = CURRENT_TIMESTAMP;
```

You can also discard an input value by assigning it to a user variable and not assigning the variable to any table column:

```
LOAD DATA INFILE 'file.txt'
INTO TABLE t1
(column1, @dummy, column2, @dummy, column3);
```

Use of the column/variable list and `SET` clause is subject to the following restrictions:

- Assignments in the `SET` clause should have only column names on the left hand side of assignment operators.
- You can use subqueries in the right hand side of `SET` assignments. A subquery that returns a value to be assigned to a column may be a scalar subquery only. Also, you cannot use a subquery to select from the table that is being loaded.
- Lines ignored by an `IGNORE number LINES` clause are not processed for the column/variable list or `SET` clause.
- User variables cannot be used when loading data with fixed-row format because user variables do not have a display width.

## Column Value Assignment

To process an input line, `LOAD DATA` splits it into fields and uses the values according to the column/variable list and the `SET` clause, if they are present. Then the resulting row is inserted into the table. If there

are `BEFORE INSERT` or `AFTER INSERT` triggers for the table, they are activated before or after inserting the row, respectively.

Interpretation of field values and assignment to table columns depends on these factors:

- The SQL mode (the value of the `sql_mode` system variable). The mode can be nonstrictive, or restrictive in various ways. For example, strict SQL mode can be enabled, or the mode can include values such as `NO_ZERO_DATE` or `NO_ZERO_IN_DATE`.
- Presence or absence of the `IGNORE` and `LOCAL` modifiers.

Those factors combine to produce restrictive or nonrestrictive data interpretation by `LOAD DATA`:

- Data interpretation is restrictive if the SQL mode is restrictive and neither the `IGNORE` nor the `LOCAL` modifier is specified. Errors terminate the load operation.
- Data interpretation is nonrestrictive if the SQL mode is nonrestrictive or the `IGNORE` or `LOCAL` modifier is specified. (In particular, either modifier if specified *overrides* a restrictive SQL mode.) Errors become warnings and the load operation continues.

Restrictive data interpretation uses these rules:

- Too many or too few fields results an error.
- Assigning `NULL` (that is, `\N`) to a non-`NULL` column results in an error.
- A value that is out of range for the column data type results in an error.
- Invalid values produce errors. For example, a value such as `'x'` for a numeric column results in an error, not conversion to 0.

By contrast, nonrestrictive data interpretation uses these rules:

- If an input line has too many fields, the extra fields are ignored and the number of warnings is incremented.
- If an input line has too few fields, the columns for which input fields are missing are assigned their default values. Default value assignment is described in [Section 11.6, “Data Type Default Values”](#).
- Assigning `NULL` (that is, `\N`) to a non-`NULL` column results in assignment of the implicit default value for the column data type. Implicit default values are described in [Section 11.6, “Data Type Default Values”](#).
- Invalid values produce warnings rather than errors, and are converted to the “closest” valid value for the column data type. Examples:
  - A value such as `'x'` for a numeric column results in conversion to 0.
  - An out-of-range numeric or temporal value is clipped to the closest endpoint of the range for the column data type.
  - An invalid value for a `DATETIME`, `DATE`, or `TIME` column is inserted as the implicit default value, regardless of the SQL mode `NO_ZERO_DATE` setting. The implicit default is the appropriate “zero” value for the type (`'0000-00-00 00:00:00'`, `'0000-00-00'`, or `'00:00:00'`). See [Section 11.2, “Date and Time Data Types”](#).
- `LOAD DATA` interprets an empty field value differently from a missing field:
  - For string types, the column is set to the empty string.



- For numeric types, the column is set to 0.
- For date and time types, the column is set to the appropriate “zero” value for the type. See [Section 11.2, “Date and Time Data Types”](#).

These are the same values that result if you assign an empty string explicitly to a string, numeric, or date or time type explicitly in an `INSERT` or `UPDATE` statement.

`TIMESTAMP` columns are set to the current date and time only if there is a `NULL` value for the column (that is, `\N`) and the column is not declared to permit `NULL` values, or if the `TIMESTAMP` column default value is the current timestamp and it is omitted from the field list when a field list is specified.

`LOAD DATA` regards all input as strings, so you cannot use numeric values for `ENUM` or `SET` columns the way you can with `INSERT` statements. All `ENUM` and `SET` values must be specified as strings.

`BIT` values cannot be loaded directly using binary notation (for example, `b'011010'`). To work around this, use the `SET` clause to strip off the leading `b'` and trailing `'` and perform a base-2 to base-10 conversion so that MySQL loads the values into the `BIT` column properly:

```
$> cat /tmp/bit_test.txt
b'10'
b'1111111'
$> mysql test
mysql> LOAD DATA INFILE '/tmp/bit_test.txt'
      INTO TABLE bit_test (@var1)
      SET b = CAST(CONV(MID(@var1, 3, LENGTH(@var1)-3), 2, 10) AS UNSIGNED);
Query OK, 2 rows affected (0.00 sec)
Records: 2  Deleted: 0  Skipped: 0  Warnings: 0

mysql> SELECT BIN(b+0) FROM bit_test;
+-----+
| BIN(b+0) |
+-----+
| 10       |
| 1111111 |
+-----+
2 rows in set (0.00 sec)
```

For `BIT` values in `0b` binary notation (for example, `0b011010`), use this `SET` clause instead to strip off the leading `0b`:

```
SET b = CAST(CONV(MID(@var1, 3, LENGTH(@var1)-2), 2, 10) AS UNSIGNED)
```

## Partitioned Table Support

`LOAD DATA` supports explicit partition selection using the `PARTITION` clause with a list of one or more comma-separated names of partitions, subpartitions, or both. When this clause is used, if any rows from the file cannot be inserted into any of the partitions or subpartitions named in the list, the statement fails with the error `Found a row not matching the given partition set`. For more information and examples, see [Section 22.5, “Partition Selection”](#).

For partitioned tables using storage engines that employ table locks, such as `MyISAM`, `LOAD DATA` cannot prune any partition locks. This does not apply to tables using storage engines that employ row-level locking, such as `InnoDB`. For more information, see [Section 22.6.4, “Partitioning and Locking”](#).

## Concurrency Considerations

With the `LOW_PRIORITY` modifier, execution of the `LOAD DATA` statement is delayed until no other clients are reading from the table. This affects only storage engines that use only table-level locking (such as `MyISAM`, `MEMORY`, and `MERGE`).

With the `CONCURRENT` modifier and a `MyISAM` table that satisfies the condition for concurrent inserts (that is, it contains no free blocks in the middle), other threads can retrieve data from the table while `LOAD DATA` is executing. This modifier affects the performance of `LOAD DATA` a bit, even if no other thread is using the table at the same time.

## Statement Result Information

When the `LOAD DATA` statement finishes, it returns an information string in the following format:

```
Records: 1 Deleted: 0 Skipped: 0 Warnings: 0
```

Warnings occur under the same circumstances as when values are inserted using the `INSERT` statement (see [Section 13.2.5, “INSERT Statement”](#)), except that `LOAD DATA` also generates warnings when there are too few or too many fields in the input row.

You can use `SHOW WARNINGS` to get a list of the first `max_error_count` warnings as information about what went wrong. See [Section 13.7.5.40, “SHOW WARNINGS Statement”](#).

If you are using the C API, you can get information about the statement by calling the `mysql_info()` function. See [mysql\\_info\(\)](#).

## Replication Considerations

For information about `LOAD DATA` in relation to replication, see [Section 16.4.1.18, “Replication and LOAD DATA”](#).

## Miscellaneous Topics

On Unix, if you need `LOAD DATA` to read from a pipe, you can use the following technique (the example loads a listing of the `/` directory into the table `db1.t1`):

```
mkfifo /mysql/data/db1/ls.dat
chmod 666 /mysql/data/db1/ls.dat
find / -ls > /mysql/data/db1/ls.dat &
mysql -e "LOAD DATA INFILE 'ls.dat' INTO TABLE t1" db1
```

Here you must run the command that generates the data to be loaded and the `mysql` commands either on separate terminals, or run the data generation process in the background (as shown in the preceding example). If you do not do this, the pipe blocks until data is read by the `mysql` process.

## 13.2.7 LOAD XML Statement

```
LOAD XML
[LOW_PRIORITY | CONCURRENT] [LOCAL]
INFILE 'file_name'
[REPLACE | IGNORE]
INTO TABLE [db_name.]tbl_name
[CHARACTER SET charset_name]
[ROWS IDENTIFIED BY '<tagname>']
[IGNORE number {LINES | ROWS}]
[(field_name_or_user_var
[, field_name_or_user_var] ...)]
[SET col_name={expr | DEFAULT}
[, col_name={expr | DEFAULT}] ...]
```

The `LOAD XML` statement reads data from an XML file into a table. The `file_name` must be given as a literal string. The `tagname` in the optional `ROWS IDENTIFIED BY` clause must also be given as a literal string, and must be surrounded by angle brackets (`<` and `>`).

`LOAD XML` acts as the complement of running the `mysql` client in XML output mode (that is, starting the client with the `--xml` option). To write data from a table to an XML file, you can invoke the `mysql` client with the `--xml` and `-e` options from the system shell, as shown here:

```
$> mysql --xml -e 'SELECT * FROM mydb.mytable' > file.xml
```

To read the file back into a table, use `LOAD XML`. By default, the `<row>` element is considered to be the equivalent of a database table row; this can be changed using the `ROWS IDENTIFIED BY` clause.

This statement supports three different XML formats:

- Column names as attributes and column values as attribute values:

```
<row column1="value1" column2="value2" .../>
```

- Column names as tags and column values as the content of these tags:

```
<row>
  <column1>value1</column1>
  <column2>value2</column2>
</row>
```

- Column names are the `name` attributes of `<field>` tags, and values are the contents of these tags:

```
<row>
  <field name='column1'>value1</field>
  <field name='column2'>value2</field>
</row>
```

This is the format used by other MySQL tools, such as `mysqldump`.

All three formats can be used in the same XML file; the import routine automatically detects the format for each row and interprets it correctly. Tags are matched based on the tag or attribute name and the column name.

In MySQL 5.7, `LOAD XML` does not support `CDATA` sections in the source XML. This limitation is removed in MySQL 8.0. (Bug #30753708, Bug #98199)

The following clauses work essentially the same way for `LOAD XML` as they do for `LOAD DATA`:

- `LOW_PRIORITY` or `CONCURRENT`
- `LOCAL`
- `REPLACE` or `IGNORE`
- `CHARACTER SET`
- `SET`

See [Section 13.2.6, “LOAD DATA Statement”](#), for more information about these clauses.

`(field_name_or_user_var, ...)` is a list of one or more comma-separated XML fields or user variables. The name of a user variable used for this purpose must match the name of a field from the XML file, prefixed with `@`. You can use field names to select only desired fields. User variables can be employed to store the corresponding field values for subsequent re-use.

The `IGNORE number LINES` or `IGNORE number ROWS` clause causes the first `number` rows in the XML file to be skipped. It is analogous to the `LOAD DATA` statement's `IGNORE ... LINES` clause.

Suppose that we have a table named `person`, created as shown here:

```
USE test;

CREATE TABLE person (
  person_id INT NOT NULL PRIMARY KEY,
  fname VARCHAR(40) NULL,
  lname VARCHAR(40) NULL,
  created TIMESTAMP
);
```

Suppose further that this table is initially empty.

Now suppose that we have a simple XML file `person.xml`, whose contents are as shown here:

```
<list>
  <person person_id="1" fname="Kapek" lname="Sainnouine"/>
  <person person_id="2" fname="Sajon" lname="Rondela"/>
  <person person_id="3"><fname>Likame</fname><lname>Örrtmons</lname></person>
  <person person_id="4"><fname>Slar</fname><lname>Manlanth</lname></person>
  <person><field name="person_id">5</field><field name="fname">Stoma</field>
  <field name="lname">Milu</field></person>
  <person><field name="person_id">6</field><field name="fname">Nirtam</field>
  <field name="lname">Sklöd</field></person>
  <person person_id="7"><fname>Sungam</fname><lname>Dulbåd</lname></person>
  <person person_id="8" fname="Sreraf" lname="Encmelt"/>
</list>
```

Each of the permissible XML formats discussed previously is represented in this example file.

To import the data in `person.xml` into the `person` table, you can use this statement:

```
mysql> LOAD XML LOCAL INFILE 'person.xml'
-> INTO TABLE person
-> ROWS IDENTIFIED BY '<person>';

Query OK, 8 rows affected (0.00 sec)
Records: 8 Deleted: 0 Skipped: 0 Warnings: 0
```

Here, we assume that `person.xml` is located in the MySQL data directory. If the file cannot be found, the following error results:

```
ERROR 2 (HY000): File '/person.xml' not found (Errcode: 2)
```

The `ROWS IDENTIFIED BY '<person>'` clause means that each `<person>` element in the XML file is considered equivalent to a row in the table into which the data is to be imported. In this case, this is the `person` table in the `test` database.

As can be seen by the response from the server, 8 rows were imported into the `test.person` table. This can be verified by a simple `SELECT` statement:

```
mysql> SELECT * FROM person;
+-----+-----+-----+-----+
| person_id | fname | lname | created |
+-----+-----+-----+-----+
| 1 | Kapek | Sainnouine | 2007-07-13 16:18:47 |
| 2 | Sajon | Rondela | 2007-07-13 16:18:47 |
| 3 | Likame | Örrtmons | 2007-07-13 16:18:47 |
| 4 | Slar | Manlanth | 2007-07-13 16:18:47 |
| 5 | Stoma | Nilu | 2007-07-13 16:18:47 |
| 6 | Nirtam | Sklöd | 2007-07-13 16:18:47 |
| 7 | Sungam | Dulbåd | 2007-07-13 16:18:47 |
| 8 | Sreraf | Encmelt | 2007-07-13 16:18:47 |
+-----+-----+-----+-----+
8 rows in set (0.00 sec)
```

This shows, as stated earlier in this section, that any or all of the 3 permitted XML formats may appear in a single file and be read using `LOAD XML`.

The inverse of the import operation just shown—that is, dumping MySQL table data into an XML file—can be accomplished using the `mysql` client from the system shell, as shown here:

```
$> mysql --xml -e "SELECT * FROM test.person" > person-dump.xml
$> cat person-dump.xml
<?xml version="1.0"?>

<resultset statement="SELECT * FROM test.person" xmlns:xsi="http://www.w3.org/2001/XMLSchema-instance">
  <row>
    <field name="person_id">1</field>
    <field name="fname">Kapek</field>
    <field name="lname">Sainnouine</field>
  </row>

  <row>
    <field name="person_id">2</field>
    <field name="fname">Sajon</field>
    <field name="lname">Rondela</field>
  </row>

  <row>
    <field name="person_id">3</field>
    <field name="fname">Likema</field>
    <field name="lname">Örrtmons</field>
  </row>

  <row>
    <field name="person_id">4</field>
    <field name="fname">Slar</field>
    <field name="lname">Manlanth</field>
  </row>

  <row>
    <field name="person_id">5</field>
    <field name="fname">Stoma</field>
    <field name="lname">Nilu</field>
  </row>

  <row>
    <field name="person_id">6</field>
    <field name="fname">Nirtam</field>
    <field name="lname">Sklöd</field>
  </row>

  <row>
    <field name="person_id">7</field>
    <field name="fname">Sungam</field>
    <field name="lname">Dulbåd</field>
  </row>

  <row>
    <field name="person_id">8</field>
    <field name="fname">Sreraf</field>
    <field name="lname">Encmelt</field>
  </row>
</resultset>
```



### Note

The `--xml` option causes the `mysql` client to use XML formatting for its output; the `-e` option causes the client to execute the SQL statement immediately following the option. See [Section 4.5.1, “mysql — The MySQL Command-Line Client”](#).

You can verify that the dump is valid by creating a copy of the `person` table and importing the dump file into the new table, like this:

```
mysql> USE test;
mysql> CREATE TABLE person2 LIKE person;
Query OK, 0 rows affected (0.00 sec)

mysql> LOAD XML LOCAL INFILE 'person-dump.xml'
-> INTO TABLE person2;
Query OK, 8 rows affected (0.01 sec)
Records: 8 Deleted: 0 Skipped: 0 Warnings: 0

mysql> SELECT * FROM person2;
```

person_id	fname	lname	created
1	Kapek	Sainnouine	2007-07-13 16:18:47
2	Sajon	Rondela	2007-07-13 16:18:47
3	Likema	Örrtmons	2007-07-13 16:18:47
4	Slar	Manlanth	2007-07-13 16:18:47
5	Stoma	Nilu	2007-07-13 16:18:47
6	Nirtam	Sklöd	2007-07-13 16:18:47
7	Sungam	Dulbåd	2007-07-13 16:18:47
8	Sreraf	Encmelt	2007-07-13 16:18:47

```
8 rows in set (0.00 sec)
```

There is no requirement that every field in the XML file be matched with a column in the corresponding table. Fields which have no corresponding columns are skipped. You can see this by first emptying the `person2` table and dropping the `created` column, then using the same `LOAD XML` statement we just employed previously, like this:

```
mysql> TRUNCATE person2;
Query OK, 8 rows affected (0.26 sec)

mysql> ALTER TABLE person2 DROP COLUMN created;
Query OK, 0 rows affected (0.52 sec)
Records: 0 Duplicates: 0 Warnings: 0

mysql> SHOW CREATE TABLE person2\G
***** 1. row *****
      Table: person2
Create Table: CREATE TABLE `person2` (
  `person_id` int(11) NOT NULL,
  `fname` varchar(40) DEFAULT NULL,
  `lname` varchar(40) DEFAULT NULL,
  PRIMARY KEY (`person_id`)
) ENGINE=InnoDB DEFAULT CHARSET=utf8
1 row in set (0.00 sec)

mysql> LOAD XML LOCAL INFILE 'person-dump.xml'
-> INTO TABLE person2;
Query OK, 8 rows affected (0.01 sec)
Records: 8 Deleted: 0 Skipped: 0 Warnings: 0

mysql> SELECT * FROM person2;
```

person_id	fname	lname
1	Kapek	Sainnouine
2	Sajon	Rondela
3	Likema	Örrtmons
4	Slar	Manlanth
5	Stoma	Nilu
6	Nirtam	Sklöd
7	Sungam	Dulbåd

```
|          8 | Sreraf | Encmelt |
+-----+-----+-----+
8 rows in set (0.00 sec)
```

The order in which the fields are given within each row of the XML file does not affect the operation of `LOAD XML`; the field order can vary from row to row, and is not required to be in the same order as the corresponding columns in the table.

As mentioned previously, you can use a `(field_name_or_user_var, ...)` list of one or more XML fields (to select desired fields only) or user variables (to store the corresponding field values for later use). User variables can be especially useful when you want to insert data from an XML file into table columns whose names do not match those of the XML fields. To see how this works, we first create a table named `individual` whose structure matches that of the `person` table, but whose columns are named differently:

```
mysql> CREATE TABLE individual (
->   individual_id INT NOT NULL PRIMARY KEY,
->   name1 VARCHAR(40) NULL,
->   name2 VARCHAR(40) NULL,
->   made TIMESTAMP
-> );
Query OK, 0 rows affected (0.42 sec)
```

In this case, you cannot simply load the XML file directly into the table, because the field and column names do not match:

```
mysql> LOAD XML INFILE '../bin/person-dump.xml' INTO TABLE test.individual;
ERROR 1263 (22004): Column set to default value; NULL supplied to NOT NULL column 'individual_id' at row 1
```

This happens because the MySQL server looks for field names matching the column names of the target table. You can work around this problem by selecting the field values into user variables, then setting the target table's columns equal to the values of those variables using `SET`. You can perform both of these operations in a single statement, as shown here:

```
mysql> LOAD XML INFILE '../bin/person-dump.xml'
->   INTO TABLE test.individual (@person_id, @fname, @lname, @created)
->   SET individual_id=@person_id, name1=@fname, name2=@lname, made=@created;
Query OK, 8 rows affected (0.05 sec)
Records: 8 Deleted: 0 Skipped: 0 Warnings: 0

mysql> SELECT * FROM individual;
+-----+-----+-----+-----+
| individual_id | name1 | name2 | made |
+-----+-----+-----+-----+
| 1 | Kapek | Sainnouine | 2007-07-13 16:18:47 |
| 2 | Sajon | Rondela | 2007-07-13 16:18:47 |
| 3 | Likema | Örrtmons | 2007-07-13 16:18:47 |
| 4 | Slar | Manlanth | 2007-07-13 16:18:47 |
| 5 | Stoma | Nilu | 2007-07-13 16:18:47 |
| 6 | Nirtam | Sklöd | 2007-07-13 16:18:47 |
| 7 | Sungam | Dulbåd | 2007-07-13 16:18:47 |
| 8 | Sreraf | Encmelt | 2007-07-13 16:18:47 |
+-----+-----+-----+-----+
8 rows in set (0.00 sec)
```

The names of the user variables *must* match those of the corresponding fields from the XML file, with the addition of the required `@` prefix to indicate that they are variables. The user variables need not be listed or assigned in the same order as the corresponding fields.

Using a `ROWS IDENTIFIED BY '<tagname>'` clause, it is possible to import data from the same XML file into database tables with different definitions. For this example, suppose that you have a file named `address.xml` which contains the following XML:

```
<?xml version="1.0"?>
<list>
  <person person_id="1">
    <fname>Robert</fname>
    <lname>Jones</lname>
    <address address_id="1" street="Mill Creek Road" zip="45365" city="Sidney"/>
    <address address_id="2" street="Main Street" zip="28681" city="Taylorsville"/>
  </person>

  <person person_id="2">
    <fname>Mary</fname>
    <lname>Smith</lname>
    <address address_id="3" street="River Road" zip="80239" city="Denver"/>
    <!-- <address address_id="4" street="North Street" zip="37920" city="Knoxville"/> -->
  </person>
</list>
```

You can again use the `test.person` table as defined previously in this section, after clearing all the existing records from the table and then showing its structure as shown here:

```
mysql> TRUNCATE person;
Query OK, 0 rows affected (0.04 sec)

mysql> SHOW CREATE TABLE person\G
***** 1. row *****
      Table: person
Create Table: CREATE TABLE `person` (
  `person_id` int(11) NOT NULL,
  `fname` varchar(40) DEFAULT NULL,
  `lname` varchar(40) DEFAULT NULL,
  `created` timestamp NOT NULL DEFAULT CURRENT_TIMESTAMP ON UPDATE CURRENT_TIMESTAMP,
  PRIMARY KEY (`person_id`)
) ENGINE=MyISAM DEFAULT CHARSET=latin1
1 row in set (0.00 sec)
```

Now create an `address` table in the `test` database using the following `CREATE TABLE` statement:

```
CREATE TABLE address (
  address_id INT NOT NULL PRIMARY KEY,
  person_id INT NULL,
  street VARCHAR(40) NULL,
  zip INT NULL,
  city VARCHAR(40) NULL,
  created TIMESTAMP
);
```

To import the data from the XML file into the `person` table, execute the following `LOAD XML` statement, which specifies that rows are to be specified by the `<person>` element, as shown here:

```
mysql> LOAD XML LOCAL INFILE 'address.xml'
-> INTO TABLE person
-> ROWS IDENTIFIED BY '<person>';
Query OK, 2 rows affected (0.00 sec)
Records: 2 Deleted: 0 Skipped: 0 Warnings: 0
```

You can verify that the records were imported using a `SELECT` statement:

```
mysql> SELECT * FROM person;
+-----+-----+-----+-----+
| person_id | fname | lname | created |
+-----+-----+-----+-----+
| 1 | Robert | Jones | 2007-07-24 17:37:06 |
| 2 | Mary | Smith | 2007-07-24 17:37:06 |
+-----+-----+-----+-----+
```



```
+-----+-----+-----+-----+
2 rows in set (0.00 sec)
```

Since the `<address>` elements in the XML file have no corresponding columns in the `person` table, they are skipped.

To import the data from the `<address>` elements into the `address` table, use the `LOAD XML` statement shown here:

```
mysql> LOAD XML LOCAL INFILE 'address.xml'
-> INTO TABLE address
-> ROWS IDENTIFIED BY '<address>';
Query OK, 3 rows affected (0.00 sec)
Records: 3 Deleted: 0 Skipped: 0 Warnings: 0
```

You can see that the data was imported using a `SELECT` statement such as this one:

```
mysql> SELECT * FROM address;
+-----+-----+-----+-----+-----+-----+
| address_id | person_id | street          | zip   | city          | created          |
+-----+-----+-----+-----+-----+-----+
|          1 |          1 | Mill Creek Road | 45365 | Sidney        | 2007-07-24 17:37:37 |
|          2 |          1 | Main Street     | 28681 | Taylorsville  | 2007-07-24 17:37:37 |
|          3 |          2 | River Road     | 80239 | Denver        | 2007-07-24 17:37:37 |
+-----+-----+-----+-----+-----+-----+
3 rows in set (0.00 sec)
```

The data from the `<address>` element that is enclosed in XML comments is not imported. However, since there is a `person_id` column in the `address` table, the value of the `person_id` attribute from the parent `<person>` element for each `<address>` is imported into the `address` table.

**Security Considerations.** As with the `LOAD DATA` statement, the transfer of the XML file from the client host to the server host is initiated by the MySQL server. In theory, a patched server could be built that would tell the client program to transfer a file of the server's choosing rather than the file named by the client in the `LOAD XML` statement. Such a server could access any file on the client host to which the client user has read access.

In a Web environment, clients usually connect to MySQL from a Web server. A user that can run any command against the MySQL server can use `LOAD XML LOCAL` to read any files to which the Web server process has read access. In this environment, the client with respect to the MySQL server is actually the Web server, not the remote program being run by the user who connects to the Web server.

You can disable loading of XML files from clients by starting the server with `--local-infile=0` or `--local-infile=OFF`. This option can also be used when starting the `mysql` client to disable `LOAD XML` for the duration of the client session.

To prevent a client from loading XML files from the server, do not grant the `FILE` privilege to the corresponding MySQL user account, or revoke this privilege if the client user account already has it.



### Important

Revoking the `FILE` privilege (or not granting it in the first place) keeps the user only from executing the `LOAD XML` statement (as well as the `LOAD_FILE()` function; it does *not* prevent the user from executing `LOAD XML LOCAL`. To disallow this statement, you must start the server or the client with `--local-infile=OFF`.

In other words, the `FILE` privilege affects only whether the client can read files on the server; it has no bearing on whether the client can read files on the local file system.

For partitioned tables using storage engines that employ table locks, such as [MyISAM](#), any locks caused by [LOAD XML](#) perform locks on all partitions of the table. This does not apply to tables using storage engines which employ row-level locking, such as [InnoDB](#). For more information, see [Section 22.6.4, “Partitioning and Locking”](#).

## 13.2.8 REPLACE Statement

```
REPLACE [LOW_PRIORITY | DELAYED]
  [INTO] tbl_name
  [PARTITION (partition_name [, partition_name] ...)]
  [(col_name [, col_name] ...)]
  {VALUES | VALUE} (value_list) [, (value_list)] ...

REPLACE [LOW_PRIORITY | DELAYED]
  [INTO] tbl_name
  [PARTITION (partition_name [, partition_name] ...)]
  SET assignment_list

REPLACE [LOW_PRIORITY | DELAYED]
  [INTO] tbl_name
  [PARTITION (partition_name [, partition_name] ...)]
  [(col_name [, col_name] ...)]
  SELECT ...

value:
  {expr | DEFAULT}

value_list:
  value [, value] ...

assignment:
  col_name = value

assignment_list:
  assignment [, assignment] ...
```

**REPLACE** works exactly like **INSERT**, except that if an old row in the table has the same value as a new row for a **PRIMARY KEY** or a **UNIQUE** index, the old row is deleted before the new row is inserted. See [Section 13.2.5, “INSERT Statement”](#).

**REPLACE** is a MySQL extension to the SQL standard. It either inserts, or *deletes* and inserts. For another MySQL extension to standard SQL—that either inserts or *updates*—see [Section 13.2.5.2, “INSERT ... ON DUPLICATE KEY UPDATE Statement”](#).

**DELAYED** inserts and replaces were deprecated in MySQL 5.6. In MySQL 5.7, **DELAYED** is not supported. The server recognizes but ignores the **DELAYED** keyword, handles the replace as a nondelayed replace, and generates an **ER\_WARN\_LEGACY\_SYNTAX\_CONVERTED** warning: **REPLACE DELAYED is no longer supported. The statement was converted to REPLACE**. The **DELAYED** keyword is scheduled for removal in a future release.



### Note

**REPLACE** makes sense only if a table has a **PRIMARY KEY** or **UNIQUE** index. Otherwise, it becomes equivalent to **INSERT**, because there is no index to be used to determine whether a new row duplicates another.

Values for all columns are taken from the values specified in the **REPLACE** statement. Any missing columns are set to their default values, just as happens for **INSERT**. You cannot refer to values from the current row and use them in the new row. If you use an assignment such as **SET *col\_name* = *col\_name* + 1**, the reference to the column name on the right hand side is treated as **DEFAULT(*col\_name*)**, so the assignment is equivalent to **SET *col\_name* = DEFAULT(*col\_name*) + 1**.

To use `REPLACE`, you must have both the `INSERT` and `DELETE` privileges for the table.

If a generated column is replaced explicitly, the only permitted value is `DEFAULT`. For information about generated columns, see [Section 13.1.18.7, “CREATE TABLE and Generated Columns”](#).

`REPLACE` supports explicit partition selection using the `PARTITION` clause with a list of comma-separated names of partitions, subpartitions, or both. As with `INSERT`, if it is not possible to insert the new row into any of these partitions or subpartitions, the `REPLACE` statement fails with the error `Found a row not matching the given partition set`. For more information and examples, see [Section 22.5, “Partition Selection”](#).

The `REPLACE` statement returns a count to indicate the number of rows affected. This is the sum of the rows deleted and inserted. If the count is 1 for a single-row `REPLACE`, a row was inserted and no rows were deleted. If the count is greater than 1, one or more old rows were deleted before the new row was inserted. It is possible for a single row to replace more than one old row if the table contains multiple unique indexes and the new row duplicates values for different old rows in different unique indexes.

The affected-rows count makes it easy to determine whether `REPLACE` only added a row or whether it also replaced any rows: Check whether the count is 1 (added) or greater (replaced).

If you are using the C API, the affected-rows count can be obtained using the `mysql_affected_rows()` function.

You cannot replace into a table and select from the same table in a subquery.

MySQL uses the following algorithm for `REPLACE` (and `LOAD DATA ... REPLACE`):

1. Try to insert the new row into the table
2. While the insertion fails because a duplicate-key error occurs for a primary key or unique index:
  - a. Delete from the table the conflicting row that has the duplicate key value
  - b. Try again to insert the new row into the table

It is possible that in the case of a duplicate-key error, a storage engine may perform the `REPLACE` as an update rather than a delete plus insert, but the semantics are the same. There are no user-visible effects other than a possible difference in how the storage engine increments `Handler_xxx` status variables.

Because the results of `REPLACE ... SELECT` statements depend on the ordering of rows from the `SELECT` and this order cannot always be guaranteed, it is possible when logging these statements for the source and the replica to diverge. For this reason, `REPLACE ... SELECT` statements are flagged as unsafe for statement-based replication. Such statements produce a warning in the error log when using statement-based mode and are written to the binary log using the row-based format when using `MIXED` mode. See also [Section 16.2.1.1, “Advantages and Disadvantages of Statement-Based and Row-Based Replication”](#).

When modifying an existing table that is not partitioned to accommodate partitioning, or, when modifying the partitioning of an already partitioned table, you may consider altering the table's primary key (see [Section 22.6.1, “Partitioning Keys, Primary Keys, and Unique Keys”](#)). You should be aware that, if you do this, the results of `REPLACE` statements may be affected, just as they would be if you modified the primary key of a nonpartitioned table. Consider the table created by the following `CREATE TABLE` statement:

```
CREATE TABLE test (  
  id INT UNSIGNED NOT NULL AUTO_INCREMENT,  
  data VARCHAR(64) DEFAULT NULL,  
  ts TIMESTAMP NOT NULL DEFAULT CURRENT_TIMESTAMP ON UPDATE CURRENT_TIMESTAMP,  
  PRIMARY KEY (id)
```

```
);
```

When we create this table and run the statements shown in the mysql client, the result is as follows:

```
mysql> REPLACE INTO test VALUES (1, 'Old', '2014-08-20 18:47:00');
Query OK, 1 row affected (0.04 sec)

mysql> REPLACE INTO test VALUES (1, 'New', '2014-08-20 18:47:42');
Query OK, 2 rows affected (0.04 sec)

mysql> SELECT * FROM test;
+----+-----+-----+
| id | data | ts                |
+----+-----+-----+
| 1  | New  | 2014-08-20 18:47:42 |
+----+-----+-----+
1 row in set (0.00 sec)
```

Now we create a second table almost identical to the first, except that the primary key now covers 2 columns, as shown here (emphasized text):

```
CREATE TABLE test2 (
  id INT UNSIGNED NOT NULL AUTO_INCREMENT,
  data VARCHAR(64) DEFAULT NULL,
  ts TIMESTAMP NOT NULL DEFAULT CURRENT_TIMESTAMP ON UPDATE CURRENT_TIMESTAMP,
  PRIMARY KEY (id, ts)
);
```

When we run on `test2` the same two `REPLACE` statements as we did on the original `test` table, we obtain a different result:

```
mysql> REPLACE INTO test2 VALUES (1, 'Old', '2014-08-20 18:47:00');
Query OK, 1 row affected (0.05 sec)

mysql> REPLACE INTO test2 VALUES (1, 'New', '2014-08-20 18:47:42');
Query OK, 1 row affected (0.06 sec)

mysql> SELECT * FROM test2;
+----+-----+-----+
| id | data | ts                |
+----+-----+-----+
| 1  | Old  | 2014-08-20 18:47:00 |
| 1  | New  | 2014-08-20 18:47:42 |
+----+-----+-----+
2 rows in set (0.00 sec)
```

This is due to the fact that, when run on `test2`, both the `id` and `ts` column values must match those of an existing row for the row to be replaced; otherwise, a row is inserted.

A `REPLACE` statement affecting a partitioned table using a storage engine such as `MyISAM` that employs table-level locks locks only those partitions containing rows that match the `REPLACE` statement `WHERE` clause, as long as none of the table partitioning columns are updated; otherwise the entire table is locked. (For storage engines such as `InnoDB` that employ row-level locking, no locking of partitions takes place.) For more information, see [Section 22.6.4, “Partitioning and Locking”](#).

## 13.2.9 SELECT Statement

```
SELECT
  [ALL | DISTINCT | DISTINCTROW ]
  [HIGH_PRIORITY]
  [STRAIGHT_JOIN]
  [SQL_SMALL_RESULT] [SQL_BIG_RESULT] [SQL_BUFFER_RESULT]
  [SQL_CACHE | SQL_NO_CACHE] [SQL_CALC_FOUND_ROWS]
```

```

select_expr [, select_expr] ...
[into_option]
[FROM table_references
  [PARTITION partition_list]]
[WHERE where_condition]
[GROUP BY {col_name | expr | position}
  [ASC | DESC], ... [WITH ROLLUP]]
[HAVING where_condition]
[ORDER BY {col_name | expr | position}
  [ASC | DESC], ...]
[LIMIT {[offset,] row_count | row_count OFFSET offset}]
[PROCEDURE procedure_name(argument_list)]
[into_option]
[FOR UPDATE | LOCK IN SHARE MODE]

into_option: {
  INTO OUTFILE 'file_name'
    [CHARACTER SET charset_name]
    export_options
  | INTO DUMPFILE 'file_name'
  | INTO var_name [, var_name] ...
}

export_options:
  [{FIELDS | COLUMNS}
  [TERMINATED BY 'string']
  [[OPTIONALLY] ENCLOSED BY 'char']
  [ESCAPED BY 'char']
  ]
  [LINES
  [STARTING BY 'string']
  [TERMINATED BY 'string']
  ]

```

**SELECT** is used to retrieve rows selected from one or more tables, and can include **UNION** statements and subqueries. See [Section 13.2.9.3, “UNION Clause”](#), and [Section 13.2.10, “Subqueries”](#).

The most commonly used clauses of **SELECT** statements are these:

- Each *select\_expr* indicates a column that you want to retrieve. There must be at least one *select\_expr*.
- *table\_references* indicates the table or tables from which to retrieve rows. Its syntax is described in [Section 13.2.9.2, “JOIN Clause”](#).
- **SELECT** supports explicit partition selection using the **PARTITION** clause with a list of partitions or subpartitions (or both) following the name of the table in a *table\_reference* (see [Section 13.2.9.2, “JOIN Clause”](#)). In this case, rows are selected only from the partitions listed, and any other partitions of the table are ignored. For more information and examples, see [Section 22.5, “Partition Selection”](#).

**SELECT ... PARTITION** from tables using storage engines such as **MyISAM** that perform table-level locks (and thus partition locks) lock only the partitions or subpartitions named by the **PARTITION** option.

For more information, see [Section 22.6.4, “Partitioning and Locking”](#).

- The **WHERE** clause, if given, indicates the condition or conditions that rows must satisfy to be selected. *where\_condition* is an expression that evaluates to true for each row to be selected. The statement selects all rows if there is no **WHERE** clause.

In the **WHERE** expression, you can use any of the functions and operators that MySQL supports, except for aggregate (group) functions. See [Section 9.5, “Expressions”](#), and [Chapter 12, \*Functions and Operators\*](#).

`SELECT` can also be used to retrieve rows computed without reference to any table.

For example:

```
mysql> SELECT 1 + 1;
-> 2
```

You are permitted to specify `DUAL` as a dummy table name in situations where no tables are referenced:

```
mysql> SELECT 1 + 1 FROM DUAL;
-> 2
```

`DUAL` is purely for the convenience of people who require that all `SELECT` statements should have `FROM` and possibly other clauses. MySQL may ignore the clauses. MySQL does not require `FROM DUAL` if no tables are referenced.

In general, clauses used must be given in exactly the order shown in the syntax description. For example, a `HAVING` clause must come after any `GROUP BY` clause and before any `ORDER BY` clause. The `INTO` clause, if present, can appear in any position indicated by the syntax description, but within a given statement can appear only once, not in multiple positions. For more information about `INTO`, see [Section 13.2.9.1, "SELECT ... INTO Statement"](#).

The list of `select_expr` terms comprises the select list that indicates which columns to retrieve. Terms specify a column or expression or can use `*`-shorthand:

- A select list consisting only of a single unqualified `*` can be used as shorthand to select all columns from all tables:

```
SELECT * FROM t1 INNER JOIN t2 ...
```

- `tbl_name.*` can be used as a qualified shorthand to select all columns from the named table:

```
SELECT t1.*, t2.* FROM t1 INNER JOIN t2 ...
```

- Use of an unqualified `*` with other items in the select list may produce a parse error. For example:

```
SELECT id, * FROM t1
```

To avoid this problem, use a qualified `tbl_name.*` reference:

```
SELECT id, t1.* FROM t1
```

Use qualified `tbl_name.*` references for each table in the select list:

```
SELECT AVG(score), t1.* FROM t1 ...
```

The following list provides additional information about other `SELECT` clauses:

- A `select_expr` can be given an alias using `AS alias_name`. The alias is used as the expression's column name and can be used in `GROUP BY`, `ORDER BY`, or `HAVING` clauses. For example:

```
SELECT CONCAT(last_name, ' ', first_name) AS full_name
FROM mytable ORDER BY full_name;
```

The `AS` keyword is optional when aliasing a `select_expr` with an identifier. The preceding example could have been written like this:

```
SELECT CONCAT(last_name, ' ', first_name) full_name
FROM mytable ORDER BY full_name;
```

However, because the `AS` is optional, a subtle problem can occur if you forget the comma between two `select_expr` expressions: MySQL interprets the second as an alias name. For example, in the following statement, `columnb` is treated as an alias name:

```
SELECT columna columnb FROM mytable;
```

For this reason, it is good practice to be in the habit of using `AS` explicitly when specifying column aliases.

It is not permissible to refer to a column alias in a `WHERE` clause, because the column value might not yet be determined when the `WHERE` clause is executed. See [Section B.3.4.4, “Problems with Column Aliases”](#).

- The `FROM table_references` clause indicates the table or tables from which to retrieve rows. If you name more than one table, you are performing a join. For information on join syntax, see [Section 13.2.9.2, “JOIN Clause”](#). For each table specified, you can optionally specify an alias.

```
tbl_name [[AS] alias] [index_hint]
```

The use of index hints provides the optimizer with information about how to choose indexes during query processing. For a description of the syntax for specifying these hints, see [Section 8.9.4, “Index Hints”](#).

You can use `SET max_seeks_for_key=value` as an alternative way to force MySQL to prefer key scans instead of table scans. See [Section 5.1.7, “Server System Variables”](#).

- You can refer to a table within the default database as `tbl_name`, or as `db_name.tbl_name` to specify a database explicitly. You can refer to a column as `col_name`, `tbl_name.col_name`, or `db_name.tbl_name.col_name`. You need not specify a `tbl_name` or `db_name.tbl_name` prefix for a column reference unless the reference would be ambiguous. See [Section 9.2.2, “Identifier Qualifiers”](#), for examples of ambiguity that require the more explicit column reference forms.
- A table reference can be aliased using `tbl_name AS alias_name` or `tbl_name alias_name`. These statements are equivalent:

```
SELECT t1.name, t2.salary FROM employee AS t1, info AS t2
WHERE t1.name = t2.name;

SELECT t1.name, t2.salary FROM employee t1, info t2
WHERE t1.name = t2.name;
```

- Columns selected for output can be referred to in `ORDER BY` and `GROUP BY` clauses using column names, column aliases, or column positions. Column positions are integers and begin with 1:

```
SELECT college, region, seed FROM tournament
ORDER BY region, seed;

SELECT college, region AS r, seed AS s FROM tournament
ORDER BY r, s;

SELECT college, region, seed FROM tournament
ORDER BY 2, 3;
```

To sort in reverse order, add the `DESC` (descending) keyword to the name of the column in the `ORDER BY` clause that you are sorting by. The default is ascending order; this can be specified explicitly using the `ASC` keyword.

If `ORDER BY` occurs within a parenthesized query expression and also is applied in the outer query, the results are undefined and may change in a future MySQL version.

Use of column positions is deprecated because the syntax has been removed from the SQL standard.

- MySQL extends the `GROUP BY` clause so that you can also specify `ASC` and `DESC` after columns named in the clause. However, this syntax is deprecated. To produce a given sort order, provide an `ORDER BY` clause.
- If you use `GROUP BY`, output rows are sorted according to the `GROUP BY` columns as if you had an `ORDER BY` for the same columns. To avoid the overhead of sorting that `GROUP BY` produces, add `ORDER BY NULL`:

```
SELECT a, COUNT(b) FROM test_table GROUP BY a ORDER BY NULL;
```

Relying on implicit `GROUP BY` sorting (that is, sorting in the absence of `ASC` or `DESC` designators) or explicit sorting for `GROUP BY` (that is, by using explicit `ASC` or `DESC` designators for `GROUP BY` columns) is deprecated. To produce a given sort order, provide an `ORDER BY` clause.

- When you use `ORDER BY` or `GROUP BY` to sort a column in a `SELECT`, the server sorts values using only the initial number of bytes indicated by the `max_sort_length` system variable.
- MySQL extends the use of `GROUP BY` to permit selecting fields that are not mentioned in the `GROUP BY` clause. If you are not getting the results that you expect from your query, please read the description of `GROUP BY` found in [Section 12.19, “Aggregate Functions”](#).
- `GROUP BY` permits a `WITH ROLLUP` modifier. See [Section 12.19.2, “GROUP BY Modifiers”](#).
- The `HAVING` clause, like the `WHERE` clause, specifies selection conditions. The `WHERE` clause specifies conditions on columns in the select list, but cannot refer to aggregate functions. The `HAVING` clause specifies conditions on groups, typically formed by the `GROUP BY` clause. The query result includes only groups satisfying the `HAVING` conditions. (If no `GROUP BY` is present, all rows implicitly form a single aggregate group.)

The `HAVING` clause is applied nearly last, just before items are sent to the client, with no optimization. (`LIMIT` is applied after `HAVING`.)

The SQL standard requires that `HAVING` must reference only columns in the `GROUP BY` clause or columns used in aggregate functions. However, MySQL supports an extension to this behavior, and permits `HAVING` to refer to columns in the `SELECT` list and columns in outer subqueries as well.

If the `HAVING` clause refers to a column that is ambiguous, a warning occurs. In the following statement, `col2` is ambiguous because it is used as both an alias and a column name:

```
SELECT COUNT(col1) AS col2 FROM t GROUP BY col2 HAVING col2 = 2;
```

Preference is given to standard SQL behavior, so if a `HAVING` column name is used both in `GROUP BY` and as an aliased column in the select column list, preference is given to the column in the `GROUP BY` column.

- Do not use `HAVING` for items that should be in the `WHERE` clause. For example, do not write the following:

```
SELECT col_name FROM tbl_name HAVING col_name > 0;
```

Write this instead:

```
SELECT col_name FROM tbl_name WHERE col_name > 0;
```

- The `HAVING` clause can refer to aggregate functions, which the `WHERE` clause cannot:



```
SELECT user, MAX(salary) FROM users
GROUP BY user HAVING MAX(salary) > 10;
```

(This did not work in some older versions of MySQL.)

- MySQL permits duplicate column names. That is, there can be more than one *select\_expr* with the same name. This is an extension to standard SQL. Because MySQL also permits *GROUP BY* and *HAVING* to refer to *select\_expr* values, this can result in an ambiguity:

```
SELECT 12 AS a, a FROM t GROUP BY a;
```

In that statement, both columns have the name *a*. To ensure that the correct column is used for grouping, use different names for each *select\_expr*.

- MySQL resolves unqualified column or alias references in *ORDER BY* clauses by searching in the *select\_expr* values, then in the columns of the tables in the *FROM* clause. For *GROUP BY* or *HAVING* clauses, it searches the *FROM* clause before searching in the *select\_expr* values. (For *GROUP BY* and *HAVING*, this differs from the pre-MySQL 5.0 behavior that used the same rules as for *ORDER BY*.)
- The *LIMIT* clause can be used to constrain the number of rows returned by the *SELECT* statement. *LIMIT* takes one or two numeric arguments, which must both be nonnegative integer constants, with these exceptions:
  - Within prepared statements, *LIMIT* parameters can be specified using *?* placeholder markers.
  - Within stored programs, *LIMIT* parameters can be specified using integer-valued routine parameters or local variables.

With two arguments, the first argument specifies the offset of the first row to return, and the second specifies the maximum number of rows to return. The offset of the initial row is 0 (not 1):

```
SELECT * FROM tbl LIMIT 5,10; # Retrieve rows 6-15
```

To retrieve all rows from a certain offset up to the end of the result set, you can use some large number for the second parameter. This statement retrieves all rows from the 96th row to the last:

```
SELECT * FROM tbl LIMIT 95,18446744073709551615;
```

With one argument, the value specifies the number of rows to return from the beginning of the result set:

```
SELECT * FROM tbl LIMIT 5; # Retrieve first 5 rows
```

In other words, *LIMIT row\_count* is equivalent to *LIMIT 0, row\_count*.

For prepared statements, you can use placeholders. The following statements return one row from the *tbl* table:

```
SET @a=1;
PREPARE STMT FROM 'SELECT * FROM tbl LIMIT ?';
EXECUTE STMT USING @a;
```

The following statements return the second to sixth row from the *tbl* table:

```
SET @skip=1; SET @numrows=5;
PREPARE STMT FROM 'SELECT * FROM tbl LIMIT ?, ?';
EXECUTE STMT USING @skip, @numrows;
```

For compatibility with PostgreSQL, MySQL also supports the *LIMIT row\_count OFFSET offset* syntax.

If `LIMIT` occurs within a parenthesized query expression and also is applied in the outer query, the results are undefined and may change in a future MySQL version.

- A `PROCEDURE` clause names a procedure that should process the data in the result set. For an example, see [Section 8.4.2.4, “Using PROCEDURE ANALYSE”](#), which describes `ANALYSE`, a procedure that can be used to obtain suggestions for optimal column data types that may help reduce table sizes.

A `PROCEDURE` clause is not permitted in a `UNION` statement.



#### Note

`PROCEDURE` syntax is deprecated as of MySQL 5.7.18, and is removed in MySQL 8.0.

- The `SELECT ... INTO` form of `SELECT` enables the query result to be written to a file or stored in variables. For more information, see [Section 13.2.9.1, “SELECT ... INTO Statement”](#).
- If you use `FOR UPDATE` with a storage engine that uses page or row locks, rows examined by the query are write-locked until the end of the current transaction. Using `LOCK IN SHARE MODE` sets a shared lock that permits other transactions to read the examined rows but not to update or delete them. See [Section 14.7.2.4, “Locking Reads”](#).

In addition, you cannot use `FOR UPDATE` as part of the `SELECT` in a statement such as `CREATE TABLE new_table SELECT ... FROM old_table ...` (If you attempt to do so, the statement is rejected with the error `Can't update table 'old_table' while 'new_table' is being created.`) This is a change in behavior from MySQL 5.5 and earlier, which permitted `CREATE TABLE ... SELECT` statements to make changes in tables other than the table being created.

Following the `SELECT` keyword, you can use a number of modifiers that affect the operation of the statement. `HIGH_PRIORITY`, `STRAIGHT_JOIN`, and modifiers beginning with `SQL_` are MySQL extensions to standard SQL.

- The `ALL` and `DISTINCT` modifiers specify whether duplicate rows should be returned. `ALL` (the default) specifies that all matching rows should be returned, including duplicates. `DISTINCT` specifies removal of duplicate rows from the result set. It is an error to specify both modifiers. `DISTINCTROW` is a synonym for `DISTINCT`.
- `HIGH_PRIORITY` gives the `SELECT` higher priority than a statement that updates a table. You should use this only for queries that are very fast and must be done at once. A `SELECT HIGH_PRIORITY` query that is issued while the table is locked for reading runs even if there is an update statement waiting for the table to be free. This affects only storage engines that use only table-level locking (such as `MyISAM`, `MEMORY`, and `MERGE`).

`HIGH_PRIORITY` cannot be used with `SELECT` statements that are part of a `UNION`.

- `STRAIGHT_JOIN` forces the optimizer to join the tables in the order in which they are listed in the `FROM` clause. You can use this to speed up a query if the optimizer joins the tables in nonoptimal order. `STRAIGHT_JOIN` also can be used in the `table_references` list. See [Section 13.2.9.2, “JOIN Clause”](#).

`STRAIGHT_JOIN` does not apply to any table that the optimizer treats as a `const` or `system` table. Such a table produces a single row, is read during the optimization phase of query execution, and references to its columns are replaced with the appropriate column values before query execution proceeds. These tables appear first in the query plan displayed by `EXPLAIN`. See [Section 8.8.1, “Optimizing Queries with EXPLAIN”](#). This exception may not apply to `const` or `system` tables that are

used on the `NULL`-complemented side of an outer join (that is, the right-side table of a `LEFT JOIN` or the left-side table of a `RIGHT JOIN`).

- `SQL_BIG_RESULT` or `SQL_SMALL_RESULT` can be used with `GROUP BY` or `DISTINCT` to tell the optimizer that the result set has many rows or is small, respectively. For `SQL_BIG_RESULT`, MySQL directly uses disk-based temporary tables if they are created, and prefers sorting to using a temporary table with a key on the `GROUP BY` elements. For `SQL_SMALL_RESULT`, MySQL uses in-memory temporary tables to store the resulting table instead of using sorting. This should not normally be needed.
- `SQL_BUFFER_RESULT` forces the result to be put into a temporary table. This helps MySQL free the table locks early and helps in cases where it takes a long time to send the result set to the client. This modifier can be used only for top-level `SELECT` statements, not for subqueries or following `UNION`.
- `SQL_CALC_FOUND_ROWS` tells MySQL to calculate how many rows there would be in the result set, disregarding any `LIMIT` clause. The number of rows can then be retrieved with `SELECT FOUND_ROWS()`. See [Section 12.15, “Information Functions”](#).
- The `SQL_CACHE` and `SQL_NO_CACHE` modifiers affect caching of query results in the query cache (see [Section 8.10.3, “The MySQL Query Cache”](#)). `SQL_CACHE` tells MySQL to store the result in the query cache if it is cacheable and the value of the `query_cache_type` system variable is `2` or `DEMAND`. With `SQL_NO_CACHE`, the server does not use the query cache. It neither checks the query cache to see whether the result is already cached, nor does it cache the query result.

These two modifiers are mutually exclusive and an error occurs if they are both specified. Also, these modifiers are not permitted in subqueries (including subqueries in the `FROM` clause), and `SELECT` statements in unions other than the first `SELECT`.

For views, `SQL_NO_CACHE` applies if it appears in any `SELECT` in the query. For a cacheable query, `SQL_CACHE` applies if it appears in the first `SELECT` of a view referred to by the query.



#### Note

The query cache is deprecated as of MySQL 5.7.20, and is removed in MySQL 8.0. Deprecation includes `SQL_CACHE` and `SQL_NO_CACHE`.

A `SELECT` from a partitioned table using a storage engine such as `MyISAM` that employs table-level locks locks only those partitions containing rows that match the `SELECT` statement `WHERE` clause. (This does not occur with storage engines such as `InnoDB` that employ row-level locking.) For more information, see [Section 22.6.4, “Partitioning and Locking”](#).

### 13.2.9.1 SELECT ... INTO Statement

The `SELECT ... INTO` form of `SELECT` enables a query result to be stored in variables or written to a file:

- `SELECT ... INTO var_list` selects column values and stores them into variables.
- `SELECT ... INTO OUTFILE` writes the selected rows to a file. Column and line terminators can be specified to produce a specific output format.
- `SELECT ... INTO DUMPFILE` writes a single row to a file without any formatting.

A given `SELECT` statement can contain at most one `INTO` clause, although as shown by the `SELECT` syntax description (see [Section 13.2.9, “SELECT Statement”](#)), the `INTO` can appear in different positions:

- Before `FROM`. Example:

```
SELECT * INTO @myvar FROM t1;
```

- Before a trailing locking clause. Example:

```
SELECT * FROM t1 INTO @myvar FOR UPDATE;
```

An `INTO` clause should not be used in a nested `SELECT` because such a `SELECT` must return its result to the outer context. There are also constraints on the use of `INTO` within `UNION` statements; see [Section 13.2.9.3, “UNION Clause”](#).

For the `INTO var_list` variant:

- `var_list` names a list of one or more variables, each of which can be a user-defined variable, stored procedure or function parameter, or stored program local variable. (Within a prepared `SELECT ... INTO var_list` statement, only user-defined variables are permitted; see [Section 13.6.4.2, “Local Variable Scope and Resolution”](#).)
- The selected values are assigned to the variables. The number of variables must match the number of columns. The query should return a single row. If the query returns no rows, a warning with error code 1329 occurs (`No data`), and the variable values remain unchanged. If the query returns multiple rows, error 1172 occurs (`Result consisted of more than one row`). If it is possible that the statement may retrieve multiple rows, you can use `LIMIT 1` to limit the result set to a single row.

```
SELECT id, data INTO @x, @y FROM test.t1 LIMIT 1;
```

User variable names are not case-sensitive. See [Section 9.4, “User-Defined Variables”](#).

The `SELECT ... INTO OUTFILE 'file_name'` form of `SELECT` writes the selected rows to a file. The file is created on the server host, so you must have the `FILE` privilege to use this syntax. `file_name` cannot be an existing file, which among other things prevents files such as `/etc/passwd` and database tables from being modified. The `character_set_filesystem` system variable controls the interpretation of the file name.

The `SELECT ... INTO OUTFILE` statement is intended to enable dumping a table to a text file on the server host. To create the resulting file on some other host, `SELECT ... INTO OUTFILE` normally is unsuitable because there is no way to write a path to the file relative to the server host file system, unless the location of the file on the remote host can be accessed using a network-mapped path on the server host file system.

Alternatively, if the MySQL client software is installed on the remote host, you can use a client command such as `mysql -e "SELECT ..." > file_name` to generate the file on that host.

`SELECT ... INTO OUTFILE` is the complement of `LOAD DATA`. Column values are written converted to the character set specified in the `CHARACTER SET` clause. If no such clause is present, values are dumped using the `binary` character set. In effect, there is no character set conversion. If a result set contains columns in several character sets, so does the output data file and it may not be possible to reload the file correctly.

The syntax for the `export_options` part of the statement consists of the same `FIELDS` and `LINES` clauses that are used with the `LOAD DATA` statement. For more detailed information about the `FIELDS` and `LINES` clauses, including their default values and permissible values, see [Section 13.2.6, “LOAD DATA Statement”](#).

`FIELDS ESCAPED BY` controls how to write special characters. If the `FIELDS ESCAPED BY` character is not empty, it is used when necessary to avoid ambiguity as a prefix that precedes following characters on output:

- The `FIELDS ESCAPED BY` character
- The `FIELDS [OPTIONALLY] ENCLOSED BY` character
- The first character of the `FIELDS TERMINATED BY` and `LINES TERMINATED BY` values
- ASCII `NUL` (the zero-valued byte; what is actually written following the escape character is ASCII 0, not a zero-valued byte)

The `FIELDS TERMINATED BY`, `ENCLOSED BY`, `ESCAPED BY`, or `LINES TERMINATED BY` characters *must* be escaped so that you can read the file back in reliably. ASCII `NUL` is escaped to make it easier to view with some pagers.

The resulting file need not conform to SQL syntax, so nothing else need be escaped.

If the `FIELDS ESCAPED BY` character is empty, no characters are escaped and `NULL` is output as `NULL`, not `\N`. It is probably not a good idea to specify an empty escape character, particularly if field values in your data contain any of the characters in the list just given.

Here is an example that produces a file in the comma-separated values (CSV) format used by many programs:

```
SELECT a,b,a+b INTO OUTFILE '/tmp/result.txt'
  FIELDS TERMINATED BY ',' OPTIONALLY ENCLOSED BY '"'
  LINES TERMINATED BY '\n'
FROM test_table;
```

If you use `INTO DUMPFILE` instead of `INTO OUTFILE`, MySQL writes only one row into the file, without any column or line termination and without performing any escape processing. This is useful for selecting a `BLOB` value and storing it in a file.



#### Note

Any file created by `INTO OUTFILE` or `INTO DUMPFILE` is writable by all users on the server host. The reason for this is that the MySQL server cannot create a file that is owned by anyone other than the user under whose account it is running. (You should *never* run `mysqld` as `root` for this and other reasons.) The file thus must be world-writable so that you can manipulate its contents.

If the `secure_file_priv` system variable is set to a nonempty directory name, the file to be written must be located in that directory.

In the context of `SELECT ... INTO` statements that occur as part of events executed by the Event Scheduler, diagnostics messages (not only errors, but also warnings) are written to the error log, and, on Windows, to the application event log. For additional information, see [Section 23.4.5, “Event Scheduler Status”](#).

### 13.2.9.2 JOIN Clause

MySQL supports the following `JOIN` syntax for the `table_references` part of `SELECT` statements and multiple-table `DELETE` and `UPDATE` statements:

```
table_references:
  escaped_table_reference [, escaped_table_reference] ...

escaped_table_reference: {
  table_reference
```

```

| { OJ table_reference }
}

table_reference: {
  table_factor
| joined_table
}

table_factor: {
  tbl_name [PARTITION (partition_names)]
  [[AS] alias] [index_hint_list]
| table_subquery [AS] alias
| ( table_references )
}

joined_table: {
  table_reference [INNER | CROSS] JOIN table_factor [join_specification]
| table_reference STRAIGHT_JOIN table_factor
| table_reference STRAIGHT_JOIN table_factor ON search_condition
| table_reference {LEFT|RIGHT} [OUTER] JOIN table_reference join_specification
| table_reference NATURAL [{LEFT|RIGHT} [OUTER]] JOIN table_factor
}

join_specification: {
  ON search_condition
| USING (join_column_list)
}

join_column_list:
  column_name [, column_name] ...

index_hint_list:
  index_hint [index_hint] ...

index_hint: {
  USE {INDEX|KEY}
  [FOR {JOIN|ORDER BY|GROUP BY}] ([index_list])
| {IGNORE|FORCE} {INDEX|KEY}
  [FOR {JOIN|ORDER BY|GROUP BY}] (index_list)
}

index_list:
  index_name [, index_name] ...

```

A table reference is also known as a join expression.

A table reference (when it refers to a partitioned table) may contain a `PARTITION` clause, including a list of comma-separated partitions, subpartitions, or both. This option follows the name of the table and precedes any alias declaration. The effect of this option is that rows are selected only from the listed partitions or subpartitions. Any partitions or subpartitions not named in the list are ignored. For more information and examples, see [Section 22.5, “Partition Selection”](#).

The syntax of `table_factor` is extended in MySQL in comparison with standard SQL. The standard accepts only `table_reference`, not a list of them inside a pair of parentheses.

This is a conservative extension if each comma in a list of `table_reference` items is considered as equivalent to an inner join. For example:

```

SELECT * FROM t1 LEFT JOIN (t2, t3, t4)
      ON (t2.a = t1.a AND t3.b = t1.b AND t4.c = t1.c)

```

is equivalent to:

```

SELECT * FROM t1 LEFT JOIN (t2 CROSS JOIN t3 CROSS JOIN t4)

```

```
ON (t2.a = t1.a AND t3.b = t1.b AND t4.c = t1.c)
```

In MySQL, [JOIN](#), [CROSS JOIN](#), and [INNER JOIN](#) are syntactic equivalents (they can replace each other). In standard SQL, they are not equivalent. [INNER JOIN](#) is used with an [ON](#) clause, [CROSS JOIN](#) is used otherwise.

In general, parentheses can be ignored in join expressions containing only inner join operations. MySQL also supports nested joins. See [Section 8.2.1.7, “Nested Join Optimization”](#).

Index hints can be specified to affect how the MySQL optimizer makes use of indexes. For more information, see [Section 8.9.4, “Index Hints”](#). Optimizer hints and the `optimizer_switch` system variable are other ways to influence optimizer use of indexes. See [Section 8.9.3, “Optimizer Hints”](#), and [Section 8.9.2, “Switchable Optimizations”](#).

The following list describes general factors to take into account when writing joins:

- A table reference can be aliased using `tbl_name AS alias_name` or `tbl_name alias_name`:

```
SELECT t1.name, t2.salary
  FROM employee AS t1 INNER JOIN info AS t2 ON t1.name = t2.name;

SELECT t1.name, t2.salary
  FROM employee t1 INNER JOIN info t2 ON t1.name = t2.name;
```

- A [table\\_subquery](#) is also known as a derived table or subquery in the [FROM](#) clause. See [Section 13.2.10.8, “Derived Tables”](#). Such subqueries *must* include an alias to give the subquery result a table name. A trivial example follows:

```
SELECT * FROM (SELECT 1, 2, 3) AS t1;
```

- The maximum number of tables that can be referenced in a single join is 61. This includes a join handled by merging derived tables and views in the [FROM](#) clause into the outer query block (see [Section 8.2.2.4, “Optimizing Derived Tables and View References with Merging or Materialization”](#)).
- [INNER JOIN](#) and `,` (comma) are semantically equivalent in the absence of a join condition: both produce a Cartesian product between the specified tables (that is, each and every row in the first table is joined to each and every row in the second table).

However, the precedence of the comma operator is less than that of [INNER JOIN](#), [CROSS JOIN](#), [LEFT JOIN](#), and so on. If you mix comma joins with the other join types when there is a join condition, an error of the form `Unknown column 'col_name' in 'on clause'` may occur. Information about dealing with this problem is given later in this section.

- The [search\\_condition](#) used with [ON](#) is any conditional expression of the form that can be used in a [WHERE](#) clause. Generally, the [ON](#) clause serves for conditions that specify how to join tables, and the [WHERE](#) clause restricts which rows to include in the result set.
- If there is no matching row for the right table in the [ON](#) or [USING](#) part in a [LEFT JOIN](#), a row with all columns set to [NULL](#) is used for the right table. You can use this fact to find rows in a table that have no counterpart in another table:

```
SELECT left_tbl.*
  FROM left_tbl LEFT JOIN right_tbl ON left_tbl.id = right_tbl.id
  WHERE right_tbl.id IS NULL;
```

This example finds all rows in `left_tbl` with an `id` value that is not present in `right_tbl` (that is, all rows in `left_tbl` with no corresponding row in `right_tbl`). See [Section 8.2.1.8, “Outer Join Optimization”](#).

- The `USING(join_column_list)` clause names a list of columns that must exist in both tables. If tables `a` and `b` both contain columns `c1`, `c2`, and `c3`, the following join compares corresponding columns from the two tables:

```
a LEFT JOIN b USING (c1, c2, c3)
```

- The `NATURAL [LEFT] JOIN` of two tables is defined to be semantically equivalent to an `INNER JOIN` or a `LEFT JOIN` with a `USING` clause that names all columns that exist in both tables.
- `RIGHT JOIN` works analogously to `LEFT JOIN`. To keep code portable across databases, it is recommended that you use `LEFT JOIN` instead of `RIGHT JOIN`.
- The `{ OJ ... }` syntax shown in the join syntax description exists only for compatibility with ODBC. The curly braces in the syntax should be written literally; they are not metasyntax as used elsewhere in syntax descriptions.

```
SELECT left_tbl.*
   FROM { OJ left_tbl LEFT OUTER JOIN right_tbl
         ON left_tbl.id = right_tbl.id }
  WHERE right_tbl.id IS NULL;
```

You can use other types of joins within `{ OJ ... }`, such as `INNER JOIN` or `RIGHT OUTER JOIN`. This helps with compatibility with some third-party applications, but is not official ODBC syntax.

- `STRAIGHT_JOIN` is similar to `JOIN`, except that the left table is always read before the right table. This can be used for those (few) cases for which the join optimizer processes the tables in a suboptimal order.

Some join examples:

```
SELECT * FROM table1, table2;

SELECT * FROM table1 INNER JOIN table2 ON table1.id = table2.id;

SELECT * FROM table1 LEFT JOIN table2 ON table1.id = table2.id;

SELECT * FROM table1 LEFT JOIN table2 USING (id);

SELECT * FROM table1 LEFT JOIN table2 ON table1.id = table2.id
  LEFT JOIN table3 ON table2.id = table3.id;
```

Natural joins and joins with `USING`, including outer join variants, are processed according to the SQL:2003 standard:

- Redundant columns of a `NATURAL` join do not appear. Consider this set of statements:

```
CREATE TABLE t1 (i INT, j INT);
CREATE TABLE t2 (k INT, j INT);
INSERT INTO t1 VALUES(1, 1);
INSERT INTO t2 VALUES(1, 1);
SELECT * FROM t1 NATURAL JOIN t2;
SELECT * FROM t1 JOIN t2 USING (j);
```

In the first `SELECT` statement, column `j` appears in both tables and thus becomes a join column, so, according to standard SQL, it should appear only once in the output, not twice. Similarly, in the second `SELECT` statement, column `j` is named in the `USING` clause and should appear only once in the output, not twice.

Thus, the statements produce this output:

```
+-----+-----+-----+
| j     | i     | k     |
```



```

+-----+-----+-----+
| 1 | 1 | 1 |
+-----+-----+-----+
| j | i | k |
+-----+-----+-----+
| 1 | 1 | 1 |
+-----+-----+-----+

```

Redundant column elimination and column ordering occurs according to standard SQL, producing this display order:

- First, coalesced common columns of the two joined tables, in the order in which they occur in the first table
- Second, columns unique to the first table, in order in which they occur in that table
- Third, columns unique to the second table, in order in which they occur in that table

The single result column that replaces two common columns is defined using the coalesce operation. That is, for two `t1.a` and `t2.a` the resulting single join column `a` is defined as `a = COALESCE(t1.a, t2.a)`, where:

```
COALESCE(x, y) = (CASE WHEN x IS NOT NULL THEN x ELSE y END)
```

If the join operation is any other join, the result columns of the join consist of the concatenation of all columns of the joined tables.

A consequence of the definition of coalesced columns is that, for outer joins, the coalesced column contains the value of the non-`NULL` column if one of the two columns is always `NULL`. If neither or both columns are `NULL`, both common columns have the same value, so it does not matter which one is chosen as the value of the coalesced column. A simple way to interpret this is to consider that a coalesced column of an outer join is represented by the common column of the inner table of a `JOIN`. Suppose that the tables `t1(a, b)` and `t2(a, c)` have the following contents:

```

t1    t2
----  ----
1 x   2 z
2 y   3 w

```

Then, for this join, column `a` contains the values of `t1.a`:

```

mysql> SELECT * FROM t1 NATURAL LEFT JOIN t2;
+-----+-----+-----+
| a | b | c |
+-----+-----+-----+
| 1 | x | NULL |
| 2 | y | z |
+-----+-----+-----+

```

By contrast, for this join, column `a` contains the values of `t2.a`.

```

mysql> SELECT * FROM t1 NATURAL RIGHT JOIN t2;
+-----+-----+-----+
| a | c | b |
+-----+-----+-----+
| 2 | z | y |
| 3 | w | NULL |
+-----+-----+-----+

```

```
+-----+-----+-----+
```

Compare those results to the otherwise equivalent queries with `JOIN ... ON`:

```
mysql> SELECT * FROM t1 LEFT JOIN t2 ON (t1.a = t2.a);
```

```
+-----+-----+-----+
| a     | b     | a     | c     |
+-----+-----+-----+
| 1     | x     | NULL  | NULL  |
| 2     | y     | 2     | z     |
+-----+-----+-----+
```

```
mysql> SELECT * FROM t1 RIGHT JOIN t2 ON (t1.a = t2.a);
```

```
+-----+-----+-----+
| a     | b     | a     | c     |
+-----+-----+-----+
| 2     | y     | 2     | z     |
| NULL  | NULL  | 3     | w     |
+-----+-----+-----+
```

- A `USING` clause can be rewritten as an `ON` clause that compares corresponding columns. However, although `USING` and `ON` are similar, they are not quite the same. Consider the following two queries:

```
a LEFT JOIN b USING (c1, c2, c3)
a LEFT JOIN b ON a.c1 = b.c1 AND a.c2 = b.c2 AND a.c3 = b.c3
```

With respect to determining which rows satisfy the join condition, both joins are semantically identical.

With respect to determining which columns to display for `SELECT *` expansion, the two joins are not semantically identical. The `USING` join selects the coalesced value of corresponding columns, whereas the `ON` join selects all columns from all tables. For the `USING` join, `SELECT *` selects these values:

```
COALESCE(a.c1, b.c1), COALESCE(a.c2, b.c2), COALESCE(a.c3, b.c3)
```

For the `ON` join, `SELECT *` selects these values:

```
a.c1, a.c2, a.c3, b.c1, b.c2, b.c3
```

With an inner join, `COALESCE(a.c1, b.c1)` is the same as either `a.c1` or `b.c1` because both columns have the same value. With an outer join (such as `LEFT JOIN`), one of the two columns can be `NULL`. That column is omitted from the result.

- An `ON` clause can refer only to its operands.

Example:

```
CREATE TABLE t1 (i1 INT);
CREATE TABLE t2 (i2 INT);
CREATE TABLE t3 (i3 INT);
SELECT * FROM t1 JOIN t2 ON (i1 = i3) JOIN t3;
```

The statement fails with an `Unknown column 'i3' in 'on clause'` error because `i3` is a column in `t3`, which is not an operand of the `ON` clause. To enable the join to be processed, rewrite the statement as follows:

```
SELECT * FROM t1 JOIN t2 JOIN t3 ON (i1 = i3);
```

- `JOIN` has higher precedence than the comma operator (`,`), so the join expression `t1, t2 JOIN t3` is interpreted as `(t1, (t2 JOIN t3))`, not as `((t1, t2) JOIN t3)`. This affects statements that

use an `ON` clause because that clause can refer only to columns in the operands of the join, and the precedence affects interpretation of what those operands are.

Example:

```
CREATE TABLE t1 (i1 INT, j1 INT);
CREATE TABLE t2 (i2 INT, j2 INT);
CREATE TABLE t3 (i3 INT, j3 INT);
INSERT INTO t1 VALUES(1, 1);
INSERT INTO t2 VALUES(1, 1);
INSERT INTO t3 VALUES(1, 1);
SELECT * FROM t1, t2 JOIN t3 ON (t1.i1 = t3.i3);
```

The `JOIN` takes precedence over the comma operator, so the operands for the `ON` clause are `t2` and `t3`. Because `t1.i1` is not a column in either of the operands, the result is an `Unknown column 't1.i1' in 'on clause'` error.

To enable the join to be processed, use either of these strategies:

- Group the first two tables explicitly with parentheses so that the operands for the `ON` clause are `(t1, t2)` and `t3`:

```
SELECT * FROM (t1, t2) JOIN t3 ON (t1.i1 = t3.i3);
```

- Avoid the use of the comma operator and use `JOIN` instead:

```
SELECT * FROM t1 JOIN t2 JOIN t3 ON (t1.i1 = t3.i3);
```

The same precedence interpretation also applies to statements that mix the comma operator with `INNER JOIN`, `CROSS JOIN`, `LEFT JOIN`, and `RIGHT JOIN`, all of which have higher precedence than the comma operator.

- A MySQL extension compared to the SQL:2003 standard is that MySQL permits you to qualify the common (coalesced) columns of `NATURAL` or `USING` joins, whereas the standard disallows that.

### 13.2.9.3 UNION Clause

```
SELECT ...
UNION [ALL | DISTINCT] SELECT ...
[UNION [ALL | DISTINCT] SELECT ...]
```

`UNION` combines the result from multiple `SELECT` statements into a single result set. Example:

```
mysql> SELECT 1, 2;
+-----+
| 1 | 2 |
+-----+
| 1 | 2 |
+-----+
mysql> SELECT 'a', 'b';
+-----+
| a | b |
+-----+
| a | b |
+-----+
mysql> SELECT 1, 2 UNION SELECT 'a', 'b';
+-----+
| 1 | 2 |
+-----+
| 1 | 2 |
| a | b |
+-----+
```

- [Result Set Column Names and Data Types](#)
- [UNION DISTINCT and UNION ALL](#)
- [ORDER BY and LIMIT in Unions](#)
- [UNION Restrictions](#)

## Result Set Column Names and Data Types

The column names for a [UNION](#) result set are taken from the column names of the first [SELECT](#) statement.

Selected columns listed in corresponding positions of each [SELECT](#) statement should have the same data type. For example, the first column selected by the first statement should have the same type as the first column selected by the other statements. If the data types of corresponding [SELECT](#) columns do not match, the types and lengths of the columns in the [UNION](#) result take into account the values retrieved by all the [SELECT](#) statements. For example, consider the following, where the column length is not constrained to the length of the value from the first [SELECT](#):

```
mysql> SELECT REPEAT('a',1) UNION SELECT REPEAT('b',20);
+-----+
| REPEAT('a',1) |
+-----+
| a              |
| bbbbbbbbbbbbbbbbbbbb |
+-----+
```

## UNION DISTINCT and UNION ALL

By default, duplicate rows are removed from [UNION](#) results. The optional [DISTINCT](#) keyword has the same effect but makes it explicit. With the optional [ALL](#) keyword, duplicate-row removal does not occur and the result includes all matching rows from all the [SELECT](#) statements.

You can mix [UNION ALL](#) and [UNION DISTINCT](#) in the same query. Mixed [UNION](#) types are treated such that a [DISTINCT](#) union overrides any [ALL](#) union to its left. A [DISTINCT](#) union can be produced explicitly by using [UNION DISTINCT](#) or implicitly by using [UNION](#) with no following [DISTINCT](#) or [ALL](#) keyword.

## ORDER BY and LIMIT in Unions

To apply an [ORDER BY](#) or [LIMIT](#) clause to an individual [SELECT](#), parenthesize the [SELECT](#) and place the clause inside the parentheses:

```
(SELECT a FROM t1 WHERE a=10 AND B=1 ORDER BY a LIMIT 10)
UNION
(SELECT a FROM t2 WHERE a=11 AND B=2 ORDER BY a LIMIT 10);
```



### Note

Previous versions of MySQL may permit such statements without parentheses. In MySQL 5.7, the requirement for parentheses is enforced.

Use of [ORDER BY](#) for individual [SELECT](#) statements implies nothing about the order in which the rows appear in the final result because [UNION](#) by default produces an unordered set of rows. Therefore, [ORDER BY](#) in this context typically is used in conjunction with [LIMIT](#), to determine the subset of the selected rows to retrieve for the [SELECT](#), even though it does not necessarily affect the order of those rows in the final [UNION](#) result. If [ORDER BY](#) appears without [LIMIT](#) in a [SELECT](#), it is optimized away because it has no effect.

To use an [ORDER BY](#) or [LIMIT](#) clause to sort or limit the entire [UNION](#) result, parenthesize the individual [SELECT](#) statements and place the [ORDER BY](#) or [LIMIT](#) after the last one:

```
(SELECT a FROM t1 WHERE a=10 AND B=1)
UNION
(SELECT a FROM t2 WHERE a=11 AND B=2)
ORDER BY a LIMIT 10;
```

A statement without parentheses is equivalent to one parenthesized as just shown.

This kind of `ORDER BY` cannot use column references that include a table name (that is, names in `tbl_name.col_name` format). Instead, provide a column alias in the first `SELECT` statement and refer to the alias in the `ORDER BY`. (Alternatively, refer to the column in the `ORDER BY` using its column position. However, use of column positions is deprecated.)

Also, if a column to be sorted is aliased, the `ORDER BY` clause *must* refer to the alias, not the column name. The first of the following statements is permitted, but the second fails with an `Unknown column 'a' in 'order clause'` error:

```
(SELECT a AS b FROM t) UNION (SELECT ...) ORDER BY b;
(SELECT a AS b FROM t) UNION (SELECT ...) ORDER BY a;
```

To cause rows in a `UNION` result to consist of the sets of rows retrieved by each `SELECT` one after the other, select an additional column in each `SELECT` to use as a sort column and add an `ORDER BY` that sorts on that column following the last `SELECT`:

```
(SELECT 1 AS sort_col, col1a, col1b, ... FROM t1)
UNION
(SELECT 2, col2a, col2b, ... FROM t2) ORDER BY sort_col;
```

To additionally maintain sort order within individual `SELECT` results, add a secondary column to the `ORDER BY` clause:

```
(SELECT 1 AS sort_col, col1a, col1b, ... FROM t1)
UNION
(SELECT 2, col2a, col2b, ... FROM t2) ORDER BY sort_col, col1a;
```

Use of an additional column also enables you to determine which `SELECT` each row comes from. Extra columns can provide other identifying information as well, such as a string that indicates a table name.

`UNION` queries with an aggregate function in an `ORDER BY` clause are rejected with an `ERAggregateOrderForUnion` error. Example:

```
SELECT 1 AS foo UNION SELECT 2 ORDER BY MAX(1);
```

## UNION Restrictions

In a `UNION`, the `SELECT` statements are normal select statements, but with the following restrictions:

- `HIGH_PRIORITY` in the first `SELECT` has no effect. `HIGH_PRIORITY` in any subsequent `SELECT` produces a syntax error.
- Only the last `SELECT` statement can use an `INTO` clause. However, the entire `UNION` result is written to the `INTO` output destination.

## 13.2.10 Subqueries

A subquery is a `SELECT` statement within another statement.

All subquery forms and operations that the SQL standard requires are supported, as well as a few features that are MySQL-specific.

Here is an example of a subquery:

```
SELECT * FROM t1 WHERE column1 = (SELECT column1 FROM t2);
```

In this example, `SELECT * FROM t1 ...` is the *outer query* (or *outer statement*), and `(SELECT column1 FROM t2)` is the *subquery*. We say that the subquery is *nested* within the outer query, and in fact it is possible to nest subqueries within other subqueries, to a considerable depth. A subquery must always appear within parentheses.

The main advantages of subqueries are:

- They allow queries that are *structured* so that it is possible to isolate each part of a statement.
- They provide alternative ways to perform operations that would otherwise require complex joins and unions.
- Many people find subqueries more readable than complex joins or unions. Indeed, it was the innovation of subqueries that gave people the original idea of calling the early SQL “Structured Query Language.”

Here is an example statement that shows the major points about subquery syntax as specified by the SQL standard and supported in MySQL:

```
DELETE FROM t1
WHERE s11 > ANY
  (SELECT COUNT(*) /* no hint */ FROM t2
  WHERE NOT EXISTS
   (SELECT * FROM t3
   WHERE ROW(5*t2.s1,77)=
    (SELECT 50,11*s1 FROM t4 UNION SELECT 50,77 FROM
     (SELECT * FROM t5) AS t5)));
```

A subquery can return a scalar (a single value), a single row, a single column, or a table (one or more rows of one or more columns). These are called scalar, column, row, and table subqueries. Subqueries that return a particular kind of result often can be used only in certain contexts, as described in the following sections.

There are few restrictions on the type of statements in which subqueries can be used. A subquery can contain many of the keywords or clauses that an ordinary `SELECT` can contain: `DISTINCT`, `GROUP BY`, `ORDER BY`, `LIMIT`, joins, index hints, `UNION` constructs, comments, functions, and so on.

A subquery's outer statement can be any one of: `SELECT`, `INSERT`, `UPDATE`, `DELETE`, `SET`, or `DO`.

In MySQL, you cannot modify a table and select from the same table in a subquery. This applies to statements such as `DELETE`, `INSERT`, `REPLACE`, `UPDATE`, and (because subqueries can be used in the `SET` clause) `LOAD DATA`.

For information about how the optimizer handles subqueries, see [Section 8.2.2, “Optimizing Subqueries, Derived Tables, and View References”](#). For a discussion of restrictions on subquery use, including performance issues for certain forms of subquery syntax, see [Section 13.2.10.12, “Restrictions on Subqueries”](#).

### 13.2.10.1 The Subquery as Scalar Operand

In its simplest form, a subquery is a scalar subquery that returns a single value. A scalar subquery is a simple operand, and you can use it almost anywhere a single column value or literal is legal, and you can expect it to have those characteristics that all operands have: a data type, a length, an indication that it can be `NULL`, and so on. For example:

```
CREATE TABLE t1 (s1 INT, s2 CHAR(5) NOT NULL);
INSERT INTO t1 VALUES(100, 'abcde');
```

```
SELECT (SELECT s2 FROM t1);
```

The subquery in this `SELECT` returns a single value ('abcde') that has a data type of `CHAR`, a length of 5, a character set and collation equal to the defaults in effect at `CREATE TABLE` time, and an indication that the value in the column can be `NULL`. Nullability of the value selected by a scalar subquery is not copied because if the subquery result is empty, the result is `NULL`. For the subquery just shown, if `t1` were empty, the result would be `NULL` even though `s2` is `NOT NULL`.

There are a few contexts in which a scalar subquery cannot be used. If a statement permits only a literal value, you cannot use a subquery. For example, `LIMIT` requires literal integer arguments, and `LOAD DATA` requires a literal string file name. You cannot use subqueries to supply these values.

When you see examples in the following sections that contain the rather spartan construct (`SELECT column1 FROM t1`), imagine that your own code contains much more diverse and complex constructions.

Suppose that we make two tables:

```
CREATE TABLE t1 (s1 INT);
INSERT INTO t1 VALUES (1);
CREATE TABLE t2 (s1 INT);
INSERT INTO t2 VALUES (2);
```

Then perform a `SELECT`:

```
SELECT (SELECT s1 FROM t2) FROM t1;
```

The result is 2 because there is a row in `t2` containing a column `s1` that has a value of 2.

A scalar subquery can be part of an expression, but remember the parentheses, even if the subquery is an operand that provides an argument for a function. For example:

```
SELECT UPPER((SELECT s1 FROM t1)) FROM t2;
```

### 13.2.10.2 Comparisons Using Subqueries

The most common use of a subquery is in the form:

```
non_subquery_operand comparison_operator (subquery)
```

Where *comparison\_operator* is one of these operators:

```
= > < >= <= <> != <=>
```

For example:

```
... WHERE 'a' = (SELECT column1 FROM t1)
```

MySQL also permits this construct:

```
non_subquery_operand LIKE (subquery)
```

At one time the only legal place for a subquery was on the right side of a comparison, and you might still find some old DBMSs that insist on this.

Here is an example of a common-form subquery comparison that you cannot do with a join. It finds all the rows in table `t1` for which the `column1` value is equal to a maximum value in table `t2`:

```
SELECT * FROM t1
WHERE column1 = (SELECT MAX(column2) FROM t2);
```

Here is another example, which again is impossible with a join because it involves aggregating for one of the tables. It finds all rows in table `t1` containing a value that occurs twice in a given column:

```
SELECT * FROM t1 AS t
WHERE 2 = (SELECT COUNT(*) FROM t1 WHERE t1.id = t.id);
```

For a comparison of the subquery to a scalar, the subquery must return a scalar. For a comparison of the subquery to a row constructor, the subquery must be a row subquery that returns a row with the same number of values as the row constructor. See [Section 13.2.10.5, “Row Subqueries”](#).

### 13.2.10.3 Subqueries with ANY, IN, or SOME

Syntax:

```
operand comparison_operator ANY (subquery)
operand IN (subquery)
operand comparison_operator SOME (subquery)
```

Where *comparison\_operator* is one of these operators:

```
= > < >= <= <> !=
```

The `ANY` keyword, which must follow a comparison operator, means “return `TRUE` if the comparison is `TRUE` for `ANY` of the values in the column that the subquery returns.” For example:

```
SELECT s1 FROM t1 WHERE s1 > ANY (SELECT s1 FROM t2);
```

Suppose that there is a row in table `t1` containing `(10)`. The expression is `TRUE` if table `t2` contains `(21, 14, 7)` because there is a value `7` in `t2` that is less than `10`. The expression is `FALSE` if table `t2` contains `(20, 10)`, or if table `t2` is empty. The expression is *unknown* (that is, `NULL`) if table `t2` contains `(NULL, NULL, NULL)`.

When used with a subquery, the word `IN` is an alias for `= ANY`. Thus, these two statements are the same:

```
SELECT s1 FROM t1 WHERE s1 = ANY (SELECT s1 FROM t2);
SELECT s1 FROM t1 WHERE s1 IN (SELECT s1 FROM t2);
```

`IN` and `= ANY` are not synonyms when used with an expression list. `IN` can take an expression list, but `= ANY` cannot. See [Section 12.4.2, “Comparison Functions and Operators”](#).

`NOT IN` is not an alias for `<> ANY`, but for `<> ALL`. See [Section 13.2.10.4, “Subqueries with ALL”](#).

The word `SOME` is an alias for `ANY`. Thus, these two statements are the same:

```
SELECT s1 FROM t1 WHERE s1 <> ANY (SELECT s1 FROM t2);
SELECT s1 FROM t1 WHERE s1 <> SOME (SELECT s1 FROM t2);
```

Use of the word `SOME` is rare, but this example shows why it might be useful. To most people, the English phrase “a is not equal to any b” means “there is no b which is equal to a,” but that is not what is meant by the SQL syntax. The syntax means “there is some b to which a is not equal.” Using `<> SOME` instead helps ensure that everyone understands the true meaning of the query.

### 13.2.10.4 Subqueries with ALL

Syntax:

```
operand comparison_operator ALL (subquery)
```

The word `ALL`, which must follow a comparison operator, means “return `TRUE` if the comparison is `TRUE` for `ALL` of the values in the column that the subquery returns.” For example:



```
SELECT s1 FROM t1 WHERE s1 > ALL (SELECT s1 FROM t2);
```

Suppose that there is a row in table `t1` containing `(10)`. The expression is `TRUE` if table `t2` contains `(-5,0,+5)` because `10` is greater than all three values in `t2`. The expression is `FALSE` if table `t2` contains `(12,6,NULL,-100)` because there is a single value `12` in table `t2` that is greater than `10`. The expression is *unknown* (that is, `NULL`) if table `t2` contains `(0,NULL,1)`.

Finally, the expression is `TRUE` if table `t2` is empty. So, the following expression is `TRUE` when table `t2` is empty:

```
SELECT * FROM t1 WHERE 1 > ALL (SELECT s1 FROM t2);
```

But this expression is `NULL` when table `t2` is empty:

```
SELECT * FROM t1 WHERE 1 > (SELECT s1 FROM t2);
```

In addition, the following expression is `NULL` when table `t2` is empty:

```
SELECT * FROM t1 WHERE 1 > ALL (SELECT MAX(s1) FROM t2);
```

In general, *tables containing NULL values* and *empty tables* are “edge cases.” When writing subqueries, always consider whether you have taken those two possibilities into account.

`NOT IN` is an alias for `<> ALL`. Thus, these two statements are the same:

```
SELECT s1 FROM t1 WHERE s1 <> ALL (SELECT s1 FROM t2);
SELECT s1 FROM t1 WHERE s1 NOT IN (SELECT s1 FROM t2);
```

### 13.2.10.5 Row Subqueries

Scalar or column subqueries return a single value or a column of values. A *row subquery* is a subquery variant that returns a single row and can thus return more than one column value. Legal operators for row subquery comparisons are:

```
= > < >= <= <> != <=>
```

Here are two examples:

```
SELECT * FROM t1
  WHERE (col1,col2) = (SELECT col3, col4 FROM t2 WHERE id = 10);
SELECT * FROM t1
  WHERE ROW(col1,col2) = (SELECT col3, col4 FROM t2 WHERE id = 10);
```

For both queries, if the table `t2` contains a single row with `id = 10`, the subquery returns a single row. If this row has `col3` and `col4` values equal to the `col1` and `col2` values of any rows in `t1`, the `WHERE` expression is `TRUE` and each query returns those `t1` rows. If the `t2` row `col3` and `col4` values are not equal the `col1` and `col2` values of any `t1` row, the expression is `FALSE` and the query returns an empty result set. The expression is *unknown* (that is, `NULL`) if the subquery produces no rows. An error occurs if the subquery produces multiple rows because a row subquery can return at most one row.

For information about how each operator works for row comparisons, see [Section 12.4.2, “Comparison Functions and Operators”](#).

The expressions `(1,2)` and `ROW(1,2)` are sometimes called *row constructors*. The two are equivalent. The row constructor and the row returned by the subquery must contain the same number of values.

A row constructor is used for comparisons with subqueries that return two or more columns. When a subquery returns a single column, this is regarded as a scalar value and not as a row, so a row constructor

cannot be used with a subquery that does not return at least two columns. Thus, the following query fails with a syntax error:

```
SELECT * FROM t1 WHERE ROW(1) = (SELECT column1 FROM t2)
```

Row constructors are legal in other contexts. For example, the following two statements are semantically equivalent (and are handled in the same way by the optimizer):

```
SELECT * FROM t1 WHERE (column1,column2) = (1,1);
SELECT * FROM t1 WHERE column1 = 1 AND column2 = 1;
```

The following query answers the request, “find all rows in table `t1` that also exist in table `t2`”:

```
SELECT column1,column2,column3
FROM t1
WHERE (column1,column2,column3) IN
      (SELECT column1,column2,column3 FROM t2);
```

For more information about the optimizer and row constructors, see [Section 8.2.1.19, “Row Constructor Expression Optimization”](#)

### 13.2.10.6 Subqueries with EXISTS or NOT EXISTS

If a subquery returns any rows at all, `EXISTS subquery` is `TRUE`, and `NOT EXISTS subquery` is `FALSE`. For example:

```
SELECT column1 FROM t1 WHERE EXISTS (SELECT * FROM t2);
```

Traditionally, an `EXISTS` subquery starts with `SELECT *`, but it could begin with `SELECT 5` or `SELECT column1` or anything at all. MySQL ignores the `SELECT` list in such a subquery, so it makes no difference.

For the preceding example, if `t2` contains any rows, even rows with nothing but `NULL` values, the `EXISTS` condition is `TRUE`. This is actually an unlikely example because a `[NOT] EXISTS` subquery almost always contains correlations. Here are some more realistic examples:

- What kind of store is present in one or more cities?

```
SELECT DISTINCT store_type FROM stores
WHERE EXISTS (SELECT * FROM cities_stores
              WHERE cities_stores.store_type = stores.store_type);
```

- What kind of store is present in no cities?

```
SELECT DISTINCT store_type FROM stores
WHERE NOT EXISTS (SELECT * FROM cities_stores
                  WHERE cities_stores.store_type = stores.store_type);
```

- What kind of store is present in all cities?

```
SELECT DISTINCT store_type FROM stores
WHERE NOT EXISTS (
  SELECT * FROM cities WHERE NOT EXISTS (
    SELECT * FROM cities_stores
    WHERE cities_stores.city = cities.city
    AND cities_stores.store_type = stores.store_type));
```

The last example is a double-nested `NOT EXISTS` query. That is, it has a `NOT EXISTS` clause within a `NOT EXISTS` clause. Formally, it answers the question “does a city exist with a store that is not in `Stores`”? But it is easier to say that a nested `NOT EXISTS` answers the question “is `x TRUE` for all `y`?”

### 13.2.10.7 Correlated Subqueries

A *correlated subquery* is a subquery that contains a reference to a table that also appears in the outer query. For example:

```
SELECT * FROM t1
WHERE column1 = ANY (SELECT column1 FROM t2
                    WHERE t2.column2 = t1.column2);
```

Notice that the subquery contains a reference to a column of `t1`, even though the subquery's `FROM` clause does not mention a table `t1`. So, MySQL looks outside the subquery, and finds `t1` in the outer query.

Suppose that table `t1` contains a row where `column1 = 5` and `column2 = 6`; meanwhile, table `t2` contains a row where `column1 = 5` and `column2 = 7`. The simple expression `... WHERE column1 = ANY (SELECT column1 FROM t2)` would be `TRUE`, but in this example, the `WHERE` clause within the subquery is `FALSE` (because `(5,6)` is not equal to `(5,7)`), so the expression as a whole is `FALSE`.

**Scoping rule:** MySQL evaluates from inside to outside. For example:

```
SELECT column1 FROM t1 AS x
WHERE x.column1 = (SELECT column1 FROM t2 AS x
                  WHERE x.column1 = (SELECT column1 FROM t3
                                    WHERE x.column2 = t3.column1));
```

In this statement, `x.column2` must be a column in table `t2` because `SELECT column1 FROM t2 AS x ...` renames `t2`. It is not a column in table `t1` because `SELECT column1 FROM t1 ...` is an outer query that is *farther out*.

For subqueries in `HAVING` or `ORDER BY` clauses, MySQL also looks for column names in the outer select list.

For certain cases, a correlated subquery is optimized. For example:

```
val IN (SELECT key_val FROM tbl_name WHERE correlated_condition)
```

Otherwise, they are inefficient and likely to be slow. Rewriting the query as a join might improve performance.

Aggregate functions in correlated subqueries may contain outer references, provided the function contains nothing but outer references, and provided the function is not contained in another function or expression.

### 13.2.10.8 Derived Tables

A derived table is an expression that generates a table within the scope of a query `FROM` clause. For example, a subquery in a `SELECT` statement `FROM` clause is a derived table:

```
SELECT ... FROM (subquery) [AS] tbl_name ...
```

The `[AS] tbl_name` clause is mandatory because every table in a `FROM` clause must have a name. Any columns in the derived table must have unique names.

For the sake of illustration, assume that you have this table:

```
CREATE TABLE t1 (s1 INT, s2 CHAR(5), s3 FLOAT);
```

Here is how to use a subquery in the `FROM` clause, using the example table:

```
INSERT INTO t1 VALUES (1, '1', 1.0);
INSERT INTO t1 VALUES (2, '2', 2.0);
SELECT sb1, sb2, sb3
FROM (SELECT s1 AS sb1, s2 AS sb2, s3*2 AS sb3 FROM t1) AS sb
WHERE sb1 > 1;
```

Result:

```
+-----+-----+-----+
| sb1 | sb2 | sb3 |
+-----+-----+-----+
|  2 |  2 |  4 |
+-----+-----+-----+
```

Here is another example: Suppose that you want to know the average of a set of sums for a grouped table. This does not work:

```
SELECT AVG(SUM(column1)) FROM t1 GROUP BY column1;
```

However, this query provides the desired information:

```
SELECT AVG(sum_column1)
FROM (SELECT SUM(column1) AS sum_column1
      FROM t1 GROUP BY column1) AS t1;
```

Notice that the column name used within the subquery (`sum_column1`) is recognized in the outer query.

A derived table can return a scalar, column, row, or table.

Derived tables are subject to these restrictions:

- A derived table cannot be a correlated subquery.
- A derived table cannot contain references to other tables of the same `SELECT`.
- A derived table cannot contain outer references. This is a MySQL restriction, not a restriction of the SQL standard.

The optimizer determines information about derived tables in such a way that `EXPLAIN` does not need to materialize them. See [Section 8.2.2.4, “Optimizing Derived Tables and View References with Merging or Materialization”](#).

It is possible under certain circumstances that using `EXPLAIN SELECT` modifies table data. This can occur if the outer query accesses any tables and an inner query invokes a stored function that changes one or more rows of a table. Suppose that there are two tables `t1` and `t2` in database `d1`, and a stored function `f1` that modifies `t2`, created as shown here:

```
CREATE DATABASE d1;
USE d1;
CREATE TABLE t1 (c1 INT);
CREATE TABLE t2 (c1 INT);
CREATE FUNCTION f1(p1 INT) RETURNS INT
BEGIN
    INSERT INTO t2 VALUES (p1);
    RETURN p1;
END;
```

Referencing the function directly in an `EXPLAIN SELECT` has no effect on `t2`, as shown here:

```
mysql> SELECT * FROM t2;
Empty set (0.02 sec)

mysql> EXPLAIN SELECT f1(5)\G
***** 1. row *****
      id: 1
  select_type: SIMPLE
        table: NULL
  partitions: NULL
         type: NULL
```

```

possible_keys: NULL
  key: NULL
  key_len: NULL
  ref: NULL
  rows: NULL
  filtered: NULL
  Extra: No tables used
1 row in set (0.01 sec)

mysql> SELECT * FROM t2;
Empty set (0.01 sec)

```

This is because the `SELECT` statement did not reference any tables, as can be seen in the `table` and `Extra` columns of the output. This is also true of the following nested `SELECT`:

```

mysql> EXPLAIN SELECT NOW() AS a1, (SELECT f1(5)) AS a2\G
***** 1. row *****
      id: 1
  select_type: SIMPLE
        table: NULL
         type: NULL
possible_keys: NULL
  key: NULL
  key_len: NULL
  ref: NULL
  rows: NULL
  filtered: NULL
  Extra: No tables used
1 row in set, 1 warning (0.00 sec)

mysql> SHOW WARNINGS;
+-----+-----+-----+
| Level | Code | Message                                     |
+-----+-----+-----+
| Note  | 1249 | Select 2 was reduced during optimization |
+-----+-----+-----+
1 row in set (0.00 sec)

mysql> SELECT * FROM t2;
Empty set (0.00 sec)

```

However, if the outer `SELECT` references any tables, the optimizer executes the statement in the subquery as well, with the result that `t2` is modified:

```

mysql> EXPLAIN SELECT * FROM t1 AS a1, (SELECT f1(5)) AS a2\G
***** 1. row *****
      id: 1
  select_type: PRIMARY
        table: <derived2>
  partitions: NULL
         type: system
possible_keys: NULL
  key: NULL
  key_len: NULL
  ref: NULL
  rows: 1
  filtered: 100.00
  Extra: NULL
***** 2. row *****
      id: 1
  select_type: PRIMARY
        table: a1
  partitions: NULL
         type: ALL
possible_keys: NULL
  key: NULL

```

```

    key_len: NULL
      ref: NULL
      rows: 1
  filtered: 100.00
  Extra: NULL
***** 3. row *****
      id: 2
  select_type: DERIVED
      table: NULL
  partitions: NULL
      type: NULL
possible_keys: NULL
      key: NULL
      key_len: NULL
      ref: NULL
      rows: NULL
  filtered: NULL
  Extra: No tables used
3 rows in set (0.00 sec)

mysql> SELECT * FROM t2;
+-----+
| c1 |
+-----+
|  5 |
+-----+
1 row in set (0.00 sec)

```

### 13.2.10.9 Subquery Errors

There are some errors that apply only to subqueries. This section describes them.

- Unsupported subquery syntax:

```

ERROR 1235 (ER_NOT_SUPPORTED_YET)
SQLSTATE = 42000
Message = "This version of MySQL does not yet support
'LIMIT & IN/ALL/ANY/SOME subquery'"

```

This means that MySQL does not support statements of the following form:

```
SELECT * FROM t1 WHERE s1 IN (SELECT s2 FROM t2 ORDER BY s1 LIMIT 1)
```

- Incorrect number of columns from subquery:

```

ERROR 1241 (ER_OPERAND_COL)
SQLSTATE = 21000
Message = "Operand should contain 1 column(s)"

```

This error occurs in cases like this:

```
SELECT (SELECT column1, column2 FROM t2) FROM t1;
```

You may use a subquery that returns multiple columns, if the purpose is row comparison. In other contexts, the subquery must be a scalar operand. See [Section 13.2.10.5, "Row Subqueries"](#).

- Incorrect number of rows from subquery:

```

ERROR 1242 (ER_SUBSELECT_NO_1_ROW)
SQLSTATE = 21000
Message = "Subquery returns more than 1 row"

```

This error occurs for statements where the subquery must return at most one row but returns multiple rows. Consider the following example:

```
SELECT * FROM t1 WHERE column1 = (SELECT column1 FROM t2);
```

If `SELECT column1 FROM t2` returns just one row, the previous query works. If the subquery returns more than one row, error 1242 occurs. In that case, the query should be rewritten as:

```
SELECT * FROM t1 WHERE column1 = ANY (SELECT column1 FROM t2);
```

- Incorrectly used table in subquery:

```
Error 1093 (ER_UPDATE_TABLE_USED)
SQLSTATE = HY000
Message = "You can't specify target table 'x'
for update in FROM clause"
```

This error occurs in cases such as the following, which attempts to modify a table and select from the same table in the subquery:

```
UPDATE t1 SET column2 = (SELECT MAX(column1) FROM t1);
```

You can use a subquery for assignment within an `UPDATE` statement because subqueries are legal in `UPDATE` and `DELETE` statements as well as in `SELECT` statements. However, you cannot use the same table (in this case, table `t1`) for both the subquery `FROM` clause and the update target.

For transactional storage engines, the failure of a subquery causes the entire statement to fail. For nontransactional storage engines, data modifications made before the error was encountered are preserved.

### 13.2.10.10 Optimizing Subqueries

Development is ongoing, so no optimization tip is reliable for the long term. The following list provides some interesting tricks that you might want to play with. See also [Section 8.2.2, “Optimizing Subqueries, Derived Tables, and View References”](#).

- Use subquery clauses that affect the number or order of the rows in the subquery. For example:

```
SELECT * FROM t1 WHERE t1.column1 IN
  (SELECT column1 FROM t2 ORDER BY column1);
SELECT * FROM t1 WHERE t1.column1 IN
  (SELECT DISTINCT column1 FROM t2);
SELECT * FROM t1 WHERE EXISTS
  (SELECT * FROM t2 LIMIT 1);
```

- Replace a join with a subquery. For example, try this:

```
SELECT DISTINCT column1 FROM t1 WHERE t1.column1 IN (
  SELECT column1 FROM t2);
```

Instead of this:

```
SELECT DISTINCT t1.column1 FROM t1, t2
WHERE t1.column1 = t2.column1;
```

- Some subqueries can be transformed to joins for compatibility with older versions of MySQL that do not support subqueries. However, in some cases, converting a subquery to a join may improve performance. See [Section 13.2.10.11, “Rewriting Subqueries as Joins”](#).
- Move clauses from outside to inside the subquery. For example, use this query:

```
SELECT * FROM t1
WHERE s1 IN (SELECT s1 FROM t1 UNION ALL SELECT s1 FROM t2);
```

Instead of this query:

```
SELECT * FROM t1
WHERE s1 IN (SELECT s1 FROM t1) OR s1 IN (SELECT s1 FROM t2);
```

For another example, use this query:

```
SELECT (SELECT column1 + 5 FROM t1) FROM t2;
```

Instead of this query:

```
SELECT (SELECT column1 FROM t1) + 5 FROM t2;
```

- Use a row subquery instead of a correlated subquery. For example, use this query:

```
SELECT * FROM t1
WHERE (column1,column2) IN (SELECT column1,column2 FROM t2);
```

Instead of this query:

```
SELECT * FROM t1
WHERE EXISTS (SELECT * FROM t2 WHERE t2.column1=t1.column1
AND t2.column2=t1.column2);
```

- Use `NOT (a = ANY (...))` rather than `a <> ALL (...)`.
- Use `x = ANY (table containing (1,2))` rather than `x=1 OR x=2`.
- Use `= ANY` rather than `EXISTS`.
- For uncorrelated subqueries that always return one row, `IN` is always slower than `=`. For example, use this query:

```
SELECT * FROM t1
WHERE t1.col_name = (SELECT a FROM t2 WHERE b = some_const);
```

Instead of this query:

```
SELECT * FROM t1
WHERE t1.col_name IN (SELECT a FROM t2 WHERE b = some_const);
```

These tricks might cause programs to go faster or slower. Using MySQL facilities like the `BENCHMARK()` function, you can get an idea about what helps in your own situation. See [Section 12.15, “Information Functions”](#).

Some optimizations that MySQL itself makes are:

- MySQL executes uncorrelated subqueries only once. Use `EXPLAIN` to make sure that a given subquery really is uncorrelated.
- MySQL rewrites `IN`, `ALL`, `ANY`, and `SOME` subqueries in an attempt to take advantage of the possibility that the select-list columns in the subquery are indexed.
- MySQL replaces subqueries of the following form with an index-lookup function, which `EXPLAIN` describes as a special join type (`unique_subquery` or `index_subquery`):

```
... IN (SELECT indexed_column FROM single_table ...)
```

- MySQL enhances expressions of the following form with an expression involving `MIN()` or `MAX()`, unless `NULL` values or empty sets are involved:



```
value {ALL|ANY|SOME} {> | < | >= | <=} (uncorrelated subquery)
```

For example, this `WHERE` clause:

```
WHERE 5 > ALL (SELECT x FROM t)
```

might be treated by the optimizer like this:

```
WHERE 5 > (SELECT MAX(x) FROM t)
```

See also [MySQL Internals: How MySQL Transforms Subqueries](#).

### 13.2.10.11 Rewriting Subqueries as Joins

Sometimes there are other ways to test membership in a set of values than by using a subquery. Also, on some occasions, it is not only possible to rewrite a query without a subquery, but it can be more efficient to make use of some of these techniques rather than to use subqueries. One of these is the `IN()` construct:

For example, this query:

```
SELECT * FROM t1 WHERE id IN (SELECT id FROM t2);
```

Can be rewritten as:

```
SELECT DISTINCT t1.* FROM t1, t2 WHERE t1.id=t2.id;
```

The queries:

```
SELECT * FROM t1 WHERE id NOT IN (SELECT id FROM t2);
SELECT * FROM t1 WHERE NOT EXISTS (SELECT id FROM t2 WHERE t1.id=t2.id);
```

Can be rewritten as:

```
SELECT table1.*
FROM table1 LEFT JOIN table2 ON table1.id=table2.id
WHERE table2.id IS NULL;
```

A `LEFT [OUTER] JOIN` can be faster than an equivalent subquery because the server might be able to optimize it better—a fact that is not specific to MySQL Server alone. Prior to SQL-92, outer joins did not exist, so subqueries were the only way to do certain things. Today, MySQL Server and many other modern database systems offer a wide range of outer join types.

MySQL Server supports multiple-table `DELETE` statements that can be used to efficiently delete rows based on information from one table or even from many tables at the same time. Multiple-table `UPDATE` statements are also supported. See [Section 13.2.2, “DELETE Statement”](#), and [Section 13.2.11, “UPDATE Statement”](#).

### 13.2.10.12 Restrictions on Subqueries

- In general, you cannot modify a table and select from the same table in a subquery. For example, this limitation applies to statements of the following forms:

```
DELETE FROM t WHERE ... (SELECT ... FROM t ...);
UPDATE t ... WHERE col = (SELECT ... FROM t ...);
{INSERT|REPLACE} INTO t (SELECT ... FROM t ...);
```

Exception: The preceding prohibition does not apply if for the modified table you are using a derived table and that derived table is materialized rather than merged into the outer query. (See [Section 8.2.2.4, “Optimizing Derived Tables and View References with Merging or Materialization”](#).) Example:

```
UPDATE t ... WHERE col = (SELECT * FROM (SELECT ... FROM t...) AS dt ...);
```

Here the result from the derived table is materialized as a temporary table, so the relevant rows in `t` have already been selected by the time the update to `t` takes place.

- Row comparison operations are only partially supported:
  - For `expr [NOT] IN subquery`, `expr` can be an  $n$ -tuple (specified using row constructor syntax) and the subquery can return rows of  $n$ -tuples. The permitted syntax is therefore more specifically expressed as `row_constructor [NOT] IN table_subquery`
  - For `expr op {ALL|ANY|SOME} subquery`, `expr` must be a scalar value and the subquery must be a column subquery; it cannot return multiple-column rows.

In other words, for a subquery that returns rows of  $n$ -tuples, this is supported:

```
(expr_1, ..., expr_n) [NOT] IN table_subquery
```

But this is not supported:

```
(expr_1, ..., expr_n) op {ALL|ANY|SOME} subquery
```

The reason for supporting row comparisons for `IN` but not for the others is that `IN` is implemented by rewriting it as a sequence of `=` comparisons and `AND` operations. This approach cannot be used for `ALL`, `ANY`, or `SOME`.

- Subqueries in the `FROM` clause cannot be correlated subqueries. They are materialized in whole (evaluated to produce a result set) during query execution, so they cannot be evaluated per row of the outer query. The optimizer delays materialization until the result is needed, which may permit materialization to be avoided. See [Section 8.2.2.4, “Optimizing Derived Tables and View References with Merging or Materialization”](#).
- MySQL does not support `LIMIT` in subqueries for certain subquery operators:

```
mysql> SELECT * FROM t1
      WHERE s1 IN (SELECT s2 FROM t2 ORDER BY s1 LIMIT 1);
ERROR 1235 (42000): This version of MySQL does not yet support
'LIMIT & IN/ALL/ANY/SOME subquery'
```

- MySQL permits a subquery to refer to a stored function that has data-modifying side effects such as inserting rows into a table. For example, if `f()` inserts rows, the following query can modify data:

```
SELECT ... WHERE x IN (SELECT f() ...);
```

This behavior is an extension to the SQL standard. In MySQL, it can produce nondeterministic results because `f()` might be executed a different number of times for different executions of a given query depending on how the optimizer chooses to handle it.

For statement-based or mixed-format replication, one implication of this indeterminism is that such a query can produce different results on the source and its replicas.

## 13.2.11 UPDATE Statement

`UPDATE` is a DML statement that modifies rows in a table.

Single-table syntax:

```
UPDATE [LOW_PRIORITY] [IGNORE] table_reference
```

```

SET assignment_list
[WHERE where_condition]
[ORDER BY ...]
[LIMIT row_count]

value:
  {expr | DEFAULT}

assignment:
  col_name = value

assignment_list:
  assignment [, assignment] ...

```

Multiple-table syntax:

```

UPDATE [LOW_PRIORITY] [IGNORE] table_references
SET assignment_list
[WHERE where_condition]

```

For the single-table syntax, the `UPDATE` statement updates columns of existing rows in the named table with new values. The `SET` clause indicates which columns to modify and the values they should be given. Each value can be given as an expression, or the keyword `DEFAULT` to set a column explicitly to its default value. The `WHERE` clause, if given, specifies the conditions that identify which rows to update. With no `WHERE` clause, all rows are updated. If the `ORDER BY` clause is specified, the rows are updated in the order that is specified. The `LIMIT` clause places a limit on the number of rows that can be updated.

For the multiple-table syntax, `UPDATE` updates rows in each table named in `table_references` that satisfy the conditions. Each matching row is updated once, even if it matches the conditions multiple times. For multiple-table syntax, `ORDER BY` and `LIMIT` cannot be used.

For partitioned tables, both the single-table and multiple-table forms of this statement support the use of a `PARTITION` clause as part of a table reference. This option takes a list of one or more partitions or subpartitions (or both). Only the partitions (or subpartitions) listed are checked for matches, and a row that is not in any of these partitions or subpartitions is not updated, whether it satisfies the `where_condition` or not.



#### Note

Unlike the case when using `PARTITION` with an `INSERT` or `REPLACE` statement, an otherwise valid `UPDATE ... PARTITION` statement is considered successful even if no rows in the listed partitions (or subpartitions) match the `where_condition`.

For more information and examples, see [Section 22.5, “Partition Selection”](#).

`where_condition` is an expression that evaluates to true for each row to be updated. For expression syntax, see [Section 9.5, “Expressions”](#).

`table_references` and `where_condition` are specified as described in [Section 13.2.9, “SELECT Statement”](#).

You need the `UPDATE` privilege only for columns referenced in an `UPDATE` that are actually updated. You need only the `SELECT` privilege for any columns that are read but not modified.

The `UPDATE` statement supports the following modifiers:

- With the `LOW_PRIORITY` modifier, execution of the `UPDATE` is delayed until no other clients are reading from the table. This affects only storage engines that use only table-level locking (such as `MyISAM`, `MEMORY`, and `MERGE`).

- With the `IGNORE` modifier, the update statement does not abort even if errors occur during the update. Rows for which duplicate-key conflicts occur on a unique key value are not updated. Rows updated to values that would cause data conversion errors are updated to the closest valid values instead. For more information, see [The Effect of IGNORE on Statement Execution](#).

`UPDATE IGNORE` statements, including those having an `ORDER BY` clause, are flagged as unsafe for statement-based replication. (This is because the order in which the rows are updated determines which rows are ignored.) Such statements produce a warning in the error log when using statement-based mode and are written to the binary log using the row-based format when using `MIXED` mode. (Bug #11758262, Bug #50439) See [Section 16.2.1.3, “Determination of Safe and Unsafe Statements in Binary Logging”](#), for more information.

If you access a column from the table to be updated in an expression, `UPDATE` uses the current value of the column. For example, the following statement sets `col1` to one more than its current value:

```
UPDATE t1 SET col1 = col1 + 1;
```

The second assignment in the following statement sets `col2` to the current (updated) `col1` value, not the original `col1` value. The result is that `col1` and `col2` have the same value. This behavior differs from standard SQL.

```
UPDATE t1 SET col1 = col1 + 1, col2 = col1;
```

Single-table `UPDATE` assignments are generally evaluated from left to right. For multiple-table updates, there is no guarantee that assignments are carried out in any particular order.

If you set a column to the value it currently has, MySQL notices this and does not update it.

If you update a column that has been declared `NOT NULL` by setting to `NULL`, an error occurs if strict SQL mode is enabled; otherwise, the column is set to the implicit default value for the column data type and the warning count is incremented. The implicit default value is `0` for numeric types, the empty string (`' '`) for string types, and the “zero” value for date and time types. See [Section 11.6, “Data Type Default Values”](#).

If a generated column is updated explicitly, the only permitted value is `DEFAULT`. For information about generated columns, see [Section 13.1.18.7, “CREATE TABLE and Generated Columns”](#).

`UPDATE` returns the number of rows that were actually changed. The `mysql_info()` C API function returns the number of rows that were matched and updated and the number of warnings that occurred during the `UPDATE`.

You can use `LIMIT row_count` to restrict the scope of the `UPDATE`. A `LIMIT` clause is a rows-matched restriction. The statement stops as soon as it has found `row_count` rows that satisfy the `WHERE` clause, whether or not they actually were changed.

If an `UPDATE` statement includes an `ORDER BY` clause, the rows are updated in the order specified by the clause. This can be useful in certain situations that might otherwise result in an error. Suppose that a table `t` contains a column `id` that has a unique index. The following statement could fail with a duplicate-key error, depending on the order in which rows are updated:

```
UPDATE t SET id = id + 1;
```

For example, if the table contains 1 and 2 in the `id` column and 1 is updated to 2 before 2 is updated to 3, an error occurs. To avoid this problem, add an `ORDER BY` clause to cause the rows with larger `id` values to be updated before those with smaller values:

```
UPDATE t SET id = id + 1 ORDER BY id DESC;
```

You can also perform `UPDATE` operations covering multiple tables. However, you cannot use `ORDER BY` or `LIMIT` with a multiple-table `UPDATE`. The `table_references` clause lists the tables involved in the join. Its syntax is described in [Section 13.2.9.2, “JOIN Clause”](#). Here is an example:

```
UPDATE items,month SET items.price=month.price
WHERE items.id=month.id;
```

The preceding example shows an inner join that uses the comma operator, but multiple-table `UPDATE` statements can use any type of join permitted in `SELECT` statements, such as `LEFT JOIN`.

If you use a multiple-table `UPDATE` statement involving `InnoDB` tables for which there are foreign key constraints, the MySQL optimizer might process tables in an order that differs from that of their parent/child relationship. In this case, the statement fails and rolls back. Instead, update a single table and rely on the `ON UPDATE` capabilities that `InnoDB` provides to cause the other tables to be modified accordingly. See [Section 13.1.18.5, “FOREIGN KEY Constraints”](#).

You cannot update a table and select directly from the same table in a subquery. You can work around this by using a multi-table update in which one of the tables is derived from the table that you actually wish to update, and referring to the derived table using an alias. Suppose you wish to update a table named `items` which is defined using the statement shown here:

```
CREATE TABLE items (
  id BIGINT NOT NULL AUTO_INCREMENT PRIMARY KEY,
  wholesale DECIMAL(6,2) NOT NULL DEFAULT 0.00,
  retail DECIMAL(6,2) NOT NULL DEFAULT 0.00,
  quantity BIGINT NOT NULL DEFAULT 0
);
```

To reduce the retail price of any items for which the markup is 30% or greater and of which you have fewer than one hundred in stock, you might try to use an `UPDATE` statement such as the one following, which uses a subquery in the `WHERE` clause. As shown here, this statement does not work:

```
mysql> UPDATE items
> SET retail = retail * 0.9
> WHERE id IN
> (SELECT id FROM items
> WHERE retail / wholesale >= 1.3 AND quantity > 100);
ERROR 1093 (HY000): You can't specify target table 'items' for update in FROM clause
```

Instead, you can employ a multi-table update in which the subquery is moved into the list of tables to be updated, using an alias to reference it in the outermost `WHERE` clause, like this:

```
UPDATE items,
  (SELECT id FROM items
   WHERE id IN
     (SELECT id FROM items
      WHERE retail / wholesale >= 1.3 AND quantity < 100))
  AS discounted
SET items.retail = items.retail * 0.9
WHERE items.id = discounted.id;
```

Because the optimizer tries by default to merge the derived table `discounted` into the outermost query block, this works only if you force materialization of the derived table. You can do this by setting the `derived_merge` flag of the `optimizer_switch` system variable to `off` before running the update, or by using the `NO_MERGE` optimizer hint, as shown here:

```
UPDATE /*+ NO_MERGE(discounted) */ items,
  (SELECT id FROM items
   WHERE retail / wholesale >= 1.3 AND quantity < 100)
  AS discounted
SET items.retail = items.retail * 0.9
```

```
WHERE items.id = discounted.id;
```

The advantage of using the optimizer hint in such a case is that it applies only within the query block where it is used, so that it is not necessary to change the value of `optimizer_switch` again after executing the `UPDATE`.

Another possibility is to rewrite the subquery so that it does not use `IN` or `EXISTS`, like this:

```
UPDATE items,
  (SELECT id, retail / wholesale AS markup, quantity FROM items)
  AS discounted
SET items.retail = items.retail * 0.9
WHERE discounted.markup >= 1.3
AND discounted.quantity < 100
AND items.id = discounted.id;
```

In this case, the subquery is materialized by default rather than merged, so it is not necessary to disable merging of the derived table.

## 13.3 Transactional and Locking Statements

MySQL supports local transactions (within a given client session) through statements such as `SET autocommit`, `START TRANSACTION`, `COMMIT`, and `ROLLBACK`. See [Section 13.3.1, “START TRANSACTION, COMMIT, and ROLLBACK Statements”](#). XA transaction support enables MySQL to participate in distributed transactions as well. See [Section 13.3.7, “XA Transactions”](#).

### 13.3.1 START TRANSACTION, COMMIT, and ROLLBACK Statements

```
START TRANSACTION
  [transaction_characteristic [, transaction_characteristic] ...]

transaction_characteristic: {
  WITH CONSISTENT SNAPSHOT
  | READ WRITE
  | READ ONLY
}

BEGIN [WORK]
COMMIT [WORK] [AND [NO] CHAIN] [[NO] RELEASE]
ROLLBACK [WORK] [AND [NO] CHAIN] [[NO] RELEASE]
SET autocommit = {0 | 1}
```

These statements provide control over use of [transactions](#):

- `START TRANSACTION` or `BEGIN` start a new transaction.
- `COMMIT` commits the current transaction, making its changes permanent.
- `ROLLBACK` rolls back the current transaction, canceling its changes.
- `SET autocommit` disables or enables the default autocommit mode for the current session.

By default, MySQL runs with `autocommit` mode enabled. This means that, when not otherwise inside a transaction, each statement is atomic, as if it were surrounded by `START TRANSACTION` and `COMMIT`. You cannot use `ROLLBACK` to undo the effect; however, if an error occurs during statement execution, the statement is rolled back.

To disable autocommit mode implicitly for a single series of statements, use the `START TRANSACTION` statement:

```
START TRANSACTION;
SELECT @A:=SUM(salary) FROM table1 WHERE type=1;
UPDATE table2 SET summary=@A WHERE type=1;
COMMIT;
```

With `START TRANSACTION`, autocommit remains disabled until you end the transaction with `COMMIT` or `ROLLBACK`. The autocommit mode then reverts to its previous state.

`START TRANSACTION` permits several modifiers that control transaction characteristics. To specify multiple modifiers, separate them by commas.

- The `WITH CONSISTENT SNAPSHOT` modifier starts a [consistent read](#) for storage engines that are capable of it. This applies only to `InnoDB`. The effect is the same as issuing a `START TRANSACTION` followed by a `SELECT` from any `InnoDB` table. See [Section 14.7.2.3, “Consistent Nonlocking Reads”](#). The `WITH CONSISTENT SNAPSHOT` modifier does not change the current transaction [isolation level](#), so it provides a consistent snapshot only if the current isolation level is one that permits a consistent read. The only isolation level that permits a consistent read is `REPEATABLE READ`. For all other isolation levels, the `WITH CONSISTENT SNAPSHOT` clause is ignored. As of MySQL 5.7.2, a warning is generated when the `WITH CONSISTENT SNAPSHOT` clause is ignored.
- The `READ WRITE` and `READ ONLY` modifiers set the transaction access mode. They permit or prohibit changes to tables used in the transaction. The `READ ONLY` restriction prevents the transaction from modifying or locking both transactional and nontransactional tables that are visible to other transactions; the transaction can still modify or lock temporary tables.

MySQL enables extra optimizations for queries on `InnoDB` tables when the transaction is known to be read-only. Specifying `READ ONLY` ensures these optimizations are applied in cases where the read-only status cannot be determined automatically. See [Section 8.5.3, “Optimizing InnoDB Read-Only Transactions”](#) for more information.

If no access mode is specified, the default mode applies. Unless the default has been changed, it is read/write. It is not permitted to specify both `READ WRITE` and `READ ONLY` in the same statement.

In read-only mode, it remains possible to change tables created with the `TEMPORARY` keyword using DML statements. Changes made with DDL statements are not permitted, just as with permanent tables.

For additional information about transaction access mode, including ways to change the default mode, see [Section 13.3.6, “SET TRANSACTION Statement”](#).

If the `read_only` system variable is enabled, explicitly starting a transaction with `START TRANSACTION READ WRITE` requires the `SUPER` privilege.



### Important

Many APIs used for writing MySQL client applications (such as JDBC) provide their own methods for starting transactions that can (and sometimes should) be used instead of sending a `START TRANSACTION` statement from the client. See [Chapter 27, Connectors and APIs](#), or the documentation for your API, for more information.

To disable autocommit mode explicitly, use the following statement:

```
SET autocommit=0;
```

After disabling autocommit mode by setting the `autocommit` variable to zero, changes to transaction-safe tables (such as those for `InnoDB` or `NDB`) are not made permanent immediately. You must use `COMMIT` to store your changes to disk or `ROLLBACK` to ignore the changes.

`autocommit` is a session variable and must be set for each session. To disable autocommit mode for each new connection, see the description of the `autocommit` system variable at [Section 5.1.7, “Server System Variables”](#).

`BEGIN` and `BEGIN WORK` are supported as aliases of `START TRANSACTION` for initiating a transaction. `START TRANSACTION` is standard SQL syntax, is the recommended way to start an ad-hoc transaction, and permits modifiers that `BEGIN` does not.

The `BEGIN` statement differs from the use of the `BEGIN` keyword that starts a `BEGIN ... END` compound statement. The latter does not begin a transaction. See [Section 13.6.1, “BEGIN ... END Compound Statement”](#).

**Note**

Within all stored programs (stored procedures and functions, triggers, and events), the parser treats `BEGIN [WORK]` as the beginning of a `BEGIN ... END` block. Begin a transaction in this context with `START TRANSACTION` instead.

The optional `WORK` keyword is supported for `COMMIT` and `ROLLBACK`, as are the `CHAIN` and `RELEASE` clauses. `CHAIN` and `RELEASE` can be used for additional control over transaction completion. The value of the `completion_type` system variable determines the default completion behavior. See [Section 5.1.7, “Server System Variables”](#).

The `AND CHAIN` clause causes a new transaction to begin as soon as the current one ends, and the new transaction has the same isolation level as the just-terminated transaction. The new transaction also uses the same access mode (`READ WRITE` or `READ ONLY`) as the just-terminated transaction. The `RELEASE` clause causes the server to disconnect the current client session after terminating the current transaction. Including the `NO` keyword suppresses `CHAIN` or `RELEASE` completion, which can be useful if the `completion_type` system variable is set to cause chaining or release completion by default.

Beginning a transaction causes any pending transaction to be committed. See [Section 13.3.3, “Statements That Cause an Implicit Commit”](#), for more information.

Beginning a transaction also causes table locks acquired with `LOCK TABLES` to be released, as though you had executed `UNLOCK TABLES`. Beginning a transaction does not release a global read lock acquired with `FLUSH TABLES WITH READ LOCK`.

For best results, transactions should be performed using only tables managed by a single transaction-safe storage engine. Otherwise, the following problems can occur:

- If you use tables from more than one transaction-safe storage engine (such as `InnoDB`), and the transaction isolation level is not `SERIALIZABLE`, it is possible that when one transaction commits, another ongoing transaction that uses the same tables sees only some of the changes made by the first transaction. That is, the atomicity of transactions is not guaranteed with mixed engines and inconsistencies can result. (If mixed-engine transactions are infrequent, you can use `SET TRANSACTION ISOLATION LEVEL` to set the isolation level to `SERIALIZABLE` on a per-transaction basis as necessary.)
- If you use tables that are not transaction-safe within a transaction, changes to those tables are stored at once, regardless of the status of autocommit mode.
- If you issue a `ROLLBACK` statement after updating a nontransactional table within a transaction, an `ER_WARNING_NOT_COMPLETE_ROLLBACK` warning occurs. Changes to transaction-safe tables are rolled back, but not changes to nontransaction-safe tables.

Each transaction is stored in the binary log in one chunk, upon `COMMIT`. Transactions that are rolled back are not logged. (**Exception:** Modifications to nontransactional tables cannot be rolled back. If a transaction



that is rolled back includes modifications to nontransactional tables, the entire transaction is logged with a `ROLLBACK` statement at the end to ensure that modifications to the nontransactional tables are replicated.) See [Section 5.4.4, “The Binary Log”](#).

You can change the isolation level or access mode for transactions with the `SET TRANSACTION` statement. See [Section 13.3.6, “SET TRANSACTION Statement”](#).

Rolling back can be a slow operation that may occur implicitly without the user having explicitly asked for it (for example, when an error occurs). Because of this, `SHOW PROCESSLIST` displays `Rolling back` in the `State` column for the session, not only for explicit rollbacks performed with the `ROLLBACK` statement but also for implicit rollbacks.



#### Note

In MySQL 5.7, `BEGIN`, `COMMIT`, and `ROLLBACK` are not affected by `--replicate-do-db` or `--replicate-ignore-db` rules.

When `InnoDB` performs a complete rollback of a transaction, all locks set by the transaction are released. If a single SQL statement within a transaction rolls back as a result of an error, such as a duplicate key error, locks set by the statement are preserved while the transaction remains active. This happens because `InnoDB` stores row locks in a format such that it cannot know afterward which lock was set by which statement.

If a `SELECT` statement within a transaction calls a stored function, and a statement within the stored function fails, that statement rolls back. If `ROLLBACK` is executed for the transaction subsequently, the entire transaction rolls back.

## 13.3.2 Statements That Cannot Be Rolled Back

Some statements cannot be rolled back. In general, these include data definition language (DDL) statements, such as those that create or drop databases, those that create, drop, or alter tables or stored routines.

You should design your transactions not to include such statements. If you issue a statement early in a transaction that cannot be rolled back, and then another statement later fails, the full effect of the transaction cannot be rolled back in such cases by issuing a `ROLLBACK` statement.

## 13.3.3 Statements That Cause an Implicit Commit

The statements listed in this section (and any synonyms for them) implicitly end any transaction active in the current session, as if you had done a `COMMIT` before executing the statement.

Most of these statements also cause an implicit commit after executing. The intent is to handle each such statement in its own special transaction because it cannot be rolled back anyway. Transaction-control and locking statements are exceptions: If an implicit commit occurs before execution, another does not occur after.

- **Data definition language (DDL) statements that define or modify database objects.** `ALTER DATABASE . . . UPGRADE DATA DIRECTORY NAME`, `ALTER EVENT`, `ALTER PROCEDURE`, `ALTER SERVER`, `ALTER TABLE`, `ALTER TABLESPACE`, `ALTER VIEW`, `CREATE DATABASE`, `CREATE EVENT`, `CREATE INDEX`, `CREATE PROCEDURE`, `CREATE SERVER`, `CREATE TABLE`, `CREATE TABLESPACE`, `CREATE TRIGGER`, `CREATE VIEW`, `DROP DATABASE`, `DROP EVENT`, `DROP INDEX`, `DROP PROCEDURE`, `DROP SERVER`, `DROP TABLE`, `DROP TABLESPACE`, `DROP TRIGGER`, `DROP VIEW`, `INSTALL PLUGIN`, `RENAME TABLE`, `TRUNCATE TABLE`, `UNINSTALL PLUGIN`.

`ALTER FUNCTION`, `CREATE FUNCTION` and `DROP FUNCTION` also cause an implicit commit when used with stored functions, but not with loadable functions. (`ALTER FUNCTION` can only be used with stored functions.)

`CREATE TABLE` and `DROP TABLE` statements do not commit a transaction if the `TEMPORARY` keyword is used. (This does not apply to other operations on temporary tables such as `ALTER TABLE` and `CREATE INDEX`, which do cause a commit.) However, although no implicit commit occurs, neither can the statement be rolled back, which means that the use of such statements causes transactional atomicity to be violated. For example, if you use `CREATE TEMPORARY TABLE` and then roll back the transaction, the table remains in existence.

The `CREATE TABLE` statement in `InnoDB` is processed as a single transaction. This means that a `ROLLBACK` from the user does not undo `CREATE TABLE` statements the user made during that transaction.

`CREATE TABLE ... SELECT` causes an implicit commit before and after the statement is executed when you are creating nontemporary tables. (No commit occurs for `CREATE TEMPORARY TABLE ... SELECT`.)

- **Statements that implicitly use or modify tables in the `mysql` database.** `ALTER USER`, `CREATE USER`, `DROP USER`, `GRANT`, `RENAME USER`, `REVOKE`, `SET PASSWORD`.
- **Transaction-control and locking statements.** `BEGIN`, `LOCK TABLES`, `SET autocommit = 1` (if the value is not already 1), `START TRANSACTION`, `UNLOCK TABLES`.

`UNLOCK TABLES` commits a transaction only if any tables currently have been locked with `LOCK TABLES` to acquire nontransactional table locks. A commit does not occur for `UNLOCK TABLES` following `FLUSH TABLES WITH READ LOCK` because the latter statement does not acquire table-level locks.

Transactions cannot be nested. This is a consequence of the implicit commit performed for any current transaction when you issue a `START TRANSACTION` statement or one of its synonyms.

Statements that cause an implicit commit cannot be used in an XA transaction while the transaction is in an `ACTIVE` state.

The `BEGIN` statement differs from the use of the `BEGIN` keyword that starts a `BEGIN ... END` compound statement. The latter does not cause an implicit commit. See [Section 13.6.1, “BEGIN ... END Compound Statement”](#).

- **Data loading statements.** `LOAD DATA`. `LOAD DATA` causes an implicit commit only for tables using the `NDB` storage engine.
- **Administrative statements.** `ANALYZE TABLE`, `CACHE INDEX`, `CHECK TABLE`, `FLUSH`, `LOAD INDEX INTO CACHE`, `OPTIMIZE TABLE`, `REPAIR TABLE`, `RESET`.
- **Replication control statements.** `START SLAVE`, `STOP SLAVE`, `RESET SLAVE`, `CHANGE MASTER TO`.

### 13.3.4 SAVEPOINT, ROLLBACK TO SAVEPOINT, and RELEASE SAVEPOINT Statements

```
SAVEPOINT identifier
ROLLBACK [WORK] TO [SAVEPOINT] identifier
RELEASE SAVEPOINT identifier
```

`InnoDB` supports the SQL statements `SAVEPOINT`, `ROLLBACK TO SAVEPOINT`, `RELEASE SAVEPOINT` and the optional `WORK` keyword for `ROLLBACK`.

The `SAVEPOINT` statement sets a named transaction savepoint with a name of *identifier*. If the current transaction has a savepoint with the same name, the old savepoint is deleted and a new one is set.

The `ROLLBACK TO SAVEPOINT` statement rolls back a transaction to the named savepoint without terminating the transaction. Modifications that the current transaction made to rows after the savepoint was set are undone in the rollback, but `InnoDB` does *not* release the row locks that were stored in memory after the savepoint. (For a new inserted row, the lock information is carried by the transaction ID stored in the row; the lock is not separately stored in memory. In this case, the row lock is released in the undo.) Savepoints that were set at a later time than the named savepoint are deleted.

If the `ROLLBACK TO SAVEPOINT` statement returns the following error, it means that no savepoint with the specified name exists:

```
ERROR 1305 (42000): SAVEPOINT identifier does not exist
```

The `RELEASE SAVEPOINT` statement removes the named savepoint from the set of savepoints of the current transaction. No commit or rollback occurs. It is an error if the savepoint does not exist.

All savepoints of the current transaction are deleted if you execute a `COMMIT`, or a `ROLLBACK` that does not name a savepoint.

A new savepoint level is created when a stored function is invoked or a trigger is activated. The savepoints on previous levels become unavailable and thus do not conflict with savepoints on the new level. When the function or trigger terminates, any savepoints it created are released and the previous savepoint level is restored.

### 13.3.5 LOCK TABLES and UNLOCK TABLES Statements

```
LOCK {TABLE | TABLES}
    tbl_name [[AS] alias] lock_type
    [, tbl_name [[AS] alias] lock_type] ...

lock_type: {
    READ [LOCAL]
    | [LOW_PRIORITY] WRITE
}

UNLOCK {TABLE | TABLES}
```

MySQL enables client sessions to acquire table locks explicitly for the purpose of cooperating with other sessions for access to tables, or to prevent other sessions from modifying tables during periods when a session requires exclusive access to them. A session can acquire or release locks only for itself. One session cannot acquire locks for another session or release locks held by another session.

Locks may be used to emulate transactions or to get more speed when updating tables. This is explained in more detail in [Table-Locking Restrictions and Conditions](#).

`LOCK TABLES` explicitly acquires table locks for the current client session. Table locks can be acquired for base tables or views. You must have the `LOCK TABLES` privilege, and the `SELECT` privilege for each object to be locked.

For view locking, `LOCK TABLES` adds all base tables used in the view to the set of tables to be locked and locks them automatically. As of MySQL 5.7.32, `LOCK TABLES` checks that the view definer has the proper privileges on the tables underlying the view.

If you lock a table explicitly with `LOCK TABLES`, any tables used in triggers are also locked implicitly, as described in [LOCK TABLES and Triggers](#).

`UNLOCK TABLES` explicitly releases any table locks held by the current session. `LOCK TABLES` implicitly releases any table locks held by the current session before acquiring new locks.

Another use for `UNLOCK TABLES` is to release the global read lock acquired with the `FLUSH TABLES WITH READ LOCK` statement, which enables you to lock all tables in all databases. See [Section 13.7.6.3, “FLUSH Statement”](#). (This is a very convenient way to get backups if you have a file system such as Veritas that can take snapshots in time.)

`LOCK TABLE` is a synonym for `LOCK TABLES`; `UNLOCK TABLE` is a synonym for `UNLOCK TABLES`.

A table lock protects only against inappropriate reads or writes by other sessions. A session holding a `WRITE` lock can perform table-level operations such as `DROP TABLE` or `TRUNCATE TABLE`. For sessions holding a `READ` lock, `DROP TABLE` and `TRUNCATE TABLE` operations are not permitted.

The following discussion applies only to non-`TEMPORARY` tables. `LOCK TABLES` is permitted (but ignored) for a `TEMPORARY` table. The table can be accessed freely by the session within which it was created, regardless of what other locking may be in effect. No lock is necessary because no other session can see the table.

- [Table Lock Acquisition](#)
- [Table Lock Release](#)
- [Interaction of Table Locking and Transactions](#)
- [LOCK TABLES and Triggers](#)
- [Table-Locking Restrictions and Conditions](#)

## Table Lock Acquisition

To acquire table locks within the current session, use the `LOCK TABLES` statement, which acquires metadata locks (see [Section 8.11.4, “Metadata Locking”](#)).

The following lock types are available:

`READ [LOCAL]` lock:

- The session that holds the lock can read the table (but not write it).
- Multiple sessions can acquire a `READ` lock for the table at the same time.
- Other sessions can read the table without explicitly acquiring a `READ` lock.
- The `LOCAL` modifier enables nonconflicting `INSERT` statements (concurrent inserts) by other sessions to execute while the lock is held. (See [Section 8.11.3, “Concurrent Inserts”](#).) However, `READ LOCAL` cannot be used if you are going to manipulate the database using processes external to the server while you hold the lock. For `InnoDB` tables, `READ LOCAL` is the same as `READ`.

`[LOW_PRIORITY] WRITE` lock:

- The session that holds the lock can read and write the table.
- Only the session that holds the lock can access the table. No other session can access it until the lock is released.
- Lock requests for the table by other sessions block while the `WRITE` lock is held.

- The `LOW_PRIORITY` modifier has no effect. In previous versions of MySQL, it affected locking behavior, but this is no longer true. It is now deprecated and its use produces a warning. Use `WRITE` without `LOW_PRIORITY` instead.

`WRITE` locks normally have higher priority than `READ` locks to ensure that updates are processed as soon as possible. This means that if one session obtains a `READ` lock and then another session requests a `WRITE` lock, subsequent `READ` lock requests wait until the session that requested the `WRITE` lock has obtained the lock and released it. (An exception to this policy can occur for small values of the `max_write_lock_count` system variable; see [Section 8.11.4, “Metadata Locking”](#).)

If the `LOCK TABLES` statement must wait due to locks held by other sessions on any of the tables, it blocks until all locks can be acquired.

A session that requires locks must acquire all the locks that it needs in a single `LOCK TABLES` statement. While the locks thus obtained are held, the session can access only the locked tables. For example, in the following sequence of statements, an error occurs for the attempt to access `t2` because it was not locked in the `LOCK TABLES` statement:

```
mysql> LOCK TABLES t1 READ;
mysql> SELECT COUNT(*) FROM t1;
+-----+
| COUNT(*) |
+-----+
|          3 |
+-----+
mysql> SELECT COUNT(*) FROM t2;
ERROR 1100 (HY000): Table 't2' was not locked with LOCK TABLES
```

Tables in the `INFORMATION_SCHEMA` database are an exception. They can be accessed without being locked explicitly even while a session holds table locks obtained with `LOCK TABLES`.

You cannot refer to a locked table multiple times in a single query using the same name. Use aliases instead, and obtain a separate lock for the table and each alias:

```
mysql> LOCK TABLE t WRITE, t AS t1 READ;
mysql> INSERT INTO t SELECT * FROM t;
ERROR 1100: Table 't' was not locked with LOCK TABLES
mysql> INSERT INTO t SELECT * FROM t AS t1;
```

The error occurs for the first `INSERT` because there are two references to the same name for a locked table. The second `INSERT` succeeds because the references to the table use different names.

If your statements refer to a table by means of an alias, you must lock the table using that same alias. It does not work to lock the table without specifying the alias:

```
mysql> LOCK TABLE t READ;
mysql> SELECT * FROM t AS myalias;
ERROR 1100: Table 'myalias' was not locked with LOCK TABLES
```

Conversely, if you lock a table using an alias, you must refer to it in your statements using that alias:

```
mysql> LOCK TABLE t AS myalias READ;
mysql> SELECT * FROM t;
ERROR 1100: Table 't' was not locked with LOCK TABLES
mysql> SELECT * FROM t AS myalias;
```



#### Note

`LOCK TABLES` or `UNLOCK TABLES`, when applied to a partitioned table, always locks or unlocks the entire table; these statements do not support partition lock pruning. See [Section 22.6.4, “Partitioning and Locking”](#).

## Table Lock Release

When the table locks held by a session are released, they are all released at the same time. A session can release its locks explicitly, or locks may be released implicitly under certain conditions.

- A session can release its locks explicitly with `UNLOCK TABLES`.
- If a session issues a `LOCK TABLES` statement to acquire a lock while already holding locks, its existing locks are released implicitly before the new locks are granted.
- If a session begins a transaction (for example, with `START TRANSACTION`), an implicit `UNLOCK TABLES` is performed, which causes existing locks to be released. (For additional information about the interaction between table locking and transactions, see [Interaction of Table Locking and Transactions](#).)

If the connection for a client session terminates, whether normally or abnormally, the server implicitly releases all table locks held by the session (transactional and nontransactional). If the client reconnects, the locks are longer in effect. In addition, if the client had an active transaction, the server rolls back the transaction upon disconnect, and if reconnect occurs, the new session begins with autocommit enabled. For this reason, clients may wish to disable auto-reconnect. With auto-reconnect in effect, the client is not notified if reconnect occurs but any table locks or current transactions are lost. With auto-reconnect disabled, if the connection drops, an error occurs for the next statement issued. The client can detect the error and take appropriate action such as reacquiring the locks or redoing the transaction. See [Automatic Reconnection Control](#).



### Note

If you use `ALTER TABLE` on a locked table, it may become unlocked. For example, if you attempt a second `ALTER TABLE` operation, the result may be an error `Table 'tbl_name' was not locked with LOCK TABLES`. To handle this, lock the table again prior to the second alteration. See also [Section B.3.6.1, "Problems with ALTER TABLE"](#).

## Interaction of Table Locking and Transactions

`LOCK TABLES` and `UNLOCK TABLES` interact with the use of transactions as follows:

- `LOCK TABLES` is not transaction-safe and implicitly commits any active transaction before attempting to lock the tables.
- `UNLOCK TABLES` implicitly commits any active transaction, but only if `LOCK TABLES` has been used to acquire table locks. For example, in the following set of statements, `UNLOCK TABLES` releases the global read lock but does not commit the transaction because no table locks are in effect:

```
FLUSH TABLES WITH READ LOCK;
START TRANSACTION;
SELECT ... ;
UNLOCK TABLES;
```

- Beginning a transaction (for example, with `START TRANSACTION`) implicitly commits any current transaction and releases existing table locks.
- `FLUSH TABLES WITH READ LOCK` acquires a global read lock and not table locks, so it is not subject to the same behavior as `LOCK TABLES` and `UNLOCK TABLES` with respect to table locking and implicit commits. For example, `START TRANSACTION` does not release the global read lock. See [Section 13.7.6.3, "FLUSH Statement"](#).
- Other statements that implicitly cause transactions to be committed do not release existing table locks. For a list of such statements, see [Section 13.3.3, "Statements That Cause an Implicit Commit"](#).

- The correct way to use `LOCK TABLES` and `UNLOCK TABLES` with transactional tables, such as InnoDB tables, is to begin a transaction with `SET autocommit = 0` (not `START TRANSACTION`) followed by `LOCK TABLES`, and to not call `UNLOCK TABLES` until you commit the transaction explicitly. For example, if you need to write to table `t1` and read from table `t2`, you can do this:

```
SET autocommit=0;
LOCK TABLES t1 WRITE, t2 READ, ...;
... do something with tables t1 and t2 here ...
COMMIT;
UNLOCK TABLES;
```

When you call `LOCK TABLES`, InnoDB internally takes its own table lock, and MySQL takes its own table lock. InnoDB releases its internal table lock at the next commit, but for MySQL to release its table lock, you have to call `UNLOCK TABLES`. You should not have `autocommit = 1`, because then InnoDB releases its internal table lock immediately after the call of `LOCK TABLES`, and deadlocks can very easily happen. InnoDB does not acquire the internal table lock at all if `autocommit = 1`, to help old applications avoid unnecessary deadlocks.

- `ROLLBACK` does not release table locks.

## LOCK TABLES and Triggers

If you lock a table explicitly with `LOCK TABLES`, any tables used in triggers are also locked implicitly:

- The locks are taken at the same time as those acquired explicitly with the `LOCK TABLES` statement.
- The lock on a table used in a trigger depends on whether the table is used only for reading. If so, a read lock suffices. Otherwise, a write lock is used.
- If a table is locked explicitly for reading with `LOCK TABLES`, but needs to be locked for writing because it might be modified within a trigger, a write lock is taken rather than a read lock. (That is, an implicit write lock needed due to the table's appearance within a trigger causes an explicit read lock request for the table to be converted to a write lock request.)

Suppose that you lock two tables, `t1` and `t2`, using this statement:

```
LOCK TABLES t1 WRITE, t2 READ;
```

If `t1` or `t2` have any triggers, tables used within the triggers are also locked. Suppose that `t1` has a trigger defined like this:

```
CREATE TRIGGER t1_a_ins AFTER INSERT ON t1 FOR EACH ROW
BEGIN
  UPDATE t4 SET count = count+1
    WHERE id = NEW.id AND EXISTS (SELECT a FROM t3);
  INSERT INTO t2 VALUES(1, 2);
END;
```

The result of the `LOCK TABLES` statement is that `t1` and `t2` are locked because they appear in the statement, and `t3` and `t4` are locked because they are used within the trigger:

- `t1` is locked for writing per the `WRITE` lock request.
- `t2` is locked for writing, even though the request is for a `READ` lock. This occurs because `t2` is inserted into within the trigger, so the `READ` request is converted to a `WRITE` request.
- `t3` is locked for reading because it is only read from within the trigger.
- `t4` is locked for writing because it might be updated within the trigger.

## Table-Locking Restrictions and Conditions

You can safely use `KILL` to terminate a session that is waiting for a table lock. See [Section 13.7.6.4, “KILL Statement”](#).

`LOCK TABLES` and `UNLOCK TABLES` cannot be used within stored programs.

Tables in the `performance_schema` database cannot be locked with `LOCK TABLES`, except the `setup_xxx` tables.

The scope of a lock generated by `LOCK TABLES` is a single MySQL server. It is not compatible with NDB Cluster, which has no way of enforcing an SQL-level lock across multiple instances of `mysqld`. You can enforce locking in an API application instead. See [Section 21.2.7.10, “Limitations Relating to Multiple NDB Cluster Nodes”](#), for more information.

The following statements are prohibited while a `LOCK TABLES` statement is in effect: `CREATE TABLE`, `CREATE TABLE ... LIKE`, `CREATE VIEW`, `DROP VIEW`, and DDL statements on stored functions and procedures and events.

For some operations, system tables in the `mysql` database must be accessed. For example, the `HELP` statement requires the contents of the server-side help tables, and `CONVERT_TZ()` might need to read the time zone tables. The server implicitly locks the system tables for reading as necessary so that you need not lock them explicitly. These tables are treated as just described:

```
mysql.help_category
mysql.help_keyword
mysql.help_relation
mysql.help_topic
mysql.proc
mysql.time_zone
mysql.time_zone_leap_second
mysql.time_zone_name
mysql.time_zone_transition
mysql.time_zone_transition_type
```

If you want to explicitly place a `WRITE` lock on any of those tables with a `LOCK TABLES` statement, the table must be the only one locked; no other table can be locked with the same statement.

Normally, you do not need to lock tables, because all single `UPDATE` statements are atomic; no other session can interfere with any other currently executing SQL statement. However, there are a few cases when locking tables may provide an advantage:

- If you are going to run many operations on a set of `MyISAM` tables, it is much faster to lock the tables you are going to use. Locking `MyISAM` tables speeds up inserting, updating, or deleting on them because MySQL does not flush the key cache for the locked tables until `UNLOCK TABLES` is called. Normally, the key cache is flushed after each SQL statement.

The downside to locking the tables is that no session can update a `READ`-locked table (including the one holding the lock) and no session can access a `WRITE`-locked table other than the one holding the lock.

- If you are using tables for a nontransactional storage engine, you must use `LOCK TABLES` if you want to ensure that no other session modifies the tables between a `SELECT` and an `UPDATE`. The example shown here requires `LOCK TABLES` to execute safely:

```
LOCK TABLES trans READ, customer WRITE;
SELECT SUM(value) FROM trans WHERE customer_id=some_id;
UPDATE customer
  SET total_value=sum_from_previous_statement
  WHERE customer_id=some_id;
```



```
UNLOCK TABLES;
```

Without `LOCK TABLES`, it is possible that another session might insert a new row in the `trans` table between execution of the `SELECT` and `UPDATE` statements.

You can avoid using `LOCK TABLES` in many cases by using relative updates (`UPDATE customer SET value=value+new_value`) or the `LAST_INSERT_ID()` function.

You can also avoid locking tables in some cases by using the user-level advisory lock functions `GET_LOCK()` and `RELEASE_LOCK()`. These locks are saved in a hash table in the server and implemented with `pthread_mutex_lock()` and `pthread_mutex_unlock()` for high speed. See [Section 12.14, “Locking Functions”](#).

See [Section 8.11.1, “Internal Locking Methods”](#), for more information on locking policy.

### 13.3.6 SET TRANSACTION Statement

```
SET [GLOBAL | SESSION] TRANSACTION
    transaction_characteristic [, transaction_characteristic] ...

transaction_characteristic: {
    ISOLATION LEVEL level
    | access_mode
}

level: {
    REPEATABLE READ
    | READ COMMITTED
    | READ UNCOMMITTED
    | SERIALIZABLE
}

access_mode: {
    READ WRITE
    | READ ONLY
}
```

This statement specifies `transaction` characteristics. It takes a list of one or more characteristic values separated by commas. Each characteristic value sets the transaction `isolation level` or access mode. The isolation level is used for operations on `InnoDB` tables. The access mode specifies whether transactions operate in read/write or read-only mode.

In addition, `SET TRANSACTION` can include an optional `GLOBAL` or `SESSION` keyword to indicate the scope of the statement.

- [Transaction Isolation Levels](#)
- [Transaction Access Mode](#)
- [Transaction Characteristic Scope](#)

#### Transaction Isolation Levels

To set the transaction isolation level, use an `ISOLATION LEVEL level` clause. It is not permitted to specify multiple `ISOLATION LEVEL` clauses in the same `SET TRANSACTION` statement.

The default isolation level is `REPEATABLE READ`. Other permitted values are `READ COMMITTED`, `READ UNCOMMITTED`, and `SERIALIZABLE`. For information about these isolation levels, see [Section 14.7.2.1, “Transaction Isolation Levels”](#).

## Transaction Access Mode

To set the transaction access mode, use a `READ WRITE` or `READ ONLY` clause. It is not permitted to specify multiple access-mode clauses in the same `SET TRANSACTION` statement.

By default, a transaction takes place in read/write mode, with both reads and writes permitted to tables used in the transaction. This mode may be specified explicitly using `SET TRANSACTION` with an access mode of `READ WRITE`.

If the transaction access mode is set to `READ ONLY`, changes to tables are prohibited. This may enable storage engines to make performance improvements that are possible when writes are not permitted.

In read-only mode, it remains possible to change tables created with the `TEMPORARY` keyword using DML statements. Changes made with DDL statements are not permitted, just as with permanent tables.

The `READ WRITE` and `READ ONLY` access modes also may be specified for an individual transaction using the `START TRANSACTION` statement.

## Transaction Characteristic Scope

You can set transaction characteristics globally, for the current session, or for the next transaction only:

- With the `GLOBAL` keyword:
  - The statement applies globally for all subsequent sessions.
  - Existing sessions are unaffected.
- With the `SESSION` keyword:
  - The statement applies to all subsequent transactions performed within the current session.
  - The statement is permitted within transactions, but does not affect the current ongoing transaction.
  - If executed between transactions, the statement overrides any preceding statement that sets the next-transaction value of the named characteristics.
- Without any `SESSION` or `GLOBAL` keyword:
  - The statement applies only to the next single transaction performed within the session.
  - Subsequent transactions revert to using the session value of the named characteristics.
  - The statement is not permitted within transactions:

```
mysql> START TRANSACTION;
Query OK, 0 rows affected (0.02 sec)

mysql> SET TRANSACTION ISOLATION LEVEL SERIALIZABLE;
ERROR 1568 (25001): Transaction characteristics can't be changed
while a transaction is in progress
```

A change to global transaction characteristics requires the `SUPER` privilege. Any session is free to change its session characteristics (even in the middle of a transaction), or the characteristics for its next transaction (prior to the start of that transaction).

To set the global isolation level at server startup, use the `--transaction-isolation=level` option on the command line or in an option file. Values of `level` for this option use dashes rather than spaces,

so the permissible values are `READ-UNCOMMITTED`, `READ-COMMITTED`, `REPEATABLE-READ`, or `SERIALIZABLE`.

Similarly, to set the global transaction access mode at server startup, use the `--transaction-read-only` option. The default is `OFF` (read/write mode) but the value can be set to `ON` for a mode of read only.

For example, to set the isolation level to `REPEATABLE READ` and the access mode to `READ WRITE`, use these lines in the `[mysqld]` section of an option file:

```
[mysqld]
transaction-isolation = REPEATABLE-READ
transaction-read-only = OFF
```

At runtime, characteristics at the global, session, and next-transaction scope levels can be set indirectly using the `SET TRANSACTION` statement, as described previously. They can also be set directly using the `SET` statement to assign values to the `transaction_isolation` and `transaction_read_only` system variables:

- `SET TRANSACTION` permits optional `GLOBAL` and `SESSION` keywords for setting transaction characteristics at different scope levels.
- The `SET` statement for assigning values to the `transaction_isolation` and `transaction_read_only` system variables has syntaxes for setting these variables at different scope levels.

The following tables show the characteristic scope level set by each `SET TRANSACTION` and variable-assignment syntax.

**Table 13.6 SET TRANSACTION Syntax for Transaction Characteristics**

Syntax	Affected Characteristic Scope
<code>SET GLOBAL TRANSACTION <i>transaction_characteristic</i></code>	Global
<code>SET SESSION TRANSACTION <i>transaction_characteristic</i></code>	Session
<code>SET TRANSACTION <i>transaction_characteristic</i></code>	Next transaction only

**Table 13.7 SET Syntax for Transaction Characteristics**

Syntax	Affected Characteristic Scope
<code>SET GLOBAL <i>var_name</i> = <i>value</i></code>	Global
<code>SET @@GLOBAL.<i>var_name</i> = <i>value</i></code>	Global
<code>SET SESSION <i>var_name</i> = <i>value</i></code>	Session
<code>SET @@SESSION.<i>var_name</i> = <i>value</i></code>	Session
<code>SET <i>var_name</i> = <i>value</i></code>	Session
<code>SET @@<i>var_name</i> = <i>value</i></code>	Next transaction only

It is possible to check the global and session values of transaction characteristics at runtime:

```
SELECT @@GLOBAL.transaction_isolation, @@GLOBAL.transaction_read_only;
SELECT @@SESSION.transaction_isolation, @@SESSION.transaction_read_only;
```

Prior to MySQL 5.7.20, use `tx_isolation` and `tx_read_only` rather than `transaction_isolation` and `transaction_read_only`.

### 13.3.7 XA Transactions

Support for XA transactions is available for the [InnoDB](#) storage engine. The MySQL XA implementation is based on the X/Open CAE document *Distributed Transaction Processing: The XA Specification*. This document is published by The Open Group and available at <http://www.opengroup.org/public/pubs/catalog/c193.htm>. Limitations of the current XA implementation are described in [Section 13.3.7.3, “Restrictions on XA Transactions”](#).

On the client side, there are no special requirements. The XA interface to a MySQL server consists of SQL statements that begin with the `XA` keyword. MySQL client programs must be able to send SQL statements and to understand the semantics of the XA statement interface. They do not need be linked against a recent client library. Older client libraries also work.

Among the MySQL Connectors, MySQL Connector/J 5.0.0 and higher supports XA directly, by means of a class interface that handles the XA SQL statement interface for you.

XA supports distributed transactions, that is, the ability to permit multiple separate transactional resources to participate in a global transaction. Transactional resources often are RDBMSs but may be other kinds of resources.

A global transaction involves several actions that are transactional in themselves, but that all must either complete successfully as a group, or all be rolled back as a group. In essence, this extends ACID properties “up a level” so that multiple ACID transactions can be executed in concert as components of a global operation that also has ACID properties. (As with nondistributed transactions, [SERIALIZABLE](#) may be preferred if your applications are sensitive to read phenomena. [REPEATABLE READ](#) may not be sufficient for distributed transactions.)

Some examples of distributed transactions:

- An application may act as an integration tool that combines a messaging service with an RDBMS. The application makes sure that transactions dealing with message sending, retrieval, and processing that also involve a transactional database all happen in a global transaction. You can think of this as “transactional email.”
- An application performs actions that involve different database servers, such as a MySQL server and an Oracle server (or multiple MySQL servers), where actions that involve multiple servers must happen as part of a global transaction, rather than as separate transactions local to each server.
- A bank keeps account information in an RDBMS and distributes and receives money through automated teller machines (ATMs). It is necessary to ensure that ATM actions are correctly reflected in the accounts, but this cannot be done with the RDBMS alone. A global transaction manager integrates the ATM and database resources to ensure overall consistency of financial transactions.

Applications that use global transactions involve one or more Resource Managers and a Transaction Manager:

- A Resource Manager (RM) provides access to transactional resources. A database server is one kind of resource manager. It must be possible to either commit or roll back transactions managed by the RM.
- A Transaction Manager (TM) coordinates the transactions that are part of a global transaction. It communicates with the RMs that handle each of these transactions. The individual transactions within a global transaction are “branches” of the global transaction. Global transactions and their branches are identified by a naming scheme described later.

The MySQL implementation of XA enables a MySQL server to act as a Resource Manager that handles XA transactions within a global transaction. A client program that connects to the MySQL server acts as the Transaction Manager.

To carry out a global transaction, it is necessary to know which components are involved, and bring each component to a point when it can be committed or rolled back. Depending on what each component reports about its ability to succeed, they must all commit or roll back as an atomic group. That is, either all components must commit, or all components must roll back. To manage a global transaction, it is necessary to take into account that any component or the connecting network might fail.

The process for executing a global transaction uses two-phase commit (2PC). This takes place after the actions performed by the branches of the global transaction have been executed.

1. In the first phase, all branches are prepared. That is, they are told by the TM to get ready to commit. Typically, this means each RM that manages a branch records the actions for the branch in stable storage. The branches indicate whether they are able to do this, and these results are used for the second phase.
2. In the second phase, the TM tells the RMs whether to commit or roll back. If all branches indicated when they were prepared that they can commit, all branches are told to commit. If any branch indicated when it was prepared that it could not commit, all branches are told to roll back.

In some cases, a global transaction might use one-phase commit (1PC). For example, when a Transaction Manager finds that a global transaction consists of only one transactional resource (that is, a single branch), that resource can be told to prepare and commit at the same time.

### 13.3.7.1 XA Transaction SQL Statements

To perform XA transactions in MySQL, use the following statements:

```
XA {START|BEGIN} xid [JOIN|RESUME]
XA END xid [SUSPEND [FOR MIGRATE]]
XA PREPARE xid
XA COMMIT xid [ONE PHASE]
XA ROLLBACK xid
XA RECOVER [CONVERT XID]
```

For `XA START`, the `JOIN` and `RESUME` clauses are recognized but have no effect.

For `XA END` the `SUSPEND [FOR MIGRATE]` clause is recognized but has no effect.

Each XA statement begins with the `XA` keyword, and most of them require an `xid` value. An `xid` is an XA transaction identifier. It indicates which transaction the statement applies to. `xid` values are supplied by the client, or generated by the MySQL server. An `xid` value has from one to three parts:

```
xid: gtrid [, bqual [, formatID ]]
```

`gtrid` is a global transaction identifier, `bqual` is a branch qualifier, and `formatID` is a number that identifies the format used by the `gtrid` and `bqual` values. As indicated by the syntax, `bqual` and `formatID` are optional. The default `bqual` value is `' '` if not given. The default `formatID` value is 1 if not given.

`gtrid` and `bqual` must be string literals, each up to 64 bytes (not characters) long. `gtrid` and `bqual` can be specified in several ways. You can use a quoted string (`'ab'`), hex string (`x'6162'`, `0x6162`), or bit value (`b'nnnn'`).

`formatID` is an unsigned integer.

The *gtrid* and *bqual* values are interpreted in bytes by the MySQL server's underlying XA support routines. However, while an SQL statement containing an XA statement is being parsed, the server works with some specific character set. To be safe, write *gtrid* and *bqual* as hex strings.

*xid* values typically are generated by the Transaction Manager. Values generated by one TM must be different from values generated by other TMs. A given TM must be able to recognize its own *xid* values in a list of values returned by the `XA RECOVER` statement.

`XA START xid` starts an XA transaction with the given *xid* value. Each XA transaction must have a unique *xid* value, so the value must not currently be used by another XA transaction. Uniqueness is assessed using the *gtrid* and *bqual* values. All following XA statements for the XA transaction must be specified using the same *xid* value as that given in the `XA START` statement. If you use any of those statements but specify an *xid* value that does not correspond to some existing XA transaction, an error occurs.

One or more XA transactions can be part of the same global transaction. All XA transactions within a given global transaction must use the same *gtrid* value in the *xid* value. For this reason, *gtrid* values must be globally unique so that there is no ambiguity about which global transaction a given XA transaction is part of. The *bqual* part of the *xid* value must be different for each XA transaction within a global transaction. (The requirement that *bqual* values be different is a limitation of the current MySQL XA implementation. It is not part of the XA specification.)

The `XA RECOVER` statement returns information for those XA transactions on the MySQL server that are in the `PREPARED` state. (See [Section 13.3.7.2, "XA Transaction States"](#).) The output includes a row for each such XA transaction on the server, regardless of which client started it.

`XA RECOVER` output rows look like this (for an example *xid* value consisting of the parts 'abc', 'def', and 7):

```
mysql> XA RECOVER;
+-----+-----+-----+-----+
| formatID | gtrid_length | bqual_length | data |
+-----+-----+-----+-----+
|          7 |              3 |              3 | abcdef |
+-----+-----+-----+-----+
```

The output columns have the following meanings:

- *formatID* is the *formatID* part of the transaction *xid*
- *gtrid\_length* is the length in bytes of the *gtrid* part of the *xid*
- *bqual\_length* is the length in bytes of the *bqual* part of the *xid*
- *data* is the concatenation of the *gtrid* and *bqual* parts of the *xid*

XID values may contain nonprintable characters. As of MySQL 5.7.5, `XA RECOVER` permits an optional `CONVERT XID` clause so that clients can request XID values in hexadecimal.

### 13.3.7.2 XA Transaction States

An XA transaction progresses through the following states:

1. Use `XA START` to start an XA transaction and put it in the `ACTIVE` state.
2. For an `ACTIVE` XA transaction, issue the SQL statements that make up the transaction, and then issue an `XA END` statement. `XA END` puts the transaction in the `IDLE` state.

3. For an `IDLE` XA transaction, you can issue either an `XA PREPARE` statement or an `XA COMMIT ... ONE PHASE` statement:
  - `XA PREPARE` puts the transaction in the `PREPARED` state. An `XA RECOVER` statement at this point includes the transaction's `xid` value in its output, because `XA RECOVER` lists all XA transactions that are in the `PREPARED` state.
  - `XA COMMIT ... ONE PHASE` prepares and commits the transaction. The `xid` value is not listed by `XA RECOVER` because the transaction terminates.
4. For a `PREPARED` XA transaction, you can issue an `XA COMMIT` statement to commit and terminate the transaction, or `XA ROLLBACK` to roll back and terminate the transaction.

Here is a simple XA transaction that inserts a row into a table as part of a global transaction:

```
mysql> XA START 'xatest';
Query OK, 0 rows affected (0.00 sec)

mysql> INSERT INTO mytable (i) VALUES(10);
Query OK, 1 row affected (0.04 sec)

mysql> XA END 'xatest';
Query OK, 0 rows affected (0.00 sec)

mysql> XA PREPARE 'xatest';
Query OK, 0 rows affected (0.00 sec)

mysql> XA COMMIT 'xatest';
Query OK, 0 rows affected (0.00 sec)
```

Within the context of a given client connection, XA transactions and local (non-XA) transactions are mutually exclusive. For example, if `XA START` has been issued to begin an XA transaction, a local transaction cannot be started until the XA transaction has been committed or rolled back. Conversely, if a local transaction has been started with `START TRANSACTION`, no XA statements can be used until the transaction has been committed or rolled back.

If an XA transaction is in the `ACTIVE` state, you cannot issue any statements that cause an implicit commit. That would violate the XA contract because you could not roll back the XA transaction. The following error is raised if you try to execute such a statement:

```
ERROR 1399 (XAE07): XAER_RMFAIL: The command cannot be executed
when global transaction is in the ACTIVE state
```

Statements to which the preceding remark applies are listed at [Section 13.3.3, “Statements That Cause an Implicit Commit”](#).

### 13.3.7.3 Restrictions on XA Transactions

XA transaction support is limited to the `InnoDB` storage engine.

For “external XA,” a MySQL server acts as a Resource Manager and client programs act as Transaction Managers. For “internal XA,” storage engines within a MySQL server act as RMs, and the server itself acts as a TM. Internal XA support is limited by the capabilities of individual storage engines. Internal XA is required for handling XA transactions that involve more than one storage engine. The implementation of internal XA requires that a storage engine support two-phase commit at the table handler level, and currently this is true only for `InnoDB`.

For `XA START`, the `JOIN` and `RESUME` clauses are recognized but have no effect.

For `XA END` the `SUSPEND [FOR MIGRATE]` clause is recognized but has no effect.

The requirement that the *bqual* part of the *xid* value be different for each XA transaction within a global transaction is a limitation of the current MySQL XA implementation. It is not part of the XA specification.

Prior to MySQL 5.7.7, XA transactions were not compatible with replication. This was because an XA transaction that was in `PREPARED` state would be rolled back on clean server shutdown or client disconnect. Similarly, an XA transaction that was in `PREPARED` state would still exist in `PREPARED` state in case the server was shutdown abnormally and then started again, but the contents of the transaction could not be written to the binary log. In both of these situations the XA transaction could not be replicated correctly.

In MySQL 5.7.7 and later, there is a change in behavior and an XA transaction is written to the binary log in two parts. When `XA PREPARE` is issued, the first part of the transaction up to `XA PREPARE` is written using an initial GTID. A `XA_prepare_log_event` is used to identify such transactions in the binary log. When `XA COMMIT` or `XA ROLLBACK` is issued, a second part of the transaction containing only the `XA COMMIT` or `XA ROLLBACK` statement is written using a second GTID. Note that the initial part of the transaction, identified by `XA_prepare_log_event`, is not necessarily followed by its `XA COMMIT` or `XA ROLLBACK`, which can cause interleaved binary logging of any two XA transactions. The two parts of the XA transaction can even appear in different binary log files. This means that an XA transaction in `PREPARED` state is now persistent until an explicit `XA COMMIT` or `XA ROLLBACK` statement is issued, ensuring that XA transactions are compatible with replication.

On a replica, immediately after the XA transaction is prepared, it is detached from the replica applier thread, and can be committed or rolled back by any thread on the replica. This means that the same XA transaction can appear in the `events_transactions_current` table with different states on different threads. The `events_transactions_current` table displays the current status of the most recent monitored transaction event on the thread, and does not update this status when the thread is idle. So the XA transaction can still be displayed in the `PREPARED` state for the original applier thread, after it has been processed by another thread. To positively identify XA transactions that are still in the `PREPARED` state and need to be recovered, use the `XA RECOVER` statement rather than the Performance Schema transaction tables.

The following restrictions exist for using XA transactions in MySQL 5.7.7 and later:

- XA transactions are not fully resilient to an unexpected halt with respect to the binary log. If there is an unexpected halt while the server is in the middle of executing an `XA PREPARE`, `XA COMMIT`, `XA ROLLBACK`, or `XA COMMIT . . . ONE PHASE` statement, the server might not be able to recover to a correct state, leaving the server and the binary log in an inconsistent state. In this situation, the binary log might either contain extra XA transactions that are not applied, or miss XA transactions that are applied. Also, if GTIDs are enabled, after recovery `@GLOBAL.GTID_EXECUTED` might not correctly describe the transactions that have been applied. Note that if an unexpected halt occurs before `XA PREPARE`, between `XA PREPARE` and `XA COMMIT` (or `XA ROLLBACK`), or after `XA COMMIT` (or `XA ROLLBACK`), the server and binary log are correctly recovered and taken to a consistent state.
- The use of replication filters or binary log filters in combination with XA transactions is not supported. Filtering of tables could cause an XA transaction to be empty on a replica, and empty XA transactions are not supported. Also, with the settings `master_info_repository=TABLE` and `relay_log_info_repository=TABLE` on a replica, which became the defaults in MySQL 8.0, the internal state of the data engine transaction is changed following a filtered XA transaction, and can become inconsistent with the replication transaction context state.

The error `ER_XA_REPLICATION_FILTERS` is logged whenever an XA transaction is impacted by a replication filter, whether or not the transaction was empty as a result. If the transaction is not empty, the replica is able to continue running, but you should take steps to discontinue the use of replication filters with XA transactions in order to avoid potential issues. If the transaction is empty, the replica stops. In that event, the replica might be in an undetermined state in which the consistency of the replication



process might be compromised. In particular, the `gtid_executed` set on a replica of the replica might be inconsistent with that on the source. To resolve this situation, isolate the source and stop all replication, then check GTID consistency across the replication topology. Undo the XA transaction that generated the error message, then restart replication.

- Prior to MySQL 5.7.19, `FLUSH TABLES WITH READ LOCK` is not compatible with XA transactions.
- XA transactions are considered unsafe for statement-based replication. If two XA transactions committed in parallel on the source are being prepared on the replica in the inverse order, locking dependencies can occur that cannot be safely resolved, and it is possible for replication to fail with deadlock on the replica. This situation can occur for a single-threaded or multithreaded replica. When `binlog_format=STATEMENT` is set, a warning is issued for DML statements inside XA transactions. When `binlog_format=MIXED` or `binlog_format=ROW` is set, DML statements inside XA transactions are logged using row-based replication, and the potential issue is not present.

## 13.4 Replication Statements

Replication can be controlled through the SQL interface using the statements described in this section. Statements are split into a group which controls replication source servers, a group which controls replica servers, and a group which can be applied to any servers in a replication topology.

### 13.4.1 SQL Statements for Controlling Replication Source Servers

This section discusses statements for managing replication source servers. [Section 13.4.2, “SQL Statements for Controlling Replica Servers”](#), discusses statements for managing replica servers.

In addition to the statements described here, the following `SHOW` statements are used with source servers in replication. For information about these statements, see [Section 13.7.5, “SHOW Statements”](#).

- `SHOW BINARY LOGS`
- `SHOW BINLOG EVENTS`
- `SHOW MASTER STATUS`
- `SHOW SLAVE HOSTS`

#### 13.4.1.1 PURGE BINARY LOGS Statement

```
PURGE { BINARY | MASTER } LOGS {
  TO 'log_name'
  | BEFORE datetime_expr
}
```

The binary log is a set of files that contain information about data modifications made by the MySQL server. The log consists of a set of binary log files, plus an index file (see [Section 5.4.4, “The Binary Log”](#)).

The `PURGE BINARY LOGS` statement deletes all the binary log files listed in the log index file prior to the specified log file name or date. `BINARY` and `MASTER` are synonyms. Deleted log files also are removed from the list recorded in the index file, so that the given log file becomes the first in the list.

`PURGE BINARY LOGS` requires the `BINLOG_ADMIN` privilege. This statement has no effect if the server was not started with the `--log-bin` option to enable binary logging.

Examples:

```
PURGE BINARY LOGS TO 'mysql-bin.010';
```

```
PURGE BINARY LOGS BEFORE '2019-04-02 22:46:26';
```

The `BEFORE` variant's `datetime_expr` argument should evaluate to a `DATETIME` value (a value in `'YYYY-MM-DD hh:mm:ss'` format).

This statement is safe to run while replicas are replicating. You need not stop them. If you have an active replica that currently is reading one of the log files you are trying to delete, this statement does not delete the log file that is in use or any log files later than that one, but it deletes any earlier log files. A warning message is issued in this situation. However, if a replica is not connected and you happen to purge one of the log files it has yet to read, the replica cannot replicate after it reconnects.

To safely purge binary log files, follow this procedure:

1. On each replica, use `SHOW SLAVE STATUS` to check which log file it is reading.
2. Obtain a listing of the binary log files on the replication source server with `SHOW BINARY LOGS`.
3. Determine the earliest log file among all the replicas. This is the target file. If all the replicas are up to date, this is the last log file on the list.
4. Make a backup of all the log files you are about to delete. (This step is optional, but always advisable.)
5. Purge all log files up to but not including the target file.

You can also set the `expire_logs_days` system variable to expire binary log files automatically after a given number of days (see [Section 5.1.7, “Server System Variables”](#)). If you are using replication, you should set the variable no lower than the maximum number of days your replicas might lag behind the source.

`PURGE BINARY LOGS TO` and `PURGE BINARY LOGS BEFORE` both fail with an error when binary log files listed in the `.index` file had been removed from the system by some other means (such as using `rm` on Linux). (Bug #18199, Bug #18453) To handle such errors, edit the `.index` file (which is a simple text file) manually to ensure that it lists only the binary log files that are actually present, then run again the `PURGE BINARY LOGS` statement that failed.

### 13.4.1.2 RESET MASTER Statement

```
RESET MASTER
```



#### Warning

Use this statement with caution to ensure you do not lose any wanted binary log file data and GTID execution history.

`RESET MASTER` requires the `RELOAD` privilege.

For a server where binary logging is enabled (`log_bin` is `ON`), `RESET MASTER` deletes all existing binary log files and resets the binary log index file, resetting the server to its state before binary logging was started. A new empty binary log file is created so that binary logging can be restarted.

For a server where GTIDs are in use (`gtid_mode` is `ON`), issuing `RESET MASTER` resets the GTID execution history. The value of the `gtid_purged` system variable is set to an empty string (`''`), the global value (but not the session value) of the `gtid_executed` system variable is set to an empty string, and the `mysql.gtid_executed` table is cleared (see [mysql.gtid\\_executed Table](#)). If the GTID-enabled server has binary logging enabled, `RESET MASTER` also resets the binary log as described above. Note that `RESET MASTER` is the method to reset the GTID execution history even if the GTID-enabled server is a

replica where binary logging is disabled; `RESET SLAVE` has no effect on the GTID execution history. For more information on resetting the GTID execution history, see [Resetting the GTID Execution History](#).



### Important

The effects of `RESET MASTER` differ from those of `PURGE BINARY LOGS` in 2 key ways:

1. `RESET MASTER` removes *all* binary log files that are listed in the index file, leaving only a single, empty binary log file with a numeric suffix of `.000001`, whereas the numbering is not reset by `PURGE BINARY LOGS`.
2. `RESET MASTER` is *not* intended to be used while any replicas are running. The behavior of `RESET MASTER` when used while replicas are running is undefined (and thus unsupported), whereas `PURGE BINARY LOGS` may be safely used while replicas are running.

See also [Section 13.4.1.1, “PURGE BINARY LOGS Statement”](#).

`RESET MASTER` can prove useful when you first set up the source and the replica, so that you can verify the setup as follows:

1. Start the source and replica, and start replication (see [Section 16.1.2, “Setting Up Binary Log File Position Based Replication”](#)).
2. Execute a few test queries on the source.
3. Check that the queries were replicated to the replica.
4. When replication is running correctly, issue `STOP SLAVE` followed by `RESET SLAVE` on the replica, then verify that any unwanted data no longer exists on the replica.
5. Issue `RESET MASTER` on the source to clean up the test queries.

After verifying the setup, resetting the source and replica and ensuring that no unwanted data or binary log files generated by testing remain on source or replica, you can start the replica and begin replicating.

### 13.4.1.3 SET sql\_log\_bin Statement

```
SET sql_log_bin = {OFF|ON}
```

The `sql_log_bin` variable controls whether logging to the binary log is enabled for the current session (assuming that the binary log itself is enabled). The default value is `ON`. To disable or enable binary logging for the current session, set the session `sql_log_bin` variable to `OFF` or `ON`.

Set this variable to `OFF` for a session to temporarily disable binary logging while making changes to the source you do not want replicated to the replica.

Setting the session value of this system variable is a restricted operation. The session user must have privileges sufficient to set restricted session variables. See [Section 5.1.8.1, “System Variable Privileges”](#).

It is not possible to set the session value of `sql_log_bin` within a transaction or subquery.

*Setting this variable to `OFF` prevents GTIDs from being assigned to transactions in the binary log.* If you are using GTIDs for replication, this means that even when binary logging is later enabled again, the GTIDs written into the log from this point do not account for any transactions that occurred in the meantime, so in effect those transactions are lost.

The global `sql_log_bin` variable is read only and cannot be modified. The global scope is deprecated; expect it to be removed in a future MySQL release.

## 13.4.2 SQL Statements for Controlling Replica Servers

This section discusses statements for managing replica servers. [Section 13.4.1, “SQL Statements for Controlling Replication Source Servers”](#), discusses statements for managing source servers.

In addition to the statements described here, `SHOW SLAVE STATUS` and `SHOW RELAYLOG EVENTS` are also used with replicas. For information about these statements, see [Section 13.7.5.34, “SHOW SLAVE STATUS Statement”](#), and [Section 13.7.5.32, “SHOW RELAYLOG EVENTS Statement”](#).

### 13.4.2.1 CHANGE MASTER TO Statement

```
CHANGE MASTER TO option [, option] ... [ channel_option ]
```

```
option: {
  MASTER_BIND = 'interface_name'
| MASTER_HOST = 'host_name'
| MASTER_USER = 'user_name'
| MASTER_PASSWORD = 'password'
| MASTER_PORT = port_num
| MASTER_CONNECT_RETRY = interval
| MASTER_RETRY_COUNT = count
| MASTER_DELAY = interval
| MASTER_HEARTBEAT_PERIOD = interval
| MASTER_LOG_FILE = 'source_log_name'
| MASTER_LOG_POS = source_log_pos
| MASTER_AUTO_POSITION = {0|1}
| RELAY_LOG_FILE = 'relay_log_name'
| RELAY_LOG_POS = relay_log_pos
| MASTER_SSL = {0|1}
| MASTER_SSL_CA = 'ca_file_name'
| MASTER_SSL_CAPATH = 'ca_directory_name'
| MASTER_SSL_CERT = 'cert_file_name'
| MASTER_SSL_CRL = 'crl_file_name'
| MASTER_SSL_CRLPATH = 'crl_directory_name'
| MASTER_SSL_KEY = 'key_file_name'
| MASTER_SSL_CIPHER = 'cipher_list'
| MASTER_SSL_VERIFY_SERVER_CERT = {0|1}
| MASTER_TLS_VERSION = 'protocol_list'
| IGNORE_SERVER_IDS = (server_id_list)
}
```

```
channel_option:
  FOR CHANNEL channel
```

```
server_id_list:
  [server_id [, server_id] ... ]
```

`CHANGE MASTER TO` changes the parameters that the replica uses for connecting to the replication source server, for reading the source's binary log, and reading the replica's relay log. It also updates the contents of the replication metadata repositories (see [Section 16.2.4, “Relay Log and Replication Metadata Repositories”](#)). `CHANGE MASTER TO` requires the `SUPER` privilege.

Prior to MySQL 5.7.4, the replication threads must be stopped, using `STOP SLAVE` if necessary, before issuing this statement. In MySQL 5.7.4 and later, you can issue `CHANGE MASTER TO` statements on a running replica without doing this, depending on the states of the replication SQL thread and replication I/O thread. The rules governing such use are provided later in this section.

When using a multithreaded replica (in other words `slave_parallel_workers` is greater than 0), stopping the replica can cause “gaps” in the sequence of transactions that have been executed from

the relay log, regardless of whether the replica was stopped intentionally or otherwise. When such gaps exist, issuing `CHANGE MASTER TO` fails. The solution in this situation is to issue `START SLAVE UNTIL SQL_AFTER_MTS_GAPS` which ensures that the gaps are closed.

The optional `FOR CHANNEL channel` clause enables you to name which replication channel the statement applies to. Providing a `FOR CHANNEL channel` clause applies the `CHANGE MASTER TO` statement to a specific replication channel, and is used to add a new channel or modify an existing channel. For example, to add a new channel called `channel2`:

```
CHANGE MASTER TO MASTER_HOST=host1, MASTER_PORT=3002 FOR CHANNEL 'channel2'
```

If no clause is named and no extra channels exist, the statement applies to the default channel.

When using multiple replication channels, if a `CHANGE MASTER TO` statement does not name a channel using a `FOR CHANNEL channel` clause, an error occurs. See [Section 16.2.2, “Replication Channels”](#) for more information.

Options not specified retain their value, except as indicated in the following discussion. Thus, in most cases, there is no need to specify options that do not change. For example, if the password to connect to your replication source server has changed, issue this statement to tell the replica about the new password:

```
CHANGE MASTER TO MASTER_PASSWORD='new3cret';
```

`MASTER_HOST`, `MASTER_USER`, `MASTER_PASSWORD`, and `MASTER_PORT` provide information to the replica about how to connect to its replication source server:

- `MASTER_HOST` and `MASTER_PORT` are the host name (or IP address) of the master host and its TCP/IP port.



#### Note

Replication cannot use Unix socket files. You must be able to connect to the replication source server using TCP/IP.

If you specify the `MASTER_HOST` or `MASTER_PORT` option, the replica assumes that the source is different from before (even if the option value is the same as its current value.) In this case, the old values for the source's binary log file name and position are considered no longer applicable, so if you do not specify `MASTER_LOG_FILE` and `MASTER_LOG_POS` in the statement, `MASTER_LOG_FILE=''` and `MASTER_LOG_POS=4` are silently appended to it.

Setting `MASTER_HOST=''` (that is, setting its value explicitly to an empty string) is *not* the same as not setting `MASTER_HOST` at all. Beginning with MySQL 5.5, trying to set `MASTER_HOST` to an empty string fails with an error. Previously, setting `MASTER_HOST` to an empty string caused `START SLAVE` subsequently to fail. (Bug #28796)

Values used for `MASTER_HOST` and other `CHANGE MASTER TO` options are checked for linefeed (`\n` or `0x0A`) characters; the presence of such characters in these values causes the statement to fail with `ER_MASTER_INFO`. (Bug #11758581, Bug #50801)

- `MASTER_USER` and `MASTER_PASSWORD` are the user name and password of the account to use for connecting to the source. If you specify `MASTER_PASSWORD`, `MASTER_USER` is also required. The password used for a replication user account in a `CHANGE MASTER TO` statement is limited to 32 characters in length; prior to MySQL 5.7.5, if the password was longer, the statement succeeded, but any excess characters were silently truncated. In MySQL 5.7.5 and later, trying to use a password of more than 32 characters causes `CHANGE MASTER TO` to fail. (Bug #11752299, Bug #43439)

It is possible to set an empty user name by specifying `MASTER_USER= ''`, but the replication channel cannot be started with an empty user name. Only set an empty `MASTER_USER` user name if you need to clear previously used credentials from the replica's repositories for security purposes, and do not attempt to use the channel afterwards.

The text of a running `CHANGE MASTER TO` statement, including values for `MASTER_USER` and `MASTER_PASSWORD`, can be seen in the output of a concurrent `SHOW PROCESSLIST` statement. (The complete text of a `START SLAVE` statement is also visible to `SHOW PROCESSLIST`.)

Setting `MASTER_SSL=1` for a replication connection and then setting no further `MASTER_SSL_XXX` options corresponds to setting `--ssl-mode=REQUIRED` for the client, as described in [Command Options for Encrypted Connections](#). With `MASTER_SSL=1`, the connection attempt only succeeds if an encrypted connection can be established. A replication connection does not fall back to an unencrypted connection, so there is no setting corresponding to the `--ssl-mode=PREFERRED` setting for replication. If `MASTER_SSL=0` is set, this corresponds to `--ssl-mode=DISABLED`.



### Important

To help prevent sophisticated man-in-the-middle attacks, it is important for the replica to verify the server's identity. You can specify additional `MASTER_SSL_XXX` options to correspond to the settings `--ssl-mode=VERIFY_CA` and `--ssl-mode=VERIFY_IDENTITY`, which are a better choice than the default setting to help prevent this type of attack. With these settings, the replica checks that the server's certificate is valid, and checks that the host name the replica is using matches the identity in the server's certificate. To implement one of these levels of verification, you must first ensure that the CA certificate for the server is reliably available to the replica, otherwise availability issues will result. For this reason, they are not the default setting.

The `MASTER_SSL_XXX` options and the `MASTER_TLS_VERSION` option specify how the replica uses encryption and ciphers to secure the replication connection. These options can be changed even on replicas that are compiled without SSL support. They are saved to the source metadata repository, but are ignored if the replica does not have SSL support enabled. The `MASTER_SSL_XXX` and `MASTER_TLS_VERSION` options perform the same functions as the `--ssl-xxx` and `--tls-version` client options described in [Command Options for Encrypted Connections](#). The correspondence between the two sets of options, and the use of the `MASTER_SSL_XXX` and `MASTER_TLS_VERSION` options to set up a secure connection, is explained in [Section 16.3.8, "Setting Up Replication to Use Encrypted Connections"](#).

The `MASTER_HEARTBEAT_PERIOD`, `MASTER_CONNECT_RETRY`, and `MASTER_RETRY_COUNT` options control how the replica recognizes that the connection to the source has been lost and makes attempts to reconnect.

- The `slave_net_timeout` system variable specifies the number of seconds that the replica waits for either more data or a heartbeat signal from the source, before the replica considers the connection broken, aborts the read, and tries to reconnect. The default value is 60 seconds (one minute). Prior to MySQL 5.7.7, the default was 3600 seconds (one hour).
- The heartbeat interval, which stops the connection timeout occurring in the absence of data if the connection is still good, is controlled by the `MASTER_HEARTBEAT_PERIOD` option. A heartbeat signal is sent to the replica after that number of seconds, and the waiting period is reset whenever the source's binary log is updated with an event. Heartbeats are therefore sent by the source only if there are no unsent events in the binary log file for a period longer than this. The heartbeat interval `interval` is a decimal value having the range 0 to 4294967 seconds and a resolution in milliseconds; the smallest nonzero value is 0.001. Setting `interval` to 0 disables heartbeats altogether. The heartbeat interval

defaults to half the value of the `slave_net_timeout` system variable. It is recorded in the source metadata repository and shown in the `replication_connection_configuration` Performance Schema table.

- Prior to MySQL 5.7.4, not including `MASTER_HEARTBEAT_PERIOD` caused `CHANGE MASTER TO` to reset the heartbeat interval to the default (half the value of the `slave_net_timeout` system variable), and `Slave_received_heartbeats` to 0. The heartbeat interval is now not reset except by `RESET SLAVE`. (Bug #18185490)
- Note that a change to the value or default setting of `slave_net_timeout` does not automatically change the heartbeat interval, whether that has been set explicitly or is using a previously calculated default. A warning is issued if you set `@@GLOBAL.slave_net_timeout` to a value less than that of the current heartbeat interval. If `slave_net_timeout` is changed, you must also issue `CHANGE MASTER TO` to adjust the heartbeat interval to an appropriate value so that the heartbeat signal occurs before the connection timeout. If you do not do this, the heartbeat signal has no effect, and if no data is received from the source, the replica can make repeated reconnection attempts, creating zombie dump threads.
- If the replica does need to reconnect, the first retry occurs immediately after the timeout. `MASTER_CONNECT_RETRY` specifies the interval between reconnection attempts, and `MASTER_RETRY_COUNT` limits the number of reconnection attempts. If both the default settings are used, the replica waits 60 seconds between reconnection attempts (`MASTER_CONNECT_RETRY=60`), and keeps attempting to reconnect at this rate for 60 days (`MASTER_RETRY_COUNT=86400`). A setting of 0 for `MASTER_RETRY_COUNT` means that there is no limit on the number of reconnection attempts, so the replica keeps trying to reconnect indefinitely. These values are recorded in the source metadata repository and shown in the `replication_connection_configuration` Performance Schema table. `MASTER_RETRY_COUNT` supersedes the `--master-retry-count` server startup option.

`MASTER_DELAY` specifies how many seconds behind the source the replica must lag. An event received from the source is not executed until at least `interval` seconds later than its execution on the source. The default is 0. An error occurs if `interval` is not a nonnegative integer in the range from 0 to  $2^{31}-1$ . For more information, see [Section 16.3.10, “Delayed Replication”](#).

From MySQL 5.7, a `CHANGE MASTER TO` statement employing the `MASTER_DELAY` option can be executed on a running replica when the replication SQL thread is stopped.

`MASTER_BIND` is for use on replicas having multiple network interfaces, and determines which of the replica's network interfaces is chosen for connecting to the source.

The address configured with this option, if any, can be seen in the `Master_Bind` column of the output from `SHOW SLAVE STATUS`. If you are using a table for the source metadata repository (server started with `master_info_repository=TABLE`), the value can also be seen as the `Master_bind` column of the `mysql.slave_master_info` table.

The ability to bind a replica to a specific network interface is also supported by NDB Cluster.

`MASTER_LOG_FILE` and `MASTER_LOG_POS` are the coordinates at which the replication I/O thread should begin reading from the source the next time the thread starts. `RELAY_LOG_FILE` and `RELAY_LOG_POS` are the coordinates at which the replication SQL thread should begin reading from the relay log the next time the thread starts. If you specify any of these options, you cannot specify `MASTER_AUTO_POSITION = 1` (described later in this section). If neither of `MASTER_LOG_FILE` or `MASTER_LOG_POS` is specified, the replica uses the last coordinates of the *replication SQL thread* before `CHANGE MASTER TO` was issued. This ensures that there is no discontinuity in replication, even if the replication SQL thread was late compared to the replication I/O thread, when you merely want to change, say, the password to use.

From MySQL 5.7, a `CHANGE MASTER TO` statement employing `RELAY_LOG_FILE`, `RELAY_LOG_POS`, or both options can be executed on a running replica when the replication SQL thread is stopped. Prior

to MySQL 5.7.4, `CHANGE MASTER TO` deletes all relay log files and starts a new one, unless you specify `RELAY_LOG_FILE` or `RELAY_LOG_POS`. In that case, relay log files are kept; the `relay_log_purge` global variable is set silently to 0. In MySQL 5.7.4 and later, relay logs are preserved if at least one of the replication SQL thread and the replication I/O thread is running. If both threads are stopped, all relay log files are deleted unless at least one of `RELAY_LOG_FILE` or `RELAY_LOG_POS` is specified. For the Group Replication applier channel (`group_replication_applier`), which only has an SQL thread and no I/O thread, this is the case if the SQL thread is stopped, but with that channel you cannot use the `RELAY_LOG_FILE` and `RELAY_LOG_POS` options.

`RELAY_LOG_FILE` can use either an absolute or relative path, and uses the same base name as `MASTER_LOG_FILE`. (Bug #12190)

When `MASTER_AUTO_POSITION = 1` is used with `CHANGE MASTER TO`, the replica attempts to connect to the source using the auto-positioning feature of GTID-based replication, rather than a binary log file based position. From MySQL 5.7, this option can be employed by `CHANGE MASTER TO` only if both the replication SQL thread and the replication I/O thread are stopped. Both the replica and the source must have GTIDs enabled (`GTID_MODE=ON`, `ON_PERMISSIVE`, or `OFF_PERMISSIVE` on the replica, and `GTID_MODE=ON` on the source). `MASTER_LOG_FILE`, `MASTER_LOG_POS`, `RELAY_LOG_FILE`, and `RELAY_LOG_POS` cannot be specified together with `MASTER_AUTO_POSITION = 1`. If multi-source replication is enabled on the replica, you need to set the `MASTER_AUTO_POSITION = 1` option for each applicable replication channel.

With `MASTER_AUTO_POSITION = 1` set, in the initial connection handshake, the replica sends a GTID set containing the transactions that it has already received, committed, or both. The source responds by sending all transactions recorded in its binary log whose GTID is not included in the GTID set sent by the replica. This exchange ensures that the source only sends the transactions with a GTID that the replica has not already recorded or committed. If the replica receives transactions from more than one source, as in the case of a diamond topology, the auto-skip function ensures that the transactions are not applied twice. For details of how the GTID set sent by the replica is computed, see [Section 16.1.3.3, “GTID Auto-Positioning”](#).

If any of the transactions that should be sent by the source have been purged from the source's binary log, or added to the set of GTIDs in the `gtid_purged` system variable by another method, the source sends the error `ER_MASTER_HAS_PURGED_REQUIRED_GTIDS` to the replica, and replication does not start. Also, if during the exchange of transactions it is found that the replica has recorded or committed transactions with the source's UUID in the GTID, but the source itself has not committed them, the source sends the error `ER_SLAVE_HAS_MORE_GTIDS_THAN_MASTER` to the replica and replication does not start. For information on how to handle these situations, see [Section 16.1.3.3, “GTID Auto-Positioning”](#).

`IGNORE_SERVER_IDS` takes a comma-separated list of 0 or more server IDs. Events originating from the corresponding servers are ignored, with the exception of log rotation and deletion events, which are still recorded in the relay log.

In circular replication, the originating server normally acts as the terminator of its own events, so that they are not applied more than once. Thus, this option is useful in circular replication when one of the servers in the circle is removed. Suppose that you have a circular replication setup with 4 servers, having server IDs 1, 2, 3, and 4, and server 3 fails. When bridging the gap by starting replication from server 2 to server 4, you can include `IGNORE_SERVER_IDS = (3)` in the `CHANGE MASTER TO` statement that you issue on server 4 to tell it to use server 2 as its source instead of server 3. Doing so causes it to ignore and not to propagate any statements that originated with the server that is no longer in use.

If a `CHANGE MASTER TO` statement is issued without any `IGNORE_SERVER_IDS` option, any existing list is preserved. To clear the list of ignored servers, it is necessary to use the option with an empty list:

```
CHANGE MASTER TO IGNORE_SERVER_IDS = ( );
```



Prior to MySQL 5.7.5, `RESET SLAVE ALL` has no effect on the server ID list. In MySQL 5.7.5 and later, `RESET SLAVE ALL` clears `IGNORE_SERVER_IDS`. (Bug #18816897)

If `IGNORE_SERVER_IDS` contains the server's own ID and the server was started with the `--replicate-same-server-id` option enabled, an error results.

The source metadata repository and the output of `SHOW SLAVE STATUS` provide the list of servers that are currently ignored. For more information, see [Section 16.2.4.2, “Replication Metadata Repositories”](#), and [Section 13.7.5.34, “SHOW SLAVE STATUS Statement”](#).

Invoking `CHANGE MASTER TO` causes the previous values for `MASTER_HOST`, `MASTER_PORT`, `MASTER_LOG_FILE`, and `MASTER_LOG_POS` to be written to the error log, along with other information about the replica's state prior to execution.

`CHANGE MASTER TO` causes an implicit commit of an ongoing transaction. See [Section 13.3.3, “Statements That Cause an Implicit Commit”](#).

In MySQL 5.7.4 and later, the strict requirement to execute `STOP SLAVE` prior to issuing any `CHANGE MASTER TO` statement (and `START SLAVE` afterward) is removed. Instead of depending on whether the replica is stopped, the behavior of `CHANGE MASTER TO` depends (in MySQL 5.7.4 and later) on the states of the replication SQL thread and the replication I/O thread; which of these threads is stopped or running now determines the options that can or cannot be used with a `CHANGE MASTER TO` statement at a given point in time. The rules for making this determination are listed here:

- If the SQL thread is stopped, you can execute `CHANGE MASTER TO` using any combination that is otherwise allowed of `RELAY_LOG_FILE`, `RELAY_LOG_POS`, and `MASTER_DELAY` options, even if the replication I/O thread is running. No other options may be used with this statement when the I/O thread is running.
- If the I/O thread is stopped, you can execute `CHANGE MASTER TO` using any of the options for this statement (in any allowed combination) *except* `RELAY_LOG_FILE`, `RELAY_LOG_POS`, `MASTER_DELAY`, or `MASTER_AUTO_POSITION = 1` even when the SQL thread is running.
- Both the SQL thread and the I/O thread must be stopped before issuing a `CHANGE MASTER TO` statement that employs `MASTER_AUTO_POSITION = 1`.

You can check the current state of the replication SQL thread and the replication I/O thread using `SHOW SLAVE STATUS`. Note that the Group Replication applier channel (`group_replication_applier`) has no I/O thread, only an SQL thread.

For more information, see [Section 16.3.7, “Switching Sources During Failover”](#).

If you are using statement-based replication and temporary tables, it is possible for a `CHANGE MASTER TO` statement following a `STOP SLAVE` statement to leave behind temporary tables on the replica. From MySQL 5.7, a warning (`ER_WARN_OPEN_TEMP_TABLES_MUST_BE_ZERO`) is issued whenever this occurs. You can avoid this in such cases by making sure that the value of the `Slave_open_temp_tables` system status variable is equal to 0 prior to executing such a `CHANGE MASTER TO` statement.

`CHANGE MASTER TO` is useful for setting up a replica when you have the snapshot of the replication source server and have recorded the source's binary log coordinates corresponding to the time of the snapshot. After loading the snapshot into the replica to synchronize it with the source, you can run `CHANGE MASTER TO MASTER_LOG_FILE='log_name', MASTER_LOG_POS=log_pos` on the replica to specify the coordinates at which the replica should begin reading the source's binary log.

The following example changes the replication source server the replica uses and establishes the source's binary log coordinates from which the replica begins reading. This is used when you want to set up the replica to replicate the source:

```
CHANGE MASTER TO
  MASTER_HOST='source2.example.com',
  MASTER_USER='replication',
  MASTER_PASSWORD='password',
  MASTER_PORT=3306,
  MASTER_LOG_FILE='source2-bin.001',
  MASTER_LOG_POS=4,
  MASTER_CONNECT_RETRY=10;
```

The next example shows an operation that is less frequently employed. It is used when the replica has relay log files that you want it to execute again for some reason. To do this, the source need not be reachable. You need only use `CHANGE MASTER TO` and start the SQL thread (`START SLAVE SQL_THREAD`):

```
CHANGE MASTER TO
  RELAY_LOG_FILE='replica-relay-bin.006',
  RELAY_LOG_POS=4025;
```

The following table shows the maximum permissible length for the string-valued options.

Option	Maximum Length
MASTER_HOST	60
MASTER_USER	96
MASTER_PASSWORD	32
MASTER_LOG_FILE	511
RELAY_LOG_FILE	511
MASTER_SSL_CA	511
MASTER_SSL_CAPATH	511
MASTER_SSL_CERT	511
MASTER_SSL_CRL	511
MASTER_SSL_CRLPATH	511
MASTER_SSL_KEY	511
MASTER_SSL_CIPHER	511
MASTER_TLS_VERSION	511

### 13.4.2.2 CHANGE REPLICATION FILTER Statement

```
CHANGE REPLICATION FILTER filter[, filter][, ...]

filter: {
  REPLICATE_DO_DB = (db_list)
  | REPLICATE_IGNORE_DB = (db_list)
  | REPLICATE_DO_TABLE = (tbl_list)
  | REPLICATE_IGNORE_TABLE = (tbl_list)
  | REPLICATE_WILD_DO_TABLE = (wild_tbl_list)
  | REPLICATE_WILD_IGNORE_TABLE = (wild_tbl_list)
  | REPLICATE_REWRITE_DB = (db_pair_list)
}

db_list:
  db_name[, db_name][, ...]

tbl_list:
  db_name.table_name[, db.table_name][, ...]

wild_tbl_list:
  'db_pattern.table_pattern'[, 'db_pattern.table_pattern'][, ...]
```

```

db_pair_list:
  (db_pair)[, (db_pair)][, ...]

db_pair:
  from_db, to_db

```

`CHANGE REPLICATION FILTER` sets one or more replication filtering rules on the replica in the same way as starting the replica `mysqld` with replication filtering options such as `--replicate-do-db` or `--replicate-wild-ignore-table`. Filters set using this statement differ from those set using the server options in two key respects:

1. The statement does not require restarting the server to take effect, only that the replication SQL thread be stopped using `STOP SLAVE SQL_THREAD` first (and restarted with `START SLAVE SQL_THREAD` afterwards).
2. The effects of the statement are not persistent; any filters set using `CHANGE REPLICATION FILTER` are lost following a restart of the replica `mysqld`.

`CHANGE REPLICATION FILTER` requires the `SUPER` privilege.



#### Note

Replication filters cannot be set on a MySQL server instance that is configured for Group Replication, because filtering transactions on some servers would make the group unable to reach agreement on a consistent state.

The following list shows the `CHANGE REPLICATION FILTER` options and how they relate to `--replicate-*` server options:

- `REPLICATE_DO_DB`: Include updates based on database name. Equivalent to `--replicate-do-db`.
- `REPLICATE_IGNORE_DB`: Exclude updates based on database name. Equivalent to `--replicate-ignore-db`.
- `REPLICATE_DO_TABLE`: Include updates based on table name. Equivalent to `--replicate-do-table`.
- `REPLICATE_IGNORE_TABLE`: Exclude updates based on table name. Equivalent to `--replicate-ignore-table`.
- `REPLICATE_WILD_DO_TABLE`: Include updates based on wildcard pattern matching table name. Equivalent to `--replicate-wild-do-table`.
- `REPLICATE_WILD_IGNORE_TABLE`: Exclude updates based on wildcard pattern matching table name. Equivalent to `--replicate-wild-ignore-table`.
- `REPLICATE_REWRITE_DB`: Perform updates on replica after substituting new name on replica for specified database on source. Equivalent to `--replicate-rewrite-db`.

The precise effects of `REPLICATE_DO_DB` and `REPLICATE_IGNORE_DB` filters are dependent on whether statement-based or row-based replication is in effect. See [Section 16.2.5, “How Servers Evaluate Replication Filtering Rules”](#), for more information.

Multiple replication filtering rules can be created in a single `CHANGE REPLICATION FILTER` statement by separating the rules with commas, as shown here:

```

CHANGE REPLICATION FILTER
  REPLICATE_DO_DB = (d1), REPLICATE_IGNORE_DB = (d2);

```

Issuing the statement just shown is equivalent to starting the replica `mysqld` with the options `--replicate-do-db=db1 --replicate-ignore-db=db2`.

If the same filtering rule is specified multiple times, only the *last* such rule is actually used. For example, the two statements shown here have exactly the same effect, because the first `REPLICATE_DO_DB` rule in the first statement is ignored:

```
CHANGE REPLICATION FILTER
  REPLICATE_DO_DB = (db1, db2), REPLICATE_DO_DB = (db3, db4);

CHANGE REPLICATION FILTER
  REPLICATE_DO_DB = (db3,db4);
```



### Caution

This behavior differs from that of the `--replicate-*` filter options where specifying the same option multiple times causes the creation of multiple filter rules.

Names of tables and database not containing any special characters need not be quoted. Values used with `REPLICATION_WILD_TABLE` and `REPLICATION_WILD_IGNORE_TABLE` are string expressions, possibly containing (special) wildcard characters, and so must be quoted. This is shown in the following example statements:

```
CHANGE REPLICATION FILTER
  REPLICATE_WILD_DO_TABLE = ('db1.old%');

CHANGE REPLICATION FILTER
  REPLICATE_WILD_IGNORE_TABLE = ('db1.new%', 'db2.new%');
```

Values used with `REPLICATE_REWRITE_DB` represent *pairs* of database names; each such value must be enclosed in parentheses. The following statement rewrites statements occurring on database `db1` on the source to database `db2` on the replica:

```
CHANGE REPLICATION FILTER REPLICATE_REWRITE_DB = ((db1, db2));
```

The statement just shown contains two sets of parentheses, one enclosing the pair of database names, and the other enclosing the entire list. This is perhaps more easily seen in the following example, which creates two `rewrite-db` rules, one rewriting database `dbA` to `dbB`, and one rewriting database `dbC` to `dbD`:

```
CHANGE REPLICATION FILTER
  REPLICATE_REWRITE_DB = ((dbA, dbB), (dbC, dbD));
```

This statement leaves any existing replication filtering rules unchanged; to unset all filters of a given type, set the filter's value to an explicitly empty list, as shown in this example, which removes all existing `REPLICATE_DO_DB` and `REPLICATE_IGNORE_DB` rules:

```
CHANGE REPLICATION FILTER
  REPLICATE_DO_DB = (), REPLICATE_IGNORE_DB = ();
```

Setting a filter to empty in this way removes all existing rules, does not create any new ones, and does not restore any rules set at `mysqld` startup using `--replicate-*` options on the command line or in the configuration file.

Values employed with `REPLICATE_WILD_DO_TABLE` and `REPLICATE_WILD_IGNORE_TABLE` must be in the format `db_name.tbl_name`. Prior to MySQL 5.7.5, this was not strictly enforced, although using nonconforming values with these options could lead to erroneous results (Bug #18095449).

For more information, see [Section 16.2.5, “How Servers Evaluate Replication Filtering Rules”](#).

### 13.4.2.3 RESET SLAVE Statement

```
RESET SLAVE [ALL] [channel_option]
```

```
channel_option:
  FOR CHANNEL channel
```

`RESET SLAVE` makes the replica forget its replication position in the source's binary log. This statement is meant to be used for a clean start: It clears the replication metadata repositories, deletes all the relay log files, and starts a new relay log file. It also resets to 0 the replication delay specified with the `MASTER_DELAY` option to `CHANGE MASTER TO`.



#### Note

All relay log files are deleted, even if they have not been completely executed by the replication SQL thread. (This is a condition likely to exist on a replica if you have issued a `STOP SLAVE` statement or if the replica is highly loaded.)

For a server where GTIDs are in use (`gtid_mode` is `ON`), issuing `RESET SLAVE` has no effect on the GTID execution history. The statement does not change the values of `gtid_executed` or `gtid_purged`, or the `mysql.gtid_executed` table. If you need to reset the GTID execution history, use `RESET MASTER`, even if the GTID-enabled server is a replica where binary logging is disabled.

`RESET SLAVE` requires the `RELOAD` privilege.

To use `RESET SLAVE`, the replication threads must be stopped, so on a running replica use `STOP SLAVE` before issuing `RESET SLAVE`. To use `RESET SLAVE` on a Group Replication group member, the member status must be `OFFLINE`, meaning that the plugin is loaded but the member does not currently belong to any group. A group member can be taken offline by using a `STOP GROUP REPLICATION` statement.

The optional `FOR CHANNEL channel` clause enables you to name which replication channel the statement applies to. Providing a `FOR CHANNEL channel` clause applies the `RESET SLAVE` statement to a specific replication channel. Combining a `FOR CHANNEL channel` clause with the `ALL` option deletes the specified channel. If no channel is named and no extra channels exist, the statement applies to the default channel. Issuing a `RESET SLAVE ALL` statement without a `FOR CHANNEL channel` clause when multiple replication channels exist deletes *all* replication channels and recreates only the default channel. See [Section 16.2.2, “Replication Channels”](#) for more information.

`RESET SLAVE` does not change any replication connection parameters such as the source's host name and port, or the replication user account name and its password.

- From MySQL 5.7.24, when `master_info_repository=TABLE` is set on the server, replication connection parameters are preserved in the crash-safe InnoDB table `mysql.slave_master_info` as part of the `RESET SLAVE` operation. They are also retained in memory. In the event of an unexpected server exit or deliberate restart after issuing `RESET SLAVE` but before issuing `START SLAVE`, the replication connection parameters are retrieved from the table and reused for the new connection.
- When `master_info_repository=FILE` is set on the server (which is the default in MySQL 5.7), replication connection parameters are only retained in memory. If the replica `mysqld` is restarted immediately after issuing `RESET SLAVE` due to an unexpected server exit or deliberate restart, the connection parameters are lost. In that case, you must issue a `CHANGE MASTER TO` statement after the server start to respecify the connection parameters before issuing `START SLAVE`.

If you want to reset the connection parameters intentionally, you need to use `RESET SLAVE ALL`, which clears the connection parameters. In that case, you must issue a `CHANGE MASTER TO` statement after the server start to specify the new connection parameters.

`RESET SLAVE` causes an implicit commit of an ongoing transaction. See [Section 13.3.3, “Statements That Cause an Implicit Commit”](#).

If the replication SQL thread was in the middle of replicating temporary tables when it was stopped, and `RESET SLAVE` is issued, these replicated temporary tables are deleted on the replica.

Prior to MySQL 5.7.5, `RESET SLAVE` also had the effect of resetting both the heartbeat period (`Slave_heartbeat_period`) and `SSL_VERIFY_SERVER_CERT`. This issue is fixed in MySQL 5.7.5 and later. (Bug #18777899, Bug #18778485)

Prior to MySQL 5.7.5, `RESET SLAVE ALL` did not clear the `IGNORE_SERVER_IDS` list set by `CHANGE MASTER TO`. In MySQL 5.7.5 and later, the statement clears the list. (Bug #18816897)



#### Note

When used on an NDB Cluster replica SQL node, `RESET SLAVE` clears the `mysql.ndb_apply_status` table. You should keep in mind when using this statement that `ndb_apply_status` uses the NDB storage engine and so is shared by all SQL nodes attached to the replica cluster.

You can override this behavior by issuing `SET GLOBAL @@ndb_clear_apply_status=OFF` prior to executing `RESET SLAVE`, which keeps the replica from purging the `ndb_apply_status` table in such cases.

### 13.4.2.4 SET GLOBAL sql\_slave\_skip\_counter Syntax

```
SET GLOBAL sql_slave_skip_counter = N
```

This statement skips the next *N* events from the master. This is useful for recovering from replication stops caused by a statement.

This statement is valid only when the slave threads are not running. Otherwise, it produces an error.

When using this statement, it is important to understand that the binary log is actually organized as a sequence of groups known as *event groups*. Each event group consists of a sequence of events.

- For transactional tables, an event group corresponds to a transaction.
- For nontransactional tables, an event group corresponds to a single SQL statement.



#### Note

A single transaction can contain changes to both transactional and nontransactional tables.

When you use `SET GLOBAL sql_slave_skip_counter` to skip events and the result is in the middle of a group, the slave continues to skip events until it reaches the end of the group. Execution then starts with the next event group.

### 13.4.2.5 START SLAVE Statement

```
START SLAVE [thread_types] [until_option] [connection_options] [channel_option]
thread_types:
  [thread_type [, thread_type] ... ]
thread_type:
  IO_THREAD | SQL_THREAD
```

```

until_option:
  UNTIL { {SQL_BEFORE_GTIDS | SQL_AFTER_GTIDS} = gtid_set
         | MASTER_LOG_FILE = 'log_name', MASTER_LOG_POS = log_pos
         | RELAY_LOG_FILE = 'log_name', RELAY_LOG_POS = log_pos
         | SQL_AFTER_MTS_GAPS }

connection_options:
  [USER='user_name'] [PASSWORD='user_pass'] [DEFAULT_AUTH='plugin_name'] [PLUGIN_DIR='plugin_dir']

channel_option:
  FOR CHANNEL channel

gtid_set:
  uuid_set [, uuid_set] ...
  | ''

uuid_set:
  uuid:interval[:interval]...

uuid:
  hhhhhhhh-hhhh-hhhh-hhhh-hhhhhhhhhhhh

h:
  [0-9,A-F]

interval:
  n[-n]

  (n >= 1)

```

**START SLAVE** starts the replication threads, either together or separately. The statement requires the **SUPER** privilege. **START SLAVE** causes an implicit commit of an ongoing transaction (see [Section 13.3.3, “Statements That Cause an Implicit Commit”](#)).

For the thread type options, you can specify **IO\_THREAD**, **SQL\_THREAD**, both of these, or neither of them. Only the threads that are started are affected by the statement.

- **START SLAVE** with no thread type options starts all of the replication threads, and so does **START SLAVE** with both of the thread type options.
- **IO\_THREAD** starts the replication receiver thread, which reads events from the source server and stores them in the relay log.
- **SQL\_THREAD** starts the replication applier thread, which reads events from the relay log and executes them. A multithreaded replica (with `slave_parallel_workers > 0`) applies transactions using a coordinator thread and multiple applier threads, and **SQL\_THREAD** starts all of these.



### Important

**START SLAVE** sends an acknowledgment to the user after all the replication threads have started. However, the replication receiver thread might not yet have connected to the source successfully, or an applier thread might stop when applying an event right after starting. **START SLAVE** does not continue to monitor the threads after they are started, so it does not warn you if they subsequently stop or cannot connect. You must check the replica's error log for error messages generated by the replication threads, or check that they are running satisfactorily with **SHOW SLAVE STATUS**. A successful **START SLAVE** statement causes **SHOW SLAVE STATUS** to show `Slave_SQL_Running=Yes`, but it might or might not show `Slave_IO_Running=Yes`, because `Slave_IO_Running=Yes` is only

shown if the receiver thread is both running and connected. For more information, see [Section 16.1.7.1, “Checking Replication Status”](#).

The optional `FOR CHANNEL channel` clause enables you to name which replication channel the statement applies to. Providing a `FOR CHANNEL channel` clause applies the `START SLAVE` statement to a specific replication channel. If no clause is named and no extra channels exist, the statement applies to the default channel. If a `START SLAVE` statement does not have a channel defined when using multiple channels, this statement starts the specified threads for all channels. See [Section 16.2.2, “Replication Channels”](#) for more information.

The replication channels for Group Replication (`group_replication_applier` and `group_replication_recovery`) are managed automatically by the server instance. The only Group Replication channel that you can interact with is the `group_replication_applier` channel. This channel only has an applier thread and has no receiver thread, so it can be started by using the `SQL_THREAD` option without the `IO_THREAD` option. `START SLAVE` cannot be used at all with the `group_replication_recovery` channel.

`START SLAVE` supports pluggable user-password authentication (see [Section 6.2.13, “Pluggable Authentication”](#)) with the `USER`, `PASSWORD`, `DEFAULT_AUTH` and `PLUGIN_DIR` options, as described in the following list. When you use these options, you must start the receiver thread (`IO_THREAD` option) or all the replication threads; you cannot start the replication applier thread (`SQL_THREAD` option) alone.

<code>USER</code>	The user name for the account. You must set this if <code>PASSWORD</code> is used. The option cannot be set to an empty or null string.
<code>PASSWORD</code>	The password for the named user account.
<code>DEFAULT_AUTH</code>	The name of the authentication plugin. The default is MySQL native authentication.
<code>PLUGIN_DIR</code>	The location of the authentication plugin.



### Important

The password that you set using `START SLAVE` is masked when it is written to MySQL Server’s logs, Performance Schema tables, and `SHOW PROCESSLIST` statements. However, it is sent in plain text over the connection to the replica server instance. To protect the password in transit, use SSL/TLS encryption, an SSH tunnel, or another method of protecting the connection from unauthorized viewing, for the connection between the replica server instance and the client that you use to issue `START SLAVE`.

The `UNTIL` clause makes the replica start replication, then process transactions up to the point that you specify in the `UNTIL` clause, then stop again. The `UNTIL` clause can be used to make a replica proceed until just before the point where you want to skip a transaction that is unwanted, and then skip the transaction as described in [Section 16.1.7.3, “Skipping Transactions”](#). To identify a transaction, you can use `mysqlbinlog` with the source’s binary log or the replica’s relay log, or use a `SHOW BINLOG EVENTS` statement.

You can also use the `UNTIL` clause for debugging replication by processing transactions one at a time or in sections. If you are using the `UNTIL` clause to do this, start the replica with the `--skip-slave-start` option to prevent the SQL thread from running when the replica server starts. Remove the option after the procedure is complete, so that it is not forgotten in the event of an unexpected server restart.

The `SHOW SLAVE STATUS` statement includes output fields that display the current values of the `UNTIL` condition. The `UNTIL` condition lasts for as long as the affected threads are still running, and is removed when they stop.



The `UNTIL` clause operates on the replication applier thread (`SQL_THREAD` option). You can use the `SQL_THREAD` option or let the replica default to starting both threads. If you use the `IO_THREAD` option alone, the `UNTIL` clause is ignored because the applier thread is not started.

The point that you specify in the `UNTIL` clause can be any one (and only one) of the following options:

`SOURCE_LOG_FILE` and  
`SOURCE_LOG_POS`

These options make the replication applier process transactions up to a position in its relay log, identified by the file name and file position of the corresponding point in the binary log on the source server. The applier thread finds the nearest transaction boundary at or after the specified position, finishes applying the transaction, and stops there.

`RELAY_LOG_FILE` and  
`RELAY_LOG_POS`

These options make the replication applier process transactions up to a position in the replica's relay log, identified by the relay log file name and a position in that file. The applier thread finds the nearest transaction boundary at or after the specified position, finishes applying the transaction, and stops there.

`SQL_BEFORE_GTIDS`

This option makes the replication applier start processing transactions and stop when it encounters any transaction that is in the specified GTID set. The encountered transaction from the GTID set is not applied, and nor are any of the other transactions in the GTID set. The option takes a GTID set containing one or more global transaction identifiers as an argument (see [GTID Sets](#)). Transactions in a GTID set do not necessarily appear in the replication stream in the order of their GTIDs, so the transaction before which the applier stops is not necessarily the earliest.

`SQL_AFTER_GTIDS`

This option makes the replication applier start processing transactions and stop when it has processed all of the transactions in a specified GTID set. The option takes a GTID set containing one or more global transaction identifiers as an argument (see [GTID Sets](#)).

With `SQL_AFTER_GTIDS`, the replication threads stop after they have processed all transactions in the GTID set. Transactions are processed in the order received, so it is possible that these include transactions which are not part of the GTID set, but which are received (and processed) before all transactions in the set have been committed. For example, executing `START SLAVE UNTIL SQL_AFTER_GTIDS = 3E11FA47-71CA-11E1-9E33-C80AA9429562:11-56` causes the replica to obtain (and process) all transactions from the source until all of the transactions having the sequence numbers 11 through 56 have been processed, and then to stop without processing any additional transactions after that point has been reached.

`SQL_AFTER_GTIDS` is not compatible with multi-threaded slaves. If this option is used with a multi-threaded slave, a warning is raised, and the slave switches to single-threaded mode. Depending on the use case, it may be possible to use `START SLAVE UNTIL MASTER_LOG_POS` or `START SLAVE UNTIL SQL_BEFORE_GTIDS` instead. You can also use `WAIT_UNTIL_SQL_THREAD_AFTER_GTIDS()`, which waits until the correct position is reached, but does not stop the slave thread.

`SQL_AFTER_MTS_GAPS`

For a multithreaded replica only (with `slave_parallel_workers > 0`), this option makes the replica process transactions up to the point

where there are no more gaps in the sequence of transactions executed from the relay log. When using a multithreaded replica, there is a chance of gaps occurring in the following situations:

- The coordinator thread is stopped.
- An error occurs in the applier threads.
- `mysqld` shuts down unexpectedly.

When a replication channel has gaps, the replica's database is in a state that might never have existed on the source. The replica tracks the gaps internally and disallows `CHANGE MASTER TO` statements that would remove the gap information if they executed.

Issuing `START SLAVE` on a multithreaded replica with gaps in the sequence of transactions executed from the relay log generates a warning. To correct this situation, the solution is to use `START SLAVE UNTIL SQL_AFTER_MTS_GAPS`. See [Section 16.4.1.32, "Replication and Transaction Inconsistencies"](#) for more information.

If you need to change a failed multithreaded replica to single-threaded mode, you can issue the following series of statements, in the order shown:

```
START SLAVE UNTIL SQL_AFTER_MTS_GAPS;
SET @@GLOBAL.slave_parallel_workers = 0;
START SLAVE SQL_THREAD;
```

### 13.4.2.6 STOP SLAVE Statement

```
STOP SLAVE [thread_types] [channel_option]

thread_types:
  [thread_type [, thread_type] ... ]

thread_type: IO_THREAD | SQL_THREAD

channel_option:
  FOR CHANNEL channel
```

Stops the replication threads. `STOP SLAVE` requires the `SUPER` privilege. Recommended best practice is to execute `STOP SLAVE` on the replica before stopping the replica server (see [Section 5.1.16, "The Server Shutdown Process"](#), for more information).

*When using the row-based logging format:* You should execute `STOP SLAVE` or `STOP SLAVE SQL_THREAD` on the replica prior to shutting down the replica server if you are replicating any tables that use a nontransactional storage engine (see the *Note* later in this section).

Like `START SLAVE`, this statement may be used with the `IO_THREAD` and `SQL_THREAD` options to name the thread or threads to be stopped. Note that the Group Replication applier channel (`group_replication_applier`) has no replication I/O thread, only a replication SQL thread. Using the `SQL_THREAD` option therefore stops this channel completely.

`STOP SLAVE` causes an implicit commit of an ongoing transaction. See [Section 13.3.3, "Statements That Cause an Implicit Commit"](#).

`gtid_next` must be set to `AUTOMATIC` before issuing this statement.

You can control how long `STOP SLAVE` waits before timing out by setting the `rpl_stop_slave_timeout` system variable. This can be used to avoid deadlocks between `STOP SLAVE` and other SQL statements using different client connections to the replica. When the timeout value is reached, the issuing client returns an error message and stops waiting, but the `STOP SLAVE` instruction remains in effect. Once the replication threads are no longer busy, the `STOP SLAVE` statement is executed and the replica stops.

Some `CHANGE MASTER TO` statements are allowed while the replica is running, depending on the states of the replication SQL thread and the replication I/O thread. However, using `STOP SLAVE` prior to executing `CHANGE MASTER TO` in such cases is still supported. See [Section 13.4.2.1, “CHANGE MASTER TO Statement”](#), and [Section 16.3.7, “Switching Sources During Failover”](#), for more information.

The optional `FOR CHANNEL channel` clause enables you to name which replication channel the statement applies to. Providing a `FOR CHANNEL channel` clause applies the `STOP SLAVE` statement to a specific replication channel. If no channel is named and no extra channels exist, the statement applies to the default channel. If a `STOP SLAVE` statement does not name a channel when using multiple channels, this statement stops the specified threads for all channels. This statement cannot be used with the `group_replication_recovery` channel. See [Section 16.2.2, “Replication Channels”](#) for more information.

*When using statement-based replication:* changing the source while it has open temporary tables is potentially unsafe. This is one of the reasons why statement-based replication of temporary tables is not recommended. You can find out whether there are any temporary tables on the replica by checking the value of `Slave_open_temp_tables`; when using statement-based replication, this value should be 0 before executing `CHANGE MASTER TO`. If there are any temporary tables open on the replica, issuing a `CHANGE MASTER TO` statement after issuing a `STOP SLAVE` causes an `ER_WARN_OPEN_TEMP_TABLES_MUST_BE_ZERO` warning.

When using a multithreaded replica (`slave_parallel_workers` is a nonzero value), any gaps in the sequence of transactions executed from the relay log are closed as part of stopping the worker threads. If the replica is stopped unexpectedly (for example due to an error in a worker thread, or another thread issuing `KILL`) while a `STOP SLAVE` statement is executing, the sequence of executed transactions from the relay log may become inconsistent. See [Section 16.4.1.32, “Replication and Transaction Inconsistencies”](#), for more information.

If the current replication event group has modified one or more nontransactional tables, `STOP SLAVE` waits for up to 60 seconds for the event group to complete, unless you issue a `KILL QUERY` or `KILL CONNECTION` statement for the replication SQL thread. If the event group remains incomplete after the timeout, an error message is logged.

## 13.4.3 SQL Statements for Controlling Group Replication

This section provides information about the statements used to control servers running the MySQL Group Replication plugin. See [Chapter 17, Group Replication](#) for more information.

### 13.4.3.1 START GROUP\_REPLICATION Statement

```
START GROUP_REPLICATION
```

Starts Group Replication on this server instance. This statement requires the `SUPER` privilege. If `super_read_only=ON` and the member should join as a primary, `super_read_only` is set to `OFF` once Group Replication successfully starts.

A server that participates in a group in single-primary mode should use `skip_replica_start=ON`. Otherwise, the server is not allowed to join a group as a secondary.

### 13.4.3.2 STOP GROUP\_REPLICATION Statement

```
STOP GROUP_REPLICATION
```

Stops Group Replication. This statement requires the [GROUP\\_REPLICATION\\_ADMIN](#) or [SUPER](#) privilege. As soon as you issue `STOP GROUP_REPLICATION` the member is set to `super_read_only=ON`, which ensures that no writes can be made to the member while Group Replication stops. Any other replication channels running on the member are also stopped.



#### Warning

Use this statement with extreme caution because it removes the server instance from the group, meaning it is no longer protected by Group Replication's consistency guarantee mechanisms. To be completely safe, ensure that your applications can no longer connect to the instance before issuing this statement to avoid any chance of stale reads.

## 13.5 Prepared Statements

MySQL 5.7 provides support for server-side prepared statements. This support takes advantage of the efficient client/server binary protocol. Using prepared statements with placeholders for parameter values has the following benefits:

- Less overhead for parsing the statement each time it is executed. Typically, database applications process large volumes of almost-identical statements, with only changes to literal or variable values in clauses such as [WHERE](#) for queries and deletes, [SET](#) for updates, and [VALUES](#) for inserts.
- Protection against SQL injection attacks. The parameter values can contain unescaped SQL quote and delimiter characters.

The following sections provide an overview of the characteristics of prepared statements:

- [Prepared Statements in Application Programs](#)
- [Prepared Statements in SQL Scripts](#)
- [PREPARE, EXECUTE, and DEALLOCATE PREPARE Statements](#)
- [SQL Syntax Permitted in Prepared Statements](#)

### Prepared Statements in Application Programs

You can use server-side prepared statements through client programming interfaces, including the [MySQL C API client library](#) for C programs, [MySQL Connector/J](#) for Java programs, and [MySQL Connector/NET](#) for programs using .NET technologies. For example, the C API provides a set of function calls that make up its prepared statement API. See [C API Prepared Statement Interface](#). Other language interfaces can provide support for prepared statements that use the binary protocol by linking in the C client library, one example being the [mysql\\_i extension](#), available in PHP 5.0 and higher.

### Prepared Statements in SQL Scripts

An alternative SQL interface to prepared statements is available. This interface is not as efficient as using the binary protocol through a prepared statement API, but requires no programming because it is available directly at the SQL level:

- You can use it when no programming interface is available to you.

- You can use it from any program that can send SQL statements to the server to be executed, such as the `mysql` client program.
- You can use it even if the client is using an old version of the client library.

SQL syntax for prepared statements is intended to be used for situations such as these:

- To test how prepared statements work in your application before coding it.
- To use prepared statements when you do not have access to a programming API that supports them.
- To interactively troubleshoot application issues with prepared statements.
- To create a test case that reproduces a problem with prepared statements, so that you can file a bug report.

## PREPARE, EXECUTE, and DEALLOCATE PREPARE Statements

SQL syntax for prepared statements is based on three SQL statements:

- `PREPARE` prepares a statement for execution (see [Section 13.5.1, “PREPARE Statement”](#)).
- `EXECUTE` executes a prepared statement (see [Section 13.5.2, “EXECUTE Statement”](#)).
- `DEALLOCATE PREPARE` releases a prepared statement (see [Section 13.5.3, “DEALLOCATE PREPARE Statement”](#)).

The following examples show two equivalent ways of preparing a statement that computes the hypotenuse of a triangle given the lengths of the two sides.

The first example shows how to create a prepared statement by using a string literal to supply the text of the statement:

```
mysql> PREPARE stmt1 FROM 'SELECT SQRT(POW(?,2) + POW(?,2)) AS hypotenuse';
mysql> SET @a = 3;
mysql> SET @b = 4;
mysql> EXECUTE stmt1 USING @a, @b;
+-----+
| hypotenuse |
+-----+
|          5 |
+-----+
mysql> DEALLOCATE PREPARE stmt1;
```

The second example is similar, but supplies the text of the statement as a user variable:

```
mysql> SET @s = 'SELECT SQRT(POW(?,2) + POW(?,2)) AS hypotenuse';
mysql> PREPARE stmt2 FROM @s;
mysql> SET @a = 6;
mysql> SET @b = 8;
mysql> EXECUTE stmt2 USING @a, @b;
+-----+
| hypotenuse |
+-----+
|          10 |
+-----+
mysql> DEALLOCATE PREPARE stmt2;
```

Here is an additional example that demonstrates how to choose the table on which to perform a query at runtime, by storing the name of the table as a user variable:

```
mysql> USE test;
```

```

mysql> CREATE TABLE t1 (a INT NOT NULL);
mysql> INSERT INTO t1 VALUES (4), (8), (11), (32), (80);

mysql> SET @table = 't1';
mysql> SET @s = CONCAT('SELECT * FROM ', @table);

mysql> PREPARE stmt3 FROM @s;
mysql> EXECUTE stmt3;
+-----+
| a     |
+-----+
| 4     |
| 8     |
| 11    |
| 32    |
| 80    |
+-----+

mysql> DEALLOCATE PREPARE stmt3;

```

A prepared statement is specific to the session in which it was created. If you terminate a session without deallocating a previously prepared statement, the server deallocates it automatically.

A prepared statement is also global to the session. If you create a prepared statement within a stored routine, it is not deallocated when the stored routine ends.

To guard against too many prepared statements being created simultaneously, set the `max_prepared_stmt_count` system variable. To prevent the use of prepared statements, set the value to 0.

## SQL Syntax Permitted in Prepared Statements

The following SQL statements can be used as prepared statements:

```

ALTER TABLE
ALTER USER
ANALYZE TABLE
CACHE INDEX
CALL
CHANGE MASTER
CHECKSUM {TABLE | TABLES}
COMMIT
{CREATE | DROP} INDEX
{CREATE | RENAME | DROP} DATABASE
{CREATE | DROP} TABLE
{CREATE | RENAME | DROP} USER
{CREATE | DROP} VIEW
DELETE
DO
FLUSH {TABLE | TABLES | TABLES WITH READ LOCK | HOSTS | PRIVILEGES
      | LOGS | STATUS | MASTER | SLAVE | DES_KEY_FILE | USER_RESOURCES}
GRANT
INSERT
INSTALL PLUGIN
KILL
LOAD INDEX INTO CACHE
OPTIMIZE TABLE
RENAME TABLE
REPAIR TABLE
REPLACE
RESET {MASTER | SLAVE | QUERY CACHE}
REVOKE
SELECT
SET
SHOW BINLOG EVENTS

```

```
SHOW CREATE {PROCEDURE | FUNCTION | EVENT | TABLE | VIEW}
SHOW {MASTER | BINARY} LOGS
SHOW {MASTER | SLAVE} STATUS
SLAVE {START | STOP}
TRUNCATE TABLE
UNINSTALL PLUGIN
UPDATE
```

Other statements are not supported.

For compliance with the SQL standard, which states that diagnostics statements are not preparable, MySQL does not support the following as prepared statements:

- `SHOW WARNINGS`, `SHOW COUNT(*) WARNINGS`
- `SHOW ERRORS`, `SHOW COUNT(*) ERRORS`
- Statements containing any reference to the `warning_count` or `error_count` system variable.

Generally, statements not permitted in SQL prepared statements are also not permitted in stored programs. Exceptions are noted in [Section 23.8, “Restrictions on Stored Programs”](#).

Metadata changes to tables or views referred to by prepared statements are detected and cause automatic reparation of the statement when it is next executed. For more information, see [Section 8.10.4, “Caching of Prepared Statements and Stored Programs”](#).

Placeholders can be used for the arguments of the `LIMIT` clause when using prepared statements. See [Section 13.2.9, “SELECT Statement”](#).

In prepared `CALL` statements used with `PREPARE` and `EXECUTE`, placeholder support for `OUT` and `INOUT` parameters is available beginning with MySQL 5.7. See [Section 13.2.1, “CALL Statement”](#), for an example and a workaround for earlier versions. Placeholders can be used for `IN` parameters regardless of version.

SQL syntax for prepared statements cannot be used in nested fashion. That is, a statement passed to `PREPARE` cannot itself be a `PREPARE`, `EXECUTE`, or `DEALLOCATE PREPARE` statement.

SQL syntax for prepared statements is distinct from using prepared statement API calls. For example, you cannot use the `mysql_stmt_prepare()` C API function to prepare a `PREPARE`, `EXECUTE`, or `DEALLOCATE PREPARE` statement.

SQL syntax for prepared statements can be used within stored procedures, but not in stored functions or triggers. However, a cursor cannot be used for a dynamic statement that is prepared and executed with `PREPARE` and `EXECUTE`. The statement for a cursor is checked at cursor creation time, so the statement cannot be dynamic.

SQL syntax for prepared statements does not support multi-statements (that is, multiple statements within a single string separated by `;` characters).

Prepared statements use the query cache under the conditions described in [Section 8.10.3.1, “How the Query Cache Operates”](#).

To write C programs that use the `CALL` SQL statement to execute stored procedures that contain prepared statements, the `CLIENT_MULTI_RESULTS` flag must be enabled. This is because each `CALL` returns a result to indicate the call status, in addition to any result sets that might be returned by statements executed within the procedure.

`CLIENT_MULTI_RESULTS` can be enabled when you call `mysql_real_connect()`, either explicitly by passing the `CLIENT_MULTI_RESULTS` flag itself, or implicitly by passing `CLIENT_MULTI_STATEMENTS`

(which also enables `CLIENT_MULTI_RESULTS`). For additional information, see [Section 13.2.1, “CALL Statement”](#).

## 13.5.1 PREPARE Statement

```
PREPARE stmt_name FROM preparable_stmt
```

The `PREPARE` statement prepares a SQL statement and assigns it a name, *stmt\_name*, by which to refer to the statement later. The prepared statement is executed with `EXECUTE` and released with `DEALLOCATE PREPARE`. For examples, see [Section 13.5, “Prepared Statements”](#).

Statement names are not case-sensitive. *preparable\_stmt* is either a string literal or a user variable that contains the text of the SQL statement. The text must represent a single statement, not multiple statements. Within the statement, `?` characters can be used as parameter markers to indicate where data values are to be bound to the query later when you execute it. The `?` characters should not be enclosed within quotation marks, even if you intend to bind them to string values. Parameter markers can be used only where data values should appear, not for SQL keywords, identifiers, and so forth.

If a prepared statement with the given name already exists, it is deallocated implicitly before the new statement is prepared. This means that if the new statement contains an error and cannot be prepared, an error is returned and no statement with the given name exists.

The scope of a prepared statement is the session within which it is created, which has several implications:

- A prepared statement created in one session is not available to other sessions.
- When a session ends, whether normally or abnormally, its prepared statements no longer exist. If auto-reconnect is enabled, the client is not notified that the connection was lost. For this reason, clients may wish to disable auto-reconnect. See [Automatic Reconnection Control](#).
- A prepared statement created within a stored program continues to exist after the program finishes executing and can be executed outside the program later.
- A statement prepared in stored program context cannot refer to stored procedure or function parameters or local variables because they go out of scope when the program ends and would be unavailable were the statement to be executed later outside the program. As a workaround, refer instead to user-defined variables, which also have session scope; see [Section 9.4, “User-Defined Variables”](#).

## 13.5.2 EXECUTE Statement

```
EXECUTE stmt_name  
[USING @var_name [, @var_name] ...]
```

After preparing a statement with `PREPARE`, you execute it with an `EXECUTE` statement that refers to the prepared statement name. If the prepared statement contains any parameter markers, you must supply a `USING` clause that lists user variables containing the values to be bound to the parameters. Parameter values can be supplied only by user variables, and the `USING` clause must name exactly as many variables as the number of parameter markers in the statement.

You can execute a given prepared statement multiple times, passing different variables to it or setting the variables to different values before each execution.

For examples, see [Section 13.5, “Prepared Statements”](#).

## 13.5.3 DEALLOCATE PREPARE Statement

```
{DEALLOCATE | DROP} PREPARE stmt_name
```



To deallocate a prepared statement produced with `PREPARE`, use a `DEALLOCATE PREPARE` statement that refers to the prepared statement name. Attempting to execute a prepared statement after deallocating it results in an error. If too many prepared statements are created and not deallocated by either the `DEALLOCATE PREPARE` statement or the end of the session, you might encounter the upper limit enforced by the `max_prepared_stmt_count` system variable.

For examples, see [Section 13.5, “Prepared Statements”](#).

## 13.6 Compound Statements

This section describes the syntax for the `BEGIN ... END` compound statement and other statements that can be used in the body of stored programs: Stored procedures and functions, triggers, and events. These objects are defined in terms of SQL code that is stored on the server for later invocation (see [Chapter 23, \*Stored Objects\*](#)).

A compound statement is a block that can contain other blocks; declarations for variables, condition handlers, and cursors; and flow control constructs such as loops and conditional tests.

### 13.6.1 BEGIN ... END Compound Statement

```
[begin_label:] BEGIN
    [statement_list]
END [end_label]
```

`BEGIN ... END` syntax is used for writing compound statements, which can appear within stored programs (stored procedures and functions, triggers, and events). A compound statement can contain multiple statements, enclosed by the `BEGIN` and `END` keywords. `statement_list` represents a list of one or more statements, each terminated by a semicolon (`;`) statement delimiter. The `statement_list` itself is optional, so the empty compound statement (`BEGIN END`) is legal.

`BEGIN ... END` blocks can be nested.

Use of multiple statements requires that a client is able to send statement strings containing the `;` statement delimiter. In the `mysql` command-line client, this is handled with the `delimiter` command. Changing the `;` end-of-statement delimiter (for example, to `//`) permit `;` to be used in a program body. For an example, see [Section 23.1, “Defining Stored Programs”](#).

A `BEGIN ... END` block can be labeled. See [Section 13.6.2, “Statement Labels”](#).

The optional `[NOT] ATOMIC` clause is not supported. This means that no transactional savepoint is set at the start of the instruction block and the `BEGIN` clause used in this context has no effect on the current transaction.



#### Note

Within all stored programs, the parser treats `BEGIN [WORK]` as the beginning of a `BEGIN ... END` block. To begin a transaction in this context, use `START TRANSACTION` instead.

### 13.6.2 Statement Labels

```
[begin_label:] BEGIN
    [statement_list]
END [end_label]

[begin_label:] LOOP
    statement_list
```

```

END LOOP [end_label]

[begin_label:] REPEAT
    statement_list
UNTIL search_condition
END REPEAT [end_label]

[begin_label:] WHILE search_condition DO
    statement_list
END WHILE [end_label]

```

Labels are permitted for `BEGIN ... END` blocks and for the `LOOP`, `REPEAT`, and `WHILE` statements. Label use for those statements follows these rules:

- *begin\_label* must be followed by a colon.
- *begin\_label* can be given without *end\_label*. If *end\_label* is present, it must be the same as *begin\_label*.
- *end\_label* cannot be given without *begin\_label*.
- Labels at the same nesting level must be distinct.
- Labels can be up to 16 characters long.

To refer to a label within the labeled construct, use an `ITERATE` or `LEAVE` statement. The following example uses those statements to continue iterating or terminate the loop:

```

CREATE PROCEDURE doitrate(p1 INT)
BEGIN
    label1: LOOP
        SET p1 = p1 + 1;
        IF p1 < 10 THEN ITERATE label1; END IF;
        LEAVE label1;
    END LOOP label1;
END;

```

The scope of a block label does not include the code for handlers declared within the block. For details, see [Section 13.6.7.2, “DECLARE ... HANDLER Statement”](#).

### 13.6.3 DECLARE Statement

The `DECLARE` statement is used to define various items local to a program:

- Local variables. See [Section 13.6.4, “Variables in Stored Programs”](#).
- Conditions and handlers. See [Section 13.6.7, “Condition Handling”](#).
- Cursors. See [Section 13.6.6, “Cursors”](#).

`DECLARE` is permitted only inside a `BEGIN ... END` compound statement and must be at its start, before any other statements.

Declarations must follow a certain order. Cursor declarations must appear before handler declarations. Variable and condition declarations must appear before cursor or handler declarations.

### 13.6.4 Variables in Stored Programs

System variables and user-defined variables can be used in stored programs, just as they can be used outside stored-program context. In addition, stored programs can use `DECLARE` to define local variables,

and stored routines (procedures and functions) can be declared to take parameters that communicate values between the routine and its caller.

- To declare local variables, use the `DECLARE` statement, as described in [Section 13.6.4.1, “Local Variable DECLARE Statement”](#).
- Variables can be set directly with the `SET` statement. See [Section 13.7.4.1, “SET Syntax for Variable Assignment”](#).
- Results from queries can be retrieved into local variables using `SELECT ... INTO var_list` or by opening a cursor and using `FETCH ... INTO var_list`. See [Section 13.2.9.1, “SELECT ... INTO Statement”](#), and [Section 13.6.6, “Cursors”](#).

For information about the scope of local variables and how MySQL resolves ambiguous names, see [Section 13.6.4.2, “Local Variable Scope and Resolution”](#).

It is not permitted to assign the value `DEFAULT` to stored procedure or function parameters or stored program local variables (for example with a `SET var_name = DEFAULT` statement). In MySQL 5.7, this results in a syntax error.

### 13.6.4.1 Local Variable DECLARE Statement

```
DECLARE var_name [, var_name] ... type [DEFAULT value]
```

This statement declares local variables within stored programs. To provide a default value for a variable, include a `DEFAULT` clause. The value can be specified as an expression; it need not be a constant. If the `DEFAULT` clause is missing, the initial value is `NULL`.

Local variables are treated like stored routine parameters with respect to data type and overflow checking. See [Section 13.1.16, “CREATE PROCEDURE and CREATE FUNCTION Statements”](#).

Variable declarations must appear before cursor or handler declarations.

Local variable names are not case-sensitive. Permissible characters and quoting rules are the same as for other identifiers, as described in [Section 9.2, “Schema Object Names”](#).

The scope of a local variable is the `BEGIN ... END` block within which it is declared. The variable can be referred to in blocks nested within the declaring block, except those blocks that declare a variable with the same name.

For examples of variable declarations, see [Section 13.6.4.2, “Local Variable Scope and Resolution”](#).

### 13.6.4.2 Local Variable Scope and Resolution

The scope of a local variable is the `BEGIN ... END` block within which it is declared. The variable can be referred to in blocks nested within the declaring block, except those blocks that declare a variable with the same name.

Because local variables are in scope only during stored program execution, references to them are not permitted in prepared statements created within a stored program. Prepared statement scope is the current session, not the stored program, so the statement could be executed after the program ends, at which point the variables would no longer be in scope. For example, `SELECT ... INTO local_var` cannot be used as a prepared statement. This restriction also applies to stored procedure and function parameters. See [Section 13.5.1, “PREPARE Statement”](#).

A local variable should not have the same name as a table column. If an SQL statement, such as a `SELECT ... INTO` statement, contains a reference to a column and a declared local variable with the

same name, MySQL currently interprets the reference as the name of a variable. Consider the following procedure definition:

```
CREATE PROCEDURE sp1 (x VARCHAR(5))
BEGIN
  DECLARE xname VARCHAR(5) DEFAULT 'bob';
  DECLARE newname VARCHAR(5);
  DECLARE xid INT;

  SELECT xname, id INTO newname, xid
    FROM table1 WHERE xname = xname;
  SELECT newname;
END;
```

MySQL interprets `xname` in the `SELECT` statement as a reference to the `xname` variable rather than the `xname` column. Consequently, when the procedure `sp1()` is called, the `newname` variable returns the value `'bob'` regardless of the value of the `table1.xname` column.

Similarly, the cursor definition in the following procedure contains a `SELECT` statement that refers to `xname`. MySQL interprets this as a reference to the variable of that name rather than a column reference.

```
CREATE PROCEDURE sp2 (x VARCHAR(5))
BEGIN
  DECLARE xname VARCHAR(5) DEFAULT 'bob';
  DECLARE newname VARCHAR(5);
  DECLARE xid INT;
  DECLARE done TINYINT DEFAULT 0;
  DECLARE cur1 CURSOR FOR SELECT xname, id FROM table1;
  DECLARE CONTINUE HANDLER FOR NOT FOUND SET done = 1;

  OPEN cur1;
  read_loop: LOOP
    FETCH FROM cur1 INTO newname, xid;
    IF done THEN LEAVE read_loop; END IF;
    SELECT newname;
  END LOOP;
  CLOSE cur1;
END;
```

See also [Section 23.8, “Restrictions on Stored Programs”](#).

## 13.6.5 Flow Control Statements

MySQL supports the `IF`, `CASE`, `ITERATE`, `LEAVE LOOP`, `WHILE`, and `REPEAT` constructs for flow control within stored programs. It also supports `RETURN` within stored functions.

Many of these constructs contain other statements, as indicated by the grammar specifications in the following sections. Such constructs may be nested. For example, an `IF` statement might contain a `WHILE` loop, which itself contains a `CASE` statement.

MySQL does not support `FOR` loops.

### 13.6.5.1 CASE Statement

```
CASE case_value
  WHEN when_value THEN statement_list
  [WHEN when_value THEN statement_list] ...
  [ELSE statement_list]
END CASE
```

Or:

```

CASE
  WHEN search_condition THEN statement_list
  [WHEN search_condition THEN statement_list] ...
  [ELSE statement_list]
END CASE

```

The `CASE` statement for stored programs implements a complex conditional construct.



### Note

There is also a `CASE operator`, which differs from the `CASE statement` described here. See [Section 12.5, “Flow Control Functions”](#). The `CASE` statement cannot have an `ELSE NULL` clause, and it is terminated with `END CASE` instead of `END`.

For the first syntax, *case\_value* is an expression. This value is compared to the *when\_value* expression in each `WHEN` clause until one of them is equal. When an equal *when\_value* is found, the corresponding `THEN` clause *statement\_list* executes. If no *when\_value* is equal, the `ELSE` clause *statement\_list* executes, if there is one.

This syntax cannot be used to test for equality with `NULL` because `NULL = NULL` is false. See [Section 3.3.4.6, “Working with NULL Values”](#).

For the second syntax, each `WHEN` clause *search\_condition* expression is evaluated until one is true, at which point its corresponding `THEN` clause *statement\_list* executes. If no *search\_condition* is equal, the `ELSE` clause *statement\_list* executes, if there is one.

If no *when\_value* or *search\_condition* matches the value tested and the `CASE` statement contains no `ELSE` clause, a `Case not found for CASE statement` error results.

Each *statement\_list* consists of one or more SQL statements; an empty *statement\_list* is not permitted.

To handle situations where no value is matched by any `WHEN` clause, use an `ELSE` containing an empty `BEGIN ... END` block, as shown in this example. (The indentation used here in the `ELSE` clause is for purposes of clarity only, and is not otherwise significant.)

```

DELIMITER |

CREATE PROCEDURE p()
  BEGIN
    DECLARE v INT DEFAULT 1;

    CASE v
      WHEN 2 THEN SELECT v;
      WHEN 3 THEN SELECT 0;
      ELSE
        BEGIN
          END;
        END CASE;
    END;
  |

```

## 13.6.5.2 IF Statement

```

IF search_condition THEN statement_list
  [ELSEIF search_condition THEN statement_list] ...
  [ELSE statement_list]
END IF

```

The `IF` statement for stored programs implements a basic conditional construct.

**Note**

There is also an `IF()` function, which differs from the `IF statement` described here. See [Section 12.5, “Flow Control Functions”](#). The `IF` statement can have `THEN`, `ELSE`, and `ELSEIF` clauses, and it is terminated with `END IF`.

If a given `search_condition` evaluates to true, the corresponding `THEN` or `ELSEIF` clause `statement_list` executes. If no `search_condition` matches, the `ELSE` clause `statement_list` executes.

Each `statement_list` consists of one or more SQL statements; an empty `statement_list` is not permitted.

An `IF ... END IF` block, like all other flow-control blocks used within stored programs, must be terminated with a semicolon, as shown in this example:

```
DELIMITER //
CREATE FUNCTION SimpleCompare(n INT, m INT)
  RETURNS VARCHAR(20)

  BEGIN
    DECLARE s VARCHAR(20);

    IF n > m THEN SET s = '>';
    ELSEIF n = m THEN SET s = '=';
    ELSE SET s = '<';
    END IF;

    SET s = CONCAT(n, ' ', s, ' ', m);

    RETURN s;
  END //
DELIMITER ;
```

As with other flow-control constructs, `IF ... END IF` blocks may be nested within other flow-control constructs, including other `IF` statements. Each `IF` must be terminated by its own `END IF` followed by a semicolon. You can use indentation to make nested flow-control blocks more easily readable by humans (although this is not required by MySQL), as shown here:

```
DELIMITER //
CREATE FUNCTION VerboseCompare (n INT, m INT)
  RETURNS VARCHAR(50)

  BEGIN
    DECLARE s VARCHAR(50);

    IF n = m THEN SET s = 'equals';
    ELSE
      IF n > m THEN SET s = 'greater';
      ELSE SET s = 'less';
      END IF;

    SET s = CONCAT('is ', s, ' than');
  END IF;

  SET s = CONCAT(n, ' ', s, ' ', m, '.');

  RETURN s;
END //
DELIMITER ;
```

In this example, the inner `IF` is evaluated only if `n` is not equal to `m`.

### 13.6.5.3 ITERATE Statement

```
ITERATE label
```

`ITERATE` can appear only within `LOOP`, `REPEAT`, and `WHILE` statements. `ITERATE` means “start the loop again.”

For an example, see [Section 13.6.5.5, “LOOP Statement”](#).

### 13.6.5.4 LEAVE Statement

```
LEAVE label
```

This statement is used to exit the flow control construct that has the given label. If the label is for the outermost stored program block, `LEAVE` exits the program.

`LEAVE` can be used within `BEGIN . . . END` or loop constructs (`LOOP`, `REPEAT`, `WHILE`).

For an example, see [Section 13.6.5.5, “LOOP Statement”](#).

### 13.6.5.5 LOOP Statement

```
[begin_label:] LOOP
  statement_list
END LOOP [end_label]
```

`LOOP` implements a simple loop construct, enabling repeated execution of the statement list, which consists of one or more statements, each terminated by a semicolon (;) statement delimiter. The statements within the loop are repeated until the loop is terminated. Usually, this is accomplished with a `LEAVE` statement. Within a stored function, `RETURN` can also be used, which exits the function entirely.

Neglecting to include a loop-termination statement results in an infinite loop.

A `LOOP` statement can be labeled. For the rules regarding label use, see [Section 13.6.2, “Statement Labels”](#).

Example:

```
CREATE PROCEDURE doiterate(p1 INT)
BEGIN
  labell: LOOP
    SET p1 = p1 + 1;
    IF p1 < 10 THEN
      ITERATE labell;
    END IF;
    LEAVE labell;
  END LOOP labell;
  SET @x = p1;
END;
```

### 13.6.5.6 REPEAT Statement

```
[begin_label:] REPEAT
  statement_list
UNTIL search_condition
END REPEAT [end_label]
```

The statement list within a `REPEAT` statement is repeated until the `search_condition` expression is true. Thus, a `REPEAT` always enters the loop at least once. `statement_list` consists of one or more statements, each terminated by a semicolon (;) statement delimiter.

A `REPEAT` statement can be labeled. For the rules regarding label use, see [Section 13.6.2, “Statement Labels”](#).

Example:

```
mysql> delimiter //

mysql> CREATE PROCEDURE dorepeat(p1 INT)
BEGIN
    SET @x = 0;
    REPEAT
        SET @x = @x + 1;
    UNTIL @x > p1 END REPEAT;
END
//
Query OK, 0 rows affected (0.00 sec)

mysql> CALL dorepeat(1000)//
Query OK, 0 rows affected (0.00 sec)

mysql> SELECT @x//
+-----+
| @x   |
+-----+
| 1001 |
+-----+
1 row in set (0.00 sec)
```

### 13.6.5.7 RETURN Statement

```
RETURN expr
```

The `RETURN` statement terminates execution of a stored function and returns the value *expr* to the function caller. There must be at least one `RETURN` statement in a stored function. There may be more than one if the function has multiple exit points.

This statement is not used in stored procedures, triggers, or events. The `LEAVE` statement can be used to exit a stored program of those types.

### 13.6.5.8 WHILE Statement

```
[begin_label:] WHILE search_condition DO
    statement_list
END WHILE [end_label]
```

The statement list within a `WHILE` statement is repeated as long as the *search\_condition* expression is true. *statement\_list* consists of one or more SQL statements, each terminated by a semicolon (`;`) statement delimiter.

A `WHILE` statement can be labeled. For the rules regarding label use, see [Section 13.6.2, “Statement Labels”](#).

Example:

```
CREATE PROCEDURE dowhile()
BEGIN
    DECLARE v1 INT DEFAULT 5;

    WHILE v1 > 0 DO
        ...
        SET v1 = v1 - 1;
    END WHILE;
END;
```



## 13.6.6 Cursors

MySQL supports cursors inside stored programs. The syntax is as in embedded SQL. Cursors have these properties:

- Asensitive: The server may or may not make a copy of its result table
- Read only: Not updatable
- Nonscrollable: Can be traversed only in one direction and cannot skip rows

Cursor declarations must appear before handler declarations and after variable and condition declarations.

Example:

```
CREATE PROCEDURE curdemo()
BEGIN
  DECLARE done INT DEFAULT FALSE;
  DECLARE a CHAR(16);
  DECLARE b, c INT;
  DECLARE cur1 CURSOR FOR SELECT id,data FROM test.t1;
  DECLARE cur2 CURSOR FOR SELECT i FROM test.t2;
  DECLARE CONTINUE HANDLER FOR NOT FOUND SET done = TRUE;

  OPEN cur1;
  OPEN cur2;

  read_loop: LOOP
    FETCH cur1 INTO a, b;
    FETCH cur2 INTO c;
    IF done THEN
      LEAVE read_loop;
    END IF;
    IF b < c THEN
      INSERT INTO test.t3 VALUES (a,b);
    ELSE
      INSERT INTO test.t3 VALUES (a,c);
    END IF;
  END LOOP;

  CLOSE cur1;
  CLOSE cur2;
END;
```

### 13.6.6.1 Cursor CLOSE Statement

```
CLOSE cursor_name
```

This statement closes a previously opened cursor. For an example, see [Section 13.6.6, “Cursors”](#).

An error occurs if the cursor is not open.

If not closed explicitly, a cursor is closed at the end of the `BEGIN ... END` block in which it was declared.

### 13.6.6.2 Cursor DECLARE Statement

```
DECLARE cursor_name CURSOR FOR select_statement
```

This statement declares a cursor and associates it with a `SELECT` statement that retrieves the rows to be traversed by the cursor. To fetch the rows later, use a `FETCH` statement. The number of columns retrieved by the `SELECT` statement must match the number of output variables specified in the `FETCH` statement.

The `SELECT` statement cannot have an `INTO` clause.

Cursor declarations must appear before handler declarations and after variable and condition declarations.

A stored program may contain multiple cursor declarations, but each cursor declared in a given block must have a unique name. For an example, see [Section 13.6.6, “Cursors”](#).

For information available through `SHOW` statements, it is possible in many cases to obtain equivalent information by using a cursor with an `INFORMATION_SCHEMA` table.

### 13.6.6.3 Cursor `FETCH` Statement

```
FETCH [[NEXT] FROM] cursor_name INTO var_name [, var_name] ...
```

This statement fetches the next row for the `SELECT` statement associated with the specified cursor (which must be open), and advances the cursor pointer. If a row exists, the fetched columns are stored in the named variables. The number of columns retrieved by the `SELECT` statement must match the number of output variables specified in the `FETCH` statement.

If no more rows are available, a No Data condition occurs with SQLSTATE value `'02000'`. To detect this condition, you can set up a handler for it (or for a `NOT FOUND` condition). For an example, see [Section 13.6.6, “Cursors”](#).

Be aware that another operation, such as a `SELECT` or another `FETCH`, may also cause the handler to execute by raising the same condition. If it is necessary to distinguish which operation raised the condition, place the operation within its own `BEGIN ... END` block so that it can be associated with its own handler.

### 13.6.6.4 Cursor `OPEN` Statement

```
OPEN cursor_name
```

This statement opens a previously declared cursor. For an example, see [Section 13.6.6, “Cursors”](#).

### 13.6.6.5 Restrictions on Server-Side Cursors

Server-side cursors are implemented in the C API using the `mysql_stmt_attr_set()` function. The same implementation is used for cursors in stored routines. A server-side cursor enables a result set to be generated on the server side, but not transferred to the client except for those rows that the client requests. For example, if a client executes a query but is only interested in the first row, the remaining rows are not transferred.

In MySQL, a server-side cursor is materialized into an internal temporary table. Initially, this is a `MEMORY` table, but is converted to a `MyISAM` table when its size exceeds the minimum value of the `max_heap_table_size` and `tmp_table_size` system variables. The same restrictions apply to internal temporary tables created to hold the result set for a cursor as for other uses of internal temporary tables. See [Section 8.4.4, “Internal Temporary Table Use in MySQL”](#). One limitation of the implementation is that for a large result set, retrieving its rows through a cursor might be slow.

Cursors are read only; you cannot use a cursor to update rows.

`UPDATE WHERE CURRENT OF` and `DELETE WHERE CURRENT OF` are not implemented, because updatable cursors are not supported.

Cursors are nonholdable (not held open after a commit).

Cursors are asensitive.

Cursors are nonscrollable.

Cursors are not named. The statement handler acts as the cursor ID.

You can have open only a single cursor per prepared statement. If you need several cursors, you must prepare several statements.

You cannot use a cursor for a statement that generates a result set if the statement is not supported in prepared mode. This includes statements such as `CHECK TABLE`, `HANDLER READ`, and `SHOW BINLOG EVENTS`.

## 13.6.7 Condition Handling

Conditions may arise during stored program execution that require special handling, such as exiting the current program block or continuing execution. Handlers can be defined for general conditions such as warnings or exceptions, or for specific conditions such as a particular error code. Specific conditions can be assigned names and referred to that way in handlers.

To name a condition, use the `DECLARE ... CONDITION` statement. To declare a handler, use the `DECLARE ... HANDLER` statement. See [Section 13.6.7.1, “DECLARE ... CONDITION Statement”](#), and [Section 13.6.7.2, “DECLARE ... HANDLER Statement”](#). For information about how the server chooses handlers when a condition occurs, see [Section 13.6.7.6, “Scope Rules for Handlers”](#).

To raise a condition, use the `SIGNAL` statement. To modify condition information within a condition handler, use `RESIGNAL`. See [Section 13.6.7.1, “DECLARE ... CONDITION Statement”](#), and [Section 13.6.7.2, “DECLARE ... HANDLER Statement”](#).

To retrieve information from the diagnostics area, use the `GET DIAGNOSTICS` statement (see [Section 13.6.7.3, “GET DIAGNOSTICS Statement”](#)). For information about the diagnostics area, see [Section 13.6.7.7, “The MySQL Diagnostics Area”](#).

### 13.6.7.1 DECLARE ... CONDITION Statement

```
DECLARE condition_name CONDITION FOR condition_value

condition_value: {
  mysql_error_code
  | SQLSTATE [VALUE] sqlstate_value
}
```

The `DECLARE ... CONDITION` statement declares a named error condition, associating a name with a condition that needs specific handling. The name can be referred to in a subsequent `DECLARE ... HANDLER` statement (see [Section 13.6.7.2, “DECLARE ... HANDLER Statement”](#)).

Condition declarations must appear before cursor or handler declarations.

The *condition\_value* for `DECLARE ... CONDITION` indicates the specific condition or class of conditions to associate with the condition name. It can take the following forms:

- *mysql\_error\_code*: An integer literal indicating a MySQL error code.

Do not use MySQL error code 0 because that indicates success rather than an error condition. For a list of MySQL error codes, see [Server Error Message Reference](#).

- SQLSTATE [VALUE] *sqlstate\_value*: A 5-character string literal indicating an SQLSTATE value.

Do not use SQLSTATE values that begin with '00' because those indicate success rather than an error condition. For a list of SQLSTATE values, see [Server Error Message Reference](#).

Condition names referred to in `SIGNAL` or use `RESIGNAL` statements must be associated with `SQLSTATE` values, not MySQL error codes.

Using names for conditions can help make stored program code clearer. For example, this handler applies to attempts to drop a nonexistent table, but that is apparent only if you know that 1051 is the MySQL error code for “unknown table”:

```
DECLARE CONTINUE HANDLER FOR 1051
BEGIN
  -- body of handler
END;
```

By declaring a name for the condition, the purpose of the handler is more readily seen:

```
DECLARE no_such_table CONDITION FOR 1051;
DECLARE CONTINUE HANDLER FOR no_such_table
BEGIN
  -- body of handler
END;
```

Here is a named condition for the same condition, but based on the corresponding `SQLSTATE` value rather than the MySQL error code:

```
DECLARE no_such_table CONDITION FOR SQLSTATE '42S02';
DECLARE CONTINUE HANDLER FOR no_such_table
BEGIN
  -- body of handler
END;
```

### 13.6.7.2 DECLARE ... HANDLER Statement

```
DECLARE handler_action HANDLER
  FOR condition_value [, condition_value] ...
  statement

handler_action: {
  CONTINUE
  | EXIT
  | UNDO
}

condition_value: {
  mysql_error_code
  | SQLSTATE [VALUE] sqlstate_value
  | condition_name
  | SQLWARNING
  | NOT FOUND
  | SQLEXCEPTION
}
```

The `DECLARE ... HANDLER` statement specifies a handler that deals with one or more conditions. If one of these conditions occurs, the specified `statement` executes. `statement` can be a simple statement such as `SET var_name = value`, or a compound statement written using `BEGIN` and `END` (see [Section 13.6.1, “BEGIN ... END Compound Statement”](#)).

Handler declarations must appear after variable or condition declarations.

The `handler_action` value indicates what action the handler takes after execution of the handler statement:

- `CONTINUE`: Execution of the current program continues.

- **EXIT**: Execution terminates for the `BEGIN ... END` compound statement in which the handler is declared. This is true even if the condition occurs in an inner block.
- **UNDO**: Not supported.

The *condition\_value* for `DECLARE ... HANDLER` indicates the specific condition or class of conditions that activates the handler. It can take the following forms:

- **mysql\_error\_code**: An integer literal indicating a MySQL error code, such as 1051 to specify “unknown table”:

```
DECLARE CONTINUE HANDLER FOR 1051
BEGIN
  -- body of handler
END;
```

Do not use MySQL error code 0 because that indicates success rather than an error condition. For a list of MySQL error codes, see [Server Error Message Reference](#).

- **SQLSTATE [VALUE] sqlstate\_value**: A 5-character string literal indicating an SQLSTATE value, such as '42S01' to specify “unknown table”:

```
DECLARE CONTINUE HANDLER FOR SQLSTATE '42S02'
BEGIN
  -- body of handler
END;
```

Do not use SQLSTATE values that begin with '00' because those indicate success rather than an error condition. For a list of SQLSTATE values, see [Server Error Message Reference](#).

- **condition\_name**: A condition name previously specified with `DECLARE ... CONDITION`. A condition name can be associated with a MySQL error code or SQLSTATE value. See [Section 13.6.7.1, “DECLARE ... CONDITION Statement”](#).
- **SQLWARNING**: Shorthand for the class of SQLSTATE values that begin with '01'.

```
DECLARE CONTINUE HANDLER FOR SQLWARNING
BEGIN
  -- body of handler
END;
```

- **NOT FOUND**: Shorthand for the class of SQLSTATE values that begin with '02'. This is relevant within the context of cursors and is used to control what happens when a cursor reaches the end of a data set. If no more rows are available, a No Data condition occurs with SQLSTATE value '02000'. To detect this condition, you can set up a handler for it or for a `NOT FOUND` condition.

```
DECLARE CONTINUE HANDLER FOR NOT FOUND
BEGIN
  -- body of handler
END;
```

For another example, see [Section 13.6.6, “Cursors”](#). The `NOT FOUND` condition also occurs for `SELECT ... INTO var_list` statements that retrieve no rows.

- **SQLEXCEPTION**: Shorthand for the class of SQLSTATE values that do not begin with '00', '01', or '02'.

```
DECLARE CONTINUE HANDLER FOR SQLEXCEPTION
BEGIN
  -- body of handler
END;
```

For information about how the server chooses handlers when a condition occurs, see [Section 13.6.7.6, “Scope Rules for Handlers”](#).

If a condition occurs for which no handler has been declared, the action taken depends on the condition class:

- For `SQLEXCEPTION` conditions, the stored program terminates at the statement that raised the condition, as if there were an `EXIT` handler. If the program was called by another stored program, the calling program handles the condition using the handler selection rules applied to its own handlers.
- For `SQLWARNING` conditions, the program continues executing, as if there were a `CONTINUE` handler.
- For `NOT FOUND` conditions, if the condition was raised normally, the action is `CONTINUE`. If it was raised by `SIGNAL` or `RESIGNAL`, the action is `EXIT`.

The following example uses a handler for `SQLSTATE '23000'`, which occurs for a duplicate-key error:

```
mysql> CREATE TABLE test.t (s1 INT, PRIMARY KEY (s1));
Query OK, 0 rows affected (0.00 sec)

mysql> delimiter //

mysql> CREATE PROCEDURE handlerdemo ()
BEGIN
  DECLARE CONTINUE HANDLER FOR SQLSTATE '23000' SET @x2 = 1;
  SET @x = 1;
  INSERT INTO test.t VALUES (1);
  SET @x = 2;
  INSERT INTO test.t VALUES (1);
  SET @x = 3;
END;
//
Query OK, 0 rows affected (0.00 sec)

mysql> CALL handlerdemo();//
Query OK, 0 rows affected (0.00 sec)

mysql> SELECT @x//
+-----+
| @x   |
+-----+
| 3    |
+-----+
1 row in set (0.00 sec)
```

Notice that `@x` is 3 after the procedure executes, which shows that execution continued to the end of the procedure after the error occurred. If the `DECLARE ... HANDLER` statement had not been present, MySQL would have taken the default action (`EXIT`) after the second `INSERT` failed due to the `PRIMARY KEY` constraint, and `SELECT @x` would have returned 2.

To ignore a condition, declare a `CONTINUE` handler for it and associate it with an empty block. For example:

```
DECLARE CONTINUE HANDLER FOR SQLWARNING BEGIN END;
```

The scope of a block label does not include the code for handlers declared within the block. Therefore, the statement associated with a handler cannot use `ITERATE` or `LEAVE` to refer to labels for blocks that enclose the handler declaration. Consider the following example, where the `REPEAT` block has a label of `retry`:

```
CREATE PROCEDURE p ()
BEGIN
```

```

DECLARE i INT DEFAULT 3;
retry:
  REPEAT
  BEGIN
    DECLARE CONTINUE HANDLER FOR SQLWARNING
    BEGIN
      ITERATE retry;    # illegal
    END;
    IF i < 0 THEN
      LEAVE retry;      # legal
    END IF;
    SET i = i - 1;
  END;
UNTIL FALSE END REPEAT;
END;
    
```

The `retry` label is in scope for the `IF` statement within the block. It is not in scope for the `CONTINUE` handler, so the reference there is invalid and results in an error:

```
ERROR 1308 (42000): LEAVE with no matching label: retry
```

To avoid references to outer labels in handlers, use one of these strategies:

- To leave the block, use an `EXIT` handler. If no block cleanup is required, the `BEGIN ... END` handler body can be empty:

```
DECLARE EXIT HANDLER FOR SQLWARNING BEGIN END;
```

Otherwise, put the cleanup statements in the handler body:

```

DECLARE EXIT HANDLER FOR SQLWARNING
BEGIN
  block cleanup statements
END;
    
```

- To continue execution, set a status variable in a `CONTINUE` handler that can be checked in the enclosing block to determine whether the handler was invoked. The following example uses the variable `done` for this purpose:

```

CREATE PROCEDURE p ()
BEGIN
  DECLARE i INT DEFAULT 3;
  DECLARE done INT DEFAULT FALSE;
  retry:
  REPEAT
  BEGIN
    DECLARE CONTINUE HANDLER FOR SQLWARNING
    BEGIN
      SET done = TRUE;
    END;
    IF done OR i < 0 THEN
      LEAVE retry;
    END IF;
    SET i = i - 1;
  END;
UNTIL FALSE END REPEAT;
END;
    
```

### 13.6.7.3 GET DIAGNOSTICS Statement

```

GET [CURRENT | STACKED] DIAGNOSTICS {
  statement_information_item
  [, statement_information_item] ...
  | CONDITION condition_number
    
```

```

    condition_information_item
    [, condition_information_item] ...
}

statement_information_item:
    target = statement_information_item_name

condition_information_item:
    target = condition_information_item_name

statement_information_item_name: {
    NUMBER
    | ROW_COUNT
}

condition_information_item_name: {
    CLASS_ORIGIN
    | SUBCLASS_ORIGIN
    | RETURNED_SQLSTATE
    | MESSAGE_TEXT
    | MYSQL_ERRNO
    | CONSTRAINT_CATALOG
    | CONSTRAINT_SCHEMA
    | CONSTRAINT_NAME
    | CATALOG_NAME
    | SCHEMA_NAME
    | TABLE_NAME
    | COLUMN_NAME
    | CURSOR_NAME
}

condition_number, target:
    (see following discussion)

```

SQL statements produce diagnostic information that populates the diagnostics area. The `GET DIAGNOSTICS` statement enables applications to inspect this information. (You can also use `SHOW WARNINGS` or `SHOW ERRORS` to see conditions or errors.)

No special privileges are required to execute `GET DIAGNOSTICS`.

The keyword `CURRENT` means to retrieve information from the current diagnostics area. The keyword `STACKED` means to retrieve information from the second diagnostics area, which is available only if the current context is a condition handler. If neither keyword is given, the default is to use the current diagnostics area.

The `GET DIAGNOSTICS` statement is typically used in a handler within a stored program. It is a MySQL extension that `GET [CURRENT] DIAGNOSTICS` is permitted outside handler context to check the execution of any SQL statement. For example, if you invoke the `mysql` client program, you can enter these statements at the prompt:

```

mysql> DROP TABLE test.no_such_table;
ERROR 1051 (42S02): Unknown table 'test.no_such_table'
mysql> GET DIAGNOSTICS CONDITION 1
        @p1 = RETURNED_SQLSTATE, @p2 = MESSAGE_TEXT;
mysql> SELECT @p1, @p2;
+-----+-----+
| @p1   | @p2   |
+-----+-----+
| 42S02 | Unknown table 'test.no_such_table' |
+-----+-----+

```

This extension applies only to the current diagnostics area. It does not apply to the second diagnostics area because `GET STACKED DIAGNOSTICS` is permitted only if the current context is a condition handler. If that is not the case, a `GET STACKED DIAGNOSTICS when handler not active` error occurs.



For a description of the diagnostics area, see [Section 13.6.7.7, “The MySQL Diagnostics Area”](#). Briefly, it contains two kinds of information:

- Statement information, such as the number of conditions that occurred or the affected-rows count.
- Condition information, such as the error code and message. If a statement raises multiple conditions, this part of the diagnostics area has a condition area for each one. If a statement raises no conditions, this part of the diagnostics area is empty.

For a statement that produces three conditions, the diagnostics area contains statement and condition information like this:

```
Statement information:
  row count
  ... other statement information items ...
Condition area list:
  Condition area 1:
    error code for condition 1
    error message for condition 1
    ... other condition information items ...
  Condition area 2:
    error code for condition 2:
    error message for condition 2
    ... other condition information items ...
  Condition area 3:
    error code for condition 3
    error message for condition 3
    ... other condition information items ...
```

`GET DIAGNOSTICS` can obtain either statement or condition information, but not both in the same statement:

- To obtain statement information, retrieve the desired statement items into target variables. This instance of `GET DIAGNOSTICS` assigns the number of available conditions and the rows-affected count to the user variables `@p1` and `@p2`:

```
GET DIAGNOSTICS @p1 = NUMBER, @p2 = ROW_COUNT;
```

- To obtain condition information, specify the condition number and retrieve the desired condition items into target variables. This instance of `GET DIAGNOSTICS` assigns the SQLSTATE value and error message to the user variables `@p3` and `@p4`:

```
GET DIAGNOSTICS CONDITION 1
  @p3 = RETURNED_SQLSTATE, @p4 = MESSAGE_TEXT;
```

The retrieval list specifies one or more `target = item_name` assignments, separated by commas. Each assignment names a target variable and either a `statement_information_item_name` or `condition_information_item_name` designator, depending on whether the statement retrieves statement or condition information.

Valid `target` designators for storing item information can be stored procedure or function parameters, stored program local variables declared with `DECLARE`, or user-defined variables.

Valid `condition_number` designators can be stored procedure or function parameters, stored program local variables declared with `DECLARE`, user-defined variables, system variables, or literals. A character literal may include a `_charset` introducer. A warning occurs if the condition number is not in the range from 1 to the number of condition areas that have information. In this case, the warning is added to the diagnostics area without clearing it.

When a condition occurs, MySQL does not populate all condition items recognized by `GET DIAGNOSTICS`. For example:

```
mysql> GET DIAGNOSTICS CONDITION 1
      @p5 = SCHEMA_NAME, @p6 = TABLE_NAME;
mysql> SELECT @p5, @p6;
+-----+-----+
| @p5   | @p6   |
+-----+-----+
|       |       |
+-----+-----+
```

In standard SQL, if there are multiple conditions, the first condition relates to the `SQLSTATE` value returned for the previous SQL statement. In MySQL, this is not guaranteed. To get the main error, you cannot do this:

```
GET DIAGNOSTICS CONDITION 1 @errno = MYSQL_ERRNO;
```

Instead, retrieve the condition count first, then use it to specify which condition number to inspect:

```
GET DIAGNOSTICS @cno = NUMBER;
GET DIAGNOSTICS CONDITION @cno @errno = MYSQL_ERRNO;
```

For information about permissible statement and condition information items, and which ones are populated when a condition occurs, see [Diagnostics Area Information Items](#).

Here is an example that uses `GET DIAGNOSTICS` and an exception handler in stored procedure context to assess the outcome of an insert operation. If the insert was successful, the procedure uses `GET DIAGNOSTICS` to get the rows-affected count. This shows that you can use `GET DIAGNOSTICS` multiple times to retrieve information about a statement as long as the current diagnostics area has not been cleared.

```
CREATE PROCEDURE do_insert(value INT)
BEGIN
  -- Declare variables to hold diagnostics area information
  DECLARE code CHAR(5) DEFAULT '00000';
  DECLARE msg TEXT;
  DECLARE nrows INT;
  DECLARE result TEXT;
  -- Declare exception handler for failed insert
  DECLARE CONTINUE HANDLER FOR SQLEXCEPTION
  BEGIN
    GET DIAGNOSTICS CONDITION 1
      code = RETURNED_SQLSTATE, msg = MESSAGE_TEXT;
  END;

  -- Perform the insert
  INSERT INTO t1 (int_col) VALUES(value);
  -- Check whether the insert was successful
  IF code = '00000' THEN
    GET DIAGNOSTICS nrows = ROW_COUNT;
    SET result = CONCAT('insert succeeded, row count = ',nrows);
  ELSE
    SET result = CONCAT('insert failed, error = ',code,', message = ',msg);
  END IF;
  -- Say what happened
  SELECT result;
END;
```

Suppose that `t1.int_col` is an integer column that is declared as `NOT NULL`. The procedure produces these results when invoked to insert non-`NULL` and `NULL` values, respectively:

```
mysql> CALL do_insert(1);
+-----+-----+
| result                                     |
+-----+-----+
| insert succeeded, row count = 1           |
+-----+-----+
```

```

+-----+
mysql> CALL do_insert(NULL);
+-----+
| result                                     |
+-----+
| insert failed, error = 23000, message = Column 'int_col' cannot be null |
+-----+

```

When a condition handler activates, a push to the diagnostics area stack occurs:

- The first (current) diagnostics area becomes the second (stacked) diagnostics area and a new current diagnostics area is created as a copy of it.
- `GET [CURRENT] DIAGNOSTICS` and `GET STACKED DIAGNOSTICS` can be used within the handler to access the contents of the current and stacked diagnostics areas.
- Initially, both diagnostics areas return the same result, so it is possible to get information from the current diagnostics area about the condition that activated the handler, *as long as* you execute no statements within the handler that change its current diagnostics area.
- However, statements executing within the handler can modify the current diagnostics area, clearing and setting its contents according to the normal rules (see [How the Diagnostics Area is Cleared and Populated](#)).

A more reliable way to obtain information about the handler-activating condition is to use the stacked diagnostics area, which cannot be modified by statements executing within the handler except `RESIGNAL`. For information about when the current diagnostics area is set and cleared, see [Section 13.6.7.7, “The MySQL Diagnostics Area”](#).

The next example shows how `GET STACKED DIAGNOSTICS` can be used within a handler to obtain information about the handled exception, even after the current diagnostics area has been modified by handler statements.

Within a stored procedure `p()`, we attempt to insert two values into a table that contains a `TEXT NOT NULL` column. The first value is a non-`NULL` string and the second is `NULL`. The column prohibits `NULL` values, so the first insert succeeds but the second causes an exception. The procedure includes an exception handler that maps attempts to insert `NULL` into inserts of the empty string:

```

DROP TABLE IF EXISTS t1;
CREATE TABLE t1 (c1 TEXT NOT NULL);
DROP PROCEDURE IF EXISTS p;
delimiter //
CREATE PROCEDURE p ()
BEGIN
  -- Declare variables to hold diagnostics area information
  DECLARE errcount INT;
  DECLARE errno INT;
  DECLARE msg TEXT;
  DECLARE EXIT HANDLER FOR SQLEXCEPTION
  BEGIN
    -- Here the current DA is nonempty because no prior statements
    -- executing within the handler have cleared it
    GET CURRENT DIAGNOSTICS CONDITION 1
      errno = MYSQL_ERRNO, msg = MESSAGE_TEXT;
    SELECT 'current DA before mapped insert' AS op, errno, msg;
    GET STACKED DIAGNOSTICS CONDITION 1
      errno = MYSQL_ERRNO, msg = MESSAGE_TEXT;
    SELECT 'stacked DA before mapped insert' AS op, errno, msg;

    -- Map attempted NULL insert to empty string insert
    INSERT INTO t1 (c1) VALUES('');
  
```

```

-- Here the current DA should be empty (if the INSERT succeeded),
-- so check whether there are conditions before attempting to
-- obtain condition information
GET CURRENT DIAGNOSTICS errcount = NUMBER;
IF errcount = 0
THEN
  SELECT 'mapped insert succeeded, current DA is empty' AS op;
ELSE
  GET CURRENT DIAGNOSTICS CONDITION 1
  errno = MYSQL_ERRNO, msg = MESSAGE_TEXT;
  SELECT 'current DA after mapped insert' AS op, errno, msg;
END IF ;
GET STACKED DIAGNOSTICS CONDITION 1
  errno = MYSQL_ERRNO, msg = MESSAGE_TEXT;
  SELECT 'stacked DA after mapped insert' AS op, errno, msg;
END;
INSERT INTO t1 (c1) VALUES('string 1');
INSERT INTO t1 (c1) VALUES(NULL);
END;
//
delimiter ;
CALL p();
SELECT * FROM t1;

```

When the handler activates, a copy of the current diagnostics area is pushed to the diagnostics area stack. The handler first displays the contents of the current and stacked diagnostics areas, which are both the same initially:

```

+-----+-----+-----+
| op                | errno | msg                |
+-----+-----+-----+
| current DA before mapped insert | 1048 | Column 'c1' cannot be null |
+-----+-----+-----+

+-----+-----+-----+
| op                | errno | msg                |
+-----+-----+-----+
| stacked DA before mapped insert | 1048 | Column 'c1' cannot be null |
+-----+-----+-----+

```

Statements executing after the `GET DIAGNOSTICS` statements may reset the current diagnostics area. For example, the handler maps the `NULL` insert to an empty-string insert and displays the result. The new insert succeeds and clears the current diagnostics area, but the stacked diagnostics area remains unchanged and still contains information about the condition that activated the handler:

```

+-----+-----+-----+
| op                |
+-----+-----+-----+
| mapped insert succeeded, current DA is empty |
+-----+-----+-----+

+-----+-----+-----+
| op                | errno | msg                |
+-----+-----+-----+
| stacked DA after mapped insert | 1048 | Column 'c1' cannot be null |
+-----+-----+-----+

```

When the condition handler ends, its current diagnostics area is popped from the stack and the stacked diagnostics area becomes the current diagnostics area in the stored procedure.

After the procedure returns, the table contains two rows. The empty row results from the attempt to insert `NULL` that was mapped to an empty-string insert:

```
+-----+
| c1      |
+-----+
| string 1 |
|         |
+-----+
```

In the preceding example, the first two `GET DIAGNOSTICS` statements within the condition handler that retrieve information from the current and stacked diagnostics areas return the same values. This is not the case if statements that reset the current diagnostics area executed earlier within the handler. Suppose that `p()` is rewritten to place the `DECLARE` statements within the handler definition rather than preceding it:

```
CREATE PROCEDURE p ()
BEGIN
  DECLARE EXIT HANDLER FOR SQLEXCEPTION
  BEGIN
    -- Declare variables to hold diagnostics area information
    DECLARE errcount INT;
    DECLARE errno INT;
    DECLARE msg TEXT;
    GET CURRENT DIAGNOSTICS CONDITION 1
      errno = MYSQL_ERRNO, msg = MESSAGE_TEXT;
    SELECT 'current DA before mapped insert' AS op, errno, msg;
    GET STACKED DIAGNOSTICS CONDITION 1
      errno = MYSQL_ERRNO, msg = MESSAGE_TEXT;
    SELECT 'stacked DA before mapped insert' AS op, errno, msg;
    ...
  
```

In this case, the result is version dependent:

- Before MySQL 5.7.2, `DECLARE` does not change the current diagnostics area, so the first two `GET DIAGNOSTICS` statements return the same result, just as in the original version of `p()`.

In MySQL 5.7.2, work was done to ensure that all nondiagnostic statements populate the diagnostics area, per the SQL standard. `DECLARE` is one of them, so in 5.7.2 and higher, `DECLARE` statements executing at the beginning of the handler clear the current diagnostics area and the `GET DIAGNOSTICS` statements produce different results:

```
+-----+-----+-----+
| op                | errno | msg      |
+-----+-----+-----+
| current DA before mapped insert | NULL  | NULL    |
+-----+-----+-----+

+-----+-----+-----+
| op                | errno | msg      |
+-----+-----+-----+
| stacked DA before mapped insert | 1048  | Column 'c1' cannot be null |
+-----+-----+-----+
```

To avoid this issue within a condition handler when seeking to obtain information about the condition that activated the handler, be sure to access the stacked diagnostics area, not the current diagnostics area.

### 13.6.7.4 RESIGNAL Statement

```
RESIGNAL [condition_value]
  [SET signal_information_item
  [, signal_information_item] ...]

condition_value: {
  SQLSTATE [VALUE] sqlstate_value
  | condition_name
}
```

```

signal_information_item:
    condition_information_item_name = simple_value_specification

condition_information_item_name: {
    CLASS_ORIGIN
| SUBCLASS_ORIGIN
| MESSAGE_TEXT
| MYSQL_ERRNO
| CONSTRAINT_CATALOG
| CONSTRAINT_SCHEMA
| CONSTRAINT_NAME
| CATALOG_NAME
| SCHEMA_NAME
| TABLE_NAME
| COLUMN_NAME
| CURSOR_NAME
}

condition_name, simple_value_specification:
    (see following discussion)

```

**RESIGNAL** passes on the error condition information that is available during execution of a condition handler within a compound statement inside a stored procedure or function, trigger, or event. **RESIGNAL** may change some or all information before passing it on. **RESIGNAL** is related to **SIGNAL**, but instead of originating a condition as **SIGNAL** does, **RESIGNAL** relays existing condition information, possibly after modifying it.

**RESIGNAL** makes it possible to both handle an error and return the error information. Otherwise, by executing an SQL statement within the handler, information that caused the handler's activation is destroyed. **RESIGNAL** also can make some procedures shorter if a given handler can handle part of a situation, then pass the condition “up the line” to another handler.

No privileges are required to execute the **RESIGNAL** statement.

All forms of **RESIGNAL** require that the current context be a condition handler. Otherwise, **RESIGNAL** is illegal and a **RESIGNAL when handler not active** error occurs.

To retrieve information from the diagnostics area, use the **GET DIAGNOSTICS** statement (see [Section 13.6.7.3, “GET DIAGNOSTICS Statement”](#)). For information about the diagnostics area, see [Section 13.6.7.7, “The MySQL Diagnostics Area”](#).

- [RESIGNAL Overview](#)
- [RESIGNAL Alone](#)
- [RESIGNAL with New Signal Information](#)
- [RESIGNAL with a Condition Value and Optional New Signal Information](#)
- [RESIGNAL Requires Condition Handler Context](#)

## RESIGNAL Overview

For *condition\_value* and *signal\_information\_item*, the definitions and rules are the same for **RESIGNAL** as for **SIGNAL**. For example, the *condition\_value* can be an **SQLSTATE** value, and the value can indicate errors, warnings, or “not found.” For additional information, see [Section 13.6.7.5, “SIGNAL Statement”](#).

The **RESIGNAL** statement takes *condition\_value* and **SET** clauses, both of which are optional. This leads to several possible uses:

- `RESIGNAL` alone:

```
RESIGNAL;
```

- `RESIGNAL` with new signal information:

```
RESIGNAL SET signal_information_item [, signal_information_item] ...;
```

- `RESIGNAL` with a condition value and possibly new signal information:

```
RESIGNAL condition_value  
[SET signal_information_item [, signal_information_item] ...];
```

These use cases all cause changes to the diagnostics and condition areas:

- A diagnostics area contains one or more condition areas.
- A condition area contains condition information items, such as the `SQLSTATE` value, `MYSQL_ERRNO`, or `MESSAGE_TEXT`.

There is a stack of diagnostics areas. When a handler takes control, it pushes a diagnostics area to the top of the stack, so there are two diagnostics areas during handler execution:

- The first (current) diagnostics area, which starts as a copy of the last diagnostics area, but is overwritten by the first statement in the handler that changes the current diagnostics area.
- The last (stacked) diagnostics area, which has the condition areas that were set up before the handler took control.

The maximum number of condition areas in a diagnostics area is determined by the value of the `max_error_count` system variable. See [Diagnostics Area-Related System Variables](#).

## RESIGNAL Alone

A simple `RESIGNAL` alone means “pass on the error with no change.” It restores the last diagnostics area and makes it the current diagnostics area. That is, it “pops” the diagnostics area stack.

Within a condition handler that catches a condition, one use for `RESIGNAL` alone is to perform some other actions, and then pass on without change the original condition information (the information that existed before entry into the handler).

Example:

```
DROP TABLE IF EXISTS xx;
delimiter //
CREATE PROCEDURE p ()
BEGIN
  DECLARE EXIT HANDLER FOR SQLEXCEPTION
  BEGIN
    SET @error_count = @error_count + 1;
    IF @a = 0 THEN RESIGNAL; END IF;
  END;
  DROP TABLE xx;
END//
delimiter ;
SET @error_count = 0;
SET @a = 0;
CALL p();
```

Suppose that the `DROP TABLE xx` statement fails. The diagnostics area stack looks like this:

```
DA 1. ERROR 1051 (42S02): Unknown table 'xx'
```

Then execution enters the `EXIT` handler. It starts by pushing a diagnostics area to the top of the stack, which now looks like this:

```
DA 1. ERROR 1051 (42S02): Unknown table 'xx'
DA 2. ERROR 1051 (42S02): Unknown table 'xx'
```

At this point, the contents of the first (current) and second (stacked) diagnostics areas are the same. The first diagnostics area may be modified by statements executing subsequently within the handler.

Usually a procedure statement clears the first diagnostics area. `BEGIN` is an exception, it does not clear, it does nothing. `SET` is not an exception, it clears, performs the operation, and produces a result of “success.” The diagnostics area stack now looks like this:

```
DA 1. ERROR 0000 (00000): Successful operation
DA 2. ERROR 1051 (42S02): Unknown table 'xx'
```

At this point, if `@a = 0`, `RESIGNAL` pops the diagnostics area stack, which now looks like this:

```
DA 1. ERROR 1051 (42S02): Unknown table 'xx'
```

And that is what the caller sees.

If `@a` is not 0, the handler simply ends, which means that there is no more use for the current diagnostics area (it has been “handled”), so it can be thrown away, causing the stacked diagnostics area to become the current diagnostics area again. The diagnostics area stack looks like this:

```
DA 1. ERROR 0000 (00000): Successful operation
```

The details make it look complex, but the end result is quite useful: Handlers can execute without destroying information about the condition that caused activation of the handler.

## RESIGNAL with New Signal Information

`RESIGNAL` with a `SET` clause provides new signal information, so the statement means “pass on the error with changes”:

```
RESIGNAL SET signal_information_item [, signal_information_item] ...;
```

As with `RESIGNAL` alone, the idea is to pop the diagnostics area stack so that the original information goes out. Unlike `RESIGNAL` alone, anything specified in the `SET` clause changes.

Example:

```
DROP TABLE IF EXISTS xx;
delimiter //
CREATE PROCEDURE p ()
BEGIN
  DECLARE EXIT HANDLER FOR SQLEXCEPTION
  BEGIN
    SET @error_count = @error_count + 1;
    IF @a = 0 THEN RESIGNAL SET MYSQL_ERRNO = 5; END IF;
  END;
  DROP TABLE xx;
END//
delimiter ;
SET @error_count = 0;
SET @a = 0;
CALL p();
```

Remember from the previous discussion that `RESIGNAL` alone results in a diagnostics area stack like this:

```
DA 1. ERROR 1051 (42S02): Unknown table 'xx'
```



The `RESIGNAL SET MYSQL_ERRNO = 5` statement results in this stack instead, which is what the caller sees:

```
DA 1. ERROR 5 (42S02): Unknown table 'xx'
```

In other words, it changes the error number, and nothing else.

The `RESIGNAL` statement can change any or all of the signal information items, making the first condition area of the diagnostics area look quite different.

## RESIGNAL with a Condition Value and Optional New Signal Information

`RESIGNAL` with a condition value means “push a condition into the current diagnostics area.” If the `SET` clause is present, it also changes the error information.

```
RESIGNAL condition_value
    [SET signal_information_item [, signal_information_item] ...];
```

This form of `RESIGNAL` restores the last diagnostics area and makes it the current diagnostics area. That is, it “pops” the diagnostics area stack, which is the same as what a simple `RESIGNAL` alone would do. However, it also changes the diagnostics area depending on the condition value or signal information.

Example:

```
DROP TABLE IF EXISTS xx;
delimiter //
CREATE PROCEDURE p ()
BEGIN
    DECLARE EXIT HANDLER FOR SQLEXCEPTION
    BEGIN
        SET @error_count = @error_count + 1;
        IF @a = 0 THEN RESIGNAL SQLSTATE '45000' SET MYSQL_ERRNO=5; END IF;
    END;
    DROP TABLE xx;
END//
delimiter ;
SET @error_count = 0;
SET @a = 0;
SET @@max_error_count = 2;
CALL p();
SHOW ERRORS;
```

This is similar to the previous example, and the effects are the same, except that if `RESIGNAL` happens, the current condition area looks different at the end. (The reason the condition adds to rather than replaces the existing condition is the use of a condition value.)

The `RESIGNAL` statement includes a condition value (`SQLSTATE '45000'`), so it adds a new condition area, resulting in a diagnostics area stack that looks like this:

```
DA 1. (condition 2) ERROR 1051 (42S02): Unknown table 'xx'
      (condition 1) ERROR 5 (45000) Unknown table 'xx'
```

The result of `CALL p()` and `SHOW ERRORS` for this example is:

```
mysql> CALL p();
ERROR 5 (45000): Unknown table 'xx'
mysql> SHOW ERRORS;
+-----+-----+-----+
| Level | Code | Message                |
+-----+-----+-----+
| Error | 1051 | Unknown table 'xx'    |
| Error | 5    | Unknown table 'xx'    |
+-----+-----+-----+
```

## RESIGNAL Requires Condition Handler Context

All forms of `RESIGNAL` require that the current context be a condition handler. Otherwise, `RESIGNAL` is illegal and a `RESIGNAL when handler not active` error occurs. For example:

```
mysql> CREATE PROCEDURE p () RESIGNAL;
Query OK, 0 rows affected (0.00 sec)

mysql> CALL p();
ERROR 1645 (0K000): RESIGNAL when handler not active
```

Here is a more difficult example:

```
delimiter //
CREATE FUNCTION f () RETURNS INT
BEGIN
  RESIGNAL;
  RETURN 5;
END//
CREATE PROCEDURE p ()
BEGIN
  DECLARE EXIT HANDLER FOR SQLEXCEPTION SET @a=f();
  SIGNAL SQLSTATE '55555';
END//
delimiter ;
CALL p();
```

`RESIGNAL` occurs within the stored function `f()`. Although `f()` itself is invoked within the context of the `EXIT` handler, execution within `f()` has its own context, which is not handler context. Thus, `RESIGNAL` within `f()` results in a “handler not active” error.

### 13.6.7.5 SIGNAL Statement

```
SIGNAL condition_value
  [SET signal_information_item
  [, signal_information_item] ...]

condition_value: {
  SQLSTATE [VALUE] sqlstate_value
  | condition_name
}

signal_information_item:
  condition_information_item_name = simple_value_specification

condition_information_item_name: {
  CLASS_ORIGIN
  | SUBCLASS_ORIGIN
  | MESSAGE_TEXT
  | MYSQL_ERRNO
  | CONSTRAINT_CATALOG
  | CONSTRAINT_SCHEMA
  | CONSTRAINT_NAME
  | CATALOG_NAME
  | SCHEMA_NAME
  | TABLE_NAME
  | COLUMN_NAME
  | CURSOR_NAME
}

condition_name, simple_value_specification:
  (see following discussion)
```

`SIGNAL` is the way to “return” an error. `SIGNAL` provides error information to a handler, to an outer portion of the application, or to the client. Also, it provides control over the error's characteristics (error number,

`SQLSTATE` value, message). Without `SIGNAL`, it is necessary to resort to workarounds such as deliberately referring to a nonexistent table to cause a routine to return an error.

No privileges are required to execute the `SIGNAL` statement.

To retrieve information from the diagnostics area, use the `GET DIAGNOSTICS` statement (see [Section 13.6.7.3, “GET DIAGNOSTICS Statement”](#)). For information about the diagnostics area, see [Section 13.6.7.7, “The MySQL Diagnostics Area”](#).

- [SIGNAL Overview](#)
- [Signal Condition Information Items](#)
- [Effect of Signals on Handlers, Cursors, and Statements](#)

## SIGNAL Overview

The *condition\_value* in a `SIGNAL` statement indicates the error value to be returned. It can be an `SQLSTATE` value (a 5-character string literal) or a *condition\_name* that refers to a named condition previously defined with `DECLARE ... CONDITION` (see [Section 13.6.7.1, “DECLARE ... CONDITION Statement”](#)).

An `SQLSTATE` value can indicate errors, warnings, or “not found.” The first two characters of the value indicate its error class, as discussed in [Signal Condition Information Items](#). Some signal values cause statement termination; see [Effect of Signals on Handlers, Cursors, and Statements](#).

The `SQLSTATE` value for a `SIGNAL` statement should not start with '00' because such values indicate success and are not valid for signaling an error. This is true whether the `SQLSTATE` value is specified directly in the `SIGNAL` statement or in a named condition referred to in the statement. If the value is invalid, a `Bad SQLSTATE` error occurs.

To signal a generic `SQLSTATE` value, use '45000', which means “unhandled user-defined exception.”

The `SIGNAL` statement optionally includes a `SET` clause that contains multiple signal items, in a list of *condition\_information\_item\_name* = *simple\_value\_specification* assignments, separated by commas.

Each *condition\_information\_item\_name* may be specified only once in the `SET` clause. Otherwise, a `Duplicate condition information item` error occurs.

Valid *simple\_value\_specification* designators can be specified using stored procedure or function parameters, stored program local variables declared with `DECLARE`, user-defined variables, system variables, or literals. A character literal may include a `_charset` introducer.

For information about permissible *condition\_information\_item\_name* values, see [Signal Condition Information Items](#).

The following procedure signals an error or warning depending on the value of `pval`, its input parameter:

```
CREATE PROCEDURE p (pval INT)
BEGIN
  DECLARE specialty CONDITION FOR SQLSTATE '45000';
  IF pval = 0 THEN
    SIGNAL SQLSTATE '01000';
  ELSEIF pval = 1 THEN
    SIGNAL SQLSTATE '45000'
    SET MESSAGE_TEXT = 'An error occurred';
  ELSEIF pval = 2 THEN
    SIGNAL specialty
```

```

        SET MESSAGE_TEXT = 'An error occurred';
    ELSE
        SIGNAL SQLSTATE '01000'
        SET MESSAGE_TEXT = 'A warning occurred', MYSQL_ERRNO = 1000;
        SIGNAL SQLSTATE '45000'
        SET MESSAGE_TEXT = 'An error occurred', MYSQL_ERRNO = 1001;
    END IF;
END;

```

If `pval` is 0, `p()` signals a warning because `SQLSTATE` values that begin with '01' are signals in the warning class. The warning does not terminate the procedure, and can be seen with `SHOW WARNINGS` after the procedure returns.

If `pval` is 1, `p()` signals an error and sets the `MESSAGE_TEXT` condition information item. The error terminates the procedure, and the text is returned with the error information.

If `pval` is 2, the same error is signaled, although the `SQLSTATE` value is specified using a named condition in this case.

If `pval` is anything else, `p()` first signals a warning and sets the message text and error number condition information items. This warning does not terminate the procedure, so execution continues and `p()` then signals an error. The error does terminate the procedure. The message text and error number set by the warning are replaced by the values set by the error, which are returned with the error information.

`SIGNAL` is typically used within stored programs, but it is a MySQL extension that it is permitted outside handler context. For example, if you invoke the `mysql` client program, you can enter any of these statements at the prompt:

```

SIGNAL SQLSTATE '77777';

CREATE TRIGGER t_bi BEFORE INSERT ON t
  FOR EACH ROW SIGNAL SQLSTATE '77777';

CREATE EVENT e ON SCHEDULE EVERY 1 SECOND
  DO SIGNAL SQLSTATE '77777';

```

`SIGNAL` executes according to the following rules:

If the `SIGNAL` statement indicates a particular `SQLSTATE` value, that value is used to signal the condition specified. Example:

```

CREATE PROCEDURE p (divisor INT)
BEGIN
  IF divisor = 0 THEN
    SIGNAL SQLSTATE '22012';
  END IF;
END;

```

If the `SIGNAL` statement uses a named condition, the condition must be declared in some scope that applies to the `SIGNAL` statement, and must be defined using an `SQLSTATE` value, not a MySQL error number. Example:

```

CREATE PROCEDURE p (divisor INT)
BEGIN
  DECLARE divide_by_zero CONDITION FOR SQLSTATE '22012';
  IF divisor = 0 THEN
    SIGNAL divide_by_zero;
  END IF;
END;

```

If the named condition does not exist in the scope of the `SIGNAL` statement, an `Undefined CONDITION` error occurs.

If `SIGNAL` refers to a named condition that is defined with a MySQL error number rather than an `SQLSTATE` value, a `SIGNAL/RESIGNAL` can only use a `CONDITION` defined with `SQLSTATE` error occurs. The following statements cause that error because the named condition is associated with a MySQL error number:

```
DECLARE no_such_table CONDITION FOR 1051;
SIGNAL no_such_table;
```

If a condition with a given name is declared multiple times in different scopes, the declaration with the most local scope applies. Consider the following procedure:

```
CREATE PROCEDURE p (divisor INT)
BEGIN
  DECLARE my_error CONDITION FOR SQLSTATE '45000';
  IF divisor = 0 THEN
    BEGIN
      DECLARE my_error CONDITION FOR SQLSTATE '22012';
      SIGNAL my_error;
    END;
  END IF;
  SIGNAL my_error;
END;
```

If `divisor` is 0, the first `SIGNAL` statement executes. The innermost `my_error` condition declaration applies, raising `SQLSTATE '22012'`.

If `divisor` is not 0, the second `SIGNAL` statement executes. The outermost `my_error` condition declaration applies, raising `SQLSTATE '45000'`.

For information about how the server chooses handlers when a condition occurs, see [Section 13.6.7.6, “Scope Rules for Handlers”](#).

Signals can be raised within exception handlers:

```
CREATE PROCEDURE p ()
BEGIN
  DECLARE EXIT HANDLER FOR SQLEXCEPTION
  BEGIN
    SIGNAL SQLSTATE VALUE '99999'
    SET MESSAGE_TEXT = 'An error occurred';
  END;
  DROP TABLE no_such_table;
END;
```

`CALL p()` reaches the `DROP TABLE` statement. There is no table named `no_such_table`, so the error handler is activated. The error handler destroys the original error (“no such table”) and makes a new error with `SQLSTATE '99999'` and message `An error occurred`.

## Signal Condition Information Items

The following table lists the names of diagnostics area condition information items that can be set in a `SIGNAL` (or `RESIGNAL`) statement. All items are standard SQL except `MYSQL_ERRNO`, which is a MySQL extension. For more information about these items see [Section 13.6.7.7, “The MySQL Diagnostics Area”](#).

Item Name	Definition
CLASS_ORIGIN	VARCHAR(64)
SUBCLASS_ORIGIN	VARCHAR(64)
CONSTRAINT_CATALOG	VARCHAR(64)
CONSTRAINT_SCHEMA	VARCHAR(64)
CONSTRAINT_NAME	VARCHAR(64)
CATALOG_NAME	VARCHAR(64)
SCHEMA_NAME	VARCHAR(64)

TABLE_NAME	VARCHAR(64)
COLUMN_NAME	VARCHAR(64)
CURSOR_NAME	VARCHAR(64)
MESSAGE_TEXT	VARCHAR(128)
MYSQL_ERRNO	SMALLINT UNSIGNED

The character set for character items is UTF-8.

It is illegal to assign `NULL` to a condition information item in a `SIGNAL` statement.

A `SIGNAL` statement always specifies an `SQLSTATE` value, either directly, or indirectly by referring to a named condition defined with an `SQLSTATE` value. The first two characters of an `SQLSTATE` value are its class, and the class determines the default value for the condition information items:

- Class = '00' (success)

Illegal. `SQLSTATE` values that begin with '00' indicate success and are not valid for `SIGNAL`.

- Class = '01' (warning)

```
MESSAGE_TEXT = 'Unhandled user-defined warning condition';
MYSQL_ERRNO = ER_SIGNAL_WARN
```

- Class = '02' (not found)

```
MESSAGE_TEXT = 'Unhandled user-defined not found condition';
MYSQL_ERRNO = ER_SIGNAL_NOT_FOUND
```

- Class > '02' (exception)

```
MESSAGE_TEXT = 'Unhandled user-defined exception condition';
MYSQL_ERRNO = ER_SIGNAL_EXCEPTION
```

For legal classes, the other condition information items are set as follows:

```
CLASS_ORIGIN = SUBCLASS_ORIGIN = '';
CONSTRAINT_CATALOG = CONSTRAINT_SCHEMA = CONSTRAINT_NAME = '';
CATALOG_NAME = SCHEMA_NAME = TABLE_NAME = COLUMN_NAME = '';
CURSOR_NAME = '';
```

The error values that are accessible after `SIGNAL` executes are the `SQLSTATE` value raised by the `SIGNAL` statement and the `MESSAGE_TEXT` and `MYSQL_ERRNO` items. These values are available from the C API:

- `mysql_sqlstate()` returns the `SQLSTATE` value.
- `mysql_errno()` returns the `MYSQL_ERRNO` value.
- `mysql_error()` returns the `MESSAGE_TEXT` value.

At the SQL level, the output from `SHOW WARNINGS` and `SHOW ERRORS` indicates the `MYSQL_ERRNO` and `MESSAGE_TEXT` values in the `Code` and `Message` columns.

To retrieve information from the diagnostics area, use the `GET DIAGNOSTICS` statement (see [Section 13.6.7.3, “GET DIAGNOSTICS Statement”](#)). For information about the diagnostics area, see [Section 13.6.7.7, “The MySQL Diagnostics Area”](#).

## Effect of Signals on Handlers, Cursors, and Statements

Signals have different effects on statement execution depending on the signal class. The class determines how severe an error is. MySQL ignores the value of the `sql_mode` system variable; in particular, strict SQL mode does not matter. MySQL also ignores `IGNORE`: The intent of `SIGNAL` is to raise a user-generated error explicitly, so a signal is never ignored.

In the following descriptions, “unhandled” means that no handler for the signaled `SQLSTATE` value has been defined with `DECLARE ... HANDLER`.

- Class = '00' (success)

Illegal. `SQLSTATE` values that begin with '00' indicate success and are not valid for `SIGNAL`.

- Class = '01' (warning)

The value of the `warning_count` system variable goes up. `SHOW WARNINGS` shows the signal. `SQLWARNING` handlers catch the signal.

Warnings cannot be returned from stored functions because the `RETURN` statement that causes the function to return clears the diagnostic area. The statement thus clears any warnings that may have been present there (and resets `warning_count` to 0).

- Class = '02' (not found)

`NOT FOUND` handlers catch the signal. There is no effect on cursors. If the signal is unhandled in a stored function, statements end.

- Class > '02' (exception)

`SQLEXCEPTION` handlers catch the signal. If the signal is unhandled in a stored function, statements end.

- Class = '40'

Treated as an ordinary exception.

### 13.6.7.6 Scope Rules for Handlers

A stored program may include handlers to be invoked when certain conditions occur within the program. The applicability of each handler depends on its location within the program definition and on the condition or conditions that it handles:

- A handler declared in a `BEGIN ... END` block is in scope only for the SQL statements following the handler declarations in the block. If the handler itself raises a condition, it cannot handle that condition, nor can any other handlers declared in the block. In the following example, handlers `H1` and `H2` are in scope for conditions raised by statements `stmt1` and `stmt2`. But neither `H1` nor `H2` are in scope for conditions raised in the body of `H1` or `H2`.

```
BEGIN -- outer block
  DECLARE EXIT HANDLER FOR ...; -- handler H1
  DECLARE EXIT HANDLER FOR ...; -- handler H2
  stmt1;
  stmt2;
END;
```

- A handler is in scope only for the block in which it is declared, and cannot be activated for conditions occurring outside that block. In the following example, handler `H1` is in scope for `stmt1` in the inner block, but not for `stmt2` in the outer block:

```
BEGIN -- outer block
  BEGIN -- inner block
    DECLARE EXIT HANDLER FOR ...; -- handler H1
    stmt1;
  END;
  stmt2;
END;
```

- A handler can be specific or general. A specific handler is for a MySQL error code, `SQLSTATE` value, or condition name. A general handler is for a condition in the `SQLWARNING`, `SQLEXCEPTION`, or `NOT FOUND` class. Condition specificity is related to condition precedence, as described later.

Multiple handlers can be declared in different scopes and with different specificities. For example, there might be a specific MySQL error code handler in an outer block, and a general `SQLWARNING` handler in an inner block. Or there might be handlers for a specific MySQL error code and the general `SQLWARNING` class in the same block.

Whether a handler is activated depends not only on its own scope and condition value, but on what other handlers are present. When a condition occurs in a stored program, the server searches for applicable handlers in the current scope (current `BEGIN . . . END` block). If there are no applicable handlers, the search continues outward with the handlers in each successive containing scope (block). When the server finds one or more applicable handlers at a given scope, it chooses among them based on condition precedence:

- A MySQL error code handler takes precedence over an `SQLSTATE` value handler.
- An `SQLSTATE` value handler takes precedence over general `SQLWARNING`, `SQLEXCEPTION`, or `NOT FOUND` handlers.
- An `SQLEXCEPTION` handler takes precedence over an `SQLWARNING` handler.
- It is possible to have several applicable handlers with the same precedence. For example, a statement could generate multiple warnings with different error codes, for each of which an error-specific handler exists. In this case, the choice of which handler the server activates is nondeterministic, and may change depending on the circumstances under which the condition occurs.

One implication of the handler selection rules is that if multiple applicable handlers occur in different scopes, handlers with the most local scope take precedence over handlers in outer scopes, even over those for more specific conditions.

If there is no appropriate handler when a condition occurs, the action taken depends on the class of the condition:

- For `SQLEXCEPTION` conditions, the stored program terminates at the statement that raised the condition, as if there were an `EXIT` handler. If the program was called by another stored program, the calling program handles the condition using the handler selection rules applied to its own handlers.
- For `SQLWARNING` conditions, the program continues executing, as if there were a `CONTINUE` handler.
- For `NOT FOUND` conditions, if the condition was raised normally, the action is `CONTINUE`. If it was raised by `SIGNAL` or `RESIGNAL`, the action is `EXIT`.

The following examples demonstrate how MySQL applies the handler selection rules.

This procedure contains two handlers, one for the specific `SQLSTATE` value (`'42S02'`) that occurs for attempts to drop a nonexistent table, and one for the general `SQLEXCEPTION` class:

```
CREATE PROCEDURE p1()  
BEGIN  
  DECLARE CONTINUE HANDLER FOR SQLSTATE '42S02'  
    SELECT 'SQLSTATE handler was activated' AS msg;  
  DECLARE CONTINUE HANDLER FOR SQLEXCEPTION  
    SELECT 'SQLEXCEPTION handler was activated' AS msg;  
  
  DROP TABLE test.t;  
END;
```



Both handlers are declared in the same block and have the same scope. However, `SQLSTATE` handlers take precedence over `SQLException` handlers, so if the table `t` is nonexistent, the `DROP TABLE` statement raises a condition that activates the `SQLSTATE` handler:

```
mysql> CALL p1();
+-----+
| msg                |
+-----+
| SQLSTATE handler was activated |
+-----+
```

This procedure contains the same two handlers. But this time, the `DROP TABLE` statement and `SQLException` handler are in an inner block relative to the `SQLSTATE` handler:

```
CREATE PROCEDURE p2()
BEGIN -- outer block
    DECLARE CONTINUE HANDLER FOR SQLSTATE '42S02'
        SELECT 'SQLSTATE handler was activated' AS msg;
    BEGIN -- inner block
        DECLARE CONTINUE HANDLER FOR SQLException
            SELECT 'SQLException handler was activated' AS msg;

        DROP TABLE test.t; -- occurs within inner block
    END;
END;
```

In this case, the handler that is more local to where the condition occurs takes precedence. The `SQLException` handler activates, even though it is more general than the `SQLSTATE` handler:

```
mysql> CALL p2();
+-----+
| msg                |
+-----+
| SQLException handler was activated |
+-----+
```

In this procedure, one of the handlers is declared in a block inner to the scope of the `DROP TABLE` statement:

```
CREATE PROCEDURE p3()
BEGIN -- outer block
    DECLARE CONTINUE HANDLER FOR SQLException
        SELECT 'SQLException handler was activated' AS msg;
    BEGIN -- inner block
        DECLARE CONTINUE HANDLER FOR SQLSTATE '42S02'
            SELECT 'SQLSTATE handler was activated' AS msg;
    END;

    DROP TABLE test.t; -- occurs within outer block
END;
```

Only the `SQLException` handler applies because the other one is not in scope for the condition raised by the `DROP TABLE`:

```
mysql> CALL p3();
+-----+
| msg                |
+-----+
| SQLException handler was activated |
+-----+
```

In this procedure, both handlers are declared in a block inner to the scope of the `DROP TABLE` statement:

```
CREATE PROCEDURE p4()
BEGIN -- outer block
```

```

BEGIN -- inner block
  DECLARE CONTINUE HANDLER FOR SQLEXCEPTION
    SELECT 'SQLEXCEPTION handler was activated' AS msg;
  DECLARE CONTINUE HANDLER FOR SQLSTATE '42S02'
    SELECT 'SQLSTATE handler was activated' AS msg;
END;

DROP TABLE test.t; -- occurs within outer block
END;

```

Neither handler applies because they are not in scope for the `DROP TABLE`. The condition raised by the statement goes unhandled and terminates the procedure with an error:

```

mysql> CALL p4();
ERROR 1051 (42S02): Unknown table 'test.t'

```

### 13.6.7.7 The MySQL Diagnostics Area

SQL statements produce diagnostic information that populates the diagnostics area. Standard SQL has a diagnostics area stack, containing a diagnostics area for each nested execution context. Standard SQL also supports `GET STACKED DIAGNOSTICS` syntax for referring to the second diagnostics area during condition handler execution. MySQL supports the `STACKED` keyword as of MySQL 5.7. Before that, MySQL does not support `STACKED`; there is a single diagnostics area containing information from the most recent statement that wrote to it.

The following discussion describes the structure of the diagnostics area in MySQL, the information items recognized by MySQL, how statements clear and set the diagnostics area, and how diagnostics areas are pushed to and popped from the stack.

- [Diagnostics Area Structure](#)
- [Diagnostics Area Information Items](#)
- [How the Diagnostics Area is Cleared and Populated](#)
- [How the Diagnostics Area Stack Works](#)
- [Diagnostics Area-Related System Variables](#)

#### Diagnostics Area Structure

The diagnostics area contains two kinds of information:

- Statement information, such as the number of conditions that occurred or the affected-rows count.
- Condition information, such as the error code and message. If a statement raises multiple conditions, this part of the diagnostics area has a condition area for each one. If a statement raises no conditions, this part of the diagnostics area is empty.

For a statement that produces three conditions, the diagnostics area contains statement and condition information like this:

```

Statement information:
  row count
  ... other statement information items ...
Condition area list:
  Condition area 1:
    error code for condition 1
    error message for condition 1
    ... other condition information items ...
  Condition area 2:

```

```

error code for condition 2:
error message for condition 2
... other condition information items ...
Condition area 3:
error code for condition 3
error message for condition 3
... other condition information items ...

```

## Diagnostics Area Information Items

The diagnostics area contains statement and condition information items. Numeric items are integers. The character set for character items is UTF-8. No item can be `NULL`. If a statement or condition item is not set by a statement that populates the diagnostics area, its value is 0 or the empty string, depending on the item data type.

The statement information part of the diagnostics area contains these items:

- **NUMBER**: An integer indicating the number of condition areas that have information.
- **ROW\_COUNT**: An integer indicating the number of rows affected by the statement. **ROW\_COUNT** has the same value as the `ROW_COUNT()` function (see [Section 12.15, “Information Functions”](#)).

The condition information part of the diagnostics area contains a condition area for each condition. Condition areas are numbered from 1 to the value of the **NUMBER** statement condition item. If **NUMBER** is 0, there are no condition areas.

Each condition area contains the items in the following list. All items are standard SQL except **MYSQL\_ERRNO**, which is a MySQL extension. The definitions apply for conditions generated other than by a signal (that is, by a **SIGNAL** or **RESIGNAL** statement). For nonsignal conditions, MySQL populates only those condition items not described as always empty. The effects of signals on the condition area are described later.

- **CLASS\_ORIGIN**: A string containing the class of the **RETURNED\_SQLSTATE** value. If the **RETURNED\_SQLSTATE** value begins with a class value defined in SQL standards document ISO 9075-2 (section 24.1, **SQLSTATE**), **CLASS\_ORIGIN** is `'ISO 9075'`. Otherwise, **CLASS\_ORIGIN** is `'MySQL'`.
- **SUBCLASS\_ORIGIN**: A string containing the subclass of the **RETURNED\_SQLSTATE** value. If **CLASS\_ORIGIN** is `'ISO 9075'` or **RETURNED\_SQLSTATE** ends with `'000'`, **SUBCLASS\_ORIGIN** is `'ISO 9075'`. Otherwise, **SUBCLASS\_ORIGIN** is `'MySQL'`.
- **RETURNED\_SQLSTATE**: A string that indicates the **SQLSTATE** value for the condition.
- **MESSAGE\_TEXT**: A string that indicates the error message for the condition.
- **MYSQL\_ERRNO**: An integer that indicates the MySQL error code for the condition.
- **CONSTRAINT\_CATALOG**, **CONSTRAINT\_SCHEMA**, **CONSTRAINT\_NAME**: Strings that indicate the catalog, schema, and name for a violated constraint. They are always empty.
- **CATALOG\_NAME**, **SCHEMA\_NAME**, **TABLE\_NAME**, **COLUMN\_NAME**: Strings that indicate the catalog, schema, table, and column related to the condition. They are always empty.
- **CURSOR\_NAME**: A string that indicates the cursor name. This is always empty.

For the **RETURNED\_SQLSTATE**, **MESSAGE\_TEXT**, and **MYSQL\_ERRNO** values for particular errors, see [Server Error Message Reference](#).

If a **SIGNAL** (or **RESIGNAL**) statement populates the diagnostics area, its **SET** clause can assign to any condition information item except **RETURNED\_SQLSTATE** any value that is legal for the item data type.

`SIGNAL` also sets the `RETURNED_SQLSTATE` value, but not directly in its `SET` clause. That value comes from the `SIGNAL` statement `SQLSTATE` argument.

`SIGNAL` also sets statement information items. It sets `NUMBER` to 1. It sets `ROW_COUNT` to -1 for errors and 0 otherwise.

## How the Diagnostics Area is Cleared and Populated

Nondiagnostic SQL statements populate the diagnostics area automatically, and its contents can be set explicitly with the `SIGNAL` and `RESIGNAL` statements. The diagnostics area can be examined with `GET DIAGNOSTICS` to extract specific items, or with `SHOW WARNINGS` or `SHOW ERRORS` to see conditions or errors.

SQL statements clear and set the diagnostics area as follows:

- When the server starts executing a statement after parsing it, it clears the diagnostics area for nondiagnostic statements. Diagnostic statements do not clear the diagnostics area. These statements are diagnostic:
  - `GET DIAGNOSTICS`
  - `SHOW ERRORS`
  - `SHOW WARNINGS`
- If a statement raises a condition, the diagnostics area is cleared of conditions that belong to earlier statements. The exception is that conditions raised by `GET DIAGNOSTICS` and `RESIGNAL` are added to the diagnostics area without clearing it.

Thus, even a statement that does not normally clear the diagnostics area when it begins executing clears it if the statement raises a condition.

The following example shows the effect of various statements on the diagnostics area, using `SHOW WARNINGS` to display information about conditions stored there.

This `DROP TABLE` statement clears the diagnostics area and populates it when the condition occurs:

```
mysql> DROP TABLE IF EXISTS test.no_such_table;
Query OK, 0 rows affected, 1 warning (0.01 sec)

mysql> SHOW WARNINGS;
+-----+-----+-----+
| Level | Code | Message                                     |
+-----+-----+-----+
| Note  | 1051 | Unknown table 'test.no_such_table'         |
+-----+-----+-----+
1 row in set (0.00 sec)
```

This `SET` statement generates an error, so it clears and populates the diagnostics area:

```
mysql> SET @x = @@x;
ERROR 1193 (HY000): Unknown system variable 'x'

mysql> SHOW WARNINGS;
+-----+-----+-----+
| Level | Code | Message                                     |
+-----+-----+-----+
| Error | 1193 | Unknown system variable 'x'               |
+-----+-----+-----+
1 row in set (0.00 sec)
```

The previous `SET` statement produced a single condition, so 1 is the only valid condition number for `GET DIAGNOSTICS` at this point. The following statement uses a condition number of 2, which produces a warning that is added to the diagnostics area without clearing it:

```
mysql> GET DIAGNOSTICS CONDITION 2 @p = MESSAGE_TEXT;
Query OK, 0 rows affected, 1 warning (0.00 sec)

mysql> SHOW WARNINGS;
+-----+-----+-----+
| Level | Code | Message                                     |
+-----+-----+-----+
| Error | 1193 | Unknown system variable 'xx'             |
| Error | 1753 | Invalid condition number                   |
+-----+-----+-----+
2 rows in set (0.00 sec)
```

Now there are two conditions in the diagnostics area, so the same `GET DIAGNOSTICS` statement succeeds:

```
mysql> GET DIAGNOSTICS CONDITION 2 @p = MESSAGE_TEXT;
Query OK, 0 rows affected (0.00 sec)

mysql> SELECT @p;
+-----+
| @p    |
+-----+
| Invalid condition number |
+-----+
1 row in set (0.01 sec)
```

## How the Diagnostics Area Stack Works

When a push to the diagnostics area stack occurs, the first (current) diagnostics area becomes the second (stacked) diagnostics area and a new current diagnostics area is created as a copy of it. Diagnostics areas are pushed to and popped from the stack under the following circumstances:

- Execution of a stored program

A push occurs before the program executes and a pop occurs afterward. If the stored program ends while handlers are executing, there can be more than one diagnostics area to pop; this occurs due to an exception for which there are no appropriate handlers or due to `RETURN` in the handler.

Any warning or error conditions in the popped diagnostics areas then are added to the current diagnostics area, except that, for triggers, only errors are added. When the stored program ends, the caller sees these conditions in its current diagnostics area.

- Execution of a condition handler within a stored program

When a push occurs as a result of condition handler activation, the stacked diagnostics area is the area that was current within the stored program prior to the push. The new now-current diagnostics area is the handler's current diagnostics area. `GET [CURRENT] DIAGNOSTICS` and `GET STACKED DIAGNOSTICS` can be used within the handler to access the contents of the current (handler) and stacked (stored program) diagnostics areas. Initially, they return the same result, but statements executing within the handler modify the current diagnostics area, clearing and setting its contents according to the normal rules (see [How the Diagnostics Area is Cleared and Populated](#)). The stacked diagnostics area cannot be modified by statements executing within the handler except `RESIGNAL`.

If the handler executes successfully, the current (handler) diagnostics area is popped and the stacked (stored program) diagnostics area again becomes the current diagnostics area. Conditions added to the handler diagnostics area during handler execution are added to the current diagnostics area.

- Execution of `RESIGNAL`

The `RESIGNAL` statement passes on the error condition information that is available during execution of a condition handler within a compound statement inside a stored program. `RESIGNAL` may change some or all information before passing it on, modifying the diagnostics stack as described in [Section 13.6.7.4](#), “`RESIGNAL` Statement”.

## Diagnostics Area-Related System Variables

Certain system variables control or are related to some aspects of the diagnostics area:

- `max_error_count` controls the number of condition areas in the diagnostics area. If more conditions than this occur, MySQL silently discards information for the excess conditions. (Conditions added by `RESIGNAL` are always added, with older conditions being discarded as necessary to make room.)
- `warning_count` indicates the number of conditions that occurred. This includes errors, warnings, and notes. Normally, `NUMBER` and `warning_count` are the same. However, as the number of conditions generated exceeds `max_error_count`, the value of `warning_count` continues to rise whereas `NUMBER` remains capped at `max_error_count` because no additional conditions are stored in the diagnostics area.
- `error_count` indicates the number of errors that occurred. This value includes “not found” and exception conditions, but excludes warnings and notes. Like `warning_count`, its value can exceed `max_error_count`.
- If the `sql_notes` system variable is set to 0, notes are not stored and do not increment `warning_count`.

Example: If `max_error_count` is 10, the diagnostics area can contain a maximum of 10 condition areas. Suppose that a statement raises 20 conditions, 12 of which are errors. In that case, the diagnostics area contains the first 10 conditions, `NUMBER` is 10, `warning_count` is 20, and `error_count` is 12.

Changes to the value of `max_error_count` have no effect until the next attempt to modify the diagnostics area. If the diagnostics area contains 10 condition areas and `max_error_count` is set to 5, that has no immediate effect on the size or content of the diagnostics area.

### 13.6.7.8 Condition Handling and OUT or INOUT Parameters

If a stored procedure exits with an unhandled exception, modified values of `OUT` and `INOUT` parameters are not propagated back to the caller.

If an exception is handled by a `CONTINUE` or `EXIT` handler that contains a `RESIGNAL` statement, execution of `RESIGNAL` pops the Diagnostics Area stack, thus signaling the exception (that is, the information that existed before entry into the handler). If the exception is an error, the values of `OUT` and `INOUT` parameters are not propagated back to the caller.

### 13.6.7.9 Restrictions on Condition Handling

`SIGNAL`, `RESIGNAL`, and `GET DIAGNOSTICS` are not permissible as prepared statements. For example, this statement is invalid:

```
PREPARE stmt1 FROM 'SIGNAL SQLSTATE "02000"';
```

`SQLSTATE` values in class '04' are not treated specially. They are handled the same as other exceptions.

In standard SQL, the first condition relates to the `SQLSTATE` value returned for the previous SQL statement. In MySQL, this is not guaranteed, so to get the main error, you cannot do this:

```
GET DIAGNOSTICS CONDITION 1 @errno = MYSQL_ERRNO;
```

Instead, do this:

```
GET DIAGNOSTICS @cno = NUMBER;
GET DIAGNOSTICS CONDITION @cno @errno = MYSQL_ERRNO;
```

## 13.7 Database Administration Statements

### 13.7.1 Account Management Statements

MySQL account information is stored in the tables of the `mysql` system database. This database and the access control system are discussed extensively in [Chapter 5, MySQL Server Administration](#), which you should consult for additional details.



#### Important

Some MySQL releases introduce changes to the grant tables to add new privileges or features. To make sure that you can take advantage of any new capabilities, update your grant tables to the current structure whenever you upgrade MySQL. See [Section 2.10, “Upgrading MySQL”](#).

When the `read_only` system variable is enabled, account-management statements require the `SUPER` privilege, in addition to any other required privileges. This is because they modify tables in the `mysql` system database.

#### 13.7.1.1 ALTER USER Statement

```
ALTER USER [IF EXISTS]
  user [auth_option] [, user [auth_option]] ...
  [REQUIRE {NONE | tls_option [[AND] tls_option] ...}]
  [WITH resource_option [resource_option] ...]
  [password_option | lock_option] ...

ALTER USER [IF EXISTS]
  USER() IDENTIFIED BY 'auth_string'

user:
  (see Section 6.2.4, “Specifying Account Names”)

auth_option: {
  IDENTIFIED BY 'auth_string'
  | IDENTIFIED WITH auth_plugin
  | IDENTIFIED WITH auth_plugin BY 'auth_string'
  | IDENTIFIED WITH auth_plugin AS 'auth_string'
}

tls_option: {
  SSL
  | X509
  | CIPHER 'cipher'
  | ISSUER 'issuer'
  | SUBJECT 'subject'
}

resource_option: {
  MAX_QUERIES_PER_HOUR count
  | MAX_UPDATES_PER_HOUR count
  | MAX_CONNECTIONS_PER_HOUR count
  | MAX_USER_CONNECTIONS count
}

password_option: {
  PASSWORD EXPIRE
  | PASSWORD EXPIRE DEFAULT
```

```

| PASSWORD EXPIRE NEVER
| PASSWORD EXPIRE INTERVAL N DAY
}

lock_option: {
  ACCOUNT LOCK
| ACCOUNT UNLOCK
}

```

The `ALTER USER` statement modifies MySQL accounts. It enables authentication, SSL/TLS, resource-limit, and password-management properties to be modified for existing accounts. It can also be used to lock and unlock accounts.

To use `ALTER USER`, you must have the global `CREATE USER` privilege or the `UPDATE` privilege for the `mysql` system database. When the `read_only` system variable is enabled, `ALTER USER` additionally requires the `SUPER` privilege.

By default, an error occurs if you try to modify a user that does not exist. If the `IF EXISTS` clause is given, the statement produces a warning for each named user that does not exist, rather than an error.



### Important

Under some circumstances, `ALTER USER` may be recorded in server logs or on the client side in a history file such as `~/.mysql_history`, which means that cleartext passwords may be read by anyone having read access to that information. For information about the conditions under which this occurs for the server logs and how to control it, see [Section 6.1.2.3, “Passwords and Logging”](#). For similar information about client-side logging, see [Section 4.5.1.3, “mysql Client Logging”](#).

There are several aspects to the `ALTER USER` statement, described under the following topics:

- [ALTER USER Overview](#)
- [ALTER USER Authentication Options](#)
- [ALTER USER SSL/TLS Options](#)
- [ALTER USER Resource-Limit Options](#)
- [ALTER USER Password-Management Options](#)
- [ALTER USER Account-Locking Options](#)

## ALTER USER Overview

For each affected account, `ALTER USER` modifies the corresponding row in the `mysql.user` system table to reflect the properties specified in the statement. Unspecified properties retain their current values.

Each account name uses the format described in [Section 6.2.4, “Specifying Account Names”](#). The host name part of the account name, if omitted, defaults to `'%'`. It is also possible to specify `CURRENT_USER` or `CURRENT_USER()` to refer to the account associated with the current session.

In one case only, the account may be specified with the `USER()` function:

```
ALTER USER USER() IDENTIFIED BY 'auth_string';
```

This syntax enables changing your own password without naming your account literally.

For `ALTER USER` syntax that permits an `auth_option` value to follow a `user` value, `auth_option` indicates how the account authenticates by specifying an account authentication plugin, credentials (for



example, a password), or both. Each *auth\_option* value applies *only* to the account named immediately preceding it.

Following the *user* specifications, the statement may include options for SSL/TLS, resource-limit, password-management, and locking properties. All such options are *global* to the statement and apply to *all* accounts named in the statement.

Example: Change an account's password and expire it. As a result, the user must connect with the named password and choose a new one at the next connection:

```
ALTER USER 'jeffrey'@'localhost'
  IDENTIFIED BY 'new_password' PASSWORD EXPIRE;
```

Example: Modify an account to use the *sha256\_password* authentication plugin and the given password. Require that a new password be chosen every 180 days:

```
ALTER USER 'jeffrey'@'localhost'
  IDENTIFIED WITH sha256_password BY 'new_password'
  PASSWORD EXPIRE INTERVAL 180 DAY;
```

Example: Lock or unlock an account:

```
ALTER USER 'jeffrey'@'localhost' ACCOUNT LOCK;
ALTER USER 'jeffrey'@'localhost' ACCOUNT UNLOCK;
```

Example: Require an account to connect using SSL and establish a limit of 20 connections per hour:

```
ALTER USER 'jeffrey'@'localhost'
  REQUIRE SSL WITH MAX_CONNECTIONS_PER_HOUR 20;
```

Example: Alter multiple accounts, specifying some per-account properties and some global properties:

```
ALTER USER
  'jeffrey'@'localhost' IDENTIFIED BY 'new_password',
  'jeanne'@'localhost'
  REQUIRE SSL WITH MAX_USER_CONNECTIONS 2;
```

The *IDENTIFIED BY* value following *jeffrey* applies only to its immediately preceding account, so it changes the password to '*jeffrey\_new\_password*' only for *jeffrey*. For *jeanne*, there is no per-account value (thus leaving the password unchanged).

The remaining properties apply globally to all accounts named in the statement, so for both accounts:

- Connections are required to use SSL.
- The account can be used for a maximum of two simultaneous connections.

In the absence of a particular type of option, the account remains unchanged in that respect. For example, with no locking option, the locking state of the account is not changed.

## ALTER USER Authentication Options

An account name may be followed by an *auth\_option* authentication option that specifies the account authentication plugin, credentials, or both:

- *auth\_plugin* names an authentication plugin. The plugin name can be a quoted string literal or an unquoted name. Plugin names are stored in the *plugin* column of the *mysql.user* system table.

For *auth\_option* syntax that does not specify an authentication plugin, the default plugin is indicated by the value of the *default\_authentication\_plugin* system variable. For descriptions of each plugin, see [Section 6.4.1, “Authentication Plugins”](#).

- Credentials are stored in the `mysql.user` system table. An `'auth_string'` value specifies account credentials, either as a cleartext (unencrypted) string or hashed in the format expected by the authentication plugin associated with the account, respectively:
  - For syntax that uses `BY 'auth_string'`, the string is cleartext and is passed to the authentication plugin for possible hashing. The result returned by the plugin is stored in the `mysql.user` table. A plugin may use the value as specified, in which case no hashing occurs.
  - For syntax that uses `AS 'auth_string'`, the string is assumed to be already in the format the authentication plugin requires, and is stored as is in the `mysql.user` table. If a plugin requires a hashed value, the value must be already hashed in a format appropriate for the plugin, or the value cannot be used by the plugin and correct authentication of client connections cannot occur.
  - If an authentication plugin performs no hashing of the authentication string, the `BY 'auth_string'` and `AS 'auth_string'` clauses have the same effect: The authentication string is stored as is in the `mysql.user` system table.

`ALTER USER` permits these `auth_option` syntaxes:

- `IDENTIFIED BY 'auth_string'`

Sets the account authentication plugin to the default plugin, passes the cleartext `'auth_string'` value to the plugin for possible hashing, and stores the result in the account row in the `mysql.user` system table.

- `IDENTIFIED WITH auth_plugin`

Sets the account authentication plugin to `auth_plugin`, clears the credentials to the empty string (the credentials are associated with the old authentication plugin, not the new one), and stores the result in the account row in the `mysql.user` system table.

In addition, the password is marked expired. The user must choose a new one when next connecting.

- `IDENTIFIED WITH auth_plugin BY 'auth_string'`

Sets the account authentication plugin to `auth_plugin`, passes the cleartext `'auth_string'` value to the plugin for possible hashing, and stores the result in the account row in the `mysql.user` system table.

- `IDENTIFIED WITH auth_plugin AS 'auth_string'`

Sets the account authentication plugin to `auth_plugin` and stores the `'auth_string'` value as is in the `mysql.user` account row. If the plugin requires a hashed string, the string is assumed to be already hashed in the format the plugin requires.

Example: Specify the password as cleartext; the default plugin is used:

```
ALTER USER 'jeffrey'@'localhost'
  IDENTIFIED BY 'password';
```

Example: Specify the authentication plugin, along with a cleartext password value:

```
ALTER USER 'jeffrey'@'localhost'
  IDENTIFIED WITH mysql_native_password
  BY 'password';
```

Example: Specify the authentication plugin, along with a hashed password value:

```
ALTER USER 'jeffrey'@'localhost'
  IDENTIFIED WITH mysql_native_password
```

```
AS '*6C8989366EAF75BB670AD8EA7A7FC1176A95CEF4';
```

For additional information about setting passwords and authentication plugins, see [Section 6.2.10](#), “Assigning Account Passwords”, and [Section 6.2.13](#), “Pluggable Authentication”.

## ALTER USER SSL/TLS Options

MySQL can check X.509 certificate attributes in addition to the usual authentication that is based on the user name and credentials. For background information on the use of SSL/TLS with MySQL, see [Section 6.3](#), “Using Encrypted Connections”.

To specify SSL/TLS-related options for a MySQL account, use a `REQUIRE` clause that specifies one or more `tls_option` values.

Order of `REQUIRE` options does not matter, but no option can be specified twice. The `AND` keyword is optional between `REQUIRE` options.

`ALTER USER` permits these `tls_option` values:

- `NONE`

Indicates that all accounts named by the statement have no SSL or X.509 requirements. Unencrypted connections are permitted if the user name and password are valid. Encrypted connections can be used, at the client's option, if the client has the proper certificate and key files.

```
ALTER USER 'jeffrey'@'localhost' REQUIRE NONE;
```

Clients attempt to establish a secure connection by default. For clients that have `REQUIRE NONE`, the connection attempt falls back to an unencrypted connection if a secure connection cannot be established. To require an encrypted connection, a client need specify only the `--ssl-mode=REQUIRED` option; the connection attempt fails if a secure connection cannot be established.

- `SSL`

Tells the server to permit only encrypted connections for all accounts named by the statement.

```
ALTER USER 'jeffrey'@'localhost' REQUIRE SSL;
```

Clients attempt to establish a secure connection by default. For accounts that have `REQUIRE SSL`, the connection attempt fails if a secure connection cannot be established.

- `X509`

For all accounts named by the statement, requires that clients present a valid certificate, but the exact certificate, issuer, and subject do not matter. The only requirement is that it should be possible to verify its signature with one of the CA certificates. Use of X.509 certificates always implies encryption, so the `SSL` option is unnecessary in this case.

```
ALTER USER 'jeffrey'@'localhost' REQUIRE X509;
```

For accounts with `REQUIRE X509`, clients must specify the `--ssl-key` and `--ssl-cert` options to connect. (It is recommended but not required that `--ssl-ca` also be specified so that the public certificate provided by the server can be verified.) This is true for `ISSUER` and `SUBJECT` as well because those `REQUIRE` options imply the requirements of `X509`.

- `ISSUER 'issuer'`

For all accounts named by the statement, requires that clients present a valid X.509 certificate issued by CA `'issuer'`. If a client presents a certificate that is valid but has a different issuer, the server rejects

the connection. Use of X.509 certificates always implies encryption, so the [SSL](#) option is unnecessary in this case.

```
ALTER USER 'jeffrey'@'localhost'
  REQUIRE ISSUER '/C=SE/ST=Stockholm/L=Stockholm/
    O=MySQL/CN=CA/emailAddress=ca@example.com';
```

Because [ISSUER](#) implies the requirements of [X509](#), clients must specify the `--ssl-key` and `--ssl-cert` options to connect. (It is recommended but not required that `--ssl-ca` also be specified so that the public certificate provided by the server can be verified.)

- [SUBJECT](#) '*subject*'

For all accounts named by the statement, requires that clients present a valid X.509 certificate containing the subject *subject*. If a client presents a certificate that is valid but has a different subject, the server rejects the connection. Use of X.509 certificates always implies encryption, so the [SSL](#) option is unnecessary in this case.

```
ALTER USER 'jeffrey'@'localhost'
  REQUIRE SUBJECT '/C=SE/ST=Stockholm/L=Stockholm/
    O=MySQL demo client certificate/
    CN=client/emailAddress=client@example.com';
```

MySQL does a simple string comparison of the '*subject*' value to the value in the certificate, so lettercase and component ordering must be given exactly as present in the certificate.

Because [SUBJECT](#) implies the requirements of [X509](#), clients must specify the `--ssl-key` and `--ssl-cert` options to connect. (It is recommended but not required that `--ssl-ca` also be specified so that the public certificate provided by the server can be verified.)

- [CIPHER](#) '*cipher*'

For all accounts named by the statement, requires a specific cipher method for encrypting connections. This option is needed to ensure that ciphers and key lengths of sufficient strength are used. Encryption can be weak if old algorithms using short encryption keys are used.

```
ALTER USER 'jeffrey'@'localhost'
  REQUIRE CIPHER 'EDH-RSA-DES-CBC3-SHA';
```

The [SUBJECT](#), [ISSUER](#), and [CIPHER](#) options can be combined in the [REQUIRE](#) clause:

```
ALTER USER 'jeffrey'@'localhost'
  REQUIRE SUBJECT '/C=SE/ST=Stockholm/L=Stockholm/
    O=MySQL demo client certificate/
    CN=client/emailAddress=client@example.com'
  AND ISSUER '/C=SE/ST=Stockholm/L=Stockholm/
    O=MySQL/CN=CA/emailAddress=ca@example.com'
  AND CIPHER 'EDH-RSA-DES-CBC3-SHA';
```

## ALTER USER Resource-Limit Options

It is possible to place limits on use of server resources by an account, as discussed in [Section 6.2.16](#), “[Setting Account Resource Limits](#)”. To do so, use a [WITH](#) clause that specifies one or more [resource\\_option](#) values.

Order of [WITH](#) options does not matter, except that if a given resource limit is specified multiple times, the last instance takes precedence.

[ALTER USER](#) permits these [resource\\_option](#) values:

- `MAX_QUERIES_PER_HOUR count`, `MAX_UPDATES_PER_HOUR count`,  
`MAX_CONNECTIONS_PER_HOUR count`

For all accounts named by the statement, these options restrict how many queries, updates, and connections to the server are permitted to each account during any given one-hour period. (Queries for which results are served from the query cache do not count against the `MAX_QUERIES_PER_HOUR` limit.) If `count` is 0 (the default), this means that there is no limitation for the account.

- `MAX_USER_CONNECTIONS count`

For all accounts named by the statement, restricts the maximum number of simultaneous connections to the server by each account. A nonzero `count` specifies the limit for the account explicitly. If `count` is 0 (the default), the server determines the number of simultaneous connections for the account from the global value of the `max_user_connections` system variable. If `max_user_connections` is also zero, there is no limit for the account.

Example:

```
ALTER USER 'jeffrey'@'localhost'
WITH MAX_QUERIES_PER_HOUR 500 MAX_UPDATES_PER_HOUR 100;
```

## ALTER USER Password-Management Options

`ALTER USER` supports several `password_option` values for password expiration management, to either expire an account password manually or establish its password expiration policy. Policy options do not expire the password. Instead, they determine how the server applies automatic expiration to the account based on account password age. For a given account, its password age is assessed from the date and time of the most recent password change.

This section describes the syntax for password-management options. For information about establishing policy for password management, see [Section 6.2.11, “Password Management”](#).

If multiple password-management options are specified, the last one takes precedence.

These options apply only to accounts that use an authentication plugin that stores credentials internally to MySQL. For accounts that use a plugin that performs authentication against a credentials system that is external to MySQL, password management must be handled externally against that system as well. For more information about internal credentials storage, see [Section 6.2.11, “Password Management”](#).

A client session operates in restricted mode if the account password was expired manually or if the password age is considered greater than its permitted lifetime per the automatic expiration policy. In restricted mode, operations performed within the session result in an error until the user establishes a new account password. For information about restricted mode, see [Section 6.2.12, “Server Handling of Expired Passwords”](#).



### Note

Although it is possible to “reset” an expired password by setting it to its current value, it is preferable, as a matter of good policy, to choose a different password.

`ALTER USER` permits these `password_option` values for controlling password expiration:

- `PASSWORD EXPIRE`

Immediately marks the password expired for all accounts named by the statement.

```
ALTER USER 'jeffrey'@'localhost' PASSWORD EXPIRE;
```

- `PASSWORD EXPIRE DEFAULT`

Sets all accounts named by the statement so that the global expiration policy applies, as specified by the `default_password_lifetime` system variable.

```
ALTER USER 'jeffrey'@'localhost' PASSWORD EXPIRE DEFAULT;
```

- `PASSWORD EXPIRE NEVER`

This expiration option overrides the global policy for all accounts named by the statement. For each, it disables password expiration so that the password never expires.

```
ALTER USER 'jeffrey'@'localhost' PASSWORD EXPIRE NEVER;
```

- `PASSWORD EXPIRE INTERVAL N DAY`

This expiration option overrides the global policy for all accounts named by the statement. For each, it sets the password lifetime to *N* days. The following statement requires the password to be changed every 180 days:

```
ALTER USER 'jeffrey'@'localhost' PASSWORD EXPIRE INTERVAL 180 DAY;
```

## ALTER USER Account-Locking Options

MySQL supports account locking and unlocking using the `ACCOUNT LOCK` and `ACCOUNT UNLOCK` options, which specify the locking state for an account. For additional discussion, see [Section 6.2.15, “Account Locking”](#).

If multiple account-locking options are specified, the last one takes precedence.

### 13.7.1.2 CREATE USER Statement

```
CREATE USER [IF NOT EXISTS]
  user [auth_option] [, user [auth_option]] ...
  [REQUIRE {NONE | tls_option [[AND] tls_option] ...}]
  [WITH resource_option [resource_option] ...]
  [password_option | lock_option] ...

user:
  (see Section 6.2.4, “Specifying Account Names”)

auth_option: {
  IDENTIFIED BY 'auth_string'
| IDENTIFIED WITH auth_plugin
| IDENTIFIED WITH auth_plugin BY 'auth_string'
| IDENTIFIED WITH auth_plugin AS 'auth_string'
| IDENTIFIED BY PASSWORD 'auth_string'
}

tls_option: {
  SSL
| X509
| CIPHER 'cipher'
| ISSUER 'issuer'
| SUBJECT 'subject'
}

resource_option: {
  MAX_QUERIES_PER_HOUR count
| MAX_UPDATES_PER_HOUR count
| MAX_CONNECTIONS_PER_HOUR count
| MAX_USER_CONNECTIONS count
}
```

```

password_option: {
  PASSWORD EXPIRE
  | PASSWORD EXPIRE DEFAULT
  | PASSWORD EXPIRE NEVER
  | PASSWORD EXPIRE INTERVAL N DAY
}

lock_option: {
  ACCOUNT LOCK
  | ACCOUNT UNLOCK
}

```

The `CREATE USER` statement creates new MySQL accounts. It enables authentication, SSL/TLS, resource-limit, and password-management properties to be established for new accounts, and controls whether accounts are initially locked or unlocked.

To use `CREATE USER`, you must have the global `CREATE USER` privilege, or the `INSERT` privilege for the `mysql` system database. When the `read_only` system variable is enabled, `CREATE USER` additionally requires the `SUPER` privilege.

An error occurs if you try to create an account that already exists. If the `IF NOT EXISTS` clause is given, the statement produces a warning for each named account that already exists, rather than an error.



### Important

Under some circumstances, `CREATE USER` may be recorded in server logs or on the client side in a history file such as `~/.mysql_history`, which means that cleartext passwords may be read by anyone having read access to that information. For information about the conditions under which this occurs for the server logs and how to control it, see [Section 6.1.2.3, “Passwords and Logging”](#). For similar information about client-side logging, see [Section 4.5.1.3, “mysql Client Logging”](#).

There are several aspects to the `CREATE USER` statement, described under the following topics:

- [CREATE USER Overview](#)
- [CREATE USER Authentication Options](#)
- [CREATE USER SSL/TLS Options](#)
- [CREATE USER Resource-Limit Options](#)
- [CREATE USER Password-Management Options](#)
- [CREATE USER Account-Locking Options](#)

## CREATE USER Overview

For each account, `CREATE USER` creates a new row in the `mysql.user` system table. The account row reflects the properties specified in the statement. Unspecified properties are set to their default values:

- Authentication: The authentication plugin defined by the `default_authentication_plugin` system variable, and empty credentials
- SSL/TLS: `NONE`
- Resource limits: Unlimited
- Password management: `PASSWORD EXPIRE DEFAULT`
- Account locking: `ACCOUNT UNLOCK`

An account when first created has no privileges. To assign privileges to this account, use one or more [GRANT](#) statements.

Each account name uses the format described in [Section 6.2.4, “Specifying Account Names”](#). For example:

```
CREATE USER 'jeffrey'@'localhost' IDENTIFIED BY 'password';
```

The host name part of the account name, if omitted, defaults to `'%'`.

Each `user` value naming an account may be followed by an optional `auth_option` value that indicates how the account authenticates. These values enable account authentication plugins and credentials (for example, a password) to be specified. Each `auth_option` value applies *only* to the account named immediately preceding it.

Following the `user` specifications, the statement may include options for SSL/TLS, resource-limit, password-management, and locking properties. All such options are *global* to the statement and apply to *all* accounts named in the statement.

Example: Create an account that uses the default authentication plugin and the given password. Mark the password expired so that the user must choose a new one at the first connection to the server:

```
CREATE USER 'jeffrey'@'localhost'
  IDENTIFIED BY 'new_password' PASSWORD EXPIRE;
```

Example: Create an account that uses the `sha256_password` authentication plugin and the given password. Require that a new password be chosen every 180 days:

```
CREATE USER 'jeffrey'@'localhost'
  IDENTIFIED WITH sha256_password BY 'new_password'
  PASSWORD EXPIRE INTERVAL 180 DAY;
```

Example: Create multiple accounts, specifying some per-account properties and some global properties:

```
CREATE USER
  'jeffrey'@'localhost' IDENTIFIED WITH mysql_native_password
                        BY 'new_password1',
  'jeanne'@'localhost' IDENTIFIED WITH sha256_password
                        BY 'new_password2'
  REQUIRE X509 WITH MAX_QUERIES_PER_HOUR 60
  ACCOUNT LOCK;
```

Each `auth_option` value (`IDENTIFIED WITH ... BY` in this case) applies only to the account named immediately preceding it, so each account uses the immediately following authentication plugin and password.

The remaining properties apply globally to all accounts named in the statement, so for both accounts:

- Connections must be made using a valid X.509 certificate.
- Up to 60 queries per hour are permitted.
- The account is locked initially, so effectively it is a placeholder and cannot be used until an administrator unlocks it.

## CREATE USER Authentication Options

An account name may be followed by an `auth_option` authentication option that specifies the account authentication plugin, credentials, or both:

- `auth_plugin` names an authentication plugin. The plugin name can be a quoted string literal or an unquoted name. Plugin names are stored in the `plugin` column of the `mysql.user` system table.



For `auth_option` syntax that does not specify an authentication plugin, the default plugin is indicated by the value of the `default_authentication_plugin` system variable. For descriptions of each plugin, see [Section 6.4.1, “Authentication Plugins”](#).

- Credentials are stored in the `mysql.user` system table. An `'auth_string'` value specifies account credentials, either as a cleartext (unencrypted) string or hashed in the format expected by the authentication plugin associated with the account, respectively:
  - For syntax that uses `BY 'auth_string'`, the string is cleartext and is passed to the authentication plugin for possible hashing. The result returned by the plugin is stored in the `mysql.user` table. A plugin may use the value as specified, in which case no hashing occurs.
  - For syntax that uses `AS 'auth_string'`, the string is assumed to be already in the format the authentication plugin requires, and is stored as is in the `mysql.user` table. If a plugin requires a hashed value, the value must be already hashed in a format appropriate for the plugin, or the value cannot be used by the plugin and correct authentication of client connections cannot occur.
  - If an authentication plugin performs no hashing of the authentication string, the `BY 'auth_string'` and `AS 'auth_string'` clauses have the same effect: The authentication string is stored as is in the `mysql.user` system table.

`CREATE USER` permits these `auth_option` syntaxes:

- `IDENTIFIED BY 'auth_string'`

Sets the account authentication plugin to the default plugin, passes the cleartext `'auth_string'` value to the plugin for possible hashing, and stores the result in the account row in the `mysql.user` system table.

- `IDENTIFIED WITH auth_plugin`

Sets the account authentication plugin to `auth_plugin`, clears the credentials to the empty string, and stores the result in the account row in the `mysql.user` system table.

- `IDENTIFIED WITH auth_plugin BY 'auth_string'`

Sets the account authentication plugin to `auth_plugin`, passes the cleartext `'auth_string'` value to the plugin for possible hashing, and stores the result in the account row in the `mysql.user` system table.

- `IDENTIFIED WITH auth_plugin AS 'auth_string'`

Sets the account authentication plugin to `auth_plugin` and stores the `'auth_string'` value as is in the `mysql.user` account row. If the plugin requires a hashed string, the string is assumed to be already hashed in the format the plugin requires.

- `IDENTIFIED BY PASSWORD 'auth_string'`

Sets the account authentication plugin to the default plugin and stores the `'auth_string'` value as is in the `mysql.user` account row. If the plugin requires a hashed string, the string is assumed to be already hashed in the format the plugin requires.

**Note**

`IDENTIFIED BY PASSWORD` syntax is deprecated; expect it to be removed in a future MySQL release.

Example: Specify the password as cleartext; the default plugin is used:

```
CREATE USER 'jeffrey'@'localhost'
  IDENTIFIED BY 'password';
```

Example: Specify the authentication plugin, along with a cleartext password value:

```
CREATE USER 'jeffrey'@'localhost'
  IDENTIFIED WITH mysql_native_password BY 'password';
```

In each case, the password value stored in the account row is the cleartext value `'password'` after it has been hashed by the authentication plugin associated with the account.

For additional information about setting passwords and authentication plugins, see [Section 6.2.10, “Assigning Account Passwords”](#), and [Section 6.2.13, “Pluggable Authentication”](#).

## CREATE USER SSL/TLS Options

MySQL can check X.509 certificate attributes in addition to the usual authentication that is based on the user name and credentials. For background information on the use of SSL/TLS with MySQL, see [Section 6.3, “Using Encrypted Connections”](#).

To specify SSL/TLS-related options for a MySQL account, use a `REQUIRE` clause that specifies one or more `tls_option` values.

Order of `REQUIRE` options does not matter, but no option can be specified twice. The `AND` keyword is optional between `REQUIRE` options.

`CREATE USER` permits these `tls_option` values:

- `NONE`

Indicates that all accounts named by the statement have no SSL or X.509 requirements. Unencrypted connections are permitted if the user name and password are valid. Encrypted connections can be used, at the client's option, if the client has the proper certificate and key files.

```
CREATE USER 'jeffrey'@'localhost' REQUIRE NONE;
```

Clients attempt to establish a secure connection by default. For clients that have `REQUIRE NONE`, the connection attempt falls back to an unencrypted connection if a secure connection cannot be established. To require an encrypted connection, a client need specify only the `--ssl-mode=REQUIRED` option; the connection attempt fails if a secure connection cannot be established.

`NONE` is the default if no SSL-related `REQUIRE` options are specified.

- `SSL`

Tells the server to permit only encrypted connections for all accounts named by the statement.

```
CREATE USER 'jeffrey'@'localhost' REQUIRE SSL;
```

Clients attempt to establish a secure connection by default. For accounts that have `REQUIRE SSL`, the connection attempt fails if a secure connection cannot be established.

- `X509`

For all accounts named by the statement, requires that clients present a valid certificate, but the exact certificate, issuer, and subject do not matter. The only requirement is that it should be possible to verify

its signature with one of the CA certificates. Use of X.509 certificates always implies encryption, so the `SSL` option is unnecessary in this case.

```
CREATE USER 'jeffrey'@'localhost' REQUIRE X509;
```

For accounts with `REQUIRE X509`, clients must specify the `--ssl-key` and `--ssl-cert` options to connect. (It is recommended but not required that `--ssl-ca` also be specified so that the public certificate provided by the server can be verified.) This is true for `ISSUER` and `SUBJECT` as well because those `REQUIRE` options imply the requirements of `X509`.

- `ISSUER 'issuer'`

For all accounts named by the statement, requires that clients present a valid X.509 certificate issued by CA `'issuer'`. If a client presents a certificate that is valid but has a different issuer, the server rejects the connection. Use of X.509 certificates always implies encryption, so the `SSL` option is unnecessary in this case.

```
CREATE USER 'jeffrey'@'localhost'
  REQUIRE ISSUER '/C=SE/ST=Stockholm/L=Stockholm/
  O=MySQL/CN=CA/emailAddress=ca@example.com';
```

Because `ISSUER` implies the requirements of `X509`, clients must specify the `--ssl-key` and `--ssl-cert` options to connect. (It is recommended but not required that `--ssl-ca` also be specified so that the public certificate provided by the server can be verified.)

- `SUBJECT 'subject'`

For all accounts named by the statement, requires that clients present a valid X.509 certificate containing the subject `subject`. If a client presents a certificate that is valid but has a different subject, the server rejects the connection. Use of X.509 certificates always implies encryption, so the `SSL` option is unnecessary in this case.

```
CREATE USER 'jeffrey'@'localhost'
  REQUIRE SUBJECT '/C=SE/ST=Stockholm/L=Stockholm/
  O=MySQL demo client certificate/
  CN=client/emailAddress=client@example.com';
```

MySQL does a simple string comparison of the `'subject'` value to the value in the certificate, so lettercase and component ordering must be given exactly as present in the certificate.

Because `SUBJECT` implies the requirements of `X509`, clients must specify the `--ssl-key` and `--ssl-cert` options to connect. (It is recommended but not required that `--ssl-ca` also be specified so that the public certificate provided by the server can be verified.)

- `CIPHER 'cipher'`

For all accounts named by the statement, requires a specific cipher method for encrypting connections. This option is needed to ensure that ciphers and key lengths of sufficient strength are used. Encryption can be weak if old algorithms using short encryption keys are used.

```
CREATE USER 'jeffrey'@'localhost'
  REQUIRE CIPHER 'EDH-RSA-DES-CBC3-SHA';
```

The `SUBJECT`, `ISSUER`, and `CIPHER` options can be combined in the `REQUIRE` clause:

```
CREATE USER 'jeffrey'@'localhost'
  REQUIRE SUBJECT '/C=SE/ST=Stockholm/L=Stockholm/
  O=MySQL demo client certificate/
  CN=client/emailAddress=client@example.com'
  AND ISSUER '/C=SE/ST=Stockholm/L=Stockholm/
```

```
O=MySQL/CN=CA/emailAddress=ca@example.com'
AND CIPHER 'EDH-RSA-DES-CBC3-SHA';
```

## CREATE USER Resource-Limit Options

It is possible to place limits on use of server resources by an account, as discussed in [Section 6.2.16, “Setting Account Resource Limits”](#). To do so, use a `WITH` clause that specifies one or more *resource\_option* values.

Order of `WITH` options does not matter, except that if a given resource limit is specified multiple times, the last instance takes precedence.

`CREATE USER` permits these *resource\_option* values:

- `MAX_QUERIES_PER_HOUR count`, `MAX_UPDATES_PER_HOUR count`,  
`MAX_CONNECTIONS_PER_HOUR count`

For all accounts named by the statement, these options restrict how many queries, updates, and connections to the server are permitted to each account during any given one-hour period. (Queries for which results are served from the query cache do not count against the `MAX_QUERIES_PER_HOUR` limit.) If *count* is 0 (the default), this means that there is no limitation for the account.

- `MAX_USER_CONNECTIONS count`

For all accounts named by the statement, restricts the maximum number of simultaneous connections to the server by each account. A nonzero *count* specifies the limit for the account explicitly. If *count* is 0 (the default), the server determines the number of simultaneous connections for the account from the global value of the `max_user_connections` system variable. If `max_user_connections` is also zero, there is no limit for the account.

Example:

```
CREATE USER 'jeffrey'@'localhost'
WITH MAX_QUERIES_PER_HOUR 500 MAX_UPDATES_PER_HOUR 100;
```

## CREATE USER Password-Management Options

Account passwords have an age, assessed from the date and time of the most recent password change.

`CREATE USER` supports several *password\_option* values for password expiration management, to either expire an account password manually or establish its password expiration policy. Policy options do not expire the password. Instead, they determine how the server applies automatic expiration to the account based on account password age. For a given account, its password age is assessed from the date and time of the most recent password change.

This section describes the syntax for password-management options. For information about establishing policy for password management, see [Section 6.2.11, “Password Management”](#).

If multiple password-management options are specified, the last one takes precedence.

These options apply only to accounts that use an authentication plugin that stores credentials internally to MySQL. For accounts that use a plugin that performs authentication against a credentials system that is external to MySQL, password management must be handled externally against that system as well. For more information about internal credentials storage, see [Section 6.2.11, “Password Management”](#).

A client session operates in restricted mode if the account password was expired manually or if the password age is considered greater than its permitted lifetime per the automatic expiration policy. In

restricted mode, operations performed within the session result in an error until the user establishes a new account password. For information about restricted mode, see [Section 6.2.12, “Server Handling of Expired Passwords”](#).

`CREATE USER` permits these *password\_option* values for controlling password expiration:

- `PASSWORD EXPIRE`

Immediately marks the password expired for all accounts named by the statement.

```
CREATE USER 'jeffrey'@'localhost' PASSWORD EXPIRE;
```

- `PASSWORD EXPIRE DEFAULT`

Sets all accounts named by the statement so that the global expiration policy applies, as specified by the `default_password_lifetime` system variable.

```
CREATE USER 'jeffrey'@'localhost' PASSWORD EXPIRE DEFAULT;
```

- `PASSWORD EXPIRE NEVER`

This expiration option overrides the global policy for all accounts named by the statement. For each, it disables password expiration so that the password never expires.

```
CREATE USER 'jeffrey'@'localhost' PASSWORD EXPIRE NEVER;
```

- `PASSWORD EXPIRE INTERVAL N DAY`

This expiration option overrides the global policy for all accounts named by the statement. For each, it sets the password lifetime to *N* days. The following statement requires the password to be changed every 180 days:

```
CREATE USER 'jeffrey'@'localhost' PASSWORD EXPIRE INTERVAL 180 DAY;
```

## CREATE USER Account-Locking Options

MySQL supports account locking and unlocking using the `ACCOUNT LOCK` and `ACCOUNT UNLOCK` options, which specify the locking state for an account. For additional discussion, see [Section 6.2.15, “Account Locking”](#).

If multiple account-locking options are specified, the last one takes precedence.

### 13.7.1.3 DROP USER Statement

```
DROP USER [IF EXISTS] user [, user] ...
```

The `DROP USER` statement removes one or more MySQL accounts and their privileges. It removes privilege rows for the account from all grant tables.

To use `DROP USER`, you must have the global `CREATE USER` privilege, or the `DELETE` privilege for the `mysql` system database. When the `read_only` system variable is enabled, `DROP USER` additionally requires the `SUPER` privilege.

An error occurs if you try to drop an account that does not exist. If the `IF EXISTS` clause is given, the statement produces a warning for each named user that does not exist, rather than an error.

Each account name uses the format described in [Section 6.2.4, “Specifying Account Names”](#). For example:

```
DROP USER 'jeffrey'@'localhost';
```

The host name part of the account name, if omitted, defaults to '`%`'.



### Important

`DROP USER` does not automatically close any open user sessions. Rather, in the event that a user with an open session is dropped, the statement does not take effect until that user's session is closed. Once the session is closed, the user is dropped, and that user's next attempt to log in fails. *This is by design.*

`DROP USER` does not automatically drop or invalidate databases or objects within them that the old user created. This includes stored programs or views for which the `DEFINER` attribute names the dropped user. Attempts to access such objects may produce an error if they execute in definer security context. (For information about security context, see [Section 23.6, “Stored Object Access Control”](#).)

## 13.7.1.4 GRANT Statement

```
GRANT
  priv_type [(column_list)]
  [, priv_type [(column_list)]] ...
ON [object_type] priv_level
TO user [auth_option] [, user [auth_option]] ...
[REQUIRE {NONE | tls_option [[AND] tls_option] ...}]
[WITH {GRANT OPTION | resource_option} ...]

GRANT PROXY ON user
  TO user [, user] ...
  [WITH GRANT OPTION]

object_type: {
  TABLE
  | FUNCTION
  | PROCEDURE
}

priv_level: {
  *
  | *.*
  | db_name.*
  | db_name.tbl_name
  | tbl_name
  | db_name.routine_name
}

user:
  (see Section 6.2.4, “Specifying Account Names”)

auth_option: {
  IDENTIFIED BY 'auth_string'
  | IDENTIFIED WITH auth_plugin
  | IDENTIFIED WITH auth_plugin BY 'auth_string'
  | IDENTIFIED WITH auth_plugin AS 'auth_string'
  | IDENTIFIED BY PASSWORD 'auth_string'
}

tls_option: {
  SSL
  | X509
  | CIPHER 'cipher'
  | ISSUER 'issuer'
  | SUBJECT 'subject'
}

resource_option: {
  | MAX_QUERIES_PER_HOUR count
```

```
| MAX_UPDATES_PER_HOUR count  
| MAX_CONNECTIONS_PER_HOUR count  
| MAX_USER_CONNECTIONS count  
}
```

The [GRANT](#) statement grants privileges to MySQL user accounts. There are several aspects to the [GRANT](#) statement, described under the following topics:

- [GRANT General Overview](#)
- [Object Quoting Guidelines](#)
- [Privileges Supported by MySQL](#)
- [Account Names and Passwords](#)
- [Global Privileges](#)
- [Database Privileges](#)
- [Table Privileges](#)
- [Column Privileges](#)
- [Stored Routine Privileges](#)
- [Proxy User Privileges](#)
- [Implicit Account Creation](#)
- [Other Account Characteristics](#)
- [MySQL and Standard SQL Versions of GRANT](#)

## GRANT General Overview

The [GRANT](#) statement grants privileges to MySQL user accounts.

To grant a privilege with [GRANT](#), you must have the [GRANT OPTION](#) privilege, and you must have the privileges that you are granting. (Alternatively, if you have the [UPDATE](#) privilege for the grant tables in the [mysql](#) system database, you can grant any account any privilege.) When the [read\\_only](#) system variable is enabled, [GRANT](#) additionally requires the [SUPER](#) privilege.

The [REVOKE](#) statement is related to [GRANT](#) and enables administrators to remove account privileges. See [Section 13.7.1.6, “REVOKE Statement”](#).

Each account name uses the format described in [Section 6.2.4, “Specifying Account Names”](#). For example:

```
GRANT ALL ON db1.* TO 'jeffrey'@'localhost';
```

The host name part of the account, if omitted, defaults to `'%'`.

Normally, a database administrator first uses [CREATE USER](#) to create an account and define its nonprivilege characteristics such as its password, whether it uses secure connections, and limits on access to server resources, then uses [GRANT](#) to define its privileges. [ALTER USER](#) may be used to change the nonprivilege characteristics of existing accounts. For example:

```
CREATE USER 'jeffrey'@'localhost' IDENTIFIED BY 'password';  
GRANT ALL ON db1.* TO 'jeffrey'@'localhost';
```

```
GRANT SELECT ON db2.invoice TO 'jeffrey'@'localhost';
ALTER USER 'jeffrey'@'localhost' WITH MAX_QUERIES_PER_HOUR 90;
```

**Note**

Examples shown here include no `IDENTIFIED` clause. It is assumed that you establish passwords with `CREATE USER` at account-creation time to avoid creating insecure accounts.

**Note**

If an account named in a `GRANT` statement does not already exist, `GRANT` may create it under the conditions described later in the discussion of the `NO_AUTO_CREATE_USER` SQL mode. It is also possible to use `GRANT` to specify nonprivilege account characteristics such as whether it uses secure connections and limits on access to server resources.

However, use of `GRANT` to create accounts or define nonprivilege characteristics is deprecated in MySQL 5.7. Instead, perform these tasks using `CREATE USER` or `ALTER USER`.

From the `mysql` program, `GRANT` responds with `Query OK, 0 rows affected` when executed successfully. To determine what privileges result from the operation, use `SHOW GRANTS`. See [Section 13.7.5.21, “SHOW GRANTS Statement”](#).

**Important**

Under some circumstances, `GRANT` may be recorded in server logs or on the client side in a history file such as `~/.mysql_history`, which means that cleartext passwords may be read by anyone having read access to that information. For information about the conditions under which this occurs for the server logs and how to control it, see [Section 6.1.2.3, “Passwords and Logging”](#). For similar information about client-side logging, see [Section 4.5.1.3, “mysql Client Logging”](#).

`GRANT` supports host names up to 60 characters long. User names can be up to 32 characters. Database, table, column, and routine names can be up to 64 characters.

**Warning**

*Do not attempt to change the permissible length for user names by altering the `mysql.user` system table. Doing so results in unpredictable behavior which may even make it impossible for users to log in to the MySQL server. Never alter the structure of tables in the `mysql` system database in any manner except by means of the procedure described in [Section 2.10, “Upgrading MySQL”](#).*

**Object Quoting Guidelines**

Several objects within `GRANT` statements are subject to quoting, although quoting is optional in many cases: Account, database, table, column, and routine names. For example, if a `user_name` or `host_name` value in an account name is legal as an unquoted identifier, you need not quote it. However, quotation marks are necessary to specify a `user_name` string containing special characters (such as `-`), or a `host_name` string containing special characters or wildcard characters such as `%` (for example, `'test-user'@'%.com'`). Quote the user name and host name separately.

To specify quoted values:

- Quote database, table, column, and routine names as identifiers.



- Quote user names and host names as identifiers or as strings.
- Quote passwords as strings.

For string-quoting and identifier-quoting guidelines, see [Section 9.1.1, “String Literals”](#), and [Section 9.2, “Schema Object Names”](#).

The `_` and `%` wildcards are permitted when specifying database names in `GRANT` statements that grant privileges at the database level (`GRANT ... ON db_name.*`). This means, for example, that to use a `_` character as part of a database name, specify it using the `\` escape character as `\_` in the `GRANT` statement, to prevent the user from being able to access additional databases matching the wildcard pattern (for example, `GRANT ... ON `foo\_bar`.* TO ...`).

Issuing multiple `GRANT` statements containing wildcards may not have the expected effect on DML statements; when resolving grants involving wildcards, MySQL takes only the first matching grant into consideration. In other words, if a user has two database-level grants using wildcards that match the same database, the grant which was created first is applied. Consider the database `db` and table `t` created using the statements shown here:

```
mysql> CREATE DATABASE db;
Query OK, 1 row affected (0.01 sec)

mysql> CREATE TABLE db.t (c INT);
Query OK, 0 rows affected (0.01 sec)

mysql> INSERT INTO db.t VALUES ROW(1);
Query OK, 1 row affected (0.00 sec)
```

Next (assuming that the current account is the MySQL `root` account or another account having the necessary privileges), we create a user `u` then issue two `GRANT` statements containing wildcards, like this:

```
mysql> CREATE USER u;
Query OK, 0 rows affected (0.01 sec)

mysql> GRANT SELECT ON `d`.* TO u;
Query OK, 0 rows affected (0.01 sec)

mysql> GRANT INSERT ON `d%`.* TO u;
Query OK, 0 rows affected (0.00 sec)

mysql> EXIT
```

```
Bye
```

If we end the session and then log in again with the `mysql` client, this time as `u`, we see that this account has only the privilege provided by the first matching grant, but not the second:

```
$> mysql -uu -hlocalhost
```

```
Welcome to the MySQL monitor.  Commands end with ; or \g.
Your MySQL connection id is 10
Server version: 5.7.52-tr Source distribution

Copyright (c) 2000, 2023, Oracle and/or its affiliates.

Oracle is a registered trademark of Oracle Corporation and/or its
affiliates. Other names may be trademarks of their respective
owners.

Type 'help;' or '\h' for help. Type '\c' to clear the current input
statement.
```

```
mysql> TABLE db.t;
+-----+
| c     |
+-----+
| 1    |
+-----+
1 row in set (0.00 sec)

mysql> INSERT INTO db.t VALUES ROW(2);
ERROR 1142 (42000): INSERT command denied to user 'u'@'localhost' for table 't'
```

When a database name is not used to grant privileges at the database level, but as a qualifier for granting privileges to some other object such as a table or routine (for example, `GRANT ... ON db_name.tbl_name`), MySQL interprets wildcard characters as literal characters.

## Privileges Supported by MySQL

The following table summarizes the permissible *priv\_type* privilege types that can be specified for the `GRANT` and `REVOKE` statements, and the levels at which each privilege can be granted. For additional information about each privilege, see [Section 6.2.2, “Privileges Provided by MySQL”](#).

**Table 13.8 Permissible Privileges for GRANT and REVOKE**

Privilege	Meaning and Grantable Levels
<code>ALL [PRIVILEGES]</code>	Grant all privileges at specified access level except <code>GRANT OPTION</code> and <code>PROXY</code> .
<code>ALTER</code>	Enable use of <code>ALTER TABLE</code> . Levels: Global, database, table.
<code>ALTER ROUTINE</code>	Enable stored routines to be altered or dropped. Levels: Global, database, routine.
<code>CREATE</code>	Enable database and table creation. Levels: Global, database, table.
<code>CREATE ROUTINE</code>	Enable stored routine creation. Levels: Global, database.
<code>CREATE TABLESPACE</code>	Enable tablespaces and log file groups to be created, altered, or dropped. Level: Global.
<code>CREATE TEMPORARY TABLES</code>	Enable use of <code>CREATE TEMPORARY TABLE</code> . Levels: Global, database.
<code>CREATE USER</code>	Enable use of <code>CREATE USER</code> , <code>DROP USER</code> , <code>RENAME USER</code> , and <code>REVOKE ALL PRIVILEGES</code> . Level: Global.
<code>CREATE VIEW</code>	Enable views to be created or altered. Levels: Global, database, table.
<code>DELETE</code>	Enable use of <code>DELETE</code> . Level: Global, database, table.
<code>DROP</code>	Enable databases, tables, and views to be dropped. Levels: Global, database, table.
<code>EVENT</code>	Enable use of events for the Event Scheduler. Levels: Global, database.
<code>EXECUTE</code>	Enable the user to execute stored routines. Levels: Global, database, routine.

Privilege	Meaning and Grantable Levels
FILE	Enable the user to cause the server to read or write files. Level: Global.
GRANT OPTION	Enable privileges to be granted to or removed from other accounts. Levels: Global, database, table, routine, proxy.
INDEX	Enable indexes to be created or dropped. Levels: Global, database, table.
INSERT	Enable use of <code>INSERT</code> . Levels: Global, database, table, column.
LOCK TABLES	Enable use of <code>LOCK TABLES</code> on tables for which you have the <code>SELECT</code> privilege. Levels: Global, database.
PROCESS	Enable the user to see all processes with <code>SHOW PROCESSLIST</code> . Level: Global.
PROXY	Enable user proxying. Level: From user to user.
REFERENCES	Enable foreign key creation. Levels: Global, database, table, column.
RELOAD	Enable use of <code>FLUSH</code> operations. Level: Global.
REPLICATION CLIENT	Enable the user to ask where source or replica servers are. Level: Global.
REPLICATION SLAVE	Enable replicas to read binary log events from the source. Level: Global.
SELECT	Enable use of <code>SELECT</code> . Levels: Global, database, table, column.
SHOW DATABASES	Enable <code>SHOW DATABASES</code> to show all databases. Level: Global.
SHOW VIEW	Enable use of <code>SHOW CREATE VIEW</code> . Levels: Global, database, table.
SHUTDOWN	Enable use of <code>mysqladmin shutdown</code> . Level: Global.
SUPER	Enable use of other administrative operations such as <code>CHANGE MASTER TO</code> , <code>KILL</code> , <code>PURGE BINARY LOGS</code> , <code>SET GLOBAL</code> , and <code>mysqladmin debug</code> command. Level: Global.
TRIGGER	Enable trigger operations. Levels: Global, database, table.
UPDATE	Enable use of <code>UPDATE</code> . Levels: Global, database, table, column.
USAGE	Synonym for “no privileges”

A trigger is associated with a table. To create or drop a trigger, you must have the `TRIGGER` privilege for the table, not the trigger.

In `GRANT` statements, the `ALL [PRIVILEGES]` or `PROXY` privilege must be named by itself and cannot be specified along with other privileges. `ALL [PRIVILEGES]` stands for all privileges available for the level at which privileges are to be granted except for the `GRANT OPTION` and `PROXY` privileges.

`USAGE` can be specified to create a user that has no privileges, or to specify the `REQUIRE` or `WITH` clauses for an account without changing its existing privileges. (However, use of `GRANT` to define nonprivilege characteristics is deprecated.)

MySQL account information is stored in the tables of the `mysql` system database. For additional details, consult [Section 6.2, “Access Control and Account Management”](#), which discusses the `mysql` system database and the access control system extensively.

If the grant tables hold privilege rows that contain mixed-case database or table names and the `lower_case_table_names` system variable is set to a nonzero value, `REVOKE` cannot be used to revoke these privileges. It is necessary to manipulate the grant tables directly. (`GRANT` does not create such rows when `lower_case_table_names` is set, but such rows might have been created prior to setting that variable.)

Privileges can be granted at several levels, depending on the syntax used for the `ON` clause. For `REVOKE`, the same `ON` syntax specifies which privileges to remove.

For the global, database, table, and routine levels, `GRANT ALL` assigns only the privileges that exist at the level you are granting. For example, `GRANT ALL ON db_name.*` is a database-level statement, so it does not grant any global-only privileges such as `FILE`. Granting `ALL` does not assign the `GRANT OPTION` or `PROXY` privilege.

The `object_type` clause, if present, should be specified as `TABLE`, `FUNCTION`, or `PROCEDURE` when the following object is a table, a stored function, or a stored procedure.

The privileges that a user holds for a database, table, column, or routine are formed additively as the logical `OR` of the account privileges at each of the privilege levels, including the global level. It is not possible to deny a privilege granted at a higher level by absence of that privilege at a lower level. For example, this statement grants the `SELECT` and `INSERT` privileges globally:

```
GRANT SELECT, INSERT ON *.* TO u1;
```

The globally granted privileges apply to all databases, tables, and columns, even though not granted at any of those lower levels.

Details of the privilege-checking procedure are presented in [Section 6.2.6, “Access Control, Stage 2: Request Verification”](#).

If you are using table, column, or routine privileges for even one user, the server examines table, column, and routine privileges for all users and this slows down MySQL a bit. Similarly, if you limit the number of queries, updates, or connections for any users, the server must monitor these values.

MySQL enables you to grant privileges on databases or tables that do not exist. For tables, the privileges to be granted must include the `CREATE` privilege. *This behavior is by design*, and is intended to enable the database administrator to prepare user accounts and privileges for databases or tables that are to be created at a later time.



### Important

MySQL does not automatically revoke any privileges when you drop a database or table. However, if you drop a routine, any routine-level privileges granted for that routine are revoked.

## Account Names and Passwords

A `user` value in a `GRANT` statement indicates a MySQL account to which the statement applies. To accommodate granting rights to users from arbitrary hosts, MySQL supports specifying the `user` value in the form `'user_name'@'host_name'`.

You can specify wildcards in the host name. For example, `'user_name'@'%.example.com'` applies to `user_name` for any host in the `example.com` domain, and `'user_name'@'198.51.100.%'` applies to `user_name` for any host in the `198.51.100` class C subnet.

The simple form `'user_name'` is a synonym for `'user_name'@'%'`.

MySQL does not support wildcards in user names. To refer to an anonymous user, specify an account with an empty user name with the `GRANT` statement:

```
GRANT ALL ON test.* TO ''@'localhost' ...;
```

In this case, any user who connects from the local host with the correct password for the anonymous user is permitted access, with the privileges associated with the anonymous user account.

For additional information about user name and host name values in account names, see [Section 6.2.4, “Specifying Account Names”](#).



### Warning

If you permit local anonymous users to connect to the MySQL server, you should also grant privileges to all local users as `'user_name'@'localhost'`. Otherwise, the anonymous user account for `localhost` in the `mysql.user` system table is used when named users try to log in to the MySQL server from the local machine. For details, see [Section 6.2.5, “Access Control, Stage 1: Connection Verification”](#).

To determine whether this issue applies to you, execute the following query, which lists any anonymous users:

```
SELECT Host, User FROM mysql.user WHERE User='';
```

To avoid the problem just described, delete the local anonymous user account using this statement:

```
DROP USER ''@'localhost';
```

For `GRANT` syntax that permits an `auth_option` value to follow a `user` value, `auth_option` begins with `IDENTIFIED` and indicates how the account authenticates by specifying an account authentication plugin, credentials (for example, a password), or both. Syntax of the `auth_option` clause is the same as for the `CREATE USER` statement. For details, see [Section 13.7.1.2, “CREATE USER Statement”](#).



### Note

Use of `GRANT` to define account authentication characteristics is deprecated in MySQL 5.7. Instead, establish or change authentication characteristics using `CREATE USER` or `ALTER USER`. Expect this `GRANT` capability to be removed in a future MySQL release.

When `IDENTIFIED` is present and you have the global grant privilege (`GRANT OPTION`), any password specified becomes the new password for the account, even if the account exists and already has a password. Without `IDENTIFIED`, the account password remains unchanged.

## Global Privileges

Global privileges are administrative or apply to all databases on a given server. To assign global privileges, use `ON *.*` syntax:

```
GRANT ALL ON *.* TO 'someuser'@'somehost';
```

```
GRANT SELECT, INSERT ON *.* TO 'someuser'@'somehost';
```

The `CREATE TABLESPACE`, `CREATE USER`, `FILE`, `PROCESS`, `RELOAD`, `REPLICATION CLIENT`, `REPLICATION SLAVE`, `SHOW DATABASES`, `SHUTDOWN`, and `SUPER` privileges are administrative and can only be granted globally.

Other privileges can be granted globally or at more specific levels.

`GRANT OPTION` granted at the global level for any global privilege applies to all global privileges.

MySQL stores global privileges in the `mysql.user` system table.

## Database Privileges

Database privileges apply to all objects in a given database. To assign database-level privileges, use `ON db_name.*` syntax:

```
GRANT ALL ON mydb.* TO 'someuser'@'somehost';
GRANT SELECT, INSERT ON mydb.* TO 'someuser'@'somehost';
```

If you use `ON *` syntax (rather than `ON *.*`), privileges are assigned at the database level for the default database. An error occurs if there is no default database.

The `CREATE`, `DROP`, `EVENT`, `GRANT OPTION`, `LOCK TABLES`, and `REFERENCES` privileges can be specified at the database level. Table or routine privileges also can be specified at the database level, in which case they apply to all tables or routines in the database.

MySQL stores database privileges in the `mysql.db` system table.

## Table Privileges

Table privileges apply to all columns in a given table. To assign table-level privileges, use `ON db_name.tbl_name` syntax:

```
GRANT ALL ON mydb.mytbl TO 'someuser'@'somehost';
GRANT SELECT, INSERT ON mydb.mytbl TO 'someuser'@'somehost';
```

If you specify `tbl_name` rather than `db_name.tbl_name`, the statement applies to `tbl_name` in the default database. An error occurs if there is no default database.

The permissible `priv_type` values at the table level are `ALTER`, `CREATE VIEW`, `CREATE`, `DELETE`, `DROP`, `GRANT OPTION`, `INDEX`, `INSERT`, `REFERENCES`, `SELECT`, `SHOW VIEW`, `TRIGGER`, and `UPDATE`.

Table-level privileges apply to base tables and views. They do not apply to tables created with `CREATE TEMPORARY TABLE`, even if the table names match. For information about `TEMPORARY` table privileges, see [Section 13.1.18.2, “CREATE TEMPORARY TABLE Statement”](#).

MySQL stores table privileges in the `mysql.tables_priv` system table.

## Column Privileges

Column privileges apply to single columns in a given table. Each privilege to be granted at the column level must be followed by the column or columns, enclosed within parentheses.

```
GRANT SELECT (col1), INSERT (col1, col2) ON mydb.mytbl TO 'someuser'@'somehost';
```

The permissible `priv_type` values for a column (that is, when you use a `column_list` clause) are `INSERT`, `REFERENCES`, `SELECT`, and `UPDATE`.

MySQL stores column privileges in the `mysql.columns_priv` system table.

## Stored Routine Privileges

The `ALTER ROUTINE`, `CREATE ROUTINE`, `EXECUTE`, and `GRANT OPTION` privileges apply to stored routines (procedures and functions). They can be granted at the global and database levels. Except for `CREATE ROUTINE`, these privileges can be granted at the routine level for individual routines.

```
GRANT CREATE ROUTINE ON mydb.* TO 'someuser'@'somehost';
GRANT EXECUTE ON PROCEDURE mydb.myproc TO 'someuser'@'somehost';
```

The permissible `priv_type` values at the routine level are `ALTER ROUTINE`, `EXECUTE`, and `GRANT OPTION`. `CREATE ROUTINE` is not a routine-level privilege because you must have the privilege at the global or database level to create a routine in the first place.

MySQL stores routine-level privileges in the `mysql.procs_priv` system table.

## Proxy User Privileges

The `PROXY` privilege enables one user to be a proxy for another. The proxy user impersonates or takes the identity of the proxied user; that is, it assumes the privileges of the proxied user.

```
GRANT PROXY ON 'localuser'@'localhost' TO 'externaluser'@'somehost';
```

When `PROXY` is granted, it must be the only privilege named in the `GRANT` statement, the `REQUIRE` clause cannot be given, and the only permitted `WITH` option is `WITH GRANT OPTION`.

Proxying requires that the proxy user authenticate through a plugin that returns the name of the proxied user to the server when the proxy user connects, and that the proxy user have the `PROXY` privilege for the proxied user. For details and examples, see [Section 6.2.14, “Proxy Users”](#).

MySQL stores proxy privileges in the `mysql.proxies_priv` system table.

## Implicit Account Creation

If an account named in a `GRANT` statement does not exist, the action taken depends on the `NO_AUTO_CREATE_USER` SQL mode:

- If `NO_AUTO_CREATE_USER` is not enabled, `GRANT` creates the account. *This is very insecure* unless you specify a nonempty password using `IDENTIFIED BY`.
- If `NO_AUTO_CREATE_USER` is enabled, `GRANT` fails and does not create the account, unless you specify a nonempty password using `IDENTIFIED BY` or name an authentication plugin using `IDENTIFIED WITH`.

If the account already exists, `IDENTIFIED WITH` is prohibited because it is intended only for use when creating new accounts.

## Other Account Characteristics

MySQL can check X.509 certificate attributes in addition to the usual authentication that is based on the user name and credentials. For background information on the use of SSL with MySQL, see [Section 6.3, “Using Encrypted Connections”](#).

The optional `REQUIRE` clause specifies SSL-related options for a MySQL account. The syntax is the same as for the `CREATE USER` statement. For details, see [Section 13.7.1.2, “CREATE USER Statement”](#).



### Note

Use of `GRANT` to define account SSL characteristics is deprecated in MySQL 5.7. Instead, establish or change SSL characteristics using `CREATE USER` or `ALTER USER`. Expect this `GRANT` capability to be removed in a future MySQL release.

The optional `WITH` clause is used for these purposes:

- To enable a user to grant privileges to other users
- To specify resource limits for a user

The `WITH GRANT OPTION` clause gives the user the ability to give to other users any privileges the user has at the specified privilege level.

To grant the `GRANT OPTION` privilege to an account without otherwise changing its privileges, do this:

```
GRANT USAGE ON *.* TO 'someuser'@'somehost' WITH GRANT OPTION;
```

Be careful to whom you give the `GRANT OPTION` privilege because two users with different privileges may be able to combine privileges!

You cannot grant another user a privilege which you yourself do not have; the `GRANT OPTION` privilege enables you to assign only those privileges which you yourself possess.

Be aware that when you grant a user the `GRANT OPTION` privilege at a particular privilege level, any privileges the user possesses (or may be given in the future) at that level can also be granted by that user to other users. Suppose that you grant a user the `INSERT` privilege on a database. If you then grant the `SELECT` privilege on the database and specify `WITH GRANT OPTION`, that user can give to other users not only the `SELECT` privilege, but also `INSERT`. If you then grant the `UPDATE` privilege to the user on the database, the user can grant `INSERT`, `SELECT`, and `UPDATE`.

For a nonadministrative user, you should not grant the `ALTER` privilege globally or for the `mysql` system database. If you do that, the user can try to subvert the privilege system by renaming tables!

For additional information about security risks associated with particular privileges, see [Section 6.2.2, “Privileges Provided by MySQL”](#).

It is possible to place limits on use of server resources by an account, as discussed in [Section 6.2.16, “Setting Account Resource Limits”](#). To do so, use a `WITH` clause that specifies one or more `resource_option` values. Limits not specified retain their current values. The syntax is the same as for the `CREATE USER` statement. For details, see [Section 13.7.1.2, “CREATE USER Statement”](#).



#### Note

Use of `GRANT` to define account resource limits is deprecated in MySQL 5.7. Instead, establish or change resource limits using `CREATE USER` or `ALTER USER`. Expect this `GRANT` capability to be removed in a future MySQL release.

## MySQL and Standard SQL Versions of GRANT

The biggest differences between the MySQL and standard SQL versions of `GRANT` are:

- MySQL associates privileges with the combination of a host name and user name and not with only a user name.
- Standard SQL does not have global or database-level privileges, nor does it support all the privilege types that MySQL supports.
- MySQL does not support the standard SQL `UNDER` privilege.
- Standard SQL privileges are structured in a hierarchical manner. If you remove a user, all privileges the user has been granted are revoked. This is also true in MySQL if you use `DROP USER`. See [Section 13.7.1.3, “DROP USER Statement”](#).



- In standard SQL, when you drop a table, all privileges for the table are revoked. In standard SQL, when you revoke a privilege, all privileges that were granted based on that privilege are also revoked. In MySQL, privileges can be dropped with `DROP USER` or `REVOKE` statements.
- In MySQL, it is possible to have the `INSERT` privilege for only some of the columns in a table. In this case, you can still execute `INSERT` statements on the table, provided that you insert values only for those columns for which you have the `INSERT` privilege. The omitted columns are set to their implicit default values if strict SQL mode is not enabled. In strict mode, the statement is rejected if any of the omitted columns have no default value. (Standard SQL requires you to have the `INSERT` privilege on all columns.) For information about strict SQL mode and implicit default values, see [Section 5.1.10, “Server SQL Modes”](#), and [Section 11.6, “Data Type Default Values”](#).

### 13.7.1.5 RENAME USER Statement

```
RENAME USER old_user TO new_user
[, old_user TO new_user] ...
```

The `RENAME USER` statement renames existing MySQL accounts. An error occurs for old accounts that do not exist or new accounts that already exist.

To use `RENAME USER`, you must have the global `CREATE USER` privilege, or the `UPDATE` privilege for the `mysql` system database. When the `read_only` system variable is enabled, `RENAME USER` additionally requires the `SUPER` privilege.

Each account name uses the format described in [Section 6.2.4, “Specifying Account Names”](#). For example:

```
RENAME USER 'jeffrey'@'localhost' TO 'jeff'@'127.0.0.1';
```

The host name part of the account name, if omitted, defaults to `'%'`.

`RENAME USER` causes the privileges held by the old user to be those held by the new user. However, `RENAME USER` does not automatically drop or invalidate databases or objects within them that the old user created. This includes stored programs or views for which the `DEFINER` attribute names the old user. Attempts to access such objects may produce an error if they execute in definer security context. (For information about security context, see [Section 23.6, “Stored Object Access Control”](#).)

The privilege changes take effect as indicated in [Section 6.2.9, “When Privilege Changes Take Effect”](#).

### 13.7.1.6 REVOKE Statement

```
REVOKE
  priv_type [(column_list)]
  [, priv_type [(column_list)] ...
  ON [object_type] priv_level
  FROM user [, user] ...

REVOKE ALL [PRIVILEGES], GRANT OPTION
  FROM user [, user] ...

REVOKE PROXY ON user
  FROM user [, user] ...
```

The `REVOKE` statement enables system administrators to revoke privileges from MySQL accounts.

For details on the levels at which privileges exist, the permissible `priv_type`, `priv_level`, and `object_type` values, and the syntax for specifying users and passwords, see [Section 13.7.1.4, “GRANT Statement”](#).

When the `read_only` system variable is enabled, `REVOKE` requires the `SUPER` privilege in addition to any other required privileges described in the following discussion.

Each account name uses the format described in [Section 6.2.4, “Specifying Account Names”](#). For example:

```
REVOKE INSERT ON *.* FROM 'jeffrey'@'localhost';
```

The host name part of the account name, if omitted, defaults to `'%'`.

To use the first `REVOKE` syntax, you must have the `GRANT OPTION` privilege, and you must have the privileges that you are revoking.

To revoke all privileges, use the second syntax, which drops all global, database, table, column, and routine privileges for the named user or users:

```
REVOKE ALL PRIVILEGES, GRANT OPTION FROM user [, user] ...
```

To use this `REVOKE` syntax, you must have the global `CREATE USER` privilege, or the `UPDATE` privilege for the `mysql` system database.

User accounts from which privileges are to be revoked must exist, but the privileges to be revoked need not be currently granted to them.

`REVOKE` removes privileges, but does not remove rows from the `mysql.user` system table. To remove a user account entirely, use `DROP USER`. See [Section 13.7.1.3, “DROP USER Statement”](#).

If the grant tables hold privilege rows that contain mixed-case database or table names and the `lower_case_table_names` system variable is set to a nonzero value, `REVOKE` cannot be used to revoke these privileges. It is necessary to manipulate the grant tables directly. (`GRANT` does not create such rows when `lower_case_table_names` is set, but such rows might have been created prior to setting the variable.)

When successfully executed from the `mysql` program, `REVOKE` responds with `Query OK, 0 rows affected`. To determine what privileges remain after the operation, use `SHOW GRANTS`. See [Section 13.7.5.21, “SHOW GRANTS Statement”](#).

### 13.7.1.7 SET PASSWORD Statement

```
SET PASSWORD [FOR user] = password_option
```

```
password_option: {
  'auth_string'
  | PASSWORD('auth_string')
}
```

The `SET PASSWORD` statement assigns a password to a MySQL user account. `'auth_string'` represents a cleartext (unencrypted) password.



#### Note

- `SET PASSWORD ... = PASSWORD('auth_string')` syntax is deprecated in MySQL 5.7 and is removed in MySQL 8.0.
- `SET PASSWORD ... = 'auth_string'` syntax is not deprecated, but `ALTER USER` is the preferred statement for account alterations, including assigning passwords. For example:

```
ALTER USER user IDENTIFIED BY 'auth_string';
```



#### Important

Under some circumstances, `SET PASSWORD` may be recorded in server logs or on the client side in a history file such as `~/mysql_history`, which means that

cleartext passwords may be read by anyone having read access to that information. For information about the conditions under which this occurs for the server logs and how to control it, see [Section 6.1.2.3, “Passwords and Logging”](#). For similar information about client-side logging, see [Section 4.5.1.3, “mysql Client Logging”](#).

`SET PASSWORD` can be used with or without a `FOR` clause that explicitly names a user account:

- With a `FOR user` clause, the statement sets the password for the named account, which must exist:

```
SET PASSWORD FOR 'jeffrey'@'localhost' = 'auth_string';
```

- With no `FOR user` clause, the statement sets the password for the current user:

```
SET PASSWORD = 'auth_string';
```

Any client who connects to the server using a nonanonymous account can change the password for that account. (In particular, you can change your own password.) To see which account the server authenticated you as, invoke the `CURRENT_USER()` function:

```
SELECT CURRENT_USER();
```

If a `FOR user` clause is given, the account name uses the format described in [Section 6.2.4, “Specifying Account Names”](#). For example:

```
SET PASSWORD FOR 'bob'@'%.example.org' = 'auth_string';
```

The host name part of the account name, if omitted, defaults to `'%'`.

Setting the password for a named account (with a `FOR` clause) requires the `UPDATE` privilege for the `mysql` system database. Setting the password for yourself (for a nonanonymous account with no `FOR` clause) requires no special privileges. When the `read_only` system variable is enabled, `SET PASSWORD` requires the `SUPER` privilege in addition to any other required privileges.

The password can be specified in these ways:

- Use a string without `PASSWORD()`

```
SET PASSWORD FOR 'jeffrey'@'localhost' = 'password';
```

`SET PASSWORD` interprets the string as a cleartext string, passes it to the authentication plugin associated with the account, and stores the result returned by the plugin in the account row in the `mysql.user` system table. (The plugin is given the opportunity to hash the value into the encryption format it expects. The plugin may use the value as specified, in which case no hashing occurs.)

- Use the `PASSWORD()` function (deprecated in MySQL 5.7)

```
SET PASSWORD FOR 'jeffrey'@'localhost' = PASSWORD('password');
```

The `PASSWORD()` argument is the cleartext (unencrypted) password. `PASSWORD()` hashes the password and returns the encrypted password string for storage in the account row in the `mysql.user` system table.

The `PASSWORD()` function hashes the password using the hashing method determined by the value of the `old_passwords` system variable value. Be sure that `old_passwords` has the value corresponding to the hashing method expected by the authentication plugin associated with the account. For example, if the account uses the `mysql_native_password` plugin, the `old_passwords` value must be 0:

```
SET old_passwords = 0;
SET PASSWORD FOR 'jeffrey'@'localhost' = PASSWORD('password');
```

If the `old_passwords` value differs from that required by the authentication plugin, the hashed password value returned by `PASSWORD()` cannot be used by the plugin and correct authentication of client connections cannot occur.

The following table shows, for each password hashing method, the permitted value of `old_passwords` and which authentication plugins use the hashing method.

Password Hashing Method	old_passwords Value	Associated Authentication Plugin
MySQL 4.1 native hashing	0	<code>mysql_native_password</code>
SHA-256 hashing	2	<code>sha256_password</code>

For additional information about setting passwords and authentication plugins, see [Section 6.2.10, “Assigning Account Passwords”](#), and [Section 6.2.13, “Pluggable Authentication”](#).

## 13.7.2 Table Maintenance Statements

### 13.7.2.1 ANALYZE TABLE Statement

```
ANALYZE [NO_WRITE_TO_BINLOG | LOCAL]
TABLE tbl_name [, tbl_name] ...
```

`ANALYZE TABLE` performs a key distribution analysis and stores the distribution for the named table or tables. For `MyISAM` tables, this statement is equivalent to using `myisamchk --analyze`.

This statement requires `SELECT` and `INSERT` privileges for the table.

`ANALYZE TABLE` works with `InnoDB`, `NDB`, and `MyISAM` tables. It does not work with views.

`ANALYZE TABLE` is supported for partitioned tables, and you can use `ALTER TABLE ... ANALYZE PARTITION` to analyze one or more partitions; for more information, see [Section 13.1.8, “ALTER TABLE Statement”](#), and [Section 22.3.4, “Maintenance of Partitions”](#).

During the analysis, the table is locked with a read lock for `InnoDB` and `MyISAM`.

`ANALYZE TABLE` removes the table from the table definition cache, which requires a flush lock. If there are long running statements or transactions still using the table, subsequent statements and transactions must wait for those operations to finish before the flush lock is released. Because `ANALYZE TABLE` itself typically finishes quickly, it may not be apparent that delayed transactions or statements involving the same table are due to the remaining flush lock.

By default, the server writes `ANALYZE TABLE` statements to the binary log so that they replicate to replicas. To suppress logging, specify the optional `NO_WRITE_TO_BINLOG` keyword or its alias `LOCAL`.

- [ANALYZE TABLE Output](#)
- [Key Distribution Analysis](#)
- [Other Considerations](#)

#### ANALYZE TABLE Output

`ANALYZE TABLE` returns a result set with the columns shown in the following table.

Column	Value
<code>Table</code>	The table name

Column	Value
Op	Always <code>analyze</code>
Msg_type	<code>status</code> , <code>error</code> , <code>info</code> , <code>note</code> , or <code>warning</code>
Msg_text	An informational message

## Key Distribution Analysis

If the table has not changed since the last key distribution analysis, the table is not analyzed again.

MySQL uses the stored key distribution to decide the table join order for joins on something other than a constant. In addition, key distributions can be used when deciding which indexes to use for a specific table within a query.

To check the stored key distribution cardinality, use the `SHOW INDEX` statement or the `INFORMATION_SCHEMA_STATISTICS` table. See [Section 13.7.5.22, “SHOW INDEX Statement”](#), and [Section 24.3.24, “The INFORMATION\\_SCHEMA\\_STATISTICS Table”](#).

For `InnoDB` tables, `ANALYZE TABLE` determines index cardinality by performing random dives on each of the index trees and updating index cardinality estimates accordingly. Because these are only estimates, repeated runs of `ANALYZE TABLE` could produce different numbers. This makes `ANALYZE TABLE` fast on `InnoDB` tables but not 100% accurate because it does not take all rows into account.

You can make the `statistics` collected by `ANALYZE TABLE` more precise and more stable by enabling `innodb_stats_persistent`, as explained in [Section 14.8.11.1, “Configuring Persistent Optimizer Statistics Parameters”](#). When `innodb_stats_persistent` is enabled, it is important to run `ANALYZE TABLE` after major changes to index column data, as statistics are not recalculated periodically (such as after a server restart).

If `innodb_stats_persistent` is enabled, you can change the number of random dives by modifying the `innodb_stats_persistent_sample_pages` system variable. If `innodb_stats_persistent` is disabled, modify `innodb_stats_transient_sample_pages` instead.

For more information about key distribution analysis in `InnoDB`, see [Section 14.8.11.1, “Configuring Persistent Optimizer Statistics Parameters”](#), and [Section 14.8.11.3, “Estimating ANALYZE TABLE Complexity for InnoDB Tables”](#).

MySQL uses index cardinality estimates in join optimization. If a join is not optimized in the right way, try running `ANALYZE TABLE`. In the few cases that `ANALYZE TABLE` does not produce values good enough for your particular tables, you can use `FORCE INDEX` with your queries to force the use of a particular index, or set the `max_seeks_for_key` system variable to ensure that MySQL prefers index lookups over table scans. See [Section B.3.5, “Optimizer-Related Issues”](#).

## Other Considerations

`ANALYZE TABLE` clears table statistics from the Information Schema `INNODB_SYS_TABLESTATS` table and sets the `STATS_INITIALIZED` column to `Uninitialized`. Statistics are collected again the next time the table is accessed.

### 13.7.2.2 CHECK TABLE Statement

```
CHECK TABLE tbl_name [, tbl_name] ... [option] ...

option: {
  FOR UPGRADE
  | QUICK
  | FAST
```

```

| MEDIUM
| EXTENDED
| CHANGED
}

```

`CHECK TABLE` checks a table or tables for errors. For `MyISAM` tables, the key statistics are updated as well. `CHECK TABLE` can also check views for problems, such as tables that are referenced in the view definition that no longer exist.

To check a table, you must have some privilege for it.

`CHECK TABLE` works for `InnoDB`, `MyISAM`, `ARCHIVE`, and `CSV` tables.

Before running `CHECK TABLE` on `InnoDB` tables, see [CHECK TABLE Usage Notes for InnoDB Tables](#).

`CHECK TABLE` is supported for partitioned tables, and you can use `ALTER TABLE ... CHECK PARTITION` to check one or more partitions; for more information, see [Section 13.1.8, “ALTER TABLE Statement”](#), and [Section 22.3.4, “Maintenance of Partitions”](#).

`CHECK TABLE` ignores virtual generated columns that are not indexed.

- [CHECK TABLE Output](#)
- [Checking Version Compatibility](#)
- [Checking Data Consistency](#)
- [CHECK TABLE Usage Notes for InnoDB Tables](#)
- [CHECK TABLE Usage Notes for MyISAM Tables](#)

## CHECK TABLE Output

`CHECK TABLE` returns a result set with the columns shown in the following table.

Column	Value
Table	The table name
Op	Always <code>check</code>
Msg_type	<code>status</code> , <code>error</code> , <code>info</code> , <code>note</code> , or <code>warning</code>
Msg_text	An informational message

The statement might produce many rows of information for each checked table. The last row has a `Msg_type` value of `status` and the `Msg_text` normally should be `OK`. For a `MyISAM` table, if you don't get `OK` or `Table is already up to date`, you should normally run a repair of the table. See [Section 7.6, “MyISAM Table Maintenance and Crash Recovery”](#). `Table is already up to date` means that the storage engine for the table indicated that there was no need to check the table.

## Checking Version Compatibility

The `FOR UPGRADE` option checks whether the named tables are compatible with the current version of MySQL. With `FOR UPGRADE`, the server checks each table to determine whether there have been any incompatible changes in any of the table's data types or indexes since the table was created. If not, the check succeeds. Otherwise, if there is a possible incompatibility, the server runs a full check on the table (which might take some time). If the full check succeeds, the server marks the table's `.frm` file with the current MySQL version number. Marking the `.frm` file ensures that further checks for the table with the same version of the server are fast.

Incompatibilities might occur because the storage format for a data type has changed or because its sort order has changed. Our aim is to avoid these changes, but occasionally they are necessary to correct problems that would be worse than an incompatibility between releases.

`FOR UPGRADE` discovers these incompatibilities:

- The indexing order for end-space in `TEXT` columns for `InnoDB` and `MyISAM` tables changed between MySQL 4.1 and 5.0.
- The storage method of the new `DECIMAL` data type changed between MySQL 5.0.3 and 5.0.5.
- If your table was created by a different version of the MySQL server than the one you are currently running, `FOR UPGRADE` indicates that the table has an `.frm` file with an incompatible version. In this case, the result set returned by `CHECK TABLE` contains a line with a `Msg_type` value of `error` and a `Msg_text` value of `Table upgrade required. Please do "REPAIR TABLE `tbl_name`" to fix it!`
- Changes are sometimes made to character sets or collations that require table indexes to be rebuilt. For details about such changes, see [Section 2.10.3, “Changes in MySQL 5.7”](#). For information about rebuilding tables, see [Section 2.10.12, “Rebuilding or Repairing Tables or Indexes”](#).
- The `YEAR(2)` data type is deprecated and support for it is removed in MySQL 5.7.5. For tables containing `YEAR(2)` columns, `CHECK TABLE` recommends `REPAIR TABLE`, which converts 2-digit `YEAR(2)` columns to 4-digit `YEAR` columns.
- As of MySQL 5.7.2, trigger creation time is maintained. If run against a table that has triggers, `CHECK TABLE ... FOR UPGRADE` displays this warning for each trigger created before MySQL 5.7.2:

```
Trigger db_name.tbl_name.trigger_name does not have CREATED attribute.
```

The warning is informational only. No change is made to the trigger.

- As of MySQL 5.7.7, a table is reported as needing a rebuild if it contains old temporal columns in pre-5.6.4 format (`TIME`, `DATETIME`, and `TIMESTAMP` columns without support for fractional seconds precision) and the `avoid_temporal_upgrade` system variable is disabled. This helps the MySQL upgrade procedure detect and upgrade tables containing old temporal columns. If `avoid_temporal_upgrade` is enabled, `FOR UPGRADE` ignores the old temporal columns present in the table; consequently, the upgrade procedure does not upgrade them.

To check for tables that contain such temporal columns and need a rebuild, disable `avoid_temporal_upgrade` before executing `CHECK TABLE ... FOR UPGRADE`.

- Warnings are issued for tables that use nonnative partitioning because nonnative partitioning is deprecated in MySQL 5.7 and removed in MySQL 8.0. See [Chapter 22, \*Partitioning\*](#).

## Checking Data Consistency

The following table shows the other check options that can be given. These options are passed to the storage engine, which may use or ignore them.

Type	Meaning
<code>QUICK</code>	Do not scan the rows to check for incorrect links. Applies to <code>InnoDB</code> and <code>MyISAM</code> tables and views.
<code>FAST</code>	Check only tables that have not been closed properly. Ignored for <code>InnoDB</code> ; applies only to <code>MyISAM</code> tables and views.

Type	Meaning
CHANGED	Check only tables that have been changed since the last check or that have not been closed properly. Ignored for InnoDB; applies only to MyISAM tables and views.
MEDIUM	Scan rows to verify that deleted links are valid. This also calculates a key checksum for the rows and verifies this with a calculated checksum for the keys. Ignored for InnoDB; applies only to MyISAM tables and views.
EXTENDED	Do a full key lookup for all keys for each row. This ensures that the table is 100% consistent, but takes a long time. Ignored for InnoDB; applies only to MyISAM tables and views.

If none of the options `QUICK`, `MEDIUM`, or `EXTENDED` are specified, the default check type for dynamic-format `MyISAM` tables is `MEDIUM`. This has the same result as running `myisamchk --medium-check tbl_name` on the table. The default check type also is `MEDIUM` for static-format `MyISAM` tables, unless `CHANGED` or `FAST` is specified. In that case, the default is `QUICK`. The row scan is skipped for `CHANGED` and `FAST` because the rows are very seldom corrupted.

You can combine check options, as in the following example that does a quick check on the table to determine whether it was closed properly:

```
CHECK TABLE test_table FAST QUICK;
```



#### Note

If `CHECK TABLE` finds no problems with a table that is marked as “corrupted” or “not closed properly”, `CHECK TABLE` may remove the mark.

If a table is corrupted, the problem is most likely in the indexes and not in the data part. All of the preceding check types check the indexes thoroughly and should thus find most errors.

To check a table that you assume is okay, use no check options or the `QUICK` option. The latter should be used when you are in a hurry and can take the very small risk that `QUICK` does not find an error in the data file. (In most cases, under normal usage, MySQL should find any error in the data file. If this happens, the table is marked as “corrupted” and cannot be used until it is repaired.)

`FAST` and `CHANGED` are mostly intended to be used from a script (for example, to be executed from `cron`) to check tables periodically. In most cases, `FAST` is to be preferred over `CHANGED`. (The only case when it is not preferred is when you suspect that you have found a bug in the `MyISAM` code.)

`EXTENDED` is to be used only after you have run a normal check but still get errors from a table when MySQL tries to update a row or find a row by key. This is very unlikely if a normal check has succeeded.

Use of `CHECK TABLE ... EXTENDED` might influence execution plans generated by the query optimizer.

Some problems reported by `CHECK TABLE` cannot be corrected automatically:

- Found row where the `auto_increment` column has the value 0.

This means that you have a row in the table where the `AUTO_INCREMENT` index column contains the value 0. (It is possible to create a row where the `AUTO_INCREMENT` column is 0 by explicitly setting the column to 0 with an `UPDATE` statement.)



This is not an error in itself, but could cause trouble if you decide to dump the table and restore it or do an `ALTER TABLE` on the table. In this case, the `AUTO_INCREMENT` column changes value according to the rules of `AUTO_INCREMENT` columns, which could cause problems such as a duplicate-key error.

To get rid of the warning, execute an `UPDATE` statement to set the column to some value other than 0.

## CHECK TABLE Usage Notes for InnoDB Tables

The following notes apply to `InnoDB` tables:

- If `CHECK TABLE` encounters a corrupt page, the server exits to prevent error propagation (Bug #10132). If the corruption occurs in a secondary index but table data is readable, running `CHECK TABLE` can still cause a server exit.
- If `CHECK TABLE` encounters a corrupted `DB_TRX_ID` or `DB_ROLL_PTR` field in a clustered index, `CHECK TABLE` can cause `InnoDB` to access an invalid undo log record, resulting in an `MVCC`-related server exit.
- If `CHECK TABLE` encounters errors in `InnoDB` tables or indexes, it reports an error, and usually marks the index and sometimes marks the table as corrupted, preventing further use of the index or table. Such errors include an incorrect number of entries in a secondary index or incorrect links.
- If `CHECK TABLE` finds an incorrect number of entries in a secondary index, it reports an error but does not cause a server exit or prevent access to the file.
- `CHECK TABLE` surveys the index page structure, then surveys each key entry. It does not validate the key pointer to a clustered record or follow the path for `BLOB` pointers.
- When an `InnoDB` table is stored in its own `.ibd` file, the first 3 pages of the `.ibd` file contain header information rather than table or index data. The `CHECK TABLE` statement does not detect inconsistencies that affect only the header data. To verify the entire contents of an `InnoDB .ibd` file, use the `innochecksum` command.
- When running `CHECK TABLE` on large `InnoDB` tables, other threads may be blocked during `CHECK TABLE` execution. To avoid timeouts, the semaphore wait threshold (600 seconds) is extended by 2 hours (7200 seconds) for `CHECK TABLE` operations. If `InnoDB` detects semaphore waits of 240 seconds or more, it starts printing `InnoDB` monitor output to the error log. If a lock request extends beyond the semaphore wait threshold, `InnoDB` aborts the process. To avoid the possibility of a semaphore wait timeout entirely, run `CHECK TABLE QUICK` instead of `CHECK TABLE`.
- `CHECK TABLE` functionality for `InnoDB SPATIAL` indexes includes an R-tree validity check and a check to ensure that the R-tree row count matches the clustered index.
- `CHECK TABLE` supports secondary indexes on virtual generated columns, which are supported by `InnoDB`.

## CHECK TABLE Usage Notes for MyISAM Tables

The following notes apply to `MyISAM` tables:

- `CHECK TABLE` updates key statistics for `MyISAM` tables.
- If `CHECK TABLE` output does not return `OK` or `Table is already up to date`, you should normally run a repair of the table. See [Section 7.6, “MyISAM Table Maintenance and Crash Recovery”](#).
- If none of the `CHECK TABLE` options `QUICK`, `MEDIUM`, or `EXTENDED` are specified, the default check type for dynamic-format `MyISAM` tables is `MEDIUM`. This has the same result as running `myisamchk`

`--medium-check tbl_name` on the table. The default check type also is `MEDIUM` for static-format `MyISAM` tables, unless `CHANGED` or `FAST` is specified. In that case, the default is `QUICK`. The row scan is skipped for `CHANGED` and `FAST` because the rows are very seldom corrupted.

### 13.7.2.3 CHECKSUM TABLE Statement

```
CHECKSUM TABLE tbl_name [, tbl_name] ... [QUICK | EXTENDED]
```

`CHECKSUM TABLE` reports a `checksum` for the contents of a table. You can use this statement to verify that the contents are the same before and after a backup, rollback, or other operation that is intended to put the data back to a known state.

This statement requires the `SELECT` privilege for the table.

This statement is not supported for views. If you run `CHECKSUM TABLE` against a view, the `Checksum` value is always `NULL`, and a warning is returned.

For a nonexistent table, `CHECKSUM TABLE` returns `NULL` and generates a warning.

During the checksum operation, the table is locked with a read lock for `InnoDB` and `MyISAM`.

### Performance Considerations

By default, the entire table is read row by row and the checksum is calculated. For large tables, this could take a long time, thus you would only perform this operation occasionally. This row-by-row calculation is what you get with the `EXTENDED` clause, with `InnoDB` and all other storage engines other than `MyISAM`, and with `MyISAM` tables not created with the `CHECKSUM=1` clause.

For `MyISAM` tables created with the `CHECKSUM=1` clause, `CHECKSUM TABLE` or `CHECKSUM TABLE ... QUICK` returns the “live” table checksum that can be returned very fast. If the table does not meet all these conditions, the `QUICK` method returns `NULL`. The `QUICK` method is not supported with `InnoDB` tables. See [Section 13.1.18, “CREATE TABLE Statement”](#) for the syntax of the `CHECKSUM` clause.

The checksum value depends on the table row format. If the row format changes, the checksum also changes. For example, the storage format for temporal types such as `TIME`, `DATETIME`, and `TIMESTAMP` changed in MySQL 5.6 prior to MySQL 5.6.5, so if a 5.5 table is upgraded to MySQL 5.6, the checksum value may change.



#### Important

If the checksums for two tables are different, then it is almost certain that the tables are different in some way. However, because the hashing function used by `CHECKSUM TABLE` is not guaranteed to be collision-free, there is a slight chance that two tables which are not identical can produce the same checksum.

### 13.7.2.4 OPTIMIZE TABLE Statement

```
OPTIMIZE [NO_WRITE_TO_BINLOG | LOCAL]
TABLE tbl_name [, tbl_name] ...
```

`OPTIMIZE TABLE` reorganizes the physical storage of table data and associated index data, to reduce storage space and improve I/O efficiency when accessing the table. The exact changes made to each table depend on the `storage engine` used by that table.

Use `OPTIMIZE TABLE` in these cases, depending on the type of table:

- After doing substantial insert, update, or delete operations on an `InnoDB` table that has its own `.ibd` file because it was created with the `innodb_file_per_table` option enabled. The table and indexes are reorganized, and disk space can be reclaimed for use by the operating system.

- After doing substantial insert, update, or delete operations on columns that are part of a `FULLTEXT` index in an `InnoDB` table. Set the configuration option `innodb_optimize_fulltext_only=1` first. To keep the index maintenance period to a reasonable time, set the `innodb_ft_num_word_optimize` option to specify how many words to update in the search index, and run a sequence of `OPTIMIZE TABLE` statements until the search index is fully updated.
- After deleting a large part of a `MyISAM` or `ARCHIVE` table, or making many changes to a `MyISAM` or `ARCHIVE` table with variable-length rows (tables that have `VARCHAR`, `VARBINARY`, `BLOB`, or `TEXT` columns). Deleted rows are maintained in a linked list and subsequent `INSERT` operations reuse old row positions. You can use `OPTIMIZE TABLE` to reclaim the unused space and to defragment the data file. After extensive changes to a table, this statement may also improve performance of statements that use the table, sometimes significantly.

This statement requires `SELECT` and `INSERT` privileges for the table.

`OPTIMIZE TABLE` works for `InnoDB`, `MyISAM`, and `ARCHIVE` tables. `OPTIMIZE TABLE` is also supported for dynamic columns of in-memory `NDB` tables. It does not work for fixed-width columns of in-memory tables, nor does it work for Disk Data tables. The performance of `OPTIMIZE` on `NDB` Cluster tables can be tuned using `--ndb-optimization-delay`, which controls the length of time to wait between processing batches of rows by `OPTIMIZE TABLE`. For more information, see [Previous NDB Cluster Issues Resolved in NDB Cluster 8.0](#).

For `NDB` Cluster tables, `OPTIMIZE TABLE` can be interrupted by (for example) killing the SQL thread performing the `OPTIMIZE` operation.

By default, `OPTIMIZE TABLE` does *not* work for tables created using any other storage engine and returns a result indicating this lack of support. You can make `OPTIMIZE TABLE` work for other storage engines by starting `mysqld` with the `--skip-new` option. In this case, `OPTIMIZE TABLE` is just mapped to `ALTER TABLE`.

This statement does not work with views.

`OPTIMIZE TABLE` is supported for partitioned tables. For information about using this statement with partitioned tables and table partitions, see [Section 22.3.4, “Maintenance of Partitions”](#).

By default, the server writes `OPTIMIZE TABLE` statements to the binary log so that they replicate to replicas. To suppress logging, specify the optional `NO_WRITE_TO_BINLOG` keyword or its alias `LOCAL`.

- [OPTIMIZE TABLE Output](#)
- [InnoDB Details](#)
- [MyISAM Details](#)
- [Other Considerations](#)

## OPTIMIZE TABLE Output

`OPTIMIZE TABLE` returns a result set with the columns shown in the following table.

Column	Value
Table	The table name
Op	Always <code>optimize</code>
Msg_type	<code>status</code> , <code>error</code> , <code>info</code> , <code>note</code> , or <code>warning</code>

Column	Value
<code>Msg_text</code>	An informational message

`OPTIMIZE TABLE` catches and throws any errors that occur while copying table statistics from the old file to the newly created file. For example, if the user ID of the owner of the `.frm`, `.MYD`, or `.MYI` file is different from the user ID of the `mysqld` process, `OPTIMIZE TABLE` generates a "cannot change ownership of the file" error unless `mysqld` is started by the `root` user.

## InnoDB Details

For InnoDB tables, `OPTIMIZE TABLE` is mapped to `ALTER TABLE ... FORCE`, which rebuilds the table to update index statistics and free unused space in the clustered index. This is displayed in the output of `OPTIMIZE TABLE` when you run it on an InnoDB table, as shown here:

```
mysql> OPTIMIZE TABLE foo;
+-----+-----+-----+-----+
| Table  | Op      | Msg_type | Msg_text                               |
+-----+-----+-----+-----+
| test.foo | optimize | note     | Table does not support optimize, doing recreate + analyze instead |
| test.foo | optimize | status   | OK                                     |
+-----+-----+-----+-----+
```

`OPTIMIZE TABLE` uses [online DDL](#) for regular and partitioned InnoDB tables, which reduces downtime for concurrent DML operations. The table rebuild triggered by `OPTIMIZE TABLE` is completed in place. An exclusive table lock is only taken briefly during the prepare phase and the commit phase of the operation. During the prepare phase, metadata is updated and an intermediate table is created. During the commit phase, table metadata changes are committed.

`OPTIMIZE TABLE` rebuilds the table using the table copy method under the following conditions:

- When the `old_alter_table` system variable is enabled.
- When the server is started with the `--skip-new` option.

`OPTIMIZE TABLE` using [online DDL](#) is not supported for InnoDB tables that contain `FULLTEXT` indexes. The table copy method is used instead.

InnoDB stores data using a page-allocation method and does not suffer from fragmentation in the same way that legacy storage engines (such as `MyISAM`) do. When considering whether or not to run `OPTIMIZE TABLE`, consider the workload of transactions that your server is expected to process:

- Some level of fragmentation is expected. InnoDB fills [pages](#) only 93% full, to leave room for updates without having to split pages.
- Delete operations might leave gaps that leave pages less filled than desired, which could make it worthwhile to optimize the table.
- Updates to rows usually rewrite the data within the same page, depending on the data type and row format, when sufficient space is available. See [Section 14.9.1.5, "How Compression Works for InnoDB Tables"](#) and [Section 14.11, "InnoDB Row Formats"](#).
- High-concurrency workloads might leave gaps in indexes over time, as InnoDB retains multiple versions of the same data due through its [MVCC](#) mechanism. See [Section 14.3, "InnoDB Multi-Versioning"](#).

## MyISAM Details

For `MyISAM` tables, `OPTIMIZE TABLE` works as follows:

1. If the table has deleted or split rows, repair the table.
2. If the index pages are not sorted, sort them.
3. If the table's statistics are not up to date (and the repair could not be accomplished by sorting the index), update them.

## Other Considerations

`OPTIMIZE TABLE` is performed online for regular and partitioned `InnoDB` tables. Otherwise, MySQL [locks the table](#) during the time `OPTIMIZE TABLE` is running.

`OPTIMIZE TABLE` does not sort R-tree indexes, such as spatial indexes on `POINT` columns. (Bug #23578)

### 13.7.2.5 REPAIR TABLE Statement

```
REPAIR [NO_WRITE_TO_BINLOG | LOCAL]
TABLE tbl_name [, tbl_name] ...
[QUICK] [EXTENDED] [USE_FRM]
```

`REPAIR TABLE` repairs a possibly corrupted table, for certain storage engines only.

This statement requires `SELECT` and `INSERT` privileges for the table.

Although normally you should never have to run `REPAIR TABLE`, if disaster strikes, this statement is very likely to get back all your data from a `MyISAM` table. If your tables become corrupted often, try to find the reason for it, to eliminate the need to use `REPAIR TABLE`. See [Section B.3.3.3, “What to Do If MySQL Keeps Crashing”](#), and [Section 15.2.4, “MyISAM Table Problems”](#).

`REPAIR TABLE` checks the table to see whether an upgrade is required. If so, it performs the upgrade, following the same rules as `CHECK TABLE ... FOR UPGRADE`. See [Section 13.7.2.2, “CHECK TABLE Statement”](#), for more information.



#### Important

- Make a backup of a table before performing a table repair operation; under some circumstances the operation might cause data loss. Possible causes include but are not limited to file system errors. See [Chapter 7, Backup and Recovery](#).
- If the server exits during a `REPAIR TABLE` operation, it is essential after restarting it that you immediately execute another `REPAIR TABLE` statement for the table before performing any other operations on it. In the worst case, you might have a new clean index file without information about the data file, and then the next operation you perform could overwrite the data file. This is an unlikely but possible scenario that underscores the value of making a backup first.
- In the event that a table on the source becomes corrupted and you run `REPAIR TABLE` on it, any resulting changes to the original table are *not* propagated to replicas.

- [REPAIR TABLE Storage Engine and Partitioning Support](#)
- [REPAIR TABLE Options](#)
- [REPAIR TABLE Output](#)

- [Table Repair Considerations](#)

## REPAIR TABLE Storage Engine and Partitioning Support

`REPAIR TABLE` works for `MyISAM`, `ARCHIVE`, and `CSV` tables. For `MyISAM` tables, it has the same effect as `myisamchk --recover tbl_name` by default. This statement does not work with views.

`REPAIR TABLE` is supported for partitioned tables. However, the `USE_FRM` option cannot be used with this statement on a partitioned table.

You can use `ALTER TABLE ... REPAIR PARTITION` to repair one or more partitions; for more information, see [Section 13.1.8, “ALTER TABLE Statement”](#), and [Section 22.3.4, “Maintenance of Partitions”](#).

## REPAIR TABLE Options

- `NO_WRITE_TO_BINLOG` or `LOCAL`

By default, the server writes `REPAIR TABLE` statements to the binary log so that they replicate to replicas. To suppress logging, specify the optional `NO_WRITE_TO_BINLOG` keyword or its alias `LOCAL`.

- `QUICK`

If you use the `QUICK` option, `REPAIR TABLE` tries to repair only the index file, and not the data file. This type of repair is like that done by `myisamchk --recover --quick`.

- `EXTENDED`

If you use the `EXTENDED` option, MySQL creates the index row by row instead of creating one index at a time with sorting. This type of repair is like that done by `myisamchk --safe-recover`.

- `USE_FRM`

The `USE_FRM` option is available for use if the `.MYI` index file is missing or if its header is corrupted. This option tells MySQL not to trust the information in the `.MYI` file header and to re-create it using information from the `.frm` file. This kind of repair cannot be done with `myisamchk`.



### Caution

Use the `USE_FRM` option *only* if you cannot use regular `REPAIR` modes. Telling the server to ignore the `.MYI` file makes important table metadata stored in the `.MYI` unavailable to the repair process, which can have deleterious consequences:

- The current `AUTO_INCREMENT` value is lost.
- The link to deleted records in the table is lost, which means that free space for deleted records remain unoccupied thereafter.
- The `.MYI` header indicates whether the table is compressed. If the server ignores this information, it cannot tell that a table is compressed and repair can cause change or loss of table contents. This means that `USE_FRM` should not be used with compressed tables. That should not be necessary, anyway: Compressed tables are read only, so they should not become corrupt.

If you use `USE_FRM` for a table that was created by a different version of the MySQL server than the one you are currently running, `REPAIR TABLE` does

not attempt to repair the table. In this case, the result set returned by `REPAIR TABLE` contains a line with a `Msg_type` value of `error` and a `Msg_text` value of `Failed repairing incompatible .FRM file`.

If `USE_FRM` is used, `REPAIR TABLE` does not check the table to see whether an upgrade is required.

## REPAIR TABLE Output

`REPAIR TABLE` returns a result set with the columns shown in the following table.

Column	Value
Table	The table name
Op	Always <code>repair</code>
Msg_type	<code>status</code> , <code>error</code> , <code>info</code> , <code>note</code> , or <code>warning</code>
Msg_text	An informational message

The `REPAIR TABLE` statement might produce many rows of information for each repaired table. The last row has a `Msg_type` value of `status` and `Msg_text` normally should be `OK`. For a `MyISAM` table, if you do not get `OK`, you should try repairing it with `myisamchk --safe-recover`. (`REPAIR TABLE` does not implement all the options of `myisamchk`. With `myisamchk --safe-recover`, you can also use options that `REPAIR TABLE` does not support, such as `--max-record-length`.)

`REPAIR TABLE` catches and throws any errors that occur while copying table statistics from the old corrupted file to the newly created file. For example, if the user ID of the owner of the `.frm`, `.MYD`, or `.MYI` file is different from the user ID of the `mysqld` process, `REPAIR TABLE` generates a "cannot change ownership of the file" error unless `mysqld` is started by the `root` user.

## Table Repair Considerations

`REPAIR TABLE` upgrades a table if it contains old temporal columns in pre-5.6.4 format (`TIME`, `DATETIME`, and `TIMESTAMP` columns without support for fractional seconds precision) and the `avoid_temporal_upgrade` system variable is disabled. If `avoid_temporal_upgrade` is enabled, `REPAIR TABLE` ignores the old temporal columns present in the table and does not upgrade them.

To upgrade tables that contain such temporal columns, disable `avoid_temporal_upgrade` before executing `REPAIR TABLE`.

You may be able to increase `REPAIR TABLE` performance by setting certain system variables. See [Section 8.6.3, "Optimizing REPAIR TABLE Statements"](#).

## 13.7.3 Plugin and Loadable Function Statements

### 13.7.3.1 CREATE FUNCTION Statement for Loadable Functions

```
CREATE [AGGREGATE] FUNCTION function_name
  RETURNS {STRING|INTEGER|REAL|DECIMAL}
  SONAME shared_library_name
```

This statement loads the loadable function named `function_name`. (`CREATE FUNCTION` is also used to create stored functions; see [Section 13.1.16, "CREATE PROCEDURE and CREATE FUNCTION Statements"](#).)

A loadable function is a way to extend MySQL with a new function that works like a native (built-in) MySQL function such as `ABS()` or `CONCAT()`. See [Adding a Loadable Function](#).

*function\_name* is the name that should be used in SQL statements to invoke the function. The `RETURNS` clause indicates the type of the function's return value. `DECIMAL` is a legal value after `RETURNS`, but currently `DECIMAL` functions return string values and should be written like `STRING` functions.

The `AGGREGATE` keyword, if given, signifies that the function is an aggregate (group) function. An aggregate function works exactly like a native MySQL aggregate function such as `SUM()` or `COUNT()`.

*shared\_library\_name* is the base name of the shared library file containing the code that implements the function. The file must be located in the plugin directory. This directory is given by the value of the `plugin_dir` system variable. For more information, see [Section 5.6.1, “Installing and Uninstalling Loadable Functions”](#).

`CREATE FUNCTION` requires the `INSERT` privilege for the `mysql` system database because it adds a row to the `mysql.func` system table to register the function.

During the normal startup sequence, the server loads functions registered in the `mysql.func` table. If the server is started with the `--skip-grant-tables` option, functions registered in the table are not loaded and are unavailable.



#### Note

To upgrade the shared library associated with a loadable function, issue a `DROP FUNCTION` statement, upgrade the shared library, and then issue a `CREATE FUNCTION` statement. If you upgrade the shared library first and then use `DROP FUNCTION`, the server may unexpectedly shut down.

### 13.7.3.2 DROP FUNCTION Statement for Loadable Functions

```
DROP FUNCTION [IF EXISTS] function_name
```

This statement drops the loadable function named *function\_name*. (`DROP FUNCTION` is also used to drop stored functions; see [Section 13.1.27, “DROP PROCEDURE and DROP FUNCTION Statements”](#).)

`DROP FUNCTION` is the complement of `CREATE FUNCTION`. It requires the `DELETE` privilege for the `mysql` system database because it removes the row from the `mysql.func` system table that registers the function.

During the normal startup sequence, the server loads functions registered in the `mysql.func` table. Because `DROP FUNCTION` removes the `mysql.func` row for the dropped function, the server does not load the function during subsequent restarts.



#### Note

To upgrade the shared library associated with a loadable function, issue a `DROP FUNCTION` statement, upgrade the shared library, and then issue a `CREATE FUNCTION` statement. If you upgrade the shared library first and then use `DROP FUNCTION`, the server may unexpectedly shut down.

### 13.7.3.3 INSTALL PLUGIN Statement

```
INSTALL PLUGIN plugin_name SONAME 'shared_library_name'
```

This statement installs a server plugin. It requires the `INSERT` privilege for the `mysql.plugin` system table because it adds a row to that table to register the plugin.

*plugin\_name* is the name of the plugin as defined in the plugin descriptor structure contained in the library file (see [Plugin Data Structures](#)). Plugin names are not case-sensitive. For maximal compatibility,



plugin names should be limited to ASCII letters, digits, and underscore because they are used in C source files, shell command lines, M4 and Bourne shell scripts, and SQL environments.

*shared\_library\_name* is the name of the shared library that contains the plugin code. The name includes the file name extension (for example, `libmyplugin.so`, `libmyplugin.dll`, or `libmyplugin.dylib`).

The shared library must be located in the plugin directory (the directory named by the `plugin_dir` system variable). The library must be in the plugin directory itself, not in a subdirectory. By default, `plugin_dir` is the `plugin` directory under the directory named by the `pkglibdir` configuration variable, but it can be changed by setting the value of `plugin_dir` at server startup. For example, set its value in a `my.cnf` file:

```
[mysqld]
plugin_dir=/path/to/plugin/directory
```

If the value of `plugin_dir` is a relative path name, it is taken to be relative to the MySQL base directory (the value of the `basedir` system variable).

`INSTALL PLUGIN` loads and initializes the plugin code to make the plugin available for use. A plugin is initialized by executing its initialization function, which handles any setup that the plugin must perform before it can be used. When the server shuts down, it executes the deinitialization function for each plugin that is loaded so that the plugin has a chance to perform any final cleanup.

`INSTALL PLUGIN` also registers the plugin by adding a line that indicates the plugin name and library file name to the `mysql.plugin` system table. During the normal startup sequence, the server loads and initializes plugins registered in `mysql.plugin`. This means that a plugin is installed with `INSTALL PLUGIN` only once, not every time the server starts. If the server is started with the `--skip-grant-tables` option, plugins registered in the `mysql.plugin` table are not loaded and are unavailable.

A plugin library can contain multiple plugins. For each of them to be installed, use a separate `INSTALL PLUGIN` statement. Each statement names a different plugin, but all of them specify the same library name.

`INSTALL PLUGIN` causes the server to read option (`my.cnf`) files just as during server startup. This enables the plugin to pick up any relevant options from those files. It is possible to add plugin options to an option file even before loading a plugin (if the `loose` prefix is used). It is also possible to uninstall a plugin, edit `my.cnf`, and install the plugin again. Restarting the plugin this way enables it to the new option values without a server restart.

For options that control individual plugin loading at server startup, see [Section 5.5.1, “Installing and Uninstalling Plugins”](#). If you need to load plugins for a single server startup when the `--skip-grant-tables` option is given (which tells the server not to read system tables), use the `--plugin-load` option. See [Section 5.1.6, “Server Command Options”](#).

To remove a plugin, use the `UNINSTALL PLUGIN` statement.

For additional information about plugin loading, see [Section 5.5.1, “Installing and Uninstalling Plugins”](#).

To see what plugins are installed, use the `SHOW PLUGINS` statement or query the `INFORMATION_SCHEMA.PLUGINS` table.

If you recompile a plugin library and need to reinstall it, you can use either of the following methods:

- Use `UNINSTALL PLUGIN` to uninstall all plugins in the library, install the new plugin library file in the plugin directory, and then use `INSTALL PLUGIN` to install all plugins in the library. This procedure has the advantage that it can be used without stopping the server. However, if the plugin library contains many plugins, you must issue many `INSTALL PLUGIN` and `UNINSTALL PLUGIN` statements.

- Stop the server, install the new plugin library file in the plugin directory, and restart the server.

### 13.7.3.4 UNINSTALL PLUGIN Statement

```
UNINSTALL PLUGIN plugin_name
```

This statement removes an installed server plugin. `UNINSTALL PLUGIN` is the complement of `INSTALL PLUGIN`. It requires the `DELETE` privilege for the `mysql.plugin` system table because it removes the row from that table that registers the plugin.

`plugin_name` must be the name of some plugin that is listed in the `mysql.plugin` table. The server executes the plugin's deinitialization function and removes the row for the plugin from the `mysql.plugin` system table, so that subsequent server restarts do not load and initialize the plugin. `UNINSTALL PLUGIN` does not remove the plugin's shared library file.

You cannot uninstall a plugin if any table that uses it is open.

Plugin removal has implications for the use of associated tables. For example, if a full-text parser plugin is associated with a `FULLTEXT` index on the table, uninstalling the plugin makes the table unusable. Any attempt to access the table results in an error. The table cannot even be opened, so you cannot drop an index for which the plugin is used. This means that uninstalling a plugin is something to do with care unless you do not care about the table contents. If you are uninstalling a plugin with no intention of reinstalling it later and you care about the table contents, you should dump the table with `mysqldump` and remove the `WITH PARSER` clause from the dumped `CREATE TABLE` statement so that you can reload the table later. If you do not care about the table, `DROP TABLE` can be used even if any plugins associated with the table are missing.

For additional information about plugin loading, see [Section 5.5.1, “Installing and Uninstalling Plugins”](#).

## 13.7.4 SET Statements

The `SET` statement has several forms. Descriptions for those forms that are not associated with a specific server capability appear in subsections of this section:

- `SET var_name = value` enables you to assign values to variables that affect the operation of the server or clients. See [Section 13.7.4.1, “SET Syntax for Variable Assignment”](#).
- `SET CHARACTER SET` and `SET NAMES` assign values to character set and collation variables associated with the current connection to the server. See [Section 13.7.4.2, “SET CHARACTER SET Statement”](#), and [Section 13.7.4.3, “SET NAMES Statement”](#).

Descriptions for the other forms appear elsewhere, grouped with other statements related to the capability they help implement:

- `SET PASSWORD` assigns account passwords. See [Section 13.7.1.7, “SET PASSWORD Statement”](#).
- `SET TRANSACTION ISOLATION LEVEL` sets the isolation level for transaction processing. See [Section 13.3.6, “SET TRANSACTION Statement”](#).

### 13.7.4.1 SET Syntax for Variable Assignment

```
SET variable = expr [, variable = expr] ...
```

```
variable: {
  user_var_name
| param_name
| local_var_name
```

```

| {GLOBAL | @@GLOBAL.} system_var_name
| [SESSION | @@SESSION. | @@] system_var_name
}

```

**SET** syntax for variable assignment enables you to assign values to different types of variables that affect the operation of the server or clients:

- User-defined variables. See [Section 9.4, “User-Defined Variables”](#).
- Stored procedure and function parameters, and stored program local variables. See [Section 13.6.4, “Variables in Stored Programs”](#).
- System variables. See [Section 5.1.7, “Server System Variables”](#). System variables also can be set at server startup, as described in [Section 5.1.8, “Using System Variables”](#).

A **SET** statement that assigns variable values is not written to the binary log, so in replication scenarios it affects only the host on which you execute it. To affect all replication hosts, execute the statement on each host.

The following sections describe **SET** syntax for setting variables. They use the = assignment operator, but the := assignment operator is also permitted for this purpose.

- [User-Defined Variable Assignment](#)
- [Parameter and Local Variable Assignment](#)
- [System Variable Assignment](#)
- [SET Error Handling](#)
- [Multiple Variable Assignment](#)
- [System Variable References in Expressions](#)

## User-Defined Variable Assignment

User-defined variables are created locally within a session and exist only within the context of that session; see [Section 9.4, “User-Defined Variables”](#).

A user-defined variable is written as `@var_name` and is assigned an expression value as follows:

```
SET @var_name = expr;
```

Examples:

```
SET @name = 43;
SET @total_tax = (SELECT SUM(tax) FROM taxable_transactions);
```

As demonstrated by those statements, `expr` can range from simple (a literal value) to more complex (the value returned by a scalar subquery).

The Performance Schema `user_variables_by_thread` table contains information about user-defined variables. See [Section 25.12.10, “Performance Schema User-Defined Variable Tables”](#).

## Parameter and Local Variable Assignment

**SET** applies to parameters and local variables in the context of the stored object within which they are defined. The following procedure uses the `increment` procedure parameter and `counter` local variable:

```
CREATE PROCEDURE p(increment INT)
BEGIN
  DECLARE counter INT DEFAULT 0;
  WHILE counter < 10 DO
    -- ... do work ...
    SET counter = counter + increment;
  END WHILE;
END;
```

## System Variable Assignment

The MySQL server maintains system variables that configure its operation. A system variable can have a global value that affects server operation as a whole, a session value that affects the current session, or both. Many system variables are dynamic and can be changed at runtime using the `SET` statement to affect operation of the current server instance. (To make a global system variable setting permanent so that it applies across server restarts, you should also set it in an option file.)

If you change a session system variable, the value remains in effect within your session until you change the variable to a different value or the session ends. The change has no effect on other sessions.

If you change a global system variable, the value is remembered and used to initialize the session value for new sessions until you change the variable to a different value or the server exits. The change is visible to any client that accesses the global value. However, the change affects the corresponding session value only for clients that connect after the change. The global variable change does not affect the session value for any current client sessions (not even the session within which the global value change occurs).



### Note

Setting a global system variable value always requires special privileges. Setting a session system variable value normally requires no special privileges and can be done by any user, although there are exceptions. For more information, see [Section 5.1.8.1, “System Variable Privileges”](#).

The following discussion describes the syntax options for setting system variables:

- To assign a value to a global system variable, precede the variable name by the `GLOBAL` keyword or the `@@GLOBAL.` qualifier:

```
SET GLOBAL max_connections = 1000;
SET @@GLOBAL.max_connections = 1000;
```

- To assign a value to a session system variable, precede the variable name by the `SESSION` or `LOCAL` keyword, by the `@@SESSION.`, `@@LOCAL.`, or `@@` qualifier, or by no keyword or no modifier at all:

```
SET SESSION sql_mode = 'TRADITIONAL';
SET LOCAL sql_mode = 'TRADITIONAL';
SET @@SESSION.sql_mode = 'TRADITIONAL';
SET @@LOCAL.sql_mode = 'TRADITIONAL';
SET @@sql_mode = 'TRADITIONAL';
SET sql_mode = 'TRADITIONAL';
```

A client can change its own session variables, but not those of any other client.

To set a global system variable value to the compiled-in MySQL default value or a session system variable to the current corresponding global value, set the variable to the value `DEFAULT`. For example, the following two statements are identical in setting the session value of `max_join_size` to the current global value:

```
SET @@SESSION.max_join_size = DEFAULT;
SET @@SESSION.max_join_size = @@GLOBAL.max_join_size;
```

To display system variable names and values:

- Use the `SHOW VARIABLES` statement; see [Section 13.7.5.39, “SHOW VARIABLES Statement”](#).
- Several Performance Schema tables provide system variable information. See [Section 25.12.13, “Performance Schema System Variable Tables”](#).

## SET Error Handling

If any variable assignment in a `SET` statement fails, the entire statement fails and no variables are changed.

`SET` produces an error under the circumstances described here. Most of the examples show `SET` statements that use keyword syntax (for example, `GLOBAL` or `SESSION`), but the principles are also true for statements that use the corresponding modifiers (for example, `@@GLOBAL.` or `@@SESSION.`).

- Use of `SET` (any variant) to set a read-only variable:

```
mysql> SET GLOBAL version = 'abc';
ERROR 1238 (HY000): Variable 'version' is a read only variable
```

- Use of `GLOBAL` to set a variable that has only a session value:

```
mysql> SET GLOBAL sql_log_bin = ON;
ERROR 1231 (42000): Variable 'sql_log_bin' can't be
set to the value of 'ON'
```

- Use of `SESSION` to set a variable that has only a global value:

```
mysql> SET SESSION max_connections = 1000;
ERROR 1229 (HY000): Variable 'max_connections' is a
GLOBAL variable and should be set with SET GLOBAL
```

- Omission of `GLOBAL` to set a variable that has only a global value:

```
mysql> SET max_connections = 1000;
ERROR 1229 (HY000): Variable 'max_connections' is a
GLOBAL variable and should be set with SET GLOBAL
```

- The `@@GLOBAL.`, `@@SESSION.`, and `@@` modifiers apply only to system variables. An error occurs for attempts to apply them to user-defined variables, stored procedure or function parameters, or stored program local variables.
- Not all system variables can be set to `DEFAULT`. In such cases, assigning `DEFAULT` results in an error.
- An error occurs for attempts to assign `DEFAULT` to user-defined variables, stored procedure or function parameters, or stored program local variables.

## Multiple Variable Assignment

A `SET` statement can contain multiple variable assignments, separated by commas. This statement assigns a value to a user-defined variable and a system variable:

```
SET @x = 1, SESSION sql_mode = '';
```

If you set multiple system variables in a single statement, the most recent `GLOBAL` or `SESSION` keyword in the statement is used for following assignments that have no keyword specified.

Examples of multiple-variable assignment:

```
SET GLOBAL sort_buffer_size = 1000000, SESSION sort_buffer_size = 1000000;
```

```
SET @@GLOBAL.sort_buffer_size = 1000000, @@LOCAL.sort_buffer_size = 1000000;
SET GLOBAL max_connections = 1000, sort_buffer_size = 1000000;
```

The `@@GLOBAL.`, `@@SESSION.`, and `@@` modifiers apply only to the immediately following system variable, not any remaining system variables. This statement sets the `sort_buffer_size` global value to 50000 and the session value to 1000000:

```
SET @@GLOBAL.sort_buffer_size = 50000, sort_buffer_size = 1000000;
```

## System Variable References in Expressions

To refer to the value of a system variable in expressions, use one of the `@@`-modifiers. For example, you can retrieve system variable values in a `SELECT` statement like this:

```
SELECT @@GLOBAL.sql_mode, @@SESSION.sql_mode, @@sql_mode;
```



### Note

A reference to a system variable in an expression as `@@var_name` (with `@@` rather than `@@GLOBAL.` or `@@SESSION.`) returns the session value if it exists and the global value otherwise. This differs from `SET @@var_name = expr`, which always refers to the session value.

### 13.7.4.2 SET CHARACTER SET Statement

```
SET {CHARACTER SET | CHARSET}
    {'charset_name' | DEFAULT}
```

This statement maps all strings sent between the server and the current client with the given mapping. `SET CHARACTER SET` sets three session system variables: `character_set_client` and `character_set_results` are set to the given character set, and `character_set_connection` to the value of `character_set_database`. See [Section 10.4, “Connection Character Sets and Collations”](#).

`charset_name` may be quoted or unquoted.

The default character set mapping can be restored by using the value `DEFAULT`. The default depends on the server configuration.

Some character sets cannot be used as the client character set. Attempting to use them with `SET CHARACTER SET` produces an error. See [Impermissible Client Character Sets](#).

### 13.7.4.3 SET NAMES Statement

```
SET NAMES {'charset_name'
    [COLLATE 'collation_name'] | DEFAULT}
```

This statement sets the three session system variables `character_set_client`, `character_set_connection`, and `character_set_results` to the given character set. Setting `character_set_connection` to `charset_name` also sets `collation_connection` to the default collation for `charset_name`. See [Section 10.4, “Connection Character Sets and Collations”](#).

The optional `COLLATE` clause may be used to specify a collation explicitly. If given, the collation must one of the permitted collations for `charset_name`.

`charset_name` and `collation_name` may be quoted or unquoted.

The default mapping can be restored by using a value of `DEFAULT`. The default depends on the server configuration.

Some character sets cannot be used as the client character set. Attempting to use them with `SET NAMES` produces an error. See [Impermissible Client Character Sets](#).

## 13.7.5 SHOW Statements

`SHOW` has many forms that provide information about databases, tables, columns, or status information about the server. This section describes those following:

```
SHOW {BINARY | MASTER} LOGS
SHOW BINLOG EVENTS [IN 'log_name'] [FROM pos] [LIMIT [offset,] row_count]
SHOW {CHARACTER SET | CHARSET} [like_or_where]
SHOW COLLATION [like_or_where]
SHOW [FULL] COLUMNS FROM tbl_name [FROM db_name] [like_or_where]
SHOW CREATE DATABASE db_name
SHOW CREATE EVENT event_name
SHOW CREATE FUNCTION func_name
SHOW CREATE PROCEDURE proc_name
SHOW CREATE TABLE tbl_name
SHOW CREATE TRIGGER trigger_name
SHOW CREATE VIEW view_name
SHOW DATABASES [like_or_where]
SHOW ENGINE engine_name {STATUS | MUTEX}
SHOW [STORAGE] ENGINES
SHOW ERRORS [LIMIT [offset,] row_count]
SHOW EVENTS
SHOW FUNCTION CODE func_name
SHOW FUNCTION STATUS [like_or_where]
SHOW GRANTS FOR user
SHOW INDEX FROM tbl_name [FROM db_name]
SHOW MASTER STATUS
SHOW OPEN TABLES [FROM db_name] [like_or_where]
SHOW PLUGINS
SHOW PROCEDURE CODE proc_name
SHOW PROCEDURE STATUS [like_or_where]
SHOW PRIVILEGES
SHOW [FULL] PROCESSLIST
SHOW PROFILE [types] [FOR QUERY n] [OFFSET n] [LIMIT n]
SHOW PROFILES
SHOW RELAYLOG EVENTS [IN 'log_name'] [FROM pos] [LIMIT [offset,] row_count]
SHOW SLAVE HOSTS
SHOW SLAVE STATUS [FOR CHANNEL channel]
SHOW [GLOBAL | SESSION] STATUS [like_or_where]
SHOW TABLE STATUS [FROM db_name] [like_or_where]
SHOW [FULL] TABLES [FROM db_name] [like_or_where]
SHOW TRIGGERS [FROM db_name] [like_or_where]
SHOW [GLOBAL | SESSION] VARIABLES [like_or_where]
SHOW WARNINGS [LIMIT [offset,] row_count]

like_or_where: {
    LIKE 'pattern'
    | WHERE expr
}
```

If the syntax for a given `SHOW` statement includes a `LIKE 'pattern'` part, `'pattern'` is a string that can contain the SQL `%` and `_` wildcard characters. The pattern is useful for restricting statement output to matching values.

Several `SHOW` statements also accept a `WHERE` clause that provides more flexibility in specifying which rows to display. See [Section 24.8, “Extensions to SHOW Statements”](#).

Many MySQL APIs (such as PHP) enable you to treat the result returned from a `SHOW` statement as you would a result set from a `SELECT`; see [Chapter 27, Connectors and APIs](#), or your API documentation for more information. In addition, you can work in SQL with results from queries on tables in the

`INFORMATION_SCHEMA` database, which you cannot easily do with results from `SHOW` statements. See [Chapter 24, `INFORMATION\_SCHEMA` Tables](#).

### 13.7.5.1 SHOW BINARY LOGS Statement

```
SHOW BINARY LOGS
SHOW MASTER LOGS
```

Lists the binary log files on the server. This statement is used as part of the procedure described in [Section 13.4.1.1, “PURGE BINARY LOGS Statement”](#), that shows how to determine which logs can be purged. A user with the `SUPER` or `REPLICATION CLIENT` privilege may execute this statement.

```
mysql> SHOW BINARY LOGS;
+-----+-----+
| Log_name          | File_size |
+-----+-----+
| binlog.000015    | 724935   |
| binlog.000016    | 733481   |
+-----+-----+
```

`SHOW MASTER LOGS` is equivalent to `SHOW BINARY LOGS`.

### 13.7.5.2 SHOW BINLOG EVENTS Statement

```
SHOW BINLOG EVENTS
  [IN 'log_name']
  [FROM pos]
  [LIMIT [offset,] row_count]
```

Shows the events in the binary log. If you do not specify `'log_name'`, the first binary log is displayed. `SHOW BINLOG EVENTS` requires the `REPLICATION SLAVE` privilege.

The `LIMIT` clause has the same syntax as for the `SELECT` statement. See [Section 13.2.9, “SELECT Statement”](#).



#### Note

Issuing a `SHOW BINLOG EVENTS` with no `LIMIT` clause could start a very time- and resource-consuming process because the server returns to the client the complete contents of the binary log (which includes all statements executed by the server that modify data). As an alternative to `SHOW BINLOG EVENTS`, use the `mysqlbinlog` utility to save the binary log to a text file for later examination and analysis. See [Section 4.6.7, “mysqlbinlog — Utility for Processing Binary Log Files”](#).

`SHOW BINLOG EVENTS` displays the following fields for each event in the binary log:

- `Log_name`  
The name of the file that is being listed.
- `Pos`  
The position at which the event occurs.
- `Event_type`  
An identifier that describes the event type.
- `Server_id`  
The server ID of the server on which the event originated.



- `End_log_pos`

The position at which the next event begins, which is equal to `Pos` plus the size of the event.

- `Info`

More detailed information about the event type. The format of this information depends on the event type.



#### Note

Some events relating to the setting of user and system variables are not included in the output from `SHOW BINLOG EVENTS`. To get complete coverage of events within a binary log, use `mysqlbinlog`.



#### Note

`SHOW BINLOG EVENTS` does *not* work with relay log files. You can use `SHOW RELAYLOG EVENTS` for this purpose.

### 13.7.5.3 SHOW CHARACTER SET Statement

```
SHOW {CHARACTER SET | CHARSET}
     [LIKE 'pattern' | WHERE expr]
```

The `SHOW CHARACTER SET` statement shows all available character sets. The `LIKE` clause, if present, indicates which character set names to match. The `WHERE` clause can be given to select rows using more general conditions, as discussed in [Section 24.8, “Extensions to SHOW Statements”](#). For example:

```
mysql> SHOW CHARACTER SET LIKE 'latin%';
+-----+-----+-----+-----+
| Charset | Description | Default collation | Maxlen |
+-----+-----+-----+-----+
| latin1  | cp1252 West European | latin1_swedish_ci | 1 |
| latin2  | ISO 8859-2 Central European | latin2_general_ci | 1 |
| latin5  | ISO 8859-9 Turkish | latin5_turkish_ci | 1 |
| latin7  | ISO 8859-13 Baltic | latin7_general_ci | 1 |
+-----+-----+-----+-----+
```

`SHOW CHARACTER SET` output has these columns:

- `Charset`

The character set name.

- `Description`

A description of the character set.

- `Default collation`

The default collation for the character set.

- `Maxlen`

The maximum number of bytes required to store one character.

The `filename` character set is for internal use only; consequently, `SHOW CHARACTER SET` does not display it.

Character set information is also available from the [INFORMATION\\_SCHEMA CHARACTER\\_SETS](#) table.

### 13.7.5.4 SHOW COLLATION Statement

```
SHOW COLLATION
[LIKE 'pattern' | WHERE expr]
```

This statement lists collations supported by the server. By default, the output from `SHOW COLLATION` includes all available collations. The `LIKE` clause, if present, indicates which collation names to match. The `WHERE` clause can be given to select rows using more general conditions, as discussed in [Section 24.8, “Extensions to SHOW Statements”](#). For example:

```
mysql> SHOW COLLATION WHERE Charset = 'latin1';
```

Collation	Charset	Id	Default	Compiled	Sortlen
latin1_german1_ci	latin1	5		Yes	1
latin1_swedish_ci	latin1	8	Yes	Yes	1
latin1_danish_ci	latin1	15		Yes	1
latin1_german2_ci	latin1	31		Yes	2
latin1_bin	latin1	47		Yes	1
latin1_general_ci	latin1	48		Yes	1
latin1_general_cs	latin1	49		Yes	1
latin1_spanish_ci	latin1	94		Yes	1

`SHOW COLLATION` output has these columns:

- `Collation`

The collation name.

- `Charset`

The name of the character set with which the collation is associated.

- `Id`

The collation ID.

- `Default`

Whether the collation is the default for its character set.

- `Compiled`

Whether the character set is compiled into the server.

- `Sortlen`

This is related to the amount of memory required to sort strings expressed in the character set.

To see the default collation for each character set, use the following statement. `Default` is a reserved word, so to use it as an identifier, it must be quoted as such:

```
mysql> SHOW COLLATION WHERE `Default` = 'Yes';
```

Collation	Charset	Id	Default	Compiled	Sortlen
big5_chinese_ci	big5	1	Yes	Yes	1
dec8_swedish_ci	dec8	3	Yes	Yes	1
cp850_general_ci	cp850	4	Yes	Yes	1

hp8_english_ci	hp8	6	Yes	Yes	1
koi8r_general_ci	koi8r	7	Yes	Yes	1
latin1_swedish_ci	latin1	8	Yes	Yes	1
...					

Collation information is also available from the `INFORMATION_SCHEMA.COLLATIONS` table. See [Section 24.3.3, “The INFORMATION\\_SCHEMA COLLATIONS Table”](#).

### 13.7.5.5 SHOW COLUMNS Statement

```
SHOW [FULL] {COLUMNS | FIELDS}
  {FROM | IN} tbl_name
  [{FROM | IN} db_name]
  [LIKE 'pattern' | WHERE expr]
```

`SHOW COLUMNS` displays information about the columns in a given table. It also works for views. `SHOW COLUMNS` displays information only for those columns for which you have some privilege.

```
mysql> SHOW COLUMNS FROM City;
+-----+-----+-----+-----+-----+-----+
| Field          | Type          | Null | Key | Default | Extra          |
+-----+-----+-----+-----+-----+-----+
| ID             | int(11)       | NO   | PRI | NULL    | auto_increment |
| Name           | char(35)      | NO   |     |         |                |
| CountryCode    | char(3)       | NO   | MUL |         |                |
| District       | char(20)      | NO   |     |         |                |
| Population     | int(11)       | NO   |     | 0       |                |
+-----+-----+-----+-----+-----+-----+
```

An alternative to `tbl_name FROM db_name` syntax is `db_name.tbl_name`. These two statements are equivalent:

```
SHOW COLUMNS FROM mytable FROM mydb;
SHOW COLUMNS FROM mydb.mytable;
```

The optional `FULL` keyword causes the output to include the column collation and comments, as well as the privileges you have for each column.

The `LIKE` clause, if present, indicates which column names to match. The `WHERE` clause can be given to select rows using more general conditions, as discussed in [Section 24.8, “Extensions to SHOW Statements”](#).

The data types may differ from what you expect them to be based on a `CREATE TABLE` statement because MySQL sometimes changes data types when you create or alter a table. The conditions under which this occurs are described in [Section 13.1.18.6, “Silent Column Specification Changes”](#).

`SHOW COLUMNS` displays the following values for each table column:

- **Field**  
The column name.
- **Type**  
The column data type.
- **Collation**  
The collation for nonbinary string columns, or `NULL` for other columns. This value is displayed only if you use the `FULL` keyword.
- **Null**

The column nullability. The value is `YES` if `NULL` values can be stored in the column, `NO` if not.

- `Key`

Whether the column is indexed:

- If `Key` is empty, the column either is not indexed or is indexed only as a secondary column in a multiple-column, nonunique index.
- If `Key` is `PRI`, the column is a `PRIMARY KEY` or is one of the columns in a multiple-column `PRIMARY KEY`.
- If `Key` is `UNI`, the column is the first column of a `UNIQUE` index. (A `UNIQUE` index permits multiple `NULL` values, but you can tell whether the column permits `NULL` by checking the `Null` field.)
- If `Key` is `MUL`, the column is the first column of a nonunique index in which multiple occurrences of a given value are permitted within the column.

If more than one of the `Key` values applies to a given column of a table, `Key` displays the one with the highest priority, in the order `PRI`, `UNI`, `MUL`.

A `UNIQUE` index may be displayed as `PRI` if it cannot contain `NULL` values and there is no `PRIMARY KEY` in the table. A `UNIQUE` index may display as `MUL` if several columns form a composite `UNIQUE` index; although the combination of the columns is unique, each column can still hold multiple occurrences of a given value.

- `Default`

The default value for the column. This is `NULL` if the column has an explicit default of `NULL`, or if the column definition includes no `DEFAULT` clause.

- `Extra`

Any additional information that is available about a given column. The value is nonempty in these cases:

- `auto_increment` for columns that have the `AUTO_INCREMENT` attribute.
- `on update CURRENT_TIMESTAMP` for `TIMESTAMP` or `DATETIME` columns that have the `ON UPDATE CURRENT_TIMESTAMP` attribute.
- `VIRTUAL GENERATED` or `STORED GENERATED` for generated columns.

- `Privileges`

The privileges you have for the column. This value is displayed only if you use the `FULL` keyword.

- `Comment`

Any comment included in the column definition. This value is displayed only if you use the `FULL` keyword.

Table column information is also available from the `INFORMATION_SCHEMA COLUMNS` table. See [Section 24.3.5, “The INFORMATION\\_SCHEMA COLUMNS Table”](#).

You can list a table's columns with the `mysqlshow db_name tbl_name` command.

The `DESCRIBE` statement provides information similar to `SHOW COLUMNS`. See [Section 13.8.1, “DESCRIBE Statement”](#).

The `SHOW CREATE TABLE`, `SHOW TABLE STATUS`, and `SHOW INDEX` statements also provide information about tables. See [Section 13.7.5, “SHOW Statements”](#).

### 13.7.5.6 SHOW CREATE DATABASE Statement

```
SHOW CREATE {DATABASE | SCHEMA} [IF NOT EXISTS] db_name
```

Shows the `CREATE DATABASE` statement that creates the named database. If the `SHOW` statement includes an `IF NOT EXISTS` clause, the output too includes such a clause. `SHOW CREATE SCHEMA` is a synonym for `SHOW CREATE DATABASE`.

```
mysql> SHOW CREATE DATABASE test\G
***** 1. row *****
      Database: test
Create Database: CREATE DATABASE `test`
                  /*!40100 DEFAULT CHARACTER SET latin1 */

mysql> SHOW CREATE SCHEMA test\G
***** 1. row *****
      Database: test
Create Database: CREATE DATABASE `test`
                  /*!40100 DEFAULT CHARACTER SET latin1 */
```

`SHOW CREATE DATABASE` quotes table and column names according to the value of the `sql_quote_show_create` option. See [Section 5.1.7, “Server System Variables”](#).

### 13.7.5.7 SHOW CREATE EVENT Statement

```
SHOW CREATE EVENT event_name
```

This statement displays the `CREATE EVENT` statement needed to re-create a given event. It requires the `EVENT` privilege for the database from which the event is to be shown. For example (using the same event `e_daily` defined and then altered in [Section 13.7.5.18, “SHOW EVENTS Statement”](#)):

```
mysql> SHOW CREATE EVENT myschema.e_daily\G
***** 1. row *****
      Event: e_daily
      sql_mode: ONLY_FULL_GROUP_BY,STRICT_TRANS_TABLES,
                NO_ZERO_IN_DATE,NO_ZERO_DATE,
                ERROR_FOR_DIVISION_BY_ZERO,
                NO_AUTO_CREATE_USER,NO_ENGINE_SUBSTITUTION
      time_zone: SYSTEM
Create Event: CREATE DEFINER=`jon`@`ghidora` EVENT `e_daily`
              ON SCHEDULE EVERY 1 DAY
              STARTS CURRENT_TIMESTAMP + INTERVAL 6 HOUR
              ON COMPLETION NOT PRESERVE
              ENABLE
              COMMENT 'Saves total number of sessions then
                       clears the table each day'
              DO BEGIN
                  INSERT INTO site_activity.totals (time, total)
                  SELECT CURRENT_TIMESTAMP, COUNT(*)
                  FROM site_activity.sessions;
                  DELETE FROM site_activity.sessions;
              END
character_set_client: utf8
collation_connection: utf8_general_ci
      Database Collation: latin1_swedish_ci
```

`character_set_client` is the session value of the `character_set_client` system variable when the event was created. `collation_connection` is the session value of the `collation_connection` system variable when the event was created. `Database Collation` is the collation of the database with which the event is associated.

The output reflects the current status of the event ([ENABLE](#)) rather than the status with which it was created.

### 13.7.5.8 SHOW CREATE FUNCTION Statement

```
SHOW CREATE FUNCTION func_name
```

This statement is similar to [SHOW CREATE PROCEDURE](#) but for stored functions. See [Section 13.7.5.9](#), “[SHOW CREATE PROCEDURE Statement](#)”.

### 13.7.5.9 SHOW CREATE PROCEDURE Statement

```
SHOW CREATE PROCEDURE proc_name
```

This statement is a MySQL extension. It returns the exact string that can be used to re-create the named stored procedure. A similar statement, [SHOW CREATE FUNCTION](#), displays information about stored functions (see [Section 13.7.5.8](#), “[SHOW CREATE FUNCTION Statement](#)”).

To use either statement, you must be the user named in the routine [DEFINER](#) clause or have [SELECT](#) access to the `mysql.proc` table. If you do not have privileges for the routine itself, the value displayed for the [Create Procedure](#) or [Create Function](#) column is `NULL`.

```
mysql> SHOW CREATE PROCEDURE test.citycount\G
***** 1. row *****
      Procedure: citycount
      sql_mode: ONLY_FULL_GROUP_BY,STRICT_TRANS_TABLES,
                NO_ZERO_IN_DATE,NO_ZERO_DATE,
                ERROR_FOR_DIVISION_BY_ZERO,
                NO_AUTO_CREATE_USER,NO_ENGINE_SUBSTITUTION
      Create Procedure: CREATE DEFINER='me'@'localhost'
                       PROCEDURE `citycount`(IN country CHAR(3), OUT cities INT)
                       BEGIN
                           SELECT COUNT(*) INTO cities FROM world.city
                           WHERE CountryCode = country;
                       END
character_set_client: utf8
collation_connection: utf8_general_ci
  Database Collation: latin1_swedish_ci

mysql> SHOW CREATE FUNCTION test.hello\G
***** 1. row *****
      Function: hello
      sql_mode: ONLY_FULL_GROUP_BY,STRICT_TRANS_TABLES,
                NO_ZERO_IN_DATE,NO_ZERO_DATE,
                ERROR_FOR_DIVISION_BY_ZERO,
                NO_AUTO_CREATE_USER,NO_ENGINE_SUBSTITUTION
      Create Function: CREATE DEFINER='me'@'localhost'
                      FUNCTION `hello`(s CHAR(20))
                      RETURNS char(50) CHARSET latin1
                      DETERMINISTIC
                      RETURN CONCAT('Hello, ',s, '!')
character_set_client: utf8
collation_connection: utf8_general_ci
  Database Collation: latin1_swedish_ci
```

`character_set_client` is the session value of the `character_set_client` system variable when the routine was created. `collation_connection` is the session value of the `collation_connection` system variable when the routine was created. `Database Collation` is the collation of the database with which the routine is associated.

### 13.7.5.10 SHOW CREATE TABLE Statement

```
SHOW CREATE TABLE tbl_name
```

Shows the `CREATE TABLE` statement that creates the named table. To use this statement, you must have some privilege for the table. This statement also works with views.

```
mysql> SHOW CREATE TABLE t\G
***** 1. row *****
      Table: t
Create Table: CREATE TABLE `t` (
  `id` int(11) NOT NULL AUTO_INCREMENT,
  `s` char(60) DEFAULT NULL,
  PRIMARY KEY (`id`)
) ENGINE=InnoDB DEFAULT CHARSET=latin1
```

`SHOW CREATE TABLE` quotes table and column names according to the value of the `sql_quote_show_create` option. See [Section 5.1.7, “Server System Variables”](#).

When altering the storage engine of a table, table options that are not applicable to the new storage engine are retained in the table definition to enable reverting the table with its previously defined options to the original storage engine, if necessary. For example, when changing the storage engine from InnoDB to MyISAM, InnoDB-specific options such as `ROW_FORMAT=COMPACT` are retained.

```
mysql> CREATE TABLE t1 (c1 INT PRIMARY KEY) ROW_FORMAT=COMPACT ENGINE=InnoDB;
mysql> ALTER TABLE t1 ENGINE=MyISAM;
mysql> SHOW CREATE TABLE t1\G
***** 1. row *****
      Table: t1
Create Table: CREATE TABLE `t1` (
  `c1` int(11) NOT NULL,
  PRIMARY KEY (`c1`)
) ENGINE=MyISAM DEFAULT CHARSET=latin1 ROW_FORMAT=COMPACT
```

When creating a table with `strict mode` disabled, the storage engine's default row format is used if the specified row format is not supported. The actual row format of the table is reported in the `Row_format` column in response to `SHOW TABLE STATUS`. `SHOW CREATE TABLE` shows the row format that was specified in the `CREATE TABLE` statement.

### 13.7.5.11 SHOW CREATE TRIGGER Statement

```
SHOW CREATE TRIGGER trigger_name
```

This statement shows the `CREATE TRIGGER` statement that creates the named trigger. This statement requires the `TRIGGER` privilege for the table associated with the trigger.

```
mysql> SHOW CREATE TRIGGER ins_sum\G
***** 1. row *****
      Trigger: ins_sum
      sql_mode: ONLY_FULL_GROUP_BY,STRICT_TRANS_TABLES,
              NO_ZERO_IN_DATE,NO_ZERO_DATE,
              ERROR_FOR_DIVISION_BY_ZERO,
              NO_AUTO_CREATE_USER,NO_ENGINE_SUBSTITUTION
SQL Original Statement: CREATE DEFINER=`me`@`localhost` TRIGGER ins_sum
                        BEFORE INSERT ON account
                        FOR EACH ROW SET @sum = @sum + NEW.amount
      character_set_client: utf8
      collation_connection: utf8_general_ci
      Database Collation: latin1_swedish_ci
      Created: 2018-08-08 10:10:07.90
```

`SHOW CREATE TRIGGER` output has these columns:

- `Trigger`: The trigger name.

- `sql_mode`: The SQL mode in effect when the trigger executes.
- `SQL Original Statement`: The `CREATE TRIGGER` statement that defines the trigger.
- `character_set_client`: The session value of the `character_set_client` system variable when the trigger was created.
- `collation_connection`: The session value of the `collation_connection` system variable when the trigger was created.
- `Database Collation`: The collation of the database with which the trigger is associated.
- `Created`: The date and time when the trigger was created. This is a `TIMESTAMP(2)` value (with a fractional part in hundredths of seconds) for triggers created in MySQL 5.7.2 or later, `NULL` for triggers created prior to 5.7.2.

Trigger information is also available from the `INFORMATION_SCHEMA TRIGGERS` table. See [Section 24.3.29, “The INFORMATION\\_SCHEMA TRIGGERS Table”](#).

### 13.7.5.12 SHOW CREATE USER Statement

```
SHOW CREATE USER user
```

This statement shows the `CREATE USER` statement that creates the named user. An error occurs if the user does not exist. The statement requires the `SELECT` privilege for the `mysql` system database, except to display information for the current user.

To name the account, use the format described in [Section 6.2.4, “Specifying Account Names”](#). The host name part of the account name, if omitted, defaults to `'%'`. It is also possible to specify `CURRENT_USER` or `CURRENT_USER()` to refer to the account associated with the current session.

```
mysql> SHOW CREATE USER 'root'@'localhost'\G
***** 1. row *****
CREATE USER for root@localhost: CREATE USER 'root'@'localhost'
IDENTIFIED WITH 'mysql_native_password'
AS '*2470C0C06DEE42FD1618BB99005ADCA2EC9D1E19'
REQUIRE NONE PASSWORD EXPIRE DEFAULT ACCOUNT UNLOCK
```

The output format is affected by the setting of the `log_built_in_as_identified_by_password` system variable.

To display the privileges granted to an account, use the `SHOW GRANTS` statement. See [Section 13.7.5.21, “SHOW GRANTS Statement”](#).

### 13.7.5.13 SHOW CREATE VIEW Statement

```
SHOW CREATE VIEW view_name
```

This statement shows the `CREATE VIEW` statement that creates the named view.

```
mysql> SHOW CREATE VIEW v\G
***** 1. row *****
View: v
Create View: CREATE ALGORITHM=UNDEFINED
DEFINER=`bob`@`localhost`
SQL SECURITY DEFINER VIEW
`v` AS select 1 AS `a`,2 AS `b`
character_set_client: utf8
collation_connection: utf8_general_ci
```



`character_set_client` is the session value of the `character_set_client` system variable when the view was created. `collation_connection` is the session value of the `collation_connection` system variable when the view was created.

Use of `SHOW CREATE VIEW` requires the `SHOW VIEW` privilege, and the `SELECT` privilege for the view in question.

View information is also available from the `INFORMATION_SCHEMA VIEWS` table. See [Section 24.3.31, “The INFORMATION\\_SCHEMA VIEWS Table”](#).

MySQL lets you use different `sql_mode` settings to tell the server the type of SQL syntax to support. For example, you might use the `ANSI` SQL mode to ensure MySQL correctly interprets the standard SQL concatenation operator, the double bar (`||`), in your queries. If you then create a view that concatenates items, you might worry that changing the `sql_mode` setting to a value different from `ANSI` could cause the view to become invalid. But this is not the case. No matter how you write out a view definition, MySQL always stores it the same way, in a canonical form. Here is an example that shows how the server changes a double bar concatenation operator to a `CONCAT()` function:

```
mysql> SET sql_mode = 'ANSI';
Query OK, 0 rows affected (0.00 sec)

mysql> CREATE VIEW test.v AS SELECT 'a' || 'b' as coll;
Query OK, 0 rows affected (0.01 sec)

mysql> SHOW CREATE VIEW test.v\G
***** 1. row *****
      View: v
      Create View: CREATE VIEW "v" AS select concat('a','b') AS "coll"
      ...
1 row in set (0.00 sec)
```

The advantage of storing a view definition in canonical form is that changes made later to the value of `sql_mode` does not affect the results from the view. However an additional consequence is that comments prior to `SELECT` are stripped from the definition by the server.

### 13.7.5.14 SHOW DATABASES Statement

```
SHOW {DATABASES | SCHEMAS}
     [LIKE 'pattern' | WHERE expr]
```

`SHOW DATABASES` lists the databases on the MySQL server host. `SHOW SCHEMAS` is a synonym for `SHOW DATABASES`. The `LIKE` clause, if present, indicates which database names to match. The `WHERE` clause can be given to select rows using more general conditions, as discussed in [Section 24.8, “Extensions to SHOW Statements”](#).

You see only those databases for which you have some kind of privilege, unless you have the global `SHOW DATABASES` privilege. You can also get this list using the `mysqlshow` command.

If the server was started with the `--skip-show-database` option, you cannot use this statement at all unless you have the `SHOW DATABASES` privilege.

MySQL implements databases as directories in the data directory, so this statement simply lists directories in that location. However, the output may include names of directories that do not correspond to actual databases.

Database information is also available from the `INFORMATION_SCHEMA SCHEMATA` table. See [Section 24.3.22, “The INFORMATION\\_SCHEMA SCHEMATA Table”](#).

**Caution**

Because a global privilege is considered a privilege for all databases, *any* global privilege enables a user to see all database names with `SHOW DATABASES` or by examining the `INFORMATION_SCHEMA SCHEMATA` table.

**13.7.5.15 SHOW ENGINE Statement**

```
SHOW ENGINE engine_name {STATUS | MUTEX}
```

`SHOW ENGINE` displays operational information about a storage engine. It requires the `PROCESS` privilege. The statement has these variants:

```
SHOW ENGINE INNODB STATUS
SHOW ENGINE INNODB MUTEX
SHOW ENGINE PERFORMANCE_SCHEMA STATUS
```

`SHOW ENGINE INNODB STATUS` displays extensive information from the standard `InnoDB` Monitor about the state of the `InnoDB` storage engine. For information about the standard monitor and other `InnoDB` Monitors that provide information about `InnoDB` processing, see [Section 14.18, “InnoDB Monitors”](#).

`SHOW ENGINE INNODB MUTEX` displays `InnoDB mutex` and `rw-lock` statistics.

**Note**

`InnoDB` mutexes and rwlocks can also be monitored using [Performance Schema](#) tables. See [Section 14.17.2, “Monitoring InnoDB Mutex Waits Using Performance Schema”](#).

`SHOW ENGINE INNODB MUTEX` output was removed in MySQL 5.7.2. It was revised and reintroduced in MySQL 5.7.8.

In MySQL 5.7.8, mutex statistics collection is configured dynamically using the following options:

- To enable the collection of mutex statistics, run:

```
SET GLOBAL innodb_monitor_enable='latch';
```

- To reset mutex statistics, run:

```
SET GLOBAL innodb_monitor_reset='latch';
```

- To disable the collection of mutex statistics, run:

```
SET GLOBAL innodb_monitor_disable='latch';
```

Collection of mutex statistics for `SHOW ENGINE INNODB MUTEX` can also be enabled by setting `innodb_monitor_enable='all'`, or disabled by setting `innodb_monitor_disable='all'`.

`SHOW ENGINE INNODB MUTEX` output has these columns:

- **Type**

Always `InnoDB`.

- **Name**

Prior to MySQL 5.7.8, the `Name` field reports the source file where the mutex is implemented, and the line number in the file where the mutex is created. The line number is specific to your version of MySQL.

As of MySQL 5.7.8, only the mutex name is reported. File name and line number are still reported for rwlocks.

- `Status`

The mutex status.

Prior to MySQL 5.7.8, the `Status` field displays several values if `WITH_DEBUG` was defined at MySQL compilation time. If `WITH_DEBUG` was not defined, the statement displays only the `os_waits` value. In the latter case (without `WITH_DEBUG`), the information on which the output is based is insufficient to distinguish regular mutexes and mutexes that protect rwlocks (which permit multiple readers or a single writer). Consequently, the output may appear to contain multiple rows for the same mutex. Pre-MySQL 5.7.8 `Status` field values include:

- `count` indicates how many times the mutex was requested.
- `spin_waits` indicates how many times the spinlock had to run.
- `spin_rounds` indicates the number of spinlock rounds. (`spin_rounds` divided by `spin_waits` provides the average round count.)
- `os_waits` indicates the number of operating system waits. This occurs when the spinlock did not work (the mutex was not locked during the spinlock and it was necessary to yield to the operating system and wait).
- `os_yields` indicates the number of times a thread trying to lock a mutex gave up its timeslice and yielded to the operating system (on the presumption that permitting other threads to run frees the mutex so that it can be locked).
- `os_wait_times` indicates the amount of time (in ms) spent in operating system waits. In MySQL 5.7 timing is disabled and this value is always 0.

As of MySQL 5.7.8, the `Status` field reports the number of spins, waits, and calls. Statistics for low-level operating system mutexes, which are implemented outside of `InnoDB`, are not reported.

- `spins` indicates the number of spins.
- `waits` indicates the number of mutex waits.
- `calls` indicates how many times the mutex was requested.

`SHOW ENGINE INNODB MUTEX` does not list mutexes and rw-locks for each buffer pool block, as the amount of output would be overwhelming on systems with a large buffer pool. `SHOW ENGINE INNODB MUTEX` does, however, print aggregate `BUF_BLOCK_MUTEX` spin, wait, and call values for buffer pool block mutexes and rw-locks. `SHOW ENGINE INNODB MUTEX` also does not list any mutexes or rw-locks that have never been waited on (`os_waits=0`). Thus, `SHOW ENGINE INNODB MUTEX` only displays information about mutexes and rw-locks outside of the buffer pool that have caused at least one OS-level `wait`.

Use `SHOW ENGINE PERFORMANCE_SCHEMA STATUS` to inspect the internal operation of the Performance Schema code:

```
mysql> SHOW ENGINE PERFORMANCE_SCHEMA STATUS\G
...
***** 3. row *****
  Type: performance_schema
  Name: events_waits_history.size
  Status: 76
```

```

***** 4. row *****
  Type: performance_schema
  Name: events_waits_history.count
  Status: 10000
***** 5. row *****
  Type: performance_schema
  Name: events_waits_history.memory
  Status: 760000
...
***** 57. row *****
  Type: performance_schema
  Name: performance_schema.memory
  Status: 26459600
...

```

This statement is intended to help the DBA understand the effects that different Performance Schema options have on memory requirements.

**Name** values consist of two parts, which name an internal buffer and a buffer attribute, respectively. Interpret buffer names as follows:

- An internal buffer that is not exposed as a table is named within parentheses. Examples: `(pfs_cond_class).size`, `(pfs_mutex_class).memory`.
- An internal buffer that is exposed as a table in the `performance_schema` database is named after the table, without parentheses. Examples: `events_waits_history.size`, `mutex_instances.count`.
- A value that applies to the Performance Schema as a whole begins with `performance_schema`. Example: `performance_schema.memory`.

Buffer attributes have these meanings:

- `size` is the size of the internal record used by the implementation, such as the size of a row in a table. `size` values cannot be changed.
- `count` is the number of internal records, such as the number of rows in a table. `count` values can be changed using Performance Schema configuration options.
- For a table, `tbl_name.memory` is the product of `size` and `count`. For the Performance Schema as a whole, `performance_schema.memory` is the sum of all the memory used (the sum of all other `memory` values).

In some cases, there is a direct relationship between a Performance Schema configuration parameter and a `SHOW ENGINE` value. For example, `events_waits_history_long.count` corresponds to `performance_schema_events_waits_history_long_size`. In other cases, the relationship is more complex. For example, `events_waits_history.count` corresponds to `performance_schema_events_waits_history_size` (the number of rows per thread) multiplied by `performance_schema_max_thread_instances` (the number of threads).

**SHOW ENGINE NDB STATUS.** If the server has the `NDB` storage engine enabled, `SHOW ENGINE NDB STATUS` displays cluster status information such as the number of connected data nodes, the cluster connectstring, and cluster binary log epochs, as well as counts of various Cluster API objects created by the MySQL Server when connected to the cluster. Sample output from this statement is shown here:

```

mysql> SHOW ENGINE NDB STATUS;
+-----+-----+-----+
| Type      | Name                                     | Status                                     |
+-----+-----+-----+
| ndbcluster | connection                             | cluster_node_id=7,
connected_host=198.51.100.103, connected_port=1186, number_of_data_nodes=4,
number_of_ready_data_nodes=3, connect_count=0 |

```

## SHOW Statements

ndbcluster	NdbTransaction	created=6, free=0, sizeof=212
ndbcluster	NdbOperation	created=8, free=8, sizeof=660
ndbcluster	NdbIndexScanOperation	created=1, free=1, sizeof=744
ndbcluster	NdbIndexOperation	created=0, free=0, sizeof=664
ndbcluster	NdbRecAttr	created=1285, free=1285, sizeof=60
ndbcluster	NdbApiSignal	created=16, free=16, sizeof=136
ndbcluster	NdbLabel	created=0, free=0, sizeof=196
ndbcluster	NdbBranch	created=0, free=0, sizeof=24
ndbcluster	NdbSubroutine	created=0, free=0, sizeof=68
ndbcluster	NdbCall	created=0, free=0, sizeof=16
ndbcluster	NdbBlob	created=1, free=1, sizeof=264
ndbcluster	NdbReceiver	created=4, free=0, sizeof=68
ndbcluster	binlog	latest_epoch=155467, latest_trans_epoch=148126, latest_received_binlog_epoch=0, latest_handled_binlog_epoch=0, latest_applied_binlog_epoch=0

The `Status` column in each of these rows provides information about the MySQL server's connection to the cluster and about the cluster binary log's status, respectively. The `Status` information is in the form of comma-delimited set of name/value pairs.

The `connection` row's `Status` column contains the name/value pairs described in the following table.

Name	Value
<code>cluster_node_id</code>	The node ID of the MySQL server in the cluster
<code>connected_host</code>	The host name or IP address of the cluster management server to which the MySQL server is connected
<code>connected_port</code>	The port used by the MySQL server to connect to the management server ( <code>connected_host</code> )
<code>number_of_data_nodes</code>	The number of data nodes configured for the cluster (that is, the number of <code>[ndbd]</code> sections in the cluster <code>config.ini</code> file)
<code>number_of_ready_data_nodes</code>	The number of data nodes in the cluster that are actually running
<code>connect_count</code>	The number of times this <code>mysqld</code> has connected or reconnected to cluster data nodes

The `binlog` row's `Status` column contains information relating to NDB Cluster Replication. The name/value pairs it contains are described in the following table.

Name	Value
<code>latest_epoch</code>	The most recent epoch most recently run on this MySQL server (that is, the sequence number of the most recent transaction run on the server)
<code>latest_trans_epoch</code>	The most recent epoch processed by the cluster's data nodes
<code>latest_received_binlog_epoch</code>	The most recent epoch received by the binary log thread
<code>latest_handled_binlog_epoch</code>	The most recent epoch processed by the binary log thread (for writing to the binary log)
<code>latest_applied_binlog_epoch</code>	The most recent epoch actually written to the binary log

See [Section 21.7, “NDB Cluster Replication”](#), for more information.

The remaining rows from the output of `SHOW ENGINE NDB STATUS` which are most likely to prove useful in monitoring the cluster are listed here by Name:

- `NdbTransaction`: The number and size of `NdbTransaction` objects that have been created. An `NdbTransaction` is created each time a table schema operation (such as `CREATE TABLE` or `ALTER TABLE`) is performed on an `NDB` table.
- `NdbOperation`: The number and size of `NdbOperation` objects that have been created.
- `NdbIndexScanOperation`: The number and size of `NdbIndexScanOperation` objects that have been created.
- `NdbIndexOperation`: The number and size of `NdbIndexOperation` objects that have been created.
- `NdbRecAttr`: The number and size of `NdbRecAttr` objects that have been created. In general, one of these is created each time a data manipulation statement is performed by an SQL node.
- `NdbBlob`: The number and size of `NdbBlob` objects that have been created. An `NdbBlob` is created for each new operation involving a `BLOB` column in an `NDB` table.
- `NdbReceiver`: The number and size of any `NdbReceiver` object that have been created. The number in the `created` column is the same as the number of data nodes in the cluster to which the MySQL server has connected.



#### Note

`SHOW ENGINE NDB STATUS` returns an empty result if no operations involving `NDB` tables have been performed during the current session by the MySQL client accessing the SQL node on which this statement is run.

### 13.7.5.16 SHOW ENGINES Statement

```
SHOW [STORAGE] ENGINES
```

`SHOW ENGINES` displays status information about the server's storage engines. This is particularly useful for checking whether a storage engine is supported, or to see what the default engine is.

For information about MySQL storage engines, see [Chapter 14, \*The InnoDB Storage Engine\*](#), and [Chapter 15, \*Alternative Storage Engines\*](#).

```
mysql> SHOW ENGINES\G
***** 1. row *****
      Engine: InnoDB
      Support: DEFAULT
      Comment: Supports transactions, row-level locking, and foreign keys
Transactions: YES
          XA: YES
      Savepoints: YES
***** 2. row *****
      Engine: MRG_MYISAM
      Support: YES
      Comment: Collection of identical MyISAM tables
Transactions: NO
          XA: NO
      Savepoints: NO
***** 3. row *****
      Engine: MEMORY
      Support: YES
```

```

    Comment: Hash based, stored in memory, useful for temporary tables
Transactions: NO
    XA: NO
    Savepoints: NO
***** 4. row *****
    Engine: BLACKHOLE
    Support: YES
    Comment: /dev/null storage engine (anything you write to it disappears)
Transactions: NO
    XA: NO
    Savepoints: NO
***** 5. row *****
    Engine: MyISAM
    Support: YES
    Comment: MyISAM storage engine
Transactions: NO
    XA: NO
    Savepoints: NO
***** 6. row *****
    Engine: CSV
    Support: YES
    Comment: CSV storage engine
Transactions: NO
    XA: NO
    Savepoints: NO
***** 7. row *****
    Engine: ARCHIVE
    Support: YES
    Comment: Archive storage engine
Transactions: NO
    XA: NO
    Savepoints: NO
***** 8. row *****
    Engine: PERFORMANCE_SCHEMA
    Support: YES
    Comment: Performance Schema
Transactions: NO
    XA: NO
    Savepoints: NO
***** 9. row *****
    Engine: FEDERATED
    Support: YES
    Comment: Federated MySQL storage engine
Transactions: NO
    XA: NO
    Savepoints: NO

```

The output from `SHOW ENGINES` may vary according to the MySQL version used and other factors.

`SHOW ENGINES` output has these columns:

- `Engine`

The name of the storage engine.

- `Support`

The server's level of support for the storage engine, as shown in the following table.

Value	Meaning
YES	The engine is supported and is active
DEFAULT	Like YES, plus this is the default engine
NO	The engine is not supported

Value	Meaning
<code>DISABLED</code>	The engine is supported but has been disabled

A value of `NO` means that the server was compiled without support for the engine, so it cannot be enabled at runtime.

A value of `DISABLED` occurs either because the server was started with an option that disables the engine, or because not all options required to enable it were given. In the latter case, the error log should contain a reason indicating why the option is disabled. See [Section 5.4.2, “The Error Log”](#).

You might also see `DISABLED` for a storage engine if the server was compiled to support it, but was started with a `--skip-engine_name` option. For the `NDB` storage engine, `DISABLED` means the server was compiled with support for NDB Cluster, but was not started with the `--ndbcluster` option.

All MySQL servers support `MyISAM` tables. It is not possible to disable `MyISAM`.

- `Comment`

A brief description of the storage engine.

- `Transactions`

Whether the storage engine supports transactions.

- `XA`

Whether the storage engine supports XA transactions.

- `Savepoints`

Whether the storage engine supports savepoints.

Storage engine information is also available from the `INFORMATION_SCHEMA.ENGINES` table. See [Section 24.3.7, “The INFORMATION\\_SCHEMA ENGINES Table”](#).

### 13.7.5.17 SHOW ERRORS Statement

```
SHOW ERRORS [LIMIT [offset,] row_count]
SHOW COUNT(*) ERRORS
```

`SHOW ERRORS` is a diagnostic statement that is similar to `SHOW WARNINGS`, except that it displays information only for errors, rather than for errors, warnings, and notes.

The `LIMIT` clause has the same syntax as for the `SELECT` statement. See [Section 13.2.9, “SELECT Statement”](#).

The `SHOW COUNT(*) ERRORS` statement displays the number of errors. You can also retrieve this number from the `error_count` variable:

```
SHOW COUNT(*) ERRORS;
SELECT @@error_count;
```

`SHOW ERRORS` and `error_count` apply only to errors, not warnings or notes. In other respects, they are similar to `SHOW WARNINGS` and `warning_count`. In particular, `SHOW ERRORS` cannot display information for more than `max_error_count` messages, and `error_count` can exceed the value of `max_error_count` if the number of errors exceeds `max_error_count`.

For more information, see [Section 13.7.5.40, “SHOW WARNINGS Statement”](#).



### 13.7.5.18 SHOW EVENTS Statement

```
SHOW EVENTS
  [{FROM | IN} schema_name]
  [LIKE 'pattern' | WHERE expr]
```

This statement displays information about Event Manager events, which are discussed in [Section 23.4, “Using the Event Scheduler”](#). It requires the `EVENT` privilege for the database from which the events are to be shown.

In its simplest form, `SHOW EVENTS` lists all of the events in the current schema:

```
mysql> SELECT CURRENT_USER(), SCHEMA();
+-----+-----+
| CURRENT_USER() | SCHEMA() |
+-----+-----+
| jon@ghidora    | myschema |
+-----+-----+
1 row in set (0.00 sec)

mysql> SHOW EVENTS\G
***** 1. row *****
      Db: myschema
      Name: e_daily
      Definer: jon@ghidora
      Time zone: SYSTEM
      Type: RECURRING
      Execute at: NULL
      Interval value: 1
      Interval field: DAY
      Starts: 2018-08-08 11:06:34
      Ends: NULL
      Status: ENABLED
      Originator: 1
character_set_client: utf8
collation_connection: utf8_general_ci
Database Collation: latin1_swedish_ci
```

To see events for a specific schema, use the `FROM` clause. For example, to see events for the `test` schema, use the following statement:

```
SHOW EVENTS FROM test;
```

The `LIKE` clause, if present, indicates which event names to match. The `WHERE` clause can be given to select rows using more general conditions, as discussed in [Section 24.8, “Extensions to SHOW Statements”](#).

`SHOW EVENTS` output has these columns:

- `Db`  
The name of the schema (database) to which the event belongs.
- `Name`  
The name of the event.
- `Definer`  
The account of the user who created the event, in '`user_name`'@'`host_name`' format.
- `Time zone`

The event time zone, which is the time zone used for scheduling the event and that is in effect within the event as it executes. The default value is `SYSTEM`.

- `Type`

The event repetition type, either `ONE TIME` (transient) or `RECURRING` (repeating).

- `Execute At`

For a one-time event, this is the `DATETIME` value specified in the `AT` clause of the `CREATE EVENT` statement used to create the event, or of the last `ALTER EVENT` statement that modified the event. The value shown in this column reflects the addition or subtraction of any `INTERVAL` value included in the event's `AT` clause. For example, if an event is created using `ON SCHEDULE AT CURRENT_TIMESTAMP + '1:6' DAY_HOUR`, and the event was created at 2018-02-09 14:05:30, the value shown in this column would be `'2018-02-10 20:05:30'`. If the event's timing is determined by an `EVERY` clause instead of an `AT` clause (that is, if the event is recurring), the value of this column is `NULL`.

- `Interval Value`

For a recurring event, the number of intervals to wait between event executions. For a transient event, the value of this column is always `NULL`.

- `Interval Field`

The time units used for the interval which a recurring event waits before repeating. For a transient event, the value of this column is always `NULL`.

- `Starts`

The start date and time for a recurring event. This is displayed as a `DATETIME` value, and is `NULL` if no start date and time are defined for the event. For a transient event, this column is always `NULL`. For a recurring event whose definition includes a `STARTS` clause, this column contains the corresponding `DATETIME` value. As with the `Execute At` column, this value resolves any expressions used. If there is no `STARTS` clause affecting the timing of the event, this column is `NULL`.

- `Ends`

For a recurring event whose definition includes a `ENDS` clause, this column contains the corresponding `DATETIME` value. As with the `Execute At` column, this value resolves any expressions used. If there is no `ENDS` clause affecting the timing of the event, this column is `NULL`.

- `Status`

The event status. One of `ENABLED`, `DISABLED`, or `SLAVESIDE_DISABLED`. `SLAVESIDE_DISABLED` indicates that the creation of the event occurred on another MySQL server acting as a replication source and replicated to the current MySQL server which is acting as a replica, but the event is not presently being executed on the replica. For more information, see [Section 16.4.1.16, “Replication of Invoked Features”](#). information.

- `Originator`

The server ID of the MySQL server on which the event was created; used in replication. This value may be updated by `ALTER EVENT` to the server ID of the server on which that statement occurs, if executed on a source server. The default value is 0.

- `character_set_client`

The session value of the `character_set_client` system variable when the event was created.

- `collation_connection`

The session value of the `collation_connection` system variable when the event was created.

- Database Collation

The collation of the database with which the event is associated.

For more information about `SLAVESIDE_DISABLED` and the `Originator` column, see [Section 16.4.1.16, “Replication of Invoked Features”](#).

Times displayed by `SHOW EVENTS` are given in the event time zone, as discussed in [Section 23.4.4, “Event Metadata”](#).

Event information is also available from the `INFORMATION_SCHEMA EVENTS` table. See [Section 24.3.8, “The INFORMATION\\_SCHEMA EVENTS Table”](#).

The event action statement is not shown in the output of `SHOW EVENTS`. Use `SHOW CREATE EVENT` or the `INFORMATION_SCHEMA EVENTS` table.

### 13.7.5.19 SHOW FUNCTION CODE Statement

```
SHOW FUNCTION CODE func_name
```

This statement is similar to `SHOW PROCEDURE CODE` but for stored functions. See [Section 13.7.5.27, “SHOW PROCEDURE CODE Statement”](#).

### 13.7.5.20 SHOW FUNCTION STATUS Statement

```
SHOW FUNCTION STATUS
  [LIKE 'pattern' | WHERE expr]
```

This statement is similar to `SHOW PROCEDURE STATUS` but for stored functions. See [Section 13.7.5.28, “SHOW PROCEDURE STATUS Statement”](#).

### 13.7.5.21 SHOW GRANTS Statement

```
SHOW GRANTS [FOR user]
```

This statement displays the privileges that are assigned to a MySQL user account, in the form of `GRANT` statements that must be executed to duplicate the privilege assignments.



#### Note

To display nonprivilege information for MySQL accounts, use the `SHOW CREATE USER` statement. See [Section 13.7.5.12, “SHOW CREATE USER Statement”](#).

`SHOW GRANTS` requires the `SELECT` privilege for the `mysql` system database, except to display privileges for the current user.

To name the account for `SHOW GRANTS`, use the same format as for the `GRANT` statement (for example, `'jeffrey'@'localhost'`):

```
mysql> SHOW GRANTS FOR 'jeffrey'@'localhost';
+-----+
| Grants for jeffrey@localhost          |
+-----+
```

```
| GRANT USAGE ON *.* TO `jeffrey`@`localhost` |
| GRANT SELECT, INSERT, UPDATE ON `db1`.* TO `jeffrey`@`localhost` |
+-----+-----+
```

The host part, if omitted, defaults to `'%'`. For additional information about specifying account names, see [Section 6.2.4, “Specifying Account Names”](#).

To display the privileges granted to the current user (the account you are using to connect to the server), you can use any of the following statements:

```
SHOW GRANTS;
SHOW GRANTS FOR CURRENT_USER;
SHOW GRANTS FOR CURRENT_USER();
```

If `SHOW GRANTS FOR CURRENT_USER` (or any equivalent syntax) is used in definer context, such as within a stored procedure that executes with definer rather than invoker privileges, the grants displayed are those of the definer and not the invoker.

`SHOW GRANTS` does not display privileges that are available to the named account but are granted to a different account. For example, if an anonymous account exists, the named account might be able to use its privileges, but `SHOW GRANTS` does not display them.

`SHOW GRANTS` output does not include `IDENTIFIED BY PASSWORD` clauses. Use the `SHOW CREATE USER` statement instead. See [Section 13.7.5.12, “SHOW CREATE USER Statement”](#).

### 13.7.5.22 SHOW INDEX Statement

```
SHOW {INDEX | INDEXES | KEYS}
  {FROM | IN} tbl_name
  [{FROM | IN} db_name]
  [WHERE expr]
```

`SHOW INDEX` returns table index information. The format resembles that of the `SQLStatistics` call in ODBC. This statement requires some privilege for any column in the table.

```
mysql> SHOW INDEX FROM City\G
***** 1. row *****
      Table: city
      Non_unique: 0
      Key_name: PRIMARY
      Seq_in_index: 1
      Column_name: ID
      Collation: A
      Cardinality: 4188
      Sub_part: NULL
      Packed: NULL
      Null:
      Index_type: BTREE
      Comment:
      Index_comment:
***** 2. row *****
      Table: city
      Non_unique: 1
      Key_name: CountryCode
      Seq_in_index: 1
      Column_name: CountryCode
      Collation: A
      Cardinality: 232
      Sub_part: NULL
      Packed: NULL
      Null:
      Index_type: BTREE
      Comment:
```

```
Index_comment:
```

An alternative to `tbl_name FROM db_name` syntax is `db_name.tbl_name`. These two statements are equivalent:

```
SHOW INDEX FROM mytable FROM mydb;  
SHOW INDEX FROM mydb.mytable;
```

The `WHERE` clause can be given to select rows using more general conditions, as discussed in [Section 24.8, “Extensions to SHOW Statements”](#).

`SHOW INDEX` returns the following fields:

- `Table`

The name of the table.

- `Non_unique`

0 if the index cannot contain duplicates, 1 if it can.

- `Key_name`

The name of the index. If the index is the primary key, the name is always `PRIMARY`.

- `Seq_in_index`

The column sequence number in the index, starting with 1.

- `Column_name`

The name of the column.

- `Collation`

How the column is sorted in the index. This can have values `A` (ascending) or `NULL` (not sorted).

- `Cardinality`

An estimate of the number of unique values in the index. To update this number, run `ANALYZE TABLE` or (for `MyISAM` tables) `myisamchk -a`.

`Cardinality` is counted based on statistics stored as integers, so the value is not necessarily exact even for small tables. The higher the cardinality, the greater the chance that MySQL uses the index when doing joins.

- `Sub_part`

The index prefix. That is, the number of indexed characters if the column is only partly indexed, `NULL` if the entire column is indexed.



#### Note

Prefix *limits* are measured in bytes. However, prefix *lengths* for index specifications in `CREATE TABLE`, `ALTER TABLE`, and `CREATE INDEX` statements are interpreted as number of characters for nonbinary string types (`CHAR`, `VARCHAR`, `TEXT`) and number of bytes for binary string types (`BINARY`, `VARBINARY`, `BLOB`). Take this into account when specifying a prefix length for a nonbinary string column that uses a multibyte character set.

For additional information about index prefixes, see [Section 8.3.4, “Column Indexes”](#), and [Section 13.1.14, “CREATE INDEX Statement”](#).

- `Packed`

Indicates how the key is packed. `NULL` if it is not.

- `Null`

Contains `YES` if the column may contain `NULL` values and `' '` if not.

- `Index_type`

The index method used (`BTREE`, `FULLTEXT`, `HASH`, `RTREE`).

- `Comment`

Information about the index not described in its own column, such as `disabled` if the index is disabled.

- `Index_comment`

Any comment provided for the index with a `COMMENT` attribute when the index was created.

Information about table indexes is also available from the `INFORMATION_SCHEMA_STATISTICS` table. See [Section 24.3.24, “The INFORMATION\\_SCHEMA\\_STATISTICS Table”](#).

You can list a table's indexes with the `mysqlshow -k db_name tbl_name` command.

### 13.7.5.23 SHOW MASTER STATUS Statement

```
SHOW MASTER STATUS
```

This statement provides status information about the binary log files of the source. It requires either the `SUPER` or `REPLICATION_CLIENT` privilege.

Example:

```
mysql> SHOW MASTER STATUS\G
***** 1. row *****
      File: source-bin.000002
      Position: 1307
      Binlog_Do_DB: test
      Binlog_Ignore_DB: manual, mysql
      Executed_Gtid_Set: 3E11FA47-71CA-11E1-9E33-C80AA9429562:1-5
1 row in set (0.00 sec)
```

When global transaction IDs are in use, `Executed_Gtid_Set` shows the set of GTIDs for transactions that have been executed on the source. This is the same as the value for the `gtid_executed` system variable on this server, as well as the value for `Executed_Gtid_Set` in the output of `SHOW SLAVE STATUS` on this server.

### 13.7.5.24 SHOW OPEN TABLES Statement

```
SHOW OPEN TABLES
  [{FROM | IN} db_name]
  [LIKE 'pattern' | WHERE expr]
```

`SHOW OPEN TABLES` lists the non-`TEMPORARY` tables that are currently open in the table cache. See [Section 8.4.3.1, “How MySQL Opens and Closes Tables”](#). The `FROM` clause, if present, restricts the tables shown to those present in the `db_name` database. The `LIKE` clause, if present, indicates which

table names to match. The `WHERE` clause can be given to select rows using more general conditions, as discussed in [Section 24.8, “Extensions to SHOW Statements”](#).

`SHOW OPEN TABLES` output has these columns:

- `Database`

The database containing the table.

- `Table`

The table name.

- `In_use`

The number of table locks or lock requests there are for the table. For example, if one client acquires a lock for a table using `LOCK TABLE t1 WRITE`, `In_use` is 1. If another client issues `LOCK TABLE t1 WRITE` while the table remains locked, the client blocks waiting for the lock, but the lock request causes `In_use` to be 2. If the count is zero, the table is open but not currently being used. `In_use` is also increased by the `HANDLER ... OPEN` statement and decreased by `HANDLER ... CLOSE`.

- `Name_locked`

Whether the table name is locked. Name locking is used for operations such as dropping or renaming tables.

If you have no privileges for a table, it does not show up in the output from `SHOW OPEN TABLES`.

### 13.7.5.25 SHOW PLUGINS Statement

```
SHOW PLUGINS
```

`SHOW PLUGINS` displays information about server plugins.

Example of `SHOW PLUGINS` output:

```
mysql> SHOW PLUGINS\G
***** 1. row *****
Name: binlog
Status: ACTIVE
Type: STORAGE ENGINE
Library: NULL
License: GPL
***** 2. row *****
Name: CSV
Status: ACTIVE
Type: STORAGE ENGINE
Library: NULL
License: GPL
***** 3. row *****
Name: MEMORY
Status: ACTIVE
Type: STORAGE ENGINE
Library: NULL
License: GPL
***** 4. row *****
Name: MyISAM
Status: ACTIVE
Type: STORAGE ENGINE
Library: NULL
License: GPL
...
```

`SHOW PLUGINS` output has these columns:

- **Name**

The name used to refer to the plugin in statements such as `INSTALL PLUGIN` and `UNINSTALL PLUGIN`.

- **Status**

The plugin status, one of `ACTIVE`, `INACTIVE`, `DISABLED`, or `DELETED`.

- **Type**

The type of plugin, such as `STORAGE ENGINE`, `INFORMATION_SCHEMA`, or `AUTHENTICATION`.

- **Library**

The name of the plugin shared library file. This is the name used to refer to the plugin file in statements such as `INSTALL PLUGIN` and `UNINSTALL PLUGIN`. This file is located in the directory named by the `plugin_dir` system variable. If the library name is `NULL`, the plugin is compiled in and cannot be uninstalled with `UNINSTALL PLUGIN`.

- **License**

How the plugin is licensed (for example, `GPL`).

For plugins installed with `INSTALL PLUGIN`, the **Name** and **Library** values are also registered in the `mysql.plugin` system table.

For information about plugin data structures that form the basis of the information displayed by `SHOW PLUGINS`, see [The MySQL Plugin API](#).

Plugin information is also available from the `INFORMATION_SCHEMA.PLUGINS` table. See [Section 24.3.17, “The INFORMATION\\_SCHEMA PLUGINS Table”](#).

### 13.7.5.26 SHOW PRIVILEGES Statement

```
SHOW PRIVILEGES
```

`SHOW PRIVILEGES` shows the list of system privileges that the MySQL server supports. The exact list of privileges depends on the version of your server.

```
mysql> SHOW PRIVILEGES\G
***** 1. row *****
Privilege: Alter
Context: Tables
Comment: To alter the table
***** 2. row *****
Privilege: Alter routine
Context: Functions,Procedures
Comment: To alter or drop stored functions/procedures
***** 3. row *****
Privilege: Create
Context: Databases,Tables,Indexes
Comment: To create new databases and tables
***** 4. row *****
Privilege: Create routine
Context: Databases
Comment: To use CREATE FUNCTION/PROCEDURE
***** 5. row *****
Privilege: Create temporary tables
Context: Databases
```



```
Comment: To use CREATE TEMPORARY TABLE
...
```

Privileges belonging to a specific user are displayed by the `SHOW GRANTS` statement. See [Section 13.7.5.21, "SHOW GRANTS Statement"](#), for more information.

### 13.7.5.27 SHOW PROCEDURE CODE Statement

```
SHOW PROCEDURE CODE proc_name
```

This statement is a MySQL extension that is available only for servers that have been built with debugging support. It displays a representation of the internal implementation of the named stored procedure. A similar statement, `SHOW FUNCTION CODE`, displays information about stored functions (see [Section 13.7.5.19, "SHOW FUNCTION CODE Statement"](#)).

To use either statement, you must be the owner of the routine or have `SELECT` access to the `mysql.proc` table.

If the named routine is available, each statement produces a result set. Each row in the result set corresponds to one "instruction" in the routine. The first column is `Pos`, which is an ordinal number beginning with 0. The second column is `Instruction`, which contains an SQL statement (usually changed from the original source), or a directive which has meaning only to the stored-routine handler.

```
mysql> DELIMITER //
mysql> CREATE PROCEDURE p1 ()
BEGIN
  DECLARE fanta INT DEFAULT 55;
  DROP TABLE t2;
  LOOP
    INSERT INTO t3 VALUES (fanta);
  END LOOP;
END//
Query OK, 0 rows affected (0.01 sec)

mysql> SHOW PROCEDURE CODE p1//
+-----+
| Pos | Instruction
+-----+
| 0 | set fanta@0 55
| 1 | stmt 9 "DROP TABLE t2"
| 2 | stmt 5 "INSERT INTO t3 VALUES (fanta)"
| 3 | jump 2
+-----+
4 rows in set (0.00 sec)

mysql> CREATE FUNCTION test.hello (s CHAR(20))
RETURNS CHAR(50) DETERMINISTIC
RETURN CONCAT('Hello, ',s,'!');
Query OK, 0 rows affected (0.00 sec)

mysql> SHOW FUNCTION CODE test.hello;
+-----+
| Pos | Instruction
+-----+
| 0 | freturn 254 concat('Hello, ',s@0, '!')
+-----+
1 row in set (0.00 sec)
```

In this example, the nonexecutable `BEGIN` and `END` statements have disappeared, and for the `DECLARE variable_name` statement, only the executable part appears (the part where the default is assigned). For each statement that is taken from source, there is a code word `stmt` followed by a type (9 means `DROP`, 5 means `INSERT`, and so on). The final row contains an instruction `jump 2`, meaning `GOTO instruction #2`.

### 13.7.5.28 SHOW PROCEDURE STATUS Statement

```
SHOW PROCEDURE STATUS
[LIKE 'pattern' | WHERE expr]
```

This statement is a MySQL extension. It returns characteristics of a stored procedure, such as the database, name, type, creator, creation and modification dates, and character set information. A similar statement, [SHOW FUNCTION STATUS](#), displays information about stored functions (see [Section 13.7.5.20](#), “[SHOW FUNCTION STATUS Statement](#)”).

To use either statement, you must be the owner of the routine or have [SELECT](#) access to the `mysql.proc` table.

The [LIKE](#) clause, if present, indicates which procedure or function names to match. The [WHERE](#) clause can be given to select rows using more general conditions, as discussed in [Section 24.8](#), “[Extensions to SHOW Statements](#)”.

```
mysql> SHOW PROCEDURE STATUS LIKE 'spl'\G
***** 1. row *****
      Db: test
      Name: spl
      Type: PROCEDURE
      Definer: testuser@localhost
      Modified: 2018-08-08 13:54:11
      Created: 2018-08-08 13:54:11
      Security_type: DEFINER
      Comment:
character_set_client: utf8
collation_connection: utf8_general_ci
      Database Collation: latin1_swedish_ci

mysql> SHOW FUNCTION STATUS LIKE 'hello'\G
***** 1. row *****
      Db: test
      Name: hello
      Type: FUNCTION
      Definer: testuser@localhost
      Modified: 2020-03-10 11:09:33
      Created: 2020-03-10 11:09:33
      Security_type: DEFINER
      Comment:
character_set_client: utf8
collation_connection: utf8_general_ci
      Database Collation: latin1_swedish_ci
```

`character_set_client` is the session value of the `character_set_client` system variable when the routine was created. `collation_connection` is the session value of the `collation_connection` system variable when the routine was created. `Database Collation` is the collation of the database with which the routine is associated.

Stored routine information is also available from the [INFORMATION\\_SCHEMA PARAMETERS](#) and [ROUTINES](#) tables. See [Section 24.3.15](#), “[The INFORMATION\\_SCHEMA PARAMETERS Table](#)”, and [Section 24.3.21](#), “[The INFORMATION\\_SCHEMA ROUTINES Table](#)”.

### 13.7.5.29 SHOW PROCESSLIST Statement

```
SHOW [FULL] PROCESSLIST
```

The MySQL process list indicates the operations currently being performed by the set of threads executing within the server. The [SHOW PROCESSLIST](#) statement is one source of process information. For a comparison of this statement with other sources, see [Sources of Process Information](#).

If you have the [PROCESS](#) privilege, you can see all threads, even those belonging to other users. Otherwise (without the [PROCESS](#) privilege), nonanonymous users have access to information about their own threads but not threads for other users, and anonymous users have no access to thread information.

Without the [FULL](#) keyword, [SHOW PROCESSLIST](#) displays only the first 100 characters of each statement in the [Info](#) field.

The [SHOW PROCESSLIST](#) statement is very useful if you get the “too many connections” error message and want to find out what is going on. MySQL reserves one extra connection to be used by accounts that have the [SUPER](#) privilege, to ensure that administrators should always be able to connect and check the system (assuming that you are not giving this privilege to all your users).

Threads can be killed with the [KILL](#) statement. See [Section 13.7.6.4, “KILL Statement”](#).

Example of [SHOW PROCESSLIST](#) output:

```
mysql> SHOW FULL PROCESSLIST\G
***** 1. row *****
  Id: 1
  User: system user
  Host:
  db: NULL
Command: Connect
  Time: 1030455
  State: Waiting for master to send event
  Info: NULL
***** 2. row *****
  Id: 2
  User: system user
  Host:
  db: NULL
Command: Connect
  Time: 1004
  State: Has read all relay log; waiting for the slave
        I/O thread to update it
  Info: NULL
***** 3. row *****
  Id: 3112
  User: replikator
  Host: artemis:2204
  db: NULL
Command: Binlog Dump
  Time: 2144
  State: Has sent all binlog to slave; waiting for binlog to be updated
  Info: NULL
***** 4. row *****
  Id: 3113
  User: replikator
  Host: iconnect2:45781
  db: NULL
Command: Binlog Dump
  Time: 2086
  State: Has sent all binlog to slave; waiting for binlog to be updated
  Info: NULL
***** 5. row *****
  Id: 3123
  User: stefan
  Host: localhost
  db: apollon
Command: Query
  Time: 0
  State: NULL
  Info: SHOW FULL PROCESSLIST
```

[SHOW PROCESSLIST](#) output has these columns:

- `Id`

The connection identifier. This is the same value displayed in the `ID` column of the `INFORMATION_SCHEMA.PROCESSLIST` table, displayed in the `PROCESSLIST_ID` column of the Performance Schema `threads` table, and returned by the `CONNECTION_ID()` function within the thread.

- `User`

The MySQL user who issued the statement. A value of `system user` refers to a nonclient thread spawned by the server to handle tasks internally, for example, a delayed-row handler thread or an I/O or SQL thread used on replica hosts. For `system user`, there is no host specified in the `Host` column. `unauthenticated user` refers to a thread that has become associated with a client connection but for which authentication of the client user has not yet occurred. `event_scheduler` refers to the thread that monitors scheduled events (see [Section 23.4, “Using the Event Scheduler”](#)).

- `Host`

The host name of the client issuing the statement (except for `system user`, for which there is no host). The host name for TCP/IP connections is reported in `host_name:client_port` format to make it easier to determine which client is doing what.

- `db`

The default database for the thread, or `NULL` if none has been selected.

- `Command`

The type of command the thread is executing on behalf of the client, or `Sleep` if the session is idle. For descriptions of thread commands, see [Section 8.14, “Examining Server Thread \(Process\) Information”](#). The value of this column corresponds to the `COM_xxx` commands of the client/server protocol and `Com_xxx` status variables. See [Section 5.1.9, “Server Status Variables”](#).

- `Time`

The time in seconds that the thread has been in its current state. For a replica SQL thread, the value is the number of seconds between the timestamp of the last replicated event and the real time of the replica host. See [Section 16.2.3, “Replication Threads”](#).

- `State`

An action, event, or state that indicates what the thread is doing. For descriptions of `State` values, see [Section 8.14, “Examining Server Thread \(Process\) Information”](#).

Most states correspond to very quick operations. If a thread stays in a given state for many seconds, there might be a problem that needs to be investigated.

- `Info`

The statement the thread is executing, or `NULL` if it is executing no statement. The statement might be the one sent to the server, or an innermost statement if the statement executes other statements. For example, if a `CALL` statement executes a stored procedure that is executing a `SELECT` statement, the `Info` value shows the `SELECT` statement.

### 13.7.5.30 SHOW PROFILE Statement

```
SHOW PROFILE [type [, type] ... ]
            [FOR QUERY n]
```

```
[LIMIT row_count [OFFSET offset]]

type: {
  ALL
  | BLOCK IO
  | CONTEXT SWITCHES
  | CPU
  | IPC
  | MEMORY
  | PAGE FAULTS
  | SOURCE
  | SWAPS
}
```

The `SHOW PROFILE` and `SHOW PROFILES` statements display profiling information that indicates resource usage for statements executed during the course of the current session.



#### Note

The `SHOW PROFILE` and `SHOW PROFILES` statements are deprecated; expect them to be removed in a future MySQL release. Use the [Performance Schema](#) instead; see [Section 25.19.1, “Query Profiling Using Performance Schema”](#).

To control profiling, use the `profiling` session variable, which has a default value of 0 (`OFF`). Enable profiling by setting `profiling` to 1 or `ON`:

```
mysql> SET profiling = 1;
```

`SHOW PROFILES` displays a list of the most recent statements sent to the server. The size of the list is controlled by the `profiling_history_size` session variable, which has a default value of 15. The maximum value is 100. Setting the value to 0 has the practical effect of disabling profiling.

All statements are profiled except `SHOW PROFILE` and `SHOW PROFILES`, so neither of those statements appears in the profile list. Malformed statements are profiled. For example, `SHOW PROFILING` is an illegal statement, and a syntax error occurs if you try to execute it, but it shows up in the profiling list.

`SHOW PROFILE` displays detailed information about a single statement. Without the `FOR QUERY n` clause, the output pertains to the most recently executed statement. If `FOR QUERY n` is included, `SHOW PROFILE` displays information for statement *n*. The values of *n* correspond to the `Query_ID` values displayed by `SHOW PROFILES`.

The `LIMIT row_count` clause may be given to limit the output to *row\_count* rows. If `LIMIT` is given, `OFFSET offset` may be added to begin the output *offset* rows into the full set of rows.

By default, `SHOW PROFILE` displays `Status` and `Duration` columns. The `Status` values are like the `State` values displayed by `SHOW PROCESSLIST`, although there might be some minor differences in interpretation for the two statements for some status values (see [Section 8.14, “Examining Server Thread \(Process\) Information”](#)).

Optional `type` values may be specified to display specific additional types of information:

- `ALL` displays all information
- `BLOCK IO` displays counts for block input and output operations
- `CONTEXT SWITCHES` displays counts for voluntary and involuntary context switches
- `CPU` displays user and system CPU usage times
- `IPC` displays counts for messages sent and received

- `MEMORY` is not currently implemented
- `PAGE FAULTS` displays counts for major and minor page faults
- `SOURCE` displays the names of functions from the source code, together with the name and line number of the file in which the function occurs
- `SWAPS` displays swap counts

Profiling is enabled per session. When a session ends, its profiling information is lost.

```
mysql> SELECT @@profiling;
+-----+
| @@profiling |
+-----+
|          0 |
+-----+
1 row in set (0.00 sec)

mysql> SET profiling = 1;
Query OK, 0 rows affected (0.00 sec)

mysql> DROP TABLE IF EXISTS t1;
Query OK, 0 rows affected, 1 warning (0.00 sec)

mysql> CREATE TABLE t1 (id INT);
Query OK, 0 rows affected (0.01 sec)

mysql> SHOW PROFILES;
+-----+-----+-----+
| Query_ID | Duration | Query |
+-----+-----+-----+
|          0 | 0.000088 | SET PROFILING = 1 |
|          1 | 0.000136 | DROP TABLE IF EXISTS t1 |
|          2 | 0.011947 | CREATE TABLE t1 (id INT) |
+-----+-----+-----+
3 rows in set (0.00 sec)

mysql> SHOW PROFILE;
+-----+-----+
| Status | Duration |
+-----+-----+
| checking permissions | 0.000040 |
| creating table | 0.000056 |
| After create | 0.011363 |
| query end | 0.000375 |
| freeing items | 0.000089 |
| logging slow query | 0.000019 |
| cleaning up | 0.000005 |
+-----+-----+
7 rows in set (0.00 sec)

mysql> SHOW PROFILE FOR QUERY 1;
+-----+-----+
| Status | Duration |
+-----+-----+
| query end | 0.000107 |
| freeing items | 0.000008 |
| logging slow query | 0.000015 |
| cleaning up | 0.000006 |
+-----+-----+
4 rows in set (0.00 sec)

mysql> SHOW PROFILE CPU FOR QUERY 2;
+-----+-----+-----+-----+
| Status | Duration | CPU_user | CPU_system |
+-----+-----+-----+-----+
```

checking permissions	0.000040	0.000038	0.000002
creating table	0.000056	0.000028	0.000028
After create	0.011363	0.000217	0.001571
query end	0.000375	0.000013	0.000028
freeing items	0.000089	0.000010	0.000014
logging slow query	0.000019	0.000009	0.000010
cleaning up	0.000005	0.000003	0.000002

7 rows in set (0.00 sec)



### Note

Profiling is only partially functional on some architectures. For values that depend on the `getrusage()` system call, `NULL` is returned on systems such as Windows that do not support the call. In addition, profiling is per process and not per thread. This means that activity on threads within the server other than your own may affect the timing information that you see.

Profiling information is also available from the `INFORMATION_SCHEMA.PROFILING` table. See [Section 24.3.19, “The INFORMATION\\_SCHEMA PROFILING Table”](#). For example, the following queries are equivalent:

```
SHOW PROFILE FOR QUERY 2;

SELECT STATE, FORMAT(DURATION, 6) AS DURATION
FROM INFORMATION_SCHEMA.PROFILING
WHERE QUERY_ID = 2 ORDER BY SEQ;
```

## 13.7.5.31 SHOW PROFILES Statement

```
SHOW PROFILES
```

The `SHOW PROFILES` statement, together with `SHOW PROFILE`, displays profiling information that indicates resource usage for statements executed during the course of the current session. For more information, see [Section 13.7.5.30, “SHOW PROFILE Statement”](#).



### Note

The `SHOW PROFILE` and `SHOW PROFILES` statements are deprecated; expect them to be removed in a future MySQL release. Use the [Performance Schema](#) instead; see [Section 25.19.1, “Query Profiling Using Performance Schema”](#).

## 13.7.5.32 SHOW RELAYLOG EVENTS Statement

```
SHOW RELAYLOG EVENTS
[IN 'log_name']
[FROM pos]
[LIMIT [offset,] row_count]
[channel_option]

channel_option:
FOR CHANNEL channel
```

Shows the events in the relay log of a replica. If you do not specify `'log_name'`, the first relay log is displayed. This statement has no effect on the source. `SHOW RELAYLOG EVENTS` requires the `REPLICATION SLAVE` privilege.

The `LIMIT` clause has the same syntax as for the `SELECT` statement. See [Section 13.2.9, “SELECT Statement”](#).

**Note**

Issuing a `SHOW RELAYLOG EVENTS` with no `LIMIT` clause could start a very time- and resource-consuming process because the server returns to the client the complete contents of the relay log (including all statements modifying data that have been received by the replica).

The optional `FOR CHANNEL channel` clause enables you to name which replication channel the statement applies to. Providing a `FOR CHANNEL channel` clause applies the statement to a specific replication channel. If no channel is named and no extra channels exist, the statement applies to the default channel.

When using multiple replication channels, if a `SHOW RELAYLOG EVENTS` statement does not have a channel defined using a `FOR CHANNEL channel` clause an error is generated. See [Section 16.2.2, “Replication Channels”](#) for more information.

`SHOW RELAYLOG EVENTS` displays the following fields for each event in the relay log:

- `Log_name`

The name of the file that is being listed.

- `Pos`

The position at which the event occurs.

- `Event_type`

An identifier that describes the event type.

- `Server_id`

The server ID of the server on which the event originated.

- `End_log_pos`

The value of `End_log_pos` for this event in the source's binary log.

- `Info`

More detailed information about the event type. The format of this information depends on the event type.

**Note**

Some events relating to the setting of user and system variables are not included in the output from `SHOW RELAYLOG EVENTS`. To get complete coverage of events within a relay log, use `mysqlbinlog`.

### 13.7.5.33 SHOW SLAVE HOSTS Statement

```
SHOW SLAVE HOSTS
```

Displays a list of replicas currently registered with the source.

`SHOW SLAVE HOSTS` should be executed on a server that acts as a replication source. `SHOW SLAVE HOSTS` requires the `REPLICATION SLAVE` privilege. The statement displays information about servers that



are or have been connected as replicas, with each row of the result corresponding to one replica server, as shown here:

```
mysql> SHOW SLAVE HOSTS;
+-----+-----+-----+-----+-----+
| Server_id | Host      | Port | Master_id | Slave_UUID |
+-----+-----+-----+-----+-----+
| 192168010 | iconnect2 | 3306 | 192168011 | 14cb6624-7f93-11e0-b2c0-c80aa9429562 |
| 1921680101 | athena    | 3306 | 192168011 | 07af4990-f41f-11df-a566-7ac56fdaf645 |
+-----+-----+-----+-----+-----+
```

- **Server\_id**: The unique server ID of the replica server, as configured in the replica server's option file, or on the command line with `--server-id=value`.
- **Host**: The host name of the replica server as specified on the replica with the `--report-host` option. This can differ from the machine name as configured in the operating system.
- **User**: The replica server user name as, specified on the replica with the `--report-user` option. Statement output includes this column only if the source server is started with the `--show-slave-auth-info` option.
- **Password**: The replica server password as, specified on the replica with the `--report-password` option. Statement output includes this column only if the source server is started with the `--show-slave-auth-info` option.
- **Port**: The port on the source to which the replica server is listening, as specified on the replica with the `--report-port` option.

A zero in this column means that the replica port (`--report-port`) was not set.

- **Master\_id**: The unique server ID of the source server that the replica server is replicating from. This is the server ID of the server on which `SHOW SLAVE HOSTS` is executed, so this same value is listed for each row in the result.
- **Slave\_UUID**: The globally unique ID of this replica, as generated on the replica and found in the replica's `auto.cnf` file.

### 13.7.5.34 SHOW SLAVE STATUS Statement

```
SHOW SLAVE STATUS [FOR CHANNEL channel]
```

This statement provides status information on essential parameters of the replica threads. It requires either the `SUPER` or `REPLICATION CLIENT` privilege.

If you issue this statement using the `mysql` client, you can use a `\G` statement terminator rather than a semicolon to obtain a more readable vertical layout:

```
mysql> SHOW SLAVE STATUS\G
***** 1. row *****
      Slave_IO_State: Waiting for master to send event
      Master_Host: localhost
      Master_User: repl
      Master_Port: 13000
      Connect_Retry: 60
      Master_Log_File: source-bin.000002
      Read_Master_Log_Pos: 1307
      Relay_Log_File: replica-relay-bin.000003
      Relay_Log_Pos: 1508
      Relay_Master_Log_File: source-bin.000002
      Slave_IO_Running: Yes
      Slave_SQL_Running: Yes
      Replicate_Do_DB:
```

```

Replicate_Ignore_DB:
Replicate_Do_Table:
Replicate_Ignore_Table:
Replicate_Wild_Do_Table:
Replicate_Wild_Ignore_Table:
    Last_Errno: 0
    Last_Error:
    Skip_Counter: 0
Exec_Master_Log_Pos: 1307
Relay_Log_Space: 1858
Until_Condition: None
Until_Log_File:
Until_Log_Pos: 0
Master_SSL_Allowed: No
Master_SSL_CA_File:
Master_SSL_CA_Path:
Master_SSL_Cert:
Master_SSL_Cipher:
Master_SSL_Key:
Seconds_Behind_Master: 0
Master_SSL_Verify_Server_Cert: No
    Last_IO_Errno: 0
    Last_IO_Error:
    Last_SQL_Errno: 0
    Last_SQL_Error:
Replicate_Ignore_Server_Ids:
    Master_Server_Id: 1
        Master_UUID: 3e11fa47-71ca-11e1-9e33-c80aa9429562
    Master_Info_File: /var/mysqld.2/data/master.info
    SQL_Delay: 0
    SQL_Remaining_Delay: NULL
Slave_SQL_Running_State: Reading event from the relay log
    Master_Retry_Count: 10
    Master_Bind:
Last_IO_Error_Timestamp:
Last_SQL_Error_Timestamp:
    Master_SSL_Crl:
    Master_SSL_Crlpath:
Retrieved_Gtid_Set: 3e11fa47-71ca-11e1-9e33-c80aa9429562:1-5
Executed_Gtid_Set: 3e11fa47-71ca-11e1-9e33-c80aa9429562:1-5
    Auto_Position: 1
Replicate_Rewrite_DB:
    Channel_name:
Master_TLS_Version: TLSv1.2

```

The Performance Schema provides tables that expose replication information. This is similar to the information available from the `SHOW SLAVE STATUS` statement, but represented in table form. For details, see [Section 25.12.11, “Performance Schema Replication Tables”](#).

The following list describes the fields returned by `SHOW SLAVE STATUS`. For additional information about interpreting their meanings, see [Section 16.1.7.1, “Checking Replication Status”](#).

- `Slave_IO_State`

A copy of the `State` field of the `SHOW PROCESSLIST` output for the replica I/O thread. This tells you what the thread is doing: trying to connect to the source, waiting for events from the source, reconnecting to the source, and so on. For a listing of possible states, see [Section 8.14.6, “Replication Replica I/O Thread States”](#).

- `Master_Host`

The source host that the replica is connected to.

- `Master_User`

The user name of the account used to connect to the source.

- `Master_Port`

The port used to connect to the source.

- `Connect_Retry`

The number of seconds between connect retries (default 60). This can be set with the `CHANGE MASTER TO` statement.

- `Master_Log_File`

The name of the source binary log file from which the I/O thread is currently reading.

- `Read_Master_Log_Pos`

The position in the current source binary log file up to which the I/O thread has read.

- `Relay_Log_File`

The name of the relay log file from which the SQL thread is currently reading and executing.

- `Relay_Log_Pos`

The position in the current relay log file up to which the SQL thread has read and executed.

- `Relay_Master_Log_File`

The name of the source binary log file containing the most recent event executed by the SQL thread.

- `Slave_IO_Running`

Whether the I/O thread is started and has connected successfully to the source. Internally, the state of this thread is represented by one of the following three values:

- **MYSQL\_SLAVE\_NOT\_RUN.** The replica I/O thread is not running. For this state, `Slave_IO_Running` is `No`.
- **MYSQL\_SLAVE\_RUN\_NOT\_CONNECT.** The replica I/O thread is running, but is not connected to a replication source. For this state, `Slave_IO_Running` is `Connecting`.
- **MYSQL\_SLAVE\_RUN\_CONNECT.** The replica I/O thread is running, and is connected to a replication source. For this state, `Slave_IO_Running` is `Yes`.

The value of the `Slave_running` system status variable corresponds with this value.

- `Slave_SQL_Running`

Whether the SQL thread is started.

- `Replicate_Do_DB, Replicate_Ignore_DB`

The lists of databases that were specified with the `--replicate-do-db` and `--replicate-ignore-db` options, if any.

- `Replicate_Do_Table, Replicate_Ignore_Table, Replicate_Wild_Do_Table, Replicate_Wild_Ignore_Table`

The lists of tables that were specified with the `--replicate-do-table`, `--replicate-ignore-table`, `--replicate-wild-do-table`, and `--replicate-wild-ignore-table` options, if any.

- `Last_Errno`, `Last_Error`

These columns are aliases for `Last_SQL_Errno` and `Last_SQL_Error`.

Issuing `RESET MASTER` or `RESET SLAVE` resets the values shown in these columns.



#### Note

When the replica SQL thread receives an error, it reports the error first, then stops the SQL thread. This means that there is a small window of time during which `SHOW SLAVE STATUS` shows a nonzero value for `Last_SQL_Errno` even though `Slave_SQL_Running` still displays `Yes`.

- `Skip_Counter`

The current value of the `sql_slave_skip_counter` system variable. See [Section 13.4.2.4, “SET GLOBAL sql\\_slave\\_skip\\_counter Syntax”](#).

- `Exec_Master_Log_Pos`

The position in the current source binary log file to which the SQL thread has read and executed, marking the start of the next transaction or event to be processed. You can use this value with the `CHANGE MASTER TO` statement's `MASTER_LOG_POS` option when starting a new replica from an existing replica, so that the new replica reads from this point. The coordinates given by (`Relay_Master_Log_File`, `Exec_Master_Log_Pos`) in the source's binary log correspond to the coordinates given by (`Relay_Log_File`, `Relay_Log_Pos`) in the relay log.

Inconsistencies in the sequence of transactions from the relay log which have been executed can cause this value to be a “low-water mark”. In other words, transactions appearing before the position are guaranteed to have committed, but transactions after the position may have committed or not. If these gaps need to be corrected, use `START SLAVE UNTIL SQL_AFTER_MTS_GAPS`. See [Section 16.4.1.32, “Replication and Transaction Inconsistencies”](#) for more information.

- `Relay_Log_Space`

The total combined size of all existing relay log files.

- `Until_Condition`, `Until_Log_File`, `Until_Log_Pos`

The values specified in the `UNTIL` clause of the `START SLAVE` statement.

`Until_Condition` has these values:

- `None` if no `UNTIL` clause was specified
- `Master` if the replica is reading until a given position in the source's binary log
- `Relay` if the replica is reading until a given position in its relay log
- `SQL_BEFORE_GTIDS` if the replica SQL thread is processing transactions until it has reached the first transaction whose GTID is listed in the `gtid_set`.
- `SQL_AFTER_GTIDS` if the replica threads are processing all transactions until the last transaction in the `gtid_set` has been processed by both threads.

- `SQL_AFTER_MTS_GAPS` if a multithreaded replica's SQL threads are running until no more gaps are found in the relay log.

`Until_Log_File` and `Until_Log_Pos` indicate the log file name and position that define the coordinates at which the SQL thread stops executing.

For more information on `UNTIL` clauses, see [Section 13.4.2.5, “START SLAVE Statement”](#).

- `Master_SSL_Allowed`, `Master_SSL_CA_File`, `Master_SSL_CA_Path`, `Master_SSL_Cert`, `Master_SSL_Cipher`, `Master_SSL_CRL_File`, `Master_SSL_CRL_Path`, `Master_SSL_Key`, `Master_SSL_Verify_Server_Cert`

These fields show the SSL parameters used by the replica to connect to the source, if any.

`Master_SSL_Allowed` has these values:

- `Yes` if an SSL connection to the source is permitted
- `No` if an SSL connection to the source is not permitted
- `Ignored` if an SSL connection is permitted but the replica server does not have SSL support enabled

The values of the other SSL-related fields correspond to the values of the `MASTER_SSL_CA`, `MASTER_SSL_CAPATH`, `MASTER_SSL_CERT`, `MASTER_SSL_CIPHER`, `MASTER_SSL_CRL`, `MASTER_SSL_CRLPATH`, `MASTER_SSL_KEY`, and `MASTER_SSL_VERIFY_SERVER_CERT` options to the `CHANGE MASTER TO` statement. See [Section 13.4.2.1, “CHANGE MASTER TO Statement”](#).

- `Seconds_Behind_Master`

This field is an indication of how “late” the replica is:

- When the replica is actively processing updates, this field shows the difference between the current timestamp on the replica and the original timestamp logged on the source for the event currently being processed on the replica.
- When no event is currently being processed on the replica, this value is 0.

In essence, this field measures the time difference in seconds between the replica SQL thread and the replica I/O thread. If the network connection between source and replica is fast, the replica I/O thread is very close to the source, so this field is a good approximation of how late the replica SQL thread is compared to the source. If the network is slow, this is *not* a good approximation; the replica SQL thread may quite often be caught up with the slow-reading replica I/O thread, so `Seconds_Behind_Master` often shows a value of 0, even if the I/O thread is late compared to the source. In other words, *this column is useful only for fast networks*.

This time difference computation works even if the source and replica do not have identical clock times, provided that the difference, computed when the replica I/O thread starts, remains constant from then on. Any changes—including NTP updates—can lead to clock skews that can make calculation of `Seconds_Behind_Master` less reliable.

In MySQL 5.7, this field is `NULL` (undefined or unknown) if the replica SQL thread is not running, or if the SQL thread has consumed all of the relay log and the replica I/O thread is not running. (In older versions of MySQL, this field was `NULL` if the replica SQL thread or the replica I/O thread was not

running or was not connected to the source.) If the I/O thread is running but the relay log is exhausted, `Seconds_Behind_Master` is set to 0.

The value of `Seconds_Behind_Master` is based on the timestamps stored in events, which are preserved through replication. This means that if a source M1 is itself a replica of M0, any event from M1's binary log that originates from M0's binary log has M0's timestamp for that event. This enables MySQL to replicate `TIMESTAMP` successfully. However, the problem for `Seconds_Behind_Master` is that if M1 also receives direct updates from clients, the `Seconds_Behind_Master` value randomly fluctuates because sometimes the last event from M1 originates from M0 and sometimes is the result of a direct update on M1.

When using a multithreaded replica, you should keep in mind that this value is based on `Exec_Master_Log_Pos`, and so may not reflect the position of the most recently committed transaction.

- `Last_IO_Errno`, `Last_IO_Error`

The error number and error message of the most recent error that caused the I/O thread to stop. An error number of 0 and message of the empty string mean “no error.” If the `Last_IO_Error` value is not empty, the error values also appear in the replica's error log.

I/O error information includes a timestamp showing when the most recent I/O thread error occurred. This timestamp uses the format `YYMMDD hh:mm:ss`, and appears in the `Last_IO_Error_Timestamp` column.

Issuing `RESET MASTER` or `RESET SLAVE` resets the values shown in these columns.

- `Last_SQL_Errno`, `Last_SQL_Error`

The error number and error message of the most recent error that caused the SQL thread to stop. An error number of 0 and message of the empty string mean “no error.” If the `Last_SQL_Error` value is not empty, the error values also appear in the replica's error log.

If the replica is multithreaded, the SQL thread is the coordinator for worker threads. In this case, the `Last_SQL_Error` field shows exactly what the `Last_Error_Message` column in the Performance Schema `replication_applier_status_by_coordinator` table shows. The field value is modified to suggest that there may be more failures in the other worker threads which can be seen in the `replication_applier_status_by_worker` table that shows each worker thread's status. If that table is not available, the replica error log can be used. The log or the `replication_applier_status_by_worker` table should also be used to learn more about the failure shown by `SHOW SLAVE STATUS` or the coordinator table.

SQL error information includes a timestamp showing when the most recent SQL thread error occurred. This timestamp uses the format `YYMMDD hh:mm:ss`, and appears in the `Last_SQL_Error_Timestamp` column.

Issuing `RESET MASTER` or `RESET SLAVE` resets the values shown in these columns.

In MySQL 5.7, all error codes and messages displayed in the `Last_SQL_Errno` and `Last_SQL_Error` columns correspond to error values listed in [Server Error Message Reference](#). This was not always true in previous versions. (Bug #11760365, Bug #52768)

- `Replicate_Ignore_Server_Ids`

In MySQL 5.7, you set a replica to ignore events from 0 or more sources using the `IGNORE_SERVER_IDS` option of the `CHANGE MASTER TO` statement. By default this is blank, and is

usually modified only when using a circular or other multi-source replication setup. The message shown for `Replicate_Ignore_Server_Ids` when not blank consists of a comma-delimited list of one or more numbers, indicating the server IDs to be ignored. For example:

```
Replicate_Ignore_Server_Ids: 2, 6, 9
```



#### Note

`Ignored_server_ids` also shows the server IDs to be ignored, but is a space-delimited list, which is preceded by the total number of server IDs to be ignored. For example, if a `CHANGE MASTER TO` statement containing the `IGNORE_SERVER_IDS = (2,6,9)` option has been issued to tell a replica to ignore sources having the server ID 2, 6, or 9, that information appears as shown here:

```
Ignored_server_ids: 3, 2, 6, 9
```

The first number (in this case 3) shows the number of server IDs being ignored.

`Replicate_Ignore_Server_Ids` filtering is performed by the I/O thread, rather than by the SQL thread, which means that events which are filtered out are not written to the relay log. This differs from the filtering actions taken by server options such `--replicate-do-table`, which apply to the SQL thread.

- `Master_Server_Id`

The `server_id` value from the source.

- `Master_UUID`

The `server_uuid` value from the source.

- `Master_Info_File`

The location of the `master.info` file.

- `SQL_Delay`

The number of seconds that the replica must lag the source.

- `SQL_Remaining_Delay`

When `Slave_SQL_Running_State` is `Waiting until MASTER_DELAY seconds after master executed event`, this field contains the number of delay seconds remaining. At other times, this field is `NULL`.

- `Slave_SQL_Running_State`

The state of the SQL thread (analogous to `Slave_IO_State`). The value is identical to the `State` value of the SQL thread as displayed by `SHOW PROCESSLIST`. [Section 8.14.7, “Replication Replica SQL Thread States”](#), provides a listing of possible states

- `Master_Retry_Count`

The number of times the replica can attempt to reconnect to the source in the event of a lost connection. This value can be set using the `MASTER_RETRY_COUNT` option of the `CHANGE MASTER TO` statement (preferred) or the older `--master-retry-count` server option (still supported for backward compatibility).

- `Master_Bind`

The network interface that the replica is bound to, if any. This is set using the `MASTER_BIND` option for the `CHANGE MASTER TO` statement.

- `Last_IO_Error_Timestamp`

A timestamp in `YYMMDD hh:mm:ss` format that shows when the most recent I/O error took place.

- `Last_SQL_Error_Timestamp`

A timestamp in `YYMMDD hh:mm:ss` format that shows when the most recent SQL error occurred.

- `Retrieved_Gtid_Set`

The set of global transaction IDs corresponding to all transactions received by this replica. Empty if GTIDs are not in use. See [GTID Sets](#) for more information.

This is the set of all GTIDs that exist or have existed in the relay logs. Each GTID is added as soon as the `Gtid_log_event` is received. This can cause partially transmitted transactions to have their GTIDs included in the set.

When all relay logs are lost due to executing `RESET SLAVE` or `CHANGE MASTER TO`, or due to the effects of the `--relay-log-recovery` option, the set is cleared. When `relay_log_purge = 1`, the newest relay log is always kept, and the set is not cleared.

- `Executed_Gtid_Set`

The set of global transaction IDs written in the binary log. This is the same as the value for the global `gtid_executed` system variable on this server, as well as the value for `Executed_Gtid_Set` in the output of `SHOW MASTER STATUS` on this server. Empty if GTIDs are not in use. See [GTID Sets](#) for more information.

- `Auto_Position`

1 if autopositioning is in use; otherwise 0.

- `Replicate_Rewrite_DB`

The `Replicate_Rewrite_DB` value displays any replication filtering rules that were specified. For example, if the following replication filter rule was set:

```
CHANGE REPLICATION FILTER REPLICATE_REWRITE_DB=((db1,db2), (db3,db4));
```

the `Replicate_Rewrite_DB` value displays:

```
Replicate_Rewrite_DB: (db1,db2),(db3,db4)
```

For more information, see [Section 13.4.2.2, “CHANGE REPLICATION FILTER Statement”](#).

- `Channel_name`

The replication channel which is being displayed. There is always a default replication channel, and more replication channels can be added. See [Section 16.2.2, “Replication Channels”](#) for more information.



- `Master_TLS_Version`

The TLS version used on the source. For TLS version information, see [Section 6.3.2, “Encrypted Connection TLS Protocols and Ciphers”](#). This column was added in MySQL 5.7.10.

### 13.7.5.35 SHOW STATUS Statement

```
SHOW [GLOBAL | SESSION] STATUS
     [LIKE 'pattern' | WHERE expr]
```



#### Note

The value of the `show_compatibility_56` system variable affects the information available from and privileges required for the statement described here. For details, see the description of that variable in [Section 5.1.7, “Server System Variables”](#).

`SHOW STATUS` provides server status information (see [Section 5.1.9, “Server Status Variables”](#)). This statement does not require any privilege. It requires only the ability to connect to the server.

Status variable information is also available from these sources:

- Performance Schema tables. See [Section 25.12.14, “Performance Schema Status Variable Tables”](#).
- The `GLOBAL_STATUS` and `SESSION_STATUS` tables. See [Section 24.3.10, “The INFORMATION\\_SCHEMA GLOBAL\\_STATUS and SESSION\\_STATUS Tables”](#).
- The `mysqladmin extended-status` command. See [Section 4.5.2, “mysqladmin — A MySQL Server Administration Program”](#).

For `SHOW STATUS`, a `LIKE` clause, if present, indicates which variable names to match. A `WHERE` clause can be given to select rows using more general conditions, as discussed in [Section 24.8, “Extensions to SHOW Statements”](#).

`SHOW STATUS` accepts an optional `GLOBAL` or `SESSION` variable scope modifier:

- With a `GLOBAL` modifier, the statement displays the global status values. A global status variable may represent status for some aspect of the server itself (for example, `Aborted_connects`), or the aggregated status over all connections to MySQL (for example, `Bytes_received` and `Bytes_sent`). If a variable has no global value, the session value is displayed.
- With a `SESSION` modifier, the statement displays the status variable values for the current connection. If a variable has no session value, the global value is displayed. `LOCAL` is a synonym for `SESSION`.
- If no modifier is present, the default is `SESSION`.

The scope for each status variable is listed at [Section 5.1.9, “Server Status Variables”](#).

Each invocation of the `SHOW STATUS` statement uses an internal temporary table and increments the global `Created_tmp_tables` value.

Partial output is shown here. The list of names and values may differ for your server. The meaning of each variable is given in [Section 5.1.9, “Server Status Variables”](#).

```
mysql> SHOW STATUS;
+-----+-----+
| Variable_name | Value |
+-----+-----+
| Aborted_clients | 0 |
```

Aborted_connects	0
Bytes_received	155372598
Bytes_sent	1176560426
Connections	30023
Created_tmp_disk_tables	0
Created_tmp_tables	8340
Created_tmp_files	60
...	
Open_tables	1
Open_files	2
Open_streams	0
Opened_tables	44600
Questions	2026873
...	
Table_locks_immediate	1920382
Table_locks_waited	0
Threads_cached	0
Threads_created	30022
Threads_connected	1
Threads_running	1
Uptime	80380

With a `LIKE` clause, the statement displays only rows for those variables with names that match the pattern:

```
mysql> SHOW STATUS LIKE 'Key%';
+-----+-----+
| Variable_name | Value |
+-----+-----+
| Key_blocks_used | 14955 |
| Key_read_requests | 96854827 |
| Key_reads | 162040 |
| Key_write_requests | 7589728 |
| Key_writes | 3813196 |
+-----+-----+
```

### 13.7.5.36 SHOW TABLE STATUS Statement

```
SHOW TABLE STATUS
  [{FROM | IN} db_name]
  [LIKE 'pattern' | WHERE expr]
```

`SHOW TABLE STATUS` works like `SHOW TABLES`, but provides a lot of information about each non-TEMPORARY table. You can also get this list using the `mysqlshow --status db_name` command. The `LIKE` clause, if present, indicates which table names to match. The `WHERE` clause can be given to select rows using more general conditions, as discussed in [Section 24.8, “Extensions to SHOW Statements”](#).

This statement also displays information about views.

`SHOW TABLE STATUS` output has these columns:

- `Name`

The name of the table.

- `Engine`

The storage engine for the table. See [Chapter 14, \*The InnoDB Storage Engine\*](#), and [Chapter 15, \*Alternative Storage Engines\*](#).

For partitioned tables, `Engine` shows the name of the storage engine used by all partitions.

- `Version`

The version number of the table's `.frm` file.

- `Row_format`

The row-storage format (`Fixed`, `Dynamic`, `Compressed`, `Redundant`, `Compact`). For `MyISAM` tables, `Dynamic` corresponds to what `myisamchk -dvv` reports as `Packed`. `InnoDB` table format is either `Redundant` or `Compact` when using the `Antelope` file format, or `Compressed` or `Dynamic` when using the `Barracuda` file format.

- `Rows`

The number of rows. Some storage engines, such as `MyISAM`, store the exact count. For other storage engines, such as `InnoDB`, this value is an approximation, and may vary from the actual value by as much as 40% to 50%. In such cases, use `SELECT COUNT(*)` to obtain an accurate count.

The `Rows` value is `NULL` for `INFORMATION_SCHEMA` tables.

For `InnoDB` tables, the row count is only a rough estimate used in SQL optimization. (This is also true if the `InnoDB` table is partitioned.)

- `Avg_row_length`

The average row length.

Refer to the notes at the end of this section for related information.

- `Data_length`

For `MyISAM`, `Data_length` is the length of the data file, in bytes.

For `InnoDB`, `Data_length` is the approximate amount of space allocated for the clustered index, in bytes. Specifically, it is the clustered index size, in pages, multiplied by the `InnoDB` page size.

Refer to the notes at the end of this section for information regarding other storage engines.

- `Max_data_length`

For `MyISAM`, `Max_data_length` is maximum length of the data file. This is the total number of bytes of data that can be stored in the table, given the data pointer size used.

Unused for `InnoDB`.

Refer to the notes at the end of this section for information regarding other storage engines.

- `Index_length`

For `MyISAM`, `Index_length` is the length of the index file, in bytes.

For `InnoDB`, `Index_length` is the approximate amount of space allocated for non-clustered indexes, in bytes. Specifically, it is the sum of non-clustered index sizes, in pages, multiplied by the `InnoDB` page size.

Refer to the notes at the end of this section for information regarding other storage engines.

- `Data_free`

The number of allocated but unused bytes.

[InnoDB](#) tables report the free space of the tablespace to which the table belongs. For a table located in the shared tablespace, this is the free space of the shared tablespace. If you are using multiple tablespaces and the table has its own tablespace, the free space is for only that table. Free space means the number of bytes in completely free extents minus a safety margin. Even if free space displays as 0, it may be possible to insert rows as long as new extents need not be allocated.

For NDB Cluster, [Data\\_free](#) shows the space allocated on disk for, but not used by, a Disk Data table or fragment on disk. (In-memory data resource usage is reported by the [Data\\_length](#) column.)

For partitioned tables, this value is only an estimate and may not be absolutely correct. A more accurate method of obtaining this information in such cases is to query the [INFORMATION\\_SCHEMA PARTITIONS](#) table, as shown in this example:

```
SELECT SUM(DATA_FREE)
  FROM INFORMATION_SCHEMA.PARTITIONS
 WHERE TABLE_SCHEMA = 'mydb'
 AND   TABLE_NAME   = 'mytable';
```

For more information, see [Section 24.3.16, “The INFORMATION\\_SCHEMA PARTITIONS Table”](#).

- [Auto\\_increment](#)

The next [AUTO\\_INCREMENT](#) value.

- [Create\\_time](#)

When the table was created.

- [Update\\_time](#)

When the data file was last updated. For some storage engines, this value is [NULL](#). For example, [InnoDB](#) stores multiple tables in its [system tablespace](#) and the data file timestamp does not apply. Even with [file-per-table](#) mode with each [InnoDB](#) table in a separate [.ibd](#) file, [change buffering](#) can delay the write to the data file, so the file modification time is different from the time of the last insert, update, or delete. For [MyISAM](#), the data file timestamp is used; however, on Windows the timestamp is not updated by updates, so the value is inaccurate.

[Update\\_time](#) displays a timestamp value for the last [UPDATE](#), [INSERT](#), or [DELETE](#) performed on [InnoDB](#) tables that are not partitioned. For MVCC, the timestamp value reflects the [COMMIT](#) time, which is considered the last update time. Timestamps are not persisted when the server is restarted or when the table is evicted from the [InnoDB](#) data dictionary cache.

The [Update\\_time](#) column also shows this information for partitioned [InnoDB](#) tables.

- [Check\\_time](#)

When the table was last checked. Not all storage engines update this time, in which case, the value is always [NULL](#).

For partitioned [InnoDB](#) tables, [Check\\_time](#) is always [NULL](#).

- [Collation](#)

The table default collation. The output does not explicitly list the table default character set, but the collation name begins with the character set name.

- [Checksum](#)

The live checksum value, if any.

- `Create_options`

Extra options used with `CREATE TABLE`.

`Create_options` shows `partitioned` for a partitioned table.

`Create_options` shows the `ENCRYPTION` option specified when creating or altering a file-per-table tablespace.

When creating a table with `strict mode` disabled, the storage engine's default row format is used if the specified row format is not supported. The actual row format of the table is reported in the `Row_format` column. `Create_options` shows the row format that was specified in the `CREATE TABLE` statement.

When altering the storage engine of a table, table options that are not applicable to the new storage engine are retained in the table definition to enable reverting the table with its previously defined options to the original storage engine, if necessary. `Create_options` may show retained options.

- `Comment`

The comment used when creating the table (or information as to why MySQL could not access the table information).

## Notes

- For `InnoDB` tables, `SHOW TABLE STATUS` does not give accurate statistics except for the physical size reserved by the table. The row count is only a rough estimate used in SQL optimization.
- For `NDB` tables, the output of this statement shows appropriate values for the `Avg_row_length` and `Data_length` columns, with the exception that `BLOB` columns are not taken into account.
- For `NDB` tables, `Data_length` includes data stored in main memory only; the `Max_data_length` and `Data_free` columns apply to Disk Data.
- For `NDB Cluster Disk Data` tables, `Max_data_length` shows the space allocated for the disk part of a Disk Data table or fragment. (In-memory data resource usage is reported by the `Data_length` column.)
- For `MEMORY` tables, the `Data_length`, `Max_data_length`, and `Index_length` values approximate the actual amount of allocated memory. The allocation algorithm reserves memory in large amounts to reduce the number of allocation operations.
- For views, all columns displayed by `SHOW TABLE STATUS` are `NULL` except that `Name` indicates the view name and `Comment` says `VIEW`.

Table information is also available from the `INFORMATION_SCHEMA TABLES` table. See [Section 24.3.25](#), “The `INFORMATION_SCHEMA TABLES` Table”.

### 13.7.5.37 SHOW TABLES Statement

```
SHOW [FULL] TABLES
  [{FROM | IN} db_name]
  [LIKE 'pattern' | WHERE expr]
```

`SHOW TABLES` lists the non-`TEMPORARY` tables in a given database. You can also get this list using the `mysqlshow db_name` command. The `LIKE` clause, if present, indicates which table names to match. The `WHERE` clause can be given to select rows using more general conditions, as discussed in [Section 24.8](#), “Extensions to `SHOW` Statements”.

Matching performed by the `LIKE` clause is dependent on the setting of the `lower_case_table_names` system variable.

This statement also lists any views in the database. The optional `FULL` modifier causes `SHOW TABLES` to display a second output column with values of `BASE TABLE` for a table, `VIEW` for a view, or `SYSTEM VIEW` for an `INFORMATION_SCHEMA` table.

If you have no privileges for a base table or view, it does not show up in the output from `SHOW TABLES` or `mysqlshow db_name`.

Table information is also available from the `INFORMATION_SCHEMA TABLES` table. See [Section 24.3.25, “The INFORMATION\\_SCHEMA TABLES Table”](#).

### 13.7.5.38 SHOW TRIGGERS Statement

```
SHOW TRIGGERS
  [{FROM | IN} db_name]
  [LIKE 'pattern' | WHERE expr]
```

`SHOW TRIGGERS` lists the triggers currently defined for tables in a database (the default database unless a `FROM` clause is given). This statement returns results only for databases and tables for which you have the `TRIGGER` privilege. The `LIKE` clause, if present, indicates which table names (not trigger names) to match and causes the statement to display triggers for those tables. The `WHERE` clause can be given to select rows using more general conditions, as discussed in [Section 24.8, “Extensions to SHOW Statements”](#).

For the `ins_sum` trigger defined in [Section 23.3, “Using Triggers”](#), the output of `SHOW TRIGGERS` is as shown here:

```
mysql> SHOW TRIGGERS LIKE 'acc%\G
***** 1. row *****
      Trigger: ins_sum
      Event: INSERT
      Table: account
      Statement: SET @sum = @sum + NEW.amount
      Timing: BEFORE
      Created: 2018-08-08 10:10:12.61
      sql_mode: ONLY_FULL_GROUP_BY,STRICT_TRANS_TABLES,
                NO_ZERO_IN_DATE,NO_ZERO_DATE,
                ERROR_FOR_DIVISION_BY_ZERO,
                NO_AUTO_CREATE_USER,NO_ENGINE_SUBSTITUTION
      Definer: me@localhost
character_set_client: utf8
collation_connection: utf8_general_ci
  Database Collation: latin1_swedish_ci
```

`SHOW TRIGGERS` output has these columns:

- `Trigger`

The name of the trigger.

- `Event`

The trigger event. This is the type of operation on the associated table for which the trigger activates. The value is `INSERT` (a row was inserted), `DELETE` (a row was deleted), or `UPDATE` (a row was modified).

- `Table`

The table for which the trigger is defined.

- `Statement`

The trigger body; that is, the statement executed when the trigger activates.

- [Timing](#)

Whether the trigger activates before or after the triggering event. The value is [BEFORE](#) or [AFTER](#).

- [Created](#)

The date and time when the trigger was created. This is a [TIMESTAMP\(2\)](#) value (with a fractional part in hundredths of seconds) for triggers created in MySQL 5.7.2 or later, [NULL](#) for triggers created prior to 5.7.2.

- [sql\\_mode](#)

The SQL mode in effect when the trigger was created, and under which the trigger executes. For the permitted values, see [Section 5.1.10, “Server SQL Modes”](#).

- [Definer](#)

The account of the user who created the trigger, in '[user\\_name](#)'@'[host\\_name](#)' format.

- [character\\_set\\_client](#)

The session value of the [character\\_set\\_client](#) system variable when the trigger was created.

- [collation\\_connection](#)

The session value of the [collation\\_connection](#) system variable when the trigger was created.

- [Database Collation](#)

The collation of the database with which the trigger is associated.

Trigger information is also available from the [INFORMATION\\_SCHEMA TRIGGERS](#) table. See [Section 24.3.29, “The INFORMATION\\_SCHEMA TRIGGERS Table”](#).

### 13.7.5.39 SHOW VARIABLES Statement

```
SHOW [GLOBAL | SESSION] VARIABLES
     [LIKE 'pattern' | WHERE expr]
```



#### Note

The value of the [show\\_compatibility\\_56](#) system variable affects the information available from and privileges required for the statement described here. For details, see the description of that variable in [Section 5.1.7, “Server System Variables”](#).

[SHOW VARIABLES](#) shows the values of MySQL system variables (see [Section 5.1.7, “Server System Variables”](#)). This statement does not require any privilege. It requires only the ability to connect to the server.

System variable information is also available from these sources:

- Performance Schema tables. See [Section 25.12.13, “Performance Schema System Variable Tables”](#).
- The [GLOBAL\\_VARIABLES](#) and [SESSION\\_VARIABLES](#) tables. See [Section 24.3.11, “The INFORMATION\\_SCHEMA GLOBAL\\_VARIABLES and SESSION\\_VARIABLES Tables”](#).

- The `mysqladmin variables` command. See [Section 4.5.2, “mysqladmin — A MySQL Server Administration Program”](#).

For `SHOW VARIABLES`, a `LIKE` clause, if present, indicates which variable names to match. A `WHERE` clause can be given to select rows using more general conditions, as discussed in [Section 24.8, “Extensions to SHOW Statements”](#).

`SHOW VARIABLES` accepts an optional `GLOBAL` or `SESSION` variable scope modifier:

- With a `GLOBAL` modifier, the statement displays global system variable values. These are the values used to initialize the corresponding session variables for new connections to MySQL. If a variable has no global value, no value is displayed.
- With a `SESSION` modifier, the statement displays the system variable values that are in effect for the current connection. If a variable has no session value, the global value is displayed. `LOCAL` is a synonym for `SESSION`.
- If no modifier is present, the default is `SESSION`.

The scope for each system variable is listed at [Section 5.1.7, “Server System Variables”](#).

`SHOW VARIABLES` is subject to a version-dependent display-width limit. For variables with very long values that are not completely displayed, use `SELECT` as a workaround. For example:

```
SELECT @@GLOBAL.innodb_data_file_path;
```

Most system variables can be set at server startup (read-only variables such as `version_comment` are exceptions). Many can be changed at runtime with the `SET` statement. See [Section 5.1.8, “Using System Variables”](#), and [Section 13.7.4.1, “SET Syntax for Variable Assignment”](#).

Partial output is shown here. The list of names and values may differ for your server. [Section 5.1.7, “Server System Variables”](#), describes the meaning of each variable, and [Section 5.1.1, “Configuring the Server”](#), provides information about tuning them.

```
mysql> SHOW VARIABLES;
+-----+-----+
| Variable_name | Value |
+-----+-----+
| auto_increment_increment | 1 |
| auto_increment_offset | 1 |
| autocommit | ON |
| automatic_sp_privileges | ON |
| back_log | 50 |
| basedir | /home/jon/bin/mysql-5.5 |
| big_tables | OFF |
| binlog_cache_size | 32768 |
| binlog_direct_non_transactional_updates | OFF |
| binlog_format | STATEMENT |
| binlog_stmt_cache_size | 32768 |
| bulk_insert_buffer_size | 8388608 |
| ... | ... |
| max_allowed_packet | 4194304 |
| max_binlog_cache_size | 18446744073709547520 |
| max_binlog_size | 1073741824 |
| max_binlog_stmt_cache_size | 18446744073709547520 |
| max_connect_errors | 100 |
| max_connections | 151 |
| max_delayed_threads | 20 |
| max_error_count | 64 |
| max_heap_table_size | 16777216 |
| max_insert_delayed_threads | 20 |
| max_join_size | 18446744073709551615 |
| ... | ... |
```



thread_handling	one-thread-per-connection
thread_stack	262144
time_format	%H:%i:%s
time_zone	SYSTEM
timestamp	1316689732
tmp_table_size	16777216
tmpdir	/tmp
transaction_alloc_block_size	8192
transaction_isolation	REPEATABLE-READ
transaction_prealloc_size	4096
transaction_read_only	OFF
tx_isolation	REPEATABLE-READ
tx_read_only	OFF
unique_checks	ON
updatable_views_with_limit	YES
version	5.7.44
version_comment	Source distribution
version_compile_machine	x86_64
version_compile_os	Linux
wait_timeout	28800
warning_count	0

With a [LIKE](#) clause, the statement displays only rows for those variables with names that match the pattern. To obtain the row for a specific variable, use a [LIKE](#) clause as shown:

```
SHOW VARIABLES LIKE 'max_join_size';
SHOW SESSION VARIABLES LIKE 'max_join_size';
```

To get a list of variables whose name match a pattern, use the `%` wildcard character in a [LIKE](#) clause:

```
SHOW VARIABLES LIKE '%size%';
SHOW GLOBAL VARIABLES LIKE '%size%';
```

Wildcard characters can be used in any position within the pattern to be matched. Strictly speaking, because `_` is a wildcard that matches any single character, you should escape it as `\_` to match it literally. In practice, this is rarely necessary.

### 13.7.5.40 SHOW WARNINGS Statement

```
SHOW WARNINGS [LIMIT [offset,] row_count]
SHOW COUNT(*) WARNINGS
```

`SHOW WARNINGS` is a diagnostic statement that displays information about the conditions (errors, warnings, and notes) resulting from executing a statement in the current session. Warnings are generated for DML statements such as [INSERT](#), [UPDATE](#), and [LOAD DATA](#) as well as DDL statements such as [CREATE TABLE](#) and [ALTER TABLE](#).

The `LIMIT` clause has the same syntax as for the [SELECT](#) statement. See [Section 13.2.9, “SELECT Statement”](#).

`SHOW WARNINGS` is also used following [EXPLAIN](#), to display the extended information generated by [EXPLAIN](#). See [Section 8.8.3, “Extended EXPLAIN Output Format”](#).

`SHOW WARNINGS` displays information about the conditions resulting from execution of the most recent nondiagnostic statement in the current session. If the most recent statement resulted in an error during parsing, `SHOW WARNINGS` shows the resulting conditions, regardless of statement type (diagnostic or nondiagnostic).

The `SHOW COUNT(*) WARNINGS` diagnostic statement displays the total number of errors, warnings, and notes. You can also retrieve this number from the `warning_count` system variable:

```
SHOW COUNT(*) WARNINGS;
SELECT @@warning_count;
```

A difference in these statements is that the first is a diagnostic statement that does not clear the message list. The second, because it is a `SELECT` statement is considered nondiagnostic and does clear the message list.

A related diagnostic statement, `SHOW ERRORS`, shows only error conditions (it excludes warnings and notes), and `SHOW COUNT(*) ERRORS` statement displays the total number of errors. See [Section 13.7.5.17, “SHOW ERRORS Statement”](#). `GET DIAGNOSTICS` can be used to examine information for individual conditions. See [Section 13.6.7.3, “GET DIAGNOSTICS Statement”](#).

Here is a simple example that shows data-conversion warnings for `INSERT`. The example assumes that strict SQL mode is disabled. With strict mode enabled, the warnings would become errors and terminate the `INSERT`.

```
mysql> CREATE TABLE t1 (a TINYINT NOT NULL, b CHAR(4));
Query OK, 0 rows affected (0.05 sec)

mysql> INSERT INTO t1 VALUES(10,'mysql'), (NULL,'test'), (300,'xyz');
Query OK, 3 rows affected, 3 warnings (0.00 sec)
Records: 3 Duplicates: 0 Warnings: 3

mysql> SHOW WARNINGS\G
***** 1. row *****
Level: Warning
Code: 1265
Message: Data truncated for column 'b' at row 1
***** 2. row *****
Level: Warning
Code: 1048
Message: Column 'a' cannot be null
***** 3. row *****
Level: Warning
Code: 1264
Message: Out of range value for column 'a' at row 3
3 rows in set (0.00 sec)
```

The `max_error_count` system variable controls the maximum number of error, warning, and note messages for which the server stores information, and thus the number of messages that `SHOW WARNINGS` displays. To change the number of messages the server can store, change the value of `max_error_count`. The default is 64.

`max_error_count` controls only how many messages are stored, not how many are counted. The value of `warning_count` is not limited by `max_error_count`, even if the number of messages generated exceeds `max_error_count`. The following example demonstrates this. The `ALTER TABLE` statement produces three warning messages (strict SQL mode is disabled for the example to prevent an error from occurring after a single conversion issue). Only one message is stored and displayed because `max_error_count` has been set to 1, but all three are counted (as shown by the value of `warning_count`):

```
mysql> SHOW VARIABLES LIKE 'max_error_count';
+-----+-----+
| Variable_name | Value |
+-----+-----+
| max_error_count | 64   |
+-----+-----+
1 row in set (0.00 sec)

mysql> SET max_error_count=1, sql_mode = '';
Query OK, 0 rows affected (0.00 sec)
```

```
mysql> ALTER TABLE t1 MODIFY b CHAR;
Query OK, 3 rows affected, 3 warnings (0.00 sec)
Records: 3 Duplicates: 0 Warnings: 3

mysql> SHOW WARNINGS;
+-----+-----+-----+
| Level | Code | Message |
+-----+-----+-----+
| Warning | 1263 | Data truncated for column 'b' at row 1 |
+-----+-----+-----+
1 row in set (0.00 sec)

mysql> SELECT @@warning_count;
+-----+
| @@warning_count |
+-----+
| 3 |
+-----+
1 row in set (0.01 sec)
```

To disable message storage, set `max_error_count` to 0. In this case, `warning_count` still indicates how many warnings occurred, but messages are not stored and cannot be displayed.

The `sql_notes` system variable controls whether note messages increment `warning_count` and whether the server stores them. By default, `sql_notes` is 1, but if set to 0, notes do not increment `warning_count` and the server does not store them:

```
mysql> SET sql_notes = 1;
mysql> DROP TABLE IF EXISTS test.no_such_table;
Query OK, 0 rows affected, 1 warning (0.00 sec)
mysql> SHOW WARNINGS;
+-----+-----+-----+
| Level | Code | Message |
+-----+-----+-----+
| Note | 1051 | Unknown table 'test.no_such_table' |
+-----+-----+-----+
1 row in set (0.00 sec)

mysql> SET sql_notes = 0;
mysql> DROP TABLE IF EXISTS test.no_such_table;
Query OK, 0 rows affected (0.00 sec)
mysql> SHOW WARNINGS;
Empty set (0.00 sec)
```

The MySQL server sends to each client a count indicating the total number of errors, warnings, and notes resulting from the most recent statement executed by that client. From the C API, this value can be obtained by calling `mysql_warning_count()`. See [mysql\\_warning\\_count\(\)](#).

In the `mysql` client, you can enable and disable automatic warnings display using the `warnings` and `nowarning` commands, respectively, or their shortcuts, `\W` and `\w` (see [Section 4.5.1.2, "mysql Client Commands"](#)). For example:

```
mysql> \W
Show warnings enabled.
mysql> SELECT 1/0;
+-----+
| 1/0 |
+-----+
| NULL |
+-----+
1 row in set, 1 warning (0.03 sec)

Warning (Code 1365): Division by 0
mysql> \w
Show warnings disabled.
```

## 13.7.6 Other Administrative Statements

### 13.7.6.1 BINLOG Statement

```
BINLOG 'str'
```

`BINLOG` is an internal-use statement. It is generated by the `mysqlbinlog` program as the printable representation of certain events in binary log files. (See [Section 4.6.7, “mysqlbinlog — Utility for Processing Binary Log Files”](#).) The `'str'` value is a base 64-encoded string that the server decodes to determine the data change indicated by the corresponding event. This statement requires the `SUPER` privilege.

This statement can execute only format description events and row events.

### 13.7.6.2 CACHE INDEX Statement

```
CACHE INDEX {
    tbl_index_list [, tbl_index_list] ...
  | tbl_name PARTITION (partition_list)
}
IN key_cache_name

tbl_index_list:
tbl_name [{INDEX|KEY} (index_name[, index_name] ...)]

partition_list: {
    partition_name[, partition_name] ...
  | ALL
}
```

The `CACHE INDEX` statement assigns table indexes to a specific key cache. It applies only to `MyISAM` tables, including partitioned `MyISAM` tables. After the indexes have been assigned, they can be preloaded into the cache if desired with `LOAD INDEX INTO CACHE`.

The following statement assigns indexes from the tables `t1`, `t2`, and `t3` to the key cache named `hot_cache`:

```
mysql> CACHE INDEX t1, t2, t3 IN hot_cache;
+-----+-----+-----+-----+
| Table | Op           | Msg_type | Msg_text |
+-----+-----+-----+-----+
| test.t1 | assign_to_keycache | status   | OK       |
| test.t2 | assign_to_keycache | status   | OK       |
| test.t3 | assign_to_keycache | status   | OK       |
+-----+-----+-----+-----+
```

The syntax of `CACHE INDEX` enables you to specify that only particular indexes from a table should be assigned to the cache. However, the implementation assigns all the table's indexes to the cache, so there is no reason to specify anything other than the table name.

The key cache referred to in a `CACHE INDEX` statement can be created by setting its size with a parameter setting statement or in the server parameter settings. For example:

```
SET GLOBAL keycache1.key_buffer_size=128*1024;
```

Key cache parameters are accessed as members of a structured system variable. See [Section 5.1.8.3, “Structured System Variables”](#).

A key cache must exist before you assign indexes to it, or an error occurs:

```
mysql> CACHE INDEX t1 IN non_existent_cache;
ERROR 1284 (HY000): Unknown key cache 'non_existent_cache'
```

By default, table indexes are assigned to the main (default) key cache created at the server startup. When a key cache is destroyed, all indexes assigned to it are reassigned to the default key cache.

Index assignment affects the server globally: If one client assigns an index to a given cache, this cache is used for all queries involving the index, no matter which client issues the queries.

`CACHE INDEX` is supported for partitioned `MyISAM` tables. You can assign one or more indexes for one, several, or all partitions to a given key cache. For example, you can do the following:

```
CREATE TABLE pt (c1 INT, c2 VARCHAR(50), INDEX i(c1))
ENGINE=MyISAM
PARTITION BY HASH(c1)
PARTITIONS 4;

SET GLOBAL kc_fast.key_buffer_size = 128 * 1024;
SET GLOBAL kc_slow.key_buffer_size = 128 * 1024;

CACHE INDEX pt PARTITION (p0) IN kc_fast;
CACHE INDEX pt PARTITION (p1, p3) IN kc_slow;
```

The previous set of statements performs the following actions:

- Creates a partitioned table with 4 partitions; these partitions are automatically named `p0`, ..., `p3`; this table has an index named `i` on column `c1`.
- Creates 2 key caches named `kc_fast` and `kc_slow`
- Assigns the index for partition `p0` to the `kc_fast` key cache and the index for partitions `p1` and `p3` to the `kc_slow` key cache; the index for the remaining partition (`p2`) uses the server's default key cache.

If you wish instead to assign the indexes for all partitions in table `pt` to a single key cache named `kc_all`, you can use either of the following two statements:

```
CACHE INDEX pt PARTITION (ALL) IN kc_all;

CACHE INDEX pt IN kc_all;
```

The two statements just shown are equivalent, and issuing either one has exactly the same effect. In other words, if you wish to assign indexes for all partitions of a partitioned table to the same key cache, the `PARTITION (ALL)` clause is optional.

When assigning indexes for multiple partitions to a key cache, the partitions need not be contiguous, and you need not list their names in any particular order. Indexes for any partitions not explicitly assigned to a key cache automatically use the server default key cache.

Index preloading is also supported for partitioned `MyISAM` tables. For more information, see [Section 13.7.6.5, "LOAD INDEX INTO CACHE Statement"](#).

### 13.7.6.3 FLUSH Statement

```
FLUSH [NO_WRITE_TO_BINLOG | LOCAL] {
    flush_option [, flush_option] ...
    | tables_option
}

flush_option: {
    BINARY LOGS
    | DES_KEY_FILE
    | ENGINE LOGS
    | ERROR LOGS
    | GENERAL LOGS
    | HOSTS
    | LOGS
```

```

| PRIVILEGES
| OPTIMIZER_COSTS
| QUERY_CACHE
| RELAY_LOGS [FOR CHANNEL channel]
| SLOW_LOGS
| STATUS
| USER_RESOURCES
}

tables_option: {
  table_synonym
  | table_synonym tbl_name [, tbl_name] ...
  | table_synonym WITH READ LOCK
  | table_synonym tbl_name [, tbl_name] ... WITH READ LOCK
  | table_synonym tbl_name [, tbl_name] ... FOR EXPORT
}

table_synonym: {
  TABLE
  | TABLES
}

```

The `FLUSH` statement has several variant forms that clear or reload various internal caches, flush tables, or acquire locks. To execute `FLUSH`, you must have the `RELOAD` privilege. Specific flush options might require additional privileges, as indicated in the option descriptions.



#### Note

It is not possible to issue `FLUSH` statements within stored functions or triggers. However, you may use `FLUSH` in stored procedures, so long as these are not called from stored functions or triggers. See [Section 23.8, “Restrictions on Stored Programs”](#).

By default, the server writes `FLUSH` statements to the binary log so that they replicate to replicas. To suppress logging, specify the optional `NO_WRITE_TO_BINLOG` keyword or its alias `LOCAL`.



#### Note

`FLUSH LOGS`, `FLUSH BINARY LOGS`, `FLUSH TABLES WITH READ LOCK` (with or without a table list), and `FLUSH TABLES tbl_name ... FOR EXPORT` are not written to the binary log in any case because they would cause problems if replicated to a replica.

The `FLUSH` statement causes an implicit commit. See [Section 13.3.3, “Statements That Cause an Implicit Commit”](#).

The `mysqladmin` utility provides a command-line interface to some flush operations, using commands such as `flush-hosts`, `flush-logs`, `flush-privileges`, `flush-status`, and `flush-tables`. See [Section 4.5.2, “mysqladmin — A MySQL Server Administration Program”](#).

Sending a `SIGHUP` signal to the server causes several flush operations to occur that are similar to various forms of the `FLUSH` statement. Signals can be sent by the `root` system account or the system account that owns the server process. This enables the flush operations to be performed without having to connect to the server, which requires a MySQL account that has privileges sufficient for those operations. See [Section 4.10, “Unix Signal Handling in MySQL”](#).

The `RESET` statement is similar to `FLUSH`. See [Section 13.7.6.6, “RESET Statement”](#), for information about using `RESET` with replication.

The following list describes the permitted `FLUSH` statement *flush\_option* values. For descriptions of the permitted *tables\_option* values, see [FLUSH TABLES Syntax](#).

- `FLUSH BINARY LOGS`

Closes and reopens any binary log file to which the server is writing. If binary logging is enabled, the sequence number of the binary log file is incremented by one relative to the previous file.

This operation has no effect on tables used for the binary and relay logs (as controlled by the `master_info_repository` and `relay_log_info_repository` system variables).

- `FLUSH DES_KEY_FILE`

Reloads the DES keys from the file that was specified with the `--des-key-file` option at server startup time.



**Note**

The `DES_ENCRYPT()` and `DES_DECRYPT()` functions are deprecated in MySQL 5.7, are removed in MySQL 8.0, and should no longer be used. Consequently, `--des-key-file` and `DES_KEY_FILE` also are deprecated and are removed in MySQL 8.0.

- `FLUSH ENGINE LOGS`

Closes and reopens any flushable logs for installed storage engines. This causes `InnoDB` to flush its logs to disk.

- `FLUSH ERROR LOGS`

Closes and reopens any error log file to which the server is writing.

- `FLUSH GENERAL LOGS`

Closes and reopens any general query log file to which the server is writing.

This operation has no effect on tables used for the general query log (see [Section 5.4.1, “Selecting General Query Log and Slow Query Log Output Destinations”](#)).

- `FLUSH HOSTS`

Empties the host cache and the Performance Schema `host_cache` table that exposes the cache contents, and unblocks any blocked hosts.

For information about why host cache flushing might be advisable or desirable, see [Section 5.1.11.2, “DNS Lookups and the Host Cache”](#).



**Note**

The statement `TRUNCATE TABLE performance_schema.host_cache`, unlike `FLUSH HOSTS`, is not written to the binary log. To obtain the same behavior from the latter, specify `NO_WRITE_TO_BINLOG` or `LOCAL` as part of the `FLUSH HOSTS` statement.

- `FLUSH LOGS`

Closes and reopens any log file to which the server is writing.

The effect of this operation is equivalent to the combined effects of these operations:

```
FLUSH BINARY LOGS
```

```
FLUSH ENGINE LOGS
FLUSH ERROR LOGS
FLUSH GENERAL LOGS
FLUSH RELAY LOGS
FLUSH SLOW LOGS
```

- `FLUSH OPTIMIZER_COSTS`

Re-reads the cost model tables so that the optimizer starts using the current cost estimates stored in them.

The server writes a warning to the error log for any unrecognized cost model table entries. For information about these tables, see [Section 8.9.5, “The Optimizer Cost Model”](#). This operation affects only sessions that begin subsequent to the flush. Existing sessions continue to use the cost estimates that were current when they began.

- `FLUSH PRIVILEGES`

Re-reads the privileges from the grant tables in the `mysql` system database.

Reloading the grant tables is necessary to enable updates to MySQL privileges and users only if you make such changes directly to the grant tables; it is not needed for account management statements such as `GRANT` or `REVOKE`, which take effect immediately. See [Section 6.2.9, “When Privilege Changes Take Effect”](#), for more information.

If the `--skip-grant-tables` option was specified at server startup to disable the MySQL privilege system, `FLUSH PRIVILEGES` provides a way to enable the privilege system at runtime.

Frees memory cached by the server as a result of `GRANT`, `CREATE USER`, `CREATE SERVER`, and `INSTALL PLUGIN` statements. This memory is not released by the corresponding `REVOKE`, `DROP USER`, `DROP SERVER`, and `UNINSTALL PLUGIN` statements, so for a server that executes many instances of the statements that cause caching, cached memory use increases unless it is freed with `FLUSH PRIVILEGES`.

- `FLUSH QUERY CACHE`

Defragment the query cache to better utilize its memory. `FLUSH QUERY CACHE` does not remove any queries from the cache, unlike `FLUSH TABLES` or `RESET QUERY CACHE`.



#### Note

The query cache is deprecated as of MySQL 5.7.20, and is removed in MySQL 8.0. Deprecation includes `FLUSH QUERY CACHE`.

- `FLUSH RELAY LOGS [FOR CHANNEL channel]`

Closes and reopens any relay log file to which the server is writing. If relay logging is enabled, the sequence number of the relay log file is incremented by one relative to the previous file.

The `FOR CHANNEL channel` clause enables you to name which replication channel the operation applies to. Execute `FLUSH RELAY LOGS FOR CHANNEL channel` to flush the relay log for a specific replication channel. If no channel is named and no extra replication channels exist, the operation applies to the default channel. If no channel is named and multiple replication channels exist, the operation applies to all replication channels, with the exception of the `group_replication_applier` channel. For more information, see [Section 16.2.2, “Replication Channels”](#).

This operation has no effect on tables used for the binary and relay logs (as controlled by the `master_info_repository` and `relay_log_info_repository` system variables).



- `FLUSH SLOW LOGS`

Closes and reopens any slow query log file to which the server is writing.

This operation has no effect on tables used for the slow query log (see [Section 5.4.1, “Selecting General Query Log and Slow Query Log Output Destinations”](#)).

- `FLUSH STATUS`

Flushes status indicators.

This operation adds the current thread's session status variable values to the global values and resets the session values to zero. Some global variables may be reset to zero as well. It also resets the counters for key caches (default and named) to zero and sets `Max_used_connections` to the current number of open connections. This information may be of use when debugging a query. See [Section 1.5, “How to Report Bugs or Problems”](#).

`FLUSH STATUS` is unaffected by `read_only` or `super_read_only`, and is always written to the binary log.



**Note**

The value of the `show_compatibility_56` system variable affects the operation of this `FLUSH` option. For details, see the description of that variable in [Section 5.1.7, “Server System Variables”](#).

- `FLUSH USER_RESOURCES`

Resets all per-hour user resource indicators to zero.

Resetting resource indicators enables clients that have reached their hourly connection, query, or update limits to resume activity immediately. `FLUSH USER_RESOURCES` does not apply to the limit on maximum simultaneous connections that is controlled by the `max_user_connections` system variable. See [Section 6.2.16, “Setting Account Resource Limits”](#).

## FLUSH TABLES Syntax

`FLUSH TABLES` flushes tables, and, depending on the variant used, acquires locks. Any `TABLES` variant used in a `FLUSH` statement must be the only option used. `FLUSH TABLE` is a synonym for `FLUSH TABLES`.



**Note**

The descriptions here that indicate tables are flushed by closing them apply differently for `InnoDB`, which flushes table contents to disk but leaves them open. This still permits table files to be copied while the tables are open, as long as other activity does not modify them.

- `FLUSH TABLES`

Closes all open tables, forces all tables in use to be closed, and flushes the query cache and prepared statement cache. `FLUSH TABLES` also removes all query results from the query cache, like the `RESET QUERY CACHE` statement. For information about query caching and prepared statement caching, see [Section 8.10.3, “The MySQL Query Cache”](#). and [Section 8.10.4, “Caching of Prepared Statements and Stored Programs”](#).

`FLUSH TABLES` is not permitted when there is an active `LOCK TABLES ... READ`. To flush and lock tables, use `FLUSH TABLES tbl_name ... WITH READ LOCK` instead.

- `FLUSH TABLES tbl_name [, tbl_name] ...`

With a list of one or more comma-separated table names, this operation is like `FLUSH TABLES` with no names except that the server flushes only the named tables. If a named table does not exist, no error occurs.

- `FLUSH TABLES WITH READ LOCK`

Closes all open tables and locks all tables for all databases with a global read lock.

This operation is a very convenient way to get backups if you have a file system such as Veritas or ZFS that can take snapshots in time. Use `UNLOCK TABLES` to release the lock.

`FLUSH TABLES WITH READ LOCK` acquires a global read lock rather than table locks, so it is not subject to the same behavior as `LOCK TABLES` and `UNLOCK TABLES` with respect to table locking and implicit commits:

- `UNLOCK TABLES` implicitly commits any active transaction only if any tables currently have been locked with `LOCK TABLES`. The commit does not occur for `UNLOCK TABLES` following `FLUSH TABLES WITH READ LOCK` because the latter statement does not acquire table locks.
- Beginning a transaction causes table locks acquired with `LOCK TABLES` to be released, as though you had executed `UNLOCK TABLES`. Beginning a transaction does not release a global read lock acquired with `FLUSH TABLES WITH READ LOCK`.

Prior to MySQL 5.7.19, `FLUSH TABLES WITH READ LOCK` is not compatible with XA transactions.

`FLUSH TABLES WITH READ LOCK` does not prevent the server from inserting rows into the log tables (see [Section 5.4.1, “Selecting General Query Log and Slow Query Log Output Destinations”](#)).

- `FLUSH TABLES tbl_name [, tbl_name] ... WITH READ LOCK`

Flushes and acquires read locks for the named tables.

Because this operation acquires table locks, it requires the `LOCK TABLES` privilege for each table, in addition to the `RELOAD` privilege.

The operation first acquires exclusive metadata locks for the tables, so it waits for transactions that have those tables open to complete. Then the operation flushes the tables from the table cache, reopens the tables, acquires table locks (like `LOCK TABLES ... READ`), and downgrades the metadata locks from exclusive to shared. After the operation acquires locks and downgrades the metadata locks, other sessions can read but not modify the tables.

This operation applies only to existing base (non-`TEMPORARY`) tables. If a name refers to a base table, that table is used. If it refers to a `TEMPORARY` table, it is ignored. If a name applies to a view, an `ER_WRONG_OBJECT` error occurs. Otherwise, an `ER_NO_SUCH_TABLE` error occurs.

Use `UNLOCK TABLES` to release the locks, `LOCK TABLES` to release the locks and acquire other locks, or `START TRANSACTION` to release the locks and begin a new transaction.

This `FLUSH TABLES` variant enables tables to be flushed and locked in a single operation. It provides a workaround for the restriction that `FLUSH TABLES` is not permitted when there is an active `LOCK TABLES ... READ`.

This operation does not perform an implicit `UNLOCK TABLES`, so an error results if you perform the operation while there is any active `LOCK TABLES` or use it a second time without first releasing the locks acquired.

If a flushed table was opened with `HANDLER`, the handler is implicitly flushed and loses its position.

- `FLUSH TABLES tbl_name [, tbl_name] ... FOR EXPORT`

This `FLUSH TABLES` variant applies to `InnoDB` tables. It ensures that changes to the named tables have been flushed to disk so that binary table copies can be made while the server is running.

Because the `FLUSH TABLES ... FOR EXPORT` operation acquires locks on tables in preparation for exporting them, it requires the `LOCK TABLES` and `SELECT` privileges for each table, in addition to the `RELOAD` privilege.

The operation works like this:

1. It acquires shared metadata locks for the named tables. The operation blocks as long as other sessions have active transactions that have modified those tables or hold table locks for them. When the locks have been acquired, the operation blocks transactions that attempt to update the tables, while permitting read-only operations to continue.
2. It checks whether all storage engines for the tables support `FOR EXPORT`. If any do not, an `ER_ILLEGAL HA` error occurs and the operation fails.
3. The operation notifies the storage engine for each table to make the table ready for export. The storage engine must ensure that any pending changes are written to disk.
4. The operation puts the session in lock-tables mode so that the metadata locks acquired earlier are not released when the `FOR EXPORT` operation completes.

This operation applies only to existing base (non-`TEMPORARY`) tables. If a name refers to a base table, that table is used. If it refers to a `TEMPORARY` table, it is ignored. If a name applies to a view, an `ER_WRONG_OBJECT` error occurs. Otherwise, an `ER_NO_SUCH_TABLE` error occurs.

`InnoDB` supports `FOR EXPORT` for tables that have their own `.ibd file` (that is, tables created with the `innodb_file_per_table` setting enabled). `InnoDB` ensures when notified by the `FOR EXPORT` operation that any changes have been flushed to disk. This permits a binary copy of table contents to be made while the `FOR EXPORT` operation is in effect because the `.ibd` file is transaction consistent and can be copied while the server is running. `FOR EXPORT` does not apply to `InnoDB` system tablespace files, or to `InnoDB` tables that have `FULLTEXT` indexes.

`FLUSH TABLES ...FOR EXPORT` is supported for partitioned `InnoDB` tables.

When notified by `FOR EXPORT`, `InnoDB` writes to disk certain kinds of data that is normally held in memory or in separate disk buffers outside the tablespace files. For each table, `InnoDB` also produces a file named `table_name.cfg` in the same database directory as the table. The `.cfg` file contains metadata needed to reimport the tablespace files later, into the same or different server.

When the `FOR EXPORT` operation completes, `InnoDB` has flushed all `dirty pages` to the table data files. Any `change buffer` entries are merged prior to flushing. At this point, the tables are locked and quiescent:

The tables are in a transactionally consistent state on disk and you can copy the `.ibd` tablespace files along with the corresponding `.cfg` files to get a consistent snapshot of those tables.

For the procedure to reimport the copied table data into a MySQL instance, see [Section 14.6.1.3, “Importing InnoDB Tables”](#).

After you are done with the tables, use `UNLOCK TABLES` to release the locks, `LOCK TABLES` to release the locks and acquire other locks, or `START TRANSACTION` to release the locks and begin a new transaction.

While any of these statements is in effect within the session, attempts to use `FLUSH TABLES ... FOR EXPORT` produce an error:

```
FLUSH TABLES ... WITH READ LOCK
FLUSH TABLES ... FOR EXPORT
LOCK TABLES ... READ
LOCK TABLES ... WRITE
```

While `FLUSH TABLES ... FOR EXPORT` is in effect within the session, attempts to use any of these statements produce an error:

```
FLUSH TABLES WITH READ LOCK
FLUSH TABLES ... WITH READ LOCK
FLUSH TABLES ... FOR EXPORT
```

### 13.7.6.4 KILL Statement

```
KILL [CONNECTION | QUERY] processlist_id
```

Each connection to `mysqld` runs in a separate thread. You can kill a thread with the `KILL processlist_id` statement.

Thread processlist identifiers can be determined from the `ID` column of the `INFORMATION_SCHEMA.PROCESSLIST` table, the `Id` column of `SHOW PROCESSLIST` output, and the `PROCESSLIST_ID` column of the Performance Schema `threads` table. The value for the current thread is returned by the `CONNECTION_ID()` function.

`KILL` permits an optional `CONNECTION` or `QUERY` modifier:

- `KILL CONNECTION` is the same as `KILL` with no modifier: It terminates the connection associated with the given `processlist_id`, after terminating any statement the connection is executing.
- `KILL QUERY` terminates the statement the connection is currently executing, but leaves the connection itself intact.

The ability to see which threads are available to be killed depends on the `PROCESS` privilege:

- Without `PROCESS`, you can see only your own threads.
- With `PROCESS`, you can see all threads.

The ability to kill threads and statements depends on the `SUPER` privilege:

- Without `SUPER`, you can kill only your own threads and statements.
- With `SUPER`, you can kill all threads and statements.

You can also use the `mysqladmin processlist` and `mysqladmin kill` commands to examine and kill threads.

**Note**

You cannot use `KILL` with the Embedded MySQL Server library because the embedded server merely runs inside the threads of the host application. It does not create any connection threads of its own.

When you use `KILL`, a thread-specific kill flag is set for the thread. In most cases, it might take some time for the thread to die because the kill flag is checked only at specific intervals:

- During `SELECT` operations, for `ORDER BY` and `GROUP BY` loops, the flag is checked after reading a block of rows. If the kill flag is set, the statement is aborted.
- `ALTER TABLE` operations that make a table copy check the kill flag periodically for each few copied rows read from the original table. If the kill flag was set, the statement is aborted and the temporary table is deleted.

The `KILL` statement returns without waiting for confirmation, but the kill flag check aborts the operation within a reasonably small amount of time. Aborting the operation to perform any necessary cleanup also takes some time.

- During `UPDATE` or `DELETE` operations, the kill flag is checked after each block read and after each updated or deleted row. If the kill flag is set, the statement is aborted. If you are not using transactions, the changes are not rolled back.
- `GET_LOCK()` aborts and returns `NULL`.
- If the thread is in the table lock handler (state: `Locked`), the table lock is quickly aborted.
- If the thread is waiting for free disk space in a write call, the write is aborted with a “disk full” error message.

**Warning**

Killing a `REPAIR TABLE` or `OPTIMIZE TABLE` operation on a `MyISAM` table results in a table that is corrupted and unusable. Any reads or writes to such a table fail until you optimize or repair it again (without interruption).

### 13.7.6.5 LOAD INDEX INTO CACHE Statement

```
LOAD INDEX INTO CACHE
  tbl_index_list [, tbl_index_list] ...

tbl_index_list:
  tbl_name
  [PARTITION (partition_list)]
  [{INDEX|KEY} (index_name[, index_name] ...)]
  [IGNORE LEAVES]

partition_list: {
  partition_name[, partition_name] ...
  | ALL
}
```

The `LOAD INDEX INTO CACHE` statement preloads a table index into the key cache to which it has been assigned by an explicit `CACHE INDEX` statement, or into the default key cache otherwise.

`LOAD INDEX INTO CACHE` applies only to `MyISAM` tables, including partitioned `MyISAM` tables. In addition, indexes on partitioned tables can be preloaded for one, several, or all partitions.

The `IGNORE LEAVES` modifier causes only blocks for the nonleaf nodes of the index to be preloaded.

`IGNORE LEAVES` is also supported for partitioned `MyISAM` tables.

The following statement preloads nodes (index blocks) of indexes for the tables `t1` and `t2`:

```
mysql> LOAD INDEX INTO CACHE t1, t2 IGNORE LEAVES;
+-----+-----+-----+-----+
| Table  | Op           | Msg_type | Msg_text |
+-----+-----+-----+-----+
| test.t1 | preload_keys | status   | OK       |
| test.t2 | preload_keys | status   | OK       |
+-----+-----+-----+-----+
```

This statement preloads all index blocks from `t1`. It preloads only blocks for the nonleaf nodes from `t2`.

The syntax of `LOAD INDEX INTO CACHE` enables you to specify that only particular indexes from a table should be preloaded. However, the implementation preloads all the table's indexes into the cache, so there is no reason to specify anything other than the table name.

It is possible to preload indexes on specific partitions of partitioned `MyISAM` tables. For example, of the following 2 statements, the first preloads indexes for partition `p0` of a partitioned table `pt`, while the second preloads the indexes for partitions `p1` and `p3` of the same table:

```
LOAD INDEX INTO CACHE pt PARTITION (p0);
LOAD INDEX INTO CACHE pt PARTITION (p1, p3);
```

To preload the indexes for all partitions in table `pt`, you can use either of the following two statements:

```
LOAD INDEX INTO CACHE pt PARTITION (ALL);
LOAD INDEX INTO CACHE pt;
```

The two statements just shown are equivalent, and issuing either one has exactly the same effect. In other words, if you wish to preload indexes for all partitions of a partitioned table, the `PARTITION (ALL)` clause is optional.

When preloading indexes for multiple partitions, the partitions need not be contiguous, and you need not list their names in any particular order.

`LOAD INDEX INTO CACHE ... IGNORE LEAVES` fails unless all indexes in a table have the same block size. To determine index block sizes for a table, use `myisamchk -dv` and check the `Blocksize` column.

### 13.7.6.6 RESET Statement

```
RESET reset_option [, reset_option] ...

reset_option: {
  MASTER
  | QUERY CACHE
  | SLAVE
}
```

The `RESET` statement is used to clear the state of various server operations. You must have the `RELOAD` privilege to execute `RESET`.

`RESET` acts as a stronger version of the `FLUSH` statement. See [Section 13.7.6.3, “FLUSH Statement”](#).

The `RESET` statement causes an implicit commit. See [Section 13.3.3, “Statements That Cause an Implicit Commit”](#).

The following list describes the permitted `RESET` statement `reset_option` values:

- [RESET MASTER](#)

Deletes all binary logs listed in the index file, resets the binary log index file to be empty, and creates a new binary log file.

- [RESET QUERY CACHE](#)

Removes all query results from the query cache.

**Note**

The query cache is deprecated as of MySQL 5.7.20, and is removed in MySQL 8.0. Deprecation includes [RESET QUERY CACHE](#).

- [RESET SLAVE](#)

Makes the replica forget its replication position in the source binary logs. Also resets the relay log by deleting any existing relay log files and beginning a new one.

### 13.7.6.7 SHUTDOWN Statement

SHUTDOWN

This statement stops the MySQL server. It requires the [SHUTDOWN](#) privilege.

[SHUTDOWN](#) provides an SQL-level interface to the same functionality available using the `mysqladmin shutdown` command or the `mysql_shutdown()` C API function. A successful [SHUTDOWN](#) sequence consists of checking the privileges, validating the arguments, and sending an OK packet to the client. Then the server is shut down.

The `Com_shutdown` status variable tracks the number of [SHUTDOWN](#) statements. Because status variables are initialized for each server startup and do not persist across restarts, `Com_shutdown` normally has a value of zero, but can be nonzero if [SHUTDOWN](#) statements were executed but failed.

Another way to stop the server is to send it a [SIGTERM](#) signal, which can be done by `root` or the account that owns the server process. [SIGTERM](#) enables server shutdown to be performed without having to connect to the server. See [Section 4.10](#), “Unix Signal Handling in MySQL”.

## 13.8 Utility Statements

### 13.8.1 DESCRIBE Statement

The [DESCRIBE](#) and [EXPLAIN](#) statements are synonyms, used either to obtain information about table structure or query execution plans. For more information, see [Section 13.7.5.5](#), “[SHOW COLUMNS Statement](#)”, and [Section 13.8.2](#), “[EXPLAIN Statement](#)”.

### 13.8.2 EXPLAIN Statement

```
{EXPLAIN | DESCRIBE | DESC}
  tbl_name [col_name | wild]

{EXPLAIN | DESCRIBE | DESC}
  [explain_type]
  {explainable_stmt | FOR CONNECTION connection_id}

explain_type: {
  EXTENDED
  | PARTITIONS
```

```

| FORMAT = format_name
}

format_name: {
  TRADITIONAL
| JSON
}

explainable_stmt: {
  SELECT statement
| DELETE statement
| INSERT statement
| REPLACE statement
| UPDATE statement
}

```

The `DESCRIBE` and `EXPLAIN` statements are synonyms. In practice, the `DESCRIBE` keyword is more often used to obtain information about table structure, whereas `EXPLAIN` is used to obtain a query execution plan (that is, an explanation of how MySQL would execute a query).

The following discussion uses the `DESCRIBE` and `EXPLAIN` keywords in accordance with those uses, but the MySQL parser treats them as completely synonymous.

- [Obtaining Table Structure Information](#)
- [Obtaining Execution Plan Information](#)

## Obtaining Table Structure Information

`DESCRIBE` provides information about the columns in a table:

```

mysql> DESCRIBE City;
+-----+-----+-----+-----+-----+-----+
| Field      | Type      | Null | Key | Default | Extra          |
+-----+-----+-----+-----+-----+-----+
| Id         | int(11)   | NO   | PRI | NULL    | auto_increment |
| Name      | char(35)  | NO   |     |         |                |
| Country   | char(3)   | NO   | UNI |         |                |
| District  | char(20)  | YES  | MUL |         |                |
| Population | int(11)   | NO   |     | 0       |                |
+-----+-----+-----+-----+-----+-----+

```

`DESCRIBE` is a shortcut for `SHOW COLUMNS`. These statements also display information for views. The description for `SHOW COLUMNS` provides more information about the output columns. See [Section 13.7.5.5, “SHOW COLUMNS Statement”](#).

By default, `DESCRIBE` displays information about all columns in the table. *col\_name*, if given, is the name of a column in the table. In this case, the statement displays information only for the named column. *wild*, if given, is a pattern string. It can contain the SQL `%` and `_` wildcard characters. In this case, the statement displays output only for the columns with names matching the string. There is no need to enclose the string within quotation marks unless it contains spaces or other special characters.

The `DESCRIBE` statement is provided for compatibility with Oracle.

The `SHOW CREATE TABLE`, `SHOW TABLE STATUS`, and `SHOW INDEX` statements also provide information about tables. See [Section 13.7.5, “SHOW Statements”](#).

## Obtaining Execution Plan Information

The `EXPLAIN` statement provides information about how MySQL executes statements:

- `EXPLAIN` works with `SELECT`, `DELETE`, `INSERT`, `REPLACE`, and `UPDATE` statements.



- When `EXPLAIN` is used with an explainable statement, MySQL displays information from the optimizer about the statement execution plan. That is, MySQL explains how it would process the statement, including information about how tables are joined and in which order. For information about using `EXPLAIN` to obtain execution plan information, see [Section 8.8.2, “EXPLAIN Output Format”](#).
- When `EXPLAIN` is used with `FOR CONNECTION connection_id` rather than an explainable statement, it displays the execution plan for the statement executing in the named connection. See [Section 8.8.4, “Obtaining Execution Plan Information for a Named Connection”](#).
- For `SELECT` statements, `EXPLAIN` produces additional execution plan information that can be displayed using `SHOW WARNINGS`. See [Section 8.8.3, “Extended EXPLAIN Output Format”](#).

**Note**

In older MySQL releases, extended information was produced using `EXPLAIN EXTENDED`. That syntax is still recognized for backward compatibility but extended output is now enabled by default, so the `EXTENDED` keyword is superfluous and deprecated. Its use results in a warning, and it is removed from `EXPLAIN` syntax in MySQL 8.0.

- `EXPLAIN` is useful for examining queries involving partitioned tables. See [Section 22.3.5, “Obtaining Information About Partitions”](#).

**Note**

In older MySQL releases, partition information was produced using `EXPLAIN PARTITIONS`. That syntax is still recognized for backward compatibility but partition output is now enabled by default, so the `PARTITIONS` keyword is superfluous and deprecated. Its use results in a warning, and it is removed from `EXPLAIN` syntax in MySQL 8.0.

- The `FORMAT` option can be used to select the output format. `TRADITIONAL` presents the output in tabular format. This is the default if no `FORMAT` option is present. `JSON` format displays the information in JSON format.

For complex statements, the JSON output can be quite large; in particular, it can be difficult when reading it to pair the closing bracket and opening brackets; to cause the JSON structure's key, if it has one, to be repeated near the closing bracket, set `end_markers_in_json=ON`. You should be aware that while this makes the output easier to read, it also renders the JSON invalid, causing JSON functions to raise an error.

`EXPLAIN` requires the same privileges required to execute the explained statement. Additionally, `EXPLAIN` also requires the `SHOW VIEW` privilege for any explained view.

With the help of `EXPLAIN`, you can see where you should add indexes to tables so that the statement executes faster by using indexes to find rows. You can also use `EXPLAIN` to check whether the optimizer joins the tables in an optimal order. To give a hint to the optimizer to use a join order corresponding to the order in which the tables are named in a `SELECT` statement, begin the statement with `SELECT STRAIGHT_JOIN` rather than just `SELECT`. (See [Section 13.2.9, “SELECT Statement”](#).)

The optimizer trace may sometimes provide information complementary to that of `EXPLAIN`. However, the optimizer trace format and content are subject to change between versions. For details, see [Section 8.15, “Tracing the Optimizer”](#).

If you have a problem with indexes not being used when you believe that they should be, run `ANALYZE TABLE` to update table statistics, such as cardinality of keys, that can affect the choices the optimizer makes. See [Section 13.7.2.1, “ANALYZE TABLE Statement”](#).

**Note**

MySQL Workbench has a Visual Explain capability that provides a visual representation of `EXPLAIN` output. See [Tutorial: Using Explain to Improve Query Performance](#).

### 13.8.3 HELP Statement

```
HELP 'search_string'
```

The `HELP` statement returns online information from the MySQL Reference Manual. Its proper operation requires that the help tables in the `mysql` database be initialized with help topic information (see [Section 5.1.14, “Server-Side Help Support”](#)).

The `HELP` statement searches the help tables for the given search string and displays the result of the search. The search string is not case-sensitive.

The search string can contain the wildcard characters `%` and `_`. These have the same meaning as for pattern-matching operations performed with the `LIKE` operator. For example, `HELP 'rep%'` returns a list of topics that begin with `rep`.

The `HELP` statement does not require a terminator such as `;` or `\G`.

The `HELP` statement understands several types of search strings:

- At the most general level, use `contents` to retrieve a list of the top-level help categories:

```
HELP 'contents'
```

- For a list of topics in a given help category, such as `Data Types`, use the category name:

```
HELP 'data types'
```

- For help on a specific help topic, such as the `ASCII()` function or the `CREATE TABLE` statement, use the associated keyword or keywords:

```
HELP 'ascii'
HELP 'create table'
```

In other words, the search string matches a category, many topics, or a single topic. The following descriptions indicate the forms that the result set can take.

- Empty result

No match could be found for the search string.

Example: `HELP 'fake'`

Yields:

```
Nothing found
Please try to run 'help contents' for a list of all accessible topics
```

- Result set containing a single row

This means that the search string yielded a hit for the help topic. The result includes the following items:

- `name`: The topic name.

- **description:** Descriptive help text for the topic.
- **example:** One or more usage examples. (May be empty.)

Example: `HELP 'log'`

Yields:

```
Name: 'LOG'
Description:
Syntax:
LOG(X), LOG(B,X)

If called with one parameter, this function returns the natural
logarithm of X. If X is less than or equal to 0.0E0, the function
returns NULL and a warning "Invalid argument for logarithm" is
reported. Returns NULL if X or B is NULL.

The inverse of this function (when called with a single argument) is
the EXP() function.

URL: https://dev.mysql.com/doc/refman/8.0/en/mathematical-functions.html

Examples:
mysql> SELECT LOG(2);
      -> 0.69314718055995
mysql> SELECT LOG(-2);
      -> NULL
```

- List of topics.

This means that the search string matched multiple help topics.

Example: `HELP 'status'`

Yields:

```
Many help items for your request exist.
To make a more specific request, please type 'help <item>',
where <item> is one of the following topics:
  FLUSH
  SHOW
  SHOW ENGINE
  SHOW FUNCTION STATUS
  SHOW MASTER STATUS
  SHOW PROCEDURE STATUS
  SHOW SLAVE STATUS
  SHOW STATUS
  SHOW TABLE STATUS
```

- List of topics.

A list is also displayed if the search string matches a category.

Example: `HELP 'functions'`

Yields:

```
You asked for help about help category: "Functions"
For more information, type 'help <item>', where <item> is one of the following
categories:
  Aggregate Functions and Modifiers
  Bit Functions
```

```
Cast Functions and Operators
Comparison Operators
Date and Time Functions
Encryption Functions
Enterprise Encryption Functions
Flow Control Functions
GROUP BY Functions and Modifiers
GTID
Information Functions
Locking Functions
Logical Operators
Miscellaneous Functions
Numeric Functions
Spatial Functions
String Functions
XML
```

### 13.8.4 USE Statement

```
USE db_name
```

The **USE** statement tells MySQL to use the named database as the default (current) database for subsequent statements. This statement requires some privilege for the database or some object within it.

The named database remains the default until the end of the session or another **USE** statement is issued:

```
USE db1;
SELECT COUNT(*) FROM mytable;    # selects from db1.mytable
USE db2;
SELECT COUNT(*) FROM mytable;    # selects from db2.mytable
```

The database name must be specified on a single line. Newlines in database names are not supported.

Making a particular database the default by means of the **USE** statement does not preclude accessing tables in other databases. The following example accesses the `author` table from the `db1` database and the `editor` table from the `db2` database:

```
USE db1;
SELECT author_name,editor_name FROM author,db2.editor
WHERE author.editor_id = db2.editor.editor_id;
```

---

# Chapter 14 The InnoDB Storage Engine

## Table of Contents

14.1 Introduction to InnoDB .....	2545
14.1.1 Benefits of Using InnoDB Tables .....	2546
14.1.2 Best Practices for InnoDB Tables .....	2547
14.1.3 Verifying that InnoDB is the Default Storage Engine .....	2548
14.1.4 Testing and Benchmarking with InnoDB .....	2548
14.1.5 Turning Off InnoDB .....	2549
14.2 InnoDB and the ACID Model .....	2549
14.3 InnoDB Multi-Versioning .....	2550
14.4 InnoDB Architecture .....	2552
14.5 InnoDB In-Memory Structures .....	2552
14.5.1 Buffer Pool .....	2552
14.5.2 Change Buffer .....	2557
14.5.3 Adaptive Hash Index .....	2561
14.5.4 Log Buffer .....	2562
14.6 InnoDB On-Disk Structures .....	2562
14.6.1 Tables .....	2562
14.6.2 Indexes .....	2586
14.6.3 Tablespaces .....	2594
14.6.4 InnoDB Data Dictionary .....	2609
14.6.5 Doublewrite Buffer .....	2609
14.6.6 Redo Log .....	2609
14.6.7 Undo Logs .....	2610
14.7 InnoDB Locking and Transaction Model .....	2612
14.7.1 InnoDB Locking .....	2612
14.7.2 InnoDB Transaction Model .....	2616
14.7.3 Locks Set by Different SQL Statements in InnoDB .....	2624
14.7.4 Phantom Rows .....	2628
14.7.5 Deadlocks in InnoDB .....	2629
14.8 InnoDB Configuration .....	2632
14.8.1 InnoDB Startup Configuration .....	2632
14.8.2 Configuring InnoDB for Read-Only Operation .....	2638
14.8.3 InnoDB Buffer Pool Configuration .....	2639
14.8.4 Configuring the Memory Allocator for InnoDB .....	2652
14.8.5 Configuring Thread Concurrency for InnoDB .....	2652
14.8.6 Configuring the Number of Background InnoDB I/O Threads .....	2653
14.8.7 Using Asynchronous I/O on Linux .....	2654
14.8.8 Configuring InnoDB I/O Capacity .....	2655
14.8.9 Configuring Spin Lock Polling .....	2656
14.8.10 Purge Configuration .....	2657
14.8.11 Configuring Optimizer Statistics for InnoDB .....	2658
14.8.12 Configuring the Merge Threshold for Index Pages .....	2670
14.9 InnoDB Table and Page Compression .....	2672
14.9.1 InnoDB Table Compression .....	2672
14.9.2 InnoDB Page Compression .....	2687
14.10 InnoDB File-Format Management .....	2691
14.10.1 Enabling File Formats .....	2692
14.10.2 Verifying File Format Compatibility .....	2692

14.10.3 Identifying the File Format in Use .....	2695
14.10.4 Modifying the File Format .....	2696
14.11 InnoDB Row Formats .....	2697
14.12 InnoDB Disk I/O and File Space Management .....	2703
14.12.1 InnoDB Disk I/O .....	2704
14.12.2 File Space Management .....	2705
14.12.3 InnoDB Checkpoints .....	2706
14.12.4 Defragmenting a Table .....	2706
14.12.5 Reclaiming Disk Space with TRUNCATE TABLE .....	2707
14.13 InnoDB and Online DDL .....	2707
14.13.1 Online DDL Operations .....	2708
14.13.2 Online DDL Performance and Concurrency .....	2720
14.13.3 Online DDL Space Requirements .....	2724
14.13.4 Simplifying DDL Statements with Online DDL .....	2724
14.13.5 Online DDL Failure Conditions .....	2725
14.13.6 Online DDL Limitations .....	2725
14.14 InnoDB Data-at-Rest Encryption .....	2726
14.15 InnoDB Startup Options and System Variables .....	2731
14.16 InnoDB INFORMATION_SCHEMA Tables .....	2815
14.16.1 InnoDB INFORMATION_SCHEMA Tables about Compression .....	2815
14.16.2 InnoDB INFORMATION_SCHEMA Transaction and Locking Information .....	2817
14.16.3 InnoDB INFORMATION_SCHEMA System Tables .....	2824
14.16.4 InnoDB INFORMATION_SCHEMA FULLTEXT Index Tables .....	2830
14.16.5 InnoDB INFORMATION_SCHEMA Buffer Pool Tables .....	2833
14.16.6 InnoDB INFORMATION_SCHEMA Metrics Table .....	2837
14.16.7 InnoDB INFORMATION_SCHEMA Temporary Table Info Table .....	2846
14.16.8 Retrieving InnoDB Tablespace Metadata from INFORMATION_SCHEMA.FILES .....	2847
14.17 InnoDB Integration with MySQL Performance Schema .....	2849
14.17.1 Monitoring ALTER TABLE Progress for InnoDB Tables Using Performance Schema .....	2851
14.17.2 Monitoring InnoDB Mutex Waits Using Performance Schema .....	2853
14.18 InnoDB Monitors .....	2856
14.18.1 InnoDB Monitor Types .....	2857
14.18.2 Enabling InnoDB Monitors .....	2857
14.18.3 InnoDB Standard Monitor and Lock Monitor Output .....	2859
14.19 InnoDB Backup and Recovery .....	2864
14.19.1 InnoDB Backup .....	2864
14.19.2 InnoDB Recovery .....	2865
14.20 InnoDB and MySQL Replication .....	2868
14.21 InnoDB memcached Plugin .....	2870
14.21.1 Benefits of the InnoDB memcached Plugin .....	2870
14.21.2 InnoDB memcached Architecture .....	2871
14.21.3 Setting Up the InnoDB memcached Plugin .....	2873
14.21.4 Security Considerations for the InnoDB memcached Plugin .....	2879
14.21.5 Writing Applications for the InnoDB memcached Plugin .....	2880
14.21.6 The InnoDB memcached Plugin and Replication .....	2893
14.21.7 InnoDB memcached Plugin Internals .....	2897
14.21.8 Troubleshooting the InnoDB memcached Plugin .....	2901
14.22 InnoDB Troubleshooting .....	2903
14.22.1 Troubleshooting InnoDB I/O Problems .....	2904
14.22.2 Forcing InnoDB Recovery .....	2905
14.22.3 Troubleshooting InnoDB Data Dictionary Operations .....	2906
14.22.4 InnoDB Error Handling .....	2911
14.23 InnoDB Limits .....	2911
14.24 InnoDB Restrictions and Limitations .....	2913

## 14.1 Introduction to InnoDB

**InnoDB** is a general-purpose storage engine that balances high reliability and high performance. In MySQL 5.7, **InnoDB** is the default MySQL storage engine. Unless you have configured a different default storage engine, issuing a `CREATE TABLE` statement without an `ENGINE` clause creates an **InnoDB** table.

### Key Advantages of InnoDB

- Its DML operations follow the ACID model, with transactions featuring commit, rollback, and crash-recovery capabilities to protect user data. See [Section 14.2, “InnoDB and the ACID Model”](#).
- Row-level locking and Oracle-style consistent reads increase multi-user concurrency and performance. See [Section 14.7, “InnoDB Locking and Transaction Model”](#).
- **InnoDB** tables arrange your data on disk to optimize queries based on primary keys. Each **InnoDB** table has a primary key index called the clustered index that organizes the data to minimize I/O for primary key lookups. See [Section 14.6.2.1, “Clustered and Secondary Indexes”](#).
- To maintain data integrity, **InnoDB** supports `FOREIGN KEY` constraints. With foreign keys, inserts, updates, and deletes are checked to ensure they do not result in inconsistencies across related tables. See [Section 13.1.18.5, “FOREIGN KEY Constraints”](#).

**Table 14.1 InnoDB Storage Engine Features**

Feature	Support
<b>B-tree indexes</b>	Yes
<b>Backup/point-in-time recovery</b> (Implemented in the server, rather than in the storage engine.)	Yes
<b>Cluster database support</b>	No
<b>Clustered indexes</b>	Yes
<b>Compressed data</b>	Yes
<b>Data caches</b>	Yes
<b>Encrypted data</b>	Yes (Implemented in the server via encryption functions; In MySQL 5.7 and later, data-at-rest encryption is supported.)
<b>Foreign key support</b>	Yes
<b>Full-text search indexes</b>	Yes (Support for FULLTEXT indexes is available in MySQL 5.6 and later.)
<b>Geospatial data type support</b>	Yes
<b>Geospatial indexing support</b>	Yes (Support for geospatial indexing is available in MySQL 5.7 and later.)
<b>Hash indexes</b>	No (InnoDB utilizes hash indexes internally for its Adaptive Hash Index feature.)
<b>Index caches</b>	Yes
<b>Locking granularity</b>	Row
<b>MVCC</b>	Yes
<b>Replication support</b> (Implemented in the server, rather than in the storage engine.)	Yes

Feature	Support
Storage limits	64TB
T-tree indexes	No
Transactions	Yes
Update statistics for data dictionary	Yes

To compare the features of [InnoDB](#) with other storage engines provided with MySQL, see the *Storage Engine Features* table in [Chapter 15, \*Alternative Storage Engines\*](#).

## InnoDB Enhancements and New Features

For information about [InnoDB](#) enhancements and new features, refer to:

- The [InnoDB](#) enhancements list in [Section 1.3, “What Is New in MySQL 5.7”](#).
- The [Release Notes](#).

## Additional InnoDB Information and Resources

- For [InnoDB](#)-related terms and definitions, see the [MySQL Glossary](#).
- For a forum dedicated to the [InnoDB](#) storage engine, see [MySQL Forums::InnoDB](#).
- [InnoDB](#) is published under the same GNU GPL License Version 2 (of June 1991) as MySQL. For more information on MySQL licensing, see <http://www.mysql.com/company/legal/licensing/>.

### 14.1.1 Benefits of Using InnoDB Tables

[InnoDB](#) tables have the following benefits:

- If the server unexpectedly exits because of a hardware or software issue, regardless of what was happening in the database at the time, you don't need to do anything special after restarting the database. [InnoDB](#) crash recovery automatically finalizes changes that were committed before the time of the crash, and undoes changes that were in process but not committed, permitting you to restart and continue from where you left off. See [Section 14.19.2, “InnoDB Recovery”](#).
- The [InnoDB](#) storage engine maintains its own buffer pool that caches table and index data in main memory as data is accessed. Frequently used data is processed directly from memory. This cache applies to many types of information and speeds up processing. On dedicated database servers, up to 80% of physical memory is often assigned to the buffer pool. See [Section 14.5.1, “Buffer Pool”](#).
- If you split up related data into different tables, you can set up foreign keys that enforce referential integrity. See [Section 13.1.18.5, “FOREIGN KEY Constraints”](#).
- If data becomes corrupted on disk or in memory, a checksum mechanism alerts you to the bogus data before you use it. The `innodb_checksum_algorithm` variable defines the checksum algorithm used by [InnoDB](#).
- When you design a database with appropriate primary key columns for each table, operations involving those columns are automatically optimized. It is very fast to reference the primary key columns in `WHERE` clauses, `ORDER BY` clauses, `GROUP BY` clauses, and join operations. See [Section 14.6.2.1, “Clustered and Secondary Indexes”](#).
- Inserts, updates, and deletes are optimized by an automatic mechanism called change buffering. [InnoDB](#) not only allows concurrent read and write access to the same table, it caches changed data to streamline disk I/O. See [Section 14.5.2, “Change Buffer”](#).



- Performance benefits are not limited to large tables with long-running queries. When the same rows are accessed over and over from a table, the Adaptive Hash Index takes over to make these lookups even faster, as if they came out of a hash table. See [Section 14.5.3, “Adaptive Hash Index”](#).
- You can compress tables and associated indexes. See [Section 14.9, “InnoDB Table and Page Compression”](#).
- You can encrypt your data. See [Section 14.14, “InnoDB Data-at-Rest Encryption”](#).
- You can create and drop indexes and perform other DDL operations with much less impact on performance and availability. See [Section 14.13.1, “Online DDL Operations”](#).
- Truncating a file-per-table tablespace is very fast and can free up disk space for the operating system to reuse rather than only `InnoDB`. See [Section 14.6.3.2, “File-Per-Table Tablespaces”](#).
- The storage layout for table data is more efficient for `BLOB` and long text fields, with the `DYNAMIC` row format. See [Section 14.11, “InnoDB Row Formats”](#).
- You can monitor the internal workings of the storage engine by querying `INFORMATION_SCHEMA` tables. See [Section 14.16, “InnoDB INFORMATION\\_SCHEMA Tables”](#).
- You can monitor the performance details of the storage engine by querying Performance Schema tables. See [Section 14.17, “InnoDB Integration with MySQL Performance Schema”](#).
- You can mix `InnoDB` tables with tables from other MySQL storage engines, even within the same statement. For example, you can use a join operation to combine data from `InnoDB` and `MEMORY` tables in a single query.
- `InnoDB` has been designed for CPU efficiency and maximum performance when processing large data volumes.
- `InnoDB` tables can handle large quantities of data, even on operating systems where file size is limited to 2GB.

For `InnoDB`-specific tuning techniques you can apply to your MySQL server and application code, see [Section 8.5, “Optimizing for InnoDB Tables”](#).

## 14.1.2 Best Practices for InnoDB Tables

This section describes best practices when using `InnoDB` tables.

- Specify a primary key for every table using the most frequently queried column or columns, or an auto-increment value if there is no obvious primary key.
- Use joins wherever data is pulled from multiple tables based on identical ID values from those tables. For fast join performance, define foreign keys on the join columns, and declare those columns with the same data type in each table. Adding foreign keys ensures that referenced columns are indexed, which can improve performance. Foreign keys also propagate deletes and updates to all affected tables, and prevent insertion of data in a child table if the corresponding IDs are not present in the parent table.
- Turn off autocommit. Committing hundreds of times a second puts a cap on performance (limited by the write speed of your storage device).
- Group sets of related DML operations into transactions by bracketing them with `START TRANSACTION` and `COMMIT` statements. While you don't want to commit too often, you also don't want to issue huge batches of `INSERT`, `UPDATE`, or `DELETE` statements that run for hours without committing.

- Do not use `LOCK TABLES` statements. InnoDB can handle multiple sessions all reading and writing to the same table at once without sacrificing reliability or high performance. To get exclusive write access to a set of rows, use the `SELECT ... FOR UPDATE` syntax to lock just the rows you intend to update.
- Enable the `innodb_file_per_table` variable or use general tablespaces to put the data and indexes for tables into separate files instead of the system tablespace. The `innodb_file_per_table` variable is enabled by default.
- Evaluate whether your data and access patterns benefit from the InnoDB table or page compression features. You can compress InnoDB tables without sacrificing read/write capability.
- Run the server with the `--sql_mode=NO_ENGINE_SUBSTITUTION` option to prevent tables from being created with storage engines that you do not want to use.

### 14.1.3 Verifying that InnoDB is the Default Storage Engine

Issue the `SHOW ENGINES` statement to view the available MySQL storage engines. Look for `DEFAULT` in the `SUPPORT` column.

```
mysql> SHOW ENGINES;
```

Alternatively, query the Information Schema `ENGINES` table.

```
mysql> SELECT * FROM INFORMATION_SCHEMA.ENGINES;
```

### 14.1.4 Testing and Benchmarking with InnoDB

If InnoDB is not the default storage engine, you can determine if your database server and applications work correctly with InnoDB by restarting the server with `--default-storage-engine=InnoDB` on the command line or with `default-storage-engine=innodb` defined in the `[mysqld]` section of the MySQL server option file.

Since changing the default storage engine only affects newly created tables, run your application installation and setup steps to confirm that everything installs properly, then exercise the application features to make sure the data loading, editing, and querying features work. If a table relies on a feature that is specific to another storage engine, you receive an error. In this case, add the `ENGINE=other_engine_name` clause to the `CREATE TABLE` statement to avoid the error.

If you did not make a deliberate decision about the storage engine, and you want to preview how certain tables work when created using InnoDB, issue the command `ALTER TABLE table_name ENGINE=InnoDB;` for each table. Alternatively, to run test queries and other statements without disturbing the original table, make a copy:

```
CREATE TABLE ... ENGINE=InnoDB AS SELECT * FROM other_engine_table;
```

To assess performance with a full application under a realistic workload, install the latest MySQL server and run benchmarks.

Test the full application lifecycle, from installation, through heavy usage, and server restart. Kill the server process while the database is busy to simulate a power failure, and verify that the data is recovered successfully when you restart the server.

Test any replication configurations, especially if you use different MySQL versions and options on the source server and replicas.

## 14.1.5 Turning Off InnoDB

Oracle recommends [InnoDB](#) as the preferred storage engine for typical database applications, from single-user wikis and blogs running on a local system, to high-end applications pushing the limits of performance. In MySQL 5.7, [InnoDB](#) is the default storage engine for new tables.



### Important

[InnoDB](#) cannot be disabled. The `--skip-innodb` option is deprecated and has no effect, and its use results in a warning. Expect it to be removed in a future MySQL release. This also applies to its synonyms (`--innodb=OFF`, `--disable-innodb`, and so forth).

## 14.2 InnoDB and the ACID Model

The [ACID](#) model is a set of database design principles that emphasize aspects of reliability that are important for business data and mission-critical applications. MySQL includes components such as the [InnoDB](#) storage engine that adhere closely to the ACID model so that data is not corrupted and results are not distorted by exceptional conditions such as software crashes and hardware malfunctions. When you rely on ACID-compliant features, you do not need to reinvent the wheel of consistency checking and crash recovery mechanisms. In cases where you have additional software safeguards, ultra-reliable hardware, or an application that can tolerate a small amount of data loss or inconsistency, you can adjust MySQL settings to trade some of the ACID reliability for greater performance or throughput.

The following sections discuss how MySQL features, in particular the [InnoDB](#) storage engine, interact with the categories of the ACID model:

- **A:** atomicity.
- **C:** consistency.
- **I:** isolation.
- **D:** durability.

### Atomicity

The **atomicity** aspect of the ACID model mainly involves [InnoDB transactions](#). Related MySQL features include:

- The `autocommit` setting.
- The `COMMIT` statement.
- The `ROLLBACK` statement.

### Consistency

The **consistency** aspect of the ACID model mainly involves internal [InnoDB](#) processing to protect data from crashes. Related MySQL features include:

- The [InnoDB](#) doublewrite buffer. See [Section 14.6.5, “Doublewrite Buffer”](#).
- [InnoDB](#) crash recovery. See [InnoDB Crash Recovery](#).

---

## Isolation

The **isolation** aspect of the ACID model mainly involves [InnoDB transactions](#), in particular the [isolation level](#) that applies to each transaction. Related MySQL features include:

- The `autocommit` setting.
- Transaction isolation levels and the `SET TRANSACTION` statement. See [Section 14.7.2.1, “Transaction Isolation Levels”](#).
- The low-level details of [InnoDB locking](#). Details can be viewed in the `INFORMATION_SCHEMA` tables. See [Section 14.16.2, “InnoDB INFORMATION\\_SCHEMA Transaction and Locking Information”](#).

## Durability

The **durability** aspect of the ACID model involves MySQL software features interacting with your particular hardware configuration. Because of the many possibilities depending on the capabilities of your CPU, network, and storage devices, this aspect is the most complicated to provide concrete guidelines for. (And those guidelines might take the form of “buy new hardware”.) Related MySQL features include:

- The [InnoDB doublewrite buffer](#). See [Section 14.6.5, “Doublewrite Buffer”](#).
- The `innodb_flush_log_at_trx_commit` variable.
- The `sync_binlog` variable.
- The `innodb_file_per_table` variable.
- The write buffer in a storage device, such as a disk drive, SSD, or RAID array.
- A battery-backed cache in a storage device.
- The operating system used to run MySQL, in particular its support for the `fsync()` system call.
- An uninterruptible power supply (UPS) protecting the electrical power to all computer servers and storage devices that run MySQL servers and store MySQL data.
- Your backup strategy, such as frequency and types of backups, and backup retention periods.
- For distributed or hosted data applications, the particular characteristics of the data centers where the hardware for the MySQL servers is located, and network connections between the data centers.

## 14.3 InnoDB Multi-Versioning

[InnoDB](#) is a multi-version storage engine. It keeps information about old versions of changed rows to support transactional features such as concurrency and rollback. This information is stored in the system tablespaces or undo tablespaces in a data structure called a rollback segment. See [Section 14.6.3.4, “Undo Tablespaces”](#). [InnoDB](#) uses the information in the rollback segment to perform the undo operations needed in a transaction rollback. It also uses the information to build earlier versions of a row for a consistent read. See [Section 14.7.2.3, “Consistent Nonlocking Reads”](#).

Internally, [InnoDB](#) adds three fields to each row stored in the database:

- A 6-byte `DB_TRX_ID` field indicates the transaction identifier for the last transaction that inserted or updated the row. Also, a deletion is treated internally as an update where a special bit in the row is set to mark it as deleted.

- A 7-byte `DB_ROLL_PTR` field called the roll pointer. The roll pointer points to an undo log record written to the rollback segment. If the row was updated, the undo log record contains the information necessary to rebuild the content of the row before it was updated.
- A 6-byte `DB_ROW_ID` field contains a row ID that increases monotonically as new rows are inserted. If `InnoDB` generates a clustered index automatically, the index contains row ID values. Otherwise, the `DB_ROW_ID` column does not appear in any index.

Undo logs in the rollback segment are divided into insert and update undo logs. Insert undo logs are needed only in transaction rollback and can be discarded as soon as the transaction commits. Update undo logs are used also in consistent reads, but they can be discarded only after there is no transaction present for which `InnoDB` has assigned a snapshot that in a consistent read could require the information in the update undo log to build an earlier version of a database row. For additional information about undo logs, see [Section 14.6.7, “Undo Logs”](#).

It is recommended that you commit transactions regularly, including transactions that issue only consistent reads. Otherwise, `InnoDB` cannot discard data from the update undo logs, and the rollback segment may grow too big, filling up the tablespace in which it resides. For information about managing undo tablespaces, see [Section 14.6.3.4, “Undo Tablespaces”](#).

The physical size of an undo log record in the rollback segment is typically smaller than the corresponding inserted or updated row. You can use this information to calculate the space needed for your rollback segment.

In the `InnoDB` multi-versioning scheme, a row is not physically removed from the database immediately when you delete it with an SQL statement. `InnoDB` only physically removes the corresponding row and its index records when it discards the update undo log record written for the deletion. This removal operation is called a purge, and it is quite fast, usually taking the same order of time as the SQL statement that did the deletion.

If you insert and delete rows in smallish batches at about the same rate in the table, the purge thread can start to lag behind and the table can grow bigger and bigger because of all the “dead” rows, making everything disk-bound and very slow. In such cases, throttle new row operations, and allocate more resources to the purge thread by tuning the `innodb_max_purge_lag` system variable. For more information, see [Section 14.8.10, “Purge Configuration”](#).

## Multi-Versioning and Secondary Indexes

`InnoDB` multiversion concurrency control (MVCC) treats secondary indexes differently than clustered indexes. Records in a clustered index are updated in-place, and their hidden system columns point undo log entries from which earlier versions of records can be reconstructed. Unlike clustered index records, secondary index records do not contain hidden system columns nor are they updated in-place.

When a secondary index column is updated, old secondary index records are delete-marked, new records are inserted, and delete-marked records are eventually purged. When a secondary index record is delete-marked or the secondary index page is updated by a newer transaction, `InnoDB` looks up the database record in the clustered index. In the clustered index, the record's `DB_TRX_ID` is checked, and the correct version of the record is retrieved from the undo log if the record was modified after the reading transaction was initiated.

If a secondary index record is marked for deletion or the secondary index page is updated by a newer transaction, the [covering index](#) technique is not used. Instead of returning values from the index structure, `InnoDB` looks up the record in the clustered index.

However, if the [index condition pushdown \(ICP\)](#) optimization is enabled, and parts of the `WHERE` condition can be evaluated using only fields from the index, the MySQL server still pushes this part of the `WHERE`

condition down to the storage engine where it is evaluated using the index. If no matching records are found, the clustered index lookup is avoided. If matching records are found, even among delete-marked records, [InnoDB](#) looks up the record in the clustered index.

## 14.4 InnoDB Architecture

The following diagram shows in-memory and on-disk structures that comprise the [InnoDB](#) storage engine architecture. For information about each structure, see [Section 14.5, “InnoDB In-Memory Structures”](#), and [Section 14.6, “InnoDB On-Disk Structures”](#).

Figure 14.1 InnoDB Architecture

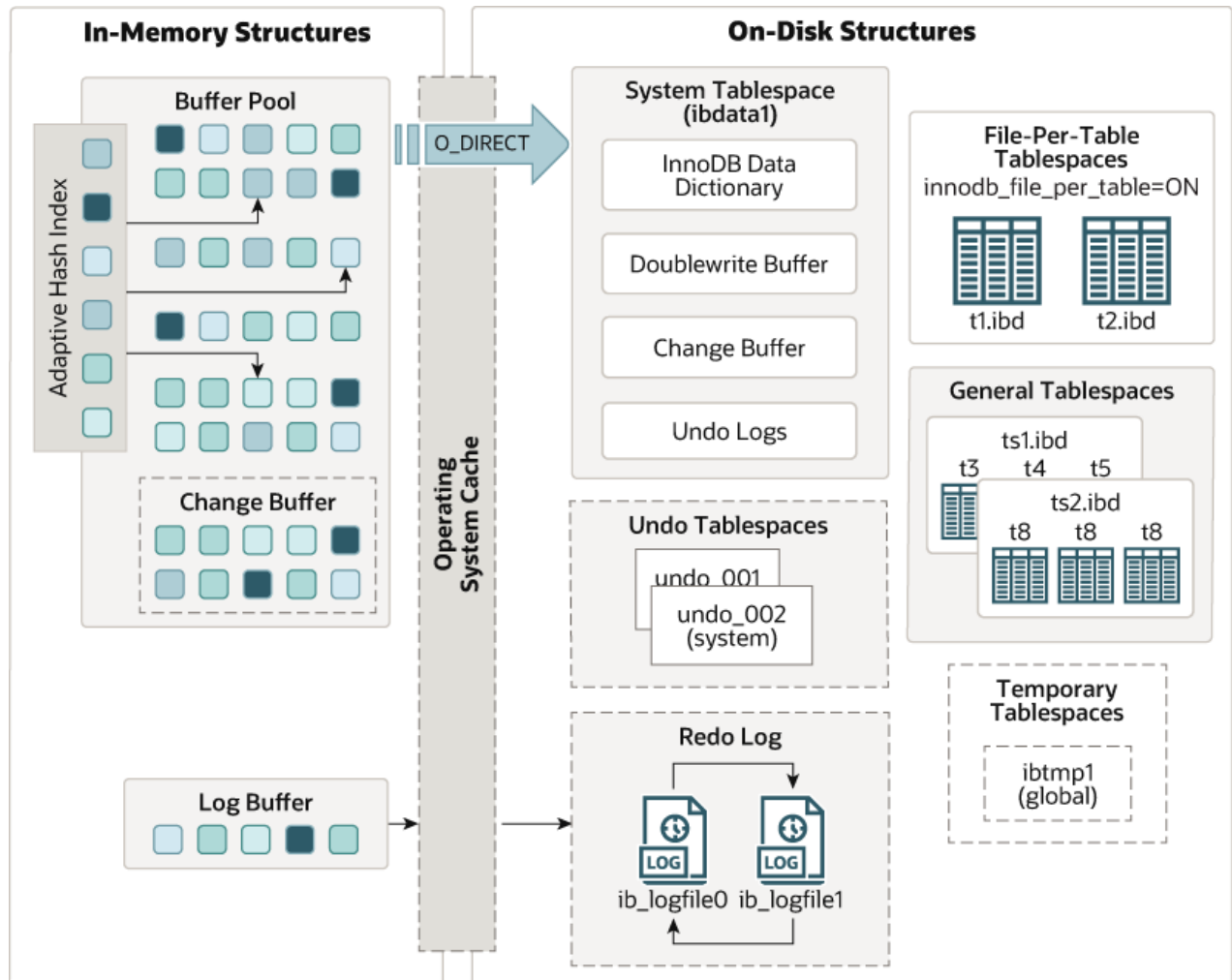

## 14.5 InnoDB In-Memory Structures

This section describes [InnoDB](#) in-memory structures and related topics.

### 14.5.1 Buffer Pool

The buffer pool is an area in main memory where [InnoDB](#) caches table and index data as it is accessed. The buffer pool permits frequently used data to be accessed directly from memory, which speeds up processing. On dedicated servers, up to 80% of physical memory is often assigned to the buffer pool.

For efficiency of high-volume read operations, the buffer pool is divided into pages that can potentially hold multiple rows. For efficiency of cache management, the buffer pool is implemented as a linked list of pages; data that is rarely used is aged out of the cache using a variation of the least recently used (LRU) algorithm.

Knowing how to take advantage of the buffer pool to keep frequently accessed data in memory is an important aspect of MySQL tuning.

## Buffer Pool LRU Algorithm

The buffer pool is managed as a list using a variation of the LRU algorithm. When room is needed to add a new page to the buffer pool, the least recently used page is evicted and a new page is added to the middle of the list. This midpoint insertion strategy treats the list as two sublists:

- At the head, a sublist of new (“young”) pages that were accessed recently
- At the tail, a sublist of old pages that were accessed less recently

**Figure 14.2 Buffer Pool List**

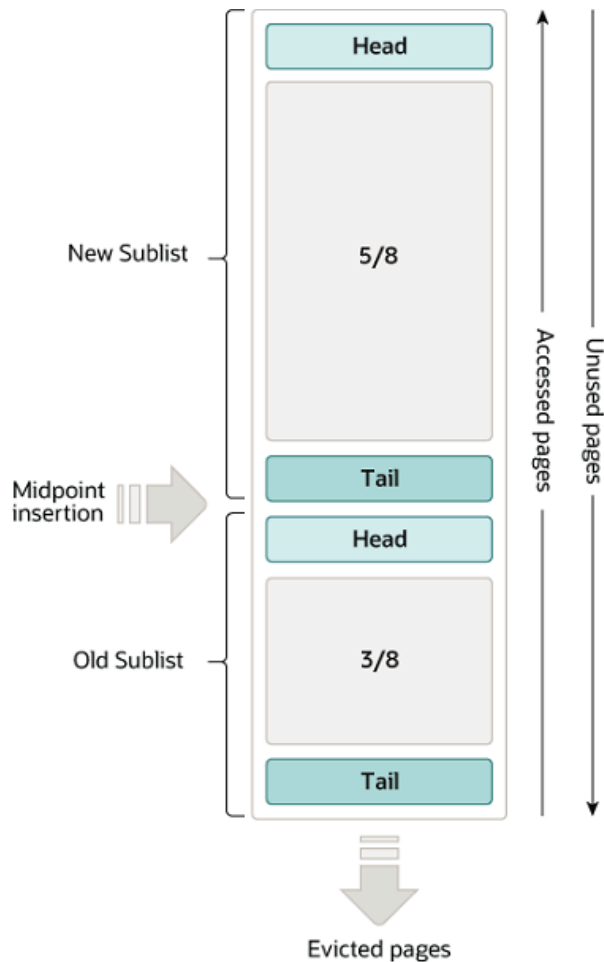

The algorithm keeps frequently used pages in the new sublist. The old sublist contains less frequently used pages; these pages are candidates for [eviction](#).

By default, the algorithm operates as follows:

- 3/8 of the buffer pool is devoted to the old sublist.
- The midpoint of the list is the boundary where the tail of the new sublist meets the head of the old sublist.
- When [InnoDB](#) reads a page into the buffer pool, it initially inserts it at the midpoint (the head of the old sublist). A page can be read because it is required for a user-initiated operation such as an SQL query, or as part of a [read-ahead](#) operation performed automatically by [InnoDB](#).
- Accessing a page in the old sublist makes it “young”, moving it to the head of the new sublist. If the page was read because it was required by a user-initiated operation, the first access occurs immediately and the page is made young. If the page was read due to a read-ahead operation, the first access does not occur immediately and might not occur at all before the page is evicted.
- As the database operates, pages in the buffer pool that are not accessed “age” by moving toward the tail of the list. Pages in both the new and old sublists age as other pages are made new. Pages in the old sublist also age as pages are inserted at the midpoint. Eventually, a page that remains unused reaches the tail of the old sublist and is evicted.

By default, pages read by queries are immediately moved into the new sublist, meaning they stay in the buffer pool longer. A table scan, performed for a [mysqldump](#) operation or a [SELECT](#) statement with no [WHERE](#) clause, for example, can bring a large amount of data into the buffer pool and evict an equivalent amount of older data, even if the new data is never used again. Similarly, pages that are loaded by the read-ahead background thread and accessed only once are moved to the head of the new list. These situations can push frequently used pages to the old sublist where they become subject to eviction. For information about optimizing this behavior, see [Section 14.8.3.3, “Making the Buffer Pool Scan Resistant”](#), and [Section 14.8.3.4, “Configuring InnoDB Buffer Pool Prefetching \(Read-Ahead\)”](#).

[InnoDB](#) Standard Monitor output contains several fields in the [BUFFER POOL AND MEMORY](#) section regarding operation of the buffer pool LRU algorithm. For details, see [Monitoring the Buffer Pool Using the InnoDB Standard Monitor](#).

## Buffer Pool Configuration

You can configure the various aspects of the buffer pool to improve performance.

- Ideally, you set the size of the buffer pool to as large a value as practical, leaving enough memory for other processes on the server to run without excessive paging. The larger the buffer pool, the more [InnoDB](#) acts like an in-memory database, reading data from disk once and then accessing the data from memory during subsequent reads. See [Section 14.8.3.1, “Configuring InnoDB Buffer Pool Size”](#).
- On 64-bit systems with sufficient memory, you can split the buffer pool into multiple parts to minimize contention for memory structures among concurrent operations. For details, see [Section 14.8.3.2, “Configuring Multiple Buffer Pool Instances”](#).
- You can keep frequently accessed data in memory regardless of sudden spikes of activity from operations that would bring large amounts of infrequently accessed data into the buffer pool. For details, see [Section 14.8.3.3, “Making the Buffer Pool Scan Resistant”](#).
- You can control how and when to perform read-ahead requests to prefetch pages into the buffer pool asynchronously in anticipation that the pages are needed soon. For details, see [Section 14.8.3.4, “Configuring InnoDB Buffer Pool Prefetching \(Read-Ahead\)”](#).
- You can control when background flushing occurs and whether or not the rate of flushing is dynamically adjusted based on workload. For details, see [Section 14.8.3.5, “Configuring Buffer Pool Flushing”](#).
- You can configure how [InnoDB](#) preserves the current buffer pool state to avoid a lengthy warmup period after a server restart. For details, see [Section 14.8.3.6, “Saving and Restoring the Buffer Pool State”](#).



## Monitoring the Buffer Pool Using the InnoDB Standard Monitor

InnoDB Standard Monitor output, which can be accessed using `SHOW ENGINE INNODB STATUS`, provides metrics regarding operation of the buffer pool. Buffer pool metrics are located in the `BUFFER POOL AND MEMORY` section of InnoDB Standard Monitor output:

```

-----
BUFFER POOL AND MEMORY
-----
Total large memory allocated 2198863872
Dictionary memory allocated 776332
Buffer pool size 131072
Free buffers 124908
Database pages 5720
Old database pages 2071
Modified db pages 910
Pending reads 0
Pending writes: LRU 0, flush list 0, single page 0
Pages made young 4, not young 0
0.10 youngs/s, 0.00 non-youngs/s
Pages read 197, created 5523, written 5060
0.00 reads/s, 190.89 creates/s, 244.94 writes/s
Buffer pool hit rate 1000 / 1000, young-making rate 0 / 1000 not
0 / 1000
Pages read ahead 0.00/s, evicted without access 0.00/s, Random read
ahead 0.00/s
LRU len: 5720, unzip_LRU len: 0
I/O sum[0]:cur[0], unzip sum[0]:cur[0]

```

The following table describes buffer pool metrics reported by the InnoDB Standard Monitor.

Per second averages provided in InnoDB Standard Monitor output are based on the elapsed time since InnoDB Standard Monitor output was last printed.

**Table 14.2 InnoDB Buffer Pool Metrics**

Name	Description
Total memory allocated	The total memory allocated for the buffer pool in bytes.
Dictionary memory allocated	The total memory allocated for the InnoDB data dictionary in bytes.
Buffer pool size	The total size in pages allocated to the buffer pool.
Free buffers	The total size in pages of the buffer pool free list.
Database pages	The total size in pages of the buffer pool LRU list.
Old database pages	The total size in pages of the buffer pool old LRU sublist.
Modified db pages	The current number of pages modified in the buffer pool.
Pending reads	The number of buffer pool pages waiting to be read into the buffer pool.
Pending writes LRU	The number of old dirty pages within the buffer pool to be written from the bottom of the LRU list.
Pending writes flush list	The number of buffer pool pages to be flushed during checkpointing.
Pending writes single page	The number of pending independent page writes within the buffer pool.

## Buffer Pool

Name	Description
Pages made young	The total number of pages made young in the buffer pool LRU list (moved to the head of sublist of “new” pages).
Pages made not young	The total number of pages not made young in the buffer pool LRU list (pages that have remained in the “old” sublist without being made young).
young/s	The per second average of accesses to old pages in the buffer pool LRU list that have resulted in making pages young. See the notes that follow this table for more information.
non-young/s	The per second average of accesses to old pages in the buffer pool LRU list that have resulted in not making pages young. See the notes that follow this table for more information.
Pages read	The total number of pages read from the buffer pool.
Pages created	The total number of pages created within the buffer pool.
Pages written	The total number of pages written from the buffer pool.
reads/s	The per second average number of buffer pool page reads per second.
creates/s	The average number of buffer pool pages created per second.
writes/s	The average number of buffer pool page writes per second.
Buffer pool hit rate	The buffer pool page hit rate for pages read from the buffer pool vs from disk storage.
young-making rate	The average hit rate at which page accesses have resulted in making pages young. See the notes that follow this table for more information.
not (young-making rate)	The average hit rate at which page accesses have not resulted in making pages young. See the notes that follow this table for more information.
Pages read ahead	The per second average of read ahead operations.
Pages evicted without access	The per second average of the pages evicted without being accessed from the buffer pool.
Random read ahead	The per second average of random read ahead operations.
LRU len	The total size in pages of the buffer pool LRU list.
unzip_LRU len	The length (in pages) of the buffer pool unzip_LRU list.
I/O sum	The total number of buffer pool LRU list pages accessed.
I/O cur	The total number of buffer pool LRU list pages accessed in the current interval.

Name	Description
I/O unzip sum	The total number of buffer pool unzip_LRU list pages decompressed.
I/O unzip cur	The total number of buffer pool unzip_LRU list pages decompressed in the current interval.

**Notes:**

- The `youngs/s` metric is applicable only to old pages. It is based on the number of page accesses. There can be multiple accesses for a given page, all of which are counted. If you see very low `youngs/s` values when there are no large scans occurring, consider reducing the delay time or increasing the percentage of the buffer pool used for the old sublist. Increasing the percentage makes the old sublist larger so that it takes longer for pages in that sublist to move to the tail, which increases the likelihood that those pages are accessed again and made young. See [Section 14.8.3.3, “Making the Buffer Pool Scan Resistant”](#).
- The `non-youngs/s` metric is applicable only to old pages. It is based on the number of page accesses. There can be multiple accesses for a given page, all of which are counted. If you do not see a higher `non-youngs/s` value when performing large table scans (and a higher `youngs/s` value), increase the delay value. See [Section 14.8.3.3, “Making the Buffer Pool Scan Resistant”](#).
- The `young-making` rate accounts for all buffer pool page accesses, not just accesses for pages in the old sublist. The `young-making` rate and `not` rate do not normally add up to the overall buffer pool hit rate. Page hits in the old sublist cause pages to move to the new sublist, but page hits in the new sublist cause pages to move to the head of the list only if they are a certain distance from the head.
- `not (young-making rate)` is the average hit rate at which page accesses have not resulted in making pages young due to the delay defined by `innodb_old_blocks_time` not being met, or due to page hits in the new sublist that did not result in pages being moved to the head. This rate accounts for all buffer pool page accesses, not just accesses for pages in the old sublist.

Buffer pool [server status variables](#) and the `INNODB_BUFFER_POOL_STATS` table provide many of the same buffer pool metrics found in InnoDB Standard Monitor output. For more information, see [Example 14.10, “Querying the INNODB\\_BUFFER\\_POOL\\_STATS Table”](#).

## 14.5.2 Change Buffer

The change buffer is a special data structure that caches changes to [secondary index](#) pages when those pages are not in the [buffer pool](#). The buffered changes, which may result from `INSERT`, `UPDATE`, or `DELETE` operations (DML), are merged later when the pages are loaded into the buffer pool by other read operations.

Figure 14.3 Change Buffer

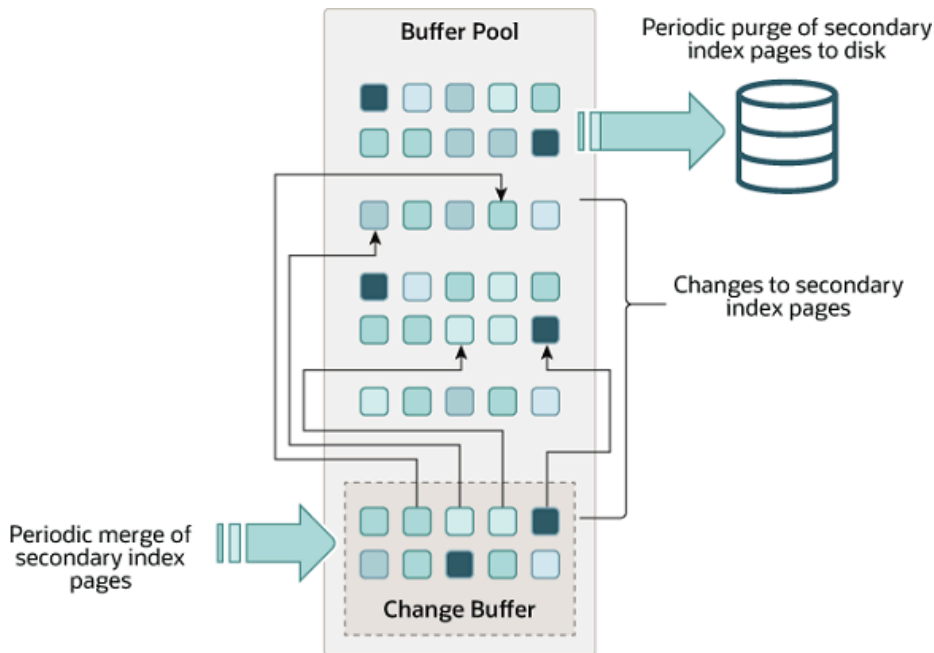

Unlike [clustered indexes](#), secondary indexes are usually nonunique, and inserts into secondary indexes happen in a relatively random order. Similarly, deletes and updates may affect secondary index pages that are not adjacently located in an index tree. Merging cached changes at a later time, when affected pages are read into the buffer pool by other operations, avoids substantial random access I/O that would be required to read secondary index pages into the buffer pool from disk.

Periodically, the purge operation that runs when the system is mostly idle, or during a slow shutdown, writes the updated index pages to disk. The purge operation can write disk blocks for a series of index values more efficiently than if each value were written to disk immediately.

Change buffer merging may take several hours when there are many affected rows and numerous secondary indexes to update. During this time, disk I/O is increased, which can cause a significant slowdown for disk-bound queries. Change buffer merging may also continue to occur after a transaction is committed, and even after a server shutdown and restart (see [Section 14.22.2, “Forcing InnoDB Recovery”](#) for more information).

In memory, the change buffer occupies part of the buffer pool. On disk, the change buffer is part of the system tablespace, where index changes are buffered when the database server is shut down.

The type of data cached in the change buffer is governed by the `innodb_change_buffering` variable. For more information, see [Configuring Change Buffering](#). You can also configure the maximum change buffer size. For more information, see [Configuring the Change Buffer Maximum Size](#).

Change buffering is not supported for a secondary index if the index contains a descending index column or if the primary key includes a descending index column.

For answers to frequently asked questions about the change buffer, see [Section A.16, “MySQL 5.7 FAQ: InnoDB Change Buffer”](#).

## Configuring Change Buffering

When `INSERT`, `UPDATE`, and `DELETE` operations are performed on a table, the values of indexed columns (particularly the values of secondary keys) are often in an unsorted order, requiring substantial I/O to bring

secondary indexes up to date. The [change buffer](#) caches changes to secondary index entries when the relevant [page](#) is not in the [buffer pool](#), thus avoiding expensive I/O operations by not immediately reading in the page from disk. The buffered changes are merged when the page is loaded into the buffer pool, and the updated page is later flushed to disk. The [InnoDB](#) main thread merges buffered changes when the server is nearly idle, and during a [slow shutdown](#).

Because it can result in fewer disk reads and writes, change buffering is most valuable for workloads that are I/O-bound; for example, applications with a high volume of DML operations such as bulk inserts benefit from change buffering.

However, the change buffer occupies a part of the buffer pool, reducing the memory available to cache data pages. If the working set almost fits in the buffer pool, or if your tables have relatively few secondary indexes, it may be useful to disable change buffering. If the working data set fits entirely within the buffer pool, change buffering does not impose extra overhead, because it only applies to pages that are not in the buffer pool.

The [innodb\\_change\\_buffering](#) variable controls the extent to which [InnoDB](#) performs change buffering. You can enable or disable buffering for inserts, delete operations (when index records are initially marked for deletion) and purge operations (when index records are physically deleted). An update operation is a combination of an insert and a delete. The default [innodb\\_change\\_buffering](#) value is [all](#).

Permitted [innodb\\_change\\_buffering](#) values include:

- [all](#)

The default value: buffer inserts, delete-marking operations, and purges.

- [none](#)

Do not buffer any operations.

- [inserts](#)

Buffer insert operations.

- [deletes](#)

Buffer delete-marking operations.

- [changes](#)

Buffer both inserts and delete-marking operations.

- [purges](#)

Buffer physical deletion operations that happen in the background.

You can set the [innodb\\_change\\_buffering](#) variable in the MySQL option file ([my.cnf](#) or [my.ini](#)) or change it dynamically with the [SET GLOBAL](#) statement, which requires privileges sufficient to set global system variables. See [Section 5.1.8.1, “System Variable Privileges”](#). Changing the setting affects the buffering of new operations; the merging of existing buffered entries is not affected.

### Configuring the Change Buffer Maximum Size

The [innodb\\_change\\_buffer\\_max\\_size](#) variable permits configuring the maximum size of the change buffer as a percentage of the total size of the buffer pool. By default, [innodb\\_change\\_buffer\\_max\\_size](#) is set to 25. The maximum setting is 50.

Consider increasing `innodb_change_buffer_max_size` on a MySQL server with heavy insert, update, and delete activity, where change buffer merging does not keep pace with new change buffer entries, causing the change buffer to reach its maximum size limit.

Consider decreasing `innodb_change_buffer_max_size` on a MySQL server with static data used for reporting, or if the change buffer consumes too much of the memory space shared with the buffer pool, causing pages to age out of the buffer pool sooner than desired.

Test different settings with a representative workload to determine an optimal configuration. The `innodb_change_buffer_max_size` variable is dynamic, which permits modifying the setting without restarting the server.

## Monitoring the Change Buffer

The following options are available for change buffer monitoring:

- **InnoDB Standard Monitor** output includes change buffer status information. To view monitor data, issue the `SHOW ENGINE INNODB STATUS` statement.

```
mysql> SHOW ENGINE INNODB STATUS\G
```

Change buffer status information is located under the `INSERT BUFFER AND ADAPTIVE HASH INDEX` heading and appears similar to the following:

```
-----
INSERT BUFFER AND ADAPTIVE HASH INDEX
-----
Ibuf: size 1, free list len 0, seg size 2, 0 merges
merged operations:
  insert 0, delete mark 0, delete 0
discarded operations:
  insert 0, delete mark 0, delete 0
Hash table size 4425293, used cells 32, node heap has 1 buffer(s)
13577.57 hash searches/s, 202.47 non-hash searches/s
```

For more information, see [Section 14.18.3, “InnoDB Standard Monitor and Lock Monitor Output”](#).

- The Information Schema `INNODB_METRICS` table provides most of the data points found in **InnoDB Standard Monitor** output plus other data points. To view change buffer metrics and a description of each, issue the following query:

```
mysql> SELECT NAME, COMMENT FROM INFORMATION_SCHEMA.INNODB_METRICS WHERE NAME LIKE '%ibuf%'\G
```

For `INNODB_METRICS` table usage information, see [Section 14.16.6, “InnoDB INFORMATION\\_SCHEMA Metrics Table”](#).

- The Information Schema `INNODB_BUFFER_PAGE` table provides metadata about each page in the buffer pool, including change buffer index and change buffer bitmap pages. Change buffer pages are identified by `PAGE_TYPE`. `IBUF_INDEX` is the page type for change buffer index pages, and `IBUF_BITMAP` is the page type for change buffer bitmap pages.



### Warning

Querying the `INNODB_BUFFER_PAGE` table can introduce significant performance overhead. To avoid impacting performance, reproduce the issue you want to investigate on a test instance and run your queries on the test instance.

For example, you can query the `INNODB_BUFFER_PAGE` table to determine the approximate number of `IBUF_INDEX` and `IBUF_BITMAP` pages as a percentage of total buffer pool pages.

```
mysql> SELECT (SELECT COUNT(*) FROM INFORMATION_SCHEMA.INNODB_BUFFER_PAGE
WHERE PAGE_TYPE LIKE 'IBUF%') AS change_buffer_pages,
(SELECT COUNT(*) FROM INFORMATION_SCHEMA.INNODB_BUFFER_PAGE) AS total_pages,
(SELECT ((change_buffer_pages/total_pages)*100))
AS change_buffer_page_percentage;
```

change_buffer_pages	total_pages	change_buffer_page_percentage
25	8192	0.3052

For information about other data provided by the `INNODB_BUFFER_PAGE` table, see [Section 24.4.2, “The INFORMATION\\_SCHEMA INNODB\\_BUFFER\\_PAGE Table”](#). For related usage information, see [Section 14.16.5, “InnoDB INFORMATION\\_SCHEMA Buffer Pool Tables”](#).

- [Performance Schema](#) provides change buffer mutex wait instrumentation for advanced performance monitoring. To view change buffer instrumentation, issue the following query:

```
mysql> SELECT * FROM performance_schema.setup_instruments
WHERE NAME LIKE '%wait/synch/mutex/innodb/ibuf%';
```

NAME	ENABLED	TIMED
wait/synch/mutex/innodb/ibuf_bitmap_mutex	YES	YES
wait/synch/mutex/innodb/ibuf_mutex	YES	YES
wait/synch/mutex/innodb/ibuf_pessimistic_insert_mutex	YES	YES

For information about monitoring `InnoDB` mutex waits, see [Section 14.17.2, “Monitoring InnoDB Mutex Waits Using Performance Schema”](#).

### 14.5.3 Adaptive Hash Index

The adaptive hash index enables `InnoDB` to perform more like an in-memory database on systems with appropriate combinations of workload and sufficient memory for the buffer pool without sacrificing transactional features or reliability. The adaptive hash index is enabled by the `innodb_adaptive_hash_index` variable, or turned off at server startup by `--skip-innodb-adaptive-hash-index`.

Based on the observed pattern of searches, a hash index is built using a prefix of the index key. The prefix can be any length, and it may be that only some values in the B-tree appear in the hash index. Hash indexes are built on demand for the pages of the index that are accessed often.

If a table fits almost entirely in main memory, a hash index speeds up queries by enabling direct lookup of any element, turning the index value into a sort of pointer. `InnoDB` has a mechanism that monitors index searches. If `InnoDB` notices that queries could benefit from building a hash index, it does so automatically.

With some workloads, the speedup from hash index lookups greatly outweighs the extra work to monitor index lookups and maintain the hash index structure. Access to the adaptive hash index can sometimes become a source of contention under heavy workloads, such as multiple concurrent joins. Queries with `LIKE` operators and `%` wildcards also tend not to benefit. For workloads that do not benefit from the adaptive hash index, turning it off reduces unnecessary performance overhead. Because it is difficult to predict in advance whether the adaptive hash index feature is appropriate for a particular system and workload, consider running benchmarks with it enabled and disabled.

In MySQL 5.7, the adaptive hash index feature is partitioned. Each index is bound to a specific partition, and each partition is protected by a separate latch. Partitioning is controlled by the `innodb_adaptive_hash_index_parts` variable. In earlier releases, the adaptive hash index feature

was protected by a single latch which could become a point of contention under heavy workloads. The `innodb_adaptive_hash_index_parts` variable is set to 8 by default. The maximum setting is 512.

You can monitor adaptive hash index use and contention in the `SEMAPHORES` section of `SHOW ENGINE INNODB STATUS` output. If there are numerous threads waiting on rw-latches created in `btr0sea.c`, consider increasing the number of adaptive hash index partitions or disabling the adaptive hash index.

For information about the performance characteristics of hash indexes, see [Section 8.3.8, “Comparison of B-Tree and Hash Indexes”](#).

## 14.5.4 Log Buffer

The log buffer is the memory area that holds data to be written to the log files on disk. Log buffer size is defined by the `innodb_log_buffer_size` variable. The default size is 16MB. The contents of the log buffer are periodically flushed to disk. A large log buffer enables large transactions to run without the need to write redo log data to disk before the transactions commit. Thus, if you have transactions that update, insert, or delete many rows, increasing the size of the log buffer saves disk I/O.

The `innodb_flush_log_at_trx_commit` variable controls how the contents of the log buffer are written and flushed to disk. The `innodb_flush_log_at_timeout` variable controls log flushing frequency.

For related information, see [Memory Configuration](#), and [Section 8.5.4, “Optimizing InnoDB Redo Logging”](#).

## 14.6 InnoDB On-Disk Structures

This section describes [InnoDB](#) on-disk structures and related topics.

### 14.6.1 Tables

This section covers topics related to [InnoDB](#) tables.

#### 14.6.1.1 Creating InnoDB Tables

[InnoDB](#) tables are created using the `CREATE TABLE` statement; for example:

```
CREATE TABLE t1 (a INT, b CHAR (20), PRIMARY KEY (a)) ENGINE=InnoDB;
```

The `ENGINE=InnoDB` clause is not required when [InnoDB](#) is defined as the default storage engine, which it is by default. However, the `ENGINE` clause is useful if the `CREATE TABLE` statement is to be replayed on a different MySQL Server instance where the default storage engine is not [InnoDB](#) or is unknown. You can determine the default storage engine on a MySQL Server instance by issuing the following statement:

```
mysql> SELECT @@default_storage_engine;
+-----+
| @@default_storage_engine |
+-----+
| InnoDB                   |
+-----+
```

[InnoDB](#) tables are created in file-per-table tablespaces by default. To create an [InnoDB](#) table in the [InnoDB](#) system tablespace, disable the `innodb_file_per_table` variable before creating the table. To create an [InnoDB](#) table in a general tablespace, use `CREATE TABLE ... TABLESPACE` syntax. For more information, see [Section 14.6.3, “Tablespaces”](#).

### .frm Files



MySQL stores data dictionary information for tables in [.frm files](#) in database directories. Unlike other MySQL storage engines, [InnoDB](#) also encodes information about the table in its own internal data dictionary inside the system tablespace. When MySQL drops a table or a database, it deletes one or more [.frm files](#) as well as the corresponding entries inside the [InnoDB](#) data dictionary. You cannot move [InnoDB](#) tables between databases simply by moving the [.frm files](#). For information about moving [InnoDB](#) tables, see [Section 14.6.1.4, “Moving or Copying InnoDB Tables”](#).

## Row Formats

The row format of an [InnoDB](#) table determines how its rows are physically stored on disk. [InnoDB](#) supports four row formats, each with different storage characteristics. Supported row formats include [REDUNDANT](#), [COMPACT](#), [DYNAMIC](#), and [COMPRESSED](#). The [DYNAMIC](#) row format is the default. For information about row format characteristics, see [Section 14.11, “InnoDB Row Formats”](#).

The `innodb_default_row_format` variable defines the default row format. The row format of a table can also be defined explicitly using the `ROW_FORMAT` table option in a `CREATE TABLE` or `ALTER TABLE` statement. See [Defining the Row Format of a Table](#).

## Primary Keys

It is recommended that you define a primary key for each table that you create. When selecting primary key columns, choose columns with the following characteristics:

- Columns that are referenced by the most important queries.
- Columns that are never left blank.
- Columns that never have duplicate values.
- Columns that rarely if ever change value once inserted.

For example, in a table containing information about people, you would not create a primary key on `(firstname, lastname)` because more than one person can have the same name, a name column may be left blank, and sometimes people change their names. With so many constraints, often there is not an obvious set of columns to use as a primary key, so you create a new column with a numeric ID to serve as all or part of the primary key. You can declare an [auto-increment](#) column so that ascending values are filled in automatically as rows are inserted:

```
# The value of ID can act like a pointer between related items in different tables.
CREATE TABLE t5 (id INT AUTO_INCREMENT, b CHAR (20), PRIMARY KEY (id));

# The primary key can consist of more than one column. Any autoinc column must come first.
CREATE TABLE t6 (id INT AUTO_INCREMENT, a INT, b CHAR (20), PRIMARY KEY (id,a));
```

For more information about auto-increment columns, see [Section 14.6.1.6, “AUTO\\_INCREMENT Handling in InnoDB”](#).

Although a table works correctly without defining a primary key, the primary key is involved with many aspects of performance and is a crucial design aspect for any large or frequently used table. It is recommended that you always specify a primary key in the `CREATE TABLE` statement. If you create the table, load data, and then run `ALTER TABLE` to add a primary key later, that operation is much slower than defining the primary key when creating the table. For more information about primary keys, see [Section 14.6.2.1, “Clustered and Secondary Indexes”](#).

## Viewing InnoDB Table Properties

To view the properties of an [InnoDB](#) table, issue a `SHOW TABLE STATUS` statement:

```
mysql> SHOW TABLE STATUS FROM test LIKE 't%' \G;
```

```

***** 1. row *****
      Name: t1
      Engine: InnoDB
      Version: 10
      Row_format: Dynamic
      Rows: 0
      Avg_row_length: 0
      Data_length: 16384
      Max_data_length: 0
      Index_length: 0
      Data_free: 0
      Auto_increment: NULL
      Create_time: 2021-02-18 12:18:28
      Update_time: NULL
      Check_time: NULL
      Collation: utf8mb4_0900_ai_ci
      Checksum: NULL
      Create_options:
      Comment:

```

For information about `SHOW TABLE STATUS` output, see [Section 13.7.5.36, “SHOW TABLE STATUS Statement”](#).

You can also access InnoDB table properties by querying the InnoDB Information Schema system tables:

```

mysql> SELECT * FROM INFORMATION_SCHEMA.INNO_DB_SYS_TABLES WHERE NAME='test/t1' \G
***** 1. row *****
      TABLE_ID: 45
      NAME: test/t1
      FLAG: 1
      N_COLS: 5
      SPACE: 35
      FILE_FORMAT: Barracuda
      ROW_FORMAT: Dynamic
      ZIP_PAGE_SIZE: 0
      SPACE_TYPE: Single

```

For more information, see [Section 14.16.3, “InnoDB INFORMATION\\_SCHEMA System Tables”](#).

### 14.6.1.2 Creating Tables Externally

There are different reasons for creating InnoDB tables externally; that is, creating tables outside of the data directory. Those reasons might include space management, I/O optimization, or placing tables on a storage device with particular performance or capacity characteristics, for example.

InnoDB supports the following methods for creating tables externally:

- [Using the DATA DIRECTORY Clause](#)
- [Using CREATE TABLE ... TABLESPACE Syntax](#)
- [Creating a Table in an External General Tablespace](#)

#### Using the DATA DIRECTORY Clause

You can create an InnoDB table in an external directory by specifying a `DATA DIRECTORY` clause in the `CREATE TABLE` statement.

```
CREATE TABLE t1 (c1 INT PRIMARY KEY) DATA DIRECTORY = '/external/directory';
```

The `DATA DIRECTORY` clause is supported for tables created in file-per-table tablespaces. Tables are implicitly created in file-per-table tablespaces when the `innodb_file_per_table` variable is enabled, which it is by default.

```
mysql> SELECT @@innodb_file_per_table;
+-----+
| @@innodb_file_per_table |
+-----+
|                          1 |
+-----+
```

For more information about file-per-table tablespaces, see [Section 14.6.3.2, “File-Per-Table Tablespaces”](#).

Be sure of the directory location you choose, as the `DATA DIRECTORY` clause cannot be used with `ALTER TABLE` to change the location later.

When you specify a `DATA DIRECTORY` clause in a `CREATE TABLE` statement, the table's data file (`table_name.ibd`) is created in a schema directory under the specified directory, and an `.isl` file (`table_name.isl`) that contains the data file path is created in the schema directory under the MySQL data directory. An `.isl` file is similar in function to a symbolic link. (Actual [symbolic links](#) are not supported for use with `InnoDB` data files.)

The following example demonstrates creating a table in an external directory using the `DATA DIRECTORY` clause. It is assumed that the `innodb_file_per_table` variable is enabled.

```
mysql> USE test;
Database changed

mysql> CREATE TABLE t1 (c1 INT PRIMARY KEY) DATA DIRECTORY = '/external/directory';

# MySQL creates the table's data file in a schema directory
# under the external directory

$> cd /external/directory/test
$> ls
t1.ibd

# An .isl file that contains the data file path is created
# in the schema directory under the MySQL data directory

$> cd /path/to/mysql/data/test
$> ls
db.opt t1.frm t1.isl
```

### Usage Notes:

- MySQL initially holds the tablespace data file open, preventing you from dismounting the device, but might eventually close the file if the server is busy. Be careful not to accidentally dismount an external device while MySQL is running, or start MySQL while the device is disconnected. Attempting to access a table when the associated data file is missing causes a serious error that requires a server restart.

A server restart might fail if the data file is not found at the expected path. In this case, manually remove the `.isl` file from the schema directory. After restarting, drop the table to remove the `.frm` file and the information about the table from the [data dictionary](#).

- Before placing a table on an NFS-mounted volume, review potential issues outlined in [Using NFS with MySQL](#).
- If using an LVM snapshot, file copy, or other file-based mechanism to back up the table's data file, always use the `FLUSH TABLES ... FOR EXPORT` statement first to ensure that all changes buffered in memory are [flushed](#) to disk before the backup occurs.
- Using the `DATA DIRECTORY` clause to create a table in an external directory is an alternative to using [symbolic links](#), which `InnoDB` does not support.

- The `DATA DIRECTORY` clause is not supported in a replication environment where the source and replica reside on the same host. The `DATA DIRECTORY` clause requires a full directory path. Replicating the path in this case would cause the source and replica to create the table in same location.

## Using CREATE TABLE ... TABLESPACE Syntax

`CREATE TABLE ... TABLESPACE` syntax can be used in combination with the `DATA DIRECTORY` clause to create a table in an external directory. To do so, specify `innodb_file_per_table` as the tablespace name.

```
mysql> CREATE TABLE t2 (c1 INT PRIMARY KEY) TABLESPACE = innodb_file_per_table
DATA DIRECTORY = '/external/directory';
```

This method is supported only for tables created in file-per-table tablespaces, but does not require the `innodb_file_per_table` variable to be enabled. In all other respects, this method is equivalent to the `CREATE TABLE ... DATA DIRECTORY` method described above. The same usage notes apply.

## Creating a Table in an External General Tablespace

You can create a table in a general tablespace that resides in an external directory.

- For information about creating a general tablespace in an external directory, see [Creating a General Tablespace](#).
- For information about creating a table in a general tablespace, see [Adding Tables to a General Tablespace](#).

### 14.6.1.3 Importing InnoDB Tables

This section describes how to import tables using the *Transportable Tablespaces* feature, which permits importing tables, partitioned tables, or individual table partitions that reside in file-per-table tablespaces. There are many reasons why you might want to import tables:

- To run reports on a non-production MySQL server instance to avoid placing extra load on a production server.
- To copy data to a new replica server.
- To restore a table from a backed-up tablespace file.
- As a faster way of moving data than importing a dump file, which requires reinserting data and rebuilding indexes.
- To move a data to a server with storage media that is better suited to your storage requirements. For example, you might move busy tables to an SSD device, or move large tables to a high-capacity HDD device.

The *Transportable Tablespaces* feature is described under the following topics in this section:

- [Prerequisites](#)
- [Importing Tables](#)
- [Importing Partitioned Tables](#)
- [Importing Table Partitions](#)
- [Limitations](#)
- [Usage Notes](#)

- [Internals](#)

## Prerequisites

- The `innodb_file_per_table` variable must be enabled, which it is by default.
- The page size of the tablespace must match the page size of the destination MySQL server instance. InnoDB page size is defined by the `innodb_page_size` variable, which is configured when initializing a MySQL server instance.
- If the table has a foreign key relationship, `foreign_key_checks` must be disabled before executing `DISCARD TABLESPACE`. Also, you should export all foreign key related tables at the same logical point in time, as `ALTER TABLE ... IMPORT TABLESPACE` does not enforce foreign key constraints on imported data. To do so, stop updating the related tables, commit all transactions, acquire shared locks on the tables, and perform the export operations.
- When importing a table from another MySQL server instance, both MySQL server instances must have General Availability (GA) status and must be the same version. Otherwise, the table must be created on the same MySQL server instance into which it is being imported.
- If the table was created in an external directory by specifying the `DATA DIRECTORY` clause in the `CREATE TABLE` statement, the table that you replace on the destination instance must be defined with the same `DATA DIRECTORY` clause. A schema mismatch error is reported if the clauses do not match. To determine if the source table was defined with a `DATA DIRECTORY` clause, use `SHOW CREATE TABLE` to view the table definition. For information about using the `DATA DIRECTORY` clause, see [Section 14.6.1.2, “Creating Tables Externally”](#).
- If a `ROW_FORMAT` option is not defined explicitly in the table definition or `ROW_FORMAT=DEFAULT` is used, the `innodb_default_row_format` setting must be the same on the source and destination instances. Otherwise, a schema mismatch error is reported when you attempt the import operation. Use `SHOW CREATE TABLE` to check the table definition. Use `SHOW VARIABLES` to check the `innodb_default_row_format` setting. For related information, see [Defining the Row Format of a Table](#).

## Importing Tables

This example demonstrates how to import a regular non-partitioned table that resides in a file-per-table tablespace.

1. On the destination instance, create a table with the same definition as the table you intend to import. (You can obtain the table definition using `SHOW CREATE TABLE` syntax.) If the table definition does not match, a schema mismatch error is reported when you attempt the import operation.

```
mysql> USE test;
mysql> CREATE TABLE t1 (c1 INT) ENGINE=INNODB;
```

2. On the destination instance, discard the tablespace of the table that you just created. (Before importing, you must discard the tablespace of the receiving table.)

```
mysql> ALTER TABLE t1 DISCARD TABLESPACE;
```

3. On the source instance, run `FLUSH TABLES ... FOR EXPORT` to quiesce the table you intend to import. When a table is quiesced, only read-only transactions are permitted on the table.

```
mysql> USE test;
mysql> FLUSH TABLES t1 FOR EXPORT;
```

`FLUSH TABLES ... FOR EXPORT` ensures that changes to the named table are flushed to disk so that a binary table copy can be made while the server is running. When `FLUSH TABLES ... FOR`

`EXPORT` is run, InnoDB generates a `.cfg` metadata file in the schema directory of the table. The `.cfg` file contains metadata that is used for schema verification during the import operation.



#### Note

The connection executing `FLUSH TABLES ... FOR EXPORT` must remain open while the operation is running; otherwise, the `.cfg` file is removed as locks are released upon connection closure.

- Copy the `.ibd` file and `.cfg` metadata file from the source instance to the destination instance. For example:

```
$> scp /path/to/datadir/test/t1.{ibd,cfg} destination-server:/path/to/datadir/test
```

The `.ibd` file and `.cfg` file must be copied before releasing the shared locks, as described in the next step.



#### Note

If you are importing a table from an encrypted tablespace, InnoDB generates a `.cfp` file in addition to a `.cfg` metadata file. The `.cfp` file must be copied to the destination instance together with the `.cfg` file. The `.cfp` file contains a transfer key and an encrypted tablespace key. On import, InnoDB uses the transfer key to decrypt the tablespace key. For related information, see [Section 14.14, “InnoDB Data-at-Rest Encryption”](#).

- On the source instance, use `UNLOCK TABLES` to release the locks acquired by the `FLUSH TABLES ... FOR EXPORT` statement:

```
mysql> USE test;
mysql> UNLOCK TABLES;
```

The `UNLOCK TABLES` operation also removes the `.cfg` file.

- On the destination instance, import the tablespace:

```
mysql> USE test;
mysql> ALTER TABLE t1 IMPORT TABLESPACE;
```

## Importing Partitioned Tables

This example demonstrates how to import a partitioned table, where each table partition resides in a file-per-table tablespace.

- On the destination instance, create a partitioned table with the same definition as the partitioned table that you want to import. (You can obtain the table definition using `SHOW CREATE TABLE` syntax.) If the table definition does not match, a schema mismatch error is reported when you attempt the import operation.

```
mysql> USE test;
mysql> CREATE TABLE t1 (i int) ENGINE = InnoDB PARTITION BY KEY (i) PARTITIONS 3;
```

In the `/datadir/test` directory, there is a tablespace `.ibd` file for each of the three partitions.

```
mysql> \! ls /path/to/datadir/test/
db.opt  t1.frm  t1#P#p0.ibd  t1#P#p1.ibd  t1#P#p2.ibd
```

- On the destination instance, discard the tablespace for the partitioned table. (Before the import operation, you must discard the tablespace of the receiving table.)

```
mysql> ALTER TABLE t1 DISCARD TABLESPACE;
```

The three tablespace `.ibd` files of the partitioned table are discarded from the `/datadir/test` directory, leaving the following files:

```
mysql> \! ls /path/to/datadir/test/
db.opt  t1.frm
```

3. On the source instance, run `FLUSH TABLES ... FOR EXPORT` to quiesce the partitioned table that you intend to import. When a table is quiesced, only read-only transactions are permitted on the table.

```
mysql> USE test;
mysql> FLUSH TABLES t1 FOR EXPORT;
```

`FLUSH TABLES ... FOR EXPORT` ensures that changes to the named table are flushed to disk so that binary table copy can be made while the server is running. When `FLUSH TABLES ... FOR EXPORT` is run, InnoDB generates `.cfg` metadata files in the schema directory of the table for each of the table's tablespace files.

```
mysql> \! ls /path/to/datadir/test/
db.opt  t1#P#p0.ibd  t1#P#p1.ibd  t1#P#p2.ibd
t1.frm  t1#P#p0.cfg  t1#P#p1.cfg  t1#P#p2.cfg
```

The `.cfg` files contain metadata that is used for schema verification when importing the tablespace. `FLUSH TABLES ... FOR EXPORT` can only be run on the table, not on individual table partitions.

4. Copy the `.ibd` and `.cfg` files from the source instance schema directory to the destination instance schema directory. For example:

```
$>scp /path/to/datadir/test/t1*.{ibd,cfg} destination-server:/path/to/datadir/test
```

The `.ibd` and `.cfg` files must be copied before releasing the shared locks, as described in the next step.



#### Note

If you are importing a table from an encrypted tablespace, InnoDB generates a `.cfp` files in addition to a `.cfg` metadata files. The `.cfp` files must be copied to the destination instance together with the `.cfg` files. The `.cfp` files contain a transfer key and an encrypted tablespace key. On import, InnoDB uses the transfer key to decrypt the tablespace key. For related information, see [Section 14.14, “InnoDB Data-at-Rest Encryption”](#).

5. On the source instance, use `UNLOCK TABLES` to release the locks acquired by `FLUSH TABLES ... FOR EXPORT`:

```
mysql> USE test;
mysql> UNLOCK TABLES;
```

6. On the destination instance, import the tablespace of the partitioned table:

```
mysql> USE test;
mysql> ALTER TABLE t1 IMPORT TABLESPACE;
```

## Importing Table Partitions

This example demonstrates how to import individual table partitions, where each partition resides in a file-per-table tablespace file.

In the following example, two partitions (`p2` and `p3`) of a four-partition table are imported.

1. On the destination instance, create a partitioned table with the same definition as the partitioned table that you want to import partitions from. (You can obtain the table definition using `SHOW CREATE TABLE` syntax.) If the table definition does not match, a schema mismatch error is reported when you attempt the import operation.

```
mysql> USE test;
mysql> CREATE TABLE t1 (i int) ENGINE = InnoDB PARTITION BY KEY (i) PARTITIONS 4;
```

In the `/datadir/test` directory, there is a tablespace `.ibd` file for each of the four partitions.

```
mysql> \! ls /path/to/datadir/test/
db.opt  t1.frm  t1#P#p0.ibd  t1#P#p1.ibd  t1#P#p2.ibd  t1#P#p3.ibd
```

2. On the destination instance, discard the partitions that you intend to import from the source instance. (Before importing partitions, you must discard the corresponding partitions from the receiving partitioned table.)

```
mysql> ALTER TABLE t1 DISCARD PARTITION p2, p3 TABLESPACE;
```

The tablespace `.ibd` files for the two discarded partitions are removed from the `/datadir/test` directory on the destination instance, leaving the following files:

```
mysql> \! ls /path/to/datadir/test/
db.opt  t1.frm  t1#P#p0.ibd  t1#P#p1.ibd
```



#### Note

When `ALTER TABLE ... DISCARD PARTITION ... TABLESPACE` is run on subpartitioned tables, both partition and subpartition table names are permitted. When a partition name is specified, subpartitions of that partition are included in the operation.

3. On the source instance, run `FLUSH TABLES ... FOR EXPORT` to quiesce the partitioned table. When a table is quiesced, only read-only transactions are permitted on the table.

```
mysql> USE test;
mysql> FLUSH TABLES t1 FOR EXPORT;
```

`FLUSH TABLES ... FOR EXPORT` ensures that changes to the named table are flushed to disk so that binary table copy can be made while the instance is running. When `FLUSH TABLES ... FOR EXPORT` is run, InnoDB generates a `.cfg` metadata file for each of the table's tablespace files in the schema directory of the table.

```
mysql> \! ls /path/to/datadir/test/
db.opt  t1#P#p0.ibd  t1#P#p1.ibd  t1#P#p2.ibd  t1#P#p3.ibd
t1.frm  t1#P#p0.cfg  t1#P#p1.cfg  t1#P#p2.cfg  t1#P#p3.cfg
```

The `.cfg` files contain metadata that used for schema verification during the import operation. `FLUSH TABLES ... FOR EXPORT` can only be run on the table, not on individual table partitions.



- Copy the `.ibd` and `.cfg` files for partition `p2` and partition `p3` from the source instance schema directory to the destination instance schema directory.

```
$> scp t1#P#p2.ibd t1#P#p2.cfg t1#P#p3.ibd t1#P#p3.cfg destination-server:/path/to/datadir/test
```

The `.ibd` and `.cfg` files must be copied before releasing the shared locks, as described in the next step.



#### Note

If you are importing partitions from an encrypted tablespace, `InnoDB` generates a `.cfp` files in addition to a `.cfg` metadata files. The `.cfp` files must be copied to the destination instance together with the `.cfg` files. The `.cfp` files contain a transfer key and an encrypted tablespace key. On import, `InnoDB` uses the transfer key to decrypt the tablespace key. For related information, see [Section 14.14, “InnoDB Data-at-Rest Encryption”](#).

- On the source instance, use `UNLOCK TABLES` to release the locks acquired by `FLUSH TABLES ... FOR EXPORT`:

```
mysql> USE test;
mysql> UNLOCK TABLES;
```

- On the destination instance, import table partitions `p2` and `p3`:

```
mysql> USE test;
mysql> ALTER TABLE t1 IMPORT PARTITION p2, p3 TABLESPACE;
```



#### Note

When `ALTER TABLE ... IMPORT PARTITION ... TABLESPACE` is run on subpartitioned tables, both partition and subpartition table names are permitted. When a partition name is specified, subpartitions of that partition are included in the operation.

## Limitations

- The *Transportable Tablespaces* feature is only supported for tables that reside in file-per-table tablespaces. It is not supported for the tables that reside in the system tablespace or general tablespaces. Tables in shared tablespaces cannot be quiesced.
- `FLUSH TABLES ... FOR EXPORT` is not supported on tables with a `FULLTEXT` index, as full-text search auxiliary tables cannot be flushed. After importing a table with a `FULLTEXT` index, run `OPTIMIZE TABLE` to rebuild the `FULLTEXT` indexes. Alternatively, drop `FULLTEXT` indexes before the export operation and recreate the indexes after importing the table on the destination instance.
- Due to a `.cfg` metadata file limitation, schema mismatches are not reported for partition type or partition definition differences when importing a partitioned table. Column differences are reported.

## Usage Notes

- `ALTER TABLE ... IMPORT TABLESPACE` does not require a `.cfg` metadata file to import a table. However, metadata checks are not performed when importing without a `.cfg` file, and a warning similar to the following is issued:

```
Message: InnoDB: IO Read error: (2, No such file or directory) Error opening './\
test\t.cfg', will attempt to import without schema verification
1 row in set (0.00 sec)
```

Importing a table without a `.cfg` metadata file should only be considered if no schema mismatches are expected. The ability to import without a `.cfg` file could be useful in crash recovery scenarios where metadata is not accessible.

- On Windows, InnoDB stores database, tablespace, and table names internally in lowercase. To avoid import problems on case-sensitive operating systems such as Linux and Unix, create all databases, tablespaces, and tables using lowercase names. A convenient way to accomplish this is to add `lower_case_table_names=1` to the `[mysqld]` section of your `my.cnf` or `my.ini` file before creating databases, tablespaces, or tables:

```
[mysqld]
lower_case_table_names=1
```

- When running `ALTER TABLE ... DISCARD PARTITION ... TABLESPACE` and `ALTER TABLE ... IMPORT PARTITION ... TABLESPACE` on subpartitioned tables, both partition and subpartition table names are permitted. When a partition name is specified, subpartitions of that partition are included in the operation.

## Internals

The following information describes internals and messages written to the error log during a table import procedure.

When `ALTER TABLE ... DISCARD TABLESPACE` is run on the destination instance:

- The table is locked in X mode.
- The tablespace is detached from the table.

When `FLUSH TABLES ... FOR EXPORT` is run on the source instance:

- The table being flushed for export is locked in shared mode.
- The purge coordinator thread is stopped.
- Dirty pages are synchronized to disk.
- Table metadata is written to the binary `.cfg` file.

Expected error log messages for this operation:

```
[Note] InnoDB: Sync to disk of "test"."t1" started.
[Note] InnoDB: Stopping purge
[Note] InnoDB: Writing table metadata to './test/t1.cfg'
[Note] InnoDB: Table "test"."t1" flushed to disk
```

When `UNLOCK TABLES` is run on the source instance:

- The binary `.cfg` file is deleted.
- The shared lock on the table or tables being imported is released and the purge coordinator thread is restarted.

Expected error log messages for this operation:

```
[Note] InnoDB: Deleting the meta-data file './test/t1.cfg'
[Note] InnoDB: Resuming purge
```

When `ALTER TABLE ... IMPORT TABLESPACE` is run on the destination instance, the import algorithm performs the following operations for each tablespace being imported:

- Each tablespace page is checked for corruption.
- The space ID and log sequence numbers (LSNs) on each page are updated.
- Flags are validated and LSN updated for the header page.
- Btree pages are updated.
- The page state is set to dirty so that it is written to disk.

Expected error log messages for this operation:

```
[Note] InnoDB: Importing tablespace for table 'test/t1' that was exported
from host 'host_name'
[Note] InnoDB: Phase I - Update all pages
[Note] InnoDB: Sync to disk
[Note] InnoDB: Sync to disk - done!
[Note] InnoDB: Phase III - Flush changes to disk
[Note] InnoDB: Phase IV - Flush complete
```



### Note

You may also receive a warning that a tablespace is discarded (if you discarded the tablespace for the destination table) and a message stating that statistics could not be calculated due to a missing `.ibd` file:

```
[Warning] InnoDB: Table "test"."t1" tablespace is set as discarded.
7f34d9a37700 InnoDB: cannot calculate statistics for table
"test"."t1" because the .ibd file is missing. For help, please refer to
http://dev.mysql.com/doc/refman/5.7/en/innodb-troubleshooting.html
```

## 14.6.1.4 Moving or Copying InnoDB Tables

This section describes techniques for moving or copying some or all [InnoDB](#) tables to a different server or instance. For example, you might move an entire MySQL instance to a larger, faster server; you might clone an entire MySQL instance to a new replica server; you might copy individual tables to another instance to develop and test an application, or to a data warehouse server to produce reports.

On Windows, [InnoDB](#) always stores database and table names internally in lowercase. To move databases in a binary format from Unix to Windows or from Windows to Unix, create all databases and tables using lowercase names. A convenient way to accomplish this is to add the following line to the `[mysqld]` section of your `my.cnf` or `my.ini` file before creating any databases or tables:

```
[mysqld]
lower_case_table_names=1
```

Techniques for moving or copying [InnoDB](#) tables include:

- [Importing Tables](#)
- [MySQL Enterprise Backup](#)
- [Copying Data Files \(Cold Backup Method\)](#)
- [Restoring from a Logical Backup](#)

### Importing Tables

A table that resides in a file-per-table tablespace can be imported from another MySQL server instance or from a backup using the *Transportable Tablespace* feature. See [Section 14.6.1.3, “Importing InnoDB Tables”](#).

## MySQL Enterprise Backup

The MySQL Enterprise Backup product lets you back up a running MySQL database with minimal disruption to operations while producing a consistent snapshot of the database. When MySQL Enterprise Backup is copying tables, reads and writes can continue. In addition, MySQL Enterprise Backup can create compressed backup files, and back up subsets of tables. In conjunction with the MySQL binary log, you can perform point-in-time recovery. MySQL Enterprise Backup is included as part of the MySQL Enterprise subscription.

For more details about MySQL Enterprise Backup, see [Section 28.1, “MySQL Enterprise Backup Overview”](#).

### Copying Data Files (Cold Backup Method)

You can move an [InnoDB](#) database simply by copying all the relevant files listed under “Cold Backups” in [Section 14.19.1, “InnoDB Backup”](#).

[InnoDB](#) data and log files are binary-compatible on all platforms having the same floating-point number format. If the floating-point formats differ but you have not used [FLOAT](#) or [DOUBLE](#) data types in your tables, then the procedure is the same: simply copy the relevant files.

When you move or copy file-per-table [.ibd](#) files, the database directory name must be the same on the source and destination systems. The table definition stored in the [InnoDB](#) shared tablespace includes the database name. The transaction IDs and log sequence numbers stored in the tablespace files also differ between databases.

To move an [.ibd](#) file and the associated table from one database to another, use a [RENAME TABLE](#) statement:

```
RENAME TABLE db1.tbl_name TO db2.tbl_name;
```

If you have a “clean” backup of an [.ibd](#) file, you can restore it to the MySQL installation from which it originated as follows:

1. The table must not have been dropped or truncated since you copied the [.ibd](#) file, because doing so changes the table ID stored inside the tablespace.
2. Issue this [ALTER TABLE](#) statement to delete the current [.ibd](#) file:

```
ALTER TABLE tbl_name DISCARD TABLESPACE;
```

3. Copy the backup [.ibd](#) file to the proper database directory.
4. Issue this [ALTER TABLE](#) statement to tell [InnoDB](#) to use the new [.ibd](#) file for the table:

```
ALTER TABLE tbl_name IMPORT TABLESPACE;
```



#### Note

The [ALTER TABLE ... IMPORT TABLESPACE](#) feature does not enforce foreign key constraints on imported data.

In this context, a “clean” [.ibd](#) file backup is one for which the following requirements are satisfied:

- There are no uncommitted modifications by transactions in the [.ibd](#) file.
- There are no unmerged insert buffer entries in the [.ibd](#) file.
- Purge has removed all delete-marked index records from the [.ibd](#) file.

- `mysqld` has flushed all modified pages of the `.ibd` file from the buffer pool to the file.

You can make a clean backup `.ibd` file using the following method:

1. Stop all activity from the `mysqld` server and commit all transactions.
2. Wait until `SHOW ENGINE INNODB STATUS` shows that there are no active transactions in the database, and the main thread status of InnoDB is `Waiting for server activity`. Then you can make a copy of the `.ibd` file.

Another method for making a clean copy of an `.ibd` file is to use the MySQL Enterprise Backup product:

1. Use MySQL Enterprise Backup to back up the InnoDB installation.
2. Start a second `mysqld` server on the backup and let it clean up the `.ibd` files in the backup.

## Restoring from a Logical Backup

You can use a utility such as `mysqldump` to perform a logical backup, which produces a set of SQL statements that can be executed to reproduce the original database object definitions and table data for transfer to another SQL server. Using this method, it does not matter whether the formats differ or if your tables contain floating-point data.

To improve the performance of this method, disable `autocommit` when importing data. Perform a commit only after importing an entire table or segment of a table.

### 14.6.1.5 Converting Tables from MyISAM to InnoDB

If you have `MyISAM` tables that you want to convert to `InnoDB` for better reliability and scalability, review the following guidelines and tips before converting.

- [Adjusting Memory Usage for MyISAM and InnoDB](#)
- [Handling Too-Long Or Too-Short Transactions](#)
- [Handling Deadlocks](#)
- [Storage Layout](#)
- [Converting an Existing Table](#)
- [Cloning the Structure of a Table](#)
- [Transferring Data](#)
- [Storage Requirements](#)
- [Defining Primary Keys](#)
- [Application Performance Considerations](#)
- [Understanding Files Associated with InnoDB Tables](#)

## Adjusting Memory Usage for MyISAM and InnoDB

As you transition away from `MyISAM` tables, lower the value of the `key_buffer_size` configuration option to free memory no longer needed for caching results. Increase the value of the `innodb_buffer_pool_size` configuration option, which performs a similar role of allocating cache memory for `InnoDB` tables. The `InnoDB` buffer pool caches both table data and index data, speeding up lookups for queries and keeping query results in memory for reuse. For guidance regarding buffer pool size configuration, see [Section 8.12.4.1, “How MySQL Uses Memory”](#).

---

On a busy server, run benchmarks with the query cache turned off. The [InnoDB](#) buffer pool provides similar benefits, so the query cache might be tying up memory unnecessarily. For information about the query cache, see [Section 8.10.3, “The MySQL Query Cache”](#).

## Handling Too-Long Or Too-Short Transactions

Because [MyISAM](#) tables do not support [transactions](#), you might not have paid much attention to the [autocommit](#) configuration option and the [COMMIT](#) and [ROLLBACK](#) statements. These keywords are important to allow multiple sessions to read and write [InnoDB](#) tables concurrently, providing substantial scalability benefits in write-heavy workloads.

While a transaction is open, the system keeps a snapshot of the data as seen at the beginning of the transaction, which can cause substantial overhead if the system inserts, updates, and deletes millions of rows while a stray transaction keeps running. Thus, take care to avoid transactions that run for too long:

- If you are using a [mysql](#) session for interactive experiments, always [COMMIT](#) (to finalize the changes) or [ROLLBACK](#) (to undo the changes) when finished. Close down interactive sessions rather than leave them open for long periods, to avoid keeping transactions open for long periods by accident.
- Make sure that any error handlers in your application also [ROLLBACK](#) incomplete changes or [COMMIT](#) completed changes.
- [ROLLBACK](#) is a relatively expensive operation, because [INSERT](#), [UPDATE](#), and [DELETE](#) operations are written to [InnoDB](#) tables prior to the [COMMIT](#), with the expectation that most changes are committed successfully and rollbacks are rare. When experimenting with large volumes of data, avoid making changes to large numbers of rows and then rolling back those changes.
- When loading large volumes of data with a sequence of [INSERT](#) statements, periodically [COMMIT](#) the results to avoid having transactions that last for hours. In typical load operations for data warehousing, if something goes wrong, you truncate the table (using [TRUNCATE TABLE](#)) and start over from the beginning rather than doing a [ROLLBACK](#).

The preceding tips save memory and disk space that can be wasted during too-long transactions. When transactions are shorter than they should be, the problem is excessive I/O. With each [COMMIT](#), MySQL makes sure each change is safely recorded to disk, which involves some I/O.

- For most operations on [InnoDB](#) tables, you should use the setting [autocommit=0](#). From an efficiency perspective, this avoids unnecessary I/O when you issue large numbers of consecutive [INSERT](#), [UPDATE](#), or [DELETE](#) statements. From a safety perspective, this allows you to issue a [ROLLBACK](#) statement to recover lost or garbled data if you make a mistake on the [mysql](#) command line, or in an exception handler in your application.
- [autocommit=1](#) is suitable for [InnoDB](#) tables when running a sequence of queries for generating reports or analyzing statistics. In this situation, there is no I/O penalty related to [COMMIT](#) or [ROLLBACK](#), and [InnoDB](#) can [automatically optimize the read-only workload](#).
- If you make a series of related changes, finalize all the changes at once with a single [COMMIT](#) at the end. For example, if you insert related pieces of information into several tables, do a single [COMMIT](#) after making all the changes. Or if you run many consecutive [INSERT](#) statements, do a single [COMMIT](#) after all the data is loaded; if you are doing millions of [INSERT](#) statements, perhaps split up the huge transaction by issuing a [COMMIT](#) every ten thousand or hundred thousand records, so the transaction does not grow too large.
- Remember that even a [SELECT](#) statement opens a transaction, so after running some report or debugging queries in an interactive [mysql](#) session, either issue a [COMMIT](#) or close the [mysql](#) session.

For related information, see [Section 14.7.2.2, “autocommit, Commit, and Rollback”](#).

## Handling Deadlocks

You might see warning messages referring to “deadlocks” in the MySQL error log, or the output of `SHOW ENGINE INNODB STATUS`. A **deadlock** is not a serious issue for **InnoDB** tables, and often does not require any corrective action. When two transactions start modifying multiple tables, accessing the tables in a different order, they can reach a state where each transaction is waiting for the other and neither can proceed. When **deadlock detection** is enabled (the default), MySQL immediately detects this condition and cancels (**rolls back**) the “smaller” transaction, allowing the other to proceed. If deadlock detection is disabled using the `innodb_deadlock_detect` configuration option, **InnoDB** relies on the `innodb_lock_wait_timeout` setting to roll back transactions in case of a deadlock.

Either way, your applications need error-handling logic to restart a transaction that is forcibly cancelled due to a deadlock. When you re-issue the same SQL statements as before, the original timing issue no longer applies. Either the other transaction has already finished and yours can proceed, or the other transaction is still in progress and your transaction waits until it finishes.

If deadlock warnings occur constantly, you might review the application code to reorder the SQL operations in a consistent way, or to shorten the transactions. You can test with the `innodb_print_all_deadlocks` option enabled to see all deadlock warnings in the MySQL error log, rather than only the last warning in the `SHOW ENGINE INNODB STATUS` output.

For more information, see [Section 14.7.5, “Deadlocks in InnoDB”](#).

## Storage Layout

To get the best performance from **InnoDB** tables, you can adjust a number of parameters related to storage layout.

When you convert **MyISAM** tables that are large, frequently accessed, and hold vital data, investigate and consider the `innodb_file_per_table`, `innodb_file_format`, and `innodb_page_size` variables, and the `ROW_FORMAT` and `KEY_BLOCK_SIZE` clauses of the `CREATE TABLE` statement.

During your initial experiments, the most important setting is `innodb_file_per_table`. When this setting is enabled, which is the default as of MySQL 5.6.6, new **InnoDB** tables are implicitly created in **file-per-table** tablespaces. In contrast with the **InnoDB** system tablespace, file-per-table tablespaces allow disk space to be reclaimed by the operating system when a table is truncated or dropped. File-per-table tablespaces also support the **Barracuda** file format and associated features such as table compression, efficient off-page storage for long variable-length columns, and large index prefixes. For more information, see [Section 14.6.3.2, “File-Per-Table Tablespaces”](#).

You can also store **InnoDB** tables in a shared general tablespace. General tablespaces support the **Barracuda** file format and can contain multiple tables. For more information, see [Section 14.6.3.3, “General Tablespaces”](#).

## Converting an Existing Table

To convert a non-**InnoDB** table to use **InnoDB** use `ALTER TABLE`:

```
ALTER TABLE table_name ENGINE=InnoDB;
```



### Warning

Do *not* convert MySQL system tables in the `mysql` database from **MyISAM** to **InnoDB** tables. This is an unsupported operation. If you do this, MySQL does not restart until you restore the old system tables from a backup or regenerate them by reinitializing the data directory (see [Section 2.9.1, “Initializing the Data Directory”](#)).

## Cloning the Structure of a Table

You might make an `InnoDB` table that is a clone of a `MyISAM` table, rather than using `ALTER TABLE` to perform conversion, to test the old and new table side-by-side before switching.

Create an empty `InnoDB` table with identical column and index definitions. Use `SHOW CREATE TABLE table_name\G` to see the full `CREATE TABLE` statement to use. Change the `ENGINE` clause to `ENGINE=INNODB`.

## Transferring Data

To transfer a large volume of data into an empty `InnoDB` table created as shown in the previous section, insert the rows with `INSERT INTO innodb_table SELECT * FROM myisam_table ORDER BY primary_key_columns`.

You can also create the indexes for the `InnoDB` table after inserting the data. Historically, creating new secondary indexes was a slow operation for `InnoDB`, but now you can create the indexes after the data is loaded with relatively little overhead from the index creation step.

If you have `UNIQUE` constraints on secondary keys, you can speed up a table import by turning off the uniqueness checks temporarily during the import operation:

```
SET unique_checks=0;
... import operation ...
SET unique_checks=1;
```

For big tables, this saves disk I/O because `InnoDB` can use its `change buffer` to write secondary index records as a batch. Be certain that the data contains no duplicate keys. `unique_checks` permits but does not require storage engines to ignore duplicate keys.

For better control over the insertion process, you can insert big tables in pieces:

```
INSERT INTO newtable SELECT * FROM oldtable
WHERE yourkey > something AND yourkey <= somethingelse;
```

After all records are inserted, you can rename the tables.

During the conversion of big tables, increase the size of the `InnoDB` buffer pool to reduce disk I/O. Typically, the recommended buffer pool size is 50 to 75 percent of system memory. You can also increase the size of `InnoDB` log files.

## Storage Requirements

If you intend to make several temporary copies of your data in `InnoDB` tables during the conversion process, it is recommended that you create the tables in file-per-table tablespaces so that you can reclaim the disk space when you drop the tables. When the `innodb_file_per_table` configuration option is enabled (the default), newly created `InnoDB` tables are implicitly created in file-per-table tablespaces.

Whether you convert the `MyISAM` table directly or create a cloned `InnoDB` table, make sure that you have sufficient disk space to hold both the old and new tables during the process. **InnoDB tables require more disk space than MyISAM tables.** If an `ALTER TABLE` operation runs out of space, it starts a rollback, and that can take hours if it is disk-bound. For inserts, `InnoDB` uses the insert buffer to merge secondary index records to indexes in batches. That saves a lot of disk I/O. For rollback, no such mechanism is used, and the rollback can take 30 times longer than the insertion.

In the case of a runaway rollback, if you do not have valuable data in your database, it may be advisable to kill the database process rather than wait for millions of disk I/O operations to complete. For the complete procedure, see [Section 14.22.2, “Forcing InnoDB Recovery”](#).



## Defining Primary Keys

The `PRIMARY KEY` clause is a critical factor affecting the performance of MySQL queries and the space usage for tables and indexes. The primary key uniquely identifies a row in a table. Every row in the table should have a primary key value, and no two rows can have the same primary key value.

These are guidelines for the primary key, followed by more detailed explanations.

- Declare a `PRIMARY KEY` for each table. Typically, it is the most important column that you refer to in `WHERE` clauses when looking up a single row.
- Declare the `PRIMARY KEY` clause in the original `CREATE TABLE` statement, rather than adding it later through an `ALTER TABLE` statement.
- Choose the column and its data type carefully. Prefer numeric columns over character or string ones.
- Consider using an auto-increment column if there is not another stable, unique, non-null, numeric column to use.
- An auto-increment column is also a good choice if there is any doubt whether the value of the primary key column could ever change. Changing the value of a primary key column is an expensive operation, possibly involving rearranging data within the table and within each secondary index.

Consider adding a `primary key` to any table that does not already have one. Use the smallest practical numeric type based on the maximum projected size of the table. This can make each row slightly more compact, which can yield substantial space savings for large tables. The space savings are multiplied if the table has any `secondary indexes`, because the primary key value is repeated in each secondary index entry. In addition to reducing data size on disk, a small primary key also lets more data fit into the `buffer pool`, speeding up all kinds of operations and improving concurrency.

If the table already has a primary key on some longer column, such as a `VARCHAR`, consider adding a new unsigned `AUTO_INCREMENT` column and switching the primary key to that, even if that column is not referenced in queries. This design change can produce substantial space savings in the secondary indexes. You can designate the former primary key columns as `UNIQUE NOT NULL` to enforce the same constraints as the `PRIMARY KEY` clause, that is, to prevent duplicate or null values across all those columns.

If you spread related information across multiple tables, typically each table uses the same column for its primary key. For example, a personnel database might have several tables, each with a primary key of employee number. A sales database might have some tables with a primary key of customer number, and other tables with a primary key of order number. Because lookups using the primary key are very fast, you can construct efficient join queries for such tables.

If you leave the `PRIMARY KEY` clause out entirely, MySQL creates an invisible one for you. It is a 6-byte value that might be longer than you need, thus wasting space. Because it is hidden, you cannot refer to it in queries.

## Application Performance Considerations

The reliability and scalability features of `InnoDB` require more disk storage than equivalent `MyISAM` tables. You might change the column and index definitions slightly, for better space utilization, reduced I/O and memory consumption when processing result sets, and better query optimization plans making efficient use of index lookups.

If you set up a numeric ID column for the primary key, use that value to cross-reference with related values in any other tables, particularly for `join` queries. For example, rather than accepting a country name as input and doing queries searching for the same name, do one lookup to determine the country ID, then

do other queries (or a single join query) to look up relevant information across several tables. Rather than storing a customer or catalog item number as a string of digits, potentially using up several bytes, convert it to a numeric ID for storing and querying. A 4-byte unsigned `INT` column can index over 4 billion items (with the US meaning of billion: 1000 million). For the ranges of the different integer types, see [Section 11.1.2, “Integer Types \(Exact Value\) - INTEGER, INT, SMALLINT, TINYINT, MEDIUMINT, BIGINT”](#).

## Understanding Files Associated with InnoDB Tables

InnoDB files require more care and planning than MyISAM files do.

- You must not delete the `ibdata` files that represent the InnoDB system tablespace.
- Methods of moving or copying InnoDB tables to a different server are described in [Section 14.6.1.4, “Moving or Copying InnoDB Tables”](#).

### 14.6.1.6 AUTO\_INCREMENT Handling in InnoDB

InnoDB provides a configurable locking mechanism that can significantly improve scalability and performance of SQL statements that add rows to tables with `AUTO_INCREMENT` columns. To use the `AUTO_INCREMENT` mechanism with an InnoDB table, an `AUTO_INCREMENT` column must be defined as the first or only column of some index such that it is possible to perform the equivalent of an indexed `SELECT MAX(ai_col)` lookup on the table to obtain the maximum column value. The index is not required to be a `PRIMARY KEY` or `UNIQUE`, but to avoid duplicate values in the `AUTO_INCREMENT` column, those index types are recommended.

This section describes the `AUTO_INCREMENT` lock modes, usage implications of different `AUTO_INCREMENT` lock mode settings, and how InnoDB initializes the `AUTO_INCREMENT` counter.

- [InnoDB AUTO\\_INCREMENT Lock Modes](#)
- [InnoDB AUTO\\_INCREMENT Lock Mode Usage Implications](#)
- [InnoDB AUTO\\_INCREMENT Counter Initialization](#)
- [Notes](#)

## InnoDB AUTO\_INCREMENT Lock Modes

This section describes the `AUTO_INCREMENT` lock modes used to generate auto-increment values, and how each lock mode affects replication. The auto-increment lock mode is configured at startup using the `innodb_autoinc_lock_mode` variable.

The following terms are used in describing `innodb_autoinc_lock_mode` settings:

- “INSERT-like” statements

All statements that generate new rows in a table, including `INSERT`, `INSERT ... SELECT`, `REPLACE`, `REPLACE ... SELECT`, and `LOAD DATA`. Includes “simple-inserts”, “bulk-inserts”, and “mixed-mode” inserts.

- “Simple inserts”

Statements for which the number of rows to be inserted can be determined in advance (when the statement is initially processed). This includes single-row and multiple-row `INSERT` and `REPLACE` statements that do not have a nested subquery, but not `INSERT ... ON DUPLICATE KEY UPDATE`.

- “Bulk inserts”

Statements for which the number of rows to be inserted (and the number of required auto-increment values) is not known in advance. This includes `INSERT ... SELECT`, `REPLACE ... SELECT`, and `LOAD DATA` statements, but not plain `INSERT`. InnoDB assigns new values for the `AUTO_INCREMENT` column one at a time as each row is processed.

- “Mixed-mode inserts”

These are “simple insert” statements that specify the auto-increment value for some (but not all) of the new rows. An example follows, where `c1` is an `AUTO_INCREMENT` column of table `t1`:

```
INSERT INTO t1 (c1,c2) VALUES (1,'a'), (NULL,'b'), (5,'c'), (NULL,'d');
```

Another type of “mixed-mode insert” is `INSERT ... ON DUPLICATE KEY UPDATE`, which in the worst case is in effect an `INSERT` followed by a `UPDATE`, where the allocated value for the `AUTO_INCREMENT` column may or may not be used during the update phase.

There are three possible settings for the `innodb_autoinc_lock_mode` variable. The settings are 0, 1, or 2, for “traditional”, “consecutive”, or “interleaved” lock mode, respectively.

- `innodb_autoinc_lock_mode = 0` (“traditional” lock mode)

The traditional lock mode provides the same behavior that existed before the `innodb_autoinc_lock_mode` variable was introduced. The traditional lock mode option is provided for backward compatibility, performance testing, and working around issues with “mixed-mode inserts”, due to possible differences in semantics.

In this lock mode, all “INSERT-like” statements obtain a special table-level `AUTO-INC` lock for inserts into tables with `AUTO_INCREMENT` columns. This lock is normally held to the end of the statement (not to the end of the transaction) to ensure that auto-increment values are assigned in a predictable and repeatable order for a given sequence of `INSERT` statements, and to ensure that auto-increment values assigned by any given statement are consecutive.

In the case of statement-based replication, this means that when an SQL statement is replicated on a replica server, the same values are used for the auto-increment column as on the source server. The result of execution of multiple `INSERT` statements is deterministic, and the replica reproduces the same data as on the source. If auto-increment values generated by multiple `INSERT` statements were interleaved, the result of two concurrent `INSERT` statements would be nondeterministic, and could not reliably be propagated to a replica server using statement-based replication.

To make this clear, consider an example that uses this table:

```
CREATE TABLE t1 (
  c1 INT(11) NOT NULL AUTO_INCREMENT,
  c2 VARCHAR(10) DEFAULT NULL,
  PRIMARY KEY (c1)
) ENGINE=InnoDB;
```

Suppose that there are two transactions running, each inserting rows into a table with an `AUTO_INCREMENT` column. One transaction is using an `INSERT ... SELECT` statement that inserts 1000 rows, and another is using a simple `INSERT` statement that inserts one row:

```
Tx1: INSERT INTO t1 (c2) SELECT 1000 rows from another table ...
Tx2: INSERT INTO t1 (c2) VALUES ('xxx');
```

InnoDB cannot tell in advance how many rows are retrieved from the `SELECT` in the `INSERT` statement in Tx1, and it assigns the auto-increment values one at a time as the statement proceeds. With a table-level lock, held to the end of the statement, only one `INSERT` statement referring to table `t1` can execute

at a time, and the generation of auto-increment numbers by different statements is not interleaved. The auto-increment values generated by the Tx1 `INSERT ... SELECT` statement are consecutive, and the (single) auto-increment value used by the `INSERT` statement in Tx2 is either smaller or larger than all those used for Tx1, depending on which statement executes first.

As long as the SQL statements execute in the same order when replayed from the binary log (when using statement-based replication, or in recovery scenarios), the results are the same as they were when Tx1 and Tx2 first ran. Thus, table-level locks held until the end of a statement make `INSERT` statements using auto-increment safe for use with statement-based replication. However, those table-level locks limit concurrency and scalability when multiple transactions are executing insert statements at the same time.

In the preceding example, if there were no table-level lock, the value of the auto-increment column used for the `INSERT` in Tx2 depends on precisely when the statement executes. If the `INSERT` of Tx2 executes while the `INSERT` of Tx1 is running (rather than before it starts or after it completes), the specific auto-increment values assigned by the two `INSERT` statements are nondeterministic, and may vary from run to run.

Under the `consecutive` lock mode, `InnoDB` can avoid using table-level `AUTO-INC` locks for “simple insert” statements where the number of rows is known in advance, and still preserve deterministic execution and safety for statement-based replication.

If you are not using the binary log to replay SQL statements as part of recovery or replication, the `interleaved` lock mode can be used to eliminate all use of table-level `AUTO-INC` locks for even greater concurrency and performance, at the cost of permitting gaps in auto-increment numbers assigned by a statement and potentially having the numbers assigned by concurrently executing statements interleaved.

- `innodb_autoinc_lock_mode = 1` (“consecutive” lock mode)

This is the default lock mode. In this mode, “bulk inserts” use the special `AUTO-INC` table-level lock and hold it until the end of the statement. This applies to all `INSERT ... SELECT`, `REPLACE ... SELECT`, and `LOAD DATA` statements. Only one statement holding the `AUTO-INC` lock can execute at a time. If the source table of the bulk insert operation is different from the target table, the `AUTO-INC` lock on the target table is taken after a shared lock is taken on the first row selected from the source table. If the source and target of the bulk insert operation are the same table, the `AUTO-INC` lock is taken after shared locks are taken on all selected rows.

“Simple inserts” (for which the number of rows to be inserted is known in advance) avoid table-level `AUTO-INC` locks by obtaining the required number of auto-increment values under the control of a mutex (a light-weight lock) that is only held for the duration of the allocation process, *not* until the statement completes. No table-level `AUTO-INC` lock is used unless an `AUTO-INC` lock is held by another transaction. If another transaction holds an `AUTO-INC` lock, a “simple insert” waits for the `AUTO-INC` lock, as if it were a “bulk insert”.

This lock mode ensures that, in the presence of `INSERT` statements where the number of rows is not known in advance (and where auto-increment numbers are assigned as the statement progresses), all auto-increment values assigned by any “`INSERT`-like” statement are consecutive, and operations are safe for statement-based replication.

Simply put, this lock mode significantly improves scalability while being safe for use with statement-based replication. Further, as with “traditional” lock mode, auto-increment numbers assigned by any

given statement are *consecutive*. There is *no change* in semantics compared to “traditional” mode for any statement that uses auto-increment, with one important exception.

The exception is for “mixed-mode inserts”, where the user provides explicit values for an `AUTO_INCREMENT` column for some, but not all, rows in a multiple-row “simple insert”. For such inserts, InnoDB allocates more auto-increment values than the number of rows to be inserted. However, all values automatically assigned are consecutively generated (and thus higher than) the auto-increment value generated by the most recently executed previous statement. “Excess” numbers are lost.

- `innodb_autoinc_lock_mode = 2` (“interleaved” lock mode)

In this lock mode, no “INSERT-like” statements use the table-level `AUTO-INC` lock, and multiple statements can execute at the same time. This is the fastest and most scalable lock mode, but it is *not safe* when using statement-based replication or recovery scenarios when SQL statements are replayed from the binary log.

In this lock mode, auto-increment values are guaranteed to be unique and monotonically increasing across all concurrently executing “INSERT-like” statements. However, because multiple statements can be generating numbers at the same time (that is, allocation of numbers is *interleaved* across statements), the values generated for the rows inserted by any given statement may not be consecutive.

If the only statements executing are “simple inserts” where the number of rows to be inserted is known ahead of time, there are no gaps in the numbers generated for a single statement, except for “mixed-mode inserts”. However, when “bulk inserts” are executed, there may be gaps in the auto-increment values assigned by any given statement.

## InnoDB AUTO\_INCREMENT Lock Mode Usage Implications

- Using auto-increment with replication

If you are using statement-based replication, set `innodb_autoinc_lock_mode` to 0 or 1 and use the same value on the source and its replicas. Auto-increment values are not ensured to be the same on the replicas as on the source if you use `innodb_autoinc_lock_mode = 2` (“interleaved”) or configurations where the source and replicas do not use the same lock mode.

If you are using row-based or mixed-format replication, all of the auto-increment lock modes are safe, since row-based replication is not sensitive to the order of execution of the SQL statements (and the mixed format uses row-based replication for any statements that are unsafe for statement-based replication).

- “Lost” auto-increment values and sequence gaps

In all lock modes (0, 1, and 2), if a transaction that generated auto-increment values rolls back, those auto-increment values are “lost”. Once a value is generated for an auto-increment column, it cannot be rolled back, whether or not the “INSERT-like” statement is completed, and whether or not the containing transaction is rolled back. Such lost values are not reused. Thus, there may be gaps in the values stored in an `AUTO_INCREMENT` column of a table.

- Specifying NULL or 0 for the `AUTO_INCREMENT` column

In all lock modes (0, 1, and 2), if a user specifies NULL or 0 for the `AUTO_INCREMENT` column in an `INSERT`, InnoDB treats the row as if the value was not specified and generates a new value for it.

- Assigning a negative value to the `AUTO_INCREMENT` column

In all lock modes (0, 1, and 2), the behavior of the auto-increment mechanism is undefined if you assign a negative value to the `AUTO_INCREMENT` column.

- If the `AUTO_INCREMENT` value becomes larger than the maximum integer for the specified integer type

In all lock modes (0, 1, and 2), the behavior of the auto-increment mechanism is undefined if the value becomes larger than the maximum integer that can be stored in the specified integer type.

- Gaps in auto-increment values for “bulk inserts”

With `innodb_autoinc_lock_mode` set to 0 (“traditional”) or 1 (“consecutive”), the auto-increment values generated by any given statement are consecutive, without gaps, because the table-level `AUTO_INCREMENT` lock is held until the end of the statement, and only one such statement can execute at a time.

With `innodb_autoinc_lock_mode` set to 2 (“interleaved”), there may be gaps in the auto-increment values generated by “bulk inserts,” but only if there are concurrently executing “`INSERT`-like” statements.

For lock modes 1 or 2, gaps may occur between successive statements because for bulk inserts the exact number of auto-increment values required by each statement may not be known and overestimation is possible.

- Auto-increment values assigned by “mixed-mode inserts”

Consider a “mixed-mode insert,” where a “simple insert” specifies the auto-increment value for some (but not all) resulting rows. Such a statement behaves differently in lock modes 0, 1, and 2. For example, assume `c1` is an `AUTO_INCREMENT` column of table `t1`, and that the most recent automatically generated sequence number is 100.

```
mysql> CREATE TABLE t1 (
-> c1 INT UNSIGNED NOT NULL AUTO_INCREMENT PRIMARY KEY,
-> c2 CHAR(1)
-> ) ENGINE = INNODB;
```

Now, consider the following “mixed-mode insert” statement:

```
mysql> INSERT INTO t1 (c1,c2) VALUES (1,'a'), (NULL,'b'), (5,'c'), (NULL,'d');
```

With `innodb_autoinc_lock_mode` set to 0 (“traditional”), the four new rows are:

```
mysql> SELECT c1, c2 FROM t1 ORDER BY c2;
+-----+-----+
| c1   | c2   |
+-----+-----+
| 1    | a    |
| 101  | b    |
| 5    | c    |
| 102  | d    |
+-----+-----+
```

The next available auto-increment value is 103 because the auto-increment values are allocated one at a time, not all at once at the beginning of statement execution. This result is true whether or not there are concurrently executing “`INSERT`-like” statements (of any type).

With `innodb_autoinc_lock_mode` set to 1 (“consecutive”), the four new rows are also:

```
mysql> SELECT c1, c2 FROM t1 ORDER BY c2;
+-----+-----+
| c1   | c2   |
+-----+-----+
| 1    | a    |
| 101  | b    |
| 5    | c    |
| 102  | d    |
+-----+-----+
```

```
+-----+-----+
```

However, in this case, the next available auto-increment value is 105, not 103 because four auto-increment values are allocated at the time the statement is processed, but only two are used. This result is true whether or not there are concurrently executing “INSERT-like” statements (of any type).

With `innodb_autoinc_lock_mode` set to 2 (“interleaved”), the four new rows are:

```
mysql> SELECT c1, c2 FROM t1 ORDER BY c2;
+-----+-----+
| c1 | c2 |
+-----+-----+
| 1 | a |
| x | b |
| 5 | c |
| y | d |
+-----+-----+
```

The values of `x` and `y` are unique and larger than any previously generated rows. However, the specific values of `x` and `y` depend on the number of auto-increment values generated by concurrently executing statements.

Finally, consider the following statement, issued when the most-recently generated sequence number is 100:

```
mysql> INSERT INTO t1 (c1,c2) VALUES (1,'a'), (NULL,'b'), (101,'c'), (NULL,'d');
```

With any `innodb_autoinc_lock_mode` setting, this statement generates a duplicate-key error 23000 (Can't write; duplicate key in table) because 101 is allocated for the row (NULL, 'b') and insertion of the row (101, 'c') fails.

- Modifying `AUTO_INCREMENT` column values in the middle of a sequence of `INSERT` statements

In all lock modes (0, 1, and 2), modifying an `AUTO_INCREMENT` column value in the middle of a sequence of `INSERT` statements could lead to “Duplicate entry” errors. For example, if you perform an `UPDATE` operation that changes an `AUTO_INCREMENT` column value to a value larger than the current maximum auto-increment value, subsequent `INSERT` operations that do not specify an unused auto-increment value could encounter “Duplicate entry” errors. This behavior is demonstrated in the following example.

```
mysql> CREATE TABLE t1 (
-> c1 INT NOT NULL AUTO_INCREMENT,
-> PRIMARY KEY (c1)
-> ) ENGINE = InnoDB;

mysql> INSERT INTO t1 VALUES(0), (0), (3);

mysql> SELECT c1 FROM t1;
+-----+
| c1 |
+-----+
| 1 |
| 2 |
| 3 |
+-----+

mysql> UPDATE t1 SET c1 = 4 WHERE c1 = 1;

mysql> SELECT c1 FROM t1;
+-----+
| c1 |
+-----+
```

```
| 2 |  
| 3 |  
| 4 |  
+----+  
  
mysql> INSERT INTO t1 VALUES(0);  
ERROR 1062 (23000): Duplicate entry '4' for key 'PRIMARY'
```

## InnoDB AUTO\_INCREMENT Counter Initialization

This section describes how [InnoDB](#) initializes [AUTO\\_INCREMENT](#) counters.

If you specify an [AUTO\\_INCREMENT](#) column for an [InnoDB](#) table, the table handle in the [InnoDB](#) data dictionary contains a special counter called the auto-increment counter that is used in assigning new values for the column. This counter is stored only in main memory, not on disk.

To initialize an auto-increment counter after a server restart, [InnoDB](#) executes the equivalent of the following statement on the first insert into a table containing an [AUTO\\_INCREMENT](#) column.

```
SELECT MAX(ai_col) FROM table_name FOR UPDATE;
```

[InnoDB](#) increments the value retrieved by the statement and assigns it to the column and to the auto-increment counter for the table. By default, the value is incremented by 1. This default can be overridden by the [auto\\_increment\\_increment](#) configuration setting.

If the table is empty, [InnoDB](#) uses the value 1. This default can be overridden by the [auto\\_increment\\_offset](#) configuration setting.

If a [SHOW TABLE STATUS](#) statement examines the table before the auto-increment counter is initialized, [InnoDB](#) initializes but does not increment the value. The value is stored for use by later inserts. This initialization uses a normal exclusive-locking read on the table and the lock lasts to the end of the transaction. [InnoDB](#) follows the same procedure for initializing the auto-increment counter for a newly created table.

After the auto-increment counter has been initialized, if you do not explicitly specify a value for an [AUTO\\_INCREMENT](#) column, [InnoDB](#) increments the counter and assigns the new value to the column. If you insert a row that explicitly specifies the column value, and the value is greater than the current counter value, the counter is set to the specified column value.

[InnoDB](#) uses the in-memory auto-increment counter as long as the server runs. When the server is stopped and restarted, [InnoDB](#) reinitializes the counter for each table for the first [INSERT](#) to the table, as described earlier.

A server restart also cancels the effect of the [AUTO\\_INCREMENT = N](#) table option in [CREATE TABLE](#) and [ALTER TABLE](#) statements, which you can use with [InnoDB](#) tables to set the initial counter value or alter the current counter value.

## Notes

- When an [AUTO\\_INCREMENT](#) integer column runs out of values, a subsequent [INSERT](#) operation returns a duplicate-key error. This is general MySQL behavior.
- When you restart the MySQL server, [InnoDB](#) may reuse an old value that was generated for an [AUTO\\_INCREMENT](#) column but never stored (that is, a value that was generated during an old transaction that was rolled back).

## 14.6.2 Indexes

This section covers topics related to [InnoDB](#) indexes.



### 14.6.2.1 Clustered and Secondary Indexes

Each [InnoDB](#) table has a special index called the clustered index that stores row data. Typically, the clustered index is synonymous with the primary key. To get the best performance from queries, inserts, and other database operations, it is important to understand how [InnoDB](#) uses the clustered index to optimize the common lookup and DML operations.

- When you define a [PRIMARY KEY](#) on a table, [InnoDB](#) uses it as the clustered index. A primary key should be defined for each table. If there is no logical unique and non-null column or set of columns to use as the primary key, add an auto-increment column. Auto-increment column values are unique and are added automatically as new rows are inserted.
- If you do not define a [PRIMARY KEY](#) for a table, [InnoDB](#) uses the first [UNIQUE](#) index with all key columns defined as [NOT NULL](#) as the clustered index.
- If a table has no [PRIMARY KEY](#) or suitable [UNIQUE](#) index, [InnoDB](#) generates a hidden clustered index named [GEN\\_CLUST\\_INDEX](#) on a synthetic column that contains row ID values. The rows are ordered by the row ID that [InnoDB](#) assigns. The row ID is a 6-byte field that increases monotonically as new rows are inserted. Thus, the rows ordered by the row ID are physically in order of insertion.

#### How the Clustered Index Speeds Up Queries

Accessing a row through the clustered index is fast because the index search leads directly to the page that contains the row data. If a table is large, the clustered index architecture often saves a disk I/O operation when compared to storage organizations that store row data using a different page from the index record.

#### How Secondary Indexes Relate to the Clustered Index

Indexes other than the clustered index are known as secondary indexes. In [InnoDB](#), each record in a secondary index contains the primary key columns for the row, as well as the columns specified for the secondary index. [InnoDB](#) uses this primary key value to search for the row in the clustered index.

If the primary key is long, the secondary indexes use more space, so it is advantageous to have a short primary key.

For guidelines to take advantage of [InnoDB](#) clustered and secondary indexes, see [Section 8.3](#), “[Optimization and Indexes](#)”.

### 14.6.2.2 The Physical Structure of an InnoDB Index

With the exception of spatial indexes, [InnoDB](#) indexes are [B-tree](#) data structures. Spatial indexes use [R-trees](#), which are specialized data structures for indexing multi-dimensional data. Index records are stored in the leaf pages of their B-tree or R-tree data structure. The default size of an index page is 16KB. The page size is determined by the [innodb\\_page\\_size](#) setting when the MySQL instance is initialized. See [Section 14.8.1](#), “[InnoDB Startup Configuration](#)”.

When new records are inserted into an [InnoDB clustered index](#), [InnoDB](#) tries to leave 1/16 of the page free for future insertions and updates of the index records. If index records are inserted in a sequential order (ascending or descending), the resulting index pages are about 15/16 full. If records are inserted in a random order, the pages are from 1/2 to 15/16 full.

[InnoDB](#) performs a bulk load when creating or rebuilding B-tree indexes. This method of index creation is known as a sorted index build. The [innodb\\_fill\\_factor](#) variable defines the percentage of space on each B-tree page that is filled during a sorted index build, with the remaining space reserved for future index growth. Sorted index builds are not supported for spatial indexes. For more information, see [Section 14.6.2.3](#), “[Sorted Index Builds](#)”. An [innodb\\_fill\\_factor](#) setting of 100 leaves 1/16 of the space in clustered index pages free for future index growth.

---

If the fill factor of an [InnoDB](#) index page drops below the `MERGE_THRESHOLD`, which is 50% by default if not specified, [InnoDB](#) tries to contract the index tree to free the page. The `MERGE_THRESHOLD` setting applies to both B-tree and R-tree indexes. For more information, see [Section 14.8.12, “Configuring the Merge Threshold for Index Pages”](#).

### 14.6.2.3 Sorted Index Builds

[InnoDB](#) performs a bulk load instead of inserting one index record at a time when creating or rebuilding indexes. This method of index creation is also known as a sorted index build. Sorted index builds are not supported for spatial indexes.

There are three phases to an index build. In the first phase, the [clustered index](#) is scanned, and index entries are generated and added to the sort buffer. When the [sort buffer](#) becomes full, entries are sorted and written out to a temporary intermediate file. This process is also known as a “run”. In the second phase, with one or more runs written to the temporary intermediate file, a merge sort is performed on all entries in the file. In the third and final phase, the sorted entries are inserted into the [B-tree](#).

Prior to the introduction of sorted index builds, index entries were inserted into the B-tree one record at a time using insert APIs. This method involved opening a B-tree [cursor](#) to find the insert position and then inserting entries into a B-tree page using an [optimistic](#) insert. If an insert failed due to a page being full, a [pessimistic](#) insert would be performed, which involves opening a B-tree cursor and splitting and merging B-tree nodes as necessary to find space for the entry. The drawbacks of this “top-down” method of building an index are the cost of searching for an insert position and the constant splitting and merging of B-tree nodes.

Sorted index builds use a “bottom-up” approach to building an index. With this approach, a reference to the right-most leaf page is held at all levels of the B-tree. The right-most leaf page at the necessary B-tree depth is allocated and entries are inserted according to their sorted order. Once a leaf page is full, a node pointer is appended to the parent page and a sibling leaf page is allocated for the next insert. This process continues until all entries are inserted, which may result in inserts up to the root level. When a sibling page is allocated, the reference to the previously pinned leaf page is released, and the newly allocated leaf page becomes the right-most leaf page and new default insert location.

#### Reserving B-tree Page Space for Future Index Growth

To set aside space for future index growth, you can use the `innodb_fill_factor` variable to reserve a percentage of B-tree page space. For example, setting `innodb_fill_factor` to 80 reserves 20 percent of the space in B-tree pages during a sorted index build. This setting applies to both B-tree leaf and non-leaf pages. It does not apply to external pages used for `TEXT` or `BLOB` entries. The amount of space that is reserved may not be exactly as configured, as the `innodb_fill_factor` value is interpreted as a hint rather than a hard limit.

#### Sorted Index Builds and Full-Text Index Support

Sorted index builds are supported for [fulltext indexes](#). Previously, SQL was used to insert entries into a fulltext index.

#### Sorted Index Builds and Compressed Tables

For [compressed tables](#), the previous index creation method appended entries to both compressed and uncompressed pages. When the modification log (representing free space on the compressed page) became full, the compressed page would be recompressed. If compression failed due to a lack of space, the page would be split. With sorted index builds, entries are only appended to uncompressed pages. When an uncompressed page becomes full, it is compressed. Adaptive padding is used to ensure that compression succeeds in most cases, but if compression fails, the page is split and compression is attempted again. This process continues until compression is successful. For more information about compression of B-Tree pages, see [Section 14.9.1.5, “How Compression Works for InnoDB Tables”](#).

## Sorted Index Builds and Redo Logging

[Redo logging](#) is disabled during a sorted index build. Instead, there is a [checkpoint](#) to ensure that the index build can withstand an unexpected exit or failure. The checkpoint forces a write of all dirty pages to disk. During a sorted index build, the [page cleaner](#) thread is signaled periodically to flush [dirty pages](#) to ensure that the checkpoint operation can be processed quickly. Normally, the page cleaner thread flushes dirty pages when the number of clean pages falls below a set threshold. For sorted index builds, dirty pages are flushed promptly to reduce checkpoint overhead and to parallelize I/O and CPU activity.

## Sorted Index Builds and Optimizer Statistics

Sorted index builds may result in [optimizer](#) statistics that differ from those generated by the previous method of index creation. The difference in statistics, which is not expected to affect workload performance, is due to the different algorithm used to populate the index.

### 14.6.2.4 InnoDB Full-Text Indexes

Full-text indexes are created on text-based columns ([CHAR](#), [VARCHAR](#), or [TEXT](#) columns) to speed up queries and DML operations on data contained within those columns.

A full-text index is defined as part of a [CREATE TABLE](#) statement or added to an existing table using [ALTER TABLE](#) or [CREATE INDEX](#).

Full-text search is performed using [MATCH\(\) ... AGAINST](#) syntax. For usage information, see [Section 12.9, “Full-Text Search Functions”](#).

[InnoDB](#) full-text indexes are described under the following topics in this section:

- [InnoDB Full-Text Index Design](#)
- [InnoDB Full-Text Index Tables](#)
- [InnoDB Full-Text Index Cache](#)
- [InnoDB Full-Text Index DOC\\_ID and FTS\\_DOC\\_ID Column](#)
- [InnoDB Full-Text Index Deletion Handling](#)
- [InnoDB Full-Text Index Transaction Handling](#)
- [Monitoring InnoDB Full-Text Indexes](#)

## InnoDB Full-Text Index Design

[InnoDB](#) full-text indexes have an inverted index design. Inverted indexes store a list of words, and for each word, a list of documents that the word appears in. To support proximity search, position information for each word is also stored, as a byte offset.

## InnoDB Full-Text Index Tables

When an [InnoDB](#) full-text index is created, a set of index tables is created, as shown in the following example:

```
mysql> CREATE TABLE opening_lines (  
  id INT UNSIGNED AUTO_INCREMENT NOT NULL PRIMARY KEY,  
  opening_line TEXT(500),  
  author VARCHAR(200),  
  title VARCHAR(200),  
  FULLTEXT idx (opening_line)
```

```

) ENGINE=InnoDB;

mysql> SELECT table_id, name, space from INFORMATION_SCHEMA.INNODB_SYS_TABLES
WHERE name LIKE 'test/%';
+-----+-----+-----+
| table_id | name | space |
+-----+-----+-----+
| 333 | test/FTS_0000000000000147_0000000000001c9_INDEX_1 | 289 |
| 334 | test/FTS_0000000000000147_0000000000001c9_INDEX_2 | 290 |
| 335 | test/FTS_0000000000000147_0000000000001c9_INDEX_3 | 291 |
| 336 | test/FTS_0000000000000147_0000000000001c9_INDEX_4 | 292 |
| 337 | test/FTS_0000000000000147_0000000000001c9_INDEX_5 | 293 |
| 338 | test/FTS_0000000000000147_0000000000001c9_INDEX_6 | 294 |
| 330 | test/FTS_0000000000000147_BEING_DELETED | 286 |
| 331 | test/FTS_0000000000000147_BEING_DELETED_CACHE | 287 |
| 332 | test/FTS_0000000000000147_CONFIG | 288 |
| 328 | test/FTS_0000000000000147_DELETED | 284 |
| 329 | test/FTS_0000000000000147_DELETED_CACHE | 285 |
| 327 | test/opening_lines | 283 |
+-----+-----+-----+

```

The first six index tables comprise the inverted index and are referred to as auxiliary index tables. When incoming documents are tokenized, the individual words (also referred to as “tokens”) are inserted into the index tables along with position information and an associated `DOC_ID`. The words are fully sorted and partitioned among the six index tables based on the character set sort weight of the word's first character.

The inverted index is partitioned into six auxiliary index tables to support parallel index creation. By default, two threads tokenize, sort, and insert words and associated data into the index tables. The number of threads that perform this work is configurable using the `innodb_ft_sort_pll_degree` variable. Consider increasing the number of threads when creating full-text indexes on large tables.

Auxiliary index table names are prefixed with `fts_` and postfixed with `index_#`. Each auxiliary index table is associated with the indexed table by a hex value in the auxiliary index table name that matches the `table_id` of the indexed table. For example, the `table_id` of the `test/opening_lines` table is `327`, for which the hex value is `0x147`. As shown in the preceding example, the “147” hex value appears in the names of auxiliary index tables that are associated with the `test/opening_lines` table.

A hex value representing the `index_id` of the full-text index also appears in auxiliary index table names. For example, in the auxiliary table name `test/FTS_0000000000000147_0000000000001c9_INDEX_1`, the hex value `1c9` has a decimal value of `457`. The index defined on the `opening_lines` table (`idx`) can be identified by querying the Information Schema `INNODB_SYS_INDEXES` table for this value (`457`).

```

mysql> SELECT index_id, name, table_id, space from INFORMATION_SCHEMA.INNODB_SYS_INDEXES
WHERE index_id=457;
+-----+-----+-----+
| index_id | name | table_id | space |
+-----+-----+-----+
| 457 | idx | 327 | 283 |
+-----+-----+-----+

```

Index tables are stored in their own tablespace if the primary table is created in a `file-per-table` tablespace. Otherwise, index tables are stored in the tablespace where the indexed table resides.

The other index tables shown in the preceding example are referred to as common index tables and are used for deletion handling and storing the internal state of full-text indexes. Unlike the inverted index tables, which are created for each full-text index, this set of tables is common to all full-text indexes created on a particular table.

Common index tables are retained even if full-text indexes are dropped. When a full-text index is dropped, the `FTS_DOC_ID` column that was created for the index is retained, as removing the `FTS_DOC_ID` column

would require rebuilding the previously indexed table. Common index tables are required to manage the `FTS_DOC_ID` column.

- `FTS_*_DELETED` and `FTS_*_DELETED_CACHE`

Contain the document IDs (`DOC_ID`) for documents that are deleted but whose data is not yet removed from the full-text index. The `FTS_*_DELETED_CACHE` is the in-memory version of the `FTS_*_DELETED` table.

- `FTS_*_BEING_DELETED` and `FTS_*_BEING_DELETED_CACHE`

Contain the document IDs (`DOC_ID`) for documents that are deleted and whose data is currently in the process of being removed from the full-text index. The `FTS_*_BEING_DELETED_CACHE` table is the in-memory version of the `FTS_*_BEING_DELETED` table.

- `FTS_*_CONFIG`

Stores information about the internal state of the full-text index. Most importantly, it stores the `FTS_SYNCED_DOC_ID`, which identifies documents that have been parsed and flushed to disk. In case of crash recovery, `FTS_SYNCED_DOC_ID` values are used to identify documents that have not been flushed to disk so that the documents can be re-parsed and added back to the full-text index cache. To view the data in this table, query the Information Schema `INNODB_FT_CONFIG` table.

## InnoDB Full-Text Index Cache

When a document is inserted, it is tokenized, and the individual words and associated data are inserted into the full-text index. This process, even for small documents, can result in numerous small insertions into the auxiliary index tables, making concurrent access to these tables a point of contention. To avoid this problem, InnoDB uses a full-text index cache to temporarily cache index table insertions for recently inserted rows. This in-memory cache structure holds insertions until the cache is full and then batch flushes them to disk (to the auxiliary index tables). You can query the Information Schema `INNODB_FT_INDEX_CACHE` table to view tokenized data for recently inserted rows.

The caching and batch flushing behavior avoids frequent updates to auxiliary index tables, which could result in concurrent access issues during busy insert and update times. The batching technique also avoids multiple insertions for the same word, and minimizes duplicate entries. Instead of flushing each word individually, insertions for the same word are merged and flushed to disk as a single entry, improving insertion efficiency while keeping auxiliary index tables as small as possible.

The `innodb_ft_cache_size` variable is used to configure the full-text index cache size (on a per-table basis), which affects how often the full-text index cache is flushed. You can also define a global full-text index cache size limit for all tables in a given instance using the `innodb_ft_total_cache_size` variable.

The full-text index cache stores the same information as auxiliary index tables. However, the full-text index cache only caches tokenized data for recently inserted rows. The data that is already flushed to disk (to the auxiliary index tables) is not brought back into the full-text index cache when queried. The data in auxiliary index tables is queried directly, and results from the auxiliary index tables are merged with results from the full-text index cache before being returned.

## InnoDB Full-Text Index `DOC_ID` and `FTS_DOC_ID` Column

InnoDB uses a unique document identifier referred to as the `DOC_ID` to map words in the full-text index to document records where the word appears. The mapping requires an `FTS_DOC_ID` column on the indexed table. If an `FTS_DOC_ID` column is not defined, InnoDB automatically adds a hidden `FTS_DOC_ID` column when the full-text index is created. The following example demonstrates this behavior.

The following table definition does not include an `FTS_DOC_ID` column:

```
mysql> CREATE TABLE opening_lines (
  id INT UNSIGNED AUTO_INCREMENT NOT NULL PRIMARY KEY,
  opening_line TEXT(500),
  author VARCHAR(200),
  title VARCHAR(200)
) ENGINE=InnoDB;
```

When you create a full-text index on the table using `CREATE FULLTEXT INDEX` syntax, a warning is returned which reports that `InnoDB` is rebuilding the table to add the `FTS_DOC_ID` column.

```
mysql> CREATE FULLTEXT INDEX idx ON opening_lines(opening_line);
Query OK, 0 rows affected, 1 warning (0.19 sec)
Records: 0 Duplicates: 0 Warnings: 1

mysql> SHOW WARNINGS;
+-----+-----+-----+
| Level | Code | Message                                     |
+-----+-----+-----+
| Warning | 124 | InnoDB rebuilding table to add column FTS_DOC_ID |
+-----+-----+-----+
```

The same warning is returned when using `ALTER TABLE` to add a full-text index to a table that does not have an `FTS_DOC_ID` column. If you create a full-text index at `CREATE TABLE` time and do not specify an `FTS_DOC_ID` column, `InnoDB` adds a hidden `FTS_DOC_ID` column, without warning.

Defining an `FTS_DOC_ID` column at `CREATE TABLE` time is less expensive than creating a full-text index on a table that is already loaded with data. If an `FTS_DOC_ID` column is defined on a table prior to loading data, the table and its indexes do not have to be rebuilt to add the new column. If you are not concerned with `CREATE FULLTEXT INDEX` performance, leave out the `FTS_DOC_ID` column to have `InnoDB` create it for you. `InnoDB` creates a hidden `FTS_DOC_ID` column along with a unique index (`FTS_DOC_ID_INDEX`) on the `FTS_DOC_ID` column. If you want to create your own `FTS_DOC_ID` column, the column must be defined as `BIGINT UNSIGNED NOT NULL` and named `FTS_DOC_ID` (all uppercase), as in the following example:



**Note**

The `FTS_DOC_ID` column does not need to be defined as an `AUTO_INCREMENT` column, but doing so could make loading data easier.

```
mysql> CREATE TABLE opening_lines (
  FTS_DOC_ID BIGINT UNSIGNED AUTO_INCREMENT NOT NULL PRIMARY KEY,
  opening_line TEXT(500),
  author VARCHAR(200),
  title VARCHAR(200)
) ENGINE=InnoDB;
```

If you choose to define the `FTS_DOC_ID` column yourself, you are responsible for managing the column to avoid empty or duplicate values. `FTS_DOC_ID` values cannot be reused, which means `FTS_DOC_ID` values must be ever increasing.

Optionally, you can create the required unique `FTS_DOC_ID_INDEX` (all uppercase) on the `FTS_DOC_ID` column.

```
mysql> CREATE UNIQUE INDEX FTS_DOC_ID_INDEX on opening_lines(FTS_DOC_ID);
```

If you do not create the `FTS_DOC_ID_INDEX`, `InnoDB` creates it automatically.

Before MySQL 5.7.13, the permitted gap between the largest used `FTS_DOC_ID` value and new `FTS_DOC_ID` value is 10000. In MySQL 5.7.13 and later, the permitted gap is 65535.

To avoid rebuilding the table, the `FTS_DOC_ID` column is retained when dropping a full-text index.

## InnoDB Full-Text Index Deletion Handling

Deleting a record that has a full-text index column could result in numerous small deletions in the auxiliary index tables, making concurrent access to these tables a point of contention. To avoid this problem, the `DOC_ID` of a deleted document is logged in a special `FTS*_DELETED` table whenever a record is deleted from an indexed table, and the indexed record remains in the full-text index. Before returning query results, information in the `FTS*_DELETED` table is used to filter out deleted `DOC_IDS`. The benefit of this design is that deletions are fast and inexpensive. The drawback is that the size of the index is not immediately reduced after deleting records. To remove full-text index entries for deleted records, run `OPTIMIZE TABLE` on the indexed table with `innodb_optimize_fulltext_only=ON` to rebuild the full-text index. For more information, see [Optimizing InnoDB Full-Text Indexes](#).

## InnoDB Full-Text Index Transaction Handling

InnoDB full-text indexes have special transaction handling characteristics due its caching and batch processing behavior. Specifically, updates and insertions on a full-text index are processed at transaction commit time, which means that a full-text search can only see committed data. The following example demonstrates this behavior. The full-text search only returns a result after the inserted lines are committed.

```
mysql> CREATE TABLE opening_lines (
  id INT UNSIGNED AUTO_INCREMENT NOT NULL PRIMARY KEY,
  opening_line TEXT(500),
  author VARCHAR(200),
  title VARCHAR(200),
  FULLTEXT idx (opening_line)
) ENGINE=InnoDB;

mysql> BEGIN;

mysql> INSERT INTO opening_lines(opening_line,author,title) VALUES
('Call me Ishmael.','Herman Melville','Moby-Dick'),
('A screaming comes across the sky.','Thomas Pynchon','Gravity\'s Rainbow'),
('I am an invisible man.','Ralph Ellison','Invisible Man'),
('Where now? Who now? When now?','Samuel Beckett','The Unnamable'),
('It was love at first sight.','Joseph Heller','Catch-22'),
('All this happened, more or less.','Kurt Vonnegut','Slaughterhouse-Five'),
('Mrs. Dalloway said she would buy the flowers herself.','Virginia Woolf','Mrs. Dalloway'),
('It was a pleasure to burn.','Ray Bradbury','Fahrenheit 451');

mysql> SELECT COUNT(*) FROM opening_lines WHERE MATCH(opening_line) AGAINST('Ishmael');
+-----+
| COUNT(*) |
+-----+
|         0 |
+-----+

mysql> COMMIT;

mysql> SELECT COUNT(*) FROM opening_lines WHERE MATCH(opening_line) AGAINST('Ishmael');
+-----+
| COUNT(*) |
+-----+
|         1 |
+-----+
```

## Monitoring InnoDB Full-Text Indexes

You can monitor and examine the special text-processing aspects of InnoDB full-text indexes by querying the following `INFORMATION_SCHEMA` tables:

- `INNODB_FT_CONFIG`

- [INNODB\\_FT\\_INDEX\\_TABLE](#)
- [INNODB\\_FT\\_INDEX\\_CACHE](#)
- [INNODB\\_FT\\_DEFAULT\\_STOPWORD](#)
- [INNODB\\_FT\\_DELETED](#)
- [INNODB\\_FT\\_BEING\\_DELETED](#)

You can also view basic information for full-text indexes and tables by querying [INNODB\\_SYS\\_INDEXES](#) and [INNODB\\_SYS\\_TABLES](#).

For more information, see [Section 14.16.4, “InnoDB INFORMATION\\_SCHEMA FULLTEXT Index Tables”](#).

## 14.6.3 Tablespaces

This section covers topics related to [InnoDB](#) tablespaces.

### 14.6.3.1 The System Tablespace

The system tablespace is the storage area for the [InnoDB](#) data dictionary, the doublewrite buffer, the change buffer, and undo logs. It may also contain table and index data if tables are created in the system tablespace rather than file-per-table or general tablespaces.

The system tablespace can have one or more data files. By default, a single system tablespace data file, named `ibdata1`, is created in the data directory. The size and number of system tablespace data files is defined by the `innodb_data_file_path` startup option. For configuration information, see [System Tablespace Data File Configuration](#).

Additional information about the system tablespace is provided under the following topics in the section:

- [Resizing the System Tablespace](#)
- [Using Raw Disk Partitions for the System Tablespace](#)

### Resizing the System Tablespace

This section describes how to increase or decrease the size of the system tablespace.

#### Increasing the Size of the System Tablespace

The easiest way to increase the size of the system tablespace is to configure it to be auto-extending. To do so, specify the `autoextend` attribute for the last data file in the `innodb_data_file_path` setting, and restart the server. For example:

```
innodb_data_file_path=ibdata1:10M:autoextend
```

When the `autoextend` attribute is specified, the data file automatically increases in size by 8MB increments as space is required. The `innodb_autoextend_increment` variable controls the increment size.

You can also increase system tablespace size by adding another data file. To do so:

1. Stop the MySQL server.
2. If the last data file in the `innodb_data_file_path` setting is defined with the `autoextend` attribute, remove it, and modify the size attribute to reflect the current data file size. To determine the appropriate data file size to specify, check your file system for the file size, and round that value down to the closest MB value, where a MB is equal to 1024 x 1024 bytes.



- Append a new data file to the `innodb_data_file_path` setting, optionally specifying the `autoextend` attribute. The `autoextend` attribute can be specified only for the last data file in the `innodb_data_file_path` setting.
- Start the MySQL server.

For example, this tablespace has one auto-extending data file:

```
innodb_data_home_dir =
innodb_data_file_path = /ibdata/ibdata1:10M:autoextend
```

Suppose that the data file has grown to 988MB over time. This is the `innodb_data_file_path` setting after modifying the size attribute to reflect the current data file size, and after specifying a new 50MB auto-extending data file:

```
innodb_data_home_dir =
innodb_data_file_path = /ibdata/ibdata1:988M;/disk2/ibdata2:50M:autoextend
```

When adding a new data file, do not specify an existing file name. InnoDB creates and initializes the new data file when you start the server.



**Note**

You cannot increase the size of an existing system tablespace data file by changing its size attribute. For example, changing the `innodb_data_file_path` setting from `ibdata1:10M:autoextend` to `ibdata1:12M:autoextend` produces the following error when starting the server:

```
[ERROR] [MY-012263] [InnoDB] The Auto-extending innodb_system
data file './ibdata1' is of a different size 640 pages (rounded down to MB) than
specified in the .cnf file: initial 768 pages, max 0 (relevant if non-zero) pages!
```

The error indicates that the existing data file size (expressed in InnoDB pages) is different from the data file size specified in the configuration file. If you encounter this error, restore the previous `innodb_data_file_path` setting, and refer to the system tablespace resizing instructions.

**Decreasing the Size of the InnoDB System Tablespace**

You cannot remove a data file from the system tablespace. To decrease the system tablespace size, use this procedure:

- Use `mysqldump` to dump all of your InnoDB tables, including InnoDB tables located in the `mysql` schema. Identify InnoDB tables in the `mysql` schema using the following query:

```
mysql> SELECT TABLE_NAME from INFORMATION_SCHEMA.TABLES WHERE TABLE_SCHEMA='mysql' and ENGINE='InnoDB';
+-----+
| TABLE_NAME |
+-----+
| engine_cost |
| gtid_executed |
| help_category |
| help_keyword |
| help_relation |
| help_topic |
| innodb_index_stats |
| innodb_table_stats |
| plugin |
| server_cost |
| servers |
| slave_master_info |
| slave_relay_log_info |
```

```

| slave_worker_info |
| time_zone         |
| time_zone_leap_second |
| time_zone_name    |
| time_zone_transition |
| time_zone_transition_type |
+-----+

```

2. Stop the server.
3. Remove all of the existing tablespace files (\*.ibd), including the `ibdata` and `ib_log` files. Do not forget to remove \*.ibd files for tables located in the `mysql` schema.
4. Remove any `.frm` files for InnoDB tables.
5. Configure the data files for the new system tablespace. See [System Tablespace Data File Configuration](#).
6. Restart the server.
7. Import the dump files.



#### Note

If your databases only use the InnoDB engine, it may be simpler to dump **all** databases, stop the server, remove all databases and InnoDB log files, restart the server, and import the dump files.

To avoid a large system tablespace, consider using file-per-table tablespaces or general tablespaces for your data. File-per-table tablespaces are the default tablespace type and are used implicitly when creating an InnoDB table. Unlike the system tablespace, file-per-table tablespaces return disk space to the operating system when they are truncated or dropped. For more information, see [Section 14.6.3.2, “File-Per-Table Tablespaces”](#). General tablespaces are multi-table tablespaces that can also be used as an alternative to the system tablespace. See [Section 14.6.3.3, “General Tablespaces”](#).

## Using Raw Disk Partitions for the System Tablespace

Raw disk partitions can be used as system tablespace data files. This technique enables nonbuffered I/O on Windows and some Linux and Unix systems without file system overhead. Perform tests with and without raw partitions to verify whether they improve performance on your system.

When using a raw disk partition, ensure that the user ID that runs the MySQL server has read and write privileges for that partition. For example, if running the server as the `mysql` user, the partition must be readable and writable by `mysql`. If running the server with the `--memlock` option, the server must be run as `root`, so the partition must be readable and writable by `root`.

The procedures described below involve option file modification. For additional information, see [Section 4.2.2.2, “Using Option Files”](#).

## Allocating a Raw Disk Partition on Linux and Unix Systems

1. To use a raw device for a new server instance, first prepare the configuration file by setting `innodb_data_file_path` with the `raw` keyword. For example:

```

[mysqld]
innodb_data_home_dir=
innodb_data_file_path=/dev/hdd1:3Graw:/dev/hdd2:2Graw

```

The partition must be at least as large as the size that you specify. Note that 1MB in InnoDB is 1024 × 1024 bytes, whereas 1MB in disk specifications usually means 1,000,000 bytes.

2. Then initialize the server for the first time by using `--initialize` or `--initialize-insecure`. InnoDB notices the `raw` keyword and initializes the new partition, and then it stops the server.
3. Now restart the server. InnoDB now permits changes to be made.

### Allocating a Raw Disk Partition on Windows

On Windows systems, the same steps and accompanying guidelines described for Linux and Unix systems apply except that the `innodb_data_file_path` setting differs slightly on Windows. For example:

```
[mysqld]
innodb_data_home_dir=
innodb_data_file_path=//./D: :10Graw
```

The `//./` corresponds to the Windows syntax of `\\.\` for accessing physical drives. In the example above, `D:` is the drive letter of the partition.

### 14.6.3.2 File-Per-Table Tablespaces

A file-per-table tablespace contains data and indexes for a single InnoDB table, and is stored on the file system in a single data file.

File-per-table tablespace characteristics are described under the following topics in this section:

- [File-Per-Table Tablespace Configuration](#)
- [File-Per-Table Tablespace Data Files](#)
- [File-Per-Table Tablespace Advantages](#)
- [File-Per-Table Tablespace Disadvantages](#)

#### File-Per-Table Tablespace Configuration

InnoDB creates tables in file-per-table tablespaces by default. This behavior is controlled by the `innodb_file_per_table` variable. Disabling `innodb_file_per_table` causes InnoDB to create tables in the system tablespace.

An `innodb_file_per_table` setting can be specified in an option file or configured at runtime using a `SET GLOBAL` statement. Changing the setting at runtime requires privileges sufficient to set global system variables. See [Section 5.1.8.1, “System Variable Privileges”](#).

Option file:

```
[mysqld]
innodb_file_per_table=ON
```

Using `SET GLOBAL` at runtime:

```
mysql> SET GLOBAL innodb_file_per_table=ON;
```

`innodb_file_per_table` is enabled by default in MySQL 5.6 and higher. You might consider disabling it if backward compatibility with earlier versions of MySQL is a concern.



#### Warning

Disabling `innodb_file_per_table` prevents table-copying `ALTER TABLE` operations from implicitly moving a table that resides in the system tablespace to a file-per-table tablespace. A table-copying `ALTER TABLE` operation recreates the table using the current `innodb_file_per_table` setting. This behavior does not apply when adding or dropping secondary indexes, nor does it apply to `ALTER`

**TABLE** operations that use the **INPLACE** algorithm, or to tables added to the system tablespace using **CREATE TABLE ... TABLESPACE** or **ALTER TABLE ... TABLESPACE** syntax.

## File-Per-Table Tablespace Data Files

A file-per-table tablespace is created in an `.ibd` data file in a schema directory under the MySQL data directory. The `.ibd` file is named for the table (`table_name.ibd`). For example, the data file for table `test.t1` is created in the `test` directory under the MySQL data directory:

```
mysql> USE test;

mysql> CREATE TABLE t1 (
  id INT PRIMARY KEY AUTO_INCREMENT,
  name VARCHAR(100)
) ENGINE = InnoDB;

$> cd /path/to/mysql/data/test
$> ls
t1.ibd
```

You can use the **DATA DIRECTORY** clause of the **CREATE TABLE** statement to implicitly create a file-per-table tablespace data file outside of the data directory. For more information, see [Section 14.6.1.2, “Creating Tables Externally”](#).

## File-Per-Table Tablespace Advantages

File-per-table tablespaces have the following advantages over shared tablespaces such as the system tablespace or general tablespaces.

- Disk space is returned to the operating system after truncating or dropping a table created in a file-per-table tablespace. Truncating or dropping a table stored in a shared tablespace creates free space within the shared tablespace data file, which can only be used for **InnoDB** data. In other words, a shared tablespace data file does not shrink in size after a table is truncated or dropped.
- A table-copying **ALTER TABLE** operation on a table that resides in a shared tablespace can increase the amount of disk space occupied by the tablespace. Such operations may require as much additional space as the data in the table plus indexes. This space is not released back to the operating system as it is for file-per-table tablespaces.
- **TRUNCATE TABLE** performance is better when executed on tables that reside in file-per-table tablespaces.
- File-per-table tablespace data files can be created on separate storage devices for I/O optimization, space management, or backup purposes. See [Section 14.6.1.2, “Creating Tables Externally”](#).
- You can import a table that resides in a file-per-table tablespace from another MySQL instance. See [Section 14.6.1.3, “Importing InnoDB Tables”](#).
- Tables created in file-per-table tablespaces use the Barracuda file format. See [Section 14.10, “InnoDB File-Format Management”](#). The Barracuda file format enables features associated with **DYNAMIC** and **COMPRESSED** row formats. See [Section 14.11, “InnoDB Row Formats”](#).
- Tables stored in individual tablespace data files can save time and improve chances for a successful recovery when data corruption occurs, when backups or binary logs are unavailable, or when the MySQL server instance cannot be restarted.
- You can backup or restore tables created in file-per-table tablespaces quickly using MySQL Enterprise Backup, without interrupting the use of other **InnoDB** tables. This is beneficial for tables on varying backup schedules or that require backup less frequently. See [Making a Partial Backup](#) for details.

- File-per-table tablespaces permit monitoring table size on the file system by monitoring the size of the tablespace data file.
- Common Linux file systems do not permit concurrent writes to a single file such as a shared tablespace data file when `innodb_flush_method` is set to `O_DIRECT`. As a result, there are possible performance improvements when using file-per-table tablespaces in conjunction with this setting.
- Tables in a shared tablespace are limited in size by the 64TB tablespace size limit. By comparison, each file-per-table tablespace has a 64TB size limit, which provides plenty of room for individual tables to grow in size.

### File-Per-Table Tablespace Disadvantages

File-per-table tablespaces have the following disadvantages compared to shared tablespaces such as the system tablespace or general tablespaces.

- With file-per-table tablespaces, each table may have unused space that can only be utilized by rows of the same table, which can lead to wasted space if not properly managed.
- `fsync` operations are performed on multiple file-per-table data files instead of a single shared tablespace data file. Because `fsync` operations are per file, write operations for multiple tables cannot be combined, which can result in a higher total number of `fsync` operations.
- `mysqld` must keep an open file handle for each file-per-table tablespace, which may impact performance if you have numerous tables in file-per-table tablespaces.
- More file descriptors are required when each table has its own data file.
- There is potential for more fragmentation, which can impede `DROP TABLE` and table scan performance. However, if fragmentation is managed, file-per-table tablespaces can improve performance for these operations.
- The buffer pool is scanned when dropping a table that resides in a file-per-table tablespace, which can take several seconds for large buffer pools. The scan is performed with a broad internal lock, which may delay other operations.
- The `innodb_autoextend_increment` variable, which defines the increment size for extending the size of an auto-extending shared tablespace file when it becomes full, does not apply to file-per-table tablespace files, which are auto-extending regardless of the `innodb_autoextend_increment` setting. Initial file-per-table tablespace extensions are by small amounts, after which extensions occur in increments of 4MB.

### 14.6.3.3 General Tablespaces

A general tablespace is a shared `InnoDB` tablespace that is created using `CREATE TABLESPACE` syntax. General tablespace capabilities and features are described under the following topics in this section:

- [General Tablespace Capabilities](#)
- [Creating a General Tablespace](#)
- [Adding Tables to a General Tablespace](#)
- [General Tablespace Row Format Support](#)
- [Moving Tables Between Tablespaces Using ALTER TABLE](#)
- [Dropping a General Tablespace](#)
- [General Tablespace Limitations](#)

## General Tablespace Capabilities

General tablespaces provide the following capabilities:

- Similar to the system tablespace, general tablespaces are shared tablespaces capable of storing data for multiple tables.
- General tablespaces have a potential memory advantage over [file-per-table tablespaces](#). The server keeps tablespace metadata in memory for the lifetime of a tablespace. Multiple tables in fewer general tablespaces consume less memory for tablespace metadata than the same number of tables in separate file-per-table tablespaces.
- General tablespace data files can be placed in a directory relative to or independent of the MySQL data directory, which provides you with many of the data file and storage management capabilities of [file-per-table tablespaces](#). As with file-per-table tablespaces, the ability to place data files outside of the MySQL data directory allows you to manage performance of critical tables separately, setup RAID or DRBD for specific tables, or bind tables to particular disks, for example.
- General tablespaces support both Antelope and Barracuda file formats, and therefore support all table row formats and associated features. With support for both file formats, general tablespaces have no dependence on `innodb_file_format` or `innodb_file_per_table` settings, nor do these variables have any effect on general tablespaces.
- The `TABLESPACE` option can be used with `CREATE TABLE` to create tables in a general tablespaces, file-per-table tablespace, or in the system tablespace.
- The `TABLESPACE` option can be used with `ALTER TABLE` to move tables between general tablespaces, file-per-table tablespaces, and the system tablespace.

## Creating a General Tablespace

General tablespaces are created using `CREATE TABLESPACE` syntax.

```
CREATE TABLESPACE tablespace_name
  ADD DATAFILE 'file_name'
  [FILE_BLOCK_SIZE = value]
  [ENGINE [=] engine_name]
```

A general tablespace can be created in the data directory or outside of it. To avoid conflicts with implicitly created file-per-table tablespaces, creating a general tablespace in a subdirectory under the data directory is not supported. When creating a general tablespace outside of the data directory, the directory must exist prior to creating the tablespace.

An `.isl` file is created in the MySQL data directory when a general tablespace is created outside of the MySQL data directory.

Examples:

Creating a general tablespace in the data directory:

```
mysql> CREATE TABLESPACE `ts1` ADD DATAFILE 'ts1.ibd' Engine=InnoDB;
```

Creating a general tablespace in a directory outside of the data directory:

```
mysql> CREATE TABLESPACE `ts1` ADD DATAFILE '/my/tablespace/directory/ts1.ibd' Engine=InnoDB;
```

You can specify a path that is relative to the data directory as long as the tablespace directory is not under the data directory. In this example, the `my_tablespace` directory is at the same level as the data directory:

```
mysql> CREATE TABLESPACE `ts1` ADD DATAFILE '../my_tablespace/ts1.ibd' Engine=InnoDB;
```



**Note**

The `ENGINE = InnoDB` clause must be defined as part of the `CREATE TABLESPACE` statement, or `InnoDB` must be defined as the default storage engine (`default_storage_engine=InnoDB`).

**Adding Tables to a General Tablespace**

After creating a general tablespace, `CREATE TABLE tbl_name ... TABLESPACE [=] tablespace_name` or `ALTER TABLE tbl_name TABLESPACE [=] tablespace_name` statements can be used to add tables to the tablespace, as shown in the following examples:

CREATE TABLE:

```
mysql> CREATE TABLE t1 (c1 INT PRIMARY KEY) TABLESPACE ts1;
```

ALTER TABLE:

```
mysql> ALTER TABLE t2 TABLESPACE ts1;
```



**Note**

Support for adding table partitions to shared tablespaces was deprecated in MySQL 5.7.24; expect it to be removed in a future version of MySQL. Shared tablespaces include the `InnoDB` system tablespace and general tablespaces.

For detailed syntax information, see `CREATE TABLE` and `ALTER TABLE`.

**General Tablespace Row Format Support**

General tablespaces support all table row formats (`REDUNDANT`, `COMPACT`, `DYNAMIC`, `COMPRESSED`) with the caveat that compressed and uncompressed tables cannot coexist in the same general tablespace due to different physical page sizes.

For a general tablespace to contain compressed tables (`ROW_FORMAT=COMPRESSED`), the `FILE_BLOCK_SIZE` option must be specified, and the `FILE_BLOCK_SIZE` value must be a valid compressed page size in relation to the `innodb_page_size` value. Also, the physical page size of the compressed table (`KEY_BLOCK_SIZE`) must be equal to `FILE_BLOCK_SIZE/1024`. For example, if `innodb_page_size=16KB` and `FILE_BLOCK_SIZE=8K`, the `KEY_BLOCK_SIZE` of the table must be 8.

The following table shows permitted `innodb_page_size`, `FILE_BLOCK_SIZE`, and `KEY_BLOCK_SIZE` combinations. `FILE_BLOCK_SIZE` values may also be specified in bytes. To determine a valid `KEY_BLOCK_SIZE` value for a given `FILE_BLOCK_SIZE`, divide the `FILE_BLOCK_SIZE` value by 1024. Table compression is not support for 32K and 64K `InnoDB` page sizes. For more information about `KEY_BLOCK_SIZE`, see `CREATE TABLE`, and [Section 14.9.1.2, “Creating Compressed Tables”](#).

**Table 14.3 Permitted Page Size, FILE\_BLOCK\_SIZE, and KEY\_BLOCK\_SIZE Combinations for Compressed Tables**

InnoDB Page Size ( <code>innodb_page_size</code> )	Permitted <code>FILE_BLOCK_SIZE</code> Value	Permitted <code>KEY_BLOCK_SIZE</code> Value
64KB	64K (65536)	Compression is not supported
32KB	32K (32768)	Compression is not supported
16KB	16K (16384)	None. If <code>innodb_page_size</code> is equal to <code>FILE_BLOCK_SIZE</code> , the tablespace cannot contain a compressed table.

InnoDB Page Size ( <code>innodb_page_size</code> )	Permitted <code>FILE_BLOCK_SIZE</code> Value	Permitted <code>KEY_BLOCK_SIZE</code> Value
16KB	8K (8192)	8
16KB	4K (4096)	4
16KB	2K (2048)	2
16KB	1K (1024)	1
8KB	8K (8192)	None. If <code>innodb_page_size</code> is equal to <code>FILE_BLOCK_SIZE</code> , the tablespace cannot contain a compressed table.
8KB	4K (4096)	4
8KB	2K (2048)	2
8KB	1K (1024)	1
4KB	4K (4096)	None. If <code>innodb_page_size</code> is equal to <code>FILE_BLOCK_SIZE</code> , the tablespace cannot contain a compressed table.
4K	2K (2048)	2
4KB	1K (1024)	1

This example demonstrates creating a general tablespace and adding a compressed table. The example assumes a default `innodb_page_size` of 16KB. The `FILE_BLOCK_SIZE` of 8192 requires that the compressed table have a `KEY_BLOCK_SIZE` of 8.

```
mysql> CREATE TABLESPACE `ts2` ADD DATAFILE 'ts2.ibd' FILE_BLOCK_SIZE = 8192 Engine=InnoDB;
mysql> CREATE TABLE t4 (c1 INT PRIMARY KEY) TABLESPACE ts2 ROW_FORMAT=COMPRESSED KEY_BLOCK_SIZE=8;
```

If you do not specify `FILE_BLOCK_SIZE` when creating a general tablespace, `FILE_BLOCK_SIZE` defaults to `innodb_page_size`. When `FILE_BLOCK_SIZE` is equal to `innodb_page_size`, the tablespace may only contain tables with an uncompressed row format (`COMPACT`, `REDUNDANT`, and `DYNAMIC` row formats).

## Moving Tables Between Tablespaces Using ALTER TABLE

`ALTER TABLE` with the `TABLESPACE` option can be used to move a table to an existing general tablespace, to a new file-per-table tablespace, or to the system tablespace.



### Note

Support for placing table partitions in shared tablespaces was deprecated in MySQL 5.7.24; expect it to be removed in a future version of MySQL. Shared tablespaces include the `InnoDB` system tablespace and general tablespaces.

To move a table from a file-per-table tablespace or from the system tablespace to a general tablespace, specify the name of the general tablespace. The general tablespace must exist. See `ALTER TABLESPACE` for more information.

```
ALTER TABLE tbl_name TABLESPACE [=] tablespace_name;
```

To move a table from a general tablespace or file-per-table tablespace to the system tablespace, specify `innodb_system` as the tablespace name.



```
ALTER TABLE tbl_name TABLESPACE [=] innodb_system;
```

To move a table from the system tablespace or a general tablespace to a file-per-table tablespace, specify `innodb_file_per_table` as the tablespace name.

```
ALTER TABLE tbl_name TABLESPACE [=] innodb_file_per_table;
```

`ALTER TABLE ... TABLESPACE` operations cause a full table rebuild, even if the `TABLESPACE` attribute has not changed from its previous value.

`ALTER TABLE ... TABLESPACE` syntax does not support moving a table from a temporary tablespace to a persistent tablespace.

The `DATA DIRECTORY` clause is permitted with `CREATE TABLE ... TABLESPACE=innodb_file_per_table` but is otherwise not supported for use in combination with the `TABLESPACE` option.

Restrictions apply when moving tables from encrypted tablespaces. See [Encryption Limitations](#).

## Dropping a General Tablespace

The `DROP TABLESPACE` statement is used to drop an InnoDB general tablespace.

All tables must be dropped from the tablespace prior to a `DROP TABLESPACE` operation. If the tablespace is not empty, `DROP TABLESPACE` returns an error.

Use a query similar to the following to identify tables in a general tablespace.

```
mysql> SELECT a.NAME AS space_name, b.NAME AS table_name FROM INFORMATION_SCHEMA.INNODB_TABLESPACES a,
        INFORMATION_SCHEMA.INNODB_TABLES b WHERE a.SPACE=b.SPACE AND a.NAME LIKE 'ts1';
+-----+-----+
| space_name | table_name |
+-----+-----+
| ts1       | test/t1   |
| ts1       | test/t2   |
| ts1       | test/t3   |
+-----+-----+
```

If a `DROP TABLESPACE` operation on an *empty* general tablespace returns an error, the tablespace may contain an orphan temporary or intermediate table that was left by an `ALTER TABLE` operation that was interrupted by a server exit. For more information, see [Section 14.22.3, “Troubleshooting InnoDB Data Dictionary Operations”](#).

A general InnoDB tablespace is not deleted automatically when the last table in the tablespace is dropped. The tablespace must be dropped explicitly using `DROP TABLESPACE tablespace_name`.

A general tablespace does not belong to any particular database. A `DROP DATABASE` operation can drop tables that belong to a general tablespace but it cannot drop the tablespace, even if the `DROP DATABASE` operation drops all tables that belong to the tablespace.

Similar to the system tablespace, truncating or dropping tables stored in a general tablespace creates free space internally in the general tablespace `.ibd data file` which can only be used for new InnoDB data. Space is not released back to the operating system as it is when a file-per-table tablespace is deleted during a `DROP TABLE` operation.

This example demonstrates how to drop an InnoDB general tablespace. The general tablespace `ts1` is created with a single table. The table must be dropped before dropping the tablespace.

```
mysql> CREATE TABLESPACE `ts1` ADD DATAFILE 'ts1.ibd' Engine=InnoDB;
mysql> CREATE TABLE t1 (c1 INT PRIMARY KEY) TABLESPACE ts1 Engine=InnoDB;
```

```
mysql> DROP TABLE t1;
mysql> DROP TABLESPACE ts1;
```

**Note**

`tablespace_name` is a case-sensitive identifier in MySQL.

## General Tablespace Limitations

- A generated or existing tablespace cannot be changed to a general tablespace.
- Creation of temporary general tablespaces is not supported.
- General tablespaces do not support temporary tables.
- Tables stored in a general tablespace may only be opened in MySQL releases that support general tablespaces.
- Similar to the system tablespace, truncating or dropping tables stored in a general tablespace creates free space internally in the general tablespace `.ibd data file` which can only be used for new `InnoDB` data. Space is not released back to the operating system as it is for `file-per-table` tablespaces.

Additionally, a table-copying `ALTER TABLE` operation on table that resides in a shared tablespace (a general tablespace or the system tablespace) can increase the amount of space used by the tablespace. Such operations require as much additional space as the data in the table plus indexes. The additional space required for the table-copying `ALTER TABLE` operation is not released back to the operating system as it is for `file-per-table` tablespaces.

- `ALTER TABLE ... DISCARD TABLESPACE` and `ALTER TABLE ... IMPORT TABLESPACE` are not supported for tables that belong to a general tablespace.
- Support for placing table partitions in general tablespaces was deprecated in MySQL 5.7.24; expect it to be removed in a future version of MySQL.
- The `ADD DATAFILE` clause is not supported in a replication environment where the source and replica reside on the same host, as it would cause the source and replica to create a tablespace of the same name in the same location.

### 14.6.3.4 Undo Tablespaces

Undo tablespaces contain undo logs, which are collections of records containing information about how to undo the latest change by a transaction to a clustered index record.

Undo logs are stored in the system tablespace by default but can be stored in one or more undo tablespaces instead. Using undo tablespaces can reduce the amount of space required for undo logs in any one tablespace. The I/O patterns for undo logs also make undo tablespaces good candidates for `SSD` storage.

The number of undo tablespaces used by `InnoDB` is controlled by the `innodb_undo_tablespaces` option. This option can only be configured when initializing the MySQL instance. It cannot be changed afterward.

**Note**

The `innodb_undo_tablespaces` option is deprecated; expect it to be removed in a future release.

Undo tablespaces and individual [segments](#) inside those tablespaces cannot be dropped. However, undo logs stored in undo tablespaces can be truncated. For more information, see [Truncating Undo Tablespaces](#).

## Configuring Undo Tablespaces

This procedure describes how to configure undo tablespaces. When undo tablespaces are configured, undo logs are stored in the undo tablespaces instead of the system tablespace.

The number of undo tablespaces can only be configured when initializing a MySQL instance and is fixed for the life of the instance, so it is recommended that you perform the following procedure on a test instance with a representative workload before deploying the configuration to a production system.

To configure undo tablespaces:

1. Specify a directory location for undo tablespaces using the `innodb_undo_directory` variable. If a directory location is not specified, undo tablespaces are created in the data directory.
2. Define the number of rollback segments using the `innodb_rollback_segments` variable. Start with a relatively low value and increase it incrementally over time to examine the effect on performance. The default setting for `innodb_rollback_segments` is 128, which is also the maximum value.

One rollback segment is always assigned to the system tablespace, and 32 rollback segments are reserved for the temporary tablespace (`ibtmp1`). Therefore, to allocate rollback segments to undo tablespaces, set `innodb_rollback_segments` to a value greater than 33. For example, if you have two undo tablespaces, set `innodb_rollback_segments` to 35 to assign one rollback segment to each of the two undo tablespaces. Rollback segments are distributed among undo tablespaces in a circular fashion.

When you add undo tablespaces, the rollback segment in the system tablespace is rendered inactive.

3. Define the number of undo tablespaces using the `innodb_undo_tablespaces` option. The specified number of undo tablespaces is fixed for the life of the MySQL instance, so if you are uncertain about an optimal value, estimate on the high side.
4. Create a new MySQL test instance using the configuration settings you have chosen.
5. Use a realistic workload on your test instance with data volume similar to your production servers to test the configuration.
6. Benchmark the performance of I/O intensive workloads.
7. Periodically increase the value of `innodb_rollback_segments` and rerun performance tests until there are no further improvements in I/O performance.

## Truncating Undo Tablespaces

Truncating undo tablespaces requires that the MySQL instance have a minimum of two active undo tablespaces, which ensures that one undo tablespace remains active while the other is taken offline to be truncated. The number of undo tablespaces is defined by the `innodb_undo_tablespaces` variable. The default value is 0. Use this statement to check the value of `innodb_undo_tablespaces`:

```
mysql> SELECT @@innodb_undo_tablespaces;
+-----+
| @@innodb_undo_tablespaces |
+-----+
|                2 |
+-----+
```

To have undo tablespaces truncated, enable the `innodb_undo_log_truncate` variable. For example:

```
mysql> SET GLOBAL innodb_undo_log_truncate=ON;
```

When the `innodb_undo_log_truncate` variable is enabled, undo tablespaces that exceed the size limit defined by the `innodb_max_undo_log_size` variable are subject to truncation. The `innodb_max_undo_log_size` variable is dynamic and has a default value of 1073741824 bytes (1024 MiB).

```
mysql> SELECT @@innodb_max_undo_log_size;
+-----+
| @@innodb_max_undo_log_size |
+-----+
|                1073741824 |
+-----+
```

When the `innodb_undo_log_truncate` variable is enabled:

1. Undo tablespaces that exceed the `innodb_max_undo_log_size` setting are marked for truncation. Selection of an undo tablespace for truncation is performed in a circular fashion to avoid truncating the same undo tablespace each time.
2. Rollback segments residing in the selected undo tablespace are made inactive so that they are not assigned to new transactions. Existing transactions that are currently using rollback segments are permitted to finish.
3. The `purge` system empties rollback segments by freeing undo logs that are no longer in use.
4. After all rollback segments in the undo tablespace are freed, the truncate operation runs and truncates the undo tablespace to its initial size. The initial size of an undo tablespace depends on the `innodb_page_size` value. For the default 16KB page size, the initial undo tablespace file size is 10MiB. For 4KB, 8KB, 32KB, and 64KB page sizes, the initial undo tablespace files sizes are 7MiB, 8MiB, 20MiB, and 40MiB, respectively.

The size of an undo tablespace after a truncate operation may be larger than the initial size due to immediate use following the completion of the operation.

The `innodb_undo_directory` variable defines the location of undo tablespace files. If the `innodb_undo_directory` variable is undefined, undo tablespaces reside in the data directory.

5. Rollback segments are reactivated so that they can be assigned to new transactions.

## Expediting Truncation of Undo Tablespaces

The purge thread is responsible for emptying and truncating undo tablespaces. By default, the purge thread looks for undo tablespaces to truncate once every 128 times that purge is invoked. The frequency with which the purge thread looks for undo tablespaces to truncate is controlled by the `innodb_purge_rseg_truncate_frequency` variable, which has a default setting of 128.

```
mysql> SELECT @@innodb_purge_rseg_truncate_frequency;
+-----+
| @@innodb_purge_rseg_truncate_frequency |
+-----+
|                                128 |
+-----+
```

To increase the frequency, decrease the `innodb_purge_rseg_truncate_frequency` setting. For example, to have the purge thread look for undo tablespaces once every 32 times that purge is invoked, set `innodb_purge_rseg_truncate_frequency` to 32.

```
mysql> SET GLOBAL innodb_purge_rseg_truncate_frequency=32;
```

When the purge thread finds an undo tablespace that requires truncation, the purge thread returns with increased frequency to quickly empty and truncate the undo tablespace.

### Performance Impact of Truncating Undo Tablespace Files

When an undo tablespace is truncated, the rollback segments in the undo tablespace are deactivated. The active rollback segments in other undo tablespaces assume responsibility for the entire system load, which may result in a slight performance degradation. The extent to which performance is affected depends on a number of factors:

- Number of undo tablespaces
- Number of undo logs
- Undo tablespace size
- Speed of the I/O subsystem
- Existing long running transactions
- System load

The easiest way to avoid the potential performance impact is to increase the number of undo tablespaces.

Also, two checkpoint operations are performed during an undo tablespace truncate operation. The first checkpoint operation removes the old undo tablespace pages from the buffer pool. The second checkpoint flushes the initial pages of the new undo tablespace to disk. On a busy system, the first checkpoint in particular can temporarily affect system performance if there is a large number of pages to remove.

### Undo Tablespace Truncation Recovery

An undo tablespace truncate operation creates a temporary `undo_space_number_trunc.log` file in the server log directory. That log directory is defined by `innodb_log_group_home_dir`. If a system failure occurs during the truncate operation, the temporary log file permits the startup process to identify undo tablespaces that were being truncated and to continue the operation.

### 14.6.3.5 The Temporary Tablespace

Non-compressed, user-created temporary tables and on-disk internal temporary tables are created in a shared temporary tablespace. The `innodb_temp_data_file_path` variable defines the relative path, name, size, and attributes for temporary tablespace data files. If no value is specified for `innodb_temp_data_file_path`, the default behavior is to create an auto-extending data file named `ibtmp1` in the `innodb_data_home_dir` directory that is slightly larger than 12MB.



#### Note

In MySQL 5.6, non-compressed temporary tables are created in individual file-per-table tablespaces in the temporary file directory, or in the `InnoDB` system tablespace in the data directory if `innodb_file_per_table` is disabled. The introduction of a shared temporary tablespace in MySQL 5.7 removes performance costs associated with creating and removing a file-per-table tablespace for each temporary table. A dedicated temporary tablespace also means that it is no longer necessary to save temporary table metadata to the `InnoDB` system tables.

Compressed temporary tables, which are temporary tables created using the `ROW_FORMAT=COMPRESSED` attribute, are created in `file-per-table` tablespaces in the temporary file directory.

The temporary tablespace is removed on normal shutdown or on an aborted initialization, and is recreated each time the server is started. The temporary tablespace receives a dynamically generated space ID when it is created. Startup is refused if the temporary tablespace cannot be created. The temporary tablespace is not removed if the server halts unexpectedly. In this case, a database administrator can remove the temporary tablespace manually or restart the server, which removes and recreates the temporary tablespace automatically.

The temporary tablespace cannot reside on a raw device.

The Information Schema `FILES` table provides metadata about the `InnoDB` temporary tablespace. Issue a query similar to this one to view temporary tablespace metadata:

```
mysql> SELECT * FROM INFORMATION_SCHEMA.FILES WHERE TABLESPACE_NAME='innodb_temporary'\G
```

The Information Schema `INNODB_TEMP_TABLE_INFO` table provides metadata about user-created temporary tables that are currently active within an `InnoDB` instance.

## Managing Temporary Tablespace Data File Size

By default, the temporary tablespace data file is autoextending and increases in size as necessary to accommodate on-disk temporary tables. For example, if an operation creates a temporary table that is 20MB in size, the temporary tablespace data file, which is 12MB in size by default when created, extends in size to accommodate it. When temporary tables are dropped, freed space can be reused for new temporary tables, but the data file remains at the extended size.

An autoextending temporary tablespace data file can become large in environments that use large temporary tables or that use temporary tables extensively. A large data file can also result from long running queries that use temporary tables.

To determine if a temporary tablespace data file is autoextending, check the `innodb_temp_data_file_path` setting:

```
mysql> SELECT @@innodb_temp_data_file_path;
+-----+
| @@innodb_temp_data_file_path |
+-----+
| ibtmp1:12M:autoextend        |
+-----+
```

To check the size of temporary tablespace data files, query the Information Schema `FILES` table using a query similar to this:

```
mysql> SELECT FILE_NAME, TABLESPACE_NAME, ENGINE, INITIAL_SIZE, TOTAL_EXTENTS*EXTENT_SIZE
AS TotalSizeBytes, DATA_FREE, MAXIMUM_SIZE FROM INFORMATION_SCHEMA.FILES
WHERE TABLESPACE_NAME = 'innodb_temporary'\G
***** 1. row *****
FILE_NAME: ./ibtmp1
TABLESPACE_NAME: innodb_temporary
ENGINE: InnoDB
INITIAL_SIZE: 12582912
TotalSizeBytes: 12582912
DATA_FREE: 6291456
MAXIMUM_SIZE: NULL
```

The `TotalSizeBytes` value reports the current size of the temporary tablespace data file. For information about other field values, see [Section 24.3.9, “The INFORMATION\\_SCHEMA FILES Table”](#).

Alternatively, check the temporary tablespace data file size on your operating system. By default, the temporary tablespace data file is located in the directory defined by the `innodb_temp_data_file_path` configuration option. If a value was not specified for this option explicitly, a temporary tablespace data file

named `ibtmp1` is created in `innodb_data_home_dir`, which defaults to the MySQL data directory if unspecified.

To reclaim disk space occupied by a temporary tablespace data file, restart the MySQL server. Restarting the server removes and recreates the temporary tablespace data file according to the attributes defined by `innodb_temp_data_file_path`.

To prevent the temporary data file from becoming too large, you can configure the `innodb_temp_data_file_path` variable to specify a maximum file size. For example:

```
[mysqld]
innodb_temp_data_file_path=ibtmp1:12M:autoextend:max:500M
```

When the data file reaches the maximum size, queries fail with an error indicating that the table is full. Configuring `innodb_temp_data_file_path` requires restarting the server.

Alternatively, configure the `default_tmp_storage_engine` and `internal_tmp_disk_storage_engine` variables, which define the storage engine to use for user-created and on-disk internal temporary tables, respectively. Both variables are set to `InnoDB` by default. The `MyISAM` storage engine uses an individual file for each temporary table, which is removed when the temporary table is dropped.

## 14.6.4 InnoDB Data Dictionary

The `InnoDB` data dictionary is comprised of internal system tables that contain metadata used to keep track of objects such as tables, indexes, and table columns. The metadata is physically located in the `InnoDB` system tablespace. For historical reasons, data dictionary metadata overlaps to some degree with information stored in `InnoDB` table metadata files (`.frm` files).

## 14.6.5 Doublewrite Buffer

The doublewrite buffer is a storage area where `InnoDB` writes pages flushed from the buffer pool before writing the pages to their proper positions in the `InnoDB` data files. If there is an operating system, storage subsystem, or unexpected `mysqld` process exit in the middle of a page write, `InnoDB` can find a good copy of the page from the doublewrite buffer during crash recovery.

Although data is written twice, the doublewrite buffer does not require twice as much I/O overhead or twice as many I/O operations. Data is written to the doublewrite buffer in a large sequential chunk, with a single `fsync()` call to the operating system (except in the case that `innodb_flush_method` is set to `O_DIRECT_NO_FSYNC`).

The doublewrite buffer is enabled by default in most cases. To disable the doublewrite buffer, set `innodb_doublewrite` to 0.

If system tablespace files (“ibdata files”) are located on Fusion-io devices that support atomic writes, doublewrite buffering is automatically disabled and Fusion-io atomic writes are used for all data files. Because the doublewrite buffer setting is global, doublewrite buffering is also disabled for data files residing on non-Fusion-io hardware. This feature is only supported on Fusion-io hardware and is only enabled for Fusion-io NVMFS on Linux. To take full advantage of this feature, an `innodb_flush_method` setting of `O_DIRECT` is recommended.

## 14.6.6 Redo Log

The redo log is a disk-based data structure used during crash recovery to correct data written by incomplete transactions. During normal operations, the redo log encodes requests to change table data that result from SQL statements or low-level API calls. Modifications that did not finish updating the data files before an unexpected shutdown are replayed automatically during initialization, and

before connections are accepted. For information about the role of the redo log in crash recovery, see [Section 14.19.2, “InnoDB Recovery”](#).

By default, the redo log is physically represented on disk by two files named `ib_logfile0` and `ib_logfile1`. MySQL writes to the redo log files in a circular fashion. Data in the redo log is encoded in terms of records affected; this data is collectively referred to as redo. The passage of data through the redo log is represented by an ever-increasing [LSN](#) value.

Information and procedures related to redo logs are described under the following topics in the section:

- [Changing the Number or Size of InnoDB Redo Log Files](#)
- [Related Topics](#)

## Changing the Number or Size of InnoDB Redo Log Files

To change the number or the size of your [InnoDB redo log](#) files, perform the following steps:

1. Stop the MySQL server and make sure that it shuts down without errors.
2. Edit `my.cnf` to change the log file configuration. To change the log file size, configure `innodb_log_file_size`. To increase the number of log files, configure `innodb_log_files_in_group`.
3. Start the MySQL server again.

If [InnoDB](#) detects that the `innodb_log_file_size` differs from the redo log file size, it writes a log checkpoint, closes and removes the old log files, creates new log files at the requested size, and opens the new log files.

## Related Topics

- [Redo Log File Configuration](#)
- [Section 8.5.4, “Optimizing InnoDB Redo Logging”](#)

## 14.6.7 Undo Logs

An undo log is a collection of undo log records associated with a single read-write transaction. An undo log record contains information about how to undo the latest change by a transaction to a [clustered index](#) record. If another transaction needs to see the original data as part of a consistent read operation, the unmodified data is retrieved from undo log records. Undo logs exist within [undo log segments](#), which are contained within [rollback segments](#). Rollback segments reside in the [system tablespace](#), in [undo tablespaces](#), and in the [temporary tablespace](#).

Undo logs that reside in the temporary tablespace are used for transactions that modify data in user-defined temporary tables. These undo logs are not redo-logged, as they are not required for crash recovery. They are used only for rollback while the server is running. This type of undo log benefits performance by avoiding redo logging I/O.

[InnoDB](#) supports a maximum of 128 rollback segments, 32 of which are allocated to the temporary tablespace. This leaves 96 rollback segments that can be assigned to transactions that modify data in regular tables. The `innodb_rollback_segments` variable defines the number of rollback segments used by [InnoDB](#).

The number of transactions that a rollback segment supports depends on the number of undo slots in the rollback segment and the number of undo logs required by each transaction. The number of undo slots in a rollback segment differs according to [InnoDB](#) page size.



InnoDB Page Size	Number of Undo Slots in a Rollback Segment (InnoDB Page Size / 16)
4096 (4KB)	256
8192 (8KB)	512
16384 (16KB)	1024
32768 (32KB)	2048
65536 (64KB)	4096

A transaction is assigned up to four undo logs, one for each of the following operation types:

1. `INSERT` operations on user-defined tables
2. `UPDATE` and `DELETE` operations on user-defined tables
3. `INSERT` operations on user-defined temporary tables
4. `UPDATE` and `DELETE` operations on user-defined temporary tables

Undo logs are assigned as needed. For example, a transaction that performs `INSERT`, `UPDATE`, and `DELETE` operations on regular and temporary tables requires a full assignment of four undo logs. A transaction that performs only `INSERT` operations on regular tables requires a single undo log.

A transaction that performs operations on regular tables is assigned undo logs from an assigned system tablespace or undo tablespace rollback segment. A transaction that performs operations on temporary tables is assigned undo logs from an assigned temporary tablespace rollback segment.

An undo log assigned to a transaction remains attached to the transaction for its duration. For example, an undo log assigned to a transaction for an `INSERT` operation on a regular table is used for all `INSERT` operations on regular tables performed by that transaction.

Given the factors described above, the following formulas can be used to estimate the number of concurrent read-write transactions that `InnoDB` is capable of supporting.



#### Note

It is possible to encounter a concurrent transaction limit error before reaching the number of concurrent read-write transactions that `InnoDB` is capable of supporting. This occurs when the rollback segment assigned to a transaction runs out of undo slots. In such cases, try rerunning the transaction.

When transactions perform operations on temporary tables, the number of concurrent read-write transactions that `InnoDB` is capable of supporting is constrained by the number of rollback segments allocated to the temporary tablespace, which is 32.

- If each transaction performs either an `INSERT` or an `UPDATE` or `DELETE` operation, the number of concurrent read-write transactions that `InnoDB` is capable of supporting is:

```
(innodb_page_size / 16) * (innodb_rollback_segments - 32)
```

- If each transaction performs an `INSERT` and an `UPDATE` or `DELETE` operation, the number of concurrent read-write transactions that `InnoDB` is capable of supporting is:

```
(innodb_page_size / 16 / 2) * (innodb_rollback_segments - 32)
```

- If each transaction performs an `INSERT` operation on a temporary table, the number of concurrent read-write transactions that `InnoDB` is capable of supporting is:

```
(innodb_page_size / 16) * 32
```

- If each transaction performs an `INSERT` and an `UPDATE` or `DELETE` operation on a temporary table, the number of concurrent read-write transactions that `InnoDB` is capable of supporting is:

```
(innodb_page_size / 16 / 2) * 32
```

## 14.7 InnoDB Locking and Transaction Model

To implement a large-scale, busy, or highly reliable database application, to port substantial code from a different database system, or to tune MySQL performance, it is important to understand `InnoDB` locking and the `InnoDB` transaction model.

This section discusses several topics related to `InnoDB` locking and the `InnoDB` transaction model with which you should be familiar.

- [Section 14.7.1, “InnoDB Locking”](#) describes lock types used by `InnoDB`.
- [Section 14.7.2, “InnoDB Transaction Model”](#) describes transaction isolation levels and the locking strategies used by each. It also discusses the use of `autocommit`, consistent non-locking reads, and locking reads.
- [Section 14.7.3, “Locks Set by Different SQL Statements in InnoDB”](#) discusses specific types of locks set in `InnoDB` for various statements.
- [Section 14.7.4, “Phantom Rows”](#) describes how `InnoDB` uses next-key locking to avoid phantom rows.
- [Section 14.7.5, “Deadlocks in InnoDB”](#) provides a deadlock example, discusses deadlock detection, and provides tips for minimizing and handling deadlocks in `InnoDB`.

### 14.7.1 InnoDB Locking

This section describes lock types used by `InnoDB`.

- [Shared and Exclusive Locks](#)
- [Intention Locks](#)
- [Record Locks](#)
- [Gap Locks](#)
- [Next-Key Locks](#)
- [Insert Intention Locks](#)
- [AUTO-INC Locks](#)
- [Predicate Locks for Spatial Indexes](#)

#### Shared and Exclusive Locks

`InnoDB` implements standard row-level locking where there are two types of locks, [shared \(S\) locks](#) and [exclusive \(X\) locks](#).

- A [shared \(S\) lock](#) permits the transaction that holds the lock to read a row.

- An **exclusive (x) lock** permits the transaction that holds the lock to update or delete a row.

If transaction **T1** holds a shared (**S**) lock on row **r**, then requests from some distinct transaction **T2** for a lock on row **r** are handled as follows:

- A request by **T2** for an **S** lock can be granted immediately. As a result, both **T1** and **T2** hold an **S** lock on **r**.
- A request by **T2** for an **x** lock cannot be granted immediately.

If a transaction **T1** holds an exclusive (**x**) lock on row **r**, a request from some distinct transaction **T2** for a lock of either type on **r** cannot be granted immediately. Instead, transaction **T2** has to wait for transaction **T1** to release its lock on row **r**.

## Intention Locks

InnoDB supports *multiple granularity locking* which permits coexistence of row locks and table locks. For example, a statement such as `LOCK TABLES ... WRITE` takes an exclusive lock (an **x** lock) on the specified table. To make locking at multiple granularity levels practical, InnoDB uses **intention locks**. Intention locks are table-level locks that indicate which type of lock (shared or exclusive) a transaction requires later for a row in a table. There are two types of intention locks:

- An **intention shared lock (IS)** indicates that a transaction intends to set a *shared* lock on individual rows in a table.
- An **intention exclusive lock (IX)** indicates that a transaction intends to set an exclusive lock on individual rows in a table.

For example, `SELECT ... LOCK IN SHARE MODE` sets an **IS** lock, and `SELECT ... FOR UPDATE` sets an **IX** lock.

The intention locking protocol is as follows:

- Before a transaction can acquire a shared lock on a row in a table, it must first acquire an **IS** lock or stronger on the table.
- Before a transaction can acquire an exclusive lock on a row in a table, it must first acquire an **IX** lock on the table.

Table-level lock type compatibility is summarized in the following matrix.

	<b>x</b>	<b>IX</b>	<b>s</b>	<b>IS</b>
<b>x</b>	Conflict	Conflict	Conflict	Conflict
<b>IX</b>	Conflict	Compatible	Conflict	Compatible
<b>s</b>	Conflict	Conflict	Compatible	Compatible
<b>IS</b>	Conflict	Compatible	Compatible	Compatible

A lock is granted to a requesting transaction if it is compatible with existing locks, but not if it conflicts with existing locks. A transaction waits until the conflicting existing lock is released. If a lock request conflicts with an existing lock and cannot be granted because it would cause **deadlock**, an error occurs.

Intention locks do not block anything except full table requests (for example, `LOCK TABLES ... WRITE`). The main purpose of intention locks is to show that someone is locking a row, or going to lock a row in the table.

Transaction data for an intention lock appears similar to the following in `SHOW ENGINE INNODB STATUS` and **InnoDB monitor** output:

```
TABLE LOCK table `test`.`t` trx id 10080 lock mode IX
```

## Record Locks

A record lock is a lock on an index record. For example, `SELECT c1 FROM t WHERE c1 = 10 FOR UPDATE;` prevents any other transaction from inserting, updating, or deleting rows where the value of `t.c1` is 10.

Record locks always lock index records, even if a table is defined with no indexes. For such cases, InnoDB creates a hidden clustered index and uses this index for record locking. See [Section 14.6.2.1, “Clustered and Secondary Indexes”](#).

Transaction data for a record lock appears similar to the following in `SHOW ENGINE INNODB STATUS` and InnoDB monitor output:

```
RECORD LOCKS space id 58 page no 3 n bits 72 index `PRIMARY` of table `test`.`t`
trx id 10078 lock_mode X locks rec but not gap
Record lock, heap no 2 PHYSICAL RECORD: n_fields 3; compact format; info bits 0
 0: len 4; hex 8000000a; asc      ;;
 1: len 6; hex 00000000274f; asc   'O';
 2: len 7; hex b60000019d0110; asc      ;;
```

## Gap Locks

A gap lock is a lock on a gap between index records, or a lock on the gap before the first or after the last index record. For example, `SELECT c1 FROM t WHERE c1 BETWEEN 10 and 20 FOR UPDATE;` prevents other transactions from inserting a value of 15 into column `t.c1`, whether or not there was already any such value in the column, because the gaps between all existing values in the range are locked.

A gap might span a single index value, multiple index values, or even be empty.

Gap locks are part of the tradeoff between performance and concurrency, and are used in some transaction isolation levels and not others.

Gap locking is not needed for statements that lock rows using a unique index to search for a unique row. (This does not include the case that the search condition includes only some columns of a multiple-column unique index; in that case, gap locking does occur.) For example, if the `id` column has a unique index, the following statement uses only an index-record lock for the row having `id` value 100 and it does not matter whether other sessions insert rows in the preceding gap:

```
SELECT * FROM child WHERE id = 100;
```

If `id` is not indexed or has a nonunique index, the statement does lock the preceding gap.

It is also worth noting here that conflicting locks can be held on a gap by different transactions. For example, transaction A can hold a shared gap lock (gap S-lock) on a gap while transaction B holds an exclusive gap lock (gap X-lock) on the same gap. The reason conflicting gap locks are allowed is that if a record is purged from an index, the gap locks held on the record by different transactions must be merged.

Gap locks in InnoDB are “purely inhibitive”, which means that their only purpose is to prevent other transactions from inserting to the gap. Gap locks can co-exist. A gap lock taken by one transaction does not prevent another transaction from taking a gap lock on the same gap. There is no difference between shared and exclusive gap locks. They do not conflict with each other, and they perform the same function.

Gap locking can be disabled explicitly. This occurs if you change the transaction isolation level to `READ COMMITTED` or enable the `innodb_locks_unsafe_for_binlog` system variable (which is now deprecated). In this case, gap locking is disabled for searches and index scans and is used only for foreign-key constraint checking and duplicate-key checking.

There are also other effects of using the `READ COMMITTED` isolation level or enabling `innodb_locks_unsafe_for_binlog`. Record locks for nonmatching rows are released after MySQL has evaluated the `WHERE` condition. For `UPDATE` statements, InnoDB does a “semi-consistent” read, such that it returns the latest committed version to MySQL so that MySQL can determine whether the row matches the `WHERE` condition of the `UPDATE`.

## Next-Key Locks

A next-key lock is a combination of a record lock on the index record and a gap lock on the gap before the index record.

InnoDB performs row-level locking in such a way that when it searches or scans a table index, it sets shared or exclusive locks on the index records it encounters. Thus, the row-level locks are actually index-record locks. A next-key lock on an index record also affects the “gap” before that index record. That is, a next-key lock is an index-record lock plus a gap lock on the gap preceding the index record. If one session has a shared or exclusive lock on record `R` in an index, another session cannot insert a new index record in the gap immediately before `R` in the index order.

Suppose that an index contains the values 10, 11, 13, and 20. The possible next-key locks for this index cover the following intervals, where a round bracket denotes exclusion of the interval endpoint and a square bracket denotes inclusion of the endpoint:

```
(negative infinity, 10]
(10, 11]
(11, 13]
(13, 20]
(20, positive infinity)
```

For the last interval, the next-key lock locks the gap above the largest value in the index and the “supremum” pseudo-record having a value higher than any value actually in the index. The supremum is not a real index record, so, in effect, this next-key lock locks only the gap following the largest index value.

By default, InnoDB operates in `REPEATABLE READ` transaction isolation level. In this case, InnoDB uses next-key locks for searches and index scans, which prevents phantom rows (see [Section 14.7.4, “Phantom Rows”](#)).

Transaction data for a next-key lock appears similar to the following in `SHOW ENGINE INNODB STATUS` and `InnoDB monitor` output:

```
RECORD LOCKS space id 58 page no 3 n bits 72 index `PRIMARY` of table `test`.`t`
trx id 10080 lock_mode X
Record lock, heap no 1 PHYSICAL RECORD: n_fields 1; compact format; info bits 0
 0: len 8; hex 73757072656d756d; asc supremum;;

Record lock, heap no 2 PHYSICAL RECORD: n_fields 3; compact format; info bits 0
 0: len 4; hex 8000000a; asc    ;;
 1: len 6; hex 00000000274f; asc    'O';
 2: len 7; hex b60000019d0110; asc    ;;
```

## Insert Intention Locks

An insert intention lock is a type of gap lock set by `INSERT` operations prior to row insertion. This lock signals the intent to insert in such a way that multiple transactions inserting into the same index gap need not wait for each other if they are not inserting at the same position within the gap. Suppose that there are index records with values of 4 and 7. Separate transactions that attempt to insert values of 5 and 6, respectively, each lock the gap between 4 and 7 with insert intention locks prior to obtaining the exclusive lock on the inserted row, but do not block each other because the rows are nonconflicting.

The following example demonstrates a transaction taking an insert intention lock prior to obtaining an exclusive lock on the inserted record. The example involves two clients, A and B.

Client A creates a table containing two index records (90 and 102) and then starts a transaction that places an exclusive lock on index records with an ID greater than 100. The exclusive lock includes a gap lock before record 102:

```
mysql> CREATE TABLE child (id int(11) NOT NULL, PRIMARY KEY(id)) ENGINE=InnoDB;
mysql> INSERT INTO child (id) values (90),(102);

mysql> START TRANSACTION;
mysql> SELECT * FROM child WHERE id > 100 FOR UPDATE;
+-----+
| id   |
+-----+
| 102 |
+-----+
```

Client B begins a transaction to insert a record into the gap. The transaction takes an insert intention lock while it waits to obtain an exclusive lock.

```
mysql> START TRANSACTION;
mysql> INSERT INTO child (id) VALUES (101);
```

Transaction data for an insert intention lock appears similar to the following in `SHOW ENGINE INNODB STATUS` and `InnoDB monitor` output:

```
RECORD LOCKS space id 31 page no 3 n bits 72 index `PRIMARY` of table `test`.`child`
trx id 8731 lock_mode X locks gap before rec insert intention waiting
Record lock, heap no 3 PHYSICAL RECORD: n_fields 3; compact format; info bits 0
 0: len 4; hex 80000066; asc f;;
 1: len 6; hex 000000002215; asc " ;;
 2: len 7; hex 9000000172011c; asc r ;;...
```

## AUTO-INC Locks

An `AUTO-INC` lock is a special table-level lock taken by transactions inserting into tables with `AUTO_INCREMENT` columns. In the simplest case, if one transaction is inserting values into the table, any other transactions must wait to do their own inserts into that table, so that rows inserted by the first transaction receive consecutive primary key values.

The `innodb_autoinc_lock_mode` variable controls the algorithm used for auto-increment locking. It allows you to choose how to trade off between predictable sequences of auto-increment values and maximum concurrency for insert operations.

For more information, see [Section 14.6.1.6, “AUTO\\_INCREMENT Handling in InnoDB”](#).

## Predicate Locks for Spatial Indexes

InnoDB supports `SPATIAL` indexing of columns containing spatial data (see [Section 11.4.8, “Optimizing Spatial Analysis”](#)).

To handle locking for operations involving `SPATIAL` indexes, next-key locking does not work well to support `REPEATABLE READ` or `SERIALIZABLE` transaction isolation levels. There is no absolute ordering concept in multidimensional data, so it is not clear which is the “next” key.

To enable support of isolation levels for tables with `SPATIAL` indexes, InnoDB uses predicate locks. A `SPATIAL` index contains minimum bounding rectangle (MBR) values, so InnoDB enforces consistent read on the index by setting a predicate lock on the MBR value used for a query. Other transactions cannot insert or modify a row that would match the query condition.

## 14.7.2 InnoDB Transaction Model

The InnoDB transaction model aims to combine the best properties of a [multi-versioning](#) database with traditional two-phase locking. InnoDB performs locking at the row level and runs queries as nonlocking [consistent reads](#) by default, in the style of Oracle. The lock information in InnoDB is stored space-efficiently so that lock escalation is not needed. Typically, several users are permitted to lock every row in InnoDB tables, or any random subset of the rows, without causing InnoDB memory exhaustion.

### 14.7.2.1 Transaction Isolation Levels

Transaction isolation is one of the foundations of database processing. Isolation is the I in the acronym [ACID](#); the isolation level is the setting that fine-tunes the balance between performance and reliability, consistency, and reproducibility of results when multiple transactions are making changes and performing queries at the same time.

InnoDB offers all four transaction isolation levels described by the SQL:1992 standard: [READ UNCOMMITTED](#), [READ COMMITTED](#), [REPEATABLE READ](#), and [SERIALIZABLE](#). The default isolation level for InnoDB is [REPEATABLE READ](#).

A user can change the isolation level for a single session or for all subsequent connections with the [SET TRANSACTION](#) statement. To set the server's default isolation level for all connections, use the `--transaction-isolation` option on the command line or in an option file. For detailed information about isolation levels and level-setting syntax, see [Section 13.3.6, "SET TRANSACTION Statement"](#).

InnoDB supports each of the transaction isolation levels described here using different [locking](#) strategies. You can enforce a high degree of consistency with the default [REPEATABLE READ](#) level, for operations on crucial data where [ACID](#) compliance is important. Or you can relax the consistency rules with [READ COMMITTED](#) or even [READ UNCOMMITTED](#), in situations such as bulk reporting where precise consistency and repeatable results are less important than minimizing the amount of overhead for locking. [SERIALIZABLE](#) enforces even stricter rules than [REPEATABLE READ](#), and is used mainly in specialized situations, such as with [XA](#) transactions and for troubleshooting issues with concurrency and [deadlocks](#).

The following list describes how MySQL supports the different transaction levels. The list goes from the most commonly used level to the least used.

- [REPEATABLE READ](#)

This is the default isolation level for InnoDB. [Consistent reads](#) within the same transaction read the [snapshot](#) established by the first read. This means that if you issue several plain (nonlocking) [SELECT](#) statements within the same transaction, these [SELECT](#) statements are consistent also with respect to each other. See [Section 14.7.2.3, "Consistent Nonlocking Reads"](#).

For [locking reads](#) ([SELECT](#) with [FOR UPDATE](#) or [LOCK IN SHARE MODE](#)), [UPDATE](#), and [DELETE](#) statements, locking depends on whether the statement uses a unique index with a unique search condition or a range-type search condition.

- For a unique index with a unique search condition, InnoDB locks only the index record found, not the [gap](#) before it.
- For other search conditions, InnoDB locks the index range scanned, using [gap locks](#) or [next-key locks](#) to block insertions by other sessions into the gaps covered by the range. For information about gap locks and next-key locks, see [Section 14.7.1, "InnoDB Locking"](#).

It is not recommended to mix locking statements ([UPDATE](#), [INSERT](#), [DELETE](#), or [SELECT . . . FOR . . .](#)) with non-locking [SELECT](#) statements in a single [REPEATABLE READ](#) transaction, because typically in such cases you want [SERIALIZABLE](#) instead. This is because a non-locking [SELECT](#) statement presents the state of the database from a read-view which consists of transactions committed before the read-view was created and before the current transaction's own writes, while the locking

statements see and modify the most recent state of the database to use locking. In general, these two different table states are inconsistent with each other and difficult to parse.

- [READ COMMITTED](#)

Each consistent read, even within the same transaction, sets and reads its own fresh snapshot. For information about consistent reads, see [Section 14.7.2.3, “Consistent Nonlocking Reads”](#).

For locking reads ([SELECT](#) with [FOR UPDATE](#) or [LOCK IN SHARE MODE](#)), [UPDATE](#) statements, and [DELETE](#) statements, [InnoDB](#) locks only index records, not the gaps before them, and thus permits the free insertion of new records next to locked records. Gap locking is only used for foreign-key constraint checking and duplicate-key checking.

Because gap locking is disabled, phantom row problems may occur, as other sessions can insert new rows into the gaps. For information about phantom rows, see [Section 14.7.4, “Phantom Rows”](#).

Only row-based binary logging is supported with the [READ COMMITTED](#) isolation level. If you use [READ COMMITTED](#) with [binlog\\_format=MIXED](#), the server automatically uses row-based logging.

Using [READ COMMITTED](#) has additional effects:

- For [UPDATE](#) or [DELETE](#) statements, [InnoDB](#) holds locks only for rows that it updates or deletes. Record locks for nonmatching rows are released after MySQL has evaluated the [WHERE](#) condition. This greatly reduces the probability of deadlocks, but they can still happen.
- For [UPDATE](#) statements, if a row is already locked, [InnoDB](#) performs a “semi-consistent” read, returning the latest committed version to MySQL so that MySQL can determine whether the row matches the [WHERE](#) condition of the [UPDATE](#). If the row matches (must be updated), MySQL reads the row again and this time [InnoDB](#) either locks it or waits for a lock on it.

Consider the following example, beginning with this table:

```
CREATE TABLE t (a INT NOT NULL, b INT) ENGINE = InnoDB;
INSERT INTO t VALUES (1,2),(2,3),(3,2),(4,3),(5,2);
COMMIT;
```

In this case, the table has no indexes, so searches and index scans use the hidden clustered index for record locking (see [Section 14.6.2.1, “Clustered and Secondary Indexes”](#)) rather than indexed columns.

Suppose that one session performs an [UPDATE](#) using these statements:

```
# Session A
START TRANSACTION;
UPDATE t SET b = 5 WHERE b = 3;
```

Suppose also that a second session performs an [UPDATE](#) by executing this statement following those of the first session:

```
# Session B
UPDATE t SET b = 4 WHERE b = 2;
```

As [InnoDB](#) executes each [UPDATE](#), it first acquires an exclusive lock for each row that it reads, and then determines whether to modify it. If [InnoDB](#) does not modify the row, it releases the lock. Otherwise, [InnoDB](#) retains the lock until the end of the transaction. This affects transaction processing as follows.

When using the default [REPEATABLE READ](#) isolation level, the first [UPDATE](#) acquires an x-lock on each row that it reads and does not release any of them:

```
x-lock(1,2); retain x-lock
```



```
x-lock(2,3); update(2,3) to (2,5); retain x-lock
x-lock(3,2); retain x-lock
x-lock(4,3); update(4,3) to (4,5); retain x-lock
x-lock(5,2); retain x-lock
```

The second `UPDATE` blocks as soon as it tries to acquire any locks (because first update has retained locks on all rows), and does not proceed until the first `UPDATE` commits or rolls back:

```
x-lock(1,2); block and wait for first UPDATE to commit or roll back
```

If `READ COMMITTED` is used instead, the first `UPDATE` acquires an x-lock on each row that it reads and releases those for rows that it does not modify:

```
x-lock(1,2); unlock(1,2)
x-lock(2,3); update(2,3) to (2,5); retain x-lock
x-lock(3,2); unlock(3,2)
x-lock(4,3); update(4,3) to (4,5); retain x-lock
x-lock(5,2); unlock(5,2)
```

For the second `UPDATE`, InnoDB does a “semi-consistent” read, returning the latest committed version of each row that it reads to MySQL so that MySQL can determine whether the row matches the `WHERE` condition of the `UPDATE`:

```
x-lock(1,2); update(1,2) to (1,4); retain x-lock
x-lock(2,3); unlock(2,3)
x-lock(3,2); update(3,2) to (3,4); retain x-lock
x-lock(4,3); unlock(4,3)
x-lock(5,2); update(5,2) to (5,4); retain x-lock
```

However, if the `WHERE` condition includes an indexed column, and InnoDB uses the index, only the indexed column is considered when taking and retaining record locks. In the following example, the first `UPDATE` takes and retains an x-lock on each row where `b = 2`. The second `UPDATE` blocks when it tries to acquire x-locks on the same records, as it also uses the index defined on column `b`.

```
CREATE TABLE t (a INT NOT NULL, b INT, c INT, INDEX (b)) ENGINE = InnoDB;
INSERT INTO t VALUES (1,2,3),(2,2,4);
COMMIT;

# Session A
START TRANSACTION;
UPDATE t SET b = 3 WHERE b = 2 AND c = 3;

# Session B
UPDATE t SET b = 4 WHERE b = 2 AND c = 4;
```

The effects of using the `READ COMMITTED` isolation level are the same as enabling the deprecated `innodb_locks_unsafe_for_binlog` variable, with these exceptions:

- Enabling `innodb_locks_unsafe_for_binlog` is a global setting and affects all sessions, whereas the isolation level can be set globally for all sessions, or individually per session.
- `innodb_locks_unsafe_for_binlog` can be set only at server startup, whereas the isolation level can be set at startup or changed at runtime.

`READ COMMITTED` therefore offers finer and more flexible control than `innodb_locks_unsafe_for_binlog`.

- [READ UNCOMMITTED](#)

`SELECT` statements are performed in a nonlocking fashion, but a possible earlier version of a row might be used. Thus, using this isolation level, such reads are not consistent. This is also called a [dirty read](#). Otherwise, this isolation level works like [READ COMMITTED](#).

- [SERIALIZABLE](#)

This level is like [REPEATABLE READ](#), but InnoDB implicitly converts all plain `SELECT` statements to `SELECT ... LOCK IN SHARE MODE` if `autocommit` is disabled. If `autocommit` is enabled, the `SELECT` is its own transaction. It therefore is known to be read only and can be serialized if performed as a consistent (nonlocking) read and need not block for other transactions. (To force a plain `SELECT` to block if other transactions have modified the selected rows, disable `autocommit`.)

### 14.7.2.2 autocommit, Commit, and Rollback

In InnoDB, all user activity occurs inside a transaction. If `autocommit` mode is enabled, each SQL statement forms a single transaction on its own. By default, MySQL starts the session for each new connection with `autocommit` enabled, so MySQL does a commit after each SQL statement if that statement did not return an error. If a statement returns an error, the commit or rollback behavior depends on the error. See [Section 14.22.4, “InnoDB Error Handling”](#).

A session that has `autocommit` enabled can perform a multiple-statement transaction by starting it with an explicit `START TRANSACTION` or `BEGIN` statement and ending it with a `COMMIT` or `ROLLBACK` statement. See [Section 13.3.1, “START TRANSACTION, COMMIT, and ROLLBACK Statements”](#).

If `autocommit` mode is disabled within a session with `SET autocommit = 0`, the session always has a transaction open. A `COMMIT` or `ROLLBACK` statement ends the current transaction and a new one starts.

If a session that has `autocommit` disabled ends without explicitly committing the final transaction, MySQL rolls back that transaction.

Some statements implicitly end a transaction, as if you had done a `COMMIT` before executing the statement. For details, see [Section 13.3.3, “Statements That Cause an Implicit Commit”](#).

A `COMMIT` means that the changes made in the current transaction are made permanent and become visible to other sessions. A `ROLLBACK` statement, on the other hand, cancels all modifications made by the current transaction. Both `COMMIT` and `ROLLBACK` release all InnoDB locks that were set during the current transaction.

### Grouping DML Operations with Transactions

By default, connection to the MySQL server begins with `autocommit` mode enabled, which automatically commits every SQL statement as you execute it. This mode of operation might be unfamiliar if you have experience with other database systems, where it is standard practice to issue a sequence of [DML](#) statements and commit them or roll them back all together.

To use multiple-statement [transactions](#), switch `autocommit` off with the SQL statement `SET autocommit = 0` and end each transaction with `COMMIT` or `ROLLBACK` as appropriate. To leave `autocommit` on, begin each transaction with `START TRANSACTION` and end it with `COMMIT` or `ROLLBACK`. The following example shows two transactions. The first is committed; the second is rolled back.

```
$> mysql test
```

```
mysql> CREATE TABLE customer (a INT, b CHAR (20), INDEX (a));
Query OK, 0 rows affected (0.00 sec)
mysql> -- Do a transaction with autocommit turned on.
mysql> START TRANSACTION;
```

```

Query OK, 0 rows affected (0.00 sec)
mysql> INSERT INTO customer VALUES (10, 'Heikki');
Query OK, 1 row affected (0.00 sec)
mysql> COMMIT;
Query OK, 0 rows affected (0.00 sec)
mysql> -- Do another transaction with autocommit turned off.
mysql> SET autocommit=0;
Query OK, 0 rows affected (0.00 sec)
mysql> INSERT INTO customer VALUES (15, 'John');
Query OK, 1 row affected (0.00 sec)
mysql> INSERT INTO customer VALUES (20, 'Paul');
Query OK, 1 row affected (0.00 sec)
mysql> DELETE FROM customer WHERE b = 'Heikki';
Query OK, 1 row affected (0.00 sec)
mysql> -- Now we undo those last 2 inserts and the delete.
mysql> ROLLBACK;
Query OK, 0 rows affected (0.00 sec)
mysql> SELECT * FROM customer;
+-----+-----+
| a     | b     |
+-----+-----+
| 10   | Heikki |
+-----+-----+
1 row in set (0.00 sec)
mysql>

```

## Transactions in Client-Side Languages

In APIs such as PHP, Perl DBI, JDBC, ODBC, or the standard C call interface of MySQL, you can send transaction control statements such as `COMMIT` to the MySQL server as strings just like any other SQL statements such as `SELECT` or `INSERT`. Some APIs also offer separate special transaction commit and rollback functions or methods.

### 14.7.2.3 Consistent Nonlocking Reads

A [consistent read](#) means that InnoDB uses multi-versioning to present to a query a snapshot of the database at a point in time. The query sees the changes made by transactions that committed before that point in time, and no changes made by later or uncommitted transactions. The exception to this rule is that the query sees the changes made by earlier statements within the same transaction. This exception causes the following anomaly: If you update some rows in a table, a `SELECT` sees the latest version of the updated rows, but it might also see older versions of any rows. If other sessions simultaneously update the same table, the anomaly means that you might see the table in a state that never existed in the database.

If the transaction [isolation level](#) is `REPEATABLE READ` (the default level), all consistent reads within the same transaction read the snapshot established by the first such read in that transaction. You can get a fresher snapshot for your queries by committing the current transaction and after that issuing new queries.

With `READ COMMITTED` isolation level, each consistent read within a transaction sets and reads its own fresh snapshot.

Consistent read is the default mode in which InnoDB processes `SELECT` statements in `READ COMMITTED` and `REPEATABLE READ` isolation levels. A consistent read does not set any locks on the tables it accesses, and therefore other sessions are free to modify those tables at the same time a consistent read is being performed on the table.

Suppose that you are running in the default `REPEATABLE READ` isolation level. When you issue a consistent read (that is, an ordinary `SELECT` statement), InnoDB gives your transaction a timepoint according to which your query sees the database. If another transaction deletes a row and commits after your timepoint was assigned, you do not see the row as having been deleted. Inserts and updates are treated similarly.



**Note**

The snapshot of the database state applies to [SELECT](#) statements within a transaction, not necessarily to [DML](#) statements. If you insert or modify some rows and then commit that transaction, a [DELETE](#) or [UPDATE](#) statement issued from another concurrent [REPEATABLE READ](#) transaction could affect those just-committed rows, even though the session could not query them. If a transaction does update or delete rows committed by a different transaction, those changes do become visible to the current transaction. For example, you might encounter a situation like the following:

```

SELECT COUNT(c1) FROM t1 WHERE c1 = 'xyz';
-- Returns 0: no rows match.
DELETE FROM t1 WHERE c1 = 'xyz';
-- Deletes several rows recently committed by other transaction.

SELECT COUNT(c2) FROM t1 WHERE c2 = 'abc';
-- Returns 0: no rows match.
UPDATE t1 SET c2 = 'cba' WHERE c2 = 'abc';
-- Affects 10 rows: another txn just committed 10 rows with 'abc' values.
SELECT COUNT(c2) FROM t1 WHERE c2 = 'cba';
-- Returns 10: this txn can now see the rows it just updated.
    
```

You can advance your timepoint by committing your transaction and then doing another [SELECT](#) or [START TRANSACTION WITH CONSISTENT SNAPSHOT](#).

This is called *multi-versioned concurrency control*.

In the following example, session A sees the row inserted by B only when B has committed the insert and A has committed as well, so that the timepoint is advanced past the commit of B.

	Session A	Session B
time	SET autocommit=0;	SET autocommit=0;
	SELECT * FROM t;	
	empty set	
		INSERT INTO t VALUES (1, 2);
	SELECT * FROM t;	
v	empty set	COMMIT;
	SELECT * FROM t;	
	empty set	
	COMMIT;	
	SELECT * FROM t;	
	-----	
	1   2	
	-----	

If you want to see the “freshest” state of the database, use either the [READ COMMITTED](#) isolation level or a [locking read](#):

```

SELECT * FROM t LOCK IN SHARE MODE;
    
```

With [READ COMMITTED](#) isolation level, each consistent read within a transaction sets and reads its own fresh snapshot. With [LOCK IN SHARE MODE](#), a locking read occurs instead: A [SELECT](#) blocks until the transaction containing the freshest rows ends (see [Section 14.7.2.4, “Locking Reads”](#)).

Consistent read does not work over certain DDL statements:

- Consistent read does not work over `DROP TABLE`, because MySQL cannot use a table that has been dropped and InnoDB destroys the table.
- Consistent read does not work over `ALTER TABLE` operations that make a temporary copy of the original table and delete the original table when the temporary copy is built. When you reissue a consistent read within a transaction, rows in the new table are not visible because those rows did not exist when the transaction's snapshot was taken. In this case, the transaction returns an error: `ER_TABLE_DEF_CHANGED`, "Table definition has changed, please retry transaction".

The type of read varies for selects in clauses like `INSERT INTO ... SELECT`, `UPDATE ... (SELECT)`, and `CREATE TABLE ... SELECT` that do not specify `FOR UPDATE` or `LOCK IN SHARE MODE`:

- By default, InnoDB uses stronger locks in those statements and the `SELECT` part acts like `READ COMMITTED`, where each consistent read, even within the same transaction, sets and reads its own fresh snapshot.
- To perform a nonlocking read in such cases, enable the `innodb_locks_unsafe_for_binlog` option and set the isolation level of the transaction to `READ UNCOMMITTED`, `READ COMMITTED`, or `REPEATABLE READ` to avoid setting locks on rows read from the selected table.

#### 14.7.2.4 Locking Reads

If you query data and then insert or update related data within the same transaction, the regular `SELECT` statement does not give enough protection. Other transactions can update or delete the same rows you just queried. InnoDB supports two types of **locking reads** that offer extra safety:

- `SELECT ... LOCK IN SHARE MODE`

Sets a shared mode lock on any rows that are read. Other sessions can read the rows, but cannot modify them until your transaction commits. If any of these rows were changed by another transaction that has not yet committed, your query waits until that transaction ends and then uses the latest values.

- `SELECT ... FOR UPDATE`

For index records the search encounters, locks the rows and any associated index entries, the same as if you issued an `UPDATE` statement for those rows. Other transactions are blocked from updating those rows, from doing `SELECT ... LOCK IN SHARE MODE`, or from reading the data in certain transaction isolation levels. Consistent reads ignore any locks set on the records that exist in the read view. (Old versions of a record cannot be locked; they are reconstructed by applying **undo logs** on an in-memory copy of the record.)

These clauses are primarily useful when dealing with tree-structured or graph-structured data, either in a single table or split across multiple tables. You traverse edges or tree branches from one place to another, while reserving the right to come back and change any of these "pointer" values.

All locks set by `LOCK IN SHARE MODE` and `FOR UPDATE` queries are released when the transaction is committed or rolled back.



#### Note

Locking reads are only possible when autocommit is disabled (either by beginning transaction with `START TRANSACTION` or by setting `autocommit` to 0).

A locking read clause in an outer statement does not lock the rows of a table in a nested subquery unless a locking read clause is also specified in the subquery. For example, the following statement does not lock rows in table `t2`.

```
SELECT * FROM t1 WHERE c1 = (SELECT c1 FROM t2) FOR UPDATE;
```

To lock rows in table `t2`, add a locking read clause to the subquery:

```
SELECT * FROM t1 WHERE c1 = (SELECT c1 FROM t2 FOR UPDATE) FOR UPDATE;
```

## Locking Read Examples

Suppose that you want to insert a new row into a table `child`, and make sure that the child row has a parent row in table `parent`. Your application code can ensure referential integrity throughout this sequence of operations.

First, use a consistent read to query the table `PARENT` and verify that the parent row exists. Can you safely insert the child row to table `CHILD`? No, because some other session could delete the parent row in the moment between your `SELECT` and your `INSERT`, without you being aware of it.

To avoid this potential issue, perform the `SELECT` using `LOCK IN SHARE MODE`:

```
SELECT * FROM parent WHERE NAME = 'Jones' LOCK IN SHARE MODE;
```

After the `LOCK IN SHARE MODE` query returns the parent 'Jones', you can safely add the child record to the `CHILD` table and commit the transaction. Any transaction that tries to acquire an exclusive lock in the applicable row in the `PARENT` table waits until you are finished, that is, until the data in all tables is in a consistent state.

For another example, consider an integer counter field in a table `CHILD_CODES`, used to assign a unique identifier to each child added to table `CHILD`. Do not use either consistent read or a shared mode read to read the present value of the counter, because two users of the database could see the same value for the counter, and a duplicate-key error occurs if two transactions attempt to add rows with the same identifier to the `CHILD` table.

Here, `LOCK IN SHARE MODE` is not a good solution because if two users read the counter at the same time, at least one of them ends up in deadlock when it attempts to update the counter.

To implement reading and incrementing the counter, first perform a locking read of the counter using `FOR UPDATE`, and then increment the counter. For example:

```
SELECT counter_field FROM child_codes FOR UPDATE;
UPDATE child_codes SET counter_field = counter_field + 1;
```

A `SELECT ... FOR UPDATE` reads the latest available data, setting exclusive locks on each row it reads. Thus, it sets the same locks a searched SQL `UPDATE` would set on the rows.

The preceding description is merely an example of how `SELECT ... FOR UPDATE` works. In MySQL, the specific task of generating a unique identifier actually can be accomplished using only a single access to the table:

```
UPDATE child_codes SET counter_field = LAST_INSERT_ID(counter_field + 1);
SELECT LAST_INSERT_ID();
```

The `SELECT` statement merely retrieves the identifier information (specific to the current connection). It does not access any table.

## 14.7.3 Locks Set by Different SQL Statements in InnoDB

A **locking read**, an `UPDATE`, or a `DELETE` generally set record locks on every index record that is scanned in the processing of an SQL statement. It does not matter whether there are `WHERE` conditions in the statement that would exclude the row. `InnoDB` does not remember the exact `WHERE` condition, but only knows which index ranges were scanned. The locks are normally **next-key locks** that also block inserts into the “gap” immediately before the record. However, **gap locking** can be disabled explicitly, which causes next-key locking not to be used. For more information, see [Section 14.7.1, “InnoDB Locking”](#). The

transaction isolation level can also affect which locks are set; see [Section 14.7.2.1, “Transaction Isolation Levels”](#).

If a secondary index is used in a search and the index record locks to be set are exclusive, InnoDB also retrieves the corresponding clustered index records and sets locks on them.

If you have no indexes suitable for your statement and MySQL must scan the entire table to process the statement, every row of the table becomes locked, which in turn blocks all inserts by other users to the table. It is important to create good indexes so that your queries do not scan more rows than necessary.

InnoDB sets specific types of locks as follows.

- `SELECT ... FROM` is a consistent read, reading a snapshot of the database and setting no locks unless the transaction isolation level is set to `SERIALIZABLE`. For `SERIALIZABLE` level, the search sets shared next-key locks on the index records it encounters. However, only an index record lock is required for statements that lock rows using a unique index to search for a unique row.
- For `SELECT ... FOR UPDATE` or `SELECT ... LOCK IN SHARE MODE`, locks are acquired for scanned rows, and expected to be released for rows that do not qualify for inclusion in the result set (for example, if they do not meet the criteria given in the `WHERE` clause). However, in some cases, rows might not be unlocked immediately because the relationship between a result row and its original source is lost during query execution. For example, in a `UNION`, scanned (and locked) rows from a table might be inserted into a temporary table before evaluating whether they qualify for the result set. In this circumstance, the relationship of the rows in the temporary table to the rows in the original table is lost and the latter rows are not unlocked until the end of query execution.
- `SELECT ... LOCK IN SHARE MODE` sets shared next-key locks on all index records the search encounters. However, only an index record lock is required for statements that lock rows using a unique index to search for a unique row.
- `SELECT ... FOR UPDATE` sets an exclusive next-key lock on every record the search encounters. However, only an index record lock is required for statements that lock rows using a unique index to search for a unique row.

For index records the search encounters, `SELECT ... FOR UPDATE` blocks other sessions from doing `SELECT ... LOCK IN SHARE MODE` or from reading in certain transaction isolation levels. Consistent reads ignore any locks set on the records that exist in the read view.

- `UPDATE ... WHERE ...` sets an exclusive next-key lock on every record the search encounters. However, only an index record lock is required for statements that lock rows using a unique index to search for a unique row.
- When `UPDATE` modifies a clustered index record, implicit locks are taken on affected secondary index records. The `UPDATE` operation also takes shared locks on affected secondary index records when performing duplicate check scans prior to inserting new secondary index records, and when inserting new secondary index records.
- `DELETE FROM ... WHERE ...` sets an exclusive next-key lock on every record the search encounters. However, only an index record lock is required for statements that lock rows using a unique index to search for a unique row.
- `INSERT` sets an exclusive lock on the inserted row. This lock is an index-record lock, not a next-key lock (that is, there is no gap lock) and does not prevent other sessions from inserting into the gap before the inserted row.

Prior to inserting the row, a type of gap lock called an insert intention gap lock is set. This lock signals the intent to insert in such a way that multiple transactions inserting into the same index gap need not wait for each other if they are not inserting at the same position within the gap. Suppose that there are

index records with values of 4 and 7. Separate transactions that attempt to insert values of 5 and 6 each lock the gap between 4 and 7 with insert intention locks prior to obtaining the exclusive lock on the inserted row, but do not block each other because the rows are nonconflicting.

If a duplicate-key error occurs, a shared lock on the duplicate index record is set. This use of a shared lock can result in deadlock should there be multiple sessions trying to insert the same row if another session already has an exclusive lock. This can occur if another session deletes the row. Suppose that an [InnoDB](#) table `t1` has the following structure:

```
CREATE TABLE t1 (i INT, PRIMARY KEY (i)) ENGINE = InnoDB;
```

Now suppose that three sessions perform the following operations in order:

Session 1:

```
START TRANSACTION;
INSERT INTO t1 VALUES(1);
```

Session 2:

```
START TRANSACTION;
INSERT INTO t1 VALUES(1);
```

Session 3:

```
START TRANSACTION;
INSERT INTO t1 VALUES(1);
```

Session 1:

```
ROLLBACK;
```

The first operation by session 1 acquires an exclusive lock for the row. The operations by sessions 2 and 3 both result in a duplicate-key error and they both request a shared lock for the row. When session 1 rolls back, it releases its exclusive lock on the row and the queued shared lock requests for sessions 2 and 3 are granted. At this point, sessions 2 and 3 deadlock: Neither can acquire an exclusive lock for the row because of the shared lock held by the other.

A similar situation occurs if the table already contains a row with key value 1 and three sessions perform the following operations in order:

Session 1:

```
START TRANSACTION;
DELETE FROM t1 WHERE i = 1;
```

Session 2:

```
START TRANSACTION;
INSERT INTO t1 VALUES(1);
```

Session 3:

```
START TRANSACTION;
```



```
INSERT INTO t1 VALUES(1);
```

Session 1:

```
COMMIT;
```

The first operation by session 1 acquires an exclusive lock for the row. The operations by sessions 2 and 3 both result in a duplicate-key error and they both request a shared lock for the row. When session 1 commits, it releases its exclusive lock on the row and the queued shared lock requests for sessions 2 and 3 are granted. At this point, sessions 2 and 3 deadlock: Neither can acquire an exclusive lock for the row because of the shared lock held by the other.

- `INSERT ... ON DUPLICATE KEY UPDATE` differs from a simple `INSERT` in that an exclusive lock rather than a shared lock is placed on the row to be updated when a duplicate-key error occurs. An exclusive index-record lock is taken for a duplicate primary key value. An exclusive next-key lock is taken for a duplicate unique key value.
- `REPLACE` is done like an `INSERT` if there is no collision on a unique key. Otherwise, an exclusive next-key lock is placed on the row to be replaced.
- `INSERT INTO T SELECT ... FROM S WHERE ...` sets an exclusive index record lock (without a gap lock) on each row inserted into `T`. If the transaction isolation level is `READ COMMITTED`, or `innodb_locks_unsafe_for_binlog` is enabled and the transaction isolation level is not `SERIALIZABLE`, InnoDB does the search on `S` as a consistent read (no locks). Otherwise, InnoDB sets shared next-key locks on rows from `S`. InnoDB has to set locks in the latter case: During roll-forward recovery using a statement-based binary log, every SQL statement must be executed in exactly the same way it was done originally.

`CREATE TABLE ... SELECT ...` performs the `SELECT` with shared next-key locks or as a consistent read, as for `INSERT ... SELECT`.

When a `SELECT` is used in the constructs `REPLACE INTO t SELECT ... FROM s WHERE ...` or `UPDATE t ... WHERE col IN (SELECT ... FROM s ...)`, InnoDB sets shared next-key locks on rows from table `s`.

- InnoDB sets an exclusive lock on the end of the index associated with the `AUTO_INCREMENT` column while initializing a previously specified `AUTO_INCREMENT` column on a table.

With `innodb_autoinc_lock_mode=0`, InnoDB uses a special `AUTO-INC` table lock mode where the lock is obtained and held to the end of the current SQL statement (not to the end of the entire transaction) while accessing the auto-increment counter. Other clients cannot insert into the table while the `AUTO-INC` table lock is held. The same behavior occurs for “bulk inserts” with `innodb_autoinc_lock_mode=1`. Table-level `AUTO-INC` locks are not used with `innodb_autoinc_lock_mode=2`. For more information, See [Section 14.6.1.6, “AUTO\\_INCREMENT Handling in InnoDB”](#).

InnoDB fetches the value of a previously initialized `AUTO_INCREMENT` column without setting any locks.

- If a `FOREIGN KEY` constraint is defined on a table, any insert, update, or delete that requires the constraint condition to be checked sets shared record-level locks on the records that it looks at to check the constraint. InnoDB also sets these locks in the case where the constraint fails.

- `LOCK TABLES` sets table locks, but it is the higher MySQL layer above the `InnoDB` layer that sets these locks. `InnoDB` is aware of table locks if `innodb_table_locks = 1` (the default) and `autocommit = 0`, and the MySQL layer above `InnoDB` knows about row-level locks.

Otherwise, `InnoDB`'s automatic deadlock detection cannot detect deadlocks where such table locks are involved. Also, because in this case the higher MySQL layer does not know about row-level locks, it is possible to get a table lock on a table where another session currently has row-level locks. However, this does not endanger transaction integrity, as discussed in [Section 14.7.5.2, “Deadlock Detection”](#).

- `LOCK TABLES` acquires two locks on each table if `innodb_table_locks=1` (the default). In addition to a table lock on the MySQL layer, it also acquires an `InnoDB` table lock. To avoid acquiring `InnoDB` table locks, set `innodb_table_locks=0`. If no `InnoDB` table lock is acquired, `LOCK TABLES` completes even if some records of the tables are being locked by other transactions.

In MySQL 5.7, `innodb_table_locks=0` has no effect for tables locked explicitly with `LOCK TABLES ... WRITE`. It does have an effect for tables locked for read or write by `LOCK TABLES ... WRITE` implicitly (for example, through triggers) or by `LOCK TABLES ... READ`.

- All `InnoDB` locks held by a transaction are released when the transaction is committed or aborted. Thus, it does not make much sense to invoke `LOCK TABLES` on `InnoDB` tables in `autocommit=1` mode because the acquired `InnoDB` table locks would be released immediately.
- You cannot lock additional tables in the middle of a transaction because `LOCK TABLES` performs an implicit `COMMIT` and `UNLOCK TABLES`.

## 14.7.4 Phantom Rows

The so-called *phantom* problem occurs within a transaction when the same query produces different sets of rows at different times. For example, if a `SELECT` is executed twice, but returns a row the second time that was not returned the first time, the row is a “phantom” row.

Suppose that there is an index on the `id` column of the `child` table and that you want to read and lock all rows from the table having an identifier value larger than 100, with the intention of updating some column in the selected rows later:

```
SELECT * FROM child WHERE id > 100 FOR UPDATE;
```

The query scans the index starting from the first record where `id` is bigger than 100. Let the table contain rows having `id` values of 90 and 102. If the locks set on the index records in the scanned range do not lock out inserts made in the gaps (in this case, the gap between 90 and 102), another session can insert a new row into the table with an `id` of 101. If you were to execute the same `SELECT` within the same transaction, you would see a new row with an `id` of 101 (a “phantom”) in the result set returned by the query. If we regard a set of rows as a data item, the new phantom child would violate the isolation principle of transactions that a transaction should be able to run so that the data it has read does not change during the transaction.

To prevent phantoms, `InnoDB` uses an algorithm called *next-key locking* that combines index-row locking with gap locking. `InnoDB` performs row-level locking in such a way that when it searches or scans a table index, it sets shared or exclusive locks on the index records it encounters. Thus, the row-level locks are actually index-record locks. In addition, a next-key lock on an index record also affects the “gap” before the index record. That is, a next-key lock is an index-record lock plus a gap lock on the gap preceding the index record. If one session has a shared or exclusive lock on record `R` in an index, another session cannot insert a new index record in the gap immediately before `R` in the index order.

When `InnoDB` scans an index, it can also lock the gap after the last record in the index. Just that happens in the preceding example: To prevent any insert into the table where `id` would be bigger than 100, the locks set by `InnoDB` include a lock on the gap following `id` value 102.

You can use next-key locking to implement a uniqueness check in your application: If you read your data in share mode and do not see a duplicate for a row you are going to insert, then you can safely insert your row and know that the next-key lock set on the successor of your row during the read prevents anyone meanwhile inserting a duplicate for your row. Thus, the next-key locking enables you to “lock” the nonexistence of something in your table.

Gap locking can be disabled as discussed in [Section 14.7.1, “InnoDB Locking”](#). This may cause phantom problems because other sessions can insert new rows into the gaps when gap locking is disabled.

## 14.7.5 Deadlocks in InnoDB

A deadlock is a situation in which multiple transactions are unable to proceed because each transaction holds a lock that is needed by another one. Because all transactions involved are waiting for the same resource to become available, none of them ever releases the lock it holds.

A deadlock can occur when transactions lock rows in multiple tables (through statements such as `UPDATE` or `SELECT ... FOR UPDATE`), but in the opposite order. A deadlock can also occur when such statements lock ranges of index records and gaps, with each transaction acquiring some locks but not others due to a timing issue. For a deadlock example, see [Section 14.7.5.1, “An InnoDB Deadlock Example”](#).

To reduce the possibility of deadlocks, use transactions rather than `LOCK TABLES` statements; keep transactions that insert or update data small enough that they do not stay open for long periods of time; when different transactions update multiple tables or large ranges of rows, use the same order of operations (such as `SELECT ... FOR UPDATE`) in each transaction; create indexes on the columns used in `SELECT ... FOR UPDATE` and `UPDATE ... WHERE` statements. The possibility of deadlocks is not affected by the isolation level, because the isolation level changes the behavior of read operations, while deadlocks occur because of write operations. For more information about avoiding and recovering from deadlock conditions, see [Section 14.7.5.3, “How to Minimize and Handle Deadlocks”](#).

When deadlock detection is enabled (the default) and a deadlock does occur, InnoDB detects the condition and rolls back one of the transactions (the victim). If deadlock detection is disabled using the `innodb_deadlock_detect` variable, InnoDB relies on the `innodb_lock_wait_timeout` setting to roll back transactions in case of a deadlock. Thus, even if your application logic is correct, you must still handle the case where a transaction must be retried. To view the last deadlock in an InnoDB user transaction, use `SHOW ENGINE INNODB STATUS`. If frequent deadlocks highlight a problem with transaction structure or application error handling, enable `innodb_print_all_deadlocks` to print information about all deadlocks to the `mysqld` error log. For more information about how deadlocks are automatically detected and handled, see [Section 14.7.5.2, “Deadlock Detection”](#).

### 14.7.5.1 An InnoDB Deadlock Example

The following example illustrates how an error can occur when a lock request causes a deadlock. The example involves two clients, A and B.

First, client A creates a table containing one row, and then begins a transaction. Within the transaction, A obtains an S lock on the row by selecting it in share mode:

```
mysql> CREATE TABLE t (i INT) ENGINE = InnoDB;
Query OK, 0 rows affected (1.07 sec)

mysql> INSERT INTO t (i) VALUES(1);
Query OK, 1 row affected (0.09 sec)

mysql> START TRANSACTION;
Query OK, 0 rows affected (0.00 sec)

mysql> SELECT * FROM t WHERE i = 1 LOCK IN SHARE MODE;
```

```
+-----+
| i     |
+-----+
|      1 |
+-----+
```

Next, client B begins a transaction and attempts to delete the row from the table:

```
mysql> START TRANSACTION;
Query OK, 0 rows affected (0.00 sec)

mysql> DELETE FROM t WHERE i = 1;
```

The delete operation requires an **X** lock. The lock cannot be granted because it is incompatible with the **S** lock that client A holds, so the request goes on the queue of lock requests for the row and client B blocks.

Finally, client A also attempts to delete the row from the table:

```
mysql> DELETE FROM t WHERE i = 1;
```

Deadlock occurs here because client A needs an **X** lock to delete the row. However, that lock request cannot be granted because client B already has a request for an **X** lock and is waiting for client A to release its **S** lock. Nor can the **S** lock held by A be upgraded to an **X** lock because of the prior request by B for an **X** lock. As a result, **InnoDB** generates an error for one of the clients and releases its locks. The client returns this error:

```
ERROR 1213 (40001): Deadlock found when trying to get lock;
try restarting transaction
```

At that point, the lock request for the other client can be granted and it deletes the row from the table.

### 14.7.5.2 Deadlock Detection

When **deadlock detection** is enabled (the default), **InnoDB** automatically detects transaction **deadlocks** and rolls back a transaction or transactions to break the deadlock. **InnoDB** tries to pick small transactions to roll back, where the size of a transaction is determined by the number of rows inserted, updated, or deleted.

**InnoDB** is aware of table locks if `innodb_table_locks = 1` (the default) and `autocommit = 0`, and the MySQL layer above it knows about row-level locks. Otherwise, **InnoDB** cannot detect deadlocks where a table lock set by a MySQL `LOCK TABLES` statement or a lock set by a storage engine other than **InnoDB** is involved. Resolve these situations by setting the value of the `innodb_lock_wait_timeout` system variable.

If the `LATEST DETECTED DEADLOCK` section of **InnoDB** Monitor output includes a message stating, “`TOO DEEP OR LONG SEARCH IN THE LOCK TABLE WAITS-FOR GRAPH, WE WILL ROLL BACK FOLLOWING TRANSACTION,`” this indicates that the number of transactions on the wait-for list has reached a limit of 200. A wait-for list that exceeds 200 transactions is treated as a deadlock and the transaction attempting to check the wait-for list is rolled back. The same error may also occur if the locking thread must look at more than 1,000,000 locks owned by transactions on the wait-for list.

For techniques to organize database operations to avoid deadlocks, see [Section 14.7.5, “Deadlocks in InnoDB”](#).

### Disabling Deadlock Detection

On high concurrency systems, deadlock detection can cause a slowdown when numerous threads wait for the same lock. At times, it may be more efficient to disable deadlock detection and rely on the `innodb_lock_wait_timeout` setting for transaction rollback when a deadlock occurs. Deadlock detection can be disabled using the `innodb_deadlock_detect` variable.

### 14.7.5.3 How to Minimize and Handle Deadlocks

This section builds on the conceptual information about deadlocks in [Section 14.7.5.2, “Deadlock Detection”](#). It explains how to organize database operations to minimize deadlocks and the subsequent error handling required in applications.

**Deadlocks** are a classic problem in transactional databases, but they are not dangerous unless they are so frequent that you cannot run certain transactions at all. Normally, you must write your applications so that they are always prepared to re-issue a transaction if it gets rolled back because of a deadlock.

**InnoDB** uses automatic row-level locking. You can get deadlocks even in the case of transactions that just insert or delete a single row. That is because these operations are not really “atomic”; they automatically set locks on the (possibly several) index records of the row inserted or deleted.

You can cope with deadlocks and reduce the likelihood of their occurrence with the following techniques:

- At any time, issue `SHOW ENGINE INNODB STATUS` to determine the cause of the most recent deadlock. That can help you to tune your application to avoid deadlocks.
- If frequent deadlock warnings cause concern, collect more extensive debugging information by enabling the `innodb_print_all_deadlocks` variable. Information about each deadlock, not just the latest one, is recorded in the MySQL [error log](#). Disable this option when you are finished debugging.
- Always be prepared to re-issue a transaction if it fails due to deadlock. Deadlocks are not dangerous. Just try again.
- Keep transactions small and short in duration to make them less prone to collision.
- Commit transactions immediately after making a set of related changes to make them less prone to collision. In particular, do not leave an interactive `mysql` session open for a long time with an uncommitted transaction.
- If you use **locking reads** (`SELECT ... FOR UPDATE` or `SELECT ... LOCK IN SHARE MODE`), try using a lower isolation level such as `READ COMMITTED`.
- When modifying multiple tables within a transaction, or different sets of rows in the same table, do those operations in a consistent order each time. Then transactions form well-defined queues and do not deadlock. For example, organize database operations into functions within your application, or call stored routines, rather than coding multiple similar sequences of `INSERT`, `UPDATE`, and `DELETE` statements in different places.
- Add well-chosen indexes to your tables so that your queries scan fewer index records and set fewer locks. Use `EXPLAIN SELECT` to determine which indexes the MySQL server regards as the most appropriate for your queries.
- Use less locking. If you can afford to permit a `SELECT` to return data from an old snapshot, do not add a `FOR UPDATE` or `LOCK IN SHARE MODE` clause to it. Using the `READ COMMITTED` isolation level is good here, because each consistent read within the same transaction reads from its own fresh snapshot.
- If nothing else helps, serialize your transactions with table-level locks. The correct way to use `LOCK TABLES` with transactional tables, such as **InnoDB** tables, is to begin a transaction with `SET autocommit = 0` (not `START TRANSACTION`) followed by `LOCK TABLES`, and to not call `UNLOCK TABLES` until you commit the transaction explicitly. For example, if you need to write to table `t1` and read from table `t2`, you can do this:

```
SET autocommit=0;
LOCK TABLES t1 WRITE, t2 READ, ...;
... do something with tables t1 and t2 here ...
```

```
COMMIT;  
UNLOCK TABLES;
```

Table-level locks prevent concurrent updates to the table, avoiding deadlocks at the expense of less responsiveness for a busy system.

- Another way to serialize transactions is to create an auxiliary “semaphore” table that contains just a single row. Have each transaction update that row before accessing other tables. In that way, all transactions happen in a serial fashion. Note that the [InnoDB](#) instant deadlock detection algorithm also works in this case, because the serializing lock is a row-level lock. With MySQL table-level locks, the timeout method must be used to resolve deadlocks.

## 14.8 InnoDB Configuration

This section provides configuration information and procedures for [InnoDB](#) initialization, startup, and various components and features of the [InnoDB](#) storage engine. For information about optimizing database operations for [InnoDB](#) tables, see [Section 8.5, “Optimizing for InnoDB Tables”](#).

### 14.8.1 InnoDB Startup Configuration

The first decisions to make about [InnoDB](#) configuration involve the configuration of data files, log files, page size, and memory buffers, which should be configured before initializing [InnoDB](#). Modifying the configuration after [InnoDB](#) is initialized may involve non-trivial procedures.

This section provides information about specifying [InnoDB](#) settings in a configuration file, viewing [InnoDB](#) initialization information, and important storage considerations.

- [Specifying Options in a MySQL Configuration File](#)
- [Viewing InnoDB Initialization Information](#)
- [Important Storage Considerations](#)
- [System Tablespace Data File Configuration](#)
- [Redo Log File Configuration](#)
- [Undo Tablespace Configuration](#)
- [Temporary Tablespace Configuration](#)
- [Page Size Configuration](#)
- [Memory Configuration](#)

### Specifying Options in a MySQL Configuration File

Because MySQL uses data file, log file, and page size settings to initialize [InnoDB](#), it is recommended that you define these settings in an option file that MySQL reads at startup, prior to initializing [InnoDB](#). Normally, [InnoDB](#) is initialized when the MySQL server is started for the first time.

You can place [InnoDB](#) settings in the `[mysqld]` group of any option file that your server reads when it starts. The locations of MySQL option files are described in [Section 4.2.2.2, “Using Option Files”](#).

To make sure that `mysqld` reads options only from a specific file, use the `--defaults-file` option as the first option on the command line when starting the server:

```
mysqld --defaults-file=path_to_option_file
```

## Viewing InnoDB Initialization Information

To view [InnoDB](#) initialization information during startup, start `mysqld` from a command prompt, which prints initialization information to the console.

For example, on Windows, if `mysqld` is located in `C:\Program Files\MySQL\MySQL Server 5.7\bin`, start the MySQL server like this:

```
C:\> "C:\Program Files\MySQL\MySQL Server 5.7\bin\mysqld" --console
```

On Unix-like systems, `mysqld` is located in the `bin` directory of your MySQL installation:

```
$> bin/mysqld --user=mysql &
```

If you do not send server output to the console, check the error log after startup to see the initialization information [InnoDB](#) printed during the startup process.

For information about starting MySQL using other methods, see [Section 2.9.5, “Starting and Stopping MySQL Automatically”](#).



### Note

[InnoDB](#) does not open all user tables and associated data files at startup. However, [InnoDB](#) does check for the existence of tablespace files referenced in the data dictionary. If a tablespace file is not found, [InnoDB](#) logs an error and continues the startup sequence. Tablespace files referenced in the redo log may be opened during crash recovery for redo application.

## Important Storage Considerations

Review the following storage-related considerations before proceeding with your startup configuration.

- In some cases, you can improve database performance by placing data and log files on separate physical disks. You can also use raw disk partitions (raw devices) for [InnoDB](#) data files, which may speed up I/O. See [Using Raw Disk Partitions for the System Tablespace](#).
- [InnoDB](#) is a transaction-safe (ACID compliant) storage engine with commit, rollback, and crash-recovery capabilities to protect user data. **However, it cannot do so** if the underlying operating system or hardware does not work as advertised. Many operating systems or disk subsystems may delay or reorder write operations to improve performance. On some operating systems, the very `fsync()` system call that should wait until all unwritten data for a file has been flushed might actually return before the data has been flushed to stable storage. Because of this, an operating system crash or a power outage may destroy recently committed data, or in the worst case, even corrupt the database because write operation have been reordered. If data integrity is important to you, perform “pull-the-plug” tests before using anything in production. On macOS, [InnoDB](#) uses a special `fcntl()` file flush method. Under Linux, it is advisable to **disable the write-back cache**.

On ATA/SATA disk drives, a command such `hdparm -W0 /dev/hda` may work to disable the write-back cache. **Beware that some drives or disk controllers may be unable to disable the write-back cache.**

- With regard to [InnoDB](#) recovery capabilities that protect user data, [InnoDB](#) uses a file flush technique involving a structure called the [doublewrite buffer](#), which is enabled by default (`innodb_doublewrite=ON`). The doublewrite buffer adds safety to recovery following an unexpected exit or power outage, and improves performance on most varieties of Unix by reducing the need for `fsync()` operations. It is recommended that the `innodb_doublewrite` option remains enabled if you are concerned with data integrity or possible failures. For information about the doublewrite buffer, see [Section 14.12.1, “InnoDB Disk I/O”](#).

- Before using NFS with [InnoDB](#), review potential issues outlined in [Using NFS with MySQL](#).
- Running MySQL server on a 4K sector hard drive on Windows is not supported with `innodb_flush_method=async_unbuffered`, which is the default setting. The workaround is to use `innodb_flush_method=normal`.

## System Tablespace Data File Configuration

The `innodb_data_file_path` option defines the name, size, and attributes of [InnoDB](#) system tablespace data files. If you do not configure this option prior to initializing the MySQL server, the default behavior is to create a single auto-extending data file, slightly larger than 12MB, named `ibdata1`:

```
mysql> SHOW VARIABLES LIKE 'innodb_data_file_path';
+-----+-----+
| Variable_name | Value |
+-----+-----+
| innodb_data_file_path | ibdata1:12M:autoextend |
+-----+-----+
```

The full data file specification syntax includes the file name, file size, `autoextend` attribute, and `max` attribute:

```
file_name:file_size[:autoextend[:max:max_file_size]]
```

File sizes are specified in kilobytes, megabytes, or gigabytes by appending `K`, `M` or `G` to the size value. If specifying the data file size in kilobytes, do so in multiples of 1024. Otherwise, kilobyte values are rounded to nearest megabyte (MB) boundary. The sum of file sizes must be, at a minimum, slightly larger than 12MB.

You can specify more than one data file using a semicolon-separated list. For example:

```
[mysqld]
innodb_data_file_path=ibdata1:50M;ibdata2:50M:autoextend
```

The `autoextend` and `max` attributes can be used only for the data file that is specified last.

When the `autoextend` attribute is specified, the data file automatically increases in size by 64MB increments as space is required. The `innodb_autoextend_increment` variable controls the increment size.

To specify a maximum size for an auto-extending data file, use the `max` attribute following the `autoextend` attribute. Use the `max` attribute only in cases where constraining disk usage is of critical importance. The following configuration permits `ibdata1` to grow to a limit of 500MB:

```
[mysqld]
innodb_data_file_path=ibdata1:12M:autoextend:max:500M
```

A minimum file size is enforced for the *first* system tablespace data file to ensure that there is enough space for doublewrite buffer pages. The following table shows minimum file sizes for each [InnoDB](#) page size. The default [InnoDB](#) page size is 16384 (16KB).

Page Size (innodb_page_size)	Minimum File Size
16384 (16KB) or less	3MB
32768 (32KB)	6MB
65536 (64KB)	12MB

If your disk becomes full, you can add a data file on another disk. For instructions, see [Resizing the System Tablespace](#).



The size limit for individual files is determined by your operating system. You can set the file size to more than 4GB on operating systems that support large files. You can also use raw disk partitions as data files. See [Using Raw Disk Partitions for the System Tablespace](#).

InnoDB is not aware of the file system maximum file size, so be cautious on file systems where the maximum file size is a small value such as 2GB.

System tablespace files are created in the data directory by default (`datadir`). To specify an alternate location, use the `innodb_data_home_dir` option. For example, to create a system tablespace data file in a directory named `myibdata`, use this configuration:

```
[mysqld]
innodb_data_home_dir = /myibdata/
innodb_data_file_path=ibdata1:50M:autoextend
```

A trailing slash is required when specifying a value for `innodb_data_home_dir`. InnoDB does not create directories, so ensure that the specified directory exists before you start the server. Also, ensure sure that the MySQL server has the proper access rights to create files in the directory.

InnoDB forms the directory path for each data file by textually concatenating the value of `innodb_data_home_dir` to the data file name. If `innodb_data_home_dir` is not defined, the default value is `./`, which is the data directory. (The MySQL server changes its current working directory to the data directory when it begins executing.)

If you specify `innodb_data_home_dir` as an empty string, you can specify absolute paths for data files listed in the `innodb_data_file_path` value. The following configuration is equivalent to the preceding one:

```
[mysqld]
innodb_data_home_dir =
innodb_data_file_path=/myibdata/ibdata1:50M:autoextend
```

## Redo Log File Configuration

InnoDB creates two 5MB redo log files named `ib_logfile0` and `ib_logfile1` in the data directory by default.

The following options can be used to modify the default configuration:

- `innodb_log_group_home_dir` defines directory path to the InnoDB log files. If this option is not configured, InnoDB log files are created in the MySQL data directory (`datadir`).

You might use this option to place InnoDB log files in a different physical storage location than InnoDB data files to avoid potential I/O resource conflicts. For example:

```
[mysqld]
innodb_log_group_home_dir = /dr3/iblogs
```



### Note

InnoDB does not create directories, so make sure that the log directory exists before you start the server. Use the Unix or DOS `mkdir` command to create any necessary directories.

Make sure that the MySQL server has the proper access rights to create files in the log directory. More generally, the server must have access rights in any directory where it needs to create log files.

- `innodb_log_files_in_group` defines the number of log files in the log group. The default and recommended value is 2.

- `innodb_log_file_size` defines the size in bytes of each log file in the log group. The combined log file size (`innodb_log_file_size * innodb_log_files_in_group`) cannot exceed the maximum value, which is slightly less than 512GB. A pair of 255 GB log files, for example, approaches the limit but does not exceed it. The default log file size is 48MB. Generally, the combined size of the log files should be large enough that the server can smooth out peaks and troughs in workload activity, which often means that there is enough redo log space to handle more than an hour of write activity. A larger log file size means less checkpoint flush activity in the buffer pool, which reduces disk I/O. For additional information, see [Section 8.5.4, “Optimizing InnoDB Redo Logging”](#).

## Undo Tablespace Configuration

Undo logs are part of the system tablespace by default. However, you can choose to store undo logs in one or more separate undo tablespaces, typically on a different storage device.

The `innodb_undo_directory` configuration option defines the path where InnoDB creates separate tablespaces for the undo logs. This option is typically used in conjunction with the `innodb_rollback_segments` and `innodb_undo tablespaces` options, which determine the disk layout of the undo logs outside the system tablespace.



### Note

`innodb_undo tablespaces` is deprecated; expect it to be removed in a future release.

For more information, see [Section 14.6.3.4, “Undo Tablespaces”](#).

## Temporary Tablespace Configuration

A single auto-extending temporary tablespace data file named `ibtmp1` is created in the `innodb_data_home_dir` directory by default. The initial file size is slightly larger than 12MB. The default temporary tablespace data file configuration can be modified at startup using the `innodb_temp_data_file_path` configuration option.

The `innodb_temp_data_file_path` option specifies the path, file name, and file size for temporary tablespace data files. The full directory path is formed by concatenating `innodb_data_home_dir` to the path specified by `innodb_temp_data_file_path`. File size is specified in KB, MB, or GB (1024MB) by appending K, M, or G to the size value. The file size or combined file size must be slightly larger than 12MB.

The `innodb_data_home_dir` default value is the MySQL data directory (`datadir`).

An autoextending temporary tablespace data file can become large in environments that use large temporary tables or that use temporary tables extensively. A large data file can also result from long running queries that use temporary tables. To prevent the temporary data file from becoming too large, configure the `innodb_temp_data_file_path` option to specify a maximum data file size. For more information see [Managing Temporary Tablespace Data File Size](#).

## Page Size Configuration

The `innodb_page_size` option specifies the page size for all InnoDB tablespaces in a MySQL instance. This value is set when the instance is created and remains constant afterward. Valid values are 64KB, 32KB, 16KB (the default), 8KB, and 4KB. Alternatively, you can specify page size in bytes (65536, 32768, 16384, 8192, 4096).

The default 16KB page size is appropriate for a wide range of workloads, particularly for queries involving table scans and DML operations involving bulk updates. Smaller page sizes might be more efficient for

OLTP workloads involving many small writes, where contention can be an issue when a single page contains many rows. Smaller pages can also be more efficient for SSD storage devices, which typically use small block sizes. Keeping the `InnoDB` page size close to the storage device block size minimizes the amount of unchanged data that is rewritten to disk.



### Important

`innodb_page_size` can be set only when initializing the data directory. See the description of this variable for more information.

## Memory Configuration

MySQL allocates memory to various caches and buffers to improve performance of database operations. When allocating memory for `InnoDB`, always consider memory required by the operating system, memory allocated to other applications, and memory allocated for other MySQL buffers and caches. For example, if you use `MyISAM` tables, consider the amount of memory allocated for the key buffer (`key_buffer_size`). For an overview of MySQL buffers and caches, see [Section 8.12.4.1, “How MySQL Uses Memory”](#).

Buffers specific to `InnoDB` are configured using the following parameters:

- `innodb_buffer_pool_size` defines size of the buffer pool, which is the memory area that holds cached data for `InnoDB` tables, indexes, and other auxiliary buffers. The size of the buffer pool is important for system performance, and it is typically recommended that `innodb_buffer_pool_size` is configured to 50 to 75 percent of system memory. The default buffer pool size is 128MB. For additional guidance, see [Section 8.12.4.1, “How MySQL Uses Memory”](#). For information about how to configure `InnoDB` buffer pool size, see [Section 14.8.3.1, “Configuring InnoDB Buffer Pool Size”](#). Buffer pool size can be configured at startup or dynamically.

On systems with a large amount of memory, you can improve concurrency by dividing the buffer pool into multiple buffer pool instances. The number of buffer pool instances is controlled by the `innodb_buffer_pool_instances` option. By default, `InnoDB` creates one buffer pool instance. The number of buffer pool instances can be configured at startup. For more information, see [Section 14.8.3.2, “Configuring Multiple Buffer Pool Instances”](#).

- `innodb_log_buffer_size` defines the size of the buffer that `InnoDB` uses to write to the log files on disk. The default size is 16MB. A large log buffer enables large transactions to run without writing the log to disk before the transactions commit. If you have transactions that update, insert, or delete many rows, you might consider increasing the size of the log buffer to save disk I/O. `innodb_log_buffer_size` can be configured at startup. For related information, see [Section 8.5.4, “Optimizing InnoDB Redo Logging”](#).



### Warning

On 32-bit GNU/Linux x86, if memory usage is set too high, `glibc` may permit the process heap to grow over the thread stacks, causing a server failure. It is a risk if the memory allocated to the `mysqld` process for global and per-thread buffers and caches is close to or exceeds 2GB.

A formula similar to the following that calculates global and per-thread memory allocation for MySQL can be used to estimate MySQL memory usage. You may need to modify the formula to account for buffers and caches in your MySQL version and configuration. For an overview of MySQL buffers and caches, see [Section 8.12.4.1, “How MySQL Uses Memory”](#).

```
innodb_buffer_pool_size
+ key_buffer_size
+ max_connections*(sort_buffer_size+read_buffer_size+binlog_cache_size)
```

```
+ max_connections*2MB
```

Each thread uses a stack (often 2MB, but only 256KB in MySQL binaries provided by Oracle Corporation.) and in the worst case also uses `sort_buffer_size` + `read_buffer_size` additional memory.

On Linux, if the kernel is enabled for large page support, InnoDB can use large pages to allocate memory for its buffer pool. See [Section 8.12.4.3, “Enabling Large Page Support”](#).

## 14.8.2 Configuring InnoDB for Read-Only Operation

You can query InnoDB tables where the MySQL data directory is on read-only media by enabling the `--innodb-read-only` configuration option at server startup.

### How to Enable

To prepare an instance for read-only operation, make sure all the necessary information is **flushed** to the data files before storing it on the read-only medium. Run the server with change buffering disabled (`innodb_change_buffering=0`) and do a **slow shutdown**.

To enable read-only mode for an entire MySQL instance, specify the following configuration options at server startup:

- `--innodb-read-only=1`
- If the instance is on read-only media such as a DVD or CD, or the `/var` directory is not writeable by all: `--pid-file=path_on_writeable_media` and `--event-scheduler=disabled`
- `--innodb-temp-data-file-path`. This option specifies the path, file name, and file size for InnoDB temporary tablespace data files. The default setting is `ibtmp1:12M:autoextend`, which creates the `ibtmp1` temporary tablespace data file in the data directory. To prepare an instance for read-only operation, set `innodb_temp_data_file_path` to a location outside of the data directory. The path must be relative to the data directory. For example:

```
--innodb-temp-data-file-path=../../tmp/ibtmp1:12M:autoextend
```

### Usage Scenarios

This mode of operation is appropriate in situations such as:

- Distributing a MySQL application, or a set of MySQL data, on a read-only storage medium such as a DVD or CD.
- Multiple MySQL instances querying the same data directory simultaneously, typically in a data warehousing configuration. You might use this technique to avoid **bottlenecks** that can occur with a heavily loaded MySQL instance, or you might use different configuration options for the various instances to tune each one for particular kinds of queries.
- Querying data that has been put into a read-only state for security or data integrity reasons, such as archived backup data.



#### Note

This feature is mainly intended for flexibility in distribution and deployment, rather than raw performance based on the read-only aspect. See [Section 8.5.3, “Optimizing InnoDB Read-Only Transactions”](#) for ways to tune the performance of read-only queries, which do not require making the entire server read-only.

## How It Works

When the server is run in read-only mode through the `--innodb-read-only` option, certain InnoDB features and components are reduced or turned off entirely:

- No [change buffering](#) is done, in particular no merges from the change buffer. To make sure the change buffer is empty when you prepare the instance for read-only operation, disable change buffering (`innodb_change_buffering=0`) and do a [slow shutdown](#) first.
- There is no [crash recovery](#) phase at startup. The instance must have performed a [slow shutdown](#) before being put into the read-only state.
- Because the [redo log](#) is not used in read-only operation, you can set `innodb_log_file_size` to the smallest size possible (1 MB) before making the instance read-only.
- Most background threads are turned off. I/O read threads remain, as well as I/O write threads and a page cleaner thread for writes to temporary files, which are permitted in read-only mode.
- Information about deadlocks, monitor output, and so on is not written to temporary files. As a consequence, `SHOW ENGINE INNODB STATUS` does not produce any output.
- If the MySQL server is started with `--innodb-read-only` but the data directory is still on writeable media, the root user can still perform [DCL](#) operations such as `GRANT` and `REVOKE`.
- Changes to configuration option settings that would normally change the behavior of write operations, have no effect when the server is in read-only mode.
- The [MVCC](#) processing to enforce [isolation levels](#) is turned off. All queries read the latest version of a record, because update and deletes are not possible.
- The [undo log](#) is not used. Disable any settings for the `innodb_undo_tablespaces` and `innodb_undo_directory` configuration options.

### 14.8.3 InnoDB Buffer Pool Configuration

This section provides configuration and tuning information for the InnoDB buffer pool.

#### 14.8.3.1 Configuring InnoDB Buffer Pool Size

You can configure InnoDB buffer pool size offline or while the server is running. Behavior described in this section applies to both methods. For additional information about configuring buffer pool size online, see [Configuring InnoDB Buffer Pool Size Online](#).

When increasing or decreasing `innodb_buffer_pool_size`, the operation is performed in chunks. Chunk size is defined by the `innodb_buffer_pool_chunk_size` configuration option, which has a default of `128M`. For more information, see [Configuring InnoDB Buffer Pool Chunk Size](#).

Buffer pool size must always be equal to or a multiple of `innodb_buffer_pool_chunk_size * innodb_buffer_pool_instances`. If you configure `innodb_buffer_pool_size` to a value that is not equal to or a multiple of `innodb_buffer_pool_chunk_size * innodb_buffer_pool_instances`, buffer pool size is automatically adjusted to a value that is equal to or a multiple of `innodb_buffer_pool_chunk_size * innodb_buffer_pool_instances`.

In the following example, `innodb_buffer_pool_size` is set to `8G`, and `innodb_buffer_pool_instances` is set to `16`. `innodb_buffer_pool_chunk_size` is `128M`, which is the default value.

`8G` is a valid `innodb_buffer_pool_size` value because `8G` is a multiple of `innodb_buffer_pool_instances=16 * innodb_buffer_pool_chunk_size=128M`, which is `2G`.

```
$> mysqld --innodb-buffer-pool-size=8G --innodb-buffer-pool-instances=16
```

```
mysql> SELECT @@innodb_buffer_pool_size/1024/1024/1024;
+-----+
| @@innodb_buffer_pool_size/1024/1024/1024 |
+-----+
|                                     8.000000000000 |
+-----+
```

In this example, `innodb_buffer_pool_size` is set to 9G, and `innodb_buffer_pool_instances` is set to 16. `innodb_buffer_pool_chunk_size` is 128M, which is the default value. In this case, 9G is not a multiple of `innodb_buffer_pool_instances=16 * innodb_buffer_pool_chunk_size=128M`, so `innodb_buffer_pool_size` is adjusted to 10G, which is a multiple of `innodb_buffer_pool_chunk_size * innodb_buffer_pool_instances`.

```
$> mysqld --innodb-buffer-pool-size=9G --innodb-buffer-pool-instances=16
```

```
mysql> SELECT @@innodb_buffer_pool_size/1024/1024/1024;
+-----+
| @@innodb_buffer_pool_size/1024/1024/1024 |
+-----+
|                                     10.000000000000 |
+-----+
```

### Configuring InnoDB Buffer Pool Chunk Size

`innodb_buffer_pool_chunk_size` can be increased or decreased in 1MB (1048576 byte) units but can only be modified at startup, in a command line string or in a MySQL configuration file.

Command line:

```
$> mysqld --innodb-buffer-pool-chunk-size=134217728
```

Configuration file:

```
[mysqld]
innodb_buffer_pool_chunk_size=134217728
```

The following conditions apply when altering `innodb_buffer_pool_chunk_size`:

- If the new `innodb_buffer_pool_chunk_size` value \* `innodb_buffer_pool_instances` is larger than the current buffer pool size when the buffer pool is initialized, `innodb_buffer_pool_chunk_size` is truncated to `innodb_buffer_pool_size / innodb_buffer_pool_instances`.

For example, if the buffer pool is initialized with a size of 2GB (2147483648 bytes), 4 buffer pool instances, and a chunk size of 1GB (1073741824 bytes), chunk size is truncated to a value equal to `innodb_buffer_pool_size / innodb_buffer_pool_instances`, as shown below:

```
$> mysqld --innodb-buffer-pool-size=2147483648 --innodb-buffer-pool-instances=4
--innodb-buffer-pool-chunk-size=1073741824;
```

```
mysql> SELECT @@innodb_buffer_pool_size;
+-----+
| @@innodb_buffer_pool_size |
+-----+
|          2147483648 |
+-----+

mysql> SELECT @@innodb_buffer_pool_instances;
+-----+
| @@innodb_buffer_pool_instances |
+-----+
|                               4 |
+-----+
```

```

+-----+
# Chunk size was set to 1GB (1073741824 bytes) on startup but was
# truncated to innodb_buffer_pool_size / innodb_buffer_pool_instances

mysql> SELECT @@innodb_buffer_pool_chunk_size;
+-----+
| @@innodb_buffer_pool_chunk_size |
+-----+
|                               536870912 |
+-----+

```

- Buffer pool size must always be equal to or a multiple of `innodb_buffer_pool_chunk_size` \* `innodb_buffer_pool_instances`. If you alter `innodb_buffer_pool_chunk_size`, `innodb_buffer_pool_size` is automatically adjusted to a value that is equal to or a multiple of `innodb_buffer_pool_chunk_size` \* `innodb_buffer_pool_instances`. The adjustment occurs when the buffer pool is initialized. This behavior is demonstrated in the following example:

```

# The buffer pool has a default size of 128MB (134217728 bytes)

mysql> SELECT @@innodb_buffer_pool_size;
+-----+
| @@innodb_buffer_pool_size |
+-----+
|                134217728 |
+-----+

# The chunk size is also 128MB (134217728 bytes)

mysql> SELECT @@innodb_buffer_pool_chunk_size;
+-----+
| @@innodb_buffer_pool_chunk_size |
+-----+
|                134217728 |
+-----+

# There is a single buffer pool instance

mysql> SELECT @@innodb_buffer_pool_instances;
+-----+
| @@innodb_buffer_pool_instances |
+-----+
|                                1 |
+-----+

# Chunk size is decreased by 1MB (1048576 bytes) at startup
# (134217728 - 1048576 = 133169152):

$> mysqld --innodb-buffer-pool-chunk-size=133169152

mysql> SELECT @@innodb_buffer_pool_chunk_size;
+-----+
| @@innodb_buffer_pool_chunk_size |
+-----+
|                133169152 |
+-----+

# Buffer pool size increases from 134217728 to 266338304
# Buffer pool size is automatically adjusted to a value that is equal to
# or a multiple of innodb_buffer_pool_chunk_size * innodb_buffer_pool_instances

mysql> SELECT @@innodb_buffer_pool_size;
+-----+
| @@innodb_buffer_pool_size |
+-----+
|                266338304 |
+-----+

```

This example demonstrates the same behavior but with multiple buffer pool instances:

```
# The buffer pool has a default size of 2GB (2147483648 bytes)

mysql> SELECT @@innodb_buffer_pool_size;
+-----+
| @@innodb_buffer_pool_size |
+-----+
|                2147483648 |
+-----+

# The chunk size is .5 GB (536870912 bytes)

mysql> SELECT @@innodb_buffer_pool_chunk_size;
+-----+
| @@innodb_buffer_pool_chunk_size |
+-----+
|                536870912 |
+-----+

# There are 4 buffer pool instances

mysql> SELECT @@innodb_buffer_pool_instances;
+-----+
| @@innodb_buffer_pool_instances |
+-----+
|                                4 |
+-----+

# Chunk size is decreased by 1MB (1048576 bytes) at startup
# (536870912 - 1048576 = 535822336):

$> mysqld --innodb-buffer-pool-chunk-size=535822336

mysql> SELECT @@innodb_buffer_pool_chunk_size;
+-----+
| @@innodb_buffer_pool_chunk_size |
+-----+
|                535822336 |
+-----+

# Buffer pool size increases from 2147483648 to 4286578688
# Buffer pool size is automatically adjusted to a value that is equal to
# or a multiple of innodb_buffer_pool_chunk_size * innodb_buffer_pool_instances

mysql> SELECT @@innodb_buffer_pool_size;
+-----+
| @@innodb_buffer_pool_size |
+-----+
|                4286578688 |
+-----+
```

Care should be taken when changing `innodb_buffer_pool_chunk_size`, as changing this value can increase the size of the buffer pool, as shown in the examples above. Before you change `innodb_buffer_pool_chunk_size`, calculate the effect on `innodb_buffer_pool_size` to ensure that the resulting buffer pool size is acceptable.



#### Note

To avoid potential performance issues, the number of chunks (`innodb_buffer_pool_size / innodb_buffer_pool_chunk_size`) should not exceed 1000.



## Configuring InnoDB Buffer Pool Size Online

The `innodb_buffer_pool_size` configuration option can be set dynamically using a `SET` statement, allowing you to resize the buffer pool without restarting the server. For example:

```
mysql> SET GLOBAL innodb_buffer_pool_size=402653184;
```



### Note

The buffer pool size must be equal to or a multiple of `innodb_buffer_pool_chunk_size * innodb_buffer_pool_instances`. Changing those variable settings requires restarting the server.

Active transactions and operations performed through InnoDB APIs should be completed before resizing the buffer pool. When initiating a resizing operation, the operation does not start until all active transactions are completed. Once the resizing operation is in progress, new transactions and operations that require access to the buffer pool must wait until the resizing operation finishes. The exception to the rule is that concurrent access to the buffer pool is permitted while the buffer pool is defragmented and pages are withdrawn when buffer pool size is decreased. A drawback of allowing concurrent access is that it could result in a temporary shortage of available pages while pages are being withdrawn.



### Note

Nested transactions could fail if initiated after the buffer pool resizing operation begins.

## Monitoring Online Buffer Pool Resizing Progress

The `InnoDB_buffer_pool_resize_status` reports buffer pool resizing progress. For example:

```
mysql> SHOW STATUS WHERE Variable_name='InnoDB_buffer_pool_resize_status';
+-----+-----+
| Variable_name | Value |
+-----+-----+
| InnoDB_buffer_pool_resize_status | Resizing also other hash tables. |
+-----+-----+
```

Buffer pool resizing progress is also logged in the server error log. This example shows notes that are logged when increasing the size of the buffer pool:

```
[Note] InnoDB: Resizing buffer pool from 134217728 to 4294967296. (unit=134217728)
[Note] InnoDB: disabled adaptive hash index.
[Note] InnoDB: buffer pool 0 : 31 chunks (253952 blocks) was added.
[Note] InnoDB: buffer pool 0 : hash tables were resized.
[Note] InnoDB: Resized hash tables at lock_sys, adaptive hash index, dictionary.
[Note] InnoDB: completed to resize buffer pool from 134217728 to 4294967296.
[Note] InnoDB: re-enabled adaptive hash index.
```

This example shows notes that are logged when decreasing the size of the buffer pool:

```
[Note] InnoDB: Resizing buffer pool from 4294967296 to 134217728. (unit=134217728)
[Note] InnoDB: disabled adaptive hash index.
[Note] InnoDB: buffer pool 0 : start to withdraw the last 253952 blocks.
[Note] InnoDB: buffer pool 0 : withdrew 253952 blocks from free list. tried to relocate 0 pages.
(253952/253952)
[Note] InnoDB: buffer pool 0 : withdrawn target 253952 blocks.
[Note] InnoDB: buffer pool 0 : 31 chunks (253952 blocks) was freed.
[Note] InnoDB: buffer pool 0 : hash tables were resized.
[Note] InnoDB: Resized hash tables at lock_sys, adaptive hash index, dictionary.
[Note] InnoDB: completed to resize buffer pool from 4294967296 to 134217728.
[Note] InnoDB: re-enabled adaptive hash index.
```

## Online Buffer Pool Resizing Internals

The resizing operation is performed by a background thread. When increasing the size of the buffer pool, the resizing operation:

- Adds pages in `chunks` (chunk size is defined by `innodb_buffer_pool_chunk_size`)
- Converts hash tables, lists, and pointers to use new addresses in memory
- Adds new pages to the free list

While these operations are in progress, other threads are blocked from accessing the buffer pool.

When decreasing the size of the buffer pool, the resizing operation:

- Defragments the buffer pool and withdraws (frees) pages
- Removes pages in `chunks` (chunk size is defined by `innodb_buffer_pool_chunk_size`)
- Converts hash tables, lists, and pointers to use new addresses in memory

Of these operations, only defragmenting the buffer pool and withdrawing pages allow other threads to access to the buffer pool concurrently.

### 14.8.3.2 Configuring Multiple Buffer Pool Instances

For systems with buffer pools in the multi-gigabyte range, dividing the buffer pool into separate instances can improve concurrency, by reducing contention as different threads read and write to cached pages. This feature is typically intended for systems with a `buffer pool` size in the multi-gigabyte range. Multiple buffer pool instances are configured using the `innodb_buffer_pool_instances` configuration option, and you might also adjust the `innodb_buffer_pool_size` value.

When the `InnoDB` buffer pool is large, many data requests can be satisfied by retrieving from memory. You might encounter bottlenecks from multiple threads trying to access the buffer pool at once. You can enable multiple buffer pools to minimize this contention. Each page that is stored in or read from the buffer pool is assigned to one of the buffer pools randomly, using a hashing function. Each buffer pool manages its own free lists, flush lists, LRUs, and all other data structures connected to a buffer pool, and is protected by its own buffer pool mutex.

To enable multiple buffer pool instances, set the `innodb_buffer_pool_instances` configuration option to a value greater than 1 (the default) up to 64 (the maximum). This option takes effect only when you set `innodb_buffer_pool_size` to a size of 1GB or more. The total size you specify is divided among all the buffer pools. For best efficiency, specify a combination of `innodb_buffer_pool_instances` and `innodb_buffer_pool_size` so that each buffer pool instance is at least 1GB.

For information about modifying `InnoDB` buffer pool size, see [Section 14.8.3.1, “Configuring InnoDB Buffer Pool Size”](#).

### 14.8.3.3 Making the Buffer Pool Scan Resistant

Rather than using a strict `LRU` algorithm, `InnoDB` uses a technique to minimize the amount of data that is brought into the `buffer pool` and never accessed again. The goal is to make sure that frequently accessed (“hot”) pages remain in the buffer pool, even as `read-ahead` and `full table scans` bring in new blocks that might or might not be accessed afterward.

Newly read blocks are inserted into the middle of the `LRU` list. All newly read pages are inserted at a location that by default is  $3/8$  from the tail of the `LRU` list. The pages are moved to the front of the list (the

most-recently used end) when they are accessed in the buffer pool for the first time. Thus, pages that are never accessed never make it to the front portion of the LRU list, and “age out” sooner than with a strict LRU approach. This arrangement divides the LRU list into two segments, where the pages downstream of the insertion point are considered “old” and are desirable victims for LRU eviction.

For an explanation of the inner workings of the [InnoDB](#) buffer pool and specifics about the LRU algorithm, see [Section 14.5.1, “Buffer Pool”](#).

You can control the insertion point in the LRU list and choose whether [InnoDB](#) applies the same optimization to blocks brought into the buffer pool by table or index scans. The configuration parameter [innodb\\_old\\_blocks\\_pct](#) controls the percentage of “old” blocks in the LRU list. The default value of [innodb\\_old\\_blocks\\_pct](#) is 37, corresponding to the original fixed ratio of 3/8. The value range is 5 (new pages in the buffer pool age out very quickly) to 95 (only 5% of the buffer pool is reserved for hot pages, making the algorithm close to the familiar LRU strategy).

The optimization that keeps the buffer pool from being churned by read-ahead can avoid similar problems due to table or index scans. In these scans, a data page is typically accessed a few times in quick succession and is never touched again. The configuration parameter [innodb\\_old\\_blocks\\_time](#) specifies the time window (in milliseconds) after the first access to a page during which it can be accessed without being moved to the front (most-recently used end) of the LRU list. The default value of [innodb\\_old\\_blocks\\_time](#) is 1000. Increasing this value makes more and more blocks likely to age out faster from the buffer pool.

Both [innodb\\_old\\_blocks\\_pct](#) and [innodb\\_old\\_blocks\\_time](#) can be specified in the MySQL option file ([my.cnf](#) or [my.ini](#)) or changed at runtime with the [SET GLOBAL](#) statement. Changing the value at runtime requires privileges sufficient to set global system variables. See [Section 5.1.8.1, “System Variable Privileges”](#).

To help you gauge the effect of setting these parameters, the [SHOW ENGINE INNODB STATUS](#) command reports buffer pool statistics. For details, see [Monitoring the Buffer Pool Using the InnoDB Standard Monitor](#).

Because the effects of these parameters can vary widely based on your hardware configuration, your data, and the details of your workload, always benchmark to verify the effectiveness before changing these settings in any performance-critical or production environment.

In mixed workloads where most of the activity is OLTP type with periodic batch reporting queries which result in large scans, setting the value of [innodb\\_old\\_blocks\\_time](#) during the batch runs can help keep the working set of the normal workload in the buffer pool.

When scanning large tables that cannot fit entirely in the buffer pool, setting [innodb\\_old\\_blocks\\_pct](#) to a small value keeps the data that is only read once from consuming a significant portion of the buffer pool. For example, setting [innodb\\_old\\_blocks\\_pct=5](#) restricts this data that is only read once to 5% of the buffer pool.

When scanning small tables that do fit into memory, there is less overhead for moving pages around within the buffer pool, so you can leave [innodb\\_old\\_blocks\\_pct](#) at its default value, or even higher, such as [innodb\\_old\\_blocks\\_pct=50](#).

The effect of the [innodb\\_old\\_blocks\\_time](#) parameter is harder to predict than the [innodb\\_old\\_blocks\\_pct](#) parameter, is relatively small, and varies more with the workload. To arrive at an optimal value, conduct your own benchmarks if the performance improvement from adjusting [innodb\\_old\\_blocks\\_pct](#) is not sufficient.

#### 14.8.3.4 Configuring InnoDB Buffer Pool Prefetching (Read-Ahead)

A [read-ahead](#) request is an I/O request to prefetch multiple pages in the [buffer pool](#) asynchronously, in anticipation that these pages are needed soon. The requests bring in all the pages in one [extent](#). InnoDB uses two read-ahead algorithms to improve I/O performance:

**Linear** read-ahead is a technique that predicts what pages might be needed soon based on pages in the buffer pool being accessed sequentially. You control when InnoDB performs a read-ahead operation by adjusting the number of sequential page accesses required to trigger an asynchronous read request, using the configuration parameter `innodb_read_ahead_threshold`. Before this parameter was added, InnoDB would only calculate whether to issue an asynchronous prefetch request for the entire next extent when it read the last page of the current extent.

The configuration parameter `innodb_read_ahead_threshold` controls how sensitive InnoDB is in detecting patterns of sequential page access. If the number of pages read sequentially from an extent is greater than or equal to `innodb_read_ahead_threshold`, InnoDB initiates an asynchronous read-ahead operation of the entire following extent. `innodb_read_ahead_threshold` can be set to any value from 0-64. The default value is 56. The higher the value, the more strict the access pattern check. For example, if you set the value to 48, InnoDB triggers a linear read-ahead request only when 48 pages in the current extent have been accessed sequentially. If the value is 8, InnoDB triggers an asynchronous read-ahead even if as few as 8 pages in the extent are accessed sequentially. You can set the value of this parameter in the MySQL [configuration file](#), or change it dynamically with the `SET GLOBAL` statement, which requires privileges sufficient to set global system variables. See [Section 5.1.8.1, “System Variable Privileges”](#).

**Random** read-ahead is a technique that predicts when pages might be needed soon based on pages already in the buffer pool, regardless of the order in which those pages were read. If 13 consecutive pages from the same extent are found in the buffer pool, InnoDB asynchronously issues a request to prefetch the remaining pages of the extent. To enable this feature, set the configuration variable `innodb_random_read_ahead` to `ON`.

The `SHOW ENGINE INNODB STATUS` command displays statistics to help you evaluate the effectiveness of the read-ahead algorithm. Statistics include counter information for the following global status variables:

- `Innodb_buffer_pool_read_ahead`
- `Innodb_buffer_pool_read_ahead_evicted`
- `Innodb_buffer_pool_read_ahead_rnd`

This information can be useful when fine-tuning the `innodb_random_read_ahead` setting.

For more information about I/O performance, see [Section 8.5.8, “Optimizing InnoDB Disk I/O”](#) and [Section 8.12.2, “Optimizing Disk I/O”](#).

### 14.8.3.5 Configuring Buffer Pool Flushing

InnoDB performs certain tasks in the background, including flushing of dirty pages from the buffer pool. Dirty pages are those that have been modified but are not yet written to the data files on disk.

In MySQL 5.7, buffer pool flushing is performed by page cleaner threads. The number of page cleaner threads is controlled by the `innodb_page_cleaners` variable, which has a default value of 4. However, if the number of page cleaner threads exceeds the number of buffer pool instances, `innodb_page_cleaners` is automatically set to the same value as `innodb_buffer_pool_instances`.

Buffer pool flushing is initiated when the percentage of dirty pages reaches the low water mark value defined by the `innodb_max_dirty_pages_pct_lwm` variable. The default low water mark is 0, which disables this early flushing behaviour.

The purpose of the `innodb_max_dirty_pages_pct_lwm` threshold is to control the percentage dirty pages in the buffer pool and to prevent the amount of dirty pages from reaching the threshold defined by the `innodb_max_dirty_pages_pct` variable, which has a default value of 75. InnoDB aggressively flushes buffer pool pages if the percentage of dirty pages in the buffer pool reaches the `innodb_max_dirty_pages_pct` threshold.

When configuring `innodb_max_dirty_pages_pct_lwm`, the value should always be lower than the `innodb_max_dirty_pages_pct` value.

Additional variables permit fine-tuning of buffer pool flushing behavior:

- The `innodb_flush_neighbors` variable defines whether flushing a page from the buffer pool also flushes other dirty pages in the same extent.
  - A setting of 0 disables `innodb_flush_neighbors`. Dirty pages in the same extent are not flushed.
  - The default setting of 1 flushes contiguous dirty pages in the same extent.
  - A setting of 2 flushes dirty pages in the same extent.

When table data is stored on a traditional HDD storage device, flushing neighbor pages in one operation reduces I/O overhead (primarily for disk seek operations) compared to flushing individual pages at different times. For table data stored on SSD, seek time is not a significant factor and you can disable this setting to spread out write operations.

- The `innodb_lru_scan_depth` variable specifies, per buffer pool instance, how far down the buffer pool LRU list the page cleaner thread scans looking for dirty pages to flush. This is a background operation performed by a page cleaner thread once per second.

A setting smaller than the default is generally suitable for most workloads. A value that is significantly higher than necessary may impact performance. Only consider increasing the value if you have spare I/O capacity under a typical workload. Conversely, if a write-intensive workload saturates your I/O capacity, decrease the value, especially in the case of a large buffer pool.

When tuning `innodb_lru_scan_depth`, start with a low value and configure the setting upward with the goal of rarely seeing zero free pages. Also, consider adjusting `innodb_lru_scan_depth` when changing the number of buffer pool instances, since `innodb_lru_scan_depth` \* `innodb_buffer_pool_instances` defines the amount of work performed by the page cleaner thread each second.

The `innodb_flush_neighbors` and `innodb_lru_scan_depth` variables are primarily intended for write-intensive workloads. With heavy DML activity, flushing can fall behind if it is not aggressive enough, or disk writes can saturate I/O capacity if flushing is too aggressive. The ideal settings depend on your workload, data access patterns, and storage configuration (for example, whether data is stored on HDD or SSD devices).

## Adaptive Flushing

InnoDB uses an adaptive flushing algorithm to dynamically adjust the rate of flushing based on the speed of redo log generation and the current rate of flushing. The intent is to smooth overall performance by ensuring that flushing activity keeps pace with the current workload. Automatically adjusting the flushing rate helps avoid sudden dips in throughput that can occur when bursts of I/O activity due to buffer pool flushing affects the I/O capacity available for ordinary read and write activity.

Sharp checkpoints, which are typically associated with write-intensive workloads that generate a lot of redo entries, can cause a sudden change in throughput, for example. A sharp checkpoint occurs when InnoDB

wants to reuse a portion of a log file. Before doing so, all dirty pages with redo entries in that portion of the log file must be flushed. If log files become full, a sharp checkpoint occurs, causing a temporary reduction in throughput. This scenario can occur even if `innodb_max_dirty_pages_pct` threshold is not reached.

The adaptive flushing algorithm helps avoid such scenarios by tracking the number of dirty pages in the buffer pool and the rate at which redo log records are being generated. Based on this information, it decides how many dirty pages to flush from the buffer pool each second, which permits it to manage sudden changes in workload.

The `innodb_adaptive_flushing_lwm` variable defines a low water mark for redo log capacity. When that threshold is crossed, adaptive flushing is enabled, even if the `innodb_adaptive_flushing` variable is disabled.

Internal benchmarking has shown that the algorithm not only maintains throughput over time, but can also improve overall throughput significantly. However, adaptive flushing can affect the I/O pattern of a workload significantly and may not be appropriate in all cases. It gives the most benefit when the redo log is in danger of filling up. If adaptive flushing is not appropriate to the characteristics of your workload, you can disable it. Adaptive flushing controlled by the `innodb_adaptive_flushing` variable, which is enabled by default.

`innodb_flushing_avg_loops` defines the number of iterations that InnoDB keeps the previously calculated snapshot of the flushing state, controlling how quickly adaptive flushing responds to foreground workload changes. A high `innodb_flushing_avg_loops` value means that InnoDB keeps the previously calculated snapshot longer, so adaptive flushing responds more slowly. When setting a high value it is important to ensure that redo log utilization does not reach 75% (the hardcoded limit at which asynchronous flushing starts), and that the `innodb_max_dirty_pages_pct` threshold keeps the number of dirty pages to a level that is appropriate for the workload.

Systems with consistent workloads, a large log file size (`innodb_log_file_size`), and small spikes that do not reach 75% log space utilization should use a high `innodb_flushing_avg_loops` value to keep flushing as smooth as possible. For systems with extreme load spikes or log files that do not provide a lot of space, a smaller value allows flushing to closely track workload changes, and helps to avoid reaching 75% log space utilization.

Be aware that if flushing falls behind, the rate of buffer pool flushing can exceed the I/O capacity available to InnoDB, as defined by `innodb_io_capacity` setting. The `innodb_io_capacity_max` value defines an upper limit on I/O capacity in such situations, so that a spike in I/O activity does not consume the entire I/O capacity of the server.

The `innodb_io_capacity` setting is applicable to all buffer pool instances. When dirty pages are flushed, I/O capacity is divided equally among buffer pool instances.

### 14.8.3.6 Saving and Restoring the Buffer Pool State

To reduce the `warmup` period after restarting the server, InnoDB saves a percentage of the most recently used pages for each buffer pool at server shutdown and restores these pages at server startup. The percentage of recently used pages that is stored is defined by the `innodb_buffer_pool_dump_pct` configuration option.

After restarting a busy server, there is typically a warmup period with steadily increasing throughput, as disk pages that were in the buffer pool are brought back into memory (as the same data is queried, updated, and so on). The ability to restore the buffer pool at startup shortens the warmup period by reloading disk pages that were in the buffer pool before the restart rather than waiting for DML operations to access corresponding rows. Also, I/O requests can be performed in large batches, making the overall I/O faster. Page loading happens in the background, and does not delay database startup.

In addition to saving the buffer pool state at shutdown and restoring it at startup, you can save and restore the buffer pool state at any time, while the server is running. For example, you can save the state of the buffer pool after reaching a stable throughput under a steady workload. You could also restore the previous buffer pool state after running reports or maintenance jobs that bring data pages into the buffer pool that are only required for those operations, or after running some other non-typical workload.

Even though a buffer pool can be many gigabytes in size, the buffer pool data that InnoDB saves to disk is tiny by comparison. Only tablespace IDs and page IDs necessary to locate the appropriate pages are saved to disk. This information is derived from the `INNODB_BUFFER_PAGE_LRU_INFORMATION_SCHEMA` table. By default, tablespace ID and page ID data is saved in a file named `ib_buffer_pool`, which is saved to the InnoDB data directory. The file name and location can be modified using the `innodb_buffer_pool_filename` configuration parameter.

Because data is cached in and aged out of the buffer pool as it is with regular database operations, there is no problem if the disk pages are recently updated, or if a DML operation involves data that has not yet been loaded. The loading mechanism skips requested pages that no longer exist.

The underlying mechanism involves a background thread that is dispatched to perform the dump and load operations.

Disk pages from compressed tables are loaded into the buffer pool in their compressed form. Pages are uncompressed as usual when page contents are accessed during DML operations. Because uncompressing pages is a CPU-intensive process, it is more efficient for concurrency to perform the operation in a connection thread rather than in the single thread that performs the buffer pool restore operation.

Operations related to saving and restoring the buffer pool state are described in the following topics:

- [Configuring the Dump Percentage for Buffer Pool Pages](#)
- [Saving the Buffer Pool State at Shutdown and Restoring it at Startup](#)
- [Saving and Restoring the Buffer Pool State Online](#)
- [Displaying Buffer Pool Dump Progress](#)
- [Displaying Buffer Pool Load Progress](#)
- [Aborting a Buffer Pool Load Operation](#)
- [Monitoring Buffer Pool Load Progress Using Performance Schema](#)

## Configuring the Dump Percentage for Buffer Pool Pages

Before dumping pages from the buffer pool, you can configure the percentage of most-recently-used buffer pool pages that you want to dump by setting the `innodb_buffer_pool_dump_pct` option. If you plan to dump buffer pool pages while the server is running, you can configure the option dynamically:

```
SET GLOBAL innodb_buffer_pool_dump_pct=40;
```

If you plan to dump buffer pool pages at server shutdown, set `innodb_buffer_pool_dump_pct` in your configuration file.

```
[mysqld]
innodb_buffer_pool_dump_pct=40
```

The `innodb_buffer_pool_dump_pct` default value was changed from 100 (dump all pages) to 25 (dump 25% of most-recently-used pages) in MySQL 5.7 when

`innodb_buffer_pool_dump_at_shutdown` and `innodb_buffer_pool_load_at_startup` were enabled by default.

### Saving the Buffer Pool State at Shutdown and Restoring it at Startup

To save the state of the buffer pool at server shutdown, issue the following statement prior to shutting down the server:

```
SET GLOBAL innodb_buffer_pool_dump_at_shutdown=ON;
```

`innodb_buffer_pool_dump_at_shutdown` is enabled by default.

To restore the buffer pool state at server startup, specify the `--innodb-buffer-pool-load-at-startup` option when starting the server:

```
mysqld --innodb-buffer-pool-load-at-startup=ON;
```

`innodb_buffer_pool_load_at_startup` is enabled by default.

### Saving and Restoring the Buffer Pool State Online

To save the state of the buffer pool while MySQL server is running, issue the following statement:

```
SET GLOBAL innodb_buffer_pool_dump_now=ON;
```

To restore the buffer pool state while MySQL is running, issue the following statement:

```
SET GLOBAL innodb_buffer_pool_load_now=ON;
```

### Displaying Buffer Pool Dump Progress

To display progress when saving the buffer pool state to disk, issue the following statement:

```
SHOW STATUS LIKE 'Innodb_buffer_pool_dump_status';
```

If the operation has not yet started, “not started” is returned. If the operation is complete, the completion time is printed (e.g. Finished at 110505 12:18:02). If the operation is in progress, status information is provided (e.g. Dumping buffer pool 5/7, page 237/2873).

### Displaying Buffer Pool Load Progress

To display progress when loading the buffer pool, issue the following statement:

```
SHOW STATUS LIKE 'Innodb_buffer_pool_load_status';
```

If the operation has not yet started, “not started” is returned. If the operation is complete, the completion time is printed (e.g. Finished at 110505 12:23:24). If the operation is in progress, status information is provided (e.g. Loaded 123/22301 pages).

### Aborting a Buffer Pool Load Operation

To abort a buffer pool load operation, issue the following statement:

```
SET GLOBAL innodb_buffer_pool_load_abort=ON;
```

### Monitoring Buffer Pool Load Progress Using Performance Schema

You can monitor buffer pool load progress using [Performance Schema](#).



The following example demonstrates how to enable the `stage/innodb/buffer pool load` stage event instrument and related consumer tables to monitor buffer pool load progress.

For information about buffer pool dump and load procedures used in this example, see [Section 14.8.3.6, “Saving and Restoring the Buffer Pool State”](#). For information about Performance Schema stage event instruments and related consumers, see [Section 25.12.5, “Performance Schema Stage Event Tables”](#).

1. Enable the `stage/innodb/buffer pool load` instrument:

```
mysql> UPDATE performance_schema.setup_instruments SET ENABLED = 'YES'
      WHERE NAME LIKE 'stage/innodb/buffer%';
```

2. Enable the stage event consumer tables, which include `events_stages_current`, `events_stages_history`, and `events_stages_history_long`.

```
mysql> UPDATE performance_schema.setup_consumers SET ENABLED = 'YES'
      WHERE NAME LIKE '%stages%';
```

3. Dump the current buffer pool state by enabling `innodb_buffer_pool_dump_now`.

```
mysql> SET GLOBAL innodb_buffer_pool_dump_now=ON;
```

4. Check the buffer pool dump status to ensure that the operation has completed.

```
mysql> SHOW STATUS LIKE 'Innodb_buffer_pool_dump_status'\G
***** 1. row *****
Variable_name: Innodb_buffer_pool_dump_status
Value: Buffer pool(s) dump completed at 150202 16:38:58
```

5. Load the buffer pool by enabling `innodb_buffer_pool_load_now`:

```
mysql> SET GLOBAL innodb_buffer_pool_load_now=ON;
```

6. Check the current status of the buffer pool load operation by querying the Performance Schema `events_stages_current` table. The `WORK_COMPLETED` column shows the number of buffer pool pages loaded. The `WORK_ESTIMATED` column provides an estimate of the remaining work, in pages.

```
mysql> SELECT EVENT_NAME, WORK_COMPLETED, WORK_ESTIMATED
      FROM performance_schema.events_stages_current;
+-----+-----+-----+
| EVENT_NAME | WORK_COMPLETED | WORK_ESTIMATED |
+-----+-----+-----+
| stage/innodb/buffer pool load | 5353 | 7167 |
+-----+-----+-----+
```

The `events_stages_current` table returns an empty set if the buffer pool load operation has completed. In this case, you can check the `events_stages_history` table to view data for the completed event. For example:

```
mysql> SELECT EVENT_NAME, WORK_COMPLETED, WORK_ESTIMATED
      FROM performance_schema.events_stages_history;
+-----+-----+-----+
| EVENT_NAME | WORK_COMPLETED | WORK_ESTIMATED |
+-----+-----+-----+
| stage/innodb/buffer pool load | 7167 | 7167 |
+-----+-----+-----+
```



#### Note

You can also monitor buffer pool load progress using Performance Schema when loading the buffer pool at startup using `innodb_buffer_pool_load_at_startup`. In this case, the `stage/innodb/`

`buffer pool load` instrument and related consumers must be enabled at startup. For more information, see [Section 25.3, “Performance Schema Startup Configuration”](#).

## 14.8.4 Configuring the Memory Allocator for InnoDB

When InnoDB was developed, the memory allocators supplied with operating systems and run-time libraries were often lacking in performance and scalability. At that time, there were no memory allocator libraries tuned for multi-core CPUs. Therefore, InnoDB implemented its own memory allocator in the `mem` subsystem. This allocator is guarded by a single mutex, which may become a [bottleneck](#). InnoDB also implements a wrapper interface around the system allocator (`malloc` and `free`) that is likewise guarded by a single mutex.

Today, as multi-core systems have become more widely available, and as operating systems have matured, significant improvements have been made in the memory allocators provided with operating systems. These new memory allocators perform better and are more scalable than they were in the past. Most workloads, especially those where memory is frequently allocated and released (such as multi-table joins), benefit from using a more highly tuned memory allocator as opposed to the internal, InnoDB-specific memory allocator.

You can control whether InnoDB uses its own memory allocator or an allocator of the operating system, by setting the value of the system configuration parameter `innodb_use_sys_malloc` in the MySQL option file (`my.cnf` or `my.ini`). If set to `ON` or `1` (the default), InnoDB uses the `malloc` and `free` functions of the underlying system rather than manage memory pools itself. This parameter is not dynamic, and takes effect only when the system is started. To continue to use the InnoDB memory allocator, set `innodb_use_sys_malloc` to `0`.

When the InnoDB memory allocator is disabled, InnoDB ignores the value of the parameter `innodb_additional_mem_pool_size`. The InnoDB memory allocator uses an additional memory pool for satisfying allocation requests without having to fall back to the system memory allocator. When the InnoDB memory allocator is disabled, all such allocation requests are fulfilled by the system memory allocator.

On Unix-like systems that use dynamic linking, replacing the memory allocator may be as easy as making the environment variable `LD_PRELOAD` or `LD_LIBRARY_PATH` point to the dynamic library that implements the allocator. On other systems, some relinking may be necessary. Please refer to the documentation of the memory allocator library of your choice.

Since InnoDB cannot track all memory use when the system memory allocator is used (`innodb_use_sys_malloc` is `ON`), the section “BUFFER POOL AND MEMORY” in the output of the `SHOW ENGINE INNODB STATUS` command only includes the buffer pool statistics in the “Total memory allocated”. Any memory allocated using the `mem` subsystem or using `ut_malloc` is excluded.



### Note

`innodb_use_sys_malloc` and `innodb_additional_mem_pool_size` were deprecated in MySQL 5.6 and removed in MySQL 5.7.

For more information about the performance implications of InnoDB memory usage, see [Section 8.10, “Buffering and Caching”](#).

## 14.8.5 Configuring Thread Concurrency for InnoDB

InnoDB uses operating system [threads](#) to process requests from user transactions. (Transactions may issue many requests to InnoDB before they commit or roll back.) On modern operating systems and servers with multi-core processors, where context switching is efficient, most workloads run well without

any limit on the number of concurrent threads. Scalability improvements in MySQL 5.5 and up reduce the need to limit the number of concurrently executing threads inside [InnoDB](#).

In situations where it is helpful to minimize context switching between threads, [InnoDB](#) can use a number of techniques to limit the number of concurrently executing operating system threads (and thus the number of requests that are processed at any one time). When [InnoDB](#) receives a new request from a user session, if the number of threads concurrently executing is at a pre-defined limit, the new request sleeps for a short time before it tries again. Threads waiting for locks are not counted in the number of concurrently executing threads.

You can limit the number of concurrent threads by setting the configuration parameter [innodb\\_thread\\_concurrency](#). Once the number of executing threads reaches this limit, additional threads sleep for a number of microseconds, set by the configuration parameter [innodb\\_thread\\_sleep\\_delay](#), before being placed into the queue.

Previously, it required experimentation to find the optimal value for [innodb\\_thread\\_sleep\\_delay](#), and the optimal value could change depending on the workload. In MySQL 5.6.3 and higher, you can set the configuration option [innodb\\_adaptive\\_max\\_sleep\\_delay](#) to the highest value you would allow for [innodb\\_thread\\_sleep\\_delay](#), and [InnoDB](#) automatically adjusts [innodb\\_thread\\_sleep\\_delay](#) up or down depending on the current thread-scheduling activity. This dynamic adjustment helps the thread scheduling mechanism to work smoothly during times when the system is lightly loaded and when it is operating near full capacity.

The default value for [innodb\\_thread\\_concurrency](#) and the implied default limit on the number of concurrent threads has been changed in various releases of MySQL and [InnoDB](#). The default value of [innodb\\_thread\\_concurrency](#) is 0, so that by default there is no limit on the number of concurrently executing threads.

[InnoDB](#) causes threads to sleep only when the number of concurrent threads is limited. When there is no limit on the number of threads, all contend equally to be scheduled. That is, if [innodb\\_thread\\_concurrency](#) is 0, the value of [innodb\\_thread\\_sleep\\_delay](#) is ignored.

When there is a limit on the number of threads (when [innodb\\_thread\\_concurrency](#) is > 0), [InnoDB](#) reduces context switching overhead by permitting multiple requests made during the execution of a *single SQL statement* to enter [InnoDB](#) without observing the limit set by [innodb\\_thread\\_concurrency](#). Since an SQL statement (such as a join) may comprise multiple row operations within [InnoDB](#), [InnoDB](#) assigns a specified number of “tickets” that allow a thread to be scheduled repeatedly with minimal overhead.

When a new SQL statement starts, a thread has no tickets, and it must observe [innodb\\_thread\\_concurrency](#). Once the thread is entitled to enter [InnoDB](#), it is assigned a number of tickets that it can use for subsequently entering [InnoDB](#) to perform row operations. If the tickets run out, the thread is evicted, and [innodb\\_thread\\_concurrency](#) is observed again which may place the thread back into the first-in/first-out queue of waiting threads. When the thread is once again entitled to enter [InnoDB](#), tickets are assigned again. The number of tickets assigned is specified by the global option [innodb\\_concurrency\\_tickets](#), which is 5000 by default. A thread that is waiting for a lock is given one ticket once the lock becomes available.

The correct values of these variables depend on your environment and workload. Try a range of different values to determine what value works for your applications. Before limiting the number of concurrently executing threads, review configuration options that may improve the performance of [InnoDB](#) on multi-core and multi-processor computers, such as [innodb\\_adaptive\\_hash\\_index](#).

For general performance information about MySQL thread handling, see [Section 5.1.11.1, “Connection Interfaces”](#).

### 14.8.6 Configuring the Number of Background InnoDB I/O Threads

InnoDB uses background [threads](#) to service various types of I/O requests. You can configure the number of background threads that service read and write I/O on data pages using the [innodb\\_read\\_io\\_threads](#) and [innodb\\_write\\_io\\_threads](#) configuration parameters. These parameters signify the number of background threads used for read and write requests, respectively. They are effective on all supported platforms. You can set values for these parameters in the MySQL option file ([my.cnf](#) or [my.ini](#)); you cannot change values dynamically. The default value for these parameters is 4 and permissible values range from 1-64.

The purpose of these configuration options is to make InnoDB more scalable on high end systems. Each background thread can handle up to 256 pending I/O requests. A major source of background I/O is [read-ahead](#) requests. InnoDB tries to balance the load of incoming requests in such way that most background threads share work equally. InnoDB also attempts to allocate read requests from the same extent to the same thread, to increase the chances of coalescing the requests. If you have a high end I/O subsystem and you see more than  $64 \times$  [innodb\\_read\\_io\\_threads](#) pending read requests in `SHOW ENGINE INNODB STATUS` output, you might improve performance by increasing the value of [innodb\\_read\\_io\\_threads](#).

On Linux systems, InnoDB uses the asynchronous I/O subsystem by default to perform read-ahead and write requests for data file pages, which changes the way that InnoDB background threads service these types of I/O requests. For more information, see [Section 14.8.7, “Using Asynchronous I/O on Linux”](#).

For more information about InnoDB I/O performance, see [Section 8.5.8, “Optimizing InnoDB Disk I/O”](#).

## 14.8.7 Using Asynchronous I/O on Linux

InnoDB uses the asynchronous I/O subsystem (native AIO) on Linux to perform read-ahead and write requests for data file pages. This behavior is controlled by the [innodb\\_use\\_native\\_aio](#) configuration option, which applies to Linux systems only and is enabled by default. On other Unix-like systems, InnoDB uses synchronous I/O only. Historically, InnoDB only used asynchronous I/O on Windows systems. Using the asynchronous I/O subsystem on Linux requires the [libaio](#) library.

With synchronous I/O, query threads queue I/O requests, and InnoDB background threads retrieve the queued requests one at a time, issuing a synchronous I/O call for each. When an I/O request is completed and the I/O call returns, the InnoDB background thread that is handling the request calls an I/O completion routine and returns to process the next request. The number of requests that can be processed in parallel is  $n$ , where  $n$  is the number of InnoDB background threads. The number of InnoDB background threads is controlled by [innodb\\_read\\_io\\_threads](#) and [innodb\\_write\\_io\\_threads](#). See [Section 14.8.6, “Configuring the Number of Background InnoDB I/O Threads”](#).

With native AIO, query threads dispatch I/O requests directly to the operating system, thereby removing the limit imposed by the number of background threads. InnoDB background threads wait for I/O events to signal completed requests. When a request is completed, a background thread calls an I/O completion routine and resumes waiting for I/O events.

The advantage of native AIO is scalability for heavily I/O-bound systems that typically show many pending reads/writes in `SHOW ENGINE INNODB STATUS\G` output. The increase in parallel processing when using native AIO means that the type of I/O scheduler or properties of the disk array controller have a greater influence on I/O performance.

A potential disadvantage of native AIO for heavily I/O-bound systems is lack of control over the number of I/O write requests dispatched to the operating system at once. Too many I/O write requests dispatched to the operating system for parallel processing could, in some cases, result in I/O read starvation, depending on the amount of I/O activity and system capabilities.

If a problem with the asynchronous I/O subsystem in the OS prevents InnoDB from starting, you can start the server with [innodb\\_use\\_native\\_aio=0](#). This option may also be disabled automatically during

startup if InnoDB detects a potential problem such as a combination of `tmpdir` location, `tmpfs` file system, and Linux kernel that does not support asynchronous I/O on `tmpfs`.

## 14.8.8 Configuring InnoDB I/O Capacity

The InnoDB master thread and other threads perform various tasks in the background, most of which are I/O related, such as flushing dirty pages from the buffer pool and writing changes from the change buffer to the appropriate secondary indexes. InnoDB attempts to perform these tasks in a way that does not adversely affect the normal working of the server. It tries to estimate the available I/O bandwidth and tune its activities to take advantage of available capacity.

The `innodb_io_capacity` variable defines the overall I/O capacity available to InnoDB. It should be set to approximately the number of I/O operations that the system can perform per second (IOPS). When `innodb_io_capacity` is set, InnoDB estimates the I/O bandwidth available for background tasks based on the set value.

You can set `innodb_io_capacity` to a value of 100 or greater. The default value is 200. Typically, values around 100 are appropriate for consumer-level storage devices, such as hard drives up to 7200 RPMs. Faster hard drives, RAID configurations, and solid state drives (SSDs) benefit from higher values.

Ideally, keep the setting as low as practical, but not so low that background activities fall behind. If the value is too high, data is removed from the buffer pool and change buffer too quickly for caching to provide a significant benefit. For busy systems capable of higher I/O rates, you can set a higher value to help the server handle the background maintenance work associated with a high rate of row changes. Generally, you can increase the value as a function of the number of drives used for InnoDB I/O. For example, you can increase the value on systems that use multiple disks or SSDs.

The default setting of 200 is generally sufficient for a lower-end SSD. For a higher-end, bus-attached SSD, consider a higher setting such as 1000, for example. For systems with individual 5400 RPM or 7200 RPM drives, you might lower the value to 100, which represents an estimated proportion of the I/O operations per second (IOPS) available to older-generation disk drives that can perform about 100 IOPS.

Although you can specify a high value such as a million, in practice such large values have little benefit. Generally, a value higher than 20000 is not recommended unless you are certain that lower values are insufficient for your workload.

Consider write workload when tuning `innodb_io_capacity`. Systems with large write workloads are likely to benefit from a higher setting. A lower setting may be sufficient for systems with a small write workload.

The `innodb_io_capacity` setting is not a per buffer pool instance setting. Available I/O capacity is distributed equally among buffer pool instances for flushing activities.

You can set the `innodb_io_capacity` value in the MySQL option file (`my.cnf` or `my.ini`) or modify it at runtime using a `SET GLOBAL` statement, which requires privileges sufficient to set global system variables. See [Section 5.1.8.1, “System Variable Privileges”](#).

### Ignoring I/O Capacity at Checkpoints

The `innodb_flush_sync` variable, which is enabled by default, causes the `innodb_io_capacity` setting to be ignored during bursts of I/O activity that occur at [checkpoints](#). To adhere to the I/O rate defined by the `innodb_io_capacity` setting, disable `innodb_flush_sync`.

You can set the `innodb_flush_sync` value in the MySQL option file (`my.cnf` or `my.ini`) or modify it at runtime using a `SET GLOBAL` statement, which requires privileges sufficient to set global system variables. See [Section 5.1.8.1, “System Variable Privileges”](#).

## Configuring an I/O Capacity Maximum

If flushing activity falls behind, InnoDB can flush more aggressively, at a higher rate of I/O operations per second (IOPS) than defined by the `innodb_io_capacity` variable. The `innodb_io_capacity_max` variable defines a maximum number of IOPS performed by InnoDB background tasks in such situations.

If you specify an `innodb_io_capacity` setting at startup but do not specify a value for `innodb_io_capacity_max`, `innodb_io_capacity_max` defaults to twice the value of `innodb_io_capacity` or 2000, whichever value is greater.

When configuring `innodb_io_capacity_max`, twice the `innodb_io_capacity` is often a good starting point. The default value of 2000 is intended for workloads that use an SSD or more than one regular disk drive. A setting of 2000 is likely too high for workloads that do not use SSDs or multiple disk drives, and could allow too much flushing. For a single regular disk drive, a setting between 200 and 400 is recommended. For a high-end, bus-attached SSD, consider a higher setting such as 2500. As with the `innodb_io_capacity` setting, keep the setting as low as practical, but not so low that InnoDB cannot sufficiently extend rate of IOPS beyond the `innodb_io_capacity` setting.

Consider write workload when tuning `innodb_io_capacity_max`. Systems with large write workloads may benefit from a higher setting. A lower setting may be sufficient for systems with a small write workload.

`innodb_io_capacity_max` cannot be set to a value lower than the `innodb_io_capacity` value.

Setting `innodb_io_capacity_max` to `DEFAULT` using a `SET` statement (`SET GLOBAL innodb_io_capacity_max=DEFAULT`) sets `innodb_io_capacity_max` to the maximum value.

The `innodb_io_capacity_max` limit applies to all buffer pool instances. It is not a per buffer pool instance setting.

## 14.8.9 Configuring Spin Lock Polling

InnoDB `mutexes` and `rw-locks` are typically reserved for short intervals. On a multi-core system, it can be more efficient for a thread to continuously check if it can acquire a mutex or rw-lock for a period of time before it sleeps. If the mutex or rw-lock becomes available during this period, the thread can continue immediately, in the same time slice. However, too-frequent polling of a shared object such as a mutex or rw-lock by multiple threads can cause “cache ping pong”, which results in processors invalidating portions of each other's cache. InnoDB minimizes this issue by forcing a random delay between polls to desynchronize polling activity. The random delay is implemented as a spin-wait loop.

The duration of a spin-wait loop is determined by the number of `PAUSE` instructions that occur in the loop. That number is generated by randomly selecting an integer ranging from 0 up to but not including the `innodb_spin_wait_delay` value, and multiplying that value by 50. For example, an integer is randomly selected from the following range for an `innodb_spin_wait_delay` setting of 6:

```
{0,1,2,3,4,5}
```

The selected integer is multiplied by 50, resulting in one of six possible `PAUSE` instruction values:

```
{0,50,100,150,200,250}
```

For that set of values, 250 is the maximum number of `PAUSE` instructions that can occur in a spin-wait loop. An `innodb_spin_wait_delay` setting of 5 results in a set of five possible values `{0,50,100,150,200}`, where 200 is the maximum number of `PAUSE` instructions, and so on. In this way, the `innodb_spin_wait_delay` setting controls the maximum delay between spin lock polls.

The duration of the delay loop depends on the C compiler and the target processor. In the 100MHz Pentium era, an `innodb_spin_wait_delay` unit was calibrated to be equivalent to one microsecond.

That time equivalence did not hold, but PAUSE instruction duration has remained fairly constant in terms of processor cycles relative to other CPU instructions on most processor architectures.

On a system where all processor cores share a fast cache memory, you might reduce the maximum delay or disable the busy loop altogether by setting `innodb_spin_wait_delay=0`. On a system with multiple processor chips, the effect of cache invalidation can be more significant and you might increase the maximum delay.

The `innodb_spin_wait_delay` variable is dynamic. It can be specified in a MySQL option file or modified at runtime using a `SET GLOBAL` statement. Runtime modification requires privileges sufficient to set global system variables. See [Section 5.1.8.1, “System Variable Privileges”](#).

## 14.8.10 Purge Configuration

InnoDB does not physically remove a row from the database immediately when you delete it with an SQL statement. A row and its index records are only physically removed when InnoDB discards the undo log record written for the deletion. This removal operation, which only occurs after the row is no longer required for multi-version concurrency control (MVCC) or rollback, is called a purge.

Purge runs on a periodic schedule. It parses and processes undo log pages from the history list, which is a list of undo log pages for committed transactions that is maintained by the InnoDB transaction system. Purge frees the undo log pages from the history list after processing them.

### Configuring Purge Threads

Purge operations are performed in the background by one or more purge threads. The number of purge threads is controlled by the `innodb_purge_threads` variable. The default value is 4. If DML action is concentrated on a single table, purge operations for the table are performed by a single purge thread. If DML action is concentrated on a few tables, keep the `innodb_purge_threads` setting low so that the threads do not contend with each other for access to the busy tables. If DML operations are spread across many tables, consider a higher `innodb_purge_threads` setting. The maximum number of purge threads is 32.

The `innodb_purge_threads` setting is the maximum number of purge threads permitted. The purge system automatically adjusts the number of purge threads that are used.

### Configuring Purge Batch Size

The `innodb_purge_batch_size` variable defines the number of undo log pages that purge parses and processes in one batch from the history list. The default value is 300. In a multithreaded purge configuration, the coordinator purge thread divides `innodb_purge_batch_size` by `innodb_purge_threads` and assigns that number of pages to each purge thread.

The purge system also frees the undo log pages that are no longer required. It does so every 128 iterations through the undo logs. In addition to defining the number of undo log pages parsed and processed in a batch, the `innodb_purge_batch_size` variable defines the number of undo log pages that purge frees every 128 iterations through the undo logs.

The `innodb_purge_batch_size` variable is intended for advanced performance tuning and experimentation. Most users need not change `innodb_purge_batch_size` from its default value.

### Configuring the Maximum Purge Lag

The `innodb_max_purge_lag` variable defines the desired maximum purge lag. When the purge lag exceeds the `innodb_max_purge_lag` threshold, a delay is imposed on `INSERT`, `UPDATE`, and `DELETE`

operations to allow time for purge operations to catch up. The default value is 0, which means there is no maximum purge lag and no delay.

The InnoDB transaction system maintains a list of transactions that have index records delete-marked by `UPDATE` or `DELETE` operations. The length of the list is the purge lag. The purge lag delay is calculated by the following formula, which results in a minimum delay of 5000 microseconds:

```
(purge_lag/innodb_max_purge_lag - 0.5) * 10000
```

The delay is calculated at the beginning of a purge batch

A typical `innodb_max_purge_lag` setting for a problematic workload might be 1000000 (1 million), assuming that transactions are small, only 100 bytes in size, and it is permissible to have 100MB of unpurged table rows.

The purge lag is presented as the `History list length` value in the `TRANSACTIONS` section of `SHOW ENGINE INNODB STATUS` output.

```
mysql> SHOW ENGINE INNODB STATUS;
...
-----
TRANSACTIONS
-----
Trx id counter 0 290328385
Purge done for trx's n:o < 0 290315608 undo n:o < 0 17
History list length 20
```

The `History list length` is typically a low value, usually less than a few thousand, but a write-heavy workload or long running transactions can cause it to increase, even for transactions that are read only. The reason that a long running transaction can cause the `History list length` to increase is that under a consistent read transaction isolation level such as `REPEATABLE READ`, a transaction must return the same result as when the read view for that transaction was created. Consequently, the InnoDB multi-version concurrency control (MVCC) system must keep a copy of the data in the undo log until all transactions that depend on that data have completed. The following are examples of long running transactions that could cause the `History list length` to increase:

- A `mysqldump` operation that uses the `--single-transaction` option while there is a significant amount of concurrent DML.
- Running a `SELECT` query after disabling `autocommit`, and forgetting to issue an explicit `COMMIT` or `ROLLBACK`.

To prevent excessive delays in extreme situations where the purge lag becomes huge, you can limit the delay by setting the `innodb_max_purge_lag_delay` variable. The `innodb_max_purge_lag_delay` variable specifies the maximum delay in microseconds for the delay imposed when the `innodb_max_purge_lag` threshold is exceeded. The specified `innodb_max_purge_lag_delay` value is an upper limit on the delay period calculated by the `innodb_max_purge_lag` formula.

## Purge and Undo Tablespace Truncation

The purge system is also responsible for truncating undo tablespaces. You can configure the `innodb_purge_rseg_truncate_frequency` variable to control the frequency with which the purge system looks for undo tablespaces to truncate. For more information, see [Truncating Undo Tablespaces](#).

### 14.8.11 Configuring Optimizer Statistics for InnoDB

This section describes how to configure persistent and non-persistent optimizer statistics for InnoDB tables.



Persistent optimizer statistics are persisted across server restarts, allowing for greater [plan stability](#) and more consistent query performance. Persistent optimizer statistics also provide control and flexibility with these additional benefits:

- You can use the `innodb_stats_auto_recalc` configuration option to control whether statistics are updated automatically after substantial changes to a table.
- You can use the `STATS_PERSISTENT`, `STATS_AUTO_RECALC`, and `STATS_SAMPLE_PAGES` clauses with `CREATE TABLE` and `ALTER TABLE` statements to configure optimizer statistics for individual tables.
- You can query optimizer statistics data in the `mysql.innodb_table_stats` and `mysql.innodb_index_stats` tables.
- You can view the `last_update` column of the `mysql.innodb_table_stats` and `mysql.innodb_index_stats` tables to see when statistics were last updated.
- You can manually modify the `mysql.innodb_table_stats` and `mysql.innodb_index_stats` tables to force a specific query optimization plan or to test alternative plans without modifying the database.

The persistent optimizer statistics feature is enabled by default (`innodb_stats_persistent=ON`).

Non-persistent optimizer statistics are cleared on each server restart and after some other operations, and recomputed on the next table access. As a result, different estimates could be produced when recomputing statistics, leading to different choices in execution plans and variations in query performance.

This section also provides information about estimating `ANALYZE TABLE` complexity, which may be useful when attempting to achieve a balance between accurate statistics and `ANALYZE TABLE` execution time.

### 14.8.11.1 Configuring Persistent Optimizer Statistics Parameters

The persistent optimizer statistics feature improves [plan stability](#) by storing statistics to disk and making them persistent across server restarts so that the [optimizer](#) is more likely to make consistent choices each time for a given query.

Optimizer statistics are persisted to disk when `innodb_stats_persistent=ON` or when individual tables are defined with `STATS_PERSISTENT=1`. `innodb_stats_persistent` is enabled by default.

Formerly, optimizer statistics were cleared when restarting the server and after some other types of operations, and recomputed on the next table access. Consequently, different estimates could be produced when recalculating statistics leading to different choices in query execution plans and variation in query performance.

Persistent statistics are stored in the `mysql.innodb_table_stats` and `mysql.innodb_index_stats` tables. See [InnoDB Persistent Statistics Tables](#).

If you prefer not to persist optimizer statistics to disk, see [Section 14.8.11.2, “Configuring Non-Persistent Optimizer Statistics Parameters”](#)

### Configuring Automatic Statistics Calculation for Persistent Optimizer Statistics

The `innodb_stats_auto_recalc` variable, which is enabled by default, controls whether statistics are calculated automatically when a table undergoes changes to more than 10% of its rows. You can also configure automatic statistics recalculation for individual tables by specifying the `STATS_AUTO_RECALC` clause when creating or altering a table.

Because of the asynchronous nature of automatic statistics recalculation, which occurs in the background, statistics may not be recalculated instantly after running a DML operation that affects more than 10% of

a table, even when `innodb_stats_auto_recalc` is enabled. Statistics recalculation can be delayed by few seconds in some cases. If up-to-date statistics are required immediately, run `ANALYZE TABLE` to initiate a synchronous (foreground) recalculation of statistics.

If `innodb_stats_auto_recalc` is disabled, you can ensure the accuracy of optimizer statistics by executing the `ANALYZE TABLE` statement after making substantial changes to indexed columns. You might also consider adding `ANALYZE TABLE` to setup scripts that you run after loading data, and running `ANALYZE TABLE` on a schedule at times of low activity.

When an index is added to an existing table, or when a column is added or dropped, index statistics are calculated and added to the `innodb_index_stats` table regardless of the value of `innodb_stats_auto_recalc`.

## Configuring Optimizer Statistics Parameters for Individual Tables

`innodb_stats_persistent`, `innodb_stats_auto_recalc`, and `innodb_stats_persistent_sample_pages` are global variables. To override these system-wide settings and configure optimizer statistics parameters for individual tables, you can define `STATS_PERSISTENT`, `STATS_AUTO_RECALC`, and `STATS_SAMPLE_PAGES` clauses in `CREATE TABLE` or `ALTER TABLE` statements.

- `STATS_PERSISTENT` specifies whether to enable [persistent statistics](#) for an InnoDB table. The value `DEFAULT` causes the persistent statistics setting for the table to be determined by the `innodb_stats_persistent` setting. A value of `1` enables persistent statistics for the table, while a value of `0` disables the feature. After enabling persistent statistics for an individual table, use `ANALYZE TABLE` to calculate statistics after table data is loaded.
- `STATS_AUTO_RECALC` specifies whether to automatically recalculate [persistent statistics](#). The value `DEFAULT` causes the persistent statistics setting for the table to be determined by the `innodb_stats_auto_recalc` setting. A value of `1` causes statistics to be recalculated when 10% of table data has changed. A value `0` prevents automatic recalculation for the table. When using a value of `0`, use `ANALYZE TABLE` to recalculate statistics after making substantial changes to the table.
- `STATS_SAMPLE_PAGES` specifies the number of index pages to sample when cardinality and other statistics are calculated for an indexed column, by an `ANALYZE TABLE` operation, for example.

All three clauses are specified in the following `CREATE TABLE` example:

```
CREATE TABLE `t1` (
  `id` int(8) NOT NULL auto_increment,
  `data` varchar(255),
  `date` datetime,
  PRIMARY KEY (`id`),
  INDEX `DATE_IX` (`date`)
) ENGINE=InnoDB,
  STATS_PERSISTENT=1,
  STATS_AUTO_RECALC=1,
  STATS_SAMPLE_PAGES=25;
```

## Configuring the Number of Sampled Pages for InnoDB Optimizer Statistics

The optimizer uses estimated [statistics](#) about key distributions to choose the indexes for an execution plan, based on the relative [selectivity](#) of the index. Operations such as `ANALYZE TABLE` cause InnoDB to sample random pages from each index on a table to estimate the [cardinality](#) of the index. This sampling technique is known as a [random dive](#).

The `innodb_stats_persistent_sample_pages` controls the number of sampled pages. You can adjust the setting at runtime to manage the quality of statistics estimates used by the optimizer. The default value is 20. Consider modifying the setting when encountering the following issues:

1. *Statistics are not accurate enough and the optimizer chooses suboptimal plans*, as shown in `EXPLAIN` output. You can check the accuracy of statistics by comparing the actual cardinality of an index (determined by running `SELECT DISTINCT` on the index columns) with the estimates in the `mysql.innodb_index_stats` table.

If it is determined that statistics are not accurate enough, the value of `innodb_stats_persistent_sample_pages` should be increased until the statistics estimates are sufficiently accurate. Increasing `innodb_stats_persistent_sample_pages` too much, however, could cause `ANALYZE TABLE` to run slowly.

2. *ANALYZE TABLE is too slow*. In this case `innodb_stats_persistent_sample_pages` should be decreased until `ANALYZE TABLE` execution time is acceptable. Decreasing the value too much, however, could lead to the first problem of inaccurate statistics and suboptimal query execution plans.

If a balance cannot be achieved between accurate statistics and `ANALYZE TABLE` execution time, consider decreasing the number of indexed columns in the table or limiting the number of partitions to reduce `ANALYZE TABLE` complexity. The number of columns in the table's primary key is also important to consider, as primary key columns are appended to each nonunique index.

For related information, see [Section 14.8.11.3, “Estimating ANALYZE TABLE Complexity for InnoDB Tables”](#).

## Including Delete-marked Records in Persistent Statistics Calculations

By default, InnoDB reads uncommitted data when calculating statistics. In the case of an uncommitted transaction that deletes rows from a table, delete-marked records are excluded when calculating row estimates and index statistics, which can lead to non-optimal execution plans for other transactions that are operating on the table concurrently using a transaction isolation level other than `READ UNCOMMITTED`. To avoid this scenario, `innodb_stats_include_delete_marked` can be enabled to ensure that delete-marked records are included when calculating persistent optimizer statistics.

When `innodb_stats_include_delete_marked` is enabled, `ANALYZE TABLE` considers delete-marked records when recalculating statistics.

`innodb_stats_include_delete_marked` is a global setting that affects all InnoDB tables, and it is only applicable to persistent optimizer statistics.

`innodb_stats_include_delete_marked` was introduced in MySQL 5.7.16.

## InnoDB Persistent Statistics Tables

The persistent statistics feature relies on the internally managed tables in the `mysql` database, named `innodb_table_stats` and `innodb_index_stats`. These tables are set up automatically in all install, upgrade, and build-from-source procedures.

**Table 14.4 Columns of `innodb_table_stats`**

Column name	Description
<code>database_name</code>	Database name
<code>table_name</code>	Table name, partition name, or subpartition name
<code>last_update</code>	A timestamp indicating the last time the row was updated
<code>n_rows</code>	The number of rows in the table
<code>clustered_index_size</code>	The size of the primary index, in pages

Column name	Description
<code>sum_of_other_index_sizes</code>	The total size of other (non-primary) indexes, in pages

**Table 14.5 Columns of `innodb_index_stats`**

Column name	Description
<code>database_name</code>	Database name
<code>table_name</code>	Table name, partition name, or subpartition name
<code>index_name</code>	Index name
<code>last_update</code>	A timestamp indicating the last time that InnoDB updated this row
<code>stat_name</code>	The name of the statistic, whose value is reported in the <code>stat_value</code> column
<code>stat_value</code>	The value of the statistic that is named in <code>stat_name</code> column
<code>sample_size</code>	The number of pages sampled for the estimate provided in the <code>stat_value</code> column
<code>stat_description</code>	Description of the statistic that is named in the <code>stat_name</code> column

The `innodb_table_stats` and `innodb_index_stats` tables include a `last_update` column that shows when index statistics were last updated:

```
mysql> SELECT * FROM innodb_table_stats \G
***** 1. row *****
      database_name: sakila
        table_name: actor
      last_update: 2014-05-28 16:16:44
          n_rows: 200
  clustered_index_size: 1
sum_of_other_index_sizes: 1
...

```

```
mysql> SELECT * FROM innodb_index_stats \G
***** 1. row *****
      database_name: sakila
        table_name: actor
      index_name: PRIMARY
  last_update: 2014-05-28 16:16:44
      stat_name: n_diff_pfx01
      stat_value: 200
      sample_size: 1
...

```

The `innodb_table_stats` and `innodb_index_stats` tables can be updated manually, which makes it possible to force a specific query optimization plan or test alternative plans without modifying the database. If you manually update statistics, use the `FLUSH TABLE tbl_name` statement to load the updated statistics.

Persistent statistics are considered local information, because they relate to the server instance. The `innodb_table_stats` and `innodb_index_stats` tables are therefore not replicated when automatic statistics recalculation takes place. If you run `ANALYZE TABLE` to initiate a synchronous recalculation of statistics, this statement is replicated (unless you suppressed logging for it), and recalculation takes place on the replicas.

## InnoDB Persistent Statistics Tables Example

The `innodb_table_stats` table contains one row for each table. The following example demonstrates the type of data collected.

Table `t1` contains a primary index (columns `a`, `b`) secondary index (columns `c`, `d`), and unique index (columns `e`, `f`):

```
CREATE TABLE t1 (
  a INT, b INT, c INT, d INT, e INT, f INT,
  PRIMARY KEY (a, b), KEY i1 (c, d), UNIQUE KEY i2uniq (e, f)
) ENGINE=INNODB;
```

After inserting five rows of sample data, table `t1` appears as follows:

```
mysql> SELECT * FROM t1;
+-----+-----+-----+-----+-----+
| a | b | c | d | e | f |
+-----+-----+-----+-----+
| 1 | 1 | 10 | 11 | 100 | 101 |
| 1 | 2 | 10 | 11 | 200 | 102 |
| 1 | 3 | 10 | 11 | 100 | 103 |
| 1 | 4 | 10 | 12 | 200 | 104 |
| 1 | 5 | 10 | 12 | 100 | 105 |
+-----+-----+-----+-----+
```

To immediately update statistics, run `ANALYZE TABLE` (if `innodb_stats_auto_recalc` is enabled, statistics are updated automatically within a few seconds assuming that the 10% threshold for changed table rows is reached):

```
mysql> ANALYZE TABLE t1;
+-----+-----+-----+-----+
| Table | Op | Msg_type | Msg_text |
+-----+-----+-----+-----+
| test.t1 | analyze | status | OK |
+-----+-----+-----+-----+
```

Table statistics for table `t1` show the last time InnoDB updated the table statistics (2014-03-14 14:36:34), the number of rows in the table (5), the clustered index size (1 page), and the combined size of the other indexes (2 pages).

```
mysql> SELECT * FROM mysql.innodb_table_stats WHERE table_name like 't1'\G
***** 1. row *****
      database_name: test
      table_name: t1
      last_update: 2014-03-14 14:36:34
      n_rows: 5
      clustered_index_size: 1
      sum_of_other_index_sizes: 2
```

The `innodb_index_stats` table contains multiple rows for each index. Each row in the `innodb_index_stats` table provides data related to a particular index statistic which is named in the `stat_name` column and described in the `stat_description` column. For example:

```
mysql> SELECT index_name, stat_name, stat_value, stat_description
FROM mysql.innodb_index_stats WHERE table_name like 't1';
+-----+-----+-----+-----+
| index_name | stat_name | stat_value | stat_description |
+-----+-----+-----+-----+
| PRIMARY | n_diff_pfx01 | 1 | a |
| PRIMARY | n_diff_pfx02 | 5 | a,b |
| PRIMARY | n_leaf_pages | 1 | Number of leaf pages in the index |
| PRIMARY | size | 1 | Number of pages in the index |
| i1 | n_diff_pfx01 | 1 | c |
+-----+-----+-----+-----+
```

## Configuring Optimizer Statistics for InnoDB

i1	n_diff_pfx02	2	c,d
i1	n_diff_pfx03	2	c,d,a
i1	n_diff_pfx04	5	c,d,a,b
i1	n_leaf_pages	1	Number of leaf pages in the index
i1	size	1	Number of pages in the index
i2uniq	n_diff_pfx01	2	e
i2uniq	n_diff_pfx02	5	e,f
i2uniq	n_leaf_pages	1	Number of leaf pages in the index
i2uniq	size	1	Number of pages in the index

The `stat_name` column shows the following types of statistics:

- `size`: Where `stat_name=size`, the `stat_value` column displays the total number of pages in the index.
- `n_leaf_pages`: Where `stat_name=n_leaf_pages`, the `stat_value` column displays the number of leaf pages in the index.
- `n_diff_pfxNN`: Where `stat_name=n_diff_pfx01`, the `stat_value` column displays the number of distinct values in the first column of the index. Where `stat_name=n_diff_pfx02`, the `stat_value` column displays the number of distinct values in the first two columns of the index, and so on. Where `stat_name=n_diff_pfxNN`, the `stat_description` column shows a comma separated list of the index columns that are counted.

To further illustrate the `n_diff_pfxNN` statistic, which provides cardinality data, consider once again the `t1` table example that was introduced previously. As shown below, the `t1` table is created with a primary index (columns `a, b`), a secondary index (columns `c, d`), and a unique index (columns `e, f`):

```
CREATE TABLE t1 (
  a INT, b INT, c INT, d INT, e INT, f INT,
  PRIMARY KEY (a, b), KEY i1 (c, d), UNIQUE KEY i2uniq (e, f)
) ENGINE=INNODB;
```

After inserting five rows of sample data, table `t1` appears as follows:

```
mysql> SELECT * FROM t1;
```

a	b	c	d	e	f
1	1	10	11	100	101
1	2	10	11	200	102
1	3	10	11	100	103
1	4	10	12	200	104
1	5	10	12	100	105

When you query the `index_name`, `stat_name`, `stat_value`, and `stat_description`, where `stat_name LIKE 'n_diff%'`, the following result set is returned:

```
mysql> SELECT index_name, stat_name, stat_value, stat_description
FROM mysql.innodb_index_stats
WHERE table_name like 't1' AND stat_name LIKE 'n_diff%';
```

index_name	stat_name	stat_value	stat_description
PRIMARY	n_diff_pfx01	1	a
PRIMARY	n_diff_pfx02	5	a,b
i1	n_diff_pfx01	1	c
i1	n_diff_pfx02	2	c,d
i1	n_diff_pfx03	2	c,d,a
i1	n_diff_pfx04	5	c,d,a,b
i2uniq	n_diff_pfx01	2	e

i2uniq	n_diff_pfx02	5	e,f
--------	--------------	---	-----

For the `PRIMARY` index, there are two `n_diff%` rows. The number of rows is equal to the number of columns in the index.



### Note

For nonunique indexes, InnoDB appends the columns of the primary key.

- Where `index_name=PRIMARY` and `stat_name=n_diff_pfx01`, the `stat_value` is 1, which indicates that there is a single distinct value in the first column of the index (column `a`). The number of distinct values in column `a` is confirmed by viewing the data in column `a` in table `t1`, in which there is a single distinct value (1). The counted column (`a`) is shown in the `stat_description` column of the result set.
- Where `index_name=PRIMARY` and `stat_name=n_diff_pfx02`, the `stat_value` is 5, which indicates that there are five distinct values in the two columns of the index (`a,b`). The number of distinct values in columns `a` and `b` is confirmed by viewing the data in columns `a` and `b` in table `t1`, in which there are five distinct values: (1,1), (1,2), (1,3), (1,4) and (1,5). The counted columns (`a,b`) are shown in the `stat_description` column of the result set.

For the secondary index (`i1`), there are four `n_diff%` rows. Only two columns are defined for the secondary index (`c,d`) but there are four `n_diff%` rows for the secondary index because InnoDB suffixes all nonunique indexes with the primary key. As a result, there are four `n_diff%` rows instead of two to account for the both the secondary index columns (`c,d`) and the primary key columns (`a,b`).

- Where `index_name=i1` and `stat_name=n_diff_pfx01`, the `stat_value` is 1, which indicates that there is a single distinct value in the first column of the index (column `c`). The number of distinct values in column `c` is confirmed by viewing the data in column `c` in table `t1`, in which there is a single distinct value: (10). The counted column (`c`) is shown in the `stat_description` column of the result set.
- Where `index_name=i1` and `stat_name=n_diff_pfx02`, the `stat_value` is 2, which indicates that there are two distinct values in the first two columns of the index (`c,d`). The number of distinct values in columns `c` and `d` is confirmed by viewing the data in columns `c` and `d` in table `t1`, in which there are two distinct values: (10,11) and (10,12). The counted columns (`c,d`) are shown in the `stat_description` column of the result set.
- Where `index_name=i1` and `stat_name=n_diff_pfx03`, the `stat_value` is 2, which indicates that there are two distinct values in the first three columns of the index (`c,d,a`). The number of distinct values in columns `c`, `d`, and `a` is confirmed by viewing the data in column `c`, `d`, and `a` in table `t1`, in which there are two distinct values: (10,11,1) and (10,12,1). The counted columns (`c,d,a`) are shown in the `stat_description` column of the result set.
- Where `index_name=i1` and `stat_name=n_diff_pfx04`, the `stat_value` is 5, which indicates that there are five distinct values in the four columns of the index (`c,d,a,b`). The number of distinct values in columns `c`, `d`, `a` and `b` is confirmed by viewing the data in columns `c`, `d`, `a`, and `b` in table `t1`, in which there are five distinct values: (10,11,1,1), (10,11,1,2), (10,11,1,3), (10,12,1,4), and (10,12,1,5). The counted columns (`c,d,a,b`) are shown in the `stat_description` column of the result set.

For the unique index (`i2uniq`), there are two `n_diff%` rows.

- Where `index_name=i2uniq` and `stat_name=n_diff_pfx01`, the `stat_value` is 2, which indicates that there are two distinct values in the first column of the index (column `e`). The number of distinct values in column `e` is confirmed by viewing the data in column `e` in table `t1`, in which there are two

distinct values: (100) and (200). The counted column (e) is shown in the `stat_description` column of the result set.

- Where `index_name=i2uniq` and `stat_name=n_diff_pfx02`, the `stat_value` is 5, which indicates that there are five distinct values in the two columns of the index (e, f). The number of distinct values in columns e and f is confirmed by viewing the data in columns e and f in table t1, in which there are five distinct values: (100,101), (200,102), (100,103), (200,104), and (100,105). The counted columns (e, f) are shown in the `stat_description` column of the result set.

## Retrieving Index Size Using the `innodb_index_stats` Table

You can retrieve the index size for tables, partitions, or subpartitions can using the `innodb_index_stats` table. In the following example, index sizes are retrieved for table t1. For a definition of table t1 and corresponding index statistics, see [InnoDB Persistent Statistics Tables Example](#).

```
mysql> SELECT SUM(stat_value) pages, index_name,
SUM(stat_value)*@@innodb_page_size size
FROM mysql.innodb_index_stats WHERE table_name='t1'
AND stat_name = 'size' GROUP BY index_name;
```

pages	index_name	size
1	PRIMARY	16384
1	i1	16384
1	i2uniq	16384

For partitions or subpartitions, you can use the same query with a modified `WHERE` clause to retrieve index sizes. For example, the following query retrieves index sizes for partitions of table t1:

```
mysql> SELECT SUM(stat_value) pages, index_name,
SUM(stat_value)*@@innodb_page_size size
FROM mysql.innodb_index_stats WHERE table_name like 't1#P%'
AND stat_name = 'size' GROUP BY index_name;
```

### 14.8.11.2 Configuring Non-Persistent Optimizer Statistics Parameters

This section describes how to configure non-persistent optimizer statistics. Optimizer statistics are not persisted to disk when `innodb_stats_persistent=OFF` or when individual tables are created or altered with `STATS_PERSISTENT=0`. Instead, statistics are stored in memory, and are lost when the server is shut down. Statistics are also updated periodically by certain operations and under certain conditions.

As of MySQL 5.6.6, optimizer statistics are persisted to disk by default, enabled by the `innodb_stats_persistent` configuration option. For information about persistent optimizer statistics, see [Section 14.8.11.1, “Configuring Persistent Optimizer Statistics Parameters”](#).

## Optimizer Statistics Updates

Non-persistent optimizer statistics are updated when:

- Running `ANALYZE TABLE`.
- Running `SHOW TABLE STATUS`, `SHOW INDEX`, or querying the Information Schema `TABLES` or `STATISTICS` tables with the `innodb_stats_on_metadata` option enabled.

The default setting for `innodb_stats_on_metadata` was changed to `OFF` when persistent optimizer statistics were enabled by default in MySQL 5.6.6. Enabling `innodb_stats_on_metadata` may reduce access speed for schemas that have a large number of tables or indexes, and reduce stability of execution plans for queries that involve InnoDB tables. `innodb_stats_on_metadata` is configured globally using a `SET` statement.



```
SET GLOBAL innodb_stats_on_metadata=ON
```



### Note

`innodb_stats_on_metadata` only applies when optimizer [statistics](#) are configured to be non-persistent (when `innodb_stats_persistent` is disabled).

- Starting a `mysql` client with the `--auto-rehash` option enabled, which is the default. The `auto-rehash` option causes all InnoDB tables to be opened, and the open table operations cause statistics to be recalculated.

To improve the start up time of the `mysql` client and to updating statistics, you can turn off `auto-rehash` using the `--disable-auto-rehash` option. The `auto-rehash` feature enables automatic name completion of database, table, and column names for interactive users.

- A table is first opened.
- InnoDB detects that 1 / 16 of table has been modified since the last time statistics were updated.

## Configuring the Number of Sampled Pages

The MySQL query optimizer uses estimated [statistics](#) about key distributions to choose the indexes for an execution plan, based on the relative [selectivity](#) of the index. When InnoDB updates optimizer statistics, it samples random pages from each index on a table to estimate the [cardinality](#) of the index. (This technique is known as [random dives](#).)

To give you control over the quality of the statistics estimate (and thus better information for the query optimizer), you can change the number of sampled pages using the parameter `innodb_stats_transient_sample_pages`. The default number of sampled pages is 8, which could be insufficient to produce an accurate estimate, leading to poor index choices by the query optimizer. This technique is especially important for large tables and tables used in [joins](#). Unnecessary [full table scans](#) for such tables can be a substantial performance issue. See [Section 8.2.1.20, “Avoiding Full Table Scans”](#) for tips on tuning such queries. `innodb_stats_transient_sample_pages` is a global parameter that can be set at runtime.

The value of `innodb_stats_transient_sample_pages` affects the index sampling for all InnoDB tables and indexes when `innodb_stats_persistent=0`. Be aware of the following potentially significant impacts when you change the index sample size:

- Small values like 1 or 2 can result in inaccurate estimates of cardinality.
- Increasing the `innodb_stats_transient_sample_pages` value might require more disk reads. Values much larger than 8 (say, 100), can cause a significant slowdown in the time it takes to open a table or execute `SHOW TABLE STATUS`.
- The optimizer might choose very different query plans based on different estimates of index selectivity.

Whatever value of `innodb_stats_transient_sample_pages` works best for a system, set the option and leave it at that value. Choose a value that results in reasonably accurate estimates for all tables in your database without requiring excessive I/O. Because the statistics are automatically recalculated at various times other than on execution of `ANALYZE TABLE`, it does not make sense to increase the index sample size, run `ANALYZE TABLE`, then decrease sample size again.

Smaller tables generally require fewer index samples than larger tables. If your database has many large tables, consider using a higher value for `innodb_stats_transient_sample_pages` than if you have mostly smaller tables.

### 14.8.11.3 Estimating ANALYZE TABLE Complexity for InnoDB Tables

`ANALYZE TABLE` complexity for InnoDB tables is dependent on:

- The number of pages sampled, as defined by `innodb_stats_persistent_sample_pages`.
- The number of indexed columns in a table
- The number of partitions. If a table has no partitions, the number of partitions is considered to be 1.

Using these parameters, an approximate formula for estimating `ANALYZE TABLE` complexity would be:

The value of `innodb_stats_persistent_sample_pages` \* number of indexed columns in a table \* the number of partitions

Typically, the greater the resulting value, the greater the execution time for `ANALYZE TABLE`.



#### Note

`innodb_stats_persistent_sample_pages` defines the number of pages sampled at a global level. To set the number of pages sampled for an individual table, use the `STATS_SAMPLE_PAGES` option with `CREATE TABLE` or `ALTER TABLE`. For more information, see [Section 14.8.11.1, “Configuring Persistent Optimizer Statistics Parameters”](#).

If `innodb_stats_persistent=OFF`, the number of pages sampled is defined by `innodb_stats_transient_sample_pages`. See [Section 14.8.11.2, “Configuring Non-Persistent Optimizer Statistics Parameters”](#) for additional information.

For a more in-depth approach to estimating `ANALYZE TABLE` complexity, consider the following example.

In [Big O notation](#), `ANALYZE TABLE` complexity is described as:

```
O(n_sample
  * (n_cols_in_uniq_i
    + n_cols_in_non_uniq_i
    + n_cols_in_pk * (1 + n_non_uniq_i))
  * n_part)
```

where:

- `n_sample` is the number of pages sampled (defined by `innodb_stats_persistent_sample_pages`)
- `n_cols_in_uniq_i` is total number of all columns in all unique indexes (not counting the primary key columns)
- `n_cols_in_non_uniq_i` is the total number of all columns in all nonunique indexes
- `n_cols_in_pk` is the number of columns in the primary key (if a primary key is not defined, InnoDB creates a single column primary key internally)
- `n_non_uniq_i` is the number of nonunique indexes in the table
- `n_part` is the number of partitions. If no partitions are defined, the table is considered to be a single partition.

Now, consider the following table (table `t`), which has a primary key (2 columns), a unique index (2 columns), and two nonunique indexes (two columns each):

```
CREATE TABLE t (
  a INT,
  b INT,
  c INT,
  d INT,
  e INT,
  f INT,
  g INT,
  h INT,
  PRIMARY KEY (a, b),
  UNIQUE KEY iluniq (c, d),
  KEY i2nonuniq (e, f),
  KEY i3nonuniq (g, h)
);
```

For the column and index data required by the algorithm described above, query the `mysql.innodb_index_stats` persistent index statistics table for table `t`. The `n_diff_pfx%` statistics show the columns that are counted for each index. For example, columns `a` and `b` are counted for the primary key index. For the nonunique indexes, the primary key columns (`a`,`b`) are counted in addition to the user defined columns.



#### Note

For additional information about the `InnoDB` persistent statistics tables, see [Section 14.8.11.1, “Configuring Persistent Optimizer Statistics Parameters”](#)

```
mysql> SELECT index_name, stat_name, stat_description
FROM mysql.innodb_index_stats WHERE
database_name='test' AND
table_name='t' AND
stat_name like 'n_diff_pfx%';
```

index_name	stat_name	stat_description
PRIMARY	n_diff_pfx01	a
PRIMARY	n_diff_pfx02	a,b
iluniq	n_diff_pfx01	c
iluniq	n_diff_pfx02	c,d
i2nonuniq	n_diff_pfx01	e
i2nonuniq	n_diff_pfx02	e,f
i2nonuniq	n_diff_pfx03	e,f,a
i2nonuniq	n_diff_pfx04	e,f,a,b
i3nonuniq	n_diff_pfx01	g
i3nonuniq	n_diff_pfx02	g,h
i3nonuniq	n_diff_pfx03	g,h,a
i3nonuniq	n_diff_pfx04	g,h,a,b

Based on the index statistics data shown above and the table definition, the following values can be determined:

- `n_cols_in_uniq_i`, the total number of all columns in all unique indexes not counting the primary key columns, is 2 (`c` and `d`)
- `n_cols_in_non_uniq_i`, the total number of all columns in all nonunique indexes, is 4 (`e`, `f`, `g` and `h`)
- `n_cols_in_pk`, the number of columns in the primary key, is 2 (`a` and `b`)
- `n_non_uniq_i`, the number of nonunique indexes in the table, is 2 (`i2nonuniq` and `i3nonuniq`)
- `n_part`, the number of partitions, is 1.

You can now calculate `innodb_stats_persistent_sample_pages * (2 + 4 + 2 * (1 + 2)) * 1` to determine the number of leaf pages that are scanned. With `innodb_stats_persistent_sample_pages` set to the default value of 20, and with a default page size of 16 KiB (`innodb_page_size=16384`), you can then estimate that `20 * 12 * 16384 bytes` are read for table `t`, or about 4 MiB.



#### Note

All 4 MiB may not be read from disk, as some leaf pages may already be cached in the buffer pool.

## 14.8.12 Configuring the Merge Threshold for Index Pages

You can configure the `MERGE_THRESHOLD` value for index pages. If the “page-full” percentage for an index page falls below the `MERGE_THRESHOLD` value when a row is deleted or when a row is shortened by an `UPDATE` operation, InnoDB attempts to merge the index page with a neighboring index page. The default `MERGE_THRESHOLD` value is 50, which is the previously hardcoded value. The minimum `MERGE_THRESHOLD` value is 1 and the maximum value is 50.

When the “page-full” percentage for an index page falls below 50%, which is the default `MERGE_THRESHOLD` setting, InnoDB attempts to merge the index page with a neighboring page. If both pages are close to 50% full, a page split can occur soon after the pages are merged. If this merge-split behavior occurs frequently, it can have an adverse affect on performance. To avoid frequent merge-splits, you can lower the `MERGE_THRESHOLD` value so that InnoDB attempts page merges at a lower “page-full” percentage. Merging pages at a lower page-full percentage leaves more room in index pages and helps reduce merge-split behavior.

The `MERGE_THRESHOLD` for index pages can be defined for a table or for individual indexes. A `MERGE_THRESHOLD` value defined for an individual index takes priority over a `MERGE_THRESHOLD` value defined for the table. If undefined, the `MERGE_THRESHOLD` value defaults to 50.

### Setting `MERGE_THRESHOLD` for a Table

You can set the `MERGE_THRESHOLD` value for a table using the `table_option COMMENT` clause of the `CREATE TABLE` statement. For example:

```
CREATE TABLE t1 (
  id INT,
  KEY id_index (id)
) COMMENT='MERGE_THRESHOLD=45';
```

You can also set the `MERGE_THRESHOLD` value for an existing table using the `table_option COMMENT` clause with `ALTER TABLE`:

```
CREATE TABLE t1 (
  id INT,
  KEY id_index (id)
);
ALTER TABLE t1 COMMENT='MERGE_THRESHOLD=40';
```

### Setting `MERGE_THRESHOLD` for Individual Indexes

To set the `MERGE_THRESHOLD` value for an individual index, you can use the `index_option COMMENT` clause with `CREATE TABLE`, `ALTER TABLE`, or `CREATE INDEX`, as shown in the following examples:

- Setting `MERGE_THRESHOLD` for an individual index using `CREATE TABLE`:

```
CREATE TABLE t1 (
```

```
id INT,
KEY id_index (id) COMMENT 'MERGE_THRESHOLD=40'
);
```

- Setting `MERGE_THRESHOLD` for an individual index using `ALTER TABLE`:

```
CREATE TABLE t1 (
  id INT,
  KEY id_index (id)
);

ALTER TABLE t1 DROP KEY id_index;
ALTER TABLE t1 ADD KEY id_index (id) COMMENT 'MERGE_THRESHOLD=40';
```

- Setting `MERGE_THRESHOLD` for an individual index using `CREATE INDEX`:

```
CREATE TABLE t1 (id INT);
CREATE INDEX id_index ON t1 (id) COMMENT 'MERGE_THRESHOLD=40';
```



### Note

You cannot modify the `MERGE_THRESHOLD` value at the index level for `GEN_CLUST_INDEX`, which is the clustered index created by InnoDB when an InnoDB table is created without a primary key or unique key index. You can only modify the `MERGE_THRESHOLD` value for `GEN_CLUST_INDEX` by setting `MERGE_THRESHOLD` for the table.

## Querying the `MERGE_THRESHOLD` Value for an Index

The current `MERGE_THRESHOLD` value for an index can be obtained by querying the `INNODB_SYS_INDEXES` table. For example:

```
mysql> SELECT * FROM INFORMATION_SCHEMA.INNODB_SYS_INDEXES WHERE NAME='id_index' \G
***** 1. row *****
INDEX_ID: 91
NAME: id_index
TABLE_ID: 68
TYPE: 0
N_FIELDS: 1
PAGE_NO: 4
SPACE: 57
MERGE_THRESHOLD: 40
```

You can use `SHOW CREATE TABLE` to view the `MERGE_THRESHOLD` value for a table, if explicitly defined using the `table_option COMMENT` clause:

```
mysql> SHOW CREATE TABLE t2 \G
***** 1. row *****
Table: t2
Create Table: CREATE TABLE `t2` (
  `id` int(11) DEFAULT NULL,
  KEY `id_index` (`id`) COMMENT 'MERGE_THRESHOLD=40'
) ENGINE=InnoDB DEFAULT CHARSET=latin1
```



### Note

A `MERGE_THRESHOLD` value defined at the index level takes priority over a `MERGE_THRESHOLD` value defined for the table. If undefined, `MERGE_THRESHOLD` defaults to 50% (`MERGE_THRESHOLD=50`, which is the previously hardcoded value).

Likewise, you can use `SHOW INDEX` to view the `MERGE_THRESHOLD` value for an index, if explicitly defined using the `index_option COMMENT` clause:

```
mysql> SHOW INDEX FROM t2 \G
***** 1. row *****
      Table: t2
      Non_unique: 1
      Key_name: id_index
      Seq_in_index: 1
      Column_name: id
      Collation: A
      Cardinality: 0
      Sub_part: NULL
      Packed: NULL
      Null: YES
      Index_type: BTREE
      Comment:
      Index_comment: MERGE_THRESHOLD=40
```

## Measuring the Effect of MERGE\_THRESHOLD Settings

The `INNODB_METRICS` table provides two counters that can be used to measure the effect of a `MERGE_THRESHOLD` setting on index page merges.

```
mysql> SELECT NAME, COMMENT FROM INFORMATION_SCHEMA.INNODB_METRICS
      WHERE NAME like '%index_page_merge%';
+-----+-----+
| NAME                                | COMMENT                                |
+-----+-----+
| index_page_merge_attempts           | Number of index page merge attempts   |
| index_page_merge_successful         | Number of successful index page merges |
+-----+-----+
```

When lowering the `MERGE_THRESHOLD` value, the objectives are:

- A smaller number of page merge attempts and successful page merges
- A similar number of page merge attempts and successful page merges

A `MERGE_THRESHOLD` setting that is too small could result in large data files due to an excessive amount of empty page space.

For information about using `INNODB_METRICS` counters, see [Section 14.16.6, “InnoDB INFORMATION\\_SCHEMA Metrics Table”](#).

## 14.9 InnoDB Table and Page Compression

This section provides information about the `InnoDB` table compression and `InnoDB` page compression features. The page compression feature is referred to as [transparent page compression](#).

Using the compression features of `InnoDB`, you can create tables where the data is stored in compressed form. Compression can help to improve both raw performance and scalability. The compression means less data is transferred between disk and memory, and takes up less space on disk and in memory. The benefits are amplified for tables with [secondary indexes](#), because index data is compressed also. Compression can be especially important for [SSD](#) storage devices, because they tend to have lower capacity than [HDD](#) devices.

### 14.9.1 InnoDB Table Compression

This section describes `InnoDB` table compression, which is supported with `InnoDB` tables that reside in [file\\_per\\_table](#) tablespaces or [general tablespaces](#). Table compression is enabled using the `ROW_FORMAT=COMPRESSED` attribute with `CREATE TABLE` or `ALTER TABLE`.

### 14.9.1.1 Overview of Table Compression

Because processors and cache memories have increased in speed more than disk storage devices, many workloads are **disk-bound**. Data **compression** enables smaller database size, reduced I/O, and improved throughput, at the small cost of increased CPU utilization. Compression is especially valuable for read-intensive applications, on systems with enough RAM to keep frequently used data in memory.

An InnoDB table created with `ROW_FORMAT=COMPRESSED` can use a smaller **page size** on disk than the configured `innodb_page_size` value. Smaller pages require less I/O to read from and write to disk, which is especially valuable for **SSD** devices.

The compressed page size is specified through the `CREATE TABLE` or `ALTER TABLE KEY_BLOCK_SIZE` parameter. The different page size requires that the table be placed in a **file-per-table** tablespace or **general tablespace** rather than in the **system tablespace**, as the system tablespace cannot store compressed tables. For more information, see [Section 14.6.3.2, “File-Per-Table Tablespaces”](#), and [Section 14.6.3.3, “General Tablespaces”](#).

The level of compression is the same regardless of the `KEY_BLOCK_SIZE` value. As you specify smaller values for `KEY_BLOCK_SIZE`, you get the I/O benefits of increasingly smaller pages. But if you specify a value that is too small, there is additional overhead to reorganize the pages when data values cannot be compressed enough to fit multiple rows in each page. There is a hard limit on how small `KEY_BLOCK_SIZE` can be for a table, based on the lengths of the key columns for each of its indexes. Specify a value that is too small, and the `CREATE TABLE` or `ALTER TABLE` statement fails.

In the buffer pool, the compressed data is held in small pages, with a page size based on the `KEY_BLOCK_SIZE` value. For extracting or updating the column values, MySQL also creates an uncompressed page in the buffer pool with the uncompressed data. Within the buffer pool, any updates to the uncompressed page are also re-written back to the equivalent compressed page. You might need to size your buffer pool to accommodate the additional data of both compressed and uncompressed pages, although the uncompressed pages are **evicted** from the buffer pool when space is needed, and then uncompressed again on the next access.

### 14.9.1.2 Creating Compressed Tables

Compressed tables can be created in **file-per-table** tablespaces or in **general tablespaces**. Table compression is not available for the InnoDB **system tablespace**. The system tablespace (space 0, the `.ibdata` files) can contain user-created tables, but it also contains internal system data, which is never compressed. Thus, compression applies only to tables (and indexes) stored in file-per-table or general tablespaces.

#### Creating a Compressed Table in File-Per-Table Tablespace

To create a compressed table in a file-per-table tablespace, `innodb_file_per_table` must be enabled (the default in MySQL 5.6.6) and `innodb_file_format` must be set to `Barracuda`. You can set these parameters in the MySQL configuration file (`my.cnf` or `my.ini`) or dynamically, using a `SET` statement.

After the `innodb_file_per_table` and `innodb_file_format` options are configured, specify the `ROW_FORMAT=COMPRESSED` clause or `KEY_BLOCK_SIZE` clause, or both, in a `CREATE TABLE` or `ALTER TABLE` statement to create a compressed table in a file-per-table tablespace.

For example, you might use the following statements:

```
SET GLOBAL innodb_file_per_table=1;
SET GLOBAL innodb_file_format=Barracuda;
CREATE TABLE t1
```

```
(c1 INT PRIMARY KEY)
ROW_FORMAT=COMPRESSED
KEY_BLOCK_SIZE=8;
```

## Creating a Compressed Table in a General Tablespace

To create a compressed table in a general tablespace, `FILE_BLOCK_SIZE` must be defined for the general tablespace, which is specified when the tablespace is created. The `FILE_BLOCK_SIZE` value must be a valid compressed page size in relation to the `innodb_page_size` value, and the page size of the compressed table, defined by the `CREATE TABLE` or `ALTER TABLE KEY_BLOCK_SIZE` clause, must be equal to `FILE_BLOCK_SIZE/1024`. For example, if `innodb_page_size=16384` and `FILE_BLOCK_SIZE=8192`, the `KEY_BLOCK_SIZE` of the table must be 8. For more information, see [Section 14.6.3.3, “General Tablespaces”](#).

The following example demonstrates creating a general tablespace and adding a compressed table. The example assumes a default `innodb_page_size` of 16K. The `FILE_BLOCK_SIZE` of 8192 requires that the compressed table have a `KEY_BLOCK_SIZE` of 8.

```
mysql> CREATE TABLESPACE `ts2` ADD DATAFILE 'ts2.ibd' FILE_BLOCK_SIZE = 8192 Engine=InnoDB;
mysql> CREATE TABLE t4 (c1 INT PRIMARY KEY) TABLESPACE ts2 ROW_FORMAT=COMPRESSED KEY_BLOCK_SIZE=8;
```

## Notes

- If you specify `ROW_FORMAT=COMPRESSED`, you can omit `KEY_BLOCK_SIZE`; the `KEY_BLOCK_SIZE` setting defaults to half the `innodb_page_size` value.
- If you specify a valid `KEY_BLOCK_SIZE` value, you can omit `ROW_FORMAT=COMPRESSED`; compression is enabled automatically.
- To determine the best value for `KEY_BLOCK_SIZE`, typically you create several copies of the same table with different values for this clause, then measure the size of the resulting `.ibd` files and see how well each performs with a realistic [workload](#). For general tablespaces, keep in mind that dropping a table does not reduce the size of the general tablespace `.ibd` file, nor does it return disk space to the operating system. For more information, see [Section 14.6.3.3, “General Tablespaces”](#).
- The `KEY_BLOCK_SIZE` value is treated as a hint; a different size could be used by InnoDB if necessary. For file-per-table tablespaces, the `KEY_BLOCK_SIZE` can only be less than or equal to the `innodb_page_size` value. If you specify a value greater than the `innodb_page_size` value, the specified value is ignored, a warning is issued, and `KEY_BLOCK_SIZE` is set to half of the `innodb_page_size` value. If `innodb_strict_mode=ON`, specifying an invalid `KEY_BLOCK_SIZE` value returns an error. For general tablespaces, valid `KEY_BLOCK_SIZE` values depend on the `FILE_BLOCK_SIZE` setting of the tablespace. For more information, see [Section 14.6.3.3, “General Tablespaces”](#).
- 32KB and 64KB page sizes do not support compression. For more information, refer to the `innodb_page_size` documentation.
- The default uncompressed size of InnoDB data [pages](#) is 16KB. Depending on the combination of option values, MySQL uses a page size of 1KB, 2KB, 4KB, 8KB, or 16KB for the tablespace data file (`.ibd` file). The actual compression algorithm is not affected by the `KEY_BLOCK_SIZE` value; the value determines how large each compressed chunk is, which in turn affects how many rows can be packed into each compressed page.
- When creating a compressed table in a file-per-table tablespace, setting `KEY_BLOCK_SIZE` equal to the InnoDB [page size](#) does not typically result in much compression. For example, setting `KEY_BLOCK_SIZE=16` typically would not result in much compression, since the normal InnoDB page



size is 16KB. This setting may still be useful for tables with many long `BLOB`, `VARCHAR` or `TEXT` columns, because such values often do compress well, and might therefore require fewer [overflow pages](#) as described in [Section 14.9.1.5, “How Compression Works for InnoDB Tables”](#). For general tablespaces, a `KEY_BLOCK_SIZE` value equal to the InnoDB page size is not permitted. For more information, see [Section 14.6.3.3, “General Tablespaces”](#).

- All indexes of a table (including the [clustered index](#)) are compressed using the same page size, as specified in the `CREATE TABLE` or `ALTER TABLE` statement. Table attributes such as `ROW_FORMAT` and `KEY_BLOCK_SIZE` are not part of the `CREATE INDEX` syntax for InnoDB tables, and are ignored if they are specified (although, if specified, they appear in the output of the `SHOW CREATE TABLE` statement).
- For performance-related configuration options, see [Section 14.9.1.3, “Tuning Compression for InnoDB Tables”](#).

## Restrictions on Compressed Tables

- MySQL versions prior to 5.1 cannot process compressed tables.
- Compressed tables cannot be stored in the InnoDB system tablespace.
- General tablespaces can contain multiple tables, but compressed and uncompressed tables cannot coexist within the same general tablespace.
- Compression applies to an entire table and all its associated indexes, not to individual rows, despite the clause name `ROW_FORMAT`.

### 14.9.1.3 Tuning Compression for InnoDB Tables

Most often, the internal optimizations described in [InnoDB Data Storage and Compression](#) ensure that the system runs well with compressed data. However, because the efficiency of compression depends on the nature of your data, you can make decisions that affect the performance of compressed tables:

- Which tables to compress.
- What compressed page size to use.
- Whether to adjust the size of the buffer pool based on run-time performance characteristics, such as the amount of time the system spends compressing and uncompressing data. Whether the workload is more like a [data warehouse](#) (primarily queries) or an [OLTP](#) system (mix of queries and [DML](#)).
- If the system performs DML operations on compressed tables, and the way the data is distributed leads to expensive [compression failures](#) at runtime, you might adjust additional advanced configuration options.

Use the guidelines in this section to help make those architectural and configuration choices. When you are ready to conduct long-term testing and put compressed tables into production, see [Section 14.9.1.4, “Monitoring InnoDB Table Compression at Runtime”](#) for ways to verify the effectiveness of those choices under real-world conditions.

## When to Use Compression

In general, compression works best on tables that include a reasonable number of character string columns and where the data is read far more often than it is written. Because there are no guaranteed ways to predict whether or not compression benefits a particular situation, always test with a specific [workload](#) and data set running on a representative configuration. Consider the following factors when deciding which tables to compress.

## Data Characteristics and Compression

A key determinant of the efficiency of compression in reducing the size of data files is the nature of the data itself. Recall that compression works by identifying repeated strings of bytes in a block of data. Completely randomized data is the worst case. Typical data often has repeated values, and so compresses effectively. Character strings often compress well, whether defined in [CHAR](#), [VARCHAR](#), [TEXT](#) or [BLOB](#) columns. On the other hand, tables containing mostly binary data (integers or floating point numbers) or data that is previously compressed (for example JPEG or PNG images) may not generally compress well, significantly or at all.

You choose whether to turn on compression for each InnoDB table. A table and all of its indexes use the same (compressed) [page size](#). It might be that the [primary key](#) (clustered) index, which contains the data for all columns of a table, compresses more effectively than the secondary indexes. For those cases where there are long rows, the use of compression might result in long column values being stored “off-page”, as discussed in [DYNAMIC Row Format](#). Those overflow pages may compress well. Given these considerations, for many applications, some tables compress more effectively than others, and you might find that your workload performs best only with a subset of tables compressed.

To determine whether or not to compress a particular table, conduct experiments. You can get a rough estimate of how efficiently your data can be compressed by using a utility that implements LZ77 compression (such as [gzip](#) or WinZip) on a copy of the [.ibd file](#) for an uncompressed table. You can expect less compression from a MySQL compressed table than from file-based compression tools, because MySQL compresses data in chunks based on the [page size](#), 16KB by default. In addition to user data, the page format includes some internal system data that is not compressed. File-based compression utilities can examine much larger chunks of data, and so might find more repeated strings in a huge file than MySQL can find in an individual page.

Another way to test compression on a specific table is to copy some data from your uncompressed table to a similar, compressed table (having all the same indexes) in a [file-per-table](#) tablespace and look at the size of the resulting [.ibd file](#). For example:

```
USE test;
SET GLOBAL innodb_file_per_table=1;
SET GLOBAL innodb_file_format=Barracuda;
SET GLOBAL autocommit=0;

-- Create an uncompressed table with a million or two rows.
CREATE TABLE big_table AS SELECT * FROM information_schema.columns;
INSERT INTO big_table SELECT * FROM big_table;
INSERT INTO big_table SELECT * FROM big_table;
INSERT INTO big_table SELECT * FROM big_table;
INSERT INTO big_table SELECT * FROM big_table;
INSERT INTO big_table SELECT * FROM big_table;
INSERT INTO big_table SELECT * FROM big_table;
INSERT INTO big_table SELECT * FROM big_table;
INSERT INTO big_table SELECT * FROM big_table;
INSERT INTO big_table SELECT * FROM big_table;
INSERT INTO big_table SELECT * FROM big_table;
INSERT INTO big_table SELECT * FROM big_table;
INSERT INTO big_table SELECT * FROM big_table;
INSERT INTO big_table SELECT * FROM big_table;
INSERT INTO big_table SELECT * FROM big_table;
INSERT INTO big_table SELECT * FROM big_table;
COMMIT;
ALTER TABLE big_table ADD id int unsigned NOT NULL PRIMARY KEY auto_increment;

SHOW CREATE TABLE big_table\G

select count(id) from big_table;

-- Check how much space is needed for the uncompressed table.
\! ls -l data/test/big_table.ibd

CREATE TABLE key_block_size_4 LIKE big_table;
ALTER TABLE key_block_size_4 key_block_size=4 row_format=compressed;
```

```
INSERT INTO key_block_size_4 SELECT * FROM big_table;
commit;

-- Check how much space is needed for a compressed table
-- with particular compression settings.
\! ls -l data/test/key_block_size_4.ibd
```

This experiment produced the following numbers, which of course could vary considerably depending on your table structure and data:

```
-rw-rw---- 1 cirrus  staff  310378496 Jan  9 13:44 data/test/big_table.ibd
-rw-rw---- 1 cirrus  staff  83886080  Jan  9 15:10 data/test/key_block_size_4.ibd
```

To see whether compression is efficient for your particular [workload](#):

- For simple tests, use a MySQL instance with no other compressed tables and run queries against the Information Schema [INNODB\\_CMP](#) table.
- For more elaborate tests involving workloads with multiple compressed tables, run queries against the Information Schema [INNODB\\_CMP\\_PER\\_INDEX](#) table. Because the statistics in the [INNODB\\_CMP\\_PER\\_INDEX](#) table are expensive to collect, you must enable the configuration option [innodb\\_cmp\\_per\\_index\\_enabled](#) before querying that table, and you might restrict such testing to a development server or a non-critical replica server.
- Run some typical SQL statements against the compressed table you are testing.
- Examine the ratio of successful compression operations to overall compression operations by querying the Information Schema [INNODB\\_CMP](#) or [INNODB\\_CMP\\_PER\\_INDEX](#) table, and comparing [COMPRESS\\_OPS](#) to [COMPRESS\\_OPS\\_OK](#).
- If a high percentage of compression operations complete successfully, the table might be a good candidate for compression.
- If you get a high proportion of [compression failures](#), you can adjust [innodb\\_compression\\_level](#), [innodb\\_compression\\_failure\\_threshold\\_pct](#), and [innodb\\_compression\\_pad\\_pct\\_max](#) options as described in [Section 14.9.1.6, “Compression for OLTP Workloads”](#), and try further tests.

### Database Compression versus Application Compression

Decide whether to compress data in your application or in the table; do not use both types of compression for the same data. When you compress the data in the application and store the results in a compressed table, extra space savings are extremely unlikely, and the double compression just wastes CPU cycles.

### Compressing in the Database

When enabled, MySQL table compression is automatic and applies to all columns and index values. The columns can still be tested with operators such as [LIKE](#), and sort operations can still use indexes even when the index values are compressed. Because indexes are often a significant fraction of the total size of a database, compression could result in significant savings in storage, I/O or processor time. The compression and decompression operations happen on the database server, which likely is a powerful system that is sized to handle the expected load.

### Compressing in the Application

If you compress data such as text in your application, before it is inserted into the database, You might save overhead for data that does not compress well by compressing some columns and not others. This approach uses CPU cycles for compression and uncompression on the client machine rather than the

database server, which might be appropriate for a distributed application with many clients, or where the client machine has spare CPU cycles.

### Hybrid Approach

Of course, it is possible to combine these approaches. For some applications, it may be appropriate to use some compressed tables and some uncompressed tables. It may be best to externally compress some data (and store it in uncompressed tables) and allow MySQL to compress (some of) the other tables in the application. As always, up-front design and real-life testing are valuable in reaching the right decision.

### Workload Characteristics and Compression

In addition to choosing which tables to compress (and the page size), the workload is another key determinant of performance. If the application is dominated by reads, rather than updates, fewer pages need to be reorganized and recompressed after the index page runs out of room for the per-page “modification log” that MySQL maintains for compressed data. If the updates predominantly change non-indexed columns or those containing [BLOBs](#) or large strings that happen to be stored “off-page”, the overhead of compression may be acceptable. If the only changes to a table are [INSERTs](#) that use a monotonically increasing primary key, and there are few secondary indexes, there is little need to reorganize and recompress index pages. Since MySQL can “delete-mark” and delete rows on compressed pages “in place” by modifying uncompressed data, [DELETE](#) operations on a table are relatively efficient.

For some environments, the time it takes to load data can be as important as run-time retrieval. Especially in data warehouse environments, many tables may be read-only or read-mostly. In those cases, it might or might not be acceptable to pay the price of compression in terms of increased load time, unless the resulting savings in fewer disk reads or in storage cost is significant.

Fundamentally, compression works best when the CPU time is available for compressing and uncompressing data. Thus, if your workload is I/O bound, rather than CPU-bound, you might find that compression can improve overall performance. When you test your application performance with different compression configurations, test on a platform similar to the planned configuration of the production system.

### Configuration Characteristics and Compression

Reading and writing database [pages](#) from and to disk is the slowest aspect of system performance. Compression attempts to reduce I/O by using CPU time to compress and uncompress data, and is most effective when I/O is a relatively scarce resource compared to processor cycles.

This is often especially the case when running in a multi-user environment with fast, multi-core CPUs. When a page of a compressed table is in memory, MySQL often uses additional memory, typically 16KB, in the [buffer pool](#) for an uncompressed copy of the page. The adaptive LRU algorithm attempts to balance the use of memory between compressed and uncompressed pages to take into account whether the workload is running in an I/O-bound or CPU-bound manner. Still, a configuration with more memory dedicated to the buffer pool tends to run better when using compressed tables than a configuration where memory is highly constrained.

### Choosing the Compressed Page Size

The optimal setting of the compressed page size depends on the type and distribution of data that the table and its indexes contain. The compressed page size should always be bigger than the maximum record size, or operations may fail as noted in [Compression of B-Tree Pages](#).

Setting the compressed page size too large wastes some space, but the pages do not have to be compressed as often. If the compressed page size is set too small, inserts or updates may require time-

consuming recompression, and the [B-tree](#) nodes may have to be split more frequently, leading to bigger data files and less efficient indexing.

Typically, you set the compressed page size to 8K or 4K bytes. Given that the maximum row size for an InnoDB table is around 8K, `KEY_BLOCK_SIZE=8` is usually a safe choice.

#### 14.9.1.4 Monitoring InnoDB Table Compression at Runtime

Overall application performance, CPU and I/O utilization and the size of disk files are good indicators of how effective compression is for your application. This section builds on the performance tuning advice from [Section 14.9.1.3, “Tuning Compression for InnoDB Tables”](#), and shows how to find problems that might not turn up during initial testing.

To dig deeper into performance considerations for compressed tables, you can monitor compression performance at runtime using the [Information Schema](#) tables described in [Example 14.1, “Using the Compression Information Schema Tables”](#). These tables reflect the internal use of memory and the rates of compression used overall.

The `INNODB_CMP` table reports information about compression activity for each compressed page size (`KEY_BLOCK_SIZE`) in use. The information in these tables is system-wide: it summarizes the compression statistics across all compressed tables in your database. You can use this data to help decide whether or not to compress a table by examining these tables when no other compressed tables are being accessed. It involves relatively low overhead on the server, so you might query it periodically on a production server to check the overall efficiency of the compression feature.

The `INNODB_CMP_PER_INDEX` table reports information about compression activity for individual tables and indexes. This information is more targeted and more useful for evaluating compression efficiency and diagnosing performance issues one table or index at a time. (Because that each [InnoDB](#) table is represented as a clustered index, MySQL does not make a big distinction between tables and indexes in this context.) The `INNODB_CMP_PER_INDEX` table does involve substantial overhead, so it is more suitable for development servers, where you can compare the effects of different [workloads](#), data, and compression settings in isolation. To guard against imposing this monitoring overhead by accident, you must enable the `innodb_cmp_per_index_enabled` configuration option before you can query the `INNODB_CMP_PER_INDEX` table.

The key statistics to consider are the number of, and amount of time spent performing, compression and uncompression operations. Since MySQL splits [B-tree](#) nodes when they are too full to contain the compressed data following a modification, compare the number of “successful” compression operations with the number of such operations overall. Based on the information in the `INNODB_CMP` and `INNODB_CMP_PER_INDEX` tables and overall application performance and hardware resource utilization, you might make changes in your hardware configuration, adjust the size of the buffer pool, choose a different page size, or select a different set of tables to compress.

If the amount of CPU time required for compressing and uncompressing is high, changing to faster or multi-core CPUs can help improve performance with the same data, application workload and set of compressed tables. Increasing the size of the buffer pool might also help performance, so that more uncompressed pages can stay in memory, reducing the need to uncompress pages that exist in memory only in compressed form.

A large number of compression operations overall (compared to the number of `INSERT`, `UPDATE` and `DELETE` operations in your application and the size of the database) could indicate that some of your compressed tables are being updated too heavily for effective compression. If so, choose a larger page size, or be more selective about which tables you compress.

If the number of “successful” compression operations (`COMPRESS_OPS_OK`) is a high percentage of the total number of compression operations (`COMPRESS_OPS`), then the system is likely performing well. If

the ratio is low, then MySQL is reorganizing, recompressing, and splitting B-tree nodes more often than is desirable. In this case, avoid compressing some tables, or increase `KEY_BLOCK_SIZE` for some of the compressed tables. You might turn off compression for tables that cause the number of “compression failures” in your application to be more than 1% or 2% of the total. (Such a failure ratio might be acceptable during a temporary operation such as a data load).

### 14.9.1.5 How Compression Works for InnoDB Tables

This section describes some internal implementation details about [compression](#) for InnoDB tables. The information presented here may be helpful in tuning for performance, but is not necessary to know for basic use of compression.

#### Compression Algorithms

Some operating systems implement compression at the file system level. Files are typically divided into fixed-size blocks that are compressed into variable-size blocks, which easily leads into fragmentation. Every time something inside a block is modified, the whole block is recompressed before it is written to disk. These properties make this compression technique unsuitable for use in an update-intensive database system.

MySQL implements compression with the help of the well-known [zlib library](#), which implements the LZ77 compression algorithm. This compression algorithm is mature, robust, and efficient in both CPU utilization and in reduction of data size. The algorithm is “lossless”, so that the original uncompressed data can always be reconstructed from the compressed form. LZ77 compression works by finding sequences of data that are repeated within the data to be compressed. The patterns of values in your data determine how well it compresses, but typical user data often compresses by 50% or more.



#### Note

Prior to MySQL 5.7.24, [InnoDB](#) supports the [zlib](#) library up to version 1.2.3. In MySQL 5.7.24 and later, [InnoDB](#) supports the [zlib](#) library up to version 1.2.11.

Unlike compression performed by an application, or compression features of some other database management systems, InnoDB compression applies both to user data and to indexes. In many cases, indexes can constitute 40-50% or more of the total database size, so this difference is significant. When compression is working well for a data set, the size of the InnoDB data files (the [file-per-table](#) tablespace or [general tablespace](#) `.ibd` files) is 25% to 50% of the uncompressed size or possibly smaller. Depending on the [workload](#), this smaller database can in turn lead to a reduction in I/O, and an increase in throughput, at a modest cost in terms of increased CPU utilization. You can adjust the balance between compression level and CPU overhead by modifying the `innodb_compression_level` configuration option.

#### InnoDB Data Storage and Compression

All user data in InnoDB tables is stored in pages comprising a [B-tree](#) index (the [clustered index](#)). In some other database systems, this type of index is called an “index-organized table”. Each row in the index node contains the values of the (user-specified or system-generated) [primary key](#) and all the other columns of the table.

[Secondary indexes](#) in InnoDB tables are also B-trees, containing pairs of values: the index key and a pointer to a row in the clustered index. The pointer is in fact the value of the primary key of the table, which is used to access the clustered index if columns other than the index key and primary key are required. Secondary index records must always fit on a single B-tree page.

The compression of B-tree nodes (of both clustered and secondary indexes) is handled differently from compression of [overflow pages](#) used to store long `VARCHAR`, `BLOB`, or `TEXT` columns, as explained in the following sections.

## Compression of B-Tree Pages

Because they are frequently updated, B-tree pages require special treatment. It is important to minimize the number of times B-tree nodes are split, as well as to minimize the need to uncompress and recompress their content.

One technique MySQL uses is to maintain some system information in the B-tree node in uncompressed form, thus facilitating certain in-place updates. For example, this allows rows to be delete-marked and deleted without any compression operation.

In addition, MySQL attempts to avoid unnecessary uncompression and recompression of index pages when they are changed. Within each B-tree page, the system keeps an uncompressed “modification log” to record changes made to the page. Updates and inserts of small records may be written to this modification log without requiring the entire page to be completely reconstructed.

When the space for the modification log runs out, InnoDB uncompresses the page, applies the changes and recompresses the page. If recompression fails (a situation known as a [compression failure](#)), the B-tree nodes are split and the process is repeated until the update or insert succeeds.

To avoid frequent compression failures in write-intensive workloads, such as for [OLTP](#) applications, MySQL sometimes reserves some empty space (padding) in the page, so that the modification log fills up sooner and the page is recompressed while there is still enough room to avoid splitting it. The amount of padding space left in each page varies as the system keeps track of the frequency of page splits. On a busy server doing frequent writes to compressed tables, you can adjust the [innodb\\_compression\\_failure\\_threshold\\_pct](#), and [innodb\\_compression\\_pad\\_pct\\_max](#) configuration options to fine-tune this mechanism.

Generally, MySQL requires that each B-tree page in an InnoDB table can accommodate at least two records. For compressed tables, this requirement has been relaxed. Leaf pages of B-tree nodes (whether of the primary key or secondary indexes) only need to accommodate one record, but that record must fit, in uncompressed form, in the per-page modification log. If [innodb\\_strict\\_mode](#) is `ON`, MySQL checks the maximum row size during `CREATE TABLE` or `CREATE INDEX`. If the row does not fit, the following error message is issued: `ERROR HY000: Too big row`.

If you create a table when [innodb\\_strict\\_mode](#) is `OFF`, and a subsequent `INSERT` or `UPDATE` statement attempts to create an index entry that does not fit in the size of the compressed page, the operation fails with `ERROR 42000: Row size too large`. (This error message does not name the index for which the record is too large, or mention the length of the index record or the maximum record size on that particular index page.) To solve this problem, rebuild the table with `ALTER TABLE` and select a larger compressed page size ([KEY\\_BLOCK\\_SIZE](#)), shorten any column prefix indexes, or disable compression entirely with `ROW_FORMAT=DYNAMIC` or `ROW_FORMAT=COMPACT`.

[innodb\\_strict\\_mode](#) is not applicable to general tablespaces, which also support compressed tables. Tablespace management rules for general tablespaces are strictly enforced independently of [innodb\\_strict\\_mode](#). For more information, see [Section 13.1.19, “CREATE TABLESPACE Statement”](#).

## Compressing BLOB, VARCHAR, and TEXT Columns

In an InnoDB table, `BLOB`, `VARCHAR`, and `TEXT` columns that are not part of the primary key may be stored on separately allocated [overflow pages](#). We refer to these columns as [off-page columns](#). Their values are stored on singly-linked lists of overflow pages.

For tables created in `ROW_FORMAT=DYNAMIC` or `ROW_FORMAT=COMPRESSED`, the values of `BLOB`, `TEXT`, or `VARCHAR` columns may be stored fully off-page, depending on their length and the length of the entire row. For columns that are stored off-page, the clustered index record only contains 20-byte pointers to

the overflow pages, one per column. Whether any columns are stored off-page depends on the page size and the total size of the row. When the row is too long to fit entirely within the page of the clustered index, MySQL chooses the longest columns for off-page storage until the row fits on the clustered index page. As noted above, if a row does not fit by itself on a compressed page, an error occurs.

**Note**

For tables created in `ROW_FORMAT=DYNAMIC` or `ROW_FORMAT=COMPRESSED`, `TEXT` and `BLOB` columns that are less than or equal to 40 bytes are always stored in-line.

Tables created in older versions of MySQL use the [Antelope](#) file format, which supports only `ROW_FORMAT=REDUNDANT` and `ROW_FORMAT=COMPACT`. In these formats, MySQL stores the first 768 bytes of `BLOB`, `VARCHAR`, and `TEXT` columns in the clustered index record along with the primary key. The 768-byte prefix is followed by a 20-byte pointer to the overflow pages that contain the rest of the column value.

When a table is in `COMPRESSED` format, all data written to overflow pages is compressed “as is”; that is, MySQL applies the `zlib` compression algorithm to the entire data item. Other than the data, compressed overflow pages contain an uncompressed header and trailer comprising a page checksum and a link to the next overflow page, among other things. Therefore, very significant storage savings can be obtained for longer `BLOB`, `TEXT`, or `VARCHAR` columns if the data is highly compressible, as is often the case with text data. Image data, such as `JPEG`, is typically already compressed and so does not benefit much from being stored in a compressed table; the double compression can waste CPU cycles for little or no space savings.

The overflow pages are of the same size as other pages. A row containing ten columns stored off-page occupies ten overflow pages, even if the total length of the columns is only 8K bytes. In an uncompressed table, ten uncompressed overflow pages occupy 160K bytes. In a compressed table with an 8K page size, they occupy only 80K bytes. Thus, it is often more efficient to use compressed table format for tables with long column values.

For [file-per-table](#) tablespaces, using a 16K compressed page size can reduce storage and I/O costs for `BLOB`, `VARCHAR`, or `TEXT` columns, because such data often compress well, and might therefore require fewer overflow pages, even though the B-tree nodes themselves take as many pages as in the uncompressed form. General tablespaces do not support a 16K compressed page size (`KEY_BLOCK_SIZE`). For more information, see [Section 14.6.3.3, “General Tablespaces”](#).

## Compression and the InnoDB Buffer Pool

In a compressed `InnoDB` table, every compressed page (whether 1K, 2K, 4K or 8K) corresponds to an uncompressed page of 16K bytes (or a smaller size if `innodb_page_size` is set). To access the data in a page, MySQL reads the compressed page from disk if it is not already in the [buffer pool](#), then uncompresses the page to its original form. This section describes how `InnoDB` manages the buffer pool with respect to pages of compressed tables.

To minimize I/O and to reduce the need to uncompress a page, at times the buffer pool contains both the compressed and uncompressed form of a database page. To make room for other required database pages, MySQL can [evict](#) from the buffer pool an uncompressed page, while leaving the compressed page in memory. Or, if a page has not been accessed in a while, the compressed form of the page might be written to disk, to free space for other data. Thus, at any given time, the buffer pool might contain both the compressed and uncompressed forms of the page, or only the compressed form of the page, or neither.

MySQL keeps track of which pages to keep in memory and which to evict using a least-recently-used ([LRU](#)) list, so that [hot](#) (frequently accessed) data tends to stay in memory. When compressed tables are accessed, MySQL uses an adaptive LRU algorithm to achieve an appropriate balance of compressed and uncompressed pages in memory. This adaptive algorithm is sensitive to whether the system is



running in an [I/O-bound](#) or [CPU-bound](#) manner. The goal is to avoid spending too much processing time uncompressing pages when the CPU is busy, and to avoid doing excess I/O when the CPU has spare cycles that can be used for uncompressing compressed pages (that may already be in memory). When the system is I/O-bound, the algorithm prefers to evict the uncompressed copy of a page rather than both copies, to make more room for other disk pages to become memory resident. When the system is CPU-bound, MySQL prefers to evict both the compressed and uncompressed page, so that more memory can be used for “hot” pages and reducing the need to uncompress data in memory only in compressed form.

## Compression and the InnoDB Redo Log Files

Before a compressed page is written to a [data file](#), MySQL writes a copy of the page to the redo log (if it has been recompressed since the last time it was written to the database). This is done to ensure that redo logs are usable for [crash recovery](#), even in the unlikely case that the [zlib](#) library is upgraded and that change introduces a compatibility problem with the compressed data. Therefore, some increase in the size of [log files](#), or a need for more frequent [checkpoints](#), can be expected when using compression. The amount of increase in the log file size or checkpoint frequency depends on the number of times compressed pages are modified in a way that requires reorganization and recompression.

Compressed tables require the [Barracuda](#) file format. To create a compressed table in a file-per-table tablespace, [innodb\\_file\\_per\\_table](#) must be enabled and [innodb\\_file\\_format](#) must be set to [Barracuda](#). There is no dependence on the [innodb\\_file\\_format](#) setting when creating a compressed table in a general tablespace. For more information, see [Section 14.6.3.3, “General Tablespaces”](#). The [MySQL Enterprise Backup](#) product supports the [Barracuda](#) file format.

### 14.9.1.6 Compression for OLTP Workloads

Traditionally, the [InnoDB compression](#) feature was recommended primarily for read-only or read-mostly [workloads](#), such as in a [data warehouse](#) configuration. The rise of [SSD](#) storage devices, which are fast but relatively small and expensive, makes compression attractive also for [OLTP](#) workloads: high-traffic, interactive websites can reduce their storage requirements and their I/O operations per second ([IOPS](#)) by using compressed tables with applications that do frequent [INSERT](#), [UPDATE](#), and [DELETE](#) operations.

Configuration options introduced in MySQL 5.6 let you adjust the way compression works for a particular MySQL instance, with an emphasis on performance and scalability for write-intensive operations:

- [innodb\\_compression\\_level](#) lets you turn the degree of compression up or down. A higher value lets you fit more data onto a storage device, at the expense of more CPU overhead during compression. A lower value lets you reduce CPU overhead when storage space is not critical, or you expect the data is not especially compressible.
- [innodb\\_compression\\_failure\\_threshold\\_pct](#) specifies a cutoff point for [compression failures](#) during updates to a compressed table. When this threshold is passed, MySQL begins to leave additional free space within each new compressed page, dynamically adjusting the amount of free space up to the percentage of page size specified by [innodb\\_compression\\_pad\\_pct\\_max](#)
- [innodb\\_compression\\_pad\\_pct\\_max](#) lets you adjust the maximum amount of space reserved within each [page](#) to record changes to compressed rows, without needing to compress the entire page again. The higher the value, the more changes can be recorded without recompressing the page. MySQL uses a variable amount of free space for the pages within each compressed table, only when a designated percentage of compression operations “fail” at runtime, requiring an expensive operation to split the compressed page.
- [innodb\\_log\\_compressed\\_pages](#) lets you disable writing of images of [re-compressed pages](#) to the [redo log](#). Re-compression may occur when changes are made to compressed data. This option is enabled by default to prevent corruption that could occur if a different version of the [zlib](#) compression

algorithm is used during recovery. If you are certain that the `zlib` version is not likely to change, disable `innodb_log_compressed_pages` to reduce redo log generation for workloads that modify compressed data.

Because working with compressed data sometimes involves keeping both compressed and uncompressed versions of a page in memory at the same time, when using compression with an OLTP-style workload, be prepared to increase the value of the `innodb_buffer_pool_size` configuration option.

### 14.9.1.7 SQL Compression Syntax Warnings and Errors

This section describes syntax warnings and errors that you may encounter when using the table compression feature with `file-per-table` tablespaces and `general` tablespaces.

#### SQL Compression Syntax Warnings and Errors for File-Per-Table Tablespaces

When `innodb_strict_mode` is enabled (the default), specifying `ROW_FORMAT=COMPRESSED` or `KEY_BLOCK_SIZE` in `CREATE TABLE` or `ALTER TABLE` statements produces the following error if `innodb_file_per_table` is disabled or if `innodb_file_format` is set to `Antelope` rather than `Barracuda`.

```
ERROR 1031 (HY000): Table storage engine for 't1' does not have this option
```



#### Note

The table is not created if the current configuration does not permit using compressed tables.

When `innodb_strict_mode` is disabled, specifying `ROW_FORMAT=COMPRESSED` or `KEY_BLOCK_SIZE` in `CREATE TABLE` or `ALTER TABLE` statements produces the following warnings if `innodb_file_per_table` is disabled.

```
mysql> SHOW WARNINGS;
```

Level	Code	Message
Warning	1478	InnoDB: KEY_BLOCK_SIZE requires innodb_file_per_table.
Warning	1478	InnoDB: ignoring KEY_BLOCK_SIZE=4.
Warning	1478	InnoDB: ROW_FORMAT=COMPRESSED requires innodb_file_per_table.
Warning	1478	InnoDB: assuming ROW_FORMAT=DYNAMIC.

Similar warnings are issued if `innodb_file_format` is set to `Antelope` rather than `Barracuda`.



#### Note

These messages are only warnings, not errors, and the table is created without compression, as if the options were not specified.

The “non-strict” behavior lets you import a `mysqldump` file into a database that does not support compressed tables, even if the source database contained compressed tables. In that case, MySQL creates the table in `ROW_FORMAT=COMPACT` instead of preventing the operation.

To import the dump file into a new database, and have the tables re-created as they exist in the original database, ensure the server has the proper settings for the configuration parameters `innodb_file_format` and `innodb_file_per_table`.

The attribute `KEY_BLOCK_SIZE` is permitted only when `ROW_FORMAT` is specified as `COMPRESSED` or is omitted. Specifying a `KEY_BLOCK_SIZE` with any other `ROW_FORMAT` generates a warning that you can

view with `SHOW WARNINGS`. However, the table is non-compressed; the specified `KEY_BLOCK_SIZE` is ignored).

Level	Code	Message
Warning	1478	InnoDB: ignoring <code>KEY_BLOCK_SIZE=n</code> unless <code>ROW_FORMAT=COMPRESSED</code> .

If you are running with `innodb_strict_mode` enabled, the combination of a `KEY_BLOCK_SIZE` with any `ROW_FORMAT` other than `COMPRESSED` generates an error, not a warning, and the table is not created.

Table 14.6, “`ROW_FORMAT` and `KEY_BLOCK_SIZE` Options” provides an overview the `ROW_FORMAT` and `KEY_BLOCK_SIZE` options that are used with `CREATE TABLE` or `ALTER TABLE`.

**Table 14.6 `ROW_FORMAT` and `KEY_BLOCK_SIZE` Options**

Option	Usage Notes	Description
<code>ROW_FORMAT=REDUNDANT</code>	Storage format used prior to MySQL 5.0.3	Less efficient than <code>ROW_FORMAT=COMPACT</code> ; for backward compatibility
<code>ROW_FORMAT=COMPACT</code>	Default storage format since MySQL 5.0.3	Stores a prefix of 768 bytes in the clustered index page, with the remaining bytes stored in an overflow page
<code>ROW_FORMAT=DYNAMIC</code>	File-per-table tablespaces require <code>innodb_file_format=Barracuda</code>	Store values within the clustered index page if they fit; if not, stores only a 20-byte pointer to an overflow page (no prefix)
<code>ROW_FORMAT=COMPRESSED</code>	File-per-table tablespaces require <code>innodb_file_format=Barracuda</code>	Compresses the table and indexes using <code>zlib</code>
<code>KEY_BLOCK_SIZE=n</code>	File-per-table tablespaces require <code>innodb_file_format=Barracuda</code>	Specifies compressed page size of 1, 2, 4, 8 or 16 kilobytes; implies <code>ROW_FORMAT=COMPRESSED</code> . For general tablespaces, a <code>KEY_BLOCK_SIZE</code> value equal to the InnoDB page size is not permitted.

Table 14.7, “`CREATE/ALTER TABLE Warnings and Errors when InnoDB Strict Mode is OFF`” summarizes error conditions that occur with certain combinations of configuration parameters and options on the `CREATE TABLE` or `ALTER TABLE` statements, and how the options appear in the output of `SHOW TABLE STATUS`.

When `innodb_strict_mode` is `OFF`, MySQL creates or alters the table, but ignores certain settings as shown below. You can see the warning messages in the MySQL error log. When `innodb_strict_mode` is `ON`, these specified combinations of options generate errors, and the table is not created or altered. To see the full description of the error condition, issue the `SHOW ERRORS` statement: example:

```
mysql> CREATE TABLE x (id INT PRIMARY KEY, c INT)
```

```
-> ENGINE=INNODB KEY_BLOCK_SIZE=33333;

ERROR 1005 (HY000): Can't create table 'test.x' (errno: 1478)

mysql> SHOW ERRORS;
+-----+-----+-----+
| Level | Code | Message                                     |
+-----+-----+-----+
| Error | 1478 | InnoDB: invalid KEY_BLOCK_SIZE=33333.     |
| Error | 1005 | Can't create table 'test.x' (errno: 1478) |
+-----+-----+-----+
```

**Table 14.7 CREATE/ALTER TABLE Warnings and Errors when InnoDB Strict Mode is OFF**

Syntax	Warning or Error Condition	Resulting <code>ROW_FORMAT</code> , as shown in <code>SHOW TABLE STATUS</code>
<code>ROW_FORMAT=REDUNDANT</code>	None	REDUNDANT
<code>ROW_FORMAT=COMPACT</code>	None	COMPACT
<code>ROW_FORMAT=COMPRESSED</code> or <code>ROW_FORMAT=DYNAMIC</code> or <code>KEY_BLOCK_SIZE</code> is specified	Ignored for file-per-table tablespaces unless both <code>innodb_file_format=Barracuda</code> and <code>innodb_file_per_table</code> are enabled. General tablespaces support all row formats (with some restrictions) regardless of <code>innodb_file_format</code> and <code>innodb_file_per_table</code> settings. See Section 14.6.3.3, “General Tablespaces”.	the default row format for file-per-table tablespaces; the specified row format for general tablespaces
Invalid <code>KEY_BLOCK_SIZE</code> is specified (not 1, 2, 4, 8 or 16)	<code>KEY_BLOCK_SIZE</code> is ignored	the specified row format, or the default row format
<code>ROW_FORMAT=COMPRESSED</code> and valid <code>KEY_BLOCK_SIZE</code> are specified	None; <code>KEY_BLOCK_SIZE</code> specified is used	COMPRESSED
<code>KEY_BLOCK_SIZE</code> is specified with <code>REDUNDANT</code> , <code>COMPACT</code> or <code>DYNAMIC</code> row format	<code>KEY_BLOCK_SIZE</code> is ignored	REDUNDANT, COMPACT or DYNAMIC
<code>ROW_FORMAT</code> is not one of <code>REDUNDANT</code> , <code>COMPACT</code> , <code>DYNAMIC</code> or <code>COMPRESSED</code>	Ignored if recognized by the MySQL parser. Otherwise, an error is issued.	the default row format or N/A

When `innodb_strict_mode` is ON, MySQL rejects invalid `ROW_FORMAT` or `KEY_BLOCK_SIZE` parameters and issues errors. When `innodb_strict_mode` is OFF, MySQL issues warnings instead of errors for ignored invalid parameters. `innodb_strict_mode` is ON by default.

When `innodb_strict_mode` is ON, MySQL rejects invalid `ROW_FORMAT` or `KEY_BLOCK_SIZE` parameters. For compatibility with earlier versions of MySQL, strict mode is not enabled by default; instead, MySQL issues warnings (not errors) for ignored invalid parameters.

It is not possible to see the chosen `KEY_BLOCK_SIZE` using `SHOW TABLE STATUS`. The statement `SHOW CREATE TABLE` displays the `KEY_BLOCK_SIZE` (even if it was ignored when creating the table). The real compressed page size of the table cannot be displayed by MySQL.

## SQL Compression Syntax Warnings and Errors for General Tablespaces

- If `FILE_BLOCK_SIZE` was not defined for the general tablespace when the tablespace was created, the tablespace cannot contain compressed tables. If you attempt to add a compressed table, an error is returned, as shown in the following example:

```
mysql> CREATE TABLESPACE `ts1` ADD DATAFILE 'ts1.ibd' Engine=InnoDB;

mysql> CREATE TABLE t1 (c1 INT PRIMARY KEY) TABLESPACE ts1 ROW_FORMAT=COMPRESSED
      KEY_BLOCK_SIZE=8;
ERROR 1478 (HY000): InnoDB: Tablespace `ts1` cannot contain a COMPRESSED table
```

- Attempting to add a table with an invalid `KEY_BLOCK_SIZE` to a general tablespace returns an error, as shown in the following example:

```
mysql> CREATE TABLESPACE `ts2` ADD DATAFILE 'ts2.ibd' FILE_BLOCK_SIZE = 8192 Engine=InnoDB;

mysql> CREATE TABLE t2 (c1 INT PRIMARY KEY) TABLESPACE ts2 ROW_FORMAT=COMPRESSED
      KEY_BLOCK_SIZE=4;
ERROR 1478 (HY000): InnoDB: Tablespace `ts2` uses block size 8192 and cannot
contain a table with physical page size 4096
```

For general tablespaces, the `KEY_BLOCK_SIZE` of the table must be equal to the `FILE_BLOCK_SIZE` of the tablespace divided by 1024. For example, if the `FILE_BLOCK_SIZE` of the tablespace is 8192, the `KEY_BLOCK_SIZE` of the table must be 8.

- Attempting to add a table with an uncompressed row format to a general tablespace configured to store compressed tables returns an error, as shown in the following example:

```
mysql> CREATE TABLESPACE `ts3` ADD DATAFILE 'ts3.ibd' FILE_BLOCK_SIZE = 8192 Engine=InnoDB;

mysql> CREATE TABLE t3 (c1 INT PRIMARY KEY) TABLESPACE ts3 ROW_FORMAT=COMPACT;
ERROR 1478 (HY000): InnoDB: Tablespace `ts3` uses block size 8192 and cannot
contain a table with physical page size 16384
```

`innodb_strict_mode` is not applicable to general tablespaces. Tablespace management rules for general tablespaces are strictly enforced independently of `innodb_strict_mode`. For more information, see [Section 13.1.19, “CREATE TABLESPACE Statement”](#).

For more information about using compressed tables with general tablespaces, see [Section 14.6.3.3, “General Tablespaces”](#).

## 14.9.2 InnoDB Page Compression

InnoDB supports page-level compression for tables that reside in [file-per-table](#) tablespaces. This feature is referred to as *Transparent Page Compression*. Page compression is enabled by specifying the `COMPRESSION` attribute with `CREATE TABLE` or `ALTER TABLE`. Supported compression algorithms include `Zlib` and `LZ4`.

### Supported Platforms

Page compression requires sparse file and hole punching support. Page compression is supported on Windows with NTFS, and on the following subset of MySQL-supported Linux platforms where the kernel level provides hole punching support:

- RHEL 7 and derived distributions that use kernel version 3.10.0-123 or higher
- OEL 5.10 (UEK2) kernel version 2.6.39 or higher
- OEL 6.5 (UEK3) kernel version 3.8.13 or higher

- OEL 7.0 kernel version 3.8.13 or higher
- SLE11 kernel version 3.0-x
- SLE12 kernel version 3.12-x
- OES11 kernel version 3.0-x
- Ubuntu 14.0.4 LTS kernel version 3.13 or higher
- Ubuntu 12.0.4 LTS kernel version 3.2 or higher
- Debian 7 kernel version 3.2 or higher



#### Note

All of the available file systems for a given Linux distribution may not support hole punching.

## How Page Compression Works

When a page is written, it is compressed using the specified compression algorithm. The compressed data is written to disk, where the hole punching mechanism releases empty blocks from the end of the page. If compression fails, data is written out as-is.

## Hole Punch Size on Linux

On Linux systems, the file system block size is the unit size used for hole punching. Therefore, page compression only works if page data can be compressed to a size that is less than or equal to the `InnoDB` page size minus the file system block size. For example, if `innodb_page_size=16K` and the file system block size is 4K, page data must compress to less than or equal to 12K to make hole punching possible.

## Hole Punch Size on Windows

On Windows systems, the underlying infrastructure for sparse files is based on NTFS compression. Hole punching size is the NTFS compression unit, which is 16 times the NTFS cluster size. Cluster sizes and their compression units are shown in the following table:

**Table 14.8 Windows NTFS Cluster Size and Compression Units**

Cluster Size	Compression Unit
512 Bytes	8 KB
1 KB	16 KB
2 KB	32 KB
4 KB	64 KB

Page compression on Windows systems only works if page data can be compressed to a size that is less than or equal to the `InnoDB` page size minus the compression unit size.

The default NTFS cluster size is 4KB, for which the compression unit size is 64KB. This means that page compression has no benefit for an out-of-the box Windows NTFS configuration, as the maximum `innodb_page_size` is also 64KB.

For page compression to work on Windows, the file system must be created with a cluster size smaller than 4K, and the `innodb_page_size` must be at least twice the size of the compression unit. For

example, for page compression to work on Windows, you could build the file system with a cluster size of 512 Bytes (which has a compression unit of 8KB) and initialize InnoDB with an `innodb_page_size` value of 16K or greater.

## Enabling Page Compression

To enable page compression, specify the `COMPRESSION` attribute in the `CREATE TABLE` statement. For example:

```
CREATE TABLE t1 (c1 INT) COMPRESSION="zlib";
```

You can also enable page compression in an `ALTER TABLE` statement. However, `ALTER TABLE ... COMPRESSION` only updates the tablespace compression attribute. Writes to the tablespace that occur after setting the new compression algorithm use the new setting, but to apply the new compression algorithm to existing pages, you must rebuild the table using `OPTIMIZE TABLE`.

```
ALTER TABLE t1 COMPRESSION="zlib";
OPTIMIZE TABLE t1;
```

## Disabling Page Compression

To disable page compression, set `COMPRESSION=None` using `ALTER TABLE`. Writes to the tablespace that occur after setting `COMPRESSION=None` no longer use page compression. To uncompress existing pages, you must rebuild the table using `OPTIMIZE TABLE` after setting `COMPRESSION=None`.

```
ALTER TABLE t1 COMPRESSION="None";
OPTIMIZE TABLE t1;
```

## Page Compression Metadata

Page compression metadata is found in the Information Schema `INNODB_SYS_TABLESPACES` table, in the following columns:

- `FS_BLOCK_SIZE`: The file system block size, which is the unit size used for hole punching.
- `FILE_SIZE`: The apparent size of the file, which represents the maximum size of the file, uncompressed.
- `ALLOCATED_SIZE`: The actual size of the file, which is the amount of space allocated on disk.



### Note

On Unix-like systems, `ls -l tablespace_name.ibd` shows the apparent file size (equivalent to `FILE_SIZE`) in bytes. To view the actual amount of space allocated on disk (equivalent to `ALLOCATED_SIZE`), use `du --block-size=1 tablespace_name.ibd`. The `--block-size=1` option prints the allocated space in bytes instead of blocks, so that it can be compared to `ls -l` output.

Use `SHOW CREATE TABLE` to view the current page compression setting (`zlib`, `Lz4`, or `None`). A table may contain a mix of pages with different compression settings.

In the following example, page compression metadata for the `employees` table is retrieved from the Information Schema `INNODB_SYS_TABLESPACES` table.

```
# Create the employees table with Zlib page compression
```

```

CREATE TABLE employees (
  emp_no      INT          NOT NULL,
  birth_date  DATE         NOT NULL,
  first_name  VARCHAR(14)  NOT NULL,
  last_name   VARCHAR(16)  NOT NULL,
  gender      ENUM ('M','F') NOT NULL,
  hire_date   DATE         NOT NULL,
  PRIMARY KEY (emp_no)
) COMPRESSION="zlib";

# Insert data (not shown)

# Query page compression metadata in INFORMATION_SCHEMA.INNODB_SYS_TABLESPACES

mysql> SELECT SPACE, NAME, FS_BLOCK_SIZE, FILE_SIZE, ALLOCATED_SIZE FROM
      INFORMATION_SCHEMA.INNODB_SYS_TABLESPACES WHERE NAME='employees/employees'\G
***** 1. row *****
SPACE: 45
NAME: employees/employees
FS_BLOCK_SIZE: 4096
FILE_SIZE: 23068672
ALLOCATED_SIZE: 19415040

```

Page compression metadata for the employees table shows that the apparent file size is 23068672 bytes while the actual file size (with page compression) is 19415040 bytes. The file system block size is 4096 bytes, which is the block size used for hole punching.

## Identifying Tables Using Page Compression

To identify tables for which page compression is enabled, you can query the Information Schema `TABLES` table's `CREATE_OPTIONS` column for tables defined with the `COMPRESSION` attribute:

```

mysql> SELECT TABLE_NAME, TABLE_SCHEMA, CREATE_OPTIONS FROM INFORMATION_SCHEMA.TABLES
      WHERE CREATE_OPTIONS LIKE '%COMPRESSION=%';
+-----+-----+-----+
| TABLE_NAME | TABLE_SCHEMA | CREATE_OPTIONS |
+-----+-----+-----+
| employees   | test          | COMPRESSION="zlib" |
+-----+-----+-----+

```

`SHOW CREATE TABLE` also shows the `COMPRESSION` attribute, if used.

## Page Compression Limitations and Usage Notes

- Page compression is disabled if the file system block size (or compression unit size on Windows) \* 2 > `innodb_page_size`.
- Page compression is not supported for tables that reside in shared tablespaces, which include the system tablespace, the temporary tablespace, and general tablespaces.
- Page compression is not supported for undo log tablespaces.
- Page compression is not supported for redo log pages.
- R-tree pages, which are used for spatial indexes, are not compressed.
- Pages that belong to compressed tables (`ROW_FORMAT=COMPRESSED`) are left as-is.
- During recovery, updated pages are written out in an uncompressed form.
- Loading a page-compressed tablespace on a server that does not support the compression algorithm that was used causes an I/O error.



- Before downgrading to an earlier version of MySQL that does not support page compression, uncompress the tables that use the page compression feature. To uncompress a table, run `ALTER TABLE ... COMPRESSION=None` and `OPTIMIZE TABLE`.
- Page-compressed tablespaces can be copied between Linux and Windows servers if the compression algorithm that was used is available on both servers.
- Preserving page compression when moving a page-compressed tablespace file from one host to another requires a utility that preserves sparse files.
- Better page compression may be achieved on Fusion-io hardware with NVMFS than on other platforms, as NVMFS is designed to take advantage of punch hole functionality.
- Using the page compression feature with a large InnoDB page size and relatively small file system block size could result in write amplification. For example, a maximum InnoDB page size of 64KB with a 4KB file system block size may improve compression but may also increase demand on the buffer pool, leading to increased I/O and potential write amplification.

## 14.10 InnoDB File-Format Management

As InnoDB evolves, data file formats that are not compatible with prior versions of InnoDB are sometimes required to support new features. To help manage compatibility in upgrade and downgrade situations, and systems that run different versions of MySQL, InnoDB uses named file formats. InnoDB currently supports two named file formats, [Antelope](#) and [Barracuda](#).

- [Antelope](#) is the original InnoDB file format, which previously did not have a name. It supports the [COMPACT](#) and [REDUNDANT](#) row formats for InnoDB tables.
- [Barracuda](#) is the newest file format. It supports all InnoDB row formats including the newer [COMPRESSED](#) and [DYNAMIC](#) row formats. The features associated with [COMPRESSED](#) and [DYNAMIC](#) row formats include compressed tables, efficient storage of off-page columns, and index key prefixes up to 3072 bytes (`innodb_large_prefix`). See [Section 14.11, “InnoDB Row Formats”](#).

This section discusses enabling InnoDB file formats for new InnoDB tables, verifying compatibility of different file formats between MySQL releases, and identifying the file format in use.

InnoDB file format settings do not apply to tables stored in [general tablespaces](#). General tablespaces provide support for all row formats and associated features. For more information, see [Section 14.6.3.3, “General Tablespaces”](#).



### Note

The following file format configuration parameters have new default values:

- The `innodb_file_format` default value was changed to [Barracuda](#). The previous default value was [Antelope](#).
- The `innodb_large_prefix` default value was changed to [ON](#). The previous default was [OFF](#).

The following file format configuration parameters are deprecated in and may be removed in a future release:

- `innodb_file_format`
- `innodb_file_format_check`

- `innodb_file_format_max`
- `innodb_large_prefix`

The file format configuration parameters were provided for creating tables compatible with earlier versions of InnoDB in MySQL 5.1. Now that MySQL 5.1 has reached the end of its product lifecycle, the parameters are no longer required.

## 14.10.1 Enabling File Formats

The `innodb_file_format` configuration option enables an InnoDB file format for [file-per-table](#) tablespaces.

[Barracuda](#) is the default `innodb_file_format` setting. In earlier releases, the default file format was [Antelope](#).



### Note

The `innodb_file_format` configuration option is deprecated and may be removed in a future release. For more information, see [Section 14.10, “InnoDB File-Format Management”](#).

You can set the value of `innodb_file_format` on the command line when you start `mysqld`, or in the option file (`my.cnf` on Unix, `my.ini` on Windows). You can also change it dynamically with a `SET GLOBAL` statement.

```
SET GLOBAL innodb_file_format=Barracuda;
```

## Usage notes

- InnoDB file format settings do not apply to tables stored in [general tablespaces](#). General tablespaces provide support for all row formats and associated features. For more information, see [Section 14.6.3.3, “General Tablespaces”](#).
- The `innodb_file_format` setting is not applicable when using the `TABLESPACE [=] innodb_system` table option with `CREATE TABLE` or `ALTER TABLE` to store a `DYNAMIC` table in the system tablespace.
- The `innodb_file_format` setting is ignored when creating tables that use the `DYNAMIC` row format. For more information, see [DYNAMIC Row Format](#).

## 14.10.2 Verifying File Format Compatibility

InnoDB incorporates several checks to guard against the possible crashes and data corruptions that might occur if you run an old release of the MySQL server on InnoDB data files that use a newer file format. These checks take place when the server is started, and when you first access a table. This section describes these checks, how you can control them, and error and warning conditions that might arise.

## Backward Compatibility

You only need to consider backward file format compatibility when using a recent version of InnoDB (MySQL 5.5 and higher with InnoDB) alongside an older version (MySQL 5.1 or earlier, with the built-in InnoDB rather than the InnoDB Plugin). To minimize the chance of compatibility issues, you can standardize on the InnoDB Plugin for all your MySQL 5.1 and earlier database servers.

In general, a newer version of InnoDB may create a table or index that cannot safely be read or written with an older version of InnoDB without risk of crashes, hangs, wrong results or corruptions. InnoDB includes a mechanism to guard against these conditions, and to help preserve compatibility among database files and versions of InnoDB. This mechanism lets you take advantage of some new features of an InnoDB release (such as performance improvements and bug fixes), and still preserve the option of using your database with an old version of InnoDB, by preventing accidental use of new features that create downward-incompatible disk files.

If a version of InnoDB supports a particular file format (whether or not that format is the default), you can query and update any table that requires that format or an earlier format. Only the creation of new tables using new features is limited based on the particular file format enabled. Conversely, if a tablespace contains a table or index that uses a file format that is not supported, it cannot be accessed at all, even for read access.

The only way to “downgrade” an InnoDB tablespace to the earlier Antelope file format is to copy the data to a new table, in a tablespace that uses the earlier format.

The easiest way to determine the file format of an existing InnoDB tablespace is to examine the properties of the table it contains, using the `SHOW TABLE STATUS` command or querying the table `INFORMATION_SCHEMA.TABLES`. If the `Row_format` of the table is reported as `'Compressed'` or `'Dynamic'`, the tablespace containing the table supports the Barracuda format.

## Internal Details

Every InnoDB file-per-table tablespace (represented by a `*.ibd` file) is labeled with a file format identifier. The system tablespace (represented by the `ibdata` files) is tagged with the “highest” file format in use in a group of InnoDB database files, and this tag is checked when the files are opened.

Creating a compressed table, or a table with `ROW_FORMAT=DYNAMIC`, updates the file header of the corresponding file-per-table `.ibd` file and the table type in the InnoDB data dictionary with the identifier for the Barracuda file format. From that point forward, the table cannot be used with a version of InnoDB that does not support the Barracuda file format. To protect against anomalous behavior, InnoDB performs a compatibility check when the table is opened. (In many cases, the `ALTER TABLE` statement recreates a table and thus changes its properties. The special case of adding or dropping indexes without rebuilding the table is described in [Section 14.13.1, “Online DDL Operations”](#).)

General tablespaces, which are also represented by a `*.ibd` file, support both Antelope and Barracuda file formats. For more information about general tablespaces, see [Section 14.6.3.3, “General Tablespaces”](#).

## Definition of ib-file set

To avoid confusion, for the purposes of this discussion we define the term “ib-file set” to mean the set of operating system files that InnoDB manages as a unit. The ib-file set includes the following files:

- The system tablespace (one or more `ibdata` files) that contain internal system information (including internal catalogs and undo information) and may include user data and indexes.
- Zero or more single-table tablespaces (also called “file per table” files, named `*.ibd` files).
- InnoDB log files; usually two, `ib_logfile0` and `ib_logfile1`. Used for crash recovery and in backups.

An “ib-file set” does not include the corresponding `.frm` files that contain metadata about InnoDB tables. The `.frm` files are created and managed by MySQL, and can sometimes get out of sync with the internal metadata in InnoDB.

Multiple tables, even from more than one database, can be stored in a single “ib-file set”. (In MySQL, a “database” is a logical collection of tables, what other systems refer to as a “schema” or “catalog”.)

### 14.10.2.1 Compatibility Check When InnoDB Is Started

To prevent possible crashes or data corruptions when InnoDB opens an ib-file set, it checks that it can fully support the file formats in use within the ib-file set. If the system is restarted following a crash, or a “fast shutdown” (i.e., `innodb_fast_shutdown` is greater than zero), there may be on-disk data structures (such as redo or undo entries, or doublewrite pages) that are in a “too-new” format for the current software. During the recovery process, serious damage can be done to your data files if these data structures are accessed. The startup check of the file format occurs before any recovery process begins, thereby preventing consistency issues with the new tables or startup problems for the MySQL server.

Beginning with version InnoDB 1.0.1, the system tablespace records an identifier or tag for the “highest” file format used by any table in any of the tablespaces that is part of the ib-file set. Checks against this file format tag are controlled by the configuration parameter `innodb_file_format_check`, which is `ON` by default.

If the file format tag in the system tablespace is newer or higher than the highest version supported by the particular currently executing software and if `innodb_file_format_check` is `ON`, the following error is issued when the server is started:

```
InnoDB: Error: the system tablespace is in a
file format that this version doesn't support
```

You can also set `innodb_file_format` to a file format name. Doing so prevents InnoDB from starting if the current software does not support the file format specified. It also sets the “high water mark” to the value you specify. The ability to set `innodb_file_format_check` is useful (with future releases) if you manually “downgrade” all of the tables in an ib-file set. You can then rely on the file format check at startup if you subsequently use an older version of InnoDB to access the ib-file set.

In some limited circumstances, you might want to start the server and use an ib-file set that is in a new file format that is not supported by the software you are using. If you set the configuration parameter `innodb_file_format_check` to `OFF`, InnoDB opens the database, but issues this warning message in the error log:

```
InnoDB: Warning: the system tablespace is in a
file format that this version doesn't support
```



#### Note

This is a dangerous setting, as it permits the recovery process to run, possibly corrupting your database if the previous shutdown was an unexpected exit or “fast shutdown”. You should only set `innodb_file_format_check` to `OFF` if you are sure that the previous shutdown was done with `innodb_fast_shutdown=0`, so that essentially no recovery process occurs.

The parameter `innodb_file_format_check` affects only what happens when a database is opened, not subsequently. Conversely, the parameter `innodb_file_format` (which enables a specific format) only determines whether or not a new table can be created in the enabled format and has no effect on whether or not a database can be opened.

The file format tag is a “high water mark”, and as such it is increased after the server is started, if a table in a “higher” format is created or an existing table is accessed for read or write (assuming its format is supported). If you access an existing table in a format higher than the format the running software

supports, the system tablespace tag is not updated, but table-level compatibility checking applies (and an error is issued), as described in [Section 14.10.2.2, “Compatibility Check When a Table Is Opened”](#). Any time the high water mark is updated, the value of `innodb_file_format_check` is updated as well, so the command `SELECT @@innodb_file_format_check;` displays the name of the latest file format known to be used by tables in the currently open ib-file set and supported by the currently executing software.

### 14.10.2.2 Compatibility Check When a Table Is Opened

When a table is first accessed, InnoDB (including some releases prior to InnoDB 1.0) checks that the file format of the tablespace in which the table is stored is fully supported. This check prevents crashes or corruptions that would otherwise occur when tables using a “too new” data structure are encountered.

All tables using any file format supported by a release can be read or written (assuming the user has sufficient privileges). The setting of the system configuration parameter `innodb_file_format` can prevent creating a new table that uses a specific file format, even if the file format is supported by a given release. Such a setting might be used to preserve backward compatibility, but it does not prevent accessing any table that uses a supported format.

Versions of MySQL older than 5.0.21 cannot reliably use database files created by newer versions if a new file format was used when a table was created. To prevent various error conditions or corruptions, InnoDB checks file format compatibility when it opens a file (for example, upon first access to a table). If the currently running version of InnoDB does not support the file format identified by the table type in the InnoDB data dictionary, MySQL reports the following error:

```
ERROR 1146 (42S02): Table 'test.t1' doesn't exist
```

InnoDB also writes a message to the error log:

```
InnoDB: table test/t1: unknown table type 33
```

The table type should be equal to the tablespace flags, which contains the file format version as discussed in [Section 14.10.3, “Identifying the File Format in Use”](#).

Versions of InnoDB prior to MySQL 4.1 did not include table format identifiers in the database files, and versions prior to MySQL 5.0.21 did not include a table format compatibility check. Therefore, there is no way to ensure proper operations if a table in a newer file format is used with versions of InnoDB prior to 5.0.21.

The file format management capability in InnoDB 1.0 and higher (tablespace tagging and run-time checks) allows InnoDB to verify as soon as possible that the running version of software can properly process the tables existing in the database.

If you permit InnoDB to open a database containing files in a format it does not support (by setting the parameter `innodb_file_format_check` to `OFF`), the table-level checking described in this section still applies.

Users are *strongly* urged not to use database files that contain Barracuda file format tables with releases of InnoDB older than the MySQL 5.1 with the InnoDB Plugin. It may be possible to rebuild such tables to use the Antelope format.

## 14.10.3 Identifying the File Format in Use

If you enable a different [file format](#) using the `innodb_file_format` configuration option, the change only applies to newly created tables. Also, when you create a new table, the tablespace containing the

table is tagged with the “earliest” or “simplest” file format that is required to support the table's features. For example, if you enable the [Barracuda](#) file format, and create a new table that does not use the Dynamic or Compressed row format, the new tablespace that contains the table is tagged as using the [Antelope](#) file format .

It is easy to identify the file format used by a given table. The table uses the [Antelope](#) file format if the row format reported by `SHOW TABLE STATUS` is either [Compact](#) or [Redundant](#). The table uses the [Barracuda](#) file format if the row format reported by `SHOW TABLE STATUS` is either [Compressed](#) or [Dynamic](#).

```
mysql> SHOW TABLE STATUS\G
***** 1. row *****
      Name: t1
      Engine: InnoDB
      Version: 10
      Row_format: Compact
      Rows: 0
      Avg_row_length: 0
      Data_length: 16384
      Max_data_length: 0
      Index_length: 16384
      Data_free: 0
      Auto_increment: 1
      Create_time: 2014-11-03 13:32:10
      Update_time: NULL
      Check_time: NULL
      Collation: latin1_swedish_ci
      Checksum: NULL
      Create_options:
      Comment:
```

You can also identify the file format used by a given table or tablespace using [InnoDB INFORMATION\\_SCHEMA](#) tables. For example:

```
mysql> SELECT * FROM INFORMATION_SCHEMA.INNOODB_SYS_TABLES WHERE NAME='test/t1'\G
***** 1. row *****
      TABLE_ID: 44
      NAME: test/t1
      FLAG: 1
      N_COLS: 6
      SPACE: 30
      FILE_FORMAT: Antelope
      ROW_FORMAT: Compact
      ZIP_PAGE_SIZE: 0

mysql> SELECT * FROM INFORMATION_SCHEMA.INNOODB_SYS_TABLESPACES WHERE NAME='test/t1'\G
***** 1. row *****
      SPACE: 30
      NAME: test/t1
      FLAG: 0
      FILE_FORMAT: Antelope
      ROW_FORMAT: Compact or Redundant
      PAGE_SIZE: 16384
      ZIP_PAGE_SIZE: 0
```

## 14.10.4 Modifying the File Format

Each InnoDB tablespace file (with a name matching `*.ibd`) is tagged with the file format used to create its table and indexes. The way to modify the file format is to re-create the table and its indexes. The easiest way to recreate a table and its indexes is to use the following command on each table that you want to modify:

```
ALTER TABLE t ROW_FORMAT=format_name;
```

If you are modifying the file format to downgrade to an older MySQL version, there may be incompatibilities in table storage formats that require additional steps. For information about downgrading to a previous MySQL version, see [Section 2.11, “Downgrading MySQL”](#).

## 14.11 InnoDB Row Formats

The row format of a table determines how its rows are physically stored, which in turn can affect the performance of queries and DML operations. As more rows fit into a single disk page, queries and index lookups can work faster, less cache memory is required in the buffer pool, and less I/O is required to write out updated values.

The data in each table is divided into pages. The pages that make up each table are arranged in a tree data structure called a B-tree index. Table data and secondary indexes both use this type of structure. The B-tree index that represents an entire table is known as the clustered index, which is organized according to the primary key columns. The nodes of a clustered index data structure contain the values of all columns in the row. The nodes of a secondary index structure contain the values of index columns and primary key columns.

Variable-length columns are an exception to the rule that column values are stored in B-tree index nodes. Variable-length columns that are too long to fit on a B-tree page are stored on separately allocated disk pages called overflow pages. Such columns are referred to as off-page columns. The values of off-page columns are stored in singly-linked lists of overflow pages, with each such column having its own list of one or more overflow pages. Depending on column length, all or a prefix of variable-length column values are stored in the B-tree to avoid wasting storage and having to read a separate page.

The InnoDB storage engine supports four row formats: [REDUNDANT](#), [COMPACT](#), [DYNAMIC](#), and [COMPRESSED](#).

**Table 14.9 InnoDB Row Format Overview**

Row Format	Compact Storage Characteristics	Enhanced Variable-Length Column Storage	Large Index Key Prefix Support	Compression Support	Supported Tablespace Types	Required File Format
<a href="#">REDUNDANT</a>	No	No	No	No	system, file-per-table, general	Antelope or Barracuda
<a href="#">COMPACT</a>	Yes	No	No	No	system, file-per-table, general	Antelope or Barracuda
<a href="#">DYNAMIC</a>	Yes	Yes	Yes	No	system, file-per-table, general	Barracuda
<a href="#">COMPRESSED</a>	Yes	Yes	Yes	Yes	file-per-table, general	Barracuda

The topics that follow describe row format storage characteristics and how to define and determine the row format of a table.

- [REDUNDANT Row Format](#)
- [COMPACT Row Format](#)

- [DYNAMIC Row Format](#)
- [COMPRESSED Row Format](#)
- [Defining the Row Format of a Table](#)
- [Determining the Row Format of a Table](#)

## REDUNDANT Row Format

The [REDUNDANT](#) format provides compatibility with older versions of MySQL.

The [REDUNDANT](#) row format is supported by both [InnoDB](#) file formats ([Antelope](#) and [Barracuda](#)). For more information, see [Section 14.10, “InnoDB File-Format Management”](#).

Tables that use the [REDUNDANT](#) row format store the first 768 bytes of variable-length column values ([VARCHAR](#), [VARBINARY](#), and [BLOB](#) and [TEXT](#) types) in the index record within the B-tree node, with the remainder stored on overflow pages. Fixed-length columns greater than or equal to 768 bytes are encoded as variable-length columns, which can be stored off-page. For example, a [CHAR\(255\)](#) column can exceed 768 bytes if the maximum byte length of the character set is greater than 3, as it is with [utf8mb4](#).

If the value of a column is 768 bytes or less, an overflow page is not used, and some savings in I/O may result, since the value is stored entirely in the B-tree node. This works well for relatively short [BLOB](#) column values, but may cause B-tree nodes to fill with data rather than key values, reducing their efficiency. Tables with many [BLOB](#) columns could cause B-tree nodes to become too full, and contain too few rows, making the entire index less efficient than if rows were shorter or column values were stored off-page.

## REDUNDANT Row Format Storage Characteristics

The [REDUNDANT](#) row format has the following storage characteristics:

- Each index record contains a 6-byte header. The header is used to link together consecutive records, and for row-level locking.
- Records in the clustered index contain fields for all user-defined columns. In addition, there is a 6-byte transaction ID field and a 7-byte roll pointer field.
- If no primary key is defined for a table, each clustered index record also contains a 6-byte row ID field.
- Each secondary index record contains all the primary key columns defined for the clustered index key that are not in the secondary index.
- A record contains a pointer to each field of the record. If the total length of the fields in a record is less than 128 bytes, the pointer is one byte; otherwise, two bytes. The array of pointers is called the record directory. The area where the pointers point is the data part of the record.
- Internally, fixed-length character columns such as [CHAR\(10\)](#) are stored in fixed-length format. Trailing spaces are not truncated from [VARCHAR](#) columns.
- Fixed-length columns greater than or equal to 768 bytes are encoded as variable-length columns, which can be stored off-page. For example, a [CHAR\(255\)](#) column can exceed 768 bytes if the maximum byte length of the character set is greater than 3, as it is with [utf8mb4](#).
- An SQL [NULL](#) value reserves one or two bytes in the record directory. An SQL [NULL](#) value reserves zero bytes in the data part of the record if stored in a variable-length column. For a fixed-length column, the fixed length of the column is reserved in the data part of the record. Reserving fixed space for [NULL](#)



values permits columns to be updated in place from `NULL` to non-`NULL` values without causing index page fragmentation.

## COMPACT Row Format

The `COMPACT` row format reduces row storage space by about 20% compared to the `REDUNDANT` row format, at the cost of increasing CPU use for some operations. If your workload is a typical one that is limited by cache hit rates and disk speed, `COMPACT` format is likely to be faster. If the workload is limited by CPU speed, compact format might be slower.

The `COMPACT` row format is supported by both `InnoDB` file formats (`Antelope` and `Barracuda`). For more information, see [Section 14.10, "InnoDB File-Format Management"](#).

Tables that use the `COMPACT` row format store the first 768 bytes of variable-length column values (`VARCHAR`, `VARBINARY`, and `BLOB` and `TEXT` types) in the index record within the `B-tree` node, with the remainder stored on overflow pages. Fixed-length columns greater than or equal to 768 bytes are encoded as variable-length columns, which can be stored off-page. For example, a `CHAR(255)` column can exceed 768 bytes if the maximum byte length of the character set is greater than 3, as it is with `utf8mb4`.

If the value of a column is 768 bytes or less, an overflow page is not used, and some savings in I/O may result, since the value is stored entirely in the `B-tree` node. This works well for relatively short `BLOB` column values, but may cause `B-tree` nodes to fill with data rather than key values, reducing their efficiency. Tables with many `BLOB` columns could cause `B-tree` nodes to become too full, and contain too few rows, making the entire index less efficient than if rows were shorter or column values were stored off-page.

## COMPACT Row Format Storage Characteristics

The `COMPACT` row format has the following storage characteristics:

- Each index record contains a 5-byte header that may be preceded by a variable-length header. The header is used to link together consecutive records, and for row-level locking.
- The variable-length part of the record header contains a bit vector for indicating `NULL` columns. If the number of columns in the index that can be `NULL` is  $N$ , the bit vector occupies  $\text{CEILING}(N/8)$  bytes. (For example, if there are anywhere from 9 to 16 columns that can be `NULL`, the bit vector uses two bytes.) Columns that are `NULL` do not occupy space other than the bit in this vector. The variable-length part of the header also contains the lengths of variable-length columns. Each length takes one or two bytes, depending on the maximum length of the column. If all columns in the index are `NOT NULL` and have a fixed length, the record header has no variable-length part.
- For each non-`NULL` variable-length field, the record header contains the length of the column in one or two bytes. Two bytes are only needed if part of the column is stored externally in overflow pages or the maximum length exceeds 255 bytes and the actual length exceeds 127 bytes. For an externally stored column, the 2-byte length indicates the length of the internally stored part plus the 20-byte pointer to the externally stored part. The internal part is 768 bytes, so the length is 768+20. The 20-byte pointer stores the true length of the column.
- The record header is followed by the data contents of non-`NULL` columns.
- Records in the clustered index contain fields for all user-defined columns. In addition, there is a 6-byte transaction ID field and a 7-byte roll pointer field.
- If no primary key is defined for a table, each clustered index record also contains a 6-byte row ID field.
- Each secondary index record contains all the primary key columns defined for the clustered index key that are not in the secondary index. If any of the primary key columns are variable length, the record

header for each secondary index has a variable-length part to record their lengths, even if the secondary index is defined on fixed-length columns.

- Internally, for nonvariable-length character sets, fixed-length character columns such as `CHAR(10)` are stored in a fixed-length format.

Trailing spaces are not truncated from `VARCHAR` columns.

- Internally, for variable-length character sets such as `utf8mb3` and `utf8mb4`, InnoDB attempts to store `CHAR(N)` in  $N$  bytes by trimming trailing spaces. If the byte length of a `CHAR(N)` column value exceeds  $N$  bytes, trailing spaces are trimmed to a minimum of the column value byte length. The maximum length of a `CHAR(N)` column is the maximum character byte length  $\times N$ .

A minimum of  $N$  bytes is reserved for `CHAR(N)`. Reserving the minimum space  $N$  in many cases enables column updates to be done in place without causing index page fragmentation. By comparison, `CHAR(N)` columns occupy the maximum character byte length  $\times N$  when using the `REDUNDANT` row format.

Fixed-length columns greater than or equal to 768 bytes are encoded as variable-length fields, which can be stored off-page. For example, a `CHAR(255)` column can exceed 768 bytes if the maximum byte length of the character set is greater than 3, as it is with `utf8mb4`.

## DYNAMIC Row Format

The `DYNAMIC` row format offers the same storage characteristics as the `COMPACT` row format but adds enhanced storage capabilities for long variable-length columns and supports large index key prefixes.

The Barracuda file format supports the `DYNAMIC` row format. See [Section 14.10, “InnoDB File-Format Management”](#).

When a table is created with `ROW_FORMAT=DYNAMIC`, InnoDB can store long variable-length column values (for `VARCHAR`, `VARBINARY`, and `BLOB` and `TEXT` types) fully off-page, with the clustered index record containing only a 20-byte pointer to the overflow page. Fixed-length fields greater than or equal to 768 bytes are encoded as variable-length fields. For example, a `CHAR(255)` column can exceed 768 bytes if the maximum byte length of the character set is greater than 3, as it is with `utf8mb4`.

Whether columns are stored off-page depends on the page size and the total size of the row. When a row is too long, the longest columns are chosen for off-page storage until the clustered index record fits on the `B-tree` page. `TEXT` and `BLOB` columns that are less than or equal to 40 bytes are stored in line.

The `DYNAMIC` row format maintains the efficiency of storing the entire row in the index node if it fits (as do the `COMPACT` and `REDUNDANT` formats), but the `DYNAMIC` row format avoids the problem of filling B-tree nodes with a large number of data bytes of long columns. The `DYNAMIC` row format is based on the idea that if a portion of a long data value is stored off-page, it is usually most efficient to store the entire value off-page. With `DYNAMIC` format, shorter columns are likely to remain in the B-tree node, minimizing the number of overflow pages required for a given row.

The `DYNAMIC` row format supports index key prefixes up to 3072 bytes. This feature is controlled by the `innodb_large_prefix` variable, which is enabled by default. See the `innodb_large_prefix` variable description for more information.

Tables that use the `DYNAMIC` row format can be stored in the system tablespace, file-per-table tablespaces, and general tablespaces. To store `DYNAMIC` tables in the system tablespace, either disable `innodb_file_per_table` and use a regular `CREATE TABLE` or `ALTER TABLE` statement, or use the `TABLESPACE [=] innodb_system` table option with `CREATE TABLE` or `ALTER TABLE`. The `innodb_file_per_table` and `innodb_file_format` variables are not applicable to general

tablespaces, nor are they applicable when using the `TABLESPACE [=] innodb_system` table option to store `DYNAMIC` tables in the system tablespace.

## DYNAMIC Row Format Storage Characteristics

The `DYNAMIC` row format is a variation of the `COMPACT` row format. For storage characteristics, see [COMPACT Row Format Storage Characteristics](#).

## COMPRESSED Row Format

The `COMPRESSED` row format offers the same storage characteristics and capabilities as the `DYNAMIC` row format but adds support for table and index data compression.

The Barracuda file format supports the `COMPRESSED` row format. See [Section 14.10, “InnoDB File-Format Management”](#).

The `COMPRESSED` row format uses similar internal details for off-page storage as the `DYNAMIC` row format, with additional storage and performance considerations from the table and index data being compressed and using smaller page sizes. With the `COMPRESSED` row format, the `KEY_BLOCK_SIZE` option controls how much column data is stored in the clustered index, and how much is placed on overflow pages. For more information about the `COMPRESSED` row format, see [Section 14.9, “InnoDB Table and Page Compression”](#).

The `COMPRESSED` row format supports index key prefixes up to 3072 bytes. This feature is controlled by the `innodb_large_prefix` variable, which is enabled by default. See the `innodb_large_prefix` variable description for more information.

Tables that use the `COMPRESSED` row format can be created in file-per-table tablespaces or general tablespaces. The system tablespace does not support the `COMPRESSED` row format. To store a `COMPRESSED` table in a file-per-table tablespace, the `innodb_file_per_table` variable must be enabled and `innodb_file_format` must be set to `Barracuda`. The `innodb_file_per_table` and `innodb_file_format` variables are not applicable to general tablespaces. General tablespaces support all row formats with the caveat that compressed and uncompressed tables cannot coexist in the same general tablespace due to different physical page sizes. For more information about, see [Section 14.6.3.3, “General Tablespaces”](#).

## Compressed Row Format Storage Characteristics

The `COMPRESSED` row format is a variation of the `COMPACT` row format. For storage characteristics, see [COMPACT Row Format Storage Characteristics](#).

## Defining the Row Format of a Table

The default row format for InnoDB tables is defined by `innodb_default_row_format` variable, which has a default value of `DYNAMIC`. The default row format is used when the `ROW_FORMAT` table option is not defined explicitly or when `ROW_FORMAT=DEFAULT` is specified.

The row format of a table can be defined explicitly using the `ROW_FORMAT` table option in a `CREATE TABLE` or `ALTER TABLE` statement. For example:

```
CREATE TABLE t1 (c1 INT) ROW_FORMAT=DYNAMIC;
```

An explicitly defined `ROW_FORMAT` setting overrides the default row format. Specifying `ROW_FORMAT=DEFAULT` is equivalent to using the implicit default.

The `innodb_default_row_format` variable can be set dynamically:

## Defining the Row Format of a Table

```
mysql> SET GLOBAL innodb_default_row_format=DYNAMIC;
```

Valid `innodb_default_row_format` options include `DYNAMIC`, `COMPACT`, and `REDUNDANT`. The `COMPRESSED` row format, which is not supported for use in the system tablespace, cannot be defined as the default. It can only be specified explicitly in a `CREATE TABLE` or `ALTER TABLE` statement. Attempting to set the `innodb_default_row_format` variable to `COMPRESSED` returns an error:

```
mysql> SET GLOBAL innodb_default_row_format=COMPRESSED;
ERROR 1231 (42000): Variable 'innodb_default_row_format'
can't be set to the value of 'COMPRESSED'
```

Newly created tables use the row format defined by the `innodb_default_row_format` variable when a `ROW_FORMAT` option is not specified explicitly, or when `ROW_FORMAT=DEFAULT` is used. For example, the following `CREATE TABLE` statements use the row format defined by the `innodb_default_row_format` variable.

```
CREATE TABLE t1 (c1 INT);
```

```
CREATE TABLE t2 (c1 INT) ROW_FORMAT=DEFAULT;
```

When a `ROW_FORMAT` option is not specified explicitly, or when `ROW_FORMAT=DEFAULT` is used, an operation that rebuilds a table silently changes the row format of the table to the format defined by the `innodb_default_row_format` variable.

Table-rebuilding operations include `ALTER TABLE` operations that use `ALGORITHM=COPY` or `ALGORITHM=INPLACE` where table rebuilding is required. See [Section 14.13.1, "Online DDL Operations"](#) for more information. `OPTIMIZE TABLE` is also a table-rebuilding operation.

The following example demonstrates a table-rebuilding operation that silently changes the row format of a table created without an explicitly defined row format.

```
mysql> SELECT @@innodb_default_row_format;
+-----+
| @@innodb_default_row_format |
+-----+
| dynamic                      |
+-----+

mysql> CREATE TABLE t1 (c1 INT);

mysql> SELECT * FROM INFORMATION_SCHEMA.INNODB_SYS_TABLES WHERE NAME LIKE 'test/t1' \G
***** 1. row *****
      TABLE_ID: 54
        NAME: test/t1
        FLAG: 33
      N_COLS: 4
      SPACE: 35
  FILE_FORMAT: Barracuda
  ROW_FORMAT: Dynamic
ZIP_PAGE_SIZE: 0
  SPACE_TYPE: Single

mysql> SET GLOBAL innodb_default_row_format=COMPACT;

mysql> ALTER TABLE t1 ADD COLUMN (c2 INT);

mysql> SELECT * FROM INFORMATION_SCHEMA.INNODB_SYS_TABLES WHERE NAME LIKE 'test/t1' \G
***** 1. row *****
      TABLE_ID: 55
        NAME: test/t1
        FLAG: 1
      N_COLS: 5
      SPACE: 36
```

```
FILE_FORMAT: Antelope
ROW_FORMAT: Compact
ZIP_PAGE_SIZE: 0
SPACE_TYPE: Single
```

Consider the following potential issues before changing the row format of existing tables from [REDUNDANT](#) or [COMPACT](#) to [DYNAMIC](#).

- The [REDUNDANT](#) and [COMPACT](#) row formats support a maximum index key prefix length of 767 bytes whereas [DYNAMIC](#) and [COMPRESSED](#) row formats support an index key prefix length of 3072 bytes. In a replication environment, if the `innodb_default_row_format` variable is set to [DYNAMIC](#) on the source, and set to [COMPACT](#) on the replica, the following DDL statement, which does not explicitly define a row format, succeeds on the source but fails on the replica:

```
CREATE TABLE t1 (c1 INT PRIMARY KEY, c2 VARCHAR(5000), KEY i1(c2(3070)));
```

For related information, see [Section 14.23, “InnoDB Limits”](#).

- Importing a table that does not explicitly define a row format results in a schema mismatch error if the `innodb_default_row_format` setting on the source server differs from the setting on the destination server. For more information, [Section 14.6.1.3, “Importing InnoDB Tables”](#).

## Determining the Row Format of a Table

To determine the row format of a table, use `SHOW TABLE STATUS`:

```
mysql> SHOW TABLE STATUS IN test1\G
***** 1. row *****
      Name: t1
      Engine: InnoDB
      Version: 10
      Row_format: Dynamic
      Rows: 0
      Avg_row_length: 0
      Data_length: 16384
      Max_data_length: 0
      Index_length: 16384
      Data_free: 0
      Auto_increment: 1
      Create_time: 2016-09-14 16:29:38
      Update_time: NULL
      Check_time: NULL
      Collation: latin1_swedish_ci
      Checksum: NULL
      Create_options:
      Comment:
```

Alternatively, query the Information Schema `INNODB_SYS_TABLES` table:

```
mysql> SELECT NAME, ROW_FORMAT FROM INFORMATION_SCHEMA.INNODB_SYS_TABLES WHERE NAME='test1/t1';
+-----+-----+
| NAME      | ROW_FORMAT |
+-----+-----+
| test1/t1  | Dynamic    |
+-----+-----+
```

## 14.12 InnoDB Disk I/O and File Space Management

As a DBA, you must manage disk I/O to keep the I/O subsystem from becoming saturated, and manage disk space to avoid filling up storage devices. The [ACID](#) design model requires a certain amount of I/O that might seem redundant, but helps to ensure data reliability. Within these constraints, [InnoDB](#) tries to optimize the database work and the organization of disk files to minimize the amount of disk I/O.

Sometimes, I/O is postponed until the database is not busy, or until everything needs to be brought to a consistent state, such as during a database restart after a [fast shutdown](#).

This section discusses the main considerations for I/O and disk space with the default kind of MySQL tables (also known as [InnoDB](#) tables):

- Controlling the amount of background I/O used to improve query performance.
- Enabling or disabling features that provide extra durability at the expense of additional I/O.
- Organizing tables into many small files, a few larger files, or a combination of both.
- Balancing the size of redo log files against the I/O activity that occurs when the log files become full.
- How to reorganize a table for optimal query performance.

### 14.12.1 InnoDB Disk I/O

[InnoDB](#) uses asynchronous disk I/O where possible, by creating a number of threads to handle I/O operations, while permitting other database operations to proceed while the I/O is still in progress. On Linux and Windows platforms, [InnoDB](#) uses the available OS and library functions to perform “native” asynchronous I/O. On other platforms, [InnoDB](#) still uses I/O threads, but the threads may actually wait for I/O requests to complete; this technique is known as “simulated” asynchronous I/O.

#### Read-Ahead

If [InnoDB](#) can determine there is a high probability that data might be needed soon, it performs read-ahead operations to bring that data into the buffer pool so that it is available in memory. Making a few large read requests for contiguous data can be more efficient than making several small, spread-out requests. There are two read-ahead heuristics in [InnoDB](#):

- In sequential read-ahead, if [InnoDB](#) notices that the access pattern to a segment in the tablespace is sequential, it posts in advance a batch of reads of database pages to the I/O system.
- In random read-ahead, if [InnoDB](#) notices that some area in a tablespace seems to be in the process of being fully read into the buffer pool, it posts the remaining reads to the I/O system.

For information about configuring read-ahead heuristics, see [Section 14.8.3.4, “Configuring InnoDB Buffer Pool Prefetching \(Read-Ahead\)”](#).

#### Doublewrite Buffer

[InnoDB](#) uses a novel file flush technique involving a structure called the [doublewrite buffer](#), which is enabled by default in most cases (`innodb_doublewrite=ON`). It adds safety to recovery following an unexpected exit or power outage, and improves performance on most varieties of Unix by reducing the need for `fsync()` operations.

Before writing pages to a data file, [InnoDB](#) first writes them to a contiguous tablespace area called the doublewrite buffer. Only after the write and the flush to the doublewrite buffer has completed does [InnoDB](#) write the pages to their proper positions in the data file. If there is an operating system, storage subsystem, or unexpected `mysqld` process exit in the middle of a page write (causing a [torn page](#) condition), [InnoDB](#) can later find a good copy of the page from the doublewrite buffer during recovery.

If system tablespace files (“ibdata files”) are located on Fusion-io devices that support atomic writes, doublewrite buffering is automatically disabled and Fusion-io atomic writes are used for all data files. Because the doublewrite buffer setting is global, doublewrite buffering is also disabled for data files residing on non-Fusion-io hardware. This feature is only supported on Fusion-io hardware and is only

enabled for Fusion-io NVMFS on Linux. To take full advantage of this feature, an `innodb_flush_method` setting of `O_DIRECT` is recommended.

## 14.12.2 File Space Management

The data files that you define in the configuration file using the `innodb_data_file_path` configuration option form the `InnoDB system tablespace`. The files are logically concatenated to form the system tablespace. There is no striping in use. You cannot define where within the system tablespace your tables are allocated. In a newly created system tablespace, `InnoDB` allocates space starting from the first data file.

To avoid the issues that come with storing all tables and indexes inside the system tablespace, you can enable the `innodb_file_per_table` configuration option (the default), which stores each newly created table in a separate tablespace file (with extension `.ibd`). For tables stored this way, there is less fragmentation within the disk file, and when the table is truncated, the space is returned to the operating system rather than still being reserved by `InnoDB` within the system tablespace. For more information, see [Section 14.6.3.2, “File-Per-Table Tablespaces”](#).

You can also store tables in `general tablespaces`. General tablespaces are shared tablespaces created using `CREATE TABLESPACE` syntax. They can be created outside of the MySQL data directory, are capable of holding multiple tables, and support tables of all row formats. For more information, see [Section 14.6.3.3, “General Tablespaces”](#).

## Pages, Extents, Segments, and Tablespaces

Each tablespace consists of database `pages`. Every tablespace in a MySQL instance has the same `page size`. By default, all tablespaces have a page size of 16KB; you can reduce the page size to 8KB or 4KB by specifying the `innodb_page_size` option when you create the MySQL instance. You can also increase the page size to 32KB or 64KB. For more information, refer to the `innodb_page_size` documentation.

The pages are grouped into `extents` of size 1MB for pages up to 16KB in size (64 consecutive 16KB pages, or 128 8KB pages, or 256 4KB pages). For a page size of 32KB, extent size is 2MB. For page size of 64KB, extent size is 4MB. The “files” inside a tablespace are called `segments` in `InnoDB`. (These segments are different from the `rollback segment`, which actually contains many tablespace segments.)

When a segment grows inside the tablespace, `InnoDB` allocates the first 32 pages to it one at a time. After that, `InnoDB` starts to allocate whole extents to the segment. `InnoDB` can add up to 4 extents at a time to a large segment to ensure good sequentiality of data.

Two segments are allocated for each index in `InnoDB`. One is for nonleaf nodes of the `B-tree`, the other is for the leaf nodes. Keeping the leaf nodes contiguous on disk enables better sequential I/O operations, because these leaf nodes contain the actual table data.

Some pages in the tablespace contain bitmaps of other pages, and therefore a few extents in an `InnoDB` tablespace cannot be allocated to segments as a whole, but only as individual pages.

When you ask for available free space in the tablespace by issuing a `SHOW TABLE STATUS` statement, `InnoDB` reports the extents that are definitely free in the tablespace. `InnoDB` always reserves some extents for cleanup and other internal purposes; these reserved extents are not included in the free space.

When you delete data from a table, `InnoDB` contracts the corresponding B-tree indexes. Whether the freed space becomes available for other users depends on whether the pattern of deletes frees individual pages or extents to the tablespace. Dropping a table or deleting all rows from it is guaranteed to release the space to other users, but remember that deleted rows are physically removed only by the `purge` operation, which happens automatically some time after they are no longer needed for transaction rollbacks or consistent reads. (See [Section 14.3, “InnoDB Multi-Versioning”](#).)

## How Pages Relate to Table Rows

The maximum row length is slightly less than half a database page for 4KB, 8KB, 16KB, and 32KB `innodb_page_size` settings. For example, the maximum row length is slightly less than 8KB for the default 16KB InnoDB page size. For 64KB pages, the maximum row length is slightly less than 16KB.

If a row does not exceed the maximum row length, all of it is stored locally within the page. If a row exceeds the maximum row length, [variable-length columns](#) are chosen for external off-page storage until the row fits within the maximum row length limit. External off-page storage for variable-length columns differs by row format:

- *COMPACT and REDUNDANT Row Formats*

When a variable-length column is chosen for external off-page storage, InnoDB stores the first 768 bytes locally in the row, and the rest externally into overflow pages. Each such column has its own list of overflow pages. The 768-byte prefix is accompanied by a 20-byte value that stores the true length of the column and points into the overflow list where the rest of the value is stored. See [Section 14.11, “InnoDB Row Formats”](#).

- *DYNAMIC and COMPRESSED Row Formats*

When a variable-length column is chosen for external off-page storage, InnoDB stores a 20-byte pointer locally in the row, and the rest externally into overflow pages. See [Section 14.11, “InnoDB Row Formats”](#).

`LONGBLOB` and `LONGTEXT` columns must be less than 4GB, and the total row length, including `BLOB` and `TEXT` columns, must be less than 4GB.

### 14.12.3 InnoDB Checkpoints

Making your [log files](#) very large may reduce disk I/O during [checkpointing](#). It often makes sense to set the total size of the log files as large as the buffer pool or even larger. Although in the past large log files could make crash recovery take excessive time, starting with MySQL 5.5, performance enhancements to crash recovery make it possible to use large log files with fast startup after a crash. (Strictly speaking, this performance improvement is available for MySQL 5.1 with the InnoDB Plugin 1.0.7 and higher. It is with MySQL 5.5 that this improvement is available in the default InnoDB storage engine.)

## How Checkpoint Processing Works

InnoDB implements a [checkpoint](#) mechanism known as [fuzzy checkpointing](#). InnoDB flushes modified database pages from the buffer pool in small batches. There is no need to flush the buffer pool in one single batch, which would disrupt processing of user SQL statements during the checkpointing process.

During [crash recovery](#), InnoDB looks for a checkpoint label written to the log files. It knows that all modifications to the database before the label are present in the disk image of the database. Then InnoDB scans the log files forward from the checkpoint, applying the logged modifications to the database.

### 14.12.4 Defragmenting a Table

Random insertions into or deletions from a secondary index can cause the index to become fragmented. Fragmentation means that the physical ordering of the index pages on the disk is not close to the index ordering of the records on the pages, or that there are many unused pages in the 64-page blocks that were allocated to the index.

One symptom of fragmentation is that a table takes more space than it “should” take. How much that is exactly, is difficult to determine. All InnoDB data and indexes are stored in [B-trees](#), and their [fill factor](#) may



vary from 50% to 100%. Another symptom of fragmentation is that a table scan such as this takes more time than it “should” take:

```
SELECT COUNT(*) FROM t WHERE non_indexed_column <> 12345;
```

The preceding query requires MySQL to perform a full table scan, the slowest type of query for a large table.

To speed up index scans, you can periodically perform a “null” `ALTER TABLE` operation, which causes MySQL to rebuild the table:

```
ALTER TABLE tbl_name ENGINE=INNODB
```

You can also use `ALTER TABLE tbl_name FORCE` to perform a “null” alter operation that rebuilds the table.

Both `ALTER TABLE tbl_name ENGINE=INNODB` and `ALTER TABLE tbl_name FORCE` use [online DDL](#). For more information, see [Section 14.13, “InnoDB and Online DDL”](#).

Another way to perform a defragmentation operation is to use `mysqldump` to dump the table to a text file, drop the table, and reload it from the dump file.

If the insertions into an index are always ascending and records are deleted only from the end, the [InnoDB](#) filesystem management algorithm guarantees that fragmentation in the index does not occur.

## 14.12.5 Reclaiming Disk Space with TRUNCATE TABLE

To reclaim operating system disk space when [truncating](#) an [InnoDB](#) table, the table must be stored in its own `.ibd` file. For a table to be stored in its own `.ibd` file, `innodb_file_per_table` must be enabled when the table is created. Additionally, there cannot be a [foreign key](#) constraint between the table being truncated and other tables, otherwise the `TRUNCATE TABLE` operation fails. A foreign key constraint between two columns in the same table, however, is permitted.

When a table is truncated, it is dropped and re-created in a new `.ibd` file, and the freed space is returned to the operating system. This is in contrast to truncating [InnoDB](#) tables that are stored within the [InnoDB system tablespace](#) (tables created when `innodb_file_per_table=OFF`) and tables stored in shared [general tablespaces](#), where only [InnoDB](#) can use the freed space after the table is truncated.

The ability to truncate tables and return disk space to the operating system also means that [physical backups](#) can be smaller. Truncating tables that are stored in the system tablespace (tables created when `innodb_file_per_table=OFF`) or in a general tablespace leaves blocks of unused space in the tablespace.

## 14.13 InnoDB and Online DDL

The online DDL feature provides support for in-place table alterations and concurrent DML. Benefits of this feature include:

- Improved responsiveness and availability in busy production environments, where making a table unavailable for minutes or hours is not practical.
- The ability to adjust the balance between performance and concurrency during DDL operations using the `LOCK` clause. See [The LOCK clause](#).
- Less disk space usage and I/O overhead than the table-copy method.

Typically, you do not need to do anything special to enable online DDL. By default, MySQL performs the operation in place, as permitted, with as little locking as possible.

You can control aspects of a DDL operation using the [ALGORITHM](#) and [LOCK](#) clauses of the [ALTER TABLE](#) statement. These clauses are placed at the end of the statement, separated from the table and column specifications by commas. For example:

```
ALTER TABLE tbl_name ADD PRIMARY KEY (column), ALGORITHM=INPLACE, LOCK=NONE;
```

The [LOCK](#) clause is useful for fine-tuning the degree of concurrent access to the table. The [ALGORITHM](#) clause is primarily intended for performance comparisons and as a fallback to the older table-copying behavior in case you encounter any issues. For example:

- To avoid accidentally making the table unavailable for reads, writes, or both, specify a clause on the [ALTER TABLE](#) statement such as [LOCK=NONE](#) (permit reads and writes) or [LOCK=SHARED](#) (permit reads). The operation halts immediately if the requested level of concurrency is not available.
- To compare performance between algorithms, run a statement with [ALGORITHM=INPLACE](#) and [ALGORITHM=COPY](#). Alternatively, run a statement with the `old_alter_table` configuration option disabled and enabled.
- To avoid tying up the server with an [ALTER TABLE](#) operation that copies the table, include [ALGORITHM=INPLACE](#). The statement halts immediately if it cannot use the in-place mechanism.

### 14.13.1 Online DDL Operations

Online support details, syntax examples, and usage notes for DDL operations are provided under the following topics in this section.

- [Index Operations](#)
- [Primary Key Operations](#)
- [Column Operations](#)
- [Generated Column Operations](#)
- [Foreign Key Operations](#)
- [Table Operations](#)
- [Tablespace Operations](#)
- [Partitioning Operations](#)

#### Index Operations

The following table provides an overview of online DDL support for index operations. An asterisk indicates additional information, an exception, or a dependency. For details, see [Syntax and Usage Notes](#).

**Table 14.10 Online DDL Support for Index Operations**

Operation	In Place	Rebuilds Table	Permits Concurrent DML	Only Modifies Metadata
Creating or adding a secondary index	Yes	No	Yes	No
Dropping an index	Yes	No	Yes	Yes
Renaming an index	Yes	No	Yes	Yes
Adding a <a href="#">FULLTEXT</a> index	Yes*	No*	No	No

Operation	In Place	Rebuilds Table	Permits Concurrent DML	Only Modifies Metadata
Adding a <a href="#">SPATIAL</a> index	Yes	No	No	No
Changing the index type	Yes	No	Yes	Yes

## Syntax and Usage Notes

- Creating or adding a secondary index

```
CREATE INDEX name ON table (col_list);
```

```
ALTER TABLE tbl_name ADD INDEX name (col_list);
```

The table remains available for read and write operations while the index is being created. The [CREATE INDEX](#) statement only finishes after all transactions that are accessing the table are completed, so that the initial state of the index reflects the most recent contents of the table.

Online DDL support for adding secondary indexes means that you can generally speed the overall process of creating and loading a table and associated indexes by creating the table without secondary indexes, then adding secondary indexes after the data is loaded.

A newly created secondary index contains only the committed data in the table at the time the [CREATE INDEX](#) or [ALTER TABLE](#) statement finishes executing. It does not contain any uncommitted values, old versions of values, or values marked for deletion but not yet removed from the old index.

If the server exits while creating a secondary index, upon recovery, MySQL drops any partially created indexes. You must re-run the [ALTER TABLE](#) or [CREATE INDEX](#) statement.

Some factors affect the performance, space usage, and semantics of this operation. For details, see [Section 14.13.6, “Online DDL Limitations”](#).

- Dropping an index

```
DROP INDEX name ON table;
```

```
ALTER TABLE tbl_name DROP INDEX name;
```

The table remains available for read and write operations while the index is being dropped. The [DROP INDEX](#) statement only finishes after all transactions that are accessing the table are completed, so that the initial state of the index reflects the most recent contents of the table.

- Renaming an index

```
ALTER TABLE tbl_name RENAME INDEX old_index_name TO new_index_name, ALGORITHM=INPLACE, LOCK=NONE;
```

- Adding a [FULLTEXT](#) index

```
CREATE FULLTEXT INDEX name ON table(column);
```

Adding the first [FULLTEXT](#) index rebuilds the table if there is no user-defined [FTS\\_DOC\\_ID](#) column. Additional [FULLTEXT](#) indexes may be added without rebuilding the table.

- Adding a [SPATIAL](#) index

```
CREATE TABLE geom (g GEOMETRY NOT NULL);
ALTER TABLE geom ADD SPATIAL INDEX(g), ALGORITHM=INPLACE, LOCK=SHARED;
```

- Changing the index type (`USING {BTREE | HASH}`)

```
ALTER TABLE tbl_name DROP INDEX i1, ADD INDEX i1(key_part,...) USING BTREE, ALGORITHM=INPLACE;
```

## Primary Key Operations

The following table provides an overview of online DDL support for primary key operations. An asterisk indicates additional information, an exception, or a dependency. See [Syntax and Usage Notes](#).

**Table 14.11 Online DDL Support for Primary Key Operations**

Operation	In Place	Rebuilds Table	Permits Concurrent DML	Only Modifies Metadata
Adding a primary key	Yes*	Yes*	Yes	No
Dropping a primary key	No	Yes	No	No
Dropping a primary key and adding another	Yes	Yes	Yes	No

## Syntax and Usage Notes

- Adding a primary key

```
ALTER TABLE tbl_name ADD PRIMARY KEY (column), ALGORITHM=INPLACE, LOCK=NONE;
```

Rebuilds the table in place. Data is reorganized substantially, making it an expensive operation. `ALGORITHM=INPLACE` is not permitted under certain conditions if columns have to be converted to `NOT NULL`.

Restructuring the [clustered index](#) always requires copying of table data. Thus, it is best to define the [primary key](#) when you create a table, rather than issuing `ALTER TABLE ... ADD PRIMARY KEY` later.

When you create a `UNIQUE` or `PRIMARY KEY` index, MySQL must do some extra work. For `UNIQUE` indexes, MySQL checks that the table contains no duplicate values for the key. For a `PRIMARY KEY` index, MySQL also checks that none of the `PRIMARY KEY` columns contains a `NULL`.

When you add a primary key using the `ALGORITHM=COPY` clause, MySQL converts `NULL` values in the associated columns to default values: 0 for numbers, an empty string for character-based columns and BLOBs, and 0000-00-00 00:00:00 for `DATETIME`. This is a non-standard behavior that Oracle recommends you not rely on. Adding a primary key using `ALGORITHM=INPLACE` is only permitted when the `SQL_MODE` setting includes the `strict_trans_tables` or `strict_all_tables` flags; when the `SQL_MODE` setting is strict, `ALGORITHM=INPLACE` is permitted, but the statement can still fail if the requested primary key columns contain `NULL` values. The `ALGORITHM=INPLACE` behavior is more standard-compliant.

If you create a table without a primary key, `InnoDB` chooses one for you, which can be the first `UNIQUE` key defined on `NOT NULL` columns, or a system-generated key. To avoid uncertainty and the potential space requirement for an extra hidden column, specify the `PRIMARY KEY` clause as part of the `CREATE TABLE` statement.

MySQL creates a new clustered index by copying the existing data from the original table to a temporary table that has the desired index structure. Once the data is completely copied to the temporary table, the original table is renamed with a different temporary table name. The temporary table comprising the new

clustered index is renamed with the name of the original table, and the original table is dropped from the database.

The online performance enhancements that apply to operations on secondary indexes do not apply to the primary key index. The rows of an InnoDB table are stored in a [clustered index](#) organized based on the [primary key](#), forming what some database systems call an “index-organized table”. Because the table structure is closely tied to the primary key, redefining the primary key still requires copying the data.

When an operation on the primary key uses [ALGORITHM=INPLACE](#), even though the data is still copied, it is more efficient than using [ALGORITHM=COPY](#) because:

- No undo logging or associated redo logging is required for [ALGORITHM=INPLACE](#). These operations add overhead to DDL statements that use [ALGORITHM=COPY](#).
- The secondary index entries are pre-sorted, and so can be loaded in order.
- The change buffer is not used, because there are no random-access inserts into the secondary indexes.

If the server exits while creating a new clustered index, no data is lost, but you must complete the recovery process using the temporary tables that exist during the process. Since it is rare to re-create a clustered index or re-define primary keys on large tables, or to encounter a system crash during this operation, this manual does not provide information on recovering from this scenario.

- Dropping a primary key

```
ALTER TABLE tbl_name DROP PRIMARY KEY, ALGORITHM=COPY;
```

Only [ALGORITHM=COPY](#) supports dropping a primary key without adding a new one in the same [ALTER TABLE](#) statement.

- Dropping a primary key and adding another

```
ALTER TABLE tbl_name DROP PRIMARY KEY, ADD PRIMARY KEY (column), ALGORITHM=INPLACE, LOCK=NONE;
```

Data is reorganized substantially, making it an expensive operation.

## Column Operations

The following table provides an overview of online DDL support for column operations. An asterisk indicates additional information, an exception, or a dependency. For details, see [Syntax and Usage Notes](#).

**Table 14.12 Online DDL Support for Column Operations**

Operation	In Place	Rebuilds Table	Permits Concurrent DML	Only Modifies Metadata
Adding a column	Yes	Yes	Yes*	No
Dropping a column	Yes	Yes	Yes	No
Renaming a column	Yes	No	Yes*	Yes
Reordering columns	Yes	Yes	Yes	No
Setting a column default value	Yes	No	Yes	Yes
Changing the column data type	No	Yes	No	No

Operation	In Place	Rebuilds Table	Permits Concurrent DML	Only Modifies Metadata
Extending <code>VARCHAR</code> column size	Yes	No	Yes	Yes
Dropping the column default value	Yes	No	Yes	Yes
Changing the auto-increment value	Yes	No	Yes	No*
Making a column <code>NULL</code>	Yes	Yes*	Yes	No
Making a column <code>NOT NULL</code>	Yes*	Yes*	Yes	No
Modifying the definition of an <code>ENUM</code> or <code>SET</code> column	Yes	No	Yes	Yes

## Syntax and Usage Notes

- Adding a column

```
ALTER TABLE tbl_name ADD COLUMN column_name column_definition, ALGORITHM=INPLACE, LOCK=NONE;
```

Concurrent DML is not permitted when adding an `auto-increment` column. Data is reorganized substantially, making it an expensive operation. At a minimum, `ALGORITHM=INPLACE`, `LOCK=SHARED` is required.

- Dropping a column

```
ALTER TABLE tbl_name DROP COLUMN column_name, ALGORITHM=INPLACE, LOCK=NONE;
```

Data is reorganized substantially, making it an expensive operation.

- Renaming a column

```
ALTER TABLE tbl CHANGE old_col_name new_col_name data_type, ALGORITHM=INPLACE, LOCK=NONE;
```

To permit concurrent DML, keep the same data type and only change the column name.

When you keep the same data type and `[NOT] NULL` attribute, only changing the column name, the operation can always be performed online.

You can also rename a column that is part of a foreign key constraint. The foreign key definition is automatically updated to use the new column name. Renaming a column participating in a foreign key only works with `ALGORITHM=INPLACE`. If you use the `ALGORITHM=COPY` clause, or some other condition causes the operation to use `ALGORITHM=COPY`, the `ALTER TABLE` statement fails.

`ALGORITHM=INPLACE` is not supported for renaming a `generated column`.

- Reordering columns

To reorder columns, use `FIRST` or `AFTER` in `CHANGE` or `MODIFY` operations.

```
ALTER TABLE tbl_name MODIFY COLUMN col_name column_definition FIRST, ALGORITHM=INPLACE, LOCK=NONE;
```

Data is reorganized substantially, making it an expensive operation.

- Changing the column data type

```
ALTER TABLE tbl_name CHANGE c1 c1 BIGINT, ALGORITHM=COPY;
```

Changing the column data type is only supported with `ALGORITHM=COPY`.

- Extending `VARCHAR` column size

```
ALTER TABLE tbl_name CHANGE COLUMN c1 c1 VARCHAR(255), ALGORITHM=INPLACE, LOCK=NONE;
```

The number of length bytes required by a `VARCHAR` column must remain the same. For `VARCHAR` columns of 0 to 255 bytes in size, one length byte is required to encode the value. For `VARCHAR` columns of 256 bytes in size or more, two length bytes are required. As a result, in-place `ALTER TABLE` only supports increasing `VARCHAR` column size from 0 to 255 bytes, or from 256 bytes to a greater size. In-place `ALTER TABLE` does not support increasing the size of a `VARCHAR` column from less than 256 bytes to a size equal to or greater than 256 bytes. In this case, the number of required length bytes changes from 1 to 2, which is only supported by a table copy (`ALGORITHM=COPY`). For example, attempting to change `VARCHAR` column size for a single byte character set from `VARCHAR(255)` to `VARCHAR(256)` using in-place `ALTER TABLE` returns this error:

```
ALTER TABLE tbl_name ALGORITHM=INPLACE, CHANGE COLUMN c1 c1 VARCHAR(256);
ERROR 0A000: ALGORITHM=INPLACE is not supported. Reason: Cannot change
column type INPLACE. Try ALGORITHM=COPY.
```



#### Note

The byte length of a `VARCHAR` column is dependant on the byte length of the character set.

Decreasing `VARCHAR` size using in-place `ALTER TABLE` is not supported. Decreasing `VARCHAR` size requires a table copy (`ALGORITHM=COPY`).

- Setting a column default value

```
ALTER TABLE tbl_name ALTER COLUMN col SET DEFAULT literal, ALGORITHM=INPLACE, LOCK=NONE;
```

Only modifies table metadata. Default column values are stored in the `.frm` file for the table, not the `InnoDB` data dictionary.

- Dropping a column default value

```
ALTER TABLE tbl ALTER COLUMN col DROP DEFAULT, ALGORITHM=INPLACE, LOCK=NONE;
```

- Changing the auto-increment value

```
ALTER TABLE table AUTO_INCREMENT=next_value, ALGORITHM=INPLACE, LOCK=NONE;
```

Modifies a value stored in memory, not the data file.

In a distributed system using replication or sharding, you sometimes reset the auto-increment counter for a table to a specific value. The next row inserted into the table uses the specified value for its auto-increment column. You might also use this technique in a data warehousing environment where you periodically empty all the tables and reload them, and restart the auto-increment sequence from 1.

- Making a column `NULL`

```
ALTER TABLE tbl_name MODIFY COLUMN column_name data_type NULL, ALGORITHM=INPLACE, LOCK=NONE;
```

Rebuilds the table in place. Data is reorganized substantially, making it an expensive operation.

- Making a column `NOT NULL`

```
ALTER TABLE tbl_name MODIFY COLUMN column_name data_type NOT NULL, ALGORITHM=INPLACE, LOCK=NONE;
```

Rebuilds the table in place. `STRICT_ALL_TABLES` or `STRICT_TRANS_TABLES SQL_MODE` is required for the operation to succeed. The operation fails if the column contains `NULL` values. The server prohibits changes to foreign key columns that have the potential to cause loss of referential integrity. See [Section 13.1.8, “ALTER TABLE Statement”](#). Data is reorganized substantially, making it an expensive operation.

- Modifying the definition of an `ENUM` or `SET` column

```
CREATE TABLE t1 (c1 ENUM('a', 'b', 'c'));
ALTER TABLE t1 MODIFY COLUMN c1 ENUM('a', 'b', 'c', 'd'), ALGORITHM=INPLACE, LOCK=NONE;
```

Modifying the definition of an `ENUM` or `SET` column by adding new enumeration or set members to the *end* of the list of valid member values may be performed in place, as long as the storage size of the data type does not change. For example, adding a member to a `SET` column that has 8 members changes the required storage per value from 1 byte to 2 bytes; this requires a table copy. Adding members in the middle of the list causes renumbering of existing members, which requires a table copy.

## Generated Column Operations

The following table provides an overview of online DDL support for generated column operations. For details, see [Syntax and Usage Notes](#).

**Table 14.13 Online DDL Support for Generated Column Operations**

Operation	In Place	Rebuilds Table	Permits Concurrent DML	Only Modifies Metadata
Adding a <code>STORED</code> column	No	Yes	No	No
Modifying <code>STORED</code> column order	No	Yes	No	No
Dropping a <code>STORED</code> column	Yes	Yes	Yes	No
Adding a <code>VIRTUAL</code> column	Yes	No	Yes	Yes
Modifying <code>VIRTUAL</code> column order	No	Yes	No	No
Dropping a <code>VIRTUAL</code> column	Yes	No	Yes	Yes

## Syntax and Usage Notes

- Adding a `STORED` column

```
ALTER TABLE t1 ADD COLUMN (c2 INT GENERATED ALWAYS AS (c1 + 1) STORED), ALGORITHM=COPY;
```

`ADD COLUMN` is not an in-place operation for stored columns (done without using a temporary table) because the expression must be evaluated by the server.



- Modifying [STORED](#) column order

```
ALTER TABLE t1 MODIFY COLUMN c2 INT GENERATED ALWAYS AS (c1 + 1) STORED FIRST, ALGORITHM=COPY;
```

Rebuilds the table in place.

- Dropping a [STORED](#) column

```
ALTER TABLE t1 DROP COLUMN c2, ALGORITHM=INPLACE, LOCK=NONE;
```

Rebuilds the table in place.

- Adding a [VIRTUAL](#) column

```
ALTER TABLE t1 ADD COLUMN (c2 INT GENERATED ALWAYS AS (c1 + 1) VIRTUAL), ALGORITHM=INPLACE, LOCK=NONE;
```

Adding a virtual column is an in-place operation for non-partitioned tables. However, adding a virtual column cannot be combined with other [ALTER TABLE](#) actions.

Adding a [VIRTUAL](#) is not an in-place operation for partitioned tables.

- Modifying [VIRTUAL](#) column order

```
ALTER TABLE t1 MODIFY COLUMN c2 INT GENERATED ALWAYS AS (c1 + 1) VIRTUAL FIRST, ALGORITHM=COPY;
```

- Dropping a [VIRTUAL](#) column

```
ALTER TABLE t1 DROP COLUMN c2, ALGORITHM=INPLACE, LOCK=NONE;
```

Dropping a [VIRTUAL](#) column is an in-place operation for non-partitioned tables. However, dropping a virtual column cannot be combined with other [ALTER TABLE](#) actions.

Dropping a [VIRTUAL](#) is not an in-place operation for partitioned tables.

## Foreign Key Operations

The following table provides an overview of online DDL support for foreign key operations. An asterisk indicates additional information, an exception, or a dependency. For details, see [Syntax and Usage Notes](#).

**Table 14.14 Online DDL Support for Foreign Key Operations**

Operation	In Place	Rebuilds Table	Permits Concurrent DML	Only Modifies Metadata
Adding a foreign key constraint	Yes*	No	Yes	Yes
Dropping a foreign key constraint	Yes	No	Yes	Yes

## Syntax and Usage Notes

- Adding a foreign key constraint

The [INPLACE](#) algorithm is supported when [foreign\\_key\\_checks](#) is disabled. Otherwise, only the [COPY](#) algorithm is supported.

```
ALTER TABLE tbl1 ADD CONSTRAINT fk_name FOREIGN KEY index (col1)
REFERENCES tbl2(col2) referential_actions;
```

- Dropping a foreign key constraint

```
ALTER TABLE tbl DROP FOREIGN KEY fk_name;
```

Dropping a foreign key can be performed online with the `foreign_key_checks` option enabled or disabled.

If you do not know the names of the foreign key constraints on a particular table, issue the following statement and find the constraint name in the `CONSTRAINT` clause for each foreign key:

```
SHOW CREATE TABLE table\G
```

Or, query the Information Schema `TABLE_CONSTRAINTS` table and use the `CONSTRAINT_NAME` and `CONSTRAINT_TYPE` columns to identify the foreign key names.

You can also drop a foreign key and its associated index in a single statement:

```
ALTER TABLE table DROP FOREIGN KEY constraint, DROP INDEX index;
```



**Note**

If **foreign keys** are already present in the table being altered (that is, it is a **child table** containing a `FOREIGN KEY ... REFERENCE` clause), additional restrictions apply to online DDL operations, even those not directly involving the foreign key columns:

- An `ALTER TABLE` on the child table could wait for another transaction to commit, if a change to the parent table causes associated changes in the child table through an `ON UPDATE` or `ON DELETE` clause using the `CASCADE` or `SET NULL` parameters.
- In the same way, if a table is the **parent table** in a foreign key relationship, even though it does not contain any `FOREIGN KEY` clauses, it could wait for the `ALTER TABLE` to complete if an `INSERT`, `UPDATE`, or `DELETE` statement causes an `ON UPDATE` or `ON DELETE` action in the child table.

## Table Operations

The following table provides an overview of online DDL support for table operations. An asterisk indicates additional information, an exception, or a dependency. For details, see [Syntax and Usage Notes](#).

**Table 14.15 Online DDL Support for Table Operations**

Operation	In Place	Rebuilds Table	Permits Concurrent DML	Only Modifies Metadata
Changing the <code>ROW_FORMAT</code>	Yes	Yes	Yes	No
Changing the <code>KEY_BLOCK_SIZE</code>	Yes	Yes	Yes	No
Setting persistent table statistics	Yes	No	Yes	Yes
Specifying a character set	Yes	Yes*	Yes	No
Converting a character set	No	Yes*	No	No

Operation	In Place	Rebuilds Table	Permits Concurrent DML	Only Modifies Metadata
Optimizing a table	Yes*	Yes	Yes	No
Rebuilding with the <a href="#">FORCE</a> option	Yes*	Yes	Yes	No
Performing a null rebuild	Yes*	Yes	Yes	No
Renaming a table	Yes	No	Yes	Yes

## Syntax and Usage Notes

- Changing the [ROW\\_FORMAT](#)

```
ALTER TABLE tbl_name ROW_FORMAT = row_format, ALGORITHM=INPLACE, LOCK=NONE;
```

Data is reorganized substantially, making it an expensive operation.

For additional information about the [ROW\\_FORMAT](#) option, see [Table Options](#).

- Changing the [KEY\\_BLOCK\\_SIZE](#)

```
ALTER TABLE tbl_name KEY_BLOCK_SIZE = value, ALGORITHM=INPLACE, LOCK=NONE;
```

Data is reorganized substantially, making it an expensive operation.

For additional information about the [KEY\\_BLOCK\\_SIZE](#) option, see [Table Options](#).

- Setting persistent table statistics options

```
ALTER TABLE tbl_name STATS_PERSISTENT=0, STATS_SAMPLE_PAGES=20, STATS_AUTO_RECALC=1, ALGORITHM=INPLACE,
```

Only modifies table metadata.

Persistent statistics include [STATS\\_PERSISTENT](#), [STATS\\_AUTO\\_RECALC](#), and [STATS\\_SAMPLE\\_PAGES](#). For more information, see [Section 14.8.11.1, “Configuring Persistent Optimizer Statistics Parameters”](#).

- Specifying a character set

```
ALTER TABLE tbl_name CHARACTER SET = charset_name, ALGORITHM=INPLACE, LOCK=NONE;
```

Rebuilds the table if the new character encoding is different.

- Converting a character set

```
ALTER TABLE tbl_name CONVERT TO CHARACTER SET charset_name, ALGORITHM=COPY;
```

Rebuilds the table if the new character encoding is different.

- Optimizing a table

```
OPTIMIZE TABLE tbl_name;
```

In-place operation is not supported for tables with [FULLTEXT](#) indexes. The operation uses the [INPLACE](#) algorithm, but [ALGORITHM](#) and [LOCK](#) syntax is not permitted.

- Rebuilding a table with the [FORCE](#) option

```
ALTER TABLE tbl_name FORCE, ALGORITHM=INPLACE, LOCK=NONE;
```

Uses `ALGORITHM=INPLACE` as of MySQL 5.6.17. `ALGORITHM=INPLACE` is not supported for tables with `FULLTEXT` indexes.

- Performing a "null" rebuild

```
ALTER TABLE tbl_name ENGINE=InnoDB, ALGORITHM=INPLACE, LOCK=NONE;
```

Uses `ALGORITHM=INPLACE` as of MySQL 5.6.17. `ALGORITHM=INPLACE` is not supported for tables with `FULLTEXT` indexes.

- Renaming a table

```
ALTER TABLE old_tbl_name RENAME TO new_tbl_name, ALGORITHM=INPLACE, LOCK=NONE;
```

MySQL renames files that correspond to the table `tbl_name` without making a copy. (You can also use the `RENAME TABLE` statement to rename tables. See [Section 13.1.33, "RENAME TABLE Statement"](#).) Privileges granted specifically for the renamed table are not migrated to the new name. They must be changed manually.

## Tablespace Operations

The following table provides an overview of online DDL support for tablespace operations. For details, see [Syntax and Usage Notes](#).

**Table 14.16 Online DDL Support for Tablespace Operations**

Operation	In Place	Rebuilds Table	Permits Concurrent DML	Only Modifies Metadata
Enabling or disabling file-per-table tablespace encryption	No	Yes	No	No

## Syntax and Usage Notes

Enabling or disabling file-per-table tablespace encryption

```
ALTER TABLE tbl_name ENCRYPTION='Y', ALGORITHM=COPY;
```

Encryption is only supported for file-per-table tablespaces. For related information, see [Section 14.14, "InnoDB Data-at-Rest Encryption"](#).

## Partitioning Operations

With the exception of most `ALTER TABLE` partitioning clauses, online DDL operations for partitioned `InnoDB` tables follow the same rules that apply to regular `InnoDB` tables.

Most `ALTER TABLE` partitioning clauses do not go through the same internal online DDL API as regular non-partitioned `InnoDB` tables. As a result, online support for `ALTER TABLE` partitioning clauses varies.

The following table shows the online status for each `ALTER TABLE` partitioning statement. Regardless of the online DDL API that is used, MySQL attempts to minimize data copying and locking where possible.

`ALTER TABLE` partitioning options that use `ALGORITHM=COPY` or that only permit "`ALGORITHM=DEFAULT, LOCK=DEFAULT`", repartition the table using the `COPY` algorithm. In other words,

a new partitioned table is created with the new partitioning scheme. The newly created table includes any changes applied by the `ALTER TABLE` statement, and table data is copied into the new table structure.

**Table 14.17 Online DDL Support for Partitioning Operations**

Partitioning Clause	In Place	Permits DML	Notes
<code>PARTITION BY</code>	No	No	Permits <code>ALGORITHM=COPY</code> , <code>LOCK= { DEFAULT   SHARED   EXCLUSIVE }</code>
<code>ADD PARTITION</code>	No	No	Only permits <code>ALGORITHM=DEFAULT</code> , <code>LOCK=DEFAULT</code> . Does not copy existing data for tables partitioned by <code>RANGE</code> or <code>LIST</code> . Concurrent queries are permitted for tables partitioned by <code>HASH</code> or <code>LIST</code> . MySQL copies the data while holding a shared lock.
<code>DROP PARTITION</code>	No	No	Only permits <code>ALGORITHM=DEFAULT</code> , <code>LOCK=DEFAULT</code> . Does not copy existing data for tables partitioned by <code>RANGE</code> or <code>LIST</code> .
<code>DISCARD PARTITION</code>	No	No	Only permits <code>ALGORITHM=DEFAULT</code> , <code>LOCK=DEFAULT</code>
<code>IMPORT PARTITION</code>	No	No	Only permits <code>ALGORITHM=DEFAULT</code> , <code>LOCK=DEFAULT</code>
<code>TRUNCATE PARTITION</code>	Yes	Yes	Does not copy existing data. It merely deletes rows; it does not alter the definition of the table itself, or of any of its partitions.
<code>COALESCE PARTITION</code>	No	No	Only permits <code>ALGORITHM=DEFAULT</code> , <code>LOCK=DEFAULT</code> . Concurrent queries are permitted for tables partitioned by <code>HASH</code> or <code>LIST</code> , as MySQL copies the data while holding a shared lock.
<code>REORGANIZE PARTITION</code>	No	No	Only permits <code>ALGORITHM=DEFAULT</code> ,

Partitioning Clause	In Place	Permits DML	Notes
			<code>LOCK=DEFAULT</code> . Concurrent queries are permitted for tables partitioned by <code>LINEAR HASH</code> or <code>LIST</code> . MySQL copies data from affected partitions while holding a shared metadata lock.
<code>EXCHANGE PARTITION</code>	Yes	Yes	
<code>ANALYZE PARTITION</code>	Yes	Yes	
<code>CHECK PARTITION</code>	Yes	Yes	
<code>OPTIMIZE PARTITION</code>	No	No	<code>ALGORITHM</code> and <code>LOCK</code> clauses are ignored. Rebuilds the entire table. See <a href="#">Section 22.3.4, “Maintenance of Partitions”</a> .
<code>REBUILD PARTITION</code>	No	No	Only permits <code>ALGORITHM=DEFAULT</code> , <code>LOCK=DEFAULT</code> . Concurrent queries are permitted for tables partitioned by <code>LINEAR HASH</code> or <code>LIST</code> . MySQL copies data from affected partitions while holding a shared metadata lock.
<code>REPAIR PARTITION</code>	Yes	Yes	
<code>REMOVE PARTITIONING</code>	No	No	Permits <code>ALGORITHM=COPY</code> , <code>LOCK={DEFAULT   SHARED   EXCLUSIVE}</code>

Non-partitioning online `ALTER TABLE` operations on partitioned tables follow the same rules that apply to regular tables. However, `ALTER TABLE` performs online operations on each table partition, which causes increased demand on system resources due to operations being performed on multiple partitions.

For additional information about `ALTER TABLE` partitioning clauses, see [Partitioning Options](#), and [Section 13.1.8.1, “ALTER TABLE Partition Operations”](#). For information about partitioning in general, see [Chapter 22, Partitioning](#).

## 14.13.2 Online DDL Performance and Concurrency

Online DDL improves several aspects of MySQL operation:

- Applications that access the table are more responsive because queries and DML operations on the table can proceed while the DDL operation is in progress. Reduced locking and waiting for MySQL server resources leads to greater scalability, even for operations that are not involved in the DDL operation.

- In-place operations avoid the disk I/O and CPU cycles associated with the table-copy method, which minimizes overall load on the database. Minimizing load helps maintain good performance and high throughput during the DDL operation.
- In-place operations read less data into the buffer pool than the table-copy operations, which reduces purging of frequently accessed data from memory. Purging of frequently accessed data can cause a temporary performance dip after a DDL operation.

## The LOCK clause

By default, MySQL uses as little locking as possible during a DDL operation. The `LOCK` clause can be specified to enforce more restrictive locking, if required. If the `LOCK` clause specifies a less restrictive level of locking than is permitted for a particular DDL operation, the statement fails with an error. `LOCK` clauses are described below, in order of least to most restrictive:

- `LOCK=NONE`:

Permits concurrent queries and DML.

For example, use this clause for tables involving customer signups or purchases, to avoid making the tables unavailable during lengthy DDL operations.

- `LOCK=SHARED`:

Permits concurrent queries but blocks DML.

For example, use this clause on data warehouse tables, where you can delay data load operations until the DDL operation is finished, but queries cannot be delayed for long periods.

- `LOCK=DEFAULT`:

Permits as much concurrency as possible (concurrent queries, DML, or both). Omitting the `LOCK` clause is the same as specifying `LOCK=DEFAULT`.

Use this clause when you know that the default locking level of the DDL statement does not cause availability problems for the table.

- `LOCK=EXCLUSIVE`:

Blocks concurrent queries and DML.

Use this clause if the primary concern is finishing the DDL operation in the shortest amount of time possible, and concurrent query and DML access is not necessary. You might also use this clause if the server is supposed to be idle, to avoid unexpected table accesses.

## Online DDL and Metadata Locks

Online DDL operations can be viewed as having three phases:

- *Phase 1: Initialization*

In the initialization phase, the server determines how much concurrency is permitted during the operation, taking into account storage engine capabilities, operations specified in the statement, and user-specified `ALGORITHM` and `LOCK` options. During this phase, a shared upgradeable metadata lock is taken to protect the current table definition.

- *Phase 2: Execution*

In this phase, the statement is prepared and executed. Whether the metadata lock is upgraded to exclusive depends on the factors assessed in the initialization phase. If an exclusive metadata lock is required, it is only taken briefly during statement preparation.

- *Phase 3: Commit Table Definition*

In the commit table definition phase, the metadata lock is upgraded to exclusive to evict the old table definition and commit the new one. Once granted, the duration of the exclusive metadata lock is brief.

Due to the exclusive metadata lock requirements outlined above, an online DDL operation may have to wait for concurrent transactions that hold metadata locks on the table to commit or rollback. Transactions started before or during the DDL operation can hold metadata locks on the table being altered. In the case of a long running or inactive transaction, an online DDL operation can time out waiting for an exclusive metadata lock. Additionally, a pending exclusive metadata lock requested by an online DDL operation blocks subsequent transactions on the table.

The following example demonstrates an online DDL operation waiting for an exclusive metadata lock, and how a pending metadata lock blocks subsequent transactions on the table.

#### Session 1:

```
mysql> CREATE TABLE t1 (c1 INT) ENGINE=InnoDB;
mysql> START TRANSACTION;
mysql> SELECT * FROM t1;
```

The session 1 `SELECT` statement takes a shared metadata lock on table t1.

#### Session 2:

```
mysql> ALTER TABLE t1 ADD COLUMN x INT, ALGORITHM=INPLACE, LOCK=NONE;
```

The online DDL operation in session 2, which requires an exclusive metadata lock on table t1 to commit table definition changes, must wait for the session 1 transaction to commit or roll back.

#### Session 3:

```
mysql> SELECT * FROM t1;
```

The `SELECT` statement issued in session 3 is blocked waiting for the exclusive metadata lock requested by the `ALTER TABLE` operation in session 2 to be granted.

You can use `SHOW FULL PROCESSLIST` to determine if transactions are waiting for a metadata lock.

```
mysql> SHOW FULL PROCESSLIST\G
...
***** 2. row *****
  Id: 5
  User: root
  Host: localhost
  db: test
Command: Query
  Time: 44
  State: Waiting for table metadata lock
  Info: ALTER TABLE t1 ADD COLUMN x INT, ALGORITHM=INPLACE, LOCK=NONE
...
***** 4. row *****
  Id: 7
  User: root
  Host: localhost
  db: test
Command: Query
  Time: 5
```



```
State: Waiting for table metadata lock
Info: SELECT * FROM t1
4 rows in set (0.00 sec)
```

Metadata lock information is also exposed through the Performance Schema `metadata_locks` table, which provides information about metadata lock dependencies between sessions, the metadata lock a session is waiting for, and the session that currently holds the metadata lock. For more information, see [Section 25.12.12.1, “The metadata\\_locks Table”](#).

## Online DDL Performance

The performance of a DDL operation is largely determined by whether the operation is performed in place and whether it rebuilds the table.

To assess the relative performance of a DDL operation, you can compare results using `ALGORITHM=INPLACE` with results using `ALGORITHM=COPY`. Alternatively, you can compare results with `old_alter_table` disabled and enabled.

For DDL operations that modify table data, you can determine whether a DDL operation performs changes in place or performs a table copy by looking at the “rows affected” value displayed after the command finishes. For example:

- Changing the default value of a column (fast, does not affect the table data):

```
Query OK, 0 rows affected (0.07 sec)
```

- Adding an index (takes time, but `0 rows affected` shows that the table is not copied):

```
Query OK, 0 rows affected (21.42 sec)
```

- Changing the data type of a column (takes substantial time and requires rebuilding all the rows of the table):

```
Query OK, 1671168 rows affected (1 min 35.54 sec)
```

Before running a DDL operation on a large table, check whether the operation is fast or slow as follows:

1. Clone the table structure.
2. Populate the cloned table with a small amount of data.
3. Run the DDL operation on the cloned table.
4. Check whether the “rows affected” value is zero or not. A nonzero value means the operation copies table data, which might require special planning. For example, you might do the DDL operation during a period of scheduled downtime, or on each replica server one at a time.



### Note

For a greater understanding of the MySQL processing associated with a DDL operation, examine Performance Schema and `INFORMATION_SCHEMA` tables related to `InnoDB` before and after DDL operations to see the number of physical reads, writes, memory allocations, and so on.

Performance Schema stage events can be used to monitor `ALTER TABLE` progress. See [Section 14.17.1, “Monitoring ALTER TABLE Progress for InnoDB Tables Using Performance Schema”](#).

Because there is some processing work involved with recording the changes made by concurrent DML operations, then applying those changes at the end, an online DDL operation could take longer overall than

the table-copy mechanism that blocks table access from other sessions. The reduction in raw performance is balanced against better responsiveness for applications that use the table. When evaluating the techniques for changing table structure, consider end-user perception of performance, based on factors such as load times for web pages.

### 14.13.3 Online DDL Space Requirements

Online DDL operations have the following space requirements:

- Temporary log files:

A temporary log file records concurrent DML when an online DDL operation creates an index or alters a table. The temporary log file is extended as required by the value of `innodb_sort_buffer_size` up to a maximum specified by `innodb_online_alter_log_max_size`. If the operation takes a long time and concurrent DML modifies the table so much that the size of the temporary log file exceeds the value of `innodb_online_alter_log_max_size`, the online DDL operation fails with a `DB_ONLINE_LOG_TOO_BIG` error and uncommitted concurrent DML operations are rolled back. A large `innodb_online_alter_log_max_size` setting permits more DML during an online DDL operation, but it also extends the period of time at the end of the DDL operation when the table is locked to apply logged DML.

The `innodb_sort_buffer_size` variable also defines the size of the temporary log file read buffer and write buffer.

- Temporary sort files:

Online DDL operations that rebuild the table write temporary sort files to the MySQL temporary directory (`$TMPDIR` on Unix, `%TEMP%` on Windows, or the directory specified by `--tmpdir`) during index creation. Temporary sort files are not created in the directory that contains the original table. Each temporary sort file is large enough to hold one column of data, and each sort file is removed when its data is merged into the final table or index. Operations involving temporary sort files may require temporary space equal to the amount of data in the table plus indexes. An error is reported if online DDL operation uses all of the available disk space on the file system where the data directory resides.

If the MySQL temporary directory is not large enough to hold the sort files, set `tmpdir` to a different directory. Alternatively, define a separate temporary directory for online DDL operations using `innodb_tmpdir`. This option was introduced in MySQL 5.7.11 to help avoid temporary directory overflows that could occur as a result of large temporary sort files.

- Intermediate table files:

Some online DDL operations that rebuild the table create a temporary intermediate table file in the same directory as the original table. An intermediate table file may require space equal to the size of the original table. Intermediate table file names begin with `#sql-ib` prefix and only appear briefly during the online DDL operation.

The `innodb_tmpdir` option is not applicable to intermediate table files.

### 14.13.4 Simplifying DDL Statements with Online DDL

Before the introduction of [online DDL](#), it was common practice to combine many DDL operations into a single `ALTER TABLE` statement. Because each `ALTER TABLE` statement involved copying and rebuilding the table, it was more efficient to make several changes to the same table at once, since those changes could all be done with a single rebuild operation for the table. The downside was that SQL code involving DDL operations was harder to maintain and to reuse in different scripts. If the specific changes were

different each time, you might have to construct a new complex `ALTER TABLE` for each slightly different scenario.

For DDL operations that can be done in place, you can separate them into individual `ALTER TABLE` statements for easier scripting and maintenance, without sacrificing efficiency. For example, you might take a complicated statement such as:

```
ALTER TABLE t1 ADD INDEX i1(c1), ADD UNIQUE INDEX i2(c2),
CHANGE c4_old_name c4_new_name INTEGER UNSIGNED;
```

and break it down into simpler parts that can be tested and performed independently, such as:

```
ALTER TABLE t1 ADD INDEX i1(c1);
ALTER TABLE t1 ADD UNIQUE INDEX i2(c2);
ALTER TABLE t1 CHANGE c4_old_name c4_new_name INTEGER UNSIGNED NOT NULL;
```

You might still use multi-part `ALTER TABLE` statements for:

- Operations that must be performed in a specific sequence, such as creating an index followed by a foreign key constraint that uses that index.
- Operations all using the same specific `LOCK` clause, that you want to either succeed or fail as a group.
- Operations that cannot be performed in place, that is, that still use the table-copy method.
- Operations for which you specify `ALGORITHM=COPY` or `old_alter_table=1`, to force the table-copying behavior if needed for precise backward-compatibility in specialized scenarios.

## 14.13.5 Online DDL Failure Conditions

The failure of an online DDL operation is typically due to one of the following conditions:

- An `ALGORITHM` clause specifies an algorithm that is not compatible with the particular type of DDL operation or storage engine.
- A `LOCK` clause specifies a low degree of locking (`SHARED` or `NONE`) that is not compatible with the particular type of DDL operation.
- A timeout occurs while waiting for an `exclusive lock` on the table, which may be needed briefly during the initial and final phases of the DDL operation.
- The `tmpdir` or `innodb_tmpdir` file system runs out of disk space, while MySQL writes temporary sort files on disk during index creation. For more information, see [Section 14.13.3, “Online DDL Space Requirements”](#).
- The operation takes a long time and concurrent DML modifies the table so much that the size of the temporary online log exceeds the value of the `innodb_online_alter_log_max_size` configuration option. This condition causes a `DB_ONLINE_LOG_TOO_BIG` error.
- Concurrent DML makes changes to the table that are allowed with the original table definition, but not with the new one. The operation only fails at the very end, when MySQL tries to apply all the changes from concurrent DML statements. For example, you might insert duplicate values into a column while a unique index is being created, or you might insert `NULL` values into a column while creating a `primary key` index on that column. The changes made by the concurrent DML take precedence, and the `ALTER TABLE` operation is effectively `rolled back`.

## 14.13.6 Online DDL Limitations

The following limitations apply to online DDL operations:

- The table is copied when creating an index on a `TEMPORARY TABLE`.
- The `ALTER TABLE` clause `LOCK=NONE` is not permitted if there are `ON . . . CASCADE` or `ON . . . SET NULL` constraints on the table.
- Before an online DDL operation can finish, it must wait for transactions that hold metadata locks on the table to commit or roll back. An online DDL operation may briefly require an exclusive metadata lock on the table during its execution phase, and always requires one in the final phase of the operation when updating the table definition. Consequently, transactions holding metadata locks on the table can cause an online DDL operation to block. The transactions that hold metadata locks on the table may have been started before or during the online DDL operation. A long running or inactive transaction that holds a metadata lock on the table can cause an online DDL operation to timeout.
- An online DDL operation on a table in a foreign key relationship does not wait for a transaction executing on the other table in the foreign key relationship to commit or rollback. The transaction holds an exclusive metadata lock on the table it is updating and shared metadata lock on the foreign-key-related table (required for foreign key checking). The shared metadata lock permits the online DDL operation to proceed but blocks the operation in its final phase, when an exclusive metadata lock is required to update the table definition. This scenario can result in deadlocks as other transactions wait for the online DDL operation to finish.
- When running an online DDL operation, the thread that runs the `ALTER TABLE` statement applies an online log of DML operations that were run concurrently on the same table from other connection threads. When the DML operations are applied, it is possible to encounter a duplicate key entry error (`ERROR 1062 (23000): Duplicate entry`), even if the duplicate entry is only temporary and would be reverted by a later entry in the online log. This is similar to the idea of a foreign key constraint check in InnoDB in which constraints must hold during a transaction.
- `OPTIMIZE TABLE` for an InnoDB table is mapped to an `ALTER TABLE` operation to rebuild the table and update index statistics and free unused space in the clustered index. Secondary indexes are not created as efficiently because keys are inserted in the order they appeared in the primary key. `OPTIMIZE TABLE` is supported with the addition of online DDL support for rebuilding regular and partitioned InnoDB tables.
- Tables created before MySQL 5.6 that include temporal columns (`DATE`, `DATETIME` or `TIMESTAMP`) and have not been rebuilt using `ALGORITHM=COPY` do not support `ALGORITHM=INPLACE`. In this case, an `ALTER TABLE . . . ALGORITHM=INPLACE` operation returns the following error:

```
ERROR 1846 (0A000): ALGORITHM=INPLACE is not supported.
Reason: Cannot change column type INPLACE. Try ALGORITHM=COPY.
```

- The following limitations are generally applicable to online DDL operations on large tables that involve rebuilding the table:
  - There is no mechanism to pause an online DDL operation or to throttle I/O or CPU usage for an online DDL operation.
  - Rollback of an online DDL operation can be expensive should the operation fail.
  - Long running online DDL operations can cause replication lag. An online DDL operation must finish running on the source before it is run on the replica. Also, DML that was processed concurrently on the source is only processed on the replica after the DDL operation on the replica is completed.

For additional information related to running online DDL operations on large tables, see [Section 14.13.2, “Online DDL Performance and Concurrency”](#).

## 14.14 InnoDB Data-at-Rest Encryption

InnoDB supports data-at-rest encryption for [file-per-table](#) tablespaces.

- [About Data-at-Rest Encryption](#)
- [Encryption Prerequisites](#)
- [Enabling File-Per-Table Tablespace Encryption](#)
- [Master Key Rotation](#)
- [Encryption and Recovery](#)
- [Exporting Encrypted Tablespaces](#)
- [Encryption and Replication](#)
- [Identifying Encrypted Tablespaces](#)
- [Encryption Usage Notes](#)
- [Encryption Limitations](#)

## About Data-at-Rest Encryption

InnoDB uses a two tier encryption key architecture, consisting of a master encryption key and tablespace keys. When a tablespace is encrypted, a tablespace key is encrypted and stored in the tablespace header. When an application or authenticated user wants to access encrypted data, InnoDB uses a master encryption key to decrypt the tablespace key. The decrypted version of a tablespace key never changes, but the master encryption key can be changed as required. This action is referred to as *master key rotation*.

The data-at-rest encryption feature relies on a keyring plugin for master encryption key management.

All MySQL editions provide a [keyring\\_file](#) plugin, which stores keyring data in a file local to the server host.

MySQL Enterprise Edition offers additional keyring plugins:

- [keyring\\_encrypted\\_file](#): Stores keyring data in an encrypted, password-protected file local to the server host.
- [keyring\\_okv](#): A KMIP 1.1 plugin for use with KMIP-compatible back end keyring storage products. Supported KMIP-compatible products include centralized key management solutions such as Oracle Key Vault, Gemalto KeySecure, Thales Vormetric key management server, and Fernetix Key Orchestration.
- [keyring\\_aws](#): Communicates with the Amazon Web Services Key Management Service (AWS KMS) as a back end for key generation and uses a local file for key storage.



### Warning

For encryption key management, the [keyring\\_file](#) and [keyring\\_encrypted\\_file](#) plugins are not intended as a regulatory compliance solution. Security standards such as PCI, FIPS, and others require use of key management systems to secure, manage, and protect encryption keys in key vaults or hardware security modules (HSMs).

A secure and robust encryption key management solution is critical for security and for compliance with various security standards. When the data-at-rest encryption feature uses a centralized key management solution, the feature is referred to as “MySQL Enterprise Transparent Data Encryption (TDE)”.

The data-at-rest encryption feature supports the Advanced Encryption Standard (AES) block-based encryption algorithm. It uses Electronic Codebook (ECB) block encryption mode for tablespace key encryption and Cipher Block Chaining (CBC) block encryption mode for data encryption.

For frequently asked questions about the data-at-rest encryption feature, see [Section A.17, “MySQL 5.7 FAQ: InnoDB Data-at-Rest Encryption”](#).

## Encryption Prerequisites

- A keyring plugin must be installed and configured. Keyring plugin installation is performed at startup using the `early-plugin-load` option. Early loading ensures that the plugin is available prior to initialization of the InnoDB storage engine. For keyring plugin installation and configuration instructions, see [Section 6.4.4, “The MySQL Keyring”](#).

Only one keyring plugin should be enabled at a time. Enabling multiple keyring plugins is unsupported and results may not be as anticipated.



### Important

Once encrypted tablespaces are created in a MySQL instance, the keyring plugin that was loaded when creating the encrypted tablespace must continue to be loaded at startup using the `early-plugin-load` option. Failing to do so results in errors when starting the server and during InnoDB recovery.

To verify that a keyring plugin is active, use the `SHOW PLUGINS` statement or query the Information Schema `PLUGINS` table. For example:

```
mysql> SELECT PLUGIN_NAME, PLUGIN_STATUS
FROM INFORMATION_SCHEMA.PLUGINS
WHERE PLUGIN_NAME LIKE 'keyring%';
+-----+-----+
| PLUGIN_NAME | PLUGIN_STATUS |
+-----+-----+
| keyring_file | ACTIVE        |
+-----+-----+
```

- When encrypting production data, ensure that you take steps to prevent loss of the master encryption key. *If the master encryption key is lost, data stored in encrypted tablespace files is unrecoverable.* If you use the `keyring_file` or `keyring_encrypted_file` plugin, create a backup of the keyring data file immediately after creating the first encrypted tablespace, before master key rotation, and after master key rotation. The `keyring_file_data` configuration option defines the keyring data file location for the `keyring_file` plugin. The `keyring_encrypted_file_data` configuration option defines the keyring data file location for the `keyring_encrypted_file` plugin. If you use the `keyring_okv` or `keyring_aws` plugin, ensure that you have performed the necessary configuration. For instructions, see [Section 6.4.4, “The MySQL Keyring”](#).

## Enabling File-Per-Table Tablespace Encryption

To enable encryption for a new file-per-table tablespace, specify the `ENCRYPTION` option in a `CREATE TABLE` statement. The following example assumes that `innodb_file_per_table` is enabled.

```
mysql> CREATE TABLE t1 (c1 INT) ENCRYPTION='Y';
```

To enable encryption for an existing file-per-table tablespace, specify the `ENCRYPTION` option in an `ALTER TABLE` statement.

```
mysql> ALTER TABLE t1 ENCRYPTION='Y';
```

To disable encryption for file-per-table tablespace, set `ENCRYPTION='N'` using `ALTER TABLE`.

```
mysql> ALTER TABLE t1 ENCRYPTION='N';
```

## Master Key Rotation

The master encryption key should be rotated periodically and whenever you suspect that the key has been compromised.

Master key rotation is an atomic, instance-level operation. Each time the master encryption key is rotated, all tablespace keys in the MySQL instance are re-encrypted and saved back to their respective tablespace headers. As an atomic operation, re-encryption must succeed for all tablespace keys once a rotation operation is initiated. If master key rotation is interrupted by a server failure, [InnoDB](#) rolls the operation forward on server restart. For more information, see [Encryption and Recovery](#).

Rotating the master encryption key only changes the master encryption key and re-encrypts tablespace keys. It does not decrypt or re-encrypt associated tablespace data.

Rotating the master encryption key requires the [SUPER](#) privilege.

To rotate the master encryption key, run:

```
mysql> ALTER INSTANCE ROTATE INNODB MASTER KEY;
```

[ALTER INSTANCE ROTATE INNODB MASTER KEY](#) supports concurrent DML. However, it cannot be run concurrently with tablespace encryption operations, and locks are taken to prevent conflicts that could arise from concurrent execution. If an [ALTER INSTANCE ROTATE INNODB MASTER KEY](#) operation is running, it must finish before a tablespace encryption operation can proceed, and vice versa.

## Encryption and Recovery

If a server failure occurs during an encryption operation, the operation is rolled forward when the server is restarted.

If a server failure occurs during master key rotation, [InnoDB](#) continues the operation on server restart.

The keyring plugin must be loaded prior to storage engine initialization so that the information necessary to decrypt tablespace data pages can be retrieved from tablespace headers before [InnoDB](#) initialization and recovery activities access tablespace data. (See [Encryption Prerequisites](#).)

When [InnoDB](#) initialization and recovery begin, the master key rotation operation resumes. Due to the server failure, some tablespace keys may already be encrypted using the new master encryption key. [InnoDB](#) reads the encryption data from each tablespace header, and if the data indicates that the tablespace key is encrypted using the old master encryption key, [InnoDB](#) retrieves the old key from the keyring and uses it to decrypt the tablespace key. [InnoDB](#) then re-encrypts the tablespace key using the new master encryption key and saves the re-encrypted tablespace key back to the tablespace header.

## Exporting Encrypted Tablespaces

When an encrypted tablespace is exported, [InnoDB](#) generates a *transfer key* that is used to encrypt the tablespace key. The encrypted tablespace key and transfer key are stored in a `tablespace_name.cfp` file. This file together with the encrypted tablespace file is required to perform an import operation. On import, [InnoDB](#) uses the transfer key to decrypt the tablespace key in the `tablespace_name.cfp` file. For related information, see [Section 14.6.1.3, “Importing InnoDB Tables”](#).

## Encryption and Replication

- The [ALTER INSTANCE ROTATE INNODB MASTER KEY](#) statement is only supported in replication environments where the source and replicas run a version of MySQL that supports at-rest data encryption.

- Successful `ALTER INSTANCE ROTATE INNODB MASTER KEY` statements are written to the binary log for replication on replicas.
- If an `ALTER INSTANCE ROTATE INNODB MASTER KEY` statement fails, it is not logged to the binary log and is not replicated on replicas.
- Replication of an `ALTER INSTANCE ROTATE INNODB MASTER KEY` operation fails if the keyring plugin is installed on the source but not on the replica.
- If the `keyring_file` or `keyring_encrypted_file` plugin is installed on both the source and a replica but the replica does not have a keyring data file, the replicated `ALTER INSTANCE ROTATE INNODB MASTER KEY` statement creates the keyring data file on the replica, assuming the keyring file data is not cached in memory. `ALTER INSTANCE ROTATE INNODB MASTER KEY` uses keyring file data that is cached in memory, if available.

## Identifying Encrypted Tablespaces

When the `ENCRYPTION` option is specified in a `CREATE TABLE` or `ALTER TABLE` statement, it is recorded in the `CREATE_OPTIONS` column of the Information Schema `TABLES` table. This column can be queried to identify tables that reside in encrypted file-per-table tablespaces.

```
mysql> SELECT TABLE_SCHEMA, TABLE_NAME, CREATE_OPTIONS FROM INFORMATION_SCHEMA.TABLES
WHERE CREATE_OPTIONS LIKE '%ENCRYPTION%';
+-----+-----+-----+
| TABLE_SCHEMA | TABLE_NAME | CREATE_OPTIONS |
+-----+-----+-----+
| test          | t1          | ENCRYPTION="Y" |
+-----+-----+-----+
```

Query `INFORMATION_SCHEMA.INNODB_SYS_TABLESPACES` to retrieve information about the tablespace associated with a particular schema and table.

```
mysql> SELECT SPACE, NAME, SPACE_TYPE FROM INFORMATION_SCHEMA.INNODB_SYS_TABLESPACES WHERE NAME='test/t1';
+-----+-----+-----+
| SPACE | NAME   | SPACE_TYPE |
+-----+-----+-----+
| 3     | test/t1 | Single     |
+-----+-----+-----+
```

## Encryption Usage Notes

- Plan appropriately when altering an existing tablespace with the `ENCRYPTION` option. The table is rebuilt using the `COPY` algorithm. The `INPLACE` algorithm is not supported.
- If the server exits or is stopped during normal operation, it is recommended to restart the server using the same encryption settings that were configured previously.
- The first master encryption key is generated when the first new or existing tablespace is encrypted.
- Master key rotation re-encrypts tablespace keys but does not change the tablespace key itself. To change a tablespace key, you must disable and re-enable encryption, which is an `ALGORITHM=COPY` operation that rebuilds the table.
- If a table is created with both the `COMPRESSION` and `ENCRYPTION` options, compression is performed before tablespace data is encrypted.
- If a keyring data file (the file named by `keyring_file_data` or `keyring_encrypted_file_data`) is empty or missing, the first execution of `ALTER INSTANCE ROTATE INNODB MASTER KEY` creates a master encryption key.



- Uninstalling the `keyring_file` or `keyring_encrypted_file` plugin does not remove an existing keyring data file.
- It is recommended that you not place a keyring data file under the same directory as tablespace data files.
- Modifying the `keyring_file_data` or `keyring_encrypted_file_data` setting at runtime or when restarting the server can cause previously encrypted tablespaces to become inaccessible, resulting in lost data.

## Encryption Limitations

- Advanced Encryption Standard (AES) is the only supported encryption algorithm. InnoDB data-at-rest encryption uses Electronic Codebook (ECB) block encryption mode for tablespace key encryption and Cipher Block Chaining (CBC) block encryption mode for data encryption. Padding is not used with CBC block encryption mode. Instead, InnoDB ensures that the text to be encrypted is a multiple of the block size.
- Altering the `ENCRYPTION` attribute of a table is performed using the `COPY` algorithm. The `INPLACE` algorithm is not supported.
- Encryption is only supported for `file-per-table` tablespaces. Encryption is not supported for other tablespace types including `general tablespaces` and the `system tablespace`.
- You cannot move or copy a table from an encrypted `file-per-table` tablespace to a tablespace type that does not support encryption.
- Encryption only applies to data in the tablespace. Data is not encrypted in the redo log, undo log, or binary log.
- It is not permitted to change the storage engine of a table that resides in, or previously resided in, an encrypted tablespace.
- Encryption is not supported for the InnoDB `FULLTEXT` index tables that are created implicitly when adding a `FULLTEXT` index. For related information, see [InnoDB Full-Text Index Tables](#).

## 14.15 InnoDB Startup Options and System Variables

- System variables that are true or false can be enabled at server startup by naming them, or disabled by using a `--skip-` prefix. For example, to enable or disable the InnoDB adaptive hash index, you can use `--innodb-adaptive-hash-index` or `--skip-innodb-adaptive-hash-index` on the command line, or `innodb_adaptive_hash_index` or `skip_innodb_adaptive_hash_index` in an option file.
- System variables that take a numeric value can be specified as `--var_name=value` on the command line or as `var_name=value` in option files.
- Many system variables can be changed at runtime (see [Section 5.1.8.2, “Dynamic System Variables”](#)).
- For information about `GLOBAL` and `SESSION` variable scope modifiers, refer to the `SET` statement documentation.
- Certain options control the locations and layout of the InnoDB data files. [Section 14.8.1, “InnoDB Startup Configuration”](#) explains how to use these options.
- Some options, which you might not use initially, help tune InnoDB performance characteristics based on machine capacity and your database [workload](#).

- For more information on specifying options and system variables, see [Section 4.2.2, “Specifying Program Options”](#).

**Table 14.18 InnoDB Option and Variable Reference**

Name	Cmd-Line	Option File	System Var	Status Var	Var Scope	Dynamic
daemon_memcached_enable	Yes	Yes	Yes		Global	No
daemon_memcached_engine_name	Yes	Yes	Yes		Global	No
daemon_memcached_engine_path	Yes	Yes	Yes		Global	No
daemon_memcached_option	Yes	Yes	Yes		Global	No
daemon_memcached_r_batch_size	Yes	Yes	Yes		Global	No
daemon_memcached_w_batch_size	Yes	Yes	Yes		Global	No
foreign_key_checks			Yes		Both	Yes
ignore_builtin_innodb	Yes	Yes	Yes		Global	No
innodb	Yes	Yes				
innodb_adaptive_flushing	Yes	Yes	Yes		Global	Yes
innodb_adaptive_flushing_lwm	Yes	Yes	Yes		Global	Yes
innodb_adaptive_hash_index	Yes	Yes	Yes		Global	Yes
innodb_adaptive_hash_index_parts	Yes	Yes	Yes		Global	No
innodb_adaptive_max_sleep_delay	Yes	Yes	Yes		Global	Yes
innodb_api_bk_commit_interval	Yes	Yes	Yes		Global	Yes
innodb_api_disable_rowlock	Yes	Yes	Yes		Global	No
innodb_api_enable_binlog	Yes	Yes	Yes		Global	No
innodb_api_enable_mdls	Yes	Yes	Yes		Global	No
innodb_api_trx_level	Yes	Yes	Yes		Global	Yes
innodb_autoextend_increment	Yes	Yes	Yes		Global	Yes
innodb_autoinc_lock_mode	Yes	Yes	Yes		Global	No
InnoDB_available_undo_logs				Yes	Global	No
innodb_background_drop_list_empty	Yes	Yes	Yes		Global	Yes
InnoDB_buffer_pool_bytes_data				Yes	Global	No
InnoDB_buffer_pool_bytes_dirty				Yes	Global	No
innodb_buffer_chunk_size	Yes	Yes	Yes		Global	No
innodb_buffer_dump_at_shutdown	Yes	Yes	Yes		Global	Yes
innodb_buffer_dump_now	Yes	Yes	Yes		Global	Yes
innodb_buffer_dump_pct	Yes	Yes	Yes		Global	Yes
InnoDB_buffer_pool_dump_status				Yes	Global	No
innodb_buffer_filename	Yes	Yes	Yes		Global	Yes
innodb_buffer_instances	Yes	Yes	Yes		Global	No
innodb_buffer_load_abort	Yes	Yes	Yes		Global	Yes
innodb_buffer_load_at_startup	Yes	Yes	Yes		Global	No
innodb_buffer_load_now	Yes	Yes	Yes		Global	Yes

## InnoDB Startup Options and System Variables

Name	Cmd-Line	Option File	System Var	Status Var	Var Scope	Dynamic
InnoDB_buffer_pool_load_status				Yes	Global	No
InnoDB_buffer_pool_pages_data				Yes	Global	No
InnoDB_buffer_pool_pages_dirty				Yes	Global	No
InnoDB_buffer_pool_pages_flushed				Yes	Global	No
InnoDB_buffer_pool_pages_free				Yes	Global	No
InnoDB_buffer_pool_pages_latched				Yes	Global	No
InnoDB_buffer_pool_pages_misc				Yes	Global	No
InnoDB_buffer_pool_pages_total				Yes	Global	No
InnoDB_buffer_pool_read_ahead				Yes	Global	No
InnoDB_buffer_pool_read_ahead_evicted				Yes	Global	No
InnoDB_buffer_pool_read_ahead_rnd				Yes	Global	No
InnoDB_buffer_pool_read_requests				Yes	Global	No
InnoDB_buffer_pool_reads				Yes	Global	No
InnoDB_buffer_pool_resize_status				Yes	Global	No
innodb_buffer_pool_size	Yes	Yes	Yes		Global	Varies
InnoDB_buffer_pool_wait_free				Yes	Global	No
InnoDB_buffer_pool_write_requests				Yes	Global	No
innodb_change_buffer_max_size	Yes	Yes	Yes		Global	Yes
innodb_change_buffering	Yes	Yes	Yes		Global	Yes
innodb_change_buffering_debug	Yes	Yes	Yes		Global	Yes
innodb_checksum_algorithm	Yes	Yes	Yes		Global	Yes
innodb_checksums	Yes	Yes	Yes		Global	No
innodb_cmp_per_index_enabled	Yes	Yes	Yes		Global	Yes
innodb_commit_concurrency	Yes	Yes	Yes		Global	Yes
innodb_compressed_debug	Yes	Yes	Yes		Global	Yes
innodb_compression_failure_threshold_pct	Yes	Yes	Yes		Global	Yes
innodb_compression_level	Yes	Yes	Yes		Global	Yes
innodb_compression_pad_pct_max	Yes	Yes	Yes		Global	Yes
innodb_concurrency_tickets	Yes	Yes	Yes		Global	Yes
innodb_data_file_path	Yes	Yes	Yes		Global	No
InnoDB_data_fsyncs				Yes	Global	No
innodb_data_home_dir	Yes	Yes	Yes		Global	No
InnoDB_data_pending_fsyncs				Yes	Global	No
InnoDB_data_pending_reads				Yes	Global	No
InnoDB_data_pending_writes				Yes	Global	No
InnoDB_data_read				Yes	Global	No
InnoDB_data_reads				Yes	Global	No
InnoDB_data_writes				Yes	Global	No

InnoDB Startup Options and System Variables

Name	Cmd-Line	Option File	System Var	Status Var	Var Scope	Dynamic
InnoDB_data_written				Yes	Global	No
InnoDB_dblwr_pages_written				Yes	Global	No
InnoDB_dblwr_writes				Yes	Global	No
innodb_deadlock_detect	Yes	Yes	Yes		Global	Yes
innodb_default_file_format	Yes	Yes	Yes		Global	Yes
innodb_disable_size_buffer_pool	Yes	Yes	Yes		Global	Yes
innodb_disable_sort_file_cache	Yes	Yes	Yes		Global	Yes
innodb_doublewrite	Yes	Yes	Yes		Global	No
innodb_fast_shutdown	Yes	Yes	Yes		Global	Yes
innodb_file_make_page_dirty_default	Yes	Yes	Yes		Global	Yes
innodb_file_format	Yes	Yes	Yes		Global	Yes
innodb_file_format_check	Yes	Yes	Yes		Global	No
innodb_file_format_max	Yes	Yes	Yes		Global	Yes
innodb_file_per_table	Yes	Yes	Yes		Global	Yes
innodb_fill_factor	Yes	Yes	Yes		Global	Yes
innodb_flush_log_at_timeout	Yes	Yes	Yes		Global	Yes
innodb_flush_log_at_trx_commit	Yes	Yes	Yes		Global	Yes
innodb_flush_method	Yes	Yes	Yes		Global	No
innodb_flush_neighbors	Yes	Yes	Yes		Global	Yes
innodb_flush_sync	Yes	Yes	Yes		Global	Yes
innodb_flushing_loop_loops	Yes	Yes	Yes		Global	Yes
innodb_force_load_corrupted	Yes	Yes	Yes		Global	No
innodb_force_recovery	Yes	Yes	Yes		Global	No
innodb_ft_aux_table			Yes		Global	Yes
innodb_ft_cache_size	Yes	Yes	Yes		Global	No
innodb_ft_enable_diag_print	Yes	Yes	Yes		Global	Yes
innodb_ft_enable_stopword	Yes	Yes	Yes		Both	Yes
innodb_ft_max_index_size	Yes	Yes	Yes		Global	No
innodb_ft_min_index_size	Yes	Yes	Yes		Global	No
innodb_ft_num_ords_optimize	Yes	Yes	Yes		Global	Yes
innodb_ft_result_cache_limit	Yes	Yes	Yes		Global	Yes
innodb_ft_server_stopword_table	Yes	Yes	Yes		Global	Yes
innodb_ft_sort_degree	Yes	Yes	Yes		Global	No
innodb_ft_total_cache_size	Yes	Yes	Yes		Global	No
innodb_ft_user_stopword_table	Yes	Yes	Yes		Both	Yes
InnoDB_have_atomic_builtins				Yes	Global	No
innodb_io_capacity	Yes	Yes	Yes		Global	Yes
innodb_io_capacity_max	Yes	Yes	Yes		Global	Yes

## InnoDB Startup Options and System Variables

Name	Cmd-Line	Option File	System Var	Status Var	Var Scope	Dynamic
innodb_large_prefix	Yes	Yes	Yes		Global	Yes
innodb_limit_operations	Yes	Yes	Yes		Global	Yes
innodb_lock_wait_timeout	Yes	Yes	Yes		Both	Yes
innodb_locks_unsafe_for_binlog	Yes	Yes	Yes		Global	No
innodb_log_buffer_size	Yes	Yes	Yes		Global	No
innodb_log_checkpoint_now	Yes	Yes	Yes		Global	Yes
innodb_log_checksums	Yes	Yes	Yes		Global	Yes
innodb_log_compressed_pages	Yes	Yes	Yes		Global	Yes
innodb_log_file_size	Yes	Yes	Yes		Global	No
innodb_log_files_in_group	Yes	Yes	Yes		Global	No
innodb_log_group_home_dir	Yes	Yes	Yes		Global	No
InnoDB_log_waits				Yes	Global	No
innodb_log_writeahead_size	Yes	Yes	Yes		Global	Yes
InnoDB_log_write_requests				Yes	Global	No
InnoDB_log_writes				Yes	Global	No
innodb_lru_scan_depth	Yes	Yes	Yes		Global	Yes
innodb_max_dirty_pages_pct	Yes	Yes	Yes		Global	Yes
innodb_max_dirty_pages_pct_for_ddl	Yes	Yes	Yes		Global	Yes
innodb_max_purge_lag	Yes	Yes	Yes		Global	Yes
innodb_max_purge_lag_delay	Yes	Yes	Yes		Global	Yes
innodb_max_undo_log_size	Yes	Yes	Yes		Global	Yes
innodb_merge_threshold_set	Yes	Yes	Yes		Global	Yes
innodb_monitor_enable	Yes	Yes	Yes		Global	Yes
innodb_monitor_enable_ddl	Yes	Yes	Yes		Global	Yes
innodb_monitor_enable_io	Yes	Yes	Yes		Global	Yes
innodb_monitor_enable_all	Yes	Yes	Yes		Global	Yes
InnoDB_num_open_files				Yes	Global	No
innodb_numa_memleave	Yes	Yes	Yes		Global	No
innodb_old_block_size_pct	Yes	Yes	Yes		Global	Yes
innodb_old_block_size_time	Yes	Yes	Yes		Global	Yes
innodb_online_log_max_size	Yes	Yes	Yes		Global	Yes
innodb_open_files	Yes	Yes	Yes		Global	No
innodb_optimize_fulltext_only	Yes	Yes	Yes		Global	Yes
InnoDB_os_log_fsyncs				Yes	Global	No
InnoDB_os_log_pending_fsyncs				Yes	Global	No
InnoDB_os_log_pending_writes				Yes	Global	No
InnoDB_os_log_written				Yes	Global	No
innodb_page_cleaners	Yes	Yes	Yes		Global	No

InnoDB Startup Options and System Variables

Name	Cmd-Line	Option File	System Var	Status Var	Var Scope	Dynamic
InnoDB_page_size				Yes	Global	No
innodb_page_size	Yes	Yes	Yes		Global	No
InnoDB_pages_created				Yes	Global	No
InnoDB_pages_read				Yes	Global	No
InnoDB_pages_written				Yes	Global	No
innodb_print_all_deadlocks	Yes	Yes	Yes		Global	Yes
innodb_purge_flush_size	Yes	Yes	Yes		Global	Yes
innodb_purge_flush_truncate_frequency	Yes	Yes	Yes		Global	Yes
innodb_purge_threads	Yes	Yes	Yes		Global	No
innodb_random_read_ahead	Yes	Yes	Yes		Global	Yes
innodb_read_ahead_threshold	Yes	Yes	Yes		Global	Yes
innodb_read_io_threads	Yes	Yes	Yes		Global	No
innodb_read_only	Yes	Yes	Yes		Global	No
innodb_replication_delay	Yes	Yes	Yes		Global	Yes
innodb_rollback_timeout	Yes	Yes	Yes		Global	No
innodb_rollback_segments	Yes	Yes	Yes		Global	Yes
InnoDB_row_lock_current_waits				Yes	Global	No
InnoDB_row_lock_time				Yes	Global	No
InnoDB_row_lock_time_avg				Yes	Global	No
InnoDB_row_lock_time_max				Yes	Global	No
InnoDB_row_lock_waits				Yes	Global	No
InnoDB_rows_deleted				Yes	Global	No
InnoDB_rows_inserted				Yes	Global	No
InnoDB_rows_read				Yes	Global	No
InnoDB_rows_updated				Yes	Global	No
innodb_saved_page_number_bug	Yes	Yes	Yes		Global	Yes
innodb_sort_buffer_size	Yes	Yes	Yes		Global	No
innodb_spin_wait_delay	Yes	Yes	Yes		Global	Yes
innodb_stats_automem_recalc	Yes	Yes	Yes		Global	Yes
innodb_stats_index_delete_mask	Yes	Yes	Yes		Global	Yes
innodb_stats_method	Yes	Yes	Yes		Global	Yes
innodb_stats_on_metadata	Yes	Yes	Yes		Global	Yes
innodb_stats_persistent	Yes	Yes	Yes		Global	Yes
innodb_stats_persistent_sample_pages	Yes	Yes	Yes		Global	Yes
innodb_stats_sample_pages	Yes	Yes	Yes		Global	Yes
innodb_stats_transient_sample_pages	Yes	Yes	Yes		Global	Yes
innodb-status-file	Yes	Yes				

Name	Cmd-Line	Option File	System Var	Status Var	Var Scope	Dynamic
innodb_status	Yes	Yes	Yes		Global	Yes
innodb_status_locks	Yes	Yes	Yes		Global	Yes
innodb_strict_mode	Yes	Yes	Yes		Both	Yes
innodb_support_large_page	Yes	Yes	Yes		Both	Yes
innodb_sync_ahead_size	Yes	Yes	Yes		Global	No
innodb_sync_debug	Yes	Yes	Yes		Global	No
innodb_sync_spin_loops	Yes	Yes	Yes		Global	Yes
innodb_table_locks	Yes	Yes	Yes		Both	Yes
innodb_temp_data_file_path	Yes	Yes	Yes		Global	No
innodb_thread_concurrency	Yes	Yes	Yes		Global	Yes
innodb_thread_spin_delay	Yes	Yes	Yes		Global	Yes
innodb_tmpdir	Yes	Yes	Yes		Both	Yes
InnoDB_truncated_status_writes				Yes	Global	No
innodb_trx_purge_view_updates	Yes	Yes	Yes		Global	Yes
innodb_trx_rseg_slots_debug	Yes	Yes	Yes		Global	Yes
innodb_undo_history	Yes	Yes	Yes		Global	No
innodb_undo_logs_truncate	Yes	Yes	Yes		Global	Yes
innodb_undo_logs	Yes	Yes	Yes		Global	Yes
innodb_undo_tablespaces	Yes	Yes	Yes		Global	No
innodb_use_native_aio	Yes	Yes	Yes		Global	No
innodb_version			Yes		Global	No
innodb_write_io_threads	Yes	Yes	Yes		Global	No
unique_checks			Yes		Both	Yes

## InnoDB Command Options

- `--innodb[=value]`

Command-Line Format	<code>--innodb[=value]</code>
Deprecated	Yes
Type	Enumeration
Default Value	<code>ON</code>
Valid Values	<code>OFF</code> <code>ON</code> <code>FORCE</code>

Controls loading of the `InnoDB` storage engine, if the server was compiled with `InnoDB` support. This option has a tristate format, with possible values of `OFF`, `ON`, or `FORCE`. See [Section 5.5.1, “Installing and Uninstalling Plugins”](#).

To disable `InnoDB`, use `--innodb=OFF` or `--skip-innodb`. In this case, because the default storage engine is `InnoDB`, the server does not start unless you also use `--default-storage-engine` and `--default-tmp-storage-engine` to set the default to some other engine for both permanent and `TEMPORARY` tables.

The `InnoDB` storage engine can no longer be disabled, and the `--innodb=OFF` and `--skip-innodb` options are deprecated and have no effect. Their use results in a warning. You should expect these options to be removed in a future MySQL release.

- `--innodb-status-file`

Command-Line Format	<code>--innodb-status-file[={OFF ON}]</code>
Type	Boolean
Default Value	<code>OFF</code>

The `--innodb-status-file` startup option controls whether `InnoDB` creates a file named `innodb_status.pid` in the data directory and writes `SHOW ENGINE INNODB STATUS` output to it every 15 seconds, approximately.

The `innodb_status.pid` file is not created by default. To create it, start `mysqld` with the `--innodb-status-file` option. `InnoDB` removes the file when the server is shut down normally. If an abnormal shutdown occurs, the status file may have to be removed manually.

The `--innodb-status-file` option is intended for temporary use, as `SHOW ENGINE INNODB STATUS` output generation can affect performance, and the `innodb_status.pid` file can become quite large over time.

For related information, see [Section 14.18.2, “Enabling InnoDB Monitors”](#).

- `--skip-innodb`

Disable the `InnoDB` storage engine. See the description of `--innodb`.

## InnoDB System Variables

- `daemon_memcached_enable_binlog`

Command-Line Format	<code>--daemon-memcached-enable-binlog[={OFF ON}]</code>
System Variable	<code>daemon_memcached_enable_binlog</code>
Scope	Global
Dynamic	No
Type	Boolean
Default Value	<code>OFF</code>

Enable this option on the source server to use the `InnoDB memcached` plugin (`daemon_memcached`) with the MySQL [binary log](#). This option can only be set at server startup. You must also enable the MySQL binary log on the source server using the `--log-bin` option.

For more information, see [Section 14.21.6, “The InnoDB memcached Plugin and Replication”](#).

- `daemon_memcached_engine_lib_name`



Command-Line Format	<code>--daemon-memcached-engine-lib-name=file_name</code>
System Variable	<code>daemon_memcached_engine_lib_name</code>
Scope	Global
Dynamic	No
Type	File name
Default Value	<code>innodb_engine.so</code>

Specifies the shared library that implements the `InnoDB memcached` plugin.

For more information, see [Section 14.21.3, “Setting Up the InnoDB memcached Plugin”](#).

- `daemon_memcached_engine_lib_path`

Command-Line Format	<code>--daemon-memcached-engine-lib-path=dir_name</code>
System Variable	<code>daemon_memcached_engine_lib_path</code>
Scope	Global
Dynamic	No
Type	Directory name
Default Value	<code>NULL</code>

The path of the directory containing the shared library that implements the `InnoDB memcached` plugin. The default value is `NULL`, representing the MySQL plugin directory. You should not need to modify this parameter unless specifying a `memcached` plugin for a different storage engine that is located outside of the MySQL plugin directory.

For more information, see [Section 14.21.3, “Setting Up the InnoDB memcached Plugin”](#).

- `daemon_memcached_option`

Command-Line Format	<code>--daemon-memcached-option=options</code>
System Variable	<code>daemon_memcached_option</code>
Scope	Global
Dynamic	No
Type	String
Default Value	

Used to pass space-separated `memcached` options to the underlying `memcached` memory object caching daemon on startup. For example, you might change the port that `memcached` listens on, reduce the maximum number of simultaneous connections, change the maximum memory size for a key-value pair, or enable debugging messages for the error log.

See [Section 14.21.3, “Setting Up the InnoDB memcached Plugin”](#) for usage details. For information about `memcached` options, refer to the `memcached` man page.

- `daemon_memcached_r_batch_size`

Command-Line Format	<code>--daemon-memcached-r-batch-size=#</code>
System Variable	<code>daemon_memcached_r_batch_size</code>
Scope	Global
Dynamic	No
Type	Integer
Default Value	1
Minimum Value	1
Maximum Value	1073741824

Specifies how many `memcached` read operations (`get` operations) to perform before doing a `COMMIT` to start a new transaction. Counterpart of `daemon_memcached_w_batch_size`.

This value is set to 1 by default, so that any changes made to the table through SQL statements are immediately visible to `memcached` operations. You might increase it to reduce the overhead from frequent commits on a system where the underlying table is only being accessed through the `memcached` interface. If you set the value too large, the amount of undo or redo data could impose some storage overhead, as with any long-running transaction.

For more information, see [Section 14.21.3, “Setting Up the InnoDB memcached Plugin”](#).

- `daemon_memcached_w_batch_size`

Command-Line Format	<code>--daemon-memcached-w-batch-size=#</code>
System Variable	<code>daemon_memcached_w_batch_size</code>
Scope	Global
Dynamic	No
Type	Integer
Default Value	1
Minimum Value	1
Maximum Value	1048576

Specifies how many `memcached` write operations, such as `add`, `set`, and `incr`, to perform before doing a `COMMIT` to start a new transaction. Counterpart of `daemon_memcached_r_batch_size`.

This value is set to 1 by default, on the assumption that data being stored is important to preserve in case of an outage and should immediately be committed. When storing non-critical data, you might increase this value to reduce the overhead from frequent commits; but then the last  $N-1$  uncommitted write operations could be lost if an unexpected exit occurs.

For more information, see [Section 14.21.3, “Setting Up the InnoDB memcached Plugin”](#).

- `ignore_builtin_innodb`

Command-Line Format	<code>--ignore-builtin-innodb[={OFF ON}]</code>
Deprecated	Yes
System Variable	<code>ignore_builtin_innodb</code>

Scope	Global
Dynamic	No
Type	Boolean

In earlier versions of MySQL, enabling this variable caused the server to behave as if the built-in `InnoDB` were not present, which enabled the `InnoDB Plugin` to be used instead. In MySQL 5.7, `InnoDB` is the default storage engine and `InnoDB Plugin` is not used, so this variable is ignored.

- `innodb_adaptive_flushing`

Command-Line Format	<code>--innodb-adaptive-flushing[={OFF ON}]</code>
System Variable	<code>innodb_adaptive_flushing</code>
Scope	Global
Dynamic	Yes
Type	Boolean
Default Value	<code>ON</code>

Specifies whether to dynamically adjust the rate of flushing `dirty pages` in the `InnoDB buffer pool` based on the workload. Adjusting the flush rate dynamically is intended to avoid bursts of I/O activity. This setting is enabled by default. See [Section 14.8.3.5, “Configuring Buffer Pool Flushing”](#) for more information. For general I/O tuning advice, see [Section 8.5.8, “Optimizing InnoDB Disk I/O”](#).

- `innodb_adaptive_flushing_lwm`

Command-Line Format	<code>--innodb-adaptive-flushing-lwm=#</code>
System Variable	<code>innodb_adaptive_flushing_lwm</code>
Scope	Global
Dynamic	Yes
Type	Integer
Default Value	<code>10</code>
Minimum Value	<code>0</code>
Maximum Value	<code>70</code>

Defines the low water mark representing percentage of `redo log` capacity at which `adaptive flushing` is enabled. For more information, see [Section 14.8.3.5, “Configuring Buffer Pool Flushing”](#).

- `innodb_adaptive_hash_index`

Command-Line Format	<code>--innodb-adaptive-hash-index[={OFF ON}]</code>
System Variable	<code>innodb_adaptive_hash_index</code>
Scope	Global
Dynamic	Yes
Type	Boolean

Default Value	ON
---------------	----

Whether the [InnoDB adaptive hash index](#) is enabled or disabled. It may be desirable, depending on your workload, to dynamically enable or disable [adaptive hash indexing](#) to improve query performance. Because the adaptive hash index may not be useful for all workloads, conduct benchmarks with it both enabled and disabled, using realistic workloads. See [Section 14.5.3, “Adaptive Hash Index”](#) for details.

This variable is enabled by default. You can modify this parameter using the `SET GLOBAL` statement, without restarting the server. Changing the setting at runtime requires privileges sufficient to set global system variables. See [Section 5.1.8.1, “System Variable Privileges”](#). You can also use `--skip-innodb-adaptive-hash-index` at server startup to disable it.

Disabling the adaptive hash index empties the hash table immediately. Normal operations can continue while the hash table is emptied, and executing queries that were using the hash table access the index B-trees directly instead. When the adaptive hash index is re-enabled, the hash table is populated again during normal operation.

- [innodb\\_adaptive\\_hash\\_index\\_parts](#)

Command-Line Format	<code>--innodb-adaptive-hash-index-parts=#</code>
System Variable	<a href="#">innodb_adaptive_hash_index_parts</a>
Scope	Global
Dynamic	No
Type	Numeric
Default Value	8
Minimum Value	1
Maximum Value	512

Partitions the adaptive hash index search system. Each index is bound to a specific partition, with each partition protected by a separate latch.

In earlier releases, the adaptive hash index search system was protected by a single latch ([btr\\_search\\_latch](#)) which could become a point of contention. With the introduction of the [innodb\\_adaptive\\_hash\\_index\\_parts](#) option, the search system is partitioned into 8 parts by default. The maximum setting is 512.

For related information, see [Section 14.5.3, “Adaptive Hash Index”](#).

- [innodb\\_adaptive\\_max\\_sleep\\_delay](#)

Command-Line Format	<code>--innodb-adaptive-max-sleep-delay=#</code>
System Variable	<a href="#">innodb_adaptive_max_sleep_delay</a>
Scope	Global
Dynamic	Yes
Type	Integer
Default Value	150000
Minimum Value	0
Maximum Value	1000000
Unit	microseconds

Permits `InnoDB` to automatically adjust the value of `innodb_thread_sleep_delay` up or down according to the current workload. Any nonzero value enables automated, dynamic adjustment of the `innodb_thread_sleep_delay` value, up to the maximum value specified in the `innodb_adaptive_max_sleep_delay` option. The value represents the number of microseconds. This option can be useful in busy systems, with greater than 16 `InnoDB` threads. (In practice, it is most valuable for MySQL systems with hundreds or thousands of simultaneous connections.)

For more information, see [Section 14.8.5, “Configuring Thread Concurrency for InnoDB”](#).

- `innodb_api_bk_commit_interval`

Command-Line Format	<code>--innodb-api-bk-commit-interval=#</code>
System Variable	<code>innodb_api_bk_commit_interval</code>
Scope	Global
Dynamic	Yes
Type	Integer
Default Value	5
Minimum Value	1
Maximum Value	1073741824
Unit	seconds

How often to auto-commit idle connections that use the `InnoDB memcached` interface, in seconds. For more information, see [Section 14.21.5.4, “Controlling Transactional Behavior of the InnoDB memcached Plugin”](#).

- `innodb_api_disable_rowlock`

Command-Line Format	<code>--innodb-api-disable-rowlock[={OFF ON}]</code>
System Variable	<code>innodb_api_disable_rowlock</code>
Scope	Global
Dynamic	No
Type	Boolean
Default Value	OFF

Use this option to disable row locks when `InnoDB memcached` performs DML operations. By default, `innodb_api_disable_rowlock` is disabled, which means that `memcached` requests row locks for `get` and `set` operations. When `innodb_api_disable_rowlock` is enabled, `memcached` requests a table lock instead of row locks.

`innodb_api_disable_rowlock` is not dynamic. It must be specified on the `mysqld` command line or entered in the MySQL configuration file. Configuration takes effect when the plugin is installed, which occurs when the MySQL server is started.

For more information, see [Section 14.21.5.4, “Controlling Transactional Behavior of the InnoDB memcached Plugin”](#).

- `innodb_api_enable_binlog`

Command-Line Format	<code>--innodb-api-enable-binlog[={OFF ON}]</code>
System Variable	<code>innodb_api_enable_binlog</code>
Scope	Global
Dynamic	No
Type	Boolean
Default Value	OFF

Lets you use the [InnoDB memcached](#) plugin with the MySQL [binary log](#). For more information, see [Enabling the InnoDB memcached Binary Log](#).

- `innodb_api_enable_md1`

Command-Line Format	<code>--innodb-api-enable-md1[={OFF ON}]</code>
System Variable	<code>innodb_api_enable_md1</code>
Scope	Global
Dynamic	No
Type	Boolean
Default Value	OFF

Locks the table used by the [InnoDB memcached](#) plugin, so that it cannot be dropped or altered by [DDL](#) through the SQL interface. For more information, see [Section 14.21.5.4, “Controlling Transactional Behavior of the InnoDB memcached Plugin”](#).

- `innodb_api_trx_level`

Command-Line Format	<code>--innodb-api-trx-level=#</code>
System Variable	<code>innodb_api_trx_level</code>
Scope	Global
Dynamic	Yes
Type	Integer
Default Value	0
Minimum Value	0
Maximum Value	3

Controls the transaction [isolation level](#) on queries processed by the [memcached](#) interface. The constants corresponding to the familiar names are:

- 0 = `READ UNCOMMITTED`
- 1 = `READ COMMITTED`
- 2 = `REPEATABLE READ`
- 3 = `SERIALIZABLE`

For more information, see [Section 14.21.5.4, “Controlling Transactional Behavior of the InnoDB memcached Plugin”](#).

- `innodb_autoextend_increment`

Command-Line Format	<code>--innodb-autoextend-increment=#</code>
System Variable	<code>innodb_autoextend_increment</code>
Scope	Global
Dynamic	Yes
Type	Integer
Default Value	64
Minimum Value	1
Maximum Value	1000
Unit	megabytes

The increment size (in megabytes) for extending the size of an auto-extending [InnoDB system tablespace](#) file when it becomes full. The default value is 64. For related information, see [System Tablespace Data File Configuration](#), and [Resizing the System Tablespace](#).

The `innodb_autoextend_increment` setting does not affect [file-per-table](#) tablespace files or [general tablespace](#) files. These files are auto-extending regardless of the `innodb_autoextend_increment` setting. The initial extensions are by small amounts, after which extensions occur in increments of 4MB.

- `innodb_autoinc_lock_mode`

Command-Line Format	<code>--innodb-autoinc-lock-mode=#</code>
System Variable	<code>innodb_autoinc_lock_mode</code>
Scope	Global
Dynamic	No
Type	Integer
Default Value	1
Valid Values	0 1 2

The [lock mode](#) to use for generating [auto-increment](#) values. Permissible values are 0, 1, or 2, for traditional, consecutive, or interleaved, respectively. The default setting is 1 (consecutive). For the characteristics of each lock mode, see [InnoDB AUTO\\_INCREMENT Lock Modes](#).

- `innodb_background_drop_list_empty`

Command-Line Format	<code>--innodb-background-drop-list-empty[={OFF ON}]</code>
Introduced	5.7.10
System Variable	<code>innodb_background_drop_list_empty</code>
Scope	Global
Dynamic	Yes
Type	Boolean

Default Value	OFF
---------------	-----

Enabling the `innodb_background_drop_list_empty` debug option helps avoid test case failures by delaying table creation until the background drop list is empty. For example, if test case A places table `t1` on the background drop list, test case B waits until the background drop list is empty before creating table `t1`.

- `innodb_buffer_pool_chunk_size`

Command-Line Format	<code>--innodb-buffer-pool-chunk-size=#</code>
System Variable	<code>innodb_buffer_pool_chunk_size</code>
Scope	Global
Dynamic	No
Type	Integer
Default Value	134217728
Minimum Value	1048576
Maximum Value	<code>innodb_buffer_pool_size / innodb_buffer_pool_instances</code>
Unit	bytes

`innodb_buffer_pool_chunk_size` defines the chunk size for InnoDB buffer pool resizing operations.

To avoid copying all buffer pool pages during resizing operations, the operation is performed in “chunks”. By default, `innodb_buffer_pool_chunk_size` is 128MB (134217728 bytes). The number of pages contained in a chunk depends on the value of `innodb_page_size`. `innodb_buffer_pool_chunk_size` can be increased or decreased in units of 1MB (1048576 bytes).

The following conditions apply when altering the `innodb_buffer_pool_chunk_size` value:

- If `innodb_buffer_pool_chunk_size * innodb_buffer_pool_instances` is larger than the current buffer pool size when the buffer pool is initialized, `innodb_buffer_pool_chunk_size` is truncated to `innodb_buffer_pool_size / innodb_buffer_pool_instances`.
- Buffer pool size must always be equal to or a multiple of `innodb_buffer_pool_chunk_size * innodb_buffer_pool_instances`. If you alter `innodb_buffer_pool_chunk_size`, `innodb_buffer_pool_size` is automatically rounded to a value that is equal to or a multiple of `innodb_buffer_pool_chunk_size * innodb_buffer_pool_instances`. The adjustment occurs when the buffer pool is initialized.



**Important**

Care should be taken when changing `innodb_buffer_pool_chunk_size`, as changing this value can automatically increase the size of the buffer pool. Before changing `innodb_buffer_pool_chunk_size`, calculate the effect it has on



`innodb_buffer_pool_size` to ensure that the resulting buffer pool size is acceptable.

To avoid potential performance issues, the number of chunks (`innodb_buffer_pool_size / innodb_buffer_pool_chunk_size`) should not exceed 1000.

The `innodb_buffer_pool_size` variable is dynamic, which permits resizing the buffer pool while the server is online. However, the buffer pool size must be equal to or a multiple of `innodb_buffer_pool_chunk_size * innodb_buffer_pool_instances`, and changing either of those variable settings requires restarting the server.

See [Section 14.8.3.1, “Configuring InnoDB Buffer Pool Size”](#) for more information.

- `innodb_buffer_pool_dump_at_shutdown`

Command-Line Format	<code>--innodb-buffer-pool-dump-at-shutdown[={OFF ON}]</code>
System Variable	<code>innodb_buffer_pool_dump_at_shutdown</code>
Scope	Global
Dynamic	Yes
Type	Boolean
Default Value	ON

Specifies whether to record the pages cached in the [InnoDB buffer pool](#) when the MySQL server is shut down, to shorten the [warmup](#) process at the next restart. Typically used in combination with `innodb_buffer_pool_load_at_startup`. The `innodb_buffer_pool_dump_pct` option defines the percentage of most recently used buffer pool pages to dump.

Both `innodb_buffer_pool_dump_at_shutdown` and `innodb_buffer_pool_load_at_startup` are enabled by default.

For more information, see [Section 14.8.3.6, “Saving and Restoring the Buffer Pool State”](#).

- `innodb_buffer_pool_dump_now`

Command-Line Format	<code>--innodb-buffer-pool-dump-now[={OFF ON}]</code>
System Variable	<code>innodb_buffer_pool_dump_now</code>
Scope	Global
Dynamic	Yes
Type	Boolean
Default Value	OFF

Immediately makes a record of pages cached in the [InnoDB buffer pool](#). Typically used in combination with `innodb_buffer_pool_load_now`.

Enabling `innodb_buffer_pool_dump_now` triggers the recording action but does not alter the variable setting, which always remains `OFF` or `0`. To view buffer pool dump status after triggering a dump, query the `InnoDB_buffer_pool_dump_status` variable.

For more information, see [Section 14.8.3.6, “Saving and Restoring the Buffer Pool State”](#).

- `innodb_buffer_pool_dump_pct`

Command-Line Format	<code>--innodb-buffer-pool-dump-pct=#</code>
System Variable	<code>innodb_buffer_pool_dump_pct</code>
Scope	Global
Dynamic	Yes
Type	Integer
Default Value	25
Minimum Value	1
Maximum Value	100

Specifies the percentage of the most recently used pages for each buffer pool to read out and dump. The range is 1 to 100. The default value is 25. For example, if there are 4 buffer pools with 100 pages each, and `innodb_buffer_pool_dump_pct` is set to 25, the 25 most recently used pages from each buffer pool are dumped.

The change to the `innodb_buffer_pool_dump_pct` default value coincides with default value changes for `innodb_buffer_pool_dump_at_shutdown` and `innodb_buffer_pool_load_at_startup`, which are both enabled by default in MySQL 5.7.

- `innodb_buffer_pool_filename`

Command-Line Format	<code>--innodb-buffer-pool-filename=file_name</code>
System Variable	<code>innodb_buffer_pool_filename</code>
Scope	Global
Dynamic	Yes
Type	File name
Default Value	<code>ib_buffer_pool</code>

Specifies the name of the file that holds the list of tablespace IDs and page IDs produced by `innodb_buffer_pool_dump_at_shutdown` or `innodb_buffer_pool_dump_now`. Tablespace IDs and page IDs are saved in the following format: `space, page_id`. By default, the file is named `ib_buffer_pool` and is located in the InnoDB data directory. A non-default location must be specified relative to the data directory.

A file name can be specified at runtime, using a `SET` statement:

```
SET GLOBAL innodb_buffer_pool_filename='file_name';
```

You can also specify a file name at startup, in a startup string or MySQL configuration file. When specifying a file name at startup, the file must exist or InnoDB returns a startup error indicating that there is no such file or directory.

For more information, see [Section 14.8.3.6, “Saving and Restoring the Buffer Pool State”](#).

- `innodb_buffer_pool_instances`

Command-Line Format	<code>--innodb-buffer-pool-instances=#</code>
System Variable	<code>innodb_buffer_pool_instances</code>

Scope	Global
Dynamic	No
Type	Integer
Default Value (Windows, 32-bit platforms)	see description
Default Value (Other)	8 (or 1 if <code>innodb_buffer_pool_size &lt; 1GB</code> )
Minimum Value	1
Maximum Value	64

The number of regions that the [InnoDB buffer pool](#) is divided into. For systems with buffer pools in the multi-gigabyte range, dividing the buffer pool into separate instances can improve concurrency, by reducing contention as different threads read and write to cached pages. Each page that is stored in or read from the buffer pool is assigned to one of the buffer pool instances randomly, using a hashing function. Each buffer pool instance manages its own free lists, [flush lists](#), [LRUs](#), and all other data structures connected to a buffer pool, and is protected by its own buffer pool [mutex](#).

This option only takes effect when setting `innodb_buffer_pool_size` to 1GB or more. The total buffer pool size is divided among all the buffer pools. For best efficiency, specify a combination of `innodb_buffer_pool_instances` and `innodb_buffer_pool_size` so that each buffer pool instance is at least 1GB.

The default value on 32-bit Windows systems depends on the value of `innodb_buffer_pool_size`, as described below:

- If `innodb_buffer_pool_size` is greater than 1.3GB, the default for `innodb_buffer_pool_instances` is `innodb_buffer_pool_size/128MB`, with individual memory allocation requests for each chunk. 1.3GB was chosen as the boundary at which there is significant risk for 32-bit Windows to be unable to allocate the contiguous address space needed for a single buffer pool.
- Otherwise, the default is 1.

On all other platforms, the default value is 8 when `innodb_buffer_pool_size` is greater than or equal to 1GB. Otherwise, the default is 1.

For related information, see [Section 14.8.3.1, “Configuring InnoDB Buffer Pool Size”](#).

- `innodb_buffer_pool_load_abort`

Command-Line Format	<code>--innodb-buffer-pool-load-abort[={OFF ON}]</code>
System Variable	<code>innodb_buffer_pool_load_abort</code>
Scope	Global
Dynamic	Yes
Type	Boolean

## InnoDB System Variables

Default Value	OFF
---------------	-----

Interrupts the process of restoring InnoDB buffer pool contents triggered by `innodb_buffer_pool_load_at_startup` or `innodb_buffer_pool_load_now`.

Enabling `innodb_buffer_pool_load_abort` triggers the abort action but does not alter the variable setting, which always remains `OFF` or `0`. To view buffer pool load status after triggering an abort action, query the `Innodb_buffer_pool_load_status` variable.

For more information, see [Section 14.8.3.6, “Saving and Restoring the Buffer Pool State”](#).

- `innodb_buffer_pool_load_at_startup`

Command-Line Format	<code>--innodb-buffer-pool-load-at-startup[={OFF ON} ]</code>
System Variable	<code>innodb_buffer_pool_load_at_startup</code>
Scope	Global
Dynamic	No
Type	Boolean
Default Value	ON

Specifies that, on MySQL server startup, the InnoDB buffer pool is automatically warmed up by loading the same pages it held at an earlier time. Typically used in combination with `innodb_buffer_pool_dump_at_shutdown`.

Both `innodb_buffer_pool_dump_at_shutdown` and `innodb_buffer_pool_load_at_startup` are enabled by default.

For more information, see [Section 14.8.3.6, “Saving and Restoring the Buffer Pool State”](#).

- `innodb_buffer_pool_load_now`

Command-Line Format	<code>--innodb-buffer-pool-load-now[={OFF ON} ]</code>
System Variable	<code>innodb_buffer_pool_load_now</code>
Scope	Global
Dynamic	Yes
Type	Boolean
Default Value	OFF

Immediately warms up the InnoDB buffer pool by loading data pages without waiting for a server restart. Can be useful to bring cache memory back to a known state during benchmarking or to ready the MySQL server to resume its normal workload after running queries for reports or maintenance.

Enabling `innodb_buffer_pool_load_now` triggers the load action but does not alter the variable setting, which always remains `OFF` or `0`. To view buffer pool load progress after triggering a load, query the `Innodb_buffer_pool_load_status` variable.

For more information, see [Section 14.8.3.6, “Saving and Restoring the Buffer Pool State”](#).

- `innodb_buffer_pool_size`

Command-Line Format	<code>--innodb-buffer-pool-size=#</code>
System Variable	<code>innodb_buffer_pool_size</code>
Scope	Global
Dynamic	Yes
Type	Integer
Default Value	134217728
Minimum Value	5242880
Maximum Value (64-bit platforms)	$2^{64}-1$
Maximum Value (32-bit platforms)	$2^{32}-1$
Unit	bytes

The size in bytes of the [buffer pool](#), the memory area where [InnoDB](#) caches table and index data. The default value is 134217728 bytes (128MB). The maximum value depends on the CPU architecture; the maximum is 4294967295 ( $2^{32}-1$ ) on 32-bit systems and 18446744073709551615 ( $2^{64}-1$ ) on 64-bit systems. On 32-bit systems, the CPU architecture and operating system may impose a lower practical maximum size than the stated maximum. When the size of the buffer pool is greater than 1GB, setting [innodb\\_buffer\\_pool\\_instances](#) to a value greater than 1 can improve the scalability on a busy server.

A larger buffer pool requires less disk I/O to access the same table data more than once. On a dedicated database server, you might set the buffer pool size to 80% of the machine's physical memory size. Be aware of the following potential issues when configuring buffer pool size, and be prepared to scale back the size of the buffer pool if necessary.

- Competition for physical memory can cause paging in the operating system.
- [InnoDB](#) reserves additional memory for buffers and control structures, so that the total allocated space is approximately 10% greater than the specified buffer pool size.
- Address space for the buffer pool must be contiguous, which can be an issue on Windows systems with DLLs that load at specific addresses.
- The time to initialize the buffer pool is roughly proportional to its size. On instances with large buffer pools, initialization time might be significant. To reduce the initialization period, you can save the buffer pool state at server shutdown and restore it at server startup. See [Section 14.8.3.6, "Saving and Restoring the Buffer Pool State"](#).

When you increase or decrease buffer pool size, the operation is performed in chunks. Chunk size is defined by the [innodb\\_buffer\\_pool\\_chunk\\_size](#) variable, which has a default of 128 MB.

Buffer pool size must always be equal to or a multiple of [innodb\\_buffer\\_pool\\_chunk\\_size](#) \* [innodb\\_buffer\\_pool\\_instances](#). If you alter the buffer pool size to a value that is not equal to or a multiple of [innodb\\_buffer\\_pool\\_chunk\\_size](#) \* [innodb\\_buffer\\_pool\\_instances](#), buffer pool size is automatically adjusted to a value that is equal to or a multiple of [innodb\\_buffer\\_pool\\_chunk\\_size](#) \* [innodb\\_buffer\\_pool\\_instances](#).

[innodb\\_buffer\\_pool\\_size](#) can be set dynamically, which allows you to resize the buffer pool without restarting the server. The [InnoDB\\_buffer\\_pool\\_resize\\_status](#) status variable reports the

status of online buffer pool resizing operations. See [Section 14.8.3.1, “Configuring InnoDB Buffer Pool Size”](#) for more information.

- [innodb\\_change\\_buffer\\_max\\_size](#)

Command-Line Format	<code>--innodb-change-buffer-max-size=#</code>
System Variable	<code>innodb_change_buffer_max_size</code>
Scope	Global
Dynamic	Yes
Type	Integer
Default Value	25
Minimum Value	0
Maximum Value	50

Maximum size for the [InnoDB change buffer](#), as a percentage of the total size of the [buffer pool](#). You might increase this value for a MySQL server with heavy insert, update, and delete activity, or decrease it for a MySQL server with unchanging data used for reporting. For more information, see [Section 14.5.2, “Change Buffer”](#). For general I/O tuning advice, see [Section 8.5.8, “Optimizing InnoDB Disk I/O”](#).

- [innodb\\_change\\_buffering](#)

Command-Line Format	<code>--innodb-change-buffering=value</code>
System Variable	<code>innodb_change_buffering</code>
Scope	Global
Dynamic	Yes
Type	Enumeration
Default Value	<code>all</code>
Valid Values	<code>none</code> <code>inserts</code> <code>deletes</code> <code>changes</code> <code>purges</code> <code>all</code>

Whether [InnoDB](#) performs [change buffering](#), an optimization that delays write operations to secondary indexes so that the I/O operations can be performed sequentially. Permitted values are described in the following table.

**Table 14.19 Permitted Values for `innodb_change_buffering`**

Value	Description
<code>none</code>	Do not buffer any operations.
<code>inserts</code>	Buffer insert operations.

Value	Description
<code>deletes</code>	Buffer delete marking operations; strictly speaking, the writes that mark index records for later deletion during a purge operation.
<code>changes</code>	Buffer inserts and delete-marking operations.
<code>purges</code>	Buffer the physical deletion operations that happen in the background.
<code>all</code>	The default. Buffer inserts, delete-marking operations, and purges.

For more information, see [Section 14.5.2, “Change Buffer”](#). For general I/O tuning advice, see [Section 8.5.8, “Optimizing InnoDB Disk I/O”](#).

- `innodb_change_buffering_debug`

Command-Line Format	<code>--innodb-change-buffering-debug=#</code>
System Variable	<code>innodb_change_buffering_debug</code>
Scope	Global
Dynamic	Yes
Type	Integer
Default Value	0
Minimum Value	0
Maximum Value	2

Sets a debug flag for InnoDB change buffering. A value of 1 forces all changes to the change buffer. A value of 2 causes an unexpected exit at merge. A default value of 0 indicates that the change buffering debug flag is not set. This option is only available when debugging support is compiled in using the `WITH_DEBUG` CMake option.

- `innodb_checksum_algorithm`

Command-Line Format	<code>--innodb-checksum-algorithm=value</code>
System Variable	<code>innodb_checksum_algorithm</code>
Scope	Global
Dynamic	Yes
Type	Enumeration
Default Value	<code>crc32</code>
Valid Values	<code>crc32</code> <code>strict_crc32</code> <code>innodb</code> <code>strict_innodb</code> <code>none</code>

	<code>strict_none</code>
--	--------------------------

Specifies how to generate and verify the `checksum` stored in the disk blocks of `InnoDB tablespaces`. `crc32` is the default value as of MySQL 5.7.7.

`innodb_checksum_algorithm` replaces the `innodb_checksums` option. The following values were provided for compatibility, up to and including MySQL 5.7.6:

- `innodb_checksums=ON` is the same as `innodb_checksum_algorithm=innodb`.
- `innodb_checksums=OFF` is the same as `innodb_checksum_algorithm=none`.

As of MySQL 5.7.7, with a default `innodb_checksum_algorithm` value of `crc32`, `innodb_checksums=ON` is now the same as `innodb_checksum_algorithm=crc32`. `innodb_checksums=OFF` is still the same as `innodb_checksum_algorithm=none`.

To avoid conflicts, remove references to `innodb_checksums` from MySQL configuration files and startup scripts.

The value `innodb` is backward-compatible with earlier versions of MySQL. The value `crc32` uses an algorithm that is faster to compute the checksum for every modified block, and to check the checksums for each disk read. It scans blocks 64 bits at a time, which is faster than the `innodb` checksum algorithm, which scans blocks 8 bits at a time. The value `none` writes a constant value in the checksum field rather than computing a value based on the block data. The blocks in a tablespace can use a mix of old, new, and no checksum values, being updated gradually as the data is modified; once blocks in a tablespace are modified to use the `crc32` algorithm, the associated tables cannot be read by earlier versions of MySQL.

The strict form of a checksum algorithm reports an error if it encounters a valid but non-matching checksum value in a tablespace. It is recommended that you only use strict settings in a new instance, to set up tablespaces for the first time. Strict settings are somewhat faster, because they do not need to compute all checksum values during disk reads.



#### Note

Prior to MySQL 5.7.8, a strict mode setting for `innodb_checksum_algorithm` caused `InnoDB` to halt when encountering a *valid* but non-matching checksum. In MySQL 5.7.8 and later, only an error message is printed, and the page is accepted as valid if it has a valid `innodb`, `crc32` or `none` checksum.

The following table shows the difference between the `none`, `innodb`, and `crc32` option values, and their strict counterparts. `none`, `innodb`, and `crc32` write the specified type of checksum value into each data block, but for compatibility accept other checksum values when verifying a block during a read operation. Strict settings also accept valid checksum values but print an error message when a valid non-matching checksum value is encountered. Using the strict form can make verification faster if all `InnoDB` data files in an instance are created under an identical `innodb_checksum_algorithm` value.

**Table 14.20 Permitted `innodb_checksum_algorithm` Values**

Value	Generated checksum (when writing)	Permitted checksums (when reading)
<code>none</code>	A constant number.	Any of the checksums generated by <code>none</code> , <code>innodb</code> , or <code>crc32</code> .



Value	Generated checksum (when writing)	Permitted checksums (when reading)
innodb	A checksum calculated in software, using the original algorithm from <code>InnoDB</code> .	Any of the checksums generated by <code>none</code> , <code>innodb</code> , or <code>crc32</code> .
crc32	A checksum calculated using the <code>crc32</code> algorithm, possibly done with a hardware assist.	Any of the checksums generated by <code>none</code> , <code>innodb</code> , or <code>crc32</code> .
strict_none	A constant number	Any of the checksums generated by <code>none</code> , <code>innodb</code> , or <code>crc32</code> . <code>InnoDB</code> prints an error message if a valid but non-matching checksum is encountered.
strict_innodb	A checksum calculated in software, using the original algorithm from <code>InnoDB</code> .	Any of the checksums generated by <code>none</code> , <code>innodb</code> , or <code>crc32</code> . <code>InnoDB</code> prints an error message if a valid but non-matching checksum is encountered.
strict_crc32	A checksum calculated using the <code>crc32</code> algorithm, possibly done with a hardware assist.	Any of the checksums generated by <code>none</code> , <code>innodb</code> , or <code>crc32</code> . <code>InnoDB</code> prints an error message if a valid but non-matching checksum is encountered.

Versions of [MySQL Enterprise Backup](#) up to 3.8.0 do not support backing up tablespaces that use CRC32 checksums. [MySQL Enterprise Backup](#) adds CRC32 checksum support in 3.8.1, with some limitations. Refer to the [MySQL Enterprise Backup 3.8.1 Change History](#) for more information.

- [innodb\\_checksums](#)

Command-Line Format	<code>--innodb-checksums [= {OFF   ON} ]</code>
Deprecated	Yes
System Variable	<a href="#">innodb_checksums</a>
Scope	Global
Dynamic	No
Type	Boolean
Default Value	<code>ON</code>

`InnoDB` can use [checksum](#) validation on all tablespace pages read from disk to ensure extra fault tolerance against hardware faults or corrupted data files. This validation is enabled by default. Under specialized circumstances (such as when running benchmarks) this safety feature can be disabled with `--skip-innodb-checksums`. You can specify the method of calculating the checksum using the [innodb\\_checksum\\_algorithm](#) option.

[innodb\\_checksums](#) is deprecated, replaced by [innodb\\_checksum\\_algorithm](#).

Prior to MySQL 5.7.7, `innodb_checksums=ON` is the same as `innodb_checksum_algorithm=innodb`. As of MySQL 5.7.7, the [innodb\\_checksum\\_algorithm](#) default value is `crc32`, and `innodb_checksums=ON` is the same as

`innodb_checksum_algorithm=crc32.innodb_checksums=OFF` is the same as `innodb_checksum_algorithm=none`.

Remove any `innodb_checksums` options from your configuration files and startup scripts to avoid conflicts with `innodb_checksum_algorithm`. `innodb_checksums=OFF` automatically sets `innodb_checksum_algorithm=none`. `innodb_checksums=ON` is ignored and overridden by any other setting for `innodb_checksum_algorithm`.

- `innodb_cmp_per_index_enabled`

Command-Line Format	<code>--innodb-cmp-per-index-enabled[={OFF ON}]</code>
System Variable	<code>innodb_cmp_per_index_enabled</code>
Scope	Global
Dynamic	Yes
Type	Boolean
Default Value	<code>OFF</code>

Enables per-index compression-related statistics in the Information Schema `INNODB_CMP_PER_INDEX` table. Because these statistics can be expensive to gather, only enable this option on development, test, or replica instances during performance tuning related to [InnoDB compressed](#) tables.

For more information, see [Section 24.4.7, “The INFORMATION\\_SCHEMA INNODB\\_CMP\\_PER\\_INDEX and INNODB\\_CMP\\_PER\\_INDEX\\_RESET Tables”](#), and [Section 14.9.1.4, “Monitoring InnoDB Table Compression at Runtime”](#).

- `innodb_commit_concurrency`

Command-Line Format	<code>--innodb-commit-concurrency=#</code>
System Variable	<code>innodb_commit_concurrency</code>
Scope	Global
Dynamic	Yes
Type	Integer
Default Value	0
Minimum Value	0
Maximum Value	1000

The number of [threads](#) that can [commit](#) at the same time. A value of 0 (the default) permits any number of [transactions](#) to commit simultaneously.

The value of `innodb_commit_concurrency` cannot be changed at runtime from zero to nonzero or vice versa. The value can be changed from one nonzero value to another.

- `innodb_compress_debug`

Command-Line Format	<code>--innodb-compress-debug=value</code>
System Variable	<code>innodb_compress_debug</code>
Scope	Global
Dynamic	Yes

Type	Enumeration
Default Value	<code>none</code>
Valid Values	<code>none</code> <code>zlib</code> <code>lz4</code> <code>lz4hc</code>

Compresses all tables using a specified compression algorithm without having to define a `COMPRESSION` attribute for each table. This option is only available if debugging support is compiled in using the `WITH_DEBUG CMake` option.

For related information, see [Section 14.9.2, “InnoDB Page Compression”](#).

- `innodb_compression_failure_threshold_pct`

Command-Line Format	<code>--innodb-compression-failure-threshold-pct=#</code>
System Variable	<code>innodb_compression_failure_threshold_pct</code>
Scope	Global
Dynamic	Yes
Type	Integer
Default Value	5
Minimum Value	0
Maximum Value	100

Defines the compression failure rate threshold for a table, as a percentage, at which point MySQL begins adding padding within `compressed` pages to avoid expensive `compression failures`. When this threshold is passed, MySQL begins to leave additional free space within each new compressed page, dynamically adjusting the amount of free space up to the percentage of page size specified by `innodb_compression_pad_pct_max`. A value of zero disables the mechanism that monitors compression efficiency and dynamically adjusts the padding amount.

For more information, see [Section 14.9.1.6, “Compression for OLTP Workloads”](#).

- `innodb_compression_level`

Command-Line Format	<code>--innodb-compression-level=#</code>
System Variable	<code>innodb_compression_level</code>
Scope	Global
Dynamic	Yes
Type	Integer
Default Value	6
Minimum Value	0

## InnoDB System Variables

Maximum Value	9
---------------	---

Specifies the level of zlib compression to use for [InnoDB compressed](#) tables and indexes. A higher value lets you fit more data onto a storage device, at the expense of more CPU overhead during compression. A lower value lets you reduce CPU overhead when storage space is not critical, or you expect the data is not especially compressible.

For more information, see [Section 14.9.1.6, “Compression for OLTP Workloads”](#).

- [innodb\\_compression\\_pad\\_pct\\_max](#)

Command-Line Format	<code>--innodb-compression-pad-pct-max=#</code>
System Variable	<a href="#">innodb_compression_pad_pct_max</a>
Scope	Global
Dynamic	Yes
Type	Integer
Default Value	50
Minimum Value	0
Maximum Value	75

Specifies the maximum percentage that can be reserved as free space within each compressed [page](#), allowing room to reorganize the data and modification log within the page when a [compressed](#) table or index is updated and the data might be recompressed. Only applies when [innodb\\_compression\\_failure\\_threshold\\_pct](#) is set to a nonzero value, and the rate of [compression failures](#) passes the cutoff point.

For more information, see [Section 14.9.1.6, “Compression for OLTP Workloads”](#).

- [innodb\\_concurrency\\_tickets](#)

Command-Line Format	<code>--innodb-concurrency-tickets=#</code>
System Variable	<a href="#">innodb_concurrency_tickets</a>
Scope	Global
Dynamic	Yes
Type	Integer
Default Value	5000
Minimum Value	1
Maximum Value	4294967295

Determines the number of [threads](#) that can enter [InnoDB](#) concurrently. A thread is placed in a queue when it tries to enter [InnoDB](#) if the number of threads has already reached the concurrency limit. When a thread is permitted to enter [InnoDB](#), it is given a number of “tickets” equal to the value of [innodb\\_concurrency\\_tickets](#), and the thread can enter and leave [InnoDB](#) freely until it has used up its tickets. After that point, the thread again becomes subject to the concurrency check (and possible queuing) the next time it tries to enter [InnoDB](#). The default value is 5000.

With a small [innodb\\_concurrency\\_tickets](#) value, small transactions that only need to process a few rows compete fairly with larger transactions that process many rows. The disadvantage of a small

`innodb_concurrency_tickets` value is that large transactions must loop through the queue many times before they can complete, which extends the amount of time required to complete their task.

With a large `innodb_concurrency_tickets` value, large transactions spend less time waiting for a position at the end of the queue (controlled by `innodb_thread_concurrency`) and more time retrieving rows. Large transactions also require fewer trips through the queue to complete their task. The disadvantage of a large `innodb_concurrency_tickets` value is that too many large transactions running at the same time can starve smaller transactions by making them wait a longer time before executing.

With a nonzero `innodb_thread_concurrency` value, you may need to adjust the `innodb_concurrency_tickets` value up or down to find the optimal balance between larger and smaller transactions. The `SHOW ENGINE INNODB STATUS` report shows the number of tickets remaining for an executing transaction in its current pass through the queue. This data may also be obtained from the `TRX_CONCURRENCY_TICKETS` column of the Information Schema `INNODB_TRX` table.

For more information, see [Section 14.8.5, “Configuring Thread Concurrency for InnoDB”](#).

- `innodb_data_file_path`

Command-Line Format	<code>--innodb-data-file-path=file_name</code>
System Variable	<code>innodb_data_file_path</code>
Scope	Global
Dynamic	No
Type	String
Default Value	<code>ibdata1:12M:autoextend</code>

Defines the name, size, and attributes of InnoDB system tablespace data files.. If you do not specify a value for `innodb_data_file_path`, the default behavior is to create a single auto-extending data file, slightly larger than 12MB, named `ibdata1`.

The full syntax for a data file specification includes the file name, file size, `autoextend` attribute, and `max` attribute:

```
file_name:file_size[:autoextend[:max:max_file_size]]
```

File sizes are specified in kilobytes, megabytes, or gigabytes by appending `K`, `M` or `G` to the size value. If specifying the data file size in kilobytes, do so in multiples of 1024. Otherwise, KB values are rounded to nearest megabyte (MB) boundary. The sum of file sizes must be, at a minimum, slightly larger than 12MB.

For additional configuration information, see [System Tablespace Data File Configuration](#). For resizing instructions, see [Resizing the System Tablespace](#).

- `innodb_data_home_dir`

Command-Line Format	<code>--innodb-data-home-dir=dir_name</code>
System Variable	<code>innodb_data_home_dir</code>
Scope	Global
Dynamic	No

Type	Directory name
------	----------------

The common part of the directory path for [InnoDB system tablespace](#) data files. The default value is the MySQL `data` directory. The setting is concatenated with the `innodb_data_file_path` setting. If you specify the value as an empty string, you can specify an absolute path for `innodb_data_file_path`.

A trailing slash is required when specifying a value for `innodb_data_home_dir`. For example:

```
[mysqld]
innodb_data_home_dir = /path/to/myibdata/
```

This setting does not affect the location of [file-per-table](#) tablespaces.

For related information, see [Section 14.8.1, “InnoDB Startup Configuration”](#).

- [innodb\\_deadlock\\_detect](#)

Command-Line Format	<code>--innodb-deadlock-detect[={OFF ON}]</code>
Introduced	5.7.15
System Variable	<a href="#">innodb_deadlock_detect</a>
Scope	Global
Dynamic	Yes
Type	Boolean
Default Value	ON

This option is used to disable deadlock detection. On high concurrency systems, deadlock detection can cause a slowdown when numerous threads wait for the same lock. At times, it may be more efficient to disable deadlock detection and rely on the `innodb_lock_wait_timeout` setting for transaction rollback when a deadlock occurs.

For related information, see [Section 14.7.5.2, “Deadlock Detection”](#).

- [innodb\\_default\\_row\\_format](#)

Command-Line Format	<code>--innodb-default-row-format=value</code>
System Variable	<a href="#">innodb_default_row_format</a>
Scope	Global
Dynamic	Yes
Type	Enumeration
Default Value	DYNAMIC
Valid Values	REDUNDANT COMPACT DYNAMIC

The `innodb_default_row_format` option defines the default row format for [InnoDB](#) tables and user-created temporary tables. The default setting is `DYNAMIC`. Other permitted values are `COMPACT` and

**REDUNDANT.** The **COMPRESSED** row format, which is not supported for use in the **system tablespace**, cannot be defined as the default.

Newly created tables use the row format defined by `innodb_default_row_format` when a `ROW_FORMAT` option is not specified explicitly or when `ROW_FORMAT=DEFAULT` is used.

When a `ROW_FORMAT` option is not specified explicitly or when `ROW_FORMAT=DEFAULT` is used, any operation that rebuilds a table also silently changes the row format of the table to the format defined by `innodb_default_row_format`. For more information, see [Defining the Row Format of a Table](#).

Internal InnoDB temporary tables created by the server to process queries use the **DYNAMIC** row format, regardless of the `innodb_default_row_format` setting.

- `innodb_disable_sort_file_cache`

Command-Line Format	<code>--innodb-disable-sort-file-cache[={OFF ON}]</code>
System Variable	<code>innodb_disable_sort_file_cache</code>
Scope	Global
Dynamic	Yes
Type	Boolean
Default Value	<code>OFF</code>

Disables the operating system file system cache for merge-sort temporary files. The effect is to open such files with the equivalent of `O_DIRECT`.

- `innodb_disable_resize_buffer_pool_debug`

Command-Line Format	<code>--innodb-disable-resize-buffer-pool-debug[={OFF ON}]</code>
System Variable	<code>innodb_disable_resize_buffer_pool_debug</code>
Scope	Global
Dynamic	Yes
Type	Boolean
Default Value	<code>ON</code>

Disables resizing of the InnoDB buffer pool. This option is only available if debugging support is compiled in using the `WITH_DEBUG CMake` option.

- `innodb_doublewrite`

Command-Line Format	<code>--innodb-doublewrite[={OFF ON}]</code>
System Variable	<code>innodb_doublewrite</code>
Scope	Global
Dynamic	No
Type	Boolean

Default Value	ON
---------------	----

When enabled (the default), InnoDB stores all data twice, first to the [doublewrite buffer](#), then to the actual [data files](#). This variable can be turned off with `--skip-innodb-doublewrite` for benchmarks or cases when top performance is needed rather than concern for data integrity or possible failures.

If system tablespace data files (`ibdata*` files) are located on Fusion-io devices that support atomic writes, doublewrite buffering is automatically disabled and Fusion-io atomic writes are used for all data files. Because the doublewrite buffer setting is global, doublewrite buffering is also disabled for data files residing on non-Fusion-io hardware. This feature is only supported on Fusion-io hardware and only enabled for Fusion-io NVMFS on Linux. To take full advantage of this feature, an `innodb_flush_method` setting of `O_DIRECT` is recommended.

For related information, see [Section 14.6.5, “Doublewrite Buffer”](#).

- `innodb_fast_shutdown`

Command-Line Format	<code>--innodb-fast-shutdown=#</code>
System Variable	<code>innodb_fast_shutdown</code>
Scope	Global
Dynamic	Yes
Type	Integer
Default Value	1
Valid Values	0 1 2

The [InnoDB shutdown](#) mode. If the value is 0, InnoDB does a [slow shutdown](#), a full [purge](#) and a change buffer merge before shutting down. If the value is 1 (the default), InnoDB skips these operations at shutdown, a process known as a [fast shutdown](#). If the value is 2, InnoDB flushes its logs and shuts down cold, as if MySQL had crashed; no committed transactions are lost, but the [crash recovery](#) operation makes the next startup take longer.

The slow shutdown can take minutes, or even hours in extreme cases where substantial amounts of data are still buffered. Use the slow shutdown technique before upgrading or downgrading between MySQL major releases, so that all data files are fully prepared in case the upgrade process updates the file format.

Use `innodb_fast_shutdown=2` in emergency or troubleshooting situations, to get the absolute fastest shutdown if data is at risk of corruption.

- `innodb_fil_make_page_dirty_debug`

Command-Line Format	<code>--innodb-fil-make-page-dirty-debug=#</code>
System Variable	<code>innodb_fil_make_page_dirty_debug</code>
Scope	Global
Dynamic	Yes
Type	Integer
Default Value	0



Minimum Value	0
Maximum Value	2**32-1

By default, setting `innodb_fil_make_page_dirty_debug` to the ID of a tablespace immediately dirties the first page of the tablespace. If `innodb_saved_page_number_debug` is set to a non-default value, setting `innodb_fil_make_page_dirty_debug` dirties the specified page. The `innodb_fil_make_page_dirty_debug` option is only available if debugging support is compiled in using the `WITH_DEBUG` CMake option.

- `innodb_file_format`

Command-Line Format	<code>--innodb-file-format=value</code>
Deprecated	Yes
System Variable	<code>innodb_file_format</code>
Scope	Global
Dynamic	Yes
Type	String
Default Value	<code>Barracuda</code>
Valid Values	<code>Antelope</code> <code>Barracuda</code>

Enables an InnoDB file format for `file-per-table` tablespaces. Supported file formats are `Antelope` and `Barracuda`. `Antelope` is the original InnoDB file format, which supports `REDUNDANT` and `COMPACT` row formats. `Barracuda` is the newer file format, which supports `COMPRESSED` and `DYNAMIC` row formats.

`COMPRESSED` and `DYNAMIC` row formats enable important storage features for InnoDB tables. See [Section 14.11, “InnoDB Row Formats”](#).

Changing the `innodb_file_format` setting does not affect the file format of existing InnoDB tablespace files.

The `innodb_file_format` setting does not apply to general tablespaces, which support tables of all row formats. See [Section 14.6.3.3, “General Tablespaces”](#).

The `innodb_file_format` default value was changed to `Barracuda` in MySQL 5.7.

The `innodb_file_format` setting is ignored when creating tables that use the `DYNAMIC` row format. A table created using the `DYNAMIC` row format always uses the `Barracuda` file format, regardless of the `innodb_file_format` setting. To use the `COMPRESSED` row format, `innodb_file_format` must be set to `Barracuda`.

The `innodb_file_format` option is deprecated; expect it to be removed in a future release. The purpose of the `innodb_file_format` option was to allow users to downgrade to the built-in version of InnoDB in earlier versions of MySQL. Now that those versions of MySQL have reached the end of their product lifecycles, downgrade support provided by this option is no longer necessary.

For more information, see [Section 14.10, “InnoDB File-Format Management”](#).

- [innodb\\_file\\_format\\_check](#)

Command-Line Format	<code>--innodb-file-format-check[={OFF ON}]</code>
Deprecated	Yes
System Variable	<a href="#">innodb_file_format_check</a>
Scope	Global
Dynamic	No
Type	Boolean
Default Value	ON

This variable can be set to 1 or 0 at server startup to enable or disable whether InnoDB checks the [file format](#) tag in the [system tablespace](#) (for example, [Antelope](#) or [Barracuda](#)). If the tag is checked and is higher than that supported by the current version of InnoDB, an error occurs and InnoDB does not start. If the tag is not higher, InnoDB sets the value of [innodb\\_file\\_format\\_max](#) to the file format tag.



**Note**

Despite the default value sometimes being displayed as ON or OFF, always use the numeric values 1 or 0 to turn this option on or off in your configuration file or command line string.

For more information, see [Section 14.10.2.1, “Compatibility Check When InnoDB Is Started”](#).

The [innodb\\_file\\_format\\_check](#) option is deprecated together with the [innodb\\_file\\_format](#) option. You should expect both options to be removed in a future release.

- [innodb\\_file\\_format\\_max](#)

Command-Line Format	<code>--innodb-file-format-max=value</code>
Deprecated	Yes
System Variable	<a href="#">innodb_file_format_max</a>
Scope	Global
Dynamic	Yes
Type	String
Default Value	Barracuda
Valid Values	<a href="#">Antelope</a>  <a href="#">Barracuda</a>

At server startup, InnoDB sets the value of this variable to the [file format](#) tag in the [system tablespace](#) (for example, [Antelope](#) or [Barracuda](#)). If the server creates or opens a table with a “higher” file format, it sets the value of [innodb\\_file\\_format\\_max](#) to that format.

For related information, see [Section 14.10, “InnoDB File-Format Management”](#).

The [innodb\\_file\\_format\\_max](#) option is deprecated together with the [innodb\\_file\\_format](#) option. You should expect both options to be removed in a future release.

- `innodb_file_per_table`

Command-Line Format	<code>--innodb-file-per-table[={OFF ON}]</code>
System Variable	<code>innodb_file_per_table</code>
Scope	Global
Dynamic	Yes
Type	Boolean
Default Value	ON

When `innodb_file_per_table` is enabled, tables are created in file-per-table tablespaces by default. When disabled, tables are created in the system tablespace by default. For information about file-per-table tablespaces, see [Section 14.6.3.2, “File-Per-Table Tablespaces”](#). For information about the InnoDB system tablespace, see [Section 14.6.3.1, “The System Tablespace”](#).

The `innodb_file_per_table` variable can be configured at runtime using a `SET GLOBAL` statement, specified on the command line at startup, or specified in an option file. Configuration at runtime requires privileges sufficient to set global system variables (see [Section 5.1.8.1, “System Variable Privileges”](#)) and immediately affects the operation of all connections.

When a table that resides in a file-per-table tablespace is truncated or dropped, the freed space is returned to the operating system. Truncating or dropping a table that resides in the system tablespace only frees space in the system tablespace. Freed space in the system tablespace can be used again for InnoDB data but is not returned to the operating system, as system tablespace data files never shrink.

When `innodb_file_per_table` is enabled, a table-copying `ALTER TABLE` operation on a table that resides in the system tablespace implicitly re-creates the table in a file-per-table tablespace. To prevent this from occurring, disable `innodb_file_per_table` before executing table-copying `ALTER TABLE` operations on tables that reside in the system tablespace.

The `innodb_file_per-table` setting does not affect the creation of temporary tables. Temporary tables are created in the temporary tablespace. See [Section 14.6.3.5, “The Temporary Tablespace”](#).

- `innodb_fill_factor`

Command-Line Format	<code>--innodb-fill-factor=#</code>
System Variable	<code>innodb_fill_factor</code>
Scope	Global
Dynamic	Yes
Type	Integer
Default Value	100
Minimum Value	10
Maximum Value	100

InnoDB performs a bulk load when creating or rebuilding indexes. This method of index creation is known as a “sorted index build”.

`innodb_fill_factor` defines the percentage of space on each B-tree page that is filled during a sorted index build, with the remaining space reserved for future index growth. For example, setting `innodb_fill_factor` to 80 reserves 20 percent of the space on each B-tree page for future index

growth. Actual percentages may vary. The `innodb_fill_factor` setting is interpreted as a hint rather than a hard limit.

An `innodb_fill_factor` setting of 100 leaves 1/16 of the space in clustered index pages free for future index growth.

`innodb_fill_factor` applies to both B-tree leaf and non-leaf pages. It does not apply to external pages used for `TEXT` or `BLOB` entries.

For more information, see [Section 14.6.2.3, “Sorted Index Builds”](#).

- `innodb_flush_log_at_timeout`

Command-Line Format	<code>--innodb-flush-log-at-timeout=#</code>
System Variable	<code>innodb_flush_log_at_timeout</code>
Scope	Global
Dynamic	Yes
Type	Integer
Default Value	1
Minimum Value	1
Maximum Value	2700
Unit	seconds

Write and flush the logs every *N* seconds. `innodb_flush_log_at_timeout` allows the timeout period between flushes to be increased in order to reduce flushing and avoid impacting performance of binary log group commit. The default setting for `innodb_flush_log_at_timeout` is once per second.

- `innodb_flush_log_at_trx_commit`

Command-Line Format	<code>--innodb-flush-log-at-trx-commit=#</code>
System Variable	<code>innodb_flush_log_at_trx_commit</code>
Scope	Global
Dynamic	Yes
Type	Enumeration
Default Value	1
Valid Values	0 1 2

Controls the balance between strict `ACID` compliance for `commit` operations and higher performance that is possible when commit-related I/O operations are rearranged and done in batches. You can achieve better performance by changing the default value but then you can lose transactions in a crash.

- The default setting of 1 is required for full `ACID` compliance. Logs are written and flushed to disk at each transaction commit.
- With a setting of 0, logs are written and flushed to disk once per second. Transactions for which logs have not been flushed can be lost in a crash.

- With a setting of 2, logs are written after each transaction commit and flushed to disk once per second. Transactions for which logs have not been flushed can be lost in a crash.
- For settings 0 and 2, once-per-second flushing is not 100% guaranteed. Flushing may occur more frequently due to DDL changes and other internal `InnoDB` activities that cause logs to be flushed independently of the `innodb_flush_log_at_trx_commit` setting, and sometimes less frequently due to scheduling issues. If logs are flushed once per second, up to one second of transactions can be lost in a crash. If logs are flushed more or less frequently than once per second, the amount of transactions that can be lost varies accordingly.
- Log flushing frequency is controlled by `innodb_flush_log_at_timeout`, which allows you to set log flushing frequency to  $N$  seconds (where  $N$  is 1 . . . 2700, with a default value of 1). However, any unexpected `mysqld` process exit can erase up to  $N$  seconds of transactions.
- DDL changes and other internal `InnoDB` activities flush the log independently of the `innodb_flush_log_at_trx_commit` setting.
- `InnoDB crash recovery` works regardless of the `innodb_flush_log_at_trx_commit` setting. Transactions are either applied entirely or erased entirely.

For durability and consistency in a replication setup that uses `InnoDB` with transactions:

- If binary logging is enabled, set `sync_binlog=1`.
- Always set `innodb_flush_log_at_trx_commit=1`.

For information on the combination of settings on a replica that is most resilient to unexpected halts, see [Section 16.3.2, “Handling an Unexpected Halt of a Replica”](#).



### Caution

Many operating systems and some disk hardware fool the flush-to-disk operation. They may tell `mysqld` that the flush has taken place, even though it has not. In this case, the durability of transactions is not guaranteed even with the recommended settings, and in the worst case, a power outage can corrupt `InnoDB` data. Using a battery-backed disk cache in the SCSI disk controller or in the disk itself speeds up file flushes, and makes the operation safer. You can also try to disable the caching of disk writes in hardware caches.

- `innodb_flush_method`

Command-Line Format	<code>--innodb-flush-method=value</code>
System Variable	<code>innodb_flush_method</code>
Scope	Global
Dynamic	No
Type	String
Default Value	NULL
Valid Values (Unix)	<code>fsync</code> <code>O_DSYNC</code> <code>littlesync</code>

## InnoDB System Variables

	<code>nosync</code> <code>O_DIRECT</code> <code>O_DIRECT_NO_FSYNC</code>
Valid Values (Windows)	<code>async_unbuffered</code> <code>normal</code> <code>unbuffered</code>

Defines the method used to flush data to InnoDB data files and log files, which can affect I/O throughput.

If `innodb_flush_method` is set to `NULL` on a Unix-like system, the `fsync` option is used by default. If `innodb_flush_method` is set to `NULL` on Windows, the `async_unbuffered` option is used by default.

The `innodb_flush_method` options for Unix-like systems include:

- `fsync`: InnoDB uses the `fsync()` system call to flush both the data and log files. `fsync` is the default setting.
- `O_DSYNC`: InnoDB uses `O_SYNC` to open and flush the log files, and `fsync()` to flush the data files. InnoDB does not use `O_DSYNC` directly because there have been problems with it on many varieties of Unix.
- `littlesync`: This option is used for internal performance testing and is currently unsupported. Use at your own risk.
- `nosync`: This option is used for internal performance testing and is currently unsupported. Use at your own risk.
- `O_DIRECT`: InnoDB uses `O_DIRECT` (or `directio()` on Solaris) to open the data files, and uses `fsync()` to flush both the data and log files. This option is available on some GNU/Linux versions, FreeBSD, and Solaris.
- `O_DIRECT_NO_FSYNC`: InnoDB uses `O_DIRECT` during flushing I/O, but skips the `fsync()` system call after each write operation.

Prior to MySQL 5.7.25, this setting is not suitable for file systems such as XFS and EXT4, which require an `fsync()` system call to synchronize file system metadata changes. If you are not sure whether your file system requires an `fsync()` system call to synchronize file system metadata changes, use `O_DIRECT` instead.

As of MySQL 5.7.25, `fsync()` is called after creating a new file, after increasing file size, and after closing a file, to ensure that file system metadata changes are synchronized. The `fsync()` system call is still skipped after each write operation.

Data loss is possible if redo log files and data files reside on different storage devices, and an unexpected exit occurs before data file writes are flushed from a device cache that is not battery-

backed. If you use or intend to use different storage devices for redo log files and data files, and your data files reside on a device with a cache that is not battery-backed, use `O_DIRECT` instead.

The `innodb_flush_method` options for Windows systems include:

- `async_unbuffered`: InnoDB uses Windows asynchronous I/O and non-buffered I/O. `async_unbuffered` is the default setting on Windows systems.

Running MySQL server on a 4K sector hard drive on Windows is not supported with `async_unbuffered`. The workaround is to use `innodb_flush_method=normal`.

- `normal`: InnoDB uses simulated asynchronous I/O and buffered I/O.
- `unbuffered`: InnoDB uses simulated asynchronous I/O and non-buffered I/O.

How each setting affects performance depends on hardware configuration and workload. Benchmark your particular configuration to decide which setting to use, or whether to keep the default setting. Examine the `InnoDB_data_fsyncs` status variable to see the overall number of `fsync()` calls for each setting. The mix of read and write operations in your workload can affect how a setting performs. For example, on a system with a hardware RAID controller and battery-backed write cache, `O_DIRECT` can help to avoid double buffering between the InnoDB buffer pool and the operating system file system cache. On some systems where InnoDB data and log files are located on a SAN, the default value or `O_DSYNC` might be faster for a read-heavy workload with mostly `SELECT` statements. Always test this parameter with hardware and workload that reflect your production environment. For general I/O tuning advice, see [Section 8.5.8, “Optimizing InnoDB Disk I/O”](#).

- `innodb_flush_neighbors`

Command-Line Format	<code>--innodb-flush-neighbors=#</code>
System Variable	<code>innodb_flush_neighbors</code>
Scope	Global
Dynamic	Yes
Type	Enumeration
Default Value	1
Valid Values	0 1 2

Specifies whether **flushing** a page from the InnoDB buffer pool also flushes other **dirty pages** in the same **extent**.

- A setting of 0 disables `innodb_flush_neighbors`. Dirty pages in the same extent are not flushed.
- The default setting of 1 flushes contiguous dirty pages in the same extent.
- A setting of 2 flushes dirty pages in the same extent.

When the table data is stored on a traditional **HDD** storage device, flushing such **neighbor pages** in one operation reduces I/O overhead (primarily for disk seek operations) compared to flushing individual pages at different times. For table data stored on **SSD**, seek time is not a significant factor and you can turn this setting off to spread out write operations. For related information, see [Section 14.8.3.5, “Configuring Buffer Pool Flushing”](#).

- [innodb\\_flush\\_sync](#)

Command-Line Format	<code>--innodb-flush-sync[={OFF ON}]</code>
System Variable	<a href="#">innodb_flush_sync</a>
Scope	Global
Dynamic	Yes
Type	Boolean
Default Value	ON

The [innodb\\_flush\\_sync](#) variable, which is enabled by default, causes the [innodb\\_io\\_capacity](#) setting to be ignored during bursts of I/O activity that occur at [checkpoints](#). To adhere to the I/O rate defined by the [innodb\\_io\\_capacity](#) setting, disable [innodb\\_flush\\_sync](#).

For information about configuring the [innodb\\_flush\\_sync](#) variable, see [Section 14.8.8, “Configuring InnoDB I/O Capacity”](#).

- [innodb\\_flushing\\_avg\\_loops](#)

Command-Line Format	<code>--innodb-flushing-avg-loops=#</code>
System Variable	<a href="#">innodb_flushing_avg_loops</a>
Scope	Global
Dynamic	Yes
Type	Integer
Default Value	30
Minimum Value	1
Maximum Value	1000

Number of iterations for which InnoDB keeps the previously calculated snapshot of the flushing state, controlling how quickly [adaptive flushing](#) responds to changing [workloads](#). Increasing the value makes the rate of [flush](#) operations change smoothly and gradually as the workload changes. Decreasing the value makes adaptive flushing adjust quickly to workload changes, which can cause spikes in flushing activity if the workload increases and decreases suddenly.

For related information, see [Section 14.8.3.5, “Configuring Buffer Pool Flushing”](#).

- [innodb\\_force\\_load\\_corrupted](#)

Command-Line Format	<code>--innodb-force-load-corrupted[={OFF ON}]</code>
System Variable	<a href="#">innodb_force_load_corrupted</a>
Scope	Global
Dynamic	No
Type	Boolean
Default Value	OFF

Permits InnoDB to load tables at startup that are marked as corrupted. Use only during troubleshooting, to recover data that is otherwise inaccessible. When troubleshooting is complete, disable this setting and restart the server.



- `innodb_force_recovery`

Command-Line Format	<code>--innodb-force-recovery=#</code>
System Variable	<code>innodb_force_recovery</code>
Scope	Global
Dynamic	No
Type	Integer
Default Value	0
Minimum Value	0
Maximum Value	6

The [crash recovery](#) mode, typically only changed in serious troubleshooting situations. Possible values are from 0 to 6. For the meanings of these values and important information about `innodb_force_recovery`, see [Section 14.22.2, “Forcing InnoDB Recovery”](#).



### Warning

Only set this variable to a value greater than 0 in an emergency situation so that you can start InnoDB and dump your tables. As a safety measure, InnoDB prevents `INSERT`, `UPDATE`, or `DELETE` operations when `innodb_force_recovery` is greater than 0. An `innodb_force_recovery` setting of 4 or greater places InnoDB into read-only mode.

These restrictions may cause replication administration commands to fail with an error because replication settings such as `relay_log_info_repository=TABLE` and `master_info_repository=TABLE` store information in InnoDB tables.

- `innodb_ft_aux_table`

System Variable	<code>innodb_ft_aux_table</code>
Scope	Global
Dynamic	Yes
Type	String

Specifies the qualified name of an InnoDB table containing a `FULLTEXT` index. This variable is intended for diagnostic purposes and can only be set at runtime. For example:

```
SET GLOBAL innodb_ft_aux_table = 'test/t1';
```

After you set this variable to a name in the format `db_name/table_name`, the `INFORMATION_SCHEMA` tables `INNODB_FT_INDEX_TABLE`, `INNODB_FT_INDEX_CACHE`, `INNODB_FT_CONFIG`, `INNODB_FT_DELETED`, and `INNODB_FT_BEING_DELETED` show information about the search index for the specified table.

For more information, see [Section 14.16.4, “InnoDB INFORMATION\\_SCHEMA FULLTEXT Index Tables”](#).

- `innodb_ft_cache_size`

Command-Line Format	<code>--innodb-ft-cache-size=#</code>	2771
---------------------	---------------------------------------	------

## InnoDB System Variables

System Variable	<code>innodb_ft_cache_size</code>
Scope	Global
Dynamic	No
Type	Integer
Default Value	8000000
Minimum Value	1600000
Maximum Value	80000000
Unit	bytes

The memory allocated, in bytes, for the `InnoDB FULLTEXT` search index cache, which holds a parsed document in memory while creating an `InnoDB FULLTEXT` index. Index inserts and updates are only committed to disk when the `innodb_ft_cache_size` size limit is reached. `innodb_ft_cache_size` defines the cache size on a per table basis. To set a global limit for all tables, see `innodb_ft_total_cache_size`.

For more information, see [InnoDB Full-Text Index Cache](#).

- `innodb_ft_enable_diag_print`

Command-Line Format	<code>--innodb-ft-enable-diag-print[={OFF ON}]</code>
System Variable	<code>innodb_ft_enable_diag_print</code>
Scope	Global
Dynamic	Yes
Type	Boolean
Default Value	<code>OFF</code>

Whether to enable additional full-text search (FTS) diagnostic output. This option is primarily intended for advanced FTS debugging and is not of interest to most users. Output is printed to the error log and includes information such as:

- FTS index sync progress (when the FTS cache limit is reached). For example:

```
FTS SYNC for table test, deleted count: 100 size: 10000 bytes
SYNC words: 100
```

- FTS optimize progress. For example:

```
FTS start optimize test
FTS_OPTIMIZE: optimize "mysql"
FTS_OPTIMIZE: processed "mysql"
```

- FTS index build progress. For example:

```
Number of doc processed: 1000
```

- For FTS queries, the query parsing tree, word weight, query processing time, and memory usage are printed. For example:

```
FTS Search Processing time: 1 secs: 100 millisec: row(s) 10000
Full Search Memory: 245666 (bytes), Row: 10000
```

- `innodb_ft_enable_stopword`

Command-Line Format	<code>--innodb-ft-enable-stopword[={OFF ON}]</code>
System Variable	<code>innodb_ft_enable_stopword</code>
Scope	Global, Session
Dynamic	Yes
Type	Boolean
Default Value	ON

Specifies that a set of [stopwords](#) is associated with an [InnoDB FULLTEXT](#) index at the time the index is created. If the `innodb_ft_user_stopword_table` option is set, the stopwords are taken from that table. Else, if the `innodb_ft_server_stopword_table` option is set, the stopwords are taken from that table. Otherwise, a built-in set of default stopwords is used.

For more information, see [Section 12.9.4, “Full-Text Stopwords”](#).

- `innodb_ft_max_token_size`

Command-Line Format	<code>--innodb-ft-max-token-size=#</code>
System Variable	<code>innodb_ft_max_token_size</code>
Scope	Global
Dynamic	No
Type	Integer
Default Value	84
Minimum Value	10
Maximum Value	84

Maximum character length of words that are stored in an [InnoDB FULLTEXT](#) index. Setting a limit on this value reduces the size of the index, thus speeding up queries, by omitting long keywords or arbitrary collections of letters that are not real words and are not likely to be search terms.

For more information, see [Section 12.9.6, “Fine-Tuning MySQL Full-Text Search”](#).

- `innodb_ft_min_token_size`

Command-Line Format	<code>--innodb-ft-min-token-size=#</code>
System Variable	<code>innodb_ft_min_token_size</code>
Scope	Global
Dynamic	No
Type	Integer
Default Value	3
Minimum Value	0
Maximum Value	16

Minimum length of words that are stored in an [InnoDB FULLTEXT](#) index. Increasing this value reduces the size of the index, thus speeding up queries, by omitting common words that are unlikely to be

significant in a search context, such as the English words “a” and “to”. For content using a CJK (Chinese, Japanese, Korean) character set, specify a value of 1.

For more information, see [Section 12.9.6, “Fine-Tuning MySQL Full-Text Search”](#).

- `innodb_ft_num_word_optimize`

Command-Line Format	<code>--innodb-ft-num-word-optimize=#</code>
System Variable	<code>innodb_ft_num_word_optimize</code>
Scope	Global
Dynamic	Yes
Type	Integer
Default Value	2000
Minimum Value	1000
Maximum Value	10000

Number of words to process during each `OPTIMIZE TABLE` operation on an InnoDB FULLTEXT index. Because a bulk insert or update operation to a table containing a full-text search index could require substantial index maintenance to incorporate all changes, you might do a series of `OPTIMIZE TABLE` statements, each picking up where the last left off.

For more information, see [Section 12.9.6, “Fine-Tuning MySQL Full-Text Search”](#).

- `innodb_ft_result_cache_limit`

Command-Line Format	<code>--innodb-ft-result-cache-limit=#</code>
System Variable	<code>innodb_ft_result_cache_limit</code>
Scope	Global
Dynamic	Yes
Type	Integer
Default Value	2000000000
Minimum Value	1000000
Maximum Value	$2^{32}-1$
Unit	bytes

The InnoDB full-text search query result cache limit (defined in bytes) per full-text search query or per thread. Intermediate and final InnoDB full-text search query results are handled in memory. Use `innodb_ft_result_cache_limit` to place a size limit on the full-text search query result cache to avoid excessive memory consumption in case of very large InnoDB full-text search query results (millions or hundreds of millions of rows, for example). Memory is allocated as required when a full-text search query is processed. If the result cache size limit is reached, an error is returned indicating that the query exceeds the maximum allowed memory.

The maximum value of `innodb_ft_result_cache_limit` for all platform types and bit sizes is  $2^{32}-1$ .

- `innodb_ft_server_stopword_table`

Command-Line Format	<code>--innodb-ft-server-stopword-table=db_name/table_name</code>
System Variable	<code>innodb_ft_server_stopword_table</code>
Scope	Global
Dynamic	Yes
Type	String
Default Value	NULL

This option is used to specify your own InnoDB FULLTEXT index stopword list for all InnoDB tables. To configure your own stopword list for a specific InnoDB table, use `innodb_ft_user_stopword_table`.

Set `innodb_ft_server_stopword_table` to the name of the table containing a list of stopwords, in the format `db_name/table_name`.

The stopword table must exist before you configure `innodb_ft_server_stopword_table`. `innodb_ft_enable_stopword` must be enabled and `innodb_ft_server_stopword_table` option must be configured before you create the FULLTEXT index.

The stopword table must be an InnoDB table, containing a single VARCHAR column named `value`.

For more information, see [Section 12.9.4, “Full-Text Stopwords”](#).

- `innodb_ft_sort_pll_degree`

Command-Line Format	<code>--innodb-ft-sort-pll-degree=#</code>
System Variable	<code>innodb_ft_sort_pll_degree</code>
Scope	Global
Dynamic	No
Type	Integer
Default Value	2
Minimum Value	1
Maximum Value	16

Number of threads used in parallel to index and tokenize text in an InnoDB FULLTEXT index when building a [search index](#).

For related information, see [Section 14.6.2.4, “InnoDB Full-Text Indexes”](#), and `innodb_sort_buffer_size`.

- `innodb_ft_total_cache_size`

Command-Line Format	<code>--innodb-ft-total-cache-size=#</code>
System Variable	<code>innodb_ft_total_cache_size</code>
Scope	Global
Dynamic	No
Type	Integer

## InnoDB System Variables

Default Value	640000000
Minimum Value	32000000
Maximum Value	1600000000
Unit	bytes

The total memory allocated, in bytes, for the InnoDB full-text search index cache for all tables. Creating numerous tables, each with a `FULLTEXT` search index, could consume a significant portion of available memory. `innodb_ft_total_cache_size` defines a global memory limit for all full-text search indexes to help avoid excessive memory consumption. If the global limit is reached by an index operation, a forced sync is triggered.

For more information, see [InnoDB Full-Text Index Cache](#).

- `innodb_ft_user_stopword_table`

Command-Line Format	<code>--innodb-ft-user-stopword-table=db_name/table_name</code>
System Variable	<code>innodb_ft_user_stopword_table</code>
Scope	Global, Session
Dynamic	Yes
Type	String
Default Value	<code>NULL</code>

This option is used to specify your own InnoDB `FULLTEXT` index stopword list on a specific table. To configure your own stopword list for all InnoDB tables, use `innodb_ft_server_stopword_table`.

Set `innodb_ft_user_stopword_table` to the name of the table containing a list of stopwords, in the format `db_name/table_name`.

The stopword table must exist before you configure `innodb_ft_user_stopword_table`. `innodb_ft_enable_stopword` must be enabled and `innodb_ft_user_stopword_table` must be configured before you create the `FULLTEXT` index.

The stopword table must be an InnoDB table, containing a single `VARCHAR` column named `value`.

For more information, see [Section 12.9.4, “Full-Text Stopwords”](#).

- `innodb_io_capacity`

Command-Line Format	<code>--innodb-io-capacity=#</code>
System Variable	<code>innodb_io_capacity</code>
Scope	Global
Dynamic	Yes
Type	Integer
Default Value	200
Minimum Value	100
Maximum Value (64-bit platforms)	$2^{*}64-1$

Maximum Value	$2^{32}-1$
---------------	------------

The `innodb_io_capacity` variable defines the number of I/O operations per second (IOPS) available to InnoDB background tasks, such as flushing pages from the buffer pool and merging data from the change buffer.

For information about configuring the `innodb_io_capacity` variable, see Section 14.8.8, “Configuring InnoDB I/O Capacity”.

- `innodb_io_capacity_max`

Command-Line Format	<code>--innodb-io-capacity-max=#</code>
System Variable	<code>innodb_io_capacity_max</code>
Scope	Global
Dynamic	Yes
Type	Integer
Default Value	<code>2 * innodb_io_capacity, min of 2000</code>
Minimum Value	100
Maximum Value (Unix, 64-bit platforms)	$2^{64}-1$
Maximum Value (Other)	$2^{32}-1$

If flushing activity falls behind, InnoDB can flush more aggressively, at a higher rate of I/O operations per second (IOPS) than defined by the `innodb_io_capacity` variable. The `innodb_io_capacity_max` variable defines a maximum number of IOPS performed by InnoDB background tasks in such situations.

For information about configuring the `innodb_io_capacity_max` variable, see Section 14.8.8, “Configuring InnoDB I/O Capacity”.

- `innodb_large_prefix`

Command-Line Format	<code>--innodb-large-prefix[={OFF ON}]</code>
Deprecated	Yes
System Variable	<code>innodb_large_prefix</code>
Scope	Global
Dynamic	Yes
Type	Boolean
Default Value	ON

When this option is enabled, index key prefixes longer than 767 bytes (up to 3072 bytes) are allowed for InnoDB tables that use `DYNAMIC` or `COMPRESSED` row format. See Section 14.23, “InnoDB Limits” for maximums associated with index key prefixes under various settings.

For tables that use `REDUNDANT` or `COMPACT` row format, this option does not affect the permitted index key prefix length.

`innodb_large_prefix` is enabled by default in MySQL 5.7. This change coincides with the default value change for `innodb_file_format`, which is set to `Barracuda` by default in MySQL 5.7.

Together, these default value changes allow larger index key prefixes to be created when using

[DYNAMIC](#) or [COMPRESSED](#) row format. If either option is set to a non-default value, index key prefixes larger than 767 bytes are silently truncated.

[innodb\\_large\\_prefix](#) is deprecated; expect it to be removed in a future release.

[innodb\\_large\\_prefix](#) was introduced to disable large index key prefixes for compatibility with earlier versions of [InnoDB](#) that do not support large index key prefixes.

- [innodb\\_limit\\_optimistic\\_insert\\_debug](#)

Command-Line Format	<code>--innodb-limit-optimistic-insert-debug=#</code>
System Variable	<a href="#">innodb_limit_optimistic_insert_debug</a>
Scope	Global
Dynamic	Yes
Type	Integer
Default Value	0
Minimum Value	0
Maximum Value	$2^{32}-1$

Limits the number of records per [B-tree](#) page. A default value of 0 means that no limit is imposed. This option is only available if debugging support is compiled in using the [WITH\\_DEBUG](#) CMake option.

- [innodb\\_lock\\_wait\\_timeout](#)

Command-Line Format	<code>--innodb-lock-wait-timeout=#</code>
System Variable	<a href="#">innodb_lock_wait_timeout</a>
Scope	Global, Session
Dynamic	Yes
Type	Integer
Default Value	50
Minimum Value	1
Maximum Value	1073741824
Unit	seconds

The length of time in seconds an [InnoDB transaction](#) waits for a [row lock](#) before giving up. The default value is 50 seconds. A transaction that tries to access a row that is locked by another [InnoDB](#) transaction waits at most this many seconds for write access to the row before issuing the following error:

```
ERROR 1205 (HY000): Lock wait timeout exceeded; try restarting transaction
```

When a lock wait timeout occurs, the current statement is [rolled back](#) (not the entire transaction). To have the entire transaction roll back, start the server with the `--innodb-rollback-on-timeout` option. See also [Section 14.22.4, "InnoDB Error Handling"](#).

You might decrease this value for highly interactive applications or [OLTP](#) systems, to display user feedback quickly or put the update into a queue for processing later. You might increase this value for



long-running back-end operations, such as a transform step in a data warehouse that waits for other large insert or update operations to finish.

`innodb_lock_wait_timeout` applies to InnoDB row locks only. A MySQL [table lock](#) does not happen inside InnoDB and this timeout does not apply to waits for table locks.

The lock wait timeout value does not apply to [deadlocks](#) when `innodb_deadlock_detect` is enabled (the default) because InnoDB detects deadlocks immediately and rolls back one of the deadlocked transactions. When `innodb_deadlock_detect` is disabled, InnoDB relies on `innodb_lock_wait_timeout` for transaction rollback when a deadlock occurs. See [Section 14.7.5.2, “Deadlock Detection”](#).

`innodb_lock_wait_timeout` can be set at runtime with the `SET GLOBAL` or `SET SESSION` statement. Changing the `GLOBAL` setting requires privileges sufficient to set global system variables (see [Section 5.1.8.1, “System Variable Privileges”](#)) and affects the operation of all clients that subsequently connect. Any client can change the `SESSION` setting for `innodb_lock_wait_timeout`, which affects only that client.

- `innodb_locks_unsafe_for_binlog`

Command-Line Format	<code>--innodb-locks-unsafe-for-binlog[={OFF ON} ]</code>
Deprecated	Yes
System Variable	<code>innodb_locks_unsafe_for_binlog</code>
Scope	Global
Dynamic	No
Type	Boolean
Default Value	<code>OFF</code>

This variable affects how InnoDB uses [gap locking](#) for searches and index scans. `innodb_locks_unsafe_for_binlog` is deprecated; expect it to be removed in a future MySQL release.

Normally, InnoDB uses an algorithm called next-key locking that combines index-row locking with [gap locking](#). InnoDB performs row-level locking in such a way that when it searches or scans a table index, it sets shared or exclusive locks on the index records it encounters. Thus, row-level locks are actually index-record locks. In addition, a next-key lock on an index record also affects the gap before the index record. That is, a next-key lock is an index-record lock plus a gap lock on the gap preceding the index record. If one session has a shared or exclusive lock on record `R` in an index, another session cannot insert a new index record in the gap immediately before `R` in the index order. See [Section 14.7.1, “InnoDB Locking”](#).

By default, the value of `innodb_locks_unsafe_for_binlog` is 0 (disabled), which means that gap locking is enabled: InnoDB uses next-key locks for searches and index scans. To enable the variable,

set it to 1. This causes gap locking to be disabled: InnoDB uses only index-record locks for searches and index scans.

Enabling `innodb_locks_unsafe_for_binlog` does not disable the use of gap locking for foreign-key constraint checking or duplicate-key checking.

The effects of enabling `innodb_locks_unsafe_for_binlog` are the same as setting the transaction isolation level to `READ COMMITTED`, with these exceptions:

- Enabling `innodb_locks_unsafe_for_binlog` is a global setting and affects all sessions, whereas the isolation level can be set globally for all sessions, or individually per session.
- `innodb_locks_unsafe_for_binlog` can be set only at server startup, whereas the isolation level can be set at startup or changed at runtime.

`READ COMMITTED` therefore offers finer and more flexible control than `innodb_locks_unsafe_for_binlog`. For more information about the effect of isolation level on gap locking, see [Section 14.7.2.1, “Transaction Isolation Levels”](#).

Enabling `innodb_locks_unsafe_for_binlog` may cause phantom problems because other sessions can insert new rows into the gaps when gap locking is disabled. Suppose that there is an index on the `id` column of the `child` table and that you want to read and lock all rows from the table having an identifier value larger than 100, with the intention of updating some column in the selected rows later:

```
SELECT * FROM child WHERE id > 100 FOR UPDATE;
```

The query scans the index starting from the first record where the `id` is greater than 100. If the locks set on the index records in that range do not lock out inserts made in the gaps, another session can insert a new row into the table. Consequently, if you were to execute the same `SELECT` again within the same transaction, you would see a new row in the result set returned by the query. This also means that if new items are added to the database, InnoDB does not guarantee serializability. Therefore, if `innodb_locks_unsafe_for_binlog` is enabled, InnoDB guarantees at most an isolation level of `READ COMMITTED`. (Conflict serializability is still guaranteed.) For more information about phantoms, see [Section 14.7.4, “Phantom Rows”](#).

Enabling `innodb_locks_unsafe_for_binlog` has additional effects:

- For `UPDATE` or `DELETE` statements, InnoDB holds locks only for rows that it updates or deletes. Record locks for nonmatching rows are released after MySQL has evaluated the `WHERE` condition. This greatly reduces the probability of deadlocks, but they can still happen.
- For `UPDATE` statements, if a row is already locked, InnoDB performs a “semi-consistent” read, returning the latest committed version to MySQL so that MySQL can determine whether the row matches the `WHERE` condition of the `UPDATE`. If the row matches (must be updated), MySQL reads the row again and this time InnoDB either locks it or waits for a lock on it.

Consider the following example, beginning with this table:

```
CREATE TABLE t (a INT NOT NULL, b INT) ENGINE = InnoDB;  
INSERT INTO t VALUES (1,2), (2,3), (3,2), (4,3), (5,2);
```

```
COMMIT;
```

In this case, table has no indexes, so searches and index scans use the hidden clustered index for record locking (see [Section 14.6.2.1, “Clustered and Secondary Indexes”](#)).

Suppose that one client performs an `UPDATE` using these statements:

```
SET autocommit = 0;
UPDATE t SET b = 5 WHERE b = 3;
```

Suppose also that a second client performs an `UPDATE` by executing these statements following those of the first client:

```
SET autocommit = 0;
UPDATE t SET b = 4 WHERE b = 2;
```

As `InnoDB` executes each `UPDATE`, it first acquires an exclusive lock for each row, and then determines whether to modify it. If `InnoDB` does not modify the row and `innodb_locks_unsafe_for_binlog` is enabled, it releases the lock. Otherwise, `InnoDB` retains the lock until the end of the transaction. This affects transaction processing as follows.

If `innodb_locks_unsafe_for_binlog` is disabled, the first `UPDATE` acquires x-locks and does not release any of them:

```
x-lock(1,2); retain x-lock
x-lock(2,3); update(2,3) to (2,5); retain x-lock
x-lock(3,2); retain x-lock
x-lock(4,3); update(4,3) to (4,5); retain x-lock
x-lock(5,2); retain x-lock
```

The second `UPDATE` blocks as soon as it tries to acquire any locks (because the first update has retained locks on all rows), and does not proceed until the first `UPDATE` commits or rolls back:

```
x-lock(1,2); block and wait for first UPDATE to commit or roll back
```

If `innodb_locks_unsafe_for_binlog` is enabled, the first `UPDATE` acquires x-locks and releases those for rows that it does not modify:

```
x-lock(1,2); unlock(1,2)
x-lock(2,3); update(2,3) to (2,5); retain x-lock
x-lock(3,2); unlock(3,2)
x-lock(4,3); update(4,3) to (4,5); retain x-lock
x-lock(5,2); unlock(5,2)
```

For the second `UPDATE`, `InnoDB` does a “semi-consistent” read, returning the latest committed version of each row to MySQL so that MySQL can determine whether the row matches the `WHERE` condition of the `UPDATE`:

```
x-lock(1,2); update(1,2) to (1,4); retain x-lock
x-lock(2,3); unlock(2,3)
x-lock(3,2); update(3,2) to (3,4); retain x-lock
x-lock(4,3); unlock(4,3)
x-lock(5,2); update(5,2) to (5,4); retain x-lock
```

- `innodb_log_buffer_size`

Command-Line Format	<code>--innodb-log-buffer-size=#</code>
System Variable	<code>innodb_log_buffer_size</code>
Scope	Global

## InnoDB System Variables

Dynamic	No
Type	Integer
Default Value	16777216
Minimum Value	1048576
Maximum Value	4294967295

The size in bytes of the buffer that InnoDB uses to write to the [log files](#) on disk. The default value changed from 8MB to 16MB with the introduction of 32KB and 64KB `innodb_page_size` values. A large [log buffer](#) enables large [transactions](#) to run without the need to write the log to disk before the transactions [commit](#). Thus, if you have transactions that update, insert, or delete many rows, making the log buffer larger saves disk I/O. For related information, see [Memory Configuration](#), and [Section 8.5.4, “Optimizing InnoDB Redo Logging”](#). For general I/O tuning advice, see [Section 8.5.8, “Optimizing InnoDB Disk I/O”](#).

- `innodb_log_checkpoint_now`

Command-Line Format	<code>--innodb-log-checkpoint-now[={OFF ON}]</code>
System Variable	<code>innodb_log_checkpoint_now</code>
Scope	Global
Dynamic	Yes
Type	Boolean
Default Value	OFF

Enable this debug option to force InnoDB to write a checkpoint. This option is only available if debugging support is compiled in using the `WITH_DEBUG CMake` option.

- `innodb_log_checksums`

Command-Line Format	<code>--innodb-log-checksums[={OFF ON}]</code>
System Variable	<code>innodb_log_checksums</code>
Scope	Global
Dynamic	Yes
Type	Boolean
Default Value	ON

Enables or disables checksums for redo log pages.

`innodb_log_checksums=ON` enables the `CRC-32C` checksum algorithm for redo log pages. When `innodb_log_checksums` is disabled, the contents of the redo log page checksum field are ignored.

Checksums on the redo log header page and redo log checkpoint pages are never disabled.

- `innodb_log_compressed_pages`

Command-Line Format	<code>--innodb-log-compressed-pages[={OFF ON}]</code>
System Variable	<code>innodb_log_compressed_pages</code>

Scope	Global
Dynamic	Yes
Type	Boolean
Default Value	ON

Specifies whether images of [re-compressed pages](#) are written to the [redo log](#). Re-compression may occur when changes are made to compressed data.

`innodb_log_compressed_pages` is enabled by default to prevent corruption that could occur if a different version of the `zlib` compression algorithm is used during recovery. If you are certain that the `zlib` version is not subject to change, you can disable `innodb_log_compressed_pages` to reduce redo log generation for workloads that modify compressed data.

To measure the effect of enabling or disabling `innodb_log_compressed_pages`, compare redo log generation for both settings under the same workload. Options for measuring redo log generation include observing the [Log sequence number \(LSN\)](#) in the `LOG` section of `SHOW ENGINE INNODB STATUS` output, or monitoring `InnoDB_os_log_written` status for the number of bytes written to the redo log files.

For related information, see [Section 14.9.1.6, “Compression for OLTP Workloads”](#).

- [innodb\\_log\\_file\\_size](#)

Command-Line Format	<code>--innodb-log-file-size=#</code>
System Variable	<code>innodb_log_file_size</code>
Scope	Global
Dynamic	No
Type	Integer
Default Value	50331648
Minimum Value (≥ 5.7.11)	4194304
Minimum Value (≤ 5.7.10)	1048576
Maximum Value	512GB / <code>innodb_log_files_in_group</code>
Unit	bytes

The size in bytes of each [log file](#) in a [log group](#). The combined size of log files (`innodb_log_file_size * innodb_log_files_in_group`) cannot exceed a maximum value that is slightly less than 512GB. A pair of 255 GB log files, for example, approaches the limit but does not exceed it. The default value is 48MB.

Generally, the combined size of the log files should be large enough that the server can smooth out peaks and troughs in workload activity, which often means that there is enough redo log space to handle more than an hour of write activity. The larger the value, the less checkpoint flush activity is required in the buffer pool, saving disk I/O. Larger log files also make [crash recovery](#) slower.

The minimum `innodb_log_file_size` value was increased from 1MB to 4MB in MySQL 5.7.11.

For related information, see [Redo Log File Configuration](#). For general I/O tuning advice, see [Section 8.5.8, “Optimizing InnoDB Disk I/O”](#).

- [innodb\\_log\\_files\\_in\\_group](#)

Command-Line Format	<code>--innodb-log-files-in-group=#</code>
System Variable	<code>innodb_log_files_in_group</code>
Scope	Global
Dynamic	No
Type	Integer
Default Value	2
Minimum Value	2
Maximum Value	100

The number of [log files](#) in the [log group](#). InnoDB writes to the files in a circular fashion. The default (and recommended) value is 2. The location of the files is specified by [innodb\\_log\\_group\\_home\\_dir](#). The combined size of log files (`innodb_log_file_size * innodb_log_files_in_group`) can be up to 512GB.

For related information, see [Redo Log File Configuration](#).

- [innodb\\_log\\_group\\_home\\_dir](#)

Command-Line Format	<code>--innodb-log-group-home-dir=dir_name</code>
System Variable	<code>innodb_log_group_home_dir</code>
Scope	Global
Dynamic	No
Type	Directory name

The directory path to the InnoDB [redo log](#) files, whose number is specified by [innodb\\_log\\_files\\_in\\_group](#). If you do not specify any InnoDB log variables, the default is to create two files named `ib_logfile0` and `ib_logfile1` in the MySQL data directory. Log file size is given by the [innodb\\_log\\_file\\_size](#) system variable.

For related information, see [Redo Log File Configuration](#).

- [innodb\\_log\\_write\\_ahead\\_size](#)

Command-Line Format	<code>--innodb-log-write-ahead-size=#</code>
System Variable	<code>innodb_log_write_ahead_size</code>
Scope	Global
Dynamic	Yes
Type	Integer
Default Value	8192
Minimum Value	512 (log file block size)
Maximum Value	Equal to <code>innodb_page_size</code>
Unit	bytes

Defines the write-ahead block size for the redo log, in bytes. To avoid “read-on-write”, set [innodb\\_log\\_write\\_ahead\\_size](#) to match the operating system or file system cache block size. The

default setting is 8192 bytes. Read-on-write occurs when redo log blocks are not entirely cached to the operating system or file system due to a mismatch between write-ahead block size for the redo log and operating system or file system cache block size.

Valid values for `innodb_log_write_ahead_size` are multiples of the InnoDB log file block size ( $2^n$ ). The minimum value is the InnoDB log file block size (512). Write-ahead does not occur when the minimum value is specified. The maximum value is equal to the `innodb_page_size` value. If you specify a value for `innodb_log_write_ahead_size` that is larger than the `innodb_page_size` value, the `innodb_log_write_ahead_size` setting is truncated to the `innodb_page_size` value.

Setting the `innodb_log_write_ahead_size` value too low in relation to the operating system or file system cache block size results in “read-on-write”. Setting the value too high may have a slight impact on `fsync` performance for log file writes due to several blocks being written at once.

For related information, see [Section 8.5.4, “Optimizing InnoDB Redo Logging”](#).

- `innodb_lru_scan_depth`

Command-Line Format	<code>--innodb-lru-scan-depth=#</code>
System Variable	<code>innodb_lru_scan_depth</code>
Scope	Global
Dynamic	Yes
Type	Integer
Default Value	1024
Minimum Value	100
Maximum Value (64-bit platforms)	$2^{64}-1$
Maximum Value	$2^{32}-1$

A parameter that influences the algorithms and heuristics for the `flush` operation for the InnoDB buffer pool. Primarily of interest to performance experts tuning I/O-intensive workloads. It specifies, per buffer pool instance, how far down the buffer pool LRU page list the page cleaner thread scans looking for `dirty` pages to flush. This is a background operation performed once per second.

A setting smaller than the default is generally suitable for most workloads. A value that is much higher than necessary may impact performance. Only consider increasing the value if you have spare I/O capacity under a typical workload. Conversely, if a write-intensive workload saturates your I/O capacity, decrease the value, especially in the case of a large buffer pool.

When tuning `innodb_lru_scan_depth`, start with a low value and configure the setting upward with the goal of rarely seeing zero free pages. Also, consider adjusting `innodb_lru_scan_depth` when changing the number of buffer pool instances, since `innodb_lru_scan_depth * innodb_buffer_pool_instances` defines the amount of work performed by the page cleaner thread each second.

For related information, see [Section 14.8.3.5, “Configuring Buffer Pool Flushing”](#). For general I/O tuning advice, see [Section 8.5.8, “Optimizing InnoDB Disk I/O”](#).

- `innodb_max_dirty_pages_pct`

Command-Line Format	<code>--innodb-max-dirty-pages-pct=#</code>
System Variable	<code>innodb_max_dirty_pages_pct</code>

## InnoDB System Variables

Scope	Global
Dynamic	Yes
Type	Numeric
Default Value	75
Minimum Value	0
Maximum Value	99.999

InnoDB tries to flush data from the buffer pool so that the percentage of dirty pages does not exceed this value. The default value is 75.

The `innodb_max_dirty_pages_pct` setting establishes a target for flushing activity. It does not affect the rate of flushing. For information about managing the rate of flushing, see [Section 14.8.3.5, “Configuring Buffer Pool Flushing”](#).

For related information, see [Section 14.8.3.5, “Configuring Buffer Pool Flushing”](#). For general I/O tuning advice, see [Section 8.5.8, “Optimizing InnoDB Disk I/O”](#).

- `innodb_max_dirty_pages_pct_lwm`

Command-Line Format	<code>--innodb-max-dirty-pages-pct-lwm=#</code>
System Variable	<code>innodb_max_dirty_pages_pct_lwm</code>
Scope	Global
Dynamic	Yes
Type	Numeric
Default Value	0
Minimum Value	0
Maximum Value	99.999

Defines a low water mark representing the percentage of dirty pages at which preflushing is enabled to control the dirty page ratio. The default of 0 disables the pre-flushing behavior entirely. The configured value should always be lower than the `innodb_max_dirty_pages_pct` value. For more information, see [Section 14.8.3.5, “Configuring Buffer Pool Flushing”](#).

- `innodb_max_purge_lag`

Command-Line Format	<code>--innodb-max-purge-lag=#</code>
System Variable	<code>innodb_max_purge_lag</code>
Scope	Global
Dynamic	Yes
Type	Integer
Default Value	0
Minimum Value	0



Maximum Value	4294967295
---------------	------------

Defines the desired maximum purge lag. If this value is exceeded, a delay is imposed on [INSERT](#), [UPDATE](#), and [DELETE](#) operations to allow time for purge to catch up. The default value is 0, which means there is no maximum purge lag and no delay.

For more information, see [Section 14.8.10, “Purge Configuration”](#).

- [innodb\\_max\\_purge\\_lag\\_delay](#)

Command-Line Format	<code>--innodb-max-purge-lag-delay=#</code>
System Variable	<code>innodb_max_purge_lag_delay</code>
Scope	Global
Dynamic	Yes
Type	Integer
Default Value	0
Minimum Value	0
Maximum Value	10000000
Unit	microseconds

Specifies the maximum delay in microseconds for the delay imposed when the [innodb\\_max\\_purge\\_lag](#) threshold is exceeded. The specified [innodb\\_max\\_purge\\_lag\\_delay](#) value is an upper limit on the delay period calculated by the [innodb\\_max\\_purge\\_lag](#) formula.

For more information, see [Section 14.8.10, “Purge Configuration”](#).

- [innodb\\_max\\_undo\\_log\\_size](#)

Command-Line Format	<code>--innodb-max-undo-log-size=#</code>
System Variable	<code>innodb_max_undo_log_size</code>
Scope	Global
Dynamic	Yes
Type	Integer
Default Value	1073741824
Minimum Value	10485760
Maximum Value	$2^{*64}-1$
Unit	bytes

Defines a threshold size for undo tablespaces. If an undo tablespace exceeds the threshold, it can be marked for truncation when [innodb\\_undo\\_log\\_truncate](#) is enabled. The default value is 1073741824 bytes (1024 MiB).

For more information, see [Truncating Undo Tablespaces](#).

- [innodb\\_merge\\_threshold\\_set\\_all\\_debug](#)

Command-Line Format	<code>--innodb-merge-threshold-set-all-debug=#</code>
---------------------	---

## InnoDB System Variables

System Variable	<code>innodb_merge_threshold_set_all_debug</code>
Scope	Global
Dynamic	Yes
Type	Integer
Default Value	50
Minimum Value	1
Maximum Value	50

Defines a page-full percentage value for index pages that overrides the current `MERGE_THRESHOLD` setting for all indexes that are currently in the dictionary cache. This option is only available if debugging support is compiled in using the `WITH_DEBUG CMake` option. For related information, see [Section 14.8.12, “Configuring the Merge Threshold for Index Pages”](#).

- `innodb_monitor_disable`

Command-Line Format	<code>--innodb-monitor-disable={counter   module   pattern   all}</code>
System Variable	<code>innodb_monitor_disable</code>
Scope	Global
Dynamic	Yes
Type	String

This variable acts as a switch, disabling [InnoDB metrics counters](#). Counter data may be queried using the Information Schema `INNODB_METRICS` table. For usage information, see [Section 14.16.6, “InnoDB INFORMATION\\_SCHEMA Metrics Table”](#).

`innodb_monitor_disable='latch'` disables statistics collection for `SHOW ENGINE INNODB MUTEX`. For more information, see [Section 13.7.5.15, “SHOW ENGINE Statement”](#).

- `innodb_monitor_enable`

Command-Line Format	<code>--innodb-monitor-enable={counter   module   pattern   all}</code>
System Variable	<code>innodb_monitor_enable</code>
Scope	Global
Dynamic	Yes
Type	String

This variable acts as a switch, enabling [InnoDB metrics counters](#). Counter data may be queried using the Information Schema `INNODB_METRICS` table. For usage information, see [Section 14.16.6, “InnoDB INFORMATION\\_SCHEMA Metrics Table”](#).

`innodb_monitor_enable='latch'` enables statistics collection for `SHOW ENGINE INNODB MUTEX`. For more information, see [Section 13.7.5.15, “SHOW ENGINE Statement”](#).

- `innodb_monitor_reset`

Command-Line Format	<code>--innodb-monitor-reset={counter   module   pattern   all}</code>
---------------------	--

System Variable	<code>innodb_monitor_reset</code>
Scope	Global
Dynamic	Yes
Type	Enumeration
Default Value	NULL
Valid Values	<code>counter</code> <code>module</code> <code>pattern</code> <code>all</code>

This variable acts as a switch, resetting the count value for [InnoDB metrics counters](#) to zero. Counter data may be queried using the Information Schema `INNODB_METRICS` table. For usage information, see [Section 14.16.6, “InnoDB INFORMATION\\_SCHEMA Metrics Table”](#).

`innodb_monitor_reset='latch'` resets statistics reported by `SHOW ENGINE INNODB MUTEX`. For more information, see [Section 13.7.5.15, “SHOW ENGINE Statement”](#).

- `innodb_monitor_reset_all`

Command-Line Format	<code>--innodb-monitor-reset-all={counter module pattern all}</code>
System Variable	<code>innodb_monitor_reset_all</code>
Scope	Global
Dynamic	Yes
Type	Enumeration
Default Value	NULL
Valid Values	<code>counter</code> <code>module</code> <code>pattern</code> <code>all</code>

This variable acts as a switch, resetting all values (minimum, maximum, and so on) for [InnoDB metrics counters](#). Counter data may be queried using the Information Schema `INNODB_METRICS` table. For usage information, see [Section 14.16.6, “InnoDB INFORMATION\\_SCHEMA Metrics Table”](#).

- `innodb_numa_interleave`

Command-Line Format	<code>--innodb-numa-interleave[={OFF ON}]</code>
System Variable	<code>innodb_numa_interleave</code>
Scope	Global
Dynamic	No
Type	Boolean

## InnoDB System Variables

Default Value	OFF
---------------	-----

Enables the NUMA interleave memory policy for allocation of the `InnoDB` buffer pool. When `innodb_numa_interleave` is enabled, the NUMA memory policy is set to `MPOL_INTERLEAVE` for the `mysqld` process. After the `InnoDB` buffer pool is allocated, the NUMA memory policy is set back to `MPOL_DEFAULT`. For the `innodb_numa_interleave` option to be available, MySQL must be compiled on a NUMA-enabled Linux system.

As of MySQL 5.7.17, `CMake` sets the default `WITH_NUMA` value based on whether the current platform has NUMA support. For more information, see [Section 2.8.7, “MySQL Source-Configuration Options”](#).

- `innodb_old_blocks_pct`

Command-Line Format	<code>--innodb-old-blocks-pct=#</code>
System Variable	<code>innodb_old_blocks_pct</code>
Scope	Global
Dynamic	Yes
Type	Integer
Default Value	37
Minimum Value	5
Maximum Value	95

Specifies the approximate percentage of the `InnoDB` buffer pool used for the old block `sublist`. The range of values is 5 to 95. The default value is 37 (that is, 3/8 of the pool). Often used in combination with `innodb_old_blocks_time`.

For more information, see [Section 14.8.3.3, “Making the Buffer Pool Scan Resistant”](#). For information about buffer pool management, the LRU algorithm, and `eviction` policies, see [Section 14.5.1, “Buffer Pool”](#).

- `innodb_old_blocks_time`

Command-Line Format	<code>--innodb-old-blocks-time=#</code>
System Variable	<code>innodb_old_blocks_time</code>
Scope	Global
Dynamic	Yes
Type	Integer
Default Value	1000
Minimum Value	0
Maximum Value	$2^{*}32-1$
Unit	milliseconds

Non-zero values protect against the `buffer pool` being filled by data that is referenced only for a brief period, such as during a `full table scan`. Increasing this value offers more protection against full table scans interfering with data cached in the buffer pool.

Specifies how long in milliseconds a block inserted into the old `sublist` must stay there after its first access before it can be moved to the new `sublist`. If the value is 0, a block inserted into the old `sublist` moves immediately to the new `sublist` the first time it is accessed, no matter how soon after insertion the

access occurs. If the value is greater than 0, blocks remain in the old sublist until an access occurs at least that many milliseconds after the first access. For example, a value of 1000 causes blocks to stay in the old sublist for 1 second after the first access before they become eligible to move to the new sublist.

The default value is 1000.

This variable is often used in combination with `innodb_old_blocks_pct`. For more information, see [Section 14.8.3.3, “Making the Buffer Pool Scan Resistant”](#). For information about buffer pool management, the LRU algorithm, and eviction policies, see [Section 14.5.1, “Buffer Pool”](#).

- `innodb_online_alter_log_max_size`

Command-Line Format	<code>--innodb-online-alter-log-max-size=#</code>
System Variable	<code>innodb_online_alter_log_max_size</code>
Scope	Global
Dynamic	Yes
Type	Integer
Default Value	134217728
Minimum Value	65536
Maximum Value	$2^{**64}-1$
Unit	bytes

Specifies an upper limit in bytes on the size of the temporary log files used during [online DDL](#) operations for [InnoDB](#) tables. There is one such log file for each index being created or table being altered. This log file stores data inserted, updated, or deleted in the table during the DDL operation. The temporary log file is extended when needed by the value of `innodb_sort_buffer_size`, up to the maximum specified by `innodb_online_alter_log_max_size`. If a temporary log file exceeds the upper size limit, the `ALTER TABLE` operation fails and all uncommitted concurrent DML operations are rolled back. Thus, a large value for this option allows more DML to happen during an online DDL operation, but also extends the period of time at the end of the DDL operation when the table is locked to apply the data from the log.

- `innodb_open_files`

Command-Line Format	<code>--innodb-open-files=#</code>
System Variable	<code>innodb_open_files</code>
Scope	Global
Dynamic	No
Type	Integer
Default Value	-1 (signifies autosizing; do not assign this literal value)
Minimum Value	10
Maximum Value	2147483647

Specifies the maximum number of files that [InnoDB](#) can have open at one time. The minimum value is 10. If `innodb_file_per_table` is disabled, the default value is 300; otherwise, the default value is 300 or the `table_open_cache` setting, whichever is higher.

- [innodb\\_optimize\\_fulltext\\_only](#)

Command-Line Format	<code>--innodb-optimize-fulltext-only[={OFF ON}]</code>
System Variable	<code>innodb_optimize_fulltext_only</code>
Scope	Global
Dynamic	Yes
Type	Boolean
Default Value	OFF

Changes the way `OPTIMIZE TABLE` operates on InnoDB tables. Intended to be enabled temporarily, during maintenance operations for InnoDB tables with FULLTEXT indexes.

By default, `OPTIMIZE TABLE` reorganizes data in the clustered index of the table. When this option is enabled, `OPTIMIZE TABLE` skips the reorganization of table data, and instead processes newly added, deleted, and updated token data for InnoDB FULLTEXT indexes. For more information, see [Optimizing InnoDB Full-Text Indexes](#).

- [innodb\\_page\\_cleaners](#)

Command-Line Format	<code>--innodb-page-cleaners=#</code>
System Variable	<code>innodb_page_cleaners</code>
Scope	Global
Dynamic	No
Type	Integer
Default Value	4
Minimum Value	1
Maximum Value	64

The number of page cleaner threads that flush dirty pages from buffer pool instances. Page cleaner threads perform flush list and LRU flushing. A single page cleaner thread was introduced in MySQL 5.6 to offload buffer pool flushing work from the InnoDB master thread. In MySQL 5.7, InnoDB provides support for multiple page cleaner threads. A value of 1 maintains the pre-MYSQL 5.7 configuration in which there is a single page cleaner thread. When there are multiple page cleaner threads, buffer pool flushing tasks for each buffer pool instance are dispatched to idle page cleaner threads. The `innodb_page_cleaners` default value was changed from 1 to 4 in MySQL 5.7. If the number of page cleaner threads exceeds the number of buffer pool instances, `innodb_page_cleaners` is automatically set to the same value as `innodb_buffer_pool_instances`.

If your workload is write-IO bound when flushing dirty pages from buffer pool instances to data files, and if your system hardware has available capacity, increasing the number of page cleaner threads may help improve write-IO throughput.

Multithreaded page cleaner support is extended to shutdown and recovery phases in MySQL 5.7.

The `setpriority()` system call is used on Linux platforms where it is supported, and where the `mysqld` execution user is authorized to give `page_cleaner` threads priority over other MySQL and

InnoDB threads to help page flushing keep pace with the current workload. `setpriority()` support is indicated by this InnoDB startup message:

```
[Note] InnoDB: If the mysqld execution user is authorized, page cleaner
thread priority can be changed. See the man page of setpriority().
```

For systems where server startup and shutdown is not managed by systemd, `mysqld` execution user authorization can be configured in `/etc/security/limits.conf`. For example, if `mysqld` is run under the `mysql` user, you can authorize the `mysql` user by adding these lines to `/etc/security/limits.conf`:

```
mysql          hard   nice    -20
mysql          soft   nice    -20
```

For systemd managed systems, the same can be achieved by specifying `LimitNICE=-20` in a localized systemd configuration file. For example, create a file named `override.conf` in `/etc/systemd/system/mysqld.service.d/override.conf` and add this entry:

```
[Service]
LimitNICE=-20
```

After creating or changing `override.conf`, reload the systemd configuration, then tell systemd to restart the MySQL service:

```
systemctl daemon-reload
systemctl restart mysqld # RPM platforms
systemctl restart mysql  # Debian platforms
```

For more information about using a localized systemd configuration file, see [Configuring systemd for MySQL](#).

After authorizing the `mysqld` execution user, use the `cat` command to verify the configured `Nice` limits for the `mysqld` process:

```
$> cat /proc/mysqld_pid/limits | grep nice
Max nice priority          18446744073709551596 18446744073709551596
```

- [innodb\\_page\\_size](#)

Command-Line Format	<code>--innodb-page-size=#</code>
System Variable	<code>innodb_page_size</code>
Scope	Global
Dynamic	No
Type	Enumeration
Default Value	16384
Valid Values	4096 8192 16384 32768

65536

Specifies the [page size](#) for [InnoDB tablespaces](#). Values can be specified in bytes or kilobytes. For example, a 16 kilobyte page size value can be specified as 16384, 16KB, or 16k.

`innodb_page_size` can only be configured prior to initializing the MySQL instance and cannot be changed afterward. If no value is specified, the instance is initialized using the default page size. See [Section 14.8.1, “InnoDB Startup Configuration”](#).

Support for 32KB and 64KB page sizes was added in MySQL 5.7. For both 32KB and 64KB page sizes, the maximum row length is approximately 16000 bytes. `ROW_FORMAT=COMPRESSED` is not supported when `innodb_page_size` is set to 32KB or 64KB. For `innodb_page_size=32k`, extent size is 2MB. For `innodb_page_size=64KB`, extent size is 4MB. `innodb_log_buffer_size` should be set to at least 16M (the default) when using 32KB or 64KB page sizes.

The default 16KB page size or larger is appropriate for a wide range of [workloads](#), particularly for queries involving table scans and DML operations involving bulk updates. Smaller page sizes might be more efficient for [OLTP](#) workloads involving many small writes, where contention can be an issue when single pages contain many rows. Smaller pages might also be efficient with [SSD](#) storage devices, which typically use small block sizes. Keeping the [InnoDB](#) page size close to the storage device block size minimizes the amount of unchanged data that is rewritten to disk.

The minimum file size for the first system tablespace data file (`ibdata1`) differs depending on the `innodb_page_size` value. See the `innodb_data_file_path` option description for more information.

A MySQL instance using a particular [InnoDB](#) page size cannot use data files or log files from an instance that uses a different page size.

For general I/O tuning advice, see [Section 8.5.8, “Optimizing InnoDB Disk I/O”](#).

- `innodb_print_all_deadlocks`

Command-Line Format	<code>--innodb-print-all-deadlocks[={OFF ON}]</code>
System Variable	<code>innodb_print_all_deadlocks</code>
Scope	Global
Dynamic	Yes
Type	Boolean
Default Value	OFF

When this option is enabled, information about all [deadlocks](#) in [InnoDB](#) user transactions is recorded in the `mysqld` [error log](#). Otherwise, you see information about only the last deadlock, using the `SHOW ENGINE INNODB STATUS` command. An occasional [InnoDB](#) deadlock is not necessarily an issue, because [InnoDB](#) detects the condition immediately and rolls back one of the transactions automatically. You might use this option to troubleshoot why deadlocks are occurring if an application does not have appropriate error-handling logic to detect the rollback and retry its operation. A large number of deadlocks might indicate the need to restructure transactions that issue [DML](#) or `SELECT ... FOR`



`UPDATE` statements for multiple tables, so that each transaction accesses the tables in the same order, thus avoiding the deadlock condition.

For related information, see [Section 14.7.5, “Deadlocks in InnoDB”](#).

- `innodb_purge_batch_size`

Command-Line Format	<code>--innodb-purge-batch-size=#</code>
System Variable	<code>innodb_purge_batch_size</code>
Scope	Global
Dynamic	Yes
Type	Integer
Default Value	300
Minimum Value	1
Maximum Value	5000

Defines the number of undo log pages that purge parses and processes in one batch from the [history list](#). In a multithreaded purge configuration, the coordinator purge thread divides `innodb_purge_batch_size` by `innodb_purge_threads` and assigns that number of pages to each purge thread. The `innodb_purge_batch_size` variable also defines the number of undo log pages that purge frees after every 128 iterations through the undo logs.

The `innodb_purge_batch_size` option is intended for advanced performance tuning in combination with the `innodb_purge_threads` setting. Most users need not change `innodb_purge_batch_size` from its default value.

For related information, see [Section 14.8.10, “Purge Configuration”](#).

- `innodb_purge_threads`

Command-Line Format	<code>--innodb-purge-threads=#</code>
System Variable	<code>innodb_purge_threads</code>
Scope	Global
Dynamic	No
Type	Integer
Default Value	4
Minimum Value	1
Maximum Value	32

The number of background threads devoted to the [InnoDB purge](#) operation. Increasing the value creates additional purge threads, which can improve efficiency on systems where [DML](#) operations are performed on multiple tables.

For related information, see [Section 14.8.10, “Purge Configuration”](#).

- `innodb_purge_rseg_truncate_frequency`

Command-Line Format	<code>--innodb-purge-rseg-truncate-frequency=#</code>
---------------------	---

## InnoDB System Variables

System Variable	<a href="#">innodb_purge_rseg_truncate_frequency</a>
Scope	Global
Dynamic	Yes
Type	Integer
Default Value	128
Minimum Value	1
Maximum Value	128

Defines the frequency with which the purge system frees rollback segments in terms of the number of times that purge is invoked. An undo tablespace cannot be truncated until its rollback segments are freed. Normally, the purge system frees rollback segments once every 128 times that purge is invoked. The default value is 128. Reducing this value increases the frequency with which the purge thread frees rollback segments.

[innodb\\_purge\\_rseg\\_truncate\\_frequency](#) is intended for use with [innodb\\_undo\\_log\\_truncate](#). For more information, see [Truncating Undo Tablespaces](#).

- [innodb\\_random\\_read\\_ahead](#)

Command-Line Format	<code>--innodb-random-read-ahead[={OFF ON}]</code>
System Variable	<a href="#">innodb_random_read_ahead</a>
Scope	Global
Dynamic	Yes
Type	Boolean
Default Value	OFF

Enables the random [read-ahead](#) technique for optimizing InnoDB I/O.

For details about performance considerations for different types of read-ahead requests, see [Section 14.8.3.4, “Configuring InnoDB Buffer Pool Prefetching \(Read-Ahead\)”](#). For general I/O tuning advice, see [Section 8.5.8, “Optimizing InnoDB Disk I/O”](#).

- [innodb\\_read\\_ahead\\_threshold](#)

Command-Line Format	<code>--innodb-read-ahead-threshold=#</code>
System Variable	<a href="#">innodb_read_ahead_threshold</a>
Scope	Global
Dynamic	Yes
Type	Integer
Default Value	56
Minimum Value	0
Maximum Value	64

Controls the sensitivity of linear [read-ahead](#) that InnoDB uses to prefetch pages into the [buffer pool](#). If InnoDB reads at least [innodb\\_read\\_ahead\\_threshold](#) pages sequentially from an [extent](#) (64 pages), it initiates an asynchronous read for the entire following extent. The permissible range of values

is 0 to 64. A value of 0 disables read-ahead. For the default of 56, InnoDB must read at least 56 pages sequentially from an extent to initiate an asynchronous read for the following extent.

Knowing how many pages are read through the read-ahead mechanism, and how many of these pages are evicted from the buffer pool without ever being accessed, can be useful when fine-tuning the `innodb_read_ahead_threshold` setting. `SHOW ENGINE INNODB STATUS` output displays counter information from the `InnoDB_buffer_pool_read_ahead` and `InnoDB_buffer_pool_read_ahead_evicted` global status variables, which report the number of pages brought into the buffer pool by read-ahead requests, and the number of such pages evicted from the buffer pool without ever being accessed, respectively. The status variables report global values since the last server restart.

`SHOW ENGINE INNODB STATUS` also shows the rate at which the read-ahead pages are read and the rate at which such pages are evicted without being accessed. The per-second averages are based on the statistics collected since the last invocation of `SHOW ENGINE INNODB STATUS` and are displayed in the `BUFFER POOL AND MEMORY` section of the `SHOW ENGINE INNODB STATUS` output.

For more information, see [Section 14.8.3.4, “Configuring InnoDB Buffer Pool Prefetching \(Read-Ahead\)”](#). For general I/O tuning advice, see [Section 8.5.8, “Optimizing InnoDB Disk I/O”](#).

- `innodb_read_io_threads`

Command-Line Format	<code>--innodb-read-io-threads=#</code>
System Variable	<code>innodb_read_io_threads</code>
Scope	Global
Dynamic	No
Type	Integer
Default Value	4
Minimum Value	1
Maximum Value	64

The number of I/O threads for read operations in InnoDB. Its counterpart for write threads is `innodb_write_io_threads`. For more information, see [Section 14.8.6, “Configuring the Number of Background InnoDB I/O Threads”](#). For general I/O tuning advice, see [Section 8.5.8, “Optimizing InnoDB Disk I/O”](#).



#### Note

On Linux systems, running multiple MySQL servers (typically more than 12) with default settings for `innodb_read_io_threads`, `innodb_write_io_threads`, and the Linux `aio-max-nr` setting can exceed system limits. Ideally, increase the `aio-max-nr` setting; as a workaround, you might reduce the settings for one or both of the MySQL variables.

- `innodb_read_only`

Command-Line Format	<code>--innodb-read-only[={OFF ON}]</code>
System Variable	<code>innodb_read_only</code>
Scope	Global
Dynamic	No
Type	Boolean

## InnoDB System Variables

Default Value	OFF
---------------	-----

Starts **InnoDB** in read-only mode. For distributing database applications or data sets on read-only media. Can also be used in data warehouses to share the same data directory between multiple instances. For more information, see [Section 14.8.2, “Configuring InnoDB for Read-Only Operation”](#).

- `innodb_replication_delay`

Command-Line Format	<code>--innodb-replication-delay=#</code>
System Variable	<code>innodb_replication_delay</code>
Scope	Global
Dynamic	Yes
Type	Integer
Default Value	0
Minimum Value	0
Maximum Value	4294967295
Unit	milliseconds

The replication thread delay in milliseconds on a replica server if `innodb_thread_concurrency` is reached.

- `innodb_rollback_on_timeout`

Command-Line Format	<code>--innodb-rollback-on-timeout[={OFF ON}]</code>
System Variable	<code>innodb_rollback_on_timeout</code>
Scope	Global
Dynamic	No
Type	Boolean
Default Value	OFF

**InnoDB** **rolls back** only the last statement on a transaction timeout by default. If `--innodb-rollback-on-timeout` is specified, a transaction timeout causes **InnoDB** to abort and roll back the entire transaction.

For more information, see [Section 14.22.4, “InnoDB Error Handling”](#).

- `innodb_rollback_segments`

Command-Line Format	<code>--innodb-rollback-segments=#</code>
System Variable	<code>innodb_rollback_segments</code>
Scope	Global
Dynamic	Yes
Type	Integer
Default Value	128
Minimum Value	1
Maximum Value	128

Defines the number of [rollback segments](#) used by [InnoDB](#) for transactions that generate undo records. The number of transactions that each rollback segment supports depends on the [InnoDB](#) page size and the number of undo logs assigned to each transaction. For more information, see [Section 14.6.7, “Undo Logs”](#).

One rollback segment is always assigned to the system tablespace, and 32 rollback segments are reserved for use by temporary tables and reside in the temporary tablespace ([ibtmp1](#)). To allocate additional rollback segment, [innodb\\_rollback\\_segments](#) must be set to a value greater than 33. If you configure separate undo tablespaces, the rollback segment in the system tablespace is rendered inactive.

When [innodb\\_rollback\\_segments](#) is set to 32 or less, [InnoDB](#) assigns one rollback segment to the system tablespace and 32 to the temporary tablespace.

When [innodb\\_rollback\\_segments](#) is set to a value greater than 32, [InnoDB](#) assigns one rollback segment to the system tablespace, 32 to the temporary tablespace, and additional rollback segments to undo tablespaces, if present. If undo tablespaces are not present, additional rollback segments are assigned to the system tablespace.

Although you can increase or decrease the number of rollback segments used by [InnoDB](#), the number of rollback segments physically present in the system never decreases. Thus, you might start with a low value and gradually increase it to avoid allocating rollback segments that are not required. The [innodb\\_rollback\\_segments](#) default and maximum value is 128.

For related information, see [Section 14.3, “InnoDB Multi-Versioning”](#). For information about configuring separate undo tablespaces, see [Section 14.6.3.4, “Undo Tablespaces”](#).

- [innodb\\_saved\\_page\\_number\\_debug](#)

Command-Line Format	<code>--innodb-saved-page-number-debug=#</code>
System Variable	<code>innodb_saved_page_number_debug</code>
Scope	Global
Dynamic	Yes
Type	Integer
Default Value	0
Minimum Value	0
Maximum Value	$2^{32}-1$

Saves a page number. Setting the [innodb\\_fil\\_make\\_page\\_dirty\\_debug](#) option dirties the page defined by [innodb\\_saved\\_page\\_number\\_debug](#). The [innodb\\_saved\\_page\\_number\\_debug](#) option is only available if debugging support is compiled in using the [WITH\\_DEBUG](#) CMake option.

- [innodb\\_sort\\_buffer\\_size](#)

Command-Line Format	<code>--innodb-sort-buffer-size=#</code>
System Variable	<code>innodb_sort_buffer_size</code>
Scope	Global
Dynamic	No
Type	Integer

## InnoDB System Variables

Default Value	1048576
Minimum Value	65536
Maximum Value	67108864
Unit	bytes

This variable defines:

- The sort buffer size for online DDL operations that create or rebuild secondary indexes.
- The amount by which the temporary log file is extended when recording concurrent DML during an [online DDL](#) operation, and the size of the temporary log file read buffer and write buffer.

For related information, see [Section 14.13.3, “Online DDL Space Requirements”](#).

- `innodb_spin_wait_delay`

Command-Line Format	<code>--innodb-spin-wait-delay=#</code>
System Variable	<code>innodb_spin_wait_delay</code>
Scope	Global
Dynamic	Yes
Type	Integer
Default Value	6
Minimum Value	0
Maximum Value (64-bit platforms)	$2^{64}-1$
Maximum Value (32-bit platforms)	$2^{32}-1$

The maximum delay between polls for a [spin](#) lock. The low-level implementation of this mechanism varies depending on the combination of hardware and operating system, so the delay does not correspond to a fixed time interval. For more information, see [Section 14.8.9, “Configuring Spin Lock Polling”](#).

- `innodb_stats_auto_recalc`

Command-Line Format	<code>--innodb-stats-auto-recalc[={OFF ON}]</code>
System Variable	<code>innodb_stats_auto_recalc</code>
Scope	Global
Dynamic	Yes
Type	Boolean
Default Value	ON

Causes [InnoDB](#) to automatically recalculate [persistent statistics](#) after the data in a table is changed substantially. The threshold value is 10% of the rows in the table. This setting applies to tables created when the `innodb_stats_persistent` option is enabled. Automatic statistics recalculation may also be configured by specifying `STATS_AUTO_RECALC=1` in a `CREATE TABLE` or `ALTER TABLE` statement. The amount of data sampled to produce the statistics is controlled by the `innodb_stats_persistent_sample_pages` variable.

For more information, see [Section 14.8.11.1, “Configuring Persistent Optimizer Statistics Parameters”](#).

- `innodb_stats_include_delete_marked`

Command-Line Format	<code>--innodb-stats-include-delete-marked[={OFF ON}]</code>
Introduced	5.7.17
System Variable	<code>innodb_stats_include_delete_marked</code>
Scope	Global
Dynamic	Yes
Type	Boolean
Default Value	OFF

By default, InnoDB reads uncommitted data when calculating statistics. In the case of an uncommitted transaction that deletes rows from a table, InnoDB excludes records that are delete-marked when calculating row estimates and index statistics, which can lead to non-optimal execution plans for other transactions that are operating on the table concurrently using a transaction isolation level other than `READ UNCOMMITTED`. To avoid this scenario, `innodb_stats_include_delete_marked` can be enabled to ensure that InnoDB includes delete-marked records when calculating persistent optimizer statistics.

When `innodb_stats_include_delete_marked` is enabled, `ANALYZE TABLE` considers delete-marked records when recalculating statistics.

`innodb_stats_include_delete_marked` is a global setting that affects all InnoDB tables. It is only applicable to persistent optimizer statistics.

For related information, see [Section 14.8.11.1, “Configuring Persistent Optimizer Statistics Parameters”](#).

- `innodb_stats_method`

Command-Line Format	<code>--innodb-stats-method=value</code>
System Variable	<code>innodb_stats_method</code>
Scope	Global
Dynamic	Yes
Type	Enumeration
Default Value	<code>nulls_equal</code>
Valid Values	<code>nulls_equal</code> <code>nulls_unequal</code> <code>nulls_ignored</code>

How the server treats `NULL` values when collecting [statistics](#) about the distribution of index values for InnoDB tables. Permitted values are `nulls_equal`, `nulls_unequal`, and `nulls_ignored`. For `nulls_equal`, all `NULL` index values are considered equal and form a single value group with a size equal to the number of `NULL` values. For `nulls_unequal`, `NULL` values are considered unequal, and each `NULL` forms a distinct value group of size 1. For `nulls_ignored`, `NULL` values are ignored.

The method used to generate table statistics influences how the optimizer chooses indexes for query execution, as described in [Section 8.3.7, “InnoDB and MyISAM Index Statistics Collection”](#).

- `innodb_stats_on_metadata`

Command-Line Format	<code>--innodb-stats-on-metadata[={OFF ON}]</code>
System Variable	<code>innodb_stats_on_metadata</code>
Scope	Global
Dynamic	Yes
Type	Boolean
Default Value	OFF

This option only applies when optimizer [statistics](#) are configured to be non-persistent. Optimizer statistics are not persisted to disk when `innodb_stats_persistent` is disabled or when individual tables are created or altered with `STATS_PERSISTENT=0`. For more information, see [Section 14.8.11.2, “Configuring Non-Persistent Optimizer Statistics Parameters”](#).

When `innodb_stats_on_metadata` is enabled, InnoDB updates non-persistent [statistics](#) when metadata statements such as `SHOW TABLE STATUS` or when accessing the Information Schema `TABLES` or `STATISTICS` tables. (These updates are similar to what happens for `ANALYZE TABLE`.) When disabled, InnoDB does not update statistics during these operations. Leaving the setting disabled can improve access speed for schemas that have a large number of tables or indexes. It can also improve the stability of [execution plans](#) for queries that involve InnoDB tables.

To change the setting, issue the statement `SET GLOBAL innodb_stats_on_metadata=mode`, where *mode* is either `ON` or `OFF` (or `1` or `0`). Changing the setting requires privileges sufficient to set global system variables (see [Section 5.1.8.1, “System Variable Privileges”](#)) and immediately affects the operation of all connections.

- `innodb_stats_persistent`

Command-Line Format	<code>--innodb-stats-persistent[={OFF ON}]</code>
System Variable	<code>innodb_stats_persistent</code>
Scope	Global
Dynamic	Yes
Type	Boolean
Default Value	ON

Specifies whether InnoDB index statistics are persisted to disk. Otherwise, statistics may be recalculated frequently which can lead to variations in [query execution plans](#). This setting is stored with each table when the table is created. You can set `innodb_stats_persistent` at the global level before creating a table, or use the `STATS_PERSISTENT` clause of the `CREATE TABLE` and `ALTER TABLE` statements to override the system-wide setting and configure persistent statistics for individual tables.

For more information, see [Section 14.8.11.1, “Configuring Persistent Optimizer Statistics Parameters”](#).

- `innodb_stats_persistent_sample_pages`

Command-Line Format	<code>--innodb-stats-persistent-sample-pages=#</code>
System Variable	<code>innodb_stats_persistent_sample_pages</code>
Scope	Global
Dynamic	Yes



Type	Integer
Default Value	20
Minimum Value	1
Maximum Value	18446744073709551615

The number of index [pages](#) to sample when estimating [cardinality](#) and other [statistics](#) for an indexed column, such as those calculated by `ANALYZE TABLE`. Increasing the value improves the accuracy of index statistics, which can improve the [query execution plan](#), at the expense of increased I/O during the execution of `ANALYZE TABLE` for an InnoDB table. For more information, see [Section 14.8.11.1, “Configuring Persistent Optimizer Statistics Parameters”](#).



#### Note

Setting a high value for `innodb_stats_persistent_sample_pages` could result in lengthy `ANALYZE TABLE` execution time. To estimate the number of database pages accessed by `ANALYZE TABLE`, see [Section 14.8.11.3, “Estimating ANALYZE TABLE Complexity for InnoDB Tables”](#).

`innodb_stats_persistent_sample_pages` only applies when `innodb_stats_persistent` is enabled for a table; when `innodb_stats_persistent` is disabled, `innodb_stats_transient_sample_pages` applies instead.

- `innodb_stats_sample_pages`

Command-Line Format	<code>--innodb-stats-sample-pages=#</code>
Deprecated	Yes
System Variable	<code>innodb_stats_sample_pages</code>
Scope	Global
Dynamic	Yes
Type	Integer
Default Value	8
Minimum Value	1
Maximum Value	$2^{64}-1$

Deprecated. Use `innodb_stats_transient_sample_pages` instead.

- `innodb_stats_transient_sample_pages`

Command-Line Format	<code>--innodb-stats-transient-sample-pages=#</code>
System Variable	<code>innodb_stats_transient_sample_pages</code>
Scope	Global
Dynamic	Yes
Type	Integer
Default Value	8
Minimum Value	1

Maximum Value	18446744073709551615
---------------	----------------------

The number of index [pages](#) to sample when estimating [cardinality](#) and other [statistics](#) for an indexed column, such as those calculated by [ANALYZE TABLE](#). The default value is 8. Increasing the value improves the accuracy of index statistics, which can improve the [query execution plan](#), at the expense of increased I/O when opening an [InnoDB](#) table or recalculating statistics. For more information, see [Section 14.8.11.2, “Configuring Non-Persistent Optimizer Statistics Parameters”](#).



#### Note

Setting a high value for `innodb_stats_transient_sample_pages` could result in lengthy [ANALYZE TABLE](#) execution time. To estimate the number of database pages accessed by [ANALYZE TABLE](#), see [Section 14.8.11.3, “Estimating ANALYZE TABLE Complexity for InnoDB Tables”](#).

`innodb_stats_transient_sample_pages` only applies when `innodb_stats_persistent` is disabled for a table; when `innodb_stats_persistent` is enabled, `innodb_stats_persistent_sample_pages` applies instead. Takes the place of `innodb_stats_sample_pages`. For more information, see [Section 14.8.11.2, “Configuring Non-Persistent Optimizer Statistics Parameters”](#).

- `innodb_status_output`

Command-Line Format	<code>--innodb-status-output[={OFF ON}]</code>
System Variable	<code>innodb_status_output</code>
Scope	Global
Dynamic	Yes
Type	Boolean
Default Value	OFF

Enables or disables periodic output for the standard [InnoDB](#) Monitor. Also used in combination with `innodb_status_output_locks` to enable or disable periodic output for the [InnoDB](#) Lock Monitor. For more information, see [Section 14.18.2, “Enabling InnoDB Monitors”](#).

- `innodb_status_output_locks`

Command-Line Format	<code>--innodb-status-output-lock[={OFF ON}]</code>
System Variable	<code>innodb_status_output_locks</code>
Scope	Global
Dynamic	Yes
Type	Boolean
Default Value	OFF

Enables or disables the [InnoDB](#) Lock Monitor. When enabled, the [InnoDB](#) Lock Monitor prints additional information about locks in `SHOW ENGINE INNODB STATUS` output and in periodic output printed to the MySQL error log. Periodic output for the [InnoDB](#) Lock Monitor is printed as part of the standard [InnoDB](#) Monitor output. The standard [InnoDB](#) Monitor must therefore be enabled for the [InnoDB](#) Lock Monitor to print data to the MySQL error log periodically. For more information, see [Section 14.18.2, “Enabling InnoDB Monitors”](#).

- `innodb_strict_mode`

Command-Line Format	<code>--innodb-strict-mode[={OFF ON}]</code>
System Variable	<code>innodb_strict_mode</code>
Scope	Global, Session
Dynamic	Yes
Type	Boolean
Default Value	ON

When `innodb_strict_mode` is enabled, InnoDB returns errors rather than warnings when checking for invalid or incompatible table options.

It checks that `KEY_BLOCK_SIZE`, `ROW_FORMAT`, `DATA DIRECTORY`, `TEMPORARY`, and `TABLESPACE` options are compatible with each other and other settings.

`innodb_strict_mode=ON` also enables a row size check when creating or altering a table, to prevent `INSERT` or `UPDATE` from failing due to the record being too large for the selected page size.

You can enable or disable `innodb_strict_mode` on the command line when starting `mysqld`, or in a MySQL configuration file. You can also enable or disable `innodb_strict_mode` at runtime with the statement `SET [GLOBAL|SESSION] innodb_strict_mode=mode`, where `mode` is either `ON` or `OFF`. Changing the `GLOBAL` setting requires privileges sufficient to set global system variables (see [Section 5.1.8.1, “System Variable Privileges”](#)) and affects the operation of all clients that subsequently connect. Any client can change the `SESSION` setting for `innodb_strict_mode`, and the setting affects only that client.

- `innodb_support_xa`

Command-Line Format	<code>--innodb-support-xa[={OFF ON}]</code>
Deprecated	5.7.10
System Variable	<code>innodb_support_xa</code>
Scope	Global, Session
Dynamic	Yes
Type	Boolean
Default Value	ON

Enables InnoDB support for two-phase commit in XA transactions, causing an extra disk flush for transaction preparation. The XA mechanism is used internally and is essential for any server that has its binary log turned on and is accepting changes to its data from more than one thread. If you disable `innodb_support_xa`, transactions can be written to the binary log in a different order than the live database is committing them, which can produce different data when the binary log is replayed in disaster recovery or on a replica. Do not disable `innodb_support_xa` on a replication source server unless you have an unusual setup where only one thread is able to change data.

`innodb_support_xa` is deprecated; expect it to be removed in a future MySQL release. InnoDB support for two-phase commit in XA transactions is always enabled as of MySQL 5.7.10. Disabling `innodb_support_xa` is no longer permitted as it makes replication unsafe and prevents performance gains associated with binary log group commit.

- [innodb\\_sync\\_array\\_size](#)

Command-Line Format	<code>--innodb-sync-array-size=#</code>
System Variable	<a href="#">innodb_sync_array_size</a>
Scope	Global
Dynamic	No
Type	Integer
Default Value	1
Minimum Value	1
Maximum Value	1024

Defines the size of the mutex/lock wait array. Increasing the value splits the internal data structure used to coordinate threads, for higher concurrency in workloads with large numbers of waiting threads. This setting must be configured when the MySQL instance is starting up, and cannot be changed afterward. Increasing the value is recommended for workloads that frequently produce a large number of waiting threads, typically greater than 768.

- [innodb\\_sync\\_spin\\_loops](#)

Command-Line Format	<code>--innodb-sync-spin-loops=#</code>
System Variable	<a href="#">innodb_sync_spin_loops</a>
Scope	Global
Dynamic	Yes
Type	Integer
Default Value	30
Minimum Value	0
Maximum Value	4294967295

The number of times a thread waits for an [InnoDB](#) mutex to be freed before the thread is suspended.

- [innodb\\_sync\\_debug](#)

Command-Line Format	<code>--innodb-sync-debug[={OFF ON}]</code>
System Variable	<a href="#">innodb_sync_debug</a>
Scope	Global
Dynamic	No
Type	Boolean
Default Value	OFF

Enables sync debug checking for the [InnoDB](#) storage engine. This option is available only if debugging support is compiled in using the `WITH_DEBUG CMake` option.

Previously, enabling [InnoDB](#) sync debug checking required that the Debug Sync facility be enabled using the `ENABLE_DEBUG_SYNC CMake` option, which has since been removed. This requirement was removed in MySQL 5.7 with the introduction of this variable.

- `innodb_table_locks`

Command-Line Format	<code>--innodb-table-locks[={OFF ON}]</code>
System Variable	<code>innodb_table_locks</code>
Scope	Global, Session
Dynamic	Yes
Type	Boolean
Default Value	ON

If `autocommit = 0`, InnoDB honors `LOCK TABLES`; MySQL does not return from `LOCK TABLES ... WRITE` until all other threads have released all their locks to the table. The default value of `innodb_table_locks` is 1, which means that `LOCK TABLES` causes InnoDB to lock a table internally if `autocommit = 0`.

`innodb_table_locks = 0` has no effect for tables locked explicitly with `LOCK TABLES ... WRITE`. It does have an effect for tables locked for read or write by `LOCK TABLES ... WRITE` implicitly (for example, through triggers) or by `LOCK TABLES ... READ`.

For related information, see [Section 14.7, “InnoDB Locking and Transaction Model”](#).

- `innodb_temp_data_file_path`

Command-Line Format	<code>--innodb-temp-data-file-path=file_name</code>
System Variable	<code>innodb_temp_data_file_path</code>
Scope	Global
Dynamic	No
Type	String
Default Value	<code>ibtmp1:12M:autoextend</code>

Defines the relative path, name, size, and attributes of [InnoDB temporary tablespace data files](#). If you do not specify a value for `innodb_temp_data_file_path`, the default behavior is to create a single, auto-extending data file named `ibtmp1` in the MySQL data directory. The initial file size is slightly larger than 12MB.

The full syntax for a temporary tablespace data file specification includes the file name, file size, and `autoextend` and `max` attributes:

```
file_name:file_size[:autoextend[:max:max_file_size]]
```

The temporary tablespace data file cannot have the same name as another [InnoDB](#) data file. Any inability or error creating a temporary tablespace data file is treated as fatal and server startup is refused.

The temporary tablespace has a dynamically generated space ID, which can change on each server restart.

File sizes are specified KB, MB or GB (1024MB) by appending **K**, **M** or **G** to the size value. The sum of the sizes of the files must be slightly larger than 12MB.

The size limit of individual files is determined by your operating system. You can set the file size to more than 4GB on operating systems that support large files. Use of raw disk partitions for temporary tablespace data files is not supported.

The `autoextend` and `max` attributes can be used only for the data file that is specified last in the `innodb_temp_data_file_path` setting. For example:

```
[mysqld]
innodb_temp_data_file_path=ibtmp1:50M;ibtmp2:12M:autoextend:max:500M
```

If you specify the `autoextend` option, **InnoDB** extends the data file if it runs out of free space. The `autoextend` increment is 64MB by default. To modify the increment, change the `innodb_autoextend_increment` system variable.

The full directory path for temporary tablespace data files is formed by concatenating the paths defined by `innodb_data_home_dir` and `innodb_temp_data_file_path`.

The temporary tablespace is shared by all non-compressed **InnoDB** temporary tables. Compressed temporary tables reside in file-per-table tablespace files created in the temporary file directory, which is defined by the `tmpdir` configuration option.

Before running **InnoDB** in read-only mode, set `innodb_temp_data_file_path` to a location outside of the data directory. The path must be relative to the data directory. For example:

```
--innodb-temp-data-file-path=../../tmp/ibtmp1:12M:autoextend
```

Metadata about active **InnoDB** temporary tables is located in the Information Schema `INNODB_TEMP_TABLE_INFO` table.

For related information, see [Section 14.6.3.5, “The Temporary Tablespace”](#).

- `innodb_thread_concurrency`

Command-Line Format	<code>--innodb-thread-concurrency=#</code>
System Variable	<code>innodb_thread_concurrency</code>
Scope	Global
Dynamic	Yes
Type	Integer
Default Value	0
Minimum Value	0

Maximum Value	1000
---------------	------

Defines the maximum number of threads permitted inside of `InnoDB`. A value of 0 (the default) is interpreted as infinite concurrency (no limit). This variable is intended for performance tuning on high concurrency systems.

`InnoDB` tries to keep the number of threads inside `InnoDB` less than or equal to the `innodb_thread_concurrency` limit. Threads waiting for locks are not counted in the number of concurrently executing threads.

The correct setting depends on workload and computing environment. Consider setting this variable if your MySQL instance shares CPU resources with other applications or if your workload or number of concurrent users is growing. Test a range of values to determine the setting that provides the best performance. `innodb_thread_concurrency` is a dynamic variable, which permits experimenting with different settings on a live test system. If a particular setting performs poorly, you can quickly set `innodb_thread_concurrency` back to 0.

Use the following guidelines to help find and maintain an appropriate setting:

- If the number of concurrent user threads for a workload is consistently small and does not affect performance, set `innodb_thread_concurrency=0` (no limit).
- If your workload is consistently heavy or occasionally spikes, set an `innodb_thread_concurrency` value and adjust it until you find the number of threads that provides the best performance. For example, suppose that your system typically has 40 to 50 users, but periodically the number increases to 60, 70, or more. Through testing, you find that performance remains largely stable with a limit of 80 concurrent users. In this case, set `innodb_thread_concurrency` to 80.
- If you do not want `InnoDB` to use more than a certain number of virtual CPUs for user threads (20 virtual CPUs, for example), set `innodb_thread_concurrency` to this number (or possibly lower, depending on performance testing). If your goal is to isolate MySQL from other applications, consider binding the `mysqld` process exclusively to the virtual CPUs. Be aware, however, that exclusive binding can result in non-optimal hardware usage if the `mysqld` process is not consistently busy. In this case, you can bind the `mysqld` process to the virtual CPUs but allow other applications to use some or all of the virtual CPUs.



#### Note

From an operating system perspective, using a resource management solution to manage how CPU time is shared among applications may be preferable to binding the `mysqld` process. For example, you could assign 90% of virtual CPU time to a given application while other critical processes *are not* running, and scale that value back to 40% when other critical processes *are* running.

- In some cases, the optimal `innodb_thread_concurrency` setting can be smaller than the number of virtual CPUs.
- An `innodb_thread_concurrency` value that is too high can cause performance regression due to increased contention on system internals and resources.

- Monitor and analyze your system regularly. Changes to workload, number of users, or computing environment may require that you adjust the `innodb_thread_concurrency` setting.

A value of 0 disables the `queries inside InnoDB` and `queries in queue` counters in the `ROW OPERATIONS` section of `SHOW ENGINE INNODB STATUS` output.

For related information, see [Section 14.8.5, “Configuring Thread Concurrency for InnoDB”](#).

- `innodb_thread_sleep_delay`

Command-Line Format	<code>--innodb-thread-sleep-delay=#</code>
System Variable	<code>innodb_thread_sleep_delay</code>
Scope	Global
Dynamic	Yes
Type	Integer
Default Value	10000
Minimum Value	0
Maximum Value	1000000
Unit	microseconds

Defines how long InnoDB threads sleep before joining the InnoDB queue, in microseconds. The default value is 10000. A value of 0 disables sleep. You can set `innodb_adaptive_max_sleep_delay` to the highest value you would allow for `innodb_thread_sleep_delay`, and InnoDB automatically adjusts `innodb_thread_sleep_delay` up or down depending on current thread-scheduling activity. This dynamic adjustment helps the thread scheduling mechanism to work smoothly during times when the system is lightly loaded or when it is operating near full capacity.

For more information, see [Section 14.8.5, “Configuring Thread Concurrency for InnoDB”](#).

- `innodb_tmpdir`

Command-Line Format	<code>--innodb-tmpdir=dir_name</code>
Introduced	5.7.11
System Variable	<code>innodb_tmpdir</code>
Scope	Global, Session
Dynamic	Yes
Type	Directory name
Default Value	NULL

Used to define an alternate directory for temporary sort files created during online `ALTER TABLE` operations that rebuild the table.

Online `ALTER TABLE` operations that rebuild the table also create an *intermediate* table file in the same directory as the original table. The `innodb_tmpdir` option is not applicable to intermediate table files.

A valid value is any directory path other than the MySQL data directory path. If the value is NULL (the default), temporary files are created MySQL temporary directory (`$TMPDIR` on Unix, `%TEMP%` on Windows, or the directory specified by the `--tmpdir` configuration option). If a directory is specified, existence of the directory and permissions are only checked when `innodb_tmpdir` is configured using



a `SET` statement. If a symlink is provided in a directory string, the symlink is resolved and stored as an absolute path. The path should not exceed 512 bytes. An online `ALTER TABLE` operation reports an error if `innodb_tmpdir` is set to an invalid directory. `innodb_tmpdir` overrides the MySQL `tmpdir` setting but only for online `ALTER TABLE` operations.

The `FILE` privilege is required to configure `innodb_tmpdir`.

The `innodb_tmpdir` option was introduced to help avoid overflowing a temporary file directory located on a `tmpfs` file system. Such overflows could occur as a result of large temporary sort files created during online `ALTER TABLE` operations that rebuild the table.

In replication environments, only consider replicating the `innodb_tmpdir` setting if all servers have the same operating system environment. Otherwise, replicating the `innodb_tmpdir` setting could result in a replication failure when running online `ALTER TABLE` operations that rebuild the table. If server operating environments differ, it is recommended that you configure `innodb_tmpdir` on each server individually.

For more information, see [Section 14.13.3, “Online DDL Space Requirements”](#). For information about online `ALTER TABLE` operations, see [Section 14.13, “InnoDB and Online DDL”](#).

- `innodb_trx_purge_view_update_only_debug`

Command-Line Format	<code>--innodb-trx-purge-view-update-only-debug[={OFF ON} ]</code>
System Variable	<code>innodb_trx_purge_view_update_only_debug</code>
Scope	Global
Dynamic	Yes
Type	Boolean
Default Value	<code>OFF</code>

Pauses purging of delete-marked records while allowing the purge view to be updated. This option artificially creates a situation in which the purge view is updated but purges have not yet been performed. This option is only available if debugging support is compiled in using the `WITH_DEBUG CMake` option.

- `innodb_trx_rseg_n_slots_debug`

Command-Line Format	<code>--innodb-trx-rseg-n-slots-debug=#</code>
System Variable	<code>innodb_trx_rseg_n_slots_debug</code>
Scope	Global
Dynamic	Yes
Type	Integer
Default Value	0
Minimum Value	0
Maximum Value	1024

Sets a debug flag that limits `TRX_RSEG_N_SLOTS` to a given value for the `trx_rsegf_undo_find_free` function that looks for free slots for undo log segments. This option is only available if debugging support is compiled in using the `WITH_DEBUG CMake` option.

- `innodb_undo_directory`

## InnoDB System Variables

Command-Line Format	<code>--innodb-undo-directory=dir_name</code>
System Variable	<code>innodb_undo_directory</code>
Scope	Global
Dynamic	No
Type	Directory name

The path where `InnoDB` creates undo tablespaces. Typically used to place undo logs on a different storage device. Used in conjunction with `innodb_rollback_segments` and `innodb_undo_tablespaces`.

There is no default value (it is NULL). If a path is not specified, undo tablespaces are created in the MySQL data directory, as defined by `datadir`.

For more information, see [Section 14.6.3.4, “Undo Tablespaces”](#).

- `innodb_undo_log_truncate`

Command-Line Format	<code>--innodb-undo-log-truncate[={OFF ON}]</code>
System Variable	<code>innodb_undo_log_truncate</code>
Scope	Global
Dynamic	Yes
Type	Boolean
Default Value	<code>OFF</code>

When enabled, undo tablespaces that exceed the threshold value defined by `innodb_max_undo_log_size` are marked for truncation. Only undo tablespaces can be truncated. Truncating undo logs that reside in the system tablespace is not supported. For truncation to occur, there must be at least two undo tablespaces and two redo-enabled undo logs configured to use undo tablespaces. This means that `innodb_undo_tablespaces` must be set to a value equal to or greater than 2, and `innodb_rollback_segments` must set to a value equal to or greater than 35.

The `innodb_purge_rseg_truncate_frequency` variable can be used to expedite truncation of undo tablespaces.

For more information, see [Truncating Undo Tablespaces](#).

- `innodb_undo_logs`

Command-Line Format	<code>--innodb-undo-logs=#</code>
Deprecated	5.7.19
System Variable	<code>innodb_undo_logs</code>
Scope	Global
Dynamic	Yes
Type	Integer
Default Value	<code>128</code>
Minimum Value	<code>1</code>

Maximum Value	128
---------------	-----

**Note**

`innodb_undo_logs` is deprecated; expect it to be removed in a future MySQL release.

Defines the number of [rollback segments](#) used by InnoDB. The `innodb_undo_logs` option is an alias for `innodb_rollback_segments`. For more information, see the description of `innodb_rollback_segments`.

- [innodb\\_undo\\_tablespaces](#)

Command-Line Format	<code>--innodb-undo-tablespaces=#</code>
Deprecated	5.7.21
System Variable	<code>innodb_undo_tablespaces</code>
Scope	Global
Dynamic	No
Type	Integer
Default Value	0
Minimum Value	0
Maximum Value	95

The number of [undo tablespaces](#) used by InnoDB. The default value is 0.

**Note**

`innodb_undo_tablespaces` is deprecated; expect it to be removed in a future MySQL release.

Because undo logs can become large during long-running transactions, having undo logs in multiple tablespaces reduces the maximum size of any one tablespace. The undo tablespace files are created in the location defined by `innodb_undo_directory`, with names in the form of `undoN`, where *N* is a sequential series of integers (including leading zeros) representing the space ID.

The initial size of an undo tablespace file depends on the `innodb_page_size` value. For the default 16KB InnoDB page size, the initial undo tablespace file size is 10MiB. For 4KB, 8KB, 32KB, and 64KB page sizes, the initial undo tablespace files sizes are 7MiB, 8MiB, 20MiB, and 40MiB, respectively.

A minimum of two undo tablespaces is required to enable truncation of undo logs. See [Truncating Undo Tablespaces](#).

**Important**

`innodb_undo_tablespaces` can only be configured prior to initializing the MySQL instance and cannot be changed afterward. If no value is specified, the instance is initialized using the default setting of 0. Attempting to restart InnoDB with a greater number of undo tablespaces than specified when the

MySQL instance was initialized results in a startup failure and an error stating that InnoDB did not find the expected number of undo tablespaces.

32 of 128 rollback segments are reserved for temporary tables, as described in [Section 14.6.7, “Undo Logs”](#). One rollback segment is always assigned to the system tablespace, which leaves 95 rollback segments available for undo tablespaces. This means the `innodb_undo_tablespaces` maximum limit is 95.

For more information, see [Section 14.6.3.4, “Undo Tablespaces”](#).

- `innodb_use_native_aio`

Command-Line Format	<code>--innodb-use-native-aio[={OFF ON}]</code>
System Variable	<code>innodb_use_native_aio</code>
Scope	Global
Dynamic	No
Type	Boolean
Default Value	ON

Specifies whether to use the Linux asynchronous I/O subsystem. This variable applies to Linux systems only, and cannot be changed while the server is running. Normally, you do not need to configure this option, because it is enabled by default.

The [asynchronous I/O](#) capability that InnoDB has on Windows systems is available on Linux systems. (Other Unix-like systems continue to use synchronous I/O calls.) This feature improves the scalability of heavily I/O-bound systems, which typically show many pending reads/writes in `SHOW ENGINE INNODB STATUS\G` output.

Running with a large number of InnoDB I/O threads, and especially running multiple such instances on the same server machine, can exceed capacity limits on Linux systems. In this case, you may receive the following error:

```
EAGAIN: The specified maxevents exceeds the user's limit of available events.
```

You can typically address this error by writing a higher limit to `/proc/sys/fs/aio-max-nr`.

However, if a problem with the asynchronous I/O subsystem in the OS prevents InnoDB from starting, you can start the server with `innodb_use_native_aio=0`. This option may also be disabled automatically during startup if InnoDB detects a potential problem such as a combination of `tmpdir` location, `tmpfs` file system, and Linux kernel that does not support AIO on `tmpfs`.

For more information, see [Section 14.8.7, “Using Asynchronous I/O on Linux”](#).

- `innodb_version`

The InnoDB version number. In MySQL 5.7, separate version numbering for InnoDB does not apply and this value is the same the `version` number of the server.

- `innodb_write_io_threads`

Command-Line Format	<code>--innodb-write-io-threads=#</code>
System Variable	<code>innodb_write_io_threads</code>
Scope	Global

Dynamic	No
Type	Integer
Default Value	4
Minimum Value	1
Maximum Value	64

The number of I/O threads for write operations in InnoDB. The default value is 4. Its counterpart for read threads is `innodb_read_io_threads`. For more information, see [Section 14.8.6, “Configuring the Number of Background InnoDB I/O Threads”](#). For general I/O tuning advice, see [Section 8.5.8, “Optimizing InnoDB Disk I/O”](#).



#### Note

On Linux systems, running multiple MySQL servers (typically more than 12) with default settings for `innodb_read_io_threads`, `innodb_write_io_threads`, and the Linux `aio-max-nr` setting can exceed system limits. Ideally, increase the `aio-max-nr` setting; as a workaround, you might reduce the settings for one or both of the MySQL variables.

Also take into consideration the value of `sync_binlog`, which controls synchronization of the binary log to disk.

For general I/O tuning advice, see [Section 8.5.8, “Optimizing InnoDB Disk I/O”](#).

## 14.16 InnoDB INFORMATION\_SCHEMA Tables

This section provides information and usage examples for InnoDB INFORMATION\_SCHEMA tables.

InnoDB INFORMATION\_SCHEMA tables provide metadata, status information, and statistics about various aspects of the InnoDB storage engine. You can view a list of InnoDB INFORMATION\_SCHEMA tables by issuing a `SHOW TABLES` statement on the INFORMATION\_SCHEMA database:

```
mysql> SHOW TABLES FROM INFORMATION_SCHEMA LIKE 'INNODB%';
```

For table definitions, see [Section 24.4, “INFORMATION\\_SCHEMA InnoDB Tables”](#). For general information regarding the MySQL INFORMATION\_SCHEMA database, see [Chapter 24, INFORMATION\\_SCHEMA Tables](#).

### 14.16.1 InnoDB INFORMATION\_SCHEMA Tables about Compression

There are two pairs of InnoDB INFORMATION\_SCHEMA tables about compression that can provide insight into how well compression is working overall:

- `INNODB_CMP` and `INNODB_CMP_RESET` provide information about the number of compression operations and the amount of time spent performing compression.
- `INNODB_CMPMEM` and `INNODB_CMPMEM_RESET` provide information about the way memory is allocated for compression.

#### 14.16.1.1 INNODB\_CMP and INNODB\_CMP\_RESET

The `INNODB_CMP` and `INNODB_CMP_RESET` tables provide status information about operations related to compressed tables, which are described in [Section 14.9, “InnoDB Table and Page Compression”](#). The `PAGE_SIZE` column reports the compressed [page size](#).

These two tables have identical contents, but reading from `INNODB_CMP_RESET` resets the statistics on compression and uncompression operations. For example, if you archive the output of `INNODB_CMP_RESET` every 60 minutes, you see the statistics for each hourly period. If you monitor the output of `INNODB_CMP` (making sure never to read `INNODB_CMP_RESET`), you see the cumulative statistics since InnoDB was started.

For the table definition, see [Section 24.4.5, “The INFORMATION\\_SCHEMA INNODB\\_CMP and INNODB\\_CMP\\_RESET Tables”](#).

### 14.16.1.2 INNODB\_CMPMEM and INNODB\_CMPMEM\_RESET

The `INNODB_CMPMEM` and `INNODB_CMPMEM_RESET` tables provide status information about compressed pages that reside in the buffer pool. Please consult [Section 14.9, “InnoDB Table and Page Compression”](#) for further information on compressed tables and the use of the buffer pool. The `INNODB_CMP` and `INNODB_CMP_RESET` tables should provide more useful statistics on compression.

#### Internal Details

InnoDB uses a [buddy allocator](#) system to manage memory allocated to [pages of various sizes](#), from 1KB to 16KB. Each row of the two tables described here corresponds to a single page size.

The `INNODB_CMPMEM` and `INNODB_CMPMEM_RESET` tables have identical contents, but reading from `INNODB_CMPMEM_RESET` resets the statistics on relocation operations. For example, if every 60 minutes you archived the output of `INNODB_CMPMEM_RESET`, it would show the hourly statistics. If you never read `INNODB_CMPMEM_RESET` and monitored the output of `INNODB_CMPMEM` instead, it would show the cumulative statistics since InnoDB was started.

For the table definition, see [Section 24.4.6, “The INFORMATION\\_SCHEMA INNODB\\_CMPMEM and INNODB\\_CMPMEM\\_RESET Tables”](#).

### 14.16.1.3 Using the Compression Information Schema Tables

#### Example 14.1 Using the Compression Information Schema Tables

The following is sample output from a database that contains compressed tables (see [Section 14.9, “InnoDB Table and Page Compression”](#), `INNODB_CMP`, `INNODB_CMP_PER_INDEX`, and `INNODB_CMPMEM`).

The following table shows the contents of the Information Schema `INNODB_CMP` table under a light [workload](#). The only compressed page size that the buffer pool contains is 8KB. Compressing or uncompressing pages has consumed less than a second since the time the statistics were reset, because the columns `COMPRESS_TIME` and `UNCOMPRESS_TIME` are zero.

page size	compress ops	compress ops ok	compress time	uncompress ops	uncompress time
1024	0	0	0	0	0
2048	0	0	0	0	0
4096	0	0	0	0	0
8192	1048	921	0	61	0
16384	0	0	0	0	0

According to `INNODB_CMPMEM`, there are 6169 compressed 8KB pages in the [buffer pool](#). The only other allocated block size is 64 bytes. The smallest `PAGE_SIZE` in `INNODB_CMPMEM` is used for block

descriptors of those compressed pages for which no uncompressed page exists in the buffer pool. We see that there are 5910 such pages. Indirectly, we see that 259 (6169-5910) compressed pages also exist in the buffer pool in uncompressed form.

The following table shows the contents of the Information Schema `INNODB_CMPMEM` table under a light workload. Some memory is unusable due to fragmentation of the memory allocator for compressed pages: `SUM(PAGE_SIZE*PAGES_FREE)=6784`. This is because small memory allocation requests are fulfilled by splitting bigger blocks, starting from the 16K blocks that are allocated from the main buffer pool, using the buddy allocation system. The fragmentation is this low because some allocated blocks have been relocated (copied) to form bigger adjacent free blocks. This copying of `SUM(PAGE_SIZE*RELOCATION_OPS)` bytes has consumed less than a second (`SUM(RELOCATION_TIME)=0`).

page size	pages used	pages free	relocation ops	relocation time
64	5910	0	2436	0
128	0	1	0	0
256	0	0	0	0
512	0	1	0	0
1024	0	0	0	0
2048	0	1	0	0
4096	0	1	0	0
8192	6169	0	5	0
16384	0	0	0	0

## 14.16.2 InnoDB INFORMATION\_SCHEMA Transaction and Locking Information

Three InnoDB `INFORMATION_SCHEMA` tables enable you to monitor transactions and diagnose potential locking problems:

- `INNODB_TRX`: Provides information about every transaction currently executing inside InnoDB, including the transaction state (for example, whether it is running or waiting for a lock), when the transaction started, and the particular SQL statement the transaction is executing.
- `INNODB_LOCKS`: Each transaction in InnoDB that is waiting for another transaction to release a lock (`INNODB_TRX.TRX_STATE` is `LOCK_WAIT`) is blocked by exactly one blocking lock request. That blocking lock request is for a row or table lock held by another transaction in an incompatible mode. A lock that blocks a transaction is always held in a mode incompatible with the mode of requested lock (read vs. write, shared vs. exclusive). The blocked transaction cannot proceed until the other transaction commits or rolls back, thereby releasing the requested lock. For every blocked transaction, `INNODB_LOCKS` contains one row that describes each lock the transaction has requested, and for which it is waiting. `INNODB_LOCKS` also contains one row for each lock that is blocking another transaction, whatever the state of the transaction that holds the lock (`INNODB_TRX.TRX_STATE` is `RUNNING`, `LOCK_WAIT`, `ROLLING_BACK` or `COMMITTING`).
- `INNODB_LOCK_WAITS`: This table indicates which transactions are waiting for a given lock, or for which lock a given transaction is waiting. This table contains one or more rows for each blocked transaction, indicating the lock it has requested and any locks that are blocking that request. The `REQUESTED_LOCK_ID` value refers to the lock requested by a transaction, and the `BLOCKING_LOCK_ID` value refers to the lock (held by another transaction) that prevents the first transaction from proceeding. For any given blocked transaction, all rows in `INNODB_LOCK_WAITS` have the same value for `REQUESTED_LOCK_ID` and different values for `BLOCKING_LOCK_ID`.

For more information about the preceding tables, see [Section 24.4.28](#), “The INFORMATION\_SCHEMA INNODB\_TRX Table”, [Section 24.4.14](#), “The INFORMATION\_SCHEMA INNODB\_LOCKS Table”, and [Section 24.4.15](#), “The INFORMATION\_SCHEMA INNODB\_LOCK\_WAITS Table”.

## 14.16.2.1 Using InnoDB Transaction and Locking Information

### Identifying Blocking Transactions

It is sometimes helpful to identify which transaction blocks another. The tables that contain information about InnoDB transactions and data locks enable you to determine which transaction is waiting for another, and which resource is being requested. (For descriptions of these tables, see [Section 14.16.2](#), “InnoDB INFORMATION\_SCHEMA Transaction and Locking Information”.)

Suppose that three sessions are running concurrently. Each session corresponds to a MySQL thread, and executes one transaction after another. Consider the state of the system when these sessions have issued the following statements, but none has yet committed its transaction:

- Session A:

```
BEGIN;
SELECT a FROM t FOR UPDATE;
SELECT SLEEP(100);
```

- Session B:

```
SELECT b FROM t FOR UPDATE;
```

- Session C:

```
SELECT c FROM t FOR UPDATE;
```

In this scenario, use the following query to see which transactions are waiting and which transactions are blocking them:

```
SELECT
  r.trx_id waiting_trx_id,
  r.trx_mysql_thread_id waiting_thread,
  r.trx_query waiting_query,
  b.trx_id blocking_trx_id,
  b.trx_mysql_thread_id blocking_thread,
  b.trx_query blocking_query
FROM      information_schema.innodb_lock_waits w
INNER JOIN information_schema.innodb_trx b
  ON b.trx_id = w.blocking_trx_id
INNER JOIN information_schema.innodb_trx r
  ON r.trx_id = w.requesting_trx_id;
```

Or, more simply, use the `sys` schema `innodb_lock_waits` view:

```
SELECT
  waiting_trx_id,
  waiting_pid,
  waiting_query,
  blocking_trx_id,
  blocking_pid,
  blocking_query
FROM sys.innodb_lock_waits;
```

If a NULL value is reported for the blocking query, see [Identifying a Blocking Query After the Issuing Session Becomes Idle](#).



waiting trx id	waiting thread	waiting query	blocking trx id	blocking thread	blocking query
A4	6	SELECT b FROM t FOR UPDATE	A3	5	SELECT SLEEP(100)
A5	7	SELECT c FROM t FOR UPDATE	A3	5	SELECT SLEEP(100)
A5	7	SELECT c FROM t FOR UPDATE	A4	6	SELECT b FROM t FOR UPDATE

In the preceding table, you can identify sessions by the “waiting query” or “blocking query” columns. As you can see:

- Session B (trx id [A4](#), thread [6](#)) and Session C (trx id [A5](#), thread [7](#)) are both waiting for Session A (trx id [A3](#), thread [5](#)).
- Session C is waiting for Session B as well as Session A.

You can see the underlying data in the tables [INNODB\\_TRX](#), [INNODB\\_LOCKS](#), and [INNODB\\_LOCK\\_WAITS](#).

The following table shows some sample contents of the Information Schema [INNODB\\_TRX](#) table.

trx id	trx state	trx started	trx requested lock id	trx wait started	trx weight	trx mysql thread id	trx query
A3	RUNNING	2008-01-15 16:44:54	NULL	NULL	2	5	SELECT SLEEP(100)
A4	LOCK WAIT	2008-01-15 16:45:09	A4:1:3:2	2008-01-15 16:45:09		6	SELECT b FROM t FOR UPDATE
A5	LOCK WAIT	2008-01-15 16:45:14	A5:1:3:2	2008-01-15 16:45:14		7	SELECT c FROM t FOR UPDATE

The following table shows some sample contents of the Information Schema [INNODB\\_LOCKS](#) table.

lock id	lock trx id	lock mode	lock type	lock table	lock index	lock data
A3:1:3:2	A3	X	RECORD	test.t	PRIMARY	0x0200
A4:1:3:2	A4	X	RECORD	test.t	PRIMARY	0x0200
A5:1:3:2	A5	X	RECORD	test.t	PRIMARY	0x0200

The following table shows some sample contents of the Information Schema [INNODB\\_LOCK\\_WAITS](#) table.

requesting trx id	requested lock id	blocking trx id	blocking lock id
A4	A4:1:3:2	A3	A3:1:3:2
A5	A5:1:3:2	A3	A3:1:3:2
A5	A5:1:3:2	A4	A4:1:3:2

## Identifying a Blocking Query After the Issuing Session Becomes Idle

When identifying blocking transactions, a NULL value is reported for the blocking query if the session that issued the query has become idle. In this case, use the following steps to determine the blocking query:

1. Identify the processlist ID of the blocking transaction. In the `sys.innodb_lock_waits` table, the processlist ID of the blocking transaction is the `blocking_pid` value.
2. Using the `blocking_pid`, query the MySQL Performance Schema `threads` table to determine the `THREAD_ID` of the blocking transaction. For example, if the `blocking_pid` is 6, issue this query:

```
SELECT THREAD_ID FROM performance_schema.threads WHERE PROCESSLIST_ID = 6;
```

3. Using the `THREAD_ID`, query the Performance Schema `events_statements_current` table to determine the last query executed by the thread. For example, if the `THREAD_ID` is 28, issue this query:

```
SELECT THREAD_ID, SQL_TEXT FROM performance_schema.events_statements_current
WHERE THREAD_ID = 28\G
```

4. If the last query executed by the thread is not enough information to determine why a lock is held, you can query the Performance Schema `events_statements_history` table to view the last 10 statements executed by the thread.

```
SELECT THREAD_ID, SQL_TEXT FROM performance_schema.events_statements_history
WHERE THREAD_ID = 28 ORDER BY EVENT_ID;
```

## Correlating InnoDB Transactions with MySQL Sessions

Sometimes it is useful to correlate internal InnoDB locking information with the session-level information maintained by MySQL. For example, you might like to know, for a given InnoDB transaction ID, the corresponding MySQL session ID and name of the session that may be holding a lock, and thus blocking other transactions.

The following output from the `INFORMATION_SCHEMA` tables is taken from a somewhat loaded system. As can be seen, there are several transactions running.

The following `INNODB_LOCKS` and `INNODB_LOCK_WAITS` tables show that:

- Transaction `77F` (executing an `INSERT`) is waiting for transactions `77E`, `77D`, and `77B` to commit.
- Transaction `77E` (executing an `INSERT`) is waiting for transactions `77D` and `77B` to commit.
- Transaction `77D` (executing an `INSERT`) is waiting for transaction `77B` to commit.
- Transaction `77B` (executing an `INSERT`) is waiting for transaction `77A` to commit.
- Transaction `77A` is running, currently executing `SELECT`.
- Transaction `E56` (executing an `INSERT`) is waiting for transaction `E55` to commit.
- Transaction `E55` (executing an `INSERT`) is waiting for transaction `19C` to commit.
- Transaction `19C` is running, currently executing an `INSERT`.



### Note

There may be inconsistencies between queries shown in the `INFORMATION_SCHEMA.PROCESSLIST` and `INNODB_TRX` tables. For an

explanation, see [Section 14.16.2.3, “Persistence and Consistency of InnoDB Transaction and Locking Information”](#).

The following table shows the contents of the Information Schema `PROCESSLIST` table for a system running a heavy *workload*.

ID	USER	HOST	DB	COMMAND	TIME	STATE	INFO
384	root	localhost	test	Query	10	update	INSERT INTO t2 VALUES ...
257	root	localhost	test	Query	3	update	INSERT INTO t2 VALUES ...
130	root	localhost	test	Query	0	update	INSERT INTO t2 VALUES ...
61	root	localhost	test	Query	1	update	INSERT INTO t2 VALUES ...
8	root	localhost	test	Query	1	update	INSERT INTO t2 VALUES ...
4	root	localhost	test	Query	0	preparing	SELECT * FROM PROCESSLIST
2	root	localhost	test	Sleep	566		NULL

The following table shows the contents of the Information Schema `INNODB_TRX` table for a system running a heavy *workload*.

trx id	trx state	trx started	trx requested lock id	trx wait started	trx weight	trx mysql thread id	trx query
77F	LOCK WAIT	2008-01-15 13:10:16	77F	2008-01-15 13:10:16		876	INSERT INTO t09 (D, B, C) VALUES ...
77E	LOCK WAIT	2008-01-15 13:10:16	77E	2008-01-15 13:10:16		875	INSERT INTO t09 (D, B, C) VALUES ...
77D	LOCK WAIT	2008-01-15 13:10:16	77D	2008-01-15 13:10:16		874	INSERT INTO t09 (D, B, C) VALUES ...
77B	LOCK WAIT	2008-01-15 13:10:16	77B:733:122	2008-01-15 13:10:16		873	INSERT INTO t09 (D, B, C) VALUES ...

trx id	trx state	trx started	trx requested lock id	trx wait started	trx weight	trx mysql thread id	trx query
77A	RUNNING	2008-01-15 13:10:16	NULL	NULL	4	872	SELECT b, c FROM t09 WHERE ...
E56	LOCK WAIT	2008-01-15 13:10:06	E56:743:6:2	2008-01-15 13:10:06		384	INSERT INTO t2 VALUES ...
E55	LOCK WAIT	2008-01-15 13:10:06	E55:743:38:2	2008-01-15 13:10:13		257	INSERT INTO t2 VALUES ...
19C	RUNNING	2008-01-15 13:09:10	NULL	NULL	2900	130	INSERT INTO t2 VALUES ...
E15	RUNNING	2008-01-15 13:08:59	NULL	NULL	5395	61	INSERT INTO t2 VALUES ...
51D	RUNNING	2008-01-15 13:08:47	NULL	NULL	9807	8	INSERT INTO t2 VALUES ...

The following table shows the contents of the Information Schema `INNODB_LOCK_WAITS` table for a system running a heavy [workload](#).

requesting trx id	requested lock id	blocking trx id	blocking lock id
77F	77F:806	77E	77E:806
77F	77F:806	77D	77D:806
77F	77F:806	77B	77B:806
77E	77E:806	77D	77D:806
77E	77E:806	77B	77B:806
77D	77D:806	77B	77B:806
77B	77B:733:12:1	77A	77A:733:12:1
E56	E56:743:6:2	E55	E55:743:6:2
E55	E55:743:38:2	19C	19C:743:38:2

The following table shows the contents of the Information Schema `INNODB_LOCKS` table for a system running a heavy [workload](#).

lock id	lock trx id	lock mode	lock type	lock table	lock index	lock data
77F:806	77F	AUTO_INC	TABLE	test.t09	NULL	NULL
77E:806	77E	AUTO_INC	TABLE	test.t09	NULL	NULL
77D:806	77D	AUTO_INC	TABLE	test.t09	NULL	NULL
77B:806	77B	AUTO_INC	TABLE	test.t09	NULL	NULL

lock id	lock trx id	lock mode	lock type	lock table	lock index	lock data
77B:733:12:	77B	X	RECORD	test.t09	PRIMARY	supremum pseudo-record
77A:733:12:	77A	X	RECORD	test.t09	PRIMARY	supremum pseudo-record
E56:743:6:2	E56	S	RECORD	test.t2	PRIMARY	0, 0
E55:743:6:2	E55	X	RECORD	test.t2	PRIMARY	0, 0
E55:743:38:	E55	S	RECORD	test.t2	PRIMARY	1922, 1922
19C:743:38:	19C	X	RECORD	test.t2	PRIMARY	1922, 1922

### 14.16.2.2 InnoDB Lock and Lock-Wait Information

When a transaction updates a row in a table, or locks it with `SELECT FOR UPDATE`, InnoDB establishes a list or queue of locks on that row. Similarly, InnoDB maintains a list of locks on a table for table-level locks. If a second transaction wants to update a row or lock a table already locked by a prior transaction in an incompatible mode, InnoDB adds a lock request for the row to the corresponding queue. For a lock to be acquired by a transaction, all incompatible lock requests previously entered into the lock queue for that row or table must be removed (which occurs when the transactions holding or requesting those locks either commit or roll back).

A transaction may have any number of lock requests for different rows or tables. At any given time, a transaction may request a lock that is held by another transaction, in which case it is blocked by that other transaction. The requesting transaction must wait for the transaction that holds the blocking lock to commit or roll back. If a transaction is not waiting for a lock, it is in a `RUNNING` state. If a transaction is waiting for a lock, it is in a `LOCK WAIT` state. (The `INFORMATION_SCHEMA.INNODB_TRX` table indicates transaction state values.)

The `INNODB_LOCKS` table holds one or more rows for each `LOCK WAIT` transaction, indicating any lock requests that prevent its progress. This table also contains one row describing each lock in a queue of locks pending for a given row or table. The `INNODB_LOCK_WAITS` table shows which locks already held by a transaction are blocking locks requested by other transactions.

### 14.16.2.3 Persistence and Consistency of InnoDB Transaction and Locking Information

The data exposed by the transaction and locking tables (`INNODB_TRX`, `INNODB_LOCKS`, and `INNODB_LOCK_WAITS`) represents a glimpse into fast-changing data. This is not like user tables, where the data changes only when application-initiated updates occur. The underlying data is internal system-managed data, and can change very quickly.

For performance reasons, and to minimize the chance of misleading joins between the transaction and locking tables, InnoDB collects the required transaction and locking information into an intermediate buffer whenever a `SELECT` on any of the tables is issued. This buffer is refreshed only if more than 0.1 seconds has elapsed since the last time the buffer was read. The data needed to fill the three tables is fetched atomically and consistently and is saved in this global internal buffer, forming a point-in-time “snapshot”. If multiple table accesses occur within 0.1 seconds (as they almost certainly do when MySQL processes a join among these tables), then the same snapshot is used to satisfy the query.

A correct result is returned when you join any of these tables together in a single query, because the data for the three tables comes from the same snapshot. Because the buffer is not refreshed with every query of any of these tables, if you issue separate queries against these tables within a tenth of a second, the

results are the same from query to query. On the other hand, two separate queries of the same or different tables issued more than a tenth of a second apart may see different results, since the data come from different snapshots.

Because InnoDB must temporarily stall while the transaction and locking data is collected, too frequent queries of these tables can negatively impact performance as seen by other users.

As these tables contain sensitive information (at least `INNODB_LOCKS.LOCK_DATA` and `INNODB_TRX.TRX_QUERY`), for security reasons, only the users with the `PROCESS` privilege are allowed to `SELECT` from them.

As described previously, the data that fills the transaction and locking tables (`INNODB_TRX`, `INNODB_LOCKS` and `INNODB_LOCK_WAITS`) is fetched automatically and saved to an intermediate buffer that provides a “point-in-time” snapshot. The data across all three tables is consistent when queried from the same snapshot. However, the underlying data changes so fast that similar glimpses at other, similarly fast-changing data, may not be in synchrony. Thus, you should be careful when comparing data in the InnoDB transaction and locking tables with data in the `PROCESSLIST` table. The data from the `PROCESSLIST` table does not come from the same snapshot as the data about locking and transactions. Even if you issue a single `SELECT` (joining `INNODB_TRX` and `PROCESSLIST`, for example), the content of those tables is generally not consistent. `INNODB_TRX` may reference rows that are not present in `PROCESSLIST` or the currently executing SQL query of a transaction shown in `INNODB_TRX.TRX_QUERY` may differ from the one in `PROCESSLIST.INFO`.

### 14.16.3 InnoDB INFORMATION\_SCHEMA System Tables

You can extract metadata about schema objects managed by InnoDB using InnoDB `INFORMATION_SCHEMA` system tables. This information comes from the InnoDB internal system tables (also referred to as the InnoDB data dictionary), which cannot be queried directly like regular InnoDB tables. Traditionally, you would get this type of information using the techniques from [Section 14.18, “InnoDB Monitors”](#), setting up InnoDB monitors and parsing the output from the `SHOW ENGINE INNODB STATUS` statement. The InnoDB `INFORMATION_SCHEMA` table interface allows you to query this data using SQL.

With the exception of `INNODB_SYS_TABLESTATS`, for which there is no corresponding internal system table, InnoDB `INFORMATION_SCHEMA` system tables are populated with data read directly from internal InnoDB system tables rather than from metadata that is cached in memory.

InnoDB `INFORMATION_SCHEMA` system tables include the tables listed below.

```
mysql> SHOW TABLES FROM INFORMATION_SCHEMA LIKE 'INNODB_SYS%';
+-----+
| Tables_in_information_schema (INNODB_SYS%) |
+-----+
| INNODB_SYS_DATAFILES                       |
| INNODB_SYS_TABLESTATS                     |
| INNODB_SYS_FOREIGN                         |
| INNODB_SYS_COLUMNS                         |
| INNODB_SYS_INDEXES                         |
| INNODB_SYS_FIELDS                          |
| INNODB_SYS_TABLESPACES                     |
| INNODB_SYS_FOREIGN_COLS                    |
| INNODB_SYS_TABLES                          |
+-----+
```

The table names are indicative of the type of data provided:

- `INNODB_SYS_TABLES` provides metadata about InnoDB tables, equivalent to the information in the `SYS_TABLES` table in the InnoDB data dictionary.

- [INNODB\\_SYS\\_COLUMNS](#) provides metadata about InnoDB table columns, equivalent to the information in the [SYS\\_COLUMNS](#) table in the InnoDB data dictionary.
- [INNODB\\_SYS\\_INDEXES](#) provides metadata about InnoDB indexes, equivalent to the information in the [SYS\\_INDEXES](#) table in the InnoDB data dictionary.
- [INNODB\\_SYS\\_FIELDS](#) provides metadata about the key columns (fields) of InnoDB indexes, equivalent to the information in the [SYS\\_FIELDS](#) table in the InnoDB data dictionary.
- [INNODB\\_SYS\\_TABLESTATS](#) provides a view of low-level status information about InnoDB tables that is derived from in-memory data structures. There is no corresponding internal InnoDB system table.
- [INNODB\\_SYS\\_DATAFILES](#) provides data file path information for InnoDB file-per-table and general tablespaces, equivalent to information in the [SYS\\_DATAFILES](#) table in the InnoDB data dictionary.
- [INNODB\\_SYS\\_TABLESPACES](#) provides metadata about InnoDB file-per-table and general tablespaces, equivalent to the information in the [SYS\\_TABLESPACES](#) table in the InnoDB data dictionary.
- [INNODB\\_SYS\\_FOREIGN](#) provides metadata about foreign keys defined on InnoDB tables, equivalent to the information in the [SYS\\_FOREIGN](#) table in the InnoDB data dictionary.
- [INNODB\\_SYS\\_FOREIGN\\_COLS](#) provides metadata about the columns of foreign keys that are defined on InnoDB tables, equivalent to the information in the [SYS\\_FOREIGN\\_COLS](#) table in the InnoDB data dictionary.

InnoDB [INFORMATION\\_SCHEMA](#) system tables can be joined together through fields such as [TABLE\\_ID](#), [INDEX\\_ID](#), and [SPACE](#), allowing you to easily retrieve all available data for an object you want to study or monitor.

Refer to the InnoDB [INFORMATION\\_SCHEMA](#) documentation for information about the columns of each table.

### Example 14.2 InnoDB INFORMATION\_SCHEMA System Tables

This example uses a simple table ([t1](#)) with a single index ([i1](#)) to demonstrate the type of metadata found in the InnoDB [INFORMATION\\_SCHEMA](#) system tables.

1. Create a test database and table [t1](#):

```
mysql> CREATE DATABASE test;

mysql> USE test;

mysql> CREATE TABLE t1 (
    col1 INT,
    col2 CHAR(10),
    col3 VARCHAR(10))
    ENGINE = InnoDB;

mysql> CREATE INDEX i1 ON t1(col1);
```

2. After creating the table [t1](#), query [INNODB\\_SYS\\_TABLES](#) to locate the metadata for [test/t1](#):

```
mysql> SELECT * FROM INFORMATION_SCHEMA.INNODB_SYS_TABLES WHERE NAME='test/t1' \G
***** 1. row *****
TABLE_ID: 71
NAME: test/t1
FLAG: 1
N_COLS: 6
SPACE: 57
```

```

FILE_FORMAT: Antelope
ROW_FORMAT: Compact
ZIP_PAGE_SIZE: 0
...

```

Table `t1` has a `TABLE_ID` of 71. The `FLAG` field provides bit level information about table format and storage characteristics. There are six columns, three of which are hidden columns created by InnoDB (`DB_ROW_ID`, `DB_TRX_ID`, and `DB_ROLL_PTR`). The ID of the table's `SPACE` is 57 (a value of 0 would indicate that the table resides in the system tablespace). The `FILE_FORMAT` is Antelope, and the `ROW_FORMAT` is Compact. `ZIP_PAGE_SIZE` only applies to tables with a `Compressed` row format.

- Using the `TABLE_ID` information from `INNODB_SYS_TABLES`, query the `INNODB_SYS_COLUMNS` table for information about the table's columns.

```

mysql> SELECT * FROM INFORMATION_SCHEMA.INNODB_SYS_COLUMNS where TABLE_ID = 71 \G
***** 1. row *****
TABLE_ID: 71
  NAME: col1
  POS: 0
  MTYPE: 6
  PRTYPE: 1027
  LEN: 4
***** 2. row *****
TABLE_ID: 71
  NAME: col2
  POS: 1
  MTYPE: 2
  PRTYPE: 524542
  LEN: 10
***** 3. row *****
TABLE_ID: 71
  NAME: col3
  POS: 2
  MTYPE: 1
  PRTYPE: 524303
  LEN: 10

```

In addition to the `TABLE_ID` and column `NAME`, `INNODB_SYS_COLUMNS` provides the ordinal position (`POS`) of each column (starting from 0 and incrementing sequentially), the column `MTYPE` or “main type” (6 = INT, 2 = CHAR, 1 = VARCHAR), the `PRTYPE` or “precise type” (a binary value with bits that represent the MySQL data type, character set code, and nullability), and the column length (`LEN`).

- Using the `TABLE_ID` information from `INNODB_SYS_TABLES` once again, query `INNODB_SYS_INDEXES` for information about the indexes associated with table `t1`.

```

mysql> SELECT * FROM INFORMATION_SCHEMA.INNODB_SYS_INDEXES WHERE TABLE_ID = 71 \G
***** 1. row *****
  INDEX_ID: 111
  NAME: GEN_CLUST_INDEX
  TABLE_ID: 71
  TYPE: 1
  N_FIELDS: 0
  PAGE_NO: 3
  SPACE: 57
MERGE_THRESHOLD: 50
***** 2. row *****
  INDEX_ID: 112
  NAME: i1
  TABLE_ID: 71
  TYPE: 0
  N_FIELDS: 1
  PAGE_NO: 4
  SPACE: 57
MERGE_THRESHOLD: 50

```



`INNODB_SYS_INDEXES` returns data for two indexes. The first index is `GEN_CLUST_INDEX`, which is a clustered index created by InnoDB if the table does not have a user-defined clustered index. The second index (`i1`) is the user-defined secondary index.

The `INDEX_ID` is an identifier for the index that is unique across all databases in an instance. The `TABLE_ID` identifies the table that the index is associated with. The index `TYPE` value indicates the type of index (1 = Clustered Index, 0 = Secondary index). The `N_FIELDS` value is the number of fields that comprise the index. `PAGE_NO` is the root page number of the index B-tree, and `SPACE` is the ID of the tablespace where the index resides. A nonzero value indicates that the index does not reside in the system tablespace. `MERGE_THRESHOLD` defines a percentage threshold value for the amount of data in an index page. If the amount of data in an index page falls below the this value (the default is 50%) when a row is deleted or when a row is shortened by an update operation, InnoDB attempts to merge the index page with a neighboring index page.

- Using the `INDEX_ID` information from `INNODB_SYS_INDEXES`, query `INNODB_SYS_FIELDS` for information about the fields of index `i1`.

```
mysql> SELECT * FROM INFORMATION_SCHEMA.INNODB_SYS_FIELDS where INDEX_ID = 112 \G
***** 1. row *****
INDEX_ID: 112
NAME: coll
POS: 0
```

`INNODB_SYS_FIELDS` provides the `NAME` of the indexed field and its ordinal position within the index. If the index (`i1`) had been defined on multiple fields, `INNODB_SYS_FIELDS` would provide metadata for each of the indexed fields.

- Using the `SPACE` information from `INNODB_SYS_TABLES`, query `INNODB_SYS_TABLESPACES` table for information about the table's tablespace.

```
mysql> SELECT * FROM INFORMATION_SCHEMA.INNODB_SYS_TABLESPACES WHERE SPACE = 57 \G
***** 1. row *****
SPACE: 57
NAME: test/t1
FLAG: 0
FILE_FORMAT: Antelope
ROW_FORMAT: Compact or Redundant
PAGE_SIZE: 16384
ZIP_PAGE_SIZE: 0
```

In addition to the `SPACE` ID of the tablespace and the `NAME` of the associated table, `INNODB_SYS_TABLESPACES` provides tablespace `FLAG` data, which is bit level information about tablespace format and storage characteristics. Also provided are tablespace `FILE_FORMAT`, `ROW_FORMAT`, `PAGE_SIZE`, and several other tablespace metadata items.

- Using the `SPACE` information from `INNODB_SYS_TABLES` once again, query `INNODB_SYS_DATAFILES` for the location of the tablespace data file.

```
mysql> SELECT * FROM INFORMATION_SCHEMA.INNODB_SYS_DATAFILES WHERE SPACE = 57 \G
***** 1. row *****
SPACE: 57
PATH: ./test/t1.ibd
```

The datafile is located in the `test` directory under MySQL's `data` directory. If a `file-per-table` tablespace were created in a location outside the MySQL data directory using the `DATA DIRECTORY` clause of the `CREATE TABLE` statement, the tablespace `PATH` would be a fully qualified directory path.

- As a final step, insert a row into table `t1` (`TABLE_ID = 71`) and view the data in the `INNODB_SYS_TABLESTATS` table. The data in this table is used by the MySQL optimizer to calculate

which index to use when querying an [InnoDB](#) table. This information is derived from in-memory data structures. There is no corresponding internal [InnoDB](#) system table.

```
mysql> INSERT INTO t1 VALUES(5, 'abc', 'def');
Query OK, 1 row affected (0.06 sec)

mysql> SELECT * FROM INFORMATION_SCHEMA.INNODB_SYS_TABLESTATS where TABLE_ID = 71 \G
***** 1. row *****
      TABLE_ID: 71
      NAME: test/t1
STATS_INITIALIZED: Initialized
      NUM_ROWS: 1
      CLUST_INDEX_SIZE: 1
      OTHER_INDEX_SIZE: 0
      MODIFIED_COUNTER: 1
      AUTOINC: 0
      REF_COUNT: 1
```

The `STATS_INITIALIZED` field indicates whether or not statistics have been collected for the table. `NUM_ROWS` is the current estimated number of rows in the table. The `CLUST_INDEX_SIZE` and `OTHER_INDEX_SIZE` fields report the number of pages on disk that store clustered and secondary indexes for the table, respectively. The `MODIFIED_COUNTER` value shows the number of rows modified by DML operations and cascade operations from foreign keys. The `AUTOINC` value is the next number to be issued for any autoincrement-based operation. There are no autoincrement columns defined on table `t1`, so the value is 0. The `REF_COUNT` value is a counter. When the counter reaches 0, it signifies that the table metadata can be evicted from the table cache.

### Example 14.3 Foreign Key INFORMATION\_SCHEMA System Tables

The `INNODB_SYS_FOREIGN` and `INNODB_SYS_FOREIGN_COLS` tables provide data about foreign key relationships. This example uses a parent table and child table with a foreign key relationship to demonstrate the data found in the `INNODB_SYS_FOREIGN` and `INNODB_SYS_FOREIGN_COLS` tables.

1. Create the test database with parent and child tables:

```
mysql> CREATE DATABASE test;

mysql> USE test;

mysql> CREATE TABLE parent (id INT NOT NULL,
      PRIMARY KEY (id)) ENGINE=INNODB;

mysql> CREATE TABLE child (id INT, parent_id INT,
      INDEX par_ind (parent_id),
      CONSTRAINT fk1
      FOREIGN KEY (parent_id) REFERENCES parent(id)
      ON DELETE CASCADE) ENGINE=INNODB;
```

2. After the parent and child tables are created, query `INNODB_SYS_FOREIGN` and locate the foreign key data for the `test/child` and `test/parent` foreign key relationship:

```
mysql> SELECT * FROM INFORMATION_SCHEMA.INNODB_SYS_FOREIGN \G
***** 1. row *****
      ID: test/fk1
      FOR_NAME: test/child
      REF_NAME: test/parent
      N_COLS: 1
      TYPE: 1
```

Metadata includes the foreign key `ID` (`fk1`), which is named for the `CONSTRAINT` that was defined on the child table. The `FOR_NAME` is the name of the child table where the foreign key is defined. `REF_NAME` is the name of the parent table (the “referenced” table). `N_COLS` is the number of columns

in the foreign key index. `TYPE` is a numerical value representing bit flags that provide additional information about the foreign key column. In this case, the `TYPE` value is 1, which indicates that the `ON DELETE CASCADE` option was specified for the foreign key. See the `INNODB_SYS_FOREIGN` table definition for more information about `TYPE` values.

- Using the foreign key `ID`, query `INNODB_SYS_FOREIGN_COLS` to view data about the columns of the foreign key.

```
mysql> SELECT * FROM INFORMATION_SCHEMA.INNODB_SYS_FOREIGN_COLS WHERE ID = 'test/fk1' \G
***** 1. row *****
      ID: test/fk1
FOR_COL_NAME: parent_id
REF_COL_NAME: id
      POS: 0
```

`FOR_COL_NAME` is the name of the foreign key column in the child table, and `REF_COL_NAME` is the name of the referenced column in the parent table. The `POS` value is the ordinal position of the key field within the foreign key index, starting at zero.

#### Example 14.4 Joining InnoDB INFORMATION\_SCHEMA System Tables

This example demonstrates joining three InnoDB `INFORMATION_SCHEMA` system tables (`INNODB_SYS_TABLES`, `INNODB_SYS_TABLESPACES`, and `INNODB_SYS_TABLESTATS`) to gather file format, row format, page size, and index size information about tables in the employees sample database.

The following table name aliases are used to shorten the query string:

- `INFORMATION_SCHEMA.INNODB_SYS_TABLES`: a
- `INFORMATION_SCHEMA.INNODB_SYS_TABLESPACES`: b
- `INFORMATION_SCHEMA.INNODB_SYS_TABLESTATS`: c

An `IF()` control flow function is used to account for compressed tables. If a table is compressed, the index size is calculated using `ZIP_PAGE_SIZE` rather than `PAGE_SIZE`. `CLUST_INDEX_SIZE` and `OTHER_INDEX_SIZE`, which are reported in bytes, are divided by `1024*1024` to provide index sizes in megabytes (MBs). MB values are rounded to zero decimal spaces using the `ROUND()` function.

```
mysql> SELECT a.NAME, a.FILE_FORMAT, a.ROW_FORMAT,
  @page_size :=
    IF(a.ROW_FORMAT='Compressed',
      b.ZIP_PAGE_SIZE, b.PAGE_SIZE)
  AS page_size,
  ROUND(@page_size * c.CLUST_INDEX_SIZE
    /(1024*1024)) AS pk_mb,
  ROUND(@page_size * c.OTHER_INDEX_SIZE
    /(1024*1024)) AS secidx_mb
  FROM INFORMATION_SCHEMA.INNODB_SYS_TABLES a
  INNER JOIN INFORMATION_SCHEMA.INNODB_SYS_TABLESPACES b on a.NAME = b.NAME
  INNER JOIN INFORMATION_SCHEMA.INNODB_SYS_TABLESTATS c on b.NAME = c.NAME
  WHERE a.NAME LIKE 'employees/%'
  ORDER BY a.NAME DESC;
```

NAME	FILE_FORMAT	ROW_FORMAT	page_size	pk_mb	secidx_mb
employees/titles	Antelope	Compact	16384	20	11
employees/salaries	Antelope	Compact	16384	91	33
employees/employees	Antelope	Compact	16384	15	0
employees/dept_manager	Antelope	Compact	16384	0	0
employees/dept_emp	Antelope	Compact	16384	12	10
employees/departments	Antelope	Compact	16384	0	0

## 14.16.4 InnoDB INFORMATION\_SCHEMA FULLTEXT Index Tables

The following tables provide metadata for `FULLTEXT` indexes:

```
mysql> SHOW TABLES FROM INFORMATION_SCHEMA LIKE 'INNODB_FT%';
+-----+-----+-----+-----+-----+-----+
| Tables_in_INFORMATION_SCHEMA (INNODB_FT%) |
+-----+-----+-----+-----+
| INNODB_FT_CONFIG                          |
| INNODB_FT_BEING_DELETED                   |
| INNODB_FT_DELETED                         |
| INNODB_FT_DEFAULT_STOPWORD               |
| INNODB_FT_INDEX_TABLE                    |
| INNODB_FT_INDEX_CACHE                    |
+-----+-----+-----+-----+
```

### Table Overview

- `INNODB_FT_CONFIG`: Provides metadata about the `FULLTEXT` index and associated processing for an `InnoDB` table.
- `INNODB_FT_BEING_DELETED`: Provides a snapshot of the `INNODB_FT_DELETED` table; it is used only during an `OPTIMIZE TABLE` maintenance operation. When `OPTIMIZE TABLE` is run, the `INNODB_FT_BEING_DELETED` table is emptied, and `DOC_ID` values are removed from the `INNODB_FT_DELETED` table. Because the contents of `INNODB_FT_BEING_DELETED` typically have a short lifetime, this table has limited utility for monitoring or debugging. For information about running `OPTIMIZE TABLE` on tables with `FULLTEXT` indexes, see [Section 12.9.6, “Fine-Tuning MySQL Full-Text Search”](#).
- `INNODB_FT_DELETED`: Stores rows that are deleted from the `FULLTEXT` index for an `InnoDB` table. To avoid expensive index reorganization during DML operations for an `InnoDB FULLTEXT` index, the information about newly deleted words is stored separately, filtered out of search results when you do a text search, and removed from the main search index only when you issue an `OPTIMIZE TABLE` statement for the `InnoDB` table.
- `INNODB_FT_DEFAULT_STOPWORD`: Holds a list of `stopwords` that are used by default when creating a `FULLTEXT` index on `InnoDB` tables.

For information about the `INNODB_FT_DEFAULT_STOPWORD` table, see [Section 12.9.4, “Full-Text Stopwords”](#).

- `INNODB_FT_INDEX_TABLE`: Provides information about the inverted index used to process text searches against the `FULLTEXT` index of an `InnoDB` table.
- `INNODB_FT_INDEX_CACHE`: Provides token information about newly inserted rows in a `FULLTEXT` index. To avoid expensive index reorganization during DML operations, the information about newly indexed words is stored separately, and combined with the main search index only when `OPTIMIZE TABLE` is run, when the server is shut down, or when the cache size exceeds a limit defined by the `innodb_ft_cache_size` or `innodb_ft_total_cache_size` system variable.



#### Note

With the exception of the `INNODB_FT_DEFAULT_STOPWORD` table, these tables are empty initially. Before querying any of them, set the value of the `innodb_ft_aux_table` system variable to the name (including the database name) of the table that contains the `FULLTEXT` index (for example, `test/articles`).

**Example 14.5 InnoDB FULLTEXT Index INFORMATION\_SCHEMA Tables**

This example uses a table with a `FULLTEXT` index to demonstrate the data contained in the `FULLTEXT` index `INFORMATION_SCHEMA` tables.

1. Create a table with a `FULLTEXT` index and insert some data:

```
mysql> CREATE TABLE articles (
  id INT UNSIGNED AUTO_INCREMENT NOT NULL PRIMARY KEY,
  title VARCHAR(200),
  body TEXT,
  FULLTEXT (title,body)
) ENGINE=InnoDB;

mysql> INSERT INTO articles (title,body) VALUES
('MySQL Tutorial','DBMS stands for DataBase ...'),
('How To Use MySQL Well','After you went through a ...'),
('Optimizing MySQL','In this tutorial we show ...'),
('1001 MySQL Tricks','1. Never run mysqld as root. 2. ...'),
('MySQL vs. YourSQL','In the following database comparison ...'),
('MySQL Security','When configured properly, MySQL ...');
```

2. Set the `innodb_ft_aux_table` variable to the name of the table with the `FULLTEXT` index. If this variable is not set, the `InnoDB FULLTEXT INFORMATION_SCHEMA` tables are empty, with the exception of `INNODB_FT_DEFAULT_STOPWORD`.

```
SET GLOBAL innodb_ft_aux_table = 'test/articles';
```

3. Query the `INNODB_FT_INDEX_CACHE` table, which shows information about newly inserted rows in a `FULLTEXT` index. To avoid expensive index reorganization during DML operations, data for newly inserted rows remains in the `FULLTEXT` index cache until `OPTIMIZE TABLE` is run (or until the server is shut down or cache limits are exceeded).

```
mysql> SELECT * FROM INFORMATION_SCHEMA.INNODB_FT_INDEX_CACHE LIMIT 5;
```

WORD	FIRST_DOC_ID	LAST_DOC_ID	DOC_COUNT	DOC_ID	POSITION
1001	5	5	1	5	0
after	3	3	1	3	22
comparison	6	6	1	6	44
configured	7	7	1	7	20
database	2	6	2	2	31

4. Enable the `innodb_optimize_fulltext_only` system variable and run `OPTIMIZE TABLE` on the table that contains the `FULLTEXT` index. This operation flushes the contents of the `FULLTEXT` index cache to the main `FULLTEXT` index. `innodb_optimize_fulltext_only` changes the way the `OPTIMIZE TABLE` statement operates on `InnoDB` tables, and is intended to be enabled temporarily, during maintenance operations on `InnoDB` tables with `FULLTEXT` indexes.

```
mysql> SET GLOBAL innodb_optimize_fulltext_only=ON;
```

```
mysql> OPTIMIZE TABLE articles;
```

Table	Op	Msg_type	Msg_text
test.articles	optimize	status	OK

5. Query the `INNODB_FT_INDEX_TABLE` table to view information about data in the main `FULLTEXT` index, including information about the data that was just flushed from the `FULLTEXT` index cache.

```
mysql> SELECT * FROM INFORMATION_SCHEMA.INNODB_FT_INDEX_TABLE LIMIT 5;
```

WORD	FIRST_DOC_ID	LAST_DOC_ID	DOC_COUNT	DOC_ID	POSITION
1001	5	5	1	5	0
after	3	3	1	3	22
comparison	6	6	1	6	44
configured	7	7	1	7	20
database	2	6	2	2	31

The `INNODB_FT_INDEX_CACHE` table is now empty since the `OPTIMIZE TABLE` operation flushed the `FULLTEXT` index cache.

```
mysql> SELECT * FROM INFORMATION_SCHEMA.INNODB_FT_INDEX_CACHE LIMIT 5;
Empty set (0.00 sec)
```

6. Delete some records from the `test/articles` table.

```
mysql> DELETE FROM test.articles WHERE id < 4;
```

7. Query the `INNODB_FT_DELETED` table. This table records rows that are deleted from the `FULLTEXT` index. To avoid expensive index reorganization during DML operations, information about newly deleted records is stored separately, filtered out of search results when you do a text search, and removed from the main search index when you run `OPTIMIZE TABLE`.

```
mysql> SELECT * FROM INFORMATION_SCHEMA.INNODB_FT_DELETED;
+-----+
| DOC_ID |
+-----+
|      2 |
|      3 |
|      4 |
+-----+
```

8. Run `OPTIMIZE TABLE` to remove the deleted records.

```
mysql> OPTIMIZE TABLE articles;
+-----+-----+-----+-----+
| Table          | Op          | Msg_type | Msg_text |
+-----+-----+-----+-----+
| test.articles | optimize    | status   | OK        |
+-----+-----+-----+-----+
```

The `INNODB_FT_DELETED` table should now be empty.

```
mysql> SELECT * FROM INFORMATION_SCHEMA.INNODB_FT_DELETED;
Empty set (0.00 sec)
```

9. Query the `INNODB_FT_CONFIG` table. This table contains metadata about the `FULLTEXT` index and related processing:

- `optimize_checkpoint_limit`: The number of seconds after which an `OPTIMIZE TABLE` run stops.
- `synced_doc_id`: The next `DOC_ID` to be issued.
- `stopword_table_name`: The `database/table` name for a user-defined stopword table. The `VALUE` column is empty if there is no user-defined stopword table.
- `use_stopword`: Indicates whether a stopword table is used, which is defined when the `FULLTEXT` index is created.

```
mysql> SELECT * FROM INFORMATION_SCHEMA.INNODB_FT_CONFIG;
```

KEY	VALUE
optimize_checkpoint_limit	180
synced_doc_id	8
stopword_table_name	
use_stopword	1

10. Disable `innodb_optimize_fulltext_only`, since it is intended to be enabled only temporarily:

```
mysql> SET GLOBAL innodb_optimize_fulltext_only=OFF;
```

## 14.16.5 InnoDB INFORMATION\_SCHEMA Buffer Pool Tables

The `INNO_DB INFORMATION_SCHEMA` buffer pool tables provide buffer pool status information and metadata about the pages within the `InnoDB` buffer pool.

The `INNO_DB INFORMATION_SCHEMA` buffer pool tables include those listed below:

```
mysql> SHOW TABLES FROM INFORMATION_SCHEMA LIKE 'INNODB_BUFFER%';
```

Tables_in_INFORMATION_SCHEMA (INNODB_BUFFER%)
INNODB_BUFFER_PAGE_LRU
INNODB_BUFFER_PAGE
INNODB_BUFFER_POOL_STATS

### Table Overview

- `INNODB_BUFFER_PAGE`: Holds information about each page in the `InnoDB` buffer pool.
- `INNODB_BUFFER_PAGE_LRU`: Holds information about the pages in the `InnoDB` buffer pool, in particular how they are ordered in the LRU list that determines which pages to evict from the buffer pool when it becomes full. The `INNODB_BUFFER_PAGE_LRU` table has the same columns as the `INNODB_BUFFER_PAGE` table, except that the `INNODB_BUFFER_PAGE_LRU` table has an `LRU_POSITION` column instead of a `BLOCK_ID` column.
- `INNODB_BUFFER_POOL_STATS`: Provides buffer pool status information. Much of the same information is provided by `SHOW ENGINE INNODB STATUS` output, or may be obtained using `InnoDB` buffer pool server status variables.



#### Warning

Querying the `INNODB_BUFFER_PAGE` or `INNODB_BUFFER_PAGE_LRU` table can affect performance. Do not query these tables on a production system unless you are aware of the performance impact and have determined it to be acceptable. To avoid impacting performance on a production system, reproduce the issue you want to investigate and query buffer pool statistics on a test instance.

#### Example 14.6 Querying System Data in the `INNODB_BUFFER_PAGE` Table

This query provides an approximate count of pages that contain system data by excluding pages where the `TABLE_NAME` value is either `NULL` or includes a slash `/` or period `.` in the table name, which indicates a user-defined table.

```
mysql> SELECT COUNT(*) FROM INFORMATION_SCHEMA.INNODB_BUFFER_PAGE
WHERE TABLE_NAME IS NULL OR (INSTR(TABLE_NAME, '/') = 0 AND INSTR(TABLE_NAME, '.') = 0);
```

```
+-----+
| COUNT(*) |
+-----+
|      1516 |
+-----+
```

This query returns the approximate number of pages that contain system data, the total number of buffer pool pages, and an approximate percentage of pages that contain system data.

```
mysql> SELECT
  (SELECT COUNT(*) FROM INFORMATION_SCHEMA.INNODB_BUFFER_PAGE
   WHERE TABLE_NAME IS NULL OR (INSTR(TABLE_NAME, '/') = 0 AND INSTR(TABLE_NAME, '.') = 0)
   ) AS system_pages,
  (
   SELECT COUNT(*)
   FROM INFORMATION_SCHEMA.INNODB_BUFFER_PAGE
   ) AS total_pages,
  (
   SELECT ROUND((system_pages/total_pages) * 100)
   ) AS system_page_percentage;
+-----+-----+-----+
| system_pages | total_pages | system_page_percentage |
+-----+-----+-----+
|           295 |          8192 |                    4 |
+-----+-----+-----+
```

The type of system data in the buffer pool can be determined by querying the `PAGE_TYPE` value. For example, the following query returns eight distinct `PAGE_TYPE` values among the pages that contain system data:

```
mysql> SELECT DISTINCT PAGE_TYPE FROM INFORMATION_SCHEMA.INNODB_BUFFER_PAGE
  WHERE TABLE_NAME IS NULL OR (INSTR(TABLE_NAME, '/') = 0 AND INSTR(TABLE_NAME, '.') = 0);
+-----+
| PAGE_TYPE |
+-----+
| SYSTEM    |
| IBUF_BITMAP |
| UNKNOWN   |
| FILE_SPACE_HEADER |
| INODE     |
| UNDO_LOG  |
| ALLOCATED |
+-----+
```

### Example 14.7 Querying User Data in the INNODB\_BUFFER\_PAGE Table

This query provides an approximate count of pages containing user data by counting pages where the `TABLE_NAME` value is `NOT NULL` and `NOT LIKE '%INNODB_SYS_TABLES%'`.

```
mysql> SELECT COUNT(*) FROM INFORMATION_SCHEMA.INNODB_BUFFER_PAGE
  WHERE TABLE_NAME IS NOT NULL AND TABLE_NAME NOT LIKE '%INNODB_SYS_TABLES%';
+-----+
| COUNT(*) |
+-----+
|      7897 |
+-----+
```

This query returns the approximate number of pages that contain user data, the total number of buffer pool pages, and an approximate percentage of pages that contain user data.

```
mysql> SELECT
  (SELECT COUNT(*) FROM INFORMATION_SCHEMA.INNODB_BUFFER_PAGE
   WHERE TABLE_NAME IS NOT NULL AND (INSTR(TABLE_NAME, '/') > 0 OR INSTR(TABLE_NAME, '.') > 0)
   ) AS system_pages,
```



```

) AS user_pages,
(
SELECT COUNT(*)
FROM INFORMATION_SCHEMA.INNODB_BUFFER_PAGE
) AS total_pages,
(
SELECT ROUND((user_pages/total_pages) * 100)
) AS user_page_percentage;

```

user_pages	total_pages	user_page_percentage
7897	8192	96

This query identifies user-defined tables with pages in the buffer pool:

```

mysql> SELECT DISTINCT TABLE_NAME FROM INFORMATION_SCHEMA.INNODB_BUFFER_PAGE
WHERE TABLE_NAME IS NOT NULL AND (INSTR(TABLE_NAME, '/') > 0 OR INSTR(TABLE_NAME, '.') > 0)
AND TABLE_NAME NOT LIKE 'mysql`.`innodb_%';

```

TABLE_NAME
`employees`.`salaries`
`employees`.`employees`

#### Example 14.8 Querying Index Data in the INNODB\_BUFFER\_PAGE Table

For information about index pages, query the `INDEX_NAME` column using the name of the index. For example, the following query returns the number of pages and total data size of pages for the `emp_no` index that is defined on the `employees.salaries` table:

```

mysql> SELECT INDEX_NAME, COUNT(*) AS Pages,
ROUND(SUM(IF(COMPRESSED_SIZE = 0, @@GLOBAL.innodb_page_size, COMPRESSED_SIZE))/1024/1024)
AS 'Total Data (MB)'
FROM INFORMATION_SCHEMA.INNODB_BUFFER_PAGE
WHERE INDEX_NAME='emp_no' AND TABLE_NAME = '`employees`.`salaries`';

```

INDEX_NAME	Pages	Total Data (MB)
emp_no	1609	25

This query returns the number of pages and total data size of pages for all indexes defined on the `employees.salaries` table:

```

mysql> SELECT INDEX_NAME, COUNT(*) AS Pages,
ROUND(SUM(IF(COMPRESSED_SIZE = 0, @@GLOBAL.innodb_page_size, COMPRESSED_SIZE))/1024/1024)
AS 'Total Data (MB)'
FROM INFORMATION_SCHEMA.INNODB_BUFFER_PAGE
WHERE TABLE_NAME = '`employees`.`salaries`'
GROUP BY INDEX_NAME;

```

INDEX_NAME	Pages	Total Data (MB)
emp_no	1608	25
PRIMARY	6086	95

#### Example 14.9 Querying LRU\_POSITION Data in the INNODB\_BUFFER\_PAGE\_LRU Table

The `INNODB_BUFFER_PAGE_LRU` table holds information about the pages in the InnoDB buffer pool, in particular how they are ordered that determines which pages to evict from the buffer pool when it becomes

full. The definition for this page is the same as for `INNODB_BUFFER_PAGE`, except this table has an `LRU_POSITION` column instead of a `BLOCK_ID` column.

This query counts the number of positions at a specific location in the LRU list occupied by pages of the `employees.employees` table.

```
mysql> SELECT COUNT(LRU_POSITION) FROM INFORMATION_SCHEMA.INNODB_BUFFER_PAGE_LRU
        WHERE TABLE_NAME='`employees`.`employees`' AND LRU_POSITION < 3072;
+-----+
| COUNT(LRU_POSITION) |
+-----+
|                   548 |
+-----+
```

### Example 14.10 Querying the INNODB\_BUFFER\_POOL\_STATS Table

The `INNODB_BUFFER_POOL_STATS` table provides information similar to `SHOW ENGINE INNODB STATUS` and InnoDB buffer pool status variables.

```
mysql> SELECT * FROM information_schema.INNODB_BUFFER_POOL_STATS \G
***** 1. row *****
          POOL_ID: 0
          POOL_SIZE: 8192
          FREE_BUFFERS: 1
          DATABASE_PAGES: 8173
          OLD_DATABASE_PAGES: 3014
          MODIFIED_DATABASE_PAGES: 0
          PENDING_DECOMPRESS: 0
          PENDING_READS: 0
          PENDING_FLUSH_LRU: 0
          PENDING_FLUSH_LIST: 0
          PAGES_MADE_YOUNG: 15907
          PAGES_NOT_MADE_YOUNG: 3803101
          PAGES_MADE_YOUNG_RATE: 0
          PAGES_MADE_NOT_YOUNG_RATE: 0
          NUMBER_PAGES_READ: 3270
          NUMBER_PAGES_CREATED: 13176
          NUMBER_PAGES_WRITTEN: 15109
          PAGES_READ_RATE: 0
          PAGES_CREATE_RATE: 0
          PAGES_WRITTEN_RATE: 0
          NUMBER_PAGES_GET: 33069332
          HIT_RATE: 0
          YOUNG_MAKE_PER_THOUSAND_GETS: 0
          NOT_YOUNG_MAKE_PER_THOUSAND_GETS: 0
          NUMBER_PAGES_READ_AHEAD: 2713
          NUMBER_READ_AHEAD_EVICTED: 0
          READ_AHEAD_RATE: 0
          READ_AHEAD_EVICTED_RATE: 0
          LRU_IO_TOTAL: 0
          LRU_IO_CURRENT: 0
          UNCOMPRESS_TOTAL: 0
          UNCOMPRESS_CURRENT: 0
```

For comparison, `SHOW ENGINE INNODB STATUS` output and InnoDB buffer pool status variable output is shown below, based on the same data set.

For more information about `SHOW ENGINE INNODB STATUS` output, see [Section 14.18.3, “InnoDB Standard Monitor and Lock Monitor Output”](#).

```
mysql> SHOW ENGINE INNODB STATUS \G
...
-----
BUFFER POOL AND MEMORY
```

```

-----
Total large memory allocated 137428992
Dictionary memory allocated 579084
Buffer pool size 8192
Free buffers 1
Database pages 8173
Old database pages 3014
Modified db pages 0
Pending reads 0
Pending writes: LRU 0, flush list 0, single page 0
Pages made young 15907, not young 3803101
0.00 youngs/s, 0.00 non-youngs/s
Pages read 3270, created 13176, written 15109
0.00 reads/s, 0.00 creates/s, 0.00 writes/s
No buffer pool page gets since the last printout
Pages read ahead 0.00/s, evicted without access 0.00/s, Random read ahead 0.00/s
LRU len: 8173, unzip_LRU len: 0
I/O sum[0]:cur[0], unzip sum[0]:cur[0]
...

```

For status variable descriptions, see [Section 5.1.9, “Server Status Variables”](#).

```

mysql> SHOW STATUS LIKE 'Innodb_buffer%';
+-----+-----+
| Variable_name | Value |
+-----+-----+
| Innodb_buffer_pool_dump_status | not started |
| Innodb_buffer_pool_load_status | not started |
| Innodb_buffer_pool_resize_status | not started |
| Innodb_buffer_pool_pages_data | 8173 |
| Innodb_buffer_pool_bytes_data | 133906432 |
| Innodb_buffer_pool_pages_dirty | 0 |
| Innodb_buffer_pool_bytes_dirty | 0 |
| Innodb_buffer_pool_pages_flushed | 15109 |
| Innodb_buffer_pool_pages_free | 1 |
| Innodb_buffer_pool_pages_misc | 18 |
| Innodb_buffer_pool_pages_total | 8192 |
| Innodb_buffer_pool_read_ahead_rnd | 0 |
| Innodb_buffer_pool_read_ahead | 2713 |
| Innodb_buffer_pool_read_ahead_evicted | 0 |
| Innodb_buffer_pool_read_requests | 33069332 |
| Innodb_buffer_pool_reads | 558 |
| Innodb_buffer_pool_wait_free | 0 |
| Innodb_buffer_pool_write_requests | 11985961 |
+-----+-----+

```

## 14.16.6 InnoDB INFORMATION\_SCHEMA Metrics Table

The `INNODB_METRICS` table provides information about InnoDB performance and resource-related counters.

`INNODB_METRICS` table columns are shown below. For column descriptions, see [Section 24.4.16, “The INFORMATION\\_SCHEMA INNODB\\_METRICS Table”](#).

```

mysql> SELECT * FROM INFORMATION_SCHEMA.INNODB_METRICS WHERE NAME="dml_inserts" \G
***** 1. row *****
      NAME: dml_inserts
     SUBSYSTEM: dml
        COUNT: 46273
     MAX_COUNT: 46273
     MIN_COUNT: NULL
     AVG_COUNT: 492.2659574468085
     COUNT_RESET: 46273
  MAX_COUNT_RESET: 46273
  MIN_COUNT_RESET: NULL

```

```

AVG_COUNT_RESET: NULL
TIME_ENABLED: 2014-11-28 16:07:53
TIME_DISABLED: NULL
TIME_ELAPSED: 94
TIME_RESET: NULL
STATUS: enabled
TYPE: status_counter
COMMENT: Number of rows inserted

```

## Enabling, Disabling, and Resetting Counters

You can enable, disable, and reset counters using the following variables:

- `innodb_monitor_enable`: Enables counters.

```
SET GLOBAL innodb_monitor_enable = [counter-name|module_name|pattern|all];
```

- `innodb_monitor_disable`: Disables counters.

```
SET GLOBAL innodb_monitor_disable = [counter-name|module_name|pattern|all];
```

- `innodb_monitor_reset`: Resets counter values to zero.

```
SET GLOBAL innodb_monitor_reset = [counter-name|module_name|pattern|all];
```

- `innodb_monitor_reset_all`: Resets all counter values. A counter must be disabled before using `innodb_monitor_reset_all`.

```
SET GLOBAL innodb_monitor_reset_all = [counter-name|module_name|pattern|all];
```

Counters and counter modules can also be enabled at startup using the MySQL server configuration file. For example, to enable the `log` module, `metadata_table_handles_opened` and `metadata_table_handles_closed` counters, enter the following line in the `[mysqld]` section of the MySQL server configuration file..

```
[mysqld]
innodb_monitor_enable = module_recovery,metadata_table_handles_opened,metadata_table_handles_closed
```

When enabling multiple counters or modules in a configuration file, specify the `innodb_monitor_enable` variable followed by counter and module names separated by a comma, as shown above. Only the `innodb_monitor_enable` variable can be used in a configuration file. The `innodb_monitor_disable` and `innodb_monitor_reset` variables are supported on the command line only.



### Note

Because each counter adds a degree of runtime overhead, use counters conservatively on production servers to diagnose specific issues or monitor specific functionality. A test or development server is recommended for more extensive use of counters.

## Counters

The list of available counters is subject to change. Query the Information Schema `INNODB_METRICS` table for counters available in your MySQL server version.

The counters enabled by default correspond to those shown in `SHOW ENGINE INNODB STATUS` output. Counters shown in `SHOW ENGINE INNODB STATUS` output are always enabled at a system level but can be disabled for the `INNODB_METRICS` table. Counter status is not persistent. Unless configured otherwise, counters revert to their default enabled or disabled status when the server is restarted.

## InnoDB INFORMATION\_SCHEMA Metrics Table

If you run programs that would be affected by the addition or removal of counters, it is recommended that you review the releases notes and query the `INNODB_METRICS` table to identify those changes as part of your upgrade process.

```
mysql> SELECT name, subsystem, status FROM INFORMATION_SCHEMA.INNODB_METRICS ORDER BY NAME;
```

name	subsystem	status
adaptive_hash_pages_added	adaptive_hash_index	disabled
adaptive_hash_pages_removed	adaptive_hash_index	disabled
adaptive_hash_rows_added	adaptive_hash_index	disabled
adaptive_hash_rows_deleted_no_hash_entry	adaptive_hash_index	disabled
adaptive_hash_rows_removed	adaptive_hash_index	disabled
adaptive_hash_rows_updated	adaptive_hash_index	disabled
adaptive_hash_searches	adaptive_hash_index	enabled
adaptive_hash_searches_btree	adaptive_hash_index	enabled
buffer_data_reads	buffer	enabled
buffer_data_written	buffer	enabled
buffer_flush_adaptive	buffer	disabled
buffer_flush_adaptive_avg_pass	buffer	disabled
buffer_flush_adaptive_avg_time_est	buffer	disabled
buffer_flush_adaptive_avg_time_slot	buffer	disabled
buffer_flush_adaptive_avg_time_thread	buffer	disabled
buffer_flush_adaptive_pages	buffer	disabled
buffer_flush_adaptive_total_pages	buffer	disabled
buffer_flush_avg_page_rate	buffer	disabled
buffer_flush_avg_pass	buffer	disabled
buffer_flush_avg_time	buffer	disabled
buffer_flush_background	buffer	disabled
buffer_flush_background_pages	buffer	disabled
buffer_flush_background_total_pages	buffer	disabled
buffer_flush_batches	buffer	disabled
buffer_flush_batch_num_scan	buffer	disabled
buffer_flush_batch_pages	buffer	disabled
buffer_flush_batch_scanned	buffer	disabled
buffer_flush_batch_scanned_per_call	buffer	disabled
buffer_flush_batch_total_pages	buffer	disabled
buffer_flush_lsn_avg_rate	buffer	disabled
buffer_flush_neighbor	buffer	disabled
buffer_flush_neighbor_pages	buffer	disabled
buffer_flush_neighbor_total_pages	buffer	disabled
buffer_flush_n_to_flush_by_age	buffer	disabled
buffer_flush_n_to_flush_requested	buffer	disabled
buffer_flush_pct_for_dirty	buffer	disabled
buffer_flush_pct_for_lsn	buffer	disabled
buffer_flush_sync	buffer	disabled
buffer_flush_sync_pages	buffer	disabled
buffer_flush_sync_total_pages	buffer	disabled
buffer_flush_sync_waits	buffer	disabled
buffer_LRU_batches_evict	buffer	disabled
buffer_LRU_batches_flush	buffer	disabled
buffer_LRU_batch_evict_pages	buffer	disabled
buffer_LRU_batch_evict_total_pages	buffer	disabled
buffer_LRU_batch_flush_avg_pass	buffer	disabled
buffer_LRU_batch_flush_avg_time_est	buffer	disabled
buffer_LRU_batch_flush_avg_time_slot	buffer	disabled
buffer_LRU_batch_flush_avg_time_thread	buffer	disabled
buffer_LRU_batch_flush_pages	buffer	disabled
buffer_LRU_batch_flush_total_pages	buffer	disabled
buffer_LRU_batch_num_scan	buffer	disabled
buffer_LRU_batch_scanned	buffer	disabled
buffer_LRU_batch_scanned_per_call	buffer	disabled
buffer_LRU_get_free_loops	buffer	disabled
buffer_LRU_get_free_search	Buffer	disabled
buffer_LRU_get_free_waits	buffer	disabled
buffer_LRU_search_num_scan	buffer	disabled

## InnoDB INFORMATION\_SCHEMA Metrics Table

buffer_LRU_search_scanned	buffer	disabled
buffer_LRU_search_scanned_per_call	buffer	disabled
buffer_LRU_single_flush_failure_count	Buffer	disabled
buffer_LRU_single_flush_num_scan	buffer	disabled
buffer_LRU_single_flush_scanned	buffer	disabled
buffer_LRU_single_flush_scanned_per_call	buffer	disabled
buffer_LRU_unzip_search_num_scan	buffer	disabled
buffer_LRU_unzip_search_scanned	buffer	disabled
buffer_LRU_unzip_search_scanned_per_call	buffer	disabled
buffer_pages_created	buffer	enabled
buffer_pages_read	buffer	enabled
buffer_pages_written	buffer	enabled
buffer_page_read_blob	buffer_page_io	disabled
buffer_page_read_fsp_hdr	buffer_page_io	disabled
buffer_page_read_ibuf_bitmap	buffer_page_io	disabled
buffer_page_read_ibuf_free_list	buffer_page_io	disabled
buffer_page_read_index_ibuf_leaf	buffer_page_io	disabled
buffer_page_read_index_ibuf_non_leaf	buffer_page_io	disabled
buffer_page_read_index_inode	buffer_page_io	disabled
buffer_page_read_index_leaf	buffer_page_io	disabled
buffer_page_read_index_non_leaf	buffer_page_io	disabled
buffer_page_read_other	buffer_page_io	disabled
buffer_page_read_system_page	buffer_page_io	disabled
buffer_page_read_trx_system	buffer_page_io	disabled
buffer_page_read_undo_log	buffer_page_io	disabled
buffer_page_read_xdes	buffer_page_io	disabled
buffer_page_read_zblob	buffer_page_io	disabled
buffer_page_read_zblob2	buffer_page_io	disabled
buffer_page_written_blob	buffer_page_io	disabled
buffer_page_written_fsp_hdr	buffer_page_io	disabled
buffer_page_written_ibuf_bitmap	buffer_page_io	disabled
buffer_page_written_ibuf_free_list	buffer_page_io	disabled
buffer_page_written_index_ibuf_leaf	buffer_page_io	disabled
buffer_page_written_index_ibuf_non_leaf	buffer_page_io	disabled
buffer_page_written_index_inode	buffer_page_io	disabled
buffer_page_written_index_leaf	buffer_page_io	disabled
buffer_page_written_index_non_leaf	buffer_page_io	disabled
buffer_page_written_other	buffer_page_io	disabled
buffer_page_written_system_page	buffer_page_io	disabled
buffer_page_written_trx_system	buffer_page_io	disabled
buffer_page_written_undo_log	buffer_page_io	disabled
buffer_page_written_xdes	buffer_page_io	disabled
buffer_page_written_zblob	buffer_page_io	disabled
buffer_page_written_zblob2	buffer_page_io	disabled
buffer_pool_bytes_data	buffer	enabled
buffer_pool_bytes_dirty	buffer	enabled
buffer_pool_pages_data	buffer	enabled
buffer_pool_pages_dirty	buffer	enabled
buffer_pool_pages_free	buffer	enabled
buffer_pool_pages_misc	buffer	enabled
buffer_pool_pages_total	buffer	enabled
buffer_pool_reads	buffer	enabled
buffer_pool_read_ahead	buffer	enabled
buffer_pool_read_ahead_evicted	buffer	enabled
buffer_pool_read_requests	buffer	enabled
buffer_pool_size	server	enabled
buffer_pool_wait_free	buffer	enabled
buffer_pool_write_requests	buffer	enabled
compression_pad_decrements	compression	disabled
compression_pad_increments	compression	disabled
compress_pages_compressed	compression	disabled
compress_pages_decompressed	compression	disabled
ddl_background_drop_indexes	ddl	disabled
ddl_background_drop_tables	ddl	disabled
ddl_log_file_alter_table	ddl	disabled
ddl_online_create_index	ddl	disabled
ddl_pending_alter_table	ddl	disabled

InnoDB INFORMATION\_SCHEMA Metrics Table

ddl_sort_file_alter_table	ddl	disabled
dml_deletes	dml	enabled
dml_inserts	dml	enabled
dml_reads	dml	disabled
dml_updates	dml	enabled
file_num_open_files	file_system	enabled
ibuf_merges	change_buffer	enabled
ibuf_merges_delete	change_buffer	enabled
ibuf_merges_delete_mark	change_buffer	enabled
ibuf_merges_discard_delete	change_buffer	enabled
ibuf_merges_discard_delete_mark	change_buffer	enabled
ibuf_merges_discard_insert	change_buffer	enabled
ibuf_merges_insert	change_buffer	enabled
ibuf_size	change_buffer	enabled
icp_attempts	icp	disabled
icp_match	icp	disabled
icp_no_match	icp	disabled
icp_out_of_range	icp	disabled
index_page_discards	index	disabled
index_page_merge_attempts	index	disabled
index_page_merge_successful	index	disabled
index_page_reorg_attempts	index	disabled
index_page_reorg_successful	index	disabled
index_page_splits	index	disabled
innodb_activity_count	server	enabled
innodb_background_drop_table_usec	server	disabled
innodb_checkpoint_usec	server	disabled
innodb_dblwr_pages_written	server	enabled
innodb_dblwr_writes	server	enabled
innodb_dict_lru_count	server	disabled
innodb_dict_lru_usec	server	disabled
innodb_ibuf_merge_usec	server	disabled
innodb_log_flush_usec	server	disabled
innodb_master_active_loops	server	disabled
innodb_master_idle_loops	server	disabled
innodb_master_purge_usec	server	disabled
innodb_master_thread_sleeps	server	disabled
innodb_mem_validate_usec	server	disabled
innodb_page_size	server	enabled
innodb_rwlock_sx_os_waits	server	enabled
innodb_rwlock_sx_spin_rounds	server	enabled
innodb_rwlock_sx_spin_waits	server	enabled
innodb_rwlock_s_os_waits	server	enabled
innodb_rwlock_s_spin_rounds	server	enabled
innodb_rwlock_s_spin_waits	server	enabled
innodb_rwlock_x_os_waits	server	enabled
innodb_rwlock_x_spin_rounds	server	enabled
innodb_rwlock_x_spin_waits	server	enabled
lock_deadlocks	lock	enabled
lock_rec_locks	lock	disabled
lock_rec_lock_created	lock	disabled
lock_rec_lock_removed	lock	disabled
lock_rec_lock_requests	lock	disabled
lock_rec_lock_waits	lock	disabled
lock_row_lock_current_waits	lock	enabled
lock_row_lock_time	lock	enabled
lock_row_lock_time_avg	lock	enabled
lock_row_lock_time_max	lock	enabled
lock_row_lock_waits	lock	enabled
lock_table_locks	lock	disabled
lock_table_lock_created	lock	disabled
lock_table_lock_removed	lock	disabled
lock_table_lock_waits	lock	disabled
lock_timeouts	lock	enabled
log_checkpoints	recovery	disabled
log_lsn_buf_pool_oldest	recovery	disabled
log_lsn_checkpoint_age	recovery	disabled

## InnoDB INFORMATION\_SCHEMA Metrics Table

log_lsn_current	recovery	disabled
log_lsn_last_checkpoint	recovery	disabled
log_lsn_last_flush	recovery	disabled
log_max_modified_age_async	recovery	disabled
log_max_modified_age_sync	recovery	disabled
log_num_log_io	recovery	disabled
log_padded	recovery	enabled
log_pending_checkpoint_writes	recovery	disabled
log_pending_log_flushes	recovery	disabled
log_waits	recovery	enabled
log_writes	recovery	enabled
log_write_requests	recovery	enabled
metadata_table_handles_closed	metadata	disabled
metadata_table_handles_opened	metadata	disabled
metadata_table_reference_count	metadata	disabled
os_data_fsyncs	os	enabled
os_data_reads	os	enabled
os_data_writes	os	enabled
os_log_bytes_written	os	enabled
os_log_fsyncs	os	enabled
os_log_pending_fsyncs	os	enabled
os_log_pending_writes	os	enabled
os_pending_reads	os	disabled
os_pending_writes	os	disabled
purge_del_mark_records	purge	disabled
purge_dml_delay_usec	purge	disabled
purge_invoked	purge	disabled
purge_resume_count	purge	disabled
purge_stop_count	purge	disabled
purge_undo_log_pages	purge	disabled
purge_upd_exist_or_extern_records	purge	disabled
trx_active_transactions	transaction	disabled
trx_commits_insert_update	transaction	disabled
trx_nl_ro_commits	transaction	disabled
trx_rollback	transaction	disabled
trx_rollback_savepoint	transaction	disabled
trx_rollback_active	transaction	disabled
trx_ro_commits	transaction	disabled
trx_rseg_current_size	transaction	disabled
trx_rseg_history_len	transaction	enabled
trx_rw_commits	transaction	disabled
trx_undo_slots_cached	transaction	disabled
trx_undo_slots_used	transaction	disabled

-----+-----+-----+  
 235 rows in set (0.01 sec)

## Counter Modules

Each counter is associated with a particular module. Module names can be used to enable, disable, or reset all counters for a particular subsystem. For example, use `module_dml` to enable all counters associated with the `dml` subsystem.

```
mysql> SET GLOBAL innodb_monitor_enable = module_dml;

mysql> SELECT name, subsystem, status FROM INFORMATION_SCHEMA.INNODB_METRICS
        WHERE subsystem = 'dml';

+-----+-----+-----+
| name      | subsystem | status |
+-----+-----+-----+
| dml_reads | dml       | enabled |
| dml_inserts | dml     | enabled |
| dml_deletes | dml     | enabled |
| dml_updates | dml     | enabled |
+-----+-----+-----+
```

Module names can be used with `innodb_monitor_enable` and related variables.



Module names and corresponding `SUBSYSTEM` names are listed below.

- `module_adaptive_hash` (subsystem = `adaptive_hash_index`)
- `module_buffer` (subsystem = `buffer`)
- `module_buffer_page` (subsystem = `buffer_page_io`)
- `module_compress` (subsystem = `compression`)
- `module_ddl` (subsystem = `ddl`)
- `module_dml` (subsystem = `dml`)
- `module_file` (subsystem = `file_system`)
- `module_ibuf_system` (subsystem = `change_buffer`)
- `module_icp` (subsystem = `icp`)
- `module_index` (subsystem = `index`)
- `module_innodb` (subsystem = `innodb`)
- `module_lock` (subsystem = `lock`)
- `module_log` (subsystem = `recovery`)
- `module_metadata` (subsystem = `metadata`)
- `module_os` (subsystem = `os`)
- `module_purge` (subsystem = `purge`)
- `module_trx` (subsystem = `transaction`)

### Example 14.11 Working with INNODB\_METRICS Table Counters

This example demonstrates enabling, disabling, and resetting a counter, and querying counter data in the `INNODB_METRICS` table.

1. Create a simple `InnoDB` table:

```
mysql> USE test;
Database changed

mysql> CREATE TABLE t1 (c1 INT) ENGINE=INNODB;
Query OK, 0 rows affected (0.02 sec)
```

2. Enable the `dml_inserts` counter.

```
mysql> SET GLOBAL innodb_monitor_enable = dml_inserts;
Query OK, 0 rows affected (0.01 sec)
```

A description of the `dml_inserts` counter can be found in the `COMMENT` column of the `INNODB_METRICS` table:

```
mysql> SELECT NAME, COMMENT FROM INFORMATION_SCHEMA.INNODB_METRICS WHERE NAME="dml_inserts";
+-----+-----+
| NAME          | COMMENT                                     |
+-----+-----+
```

```
| dml_inserts | Number of rows inserted |
+-----+-----+
```

- Query the `INNODB_METRICS` table for the `dml_inserts` counter data. Because no DML operations have been performed, the counter values are zero or NULL. The `TIME_ENABLED` and `TIME_ELAPSED` values indicate when the counter was last enabled and how many seconds have elapsed since that time.

```
mysql> SELECT * FROM INFORMATION_SCHEMA.INNODB_METRICS WHERE NAME="dml_inserts" \G
***** 1. row *****
      NAME: dml_inserts
     SUBSYSTEM: dml
        COUNT: 0
     MAX_COUNT: 0
     MIN_COUNT: NULL
     AVG_COUNT: 0
   COUNT_RESET: 0
MAX_COUNT_RESET: 0
MIN_COUNT_RESET: NULL
AVG_COUNT_RESET: NULL
   TIME_ENABLED: 2014-12-04 14:18:28
   TIME_DISABLED: NULL
   TIME_ELAPSED: 28
     TIME_RESET: NULL
        STATUS: enabled
         TYPE: status_counter
     COMMENT: Number of rows inserted
```

- Insert three rows of data into the table.

```
mysql> INSERT INTO t1 values(1);
Query OK, 1 row affected (0.00 sec)

mysql> INSERT INTO t1 values(2);
Query OK, 1 row affected (0.00 sec)

mysql> INSERT INTO t1 values(3);
Query OK, 1 row affected (0.00 sec)
```

- Query the `INNODB_METRICS` table again for the `dml_inserts` counter data. A number of counter values have now incremented including `COUNT`, `MAX_COUNT`, `AVG_COUNT`, and `COUNT_RESET`. Refer to the `INNODB_METRICS` table definition for descriptions of these values.

```
mysql> SELECT * FROM INFORMATION_SCHEMA.INNODB_METRICS WHERE NAME="dml_inserts"\G
***** 1. row *****
      NAME: dml_inserts
     SUBSYSTEM: dml
        COUNT: 3
     MAX_COUNT: 3
     MIN_COUNT: NULL
     AVG_COUNT: 0.046153846153846156
   COUNT_RESET: 3
MAX_COUNT_RESET: 3
MIN_COUNT_RESET: NULL
AVG_COUNT_RESET: NULL
   TIME_ENABLED: 2014-12-04 14:18:28
   TIME_DISABLED: NULL
   TIME_ELAPSED: 65
     TIME_RESET: NULL
        STATUS: enabled
         TYPE: status_counter
     COMMENT: Number of rows inserted
```

- Reset the `dml_inserts` counter and query the `INNODB_METRICS` table again for the `dml_inserts` counter data. The `_%_RESET` values that were reported previously, such as `COUNT_RESET` and

`MAX_RESET`, are set back to zero. Values such as `COUNT`, `MAX_COUNT`, and `AVG_COUNT`, which cumulatively collect data from the time the counter is enabled, are unaffected by the reset.

```
mysql> SET GLOBAL innodb_monitor_reset = dml_inserts;
Query OK, 0 rows affected (0.00 sec)

mysql> SELECT * FROM INFORMATION_SCHEMA.INNODB_METRICS WHERE NAME="dml_inserts"\G
***** 1. row *****
      NAME: dml_inserts
    SUBSYSTEM: dml
      COUNT: 3
    MAX_COUNT: 3
    MIN_COUNT: NULL
    AVG_COUNT: 0.03529411764705882
    COUNT_RESET: 0
MAX_COUNT_RESET: 0
MIN_COUNT_RESET: NULL
AVG_COUNT_RESET: 0
    TIME_ENABLED: 2014-12-04 14:18:28
    TIME_DISABLED: NULL
    TIME_ELAPSED: 85
    TIME_RESET: 2014-12-04 14:19:44
      STATUS: enabled
      TYPE: status_counter
    COMMENT: Number of rows inserted
```

- To reset all counter values, you must first disable the counter. Disabling the counter sets the `STATUS` value to `disabled`.

```
mysql> SET GLOBAL innodb_monitor_disable = dml_inserts;
Query OK, 0 rows affected (0.00 sec)

mysql> SELECT * FROM INFORMATION_SCHEMA.INNODB_METRICS WHERE NAME="dml_inserts"\G
***** 1. row *****
      NAME: dml_inserts
    SUBSYSTEM: dml
      COUNT: 3
    MAX_COUNT: 3
    MIN_COUNT: NULL
    AVG_COUNT: 0.030612244897959183
    COUNT_RESET: 0
MAX_COUNT_RESET: 0
MIN_COUNT_RESET: NULL
AVG_COUNT_RESET: 0
    TIME_ENABLED: 2014-12-04 14:18:28
    TIME_DISABLED: 2014-12-04 14:20:06
    TIME_ELAPSED: 98
    TIME_RESET: NULL
      STATUS: disabled
      TYPE: status_counter
    COMMENT: Number of rows inserted
```



#### Note

Wildcard match is supported for counter and module names. For example, instead of specifying the full `dml_inserts` counter name, you can specify `dml_i%`. You can also enable, disable, or reset multiple counters or modules at once using a wildcard match. For example, specify `dml_%` to enable, disable, or reset all counters that begin with `dml_`.

- After the counter is disabled, you can reset all counter values using the `innodb_monitor_reset_all` option. All values are set to zero or NULL.

```
mysql> SET GLOBAL innodb_monitor_reset_all = dml_inserts;
```

```

Query OK, 0 rows affected (0.00 sec)

mysql> SELECT * FROM INFORMATION_SCHEMA.INNO_DB_METRICS WHERE NAME="dml_inserts"\G
***** 1. row *****
      NAME: dml_inserts
      SUBSYSTEM: dml
      COUNT: 0
      MAX_COUNT: NULL
      MIN_COUNT: NULL
      AVG_COUNT: NULL
      COUNT_RESET: 0
      MAX_COUNT_RESET: NULL
      MIN_COUNT_RESET: NULL
      AVG_COUNT_RESET: NULL
      TIME_ENABLED: NULL
      TIME_DISABLED: NULL
      TIME_ELAPSED: NULL
      TIME_RESET: NULL
      STATUS: disabled
      TYPE: status_counter
      COMMENT: Number of rows inserted

```

## 14.16.7 InnoDB INFORMATION\_SCHEMA Temporary Table Info Table

`INNODB_TEMP_TABLE_INFO` provides information about user-created InnoDB temporary tables that are active in the InnoDB instance. It does not provide information about internal InnoDB temporary tables used by the optimizer.

```

mysql> SHOW TABLES FROM INFORMATION_SCHEMA LIKE 'INNODB_TEMP%';
+-----+
| Tables_in_INFORMATION_SCHEMA (INNODB_TEMP%) |
+-----+
| INNODB_TEMP_TABLE_INFO                       |
+-----+

```

For the table definition, see [Section 24.4.27](#), “The INFORMATION\_SCHEMA INNODB\_TEMP\_TABLE\_INFO Table”.

### Example 14.12 INNODB\_TEMP\_TABLE\_INFO

This example demonstrates characteristics of the `INNODB_TEMP_TABLE_INFO` table.

1. Create a simple InnoDB temporary table:

```
mysql> CREATE TEMPORARY TABLE t1 (c1 INT PRIMARY KEY) ENGINE=INNODB;
```

2. Query `INNODB_TEMP_TABLE_INFO` to view the temporary table metadata.

```

mysql> SELECT * FROM INFORMATION_SCHEMA.INNO_DB_TEMP_TABLE_INFO\G
***** 1. row *****
      TABLE_ID: 194
      NAME: #sql17a79_1_0
      N_COLS: 4
      SPACE: 182
      PER_TABLE_TABLESPACE: FALSE
      IS_COMPRESSED: FALSE

```

The `TABLE_ID` is a unique identifier for the temporary table. The `NAME` column displays the system-generated name for the temporary table, which is prefixed with “#sql”. The number of columns (`N_COLS`) is 4 rather than 1 because InnoDB always creates three hidden table columns (`DB_ROW_ID`, `DB_TRX_ID`, and `DB_ROLL_PTR`). `PER_TABLE_TABLESPACE` and `IS_COMPRESSED` report `TRUE` for compressed temporary tables. Otherwise, these fields report `FALSE`.

3. Create a compressed temporary table.

```
mysql> CREATE TEMPORARY TABLE t2 (c1 INT) ROW_FORMAT=COMPRESSED ENGINE=INNODB;
```

4. Query `INNODB_TEMP_TABLE_INFO` again.

```
mysql> SELECT * FROM INFORMATION_SCHEMA.INNODB_TEMP_TABLE_INFO\G
***** 1. row *****
      TABLE_ID: 195
      NAME: #sql7a79_1_1
      N_COLS: 4
      SPACE: 183
PER_TABLE_TABLESPACE: TRUE
      IS_COMPRESSED: TRUE
***** 2. row *****
      TABLE_ID: 194
      NAME: #sql7a79_1_0
      N_COLS: 4
      SPACE: 182
PER_TABLE_TABLESPACE: FALSE
      IS_COMPRESSED: FALSE
```

`PER_TABLE_TABLESPACE` and `IS_COMPRESSED` report `TRUE` for the compressed temporary table. The `SPACE` ID for the compressed temporary table is different because compressed temporary tables are created in separate file-per-table tablespaces. Non-compressed temporary tables are created in the shared temporary tablespace (`ibtmp1`) and report the same `SPACE` ID.

5. Restart MySQL and query `INNODB_TEMP_TABLE_INFO`.

```
mysql> SELECT * FROM INFORMATION_SCHEMA.INNODB_TEMP_TABLE_INFO\G
Empty set (0.00 sec)
```

An empty set is returned because `INNODB_TEMP_TABLE_INFO` and its data are not persisted to disk when the server is shut down.

6. Create a new temporary table.

```
mysql> CREATE TEMPORARY TABLE t1 (c1 INT PRIMARY KEY) ENGINE=INNODB;
```

7. Query `INNODB_TEMP_TABLE_INFO` to view the temporary table metadata.

```
mysql> SELECT * FROM INFORMATION_SCHEMA.INNODB_TEMP_TABLE_INFO\G
***** 1. row *****
      TABLE_ID: 196
      NAME: #sql7b0e_1_0
      N_COLS: 4
      SPACE: 184
PER_TABLE_TABLESPACE: FALSE
      IS_COMPRESSED: FALSE
```

The `SPACE` ID may be different because it is dynamically generated when the server is started.

## 14.16.8 Retrieving InnoDB Tablespace Metadata from INFORMATION\_SCHEMA.FILES

The Information Schema `FILES` table provides metadata about all InnoDB tablespace types including [file-per-table tablespaces](#), [general tablespaces](#), the [system tablespace](#), [temporary table tablespaces](#), and [undo tablespaces](#) (if present).

This section provides InnoDB-specific usage examples. For more information, see [Section 24.3.9, “The INFORMATION\\_SCHEMA FILES Table”](#).

**Note**

The `INNODB_SYS_TABLESPACES` and `INNODB_SYS_DATAFILES` tables also provide metadata about InnoDB tablespaces, but data is limited to file-per-table and general tablespaces.

This query retrieves metadata about the InnoDB system tablespace from columns of the Information Schema `FILES` table that are pertinent to InnoDB tablespaces. `FILES` columns that are not relevant to InnoDB always return `NULL`, and are excluded from the query.

```
mysql> SELECT FILE_ID, FILE_NAME, FILE_TYPE, TABLESPACE_NAME, FREE_EXTENTS,
TOTAL_EXTENTS, EXTENT_SIZE, INITIAL_SIZE, MAXIMUM_SIZE, AUTOEXTEND_SIZE, DATA_FREE, STATUS ENGINE
FROM INFORMATION_SCHEMA.FILES WHERE TABLESPACE_NAME LIKE 'innodb_system' \G
***** 1. row *****
FILE_ID: 0
FILE_NAME: ./ibdata1
FILE_TYPE: TABLESPACE
TABLESPACE_NAME: innodb_system
FREE_EXTENTS: 0
TOTAL_EXTENTS: 12
EXTENT_SIZE: 1048576
INITIAL_SIZE: 12582912
MAXIMUM_SIZE: NULL
AUTOEXTEND_SIZE: 67108864
DATA_FREE: 4194304
ENGINE: NORMAL
```

This query retrieves the `FILE_ID` (equivalent to the space ID) and the `FILE_NAME` (which includes path information) for InnoDB file-per-table and general tablespaces. File-per-table and general tablespaces have a `.ibd` file extension.

```
mysql> SELECT FILE_ID, FILE_NAME FROM INFORMATION_SCHEMA.FILES
WHERE FILE_NAME LIKE '%.ibd%' ORDER BY FILE_ID;
+-----+-----+
| FILE_ID | FILE_NAME |
+-----+-----+
| 2 | ./mysql/plugin.ibd |
| 3 | ./mysql/servers.ibd |
| 4 | ./mysql/help_topic.ibd |
| 5 | ./mysql/help_category.ibd |
| 6 | ./mysql/help_relation.ibd |
| 7 | ./mysql/help_keyword.ibd |
| 8 | ./mysql/time_zone_name.ibd |
| 9 | ./mysql/time_zone.ibd |
| 10 | ./mysql/time_zone_transition.ibd |
| 11 | ./mysql/time_zone_transition_type.ibd |
| 12 | ./mysql/time_zone_leap_second.ibd |
| 13 | ./mysql/innodb_table_stats.ibd |
| 14 | ./mysql/innodb_index_stats.ibd |
| 15 | ./mysql/slave_relay_log_info.ibd |
| 16 | ./mysql/slave_master_info.ibd |
| 17 | ./mysql/slave_worker_info.ibd |
| 18 | ./mysql/gtid_executed.ibd |
| 19 | ./mysql/server_cost.ibd |
| 20 | ./mysql/engine_cost.ibd |
| 21 | ./sys/sys_config.ibd |
| 23 | ./test/t1.ibd |
| 26 | /home/user/test/test/t2.ibd |
+-----+-----+
```

This query retrieves the `FILE_ID` and `FILE_NAME` for InnoDB temporary tablespaces. Temporary tablespace file names are prefixed by `ibttmp`.

```
mysql> SELECT FILE_ID, FILE_NAME FROM INFORMATION_SCHEMA.FILES
WHERE FILE_NAME LIKE '%ibttmp%';
```

```

+-----+
| FILE_ID | FILE_NAME |
+-----+
|      22 | ./ibtmp1  |
+-----+

```

Similarly, InnoDB undo tablespace file names are prefixed by `undo`. The following query returns the `FILE_ID` and `FILE_NAME` for InnoDB undo tablespaces, if separate undo tablespaces are configured.

```

mysql> SELECT FILE_ID, FILE_NAME FROM INFORMATION_SCHEMA.FILES
       WHERE FILE_NAME LIKE '%undo%';

```

## 14.17 InnoDB Integration with MySQL Performance Schema

This section provides a brief introduction to InnoDB integration with Performance Schema. For comprehensive Performance Schema documentation, see [Chapter 25, MySQL Performance Schema](#).

You can profile certain internal InnoDB operations using the MySQL [Performance Schema feature](#). This type of tuning is primarily for expert users who evaluate optimization strategies to overcome performance bottlenecks. DBAs can also use this feature for capacity planning, to see whether their typical workload encounters any performance bottlenecks with a particular combination of CPU, RAM, and disk storage; and if so, to judge whether performance can be improved by increasing the capacity of some part of the system.

To use this feature to examine InnoDB performance:

- You must be generally familiar with how to use the [Performance Schema feature](#). For example, you should know how enable instruments and consumers, and how to query `performance_schema` tables to retrieve data. For an introductory overview, see [Section 25.1, “Performance Schema Quick Start”](#).
- You should be familiar with Performance Schema instruments that are available for InnoDB. To view InnoDB-related instruments, you can query the `setup_instruments` table for instrument names that contain `'innodb'`.

```

mysql> SELECT *
       FROM performance_schema.setup_instruments
       WHERE NAME LIKE '%innodb%';

```

NAME	ENABLED	TIMED
wait/synch/mutex/innodb/commit_cond_mutex	NO	NO
wait/synch/mutex/innodb/innobase_share_mutex	NO	NO
wait/synch/mutex/innodb/autoinc_mutex	NO	NO
wait/synch/mutex/innodb/buf_pool_mutex	NO	NO
wait/synch/mutex/innodb/buf_pool_zip_mutex	NO	NO
wait/synch/mutex/innodb/cache_last_read_mutex	NO	NO
wait/synch/mutex/innodb/dict_foreign_err_mutex	NO	NO
wait/synch/mutex/innodb/dict_sys_mutex	NO	NO
wait/synch/mutex/innodb/recalc_pool_mutex	NO	NO
wait/synch/mutex/innodb/file_format_max_mutex	NO	NO
...		
wait/io/file/innodb/innodb_data_file	YES	YES
wait/io/file/innodb/innodb_log_file	YES	YES
wait/io/file/innodb/innodb_temp_file	YES	YES
stage/innodb/alter table (end)	YES	YES
stage/innodb/alter table (flush)	YES	YES
stage/innodb/alter table (insert)	YES	YES
stage/innodb/alter table (log apply index)	YES	YES
stage/innodb/alter table (log apply table)	YES	YES
stage/innodb/alter table (merge sort)	YES	YES
stage/innodb/alter table (read PK and internal sort)	YES	YES
stage/innodb/buffer pool load	YES	YES
memory/innodb/buf_buf_pool	NO	NO

```

| memory/innodb/dict_stats_bg_recalc_pool_t | NO | NO |
| memory/innodb/dict_stats_index_map_t     | NO | NO |
| memory/innodb/dict_stats_n_diff_on_level | NO | NO |
| memory/innodb/other                      | NO | NO |
| memory/innodb/row_log_buf                | NO | NO |
| memory/innodb/row_merge_sort             | NO | NO |
| memory/innodb/std                        | NO | NO |
| memory/innodb/sync_debug_latches         | NO | NO |
| memory/innodb/trx_sys_t::rw_trx_ids      | NO | NO |
...
+-----+-----+-----+
155 rows in set (0.00 sec)

```

For additional information about the instrumented [InnoDB](#) objects, you can query Performance Schema [instances tables](#), which provide additional information about instrumented objects. Instance tables relevant to [InnoDB](#) include:

- The [mutex\\_instances](#) table
- The [rwlock\\_instances](#) table
- The [cond\\_instances](#) table
- The [file\\_instances](#) table



### Note

Mutexes and RW-locks related to the [InnoDB](#) buffer pool are not included in this coverage; the same applies to the output of the `SHOW ENGINE INNODB MUTEX` command.

For example, to view information about instrumented [InnoDB](#) file objects seen by the Performance Schema when executing file I/O instrumentation, you might issue the following query:

```

mysql> SELECT *
      FROM performance_schema.file_instances
      WHERE EVENT_NAME LIKE '%innodb%'\G
***** 1. row *****
FILE_NAME: /path/to/mysql-5.7/data/ibdata1
EVENT_NAME: wait/io/file/innodb/innodb_data_file
OPEN_COUNT: 3
***** 2. row *****
FILE_NAME: /path/to/mysql-5.7/data/ib_logfile0
EVENT_NAME: wait/io/file/innodb/innodb_log_file
OPEN_COUNT: 2
***** 3. row *****
FILE_NAME: /path/to/mysql-5.7/data/ib_logfile1
EVENT_NAME: wait/io/file/innodb/innodb_log_file
OPEN_COUNT: 2
***** 4. row *****
FILE_NAME: /path/to/mysql-5.7/data/mysql/engine_cost.ibd
EVENT_NAME: wait/io/file/innodb/innodb_data_file
OPEN_COUNT: 3
...

```



- You should be familiar with `performance_schema` tables that store InnoDB event data. Tables relevant to InnoDB-related events include:
  - The `Wait Event` tables, which store wait events.
  - The `Summary` tables, which provide aggregated information for terminated events over time. Summary tables include `file I/O summary tables`, which aggregate information about I/O operations.
  - `Stage Event` tables, which store event data for InnoDB ALTER TABLE and buffer pool load operations. For more information, see [Section 14.17.1, “Monitoring ALTER TABLE Progress for InnoDB Tables Using Performance Schema”](#), and [Monitoring Buffer Pool Load Progress Using Performance Schema](#).

If you are only interested in InnoDB-related objects, use the clause `WHERE EVENT_NAME LIKE '%innodb%'` or `WHERE NAME LIKE '%innodb%'` (as required) when querying these tables.

## 14.17.1 Monitoring ALTER TABLE Progress for InnoDB Tables Using Performance Schema

You can monitor ALTER TABLE progress for InnoDB tables using [Performance Schema](#).

There are seven stage events that represent different phases of ALTER TABLE. Each stage event reports a running total of `WORK_COMPLETED` and `WORK_ESTIMATED` for the overall ALTER TABLE operation as it progresses through its different phases. `WORK_ESTIMATED` is calculated using a formula that takes into account all of the work that ALTER TABLE performs, and may be revised during ALTER TABLE processing. `WORK_COMPLETED` and `WORK_ESTIMATED` values are an abstract representation of all of the work performed by ALTER TABLE.

In order of occurrence, ALTER TABLE stage events include:

- `stage/innodb/alter table (read PK and internal sort)`: This stage is active when ALTER TABLE is in the reading-primary-key phase. It starts with `WORK_COMPLETED=0` and `WORK_ESTIMATED` set to the estimated number of pages in the primary key. When the stage is completed, `WORK_ESTIMATED` is updated to the actual number of pages in the primary key.
- `stage/innodb/alter table (merge sort)`: This stage is repeated for each index added by the ALTER TABLE operation.
- `stage/innodb/alter table (insert)`: This stage is repeated for each index added by the ALTER TABLE operation.
- `stage/innodb/alter table (log apply index)`: This stage includes the application of DML log generated while ALTER TABLE was running.
- `stage/innodb/alter table (flush)`: Before this stage begins, `WORK_ESTIMATED` is updated with a more accurate estimate, based on the length of the flush list.
- `stage/innodb/alter table (log apply table)`: This stage includes the application of concurrent DML log generated while ALTER TABLE was running. The duration of this phase depends on the extent of table changes. This phase is instant if no concurrent DML was run on the table.
- `stage/innodb/alter table (end)`: Includes any remaining work that appeared after the flush phase, such as reapplying DML that was executed on the table while ALTER TABLE was running.



### Note

InnoDB ALTER TABLE stage events do not currently account for the addition of spatial indexes.

## ALTER TABLE Monitoring Example Using Performance Schema

The following example demonstrates how to enable the `stage/innodb/alter table%` stage event instruments and related consumer tables to monitor `ALTER TABLE` progress. For information about Performance Schema stage event instruments and related consumers, see [Section 25.12.5, “Performance Schema Stage Event Tables”](#).

1. Enable the `stage/innodb/alter%` instruments:

```
mysql> UPDATE performance_schema.setup_instruments
      SET ENABLED = 'YES'
      WHERE NAME LIKE 'stage/innodb/alter%';
Query OK, 7 rows affected (0.00 sec)
Rows matched: 7  Changed: 7  Warnings: 0
```

2. Enable the stage event consumer tables, which include `events_stages_current`, `events_stages_history`, and `events_stages_history_long`.

```
mysql> UPDATE performance_schema.setup_consumers
      SET ENABLED = 'YES'
      WHERE NAME LIKE '%stages%';
Query OK, 3 rows affected (0.00 sec)
Rows matched: 3  Changed: 3  Warnings: 0
```

3. Run an `ALTER TABLE` operation. In this example, a `middle_name` column is added to the `employees` table of the `employees` sample database.

```
mysql> ALTER TABLE employees.employees ADD COLUMN middle_name varchar(14) AFTER first_name;
Query OK, 0 rows affected (9.27 sec)
Records: 0  Duplicates: 0  Warnings: 0
```

4. Check the progress of the `ALTER TABLE` operation by querying the Performance Schema `events_stages_current` table. The stage event shown differs depending on which `ALTER TABLE` phase is currently in progress. The `WORK_COMPLETED` column shows the work completed. The `WORK_ESTIMATED` column provides an estimate of the remaining work.

```
mysql> SELECT EVENT_NAME, WORK_COMPLETED, WORK_ESTIMATED
      FROM performance_schema.events_stages_current;
+-----+-----+-----+
| EVENT_NAME | WORK_COMPLETED | WORK_ESTIMATED |
+-----+-----+-----+
| stage/innodb/alter table (read PK and internal sort) | 280 | 1245 |
+-----+-----+-----+
1 row in set (0.01 sec)
```

The `events_stages_current` table returns an empty set if the `ALTER TABLE` operation has completed. In this case, you can check the `events_stages_history` table to view event data for the completed operation. For example:

```
mysql> SELECT EVENT_NAME, WORK_COMPLETED, WORK_ESTIMATED
      FROM performance_schema.events_stages_history;
+-----+-----+-----+
| EVENT_NAME | WORK_COMPLETED | WORK_ESTIMATED |
+-----+-----+-----+
| stage/innodb/alter table (read PK and internal sort) | 886 | 1213 |
| stage/innodb/alter table (flush) | 1213 | 1213 |
| stage/innodb/alter table (log apply table) | 1597 | 1597 |
| stage/innodb/alter table (end) | 1597 | 1597 |
| stage/innodb/alter table (log apply table) | 1981 | 1981 |
+-----+-----+-----+
5 rows in set (0.00 sec)
```

As shown above, the `WORK_ESTIMATED` value was revised during `ALTER TABLE` processing. The estimated work after completion of the initial stage is 1213. When `ALTER TABLE` processing completed, `WORK_ESTIMATED` was set to the actual value, which is 1981.

## 14.17.2 Monitoring InnoDB Mutex Waits Using Performance Schema

A mutex is a synchronization mechanism used in the code to enforce that only one thread at a given time can have access to a common resource. When two or more threads executing in the server need to access the same resource, the threads compete against each other. The first thread to obtain a lock on the mutex causes the other threads to wait until the lock is released.

For InnoDB mutexes that are instrumented, mutex waits can be monitored using Performance Schema. Wait event data collected in Performance Schema tables can help identify mutexes with the most waits or the greatest total wait time, for example.

The following example demonstrates how to enable InnoDB mutex wait instruments, how to enable associated consumers, and how to query wait event data.

1. To view available InnoDB mutex wait instruments, query the Performance Schema `setup_instruments` table, as shown below. All InnoDB mutex wait instruments are disabled by default.

```
mysql> SELECT *
      FROM performance_schema.setup_instruments
      WHERE NAME LIKE '%wait/synch/mutex/innodb%';
```

NAME	ENABLED	TIMED
wait/synch/mutex/innodb/commit_cond_mutex	NO	NO
wait/synch/mutex/innodb/innobase_share_mutex	NO	NO
wait/synch/mutex/innodb/autoinc_mutex	NO	NO
wait/synch/mutex/innodb/buf_pool_mutex	NO	NO
wait/synch/mutex/innodb/buf_pool_zip_mutex	NO	NO
wait/synch/mutex/innodb/cache_last_read_mutex	NO	NO
wait/synch/mutex/innodb/dict_foreign_err_mutex	NO	NO
wait/synch/mutex/innodb/dict_sys_mutex	NO	NO
wait/synch/mutex/innodb/recalc_pool_mutex	NO	NO
wait/synch/mutex/innodb/file_format_max_mutex	NO	NO
wait/synch/mutex/innodb/fil_system_mutex	NO	NO
wait/synch/mutex/innodb/flush_list_mutex	NO	NO
wait/synch/mutex/innodb/fts_bg_threads_mutex	NO	NO
wait/synch/mutex/innodb/fts_delete_mutex	NO	NO
wait/synch/mutex/innodb/fts_optimize_mutex	NO	NO
wait/synch/mutex/innodb/fts_doc_id_mutex	NO	NO
wait/synch/mutex/innodb/log_flush_order_mutex	NO	NO
wait/synch/mutex/innodb/hash_table_mutex	NO	NO
wait/synch/mutex/innodb/ibuf_bitmap_mutex	NO	NO
wait/synch/mutex/innodb/ibuf_mutex	NO	NO
wait/synch/mutex/innodb/ibuf_pessimistic_insert_mutex	NO	NO
wait/synch/mutex/innodb/log_sys_mutex	NO	NO
wait/synch/mutex/innodb/page_zip_stat_per_index_mutex	NO	NO
wait/synch/mutex/innodb/purge_sys_pq_mutex	NO	NO
wait/synch/mutex/innodb/recv_sys_mutex	NO	NO
wait/synch/mutex/innodb/recv_writer_mutex	NO	NO
wait/synch/mutex/innodb/redo_rseg_mutex	NO	NO
wait/synch/mutex/innodb/noredolog_rseg_mutex	NO	NO
wait/synch/mutex/innodb/rw_lock_list_mutex	NO	NO
wait/synch/mutex/innodb/rw_lock_mutex	NO	NO
wait/synch/mutex/innodb/srv_dict_tmpfile_mutex	NO	NO
wait/synch/mutex/innodb/srv_innodb_monitor_mutex	NO	NO
wait/synch/mutex/innodb/srv_misc_tmpfile_mutex	NO	NO
wait/synch/mutex/innodb/srv_monitor_file_mutex	NO	NO

```

| wait/synch/mutex/innodb/buf_dblwr_mutex | NO | NO |
| wait/synch/mutex/innodb/trx_undo_mutex | NO | NO |
| wait/synch/mutex/innodb/trx_pool_mutex | NO | NO |
| wait/synch/mutex/innodb/trx_pool_manager_mutex | NO | NO |
| wait/synch/mutex/innodb/srv_sys_mutex | NO | NO |
| wait/synch/mutex/innodb/lock_mutex | NO | NO |
| wait/synch/mutex/innodb/lock_wait_mutex | NO | NO |
| wait/synch/mutex/innodb/trx_mutex | NO | NO |
| wait/synch/mutex/innodb/srv_threads_mutex | NO | NO |
| wait/synch/mutex/innodb/rtr_active_mutex | NO | NO |
| wait/synch/mutex/innodb/rtr_match_mutex | NO | NO |
| wait/synch/mutex/innodb/rtr_path_mutex | NO | NO |
| wait/synch/mutex/innodb/rtr_ssn_mutex | NO | NO |
| wait/synch/mutex/innodb/trx_sys_mutex | NO | NO |
| wait/synch/mutex/innodb/zip_pad_mutex | NO | NO |
+-----+-----+-----+
49 rows in set (0.02 sec)

```

- Some [InnoDB](#) mutex instances are created at server startup and are only instrumented if the associated instrument is also enabled at server startup. To ensure that all [InnoDB](#) mutex instances are instrumented and enabled, add the following [performance-schema-instrument](#) rule to your MySQL configuration file:

```
performance-schema-instrument='wait/synch/mutex/innodb/%=ON'
```

If you do not require wait event data for all [InnoDB](#) mutexes, you can disable specific instruments by adding additional [performance-schema-instrument](#) rules to your MySQL configuration file. For example, to disable [InnoDB](#) mutex wait event instruments related to full-text search, add the following rule:

```
performance-schema-instrument='wait/synch/mutex/innodb/fts%=OFF'
```



#### Note

Rules with a longer prefix such as `wait/synch/mutex/innodb/fts%` take precedence over rules with shorter prefixes such as `wait/synch/mutex/innodb/%`.

After adding the [performance-schema-instrument](#) rules to your configuration file, restart the server. All the [InnoDB](#) mutexes except for those related to full text search are enabled. To verify, query the [setup\\_instruments](#) table. The [ENABLED](#) and [TIMED](#) columns should be set to [YES](#) for the instruments that you enabled.

```

mysql> SELECT *
      FROM performance_schema.setup_instruments
      WHERE NAME LIKE '%wait/synch/mutex/innodb%';
+-----+-----+-----+
| NAME | ENABLED | TIMED |
+-----+-----+-----+
| wait/synch/mutex/innodb/commit_cond_mutex | YES | YES |
| wait/synch/mutex/innodb/innobase_share_mutex | YES | YES |
| wait/synch/mutex/innodb/autoinc_mutex | YES | YES |
| ... | | |
| wait/synch/mutex/innodb/zip_pad_mutex | YES | YES |
+-----+-----+-----+
49 rows in set (0.00 sec)

```

- Enable wait event consumers by updating the [setup\\_consumers](#) table. Wait event consumers are disabled by default.

```

mysql> UPDATE performance_schema.setup_consumers
      SET enabled = 'YES'
      WHERE name like 'events_waits%';

```

```
Query OK, 3 rows affected (0.00 sec)
Rows matched: 3  Changed: 3  Warnings: 0
```

You can verify that wait event consumers are enabled by querying the `setup_consumers` table. The `events_waits_current`, `events_waits_history`, and `events_waits_history_long` consumers should be enabled.

```
mysql> SELECT * FROM performance_schema.setup_consumers;
+-----+-----+
| NAME                                | ENABLED |
+-----+-----+
| events_stages_current                | NO      |
| events_stages_history                 | NO      |
| events_stages_history_long           | NO      |
| events_statements_current             | YES     |
| events_statements_history             | YES     |
| events_statements_history_long       | NO      |
| events_transactions_current           | YES     |
| events_transactions_history           | YES     |
| events_transactions_history_long     | NO      |
| events_waits_current                  | YES     |
| events_waits_history                  | YES     |
| events_waits_history_long             | YES     |
| global_instrumentation                | YES     |
| thread_instrumentation                | YES     |
| statements_digest                     | YES     |
+-----+-----+
15 rows in set (0.00 sec)
```

- Once instruments and consumers are enabled, run the workload that you want to monitor. In this example, the `mysqlslap` load emulation client is used to simulate a workload.

```
$> ./mysqlslap --auto-generate-sql --concurrency=100 --iterations=10
      --number-of-queries=1000 --number-char-cols=6 --number-int-cols=6;
```

- Query the wait event data. In this example, wait event data is queried from the `events_waits_summary_global_by_event_name` table which aggregates data found in the `events_waits_current`, `events_waits_history`, and `events_waits_history_long` tables. Data is summarized by event name (`EVENT_NAME`), which is the name of the instrument that produced the event. Summarized data includes:

- `COUNT_STAR`

The number of summarized wait events.

- `SUM_TIMER_WAIT`

The total wait time of the summarized timed wait events.

- `MIN_TIMER_WAIT`

The minimum wait time of the summarized timed wait events.

- `AVG_TIMER_WAIT`

The average wait time of the summarized timed wait events.

- `MAX_TIMER_WAIT`

The maximum wait time of the summarized timed wait events.

The following query returns the instrument name (`EVENT_NAME`), the number of wait events (`COUNT_STAR`), and the total wait time for the events for that instrument (`SUM_TIMER_WAIT`). Because waits are timed in picoseconds (trillionths of a second) by default, wait times are divided by 1000000000 to show wait times in milliseconds. Data is presented in descending order, by the number of summarized wait events (`COUNT_STAR`). You can adjust the `ORDER BY` clause to order the data by total wait time.

```
mysql> SELECT EVENT_NAME, COUNT_STAR, SUM_TIMER_WAIT/1000000000 SUM_TIMER_WAIT_MS
FROM performance_schema.events_waits_summary_global_by_event_name
WHERE SUM_TIMER_WAIT > 0 AND EVENT_NAME LIKE 'wait/synch/mutex/innodb/%'
ORDER BY COUNT_STAR DESC;
```

EVENT_NAME	COUNT_STAR	SUM_TIMER_WAIT_MS
wait/synch/mutex/innodb/os_mutex	78831	10.3283
wait/synch/mutex/innodb/log_sys_mutex	41488	6510.3233
wait/synch/mutex/innodb/trx_sys_mutex	29770	1107.9687
wait/synch/mutex/innodb/lock_mutex	24212	104.0724
wait/synch/mutex/innodb/trx_mutex	22756	1.9421
wait/synch/mutex/innodb/rseg_mutex	20333	3.6220
wait/synch/mutex/innodb/dict_sys_mutex	13422	2.2284
wait/synch/mutex/innodb/mutex_list_mutex	12694	344.1164
wait/synch/mutex/innodb/file_system_mutex	9208	0.9542
wait/synch/mutex/innodb/rw_lock_list_mutex	8304	0.1794
wait/synch/mutex/innodb/trx_undo_mutex	6190	0.6801
wait/synch/mutex/innodb/buf_pool_mutex	2869	29.4623
wait/synch/mutex/innodb/innobase_share_mutex	2005	0.1349
wait/synch/mutex/innodb/flush_list_mutex	1274	0.1300
wait/synch/mutex/innodb/file_format_max_mutex	1016	0.0469
wait/synch/mutex/innodb/purge_sys_bh_mutex	1004	0.0326
wait/synch/mutex/innodb/buf_dblwr_mutex	640	0.0437
wait/synch/mutex/innodb/log_flush_order_mutex	437	0.0510
wait/synch/mutex/innodb/recv_sys_mutex	394	0.0202
wait/synch/mutex/innodb/srv_sys_mutex	169	0.5259
wait/synch/mutex/innodb/lock_wait_mutex	154	0.1172
wait/synch/mutex/innodb/ibuf_mutex	9	0.0027
wait/synch/mutex/innodb/srv_innodb_monitor_mutex	2	0.0009
wait/synch/mutex/innodb/ut_list_mutex	1	0.0001
wait/synch/mutex/innodb/recv_writer_mutex	1	0.0005

25 rows in set (0.01 sec)



**Note**

The preceding result set includes wait event data produced during the startup process. To exclude this data, you can truncate the `events_waits_summary_global_by_event_name` table immediately after startup and before running your workload. However, the truncate operation itself may produce a negligible amount wait event data.

```
mysql> TRUNCATE performance_schema.events_waits_summary_global_by_event_name;
```

## 14.18 InnoDB Monitors

InnoDB monitors provide information about the InnoDB internal state. This information is useful for performance tuning.

## 14.18.1 InnoDB Monitor Types

There are two types of [InnoDB](#) monitor:

- The standard [InnoDB](#) Monitor displays the following types of information:
  - Work done by the main background thread
  - Semaphore waits
  - Data about the most recent foreign key and deadlock errors
  - Lock waits for transactions
  - Table and record locks held by active transactions
  - Pending I/O operations and related statistics
  - Insert buffer and adaptive hash index statistics
  - Redo log data
  - Buffer pool statistics
  - Row operation data
- The [InnoDB](#) Lock Monitor prints additional lock information as part of the standard [InnoDB](#) Monitor output.

## 14.18.2 Enabling InnoDB Monitors

When [InnoDB](#) monitors are enabled for periodic output, [InnoDB](#) writes the output to `mysqld` server standard error output (`stderr`) every 15 seconds, approximately.

[InnoDB](#) sends the monitor output to `stderr` rather than to `stdout` or fixed-size memory buffers to avoid potential buffer overflows.

On Windows, `stderr` is directed to the default log file unless configured otherwise. If you want to direct the output to the console window rather than to the error log, start the server from a command prompt in a console window with the `--console` option. For more information, see [Section 5.4.2.1, “Error Logging on Windows”](#).

On Unix and Unix-like systems, `stderr` is typically directed to the terminal unless configured otherwise. For more information, see [Section 5.4.2.2, “Error Logging on Unix and Unix-Like Systems”](#).

[InnoDB](#) monitors should only be enabled when you actually want to see monitor information because output generation causes some performance decrement. Also, if monitor output is directed to the error log, the log may become quite large if you forget to disable the monitor later.



### Note

To assist with troubleshooting, [InnoDB](#) temporarily enables standard [InnoDB](#) Monitor output under certain conditions. For more information, see [Section 14.22, “InnoDB Troubleshooting”](#).

[InnoDB](#) monitor output begins with a header containing a timestamp and the monitor name. For example:

```
=====
2014-10-16 18:37:29 0x7fc2a95c1700 INNODB MONITOR OUTPUT
```

The header for the standard InnoDB Monitor (`INNODB MONITOR OUTPUT`) is also used for the Lock Monitor because the latter produces the same output with the addition of extra lock information.

The `innodb_status_output` and `innodb_status_output_locks` system variables are used to enable the standard InnoDB Monitor and InnoDB Lock Monitor.

The `PROCESS` privilege is required to enable or disable InnoDB Monitors.

## Enabling the Standard InnoDB Monitor

Enable the standard InnoDB Monitor by setting the `innodb_status_output` system variable to `ON`.

```
SET GLOBAL innodb_status_output=ON;
```

To disable the standard InnoDB Monitor, set `innodb_status_output` to `OFF`.

When you shut down the server, the `innodb_status_output` variable is set to the default `OFF` value.

## Enabling the InnoDB Lock Monitor

InnoDB Lock Monitor data is printed with the InnoDB Standard Monitor output. Both the InnoDB Standard Monitor and InnoDB Lock Monitor must be enabled to have InnoDB Lock Monitor data printed periodically.

To enable the InnoDB Lock Monitor, set the `innodb_status_output_locks` system variable to `ON`. Both the InnoDB standard Monitor and InnoDB Lock Monitor must be enabled to have InnoDB Lock Monitor data printed periodically:

```
SET GLOBAL innodb_status_output=ON;
SET GLOBAL innodb_status_output_locks=ON;
```

To disable the InnoDB Lock Monitor, set `innodb_status_output_locks` to `OFF`. Set `innodb_status_output` to `OFF` to also disable the InnoDB Standard Monitor.

When you shut down the server, the `innodb_status_output` and `innodb_status_output_locks` variables are set to the default `OFF` value.



### Note

To enable the InnoDB Lock Monitor for `SHOW ENGINE INNODB STATUS` output, you are only required to enable `innodb_status_output_locks`.

## Obtaining Standard InnoDB Monitor Output On Demand

As an alternative to enabling the standard InnoDB Monitor for periodic output, you can obtain standard InnoDB Monitor output on demand using the `SHOW ENGINE INNODB STATUS` SQL statement, which fetches the output to your client program. If you are using the `mysql` interactive client, the output is more readable if you replace the usual semicolon statement terminator with `\G`:

```
mysql> SHOW ENGINE INNODB STATUS\G
```

`SHOW ENGINE INNODB STATUS` output also includes InnoDB Lock Monitor data if the InnoDB Lock Monitor is enabled.

## Directing Standard InnoDB Monitor Output to a Status File

Standard InnoDB Monitor output can be enabled and directed to a status file by specifying the `--innodb-status-file` option at startup. When this option is used, InnoDB creates a file named `innodb_status.pid` in the data directory and writes output to it every 15 seconds, approximately.



InnoDB removes the status file when the server is shut down normally. If an abnormal shutdown occurs, the status file may have to be removed manually.

The `--innodb-status-file` option is intended for temporary use, as output generation can affect performance, and the `innodb_status.pid` file can become quite large over time.

### 14.18.3 InnoDB Standard Monitor and Lock Monitor Output

The Lock Monitor is the same as the Standard Monitor except that it includes additional lock information. Enabling either monitor for periodic output turns on the same output stream, but the stream includes extra information if the Lock Monitor is enabled. For example, if you enable the Standard Monitor and Lock Monitor, that turns on a single output stream. The stream includes extra lock information until you disable the Lock Monitor.

Standard Monitor output is limited to 1MB when produced using the `SHOW ENGINE INNODB STATUS` statement. This limit does not apply to output written to tserver standard error output (`stderr`).

Example Standard Monitor output:

```
mysql> SHOW ENGINE INNODB STATUS\G
***** 1. row *****
Type: InnoDB
Name:
Status:
=====
2014-10-16 18:37:29 0x7fc2a95c1700 INNODB MONITOR OUTPUT
=====
Per second averages calculated from the last 20 seconds
-----
BACKGROUND THREAD
-----
srv_master_thread loops: 38 srv_active, 0 srv_shutdown, 252 srv_idle
srv_master_thread log flush and writes: 290
-----
SEMAPHORES
-----
OS WAIT ARRAY INFO: reservation count 119
OS WAIT ARRAY INFO: signal count 103
Mutex spin waits 0, rounds 0, OS waits 0
RW-shared spins 38, rounds 76, OS waits 38
RW-excl spins 2, rounds 9383715, OS waits 3
RW-sx spins 0, rounds 0, OS waits 0
Spin rounds per wait: 0.00 mutex, 2.00 RW-shared, 4691857.50 RW-excl,
0.00 RW-sx
-----
LATEST FOREIGN KEY ERROR
-----
2014-10-16 18:35:18 0x7fc2a95c1700 Transaction:
TRANSACTION 1814, ACTIVE 0 sec inserting
mysql tables in use 1, locked 1
4 lock struct(s), heap size 1136, 3 row lock(s), undo log entries 3
MySQL thread id 2, OS thread handle 140474041767680, query id 74 localhost
root update
INSERT INTO child VALUES
  (NULL, 1)
  , (NULL, 2)
  , (NULL, 3)
  , (NULL, 4)
  , (NULL, 5)
  , (NULL, 6)
Foreign key constraint fails for table `mysql`.`child`:
'
CONSTRAINT `child_ibfk_1` FOREIGN KEY (`parent_id`) REFERENCES `parent`
(`id`) ON DELETE CASCADE ON UPDATE CASCADE
```

## InnoDB Standard Monitor and Lock Monitor Output

```
Trying to add in child table, in index par_ind tuple:
DATA TUPLE: 2 fields;
 0: len 4; hex 80000003; asc      ;;
 1: len 4; hex 80000003; asc      ;;

But in parent table `mysql`.`parent`, in index PRIMARY,
the closest match we can find is record:
PHYSICAL RECORD: n_fields 3; compact format; info bits 0
 0: len 4; hex 80000004; asc      ;;
 1: len 6; hex 00000000070a; asc   ;;
 2: len 7; hex aa0000011d0134; asc 4;;

-----
LATEST DETECTED DEADLOCK
-----

2014-10-16 18:36:30 0x7fc2a95c1700
*** (1) TRANSACTION:
TRANSACTION 1824, ACTIVE 9 sec starting index read
mysql tables in use 1, locked 1
LOCK WAIT 2 lock struct(s), heap size 1136, 1 row lock(s)
MySQL thread id 3, OS thread handle 140474041501440, query id 80 localhost
root updating
DELETE FROM t WHERE i = 1
*** (1) WAITING FOR THIS LOCK TO BE GRANTED:
RECORD LOCKS space id 35 page no 3 n bits 72 index GEN_CLUST_INDEX of table
`mysql`.`t` trx id 1824 lock_mode X waiting
Record lock, heap no 2 PHYSICAL RECORD: n_fields 4; compact format; info
bits 0
 0: len 6; hex 000000000200; asc      ;;
 1: len 6; hex 00000000071f; asc      ;;
 2: len 7; hex b80000012b0110; asc   + ;;
 3: len 4; hex 80000001; asc        ;;

*** (2) TRANSACTION:
TRANSACTION 1825, ACTIVE 29 sec starting index read
mysql tables in use 1, locked 1
4 lock struct(s), heap size 1136, 3 row lock(s)
MySQL thread id 2, OS thread handle 140474041767680, query id 81 localhost
root updating
DELETE FROM t WHERE i = 1
*** (2) HOLDS THE LOCK(S):
RECORD LOCKS space id 35 page no 3 n bits 72 index GEN_CLUST_INDEX of table
`mysql`.`t` trx id 1825 lock mode S
Record lock, heap no 1 PHYSICAL RECORD: n_fields 1; compact format; info
bits 0
 0: len 8; hex 73757072656d756d; asc supremum;;

Record lock, heap no 2 PHYSICAL RECORD: n_fields 4; compact format; info bits 0
 0: len 6; hex 000000000200; asc      ;;
 1: len 6; hex 00000000071f; asc      ;;
 2: len 7; hex b80000012b0110; asc   + ;;
 3: len 4; hex 80000001; asc        ;;

*** (2) WAITING FOR THIS LOCK TO BE GRANTED:
RECORD LOCKS space id 35 page no 3 n bits 72 index GEN_CLUST_INDEX of table
`mysql`.`t` trx id 1825 lock_mode X waiting
Record lock, heap no 2 PHYSICAL RECORD: n_fields 4; compact format; info
bits 0
 0: len 6; hex 000000000200; asc      ;;
 1: len 6; hex 00000000071f; asc      ;;
 2: len 7; hex b80000012b0110; asc   + ;;
 3: len 4; hex 80000001; asc        ;;

*** WE ROLL BACK TRANSACTION (1)
-----
TRANSACTIONS
-----
```

## InnoDB Standard Monitor and Lock Monitor Output

```
Trx id counter 1950
Purge done for trx's n:o < 1933 undo n:o < 0 state: running but idle
History list length 23
LIST OF TRANSACTIONS FOR EACH SESSION:
---TRANSACTION 421949033065200, not started
0 lock struct(s), heap size 1136, 0 row lock(s)
---TRANSACTION 421949033064280, not started
0 lock struct(s), heap size 1136, 0 row lock(s)
---TRANSACTION 1949, ACTIVE 0 sec inserting
mysql tables in use 1, locked 1
8 lock struct(s), heap size 1136, 1850 row lock(s), undo log entries 17415
MySQL thread id 4, OS thread handle 140474041235200, query id 176 localhost
root update
INSERT INTO `salaries` VALUES (55723,39746,'1997-02-25','1998-02-25'),
(55723,40758,'1998-02-25','1999-02-25'),(55723,44559,'1999-02-25','2000-02-25'),
(55723,44081,'2000-02-25','2001-02-24'),(55723,44112,'2001-02-24','2001-08-16'),
(55724,46461,'1996-12-06','1997-12-06'),(55724,48916,'1997-12-06','1998-12-06'),
(55724,51269,'1998-12-06','1999-12-06'),(55724,51932,'1999-12-06','2000-12-05'),
(55724,52617,'2000-12-05','2001-12-05'),(55724,56658,'2001-12-05','9999-01-01'),
(55725,40000,'1993-01-30','1994-01-30'),(55725,41472,'1994-01-30','1995-01-30'),
(55725,45293,'1995-01-30','1996-01-30'),(55725,473
-----
FILE I/O
-----
I/O thread 0 state: waiting for completed aio requests (insert buffer thread)
I/O thread 1 state: waiting for completed aio requests (log thread)
I/O thread 2 state: waiting for completed aio requests (read thread)
I/O thread 3 state: waiting for completed aio requests (read thread)
I/O thread 4 state: waiting for completed aio requests (read thread)
I/O thread 5 state: waiting for completed aio requests (read thread)
I/O thread 6 state: waiting for completed aio requests (write thread)
I/O thread 7 state: waiting for completed aio requests (write thread)
I/O thread 8 state: waiting for completed aio requests (write thread)
I/O thread 9 state: waiting for completed aio requests (write thread)
Pending normal aio reads: 0 [0, 0, 0, 0] , aio writes: 0 [0, 0, 0, 0] ,
  ibuf aio reads: 0, log i/o's: 0, sync i/o's: 0
Pending flushes (fsync) log: 0; buffer pool: 0
224 OS file reads, 5770 OS file writes, 803 OS fsyncs
0.00 reads/s, 0 avg bytes/read, 264.84 writes/s, 23.05 fsyncs/s
-----
INSERT BUFFER AND ADAPTIVE HASH INDEX
-----
Ibuf: size 1, free list len 0, seg size 2, 0 merges
merged operations:
  insert 0, delete mark 0, delete 0
discarded operations:
  insert 0, delete mark 0, delete 0
Hash table size 4425293, node heap has 444 buffer(s)
68015.25 hash searches/s, 106259.24 non-hash searches/s
---
LOG
---
Log sequence number 165913808
Log flushed up to 164814979
Pages flushed up to 141544038
Last checkpoint at 130503656
0 pending log flushes, 0 pending chkp writes
258 log i/o's done, 6.65 log i/o's/second
-----
BUFFER POOL AND MEMORY
-----
Total large memory allocated 2198863872
Dictionary memory allocated 776332
Buffer pool size 131072
Free buffers 124908
Database pages 5720
Old database pages 2071
```

## InnoDB Standard Monitor and Lock Monitor Output

```
Modified db pages 910
Pending reads 0
Pending writes: LRU 0, flush list 0, single page 0
Pages made young 4, not young 0
0.10 youngs/s, 0.00 non-youngs/s
Pages read 197, created 5523, written 5060
0.00 reads/s, 190.89 creates/s, 244.94 writes/s
Buffer pool hit rate 1000 / 1000, young-making rate 0 / 1000 not
0 / 1000
Pages read ahead 0.00/s, evicted without access 0.00/s, Random read
ahead 0.00/s
LRU len: 5720, unzip_LRU len: 0
I/O sum[0]:cur[0], unzip sum[0]:cur[0]
-----
INDIVIDUAL BUFFER POOL INFO
-----
---BUFFER POOL 0
Buffer pool size 65536
Free buffers 62412
Database pages 2899
Old database pages 1050
Modified db pages 449
Pending reads 0
Pending writes: LRU 0, flush list 0, single page 0
Pages made young 3, not young 0
0.05 youngs/s, 0.00 non-youngs/s
Pages read 107, created 2792, written 2586
0.00 reads/s, 92.65 creates/s, 122.89 writes/s
Buffer pool hit rate 1000 / 1000, young-making rate 0 / 1000 not 0 / 1000
Pages read ahead 0.00/s, evicted without access 0.00/s, Random read ahead
0.00/s
LRU len: 2899, unzip_LRU len: 0
I/O sum[0]:cur[0], unzip sum[0]:cur[0]
---BUFFER POOL 1
Buffer pool size 65536
Free buffers 62496
Database pages 2821
Old database pages 1021
Modified db pages 461
Pending reads 0
Pending writes: LRU 0, flush list 0, single page 0
Pages made young 1, not young 0
0.05 youngs/s, 0.00 non-youngs/s
Pages read 90, created 2731, written 2474
0.00 reads/s, 98.25 creates/s, 122.04 writes/s
Buffer pool hit rate 1000 / 1000, young-making rate 0 / 1000 not 0 / 1000
Pages read ahead 0.00/s, evicted without access 0.00/s, Random read ahead
0.00/s
LRU len: 2821, unzip_LRU len: 0
I/O sum[0]:cur[0], unzip sum[0]:cur[0]
-----
ROW OPERATIONS
-----
0 queries inside InnoDB, 0 queries in queue
0 read views open inside InnoDB
Process ID=35909, Main thread ID=140471692396288, state: sleeping
Number of rows inserted 1526363, updated 0, deleted 3, read 11
52671.72 inserts/s, 0.00 updates/s, 0.00 deletes/s, 0.00 reads/s
-----
END OF INNODB MONITOR OUTPUT
=====
```

## Standard Monitor Output Sections

For a description of each metric reported by the Standard Monitor, refer to the [Metrics](#) chapter in the [Oracle Enterprise Manager for MySQL Database User's Guide](#).

- [Status](#)

This section shows the timestamp, the monitor name, and the number of seconds that per-second averages are based on. The number of seconds is the elapsed time between the current time and the last time [InnoDB Monitor](#) output was printed.

- [BACKGROUND THREAD](#)

The `srv_master_thread` lines shows work done by the main background thread.

- [SEMAPHORES](#)

This section reports threads waiting for a semaphore and statistics on how many times threads have needed a spin or a wait on a mutex or a rw-lock semaphore. A large number of threads waiting for semaphores may be a result of disk I/O, or contention problems inside [InnoDB](#). Contention can be due to heavy parallelism of queries or problems in operating system thread scheduling. Setting the `innodb_thread_concurrency` system variable smaller than the default value might help in such situations. The `Spin rounds per wait` line shows the number of spinlock rounds per OS wait for a mutex.

Mutex metrics are reported by `SHOW ENGINE INNODB MUTEX`.

- [LATEST FOREIGN KEY ERROR](#)

This section provides information about the most recent foreign key constraint error. It is not present if no such error has occurred. The contents include the statement that failed as well as information about the constraint that failed and the referenced and referencing tables.

- [LATEST DETECTED DEADLOCK](#)

This section provides information about the most recent deadlock. It is not present if no deadlock has occurred. The contents show which transactions are involved, the statement each was attempting to execute, the locks they have and need, and which transaction [InnoDB](#) decided to roll back to break the deadlock. The lock modes reported in this section are explained in [Section 14.7.1, “InnoDB Locking”](#).

- [TRANSACTIONS](#)

If this section reports lock waits, your applications might have lock contention. The output can also help to trace the reasons for transaction deadlocks.

- [FILE I/O](#)

This section provides information about threads that [InnoDB](#) uses to perform various types of I/O. The first few of these are dedicated to general [InnoDB](#) processing. The contents also display information for pending I/O operations and statistics for I/O performance.

The number of these threads are controlled by the `innodb_read_io_threads` and `innodb_write_io_threads` parameters. See [Section 14.15, “InnoDB Startup Options and System Variables”](#).

- [INSERT BUFFER AND ADAPTIVE HASH INDEX](#)

This section shows the status of the [InnoDB](#) insert buffer (also referred to as the [change buffer](#)) and the adaptive hash index.

For related information, see [Section 14.5.2, “Change Buffer”](#), and [Section 14.5.3, “Adaptive Hash Index”](#).

- [LOG](#)

This section displays information about the [InnoDB](#) log. The contents include the current log sequence number, how far the log has been flushed to disk, and the position at which [InnoDB](#) last took a checkpoint. (See [Section 14.12.3, “InnoDB Checkpoints”](#).) The section also displays information about pending writes and write performance statistics.

- [BUFFER POOL AND MEMORY](#)

This section gives you statistics on pages read and written. You can calculate from these numbers how many data file I/O operations your queries currently are doing.

For buffer pool statistics descriptions, see [Monitoring the Buffer Pool Using the InnoDB Standard Monitor](#). For additional information about the operation of the buffer pool, see [Section 14.5.1, “Buffer Pool”](#).

- [ROW OPERATIONS](#)

This section shows what the main thread is doing, including the number and performance rate for each type of row operation.

## 14.19 InnoDB Backup and Recovery

This section covers topics related to [InnoDB](#) backup and recovery.

- For information about backup techniques applicable to [InnoDB](#), see [Section 14.19.1, “InnoDB Backup”](#).
- For information about point-in-time recovery, recovery from disk failure or corruption, and how [InnoDB](#) performs crash recovery, see [Section 14.19.2, “InnoDB Recovery”](#).

### 14.19.1 InnoDB Backup

The key to safe database management is making regular backups. Depending on your data volume, number of MySQL servers, and database workload, you can use these backup techniques, alone or in combination: [hot backup](#) with MySQL Enterprise Backup; [cold backup](#) by copying files while the MySQL server is shut down; [logical backup](#) with `mysqldump` for smaller data volumes or to record the structure of schema objects. Hot and cold backups are [physical backups](#) that copy actual data files, which can be used directly by the `mysqld` server for faster restore.

Using *MySQL Enterprise Backup* is the recommended method for backing up [InnoDB](#) data.



#### Note

[InnoDB](#) does not support databases that are restored using third-party backup tools.

### Hot Backups

The `mysqlbackup` command, part of the MySQL Enterprise Backup component, lets you back up a running MySQL instance, including [InnoDB](#) tables, with minimal disruption to operations while producing a consistent snapshot of the database. When `mysqlbackup` is copying [InnoDB](#) tables, reads and writes to [InnoDB](#) tables can continue. MySQL Enterprise Backup can also create compressed backup files, and back up subsets of tables and databases. In conjunction with the MySQL binary log, users can perform point-in-time recovery. MySQL Enterprise Backup is part of the MySQL Enterprise subscription. For more details, see [Section 28.1, “MySQL Enterprise Backup Overview”](#).

## Cold Backups

If you can shut down the MySQL server, you can make a physical backup that consists of all files used by InnoDB to manage its tables. Use the following procedure:

1. Perform a [slow shutdown](#) of the MySQL server and make sure that it stops without errors.
2. Copy all InnoDB data files (`ibdata` files and `.ibd` files) into a safe place.
3. Copy all the `.frm` files for InnoDB tables to a safe place.
4. Copy all InnoDB log files (`ib_logfile` files) to a safe place.
5. Copy your `my.cnf` configuration file or files to a safe place.

## Logical Backups Using mysqldump

In addition to physical backups, it is recommended that you regularly create logical backups by dumping your tables using `mysqldump`. A binary file might be corrupted without you noticing it. Dumped tables are stored into text files that are human-readable, so spotting table corruption becomes easier. Also, because the format is simpler, the chance for serious data corruption is smaller. `mysqldump` also has a `--single-transaction` option for making a consistent snapshot without locking out other clients. See [Section 7.3.1, “Establishing a Backup Policy”](#).

Replication works with InnoDB tables, so you can use MySQL replication capabilities to keep a copy of your database at database sites requiring high availability. See [Section 14.20, “InnoDB and MySQL Replication”](#).

## 14.19.2 InnoDB Recovery

This section describes InnoDB recovery. Topics include:

- [Point-in-Time Recovery](#)
- [Recovery from Data Corruption or Disk Failure](#)
- [InnoDB Crash Recovery](#)
- [Tablespace Discovery During Crash Recovery](#)

### Point-in-Time Recovery

To recover an InnoDB database to the present from the time at which the physical backup was made, you must run MySQL server with binary logging enabled, even before taking the backup. To achieve point-in-time recovery after restoring a backup, you can apply changes from the binary log that occurred after the backup was made. See [Section 7.5, “Point-in-Time \(Incremental\) Recovery”](#).

### Recovery from Data Corruption or Disk Failure

If your database becomes corrupted or disk failure occurs, you must perform the recovery using a backup. In the case of corruption, first find a backup that is not corrupted. After restoring the base backup, do a point-in-time recovery from the binary log files using `mysqlbinlog` and `mysql` to restore the changes that occurred after the backup was made.

In some cases of database corruption, it is enough to dump, drop, and re-create one or a few corrupt tables. You can use the `CHECK TABLE` statement to check whether a table is corrupt, although `CHECK TABLE` naturally cannot detect every possible kind of corruption.

In some cases, apparent database page corruption is actually due to the operating system corrupting its own file cache, and the data on disk may be okay. It is best to try restarting the computer first. Doing so may eliminate errors that appeared to be database page corruption. If MySQL still has trouble starting because of [InnoDB](#) consistency problems, see [Section 14.22.2, “Forcing InnoDB Recovery”](#) for steps to start the instance in recovery mode, which permits you to dump the data.

## InnoDB Crash Recovery

To recover from an unexpected MySQL server exit, the only requirement is to restart the MySQL server. [InnoDB](#) automatically checks the logs and performs a roll-forward of the database to the present. [InnoDB](#) automatically rolls back uncommitted transactions that were present at the time of the crash. During recovery, `mysqld` displays output similar to this:

```
InnoDB: Log scan progressed past the checkpoint lsn 369163704
InnoDB: Doing recovery: scanned up to log sequence number 374340608
InnoDB: Doing recovery: scanned up to log sequence number 379583488
InnoDB: Doing recovery: scanned up to log sequence number 384826368
InnoDB: Doing recovery: scanned up to log sequence number 390069248
InnoDB: Doing recovery: scanned up to log sequence number 395312128
InnoDB: Doing recovery: scanned up to log sequence number 400555008
InnoDB: Doing recovery: scanned up to log sequence number 405797888
InnoDB: Doing recovery: scanned up to log sequence number 411040768
InnoDB: Doing recovery: scanned up to log sequence number 414724794
InnoDB: Database was not shutdown normally!
InnoDB: Starting crash recovery.
InnoDB: 1 transaction(s) which must be rolled back or cleaned up in
total 518425 row operations to undo
InnoDB: Trx id counter is 1792
InnoDB: Starting an apply batch of log records to the database...
InnoDB: Progress in percent: 0 1 2 3 4 5 6 7 8 9 10 11 12 13 14 15
16 17 18 19 20 21 22 23 24 25 26 27 28 29 30 31 32 33 34 35 36 37
38 39 40 41 42 43 44 45 46 47 48 49 50 51 52 53 54 55 56 57 58 59
60 61 62 63 64 65 66 67 68 69 70 71 72 73 74 75 76 77 78 79 80 81
82 83 84 85 86 87 88 89 90 91 92 93 94 95 96 97 98 99
InnoDB: Apply batch completed
...
InnoDB: Starting in background the rollback of uncommitted transactions
InnoDB: Rolling back trx with id 1511, 518425 rows to undo
...
InnoDB: Waiting for purge to start
InnoDB: 5.7.18 started; log sequence number 414724794
...
./mysqld: ready for connections.
```

[InnoDB crash recovery](#) consists of several steps:

- [Tablespace discovery](#)

Tablespace discovery is the process that [InnoDB](#) uses to identify tablespaces that require redo log application. See [Tablespace Discovery During Crash Recovery](#).

- [Redo log application](#)

Redo log application is performed during initialization, before accepting any connections. If all changes are flushed from the [buffer pool](#) to the [tablespaces](#) (`ibdata*` and `*.ibd` files) at the time of the shutdown or crash, redo log application is skipped. [InnoDB](#) also skips redo log application if redo log files are missing at startup.

Removing redo logs to speed up recovery is not recommended, even if some data loss is acceptable. Removing redo logs should only be considered after a clean shutdown, with `innodb_fast_shutdown` set to 0 or 1.



For information about the process that InnoDB uses to identify tablespaces that require redo log application, see [Tablespace Discovery During Crash Recovery](#).

- [Roll back](#) of incomplete [transactions](#)

Incomplete transactions are any transactions that were active at the time of unexpected exit or [fast shutdown](#). The time it takes to roll back an incomplete transaction can be three or four times the amount of time a transaction is active before it is interrupted, depending on server load.

You cannot cancel transactions that are being rolled back. In extreme cases, when rolling back transactions is expected to take an exceptionally long time, it may be faster to start InnoDB with an `innodb_force_recovery` setting of 3 or greater. See [Section 14.22.2, “Forcing InnoDB Recovery”](#).

- [Change buffer](#) merge

Applying changes from the change buffer (part of the [system tablespace](#)) to leaf pages of secondary indexes, as the index pages are read to the buffer pool.

- [Purge](#)

Deleting delete-marked records that are no longer visible to active transactions.

The steps that follow redo log application do not depend on the redo log (other than for logging the writes) and are performed in parallel with normal processing. Of these, only rollback of incomplete transactions is special to crash recovery. The insert buffer merge and the purge are performed during normal processing.

After redo log application, InnoDB attempts to accept connections as early as possible, to reduce downtime. As part of crash recovery, InnoDB rolls back transactions that were not committed or in `XA PREPARE` state when the server exited. The rollback is performed by a background thread, executed in parallel with transactions from new connections. Until the rollback operation is completed, new connections may encounter locking conflicts with recovered transactions.

In most situations, even if the MySQL server was killed unexpectedly in the middle of heavy activity, the recovery process happens automatically and no action is required of the DBA. If a hardware failure or severe system error corrupted InnoDB data, MySQL might refuse to start. In this case, see [Section 14.22.2, “Forcing InnoDB Recovery”](#).

For information about the binary log and InnoDB crash recovery, see [Section 5.4.4, “The Binary Log”](#).

## Tablespace Discovery During Crash Recovery

If, during recovery, InnoDB encounters redo logs written since the last checkpoint, the redo logs must be applied to affected tablespaces. The process that identifies affected tablespaces during recovery is referred to as *tablespace discovery*.

Tablespace discovery is performed by scanning redo logs from the last checkpoint to the end of the log for `MLOG_FILE_NAME` records that are written when a tablespace page is modified. An `MLOG_FILE_NAME` record contains the tablespace space ID and file name.

On startup, InnoDB opens the system tablespace and redo log. If there are redo log records written since the last checkpoint, affected tablespace files are opened based on `MLOG_FILE_NAME` records.

`MLOG_FILE_NAME` records are written for all persistent tablespace types including file-per-table tablespaces, general tablespaces, the system tablespace, and undo log tablespaces.

Redo-log-based discovery has the following characteristics:

- Only tablespace `*.ibd` files modified since the last checkpoint are accessed.

- Tablespace `*.ibd` files that are not attached to the [InnoDB](#) instance are ignored when redo logs are applied.
- If `MLOG_FILE_NAME` records for the system tablespace do not match the server configuration affecting system tablespace data file names, recovery fails with an error before redo logs are applied.
- If tablespace files referenced in the scanned portion of the log are missing, startup is refused.
- Redo logs for missing tablespace `*.ibd` files are only disregarded if there is a file-delete redo log record (`MLOG_FILE_DELETE`) in the log. For example, a table rename failure could result in a “missing” `*.ibd` file without an `MLOG_FILE_DELETE` record. In this case, you could manually rename the tablespace file and restart crash recovery, or you could restart the server in recovery mode using the `innodb_force_recovery` option. Missing `*.ibd` files are ignored when the server is started in recovery mode.

Redo-log-based discovery, introduced in MySQL 5.7, replaces directory scans that were used in earlier MySQL releases to construct a “space ID-to-tablespace file name” map that was required to apply redo logs.

## 14.20 InnoDB and MySQL Replication

It is possible to use replication in a way where the storage engine on the replica is not the same as the storage engine on the source. For example, you can replicate modifications to an [InnoDB](#) table on the source to a [MyISAM](#) table on the replica. For more information see, [Section 16.3.3, “Using Replication with Different Source and Replica Storage Engines”](#).

For information about setting up a replica, see [Section 16.1.2.5, “Setting Up Replicas”](#), and [Section 16.1.2.4, “Choosing a Method for Data Snapshots”](#). To make a new replica without taking down the source or an existing replica, use the [MySQL Enterprise Backup](#) product.

Transactions that fail on the source do not affect replication. MySQL replication is based on the binary log where MySQL writes SQL statements that modify data. A transaction that fails (for example, because of a foreign key violation, or because it is rolled back) is not written to the binary log, so it is not sent to replicas. See [Section 13.3.1, “START TRANSACTION, COMMIT, and ROLLBACK Statements”](#).

**Replication and CASCADE.** Cascading actions for [InnoDB](#) tables on the source are executed on the replica *only* if the tables sharing the foreign key relation use [InnoDB](#) on both the source and replica. This is true whether you are using statement-based or row-based replication. Suppose that you have started replication, and then create two tables on the source, where [InnoDB](#) is defined as the default storage engine, using the following `CREATE TABLE` statements:

```
CREATE TABLE fc1 (
  i INT PRIMARY KEY,
  j INT
);

CREATE TABLE fc2 (
  m INT PRIMARY KEY,
  n INT,
  FOREIGN KEY ni (n) REFERENCES fc1 (i)
  ON DELETE CASCADE
);
```

If the replica has [MyISAM](#) defined as the default storage engine, the same tables are created on the replica, but they use the [MyISAM](#) storage engine, and the `FOREIGN KEY` option is ignored. Now we insert some rows into the tables on the source:

```
source> INSERT INTO fc1 VALUES (1, 1), (2, 2);
Query OK, 2 rows affected (0.09 sec)
```

```
Records: 2 Duplicates: 0 Warnings: 0

source> INSERT INTO fc2 VALUES (1, 1), (2, 2), (3, 1);
Query OK, 3 rows affected (0.19 sec)
Records: 3 Duplicates: 0 Warnings: 0
```

At this point, on both the source and the replica, table `fc1` contains 2 rows, and table `fc2` contains 3 rows, as shown here:

```
source> SELECT * FROM fc1;
+----+-----+
| i | j |
+----+-----+
| 1 | 1 |
| 2 | 2 |
+----+-----+
2 rows in set (0.00 sec)

source> SELECT * FROM fc2;
+----+-----+
| m | n |
+----+-----+
| 1 | 1 |
| 2 | 2 |
| 3 | 1 |
+----+-----+
3 rows in set (0.00 sec)

replica> SELECT * FROM fc1;
+----+-----+
| i | j |
+----+-----+
| 1 | 1 |
| 2 | 2 |
+----+-----+
2 rows in set (0.00 sec)

replica> SELECT * FROM fc2;
+----+-----+
| m | n |
+----+-----+
| 1 | 1 |
| 2 | 2 |
| 3 | 1 |
+----+-----+
3 rows in set (0.00 sec)
```

Now suppose that you perform the following `DELETE` statement on the source:

```
source> DELETE FROM fc1 WHERE i=1;
Query OK, 1 row affected (0.09 sec)
```

Due to the cascade, table `fc2` on the source now contains only 1 row:

```
source> SELECT * FROM fc2;
+----+-----+
| m | n |
+----+-----+
| 2 | 2 |
+----+-----+
1 row in set (0.00 sec)
```

However, the cascade does not propagate on the replica because on the replica the `DELETE` for `fc1` deletes no rows from `fc2`. The replica's copy of `fc2` still contains all of the rows that were originally inserted:

```

replica> SELECT * FROM fc2;
+-----+
| m | n |
+-----+
| 1 | 1 |
| 3 | 1 |
| 2 | 2 |
+-----+
3 rows in set (0.00 sec)

```

This difference is due to the fact that the cascading deletes are handled internally by the [InnoDB](#) storage engine, which means that none of the changes are logged.

## 14.21 InnoDB memcached Plugin

The [InnoDB memcached](#) plugin (`daemon_memcached`) provides an integrated [memcached](#) daemon that automatically stores and retrieves data from [InnoDB](#) tables, turning the MySQL server into a fast “key-value store”. Instead of formulating queries in SQL, you can use simple `get`, `set`, and `incr` operations that avoid the performance overhead associated with SQL parsing and constructing a query optimization plan. You can also access the same [InnoDB](#) tables through SQL for convenience, complex queries, bulk operations, and other strengths of traditional database software.

This “NoSQL-style” interface uses the [memcached](#) API to speed up database operations, letting [InnoDB](#) handle memory caching using its [buffer pool](#) mechanism. Data modified through [memcached](#) operations such as `add`, `set`, and `incr` are stored to disk, in [InnoDB](#) tables. The combination of [memcached](#) simplicity and [InnoDB](#) reliability and consistency provides users with the best of both worlds, as explained in [Section 14.21.1, “Benefits of the InnoDB memcached Plugin”](#). For an architectural overview, see [Section 14.21.2, “InnoDB memcached Architecture”](#).

### 14.21.1 Benefits of the InnoDB memcached Plugin

This section outlines advantages the `daemon_memcached` plugin. The combination of [InnoDB](#) tables and [memcached](#) offers advantages over using either by themselves.

- Direct access to the [InnoDB](#) storage engine avoids the parsing and planning overhead of SQL.
- Running [memcached](#) in the same process space as the MySQL server avoids the network overhead of passing requests back and forth.
- Data written using the [memcached](#) protocol is transparently written to an [InnoDB](#) table, without going through the MySQL SQL layer. You can control frequency of writes to achieve higher raw performance when updating non-critical data.
- Data requested through the [memcached](#) protocol is transparently queried from an [InnoDB](#) table, without going through the MySQL SQL layer.
- Subsequent requests for the same data is served from the [InnoDB](#) buffer pool. The buffer pool handles the in-memory caching. You can tune performance of data-intensive operations using [InnoDB](#) configuration options.
- Data can be unstructured or structured, depending on the type of application. You can create a new table for data, or use existing tables.
- [InnoDB](#) can handle composing and decomposing multiple column values into a single [memcached](#) item value, reducing the amount of string parsing and concatenation required in your application. For example, you can store the string value `2|4|6|8` in the [memcached](#) cache, and have [InnoDB](#) split the value based on a separator character, then store the result in four numeric columns.

- The transfer between memory and disk is handled automatically, simplifying application logic.
- Data is stored in a MySQL database to protect against crashes, outages, and corruption.
- You can access the underlying [InnoDB](#) table through SQL for reporting, analysis, ad hoc queries, bulk loading, multi-step transactional computations, set operations such as union and intersection, and other operations suited to the expressiveness and flexibility of SQL.
- You can ensure high availability by using the [daemon\\_memcached](#) plugin on a source server in combination with MySQL replication.
- The integration of [memcached](#) with MySQL provides a way to make in-memory data persistent, so you can use it for more significant kinds of data. You can use more [add](#), [incr](#), and similar write operations in your application without concern that data could be lost. You can stop and start the [memcached](#) server without losing updates made to cached data. To guard against unexpected outages, you can take advantage of [InnoDB](#) crash recovery, replication, and backup capabilities.
- The way [InnoDB](#) does fast [primary key](#) lookups is a natural fit for [memcached](#) single-item queries. The direct, low-level database access path used by the [daemon\\_memcached](#) plugin is much more efficient for key-value lookups than equivalent SQL queries.
- The serialization features of [memcached](#), which can turn complex data structures, binary files, or even code blocks into storable strings, offer a simple way to get such objects into a database.
- Because you can access the underlying data through SQL, you can produce reports, search or update across multiple keys, and call functions such as [AVG\(\)](#) and [MAX\(\)](#) on [memcached](#) data. All of these operations are expensive or complicated using [memcached](#) by itself.
- You do not need to manually load data into [memcached](#) at startup. As particular keys are requested by an application, values are retrieved from the database automatically, and cached in memory using the [InnoDB buffer pool](#).
- Because [memcached](#) consumes relatively little CPU, and its memory footprint is easy to control, it can run comfortably alongside a MySQL instance on the same system.
- Because data consistency is enforced by mechanisms used for regular [InnoDB](#) tables, you do not have to worry about stale [memcached](#) data or fallback logic to query the database in the case of a missing key.

## 14.21.2 InnoDB memcached Architecture

The [InnoDB memcached](#) plugin implements [memcached](#) as a MySQL plugin daemon that accesses the [InnoDB](#) storage engine directly, bypassing the MySQL SQL layer.

The following diagram illustrates how an application accesses data through the [daemon\\_memcached](#) plugin, compared with SQL.

Figure 14.4 MySQL Server with Integrated memcached Server

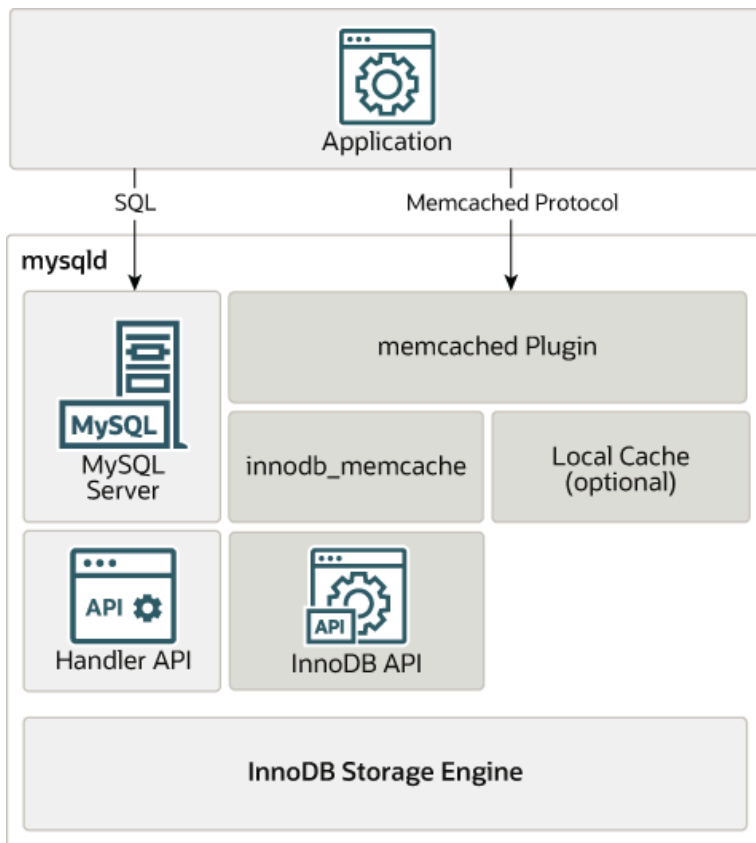

Features of the `daemon_memcached` plugin:

- `memcached` as a daemon plugin of `mysqld`. Both `mysqld` and `memcached` run in the same process space, with very low latency access to data.
- Direct access to `InnoDB` tables, bypassing the SQL parser, the optimizer, and even the Handler API layer.
- Standard `memcached` protocols, including the text-based protocol and the binary protocol. The `daemon_memcached` plugin passes all 55 compatibility tests of the `memcapable` command.
- Multi-column support. You can map multiple columns into the “value” part of the key-value store, with column values delimited by a user-specified separator character.
- By default, the `memcached` protocol is used to read and write data directly to `InnoDB`, letting MySQL manage in-memory caching using the `InnoDB buffer pool`. The default settings represent a combination of high reliability and the fewest surprises for database applications. For example, default settings avoid uncommitted data on the database side, or stale data returned for `memcached get` requests.
- Advanced users can configure the system as a traditional `memcached` server, with all data cached only in the `memcached` engine (memory caching), or use a combination of the “`memcached` engine” (memory caching) and the `InnoDB memcached` engine (`InnoDB` as back-end persistent storage).
- Control over how often data is passed back and forth between `InnoDB` and `memcached` operations through the `innodb_api_bk_commit_interval`, `daemon_memcached_r_batch_size`, and `daemon_memcached_w_batch_size` configuration options. Batch size options default to a value of 1 for maximum reliability.

- The ability to specify `memcached` options through the `daemon_memcached_option` configuration parameter. For example, you can change the port that `memcached` listens on, reduce the maximum number of simultaneous connections, change the maximum memory size for a key-value pair, or enable debugging messages for the error log.
- The `innodb_api_trx_level` configuration option controls the transaction `isolation level` on queries processed by `memcached`. Although `memcached` has no concept of `transactions`, you can use this option to control how soon `memcached` sees changes caused by SQL statements issued on the table used by the `daemon_memcached` plugin. By default, `innodb_api_trx_level` is set to `READ UNCOMMITTED`.
- The `innodb_api_enable_md1` option can be used to lock the table at the MySQL level, so that the mapped table cannot be dropped or altered by `DDL` through the SQL interface. Without the lock, the table can be dropped from the MySQL layer, but kept in `InnoDB` storage until `memcached` or some other user stops using it. “MDL” stands for “metadata locking”.

### 14.21.3 Setting Up the InnoDB memcached Plugin

This section describes how to set up the `daemon_memcached` plugin on a MySQL server. Because the `memcached` daemon is tightly integrated with the MySQL server to avoid network traffic and minimize latency, you perform this process on each MySQL instance that uses this feature.



#### Note

Before setting up the `daemon_memcached` plugin, consult [Section 14.21.4, “Security Considerations for the InnoDB memcached Plugin”](#) to understand the security procedures required to prevent unauthorized access.

#### Prerequisites

- The `daemon_memcached` plugin is only supported on Linux, Solaris, and macOS platforms. Other operating systems are not supported.
- When building MySQL from source, you must build with `-DWITH_INNOODB_MEMCACHED=ON`. This build option generates two shared libraries in the MySQL plugin directory (`plugin_dir`) that are required to run the `daemon_memcached` plugin:
  - `libmemcached.so`: the `memcached` daemon plugin to MySQL.
  - `innodb_engine.so`: an `InnoDB` API plugin to `memcached`.
- `libevent` must be installed.
  - If you did not build MySQL from source, the `libevent` library is not included in your installation. Use the installation method for your operating system to install `libevent` 1.4.12 or later. For example, depending on the operating system, you might use `apt-get`, `yum`, or `port install`. For example, on Ubuntu Linux, use:

```
sudo apt-get install libevent-dev
```

- If you installed MySQL from a source code release, `libevent` 1.4.12 is bundled with the package and is located at the top level of the MySQL source code directory. If you use the bundled version of `libevent`, no action is required. If you want to use a local system version of `libevent`, you must build MySQL with the `-DWITH_LIBEVENT` build option set to `system` or `yes`.

### Installing and Configuring the InnoDB memcached Plugin

1. Configure the `daemon_memcached` plugin so it can interact with InnoDB tables by running the `innodb_memcached_config.sql` configuration script, which is located in `MYSQL_HOME/share`. This script installs the `innodb_memcache` database with three required tables (`cache_policies`, `config_options`, and `containers`). It also installs the `demo_test` sample table in the `test` database.

```
mysql> source MYSQL_HOME/share/innodb_memcached_config.sql
```

Running the `innodb_memcached_config.sql` script is a one-time operation. The tables remain in place if you later uninstall and re-install the `daemon_memcached` plugin.

```
mysql> USE innodb_memcache;
mysql> SHOW TABLES;
+-----+
| Tables_in_innodb_memcache |
+-----+
| cache_policies            |
| config_options            |
| containers                 |
+-----+

mysql> USE test;
mysql> SHOW TABLES;
+-----+
| Tables_in_test            |
+-----+
| demo_test                 |
+-----+
```

Of these tables, the `innodb_memcache.containers` table is the most important. Entries in the `containers` table provide a mapping to InnoDB table columns. Each InnoDB table used with the `daemon_memcached` plugin requires an entry in the `containers` table.

The `innodb_memcached_config.sql` script inserts a single entry in the `containers` table that provides a mapping for the `demo_test` table. It also inserts a single row of data into the `demo_test` table. This data allows you to immediately verify the installation after the setup is completed.

```
mysql> SELECT * FROM innodb_memcache.containers\G
***** 1. row *****
      name: aaa
    db_schema: test
    db_table: demo_test
  key_columns: c1
value_columns: c2
      flags: c3
   cas_column: c4
expire_time_column: c5
unique_idx_name_on_key: PRIMARY

mysql> SELECT * FROM test.demo_test;
+-----+-----+-----+-----+-----+
| c1 | c2          | c3 | c4 | c5 |
+-----+-----+-----+-----+-----+
| AA | HELLO, HELLO | 8 | 0 | 0 |
+-----+-----+-----+-----+-----+
```

For more information about `innodb_memcache` tables and the `demo_test` sample table, see [Section 14.21.7, “InnoDB memcached Plugin Internals”](#).



2. Activate the `daemon_memcached` plugin by running the `INSTALL PLUGIN` statement:

```
mysql> INSTALL PLUGIN daemon_memcached soname "libmemcached.so";
```

Once the plugin is installed, it is automatically activated each time the MySQL server is restarted.

## Verifying the InnoDB and memcached Setup

To verify the `daemon_memcached` plugin setup, use a `telnet` session to issue `memcached` commands. By default, the `memcached` daemon listens on port 11211.

1. Retrieve data from the `test.demo_test` table. The single row of data in the `demo_test` table has a key value of `AA`.

```
telnet localhost 11211
Trying 127.0.0.1...
Connected to localhost.
Escape character is '^]'.
get AA
VALUE AA 8 12
HELLO, HELLO
END
```

2. Insert data using a `set` command.

```
set BB 10 0 16
GOODBYE, GOODBYE
STORED
```

where:

- `set` is the command to store a value
  - `BB` is the key
  - `10` is a flag for the operation; ignored by `memcached` but may be used by the client to indicate any type of information; specify `0` if unused
  - `0` is the expiration time (TTL); specify `0` if unused
  - `16` is the length of the supplied value block in bytes
  - `GOODBYE, GOODBYE` is the value that is stored
3. Verify that the data inserted is stored in MySQL by connecting to the MySQL server and querying the `test.demo_test` table.

```
mysql> SELECT * FROM test.demo_test;
+-----+-----+-----+-----+-----+
| c1 | c2 | c3 | c4 | c5 |
+-----+-----+-----+-----+
| AA | HELLO, HELLO | 8 | 0 | 0 |
| BB | GOODBYE, GOODBYE | 10 | 1 | 0 |
+-----+-----+-----+-----+
```

4. Return to the `telnet` session and retrieve the data that you inserted earlier using key `BB`.

```
get BB
VALUE BB 10 16
GOODBYE, GOODBYE
END
quit
```

If you shut down the MySQL server, which also shuts off the integrated `memcached` server, further attempts to access the `memcached` data fail with a connection error. Normally, the `memcached` data also disappears at this point, and you would require application logic to load the data back into memory when `memcached` is restarted. However, the `InnoDB memcached` plugin automates this process for you.

When you restart MySQL, `get` operations once again return the key-value pairs you stored in the earlier `memcached` session. When a key is requested and the associated value is not already in the memory cache, the value is automatically queried from the MySQL `test.demo_test` table.

## Creating a New Table and Column Mapping

This example shows how to setup your own `InnoDB` table with the `daemon_memcached` plugin.

1. Create an `InnoDB` table. The table must have a key column with a unique index. The key column of the city table is `city_id`, which is defined as the primary key. The table must also include columns for `flags`, `cas`, and `expiry` values. There may be one or more value columns. The `city` table has three value columns (`name`, `state`, `country`).



### Note

There is no special requirement with respect to column names as long as a valid mapping is added to the `innodb_memcache.containers` table.

```
mysql> CREATE TABLE city (
  city_id VARCHAR(32),
  name VARCHAR(1024),
  state VARCHAR(1024),
  country VARCHAR(1024),
  flags INT,
  cas BIGINT UNSIGNED,
  expiry INT,
  primary key(city_id)
) ENGINE=InnoDB;
```

2. Add an entry to the `innodb_memcache.containers` table so that the `daemon_memcached` plugin knows how to access the `InnoDB` table. The entry must satisfy the `innodb_memcache.containers` table definition. For a description of each field, see [Section 14.21.7, “InnoDB memcached Plugin Internals”](#).

```
mysql> DESCRIBE innodb_memcache.containers;
+-----+-----+-----+-----+-----+-----+
| Field          | Type          | Null | Key | Default | Extra |
+-----+-----+-----+-----+-----+-----+
| name           | varchar(50)   | NO   | PRI | NULL    |       |
| db_schema      | varchar(250)  | NO   |     | NULL    |       |
| db_table       | varchar(250)  | NO   |     | NULL    |       |
| key_columns    | varchar(250)  | NO   |     | NULL    |       |
| value_columns  | varchar(250)  | YES  |     | NULL    |       |
| flags          | varchar(250)  | NO   |     | 0       |       |
| cas_column     | varchar(250)  | YES  |     | NULL    |       |
| expire_time_column | varchar(250) | YES  |     | NULL    |       |
| unique_idx_name_on_key | varchar(250) | NO   |     | NULL    |       |
+-----+-----+-----+-----+-----+-----+
```

The `innodb_memcache.containers` table entry for the city table is defined as:

```
mysql> INSERT INTO `innodb_memcache`.`containers` (
  `name`, `db_schema`, `db_table`, `key_columns`, `value_columns`,
  `flags`, `cas_column`, `expire_time_column`, `unique_idx_name_on_key`)
VALUES ('default', 'test', 'city', 'city_id', 'name|state|country',
  'flags','cas','expiry','PRIMARY');
```

- `default` is specified for the `containers.name` column to configure the `city` table as the default InnoDB table to be used with the `daemon_memcached` plugin.
  - Multiple InnoDB table columns (`name`, `state`, `country`) are mapped to `containers.value_columns` using a “|” delimiter.
  - The `flags`, `cas_column`, and `expire_time_column` fields of the `innodb_memcache.containers` table are typically not significant in applications using the `daemon_memcached` plugin. However, a designated InnoDB table column is required for each. When inserting data, specify `0` for these columns if they are unused.
3. After updating the `innodb_memcache.containers` table, restart the `daemon_memcache` plugin to apply the changes.

```
mysql> UNINSTALL PLUGIN daemon_memcached;
mysql> INSTALL PLUGIN daemon_memcached soname "libmemcached.so";
```

4. Using telnet, insert data into the `city` table using a `memcached set` command.

```
telnet localhost 11211
Trying 127.0.0.1...
Connected to localhost.
Escape character is '^]'.
set B 0 0 22
BANGALORE|BANGALORE|IN
STORED
```

5. Using MySQL, query the `test.city` table to verify that the data you inserted was stored.

```
mysql> SELECT * FROM test.city;
+-----+-----+-----+-----+-----+-----+-----+
| city_id | name      | state      | country | flags | cas | expiry |
+-----+-----+-----+-----+-----+-----+-----+
| B       | BANGALORE | BANGALORE | IN      | 0     | 3   | 0       |
+-----+-----+-----+-----+-----+-----+-----+
```

6. Using MySQL, insert additional data into the `test.city` table.

```
mysql> INSERT INTO city VALUES ('C','CHENNAI','TAMIL NADU','IN', 0, 0 ,0);
mysql> INSERT INTO city VALUES ('D','DELHI','DELHI','IN', 0, 0, 0);
mysql> INSERT INTO city VALUES ('H','HYDERABAD','TELANGANA','IN', 0, 0, 0);
mysql> INSERT INTO city VALUES ('M','MUMBAI','MAHARASHTRA','IN', 0, 0, 0);
```



#### Note

It is recommended that you specify a value of `0` for the `flags`, `cas_column`, and `expire_time_column` fields if they are unused.

7. Using telnet, issue a `memcached get` command to retrieve data you inserted using MySQL.

```
get H
VALUE H 0 22
HYDERABAD|TELANGANA|IN
END
```

## Configuring the InnoDB memcached Plugin

Traditional `memcached` configuration options may be specified in a MySQL configuration file or a `mysqld` startup string, encoded in the argument of the `daemon_memcached_option` configuration parameter.

`memcached` configuration options take effect when the plugin is loaded, which occurs each time the MySQL server is started.

For example, to make `memcached` listen on port 11222 instead of the default port 11211, specify `-p11222` as an argument of the `daemon_memcached_option` configuration option:

```
mysqld .... --daemon_memcached_option="-p11222"
```

Other `memcached` options can be encoded in the `daemon_memcached_option` string. For example, you can specify options to reduce the maximum number of simultaneous connections, change the maximum memory size for a key-value pair, or enable debugging messages for the error log, and so on.

There are also configuration options specific to the `daemon_memcached` plugin. These include:

- `daemon_memcached_engine_lib_name`: Specifies the shared library that implements the InnoDB `memcached` plugin. The default setting is `innodb_engine.so`.
- `daemon_memcached_engine_lib_path`: The path of the directory containing the shared library that implements the InnoDB `memcached` plugin. The default is NULL, representing the plugin directory.
- `daemon_memcached_r_batch_size`: Defines the batch commit size for read operations (`get`). It specifies the number of `memcached` read operations after which a `commit` occurs. `daemon_memcached_r_batch_size` is set to 1 by default so that every `get` request accesses the most recently committed data in the InnoDB table, whether the data was updated through `memcached` or by SQL. When the value is greater than 1, the counter for read operations is incremented with each `get` call. A `flush_all` call resets both read and write counters.
- `daemon_memcached_w_batch_size`: Defines the batch commit size for write operations (`set`, `replace`, `append`, `prepend`, `incr`, `decr`, and so on). `daemon_memcached_w_batch_size` is set to 1 by default so that no uncommitted data is lost in case of an outage, and so that SQL queries on the underlying table access the most recent data. When the value is greater than 1, the counter for write operations is incremented for each `add`, `set`, `incr`, `decr`, and `delete` call. A `flush_all` call resets both read and write counters.

By default, you do not need to modify `daemon_memcached_engine_lib_name` or `daemon_memcached_engine_lib_path`. You might configure these options if, for example, you want to use a different storage engine for `memcached` (such as the NDB `memcached` engine).

`daemon_memcached` plugin configuration parameters may be specified in the MySQL configuration file or in a `mysqld` startup string. They take effect when you load the `daemon_memcached` plugin.

When making changes to `daemon_memcached` plugin configuration, reload the plugin to apply the changes. To do so, issue the following statements:

```
mysql> UNINSTALL PLUGIN daemon_memcached;
mysql> INSTALL PLUGIN daemon_memcached soname "libmemcached.so";
```

Configuration settings, required tables, and data are preserved when the plugin is restarted.

For additional information about enabling and disabling plugins, see [Section 5.5.1, “Installing and Uninstalling Plugins”](#).

## 14.21.4 Security Considerations for the InnoDB memcached Plugin



### Caution

Consult this section before deploying the `daemon_memcached` plugin on a production server, or even on a test server if the MySQL instance contains sensitive data.

Because `memcached` does not use an authentication mechanism by default, and the optional SASL authentication is not as strong as traditional DBMS security measures, only keep non-sensitive data in the MySQL instance that uses the `daemon_memcached` plugin, and wall off any servers that use this configuration from potential intruders. Do not allow `memcached` access to these servers from the Internet; only allow access from within a firewalled intranet, ideally from a subnet whose membership you can restrict.

### Password-Protecting memcached Using SASL

SASL support provides the capability to protect your MySQL database from unauthenticated access through `memcached` clients. This section explains how to enable SASL with the `daemon_memcached` plugin. The steps are almost identical to those performed to enable SASL for a traditional `memcached` server.

SASL stands for “Simple Authentication and Security Layer”, a standard for adding authentication support to connection-based protocols. `memcached` added SASL support in version 1.4.3.

SASL authentication is only supported with the binary protocol.

`memcached` clients are only able to access InnoDB tables that are registered in the `innodb_memcache.containers` table. Even though a DBA can place access restrictions on such tables, access through `memcached` applications cannot be controlled. For this reason, SASL support is provided to control access to InnoDB tables associated with the `daemon_memcached` plugin.

The following section shows how to build, enable, and test an SASL-enabled `daemon_memcached` plugin.

### Building and Enabling SASL with the InnoDB memcached Plugin

By default, an SASL-enabled `daemon_memcached` plugin is not included in MySQL release packages, since an SASL-enabled `daemon_memcached` plugin requires building `memcached` with SASL libraries. To enable SASL support, download the MySQL source and rebuild the `daemon_memcached` plugin after downloading the SASL libraries:

1. Install the SASL development and utility libraries. For example, on Ubuntu, use `apt-get` to obtain the libraries:

```
sudo apt-get -f install libsasl2-2 sasldb-bin libsasl2-2 libsasl2-dev libsasl2-modules
```

2. Build the `daemon_memcached` plugin shared libraries with SASL capability by adding `ENABLE_MEMCACHED_SASL=1` to your `cmake` options. `memcached` also provides *simple cleartext password support*, which facilitates testing. To enable simple cleartext password support, specify the `ENABLE_MEMCACHED_SASL_PWDB=1` `cmake` option.

In summary, add following three `cmake` options:

```
cmake ... -DWITH_INNOODB_MEMCACHED=1 -DENABLE_MEMCACHED_SASL=1 -DENABLE_MEMCACHED_SASL_PWDB=1
```

3. Install the `daemon_memcached` plugin, as described in [Section 14.21.3, “Setting Up the InnoDB memcached Plugin”](#).

4. Configure a user name and password file. (This example uses `memcached` simple cleartext password support.)

- a. In a file, create a user named `testname` and define the password as `testpasswd`:

```
echo "testname:testpasswd:::::::::" >/home/jy/memcached-sasl-db
```

- b. Configure the `MEMCACHED_SASL_PWDB` environment variable to inform `memcached` of the user name and password file:

```
export MEMCACHED_SASL_PWDB=/home/jy/memcached-sasl-db
```

- c. Inform `memcached` that a cleartext password is used:

```
echo "mech_list: plain" > /home/jy/work2/msasl/clients/memcached.conf
export SASL_CONF_PATH=/home/jy/work2/msasl/clients
```

5. Enable SASL by restarting the MySQL server with the `memcached -S` option encoded in the `daemon_memcached_option` configuration parameter:

```
mysqld ... --daemon_memcached_option="-S"
```

6. To test the setup, use an SASL-enabled client such as [SASL-enabled libmemcached](#).

```
memcp --servers=localhost:11211 --binary --username=testname
--password=password myfile.txt

memcat --servers=localhost:11211 --binary --username=testname
--password=password myfile.txt
```

If you specify an incorrect user name or password, the operation is rejected with a `memcache error AUTHENTICATION FAILURE` message. In this case, examine the cleartext password set in the `memcached-sasl-db` file to verify that the credentials you supplied are correct.

There are other methods to test SASL authentication with `memcached`, but the method described above is the most straightforward.

## 14.21.5 Writing Applications for the InnoDB memcached Plugin

Typically, writing an application for the `InnoDB memcached` plugin involves some degree of rewriting or adapting existing code that uses MySQL or the `memcached` API.

- With the `daemon_memcached` plugin, instead of many traditional `memcached` servers running on low-powered machines, you have the same number of `memcached` servers as MySQL servers, running on relatively high-powered machines with substantial disk storage and memory. You might reuse some existing code that works with the `memcached` API, but adaptation is likely required due to the different server configuration.
- The data stored through the `daemon_memcached` plugin goes into `VARCHAR`, `TEXT`, or `BLOB` columns, and must be converted to do numeric operations. You can perform the conversion on the application side, or by using the `CAST()` function in queries.
- Coming from a database background, you might be used to general-purpose SQL tables with many columns. The tables accessed by `memcached` code likely have only a few or even a single column holding data values.

- You might adapt parts of your application that perform single-row queries, inserts, updates, or deletes, to improve performance in critical sections of code. Both [queries](#) (read) and [DML](#) (write) operations can be substantially faster when performed through the [InnoDB memcached](#) interface. The performance improvement for writes is typically greater than the performance improvement for reads, so you might focus on adapting code that performs logging or records interactive choices on a website.

The following sections explore these points in more detail.

### 14.21.5.1 Adapting an Existing MySQL Schema for the InnoDB memcached Plugin

Consider these aspects of [memcached](#) applications when adapting an existing MySQL schema or application to use the [daemon\\_memcached](#) plugin:

- [memcached](#) keys cannot contain spaces or newlines, because these characters are used as separators in the ASCII protocol. If you are using lookup values that contain spaces, transform or hash them into values without spaces before using them as keys in calls to [add\(\)](#), [set\(\)](#), [get\(\)](#), and so on. Although theoretically these characters are allowed in keys in programs that use the binary protocol, you should restrict the characters used in keys to ensure compatibility with a broad range of clients.
- If there is a short numeric [primary key](#) column in an [InnoDB](#) table, use it as the unique lookup key for [memcached](#) by converting the integer to a string value. If the [memcached](#) server is used for multiple applications, or with more than one [InnoDB](#) table, consider modifying the name to ensure that it is unique. For example, prepend the table name, or the database name and the table name, before the numeric value.



#### Note

The [daemon\\_memcached](#) plugin supports inserts and reads on mapped [InnoDB](#) tables that have an [INTEGER](#) defined as the primary key.

- You cannot use a partitioned table for data queried or stored using [memcached](#).
- The [memcached](#) protocol passes numeric values around as strings. To store numeric values in the underlying [InnoDB](#) table, to implement counters that can be used in SQL functions such as [SUM\(\)](#) or [AVG\(\)](#), for example:
  - Use [VARCHAR](#) columns with enough characters to hold all the digits of the largest expected number (and additional characters if appropriate for the negative sign, decimal point, or both).
  - In any query that performs arithmetic using column values, use the [CAST\(\)](#) function to convert the values from string to integer, or to some other numeric type. For example:

```
# Alphabetic entries are returned as zero.

SELECT CAST(c2 as unsigned integer) FROM demo_test;

# Since there could be numeric values of 0, can't disqualify them.
# Test the string values to find the ones that are integers, and average only those.

SELECT AVG(cast(c2 as unsigned integer)) FROM demo_test
WHERE c2 BETWEEN '0' and '9999999999';

# Views let you hide the complexity of queries. The results are already converted;
# no need to repeat conversion functions and WHERE clauses each time.

CREATE VIEW numbers AS SELECT c1 KEY, CAST(c2 AS UNSIGNED INTEGER) val
FROM demo_test WHERE c2 BETWEEN '0' and '9999999999';
SELECT SUM(val) FROM numbers;
```

**Note**

Any alphabetic values in the result set are converted into 0 by the call to `CAST()`. When using functions such as `AVG()`, which depend on the number of rows in the result set, include `WHERE` clauses to filter out non-numeric values.

- If the `InnoDB` column used as a key could have values longer than 250 bytes, hash the value to less than 250 bytes.
- To use an existing table with the `daemon_memcached` plugin, define an entry for it in the `innodb_memcache.containers` table. To make that table the default for all `memcached` requests, specify a value of `default` in the `name` column, then restart the MySQL server to make the change take effect. If you use multiple tables for different classes of `memcached` data, set up multiple entries in the `innodb_memcache.containers` table with `name` values of your choice, then issue a `memcached` request in the form of `get @@name` or `set @@name` within the application to specify the table to be used for subsequent `memcached` requests.

For an example of using a table other than the predefined `test.demo_test` table, see [Example 14.13, “Using Your Own Table with an InnoDB memcached Application”](#). For the required table layout, see [Section 14.21.7, “InnoDB memcached Plugin Internals”](#).

- To use multiple `InnoDB` table column values with `memcached` key-value pairs, specify column names separated by comma, semicolon, space, or pipe characters in the `value_columns` field of the `innodb_memcache.containers` entry for the `InnoDB` table. For example, specify `col1,col2,col3` or `col1|col2|col3` in the `value_columns` field.

Concatenate the column values into a single string using the pipe character as a separator before passing the string to `memcached add` or `set` calls. The string is unpacked automatically into the correct column. Each `get` call returns a single string containing the column values that is also delimited by the pipe character. You can unpack the values using the appropriate application language syntax.

**Example 14.13 Using Your Own Table with an InnoDB memcached Application**

This example shows how to use your own table with a sample Python application that uses `memcached` for data manipulation.

The example assumes that the `daemon_memcached` plugin is installed as described in [Section 14.21.3, “Setting Up the InnoDB memcached Plugin”](#). It also assumes that your system is configured to run a Python script that uses the `python-memcache` module.

1. Create the `multicol` table which stores country information including population, area, and driver side data ('R' for right and 'L' for left).

```
mysql> USE test;

mysql> CREATE TABLE `multicol` (
  `country` varchar(128) NOT NULL DEFAULT '',
  `population` varchar(10) DEFAULT NULL,
  `area_sq_km` varchar(9) DEFAULT NULL,
  `drive_side` varchar(1) DEFAULT NULL,
  `c3` int(11) DEFAULT NULL,
  `c4` bigint(20) unsigned DEFAULT NULL,
  `c5` int(11) DEFAULT NULL,
  PRIMARY KEY (`country`)
) ENGINE=InnoDB DEFAULT CHARSET=latin1;
```

2. Insert a record into the `innodb_memcache.containers` table so that the `daemon_memcached` plugin can access the `multicol` table.



```
mysql> INSERT INTO innodb_memcache.containers
(name,db_schema,db_table,key_columns,value_columns,flags,cas_column,
expire_time_column,unique_idx_name_on_key)
VALUES
('bbb','test','multicol','country','population,area_sq_km,drive_side',
'c3','c4','c5','PRIMARY');

mysql> COMMIT;
```

- The `innodb_memcache.containers` record for the `multicol` table specifies a `name` value of `'bbb'`, which is the table identifier.



#### Note

If a single InnoDB table is used for all memcached applications, the `name` value can be set to `default` to avoid using `@@` notation to switch tables.

- The `db_schema` column is set to `test`, which is the name of the database where the `multicol` table resides.
  - The `db_table` column is set to `multicol`, which is the name of the InnoDB table.
  - `key_columns` is set to the unique `country` column. The `country` column is defined as the primary key in the `multicol` table definition.
  - Rather than a single InnoDB table column to hold a composite data value, data is divided among three table columns (`population`, `area_sq_km`, and `drive_side`). To accommodate multiple value columns, a comma-separated list of columns is specified in the `value_columns` field. The columns defined in the `value_columns` field are the columns used when storing or retrieving values.
  - Values for the `flags`, `expire_time`, and `cas_column` fields are based on values used in the `demo.test` sample table. These fields are typically not significant in applications that use the `daemon_memcached` plugin because MySQL keeps data synchronized, and there is no need to worry about data expiring or becoming stale.
  - The `unique_idx_name_on_key` field is set to `PRIMARY`, which refers to the primary index defined on the unique `country` column in the `multicol` table.
3. Copy the sample Python application into a file. In this example, the sample script is copied to a file named `multicol.py`.

The sample Python application inserts data into the `multicol` table and retrieves data for all keys, demonstrating how to access an InnoDB table through the `daemon_memcached` plugin.

```
import sys, os
import memcache

def connect_to_memcached():
    memc = memcache.Client(['127.0.0.1:11211'], debug=0);
    print "Connected to memcached."
    return memc

def banner(message):
    print
    print "=" * len(message)
    print message
    print "=" * len(message)

country_data = [
```

```

("Canada", "34820000", "9984670", "R"),
("USA", "314242000", "9826675", "R"),
("Ireland", "6399152", "84421", "L"),
("UK", "62262000", "243610", "L"),
("Mexico", "113910608", "1972550", "R"),
("Denmark", "5543453", "43094", "R"),
("Norway", "5002942", "385252", "R"),
("UAE", "8264070", "83600", "R"),
("India", "1210193422", "3287263", "L"),
("China", "1347350000", "9640821", "R"),
]

def switch_table(memc, table):
    key = "@@" + table
    print "Switching default table to '" + table + "' by issuing GET for '" + key + "'."
    result = memc.get(key)

def insert_country_data(memc):
    banner("Inserting initial data via memcached interface")
    for item in country_data:
        country = item[0]
        population = item[1]
        area = item[2]
        drive_side = item[3]

        key = country
        value = "|".join([population, area, drive_side])
        print "Key = " + key
        print "Value = " + value

        if memc.add(key, value):
            print "Added new key, value pair."
        else:
            print "Updating value for existing key."
            memc.set(key, value)

def query_country_data(memc):
    banner("Retrieving data for all keys (country names)")
    for item in country_data:
        key = item[0]
        result = memc.get(key)
        print "Here is the result retrieved from the database for key " + key + ":"
        print result
        (m_population, m_area, m_drive_side) = result.split("|")
        print "Unpacked population value: " + m_population
        print "Unpacked area value      : " + m_area
        print "Unpacked drive side value: " + m_drive_side

if __name__ == '__main__':
    memc = connect_to_memcached()
    switch_table(memc, "bbb")
    insert_country_data(memc)
    query_country_data(memc)

    sys.exit(0)

```

#### Sample Python application notes:

- No database authorization is required to run the application, since data manipulation is performed through the `memcached` interface. The only required information is the port number on the local system where the `memcached` daemon listens.
- To make sure the application uses the `multicol` table, the `switch_table()` function is called, which performs a dummy `get` or `set` request using `@@` notation. The `name` value in the request is

`bbb`, which is the `multicol` table identifier defined in the `innodb_memcache.containers.name` field.

A more descriptive `name` value might be used in a real-world application. This example simply illustrates that a table identifier is specified rather than the table name in `get @@...` requests.

- The utility functions used to insert and query data demonstrate how to turn a Python data structure into pipe-separated values for sending data to MySQL with `add` or `set` requests, and how to unpack the pipe-separated values returned by `get` requests. This extra processing is only required when mapping a single `memcached` value to multiple MySQL table columns.

#### 4. Run the sample Python application.

```
$> python multicol.py
```

If successful, the sample application returns this output:

```
Connected to memcached.
Switching default table to 'bbb' by issuing GET for '@@bbb'.

=====
Inserting initial data via memcached interface
=====
Key = Canada
Value = 34820000|9984670|R
Added new key, value pair.
Key = USA
Value = 314242000|9826675|R
Added new key, value pair.
Key = Ireland
Value = 6399152|84421|L
Added new key, value pair.
Key = UK
Value = 62262000|243610|L
Added new key, value pair.
Key = Mexico
Value = 113910608|1972550|R
Added new key, value pair.
Key = Denmark
Value = 5543453|43094|R
Added new key, value pair.
Key = Norway
Value = 5002942|385252|R
Added new key, value pair.
Key = UAE
Value = 8264070|83600|R
Added new key, value pair.
Key = India
Value = 1210193422|3287263|L
Added new key, value pair.
Key = China
Value = 1347350000|9640821|R
Added new key, value pair.

=====
Retrieving data for all keys (country names)
=====
Here is the result retrieved from the database for key Canada:
34820000|9984670|R
Unpacked population value: 34820000
Unpacked area value      : 9984670
Unpacked drive side value: R
Here is the result retrieved from the database for key USA:
314242000|9826675|R
Unpacked population value: 314242000
```

```

Unpacked area value      : 9826675
Unpacked drive side value: R
Here is the result retrieved from the database for key Ireland:
6399152|84421|L
Unpacked population value: 6399152
Unpacked area value      : 84421
Unpacked drive side value: L
Here is the result retrieved from the database for key UK:
62262000|243610|L
Unpacked population value: 62262000
Unpacked area value      : 243610
Unpacked drive side value: L
Here is the result retrieved from the database for key Mexico:
113910608|1972550|R
Unpacked population value: 113910608
Unpacked area value      : 1972550
Unpacked drive side value: R
Here is the result retrieved from the database for key Denmark:
5543453|43094|R
Unpacked population value: 5543453
Unpacked area value      : 43094
Unpacked drive side value: R
Here is the result retrieved from the database for key Norway:
5002942|385252|R
Unpacked population value: 5002942
Unpacked area value      : 385252
Unpacked drive side value: R
Here is the result retrieved from the database for key UAE:
8264070|83600|R
Unpacked population value: 8264070
Unpacked area value      : 83600
Unpacked drive side value: R
Here is the result retrieved from the database for key India:
1210193422|3287263|L
Unpacked population value: 1210193422
Unpacked area value      : 3287263
Unpacked drive side value: L
Here is the result retrieved from the database for key China:
1347350000|9640821|R
Unpacked population value: 1347350000
Unpacked area value      : 9640821
Unpacked drive side value: R

```

5. Query the `innodb_memcache.containers` table to view the record you inserted earlier for the `multicol` table. The first record is the sample entry for the `demo_test` table that is created during the initial `daemon_memcached` plugin setup. The second record is the entry you inserted for the `multicol` table.

```

mysql> SELECT * FROM innodb_memcache.containers\G
***** 1. row *****
      name: aaa
      db_schema: test
      db_table: demo_test
      key_columns: c1
      value_columns: c2
      flags: c3
      cas_column: c4
      expire_time_column: c5
      unique_idx_name_on_key: PRIMARY
***** 2. row *****
      name: bbb
      db_schema: test
      db_table: multicol
      key_columns: country
      value_columns: population,area_sq_km,drive_side
      flags: c3

```

```
cas_column: c4
expire_time_column: c5
unique_idx_name_on_key: PRIMARY
```

- Query the `multicol` table to view data inserted by the sample Python application. The data is available for MySQL [queries](#), which demonstrates how the same data can be accessed using SQL or through applications (using the appropriate [MySQL Connector or API](#)).

```
mysql> SELECT * FROM test.multicol;
+-----+-----+-----+-----+-----+-----+-----+
| country | population | area_sq_km | drive_side | c3 | c4 | c5 |
+-----+-----+-----+-----+-----+-----+-----+
| Canada | 34820000 | 9984670 | R | 0 | 11 | 0 |
| China | 1347350000 | 9640821 | R | 0 | 20 | 0 |
| Denmark | 5543453 | 43094 | R | 0 | 16 | 0 |
| India | 1210193422 | 3287263 | L | 0 | 19 | 0 |
| Ireland | 6399152 | 84421 | L | 0 | 13 | 0 |
| Mexico | 113910608 | 1972550 | R | 0 | 15 | 0 |
| Norway | 5002942 | 385252 | R | 0 | 17 | 0 |
| UAE | 8264070 | 83600 | R | 0 | 18 | 0 |
| UK | 62262000 | 243610 | L | 0 | 14 | 0 |
| USA | 314242000 | 9826675 | R | 0 | 12 | 0 |
+-----+-----+-----+-----+-----+-----+-----+
```



### Note

Always allow sufficient size to hold necessary digits, decimal points, sign characters, leading zeros, and so on when defining the length for columns that are treated as numbers. Too-long values in a string column such as a `VARCHAR` are truncated by removing some characters, which could produce nonsensical numeric values.

- Optionally, run report-type queries on the `InnoDB` table that stores the `memcached` data.

You can produce reports through SQL queries, performing calculations and tests across any columns, not just the `country` key column. (Because the following examples use data from only a few countries, the numbers are for illustration purposes only.) The following queries return the average population of countries where people drive on the right, and the average size of countries whose names start with “U”:

```
mysql> SELECT AVG(population) FROM multicol WHERE drive_side = 'R';
+-----+
| avg(population) |
+-----+
| 261304724.7142857 |
+-----+

mysql> SELECT SUM(area_sq_km) FROM multicol WHERE country LIKE 'U%';
+-----+
| sum(area_sq_km) |
+-----+
| 10153885 |
+-----+
```

Because the `population` and `area_sq_km` columns store character data rather than strongly typed numeric data, functions such as `AVG()` and `SUM()` work by converting each value to a number first. This approach *does not work* for operators such as `<` or `>`, for example, when comparing character-based values, `9 > 1000`, which is not expected from a clause such as `ORDER BY population DESC`. For the most accurate type treatment, perform queries against views that cast numeric columns to the appropriate types. This technique lets you issue simple `SELECT *` queries from database applications, while ensuring that casting, filtering, and ordering is correct. The following example shows

a view that can be queried to find the top three countries in descending order of population, with the results reflecting the latest data in the `multicol` table, and with population and area figures treated as numbers:

```
mysql> CREATE VIEW populous_countries AS
SELECT
  country,
  cast(population as unsigned integer) population,
  cast(area_sq_km as unsigned integer) area_sq_km,
  drive_side FROM multicol
ORDER BY CAST(population as unsigned integer) DESC
LIMIT 3;
```

```
mysql> SELECT * FROM populous_countries;
```

country	population	area_sq_km	drive_side
China	1347350000	9640821	R
India	1210193422	3287263	L
USA	314242000	9826675	R

```
mysql> DESC populous_countries;
```

Field	Type	Null	Key	Default	Extra
country	varchar(128)	NO			
population	bigint(10) unsigned	YES		NULL	
area_sq_km	int(9) unsigned	YES		NULL	
drive_side	varchar(1)	YES		NULL	

### 14.21.5.2 Adapting a memcached Application for the InnoDB memcached Plugin

Consider these aspects of MySQL and InnoDB tables when adapting existing `memcached` applications to use the `daemon_memcached` plugin:

- If there are key values longer than a few bytes, it may be more efficient to use a numeric auto-increment column as the **primary key** of the InnoDB table, and to create a unique **secondary index** on the column that contains the `memcached` key values. This is because InnoDB performs best for large-scale insertions if primary key values are added in sorted order (as they are with auto-increment values). Primary key values are included in secondary indexes, which takes up unnecessary space if the primary key is a long string value.
- If you store several different classes of information using `memcached`, consider setting up a separate InnoDB table for each type of data. Define additional table identifiers in the `innodb_memcache.containers` table, and use the `@@table_id.key` notation to store and retrieve items from different tables. Physically dividing different types of information allows you tune the characteristics of each table for optimum space utilization, performance, and reliability. For example, you might enable **compression** for a table that holds blog posts, but not for a table that holds thumbnail images. You might back up one table more frequently than another because it holds critical data. You might create additional **secondary indexes** on tables that are frequently used to generate reports using SQL.
- Preferably, configure a stable set of table definitions for use with the `daemon_memcached` plugin, and leave the tables in place permanently. Changes to the `innodb_memcache.containers` table take effect the next time the `innodb_memcache.containers` table is queried. Entries in the containers table are processed at startup, and are consulted whenever an unrecognized table identifier (as defined by `containers.name`) is requested using `@@` notation. Thus, new entries are visible as soon as you use the associated table identifier, but changes to existing entries require a server restart before they take effect.

- When you use the default `innodb_only` caching policy, calls to `add()`, `set()`, `incr()`, and so on can succeed but still trigger debugging messages such as `while expecting 'STORED', got unexpected response 'NOT_STORED'`. Debug messages occur because new and updated values are sent directly to the InnoDB table without being saved in the memory cache, due to the `innodb_only` caching policy.

### 14.21.5.3 Tuning InnoDB memcached Plugin Performance

Because using InnoDB in combination with memcached involves writing all data to disk, whether immediately or sometime later, raw performance is expected to be somewhat slower than using memcached by itself. When using the InnoDB memcached plugin, focus tuning goals for memcached operations on achieving better performance than equivalent SQL operations.

Benchmarks suggest that queries and DML operations (inserts, updates, and deletes) that use the memcached interface are faster than traditional SQL. DML operations typically see a larger improvements. Therefore, consider adapting write-intensive applications to use the memcached interface first. Also consider prioritizing adaptation of write-intensive applications that use fast, lightweight mechanisms that lack reliability.

### Adapting SQL Queries

The types of queries that are most suited to simple GET requests are those with a single clause or a set of AND conditions in the WHERE clause:

```
SQL:
SELECT col FROM tbl WHERE key = 'key_value';

memcached:
get key_value

SQL:
SELECT col FROM tbl WHERE col1 = val1 and col2 = val2 and col3 = val3;

memcached:
# Since you must always know these 3 values to look up the key,
# combine them into a unique string and use that as the key
# for all ADD, SET, and GET operations.
key_value = val1 + ":" + val2 + ":" + val3
get key_value

SQL:
SELECT 'key exists!' FROM tbl
  WHERE EXISTS (SELECT col1 FROM tbl WHERE KEY = 'key_value') LIMIT 1;

memcached:
# Test for existence of key by asking for its value and checking if the call succeeds,
# ignoring the value itself. For existence checking, you typically only store a very
# short value such as "1".
get key_value
```

### Using System Memory

For best performance, deploy the `daemon_memcached` plugin on machines that are configured as typical database servers, where the majority of system RAM is devoted to the InnoDB buffer pool, through the `innodb_buffer_pool_size` configuration option. For systems with multi-gigabyte buffer pools, consider raising the value of `innodb_buffer_pool_instances` for maximum throughput when most operations involve data that is already cached in memory.

## Reducing Redundant I/O

InnoDB has a number of settings that let you choose the balance between high reliability, in case of a crash, and the amount of I/O overhead during high write workloads. For example, consider setting the `innodb_doublewrite` to 0 and `innodb_flush_log_at_trx_commit` to 2. Measure performance with different `innodb_flush_method` settings.



### Note

`innodb_support_xa` is deprecated; expect it to be removed in a future release. As of MySQL 5.7.10, InnoDB support for two-phase commit in XA transactions is always enabled and disabling `innodb_support_xa` is no longer permitted.

For other ways to reduce or tune I/O for table operations, see [Section 8.5.8, “Optimizing InnoDB Disk I/O”](#).

## Reducing Transactional Overhead

A default value of 1 for `daemon_memcached_r_batch_size` and `daemon_memcached_w_batch_size` is intended for maximum reliability of results and safety of stored or updated data.

Depending on the type of application, you might increase one or both of these settings to reduce the overhead of frequent `commit` operations. On a busy system, you might increase `daemon_memcached_r_batch_size`, knowing that changes to data made through SQL may not become visible to `memcached` immediately (that is, until  $N$  more `get` operations are processed). When processing data where every write operation must be reliably stored, leave `daemon_memcached_w_batch_size` set to 1. Increase the setting when processing large numbers of updates intended only for statistical analysis, where losing the last  $N$  updates in an unexpected exit is an acceptable risk.

For example, imagine a system that monitors traffic crossing a busy bridge, recording data for approximately 100,000 vehicles each day. If the application counts different types of vehicles to analyze traffic patterns, changing `daemon_memcached_w_batch_size` from 1 to 100 reduces I/O overhead for commit operations by 99%. In case of an outage, a maximum of 100 records are lost, which may be an acceptable margin of error. If instead the application performed automated toll collection for each car, you would set `daemon_memcached_w_batch_size` to 1 to ensure that each toll record is immediately saved to disk.

Because of the way InnoDB organizes `memcached` key values on disk, if you have a large number of keys to create, it may be faster to sort the data items by key value in the application and `add` them in sorted order, rather than create keys in arbitrary order.

The `memslap` command, which is part of the regular `memcached` distribution but not included with the `daemon_memcached` plugin, can be useful for benchmarking different configurations. It can also be used to generate sample key-value pairs to use in your own benchmarks.

### 14.21.5.4 Controlling Transactional Behavior of the InnoDB memcached Plugin

Unlike traditional `memcached`, the `daemon_memcached` plugin allows you to control durability of data values produced through calls to `add`, `set`, `incr`, and so on. By default, data written through the `memcached` interface is stored to disk, and calls to `get` return the most recent value from disk. Although the default behavior does not offer the best possible raw performance, it is still fast compared to the SQL interface for InnoDB tables.

As you gain experience using the `daemon_memcached` plugin, you can consider relaxing durability settings for non-critical classes of data, at the risk of losing some updated values in the event of an outage, or returning data that is slightly out-of-date.



## Frequency of Commits

One tradeoff between durability and raw performance is how frequently new and changed data is [committed](#). If data is critical, it should be committed immediately so that it is safe in case of an unexpected exit or outage. If data is less critical, such as counters that are reset after an unexpected exit or logging data that you can afford to lose, you might prefer higher raw throughput that is available with less frequent commits.

When a [memcached](#) operation inserts, updates, or deletes data in the underlying [InnoDB](#) table, the change might be committed to the [InnoDB](#) table instantly (if `daemon_memcached_w_batch_size=1`) or some time later (if the `daemon_memcached_w_batch_size` value is greater than 1). In either case, the change cannot be rolled back. If you increase the value of `daemon_memcached_w_batch_size` to avoid high I/O overhead during busy times, commits could become infrequent when the workload decreases. As a safety measure, a background thread automatically commits changes made through the [memcached](#) API at regular intervals. The interval is controlled by the `innodb_api_bk_commit_interval` configuration option, which has a default setting of 5 seconds.

When a [memcached](#) operation inserts or updates data in the underlying [InnoDB](#) table, the changed data is immediately visible to other [memcached](#) requests because the new value remains in the memory cache, even if it is not yet committed on the MySQL side.

## Transaction Isolation

When a [memcached](#) operation such as `get` or `incr` causes a query or DML operation on the underlying [InnoDB](#) table, you can control whether the operation sees the very latest data written to the table, only data that has been committed, or other variations of transaction [isolation level](#). Use the `innodb_api_trx_level` configuration option to control this feature. The numeric values specified for this option correspond to isolation levels such as `REPEATABLE READ`. See the description of the `innodb_api_trx_level` option for information about other settings.

A strict isolation level ensures that data you retrieve is not rolled back or changed suddenly causing subsequent queries to return different values. However, strict isolation levels require greater [locking](#) overhead, which can cause waits. For a NoSQL-style application that does not use long-running transactions, you can typically use the default isolation level or switch to a less strict isolation level.

## Disabling Row Locks for memcached DML Operations

The `innodb_api_disable_rowlock` option can be used to disable row locks when [memcached](#) requests through the [daemon\\_memcached](#) plugin cause DML operations. By default, `innodb_api_disable_rowlock` is set to `OFF` which means that [memcached](#) requests row locks for `get` and `set` operations. When `innodb_api_disable_rowlock` is set to `ON`, [memcached](#) requests a table lock instead of row locks.

The `innodb_api_disable_rowlock` option is not dynamic. It must be specified at startup on the `mysqld` command line or entered in a MySQL configuration file.

## Allowing or Disallowing DDL

By default, you can perform [DDL](#) operations such as `ALTER TABLE` on tables used by the [daemon\\_memcached](#) plugin. To avoid potential slowdowns when these tables are used for high-throughput applications, disable DDL operations on these tables by enabling `innodb_api_enable_md1` at startup. This option is less appropriate when accessing the same tables through both [memcached](#) and SQL, because it blocks `CREATE INDEX` statements on the tables, which could be important for running reporting queries.

## Storing Data on Disk, in Memory, or Both

The `innodb_memcache.cache_policies` table specifies whether to store data written through the `memcached` interface to disk (`innodb_only`, the default); in memory only, as with traditional `memcached` (`cache_only`); or both (`caching`).

With the `caching` setting, if `memcached` cannot find a key in memory, it searches for the value in an InnoDB table. Values returned from `get` calls under the `caching` setting could be out-of-date if the values were updated on disk in the InnoDB table but are not yet expired from the memory cache.

The `caching` policy can be set independently for `get`, `set` (including `incr` and `decr`), `delete`, and `flush` operations.

For example, you might allow `get` and `set` operations to query or update a table and the `memcached` memory cache at the same time (using the `caching` setting), while making `delete`, `flush`, or both operate only on the in-memory copy (using the `cache_only` setting). That way, deleting or flushing an item only expires the item from the cache, and the latest value is returned from the InnoDB table the next time the item is requested.

```
mysql> SELECT * FROM innodb_memcache.cache_policies;
+-----+-----+-----+-----+-----+
| policy_name | get_policy | set_policy | delete_policy | flush_policy |
+-----+-----+-----+-----+-----+
| cache_policy | innodb_only | innodb_only | innodb_only | innodb_only |
+-----+-----+-----+-----+-----+

mysql> UPDATE innodb_memcache.cache_policies SET set_policy = 'caching'
        WHERE policy_name = 'cache_policy';
```

`innodb_memcache.cache_policies` values are only read at startup. After changing values in this table, uninstall and reinstall the `daemon_memcached` plugin to ensure that changes take effect.

```
mysql> UNINSTALL PLUGIN daemon_memcached;

mysql> INSTALL PLUGIN daemon_memcached soname "libmemcached.so";
```

### 14.21.5.5 Adapting DML Statements to memcached Operations

Benchmarks suggest that the `daemon_memcached` plugin speeds up **DML** operations (inserts, updates, and deletes) more than it speeds up queries. Therefore, consider focussing initial development efforts on write-intensive applications that are I/O-bound, and look for opportunities to use MySQL with the `daemon_memcached` plugin for new write-intensive applications.

Single-row DML statements are the easiest types of statements to turn into `memcached` operations. `INSERT` becomes `add`, `UPDATE` becomes `set`, `incr` or `decr`, and `DELETE` becomes `delete`. These operations are guaranteed to only affect one row when issued through the `memcached` interface, because the `key` is unique within the table.

In the following SQL examples, `t1` refers to the table used for `memcached` operations, based on the configuration in the `innodb_memcache.containers` table. `key` refers to the column listed under `key_columns`, and `val` refers to the column listed under `value_columns`.

```
INSERT INTO t1 (key,val) VALUES (some_key,some_value);
SELECT val FROM t1 WHERE key = some_key;
UPDATE t1 SET val = new_value WHERE key = some_key;
UPDATE t1 SET val = val + x WHERE key = some_key;
DELETE FROM t1 WHERE key = some_key;
```

The following `TRUNCATE TABLE` and `DELETE` statements, which remove all rows from the table, correspond to the `flush_all` operation, where `t1` is configured as the table for `memcached` operations, as in the previous example.

```
TRUNCATE TABLE t1;
DELETE FROM t1;
```

### 14.21.5.6 Performing DML and DDL Statements on the Underlying InnoDB Table

You can access the underlying `InnoDB` table (which is `test.demo_test` by default) through standard SQL interfaces. However, there are some restrictions:

- When querying a table that is also accessed through the `memcached` interface, remember that `memcached` operations can be configured to be committed periodically rather than after every write operation. This behavior is controlled by the `daemon_memcached_w_batch_size` option. If this option is set to a value greater than `1`, use `READ UNCOMMITTED` queries to find rows that were just inserted.

```
mysql> SET SESSION TRANSACTION ISOLATION LEVEL READ UNCOMMITTED;

mysql> SELECT * FROM demo_test;
+-----+-----+-----+-----+-----+-----+-----+-----+-----+-----+-----+
| cx   | cy   | c1   | cz   | c2   | ca   | CB   | c3   | cu   | c4   | C5   |
+-----+-----+-----+-----+-----+-----+-----+-----+-----+-----+-----+
| NULL | NULL | a11  | NULL | 123456789 | NULL | NULL | 10  | NULL | 3   | NULL |
+-----+-----+-----+-----+-----+-----+-----+-----+-----+-----+-----+-----+
```

- When modifying a table using SQL that is also accessed through the `memcached` interface, you can configure `memcached` operations to start a new transaction periodically rather than for every read operation. This behavior is controlled by the `daemon_memcached_r_batch_size` option. If this option is set to a value greater than `1`, changes made to the table using SQL are not immediately visible to `memcached` operations.
- The `InnoDB` table is either IS (intention shared) or IX (intention exclusive) locked for all operations in a transaction. If you increase `daemon_memcached_r_batch_size` and `daemon_memcached_w_batch_size` substantially from their default value of `1`, the table is most likely locked between each operation, preventing `DDL` statements on the table.

## 14.21.6 The InnoDB memcached Plugin and Replication

Because the `daemon_memcached` plugin supports the MySQL `binary log`, updates made on a source server through the `memcached` interface can be replicated for backup, balancing intensive read workloads, and high availability. All `memcached` commands are supported with binary logging.

You do not need to set up the `daemon_memcached` plugin on replica servers. The primary advantage of this configuration is increased write throughput on the source. The speed of the replication mechanism is not affected.

The following sections show how to use the binary log capability when using the `daemon_memcached` plugin with MySQL replication. It is assumed that you have completed the setup described in [Section 14.21.3, “Setting Up the InnoDB memcached Plugin”](#).

### Enabling the InnoDB memcached Binary Log

- To use the `daemon_memcached` plugin with the MySQL `binary log`, enable the `innodb_api_enable_binlog` configuration option on the source server. This option can only be set at server startup. You must also enable the MySQL binary log on the source server using the `--log-bin` option. You can add these options to the MySQL configuration file, or on the `mysqld` command line.

```
mysqld ... --log-bin --innodb_api_enable_binlog=1
```

- Configure the source and replica server, as described in [Section 16.1.2, “Setting Up Binary Log File Position Based Replication”](#).

- Use `mysqldump` to create a source data snapshot, and sync the snapshot to the replica server.

```
source $> mysqldump --all-databases --lock-all-tables > dbdump.db
replica $> mysql < dbdump.db
```

- On the source server, issue `SHOW MASTER STATUS` to obtain the source binary log coordinates.

```
mysql> SHOW MASTER STATUS;
```

- On the replica server, use a `CHANGE MASTER TO` statement to set up a replica server using the source binary log coordinates.

```
mysql> CHANGE MASTER TO
  MASTER_HOST='localhost',
  MASTER_USER='root',
  MASTER_PASSWORD='',
  MASTER_PORT = 13000,
  MASTER_LOG_FILE='0.000001',
  MASTER_LOG_POS=114;
```

- Start the replica.

```
mysql> START SLAVE;
```

If the error log prints output similar to the following, the replica is ready for replication.

```
2013-09-24T13:04:38.639684Z 49 [Note] Slave I/O thread: connected to
master 'root@localhost:13000', replication started in log '0.000001'
at position 114
```

## Testing the InnoDB memcached Replication Configuration

This example demonstrates how to test the `InnoDB memcached` replication configuration using the `memcached` and `telnet` to insert, update, and delete data. A MySQL client is used to verify results on the source and replica servers.

The example uses the `demo_test` table, which was created by the `innodb_memcached_config.sql` configuration script during the initial setup of the `daemon_memcached` plugin. The `demo_test` table contains a single example record.

- Use the `set` command to insert a record with a key of `test1`, a flag value of `10`, an expiration value of `0`, a cas value of `1`, and a value of `t1`.

```
telnet 127.0.0.1 11211
Trying 127.0.0.1...
Connected to 127.0.0.1.
Escape character is '^]'.
set test1 10 0 1
t1
STORED
```

- On the source server, check that the record was inserted into the `demo_test` table. Assuming the `demo_test` table was not previously modified, there should be two records. The example record with a key of `AA`, and the record you just inserted, with a key of `test1`. The `c1` column maps to the key, the `c2` column to the value, the `c3` column to the flag value, the `c4` column to the cas value, and the `c5` column to the expiration time. The expiration time was set to `0`, since it is unused.

```
mysql> SELECT * FROM test.demo_test;
+-----+-----+-----+-----+-----+
| c1   | c2           | c3   | c4   | c5   |
+-----+-----+-----+-----+-----+
| AA   | HELLO, HELLO | 8    | 0    | 0    |
```

```
| test1 | t1 | 10 | 1 | 0 |
+-----+-----+-----+-----+-----+
```

3. Check to verify that the same record was replicated to the replica server.

```
mysql> SELECT * FROM test.demo_test;
+-----+-----+-----+-----+-----+
| c1 | c2 | c3 | c4 | c5 |
+-----+-----+-----+-----+
| AA | HELLO, HELLO | 8 | 0 | 0 |
| test1 | t1 | 10 | 1 | 0 |
+-----+-----+-----+-----+-----+
```

4. Use the `set` command to update the key to a value of `new`.

```
telnet 127.0.0.1 11211
Trying 127.0.0.1...
Connected to 127.0.0.1.
Escape character is '^]'.
set test1 10 0 2
new
STORED
```

The update is replicated to the replica server (notice that the `cas` value is also updated).

```
mysql> SELECT * FROM test.demo_test;
+-----+-----+-----+-----+-----+
| c1 | c2 | c3 | c4 | c5 |
+-----+-----+-----+-----+
| AA | HELLO, HELLO | 8 | 0 | 0 |
| test1 | new | 10 | 2 | 0 |
+-----+-----+-----+-----+-----+
```

5. Delete the `test1` record using a `delete` command.

```
telnet 127.0.0.1 11211
Trying 127.0.0.1...
Connected to 127.0.0.1.
Escape character is '^]'.
delete test1
DELETED
```

When the `delete` operation is replicated to the replica, the `test1` record on the replica is also deleted.

```
mysql> SELECT * FROM test.demo_test;
+-----+-----+-----+-----+-----+
| c1 | c2 | c3 | c4 | c5 |
+-----+-----+-----+-----+
| AA | HELLO, HELLO | 8 | 0 | 0 |
+-----+-----+-----+-----+-----+
```

6. Remove all rows from the table using the `flush_all` command.

```
telnet 127.0.0.1 11211
Trying 127.0.0.1...
Connected to 127.0.0.1.
Escape character is '^]'.
flush_all
OK
```

```
mysql> SELECT * FROM test.demo_test;
Empty set (0.00 sec)
```

7. Telnet to the source server and enter two new records.

```
telnet 127.0.0.1 11211
```

```
Trying 127.0.0.1...
Connected to 127.0.0.1.
Escape character is '^]'
set test2 10 0 4
again
STORED
set test3 10 0 5
again1
STORED
```

- Confirm that the two records were replicated to the replica server.

```
mysql> SELECT * FROM test.demo_test;
+-----+-----+-----+-----+-----+
| c1    | c2          | c3    | c4    | c5    |
+-----+-----+-----+-----+-----+
| test2 | again       | 10    | 4     | 0     |
| test3 | again1     | 10    | 5     | 0     |
+-----+-----+-----+-----+-----+
```

- Remove all rows from the table using the `flush_all` command.

```
telnet 127.0.0.1 11211
Trying 127.0.0.1...
Connected to 127.0.0.1.
Escape character is '^]'.
flush_all
OK
```

- Check to ensure that the `flush_all` operation was replicated on the replica server.

```
mysql> SELECT * FROM test.demo_test;
Empty set (0.00 sec)
```

## InnoDB memcached Binary Log Notes

### Binary Log Format:

- Most `memcached` operations are mapped to **DML** statements (analogous to insert, delete, update). Since there is no actual SQL statement being processed by the MySQL server, all `memcached` commands (except for `flush_all`) use Row-Based Replication (RBR) logging, which is independent of any server `binlog_format` setting.
- The `memcached flush_all` command is mapped to the `TRUNCATE TABLE` command. Since **DDL** commands can only use statement-based logging, the `flush_all` command is replicated by sending a `TRUNCATE TABLE` statement.

### Transactions:

- The concept of **transactions** has not typically been part of `memcached` applications. For performance considerations, `daemon_memcached_r_batch_size` and `daemon_memcached_w_batch_size` are used to control the batch size for read and write transactions. These settings do not affect replication. Each SQL operation on the underlying **InnoDB** table is replicated after successful completion.
- The default value of `daemon_memcached_w_batch_size` is 1, which means that each `memcached` write operation is committed immediately. This default setting incurs a certain amount of performance overhead to avoid inconsistencies in the data that is visible on the source and replica servers. The replicated records are always available immediately on the replica server. If you set `daemon_memcached_w_batch_size` to a value greater than 1, records inserted or updated through `memcached` are not immediately visible on the source server; to view the records on the source server before they are committed, issue `SET TRANSACTION ISOLATION LEVEL READ UNCOMMITTED`.

## 14.21.7 InnoDB memcached Plugin Internals

### InnoDB API for the InnoDB memcached Plugin

The `InnoDB memcached` engine accesses `InnoDB` through `InnoDB` APIs, most of which are directly adopted from embedded `InnoDB`. `InnoDB` API functions are passed to the `InnoDB memcached` engine as callback functions. `InnoDB` API functions access the `InnoDB` tables directly, and are mostly DML operations with the exception of `TRUNCATE TABLE`.

`memcached` commands are implemented through the `InnoDB memcached` API. The following table outlines how `memcached` commands are mapped to DML or DDL operations.

**Table 14.21 memcached Commands and Associated DML or DDL Operations**

memcached Command	DML or DDL Operations
<code>get</code>	a read/fetch command
<code>set</code>	a search followed by an <code>INSERT</code> or <code>UPDATE</code> (depending on whether or not a key exists)
<code>add</code>	a search followed by an <code>INSERT</code> or <code>UPDATE</code>
<code>replace</code>	a search followed by an <code>UPDATE</code>
<code>append</code>	a search followed by an <code>UPDATE</code> (appends data to the result before <code>UPDATE</code> )
<code>prepend</code>	a search followed by an <code>UPDATE</code> (prepends data to the result before <code>UPDATE</code> )
<code>incr</code>	a search followed by an <code>UPDATE</code>
<code>decr</code>	a search followed by an <code>UPDATE</code>
<code>delete</code>	a search followed by a <code>DELETE</code>
<code>flush_all</code>	<code>TRUNCATE TABLE</code> (DDL)

### InnoDB memcached Plugin Configuration Tables

This section describes configuration tables used by the `daemon_memcached` plugin. The `cache_policies` table, `config_options` table, and `containers` table are created by the `innodb_memcached_config.sql` configuration script in the `innodb_memcache` database.

```
mysql> USE innodb_memcache;
Database changed
mysql> SHOW TABLES;
+-----+
| Tables_in_innodb_memcache |
+-----+
| cache_policies            |
| config_options            |
| containers                 |
+-----+
```

#### cache\_policies Table

The `cache_policies` table defines a cache policy for the `InnoDB memcached` installation. You can specify individual policies for `get`, `set`, `delete`, and `flush` operations, within a single cache policy. The default setting for all operations is `innodb_only`.

- `innodb_only`: Use `InnoDB` as the data store.

- `cache_only`: Use the `memcached` engine as the data store.
- `caching`: Use both `InnoDB` and the `memcached` engine as data stores. In this case, if `memcached` cannot find a key in memory, it searches for the value in an `InnoDB` table.
- `disable`: Disable caching.

Table 14.22 `cache_policies` Columns

Column	Description
<code>policy_name</code>	Name of the cache policy. The default cache policy name is <code>cache_policy</code> .
<code>get_policy</code>	The cache policy for get operations. Valid values are <code>innodb_only</code> , <code>cache_only</code> , <code>caching</code> , or <code>disabled</code> . The default setting is <code>innodb_only</code> .
<code>set_policy</code>	The cache policy for set operations. Valid values are <code>innodb_only</code> , <code>cache_only</code> , <code>caching</code> , or <code>disabled</code> . The default setting is <code>innodb_only</code> .
<code>delete_policy</code>	The cache policy for delete operations. Valid values are <code>innodb_only</code> , <code>cache_only</code> , <code>caching</code> , or <code>disabled</code> . The default setting is <code>innodb_only</code> .
<code>flush_policy</code>	The cache policy for flush operations. Valid values are <code>innodb_only</code> , <code>cache_only</code> , <code>caching</code> , or <code>disabled</code> . The default setting is <code>innodb_only</code> .

## config\_options Table

The `config_options` table stores `memcached`-related settings that can be changed at runtime using SQL. Supported configuration options are `separator` and `table_map_delimiter`.

Table 14.23 `config_options` Columns

Column	Description
Name	<p>Name of the <code>memcached</code>-related configuration option. The following configuration options are supported by the <code>config_options</code> table:</p> <ul style="list-style-type: none"> <li>• <code>separator</code>: Used to separate values of a long string into separate values when there are multiple <code>value_columns</code> defined. By default, the <code>separator</code> is a <code> </code> character. For example, if you define <code>col1</code>, <code>col2</code> as value columns, and you define <code> </code> as the separator, you can issue the following <code>memcached</code> command to insert values into <code>col1</code> and <code>col2</code>, respectively: <pre>set keyx 10 0 19 valuecolx valuecoly</pre> <code>valuecol1x</code> is stored in <code>col1</code> and <code>valuecoly</code> is stored in <code>col2</code>.</li> <li>• <code>table_map_delimiter</code>: The character separating the schema name and the table name</li> </ul>



Column	Description
	when you use the @@ notation in a key name to access a key in a specific table. For example, @t1.some_key and @@t2.some_key have the same key value, but are stored in different tables.
Value	The value assigned to the memcached-related configuration option.

## containers Table

The `containers` table is the most important of the three configuration tables. Each InnoDB table that is used to store memcached values must have an entry in the `containers` table. The entry provides a mapping between InnoDB table columns and container table columns, which is required for memcached to work with InnoDB tables.

The `containers` table contains a default entry for the `test.demo_test` table, which is created by the `innodb_memcached_config.sql` configuration script. To use the `daemon_memcached` plugin with your own InnoDB table, you must create an entry in the `containers` table.

**Table 14.24 containers Columns**

Column	Description
<code>name</code>	The name given to the container. If an InnoDB table is not requested by name using @@ notation, the <code>daemon_memcached</code> plugin uses the InnoDB table with a <code>containers.name</code> value of <code>default</code> . If there is no such entry, the first entry in the <code>containers</code> table, ordered alphabetically by <code>name</code> (ascending), determines the default InnoDB table.
<code>db_schema</code>	The name of the database where the InnoDB table resides. This is a required value.
<code>db_table</code>	The name of the InnoDB table that stores memcached values. This is a required value.
<code>key_columns</code>	The column in the InnoDB table that contains lookup key values for memcached operations. This is a required value.
<code>value_columns</code>	The InnoDB table columns (one or more) that store memcached data. Multiple columns can be specified using the separator character specified in the <code>innodb_memcached.config_options</code> table. By default, the separator is a pipe character (“ ”). To specify multiple columns, separate them with the defined separator character. For example: <code>col1 col2 col3</code> . This is a required value.
<code>flags</code>	The InnoDB table columns that are used as flags (a user-defined numeric value that is stored and retrieved along with the main value) for memcached. A flag value can be used as a column specifier for some operations (such as <code>incr</code> , <code>prepend</code> ) if a memcached value is mapped to multiple columns, so that an operation is performed on a specified

Column	Description
	column. For example, if you have mapped a <code>value_columns</code> to three InnoDB table columns, and only want the increment operation performed on one columns, use the <code>flags</code> column to specify the column. If you do not use the <code>flags</code> column, set a value of <code>0</code> to indicate that it is unused.
<code>cas_column</code>	The InnoDB table column that stores compare-and-swap (cas) values. The <code>cas_column</code> value is related to the way <code>memcached</code> hashes requests to different servers and caches data in memory. Because the InnoDB <code>memcached</code> plugin is tightly integrated with a single <code>memcached</code> daemon, and the in-memory caching mechanism is handled by MySQL and the InnoDB <code>buffer pool</code> , this column is rarely needed. If you do not use this column, set a value of <code>0</code> to indicate that it is unused.
<code>expire_time_column</code>	The InnoDB table column that stores expiration values. The <code>expire_time_column</code> value is related to the way <code>memcached</code> hashes requests to different servers and caches data in memory. Because the InnoDB <code>memcached</code> plugin is tightly integrated with a single <code>memcached</code> daemon, and the in-memory caching mechanism is handled by MySQL and the InnoDB <code>buffer pool</code> , this column is rarely needed. If you do not use this column, set a value of <code>0</code> to indicate that the column is unused. The maximum expire time is defined as <code>INT_MAX32</code> or 2147483647 seconds (approximately 68 years).
<code>unique_idx_name_on_key</code>	The name of the index on the key column. It must be a unique index. It can be the <code>primary key</code> or a <code>secondary index</code> . Preferably, use the primary key of the InnoDB table. Using the primary key avoids a lookup that is performed when using a secondary index. You cannot make a <code>covering index</code> for <code>memcached</code> lookups; InnoDB returns an error if you try to define a composite secondary index over both the key and value columns.

### containers Table Column Constraints

- You must supply a value for `db_schema`, `db_name`, `key_columns`, `value_columns` and `unique_idx_name_on_key`. Specify `0` for `flags`, `cas_column`, and `expire_time_column` if they are unused. Failing to do so could cause your setup to fail.
- `key_columns`: The maximum limit for a `memcached` key is 250 characters, which is enforced by `memcached`. The mapped key must be a non-Null `CHAR` or `VARCHAR` type.
- `value_columns`: Must be mapped to a `CHAR`, `VARCHAR`, or `BLOB` column. There is no length restriction and the value can be NULL.
- `cas_column`: The `cas` value is a 64 bit integer. It must be mapped to a `BIGINT` of at least 8 bytes. If you do not use this column, set a value of `0` to indicate that it is unused.

- `expiration_time_column`: Must mapped to an `INTEGER` of at least 4 bytes. Expiration time is defined as a 32-bit integer for Unix time (the number of seconds since January 1, 1970, as a 32-bit value), or the number of seconds starting from the current time. For the latter, the number of seconds may not exceed  $60*60*24*30$  (the number of seconds in 30 days). If the number sent by a client is larger, the server considers it to be a real Unix time value rather than an offset from the current time. If you do not use this column, set a value of 0 to indicate that it is unused.
- `flags`: Must be mapped to an `INTEGER` of at least 32-bits and can be NULL. If you do not use this column, set a value of 0 to indicate that it is unused.

A pre-check is performed at plugin load time to enforce column constraints. If mismatches are found, the plugin is not loaded.

### Multiple Value Column Mapping

- During plugin initialization, when `InnoDB memcached` is configured with information defined in the `containers` table, each mapped column defined in `containers.value_columns` is verified against the mapped `InnoDB` table. If multiple `InnoDB` table columns are mapped, there is a check to ensure that each column exists and is the right type.
- At run-time, for `memcached` insert operations, if there are more delimited values than the number of mapped columns, only the number of mapped values are taken. For example, if there are six mapped columns, and seven delimited values are provided, only the first six delimited values are taken. The seventh delimited value is ignored.
- If there are fewer delimited values than mapped columns, unfilled columns are set to NULL. If an unfilled column cannot be set to NULL, insert operations fail.
- If a table has more columns than mapped values, the extra columns do not affect results.

### The demo\_test Example Table

The `innodb_memcached_config.sql` configuration script creates a `demo_test` table in the `test` database, which can be used to verify `InnoDB memcached` plugin installation immediately after setup.

The `innodb_memcached_config.sql` configuration script also creates an entry for the `demo_test` table in the `innodb_memcache.containers` table.

```
mysql> SELECT * FROM innodb_memcache.containers\G
***** 1. row *****
      name: aaa
      db_schema: test
      db_table: demo_test
      key_columns: c1
      value_columns: c2
      flags: c3
      cas_column: c4
      expire_time_column: c5
      unique_idx_name_on_key: PRIMARY

mysql> SELECT * FROM test.demo_test;
+-----+-----+-----+-----+-----+
| c1 | c2          | c3 | c4 | c5 |
+-----+-----+-----+-----+
| AA | HELLO, HELLO | 8 | 0 | 0 |
+-----+-----+-----+-----+
```

## 14.21.8 Troubleshooting the InnoDB memcached Plugin

This section describes issues that you may encounter when using the `InnoDB memcached` plugin.

- If you encounter the following error in the MySQL error log, the server might fail to start:

```
failed to set rlimit for open files. Try running as root or requesting
smaller maxconns value.
```

The error message is from the `memcached` daemon. One solution is to raise the OS limit for the number of open files. The commands for checking and increasing the open file limit varies by operating system. This example shows commands for Linux and macOS:

```
# Linux
$> ulimit -n
1024
$> ulimit -n 4096
$> ulimit -n
4096

# macOS
$> ulimit -n
256
$> ulimit -n 4096
$> ulimit -n
4096
```

The other solution is to reduce the number of concurrent connections permitted for the `memcached` daemon. To do so, encode the `-c memcached` option in the `daemon_memcached_option` configuration parameter in the MySQL configuration file. The `-c` option has a default value of 1024.

```
[mysqld]
...
loose-daemon_memcached_option='-c 64'
```

- To troubleshoot problems where the `memcached` daemon is unable to store or retrieve InnoDB table data, encode the `-vvv memcached` option in the `daemon_memcached_option` configuration parameter in the MySQL configuration file. Examine the MySQL error log for debug output related to `memcached` operations.

```
[mysqld]
...
loose-daemon_memcached_option='-vvv'
```

- If columns specified to hold `memcached` values are the wrong data type, such as a numeric type instead of a string type, attempts to store key-value pairs fail with no specific error code or message.
- If the `daemon_memcached` plugin causes MySQL server startup issues, you can temporarily disable the `daemon_memcached` plugin while troubleshooting by adding this line under the `[mysqld]` group in the MySQL configuration file:

```
daemon_memcached=OFF
```

For example, if you run the `INSTALL PLUGIN` statement before running the `innodb_memcached_config.sql` configuration script to set up the necessary database and tables, the server might unexpectedly exit and fail to start. The server could also fail to start if you incorrectly configure an entry in the `innodb_memcache.containers` table.

To uninstall the `memcached` plugin for a MySQL instance, issue the following statement:

```
mysql> UNINSTALL PLUGIN daemon_memcached;
```

- If you run more than one instance of MySQL on the same machine with the `daemon_memcached` plugin enabled in each instance, use the `daemon_memcached_option` configuration parameter to specify a unique `memcached` port for each `daemon_memcached` plugin.

- If an SQL statement cannot find the `InnoDB` table or finds no data in the table, but `memcached` API calls retrieve the expected data, you may be missing an entry for the `InnoDB` table in the `innodb_memcache.containers` table, or you may have not switched to the correct `InnoDB` table by issuing a `get` or `set` request using `@@table_id` notation. This problem could also occur if you change an existing entry in the `innodb_memcache.containers` table without restarting the MySQL server afterward. The free-form storage mechanism is flexible enough that your requests to store or retrieve a multi-column value such as `col1|col2|col3` may still work, even if the daemon is using the `test.demo_test` table which stores values in a single column.
- When defining your own `InnoDB` table for use with the `daemon_memcached` plugin, and columns in the table are defined as `NOT NULL`, ensure that values are supplied for the `NOT NULL` columns when inserting a record for the table into the `innodb_memcache.containers` table. If the `INSERT` statement for the `innodb_memcache.containers` record contains fewer delimited values than there are mapped columns, unfilled columns are set to `NULL`. Attempting to insert a `NULL` value into a `NOT NULL` column causes the `INSERT` to fail, which may only become evident after you reinitialize the `daemon_memcached` plugin to apply changes to the `innodb_memcache.containers` table.
- If `cas_column` and `expire_time_column` fields of the `innodb_memcached.containers` table are set to `NULL`, the following error is returned when attempting to load the `memcached` plugin:

```
InnoDB_Memcached: column 6 in the entry for config table 'containers' in
database 'innodb_memcache' has an invalid NULL value.
```

The `memcached` plugin rejects usage of `NULL` in the `cas_column` and `expire_time_column` columns. Set the value of these columns to `0` when the columns are unused.

- As the length of the `memcached` key and values increase, you might encounter size and length limits.
  - When the key exceeds 250 bytes, `memcached` operations return an error. This is currently a fixed limit within `memcached`.
  - `InnoDB` table limits may be encountered if values exceed 768 bytes in size, 3072 bytes in size, or half of the `innodb_page_size` value. These limits primarily apply if you intend to create an index on a value column to run report-generating queries on that column using SQL. See [Section 14.23, “InnoDB Limits”](#) for details.
  - The maximum size for the key-value combination is 1 MB.
- If you share configuration files across MySQL servers of different versions, using the latest configuration options for the `daemon_memcached` plugin could cause startup errors on older MySQL versions. To avoid compatibility problems, use the `loose` prefix with option names. For example, use `loose-daemon_memcached_option='-c 64'` instead of `daemon_memcached_option='-c 64'`.
- There is no restriction or check in place to validate character set settings. `memcached` stores and retrieves keys and values in bytes and is therefore not character set-sensitive. However, you must ensure that the `memcached` client and the MySQL table use the same character set.
- `memcached` connections are blocked from accessing tables that contain an indexed virtual column. Accessing an indexed virtual column requires a callback to the server, but a `memcached` connection does not have access to the server code.

## 14.22 InnoDB Troubleshooting

The following general guidelines apply to troubleshooting `InnoDB` problems:

- When an operation fails or you suspect a bug, look at the MySQL server error log (see [Section 5.4.2, “The Error Log”](#)). [Server Error Message Reference](#) provides troubleshooting information for some of the common InnoDB-specific errors that you may encounter.
- If the failure is related to a [deadlock](#), run with the `innodb_print_all_deadlocks` option enabled so that details about each deadlock are printed to the MySQL server error log. For information about deadlocks, see [Section 14.7.5, “Deadlocks in InnoDB”](#).
- Issues relating to the InnoDB data dictionary include failed `CREATE TABLE` statements (orphan table files), inability to open InnoDB files, and `system cannot find the path specified` errors. For information about these sorts of problems and errors, see [Section 14.22.3, “Troubleshooting InnoDB Data Dictionary Operations”](#).
- When troubleshooting, it is usually best to run the MySQL server from the command prompt, rather than through `mysqld_safe` or as a Windows service. You can then see what `mysqld` prints to the console, and so have a better grasp of what is going on. On Windows, start `mysqld` with the `--console` option to direct the output to the console window.
- Enable the InnoDB Monitors to obtain information about a problem (see [Section 14.18, “InnoDB Monitors”](#)). If the problem is performance-related, or your server appears to be hung, you should enable the standard Monitor to print information about the internal state of InnoDB. If the problem is with locks, enable the Lock Monitor. If the problem is with table creation, tablespaces, or data dictionary operations, refer to the [InnoDB Information Schema system tables](#) to examine contents of the InnoDB internal data dictionary.

InnoDB temporarily enables standard InnoDB Monitor output under the following conditions:

- A long semaphore wait
- InnoDB cannot find free blocks in the buffer pool
- Over 67% of the buffer pool is occupied by lock heaps or the adaptive hash index
- If you suspect that a table is corrupt, run `CHECK TABLE` on that table.

## 14.22.1 Troubleshooting InnoDB I/O Problems

The troubleshooting steps for InnoDB I/O problems depend on when the problem occurs: during startup of the MySQL server, or during normal operations when a DML or DDL statement fails due to problems at the file system level.

### Initialization Problems

If something goes wrong when InnoDB attempts to initialize its tablespace or its log files, delete all files created by InnoDB: all `ibdata` files and all `ib_logfile` files. If you already created some InnoDB tables, also delete the corresponding `.frm` files for these tables, and any `.ibd` files if you are using multiple tablespaces, from the MySQL database directories. Then try the InnoDB database creation again. For easiest troubleshooting, start the MySQL server from a command prompt so that you see what is happening.

### Runtime Problems

If InnoDB prints an operating system error during a file operation, usually the problem has one of the following solutions:

- Make sure the InnoDB data file directory and the InnoDB log directory exist.

- Make sure `mysqld` has access rights to create files in those directories.
- Make sure `mysqld` can read the proper `my.cnf` or `my.ini` option file, so that it starts with the options that you specified.
- Make sure the disk is not full and you are not exceeding any disk quota.
- Make sure that the names you specify for subdirectories and data files do not clash.
- Doublecheck the syntax of the `innodb_data_home_dir` and `innodb_data_file_path` values. In particular, any `MAX` value in the `innodb_data_file_path` option is a hard limit, and exceeding that limit causes a fatal error.

## 14.22.2 Forcing InnoDB Recovery

To investigate database page corruption, you might dump your tables from the database with `SELECT ... INTO OUTFILE`. Usually, most of the data obtained in this way is intact. Serious corruption might cause `SELECT * FROM tbl_name` statements or InnoDB background operations to unexpectedly exit or assert, or even cause InnoDB roll-forward recovery to crash. In such cases, you can use the `innodb_force_recovery` option to force the InnoDB storage engine to start up while preventing background operations from running, so that you can dump your tables. For example, you can add the following line to the `[mysqld]` section of your option file before restarting the server:

```
[mysqld]
innodb_force_recovery = 1
```

For information about using option files, see [Section 4.2.2.2, “Using Option Files”](#).



### Warning

Only set `innodb_force_recovery` to a value greater than 0 in an emergency situation, so that you can start InnoDB and dump your tables. Before doing so, ensure that you have a backup copy of your database in case you need to recreate it. Values of 4 or greater can permanently corrupt data files. Only use an `innodb_force_recovery` setting of 4 or greater on a production server instance after you have successfully tested the setting on a separate physical copy of your database. When forcing InnoDB recovery, you should always start with `innodb_force_recovery=1` and only increase the value incrementally, as necessary.

`innodb_force_recovery` is 0 by default (normal startup without forced recovery). The permissible nonzero values for `innodb_force_recovery` are 1 to 6. A larger value includes the functionality of lesser values. For example, a value of 3 includes all of the functionality of values 1 and 2.

If you are able to dump your tables with an `innodb_force_recovery` value of 3 or less, then you are relatively safe that only some data on corrupt individual pages is lost. A value of 4 or greater is considered dangerous because data files can be permanently corrupted. A value of 6 is considered drastic because database pages are left in an obsolete state, which in turn may introduce more corruption into [B-trees](#) and other database structures.

As a safety measure, InnoDB prevents `INSERT`, `UPDATE`, or `DELETE` operations when `innodb_force_recovery` is greater than 0. An `innodb_force_recovery` setting of 4 or greater places InnoDB in read-only mode.

- 1 (`SRV_FORCE_IGNORE_CORRUPT`)

Lets the server run even if it detects a corrupt [page](#). Tries to make `SELECT * FROM tbl_name` jump over corrupt index records and pages, which helps in dumping tables.

- 2 (`SRV_FORCE_NO_BACKGROUND`)

Prevents the [master thread](#) and any [purge threads](#) from running. If an unexpected exit would occur during the [purge](#) operation, this recovery value prevents it.

- 3 (`SRV_FORCE_NO_TRX_UNDO`)

Does not run transaction [rollbacks](#) after [crash recovery](#).

- 4 (`SRV_FORCE_NO_IBUF_MERGE`)

Prevents [insert buffer](#) merge operations. If they would cause a crash, does not do them. Does not calculate table [statistics](#). This value can permanently corrupt data files. After using this value, be prepared to drop and recreate all secondary indexes. Sets [InnoDB](#) to read-only.

- 5 (`SRV_FORCE_NO_UNDO_LOG_SCAN`)

Does not look at [undo logs](#) when starting the database: [InnoDB](#) treats even incomplete transactions as committed. This value can permanently corrupt data files. Sets [InnoDB](#) to read-only.

- 6 (`SRV_FORCE_NO_LOG_REDO`)

Does not do the [redo log](#) roll-forward in connection with recovery. This value can permanently corrupt data files. Leaves database pages in an obsolete state, which in turn may introduce more corruption into B-trees and other database structures. Sets [InnoDB](#) to read-only.

You can [SELECT](#) from tables to dump them. With an `innodb_force_recovery` value of 3 or less you can [DROP](#) or [CREATE](#) tables. `DROP TABLE` is also supported with an `innodb_force_recovery` value greater than 3, up to MySQL 5.7.17. As of MySQL 5.7.18, `DROP TABLE` is not permitted with an `innodb_force_recovery` value greater than 4.

If you know that a given table is causing an unexpected exit on rollback, you can drop it. If you encounter a runaway rollback caused by a failing mass import or `ALTER TABLE`, you can kill the `mysqld` process and set `innodb_force_recovery` to 3 to bring the database up without the rollback, and then `DROP` the table that is causing the runaway rollback.

If corruption within the table data prevents you from dumping the entire table contents, a query with an `ORDER BY primary_key DESC` clause might be able to dump the portion of the table after the corrupted part.

If a high `innodb_force_recovery` value is required to start [InnoDB](#), there may be corrupted data structures that could cause complex queries (queries containing `WHERE`, `ORDER BY`, or other clauses) to fail. In this case, you may only be able to run basic `SELECT * FROM t` queries.

### 14.22.3 Troubleshooting InnoDB Data Dictionary Operations

Information about table definitions is stored both in the `.frm` files, and in the [InnoDB data dictionary](#). If you move `.frm` files around, or if the server crashes in the middle of a data dictionary operation, these sources of information can become inconsistent.

If a data dictionary corruption or consistency issue prevents you from starting [InnoDB](#), see [Section 14.22.2, “Forcing InnoDB Recovery”](#) for information about manual recovery.

#### CREATE TABLE Failure Due to Orphan Table

A symptom of an out-of-sync data dictionary is that a `CREATE TABLE` statement fails. If this occurs, look in the server's error log. If the log says that the table already exists inside the [InnoDB](#) internal data dictionary,



you have an orphan table inside the [InnoDB](#) tablespace files that has no corresponding `.frm` file. The error message looks like this:

```
InnoDB: Error: table test/parent already exists in InnoDB internal
InnoDB: data dictionary. Have you deleted the .frm file
InnoDB: and not used DROP TABLE? Have you used DROP DATABASE
InnoDB: for InnoDB tables in MySQL version <= 3.23.43?
InnoDB: See the Restrictions section of the InnoDB manual.
InnoDB: You can drop the orphaned table inside InnoDB by
InnoDB: creating an InnoDB table with the same name in another
InnoDB: database and moving the .frm file to the current database.
InnoDB: Then MySQL thinks the table exists, and DROP TABLE will
InnoDB: succeed.
```

You can drop the orphan table by following the instructions given in the error message. If you are still unable to use `DROP TABLE` successfully, the problem may be due to name completion in the `mysql` client. To work around this problem, start the `mysql` client with the `--skip-auto-rehash` option and try `DROP TABLE` again. (With name completion on, `mysql` tries to construct a list of table names, which fails when a problem such as just described exists.)

## Cannot Open Datafile

With `innodb_file_per_table` enabled (the default), the following messages may appear at startup if a `file-per-table` tablespace file (`.ibd` file) is missing:

```
[ERROR] InnoDB: Operating system error number 2 in a file operation.
[ERROR] InnoDB: The error means the system cannot find the path specified.
[ERROR] InnoDB: Cannot open datafile for read-only: './test/t1.ibd' OS error: 71
[Warning] InnoDB: Ignoring tablespace `test/t1` because it could not be opened.
```

To address these messages, issue `DROP TABLE` statement to remove data about the missing table from the data dictionary.

## Cannot Open File Error

Another symptom of an out-of-sync data dictionary is that MySQL prints an error that it cannot open an [InnoDB](#) file:

```
ERROR 1016: Can't open file: 'child2.ibd'. (errno: 1)
```

In the error log you can find a message like this:

```
InnoDB: Cannot find table test/child2 from the internal data dictionary
InnoDB: of InnoDB though the .frm file for the table exists. Maybe you
InnoDB: have deleted and recreated InnoDB data files but have forgotten
InnoDB: to delete the corresponding .frm files of InnoDB tables?
```

This means that there is an orphan `.frm` file without a corresponding table inside [InnoDB](#). You can drop the orphan `.frm` file by deleting it manually.

## Orphan Intermediate Tables

If MySQL exits in the middle of an in-place `ALTER TABLE` operation (`ALGORITHM=INPLACE`), you may be left with an orphan intermediate table that takes up space on your system. Also, an orphan intermediate table in an otherwise empty [general tablespace](#) prevents you from dropping the general tablespace. This section describes how to identify and remove orphan intermediate tables.

Intermediate table names begin with an `#sql-ib` prefix (e.g., `#sql-ib87-856498050`). The accompanying `.frm` file has an `#sql-*` prefix and is named differently (e.g., `#sql-36ab_2.frm`).

To identify orphan intermediate tables on your system, you can query the Information Schema `INNODB_SYS_TABLES` table. Look for table names that begin with `#sql`. If the original table resides in

a [file-per-table](#) tablespace, the tablespace file (the `#sql-*.ibd` file) for the orphan intermediate table should be visible in the database directory.

```
SELECT * FROM INFORMATION_SCHEMA.INNODB_SYS_TABLES WHERE NAME LIKE '%sql%';
```

To remove an orphan intermediate table, perform the following steps:

1. In the database directory, rename the `#sql-*.frm` file to match the base name of the orphan intermediate table:

```
$> mv #sql-36ab_2.frm #sql-ib87-856498050.frm
```



#### Note

If there is no `.frm` file, you can recreate it. The `.frm` file must have the same table schema as the orphan intermediate table (it must have the same columns and indexes) and must be placed in the database directory of the orphan intermediate table.

2. Drop the orphan intermediate table by issuing a `DROP TABLE` statement, prefixing the name of the table with `#mysql50#` and enclosing the table name in backticks. For example:

```
mysql> DROP TABLE `#mysql50##sql-ib87-856498050`;
```

The `#mysql50#` prefix tells MySQL to ignore [file name safe encoding](#) introduced in MySQL 5.1. Enclosing the table name in backticks is required to perform SQL statements on table names with special characters such as “#”.



#### Note

If an unexpected exit occurs during an in-place `ALTER TABLE` operation that was moving a table to a different tablespace, the recovery process restores the table to its original location but leaves an orphan intermediate table in the destination tablespace.



#### Note

If MySQL exits in the middle of an in-place `ALTER TABLE` operation on a partitioned table, you may be left with multiple orphan intermediate tables, one per partition. In this case, use the following procedure to remove the orphan intermediate tables:

1. In a separate instance of the same MySQL version, create a non-partitioned table with the same schema name and columns as the partitioned table.
2. Copy the `.frm` file of the non-partitioned table to the database directory with the orphan intermediate tables.
3. Make a copy of the `.frm` file for each table, and rename the `.frm` files to match names of the orphan intermediate tables (as described above).
4. Perform a `DROP TABLE` operation (as described above) for each table.

## Orphan Temporary Tables

If MySQL exits in the middle of a table-copying `ALTER TABLE` operation (`ALGORITHM=COPY`), you may be left with an orphan temporary table that takes up space on your system. Also, an orphan temporary table

in an otherwise empty [general tablespace](#) prevents you from dropping the general tablespace. This section describes how to identify and remove orphan temporary tables.

Orphan temporary table names begin with an `#sql-` prefix (e.g., `#sql-540_3`). The accompanying `.frm` file has the same base name as the orphan temporary table.



#### Note

If there is no `.frm` file, you can recreate it. The `.frm` file must have the same table schema as the orphan temporary table (it must have the same columns and indexes) and must be placed in the database directory of the orphan temporary table.

To identify orphan temporary tables on your system, you can query the Information Schema `INNODB_SYS_TABLES` table. Look for table names that begin with `#sql`. If the original table resides in a [file-per-table](#) tablespace, the tablespace file (the `#sql-*.ibd` file) for the orphan temporary table should be visible in the database directory.

```
SELECT * FROM INFORMATION_SCHEMA.INNODB_SYS_TABLES WHERE NAME LIKE '%#sql%';
```

To remove an orphan temporary table, drop the table by issuing a `DROP TABLE` statement, prefixing the name of the table with `#mysql50#` and enclosing the table name in backticks. For example:

```
mysql> DROP TABLE `#mysql50##sql-540_3`;
```

The `#mysql50#` prefix tells MySQL to ignore [file name safe encoding](#) introduced in MySQL 5.1. Enclosing the table name in backticks is required to perform SQL statements on table names with special characters such as `#`.



#### Note

If MySQL exits in the middle of an table-copying `ALTER TABLE` operation on a partitioned table, you may be left with multiple orphan temporary tables, one per partition. In this case, use the following procedure to remove the orphan temporary tables:

1. In a separate instance of the same MySQL version, create a non-partitioned table with the same schema name and columns as the partitioned table.
2. Copy the `.frm` file of the non-partitioned table to the database directory with the orphan temporary tables.
3. Make a copy of the `.frm` file for each table, and rename the `.frm` files to match the names of the orphan temporary tables (as described above).
4. Perform a `DROP TABLE` operation (as described above) for each table.

## Tablespace Does Not Exist

With `innodb_file_per_table` enabled, the following message might occur if the `.frm` or `.ibd` files (or both) are missing:

```
InnoDB: in InnoDB data dictionary has tablespace id N,
InnoDB: but tablespace with that id or name does not exist. Have
InnoDB: you deleted or moved .ibd files?
InnoDB: This may also be a table created with CREATE TEMPORARY TABLE
InnoDB: whose .ibd and .frm files MySQL automatically removed, but the
InnoDB: table still exists in the InnoDB internal data dictionary.
```

If this occurs, try the following procedure to resolve the problem:

1. Create a matching `.frm` file in some other database directory and copy it to the database directory where the orphan table is located.
2. Issue `DROP TABLE` for the original table. That should successfully drop the table and InnoDB should print a warning to the error log that the `.ibd` file was missing.

## Restoring Orphan File-Per-Table `ibd` Files

This procedure describes how to restore orphan `file-per-table .ibd` files to another MySQL instance. You might use this procedure if the system tablespace is lost or unrecoverable and you want to restore `.ibd` file backups on a new MySQL instance.

The procedure is not supported for `general tablespace .ibd` files.

The procedure assumes that you only have `.ibd` file backups, you are recovering to the same version of MySQL that initially created the orphan `.ibd` files, and that `.ibd` file backups are clean. See [Section 14.6.1.4, “Moving or Copying InnoDB Tables”](#) for information about creating clean backups.

Table import limitations outlined in [Section 14.6.1.3, “Importing InnoDB Tables”](#) are applicable to this procedure.

1. On the new MySQL instance, recreate the table in a database of the same name.

```
mysql> CREATE DATABASE sakila;

mysql> USE sakila;

mysql> CREATE TABLE actor (
    actor_id SMALLINT UNSIGNED NOT NULL AUTO_INCREMENT,
    first_name VARCHAR(45) NOT NULL,
    last_name VARCHAR(45) NOT NULL,
    last_update TIMESTAMP NOT NULL DEFAULT CURRENT_TIMESTAMP ON UPDATE CURRENT_TIMESTAMP,
    PRIMARY KEY (actor_id),
    KEY idx_actor_last_name (last_name)
)ENGINE=InnoDB DEFAULT CHARSET=utf8;
```

2. Discard the tablespace of the newly created table.

```
mysql> ALTER TABLE sakila.actor DISCARD TABLESPACE;
```

3. Copy the orphan `.ibd` file from your backup directory to the new database directory.

```
$> cp /backup_directory/actor.ibd path/to/mysql-5.7/data/sakila/
```

4. Ensure that the `.ibd` file has the necessary file permissions.
5. Import the orphan `.ibd` file. A warning is issued indicating that InnoDB tries to import the file without schema verification.

```
mysql> ALTER TABLE sakila.actor IMPORT TABLESPACE; SHOW WARNINGS;
Query OK, 0 rows affected, 1 warning (0.15 sec)

Warning | 1810 | InnoDB: IO Read error: (2, No such file or directory)
Error opening './sakila/actor.cfg', will attempt to import
without schema verification
```

6. Query the table to verify that the `.ibd` file was successfully restored.

```
mysql> SELECT COUNT(*) FROM sakila.actor;
```

```

+-----+
| count(*) |
+-----+
|      200 |
+-----+

```

## 14.22.4 InnoDB Error Handling

The following items describe how [InnoDB](#) performs error handling. [InnoDB](#) sometimes rolls back only the statement that failed, other times it rolls back the entire transaction.

- If you run out of file space in a [tablespace](#), a MySQL [Table is full](#) error occurs and [InnoDB](#) rolls back the SQL statement.
- A transaction [deadlock](#) causes [InnoDB](#) to [roll back](#) the entire [transaction](#). Retry the entire transaction when this happens.

A lock wait timeout causes [InnoDB](#) to roll back the current statement (the statement that was waiting for the lock and encountered the timeout). To have the entire transaction roll back, start the server with `--innodb-rollback-on-timeout` enabled. Retry the statement if using the default behavior, or the entire transaction if `--innodb-rollback-on-timeout` is enabled.

Both deadlocks and lock wait timeouts are normal on busy servers and it is necessary for applications to be aware that they may happen and handle them by retrying. You can make them less likely by doing as little work as possible between the first change to data during a transaction and the commit, so the locks are held for the shortest possible time and for the smallest possible number of rows. Sometimes splitting work between different transactions may be practical and helpful.

- A duplicate-key error rolls back the SQL statement, if you have not specified the [IGNORE](#) option in your statement.
- A [row too long error](#) rolls back the SQL statement.
- Other errors are mostly detected by the MySQL layer of code (above the [InnoDB](#) storage engine level), and they roll back the corresponding SQL statement. Locks are not released in a rollback of a single SQL statement.

During implicit rollbacks, as well as during the execution of an explicit [ROLLBACK](#) SQL statement, [SHOW PROCESSLIST](#) displays [Rolling back](#) in the [State](#) column for the relevant connection.

## 14.23 InnoDB Limits

This section describes limits for [InnoDB](#) tables, indexes, tablespaces, and other aspects of the [InnoDB](#) storage engine.

- A table can contain a maximum of 1017 columns (raised in MySQL 5.6.9 from the earlier limit of 1000). Virtual generated columns are included in this limit.
- A table can contain a maximum of 64 [secondary indexes](#).
- If `innodb_large_prefix` is enabled (the default), the index key prefix limit is 3072 bytes for [InnoDB](#) tables that use the [DYNAMIC](#) or [COMPRESSED](#) row format. If `innodb_large_prefix` is disabled, the index key prefix limit is 767 bytes for tables of any row format.

`innodb_large_prefix` is deprecated; expect it to be removed in a future MySQL release. `innodb_large_prefix` was introduced in MySQL 5.5 to disable large index key prefixes for compatibility with earlier versions of [InnoDB](#) that do not support large index key prefixes.

The index key prefix length limit is 767 bytes for [InnoDB](#) tables that use the [REDUNDANT](#) or [COMPACT](#) row format. For example, you might hit this limit with a [column prefix](#) index of more than 255 characters on a [TEXT](#) or [VARCHAR](#) column, assuming a [utf8mb3](#) character set and the maximum of 3 bytes for each character.

Attempting to use an index key prefix length that exceeds the limit returns an error. To avoid such errors in replication configurations, avoid enabling [innodb\\_large\\_prefix](#) on the source if it cannot also be enabled on replicas.

If you reduce the [InnoDB page size](#) to 8KB or 4KB by specifying the [innodb\\_page\\_size](#) option when creating the MySQL instance, the maximum length of the index key is lowered proportionally, based on the limit of 3072 bytes for a 16KB page size. That is, the maximum index key length is 1536 bytes when the page size is 8KB, and 768 bytes when the page size is 4KB.

The limits that apply to index key prefixes also apply to full-column index keys.

- A maximum of 16 columns is permitted for multicolumn indexes. Exceeding the limit returns an error.

```
ERROR 1070 (42000): Too many key parts specified; max 16 parts allowed
```

- The maximum row size, excluding any variable-length columns that are stored off-page, is slightly less than half of a page for 4KB, 8KB, 16KB, and 32KB page sizes. For example, the maximum row size for the default [innodb\\_page\\_size](#) of 16KB is about 8000 bytes. However, for an [InnoDB](#) page size of 64KB, the maximum row size is approximately 16000 bytes. [LONGBLOB](#) and [LONGTEXT](#) columns must be less than 4GB, and the total row size, including [BLOB](#) and [TEXT](#) columns, must be less than 4GB.

If a row is less than half a page long, all of it is stored locally within the page. If it exceeds half a page, variable-length columns are chosen for external off-page storage until the row fits within half a page, as described in [Section 14.12.2, “File Space Management”](#).

- Although [InnoDB](#) supports row sizes larger than 65,535 bytes internally, MySQL itself imposes a row-size limit of 65,535 for the combined size of all columns. See [Section 8.4.7, “Limits on Table Column Count and Row Size”](#).
- On some older operating systems, files must be less than 2GB. This is not an [InnoDB](#) limitation. If you require a large system tablespace, configure it using several smaller data files rather than one large data file, or distribute table data across file-per-table and general tablespace data files.
- The combined maximum size for [InnoDB](#) log files is 512GB.
- The minimum tablespace size is slightly larger than 10MB. The maximum tablespace size depends on the [InnoDB](#) page size.

**Table 14.25 InnoDB Maximum Tablespace Size**

InnoDB Page Size	Maximum Tablespace Size
4KB	16TB
8KB	32TB
16KB	64TB
32KB	128TB
64KB	256TB

The maximum tablespace size is also the maximum size for a table.

- Tablespace files cannot exceed 4GB on Windows 32-bit systems (Bug #80149).

- An [InnoDB](#) instance supports up to  $2^{32}$  (4294967296) tablespaces, with a small number of those tablespaces reserved for undo and temporary tables.
- Shared tablespaces support up to  $2^{32}$  (4294967296) tables.
- The path of a tablespace file, including the file name, cannot exceed the [MAX\\_PATH](#) limit on Windows. Prior to Windows 10, the [MAX\\_PATH](#) limit is 260 characters. As of Windows 10, version 1607, [MAX\\_PATH](#) limitations are removed from common Win32 file and directory functions, but you must enable the new behavior.
- [ROW\\_FORMAT=COMPRESSED](#) in the [Barracuda](#) file format assumes that the page size is at most 16KB and uses 14-bit pointers.
- For limits associated with concurrent read-write transactions, see [Section 14.6.7, “Undo Logs”](#).

## 14.24 InnoDB Restrictions and Limitations

This section describes restrictions and limitations of the [InnoDB](#) storage engine.

- You cannot create a table with a column name that matches the name of an internal [InnoDB](#) column (including [DB\\_ROW\\_ID](#), [DB\\_TRX\\_ID](#), and [DB\\_ROLL\\_PTR](#)). This restriction applies to use of the names in any lettercase.

```
mysql> CREATE TABLE t1 (c1 INT, db_row_id INT) ENGINE=INNODB;  
ERROR 1166 (42000): Incorrect column name 'db_row_id'
```

- [SHOW TABLE STATUS](#) does not provide accurate statistics for [InnoDB](#) tables except for the physical size reserved by the table. The row count is only a rough estimate used in SQL optimization.
- [InnoDB](#) does not keep an internal count of rows in a table because concurrent transactions might “see” different numbers of rows at the same time. Consequently, [SELECT COUNT\(\\*\)](#) statements only count rows visible to the current transaction.

For information about how [InnoDB](#) processes [SELECT COUNT\(\\*\)](#) statements, refer to the [COUNT\(\)](#) description in [Section 12.19.1, “Aggregate Function Descriptions”](#).

- [ROW\\_FORMAT=COMPRESSED](#) is unsupported for page sizes greater than 16KB.
- A MySQL instance using a particular [InnoDB](#) page size ([innodb\\_page\\_size](#)) cannot use data files or log files from an instance that uses a different page size.
- For limitations associated with importing tables using the *Transportable Tablespaces* feature, see [Table Import Limitations](#).
- For limitations associated with online DDL, see [Section 14.13.6, “Online DDL Limitations”](#).
- For limitations associated with general tablespaces, see [General Tablespace Limitations](#).
- For limitations associated with data-at-rest encryption, see [Encryption Limitations](#).





---

# Chapter 15 Alternative Storage Engines

## Table of Contents

15.1	Setting the Storage Engine .....	2918
15.2	The MyISAM Storage Engine .....	2919
15.2.1	MyISAM Startup Options .....	2922
15.2.2	Space Needed for Keys .....	2923
15.2.3	MyISAM Table Storage Formats .....	2924
15.2.4	MyISAM Table Problems .....	2926
15.3	The MEMORY Storage Engine .....	2928
15.4	The CSV Storage Engine .....	2933
15.4.1	Repairing and Checking CSV Tables .....	2933
15.4.2	CSV Limitations .....	2934
15.5	The ARCHIVE Storage Engine .....	2934
15.6	The BLACKHOLE Storage Engine .....	2936
15.7	The MERGE Storage Engine .....	2938
15.7.1	MERGE Table Advantages and Disadvantages .....	2941
15.7.2	MERGE Table Problems .....	2942
15.8	The FEDERATED Storage Engine .....	2943
15.8.1	FEDERATED Storage Engine Overview .....	2944
15.8.2	How to Create FEDERATED Tables .....	2945
15.8.3	FEDERATED Storage Engine Notes and Tips .....	2948
15.8.4	FEDERATED Storage Engine Resources .....	2949
15.9	The EXAMPLE Storage Engine .....	2949
15.10	Other Storage Engines .....	2950
15.11	Overview of MySQL Storage Engine Architecture .....	2950
15.11.1	Pluggable Storage Engine Architecture .....	2950
15.11.2	The Common Database Server Layer .....	2951

Storage engines are MySQL components that handle the SQL operations for different table types. [InnoDB](#) is the default and most general-purpose storage engine, and Oracle recommends using it for tables except for specialized use cases. (The [CREATE TABLE](#) statement in MySQL 5.7 creates [InnoDB](#) tables by default.)

MySQL Server uses a pluggable storage engine architecture that enables storage engines to be loaded into and unloaded from a running MySQL server.

To determine which storage engines your server supports, use the [SHOW ENGINES](#) statement. The value in the [Support](#) column indicates whether an engine can be used. A value of [YES](#), [NO](#), or [DEFAULT](#) indicates that an engine is available, not available, or available and currently set as the default storage engine.

```
mysql> SHOW ENGINES\G
***** 1. row *****
  Engine: PERFORMANCE_SCHEMA
  Support: YES
  Comment: Performance Schema
Transactions: NO
  XA: NO
  Savepoints: NO
***** 2. row *****
  Engine: InnoDB
  Support: DEFAULT
```

```

    Comment: Supports transactions, row-level locking, and foreign keys
Transactions: YES
    XA: YES
  Savepoints: YES
***** 3. row *****
    Engine: MRG_MYISAM
    Support: YES
    Comment: Collection of identical MyISAM tables
Transactions: NO
    XA: NO
  Savepoints: NO
***** 4. row *****
    Engine: BLACKHOLE
    Support: YES
    Comment: /dev/null storage engine (anything you write to it disappears)
Transactions: NO
    XA: NO
  Savepoints: NO
***** 5. row *****
    Engine: MyISAM
    Support: YES
    Comment: MyISAM storage engine
Transactions: NO
    XA: NO
  Savepoints: NO
...

```

This chapter covers use cases for special-purpose MySQL storage engines. It does not cover the default [InnoDB](#) storage engine or the [NDB](#) storage engine which are covered in [Chapter 14, \*The InnoDB Storage Engine\*](#), and [Chapter 21, \*MySQL NDB Cluster 7.5 and NDB Cluster 7.6\*](#). For advanced users, this chapter also contains a description of the pluggable storage engine architecture (see [Section 15.11, “Overview of MySQL Storage Engine Architecture”](#)).

For information about features offered in commercial MySQL Server binaries, see [MySQL Editions](#), on the MySQL website. The storage engines available might depend on which edition of MySQL you are using.

For answers to commonly asked questions about MySQL storage engines, see [Section A.2, “MySQL 5.7 FAQ: Storage Engines”](#).

## MySQL 5.7 Supported Storage Engines

- **InnoDB**: The default storage engine in MySQL 5.7. [InnoDB](#) is a transaction-safe (ACID compliant) storage engine for MySQL that has commit, rollback, and crash-recovery capabilities to protect user data. [InnoDB](#) row-level locking (without escalation to coarser granularity locks) and Oracle-style consistent nonlocking reads increase multi-user concurrency and performance. [InnoDB](#) stores user data in clustered indexes to reduce I/O for common queries based on primary keys. To maintain data integrity, [InnoDB](#) also supports [FOREIGN KEY](#) referential-integrity constraints. For more information about [InnoDB](#), see [Chapter 14, \*The InnoDB Storage Engine\*](#).
- **MyISAM**: These tables have a small footprint. [Table-level locking](#) limits the performance in read/write workloads, so it is often used in read-only or read-mostly workloads in Web and data warehousing configurations.
- **Memory**: Stores all data in RAM, for fast access in environments that require quick lookups of non-critical data. This engine was formerly known as the [HEAP](#) engine. Its use cases are decreasing; [InnoDB](#) with its buffer pool memory area provides a general-purpose and durable way to keep most or all data in memory, and [NDBCLUSTER](#) provides fast key-value lookups for huge distributed data sets.
- **CSV**: Its tables are really text files with comma-separated values. CSV tables let you import or dump data in CSV format, to exchange data with scripts and applications that read and write that same format.

Because CSV tables are not indexed, you typically keep the data in [InnoDB](#) tables during normal operation, and only use CSV tables during the import or export stage.

- [Archive](#): These compact, unindexed tables are intended for storing and retrieving large amounts of seldom-referenced historical, archived, or security audit information.
- [Blackhole](#): The Blackhole storage engine accepts but does not store data, similar to the Unix `/dev/null` device. Queries always return an empty set. These tables can be used in replication configurations where DML statements are sent to replica servers, but the source server does not keep its own copy of the data.
- [NDB](#) (also known as [NDBCLUSTER](#)): This clustered database engine is particularly suited for applications that require the highest possible degree of uptime and availability.
- [Merge](#): Enables a MySQL DBA or developer to logically group a series of identical [MyISAM](#) tables and reference them as one object. Good for VLDB environments such as data warehousing.
- [Federated](#): Offers the ability to link separate MySQL servers to create one logical database from many physical servers. Very good for distributed or data mart environments.
- [Example](#): This engine serves as an example in the MySQL source code that illustrates how to begin writing new storage engines. It is primarily of interest to developers. The storage engine is a “stub” that does nothing. You can create tables with this engine, but no data can be stored in them or retrieved from them.

You are not restricted to using the same storage engine for an entire server or schema. You can specify the storage engine for any table. For example, an application might use mostly [InnoDB](#) tables, with one [CSV](#) table for exporting data to a spreadsheet and a few [MEMORY](#) tables for temporary workspaces.

### Choosing a Storage Engine

The various storage engines provided with MySQL are designed with different use cases in mind. The following table provides an overview of some storage engines provided with MySQL, with clarifying notes following the table.

**Table 15.1 Storage Engines Feature Summary**

Feature	MyISAM	Memory	InnoDB	Archive	NDB
B-tree indexes	Yes	Yes	Yes	No	No
Backup/point-in-time recovery (note 1)	Yes	Yes	Yes	Yes	Yes
Cluster database support	No	No	No	No	Yes
Clustered indexes	No	No	Yes	No	No
Compressed data	Yes (note 2)	No	Yes	Yes	No
Data caches	No	N/A	Yes	No	Yes
Encrypted data	Yes (note 3)	Yes (note 3)	Yes (note 4)	Yes (note 3)	Yes (note 5)
Foreign key support	No	No	Yes	No	Yes

Feature	MyISAM	Memory	InnoDB	Archive	NDB
Full-text search indexes	Yes	No	Yes (note 6)	No	No
Geospatial data type support	Yes	No	Yes	Yes	Yes
Geospatial indexing support	Yes	No	Yes (note 7)	No	No
Hash indexes	No	Yes	No (note 8)	No	Yes
Index caches	Yes	N/A	Yes	No	Yes
Locking granularity	Table	Table	Row	Row	Row
MVCC	No	No	Yes	No	No
Replication support (note 1)	Yes	Limited (note 9)	Yes	Yes	Yes
Storage limits	256TB	RAM	64TB	None	384EB
T-tree indexes	No	No	No	No	Yes
Transactions	No	No	Yes	No	Yes
Update statistics for data dictionary	Yes	Yes	Yes	Yes	Yes

**Notes:**

1. Implemented in the server, rather than in the storage engine.
2. Compressed MyISAM tables are supported only when using the compressed row format. Tables using the compressed row format with MyISAM are read only.
3. Implemented in the server via encryption functions.
4. Implemented in the server via encryption functions; In MySQL 5.7 and later, data-at-rest encryption is supported.
5. Implemented in the server via encryption functions; encrypted NDB backups as of NDB 8.0.22; transparent NDB file system encryption supported in NDB 8.0.29 and later.
6. Support for FULLTEXT indexes is available in MySQL 5.6 and later.
7. Support for geospatial indexing is available in MySQL 5.7 and later.
8. InnoDB utilizes hash indexes internally for its Adaptive Hash Index feature.
9. See the discussion later in this section.

## 15.1 Setting the Storage Engine

When you create a new table, you can specify which storage engine to use by adding an [ENGINE](#) table option to the `CREATE TABLE` statement:

```
-- ENGINE=INNODB not needed unless you have set a different
-- default storage engine.
CREATE TABLE t1 (i INT) ENGINE = INNODB;
-- Simple table definitions can be switched from one to another.
```

```
CREATE TABLE t2 (i INT) ENGINE = CSV;
CREATE TABLE t3 (i INT) ENGINE = MEMORY;
```

When you omit the `ENGINE` option, the default storage engine is used. The default engine is `InnoDB` in MySQL 5.7. You can specify the default engine by using the `--default-storage-engine` server startup option, or by setting the `default-storage-engine` option in the `my.cnf` configuration file.

You can set the default storage engine for the current session by setting the `default_storage_engine` variable:

```
SET default_storage_engine=NDBCLUSTER;
```

The storage engine for `TEMPORARY` tables created with `CREATE TEMPORARY TABLE` can be set separately from the engine for permanent tables by setting the `default_tmp_storage_engine`, either at startup or at runtime.

To convert a table from one storage engine to another, use an `ALTER TABLE` statement that indicates the new engine:

```
ALTER TABLE t ENGINE = InnoDB;
```

See [Section 13.1.18, “CREATE TABLE Statement”](#), and [Section 13.1.8, “ALTER TABLE Statement”](#).

If you try to use a storage engine that is not compiled in or that is compiled in but deactivated, MySQL instead creates a table using the default storage engine. For example, in a replication setup, perhaps your source server uses `InnoDB` tables for maximum safety, but the replica servers use other storage engines for speed at the expense of durability or concurrency.

By default, a warning is generated whenever `CREATE TABLE` or `ALTER TABLE` cannot use the default storage engine. To prevent confusing, unintended behavior if the desired engine is unavailable, enable the `NO_ENGINE_SUBSTITUTION` SQL mode. If the desired engine is unavailable, this setting produces an error instead of a warning, and the table is not created or altered. See [Section 5.1.10, “Server SQL Modes”](#).

For new tables, MySQL always creates an `.frm` file to hold the table and column definitions. The table's index and data may be stored in one or more other files, depending on the storage engine. The server creates the `.frm` file above the storage engine level. Individual storage engines create any additional files required for the tables that they manage. If a table name contains special characters, the names for the table files contain encoded versions of those characters as described in [Section 9.2.4, “Mapping of Identifiers to File Names”](#).

## 15.2 The MyISAM Storage Engine

`MyISAM` is based on the older (and no longer available) `ISAM` storage engine but has many useful extensions.

**Table 15.2 MyISAM Storage Engine Features**

Feature	Support
<b>B-tree indexes</b>	Yes
<b>Backup/point-in-time recovery</b> (Implemented in the server, rather than in the storage engine.)	Yes
<b>Cluster database support</b>	No
<b>Clustered indexes</b>	No
<b>Compressed data</b>	Yes (Compressed MyISAM tables are supported only when using the compressed row format. Tables

Feature	Support
	using the compressed row format with MyISAM are read only.)
<b>Data caches</b>	No
<b>Encrypted data</b>	Yes (Implemented in the server via encryption functions.)
<b>Foreign key support</b>	No
<b>Full-text search indexes</b>	Yes
<b>Geospatial data type support</b>	Yes
<b>Geospatial indexing support</b>	Yes
<b>Hash indexes</b>	No
<b>Index caches</b>	Yes
<b>Locking granularity</b>	Table
<b>MVCC</b>	No
<b>Replication support</b> (Implemented in the server, rather than in the storage engine.)	Yes
<b>Storage limits</b>	256TB
<b>T-tree indexes</b>	No
<b>Transactions</b>	No
<b>Update statistics for data dictionary</b>	Yes

Each [MyISAM](#) table is stored on disk in three files. The files have names that begin with the table name and have an extension to indicate the file type. An `.frm` file stores the table format. The data file has an `.MYD` (`MYData`) extension. The index file has an `.MYI` (`MYIndex`) extension.

To specify explicitly that you want a [MyISAM](#) table, indicate that with an `ENGINE` table option:

```
CREATE TABLE t (i INT) ENGINE = MYISAM;
```

In MySQL 5.7, it is normally necessary to use `ENGINE` to specify the [MyISAM](#) storage engine because [InnoDB](#) is the default engine.

You can check or repair [MyISAM](#) tables with the `mysqlcheck` client or `myisamchk` utility. You can also compress [MyISAM](#) tables with `myisampack` to take up much less space. See [Section 4.5.3, “mysqlcheck — A Table Maintenance Program”](#), [Section 4.6.3, “myisamchk — MyISAM Table-Maintenance Utility”](#), and [Section 4.6.5, “myisampack — Generate Compressed, Read-Only MyISAM Tables”](#).

[MyISAM](#) tables have the following characteristics:

- All data values are stored with the low byte first. This makes the data machine and operating system independent. The only requirements for binary portability are that the machine uses two's-complement signed integers and IEEE floating-point format. These requirements are widely used among mainstream machines. Binary compatibility might not be applicable to embedded systems, which sometimes have peculiar processors.

There is no significant speed penalty for storing data low byte first; the bytes in a table row normally are unaligned and it takes little more processing to read an unaligned byte in order than in reverse order. Also, the code in the server that fetches column values is not time critical compared to other code.

- All numeric key values are stored with the high byte first to permit better index compression.

- Large files (up to 63-bit file length) are supported on file systems and operating systems that support large files.
- There is a limit of  $(2^{32})^2$  (1.844E+19) rows in a `MyISAM` table.
- The maximum number of indexes per `MyISAM` table is 64.  
The maximum number of columns per index is 16.
- The maximum key length is 1000 bytes. This can also be changed by changing the source and recompiling. For the case of a key longer than 250 bytes, a larger key block size than the default of 1024 bytes is used.
- When rows are inserted in sorted order (as when you are using an `AUTO_INCREMENT` column), the index tree is split so that the high node only contains one key. This improves space utilization in the index tree.
- Internal handling of one `AUTO_INCREMENT` column per table is supported. `MyISAM` automatically updates this column for `INSERT` and `UPDATE` operations. This makes `AUTO_INCREMENT` columns faster (at least 10%). Values at the top of the sequence are not reused after being deleted. (When an `AUTO_INCREMENT` column is defined as the last column of a multiple-column index, reuse of values deleted from the top of a sequence does occur.) The `AUTO_INCREMENT` value can be reset with `ALTER TABLE` or `myisamchk`.
- Dynamic-sized rows are much less fragmented when mixing deletes with updates and inserts. This is done by automatically combining adjacent deleted blocks and by extending blocks if the next block is deleted.
- `MyISAM` supports concurrent inserts: If a table has no free blocks in the middle of the data file, you can `INSERT` new rows into it at the same time that other threads are reading from the table. A free block can occur as a result of deleting rows or an update of a dynamic length row with more data than its current contents. When all free blocks are used up (filled in), future inserts become concurrent again. See [Section 8.11.3, “Concurrent Inserts”](#).
- You can put the data file and index file in different directories on different physical devices to get more speed with the `DATA DIRECTORY` and `INDEX DIRECTORY` table options to `CREATE TABLE`. See [Section 13.1.18, “CREATE TABLE Statement”](#).
- `BLOB` and `TEXT` columns can be indexed.
- `NULL` values are permitted in indexed columns. This takes 0 to 1 bytes per key.
- Each character column can have a different character set. See [Chapter 10, Character Sets, Collations, Unicode](#).
- There is a flag in the `MyISAM` index file that indicates whether the table was closed correctly. If `mysqld` is started with the `myisam_recover_options` system variable set, `MyISAM` tables are automatically checked when opened, and are repaired if the table wasn't closed properly.
- `myisamchk` marks tables as checked if you run it with the `--update-state` option. `myisamchk --fast` checks only those tables that don't have this mark.
- `myisamchk --analyze` stores statistics for portions of keys, as well as for entire keys.
- `myisampack` can pack `BLOB` and `VARCHAR` columns.

`MyISAM` also supports the following features:

- Support for a true `VARCHAR` type; a `VARCHAR` column starts with a length stored in one or two bytes.

- Tables with `VARCHAR` columns may have fixed or dynamic row length.
- The sum of the lengths of the `VARCHAR` and `CHAR` columns in a table may be up to 64KB.
- Arbitrary length `UNIQUE` constraints.

## Additional Resources

- A forum dedicated to the `MyISAM` storage engine is available at <https://forums.mysql.com/list.php?21>.

### 15.2.1 MyISAM Startup Options

The following options to `mysqld` can be used to change the behavior of `MyISAM` tables. For additional information, see [Section 5.1.6, “Server Command Options”](#).

**Table 15.3 MyISAM Option and Variable Reference**

Name	Cmd-Line	Option File	System Var	Status Var	Var Scope	Dynamic
<code>bulk_insert_buffer_size</code>	Yes	Yes	Yes		Both	Yes
<code>concurrent_insert</code>	Yes	Yes	Yes		Global	Yes
<code>delay_key_write</code>	Yes	Yes	Yes		Global	Yes
<code>have_rtree_keys</code>			Yes		Global	No
<code>key_buffer_size</code>	Yes	Yes	Yes		Global	Yes
<code>log-isam</code>	Yes	Yes				
<code>myisam-block-size</code>	Yes	Yes				
<code>myisam_data_pointer_size</code>	Yes	Yes	Yes		Global	Yes
<code>myisam_max_size_of_index</code>	Yes	Yes	Yes		Global	Yes
<code>myisam_mmap_size</code>	Yes	Yes	Yes		Global	No
<code>myisam_recover_options</code>	Yes	Yes	Yes		Global	No
<code>myisam_repair_threads</code>	Yes	Yes	Yes		Both	Yes
<code>myisam_sort_buffer_size</code>	Yes	Yes	Yes		Both	Yes
<code>myisam_stats_method</code>	Yes	Yes	Yes		Both	Yes
<code>myisam_use_mmap</code>	Yes	Yes	Yes		Global	Yes
<code>tmp_table_size</code>	Yes	Yes	Yes		Both	Yes

The following system variables affect the behavior of `MyISAM` tables. For additional information, see [Section 5.1.7, “Server System Variables”](#).

- `bulk_insert_buffer_size`

The size of the tree cache used in bulk insert optimization.



#### Note

This is a limit *per thread*!

- `delay_key_write=ALL`

Don't flush key buffers between writes for any `MyISAM` table.



**Note**

If you do this, you should not access `MyISAM` tables from another program (such as from another MySQL server or with `myisamchk`) when the tables are in use. Doing so risks index corruption. Using `--external-locking` does not eliminate this risk.

- `myisam_max_sort_file_size`

The maximum size of the temporary file that MySQL is permitted to use while re-creating a `MyISAM` index (during `REPAIR TABLE`, `ALTER TABLE`, or `LOAD DATA`). If the file size would be larger than this value, the index is created using the key cache instead, which is slower. The value is given in bytes.

- `myisam_recover_options=mode`

Set the mode for automatic recovery of crashed `MyISAM` tables.

- `myisam_sort_buffer_size`

Set the size of the buffer used when recovering tables.

Automatic recovery is activated if you start `mysqld` with the `myisam_recover_options` system variable set. In this case, when the server opens a `MyISAM` table, it checks whether the table is marked as crashed or whether the open count variable for the table is not 0 and you are running the server with external locking disabled. If either of these conditions is true, the following happens:

- The server checks the table for errors.
- If the server finds an error, it tries to do a fast table repair (with sorting and without re-creating the data file).
- If the repair fails because of an error in the data file (for example, a duplicate-key error), the server tries again, this time re-creating the data file.
- If the repair still fails, the server tries once more with the old repair option method (write row by row without sorting). This method should be able to repair any type of error and has low disk space requirements.

If the recovery wouldn't be able to recover all rows from previously completed statements and you didn't specify `FORCE` in the value of the `myisam_recover_options` system variable, automatic repair aborts with an error message in the error log:

```
Error: Couldn't repair table: test.g00pages
```

If you specify `FORCE`, a warning like this is written instead:

```
Warning: Found 344 of 354 rows when repairing ./test/g00pages
```

If the automatic recovery value includes `BACKUP`, the recovery process creates files with names of the form `tbl_name-datetime.BAK`. You should have a `cron` script that automatically moves these files from the database directories to backup media.

## 15.2.2 Space Needed for Keys

`MyISAM` tables use B-tree indexes. You can roughly calculate the size for the index file as  $(key\_length + 4) / 0.67$ , summed over all keys. This is for the worst case when all keys are inserted in sorted order and the table does not have any compressed keys.

String indexes are space compressed. If the first index part is a string, it is also prefix compressed. Space compression makes the index file smaller than the worst-case figure if a string column has a lot of trailing space or is a `VARCHAR` column that is not always used to the full length. Prefix compression is used on keys that start with a string. Prefix compression helps if there are many strings with an identical prefix.

In `MyISAM` tables, you can also prefix compress numbers by specifying the `PACK_KEYS=1` table option when you create the table. Numbers are stored with the high byte first, so this helps when you have many integer keys that have an identical prefix.

## 15.2.3 MyISAM Table Storage Formats

`MyISAM` supports three different storage formats. Two of them, fixed and dynamic format, are chosen automatically depending on the type of columns you are using. The third, compressed format, can be created only with the `myisampack` utility (see [Section 4.6.5, “myisampack — Generate Compressed, Read-Only MyISAM Tables”](#)).

When you use `CREATE TABLE` or `ALTER TABLE` for a table that has no `BLOB` or `TEXT` columns, you can force the table format to `FIXED` or `DYNAMIC` with the `ROW_FORMAT` table option.

See [Section 13.1.18, “CREATE TABLE Statement”](#), for information about `ROW_FORMAT`.

You can decompress (unpack) compressed `MyISAM` tables using `myisamchk --unpack`; see [Section 4.6.3, “myisamchk — MyISAM Table-Maintenance Utility”](#), for more information.

### 15.2.3.1 Static (Fixed-Length) Table Characteristics

Static format is the default for `MyISAM` tables. It is used when the table contains no variable-length columns (`VARCHAR`, `VARBINARY`, `BLOB`, or `TEXT`). Each row is stored using a fixed number of bytes.

Of the three `MyISAM` storage formats, static format is the simplest and most secure (least subject to corruption). It is also the fastest of the on-disk formats due to the ease with which rows in the data file can be found on disk: To look up a row based on a row number in the index, multiply the row number by the row length to calculate the row position. Also, when scanning a table, it is very easy to read a constant number of rows with each disk read operation.

The security is evidenced if your computer crashes while the MySQL server is writing to a fixed-format `MyISAM` file. In this case, `myisamchk` can easily determine where each row starts and ends, so it can usually reclaim all rows except the partially written one. `MyISAM` table indexes can always be reconstructed based on the data rows.



#### Note

Fixed-length row format is only available for tables without `BLOB` or `TEXT` columns. Creating a table with these columns with an explicit `ROW_FORMAT` clause does not raise an error or warning; the format specification is ignored.

Static-format tables have these characteristics:

- `CHAR` and `VARCHAR` columns are space-padded to the specified column width, although the column type is not altered. `BINARY` and `VARBINARY` columns are padded with `0x00` bytes to the column width.
- `NULL` columns require additional space in the row to record whether their values are `NULL`. Each `NULL` column takes one bit extra, rounded up to the nearest byte.
- Very quick.
- Easy to cache.

- Easy to reconstruct after a crash, because rows are located in fixed positions.
- Reorganization is unnecessary unless you delete a huge number of rows and want to return free disk space to the operating system. To do this, use `OPTIMIZE TABLE` or `myisamchk -r`.
- Usually require more disk space than dynamic-format tables.
- The expected row length in bytes for static-sized rows is calculated using the following expression:

```
row length = 1
             + (sum of column lengths)
             + (number of NULL columns + delete_flag + 7) / 8
             + (number of variable-length columns)
```

`delete_flag` is 1 for tables with static row format. Static tables use a bit in the row record for a flag that indicates whether the row has been deleted. `delete_flag` is 0 for dynamic tables because the flag is stored in the dynamic row header.

### 15.2.3.2 Dynamic Table Characteristics

Dynamic storage format is used if a MyISAM table contains any variable-length columns (`VARCHAR`, `VARBINARY`, `BLOB`, or `TEXT`), or if the table was created with the `ROW_FORMAT=DYNAMIC` table option.

Dynamic format is a little more complex than static format because each row has a header that indicates how long it is. A row can become fragmented (stored in noncontiguous pieces) when it is made longer as a result of an update.

You can use `OPTIMIZE TABLE` or `myisamchk -r` to defragment a table. If you have fixed-length columns that you access or change frequently in a table that also contains some variable-length columns, it might be a good idea to move the variable-length columns to other tables just to avoid fragmentation.

Dynamic-format tables have these characteristics:

- All string columns are dynamic except those with a length less than four.
- Each row is preceded by a bitmap that indicates which columns contain the empty string (for string columns) or zero (for numeric columns). This does not include columns that contain `NULL` values. If a string column has a length of zero after trailing space removal, or a numeric column has a value of zero, it is marked in the bitmap and not saved to disk. Nonempty strings are saved as a length byte plus the string contents.
- `NULL` columns require additional space in the row to record whether their values are `NULL`. Each `NULL` column takes one bit extra, rounded up to the nearest byte.
- Much less disk space usually is required than for fixed-length tables.
- Each row uses only as much space as is required. However, if a row becomes larger, it is split into as many pieces as are required, resulting in row fragmentation. For example, if you update a row with information that extends the row length, the row becomes fragmented. In this case, you may have to run `OPTIMIZE TABLE` or `myisamchk -r` from time to time to improve performance. Use `myisamchk -ei` to obtain table statistics.
- More difficult than static-format tables to reconstruct after a crash, because rows may be fragmented into many pieces and links (fragments) may be missing.
- The expected row length for dynamic-sized rows is calculated using the following expression:

```
3
+ (number of columns + 7) / 8
```

```
+ (number of char columns)
+ (packed size of numeric columns)
+ (length of strings)
+ (number of NULL columns + 7) / 8
```

There is a penalty of 6 bytes for each link. A dynamic row is linked whenever an update causes an enlargement of the row. Each new link is at least 20 bytes, so the next enlargement probably goes in the same link. If not, another link is created. You can find the number of links using `myisamchk -ed`. All links may be removed with `OPTIMIZE TABLE` or `myisamchk -r`.

### 15.2.3.3 Compressed Table Characteristics

Compressed storage format is a read-only format that is generated with the `mysampack` tool. Compressed tables can be uncompressed with `myisamchk`.

Compressed tables have the following characteristics:

- Compressed tables take very little disk space. This minimizes disk usage, which is helpful when using slow disks (such as CD-ROMs).
- Each row is compressed separately, so there is very little access overhead. The header for a row takes up one to three bytes depending on the biggest row in the table. Each column is compressed differently. There is usually a different Huffman tree for each column. Some of the compression types are:
  - Suffix space compression.
  - Prefix space compression.
  - Numbers with a value of zero are stored using one bit.
  - If values in an integer column have a small range, the column is stored using the smallest possible type. For example, a `BIGINT` column (eight bytes) can be stored as a `TINYINT` column (one byte) if all its values are in the range from `-128` to `127`.
  - If a column has only a small set of possible values, the data type is converted to `ENUM`.
  - A column may use any combination of the preceding compression types.
- Can be used for fixed-length or dynamic-length rows.



#### Note

While a compressed table is read only, and you cannot therefore update or add rows in the table, DDL (Data Definition Language) operations are still valid. For example, you may still use `DROP` to drop the table, and `TRUNCATE TABLE` to empty the table.

## 15.2.4 MyISAM Table Problems

The file format that MySQL uses to store data has been extensively tested, but there are always circumstances that may cause database tables to become corrupted. The following discussion describes how this can happen and how to handle it.

### 15.2.4.1 Corrupted MyISAM Tables

Even though the `MyISAM` table format is very reliable (all changes to a table made by an SQL statement are written before the statement returns), you can still get corrupted tables if any of the following events occur:

- The `mysqld` process is killed in the middle of a write.
- An unexpected computer shutdown occurs (for example, the computer is turned off).
- Hardware failures.
- You are using an external program (such as `myisamchk`) to modify a table that is being modified by the server at the same time.
- A software bug in the MySQL or MyISAM code.

Typical symptoms of a corrupt table are:

- You get the following error while selecting data from the table:

```
Incorrect key file for table: '...'. Try to repair it
```

- Queries don't find rows in the table or return incomplete results.

You can check the health of a MyISAM table using the `CHECK TABLE` statement, and repair a corrupted MyISAM table with `REPAIR TABLE`. When `mysqld` is not running, you can also check or repair a table with the `myisamchk` command. See [Section 13.7.2.2, “CHECK TABLE Statement”](#), [Section 13.7.2.5, “REPAIR TABLE Statement”](#), and [Section 4.6.3, “myisamchk — MyISAM Table-Maintenance Utility”](#).

If your tables become corrupted frequently, you should try to determine why this is happening. The most important thing to know is whether the table became corrupted as a result of an unexpected server exit. You can verify this easily by looking for a recent `restarted mysqld` message in the error log. If there is such a message, it is likely that table corruption is a result of the server dying. Otherwise, corruption may have occurred during normal operation. This is a bug. You should try to create a reproducible test case that demonstrates the problem. See [Section B.3.3.3, “What to Do If MySQL Keeps Crashing”](#), and [Section 5.8, “Debugging MySQL”](#).

#### 15.2.4.2 Problems from Tables Not Being Closed Properly

Each MyISAM index file (`.MYI` file) has a counter in the header that can be used to check whether a table has been closed properly. If you get the following warning from `CHECK TABLE` or `myisamchk`, it means that this counter has gone out of sync:

```
clients are using or haven't closed the table properly
```

This warning does not necessarily mean that the table is corrupted, but you should at least check the table.

The counter works as follows:

- The first time a table is updated in MySQL, a counter in the header of the index files is incremented.
- The counter is not changed during further updates.
- When the last instance of a table is closed (because a `FLUSH TABLES` operation was performed or because there is no room in the table cache), the counter is decremented if the table has been updated at any point.
- When you repair the table or check the table and it is found to be okay, the counter is reset to zero.
- To avoid problems with interaction with other processes that might check the table, the counter is not decremented on close if it was zero.

In other words, the counter can become incorrect only under these conditions:

- A `MyISAM` table is copied without first issuing `LOCK TABLES` and `FLUSH TABLES`.
- MySQL has crashed between an update and the final close. (The table may still be okay because MySQL always issues writes for everything between each statement.)
- A table was modified by `myisamchk --recover` or `myisamchk --update-state` at the same time that it was in use by `mysqld`.
- Multiple `mysqld` servers are using the table and one server performed a `REPAIR TABLE` or `CHECK TABLE` on the table while it was in use by another server. In this setup, it is safe to use `CHECK TABLE`, although you might get the warning from other servers. However, `REPAIR TABLE` should be avoided because when one server replaces the data file with a new one, this is not known to the other servers.

In general, it is a bad idea to share a data directory among multiple servers. See [Section 5.7, “Running Multiple MySQL Instances on One Machine”](#), for additional discussion.

## 15.3 The MEMORY Storage Engine

The `MEMORY` storage engine (formerly known as `HEAP`) creates special-purpose tables with contents that are stored in memory. Because the data is vulnerable to crashes, hardware issues, or power outages, only use these tables as temporary work areas or read-only caches for data pulled from other tables.

**Table 15.4 MEMORY Storage Engine Features**

Feature	Support
<b>B-tree indexes</b>	Yes
<b>Backup/point-in-time recovery</b> (Implemented in the server, rather than in the storage engine.)	Yes
<b>Cluster database support</b>	No
<b>Clustered indexes</b>	No
<b>Compressed data</b>	No
<b>Data caches</b>	N/A
<b>Encrypted data</b>	Yes (Implemented in the server via encryption functions.)
<b>Foreign key support</b>	No
<b>Full-text search indexes</b>	No
<b>Geospatial data type support</b>	No
<b>Geospatial indexing support</b>	No
<b>Hash indexes</b>	Yes
<b>Index caches</b>	N/A
<b>Locking granularity</b>	Table
<b>MVCC</b>	No
<b>Replication support</b> (Implemented in the server, rather than in the storage engine.)	Limited (See the discussion later in this section.)
<b>Storage limits</b>	RAM
<b>T-tree indexes</b>	No
<b>Transactions</b>	No

Feature	Support
Update statistics for data dictionary	Yes

- [When to Use MEMORY or NDB Cluster](#)
- [Performance Characteristics](#)
- [Characteristics of MEMORY Tables](#)
- [DDL Operations for MEMORY Tables](#)
- [Indexes](#)
- [User-Created and Temporary Tables](#)
- [Loading Data](#)
- [MEMORY Tables and Replication](#)
- [Managing Memory Use](#)
- [Additional Resources](#)

## When to Use MEMORY or NDB Cluster

Developers looking to deploy applications that use the [MEMORY](#) storage engine for important, highly available, or frequently updated data should consider whether NDB Cluster is a better choice. A typical use case for the [MEMORY](#) engine involves these characteristics:

- Operations involving transient, non-critical data such as session management or caching. When the MySQL server halts or restarts, the data in [MEMORY](#) tables is lost.
- In-memory storage for fast access and low latency. Data volume can fit entirely in memory without causing the operating system to swap out virtual memory pages.
- A read-only or read-mostly data access pattern (limited updates).

NDB Cluster offers the same features as the [MEMORY](#) engine with higher performance levels, and provides additional features not available with [MEMORY](#):

- Row-level locking and multiple-thread operation for low contention between clients.
- Scalability even with statement mixes that include writes.
- Optional disk-backed operation for data durability.
- Shared-nothing architecture and multiple-host operation with no single point of failure, enabling 99.999% availability.
- Automatic data distribution across nodes; application developers need not craft custom sharding or partitioning solutions.
- Support for variable-length data types (including [BLOB](#) and [TEXT](#)) not supported by [MEMORY](#).

## Performance Characteristics

[MEMORY](#) performance is constrained by contention resulting from single-thread execution and table lock overhead when processing updates. This limits scalability when load increases, particularly for statement mixes that include writes.

Despite the in-memory processing for `MEMORY` tables, they are not necessarily faster than `InnoDB` tables on a busy server, for general-purpose queries, or under a read/write workload. In particular, the table locking involved with performing updates can slow down concurrent usage of `MEMORY` tables from multiple sessions.

Depending on the kinds of queries performed on a `MEMORY` table, you might create indexes as either the default hash data structure (for looking up single values based on a unique key), or a general-purpose B-tree data structure (for all kinds of queries involving equality, inequality, or range operators such as less than or greater than). The following sections illustrate the syntax for creating both kinds of indexes. A common performance issue is using the default hash indexes in workloads where B-tree indexes are more efficient.

## Characteristics of MEMORY Tables

The `MEMORY` storage engine associates each table with one disk file, which stores the table definition (not the data). The file name begins with the table name and has an extension of `.frm`.

`MEMORY` tables have the following characteristics:

- Space for `MEMORY` tables is allocated in small blocks. Tables use 100% dynamic hashing for inserts. No overflow area or extra key space is needed. No extra space is needed for free lists. Deleted rows are put in a linked list and are reused when you insert new data into the table. `MEMORY` tables also have none of the problems commonly associated with deletes plus inserts in hashed tables.
- `MEMORY` tables use a fixed-length row-storage format. Variable-length types such as `VARCHAR` are stored using a fixed length.
- `MEMORY` tables cannot contain `BLOB` or `TEXT` columns.
- `MEMORY` includes support for `AUTO_INCREMENT` columns.
- Non-`TEMPORARY MEMORY` tables are shared among all clients, just like any other non-`TEMPORARY` table.

## DDL Operations for MEMORY Tables

To create a `MEMORY` table, specify the clause `ENGINE=MEMORY` on the `CREATE TABLE` statement.

```
CREATE TABLE t (i INT) ENGINE = MEMORY;
```

As indicated by the engine name, `MEMORY` tables are stored in memory. They use hash indexes by default, which makes them very fast for single-value lookups, and very useful for creating temporary tables. However, when the server shuts down, all rows stored in `MEMORY` tables are lost. The tables themselves continue to exist because their definitions are stored in `.frm` files on disk, but they are empty when the server restarts.

This example shows how you might create, use, and remove a `MEMORY` table:

```
mysql> CREATE TABLE test ENGINE=MEMORY
      SELECT ip,SUM(downloads) AS down
      FROM log_table GROUP BY ip;
mysql> SELECT COUNT(ip),AVG(down) FROM test;
mysql> DROP TABLE test;
```

The maximum size of `MEMORY` tables is limited by the `max_heap_table_size` system variable, which has a default value of 16MB. To enforce different size limits for `MEMORY` tables, change the value of this variable. The value in effect for `CREATE TABLE`, or a subsequent `ALTER TABLE` or `TRUNCATE TABLE`,



is the value used for the life of the table. A server restart also sets the maximum size of existing `MEMORY` tables to the global `max_heap_table_size` value. You can set the size for individual tables as described later in this section.

## Indexes

The `MEMORY` storage engine supports both `HASH` and `BTREE` indexes. You can specify one or the other for a given index by adding a `USING` clause as shown here:

```
CREATE TABLE lookup
  (id INT, INDEX USING HASH (id))
ENGINE = MEMORY;
CREATE TABLE lookup
  (id INT, INDEX USING BTREE (id))
ENGINE = MEMORY;
```

For general characteristics of B-tree and hash indexes, see [Section 8.3.1, “How MySQL Uses Indexes”](#).

`MEMORY` tables can have up to 64 indexes per table, 16 columns per index and a maximum key length of 3072 bytes.

If a `MEMORY` table hash index has a high degree of key duplication (many index entries containing the same value), updates to the table that affect key values and all deletes are significantly slower. The degree of this slowdown is proportional to the degree of duplication (or, inversely proportional to the index cardinality). You can use a `BTREE` index to avoid this problem.

`MEMORY` tables can have nonunique keys. (This is an uncommon feature for implementations of hash indexes.)

Columns that are indexed can contain `NULL` values.

## User-Created and Temporary Tables

`MEMORY` table contents are stored in memory, which is a property that `MEMORY` tables share with internal temporary tables that the server creates on the fly while processing queries. However, the two types of tables differ in that `MEMORY` tables are not subject to storage conversion, whereas internal temporary tables are:

- If an internal temporary table becomes too large, the server automatically converts it to on-disk storage, as described in [Section 8.4.4, “Internal Temporary Table Use in MySQL”](#).
- User-created `MEMORY` tables are never converted to disk tables.

## Loading Data

To populate a `MEMORY` table when the MySQL server starts, you can use the `init_file` system variable. For example, you can put statements such as `INSERT INTO ... SELECT` or `LOAD DATA` into a file to load the table from a persistent data source, and use `init_file` to name the file. See [Section 5.1.7, “Server System Variables”](#), and [Section 13.2.6, “LOAD DATA Statement”](#).

## MEMORY Tables and Replication

When a replication source server shuts down and restarts, its `MEMORY` tables become empty. To replicate this effect to replicas, the first time that the source uses a given `MEMORY` table after startup, it logs an event that notifies replicas that the table must be emptied by writing a `DELETE` or (from MySQL 5.7.32)

`TRUNCATE TABLE` statement for that table to the binary log. When a replica server shuts down and restarts, its `MEMORY` tables also become empty, and it writes a `DELETE` or (from MySQL 5.7.32) `TRUNCATE TABLE` statement to its own binary log, which is passed on to any downstream replicas.

When you use `MEMORY` tables in a replication topology, in some situations, the table on the source and the table on the replica may differ. For information on handling each of these situations to prevent stale reads or errors, see [Section 16.4.1.20, “Replication and MEMORY Tables”](#).

## Managing Memory Use

The server needs sufficient memory to maintain all `MEMORY` tables that are in use at the same time.

Memory is not reclaimed if you delete individual rows from a `MEMORY` table. Memory is reclaimed only when the entire table is deleted. Memory that was previously used for deleted rows is re-used for new rows within the same table. To free all the memory used by a `MEMORY` table when you no longer require its contents, execute `DELETE` or `TRUNCATE TABLE` to remove all rows, or remove the table altogether using `DROP TABLE`. To free up the memory used by deleted rows, use `ALTER TABLE ENGINE=MEMORY` to force a table rebuild.

The memory needed for one row in a `MEMORY` table is calculated using the following expression:

```
SUM_OVER_ALL_BTREE_KEYS(max_length_of_key + sizeof(char*) * 4)
+ SUM_OVER_ALL_HASH_KEYS(sizeof(char*) * 2)
+ ALIGN(length_of_row+1, sizeof(char*))
```

`ALIGN()` represents a round-up factor to cause the row length to be an exact multiple of the `char` pointer size. `sizeof(char*)` is 4 on 32-bit machines and 8 on 64-bit machines.

As mentioned earlier, the `max_heap_table_size` system variable sets the limit on the maximum size of `MEMORY` tables. To control the maximum size for individual tables, set the session value of this variable before creating each table. (Do not change the global `max_heap_table_size` value unless you intend the value to be used for `MEMORY` tables created by all clients.) The following example creates two `MEMORY` tables, with a maximum size of 1MB and 2MB, respectively:

```
mysql> SET max_heap_table_size = 1024*1024;
Query OK, 0 rows affected (0.00 sec)

mysql> CREATE TABLE t1 (id INT, UNIQUE(id)) ENGINE = MEMORY;
Query OK, 0 rows affected (0.01 sec)

mysql> SET max_heap_table_size = 1024*1024*2;
Query OK, 0 rows affected (0.00 sec)

mysql> CREATE TABLE t2 (id INT, UNIQUE(id)) ENGINE = MEMORY;
Query OK, 0 rows affected (0.00 sec)
```

Both tables revert to the server's global `max_heap_table_size` value if the server restarts.

You can also specify a `MAX_ROWS` table option in `CREATE TABLE` statements for `MEMORY` tables to provide a hint about the number of rows you plan to store in them. This does not enable the table to grow beyond the `max_heap_table_size` value, which still acts as a constraint on maximum table size. For maximum flexibility in being able to use `MAX_ROWS`, set `max_heap_table_size` at least as high as the value to which you want each `MEMORY` table to be able to grow.

## Additional Resources

A forum dedicated to the `MEMORY` storage engine is available at <https://forums.mysql.com/list.php?92>.

## 15.4 The CSV Storage Engine

The `CSV` storage engine stores data in text files using comma-separated values format.

The `CSV` storage engine is always compiled into the MySQL server.

To examine the source for the `CSV` engine, look in the `storage/csv` directory of a MySQL source distribution.

When you create a `CSV` table, the server creates a table format file in the database directory. The file begins with the table name and has an `.frm` extension. The storage engine also creates plain text data file having a name that begins with the table name and has a `.CSV` extension. When you store data into the table, the storage engine saves it into the data file in comma-separated values format.

```
mysql> CREATE TABLE test (i INT NOT NULL, c CHAR(10) NOT NULL)
ENGINE = CSV;
Query OK, 0 rows affected (0.06 sec)

mysql> INSERT INTO test VALUES(1,'record one'),(2,'record two');
Query OK, 2 rows affected (0.05 sec)
Records: 2 Duplicates: 0 Warnings: 0

mysql> SELECT * FROM test;
+-----+
| i | c          |
+-----+
| 1 | record one |
| 2 | record two |
+-----+
2 rows in set (0.00 sec)
```

Creating a `CSV` table also creates a corresponding metafile that stores the state of the table and the number of rows that exist in the table. The name of this file is the same as the name of the table with the extension `CSM`.

If you examine the `test.CSV` file in the database directory created by executing the preceding statements, its contents should look like this:

```
"1","record one"
"2","record two"
```

This format can be read, and even written, by spreadsheet applications such as Microsoft Excel.

### 15.4.1 Repairing and Checking CSV Tables

The `CSV` storage engine supports the `CHECK TABLE` and `REPAIR TABLE` statements to verify and, if possible, repair a damaged `CSV` table.

When running the `CHECK TABLE` statement, the `CSV` file is checked for validity by looking for the correct field separators, escaped fields (matching or missing quotation marks), the correct number of fields compared to the table definition and the existence of a corresponding `CSV` metafile. The first invalid row discovered reports an error. Checking a valid table produces output like that shown below:

```
mysql> CHECK TABLE csvtest;
+-----+-----+-----+-----+
| Table          | Op    | Msg_type | Msg_text |
+-----+-----+-----+-----+
| test.csvtest  | check | status   | OK       |
+-----+-----+-----+-----+
```

A check on a corrupted table returns a fault such as

```
mysql> CHECK TABLE csvtest;
+-----+-----+-----+-----+
| Table      | Op    | Msg_type | Msg_text |
+-----+-----+-----+-----+
| test.csvtest | check | error    | Corrupt  |
+-----+-----+-----+-----+
```

To repair a table, use `REPAIR TABLE`, which copies as many valid rows from the existing CSV data as possible, and then replaces the existing CSV file with the recovered rows. Any rows beyond the corrupted data are lost.

```
mysql> REPAIR TABLE csvtest;
+-----+-----+-----+-----+
| Table      | Op    | Msg_type | Msg_text |
+-----+-----+-----+-----+
| test.csvtest | repair | status   | OK       |
+-----+-----+-----+-----+
```



**Warning**

During repair, only the rows from the CSV file up to the first damaged row are copied to the new table. All other rows from the first damaged row to the end of the table are removed, even valid rows.

### 15.4.2 CSV Limitations

The CSV storage engine does not support indexing.

Partitioning is not supported for tables using the CSV storage engine.

All tables that you create using the CSV storage engine must have the `NOT NULL` attribute on all columns.

## 15.5 The ARCHIVE Storage Engine

The ARCHIVE storage engine produces special-purpose tables that store large amounts of unindexed data in a very small footprint.

**Table 15.5 ARCHIVE Storage Engine Features**

Feature	Support
<b>B-tree indexes</b>	No
<b>Backup/point-in-time recovery</b> (Implemented in the server, rather than in the storage engine.)	Yes
<b>Cluster database support</b>	No
<b>Clustered indexes</b>	No
<b>Compressed data</b>	Yes
<b>Data caches</b>	No
<b>Encrypted data</b>	Yes (Implemented in the server via encryption functions.)
<b>Foreign key support</b>	No
<b>Full-text search indexes</b>	No

Feature	Support
Geospatial data type support	Yes
Geospatial indexing support	No
Hash indexes	No
Index caches	No
Locking granularity	Row
MVCC	No
Replication support (Implemented in the server, rather than in the storage engine.)	Yes
Storage limits	None
T-tree indexes	No
Transactions	No
Update statistics for data dictionary	Yes

The [ARCHIVE](#) storage engine is included in MySQL binary distributions. To enable this storage engine if you build MySQL from source, invoke `CMake` with the `-DWITH_ARCHIVE_STORAGE_ENGINE` option.

To examine the source for the [ARCHIVE](#) engine, look in the `storage/archive` directory of a MySQL source distribution.

You can check whether the [ARCHIVE](#) storage engine is available with the `SHOW ENGINES` statement.

When you create an [ARCHIVE](#) table, the server creates a table format file in the database directory. The file begins with the table name and has an `.frm` extension. The storage engine creates other files, all having names beginning with the table name. The data file has an extension of `.ARZ`. An `.ARN` file may appear during optimization operations.

The [ARCHIVE](#) engine supports `INSERT`, `REPLACE`, and `SELECT`, but not `DELETE` or `UPDATE`. It does support `ORDER BY` operations, `BLOB` columns, and basically all data types including spatial data types (see [Section 11.4.1, “Spatial Data Types”](#)). Geographic spatial reference systems are not supported. The [ARCHIVE](#) engine uses row-level locking.

The [ARCHIVE](#) engine supports the `AUTO_INCREMENT` column attribute. The `AUTO_INCREMENT` column can have either a unique or nonunique index. Attempting to create an index on any other column results in an error. The [ARCHIVE](#) engine also supports the `AUTO_INCREMENT` table option in `CREATE TABLE` statements to specify the initial sequence value for a new table or reset the sequence value for an existing table, respectively.

[ARCHIVE](#) does not support inserting a value into an `AUTO_INCREMENT` column less than the current maximum column value. Attempts to do so result in an `ER_DUP_KEY` error.

The [ARCHIVE](#) engine ignores `BLOB` columns if they are not requested and scans past them while reading.

**Storage:** Rows are compressed as they are inserted. The [ARCHIVE](#) engine uses `zlib` lossless data compression (see <http://www.zlib.net/>). You can use `OPTIMIZE TABLE` to analyze the table and pack it into a smaller format (for a reason to use `OPTIMIZE TABLE`, see later in this section). The engine also supports `CHECK TABLE`. There are several types of insertions that are used:

- An `INSERT` statement just pushes rows into a compression buffer, and that buffer flushes as necessary. The insertion into the buffer is protected by a lock. A `SELECT` forces a flush to occur.

- A bulk insert is visible only after it completes, unless other inserts occur at the same time, in which case it can be seen partially. A `SELECT` never causes a flush of a bulk insert unless a normal insert occurs while it is loading.

**Retrieval:** On retrieval, rows are uncompressed on demand; there is no row cache. A `SELECT` operation performs a complete table scan: When a `SELECT` occurs, it finds out how many rows are currently available and reads that number of rows. `SELECT` is performed as a consistent read. Note that lots of `SELECT` statements during insertion can deteriorate the compression, unless only bulk or delayed inserts are used. To achieve better compression, you can use `OPTIMIZE TABLE` or `REPAIR TABLE`. The number of rows in `ARCHIVE` tables reported by `SHOW TABLE STATUS` is always accurate. See [Section 13.7.2.4, “OPTIMIZE TABLE Statement”](#), [Section 13.7.2.5, “REPAIR TABLE Statement”](#), and [Section 13.7.5.36, “SHOW TABLE STATUS Statement”](#).

## Additional Resources

- A forum dedicated to the `ARCHIVE` storage engine is available at <https://forums.mysql.com/list.php?112>.

## 15.6 The BLACKHOLE Storage Engine

The `BLACKHOLE` storage engine acts as a “black hole” that accepts data but throws it away and does not store it. Retrievals always return an empty result:

```
mysql> CREATE TABLE test(i INT, c CHAR(10)) ENGINE = BLACKHOLE;
Query OK, 0 rows affected (0.03 sec)

mysql> INSERT INTO test VALUES(1,'record one'),(2,'record two');
Query OK, 2 rows affected (0.00 sec)
Records: 2 Duplicates: 0 Warnings: 0

mysql> SELECT * FROM test;
Empty set (0.00 sec)
```

To enable the `BLACKHOLE` storage engine if you build MySQL from source, invoke `CMake` with the `-DWITH_BLACKHOLE_STORAGE_ENGINE` option.

To examine the source for the `BLACKHOLE` engine, look in the `sql` directory of a MySQL source distribution.

When you create a `BLACKHOLE` table, the server creates a table format file in the database directory. The file begins with the table name and has an `.frm` extension. There are no other files associated with the table.

The `BLACKHOLE` storage engine supports all kinds of indexes. That is, you can include index declarations in the table definition.

The maximum key length is 1000 bytes.

You can check whether the `BLACKHOLE` storage engine is available with the `SHOW ENGINES` statement.

Inserts into a `BLACKHOLE` table do not store any data, but if statement based binary logging is enabled, the SQL statements are logged and replicated to replica servers. This can be useful as a repeater or filter mechanism.

Suppose that your application requires replica-side filtering rules, but transferring all binary log data to the replica first results in too much traffic. In such a case, it is possible to set up on the source host a “dummy” replica process whose default storage engine is `BLACKHOLE`, depicted as follows:

Figure 15.1 Replication using BLACKHOLE for Filtering

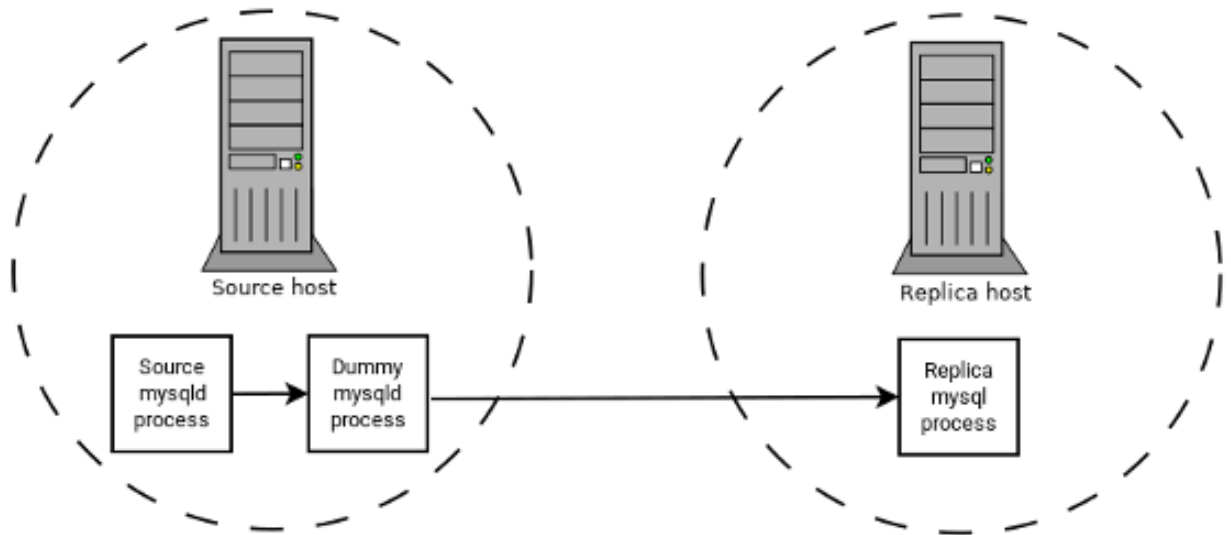

The source writes to its binary log. The “dummy” `mysqld` process acts as a replica, applying the desired combination of `replicate-do-*` and `replicate-ignore-*` rules, and writes a new, filtered binary log of its own. (See [Section 16.1.6, “Replication and Binary Logging Options and Variables”](#).) This filtered log is provided to the replica.

The dummy process does not actually store any data, so there is little processing overhead incurred by running the additional `mysqld` process on the replication source host. This type of setup can be repeated with additional replication replicas.

`INSERT` triggers for `BLACKHOLE` tables work as expected. However, because the `BLACKHOLE` table does not actually store any data, `UPDATE` and `DELETE` triggers are not activated: The `FOR EACH ROW` clause in the trigger definition does not apply because there are no rows.

Other possible uses for the `BLACKHOLE` storage engine include:

- Verification of dump file syntax.
- Measurement of the overhead from binary logging, by comparing performance using `BLACKHOLE` with and without binary logging enabled.
- `BLACKHOLE` is essentially a “no-op” storage engine, so it could be used for finding performance bottlenecks not related to the storage engine itself.

The `BLACKHOLE` engine is transaction-aware, in the sense that committed transactions are written to the binary log and rolled-back transactions are not.

### Blackhole Engine and Auto Increment Columns

The Blackhole engine is a no-op engine. Any operations performed on a table using `BLACKHOLE` have no effect. This should be borne in mind when considering the behavior of primary key columns that auto increment. The engine does not automatically increment field values, and does not retain auto increment column state. This has important implications in replication.

Consider the following replication scenario where all three of the following conditions apply:

1. On a source server there is a blackhole table with an auto increment field that is a primary key.
2. On a replica the same table exists but using the MyISAM engine.
3. Inserts are performed into the source's table without explicitly setting the auto increment value in the `INSERT` statement itself or through using a `SET INSERT_ID` statement.

In this scenario, replication fails with a duplicate entry error on the primary key column.

In statement based replication, the value of `INSERT_ID` in the context event is always the same. Replication therefore fails due to trying insert a row with a duplicate value for a primary key column.

In row based replication, the value that the engine returns for the row always be the same for each insert. This results in the replica attempting to replay two insert log entries using the same value for the primary key column, and so replication fails.

### Column Filtering

When using row-based replication, (`binlog_format=ROW`), a replica where the last columns are missing from a table is supported, as described in the section [Section 16.4.1.10, “Replication with Differing Table Definitions on Source and Replica”](#).

This filtering works on the replica side, that is, the columns are copied to the replica before they are filtered out. There are at least two cases where it is not desirable to copy the columns to the replica:

1. If the data is confidential, so the replica server should not have access to it.
2. If the source has many replicas, filtering before sending to the replicas may reduce network traffic.

Source column filtering can be achieved using the `BLACKHOLE` engine. This is carried out in a way similar to how source table filtering is achieved - by using the `BLACKHOLE` engine and the `--replicate-do-table` or `--replicate-ignore-table` option.

The setup for the source is:

```
CREATE TABLE t1 (public_col_1, ..., public_col_N,
                 secret_col_1, ..., secret_col_M) ENGINE=MyISAM;
```

The setup for the trusted replica is:

```
CREATE TABLE t1 (public_col_1, ..., public_col_N) ENGINE=BLACKHOLE;
```

The setup for the untrusted replica is:

```
CREATE TABLE t1 (public_col_1, ..., public_col_N) ENGINE=MyISAM;
```

## 15.7 The MERGE Storage Engine

The `MERGE` storage engine, also known as the `MRG_MyISAM` engine, is a collection of identical `MyISAM` tables that can be used as one. “Identical” means that all tables have identical column data types and index information. You cannot merge `MyISAM` tables in which the columns are listed in a different order, do not have exactly the same data types in corresponding columns, or have the indexes in different order. However, any or all of the `MyISAM` tables can be compressed with `myisampack`. See [Section 4.6.5, “myisampack — Generate Compressed, Read-Only MyISAM Tables”](#). Differences between tables such as these do not matter:



- Names of corresponding columns and indexes can differ.
- Comments for tables, columns, and indexes can differ.
- Table options such as `AVG_ROW_LENGTH`, `MAX_ROWS`, or `PACK_KEYS` can differ.

An alternative to a `MERGE` table is a partitioned table, which stores partitions of a single table in separate files. Partitioning enables some operations to be performed more efficiently and is not limited to the `MyISAM` storage engine. For more information, see [Chapter 22, Partitioning](#).

When you create a `MERGE` table, MySQL creates two files on disk. The files have names that begin with the table name and have an extension to indicate the file type. An `.frm` file stores the table format, and an `.MRG` file contains the names of the underlying `MyISAM` tables that should be used as one. The tables do not have to be in the same database as the `MERGE` table.

You can use `SELECT`, `DELETE`, `UPDATE`, and `INSERT` on `MERGE` tables. You must have `SELECT`, `DELETE`, and `UPDATE` privileges on the `MyISAM` tables that you map to a `MERGE` table.



### Note

The use of `MERGE` tables entails the following security issue: If a user has access to `MyISAM` table `t`, that user can create a `MERGE` table `m` that accesses `t`. However, if the user's privileges on `t` are subsequently revoked, the user can continue to access `t` by doing so through `m`.

Use of `DROP TABLE` with a `MERGE` table drops only the `MERGE` specification. The underlying tables are not affected.

To create a `MERGE` table, you must specify a `UNION=(list-of-tables)` option that indicates which `MyISAM` tables to use. You can optionally specify an `INSERT_METHOD` option to control how inserts into the `MERGE` table take place. Use a value of `FIRST` or `LAST` to cause inserts to be made in the first or last underlying table, respectively. If you specify no `INSERT_METHOD` option or if you specify it with a value of `NO`, inserts into the `MERGE` table are not permitted and attempts to do so result in an error.

The following example shows how to create a `MERGE` table:

```
mysql> CREATE TABLE t1 (
->   a INT NOT NULL AUTO_INCREMENT PRIMARY KEY,
->   message CHAR(20)) ENGINE=MyISAM;
mysql> CREATE TABLE t2 (
->   a INT NOT NULL AUTO_INCREMENT PRIMARY KEY,
->   message CHAR(20)) ENGINE=MyISAM;
mysql> INSERT INTO t1 (message) VALUES ('Testing'),('table'),('t1');
mysql> INSERT INTO t2 (message) VALUES ('Testing'),('table'),('t2');
mysql> CREATE TABLE total (
->   a INT NOT NULL AUTO_INCREMENT,
->   message CHAR(20), INDEX(a))
->   ENGINE=MERGE UNION=(t1,t2) INSERT_METHOD=LAST;
```

Column `a` is indexed as a `PRIMARY KEY` in the underlying `MyISAM` tables, but not in the `MERGE` table. There it is indexed but not as a `PRIMARY KEY` because a `MERGE` table cannot enforce uniqueness over the set of underlying tables. (Similarly, a column with a `UNIQUE` index in the underlying tables should be indexed in the `MERGE` table but not as a `UNIQUE` index.)

After creating the `MERGE` table, you can use it to issue queries that operate on the group of tables as a whole:

```
mysql> SELECT * FROM total;
```

```

+-----+
| a | message |
+-----+
| 1 | Testing |
| 2 | table   |
| 3 | t1      |
| 1 | Testing |
| 2 | table   |
| 3 | t2      |
+-----+

```

To remap a [MERGE](#) table to a different collection of [MyISAM](#) tables, you can use one of the following methods:

- [DROP](#) the [MERGE](#) table and re-create it.
- Use [ALTER TABLE \*tbl\\_name\* UNION=\(...\)](#) to change the list of underlying tables.

It is also possible to use [ALTER TABLE ... UNION=\(\)](#) (that is, with an empty [UNION](#) clause) to remove all of the underlying tables. However, in this case, the table is effectively empty and inserts fail because there is no underlying table to take new rows. Such a table might be useful as a template for creating new [MERGE](#) tables with [CREATE TABLE ... LIKE](#).

The underlying table definitions and indexes must conform closely to the definition of the [MERGE](#) table. Conformance is checked when a table that is part of a [MERGE](#) table is opened, not when the [MERGE](#) table is created. If any table fails the conformance checks, the operation that triggered the opening of the table fails. This means that changes to the definitions of tables within a [MERGE](#) may cause a failure when the [MERGE](#) table is accessed. The conformance checks applied to each table are:

- The underlying table and the [MERGE](#) table must have the same number of columns.
- The column order in the underlying table and the [MERGE](#) table must match.
- Additionally, the specification for each corresponding column in the parent [MERGE](#) table and the underlying tables are compared and must satisfy these checks:
  - The column type in the underlying table and the [MERGE](#) table must be equal.
  - The column length in the underlying table and the [MERGE](#) table must be equal.
  - The column of the underlying table and the [MERGE](#) table can be [NULL](#).
- The underlying table must have at least as many indexes as the [MERGE](#) table. The underlying table may have more indexes than the [MERGE](#) table, but cannot have fewer.



#### Note

A known issue exists where indexes on the same columns must be in identical order, in both the [MERGE](#) table and the underlying [MyISAM](#) table. See Bug #33653.

Each index must satisfy these checks:

- The index type of the underlying table and the [MERGE](#) table must be the same.
- The number of index parts (that is, multiple columns within a compound index) in the index definition for the underlying table and the [MERGE](#) table must be the same.
- For each index part:

- Index part lengths must be equal.
- Index part types must be equal.
- Index part languages must be equal.
- Check whether index parts can be `NULL`.

If a `MERGE` table cannot be opened or used because of a problem with an underlying table, `CHECK TABLE` displays information about which table caused the problem.

## Additional Resources

- A forum dedicated to the `MERGE` storage engine is available at <https://forums.mysql.com/list.php?93>.

### 15.7.1 MERGE Table Advantages and Disadvantages

`MERGE` tables can help you solve the following problems:

- Easily manage a set of log tables. For example, you can put data from different months into separate tables, compress some of them with `myisampack`, and then create a `MERGE` table to use them as one.
- Obtain more speed. You can split a large read-only table based on some criteria, and then put individual tables on different disks. A `MERGE` table structured this way could be much faster than using a single large table.
- Perform more efficient searches. If you know exactly what you are looking for, you can search in just one of the underlying tables for some queries and use a `MERGE` table for others. You can even have many different `MERGE` tables that use overlapping sets of tables.
- Perform more efficient repairs. It is easier to repair individual smaller tables that are mapped to a `MERGE` table than to repair a single large table.
- Instantly map many tables as one. A `MERGE` table need not maintain an index of its own because it uses the indexes of the individual tables. As a result, `MERGE` table collections are *very* fast to create or remap. (You must still specify the index definitions when you create a `MERGE` table, even though no indexes are created.)
- If you have a set of tables from which you create a large table on demand, you can instead create a `MERGE` table from them on demand. This is much faster and saves a lot of disk space.
- Exceed the file size limit for the operating system. Each `MyISAM` table is bound by this limit, but a collection of `MyISAM` tables is not.
- You can create an alias or synonym for a `MyISAM` table by defining a `MERGE` table that maps to that single table. There should be no really notable performance impact from doing this (only a couple of indirect calls and `memcpy()` calls for each read).

The disadvantages of `MERGE` tables are:

- You can use only identical `MyISAM` tables for a `MERGE` table.
- Some `MyISAM` features are unavailable in `MERGE` tables. For example, you cannot create `FULLTEXT` indexes on `MERGE` tables. (You can create `FULLTEXT` indexes on the underlying `MyISAM` tables, but you cannot search the `MERGE` table with a full-text search.)

- If the `MERGE` table is nontemporary, all underlying `MyISAM` tables must be nontemporary. If the `MERGE` table is temporary, the `MyISAM` tables can be any mix of temporary and nontemporary.
- `MERGE` tables use more file descriptors than `MyISAM` tables. If 10 clients are using a `MERGE` table that maps to 10 tables, the server uses  $(10 \times 10) + 10$  file descriptors. (10 data file descriptors for each of the 10 clients, and 10 index file descriptors shared among the clients.)
- Index reads are slower. When you read an index, the `MERGE` storage engine needs to issue a read on all underlying tables to check which one most closely matches a given index value. To read the next index value, the `MERGE` storage engine needs to search the read buffers to find the next value. Only when one index buffer is used up does the storage engine need to read the next index block. This makes `MERGE` indexes much slower on `eq_ref` searches, but not much slower on `ref` searches. For more information about `eq_ref` and `ref`, see [Section 13.8.2, “EXPLAIN Statement”](#).

## 15.7.2 MERGE Table Problems

The following are known problems with `MERGE` tables:

- `MERGE` child tables are locked through the parent table. If the parent is a temporary table, it is not locked, and thus the child tables are also not locked; this means that parallel use of the underlying `MyISAM` tables corrupts them.
- If you use `ALTER TABLE` to change a `MERGE` table to another storage engine, the mapping to the underlying tables is lost. Instead, the rows from the underlying `MyISAM` tables are copied into the altered table, which then uses the specified storage engine.
- The `INSERT_METHOD` table option for a `MERGE` table indicates which underlying `MyISAM` table to use for inserts into the `MERGE` table. However, use of the `AUTO_INCREMENT` table option for that `MyISAM` table has no effect for inserts into the `MERGE` table until at least one row has been inserted directly into the `MyISAM` table.
- A `MERGE` table cannot maintain uniqueness constraints over the entire table. When you perform an `INSERT`, the data goes into the first or last `MyISAM` table (as determined by the `INSERT_METHOD` option). MySQL ensures that unique key values remain unique within that `MyISAM` table, but not over all the underlying tables in the collection.
- Because the `MERGE` engine cannot enforce uniqueness over the set of underlying tables, `REPLACE` does not work as expected. The two key facts are:
  - `REPLACE` can detect unique key violations only in the underlying table to which it is going to write (which is determined by the `INSERT_METHOD` option). This differs from violations in the `MERGE` table itself.
  - If `REPLACE` detects a unique key violation, it changes only the corresponding row in the underlying table it is writing to; that is, the first or last table, as determined by the `INSERT_METHOD` option.

Similar considerations apply for `INSERT ... ON DUPLICATE KEY UPDATE`.

- `MERGE` tables do not support partitioning. That is, you cannot partition a `MERGE` table, nor can any of a `MERGE` table's underlying `MyISAM` tables be partitioned.
- You should not use `ANALYZE TABLE`, `REPAIR TABLE`, `OPTIMIZE TABLE`, `ALTER TABLE`, `DROP TABLE`, `DELETE` without a `WHERE` clause, or `TRUNCATE TABLE` on any of the tables that are mapped into an open `MERGE` table. If you do so, the `MERGE` table may still refer to the original table and yield unexpected results. To work around this problem, ensure that no `MERGE` tables remain open by issuing a `FLUSH TABLES` statement prior to performing any of the named operations.

The unexpected results include the possibility that the operation on the `MERGE` table reports table corruption. If this occurs after one of the named operations on the underlying `MyISAM` tables, the corruption message is spurious. To deal with this, issue a `FLUSH TABLES` statement after modifying the `MyISAM` tables.

- `DROP TABLE` on a table that is in use by a `MERGE` table does not work on Windows because the `MERGE` storage engine's table mapping is hidden from the upper layer of MySQL. Windows does not permit open files to be deleted, so you first must flush all `MERGE` tables (with `FLUSH TABLES`) or drop the `MERGE` table before dropping the table.
- The definition of the `MyISAM` tables and the `MERGE` table are checked when the tables are accessed (for example, as part of a `SELECT` or `INSERT` statement). The checks ensure that the definitions of the tables and the parent `MERGE` table definition match by comparing column order, types, sizes and associated indexes. If there is a difference between the tables, an error is returned and the statement fails. Because these checks take place when the tables are opened, any changes to the definition of a single table, including column changes, column ordering, and engine alterations causes the statement to fail.
- The order of indexes in the `MERGE` table and its underlying tables should be the same. If you use `ALTER TABLE` to add a `UNIQUE` index to a table used in a `MERGE` table, and then use `ALTER TABLE` to add a nonunique index on the `MERGE` table, the index ordering is different for the tables if there was already a nonunique index in the underlying table. (This happens because `ALTER TABLE` puts `UNIQUE` indexes before nonunique indexes to facilitate rapid detection of duplicate keys.) Consequently, queries on tables with such indexes may return unexpected results.
- If you encounter an error message similar to `ERROR 1017 (HY000): Can't find file: 'tbl_name.MRG' (errno: 2)`, it generally indicates that some of the underlying tables do not use the `MyISAM` storage engine. Confirm that all of these tables are `MyISAM`.
- The maximum number of rows in a `MERGE` table is  $2^{64}$  (~1.844E+19; the same as for a `MyISAM` table). It is not possible to merge multiple `MyISAM` tables into a single `MERGE` table that would have more than this number of rows.
- Use of underlying `MyISAM` tables of differing row formats with a parent `MERGE` table is currently known to fail. See Bug #32364.
- You cannot change the union list of a nontemporary `MERGE` table when `LOCK TABLES` is in effect. The following does *not* work:

```
CREATE TABLE m1 ... ENGINE=MRG_MYISAM ...;
LOCK TABLES t1 WRITE, t2 WRITE, m1 WRITE;
ALTER TABLE m1 ... UNION=(t1,t2) ...;
```

However, you can do this with a temporary `MERGE` table.

- You cannot create a `MERGE` table with `CREATE ... SELECT`, neither as a temporary `MERGE` table, nor as a nontemporary `MERGE` table. For example:

```
CREATE TABLE m1 ... ENGINE=MRG_MYISAM ... SELECT ...;
```

Attempts to do this result in an error: `tbl_name` is not `BASE TABLE`.

- In some cases, differing `PACK_KEYS` table option values among the `MERGE` and underlying tables cause unexpected results if the underlying tables contain `CHAR` or `BINARY` columns. As a workaround, use `ALTER TABLE` to ensure that all involved tables have the same `PACK_KEYS` value. (Bug #50646)

## 15.8 The FEDERATED Storage Engine

The **FEDERATED** storage engine lets you access data from a remote MySQL database without using replication or cluster technology. Querying a local **FEDERATED** table automatically pulls the data from the remote (federated) tables. No data is stored on the local tables.

To include the **FEDERATED** storage engine if you build MySQL from source, invoke **CMake** with the `-DWITH_FEDERATED_STORAGE_ENGINE` option.

The **FEDERATED** storage engine is not enabled by default in the running server; to enable **FEDERATED**, you must start the MySQL server binary using the `--federated` option.

To examine the source for the **FEDERATED** engine, look in the `storage/federated` directory of a MySQL source distribution.

## 15.8.1 FEDERATED Storage Engine Overview

When you create a table using one of the standard storage engines (such as **MyISAM**, **CSV** or **InnoDB**), the table consists of the table definition and the associated data. When you create a **FEDERATED** table, the table definition is the same, but the physical storage of the data is handled on a remote server.

A **FEDERATED** table consists of two elements:

- A *remote server* with a database table, which in turn consists of the table definition (stored in the `.frm` file) and the associated table. The table type of the remote table may be any type supported by the remote `mysqld` server, including **MyISAM** or **InnoDB**.
- A *local server* with a database table, where the table definition matches that of the corresponding table on the remote server. The table definition is stored within the `.frm` file. However, there is no data file on the local server. Instead, the table definition includes a connection string that points to the remote table.

When executing queries and statements on a **FEDERATED** table on the local server, the operations that would normally insert, update or delete information from a local data file are instead sent to the remote server for execution, where they update the data file on the remote server or return matching rows from the remote server.

The basic structure of a **FEDERATED** table setup is shown in [Figure 15.2, “FEDERATED Table Structure”](#).

**Figure 15.2 FEDERATED Table Structure**

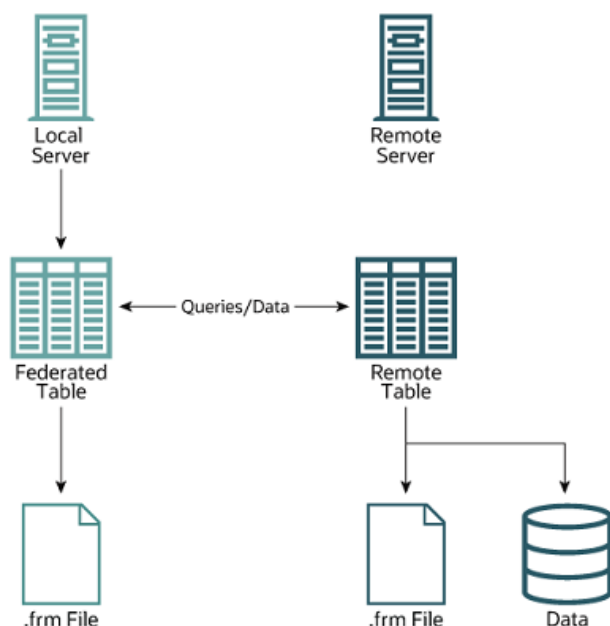

When a client issues an SQL statement that refers to a [FEDERATED](#) table, the flow of information between the local server (where the SQL statement is executed) and the remote server (where the data is physically stored) is as follows:

1. The storage engine looks through each column that the [FEDERATED](#) table has and constructs an appropriate SQL statement that refers to the remote table.
2. The statement is sent to the remote server using the MySQL client API.
3. The remote server processes the statement and the local server retrieves any result that the statement produces (an affected-rows count or a result set).
4. If the statement produces a result set, each column is converted to internal storage engine format that the [FEDERATED](#) engine expects and can use to display the result to the client that issued the original statement.

The local server communicates with the remote server using MySQL client C API functions. It invokes `mysql_real_query()` to send the statement. To read a result set, it uses `mysql_store_result()` and fetches rows one at a time using `mysql_fetch_row()`.

### 15.8.2 How to Create FEDERATED Tables

To create a [FEDERATED](#) table you should follow these steps:

1. Create the table on the remote server. Alternatively, make a note of the table definition of an existing table, perhaps using the `SHOW CREATE TABLE` statement.
2. Create the table on the local server with an identical table definition, but adding the connection information that links the local table to the remote table.

For example, you could create the following table on the remote server:

```
CREATE TABLE test_table (  
  id      INT(20) NOT NULL AUTO_INCREMENT,  
  name    VARCHAR(32) NOT NULL DEFAULT '',  
  other   INT(20) NOT NULL DEFAULT '0',  
  PRIMARY KEY (id),  
  INDEX name (name),  
  INDEX other_key (other)  
)  
ENGINE=MyISAM  
DEFAULT CHARSET=latin1;
```

For creating the local table to be federated to the remote table, there are two options available. You can either create the local table and specify the connection string (containing the server name, login, password) to be used to connect to the remote table using the [CONNECTION](#), or you can use an existing connection that you have previously created using the [CREATE SERVER](#) statement.



#### Important

When you create the local table it *must* have an identical field definition to the remote table.



#### Note

You can improve the performance of a [FEDERATED](#) table by adding indexes to the table on the host. The optimization occurs because the query sent to the remote server includes the contents of the [WHERE](#) clause, and is sent to the remote server

and subsequently executed locally. This reduces the network traffic that would otherwise request the entire table from the server for local processing.

### 15.8.2.1 Creating a FEDERATED Table Using CONNECTION

To use the first method, you must specify the `CONNECTION` string after the engine type in a `CREATE TABLE` statement. For example:

```
CREATE TABLE federated_table (
  id      INT(20) NOT NULL AUTO_INCREMENT,
  name    VARCHAR(32) NOT NULL DEFAULT '',
  other   INT(20) NOT NULL DEFAULT '0',
  PRIMARY KEY (id),
  INDEX name (name),
  INDEX other_key (other)
)
ENGINE=FEDERATED
DEFAULT CHARSET=latin1
CONNECTION='mysql://fed_user@remote_host:9306/federated/test_table';
```



#### Note

`CONNECTION` replaces the `COMMENT` used in some previous versions of MySQL.

The `CONNECTION` string contains the information required to connect to the remote server containing the table used for physical storage of the data. The connection string specifies the server name, login credentials, port number and database/table information. In the example, the remote table is on the server `remote_host`, using port 9306. The name and port number should match the host name (or IP address) and port number of the remote MySQL server instance you want to use as your remote table.

The format of the connection string is as follows:

```
scheme://user_name[:password]@host_name[:port_num]/db_name/tbl_name
```

Where:

- *scheme*: A recognized connection protocol. Only `mysql` is supported as the *scheme* value at this point.
- *user\_name*: The user name for the connection. This user must have been created on the remote server, and must have suitable privileges to perform the required actions (`SELECT`, `INSERT`, `UPDATE`, and so forth) on the remote table.
- *password*: (Optional) The corresponding password for *user\_name*.
- *host\_name*: The host name or IP address of the remote server.
- *port\_num*: (Optional) The port number for the remote server. The default is 3306.
- *db\_name*: The name of the database holding the remote table.
- *tbl\_name*: The name of the remote table. The name of the local and the remote table do not have to match.

Sample connection strings:

```
CONNECTION='mysql://username:password@hostname:port/database/tablename'
CONNECTION='mysql://username@hostname/database/tablename'
CONNECTION='mysql://username:password@hostname/database/tablename'
```



### 15.8.2.2 Creating a FEDERATED Table Using CREATE SERVER

If you are creating a number of [FEDERATED](#) tables on the same server, or if you want to simplify the process of creating [FEDERATED](#) tables, you can use the [CREATE SERVER](#) statement to define the server connection parameters, just as you would with the [CONNECTION](#) string.

The format of the [CREATE SERVER](#) statement is:

```
CREATE SERVER
server_name
FOREIGN DATA WRAPPER wrapper_name
OPTIONS (option [, option] ...)
```

The *server\_name* is used in the connection string when creating a new [FEDERATED](#) table.

For example, to create a server connection identical to the [CONNECTION](#) string:

```
CONNECTION='mysql://fed_user@remote_host:9306/federated/test_table';
```

You would use the following statement:

```
CREATE SERVER fedlink
FOREIGN DATA WRAPPER mysql
OPTIONS (USER 'fed_user', HOST 'remote_host', PORT 9306, DATABASE 'federated');
```

To create a [FEDERATED](#) table that uses this connection, you still use the [CONNECTION](#) keyword, but specify the name you used in the [CREATE SERVER](#) statement.

```
CREATE TABLE test_table (
  id      INT(20) NOT NULL AUTO_INCREMENT,
  name    VARCHAR(32) NOT NULL DEFAULT '',
  other   INT(20) NOT NULL DEFAULT '0',
  PRIMARY KEY (id),
  INDEX name (name),
  INDEX other_key (other)
)
ENGINE=FEDERATED
DEFAULT CHARSET=latin1
CONNECTION='fedlink/test_table';
```

The connection name in this example contains the name of the connection (*fedlink*) and the name of the table (*test\_table*) to link to, separated by a slash. If you specify only the connection name without a table name, the table name of the local table is used instead.

For more information on [CREATE SERVER](#), see [Section 13.1.17, “CREATE SERVER Statement”](#).

The [CREATE SERVER](#) statement accepts the same arguments as the [CONNECTION](#) string. The [CREATE SERVER](#) statement updates the rows in the `mysql.servers` table. See the following table for information on the correspondence between parameters in a connection string, options in the [CREATE SERVER](#) statement, and the columns in the `mysql.servers` table. For reference, the format of the [CONNECTION](#) string is as follows:

```
scheme://user_name[:password]@host_name[:port_num]/db_name/tbl_name
```

Description	CONNECTION string	CREATE SERVER option	mysql.servers column
Connection scheme	<i>scheme</i>	<i>wrapper_name</i>	Wrapper
Remote user	<i>user_name</i>	USER	Username

Description	CONNECTION string	CREATE SERVER option	mysql.servers column
Remote password	<i>password</i>	PASSWORD	Password
Remote host	<i>host_name</i>	HOST	Host
Remote port	<i>port_num</i>	PORT	Port
Remote database	<i>db_name</i>	DATABASE	Db

### 15.8.3 FEDERATED Storage Engine Notes and Tips

You should be aware of the following points when using the `FEDERATED` storage engine:

- `FEDERATED` tables may be replicated to other replicas, but you must ensure that the replica servers are able to use the user/password combination that is defined in the `CONNECTION` string (or the row in the `mysql.servers` table) to connect to the remote server.

The following items indicate features that the `FEDERATED` storage engine does and does not support:

- The remote server must be a MySQL server.
- The remote table that a `FEDERATED` table points to *must* exist before you try to access the table through the `FEDERATED` table.
- It is possible for one `FEDERATED` table to point to another, but you must be careful not to create a loop.
- A `FEDERATED` table does not support indexes in the usual sense; because access to the table data is handled remotely, it is actually the remote table that makes use of indexes. This means that, for a query that cannot use any indexes and so requires a full table scan, the server fetches all rows from the remote table and filters them locally. This occurs regardless of any `WHERE` or `LIMIT` used with this `SELECT` statement; these clauses are applied locally to the returned rows.

Queries that fail to use indexes can thus cause poor performance and network overload. In addition, since returned rows must be stored in memory, such a query can also lead to the local server swapping, or even hanging.

- Care should be taken when creating a `FEDERATED` table since the index definition from an equivalent `MyISAM` or other table may not be supported. For example, creating a `FEDERATED` table with an index prefix fails for `VARCHAR`, `TEXT` or `BLOB` columns. The following definition in `MyISAM` is valid:

```
CREATE TABLE `T1` (`A` VARCHAR(100),UNIQUE KEY(`A`(30))) ENGINE=MYISAM;
```

The key prefix in this example is incompatible with the `FEDERATED` engine, and the equivalent statement fails:

```
CREATE TABLE `T1` (`A` VARCHAR(100),UNIQUE KEY(`A`(30))) ENGINE=FEDERATED
CONNECTION='MYSQL://127.0.0.1:3306/TEST/T1';
```

If possible, you should try to separate the column and index definition when creating tables on both the remote server and the local server to avoid these index issues.

- Internally, the implementation uses `SELECT`, `INSERT`, `UPDATE`, and `DELETE`, but not `HANDLER`.
- The `FEDERATED` storage engine supports `SELECT`, `INSERT`, `UPDATE`, `DELETE`, `TRUNCATE TABLE`, and indexes. It does not support `ALTER TABLE`, or any Data Definition Language statements that directly affect the structure of the table, other than `DROP TABLE`. The current implementation does not use prepared statements.

- `FEDERATED` accepts `INSERT ... ON DUPLICATE KEY UPDATE` statements, but if a duplicate-key violation occurs, the statement fails with an error.
- Transactions are not supported.
- `FEDERATED` performs bulk-insert handling such that multiple rows are sent to the remote table in a batch, which improves performance. Also, if the remote table is transactional, it enables the remote storage engine to perform statement rollback properly should an error occur. This capability has the following limitations:
  - The size of the insert cannot exceed the maximum packet size between servers. If the insert exceeds this size, it is broken into multiple packets and the rollback problem can occur.
  - Bulk-insert handling does not occur for `INSERT ... ON DUPLICATE KEY UPDATE`.
- There is no way for the `FEDERATED` engine to know if the remote table has changed. The reason for this is that this table must work like a data file that would never be written to by anything other than the database system. The integrity of the data in the local table could be breached if there was any change to the remote database.
- When using a `CONNECTION` string, you cannot use an '@' character in the password. You can get round this limitation by using the `CREATE SERVER` statement to create a server connection.
- The `insert_id` and `timestamp` options are not propagated to the data provider.
- Any `DROP TABLE` statement issued against a `FEDERATED` table drops only the local table, not the remote table.
- `FEDERATED` tables do not work with the query cache.
- User-defined partitioning is not supported for `FEDERATED` tables.

## 15.8.4 FEDERATED Storage Engine Resources

The following additional resources are available for the `FEDERATED` storage engine:

- A forum dedicated to the `FEDERATED` storage engine is available at <https://forums.mysql.com/list.php?105>.

## 15.9 The EXAMPLE Storage Engine

The `EXAMPLE` storage engine is a stub engine that does nothing. Its purpose is to serve as an example in the MySQL source code that illustrates how to begin writing new storage engines. As such, it is primarily of interest to developers.

To enable the `EXAMPLE` storage engine if you build MySQL from source, invoke `CMake` with the `-DWITH_EXAMPLE_STORAGE_ENGINE` option.

To examine the source for the `EXAMPLE` engine, look in the `storage/example` directory of a MySQL source distribution.

When you create an `EXAMPLE` table, the server creates a table format file in the database directory. The file begins with the table name and has an `.frm` extension. No other files are created. No data can be stored into the table. Retrievals return an empty result.

```
mysql> CREATE TABLE test (i INT) ENGINE = EXAMPLE;
Query OK, 0 rows affected (0.78 sec)
```

```
mysql> INSERT INTO test VALUES(1),(2),(3);
ERROR 1031 (HY000): Table storage engine for 'test' doesn't »
      have this option

mysql> SELECT * FROM test;
Empty set (0.31 sec)
```

The `EXAMPLE` storage engine does not support indexing.

## 15.10 Other Storage Engines

Other storage engines may be available from third parties and community members that have used the Custom Storage Engine interface.

Third party engines are not supported by MySQL. For further information, documentation, installation guides, bug reporting or for any help or assistance with these engines, please contact the developer of the engine directly.

For more information on developing a customer storage engine that can be used with the Pluggable Storage Engine Architecture, see [MySQL Internals: Writing a Custom Storage Engine](#).

## 15.11 Overview of MySQL Storage Engine Architecture

The MySQL pluggable storage engine architecture enables a database professional to select a specialized storage engine for a particular application need while being completely shielded from the need to manage any specific application coding requirements. The MySQL server architecture isolates the application programmer and DBA from all of the low-level implementation details at the storage level, providing a consistent and easy application model and API. Thus, although there are different capabilities across different storage engines, the application is shielded from these differences.

The pluggable storage engine architecture provides a standard set of management and support services that are common among all underlying storage engines. The storage engines themselves are the components of the database server that actually perform actions on the underlying data that is maintained at the physical server level.

This efficient and modular architecture provides huge benefits for those wishing to specifically target a particular application need—such as data warehousing, transaction processing, or high availability situations—while enjoying the advantage of utilizing a set of interfaces and services that are independent of any one storage engine.

The application programmer and DBA interact with the MySQL database through Connector APIs and service layers that are above the storage engines. If application changes bring about requirements that demand the underlying storage engine change, or that one or more storage engines be added to support new needs, no significant coding or process changes are required to make things work. The MySQL server architecture shields the application from the underlying complexity of the storage engine by presenting a consistent and easy-to-use API that applies across storage engines.

### 15.11.1 Pluggable Storage Engine Architecture

MySQL Server uses a pluggable storage engine architecture that enables storage engines to be loaded into and unloaded from a running MySQL server.

#### Plugging in a Storage Engine

Before a storage engine can be used, the storage engine plugin shared library must be loaded into MySQL using the `INSTALL PLUGIN` statement. For example, if the `EXAMPLE` engine plugin is named `example` and the shared library is named `ha_example.so`, you load it with the following statement:

```
INSTALL PLUGIN example SONAME 'ha_example.so';
```

To install a pluggable storage engine, the plugin file must be located in the MySQL plugin directory, and the user issuing the `INSTALL PLUGIN` statement must have `INSERT` privilege for the `mysql.plugin` table.

The shared library must be located in the MySQL server plugin directory, the location of which is given by the `plugin_dir` system variable.

### Unplugging a Storage Engine

To unplug a storage engine, use the `UNINSTALL PLUGIN` statement:

```
UNINSTALL PLUGIN example;
```

If you unplug a storage engine that is needed by existing tables, those tables become inaccessible, but are still present on disk (where applicable). Ensure that there are no tables using a storage engine before you unplug the storage engine.

## 15.11.2 The Common Database Server Layer

A MySQL pluggable storage engine is the component in the MySQL database server that is responsible for performing the actual data I/O operations for a database as well as enabling and enforcing certain feature sets that target a specific application need. A major benefit of using specific storage engines is that you are only delivered the features needed for a particular application, and therefore you have less system overhead in the database, with the end result being more efficient and higher database performance. This is one of the reasons that MySQL has always been known to have such high performance, matching or beating proprietary monolithic databases in industry standard benchmarks.

From a technical perspective, what are some of the unique supporting infrastructure components that are in a storage engine? Some of the key feature differentiations include:

- *Concurrency*: Some applications have more granular lock requirements (such as row-level locks) than others. Choosing the right locking strategy can reduce overhead and therefore improve overall performance. This area also includes support for capabilities such as multi-version concurrency control or “snapshot” read.
- *Transaction Support*: Not every application needs transactions, but for those that do, there are very well defined requirements such as ACID compliance and more.
- *Referential Integrity*: The need to have the server enforce relational database referential integrity through DDL defined foreign keys.
- *Physical Storage*: This involves everything from the overall page size for tables and indexes as well as the format used for storing data to physical disk.
- *Index Support*: Different application scenarios tend to benefit from different index strategies. Each storage engine generally has its own indexing methods, although some (such as B-tree indexes) are common to nearly all engines.
- *Memory Caches*: Different applications respond better to some memory caching strategies than others, so although some memory caches are common to all storage engines (such as those used for user connections or MySQL's high-speed Query Cache), others are uniquely defined only when a particular storage engine is put in play.
- *Performance Aids*: This includes multiple I/O threads for parallel operations, thread concurrency, database checkpointing, bulk insert handling, and more.

- *Miscellaneous Target Features*: This may include support for geospatial operations, security restrictions for certain data manipulation operations, and other similar features.

Each set of the pluggable storage engine infrastructure components are designed to offer a selective set of benefits for a particular application. Conversely, avoiding a set of component features helps reduce unnecessary overhead. It stands to reason that understanding a particular application's set of requirements and selecting the proper MySQL storage engine can have a dramatic impact on overall system efficiency and performance.

---

# Chapter 16 Replication

## Table of Contents

16.1	Configuring Replication .....	2955
16.1.1	Binary Log File Position Based Replication Configuration Overview .....	2955
16.1.2	Setting Up Binary Log File Position Based Replication .....	2956
16.1.3	Replication with Global Transaction Identifiers .....	2965
16.1.4	Changing Replication Modes on Online Servers .....	2987
16.1.5	MySQL Multi-Source Replication .....	2993
16.1.6	Replication and Binary Logging Options and Variables .....	2998
16.1.7	Common Replication Administration Tasks .....	3078
16.2	Replication Implementation .....	3084
16.2.1	Replication Formats .....	3084
16.2.2	Replication Channels .....	3091
16.2.3	Replication Threads .....	3095
16.2.4	Relay Log and Replication Metadata Repositories .....	3098
16.2.5	How Servers Evaluate Replication Filtering Rules .....	3104
16.3	Replication Solutions .....	3110
16.3.1	Using Replication for Backups .....	3111
16.3.2	Handling an Unexpected Halt of a Replica .....	3114
16.3.3	Using Replication with Different Source and Replica Storage Engines .....	3116
16.3.4	Using Replication for Scale-Out .....	3118
16.3.5	Replicating Different Databases to Different Replicas .....	3119
16.3.6	Improving Replication Performance .....	3120
16.3.7	Switching Sources During Failover .....	3121
16.3.8	Setting Up Replication to Use Encrypted Connections .....	3124
16.3.9	Semisynchronous Replication .....	3125
16.3.10	Delayed Replication .....	3131
16.4	Replication Notes and Tips .....	3132
16.4.1	Replication Features and Issues .....	3132
16.4.2	Replication Compatibility Between MySQL Versions .....	3158
16.4.3	Upgrading a Replication Topology .....	3159
16.4.4	Troubleshooting Replication .....	3161
16.4.5	How to Report Replication Bugs or Problems .....	3163

Replication enables data from one MySQL database server (the source) to be copied to one or more MySQL database servers (the replicas). Replication is asynchronous by default; replicas do not need to be connected permanently to receive updates from the source. Depending on the configuration, you can replicate all databases, selected databases, or even selected tables within a database.

Advantages of replication in MySQL include:

- Scale-out solutions - spreading the load among multiple replicas to improve performance. In this environment, all writes and updates must take place on the replication source server. Reads, however, may take place on one or more replicas. This model can improve the performance of writes (since the source is dedicated to updates), while dramatically increasing read speed across an increasing number of replicas.
- Data security - because data is replicated to the replica, and the replica can pause the replication process, it is possible to run backup services on the replica without corrupting the corresponding source data.

- 
- Analytics - live data can be created on the source, while the analysis of the information can take place on the replica without affecting the performance of the source.
  - Long-distance data distribution - you can use replication to create a local copy of data for a remote site to use, without permanent access to the source.

For information on how to use replication in such scenarios, see [Section 16.3, “Replication Solutions”](#).

MySQL 5.7 supports different methods of replication. The traditional method is based on replicating events from the source's binary log, and requires the log files and positions in them to be synchronized between source and replica. The newer method based on *global transaction identifiers* (GTIDs) is transactional and therefore does not require working with log files or positions within these files, which greatly simplifies many common replication tasks. Replication using GTIDs guarantees consistency between source and replica as long as all transactions committed on the source have also been applied on the replica. For more information about GTIDs and GTID-based replication in MySQL, see [Section 16.1.3, “Replication with Global Transaction Identifiers”](#). For information on using binary log file position based replication, see [Section 16.1, “Configuring Replication”](#).

Replication in MySQL supports different types of synchronization. The original type of synchronization is one-way, asynchronous replication, in which one server acts as the source, while one or more other servers act as replicas. This is in contrast to the *synchronous* replication which is a characteristic of NDB Cluster (see [Chapter 21, MySQL NDB Cluster 7.5 and NDB Cluster 7.6](#)). In MySQL 5.7, semisynchronous replication is supported in addition to the built-in asynchronous replication. With semisynchronous replication, a commit performed on the source blocks before returning to the session that performed the transaction until at least one replica acknowledges that it has received and logged the events for the transaction; see [Section 16.3.9, “Semisynchronous Replication”](#). MySQL 5.7 also supports delayed replication such that a replica deliberately lags behind the source by at least a specified amount of time; see [Section 16.3.10, “Delayed Replication”](#). For scenarios where *synchronous* replication is required, use NDB Cluster (see [Chapter 21, MySQL NDB Cluster 7.5 and NDB Cluster 7.6](#)).

There are a number of solutions available for setting up replication between servers, and the best method to use depends on the presence of data and the engine types you are using. For more information on the available options, see [Section 16.1.2, “Setting Up Binary Log File Position Based Replication”](#).

There are two core types of replication format, Statement Based Replication (SBR), which replicates entire SQL statements, and Row Based Replication (RBR), which replicates only the changed rows. You can also use a third variety, Mixed Based Replication (MBR). For more information on the different replication formats, see [Section 16.2.1, “Replication Formats”](#).

Replication is controlled through a number of different options and variables. For more information, see [Section 16.1.6, “Replication and Binary Logging Options and Variables”](#).

You can use replication to solve a number of different problems, including performance, supporting the backup of different databases, and as part of a larger solution to alleviate system failures. For information on how to address these issues, see [Section 16.3, “Replication Solutions”](#).

For notes and tips on how different data types and statements are treated during replication, including details of replication features, version compatibility, upgrades, and potential problems and their resolution, see [Section 16.4, “Replication Notes and Tips”](#). For answers to some questions often asked by those who are new to MySQL Replication, see [Section A.14, “MySQL 5.7 FAQ: Replication”](#).

For detailed information on the implementation of replication, how replication works, the process and contents of the binary log, background threads and the rules used to decide how statements are recorded and replicated, see [Section 16.2, “Replication Implementation”](#).



## 16.1 Configuring Replication

This section describes how to configure the different types of replication available in MySQL and includes the setup and configuration required for a replication environment, including step-by-step instructions for creating a new replication environment. The major components of this section are:

- For a guide to setting up two or more servers for replication using binary log file positions, [Section 16.1.2, “Setting Up Binary Log File Position Based Replication”](#), deals with the configuration of the servers and provides methods for copying data between the source and replicas.
- For a guide to setting up two or more servers for replication using GTID transactions, [Section 16.1.3, “Replication with Global Transaction Identifiers”](#), deals with the configuration of the servers.
- Events in the binary log are recorded using a number of formats. These are referred to as statement-based replication (SBR) or row-based replication (RBR). A third type, mixed-format replication (MIXED), uses SBR or RBR replication automatically to take advantage of the benefits of both SBR and RBR formats when appropriate. The different formats are discussed in [Section 16.2.1, “Replication Formats”](#).
- Detailed information on the different configuration options and variables that apply to replication is provided in [Section 16.1.6, “Replication and Binary Logging Options and Variables”](#).
- Once started, the replication process should require little administration or monitoring. However, for advice on common tasks that you may want to execute, see [Section 16.1.7, “Common Replication Administration Tasks”](#).

### 16.1.1 Binary Log File Position Based Replication Configuration Overview

This section describes replication between MySQL servers based on the binary log file position method, where the MySQL instance operating as the source (where the database changes originate) writes updates and changes as “events” to the binary log. The information in the binary log is stored in different logging formats according to the database changes being recorded. Replicas are configured to read the binary log from the source and to execute the events in the binary log on the replica's local database.

Each replica receives a copy of the entire contents of the binary log. It is the responsibility of the replica to decide which statements in the binary log should be executed. Unless you specify otherwise, all events in the source's binary log are executed on the replica. If required, you can configure the replica to process only events that apply to particular databases or tables.



#### Important

You cannot configure the source to log only certain events.

Each replica keeps a record of the binary log coordinates: the file name and position within the file that it has read and processed from the source. This means that multiple replicas can be connected to the source and executing different parts of the same binary log. Because the replicas control this process, individual replicas can be connected and disconnected from the server without affecting the source's operation. Also, because each replica records the current position within the binary log, it is possible for replicas to be disconnected, reconnect and then resume processing.

The source and each replica must be configured with a unique ID (using the `server_id` system variable). In addition, each replica must be configured with information about the source's host name, log file name, and position within that file. These details can be controlled from within a MySQL session using the `CHANGE MASTER TO` statement on the replica. The details are stored within the replica's connection metadata repository, which can be either a file or a table (see [Section 16.2.4, “Relay Log and Replication Metadata Repositories”](#)).

## 16.1.2 Setting Up Binary Log File Position Based Replication

This section describes how to set up a MySQL server to use binary log file position based replication. There are a number of different methods for setting up replication, and the exact method to use depends on how you are setting up replication, and whether you already have data in the database on the source.

There are some generic tasks that are common to all setups:

- On the source, you must enable binary logging and configure a unique server ID. This might require a server restart. See [Section 16.1.2.1, “Setting the Replication Source Configuration”](#).
- On each replica that you want to connect to the source, you must configure a unique server ID. This might require a server restart. See [Setting the Replica Configuration](#).
- Optionally, create a separate user for your replicas to use during authentication with the source when reading the binary log for replication. See [Section 16.1.2.2, “Creating a User for Replication”](#).
- Before creating a data snapshot or starting the replication process, on the source you should record the current position in the binary log. You need this information when configuring the replica so that the replica knows where in the binary log to start executing events. See [Section 16.1.2.3, “Obtaining the Replication Source’s Binary Log Coordinates”](#).
- If you already have data on the source and want to use it to synchronize the replica, you need to create a data snapshot to copy the data to the replica. The storage engine you are using has an impact on how you create the snapshot. When you are using [MyISAM](#), you must stop processing statements on the source to obtain a read-lock, then obtain its current binary log coordinates and dump its data, before permitting the source to continue executing statements. If you do not stop the execution of statements, the data dump and the source’s status information do not match, resulting in inconsistent or corrupted databases on the replicas. For more information on replicating a [MyISAM](#) source, see [Section 16.1.2.3, “Obtaining the Replication Source’s Binary Log Coordinates”](#). If you are using [InnoDB](#), you do not need a read-lock and a transaction that is long enough to transfer the data snapshot is sufficient. For more information, see [Section 14.20, “InnoDB and MySQL Replication”](#).
- Configure the replica with settings for connecting to the source, such as the host name, login credentials, and binary log file name and position. See [Setting the Source Configuration on the Replica](#).



### Note

Certain steps within the setup process require the [SUPER](#) privilege. If you do not have this privilege, it might not be possible to enable replication.

After configuring the basic options, select your scenario:

- To set up replication for a fresh installation of a source and replicas that contain no data, see [Setting Up Replication between a New Source and Replicas](#).
- To set up replication of a new source using the data from an existing MySQL server, see [Setting Up Replication with Existing Data](#).
- To add replicas to an existing replication environment, see [Section 16.1.2.6, “Adding Replicas to a Replication Topology”](#).

Before administering MySQL replication servers, read this entire chapter and try all statements mentioned in [Section 13.4.1, “SQL Statements for Controlling Replication Source Servers”](#), and [Section 13.4.2, “SQL Statements for Controlling Replica Servers”](#). Also familiarize yourself with the replication startup options described in [Section 16.1.6, “Replication and Binary Logging Options and Variables”](#).

### 16.1.2.1 Setting the Replication Source Configuration

To configure a source to use binary log file position based replication, you must ensure that binary logging is enabled, and establish a unique server ID.

Each server within a replication topology must be configured with a unique server ID, which you can specify using the `server_id` system variable. This server ID is used to identify individual servers within the replication topology, and must be a positive integer between 1 and  $(2^{32})-1$ . You can change the `server_id` value dynamically by issuing a statement like this:

```
SET GLOBAL server_id = 2;
```

With the default server ID of 0, a source refuses any connections from replicas, and a replica refuses to connect to a source, so this value cannot be used in a replication topology. Other than that, how you organize and select the server IDs is your choice, so long as each server ID is different from every other server ID in use by any other server in the replication topology. Note that if a value of 0 was set previously for the server ID, you must restart the server to initialize the source with your new nonzero server ID. Otherwise, a server restart is not needed, unless you need to enable binary logging or make other configuration changes that require a restart.

Binary logging *must* be enabled on the source because the binary log is the basis for replicating changes from the source to its replicas. If binary logging is not enabled on the source using the `log-bin` option, replication is not possible. To enable binary logging on a server where it is not already enabled, you must restart the server. In this case, shut down the MySQL server and edit the `my.cnf` or `my.ini` file. Within the `[mysqld]` section of the configuration file, add the `log-bin` and `server-id` options. If these options already exist, but are commented out, uncomment the options and alter them according to your needs. For example, to enable binary logging using a log file name prefix of `mysql-bin`, and configure a server ID of 1, use these lines:

```
[mysqld]
log-bin=mysql-bin
server-id=1
```

After making the changes, restart the server.



#### Note

The following options have an impact on this procedure:

- For the greatest possible durability and consistency in a replication setup using InnoDB with transactions, you should use `innodb_flush_log_at_trx_commit=1` and `sync_binlog=1` in the source's `my.cnf` file.
- Ensure that the `skip_networking` system variable is not enabled on your source. If networking has been disabled, the replica cannot communicate with the source and replication fails.

### 16.1.2.2 Creating a User for Replication

Each replica connects to the source using a MySQL user name and password, so there must be a user account on the source that the replica can use to connect. The user name is specified by the `MASTER_USER` option on the `CHANGE MASTER TO` command when you set up a replica. Any account can be used for this operation, providing it has been granted the `REPLICATION SLAVE` privilege. You can choose to create a different account for each replica, or connect to the source using the same account for each replica.

Although you do not have to create an account specifically for replication, you should be aware that the replication user name and password are stored in plain text in the replication metadata repositories (see [Section 16.2.4.2, “Replication Metadata Repositories”](#)). Therefore, you may want to create a separate account that has privileges only for the replication process, to minimize the possibility of compromise to other accounts.

To create a new account, use `CREATE USER`. To grant this account the privileges required for replication, use the `GRANT` statement. If you create an account solely for the purposes of replication, that account needs only the `REPLICATION SLAVE` privilege. For example, to set up a new user, `repl`, that can connect for replication from any host within the `example.com` domain, issue these statements on the source:

```
mysql> CREATE USER 'repl'@'%example.com' IDENTIFIED BY 'password';
mysql> GRANT REPLICATION SLAVE ON *.* TO 'repl'@'%example.com';
```

See [Section 13.7.1, “Account Management Statements”](#), for more information on statements for manipulation of user accounts.

### 16.1.2.3 Obtaining the Replication Source's Binary Log Coordinates

To configure the replica to start the replication process at the correct point, you need to note the source's current coordinates within its binary log.



#### Warning

This procedure uses `FLUSH TABLES WITH READ LOCK`, which blocks `COMMIT` operations for `InnoDB` tables.

If you are planning to shut down the source to create a data snapshot, you can optionally skip this procedure and instead store a copy of the binary log index file along with the data snapshot. In that situation, the source creates a new binary log file on restart. The source's binary log coordinates where the replica must start the replication process are therefore the start of that new file, which is the next binary log file on the source following after the files that are listed in the copied binary log index file.

To obtain the source's binary log coordinates, follow these steps:

1. Start a session on the source by connecting to it with the command-line client, and flush all tables and block write statements by executing the `FLUSH TABLES WITH READ LOCK` statement:

```
mysql> FLUSH TABLES WITH READ LOCK;
```



#### Warning

Leave the client from which you issued the `FLUSH TABLES` statement running so that the read lock remains in effect. If you exit the client, the lock is released.

2. In a different session on the source, use the `SHOW MASTER STATUS` statement to determine the current binary log file name and position:

```
mysql> SHOW MASTER STATUS\G
***** 1. row *****
      File: mysql-bin.000003
      Position: 73
      Binlog_Do_DB: test
      Binlog_Ignore_DB: manual, mysql
      Executed_Gtid_Set: 3E11FA47-71CA-11E1-9E33-C80AA9429562:1-5
1 row in set (0.00 sec)
```

The `File` column shows the name of the log file and the `Position` column shows the position within the file. In this example, the binary log file is `mysql-bin.000003` and the position is 73. Record

these values. You need them later when you are setting up the replica. They represent the replication coordinates at which the replica should begin processing new updates from the source.

If the source has been running previously without binary logging enabled, the log file name and position values displayed by `SHOW MASTER STATUS` or `mysqldump --master-data` are empty. In that case, the values that you need to use later when specifying the source's log file and position are the empty string ( ' ' ) and 4.

You now have the information you need to enable the replica to start reading from the binary log in the correct place to start replication.

The next step depends on whether you have existing data on the source. Choose one of the following options:

- If you have existing data that needs to be synchronized with the replica before you start replication, leave the client running so that the lock remains in place. This prevents any further changes being made, so that the data copied to the replica is in synchrony with the source. Proceed to [Section 16.1.2.4, “Choosing a Method for Data Snapshots”](#).
- If you are setting up a new replication topology, you can exit the first session to release the read lock. See [Setting Up Replication between a New Source and Replicas](#) for how to proceed.

#### 16.1.2.4 Choosing a Method for Data Snapshots

If the database on the source contains existing data it is necessary to copy this data to each replica. There are different ways to dump the data from the source. The following sections describe possible options.

To select the appropriate method of dumping the database, choose between these options:

- Use the `mysqldump` tool to create a dump of all the databases you want to replicate. This is the recommended method, especially when using `InnoDB`.
- If your database is stored in binary portable files, you can copy the raw data files to a replica. This can be more efficient than using `mysqldump` and importing the file on each replica, because it skips the overhead of updating indexes as the `INSERT` statements are replayed. With storage engines such as `InnoDB` this is not recommended.

#### Creating a Data Snapshot Using `mysqldump`

To create a snapshot of the data in an existing source, use the `mysqldump` tool. Once the data dump has been completed, import this data into the replica before starting the replication process.

The following example dumps all databases to a file named `dbdump.db`, and includes the `--master-data` option which automatically appends the `CHANGE MASTER TO` statement required on the replica to start the replication process:

```
$> mysqldump --all-databases --master-data > dbdump.db
```



#### Note

If you do not use `--master-data`, then it is necessary to lock all tables in a separate session manually. See [Section 16.1.2.3, “Obtaining the Replication Source's Binary Log Coordinates”](#).

It is possible to exclude certain databases from the dump using the `mysqldump` tool. If you want to choose which databases to include in the dump, do not use `--all-databases`. Choose one of these options:

- Exclude all the tables in the database using `--ignore-table` option.

- Name only those databases which you want dumped using the `--databases` option.

For more information, see [Section 4.5.4, “mysqldump — A Database Backup Program”](#).

To import the data, either copy the dump file to the replica, or access the file from the source when connecting remotely to the replica.

### Creating a Data Snapshot Using Raw Data Files

This section describes how to create a data snapshot using the raw files which make up the database. Employing this method with a table using a storage engine that has complex caching or logging algorithms requires extra steps to produce a perfect “point in time” snapshot: the initial copy command could leave out cache information and logging updates, even if you have acquired a global read lock. How the storage engine responds to this depends on its crash recovery abilities.

If you use `InnoDB` tables, you can use the `mysqlbackup` command from the MySQL Enterprise Backup component to produce a consistent snapshot. This command records the log name and offset corresponding to the snapshot to be used on the replica. MySQL Enterprise Backup is a commercial product that is included as part of a MySQL Enterprise subscription. See [Section 28.1, “MySQL Enterprise Backup Overview”](#) for detailed information.

This method also does not work reliably if the source and replica have different values for `ft_stopword_file`, `ft_min_word_len`, or `ft_max_word_len` and you are copying tables having full-text indexes.

Assuming the above exceptions do not apply to your database, use the `cold backup` technique to obtain a reliable binary snapshot of `InnoDB` tables: do a `slow shutdown` of the MySQL Server, then copy the data files manually.

To create a raw data snapshot of `MyISAM` tables when your MySQL data files exist on a single file system, you can use standard file copy tools such as `cp` or `copy`, a remote copy tool such as `scp` or `rsync`, an archiving tool such as `zip` or `tar`, or a file system snapshot tool such as `dump`. If you are replicating only certain databases, copy only those files that relate to those tables. For `InnoDB`, all tables in all databases are stored in the `system tablespace` files, unless you have the `innodb_file_per_table` option enabled.

The following files are not required for replication:

- Files relating to the `mysql` database.
- The replica's connection metadata repository file, if used (see [Section 16.2.4, “Relay Log and Replication Metadata Repositories”](#)).
- The source's binary log files, with the exception of the binary log index file if you are going to use this to locate the source's binary log coordinates for the replica.
- Any relay log files.

Depending on whether you are using `InnoDB` tables or not, choose one of the following:

If you are using `InnoDB` tables, and also to get the most consistent results with a raw data snapshot, shut down the source server during the process, as follows:

1. Acquire a read lock and get the source's status. See [Section 16.1.2.3, “Obtaining the Replication Source's Binary Log Coordinates”](#).
2. In a separate session, shut down the source server:

```
$> mysqladmin shutdown
```

3. Make a copy of the MySQL data files. The following examples show common ways to do this. You need to choose only one of them:

```
$> tar cf /tmp/db.tar ./data
$> zip -r /tmp/db.zip ./data
$> rsync --recursive ./data /tmp/dbdata
```

4. Restart the source server.

If you are not using [InnoDB](#) tables, you can get a snapshot of the system from a source without shutting down the server as described in the following steps:

1. Acquire a read lock and get the source's status. See [Section 16.1.2.3, "Obtaining the Replication Source's Binary Log Coordinates"](#).
2. Make a copy of the MySQL data files. The following examples show common ways to do this. You need to choose only one of them:

```
$> tar cf /tmp/db.tar ./data
$> zip -r /tmp/db.zip ./data
$> rsync --recursive ./data /tmp/dbdata
```

3. In the client where you acquired the read lock, release the lock:

```
mysql> UNLOCK TABLES;
```

Once you have created the archive or copy of the database, copy the files to each replica before starting the replication process.

### 16.1.2.5 Setting Up Replicas

The following sections describe how to set up replicas. Before you proceed, ensure that you have:

- Configured the source with the necessary configuration properties. See [Section 16.1.2.1, "Setting the Replication Source Configuration"](#).
- Obtained the source's status information, or a copy of the source's binary log index file made during a shutdown for the data snapshot. See [Section 16.1.2.3, "Obtaining the Replication Source's Binary Log Coordinates"](#).
- On the source, released the read lock:

```
mysql> UNLOCK TABLES;
```

### Setting the Replica Configuration

Each replica must have a unique server ID, as specified by the `server_id` system variable. If you are setting up multiple replicas, each one must have a unique `server_id` value that differs from that of the source and from any of the other replicas. If the replica's server ID is not already set, or the current value conflicts with the value that you have chosen for the source server or another replica, you must change it. With the default `server_id` value of 0, a replica refuses to connect to a source.

You can change the `server_id` value dynamically by issuing a statement like this:

```
SET GLOBAL server_id = 21;
```

If the default `server_id` value of 0 was set previously, you must restart the server to initialize the replica with your new nonzero server ID. Otherwise, a server restart is not needed when you change the server ID, unless you make other configuration changes that require it. For example, if binary logging was disabled on the server and you want it enabled for your replica, a server restart is required to enable this.

If you are shutting down the replica server, you can edit the `[mysqld]` section of the configuration file to specify a unique server ID. For example:

```
[mysqld]
server-id=21
```

A replica is not required to have binary logging enabled for replication to take place. However, binary logging on a replica means that the replica's binary log can be used for data backups and crash recovery. Replicas that have binary logging enabled can also be used as part of a more complex replication topology. If you want to enable binary logging on a replica, use the `log-bin` option in the `[mysqld]` section of the configuration file. A server restart is required to start binary logging on a server that did not previously use it.

## Setting the Source Configuration on the Replica

To set up the replica to communicate with the source for replication, configure the replica with the necessary connection information. To do this, execute the following statement on the replica, replacing the option values with the actual values relevant to your system:

```
mysql> CHANGE MASTER TO
->     MASTER_HOST='source_host_name',
->     MASTER_USER='replication_user_name',
->     MASTER_PASSWORD='replication_password',
->     MASTER_LOG_FILE='recorded_log_file_name',
->     MASTER_LOG_POS=recorded_log_position;
```



### Note

Replication cannot use Unix socket files. You must be able to connect to the source MySQL server using TCP/IP.

The `CHANGE MASTER TO` statement has other options as well. For example, it is possible to set up secure replication using SSL. For a full list of options, and information about the maximum permissible length for the string-valued options, see [Section 13.4.2.1, “CHANGE MASTER TO Statement”](#).

The next steps depend on whether you have existing data to import to the replica or not. See [Section 16.1.2.4, “Choosing a Method for Data Snapshots”](#) for more information. Choose one of the following:

- If you do not have a snapshot of a database to import, see [Setting Up Replication between a New Source and Replicas](#).
- If you have a snapshot of a database to import, see [Setting Up Replication with Existing Data](#).

## Setting Up Replication between a New Source and Replicas

When there is no snapshot of a previous database to import, configure the replica to start replication from the new source.

To set up replication between a source and a new replica:

1. Start up the replica and connect to it.
2. Execute a `CHANGE MASTER TO` statement to set the source configuration. See [Setting the Source Configuration on the Replica](#).

Perform these setup steps on each replica.

This method can also be used if you are setting up new servers but have an existing dump of the databases from a different server that you want to load into your replication configuration. By loading the data into a new source, the data is automatically replicated to the replicas.



If you are setting up a new replication environment using the data from a different existing database server to create a new source, run the dump file generated from that server on the new source. The database updates are automatically propagated to the replicas:

```
$> mysql -h master < fulldb.dump
```

## Setting Up Replication with Existing Data

When setting up replication with existing data, transfer the snapshot from the source to the replica before starting replication. The process for importing data to the replica depends on how you created the snapshot of data on the source.

Follow this procedure to set up replication with existing data:

1. Import the data to the replica using one of the following methods:
  - a. If you used `mysqldump`, start the replica server, ensuring that replication does not start by using the `--skip-slave-start` option. Then import the dump file:

```
$> mysql < fulldb.dump
```

- b. If you created a snapshot using the raw data files, extract the data files into your replica's data directory. For example:

```
$> tar xvf dbdump.tar
```

You may need to set permissions and ownership on the files so that the replica server can access and modify them. Then start the replica server, ensuring that replication does not start by using the `--skip-slave-start` option.

2. Configure the replica with the replication coordinates from the source. This tells the replica the binary log file and position within the file where replication needs to start. Also, configure the replica with the login credentials and host name of the source. For more information on the `CHANGE MASTER TO` statement required, see [Setting the Source Configuration on the Replica](#).
3. Start the replication threads:

```
mysql> START SLAVE;
```

After you have performed this procedure, the replica connects to the source and replicates any updates that have occurred on the source since the snapshot was taken.

If the `server_id` system variable for the source is not correctly set, replicas cannot connect to it. Similarly, if you have not set `server_id` correctly for the replica, you get the following error in the replica's error log:

```
Warning: You should set server-id to a non-0 value if master_host is set; we will force server id to 2, but this MySQL server will not act as a slave.
```

You also find error messages in the replica's error log if it is not able to replicate for any other reason.

The replica stores information about the source you have configured in its connection metadata repository. The connection metadata repository can be in the form of files or a table, as determined by the value set for the `master_info_repository` system variable. When a replica runs with `master_info_repository=FILE`, two files are stored in the data directory, named `master.info` and `relay-log.info`. If `master_info_repository=TABLE` instead, this information is saved in the `master_slave_info` table in the `mysql` database. In either case, do *not* remove or edit the files or table. Always use the `CHANGE MASTER TO` statement to change replication parameters. The replica can use the

values specified in the statement to update the status files automatically. See [Section 16.2.4, “Relay Log and Replication Metadata Repositories”](#), for more information.



#### Note

The contents of the connection metadata repository override some of the server options specified on the command line or in `my.cnf`. See [Section 16.1.6, “Replication and Binary Logging Options and Variables”](#), for more details.

A single snapshot of the source suffices for multiple replicas. To set up additional replicas, use the same source snapshot and follow the replica portion of the procedure just described.

### 16.1.2.6 Adding Replicas to a Replication Topology

You can add another replica to an existing replication configuration without stopping the source server. To do this, you can set up the new replica by copying the data directory of an existing replica, and giving the new replica a different server ID (which is user-specified) and server UUID (which is generated at startup).

To duplicate an existing replica:

1. Stop the existing replica and record the replica status information, particularly the source's binary log file and relay log file positions. You can view the replica status either in the Performance Schema replication tables (see [Section 25.12.11, “Performance Schema Replication Tables”](#)), or by issuing `SHOW SLAVE STATUS` as follows:

```
mysql> STOP SLAVE;
mysql> SHOW SLAVE STATUS\G
```

2. Shut down the existing replica:

```
$> mysqladmin shutdown
```

3. Copy the data directory from the existing replica to the new replica, including the log files and relay log files. You can do this by creating an archive using `tar` or `WinZip`, or by performing a direct copy using a tool such as `cp` or `rsync`.



#### Important

- Before copying, verify that all the files relating to the existing replica actually are stored in the data directory. For example, the `InnoDB` system tablespace, undo tablespace, and redo log might be stored in an alternative location. `InnoDB` tablespace files and file-per-table tablespaces might have been created in other directories. The binary logs and relay logs for the replica might be in their own directories outside the data directory. Check through the system variables that are set for the existing replica and look for any alternative paths that have been specified. If you find any, copy these directories over as well.
- During copying, if files have been used for the replication metadata repositories (see [Section 16.2.4, “Relay Log and Replication Metadata Repositories”](#)), which is the default in MySQL 5.7, ensure that you also copy these files from the existing replica to the new replica. If tables have been used for the repositories, the tables are in the data directory.
- After copying, delete the `auto.cnf` file from the copy of the data directory on the new replica, so that the new replica is started with a different generated server UUID. The server UUID must be unique.

A common problem that is encountered when adding new replicas is that the new replica fails with a series of warning and error messages like these:

```
071118 16:44:10 [Warning] Neither --relay-log nor --relay-log-index were used; so
replication may break when this MySQL server acts as a slave and has his hostname
changed!! Please use '--relay-log=new_replica_hostname-relay-bin' to avoid this problem.
071118 16:44:10 [ERROR] Failed to open the relay log './old_replica_hostname-relay-bin.003525'
(relay_log_pos 22940879)
071118 16:44:10 [ERROR] Could not find target log during relay log initialization
071118 16:44:10 [ERROR] Failed to initialize the master info structure
```

This situation can occur if the `relay_log` system variable is not specified, as the relay log files contain the host name as part of their file names. This is also true of the relay log index file if the `relay_log_index` system variable is not used. For more information about these variables, see [Section 16.1.6, “Replication and Binary Logging Options and Variables”](#).

To avoid this problem, use the same value for `relay_log` on the new replica that was used on the existing replica. If this option was not set explicitly on the existing replica, use `existing_replica_hostname-relay-bin`. If this is not possible, copy the existing replica's relay log index file to the new replica and set the `relay_log_index` system variable on the new replica to match what was used on the existing replica. If this option was not set explicitly on the existing replica, use `existing_replica_hostname-relay-bin.index`. Alternatively, if you have already tried to start the new replica after following the remaining steps in this section and have encountered errors like those described previously, then perform the following steps:

- a. If you have not already done so, issue `STOP SLAVE` on the new replica.  
  
If you have already started the existing replica again, issue `STOP SLAVE` on the existing replica as well.
  - b. Copy the contents of the existing replica's relay log index file into the new replica's relay log index file, making sure to overwrite any content already in the file.
  - c. Proceed with the remaining steps in this section.
4. When copying is complete, restart the existing replica.
  5. On the new replica, edit the configuration and give the new replica a unique server ID (using the `server_id` system variable) that is not used by the source or any of the existing replicas.
  6. Start the new replica server, specifying the `--skip-slave-start` option so that replication does not start yet. Use the Performance Schema replication tables or issue `SHOW SLAVE STATUS` to confirm that the new replica has the correct settings when compared with the existing replica. Also display the server ID and server UUID and verify that these are correct and unique for the new replica.
  7. Start the replication threads by issuing a `START SLAVE` statement:

```
mysql> START SLAVE;
```

The new replica now uses the information in its connection metadata repository to start the replication process.

### 16.1.3 Replication with Global Transaction Identifiers

This section explains transaction-based replication using *global transaction identifiers* (GTIDs). When using GTIDs, each transaction can be identified and tracked as it is committed on the originating server and applied by any replicas; this means that it is not necessary when using GTIDs to refer to log files

or positions within those files when starting a new replica or failing over to a new source, which greatly simplifies these tasks. Because GTID-based replication is completely transaction-based, it is simple to determine whether sources and replicas are consistent; as long as all transactions committed on a source are also committed on a replica, consistency between the two is guaranteed. You can use either statement-based or row-based replication with GTIDs (see [Section 16.2.1, “Replication Formats”](#)); however, for best results, we recommend that you use the row-based format.

GTIDs are always preserved between source and replica. This means that you can always determine the source for any transaction applied on any replica by examining its binary log. In addition, once a transaction with a given GTID is committed on a given server, any subsequent transaction having the same GTID is ignored by that server. Thus, a transaction committed on the source can be applied no more than once on the replica, which helps to guarantee consistency.

This section discusses the following topics:

- How GTIDs are defined and created, and how they are represented in a MySQL server (see [Section 16.1.3.1, “GTID Format and Storage”](#)).
- The life cycle of a GTID (see [Section 16.1.3.2, “GTID Life Cycle”](#)).
- The auto-positioning function for synchronizing a replica and source that use GTIDs (see [Section 16.1.3.3, “GTID Auto-Positioning”](#)).
- A general procedure for setting up and starting GTID-based replication (see [Section 16.1.3.4, “Setting Up Replication Using GTIDs”](#)).
- Suggested methods for provisioning new replication servers when using GTIDs (see [Section 16.1.3.5, “Using GTIDs for Failover and Scaleout”](#)).
- Restrictions and limitations that you should be aware of when using GTID-based replication (see [Section 16.1.3.6, “Restrictions on Replication with GTIDs”](#)).
- Stored functions that you can use to work with GTIDs (see [Section 16.1.3.7, “Stored Function Examples to Manipulate GTIDs”](#)).

For information about MySQL Server options and variables relating to GTID-based replication, see [Section 16.1.6.5, “Global Transaction ID System Variables”](#). See also [Section 12.18, “Functions Used with Global Transaction Identifiers \(GTIDs\)”](#), which describes SQL functions supported by MySQL 5.7 for use with GTIDs.

### 16.1.3.1 GTID Format and Storage

A global transaction identifier (GTID) is a unique identifier created and associated with each transaction committed on the server of origin (the source). This identifier is unique not only to the server on which it originated, but is unique across all servers in a given replication topology.

GTID assignment distinguishes between client transactions, which are committed on the source, and replicated transactions, which are reproduced on a replica. When a client transaction is committed on the source, it is assigned a new GTID, provided that the transaction was written to the binary log. Client transactions are guaranteed to have monotonically increasing GTIDs without gaps between the generated numbers. If a client transaction is not written to the binary log (for example, because the transaction was filtered out, or the transaction was read-only), it is not assigned a GTID on the server of origin.

Replicated transactions retain the same GTID that was assigned to the transaction on the server of origin. The GTID is present before the replicated transaction begins to execute, and is persisted even if the replicated transaction is not written to the binary log on the replica, or is filtered out on the replica.

The MySQL system table `mysql.gtid_executed` is used to preserve the assigned GTIDs of all the transactions applied on a MySQL server, except those that are stored in a currently active binary log file.

The auto-skip function for GTIDs means that a transaction committed on the source can be applied no more than once on the replica, which helps to guarantee consistency. Once a transaction with a given GTID has been committed on a given server, any attempt to execute a subsequent transaction with the same GTID is ignored by that server. No error is raised, and no statement in the transaction is executed.

If a transaction with a given GTID has started to execute on a server, but has not yet committed or rolled back, any attempt to start a concurrent transaction on the server with the same GTID blocks. The server neither begins to execute the concurrent transaction nor returns control to the client. Once the first attempt at the transaction commits or rolls back, concurrent sessions that were blocking on the same GTID may proceed. If the first attempt rolled back, one concurrent session proceeds to attempt the transaction, and any other concurrent sessions that were blocking on the same GTID remain blocked. If the first attempt committed, all the concurrent sessions stop being blocked, and auto-skip all the statements of the transaction.

A GTID is represented as a pair of coordinates, separated by a colon character (:), as shown here:

```
GTID = source_id:transaction_id
```

The `source_id` identifies the originating server. Normally, the source's `server_uuid` is used for this purpose. The `transaction_id` is a sequence number determined by the order in which the transaction was committed on the source. For example, the first transaction to be committed has `1` as its `transaction_id`, and the tenth transaction to be committed on the same originating server is assigned a `transaction_id` of `10`. It is not possible for a transaction to have `0` as a sequence number in a GTID. For example, the twenty-third transaction to be committed originally on the server with the UUID `3E11FA47-71CA-11E1-9E33-C80AA9429562` has this GTID:

```
3E11FA47-71CA-11E1-9E33-C80AA9429562:23
```

The upper limit for sequence numbers for GTIDs on a server instance is the number of non-negative values for a signed 64-bit integer (2 to the power of 63 minus 1, or 9,223,372,036,854,775,807). If the server runs out of GTIDs, it takes the action specified by `binlog_error_action`.

The GTID for a transaction is shown in the output from `mysqlbinlog`, and it is used to identify an individual transaction in the Performance Schema replication status tables, for example, `replication_applier_status_by_worker`. The value stored by the `gtid_next` system variable (`@@GLOBAL.gtid_next`) is a single GTID.

## GTID Sets

A GTID set is a set comprising one or more single GTIDs or ranges of GTIDs. GTID sets are used in a MySQL server in several ways. For example, the values stored by the `gtid_executed` and `gtid_purged` system variables are GTID sets. The `START SLAVE` clauses `UNTIL SQL_BEFORE_GTIDS` and `UNTIL SQL_AFTER_GTIDS` can be used to make a replica process transactions only up to the first GTID in a GTID set, or stop after the last GTID in a GTID set. The built-in functions `GTID_SUBSET()` and `GTID_SUBTRACT()` require GTID sets as input.

A range of GTIDs originating from the same server can be collapsed into a single expression, as shown here:

```
3E11FA47-71CA-11E1-9E33-C80AA9429562:1-5
```

The above example represents the first through fifth transactions originating on the MySQL server whose `server_uuid` is `3E11FA47-71CA-11E1-9E33-C80AA9429562`. Multiple single GTIDs or ranges of GTIDs originating from the same server can also be included in a single expression, with the GTIDs or ranges separated by colons, as in the following example:

```
3E11FA47-71CA-11E1-9E33-C80AA9429562:1-3,11:47-49
```

A GTID set can include any combination of single GTIDs and ranges of GTIDs, and it can include GTIDs originating from different servers. This example shows the GTID set stored in the `gtid_executed` system variable (`@GLOBAL.gtid_executed`) of a replica that has applied transactions from more than one source:

```
2174B383-5441-11E8-B90A-C80AA9429562:1-3, 24DA167-0C0C-11E8-8442-00059A3C7B00:1-19
```

When GTID sets are returned from server variables, UUIDs are in alphabetical order, and numeric intervals are merged and in ascending order.

The syntax for a GTID set is as follows:

```
gtid_set:
  uuid_set [, uuid_set] ...
  | ''

uuid_set:
  uuid:interval[:interval]...

uuid:
  hhhhhhhh-hhhh-hhhh-hhhh-hhhhhhhhhhhh

h:
  [0-9|A-F]

interval:
  n[-n]

(n >= 1)
```

## mysql.gtid\_executed Table

GTIDs are stored in a table named `gtid_executed`, in the `mysql` database. A row in this table contains, for each GTID or set of GTIDs that it represents, the UUID of the originating server, and the starting and ending transaction IDs of the set; for a row referencing only a single GTID, these last two values are the same.

The `mysql.gtid_executed` table is created (if it does not already exist) when MySQL Server is installed or upgraded, using a `CREATE TABLE` statement similar to that shown here:

```
CREATE TABLE gtid_executed (
  source_uuid CHAR(36) NOT NULL,
  interval_start BIGINT(20) NOT NULL,
  interval_end BIGINT(20) NOT NULL,
  PRIMARY KEY (source_uuid, interval_start)
)
```



### Warning

As with other MySQL system tables, do not attempt to create or modify this table yourself.

The `mysql.gtid_executed` table is provided for internal use by the MySQL server. It enables a replica to use GTIDs when binary logging is disabled on the replica, and it enables retention of the GTID state when the binary logs have been lost. Note that the `mysql.gtid_executed` table is cleared if you issue `RESET MASTER`.

GTIDs are stored in the `mysql.gtid_executed` table only when `gtid_mode` is `ON` or `ON_PERMISSIVE`. The point at which GTIDs are stored depends on whether binary logging is enabled or disabled:

- If binary logging is disabled (`log_bin` is `OFF`), or if `log_slave_updates` is disabled, the server stores the GTID belonging to each transaction together with the transaction in the buffer when the transaction is committed, and the background thread adds the contents of the buffer periodically as one or more entries to the `mysql.gtid_executed` table. In addition, the table is compressed periodically at a user-configurable rate; see [mysql.gtid\\_executed Table Compression](#), for more information. This situation can only apply on a replica where binary logging or replica update logging is disabled. It does not apply on a replication source server, because on the source, binary logging must be enabled for replication to take place.
- If binary logging is enabled (`log_bin` is `ON`), whenever the binary log is rotated or the server is shut down, the server writes GTIDs for all transactions that were written into the previous binary log into the `mysql.gtid_executed` table. This situation applies on a replication source server, or a replica where binary logging is enabled.

In the event of the server stopping unexpectedly, the set of GTIDs from the current binary log file is not saved in the `mysql.gtid_executed` table. These GTIDs are added to the table from the binary log file during recovery. The exception to this is if binary logging is not enabled when the server is restarted. In this situation, the server cannot access the binary log file to recover the GTIDs, so replication cannot be started.

When binary logging is enabled, the `mysql.gtid_executed` table does not hold a complete record of the GTIDs for all executed transactions. That information is provided by the global value of the `gtid_executed` system variable. Always use `@@GLOBAL.gtid_executed`, which is updated after every commit, to represent the GTID state for the MySQL server, and do not query the `mysql.gtid_executed` table.

### mysql.gtid\_executed Table Compression

Over the course of time, the `mysql.gtid_executed` table can become filled with many rows referring to individual GTIDs that originate on the same server, and whose transaction IDs make up a range, similar to what is shown here:

source_uuid	interval_start	interval_end
3E11FA47-71CA-11E1-9E33-C80AA9429562	37	37
3E11FA47-71CA-11E1-9E33-C80AA9429562	38	38
3E11FA47-71CA-11E1-9E33-C80AA9429562	39	39
3E11FA47-71CA-11E1-9E33-C80AA9429562	40	40
3E11FA47-71CA-11E1-9E33-C80AA9429562	41	41
3E11FA47-71CA-11E1-9E33-C80AA9429562	42	42
3E11FA47-71CA-11E1-9E33-C80AA9429562	43	43

To save space, the MySQL server compresses the `mysql.gtid_executed` table periodically by replacing each such set of rows with a single row that spans the entire interval of transaction identifiers, like this:

source_uuid	interval_start	interval_end
3E11FA47-71CA-11E1-9E33-C80AA9429562	37	43

You can control the number of transactions that are allowed to elapse before the table is compressed, and thus the compression rate, by setting the `gtid_executed_compression_period` system variable. This variable's default value is 1000, meaning that by default, compression of the table is performed after each 1000 transactions. Setting `gtid_executed_compression_period` to 0 prevents the compression from

being performed at all, and you should be prepared for a potentially large increase in the amount of disk space that may be required by the `gtid_executed` table if you do this.



#### Note

When binary logging is enabled, the value of `gtid_executed_compression_period` is *not* used and the `mysql.gtid_executed` table is compressed on each binary log rotation.

Compression of the `mysql.gtid_executed` table is performed by a dedicated foreground thread named `thread/sql/compress_gtid_table`. This thread is not listed in the output of `SHOW PROCESSLIST`, but it can be viewed as a row in the `threads` table, as shown here:

```
mysql> SELECT * FROM performance_schema.threads WHERE NAME LIKE '%gtid%'\G
***** 1. row *****
      THREAD_ID: 26
      NAME: thread/sql/compress_gtid_table
      TYPE: FOREGROUND
      PROCESSLIST_ID: 1
      PROCESSLIST_USER: NULL
      PROCESSLIST_HOST: NULL
      PROCESSLIST_DB: NULL
      PROCESSLIST_COMMAND: Daemon
      PROCESSLIST_TIME: 1509
      PROCESSLIST_STATE: Suspending
      PROCESSLIST_INFO: NULL
      PARENT_THREAD_ID: 1
      ROLE: NULL
      INSTRUMENTED: YES
      HISTORY: YES
      CONNECTION_TYPE: NULL
      THREAD_OS_ID: 18677
```

The `thread/sql/compress_gtid_table` thread normally sleeps until `gtid_executed_compression_period` transactions have been executed, then wakes up to perform compression of the `mysql.gtid_executed` table as described previously. It then sleeps until another `gtid_executed_compression_period` transactions have taken place, then wakes up to perform the compression again, repeating this loop indefinitely. Setting this value to 0 when binary logging is disabled means that the thread always sleeps and never wakes up, meaning that this explicit compression method is not used. Instead, compression occurs implicitly as required.

### 16.1.3.2 GTID Life Cycle

The life cycle of a GTID consists of the following steps:

1. A transaction is executed and committed on the replication source server. This client transaction is assigned a GTID composed of the source's UUID and the smallest nonzero transaction sequence number not yet used on this server. The GTID is written to the source's binary log (immediately preceding the transaction itself in the log). If a client transaction is not written to the binary log (for example, because the transaction was filtered out, or the transaction was read-only), it is not assigned a GTID.
2. If a GTID was assigned for the transaction, the GTID is persisted atomically at commit time by writing it to the binary log at the beginning of the transaction (as a `Gtid_log_event`). Whenever the binary log is rotated or the server is shut down, the server writes GTIDs for all transactions that were written into the previous binary log file into the `mysql.gtid_executed` table.
3. If a GTID was assigned for the transaction, the GTID is externalized non-atomically (very shortly after the transaction is committed) by adding it to the set of GTIDs in the `gtid_executed` system variable (`@GLOBAL.gtid_executed`). This GTID set contains a representation of the set of all committed



GTID transactions, and it is used in replication as a token that represents the server state. With binary logging enabled (as required for the source), the set of GTIDs in the `gtid_executed` system variable is a complete record of the transactions applied, but the `mysql.gtid_executed` table is not, because the most recent history is still in the current binary log file.

4. After the binary log data is transmitted to the replica and stored in the replica's relay log (using established mechanisms for this process, see [Section 16.2, "Replication Implementation"](#), for details), the replica reads the GTID and sets the value of its `gtid_next` system variable as this GTID. This tells the replica that the next transaction must be logged using this GTID. It is important to note that the replica sets `gtid_next` in a session context.
5. The replica verifies that no thread has yet taken ownership of the GTID in `gtid_next` in order to process the transaction. By reading and checking the replicated transaction's GTID first, before processing the transaction itself, the replica guarantees not only that no previous transaction having this GTID has been applied on the replica, but also that no other session has already read this GTID but has not yet committed the associated transaction. So if multiple clients attempt to apply the same transaction concurrently, the server resolves this by letting only one of them execute. The `gtid_owned` system variable (`@@GLOBAL.gtid_owned`) for the replica shows each GTID that is currently in use and the ID of the thread that owns it. If the GTID has already been used, no error is raised, and the auto-skip function is used to ignore the transaction.
6. If the GTID has not been used, the replica applies the replicated transaction. Because `gtid_next` is set to the GTID already assigned by the source, the replica does not attempt to generate a new GTID for this transaction, but instead uses the GTID stored in `gtid_next`.
7. If binary logging is enabled on the replica, the GTID is persisted atomically at commit time by writing it to the binary log at the beginning of the transaction (as a `Gtid_log_event`). Whenever the binary log is rotated or the server is shut down, the server writes GTIDs for all transactions that were written into the previous binary log file into the `mysql.gtid_executed` table.
8. If binary logging is disabled on the replica, the GTID is persisted atomically by writing it directly into the `mysql.gtid_executed` table. MySQL appends a statement to the transaction to insert the GTID into the table. In this situation, the `mysql.gtid_executed` table is a complete record of the transactions applied on the replica. Note that in MySQL 5.7, the operation to insert the GTID into the table is atomic for DML statements, but not for DDL statements, so if the server exits unexpectedly after a transaction involving DDL statements, the GTID state might become inconsistent. From MySQL 8.0, the operation is atomic for DDL statements as well as for DML statements.
9. Very shortly after the replicated transaction is committed on the replica, the GTID is externalized non-atomically by adding it to the set of GTIDs in the `gtid_executed` system variable (`@@GLOBAL.gtid_executed`) for the replica. As for the source, this GTID set contains a representation of the set of all committed GTID transactions. If binary logging is disabled on the replica, the `mysql.gtid_executed` table is also a complete record of the transactions applied on the replica. If binary logging is enabled on the replica, meaning that some GTIDs are only recorded in the binary log, the set of GTIDs in the `gtid_executed` system variable is the only complete record.

Client transactions that are completely filtered out on the source are not assigned a GTID, therefore they are not added to the set of transactions in the `gtid_executed` system variable, or added to the `mysql.gtid_executed` table. However, the GTIDs of replicated transactions that are completely filtered out on the replica are persisted. If binary logging is enabled on the replica, the filtered-out transaction is written to the binary log as a `Gtid_log_event` followed by an empty transaction containing only `BEGIN` and `COMMIT` statements. If binary logging is disabled, the GTID of the filtered-out transaction is written to the `mysql.gtid_executed` table. Preserving the GTIDs for filtered-out transactions ensures that the `mysql.gtid_executed` table and the set of GTIDs in the `gtid_executed` system variable can be compressed. It also ensures that the filtered-out transactions are not retrieved again if the replica reconnects to the source, as explained in [Section 16.1.3.3, "GTID Auto-Positioning"](#).

On a multithreaded replica (with `slave_parallel_workers > 0`), transactions can be applied in parallel, so replicated transactions can commit out of order (unless `slave_preserve_commit_order=1` is set). When that happens, the set of GTIDs in the `gtid_executed` system variable contains multiple GTID ranges with gaps between them. (On a source or a single-threaded replica, there are monotonically increasing GTIDs without gaps between the numbers.) Gaps on multithreaded replicas only occur among the most recently applied transactions, and are filled in as replication progresses. When replication threads are stopped cleanly using the `STOP SLAVE` statement, ongoing transactions are applied so that the gaps are filled in. In the event of a shutdown such as a server failure or the use of the `KILL` statement to stop replication threads, the gaps might remain.

## What changes are assigned a GTID?

The typical scenario is that the server generates a new GTID for a committed transaction. However, GTIDs can also be assigned to other changes besides transactions, and in some cases a single transaction can be assigned multiple GTIDs.

Every database change (DDL or DML) that is written to the binary log is assigned a GTID. This includes changes that are autocommitted, and changes that are committed using `BEGIN` and `COMMIT` or `START TRANSACTION` statements. A GTID is also assigned to the creation, alteration, or deletion of a database, and of a non-table database object such as a procedure, function, trigger, event, view, user, role, or grant.

Non-transactional updates as well as transactional updates are assigned GTIDs. In addition, for a non-transactional update, if a disk write failure occurs while attempting to write to the binary log cache and a gap is therefore created in the binary log, the resulting incident log event is assigned a GTID.

When a table is automatically dropped by a generated statement in the binary log, a GTID is assigned to the statement. Temporary tables are dropped automatically when a replica begins to apply events from a source that has just been started, and when statement-based replication is in use (`binlog_format=STATEMENT`) and a user session that has open temporary tables disconnects. Tables that use the `MEMORY` storage engine are deleted automatically the first time they are accessed after the server is started, because rows might have been lost during the shutdown.

When a transaction is not written to the binary log on the server of origin, the server does not assign a GTID to it. This includes transactions that are rolled back and transactions that are executed while binary logging is disabled on the server of origin, either globally (with `--skip-log-bin` specified in the server's configuration) or for the session (`SET @@SESSION.sql_log_bin = 0`). This also includes no-op transactions when row-based replication is in use (`binlog_format=ROW`).

XA transactions are assigned separate GTIDs for the `XA PREPARE` phase of the transaction and the `XA COMMIT` or `XA ROLLBACK` phase of the transaction. XA transactions are persistently prepared so that users can commit them or roll them back in the case of a failure (which in a replication topology might include a failover to another server). The two parts of the transaction are therefore replicated separately, so they must have their own GTIDs, even though a non-XA transaction that is rolled back would not have a GTID.

In the following special cases, a single statement can generate multiple transactions, and therefore be assigned multiple GTIDs:

- A stored procedure is invoked that commits multiple transactions. One GTID is generated for each transaction that the procedure commits.
- A multi-table `DROP TABLE` statement drops tables of different types.
- A `CREATE TABLE ... SELECT` statement is issued when row-based replication is in use (`binlog_format=ROW`). One GTID is generated for the `CREATE TABLE` action and one GTID is generated for the row-insert actions.

## The `gtid_next` System Variable

By default, for new transactions committed in user sessions, the server automatically generates and assigns a new GTID. When the transaction is applied on a replica, the GTID from the server of origin is preserved. You can change this behavior by setting the session value of the `gtid_next` system variable:

- When `gtid_next` is set to `AUTOMATIC`, which is the default, and a transaction is committed and written to the binary log, the server automatically generates and assigns a new GTID. If a transaction is rolled back or not written to the binary log for another reason, the server does not generate and assign a GTID.
- If you set `gtid_next` to a valid GTID (consisting of a UUID and a transaction sequence number, separated by a colon), the server assigns that GTID to your transaction. This GTID is assigned and added to `gtid_executed` even when the transaction is not written to the binary log, or when the transaction is empty.

Note that after you set `gtid_next` to a specific GTID, and the transaction has been committed or rolled back, an explicit `SET @@SESSION.gtid_next` statement must be issued before any other statement. You can use this to set the GTID value back to `AUTOMATIC` if you do not want to assign any more GTIDs explicitly.

When replication applier threads apply replicated transactions, they use this technique, setting `@@SESSION.gtid_next` explicitly to the GTID of the replicated transaction as assigned on the server of origin. This means the GTID from the server of origin is retained, rather than a new GTID being generated and assigned by the replica. It also means the GTID is added to `gtid_executed` on the replica even when binary logging or replica update logging is disabled on the replica, or when the transaction is a no-op or is filtered out on the replica.

It is possible for a client to simulate a replicated transaction by setting `@@SESSION.gtid_next` to a specific GTID before executing the transaction. This technique is used by `mysqlbinlog` to generate a dump of the binary log that the client can replay to preserve GTIDs. A simulated replicated transaction committed through a client is completely equivalent to a replicated transaction committed through a replication applier thread, and they cannot be distinguished after the fact.

## The `gtid_purged` System Variable

The set of GTIDs in the `gtid_purged` system variable (`@@GLOBAL.gtid_purged`) contains the GTIDs of all the transactions that have been committed on the server, but do not exist in any binary log file on the server. `gtid_purged` is a subset of `gtid_executed`. The following categories of GTIDs are in `gtid_purged`:

- GTIDs of replicated transactions that were committed with binary logging disabled on the replica.
- GTIDs of transactions that were written to a binary log file that has now been purged.
- GTIDs that were added explicitly to the set by the statement `SET @@GLOBAL.gtid_purged`.

You can change the value of `gtid_purged` in order to record on the server that the transactions in a certain GTID set have been applied, although they do not exist in any binary log on the server. When you add GTIDs to `gtid_purged`, they are also added to `gtid_executed`. An example use case for this action is when you are restoring a backup of one or more databases on a server, but you do not have the relevant binary logs containing the transactions on the server. In MySQL 5.7, you can only change the value of `gtid_purged` when `gtid_executed` (and therefore `gtid_purged`) is empty. For details of how to do this, see the description for `gtid_purged`.

The sets of GTIDs in the `gtid_executed` and `gtid_purged` system variables are initialized when the server starts. Every binary log file begins with the event `Previous_gtid_log_event`, which contains the set of GTIDs in all previous binary log files (composed from the GTIDs in the preceding file's `Previous_gtid_log_event`, and the GTIDs of every `Gtid_log_event` in the preceding file itself).

The contents of `Previous_gtids_log_event` in the oldest and most recent binary log files are used to compute the `gtid_executed` and `gtid_purged` sets at server startup:

- `gtid_executed` is computed as the union of the GTIDs in `Previous_gtids_log_event` in the most recent binary log file, the GTIDs of transactions in that binary log file, and the GTIDs stored in the `mysql.gtid_executed` table. This GTID set contains all the GTIDs that have been used (or added explicitly to `gtid_purged`) on the server, whether or not they are currently in a binary log file on the server. It does not include the GTIDs for transactions that are currently being processed on the server (`@@GLOBAL.gtid_owned`).
- `gtid_purged` is computed by first adding the GTIDs in `Previous_gtids_log_event` in the most recent binary log file and the GTIDs of transactions in that binary log file. This step gives the set of GTIDs that are currently, or were once, recorded in a binary log on the server (`gtids_in_binlog`). Next, the GTIDs in `Previous_gtids_log_event` in the oldest binary log file are subtracted from `gtids_in_binlog`. This step gives the set of GTIDs that are currently recorded in a binary log on the server (`gtids_in_binlog_not_purged`). Finally, `gtids_in_binlog_not_purged` is subtracted from `gtid_executed`. The result is the set of GTIDs that have been used on the server, but are not currently recorded in a binary log file on the server, and this result is used to initialize `gtid_purged`.

If binary logs from MySQL 5.7.7 or older are involved in these computations, it is possible for incorrect GTID sets to be computed for `gtid_executed` and `gtid_purged`, and they remain incorrect even if the server is later restarted. For details, see the description for the `binlog_gtid_simple_recovery` system variable, which controls how the binary logs are iterated to compute the GTID sets. If one of the situations described there applies on a server, set `binlog_gtid_simple_recovery=FALSE` in the server's configuration file before starting it. That setting makes the server iterate all the binary log files (not just the newest and oldest) to find where GTID events start to appear. This process could take a long time if the server has a large number of binary log files without GTID events.

## Resetting the GTID Execution History

If you need to reset the GTID execution history on a server, use the `RESET MASTER` statement. For example, you might need to do this after carrying out test queries to verify a replication setup on new GTID-enabled servers, or when you want to join a new server to a replication group but it contains some unwanted local transactions that are not accepted by Group Replication.



### Warning

Use `RESET MASTER` with caution to avoid losing any wanted GTID execution history and binary log files.

Before issuing `RESET MASTER`, ensure that you have backups of the server's binary log files and binary log index file, if any, and obtain and save the GTID set held in the global value of the `gtid_executed` system variable (for example, by issuing a `SELECT @@GLOBAL.gtid_executed` statement and saving the results). If you are removing unwanted transactions from that GTID set, use `mysqlbinlog` to examine the contents of the transactions to ensure that they have no value, contain no data that must be saved or replicated, and did not result in data changes on the server.

When you issue `RESET MASTER`, the following reset operations are carried out:

- The value of the `gtid_purged` system variable is set to an empty string ('').
- The global value (but not the session value) of the `gtid_executed` system variable is set to an empty string.
- The `mysql.gtid_executed` table is cleared (see [mysql.gtid\\_executed Table](#)).
- If the server has binary logging enabled, the existing binary log files are deleted and the binary log index file is cleared.

Note that `RESET MASTER` is the method to reset the GTID execution history even if the server is a replica where binary logging is disabled. `RESET SLAVE` has no effect on the GTID execution history.

### 16.1.3.3 GTID Auto-Positioning

GTIDs replace the file-offset pairs previously required to determine points for starting, stopping, or resuming the flow of data between source and replica. When GTIDs are in use, all the information that the replica needs for synchronizing with the source is obtained directly from the replication data stream.

To start a replica using GTID-based replication, you do not include `MASTER_LOG_FILE` or `MASTER_LOG_POS` options in the `CHANGE MASTER TO` statement used to direct the replica to replicate from a given source. These options specify the name of the log file and the starting position within the file, but with GTIDs the replica does not need this nonlocal data. Instead, you need to enable the `MASTER_AUTO_POSITION` option. For full instructions to configure and start sources and replicas using GTID-based replication, see [Section 16.1.3.4, “Setting Up Replication Using GTIDs”](#).

The `MASTER_AUTO_POSITION` option is disabled by default. If multi-source replication is enabled on the replica, you need to set this option for each applicable replication channel. Disabling the `MASTER_AUTO_POSITION` option again causes the replica to revert to position-based replication.

When a replica has GTIDs enabled (`GTID_MODE=ON`, `ON_PERMISSIVE`, or `OFF_PERMISSIVE`) and the `MASTER_AUTO_POSITION` option enabled, auto-positioning is activated for connection to the source. The source must have `GTID_MODE=ON` set in order for the connection to succeed. In the initial handshake, the replica sends a GTID set containing the transactions that it has already received, committed, or both. This GTID set is equal to the union of the set of GTIDs in the `gtid_executed` system variable (`@@GLOBAL.gtid_executed`), and the set of GTIDs recorded in the Performance Schema `replication_connection_status` table as received transactions (the result of the statement `SELECT RECEIVED_TRANSACTION_SET FROM PERFORMANCE_SCHEMA.replication_connection_status`).

The source responds by sending all transactions recorded in its binary log whose GTID is not included in the GTID set sent by the replica. To do this, the source first identifies the appropriate binary log file to begin working with, by checking the `Previous_gtid_log_event` in the header of each of its binary log files, starting with the most recent. When the source finds the first `Previous_gtid_log_event` which contains no transactions that the replica is missing, it begins with that binary log file. This method is efficient and only takes a significant amount of time if the replica is behind the source by a large number of binary log files. The source then reads the transactions in that binary log file and subsequent files up to the current one, sending the transactions with GTIDs that the replica is missing, and skipping the transactions that were in the GTID set sent by the replica. The elapsed time until the replica receives the first missing transaction depends on its offset in the binary log file. This exchange ensures that the source only sends the transactions with a GTID that the replica has not already received or committed. If the replica receives transactions from more than one source, as in the case of a diamond topology, the auto-skip function ensures that the transactions are not applied twice.

If any of the transactions that should be sent by the source have been purged from the source's binary log, or added to the set of GTIDs in the `gtid_purged` system variable by another method, the source sends the error `ER_MASTER_HAS_PURGED_REQUIRED_GTIDS` to the replica, and replication does not start. The GTIDs of the missing purged transactions are identified and listed in the source's error log in the warning message `ER_FOUND_MISSING_GTIDS`. The replica cannot recover automatically from this error because parts of the transaction history that are needed to catch up with the source have been purged. Attempting to reconnect without the `MASTER_AUTO_POSITION` option enabled only results in the loss of the purged transactions on the replica. The correct approach to recover from this situation is for the replica to replicate the missing transactions listed in the `ER_FOUND_MISSING_GTIDS` message from another source, or for the replica to be replaced by a new replica created from a more recent backup. Consider revising the binary log expiration period on the source to ensure that the situation does not occur again.

If during the exchange of transactions it is found that the replica has received or committed transactions with the source's UUID in the GTID, but the source itself does not have a record of them, the source sends the error `ER_SLAVE_HAS_MORE_GTIDS_THAN_MASTER` to the replica and replication does not start. This situation can occur if a source that does not have `sync_binlog=1` set experiences a power failure or operating system crash, and loses committed transactions that have not yet been synchronized to the binary log file, but have been received by the replica. The source and replica can diverge if any clients commit transactions on the source after it is restarted, which can lead to the situation where the source and replica are using the same GTID for different transactions. The correct approach to recover from this situation is to check manually whether the source and replica have diverged. If the same GTID is now in use for different transactions, you either need to perform manual conflict resolution for individual transactions as required, or remove either the source or the replica from the replication topology. If the issue is only missing transactions on the source, you can make the source into a replica instead, allow it to catch up with the other servers in the replication topology, and then make it a source again if needed.

### 16.1.3.4 Setting Up Replication Using GTIDs

This section describes a process for configuring and starting GTID-based replication in MySQL 5.7. This is a “cold start” procedure that assumes either that you are starting the replication source server for the first time, or that it is possible to stop it; for information about provisioning replicas using GTIDs from a running source, see [Section 16.1.3.5, “Using GTIDs for Failover and Scaleout”](#). For information about changing GTID mode on servers online, see [Section 16.1.4, “Changing Replication Modes on Online Servers”](#).

The key steps in this startup process for the simplest possible GTID replication topology, consisting of one source and one replica, are as follows:

1. If replication is already running, synchronize both servers by making them read-only.
2. Stop both servers.
3. Restart both servers with GTIDs enabled and the correct options configured.

The `mysqld` options necessary to start the servers as described are discussed in the example that follows later in this section.

4. Instruct the replica to use the source as the replication data source and to use auto-positioning. The SQL statements needed to accomplish this step are described in the example that follows later in this section.
5. Take a new backup. Binary logs containing transactions without GTIDs cannot be used on servers where GTIDs are enabled, so backups taken before this point cannot be used with your new configuration.
6. Start the replica, then disable read-only mode on both servers, so that they can accept updates.

In the following example, two servers are already running as source and replica, using MySQL's binary log position-based replication protocol. If you are starting with new servers, see [Section 16.1.2.2, “Creating a User for Replication”](#) for information about adding a specific user for replication connections and [Section 16.1.2.1, “Setting the Replication Source Configuration”](#) for information about setting the `server_id` variable. The following examples show how to store `mysqld` startup options in server's option file, see [Section 4.2.2.2, “Using Option Files”](#) for more information. Alternatively you can use startup options when running `mysqld`.

Most of the steps that follow require the use of the MySQL `root` account or another MySQL user account that has the `SUPER` privilege. `mysqladmin shutdown` requires either the `SUPER` privilege or the `SHUTDOWN` privilege.

**Step 1: Synchronize the servers.** This step is only required when working with servers which are already replicating without using GTIDs. For new servers proceed to Step 3. Make the servers read-only by setting the `read_only` system variable to `ON` on each server by issuing the following:

```
mysql> SET @@GLOBAL.read_only = ON;
```

Wait for all ongoing transactions to commit or roll back. Then, allow the replica to catch up with the source. *It is extremely important that you make sure the replica has processed all updates before continuing.*

If you use binary logs for anything other than replication, for example to do point in time backup and restore, wait until you do not need the old binary logs containing transactions without GTIDs. Ideally, wait for the server to purge all binary logs, and wait for any existing backup to expire.



### Important

It is important to understand that logs containing transactions without GTIDs cannot be used on servers where GTIDs are enabled. Before proceeding, you must be sure that transactions without GTIDs do not exist anywhere in the topology.

**Step 2: Stop both servers.** Stop each server using `mysqladmin` as shown here, where `username` is the user name for a MySQL user having sufficient privileges to shut down the server:

```
$> mysqladmin -uusername -p shutdown
```

Then supply this user's password at the prompt.

**Step 3: Start both servers with GTIDs enabled.** To enable GTID-based replication, each server must be started with GTID mode enabled by setting the `gtid_mode` variable to `ON`, and with the `enforce_gtid_consistency` variable enabled to ensure that only statements which are safe for GTID-based replication are logged. For example:

```
gtid_mode=ON
enforce-gtid-consistency=ON
```

In addition, you should start replicas with the `--skip-slave-start` option before configuring the replica settings. For more information on GTID related options and variables, see [Section 16.1.6.5, “Global Transaction ID System Variables”](#).

It is not mandatory to have binary logging enabled in order to use GTIDs when using the [mysql.gtid\\_executed Table](#). Replication source server must always have binary logging enabled in order to be able to replicate. However, replica servers can use GTIDs but without binary logging. If you need to disable binary logging on a replica, you can do this by specifying the `--skip-log-bin` and `--log-slave-updates=OFF` options for the replica.

**Step 4: Configure the replica to use GTID-based auto-positioning.** Tell the replica to use the source with GTID based transactions as the replication data source, and to use GTID-based auto-positioning rather than file-based positioning. Issue a `CHANGE MASTER TO` statement on the replica, including the `MASTER_AUTO_POSITION` option in the statement to tell the replica that the source's transactions are identified by GTIDs.

You may also need to supply appropriate values for the source's host name and port number as well as the user name and password for a replication user account which can be used by the replica to connect to the source; if these have already been set prior to Step 1 and no further changes need to be made, the corresponding options can safely be omitted from the statement shown here.

```
mysql> CHANGE MASTER TO
>     MASTER_HOST = host,
>     MASTER_PORT = port,
>     MASTER_USER = user,
```

```
> MASTER_PASSWORD = password,  
> MASTER_AUTO_POSITION = 1;
```

Neither the `MASTER_LOG_FILE` option nor the `MASTER_LOG_POS` option may be used with `MASTER_AUTO_POSITION` set equal to 1. Attempting to do so causes the `CHANGE MASTER TO` statement to fail with an error.

**Step 5: Take a new backup.** Existing backups that were made before you enabled GTIDs can no longer be used on these servers now that you have enabled GTIDs. Take a new backup at this point, so that you are not left without a usable backup.

For instance, you can execute `FLUSH LOGS` on the server where you are taking backups. Then either explicitly take a backup or wait for the next iteration of any periodic backup routine you may have set up.

**Step 6: Start the replica and disable read-only mode.** Start the replica like this:

```
mysql> START SLAVE;
```

The following step is only necessary if you configured a server to be read-only in Step 1. To allow the server to begin accepting updates again, issue the following statement:

```
mysql> SET @@GLOBAL.read_only = OFF;
```

GTID-based replication should now be running, and you can begin (or resume) activity on the source as before. [Section 16.1.3.5, “Using GTIDs for Failover and Scaleout”](#), discusses creation of new replicas when using GTIDs.

### 16.1.3.5 Using GTIDs for Failover and Scaleout

There are a number of techniques when using MySQL Replication with Global Transaction Identifiers (GTIDs) for provisioning a new replica which can then be used for scaleout, being promoted to source as necessary for failover. This section describes the following techniques:

- [Simple replication](#)
- [Copying data and transactions to the replica](#)
- [Injecting empty transactions](#)
- [Excluding transactions with `gtid\_purged`](#)
- [Restoring GTID mode replicas](#)

Global transaction identifiers were added to MySQL Replication for the purpose of simplifying in general management of the replication data flow and of failover activities in particular. Each identifier uniquely identifies a set of binary log events that together make up a transaction. GTIDs play a key role in applying changes to the database: the server automatically skips any transaction having an identifier which the server recognizes as one that it has processed before. This behavior is critical for automatic replication positioning and correct failover.

The mapping between identifiers and sets of events comprising a given transaction is captured in the binary log. This poses some challenges when provisioning a new server with data from another existing server. To reproduce the identifier set on the new server, it is necessary to copy the identifiers from the old server to the new one, and to preserve the relationship between the identifiers and the actual events. This is necessary for restoring a replica that is immediately available as a candidate to become a new source on failover or switchover.

**Simple replication.** The easiest way to reproduce all identifiers and transactions on a new server is to make the new server into the replica of a source that has the entire execution history, and enable global



transaction identifiers on both servers. See [Section 16.1.3.4, “Setting Up Replication Using GTIDs”](#), for more information.

Once replication is started, the new server copies the entire binary log from the source and thus obtains all information about all GTIDs.

This method is simple and effective, but requires the replica to read the binary log from the source; it can sometimes take a comparatively long time for the new replica to catch up with the source, so this method is not suitable for fast failover or restoring from backup. This section explains how to avoid fetching all of the execution history from the source by copying binary log files to the new server.

**Copying data and transactions to the replica.** Executing the entire transaction history can be time-consuming when the source server has processed a large number of transactions previously, and this can represent a major bottleneck when setting up a new replica. To eliminate this requirement, a snapshot of the data set, the binary logs and the global transaction information the source server contains can be imported to the new replica. The source server can be either the source or the replica, but you must ensure that the source has processed all required transactions before copying the data.

There are several variants of this method, the difference being in the manner in which data dumps and transactions from binary logs are transferred to the replica, as outlined here:

Data Set

1. Create a dump file using `mysqldump` on the source server. Set the `mysqldump` option `--master-data` (with the default value of 1) to include a `CHANGE MASTER TO` statement with binary logging information. Set the `--set-gtid-purged` option to `AUTO` (the default) or `ON`, to include information about executed transactions in the dump. Then use the `mysql` client to import the dump file on the target server.
2. Alternatively, create a data snapshot of the source server using raw data files, then copy these files to the target server, following the instructions in [Section 16.1.2.4, “Choosing a Method for Data Snapshots”](#). If you use `InnoDB` tables, you can use the `mysqlbackup` command from the MySQL Enterprise Backup component to produce a consistent snapshot. This command records the log name and offset corresponding to the snapshot to be used on the replica. MySQL Enterprise Backup is a commercial product that is included as part of a MySQL Enterprise subscription. See [Section 28.1, “MySQL Enterprise Backup Overview”](#) for detailed information.
3. Alternatively, stop both the source and target servers, copy the contents of the source's data directory to the new replica's data directory, then restart the replica. If you use this method, the replica must be configured for GTID-based replication, in other words with `gtid_mode=ON`. For instructions and important information for this method, see [Section 16.1.2.6, “Adding Replicas to a Replication Topology”](#).

Transaction History

If the source server has a complete transaction history in its binary logs (that is, the GTID set `@@GLOBAL.gtid_purged` is empty), you can use these methods.

1. Import the binary logs from the source server to the new replica using `mysqlbinlog`, with the `--read-from-remote-server` and `--read-from-remote-master` options.

2. Alternatively, copy the source server's binary log files to the replica. You can make copies from the replica using `mysqlbinlog` with the `--read-from-remote-server` and `--raw` options. These can be read into the replica by using `mysqlbinlog > file` (without the `--raw` option) to export the binary log files to SQL files, then passing these files to the `mysql` client for processing. Ensure that all of the binary log files are processed using a single `mysql` process, rather than multiple connections. For example:

```
$> mysqlbinlog copied-binlog.000001 copied-binlog.000002 | mysql -u root -p
```

For more information, see [Section 4.6.7.3, “Using mysqlbinlog to Back Up Binary Log Files”](#).

This method has the advantage that a new server is available almost immediately; only those transactions that were committed while the snapshot or dump file was being replayed still need to be obtained from the existing source. This means that the replica's availability is not instantaneous, but only a relatively short amount of time should be required for the replica to catch up with these few remaining transactions.

Copying over binary logs to the target server in advance is usually faster than reading the entire transaction execution history from the source in real time. However, it may not always be feasible to move these files to the target when required, due to size or other considerations. The two remaining methods for provisioning a new replica discussed in this section use other means to transfer information about transactions to the new replica.

**Injecting empty transactions.** The source's global `gtid_executed` variable contains the set of all transactions executed on the source. Rather than copy the binary logs when taking a snapshot to provision a new server, you can instead note the content of `gtid_executed` on the server from which the snapshot was taken. Before adding the new server to the replication chain, simply commit an empty transaction on the new server for each transaction identifier contained in the source's `gtid_executed`, like this:

```
SET GTID_NEXT='aaa-bbb-ccc-ddd:N' ;

BEGIN;
COMMIT;

SET GTID_NEXT='AUTOMATIC' ;
```

Once all transaction identifiers have been reinstated in this way using empty transactions, you must flush and purge the replica's binary logs, as shown here, where `N` is the nonzero suffix of the current binary log file name:

```
FLUSH LOGS;
PURGE BINARY LOGS TO 'source-bin.00000N' ;
```

You should do this to prevent this server from flooding the replication stream with false transactions in the event that it is later promoted to source. (The `FLUSH LOGS` statement forces the creation of a new binary log file; `PURGE BINARY LOGS` purges the empty transactions, but retains their identifiers.)

This method creates a server that is essentially a snapshot, but in time is able to become a source as its binary log history converges with that of the replication stream (that is, as it catches up with the source or sources). This outcome is similar in effect to that obtained using the remaining provisioning method, which we discuss in the next few paragraphs.

**Excluding transactions with `gtid_purged`.** The source's global `gtid_purged` variable contains the set of all transactions that have been purged from the source's binary log. As with the method discussed previously (see [Injecting empty transactions](#)), you can record the value of `gtid_executed` on the server

from which the snapshot was taken (in place of copying the binary logs to the new server). Unlike the previous method, there is no need to commit empty transactions (or to issue `PURGE BINARY LOGS`); instead, you can set `gtid_purged` on the replica directly, based on the value of `gtid_executed` on the server from which the backup or snapshot was taken.

As with the method using empty transactions, this method creates a server that is functionally a snapshot, but in time is able to become a source as its binary log history converges with that of the replication source server or the group.

**Restoring GTID mode replicas.** When restoring a replica in a GTID based replication setup that has encountered an error, injecting an empty transaction may not solve the problem because an event does not have a GTID.

Use `mysqlbinlog` to find the next transaction, which is probably the first transaction in the next log file after the event. Copy everything up to the `COMMIT` for that transaction, being sure to include the `SET @@SESSION.GTID_NEXT`. Even if you are not using row-based replication, you can still run binary log row events in the command line client.

Stop the replica and run the transaction you copied. The `mysqlbinlog` output sets the delimiter to `/*! */;`, so set it back:

```
mysql> DELIMITER ;
```

Restart replication from the correct position automatically:

```
mysql> SET GTID_NEXT=automatic;
mysql> RESET SLAVE;
mysql> START SLAVE;
```

### 16.1.3.6 Restrictions on Replication with GTIDs

Because GTID-based replication is dependent on transactions, some features otherwise available in MySQL are not supported when using it. This section provides information about restrictions on and limitations of replication with GTIDs.

**Updates involving nontransactional storage engines.** When using GTIDs, updates to tables using nontransactional storage engines such as `MyISAM` cannot be made in the same statement or transaction as updates to tables using transactional storage engines such as `InnoDB`.

This restriction is due to the fact that updates to tables that use a nontransactional storage engine mixed with updates to tables that use a transactional storage engine within the same transaction can result in multiple GTIDs being assigned to the same transaction.

Such problems can also occur when the source and the replica use different storage engines for their respective versions of the same table, where one storage engine is transactional and the other is not. Also be aware that triggers that are defined to operate on nontransactional tables can be the cause of these problems.

In any of the cases just mentioned, the one-to-one correspondence between transactions and GTIDs is broken, with the result that GTID-based replication cannot function correctly.

**CREATE TABLE ... SELECT statements.** `CREATE TABLE ... SELECT` statements are not allowed when using GTID-based replication. When `binlog_format` is set to `STATEMENT`, a `CREATE TABLE ... SELECT` statement is recorded in the binary log as one transaction with one GTID, but if `ROW` format is used, the statement is recorded as two transactions with two GTIDs. If a source used `STATEMENT` format and a replica used `ROW` format, the replica would be unable to handle the transaction correctly, therefore the `CREATE TABLE ... SELECT` statement is disallowed with GTIDs to prevent this scenario.

**Temporary tables.** `CREATE TEMPORARY TABLE` and `DROP TEMPORARY TABLE` statements are not supported inside transactions, procedures, functions, and triggers when using GTIDs (that is, when the `enforce_gtid_consistency` system variable is set to `ON`). It is possible to use these statements with GTIDs enabled, but only outside of any transaction, and only with `autocommit=1`.

**Preventing execution of unsupported statements.** To prevent execution of statements that would cause GTID-based replication to fail, all servers must be started with the `--enforce-gtid-consistency` option when enabling GTIDs. This causes statements of any of the types discussed previously in this section to fail with an error.

Note that `--enforce-gtid-consistency` only takes effect if binary logging takes place for a statement. If binary logging is disabled on the server, or if statements are not written to the binary log because they are removed by a filter, GTID consistency is not checked or enforced for the statements that are not logged.

For information about other required startup options when enabling GTIDs, see [Section 16.1.3.4, “Setting Up Replication Using GTIDs”](#).

**Skipping transactions.** `sql_slave_skip_counter` is not supported when using GTIDs. If you need to skip transactions, use the value of the source's `gtid_executed` variable instead. For instructions, see [Section 16.1.7.3, “Skipping Transactions”](#).

**Ignoring servers.** The `IGNORE_SERVER_IDS` option of the `CHANGE MASTER TO` statement is deprecated when using GTIDs, because transactions that have already been applied are automatically ignored. Before starting GTID-based replication, check for and clear all ignored server ID lists that have previously been set on the servers involved. The `SHOW SLAVE STATUS` statement, which can be issued for individual channels, displays the list of ignored server IDs if there is one. If there is no list, the `Replicate_Ignore_Server_Ids` field is blank.

**GTID mode and mysqldump.** It is possible to import a dump made using `mysqldump` into a MySQL server running with GTID mode enabled, provided that there are no GTIDs in the target server's binary log.

**GTID mode and mysql\_upgrade.** When the server is running with global transaction identifiers (GTIDs) enabled (`gtid_mode=ON`), do not enable binary logging by `mysql_upgrade` (the `--write-binlog` option).

### 16.1.3.7 Stored Function Examples to Manipulate GTIDs

This section provides examples of stored functions (see [Chapter 23, \*Stored Objects\*](#)) which you can create using some of the built-in functions provided by MySQL for use with GTID-based replication, listed here:

- `GTID_SUBSET()`: Shows whether one GTID set is a subset of another.
- `GTID_SUBTRACT()`: Returns the GTIDs from one GTID set that are not in another.
- `WAIT_FOR_EXECUTED_GTID_SET()`: Waits until all transactions in a given GTID set have been executed.

See [Section 12.18, “Functions Used with Global Transaction Identifiers \(GTIDs\)”](#), for more information about the functions just listed.

Note that in these stored functions, the delimiter command has been used to change the MySQL statement delimiter to a vertical bar, like this:

```
mysql> delimiter |
```

All of the stored functions shown in this section take string representations of GTID sets as arguments, so GTID sets must always be quoted when used with them.

This function returns nonzero (true) if two GTID sets are the same set, even if they are not formatted in the same way:

```
CREATE FUNCTION GTID_IS_EQUAL(gs1 LONGTEXT, gs2 LONGTEXT)
  RETURNS INT
  RETURN GTID_SUBSET(gs1, gs2) AND GTID_SUBSET(gs2, gs1)
|
```

This function returns nonzero (true) if two GTID sets are disjoint:

```
CREATE FUNCTION GTID_IS_DISJOINT(gs1 LONGTEXT, gs2 LONGTEXT)
  RETURNS INT
  RETURN GTID_SUBSET(gs1, GTID_SUBTRACT(gs1, gs2))
|
```

This function returns nonzero (true) if two GTID sets are disjoint and `sum` is their union:

```
CREATE FUNCTION GTID_IS_DISJOINT_UNION(gs1 LONGTEXT, gs2 LONGTEXT, sum LONGTEXT)
  RETURNS INT
  RETURN GTID_IS_EQUAL(GTID_SUBTRACT(sum, gs1), gs2) AND
  GTID_IS_EQUAL(GTID_SUBTRACT(sum, gs2), gs1)
|
```

This function returns a normalized form of the GTID set, in all uppercase, with no whitespace and no duplicates, with UUIDs in alphabetic order and intervals in numeric order:

```
CREATE FUNCTION GTID_NORMALIZE(gs LONGTEXT)
  RETURNS LONGTEXT
  RETURN GTID_SUBTRACT(gs, '')
|
```

This function returns the union of two GTID sets:

```
CREATE FUNCTION GTID_UNION(gs1 LONGTEXT, gs2 LONGTEXT)
  RETURNS LONGTEXT
  RETURN GTID_NORMALIZE(CONCAT(gs1, ',', gs2))
|
```

This function returns the intersection of two GTID sets.

```
CREATE FUNCTION GTID_INTERSECTION(gs1 LONGTEXT, gs2 LONGTEXT)
  RETURNS LONGTEXT
  RETURN GTID_SUBTRACT(gs1, GTID_SUBTRACT(gs1, gs2))
|
```

This function returns the symmetric difference between two GTID sets, that is, the GTIDs that exist in `gs1` but not in `gs2`, as well as the GTIDs that exist in `gs2` but not in `gs1`.

```
CREATE FUNCTION GTID_SYMMETRIC_DIFFERENCE(gs1 LONGTEXT, gs2 LONGTEXT)
  RETURNS LONGTEXT
  RETURN GTID_SUBTRACT(CONCAT(gs1, ',', gs2), GTID_INTERSECTION(gs1, gs2))
|
```

This function removes from a GTID set all the GTIDs with the specified origin, and returns the remaining GTIDs, if any. The UUID is the identifier used by the server where the transaction originated, which is normally the value of `server_uuid`.

```
CREATE FUNCTION GTID_SUBTRACT_UUID(gs LONGTEXT, uuid TEXT)
  RETURNS LONGTEXT
  RETURN GTID_SUBTRACT(gs, CONCAT(UUID, ':1-', (1 << 63) - 2))
|
```

This function acts as the reverse of the previous one; it returns only those GTIDs from the GTID set that originate from the server with the specified identifier (UUID).

```
CREATE FUNCTION GTID_INTERSECTION_WITH_UUID(gs LONGTEXT, uuid TEXT)
RETURNS LONGTEXT
RETURN GTID_SUBTRACT(gs, GTID_SUBTRACT_UUID(gs, uuid))
|
```

### Example 16.1 Verifying that a replica is up to date

The built-in functions `GTID_SUBSET()` and `GTID_SUBTRACT()` can be used to check that a replica has applied at least every transaction that a source has applied.

To perform this check with `GTID_SUBSET()`, execute the following statement on the replica:

```
SELECT GTID_SUBSET(source_gtid_executed, replica_gtid_executed);
```

If the returns value is 0 (false), this means that some GTIDs in `source_gtid_executed` are not present in `replica_gtid_executed`, and that the replica has not yet applied transactions that were applied on the source, which means that the replica is not up to date.

To perform the same check with `GTID_SUBTRACT()`, execute the following statement on the replica:

```
SELECT GTID_SUBTRACT(source_gtid_executed, replica_gtid_executed);
```

This statement returns any GTIDs that are in `source_gtid_executed` but not in `replica_gtid_executed`. If any GTIDs are returned, the source has applied some transactions that the replica has not applied, and the replica is therefore not up to date.

### Example 16.2 Backup and restore scenario

The stored functions `GTID_IS_EQUAL()`, `GTID_IS_DISJOINT()`, and `GTID_IS_DISJOINT_UNION()` can be used to verify backup and restore operations involving multiple databases and servers. In this example scenario, `server1` contains database `db1`, and `server2` contains database `db2`. The goal is to copy database `db2` to `server1`, and the result on `server1` should be the union of the two databases. The procedure used is to back up `server2` using `mysqldump`, then to restore this backup on `server1`.

Provided that `mysqldump` was run with `--set-gtid-purged` set to `ON` or `AUTO` (the default), the output contains a `SET @@GLOBAL.gtid_purged` statement which adds the `gtid_executed` set from `server2` to the `gtid_purged` set on `server1`. `gtid_purged` contains the GTIDs of all the transactions that have been committed on a given server but which do not exist in any binary log file on the server. When database `db2` is copied to `server1`, the GTIDs of the transactions committed on `server2`, which are not in the binary log files on `server1`, must be added to `gtid_purged` for `server1` to make the set complete.

The stored functions can be used to assist with the following steps in this scenario:

- Use `GTID_IS_EQUAL()` to verify that the backup operation computed the correct GTID set for the `SET @@GLOBAL.gtid_purged` statement. On `server2`, extract that statement from the `mysqldump` output, and store the GTID set into a local variable, such as `$gtid_purged_set`. Then execute the following statement:

```
server2> SELECT GTID_IS_EQUAL($gtid_purged_set, @@GLOBAL.gtid_executed);
```

If the result is 1, the two GTID sets are equal, and the set has been computed correctly.

- Use `GTID_IS_DISJOINT()` to verify that the GTID set in the `mysqldump` output does not overlap with the `gtid_executed` set on `server1`. Having identical GTIDs present on both servers causes errors when copying database `db2` to `server1`. To check, on `server1`, extract and store `gtid_purged` from the output into a local variable as done previously, then execute the following statement:

```
server1> SELECT GTID_IS_DISJOINT($gtid_purged_set, @@GLOBAL.gtid_executed);
```

If the result is 1, there is no overlap between the two GTID sets, so no duplicate GTIDs are present.

- Use `GTID_IS_DISJOINT_UNION()` to verify that the restore operation resulted in the correct GTID state on `server1`. Before restoring the backup, on `server1`, obtain the existing `gtid_executed` set by executing the following statement:

```
server1> SELECT @@GLOBAL.gtid_executed;
```

Store the result in a local variable `$original_gtid_executed`, as well as the set from `gtid_purged` in another local variable as described previously. When the backup from `server2` has been restored onto `server1`, execute the following statement to verify the GTID state:

```
server1> SELECT
->   GTID_IS_DISJOINT_UNION($original_gtid_executed,
->                           $gtid_purged_set,
->                           @@GLOBAL.gtid_executed);
```

If the result is 1, the stored function has verified that the original `gtid_executed` set from `server1` (`$original_gtid_executed`) and the `gtid_purged` set that was added from `server2` (`$gtid_purged_set`) have no overlap, and that the updated `gtid_executed` set on `server1` now consists of the previous `gtid_executed` set from `server1` plus the `gtid_purged` set from `server2`, which is the desired result. Ensure that this check is carried out before any further transactions take place on `server1`, otherwise the new transactions in `gtid_executed` cause it to fail.

### Example 16.3 Selecting the most up-to-date replica for manual failover

The stored function `GTID_UNION()` can be used to identify the most up-to-date replica from a set of replicas, in order to perform a manual failover operation after a source server has stopped unexpectedly. If some of the replicas are experiencing replication lag, this stored function can be used to compute the most up-to-date replica without waiting for all the replicas to apply their existing relay logs, and therefore to minimize the failover time. The function can return the union of `gtid_executed` on each replica with the set of transactions received by the replica, which is recorded in the Performance Schema `replication_connection_status` table. You can compare these results to find which replica's record of transactions is the most up to date, even if not all of the transactions have been committed yet.

On each replica, compute the complete record of transactions by issuing the following statement:

```
SELECT GTID_UNION(RECEIVED_TRANSACTION_SET, @@GLOBAL.gtid_executed)
FROM performance_schema.replication_connection_status
WHERE channel_name = 'name';
```

You can then compare the results from each replica to see which one has the most up-to-date record of transactions, and use this replica as the new source.

### Example 16.4 Checking for extraneous transactions on a replica

The stored function `GTID_SUBTRACT_UUID()` can be used to check whether a replica has received transactions that did not originate from its designated source or sources. If it has, there might be an issue with your replication setup, or with a proxy, router, or load balancer. This function works by removing from a GTID set all the GTIDs from a specified originating server, and returning the remaining GTIDs, if any.

For a replica with a single source, issue the following statement, giving the identifier of the originating source, which is normally the same as `server_uuid`:

```
SELECT GTID_SUBTRACT_UUID(@@GLOBAL.gtid_executed, server_uuid_of_source);
```

If the result is not empty, the transactions returned are extra transactions that did not originate from the designated source.

For a replica in a multisource topology, include the server UUID of each source in the function call, like this:

```
SELECT
  GTID_SUBTRACT_UUID(GTID_SUBTRACT_UUID(@@GLOBAL.gtid_executed,
                                         server_uuid_of_source_1),
                    server_uuid_of_source_2);
```

If the result is not empty, the transactions returned are extra transactions that did not originate from any of the designated sources.

### Example 16.5 Verifying that a server in a replication topology is read-only

The stored function `GTID_INTERSECTION_WITH_UUID()` can be used to verify that a server has not originated any GTIDs and is in a read-only state. The function returns only those GTIDs from the GTID set that originate from the server with the specified identifier. If any of the transactions listed in `gtid_executed` from this server use the server's own identifier, the server itself originated those transactions. You can issue the following statement on the server to check:

```
SELECT GTID_INTERSECTION_WITH_UUID(@@GLOBAL.gtid_executed, my_server_uuid);
```

### Example 16.6 Validating an additional replica in multisource replication

The stored function `GTID_INTERSECTION_WITH_UUID()` can be used to find out if a replica attached to a multisource replication setup has applied all the transactions originating from one particular source. In this scenario, `source1` and `source2` are both sources and replicas and replicate to each other. `source2` also has its own replica. The replica also receives and applies transactions from `source1` if `source2` is configured with `log_replica_updates=ON`, but it does not do so if `source2` uses `log_replica_updates=OFF`. Whichever the case, we currently want only to find out if the replica is up to date with `source2`. In this situation, `GTID_INTERSECTION_WITH_UUID()` can be used to identify the transactions that `source2` originated, discarding the transactions that `source2` has replicated from `source1`. The built-in function `GTID_SUBSET()` can then be used to compare the result with the `gtid_executed` set on the replica. If the replica is up to date with `source2`, the `gtid_executed` set on the replica contains all the transactions in the intersection set (the transactions that originated from `source2`).

To carry out this check, store the values of `gtid_executed` and the server UUID from `source2` and the value of `gtid_executed` from the replica into user variables as follows:

```
source2> SELECT @@GLOBAL.gtid_executed INTO @source2_gtid_executed;
source2> SELECT @@GLOBAL.server_uuid INTO @source2_server_uuid;
replica> SELECT @@GLOBAL.gtid_executed INTO @replica_gtid_executed;
```

Then use `GTID_INTERSECTION_WITH_UUID()` and `GTID_SUBSET()` with these variables as input, as follows:

```
SELECT
  GTID_SUBSET(
    GTID_INTERSECTION_WITH_UUID(@source2_gtid_executed,
                               @source2_server_uuid),
    @replica_gtid_executed);
```

The server identifier from `source2` (`@source2_server_uuid`) is used with `GTID_INTERSECTION_WITH_UUID()` to identify and return only those GTIDs from the set of GTIDs that originated on `source2`, omitting those that originated on `source1`. The resulting GTID set is then compared with the set of all executed GTIDs on the replica, using `GTID_SUBSET()`. If this statement returns nonzero (true), all the identified GTIDs from `source2` (the first set input) are also found in `gtid_executed` from the replica, meaning that the replica has received and executed all the transactions that originated from `source2`.



## 16.1.4 Changing Replication Modes on Online Servers

This section describes how to change the mode of replication being used without having to take the server offline.

### 16.1.4.1 Replication Mode Concepts

To be able to safely configure the replication mode of an online server it is important to understand some key concepts of replication. This section explains these concepts and is essential reading before attempting to modify the replication mode of an online server.

The modes of replication available in MySQL rely on different techniques for identifying transactions which are logged. The types of transactions used by replication are as follows:

- GTID transactions are identified by a global transaction identifier (GTID) in the form `UUID:NUMBER`. Every GTID transaction in a log is always preceded by a `Gtid_log_event`. GTID transactions can be addressed using either the GTID or using the file name and position.
- Anonymous transactions do not have a GTID assigned, and MySQL ensures that every anonymous transaction in a log is preceded by an `Anonymous_gtid_log_event`. In previous versions, anonymous transactions were not preceded by any particular event. Anonymous transactions can only be addressed using file name and position.

When using GTIDs you can take advantage of auto-positioning and automatic fail-over, as well as use `WAIT_FOR_EXECUTED_GTID_SET()`, `session_track_gtids`, and monitor replicated transactions using Performance Schema tables. With GTIDs enabled you cannot use `sql_slave_skip_counter`, instead use empty transactions.

Transactions in a relay log that was received from a source running a previous version of MySQL may not be preceded by any particular event at all, but after being replayed and logged in the replica's binary log, they are preceded with an `Anonymous_gtid_log_event`.

The ability to configure the replication mode online means that the `gtid_mode` and `enforce_gtid_consistency` variables are now both dynamic and can be set from a top-level statement by an account that has privileges sufficient to set global system variables. See [Section 5.1.8.1, "System Variable Privileges"](#). In previous versions, both of these variables could only be configured using the appropriate option at server start, meaning that changes to the replication mode required a server restart. In all versions `gtid_mode` could be set to `ON` or `OFF`, which corresponded to whether GTIDs were used to identify transactions or not. When `gtid_mode=ON` it is not possible to replicate anonymous transactions, and when `gtid_mode=OFF` only anonymous transactions can be replicated. As of MySQL 5.7.6, the `gtid_mode` variable has two additional states, `OFF_PERMISSIVE` and `ON_PERMISSIVE`. When `gtid_mode=OFF_PERMISSIVE` then *new* transactions are anonymous while permitting replicated transactions to be either GTID or anonymous transactions. When `gtid_mode=ON_PERMISSIVE` then *new* transactions use GTIDs while permitting replicated transactions to be either GTID or anonymous transactions. This means it is possible to have a replication topology that has servers using both anonymous and GTID transactions. For example a source with `gtid_mode=ON` could be replicating to a replica with `gtid_mode=ON_PERMISSIVE`. The valid values for `gtid_mode` are as follows and in this order:

- `OFF`
- `OFF_PERMISSIVE`
- `ON_PERMISSIVE`
- `ON`

It is important to note that the state of `gtid_mode` can only be changed by one step at a time based on the above order. For example, if `gtid_mode` is currently set to `OFF_PERMISSIVE`, it is possible to change to `OFF` or `ON_PERMISSIVE` but not to `ON`. This is to ensure that the process of changing from anonymous transactions to GTID transactions online is correctly handled by the server. When you switch between `gtid_mode=ON` and `gtid_mode=OFF`, the GTID state (in other words the value of `gtid_executed`) is persistent. This ensures that the GTID set that has been applied by the server is always retained, regardless of changes between types of `gtid_mode`.

As part of the changes introduced by MySQL 5.7.6, the fields related to GTIDs have been modified so that they display the correct information regardless of the currently selected `gtid_mode`. This means that fields which display GTID sets, such as `gtid_executed`, `gtid_purged`, `RECEIVED_TRANSACTION_SET` in the `replication_connection_status` Performance Schema table, and the GTID related results of `SHOW SLAVE STATUS`, now return the empty string when there are no GTIDs present. Fields that display a single GTID, such as `CURRENT_TRANSACTION` in the Performance Schema `replication_applier_status_by_worker` table, now display `ANONYMOUS` when GTID transactions are not being used.

Replication from a source using `gtid_mode=ON` provides the ability to use auto-positioning, configured using the `CHANGE MASTER TO MASTER_AUTO_POSITION = 1;` statement. The replication topology being used impacts on whether it is possible to enable auto-positioning or not, as this feature relies on GTIDs and is not compatible with anonymous transactions. An error is generated if auto-positioning is enabled and an anonymous transaction is encountered. It is strongly recommended to ensure there are no anonymous transactions remaining in the topology before enabling auto-positioning, see [Section 16.1.4.2, “Enabling GTID Transactions Online”](#). The valid combinations of `gtid_mode` and auto-positioning on source and replica are shown in the following table, where the source's `gtid_mode` is shown on the horizontal and the replica's `gtid_mode` is on the vertical:

**Table 16.1 Valid Combinations of Source and Replica `gtid_mode`**

<code>gtid_mode</code>	Source <code>OFF</code>	Source <code>OFF_PERMISSIVE</code>	Source <code>ON_PERMISSIVE</code>
Replica <code>OFF</code>	Y	Y	N
Replica <code>OFF_PERMISSIVE</code>	Y	Y	Y
Replica <code>ON_PERMISSIVE</code>	Y	Y	Y
Replica <code>ON</code>	N	N	Y

In the above table, the entries are:

- **Y**: the `gtid_mode` of source and replica is compatible
- **N**: the `gtid_mode` of source and replica is not compatible
- **\***: auto-positioning can be used

The currently selected `gtid_mode` also impacts on the `gtid_next` variable. The following table shows the behavior of the server for the different values of `gtid_mode` and `gtid_next`.

**Table 16.2 Valid Combinations of `gtid_mode` and `gtid_next`**

<code>gtid_next</code>	<b>AUTOMATIC binary log on</b>	<b>AUTOMATIC binary log off</b>	<b>ANONYMOUS</b>	<b>UUID:NUMBER</b>
<code>&gt;OFF</code>	ANONYMOUS	ANONYMOUS	ANONYMOUS	Error
<code>&gt;OFF_PERMISSIVE</code>	ANONYMOUS	ANONYMOUS	ANONYMOUS	UUID:NUMBER
<code>&gt;ON_PERMISSIVE</code>	New GTID	ANONYMOUS	ANONYMOUS	UUID:NUMBER

<code>gtid_next</code>	<b>AUTOMATIC</b> <b>binary log on</b>	<b>AUTOMATIC</b> <b>binary log off</b>	<b>ANONYMOUS</b>	<b>UUID:NUMBER</b>
<code>&gt;ON</code>	New GTID	ANONYMOUS	Error	UUID:NUMBER

In the above table, the entries are:

- **ANONYMOUS**: generate an anonymous transaction.
- **Error**: generate an error and fail to execute `SET GTID_NEXT`.
- **UUID:NUMBER**: generate a GTID with the specified UUID:NUMBER.
- **New GTID**: generate a GTID with an automatically generated number.

When the binary log is off and `gtid_next` is set to **AUTOMATIC**, then no GTID is generated. This is consistent with the behavior of previous versions.

### 16.1.4.2 Enabling GTID Transactions Online

This section describes how to enable GTID transactions, and optionally auto-positioning, on servers that are already online and using anonymous transactions. This procedure does not require taking the server offline and is suited to use in production. However, if you have the possibility to take the servers offline when enabling GTID transactions that process is easier.

Before you start, ensure that the servers meet the following pre-conditions:

- All servers in your topology must use MySQL 5.7.6 or later. You cannot enable GTID transactions online on any single server unless *all* servers which are in the topology are using this version.
- All servers have `gtid_mode` set to the default value **OFF**.

The following procedure can be paused at any time and later resumed where it was, or reversed by jumping to the corresponding step of [Section 16.1.4.3, “Disabling GTID Transactions Online”](#), the online procedure to disable GTIDs. This makes the procedure fault-tolerant because any unrelated issues that may appear in the middle of the procedure can be handled as usual, and then the procedure continued where it was left off.



#### Note

It is crucial that you complete every step before continuing to the next step.

To enable GTID transactions:

1. On each server, execute:

```
SET @@GLOBAL.ENFORCE_GTID_CONSISTENCY = WARN;
```

Let the server run for a while with your normal workload and monitor the logs. If this step causes any warnings in the log, adjust your application so that it only uses GTID-compatible features and does not generate any warnings.



#### Important

This is the first important step. You must ensure that no warnings are being generated in the error logs before going to the next step.

2. On each server, execute:

```
SET @@GLOBAL.ENFORCE_GTID_CONSISTENCY = ON;
```

3. On each server, execute:

```
SET @@GLOBAL.GTID_MODE = OFF_PERMISSIVE;
```

It does not matter which server executes this statement first, but it is important that all servers complete this step before any server begins the next step.

4. On each server, execute:

```
SET @@GLOBAL.GTID_MODE = ON_PERMISSIVE;
```

It does not matter which server executes this statement first.

5. On each server, wait until the status variable `ONGOING_ANONYMOUS_TRANSACTION_COUNT` is zero. This can be checked using:

```
SHOW STATUS LIKE 'ONGOING_ANONYMOUS_TRANSACTION_COUNT';
```



### Note

On a replica, it is theoretically possible that this shows zero and then nonzero again. This is not a problem, it suffices that it shows zero once.

6. Wait for all transactions generated up to step 5 to replicate to all servers. You can do this without stopping updates: the only important thing is that all anonymous transactions get replicated.

See [Section 16.1.4.4, “Verifying Replication of Anonymous Transactions”](#) for one method of checking that all anonymous transactions have replicated to all servers.

7. If you use binary logs for anything other than replication, for example point in time backup and restore, wait until you do not need the old binary logs having transactions without GTIDs.

For instance, after step 6 has completed, you can execute `FLUSH LOGS` on the server where you are taking backups. Then either explicitly take a backup or wait for the next iteration of any periodic backup routine you may have set up.

Ideally, wait for the server to purge all binary logs that existed when step 6 was completed. Also wait for any backup taken before step 6 to expire.



### Important

This is the second important point. It is vital to understand that binary logs containing anonymous transactions, without GTIDs cannot be used after the next step. After this step, you must be sure that transactions without GTIDs do not exist anywhere in the topology.

8. On each server, execute:

```
SET @@GLOBAL.GTID_MODE = ON;
```

9. On each server, add `gtid_mode=ON` and `enforce_gtid_consistency=ON` to `my.cnf`.

You are now guaranteed that all transactions have a GTID (except transactions generated in step 5 or earlier, which have already been processed). To start using the GTID protocol so that you can later perform automatic fail-over, execute the following on each replica. Optionally, if you use multi-source replication, do this for each channel and include the `FOR CHANNEL channel` clause:

```
STOP SLAVE [FOR CHANNEL 'channel'];
CHANGE MASTER TO MASTER_AUTO_POSITION = 1 [FOR CHANNEL 'channel'];
START SLAVE [FOR CHANNEL 'channel'];
```

### 16.1.4.3 Disabling GTID Transactions Online

This section describes how to disable GTID transactions on servers that are already online. This procedure does not require taking the server offline and is suited to use in production. However, if you have the possibility to take the servers offline when disabling GTIDs mode that process is easier.

The process is similar to enabling GTID transactions while the server is online, but reversing the steps. The only thing that differs is the point at which you wait for logged transactions to replicate.

Before you start, ensure that the servers meet the following pre-conditions:

- All servers in your topology must use MySQL 5.7.6 or later. You cannot disable GTID transactions online on any single server unless *all* servers which are in the topology are using this version.
  - All servers have `gtid_mode` set to `ON`.
1. Execute the following on each replica, and if you using multi-source replication, do it for each channel and include the `FOR CHANNEL` channel clause:

```
STOP SLAVE [FOR CHANNEL 'channel'];
CHANGE MASTER TO MASTER_AUTO_POSITION = 0, MASTER_LOG_FILE = file, \
MASTER_LOG_POS = position [FOR CHANNEL 'channel'];
START SLAVE [FOR CHANNEL 'channel'];
```

2. On each server, execute:

```
SET @@GLOBAL.GTID_MODE = ON_PERMISSIVE;
```

3. On each server, execute:

```
SET @@GLOBAL.GTID_MODE = OFF_PERMISSIVE;
```

4. On each server, wait until the variable `@@GLOBAL.GTID_OWNED` is equal to the empty string. This can be checked using:

```
SELECT @@GLOBAL.GTID_OWNED;
```

On a replica, it is theoretically possible that this is empty and then nonempty again. This is not a problem, it suffices that it is empty once.

5. Wait for all transactions that currently exist in any binary log to replicate to all replicas. See [Section 16.1.4.4, “Verifying Replication of Anonymous Transactions”](#) for one method of checking that all anonymous transactions have replicated to all servers.
6. If you use binary logs for anything else than replication, for example to do point in time backup or restore: wait until you do not need the old binary logs having GTID transactions.

For instance, after step 5 has completed, you can execute `FLUSH LOGS` on the server where you are taking the backup. Then either explicitly take a backup or wait for the next iteration of any periodic backup routine you may have set up.

Ideally, wait for the server to purge all binary logs that existed when step 5 was completed. Also wait for any backup taken before step 5 to expire.

**Important**

This is the one important point during this procedure. It is important to understand that logs containing GTID transactions cannot be used after the next step. Before proceeding you must be sure that GTID transactions do not exist anywhere in the topology.

7. On each server, execute:

```
SET @@GLOBAL.GTID_MODE = OFF;
```

8. On each server, set `gtid_mode=OFF` in `my.cnf`.

If you want to set `enforce_gtid_consistency=OFF`, you can do so now. After setting it, you should add `enforce_gtid_consistency=OFF` to your configuration file.

If you want to downgrade to an earlier version of MySQL, you can do so now, using the normal downgrade procedure.

#### 16.1.4.4 Verifying Replication of Anonymous Transactions

This section explains how to monitor a replication topology and verify that all anonymous transactions have been replicated. This is helpful when changing the replication mode online as you can verify that it is safe to change to GTID transactions.

There are several possible ways to wait for transactions to replicate:

The simplest method, which works regardless of your topology but relies on timing is as follows: if you are sure that the replica never lags more than N seconds, just wait for a bit more than N seconds. Or wait for a day, or whatever time period you consider safe for your deployment.

A safer method in the sense that it does not depend on timing: if you only have a source with one or more replicas, do the following:

1. On the source, execute:

```
SHOW MASTER STATUS;
```

Note down the values in the `File` and `Position` column.

2. On every replica, use the file and position information from the source to execute:

```
SELECT MASTER_POS_WAIT(file, position);
```

If you have a source and multiple levels of replicas, or in other words you have replicas of replicas, repeat step 2 on each level, starting from the source, then all the direct replicas, then all the replicas of replicas, and so on.

If you use a circular replication topology where multiple servers may have write clients, perform step 2 for each source-replica connection, until you have completed the full circle. Repeat the whole process so that you do the full circle *twice*.

For example, suppose you have three servers A, B, and C, replicating in a circle so that A -> B -> C -> A. The procedure is then:

- Do step 1 on A and step 2 on B.
- Do step 1 on B and step 2 on C.

- Do step 1 on C and step 2 on A.
- Do step 1 on A and step 2 on B.
- Do step 1 on B and step 2 on C.
- Do step 1 on C and step 2 on A.

## 16.1.5 MySQL Multi-Source Replication

MySQL multi-source replication enables a replica to receive transactions from multiple immediate sources in parallel. In a multi-source replication topology, a replica creates a replication channel for each source that it should receive transactions from. For more information on how replication channels function, see [Section 16.2.2, “Replication Channels”](#).

You might choose to implement multi-source replication to achieve goals like these:

- Backing up multiple servers to a single server.
- Merging table shards.
- Consolidating data from multiple servers to a single server.

Multi-source replication does not implement any conflict detection or resolution when applying transactions, and those tasks are left to the application if required.



### Note

Each channel on a multi-source replica must replicate from a different source. You cannot set up multiple replication channels from a single replica to a single source. This is because the server IDs of replicas must be unique in a replication topology. The source distinguishes replicas only by their server IDs, not by the names of the replication channels, so it cannot recognize different replication channels from the same replica.

A multi-source replica can also be set up as a multi-threaded replica, by setting the `slave_parallel_workers` system variable to a value greater than 0. When you do this on a multi-source replica, each channel on the replica has the specified number of applier threads, plus a coordinator thread to manage them. You cannot configure the number of applier threads for individual channels.

This section provides tutorials on how to configure sources and replicas for multi-source replication, how to start, stop and reset multi-source replicas, and how to monitor multi-source replication.

### 16.1.5.1 Configuring Multi-Source Replication

A multi-source replication topology requires at least two sources and one replica configured. In these tutorials, we assume you have two sources `source1` and `source2`, and a replica `replicahost`. The replica replicates one database from each of the sources, `db1` from `source1` and `db2` from `source2`.

Sources in a multi-source replication topology can be configured to use either GTID-based replication, or binary log position-based replication. See [Section 16.1.3.4, “Setting Up Replication Using GTIDs”](#) for how to configure a source using GTID-based replication. See [Section 16.1.2.1, “Setting the Replication Source Configuration”](#) for how to configure a source using file position based replication.

Replicas in a multi-source replication topology require `TABLE` repositories for the connection metadata repository and applier metadata repository, as specified by the `master_info_repository` and `relay_log_info_repository` system variables. Multi-source replication is not compatible with `FILE` repositories.

To modify an existing replica that is using `FILE` repositories for the replication metadata repositories to use `TABLE` repositories, you can convert the existing repositories dynamically by using the `mysql` client to issue the following statements on the replica:

```
mysql> STOP SLAVE;
mysql> SET GLOBAL master_info_repository = 'TABLE';
mysql> SET GLOBAL relay_log_info_repository = 'TABLE';
```

Create a suitable user account on all the replication source servers that the replica can use to connect. You can use the same account on all the sources, or a different account on each. If you create an account solely for the purposes of replication, that account needs only the `REPLICATION SLAVE` privilege. For example, to set up a new user, `ted`, that can connect from the replica `replicahost`, use the `mysql` client to issue these statements on each of the sources:

```
mysql> CREATE USER 'ted'@'replicahost' IDENTIFIED BY 'password';
mysql> GRANT REPLICATION SLAVE ON *.* TO 'ted'@'replicahost';
```

For more details, see [Section 16.1.2.2, “Creating a User for Replication”](#).

### 16.1.5.2 Provisioning a Multi-Source Replica for GTID-Based Replication

If the sources in the multi-source replication topology have existing data, it can save time to provision the replica with the relevant data before starting replication. In a multi-source replication topology, copying the data directory cannot be used to provision the replica with data from all of the sources, and you might also want to replicate only specific databases from each source. The best strategy for provisioning such a replica is therefore to use `mysqldump` to create an appropriate dump file on each source, then use the `mysql` client to import the dump file on the replica.

If you are using GTID-based replication, you need to pay attention to the `SET @@GLOBAL.gtid_purged` statement that `mysqldump` places in the dump output. This statement transfers the GTIDs for the transactions executed on the source to the replica, and the replica requires this information. However, for any case more complex than provisioning one new, empty replica from one source, you need to check what effect the statement has in the replica's version of MySQL, and handle the statement accordingly. The following guidance summarizes suitable actions, but for more details, see the `mysqldump` documentation.

In MySQL 5.6 and 5.7, the `SET @@GLOBAL.gtid_purged` statement written by `mysqldump` replaces the value of `gtid_purged` on the replica. Also in those releases that value can only be changed when the replica's record of transactions with GTIDs (the `gtid_executed` set) is empty. In a multi-source replication topology, you must therefore remove the `SET @@GLOBAL.gtid_purged` statement from the dump output before replaying the dump files, because you cannot apply a second or subsequent dump file including this statement. As an alternative to removing the `SET @@GLOBAL.gtid_purged` statement, if you are provisioning the replica with two partial dumps from the same source, and the GTID set in the second dump is the same as the first (so no new transactions have been executed on the source in between the dumps), you can set `mysqldump`'s `--set-gtid-purged` option to `OFF` when you output the second dump file, to omit the statement.

For MySQL 5.6 and 5.7, these limitations mean all the dump files from the sources must be applied in a single operation on a replica with an empty `gtid_executed` set. You can clear a replica's GTID execution history by issuing `RESET MASTER` on the replica, but if you have other, wanted transactions with GTIDs on the replica, choose an alternative method of provisioning from those described in [Section 16.1.3.5, “Using GTIDs for Failover and Scaleout”](#).

In the following provisioning example, we assume that the `SET @@GLOBAL.gtid_purged` statement needs to be removed from the files and handled manually. We also assume that there are no wanted transactions with GTIDs on the replica before provisioning starts.

1. To create dump files for a database named `db1` on `source1` and a database named `db2` on `source2`, run `mysqldump` for `source1` as follows:



```
mysqldump -u<user> -p<password> --single-transaction --triggers --routines --set-gtid-purged=ON --datab
```

Then run `mysqldump` for `source2` as follows:

```
mysqldump -u<user> -p<password> --single-transaction --triggers --routines --set-gtid-purged=ON --datab
```

- Record the `gtid_purged` value that `mysqldump` added to each of the dump files. For example, for dump files created on MySQL 5.6 or 5.7, you can extract the value like this:

```
cat dumpM1.sql | grep GTID_PURGED | cut -f2 -d=' ' | cut -f2 -d$'\''
cat dumpM2.sql | grep GTID_PURGED | cut -f2 -d=' ' | cut -f2 -d$'\''
```

The result in each case should be a GTID set, for example:

```
source1: 2174B383-5441-11E8-B90A-C80AA9429562:1-1029
source2: 224DA167-0C0C-11E8-8442-00059A3C7B00:1-2695
```

- Remove the line from each dump file that contains the `SET @@GLOBAL.gtid_purged` statement. For example:

```
sed '/GTID_PURGED/d' dumpM1.sql > dumpM1_nopurge.sql
sed '/GTID_PURGED/d' dumpM2.sql > dumpM2_nopurge.sql
```

- Use the `mysql` client to import each edited dump file into the replica. For example:

```
mysql -u<user> -p<password> < dumpM1_nopurge.sql
mysql -u<user> -p<password> < dumpM2_nopurge.sql
```

- On the replica, issue `RESET MASTER` to clear the GTID execution history (assuming, as explained above, that all the dump files have been imported and that there are no wanted transactions with GTIDs on the replica). Then issue a `SET @@GLOBAL.gtid_purged` statement to set the `gtid_purged` value to the union of all the GTID sets from all the dump files, as you recorded in Step 2. For example:

```
mysql> RESET MASTER;
mysql> SET @@GLOBAL.gtid_purged = "2174B383-5441-11E8-B90A-C80AA9429562:1-1029, 224DA167-0C0C-11E8-8442-00059A3C7B00:1-2695";
```

If there are, or might be, overlapping transactions between the GTID sets in the dump files, you can use the stored functions described in [Section 16.1.3.7, “Stored Function Examples to Manipulate GTIDs”](#) to check this beforehand and to calculate the union of all the GTID sets.

### 16.1.5.3 Adding GTID-Based Sources to a Multi-Source Replica

These steps assume you have enabled GTIDs for transactions on the replication source servers using `gtid_mode=ON`, created a replication user, ensured that the replica is using `TABLE` based replication metadata repositories, and provisioned the replica with data from the sources if appropriate.

Use the `CHANGE MASTER TO` statement to configure a replication channel for each source on the replica (see [Section 16.2.2, “Replication Channels”](#)). The `FOR CHANNEL` clause is used to specify the channel. For GTID-based replication, GTID auto-positioning is used to synchronize with the source (see [Section 16.1.3.3, “GTID Auto-Positioning”](#)). The `MASTER_AUTO_POSITION` option is set to specify the use of auto-positioning.

For example, to add `source1` and `source2` as sources to the replica, use the `mysql` client to issue the `CHANGE MASTER TO` statement twice on the replica, like this:

```
mysql> CHANGE MASTER TO MASTER_HOST="source1", MASTER_USER="ted", \
MASTER_PASSWORD="password", MASTER_AUTO_POSITION=1 FOR CHANNEL "source_1";
mysql> CHANGE MASTER TO MASTER_HOST="source2", MASTER_USER="ted", \
MASTER_PASSWORD="password", MASTER_AUTO_POSITION=1 FOR CHANNEL "source_2";
```

For the full syntax of the `CHANGE MASTER TO` statement and other available options, see [Section 13.4.2.1, “CHANGE MASTER TO Statement”](#).

#### 16.1.5.4 Adding a Binary Log Based Source to a Multi-Source Replica

These steps assume that you have enabled binary logging on the replication source server using `--log-bin`, the replica is using `TABLE` based replication metadata repositories, and that you have enabled a replication user and noted the current binary log position. You need to know the current `MASTER_LOG_FILE` and `MASTER_LOG_POSITION`.

Use the `CHANGE MASTER TO` statement to configure a replication channel for each source on the replica (see [Section 16.2.2, “Replication Channels”](#)). The `FOR CHANNEL` clause is used to specify the channel. For example, to add `source1` and `source2` as sources to the replica, use the `mysql` client to issue the `CHANGE MASTER TO` statement twice on the replica, like this:

```
mysql> CHANGE MASTER TO MASTER_HOST="source1", MASTER_USER="ted", MASTER_PASSWORD="password", \
MASTER_LOG_FILE='source1-bin.000006', MASTER_LOG_POS=628 FOR CHANNEL "source_1";
mysql> CHANGE MASTER TO MASTER_HOST="source2", MASTER_USER="ted", MASTER_PASSWORD="password", \
MASTER_LOG_FILE='source2-bin.000018', MASTER_LOG_POS=104 FOR CHANNEL "source_2";
```

For the full syntax of the `CHANGE MASTER TO` statement and other available options, see [Section 13.4.2.1, “CHANGE MASTER TO Statement”](#).

#### 16.1.5.5 Starting Multi-Source Replicas

Once you have added channels for all of the sources, issue a `START SLAVE` statement to start replication. When you have enabled multiple channels on a replica, you can choose to either start all channels, or select a specific channel to start. For example, to start the two channels separately, use the `mysql` client to issue the following statements:

```
mysql> START SLAVE FOR CHANNEL "source_1";
mysql> START SLAVE FOR CHANNEL "source_2";
```

For the full syntax of the `START SLAVE` command and other available options, see [Section 13.4.2.5, “START SLAVE Statement”](#).

To verify that both channels have started and are operating correctly, you can issue `SHOW SLAVE STATUS` statements on the replica, for example:

```
mysql> SHOW SLAVE STATUS FOR CHANNEL "source_1"\G
mysql> SHOW SLAVE STATUS FOR CHANNEL "source_2"\G
```

#### 16.1.5.6 Stopping Multi-Source Replicas

The `STOP SLAVE` statement can be used to stop a multi-source replica. By default, if you use the `STOP SLAVE` statement on a multi-source replica all channels are stopped. Optionally, use the `FOR CHANNEL channel` clause to stop only a specific channel.

- To stop all currently configured replication channels:

```
STOP SLAVE;
```

- To stop only a named channel, use a `FOR CHANNEL channel` clause:

```
STOP SLAVE FOR CHANNEL "source_1";
```

For the full syntax of the `STOP SLAVE` command and other available options, see [Section 13.4.2.6, “STOP SLAVE Statement”](#).

#### 16.1.5.7 Resetting Multi-Source Replicas

The `RESET SLAVE` statement can be used to reset a multi-source replica. By default, if you use the `RESET SLAVE` statement on a multi-source replica all channels are reset. Optionally, use the `FOR CHANNEL channel` clause to reset only a specific channel.

- To reset all currently configured replication channels:

```
RESET SLAVE;
```

- To reset only a named channel, use a `FOR CHANNEL channel` clause:

```
RESET SLAVE FOR CHANNEL "source_1";
```

For GTID-based replication, note that `RESET SLAVE` has no effect on the replica's GTID execution history. If you want to clear this, issue `RESET MASTER` on the replica.

`RESET SLAVE` makes the replica forget its replication position, and clears the relay log, but it does not change any replication connection parameters, such as the source's host name. If you want to remove these for a channel, issue `RESET SLAVE ALL`.

For the full syntax of the `RESET SLAVE` command and other available options, see [Section 13.4.2.3, “RESET SLAVE Statement”](#).

### 16.1.5.8 Multi-Source Replication Monitoring

To monitor the status of replication channels the following options exist:

- Using the replication Performance Schema tables. The first column of these tables is `Channel_Name`. This enables you to write complex queries based on `Channel_Name` as a key. See [Section 25.12.11, “Performance Schema Replication Tables”](#).
- Using `SHOW SLAVE STATUS FOR CHANNEL channel`. By default, if the `FOR CHANNEL channel` clause is not used, this statement shows the replica status for all channels with one row per channel. The identifier `Channel_name` is added as a column in the result set. If a `FOR CHANNEL channel` clause is provided, the results show the status of only the named replication channel.



#### Note

The `SHOW VARIABLES` statement does not work with multiple replication channels. The information that was available through these variables has been migrated to the replication performance tables. Using a `SHOW VARIABLES` statement in a topology with multiple channels shows the status of only the default channel.

### Monitoring Channels Using Performance Schema Tables

This section explains how to use the replication Performance Schema tables to monitor channels. You can choose to monitor all channels, or a subset of the existing channels.

To monitor the connection status of all channels:

```
mysql> SELECT * FROM replication_connection_status\G;
***** 1. row *****
CHANNEL_NAME: source_1
GROUP_NAME:
SOURCE_UUID: 046e41f8-a223-11e4-a975-0811960cc264
THREAD_ID: 24
SERVICE_STATE: ON
COUNT_RECEIVED_HEARTBEATS: 0
LAST_HEARTBEAT_TIMESTAMP: 0000-00-00 00:00:00
RECEIVED_TRANSACTION_SET: 046e41f8-a223-11e4-a975-0811960cc264:4-37
LAST_ERROR_NUMBER: 0
```

```

LAST_ERROR_MESSAGE:
LAST_ERROR_TIMESTAMP: 0000-00-00 00:00:00
***** 2. row *****
CHANNEL_NAME: source_2
GROUP_NAME:
SOURCE_UUID: 7475e474-a223-11e4-a978-0811960cc264
THREAD_ID: 26
SERVICE_STATE: ON
COUNT_RECEIVED_HEARTBEATS: 0
LAST_HEARTBEAT_TIMESTAMP: 0000-00-00 00:00:00
RECEIVED_TRANSACTION_SET: 7475e474-a223-11e4-a978-0811960cc264:4-6
LAST_ERROR_NUMBER: 0
LAST_ERROR_MESSAGE:
LAST_ERROR_TIMESTAMP: 0000-00-00 00:00:00
2 rows in set (0.00 sec)
    
```

In the above output there are two channels enabled, and as shown by the `CHANNEL_NAME` field they are called `source_1` and `source_2`.

The addition of the `CHANNEL_NAME` field enables you to query the Performance Schema tables for a specific channel. To monitor the connection status of a named channel, use a `WHERE CHANNEL_NAME=channel` clause:

```

mysql> SELECT * FROM replication_connection_status WHERE CHANNEL_NAME='source_1'\G
***** 1. row *****
CHANNEL_NAME: source_1
GROUP_NAME:
SOURCE_UUID: 046e41f8-a223-11e4-a975-0811960cc264
THREAD_ID: 24
SERVICE_STATE: ON
COUNT_RECEIVED_HEARTBEATS: 0
LAST_HEARTBEAT_TIMESTAMP: 0000-00-00 00:00:00
RECEIVED_TRANSACTION_SET: 046e41f8-a223-11e4-a975-0811960cc264:4-37
LAST_ERROR_NUMBER: 0
LAST_ERROR_MESSAGE:
LAST_ERROR_TIMESTAMP: 0000-00-00 00:00:00
1 row in set (0.00 sec)
    
```

Similarly, the `WHERE CHANNEL_NAME=channel` clause can be used to monitor the other replication Performance Schema tables for a specific channel. For more information, see [Section 25.12.11, “Performance Schema Replication Tables”](#).

## 16.1.6 Replication and Binary Logging Options and Variables

The following sections contain information about `mysqld` options and server variables that are used in replication and for controlling the binary log. Options and variables for use on sources and replicas are covered separately, as are options and variables relating to binary logging and global transaction identifiers (GTIDs). A set of quick-reference tables providing basic information about these options and variables is also included.

Of particular importance is the `server_id` system variable.

Command-Line Format	<code>--server-id=#</code>
System Variable	<code>server_id</code>
Scope	Global
Dynamic	Yes
Type	Integer
Default Value	0

Minimum Value	0
Maximum Value	4294967295

This variable specifies the server ID. In MySQL 5.7, `server_id` must be specified if binary logging is enabled, otherwise the server is not allowed to start.

`server_id` is set to 0 by default. On a replication source server and each replica, you *must* specify `server_id` to establish a unique replication ID in the range from 1 to  $2^{32} - 1$ . “Unique”, means that each ID must be different from every other ID in use by any other source or replica in the replication topology. For additional information, see [Section 16.1.6.2, “Replication Source Options and Variables”](#), and [Section 16.1.6.3, “Replica Server Options and Variables”](#).

If the server ID is set to 0, binary logging takes place, but a source with a server ID of 0 refuses any connections from replicas, and a replica with a server ID of 0 refuses to connect to a source. Note that although you can change the server ID dynamically to a nonzero value, doing so does not enable replication to start immediately. You must change the server ID and then restart the server to initialize the replica.

For more information, see [Setting the Replica Configuration](#).

#### `server_uuid`

In MySQL 5.7, the server generates a true UUID in addition to the `server_id` value supplied by the user. This is available as the global, read-only `server_uuid` system variable.



#### Note

The presence of the `server_uuid` system variable in MySQL 5.7 does not change the requirement for setting a unique `server_id` value for each MySQL server as part of preparing and running MySQL replication, as described earlier in this section.

System Variable	<code>server_uuid</code>
Scope	Global
Dynamic	No
Type	String

When starting, the MySQL server automatically obtains a UUID as follows:

1. Attempt to read and use the UUID written in the file `data_dir/auto.cnf` (where `data_dir` is the server's data directory).
2. If `data_dir/auto.cnf` is not found, generate a new UUID and save it to this file, creating the file if necessary.

The `auto.cnf` file has a format similar to that used for `my.cnf` or `my.ini` files. In MySQL 5.7, `auto.cnf` has only a single `[auto]` section containing a single `server_uuid` setting and value; the file's contents appear similar to what is shown here:

```
[auto]
server_uuid=8a94f357-aab4-11df-86ab-c80aa9429562
```



#### Important

The `auto.cnf` file is automatically generated; do not attempt to write or modify this file.

When using MySQL replication, sources and replicas know each other's UUIDs. The value of a replica's UUID can be seen in the output of `SHOW SLAVE HOSTS`. Once `START SLAVE` has been executed, the value of the source's UUID is available on the replica in the output of `SHOW SLAVE STATUS`.



#### Note

Issuing a `STOP SLAVE` or `RESET SLAVE` statement does *not* reset the source's UUID as used on the replica.

A server's `server_uuid` is also used in GTIDs for transactions originating on that server. For more information, see [Section 16.1.3, “Replication with Global Transaction Identifiers”](#).

When starting, the replication I/O thread generates an error and aborts if its source's UUID is equal to its own unless the `--replicate-same-server-id` option has been set. In addition, the replication I/O thread generates a warning if either of the following is true:

- No source having the expected `server_uuid` exists.
- The source's `server_uuid` has changed, although no `CHANGE MASTER TO` statement has ever been executed.

### 16.1.6.1 Replication and Binary Logging Option and Variable Reference

The following two sections provide basic information about the MySQL command-line options and system variables applicable to replication and the binary log.

#### Replication Options and Variables

The command-line options and system variables in the following list relate to replication source servers and replicas. [Section 16.1.6.2, “Replication Source Options and Variables”](#) provides more detailed information about options and variables relating to replication source servers. For more information about options and variables relating to replicas, see [Section 16.1.6.3, “Replica Server Options and Variables”](#).

- `abort-slave-event-count`: Option used by `mysql-test` for debugging and testing of replication.
- `auto_increment_increment`: AUTO\_INCREMENT columns are incremented by this value.
- `auto_increment_offset`: Offset added to AUTO\_INCREMENT columns.
- `Com_change_master`: Count of CHANGE REPLICATION SOURCE TO and CHANGE MASTER TO statements.
- `Com_show_master_status`: Count of SHOW MASTER STATUS statements.
- `Com_show_slave_hosts`: Count of SHOW REPLICAS and SHOW SLAVE HOSTS statements.
- `Com_show_slave_status`: Count of SHOW REPLICATION STATUS and SHOW SLAVE STATUS statements.
- `Com_slave_start`: Count of START REPLICATION and START SLAVE statements.
- `Com_slave_stop`: Count of STOP REPLICATION and STOP SLAVE statements.
- `disconnect-slave-event-count`: Option used by `mysql-test` for debugging and testing of replication.
- `enforce_gtid_consistency`: Prevents execution of statements that cannot be logged in transactionally safe manner.

- `expire_logs_days`: Purge binary logs after this many days.
- `gtid_executed`: Global: All GTIDs in binary log (global) or current transaction (session). Read-only.
- `gtid_executed_compression_period`: Compress `gtid_executed` table each time this many transactions have occurred. 0 means never compress this table. Applies only when binary logging is disabled.
- `gtid_mode`: Controls whether GTID based logging is enabled and what type of transactions logs can contain.
- `gtid_next`: Specifies GTID for subsequent transaction or transactions; see documentation for details.
- `gtid_owned`: Set of GTIDs owned by this client (session), or by all clients, together with thread ID of owner (global). Read-only.
- `gtid_purged`: Set of all GTIDs that have been purged from binary log.
- `init_slave`: Statements that are executed when replica connects to source.
- `log_bin_trust_function_creators`: If equal to 0 (default), then when `--log-bin` is used, stored function creation is allowed only to users having SUPER privilege and only if function created does not break binary logging.
- `log_builtin_as_identified_by_password`: Whether to log CREATE/ALTER USER, GRANT in backward-compatible fashion.
- `log_statements_unsafe_for_binlog`: Disables error 1592 warnings being written to error log.
- `master-info-file`: Location and name of file that remembers source and where I/O replication thread is in source's binary log.
- `master-retry-count`: Number of tries replica makes to connect to source before giving up.
- `master_info_repository`: Whether to write connection metadata repository, containing source information and replication I/O thread location in source's binary log, to file or table.
- `max_relay_log_size`: If nonzero, relay log is rotated automatically when its size exceeds this value. If zero, size at which rotation occurs is determined by value of `max_binlog_size`.
- `relay_log`: Location and base name to use for relay logs.
- `relay_log_basename`: Complete path to relay log, including file name.
- `relay_log_index`: Location and name to use for file that keeps list of last relay logs.
- `relay_log_info_file`: File name for applier metadata repository in which replica records information about relay logs.
- `relay_log_info_repository`: Whether to write location of replication SQL thread in relay logs to file or table.
- `relay_log_purge`: Determines whether relay logs are purged.
- `relay_log_recovery`: Whether automatic recovery of relay log files from source at startup is enabled; must be enabled for crash-safe replica.
- `relay_log_space_limit`: Maximum space to use for all relay logs.
- `replicate-do-db`: Tells replication SQL thread to restrict replication to specified database.

- `replicate-do-table`: Tells replication SQL thread to restrict replication to specified table.
- `replicate-ignore-db`: Tells replication SQL thread not to replicate to specified database.
- `replicate-ignore-table`: Tells replication SQL thread not to replicate to specified table.
- `replicate-rewrite-db`: Updates to database with different name from original.
- `replicate-same-server-id`: In replication, if enabled, do not skip events having our server id.
- `replicate-wild-do-table`: Tells replication SQL thread to restrict replication to tables that match specified wildcard pattern.
- `replicate-wild-ignore-table`: Tells replication SQL thread not to replicate to tables that match given wildcard pattern.
- `replication_optimize_for_static_plugin_config`: Shared locks for semisynchronous replication.
- `replication_sender_observe_commit_only`: Limited callbacks for semisynchronous replication.
- `report_host`: Host name or IP of replica to be reported to source during replica registration.
- `report_password`: Arbitrary password which replica server should report to source; not same as password for replication user account.
- `report_port`: Port for connecting to replica reported to source during replica registration.
- `report_user`: Arbitrary user name which replica server should report to source; not same as name used for replication user account.
- `Rpl_semi_sync_master_clients`: Number of semisynchronous replicas.
- `rpl_semi_sync_master_enabled`: Whether semisynchronous replication is enabled on source.
- `Rpl_semi_sync_master_net_avg_wait_time`: Average time source has waited for replies from replica.
- `Rpl_semi_sync_master_net_wait_time`: Total time source has waited for replies from replica.
- `Rpl_semi_sync_master_net_waits`: Total number of times source waited for replies from replica.
- `Rpl_semi_sync_master_no_times`: Number of times source turned off semisynchronous replication.
- `Rpl_semi_sync_master_no_tx`: Number of commits not acknowledged successfully.
- `Rpl_semi_sync_master_status`: Whether semisynchronous replication is operational on source.
- `Rpl_semi_sync_master_timefunc_failures`: Number of times source failed when calling time functions.
- `rpl_semi_sync_master_timeout`: Number of milliseconds to wait for replica acknowledgment.
- `rpl_semi_sync_master_trace_level`: Semisynchronous replication debug trace level on source.
- `Rpl_semi_sync_master_tx_avg_wait_time`: Average time source waited for each transaction.
- `Rpl_semi_sync_master_tx_wait_time`: Total time source waited for transactions.
- `Rpl_semi_sync_master_tx_waits`: Total number of times source waited for transactions.



- `rpl_semi_sync_master_wait_for_slave_count`: Number of replica acknowledgments source must receive per transaction before proceeding.
- `rpl_semi_sync_master_wait_no_slave`: Whether source waits for timeout even with no replicas.
- `rpl_semi_sync_master_wait_point`: Wait point for replica transaction receipt acknowledgment.
- `Rpl_semi_sync_master_wait_pos_backtraverse`: Total number of times source has waited for event with binary coordinates lower than events waited for previously.
- `Rpl_semi_sync_master_wait_sessions`: Number of sessions currently waiting for replica replies.
- `Rpl_semi_sync_master_yes_tx`: Number of commits acknowledged successfully.
- `rpl_semi_sync_slave_enabled`: Whether semisynchronous replication is enabled on replica.
- `Rpl_semi_sync_slave_status`: Whether semisynchronous replication is operational on replica.
- `rpl_semi_sync_slave_trace_level`: Semisynchronous replication debug trace level on replica.
- `rpl_stop_slave_timeout`: Number of seconds that STOP REPLICAS or STOP SLAVE waits before timing out.
- `server_uuid`: Server's globally unique ID, automatically (re)generated at server start.
- `show-slave-auth-info`: Show user name and password in SHOW REPLICAS and SHOW SLAVE HOSTS on this source.
- `skip-slave-start`: If set, replication is not autostarted when replica server starts.
- `slave-skip-errors`: Tells replication thread to continue replication when query returns error from provided list.
- `slave_checkpoint_group`: Maximum number of transactions processed by multithreaded replica before checkpoint operation is called to update progress status. Not supported by NDB Cluster.
- `slave_checkpoint_period`: Update progress status of multithreaded replica and flush relay log info to disk after this number of milliseconds. Not supported by NDB Cluster.
- `slave_compressed_protocol`: Use compression of source/replica protocol.
- `slave_exec_mode`: Allows for switching replication thread between IDEMPOTENT mode (key and some other errors suppressed) and STRICT mode; STRICT mode is default, except for NDB Cluster, where IDEMPOTENT is always used.
- `Slave_heartbeat_period`: Replica's replication heartbeat interval, in seconds.
- `Slave_last_heartbeat`: Shows when latest heartbeat signal was received, in TIMESTAMP format.
- `slave_load_tmpdir`: Location where replica should put its temporary files when replicating LOAD DATA statements.
- `slave_max_allowed_packet`: Maximum size, in bytes, of packet that can be sent from replication source server to replica; overrides `max_allowed_packet`.
- `slave_net_timeout`: Number of seconds to wait for more data from source/replica connection before aborting read.
- `Slave_open_temp_tables`: Number of temporary tables that replication SQL thread currently has open.

- `slave_parallel_type`: Tells replica to use timestamp information (`LOGICAL_CLOCK`) or database partitioning (`DATABASE`) to parallelize transactions.
- `slave_parallel_workers`: Number of applier threads for executing replication transactions in parallel; 0 or 1 disables replica multithreading. NDB Cluster: see documentation.
- `slave_pending_jobs_size_max`: Maximum size of replica worker queues holding events not yet applied.
- `slave_preserve_commit_order`: Ensures that all commits by replica workers happen in same order as on source to maintain consistency when using parallel applier threads.
- `Slave_received_heartbeats`: Number of heartbeats received by replica since previous reset.
- `Slave_retried_transactions`: Total number of times since startup that replication SQL thread has retried transactions.
- `Slave_rows_last_search_algorithm_used`: Search algorithm most recently used by this replica to locate rows for row-based replication (index, table, or hash scan).
- `slave_rows_search_algorithms`: Determines search algorithms used for replica update batching. Any 2 or 3 from this list: `INDEX_SEARCH`, `TABLE_SCAN`, `HASH_SCAN`.
- `Slave_running`: State of this server as replica (replication I/O thread status).
- `slave_transaction_retries`: Number of times replication SQL thread retries transaction in case it failed with deadlock or elapsed lock wait timeout, before giving up and stopping.
- `slave_type_conversions`: Controls type conversion mode on replica. Value is list of zero or more elements from this list: `ALL_LOSSY`, `ALL_NON_LOSSY`. Set to empty string to disallow type conversions between source and replica.
- `sql_log_bin`: Controls binary logging for current session.
- `sql_slave_skip_counter`: Number of events from source that replica should skip. Not compatible with GTID replication.
- `sync_master_info`: Synchronize source information after every #th event.
- `sync_relay_log`: Synchronize relay log to disk after every #th event.
- `sync_relay_log_info`: Synchronize relay.info file to disk after every #th event.
- `transaction_write_set_extraction`: Defines algorithm used to hash writes extracted during transaction.

For a listing of all command-line options, system variables, and status variables used with `mysqld`, see [Section 5.1.3, “Server Option, System Variable, and Status Variable Reference”](#).

## Binary Logging Options and Variables

The command-line options and system variables in the following list relate to the binary log. [Section 16.1.6.4, “Binary Logging Options and Variables”](#), provides more detailed information about options and variables relating to binary logging. For additional general information about the binary log, see [Section 5.4.4, “The Binary Log”](#).

- `binlog-checksum`: Enable or disable binary log checksums.
- `binlog-do-db`: Limits binary logging to specific databases.

- `binlog-ignore-db`: Tells source that updates to given database should not be written to binary log.
- `binlog-row-event-max-size`: Binary log max event size.
- `Binlog_cache_disk_use`: Number of transactions which used temporary file instead of binary log cache.
- `binlog_cache_size`: Size of cache to hold SQL statements for binary log during transaction.
- `Binlog_cache_use`: Number of transactions that used temporary binary log cache.
- `binlog_checksum`: Enable or disable binary log checksums.
- `binlog_direct_non_transactional_updates`: Causes updates using statement format to nontransactional engines to be written directly to binary log. See documentation before using.
- `binlog_error_action`: Controls what happens when server cannot write to binary log.
- `binlog_format`: Specifies format of binary log.
- `binlog_group_commit_sync_delay`: Sets number of microseconds to wait before synchronizing transactions to disk.
- `binlog_group_commit_sync_no_delay_count`: Sets maximum number of transactions to wait for before aborting current delay specified by `binlog_group_commit_sync_delay`.
- `binlog_gtid_simple_recovery`: Controls how binary logs are iterated during GTID recovery.
- `binlog_max_flush_queue_time`: How long to read transactions before flushing to binary log.
- `binlog_order_commits`: Whether to commit in same order as writes to binary log.
- `binlog_row_image`: Use full or minimal images when logging row changes.
- `binlog_rows_query_log_events`: When enabled, enables logging of rows query log events when using row-based logging. Disabled by default..
- `Binlog_stmt_cache_disk_use`: Number of nontransactional statements that used temporary file instead of binary log statement cache.
- `binlog_stmt_cache_size`: Size of cache to hold nontransactional statements for binary log during transaction.
- `Binlog_stmt_cache_use`: Number of statements that used temporary binary log statement cache.
- `binlog_transaction_dependency_history_size`: Number of row hashes kept for looking up transaction that last updated some row.
- `binlog_transaction_dependency_tracking`: Source of dependency information (commit timestamps or transaction write sets) from which to assess which transactions can be executed in parallel by replica's multithreaded applier.
- `Com_show_binlog_events`: Count of SHOW BINLOG EVENTS statements.
- `Com_show_binlogs`: Count of SHOW BINLOGS statements.
- `log-bin`: Base name for binary log files.
- `log-bin-index`: Name of binary log index file.
- `log_bin`: Whether binary log is enabled.

- `log_bin_basename`: Path and base name for binary log files.
- `log_bin_use_v1_row_events`: Whether server is using version 1 binary log row events.
- `log_slave_updates`: Whether replica should log updates performed by its replication SQL thread to its own binary log.
- `master_verify_checksum`: Cause source to examine checksums when reading from binary log.
- `max-binlog-dump-events`: Option used by `mysql-test` for debugging and testing of replication.
- `max_binlog_cache_size`: Can be used to restrict total size in bytes used to cache multi-statement transactions.
- `max_binlog_size`: Binary log is rotated automatically when size exceeds this value.
- `max_binlog_stmt_cache_size`: Can be used to restrict total size used to cache all nontransactional statements during transaction.
- `slave-sql-verify-checksum`: Cause replica to examine checksums when reading from relay log.
- `slave_sql_verify_checksum`: Cause replica to examine checksums when reading from relay log.
- `sporadic-binlog-dump-fail`: Option used by `mysql-test` for debugging and testing of replication.
- `sync_binlog`: Synchronously flush binary log to disk after every #th event.

For a listing of all command-line options, system and status variables used with `mysqld`, see [Section 5.1.3, “Server Option, System Variable, and Status Variable Reference”](#).

### 16.1.6.2 Replication Source Options and Variables

This section describes the server options and system variables that you can use on replication source servers. You can specify the options either on the [command line](#) or in an [option file](#). You can specify system variable values using `SET`.

On the source and each replica, you must set the `server_id` system variable to establish a unique replication ID. For each server, you should pick a unique positive integer in the range from 1 to  $2^{32} - 1$ , and each ID must be different from every other ID in use by any other source or replica in the replication topology. Example: `server-id=3`.

For options used on the source for controlling binary logging, see [Section 16.1.6.4, “Binary Logging Options and Variables”](#).

### Startup Options for Replication Source Servers

The following list describes startup options for controlling replication source servers. Replication-related system variables are discussed later in this section.

- `--show-slave-auth-info`

Command-Line Format	<code>--show-slave-auth-info[={OFF ON} ]</code>
Type	Boolean
Default Value	OFF

Display replica user names and passwords in the output of `SHOW SLAVE HOSTS` on the source server for replicas started with the `--report-user` and `--report-password` options.

## System Variables Used on Replication Source Servers

The following system variables are used to control sources:

- `auto_increment_increment`

Command-Line Format	<code>--auto-increment-increment=#</code>
System Variable	<code>auto_increment_increment</code>
Scope	Global, Session
Dynamic	Yes
Type	Integer
Default Value	1
Minimum Value	1
Maximum Value	65535

`auto_increment_increment` and `auto_increment_offset` are intended for use with source-to-source replication, and can be used to control the operation of `AUTO_INCREMENT` columns. Both variables have global and session values, and each can assume an integer value between 1 and 65,535 inclusive. Setting the value of either of these two variables to 0 causes its value to be set to 1 instead. Attempting to set the value of either of these two variables to an integer greater than 65,535 or less than 0 causes its value to be set to 65,535 instead. Attempting to set the value of `auto_increment_increment` or `auto_increment_offset` to a noninteger value produces an error, and the actual value of the variable remains unchanged.



### Note

`auto_increment_increment` is also supported for use with `NDB` tables.

When Group Replication is started on a server, the value of `auto_increment_increment` is changed to the value of `group_replication_auto_increment_increment`, which defaults to 7, and the value of `auto_increment_offset` is changed to the server ID. The changes are reverted when Group Replication is stopped. These changes are only made and reverted if `auto_increment_increment` and `auto_increment_offset` each have their default value of 1. If their values have already been modified from the default, Group Replication does not alter them.

`auto_increment_increment` and `auto_increment_offset` affect `AUTO_INCREMENT` column behavior as follows:

- `auto_increment_increment` controls the interval between successive column values. For example:

```
mysql> SHOW VARIABLES LIKE 'auto_inc%';
+-----+-----+
| Variable_name          | Value |
+-----+-----+
| auto_increment_increment | 1     |
| auto_increment_offset   | 1     |
+-----+-----+
2 rows in set (0.00 sec)

mysql> CREATE TABLE autoincl
-> (col INT NOT NULL AUTO_INCREMENT PRIMARY KEY);
Query OK, 0 rows affected (0.04 sec)

mysql> SET @@auto_increment_increment=10;
```

```

Query OK, 0 rows affected (0.00 sec)

mysql> SHOW VARIABLES LIKE 'auto_inc%';
+-----+-----+
| Variable_name          | Value |
+-----+-----+
| auto_increment_increment | 10    |
| auto_increment_offset   | 1     |
+-----+-----+
2 rows in set (0.01 sec)

mysql> INSERT INTO autoinc1 VALUES (NULL), (NULL), (NULL), (NULL);
Query OK, 4 rows affected (0.00 sec)
Records: 4 Duplicates: 0 Warnings: 0

mysql> SELECT col FROM autoinc1;
+-----+
| col |
+-----+
| 1   |
| 11  |
| 21  |
| 31  |
+-----+
4 rows in set (0.00 sec)
    
```

- `auto_increment_offset` determines the starting point for the `AUTO_INCREMENT` column value. Consider the following, assuming that these statements are executed during the same session as the example given in the description for `auto_increment_increment`:

```

mysql> SET @@auto_increment_offset=5;
Query OK, 0 rows affected (0.00 sec)

mysql> SHOW VARIABLES LIKE 'auto_inc%';
+-----+-----+
| Variable_name          | Value |
+-----+-----+
| auto_increment_increment | 10    |
| auto_increment_offset   | 5     |
+-----+-----+
2 rows in set (0.00 sec)

mysql> CREATE TABLE autoinc2
  -> (col INT NOT NULL AUTO_INCREMENT PRIMARY KEY);
Query OK, 0 rows affected (0.06 sec)

mysql> INSERT INTO autoinc2 VALUES (NULL), (NULL), (NULL), (NULL);
Query OK, 4 rows affected (0.00 sec)
Records: 4 Duplicates: 0 Warnings: 0

mysql> SELECT col FROM autoinc2;
+-----+
| col |
+-----+
| 5   |
| 15  |
| 25  |
| 35  |
+-----+
    
```

```
4 rows in set (0.02 sec)
```

When the value of `auto_increment_offset` is greater than that of `auto_increment_increment`, the value of `auto_increment_offset` is ignored.

If either of these variables is changed, and then new rows inserted into a table containing an `AUTO_INCREMENT` column, the results may seem counterintuitive because the series of `AUTO_INCREMENT` values is calculated without regard to any values already present in the column, and the next value inserted is the least value in the series that is greater than the maximum existing value in the `AUTO_INCREMENT` column. The series is calculated like this:

$$\text{auto\_increment\_offset} + N \times \text{auto\_increment\_increment}$$

where  $N$  is a positive integer value in the series [1, 2, 3, ...]. For example:

```
mysql> SHOW VARIABLES LIKE 'auto_inc%';
+-----+-----+
| Variable_name          | Value |
+-----+-----+
| auto_increment_increment | 10    |
| auto_increment_offset   | 5     |
+-----+-----+
2 rows in set (0.00 sec)

mysql> SELECT col FROM autoinc1;
+-----+
| col |
+-----+
| 1   |
| 11  |
| 21  |
| 31  |
+-----+
4 rows in set (0.00 sec)

mysql> INSERT INTO autoinc1 VALUES (NULL), (NULL), (NULL), (NULL);
Query OK, 4 rows affected (0.00 sec)
Records: 4 Duplicates: 0 Warnings: 0

mysql> SELECT col FROM autoinc1;
+-----+
| col |
+-----+
| 1   |
| 11  |
| 21  |
| 31  |
| 35  |
| 45  |
| 55  |
| 65  |
+-----+
8 rows in set (0.00 sec)
```

The values shown for `auto_increment_increment` and `auto_increment_offset` generate the series  $5 + N \times 10$ , that is, [5, 15, 25, 35, 45, ...]. The highest value present in the `col` column prior to the `INSERT` is 31, and the next available value in the `AUTO_INCREMENT` series is 35, so the inserted values for `col` begin at that point and the results are as shown for the `SELECT` query.

It is not possible to restrict the effects of these two variables to a single table; these variables control the behavior of all `AUTO_INCREMENT` columns in *all* tables on the MySQL server. If the global value of either variable is set, its effects persist until the global value is changed or overridden by setting the session

value, or until `mysqld` is restarted. If the local value is set, the new value affects `AUTO_INCREMENT` columns for all tables into which new rows are inserted by the current user for the duration of the session, unless the values are changed during that session.

The default value of `auto_increment_increment` is 1. See [Section 16.4.1.1, “Replication and AUTO\\_INCREMENT”](#).

- `auto_increment_offset`

Command-Line Format	<code>--auto-increment-offset=#</code>
System Variable	<code>auto_increment_offset</code>
Scope	Global, Session
Dynamic	Yes
Type	Integer
Default Value	1
Minimum Value	1
Maximum Value	65535

This variable has a default value of 1. If it is left with its default value, and Group Replication is started on the server, it is changed to the server ID. For more information, see the description for `auto_increment_increment`.



#### Note

`auto_increment_offset` is also supported for use with `NDB` tables.

- `rpl_semi_sync_master_enabled`

Command-Line Format	<code>--rpl-semi-sync-master-enabled[={OFF ON} ]</code>
System Variable	<code>rpl_semi_sync_master_enabled</code>
Scope	Global
Dynamic	Yes
Type	Boolean
Default Value	<code>OFF</code>

Controls whether semisynchronous replication is enabled on the source. To enable or disable the plugin, set this variable to `ON` or `OFF` (or 1 or 0), respectively. The default is `OFF`.

This variable is available only if the source-side semisynchronous replication plugin is installed.

- `rpl_semi_sync_master_timeout`

Command-Line Format	<code>--rpl-semi-sync-master-timeout=#</code>
System Variable	<code>rpl_semi_sync_master_timeout</code>
Scope	Global
Dynamic	Yes
Type	Integer



Default Value	10000
Minimum Value	0
Maximum Value	4294967295
Unit	milliseconds

A value in milliseconds that controls how long the source waits on a commit for acknowledgment from a replica before timing out and reverting to asynchronous replication. The default value is 10000 (10 seconds).

This variable is available only if the source-side semisynchronous replication plugin is installed.

- `rpl_semi_sync_master_trace_level`

Command-Line Format	<code>--rpl-semi-sync-master-trace-level=#</code>
System Variable	<code>rpl_semi_sync_master_trace_level</code>
Scope	Global
Dynamic	Yes
Type	Integer
Default Value	32
Minimum Value	0
Maximum Value	4294967295

The semisynchronous replication debug trace level on the source. Four levels are defined:

- 1 = general level (for example, time function failures)
- 16 = detail level (more verbose information)
- 32 = net wait level (more information about network waits)
- 64 = function level (information about function entry and exit)

This variable is available only if the source-side semisynchronous replication plugin is installed.

- `rpl_semi_sync_master_wait_for_slave_count`

Command-Line Format	<code>--rpl-semi-sync-master-wait-for-slave-count=#</code>
System Variable	<code>rpl_semi_sync_master_wait_for_slave_count</code>
Scope	Global
Dynamic	Yes
Type	Integer
Default Value	1
Minimum Value	1
Maximum Value	65535

The number of replica acknowledgments the source must receive per transaction before proceeding. By default `rpl_semi_sync_master_wait_for_slave_count` is 1, meaning that semisynchronous

replication proceeds after receiving a single replica acknowledgment. Performance is best for small values of this variable.

For example, if `rpl_semi_sync_master_wait_for_slave_count` is 2, then 2 replicas must acknowledge receipt of the transaction before the timeout period configured by `rpl_semi_sync_master_timeout` for semisynchronous replication to proceed. If fewer replicas acknowledge receipt of the transaction during the timeout period, the source reverts to normal replication.



#### Note

This behavior also depends on `rpl_semi_sync_master_wait_no_slave`

This variable is available only if the source-side semisynchronous replication plugin is installed.

- `rpl_semi_sync_master_wait_no_slave`

Command-Line Format	<code>--rpl-semi-sync-master-wait-no-slave[={OFF ON}]</code>
System Variable	<code>rpl_semi_sync_master_wait_no_slave</code>
Scope	Global
Dynamic	Yes
Type	Boolean
Default Value	ON

Controls whether the source waits for the timeout period configured by `rpl_semi_sync_master_timeout` to expire, even if the replica count drops to less than the number of replicas configured by `rpl_semi_sync_master_wait_for_slave_count` during the timeout period.

When the value of `rpl_semi_sync_master_wait_no_slave` is ON (the default), it is permissible for the replica count to drop to less than `rpl_semi_sync_master_wait_for_slave_count` during the timeout period. As long as enough replicas acknowledge the transaction before the timeout period expires, semisynchronous replication continues.

When the value of `rpl_semi_sync_master_wait_no_slave` is OFF, if the replica count drops to less than the number configured in `rpl_semi_sync_master_wait_for_slave_count` at any time during the timeout period configured by `rpl_semi_sync_master_timeout`, the source reverts to normal replication.

This variable is available only if the source-side semisynchronous replication plugin is installed.

- `rpl_semi_sync_master_wait_point`

Command-Line Format	<code>--rpl-semi-sync-master-wait-point=value</code>
System Variable	<code>rpl_semi_sync_master_wait_point</code>
Scope	Global
Dynamic	Yes
Type	Enumeration
Default Value	AFTER_SYNC

Valid Values	<a href="#">AFTER_SYNC</a> <a href="#">AFTER_COMMIT</a>
--------------	--

This variable controls the point at which a semisynchronous source waits for replica acknowledgment of transaction receipt before returning a status to the client that committed the transaction. These values are permitted:

- [AFTER\\_SYNC](#) (the default): The source writes each transaction to its binary log and the replica, and syncs the binary log to disk. The source waits for replica acknowledgment of transaction receipt after the sync. Upon receiving acknowledgment, the source commits the transaction to the storage engine and returns a result to the client, which then can proceed.
- [AFTER\\_COMMIT](#): The source writes each transaction to its binary log and the replica, syncs the binary log, and commits the transaction to the storage engine. The source waits for replica acknowledgment of transaction receipt after the commit. Upon receiving acknowledgment, the source returns a result to the client, which then can proceed.

The replication characteristics of these settings differ as follows:

- With [AFTER\\_SYNC](#), all clients see the committed transaction at the same time: After it has been acknowledged by the replica and committed to the storage engine on the source. Thus, all clients see the same data on the source.

In the event of source failure, all transactions committed on the source have been replicated to the replica (saved to its relay log). An unexpected exit of the source and failover to the replica is lossless because the replica is up to date. Note, however, that the source cannot be restarted in this scenario and must be discarded, because its binary log might contain uncommitted transactions that would cause a conflict with the replica when externalized after binary log recovery.

- With [AFTER\\_COMMIT](#), the client issuing the transaction gets a return status only after the server commits to the storage engine and receives replica acknowledgment. After the commit and before replica acknowledgment, other clients can see the committed transaction before the committing client.

If something goes wrong such that the replica does not process the transaction, then in the event of an unexpected source exit and failover to the replica, it is possible for such clients to see a loss of data relative to what they saw on the source.

This variable is available only if the source-side semisynchronous replication plugin is installed.

[rpl\\_semi\\_sync\\_master\\_wait\\_point](#) was added in MySQL 5.7.2. For older versions, semisynchronous source behavior is equivalent to a setting of [AFTER\\_COMMIT](#).

This change introduces a version compatibility constraint because it increments the semisynchronous interface version: Servers for MySQL 5.7.2 and up do not work with semisynchronous replication plugins from older versions, nor do servers from older versions work with semisynchronous replication plugins for MySQL 5.7.2 and up.

### 16.1.6.3 Replica Server Options and Variables

This section explains the server options and system variables that apply to replicas and contains the following:

- [Startup Options for Replicas](#)
- [Options for Logging Replica Status to Tables](#)

- [System Variables Used on Replicas](#)

Specify the options either on the [command line](#) or in an [option file](#). Many of the options can be set while the server is running by using the [CHANGE MASTER TO](#) statement. Specify system variable values using [SET](#).

**Server ID.** On the source and each replica, you must set the `server_id` system variable to establish a unique replication ID in the range from 1 to  $2^{32} - 1$ . “Unique” means that each ID must be different from every other ID in use by any other source or replica in the replication topology. Example `my.cnf` file:

```
[mysqld]
server-id=3
```

## Startup Options for Replicas

This section explains startup options for controlling replica servers. Many of these options can be set while the server is running by using the [CHANGE MASTER TO](#) statement. Others, such as the `--replicate-*` options, can be set only when the replica server starts. Replication-related system variables are discussed later in this section.

- `--log-warnings[=level]`

Command-Line Format	<code>--log-warnings[=#]</code>
Deprecated	Yes
System Variable	<code>log_warnings</code>
Scope	Global
Dynamic	Yes
Type	Integer
Default Value	2
Minimum Value	0
Maximum Value (64-bit platforms)	18446744073709551615
Maximum Value (32-bit platforms)	4294967295



### Note

The `log_error_verbosity` system variable is preferred over, and should be used instead of, the `--log-warnings` option or `log_warnings` system variable. For more information, see the descriptions of `log_error_verbosity` and `log_warnings`. The `--log-warnings` command-line option and `log_warnings` system variable are deprecated; expect them to be removed in a future MySQL release.

Causes the server to record more messages to the error log about what it is doing. With respect to replication, the server generates warnings that it succeeded in reconnecting after a network or connection failure, and provides information about how each replication thread started. This variable is set to 2 by default. To disable it, set it to 0. The server logs messages about statements that are unsafe for statement-based logging if the value is greater than 0. Aborted connections and access-denied errors for new connection attempts are logged if the value is greater than 1. See [Section B.3.2.9, “Communication Errors and Aborted Connections”](#).



### Note

The effects of this option are not limited to replication. It affects diagnostic messages across a spectrum of server activities.

- `--master-info-file=file_name`

Command-Line Format	<code>--master-info-file=file_name</code>
Type	File name
Default Value	<code>master.info</code>

The name to use for the file in which the replica records information about the source. The default name is `master.info` in the data directory. For information about the format of this file, see [Section 16.2.4.2, “Replication Metadata Repositories”](#).

- `--master-retry-count=count`

Command-Line Format	<code>--master-retry-count=#</code>
Deprecated	Yes
Type	Integer
Default Value	86400
Minimum Value	0
Maximum Value (64-bit platforms)	18446744073709551615
Maximum Value (32-bit platforms)	4294967295

The number of times that the replica tries to reconnect to the source before giving up. The default value is 86400 times. A value of 0 means “infinite”, and the replica attempts to connect forever. Reconnection attempts are triggered when the replica reaches its connection timeout (specified by the `slave_net_timeout` system variable) without receiving data or a heartbeat signal from the source. Reconnection is attempted at intervals set by the `MASTER_CONNECT_RETRY` option of the `CHANGE MASTER TO` statement (which defaults to every 60 seconds).

This option is deprecated; expect it to be removed in a future MySQL release. Use the `MASTER_RETRY_COUNT` option of the `CHANGE MASTER TO` statement instead.

- `--max-relay-log-size=size`

Command-Line Format	<code>--max-relay-log-size=#</code>
System Variable	<code>max_relay_log_size</code>
Scope	Global
Dynamic	Yes
Type	Integer
Default Value	0
Minimum Value	0
Maximum Value	1073741824
Unit	bytes
Block Size	4096

The size at which the server rotates relay log files automatically. If this value is nonzero, the relay log is rotated automatically when its size exceeds this value. If this value is zero (the default), the size at which relay log rotation occurs is determined by the value of `max_binlog_size`. For more information, see [Section 16.2.4.1, “The Relay Log”](#).

- `--relay-log-purge={0|1}`

Command-Line Format	<code>--relay-log-purge[={OFF ON}]</code>
System Variable	<code>relay_log_purge</code>
Scope	Global
Dynamic	Yes
Type	Boolean
Default Value	ON

Disable or enable automatic purging of relay logs as soon as they are no longer needed. The default value is 1 (enabled). This is a global variable that can be changed dynamically with `SET GLOBAL relay_log_purge = N`. Disabling purging of relay logs when enabling the `--relay-log-recovery` option puts data consistency at risk.

- `--relay-log-space-limit=size`

Command-Line Format	<code>--relay-log-space-limit=#</code>
System Variable	<code>relay_log_space_limit</code>
Scope	Global
Dynamic	No
Type	Integer
Default Value	0
Minimum Value	0
Maximum Value	18446744073709551615
Unit	bytes

This option places an upper limit on the total size in bytes of all relay logs on the replica. A value of 0 means “no limit”. This is useful for a replica server host that has limited disk space. When the limit is reached, the replication I/O thread stops reading binary log events from the source until the replication SQL thread has caught up and deleted some unused relay logs. Note that this limit is not absolute: There are cases where the SQL thread needs more events before it can delete relay logs. In that case, the I/O thread exceeds the limit until it becomes possible for the SQL thread to delete some relay logs because not doing so would cause a deadlock. You should not set `--relay-log-space-limit` to less than twice the value of `--max-relay-log-size` (or `--max-binlog-size` if `--max-relay-log-size` is 0). In that case, there is a chance that the I/O thread waits for free space because `--relay-log-space-limit` is exceeded, but the SQL thread has no relay log to purge and is unable to satisfy the I/O thread. This forces the I/O thread to ignore `--relay-log-space-limit` temporarily.

- `--replicate-do-db=db_name`

Command-Line Format	<code>--replicate-do-db=name</code>
---------------------	-------------------------------------

Type	String
------	--------

Creates a replication filter using the name of a database. Such filters can also be created using `CHANGE REPLICATION FILTER REPLICATE_DO_DB`. The precise effect of this filtering depends on whether statement-based or row-based replication is in use, and are described in the next several paragraphs.



### Important

Replication filters cannot be used on a MySQL server instance that is configured for Group Replication, because filtering transactions on some servers would make the group unable to reach agreement on a consistent state.

**Statement-based replication.** Tell the replication SQL thread to restrict replication to statements where the default database (that is, the one selected by `USE`) is `db_name`. To specify more than one database, use this option multiple times, once for each database; however, doing so does *not* replicate cross-database statements such as `UPDATE some_db.some_table SET foo='bar'` while a different database (or no database) is selected.



### Warning

To specify multiple databases you *must* use multiple instances of this option. Because database names can contain commas, if you supply a comma separated list then the list is treated as the name of a single database.

An example of what does not work as you might expect when using statement-based replication: If the replica is started with `--replicate-do-db=sales` and you issue the following statements on the source, the `UPDATE` statement is *not* replicated:

```
USE prices;
UPDATE sales.january SET amount=amount+1000;
```

The main reason for this “check just the default database” behavior is that it is difficult from the statement alone to know whether it should be replicated (for example, if you are using multiple-table `DELETE` statements or multiple-table `UPDATE` statements that act across multiple databases). It is also faster to check only the default database rather than all databases if there is no need.

**Row-based replication.** Tells the replication SQL thread to restrict replication to database `db_name`. Only tables belonging to `db_name` are changed; the current database has no effect on this. Suppose that the replica is started with `--replicate-do-db=sales` and row-based replication is in effect, and then the following statements are run on the source:

```
USE prices;
UPDATE sales.february SET amount=amount+100;
```

The `february` table in the `sales` database on the replica is changed in accordance with the `UPDATE` statement; this occurs whether or not the `USE` statement was issued. However, issuing the following statements on the source has no effect on the replica when using row-based replication and `--replicate-do-db=sales`:

```
USE prices;
UPDATE prices.march SET amount=amount-25;
```

Even if the statement `USE prices` were changed to `USE sales`, the `UPDATE` statement's effects would still not be replicated.

Another important difference in how `--replicate-do-db` is handled in statement-based replication as opposed to row-based replication occurs with regard to statements that refer to multiple databases.

Suppose that the replica is started with `--replicate-do-db=db1`, and the following statements are executed on the source:

```
USE db1;
UPDATE db1.table1, db2.table2 SET db1.table1.col1 = 10, db2.table2.col2 = 20;
```

If you are using statement-based replication, then both tables are updated on the replica. However, when using row-based replication, only `table1` is affected on the replica; since `table2` is in a different database, `table2` on the replica is not changed by the `UPDATE`. Now suppose that, instead of the `USE db1` statement, a `USE db4` statement had been used:

```
USE db4;
UPDATE db1.table1, db2.table2 SET db1.table1.col1 = 10, db2.table2.col2 = 20;
```

In this case, the `UPDATE` statement would have no effect on the replica when using statement-based replication. However, if you are using row-based replication, the `UPDATE` would change `table1` on the replica, but not `table2`—in other words, only tables in the database named by `--replicate-do-db` are changed, and the choice of default database has no effect on this behavior.

If you need cross-database updates to work, use `--replicate-wild-do-table=db_name.%` instead. See [Section 16.2.5, “How Servers Evaluate Replication Filtering Rules”](#).



#### Note

This option affects replication in the same manner that `--binlog-do-db` affects binary logging, and the effects of the replication format on how `--replicate-do-db` affects replication behavior are the same as those of the logging format on the behavior of `--binlog-do-db`.

This option has no effect on `BEGIN`, `COMMIT`, or `ROLLBACK` statements.

- `--replicate-ignore-db=db_name`

Command-Line Format	<code>--replicate-ignore-db=name</code>
Type	String

Creates a replication filter using the name of a database. Such filters can also be created using `CHANGE REPLICATION FILTER REPLICATE_IGNORE_DB`. As with `--replicate-do-db`, the precise effect of



this filtering depends on whether statement-based or row-based replication is in use, and are described in the next several paragraphs.



### Important

Replication filters cannot be used on a MySQL server instance that is configured for Group Replication, because filtering transactions on some servers would make the group unable to reach agreement on a consistent state.

**Statement-based replication.** Tells the replication SQL thread not to replicate any statement where the default database (that is, the one selected by `USE`) is `db_name`.

**Row-based replication.** Tells the replication SQL thread not to update any tables in the database `db_name`. The default database has no effect.

When using statement-based replication, the following example does not work as you might expect. Suppose that the replica is started with `--replicate-ignore-db=sales` and you issue the following statements on the source:

```
USE prices;
UPDATE sales.january SET amount=amount+1000;
```

The `UPDATE` statement *is* replicated in such a case because `--replicate-ignore-db` applies only to the default database (determined by the `USE` statement). Because the `sales` database was specified explicitly in the statement, the statement has not been filtered. However, when using row-based replication, the `UPDATE` statement's effects are *not* propagated to the replica, and the replica's copy of the `sales.january` table is unchanged; in this instance, `--replicate-ignore-db=sales` causes *all* changes made to tables in the source's copy of the `sales` database to be ignored by the replica.

To specify more than one database to ignore, use this option multiple times, once for each database. Because database names can contain commas, if you supply a comma separated list then the list is treated as the name of a single database.

You should not use this option if you are using cross-database updates and you do not want these updates to be replicated. See [Section 16.2.5, “How Servers Evaluate Replication Filtering Rules”](#).

If you need cross-database updates to work, use `--replicate-wild-ignore-table=db_name.%` instead. See [Section 16.2.5, “How Servers Evaluate Replication Filtering Rules”](#).



### Note

This option affects replication in the same manner that `--binlog-ignore-db` affects binary logging, and the effects of the replication format on how `--replicate-ignore-db` affects replication behavior are the same as those of the logging format on the behavior of `--binlog-ignore-db`.

This option has no effect on `BEGIN`, `COMMIT`, or `ROLLBACK` statements.

- `--replicate-do-table=db_name.tbl_name`

Command-Line Format	<code>--replicate-do-table=name</code>
Type	String

Creates a replication filter by telling the replication SQL thread to restrict replication to a given table.

To specify more than one table, use this option multiple times, once for each table. This works for both

cross-database updates and default database updates, in contrast to `--replicate-do-db`. See [Section 16.2.5, “How Servers Evaluate Replication Filtering Rules”](#). You can also create such a filter by issuing a `CHANGE REPLICATION FILTER REPLICATE_DO_TABLE` statement.



### Important

Replication filters cannot be used on a MySQL server instance that is configured for Group Replication, because filtering transactions on some servers would make the group unable to reach agreement on a consistent state.

This option affects only statements that apply to tables. It does not affect statements that apply only to other database objects, such as stored routines. To filter statements operating on stored routines, use one or more of the `--replicate-*-db` options.

- `--replicate-ignore-table=db_name.tbl_name`

Command-Line Format	<code>--replicate-ignore-table=name</code>
Type	String

Creates a replication filter by telling the replication SQL thread not to replicate any statement that updates the specified table, even if any other tables might be updated by the same statement. To specify more than one table to ignore, use this option multiple times, once for each table. This works for cross-database updates, in contrast to `--replicate-ignore-db`. See [Section 16.2.5, “How Servers Evaluate Replication Filtering Rules”](#). You can also create such a filter by issuing a `CHANGE REPLICATION FILTER REPLICATE_IGNORE_TABLE` statement.



### Note

Replication filters cannot be used on a MySQL server instance that is configured for Group Replication, because filtering transactions on some servers would make the group unable to reach agreement on a consistent state.

This option affects only statements that apply to tables. It does not affect statements that apply only to other database objects, such as stored routines. To filter statements operating on stored routines, use one or more of the `--replicate-*-db` options.

- `--replicate-rewrite-db=from_name->to_name`

Command-Line Format	<code>--replicate-rewrite-db=old_name-&gt;new_name</code>
Type	String

Tells the replica to create a replication filter that translates the specified database to `to_name` if it was `from_name` on the source. Only statements involving tables are affected, not statements such as `CREATE DATABASE`, `DROP DATABASE`, and `ALTER DATABASE`.

To specify multiple rewrites, use this option multiple times. The server uses the first one with a `from_name` value that matches. The database name translation is done *before* the `--replicate-`

\* rules are tested. You can also create such a filter by issuing a `CHANGE REPLICATION FILTER REPLICATE_REWRITE_DB` statement.

If you use the `--replicate-rewrite-db` option on the command line and the `>` character is special to your command interpreter, quote the option value. For example:

```
$> mysqld --replicate-rewrite-db="olddb->newdb"
```

The effect of the `--replicate-rewrite-db` option differs depending on whether statement-based or row-based binary logging format is used for the query. With statement-based format, DML statements are translated based on the current database, as specified by the `USE` statement. With row-based format, DML statements are translated based on the database where the modified table exists. DDL statements are always filtered based on the current database, as specified by the `USE` statement, regardless of the binary logging format.

To ensure that rewriting produces the expected results, particularly in combination with other replication filtering options, follow these recommendations when you use the `--replicate-rewrite-db` option:

- Create the `from_name` and `to_name` databases manually on the source and the replica with different names.
- If you use statement-based or mixed binary logging format, do not use cross-database queries, and do not specify database names in queries. For both DDL and DML statements, rely on the `USE` statement to specify the current database, and use only the table name in queries.
- If you use row-based binary logging format exclusively, for DDL statements, rely on the `USE` statement to specify the current database, and use only the table name in queries. For DML statements, you can use a fully qualified table name (`db.table`) if you want.

If these recommendations are followed, it is safe to use the `--replicate-rewrite-db` option in combination with table-level replication filtering options such as `--replicate-do-table`.



**Note**

Global replication filters cannot be used on a MySQL server instance that is configured for Group Replication, because filtering transactions on some servers would make the group unable to reach agreement on a consistent state.

- `--replicate-same-server-id`

Command-Line Format	<code>--replicate-same-server-id[={OFF ON}]</code>
Type	Boolean
Default Value	OFF

To be used on replica servers. Usually you should use the default setting of 0, to prevent infinite loops caused by circular replication. If set to 1, the replica does not skip events having its own server ID. Normally, this is useful only in rare configurations. Cannot be set to 1 if `log_slave_updates` is enabled. By default, the replication I/O thread does not write binary log events to the relay log if they have the replica's server ID (this optimization helps save disk usage). If you want to use `--replicate-same-server-id`, be sure to start the replica with this option before you make the replica read its own events that you want the replication SQL thread to execute.

- `--replicate-wild-do-table=db_name.tbl_name`

Command-Line Format	<code>--replicate-wild-do-table=name</code>	3021
---------------------	---	------

Type	String
------	--------

Creates a replication filter by telling the replication SQL thread to restrict replication to statements where any of the updated tables match the specified database and table name patterns. Patterns can contain the `%` and `_` wildcard characters, which have the same meaning as for the `LIKE` pattern-matching operator. To specify more than one table, use this option multiple times, once for each table. This works for cross-database updates. See [Section 16.2.5, “How Servers Evaluate Replication Filtering Rules”](#). You can also create such a filter by issuing a `CHANGE REPLICATION FILTER REPLICATE_WILD_DO_TABLE` statement.



#### Note

Replication filters cannot be used on a MySQL server instance that is configured for Group Replication, because filtering transactions on some servers would make the group unable to reach agreement on a consistent state.

This option applies to tables, views, and triggers. It does not apply to stored procedures and functions, or events. To filter statements operating on the latter objects, use one or more of the `--replicate-*-db` options.

As an example, `--replicate-wild-do-table=foo%.bar%` replicates only updates that use a table where the database name starts with `foo` and the table name starts with `bar`.

If the table name pattern is `%`, it matches any table name and the option also applies to database-level statements (`CREATE DATABASE`, `DROP DATABASE`, and `ALTER DATABASE`). For example, if you use `--replicate-wild-do-table=foo%.%`, database-level statements are replicated if the database name matches the pattern `foo%`.



#### Important

Table-level replication filters are only applied to tables that are explicitly mentioned and operated on in the query. They do not apply to tables that are implicitly updated by the query. For example, a `GRANT` statement, which updates the `mysql.user` system table but does not mention that table, is not affected by a filter that specifies `mysql.%` as the wildcard pattern.

To include literal wildcard characters in the database or table name patterns, escape them with a backslash. For example, to replicate all tables of a database that is named `my_own%db`, but not replicate tables from the `my1ownAABCdb` database, you should escape the `_` and `%` characters like this: `--replicate-wild-do-table=my\_own\%db`. If you use the option on the command line, you might need to double the backslashes or quote the option value, depending on your command interpreter. For example, with the `bash` shell, you would need to type `--replicate-wild-do-table=my\\_own\\%db`.

- `--replicate-wild-ignore-table=db_name.tbl_name`

Command-Line Format	<code>--replicate-wild-ignore-table=name</code>
Type	String

Creates a replication filter which keeps the replication SQL thread from replicating a statement in which any table matches the given wildcard pattern. To specify more than one table to ignore, use this option multiple times, once for each table. This works for cross-database updates. See [Section 16.2.5, “How](#)

[Servers Evaluate Replication Filtering Rules](#)". You can also create such a filter by issuing a `CHANGE REPLICATION FILTER REPLICATE_WILD_IGNORE_TABLE` statement.



### Important

Replication filters cannot be used on a MySQL server instance that is configured for Group Replication, because filtering transactions on some servers would make the group unable to reach agreement on a consistent state.

As an example, `--replicate-wild-ignore-table=foo%.bar%` does not replicate updates that use a table where the database name starts with `foo` and the table name starts with `bar`.

For information about how matching works, see the description of the `--replicate-wild-do-table` option. The rules for including literal wildcard characters in the option value are the same as for `--replicate-wild-ignore-table` as well.



### Important

Table-level replication filters are only applied to tables that are explicitly mentioned and operated on in the query. They do not apply to tables that are implicitly updated by the query. For example, a `GRANT` statement, which updates the `mysql.user` system table but does not mention that table, is not affected by a filter that specifies `mysql.%` as the wildcard pattern.

If you need to filter out `GRANT` statements or other administrative statements, a possible workaround is to use the `--replicate-ignore-db` filter. This filter operates on the default database that is currently in effect, as determined by the `USE` statement. You can therefore create a filter to ignore statements for a database that is not replicated, then issue the `USE` statement to switch the default database to that one immediately before issuing any administrative statements that you want to ignore. In the administrative statement, name the actual database where the statement is applied.

For example, if `--replicate-ignore-db=nonreplicated` is configured on the replica server, the following sequence of statements causes the `GRANT` statement to be ignored, because the default database `nonreplicated` is in effect:

```
USE nonreplicated;
GRANT SELECT, INSERT ON replicated.t1 TO 'someuser'@'somehost';
```

- `--skip-slave-start`

Command-Line Format	<code>--skip-slave-start[={OFF ON}]</code>
System Variable	<code>skip_slave_start</code>
Scope	Global
Dynamic	No
Type	Boolean
Default Value	<code>OFF</code>

Tells the replica server not to start the replication threads when the server starts. To start the threads later, use a `START SLAVE` statement.

- `--slave-skip-errors=[err_code1,err_code2,...|all|ddl_exist_errors]`

Command-Line Format	<code>--slave-skip-errors=name</code>
System Variable	<code>slave_skip_errors</code>

Scope	Global
Dynamic	No
Type	String
Default Value	OFF
Valid Values	OFF  [list of error codes]  all  ddl_exist_errors

Normally, replication stops when an error occurs on the replica, which gives you the opportunity to resolve the inconsistency in the data manually. This option causes the replication SQL thread to continue replication when a statement returns any of the errors listed in the option value.

Do not use this option unless you fully understand why you are getting errors. If there are no bugs in your replication setup and client programs, and no bugs in MySQL itself, an error that stops replication should never occur. Indiscriminate use of this option results in replicas becoming hopelessly out of synchrony with the source, with you having no idea why this has occurred.

For error codes, you should use the numbers provided by the error message in the replica's error log and in the output of `SHOW SLAVE STATUS`. [Appendix B, Error Messages and Common Problems](#), lists server error codes.

The shorthand value `ddl_exist_errors` is equivalent to the error code list `1007,1008,1050,1051,1054,1060,1061,1068,1091,1146`.

You can also (but should not) use the very nonrecommended value of `all` to cause the replica to ignore all error messages and keeps going regardless of what happens. Needless to say, if you use `all`, there are no guarantees regarding the integrity of your data. Please do not complain (or file bug reports) in this case if the replica's data is not anywhere close to what it is on the source. *You have been warned.*

This option does not work in the same way when replicating between NDB Clusters, due to the internal NDB mechanism for checking epoch sequence numbers; as soon as NDB detects an epoch number that is missing or otherwise out of sequence, it immediately stops the replica applier thread.

Examples:

```
--slave-skip-errors=1062,1053
--slave-skip-errors=all
--slave-skip-errors=ddl_exist_errors
```

- `--slave-sql-verify-checksum={0|1}`

Command-Line Format	<code>--slave-sql-verify-checksum[={OFF ON}]</code>
Type	Boolean
Default Value	ON

When this option is enabled, the replica examines checksums read from the relay log,. In the event of a mismatch, the replica stops with an error.

The following options are used internally by the MySQL test suite for replication testing and debugging. They are not intended for use in a production setting.

- `--abort-slave-event-count`

Command-Line Format	<code>--abort-slave-event-count=#</code>
Type	Integer
Default Value	0
Minimum Value	0

When this option is set to some positive integer *value* other than 0 (the default) it affects replication behavior as follows: After the replication SQL thread has started, *value* log events are permitted to be executed; after that, the replication SQL thread does not receive any more events, just as if the network connection from the source were cut. The replication SQL thread continues to run, and the output from `SHOW SLAVE STATUS` displays `Yes` in both the `Slave_IO_Running` and the `Slave_SQL_Running` columns, but no further events are read from the relay log.

This option is used internally by the MySQL test suite for replication testing and debugging. It is not intended for use in a production setting.

- `--disconnect-slave-event-count`

Command-Line Format	<code>--disconnect-slave-event-count=#</code>
Type	Integer
Default Value	0

This option is used internally by the MySQL test suite for replication testing and debugging. It is not intended for use in a production setting.

## Options for Logging Replica Status to Tables

MySQL 5.7 supports logging of replication metadata to tables rather than files. Writing of the replica's connection metadata repository and applier metadata repository can be configured separately using these two system variables:

- `master_info_repository`
- `relay_log_info_repository`

For information about these variables, see [Section 16.1.6.3, “Replica Server Options and Variables”](#).

These variables can be used to make a replica resilient to unexpected halts. See [Section 16.3.2, “Handling an Unexpected Halt of a Replica”](#), for more information.

The info log tables and their contents are considered local to a given MySQL Server. They are not replicated, and changes to them are not written to the binary log.

For more information, see [Section 16.2.4, “Relay Log and Replication Metadata Repositories”](#).

## System Variables Used on Replicas

The following list describes system variables for controlling replica servers. They can be set at server startup and some of them can be changed at runtime using `SET`. Server options used with replicas are listed earlier in this section.

- `init_slave`

Command-Line Format	<code>--init-slave=name</code>
System Variable	<code>init_slave</code>
Scope	Global
Dynamic	Yes
Type	String

This variable is similar to `init_connect`, but is a string to be executed by a replica server each time the replication SQL thread starts. The format of the string is the same as for the `init_connect` variable. The setting of this variable takes effect for subsequent `START SLAVE` statements.



#### Note

The replication SQL thread sends an acknowledgment to the client before it executes `init_slave`. Therefore, it is not guaranteed that `init_slave` has been executed when `START SLAVE` returns. See [Section 13.4.2.5, “START SLAVE Statement”](#), for more information.

- `log_slow_slave_statements`

Command-Line Format	<code>--log-slow-slave-statements[={OFF ON}]</code>
System Variable	<code>log_slow_slave_statements</code>
Scope	Global
Dynamic	Yes
Type	Boolean
Default Value	<code>OFF</code>

When the slow query log is enabled, this variable enables logging for queries that have taken more than `long_query_time` seconds to execute on the replica. Note that if row-based replication is in use (`binlog_format=ROW`), `log_slow_slave_statements` has no effect. Queries are only added to the replica's slow query log when they are logged in statement format in the binary log, that is, when `binlog_format=STATEMENT` is set, or when `binlog_format=MIXED` is set and the statement is logged in statement format. Slow queries that are logged in row format when `binlog_format=MIXED` is set, or that are logged when `binlog_format=ROW` is set, are not added to the replica's slow query log, even if `log_slow_slave_statements` is enabled.

Setting `log_slow_slave_statements` has no immediate effect. The state of the variable applies on all subsequent `START SLAVE` statements. Also note that the global setting for `long_query_time` applies for the lifetime of the SQL thread. If you change that setting, you must stop and restart the replication SQL thread to implement the change there (for example, by issuing `STOP SLAVE` and `START SLAVE` statements with the `SQL_THREAD` option).

- `master_info_repository`

Command-Line Format	<code>--master-info-repository={FILE TABLE}</code>
System Variable	<code>master_info_repository</code>
Scope	Global
Dynamic	Yes
Type	String



Default Value	FILE
Valid Values	FILE TABLE

The setting of this variable determines whether the replica records metadata about the source, consisting of status and connection information, to an InnoDB table in the `mysql` system database, or as a file in the data directory. For more information on the connection metadata repository, see [Section 16.2.4, “Relay Log and Replication Metadata Repositories”](#).

The default setting is `FILE`. As a file, the replica's connection metadata repository is named `master.info` by default. You can change this name using the `--master-info-file` option.

The alternative setting is `TABLE`. As an InnoDB table, the replica's connection metadata repository is named `mysql.slave_master_info`. The `TABLE` setting is required when multiple replication channels are configured.

This variable must be set to `TABLE` before configuring multiple replication channels. If you are using multiple replication channels, you cannot set the value back to `FILE`.

The setting for the location of the connection metadata repository has a direct influence on the effect had by the setting of the `sync_master_info` system variable. You can change the setting only when no replication threads are executing.

- `max_relay_log_size`

Command-Line Format	<code>--max-relay-log-size=#</code>
System Variable	<code>max_relay_log_size</code>
Scope	Global
Dynamic	Yes
Type	Integer
Default Value	0
Minimum Value	0
Maximum Value	1073741824
Unit	bytes
Block Size	4096

If a write by a replica to its relay log causes the current log file size to exceed the value of this variable, the replica rotates the relay logs (closes the current file and opens the next one). If `max_relay_log_size` is 0, the server uses `max_binlog_size` for both the binary log and the relay log. If `max_relay_log_size` is greater than 0, it constrains the size of the relay log, which enables you to have different sizes for the two logs. You must set `max_relay_log_size` to between 4096 bytes and 1GB (inclusive), or to 0. The default value is 0. See [Section 16.2.3, “Replication Threads”](#).

- `relay_log`

Command-Line Format	<code>--relay-log=file_name</code>
System Variable	<code>relay_log</code>
Scope	Global
Dynamic	No

Type	File name
------	-----------

The base name for relay log files. For the default replication channel, the default base name for relay logs is `host_name-relay-bin`. For non-default replication channels, the default base name for relay logs is `host_name-relay-bin-channel`, where `channel` is the name of the replication channel recorded in this relay log.

The server writes the file in the data directory unless the base name is given with a leading absolute path name to specify a different directory. The server creates relay log files in sequence by adding a numeric suffix to the base name.

Due to the manner in which MySQL parses server options, if you specify this variable at server startup, you must supply a value; *the default base name is used only if the option is not actually specified*. If you specify the `relay_log` system variable at server startup without specifying a value, unexpected behavior is likely to result; this behavior depends on the other options used, the order in which they are specified, and whether they are specified on the command line or in an option file. For more information about how MySQL handles server options, see [Section 4.2.2, “Specifying Program Options”](#).

If you specify this variable, the value specified is also used as the base name for the relay log index file. You can override this behavior by specifying a different relay log index file base name using the `relay_log_index` system variable.

When the server reads an entry from the index file, it checks whether the entry contains a relative path. If it does, the relative part of the path is replaced with the absolute path set using the `relay_log` system variable. An absolute path remains unchanged; in such a case, the index must be edited manually to enable the new path or paths to be used.

You may find the `relay_log` system variable useful in performing the following tasks:

- Creating relay logs whose names are independent of host names.
- If you need to put the relay logs in some area other than the data directory because your relay logs tend to be very large and you do not want to decrease `max_relay_log_size`.
- To increase speed by using load-balancing between disks.

You can obtain the relay log file name (and path) from the `relay_log_basename` system variable.

- `relay_log_basename`

System Variable	<code>relay_log_basename</code>
Scope	Global
Dynamic	No
Type	File name
Default Value	<code>datadir + '/' + hostname + '-relay-bin'</code>

Holds the base name and complete path to the relay log file. The maximum variable length is 256. This variable is set by the server and is read only.

- `relay_log_index`

Command-Line Format	<code>--relay-log-index=file_name</code>
---------------------	--

System Variable	<code>relay_log_index</code>
Scope	Global
Dynamic	No
Type	File name
Default Value	<code>*host_name*-relay-bin.index</code>

The name for the relay log index file. The maximum variable length is 256. For the default replication channel, the default name is `host_name-relay-bin.index`. For non-default replication channels, the default name is `host_name-relay-bin-channel.index`, where `channel` is the name of the replication channel recorded in this relay log index.

The server writes the file in the data directory unless the name is given with a leading absolute path name to specify a different directory. name.

Due to the manner in which MySQL parses server options, if you specify this variable at server startup, you must supply a value; *the default base name is used only if the option is not actually specified*. If you specify the `relay_log_index` system variable at server startup without specifying a value, unexpected behavior is likely to result; this behavior depends on the other options used, the order in which they are specified, and whether they are specified on the command line or in an option file. For more information about how MySQL handles server options, see [Section 4.2.2, “Specifying Program Options”](#).

- `relay_log_info_file`

Command-Line Format	<code>--relay-log-info-file=file_name</code>
System Variable	<code>relay_log_info_file</code>
Scope	Global
Dynamic	No
Type	File name
Default Value	<code>relay-log.info</code>

The name of the file in which the replica records information about the relay logs, when `relay_log_info_repository=FILE`. If `relay_log_info_repository=TABLE`, it is the file name that would be used in case the repository was changed to `FILE`). The default name is `relay-log.info` in the data directory. For information about the applier metadata repository, see [Section 16.2.4.2, “Replication Metadata Repositories”](#).

- `relay_log_info_repository`

Command-Line Format	<code>--relay-log-info-repository=value</code>
System Variable	<code>relay_log_info_repository</code>
Scope	Global
Dynamic	Yes
Type	String
Default Value	<code>FILE</code>
Valid Values	<code>FILE</code>

	TABLE
--	-------

The setting of this variable determines whether the replica server stores its applier metadata repository as an `InnoDB` table in the `mysql` system database, or as a file in the data directory. For more information on the applier metadata repository, see [Section 16.2.4, “Relay Log and Replication Metadata Repositories”](#).

The default setting is `FILE`. As a file, the replica's applier metadata repository is named `relay-log.info` by default, and you can change this name using the `relay_log_info_file` system variable.

With the setting `TABLE`, as an `InnoDB` table, the replica's applier metadata repository is named `mysql.slave_relay_log_info`. The `TABLE` setting is required when multiple replication channels are configured. The `TABLE` setting for the replica's applier metadata repository is also required to make replication resilient to unexpected halts. See [Section 16.3.2, “Handling an Unexpected Halt of a Replica”](#) for more information.

This variable must be set to `TABLE` before configuring multiple replication channels. If you are using multiple replication channels then you cannot set the value back to `FILE`.

The setting for the location of the applier metadata repository has a direct influence on the effect had by the setting of the `sync_relay_log_info` system variable. You can change the setting only when no replication threads are executing.

- `relay_log_purge`

Command-Line Format	<code>--relay-log-purge[={OFF ON}]</code>
System Variable	<code>relay_log_purge</code>
Scope	Global
Dynamic	Yes
Type	Boolean
Default Value	<code>ON</code>

Disables or enables automatic purging of relay log files as soon as they are not needed any more. The default value is 1 (`ON`).

- `relay_log_recovery`

Command-Line Format	<code>--relay-log-recovery[={OFF ON}]</code>
System Variable	<code>relay_log_recovery</code>
Scope	Global
Dynamic	No
Type	Boolean
Default Value	<code>OFF</code>

If enabled, this variable enables automatic relay log recovery immediately following server startup. The recovery process creates a new relay log file, initializes the SQL thread position to this new relay log,

and initializes the I/O thread to the SQL thread position. Reading of the relay log from the source then continues.

This global variable is read-only at runtime. Its value can be set with the `--relay-log-recovery` option at replica server startup, which should be used following an unexpected halt of a replica to ensure that no possibly corrupted relay logs are processed, and must be used in order to guarantee a crash-safe replica. The default value is 0 (disabled). For information on the combination of settings on a replica that is most resilient to unexpected halts, see [Section 16.3.2, “Handling an Unexpected Halt of a Replica”](#).

This variable also interacts with the `relay_log_purge` variable, which controls purging of logs when they are no longer needed. Enabling `relay_log_recovery` when `relay_log_purge` is disabled risks reading the relay log from files that were not purged, leading to data inconsistency.

For a multithreaded replica (where `slave_parallel_workers` is greater than 0), from MySQL 5.7.13, setting `relay_log_recovery = ON` automatically handles any inconsistencies and gaps in the sequence of transactions that have been executed from the relay log. These gaps can occur when file position based replication is in use. (For more details, see [Section 16.4.1.32, “Replication and Transaction Inconsistencies”](#).) The relay log recovery process deals with gaps using the same method as the `START SLAVE UNTIL SQL_AFTER_MTS_GAPS` statement would. When the replica reaches a consistent gap-free state, the relay log recovery process goes on to fetch further transactions from the source beginning at the replication SQL thread position. In MySQL versions prior to MySQL 5.7.13, this process was not automatic and required starting the server with `relay_log_recovery=0`, starting the replica with `START SLAVE UNTIL SQL_AFTER_MTS_GAPS` to fix any transaction inconsistencies, and then restarting the replica with `relay_log_recovery=1`. When GTID-based replication is in use, from MySQL 5.7.28 a multithreaded replica checks first whether `MASTER_AUTO_POSITION` is set to `ON`, and if it is, omits the step of calculating the transactions that should be skipped or not skipped, so that the old relay logs are not required for the recovery process.



#### Note

This variable does not affect the following Group Replication channels:

- `group_replication_applier`
- `group_replication_recovery`

Any other channels running on a group are affected, such as a channel which is replicating from an outside source or another group.

- `relay_log_space_limit`

Command-Line Format	<code>--relay-log-space-limit=#</code>
System Variable	<code>relay_log_space_limit</code>
Scope	Global
Dynamic	No
Type	Integer
Default Value	0
Minimum Value	0
Maximum Value	18446744073709551615

Unit	bytes
------	-------

The maximum amount of space to use for all relay logs.

- [replication\\_optimize\\_for\\_static\\_plugin\\_config](#)

Command-Line Format	<code>--replication-optimize-for-static-plugin-config[={OFF ON}]</code>
Introduced	5.7.33
System Variable	<a href="#">replication_optimize_for_static_plugin_config</a>
Scope	Global
Dynamic	Yes
Type	Boolean
Default Value	OFF

Use shared locks, and avoid unnecessary lock acquisitions, to improve performance for semisynchronous replication. While this system variable is enabled, the semisynchronous replication plugin cannot be uninstalled, so you must disable the system variable before the uninstall can complete.

This system variable can be enabled before or after installing the semisynchronous replication plugin, and can be enabled while replication is running. Semisynchronous replication source servers can also get performance benefits from enabling this system variable, because they use the same locking mechanisms as the replicas.

[replication\\_optimize\\_for\\_static\\_plugin\\_config](#) can be enabled when Group Replication is in use on a server. In that scenario, it might benefit performance when there is contention for locks due to high workloads.

- [replication\\_sender\\_observe\\_commit\\_only](#)

Command-Line Format	<code>--replication-sender-observe-commit-only[={OFF ON}]</code>
Introduced	5.7.33
System Variable	<a href="#">replication_sender_observe_commit_only</a>
Scope	Global
Dynamic	Yes
Type	Boolean
Default Value	OFF

Limit callbacks to improve performance for semisynchronous replication. This system variable can be enabled before or after installing the semisynchronous replication plugin, and can be enabled while replication is running. Semisynchronous replication source servers can also get performance benefits from enabling this system variable, because they use the same locking mechanisms as the replicas.

- [report\\_host](#)

Command-Line Format	<code>--report-host=host_name</code>
System Variable	<a href="#">report_host</a>
Scope	Global

Dynamic	No
Type	String

The host name or IP address of the replica to be reported to the source during replica registration. This value appears in the output of `SHOW SLAVE HOSTS` on the source server. Leave the value unset if you do not want the replica to register itself with the source.



#### Note

It is not sufficient for the source to simply read the IP address of the replica from the TCP/IP socket after the replica connects. Due to NAT and other routing issues, that IP may not be valid for connecting to the replica from the source or other hosts.

- `report_password`

Command-Line Format	<code>--report-password=name</code>
System Variable	<code>report_password</code>
Scope	Global
Dynamic	No
Type	String

The replication user account password of the replica to be reported to the source during replica registration. This value appears in the output of `SHOW SLAVE HOSTS` on the source server if the source was started with `--show-slave-auth-info`.

Although the name of this variable might imply otherwise, `report_password` is not connected to the MySQL user privilege system and so is not necessarily (or even likely to be) the same as the password for the MySQL replication user account.

- `report_port`

Command-Line Format	<code>--report-port=port_num</code>
System Variable	<code>report_port</code>
Scope	Global
Dynamic	No
Type	Integer
Default Value	<code>[slave_port]</code>
Minimum Value	0
Maximum Value	65535

The TCP/IP port number for connecting to the replica, to be reported to the source during replica registration. Set this only if the replica is listening on a nondefault port or if you have a special tunnel from the source or other clients to the replica. If you are not sure, do not use this option.

The default value for this option is the port number actually used by the replica. This is also the default value displayed by `SHOW SLAVE HOSTS`.

- `report_user`

Command-Line Format	<code>--report-user=name</code>
System Variable	<code>report_user</code>
Scope	Global
Dynamic	No
Type	String

The account user name of the replica to be reported to the source during replica registration. This value appears in the output of `SHOW SLAVE HOSTS` on the source server if the source was started with `--show-slave-auth-info`.

Although the name of this variable might imply otherwise, `report_user` is not connected to the MySQL user privilege system and so is not necessarily (or even likely to be) the same as the name of the MySQL replication user account.

- `rpl_semi_sync_slave_enabled`

Command-Line Format	<code>--rpl-semi-sync-slave-enabled[={OFF ON}]</code>
System Variable	<code>rpl_semi_sync_slave_enabled</code>
Scope	Global
Dynamic	Yes
Type	Boolean
Default Value	<code>OFF</code>

Controls whether semisynchronous replication is enabled on the replica. To enable or disable the plugin, set this variable to `ON` or `OFF` (or 1 or 0), respectively. The default is `OFF`.

This variable is available only if the replica-side semisynchronous replication plugin is installed.

- `rpl_semi_sync_slave_trace_level`

Command-Line Format	<code>--rpl-semi-sync-slave-trace-level=#</code>
System Variable	<code>rpl_semi_sync_slave_trace_level</code>
Scope	Global
Dynamic	Yes
Type	Integer
Default Value	32
Minimum Value	0
Maximum Value	4294967295

The semisynchronous replication debug trace level on the replica. See `rpl_semi_sync_master_trace_level` for the permissible values.

This variable is available only if the replica-side semisynchronous replication plugin is installed.



- `rpl_stop_slave_timeout`

Command-Line Format	<code>--rpl-stop-slave-timeout=#</code>
System Variable	<code>rpl_stop_slave_timeout</code>
Scope	Global
Dynamic	Yes
Type	Integer
Default Value	31536000
Minimum Value	2
Maximum Value	31536000
Unit	seconds

You can control the length of time (in seconds) that `STOP SLAVE` waits before timing out by setting this variable. This can be used to avoid deadlocks between `STOP SLAVE` and other SQL statements using different client connections to the replica.

The maximum and default value of `rpl_stop_slave_timeout` is 31536000 seconds (1 year). The minimum is 2 seconds. Changes to this variable take effect for subsequent `STOP SLAVE` statements.

This variable affects only the client that issues a `STOP SLAVE` statement. When the timeout is reached, the issuing client returns an error message stating that the command execution is incomplete. The client then stops waiting for the replication threads to stop, but the replication threads continue to try to stop, and the `STOP SLAVE` instruction remains in effect. Once the replication threads are no longer busy, the `STOP SLAVE` statement is executed and the replica stops.

- `slave_checkpoint_group`

Command-Line Format	<code>--slave-checkpoint-group=#</code>
System Variable	<code>slave_checkpoint_group</code>
Scope	Global
Dynamic	Yes
Type	Integer
Default Value	512
Minimum Value	32
Maximum Value	524280
Block Size	8

Sets the maximum number of transactions that can be processed by a multithreaded replica before a checkpoint operation is called to update its status as shown by `SHOW SLAVE STATUS`. Setting this

variable has no effect on replicas for which multithreading is not enabled. Setting this variable has no immediate effect. The state of the variable applies on all subsequent `START SLAVE` commands.



#### Note

Multithreaded replicas are not currently supported by NDB Cluster, which silently ignores the setting for this variable. See [Section 21.7.3, “Known Issues in NDB Cluster Replication”](#), for more information.

This variable works in combination with the `slave_checkpoint_period` system variable in such a way that, when either limit is exceeded, the checkpoint is executed and the counters tracking both the number of transactions and the time elapsed since the last checkpoint are reset.

The minimum allowed value for this variable is 32, unless the server was built using `-DWITH_DEBUG`, in which case the minimum value is 1. The effective value is always a multiple of 8; you can set it to a value that is not such a multiple, but the server rounds it down to the next lower multiple of 8 before storing the value. (*Exception:* No such rounding is performed by the debug server.) Regardless of how the server was built, the default value is 512, and the maximum allowed value is 524280.

- `slave_checkpoint_period`

Command-Line Format	<code>--slave-checkpoint-period=#</code>
System Variable	<code>slave_checkpoint_period</code>
Scope	Global
Dynamic	Yes
Type	Integer
Default Value	300
Minimum Value	1
Maximum Value	4294967295
Unit	milliseconds

Sets the maximum time (in milliseconds) that is allowed to pass before a checkpoint operation is called to update the status of a multithreaded replica as shown by `SHOW SLAVE STATUS`. Setting this variable has no effect on replicas for which multithreading is not enabled. Setting this variable takes effect for all replication channels immediately, including running channels.



#### Note

Multithreaded replicas are not currently supported by NDB Cluster, which silently ignores the setting for this variable. See [Section 21.7.3, “Known Issues in NDB Cluster Replication”](#), for more information.

This variable works in combination with the `slave_checkpoint_group` system variable in such a way that, when either limit is exceeded, the checkpoint is executed and the counters tracking both the number of transactions and the time elapsed since the last checkpoint are reset.

The minimum allowed value for this variable is 1, unless the server was built using `-DWITH_DEBUG`, in which case the minimum value is 0. Regardless of how the server was built, the default value is 300 milliseconds, and the maximum possible value is 4294967295 milliseconds (approximately 49.7 days).

- `slave_compressed_protocol`

Command-Line Format	<code>--slave-compressed-protocol[={OFF ON}]</code>
System Variable	<code>slave_compressed_protocol</code>
Scope	Global
Dynamic	Yes
Type	Boolean
Default Value	<code>OFF</code>

Whether to use compression of the source/replica protocol if both source and replica support it. If this variable is disabled (the default), connections are uncompressed. Changes to this variable take effect on subsequent connection attempts; this includes after issuing a `START SLAVE` statement, as well as reconnections made by a running replication I/O thread (for example, after setting the `MASTER_RETRY_COUNT` option for the `CHANGE MASTER TO` statement). See also [Section 4.2.6, “Connection Compression Control”](#).

- `slave_exec_mode`

Command-Line Format	<code>--slave-exec-mode=mode</code>
System Variable	<code>slave_exec_mode</code>
Scope	Global
Dynamic	Yes
Type	Enumeration
Default Value	<code>IDEMPOTENT (NDB)</code> <code>STRICT (Other)</code>
Valid Values	<code>STRICT</code> <code>IDEMPOTENT</code>

Controls how a replication thread resolves conflicts and errors during replication. `IDEMPOTENT` mode causes suppression of duplicate-key and no-key-found errors; `STRICT` means no such suppression takes place.

`IDEMPOTENT` mode is intended for use in multi-source replication, circular replication, and some other special replication scenarios for NDB Cluster Replication. (See [Section 21.7.10, “NDB Cluster Replication: Bidirectional and Circular Replication”](#), and [Section 21.7.11, “NDB Cluster Replication Conflict Resolution”](#), for more information.) NDB Cluster ignores any value explicitly set for `slave_exec_mode`, and always treats it as `IDEMPOTENT`.

In MySQL Server 5.7, `STRICT` mode is the default value.

For storage engines other than `NDB`, `IDEMPOTENT` mode should be used only when you are absolutely sure that duplicate-key errors and key-not-found errors can safely be ignored. It is meant to be used in fail-over scenarios for NDB Cluster where multi-source replication or circular replication is employed, and is not recommended for use in other cases.

- `slave_load_tmpdir`

Command-Line Format	<code>--slave-load-tmpdir=dir_name</code>
---------------------	---

System Variable	<code>slave_load_tmpdir</code>
Scope	Global
Dynamic	No
Type	Directory name
Default Value	Value of <code>--tmpdir</code>

The name of the directory where the replica creates temporary files. Setting this variable takes effect for all replication channels immediately, including running channels. The variable value is by default equal to the value of the `tmpdir` system variable, or the default that applies when that system variable is not specified.

When the replication SQL thread replicates a `LOAD DATA` statement, it extracts the file to be loaded from the relay log into temporary files, and then loads these into the table. If the file loaded on the source is huge, the temporary files on the replica are huge, too. Therefore, it might be advisable to use this option to tell the replica to put temporary files in a directory located in some file system that has a lot of available space. In that case, the relay logs are huge as well, so you might also want to set the `relay_log` system variable to place the relay logs in that file system.

The directory specified by this option should be located in a disk-based file system (not a memory-based file system) so that the temporary files used to replicate `LOAD DATA` statements can survive machine restarts. The directory also should not be one that is cleared by the operating system during the system startup process. However, replication can now continue after a restart if the temporary files have been removed.

- `slave_max_allowed_packet`

Command-Line Format	<code>--slave-max-allowed-packet=#</code>
System Variable	<code>slave_max_allowed_packet</code>
Scope	Global
Dynamic	Yes
Type	Integer
Default Value	1073741824
Minimum Value	1024
Maximum Value	1073741824
Unit	bytes
Block Size	1024

This variable sets the maximum packet size for the replication SQL and I/O threads, so that large updates using row-based replication do not cause replication to fail because an update exceeded `max_allowed_packet`. Setting this variable takes effect for all replication channels immediately, including running channels.

This global variable always has a value that is a positive integer multiple of 1024; if you set it to some value that is not, the value is rounded down to the next highest multiple of 1024 for it is stored or used; setting `slave_max_allowed_packet` to 0 causes 1024 to be used. (A truncation warning is issued in all such cases.) The default and maximum value is 1073741824 (1 GB); the minimum is 1024.

- `slave_net_timeout`

Command-Line Format	<code>--slave-net-timeout=#</code>
System Variable	<code>slave_net_timeout</code>
Scope	Global
Dynamic	Yes
Type	Integer
Default Value	60
Minimum Value	1
Maximum Value	31536000
Unit	seconds

The number of seconds to wait for more data or a heartbeat signal from the source before the replica considers the connection broken, aborts the read, and tries to reconnect. Setting this variable has no immediate effect. The state of the variable applies on all subsequent `START SLAVE` commands.

The first retry occurs immediately after the timeout. The interval between retries is controlled by the `MASTER_CONNECT_RETRY` option for the `CHANGE MASTER TO` statement, and the number of reconnection attempts is limited by the `MASTER_RETRY_COUNT` option for the `CHANGE MASTER TO` statement.

The heartbeat interval, which stops the connection timeout occurring in the absence of data if the connection is still good, is controlled by the `MASTER_HEARTBEAT_PERIOD` option for the `CHANGE MASTER TO` statement. The heartbeat interval defaults to half the value of `slave_net_timeout`, and it is recorded in the replica's connection metadata repository and shown in the `replication_connection_configuration` Performance Schema table. Note that a change to the value or default setting of `slave_net_timeout` does not automatically change the heartbeat interval, whether that has been set explicitly or is using a previously calculated default. If the connection timeout is changed, you must also issue `CHANGE MASTER TO` to adjust the heartbeat interval to an appropriate value so that it occurs before the connection timeout.

- `slave_parallel_type`

Command-Line Format	<code>--slave-parallel-type=value</code>
System Variable	<code>slave_parallel_type</code>
Scope	Global
Dynamic	Yes
Type	Enumeration
Default Value	<code>DATABASE</code>
Valid Values	<code>DATABASE</code> <code>LOGICAL_CLOCK</code>

When using a multithreaded replica (`slave_parallel_workers` is greater than 0), this variable specifies the policy used to decide which transactions are allowed to execute in parallel on the replica. The variable has no effect on replicas for which multithreading is not enabled. The possible values are:

- `LOGICAL_CLOCK`: Transactions that are part of the same binary log group commit on a source are applied in parallel on a replica. The dependencies between transactions are tracked based on

their timestamps to provide additional parallelization where possible. When this value is set, the `binlog_transaction_dependency_tracking` system variable can be used on the source to specify that write sets are used for parallelization in place of timestamps, if a write set is available for the transaction and gives improved results compared to timestamps.

- **DATABASE:** Transactions that update different databases are applied in parallel. This value is only appropriate if data is partitioned into multiple databases which are being updated independently and concurrently on the source. There must be no cross-database constraints, as such constraints may be violated on the replica.

When `slave_preserve_commit_order` is 1, `slave_parallel_type` must be `LOGICAL_CLOCK`.

All replication applier threads must be stopped prior to setting `slave_parallel_type`.

When your replication topology uses multiple levels of replicas, `LOGICAL_CLOCK` may achieve less parallelization for each level the replica is away from the source. You can reduce this effect by using `binlog_transaction_dependency_tracking` on the source to specify that write sets are used instead of timestamps for parallelization where possible.

- `slave_parallel_workers`

Command-Line Format	<code>--slave-parallel-workers=#</code>
System Variable	<code>slave_parallel_workers</code>
Scope	Global
Dynamic	Yes
Type	Integer
Default Value	0
Minimum Value	0
Maximum Value	1024

Sets the number of applier threads for executing replication transactions in parallel. Setting this variable to a number greater than 0 creates a multithreaded replica with this number of applier threads. When set to 0 (the default) parallel execution is disabled and the replica uses a single applier thread. Setting `slave_parallel_workers` has no immediate effect. The state of the variable applies on all subsequent `START SLAVE` statements.



#### Note

Multithreaded replicas are not currently supported by NDB Cluster, which silently ignores the setting for this variable. See [Section 21.7.3, “Known Issues in NDB Cluster Replication”](#), for more information.

A multithreaded replica provides parallel execution by using a coordinator thread and the number of applier threads configured by this variable. The way which transactions are distributed among applier threads is configured by `slave_parallel_type`. The transactions that the replica applies in parallel may commit out of order, unless `slave_preserve_commit_order=1`. Therefore, checking for the most recently executed transaction does not guarantee that all previous transactions from the source have been executed on the replica. This has implications for logging and recovery when using a

multithreaded replica. For example, on a multithreaded replica the `START SLAVE UNTIL` statement only supports using `SQL_AFTER_MTS_GAPS`.

In MySQL 5.7, retrying of transactions is supported when multithreading is enabled on a replica. In previous versions, `slave_transaction_retries` was treated as equal to 0 when using multithreaded replicas.

Multithreaded replicas are not currently supported by NDB Cluster. See [Section 21.7.3, “Known Issues in NDB Cluster Replication”](#), for more information about how NDB handles settings for this variable.

- `slave_pending_jobs_size_max`

Command-Line Format	<code>--slave-pending-jobs-size-max=#</code>
System Variable	<code>slave_pending_jobs_size_max</code>
Scope	Global
Dynamic	Yes
Type	Integer
Default Value	16M
Minimum Value	1024
Maximum Value	16EiB
Unit	bytes
Block Size	1024

For multithreaded replicas, this variable sets the maximum amount of memory (in bytes) available to worker queues holding events not yet applied. Setting this variable has no effect on replicas for which multithreading is not enabled. Setting this variable has no immediate effect. The state of the variable applies on all subsequent `START SLAVE` commands.

The minimum possible value for this variable is 1024; the default is 16MB. The maximum possible value is 18446744073709551615 (16 exabytes). Values that are not exact multiples of 1024 are rounded down to the next-highest multiple of 1024 prior to being stored.

The value of this variable is a soft limit and can be set to match the normal workload. If an unusually large event exceeds this size, the transaction is held until all the worker threads have empty queues, and then processed. All subsequent transactions are held until the large transaction has been completed.

- `slave_preserve_commit_order`

Command-Line Format	<code>--slave-preserve-commit-order[={OFF ON}]</code>
System Variable	<code>slave_preserve_commit_order</code>
Scope	Global
Dynamic	Yes
Type	Boolean
Default Value	OFF

For multithreaded replicas, the setting 1 for this variable ensures that transactions are externalized on the replica in the same order as they appear in the replica's relay log, and prevents gaps in the sequence of transactions that have been executed from the relay log. This variable has no effect on replicas for which multithreading is not enabled. Note that `slave_preserve_commit_order=1` does not preserve

the order of non-transactional DML updates, so these might commit before transactions that precede them in the relay log, which might result in gaps.

`slave_preserve_commit_order=1` requires that `--log-bin` and `--log-slave-updates` are enabled on the replica, and `slave_parallel_type` is set to `LOGICAL_CLOCK`. Before changing this variable, all replication applier threads (for all replication channels if you are using multiple replication channels) must be stopped.

With `slave_preserve_commit_order` enabled, the executing thread waits until all previous transactions are committed before committing. While the thread is waiting for other workers to commit their transactions it reports its status as `Waiting for preceding transaction to commit`. (Prior to MySQL 5.7.8, this was shown as `Waiting for its turn to commit`.) Enabling this mode on a multithreaded replica ensures that it never enters a state that the source was not in. This supports the use of replication for read scale-out. See [Section 16.3.4, “Using Replication for Scale-Out”](#).

If `slave_preserve_commit_order` is 0, the transactions that the replica applies in parallel may commit out of order. Therefore, checking for the most recently executed transaction does not guarantee that all previous transactions from the source have been executed on the replica. There is a chance of gaps in the sequence of transactions that have been executed from the replica's relay log. This has implications for logging and recovery when using a multithreaded replica. Note that the setting `slave_preserve_commit_order=1` prevents gaps, but does not prevent source binary log position lag (where `Exec_master_log_pos` is behind the position up to which transactions have been executed). See [Section 16.4.1.32, “Replication and Transaction Inconsistencies”](#) for more information.

- `slave_rows_search_algorithms`

Command-Line Format	<code>--slave-rows-search-algorithms=value</code>
System Variable	<code>slave_rows_search_algorithms</code>
Scope	Global
Dynamic	Yes
Type	Set
Default Value	<code>TABLE_SCAN, INDEX_SCAN</code>
Valid Values	<code>TABLE_SCAN, INDEX_SCAN</code>  <code>INDEX_SCAN, HASH_SCAN</code>  <code>TABLE_SCAN, HASH_SCAN</code>  <code>TABLE_SCAN, INDEX_SCAN, HASH_SCAN</code> (equivalent to <code>INDEX_SCAN, HASH_SCAN</code> )

When preparing batches of rows for row-based logging and replication, this variable controls how the rows are searched for matches, in particular whether hash scans are used. Setting this variable takes effect for all replication channels immediately, including running channels.

Specify a comma-separated list of the following combinations of 2 values from the list `INDEX_SCAN`, `TABLE_SCAN`, `HASH_SCAN`. The value is expected as a string, so if set at runtime rather than at server startup, the value must be quoted. In addition, the value must not contain any spaces. The recommended combinations (lists) and their effects are shown in the following table:

Index used / option value	<code>INDEX_SCAN, HASH_SCAN</code>	<code>INDEX_SCAN, TABLE_SCAN</code>
<i>Primary key or unique key</i>	Index scan	Index scan



Index used / option value	<code>INDEX_SCAN, HASH_SCAN</code>	<code>INDEX_SCAN, TABLE_SCAN</code>
<i>(Other) Key</i>	Hash scan over index	Index scan
<i>No index</i>	Hash scan	Table scan

- The default value is `INDEX_SCAN, TABLE_SCAN`, which means that all searches that can use indexes do use them, and searches without any indexes use table scans.
- To use hashing for any searches that do not use a primary or unique key, set `INDEX_SCAN, HASH_SCAN`. Specifying `INDEX_SCAN, HASH_SCAN` has the same effect as specifying `INDEX_SCAN, TABLE_SCAN, HASH_SCAN`, which is allowed.
- Do not use the combination `TABLE_SCAN, HASH_SCAN`. This setting forces hashing for all searches. It has no advantage over `INDEX_SCAN, HASH_SCAN`, and it can lead to “record not found” errors or duplicate key errors in the case of a single event containing multiple updates to the same row, or updates that are order-dependent.

The order in which the algorithms are specified in the list makes no difference to the order in which they are displayed by a `SELECT` or `SHOW VARIABLES` statement.

It is possible to specify a single value, but this is not optimal, because setting a single value limits searches to using only that algorithm. In particular, setting `INDEX_SCAN` alone is not recommended, as in that case searches are unable to find rows at all if no index is present.

- `slave_skip_errors`

Command-Line Format	<code>--slave-skip-errors=name</code>
System Variable	<code>slave_skip_errors</code>
Scope	Global
Dynamic	No
Type	String
Default Value	<code>OFF</code>
Valid Values	<code>OFF</code>  <code>[list of error codes]</code>  <code>all</code>  <code>ddl_exist_errors</code>

Normally, replication stops when an error occurs on the replica, which gives you the opportunity to resolve the inconsistency in the data manually. This variable causes the replication SQL thread to continue replication when a statement returns any of the errors listed in the variable value.

- `slave_sql_verify_checksum`

Command-Line Format	<code>--slave-sql-verify-checksum[={OFF   ON} ]</code>
System Variable	<code>slave_sql_verify_checksum</code>
Scope	Global
Dynamic	Yes

Type	Boolean
Default Value	ON

Cause the replication SQL thread to verify data using the checksums read from the relay log. In the event of a mismatch, the replica stops with an error. Setting this variable takes effect for all replication channels immediately, including running channels.



**Note**

The replication I/O thread always reads checksums if possible when accepting events from over the network.

- [slave\\_transaction\\_retries](#)

Command-Line Format	<code>--slave-transaction-retries=#</code>
System Variable	<code>slave_transaction_retries</code>
Scope	Global
Dynamic	Yes
Type	Integer
Default Value	10
Minimum Value	0
Maximum Value (64-bit platforms)	18446744073709551615
Maximum Value (32-bit platforms)	4294967295

If a replication SQL thread fails to execute a transaction because of an `InnoDB` deadlock or because the transaction's execution time exceeded `InnoDB`'s `innodb_lock_wait_timeout` or `NDB`'s `TransactionDeadlockDetectionTimeout` or `TransactionInactiveTimeout`, it automatically retries `slave_transaction_retries` times before stopping with an error. Transactions with a non-temporary error are not retried.

The default value for `slave_transaction_retries` is 10. Setting the variable to 0 disables automatic retrying of transactions. Setting the variable takes effect for all replication channels immediately, including running channels.

As of MySQL 5.7.5, retrying of transactions is supported when multithreading is enabled on a replica. In previous versions, `slave_transaction_retries` was treated as equal to 0 when using multithreaded replicas.

The Performance Schema table `replication_applier_status` shows the number of retries that took place on each replication channel, in the `COUNT_TRANSACTIONS_RETRIES` column.

- [slave\\_type\\_conversions](#)

Command-Line Format	<code>--slave-type-conversions=set</code>
System Variable	<code>slave_type_conversions</code>
Scope	Global
Dynamic	Yes
Type	Set
Default Value	

Valid Values	<a href="#">ALL_LOSSY</a> <a href="#">ALL_NON_LOSSY</a> <a href="#">ALL_SIGNED</a> <a href="#">ALL_UNSIGNED</a>
--------------	--

Controls the type conversion mode in effect on the replica when using row-based replication. In MySQL 5.7.2 and higher, its value is a comma-delimited set of zero or more elements from the list: [ALL\\_LOSSY](#), [ALL\\_NON\\_LOSSY](#), [ALL\\_SIGNED](#), [ALL\\_UNSIGNED](#). Set this variable to an empty string to disallow type conversions between the source and the replica. Setting this variable takes effect for all replication channels immediately, including running channels.

[ALL\\_SIGNED](#) and [ALL\\_UNSIGNED](#) were added in MySQL 5.7.2 (Bug#15831300). For additional information on type conversion modes applicable to attribute promotion and demotion in row-based replication, see [Row-based replication: attribute promotion and demotion](#).

- [sql\\_slave\\_skip\\_counter](#)

System Variable	<a href="#">sql_slave_skip_counter</a>
Scope	Global
Dynamic	Yes
Type	Integer
Default Value	0
Minimum Value	0
Maximum Value	4294967295

The number of events from the source that a replica should skip. Setting the option has no immediate effect. The variable applies to the next [START SLAVE](#) statement; the next [START SLAVE](#) statement also changes the value back to 0. When this variable is set to a nonzero value and there are multiple replication channels configured, the [START SLAVE](#) statement can only be used with the [FOR CHANNEL channel](#) clause.

This option is incompatible with GTID-based replication, and must not be set to a nonzero value when [gtid\\_mode=ON](#). If you need to skip transactions when employing GTIDs, use [gtid\\_executed](#) from the source instead. See [Section 16.1.7.3, “Skipping Transactions”](#).



### Important

If skipping the number of events specified by setting this variable would cause the replica to begin in the middle of an event group, the replica continues to skip until it finds the beginning of the next event group and begins from that point. For more information, see [Section 16.1.7.3, “Skipping Transactions”](#).

- [sync\\_master\\_info](#)

Command-Line Format	<a href="#">--sync-master-info=#</a>
System Variable	<a href="#">sync_master_info</a>
Scope	Global
Dynamic	Yes

Type	Integer
Default Value	10000
Minimum Value	0
Maximum Value	4294967295

The effects of this variable on a replica depend on whether the replica's `master_info_repository` is set to `FILE` or `TABLE`, as explained in the following paragraphs.

**master\_info\_repository = FILE.** If the value of `sync_master_info` is greater than 0, the replica synchronizes its `master.info` file to disk (using `fdatasync()`) after every `sync_master_info` events. If it is 0, the MySQL server performs no synchronization of the `master.info` file to disk; instead, the server relies on the operating system to flush its contents periodically as with any other file.

**master\_info\_repository = TABLE.** If the value of `sync_master_info` is greater than 0, the replica updates its connection metadata repository table after every `sync_master_info` events. If it is 0, the table is never updated.

The default value for `sync_master_info` is 10000. Setting this variable takes effect for all replication channels immediately, including running channels.

- `sync_relay_log`

Command-Line Format	<code>--sync-relay-log=#</code>
System Variable	<code>sync_relay_log</code>
Scope	Global
Dynamic	Yes
Type	Integer
Default Value	10000
Minimum Value	0
Maximum Value	4294967295

If the value of this variable is greater than 0, the MySQL server synchronizes its relay log to disk (using `fdatasync()`) after every `sync_relay_log` events are written to the relay log. Setting this variable takes effect for all replication channels immediately, including running channels.

Setting `sync_relay_log` to 0 causes no synchronization to be done to disk; in this case, the server relies on the operating system to flush the relay log's contents from time to time as for any other file.

A value of 1 is the safest choice because in the event of an unexpected halt you lose at most one event from the relay log. However, it is also the slowest choice (unless the disk has a battery-backed cache, which makes synchronization very fast). For information on the combination of settings on a replica that is most resilient to unexpected halts, see [Section 16.3.2, "Handling an Unexpected Halt of a Replica"](#).

- `sync_relay_log_info`

Command-Line Format	<code>--sync-relay-log-info=#</code>
System Variable	<code>sync_relay_log_info</code>
Scope	Global
Dynamic	Yes

Type	Integer
Default Value	10000
Minimum Value	0
Maximum Value	4294967295

The default value for `sync_relay_log_info` is 10000. Setting this variable takes effect for all replication channels immediately, including running channels.

The effects of this variable on the replica depend on the server's `relay_log_info_repository` setting (`FILE` or `TABLE`). If the setting is `TABLE`, the effects of the variable also depend on whether the storage engine used by the relay log info table is transactional (such as `InnoDB`) or not transactional (`MyISAM`). The effects of these factors on the behavior of the server for `sync_relay_log_info` values of zero and greater than zero are as follows:

- `sync_relay_log_info = 0`
- If `relay_log_info_repository` is set to `FILE`, the MySQL server performs no synchronization of the `relay-log.info` file to disk; instead, the server relies on the operating system to flush its contents periodically as with any other file.
  - If `relay_log_info_repository` is set to `TABLE`, and the storage engine for that table is transactional, the table is updated after each transaction. (The `sync_relay_log_info` setting is effectively ignored in this case.)
  - If `relay_log_info_repository` is set to `TABLE`, and the storage engine for that table is not transactional, the table is never updated.
- `sync_relay_log_info = N`  
`> 0`
- If `relay_log_info_repository` is set to `FILE`, the replica synchronizes its `relay-log.info` file to disk (using `fdatsync()`) after every `N` transactions.
  - If `relay_log_info_repository` is set to `TABLE`, and the storage engine for that table is transactional, the table is updated after each transaction. (The `sync_relay_log_info` setting is effectively ignored in this case.)
  - If `relay_log_info_repository` is set to `TABLE`, and the storage engine for that table is not transactional, the table is updated after every `N` events.

#### 16.1.6.4 Binary Logging Options and Variables

- [Startup Options Used with Binary Logging](#)
- [System Variables Used with Binary Logging](#)

You can use the `mysqld` options and system variables that are described in this section to affect the operation of the binary log as well as to control which statements are written to the binary log. For additional information about the binary log, see [Section 5.4.4, “The Binary Log”](#). For additional information about using MySQL server options and system variables, see [Section 5.1.6, “Server Command Options”](#), and [Section 5.1.7, “Server System Variables”](#).

## Startup Options Used with Binary Logging

The following list describes startup options for enabling and configuring the binary log. System variables used with binary logging are discussed later in this section.

- `--binlog-row-event-max-size=N`

Command-Line Format	<code>--binlog-row-event-max-size=#</code>
Type	Integer
Default Value	8192
Minimum Value	256
Maximum Value (64-bit platforms)	18446744073709551615
Maximum Value (32-bit platforms)	4294967295
Unit	bytes

Specify the maximum size of a row-based binary log event, in bytes. Rows are grouped into events smaller than this size if possible. The value should be a multiple of 256. The default is 8192. See [Section 16.2.1, “Replication Formats”](#).

- `--log-bin[=base_name]`

Command-Line Format	<code>--log-bin=file_name</code>
Type	File name

Enables binary logging. With binary logging enabled, the server logs all statements that change data to the binary log, which is used for backup and replication. The binary log is a sequence of files with a base name and numeric extension. For information on the format and management of the binary log, see [Section 5.4.4, “The Binary Log”](#).

If you supply a value for the `--log-bin` option, the value is used as the base name for the log sequence. The server creates binary log files in sequence by adding a numeric suffix to the base name. In MySQL 5.7, the base name defaults to `host_name-bin`, using the name of the host machine. It is recommended that you specify a base name, so that you can continue to use the same binary log file names regardless of changes to the default name.

The default location for binary log files is the data directory. You can use the `--log-bin` option to specify an alternative location, by adding a leading absolute path name to the base name to specify a different directory. When the server reads an entry from the binary log index file, which tracks the binary log files that have been used, it checks whether the entry contains a relative path. If it does, the relative part of the path is replaced with the absolute path set using the `--log-bin` option. An absolute path recorded in the binary log index file remains unchanged; in such a case, the index file must be edited manually to enable a new path or paths to be used. (In older versions of MySQL, manual intervention was required whenever relocating the binary log or relay log files.) (Bug #11745230, Bug #12133)

Setting this option causes the `log_bin` system variable to be set to `ON` (or `1`), and not to the base name. The binary log file base name and any specified path are available as the `log_bin_basename` system variable.

If you specify the `--log-bin` option without also specifying the `server_id` system variable, the server is not allowed to start. (Bug #11763963, Bug #56739)

When GTIDs are in use on the server, if binary logging is not enabled when restarting the server after an abnormal shutdown, some GTIDs are likely to be lost, causing replication to fail. In a normal shutdown,

the set of GTIDs from the current binary log file is saved in the `mysql.gtid_executed` table. Following an abnormal shutdown where this did not happen, during recovery the GTIDs are added to the table from the binary log file, provided that binary logging is still enabled. If binary logging is disabled for the server restart, the server cannot access the binary log file to recover the GTIDs, so replication cannot be started. Binary logging can be disabled safely after a normal shutdown.

If you want to disable binary logging for a server start but keep the `--log-bin` setting intact, you can specify the `--skip-log-bin` or `--disable-log-bin` option at startup. Specify the option after the `--log-bin` option, so that it takes precedence. When binary logging is disabled, the `log_bin` system variable is set to OFF.

- `--log-bin-index[=file_name]`

Command-Line Format	<code>--log-bin-index=file_name</code>
System Variable	<code>log_bin_index</code>
Scope	Global
Dynamic	No
Type	File name

The name for the binary log index file, which contains the names of the binary log files. By default, it has the same location and base name as the value specified for the binary log files using the `--log-bin` option, plus the extension `.index`. If you do not specify `--log-bin`, the default binary log index file name is `binlog.index`. If you omit the file name and do not specify one with `--log-bin`, the default binary log index file name is `host_name-bin.index`, using the name of the host machine.

For information on the format and management of the binary log, see [Section 5.4.4, “The Binary Log”](#).

**Statement selection options.** The options in the following list affect which statements are written to the binary log, and thus sent by a replication source server to its replicas. There are also options for replica servers that control which statements received from the source should be executed or ignored. For details, see [Section 16.1.6.3, “Replica Server Options and Variables”](#).

- `--binlog-do-db=db_name`

Command-Line Format	<code>--binlog-do-db=name</code>
Type	String

This option affects binary logging in a manner similar to the way that `--replicate-do-db` affects replication.

The effects of this option depend on whether the statement-based or row-based logging format is in use, in the same way that the effects of `--replicate-do-db` depend on whether statement-based or row-based replication is in use. You should keep in mind that the format used to log a given statement may not necessarily be the same as that indicated by the value of `binlog_format`. For example, DDL statements such as `CREATE TABLE` and `ALTER TABLE` are always logged as statements, without regard to the logging format in effect, so the following statement-based rules for `--binlog-do-db` always apply in determining whether or not the statement is logged.

**Statement-based logging.** Only those statements are written to the binary log where the default database (that is, the one selected by `USE`) is `db_name`. To specify more than one database, use this option multiple times, once for each database; however, doing so does *not* cause cross-database statements such as `UPDATE some_db.some_table SET foo='bar'` to be logged while a different database (or no database) is selected.

**Warning**

To specify multiple databases you *must* use multiple instances of this option. Because database names can contain commas, the list is treated as the name of a single database if you supply a comma-separated list.

An example of what does not work as you might expect when using statement-based logging: If the server is started with `--binlog-do-db=sales` and you issue the following statements, the `UPDATE` statement is *not* logged:

```
USE prices;
UPDATE sales.january SET amount=amount+1000;
```

The main reason for this “just check the default database” behavior is that it is difficult from the statement alone to know whether it should be replicated (for example, if you are using multiple-table `DELETE` statements or multiple-table `UPDATE` statements that act across multiple databases). It is also faster to check only the default database rather than all databases if there is no need.

Another case which may not be self-evident occurs when a given database is replicated even though it was not specified when setting the option. If the server is started with `--binlog-do-db=sales`, the following `UPDATE` statement is logged even though `prices` was not included when setting `--binlog-do-db`:

```
USE sales;
UPDATE prices.discounts SET percentage = percentage + 10;
```

Because `sales` is the default database when the `UPDATE` statement is issued, the `UPDATE` is logged.

**Row-based logging.** Logging is restricted to database `db_name`. Only changes to tables belonging to `db_name` are logged; the default database has no effect on this. Suppose that the server is started with `--binlog-do-db=sales` and row-based logging is in effect, and then the following statements are executed:

```
USE prices;
UPDATE sales.february SET amount=amount+100;
```

The changes to the `february` table in the `sales` database are logged in accordance with the `UPDATE` statement; this occurs whether or not the `USE` statement was issued. However, when using the row-based logging format and `--binlog-do-db=sales`, changes made by the following `UPDATE` are not logged:

```
USE prices;
UPDATE prices.march SET amount=amount-25;
```

Even if the `USE prices` statement were changed to `USE sales`, the `UPDATE` statement's effects would still not be written to the binary log.

Another important difference in `--binlog-do-db` handling for statement-based logging as opposed to the row-based logging occurs with regard to statements that refer to multiple databases. Suppose that the server is started with `--binlog-do-db=db1`, and the following statements are executed:

```
USE db1;
UPDATE db1.table1, db2.table2 SET db1.table1.col1 = 10, db2.table2.col2 = 20;
```

If you are using statement-based logging, the updates to both tables are written to the binary log. However, when using the row-based format, only the changes to `table1` are logged; `table2` is in a



different database, so it is not changed by the `UPDATE`. Now suppose that, instead of the `USE db1` statement, a `USE db4` statement had been used:

```
USE db4;
UPDATE db1.table1, db2.table2 SET db1.table1.col1 = 10, db2.table2.col2 = 20;
```

In this case, the `UPDATE` statement is not written to the binary log when using statement-based logging. However, when using row-based logging, the change to `table1` is logged, but not that to `table2`—in other words, only changes to tables in the database named by `--binlog-do-db` are logged, and the choice of default database has no effect on this behavior.

- `--binlog-ignore-db=db_name`

Command-Line Format	<code>--binlog-ignore-db=name</code>
Type	String

This option affects binary logging in a manner similar to the way that `--replicate-ignore-db` affects replication.

The effects of this option depend on whether the statement-based or row-based logging format is in use, in the same way that the effects of `--replicate-ignore-db` depend on whether statement-based or row-based replication is in use. You should keep in mind that the format used to log a given statement may not necessarily be the same as that indicated by the value of `binlog_format`. For example, DDL statements such as `CREATE TABLE` and `ALTER TABLE` are always logged as statements, without regard to the logging format in effect, so the following statement-based rules for `--binlog-ignore-db` always apply in determining whether or not the statement is logged.

**Statement-based logging.** Tells the server to not log any statement where the default database (that is, the one selected by `USE`) is `db_name`.

Prior to MySQL 5.7.2, this option caused any statements containing fully qualified table names not to be logged if there was no default database specified (that is, when `SELECT DATABASE()` returned `NULL`). In MySQL 5.7.2 and higher, when there is no default database, no `--binlog-ignore-db` options are applied, and such statements are always logged. (Bug #11829838, Bug #60188)

**Row-based format.** Tells the server not to log updates to any tables in the database `db_name`. The current database has no effect.

When using statement-based logging, the following example does not work as you might expect. Suppose that the server is started with `--binlog-ignore-db=sales` and you issue the following statements:

```
USE prices;
UPDATE sales.january SET amount=amount+1000;
```

The `UPDATE` statement *is* logged in such a case because `--binlog-ignore-db` applies only to the default database (determined by the `USE` statement). Because the `sales` database was specified explicitly in the statement, the statement has not been filtered. However, when using row-based logging, the `UPDATE` statement's effects are *not* written to the binary log, which means that no changes to the

`sales.january` table are logged; in this instance, `--binlog-ignore-db=sales` causes *all* changes made to tables in the source's copy of the `sales` database to be ignored for purposes of binary logging.

To specify more than one database to ignore, use this option multiple times, once for each database. Because database names can contain commas, the list is treated as the name of a single database if you supply a comma-separated list.

You should not use this option if you are using cross-database updates and you do not want these updates to be logged.

**Checksum options.** MySQL supports reading and writing of binary log checksums. These are enabled using the two options listed here:

- `--binlog-checksum={NONE|CRC32}`

Command-Line Format	<code>--binlog-checksum=type</code>
Type	String
Default Value	<code>CRC32</code>
Valid Values	<code>NONE</code>  <code>CRC32</code>

Enabling this option causes the source to write checksums for events written to the binary log. Set to `NONE` to disable, or the name of the algorithm to be used for generating checksums; currently, only `CRC32` checksums are supported, and `CRC32` is the default. You cannot change the setting for this option within a transaction.

To control reading of checksums by the replica (from the relay log), use the `--slave-sql-verify-checksum` option.

**Testing and debugging options.** The following binary log options are used in replication testing and debugging. They are not intended for use in normal operations.

- `--max-binlog-dump-events=N`

Command-Line Format	<code>--max-binlog-dump-events=#</code>
Type	Integer
Default Value	<code>0</code>

This option is used internally by the MySQL test suite for replication testing and debugging.

- `--sporadic-binlog-dump-fail`

Command-Line Format	<code>--sporadic-binlog-dump-fail[={OFF ON} ]</code>
Type	Boolean
Default Value	<code>OFF</code>

This option is used internally by the MySQL test suite for replication testing and debugging.

## System Variables Used with Binary Logging

The following list describes system variables for controlling binary logging. They can be set at server startup and some of them can be changed at runtime using `SET`. Server options used to control binary logging are listed earlier in this section.

- `binlog_cache_size`

Command-Line Format	<code>--binlog-cache-size=#</code>
System Variable	<code>binlog_cache_size</code>
Scope	Global
Dynamic	Yes
Type	Integer
Default Value	32768
Minimum Value	4096
Maximum Value (64-bit platforms)	18446744073709547520
Maximum Value (32-bit platforms)	4294963200
Unit	bytes
Block Size	4096

The size of the cache to hold changes to the binary log during a transaction.

A binary log cache is allocated for each client if the server supports any transactional storage engines and if the server has the binary log enabled (`--log-bin` option). If you often use large transactions, you can increase this cache size to get better performance. The `Binlog_cache_use` and `Binlog_cache_disk_use` status variables can be useful for tuning the size of this variable. See [Section 5.4.4, “The Binary Log”](#).

`binlog_cache_size` sets the size for the transaction cache only; the size of the statement cache is governed by the `binlog_stmt_cache_size` system variable.

- `binlog_checksum`

Command-Line Format	<code>--binlog-checksum=type</code>
System Variable	<code>binlog_checksum</code>
Scope	Global
Dynamic	Yes
Type	String
Default Value	<code>CRC32</code>
Valid Values	<code>NONE</code> <code>CRC32</code>

When enabled, this variable causes the source to write a checksum for each event in the binary log. `binlog_checksum` supports the values `NONE` (disabled) and `CRC32`. The default is `CRC32`. You cannot change the value of `binlog_checksum` within a transaction.

When `binlog_checksum` is disabled (value `NONE`), the server verifies that it is writing only complete events to the binary log by writing and checking the event length (rather than a checksum) for each event.

Changing the value of this variable causes the binary log to be rotated; checksums are always written to an entire binary log file, and never to only part of one.

Setting this variable on the source to a value unrecognized by the replica causes the replica to set its own `binlog_checksum` value to `NONE`, and to stop replication with an error. (Bug #13553750, Bug #61096) If backward compatibility with older replicas is a concern, you may want to set the value explicitly to `NONE`.

- `binlog_direct_non_transactional_updates`

Command-Line Format	<code>--binlog-direct-non-transactional-updates[={OFF ON}]</code>
System Variable	<code>binlog_direct_non_transactional_updates</code>
Scope	Global, Session
Dynamic	Yes
Type	Boolean
Default Value	<code>OFF</code>

Due to concurrency issues, a replica can become inconsistent when a transaction contains updates to both transactional and nontransactional tables. MySQL tries to preserve causality among these statements by writing nontransactional statements to the transaction cache, which is flushed upon commit. However, problems arise when modifications done to nontransactional tables on behalf of a transaction become immediately visible to other connections because these changes may not be written immediately into the binary log.

The `binlog_direct_non_transactional_updates` variable offers one possible workaround to this issue. By default, this variable is disabled. Enabling `binlog_direct_non_transactional_updates` causes updates to nontransactional tables to be written directly to the binary log, rather than to the transaction cache.

*`binlog_direct_non_transactional_updates` works only for statements that are replicated using the statement-based binary logging format; that is, it works only when the value of `binlog_format` is `STATEMENT`, or when `binlog_format` is `MIXED` and a given statement is being replicated using the statement-based format. This variable has no effect when the binary log format is `ROW`, or when `binlog_format` is set to `MIXED` and a given statement is replicated using the row-based format.*



### Important

Before enabling this variable, you must make certain that there are no dependencies between transactional and nontransactional tables; an example of such a dependency would be the statement `INSERT INTO myisam_table SELECT * FROM innodb_table`. Otherwise, such statements are likely to cause the replica to diverge from the source.

This variable has no effect when the binary log format is `ROW` or `MIXED`.

- `binlog_error_action`

Command-Line Format	<code>--binlog-error-action[=value]</code>
System Variable	<code>binlog_error_action</code>
Scope	Global
Dynamic	Yes
Type	Enumeration
Default Value	<code>ABORT_SERVER</code>
Valid Values	<code>IGNORE_ERROR</code> <code>ABORT_SERVER</code>

Controls what happens when the server encounters an error such as not being able to write to, flush or synchronize the binary log, which can cause the source's binary log to become inconsistent and replicas to lose synchronization.

In MySQL 5.7.7 and higher, this variable defaults to `ABORT_SERVER`, which makes the server halt logging and shut down whenever it encounters such an error with the binary log. On restart, recovery proceeds as in the case of an unexpected server halt (see [Section 16.3.2, “Handling an Unexpected Halt of a Replica”](#)).

When `binlog_error_action` is set to `IGNORE_ERROR`, if the server encounters such an error it continues the ongoing transaction, logs the error then halts logging, and continues performing updates. To resume binary logging `log_bin` must be enabled again, which requires a server restart. This setting provides backward compatibility with older versions of MySQL.

In previous releases this variable was named `binlogging_impossible_mode`.

- `binlog_format`

Command-Line Format	<code>--binlog-format=format</code>
System Variable	<code>binlog_format</code>
Scope	Global, Session
Dynamic	Yes
Type	Enumeration
Default Value	<code>ROW</code>
Valid Values	<code>MIXED</code> <code>STATEMENT</code> <code>ROW</code>

This system variable sets the binary logging format, and can be any one of `STATEMENT`, `ROW`, or `MIXED`. See [Section 16.2.1, “Replication Formats”](#). The setting takes effect when binary logging is enabled on

the server, which is the case when the `log_bin` system variable is set to `ON`. In MySQL 5.7, binary logging is not enabled by default, and you enable it using the `--log-bin` option.

`binlog_format` can be set at startup or at runtime, except that under some conditions, changing this variable at runtime is not possible or causes replication to fail, as described later.

Prior to MySQL 5.7.7, the default format was `STATEMENT`. In MySQL 5.7.7 and higher, the default is `ROW`. *Exception:* In NDB Cluster, the default is `MIXED`; statement-based replication is not supported for NDB Cluster.

Setting the session value of this system variable is a restricted operation. The session user must have privileges sufficient to set restricted session variables. See [Section 5.1.8.1, “System Variable Privileges”](#).

The rules governing when changes to this variable take effect and how long the effect lasts are the same as for other MySQL server system variables. For more information, see [Section 13.7.4.1, “SET Syntax for Variable Assignment”](#).

When `MIXED` is specified, statement-based replication is used, except for cases where only row-based replication is guaranteed to lead to proper results. For example, this happens when statements contain loadable functions or the `UUID()` function.

For details of how stored programs (stored procedures and functions, triggers, and events) are handled when each binary logging format is set, see [Section 23.7, “Stored Program Binary Logging”](#).

There are exceptions when you cannot switch the replication format at runtime:

- From within a stored function or a trigger.
- If the session is currently in row-based replication mode and has open temporary tables.
- From within a transaction.

Trying to switch the format in those cases results in an error.

Changing the logging format on a replication source server does not cause a replica to change its logging format to match. Switching the replication format while replication is ongoing can cause issues if a replica has binary logging enabled, and the change results in the replica using `STATEMENT` format logging while the source is using `ROW` or `MIXED` format logging. A replica is not able to convert binary log entries received in `ROW` logging format to `STATEMENT` format for use in its own binary log, so this situation can cause replication to fail. For more information, see [Section 5.4.4.2, “Setting The Binary Log Format”](#).

The binary log format affects the behavior of the following server options:

- `--replicate-do-db`
- `--replicate-ignore-db`
- `--binlog-do-db`
- `--binlog-ignore-db`

These effects are discussed in detail in the descriptions of the individual options.

- `binlog_group_commit_sync_delay`

Command-Line Format	<code>--binlog-group-commit-sync-delay=#</code>
---------------------	---

System Variable	<code>binlog_group_commit_sync_delay</code>
Scope	Global
Dynamic	Yes
Type	Integer
Default Value	0
Minimum Value	0
Maximum Value	1000000
Unit	microseconds

Controls how many microseconds the binary log commit waits before synchronizing the binary log file to disk. By default `binlog_group_commit_sync_delay` is set to 0, meaning that there is no delay. Setting `binlog_group_commit_sync_delay` to a microsecond delay enables more transactions to be synchronized together to disk at once, reducing the overall time to commit a group of transactions because the larger groups require fewer time units per group.

When `sync_binlog=0` or `sync_binlog=1` is set, the delay specified by `binlog_group_commit_sync_delay` is applied for every binary log commit group before synchronization (or in the case of `sync_binlog=0`, before proceeding). When `sync_binlog` is set to a value  $n$  greater than 1, the delay is applied after every  $n$  binary log commit groups.

Setting `binlog_group_commit_sync_delay` can increase the number of parallel committing transactions on any server that has (or might have after a failover) a replica, and therefore can increase parallel execution on the replicas. To benefit from this effect, the replica servers must have `slave_parallel_type=LOGICAL_CLOCK` set, and the effect is more significant when `binlog_transaction_dependency_tracking=COMMIT_ORDER` is also set. It is important to take into account both the source's throughput and the replicas' throughput when you are tuning the setting for `binlog_group_commit_sync_delay`.

Setting `binlog_group_commit_sync_delay` can also reduce the number of `fsync()` calls to the binary log on any server (source or replica) that has a binary log.

Note that setting `binlog_group_commit_sync_delay` increases the latency of transactions on the server, which might affect client applications. Also, on highly concurrent workloads, it is possible for the delay to increase contention and therefore reduce throughput. Typically, the benefits of setting a delay outweigh the drawbacks, but tuning should always be carried out to determine the optimal setting.

- `binlog_group_commit_sync_no_delay_count`

Command-Line Format	<code>--binlog-group-commit-sync-no-delay-count=#</code>
System Variable	<code>binlog_group_commit_sync_no_delay_count</code>
Scope	Global
Dynamic	Yes
Type	Integer
Default Value	0
Minimum Value	0

Maximum Value	100000
---------------	--------

The maximum number of transactions to wait for before aborting the current delay as specified by `binlog_group_commit_sync_delay`. If `binlog_group_commit_sync_delay` is set to 0, then this option has no effect.

- `binlog_max_flush_queue_time`

Command-Line Format	<code>--binlog-max-flush-queue-time=#</code>
Deprecated	Yes
System Variable	<code>binlog_max_flush_queue_time</code>
Scope	Global
Dynamic	Yes
Type	Integer
Default Value	0
Minimum Value	0
Maximum Value	100000
Unit	microseconds

Formerly, this controlled the time in microseconds to continue reading transactions from the flush queue before proceeding with group commit. In MySQL 5.7, this variable no longer has any effect.

`binlog_max_flush_queue_time` is deprecated as of MySQL 5.7.9, and is marked for eventual removal in a future MySQL release.

- `binlog_order_commits`

Command-Line Format	<code>--binlog-order-commits[={OFF ON}]</code>
System Variable	<code>binlog_order_commits</code>
Scope	Global
Dynamic	Yes
Type	Boolean
Default Value	ON

When this variable is enabled on a replication source server (which is the default), transaction commit instructions issued to storage engines are serialized on a single thread, so that transactions are always committed in the same order as they are written to the binary log. Disabling this variable permits transaction commit instructions to be issued using multiple threads. Used in combination with binary log group commit, this prevents the commit rate of a single transaction being a bottleneck to throughput, and might therefore produce a performance improvement.

Transactions are written to the binary log at the point when all the storage engines involved have confirmed that the transaction is prepared to commit. The binary log group commit logic then commits a group of transactions after their binary log write has taken place. When `binlog_order_commits` is disabled, because multiple threads are used for this process, transactions in a commit group might be committed in a different order from their order in the binary log. (Transactions from a single client always commit in chronological order.) In many cases this does not matter, as operations carried out in separate



transactions should produce consistent results, and if that is not the case, a single transaction ought to be used instead.

If you want to ensure that the transaction history on the source and on a multithreaded replica remains identical, set `slave_preserve_commit_order=1` on the replica.

- `binlog_row_image`

Command-Line Format	<code>--binlog-row-image=image_type</code>
System Variable	<code>binlog_row_image</code>
Scope	Global, Session
Dynamic	Yes
Type	Enumeration
Default Value	<code>full</code>
Valid Values	<p><code>full</code> (Log all columns)</p> <p><code>minimal</code> (Log only changed columns, and columns needed to identify rows)</p> <p><code>noblob</code> (Log all columns, except for unneeded BLOB and TEXT columns)</p>

For MySQL row-based replication, this variable determines how row images are written to the binary log.

In MySQL row-based replication, each row change event contains two images, a “before” image whose columns are matched against when searching for the row to be updated, and an “after” image containing the changes. Normally, MySQL logs full rows (that is, all columns) for both the before and after images. However, it is not strictly necessary to include every column in both images, and we can often save disk, memory, and network usage by logging only those columns which are actually required.



#### Note

When deleting a row, only the before image is logged, since there are no changed values to propagate following the deletion. When inserting a row, only the after image is logged, since there is no existing row to be matched. Only when updating a row are both the before and after images required, and both written to the binary log.

For the before image, it is necessary only that the minimum set of columns required to uniquely identify rows is logged. If the table containing the row has a primary key, then only the primary key column or columns are written to the binary log. Otherwise, if the table has a unique key all of whose columns are `NOT NULL`, then only the columns in the unique key need be logged. (If the table has neither a primary key nor a unique key without any `NULL` columns, then all columns must be used in the before image, and logged.) In the after image, it is necessary to log only the columns which have actually changed.

You can cause the server to log full or minimal rows using the `binlog_row_image` system variable. This variable actually takes one of three possible values, as shown in the following list:

- `full`: Log all columns in both the before image and the after image.
- `minimal`: Log only those columns in the before image that are required to identify the row to be changed; log only those columns in the after image where a value was specified by the SQL statement, or generated by auto-increment.

- `noblob`: Log all columns (same as `full`), except for `BLOB` and `TEXT` columns that are not required to identify rows, or that have not changed.

**Note**

This variable is not supported by NDB Cluster; setting it has no effect on the logging of `NDB` tables.

The default value is `full`.

When using `minimal` or `noblob`, deletes and updates are guaranteed to work correctly for a given table if and only if the following conditions are true for both the source and destination tables:

- All columns must be present and in the same order; each column must use the same data type as its counterpart in the other table.
- The tables must have identical primary key definitions.

(In other words, the tables must be identical with the possible exception of indexes that are not part of the tables' primary keys.)

If these conditions are not met, it is possible that the primary key column values in the destination table may prove insufficient to provide a unique match for a delete or update. In this event, no warning or error is issued; the source and replica silently diverge, thus breaking consistency.

Setting this variable has no effect when the binary logging format is `STATEMENT`. When `binlog_format` is `MIXED`, the setting for `binlog_row_image` is applied to changes that are logged using row-based format, but this setting has no effect on changes logged as statements.

Setting `binlog_row_image` on either the global or session level does not cause an implicit commit; this means that this variable can be changed while a transaction is in progress without affecting the transaction.

- `binlog_rows_query_log_events`

Command-Line Format	<code>--binlog-rows-query-log-events[={OFF ON}]</code>
System Variable	<code>binlog_rows_query_log_events</code>
Scope	Global, Session
Dynamic	Yes
Type	Boolean
Default Value	<code>OFF</code>

This system variable affects row-based logging only. When enabled, it causes the server to write informational log events such as row query log events into its binary log. This information can be used for debugging and related purposes, such as obtaining the original query issued on the source when it cannot be reconstructed from the row updates.

These informational events are normally ignored by MySQL programs reading the binary log and so cause no issues when replicating or restoring from backup. To view them, increase the verbosity level by using `mysqlbinlog`'s `--verbose` option twice, either as `-vv` or `--verbose --verbose`.

- `binlog_stmt_cache_size`

Command-Line Format	<code>--binlog-stmt-cache-size=#</code>
System Variable	<code>binlog_stmt_cache_size</code>
Scope	Global
Dynamic	Yes
Type	Integer
Default Value	32768
Minimum Value	4096
Maximum Value (64-bit platforms)	18446744073709547520
Maximum Value (32-bit platforms)	4294963200
Unit	bytes
Block Size	4096

This variable determines the size of the cache for the binary log to hold nontransactional statements issued during a transaction.

Separate binary log transaction and statement caches are allocated for each client if the server supports any transactional storage engines and if the server has the binary log enabled (`--log-bin` option). If you often use large nontransactional statements during transactions, you can increase this cache size to get better performance. The `Binlog_stmt_cache_use` and `Binlog_stmt_cache_disk_use` status variables can be useful for tuning the size of this variable. See [Section 5.4.4, “The Binary Log”](#).

The `binlog_cache_size` system variable sets the size for the transaction cache.

- `binlog_transaction_dependency_tracking`

Command-Line Format	<code>--binlog-transaction-dependency-tracking=value</code>
Introduced	5.7.22
System Variable	<code>binlog_transaction_dependency_tracking</code>
Scope	Global
Dynamic	Yes
Type	Enumeration
Default Value	<code>COMMIT_ORDER</code>
Valid Values	<code>COMMIT_ORDER</code> <code>WRITESET</code> <code>WRITESET_SESSION</code>

The source of dependency information that the source uses to determine which transactions can be executed in parallel by the replica's multithreaded applier. This variable can take one of the three values described in the following list:

- `COMMIT_ORDER`: Dependency information is generated from the source's commit timestamps. This is the default.

- `WRITESET`: Dependency information is generated from the source's write set, and any transactions which write different tuples can be parallelized.
- `WRITESET_SESSION`: Dependency information is generated from the source's write set, and any transactions that write different tuples can be parallelized, with the exception that no two updates from the same session can be reordered.

In `WRITESET` or `WRITESET_SESSION` mode, transactions can commit out of order unless you also set `slave_preserve_commit_order=1`.

For some transactions, the `WRITESET` and `WRITESET_SESSION` modes cannot improve on the results that would have been returned in `COMMIT_ORDER` mode. This is the case for transactions that have empty or partial write sets, transactions that update tables without primary or unique keys, and transactions that update parent tables in a foreign key relationship. In these situations, the source uses `COMMIT_ORDER` mode to generate the dependency information instead.

The value of this variable cannot be set to anything other than `COMMIT_ORDER` if `transaction_write_set_extraction` is `OFF`. You should also note that the value of `transaction_write_set_extraction` cannot be changed if the current value of `binlog_transaction_dependency_tracking` is `WRITESET` or `WRITESET_SESSION`. If you change the value, the new value does not take effect on replicas until after the replica has been stopped and restarted with `STOP SLAVE` and `START SLAVE` statements.

The number of row hashes to be kept and checked for the latest transaction to have changed a given row is determined by the value of `binlog_transaction_dependency_history_size`.

- `binlog_transaction_dependency_history_size`

Command-Line Format	<code>--binlog-transaction-dependency-history-size=#</code>
Introduced	5.7.22
System Variable	<code>binlog_transaction_dependency_history_size</code>
Scope	Global
Dynamic	Yes
Type	Integer
Default Value	25000
Minimum Value	1
Maximum Value	1000000

Sets an upper limit on the number of row hashes which are kept in memory and used for looking up the transaction that last modified a given row. Once this number of hashes has been reached, the history is purged.

- `expire_logs_days`

Command-Line Format	<code>--expire-logs-days=#</code>
System Variable	<code>expire_logs_days</code>
Scope	Global
Dynamic	Yes

Type	Integer
Default Value	0
Minimum Value	0
Maximum Value	99
Unit	days

The number of days for automatic binary log file removal. The default is 0, which means “no automatic removal.” Possible removals happen at startup and when the binary log is flushed. Log flushing occurs as indicated in [Section 5.4, “MySQL Server Logs”](#).

To remove binary log files manually, use the `PURGE BINARY LOGS` statement. See [Section 13.4.1.1, “PURGE BINARY LOGS Statement”](#).

- `log_bin`

System Variable	<code>log_bin</code>
Scope	Global
Dynamic	No
Type	Boolean

Whether the binary log is enabled. If the `--log-bin` option is used, then the value of this variable is `ON`; otherwise it is `OFF`. This variable reports only on the status of binary logging (enabled or disabled); it does not actually report the value to which `--log-bin` is set.

See [Section 5.4.4, “The Binary Log”](#).

- `log_bin_basename`

System Variable	<code>log_bin_basename</code>
Scope	Global
Dynamic	No
Type	File name

Holds the base name and path for the binary log files, which can be set with the `--log-bin` server option. The maximum variable length is 256. In MySQL 5.7, the default base name is the name of the host machine with the suffix `-bin`. The default location is the data directory.

- `log_bin_index`

Command-Line Format	<code>--log-bin-index=file_name</code>
System Variable	<code>log_bin_index</code>
Scope	Global
Dynamic	No
Type	File name

Holds the base name and path for the binary log index file, which can be set with the `--log-bin-index` server option. The maximum variable length is 256.

- `log_bin_trust_function_creators`

Command-Line Format	<code>--log-bin-trust-function-creators[={OFF ON}]</code>
System Variable	<code>log_bin_trust_function_creators</code>
Scope	Global
Dynamic	Yes
Type	Boolean
Default Value	OFF

This variable applies when binary logging is enabled. It controls whether stored function creators can be trusted not to create stored functions that causes unsafe events to be written to the binary log. If set to 0 (the default), users are not permitted to create or alter stored functions unless they have the `SUPER` privilege in addition to the `CREATE ROUTINE` or `ALTER ROUTINE` privilege. A setting of 0 also enforces the restriction that a function must be declared with the `DETERMINISTIC` characteristic, or with the `READS SQL DATA` or `NO SQL` characteristic. If the variable is set to 1, MySQL does not enforce these restrictions on stored function creation. This variable also applies to trigger creation. See [Section 23.7, “Stored Program Binary Logging”](#).

- `log_bin_use_v1_row_events`

Command-Line Format	<code>--log-bin-use-v1-row-events[={OFF ON}]</code>
System Variable	<code>log_bin_use_v1_row_events</code>
Scope	Global
Dynamic	Yes
Type	Boolean
Default Value	OFF

Whether Version 2 binary logging is in use. If this variable is 0 (disabled, the default), Version 2 binary log events are in use. If this variable is 1 (enabled), the server writes the binary log using Version 1 logging events (the only version of binary log events used in previous releases), and thus produces a binary log that can be read by older replicas.

MySQL 5.7 uses Version 2 binary log row events by default. However, Version 2 events cannot be read by MySQL Server releases prior to MySQL 5.6.6. Enabling `log_bin_use_v1_row_events` causes `mysqld` to write the binary log using Version 1 logging events.

This variable is read-only at runtime. To switch between Version 1 and Version 2 binary event binary logging, it is necessary to set `log_bin_use_v1_row_events` at server startup.

Other than when performing upgrades of NDB Cluster Replication, `log_bin_use_v1_row_events` is chiefly of interest when setting up replication conflict detection and resolution using `NDB`

`$EPOCH_TRANS()` as the conflict detection function, which requires Version 2 binary log row events. Thus, this variable and `--ndb-log-transaction-id` are not compatible.



#### Note

MySQL NDB Cluster 7.5 uses Version 2 binary log row events by default. You should keep this mind when planning upgrades or downgrades, and for setups using NDB Cluster Replication.

For more information, see [Section 21.7.11, “NDB Cluster Replication Conflict Resolution”](#).

- `log_builtin_as_identified_by_password`

Command-Line Format	<code>--log-builtin-as-identified-by-password[={OFF ON}]</code>
System Variable	<code>log_builtin_as_identified_by_password</code>
Scope	Global
Dynamic	Yes
Type	Boolean
Default Value	<code>OFF</code>

This variable affects binary logging of user-management statements. When enabled, the variable has the following effects:

- Binary logging for `CREATE USER` statements involving built-in authentication plugins rewrites the statements to include an `IDENTIFIED BY PASSWORD` clause.
- `SET PASSWORD` statements are logged as `SET PASSWORD` statements, rather than being rewritten to `ALTER USER` statements.
- `SET PASSWORD` statements are changed to log the hash of the password instead of the supplied cleartext (unencrypted) password.

Enabling this variable ensures better compatibility for cross-version replication with 5.6 and pre-5.7.6 replicas, and for applications that expect this syntax in the binary log.

- `log_slave_updates`

Command-Line Format	<code>--log-slave-updates[={OFF ON}]</code>
System Variable	<code>log_slave_updates</code>
Scope	Global
Dynamic	No
Type	Boolean
Default Value	<code>OFF</code>

Whether updates received by a replica server from a source server should be logged to the replica's own binary log.

Normally, a replica does not log to its own binary log any updates that are received from a source server. Enabling this variable causes the replica to write the updates performed by its replication SQL thread to its own binary log. For this option to have any effect, the replica must also be started with the `--log-`

`bin` option to enable binary logging. See [Section 16.1.6, “Replication and Binary Logging Options and Variables”](#).

`log_slave_updates` is enabled when you want to chain replication servers. For example, you might want to set up replication servers using this arrangement:

```
A -> B -> C
```

Here, **A** serves as the source for the replica **B**, and **B** serves as the source for the replica **C**. For this to work, **B** must be both a source *and* a replica. You must start both **A** and **B** with `--log-bin` to enable binary logging, and **B** with `log_slave_updates` enabled so that updates received from **A** are logged by **B** to its binary log.

- `log_statements_unsafe_for_binlog`

Command-Line Format	<code>--log-statements-unsafe-for-binlog[={OFF ON}]</code>
Introduced	5.7.11
System Variable	<code>log_statements_unsafe_for_binlog</code>
Scope	Global
Dynamic	Yes
Type	Boolean
Default Value	ON

If error 1592 is encountered, controls whether the generated warnings are added to the error log or not.

- `master_verify_checksum`

Command-Line Format	<code>--master-verify-checksum[={OFF ON}]</code>
System Variable	<code>master_verify_checksum</code>
Scope	Global
Dynamic	Yes
Type	Boolean
Default Value	OFF

Enabling this variable causes the source to verify events read from the binary log by examining checksums, and to stop with an error in the event of a mismatch. `master_verify_checksum` is disabled by default; in this case, the source uses the event length from the binary log to verify events, so that only complete events are read from the binary log.

- `max_binlog_cache_size`

Command-Line Format	<code>--max-binlog-cache-size=#</code>
System Variable	<code>max_binlog_cache_size</code>
Scope	Global
Dynamic	Yes
Type	Integer
Default Value (64-bit platforms)	18446744073709547520
Default Value (32-bit platforms)	4294967295



Minimum Value	4096
Maximum Value (64-bit platforms)	18446744073709547520
Maximum Value (32-bit platforms)	4294967295
Unit	bytes
Block Size	4096

If a transaction requires more than this many bytes, the server generates a [Multi-statement transaction required more than 'max\\_binlog\\_cache\\_size' bytes of storage error](#). When `gtid_mode` is not `ON`, the maximum recommended value is 4GB, due to the fact that, in this case, MySQL cannot work with binary log positions greater than 4GB; when `gtid_mode` is `ON`, this limitation does not apply, and the server can work with binary log positions of arbitrary size.

If, because `gtid_mode` is not `ON`, or for some other reason, you need to guarantee that the binary log does not exceed a given size `maxsize`, you should set this variable according to the formula shown here:

```
max_binlog_cache_size <
  (((maxsize - max_binlog_size) / max_connections) - 1000) / 1.2
```

This calculation takes into account the following conditions:

- The server writes to the binary log as long as the size before it begins to write is less than `max_binlog_size`.
- The server does not write single transactions, but rather groups of transactions. The maximum possible number of transactions in a group is equal to `max_connections`.
- The server writes data that is not included in the cache. This includes a 4-byte checksum for each event; while this adds less than 20% to the transaction size, this amount is non-negible. In addition, the server writes a `Gtid_log_event` for each transaction; each of these events can add another 1 KB to what is written to the binary log.

`max_binlog_cache_size` sets the size for the transaction cache only; the upper limit for the statement cache is governed by the `max_binlog_stmt_cache_size` system variable.

The visibility to sessions of `max_binlog_cache_size` matches that of the `binlog_cache_size` system variable; in other words, changing its value affects only new sessions that are started after the value is changed.

- `max_binlog_size`

Command-Line Format	<code>--max-binlog-size=#</code>
System Variable	<code>max_binlog_size</code>
Scope	Global
Dynamic	Yes
Type	Integer
Default Value	1073741824
Minimum Value	4096
Maximum Value	1073741824
Unit	bytes

Block Size	4096
------------	------

If a write to the binary log causes the current log file size to exceed the value of this variable, the server rotates the binary logs (closes the current file and opens the next one). The minimum value is 4096 bytes. The maximum and default value is 1GB.

A transaction is written in one chunk to the binary log, so it is never split between several binary logs. Therefore, if you have big transactions, you might see binary log files larger than `max_binlog_size`.

If `max_relay_log_size` is 0, the value of `max_binlog_size` applies to relay logs as well.

- `max_binlog_stmt_cache_size`

Command-Line Format	<code>--max-binlog-stmt-cache-size=#</code>
System Variable	<code>max_binlog_stmt_cache_size</code>
Scope	Global
Dynamic	Yes
Type	Integer
Default Value	18446744073709547520
Minimum Value	4096
Maximum Value	18446744073709547520
Unit	bytes
Block Size	4096

If nontransactional statements within a transaction require more than this many bytes of memory, the server generates an error. The minimum value is 4096. The maximum and default values are 4GB on 32-bit platforms and 16EB (exabytes) on 64-bit platforms.

`max_binlog_stmt_cache_size` sets the size for the statement cache only; the upper limit for the transaction cache is governed exclusively by the `max_binlog_cache_size` system variable.

- `sql_log_bin`

System Variable	<code>sql_log_bin</code>
Scope	Session
Dynamic	Yes
Type	Boolean

Default Value	ON
---------------	----

This variable controls whether logging to the binary log is enabled for the current session (assuming that the binary log itself is enabled). The default value is `ON`. To disable or enable binary logging for the current session, set the session `sql_log_bin` variable to `OFF` or `ON`.

Set this variable to `OFF` for a session to temporarily disable binary logging while making changes to the source you do not want replicated to the replica.

Setting the session value of this system variable is a restricted operation. The session user must have privileges sufficient to set restricted session variables. See [Section 5.1.8.1, “System Variable Privileges”](#).

It is not possible to set the session value of `sql_log_bin` within a transaction or subquery.

*Setting this variable to `OFF` prevents GTIDs from being assigned to transactions in the binary log.* If you are using GTIDs for replication, this means that even when binary logging is later enabled again, the GTIDs written into the log from this point do not account for any transactions that occurred in the meantime, so in effect those transactions are lost.

The global `sql_log_bin` variable is read only and cannot be modified. The global scope is deprecated; expect it to be removed in a future MySQL release.

- `sync_binlog`

Command-Line Format	<code>--sync-binlog=#</code>
System Variable	<code>sync_binlog</code>
Scope	Global
Dynamic	Yes
Type	Integer
Default Value	1
Minimum Value	0
Maximum Value	4294967295

Controls how often the MySQL server synchronizes the binary log to disk.

- `sync_binlog=0`: Disables synchronization of the binary log to disk by the MySQL server. Instead, the MySQL server relies on the operating system to flush the binary log to disk from time to time as it does for any other file. This setting provides the best performance, but in the event of a power failure or operating system crash, it is possible that the server has committed transactions that have not been synchronized to the binary log.
- `sync_binlog=1`: Enables synchronization of the binary log to disk before transactions are committed. This is the safest setting but can have a negative impact on performance due to the increased number of disk writes. In the event of a power failure or operating system crash, transactions that are missing from the binary log are only in a prepared state. This permits the automatic recovery routine to roll back the transactions, which guarantees that no transaction is lost from the binary log.
- `sync_binlog=N`, where `N` is a value other than 0 or 1: The binary log is synchronized to disk after `N` binary log commit groups have been collected. In the event of a power failure or operating system crash, it is possible that the server has committed transactions that have not been flushed to the

binary log. This setting can have a negative impact on performance due to the increased number of disk writes. A higher value improves performance, but with an increased risk of data loss.

For the greatest possible durability and consistency in a replication setup that uses [InnoDB](#) with transactions, use these settings:

- `sync_binlog=1`.
- `innodb_flush_log_at_trx_commit=1`.



### Caution

Many operating systems and some disk hardware fool the flush-to-disk operation. They may tell `mysqld` that the flush has taken place, even though it has not. In this case, the durability of transactions is not guaranteed even with the recommended settings, and in the worst case, a power outage can corrupt [InnoDB](#) data. Using a battery-backed disk cache in the SCSI disk controller or in the disk itself speeds up file flushes, and makes the operation safer. You can also try to disable the caching of disk writes in hardware caches.

- `transaction_write_set_extraction`

Command-Line Format	<code>--transaction-write-set-extraction[=value]</code>
System Variable	<code>transaction_write_set_extraction</code>
Scope	Global, Session
Dynamic	Yes
Type	Enumeration
Default Value	OFF
Valid Values (≥ 5.7.14)	OFF MURMUR32 XXHASH64
Valid Values (≤ 5.7.13)	OFF MURMUR32

Defines the algorithm used to generate a hash identifying the writes associated with a transaction. If you are using Group Replication, the hash value is used for distributed conflict detection and handling. On 64-bit systems running Group Replication, we recommend setting this to `XXHASH64` in order to avoid unnecessary hash collisions which result in certification failures and the roll back of user transactions. See [Section 17.3.1, “Group Replication Requirements”](#). `binlog_format` must be set to `ROW` to change the value of this variable. If you change the value, the new value does not take effect on replicas until after the replica has been stopped and restarted with `STOP SLAVE` and `START SLAVE` statements.



### Note

When `WRITESET` or `WRITESET_SESSION` is set as the value for `binlog_transaction_dependency_tracking`, `transaction_write_set_extraction` must be set to specify an algorithm (not set to `OFF`). While the current value of `binlog_transaction_dependency_tracking` is `WRITESET`

or `WRITESET_SESSION`, you cannot change the value of `transaction_write_set_extraction`.

### 16.1.6.5 Global Transaction ID System Variables

The MySQL Server system variables described in this section are used to monitor and control Global Transaction Identifiers (GTIDs). For additional information, see [Section 16.1.3, “Replication with Global Transaction Identifiers”](#).

- `binlog_gtid_simple_recovery`

Command-Line Format	<code>--binlog-gtid-simple-recovery[={OFF ON}]</code>
System Variable	<code>binlog_gtid_simple_recovery</code>
Scope	Global
Dynamic	No
Type	Boolean
Default Value	ON

This variable controls how binary log files are iterated during the search for GTIDs when MySQL starts or restarts.

When `binlog_gtid_simple_recovery=TRUE`, which is the default, the values of `gtid_executed` and `gtid_purged` are computed at startup based on the values of `Previous_gtids_log_event` in the most recent and oldest binary log files. For a description of the computation, see [The `gtid\_purged` System Variable](#). This setting accesses only two binary log files during server restart. If all binary logs on the server were generated using MySQL 5.7.8 or later and you are using MySQL 5.7.8 or later, `binlog_gtid_simple_recovery=TRUE` can always safely be used.

With `binlog_gtid_simple_recovery=TRUE`, `gtid_executed` and `gtid_purged` might be initialized incorrectly in the following two situations:

- The newest binary log was generated by MySQL 5.7.5 or earlier, and `gtid_mode` was `ON` for some binary logs but `OFF` for the newest binary log.
- A `SET @@GLOBAL.gtid_purged` statement was issued on MySQL 5.7.7 or earlier, and the binary log that was active at the time of the `SET @@GLOBAL.gtid_purged` statement has not yet been purged.

If an incorrect GTID set is computed in either situation, it remains incorrect even if the server is later restarted with `binlog_gtid_simple_recovery=FALSE`. If either of these situations applies on the server, set `binlog_gtid_simple_recovery=FALSE` before starting or restarting the server. To check for the second situation, if you are using MySQL 5.7.7 or earlier, after issuing a `SET @@GLOBAL.gtid_purged` statement note down the current binary log file name, which can be checked using `SHOW MASTER STATUS`. If the server is restarted before this file has been purged, then you should set `binlog_gtid_simple_recovery=FALSE`.

When `binlog_gtid_simple_recovery=FALSE` is set, the method of computing `gtid_executed` and `gtid_purged` as described in [The `gtid\_purged` System Variable](#) is changed to iterate the binary log files as follows:

- Instead of using the value of `Previous_gtids_log_event` and GTID log events from the newest binary log file, the computation for `gtid_executed` iterates from the newest binary log file, and uses the value of `Previous_gtids_log_event` and any GTID log events from the first binary log file

where it finds a `Previous_gtids_log_event` value. If the server's most recent binary log files do not have GTID log events, for example if `gtid_mode=ON` was used but the server was later changed to `gtid_mode=OFF`, this process can take a long time.

- Instead of using the value of `Previous_gtids_log_event` from the oldest binary log file, the computation for `gtid_purged` iterates from the oldest binary log file, and uses the value of `Previous_gtids_log_event` from the first binary log file where it finds either a nonempty `Previous_gtids_log_event` value, or at least one GTID log event (indicating that the use of GTIDs starts at that point). If the server's older binary log files do not have GTID log events, for example if `gtid_mode=ON` was only set recently on the server, this process can take a long time.

In MySQL version 5.7.5, this variable was added as `simplified_binlog_gtid_recovery` and in MySQL version 5.7.6 it was renamed to `binlog_gtid_simple_recovery`.

- `enforce_gtid_consistency`

Command-Line Format	<code>--enforce-gtid-consistency[=value]</code>
System Variable	<code>enforce_gtid_consistency</code>
Scope	Global
Dynamic	Yes
Type	Enumeration
Default Value	OFF
Valid Values	OFF ON WARN

Depending on the value of this variable, the server enforces GTID consistency by allowing execution of only statements that can be safely logged using a GTID. You *must* set this variable to `ON` before enabling GTID based replication.

The values that `enforce_gtid_consistency` can be configured to are:

- `OFF`: all transactions are allowed to violate GTID consistency.
- `ON`: no transaction is allowed to violate GTID consistency.
- `WARN`: all transactions are allowed to violate GTID consistency, but a warning is generated in this case. `WARN` was added in MySQL 5.7.6.

Only statements that can be logged using GTID safe statements can be logged when `enforce_gtid_consistency` is set to `ON`, so the operations listed here cannot be used with this option:

- `CREATE TABLE ... SELECT` statements
- `CREATE TEMPORARY TABLE` or `DROP TEMPORARY TABLE` statements inside transactions

- Transactions or statements that update both transactional and nontransactional tables. There is an exception that nontransactional DML is allowed in the same transaction or in the same statement as transactional DML, if all *nontransactional* tables are temporary.

`--enforce-gtid-consistency` only takes effect if binary logging takes place for a statement. If binary logging is disabled on the server, or if statements are not written to the binary log because they are removed by a filter, GTID consistency is not checked or enforced for the statements that are not logged.

For more information, see [Section 16.1.3.6, “Restrictions on Replication with GTIDs”](#).

Prior to MySQL 5.7.6, the boolean `enforce_gtid_consistency` defaulted to `OFF`. To maintain compatibility with previous releases, in MySQL 5.7.6 the enumeration defaults to `OFF`, and setting `--enforce-gtid-consistency` without a value is interpreted as setting the value to `ON`. The variable also has multiple textual aliases for the values: `0=OFF=FALSE`, `1=ON=TRUE`, `2=WARN`. This differs from other enumeration types but maintains compatibility with the boolean type used in previous versions. These changes impact on what is returned by the variable. Using `SELECT @@ENFORCE_GTID_CONSISTENCY`, `SHOW VARIABLES LIKE 'ENFORCE_GTID_CONSISTENCY'`, and `SELECT * FROM INFORMATION_SCHEMA.VARIABLES WHERE 'VARIABLE_NAME' = 'ENFORCE_GTID_CONSISTENCY'`, all return the textual form, not the numeric form. This is an incompatible change, since `@@ENFORCE_GTID_CONSISTENCY` returns the numeric form for booleans but returns the textual form for `SHOW` and the Information Schema.

- `gtid_executed`

System Variable	<code>gtid_executed</code>
Scope	Global
Dynamic	No
Type	String
Unit	set of GTIDs

When used with global scope, this variable contains a representation of the set of all transactions executed on the server and GTIDs that have been set by a `SET gtid_purged` statement. This is the same as the value of the `Executed_Gtid_Set` column in the output of `SHOW MASTER STATUS` and `SHOW SLAVE STATUS`. The value of this variable is a GTID set, see [GTID Sets](#) for more information.

When the server starts, `@@GLOBAL.gtid_executed` is initialized. See [binlog\\_gtid\\_simple\\_recovery](#) for more information on how binary logs are iterated to populate `gtid_executed`. GTIDs are then added to the set as transactions are executed, or if any `SET gtid_purged` statement is executed.

The set of transactions that can be found in the binary logs at any given time is equal to `GTID_SUBTRACT(@@GLOBAL.gtid_executed, @@GLOBAL.gtid_purged)`; that is, to all transactions in the binary log that have not yet been purged.

Issuing `RESET MASTER` causes the global value (but not the session value) of this variable to be reset to an empty string. GTIDs are not otherwise removed from this set other than when the set is cleared due to `RESET MASTER`.

Prior to MySQL 5.7.7, this variable could also be used with session scope, where it contained a representation of the set of transactions that are written to the cache in the current session. The session scope was deprecated in MySQL 5.7.7.

- `gtid_executed_compression_period`

Command-Line Format	<code>--gtid-executed-compression-period=#</code>
System Variable	<code>gtid_executed_compression_period</code>
Scope	Global
Dynamic	Yes
Type	Integer
Default Value	1000
Minimum Value	0
Maximum Value	4294967295

Compress the `mysql.gtid_executed` table each time this many transactions have been processed. When binary logging is enabled on the server, this compression method is not used, and instead the `mysql.gtid_executed` table is compressed on each binary log rotation. When binary logging is disabled on the server, the compression thread sleeps until the specified number of transactions have been executed, then wakes up to perform compression of the `mysql.gtid_executed` table. Setting the value of this system variable to 0 means that the thread never wakes up, so this explicit compression method is not used. Instead, compression occurs implicitly as required.

See [mysql.gtid\\_executed Table Compression](#) for more information.

This variable was added in MySQL version 5.7.5 as `executed_gtids_compression_period` and renamed in MySQL version 5.7.6 to `gtid_executed_compression_period`.

- `gtid_mode`

Command-Line Format	<code>--gtid-mode=MODE</code>
System Variable	<code>gtid_mode</code>
Scope	Global
Dynamic	Yes
Type	Enumeration
Default Value	OFF
Valid Values	OFF OFF_PERMISSIVE ON_PERMISSIVE ON

Controls whether GTID based logging is enabled and what type of transactions the logs can contain. Prior to MySQL 5.7.6, this variable was read-only and was set using `--gtid-mode` at server startup only. Prior to MySQL 5.7.5, starting the server with `--gtid-mode=ON` required that the server also be started with the `--log-bin` and `--log-slave-updates` options. As of MySQL 5.7.5, this is no longer a requirement. See [mysql.gtid\\_executed Table](#).

MySQL 5.7.6 enables this variable to be set dynamically. You must have privileges sufficient to set global system variables. See [Section 5.1.8.1, “System Variable Privileges”](#).



`enforce_gtid_consistency` must be set to `ON` before you can set `gtid_mode=ON`. Before modifying this variable, see [Section 16.1.4, “Changing Replication Modes on Online Servers”](#).

Transactions logged in MySQL 5.7.6 and higher can be either anonymous or use GTIDs. Anonymous transactions rely on binary log file and position to identify specific transactions. GTID transactions have a unique identifier that is used to refer to transactions. The `OFF_PERMISSIVE` and `ON_PERMISSIVE` modes added in MySQL 5.7.6 permit a mix of these transaction types in the topology. The different modes are now:

- `OFF`: Both new and replicated transactions must be anonymous.
- `OFF_PERMISSIVE`: New transactions are anonymous. Replicated transactions can be either anonymous or GTID transactions.
- `ON_PERMISSIVE`: New transactions are GTID transactions. Replicated transactions can be either anonymous or GTID transactions.
- `ON`: Both new and replicated transactions must be GTID transactions.

Changes from one value to another can only be one step at a time. For example, if `gtid_mode` is currently set to `OFF_PERMISSIVE`, it is possible to change to `OFF` or `ON_PERMISSIVE` but not to `ON`.

In MySQL 5.7.6 and higher, the values of `gtid_purged` and `gtid_executed` are persistent regardless of the value of `gtid_mode`. Therefore even after changing the value of `gtid_mode`, these variables contain the correct values. In MySQL 5.7.5 and earlier, the values of `gtid_purged` and `gtid_executed` are not persistent while `gtid_mode=OFF`. Therefore, after changing `gtid_mode` to `OFF`, once all binary logs containing GTIDs are purged, the values of these variables are lost.

- `gtid_next`

System Variable	<code>gtid_next</code>
Scope	Session
Dynamic	Yes
Type	Enumeration
Default Value	<code>AUTOMATIC</code>
Valid Values	<code>AUTOMATIC</code> <code>ANONYMOUS</code> <code>&lt;UUID&gt; : &lt;NUMBER&gt;</code>

This variable is used to specify whether and how the next GTID is obtained.

Setting the session value of this system variable is a restricted operation. The session user must have privileges sufficient to set restricted session variables. See [Section 5.1.8.1, “System Variable Privileges”](#).

`gtid_next` can take any of the following values:

- `AUTOMATIC`: Use the next automatically-generated global transaction ID.
- `ANONYMOUS`: Transactions do not have global identifiers, and are identified by file and position only.

- A global transaction ID in `UUID:NUMBER` format.

Exactly which of the above options are valid depends on the setting of `gtid_mode`, see [Section 16.1.4.1, “Replication Mode Concepts”](#) for more information. Setting this variable has no effect if `gtid_mode` is `OFF`.

After this variable has been set to `UUID:NUMBER`, and a transaction has been committed or rolled back, an explicit `SET GTID_NEXT` statement must again be issued before any other statement.

In MySQL 5.7.5 and higher, `DROP TABLE` or `DROP TEMPORARY TABLE` fails with an explicit error when used on a combination of nontemporary tables with temporary tables, or of temporary tables using transactional storage engines with temporary tables using nontransactional storage engines. Prior to MySQL 5.7.5, when GTIDs were enabled but `gtid_next` was not `AUTOMATIC`, `DROP TABLE` did not work correctly when used with either of these combinations of tables. (Bug #17620053)

In MySQL 5.7.1, you cannot execute any of the statements `CHANGE MASTER TO`, `START SLAVE`, `STOP SLAVE`, `REPAIR TABLE`, `OPTIMIZE TABLE`, `ANALYZE TABLE`, `CHECK TABLE`, `CREATE SERVER`, `ALTER SERVER`, `DROP SERVER`, `CACHE INDEX`, `LOAD INDEX INTO CACHE`, `FLUSH`, or `RESET` when `gtid_next` is set to any value other than `AUTOMATIC`; in such cases, the statement fails with an error. Such statements are *not* disallowed in MySQL 5.7.2 and later. (Bug #16062608, Bug #16715809, Bug #69045) (Bug #16062608)

- `gtid_owned`

System Variable	<code>gtid_owned</code>
Scope	Global, Session
Dynamic	No
Type	String
Unit	set of GTIDs

This read-only variable is primarily for internal use. Its contents depend on its scope.

- When used with global scope, `gtid_owned` holds a list of all the GTIDs that are currently in use on the server, with the IDs of the threads that own them. This variable is mainly useful for a multi-threaded replica to check whether a transaction is already being applied on another thread. An applier thread takes ownership of a transaction's GTID all the time it is processing the transaction, so `@@global.gtid_owned` shows the GTID and owner for the duration of processing. When a transaction has been committed (or rolled back), the applier thread releases ownership of the GTID.
- When used with session scope, `gtid_owned` holds a single GTID that is currently in use by and owned by this session. This variable is mainly useful for testing and debugging the use of GTIDs when the client has explicitly assigned a GTID for the transaction by setting `gtid_next`. In this case, `@@session.gtid_owned` displays the GTID all the time the client is processing the transaction, until the transaction has been committed (or rolled back). When the client has finished processing the transaction, the variable is cleared. If `gtid_next=AUTOMATIC` is used for the session, `gtid_owned` is only populated briefly during the execution of the commit statement for the transaction, so it cannot be observed from the session concerned, although it is listed if `@@global.gtid_owned` is read at the right point. If you have a requirement to track the GTIDs that are handled by a client in a session, you can enable the session state tracker controlled by the `session_track_gtids` system variable.
- `gtid_purged`

System Variable	<code>gtid_purged</code>
-----------------	--------------------------

Scope	Global
Dynamic	Yes
Type	String
Unit	set of GTIDs

The global value of the `gtid_purged` system variable (`@@GLOBAL.gtid_purged`) is a GTID set consisting of the GTIDs of all the transactions that have been committed on the server, but do not exist in any binary log file on the server. `gtid_purged` is a subset of `gtid_executed`. The following categories of GTIDs are in `gtid_purged`:

- GTIDs of replicated transactions that were committed with binary logging disabled on the replica.
- GTIDs of transactions that were written to a binary log file that has now been purged.
- GTIDs that were added explicitly to the set by the statement `SET @@GLOBAL.gtid_purged`.

When the server starts or restarts, the global value of `gtid_purged` is initialized to a set of GTIDs. For information on how this GTID set is computed, see [The `gtid\_purged` System Variable](#). If binary logs from MySQL 5.7.7 or older are present on the server, you might need to set `binlog_gtid_simple_recovery=FALSE` in the server's configuration file to produce the correct computation. See the description for `binlog_gtid_simple_recovery` for details of the situations in which this setting is needed.

Issuing `RESET MASTER` causes the value of `gtid_purged` to be reset to an empty string.

You can set the value of `gtid_purged` in order to record on the server that the transactions in a certain GTID set have been applied, although they do not exist in any binary log on the server. An example use case for this action is when you are restoring a backup of one or more databases on a server, but you do not have the relevant binary logs containing the transactions on the server.



### Important

GTIDs are only available on a server instance up to the number of non-negative values for a signed 64-bit integer (2 to the power of 63, minus 1). If you set the value of `gtid_purged` to a number that approaches this limit, subsequent commits can cause the server to run out of GTIDs and take the action specified by `binlog_error_action`.

In MySQL 5.7, it is possible to update the value of `gtid_purged` only when `gtid_executed` is the empty string, and therefore `gtid_purged` is the empty string. This is the case either when replication has not been started previously, or when replication did not previously use GTIDs. Prior to MySQL 5.7.6, `gtid_purged` was also settable only when `gtid_mode=ON`. In MySQL 5.7.6 and higher, `gtid_purged` is settable regardless of the value of `gtid_mode`.

To replace the value of `gtid_purged` with your specified GTID set, use the following statement:

```
SET @@GLOBAL.gtid_purged = 'gtid_set'
```



### Note

If you are using MySQL 5.7.7 or earlier, after issuing a `SET @@GLOBAL.gtid_purged` statement, you might need to set `binlog_gtid_simple_recovery=FALSE` in the server's configuration file before restarting the server, otherwise `gtid_purged` can be computed incorrectly. See the description for `binlog_gtid_simple_recovery` for

details of the situations in which this setting is needed. If all binary logs on the server were generated using MySQL 5.7.8 or later and you are using MySQL 5.7.8 or later, `binlog_gtid_simple_recovery=TRUE` (which is the default setting from MySQL 5.7.7) can always safely be used.

## 16.1.7 Common Replication Administration Tasks

Once replication has been started it executes without requiring much regular administration. This section describes how to check the status of replication and how to pause a replica.

### 16.1.7.1 Checking Replication Status

The most common task when managing a replication process is to ensure that replication is taking place and that there have been no errors between the replica and the source.

The `SHOW SLAVE STATUS` statement, which you must execute on each replica, provides information about the configuration and status of the connection between the replica server and the source server. From MySQL 5.7, the Performance Schema has replication tables that provide this information in a more accessible form. See [Section 25.12.11, “Performance Schema Replication Tables”](#).

The `SHOW STATUS` statement also provided some information relating specifically to replicas. As of MySQL version 5.7.5, the following status variables previously monitored using `SHOW STATUS` were deprecated and moved to the Performance Schema replication tables:

- `Slave_retried_transactions`
- `Slave_last_heartbeat`
- `Slave_received_heartbeats`
- `Slave_heartbeat_period`
- `Slave_running`

The replication heartbeat information shown in the Performance Schema replication tables lets you check that the replication connection is active even if the source has not sent events to the replica recently. The source sends a heartbeat signal to a replica if there are no updates to, and no unsent events in, the binary log for a longer period than the heartbeat interval. The `MASTER_HEARTBEAT_PERIOD` setting on the source (set by the `CHANGE MASTER TO` statement) specifies the frequency of the heartbeat, which defaults to half of the connection timeout interval for the replica (`slave_net_timeout`). The `replication_connection_status` Performance Schema table shows when the most recent heartbeat signal was received by a replica, and how many heartbeat signals it has received.

If you are using the `SHOW SLAVE STATUS` statement to check on the status of an individual replica, the statement provides the following information:

```
mysql> SHOW SLAVE STATUS\G
***** 1. row *****
      Slave_IO_State: Waiting for master to send event
      Master_Host: source1
      Master_User: root
      Master_Port: 3306
      Connect_Retry: 60
      Master_Log_File: mysql-bin.000004
      Read_Master_Log_Pos: 931
      Relay_Log_File: replical-relay-bin.000056
      Relay_Log_Pos: 950
      Relay_Master_Log_File: mysql-bin.000004
```

```

Slave_IO_Running: Yes
Slave_SQL_Running: Yes
Replicate_Do_DB:
Replicate_Ignore_DB:
Replicate_Do_Table:
Replicate_Ignore_Table:
Replicate_Wild_Do_Table:
Replicate_Wild_Ignore_Table:
    Last_Errno: 0
    Last_Error:
    Skip_Counter: 0
Exec_Master_Log_Pos: 931
Relay_Log_Space: 1365
Until_Condition: None
Until_Log_File:
Until_Log_Pos: 0
Master_SSL_Allowed: No
Master_SSL_CA_File:
Master_SSL_CA_Path:
Master_SSL_Cert:
Master_SSL_Cipher:
Master_SSL_Key:
Seconds_Behind_Master: 0
Master_SSL_Verify_Server_Cert: No
    Last_IO_Errno: 0
    Last_IO_Error:
    Last_SQL_Errno: 0
    Last_SQL_Error:
Replicate_Ignore_Server_Ids: 0

```

The key fields from the status report to examine are:

- **Slave\_IO\_State**: The current status of the replica. See [Section 8.14.6, “Replication Replica I/O Thread States”](#), and [Section 8.14.7, “Replication Replica SQL Thread States”](#), for more information.
- **Slave\_IO\_Running**: Whether the I/O thread for reading the source's binary log is running. Normally, you want this to be **Yes** unless you have not yet started replication or have explicitly stopped it with **STOP SLAVE**.
- **Slave\_SQL\_Running**: Whether the SQL thread for executing events in the relay log is running. As with the I/O thread, this should normally be **Yes**.
- **Last\_IO\_Error**, **Last\_SQL\_Error**: The last errors registered by the I/O and SQL threads when processing the relay log. Ideally these should be blank, indicating no errors.
- **Seconds\_Behind\_Master**: The number of seconds that the replication SQL thread is behind processing the source's binary log. A high number (or an increasing one) can indicate that the replica is unable to handle events from the source in a timely fashion.

A value of 0 for **Seconds\_Behind\_Master** can usually be interpreted as meaning that the replica has caught up with the source, but there are some cases where this is not strictly true. For example, this can occur if the network connection between source and replica is broken but the replication I/O thread has not yet noticed this—that is, **slave\_net\_timeout** has not yet elapsed.

It is also possible that transient values for **Seconds\_Behind\_Master** may not reflect the situation accurately. When the replication SQL thread has caught up on I/O, **Seconds\_Behind\_Master** displays 0; but when the replication I/O thread is still queuing up a new event, **Seconds\_Behind\_Master** may show a large value until the SQL thread finishes executing the new event. This is especially likely when the events have old timestamps; in such cases, if you execute **SHOW SLAVE STATUS** several times in a relatively short period, you may see this value change back and forth repeatedly between 0 and a relatively large value.

Several pairs of fields provide information about the progress of the replica in reading events from the source's binary log and processing them in the relay log:

- ([Master\\_Log\\_file](#), [Read\\_Master\\_Log\\_Pos](#)): Coordinates in the source's binary log indicating how far the replication I/O thread has read events from that log.
- ([Relay\\_Master\\_Log\\_File](#), [Exec\\_Master\\_Log\\_Pos](#)): Coordinates in the source's binary log indicating how far the replication SQL thread has executed events received from that log.
- ([Relay\\_Log\\_File](#), [Relay\\_Log\\_Pos](#)): Coordinates in the replica's relay log indicating how far the replication SQL thread has executed the relay log. These correspond to the preceding coordinates, but are expressed in the replica's relay log coordinates rather than the source's binary log coordinates.

On the source, you can check the status of connected replicas using `SHOW PROCESSLIST` to examine the list of running processes. Replica connections have `Binlog Dump` in the `Command` field:

```
mysql> SHOW PROCESSLIST \G;
***** 4. row *****
      Id: 10
     User: root
    Host: replical:58371
       db: NULL
Command: Binlog Dump
      Time: 777
     State: Has sent all binlog to slave; waiting for binlog to be updated
      Info: NULL
```

Because it is the replica that drives the replication process, very little information is available in this report.

For replicas that were started with the `--report-host` option and are connected to the source, the `SHOW SLAVE HOSTS` statement on the source shows basic information about the replicas. The output includes the ID of the replica server, the value of the `--report-host` option, the connecting port, and source ID:

```
mysql> SHOW SLAVE HOSTS;
+-----+-----+-----+-----+-----+
| Server_id | Host      | Port | Rpl_recovery_rank | Master_id |
+-----+-----+-----+-----+-----+
|          10 | replical | 3306 |          0 |          1 |
+-----+-----+-----+-----+-----+
1 row in set (0.00 sec)
```

### 16.1.7.2 Pausing Replication on the Replica

You can stop and start replication on the replica using the `STOP SLAVE` and `START SLAVE` statements.

To stop processing of the binary log from the source, use `STOP SLAVE`:

```
mysql> STOP SLAVE;
```

When replication is stopped, the replication I/O thread stops reading events from the source's binary log and writing them to the relay log, and the replication SQL thread stops reading events from the relay log and executing them. You can pause the replication I/O and SQL threads individually by specifying the thread type:

```
mysql> STOP SLAVE IO_THREAD;
mysql> STOP SLAVE SQL_THREAD;
```

To start execution again, use the `START SLAVE` statement:

```
mysql> START SLAVE;
```

To start a particular thread, specify the thread type:

```
mysql> START SLAVE IO_THREAD;
mysql> START SLAVE SQL_THREAD;
```

For a replica that performs updates only by processing events from the source, stopping only the replication SQL thread can be useful if you want to perform a backup or other task. The replication I/O thread continues to read events from the source but they are not executed. This makes it easier for the replica to catch up when you restart the replication SQL thread.

Stopping only the replication I/O thread enables the events in the relay log to be executed by the replication SQL thread up to the point where the relay log ends. This can be useful when you want to pause execution to catch up with events already received from the source, when you want to perform administration on the replica but also ensure that it has processed all updates to a specific point. This method can also be used to pause event receipt on the replica while you conduct administration on the source. Stopping the I/O thread but permitting the SQL thread to run helps ensure that there is not a massive backlog of events to be executed when replication is started again.

### 16.1.7.3 Skipping Transactions

If replication stops due to an issue with an event in a replicated transaction, you can resume replication by skipping the failed transaction on the replica. Before skipping a transaction, ensure that the replication I/O thread is stopped as well as the replication SQL thread.

First you need to identify the replicated event that caused the error. Details of the error and the last successfully applied transaction are recorded in the Performance Schema table `replication_applier_status_by_worker`. You can use `mysqlbinlog` to retrieve and display the events that were logged around the time of the error. For instructions to do this, see [Section 7.5, “Point-in-Time \(Incremental\) Recovery”](#). Alternatively, you can issue `SHOW RELAYLOG EVENTS` on the replica or `SHOW BINLOG EVENTS` on the source.

Before skipping the transaction and restarting the replica, check these points:

- Is the transaction that stopped replication from an unknown or untrusted source? If so, investigate the cause in case there are any security considerations that indicate the replica should not be restarted.
- Does the transaction that stopped replication need to be applied on the replica? If so, either make the appropriate corrections and reapply the transaction, or manually reconcile the data on the replica.
- Did the transaction that stopped replication need to be applied on the source? If not, undo the transaction manually on the server where it originally took place.

To skip the transaction, choose one of the following methods as appropriate:

- When GTIDs are in use (`gtid_mode` is `ON`), see [Skipping Transactions With GTIDs](#).
- When GTIDs are not in use or are being phased in (`gtid_mode` is `OFF`, `OFF_PERMISSIVE`, or `ON_PERMISSIVE`), see [Skipping Transactions Without GTIDs](#).

To restart replication after skipping the transaction, issue `START SLAVE`, with the `FOR CHANNEL` clause if the replica is a multi-source replica.

### Skipping Transactions With GTIDs

When GTIDs are in use (`gtid_mode` is `ON`), the GTID for a committed transaction is persisted on the replica even if the content of the transaction is filtered out. This feature prevents a replica from retrieving

previously filtered transactions when it reconnects to the source using GTID auto-positioning. It can also be used to skip a transaction on the replica, by committing an empty transaction in place of the failing transaction.

If the failing transaction generated an error in a worker thread, you can obtain its GTID directly from the `APPLYING_TRANSACTION` field in the Performance Schema table `replication_applier_status_by_worker`. To see what the transaction is, issue `SHOW RELAYLOG EVENTS` on the replica or `SHOW BINLOG EVENTS` on the source, and search the output for a transaction preceded by that GTID.

When you have assessed the failing transaction for any other appropriate actions as described previously (such as security considerations), to skip it, commit an empty transaction on the replica that has the same GTID as the failing transaction. For example:

```
SET GTID_NEXT='aaa-bbb-ccc-ddd:N';
BEGIN;
COMMIT;
SET GTID_NEXT='AUTOMATIC';
```

The presence of this empty transaction on the replica means that when you issue a `START SLAVE` statement to restart replication, the replica uses the auto-skip function to ignore the failing transaction, because it sees a transaction with that GTID has already been applied. If the replica is a multi-source replica, you do not need to specify the channel name when you commit the empty transaction, but you do need to specify the channel name when you issue `START SLAVE`.

Note that if binary logging is in use on this replica, the empty transaction enters the replication stream if the replica becomes a source or primary in the future. If you need to avoid this possibility, consider flushing and purging the replica's binary logs, as in this example:

```
FLUSH LOGS;
PURGE BINARY LOGS TO 'binlog.000146';
```

The GTID of the empty transaction is persisted, but the transaction itself is removed by purging the binary log files.

## Skipping Transactions Without GTIDs

To skip failing transactions when GTIDs are not in use or are being phased in (`gtid_mode` is `OFF`, `OFF_PERMISSIVE`, or `ON_PERMISSIVE`), you can skip a specified number of events by issuing a `SET GLOBAL sql_slave_skip_counter` statement. Alternatively, you can skip past an event or events by issuing a `CHANGE MASTER TO` statement to move the source's binary log position forward.

When you use these methods, it is important to understand that you are not necessarily skipping a complete transaction, as is always the case with the GTID-based method described previously. These non-GTID-based methods are not aware of transactions as such, but instead operate on events. The binary log is organized as a sequence of groups known as event groups, and each event group consists of a sequence of events.

- For transactional tables, an event group corresponds to a transaction.
- For nontransactional tables, an event group corresponds to a single SQL statement.

A single transaction can contain changes to both transactional and nontransactional tables.

When you use a `SET GLOBAL sql_slave_skip_counter` statement to skip events and the resulting position is in the middle of an event group, the replica continues to skip events until it reaches the end of the group. Execution then starts with the next event group. The `CHANGE MASTER TO` statement does



not have this function, so you must be careful to identify the correct location to restart replication at the beginning of an event group. However, using `CHANGE MASTER TO` means you do not have to count the events that need to be skipped, as you do with a `SET GLOBAL sql_slave_skip_counter`, and instead you can just specify the location to restart.

### Skipping Transactions With `SET GLOBAL sql_slave_skip_counter`

When you have assessed the failing transaction for any other appropriate actions as described previously (such as security considerations), count the number of events that you need to skip. One event normally corresponds to one SQL statement in the binary log, but note that statements that use `AUTO_INCREMENT` or `LAST_INSERT_ID()` count as two events in the binary log.

If you want to skip the complete transaction, you can count the events to the end of the transaction, or you can just skip the relevant event group. Remember that with `SET GLOBAL sql_slave_skip_counter`, the replica continues to skip to the end of an event group. Make sure you do not skip too far forward and go into the next event group or transaction, as this then causes it to be skipped as well.

Issue the `SET` statement as follows, where *N* is the number of events from the source to skip:

```
SET GLOBAL sql_slave_skip_counter = N
```

This statement cannot be issued if `gtid_mode=ON` is set, or if the replica threads are running.

The `SET GLOBAL sql_slave_skip_counter` statement has no immediate effect. When you issue the `START SLAVE` statement for the next time following this `SET` statement, the new value for the system variable `sql_slave_skip_counter` is applied, and the events are skipped. That `START SLAVE` statement also automatically sets the value of the system variable back to 0. If the replica is a multi-source replica, when you issue that `START SLAVE` statement, the `FOR CHANNEL` clause is required. Make sure that you name the correct channel, otherwise events are skipped on the wrong channel.

### Skipping Transactions With `CHANGE MASTER TO`

When you have assessed the failing transaction for any other appropriate actions as described previously (such as security considerations), identify the coordinates (file and position) in the source's binary log that represent a suitable position to restart replication. This can be the start of the event group following the event that caused the issue, or the start of the next transaction. The replication I/O thread begins reading from the source at these coordinates the next time the thread starts, skipping the failing event. Make sure that you have identified the position accurately, because this statement does not take event groups into account.

Issue the `CHANGE MASTER TO` statement as follows, where *source\_log\_name* is the binary log file that contains the restart position, and *source\_log\_pos* is the number representing the restart position as stated in the binary log file:

```
CHANGE MASTER TO MASTER_LOG_FILE='source_log_name', MASTER_LOG_POS=source_log_pos;
```

If the replica is a multi-source replica, you must use the `FOR CHANNEL` clause to name the appropriate channel on the `CHANGE MASTER TO` statement.

This statement cannot be issued if `MASTER_AUTO_POSITION=1` is set, or if the replication threads are running. If you need to use this method of skipping a transaction when `MASTER_AUTO_POSITION=1` is normally set, you can change the setting to `MASTER_AUTO_POSITION=0` while issuing the statement, then change it back again afterwards. For example:

```
CHANGE MASTER TO MASTER_AUTO_POSITION=0, MASTER_LOG_FILE='binlog.000145', MASTER_LOG_POS=235;  
CHANGE MASTER TO MASTER_AUTO_POSITION=1;
```

## 16.2 Replication Implementation

Replication is based on the replication source server keeping track of all changes to its databases (updates, deletes, and so on) in its binary log. The binary log serves as a written record of all events that modify database structure or content (data) from the moment the server was started. Typically, `SELECT` statements are not recorded because they modify neither database structure nor content.

Each replica that connects to the source requests a copy of the binary log. That is, it pulls the data from the source, rather than the source pushing the data to the replica. The replica also executes the events from the binary log that it receives. This has the effect of repeating the original changes just as they were made on the source. Tables are created or their structure modified, and data is inserted, deleted, and updated according to the changes that were originally made on the source.

Because each replica is independent, the replaying of the changes from the source's binary log occurs independently on each replica that is connected to the source. In addition, because each replica receives a copy of the binary log only by requesting it from the source, the replica is able to read and update the copy of the database at its own pace and can start and stop the replication process at will without affecting the ability to update to the latest database status on either the source or replica side.

For more information on the specifics of the replication implementation, see [Section 16.2.3, “Replication Threads”](#).

Sources and replicas report their status in respect of the replication process regularly so that you can monitor them. See [Section 8.14, “Examining Server Thread \(Process\) Information”](#), for descriptions of all replicated-related states.

The source's binary log is written to a local relay log on the replica before it is processed. The replica also records information about the current position with the source's binary log and the replica's relay log. See [Section 16.2.4, “Relay Log and Replication Metadata Repositories”](#).

Database changes are filtered on the replica according to a set of rules that are applied according to the various configuration options and variables that control event evaluation. For details on how these rules are applied, see [Section 16.2.5, “How Servers Evaluate Replication Filtering Rules”](#).

### 16.2.1 Replication Formats

Replication works because events written to the binary log are read from the source and then processed on the replica. The events are recorded within the binary log in different formats according to the type of event. The different replication formats used correspond to the binary logging format used when the events were recorded in the source's binary log. The correlation between binary logging formats and the terms used during replication are:

- When using statement-based binary logging, the source writes SQL statements to the binary log. Replication of the source to the replica works by executing the SQL statements on the replica. This is called *statement-based replication* (which can be abbreviated as *SBR*), which corresponds to the MySQL statement-based binary logging format.
- When using row-based logging, the source writes *events* to the binary log that indicate how individual table rows are changed. Replication of the source to the replica works by copying the events representing the changes to the table rows to the replica. This is called *row-based replication* (which can be abbreviated as *RBR*).
- You can also configure MySQL to use a mix of both statement-based and row-based logging, depending on which is most appropriate for the change to be logged. This is called *mixed-format logging*. When using mixed-format logging, a statement-based log is used by default. Depending on certain statements, and also the storage engine being used, the log is automatically switched to row-based in particular

cases. Replication using the mixed format is referred to as *mixed-based replication* or *mixed-format replication*. For more information, see [Section 5.4.4.3, “Mixed Binary Logging Format”](#).

Prior to MySQL 5.7.7, statement-based format was the default. In MySQL 5.7.7 and later, row-based format is the default.

**NDB Cluster.** The default binary logging format in MySQL NDB Cluster 7.5 is `MIXED`. You should note that NDB Cluster Replication always uses row-based replication, and that the `NDB` storage engine is incompatible with statement-based replication. See [Section 21.7.2, “General Requirements for NDB Cluster Replication”](#), for more information.

When using `MIXED` format, the binary logging format is determined in part by the storage engine being used and the statement being executed. For more information on mixed-format logging and the rules governing the support of different logging formats, see [Section 5.4.4.3, “Mixed Binary Logging Format”](#).

The logging format in a running MySQL server is controlled by setting the `binlog_format` server system variable. This variable can be set with session or global scope. The rules governing when and how the new setting takes effect are the same as for other MySQL server system variables. Setting the variable for the current session lasts only until the end of that session, and the change is not visible to other sessions. Setting the variable globally takes effect for clients that connect after the change, but not for any current client sessions, including the session where the variable setting was changed. To make the global system variable setting permanent so that it applies across server restarts, you must set it in an option file. For more information, see [Section 13.7.4.1, “SET Syntax for Variable Assignment”](#).

There are conditions under which you cannot change the binary logging format at runtime or doing so causes replication to fail. See [Section 5.4.4.2, “Setting The Binary Log Format”](#).

Changing the global `binlog_format` value requires privileges sufficient to set global system variables. Changing the session `binlog_format` value requires privileges sufficient to set restricted session system variables. See [Section 5.1.8.1, “System Variable Privileges”](#).

The statement-based and row-based replication formats have different issues and limitations. For a comparison of their relative advantages and disadvantages, see [Section 16.2.1.1, “Advantages and Disadvantages of Statement-Based and Row-Based Replication”](#).

With statement-based replication, you may encounter issues with replicating stored routines or triggers. You can avoid these issues by using row-based replication instead. For more information, see [Section 23.7, “Stored Program Binary Logging”](#).

### 16.2.1.1 Advantages and Disadvantages of Statement-Based and Row-Based Replication

Each binary logging format has advantages and disadvantages. For most users, the mixed replication format should provide the best combination of data integrity and performance. If, however, you want to take advantage of the features specific to the statement-based or row-based replication format when performing certain tasks, you can use the information in this section, which provides a summary of their relative advantages and disadvantages, to determine which is best for your needs.

- [Advantages of statement-based replication](#)
- [Disadvantages of statement-based replication](#)
- [Advantages of row-based replication](#)
- [Disadvantages of row-based replication](#)

#### Advantages of statement-based replication

- Proven technology.

- Less data written to log files. When updates or deletes affect many rows, this results in *much* less storage space required for log files. This also means that taking and restoring from backups can be accomplished more quickly.
- Log files contain all statements that made any changes, so they can be used to audit the database.

### Disadvantages of statement-based replication

- **Statements that are unsafe for SBR.**

Not all statements which modify data (such as `INSERT DELETE`, `UPDATE`, and `REPLACE` statements) can be replicated using statement-based replication. Any nondeterministic behavior is difficult to replicate when using statement-based replication. Examples of such Data Modification Language (DML) statements include the following:

- A statement that depends on a loadable function or stored program that is nondeterministic, since the value returned by such a function or stored program depends on factors other than the parameters supplied to it. (Row-based replication, however, simply replicates the value returned by the function or stored program, so its effect on table rows and data is the same on both the source and replica.) See [Section 16.4.1.16, “Replication of Invoked Features”](#), for more information.
- `DELETE` and `UPDATE` statements that use a `LIMIT` clause without an `ORDER BY` are nondeterministic. See [Section 16.4.1.17, “Replication and LIMIT”](#).
- Deterministic loadable functions must be applied on the replicas.
- Statements using any of the following functions cannot be replicated properly using statement-based replication:
  - `LOAD_FILE()`
  - `UUID()`, `UUID_SHORT()`
  - `USER()`
  - `FOUND_ROWS()`
  - `SYSDATE()` (unless both the source and the replica are started with the `--sysdate-is-now` option)
  - `GET_LOCK()`
  - `IS_FREE_LOCK()`
  - `IS_USED_LOCK()`
  - `MASTER_POS_WAIT()`
  - `RAND()`
  - `RELEASE_LOCK()`
  - `SLEEP()`
  - `VERSION()`

However, all other functions are replicated correctly using statement-based replication, including `NOW()` and so forth.

For more information, see [Section 16.4.1.15, “Replication and System Functions”](#).

Statements that cannot be replicated correctly using statement-based replication are logged with a warning like the one shown here:

```
[Warning] Statement is not safe to log in statement format.
```

A similar warning is also issued to the client in such cases. The client can display it using `SHOW WARNINGS`.

- `INSERT ... SELECT` requires a greater number of row-level locks than with row-based replication.
- `UPDATE` statements that require a table scan (because no index is used in the `WHERE` clause) must lock a greater number of rows than with row-based replication.
- For `InnoDB`: An `INSERT` statement that uses `AUTO_INCREMENT` blocks other nonconflicting `INSERT` statements.
- For complex statements, the statement must be evaluated and executed on the replica before the rows are updated or inserted. With row-based replication, the replica only has to modify the affected rows, not execute the full statement.
- If there is an error in evaluation on the replica, particularly when executing complex statements, statement-based replication may slowly increase the margin of error across the affected rows over time. See [Section 16.4.1.27, “Replica Errors During Replication”](#).
- Stored functions execute with the same `NOW()` value as the calling statement. However, this is not true of stored procedures.
- Table definitions must be (nearly) identical on source and replica. See [Section 16.4.1.10, “Replication with Differing Table Definitions on Source and Replica”](#), for more information.

### Advantages of row-based replication

- All changes can be replicated. This is the safest form of replication.



#### Note

Statements that update the information in the `mysql` system database, such as `GRANT`, `REVOKE` and the manipulation of triggers, stored routines (including stored procedures), and views, are all replicated to replicas using statement-based replication.

For statements such as `CREATE TABLE ... SELECT`, a `CREATE` statement is generated from the table definition and replicated using statement-based format, while the row insertions are replicated using row-based format.

- Fewer row locks are required on the source, which thus achieves higher concurrency, for the following types of statements:
  - `INSERT ... SELECT`
  - `INSERT` statements with `AUTO_INCREMENT`
  - `UPDATE` or `DELETE` statements with `WHERE` clauses that do not use keys or do not change most of the examined rows.
- Fewer row locks are required on the replica for any `INSERT`, `UPDATE`, or `DELETE` statement.

## Disadvantages of row-based replication

- RBR can generate more data that must be logged. To replicate a DML statement (such as an `UPDATE` or `DELETE` statement), statement-based replication writes only the statement to the binary log. By contrast, row-based replication writes each changed row to the binary log. If the statement changes many rows, row-based replication may write significantly more data to the binary log; this is true even for statements that are rolled back. This also means that making and restoring a backup can require more time. In addition, the binary log is locked for a longer time to write the data, which may cause concurrency problems. Use `binlog_row_image=minimal` to reduce the disadvantage considerably.
- Deterministic loadable functions that generate large `BLOB` values take longer to replicate with row-based replication than with statement-based replication. This is because the `BLOB` column value is logged, rather than the statement generating the data.
- You cannot see on the replica what statements were received from the source and executed. However, you can see what data was changed using `mysqlbinlog` with the options `--base64-output=DECODE-ROWS` and `--verbose`.

Alternatively, use the `binlog_rows_query_log_events` variable, which if enabled adds a `Rows_query` event with the statement to `mysqlbinlog` output when the `-vv` option is used.

- For tables using the `MyISAM` storage engine, a stronger lock is required on the replica for `INSERT` statements when applying them as row-based events to the binary log than when applying them as statements. This means that concurrent inserts on `MyISAM` tables are not supported when using row-based replication.

### 16.2.1.2 Usage of Row-Based Logging and Replication

MySQL uses statement-based logging (SBL), row-based logging (RBL) or mixed-format logging. The type of binary log used impacts the size and efficiency of logging. Therefore the choice between row-based replication (RBR) or statement-based replication (SBR) depends on your application and environment. This section describes known issues when using a row-based format log, and describes some best practices using it in replication.

For additional information, see [Section 16.2.1, “Replication Formats”](#), and [Section 16.2.1.1, “Advantages and Disadvantages of Statement-Based and Row-Based Replication”](#).

For information about issues specific to NDB Cluster Replication (which depends on row-based replication), see [Section 21.7.3, “Known Issues in NDB Cluster Replication”](#).

- **Row-based logging of temporary tables.** As noted in [Section 16.4.1.29, “Replication and Temporary Tables”](#), temporary tables are not replicated when using row-based format. When using mixed format logging, “safe” statements involving temporary tables are logged using statement-based format. For more information, see [Section 16.2.1.1, “Advantages and Disadvantages of Statement-Based and Row-Based Replication”](#).

Temporary tables are not replicated when using row-based format because there is no need. In addition, because temporary tables can be read only from the thread which created them, there is seldom if ever any benefit obtained from replicating them, even when using statement-based format.

You can switch from statement-based to row-based binary logging format at runtime even when temporary tables have been created. From MySQL 5.7.25, the MySQL server tracks the logging mode that was in effect when each temporary table was created. When a given client session ends, the server logs a `DROP TEMPORARY TABLE IF EXISTS` statement for each temporary table that still exists and was created when statement-based binary logging was in use. If row-based or mixed format binary logging was in use when the table was created, the `DROP TEMPORARY TABLE IF EXISTS` statement

is not logged. In previous releases, the `DROP TEMPORARY TABLE IF EXISTS` statement was logged regardless of the logging mode that was in effect.

Nontransactional DML statements involving temporary tables are allowed when using `binlog_format=ROW`, as long as any nontransactional tables affected by the statements are temporary tables (Bug #14272672).

- **RBL and synchronization of nontransactional tables.** When many rows are affected, the set of changes is split into several events; when the statement commits, all of these events are written to the binary log. When executing on the replica, a table lock is taken on all tables involved, and then the rows are applied in batch mode. Depending on the engine used for the replica's copy of the table, this may or may not be effective.
- **Latency and binary log size.** RBL writes changes for each row to the binary log and so its size can increase quite rapidly. This can significantly increase the time required to make changes on the replica that match those on the source. You should be aware of the potential for this delay in your applications.
- **Reading the binary log.** `mysqlbinlog` displays row-based events in the binary log using the `BINLOG` statement (see Section 13.7.6.1, “BINLOG Statement”). This statement displays an event as a base 64-encoded string, the meaning of which is not evident. When invoked with the `--base64-output=DECODE-ROWS` and `--verbose` options, `mysqlbinlog` formats the contents of the binary log to be human readable. When binary log events were written in row-based format and you want to read or recover from a replication or database failure you can use this command to read contents of the binary log. For more information, see Section 4.6.7.2, “mysqlbinlog Row Event Display”.
- **Binary log execution errors and replica execution mode.** Using `slave_exec_mode=IDEMPOTENT` is generally only useful with MySQL NDB Cluster replication, for which `IDEMPOTENT` is the default value. (See Section 21.7.10, “NDB Cluster Replication: Bidirectional and Circular Replication”). When `slave_exec_mode` is `IDEMPOTENT`, a failure to apply changes from RBL because the original row cannot be found does not trigger an error or cause replication to fail. This means that it is possible that updates are not applied on the replica, so that the source and replica are no longer synchronized. Latency issues and use of nontransactional tables with RBR when `slave_exec_mode` is `IDEMPOTENT` can cause the source and replica to diverge even further. For more information about `slave_exec_mode`, see Section 5.1.7, “Server System Variables”.

For other scenarios, setting `slave_exec_mode` to `STRICT` is normally sufficient; this is the default value for storage engines other than `NDB`.

- **Filtering based on server ID not supported.** You can filter based on server ID by using the `IGNORE_SERVER_IDS` option for the `CHANGE MASTER TO` statement. This option works with statement-based and row-based logging formats. Another method to filter out changes on some replicas is to use a `WHERE` clause that includes the relation `@@server_id <> id_value` clause with `UPDATE` and `DELETE` statements. For example, `WHERE @@server_id <> 1`. However, this does not work correctly with row-based logging. To use the `server_id` system variable for statement filtering, use statement-based logging.
- **RBL, nontransactional tables, and stopped replicas.** When using row-based logging, if the replica server is stopped while a replication thread is updating a nontransactional table, the replica database can reach an inconsistent state. For this reason, it is recommended that you use a transactional storage engine such as `InnoDB` for all tables replicated using the row-based format. Use of `STOP SLAVE` or `STOP SLAVE SQL_THREAD` prior to shutting down the replica server helps prevent issues from occurring, and is always recommended regardless of the logging format or storage engine you use.

### 16.2.1.3 Determination of Safe and Unsafe Statements in Binary Logging

The “safeness” of a statement in MySQL Replication, refers to whether the statement and its effects can be replicated correctly using statement-based format. If this is true of the statement, we refer to the statement as *safe*; otherwise, we refer to it as *unsafe*.

In general, a statement is safe if it deterministic, and unsafe if it is not. However, certain nondeterministic functions are *not* considered unsafe (see [Nondeterministic functions not considered unsafe](#), later in this section). In addition, statements using results from floating-point math functions—which are hardware-dependent—are always considered unsafe (see [Section 16.4.1.12, “Replication and Floating-Point Values”](#)).

**Handling of safe and unsafe statements.** A statement is treated differently depending on whether the statement is considered safe, and with respect to the binary logging format (that is, the current value of `binlog_format`).

- When using row-based logging, no distinction is made in the treatment of safe and unsafe statements.
- When using mixed-format logging, statements flagged as unsafe are logged using the row-based format; statements regarded as safe are logged using the statement-based format.
- When using statement-based logging, statements flagged as being unsafe generate a warning to this effect. Safe statements are logged normally.

Each statement flagged as unsafe generates a warning. Formerly, if a large number of such statements were executed on the source, this could lead to excessively large error log files. To prevent this, MySQL 5.7 provides a warning suppression mechanism, which behaves as follows: Whenever the 50 most recent `ER_BINLOG_UNSAFE_STATEMENT` warnings have been generated more than 50 times in any 50-second period, warning suppression is enabled. When activated, this causes such warnings not to be written to the error log; instead, for each 50 warnings of this type, a note `The last warning was repeated N times in last S seconds` is written to the error log. This continues as long as the 50 most recent such warnings were issued in 50 seconds or less; once the rate has decreased below this threshold, the warnings are once again logged normally. Warning suppression has no effect on how the safety of statements for statement-based logging is determined, nor on how warnings are sent to the client. MySQL clients still receive one warning for each such statement.

For more information, see [Section 16.2.1, “Replication Formats”](#).

#### Statements considered unsafe.

Statements with the following characteristics are considered unsafe:

- **Statements containing system functions that may return a different value on a replica.** These functions include `FOUND_ROWS()`, `GET_LOCK()`, `IS_FREE_LOCK()`, `IS_USED_LOCK()`, `LOAD_FILE()`, `MASTER_POS_WAIT()`, `PASSWORD()`, `RAND()`, `RELEASE_LOCK()`, `ROW_COUNT()`, `SESSION_USER()`, `SLEEP()`, `SYSDATE()`, `SYSTEM_USER()`, `USER()`, `UUID()`, and `UUID_SHORT()`.

**Nondeterministic functions not considered unsafe.** Although these functions are not deterministic, they are treated as safe for purposes of logging and replication: `CONNECTION_ID()`, `CURDATE()`, `CURRENT_DATE()`, `CURRENT_TIME()`, `CURRENT_TIMESTAMP()`, `CURTIME()`, `LAST_INSERT_ID()`, `LOCALTIME()`, `LOCALTIMESTAMP()`, `NOW()`, `UNIX_TIMESTAMP()`, `UTC_DATE()`, `UTC_TIME()`, and `UTC_TIMESTAMP()`.

For more information, see [Section 16.4.1.15, “Replication and System Functions”](#).

- **References to system variables.** Most system variables are not replicated correctly using the statement-based format. See [Section 16.4.1.37, “Replication and Variables”](#). For exceptions, see [Section 5.4.4.3, “Mixed Binary Logging Format”](#).
- **Loadable Functions.** Since we have no control over what a loadable function does, we must assume that it is executing unsafe statements.



- **Fulltext plugin.** This plugin may behave differently on different MySQL servers; therefore, statements depending on it could have different results. For this reason, all statements relying on the fulltext plugin are treated as unsafe (Bug #11756280, Bug #48183).
- **Trigger or stored program updates a table having an AUTO\_INCREMENT column.** This is unsafe because the order in which the rows are updated may differ on the source and the replica.

In addition, an `INSERT` into a table that has a composite primary key containing an `AUTO_INCREMENT` column that is not the first column of this composite key is unsafe.

For more information, see [Section 16.4.1.1, “Replication and AUTO\\_INCREMENT”](#).

- **INSERT ... ON DUPLICATE KEY UPDATE statements on tables with multiple primary or unique keys.** When executed against a table that contains more than one primary or unique key, this statement is considered unsafe, being sensitive to the order in which the storage engine checks the keys, which is not deterministic, and on which the choice of rows updated by the MySQL Server depends.

An `INSERT ... ON DUPLICATE KEY UPDATE` statement against a table having more than one unique or primary key is marked as unsafe for statement-based replication. (Bug #11765650, Bug #58637)

- **Updates using LIMIT.** The order in which rows are retrieved is not specified, and is therefore considered unsafe. See [Section 16.4.1.17, “Replication and LIMIT”](#).
- **Accesses or references log tables.** The contents of the system log table may differ between source and replica.
- **Nontransactional operations after transactional operations.** Within a transaction, allowing any nontransactional reads or writes to execute after any transactional reads or writes is considered unsafe.

For more information, see [Section 16.4.1.33, “Replication and Transactions”](#).

- **Accesses or references self-logging tables.** All reads and writes to self-logging tables are considered unsafe. Within a transaction, any statement following a read or write to self-logging tables is also considered unsafe.
- **LOAD DATA statements.** `LOAD DATA` is treated as unsafe and when `binlog_format=mixed` the statement is logged in row-based format. When `binlog_format=statement` `LOAD DATA` does not generate a warning, unlike other unsafe statements.
- **XA transactions.** If two XA transactions committed in parallel on the source are being prepared on the replica in the inverse order, locking dependencies can occur with statement-based replication that cannot be safely resolved, and it is possible for replication to fail with deadlock on the replica. When `binlog_format=STATEMENT` is set, DML statements inside XA transactions are flagged as being unsafe and generate a warning. When `binlog_format=MIXED` or `binlog_format=ROW` is set, DML statements inside XA transactions are logged using row-based replication, and the potential issue is not present.

For additional information, see [Section 16.4.1, “Replication Features and Issues”](#).

## 16.2.2 Replication Channels

In MySQL multi-source replication, a replica opens multiple replication channels, one for each replication source server. The replication channels represent the path of transactions flowing from a source to the replica. Each replication channel has its own receiver (I/O) thread, one or more applier (SQL) threads, and

relay log. When transactions from a source are received by a channel's receiver thread, they are added to the channel's relay log file and passed through to the channel's applier threads. This enables each channel to function independently.

This section describes how channels can be used in a replication topology, and the impact they have on single-source replication. For instructions to configure sources and replicas for multi-source replication, to start, stop and reset multi-source replicas, and to monitor multi-source replication, see [Section 16.1.5, “MySQL Multi-Source Replication”](#).

The maximum number of channels that can be created on one replica in a multi-source replication topology is 256. Each replication channel must have a unique (nonempty) name, as explained in [Section 16.2.2.4, “Replication Channel Naming Conventions”](#). The error codes and messages that are issued when multi-source replication is enabled specify the channel that generated the error.



**Note**

Each channel on a multi-source replica must replicate from a different source. You cannot set up multiple replication channels from a single replica to a single source. This is because the server IDs of replicas must be unique in a replication topology. The source distinguishes replicas only by their server IDs, not by the names of the replication channels, so it cannot recognize different replication channels from the same replica.

A multi-source replica can also be set up as a multi-threaded replica, by setting the `slave_parallel_workers` system variable to a value greater than 0. When you do this on a multi-source replica, each channel on the replica has the specified number of applier threads, plus a coordinator thread to manage them. You cannot configure the number of applier threads for individual channels.

To provide compatibility with previous versions, the MySQL server automatically creates on startup a default channel whose name is the empty string ( " "). This channel is always present; it cannot be created or destroyed by the user. If no other channels (having nonempty names) have been created, replication statements act on the default channel only, so that all replication statements from older replicas function as expected (see [Section 16.2.2.2, “Compatibility with Previous Replication Statements”](#)). Statements applying to replication channels as described in this section can be used only when there is at least one named channel.

### 16.2.2.1 Commands for Operations on a Single Channel

To enable MySQL replication operations to act on individual replication channels, use the `FOR CHANNEL channel` clause with the following replication statements:

- `CHANGE MASTER TO`
- `START SLAVE`
- `STOP SLAVE`
- `SHOW RELAYLOG EVENTS`
- `FLUSH RELAY LOGS`
- `SHOW SLAVE STATUS`
- `RESET SLAVE`

Similarly, an additional `channel` parameter is introduced for the following functions:

- `MASTER_POS_WAIT()`
- `WAIT_UNTIL_SQL_THREAD_AFTER_GTIDS()`

The following statements are disallowed for the `group_replication_recovery` channel:

- `START SLAVE`
- `STOP SLAVE`

The following statements are disallowed for the `group_replication_applier` channel:

- `START SLAVE`
- `STOP SLAVE`
- `SHOW SLAVE STATUS`
- `FLUSH RELAY LOGS`

### 16.2.2.2 Compatibility with Previous Replication Statements

When a replica has multiple channels and a `FOR CHANNEL channel` option is not specified, a valid statement generally acts on all available channels, with some specific exceptions.

For example, the following statements behave as expected for all except certain Group Replication channels:

- `START SLAVE` starts replication threads for all channels, except the `group_replication_recovery` and `group_replication_applier` channels.
- `STOP SLAVE` stops replication threads for all channels, except the `group_replication_recovery` and `group_replication_applier` channels.
- `SHOW SLAVE STATUS` reports the status for all channels, except the `group_replication_applier` channel.
- `FLUSH RELAY LOGS` flushes the relay logs for all channels, except the `group_replication_applier` channel.
- `RESET SLAVE` resets all channels.



#### Warning

Use `RESET SLAVE` with caution as this statement deletes all existing channels, purges their relay log files, and recreates only the default channel.

Some replication statements cannot operate on all channels. In this case, error 1964 `Multiple channels exist on the slave. Please provide channel name as an argument.` is generated. The following statements and functions generate this error when used in a multi-source replication topology and a `FOR CHANNEL channel` option is not used to specify which channel to act on:

- `SHOW RELAYLOG EVENTS`
- `CHANGE MASTER TO`
- `MASTER_POS_WAIT()`
- `WAIT_UNTIL_SQL_THREAD_AFTER_GTIDS()`

Note that a default channel always exists in a single source replication topology, where statements and functions behave as in previous versions of MySQL.

### 16.2.2.3 Startup Options and Replication Channels

This section describes startup options which are impacted by the addition of replication channels.

The following startup settings *must* be configured correctly to use multi-source replication.

- `relay_log_info_repository`.

This must be set to `TABLE`. If this variable is set to `FILE`, attempting to add more sources to a replica fails with `ER_SLAVE_NEW_CHANNEL_WRONG_REPOSITORY`.

- `master_info_repository`

This must be set to `TABLE`. If this variable is set to `FILE`, attempting to add more sources to a replica fails with `ER_SLAVE_NEW_CHANNEL_WRONG_REPOSITORY`.

The following startup options now affect *all* channels in a replication topology.

- `--log-slave-updates`

All transactions received by the replica (even from multiple sources) are written in the binary log.

- `--relay-log-purge`

When set, each channel purges its own relay log automatically.

- `--slave_transaction_retries`

Applier threads of all channels retry transactions.

- `--skip-slave-start`

No replication threads start on any channels.

- `--slave-skip-errors`

Execution continues and errors are skipped for all channels.

The values set for the following startup options apply on each channel; since these are `mysqld` startup options, they are applied on every channel.

- `--max-relay-log-size=size`

Maximum size of the individual relay log file for each channel; after reaching this limit, the file is rotated.

- `--relay-log-space-limit=size`

Upper limit for the total size of all relay logs combined, for each individual channel. For  $N$  channels, the combined size of these logs is limited to `relay_log_space_limit * N`.

- `--slave-parallel-workers=value`

Number of worker threads per channel.

- `slave_checkpoint_group`

Waiting time by an I/O thread for each source.

- `--relay-log-index=filename`

Base name for each channel's relay log index file. See [Section 16.2.2.4, “Replication Channel Naming Conventions”](#).

- `--relay-log=filename`

Denotes the base name of each channel's relay log file. See [Section 16.2.2.4, “Replication Channel Naming Conventions”](#).

- `--slave_net_timeout=N`

This value is set per channel, so that each channel waits for *N* seconds to check for a broken connection.

- `--slave-skip-counter=N`

This value is set per channel, so that each channel skips *N* events from its source.

### 16.2.2.4 Replication Channel Naming Conventions

This section describes how naming conventions are impacted by replication channels.

Each replication channel has a unique name which is a string with a maximum length of 64 characters and is case-insensitive. Because channel names are used in replication metadata repositories, the character set used for these is always UTF-8. Although you are generally free to use any name for channels, the following names are reserved:

- `group_replication_applier`
- `group_replication_recovery`

The name you choose for a replication channel also influences the file names used by a multi-source replica. The relay log files and index files for each channel are named `relay_log_basename-channel.xxxxxx`, where `relay_log_basename` is a base name specified using the `relay_log` system variable, and `channel` is the name of the channel logged to this file. If you do not specify the `relay_log` system variable, a default file name is used that also includes the name of the channel.

### 16.2.3 Replication Threads

MySQL replication capabilities are implemented using three main threads, one on the source server and two on the replica:

- **Binary log dump thread.** The source creates a thread to send the binary log contents to a replica when the replica connects. This thread can be identified in the output of `SHOW PROCESSLIST` on the source as the `Binlog Dump` thread.

The binary log dump thread acquires a lock on the source's binary log for reading each event that is to be sent to the replica. As soon as the event has been read, the lock is released, even before the event is sent to the replica.

- **Replication I/O thread.** When a `START SLAVE` statement is issued on a replica server, the replica creates an I/O thread, which connects to the source and asks it to send the updates recorded in its binary logs.

The replication I/O thread reads the updates that the source's `Binlog Dump` thread sends (see previous item) and copies them to local files that comprise the replica's relay log.

The state of this thread is shown as `Slave_IO_running` in the output of `SHOW SLAVE STATUS`.

- **Replication SQL thread.** The replica creates an SQL thread to read the relay log that is written by the replication I/O thread and execute the transactions contained in it.

There are three main threads for each source/replica connection. A source that has multiple replicas creates one binary log dump thread for each currently connected replica, and each replica has its own replication I/O and SQL threads.

A replica uses two threads to separate reading updates from the source and executing them into independent tasks. Thus, the task of reading transactions is not slowed down if the process of applying them is slow. For example, if the replica server has not been running for a while, its I/O thread can quickly fetch all the binary log contents from the source when the replica starts, even if the SQL thread lags far behind. If the replica stops before the SQL thread has executed all the fetched statements, the I/O thread has at least fetched everything so that a safe copy of the transactions is stored locally in the replica's relay logs, ready for execution the next time that the replica starts.

You can enable further parallelization for tasks on a replica by setting the `slave_parallel_workers` system variable to a value greater than 0 (the default). When this system variable is set, the replica creates the specified number of worker threads to apply transactions, plus a coordinator thread to manage them. If you are using multiple replication channels, each channel has this number of threads. A replica with `slave_parallel_workers` set to a value greater than 0 is called a multithreaded replica. With this setup, transactions that fail can be retried.



#### Note

Multithreaded replicas are not currently supported by NDB Cluster, which silently ignores the setting for this variable. See [Section 21.7.3, “Known Issues in NDB Cluster Replication”](#) for more information.

### 16.2.3.1 Monitoring Replication Main Threads

The `SHOW PROCESSLIST` statement provides information that tells you what is happening on the source and on the replica regarding replication. For information on source states, see [Section 8.14.5, “Replication Source Thread States”](#). For replica states, see [Section 8.14.6, “Replication Replica I/O Thread States”](#), and [Section 8.14.7, “Replication Replica SQL Thread States”](#).

The following example illustrates how the three main replication threads, the binary log dump thread, replication I/O thread, and replication SQL thread, show up in the output from `SHOW PROCESSLIST`.

On the source server, the output from `SHOW PROCESSLIST` looks like this:

```
mysql> SHOW PROCESSLIST\G
***** 1. row *****
  Id: 2
  User: root
  Host: localhost:32931
  db: NULL
Command: Binlog Dump
  Time: 94
  State: Has sent all binlog to slave; waiting for binlog to
         be updated
  Info: NULL
```

Here, thread 2 is a `Binlog Dump` thread that services a connected replica. The `State` information indicates that all outstanding updates have been sent to the replica and that the source is waiting for more

updates to occur. If you see no [Binlog Dump](#) threads on a source server, this means that replication is not running; that is, no replicas are currently connected.

On a replica server, the output from `SHOW PROCESSLIST` looks like this:

```
mysql> SHOW PROCESSLIST\G
***** 1. row *****
  Id: 10
  User: system user
  Host:
  db: NULL
Command: Connect
  Time: 11
  State: Waiting for master to send event
  Info: NULL
***** 2. row *****
  Id: 11
  User: system user
  Host:
  db: NULL
Command: Connect
  Time: 11
  State: Has read all relay log; waiting for the slave I/O
        thread to update it
  Info: NULL
```

The `State` information indicates that thread 10 is the replication I/O thread that is communicating with the source server, and thread 11 is the replication SQL thread that is processing the updates stored in the relay logs. At the time that `SHOW PROCESSLIST` was run, both threads were idle, waiting for further updates.

The value in the `Time` column can show how late the replica is compared to the source. See [Section A.14, “MySQL 5.7 FAQ: Replication”](#). If sufficient time elapses on the source side without activity on the [Binlog Dump](#) thread, the source determines that the replica is no longer connected. As for any other client connection, the timeouts for this depend on the values of `net_write_timeout` and `net_retry_count`; for more information about these, see [Section 5.1.7, “Server System Variables”](#).

The `SHOW SLAVE STATUS` statement provides additional information about replication processing on a replica server. See [Section 16.1.7.1, “Checking Replication Status”](#).

### 16.2.3.2 Monitoring Replication Applier Worker Threads

On a multithreaded replica, the Performance Schema tables `replication_applier_status_by_coordinator` and `replication_applier_status_by_worker` show status information for the replica's coordinator thread and applier worker threads respectively. For a replica with multiple channels, the threads for each channel are identified.

A multithreaded replica's coordinator thread also prints statistics to the replica's error log on a regular basis if the verbosity setting is set to display informational messages. The statistics are printed depending on the volume of events that the coordinator thread has assigned to applier worker threads, with a maximum frequency of once every 120 seconds. The message lists the following statistics for the relevant replication channel, or the default replication channel (which is not named):

Seconds elapsed	The difference in seconds between the current time and the last time this information was printed to the error log.
Events assigned	The total number of events that the coordinator thread has queued to all applier worker threads since the coordinator thread was started.

---

Worker queues filled over overrun level	The current number of events that are queued to any of the applier worker threads in excess of the overrun level, which is set at 90% of the maximum queue length of 16384 events. If this value is zero, no applier worker threads are operating at the upper limit of their capacity.
Waited due to worker queue full	The number of times that the coordinator thread had to wait to schedule an event because an applier worker thread's queue was full. If this value is zero, no applier worker threads exhausted their capacity.
Waited due to the total size	The number of times that the coordinator thread had to wait to schedule an event because the <code>slave_pending_jobs_size_max</code> limit had been reached. This system variable sets the maximum amount of memory (in bytes) available to applier worker thread queues holding events not yet applied. If an unusually large event exceeds this size, the transaction is held until all the applier worker threads have empty queues, and then processed. All subsequent transactions are held until the large transaction has been completed.
Waited at clock conflicts	The number of nanoseconds that the coordinator thread had to wait to schedule an event because a transaction that the event depended on had not yet been committed. If <code>slave_parallel_type</code> is set to <code>DATABASE</code> (rather than <code>LOGICAL_CLOCK</code> ), this value is always zero.
Waited (count) when workers occupied	The number of times that the coordinator thread slept for a short period, which it might do in two situations. The first situation is where the coordinator thread assigns an event and finds the applier worker thread's queue is filled beyond the underrun level of 10% of the maximum queue length, in which case it sleeps for a maximum of 1 millisecond. The second situation is where <code>slave_parallel_type</code> is set to <code>LOGICAL_CLOCK</code> and the coordinator thread needs to assign the first event of a transaction to an applier worker thread's queue, it only does this to a worker with an empty queue, so if no queues are empty, the coordinator thread sleeps until one becomes empty.
Waited when workers occupied	The number of nanoseconds that the coordinator thread slept while waiting for an empty applier worker thread queue (that is, in the second situation described above, where <code>slave_parallel_type</code> is set to <code>LOGICAL_CLOCK</code> and the first event of a transaction needs to be assigned).

## 16.2.4 Relay Log and Replication Metadata Repositories

A replica server creates several repositories of information to use for the replication process:

- The *relay log*, which is written by the replication I/O thread, contains the transactions read from the replication source server's binary log. The transactions in the relay log are applied on the replica by the replication SQL thread. For information about the relay log, see [Section 16.2.4.1, “The Relay Log”](#).
- The replica's *connection metadata repository* contains information that the replication I/O thread needs to connect to the replication source server and retrieve transactions from the source's binary log. The connection metadata repository is written to the `mysql.slave_master_info` table or to a file.
- The replica's *applier metadata repository* contains information that the replication SQL thread needs to read and apply transactions from the replica's relay log. The applier metadata repository is written to the `mysql.slave_relay_log_info` table or to a file.



The connection metadata repository and applier metadata repository are collectively known as the replication metadata repositories. For information about these, see [Section 16.2.4.2, “Replication Metadata Repositories”](#).

**Making replication resilient to unexpected halts.** The `mysql.slave_master_info` and `mysql.slave_relay_log_info` tables are created using the transactional storage engine `InnoDB`. Updates to the replica's applier metadata repository table are committed together with the transactions, meaning that the replica's progress information recorded in that repository is always consistent with what has been applied to the database, even in the event of an unexpected server halt. For information on the combination of settings on the replica that is most resilient to unexpected halts, see [Section 16.3.2, “Handling an Unexpected Halt of a Replica”](#).

### 16.2.4.1 The Relay Log

The relay log, like the binary log, consists of a set of numbered files containing events that describe database changes, and an index file that contains the names of all used relay log files.

The term “relay log file” generally denotes an individual numbered file containing database events. The term “relay log” collectively denotes the set of numbered relay log files plus the index file.

Relay log files have the same format as binary log files and can be read using `mysqlbinlog` (see [Section 4.6.7, “mysqlbinlog — Utility for Processing Binary Log Files”](#)).

By default, relay log file names have the form `host_name-relay-bin.nnnnnn` in the data directory, where `host_name` is the name of the replica server host and `nnnnnn` is a sequence number. Successive relay log files are created using successive sequence numbers, beginning with `000001`. The replica uses an index file to track the relay log files currently in use. The default relay log index file name is `host_name-relay-bin.index` in the data directory.

The default relay log file and relay log index file names can be overridden with, respectively, the `relay_log` and `relay_log_index` system variables (see [Section 16.1.6, “Replication and Binary Logging Options and Variables”](#)).

If a replica uses the default host-based relay log file names, changing a replica's host name after replication has been set up can cause replication to fail with the errors `Failed to open the relay log` and `Could not find target log during relay log initialization`. This is a known issue (see Bug #2122). If you anticipate that a replica's host name might change in the future (for example, if networking is set up on the replica such that its host name can be modified using DHCP), you can avoid this issue entirely by using the `relay_log` and `relay_log_index` system variables to specify relay log file names explicitly when you initially set up the replica. This makes the names independent of server host name changes.

If you encounter the issue after replication has already begun, one way to work around it is to stop the replica server, prepend the contents of the old relay log index file to the new one, and then restart the replica. On a Unix system, this can be done as shown here:

```
$> cat new_relay_log_name.index >> old_relay_log_name.index
$> mv old_relay_log_name.index new_relay_log_name.index
```

A replica server creates a new relay log file under the following conditions:

- Each time the replication I/O thread starts.
- When the logs are flushed (for example, with `FLUSH LOGS` or `mysqladmin flush-logs`).
- When the size of the current relay log file becomes too large, determined as follows:
  - If the value of `max_relay_log_size` is greater than 0, that is the maximum relay log file size.

- If the value of `max_relay_log_size` is 0, `max_binlog_size` determines the maximum relay log file size.

The replication SQL thread automatically deletes each relay log file after it has executed all events in the file and no longer needs it. There is no explicit mechanism for deleting relay logs because the replication SQL thread takes care of doing so. However, `FLUSH LOGS` rotates relay logs, which influences when the replication SQL thread deletes them.

### 16.2.4.2 Replication Metadata Repositories

A replica server creates two replication metadata repositories, the connection metadata repository and the applier metadata repository. The replication metadata repositories survive a replica server's shutdown. If binary log file position based replication is in use, when the replica restarts, it reads the two repositories to determine how far it previously proceeded in reading the binary log from the source and in processing its own relay log. If GTID-based replication is in use, the replica does not use the replication metadata repositories for that purpose, but does need them for the other metadata that they contain.

- The replica's *connection metadata repository* contains information that the replication I/O thread needs to connect to the replication source server and retrieve transactions from the source's binary log. The metadata in this repository includes the connection configuration, the replication user account details, the SSL settings for the connection, and the file name and position where the replication I/O thread is currently reading from the source's binary log.
- The replica's *applier metadata repository* contains information that the replication SQL thread needs to read and apply transactions from the replica's relay log. The metadata in this repository includes the file name and position up to which the replication SQL thread has executed the transactions in the relay log, and the equivalent position in the source's binary log. It also includes metadata for the process of applying transactions, such as the number of worker threads.

By default, the replication metadata repositories are created as files in the data directory named `master.info` and `relay-log.info`, or with alternative names and locations specified by the `--master-info-file` option and `relay_log_info_file` system variable. To create the replication metadata repositories as tables, specify `master_info_repository=TABLE` and `relay_log_info_repository=TABLE` at server startup. In that case, the replica's connection metadata repository is written to the `slave_master_info` table in the `mysql` system schema, and the replica's applier metadata repository is written to the `slave_relay_log_info` table in the `mysql` system schema. A warning message is issued if `mysqld` is unable to initialize the tables for the replication metadata repositories, but the replica is allowed to continue starting. This situation is most likely to occur when upgrading from a version of MySQL that does not support the use of tables for the repositories to one in which they are supported.



#### Important

1. Do not attempt to update or insert rows in the `mysql.slave_master_info` or `mysql.slave_relay_log_info` tables manually. Doing so can cause undefined behavior, and is not supported. Execution of any statement requiring a write lock on either or both of the `slave_master_info` and `slave_relay_log_info` tables is disallowed while replication is ongoing (although statements that perform only reads are permitted at any time).
2. Access to the replica's connection metadata repository file or table should be restricted to the database administrator, because it contains the replication user account name and password for connecting to the source. Use a restricted access mode to protect database backups that include this repository.

`RESET SLAVE` clears the data in the replication metadata repositories, with the exception of the replication connection parameters (depending on the MySQL Server release and repository type). For details, see the description for `RESET SLAVE`.

If you set `master_info_repository` and `relay_log_info_repository` to `TABLE`, the `mysql.slave_master_info` and `mysql.slave_relay_log_info` tables are created using the InnoDB transactional storage engine. Updates to the replica's applier metadata repository table are committed together with the transactions, meaning that the replica's progress information recorded in that repository is always consistent with what has been applied to the database, even in the event of an unexpected server halt. The `--relay-log-recovery` option must be enabled on the replica to guarantee resilience. For more details, see [Section 16.3.2, "Handling an Unexpected Halt of a Replica"](#).

When you back up the replica's data or transfer a snapshot of its data to create a new replica, ensure that you include the `mysql.slave_master_info` and `mysql.slave_relay_log_info` tables containing the replication metadata repositories, or the equivalent files (`master.info` and `relay-log.info` in the data directory, unless you specified alternative names and locations). When binary log file position based replication is in use, the replication metadata repositories are needed to resume replication after restarting the restored or copied replica. If you do not have the relay log files, but still have the replica's applier metadata repository, you can check it to determine how far the replication SQL thread has executed in the source's binary log. Then you can use a `CHANGE MASTER TO` statement with the `MASTER_LOG_FILE` and `MASTER_LOG_POS` options to tell the replica to re-read the binary logs from the source from that point (provided that the required binary logs still exist on the source).

One additional repository, the applier worker metadata repository, is created primarily for internal use, and holds status information about worker threads on a multithreaded replica. The applier worker metadata repository includes the names and positions for the relay log file and the source's binary log file for each worker thread. If the replica's applier metadata repository is created as a table, which is the default, the applier worker metadata repository is written to the `mysql.slave_worker_info` table. If the applier metadata repository is written to a file, the applier worker metadata repository is written to the `worker-relay-log.info` file. For external use, status information for worker threads is presented in the Performance Schema `replication_applier_status_by_worker` table.

The replication metadata repositories originally contained information similar to that shown in the output of the `SHOW SLAVE STATUS` statement, which is discussed in [Section 13.4.2, "SQL Statements for Controlling Replica Servers"](#). Further information has since been added to the replication metadata repositories which is not displayed by the `SHOW SLAVE STATUS` statement.

For the connection metadata repository, the following table shows the correspondence between the columns in the `mysql.slave_master_info` table, the columns displayed by `SHOW SLAVE STATUS`, and the lines in the `master.info` file.

<code>master.info</code> File Line	<code>slave_master_info</code> Table Column	<code>SHOW SLAVE STATUS</code> Column	Description
1	<code>Number_of_lines</code>	[None]	Number of lines in the file, or columns in the table
2	<code>Master_log_name</code>	<code>Master_Log_File</code>	The name of the binary log currently being read from the source
3	<code>Master_log_pos</code>	<code>Read_Master_Log_Pos</code>	The current position within the binary log that has been read from the source

## Relay Log and Replication Metadata Repositories

<code>master.info</code> File Line	<code>slave_master_info</code> Table Column	<code>SHOW SLAVE STATUS</code> Column	Description
4	<code>Host</code>	<code>Master_Host</code>	The host name of the source server
5	<code>User_name</code>	<code>Master_User</code>	The replication user name used to connect to the source
6	<code>User_password</code>	Password (not shown by <code>SHOW SLAVE STATUS</code> )	The password used to connect to the source
7	<code>Port</code>	<code>Master_Port</code>	The network port used to connect to the source
8	<code>Connect_retry</code>	<code>Connect_Retry</code>	The period (in seconds) that the replica waits before trying to reconnect to the source
9	<code>Enabled_ssl</code>	<code>Master_SSL_Allowed</code>	Indicates whether the server supports SSL connections
10	<code>Ssl_ca</code>	<code>Master_SSL_CA_File</code>	The file used for the Certificate Authority (CA) certificate
11	<code>Ssl_capath</code>	<code>Master_SSL_CA_Path</code>	The path to the Certificate Authority (CA) certificates
12	<code>Ssl_cert</code>	<code>Master_SSL_Cert</code>	The name of the SSL certificate file
13	<code>Ssl_cipher</code>	<code>Master_SSL_Cipher</code>	The list of possible ciphers used in the handshake for the SSL connection
14	<code>Ssl_key</code>	<code>Master_SSL_Key</code>	The name of the SSL key file
15	<code>Ssl_verify_server_cert</code>	<code>Master_SSL_Verify_Server_Cert</code>	Whether to verify the server certificate
16	<code>Heartbeat</code>	[None]	Interval between replication heartbeats, in seconds
17	<code>Bind</code>	<code>Master_Bind</code>	Which of the replica's network interfaces should be used for connecting to the source
18	<code>Ignored_server_ids</code>	<code>Replicate_Ignore_Server_Ids</code>	The list of server IDs to be ignored. Note that for <code>Ignored_server_ids</code> the list of server IDs is preceded by the total number of server IDs to ignore.

<code>master.info</code> File Line	<code>slave_master_info</code> Table Column	<code>SHOW SLAVE STATUS</code> Column	Description
19	<code>Uuid</code>	<code>Master_UUID</code>	The source's unique ID
20	<code>Retry_count</code>	<code>Master_Retry_Count</code>	Maximum number of reconnection attempts permitted
21	<code>Ssl_crl</code>	[None]	Path to an SSL certificate revocation-list file
22	<code>Ssl_crlpath</code>	[None]	Path to a directory containing SSL certificate revocation-list files
23	<code>Enabled_auto_positioning</code>	<code>Auto_position</code>	If autopositioning is in use or not
24	<code>Channel_name</code>	<code>Channel_name</code>	The name of the replication channel
25	<code>Tls_version</code>	<code>Master_TLS_Version</code>	TLS version on source

For the applier metadata repository, the following table shows the correspondence between the columns in the `mysql.slave_relay_log_info` table, the columns displayed by `SHOW SLAVE STATUS`, and the lines in the `relay-log.info` file.

Line in <code>relay-log.info</code>	<code>slave_relay_log_info</code> Table Column	<code>SHOW SLAVE STATUS</code> Column	Description
1	<code>Number_of_lines</code>	[None]	Number of lines in the file or columns in the table
2	<code>Relay_log_name</code>	<code>Relay_Log_File</code>	The name of the current relay log file
3	<code>Relay_log_pos</code>	<code>Relay_Log_Pos</code>	The current position within the relay log file; events up to this position have been executed on the replica database
4	<code>Master_log_name</code>	<code>Relay_Master_Log_File</code>	The name of the source's binary log file from which the events in the relay log file were read
5	<code>Master_log_pos</code>	<code>Exec_Master_Log_Pos</code>	The equivalent position within the source's binary log file of events that have already been executed
6	<code>Sql_delay</code>	<code>SQL_Delay</code>	The number of seconds that the replica must lag the source
7	<code>Number_of_workers</code>	[None]	The number of worker threads on the replica for executing replication

Line in <code>relay-log.info</code>	<code>slave_relay_log_info</code> Table Column	<code>SHOW SLAVE STATUS</code> Column	Description
			events (transactions) in parallel
8	<code>Id</code>	[None]	ID used for internal purposes; currently this is always 1
9	<code>Channel_name</code>	<code>Channel_name</code>	The name of the replication channel

In versions of MySQL prior to MySQL 5.6, the `relay-log.info` file does not include a line count or a delay value (and the `slave_relay_log_info` table is not available).

Line	Status Column	Description
1	<code>Relay_Log_File</code>	The name of the current relay log file
2	<code>Relay_Log_Pos</code>	The current position within the relay log file; events up to this position have been executed on the replica database
3	<code>Relay_Master_Log_File</code>	The name of the source's binary log file from which the events in the relay log file were read
4	<code>Exec_Master_Log_Pos</code>	The equivalent position within the source's binary log file of events that have already been executed



**Note**

If you downgrade a replica server to a version older than MySQL 5.6, the older server does not read the `relay-log.info` file correctly. To address this, modify the file in a text editor by deleting the initial line containing the number of lines.

The contents of the `relay-log.info` file and the states shown by the `SHOW SLAVE STATUS` statement might not match if the `relay-log.info` file has not been flushed to disk. Ideally, you should only view `relay-log.info` on a replica that is offline (that is, `mysqld` is not running). For a running system, you can use `SHOW SLAVE STATUS`, or query the `mysql.slave_master_info` and `mysql.slave_relay_log_info` tables if you are writing the replication metadata repositories to tables.

## 16.2.5 How Servers Evaluate Replication Filtering Rules

If a replication source server does not write a statement to its binary log, the statement is not replicated. If the server does log the statement, the statement is sent to all replicas and each replica determines whether to execute it or ignore it.

On the source, you can control which databases to log changes for by using the `--binlog-do-db` and `--binlog-ignore-db` options to control binary logging. For a description of the rules that servers use in evaluating these options, see [Section 16.2.5.1, “Evaluation of Database-Level Replication and Binary Logging Options”](#). You should not use these options to control which databases and tables are replicated. Instead, use filtering on the replica to control the events that are executed on the replica.

On the replica side, decisions about whether to execute or ignore statements received from the source are made according to the `--replicate-*` options that the replica was started with. (See [Section 16.1.6,](#)

“[Replication and Binary Logging Options and Variables](#)”.) The filters governed by these options can also be set dynamically using the `CHANGE REPLICATION FILTER` statement. The rules governing such filters are the same whether they are created on startup using `--replicate-*` options or while the replica server is running by `CHANGE REPLICATION FILTER`. Note that replication filters cannot be used on a MySQL server instance that is configured for Group Replication, because filtering transactions on some servers would make the group unable to reach agreement on a consistent state.

In the simplest case, when there are no `--replicate-*` options, the replica executes all statements that it receives from the source. Otherwise, the result depends on the particular options given.

Database-level options (`--replicate-do-db`, `--replicate-ignore-db`) are checked first; see [Section 16.2.5.1, “Evaluation of Database-Level Replication and Binary Logging Options”](#), for a description of this process. If no database-level options are used, option checking proceeds to any table-level options that may be in use (see [Section 16.2.5.2, “Evaluation of Table-Level Replication Options”](#), for a discussion of these). If one or more database-level options are used but none are matched, the statement is not replicated.

For statements affecting databases only (that is, `CREATE DATABASE`, `DROP DATABASE`, and `ALTER DATABASE`), database-level options always take precedence over any `--replicate-wild-do-table` options. In other words, for such statements, `--replicate-wild-do-table` options are checked if and only if there are no database-level options that apply. This is a change in behavior from previous versions of MySQL, where the statement `CREATE DATABASE dbx` was not replicated if the replica had been started with `--replicate-do-db=dbx --replicate-wild-do-table=db%.t1`. (Bug #46110)

To make it easier to determine what effect an option set has, it is recommended that you avoid mixing “do” and “ignore” options, or wildcard and nonwildcard options.

If any `--replicate-rewrite-db` options were specified, they are applied before the `--replicate-*` filtering rules are tested.



#### Note

All replication filtering options follow the same rules for case sensitivity that apply to names of databases and tables elsewhere in the MySQL server, including the effects of the `lower_case_table_names` system variable.

### 16.2.5.1 Evaluation of Database-Level Replication and Binary Logging Options

When evaluating replication options, the replica begins by checking to see whether there are any `--replicate-do-db` or `--replicate-ignore-db` options that apply. When using `--binlog-do-db` or `--binlog-ignore-db`, the process is similar, but the options are checked on the source.

The database that is checked for a match depends on the binary log format of the statement that is being handled. If the statement has been logged using the row format, the database where data is to be changed is the database that is checked. If the statement has been logged using the statement format, the default database (specified with a `USE` statement) is the database that is checked.



#### Note

Only DML statements can be logged using the row format. DDL statements are always logged as statements, even when `binlog_format=ROW`. All DDL statements are therefore always filtered according to the rules for statement-based replication. This means that you must select the default database explicitly with a `USE` statement in order for a DDL statement to be applied.

For replication, the steps involved are listed here:

1. Which logging format is used?

- **STATEMENT.** Test the default database.
  - **ROW.** Test the database affected by the changes.
2. Are there any `--replicate-do-db` options?
    - **Yes.** Does the database match any of them?
      - **Yes.** Continue to Step 4.
      - **No.** Ignore the update and exit.
    - **No.** Continue to step 3.
  3. Are there any `--replicate-ignore-db` options?
    - **Yes.** Does the database match any of them?
      - **Yes.** Ignore the update and exit.
      - **No.** Continue to step 4.
    - **No.** Continue to step 4.
  4. Proceed to checking the table-level replication options, if there are any. For a description of how these options are checked, see [Section 16.2.5.2, “Evaluation of Table-Level Replication Options”](#).



**Important**

A statement that is still permitted at this stage is not yet actually executed. The statement is not executed until all table-level options (if any) have also been checked, and the outcome of that process permits execution of the statement.

For binary logging, the steps involved are listed here:

1. Are there any `--binlog-do-db` or `--binlog-ignore-db` options?
  - **Yes.** Continue to step 2.
  - **No.** Log the statement and exit.
2. Is there a default database (has any database been selected by `USE`)?
  - **Yes.** Continue to step 3.
  - **No.** Ignore the statement and exit.
3. There is a default database. Are there any `--binlog-do-db` options?
  - **Yes.** Do any of them match the database?
    - **Yes.** Log the statement and exit.
    - **No.** Ignore the statement and exit.
  - **No.** Continue to step 4.
4. Do any of the `--binlog-ignore-db` options match the database?



- **Yes.** Ignore the statement and exit.
- **No.** Log the statement and exit.



### Important

For statement-based logging, an exception is made in the rules just given for the `CREATE DATABASE`, `ALTER DATABASE`, and `DROP DATABASE` statements. In those cases, the database being *created*, *altered*, or *dropped* replaces the default database when determining whether to log or ignore updates.

`--binlog-do-db` can sometimes mean “ignore other databases”. For example, when using statement-based logging, a server running with only `--binlog-do-db=sales` does not write to the binary log statements for which the default database differs from `sales`. When using row-based logging with the same option, the server logs only those updates that change data in `sales`.

## 16.2.5.2 Evaluation of Table-Level Replication Options

The replica checks for and evaluates table options only if either of the following two conditions is true:

- No matching database options were found.
- One or more database options were found, and were evaluated to arrive at an “execute” condition according to the rules described in the previous section (see [Section 16.2.5.1, “Evaluation of Database-Level Replication and Binary Logging Options”](#)).

First, as a preliminary condition, the replica checks whether statement-based replication is enabled. If so, and the statement occurs within a stored function, the replica executes the statement and exits. If row-based replication is enabled, the replica does not know whether a statement occurred within a stored function on the source, so this condition does not apply.



### Note

For statement-based replication, replication events represent statements (all changes making up a given event are associated with a single SQL statement); for row-based replication, each event represents a change in a single table row (thus a single statement such as `UPDATE mytable SET mycol = 1` may yield many row-based events). When viewed in terms of events, the process of checking table options is the same for both row-based and statement-based replication.

Having reached this point, if there are no table options, the replica simply executes all events. If there are any `--replicate-do-table` or `--replicate-wild-do-table` options, the event must match one of these if it is to be executed; otherwise, it is ignored. If there are any `--replicate-ignore-table` or `--replicate-wild-ignore-table` options, all events are executed except those that match any of these options.



### Important

Table-level replication filters are only applied to tables that are explicitly mentioned and operated on in the query. They do not apply to tables that are implicitly updated by the query. For example, a `GRANT` statement, which updates the `mysql.user` system table but does not mention that table, is not affected by a filter that specifies `mysql.%` as the wildcard pattern.

The following steps describe this evaluation in more detail. The starting point is the end of the evaluation of the database-level options, as described in [Section 16.2.5.1, “Evaluation of Database-Level Replication and Binary Logging Options”](#).

1. Are there any table replication options?
  - **Yes.** Continue to step 2.
  - **No.** Execute the update and exit.
2. Which logging format is used?
  - **STATEMENT.** Carry out the remaining steps for each statement that performs an update.
  - **ROW.** Carry out the remaining steps for each update of a table row.
3. Are there any `--replicate-do-table` options?
  - **Yes.** Does the table match any of them?
    - **Yes.** Execute the update and exit.
    - **No.** Continue to step 4.
  - **No.** Continue to step 4.
4. Are there any `--replicate-ignore-table` options?
  - **Yes.** Does the table match any of them?
    - **Yes.** Ignore the update and exit.
    - **No.** Continue to step 5.
  - **No.** Continue to step 5.
5. Are there any `--replicate-wild-do-table` options?
  - **Yes.** Does the table match any of them?
    - **Yes.** Execute the update and exit.
    - **No.** Continue to step 6.
  - **No.** Continue to step 6.
6. Are there any `--replicate-wild-ignore-table` options?
  - **Yes.** Does the table match any of them?
    - **Yes.** Ignore the update and exit.
    - **No.** Continue to step 7.
  - **No.** Continue to step 7.
7. Is there another table to be tested?
  - **Yes.** Go back to step 3.
  - **No.** Continue to step 8.
8. Are there any `--replicate-do-table` or `--replicate-wild-do-table` options?

- **Yes.** Ignore the update and exit.
- **No.** Execute the update and exit.



#### Note

Statement-based replication stops if a single SQL statement operates on both a table that is included by a `--replicate-do-table` or `--replicate-wild-do-table` option, and another table that is ignored by a `--replicate-ignore-table` or `--replicate-wild-ignore-table` option. The replica must either execute or ignore the complete statement (which forms a replication event), and it cannot logically do this. This also applies to row-based replication for DDL statements, because DDL statements are always logged as statements, without regard to the logging format in effect. The only type of statement that can update both an included and an ignored table and still be replicated successfully is a DML statement that has been logged with `binlog_format=ROW`.

### 16.2.5.3 Interactions Between Replication Filtering Options

If you use a combination of database-level and table-level replication filtering options, the replica first accepts or ignores events using the database options, then it evaluates all events permitted by those options according to the table options. This can sometimes lead to results that seem counterintuitive. It is also important to note that the results vary depending on whether the operation is logged using statement-based or row-based binary logging format. If you want to be sure that your replication filters always operate in the same way independently of the binary logging format, which is particularly important if you are using mixed binary logging format, follow the guidance in this topic.

The effect of the replication filtering options differs between binary logging formats because of the way the database name is identified. With statement-based format, DML statements are handled based on the current database, as specified by the `USE` statement. With row-based format, DML statements are handled based on the database where the modified table exists. DDL statements are always filtered based on the current database, as specified by the `USE` statement, regardless of the binary logging format.

An operation that involves multiple tables can also be affected differently by replication filtering options depending on the binary logging format. Operations to watch out for include transactions involving multi-table `UPDATE` statements, triggers, cascading foreign keys, stored functions that update multiple tables, and DML statements that invoke stored functions that update one or more tables. If these operations update both filtered-in and filtered-out tables, the results can vary with the binary logging format.

If you need to guarantee that your replication filters operate consistently regardless of the binary logging format, particularly if you are using mixed binary logging format (`binlog_format=MIXED`), use only table-level replication filtering options, and do not use database-level replication filtering options. Also, do not use multi-table DML statements that update both filtered-in and filtered-out tables.

If you need to use a combination of database-level and table-level replication filters, and want these to operate as consistently as possible, choose one of the following strategies:

1. If you use row-based binary logging format (`binlog_format=ROW`), for DDL statements, rely on the `USE` statement to set the database and do not specify the database name. You can consider changing to row-based binary logging format for improved consistency with replication filtering. See [Section 5.4.4.2, “Setting The Binary Log Format”](#) for the conditions that apply to changing the binary logging format.
2. If you use statement-based or mixed binary logging format (`binlog_format=STATEMENT` or `MIXED`), for both DML and DDL statements, rely on the `USE` statement and do not use the database name. Also, do not use multi-table DML statements that update both filtered-in and filtered-out tables.

**Example 16.7 A --replicate-ignore-db option and a --replicate-do-table option**

On the source, the following statements are issued:

```
USE db1;
CREATE TABLE t2 LIKE t1;
INSERT INTO db2.t3 VALUES (1);
```

The replica has the following replication filtering options set:

```
replicate-ignore-db = db1
replicate-do-table = db2.t3
```

The DDL statement `CREATE TABLE` creates the table in `db1`, as specified by the preceding `USE` statement. The replica filters out this statement according to its `--replicate-ignore-db = db1` option, because `db1` is the current database. This result is the same whatever the binary logging format is on the source. However, the result of the DML `INSERT` statement is different depending on the binary logging format:

- If row-based binary logging format is in use on the source (`binlog_format=ROW`), the replica evaluates the `INSERT` operation using the database where the table exists, which is named as `db2`. The database-level option `--replicate-ignore-db = db1`, which is evaluated first, therefore does not apply. The table-level option `--replicate-do-table = db2.t3` does apply, so the replica applies the change to table `t3`.
- If statement-based binary logging format is in use on the source (`binlog_format=STATEMENT`), the replica evaluates the `INSERT` operation using the default database, which was set by the `USE` statement to `db1` and has not been changed. According to its database-level `--replicate-ignore-db = db1` option, it therefore ignores the operation and does not apply the change to table `t3`. The table-level option `--replicate-do-table = db2.t3` is not checked, because the statement already matched a database-level option and was ignored.

If the `--replicate-ignore-db = db1` option on the replica is necessary, and the use of statement-based (or mixed) binary logging format on the source is also necessary, the results can be made consistent by omitting the database name from the `INSERT` statement and relying on a `USE` statement instead, as follows:

```
USE db1;
CREATE TABLE t2 LIKE t1;
USE db2;
INSERT INTO t3 VALUES (1);
```

In this case, the replica always evaluates the `INSERT` statement based on the database `db2`. Whether the operation is logged in statement-based or row-based binary format, the results remain the same.

## 16.3 Replication Solutions

Replication can be used in many different environments for a range of purposes. This section provides general notes and advice on using replication for specific solution types.

For information on using replication in a backup environment, including notes on the setup, backup procedure, and files to back up, see [Section 16.3.1, “Using Replication for Backups”](#).

For advice and tips on using different storage engines on the source and replicas, see [Section 16.3.3, “Using Replication with Different Source and Replica Storage Engines”](#).

Using replication as a scale-out solution requires some changes in the logic and operation of applications that use the solution. See [Section 16.3.4, “Using Replication for Scale-Out”](#).

For performance or data distribution reasons, you may want to replicate different databases to different replicas. See [Section 16.3.5, “Replicating Different Databases to Different Replicas”](#)

As the number of replicas increases, the load on the source can increase and lead to reduced performance (because of the need to replicate the binary log to each replica). For tips on improving your replication performance, including using a single secondary server as a replication source server, see [Section 16.3.6, “Improving Replication Performance”](#).

For guidance on switching sources, or converting replicas into sources as part of an emergency failover solution, see [Section 16.3.7, “Switching Sources During Failover”](#).

To secure your replication communication, you can encrypt the communication channel. For step-by-step instructions, see [Section 16.3.8, “Setting Up Replication to Use Encrypted Connections”](#).

## 16.3.1 Using Replication for Backups

To use replication as a backup solution, replicate data from the source to a replica, and then back up the replica. The replica can be paused and shut down without affecting the running operation of the source, so you can produce an effective snapshot of “live” data that would otherwise require the source to be shut down.

How you back up a database depends on its size and whether you are backing up only the data, or the data and the replica state so that you can rebuild the replica in the event of failure. There are therefore two choices:

- If you are using replication as a solution to enable you to back up the data on the source, and the size of your database is not too large, the `mysqldump` tool may be suitable. See [Section 16.3.1.1, “Backing Up a Replica Using mysqldump”](#).
- For larger databases, where `mysqldump` would be impractical or inefficient, you can back up the raw data files instead. Using the raw data files option also means that you can back up the binary and relay logs that enable you to re-create the replica in the event of a replica failure. For more information, see [Section 16.3.1.2, “Backing Up Raw Data from a Replica”](#).

Another backup strategy, which can be used for either source or replica servers, is to put the server in a read-only state. The backup is performed against the read-only server, which then is changed back to its usual read/write operational status. See [Section 16.3.1.3, “Backing Up a Source or Replica by Making It Read Only”](#).

### 16.3.1.1 Backing Up a Replica Using mysqldump

Using `mysqldump` to create a copy of a database enables you to capture all of the data in the database in a format that enables the information to be imported into another instance of MySQL Server (see [Section 4.5.4, “mysqldump — A Database Backup Program”](#)). Because the format of the information is SQL statements, the file can easily be distributed and applied to running servers in the event that you need access to the data in an emergency. However, if the size of your data set is very large, `mysqldump` may be impractical.

When using `mysqldump`, you should stop replication on the replica before starting the dump process to ensure that the dump contains a consistent set of data:

1. Stop the replica from processing requests. You can stop replication completely on the replica using `mysqladmin`:

```
$> mysqladmin stop-slave
```

Alternatively, you can stop only the replication SQL thread to pause event execution:

```
$> mysql -e 'STOP SLAVE SQL_THREAD;'
```

This enables the replica to continue to receive data change events from the source's binary log and store them in the relay logs using the I/O thread, but prevents the replica from executing these events and changing its data. Within busy replication environments, permitting the I/O thread to run during backup may speed up the catch-up process when you restart the replication SQL thread.

2. Run `mysqldump` to dump your databases. You may either dump all databases or select databases to be dumped. For example, to dump all databases:

```
$> mysqldump --all-databases > fulldb.dump
```

3. Once the dump has completed, start replica operations again:

```
$> mysqladmin start-slave
```

In the preceding example, you may want to add login credentials (user name, password) to the commands, and bundle the process up into a script that you can run automatically each day.

If you use this approach, make sure you monitor the replication process to ensure that the time taken to run the backup does not affect the replica's ability to keep up with events from the source. See [Section 16.1.7.1, "Checking Replication Status"](#). If the replica is unable to keep up, you may want to add another replica and distribute the backup process. For an example of how to configure this scenario, see [Section 16.3.5, "Replicating Different Databases to Different Replicas"](#).

### 16.3.1.2 Backing Up Raw Data from a Replica

To guarantee the integrity of the files that are copied, backing up the raw data files on your MySQL replica should take place while your replica server is shut down. If the MySQL server is still running, background tasks may still be updating the database files, particularly those involving storage engines with background processes such as `InnoDB`. With `InnoDB`, these problems should be resolved during crash recovery, but since the replica server can be shut down during the backup process without affecting the execution of the source it makes sense to take advantage of this capability.

To shut down the server and back up the files:

1. Shut down the replica MySQL server:

```
$> mysqladmin shutdown
```

2. Copy the data files. You can use any suitable copying or archive utility, including `cp`, `tar` or `WinZip`. For example, assuming that the data directory is located under the current directory, you can archive the entire directory as follows:

```
$> tar cf /tmp/dbbackup.tar ./data
```

3. Start the MySQL server again. Under Unix:

```
$> mysqld_safe &
```

Under Windows:

```
C:\> "C:\Program Files\MySQL\MySQL Server 5.7\bin\mysqld"
```

Normally you should back up the entire data directory for the replica MySQL server. If you want to be able to restore the data and operate as a replica (for example, in the event of failure of the replica), then in addition to the replica's data, you should also back up the replica status files, the replication metadata repositories, and the relay log files. These files are needed to resume replication after you restore the replica's data.

If you lose the relay logs but still have the `relay-log.info` file, you can check it to determine how far the replication SQL thread has executed in the source's binary logs. Then you can use `CHANGE MASTER TO` with the `MASTER_LOG_FILE` and `MASTER_LOG_POS` options to tell the replica to re-read the binary logs from that point. This requires that the binary logs still exist on the source server.

If your replica is replicating `LOAD DATA` statements, you should also back up any `SQL_LOAD-*` files that exist in the directory that the replica uses for this purpose. The replica needs these files to resume replication of any interrupted `LOAD DATA` operations. The location of this directory is the value of the `slave_load_tmpdir` system variable. If the server was not started with that variable set, the directory location is the value of the `tmpdir` system variable.

### 16.3.1.3 Backing Up a Source or Replica by Making It Read Only

It is possible to back up either source or replica servers in a replication setup by acquiring a global read lock and manipulating the `read_only` system variable to change the read-only state of the server to be backed up:

1. Make the server read-only, so that it processes only retrievals and blocks updates.
2. Perform the backup.
3. Change the server back to its normal read/write state.



#### Note

The instructions in this section place the server to be backed up in a state that is safe for backup methods that get the data from the server, such as `mysqldump` (see [Section 4.5.4, “mysqldump — A Database Backup Program”](#)). You should not attempt to use these instructions to make a binary backup by copying files directly because the server may still have modified data cached in memory and not flushed to disk.

The following instructions describe how to do this for a source server and for a replica server. For both scenarios discussed here, suppose that you have the following replication setup:

- A source server S1
- A replica server R1 that has S1 as its source
- A client C1 connected to S1
- A client C2 connected to R1

In either scenario, the statements to acquire the global read lock and manipulate the `read_only` variable are performed on the server to be backed up and do not propagate to any replicas of that server.

#### Scenario 1: Backup with a Read-Only Source

Put the source S1 in a read-only state by executing these statements on it:

```
mysql> FLUSH TABLES WITH READ LOCK;
mysql> SET GLOBAL read_only = ON;
```

While S1 is in a read-only state, the following properties are true:

- Requests for updates sent by C1 to S1 block because the server is in read-only mode.
- Requests for query results sent by C1 to S1 succeed.
- Making a backup on S1 is safe.

- Making a backup on R1 is not safe. This server is still running, and might be processing the binary log or update requests coming from client C2

While S1 is read only, perform the backup. For example, you can use `mysqldump`.

After the backup operation on S1 completes, restore S1 to its normal operational state by executing these statements:

```
mysql> SET GLOBAL read_only = OFF;
mysql> UNLOCK TABLES;
```

Although performing the backup on S1 is safe (as far as the backup is concerned), it is not optimal for performance because clients of S1 are blocked from executing updates.

This strategy applies to backing up a source server in a replication setup, but can also be used for a single server in a nonreplication setting.

### Scenario 2: Backup with a Read-Only Replica

Put the replica R1 in a read-only state by executing these statements on it:

```
mysql> FLUSH TABLES WITH READ LOCK;
mysql> SET GLOBAL read_only = ON;
```

While R1 is in a read-only state, the following properties are true:

- The source S1 continues to operate, so making a backup on the source is not safe.
- The replica R1 is stopped, so making a backup on the replica R1 is safe.

These properties provide the basis for a popular backup scenario: Having one replica busy performing a backup for a while is not a problem because it does not affect the entire network, and the system is still running during the backup. In particular, clients can still perform updates on the source server, which remains unaffected by backup activity on the replica.

While R1 is read only, perform the backup. For example, you can use `mysqldump`.

After the backup operation on R1 completes, restore R1 to its normal operational state by executing these statements:

```
mysql> SET GLOBAL read_only = OFF;
mysql> UNLOCK TABLES;
```

After the replica is restored to normal operation, it again synchronizes to the source by catching up with any outstanding updates from the binary log of the source.

## 16.3.2 Handling an Unexpected Halt of a Replica

In order for replication to be resilient to unexpected halts of the server (sometimes described as crash-safe) it must be possible for the replica to recover its state before halting. This section describes the impact of an unexpected halt of a replica during replication, and how to configure a replica for the best chance of recovery to continue replication.

After an unexpected halt of a replica, upon restart the replication SQL thread must recover information about which transactions have been executed already. The information required for recovery is stored in the replica's applier metadata repository. In older MySQL Server versions, this repository could only be created as a file in the data directory that was updated after the transaction had been applied. In MySQL 5.7 you can instead use an InnoDB table named `mysql.slave_relay_log_info` to store the applier metadata repository. As a table, updates to the applier metadata repository are committed together with



the transactions, meaning that the replica's progress information recorded in that repository is always consistent with what has been applied to the database, even in the event of an unexpected server halt. To configure MySQL 5.7 to store the applier metadata repository as an `InnoDB` table, set the system variable `relay_log_info_repository` to `TABLE`. For more information on the applier metadata repository, see [Section 16.2.4, “Relay Log and Replication Metadata Repositories”](#).

The recovery process by which a replica recovers from an unexpected halt varies depending on the configuration of the replica. The details of the recovery process are influenced by the chosen method of replication, whether the replica is single-threaded or multithreaded, and the setting of relevant system variables. The overall aim of the recovery process is to identify what transactions had already been applied on the replica's database before the unexpected halt occurred, and retrieve and apply the transactions that the replica missed following the unexpected halt.

- For GTID-based replication, the recovery process needs the GTIDs of the transactions that were already received or committed by the replica. The missing transactions can be retrieved from the source using GTID auto-positioning, which automatically compares the source's transactions to the replica's transactions and identifies the missing transactions.
- For file position based replication, the recovery process needs an accurate replication SQL thread (applier) position showing the last transaction that was applied on the replica. Based on that position, the replication I/O thread (receiver) retrieves from the source's binary log all of the transactions that should be applied on the replica from that point on.

Using GTID-based replication makes it easiest to configure replication to be resilient to unexpected halts. GTID auto-positioning means the replica can reliably identify and retrieve missing transactions, even if there are gaps in the sequence of applied transactions.

The following information provides combinations of settings that are appropriate for different types of replica to guarantee recovery as far as this is under the control of replication.



### Important

Some factors outside the control of replication can have an impact on the replication recovery process and the overall state of replication after the recovery process. In particular, the settings that influence the recovery process for individual storage engines might result in transactions being lost in the event of an unexpected halt of a replica, and therefore unavailable to the replication recovery process. The `innodb_flush_log_at_trx_commit=1` setting mentioned in the list below is a key setting for a replication setup that uses `InnoDB` with transactions. However, other settings specific to `InnoDB` or to other storage engines, especially those relating to flushing or synchronization, can also have an impact. Always check for and apply recommendations made by your chosen storage engines about crash-safe settings.

The following combination of settings on a replica is the most resilient to unexpected halts:

- When GTID-based replication is in use (`gtid_mode=ON`), set `MASTER_AUTO_POSITION=1`, which activates GTID auto-positioning for the connection to the source to automatically identify and retrieve missing transactions. This option is set using a `CHANGE MASTER TO` statement. If the replica has multiple replication channels, you need to set this option for each channel individually. For details of how GTID auto-positioning works, see [Section 16.1.3.3, “GTID Auto-Positioning”](#). When file position based replication is in use, `MASTER_AUTO_POSITION=1` is not used, and instead the binary log position or relay log position is used to control where replication starts.
- Set `sync_relay_log=1`, which instructs the replication I/O thread to synchronize the relay log to disk after each received transaction is written to it. This means the replica's record of the current position

read from the source's binary log (in the source metadata repository) is never ahead of the record of transactions saved in the relay log. Note that although this setting is the safest, it is also the slowest due to the number of disk writes involved. With `sync_relay_log > 1`, or `sync_relay_log=0` (where synchronization is handled by the operating system), in the event of an unexpected halt of a replica there might be committed transactions that have not been synchronized to disk. Such transactions can cause the recovery process to fail if the recovering replica, based on the information it has in the relay log as last synchronized to disk, tries to retrieve and apply the transactions again instead of skipping them. Setting `sync_relay_log=1` is particularly important for a multi-threaded replica, where the recovery process fails if gaps in the sequence of transactions cannot be filled using the information in the relay log. For a single-threaded replica, the recovery process only needs to use the relay log if the relevant information is not available in the applier metadata repository.

- Set `innodb_flush_log_at_trx_commit=1`, which synchronizes the InnoDB logs to disk before each transaction is committed. This setting, which is the default, ensures that InnoDB tables and the InnoDB logs are saved on disk so that there is no longer a requirement for the information in the relay log regarding the transaction. Combined with the setting `sync_relay_log=1`, this setting further ensures that the content of the InnoDB tables and the InnoDB logs is consistent with the content of the relay log at all times, so that purging the relay log files cannot cause unfillable gaps in the replica's history of transactions in the event of an unexpected halt.
- Set `relay_log_info_repository = TABLE`, which stores the replication SQL thread position in the InnoDB table `mysql.slave_relay_log_info`, and updates it together with the transaction commit to ensure a record that is always accurate. This setting is *not* the default in MySQL 5.7. If the default `FILE` setting is used, the information is stored in a file in the data directory that is updated after the transaction has been applied. This creates a risk of losing synchrony with the source depending at which stage of processing a transaction the replica halts at, or even corruption of the file itself. With the setting `relay_log_info_repository = FILE`, recovery is not guaranteed.
- Set `relay_log_recovery = ON`, which enables automatic relay log recovery immediately following server startup. This global variable defaults to `OFF` and is read-only at runtime, but you can set it to `ON` with the `--relay-log-recovery` option at replica startup following an unexpected halt of a replica. Note that this setting ignores the existing relay log files, in case they are corrupted or inconsistent. The relay log recovery process starts a new relay log file and fetches transactions from the source beginning at the replication SQL thread position recorded in the applier metadata repository. The previous relay log files are removed over time by the replica's normal purge mechanism.

For a multithreaded replica, from MySQL 5.7.13, setting `relay_log_recovery = ON` automatically handles any inconsistencies and gaps in the sequence of transactions that have been executed from the relay log. These gaps can occur when file position based replication is in use. (For more details, see [Section 16.4.1.32, “Replication and Transaction Inconsistencies”](#).) The relay log recovery process deals with gaps using the same method as the `START SLAVE UNTIL SQL_AFTER_MTS_GAPS` statement would. When the replica reaches a consistent gap-free state, the relay log recovery process goes on to fetch further transactions from the source beginning at the replication SQL thread position. In MySQL versions prior to MySQL 5.7.13, this process was not automatic and required starting the server with `relay_log_recovery = OFF`, starting the replica with `START SLAVE UNTIL SQL_AFTER_MTS_GAPS` to fix any transaction inconsistencies, and then restarting the replica with `relay_log_recovery = ON`. When GTID-based replication is in use, from MySQL 5.7.28 a multithreaded replica checks first whether `MASTER_AUTO_POSITION` is set to `ON`, and if it is, omits the step of calculating the transactions that should be skipped or not skipped, so that the old relay logs are not required for the recovery process.

### 16.3.3 Using Replication with Different Source and Replica Storage Engines

It does not matter for the replication process whether the source table on the source and the replicated table on the replica use different engine types. In fact, the `default_storage_engine` system variable is not replicated.

This provides a number of benefits in the replication process in that you can take advantage of different engine types for different replication scenarios. For example, in a typical scale-out scenario (see [Section 16.3.4, “Using Replication for Scale-Out”](#)), you want to use [InnoDB](#) tables on the source to take advantage of the transactional functionality, but use [MyISAM](#) on the replicas where transaction support is not required because the data is only read. When using replication in a data-logging environment you may want to use the [Archive](#) storage engine on the replica.

Configuring different engines on the source and replica depends on how you set up the initial replication process:

- If you used `mysqldump` to create the database snapshot on your source, you could edit the dump file text to change the engine type used on each table.

Another alternative for `mysqldump` is to disable engine types that you do not want to use on the replica before using the dump to build the data on the replica. For example, you can add the `--skip-federated` option on your replica to disable the `FEDERATED` engine. If a specific engine does not exist for a table to be created, MySQL uses the default engine type, usually `MyISAM`. (This requires that the `NO_ENGINE_SUBSTITUTION` SQL mode is not enabled.) If you want to disable additional engines in this way, you may want to consider building a special binary to be used on the replica that supports only the engines you want.

- If you are using raw data files (a binary backup) to set up the replica, you cannot change the initial table format. Instead, use `ALTER TABLE` to change the table types after the replica has been started.
- For new source/replica replication setups where there are currently no tables on the source, avoid specifying the engine type when creating new tables.

If you are already running a replication solution and want to convert your existing tables to another engine type, follow these steps:

1. Stop the replica from running replication updates:

```
mysql> STOP SLAVE;
```

This enables you to change engine types without interruptions.

2. Execute an `ALTER TABLE ... ENGINE='engine_type'` for each table to be changed.
3. Start the replication process again:

```
mysql> START SLAVE;
```

Although the `default_storage_engine` variable is not replicated, be aware that `CREATE TABLE` and `ALTER TABLE` statements that include the engine specification are correctly replicated to the replica. For example, if you have a CSV table and you execute:

```
mysql> ALTER TABLE csvtable Engine='MyISAM';
```

The previous statement is replicated to the replica and the engine type on the replica is converted to `MyISAM`, even if you have previously changed the table type on the replica to an engine other than CSV. If you want to retain engine differences on the source and replica, you should be careful to use the `default_storage_engine` variable on the source when creating a new table. For example, instead of:

```
mysql> CREATE TABLE tablea (columna int) Engine=MyISAM;
```

Use this format:

```
mysql> SET default_storage_engine=MyISAM;
mysql> CREATE TABLE tablea (columna int);
```

When replicated, the `default_storage_engine` variable will be ignored, and the `CREATE TABLE` statement executes on the replica using the replica's default engine.

### 16.3.4 Using Replication for Scale-Out

You can use replication as a scale-out solution; that is, where you want to split up the load of database queries across multiple database servers, within some reasonable limitations.

Because replication works from the distribution of one source to one or more replicas, using replication for scale-out works best in an environment where you have a high number of reads and low number of writes/updates. Most websites fit into this category, where users are browsing the website, reading articles, posts, or viewing products. Updates only occur during session management, or when making a purchase or adding a comment/message to a forum.

Replication in this situation enables you to distribute the reads over the replicas, while still enabling your web servers to communicate with the source when a write is required. You can see a sample replication layout for this scenario in [Figure 16.1, “Using Replication to Improve Performance During Scale-Out”](#).

**Figure 16.1 Using Replication to Improve Performance During Scale-Out**

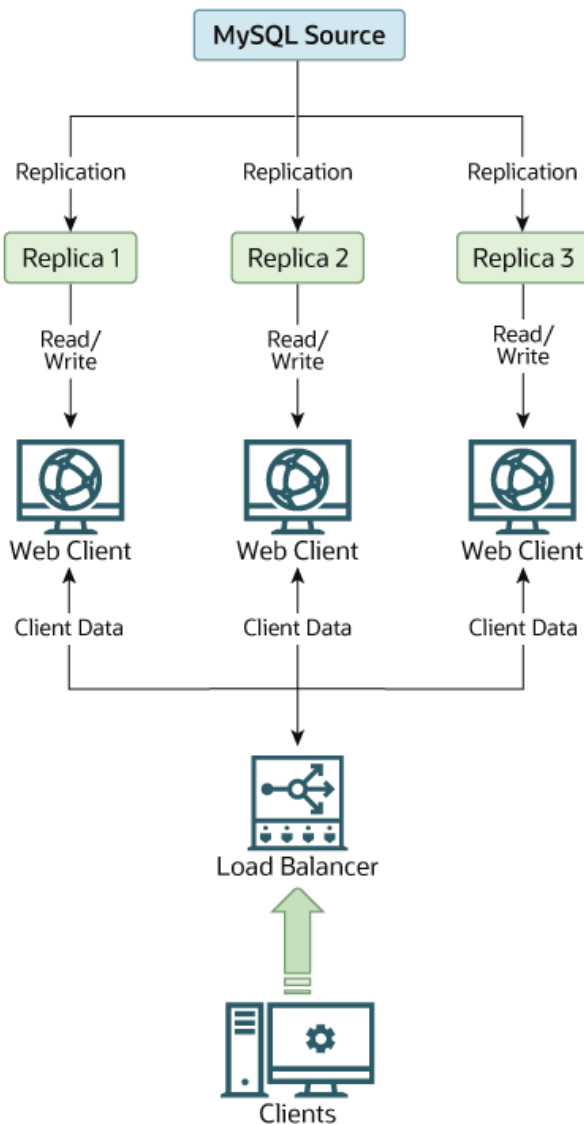

If the part of your code that is responsible for database access has been properly abstracted/modularized, converting it to run with a replicated setup should be very smooth and easy. Change the implementation of your database access to send all writes to the source, and to send reads to either the source or a replica. If your code does not have this level of abstraction, setting up a replicated system gives you the opportunity and motivation to clean it up. Start by creating a wrapper library or module that implements the following functions:

- `safe_writer_connect()`
- `safe_reader_connect()`
- `safe_reader_statement()`
- `safe_writer_statement()`

`safe_` in each function name means that the function takes care of handling all error conditions. You can use different names for the functions. The important thing is to have a unified interface for connecting for reads, connecting for writes, doing a read, and doing a write.

Then convert your client code to use the wrapper library. This may be a painful and scary process at first, but it pays off in the long run. All applications that use the approach just described are able to take advantage of a source/replica configuration, even one involving multiple replicas. The code is much easier to maintain, and adding troubleshooting options is trivial. You need modify only one or two functions (for example, to log how long each statement took, or which statement among those issued gave you an error).

If you have written a lot of code, you may want to automate the conversion task by using the `replace` utility that comes with standard MySQL distributions, or write your own conversion script. Ideally, your code uses consistent programming style conventions. If not, then you are probably better off rewriting it anyway, or at least going through and manually regularizing it to use a consistent style.

### 16.3.5 Replicating Different Databases to Different Replicas

There may be situations where you have a single source and want to replicate different databases to different replicas. For example, you may want to distribute different sales data to different departments to help spread the load during data analysis. A sample of this layout is shown in [Figure 16.2, “Replicating Databases to Separate Replicas”](#).

**Figure 16.2 Replicating Databases to Separate Replicas**

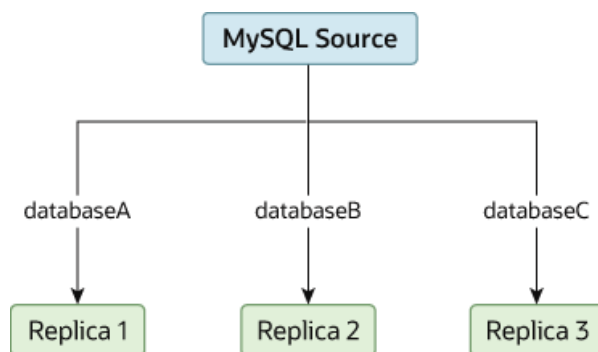

You can achieve this separation by configuring the source and replicas as normal, and then limiting the binary log statements that each replica processes by using the `--replicate-wild-do-table` configuration option on each replica.

**Important**

You should *not* use `--replicate-do-db` for this purpose when using statement-based replication, since statement-based replication causes this option's effects to vary according to the database that is currently selected. This applies to mixed-format replication as well, since this enables some updates to be replicated using the statement-based format.

However, it should be safe to use `--replicate-do-db` for this purpose if you are using row-based replication only, since in this case the currently selected database has no effect on the option's operation.

For example, to support the separation as shown in [Figure 16.2, “Replicating Databases to Separate Replicas”](#), you should configure each replica as follows, before executing `START SLAVE`:

- Replica 1 should use `--replicate-wild-do-table=databaseA.%`.
- Replica 2 should use `--replicate-wild-do-table=databaseB.%`.
- Replica 3 should use `--replicate-wild-do-table=databaseC.%`.

Each replica in this configuration receives the entire binary log from the source, but executes only those events from the binary log that apply to the databases and tables included by the `--replicate-wild-do-table` option in effect on that replica.

If you have data that must be synchronized to the replicas before replication starts, you have a number of choices:

- Synchronize all the data to each replica, and delete the databases, tables, or both that you do not want to keep.
- Use `mysqldump` to create a separate dump file for each database and load the appropriate dump file on each replica.
- Use a raw data file dump and include only the specific files and databases that you need for each replica.

**Note**

This does not work with `InnoDB` databases unless you use `innodb_file_per_table`.

## 16.3.6 Improving Replication Performance

As the number of replicas connecting to a source increases, the load, although minimal, also increases, as each replica uses a client connection to the source. Also, as each replica must receive a full copy of the source's binary log, the network load on the source may also increase and create a bottleneck.

If you are using a large number of replicas connected to one source, and that source is also busy processing requests (for example, as part of a scale-out solution), then you may want to improve the performance of the replication process.

One way to improve the performance of the replication process is to create a deeper replication structure that enables the source to replicate to only one replica, and for the remaining replicas to connect to this primary replica for their individual replication requirements. A sample of this structure is shown in [Figure 16.3, “Using an Additional Replication Source to Improve Performance”](#).

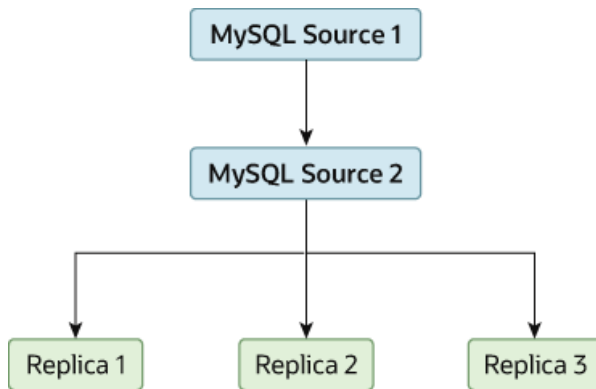
**Figure 16.3 Using an Additional Replication Source to Improve Performance**

For this to work, you must configure the MySQL instances as follows:

- Source 1 is the primary source where all changes and updates are written to the database. Binary logging should be enabled on this machine.
- Source 2 is the replica of Source 1 that provides the replication functionality to the remainder of the replicas in the replication structure. Source 2 is the only machine permitted to connect to Source 1. Source 2 also has binary logging enabled, and the `log_slave_updates` system variable enabled so that replication instructions from Source 1 are also written to Source 2's binary log so that they can then be replicated to the true replicas.
- Replica 1, Replica 2, and Replica 3 act as replicas to Source 2, and replicate the information from Source 2, which actually consists of the upgrades logged on Source 1.

The above solution reduces the client load and the network interface load on the primary source, which should improve the overall performance of the primary source when used as a direct database solution.

If your replicas are having trouble keeping up with the replication process on the source, there are a number of options available:

- If possible, put the relay logs and the data files on different physical drives. To do this, set the `relay_log` system variable to specify the location of the relay log.
- If the replicas are significantly slower than the source, you may want to divide up the responsibility for replicating different databases to different replicas. See [Section 16.3.5, “Replicating Different Databases to Different Replicas”](#).
- If your source makes use of transactions and you are not concerned about transaction support on your replicas, use `MyISAM` or another nontransactional engine on the replicas. See [Section 16.3.3, “Using Replication with Different Source and Replica Storage Engines”](#).
- If your replicas are not acting as sources, and you have a potential solution in place to ensure that you can bring up a source in the event of failure, then you can disable the `log_slave_updates` system variable on the replicas. This prevents “dumb” replicas from also logging events they have executed into their own binary log.

### 16.3.7 Switching Sources During Failover

You can tell a replica to change to a new source using the `CHANGE MASTER TO` statement. The replica does not check whether the databases on the source are compatible with those on the replica; it simply begins reading and executing events from the specified coordinates in the new source's binary log. In a failover situation, all the servers in the group are typically executing the same events from the same binary

log file, so changing the source of the events should not affect the structure or integrity of the database, provided that you exercise care in making the change.

Replicas should be run with binary logging enabled (the `--log-bin` option), which is the default. If you are not using GTIDs for replication, then the replicas should also be run with `--log-slave-updates=OFF` (logging replica updates is the default). In this way, the replica is ready to become a source without restarting the replica `mysqld`. Assume that you have the structure shown in [Figure 16.4, “Redundancy Using Replication, Initial Structure”](#).

**Figure 16.4 Redundancy Using Replication, Initial Structure**

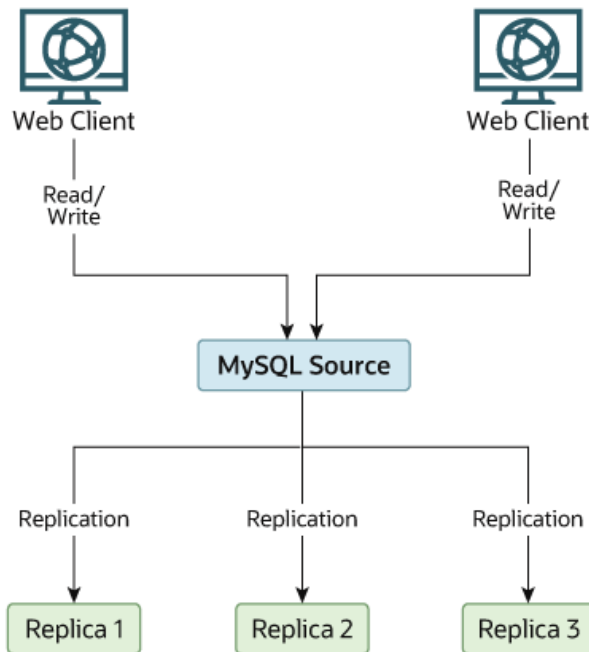

In this diagram, the [Source](#) holds the source database, the [Replica\\*](#) hosts are replicas, and the [Web Client](#) machines are issuing database reads and writes. Web clients that issue only reads (and would normally be connected to the replicas) are not shown, as they do not need to switch to a new server in the event of failure. For a more detailed example of a read/write scale-out replication structure, see [Section 16.3.4, “Using Replication for Scale-Out”](#).

Each MySQL replica ([Replica 1](#), [Replica 2](#), and [Replica 3](#)) is a replica running with binary logging enabled, and with `--log-slave-updates=OFF`. Because updates received by a replica from the source are not written to the binary log when `--log-slave-updates=OFF` is specified, the binary log on each replica is initially empty. If for some reason [Source](#) becomes unavailable, you can pick one of the replicas to become the new source. For example, if you pick [Replica 1](#), all [Web Clients](#) should be redirected to [Replica 1](#), which writes the updates to its binary log. [Replica 2](#) and [Replica 3](#) should then replicate from [Replica 1](#).

The reason for running the replica with `--log-slave-updates=OFF` is to prevent replicas from receiving updates twice in case you cause one of the replicas to become the new source. If [Replica 1](#) has `--log-slave-updates` enabled, which is the default, it writes any updates that it receives from [Source](#) in its own binary log. This means that, when [Replica 2](#) changes from [Source](#) to [Replica 1](#) as its source, it may receive updates from [Replica 1](#) that it has already received from [Source](#).

Make sure that all replicas have processed any statements in their relay log. On each replica, issue `STOP SLAVE IO_THREAD`, then check the output of `SHOW PROCESSLIST` until you see `Has read all relay log`. When this is true for all replicas, they can be reconfigured to the new setup. On the replica [Replica 1](#) being promoted to become the source, issue `STOP SLAVE` and `RESET MASTER`.



On the other replicas `Replica 2` and `Replica 3`, use `STOP SLAVE` and `CHANGE MASTER TO MASTER_HOST='Replica1'` (where `'Replica1'` represents the real host name of `Replica 1`). To use `CHANGE MASTER TO`, add all information about how to connect to `Replica 1` from `Replica 2` or `Replica 3` (`user`, `password`, `port`). When issuing the statement in this scenario, there is no need to specify the name of the `Replica 1` binary log file or log position to read from, since the first binary log file and position 4 are the defaults. Finally, execute `START SLAVE` on `Replica 2` and `Replica 3`.

Once the new replication setup is in place, you need to tell each `Web Client` to direct its statements to `Replica 1`. From that point on, all updates sent by `Web Client` to `Replica 1` are written to the binary log of `Replica 1`, which then contains every update sent to `Replica 1` since `Source` became unavailable.

The resulting server structure is shown in [Figure 16.5, “Redundancy Using Replication, After Source Failure”](#).

**Figure 16.5 Redundancy Using Replication, After Source Failure**

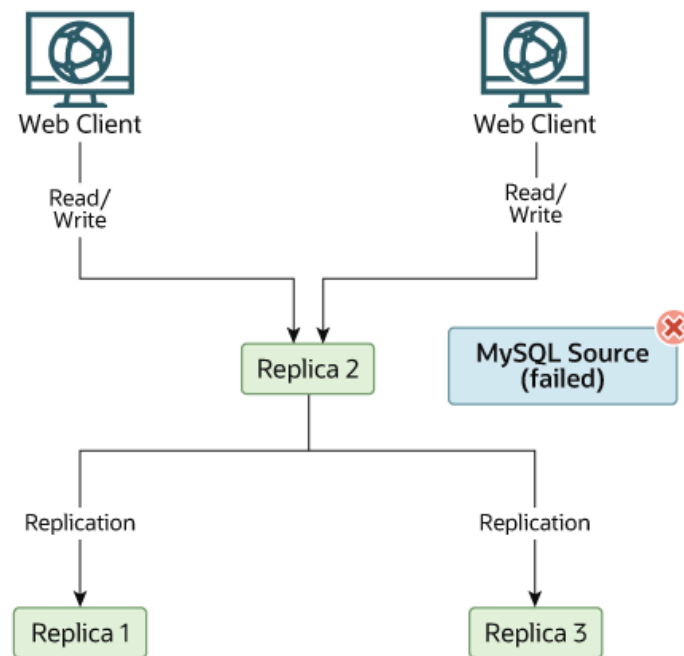

When `Source` becomes available again, you should make it a replica of `Replica 1`. To do this, issue on `Source` the same `CHANGE MASTER TO` statement as that issued on `Replica 2` and `Replica 3` previously. `Source` then becomes a replica of `Replica 1` and picks up the `Web Client` writes that it missed while it was offline.

To make `Source` a source again, use the preceding procedure as if `Replica 1` were unavailable and `Source` were to be the new source. During this procedure, do not forget to run `RESET MASTER` on `Source` before making `Replica 1`, `Replica 2`, and `Replica 3` replicas of `Source`. If you fail to do this, the replicas may pick up stale writes from the `Web Client` applications dating from before the point at which `Source` became unavailable.

You should be aware that there is no synchronization between replicas, even when they share the same source, and thus some replicas might be considerably ahead of others. This means that in some cases the procedure outlined in the previous example might not work as expected. In practice, however, relay logs on all replicas should be relatively close together.

One way to keep applications informed about the location of the source is to have a dynamic DNS entry for the source host. With `BIND`, you can use `nsupdate` to update the DNS dynamically.

## 16.3.8 Setting Up Replication to Use Encrypted Connections

To use an encrypted connection for the transfer of the binary log required during replication, both the source and the replica servers must support encrypted network connections. If either server does not support encrypted connections (because it has not been compiled or configured for them), replication through an encrypted connection is not possible.

Setting up encrypted connections for replication is similar to doing so for client/server connections. You must obtain (or create) a suitable security certificate that you can use on the source, and a similar certificate (from the same certificate authority) on each replica. You must also obtain suitable key files.

For more information on setting up a server and client for encrypted connections, see [Section 6.3.1, “Configuring MySQL to Use Encrypted Connections”](#).

To enable encrypted connections on the source, you must create or obtain suitable certificate and key files, and then add the following configuration parameters to the source's configuration within the `[mysqld]` section of the source's `my.cnf` file, changing the file names as necessary:

```
[mysqld]
ssl_ca=cacert.pem
ssl_cert=server-cert.pem
ssl_key=server-key.pem
```

The paths to the files may be relative or absolute; we recommend that you always use complete paths for this purpose.

The configuration parameters are as follows:

- `ssl_ca`: The path name of the Certificate Authority (CA) certificate file. (`--ssl-capath` is similar but specifies the path name of a directory of CA certificate files.)
- `ssl_cert`: The path name of the server public key certificate file. This certificate can be sent to the client and authenticated against the CA certificate that it has.
- `ssl_key`: The path name of the server private key file.

To enable encrypted connections on the replica, use the `CHANGE MASTER TO` statement.

- To name the replica's certificate and SSL private key files using `CHANGE MASTER TO`, add the appropriate `MASTER_SSL_XXX` options, like this:

```
-> MASTER_SSL_CA = 'ca_file_name',
-> MASTER_SSL_CAPATH = 'ca_directory_name',
-> MASTER_SSL_CERT = 'cert_file_name',
-> MASTER_SSL_KEY = 'key_file_name',
```

These options correspond to the `--ssl-xxx` options with the same names, as described in [Command Options for Encrypted Connections](#). For these options to take effect, `MASTER_SSL=1` must also be set. For a replication connection, specifying a value for either of `MASTER_SSL_CA` or `MASTER_SSL_CAPATH` corresponds to setting `--ssl-mode=VERIFY_CA`. The connection attempt succeeds only if a valid matching Certificate Authority (CA) certificate is found using the specified information.

- To activate host name identity verification, add the `MASTER_SSL_VERIFY_SERVER_CERT` option:

```
-> MASTER_SSL_VERIFY_SERVER_CERT=1,
```

This option corresponds to the `--ssl-verify-server-cert` option, which is deprecated as of MySQL 5.7.11 and removed in MySQL 8.0. For a replication connection, specifying `MASTER_SSL_VERIFY_SERVER_CERT=1` corresponds to setting `--ssl-mode=VERIFY_IDENTITY`,

as described in [Command Options for Encrypted Connections](#). For this option to take effect, `MASTER_SSL=1` must also be set. Host name identity verification does not work with self-signed certificates.

- To activate certificate revocation list (CRL) checks, add the `MASTER_SSL_CRL` or `MASTER_SSL_CRLPATH` option, as shown here:

```
-> MASTER_SSL_CRL = 'crl_file_name',
-> MASTER_SSL_CRLPATH = 'crl_directory_name',
```

These options correspond to the `--ssl-xxx` options with the same names, as described in [Command Options for Encrypted Connections](#). If they are not specified, no CRL checking takes place.

- To specify lists of ciphers and encryption protocols permitted by the replica for the replication connection, add the `MASTER_SSL_CIPHER` and `MASTER_TLS_VERSION` options, like this:

```
-> MASTER_SSL_CIPHER = 'cipher_list',
-> MASTER_TLS_VERSION = 'protocol_list',
-> SOURCE_TLS_CIPHERSUITES = 'ciphersuite_list',
```

The `MASTER_SSL_CIPHER` option specifies the list of ciphers permitted by the replica for the replication connection, with one or more cipher names separated by colons. The `MASTER_TLS_VERSION` option specifies the encryption protocols permitted by the replica for the replication connection. The format is like that for the `tls_version` system variable, with one or more comma-separated protocol versions. The protocols and ciphers that you can use in these lists depend on the SSL library used to compile MySQL. For information about the formats and permitted values, see [Section 6.3.2, “Encrypted Connection TLS Protocols and Ciphers”](#).

- After the source information has been updated, start the replication process on the replica, like this:

```
mysql> START SLAVE;
```

You can use the `SHOW SLAVE STATUS` statement to confirm that an encrypted connection was established successfully.

- Requiring encrypted connections on the replica does not ensure that the source requires encrypted connections from replicas. If you want to ensure that the source only accepts replicas that connect using encrypted connections, create a replication user account on the source using the `REQUIRE SSL` option, then grant that user the `REPLICATION SLAVE` privilege. For example:

```
mysql> CREATE USER 'repl'@'%.example.com' IDENTIFIED BY 'password'
-> REQUIRE SSL;
mysql> GRANT REPLICATION SLAVE ON *.*
-> TO 'repl'@'%.example.com';
```

If you have an existing replication user account on the source, you can add `REQUIRE SSL` to it with this statement:

```
mysql> ALTER USER 'repl'@'%.example.com' REQUIRE SSL;
```

## 16.3.9 Semisynchronous Replication

In addition to the built-in asynchronous replication, MySQL 5.7 supports an interface to semisynchronous replication that is implemented by plugins. This section discusses what semisynchronous replication is and how it works. The following sections cover the administrative interface to semisynchronous replication and how to install, configure, and monitor it.

MySQL replication by default is asynchronous. The source writes events to its binary log and replicas request them when they are ready. The source does not know whether or when a replica has retrieved

and processed the transactions, and there is no guarantee that any event ever reaches any replica. With asynchronous replication, if the source crashes, transactions that it has committed might not have been transmitted to any replica. Failover from source to replica in this case might result in failover to a server that is missing transactions relative to the source.

With fully synchronous replication, when a source commits a transaction, all replicas must also have committed the transaction before the source returns to the session that performed the transaction. Fully synchronous replication means failover from the source to any replica is possible at any time. The drawback of fully synchronous replication is that there might be a lot of delay to complete a transaction.

Semisynchronous replication falls between asynchronous and fully synchronous replication. The source waits until at least one replica has received and logged the events (the required number of replicas is configurable), and then commits the transaction. The source does not wait for all replicas to acknowledge receipt, and it requires only an acknowledgement from the replicas, not that the events have been fully executed and committed on the replica side. Semisynchronous replication therefore guarantees that if the source crashes, all the transactions that it has committed have been transmitted to at least one replica.

Compared to asynchronous replication, semisynchronous replication provides improved data integrity, because when a commit returns successfully, it is known that the data exists in at least two places. Until a semisynchronous source receives acknowledgment from the required number of replicas, the transaction is on hold and not committed.

Compared to fully synchronous replication, semisynchronous replication is faster, because it can be configured to balance your requirements for data integrity (the number of replicas acknowledging receipt of the transaction) with the speed of commits, which are slower due to the need to wait for replicas.



### Important

With semisynchronous replication, if the source crashes and a failover to a replica is carried out, the failed source should not be reused as the replication source server, and should be discarded. It could have transactions that were not acknowledged by any replica, which were therefore not committed before the failover.

If your goal is to implement a fault-tolerant replication topology where all the servers receive the same transactions in the same order, and a server that crashes can rejoin the group and be brought up to date automatically, you can use Group Replication to achieve this. For information, see [Chapter 17, Group Replication](#).

The performance impact of semisynchronous replication compared to asynchronous replication is the tradeoff for increased data integrity. The amount of slowdown is at least the TCP/IP roundtrip time to send the commit to the replica and wait for the acknowledgment of receipt by the replica. This means that semisynchronous replication works best for close servers communicating over fast networks, and worst for distant servers communicating over slow networks. Semisynchronous replication also places a rate limit on busy sessions by constraining the speed at which binary log events can be sent from source to replica. When one user is too busy, this slows it down, which can be useful in some deployment situations.

Semisynchronous replication between a source and its replicas operates as follows:

- A replica indicates whether it is semisynchronous-capable when it connects to the source.
- If semisynchronous replication is enabled on the source side and there is at least one semisynchronous replica, a thread that performs a transaction commit on the source blocks and waits until at least one semisynchronous replica acknowledges that it has received all events for the transaction, or until a timeout occurs.
- The replica acknowledges receipt of a transaction's events only after the events have been written to its relay log and flushed to disk.

- If a timeout occurs without any replica having acknowledged the transaction, the source reverts to asynchronous replication. When at least one semisynchronous replica catches up, the source returns to semisynchronous replication.
- Semisynchronous replication must be enabled on both the source and replica sides. If semisynchronous replication is disabled on the source, or enabled on the source but on no replicas, the source uses asynchronous replication.

While the source is blocking (waiting for acknowledgment from a replica), it does not return to the session that performed the transaction. When the block ends, the source returns to the session, which then can proceed to execute other statements. At this point, the transaction has committed on the source side, and receipt of its events has been acknowledged by at least one replica. The number of replica acknowledgments the source must receive per transaction before returning to the session is configurable using the `rpl_semi_sync_master_wait_for_slave_count` system variable, for which the default value is 1.

Blocking also occurs after rollbacks that are written to the binary log, which occurs when a transaction that modifies nontransactional tables is rolled back. The rolled-back transaction is logged even though it has no effect for transactional tables because the modifications to the nontransactional tables cannot be rolled back and must be sent to replicas.

For statements that do not occur in transactional context (that is, when no transaction has been started with `START TRANSACTION` or `SET autocommit = 0`), autocommit is enabled and each statement commits implicitly. With semisynchronous replication, the source blocks for each such statement, just as it does for explicit transaction commits.

The `rpl_semi_sync_master_wait_point` system variable controls the point at which a semisynchronous replication source waits for replica acknowledgment of transaction receipt before returning a status to the client that committed the transaction. These values are permitted:

- `AFTER_SYNC` (the default): The source writes each transaction to its binary log and the replica, and syncs the binary log to disk. The source waits for replica acknowledgment of transaction receipt after the sync. Upon receiving acknowledgment, the source commits the transaction to the storage engine and returns a result to the client, which then can proceed.
- `AFTER_COMMIT`: The source writes each transaction to its binary log and the replica, syncs the binary log, and commits the transaction to the storage engine. The source waits for replica acknowledgment of transaction receipt after the commit. Upon receiving acknowledgment, the source returns a result to the client, which then can proceed.

The replication characteristics of these settings differ as follows:

- With `AFTER_SYNC`, all clients see the committed transaction at the same time, which is after it has been acknowledged by the replica and committed to the storage engine on the source. Thus, all clients see the same data on the source.

In the event of source failure, all transactions committed on the source have been replicated to the replica (saved to its relay log). An unexpected exit of the source and failover to the replica is lossless because the replica is up to date. As noted above, the source should not be reused after the failover.

- With `AFTER_COMMIT`, the client issuing the transaction gets a return status only after the server commits to the storage engine and receives replica acknowledgment. After the commit and before replica acknowledgment, other clients can see the committed transaction before the committing client.

If something goes wrong such that the replica does not process the transaction, then in the event of an unexpected source exit and failover to the replica, it is possible that such clients see a loss of data relative to what they saw on the source.

### 16.3.9.1 Semisynchronous Replication Administrative Interface

The administrative interface to semisynchronous replication has several components:

- Two plugins implement semisynchronous capability. There is one plugin for the source side and one for the replica side.
- System variables control plugin behavior. Some examples:

- `rpl_semi_sync_master_enabled`

Controls whether semisynchronous replication is enabled on the source. To enable or disable the plugin, set this variable to 1 or 0, respectively. The default is 0 (off).

- `rpl_semi_sync_master_timeout`

A value in milliseconds that controls how long the source waits on a commit for acknowledgment from a replica before timing out and reverting to asynchronous replication. The default value is 10000 (10 seconds).

- `rpl_semi_sync_slave_enabled`

Similar to `rpl_semi_sync_master_enabled`, but controls the replica plugin.

All `rpl_semi_sync_xxx` system variables are described at [Section 16.1.6.2, “Replication Source Options and Variables”](#) and [Section 16.1.6.3, “Replica Server Options and Variables”](#).

- From MySQL 5.7.33, you can improve the performance of semisynchronous replication by enabling the system variables `replication_sender_observe_commit_only`, which limits callbacks, and `replication_optimize_for_static_plugin_config`, which adds shared locks and avoids unnecessary lock acquisitions. These settings help as the number of replicas increases, because contention for locks can slow down performance. Semisynchronous replication source servers can also get performance benefits from enabling these system variables, because they use the same locking mechanisms as the replicas.
- Status variables enable semisynchronous replication monitoring. Some examples:

- `Rpl_semi_sync_master_clients`

The number of semisynchronous replicas.

- `Rpl_semi_sync_master_status`

Whether semisynchronous replication currently is operational on the source. The value is 1 if the plugin has been enabled and a commit acknowledgment has not occurred. It is 0 if the plugin is not enabled or the source has fallen back to asynchronous replication due to commit acknowledgment timeout.

- `Rpl_semi_sync_master_no_tx`

The number of commits that were not acknowledged successfully by a replica.

- `Rpl_semi_sync_master_yes_tx`

The number of commits that were acknowledged successfully by a replica.

- `Rpl_semi_sync_slave_status`

Whether semisynchronous replication currently is operational on the replica. This is 1 if the plugin has been enabled and the replication I/O thread is running, 0 otherwise.

All `Rpl_semi_sync_xxx` status variables are described at [Section 5.1.9, “Server Status Variables”](#).

The system and status variables are available only if the appropriate source or replica plugin has been installed with `INSTALL PLUGIN`.

### 16.3.9.2 Semisynchronous Replication Installation and Configuration

Semisynchronous replication is implemented using plugins, so the plugins must be installed into the server to make them available. After a plugin has been installed, you control it by means of the system variables associated with it. These system variables are unavailable until the associated plugin has been installed.

This section describes how to install the semisynchronous replication plugins. For general information about installing plugins, see [Section 5.5.1, “Installing and Uninstalling Plugins”](#).

To use semisynchronous replication, the following requirements must be satisfied:

- The capability of installing plugins requires a MySQL server that supports dynamic loading. To verify this, check that the value of the `have_dynamic_loading` system variable is `YES`. Binary distributions should support dynamic loading.
- Replication must already be working, see [Section 16.1, “Configuring Replication”](#).
- There must not be multiple replication channels configured. Semisynchronous replication is only compatible with the default replication channel. See [Section 16.2.2, “Replication Channels”](#).

To set up semisynchronous replication, use the following instructions. The `INSTALL PLUGIN`, `SET GLOBAL`, `STOP SLAVE`, and `START SLAVE` statements mentioned here require the `SUPER` privilege.

MySQL distributions include semisynchronous replication plugin files for the source side and the replica side.

To be usable by a source or replica server, the appropriate plugin library file must be located in the MySQL plugin directory (the directory named by the `plugin_dir` system variable). If necessary, configure the plugin directory location by setting the value of `plugin_dir` at server startup.

The plugin library file base names are `semisync_master` and `semisync_slave`. The file name suffix differs per platform (for example, `.so` for Unix and Unix-like systems, `.dll` for Windows).

The source plugin library file must be present in the plugin directory of the source server. The replica plugin library file must be present in the plugin directory of each replica server.

To load the plugins, use the `INSTALL PLUGIN` statement on the source and on each replica that is to be semisynchronous, adjusting the `.so` suffix for your platform as necessary.

On the source:

```
INSTALL PLUGIN rpl_semi_sync_master SONAME 'semisync_master.so';
```

On each replica:

```
INSTALL PLUGIN rpl_semi_sync_slave SONAME 'semisync_slave.so';
```

If an attempt to install a plugin results in an error on Linux similar to that shown here, you must install `libimf`:

## Semisynchronous Replication

```
mysql> INSTALL PLUGIN rpl_semi_sync_master SONAME 'semisync_master.so';
ERROR 1126 (HY000): Can't open shared library
'/usr/local/mysql/lib/plugin/semisync_master.so'
(errno: 22 libimf.so: cannot open shared object file:
No such file or directory)
```

You can obtain `libimf` from <https://dev.mysql.com/downloads/os-linux.html>.

To see which plugins are installed, use the `SHOW PLUGINS` statement, or query the Information Schema `PLUGINS` table.

To verify plugin installation, examine the Information Schema `PLUGINS` table or use the `SHOW PLUGINS` statement (see [Section 5.5.2, “Obtaining Server Plugin Information”](#)). For example:

```
mysql> SELECT PLUGIN_NAME, PLUGIN_STATUS
FROM INFORMATION_SCHEMA.PLUGINS
WHERE PLUGIN_NAME LIKE '%semi%';
+-----+-----+
| PLUGIN_NAME          | PLUGIN_STATUS |
+-----+-----+
| rpl_semi_sync_master | ACTIVE        |
+-----+-----+
```

If the plugin fails to initialize, check the server error log for diagnostic messages.

After a semisynchronous replication plugin has been installed, it is disabled by default. The plugins must be enabled both on the source side and the replica side to enable semisynchronous replication. If only one side is enabled, replication is asynchronous.

To control whether an installed plugin is enabled, set the appropriate system variables. You can set these variables at runtime using `SET GLOBAL`, or at server startup on the command line or in an option file.

At runtime, these source-side system variables are available:

```
SET GLOBAL rpl_semi_sync_master_enabled = {0|1};
SET GLOBAL rpl_semi_sync_master_timeout = N;
```

On the replica side, this system variable is available:

```
SET GLOBAL rpl_semi_sync_slave_enabled = {0|1};
```

For `rpl_semi_sync_master_enabled` or `rpl_semi_sync_slave_enabled`, the value should be 1 to enable semisynchronous replication or 0 to disable it. By default, these variables are set to 0.

For `rpl_semi_sync_master_timeout`, the value `N` is given in milliseconds. The default value is 10000 (10 seconds).

If you enable semisynchronous replication on a replica at runtime, you must also start the replication I/O thread (stopping it first if it is already running) to cause the replica to connect to the source and register as a semisynchronous replica:

```
STOP SLAVE IO_THREAD;
START SLAVE IO_THREAD;
```

If the replication I/O thread is already running and you do not restart it, the replica continues to use asynchronous replication.

At server startup, the variables that control semisynchronous replication can be set as command-line options or in an option file. A setting listed in an option file takes effect each time the server starts. For example, you can set the variables in `my.cnf` files on the source and replica sides as follows.



On the source:

```
[mysqld]
rpl_semi_sync_master_enabled=1
rpl_semi_sync_master_timeout=1000 # 1 second
```

On each replica:

```
[mysqld]
rpl_semi_sync_slave_enabled=1
```

### 16.3.9.3 Semisynchronous Replication Monitoring

The plugins for the semisynchronous replication capability expose several system and status variables that you can examine to determine its configuration and operational state.

The system variable reflect how semisynchronous replication is configured. To check their values, use `SHOW VARIABLES`:

```
mysql> SHOW VARIABLES LIKE 'rpl_semi_sync%';
```

The status variables enable you to monitor the operation of semisynchronous replication. To check their values, use `SHOW STATUS`:

```
mysql> SHOW STATUS LIKE 'Rpl_semi_sync%';
```

When the source switches between asynchronous or semisynchronous replication due to commit-blocking timeout or a replica catching up, it sets the value of the `Rpl_semi_sync_master_status` status variable appropriately. Automatic fallback from semisynchronous to asynchronous replication on the source means that it is possible for the `rpl_semi_sync_master_enabled` system variable to have a value of 1 on the source side even when semisynchronous replication is in fact not operational at the moment. You can monitor the `Rpl_semi_sync_master_status` status variable to determine whether the source currently is using asynchronous or semisynchronous replication.

To see how many semisynchronous replicas are connected, check `Rpl_semi_sync_master_clients`.

The number of commits that have been acknowledged successfully or unsuccessfully by replicas are indicated by the `Rpl_semi_sync_master_yes_tx` and `Rpl_semi_sync_master_no_tx` variables.

On the replica side, `Rpl_semi_sync_slave_status` indicates whether semisynchronous replication currently is operational.

## 16.3.10 Delayed Replication

MySQL 5.7 supports delayed replication such that a replica server deliberately lags behind the source by at least a specified amount of time. The default delay is 0 seconds. Use the `MASTER_DELAY` option for `CHANGE MASTER TO` to set the delay to `N` seconds:

```
CHANGE MASTER TO MASTER_DELAY = N;
```

An event received from the source is not executed until at least `N` seconds later than its execution on the source. The exceptions are that there is no delay for format description events or log file rotation events, which affect only the internal state of the SQL thread.

Delayed replication can be used for several purposes:

- To protect against user mistakes on the source. A DBA can roll back a delayed replica to the time just before the disaster.

- To test how the system behaves when there is a lag. For example, in an application, a lag might be caused by a heavy load on the replica. However, it can be difficult to generate this load level. Delayed replication can simulate the lag without having to simulate the load. It can also be used to debug conditions related to a lagging replica.
- To inspect what the database looked like long ago, without having to reload a backup. For example, if the delay is one week and the DBA needs to see what the database looked like before the last few days' worth of development, the delayed replica can be inspected.

`START SLAVE` and `STOP SLAVE` take effect immediately and ignore any delay. `RESET SLAVE` resets the delay to 0.

`SHOW SLAVE STATUS` has three fields that provide information about the delay:

- `SQL_Delay`: A nonnegative integer indicating the number of seconds that the replica must lag the source.
- `SQL_Remaining_Delay`: When `Slave_SQL_Running_State` is `Waiting until MASTER_DELAY seconds after master executed event`, this field contains an integer indicating the number of seconds left of the delay. At other times, this field is `NULL`.
- `Slave_SQL_Running_State`: A string indicating the state of the SQL thread (analogous to `Slave_IO_State`). The value is identical to the `State` value of the SQL thread as displayed by `SHOW PROCESSLIST`.

When the replication SQL thread is waiting for the delay to elapse before executing an event, `SHOW PROCESSLIST` displays its `State` value as `Waiting until MASTER_DELAY seconds after master executed event`.

## 16.4 Replication Notes and Tips

### 16.4.1 Replication Features and Issues

The following sections provide information about what is supported and what is not in MySQL replication, and about specific issues and situations that may occur when replicating certain statements.

Statement-based replication depends on compatibility at the SQL level between the source and replica. In other words, successful statement-based replication requires that any SQL features used be supported by both the source and the replica servers. If you use a feature on the source server that is available only in the current version of MySQL, you cannot replicate to a replica that uses an earlier version of MySQL. Such incompatibilities can also occur within a release series as well as between versions.

If you are planning to use statement-based replication between MySQL 5.7 and a previous MySQL release series, it is a good idea to consult the edition of the *MySQL Reference Manual* corresponding to the earlier release series for information regarding the replication characteristics of that series.

With MySQL's statement-based replication, there may be issues with replicating stored routines or triggers. You can avoid these issues by using MySQL's row-based replication instead. For a detailed list of issues, see [Section 23.7, “Stored Program Binary Logging”](#). For more information about row-based logging and row-based replication, see [Section 5.4.4.1, “Binary Logging Formats”](#), and [Section 16.2.1, “Replication Formats”](#).

For additional information specific to replication and `InnoDB`, see [Section 14.20, “InnoDB and MySQL Replication”](#). For information relating to replication with NDB Cluster, see [Section 21.7, “NDB Cluster Replication”](#).

### 16.4.1.1 Replication and AUTO\_INCREMENT

Statement-based replication of `AUTO_INCREMENT`, `LAST_INSERT_ID()`, and `TIMESTAMP` values is done correctly, subject to the following exceptions:

- When using statement-based replication prior to MySQL 5.7.1, `AUTO_INCREMENT` columns in tables on the replica must match the same columns on the source; that is, `AUTO_INCREMENT` columns must be replicated to `AUTO_INCREMENT` columns.
- A statement invoking a trigger or function that causes an update to an `AUTO_INCREMENT` column is not replicated correctly using statement-based replication. These statements are marked as unsafe. (Bug #45677)
- An `INSERT` into a table that has a composite primary key that includes an `AUTO_INCREMENT` column that is not the first column of this composite key is not safe for statement-based logging or replication. These statements are marked as unsafe. (Bug #11754117, Bug #45670)

This issue does not affect tables using the `InnoDB` storage engine, since an `InnoDB` table with an `AUTO_INCREMENT` column requires at least one key where the auto-increment column is the only or leftmost column.

- Adding an `AUTO_INCREMENT` column to a table with `ALTER TABLE` might not produce the same ordering of the rows on the replica and the source. This occurs because the order in which the rows are numbered depends on the specific storage engine used for the table and the order in which the rows were inserted. If it is important to have the same order on the source and replica, the rows must be ordered before assigning an `AUTO_INCREMENT` number. Assuming that you want to add an `AUTO_INCREMENT` column to a table `t1` that has columns `col1` and `col2`, the following statements produce a new table `t2` identical to `t1` but with an `AUTO_INCREMENT` column:

```
CREATE TABLE t2 LIKE t1;
ALTER TABLE t2 ADD id INT AUTO_INCREMENT PRIMARY KEY;
INSERT INTO t2 SELECT * FROM t1 ORDER BY col1, col2;
```



#### Important

To guarantee the same ordering on both source and replica, the `ORDER BY` clause must name *all* columns of `t1`.

The instructions just given are subject to the limitations of `CREATE TABLE ... LIKE`: Foreign key definitions are ignored, as are the `DATA DIRECTORY` and `INDEX DIRECTORY` table options. If a table definition includes any of those characteristics, create `t2` using a `CREATE TABLE` statement that is identical to the one used to create `t1`, but with the addition of the `AUTO_INCREMENT` column.

Regardless of the method used to create and populate the copy having the `AUTO_INCREMENT` column, the final step is to drop the original table and then rename the copy:

```
DROP t1;
ALTER TABLE t2 RENAME t1;
```

See also [Section B.3.6.1, “Problems with ALTER TABLE”](#).

### 16.4.1.2 Replication and BLACKHOLE Tables

The `BLACKHOLE` storage engine accepts data but discards it and does not store it. When performing binary logging, all inserts to such tables are always logged, regardless of the logging format in use. Updates and deletes are handled differently depending on whether statement based or row based logging is in use. With the statement based logging format, all statements affecting `BLACKHOLE` tables are logged, but their

effects ignored. When using row-based logging, updates and deletes to such tables are simply skipped—they are not written to the binary log. A warning is logged whenever this occurs (Bug #13004581).

For this reason we recommend when you replicate to tables using the `BLACKHOLE` storage engine that you have the `binlog_format` server variable set to `STATEMENT`, and not to either `ROW` or `MIXED`.

### 16.4.1.3 Replication and Character Sets

The following applies to replication between MySQL servers that use different character sets:

- If the source has databases with a character set different from the global `character_set_server` value, you should design your `CREATE TABLE` statements so that they do not implicitly rely on the database default character set. A good workaround is to state the character set and collation explicitly in `CREATE TABLE` statements.

### 16.4.1.4 Replication and CHECKSUM TABLE

`CHECKSUM TABLE` returns a checksum that is calculated row by row, using a method that depends on the table row storage format. The storage format is not guaranteed to remain the same between MySQL versions, so the checksum value might change following an upgrade.

### 16.4.1.5 Replication of CREATE ... IF NOT EXISTS Statements

MySQL applies these rules when various `CREATE ... IF NOT EXISTS` statements are replicated:

- Every `CREATE DATABASE IF NOT EXISTS` statement is replicated, whether or not the database already exists on the source.
- Similarly, every `CREATE TABLE IF NOT EXISTS` statement without a `SELECT` is replicated, whether or not the table already exists on the source. This includes `CREATE TABLE IF NOT EXISTS ... LIKE`. Replication of `CREATE TABLE IF NOT EXISTS ... SELECT` follows somewhat different rules; see [Section 16.4.1.6, “Replication of CREATE TABLE ... SELECT Statements”](#), for more information.
- `CREATE EVENT IF NOT EXISTS` is always replicated, whether or not the event named in the statement already exists on the source.

### 16.4.1.6 Replication of CREATE TABLE ... SELECT Statements

This section discusses how MySQL replicates `CREATE TABLE ... SELECT` statements.

MySQL 5.7 does not allow a `CREATE TABLE ... SELECT` statement to make any changes in tables other than the table that is created by the statement. Some older versions of MySQL permitted these statements to do so; this means that, when using replication between a MySQL 5.6 or later replica and a source running a previous version of MySQL, a `CREATE TABLE ... SELECT` statement causing changes in other tables on the source fails on the replica, causing replication to stop. To prevent this from happening, you should use row-based replication, rewrite the offending statement before running it on the source, or upgrade the source to MySQL 5.7. (If you choose to upgrade the source, keep in mind that such a `CREATE TABLE ... SELECT` statement fails following the upgrade unless it is rewritten to remove any side effects on other tables.)

These behaviors are not dependent on MySQL version:

- `CREATE TABLE ... SELECT` always performs an implicit commit ([Section 13.3.3, “Statements That Cause an Implicit Commit”](#)).
- If destination table does not exist, logging occurs as follows. It does not matter whether `IF NOT EXISTS` is present.

- `STATEMENT` or `MIXED` format: The statement is logged as written.
- `ROW` format: The statement is logged as a `CREATE TABLE` statement followed by a series of insert-row events.
- If the statement fails, nothing is logged. This includes the case that the destination table exists and `IF NOT EXISTS` is not given.

When the destination table exists and `IF NOT EXISTS` is given, MySQL 5.7 ignores the statement completely; nothing is inserted or logged.

### 16.4.1.7 Replication of `CREATE SERVER`, `ALTER SERVER`, and `DROP SERVER`

The statements `CREATE SERVER`, `ALTER SERVER`, and `DROP SERVER` are not written to the binary log, regardless of the binary logging format that is in use.

### 16.4.1.8 Replication of `CURRENT_USER()`

The following statements support use of the `CURRENT_USER()` function to take the place of the name of, and possibly the host for, an affected user or a definer:

- `DROP USER`
- `RENAME USER`
- `GRANT`
- `REVOKE`
- `CREATE FUNCTION`
- `CREATE PROCEDURE`
- `CREATE TRIGGER`
- `CREATE EVENT`
- `CREATE VIEW`
- `ALTER EVENT`
- `ALTER VIEW`
- `SET PASSWORD`

When binary logging is enabled and `CURRENT_USER()` or `CURRENT_USER` is used as the definer in any of these statements, MySQL Server ensures that the statement is applied to the same user on both the source and the replica when the statement is replicated. In some cases, such as statements that change passwords, the function reference is expanded before it is written to the binary log, so that the statement includes the user name. For all other cases, the name of the current user on the source is replicated to the replica as metadata, and the replica applies the statement to the current user named in the metadata, rather than to the current user on the replica.

### 16.4.1.9 Replication of `DROP ... IF EXISTS` Statements

The `DROP DATABASE IF EXISTS`, `DROP TABLE IF EXISTS`, and `DROP VIEW IF EXISTS` statements are always replicated, even if the database, table, or view to be dropped does not exist on the

source. This is to ensure that the object to be dropped no longer exists on either the source or the replica, once the replica has caught up with the source.

`DROP ... IF EXISTS` statements for stored programs (stored procedures and functions, triggers, and events) are also replicated, even if the stored program to be dropped does not exist on the source.

### 16.4.1.10 Replication with Differing Table Definitions on Source and Replica

Source and target tables for replication do not have to be identical. A table on the source can have more or fewer columns than the replica's copy of the table. In addition, corresponding table columns on the source and the replica can use different data types, subject to certain conditions.



#### Note

Replication between tables which are partitioned differently from one another is not supported. See [Section 16.4.1.23, “Replication and Partitioning”](#).

In all cases where the source and target tables do not have identical definitions, the database and table names must be the same on both the source and the replica. Additional conditions are discussed, with examples, in the following two sections.

### Replication with More Columns on Source or Replica

You can replicate a table from the source to the replica such that the source and replica copies of the table have differing numbers of columns, subject to the following conditions:

- Columns common to both versions of the table must be defined in the same order on the source and the replica.

(This is true even if both tables have the same number of columns.)

- Columns common to both versions of the table must be defined before any additional columns.

This means that executing an `ALTER TABLE` statement on the replica where a new column is inserted into the table within the range of columns common to both tables causes replication to fail, as shown in the following example:

Suppose that a table `t`, existing on the source and the replica, is defined by the following `CREATE TABLE` statement:

```
CREATE TABLE t (
  c1 INT,
  c2 INT,
  c3 INT
);
```

Suppose that the `ALTER TABLE` statement shown here is executed on the replica:

```
ALTER TABLE t ADD COLUMN cnew1 INT AFTER c3;
```

The previous `ALTER TABLE` is permitted on the replica because the columns `c1`, `c2`, and `c3` that are common to both versions of table `t` remain grouped together in both versions of the table, before any columns that differ.

However, the following `ALTER TABLE` statement cannot be executed on the replica without causing replication to break:

```
ALTER TABLE t ADD COLUMN cnew2 INT AFTER c2;
```

Replication fails after execution on the replica of the `ALTER TABLE` statement just shown, because the new column `cnew2` comes between columns common to both versions of `t`.

- Each “extra” column in the version of the table having more columns must have a default value.

A column's default value is determined by a number of factors, including its type, whether it is defined with a `DEFAULT` option, whether it is declared as `NULL`, and the server SQL mode in effect at the time of its creation; for more information, see [Section 11.6, “Data Type Default Values”](#).

In addition, when the replica's copy of the table has more columns than the source's copy, each column common to the tables must use the same data type in both tables.

**Examples.** The following examples illustrate some valid and invalid table definitions:

**More columns on the source.** The following table definitions are valid and replicate correctly:

```
source> CREATE TABLE t1 (c1 INT, c2 INT, c3 INT);
replica> CREATE TABLE t1 (c1 INT, c2 INT);
```

The following table definitions would raise an error because the definitions of the columns common to both versions of the table are in a different order on the replica than they are on the source:

```
source> CREATE TABLE t1 (c1 INT, c2 INT, c3 INT);
replica> CREATE TABLE t1 (c2 INT, c1 INT);
```

The following table definitions would also raise an error because the definition of the extra column on the source appears before the definitions of the columns common to both versions of the table:

```
source> CREATE TABLE t1 (c3 INT, c1 INT, c2 INT);
replica> CREATE TABLE t1 (c1 INT, c2 INT);
```

**More columns on the replica.** The following table definitions are valid and replicate correctly:

```
source> CREATE TABLE t1 (c1 INT, c2 INT);
replica> CREATE TABLE t1 (c1 INT, c2 INT, c3 INT);
```

The following definitions raise an error because the columns common to both versions of the table are not defined in the same order on both the source and the replica:

```
source> CREATE TABLE t1 (c1 INT, c2 INT);
replica> CREATE TABLE t1 (c2 INT, c1 INT, c3 INT);
```

The following table definitions also raise an error because the definition for the extra column in the replica's version of the table appears before the definitions for the columns which are common to both versions of the table:

```
source> CREATE TABLE t1 (c1 INT, c2 INT);
replica> CREATE TABLE t1 (c3 INT, c1 INT, c2 INT);
```

The following table definitions fail because the replica's version of the table has additional columns compared to the source's version, and the two versions of the table use different data types for the common column `c2`:

```
source> CREATE TABLE t1 (c1 INT, c2 BIGINT);
replica> CREATE TABLE t1 (c1 INT, c2 INT, c3 INT);
```

## Replication of Columns Having Different Data Types

Corresponding columns on the source's and the replica's copies of the same table ideally should have the same data type. However, this is not always strictly enforced, as long as certain conditions are met.

It is usually possible to replicate from a column of a given data type to another column of the same type and same size or width, where applicable, or larger. For example, you can replicate from a `CHAR(10)` column to another `CHAR(10)`, or from a `CHAR(10)` column to a `CHAR(25)` column without any problems. In certain cases, it is also possible to replicate from a column having one data type (on the source) to a column having a different data type (on the replica); when the data type of the source's version of the column is promoted to a type that is the same size or larger on the replica, this is known as *attribute promotion*.

Attribute promotion can be used with both statement-based and row-based replication, and is not dependent on the storage engine used by either the source or the replica. However, the choice of logging format does have an effect on the type conversions that are permitted; the particulars are discussed later in this section.



**Important**

Whether you use statement-based or row-based replication, the replica's copy of the table cannot contain more columns than the source's copy if you wish to employ attribute promotion.

**Statement-based replication.** When using statement-based replication, a simple rule of thumb to follow is, "If the statement run on the source would also execute successfully on the replica, it should also replicate successfully". In other words, if the statement uses a value that is compatible with the type of a given column on the replica, the statement can be replicated. For example, you can insert any value that fits in a `TINYINT` column into a `BIGINT` column as well; it follows that, even if you change the type of a `TINYINT` column in the replica's copy of a table to `BIGINT`, any insert into that column on the source that succeeds should also succeed on the replica, since it is impossible to have a legal `TINYINT` value that is large enough to exceed a `BIGINT` column.

Prior to MySQL 5.7.1, when using statement-based replication, `AUTO_INCREMENT` columns were required to be the same on both the source and the replica; otherwise, updates could be applied to the wrong table on the replica. (Bug #12669186)

**Row-based replication: attribute promotion and demotion.** Row-based replication supports attribute promotion and demotion between smaller data types and larger types. It is also possible to specify whether or not to permit lossy (truncated) or non-lossy conversions of demoted column values, as explained later in this section.

**Lossy and non-lossy conversions.** In the event that the target type cannot represent the value being inserted, a decision must be made on how to handle the conversion. If we permit the conversion but truncate (or otherwise modify) the source value to achieve a "fit" in the target column, we make what is known as a *lossy conversion*. A conversion which does not require truncation or similar modifications to fit the source column value in the target column is a *non-lossy conversion*.

**Type conversion modes (slave\_type\_conversions variable).** The setting of the `slave_type_conversions` global server variable controls the type conversion mode used on the replica. This variable takes a set of values from the following table, which shows the effects of each mode on the replica's type-conversion behavior:

Mode	Effect
<code>ALL_LOSSY</code>	In this mode, type conversions that would mean loss of information are permitted.



Mode	Effect
	This does not imply that non-lossy conversions are permitted, merely that only cases requiring either lossy conversions or no conversion at all are permitted; for example, enabling <i>only</i> this mode permits an <code>INT</code> column to be converted to <code>TINYINT</code> (a lossy conversion), but not a <code>TINYINT</code> column to an <code>INT</code> column (non-lossy). Attempting the latter conversion in this case would cause replication to stop with an error on the replica.
<code>ALL_NON_LOSSY</code>	This mode permits conversions that do not require truncation or other special handling of the source value; that is, it permits conversions where the target type has a wider range than the source type.  Setting this mode has no bearing on whether lossy conversions are permitted; this is controlled with the <code>ALL_LOSSY</code> mode. If only <code>ALL_NON_LOSSY</code> is set, but not <code>ALL_LOSSY</code> , then attempting a conversion that would result in the loss of data (such as <code>INT</code> to <code>TINYINT</code> , or <code>CHAR(25)</code> to <code>VARCHAR(20)</code> ) causes the replica to stop with an error.
<code>ALL_LOSSY, ALL_NON_LOSSY</code>	When this mode is set, all supported type conversions are permitted, whether or not they are lossy conversions.
<code>ALL_SIGNED</code>	Treat promoted integer types as signed values (the default behavior).
<code>ALL_UNSIGNED</code>	Treat promoted integer types as unsigned values.
<code>ALL_SIGNED, ALL_UNSIGNED</code>	Treat promoted integer types as signed if possible, otherwise as unsigned.
[empty]	When <code>slave_type_conversions</code> is not set, no attribute promotion or demotion is permitted; this means that all columns in the source and target tables must be of the same types.  This mode is the default.

When an integer type is promoted, its signedness is not preserved. By default, the replica treats all such values as signed. Beginning with MySQL 5.7.2, you can control this behavior using `ALL_SIGNED`, `ALL_UNSIGNED`, or both. (Bug#15831300) `ALL_SIGNED` tells the replica to treat all promoted integer types as signed; `ALL_UNSIGNED` instructs it to treat these as unsigned. Specifying both causes the replica to treat the value as signed if possible, otherwise to treat it as unsigned; the order in which they are listed is not significant. Neither `ALL_SIGNED` nor `ALL_UNSIGNED` has any effect if at least one of `ALL_LOSSY` or `ALL_NONLOSSY` is not also used.

Changing the type conversion mode requires restarting the replica with the new `slave_type_conversions` setting.

**Supported conversions.** Supported conversions between different but similar data types are shown in the following list:

- Between any of the integer types `TINYINT`, `SMALLINT`, `MEDIUMINT`, `INT`, and `BIGINT`.

This includes conversions between the signed and unsigned versions of these types.

Lossy conversions are made by truncating the source value to the maximum (or minimum) permitted by the target column. For ensuring non-lossy conversions when going from unsigned to signed types, the target column must be large enough to accommodate the range of values in the source column. For example, you can demote `TINYINT UNSIGNED` non-lossily to `SMALLINT`, but not to `TINYINT`.

- Between any of the decimal types `DECIMAL`, `FLOAT`, `DOUBLE`, and `NUMERIC`.

`FLOAT` to `DOUBLE` is a non-lossy conversion; `DOUBLE` to `FLOAT` can only be handled lossily. A conversion from `DECIMAL(M,D)` to `DECIMAL(M',D')` where  $D' \geq D$  and  $(M' - D') \geq (M - D)$  is non-lossy; for any case where  $M' < M$ ,  $D' < D$ , or both, only a lossy conversion can be made.

For any of the decimal types, if a value to be stored cannot be fit in the target type, the value is rounded down according to the rounding rules defined for the server elsewhere in the documentation. See [Section 12.21.4, “Rounding Behavior”](#), for information about how this is done for decimal types.

- Between any of the string types `CHAR`, `VARCHAR`, and `TEXT`, including conversions between different widths.

Conversion of a `CHAR`, `VARCHAR`, or `TEXT` to a `CHAR`, `VARCHAR`, or `TEXT` column the same size or larger is never lossy. Lossy conversion is handled by inserting only the first  $N$  characters of the string on the replica, where  $N$  is the width of the target column.



#### Important

Replication between columns using different character sets is not supported.

- Between any of the binary data types `BINARY`, `VARBINARY`, and `BLOB`, including conversions between different widths.

Conversion of a `BINARY`, `VARBINARY`, or `BLOB` to a `BINARY`, `VARBINARY`, or `BLOB` column the same size or larger is never lossy. Lossy conversion is handled by inserting only the first  $N$  bytes of the string on the replica, where  $N$  is the width of the target column.

- Between any 2 `BIT` columns of any 2 sizes.

When inserting a value from a `BIT(M)` column into a `BIT(M')` column, where  $M' > M$ , the most significant bits of the `BIT(M')` columns are cleared (set to zero) and the  $M$  bits of the `BIT(M)` value are set as the least significant bits of the `BIT(M')` column.

When inserting a value from a source `BIT(M)` column into a target `BIT(M')` column, where  $M' < M$ , the maximum possible value for the `BIT(M')` column is assigned; in other words, an “all-set” value is assigned to the target column.

Conversions between types not in the previous list are not permitted.

#### 16.4.1.11 Replication and `DIRECTORY` Table Options

If a `DATA DIRECTORY` or `INDEX DIRECTORY` table option is used in a `CREATE TABLE` statement on the source server, the table option is also used on the replica. This can cause problems if no corresponding directory exists in the replica host's file system or if it exists but is not accessible to the replica server. This can be overridden by using the `NO_DIR_IN_CREATE` server SQL mode on the replica, which causes the replica to ignore the `DATA DIRECTORY` and `INDEX DIRECTORY` table options when replicating `CREATE TABLE` statements. The result is that `MyISAM` data and index files are created in the table's database directory.

For more information, see [Section 5.1.10, “Server SQL Modes”](#).

#### 16.4.1.12 Replication and Floating-Point Values

With statement-based replication, values are converted from decimal to binary. Because conversions between decimal and binary representations of them may be approximate, comparisons involving floating-point values are inexact. This is true for operations that use floating-point values explicitly, or that use values that are converted to floating-point implicitly. Comparisons of floating-point values might yield different results on source and replica servers due to differences in computer architecture, the compiler used to build MySQL, and so forth. See [Section 12.3, “Type Conversion in Expression Evaluation”](#), and [Section B.3.4.8, “Problems with Floating-Point Values”](#).

#### 16.4.1.13 Replication and Fractional Seconds Support

MySQL 5.7 permits fractional seconds for `TIME`, `DATETIME`, and `TIMESTAMP` values, with up to microseconds (6 digits) precision. See [Section 11.2.7, “Fractional Seconds in Time Values”](#).

There may be problems replicating from a source server that understands fractional seconds to an older replica (MySQL 5.6.3 and earlier) that does not:

- For `CREATE TABLE` statements containing columns that have an `fsp` (fractional seconds precision) value greater than 0, replication fails due to parser errors.
- Statements that use temporal data types with an `fsp` value of 0 work with statement-based logging but not row-based logging. In the latter case, the data types have binary formats and type codes on the source that differ from those on the replica.
- Some expression results differ on source and replica. Examples: On the source, the `timestamp` system variable returns a value that includes a microseconds fractional part; on the replica, it returns an integer. On the source, functions that return a result that includes the current time (such as `CURTIME()`, `SYSDATE()`, or `UTC_TIMESTAMP()`) interpret an argument as an `fsp` value and the return value includes a fractional seconds part of that many digits. On the replica, these functions permit an argument but ignore it.

#### 16.4.1.14 Replication and FLUSH

Some forms of the `FLUSH` statement are not logged because they could cause problems if replicated to a replica: `FLUSH LOGS` and `FLUSH TABLES WITH READ LOCK`. For a syntax example, see [Section 13.7.6.3, “FLUSH Statement”](#). The `FLUSH TABLES`, `ANALYZE TABLE`, `OPTIMIZE TABLE`, and `REPAIR TABLE` statements are written to the binary log and thus replicated to replicas. This is not normally a problem because these statements do not modify table data.

However, this behavior can cause difficulties under certain circumstances. If you replicate the privilege tables in the `mysql` database and update those tables directly without using `GRANT`, you must issue a `FLUSH PRIVILEGES` on the replicas to put the new privileges into effect. In addition, if you use `FLUSH TABLES` when renaming a `MyISAM` table that is part of a `MERGE` table, you must issue `FLUSH TABLES` manually on the replicas. These statements are written to the binary log unless you specify `NO_WRITE_TO_BINLOG` or its alias `LOCAL`.

#### 16.4.1.15 Replication and System Functions

Certain functions do not replicate well under some conditions:

- The `USER()`, `CURRENT_USER()` (or `CURRENT_USER`), `UUID()`, `VERSION()`, and `LOAD_FILE()` functions are replicated without change and thus do not work reliably on the replica unless row-based replication is enabled. (See [Section 16.2.1, “Replication Formats”](#).)

`USER()` and `CURRENT_USER()` are automatically replicated using row-based replication when using `MIXED` mode, and generate a warning in `STATEMENT` mode. (See also [Section 16.4.1.8, “Replication of CURRENT\\_USER\(\)”](#).) This is also true for `VERSION()` and `RAND()`.

- For `NOW()`, the binary log includes the timestamp. This means that the value *as returned by the call to this function on the source* is replicated to the replica. To avoid unexpected results when replicating between MySQL servers in different time zones, set the time zone on both source and replica. For more information, see [Section 16.4.1.31, “Replication and Time Zones”](#).

To explain the potential problems when replicating between servers which are in different time zones, suppose that the source is located in New York, the replica is located in Stockholm, and both servers are using local time. Suppose further that, on the source, you create a table `mytable`, perform an `INSERT` statement on this table, and then select from the table, as shown here:

```
mysql> CREATE TABLE mytable (mycol TEXT);
Query OK, 0 rows affected (0.06 sec)

mysql> INSERT INTO mytable VALUES ( NOW() );
Query OK, 1 row affected (0.00 sec)

mysql> SELECT * FROM mytable;
+-----+
| mycol |
+-----+
| 2009-09-01 12:00:00 |
+-----+
1 row in set (0.00 sec)
```

Local time in Stockholm is 6 hours later than in New York; so, if you issue `SELECT NOW()` on the replica at that exact same instant, the value `2009-09-01 18:00:00` is returned. For this reason, if you select from the replica's copy of `mytable` after the `CREATE TABLE` and `INSERT` statements just shown have been replicated, you might expect `mycol` to contain the value `2009-09-01 18:00:00`. However, this is not the case; when you select from the replica's copy of `mytable`, you obtain exactly the same result as on the source:

```
mysql> SELECT * FROM mytable;
+-----+
| mycol |
+-----+
| 2009-09-01 12:00:00 |
+-----+
1 row in set (0.00 sec)
```

Unlike `NOW()`, the `SYSDATE()` function is not replication-safe because it is not affected by `SET TIMESTAMP` statements in the binary log and is nondeterministic if statement-based logging is used. This is not a problem if row-based logging is used.

An alternative is to use the `--sysdate-is-now` option to cause `SYSDATE()` to be an alias for `NOW()`. This must be done on the source and the replica to work correctly. In such cases, a warning is still issued by this function, but can safely be ignored as long as `--sysdate-is-now` is used on both the source and the replica.

`SYSDATE()` is automatically replicated using row-based replication when using `MIXED` mode, and generates a warning in `STATEMENT` mode.

See also [Section 16.4.1.31, “Replication and Time Zones”](#).

- *The following restriction applies to statement-based replication only, not to row-based replication.* The `GET_LOCK()`, `RELEASE_LOCK()`, `IS_FREE_LOCK()`, and `IS_USED_LOCK()` functions that handle

user-level locks are replicated without the replica knowing the concurrency context on the source. Therefore, these functions should not be used to insert into a source table because the content on the replica would differ. For example, do not issue a statement such as `INSERT INTO mytable VALUES (GET_LOCK( . . . ))`.

These functions are automatically replicated using row-based replication when using `MIXED` mode, and generate a warning in `STATEMENT` mode.

As a workaround for the preceding limitations when statement-based replication is in effect, you can use the strategy of saving the problematic function result in a user variable and referring to the variable in a later statement. For example, the following single-row `INSERT` is problematic due to the reference to the `UUID()` function:

```
INSERT INTO t VALUES(UUID());
```

To work around the problem, do this instead:

```
SET @my_uuid = UUID();
INSERT INTO t VALUES(@my_uuid);
```

That sequence of statements replicates because the value of `@my_uuid` is stored in the binary log as a user-variable event prior to the `INSERT` statement and is available for use in the `INSERT`.

The same idea applies to multiple-row inserts, but is more cumbersome to use. For a two-row insert, you can do this:

```
SET @my_uuid1 = UUID(); @my_uuid2 = UUID();
INSERT INTO t VALUES(@my_uuid1),(@my_uuid2);
```

However, if the number of rows is large or unknown, the workaround is difficult or impracticable. For example, you cannot convert the following statement to one in which a given individual user variable is associated with each row:

```
INSERT INTO t2 SELECT UUID(), * FROM t1;
```

Within a stored function, `RAND()` replicates correctly as long as it is invoked only once during the execution of the function. (You can consider the function execution timestamp and random number seed as implicit inputs that are identical on the source and replica.)

The `FOUND_ROWS()` and `ROW_COUNT()` functions are not replicated reliably using statement-based replication. A workaround is to store the result of the function call in a user variable, and then use that in the `INSERT` statement. For example, if you wish to store the result in a table named `mytable`, you might normally do so like this:

```
SELECT SQL_CALC_FOUND_ROWS FROM mytable LIMIT 1;
INSERT INTO mytable VALUES( FOUND_ROWS() );
```

However, if you are replicating `mytable`, you should use `SELECT . . . INTO`, and then store the variable in the table, like this:

```
SELECT SQL_CALC_FOUND_ROWS INTO @found_rows FROM mytable LIMIT 1;
INSERT INTO mytable VALUES(@found_rows);
```

In this way, the user variable is replicated as part of the context, and applied on the replica correctly.

These functions are automatically replicated using row-based replication when using `MIXED` mode, and generate a warning in `STATEMENT` mode. (Bug #12092, Bug #30244)

Prior to MySQL 5.7.3, the value of `LAST_INSERT_ID()` was not replicated correctly if any filtering options such as `--replicate-ignore-db` and `--replicate-do-table` were enabled on the replica. (Bug #17234370, BUG# 69861)

### 16.4.1.16 Replication of Invoked Features

Replication of invoked features such as loadable functions and stored programs (stored procedures and functions, triggers, and events) provides the following characteristics:

- The effects of the feature are always replicated.
- The following statements are replicated using statement-based replication:
  - `CREATE EVENT`
  - `ALTER EVENT`
  - `DROP EVENT`
  - `CREATE PROCEDURE`
  - `DROP PROCEDURE`
  - `CREATE FUNCTION`
  - `DROP FUNCTION`
  - `CREATE TRIGGER`
  - `DROP TRIGGER`

However, the *effects* of features created, modified, or dropped using these statements are replicated using row-based replication.



#### Note

Attempting to replicate invoked features using statement-based replication produces the warning `Statement is not safe to log in statement format`. For example, trying to replicate a loadable function with statement-based replication generates this warning because it currently cannot be determined by the MySQL server whether the function is deterministic. If you are absolutely certain that the invoked feature's effects are deterministic, you can safely disregard such warnings.

- In the case of `CREATE EVENT` and `ALTER EVENT`:
  - The status of the event is set to `SLAVESIDE_DISABLED` on the replica regardless of the state specified (this does not apply to `DROP EVENT`).
  - The source on which the event was created is identified on the replica by its server ID. The `ORIGINATOR` column in the Information Schema `EVENTS` table and the `originator` column in `mysql.event` store this information. See [Section 24.3.8, “The INFORMATION\\_SCHEMA EVENTS Table”](#), and [Section 13.7.5.18, “SHOW EVENTS Statement”](#), for more information.
- The feature implementation resides on the replica in a renewable state so that if the source fails, the replica can be used as the source without loss of event processing.

To determine whether there are any scheduled events on a MySQL server that were created on a different server (that was acting as a replication source server), query the Information Schema `EVENTS` table in a manner similar to what is shown here:

```
SELECT EVENT_SCHEMA, EVENT_NAME
```

```
FROM INFORMATION_SCHEMA.EVENTS
WHERE STATUS = 'SLAVESIDE_DISABLED';
```

Alternatively, you can use the `SHOW EVENTS` statement, like this:

```
SHOW EVENTS
WHERE STATUS = 'SLAVESIDE_DISABLED';
```

When promoting a replica having such events to a replication source server, you must enable each event using `ALTER EVENT event_name ENABLE`, where *event\_name* is the name of the event.

If more than one source was involved in creating events on this replica, and you wish to identify events that were created only on a given source having the server ID *source\_id*, modify the previous query on the `EVENTS` table to include the `ORIGINATOR` column, as shown here:

```
SELECT EVENT_SCHEMA, EVENT_NAME, ORIGINATOR
FROM INFORMATION_SCHEMA.EVENTS
WHERE STATUS = 'SLAVESIDE_DISABLED'
AND ORIGINATOR = 'source_id'
```

You can employ `ORIGINATOR` with the `SHOW EVENTS` statement in a similar fashion:

```
SHOW EVENTS
WHERE STATUS = 'SLAVESIDE_DISABLED'
AND ORIGINATOR = 'source_id'
```

Before enabling events that were replicated from the source, you should disable the MySQL Event Scheduler on the replica (using a statement such as `SET GLOBAL event_scheduler = OFF;`), run any necessary `ALTER EVENT` statements, restart the server, then re-enable the Event Scheduler on the replica afterward (using a statement such as `SET GLOBAL event_scheduler = ON;`)-

If you later demote the new source back to being a replica, you must disable manually all events enabled by the `ALTER EVENT` statements. You can do this by storing in a separate table the event names from the `SELECT` statement shown previously, or using `ALTER EVENT` statements to rename the events with a common prefix such as `replicated_` to identify them.

If you rename the events, then when demoting this server back to being a replica, you can identify the events by querying the `EVENTS` table, as shown here:

```
SELECT CONCAT(EVENT_SCHEMA, '.', EVENT_NAME) AS 'Db.Event'
FROM INFORMATION_SCHEMA.EVENTS
WHERE INSTR(EVENT_NAME, 'replicated_') = 1;
```

### 16.4.1.17 Replication and LIMIT

Statement-based replication of `LIMIT` clauses in `DELETE`, `UPDATE`, and `INSERT ... SELECT` statements is unsafe since the order of the rows affected is not defined. (Such statements can be replicated correctly with statement-based replication only if they also contain an `ORDER BY` clause.) When such a statement is encountered:

- When using `STATEMENT` mode, a warning that the statement is not safe for statement-based replication is now issued.

When using `STATEMENT` mode, warnings are issued for DML statements containing `LIMIT` even when they also have an `ORDER BY` clause (and so are made deterministic). This is a known issue. (Bug #42851)

- When using `MIXED` mode, the statement is now automatically replicated using row-based mode.

### 16.4.1.18 Replication and LOAD DATA

`LOAD DATA` is considered unsafe for statement-based logging (see [Section 16.2.1.3, “Determination of Safe and Unsafe Statements in Binary Logging”](#)). When `binlog_format=MIXED` is set, the statement is logged in row-based format. When `binlog_format=STATEMENT` is set, note that `LOAD DATA` does not generate a warning, unlike other unsafe statements.

When `mysqlbinlog` reads log events for `LOAD DATA` statements logged in statement-based format, a generated local file is created in a temporary directory. These temporary files are not automatically removed by `mysqlbinlog` or any other MySQL program. If you do use `LOAD DATA` statements with statement-based binary logging, you should delete the temporary files yourself after you no longer need the statement log. For more information, see [Section 4.6.7, “mysqlbinlog — Utility for Processing Binary Log Files”](#).

### 16.4.1.19 Replication and max\_allowed\_packet

`max_allowed_packet` sets an upper limit on the size of any single message between the MySQL server and clients, including replicas. If you are replicating large column values (such as might be found in `TEXT` or `BLOB` columns) and `max_allowed_packet` is too small on the source, the source fails with an error, and the replica shuts down the replication I/O thread. If `max_allowed_packet` is too small on the replica, this also causes the replica to stop the replication I/O thread.

Row-based replication sends all columns and column values for updated rows from the source to the replica, including values of columns that were not actually changed by the update. This means that, when you are replicating large column values using row-based replication, you must take care to set `max_allowed_packet` large enough to accommodate the largest row in any table to be replicated, even if you are replicating updates only, or you are inserting only relatively small values.

On a multi-threaded replica (`slave_parallel_workers > 0`), ensure that the system variable `slave_pending_jobs_size_max` is set to a value equal to or greater than the setting for the `max_allowed_packet` system variable on the source. The default setting for `slave_pending_jobs_size_max`, 128M, is twice the default setting for `max_allowed_packet`, which is 64M. `max_allowed_packet` limits the packet size that the source can send, but the addition of an event header can produce a binary log event exceeding this size. Also, in row-based replication, a single event can be significantly larger than the `max_allowed_packet` size, because the value of `max_allowed_packet` only limits each column of the table.

The replica actually accepts packets up to the limit set by its `slave_max_allowed_packet` setting, which default to the maximum setting of 1GB, to prevent a replication failure due to a large packet. However, the value of `slave_pending_jobs_size_max` controls the memory that is made available on the replica to hold incoming packets. The specified memory is shared among all the replica worker queues.

The value of `slave_pending_jobs_size_max` is a soft limit, and if an unusually large event (consisting of one or multiple packets) exceeds this size, the transaction is held until all the replica workers have empty queues, and then processed. All subsequent transactions are held until the large transaction has been completed. So although unusual events larger than `slave_pending_jobs_size_max` can be processed, the delay to clear the queues of all the replica workers and the wait to queue subsequent transactions can cause lag on the replica and decreased concurrency of the replica workers. `slave_pending_jobs_size_max` should therefore be set high enough to accommodate most expected event sizes.

### 16.4.1.20 Replication and MEMORY Tables

When a replication source server shuts down and restarts, its `MEMORY` tables become empty. To replicate this effect to replicas, the first time that the source uses a given `MEMORY` table after startup, it logs an



event that notifies replicas that the table must be emptied by writing a `DELETE` or (from MySQL 5.7.32) `TRUNCATE TABLE` statement for that table to the binary log. This generated event is identifiable by a comment in the binary log, and if GTIDs are in use on the server, it has a GTID assigned. The statement is always logged in statement format, even if the binary logging format is set to `ROW`, and it is written even if `read_only` or `super_read_only` mode is set on the server. Note that the replica still has outdated data in a `MEMORY` table during the interval between the source's restart and its first use of the table. To avoid this interval when a direct query to the replica could return stale data, you can set the `init_file` system variable to name a file containing statements that populate the `MEMORY` table on the source at startup.

When a replica server shuts down and restarts, its `MEMORY` tables become empty. This causes the replica to be out of synchrony with the source and may lead to other failures or cause the replica to stop:

- Row-format updates and deletes received from the source may fail with `Can't find record in 'memory_table'`.
- Statements such as `INSERT INTO ... SELECT FROM memory_table` may insert a different set of rows on the source and replica.

The replica also writes a `DELETE` or (from MySQL 5.7.32) `TRUNCATE TABLE` statement to its own binary log, which is passed on to any downstream replicas, causing them to empty their own `MEMORY` tables.

The safe way to restart a replica that is replicating `MEMORY` tables is to first drop or delete all rows from the `MEMORY` tables on the source and wait until those changes have replicated to the replica. Then it is safe to restart the replica.

An alternative restart method may apply in some cases. When `binlog_format=ROW`, you can prevent the replica from stopping if you set `slave_exec_mode=IDEMPOTENT` before you start the replica again. This allows the replica to continue to replicate, but its `MEMORY` tables still differ from those on the source. This is acceptable if the application logic is such that the contents of `MEMORY` tables can be safely lost (for example, if the `MEMORY` tables are used for caching). `slave_exec_mode=IDEMPOTENT` applies globally to all tables, so it may hide other replication errors in non-`MEMORY` tables.

(The method just described is not applicable in NDB Cluster, where `slave_exec_mode` is always `IDEMPOTENT`, and cannot be changed.)

The size of `MEMORY` tables is limited by the value of the `max_heap_table_size` system variable, which is not replicated (see [Section 16.4.1.37, “Replication and Variables”](#)). A change in `max_heap_table_size` takes effect for `MEMORY` tables that are created or updated using `ALTER TABLE ... ENGINE = MEMORY` or `TRUNCATE TABLE` following the change, or for all `MEMORY` tables following a server restart. If you increase the value of this variable on the source without doing so on the replica, it becomes possible for a table on the source to grow larger than its counterpart on the replica, leading to inserts that succeed on the source but fail on the replica with `Table is full` errors. This is a known issue (Bug #48666). In such cases, you must set the global value of `max_heap_table_size` on the replica as well as on the source, then restart replication. It is also recommended that you restart both the source and replica MySQL servers, to insure that the new value takes complete (global) effect on each of them.

See [Section 15.3, “The MEMORY Storage Engine”](#), for more information about `MEMORY` tables.

### 16.4.1.21 Replication of the mysql System Database

Data modification statements made to tables in the `mysql` database are replicated according to the value of `binlog_format`; if this value is `MIXED`, these statements are replicated using row-based format. However, statements that would normally update this information indirectly—such as `GRANT`, `REVOKE`, and statements manipulating triggers, stored routines, and views—are replicated to replicas using statement-based replication.

### 16.4.1.22 Replication and the Query Optimizer

It is possible for the data on the source and replica to become different if a statement is written in such a way that the data modification is nondeterministic; that is, left up to the query optimizer. (In general, this is not a good practice, even outside of replication.) Examples of nondeterministic statements include `DELETE` or `UPDATE` statements that use `LIMIT` with no `ORDER BY` clause; see [Section 16.4.1.17, “Replication and LIMIT”](#), for a detailed discussion of these.

### 16.4.1.23 Replication and Partitioning

Replication is supported between partitioned tables as long as they use the same partitioning scheme and otherwise have the same structure except where an exception is specifically allowed (see [Section 16.4.1.10, “Replication with Differing Table Definitions on Source and Replica”](#)).

Replication between tables having different partitioning is generally not supported. This is because statements (such as `ALTER TABLE ... DROP PARTITION`) acting directly on partitions in such cases may produce different results on source and replica. In the case where a table is partitioned on the source but not on the replica, any statements operating on partitions on the source's copy of the replica fail on the replica. When the replica's copy of the table is partitioned but the source's copy is not, statements acting on partitions cannot be run on the source without causing errors there.

Due to these dangers of causing replication to fail entirely (on account of failed statements) and of inconsistencies (when the result of a partition-level SQL statement produces different results on source and replica), we recommend that insure that the partitioning of any tables to be replicated from the source is matched by the replica's versions of these tables.

### 16.4.1.24 Replication and REPAIR TABLE

When used on a corrupted or otherwise damaged table, it is possible for the `REPAIR TABLE` statement to delete rows that cannot be recovered. However, any such modifications of table data performed by this statement are not replicated, which can cause source and replica to lose synchronization. For this reason, in the event that a table on the source becomes damaged and you use `REPAIR TABLE` to repair it, you should first stop replication (if it is still running) before using `REPAIR TABLE`, then afterward compare the source's and replica's copies of the table and be prepared to correct any discrepancies manually, before restarting replication.

### 16.4.1.25 Replication and Reserved Words

You can encounter problems when you attempt to replicate from an older source to a newer replica and you make use of identifiers on the source that are reserved words in the newer MySQL version running on the replica. An example of this is using a table column named `virtual` on a 5.6 source that is replicating to a 5.7 or higher replica because `VIRTUAL` is a reserved word beginning in MySQL 5.7. Replication can fail in such cases with Error 1064 *You have an error in your SQL syntax..., even if a database or table named using the reserved word or a table having a column named using the reserved word is excluded from replication*. This is due to the fact that each SQL event must be parsed by the replica prior to execution, so that the replica knows which database object or objects would be affected; only after the event is parsed can the replica apply any filtering rules defined by `--replicate-do-db`, `--replicate-do-table`, `--replicate-ignore-db`, and `--replicate-ignore-table`.

To work around the problem of database, table, or column names on the source which would be regarded as reserved words by the replica, do one of the following:

- Use one or more `ALTER TABLE` statements on the source to change the names of any database objects where these names would be considered reserved words on the replica, and change any SQL statements that use the old names to use the new names instead.

- In any SQL statements using these database object names, write the names as quoted identifiers using backtick characters (```).

For listings of reserved words by MySQL version, see [Keywords and Reserved Words in MySQL 5.7](#), in the *MySQL Server Version Reference*. For identifier quoting rules, see [Section 9.2, “Schema Object Names”](#).

### 16.4.1.26 Replication and Source or Replica Shutdowns

It is safe to shut down a source server and restart it later. When a replica loses its connection to the source, the replica tries to reconnect immediately and retries periodically if that fails. The default is to retry every 60 seconds. This may be changed with the `CHANGE MASTER TO` statement. A replica also is able to deal with network connectivity outages. However, the replica notices the network outage only after receiving no data from the source for `slave_net_timeout` seconds. If your outages are short, you may want to decrease `slave_net_timeout`. See [Section 16.3.2, “Handling an Unexpected Halt of a Replica”](#).

An unclean shutdown (for example, a crash) on the source side can result in the source's binary log having a final position less than the most recent position read by the replica, due to the source's binary log file not being flushed. This can cause the replica not to be able to replicate when the source comes back up. Setting `sync_binlog=1` in the source's `my.cnf` file helps to minimize this problem because it causes the source to flush its binary log more frequently. For the greatest possible durability and consistency in a replication setup using InnoDB with transactions, you should also set `innodb_flush_log_at_trx_commit=1`. With this setting, the contents of the InnoDB redo log buffer are written out to the log file at each transaction commit and the log file is flushed to disk. Note that the durability of transactions is still not guaranteed with this setting, because operating systems or disk hardware may tell `mysqld` that the flush-to-disk operation has taken place, even though it has not.

Shutting down a replica cleanly is safe because it keeps track of where it left off. However, be careful that the replica does not have temporary tables open; see [Section 16.4.1.29, “Replication and Temporary Tables”](#). Unclean shutdowns might produce problems, especially if the disk cache was not flushed to disk before the problem occurred:

- For transactions, the replica commits and then updates `relay-log.info`. If an unexpected exit occurs between these two operations, relay log processing proceeds further than the information file indicates and the replica re-executes the events from the last transaction in the relay log after it has been restarted.
- A similar problem can occur if the replica updates `relay-log.info` but the server host crashes before the write has been flushed to disk. To minimize the chance of this occurring, set `sync_relay_log_info=1` in the replica `my.cnf` file. Setting `sync_relay_log_info` to 0 causes no writes to be forced to disk and the server relies on the operating system to flush the file from time to time.

The fault tolerance of your system for these types of problems is greatly increased if you have a good uninterruptible power supply.

### 16.4.1.27 Replica Errors During Replication

If a statement produces the same error (identical error code) on both the source and the replica, the error is logged, but replication continues.

If a statement produces different errors on the source and the replica, the replication SQL thread terminates, and the replica writes a message to its error log and waits for the database administrator to decide what to do about the error. This includes the case that a statement produces an error on the source or the replica, but not both. To address the issue, connect to the replica manually and determine the cause of the problem. `SHOW SLAVE STATUS` is useful for this. Then fix the problem and run `START SLAVE`. For example, you might need to create a nonexistent table before you can start the replica again.

**Note**

If a temporary error is recorded in the replica's error log, you do not necessarily have to take any action suggested in the quoted error message. Temporary errors should be handled by the client retrying the transaction. For example, if the replication SQL thread records a temporary error relating to a deadlock, you do not need to restart the transaction manually on the replica, unless the replication SQL thread subsequently terminates with a nontemporary error message.

If this error code validation behavior is not desirable, some or all errors can be masked out (ignored) with the `--slave-skip-errors` option.

For nontransactional storage engines such as [MyISAM](#), it is possible to have a statement that only partially updates a table and returns an error code. This can happen, for example, on a multiple-row insert that has one row violating a key constraint, or if a long update statement is killed after updating some of the rows. If that happens on the source, the replica expects execution of the statement to result in the same error code. If it does not, the replication SQL thread stops as described previously.

If you are replicating between tables that use different storage engines on the source and replica, keep in mind that the same statement might produce a different error when run against one version of the table, but not the other, or might cause an error for one version of the table, but not the other. For example, since [MyISAM](#) ignores foreign key constraints, an `INSERT` or `UPDATE` statement accessing an [InnoDB](#) table on the source might cause a foreign key violation but the same statement performed on a [MyISAM](#) version of the same table on the replica would produce no such error, causing replication to stop.

### 16.4.1.28 Replication and Server SQL Mode

Using different server SQL mode settings on the source and the replica may cause the same `INSERT` statements to be handled differently on the source and the replica, leading the source and replica to diverge. For best results, you should always use the same server SQL mode on the source and on the replica. This advice applies whether you are using statement-based or row-based replication.

If you are replicating partitioned tables, using different SQL modes on the source and the replica is likely to cause issues. At a minimum, this is likely to cause the distribution of data among partitions to be different in the source's and replica's copies of a given table. It may also cause inserts into partitioned tables that succeed on the source to fail on the replica.

For more information, see [Section 5.1.10, "Server SQL Modes"](#). In particular, see [SQL Mode Changes in MySQL 5.7](#), which describes changes in MySQL 5.7, so that you can assess whether your applications are affected.

### 16.4.1.29 Replication and Temporary Tables

The discussion in the following paragraphs does not apply when `binlog_format=ROW` because, in that case, temporary tables are not replicated; this means that there are never any temporary tables on the replica to be lost in the event of an unplanned shutdown by the replica. The remainder of this section applies only when using statement-based or mixed-format replication. Loss of replicated temporary tables on the replica can be an issue, whenever `binlog_format` is `STATEMENT` or `MIXED`, for statements involving temporary tables that can be logged safely using statement-based format. For more information about row-based replication and temporary tables, see [Row-based logging of temporary tables](#).

**Safe replica shutdown when using temporary tables.** Temporary tables are replicated except in the case where you stop the replica server (not just the replication threads) and you have replicated temporary tables that are open for use in updates that have not yet been executed on the replica. If you stop the replica server, the temporary tables needed by those updates are no longer available when the replica is

restarted. To avoid this problem, do not shut down the replica while it has temporary tables open. Instead, use the following procedure:

1. Issue a `STOP SLAVE SQL_THREAD` statement.
2. Use `SHOW STATUS` to check the value of the `Slave_open_temp_tables` variable.
3. If the value is not 0, restart the replication SQL thread with `START SLAVE SQL_THREAD` and repeat the procedure later.
4. When the value is 0, issue a `mysqladmin shutdown` command to stop the replica.

**Temporary tables and replication options.** By default, all temporary tables are replicated; this happens whether or not there are any matching `--replicate-do-db`, `--replicate-do-table`, or `--replicate-wild-do-table` options in effect. However, the `--replicate-ignore-table` and `--replicate-wild-ignore-table` options are honored for temporary tables. The exception is that to enable correct removal of temporary tables at the end of a session, a replica always replicates a `DROP TEMPORARY TABLE IF EXISTS` statement, regardless of any exclusion rules that would normally apply for the specified table.

A recommended practice when using statement-based or mixed-format replication is to designate a prefix for exclusive use in naming temporary tables that you do not want replicated, then employ a `--replicate-wild-ignore-table` option to match that prefix. For example, you might give all such tables names beginning with `norep` (such as `norepmytable`, `norepyourtable`, and so on), then use `--replicate-wild-ignore-table=norep%` to prevent them from being replicated.

### 16.4.1.30 Replication Retries and Timeouts

The global system variable `slave_transaction_retries` affects replication as follows: If the replication SQL thread fails to execute a transaction because of an InnoDB deadlock or because it exceeded the InnoDB `innodb_lock_wait_timeout` value, or the NDB `TransactionDeadlockDetectionTimeout` or `TransactionInactiveTimeout` value, the replica automatically retries the transaction `slave_transaction_retries` times before stopping with an error. The default value is 10. The total retry count can be seen in the output of `SHOW STATUS`; see [Section 5.1.9, “Server Status Variables”](#).

### 16.4.1.31 Replication and Time Zones

By default, source and replica servers assume that they are in the same time zone. If you are replicating between servers in different time zones, the time zone must be set on both source and replica. Otherwise, statements depending on the local time on the source are not replicated properly, such as statements that use the `NOW()` or `FROM_UNIXTIME()` functions.

Verify that your combination of settings for the system time zone (`system_time_zone`), server current time zone (the global value of `time_zone`), and per-session time zones (the session value of `time_zone`) on the source and replica is producing the correct results. In particular, if the `time_zone` system variable is set to the value `SYSTEM`, indicating that the server time zone is the same as the system time zone, this can cause the source and replica to apply different time zones. For example, a source could write the following statement in the binary log:

```
SET @@session.time_zone='SYSTEM';
```

If this source and its replica have a different setting for their system time zones, this statement can produce unexpected results on the replica, even if the replica's global `time_zone` value has been set to match the source's. For an explanation of MySQL Server's time zone settings, and how to change them, see [Section 5.1.13, “MySQL Server Time Zone Support”](#).

See also [Section 16.4.1.15, “Replication and System Functions”](#).

### 16.4.1.32 Replication and Transaction Inconsistencies

Inconsistencies in the sequence of transactions that have been executed from the relay log can occur depending on your replication configuration. This section explains how to avoid inconsistencies and solve any problems they cause.

The following types of inconsistencies can exist:

- *Half-applied transactions.* A transaction which updates non-transactional tables has applied some but not all of its changes.
- *Gaps.* A gap is a transaction that has not been fully applied, even though some transaction later in the sequence has been applied. Gaps can only appear when using a multithreaded replica. To avoid gaps occurring, set `slave_preserve_commit_order=1`, which requires `slave_parallel_type=LOGICAL_CLOCK`, and that `log-bin` and `log-slave-updates` are also enabled. Note that `slave_preserve_commit_order=1` does not preserve the order of non-transactional DML updates, so these might commit before transactions that precede them in the relay log, which might result in gaps.
- *Source binary log position lag.* Even in the absence of gaps, it is possible that transactions after `Exec_master_log_pos` have been applied. That is, all transactions up to point `N` have been applied, and no transactions after `N` have been applied, but `Exec_master_log_pos` has a value smaller than `N`. In this situation, `Exec_master_log_pos` is a “low-water mark” of the transactions applied, and lags behind the position of the most recently applied transaction. This can only happen on multithreaded replicas. Enabling `slave_preserve_commit_order` does not prevent source binary log position lag.

The following scenarios are relevant to the existence of half-applied transactions, gaps, and source binary log position lag:

1. While replication threads are running, there may be gaps and half-applied transactions.
2. `mysqld` shuts down. Both clean and unclean shutdown abort ongoing transactions and may leave gaps and half-applied transactions.
3. `KILL` of replication threads (the SQL thread when using a single-threaded replica, the coordinator thread when using a multithreaded replica). This aborts ongoing transactions and may leave gaps and half-applied transactions.
4. Error in applier threads. This may leave gaps. If the error is in a mixed transaction, that transaction is half-applied. When using a multithreaded replica, workers which have not received an error complete their queues, so it may take time to stop all threads.
5. `STOP SLAVE` when using a multithreaded replica. After issuing `STOP SLAVE`, the replica waits for any gaps to be filled and then updates `Exec_master_log_pos`. This ensures it never leaves gaps or source binary log position lag, unless any of the cases above applies, in other words, before `STOP SLAVE` completes, either an error happens, or another thread issues `KILL`, or the server restarts. In these cases, `STOP SLAVE` returns successfully.
6. If the last transaction in the relay log is only half-received and the multithreaded replica coordinator has started to schedule the transaction to a worker, then `STOP SLAVE` waits up to 60 seconds for the transaction to be received. After this timeout, the coordinator gives up and aborts the transaction. If the transaction is mixed, it may be left half-completed.
7. `STOP SLAVE` when the ongoing transaction updates transactional tables only, in which case it is rolled back and `STOP SLAVE` stops immediately. If the ongoing transaction is mixed, `STOP SLAVE` waits up

to 60 seconds for the transaction to complete. After this timeout, it aborts the transaction, so it may be left half-completed.

The global variable `rpl_stop_slave_timeout` is unrelated to the process of stopping the replication threads. It only makes the client that issues `STOP SLAVE` return to the client, but the replication threads continue to try to stop.

If a replication channel has gaps, it has the following consequences:

1. The replica database is in a state that may never have existed on the source.
2. The field `Exec_master_log_pos` in `SHOW SLAVE STATUS` is only a “low-water mark”. In other words, transactions appearing before the position are guaranteed to have committed, but transactions after the position may have committed or not.
3. `CHANGE MASTER TO` statements for that channel fail with an error, unless the applier threads are running and the `CHANGE MASTER TO` statement only sets receiver options.
4. If `mysqld` is started with `--relay-log-recovery`, no recovery is done for that channel, and a warning is printed.
5. If `mysqldump` is used with `--dump-slave`, it does not record the existence of gaps; thus it prints `CHANGE MASTER TO` with `RELAY_LOG_POS` set to the “low-water mark” position in `Exec_master_log_pos`.

After applying the dump on another server, and starting the replication threads, transactions appearing after the position are replicated again. Note that this is harmless if GTIDs are enabled (however, in that case it is not recommended to use `--dump-slave`).

If a replication channel has source binary log position lag but no gaps, cases 2 to 5 above apply, but case 1 does not.

The source binary log position information is persisted in binary format in the internal table `mysql.slave_worker_info`. `START SLAVE [SQL_THREAD]` always consults this information so that it applies only the correct transactions. This remains true even if `slave_parallel_workers` has been changed to 0 before `START SLAVE`, and even if `START SLAVE` is used with `UNTIL` clauses. `START SLAVE UNTIL SQL_AFTER_MTS_GAPS` only applies as many transactions as needed in order to fill in the gaps. If `START SLAVE` is used with `UNTIL` clauses that tell it to stop before it has consumed all the gaps, then it leaves remaining gaps.



### Warning

`RESET SLAVE` removes the relay logs and resets the replication position. Thus issuing `RESET SLAVE` on a replica with gaps means the replica loses any information about the gaps, without correcting the gaps.

When GTID-based replication is in use, from MySQL 5.7.28 a multithreaded replica checks first whether `MASTER_AUTO_POSITION` is set to `ON`, and if it is, omits the step of calculating the transactions that should be skipped or not skipped. In that situation, the old relay logs are not required for the recovery process.

### 16.4.1.33 Replication and Transactions

**Mixing transactional and nontransactional statements within the same transaction.** In general, you should avoid transactions that update both transactional and nontransactional tables in a replication environment. You should also avoid using any statement that accesses both transactional (or temporary) and nontransactional tables and writes to any of them.

The server uses these rules for binary logging:

- If the initial statements in a transaction are nontransactional, they are written to the binary log immediately. The remaining statements in the transaction are cached and not written to the binary log until the transaction is committed. (If the transaction is rolled back, the cached statements are written to the binary log only if they make nontransactional changes that cannot be rolled back. Otherwise, they are discarded.)
- For statement-based logging, logging of nontransactional statements is affected by the `binlog_direct_non_transactional_updates` system variable. When this variable is `OFF` (the default), logging is as just described. When this variable is `ON`, logging occurs immediately for nontransactional statements occurring anywhere in the transaction (not just initial nontransactional statements). Other statements are kept in the transaction cache and logged when the transaction commits. `binlog_direct_non_transactional_updates` has no effect for row-format or mixed-format binary logging.

### Transactional, nontransactional, and mixed statements.

To apply those rules, the server considers a statement nontransactional if it changes only nontransactional tables, and transactional if it changes only transactional tables. A statement that references both nontransactional and transactional tables and updates *any* of the tables involved, is considered a “mixed” statement. (In some past MySQL versions, only a statement that updated *both* nontransactional and transactional tables was considered mixed.) Mixed statements, like transactional statements, are cached and logged when the transaction commits.

A mixed statement that updates a transactional table is considered unsafe if the statement also performs either of the following actions:

- Updates or reads a temporary table
- Reads a nontransactional table and the transaction isolation level is less than `REPEATABLE_READ`

A mixed statement following the update of a transactional table within a transaction is considered unsafe if it performs either of the following actions:

- Updates any table and reads from any temporary table
- Updates a nontransactional table and `binlog_direct_non_transactional_updates` is `OFF`

For more information, see [Section 16.2.1.3, “Determination of Safe and Unsafe Statements in Binary Logging”](#).



#### Note

A mixed statement is unrelated to mixed binary logging format.

In situations where transactions mix updates to transactional and nontransactional tables, the order of statements in the binary log is correct, and all needed statements are written to the binary log even in case of a `ROLLBACK`. However, when a second connection updates the nontransactional table before the first connection transaction is complete, statements can be logged out of order because the second connection update is written immediately after it is performed, regardless of the state of the transaction being performed by the first connection.

**Using different storage engines on source and replica.** It is possible to replicate transactional tables on the source using nontransactional tables on the replica. For example, you can replicate an `InnoDB` source table as a `MyISAM` replica table. However, if you do this, there are problems if the replica is stopped in the middle of a `BEGIN ... COMMIT` block because the replica restarts at the beginning of the `BEGIN` block.



It is also safe to replicate transactions from [MyISAM](#) tables on the source to transactional tables, such as tables that use the [InnoDB](#) storage engine, on the replica. In such cases, an `AUTOCOMMIT=1` statement issued on the source is replicated, thus enforcing `AUTOCOMMIT` mode on the replica.

When the storage engine type of the replica is nontransactional, transactions on the source that mix updates of transactional and nontransactional tables should be avoided because they can cause inconsistency of the data between the source transactional table and the replica nontransactional table. That is, such transactions can lead to source storage engine-specific behavior with the possible effect of replication going out of synchrony. MySQL does not issue a warning about this currently, so extra care should be taken when replicating transactional tables from the source to nontransactional tables on the replicas.

**Changing the binary logging format within transactions.** The `binlog_format` and `binlog_checksum` system variables are read-only as long as a transaction is in progress.

Every transaction (including `autocommit` transactions) is recorded in the binary log as though it starts with a `BEGIN` statement, and ends with either a `COMMIT` or a `ROLLBACK` statement. This is even true for statements affecting tables that use a nontransactional storage engine (such as [MyISAM](#)).



#### Note

For restrictions that apply specifically to XA transactions, see [Section 13.3.7.3, “Restrictions on XA Transactions”](#).

### 16.4.1.34 Replication and Triggers

With statement-based replication, triggers executed on the source also execute on the replica. With row-based replication, triggers executed on the source do not execute on the replica. Instead, the row changes on the source resulting from trigger execution are replicated and applied on the replica.

This behavior is by design. If under row-based replication the replica applied the triggers as well as the row changes caused by them, the changes would in effect be applied twice on the replica, leading to different data on the source and the replica.

If you want triggers to execute on both the source and the replica, perhaps because you have different triggers on the source and replica, you must use statement-based replication. However, to enable replica-side triggers, it is not necessary to use statement-based replication exclusively. It is sufficient to switch to statement-based replication only for those statements where you want this effect, and to use row-based replication the rest of the time.

A statement invoking a trigger (or function) that causes an update to an `AUTO_INCREMENT` column is not replicated correctly using statement-based replication. MySQL 5.7 marks such statements as unsafe. (Bug #45677)

A trigger can have triggers for different combinations of trigger event (`INSERT`, `UPDATE`, `DELETE`) and action time (`BEFORE`, `AFTER`), but before MySQL 5.7.2 cannot have multiple triggers that have the same trigger event and action time. MySQL 5.7.2 lifts this limitation and multiple triggers are permitted. This change has replication implications for upgrades and downgrades.

For brevity, “multiple triggers” here is shorthand for “multiple triggers that have the same trigger event and action time.”

**Upgrades.** Suppose that you upgrade an old server that does not support multiple triggers to MySQL 5.7.2 or higher. If the new server is a replication source server and has old replicas that do not support multiple triggers, an error occurs on those replicas if a trigger is created on the source for a table that already has a

trigger with the same trigger event and action time. To avoid this problem, upgrade the replicas first, then upgrade the source.

**Downgrades.** If you downgrade a server that supports multiple triggers to an older version that does not, the downgrade has these effects:

- For each table that has triggers, all trigger definitions remain in the `.TRG` file for the table. However, if there are multiple triggers with the same trigger event and action time, the server executes only one of them when the trigger event occurs. For information about `.TRG` files, see the Table Trigger Storage section of the MySQL Server Doxygen documentation, available at <https://dev.mysql.com/doc/index-other.html>.
- If triggers for the table are added or dropped subsequent to the downgrade, the server rewrites the table's `.TRG` file. The rewritten file retains only one trigger per combination of trigger event and action time; the others are lost.

To avoid these problems, modify your triggers before downgrading. For each table that has multiple triggers per combination of trigger event and action time, convert each such set of triggers to a single trigger as follows:

1. For each trigger, create a stored routine that contains all the code in the trigger. Values accessed using `NEW` and `OLD` can be passed to the routine using parameters. If the trigger needs a single result value from the code, you can put the code in a stored function and have the function return the value. If the trigger needs multiple result values from the code, you can put the code in a stored procedure and return the values using `OUT` parameters.
2. Drop all triggers for the table.
3. Create one new trigger for the table that invokes the stored routines just created. The effect for this trigger is thus the same as the multiple triggers it replaces.

### 16.4.1.35 Replication and TRUNCATE TABLE

`TRUNCATE TABLE` is normally regarded as a DML statement, and so would be expected to be logged and replicated using row-based format when the binary logging mode is `ROW` or `MIXED`. However this caused issues when logging or replicating, in `STATEMENT` or `MIXED` mode, tables that used transactional storage engines such as `InnoDB` when the transaction isolation level was `READ COMMITTED` or `READ UNCOMMITTED`, which precludes statement-based logging.

`TRUNCATE TABLE` is treated for purposes of logging and replication as DDL rather than DML so that it can be logged and replicated as a statement. However, the effects of the statement as applicable to `InnoDB` and other transactional tables on replicas still follow the rules described in [Section 13.1.34, “TRUNCATE TABLE Statement”](#) governing such tables. (Bug #36763)

### 16.4.1.36 Replication and User Name Length

The maximum length of MySQL user names was increased from 16 characters to 32 characters in MySQL 5.7.8. Replication of user names longer than 16 characters to a replica that supports only shorter user names fails. However, this should occur only when replicating from a newer source to an older replica, which is not a recommended configuration.

### 16.4.1.37 Replication and Variables

System variables are not replicated correctly when using `STATEMENT` mode, except for the following variables when they are used with session scope:

- `auto_increment_increment`
- `auto_increment_offset`
- `character_set_client`
- `character_set_connection`
- `character_set_database`
- `character_set_server`
- `collation_connection`
- `collation_database`
- `collation_server`
- `foreign_key_checks`
- `identity`
- `last_insert_id`
- `lc_time_names`
- `pseudo_thread_id`
- `sql_auto_is_null`
- `time_zone`
- `timestamp`
- `unique_checks`

When `MIXED` mode is used, the variables in the preceding list, when used with session scope, cause a switch from statement-based to row-based logging. See [Section 5.4.4.3, “Mixed Binary Logging Format”](#).

`sql_mode` is also replicated except for the `NO_DIR_IN_CREATE` mode; the replica always preserves its own value for `NO_DIR_IN_CREATE`, regardless of changes to it on the source. This is true for all replication formats.

However, when `mysqlbinlog` parses a `SET @@sql_mode = mode` statement, the full `mode` value, including `NO_DIR_IN_CREATE`, is passed to the receiving server. For this reason, replication of such a statement may not be safe when `STATEMENT` mode is in use.

The `default_storage_engine` system variable is not replicated, regardless of the logging mode; this is intended to facilitate replication between different storage engines.

The `read_only` system variable is not replicated. In addition, the enabling this variable has different effects with regard to temporary tables, table locking, and the `SET PASSWORD` statement in different MySQL versions.

The `max_heap_table_size` system variable is not replicated. Increasing the value of this variable on the source without doing so on the replica can lead eventually to `Table is full` errors on the replica when trying to execute `INSERT` statements on a `MEMORY` table on the source that is thus permitted to grow larger than its counterpart on the replica. For more information, see [Section 16.4.1.20, “Replication and MEMORY Tables”](#).

In statement-based replication, session variables are not replicated properly when used in statements that update tables. For example, the following sequence of statements do not insert the same data on the source and the replica:

```
SET max_join_size=1000;
INSERT INTO mytable VALUES(@@max_join_size);
```

This does not apply to the common sequence:

```
SET time_zone=...;
INSERT INTO mytable VALUES(CONVERT_TZ(..., ..., @@time_zone));
```

Replication of session variables is not a problem when row-based replication is being used, in which case, session variables are always replicated safely. See [Section 16.2.1, “Replication Formats”](#).

The following session variables are written to the binary log and honored by the replica when parsing the binary log, regardless of the logging format:

- `sql_mode`
- `foreign_key_checks`
- `unique_checks`
- `character_set_client`
- `collation_connection`
- `collation_database`
- `collation_server`
- `sql_auto_is_null`



### Important

Even though session variables relating to character sets and collations are written to the binary log, replication between different character sets is not supported.

To help reduce possible confusion, we recommend that you always use the same setting for the `lower_case_table_names` system variable on both source and replica, especially when you are running MySQL on platforms with case-sensitive file systems.

### 16.4.1.38 Replication and Views

Views are always replicated to replicas. Views are filtered by their own name, not by the tables they refer to. This means that a view can be replicated to the replica even if the view contains a table that would normally be filtered out by `replication-ignore-table` rules. Care should therefore be taken to ensure that views do not replicate table data that would normally be filtered for security reasons.

Replication from a table to a same-named view is supported using statement-based logging, but not when using row-based logging. Trying to do so when row-based logging is in effect causes an error. (Bug #11752707, Bug #43975)

## 16.4.2 Replication Compatibility Between MySQL Versions

MySQL supports replication from one release series to the next higher release series. For example, you can replicate from a source running MySQL 5.6 to a replica running MySQL 5.7, from a source running MySQL 5.7 to a replica running MySQL 8.0, and so on. However, you may encounter difficulties when

replicating from an older source to a newer replica if the source uses statements or relies on behavior no longer supported in the version of MySQL used on the replica. For example, foreign key names longer than 64 characters are no longer supported from MySQL 8.0.

The use of more than two MySQL Server versions is not supported in replication setups involving multiple sources, regardless of the number of source or replica MySQL servers. This restriction applies not only to release series, but to version numbers within the same release series as well. For example, if you are using a chained or circular replication setup, you cannot use MySQL 5.7.22, MySQL 5.7.23, and MySQL 5.7.24 concurrently, although you could use any two of these releases together.



### Important

It is strongly recommended to use the most recent release available within a given MySQL release series because replication (and other) capabilities are continually being improved. It is also recommended to upgrade sources and replicas that use early releases of a release series of MySQL to GA (production) releases when the latter become available for that release series.

Replication from newer sources to older replicas may be possible, but is generally not supported. This is due to a number of factors:

- **Binary log format changes.** The binary log format can change between major releases. While we attempt to maintain backward compatibility, this is not always possible.

This also has significant implications for upgrading replication servers; see [Section 16.4.3, “Upgrading a Replication Topology”](#), for more information.

- For more information about row-based replication, see [Section 16.2.1, “Replication Formats”](#).
- **SQL incompatibilities.** You cannot replicate from a newer source to an older replica using statement-based replication if the statements to be replicated use SQL features available on the source but not on the replica.

However, if both the source and the replica support row-based replication, and there are no data definition statements to be replicated that depend on SQL features found on the source but not on the replica, you can use row-based replication to replicate the effects of data modification statements even if the DDL run on the source is not supported on the replica.

For more information on potential replication issues, see [Section 16.4.1, “Replication Features and Issues”](#).

## 16.4.3 Upgrading a Replication Topology

When you upgrade servers that participate in a replication topology, you need to take into account each server's role in the topology and look out for issues specific to replication. For general information and instructions for upgrading a MySQL Server instance, see [Section 2.10, “Upgrading MySQL”](#).

As explained in [Section 16.4.2, “Replication Compatibility Between MySQL Versions”](#), MySQL supports replication from a source running one release series to a replica running the next higher release series, but does not support replication from a source running a later release to a replica running an earlier release. A replica at an earlier release might not have the required capability to process transactions that can be handled by the source at a later release. You must therefore upgrade all of the replicas in a replication topology to the target MySQL Server release, before you upgrade the source server to the target release. In this way you will never be in the situation where a replica still at the earlier release is attempting to handle transactions from a source at the later release.

In a replication topology where there are multiple sources (multi-source replication), the use of more than two MySQL Server versions is not supported, regardless of the number of source or replica MySQL

servers. This restriction applies not only to release series, but to version numbers within the same release series as well. For example, you cannot use MySQL 5.7.22, MySQL 5.7.24, and MySQL 5.7.28 concurrently in such a setup, although you could use any two of these releases together.

If you need to downgrade the servers in a replication topology, the source must be downgraded before the replicas are downgraded. On the replicas, you must ensure that the binary log and relay log have been fully processed, and remove them before proceeding with the downgrade.

### Behavior Changes Between Releases

Although this upgrade sequence is correct, it is possible to still encounter replication difficulties when replicating from a source at an earlier release that has not yet been upgraded, to a replica at a later release that has been upgraded. This can happen if the source uses statements or relies on behavior that is no longer supported in the later release installed on the replica. You can use MySQL Shell's upgrade checker utility `util.checkForServerUpgrade()` to check MySQL 5.7 server instances or MySQL 8.0 server instances for upgrade to a GA MySQL 8.0 release. The utility identifies anything that needs to be fixed for that server instance so that it does not cause an issue after the upgrade, including features and behaviors that are no longer available in the later release. See [Upgrade Checker Utility](#) for information on the upgrade checker utility.

If you are upgrading an existing replication setup from a version of MySQL that does not support global transaction identifiers (GTIDs) to a version that does, only enable GTIDs on the source and the replicas when you have made sure that the setup meets all the requirements for GTID-based replication. See [Section 16.1.3.4, “Setting Up Replication Using GTIDs”](#) for information about converting binary log file position based replication setups to use GTID-based replication.

Changes affecting operations in strict SQL mode (`STRICT_TRANS_TABLES` or `STRICT_ALL_TABLES`) may result in replication failure on an upgraded replica. If you use statement-based logging (`binlog_format=STATEMENT`), if a replica is upgraded before the source, the source executes statements which succeed there but which may fail on the replica and so cause replication to stop. To deal with this, stop all new statements on the source and wait until the replicas catch up, then upgrade the replicas. Alternatively, if you cannot stop new statements, temporarily change to row-based logging on the source (`binlog_format=ROW`) and wait until all replicas have processed all binary logs produced up to the point of this change, then upgrade the replicas.

The default character set has changed from `latin1` to `utf8mb4` in MySQL 8.0. In a replicated setting, when upgrading from MySQL 5.7 to 8.0, it is advisable to change the default character set back to the character set used in MySQL 5.7 before upgrading. After the upgrade is completed, the default character set can be changed to `utf8mb4`. Assuming that the previous defaults were used, one way to preserve them is to start the server with these lines in the `my.cnf` file:

```
[mysqld]
character_set_server=latin1
collation_server=latin1_swedish_ci
```

### Standard Upgrade Procedure

To upgrade a replication topology, follow the instructions in [Section 2.10, “Upgrading MySQL”](#) for each individual MySQL Server instance, using this overall procedure:

1. Upgrade the replicas first. On each replica instance:
  - Carry out the preliminary checks and steps described in [Preparing Your Installation for Upgrade](#).
  - Shut down MySQL Server.
  - Upgrade the MySQL Server binaries or packages.

- Restart MySQL Server.
  - If you have upgraded to a release earlier than MySQL 8.0.16, invoke `mysql_upgrade` manually to upgrade the system tables and schemas. When the server is running with global transaction identifiers (GTIDs) enabled (`gtid_mode=ON`), do not enable binary logging by `mysql_upgrade` (so do not use the `--write-binlog` option). Then shut down and restart the server.
  - If you have upgraded to MySQL 8.0.16 or later, do not invoke `mysql_upgrade`. From that release, MySQL Server performs the entire MySQL upgrade procedure, disabling binary logging during the upgrade.
  - Restart replication using a `START REPLICAS` or `START SLAVE` statement.
2. When all the replicas have been upgraded, follow the same steps to upgrade and restart the source server, with the exception of the `START REPLICAS` or `START SLAVE` statement. If you made a temporary change to row-based logging or to the default character set, you can revert the change now.

## Upgrade Procedure With Table Repair Or Rebuild

Some upgrades may require that you drop and re-create database objects when you move from one MySQL series to the next. For example, collation changes might require that table indexes be rebuilt. Such operations, if necessary, are detailed at [Section 2.10.3, “Changes in MySQL 5.7”](#). It is safest to perform these operations separately on the replicas and the source, and to disable replication of these operations from the source to the replica. To achieve this, use the following procedure:

1. Stop all the replicas and upgrade the binaries or packages. Restart them with the `--skip-slave-start` option, or from MySQL 8.0.24, the `skip_slave_start` system variable, so that they do not connect to the source. Perform any table repair or rebuilding operations needed to re-create database objects, such as use of `REPAIR TABLE` or `ALTER TABLE`, or dumping and reloading tables or triggers.
2. Disable the binary log on the source. To do this without restarting the source, execute a `SET sql_log_bin = OFF` statement. Alternatively, stop the source and restart it with the `--skip-log-bin` option. If you restart the source, you might also want to disallow client connections. For example, if all clients connect using TCP/IP, enable the `skip_networking` system variable when you restart the source.
3. With the binary log disabled, perform any table repair or rebuilding operations needed to re-create database objects. The binary log must be disabled during this step to prevent these operations from being logged and sent to the replicas later.
4. Re-enable the binary log on the source. If you set `sql_log_bin` to `OFF` earlier, execute a `SET sql_log_bin = ON` statement. If you restarted the source to disable the binary log, restart it without `--skip-log-bin`, and without enabling the `skip_networking` system variable so that clients and replicas can connect.
5. Restart the replicas, this time without the `--skip-slave-start` option or `skip_slave_start` system variable.

## 16.4.4 Troubleshooting Replication

If you have followed the instructions but your replication setup is not working, the first thing to do is *check the error log for messages*. Many users have lost time by not doing this soon enough after encountering problems.

If you cannot tell from the error log what the problem was, try the following techniques:

- Verify that the source has binary logging enabled by issuing a `SHOW MASTER STATUS` statement. If logging is enabled, `Position` is nonzero. If binary logging is not enabled, verify that you are running the source server with the `--log-bin` option.
- Verify that the `server_id` system variable was set at startup on both the source and replica and that the ID value is unique on each server.
- Verify that the replica is running. Use `SHOW SLAVE STATUS` to check whether the `Slave_IO_Running` and `Slave_SQL_Running` values are both `Yes`. If not, verify the options that were used when starting the replica server. For example, `--skip-slave-start` prevents the replica threads from starting until you issue a `START SLAVE` statement.
- If the replica is running, check whether it established a connection to the source. Use `SHOW PROCESSLIST`, find the I/O and SQL threads and check their `State` column to see what they display. See [Section 16.2.3, “Replication Threads”](#). If the replication I/O thread state says `Connecting to master`, check the following:
  - Verify the privileges for the user being used for replication on the source.
  - Check that the host name of the source is correct and that you are using the correct port to connect to the source. The port used for replication is the same as used for client network communication (the default is `3306`). For the host name, ensure that the name resolves to the correct IP address.
  - Check the configuration file to see whether the `skip_networking` system variable has been enabled on the source or replica to disable networking. If so, comment the setting or remove it.
  - If the source has a firewall or IP filtering configuration, ensure that the network port being used for MySQL is not being filtered.
  - Check that you can reach the source by using `ping` or `traceroute/tracert` to reach the host.
- If the replica was running previously but has stopped, the reason usually is that some statement that succeeded on the source failed on the replica. This should never happen if you have taken a proper snapshot of the source, and never modified the data on the replica outside of the replication threads. If the replica stops unexpectedly, it is a bug or you have encountered one of the known replication limitations described in [Section 16.4.1, “Replication Features and Issues”](#). If it is a bug, see [Section 16.4.5, “How to Report Replication Bugs or Problems”](#), for instructions on how to report it.
- If a statement that succeeded on the source refuses to run on the replica, try the following procedure if it is not feasible to do a full database resynchronization by deleting the replica's databases and copying a new snapshot from the source:
  1. Determine whether the affected table on the replica is different from the table on the source. Try to understand how this happened. Then make the replica's table identical to the source's and run `START SLAVE`.
  2. If the preceding step does not work or does not apply, try to understand whether it would be safe to make the update manually (if needed) and then ignore the next statement from the source.
  3. If you decide that the replica can skip the next statement from the source, issue the following statements:

```
mysql> SET GLOBAL sql_slave_skip_counter = N;  
mysql> START SLAVE;
```

The value of `N` should be 1 if the next statement from the source does not use `AUTO_INCREMENT` or `LAST_INSERT_ID()`. Otherwise, the value should be 2. The reason for using a value of 2 for



statements that use `AUTO_INCREMENT` or `LAST_INSERT_ID()` is that they take two events in the binary log of the source.

See also [Section 13.4.2.4, “SET GLOBAL sql\\_slave\\_skip\\_counter Syntax”](#).

4. If you are sure that the replica started out perfectly synchronized with the source, and that no one has updated the tables involved outside of the replication threads, then presumably the discrepancy is the result of a bug. If you are running the most recent version of MySQL, please report the problem. If you are running an older version, try upgrading to the latest production release to determine whether the problem persists.

## 16.4.5 How to Report Replication Bugs or Problems

When you have determined that there is no user error involved, and replication still either does not work at all or is unstable, it is time to send us a bug report. We need to obtain as much information as possible from you to be able to track down the bug. Please spend some time and effort in preparing a good bug report.

If you have a repeatable test case that demonstrates the bug, please enter it into our bugs database using the instructions given in [Section 1.5, “How to Report Bugs or Problems”](#). If you have a “phantom” problem (one that you cannot duplicate at will), use the following procedure:

1. Verify that no user error is involved. For example, if you update the replica outside of the replication thread, the data goes out of synchrony, and you can have unique key violations on updates. In this case, the replication SQL thread stops and waits for you to clean up the tables manually to bring them into synchrony. *This is not a replication problem. It is a problem of outside interference causing replication to fail.*
2. Run the replica with the `--log-slave-updates` and `--log-bin` options. These options cause the replica to log the updates that it receives from the source into its own binary logs.
3. Save all evidence before resetting the replication state. If we have no information or only sketchy information, it becomes difficult or impossible for us to track down the problem. The evidence you should collect is:
  - All binary log files from the source
  - All binary log files from the replica
  - The output of `SHOW MASTER STATUS` from the source at the time you discovered the problem
  - The output of `SHOW SLAVE STATUS` from the replica at the time you discovered the problem
  - Error logs from the source and the replica
4. Use `mysqlbinlog` to examine the binary logs. The following should be helpful to find the problem statement. `log_file` and `log_pos` are the `Master_Log_File` and `Read_Master_Log_Pos` values from `SHOW SLAVE STATUS`.

```
$> mysqlbinlog --start-position=log_pos log_file | head
```

After you have collected the evidence for the problem, try to isolate it as a separate test case first. Then enter the problem with as much information as possible into our bugs database using the instructions at [Section 1.5, “How to Report Bugs or Problems”](#).



---

# Chapter 17 Group Replication

## Table of Contents

17.1 Group Replication Background .....	3166
17.1.1 Replication Technologies .....	3167
17.1.2 Group Replication Use Cases .....	3169
17.1.3 Group Replication Details .....	3170
17.2 Getting Started .....	3172
17.2.1 Deploying Group Replication in Single-Primary Mode .....	3172
17.2.2 Deploying Group Replication Locally .....	3183
17.3 Requirements and Limitations .....	3184
17.3.1 Group Replication Requirements .....	3184
17.3.2 Group Replication Limitations .....	3186
17.4 Monitoring Group Replication .....	3188
17.4.1 Group Replication Server States .....	3189
17.4.2 The replication_group_members Table .....	3190
17.4.3 The replication_group_member_stats Table .....	3190
17.5 Group Replication Operations .....	3191
17.5.1 Deploying in Multi-Primary or Single-Primary Mode .....	3191
17.5.2 Tuning Recovery .....	3193
17.5.3 Network Partitioning .....	3194
17.5.4 Restarting a Group .....	3199
17.5.5 Using MySQL Enterprise Backup with Group Replication .....	3201
17.6 Group Replication Security .....	3206
17.6.1 Group Replication IP Address Allowlisting .....	3206
17.6.2 Group Replication Secure Socket Layer (SSL) Support .....	3208
17.6.3 Group Replication and Virtual Private Networks (VPNs) .....	3210
17.7 Group Replication Variables .....	3210
17.7.1 Group Replication System Variables .....	3211
17.7.2 Group Replication Status Variables .....	3232
17.8 Frequently Asked Questions .....	3232
17.9 Group Replication Technical Details .....	3236
17.9.1 Group Replication Plugin Architecture .....	3236
17.9.2 The Group .....	3237
17.9.3 Data Manipulation Statements .....	3237
17.9.4 Data Definition Statements .....	3238
17.9.5 Distributed Recovery .....	3238
17.9.6 Observability .....	3245
17.9.7 Group Replication Performance .....	3245

This chapter explains MySQL Group Replication and how to install, configure and monitor groups. MySQL Group Replication is a MySQL Server plugin that enables you to create elastic, highly-available, fault-tolerant replication topologies.

Groups can operate in a single-primary mode with automatic primary election, where only one server accepts updates at a time. Alternatively, for more advanced users, groups can be deployed in multi-primary mode, where all servers can accept updates, even if they are issued concurrently.

There is a built-in group membership service that keeps the view of the group consistent and available for all servers at any given point in time. Servers can leave and join the group and the view is updated

accordingly. Sometimes servers can leave the group unexpectedly, in which case the failure detection mechanism detects this and notifies the group that the view has changed. This is all automatic.

The chapter is structured as follows:

- [Section 17.1, “Group Replication Background”](#) provides an introduction to groups and how Group Replication works.
- [Section 17.2, “Getting Started”](#) explains how to configure multiple MySQL Server instances to create a group.
- [Section 17.3, “Requirements and Limitations”](#) explains architecture and setup requirements and limitations for Group Replication.
- [Section 17.4, “Monitoring Group Replication”](#) explains how to monitor a group.
- [Section 17.5, “Group Replication Operations”](#) explains how to work with a group.
- [Section 17.6, “Group Replication Security”](#) explains how to secure a group.
- [Upgrading Group Replication](#) explains how to upgrade a group.
- [Section 17.7, “Group Replication Variables”](#) is a reference for the system variables specific to Group Replication.
- [Section 17.8, “Frequently Asked Questions”](#) provides answers to some technical questions about deploying and operating Group Replication.
- [Section 17.9, “Group Replication Technical Details”](#) provides in-depth information about how Group Replication works.

## 17.1 Group Replication Background

This section provides background information on MySQL Group Replication.

The most common way to create a fault-tolerant system is to resort to making components redundant, in other words the component can be removed and the system should continue to operate as expected. This creates a set of challenges that raise complexity of such systems to a whole different level. Specifically, replicated databases have to deal with the fact that they require maintenance and administration of several servers instead of just one. Moreover, as servers are cooperating together to create the group several other classic distributed systems problems have to be dealt with, such as network partitioning or split brain scenarios.

Therefore, the ultimate challenge is to fuse the logic of the database and data replication with the logic of having several servers coordinated in a consistent and simple way. In other words, to have multiple servers agreeing on the state of the system and the data on each and every change that the system goes through. This can be summarized as having servers reaching agreement on each database state transition, so that they all progress as one single database or alternatively that they eventually converge to the same state. Meaning that they need to operate as a (distributed) state machine.

MySQL Group Replication provides distributed state machine replication with strong coordination between servers. Servers coordinate themselves automatically when they are part of the same group. The group can operate in a single-primary mode with automatic primary election, where only one server accepts updates at a time. Alternatively, for more advanced users the group can be deployed in multi-primary mode, where all servers can accept updates, even if they are issued concurrently. This power comes at the expense of applications having to work around the limitations imposed by such deployments.

There is a built-in group membership service that keeps the view of the group consistent and available for all servers at any given point in time. Servers can leave and join the group and the view is updated accordingly. Sometimes servers can leave the group unexpectedly, in which case the failure detection mechanism detects this and notifies the group that the view has changed. This is all automatic.

For a transaction to commit, the majority of the group have to agree on the order of a given transaction in the global sequence of transactions. Deciding to commit or abort a transaction is done by each server individually, but all servers make the same decision. If there is a network partition, resulting in a split where members are unable to reach agreement, then the system does not progress until this issue is resolved. Hence there is also a built-in, automatic, split-brain protection mechanism.

All of this is powered by the provided Group Communication System (GCS) protocols. These provide a failure detection mechanism, a group membership service, and safe and completely ordered message delivery. All these properties are key to creating a system which ensures that data is consistently replicated across the group of servers. At the very core of this technology lies an implementation of the Paxos algorithm. It acts as the group communication engine.

## 17.1.1 Replication Technologies

Before getting into the details of MySQL Group Replication, this section introduces some background concepts and an overview of how things work. This provides some context to help understand what is required for Group Replication and what the differences are between classic asynchronous MySQL Replication and Group Replication.

### 17.1.1.1 Primary-Secondary Replication

Traditional MySQL Replication provides a simple Primary-Secondary approach to replication. There is a primary (source) and there are one or more secondaries (replicas). The primary executes transactions, commits them and then they are later (thus asynchronously) sent to the secondaries to be either re-executed (in statement-based replication) or applied (in row-based replication). It is a shared-nothing system, where all servers have a full copy of the data by default.

**Figure 17.1 MySQL Asynchronous Replication**

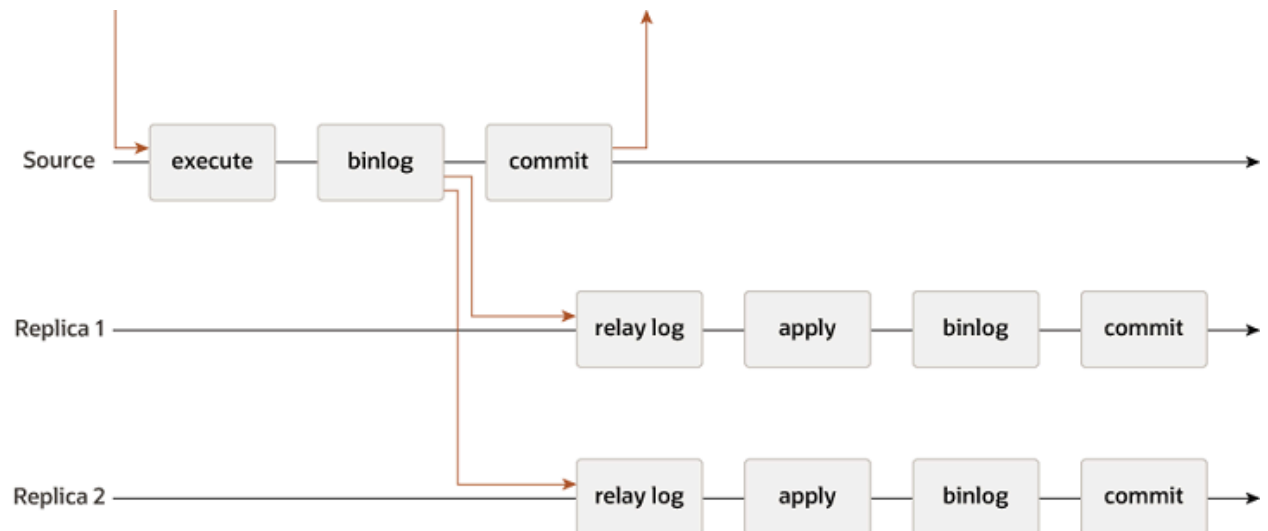

There is also semisynchronous replication, which adds one synchronization step to the protocol. This means that the Primary waits, at commit time, for the secondary to acknowledge that it has *received* the transaction. Only then does the Primary resume the commit operation.

Figure 17.2 MySQL Semisynchronous Replication

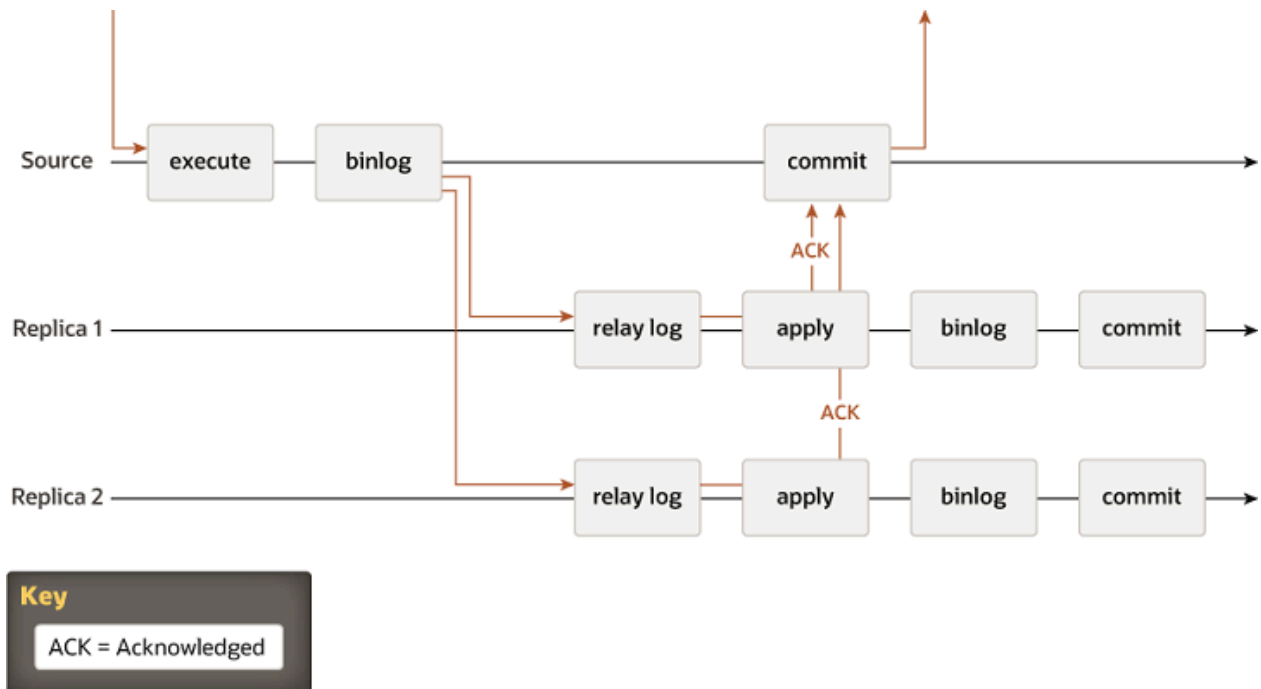

In the two pictures above, you can see a diagram of the classic asynchronous MySQL Replication protocol (and its semisynchronous variant as well). The arrows between the different instances represent messages exchanged between servers or messages exchanged between servers and the client application.

### 17.1.1.2 Group Replication

Group Replication is a technique that can be used to implement fault-tolerant systems. The replication group is a set of servers that each have their own entire copy of the data (a shared-nothing replication scheme), and interact with each other through message passing. The communication layer provides a set of guarantees such as atomic message and total order message delivery. These are very powerful properties that translate into very useful abstractions that one can resort to build more advanced database replication solutions.

MySQL Group Replication builds on top of such properties and abstractions and implements a multi-source update everywhere replication protocol. A replication group is formed by multiple servers and each server in the group may execute transactions independently at any time. However, all read-write transactions commit only after they have been approved by the group. In other words, for any read-write transaction the group needs to decide whether it commits or not, so the commit operation is not a unilateral decision from the originating server. Read-only transactions need no coordination within the group and commit immediately.

When a read-write transaction is ready to commit at the originating server, the server atomically broadcasts the write values (the rows that were changed) and the corresponding write set (the unique identifiers of the rows that were updated). Because the transaction is sent through an atomic broadcast, either all servers in the group receive the transaction or none do. If they receive it, then they all receive it in the same order with respect to other transactions that were sent before. All servers therefore receive the same set of transactions in the same order, and a global total order is established for the transactions.

However, there may be conflicts between transactions that execute concurrently on different servers. Such conflicts are detected by inspecting and comparing the write sets of two different and concurrent

transactions, in a process called *certification*. During certification, conflict detection is carried out at row level: if two concurrent transactions, that executed on different servers, update the same row, then there is a conflict. The conflict resolution procedure states that the transaction that was ordered first commits on all servers, and the transaction ordered second aborts, and is therefore rolled back on the originating server and dropped by the other servers in the group. For example, if t1 and t2 execute concurrently at different sites, both changing the same row, and t2 is ordered before t1, then t2 wins the conflict and t1 is rolled back. This is in fact a distributed first commit wins rule. Note that if two transactions are bound to conflict more often than not, then it is a good practice to start them on the same server, where they have a chance to synchronize on the local lock manager instead of being rolled back as a result of certification.

For applying and externalizing the certified transactions, Group Replication permits servers to deviate from the agreed order of the transactions if this does not break consistency and validity. Group Replication is an eventual consistency system, meaning that as soon as the incoming traffic slows down or stops, all group members have the same data content. While traffic is flowing, transactions can be externalized in a slightly different order, or externalized on some members before the others. For example, in multi-primary mode, a local transaction might be externalized immediately following certification, although a remote transaction that is earlier in the global order has not yet been applied. This is permitted when the certification process has established that there is no conflict between the transactions. In single-primary mode, on the primary server, there is a small chance that concurrent, non-conflicting local transactions might be committed and externalized in a different order from the global order agreed by Group Replication. On the secondaries, which do not accept writes from clients, transactions are always committed and externalized in the agreed order.

The following figure depicts the MySQL Group Replication protocol and by comparing it to MySQL Replication (or even MySQL semisynchronous replication) you can see some differences. Note that some underlying consensus and Paxos related messages are missing from this picture for the sake of clarity.

**Figure 17.3 MySQL Group Replication Protocol**

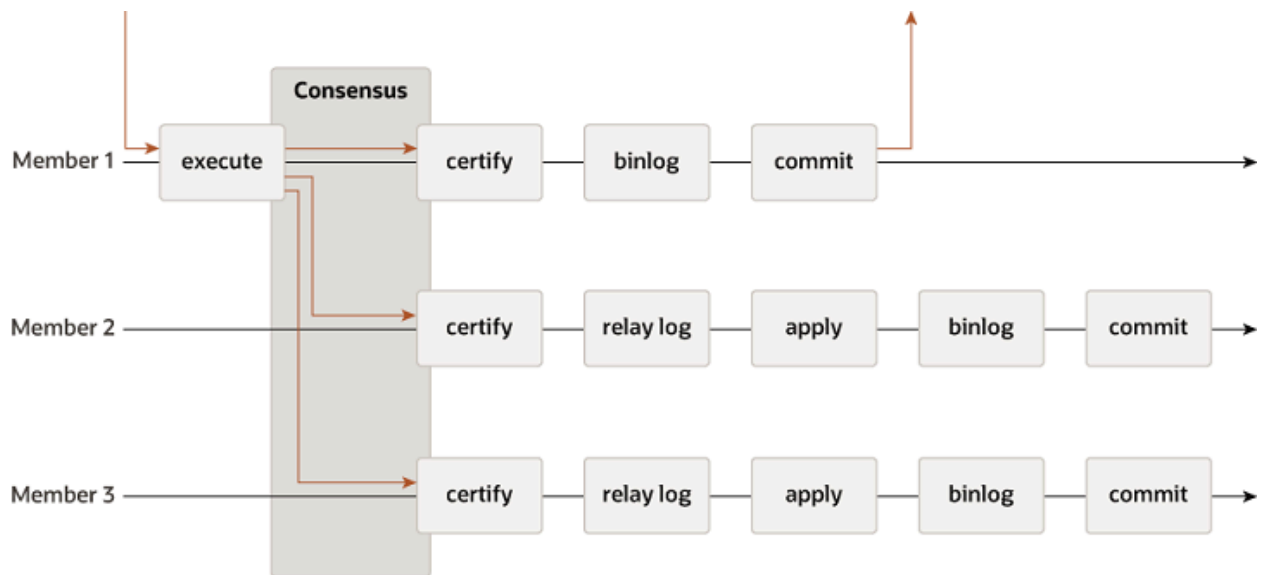

## 17.1.2 Group Replication Use Cases

Group Replication enables you to create fault-tolerant systems with redundancy by replicating the system state to a set of servers. Even if some of the servers subsequently fail, as long as it is not all or a majority, the system is still available. Depending on the number of servers which fail the group might have degraded performance or scalability, but it is still available. Server failures are isolated and independent. They are

tracked by a group membership service which relies on a distributed failure detector that is able to signal when any servers leave the group, either voluntarily or due to an unexpected halt. There is a distributed recovery procedure to ensure that when servers join the group they are brought up to date automatically. There is no need for server fail-over, and the multi-source update everywhere nature ensures that even updates are not blocked in the event of a single server failure. To summarize, MySQL Group Replication guarantees that the database service is continuously available.

It is important to understand that although the database service is available, in the event of an unexpected server exit, those clients connected to it must be redirected, or failed over, to a different server. This is not something Group Replication attempts to resolve. A connector, load balancer, router, or some form of middleware are more suitable to deal with this issue. For example see [MySQL Router 8.0](#).

To summarize, MySQL Group Replication provides a highly available, highly elastic, dependable MySQL service.

### 17.1.2.1 Examples of Use Case Scenarios

The following examples are typical use cases for Group Replication.

- *Elastic Replication* - Environments that require a very fluid replication infrastructure, where the number of servers has to grow or shrink dynamically and with as few side-effects as possible. For instance, database services for the cloud.
- *Highly Available Shards* - Sharding is a popular approach to achieve write scale-out. Use MySQL Group Replication to implement highly available shards, where each shard maps to a replication group.
- *Alternative to Source-Replica replication* - In certain situations, using a single source server makes it a single point of contention. Writing to an entire group may prove more scalable under certain circumstances.
- *Autonomic Systems* - Additionally, you can deploy MySQL Group Replication purely for the automation that is built into the replication protocol (described already in this and previous chapters).

### 17.1.3 Group Replication Details

This section presents details about some of the services that Group Replication builds on.

#### 17.1.3.1 Group Membership

In MySQL Group Replication, a set of servers forms a replication group. A group has a name, which takes the form of a UUID. The group is dynamic and servers can leave (either voluntarily or involuntarily) and join it at any time. The group adjusts itself whenever servers join or leave.

If a server joins the group, it automatically brings itself up to date by fetching the missing state from an existing server. If a server leaves the group, for instance it was taken down for maintenance, the remaining servers notice that it has left and reconfigure the group automatically.

Group Replication has a group membership service that defines which servers are online and participating in the group. The list of online servers is referred to as a *view*. Every server in the group has a consistent view of which servers are the members participating actively in the group at a given moment in time.

Group members must agree not only on transaction commits, but also on which is the current view. If existing members agree that a new server should become part of the group, the group is reconfigured to integrate that server in it, which triggers a view change. If a server leaves the group, either voluntarily or not, the group dynamically rearranges its configuration and a view change is triggered.



In the case where a member leaves the group voluntarily, it first initiates a dynamic group reconfiguration, during which all members have to agree on a new view without the leaving server. However, if a member leaves the group involuntarily, for example because it has stopped unexpectedly or the network connection is down, it cannot initiate the reconfiguration. In this situation, Group Replication's failure detection mechanism recognizes after a short period of time that the member has left, and a reconfiguration of the group without the failed member is proposed. As with a member that leaves voluntarily, the reconfiguration requires agreement from the majority of servers in the group. However, if the group is not able to reach agreement, for example because it partitioned in such a way that there is no majority of servers online, the system is not able to dynamically change the configuration, and blocks to prevent a split-brain situation. This situation requires intervention from an administrator.

It is possible for a member to go offline for a short time, then attempt to rejoin the group again before the failure detection mechanism has detected its failure, and before the group has been reconfigured to remove the member. In this situation, the rejoining member forgets its previous state, but if other members send it messages that are intended for its pre-crash state, this can cause issues including possible data inconsistency. If a member in this situation participates in XCom's consensus protocol, it could potentially cause XCom to deliver different values for the same consensus round, by making a different decision before and after failure.

To counter this possibility, from MySQL 5.7.22, servers are given a unique identifier when they join a group. This enables Group Replication to be aware of the situation where a new incarnation of the same server (with the same address but a new identifier) is trying to join the group while its old incarnation is still listed as a member. The new incarnation is blocked from joining the group until the old incarnation can be removed by a reconfiguration. If Group Replication is stopped and restarted on the server, the member becomes a new incarnation and cannot rejoin until the suspicion times out.

### 17.1.3.2 Failure Detection

Group Replication's failure detection mechanism is a distributed service which is able to identify that a server in the group is not communicating with the others, and is therefore suspected of being out of service. If the group's consensus is that the suspicion is probably true, the group takes a coordinated decision to expel the member. Expelling a member that is not communicating is necessary because the group needs a majority of its members to agree on a transaction or view change. If a member is not participating in these decisions, the group must remove it to increase the chance that the group contains a majority of correctly working members, and can therefore continue to process transactions.

In a replication group, each member has a point-to-point communication channel to each other member, creating a fully connected graph. These connections are managed by the group communication engine (XCom, a Paxos variant) and use TCP/IP sockets. One channel is used to send messages to the member and the other channel is used to receive messages from the member. If a member does not receive messages from another member for 5 seconds, it suspects that the member has failed, and lists the status of that member as `UNREACHABLE` in its own Performance Schema table `replication_group_members`. Usually, two members will suspect each other of having failed because they are each not communicating with the other. It is possible, though less likely, that member A suspects member B of having failed but member B does not suspect member A of having failed - perhaps due to a routing or firewall issue. A member can also create a suspicion of itself. A member that is isolated from the rest of the group suspects that all the others have failed.

If a suspicion lasts for more than 10 seconds, the suspecting member tries to propagate its view that the suspect member is faulty to the other members of the group. A suspecting member only does this if it is a notifier, as calculated from its internal XCom node number. If a member is actually isolated from the rest of the group, it might attempt to propagate its view, but that will have no consequences as it cannot secure a quorum of the other members to agree on it. A suspicion only has consequences if a member is a notifier, and its suspicion lasts long enough to be propagated to the other members of the group, and the

other members agree on it. In that case, the suspect member is marked for expulsion from the group in a coordinated decision, and is expelled after the expelling mechanism detects and implements the expulsion.

For information on the Group Replication system variables that you can configure to specify the responses of working group members to failure situations, and the actions taken by group members that are suspected of having failed, see [Responses to Failure Detection and Network Partitioning](#).

### 17.1.3.3 Fault-tolerance

MySQL Group Replication builds on an implementation of the Paxos distributed algorithm to provide distributed coordination between servers. As such, it requires a majority of servers to be active to reach quorum and thus make a decision. This has direct impact on the number of failures the system can tolerate without compromising itself and its overall functionality. The number of servers ( $n$ ) needed to tolerate  $f$  failures is then  $n = 2 \times f + 1$ .

In practice this means that to tolerate one failure the group must have three servers in it. As such if one server fails, there are still two servers to form a majority (two out of three) and allow the system to continue to make decisions automatically and progress. However, if a second server fails *involuntarily*, then the group (with one server left) blocks, because there is no majority to reach a decision.

The following is a small table illustrating the formula above.

Group Size	Majority	Instant Failures Tolerated
1	1	0
2	2	0
3	2	1
4	3	1
5	3	2
6	4	2
7	4	3

The next Chapter covers technical aspects of Group Replication.

## 17.2 Getting Started

MySQL Group Replication is provided as a plugin for the MySQL server; each server in a group requires configuration and installation of the plugin. This section provides a detailed tutorial with the steps required to create a replication group with at least three members.



### Tip

An alternative way to deploy multiple instances of MySQL is by using InnoDB Cluster, which uses Group Replication and wraps it in a programmatic environment that enables you to easily work with groups of MySQL server instances in the [MySQL Shell 8.0](#). In addition, InnoDB Cluster interfaces seamlessly with MySQL Router and simplifies deploying MySQL with high availability. See [MySQL AdminAPI](#).

### 17.2.1 Deploying Group Replication in Single-Primary Mode

Each of the MySQL server instances in a group can run on an independent physical host machine, which is the recommended way to deploy Group Replication. This section explains how to create a replication group with three MySQL Server instances, each running on a different host machine. See [Section 17.2.2](#),

[“Deploying Group Replication Locally”](#) for information about deploying multiple MySQL server instances running Group Replication on the same host machine, for example for testing purposes.

**Figure 17.4 Group Architecture**

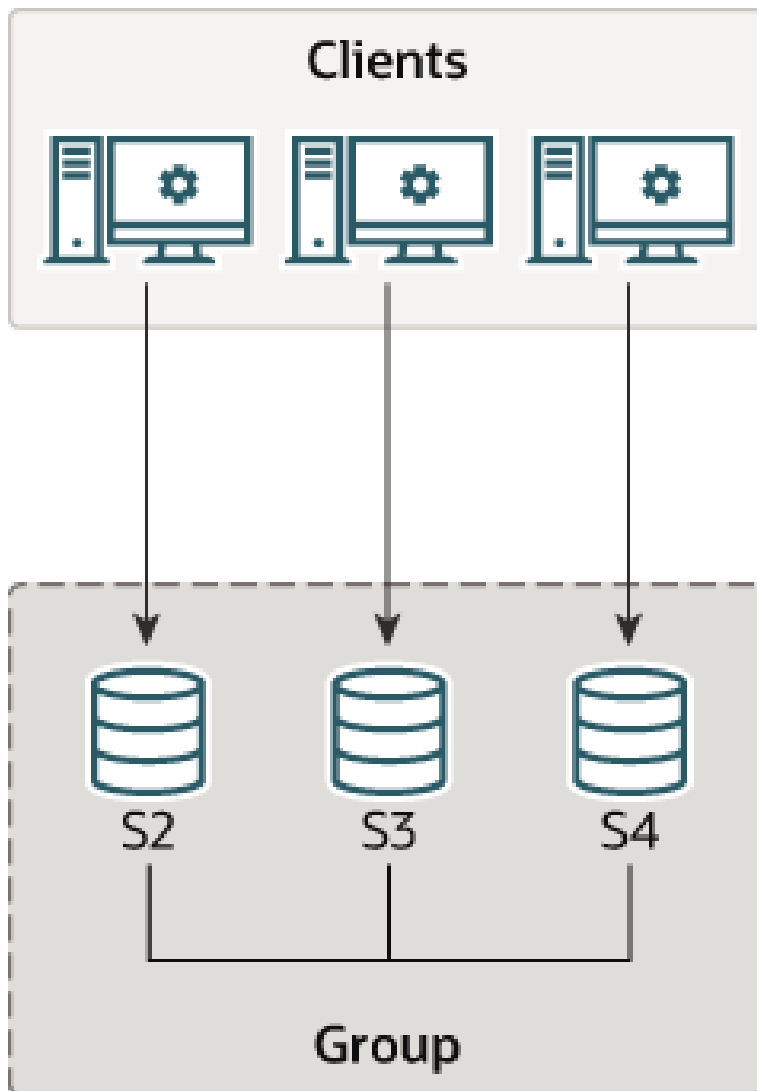

This tutorial explains how to get and deploy MySQL Server with the Group Replication plugin, how to configure each server instance before creating a group, and how to use Performance Schema monitoring to verify that everything is working correctly.

### 17.2.1.1 Deploying Instances for Group Replication

The first step is to deploy at least three instances of MySQL Server, this procedure demonstrates using multiple hosts for the instances, named s1, s2, and s3. It is assumed that MySQL Server is installed on each host (see [Chapter 2, \*Installing and Upgrading MySQL\*](#)). The Group Replication plugin is provided with MySQL Server 5.7.17 and later; no additional software is required, although the plugin must be installed in the running MySQL server. See [Section 17.2.1.1, “Deploying Instances for Group Replication”](#); for additional information, see [Section 5.5, “MySQL Server Plugins”](#).

In this example, three instances are used for the group, which is the minimum number of instances to create a group. Adding more instances increases the fault tolerance of the group. For example if the

group consists of three members, in event of failure of one instance the group can continue. But in the event of another failure the group can no longer continue processing write transactions. By adding more instances, the number of servers which can fail while the group continues to process transactions also increases. The maximum number of instances which can be used in a group is nine. For more information see [Section 17.1.3.2, “Failure Detection”](#).

### 17.2.1.2 Configuring an Instance for Group Replication

This section explains the configuration settings required for MySQL Server instances that you want to use for Group Replication. For background information, see [Section 17.3, “Requirements and Limitations”](#).

- [Storage Engines](#)
- [Replication Framework](#)
- [Group Replication Settings](#)

#### Storage Engines

For Group Replication, data must be stored in the InnoDB transactional storage engine (for details of why, see [Section 17.3.1, “Group Replication Requirements”](#)). The use of other storage engines, including the temporary `MEMORY` storage engine, might cause errors in Group Replication. Set the `disabled_storage_engines` system variable as follows to prevent their use:

```
disabled_storage_engines="MyISAM,BLACKHOLE,FEDERATED,ARCHIVE,MEMORY"
```

Note that with the `MyISAM` storage engine disabled, when you are upgrading a MySQL instance to a release where `mysql_upgrade` is still used (before MySQL 8.0.16), `mysql_upgrade` might fail with an error. To handle this, you can re-enable that storage engine while you run `mysql_upgrade`, then disable it again when you restart the server. For more information, see [Section 4.4.7, “mysql\\_upgrade — Check and Upgrade MySQL Tables”](#).

#### Replication Framework

The following settings configure replication according to the MySQL Group Replication requirements.

```
server_id=1
gtid_mode=ON
enforce_gtid_consistency=ON
master_info_repository=TABLE
relay_log_info_repository=TABLE
binlog_checksum=NONE
log_slave_updates=ON
log_bin=binlog
binlog_format=ROW
```

These settings configure the server to use the unique identifier number 1, to enable global transaction identifiers and to store replication metadata in system tables instead of files. Additionally, it instructs the server to turn on binary logging, use row-based format and disable binary log event checksums. For more details see [Section 17.3.1, “Group Replication Requirements”](#).

#### Group Replication Settings

At this point the option file ensures that the server is configured and is instructed to instantiate the replication infrastructure under a given configuration. The following section configures the Group Replication settings for the server.

```
plugin_load_add='group_replication.so'
transaction_write_set_extraction=XXHASH64
group_replication_group_name="aaaaaaaa-aaaa-aaaa-aaaa-aaaaaaaaaaaaaa"
```

```
group_replication_start_on_boot=off
group_replication_local_address= "s1:33061"
group_replication_group_seeds= "s1:33061,s2:33061,s3:33061"
group_replication_bootstrap_group=off
```

- `plugin-load-add` adds the Group Replication plugin to the list of plugins which the server loads at startup. This is preferable in a production deployment to installing the plugin manually.
- Configuring `group_replication_group_name` tells the plugin that the group that it is joining, or creating, is named "aaaaaaaa-aaaa-aaaa-aaaa-aaaaaaaaaaaa".

The value of `group_replication_group_name` must be a valid UUID. This UUID is used internally when setting GTIDs for Group Replication events in the binary log. You can use `SELECT UUID()` to generate a UUID.

- Configuring the `group_replication_start_on_boot` variable to `off` instructs the plugin to not start operations automatically when the server starts. This is important when setting up Group Replication as it ensures you can configure the server before manually starting the plugin. Once the member is configured you can set `group_replication_start_on_boot` to `on` so that Group Replication starts automatically upon server boot.
- Configuring `group_replication_local_address` sets the network address and port which the member uses for internal communication with other members in the group. Group Replication uses this address for internal member-to-member connections involving remote instances of the group communication engine (XCom, a Paxos variant).



#### Important

This address must be different to the `hostname` and `port` used for SQL and it must not be used for client applications. It must be only be used for internal communication between the members of the group while running Group Replication.

The network address configured by `group_replication_local_address` must be resolvable by all group members. For example, if each server instance is on a different machine with a fixed network address, you could use the IP address of the machine, such as 10.0.0.1. If you use a host name, you must use a fully qualified name, and ensure it is resolvable through DNS, correctly configured `/etc/hosts` files, or other name resolution processes. From MySQL 8.0.14, IPv6 addresses (or host names that resolve to them) can be used as well as IPv4 addresses. A group can contain a mix of members using IPv6 and members using IPv4. For more information on Group Replication support for IPv6 networks and on mixed IPv4 and IPv6 groups, see [Support For IPv6 And For Mixed IPv6 And IPv4 Groups](#).

The recommended port for `group_replication_local_address` is 33061. `group_replication_local_address` is used by Group Replication as the unique identifier for a group member within the replication group. You can use the same port for all members of a replication group as long as the host names or IP addresses are all different, as demonstrated in this tutorial. Alternatively you can use the same host name or IP address for all members as long as the ports are all different, for example as shown in [Section 17.2.2, "Deploying Group Replication Locally"](#).

- Configuring `group_replication_group_seeds` sets the hostname and port of the group members which are used by the new member to establish its connection to the group. These members are called the seed members. Once the connection is established, the group membership information is listed at `performance_schema.replication_group_members`. Usually the `group_replication_group_seeds` list contains the `hostname:port` of each of the group member's `group_replication_local_address`, but this is not obligatory and a subset of the group members can be chosen as seeds.

**Important**

The `hostname:port` listed in `group_replication_group_seeds` is the seed member's internal network address, configured by `group_replication_local_address` and not the SQL `hostname:port` used for client connections, and shown for example in `performance_schema.replication_group_members` table.

The server that starts the group does not make use of this option, since it is the initial server and as such, it is in charge of bootstrapping the group. In other words, any existing data which is on the server bootstrapping the group is what is used as the data for the next joining member. The second server joining asks the one and only member in the group to join, any missing data on the second server is replicated from the donor data on the bootstrapping member, and then the group expands. The third server joining can ask any of these two to join, data is synchronized to the new member, and then the group expands again. Subsequent servers repeat this procedure when joining.

**Warning**

When joining multiple servers at the same time, make sure that they point to seed members that are already in the group. Do not use members that are also joining the group as seeds, because they might not yet be in the group when contacted.

It is good practice to start the bootstrap member first, and let it create the group. Then make it the seed member for the rest of the members that are joining. This ensures that there is a group formed when joining the rest of the members.

Creating a group and joining multiple members at the same time is not supported. It might work, but chances are that the operations race and then the act of joining the group ends up in an error or a time out.

- Configuring `group_replication_bootstrap_group` instructs the plugin whether to bootstrap the group or not. In this case, even though `s1` is the first member of the group we set this variable to off in the option file. Instead we configure `group_replication_bootstrap_group` when the instance is running, to ensure that only one member actually bootstraps the group.

**Important**

The `group_replication_bootstrap_group` variable must only be enabled on one server instance belonging to a group at any time, usually the first time you bootstrap the group (or in case the entire group is brought down and back up again). If you bootstrap the group multiple times, for example when multiple server instances have this option set, then they could create an artificial split brain scenario, in which two distinct groups with the same name exist. Always set `group_replication_bootstrap_group=off` after the first server instance comes online.

Configuration for all servers in the group is quite similar. You need to change the specifics about each server (for example `server_id`, `datadir`, `group_replication_local_address`). This is illustrated later in this tutorial.

### 17.2.1.3 User Credentials

Group Replication uses the asynchronous replication protocol to achieve [Section 17.9.5, “Distributed Recovery”](#), synchronizing group members before joining them to the group. The distributed recovery process relies on a replication channel named `group_replication_recovery` which is used to

transfer transactions from donor members to members that join the group. Therefore you need to set up a replication user with the correct permissions so that Group Replication can establish direct member-to-member recovery replication channels.

Start the MySQL server instance and then connect a client to it. Create a MySQL user with the `REPLICATION SLAVE` privilege. This process can be captured in the binary log and then you can rely on distributed recovery to replicate the statements used to create the user. Alternatively, you can disable binary logging using `SET SQL_LOG_BIN=0;` and then create the user manually on each member, for example if you want to avoid the changes being propagated to other server instances. If you do decide to disable binary logging, ensure you enable it once you have configured the user.

In the following example the user `rpl_user` with the password `password` is shown. When configuring your servers use a suitable user name and password.

```
mysql> CREATE USER rpl_user@'%' IDENTIFIED BY 'password';
mysql> GRANT REPLICATION SLAVE ON *.* TO rpl_user@'%';
mysql> FLUSH PRIVILEGES;
```

If binary logging was disabled, enable it again once the user has been created using `SET SQL_LOG_BIN=1;`

Once the user has been configured, use the `CHANGE MASTER TO` statement to configure the server to use the given credentials for the `group_replication_recovery` replication channel the next time it needs to recover its state from another member. Issue the following, replacing `rpl_user` and `password` with the values used when creating the user.

```
mysql> CHANGE MASTER TO MASTER_USER='rpl_user', MASTER_PASSWORD='password' \
FOR CHANNEL 'group_replication_recovery';
```

Distributed recovery is the first step taken by a server that joins the group and does not have the same set of transactions as the group members. If these credentials are not set correctly for the `group_replication_recovery` replication channel and the `rpl_user` as shown, the server cannot connect to the donor members and run the distributed recovery process to gain synchrony with the other group members, and hence ultimately cannot join the group. See [Section 17.9.5, “Distributed Recovery”](#).

Similarly, if the server cannot correctly identify the other members via the server's `hostname` the recovery process can fail. It is recommended that operating systems running MySQL have a properly configured unique `hostname`, either using DNS or local settings. This `hostname` can be verified in the `Member_host` column of the `performance_schema.replication_group_members` table. If multiple group members externalize a default `hostname` set by the operating system, there is a chance of the member not resolving to the correct member address and not being able to join the group. In such a situation use `report_host` to configure a unique `hostname` to be externalized by each of the servers.

### 17.2.1.4 Launching Group Replication

It is first necessary to ensure that the Group Replication plugin is installed on server `s1`. If you used `plugin_load_add='group_replication.so'` in the option file then the Group Replication plugin is already installed, and you can proceed to the next step. Otherwise, you must install the plugin manually; to do this, connect to the server using the `mysql` client, and issue the SQL statement shown here:

```
mysql> INSTALL PLUGIN group_replication SONAME 'group_replication.so';
```



#### Important

The `mysql.session` user must exist before you can load Group Replication. `mysql.session` was added in MySQL version 5.7.19. If your data dictionary was initialized using an earlier version you must perform the MySQL upgrade

procedure (see [Section 2.10, “Upgrading MySQL”](#)). If the upgrade is not run, Group Replication fails to start with the error message `There was an error when trying to access the server with user: mysql.session@localhost`. Make sure the user is present in the server and that `mysql_upgrade` was ran after a server update.

To check that the plugin was installed successfully, issue `SHOW PLUGINS;` and check the output. It should show something like this:

```
mysql> SHOW PLUGINS;
+-----+-----+-----+-----+-----+
| Name          | Status | Type          | Library          | License          |
+-----+-----+-----+-----+-----+
| binlog        | ACTIVE | STORAGE ENGINE | NULL             | PROPRIETARY     |
| (...)        |       |               |                 |                 |
| group_replication | ACTIVE | GROUP REPLICATION | group_replication.so | PROPRIETARY     |
+-----+-----+-----+-----+-----+
```

### 17.2.1.5 Bootstrapping the Group

The process of starting a group for the first time is called bootstrapping. You use the `group_replication_bootstrap_group` system variable to bootstrap a group. The bootstrap should only be done by a single server, the one that starts the group and only once. This is why the value of the `group_replication_bootstrap_group` option was not stored in the instance's option file. If it is saved in the option file, upon restart the server automatically bootstraps a second group with the same name. This would result in two distinct groups with the same name. The same reasoning applies to stopping and restarting the plugin with this option set to `ON`. Therefore to safely bootstrap the group, connect to `s1` and issue:

```
mysql> SET GLOBAL group_replication_bootstrap_group=ON;
mysql> START GROUP_REPLICATION;
mysql> SET GLOBAL group_replication_bootstrap_group=OFF;
```

Once the `START GROUP_REPLICATION` statement returns, the group has been started. You can check that the group is now created and that there is one member in it:

```
mysql> SELECT * FROM performance_schema.replication_group_members;
+-----+-----+-----+-----+-----+
| CHANNEL_NAME | MEMBER_ID | MEMBER_HOST | MEMBER_PORT | MEMBER_STATE |
+-----+-----+-----+-----+-----+
| group_replication_applier | ce9be252-2b71-11e6-b8f4-00212844f856 | s1 | 3306 | ONLINE |
+-----+-----+-----+-----+-----+
```

The information in this table confirms that there is a member in the group with the unique identifier `ce9be252-2b71-11e6-b8f4-00212844f856`, that it is `ONLINE` and is at `s1` listening for client connections on port `3306`.

For the purpose of demonstrating that the server is indeed in a group and that it is able to handle load, create a table and add some content to it.

```
mysql> CREATE DATABASE test;
mysql> USE test;
mysql> CREATE TABLE t1 (c1 INT PRIMARY KEY, c2 TEXT NOT NULL);
mysql> INSERT INTO t1 VALUES (1, 'Luis');
```

Check the content of table `t1` and the binary log.

```
mysql> SELECT * FROM t1;
+-----+
| c1 | c2 |
+-----+
| 1 | Luis |
+-----+
```



```

+-----+
| 1 | Luis |
+-----+

mysql> SHOW BINLOG EVENTS;
+-----+-----+-----+-----+-----+-----+
| Log_name      | Pos | Event_type      | Server_id | End_log_pos | Info
+-----+-----+-----+-----+-----+-----+
| binlog.000001 | 4   | Format_desc     | 1         | 123         | Server ver: 5.7.44-log, Binlog ver: 4
| binlog.000001 | 123 | Previous_gtids  | 1         | 150         |
| binlog.000001 | 150 | Gtid            | 1         | 211         | SET @@SESSION.GTID_NEXT= 'aaaaaaaa-aaaa
| binlog.000001 | 211 | Query          | 1         | 270         | BEGIN
| binlog.000001 | 270 | View_change    | 1         | 369         | view_id=14724817264259180:1
| binlog.000001 | 369 | Query          | 1         | 434         | COMMIT
| binlog.000001 | 434 | Gtid            | 1         | 495         | SET @@SESSION.GTID_NEXT= 'aaaaaaaa-aaaa
| binlog.000001 | 495 | Query          | 1         | 585         | CREATE DATABASE test
| binlog.000001 | 585 | Gtid            | 1         | 646         | SET @@SESSION.GTID_NEXT= 'aaaaaaaa-aaaa
| binlog.000001 | 646 | Query          | 1         | 770         | use `test`; CREATE TABLE t1 (c1 INT PRI
| binlog.000001 | 770 | Gtid            | 1         | 831         | SET @@SESSION.GTID_NEXT= 'aaaaaaaa-aaaa
| binlog.000001 | 831 | Query          | 1         | 899         | BEGIN
| binlog.000001 | 899 | Table_map      | 1         | 942         | table_id: 108 (test.t1)
| binlog.000001 | 942 | Write_rows     | 1         | 984         | table_id: 108 flags: STMT_END_F
| binlog.000001 | 984 | Xid            | 1         | 1011        | COMMIT /* xid=38 */
+-----+-----+-----+-----+-----+-----+

```

As seen above, the database and the table objects were created and their corresponding DDL statements were written to the binary log. Also, the data was inserted into the table and written to the binary log. The importance of the binary log entries is illustrated in the following section when the group grows and distributed recovery is executed as new members try to catch up and become online.

### 17.2.1.6 Adding Instances to the Group

At this point, the group has one member in it, server s1, which has some data in it. It is now time to expand the group by adding the other two servers configured previously.

#### Adding a Second Instance

In order to add a second instance, server s2, first create the configuration file for it. The configuration is similar to the one used for server s1, except for things such as the `server_id`.

```

[mysqld]

#
# Disable other storage engines
#
disabled_storage_engines="MyISAM,BLACKHOLE,FEDERATED,ARCHIVE,MEMORY"

#
# Replication configuration parameters
#
server_id=2
gtid_mode=ON
enforce_gtid_consistency=ON
master_info_repository=TABLE
relay_log_info_repository=TABLE
binlog_checksum=NONE
log_slave_updates=ON
log_bin=binlog
binlog_format=ROW

#
# Group Replication configuration
#
transaction_write_set_extraction=XXHASH64

```

```
group_replication_group_name="aaaaaaaa-aaaa-aaaa-aaaa-aaaaaaaaaaaa"
group_replication_start_on_boot=off
group_replication_local_address= "s2:33061"
group_replication_group_seeds= "s1:33061,s2:33061,s3:33061"
group_replication_bootstrap_group= off
```

Similar to the procedure for server s1, with the option file in place you launch the server. Then configure the recovery credentials as follows. The commands are the same as used when setting up server s1 as the user is shared within the group. This member needs to have the same replication user configured in [Section 17.2.1.3, “User Credentials”](#). If you are relying on distributed recovery to configure the user on all members, when s2 connects to the seed s1 the replication user is relicated to s1. If you did not have binary logging enabled when you configured the user credentials on s1, you must create the replication user on s2. In this case, connect to s2 and issue:

```
SET SQL_LOG_BIN=0;
CREATE USER rpl_user@%' IDENTIFIED BY 'password';
GRANT REPLICATION SLAVE ON *.* TO rpl_user@%';
SET SQL_LOG_BIN=1;
CHANGE MASTER TO MASTER_USER='rpl_user', MASTER_PASSWORD='password' \\\
FOR CHANNEL 'group_replication_recovery';
```

If necessary, install the Group Replication plugin, see [Section 17.2.1.4, “Launching Group Replication”](#).

Start Group Replication and s2 starts the process of joining the group.

```
mysql> START GROUP_REPLICATION;
```

Unlike the previous steps that were the same as those executed on s1, here there is a difference in that you do *not* need to bootstrap the group because the group already exists. In other words on s2 `group_replication_bootstrap_group` is set to off, and you do not issue `SET GLOBAL group_replication_bootstrap_group=ON;` before starting Group Replication, because the group has already been created and bootstrapped by server s1. At this point server s2 only needs to be added to the already existing group.



### Tip

When Group Replication starts successfully and the server joins the group it checks the `super_read_only` variable. By setting `super_read_only` to ON in the member's configuration file, you can ensure that servers which fail when starting Group Replication for any reason do not accept transactions. If the server should join the group as read-write instance, for example as the primary in a single-primary group or as a member of a multi-primary group, when the `super_read_only` variable is set to ON then it is set to OFF upon joining the group.

Checking the `performance_schema.replication_group_members` table again shows that there are now two *ONLINE* servers in the group.

```
mysql> SELECT * FROM performance_schema.replication_group_members;
```

CHANNEL_NAME	MEMBER_ID	MEMBER_HOST	MEMBER_PORT	MEMBER_STATE
group_replication_applier	395409e1-6dfa-11e6-970b-00212844f856	s1	3306	ONLINE
group_replication_applier	ac39f1e6-6dfa-11e6-a69d-00212844f856	s2	3306	ONLINE

When s2 attempted to join the group, [Section 17.9.5, “Distributed Recovery”](#) ensured that s2 applied the same transactions which s1 had applied. Once this process completed, s2 could join the group as a member, and at this point it is marked as *ONLINE*. In other words it must have already caught up with server s1 automatically. Once s2 is *ONLINE*, it then begins to process transactions with the group. Verify that s2 has indeed synchronized with server s1 as follows.

```
mysql> SHOW DATABASES LIKE 'test';
+-----+
| Database (test) |
+-----+
| test            |
+-----+

mysql> SELECT * FROM test.t1;
+----+-----+
| c1 | c2    |
+----+-----+
| 1  | Luis  |
+----+-----+

mysql> SHOW BINLOG EVENTS;
+-----+-----+-----+-----+-----+-----+
| Log_name          | Pos  | Event_type      | Server_id | End_log_pos | Info
+-----+-----+-----+-----+-----+-----+
| binlog.000001    | 4    | Format_desc     | 2         | 123         | Server ver: 5.7.44-log, Binlog ver: 4
| binlog.000001    | 123  | Previous_gtids  | 2         | 150         |
| binlog.000001    | 150  | Gtid            | 1         | 211         | SET @@SESSION.GTID_NEXT= 'aaaaaaaa-aaa
| binlog.000001    | 211  | Query           | 1         | 270         | BEGIN
| binlog.000001    | 270  | View_change     | 1         | 369         | view_id=14724832985483517:1
| binlog.000001    | 369  | Query           | 1         | 434         | COMMIT
| binlog.000001    | 434  | Gtid            | 1         | 495         | SET @@SESSION.GTID_NEXT= 'aaaaaaaa-aaa
| binlog.000001    | 495  | Query           | 1         | 585         | CREATE DATABASE test
| binlog.000001    | 585  | Gtid            | 1         | 646         | SET @@SESSION.GTID_NEXT= 'aaaaaaaa-aaa
| binlog.000001    | 646  | Query           | 1         | 770         | use `test`; CREATE TABLE t1 (c1 INT PR
| binlog.000001    | 770  | Gtid            | 1         | 831         | SET @@SESSION.GTID_NEXT= 'aaaaaaaa-aaa
| binlog.000001    | 831  | Query           | 1         | 890         | BEGIN
| binlog.000001    | 890  | Table_map       | 1         | 933         | table_id: 108 (test.t1)
| binlog.000001    | 933  | Write_rows      | 1         | 975         | table_id: 108 flags: STMT_END_F
| binlog.000001    | 975  | Xid             | 1         | 1002        | COMMIT /* xid=30 */
| binlog.000001    | 1002 | Gtid            | 1         | 1063        | SET @@SESSION.GTID_NEXT= 'aaaaaaaa-aaa
| binlog.000001    | 1063 | Query           | 1         | 1122        | BEGIN
| binlog.000001    | 1122 | View_change     | 1         | 1261        | view_id=14724832985483517:2
| binlog.000001    | 1261 | Query           | 1         | 1326        | COMMIT
+-----+-----+-----+-----+-----+-----+
```

As seen above, the second server has been added to the group and it has replicated the changes from server s1 automatically using distributed recovery. In other words, the transactions applied on s1 up to the point in time that s2 joined the group have been replicated to s2.

## Adding Additional Instances

Adding additional instances to the group is essentially the same sequence of steps as adding the second server, except that the configuration has to be changed as it had to be for server s2. To summarise the required commands:

### 1. Create the configuration file

```
[mysqld]

#
# Disable other storage engines
#
disabled_storage_engines="MyISAM,BLACKHOLE,FEDERATED,ARCHIVE,MEMORY"

#
# Replication configuration parameters
#
server_id=3
gtid_mode=ON
enforce_gtid_consistency=ON
master_info_repository=TABLE
```

```

relay_log_info_repository=TABLE
binlog_checksum=NONE
log_slave_updates=ON
log_bin=binlog
binlog_format=ROW

#
# Group Replication configuration
#
group_replication_group_name="aaaaaaaa-aaaa-aaaa-aaaa-aaaaaaaaaaaaa"
group_replication_start_on_boot=off
group_replication_local_address= "s3:33061"
group_replication_group_seeds= "s1:33061,s2:33061,s3:33061"
group_replication_bootstrap_group= off
    
```

2. Start the server and connect to it. Configure the recovery credentials for the `group_replication_recovery` channel.

```

SET SQL_LOG_BIN=0;
CREATE USER rpl_user@'%' IDENTIFIED BY 'password';
GRANT REPLICATION SLAVE ON *.* TO rpl_user@'%';
FLUSH PRIVILEGES;
SET SQL_LOG_BIN=1;
CHANGE MASTER TO MASTER_USER='rpl_user', MASTER_PASSWORD='password' \\\
FOR CHANNEL 'group_replication_recovery';
    
```

4. Install the Group Replication plugin and start it.

```

INSTALL PLUGIN group_replication SONAME 'group_replication.so';
START GROUP_REPLICATION;
    
```

At this point server s3 is booted and running, has joined the group and caught up with the other servers in the group. Consulting the `performance_schema.replication_group_members` table again confirms this is the case.

```
mysql> SELECT * FROM performance_schema.replication_group_members;
```

CHANNEL_NAME	MEMBER_ID	MEMBER_HOST	MEMBER_PORT	MEMBER_STATE
group_replication_applier	395409e1-6dfa-11e6-970b-00212844f856	s1	3306	ONLINE
group_replication_applier	7eb217ff-6df3-11e6-966c-00212844f856	s3	3306	ONLINE
group_replication_applier	ac39f1e6-6dfa-11e6-a69d-00212844f856	s2	3306	ONLINE

Issuing this same query on server s2 or server s1 yields the same result. Also, you can verify that server s3 has caught up:

```
mysql> SHOW DATABASES LIKE 'test';
```

```

+-----+
| Database (test) |
+-----+
| test            |
+-----+
    
```

```
mysql> SELECT * FROM test.t1;
```

```

+-----+
| c1 | c2 |
+-----+
| 1  | Luis |
+-----+
    
```

```
mysql> SHOW BINLOG EVENTS;
```

```

+-----+-----+-----+-----+-----+
| Log_name | Pos | Event_type | Server_id | End_log_pos | Info |
+-----+-----+-----+-----+-----+
    
```

binlog.000001	4	Format_desc	3	123	Server ver: 5.7.44-log, Binlog ver: 4
binlog.000001	123	Previous_gtids	3	150	
binlog.000001	150	Gtid	1	211	SET @@SESSION.GTID_NEXT= 'aaaaaaaa-aaa
binlog.000001	211	Query	1	270	BEGIN
binlog.000001	270	View_change	1	369	view_id=14724832985483517:1
binlog.000001	369	Query	1	434	COMMIT
binlog.000001	434	Gtid	1	495	SET @@SESSION.GTID_NEXT= 'aaaaaaaa-aaa
binlog.000001	495	Query	1	585	CREATE DATABASE test
binlog.000001	585	Gtid	1	646	SET @@SESSION.GTID_NEXT= 'aaaaaaaa-aaa
binlog.000001	646	Query	1	770	use `test`; CREATE TABLE t1 (c1 INT PR
binlog.000001	770	Gtid	1	831	SET @@SESSION.GTID_NEXT= 'aaaaaaaa-aaa
binlog.000001	831	Query	1	890	BEGIN
binlog.000001	890	Table_map	1	933	table_id: 108 (test.t1)
binlog.000001	933	Write_rows	1	975	table_id: 108 flags: STMT_END_F
binlog.000001	975	Xid	1	1002	COMMIT /* xid=29 */
binlog.000001	1002	Gtid	1	1063	SET @@SESSION.GTID_NEXT= 'aaaaaaaa-aaa
binlog.000001	1063	Query	1	1122	BEGIN
binlog.000001	1122	View_change	1	1261	view_id=14724832985483517:2
binlog.000001	1261	Query	1	1326	COMMIT
binlog.000001	1326	Gtid	1	1387	SET @@SESSION.GTID_NEXT= 'aaaaaaaa-aaa
binlog.000001	1387	Query	1	1446	BEGIN
binlog.000001	1446	View_change	1	1585	view_id=14724832985483517:3
binlog.000001	1585	Query	1	1650	COMMIT

## 17.2.2 Deploying Group Replication Locally

The most common way to deploy Group Replication is using multiple server instances, to provide high availability. It is also possible to deploy Group Replication locally, for example for testing purposes. This section explains how you can deploy Group Replication locally.



### Important

Group Replication is usually deployed on multiple hosts because this ensures that high-availability is provided. The instructions in this section are not suitable for production deployments because all MySQL server instances are running on the same single host. In the event of failure of this host, the whole group fails. Therefore this information should be used for testing purposes and it should not be used in a production environments.

This section explains how to create a replication group with three MySQL Server instances on one physical machine. This means that three data directories are needed, one per server instance, and that you need to configure each instance independently. This procedure assumes that MySQL Server was downloaded and unpacked into the directory named `mysql-5.7`. Each MySQL server instance requires a specific data directory. Create a directory named `data`, then in that directory create a subdirectory for each server instance, for example `s1`, `s2` and `s3`, and initialize each one.

```
mysql-5.7/bin/mysqld --initialize-insecure --basedir=$PWD/mysql-5.7 --datadir=$PWD/data/s1
mysql-5.7/bin/mysqld --initialize-insecure --basedir=$PWD/mysql-5.7 --datadir=$PWD/data/s2
mysql-5.7/bin/mysqld --initialize-insecure --basedir=$PWD/mysql-5.7 --datadir=$PWD/data/s3
```

Inside `data/s1`, `data/s2`, `data/s3` is an initialized data directory, containing the mysql system database and related tables and much more. To learn more about the initialization procedure, see [Section 2.9.1, “Initializing the Data Directory”](#).



### Warning

Do not use `--initialize-insecure` in production environments, it is only used here to simplify the tutorial. For more information on security settings, see [Section 17.6, “Group Replication Security”](#).

## Configuration of Local Group Replication Members

When you are following [Section 17.2.1.2, “Configuring an Instance for Group Replication”](#), you need to add configuration for the data directories added in the previous section. For example:

```
[mysqld]

# server configuration
datadir=<full_path_to_data>/data/s1
basedir=<full_path_to_bin>/mysql-8.0/

port=24801
socket=<full_path_to_sock_dir>/s1.sock
```

These settings configure MySQL server to use the data directory created earlier and which port the server should open and start listening for incoming connections.



### Note

The non-default port of 24801 is used because in this tutorial the three server instances use the same hostname. In a setup with three different machines this would not be required.

Group Replication requires a network connection between the members, which means that each member must be able to resolve the network address of all of the other members. For example in this tutorial all three instances run on one machine, so to ensure that the members can contact each other you could add a line to the option file such as `report_host=127.0.0.1`.

Then each member needs to be able to connect to the other members on their `group_replication_local_address`. For example in the option file of member s1 add:

```
group_replication_local_address= "127.0.0.1:24901"
group_replication_group_seeds= "127.0.0.1:24901,127.0.0.1:24902,127.0.0.1:24903"
```

This configures s1 to use port 24901 for internal group communication with seed members. For each server instance you want to add to the group, make these changes in the option file of the member. For each member you must ensure a unique address is specified, so use a unique port per instance for `group_replication_local_address`. Usually you want all members to be able to serve as seeds for members that are joining the group and have not got the transactions processed by the group. In this case, add all of the ports to `group_replication_group_seeds` as shown above.

The remaining steps of [Section 17.2.1, “Deploying Group Replication in Single-Primary Mode”](#) apply equally to a group which you have deployed locally in this way.

## 17.3 Requirements and Limitations

This section lists and explains the requirements and limitations of Group Replication.

### 17.3.1 Group Replication Requirements

Server instances that you want to use for Group Replication must satisfy the following requirements.

#### Infrastructure

- **InnoDB Storage Engine.** Data must be stored in the [InnoDB](#) transactional storage engine. Transactions are executed optimistically and then, at commit time, are checked for conflicts. If there are conflicts, in order to maintain consistency across the group, some transactions are rolled back. This

means that a transactional storage engine is required. Moreover, [InnoDB](#) provides some additional functionality that enables better management and handling of conflicts when operating together with Group Replication. The use of other storage engines, including the temporary [MEMORY](#) storage engine, might cause errors in Group Replication. Convert any tables in other storage engines to use [InnoDB](#) before using the instance with Group Replication. You can prevent the use of other storage engines by setting the [disabled\\_storage\\_engines](#) system variable on group members, for example:

```
disabled_storage_engines="MyISAM, BLACKHOLE, FEDERATED, ARCHIVE, MEMORY"
```

- **Primary Keys.** Every table that is to be replicated by the group must have a defined primary key, or primary key equivalent where the equivalent is a non-null unique key. Such keys are required as a unique identifier for every row within a table, enabling the system to determine which transactions conflict by identifying exactly which rows each transaction has modified.
- **IPv4 Network.** The group communication engine used by MySQL Group Replication only supports IPv4. Therefore, Group Replication requires an IPv4 network infrastructure.
- **Network Performance.** MySQL Group Replication is designed to be deployed in a cluster environment where server instances are very close to each other. The performance and stability of a group can be impacted by both network latency and network bandwidth. Bi-directional communication must be maintained at all times between all group members. If either inbound or outbound communication is blocked for a server instance (for example, by a firewall, or by connectivity issues), the member cannot function in the group, and the group members (including the member with issues) might not be able to report the correct member status for the affected server instance.

## Server Instance Configuration

The following options must be configured on server instances that are members of a group.

- **Unique Server Identifier.** Use the [server\\_id](#) system variable to configure the server with a unique server ID, as required for all servers in replication topologies. With the default server ID of 0, servers in a replication topology cannot connect to each other. The server ID must be a positive integer between 1 and  $(2^{32})-1$ , and it must be different from every other server ID in use by any other server in the replication topology.
- **Binary Log Active.** Set `--log-bin[=log\_file\_name]`. MySQL Group Replication replicates binary log contents, therefore the binary log needs to be on for it to operate. This option is enabled by default. See [Section 5.4.4, “The Binary Log”](#).
- **Replica Updates Logged.** Set `--log-slave-updates`. Servers need to log binary logs that are applied through the replication applier. Servers in the group need to log all transactions that they receive and apply from the group. This is required because recovery is conducted by relying on binary logs from participants in the group. Therefore, copies of each transaction need to exist on every server, even for those transactions that were not initiated on the server itself.
- **Binary Log Row Format.** Set `--binlog-format=row`. Group Replication relies on row-based replication format to propagate changes consistently among the servers in the group. It relies on row-based infrastructure to be able to extract the necessary information to detect conflicts among transactions that execute concurrently in different servers in the group. See [Section 16.2.1, “Replication Formats”](#).
- **Binary Log Checksums Off.** Set `--binlog-checksum=NONE`. Due to a design limitation of replication event checksums, Group Replication cannot make use of them, and they must be disabled.
- **Global Transaction Identifiers On.** Set `gtid_mode=ON` and `enforce_gtid_consistency=ON`. Group Replication uses global transaction identifiers to track exactly which transactions have been

committed on every server instance and thus be able to infer which servers have executed transactions that could conflict with already committed transactions elsewhere. In other words, explicit transaction identifiers are a fundamental part of the framework to be able to determine which transactions may conflict. See [Section 16.1.3, “Replication with Global Transaction Identifiers”](#).

In addition, if you need to set the value of `gtid_purged`, you must do so while Group Replication is not running.

- **Replication Information Repositories.** Set `master_info_repository=TABLE` and `relay_log_info_repository=TABLE`. The replication applier needs to have the source and replica metadata written to the `mysql.slave_master_info` and `mysql.slave_relay_log_info` system tables. This ensures the Group Replication plugin has consistent recoverability and transactional management of the replication metadata. See [Section 16.2.4.2, “Replication Metadata Repositories”](#).
- **Transaction Write Set Extraction.** Set `--transaction-write-set-extraction=XXHASH64` so that while collecting rows to log them to the binary log, the server collects the write set as well. The write set is based on the primary keys of each row and is a simplified and compact view of a tag that uniquely identifies the row that was changed. This tag is then used for detecting conflicts.
- **Lower Case Table Names.** Set `--lower-case-table-names` to the same value on all group members. A setting of 1 is correct for the use of the InnoDB storage engine, which is required for Group Replication. Note that this setting is not the default on all platforms.
- **Multithreaded Appliers.** Group Replication members can be configured as multithreaded replicas, enabling transactions to be applied in parallel. A nonzero value for `slave_parallel_workers` enables the multithreaded applier on the member, and up to 1024 parallel applier threads can be specified. If you do this, the following settings are also required:

`slave_preserve_commit_order=1` This setting is required to ensure that the final commit of parallel transactions is in the same order as the original transactions. Group Replication relies on consistency mechanisms built around the guarantee that all participating members receive and apply committed transactions in the same order.

`slave_parallel_type=LOGICAL` This setting is required with `slave_preserve_commit_order=1`. It specifies the policy used to decide which transactions are allowed to execute in parallel on the replica.

Setting `slave_parallel_workers=0` disables parallel execution and gives the replica a single applier thread and no coordinator thread. With that setting, the `slave_parallel_type` and `slave_preserve_commit_order` options have no effect and are ignored.

## 17.3.2 Group Replication Limitations

The following known limitations exist for Group Replication. Note that the limitations and issues described for multi-primary mode groups can also apply in single-primary mode clusters during a failover event, while the newly elected primary flushes out its applier queue from the old primary.



### Tip

Group Replication is built on GTID based replication, therefore you should also be aware of [Section 16.1.3.6, “Restrictions on Replication with GTIDs”](#).

- **Gap Locks.** Group Replication's certification process for concurrent transactions does not take into account [gap locks](#), as information about gap locks is not available outside of InnoDB. See [Gap Locks](#) for more information.



**Note**

For a group in multi-primary mode, unless you rely on [REPEATABLE READ](#) semantics in your applications, we recommend using the [READ COMMITTED](#) isolation level with Group Replication. InnoDB does not use gap locks in [READ COMMITTED](#), which aligns the local conflict detection within InnoDB with the distributed conflict detection performed by Group Replication. For a group in single-primary mode, only the primary accepts writes, so the [READ COMMITTED](#) isolation level is not important to Group Replication.

- **Table Locks and Named Locks.** The certification process does not take into account table locks (see [Section 13.3.5, “LOCK TABLES and UNLOCK TABLES Statements”](#)) or named locks (see [GET\\_LOCK\( \)](#)).
- **Replication Event Checksums.** Due to a design limitation of replication event checksums, Group Replication cannot currently make use of them. Therefore set `--binlog-checksum=NONE`.
- **SERIALIZABLE Isolation Level.** [SERIALIZABLE](#) isolation level is not supported in multi-primary groups by default. Setting a transaction isolation level to [SERIALIZABLE](#) configures Group Replication to refuse to commit the transaction.
- **Concurrent DDL versus DML Operations.** Concurrent data definition statements and data manipulation statements executing against the same object but on different servers is not supported when using multi-primary mode. During execution of Data Definition Language (DDL) statements on an object, executing concurrent Data Manipulation Language (DML) on the same object but on a different server instance has the risk of conflicting DDL executing on different instances not being detected.
- **Foreign Keys with Cascading Constraints.** Multi-primary mode groups (members all configured with `group_replication_single_primary_mode=OFF`) do not support tables with multi-level foreign key dependencies, specifically tables that have defined [CASCADING foreign key constraints](#). This is because foreign key constraints that result in cascading operations executed by a multi-primary mode group can result in undetected conflicts and lead to inconsistent data across the members of the group. Therefore we recommend setting `group_replication_enforce_update_everywhere_checks=ON` on server instances used in multi-primary mode groups to avoid undetected conflicts.  
  
In single-primary mode this is not a problem as it does not allow concurrent writes to multiple members of the group and thus there is no risk of undetected conflicts.
- **MySQL Enterprise Audit and MySQL Enterprise Firewall.** Prior to version 5.7.21 MySQL Enterprise Audit and MySQL Enterprise Firewall use [MyISAM](#) tables in the `mysql` system database. Group Replication does not support [MyISAM](#) tables.
- **Multi-primary Mode Deadlock.** When a group is operating in multi-primary mode, [SELECT .. FOR UPDATE](#) statements can result in a deadlock. This is because the lock is not shared across the members of the group, therefore the expectation for such a statement might not be reached.
- **Replication Filters.** Replication filters cannot be used on a MySQL server instance that is configured for Group Replication, because filtering transactions on some servers would make the group unable to reach agreement on a consistent state.

## Limit on Group Size

The maximum number of MySQL servers that can be members of a single replication group is 9. If further members attempt to join the group, their request is refused. This limit has been identified from testing and benchmarking as a safe boundary where the group performs reliably on a stable local area network.

## Limits on Transaction Size

If an individual transaction results in message contents which are large enough that the message cannot be copied between group members over the network within a 5-second window, members can be suspected of having failed, and then expelled, just because they are busy processing the transaction. Large transactions can also cause the system to slow due to problems with memory allocation. To avoid these issues use the following mitigations:

- Where possible, try and limit the size of your transactions. For example, split up files used with `LOAD DATA` into smaller chunks.
- Use the system variable `group_replication_transaction_size_limit` to specify the maximum transaction size that the group accepts. In releases up to and including MySQL 5.7.37, this system variable defaults to zero, but from MySQL 5.7.38, and in MySQL 8.0, it defaults to a maximum transaction size of 150000000 bytes (approximately 143 MB). Transactions above this limit are rolled back and are not sent to Group Replication's Group Communication System (GCS) for distribution to the group. Adjust the value of this variable depending on the maximum message size that you need the group to tolerate, bearing in mind that the time taken to process a transaction is proportional to its size.



### Note

When you upgrade from MySQL 5.7.37 or earlier to MySQL 5.7.38 or later, if your Group Replication servers previously accepted transactions larger than the new default limit, and you were allowing `group_replication_transaction_size_limit` to default to the old zero limit, those transactions will start to fail after the upgrade to the new default. You must either specify an appropriate size limit that allows the maximum message size you need the group to tolerate (which is the recommended solution), or specify a zero setting to restore the previous behavior.

- Use the system variable `group_replication_compression_threshold` to specify a message size above which compression is applied. This system variable defaults to 1000000 bytes (1 MB), so large messages are automatically compressed. Compression is carried out by Group Replication's Group Communication System (GCS) when it receives a message that was permitted by the `group_replication_transaction_size_limit` setting but exceeds the `group_replication_compression_threshold` setting. If you set the system variable value to zero, compression is deactivated. For more information, see [Section 17.9.7.2, “Message Compression”](#).

If you have deactivated message compression and do not specify a maximum transaction size, the upper size limit for a message that can be handled by the applier thread on a member of a replication group is the value of the member's `slave_max_allowed_packet` system variable, which has a default and maximum value of 1073741824 bytes (1 GB). A message that exceeds this limit fails when the receiving member attempts to handle it. The upper size limit for a message that a group member can originate and attempt to transmit to the group is 4294967295 bytes (approximately 4 GB). This is a hard limit on the packet size that is accepted by the group communication engine for Group Replication (XCom, a Paxos variant), which receives messages after GCS has handled them. A message that exceeds this limit fails when the originating member attempts to broadcast it.

## 17.4 Monitoring Group Replication

You can use the MySQL [Performance Schema](#) to monitor Group Replication. These Performance Schema tables display information specific to Group Replication:

- `replication_group_member_stats`: See [Section 17.4.3, “The replication\\_group\\_member\\_stats Table”](#).

- `replication_group_members`: See [Section 17.4.2, “The replication\\_group\\_members Table”](#).

These Performance Schema replication tables also show information relating to Group Replication:

- `replication_connection_status` shows information regarding Group Replication, such as transactions received from the group and queued in the applier queue (relay log).
- `replication_applier_status` shows the states of channels and threads relating to Group Replication. These can also be used to monitor what individual worker threads are doing.

Replication channels created by the Group Replication plugin are listed here:

- `group_replication_recovery`: Used for replication changes related to distributed recovery.
- `group_replication_applier`: Used for the incoming changes from the group, to apply transactions coming directly from the group.

For information about system variables affecting Group Replication, see [Section 17.7.1, “Group Replication System Variables”](#). See [Section 17.7.2, “Group Replication Status Variables”](#), for status variables providing information about Group Replication.



#### Note

If you are monitoring one or more secondary instances using `mysqladmin`, you should be aware that a `FLUSH STATUS` statement executed by this utility creates a GTID event on the local instance which may impact future group operations.

## 17.4.1 Group Replication Server States

There are various states that a server instance can be in. If servers are communicating properly, all report the same states for all servers. However, if there is a network partition, or a server leaves the group, then different information could be reported, depending on which server is queried. If the server has left the group then it cannot report updated information about the other servers' states. If there is a partition, such that quorum is lost, servers are not able to coordinate between themselves. As a consequence, they cannot guess what the status of different servers is. Therefore, instead of guessing their state they report that some servers are unreachable.

**Table 17.1 Server State**

Field	Description	Group Synchronized
<code>ONLINE</code>	The member is ready to serve as a fully functional group member, meaning that the client can connect and start executing transactions.	Yes
<code>RECOVERING</code>	The member is in the process of becoming an active member of the group and is currently going through the recovery process, receiving state information from a donor.	No
<code>OFFLINE</code>	The plugin is loaded but the member does not belong to any group.	No

Field	Description	Group Synchronized
<a href="#">ERROR</a>	The state of the member. Whenever there is an error on the recovery phase or while applying changes, the server enters this state.	No
<a href="#">UNREACHABLE</a>	Whenever the local failure detector suspects that a given server is not reachable, because for example it was disconnected involuntarily, it shows that server's state as <a href="#">UNREACHABLE</a> .	No



### Important

Once an instance enters [ERROR](#) state, the `super_read_only` option is set to `ON`. To leave the [ERROR](#) state you must manually configure the instance with `super_read_only=OFF`.

Note that Group Replication is *not* synchronous, but eventually synchronous. More precisely, transactions are delivered to all group members in the same order, but their execution is not synchronized, meaning that after a transaction is accepted to be committed, each member commits at its own pace.

## 17.4.2 The replication\_group\_members Table

The `performance_schema.replication_group_members` table is used for monitoring the status of the different server instances that are members of the group. The information in the table is updated whenever there is a view change, for example when the configuration of the group is dynamically changed when a new member joins. At that point, servers exchange some of their metadata to synchronize themselves and continue to cooperate together. The information is shared between all the server instances that are members of the replication group, so information on all the group members can be queried from any member. This table can be used to get a high level view of the state of a replication group, for example by issuing:

```
SELECT * FROM performance_schema.replication_group_members;
```

CHANNEL_NAME	MEMBER_ID	MEMBER_HOST	MEMBER_PORT	MEMBER_STATE
group_replication_applier	041f26d8-f3f3-11e8-adff-080027337932	example1	3306	ONLINE
group_replication_applier	f60a3e10-f3f2-11e8-8258-080027337932	example2	3306	ONLINE
group_replication_applier	fc890014-f3f2-11e8-a9fd-080027337932	example3	3306	ONLINE

Based on this result we can see that the group consists of three members, each member's host and port number which clients use to connect to the member, and the `server_uuid` of the member. The `MEMBER_STATE` column shows one of the [Section 17.4.1, "Group Replication Server States"](#), in this case it shows that all three members in this group are `ONLINE`, and the `MEMBER_ROLE` column shows that there are two secondaries, and a single primary. Therefore this group must be running in single-primary mode. The `MEMBER_VERSION` column can be useful when you are upgrading a group and are combining members running different MySQL versions. See [Section 17.4.1, "Group Replication Server States"](#) for more information.

For more information about the `Member_host` value and its impact on the distributed recovery process, see [Section 17.2.1.3, "User Credentials"](#).

## 17.4.3 The replication\_group\_member\_stats Table

Each member in a replication group certifies and applies transactions received by the group. Statistics regarding the certifier and applier procedures are useful to understand how the applier queue is growing, how many conflicts have been found, how many transactions were checked, which transactions are committed everywhere, and so on.

The `performance_schema.replication_group_member_stats` table provides group-level information related to the certification process, and also statistics for the transactions received and originated by each individual member of the replication group. The information is shared between all the server instances that are members of the replication group, so information on all the group members can be queried from any member. Note that refreshing of statistics for remote members is controlled by the message period specified in the `group_replication_flow_control_period` option, so these can differ slightly from the locally collected statistics for the member where the query is made. To use this table to monitor a Group Replication member, issue the following statement:

```
mysql> SELECT * FROM performance_schema.replication_group_member_stats\G
```

These columns are important for monitoring the performance of the members connected in the group. Suppose that one of the group's members always reports a large number of transactions in its queue compared to other members. This means that the member is delayed and is not able to keep up to date with the other members of the group. Based on this information, you could decide to either remove the member from the group, or delay the processing of transactions on the other members of the group in order to reduce the number of queued transactions. This information can also help you to decide how to adjust the flow control of the Group Replication plugin, see [Section 17.9.7.3, “Flow Control”](#).

## 17.5 Group Replication Operations

This section describes the different modes of deploying Group Replication, explains common operations for managing groups and provides information about how to tune your groups. .

### 17.5.1 Deploying in Multi-Primary or Single-Primary Mode

Group Replication operates in the following different modes:

- single-primary mode
- multi-primary mode

The default mode is single-primary. It is not possible to have members of the group deployed in different modes, for example one configured in multi-primary mode while another one is in single-primary mode. To switch between modes, the group and not the server, needs to be restarted with a different operating configuration. Regardless of the deployed mode, Group Replication does not handle client-side fail-over, that must be handled by the application itself, a connector or a middleware framework such as a proxy or [MySQL Router 8.0](#).

When deployed in multi-primary mode, statements are checked to ensure they are compatible with the mode. The following checks are made when Group Replication is deployed in multi-primary mode:

- If a transaction is executed under the `SERIALIZABLE` isolation level, then its commit fails when synchronizing itself with the group.
- If a transaction executes against a table that has foreign keys with cascading constraints, then the transaction fails to commit when synchronizing itself with the group.

These checks can be deactivated by setting the option `group_replication_enforce_update_everywhere_checks` to `FALSE`. When deploying in single-primary mode, this option *must* be set to `FALSE`.

### 17.5.1.1 Single-Primary Mode

In this mode the group has a single-primary server that is set to read-write mode. All the other members in the group are set to read-only mode (with `super-read-only=ON`). This happens automatically. The primary is typically the first server to bootstrap the group, all other servers that join automatically learn about the primary server and are set to read only.

Figure 17.5 New Primary Election

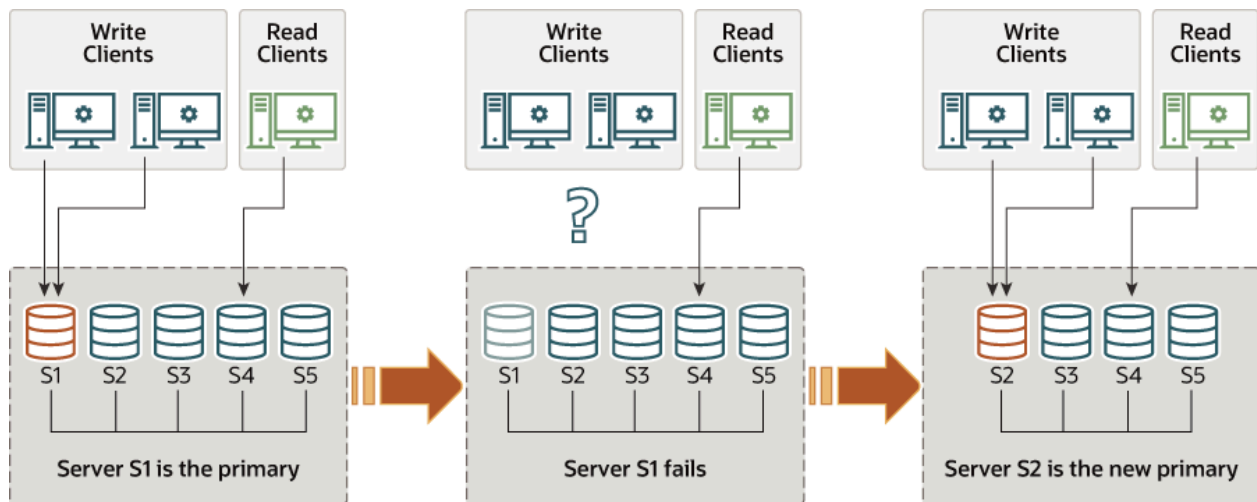

When in single-primary mode, some of the checks deployed in multi-primary mode are disabled, because the system enforces that only a single server writes to the group. For example, changes to tables that have cascading foreign keys are allowed, whereas in multi-primary mode they are not. Upon primary member failure, an automatic primary election mechanism chooses the new primary member. The election process is performed by looking at the new view, and ordering the potential new primaries based on the value of `group_replication_member_weight`. Assuming the group is operating with all members running the same MySQL version, then the member with the highest value for `group_replication_member_weight` is elected as the new primary. In the event that multiple servers have the same `group_replication_member_weight`, the servers are then prioritized based on their `server_uuid` in lexicographical order and by picking the first one. Once a new primary is elected, it is automatically set to read-write and the other secondaries remain as secondaries, and as such, read-only.

When a new primary is elected, it is only writable once it has processed all of the transactions that came from the old primary. This avoids possible concurrency issues between old transactions from the old primary and the new ones being executed on this member. It is a good practice to wait for the new primary to apply its replication related relay-log before re-routing client applications to it.

If the group is operating with members that are running different versions of MySQL then the election process can be impacted. For example, if any member does not support `group_replication_member_weight`, then the primary is chosen based on `server_uuid` order from the members of the lower major version. Alternatively, if all members running different MySQL versions do support `group_replication_member_weight`, the primary is chosen based on `group_replication_member_weight` from the members of the lower major version.

### 17.5.1.2 Multi-Primary Mode

In multi-primary mode, there is no notion of a single primary. There is no need to engage an election procedure because there is no server playing any special role.

Figure 17.6 Client Failover

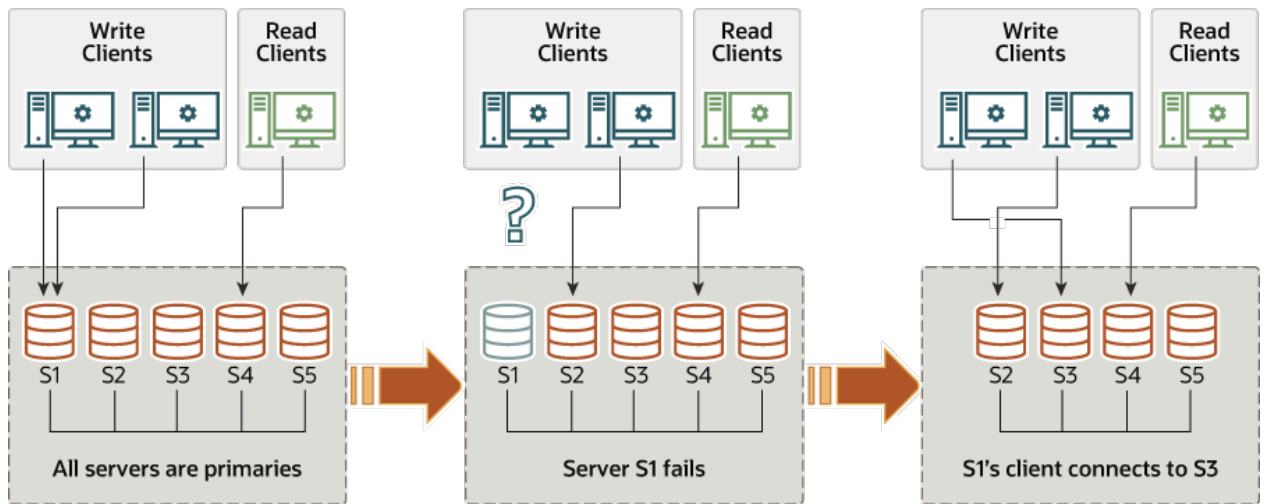

All servers are set to read-write mode when joining the group.

### 17.5.1.3 Finding the Primary

The following example shows how to find out which server is currently the primary when deployed in single-primary mode.

```
mysql> SHOW STATUS LIKE 'group_replication_primary_member';
```

## 17.5.2 Tuning Recovery

Whenever a new member joins a replication group, it connects to a suitable donor and fetches the data that it has missed up until the point it is declared online. This critical component in Group Replication is fault tolerant and configurable. The following section explains how recovery works and how to tune the settings

### Donor Selection

A random donor is selected from the existing online members in the group. This way there is a good chance that the same server is not selected more than once when multiple members enter the group.

If the connection to the selected donor fails, a new connection is automatically attempted to a new candidate donor. Once the connection retry limit is reached the recovery procedure terminates with an error.



#### Note

A donor is picked randomly from the list of online members in the current view.

### Enhanced Automatic Donor Switchover

The other main point of concern in recovery as a whole is to make sure that it copes with failures. Hence, Group Replication provides robust error detection mechanisms. In earlier versions of Group Replication, when reaching out to a donor, recovery could only detect connection errors due to authentication issues or some other problem. The reaction to such problematic scenarios was to switch over to a new donor thus a new connection attempt was made to a different member.

This behavior was extended to also cover other failure scenarios:

- *Purged data scenarios* - If the selected donor contains some purged data that is needed for the recovery process then an error occurs. Recovery detects this error and a new donor is selected.
- *Duplicated data* - If a server joining the group already contains some data that conflicts with the data coming from the selected donor during recovery then an error occurs. This could be caused by some errant transactions present in the server joining the group.

One could argue that recovery should fail instead of switching over to another donor, but in heterogeneous groups there is chance that other members share the conflicting transactions and others do not. For that reason, upon error, recovery selects another donor from the group.

- *Other errors* - If any of the recovery threads fail (receiver or applier threads fail) then an error occurs and recovery switches over to a new donor.



#### Note

In case of some persistent failures or even transient failures recovery automatically retries connecting to the same or a new donor.

## Donor Connection Retries

The recovery data transfer relies on the binary log and existing MySQL replication framework, therefore it is possible that some transient errors could cause errors in the receiver or applier threads. In such cases, the donor switch over process has retry functionality, similar to that found in regular replication.

## Number of Attempts

The number of attempts a server joining the group makes when trying to connect to a donor from the pool of donors is 10. This is configured through the `group_replication_recovery_retry_count` plugin variable. The following command sets the maximum number of attempts to connect to a donor to 10.

```
mysql> SET GLOBAL group_replication_recovery_retry_count= 10;
```

Note that this accounts for the global number of attempts that the server joining the group makes connecting to each one of the suitable donors.

## Sleep Routines

The `group_replication_recovery_reconnect_interval` plugin variable defines how much time the recovery process should sleep between donor connection attempts. This variable has its default set to 60 seconds and you can change this value dynamically. The following command sets the recovery donor connection retry interval to 120 seconds.

```
mysql> SET GLOBAL group_replication_recovery_reconnect_interval= 120;
```

Note, however, that recovery does not sleep after every donor connection attempt. As the server joining the group is connecting to different servers and not to the same one over and over again, it can assume that the problem that affects server A does not affect server B. As such, recovery suspends only when it has gone through all the possible donors. Once the server joining the group has tried to connect to all the suitable donors in the group and none remains, the recovery process sleeps for the number of seconds configured by the `group_replication_recovery_reconnect_interval` variable.

## 17.5.3 Network Partitioning



The group needs to achieve consensus whenever a change that needs to be replicated happens. This is the case for regular transactions but is also required for group membership changes and some internal messaging that keeps the group consistent. Consensus requires a majority of group members to agree on a given decision. When a majority of group members is lost, the group is unable to progress and blocks because it cannot secure majority or quorum.

Quorum may be lost when there are multiple involuntary failures, causing a majority of servers to be removed abruptly from the group. For example, in a group of 5 servers, if 3 of them become silent at once, the majority is compromised and thus no quorum can be achieved. In fact, the remaining two are not able to tell if the other 3 servers have crashed or whether a network partition has isolated these 2 alone and therefore the group cannot be reconfigured automatically.

On the other hand, if servers exit the group voluntarily, they instruct the group that it should reconfigure itself. In practice, this means that a server that is leaving tells others that it is going away. This means that other members can reconfigure the group properly, the consistency of the membership is maintained and the majority is recalculated. For example, in the above scenario of 5 servers where 3 leave at once, if the 3 leaving servers warn the group that they are leaving, one by one, then the membership is able to adjust itself from 5 to 2, and at the same time, securing quorum while that happens.



### Note

Loss of quorum is by itself a side-effect of bad planning. Plan the group size for the number of expected failures (regardless whether they are consecutive, happen all at once or are sporadic).

The following sections explain what to do if the system partitions in such a way that no quorum is automatically achieved by the servers in the group.



### Tip

A primary that has been excluded from a group after a majority loss followed by a reconfiguration can contain extra transactions that are not included in the new group. If this happens, the attempt to add back the excluded member from the group results in an error with the message `This member has more executed transactions than those present in the group.`

## Detecting Partitions

The `replication_group_members` performance schema table presents the status of each server in the current view from the perspective of this server. The majority of the time the system does not run into partitioning, and therefore the table shows information that is consistent across all servers in the group. In other words, the status of each server on this table is agreed by all in the current view. However, if there is network partitioning, and quorum is lost, then the table shows the status `UNREACHABLE` for those servers that it cannot contact. This information is exported by the local failure detector built into Group Replication.

Figure 17.7 Losing Quorum

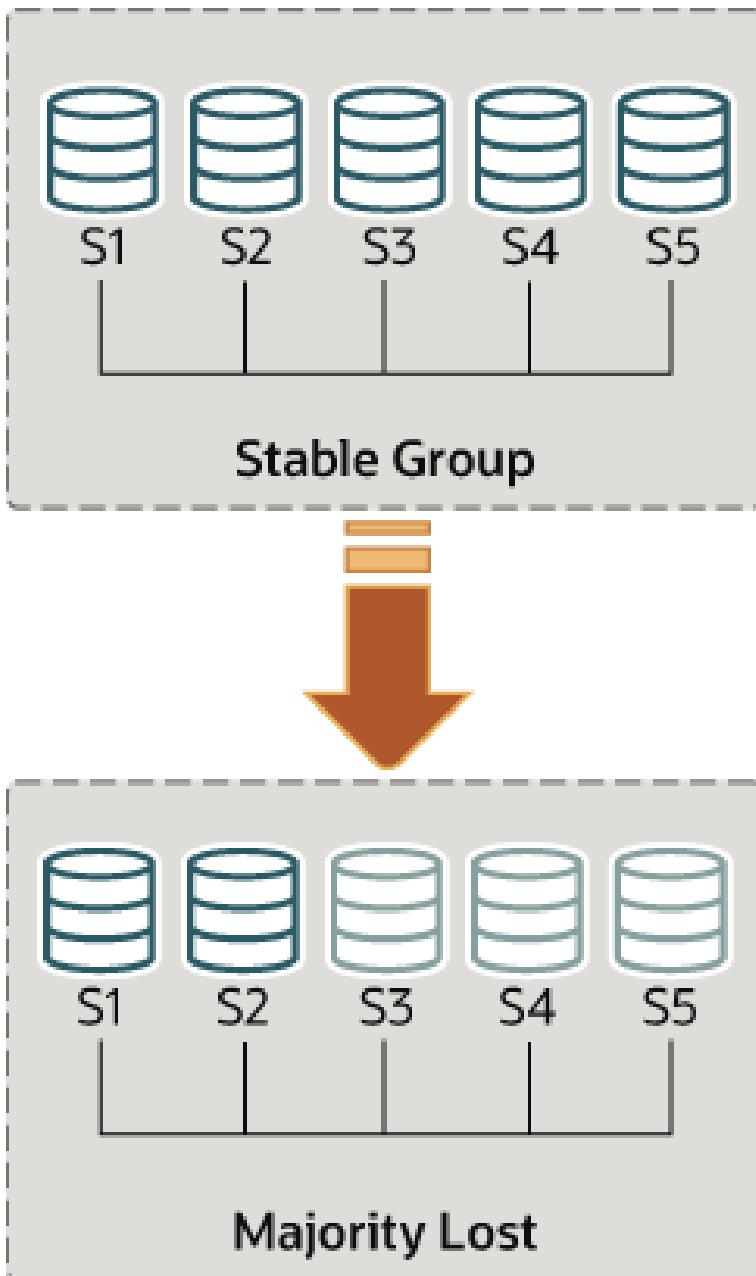

To understand this type of network partition the following section describes a scenario where there are initially 5 servers working together correctly, and the changes that then happen to the group once only 2 servers are online. The scenario is depicted in the figure.

As such, lets assume that there is a group with these 5 servers in it:

- Server s1 with member identifier `199b2df7-4aaf-11e6-bb16-28b2bd168d07`
- Server s2 with member identifier `199bb88e-4aaf-11e6-babe-28b2bd168d07`
- Server s3 with member identifier `1999b9fb-4aaf-11e6-bb54-28b2bd168d07`
- Server s4 with member identifier `19ab72fc-4aaf-11e6-bb51-28b2bd168d07`

- Server s5 with member identifier `19b33846-4aaf-11e6-ba81-28b2bd168d07`

Initially the group is running fine and the servers are happily communicating with each other. You can verify this by logging into s1 and looking at its `replication_group_members` performance schema table. For example:

```
mysql> SELECT MEMBER_ID, MEMBER_STATE, MEMBER_ROLE FROM performance_schema.replication_group_members;
```

MEMBER_ID	MEMBER_STATE	MEMBER_ROLE
1999b9fb-4aaf-11e6-bb54-28b2bd168d07	ONLINE	SECONDARY
199b2df7-4aaf-11e6-bb16-28b2bd168d07	ONLINE	PRIMARY
199bb88e-4aaf-11e6-babe-28b2bd168d07	ONLINE	SECONDARY
19ab72fc-4aaf-11e6-bb51-28b2bd168d07	ONLINE	SECONDARY
19b33846-4aaf-11e6-ba81-28b2bd168d07	ONLINE	SECONDARY

However, moments later there is a catastrophic failure and servers s3, s4 and s5 stop unexpectedly. A few seconds after this, looking again at the `replication_group_members` table on s1 shows that it is still online, but several others members are not. In fact, as seen below they are marked as `UNREACHABLE`. Moreover, the system could not reconfigure itself to change the membership, because the majority has been lost.

```
mysql> SELECT MEMBER_ID, MEMBER_STATE FROM performance_schema.replication_group_members;
```

MEMBER_ID	MEMBER_STATE
1999b9fb-4aaf-11e6-bb54-28b2bd168d07	UNREACHABLE
199b2df7-4aaf-11e6-bb16-28b2bd168d07	ONLINE
199bb88e-4aaf-11e6-babe-28b2bd168d07	ONLINE
19ab72fc-4aaf-11e6-bb51-28b2bd168d07	UNREACHABLE
19b33846-4aaf-11e6-ba81-28b2bd168d07	UNREACHABLE

The table shows that s1 is now in a group that has no means of progressing without external intervention, because a majority of the servers are unreachable. In this particular case, the group membership list needs to be reset to allow the system to proceed, which is explained in this section. Alternatively, you could also choose to stop Group Replication on s1 and s2 (or stop completely s1 and s2), figure out what happened with s3, s4 and s5 and then restart Group Replication (or the servers).

## Unblocking a Partition

Group replication enables you to reset the group membership list by forcing a specific configuration. For instance in the case above, where s1 and s2 are the only servers online, you could chose to force a membership configuration consisting of only s1 and s2. This requires checking some information about s1 and s2 and then using the `group_replication_force_members` variable.

Figure 17.8 Forcing a New Membership

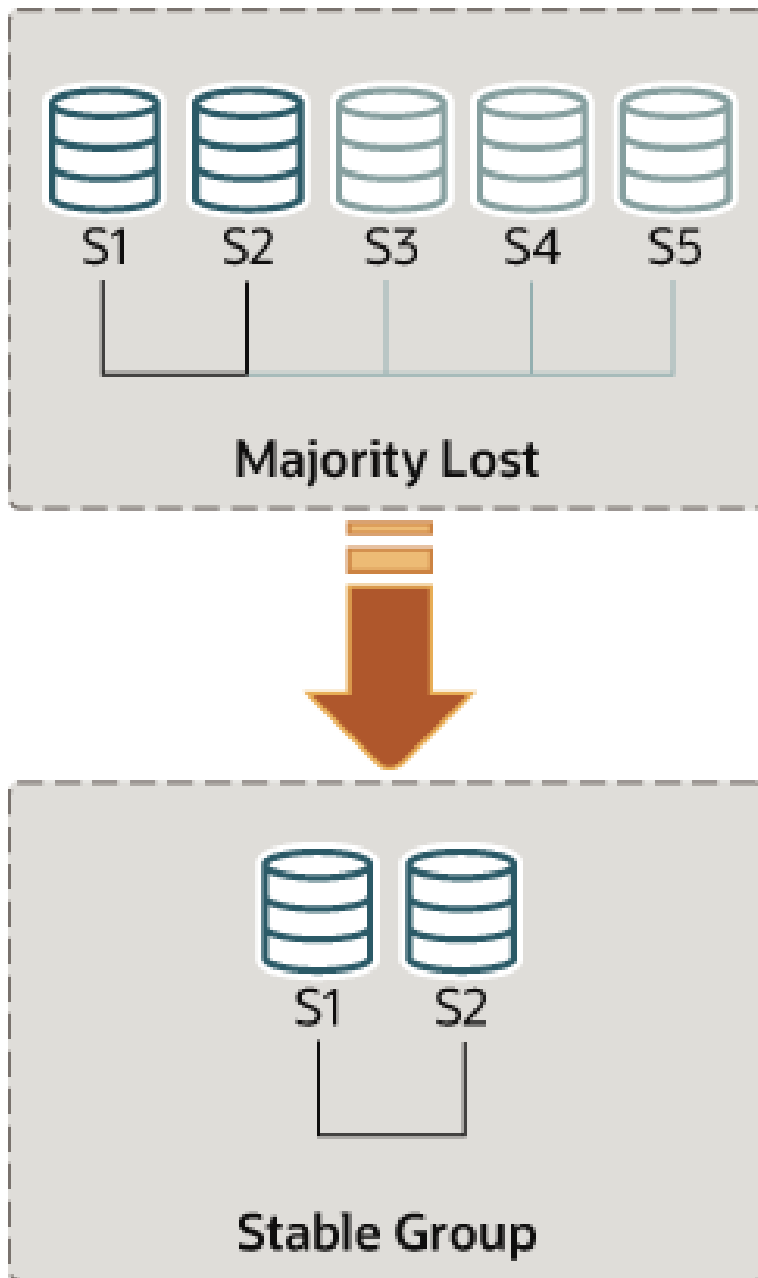

Suppose that you are back in the situation where s1 and s2 are the only servers left in the group. Servers s3, s4 and s5 have left the group unexpectedly. To make servers s1 and s2 continue, you want to force a membership configuration that contains only s1 and s2.

**Warning**

This procedure uses `group_replication_force_members` and should be considered a last resort remedy. It *must* be used with extreme care and only for overriding loss of quorum. If misused, it could create an artificial split-brain scenario or block the entire system altogether.

Recall that the system is blocked and the current configuration is the following (as perceived by the local failure detector on s1):

```
mysql> SELECT MEMBER_ID, MEMBER_STATE FROM performance_schema.replication_group_members;
+-----+-----+
| MEMBER_ID                | MEMBER_STATE |
+-----+-----+
| 1999b9fb-4aaf-11e6-bb54-28b2bd168d07 | UNREACHABLE  |
| 199b2df7-4aaf-11e6-bb16-28b2bd168d07 | ONLINE       |
| 199bb88e-4aaf-11e6-babe-28b2bd168d07 | ONLINE       |
| 19ab72fc-4aaf-11e6-bb51-28b2bd168d07 | UNREACHABLE  |
| 19b33846-4aaf-11e6-ba81-28b2bd168d07 | UNREACHABLE  |
+-----+-----+
```

The first thing to do is to check what is the local address (group communication identifier) for s1 and s2. Log in to s1 and s2 and get that information as follows.

```
mysql> SELECT @@group_replication_local_address;
```

Once you know the group communication addresses of s1 (127.0.0.1:10000) and s2 (127.0.0.1:10001), you can use that on one of the two servers to inject a new membership configuration, thus overriding the existing one that has lost quorum. To do that on s1:

```
mysql> SET GLOBAL group_replication_force_members="127.0.0.1:10000,127.0.0.1:10001";
```

This unblocks the group by forcing a different configuration. Check `replication_group_members` on both s1 and s2 to verify the group membership after this change. First on s1.

```
mysql> SELECT MEMBER_ID, MEMBER_STATE FROM performance_schema.replication_group_members;
+-----+-----+
| MEMBER_ID                | MEMBER_STATE |
+-----+-----+
| b5ffe505-4ab6-11e6-b04b-28b2bd168d07 | ONLINE       |
| b60907e7-4ab6-11e6-afb7-28b2bd168d07 | ONLINE       |
+-----+-----+
```

And then on s2.

```
mysql> SELECT * FROM performance_schema.replication_group_members;
+-----+-----+
| MEMBER_ID                | MEMBER_STATE |
+-----+-----+
| b5ffe505-4ab6-11e6-b04b-28b2bd168d07 | ONLINE       |
| b60907e7-4ab6-11e6-afb7-28b2bd168d07 | ONLINE       |
+-----+-----+
```

When forcing a new membership configuration, make sure that any servers are going to be forced out of the group are indeed stopped. In the scenario depicted above, if s3, s4 and s5 are not really unreachable but instead are online, they may have formed their own functional partition (they are 3 out of 5, hence they have the majority). In that case, forcing a group membership list with s1 and s2 could create an artificial split-brain situation. Therefore it is important before forcing a new membership configuration to ensure that the servers to be excluded are indeed shutdown and if they are not, shut them down before proceeding.

After you have used the `group_replication_force_members` system variable to successfully force a new group membership and unblock the group, ensure that you clear the system variable. `group_replication_force_members` must be empty in order to issue a `START GROUP_REPLICATION` statement.

## 17.5.4 Restarting a Group

Group Replication is designed to ensure that the database service is continuously available, even if some of the servers that form the group are currently unable to participate in it due to planned maintenance or

unplanned issues. As long as the remaining members are a majority of the group they can elect a new primary and continue to function as a group. However, if every member of a replication group leaves the group, and Group Replication is stopped on every member by a `STOP GROUP_REPLICATION` statement or system shutdown, the group now only exists in theory, as a configuration on the members. In that situation, to re-create the group, it must be started by bootstrapping as if it was being started for the first time.

The difference between bootstrapping a group for the first time and doing it for the second or subsequent times is that in the latter situation, the members of a group that was shut down might have different transaction sets from each other, depending on the order in which they were stopped or failed. A member cannot join a group if it has transactions that are not present on the other group members. For Group Replication, this includes both transactions that have been committed and applied, which are in the `gtid_executed` GTID set, and transactions that have been certified but not yet applied, which are in the `group_replication_applier` channel. A Group Replication group member never removes a transaction that has been certified, which is a declaration of the member's intent to commit the transaction.

The replication group must therefore be restarted beginning with the most up to date member, that is, the member that has the most transactions executed and certified. The members with fewer transactions can then join and catch up with the transactions they are missing through distributed recovery. It is not correct to assume that the last known primary member of the group is the most up to date member of the group, because a member that was shut down later than the primary might have more transactions. You must therefore restart each member to check the transactions, compare all the transaction sets, and identify the most up to date member. This member can then be used to bootstrap the group.

Follow this procedure to restart a replication group safely after every member shuts down.

1. For each group member in turn, in any order:
  - a. Connect a client to the group member. If Group Replication is not already stopped, issue a `STOP GROUP_REPLICATION` statement and wait for Group Replication to stop.
  - b. Edit the MySQL Server configuration file (typically named `my.cnf` on Linux and Unix systems, or `my.ini` on Windows systems) and set the system variable `group_replication_start_on_boot=OFF`. This setting prevents Group Replication from starting when MySQL Server is started, which is the default.

If you cannot change that setting on the system, you can just allow the server to attempt to start Group Replication, which will fail because the group has been fully shut down and not yet bootstrapped. If you take that approach, do not set `group_replication_bootstrap_group=ON` on any server at this stage.

- c. Start the MySQL Server instance, and verify that Group Replication has not been started (or has failed to start). Do not start Group Replication at this stage.
    - d. Collect the following information from the group member:
      - The contents of the `gtid_executed` GTID set. You can get this by issuing the following statement:

```
mysql> SELECT @@GLOBAL.GTID_EXECUTED
```

- The set of certified transactions on the `group_replication_applier` channel. You can get this by issuing the following statement:

```
mysql> SELECT received_transaction_set FROM \
performance_schema.replication_connection_status WHERE \
channel_name="group_replication_applier";
```

- When you have collected the transaction sets from all the group members, compare them to find which member has the biggest transaction set overall, including both the executed transactions (`gtid_executed`) and the certified transactions (on the `group_replication_applier` channel). You can do this manually by looking at the GTIDs, or you can compare the GTID sets using stored functions, as described in [Section 16.1.3.7, “Stored Function Examples to Manipulate GTIDs”](#).
- Use the member that has the biggest transaction set to bootstrap the group, by connecting a client to the group member and issuing the following statements:

```
mysql> SET GLOBAL group_replication_bootstrap_group=ON;
mysql> START GROUP_REPLICATION;
mysql> SET GLOBAL group_replication_bootstrap_group=OFF;
```

It is important not to store the setting `group_replication_bootstrap_group=ON` in the configuration file, otherwise when the server is restarted again, a second group with the same name is set up.

- To verify that the group now exists with this founder member in it, issue this statement on the member that bootstrapped it:

```
mysql> SELECT * FROM performance_schema.replication_group_members;
```

- Add each of the other members back into the group, in any order, by issuing a `START GROUP_REPLICATION` statement on each of them:

```
mysql> START GROUP_REPLICATION;
```

- To verify that each member has joined the group, issue this statement on any member:

```
mysql> SELECT * FROM performance_schema.replication_group_members;
```

- When the members have rejoined the group, if you edited their configuration files to set `group_replication_start_on_boot=OFF`, you can edit them again to set `ON` (or remove the system variable, since `ON` is the default).

## 17.5.5 Using MySQL Enterprise Backup with Group Replication

[MySQL Enterprise Backup](#) is a commercially-licensed backup utility for MySQL Server, available with [MySQL Enterprise Edition](#). This section explains how to back up and subsequently restore a Group Replication member using MySQL Enterprise Backup. The same technique can be used to quickly add a new member to a group.

### Backing up a Group Replication Member Using MySQL Enterprise Backup

Backing up a Group Replication member is similar to backing up a stand-alone MySQL instance. The following instructions assume that you are already familiar with how to use MySQL Enterprise Backup to perform a backup; if that is not the case, please review the [MySQL Enterprise Backup 4.1 User's Guide](#), especially [Backing Up a Database Server](#). Also note the requirements described in [Grant MySQL Privileges to Backup Administrator](#) and [Using MySQL Enterprise Backup with Group Replication](#).

Consider the following group with three members, `s1`, `s2`, and `s3`, running on hosts with the same names:

```
mysql> SELECT member_host, member_port, member_state FROM performance_schema.replication_group_members;
+-----+-----+-----+
| member_host | member_port | member_state |
+-----+-----+-----+
| s1          |          3306 | ONLINE       |
| s2          |          3306 | ONLINE       |
| s3          |          3306 | ONLINE       |
+-----+-----+-----+
```

Using MySQL Enterprise Backup, create a backup of `s2` by issuing on its host, for example, the following command:

```
s2> mysqlbackup --defaults-file=/etc/my.cnf --backup-image=/backups/my.mbi_`date +%d%m_%H%M` \
--backup-dir=/backups/backup_`date +%d%m_%H%M` --user=root -p \
--host=127.0.0.1 backup-to-image
```



### Note

- When backing up a secondary member, as MySQL Enterprise Backup cannot write backup status and metadata to a read-only server instance, it might issue warnings similar to the following one during the backup operation:

```
181113 21:31:08 MAIN WARNING: This backup operation cannot write to backup
progress. The MySQL server is running with the --super-read-only option.
```

You can avoid the warning by using the `--no-history-logging` option with your backup command.

## Restoring a Failed Member

Assume one of the members (`s3` in the following example) is irreconcilably corrupted. The most recent backup of group member `s2` can be used to restore `s3`. Here are the steps for performing the restore:

1. *Copy the backup of `s2` onto the host for `s3`.* The exact way to copy the backup depends on the operating system and tools available to you. In this example, we assume the hosts are both Linux servers and use SCP to copy the files between them:

```
s2/backups> scp my.mbi_2206_1429 s3:/backups
```

2. *Restore the backup.* Connect to the target host (the host for `s3` in this case), and restore the backup using MySQL Enterprise Backup. Here are the steps:

- a. Stop the corrupted server, if it is still running. For example, on Linux distributions that use `systemd`:

```
s3> systemctl stop mysqld
```

- b. Preserve the configuration file `auto.cnf`, located in the corrupted server's data directory, by copying it to a safe location outside of the data directory. This is for preserving the [server's UUID](#), which is needed later.
- c. Delete all contents in the data directory of `s3`. For example:

```
s3> rm -rf /var/lib/mysql/*
```

If the system variables `innodb_data_home_dir`, `innodb_log_group_home_dir`, and `innodb_undo_directory` point to any directories other than the data directory, they should also be made empty; otherwise, the restore operation fails.

- d. Restore backup of `s2` onto the host for `s3`:

```
s3> mysqlbackup --defaults-file=/etc/my.cnf \
--datadir=/var/lib/mysql \
--backup-image=/backups/my.mbi_2206_1429 \
--backup-dir=/tmp/restore_`date +%d%m_%H%M` copy-back-and-apply-log
```



### Note

The command above assumes that the binary logs and relay logs on `s2` and `s3` have the same base name and are at the same location on the two



servers. If these conditions are not met, for MySQL Enterprise Backup 4.1.2 and later, you should use the `--log-bin` and `--relay-log` options to restore the binary log and relay log to their original file paths on `s3`. For example, if you know that on `s3` the binary log's base name is `s3-bin` and the relay-log's base name is `s3-relay-bin`, your restore command should look like:

```
mysqlbackup --defaults-file=/etc/my.cnf \
  --datadir=/var/lib/mysql \
  --backup-image=/backups/my.mbi_2206_1429 \
  --log-bin=s3-bin --relay-log=s3-relay-bin \
  --backup-dir=/tmp/restore_`date +%d%m_%H%M` copy-back-and-apply-log
```

Being able to restore the binary log and relay log to the right file paths makes the restore process easier; if that is impossible for some reason, see [Rebuild the Failed Member to Rejoin as a New Member](#).

3. *Restore the `auto.cnf` file for `s3`.* To rejoin the replication group, the restored member *must* have the same `server_uuid` it used to join the group before. Supply the old server UUID by copying the `auto.cnf` file preserved in step 2 above into the data directory of the restored member.



#### Note

If you cannot supply the failed member's original `server_uuid` to the restored member by restoring its old `auto.cnf` file, you must let the restored member join the group as a new member; see instructions in [Rebuild the Failed Member to Rejoin as a New Member](#) below on how to do that.

4. *Start the restored server.* For example, on Linux distributions that use `systemd`:

```
systemctl start mysqld
```



#### Note

If the server you are restoring is a primary member, perform the steps described in [Restoring a Primary Member before starting the restored server](#).

5. *Restart Group Replication.* Connect to the restarted `s3` using, for example, a `mysql` client, and issue the following command:

```
mysql> START GROUP_REPLICATION;
```

Before the restored instance can become an online member of the group, it needs to apply any transactions that have happened to the group after the backup was taken; this is achieved using Group Replication's [distributed recovery](#) mechanism, and the process starts after the `START GROUP_REPLICATION` statement has been issued. To check the member status of the restored instance, issue:

```
mysql> SELECT member_host, member_port, member_state FROM performance_schema.replication_group_members;
+-----+-----+-----+
| member_host | member_port | member_state |
+-----+-----+-----+
| s1          | 3306        | ONLINE       |
| s2          | 3306        | ONLINE       |
| s3          | 3306        | RECOVERING   |
+-----+-----+-----+
```

This shows that `s3` is applying transactions to catch up with the group. Once it has caught up with the rest of the group, its `member_state` changes to `ONLINE`:

```
mysql> SELECT member_host, member_port, member_state FROM performance_schema.replication_group_members;
+-----+-----+-----+
| member_host | member_port | member_state |
+-----+-----+-----+
| s1          | 3306        | ONLINE       |
| s2          | 3306        | ONLINE       |
| s3          | 3306        | ONLINE       |
+-----+-----+-----+
```



#### Note

If the server you are restoring is a primary member, once it has gained synchrony with the group and become `ONLINE`, perform the steps described at the end of [Restoring a Primary Member](#) to revert the configuration changes you had made to the server before you started it.

The member has now been fully restored from the backup and functions as a regular member of the group.

## Rebuild the Failed Member to Rejoin as a New Member

Sometimes, the steps outlined above in [Restoring a Failed Member](#) cannot be carried out because, for example, the binary log or relay log is corrupted, or it is just missing from the backup. In such a situation, use the backup to rebuild the member, and then add it to the group as a new member. In the steps below, we assume the rebuilt member is named `s3`, like the failed member, and it is run on the same host as `s3` was:

1. *Copy the backup of `s2` onto the host for `s3`.* The exact way to copy the backup depends on the operating system and tools available to you. In this example we assume the hosts are both Linux servers and use SCP to copy the files between them:

```
s2/backups> scp my.mbi_2206_1429 s3:/backups
```

2. *Restore the backup.* Connect to the target host (the host for `s3` in this case), and restore the backup using MySQL Enterprise Backup. Here are the steps:

- a. Stop the corrupted server, if it is still running. For example, on Linux distributions that use `systemd`:

```
s3> systemctl stop mysqld
```

- b. Delete all contents in the data directory of `s3`. For example:

```
s3> rm -rf /var/lib/mysql/*
```

If the system variables `innodb_data_home_dir`, `innodb_log_group_home_dir`, and `innodb_undo_directory` point to any directories other than the data directory, they should also be made empty; otherwise, the restore operation fails.

- c. Restore the backup of `s2` onto the host of `s3`. With this approach, we are rebuilding `s3` as a new member, for which we do not need or do not want to use the old binary and relay logs in the backup; therefore, if these logs have been included in your backup, exclude them using the `--skip-binlog` and `--skip-relaylog` options:

```
s3> mysqlbackup --defaults-file=/etc/my.cnf \
  --datadir=/var/lib/mysql \
  --backup-image=/backups/my.mbi_2206_1429 \
```

```
--backup-dir=/tmp/restore_`date +%d%m_%H%M` \
--skip-binlog --skip-relaylog \
copy-back-and-apply-log
```



### Notes

- If you have healthy binary log and relay logs in the backup that you can transfer onto the target host with no issues, you are recommended to follow the easier procedure as described in [Restoring a Failed Member](#) above.
- Do NOT restore manually the corrupted server's `auto.cnf` file to the data directory of the new member—when the rebuilt `s3` joins the group as a new member, it is going to be assigned a new server UUID.

3. *Start the restored server.* For example, on Linux distributions that use `systemd`:

```
systemctl start mysqld
```



### Note

If the server you are restoring is a primary member, perform the steps described in [Restoring a Primary Member](#) *before starting the restored server*.

4. *Reconfigure the restored member to join Group Replication.* Connect to the restored server with a `mysql` client and reset the source and replica information with the following commands:

```
mysql> RESET MASTER;
```

```
mysql> RESET SLAVE ALL;
```

For the restored server to be able to recover automatically using Group Replication's built-in mechanism for [distributed recovery](#), configure the server's `gtid_executed` variable. To do this, use the `backup_gtid_executed.sql` file included in the backup of `s2`, which is usually restored under the restored member's data directory. Disable binary logging, use the `backup_gtid_executed.sql` file to configure `gtid_executed`, and then re-enable binary logging by issuing the following statements with your `mysql` client:

```
mysql> SET SQL_LOG_BIN=OFF;
mysql> SOURCE datadir/backup_gtid_executed.sql
mysql> SET SQL_LOG_BIN=ON;
```

Then, configure the [Group Replication user credentials](#) on the member:

```
mysql> CHANGE MASTER TO MASTER_USER='rpl_user', MASTER_PASSWORD='password' /
FOR CHANNEL 'group_replication_recovery';
```

5. *Restart Group Replication.* Issue the following command to the restored server with your `mysql` client:

```
mysql> START GROUP_REPLICATION;
```

Before the restored instance can become an online member of the group, it needs to apply any transactions that have happened to the group after the backup was taken; this is achieved using Group Replication's [distributed recovery](#) mechanism, and the process starts after the [START GROUP\\_REPLICATION](#) statement has been issued. To check the member status of the restored instance, issue:

```
mysql> SELECT member_host, member_port, member_state FROM performance_schema.replication_group_members;
+-----+-----+-----+
| member_host | member_port | member_state |
```

member_host	member_port	member_state
s3	3306	RECOVERING
s2	3306	ONLINE
s1	3306	ONLINE

This shows that `s3` is applying transactions to catch up with the group. Once it has caught up with the rest of the group, its `member_state` changes to `ONLINE`:

```
mysql> SELECT member_host, member_port, member_state FROM performance_schema.replication_group_members;
```

member_host	member_port	member_state
s3	3306	ONLINE
s2	3306	ONLINE
s1	3306	ONLINE



### Note

If the server you are restoring is a primary member, once it has gained synchrony with the group and become `ONLINE`, perform the steps described at the end of [Restoring a Primary Member](#) to revert the configuration changes you had made to the server before you started it.

The member has now been restored to the group as a new member.

**Restoring a Primary Member.** If the restored member is a primary in the group, care must be taken to prevent writes to the restored database during the Group Replication recovery phase: Depending on how the group is accessed by clients, there is a possibility of DML statements being executed on the restored member once it becomes accessible on the network, prior to the member finishing its catch-up on the activities it has missed while off the group. To avoid this, *before starting the restored server*, configure the following system variables in the server option file:

```
group_replication_start_on_boot=OFF
super_read_only=ON
event_scheduler=OFF
```

These settings ensure that the member becomes read-only at startup and that the event scheduler is turned off while the member is catching up with the group during the recovery phase. Adequate error handling must also be configured on the clients, as they are prevented temporarily from performing DML operations during this period on the restored member. Once the restore process is fully completed and the restored member is in-sync with the rest of the group, revert those changes; restart the event scheduler:

```
mysql> SET global event_scheduler=ON;
```

Edit the following system variables in the member's option file, so things are correctly configured for the next startup:

```
group_replication_start_on_boot=ON
super_read_only=OFF
event_scheduler=ON
```

## 17.6 Group Replication Security

This section explains how to secure a group, securing the connections between members of a group, or by establishing a security perimeter using IP address allowlisting.

### 17.6.1 Group Replication IP Address Allowlisting

The Group Replication plugin has a configuration option to determine from which hosts an incoming Group Communication System connection can be accepted. This option is called `group_replication_ip_whitelist`. If you set this option on a server `s1`, then when server `s2` is establishing a connection to `s1` for the purpose of engaging group communication, `s1` first checks the allowlist before accepting the connection from `s2`. If `s2` is in the allowlist, then `s1` accepts the connection, otherwise `s1` rejects the connection attempt by `s2`.

If you do not specify an allowlist explicitly, the group communication engine (XCom) automatically scans active interfaces on the host, and identifies those with addresses on private subnetworks. These addresses and the `localhost` IP address for IPv4 are used to create an automatic Group Replication allowlist. The automatic allowlist therefore includes any IP addresses found for the host in the following ranges:

```
10/8 prefix      (10.0.0.0 - 10.255.255.255) - Class A
172.16/12 prefix (172.16.0.0 - 172.31.255.255) - Class B
192.168/16 prefix (192.168.0.0 - 192.168.255.255) - Class C
127.0.0.1 - localhost for IPv4
```

An entry is added to the error log stating the addresses that have been allowlisted automatically for the host.

The automatic allowlist of private addresses cannot be used for connections from servers outside the private network, so a server, even if it has interfaces on public IPs, does not by default allow Group Replication connections from external hosts. For Group Replication connections between server instances that are on different machines, you must provide public IP addresses and specify these as an explicit allowlist. If you specify any entries for the allowlist, the private and `localhost` addresses are not added automatically, so if you use any of these, you must specify them explicitly.

To specify an allowlist manually, use the `group_replication_ip_whitelist` option. You cannot change the allowlist on a server while it is an active member of a replication group. If the member is active, you must issue a `STOP GROUP_REPLICATION` statement before changing the allowlist, and a `START GROUP_REPLICATION` statement afterwards.

In the allowlist, you can specify any combination of the following:

- IPv4 addresses (for example, `198.51.100.44`)
- IPv4 addresses with CIDR notation (for example, `192.0.2.21/24`)
- Host names, from MySQL 5.7.21 (for example, `example.org`)
- Host names with CIDR notation, from MySQL 5.7.21 (for example, `www.example.com/24`)

IPv6 addresses, and host names that resolve to IPv6 addresses, are not supported in MySQL 5.7. You can use CIDR notation in combination with host names or IP addresses to allowlist a block of IP addresses with a particular network prefix, but do ensure that all the IP addresses in the specified subnet are under your control.

You must stop and restart Group Replication on a member in order to change its allowlist. A comma must separate each entry in the allowlist. For example:

```
mysql> STOP GROUP_REPLICATION;
mysql> SET GLOBAL group_replication_ip_whitelist="192.0.2.21/24,198.51.100.44,203.0.113.0/24,example.org,w
mysql> START GROUP_REPLICATION;
```

The allowlist must contain the IP address or host name that is specified in each member's `group_replication_local_address` system variable. This address is not the same as the MySQL

server SQL protocol host and port, and is not specified in the `bind_address` system variable for the server instance.

When a replication group is reconfigured (for example, when a new primary is elected or a member joins or leaves), the group members re-establish connections between themselves. If a group member is only allowlisted by servers that are no longer part of the replication group after the reconfiguration, it is unable to reconnect to the remaining servers in the replication group that do not allowlist it. To avoid this scenario entirely, specify the same allowlist for all servers that are members of the replication group.



#### Note

It is possible to configure different allowlists on different group members according to your security requirements, for example, in order to keep different subnets separate. If you need to configure different allowlists to meet your security requirements, ensure that there is sufficient overlap between the allowlists in the replication group to maximize the possibility of servers being able to reconnect in the absence of their original seed member.

For host names, name resolution takes place only when a connection request is made by another server. A host name that cannot be resolved is not considered for allowlist validation, and a warning message is written to the error log. Forward-confirmed reverse DNS (FCrDNS) verification is carried out for resolved host names.



#### Warning

Host names are inherently less secure than IP addresses in an allowlist. FCrDNS verification provides a good level of protection, but can be compromised by certain types of attack. Specify host names in your allowlist only when strictly necessary, and ensure that all components used for name resolution, such as DNS servers, are maintained under your control. You can also implement name resolution locally using the hosts file, to avoid the use of external components.

## 17.6.2 Group Replication Secure Socket Layer (SSL) Support

Group communication connections as well as recovery connections, are secured using SSL. The following sections explain how to configure connections.

### Configuring SSL for Group Replication Recovery

Recovery is performed through a regular asynchronous replication connection. Once the donor is selected, the server joining the group establishes an asynchronous replication connection. This is all automatic.

However, a user that requires an SSL connection must have been created before the server joining the group connects to the donor. Typically, this is set up at the time one is provisioning a server to join the group.

```
donor> SET SQL_LOG_BIN=0;
donor> CREATE USER 'rec_ssl_user'@'%' REQUIRE SSL;
donor> GRANT replication slave ON *.* TO 'rec_ssl_user'@'%';
donor> SET SQL_LOG_BIN=1;
```

Assuming that all servers already in the group have a replication user set up to use SSL, you configure the server joining the group to use those credentials when connecting to the donor. That is done according to the values of the SSL options provided for the Group Replication plugin.

```
new_member> SET GLOBAL group_replication_recovery_use_ssl=1;
```

```
new_member> SET GLOBAL group_replication_recovery_ssl_ca= '.../cacert.pem';
new_member> SET GLOBAL group_replication_recovery_ssl_cert= '.../client-cert.pem';
new_member> SET GLOBAL group_replication_recovery_ssl_key= '.../client-key.pem';
```

And by configuring the recovery channel to use the credentials of the user that requires an SSL connection.

```
new_member> CHANGE MASTER TO MASTER_USER="rec_ssl_user" FOR CHANNEL "group_replication_recovery";
new_member> START GROUP_REPLICATION;
```

## Configuring SSL for Group Communication

Secure sockets can be used to establish communication between members in a group. The configuration for this depends on the server's SSL configuration. As such, if the server has SSL configured, the Group Replication plugin also has SSL configured. For more information on the options for configuring the server SSL, see [Command Options for Encrypted Connections](#). The options which configure Group Replication are shown in the following table.

**Table 17.2 SSL Options**

Server Configuration	Plugin Configuration Description
ssl_key	Path of key file. To be used as client and server certificate.
ssl_cert	Path of certificate file. To be used as client and server certificate.
ssl_ca	Path of file with SSL Certificate Authorities that are trusted.
ssl_capath	Path of directory containing certificates for SSL Certificate Authorities that are trusted.
ssl_crl	Path of file containing the certificate revocation lists.
ssl_crlpath	Path of directory containing revoked certificate lists.
ssl_cipher	Permitted ciphers to use while encrypting data over the connection.
tls_version	Secure communication uses this version and its protocols.

These options are MySQL Server configuration options which Group Replication relies on for its configuration. In addition there is the following Group Replication specific option to configure SSL on the plugin itself.

- `group_replication_ssl_mode` - specifies the security state of the connection between Group Replication members.

**Table 17.3 group\_replication\_ssl\_mode configuration values**

Value	Description
<code>DISABLED</code>	Establish an unencrypted connection ( <i>default</i> ).
<code>REQUIRED</code>	Establish a secure connection if the server supports secure connections.
<code>VERIFY_CA</code>	Like <code>REQUIRED</code> , but additionally verify the server TLS certificate against the configured Certificate Authority (CA) certificates.

Value	Description
VERIFY_IDENTITY	Like VERIFY_CA, but additionally verify that the server certificate matches the host to which the connection is attempted.

The following example shows an example my.cnf file section used to configure SSL on a server and how activate it for Group Replication.

```
[mysqld]
ssl_ca = "cacert.pem"
ssl_capath = "/../ca_directory"
ssl_cert = "server-cert.pem"
ssl_cipher = "DHE-RSA-AES256-SHA"
ssl_crl = "crl-server-revoked.crl"
ssl_crlpath = "/../crl_directory"
ssl_key = "server-key.pem"
group_replication_ssl_mode= REQUIRED
```

The only plugin specific configuration option that is listed is `group_replication_ssl_mode`. This option activates the SSL communication between members of the group, by configuring the SSL framework with the `ssl_*` parameters that are provided to the server.

### 17.6.3 Group Replication and Virtual Private Networks (VPNs)

There is nothing preventing Group Replication from operating over a virtual private network. At its core, it just relies on an IPv4 socket to establish connections between servers for the purpose of propagating messages between them.

## 17.7 Group Replication Variables

The next two sections contain information about MySQL server system and server status variables which are specific to the Group Replication plugin.

**Table 17.4 Group Replication Variable and Option Summary**

Name	Cmd-Line	Option File	System Var	Status Var	Var Scope	Dynamic
<a href="#">group_replication_allow_local_instant_gtid</a>	Yes	Yes	Yes		Global	Yes
<a href="#">group_replication_allow_local_instant_version</a>	Yes	Yes	Yes		Global	Yes
<a href="#">group_replication_auto_increment_increment</a>	Yes	Yes	Yes		Global	Yes
<a href="#">group_replication_bootstrap_group</a>	Yes	Yes	Yes		Global	Yes
<a href="#">group_replication_components_bootstrap_timeout</a>	Yes	Yes	Yes		Global	Yes
<a href="#">group_replication_compression_threshold</a>	Yes	Yes	Yes		Global	Yes
<a href="#">group_replication_enforce_update_everywhere_checks</a>	Yes	Yes	Yes		Global	Yes
<a href="#">group_replication_exit_state_action</a>	Yes	Yes	Yes		Global	Yes
<a href="#">group_replication_flow_control_applier_threshold</a>	Yes	Yes	Yes		Global	Yes
<a href="#">group_replication_flow_control_certifier_threshold</a>	Yes	Yes	Yes		Global	Yes
<a href="#">group_replication_flow_control_mode</a>	Yes	Yes	Yes		Global	Yes
<a href="#">group_replication_force_members</a>	Yes	Yes	Yes		Global	Yes
<a href="#">group_replication_group_name</a>	Yes	Yes	Yes		Global	Yes



Name	Cmd-Line	Option File	System Var	Status Var	Var Scope	Dynamic
group_replication_group_seeds	Yes	Yes	Yes		Global	Yes
group_replication_group_tid_assignment_block_size	Yes	Yes	Yes		Global	Yes
group_replication_group_whitelist	Yes	Yes	Yes		Global	Yes
group_replication_group_local_address	Yes	Yes	Yes		Global	Yes
group_replication_group_member_weight	Yes	Yes	Yes		Global	Yes
group_replication_group_poll_spin_loops	Yes	Yes	Yes		Global	Yes
group_replication_group_primary_member				Yes	Global	No
group_replication_group_recovery_complete_at	Yes	Yes	Yes		Global	Yes
group_replication_group_recovery_reconnect_interval	Yes	Yes	Yes		Global	Yes
group_replication_group_recovery_retry_count	Yes	Yes	Yes		Global	Yes
group_replication_group_recovery_ssl	Yes	Yes	Yes		Global	Yes
group_replication_group_recovery_ssl_path	Yes	Yes	Yes		Global	Yes
group_replication_group_recovery_ssl_cert	Yes	Yes	Yes		Global	Yes
group_replication_group_recovery_ssl_cipher	Yes	Yes	Yes		Global	Yes
group_replication_group_recovery_ssl_key	Yes	Yes	Yes		Global	Yes
group_replication_group_recovery_ssl_path	Yes	Yes	Yes		Global	Yes
group_replication_group_recovery_ssl_key	Yes	Yes	Yes		Global	Yes
group_replication_group_recovery_ssl_verify_server_cert	Yes	Yes	Yes		Global	Yes
group_replication_group_recovery_use_ssl	Yes	Yes	Yes		Global	Yes
group_replication_group_single_primary_mode	Yes	Yes	Yes		Global	Yes
group_replication_group_ssl_mode	Yes	Yes	Yes		Global	Yes
group_replication_group_start_on_boot	Yes	Yes	Yes		Global	Yes
group_replication_group_transaction_log_size_limit	Yes	Yes	Yes		Global	Yes
group_replication_group_unreachable_majority_timeout	Yes	Yes	Yes		Global	Yes

### 17.7.1 Group Replication System Variables

This section lists the system variables that are specific to the Group Replication plugin.

The name of each Group Replication system variable is prefixed with `group_replication_`.

Most system variables for Group Replication are described as dynamic, and their values can be changed while the server is running. However, in most cases, the change only takes effect after you stop and restart Group Replication on the group member using a `STOP GROUP_REPLICATION` statement followed by a `START GROUP_REPLICATION` statement. Changes to the following system variables take effect without stopping and restarting Group Replication:

- `group_replication_exit_state_action`
- `group_replication_flow_control_applier_threshold`
- `group_replication_flow_control_certifier_threshold`
- `group_replication_flow_control_hold_percent`

- `group_replication_flow_control_max_quota`
- `group_replication_flow_control_member_quota_percent`
- `group_replication_flow_control_min_quota`
- `group_replication_flow_control_min_recovery_quota`
- `group_replication_flow_control_mode`
- `group_replication_force_members`
- `group_replication_member_weight`
- `group_replication_transaction_size_limit`
- `group_replication_unreachable_majority_timeout`

Most system variables for Group Replication can have different values on different group members. For the following system variables, it is advisable to set the same value on all members of a group in order to avoid unnecessary rollback of transactions, failure of message delivery, or failure of message recovery:

- `group_replication_auto_increment_increment`
- `group_replication_compression_threshold`
- `group_replication_transaction_size_limit`

Some system variables on a Group Replication group member, including some Group Replication-specific system variables and some general system variables, are group-wide configuration settings. These system variables must have the same value on all group members, cannot be changed while Group Replication is running, and require a full reboot of the group (a bootstrap by a server with `group_replication_bootstrap_group=ON`) in order for the value change to take effect. These conditions apply to the following system variables:

- `group_replication_single_primary_mode`
- `group_replication_enforce_update_everywhere_checks`
- `group_replication_gtid_assignment_block_size`
- `default_table_encryption`
- `lower_case_table_names`
- `transaction_write_set_extraction`



### Important

- A number of system variables for Group Replication are not completely validated during server startup if they are passed as command line arguments to the server. These system variables include `group_replication_group_name`, `group_replication_single_primary_mode`, `group_replication_force_members`, the SSL variables, and the flow control system variables. They are only fully validated after the server has started.
- System variables for Group Replication that specify IP addresses or host names for group members are not validated until a `START GROUP_REPLICATION`

statement is issued. Group Replication's Group Communication System (GCS) is not available to validate the values until that point.

The system variables that are specific to the Group Replication plugin are as follows:

- [group\\_replication\\_allow\\_local\\_disjoint\\_gtids\\_join](#)

Command-Line Format	<code>--group-replication-allow-local-disjoint-gtids-join[={OFF ON}]</code>
Introduced	5.7.17
Deprecated	5.7.21
System Variable	<a href="#">group_replication_allow_local_disjoint_gtids_join</a>
Scope	Global
Dynamic	Yes
Type	Boolean
Default Value	OFF

Deprecated in version 5.7.21 and scheduled for removal in a future version. Allows the server to join the group even if it has local transactions that are not present in the group.



#### Warning

Use caution when enabling this option as incorrect usage can lead to conflicts in the group and rollback of transactions. The option should only be enabled as a last resort method to allow a server that has local transactions to join an existing group, and then only if the local transactions do not affect the data that is handled by the group (for example, an administrative action that was written to the binary log). The option should not be left enabled on all group members.

- [group\\_replication\\_allow\\_local\\_lower\\_version\\_join](#)

Command-Line Format	<code>--group-replication-allow-local-lower-version-join[={OFF ON}]</code>
Introduced	5.7.17
System Variable	<a href="#">group_replication_allow_local_lower_version_join</a>
Scope	Global
Dynamic	Yes
Type	Boolean
Default Value	OFF

Allows the current server to join the group even if it has a lower major version than the group. With the default setting `OFF`, servers are not permitted to join a replication group if they have a lower major version than the existing group members. For example, a MySQL 5.7 server cannot join a group that consists of MySQL 8.0 servers. This standard policy ensures that all members of a group are able to exchange messages and apply transactions. Set [group\\_replication\\_allow\\_local\\_lower\\_version\\_join](#) to `ON` only in the following scenarios:

- A server must be added to the group in an emergency in order to improve the group's fault tolerance, and only older versions are available.

- You want to carry out a downgrade of the replication group members without shutting down the whole group and bootstrapping it again.



### Warning

Setting this option to `ON` does not make the new member compatible with the group, and allows it to join the group without any safeguards against incompatible behaviors by the existing members. To ensure the new member's correct operation, take *both* of the following precautions:

- Before the server with the lower major version joins the group, stop all writes on that server.
- From the point where the server with the lower major version joins the group, stop all writes on the other servers in the group.

Without these precautions, the server with the lower major version is likely to experience difficulties and terminate with an error.

- `group_replication_auto_increment_increment`

Command-Line Format	<code>--group-replication-auto-increment-increment=#</code>
Introduced	5.7.17
System Variable	<code>group_replication_auto_increment_increment</code>
Scope	Global
Dynamic	Yes
Type	Integer
Default Value	7
Minimum Value	1
Maximum Value	65535

Determines the interval between successive column values for transactions that execute on this server instance. This system variable should have the same value on all group members. When Group Replication is started on a server, the value of the server system variable `auto_increment_increment` is changed to this value, and the value of the server system variable `auto_increment_offset` is changed to the server ID. These settings avoid the selection of duplicate auto-increment values for writes on group members, which causes rollback of transactions. The changes are reverted when Group Replication is stopped. These changes are only made and reverted if `auto_increment_increment` and `auto_increment_offset` each have their default value of 1. If their values have already been modified from the default, Group Replication does not alter them.

The default value of 7 represents a balance between the number of usable values and the permitted maximum size of a replication group (9 members). If your group has more or fewer members, you can set this system variable to match the expected number of group members before Group Replication is started. You cannot change the setting while Group Replication is running.



### Important

Setting `group_replication_auto_increment_increment` has no effect when `group_replication_single_primary_mode` is `ON`.

- `group_replication_bootstrap_group`

Command-Line Format	<code>--group-replication-bootstrap-group[={OFF ON}]</code>
Introduced	5.7.17
System Variable	<code>group_replication_bootstrap_group</code>
Scope	Global
Dynamic	Yes
Type	Boolean
Default Value	<code>OFF</code>

Configure this server to bootstrap the group. This option must only be set on one server and only when starting the group for the first time or restarting the entire group. After the group has been bootstrapped, set this option to `OFF`. It should be set to `OFF` both dynamically and in the configuration files. Starting two servers or restarting one server with this option set while the group is running may lead to an artificial split brain situation, where two independent groups with the same name are bootstrapped.

- `group_replication_components_stop_timeout`

Command-Line Format	<code>--group-replication-components-stop-timeout=#</code>
Introduced	5.7.17
System Variable	<code>group_replication_components_stop_timeout</code>
Scope	Global
Dynamic	Yes
Type	Integer
Default Value	31536000
Minimum Value	2
Maximum Value	31536000
Unit	seconds

Timeout, in seconds, that Group Replication waits for each of the components when shutting down.

- `group_replication_compression_threshold`

Command-Line Format	<code>--group-replication-compression-threshold=#</code>
Introduced	5.7.17
System Variable	<code>group_replication_compression_threshold</code>
Scope	Global
Dynamic	Yes
Type	Integer
Default Value	1000000
Minimum Value	0
Maximum Value	4294967295

Unit	bytes
------	-------

The threshold value in bytes above which compression is applied to messages sent between group members. If this system variable is set to zero, compression is disabled. The value of `group_replication_compression_threshold` should be the same on all group members.

Group Replication uses the LZ4 compression algorithm to compress messages sent in the group. Note that the maximum supported input size for the LZ4 compression algorithm is 2113929216 bytes. This limit is lower than the maximum possible value for the `group_replication_compression_threshold` system variable, which is matched to the maximum message size accepted by XCom. With the LZ4 compression algorithm, do not set a value greater than 2113929216 bytes for `group_replication_compression_threshold`, because transactions above this size cannot be committed when message compression is enabled.

For more information, see [Section 17.9.7.2, “Message Compression”](#).

- `group_replication_enforce_update_everywhere_checks`

Command-Line Format	<code>--group-replication-enforce-update-everywhere-checks[={OFF ON}]</code>
Introduced	5.7.17
System Variable	<code>group_replication_enforce_update_everywhere_checks</code>
Scope	Global
Dynamic	Yes
Type	Boolean
Default Value	OFF

Enable or disable strict consistency checks for multi-primary update everywhere. The default is that checks are disabled. In single-primary mode, this option must be disabled on all group members. In multi-primary mode, when this option is enabled, statements are checked as follows to ensure they are compatible with multi-primary mode:

- If a transaction is executed under the `SERIALIZABLE` isolation level, then its commit fails when synchronizing itself with the group.
- If a transaction executes against a table that has foreign keys with cascading constraints, then the transaction fails to commit when synchronizing itself with the group.

This system variable is a group-wide configuration setting. It must have the same value on all group members, cannot be changed while Group Replication is running, and requires a full reboot of the group (a bootstrap by a server with `group_replication_bootstrap_group=ON`) in order for the value change to take effect.

- `group_replication_exit_state_action`

Command-Line Format	<code>--group-replication-exit-state-action=value</code>
Introduced	5.7.24
System Variable	<code>group_replication_exit_state_action</code>
Scope	Global
Dynamic	Yes

Type	Enumeration
Default Value	<code>READ_ONLY</code>
Valid Values	<code>ABORT_SERVER</code> <code>READ_ONLY</code>

Configures how Group Replication behaves when a server instance leaves the group unintentionally, for example after encountering an applier error, or in the case of a loss of majority, or when another member of the group expels it due to a suspicion timing out. The timeout period for a member to leave the group in the case of a loss of majority is set by the `group_replication_unreachable_majority_timeout` system variable. Note that an expelled group member does not know that it was expelled until it reconnects to the group, so the specified action is only taken if the member manages to reconnect, or if the member raises a suspicion on itself and expels itself.

When `group_replication_exit_state_action` is set to `ABORT_SERVER`, if the member exits the group unintentionally, the instance shuts down MySQL.

When `group_replication_exit_state_action` is set to `READ_ONLY`, if the member exits the group unintentionally, the instance switches MySQL to super read only mode (by setting the system variable `super_read_only` to `ON`). This setting is the default in MySQL 5.7.



**Important**

If a failure occurs before the member has successfully joined the group, the specified exit action *is not taken*. This is the case if there is a failure during the local configuration check, or a mismatch between the configuration of the joining member and the configuration of the group. In these situations, the `super_read_only` system variable is left with its original value, and the server does not shut down MySQL. To ensure that the server cannot accept updates when Group Replication did not start, we therefore recommend that `super_read_only=ON` is set in the server's configuration file at startup, which Group Replication changes to `OFF` on primary members after it has been started successfully. This safeguard is particularly important when the server is configured to start Group Replication on server boot (`group_replication_start_on_boot=ON`), but it is also useful when Group Replication is started manually using a `START GROUP_REPLICATION` command.

If a failure occurs after the member has successfully joined the group, the specified exit action *is taken*. This is the case if there is an applier error, if the member is expelled from the group, or if the member is set to time out in the event of an unreachable majority. In these situations, if `READ_ONLY` is the exit action, the `super_read_only` system variable is set to `ON`, or if `ABORT_SERVER` is the exit action, the server shuts down MySQL.

**Table 17.5 Exit actions in Group Replication failure situations**

Failure situation	Group Replication started with <code>START GROUP_REPLICATION</code>	Group Replication started with <code>group_replication_start_on_boot=ON</code>
Member fails local configuration check OR	<code>super_read_only</code> unchanged MySQL continues running	<code>super_read_only</code> unchanged MySQL continues running

Failure situation	Group Replication started with <code>START GROUP_REPLICATION</code>	Group Replication started with <code>group_replication_start_on_boot=ON</code>
Mismatch between joining member and group configuration	Set <code>super_read_only=ON</code> at startup to prevent updates	Set <code>super_read_only=ON</code> at startup to prevent updates (Important)
Applier error on member	<code>super_read_only</code> set to ON	<code>super_read_only</code> set to ON
OR	OR	OR
Member expelled from group	MySQL shuts down	MySQL shuts down
OR		
Unreachable majority timeout		

- `group_replication_flow_control_applier_threshold`

Command-Line Format	<code>--group-replication-flow-control-applier-threshold=#</code>
Introduced	5.7.17
System Variable	<code>group_replication_flow_control_applier_threshold</code>
Scope	Global
Dynamic	Yes
Type	Integer
Default Value	25000
Minimum Value	0
Maximum Value	2147483647
Unit	transactions

Specifies the number of waiting transactions in the applier queue that trigger flow control. This variable can be changed without resetting Group Replication.

- `group_replication_flow_control_certifier_threshold`

Command-Line Format	<code>--group-replication-flow-control-certifier-threshold=#</code>
Introduced	5.7.17
System Variable	<code>group_replication_flow_control_certifier_threshold</code>
Scope	Global
Dynamic	Yes
Type	Integer
Default Value	25000
Minimum Value	0
Maximum Value	2147483647



Unit	transactions
------	--------------

Specifies the number of waiting transactions in the certifier queue that trigger flow control. This variable can be changed without resetting Group Replication.

- [group\\_replication\\_flow\\_control\\_hold\\_percent](#)

Command-Line Format	<code>--group-replication-flow-control-hold-percent=#</code>
System Variable	<a href="#">group_replication_flow_control_hold_percent</a>
Scope	Global
Dynamic	Yes
Type	Integer
Default Value	10
Minimum Value	0
Maximum Value	100
Unit	percentage

Defines what percentage of the group quota remains unused to allow a cluster under flow control to catch up on backlog. A value of 0 implies that no part of the quota is reserved for catching up on the work backlog.

- [group\\_replication\\_flow\\_control\\_max\\_quota](#)

Command-Line Format	<code>--group-replication-flow-control-max-quota=#</code>
System Variable	<a href="#">group_replication_flow_control_max_quota</a>
Scope	Global
Dynamic	Yes
Type	Integer
Default Value	0
Minimum Value	0
Maximum Value	2147483647

Defines the maximum flow control quota of the group, or the maximum available quota for any period while flow control is enabled. A value of 0 implies that there is no maximum quota set. Cannot be smaller than [group\\_replication\\_flow\\_control\\_min\\_quota](#) and [group\\_replication\\_flow\\_control\\_min\\_recovery\\_quota](#).

- [group\\_replication\\_flow\\_control\\_member\\_quota\\_percent](#)

Command-Line Format	<code>--group-replication-flow-control-member-quota-percent=#</code>
System Variable	<a href="#">group_replication_flow_control_member_quota_percent</a>
Scope	Global
Dynamic	Yes
Type	Integer

## Group Replication System Variables

Default Value	0
Minimum Value	0
Maximum Value	100
Unit	percentage

Defines the percentage of the quota that a member should assume is available for itself when calculating the quotas. A value of 0 implies that the quota should be split equally between members that were writers in the last period.

- [group\\_replication\\_flow\\_control\\_min\\_quota](#)

Command-Line Format	<code>--group-replication-flow-control-min-quota=#</code>
System Variable	<a href="#">group_replication_flow_control_min_quota</a>
Scope	Global
Dynamic	Yes
Type	Integer
Default Value	0
Minimum Value	0
Maximum Value	2147483647

Controls the lowest flow control quota that can be assigned to a member, independently of the calculated minimum quota executed in the last period. A value of 0 implies that there is no minimum quota. Cannot be larger than [group\\_replication\\_flow\\_control\\_max\\_quota](#).

- [group\\_replication\\_flow\\_control\\_min\\_recovery\\_quota](#)

Command-Line Format	<code>--group-replication-flow-control-min-recovery-quota=#</code>
System Variable	<a href="#">group_replication_flow_control_min_recovery_quota</a>
Scope	Global
Dynamic	Yes
Type	Integer
Default Value	0
Minimum Value	0
Maximum Value	2147483647

Controls the lowest quota that can be assigned to a member because of another recovering member in the group, independently of the calculated minimum quota executed in the last period. A value of 0 implies that there is no minimum quota. Cannot be larger than [group\\_replication\\_flow\\_control\\_max\\_quota](#).

- [group\\_replication\\_flow\\_control\\_mode](#)

Command-Line Format	<code>--group-replication-flow-control-mode=value</code>
Introduced	5.7.17

System Variable	<a href="#">group_replication_flow_control_mode</a>
Scope	Global
Dynamic	Yes
Type	Enumeration
Default Value	<a href="#">QUOTA</a>
Valid Values	<a href="#">DISABLED</a> <a href="#">QUOTA</a>

Specifies the mode used for flow control. This variable can be changed without resetting Group Replication.

- [group\\_replication\\_force\\_members](#)

Command-Line Format	<code>--group-replication-force-members=value</code>
Introduced	5.7.17
System Variable	<a href="#">group_replication_force_members</a>
Scope	Global
Dynamic	Yes
Type	String

A list of peer addresses as a comma separated list such as `host1:port1,host2:port2`. This option is used to force a new group membership, in which the excluded members do not receive a new view and are blocked. (You need to manually kill the excluded servers.) Any invalid host names in the list could cause this action to fail because they could block group membership. For a description of the procedure to follow, see [Section 17.5.3, “Network Partitioning”](#).

You must specify the address or host name and port as they are given in the [group\\_replication\\_local\\_address](#) option for each member. For example:

```
"198.51.100.44:33061,example.org:33061"
```

After you have used the [group\\_replication\\_force\\_members](#) system variable to successfully force a new group membership and unblock the group, ensure that you clear the system variable. [group\\_replication\\_force\\_members](#) must be empty in order to issue a `START GROUP_REPLICATION` statement.

- [group\\_replication\\_group\\_name](#)

Command-Line Format	<code>--group-replication-group-name=value</code>
Introduced	5.7.17
System Variable	<a href="#">group_replication_group_name</a>
Scope	Global
Dynamic	Yes

Type	String
------	--------

The name of the group which this server instance belongs to. Must be a valid UUID. This UUID is used internally when setting GTIDs for Group Replication events in the binary log.



### Important

A unique UUID must be used.

- [group\\_replication\\_group\\_seeds](#)

Command-Line Format	<code>--group-replication-group-seeds=value</code>
Introduced	5.7.17
System Variable	<a href="#">group_replication_group_seeds</a>
Scope	Global
Dynamic	Yes
Type	String

A list of group members to which a joining member can connect to obtain details of all the current group members. The joining member uses these details to select and connect to a group member to obtain the data needed for synchrony with the group. The list consists of the seed member's network addresses specified as a comma separated list, such as `host1:port1,host2:port2`.



### Important

These addresses must not be the member's SQL hostname and port.

Note that the value you specify for this variable is not validated until a `START GROUP_REPLICATION` statement is issued and the Group Communication System (GCS) is available.

Usually this list consists of all members of the group, but you can choose a subset of the group members to be seeds. The list must contain at least one valid member address. Each address is validated when starting Group Replication. If the list does not contain any valid host names, issuing `START GROUP_REPLICATION` fails.

- [group\\_replication\\_gtid\\_assignment\\_block\\_size](#)

Command-Line Format	<code>--group-replication-gtid-assignment-block-size=#</code>
Introduced	5.7.17
System Variable	<a href="#">group_replication_gtid_assignment_block_size</a>
Scope	Global
Dynamic	Yes
Type	Integer
Default Value	1000000
Minimum Value	1
Maximum Value (64-bit platforms)	9223372036854775807

Maximum Value (32-bit platforms)	4294967295
----------------------------------	------------

The number of consecutive GTIDs that are reserved for each member. Each member consumes its blocks and reserves more when needed.

This system variable is a group-wide configuration setting. It must have the same value on all group members, cannot be changed while Group Replication is running, and requires a full reboot of the group (a bootstrap by a server with `group_replication_bootstrap_group=ON`) in order for the value change to take effect.

- `group_replication_ip_whitelist`

Command-Line Format	<code>--group-replication-ip-whitelist=value</code>
Introduced	5.7.17
System Variable	<code>group_replication_ip_whitelist</code>
Scope	Global
Dynamic	Yes
Type	String
Default Value	<code>AUTOMATIC</code>

Specifies the allowlist of hosts that are permitted to connect to the group. The address that you specify for each group member in `group_replication_local_address` must be allowlisted on the other servers in the replication group. Note that the value you specify for this variable is not validated until a `START GROUP_REPLICATION` statement is issued and the Group Communication System (GCS) is available.

By default, this system variable is set to `AUTOMATIC`, which permits connections from private subnetworks active on the host. The group communication engine (XCom) automatically scans active interfaces on the host, and identifies those with addresses on private subnetworks. These addresses and the `localhost` IP address for IPv4 are used to create the Group Replication allowlist. For a list of the ranges from which addresses are automatically allowlisted, see [Section 17.6.1, “Group Replication IP Address Allowlisting”](#).

The automatic allowlist of private addresses cannot be used for connections from servers outside the private network. For Group Replication connections between server instances that are on different machines, you must provide public IP addresses and specify these as an explicit allowlist. If you specify any entries for the allowlist, the private addresses are not added automatically, so if you use any of these, you must specify them explicitly. The `localhost` IP address is added automatically.

As the value of the `group_replication_ip_whitelist` option, you can specify any combination of the following:

- IPv4 addresses (for example, `198.51.100.44`)
- IPv4 addresses with CIDR notation (for example, `192.0.2.21/24`)
- Host names, from MySQL 5.7.21 (for example, `example.org`)
- Host names with CIDR notation, from MySQL 5.7.21 (for example, `www.example.com/24`)

IPv6 addresses, and host names that resolve to IPv6 addresses, are not supported in MySQL 5.7. You can use CIDR notation in combination with host names or IP addresses to allowlist a block of IP

addresses with a particular network prefix, but do ensure that all the IP addresses in the specified subnet are under your control.

A comma must separate each entry in the allowlist. For example:

```
192.0.2.22,198.51.100.0/24,example.org,www.example.com/24
```

It is possible to configure different allowlists on different group members according to your security requirements, for example, in order to keep different subnets separate. However, this can cause issues when a group is reconfigured. If you do not have a specific security requirement to do otherwise, use the same allowlist on all members of a group. For more details, see [Section 17.6.1, “Group Replication IP Address Allowlisting”](#).

For host names, name resolution takes place only when a connection request is made by another server. A host name that cannot be resolved is not considered for allowlist validation, and a warning message is written to the error log. Forward-confirmed reverse DNS (FCrDNS) verification is carried out for resolved host names.



### Warning

Host names are inherently less secure than IP addresses in an allowlist. FCrDNS verification provides a good level of protection, but can be compromised by certain types of attack. Specify host names in your allowlist only when strictly necessary, and ensure that all components used for name resolution, such as DNS servers, are maintained under your control. You can also implement name resolution locally using the hosts file, to avoid the use of external components.

- [group\\_replication\\_local\\_address](#)

Command-Line Format	<code>--group-replication-local-address=value</code>
Introduced	5.7.17
System Variable	<a href="#">group_replication_local_address</a>
Scope	Global
Dynamic	Yes
Type	String

The network address which the member provides for connections from other members, specified as a `host:port` formatted string. This address must be reachable by all members of the group because it is used by the group communication engine for Group Replication (XCom, a Paxos variant) for TCP communication between remote XCom instances. Communication with the local instance is over an input channel using shared memory.



### Warning

Do not use this address for communication with the member.

Other Group Replication members contact this member through this `host:port` for all internal group communication. This is not the MySQL server SQL protocol host and port.

The address or host name that you specify in [group\\_replication\\_local\\_address](#) is used by Group Replication as the unique identifier for a group member within the replication group. You can use the same port for all members of a replication group as long as the host names or IP addresses are all

different, and you can use the same host name or IP address for all members as long as the ports are all different. The recommended port for `group_replication_local_address` is 33061. Note that the value you specify for this variable is not validated until the `START GROUP_REPLICATION` statement is issued and the Group Communication System (GCS) is available.

- `group_replication_member_weight`

Command-Line Format	<code>--group-replication-member-weight=#</code>
Introduced	5.7.20
System Variable	<code>group_replication_member_weight</code>
Scope	Global
Dynamic	Yes
Type	Integer
Default Value	50
Minimum Value	0
Maximum Value	100
Unit	percentage

A percentage weight that can be assigned to members to influence the chance of the member being elected as primary in the event of failover, for example when the existing primary leaves a single-primary group. Assign numeric weights to members to ensure that specific members are elected, for example during scheduled maintenance of the primary or to ensure certain hardware is prioritized in the event of failover.

For a group with members configured as follows:

- `member-1`: `group_replication_member_weight=30, server_uuid=aaaa`
- `member-2`: `group_replication_member_weight=40, server_uuid=bbbb`
- `member-3`: `group_replication_member_weight=40, server_uuid=cccc`
- `member-4`: `group_replication_member_weight=40, server_uuid=dddd`

during election of a new primary the members above would be sorted as `member-2`, `member-3`, `member-4`, and `member-1`. This results in `member-2` being chosen as the new primary in the event of failover. For more information, see [Section 17.5.1.1, “Single-Primary Mode”](#).

- `group_replication_poll_spin_loops`

Command-Line Format	<code>--group-replication-poll-spin-loops=#</code>
Introduced	5.7.17
System Variable	<code>group_replication_poll_spin_loops</code>
Scope	Global
Dynamic	Yes
Type	Integer
Default Value	0
Minimum Value	0
Maximum Value (64-bit platforms)	18446744073709551615

Maximum Value (32-bit platforms)	4294967295
----------------------------------	------------

The number of times the group communication thread waits for the communication engine mutex to be released before the thread waits for more incoming network messages.

- `group_replication_recovery_complete_at`

Command-Line Format	<code>--group-replication-recovery-complete-at=value</code>
Introduced	5.7.17
System Variable	<code>group_replication_recovery_complete_at</code>
Scope	Global
Dynamic	Yes
Type	Enumeration
Default Value	<code>TRANSACTIONS_APPLIED</code>
Valid Values	<code>TRANSACTIONS_CERTIFIED</code> <code>TRANSACTIONS_APPLIED</code>

Recovery policies when handling cached transactions after state transfer. This option specifies whether a member is marked online after it has received all transactions that it missed before it joined the group (`TRANSACTIONS_CERTIFIED`) or after it has received and applied them (`TRANSACTIONS_APPLIED`).

- `group_replication_recovery_retry_count`

Command-Line Format	<code>--group-replication-recovery-retry-count=#</code>
Introduced	5.7.17
System Variable	<code>group_replication_recovery_retry_count</code>
Scope	Global
Dynamic	Yes
Type	Integer
Default Value	10
Minimum Value	0
Maximum Value	31536000

The number of times that the member that is joining tries to connect to the available donors before giving up.

- `group_replication_recovery_reconnect_interval`

Command-Line Format	<code>--group-replication-recovery-reconnect-interval=#</code>
Introduced	5.7.17
System Variable	<code>group_replication_recovery_reconnect_interval</code>
Scope	Global
Dynamic	Yes



Type	Integer
Default Value	60
Minimum Value	0
Maximum Value	31536000
Unit	seconds

The sleep time, in seconds, between reconnection attempts when no donor was found in the group.

- [group\\_replication\\_recovery\\_ssl\\_ca](#)

Command-Line Format	<code>--group-replication-recovery-ssl-ca=value</code>
Introduced	5.7.17
System Variable	<a href="#">group_replication_recovery_ssl_ca</a>
Scope	Global
Dynamic	Yes
Type	String

The path to a file that contains a list of trusted SSL certificate authorities.

- [group\\_replication\\_recovery\\_ssl\\_capath](#)

Command-Line Format	<code>--group-replication-recovery-ssl-capath=value</code>
Introduced	5.7.17
System Variable	<a href="#">group_replication_recovery_ssl_capath</a>
Scope	Global
Dynamic	Yes
Type	String

The path to a directory that contains trusted SSL certificate authority certificates.

- [group\\_replication\\_recovery\\_ssl\\_cert](#)

Command-Line Format	<code>--group-replication-recovery-ssl-cert=value</code>
Introduced	5.7.17
System Variable	<a href="#">group_replication_recovery_ssl_cert</a>
Scope	Global
Dynamic	Yes
Type	String

The name of the SSL certificate file to use for establishing a secure connection.

- `group_replication_recovery_ssl_key`

Command-Line Format	<code>--group-replication-recovery-ssl-key=value</code>
Introduced	5.7.17
System Variable	<code>group_replication_recovery_ssl_key</code>
Scope	Global
Dynamic	Yes
Type	String

The name of the SSL key file to use for establishing a secure connection.

- `group_replication_recovery_ssl_cipher`

Command-Line Format	<code>--group-replication-recovery-ssl-cipher=value</code>
Introduced	5.7.17
System Variable	<code>group_replication_recovery_ssl_cipher</code>
Scope	Global
Dynamic	Yes
Type	String

The list of permissible ciphers for SSL encryption.

- `group_replication_recovery_ssl_crl`

Command-Line Format	<code>--group-replication-recovery-ssl-crl=value</code>
Introduced	5.7.17
System Variable	<code>group_replication_recovery_ssl_crl</code>
Scope	Global
Dynamic	Yes
Type	File name

The path to a directory that contains files containing certificate revocation lists.

- `group_replication_recovery_ssl_crlpath`

Command-Line Format	<code>--group-replication-recovery-ssl-crlpath=value</code>
Introduced	5.7.17
System Variable	<code>group_replication_recovery_ssl_crlpath</code>
Scope	Global
Dynamic	Yes
Type	Directory name

The path to a directory that contains files containing certificate revocation lists.

- [group\\_replication\\_recovery\\_ssl\\_verify\\_server\\_cert](#)

Command-Line Format	<code>--group-replication-recovery-ssl-verify-server-cert[={OFF ON}]</code>
Introduced	5.7.17
System Variable	<a href="#">group_replication_recovery_ssl_verify_server_cert</a>
Scope	Global
Dynamic	Yes
Type	Boolean
Default Value	OFF

Make the recovery process check the server's Common Name value in the donor sent certificate.

- [group\\_replication\\_recovery\\_use\\_ssl](#)

Command-Line Format	<code>--group-replication-recovery-use-ssl[={OFF ON}]</code>
Introduced	5.7.17
System Variable	<a href="#">group_replication_recovery_use_ssl</a>
Scope	Global
Dynamic	Yes
Type	Boolean
Default Value	OFF

Whether Group Replication recovery connection should use SSL or not.

- [group\\_replication\\_single\\_primary\\_mode](#)

Command-Line Format	<code>--group-replication-single-primary-mode[={OFF ON}]</code>
Introduced	5.7.17
System Variable	<a href="#">group_replication_single_primary_mode</a>
Scope	Global
Dynamic	Yes
Type	Boolean
Default Value	ON



**Note**

This system variable is a group-wide configuration setting, and a full reboot of the replication group is required for a change to take effect.

[group\\_replication\\_single\\_primary\\_mode](#) instructs the group to pick a single server automatically to be the one that handles read/write workload. This server is the primary and all others are secondaries.

This system variable is a group-wide configuration setting. It must have the same value on all group members, cannot be changed while Group Replication is running, and requires a full reboot of the

group (a bootstrap by a server with `group_replication_bootstrap_group=ON`) in order for the value change to take effect. For instructions to safely bootstrap a group where transactions have been executed and certified, see [Section 17.5.4, “Restarting a Group”](#).

If the group has a value set for this system variable, and a joining member has a different value set for the system variable, the joining member cannot join the group until the value is changed to match. If the group members have a value set for this system variable, and the joining member does not support the system variable, it cannot join the group.

Setting this variable `ON` causes any setting for `group_replication_auto_increment_increment` to be ignored.

- `group_replication_ssl_mode`

Command-Line Format	<code>--group-replication-ssl-mode=value</code>
Introduced	5.7.17
System Variable	<code>group_replication_ssl_mode</code>
Scope	Global
Dynamic	Yes
Type	Enumeration
Default Value	<code>DISABLED</code>
Valid Values	<code>DISABLED</code> <code>REQUIRED</code> <code>VERIFY_CA</code> <code>VERIFY_IDENTITY</code>

Specifies the security state of the connection between Group Replication members.

- `group_replication_start_on_boot`

Command-Line Format	<code>--group-replication-start-on-boot[={OFF ON}]</code>
Introduced	5.7.17
System Variable	<code>group_replication_start_on_boot</code>
Scope	Global
Dynamic	Yes
Type	Boolean
Default Value	<code>ON</code>

Whether the server should start Group Replication or not during server start.

- `group_replication_transaction_size_limit`

Command-Line Format	<code>--group-replication-transaction-size-limit=#</code>
Introduced	5.7.19

System Variable	<a href="#">group_replication_transaction_size_limit</a>
Scope	Global
Dynamic	Yes
Type	Integer
Default Value ( $\geq$ 5.7.38)	150000000
Default Value ( $\geq$ 5.7.19, $\leq$ 5.7.37)	0
Minimum Value	0
Maximum Value	2147483647
Unit	bytes

Configures the maximum transaction size in bytes which the replication group accepts. Transactions larger than this size are rolled back by the receiving member and are not broadcast to the group. Large transactions can cause problems for a replication group in terms of memory allocation, which can cause the system to slow down, or in terms of network bandwidth consumption, which can cause a member to be suspected of having failed because it is busy processing the large transaction.

When this system variable is set to 0, there is no limit to the size of transactions the group accepts. In releases up to and including MySQL 5.7.37, the default setting for this system variable is 0. From MySQL 5.7.38, and in MySQL 8.0, the default setting is 150000000 bytes (approximately 143 MB). Adjust the value of this system variable depending on the maximum message size that you need the group to tolerate, bearing in mind that the time taken to process a transaction is proportional to its size. The value of [group\\_replication\\_transaction\\_size\\_limit](#) should be the same on all group members. For further mitigation strategies for large transactions, see [Section 17.3.2, “Group Replication Limitations”](#).

- [group\\_replication\\_unreachable\\_majority\\_timeout](#)

Command-Line Format	<code>--group-replication-unreachable-majority-timeout=#</code>
Introduced	5.7.19
System Variable	<a href="#">group_replication_unreachable_majority_timeout</a>
Scope	Global
Dynamic	Yes
Type	Integer
Default Value	0
Minimum Value	0
Maximum Value	31536000
Unit	seconds

Configures how long members that suffer a network partition and cannot connect to the majority wait before leaving the group.

In a group of 5 servers (S1,S2,S3,S4,S5), if there is a disconnection between (S1,S2) and (S3,S4,S5) there is a network partition. The first group (S1,S2) is now in a minority because it cannot contact more than half of the group. While the majority group (S3,S4,S5) remains running, the minority group waits for the specified time for a network reconnection. Any transactions processed by the minority group are blocked until Group Replication is stopped using `STOP GROUP REPLICATION` on the members of the

minority. Note that `group_replication_unreachable_majority_timeout` has no effect if it is set on the servers in the minority group after the loss of majority has been detected.

By default, this system variable is set to 0, which means that members that find themselves in a minority due to a network partition wait forever to leave the group. If configured to a number of seconds, members wait for this amount of time after losing contact with the majority of members before leaving the group. When the specified time elapses, all pending transactions processed by the minority are rolled back, and the servers in the minority partition move to the `ERROR` state. These servers then follow the action specified by the system variable `group_replication_exit_state_action`, which can be set to set themselves to super read only mode or shut down MySQL.

**Warning**

When you have a symmetric group, with just two members for example (S0,S2), if there is a network partition and there is no majority, after the configured timeout all members enter `ERROR` state.

## 17.7.2 Group Replication Status Variables

MySQL 5.7 supports one status variable providing information about Group Replication. This variable is described here:

- `group_replication_primary_member`

Shows the primary member's UUID when the group is operating in single-primary mode. If the group is operating in multi-primary mode, shows an empty string. See [Section 17.5.1.3, “Finding the Primary”](#).

## 17.8 Frequently Asked Questions

This section provides answers to frequently asked questions.

### What is the maximum number of MySQL servers in a group?

A group can consist of maximum 9 servers. Attempting to add another server to a group with 9 members causes the request to join to be refused. This limit has been identified from testing and benchmarking as a safe boundary where the group performs reliably on a stable local area network.

### How are servers in a group connected?

Servers in a group connect to the other servers in the group by opening a peer-to-peer TCP connection. These connections are only used for internal communication and message passing between servers in the group. This address is configured by the `group_replication_local_address` variable.

### What is the `group_replication_bootstrap_group` option used for?

The bootstrap flag instructs a member to *create* a group and act as the initial seed server. The second member joining the group needs to ask the member that bootstrapped the group to dynamically change the configuration in order for it to be added to the group.

A member needs to bootstrap the group in two scenarios. When the group is originally created, or when shutting down and restarting the entire group.

### How do I set credentials for the recovery procedure?

You pre-configure the Group Replication recovery channel credentials using the `CHANGE MASTER TO` statement.

## Can I scale-out my write-load using Group Replication?

Not directly, but MySQL Group replication is a shared nothing full replication solution, where all servers in the group replicate the same amount of data. Therefore if one member in the group writes N bytes to storage as the result of a transaction commit operation, then roughly N bytes are written to storage on other members as well, because the transaction is replicated everywhere.

However, given that other members do not have to do the same amount of processing that the original member had to do when it originally executed the transaction, they apply the changes faster. Transactions are replicated in a format that is used to apply row transformations only, without having to re-execute transactions again (row-based format).

Furthermore, given that changes are propagated and applied in row-based format, this means that they are received in an optimized and compact format, and likely reducing the number of IO operations required when compared to the originating member.

To summarize, you can scale-out processing, by spreading conflict free transactions throughout different members in the group. And you can likely scale-out a small fraction of your IO operations, since remote servers receive only the necessary changes to read-modify-write changes to stable storage.

## Does Group Replication require more network bandwidth and CPU, when compared to simple replication and under the same workload?

Some additional load is expected because servers need to be constantly interacting with each other for synchronization purposes. It is difficult to quantify how much more data. It also depends on the size of the group (three servers puts less stress on the bandwidth requirements than nine servers in the group).

Also the memory and CPU footprint are larger, because more complex work is done for the server synchronization part and for the group messaging.

## Can I deploy Group Replication across wide-area networks?

Yes, but the network connection between each member *must* be reliable and have suitable performance. Low latency, high bandwidth network connections are a requirement for optimal performance.

If network bandwidth alone is an issue, then [Section 17.9.7.2, "Message Compression"](#) can be used to lower the bandwidth required. However, if the network drops packets, leading to re-transmissions and higher end-to-end latency, throughput and latency are both negatively affected.



### Warning

When the network round-trip time (RTT) between any group members is 5 seconds or more you could encounter problems as the built-in failure detection mechanism could be incorrectly triggered.

## Do members automatically rejoin a group in case of temporary connectivity problems?

This depends on the reason for the connectivity problem. If the connectivity problem is transient and the reconnection is quick enough that the failure detector is not aware of it, then the server may not be removed from the group. If it is a "long" connectivity problem, then the failure detector eventually suspects a problem and the server is removed from the group.

Once a server is removed from the group, you need to join it back again. In other words, after a server is removed explicitly from the group you need to rejoin it manually (or have a script doing it automatically).

## When is a member excluded from a group?

If the member becomes silent, the other members remove it from the group configuration. In practice this may happen when the member has crashed or there is a network disconnection.

The failure is detected after a given timeout elapses for a given member and a new configuration without the silent member in it is created.

## What happens when one node is significantly lagging behind?

There is no method for defining policies for when to expel members automatically from the group. You need to find out why a member is lagging behind and fix that or remove the member from the group. Otherwise, if the server is so slow that it triggers the flow control, then the entire group slows down as well. The flow control can be configured according to the your needs.

## Upon suspicion of a problem in the group, is there a special member responsible for triggering a reconfiguration?

No, there is no special member in the group in charge of triggering a reconfiguration.

Any member can suspect that there is a problem. All members need to (automatically) agree that a given member has failed. One member is in charge of expelling it from the group, by triggering a reconfiguration. Which member is responsible for expelling the member is not something you can control or set.

## Can I use Group Replication for sharding?

Group Replication is designed to provide highly available replica sets; data and writes are duplicated on each member in the group. For scaling beyond what a single system can provide, you need an orchestration and sharding framework built around a number of Group Replication sets, where each replica set maintains and manages a given shard or partition of your total dataset. This type of setup, often called a “sharded cluster”, allows you to scale reads and writes linearly and without limit.

## How do I use Group Replication with SELinux?

If SELinux is enabled, which you can verify using `sestatus -v`, then you need to enable the use of the Group Replication communication port. See [Setting the TCP Port Context for Group Replication](#).

## How do I use Group Replication with iptables?

If `iptables` is enabled, then you need to open up the Group Replication port for communication between the machines. To see the current rules in place on each machine, issue `iptables -L`. Assuming the port configured is 33061, enable communication over the necessary port by issuing `iptables -A INPUT -p tcp --dport 33061 -j ACCEPT`.

## How do I recover the relay log for a replication channel used by a group member?

The replication channels used by Group Replication behave in the same way as replication channels used in source to replica replication, and as such rely on the relay log. In the event of a change of the `relay_log` variable, or when the option is not set and the host name changes, there is a chance of errors. See [Section 16.2.4.1, “The Relay Log”](#) for a recovery procedure in this situation. Alternatively, another way of fixing the issue specifically in Group Replication is to issue a `STOP GROUP_REPLICATION` statement and then a `START GROUP_REPLICATION` statement to restart the instance. The Group Replication plugin creates the `group_replication_applier` channel again.



## Why does Group Replication use two bind addresses?

Group Replication uses two bind addresses in order to split network traffic between the SQL address, used by clients to communicate with the member, and the `group_replication_local_address`, used internally by the group members to communicate. For example, assume a server with two network interfaces assigned to the network addresses `203.0.113.1` and `198.51.100.179`. In such a situation you could use `203.0.113.1:33061` for the internal group network address by setting `group_replication_local_address=203.0.113.1:33061`. Then you could use `198.51.100.179` for `hostname` and `3306` for the `port`. Client SQL applications would then connect to the member at `198.51.100.179:3306`. This enables you to configure different rules on the different networks. Similarly, the internal group communication can be separated from the network connection used for client applications, for increased security.

## How does Group Replication use network addresses and hostnames?

Group Replication uses network connections between members and therefore its functionality is directly impacted by how you configure hostnames and ports. For example, the Group Replication recovery procedure is based on asynchronous replication which uses the server's hostname and port. When a member joins a group it receives the group membership information, using the network address information that is listed at `performance_schema.replication_group_members`. One of the members listed in that table is selected as the donor of the missing data from the group to the new member.

This means that any value you configure using a hostname, such as the SQL network address or the group seeds address, must be a fully qualified name and resolvable by each member of the group. You can ensure this for example through DNS, or correctly configured `/etc/hosts` files, or other local processes. If a you want to configure the `MEMBER_HOST` value on a server, specify it using the `--report-host` option on the server before joining it to the group.



### Important

The assigned value is used directly and is not affected by the `skip_name_resolve` system variable.

To configure `MEMBER_PORT` on a server, specify it using the `report_port` system variable.

## Why did the auto increment setting on the server change?

When Group Replication is started on a server, the value of `auto_increment_increment` is changed to the value of `group_replication_auto_increment_increment`, which defaults to 7, and the value of `auto_increment_offset` is changed to the server ID. The changes are reverted when Group Replication is stopped. These settings avoid the selection of duplicate auto-increment values for writes on group members, which causes rollback of transactions. The default auto increment value of 7 for Group Replication represents a balance between the number of usable values and the permitted maximum size of a replication group (9 members).

The changes are only made and reverted if `auto_increment_increment` and `auto_increment_offset` each have their default value of 1. If their values have already been modified from the default, Group Replication does not alter them.

## How do I find the primary?

If the group is operating in single-primary mode, it can be useful to find out which member is the primary. See [Section 17.5.1.3, “Finding the Primary”](#)

## 17.9 Group Replication Technical Details

This section provides more technical details about MySQL Group Replication.

### 17.9.1 Group Replication Plugin Architecture

MySQL Group Replication is a MySQL plugin and it builds on the existing MySQL replication infrastructure, taking advantage of features such as the binary log, row-based logging, and global transaction identifiers. It integrates with current MySQL frameworks, such as the performance schema or plugin and service infrastructures. The following figure presents a block diagram depicting the overall architecture of MySQL Group Replication.

Figure 17.9 Group Replication Plugin Block Diagram

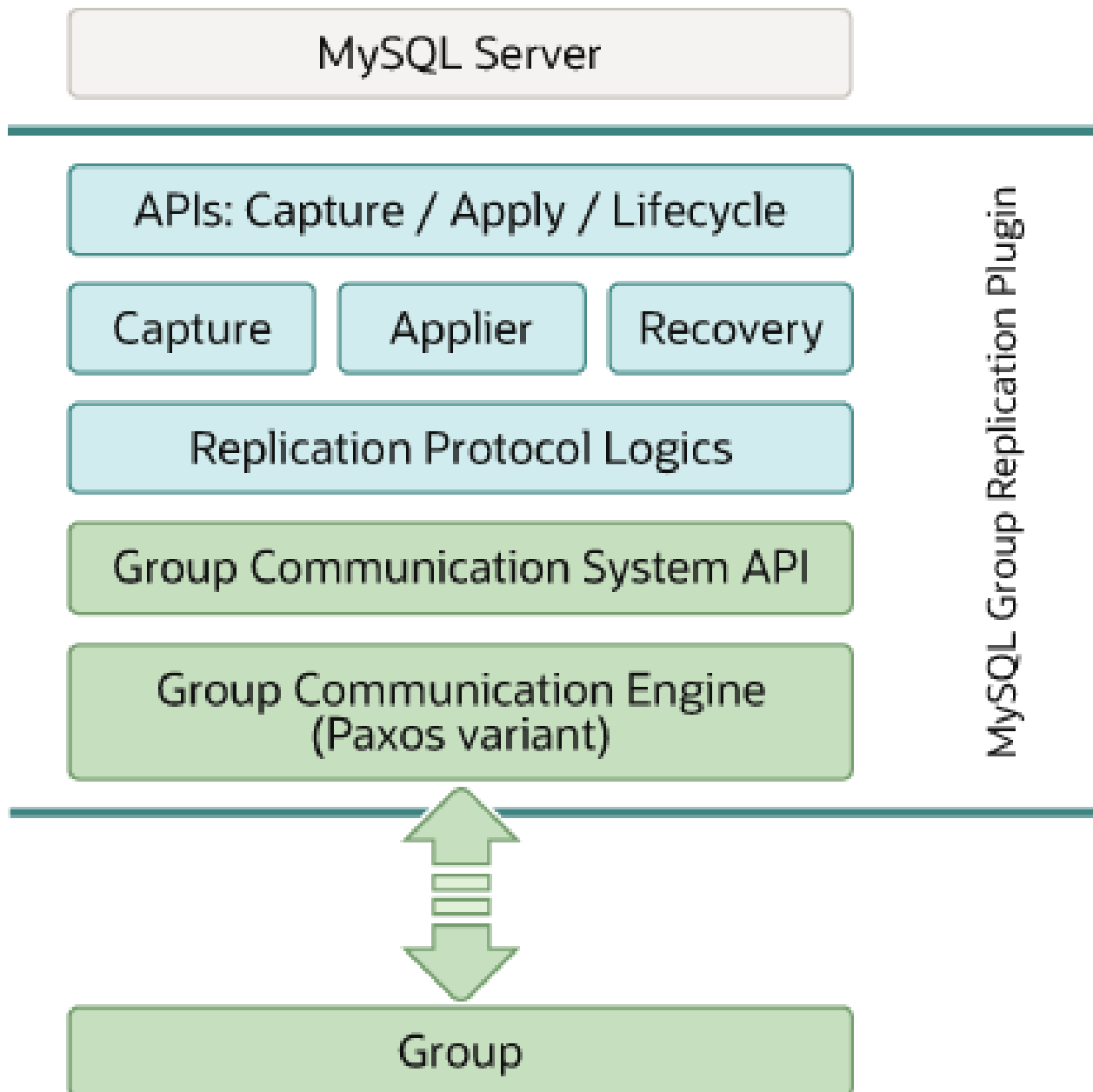

The MySQL Group Replication plugin includes a set of APIs for capture, apply, and lifecycle, which control how the plugin interacts with MySQL Server. There are interfaces to make information flow from the server to the plugin and vice versa. These interfaces isolate the MySQL Server core from the Group Replication plugin, and are mostly hooks placed in the transaction execution pipeline. In one direction, from server to the plugin, there are notifications for events such as the server starting, the server recovering, the server being ready to accept connections, and the server being about to commit a transaction. In the other direction, the plugin instructs the server to perform actions such as committing or aborting ongoing transactions, or queuing transactions in the relay log.

The next layer of the Group Replication plugin architecture is a set of components that react when a notification is routed to them. The capture component is responsible for keeping track of context related to transactions that are executing. The applier component is responsible for executing remote transactions on the database. The recovery component manages distributed recovery, and is responsible for getting a server that is joining the group up to date by selecting the donor, orchestrating the catch up procedure and reacting to donor failures.

Continuing down the stack, the replication protocol module contains the specific logic of the replication protocol. It handles conflict detection, and receives and propagates transactions to the group.

The final two layers of the Group Replication plugin architecture are the Group Communication System (GCS) API, and an implementation of a Paxos-based group communication engine (XCom). The GCS API is a high level API that abstracts the properties required to build a replicated state machine (see [Section 17.1, “Group Replication Background”](#)). It therefore decouples the implementation of the messaging layer from the remaining upper layers of the plugin. The group communication engine handles communications with the members of the replication group.

## 17.9.2 The Group

In MySQL Group Replication, a set of servers forms a replication group. A group has a name, which takes the form of a UUID. The group is dynamic and servers can leave (either voluntarily or involuntarily) and join it at any time. The group adjusts itself whenever servers join or leave.

If a server joins the group, it automatically brings itself up to date by fetching the missing state from an existing server. This state is transferred by means of Asynchronous MySQL replication. If a server leaves the group, for instance it was taken down for maintenance, the remaining servers notice that it has left and reconfigure the group automatically. The group membership service described at [Section 17.1.3.1, “Group Membership”](#) powers all of this.

## 17.9.3 Data Manipulation Statements

As there are no primary servers (sources) for any particular data set, every server in the group is allowed to execute transactions at any time, even transactions that change state (RW transactions).

Any server may execute a transaction without any *a priori* coordination. But, at commit time, it coordinates with the rest of the servers in the group to reach a decision on the fate of that transaction. This coordination serves two purposes: (i) check whether the transaction should commit or not; (ii) and propagate the changes so that other servers can apply the transaction as well.

As a transaction is sent through an atomic broadcast, either all servers in the group receive the transaction or none do. If they receive it, then they all receive it in the same order with respect to other transactions that were sent before. Conflict detection is carried out by inspecting and comparing write sets of transactions. Thus, they are detected at the row level. Conflict resolution follows the first committer wins rule. If t1 and t2 execute concurrently at different sites, because t2 is ordered before t1, and both changed the same row, then t2 wins the conflict and t1 aborts. In other words, t1 was trying to change data that had been rendered stale by t2.

**Note**

If two transactions are bound to conflict more often than not, then it is a good practice to start them on the same server. They then have a chance to synchronize on the local lock manager instead of aborting later in the replication protocol.

## 17.9.4 Data Definition Statements

In a Group Replication topology, care needs to be taken when executing data definition statements also commonly known as data definition language (DDL). Given that MySQL does not support atomic or transactional DDL, one cannot optimistically execute DDL statements and later roll back if needs be. Consequently, the lack of atomicity does not fit directly into the optimistic replication paradigm that Group Replication is based on.

Therefore, more care needs to be taken when replicating data definition statements. Schema changes and changes to the data that the object contains need to be handled through the same server while the schema operation has not yet completed and replicated everywhere. Failure to do so can result in data inconsistency.

**Note**

If the group is deployed in single-primary mode, then this is not a problem, because all changes are performed through the same server, the primary.

**Warning**

MySQL DDL execution is not atomic or transactional. The server executes and commits without securing group agreement first. As such, you must route DDL and DML for the same object through the same server, while the DDL is executing and has not replicated everywhere yet.

## 17.9.5 Distributed Recovery

This section describes the process through which a member joining a group catches up with the remaining servers in the group, called distributed recovery. Distributed recovery can be summarized as the process through which a server gets missing transactions from the group so that it can then join the group having processed the same set of transactions as the other group members.

### 17.9.5.1 Distributed Recovery Basics

Whenever a member joins a replication group, it connects to an existing member to carry out state transfer. The server joining the group transfers all the transactions that took place in the group before it joined, which are provided by the existing member (called the *donor*). Next, the server joining the group applies the transactions that took place in the group while this state transfer was in progress. When the server joining the group has caught up with the remaining servers in the group, it begins to participate normally in the group. This process is called distributed recovery.

#### Phase 1

In the first phase, the server joining the group selects one of the online servers on the group to be the *donor* of the state that it is missing. The donor is responsible for providing the server joining the group all the data it is missing up to the moment it has joined the group. This is achieved by relying on a standard asynchronous replication channel, established between the donor and the server joining the group, see [Section 16.2.2, “Replication Channels”](#). Through this replication channel, the donor's binary logs are replicated until the point that the view change happened when the server joining the group became part of the group. The server joining the group applies the donor's binary logs as it receives them.

While the binary log is being replicated, the server joining the group also caches every transaction that is exchanged within the group. In other words it is listening for transactions that are happening after it joined the group and while it is applying the missing state from the donor. When the first phase ends and the replication channel to the donor is closed, the server joining the group then starts phase two: the catch up.

## Phase 2

In this phase, the server joining the group proceeds to the execution of the cached transactions. When the number of transactions queued for execution finally reaches zero, the member is declared online.

## Resilience

The recovery procedure withstands donor failures while the server joining the group is fetching binary logs from it. In such cases, whenever a donor fails during phase 1, the server joining the group fails over to a new donor and resumes from that one. When that happens the server joining the group closes the connection to the failed server joining the group explicitly and opens a connection to a new donor. This happens automatically.

### 17.9.5.2 Recovering From a Point-in-time

To synchronize the server joining the group with the donor up to a specific point in time, the server joining the group and donor make use of the MySQL Global Transaction Identifiers (GTIDs) mechanism. See [Section 16.1.3, “Replication with Global Transaction Identifiers”](#). However, GTIDS only provide a means to realize which transactions the server joining the group is missing, they do not help marking a specific point in time to which the server joining the group must catch up, nor do they help conveying certification information. This is the job of binary log view markers, which mark view changes in the binary log stream, and also contain additional metadata information, provisioning the server joining the group with missing certification related data.

## View and View Changes

To explain the concept of view change markers, it is important to understand what a view and a view change are.

A *view* corresponds to a group of members participating actively in the current configuration, in other words at a specific point in time. They are correct and online in the system.

A *view change* occurs when a modification to the group configuration happens, such as a member joining or leaving. Any group membership change results in an independent view change communicated to all members at the same logical point in time.

A *view identifier* uniquely identifies a view. It is generated whenever a view change happens

At the group communication layer, view changes with their associated view ids are then boundaries between the data exchanged before and after a member joins. This concept is implemented through a new binary log event: the "view change log event". The view id thus becomes a marker as well for transactions transmitted before and after changes happen in the group membership.

The view identifier itself is built from two parts: (i) one that is randomly generated and (ii) a monotonically increasing integer. The first part is generated when the group is created, and remains unchanged while there is at least one member in the group. The second part is incremented every time a view change happens.

The reason for this heterogeneous pair that makes up the view id is the need to unambiguously mark group changes whenever a member joins or leaves but also whenever all members leave the group and no information remains of what view the group was in. In fact, the sole use of monotonic increasing identifiers

could lead to the reuse of the same id after full group shutdowns, destroying the uniqueness of the binary log data markers that recovery depends on. To summarize, the first part identifies whenever the group was started from the beginning and the incremental part when the group changed from that point on.

### 17.9.5.3 View Changes

This section explains the process which controls how the view change identifier is incorporated into a binary log event and written to the log. The following steps are taken:

#### Begin: Stable Group

All servers are online and processing incoming transactions from the group. Some servers may be a little behind in terms of transactions replicated, but eventually they converge. The group acts as one distributed and replicated database.

Figure 17.10 Stable Group

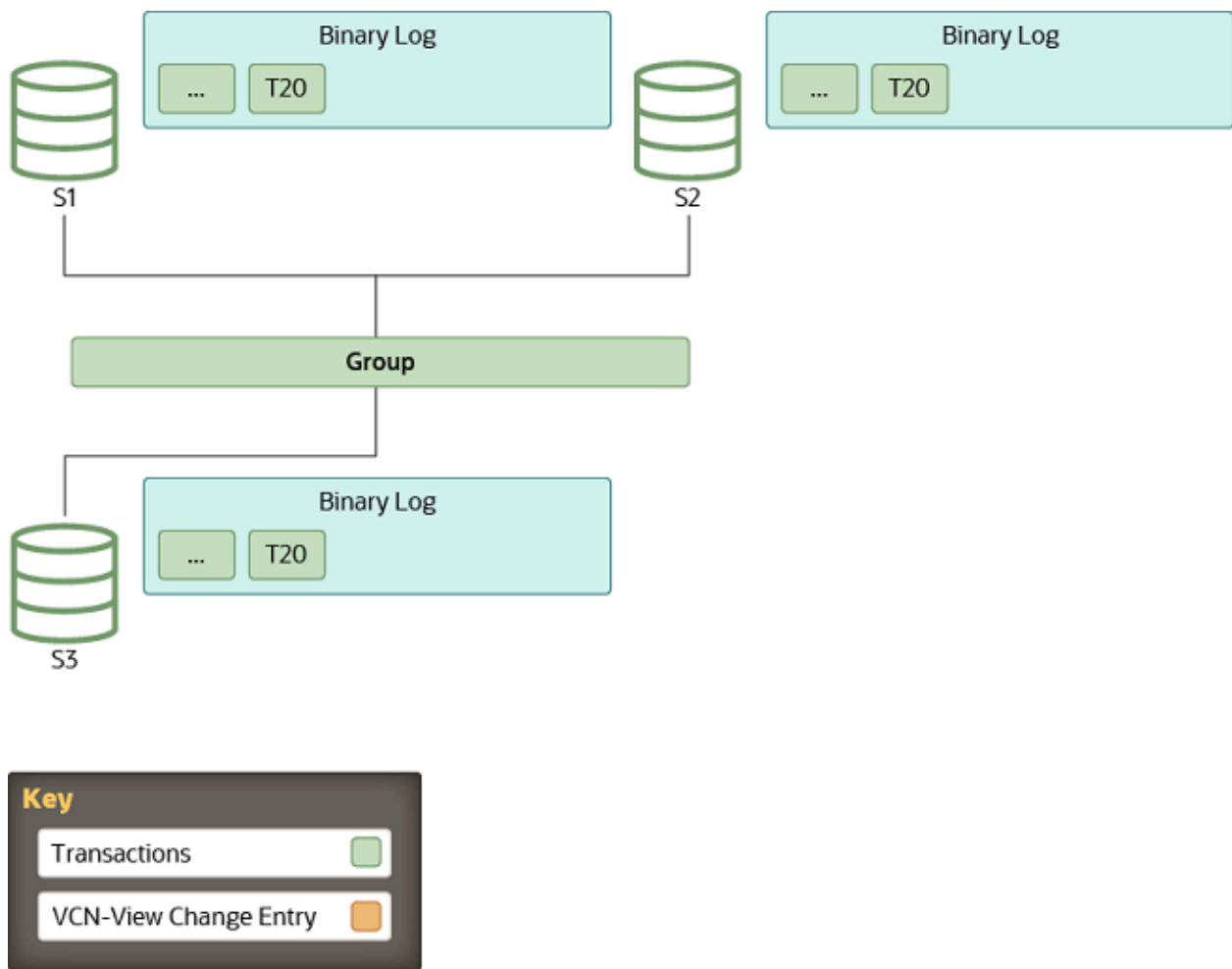

#### View Change: a Member Joins

Whenever a new member joins the group and therefore a view change is performed, every online server queues a view change log event for execution. This is queued because before the view change, several transactions can be queued on the server to be applied and as such, these belong to the old view. Queuing the view change event after them guarantees a correct marking of when this happened.

Meanwhile, the server joining the group selects the donor from the list of online servers as stated by the membership service through the view abstraction. A member joins on view 4 and the online members write a View change event to the binary log.

**Figure 17.11 A Member Joins**

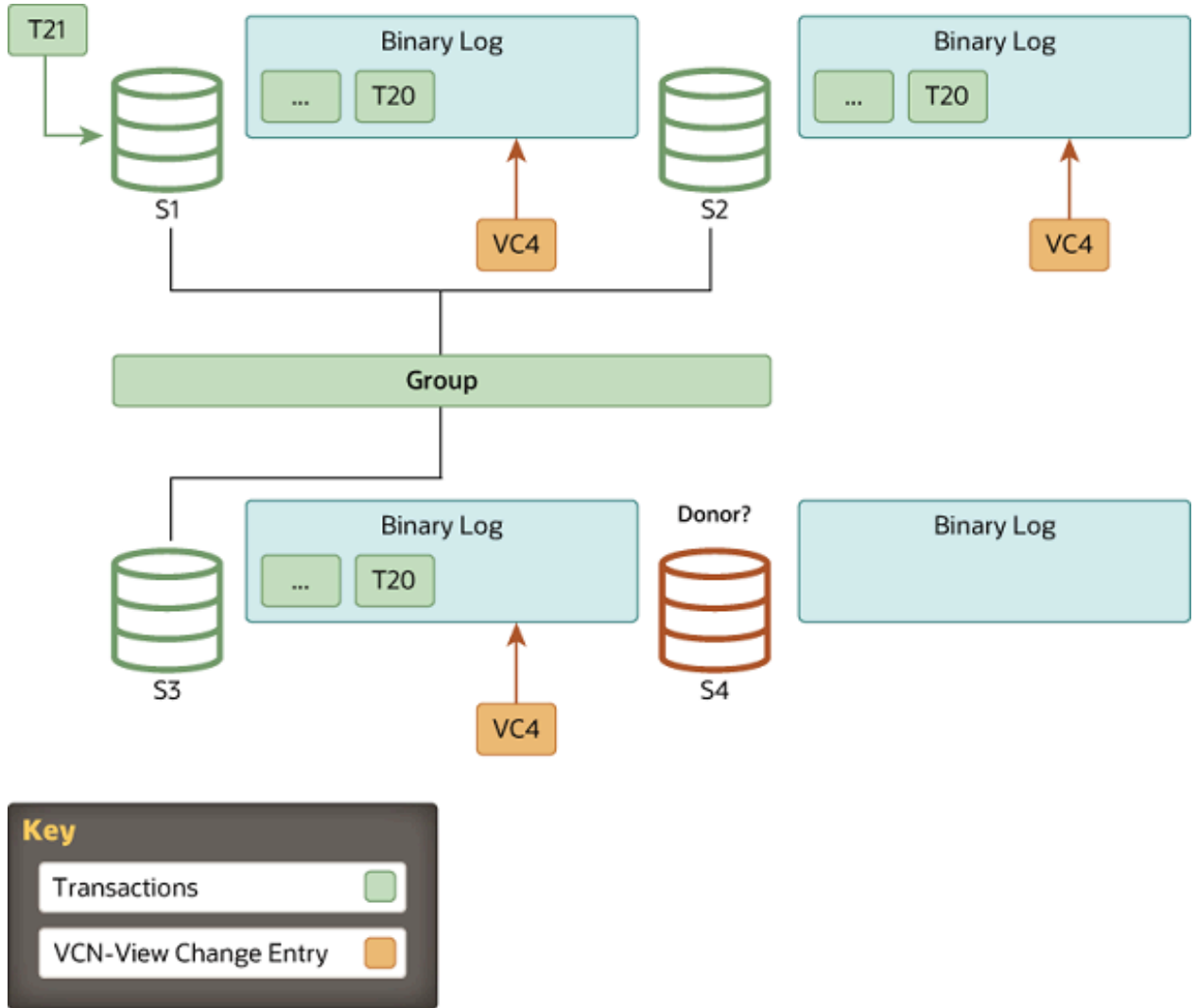

### State Transfer: Catching Up

Once the server joining the group has chosen which server in the group is to be the donor, a new asynchronous replication connection is established between the two and the state transfer begins (phase 1). This interaction with the donor continues until the server joining the group's applier thread processes the view change log event that corresponds to the view change triggered when the server joining the group came into the group. In other words, the server joining the group replicates from the donor, until it gets to the marker with the view identifier which matches the view marker it is already in.

Figure 17.12 State Transfer: Catching Up

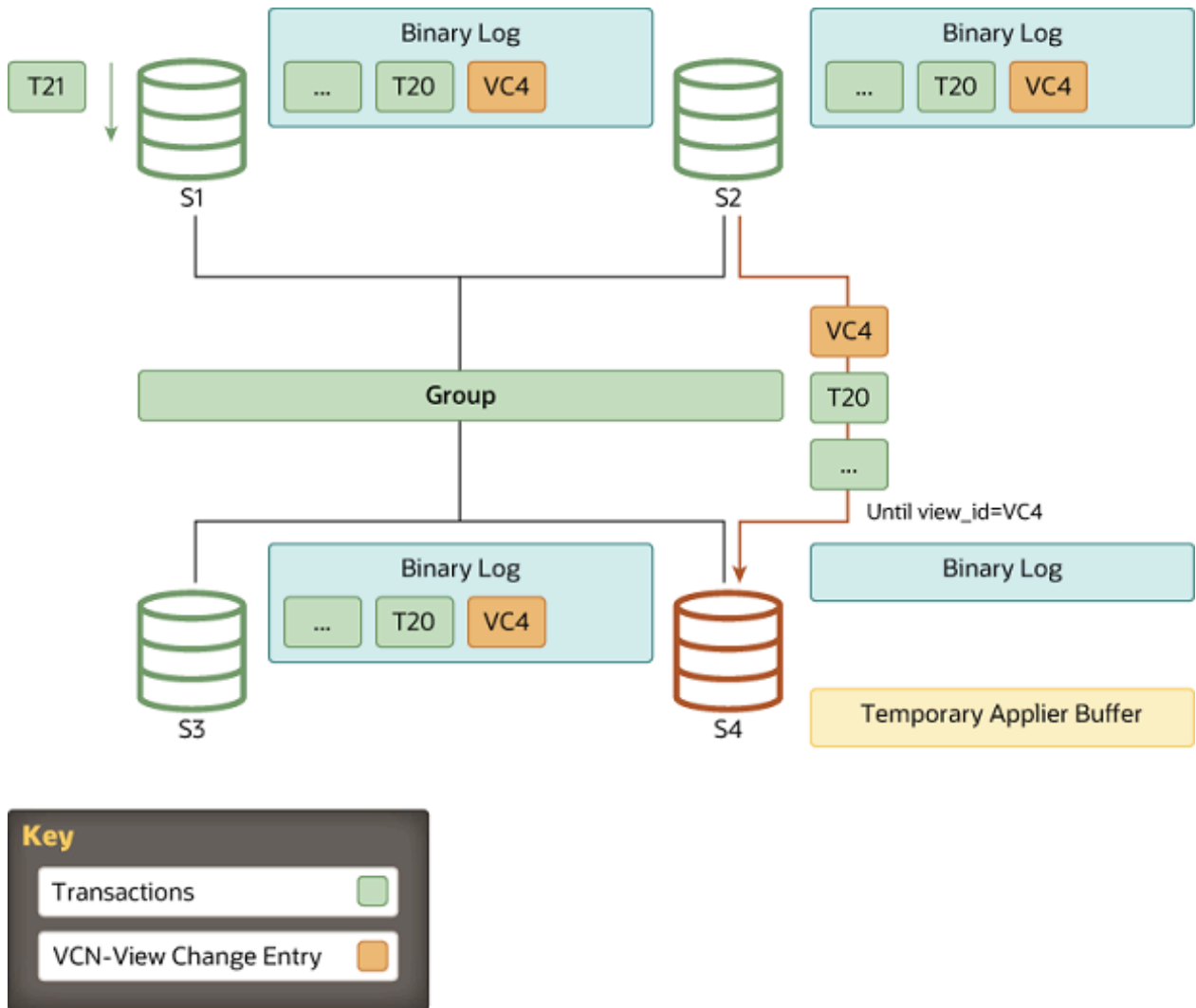

As view identifiers are transmitted to all members in the group at the same logical time, the server joining the group knows at which view identifier it should stop replicating. This avoids complex GTID set calculations because the view id clearly marks which data belongs to each group view.

While the server joining the group is replicating from the donor, it is also caching incoming transactions from the group. Eventually, it stops replicating from the donor and switches to applying those that are cached.



Figure 17.13 Queued Transactions

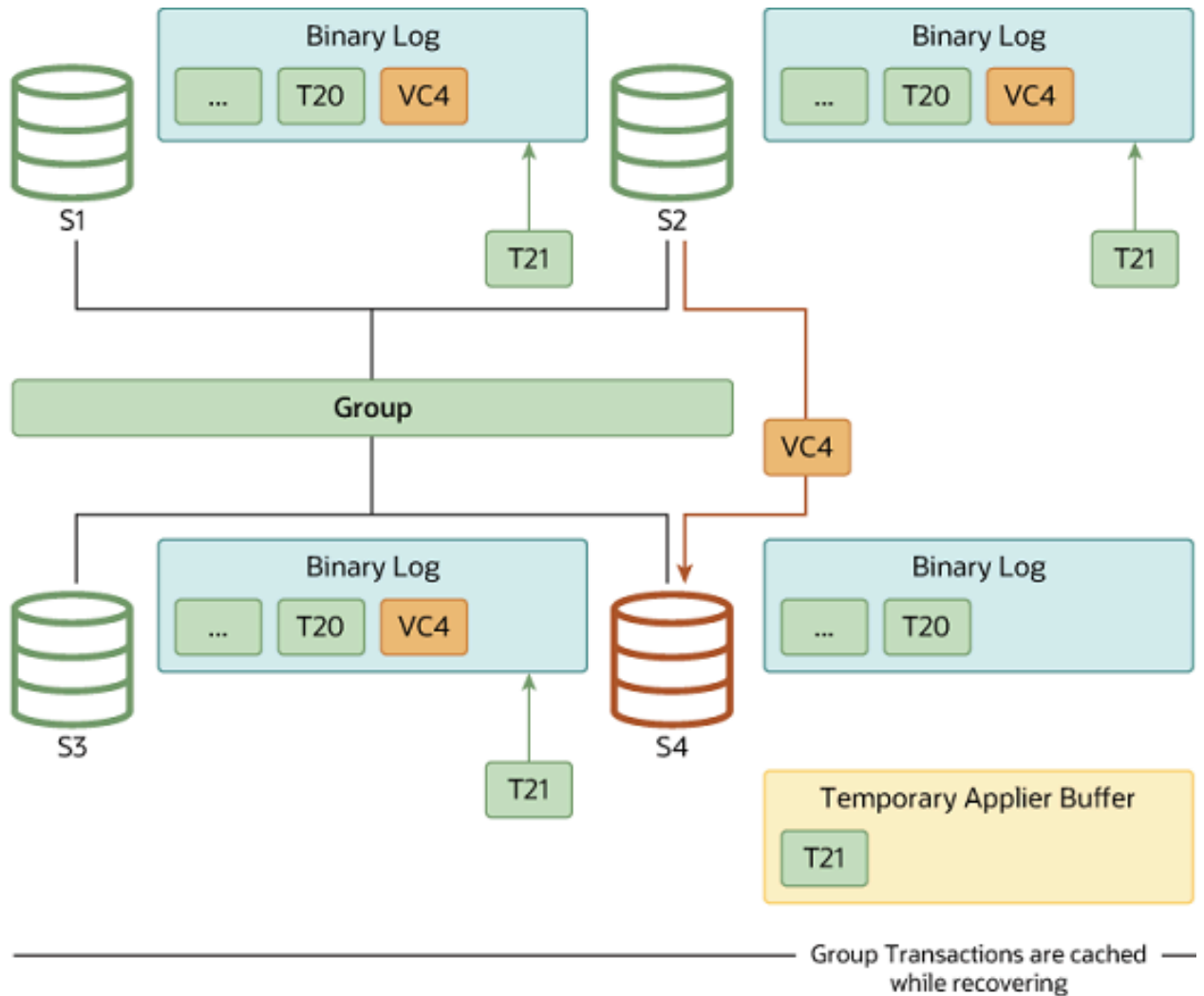

**Key**

- Transactions █
- VCN-View Change Entry █

**Finish: Caught Up**

When the server joining the group recognizes a view change log event with the expected view identifier, the connection to the donor is terminated and it starts applying the cached transactions. An important point to understand is the final recovery procedure. Although it acts as a marker in the binary log, delimiting view changes, the view change log event also plays another role. It conveys the certification information as perceived by all servers when the server joining the group entered the group, in other words the last view change. Without it, the server joining the group would not have the necessary information to be able to certify (detect conflicts) subsequent transactions.

The duration of the catch up (phase 2) is not deterministic, because it depends on the workload and the rate of incoming transactions to the group. This process is completely online and the server joining the group does not block any other server in the group while it is catching up. Therefore the number of transactions the server joining the group is behind when it moves to phase 2 can, for this reason, vary and thus increase or decrease according to the workload.

When the server joining the group reaches zero queued transactions and its stored data is equal to the other members, its public state changes to online.

**Figure 17.14 Instance Online**

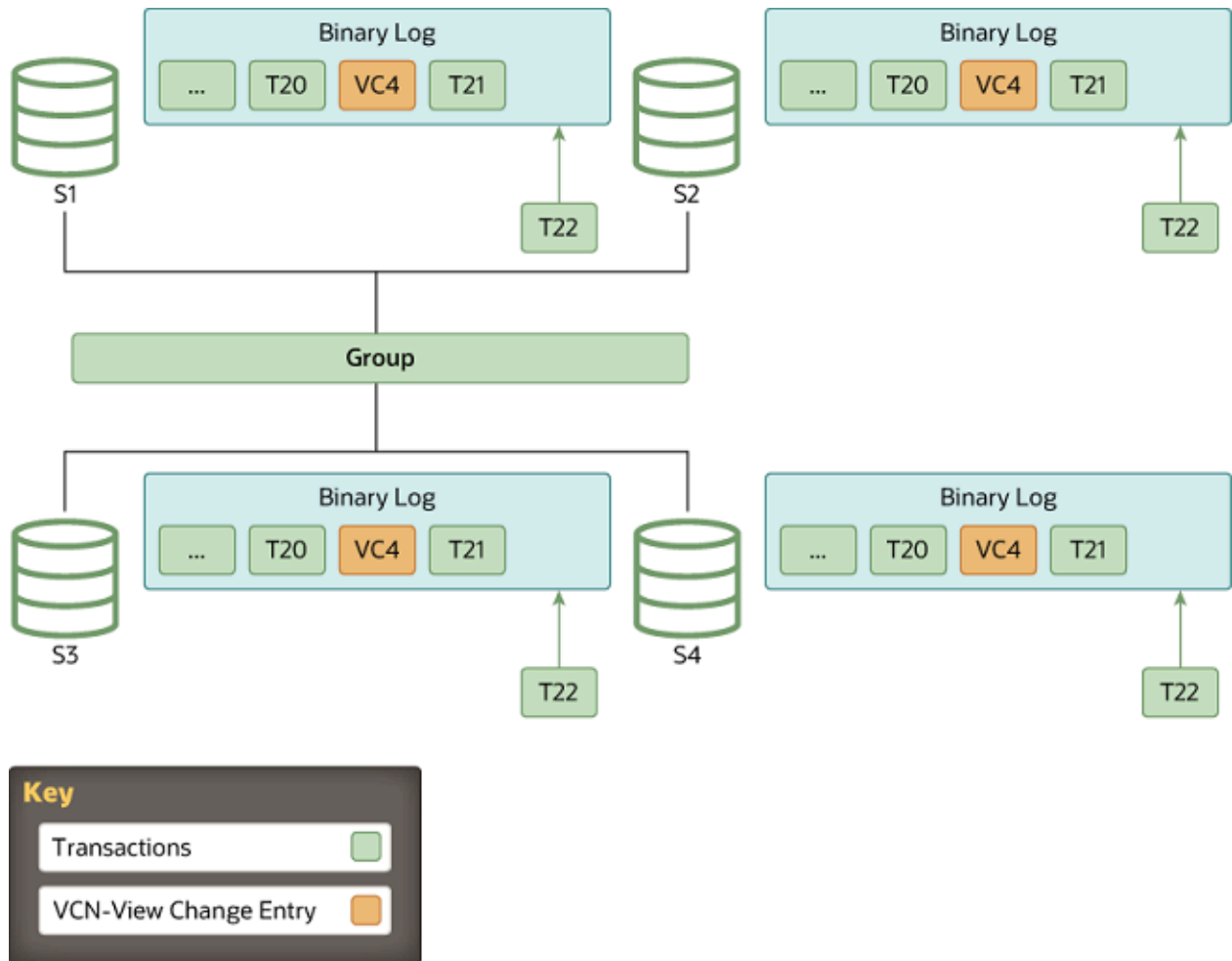

#### 17.9.5.4 Usage Advice and Limitations of Distributed Recovery

Distributed recovery does have some limitations. It is based on classic asynchronous replication and as such it may be slow if the server joining the group is not provisioned at all or is provisioned with a very old backup image. This means that if the data to transfer is too big at phase 1, the server may take a very long time to recover. As such, the recommendation is that before adding a server to the group, one should provision it with a fairly recent snapshot of a server already in the group. This minimizes the length of phase 1 and reduces the impact on the donor server, since it has to save and transfer less binary logs.



#### Warning

It is recommended that a server is provisioned before it is added to a group. That way, one minimizes the time spent on the recovery step.

## 17.9.6 Observability

There is a lot of automation built into the Group Replication plugin. Nonetheless, you might sometimes need to understand what is happening behind the scenes. This is where the instrumentation of Group Replication and Performance Schema becomes important. The entire state of the system (including the view, conflict statistics and service states) can be queried through `performance_schema` tables. The distributed nature of the replication protocol and the fact that server instances agree and thus synchronize on transactions and metadata makes it simpler to inspect the state of the group. For example, you can connect to a single server in the group and obtain both local and global information by issuing select statements on the Group Replication related Performance Schema tables. For more information, see [Section 17.4, “Monitoring Group Replication”](#).

## 17.9.7 Group Replication Performance

This section explains how to use the available configuration options to gain the best performance from your group.

### 17.9.7.1 Fine Tuning the Group Communication Thread

The group communication thread (GCT) runs in a loop while the Group Replication plugin is loaded. The GCT receives messages from the group and from the plugin, handles quorum and failure detection related tasks, sends out some keep alive messages and also handles the incoming and outgoing transactions from/to the server/group. The GCT waits for incoming messages in a queue. When there are no messages, the GCT waits. By configuring this wait to be a little longer (doing an active wait) before actually going to sleep can prove to be beneficial in some cases. This is because the alternative is for the operating system to switch out the GCT from the processor and do a context switch.

To force the GCT do an active wait, use the `group_replication_poll_spin_loops` option, which makes the GCT loop, doing nothing relevant for the configured number of loops, before actually polling the queue for the next message.

For example:

```
mysql> SET GLOBAL group_replication_poll_spin_loops= 10000;
```

### 17.9.7.2 Message Compression

For messages sent between online group members, Group Replication enables message compression by default. Whether a specific message is compressed depends on the threshold that you configure using the `group_replication_compression_threshold` system variable. Messages that have a payload larger than the specified number of bytes are compressed.

The default compression threshold is 1000000 bytes. You could use the following statements to increase the compression threshold to 2MB, for example:

```
STOP GROUP_REPLICATION;  
SET GLOBAL group_replication_compression_threshold = 2097152;  
START GROUP_REPLICATION;
```

If you set `group_replication_compression_threshold` to zero, message compression is disabled.

Group Replication uses the LZ4 compression algorithm to compress messages sent in the group. Note that the maximum supported input size for the LZ4 compression algorithm is 2113929216 bytes. This limit is lower than the maximum possible value for the `group_replication_compression_threshold`

system variable, which is matched to the maximum message size accepted by XCom. The LZ4 maximum input size is therefore a practical limit for message compression, and transactions above this size cannot be committed when message compression is enabled. With the LZ4 compression algorithm, do not set a value greater than 2113929216 bytes for `group_replication_compression_threshold`.

The value of `group_replication_compression_threshold` is not required by Group Replication to be the same on all group members. However, it is advisable to set the same value on all group members in order to avoid unnecessary rollback of transactions, failure of message delivery, or failure of message recovery.

Compression for messages sent in the group happens at the group communication engine level, before the data is handed over to the group communication thread, so it takes place within the context of the `mysql` user session thread. If the message payload size exceeds the threshold set by `group_replication_compression_threshold`, the transaction payload is compressed before being sent out to the group, and decompressed when it is received. Upon receiving a message, the member checks the message envelope to verify whether it is compressed or not. If needed, then the member decompresses the transaction, before delivering it to the upper layer. This process is shown in the following figure.

Figure 17.15 Compression Support

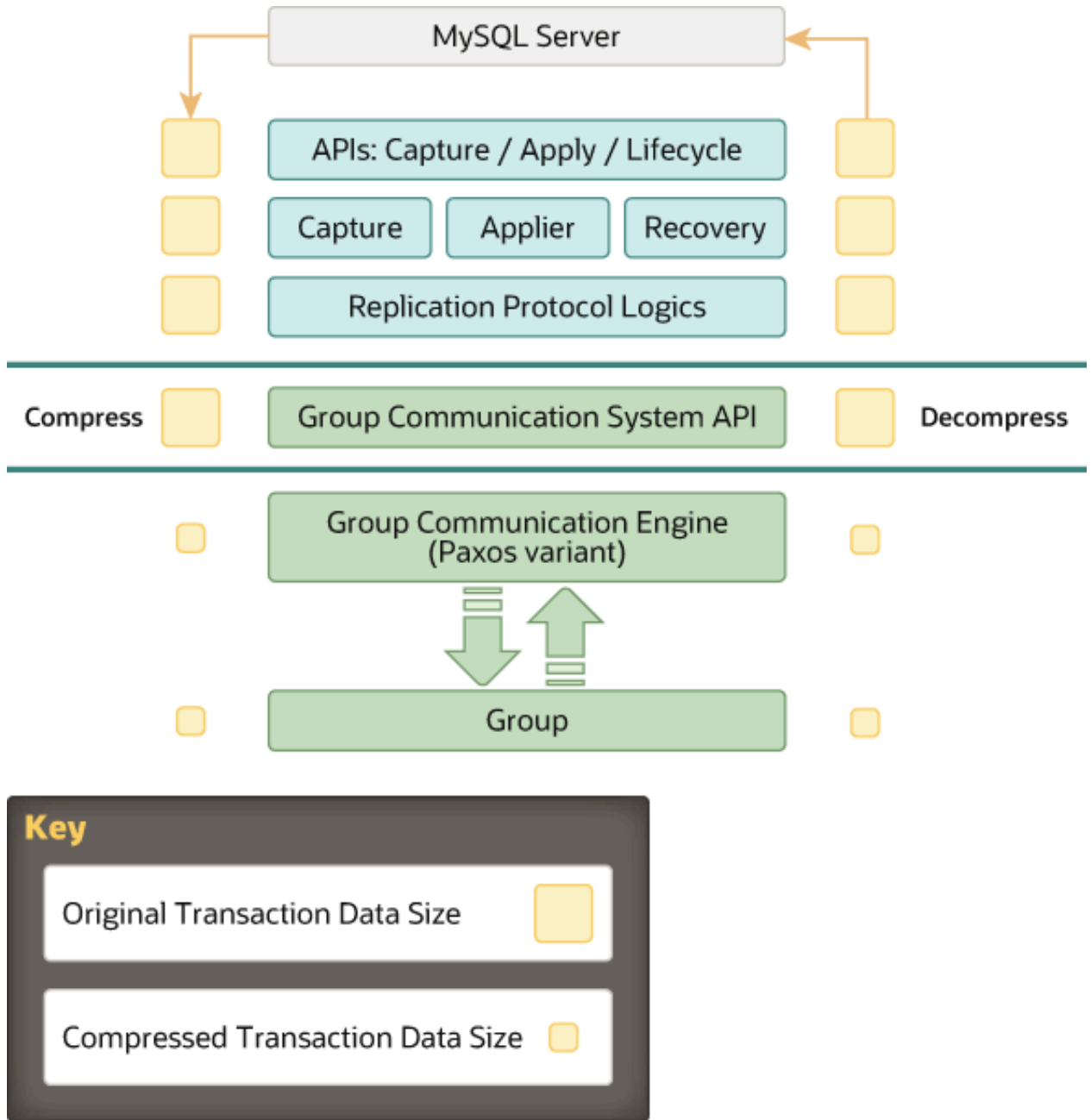

When network bandwidth is a bottleneck, message compression can provide up to 30-40% throughput improvement at the group communication level. This is especially important within the context of large groups of servers under load. The TCP peer-to-peer nature of the interconnections between  $N$  participants in the group makes the sender send the same amount of data  $N$  times. Furthermore, binary logs are likely to exhibit a high compression ratio. This makes compression a compelling feature for Group Replication workloads that contain large transactions.

### 17.9.7.3 Flow Control

Group Replication ensures that a transaction only commits after a majority of the members in a group have received it and agreed on the relative order between all transactions that were sent concurrently.

This approach works well if the total number of writes to the group does not exceed the write capacity of any member in the group. If it does and some of the members have less write throughput than others, particularly less than the writer members, those members can start lagging behind of the writers.

Having some members lagging behind the group brings some problematic consequences, particularly, the reads on such members may externalize very old data. Depending on why the member is lagging behind, other members in the group may have to save more or less replication context to be able to fulfil potential data transfer requests from the slow member.

There is however a mechanism in the replication protocol to avoid having too much distance, in terms of transactions applied, between fast and slow members. This is known as the flow control mechanism. It tries to address several goals:

1. to keep the members close enough to make buffering and de-synchronization between members a small problem;
2. to adapt quickly to changing conditions like different workloads or more writers in the group;
3. to give each member a fair share of the available write capacity;
4. to not reduce throughput more than strictly necessary to avoid wasting resources.

Given the design of Group Replication, the decision whether to throttle or not may be decided taking into account two work queues: (i) the *certification* queue; (ii) and on the binary log *applier* queue. Whenever the size of one of these queues exceeds the user-defined threshold, the throttling mechanism is triggered. Only configure: (i) whether to do flow control at the certifier or at the applier level, or both; and (ii) what is the threshold for each queue.

The flow control depends on two basic mechanisms:

1. the monitoring of members to collect some statistics on throughput and queue sizes of all group members to make educated guesses on what is the maximum write pressure each member should be subjected to;
2. the throttling of members that are trying to write beyond their fair-share of the available capacity at each moment in time.

### Probes and Statistics

The monitoring mechanism works by having each member deploying a set of probes to collect information about its work queues and throughput. It then propagates that information to the group periodically to share that data with the other members.

Such probes are scattered throughout the plugin stack and allow one to establish metrics, such as:

- the certifier queue size;
- the replication applier queue size;
- the total number of transactions certified;
- the total number of remote transactions applied in the member;
- the total number of local transactions.

Once a member receives a message with statistics from another member, it calculates additional metrics regarding how many transactions were certified, applied and locally executed in the last monitoring period.

Monitoring data is shared with others in the group periodically. The monitoring period must be high enough to allow the other members to decide on the current write requests, but low enough that it has minimal impact on group bandwidth. The information is shared every second, and this period is sufficient to address both concerns.

### **Group Replication Throttling**

Based on the metrics gathered across all servers in the group, a throttling mechanism kicks in and decides whether to limit the rate a member is able to execute/commit new transactions.

Therefore, metrics acquired from all members are the basis for calculating the capacity of each member: if a member has a large queue (for certification or the applier thread), then the capacity to execute new transactions should be close to ones certified or applied in the last period.

The lowest capacity of all the members in the group determines the real capacity of the group, while the number of local transactions determines how many members are writing to it, and, consequently, how many members should that available capacity be shared with.

This means that every member has an established write quota based on the available capacity, in other words a number of transactions it can safely issue for the next period. The writer quota is enforced by the throttling mechanism if the queue size of the certifier or the binary log applier exceeds a user defined threshold.

The quota is reduced by the number of transactions that were delayed in the last period, and then also further reduced by 10% to allow the queue that triggered the problem to reduce its size. In order to avoid large jumps in throughput once the queue size goes beyond the threshold, the throughput is only allowed to grow by the same 10% per period after that.

The current throttling mechanism does not penalize transactions below quota, but delays finishing those transactions that exceed it until the end of the monitoring period. As a consequence, if the quota is very small for the write requests issued some transactions may have latencies close to the monitoring period.





---

## Chapter 18 MySQL Shell

MySQL Shell is an advanced client and code editor for MySQL Server. In addition to the provided SQL functionality, similar to `mysql`, MySQL Shell provides scripting capabilities for JavaScript and Python and includes APIs for working with MySQL. MySQL Shell is a component that you can install separately.

The following discussion briefly describes MySQL Shell's capabilities. For more information, see the MySQL Shell manual, available at <https://dev.mysql.com/doc/mysql-shell/en/>.

MySQL Shell includes the following APIs implemented in JavaScript and Python which you can use to develop code that interacts with MySQL.

- The X DevAPI enables developers to work with both relational and document data when MySQL Shell is connected to a MySQL server using the X Protocol. This enables you to use MySQL as a Document Store, sometimes referred to as “using NoSQL”. For more information, see [Chapter 19, Using MySQL as a Document Store](#). For documentation on the concepts and usage of X DevAPI, which is implemented in MySQL Shell, see [X DevAPI User Guide](#).
- The AdminAPI enables database administrators to work with InnoDB Cluster, which provides an integrated solution for high availability and scalability using InnoDB based MySQL databases, without requiring advanced MySQL expertise. The AdminAPI also includes support for InnoDB ReplicaSet, which enables you to administer a set of MySQL instances running asynchronous GTID-based replication in a similar way to InnoDB Cluster. Additionally, the AdminAPI makes administration of MySQL Router easier, including integration with both InnoDB Cluster and InnoDB ReplicaSet. See [MySQL AdminAPI](#).

MySQL Shell is available in two editions, the Community Edition and the Commercial Edition. The Community Edition is available free of charge. The Commercial Edition provides additional Enterprise features at low cost.



---

# Chapter 19 Using MySQL as a Document Store

## Table of Contents

19.1 Key Concepts .....	3254
19.2 Setting Up MySQL as a Document Store .....	3255
19.2.1 Installing MySQL Shell .....	3257
19.2.2 Starting MySQL Shell .....	3261
19.3 Quick-Start Guide: MySQL for Visual Studio .....	3261
19.4 X Plugin .....	3263
19.4.1 Using Encrypted Connections with X Plugin .....	3263
19.4.2 X Plugin Options and Variables .....	3264
19.4.3 Monitoring X Plugin .....	3277

This chapter introduces an alternative way of working with MySQL as a document store, sometimes referred to as “using NoSQL”. If your intention is to use MySQL in a traditional (SQL) way, this chapter is probably not relevant to you.



### Important

MySQL Shell 8.0 is the most recent version and is highly recommended for use with MySQL Server 5.7. Please upgrade to MySQL Shell 8.0. If you have not yet installed MySQL Shell, download it from the [download site](#). See the [MySQL Shell 8.0](#) documentation for the latest documentation. This chapter covers configuring MySQL 5.7 server as a document store and is compatible with version 8.0 clients such as MySQL Shell and MySQL Connectors.

Relational databases such as MySQL usually required a document schema to be defined before documents can be stored. The features described in this section enable you to use MySQL as a document store, which is a schema-less, and therefore schema-flexible, storage system for documents. When using MySQL as a document store, to create documents describing products you do not need to know and define all possible attributes of any products before storing them and operating with them. This differs from working with a relational database and storing products in a table, when all columns of the table must be known and defined before adding any products to the database. The features described in this chapter enable you to choose how you configure MySQL, using only the document store model, or combining the flexibility of the document store model with the power of the relational model.

These sections cover the usage of MySQL as a document store:

- The [Section 19.1, “Key Concepts”](#) section covers concepts like Document, Collection, Session, and Schema to help you understand how to use MySQL as a document store.
- The [Section 19.2, “Setting Up MySQL as a Document Store”](#) section explains how to configure X Plugin on a MySQL Server, so it can function as a document store, and how to install MySQL Shell to use as a client.
- [MySQL Shell 8.0](#) provides more detailed information about using MySQL Shell.
- *X DevAPI User guide*.

Clients that communicate with a MySQL Server using the X Protocol can use the X DevAPI to develop applications. For example MySQL Shell and MySQL Connectors provide this ability by implementing the

X DevAPI. X DevAPI offers a modern programming interface with a simple yet powerful design which provides support for established industry standard concepts. See [X DevAPI User Guide](#) for in-depth tutorials on using X DevAPI.

- The following MySQL products support the X Protocol and enable you to use X DevAPI in your chosen language to develop applications that communicate with a MySQL Server functioning as a document store.
  - MySQL Shell provides implementations of X DevAPI in JavaScript and Python.
  - Connector/C++
  - Connector/J
  - Connector/Node.js
  - Connector/NET
  - Connector/Python

## 19.1 Key Concepts

This section explains the concepts introduced as part of using MySQL as a document store.

### Document

A Document is a set of key and value pairs, as represented by a JSON object. A Document is represented internally using the MySQL binary JSON object, through the JSON MySQL datatype. The values of fields can contain other documents, arrays, and lists of documents.

```
{
  "GNP": 4834,
  "_id": "00005de917d800000000000000023",
  "Code": "BWA",
  "Name": "Botswana",
  "IndepYear": 1966,
  "geography": {
    "Region": "Southern Africa",
    "Continent": "Africa",
    "SurfaceArea": 581730
  },
  "government": {
    "HeadOfState": "Festus G. Mogae",
    "GovernmentForm": "Republic"
  },
  "demographics": {
    "Population": 1622000,
    "LifeExpectancy": 39.29999923706055
  }
}
```

### Collection

A Collection is a container that may be used to store Documents in a MySQL database.

### CRUD Operations

Create, Read, Update and Delete (CRUD) operations are the four basic operations that can be performed on a database Collection or Table. In terms of MySQL this means:

- Create a new entry (insertion or addition)
- Read entries (queries)
- Update entries
- Delete entries

## X Plugin

The MySQL Server plugin which enables communication using X Protocol. Supports clients that implement X DevAPI and enables you to use MySQL as a document store.

## X Protocol

A protocol to communicate with a MySQL Server running X Plugin. X Protocol supports both CRUD and SQL operations, authentication via SASL, allows streaming (pipelining) of commands and is extensible on the protocol and the message layer.

## 19.2 Setting Up MySQL as a Document Store

To use MySQL 5.7 as a document store, the X Plugin needs to be installed. Then you can use X Protocol to communicate with the server. Without the X Plugin running, X Protocol clients cannot connect to the server. The X Plugin is supplied with MySQL (5.7.12 or higher) — installing it does not involve a separate download. This section describes how to install X Plugin.

Follow the steps outlined here:

### 1. Install or upgrade to MySQL 5.7.12 or higher.

When the [installation](#) or upgrade is done, start the server. For server startup instructions, see [Section 2.9.2, “Starting the Server”](#).



#### Note

MySQL Installer enables you to perform this and the next step (Install the X Plugin) at the same time for new installations on Microsoft Windows. In the **Plugin and Extensions** screen, check mark the **Enable X Protocol/MySQL as a Document Store** check box. After the installation, verify that the X Plugin has been installed.

### 2. Install the X Plugin. A non-root account can be used to install the plugin as long as the account has `INSERT` privilege for the `mysql.plugin` table.

Always save your existing configuration settings before reconfiguring the server.

To install the built-in X Plugin, do one of the following:

- Using [MySQL Installer for Windows](#):
  - a. Launch MySQL Installer for Windows. MySQL Installer dashboard opens.
  - b. Click the **Reconfigure** quick action for MySQL Server. Use **Next** and **Back** to configure the following items:
    - In **Accounts and Roles**, confirm the current `root` account password.

- In **Plugin and Extensions**, check mark the **Enable X Protocol/MySQL as a Document Store** check box. MySQL Installer provides a default port number and opens the firewall port for network access.
  - In **Apply Server Configuration**, click **Execute**.
  - Click **Finish** to close MySQL Installer.
- c. [Install MySQL Shell](#).
- Using MySQL Shell:
    - a. [Install MySQL Shell](#).
    - b. Open a terminal window (command prompt on Windows) and navigate to the MySQL binaries location (for example, `/usr/bin/` on Linux).
    - c. Run the following command:

```
mysqlsh -u user -h localhost --classic --dba enableXProtocol
```

- Using the MySQL Client program:
  - a. Open a terminal window (command prompt on Windows) and navigate to the MySQL binaries location (for example, `/usr/bin/` on Linux).
  - b. Invoke the `mysql` command-line client:

```
mysql -u user -p
```

- c. Issue the following statement:

```
mysql> INSTALL PLUGIN mysqlx SONAME 'mysqlx.so';
```

Replace `mysqlx.so` with `mysqlx.dll` for Windows.



### Important

The `mysql.session` user must exist before you can load X Plugin. `mysql.session` was added in MySQL version 5.7.19. If your data dictionary was initialized using an earlier version you must run the `mysql_upgrade` procedure. If the upgrade is not run, X Plugin fails to start with the error message `There was an error when trying to access the server with user: mysql.session@localhost`. Make sure the user is present in the server and that `mysql_upgrade` was ran after a server update..

- d. [Install MySQL Shell](#).

### 3. Verify that the X Plugin has been installed.

When the X Plugin is installed properly, it shows up in the list when you query for active plugins on the server with one of the following commands:

- MySQL Shell command:

```
mysqlsh -u user --sqlc -e "show plugins"
```

- MySQL Client program command:

```
mysql -u user -p -e "show plugins"
```

If you encounter problems with the X Plugin installation, or if you want to learn about alternative ways of installing, configuring, or uninstalling server plugins, see [Section 5.5.1, “Installing and Uninstalling Plugins”](#).

## mysqlxsys@localhost User Account

Installing the X Plugin creates a `mysqlxsys@localhost` user account. If, for some reason, creating the user account fails, the X Plugin installation fails, too. Here is an explanation on what the `mysqlxsys@localhost` user account is for and what to do when its creation fails.

The X Plugin installation process uses the MySQL `root` user to create an internal account for the `mysqlxsys@localhost` user. The `mysqlxsys@localhost` account is used by the X Plugin for authentication of external users against the MySQL account system and for killing sessions when requested by a privileged user. The `mysqlxsys@localhost` account is created as locked, so it cannot be used to log in by external users. If for some reason the MySQL `root` account is not available, before you start the X Plugin installation you must manually create the `mysqlxsys@localhost` user by issuing the following statements in the `mysql` command-line client:

```
CREATE USER IF NOT EXISTS mysqlxsys@localhost IDENTIFIED WITH
mysql_native_password AS 'password' ACCOUNT LOCK;
GRANT SELECT ON mysql.user TO mysqlxsys@localhost;
GRANT SUPER ON *.* TO mysqlxsys@localhost;
```

## Uninstalling the X Plugin

If you ever want to uninstall (deactivate) the X Plugin, issue the following statement in the `mysql` command-line client:

```
UNINSTALL PLUGIN mysqlx;
```

Do not use MySQL Shell to issue the previous statement. It works from MySQL Shell, but you get an error (code 1130). Also, uninstalling the plugin removes the `mysqlxsys` user.

### 19.2.1 Installing MySQL Shell

This section describes how to download, install, and start MySQL Shell, which is an interactive JavaScript, Python, or SQL interface supporting development and administration for the MySQL Server. MySQL Shell is a component that you can install separately.

#### Requirements

MySQL Shell is available on Microsoft Windows, Linux, and macOS for 64-bit platforms. MySQL Shell requires that the built-in X Plugin be active. You can install the server plugin before or after you install MySQL Shell. For instructions, see [Installing the X Plugin](#).

### 19.2.1.1 Installing MySQL Shell on Microsoft Windows



#### Important

The Community version of MySQL Shell requires the Visual C++ Redistributable for Visual Studio 2013 (available at the [Microsoft Download Center](http://www.microsoft.com/download/details.aspx?id=40131)) to work; make sure that is installed on your Windows system before installing MySQL Shell.



#### Note

MySQL Shell is currently not supplied with an MSI Installer. See [Installing MySQL Shell Binaries](#) for the manual install procedure.

To install MySQL Shell on Microsoft Windows using the MSI Installer, do the following:

1. Download the **Windows (x86, 64-bit), MSI Installer** package from <http://dev.mysql.com/downloads/shell/>.
2. When prompted, click **Run**.
3. Follow the steps in the Setup Wizard.

**Figure 19.1** Installation of MySQL Shell on Windows

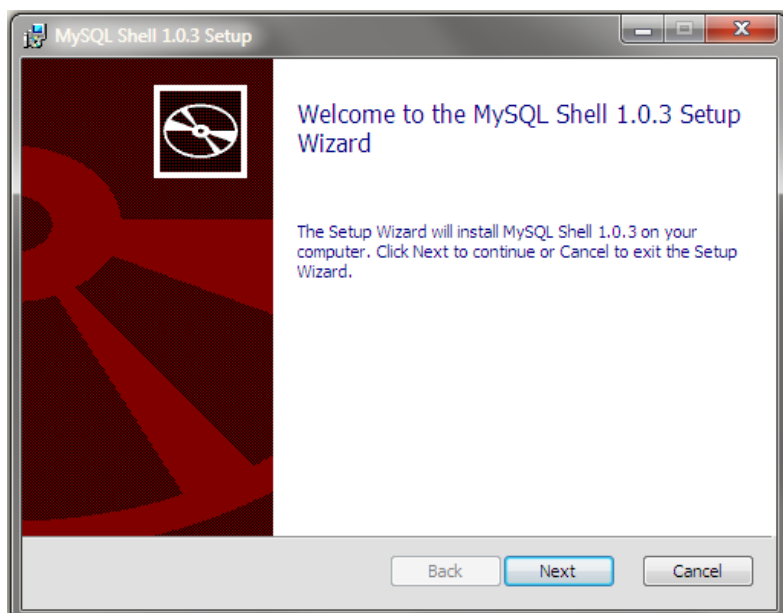

If you have installed MySQL without enabling the X Plugin, then later on decide you want to install the X Plugin, or if you are installing MySQL *without* using MySQL Installer, see [Installing the X Plugin](#).

### Installing MySQL Shell Binaries

To install MySQL Shell binaries:

1. Unzip the content of the Zip file to the MySQL products directory, for example `C:\Program Files\MySQL\`.
2. To be able to start MySQL Shell from a command prompt add the bin directory `C:\Program Files\MySQL\mysql-shell-1.0.8-rc-windows-x86-64bit\bin` to the `PATH` system variable.



### 19.2.1.2 Installing MySQL Shell on Linux



#### Note

Installation packages for MySQL Shell are available only for a limited number of Linux distributions, and only for 64-bit systems.

For supported Linux distributions, the easiest way to install MySQL Shell on Linux is to use the [MySQL APT repository](#) or [MySQL Yum repository](#). For systems not using the MySQL repositories, MySQL Shell can also be downloaded and installed directly.

#### Installing MySQL Shell with the MySQL APT Repository

For Linux distributions supported by the [MySQL APT repository](#), follow one of the paths below:

- If you do not yet have the [MySQL APT repository](#) as a software repository on your system, do the following:
  - Follow the steps given in [Adding the MySQL APT Repository](#), paying special attention to the following:
    - During the installation of the configuration package, when asked in the dialogue box to configure the repository, make sure you choose MySQL 5.7 (which is the default option) as the release series you want, and enable the **MySQL Preview Packages** component.
  - Make sure you do not skip the step for updating package information for the MySQL APT repository:

```
sudo apt-get update
```

- Install MySQL Shell with this command:

```
sudo apt-get install mysql-shell
```

- If you already have the [MySQL APT repository](#) as a software repository on your system, do the following:
  - Update package information for the MySQL APT repository:

```
sudo apt-get update
```

- Update the MySQL APT repository configuration package with the following command:

```
sudo apt-get install mysql-apt-config
```

When asked in the dialogue box to configure the repository, make sure you choose MySQL 5.7 (which is the default option) as the release series you want, and enable the **MySQL Preview Packages** component.

- Install MySQL Shell with this command:

```
sudo apt-get install mysql-shell
```

#### Installing MySQL Shell with the MySQL Yum Repository

For Linux distributions supported by the [MySQL Yum repository](#), follow these steps to install MySQL Shell:

- Do one of the following:
  - If you already have the [MySQL Yum repository](#) as a software repository on your system and the repository was configured with the new release package `mysql57-community-release`, skip to the next step (“Enable the MySQL Tools Preview subrepository...”).

- If you already have the [MySQL Yum repository](#) as a software repository on your system but have configured the repository with the old release package `mysql-community-release`, it is easiest to install MySQL Shell by first reconfiguring the MySQL Yum repository with the new `mysql57-community-release` package. To do so, you need to remove your old release package first, with the following command :

```
sudo yum remove mysql-community-release
```

For dnf-enabled systems, do this instead:

```
sudo dnf erase mysql-community-release
```

Then, follow the steps given in [Adding the MySQL Yum Repository](#) to install the new release package, `mysql57-community-release`.

- If you do not yet have the [MySQL Yum repository](#) as a software repository on your system, follow the steps given in [Adding the MySQL Yum Repository](#).
- Enable the MySQL Tools Preview subrepository. You can do that by editing manually the `/etc/yum.repos.d/mysql-community.repo` file. This is an example of the subrepository's default entry in the file (the `baseurl` entry in your file might look different, depending on your Linux distribution):

```
[mysql-tools-preview]
name=MySQL Tools Preview
baseurl=http://repo.mysql.com/yum/mysql-tools-preview/el/6/$basearch/
enabled=0
gpgcheck=1
gpgkey=file:///etc/pki/rpm-gpg/RPM-GPG-KEY-mysql
```

Change the entry `enabled=0` to `enabled=1` to enable the subrepository.

- Install MySQL Shell with this command:

```
sudo yum install mysql-shell
```

For dnf-enabled systems, do this instead:

```
sudo dnf install mysql-shell
```

### Installing MySQL Shell from Direct Downloads from the MySQL Developer Zone

RPM, Debian, and source packages for installing MySQL Shell are also available for download at [Download MySQL Shell](#).

#### 19.2.1.3 Installing MySQL Shell on macOS

To install MySQL Shell on macOS, do the following:

1. Download the package from <http://dev.mysql.com/downloads/shell/>.
2. Double-click the downloaded DMG to mount it. Finder opens.
3. Double-click the `.pkg` file shown in the Finder window.
4. Follow the steps in the installation wizard.

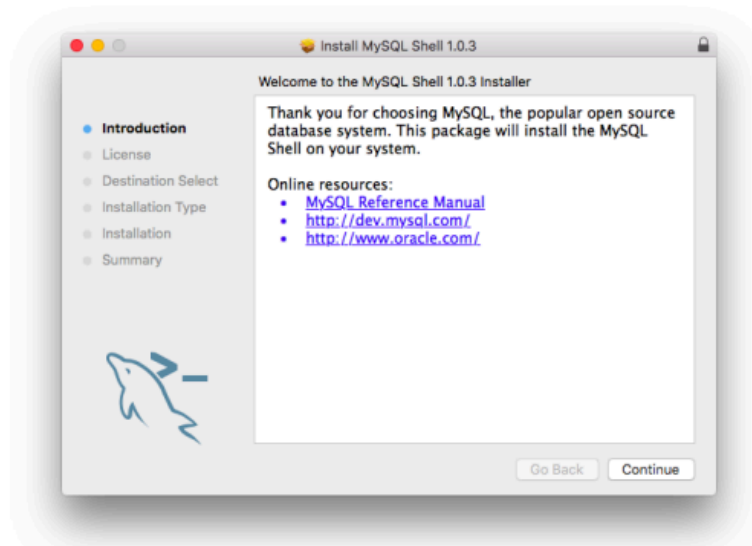
**Figure 19.2 Installation of MySQL Shell on macOS**

5. When the installer finishes, eject the DMG. (It can be deleted.)

## 19.2.2 Starting MySQL Shell

You need an account name and password to establish a session using MySQL Shell. Replace *user* with your account name.

On the same system where the server instance is running, open a terminal window (command prompt on Windows) and start MySQL Shell with the following command:

```
mysqlsh --uri user@localhost
```

You are prompted to input your password and then this establishes an X Session.

For instructions to get you started using MySQL as a document store, see the following quick-start guides:

- [Quick-Start Guide: MySQL Shell for JavaScript](#)
- [Quick-Start Guide: MySQL Shell for Python](#)

## 19.3 Quick-Start Guide: MySQL for Visual Studio

This section explains how to use MySQL Shell to script a server using MySQL for Visual Studio.

### Introduction

MySQL for Visual Studio provides access to MySQL objects and data without forcing developers to leave Visual Studio. Designed and developed as a Visual Studio package, MySQL for Visual Studio integrates directly into Server Explorer providing a seamless experience for setting up new connections and working with database objects.

The following MySQL for Visual Studio features are available as of version 2.0.2:

- JavaScript and Python code editors, where scripts in those languages can be executed to query data from a MySQL database.

- Better integration with the Server Explorer to open MySQL, JavaScript, and Python code editors directly from a connected MySQL instance.
- A newer user interface for displaying query results, where different views are presented from result sets returned by a MySQL Server like:
  - Multiple tabs for each result set returned by an executed query.
  - Results view, where the information can be seen in grid, tree, or text representation for JSON results.
  - Field types view, where information about the columns of a result set is shown, such as names, data types, character sets, and more.
  - Query statistics view, displaying information about the executed query such as execution times, processed rows, index and temporary tables usage, and more.
  - Execution plan view, displaying an explanation of the query execution done internally by the MySQL Server.

## Getting Started

The requirements are MySQL for Visual Studio 2.0.2 or higher, and Visual Studio 2010 or higher. X DevAPI support requires MySQL Server 5.7.12 or higher with the X plugin enabled.

## Opening a Code Editor

Before opening a code editor that can execute queries against a MySQL server, a connection needs to be established:

1. Open the Server Explorer pane through the View menu, or with **Control + W, K**.
2. Right-click on the Data Connections node, select **Add Connection...**
3. In the **Add Connection** dialog, make sure the MySQL Data Provider is being used and fill in all the information.



### Note

To enter the port number, click **Advanced...** and set the Port among the list of connection properties.

4. Click **Test Connection** to ensure you have a valid connection, then click **OK**.
5. Right-click your newly created connection, select **New MySQL Script** and then the language for the code editor you want to open.

For existing MySQL connections, to create a new editor you need only to do the last step.

## Using the Code Editor

The MySQL script editors have a toolbar at the start where information about the session is displayed, along with the actions that can be executed.



### Note

Note the first two buttons in the toolbar represent a way to connect or disconnect from a MySQL server. If the editor was opened from the Server Explorer, the connection should be already established for the new editor window.

The third button is the **Run** button, the script contained in the editor window is executed by clicking it and results from the script execution are displayed below the script window.



### Note

Some commands in the MySQL Shell can be executed without appending `execute()` while in interactive mode. In MySQL for Visual Studio, these commands do require `execute()`. In other words, append ".execute()" to execute commands.

## 19.4 X Plugin

This section explains how to configure and monitor the X Plugin.

### 19.4.1 Using Encrypted Connections with X Plugin

This section explains how to configure X Plugin to use encrypted connections. For more background information, see [Section 6.3, “Using Encrypted Connections”](#).

To enable configuring support for encrypted connections, X Plugin has `mysqlx_ssl_xxx` system variables, which can have different values from the `ssl_xxx` system variables used with MySQL Server. For example, X Plugin can have SSL key, certificate, and certificate authority files that differ from those used for MySQL Server. These variables are described at [Section 19.4.2.2, “X Plugin Options and System Variables”](#). Similarly, X Plugin has its own `mysqlx_ssl_xxx` status variables that correspond to the MySQL Server encrypted-connection `ssl_xxx` status variables. See [Section 19.4.2.3, “X Plugin Status Variables”](#).

At initialization, X Plugin determines its configuration for encrypted connections as follows:

- If all `mysqlx_ssl_xxx` system variables have their default values, X Plugin configures encrypted connections using the values of the MySQL Server `ssl_xxx` system variables.
- If any `mysqlx_ssl_xxx` variable has a nondefault value, X Plugin configures encrypted connections using the values of its own system variables. (This is the case if any `mysqlx_ssl_xxx` system variable is set to a value different from its default.)

This means that, on a server with X Plugin enabled, you can choose to have MySQL Protocol and X Protocol connections share the same encryption configuration by setting only the `ssl_xxx` variables, or have separate encryption configurations for MySQL Protocol and X Protocol connections by configuring the `ssl_xxx` and `mysqlx_ssl_xxx` variables separately.

To have MySQL Protocol and X Protocol connections use the same encryption configuration, set only the `ssl_xxx` system variables in `my.cnf`:

```
[mysqld]
ssl_ca=ca.pem
ssl_cert=server-cert.pem
ssl_key=server-key.pem
```

To configure encryption separately for MySQL Protocol and X Protocol connections, set both the `ssl_xxx` and `mysqlx_ssl_xxx` system variables in `my.cnf`:

```
[mysqld]
ssl_ca=ca1.pem
ssl_cert=server-cert1.pem
ssl_key=server-key1.pem

mysqlx_ssl_ca=ca2.pem
mysqlx_ssl_cert=server-cert2.pem
mysqlx_ssl_key=server-key2.pem
```

For general information about configuring connection-encryption support, see [Section 6.3.1, “Configuring MySQL to Use Encrypted Connections”](#). That discussion is written for MySQL Server, but the parameter names are similar for X Plugin. (The X Plugin `mysqlx_ssl_xxx` system variable names correspond to the MySQL Server `ssl_xxx` system variable names.)

The `tls_version` system variable that determines the permitted TLS versions for MySQL Protocol connections also applies to X Protocol connections. The permitted TLS versions for both types of connections are therefore the same.

Encryption per connection is optional, but a specific user can be required to use encryption for X Protocol and MySQL Protocol connections by including an appropriate `REQUIRE` clause in the `CREATE USER` statement that creates the user. For details, see [Section 13.7.1.2, “CREATE USER Statement”](#). Alternatively, to require all users to use encryption for X Protocol and MySQL Protocol connections, enable the `require_secure_transport` system variable. For additional information, see [Configuring Encrypted Connections as Mandatory](#).

## 19.4.2 X Plugin Options and Variables

This section describes the command options and system variables that configure X Plugin, as well as the status variables available for monitoring purposes. If configuration values specified at startup time are incorrect, X Plugin could fail to initialize properly and the server does not load it. In this case, the server could also produce error messages for other X Plugin settings because it cannot recognize them.

### 19.4.2.1 X Plugin Option and Variable Reference

This table provides an overview of the command options, system variables, and status variables provided by X Plugin.

**Table 19.1 X Plugin Option and Variable Reference**

Name	Cmd-Line	Option File	System Var	Status Var	Var Scope	Dynamic
<code>mysqlx</code>	Yes	Yes				
<code>mysqlx_address</code>				Yes	Global	No
<code>mysqlx_bind_address</code>	Yes	Yes	Yes		Global	No
<code>mysqlx_bytes_received</code>				Yes	Both	No
<code>mysqlx_bytes_sent</code>				Yes	Both	No
<code>mysqlx_connection_timeout</code>	Yes	Yes	Yes		Global	Yes
<code>mysqlx_connection_accept_errors</code>				Yes	Both	No
<code>mysqlx_connection_errors</code>				Yes	Both	No
<code>mysqlx_connections_accepted</code>				Yes	Global	No
<code>mysqlx_connections_closed</code>				Yes	Global	No
<code>mysqlx_connections_rejected</code>				Yes	Global	No
<code>mysqlx_crud_create_view</code>				Yes	Both	No
<code>mysqlx_crud_delete</code>				Yes	Both	No
<code>mysqlx_crud_drop_view</code>				Yes	Both	No
<code>mysqlx_crud_find</code>				Yes	Both	No
<code>mysqlx_crud_insert</code>				Yes	Both	No
<code>mysqlx_crud_modify_view</code>				Yes	Both	No
<code>mysqlx_crud_update</code>				Yes	Both	No

Name	Cmd-Line	Option File	System Var	Status Var	Var Scope	Dynamic
Mysqlx_errors_sent				Yes	Both	No
Mysqlx_errors_unknown_message_type				Yes	Both	No
Mysqlx_expect_close				Yes	Both	No
Mysqlx_expect_open				Yes	Both	No
mysqlx_idle_worker_thread_timeout	Yes	Yes	Yes		Global	Yes
Mysqlx_init_error				Yes	Both	No
mysqlx_max_allowed_packet	Yes	Yes	Yes		Global	Yes
mysqlx_max_connections	Yes	Yes	Yes		Global	Yes
mysqlx_min_worker_threads	Yes	Yes	Yes		Global	Yes
Mysqlx_notice_other_sent				Yes	Both	No
Mysqlx_notice_warning_sent				Yes	Both	No
Mysqlx_port				Yes	Global	No
mysqlx_port	Yes	Yes	Yes		Global	No
mysqlx_port_open_timeout	Yes	Yes	Yes		Global	No
Mysqlx_rows_sent				Yes	Both	No
Mysqlx_sessions				Yes	Global	No
Mysqlx_sessions_accepted				Yes	Global	No
Mysqlx_sessions_closed				Yes	Global	No
Mysqlx_sessions_fatal_error				Yes	Global	No
Mysqlx_sessions_killed				Yes	Global	No
Mysqlx_sessions_rejected				Yes	Global	No
Mysqlx_socket				Yes	Global	No
mysqlx_socket	Yes	Yes	Yes		Global	No
Mysqlx_ssl_accept_renegotiates				Yes	Global	No
Mysqlx_ssl_accepts				Yes	Global	No
Mysqlx_ssl_active				Yes	Both	No
mysqlx_ssl_ca	Yes	Yes	Yes		Global	No
mysqlx_ssl_capath	Yes	Yes	Yes		Global	No
mysqlx_ssl_cert	Yes	Yes	Yes		Global	No
Mysqlx_ssl_cipher				Yes	Both	No
mysqlx_ssl_cipher	Yes	Yes	Yes		Global	No
Mysqlx_ssl_cipher_list				Yes	Both	No
mysqlx_ssl_crl	Yes	Yes	Yes		Global	No
mysqlx_ssl_crlpath	Yes	Yes	Yes		Global	No
Mysqlx_ssl_ctx_verify_depth				Yes	Both	No
Mysqlx_ssl_ctx_verify_mode				Yes	Both	No
Mysqlx_ssl_finished_accepts				Yes	Global	No
mysqlx_ssl_key	Yes	Yes	Yes		Global	No

Name	Cmd-Line	Option File	System Var	Status Var	Var Scope	Dynamic
<a href="#">Mysqlx_ssl_server_not_after</a>				Yes	Global	No
<a href="#">Mysqlx_ssl_server_not_before</a>				Yes	Global	No
<a href="#">Mysqlx_ssl_verify_depth</a>				Yes	Global	No
<a href="#">Mysqlx_ssl_verify_mode</a>				Yes	Global	No
<a href="#">Mysqlx_ssl_version</a>				Yes	Both	No
<a href="#">Mysqlx_stmt_create_collection</a>				Yes	Both	No
<a href="#">Mysqlx_stmt_create_collection_index</a>				Yes	Both	No
<a href="#">Mysqlx_stmt_disable_notices</a>				Yes	Both	No
<a href="#">Mysqlx_stmt_drop_collection</a>				Yes	Both	No
<a href="#">Mysqlx_stmt_drop_collection_index</a>				Yes	Both	No
<a href="#">Mysqlx_stmt_enable_notices</a>				Yes	Both	No
<a href="#">Mysqlx_stmt_ensure_collection</a>				Yes	Both	No
<a href="#">Mysqlx_stmt_execute_mysqlx</a>				Yes	Both	No
<a href="#">Mysqlx_stmt_execute_sql</a>				Yes	Both	No
<a href="#">Mysqlx_stmt_execute_xplugin</a>				Yes	Both	No
<a href="#">Mysqlx_stmt_kill_client</a>				Yes	Both	No
<a href="#">Mysqlx_stmt_list_clients</a>				Yes	Both	No
<a href="#">Mysqlx_stmt_list_notices</a>				Yes	Both	No
<a href="#">Mysqlx_stmt_list_objects</a>				Yes	Both	No
<a href="#">Mysqlx_stmt_ping</a>				Yes	Both	No
<a href="#">Mysqlx_worker_threads</a>				Yes	Global	No
<a href="#">Mysqlx_worker_threads_active</a>				Yes	Global	No

### 19.4.2.2 X Plugin Options and System Variables

To control activation of X Plugin, use this option:

- `--mysqlx[=value]`

Command-Line Format	<code>--mysqlx[=<i>value</i>]</code>
Introduced	5.7.12
Type	Enumeration
Default Value	ON
Valid Values	ON  OFF  FORCE  FORCE_PLUS_PERMANENT

This option controls how the server loads X Plugin at startup. It is available only if the plugin has been previously registered with `INSTALL PLUGIN` or is loaded with `--plugin-load` or `--plugin-load-add`.



The option value should be one of those available for plugin-loading options, as described in [Section 5.5.1, “Installing and Uninstalling Plugins”](#). For example, `--mysqlx=FORCE_PLUS_PERMANENT` tells the server to load the plugin and prevent it from being removed while the server is running.

If X Plugin is enabled, it exposes several system variables that permit control over its operation:

- `mysqlx_bind_address`

Command-Line Format	<code>--mysqlx-bind-address=addr</code>
Introduced	5.7.17
System Variable	<code>mysqlx_bind_address</code>
Scope	Global
Dynamic	No
Type	String
Default Value	*

The network address on which X Plugin listens for TCP/IP connections. This variable is not dynamic and can be configured only at startup. This is the X Plugin equivalent of the `bind_address` system variable; see that variable description for more information.

`mysqlx_bind_address` accepts a single address value, which may specify a single non-wildcard IP address or host name, or one of the wildcard address formats that permit listening on multiple network interfaces (`*`, `0.0.0.0`, or `::`).

An IP address can be specified as an IPv4 or IPv6 address. If the value is a host name, X Plugin resolves the name to an IP address and binds to that address. If a host name resolves to multiple IP addresses, X Plugin uses the first IPv4 address if there are any, or the first IPv6 address otherwise.

X Plugin treats different types of addresses as follows:

- If the address is `*`, X Plugin accepts TCP/IP connections on all server host IPv4 interfaces, and, if the server host supports IPv6, on all IPv6 interfaces. Use this address to permit both IPv4 and IPv6 connections for X Plugin. This value is the default.
- If the address is `0.0.0.0`, X Plugin accepts TCP/IP connections on all server host IPv4 interfaces.
- If the address is `::`, X Plugin accepts TCP/IP connections on all server host IPv4 and IPv6 interfaces.
- If the address is an IPv4-mapped address, X Plugin accepts TCP/IP connections for that address, in either IPv4 or IPv6 format. For example, if X Plugin is bound to `::ffff:127.0.0.1`, a client such as MySQL Shell can connect using `--host=127.0.0.1` or `--host>::ffff:127.0.0.1`.
- If the address is a “regular” IPv4 or IPv6 address (such as `127.0.0.1` or `:::1`), X Plugin accepts TCP/IP connections only for that IPv4 or IPv6 address.

If binding to the address fails, X Plugin produces an error and the server does not load it.

- `mysqlx_connect_timeout`

Command-Line Format	<code>--mysqlx-connect-timeout=#</code>
Introduced	5.7.12
System Variable	<code>mysqlx_connect_timeout</code>

Scope	Global
Dynamic	Yes
Type	Integer
Default Value	30
Minimum Value	1
Maximum Value	1000000000
Unit	seconds

The number of seconds X Plugin waits for the first packet to be received from newly connected clients. This is the X Plugin equivalent of `connect_timeout`; see that variable description for more information.

- `mysqlx_idle_worker_thread_timeout`

Command-Line Format	<code>--mysqlx-idle-worker-thread-timeout=#</code>
Introduced	5.7.12
System Variable	<code>mysqlx_idle_worker_thread_timeout</code>
Scope	Global
Dynamic	Yes
Type	Integer
Default Value	60
Minimum Value	0
Maximum Value	3600
Unit	seconds

The number of seconds after which idle worker threads are terminated.

- `mysqlx_max_allowed_packet`

Command-Line Format	<code>--mysqlx-max-allowed-packet=#</code>
Introduced	5.7.12
System Variable	<code>mysqlx_max_allowed_packet</code>
Scope	Global
Dynamic	Yes
Type	Integer
Default Value	67108864
Minimum Value	512
Maximum Value	1073741824
Unit	bytes

The maximum size of network packets that can be received by X Plugin. This is the X Plugin equivalent of `max_allowed_packet`; see that variable description for more information.

- `mysqlx_max_connections`

Command-Line Format	<code>--mysqlx-max-connections=#</code>
---------------------	---

Introduced	5.7.12
System Variable	<a href="#">mysqlx_max_connections</a>
Scope	Global
Dynamic	Yes
Type	Integer
Default Value	100
Minimum Value	1
Maximum Value	65535

The maximum number of concurrent client connections X Plugin can accept. This is the X Plugin equivalent of [max\\_connections](#); see that variable description for more information.

For modifications to this variable, if the new value is smaller than the current number of connections, the new limit is taken into account only for new connections.

- [mysqlx\\_min\\_worker\\_threads](#)

Command-Line Format	<code>--mysqlx-min-worker-threads=#</code>
Introduced	5.7.12
System Variable	<a href="#">mysqlx_min_worker_threads</a>
Scope	Global
Dynamic	Yes
Type	Integer
Default Value	2
Minimum Value	1
Maximum Value	100

The minimum number of worker threads used by X Plugin for handling client requests.

- [mysqlx\\_port](#)

Command-Line Format	<code>--mysqlx-port=port_num</code>
Introduced	5.7.12
System Variable	<a href="#">mysqlx_port</a>
Scope	Global
Dynamic	No
Type	Integer
Default Value	33060
Minimum Value	1
Maximum Value	65535

The network port on which X Plugin listens for TCP/IP connections. This is the X Plugin equivalent of [port](#); see that variable description for more information.

- `mysqlx_port_open_timeout`

Command-Line Format	<code>--mysqlx-port-open-timeout=#</code>
Introduced	5.7.17
System Variable	<code>mysqlx_port_open_timeout</code>
Scope	Global
Dynamic	No
Type	Integer
Default Value	0
Minimum Value	0
Maximum Value	120
Unit	seconds

The number of seconds X Plugin waits for a TCP/IP port to become free.

- `mysqlx_socket`

Command-Line Format	<code>--mysqlx-socket=file_name</code>
Introduced	5.7.15
System Variable	<code>mysqlx_socket</code>
Scope	Global
Dynamic	No
Type	String
Default Value	<code>/tmp/mysqlx.sock</code>

The path to a Unix socket file which X Plugin uses for connections. This setting is only used by MySQL Server when running on Unix operating systems. Clients can use this socket to connect to MySQL Server using X Plugin.

The default `mysqlx_socket` path and file name is based on the default path and file name for the main socket file for MySQL Server, with the addition of an `x` appended to the file name. The default path and file name for the main socket file is `/tmp/mysql.sock`, therefore the default path and file name for the X Plugin socket file is `/tmp/mysqlx.sock`.

If you specify an alternative path and file name for the main socket file at server startup using the `socket` system variable, this does not affect the default for the X Plugin socket file. In this situation, if you want to store both sockets at a single path, you must set the `mysqlx_socket` system variable as well. For example in a configuration file:

```
socket=/home/sockets/mysqld/mysql.sock
mysqlx_socket=/home/sockets/xplugin/xplugin.sock
```

If you change the default path and file name for the main socket file at compile time using the `MYSQL_UNIX_ADDR` compile option, this does affect the default for the X Plugin socket file, which is

formed by appending an `x` to the `MYSQL_UNIX_ADDR` file name. If you want to set a different default for the X Plugin socket file at compile time, use the `MYSQLX_UNIX_ADDR` compile option.

The `MYSQLX_UNIX_PORT` environment variable can also be used to set a default for the X Plugin socket file at server startup (see [Section 4.9, “Environment Variables”](#)). If you set this environment variable, it overrides the compiled `MYSQLX_UNIX_ADDR` value, but is overridden by the `mysqlx_socket` value.

- `mysqlx_ssl_ca`

Command-Line Format	<code>--mysqlx-ssl-ca=file_name</code>
Introduced	5.7.12
System Variable	<code>mysqlx_ssl_ca</code>
Scope	Global
Dynamic	No
Type	File name
Default Value	NULL

The `mysqlx_ssl_ca` system variable is like `ssl_ca`, except that it applies to X Plugin rather than the MySQL Server main connection interface. For information about configuring encryption support for X Plugin, see [Section 19.4.1, “Using Encrypted Connections with X Plugin”](#).

- `mysqlx_ssl_capath`

Command-Line Format	<code>--mysqlx-ssl-capath=dir_name</code>
Introduced	5.7.12
System Variable	<code>mysqlx_ssl_capath</code>
Scope	Global
Dynamic	No
Type	Directory name
Default Value	NULL

The `mysqlx_ssl_capath` system variable is like `ssl_capath`, except that it applies to X Plugin rather than the MySQL Server main connection interface. For information about configuring encryption support for X Plugin, see [Section 19.4.1, “Using Encrypted Connections with X Plugin”](#).

- `mysqlx_ssl_cert`

Command-Line Format	<code>--mysqlx-ssl-cert=file_name</code>
Introduced	5.7.12
System Variable	<code>mysqlx_ssl_cert</code>
Scope	Global
Dynamic	No
Type	File name
Default Value	NULL

The `mysqlx_ssl_cert` system variable is like `ssl_cert`, except that it applies to X Plugin rather than the MySQL Server main connection interface. For information about configuring encryption support for X Plugin, see [Section 19.4.1, “Using Encrypted Connections with X Plugin”](#).

- `mysqlx_ssl_cipher`

Command-Line Format	<code>--mysqlx-ssl-cipher=name</code>
Introduced	5.7.12
System Variable	<code>mysqlx_ssl_cipher</code>
Scope	Global
Dynamic	No
Type	String
Default Value	NULL

The `mysqlx_ssl_cipher` system variable is like `ssl_cipher`, except that it applies to X Plugin rather than the MySQL Server main connection interface. For information about configuring encryption support for X Plugin, see [Section 19.4.1, “Using Encrypted Connections with X Plugin”](#).

- `mysqlx_ssl_crl`

Command-Line Format	<code>--mysqlx-ssl-crl=file_name</code>
Introduced	5.7.12
System Variable	<code>mysqlx_ssl_crl</code>
Scope	Global
Dynamic	No
Type	File name
Default Value	NULL

The `mysqlx_ssl_crl` system variable is like `ssl_crl`, except that it applies to X Plugin rather than the MySQL Server main connection interface. For information about configuring encryption support for X Plugin, see [Section 19.4.1, “Using Encrypted Connections with X Plugin”](#).

- `mysqlx_ssl_crlpath`

Command-Line Format	<code>--mysqlx-ssl-crlpath=dir_name</code>
Introduced	5.7.12
System Variable	<code>mysqlx_ssl_crlpath</code>
Scope	Global
Dynamic	No
Type	Directory name
Default Value	NULL

The `mysqlx_ssl_crlpath` system variable is like `ssl_crlpath`, except that it applies to X Plugin rather than the MySQL Server main connection interface. For information about configuring encryption support for X Plugin, see [Section 19.4.1, “Using Encrypted Connections with X Plugin”](#).

- `mysqlx_ssl_key`

Command-Line Format	<code>--mysqlx-ssl-key=file_name</code>
Introduced	5.7.12
System Variable	<code>mysqlx_ssl_key</code>

Scope	Global
Dynamic	No
Type	File name
Default Value	NULL

The `mysqlx_ssl_key` system variable is like `ssl_key`, except that it applies to X Plugin rather than the MySQL Server main connection interface. For information about configuring encryption support for X Plugin, see [Section 19.4.1, “Using Encrypted Connections with X Plugin”](#).

### 19.4.2.3 X Plugin Status Variables

The X Plugin status variables have the following meanings.

- `mysqlx_address`

The network address which X Plugin is bound to. If the bind has failed, or if the `skip_networking` option has been used, the value shows `UNDEFINED`.

- `mysqlx_bytes_received`

The number of bytes received through the network.

- `mysqlx_bytes_sent`

The number of bytes sent through the network.

- `mysqlx_connection_accept_errors`

The number of connections which have caused accept errors.

- `mysqlx_connection_errors`

The number of connections which have caused errors.

- `mysqlx_connections_accepted`

The number of connections which have been accepted.

- `mysqlx_connections_closed`

The number of connections which have been closed.

- `mysqlx_connections_rejected`

The number of connections which have been rejected.

- `mysqlx_crud_create_view`

The number of create view requests received.

- `mysqlx_crud_delete`

The number of delete requests received.

- `mysqlx_crud_drop_view`

The number of drop view requests received.

- `Mysqlx_crud_find`  
The number of find requests received.
- `Mysqlx_crud_insert`  
The number of insert requests received.
- `Mysqlx_crud_modify_view`  
The number of modify view requests received.
- `Mysqlx_crud_update`  
The number of update requests received.
- `Mysqlx_errors_sent`  
The number of errors sent to clients.
- `Mysqlx_errors_unknown_message_type`  
The number of unknown message types that have been received.
- `Mysqlx_expect_close`  
The number of expectation blocks closed.
- `Mysqlx_expect_open`  
The number of expectation blocks opened.
- `Mysqlx_init_error`  
The number of errors during initialisation.
- `Mysqlx_notice_other_sent`  
The number of other types of notices sent back to clients.
- `Mysqlx_notice_warning_sent`  
The number of warning notices sent back to clients.
- `Mysqlx_port`  
The TCP port which X Plugin is listening to. If a network bind has failed, or if the `skip_networking` system variable is enabled, the value shows `UNDEFINED`.
- `Mysqlx_rows_sent`  
The number of rows sent back to clients.
- `Mysqlx_sessions`  
The number of sessions that have been opened.
- `Mysqlx_sessions_accepted`  
The number of session attempts which have been accepted.



- `Mysqlx_sessions_closed`  
The number of sessions that have been closed.
- `Mysqlx_sessions_fatal_error`  
The number of sessions that have closed with a fatal error.
- `Mysqlx_sessions_killed`  
The number of sessions which have been killed.
- `Mysqlx_sessions_rejected`  
The number of session attempts which have been rejected.
- `Mysqlx_socket`  
The Unix socket which X Plugin is listening to.
- `Mysqlx_ssl_accept_renegotiates`  
The number of negotiations needed to establish the connection.
- `Mysqlx_ssl_accepts`  
The number of accepted SSL connections.
- `Mysqlx_ssl_active`  
If SSL is active.
- `Mysqlx_ssl_cipher`  
The current SSL cipher (empty for non-SSL connections).
- `Mysqlx_ssl_cipher_list`  
A list of possible SSL ciphers (empty for non-SSL connections).
- `Mysqlx_ssl_ctx_verify_depth`  
The certificate verification depth limit currently set in ctx.
- `Mysqlx_ssl_ctx_verify_mode`  
The certificate verification mode currently set in ctx.
- `Mysqlx_ssl_finished_accepts`  
The number of successful SSL connections to the server.
- `Mysqlx_ssl_server_not_after`  
The last date for which the SSL certificate is valid.
- `Mysqlx_ssl_server_not_before`  
The first date for which the SSL certificate is valid.

- `Mysqlx_ssl_verify_depth`  
The certificate verification depth for SSL connections.
- `Mysqlx_ssl_verify_mode`  
The certificate verification mode for SSL connections.
- `Mysqlx_ssl_version`  
The name of the protocol used for SSL connections.
- `Mysqlx_stmt_create_collection`  
The number of create collection statements received.
- `Mysqlx_stmt_create_collection_index`  
The number of create collection index statements received.
- `Mysqlx_stmt_disable_notices`  
The number of disable notice statements received.
- `Mysqlx_stmt_drop_collection`  
The number of drop collection statements received.
- `Mysqlx_stmt_drop_collection_index`  
The number of drop collection index statements received.
- `Mysqlx_stmt_enable_notices`  
The number of enable notice statements received.
- `Mysqlx_stmt_ensure_collection`  
The number of ensure collection statements received.
- `Mysqlx_stmt_execute_mysqlx`  
The number of StmtExecute messages received with namespace set to `mysqlx`.
- `Mysqlx_stmt_execute_sql`  
The number of StmtExecute requests received for the SQL namespace.
- `Mysqlx_stmt_execute_xplugin`  
The number of StmtExecute requests received for the X Plugin namespace.
- `Mysqlx_stmt_kill_client`  
The number of kill client statements received.
- `Mysqlx_stmt_list_clients`  
The number of list client statements received.

- `Mysqlx_stmt_list_notices`  
The number of list notice statements received.
- `Mysqlx_stmt_list_objects`  
The number of list object statements received.
- `Mysqlx_stmt_ping`  
The number of ping statements received.
- `Mysqlx_worker_threads`  
The number of worker threads available.
- `Mysqlx_worker_threads_active`  
The number of worker threads currently used.

### 19.4.3 Monitoring X Plugin

To monitor X Plugin, use the status variables that it exposes. See [Section 19.4.2.3, “X Plugin Status Variables”](#).



## Chapter 20 InnoDB Cluster

This chapter introduces MySQL InnoDB Cluster, which combines MySQL technologies to enable you to deploy and administer a complete integrated high availability solution for MySQL. This content is a high-level overview of InnoDB Cluster, for full documentation, see [MySQL InnoDB Cluster](#).



### Important

InnoDB Cluster does not provide support for MySQL NDB Cluster. For more information about MySQL NDB Cluster, see [Chapter 21, MySQL NDB Cluster 7.5 and NDB Cluster 7.6](#) and [Section 21.2.6, “MySQL Server Using InnoDB Compared with NDB Cluster”](#).

An InnoDB Cluster consists of at least three MySQL Server instances, and it provides high-availability and scaling features. InnoDB Cluster uses the following MySQL technologies:

- [MySQL Shell](#), which is an advanced client and code editor for MySQL.
- MySQL Server, and [Group Replication](#), which enables a set of MySQL instances to provide high-availability. InnoDB Cluster provides an alternative, easy to use programmatic way to work with Group Replication.
- [MySQL Router](#), a lightweight middleware that provides transparent routing between your application and InnoDB Cluster.

The following diagram shows an overview of how these technologies work together:

**Figure 20.1 InnoDB Cluster overview**

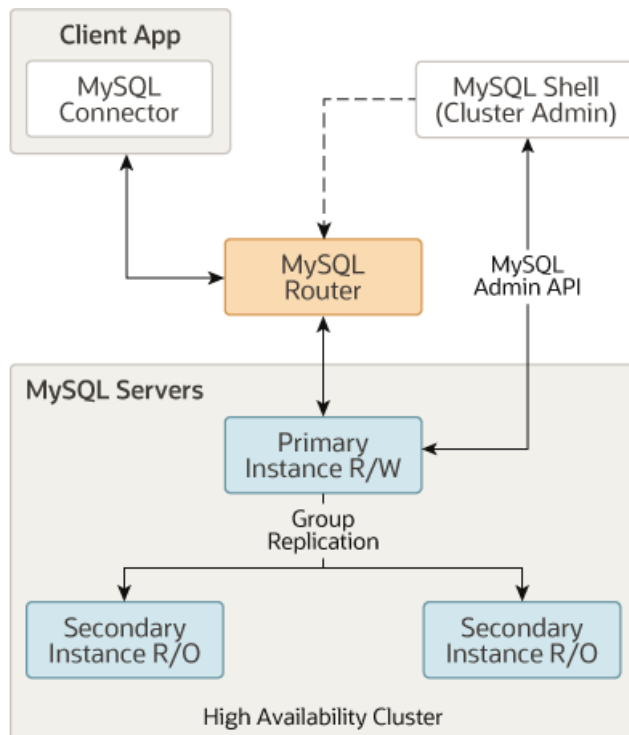

Being built on MySQL [Group Replication](#), provides features such as automatic membership management, fault tolerance, automatic failover, and so on. An InnoDB Cluster usually runs in a single-primary mode,

---

with one primary instance (read-write) and multiple secondary instances (read-only). Advanced users can also take advantage of a [multi-primary](#) mode, where all instances are primaries.

You work with InnoDB Cluster using the [AdminAPI](#), provided as part of MySQL Shell. AdminAPI is available in JavaScript and Python, and is well suited to scripting and automation of deployments of MySQL to achieve high-availability and scalability. By using MySQL Shell's AdminAPI, you can avoid the need to configure many instances manually. Instead, AdminAPI provides an effective modern interface to sets of MySQL instances and enables you to provision, administer, and monitor your deployment from one central tool.

To get started with InnoDB Cluster you need to [download](#) and [install](#) MySQL Shell. You need some hosts with MySQL Server instances [installed](#), and you can also [install](#) MySQL Router.

InnoDB Cluster supports [MySQL Clone](#), which enables you to provision instances simply. In the past, to provision a new instance before it joins a set of MySQL instances you would need to somehow manually transfer the transactions to the joining instance. This could involve making file copies, manually copying them, and so on. Using InnoDB Cluster, you can simply [add an instance](#) to the cluster and it is automatically provisioned.

Similarly, InnoDB Cluster is tightly integrated with [MySQL Router](#), and you can use AdminAPI to [work with](#) them together. MySQL Router can automatically configure itself based on an InnoDB Cluster, in a process called [bootstrapping](#), which removes the need for you to configure routing manually. MySQL Router then transparently connects client applications to the InnoDB Cluster, providing routing and load-balancing for client connections. This integration also enables you to administer some aspects of a MySQL Router bootstrapped against an InnoDB Cluster using AdminAPI. InnoDB Cluster status information includes details about MySQL Routers bootstrapped against the cluster. Operations enable you to [create MySQL Router users](#) at the cluster level, to work with the MySQL Routers bootstrapped against the cluster, and so on.

AdminAPI is compatible with instances running MySQL 5.7, but with a reduced feature set. For more information, see [Using Instances Running MySQL 5.7](#). For the best experience using AdminAPI and InnoDB Cluster [upgrade](#) to MySQL 8.0.

For more information on these technologies, see the user documentation linked in the descriptions. In addition to this user documentation, there is developer documentation for all AdminAPI methods in the [MySQL Shell JavaScript API Reference](#) or [MySQL Shell Python API Reference](#), available from [Connectors and APIs](#).

---

# Chapter 21 MySQL NDB Cluster 7.5 and NDB Cluster 7.6

## Table of Contents

21.1	General Information .....	3283
21.2	NDB Cluster Overview .....	3285
21.2.1	NDB Cluster Core Concepts .....	3287
21.2.2	NDB Cluster Nodes, Node Groups, Fragment Replicas, and Partitions .....	3290
21.2.3	NDB Cluster Hardware, Software, and Networking Requirements .....	3293
21.2.4	What is New in MySQL NDB Cluster .....	3294
21.2.5	NDB: Added, Deprecated, and Removed Options, Variables, and Parameters .....	3311
21.2.6	MySQL Server Using InnoDB Compared with NDB Cluster .....	3315
21.2.7	Known Limitations of NDB Cluster .....	3318
21.3	NDB Cluster Installation .....	3331
21.3.1	Installation of NDB Cluster on Linux .....	3333
21.3.2	Installing NDB Cluster on Windows .....	3341
21.3.3	Initial Configuration of NDB Cluster .....	3350
21.3.4	Initial Startup of NDB Cluster .....	3352
21.3.5	NDB Cluster Example with Tables and Data .....	3353
21.3.6	Safe Shutdown and Restart of NDB Cluster .....	3356
21.3.7	Upgrading and Downgrading NDB Cluster .....	3357
21.3.8	The NDB Cluster Auto-Installer (NDB 7.5) (NO LONGER SUPPORTED) .....	3361
21.3.9	The NDB Cluster Auto-Installer (NO LONGER SUPPORTED) .....	3361
21.4	Configuration of NDB Cluster .....	3361
21.4.1	Quick Test Setup of NDB Cluster .....	3362
21.4.2	Overview of NDB Cluster Configuration Parameters, Options, and Variables .....	3364
21.4.3	NDB Cluster Configuration Files .....	3383
21.4.4	Using High-Speed Interconnects with NDB Cluster .....	3570
21.5	NDB Cluster Programs .....	3570
21.5.1	ndbd — The NDB Cluster Data Node Daemon .....	3570
21.5.2	ndbinfo_select_all — Select From ndbinfo Tables .....	3581
21.5.3	ndbmtd — The NDB Cluster Data Node Daemon (Multi-Threaded) .....	3587
21.5.4	ndb_mgmd — The NDB Cluster Management Server Daemon .....	3588
21.5.5	ndb_mgm — The NDB Cluster Management Client .....	3600
21.5.6	ndb_blob_tool — Check and Repair BLOB and TEXT columns of NDB Cluster Tables ....	3606
21.5.7	ndb_config — Extract NDB Cluster Configuration Information .....	3612
21.5.8	ndb_cpctest — Automate Testing for NDB Development .....	3624
21.5.9	ndb_delete_all — Delete All Rows from an NDB Table .....	3624
21.5.10	ndb_desc — Describe NDB Tables .....	3629
21.5.11	ndb_drop_index — Drop Index from an NDB Table .....	3639
21.5.12	ndb_drop_table — Drop an NDB Table .....	3644
21.5.13	ndb_error_reporter — NDB Error-Reporting Utility .....	3648
21.5.14	ndb_import — Import CSV Data Into NDB .....	3650
21.5.15	ndb_index_stat — NDB Index Statistics Utility .....	3669
21.5.16	ndb_move_data — NDB Data Copy Utility .....	3677
21.5.17	ndb_perror — Obtain NDB Error Message Information .....	3683
21.5.18	ndb_print_backup_file — Print NDB Backup File Contents .....	3685
21.5.19	ndb_print_file — Print NDB Disk Data File Contents .....	3685
21.5.20	ndb_print_frag_file — Print NDB Fragment List File Contents .....	3686
21.5.21	ndb_print_schema_file — Print NDB Schema File Contents .....	3687
21.5.22	ndb_print_sys_file — Print NDB System File Contents .....	3687

21.5.23	<code>ndb_redo_log_reader</code> — Check and Print Content of Cluster Redo Log .....	3687
21.5.24	<code>ndb_restore</code> — Restore an NDB Cluster Backup .....	3690
21.5.25	<code>ndb_select_all</code> — Print Rows from an NDB Table .....	3721
21.5.26	<code>ndb_select_count</code> — Print Row Counts for NDB Tables .....	3728
21.5.27	<code>ndb_show_tables</code> — Display List of NDB Tables .....	3732
21.5.28	<code>ndb_size.pl</code> — NDBCLUSTER Size Requirement Estimator .....	3737
21.5.29	<code>ndb_top</code> — View CPU usage information for NDB threads .....	3740
21.5.30	<code>ndb_waiter</code> — Wait for NDB Cluster to Reach a Given Status .....	3747
21.6	Management of NDB Cluster .....	3754
21.6.1	Commands in the NDB Cluster Management Client .....	3755
21.6.2	NDB Cluster Log Messages .....	3761
21.6.3	Event Reports Generated in NDB Cluster .....	3780
21.6.4	Summary of NDB Cluster Start Phases .....	3792
21.6.5	Performing a Rolling Restart of an NDB Cluster .....	3794
21.6.6	NDB Cluster Single User Mode .....	3796
21.6.7	Adding NDB Cluster Data Nodes Online .....	3797
21.6.8	Online Backup of NDB Cluster .....	3808
21.6.9	Importing Data Into MySQL Cluster .....	3813
21.6.10	MySQL Server Usage for NDB Cluster .....	3814
21.6.11	NDB Cluster Disk Data Tables .....	3816
21.6.12	Online Operations with ALTER TABLE in NDB Cluster .....	3822
21.6.13	Distributed Privileges Using Shared Grant Tables .....	3826
21.6.14	NDB API Statistics Counters and Variables .....	3829
21.6.15	<code>ndbinfo</code> : The NDB Cluster Information Database .....	3840
21.6.16	INFORMATION_SCHEMA Tables for NDB Cluster .....	3914
21.6.17	Quick Reference: NDB Cluster SQL Statements .....	3914
21.6.18	NDB Cluster Security Issues .....	3923
21.7	NDB Cluster Replication .....	3930
21.7.1	NDB Cluster Replication: Abbreviations and Symbols .....	3932
21.7.2	General Requirements for NDB Cluster Replication .....	3932
21.7.3	Known Issues in NDB Cluster Replication .....	3933
21.7.4	NDB Cluster Replication Schema and Tables .....	3940
21.7.5	Preparing the NDB Cluster for Replication .....	3947
21.7.6	Starting NDB Cluster Replication (Single Replication Channel) .....	3949
21.7.7	Using Two Replication Channels for NDB Cluster Replication .....	3951
21.7.8	Implementing Failover with NDB Cluster Replication .....	3952
21.7.9	NDB Cluster Backups With NDB Cluster Replication .....	3954
21.7.10	NDB Cluster Replication: Bidirectional and Circular Replication .....	3960
21.7.11	NDB Cluster Replication Conflict Resolution .....	3965
21.8	NDB Cluster Release Notes .....	3978

This chapter provides information about MySQL *NDB Cluster*, a high-availability, high-redundancy version of MySQL adapted for the distributed computing environment which enables running several computers with MySQL servers and other software in a cluster. This chapter also provides information specific to NDB Cluster 7.5 releases through 5.7.44-ndb-7.5.36 and NDB Cluster 7.6 releases through 5.7.44-ndb-7.6.36, both of which are previous General Availability (GA) releases still supported in production. The latest available releases of these are 5.7.44-ndb-7.5.36 and 5.7.44-ndb-7.6.35, respectively. A more recent NDB Cluster stable release series uses version 8.0 of the [NDB](#) storage engine (also known as [NDBCLUSTER](#)). NDB Cluster 8.0, now available as a General Availability (GA) release beginning with version 8.0.19, incorporates version 8.0 of the [NDB](#) storage engine; see [MySQL NDB Cluster 8.0](#), for more information about NDB 8.0. NDB Cluster 8.4 (NDB 8.4.7), based on version 8.4 of the NDB storage engine, is also available as an LTS release. See [What is New in MySQL NDB Cluster 8.4](#), for information about differences in NDB 8.4 as compared to earlier releases. Previous GA releases NDB Cluster 7.4 and



NDB Cluster 7.3 incorporated [NDB](#) versions 7.4 and 7.3, respectively. *NDB 7.4 and older release series are no longer supported or maintained.* Both NDB 8.0 and NDB 8.1 are supported in production, and are recommended for new deployments.

## 21.1 General Information

MySQL NDB Cluster uses the MySQL server with the [NDB](#) storage engine. Support for the [NDB](#) storage engine is not included in standard MySQL Server 5.7 binaries built by Oracle. Instead, users of NDB Cluster binaries from Oracle should upgrade to the most recent binary release of NDB Cluster for supported platforms—these include RPMs that should work with most Linux distributions. NDB Cluster users who build from source should use the sources provided for NDB Cluster. (Locations where the sources can be obtained are listed later in this section.)



### Important

MySQL NDB Cluster does not support InnoDB Cluster, which must be deployed using MySQL Server 5.7 with the [InnoDB](#) storage engine as well as additional applications that are not included in the NDB Cluster distribution. MySQL Server 5.7 binaries cannot be used with MySQL NDB Cluster. For more information about deploying and using InnoDB Cluster, see [MySQL AdminAPI, Section 21.2.6, “MySQL Server Using InnoDB Compared with NDB Cluster”](#), discusses differences between the [NDB](#) and [InnoDB](#) storage engines.

**Supported Platforms.** NDB Cluster is currently available and supported on a number of platforms. For exact levels of support available for on specific combinations of operating system versions, operating system distributions, and hardware platforms, please refer to <https://www.mysql.com/support/supportedplatforms/cluster.html>.

**Availability.** NDB Cluster binary and source packages are available for supported platforms from <https://dev.mysql.com/downloads/cluster/>.

**NDB Cluster release numbers.** NDB Cluster follows a somewhat different release pattern from the mainline MySQL Server 5.7 series of releases. In this *Manual* and other MySQL documentation, we identify these and later NDB Cluster releases employing a version number that begins with “NDB”. This version number is that of the [NDBCLUSTER](#) storage engine used in the release, and not of the MySQL server version on which the NDB Cluster release is based.

**Version strings used in NDB Cluster software.** The version string displayed by NDB Cluster programs uses this format:

```
mysql-mysql_server_version-ndb-ndb_engine_version
```

*mysql\_server\_version* represents the version of the MySQL Server on which the NDB Cluster release is based. For all NDB Cluster 7.5 and NDB Cluster 7.6 releases, this is “5.7”. *ndb\_engine\_version* is the version of the [NDB](#) storage engine used by this release of the NDB Cluster software. You can see this format used in the [mysql](#) client, as shown here:

```
$> mysql
Welcome to the MySQL monitor.  Commands end with ; or \g.
Your MySQL connection id is 2
Server version: 5.7.44-ndb-7.5.36 Source distribution

Type 'help;' or '\h' for help. Type '\c' to clear the buffer.

mysql> SELECT VERSION()\G
```

```
***** 1. row *****
VERSION(): 5.7.44-ndb-7.5.36
1 row in set (0.00 sec)
```

This version string is also displayed in the output of the `SHOW` command in the `ndb_mgm` client:

```
ndb_mgm> SHOW
Connected to Management Server at: localhost:1186
Cluster Configuration
-----
[ndbd(NDB)] 2 node(s)
id=1 @10.0.10.6 (5.7.44-ndb-7.5.36, Nodegroup: 0, *)
id=2 @10.0.10.8 (5.7.44-ndb-7.5.36, Nodegroup: 0)

[ndb_mgmd(MGM)] 1 node(s)
id=3 @10.0.10.2 (5.7.44-ndb-7.5.36)

[mysqld(API)] 2 node(s)
id=4 @10.0.10.10 (5.7.44-ndb-7.5.36)
id=5 (not connected, accepting connect from any host)
```

The version string identifies the mainline MySQL version from which the NDB Cluster release was branched and the version of the `NDB` storage engine used. For example, the full version string for NDB 7.5.4 (the first NDB 7.5 GA release) was `mysql-5.7.16-ndb-7.5.4`. From this we can determine the following:

- Since the portion of the version string preceding `-ndb-` is the base MySQL Server version, this means that NDB 7.5.4 derived from MySQL 5.7.16, and contained all feature enhancements and bug fixes from MySQL 5.7 up to and including MySQL 5.7.16.
- Since the portion of the version string following `-ndb-` represents the version number of the `NDB` (or `NDBCLUSTER`) storage engine, NDB 7.5.4 used version 7.5.4 of the `NDBCLUSTER` storage engine.

New NDB Cluster releases are numbered according to updates in the `NDB` storage engine, and do not necessarily correspond in a one-to-one fashion with mainline MySQL Server releases. For example, NDB 7.5.4 (as previously noted) was based on MySQL 5.7.16, while NDB 7.5.3 was based on MySQL 5.7.13 (version string: `mysql-5.7.13-ndb-7.5.3`).

**Compatibility with standard MySQL 5.7 releases.** While many standard MySQL schemas and applications can work using NDB Cluster, it is also true that unmodified applications and database schemas may be slightly incompatible or have suboptimal performance when run using NDB Cluster (see [Section 21.2.7, “Known Limitations of NDB Cluster”](#)). Most of these issues can be overcome, but this also means that you are very unlikely to be able to switch an existing application datastore—that currently uses, for example, `MyISAM` or `InnoDB`—to use the `NDB` storage engine without allowing for the possibility of changes in schemas, queries, and applications. In addition, the MySQL Server and NDB Cluster codebases diverge considerably, so that the standard `mysqld` cannot function as a drop-in replacement for the version of `mysqld` supplied with NDB Cluster.

**NDB Cluster development source trees.** NDB Cluster development trees can also be accessed from <https://github.com/mysql/mysql-server>.

The NDB Cluster development sources maintained at <https://github.com/mysql/mysql-server> are licensed under the GPL. For information about obtaining MySQL sources using Git and building them yourself, see [Section 2.8.5, “Installing MySQL Using a Development Source Tree”](#).



### Note

NDB Cluster 7.6 releases are built using `CMake`.

NDB Cluster 8.0 (GA) and NDB Cluster 8.4 (LTS), are recommended for new deployments; see [What is New in MySQL NDB Cluster 8.0](#), and [What is New in MySQL NDB Cluster 8.4](#), respectively, for more information about these release series. NDB Cluster 9.3 is also available as an Innovation release (see [What is New in MySQL NDB Cluster 9.4](#)). NDB Cluster 7.6 is a previous GA release still supported in production. NDB Cluster 7.5 and earlier are previous GA releases which are no longer maintained. We recommend that new deployments for production use MySQL NDB Cluster 8.0.

The contents of this chapter are subject to revision as NDB Cluster continues to evolve. Additional information regarding NDB Cluster can be found on the MySQL website at <http://www.mysql.com/products/cluster/>.

**Additional Resources.** More information about NDB Cluster can be found in the following places:

- For answers to some commonly asked questions about NDB Cluster, see [Section A.10, “MySQL 5.7 FAQ: NDB Cluster”](#).
- The NDB Cluster Forum: <https://forums.mysql.com/list.php?25>.
- Many NDB Cluster users and developers blog about their experiences with NDB Cluster, and make feeds of these available through [PlanetMySQL](#).

## 21.2 NDB Cluster Overview

*NDB Cluster* is a technology that enables clustering of in-memory databases in a shared-nothing system. The shared-nothing architecture enables the system to work with very inexpensive hardware, and with a minimum of specific requirements for hardware or software.

NDB Cluster is designed not to have any single point of failure. In a shared-nothing system, each component is expected to have its own memory and disk, and the use of shared storage mechanisms such as network shares, network file systems, and SANs is not recommended or supported.

NDB Cluster integrates the standard MySQL server with an in-memory clustered storage engine called **NDB** (which stands for “Network *DataBase*”). In our documentation, the term **NDB** refers to the part of the setup that is specific to the storage engine, whereas “MySQL NDB Cluster” refers to the combination of one or more MySQL servers with the **NDB** storage engine.

An NDB Cluster consists of a set of computers, known as *hosts*, each running one or more processes. These processes, known as *nodes*, may include MySQL servers (for access to NDB data), data nodes (for storage of the data), one or more management servers, and possibly other specialized data access programs. The relationship of these components in an NDB Cluster is shown here:

Figure 21.1 NDB Cluster Components

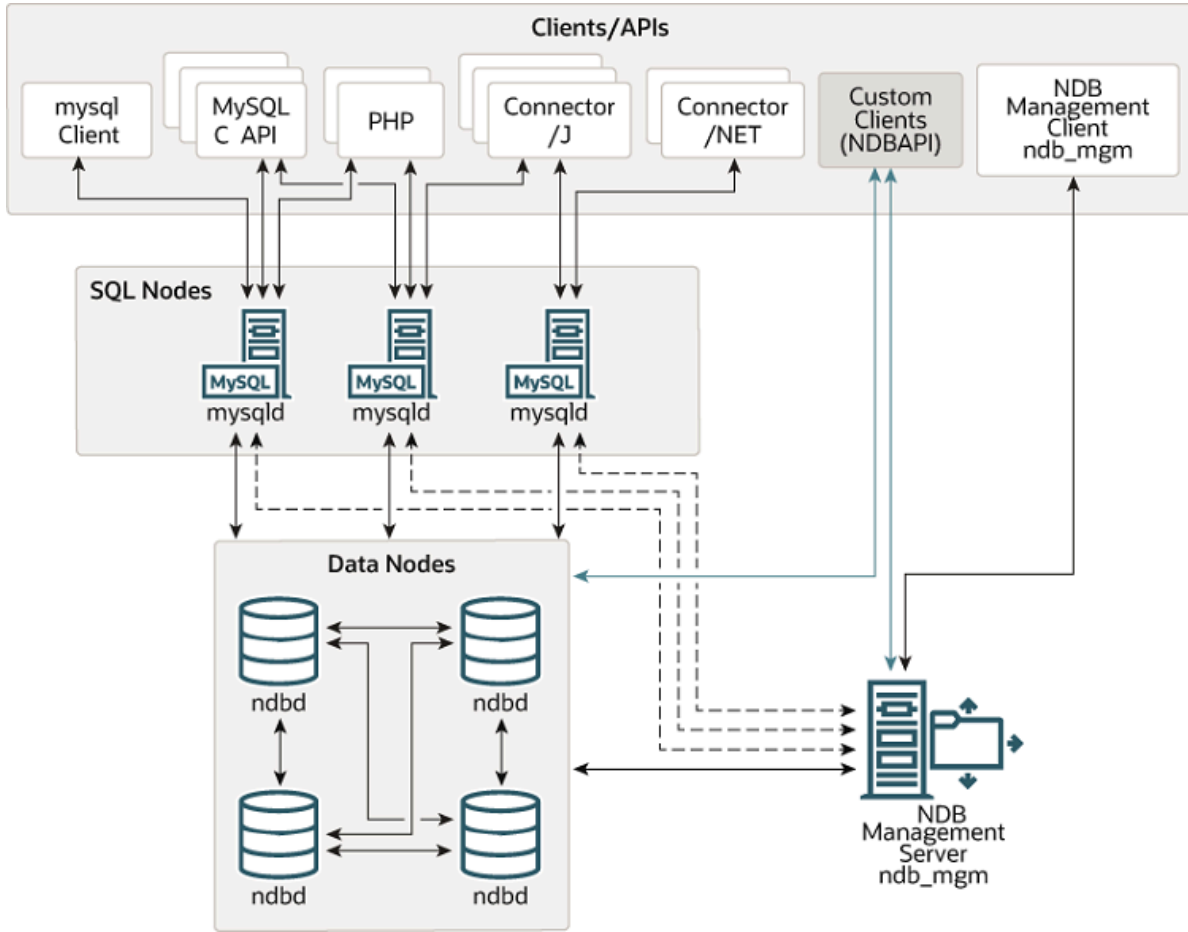

All these programs work together to form an NDB Cluster (see [Section 21.5, “NDB Cluster Programs”](#)). When data is stored by the **NDB** storage engine, the tables (and table data) are stored in the data nodes. Such tables are directly accessible from all other MySQL servers (SQL nodes) in the cluster. Thus, in a payroll application storing data in a cluster, if one application updates the salary of an employee, all other MySQL servers that query this data can see this change immediately.

Although an NDB Cluster SQL node uses the `mysqld` server daemon, it differs in a number of critical respects from the `mysqld` binary supplied with the MySQL 5.7 distributions, and the two versions of `mysqld` are not interchangeable.

In addition, a MySQL server that is not connected to an NDB Cluster cannot use the **NDB** storage engine and cannot access any NDB Cluster data.

The data stored in the data nodes for NDB Cluster can be mirrored; the cluster can handle failures of individual data nodes with no other impact than that a small number of transactions are aborted due to losing the transaction state. Because transactional applications are expected to handle transaction failure, this should not be a source of problems.

Individual nodes can be stopped and restarted, and can then rejoin the system (cluster). Rolling restarts (in which all nodes are restarted in turn) are used in making configuration changes and software upgrades (see [Section 21.6.5, “Performing a Rolling Restart of an NDB Cluster”](#)). Rolling restarts are also used as part of the process of adding new data nodes online (see [Section 21.6.7, “Adding NDB Cluster Data Nodes Online”](#)). For more information about data nodes, how they are organized in an NDB Cluster, and how they

handle and store NDB Cluster data, see [Section 21.2.2, “NDB Cluster Nodes, Node Groups, Fragment Replicas, and Partitions”](#).

Backing up and restoring NDB Cluster databases can be done using the NDB-native functionality found in the NDB Cluster management client and the `ndb_restore` program included in the NDB Cluster distribution. For more information, see [Section 21.6.8, “Online Backup of NDB Cluster”](#), and [Section 21.5.24, “ndb\\_restore — Restore an NDB Cluster Backup”](#). You can also use the standard MySQL functionality provided for this purpose in `mysqldump` and the MySQL server. See [Section 4.5.4, “mysqldump — A Database Backup Program”](#), for more information.

NDB Cluster nodes can employ different transport mechanisms for inter-node communications; TCP/IP over standard 100 Mbps or faster Ethernet hardware is used in most real-world deployments.

## 21.2.1 NDB Cluster Core Concepts

`NDBCLUSTER` (also known as `NDB`) is an in-memory storage engine offering high-availability and data-persistence features.

The `NDBCLUSTER` storage engine can be configured with a range of failover and load-balancing options, but it is easiest to start with the storage engine at the cluster level. NDB Cluster's `NDB` storage engine contains a complete set of data, dependent only on other data within the cluster itself.

The “Cluster” portion of NDB Cluster is configured independently of the MySQL servers. In an NDB Cluster, each part of the cluster is considered to be a *node*.



### Note

In many contexts, the term “node” is used to indicate a computer, but when discussing NDB Cluster it means a *process*. It is possible to run multiple nodes on a single computer; for a computer on which one or more cluster nodes are being run we use the term *cluster host*.

There are three types of cluster nodes, and in a minimal NDB Cluster configuration, there must be at least three nodes, one of each of these types:

- *Management node*: The role of this type of node is to manage the other nodes within the NDB Cluster, performing such functions as providing configuration data, starting and stopping nodes, and running backups. Because this node type manages the configuration of the other nodes, a node of this type should be started first, before any other node. A management node is started with the command `ndb_mgmd`.
- *Data node*: This type of node stores cluster data. There are as many data nodes as there are fragment replicas, times the number of fragments (see [Section 21.2.2, “NDB Cluster Nodes, Node Groups, Fragment Replicas, and Partitions”](#)). For example, with two fragment replicas, each having two fragments, you need four data nodes. One fragment replica is sufficient for data storage, but provides no redundancy; therefore, it is recommended to have two (or more) fragment replicas to provide redundancy, and thus high availability. A data node is started with the command `ndbd` (see [Section 21.5.1, “ndbd — The NDB Cluster Data Node Daemon”](#)) or `ndbmtd` (see [Section 21.5.3, “ndbmtd — The NDB Cluster Data Node Daemon \(Multi-Threaded\)”](#)).

NDB Cluster tables are normally stored completely in memory rather than on disk (this is why we refer to NDB Cluster as an *in-memory* database). However, some NDB Cluster data can be stored on disk; see [Section 21.6.11, “NDB Cluster Disk Data Tables”](#), for more information.

- *SQL node*: This is a node that accesses the cluster data. In the case of NDB Cluster, an SQL node is a traditional MySQL server that uses the `NDBCLUSTER` storage engine. An SQL node is a `mysqld` process

started with the `--ndbcluster` and `--ndb-connectstring` options, which are explained elsewhere in this chapter, possibly with additional MySQL server options as well.

An SQL node is actually just a specialized type of *API node*, which designates any application which accesses NDB Cluster data. Another example of an API node is the `ndb_restore` utility that is used to restore a cluster backup. It is possible to write such applications using the NDB API. For basic information about the NDB API, see [Getting Started with the NDB API](#).



### Important

It is not realistic to expect to employ a three-node setup in a production environment. Such a configuration provides no redundancy; to benefit from NDB Cluster's high-availability features, you must use multiple data and SQL nodes. The use of multiple management nodes is also highly recommended.

For a brief introduction to the relationships between nodes, node groups, fragment replicas, and partitions in NDB Cluster, see [Section 21.2.2, “NDB Cluster Nodes, Node Groups, Fragment Replicas, and Partitions”](#).

Configuration of a cluster involves configuring each individual node in the cluster and setting up individual communication links between nodes. NDB Cluster is currently designed with the intention that data nodes are homogeneous in terms of processor power, memory space, and bandwidth. In addition, to provide a single point of configuration, all configuration data for the cluster as a whole is located in one configuration file.

The management server manages the cluster configuration file and the cluster log. Each node in the cluster retrieves the configuration data from the management server, and so requires a way to determine where the management server resides. When interesting events occur in the data nodes, the nodes transfer information about these events to the management server, which then writes the information to the cluster log.

In addition, there can be any number of cluster client processes or applications. These include standard MySQL clients, NDB-specific API programs, and management clients. These are described in the next few paragraphs.

**Standard MySQL clients.** NDB Cluster can be used with existing MySQL applications written in PHP, Perl, C, C++, Java, Python, and so on. Such client applications send SQL statements to and receive responses from MySQL servers acting as NDB Cluster SQL nodes in much the same way that they interact with standalone MySQL servers.

MySQL clients using an NDB Cluster as a data source can be modified to take advantage of the ability to connect with multiple MySQL servers to achieve load balancing and failover. For example, Java clients using Connector/J 5.0.6 and later can use `jdbc:mysql:loadbalance://` URLs (improved in Connector/J 5.1.7) to achieve load balancing transparently; for more information about using Connector/J with NDB Cluster, see [Using Connector/J with NDB Cluster](#).

**NDB client programs.** Client programs can be written that access NDB Cluster data directly from the `NDBCLUSTER` storage engine, bypassing any MySQL Servers that may be connected to the cluster, using the *NDB API*, a high-level C++ API. Such applications may be useful for specialized purposes where an SQL interface to the data is not needed. For more information, see [The NDB API](#).

NDB-specific Java applications can also be written for NDB Cluster using the *NDB Cluster Connector for Java*. This NDB Cluster Connector includes *ClusterJ*, a high-level database API similar to object-relational mapping persistence frameworks such as Hibernate and JPA that connect directly to `NDBCLUSTER`, and so does not require access to a MySQL Server. See [Java and NDB Cluster](#), and [The ClusterJ API and Data Object Model](#), for more information.

**Management clients.** These clients connect to the management server and provide commands for starting and stopping nodes gracefully, starting and stopping message tracing (debug versions only), showing node versions and status, starting and stopping backups, and so on. An example of this type of program is the `ndb_mgm` management client supplied with NDB Cluster (see [Section 21.5.5, “ndb\\_mgm — The NDB Cluster Management Client”](#)). Such applications can be written using the *MGM API*, a C-language API that communicates directly with one or more NDB Cluster management servers. For more information, see [The MGM API](#).

Oracle also makes available MySQL Cluster Manager, which provides an advanced command-line interface simplifying many complex NDB Cluster management tasks, such as restarting an NDB Cluster with a large number of nodes. The MySQL Cluster Manager client also supports commands for getting and setting the values of most node configuration parameters as well as `mysqld` server options and variables relating to NDB Cluster. See [MySQL Cluster Manager 1.4.8 User Manual](#), for more information.

**Event logs.** NDB Cluster logs events by category (startup, shutdown, errors, checkpoints, and so on), priority, and severity. A complete listing of all reportable events may be found in [Section 21.6.3, “Event Reports Generated in NDB Cluster”](#). Event logs are of the two types listed here:

- *Cluster log*: Keeps a record of all desired reportable events for the cluster as a whole.
- *Node log*: A separate log which is also kept for each individual node.

**Note**

Under normal circumstances, it is necessary and sufficient to keep and examine only the cluster log. The node logs need be consulted only for application development and debugging purposes.

**Checkpoint.** Generally speaking, when data is saved to disk, it is said that a *checkpoint* has been reached. More specific to NDB Cluster, a checkpoint is a point in time where all committed transactions are stored on disk. With regard to the `NDB` storage engine, there are two types of checkpoints which work together to ensure that a consistent view of the cluster's data is maintained. These are shown in the following list:

- *Local Checkpoint (LCP)*: This is a checkpoint that is specific to a single node; however, LCPs take place for all nodes in the cluster more or less concurrently. An LCP usually occurs every few minutes; the precise interval varies, and depends upon the amount of data stored by the node, the level of cluster activity, and other factors.

Previously, an LCP involved saving all of a node's data to disk. NDB 7.6 introduces support for partial LCPs, which can significantly improve recovery time under some conditions. See [Section 21.2.4.2, “What is New in NDB Cluster 7.6”](#), for more information, as well as the descriptions of the `EnablePartialLcp` and `RecoveryWork` configuration parameters which enable partial LCPs and control the amount of storage they use.

- *Global Checkpoint (GCP)*: A GCP occurs every few seconds, when transactions for all nodes are synchronized and the redo-log is flushed to disk.

For more information about the files and directories created by local checkpoints and global checkpoints, see [NDB Cluster Data Node File System Directory](#).

**Transporter.** We use the term *transporter* for the data transport mechanism employed between data nodes. MySQL NDB Cluster 7.5 and 7.6 support three of these, which are listed here:

- *TCP/IP over Ethernet*. See [Section 21.4.3.10, “NDB Cluster TCP/IP Connections”](#).
- *Direct TCP/IP*. Uses machine-to-machine connections. See [Section 21.4.3.11, “NDB Cluster TCP/IP Connections Using Direct Connections”](#).

Although this transporter uses the same TCP/IP protocol as mentioned in the previous item, it requires setting up the hardware differently and is configured differently as well. For this reason, it is considered a separate transport mechanism for NDB Cluster.

- *Shared memory (SHM)*. See [Section 21.4.3.12, “NDB Cluster Shared Memory Connections”](#).

Because it is ubiquitous, most users employ TCP/IP over Ethernet for NDB Cluster.

Regardless of the transporter used, NDB attempts to make sure that communication between data node processes is performed using chunks that are as large as possible since this benefits all types of data transmission.

## 21.2.2 NDB Cluster Nodes, Node Groups, Fragment Replicas, and Partitions

This section discusses the manner in which NDB Cluster divides and duplicates data for storage.

A number of concepts central to an understanding of this topic are discussed in the next few paragraphs.

**Data node.** An `ndbd` or `ndbmt` process, which stores one or more *fragment replicas*—that is, copies of the *partitions* (discussed later in this section) assigned to the node group of which the node is a member.

Each data node should be located on a separate computer. While it is also possible to host multiple data node processes on a single computer, such a configuration is not usually recommended.

It is common for the terms “node” and “data node” to be used interchangeably when referring to an `ndbd` or `ndbmt` process; where mentioned, management nodes (`ndb_mgmd` processes) and SQL nodes (`mysqld` processes) are specified as such in this discussion.

**Node group.** A node group consists of one or more nodes, and stores partitions, or sets of *fragment replicas* (see next item).

The number of node groups in an NDB Cluster is not directly configurable; it is a function of the number of data nodes and of the number of fragment replicas (`NoOfReplicas` configuration parameter), as shown here:

```
[# of node groups] = [# of data nodes] / NoOfReplicas
```

Thus, an NDB Cluster with 4 data nodes has 4 node groups if `NoOfReplicas` is set to 1 in the `config.ini` file, 2 node groups if `NoOfReplicas` is set to 2, and 1 node group if `NoOfReplicas` is set to 4. Fragment replicas are discussed later in this section; for more information about `NoOfReplicas`, see [Section 21.4.3.6, “Defining NDB Cluster Data Nodes”](#).



### Note

All node groups in an NDB Cluster must have the same number of data nodes.

You can add new node groups (and thus new data nodes) online, to a running NDB Cluster; see [Section 21.6.7, “Adding NDB Cluster Data Nodes Online”](#), for more information.

**Partition.** This is a portion of the data stored by the cluster. Each node is responsible for keeping at least one copy of any partitions assigned to it (that is, at least one fragment replica) available to the cluster.

The number of partitions used by default by NDB Cluster depends on the number of data nodes and the number of LDM threads in use by the data nodes, as shown here:



```
[# of partitions] = [# of data nodes] * [# of LDM threads]
```

When using data nodes running `ndbmt`, the number of LDM threads is controlled by the setting for `MaxNoOfExecutionThreads`. When using `ndbd` there is a single LDM thread, which means that there are as many cluster partitions as nodes participating in the cluster. This is also the case when using `ndbmt` with `MaxNoOfExecutionThreads` set to 3 or less. (You should be aware that the number of LDM threads increases with the value of this parameter, but not in a strictly linear fashion, and that there are additional constraints on setting it; see the description of `MaxNoOfExecutionThreads` for more information.)

**NDB and user-defined partitioning.** NDB Cluster normally partitions `NDBCLUSTER` tables automatically. However, it is also possible to employ user-defined partitioning with `NDBCLUSTER` tables. This is subject to the following limitations:

1. Only the `KEY` and `LINEAR KEY` partitioning schemes are supported in production with `NDB` tables.
2. The maximum number of partitions that may be defined explicitly for any `NDB` table is  $8 * [\textit{number of LDM threads}] * [\textit{number of node groups}]$ , the number of node groups in an NDB Cluster being determined as discussed previously in this section. When running `ndbd` for data node processes, setting the number of LDM threads has no effect (since `ThreadConfig` applies only to `ndbmt`); in such cases, this value can be treated as though it were equal to 1 for purposes of performing this calculation.

See [Section 21.5.3, “ndbmt — The NDB Cluster Data Node Daemon \(Multi-Threaded\)”](#), for more information.

For more information relating to NDB Cluster and user-defined partitioning, see [Section 21.2.7, “Known Limitations of NDB Cluster”](#), and [Section 22.6.2, “Partitioning Limitations Relating to Storage Engines”](#).

**Fragment replica.** This is a copy of a cluster partition. Each node in a node group stores a fragment replica. Also sometimes known as a *partition replica*. The number of fragment replicas is equal to the number of nodes per node group.

A fragment replica belongs entirely to a single node; a node can (and usually does) store several fragment replicas.

The following diagram illustrates an NDB Cluster with four data nodes running `ndbd`, arranged in two node groups of two nodes each; nodes 1 and 2 belong to node group 0, and nodes 3 and 4 belong to node group 1.



#### Note

Only data nodes are shown here; although a working NDB Cluster requires an `ndb_mgmd` process for cluster management and at least one SQL node to access the data stored by the cluster, these have been omitted from the figure for clarity.

Figure 21.2 NDB Cluster with Two Node Groups

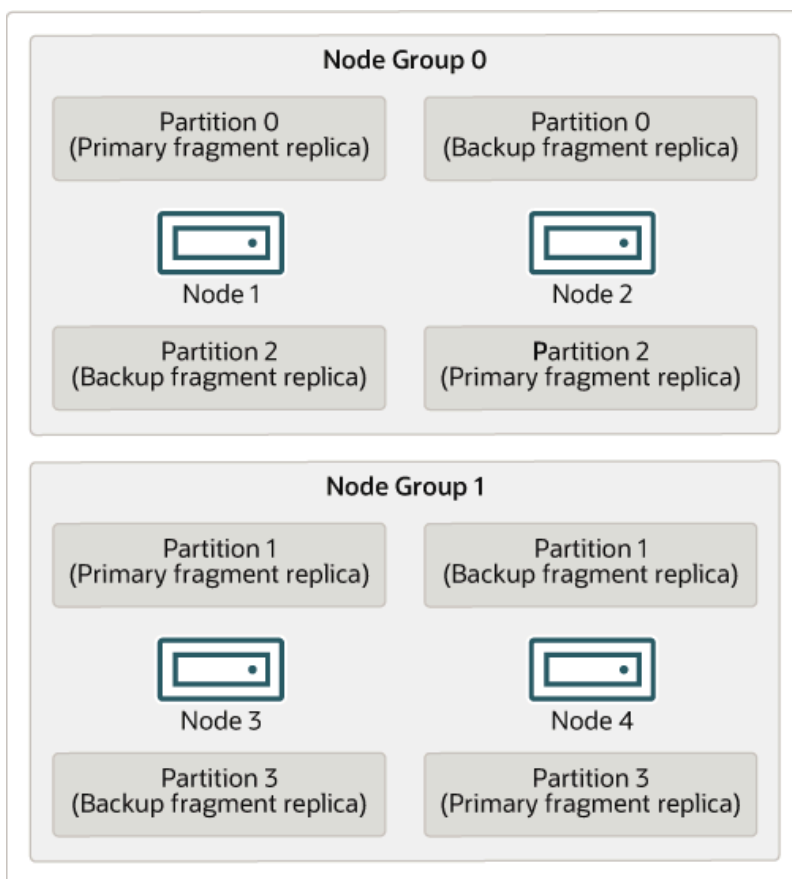

The data stored by the cluster is divided into four partitions, numbered 0, 1, 2, and 3. Each partition is stored—in multiple copies—on the same node group. Partitions are stored on alternate node groups as follows:

- Partition 0 is stored on node group 0; a *primary fragment replica* (primary copy) is stored on node 1, and a *backup fragment replica* (backup copy of the partition) is stored on node 2.
- Partition 1 is stored on the other node group (node group 1); this partition's primary fragment replica is on node 3, and its backup fragment replica is on node 4.
- Partition 2 is stored on node group 0. However, the placing of its two fragment replicas is reversed from that of Partition 0; for Partition 2, the primary fragment replica is stored on node 2, and the backup on node 1.
- Partition 3 is stored on node group 1, and the placement of its two fragment replicas are reversed from those of partition 1. That is, its primary fragment replica is located on node 4, with the backup on node 3.

What this means regarding the continued operation of an NDB Cluster is this: so long as each node group participating in the cluster has at least one node operating, the cluster has a complete copy of all data and remains viable. This is illustrated in the next diagram.

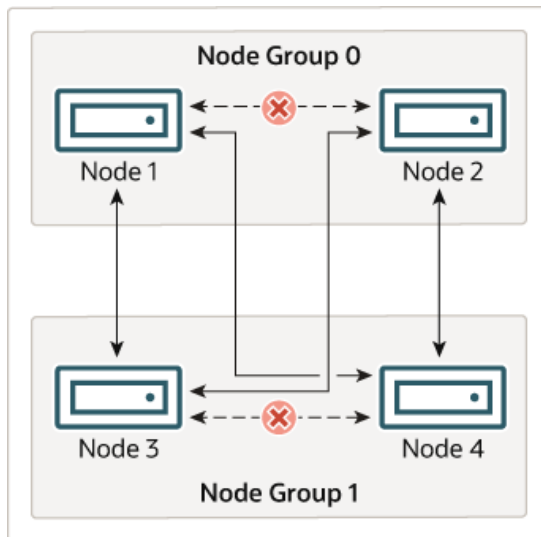
**Figure 21.3 Nodes Required for a 2x2 NDB Cluster**

In this example, the cluster consists of two node groups each consisting of two data nodes. Each data node is running an instance of `ndbd`. Any combination of at least one node from node group 0 and at least one node from node group 1 is sufficient to keep the cluster “alive”. However, if both nodes from a single node group fail, the combination consisting of the remaining two nodes in the other node group is not sufficient. In this situation, the cluster has lost an entire partition and so can no longer provide access to a complete set of all NDB Cluster data.

In NDB 7.5.4 and later, the maximum number of node groups supported for a single NDB Cluster instance is 48 (Bug#80845, Bug #22996305).

### 21.2.3 NDB Cluster Hardware, Software, and Networking Requirements

One of the strengths of NDB Cluster is that it can be run on commodity hardware and has no unusual requirements in this regard, other than for large amounts of RAM, due to the fact that all live data storage is done in memory. (It is possible to reduce this requirement using Disk Data tables—see [Section 21.6.11, “NDB Cluster Disk Data Tables”](#), for more information about these.) Naturally, multiple and faster CPUs can enhance performance. Memory requirements for other NDB Cluster processes are relatively small.

The software requirements for NDB Cluster are also modest. Host operating systems do not require any unusual modules, services, applications, or configuration to support NDB Cluster. For supported operating systems, a standard installation should be sufficient. The MySQL software requirements are simple: all that is needed is a production release of NDB Cluster. It is not strictly necessary to compile MySQL yourself merely to be able to use NDB Cluster. We assume that you are using the binaries appropriate to your platform, available from the NDB Cluster software downloads page at <https://dev.mysql.com/downloads/cluster/>.

For communication between nodes, NDB Cluster supports TCP/IP networking in any standard topology, and the minimum expected for each host is a standard 100 Mbps Ethernet card, plus a switch, hub, or router to provide network connectivity for the cluster as a whole. We strongly recommend that an NDB Cluster be run on its own subnet which is not shared with machines not forming part of the cluster for the following reasons:

- **Security.** Communications between NDB Cluster nodes are not encrypted or shielded in any way. The only means of protecting transmissions within an NDB Cluster is to run your NDB Cluster on a protected network. If you intend to use NDB Cluster for Web applications, the cluster should definitely reside behind your firewall and not in your network’s De-Militarized Zone (DMZ) or elsewhere.

See [Section 21.6.18.1, “NDB Cluster Security and Networking Issues”](#), for more information.

- **Efficiency.** Setting up an NDB Cluster on a private or protected network enables the cluster to make exclusive use of bandwidth between cluster hosts. Using a separate switch for your NDB Cluster not only helps protect against unauthorized access to NDB Cluster data, it also ensures that NDB Cluster nodes are shielded from interference caused by transmissions between other computers on the network. For enhanced reliability, you can use dual switches and dual cards to remove the network as a single point of failure; many device drivers support failover for such communication links.

**Network communication and latency.** NDB Cluster requires communication between data nodes and API nodes (including SQL nodes), as well as between data nodes and other data nodes, to execute queries and updates. Communication latency between these processes can directly affect the observed performance and latency of user queries. In addition, to maintain consistency and service despite the silent failure of nodes, NDB Cluster uses heartbeating and timeout mechanisms which treat an extended loss of communication from a node as node failure. This can lead to reduced redundancy. Recall that, to maintain data consistency, an NDB Cluster shuts down when the last node in a node group fails. Thus, to avoid increasing the risk of a forced shutdown, breaks in communication between nodes should be avoided wherever possible.

The failure of a data or API node results in the abort of all uncommitted transactions involving the failed node. Data node recovery requires synchronization of the failed node's data from a surviving data node, and re-establishment of disk-based redo and checkpoint logs, before the data node returns to service. This recovery can take some time, during which the Cluster operates with reduced redundancy.

Heartbeating relies on timely generation of heartbeat signals by all nodes. This may not be possible if the node is overloaded, has insufficient machine CPU due to sharing with other programs, or is experiencing delays due to swapping. If heartbeat generation is sufficiently delayed, other nodes treat the node that is slow to respond as failed.

This treatment of a slow node as a failed one may or may not be desirable in some circumstances, depending on the impact of the node's slowed operation on the rest of the cluster. When setting timeout values such as `HeartbeatIntervalDbDb` and `HeartbeatIntervalDbApi` for NDB Cluster, care must be taken to achieve quick detection, failover, and return to service, while avoiding potentially expensive false positives.

Where communication latencies between data nodes are expected to be higher than would be expected in a LAN environment (on the order of 100  $\mu$ s), timeout parameters must be increased to ensure that any allowed periods of latency periods are well within configured timeouts. Increasing timeouts in this way has a corresponding effect on the worst-case time to detect failure and therefore time to service recovery.

LAN environments can typically be configured with stable low latency, and such that they can provide redundancy with fast failover. Individual link failures can be recovered from with minimal and controlled latency visible at the TCP level (where NDB Cluster normally operates). WAN environments may offer a range of latencies, as well as redundancy with slower failover times. Individual link failures may require route changes to propagate before end-to-end connectivity is restored. At the TCP level this can appear as large latencies on individual channels. The worst-case observed TCP latency in these scenarios is related to the worst-case time for the IP layer to reroute around the failures.

## 21.2.4 What is New in MySQL NDB Cluster

The following sections describe changes in the implementation of MySQL NDB Cluster in NDB Cluster 7.6 through 5.7.44-ndb-7.6.36 and NDB Cluster 7.5 through 5.7.44-ndb-7.5.36 as compared to earlier release series. NDB Cluster 8.0 is available as a General Availability (GA) release, beginning with NDB 8.0.19; see [What is New in MySQL NDB Cluster 8.0](#), for more information about new features and other changes in NDB 8.0. NDB Cluster 7.6 and 7.5 are previous GA releases still supported in production; for information

about NDB Cluster 7.6, see [Section 21.2.4.2, “What is New in NDB Cluster 7.6”](#). For information about NDB Cluster 7.5, see [Section 21.2.4.1, “What is New in NDB Cluster 7.5”](#). NDB Cluster 7.4 and 7.3 were previous GA releases which have reached their end of life, and which are no longer supported or maintained. We recommend that new deployments for production use MySQL NDB Cluster 8.0.

### 21.2.4.1 What is New in NDB Cluster 7.5

Major changes and new features in NDB Cluster 7.5 which are likely to be of interest are shown in the following list:

- **ndbinfo Enhancements.** A number of changes are made in the `ndbinfo` database, chief of which is that it now provides detailed information about NDB Cluster node configuration parameters.

The `config_params` table has been made read-only, and has been enhanced with additional columns providing information about each configuration parameter, including the parameter's type, default value, maximum and minimum values (where applicable), a brief description of the parameter, and whether the parameter is required. This table also provides each parameter with a unique `param_number`.

A row in the `config_values` table shows the current value of a given parameter on the node having a specified ID. The parameter is identified by the value of the `config_param` column, which maps to the `config_params` table's `param_number`.

Using this relationship you can write a join on these two tables to obtain the default, maximum, minimum, and current values for one or more NDB Cluster configuration parameters by name. An example SQL statement using such a join is shown here:

```
SELECT  p.param_name AS Name,
        v.node_id AS Node,
        p.param_type AS Type,
        p.param_default AS 'Default',
        p.param_min AS Minimum,
        p.param_max AS Maximum,
        CASE p.param_mandatory WHEN 1 THEN 'Y' ELSE 'N' END AS 'Required',
        v.config_value AS Current
FROM    config_params p
JOIN    config_values v
ON      p.param_number = v.config_param
WHERE   p.param_name IN ('NodeId', 'HostName', 'DataMemory', 'IndexMemory');
```

For more information about these changes, see [Section 21.6.15.8, “The ndbinfo config\\_params Table”](#). See [Section 21.6.15.9, “The ndbinfo config\\_values Table”](#), for further information and examples.

In addition, the `ndbinfo` database no longer depends on the `MyISAM` storage engine. All `ndbinfo` tables and views now use `NDB` (shown as `NDBINFO`).

Several new `ndbinfo` tables were introduced in NDB 7.5.4. These tables are listed here, with brief descriptions:

- `dict_obj_info` provides the names and types of database objects in `NDB`, as well as information about parent objects where applicable
- `table_distribution_status` provides `NDB` table distribution status information
- `table_fragments` provides information about the distribution of `NDB` table fragments
- `table_info` provides information about logging, checkpointing, storage, and other options in force for each `NDB` table
- `table_replicas` provides information about fragment replicas

See the descriptions of the individual tables for more information.

- **Default row and column format changes.** Starting with NDB 7.5.1, the default value for both the `ROW_FORMAT` option and the `COLUMN_FORMAT` option for `CREATE TABLE` can be set to `DYNAMIC` rather than `FIXED`, using a new MySQL server variable `ndb_default_column_format` is added as part of this change; set this to `FIXED` or `DYNAMIC` (or start `mysqld` with the equivalent option `--ndb-default-column-format=FIXED`) to force this value to be used for `COLUMN_FORMAT` and `ROW_FORMAT`. Prior to NDB 7.5.4, the default for this variable was `DYNAMIC`; in this and later versions, the default is `FIXED`, which provides backwards compatibility with prior releases (Bug #24487363).

The row format and column format used by existing table columns are unaffected by this change. New columns added to such tables use the new defaults for these (possibly overridden by `ndb_default_column_format`), and existing columns are changed to use these as well, provided that the `ALTER TABLE` statement performing this operation specifies `ALGORITHM=COPY`.



**Note**

A copying `ALTER TABLE` cannot be done implicitly if `mysqld` is run with `--ndb-allow-copying-alter-table=FALSE`.

- **ndb\_binlog\_index no longer dependent on MyISAM.** As of NDB 7.5.2, the `ndb_binlog_index` table employed in NDB Cluster Replication now uses the `InnoDB` storage engine instead of `MyISAM`. When upgrading, you can run `mysql_upgrade` with `--force --upgrade-system-tables` to cause it to execute `ALTER TABLE ... ENGINE=INNODB` on this table. Use of `MyISAM` for this table remains supported for backward compatibility.

A benefit of this change is that it makes it possible to depend on transactional behavior and lock-free reads for this table, which can help alleviate concurrency issues during purge operations and log rotation, and improve the availability of this table.

- **ALTER TABLE changes.** NDB Cluster formerly supported an alternative syntax for online `ALTER TABLE`. This is no longer supported in NDB Cluster 7.5, which makes exclusive use of `ALGORITHM = DEFAULT | COPY | INPLACE` for table DDL, as in the standard MySQL Server.

Another change affecting the use of this statement is that `ALTER TABLE ... ALGORITHM=INPLACE RENAME` may now contain DDL operations in addition to the renaming.

- **ExecuteOnComputer parameter deprecated.** The `ExecuteOnComputer` configuration parameter for `management nodes`, `data nodes`, and `API nodes` has been deprecated and is now subject to removal in a future release of NDB Cluster. You should use the equivalent `HostName` parameter for all three types of nodes.
- **records-per-key optimization.** The NDB handler now uses the records-per-key interface for index statistics implemented for the optimizer in MySQL 5.7.5. Some of the benefits from this change include those listed here:
  - The optimizer now chooses better execution plans in many cases where a less optimal join index or table join order would previously have been chosen
  - Row estimates shown by `EXPLAIN` are more accurate
  - Cardinality estimates shown by `SHOW INDEX` are improved
- **Connection pool node IDs.** NDB 7.5.0 adds the `mysqld --ndb-cluster-connection-pool-nodeids` option, which allows a set of node IDs to be set for the connection pool. This setting overrides

`--ndb-nodeid`, which means that it also overrides both the `--ndb-connectstring` option and the `NDB_CONNECTSTRING` environment variable.



**Note**

You can set the size for the connection pool using the `--ndb-cluster-connection-pool` option for `mysqld`.

- **create\_old\_temporals removed.** The `create_old_temporals` system variable was deprecated in NDB Cluster 7.4, and has now been removed.
- **ndb\_mgm Client PROMPT command.** NDB Cluster 7.5 adds a new command for setting the client's command-line prompt. The following example illustrates the use of the `PROMPT` command:

```
ndb_mgm> PROMPT mgm#1:
mgm#1: SHOW
Cluster Configuration
-----
[ndbd(NDB)]      4 node(s)
id=5   @10.100.1.1  (mysql-5.7.44-ndb-7.5.36, Nodegroup: 0, *)
id=6   @10.100.1.3  (mysql-5.7.44-ndb-7.5.36, Nodegroup: 0)
id=7   @10.100.1.9  (mysql-5.7.44-ndb-7.5.36, Nodegroup: 1)
id=8   @10.100.1.11 (mysql-5.7.44-ndb-7.5.36, Nodegroup: 1)

[ndb_mgmd(MGM)] 1 node(s)
id=50  @10.100.1.8  (mysql-5.7.44-ndb-7.5.36)

[mysqld(API)]   2 node(s)
id=100 @10.100.1.8  (5.7.44-ndb-7.5.36)
id=101 @10.100.1.10  (5.7.44-ndb-7.5.36)

mgm#1: PROMPT
ndb_mgm> EXIT
jon@valhøj:/usr/local/mysql/bin>
```

For additional information and examples, see [Section 21.6.1, “Commands in the NDB Cluster Management Client”](#).

- **Increased FIXED column storage per fragment.** NDB Cluster 7.5 and later supports a maximum of 128 TB per fragment of data in `FIXED` columns. In NDB Cluster 7.4 and earlier, this was 16 GB per fragment.
- **Deprecated parameters removed.** The following NDB Cluster data node configuration parameters were deprecated in previous releases of NDB Cluster, and were removed in NDB 7.5.0:
  - `Id`: deprecated in NDB 7.1.9; replaced by `NodeId`.
  - `NoOfDiskPagesToDiskDuringRestartTUP`, `NoOfDiskPagesToDiskDuringRestartACC`: both deprecated, had no effect; replaced in MySQL 5.1.6 by `DiskCheckpointSpeedInRestart`, which itself was later deprecated (in NDB 7.4.1) and is now also removed.
  - `NoOfDiskPagesToDiskAfterRestartACC`, `NoOfDiskPagesToDiskAfterRestartTUP`: both deprecated, and had no effect; replaced in MySQL 5.1.6 by `DiskCheckpointSpeed`, which itself was later deprecated (in NDB 7.4.1) and is now also removed.
  - `ReservedSendBufferMemory`: Deprecated; no longer had any effect.
  - `MaxNoOfIndexes`: archaic (pre-MySQL 4.1), had no effect; long since replaced by `MaxNoOfOrderedIndexes` or `MaxNoOfUniqueHashIndexes`.
  - `Discless`: archaic (pre-MySQL 4.1) synonym for and long since replaced by `Diskless`.

The archaic and unused (and for this reason also previously undocumented) `ByteOrder` computer configuration parameter was also removed in NDB 7.5.0.

The parameters just described are not supported in NDB 7.5. Attempting to use any of these parameters in an NDB Cluster configuration file now results in an error.

- **DBTC scan enhancements.** Scans have been improved by reducing the number of signals used for communication between the `DBTC` and `DBDIH` kernel blocks in `NDB`, enabling higher scalability of data nodes when used for scan operations by decreasing the use of CPU resources for scan operations, in some cases by an estimated five percent.

Also as result of these changes response times should be greatly improved, which could help prevent issues with overload of the main threads. In addition, scans made in the `BACKUP` kernel block have also been improved and made more efficient than in previous releases.

- **JSON column support.** NDB 7.5.2 and later supports the `JSON` column type for `NDB` tables and the `JSON` functions found in the MySQL Server, subject to the limitation that an `NDB` table can have at most 3 `JSON` columns.
- **Read from any fragment replica; specify number of hashmap partition fragments.** Previously, all reads were directed towards the primary fragment replica except for simple reads. (A simple read is a read that locks the row while reading it.) Beginning with NDB 7.5.2, it is possible to enable reads from any fragment replica. This is disabled by default but can be enabled for a given SQL node using the `ndb_read_backup` system variable added in this release.

Previously, it was possible to define tables with only one type of partition mapping, with one primary partition on each LDM in each node, but in NDB 7.5.2 it becomes possible to be more flexible about the assignment of partitions by setting a partition balance (fragment count type). Possible balance schemes are one per node, one per node group, one per LDM per node, and one per LDM per node group.

This setting can be controlled for individual tables by means of a `PARTITION_BALANCE` option (renamed from `FRAGMENT_COUNT_TYPE` in NDB 7.5.4) embedded in `NDB_TABLE` comments in `CREATE TABLE` or `ALTER TABLE` statements. Settings for table-level `READ_BACKUP` are also supported using this syntax. For more information and examples, see [Section 13.1.18.9, “Setting NDB Comment Options”](#).

In NDB API applications, a table's partition balance can also be get and set using methods supplied for this purpose; see `Table::getPartitionBalance()`, and `Table::setPartitionBalance()`, as well as `Object::PartitionBalance`, for more information about these.

As part of this work, NDB 7.5.2 also introduces the `ndb_data_node_neighbour` system variable. This is intended for use, in transaction hinting, to provide a “nearby” data node to this SQL node.

In addition, when restoring table schemas, `ndb_restore --restore-meta` now uses the target cluster's default partitioning, rather than using the same number of partitions as the original cluster from which the backup was taken. See [Restoring to More Nodes Than the Original](#), for more information and an example.

NDB 7.5.3 adds a further enhancement to `READ_BACKUP`: In this and later versions, it is possible to set `READ_BACKUP` for a given table online as part of `ALTER TABLE ... ALGORITHM=INPLACE ...`



- **ThreadConfig improvements.** A number of enhancements and feature additions are implemented in NDB 7.5.2 for the `ThreadConfig` multithreaded data node (`ndbmtd`) configuration parameter, including support for an increased number of platforms. These changes are described in the next few paragraphs.

Non-exclusive CPU locking is now supported on FreeBSD and Windows, using `cpubind` and `cpuset`. Exclusive CPU locking is now supported on Solaris (only) using the `cpubind_exclusive` and `cpuset_exclusive` parameters which are introduced in this release.

Thread prioritization is now available, controlled by the new `thread_prio` parameter. `thread_prio` is supported on Linux, FreeBSD, Windows, and Solaris, and varies somewhat by platform. For more information, see the description of `ThreadConfig`.

The `realtime` parameter is now supported on Windows platforms.

- **Partitions larger than 16 GB.** Due to an improvement in the hash index implementation used by NDB Cluster data nodes, partitions of NDB tables may now contain more than 16 GB of data for fixed columns, and the maximum partition size for fixed columns is now raised to 128 TB. The previous limitation was due to the fact that the `DBACC` block in the NDB kernel used only 32-bit references to the fixed-size part of a row in the `DBTUP` block, although 45-bit references to this data are used in `DBTUP` itself and elsewhere in the kernel outside `DBACC`; all such references in to the data handled in the `DBACC` block now use 45 bits instead.
- **Print SQL statements from `ndb_restore`.** NDB 7.5.4 adds the `--print-sql-log` option for the `ndb_restore` utility provided with the NDB Cluster distribution. This option enables SQL logging to `stdout`. **Important:** Every table to be restored using this option must have an explicitly defined primary key.

See [Section 21.5.24, “ndb\\_restore — Restore an NDB Cluster Backup”](#), for more information.

- **Organization of RPM packages.** Beginning with NDB 7.5.4, the naming and organization of RPM packages provided for NDB Cluster align more closely with those released for the MySQL server. The names of all NDB Cluster RPMs are now prefixed with `mysql-cluster`. Data nodes are now installed using the `data-node` package; management nodes are now installed from the `management-server` package; and SQL nodes require the `server` and `common` packages. MySQL and NDB client programs, including the `mysql` client and the `ndb_mgm` management client, are now included in the `client` RPM.

For a detailed listing of NDB Cluster RPMs and other information, see [Section 21.3.1.2, “Installing NDB Cluster from RPM”](#).

- **ndbinfo processes and config\_nodes tables.** NDB 7.5.7 adds two tables to the `ndbinfo` information database to provide information about cluster nodes; these tables are listed here:
  - `config_nodes`: This table provides the node ID, process type, and host name for each node listed in an NDB cluster's configuration file.
  - The `processes` shows information about nodes currently connected to the cluster; this information includes the process name and system process ID; for each data node and SQL node, it also shows the process ID of the node's angel process. In addition, the table shows a service address for each connected node; this address can be set in NDB API applications using the `Ndb_cluster_connection::set_service_uri()` method, which is also added in NDB 7.5.7.
- **System name.** The system name of an NDB cluster can be used to identify a specific cluster. Beginning with NDB 7.5.7, the MySQL Server shows this name as the

value of the `Ndb_system_name` status variable; NDB API applications can use the `Ndb_cluster_connection::get_system_name()` method which is added in the same release.

A system name based on the time the management server was started is generated automatically; you can override this value by adding a `[system]` section to the cluster's configuration file and setting the `Name` parameter to a value of your choice in this section, prior to starting the management server.

- **ndb\_restore options.** Beginning with NDB 7.5.13, the `--nodeid` and `--backupid` options are both required when invoking `ndb_restore`.
- **ndb\_blob\_tool enhancements.** Beginning with NDB 7.5.18, the `ndb_blob_tool` utility can detect missing blob parts for which inline parts exist and replace these with placeholder blob parts (consisting of space characters) of the correct length. To check whether there are missing blob parts, use the `--check-missing` option with this program. To replace any missing blob parts with placeholders, use the `--add-missing` option.

For more information, see [Section 21.5.6, “ndb\\_blob\\_tool — Check and Repair BLOB and TEXT columns of NDB Cluster Tables”](#).

- **--ndb-log-fail-terminate option.** Beginning with NDB 7.5.18, you can cause the SQL node to terminate whenever it is unable to log all row events fully. This can be done by starting `mysqld` with the `--ndb-log-fail-terminate` option.
- **NDB programs—NDBT dependency removal.** The dependency of a number of NDB utility programs on the NDBT library has been removed. This library is used internally for development, and is not required for normal use; its inclusion in these programs could lead to unwanted issues when testing.

Affected programs are listed here, along with the NDB versions in which the dependency was removed:

- `ndb_restore`, in NDB 7.5.15
- `ndb_show_tables`, in NDB 7.5.18
- `ndb_waiter`, in NDB 7.5.18

The principal effect of this change for users is that these programs no longer print `NDBT_ProgramExit - status` following completion of a run. Applications that depend upon such behavior should be updated to reflect the change when upgrading to the indicated versions.

- **Auto-Installer deprecation and removal.** The MySQL NDB Cluster Auto-Installer web-based installation tool (`ndb_setup.py`) is deprecated in NDB 7.5.20, and is removed in NDB 7.5.21 and later. It is no longer supported.
- **ndbmemcache deprecation and removal.** `ndbmemcache` is no longer supported. `ndbmemcache` was deprecated in NDB 7.5.20, and removed in NDB 7.5.21.
- **Node.js support removed.** Beginning with the NDB Cluster 7.5.20 release, support for Node.js by NDB 7.5 has been removed.

Support for Node.js by NDB Cluster is maintained in NDB 8.0 only.

- **Conversion between NULL and NOT NULL during restore operations.** Beginning with NDB 7.5.23, `ndb_restore` can support restoring of `NULL` columns as `NOT NULL` and the reverse, using the options listed here:

- To restore a `NULL` column as `NOT NULL`, use the `--lossy-conversions` option.

The column originally declared as `NULL` must not contain any `NULL` rows; if it does, `ndb_restore` exits with an error.

- To restore a `NOT NULL` column as `NULL`, use the `--promote-attributes` option.

For more information, see the descriptions of the indicated `ndb_restore` options.

- **OpenSSL 3.0 support.** Beginning with NDB 7.5.31, all MySQL server and client binaries included in the `NDB` distribution are compiled with support for Open SSL 3.0

ClusterJPA is no longer supported beginning with NDB 7.5.7; its source code and binary have been removed from the NDB Cluster distribution.

NDB Cluster 7.5 is also supported by MySQL Cluster Manager, which provides an advanced command-line interface that can simplify many complex NDB Cluster management tasks. See [MySQL Cluster Manager 1.4.8 User Manual](#), for more information.

## 21.2.4.2 What is New in NDB Cluster 7.6

New features and other important changes in NDB Cluster 7.6 which are likely to be of interest are shown in the following list:

- **New Disk Data table file format.** A new file format is used in NDB 7.6 for NDB Disk Data tables, which makes it possible for each Disk Data table to be uniquely identified without reusing any table IDs. This should help resolve issues with page and extent handling that were visible to the user as problems with rapid creating and dropping of Disk Data tables, and for which the old format did not provide a ready means to fix.

The new format is now used whenever new undo log file groups and tablespace data files are created. Files relating to existing Disk Data tables continue to use the old format until their tablespaces and undo log file groups are re-created.



### Important

The old and new formats are not compatible; different data files or undo log files that are used by the same Disk Data table or tablespace cannot use a mix of formats.

To avoid problems relating to the changes in format, you should re-create any existing tablespaces and undo log file groups when upgrading to NDB 7.6. You can do this by performing an initial restart of each data node (that is, using the `--initial` option) as part of the upgrade process. You can expect this step to be made mandatory as part of upgrading from NDB 7.5 or an earlier release series to NDB 7.6 or later.

If you are using Disk Data tables, a downgrade from *any* NDB 7.6 release—without regard to release status—to any NDB 7.5 or earlier release requires that you restart all data nodes with `--initial` as part of the downgrade process. This is because NDB 7.5 and earlier release series are not able to read the new Disk Data file format.

For more information, see [Section 21.3.7, “Upgrading and Downgrading NDB Cluster”](#).

- **Data memory pooling and dynamic index memory.** Memory required for indexes on [NDB](#) table columns is now allocated dynamically from that allocated for [DataMemory](#). For this reason, the [IndexMemory](#) configuration parameter is now deprecated, and subject to removal in a future release series.



### Important

In NDB 7.6, if [IndexMemory](#) is set in the `config.ini` file, the management server issues the warning `IndexMemory is deprecated, use Number bytes on each ndbd(DB) node allocated for storing indexes instead` on startup, and any memory assigned to this parameter is automatically added to [DataMemory](#).

In addition, the default value for [DataMemory](#) has been increased to 98M; the default for [IndexMemory](#) has been decreased to 0.

The pooling together of index memory with data memory simplifies the configuration of [NDB](#); a further benefit of these changes is that scaling up by increasing the number of LDM threads is no longer limited by having set an insufficiently large value for [IndexMemory](#). This is because index memory is no longer a static quantity which is allocated only once (when the cluster starts), but can now be allocated and deallocated as required. Previously, it was sometimes the case that increasing the number of LDM threads could lead to index memory exhaustion while large amounts of [DataMemory](#) remained available.

As part of this work, a number of instances of [DataMemory](#) usage not directly related to storage of table data now use transaction memory instead.

For this reason, it may be necessary on some systems to increase [SharedGlobalMemory](#) to allow transaction memory to increase when needed, such as when using [NDB Cluster Replication](#), which requires a great deal of buffering on the data nodes. On systems performing initial bulk loads of data, it may be necessary to break up very large transactions into smaller parts.

In addition, data nodes now generate [MemoryUsage](#) events (see [Section 21.6.3.2, “NDB Cluster Log Events”](#)) and write appropriate messages in the cluster log when resource usage reaches 99%, as well as when it reaches 80%, 90%, or 100%, as before.

Other related changes are listed here:

- [IndexMemory](#) is no longer one of the values displayed in the `ndbinfo.memoryusage` table's `memory_type` column; is also no longer displayed in the output of `ndb_config`.
- `REPORT MEMORYUSAGE` and other commands which expose memory consumption now shows index memory consumption using 32K pages (previously these were 8K pages).
- The `ndbinfo.resources` table now shows the `DISK_OPERATIONS` resource as `TRANSACTION_MEMORY`, and the `RESERVED` resource has been removed.
- **ndbinfo processes and config\_nodes tables.** NDB 7.6 adds two tables to the `ndbinfo` information database to provide information about cluster nodes; these tables are listed here:
  - `config_nodes`: This table the node ID, process type, and host name for each node listed in an NDB cluster's configuration file.
  - The `processes` shows information about nodes currently connected to the cluster; this information includes the process name and system process ID; for each data node and SQL node, it also shows the process ID of the node's angel process. In addition, the table shows a service

address for each connected node; this address can be set in NDB API applications using the `Ndb_cluster_connection::set_service_uri()` method, which is also added in NDB 7.6.

- **System name.** The system name of an NDB cluster can be used to identify a specific cluster. In NDB 7.6, the MySQL Server shows this name as the value of the `Ndb_system_name` status variable; NDB API applications can use the `Ndb_cluster_connection::get_system_name()` method which is added in the same release.

A system name based on the time the management server was started is generated automatically; you can override this value by adding a `[system]` section to the cluster's configuration file and setting the `Name` parameter to a value of your choice in this section, prior to starting the management server.

- **ndb\_import CSV import tool.** `ndb_import`, added in NDB Cluster 7.6, loads CSV-formatted data directly into an NDB table using the NDB API (a MySQL server is needed only to create the table and database in which it is located). `ndb_import` can be regarded as an analog of `mysqlimport` or the `LOAD DATA` SQL statement, and supports many of the same or similar options for formatting of the data.

Assuming that the database and target NDB table exist, `ndb_import` needs only a connection to the cluster's management server (`ndb_mgmd`) to perform the importation; for this reason, there must be an `[api]` slot available to the tool in the cluster's `config.ini` file purpose.

See [Section 21.5.14, “ndb\\_import — Import CSV Data Into NDB”](#), for more information.

- **ndb\_top monitoring tool.** Added the `ndb_top` utility, which shows CPU load and usage information for an NDB data node in real time. This information can be displayed in text format, as an ASCII graph, or both. The graph can be shown in color, or using grayscale.

`ndb_top` connects to an NDB Cluster SQL node (that is, a MySQL Server). For this reason, the program must be able to connect as a MySQL user having the `SELECT` privilege on tables in the `ndbinfo` database.

`ndb_top` is available for Linux, Solaris, and macOS platforms, but is not currently available for Windows platforms.

For more information, see [Section 21.5.29, “ndb\\_top — View CPU usage information for NDB threads”](#).

- **Code cleanup.** A significant number of debugging statements and printouts not necessary for normal operations have been moved into code used only when testing or debugging NDB, or dispensed with altogether. This removal of overhead should result in a noticeable improvement in the performance of LDM and TC threads on the order of 10% in many cases.
- **LDM thread and LCP improvements.** Previously, when a local data management thread experienced I/O lag, it wrote to local checkpoints more slowly. This could happen, for example, during a disk overload condition. Problems could occur because other LDM threads did not always observe this state, or do likewise. NDB now tracks I/O lag mode globally, so that this state is reported as soon as at least one thread is writing in I/O lag mode; it then makes sure that the reduced write speed for this LCP is enforced for all LDM threads for the duration of the slowdown condition. Because the reduction in write speed is now observed by other LDM instances, overall capacity is increased; this enables the disk overload (or other condition inducing I/O lag) to be overcome more quickly in such cases than it was previously.
- **NDB error identification.** Error messages and information can be obtained using the `mysql` client in NDB 7.6 from a new `error_messages` table in the `ndbinfo` information database. In addition, NDB 7.6 introduces a new command-line client `ndb_perror` for obtaining information from NDB error codes; this replaces using `perror` with `--ndb`, which is now deprecated and subject to removal in a future release.

For more information, see [Section 21.6.15.21, “The ndbinfo error\\_messages Table”](#), and [Section 21.5.17, “ndb\\_perror — Obtain NDB Error Message Information”](#).

- **SPJ improvements.** When executing a scan as a pushed join (that is, the root of the query is a scan), the `DBTC` block sends an SPJ request to a `DBSPJ` instance on the same node as the fragment to be scanned. Formerly, one such request was sent for each of the node's fragments. As the number of `DBTC` and `DBSPJ` instances is normally set less than the number of LDM instances, this means that all SPJ instances were involved in the execution of a single query, and, in fact, some SPJ instances could (and did) receive multiple requests from the same query. NDB 7.6 makes it possible for a single SPJ request to handle a set of root fragments to be scanned, so that only a single SPJ request (`SCAN_FRAGREQ`) needs to be sent to any given SPJ instance (`DBSPJ` block) on each node.

Since `DBSPJ` consumes a relatively small amount of the total CPU used when evaluating a pushed join, unlike the LDM block (which is responsible for the majority of the CPU usage), introducing multiple SPJ blocks adds some parallelism, but the additional overhead also increases. By enabling a single SPJ request to handle a set of root fragments to be scanned, such that only a single SPJ request is sent to each `DBSPJ` instance on each node and batch sizes are allocated per fragment, the multi-fragment scan can obtain a larger total batch size, allowing for some scheduling optimizations to be done within the SPJ block, which can scan a single fragment at a time (giving it the total batch size allocation), scan all fragments in parallel using smaller sub-batches, or some combination of the two.

This work is expected to increase performance of pushed-down joins for the following reasons:

- Since multiple root fragments can be scanned for each SPJ request, it is necessary to request fewer SPJ instances when executing a pushed join
- Increased available batch size allocation, and for each fragment, should also in most cases result in fewer requests being needed to complete a join
- **Improved `O_DIRECT` handling for redo logs.** NDB 7.6 provides a new data node configuration parameter `ODirectSyncFlag` which causes completed redo log writes using `O_DIRECT` to be handled as `fsync` calls. `ODirectSyncFlag` is disabled by default; to enable it, set it to `true`.

You should bear in mind that the setting for this parameter is ignored when at least one of the following conditions is true:

- `ODirect` is not enabled.
- `InitFragmentLogFiles` is set to `SPARSE`.
- **Locking of CPUs to offline index build threads.** In NDB 7.6, offline index builds by default use all cores available to `ndbmt.d`, instead of being limited to the single core reserved for the I/O thread. It also becomes possible to specify a desired set of cores to be used for I/O threads performing offline multithreaded builds of ordered indexes. This can improve restart and restore times and performance, as well as availability.



#### Note

“Offline” as used here refers to an ordered index build that takes place while a given table is not being written to. Such index builds occur during a node or system restart, or when restoring a cluster from backup using `ndb_restore --rebuild-indexes`.

This improvement involves several related changes. The first of these is to change the default value for the `BuildIndexThreads` configuration parameter (from 0 to 128), means

that offline ordered index builds are now multithreaded by default. The default value for the `TwoPassInitialNodeRestartCopy` is also changed (from `false` to `true`), so that an initial node restart first copies all data without any creation of indexes from a “live” node to the node which is being started, builds the ordered indexes offline after the data has been copied, then again synchronizes with the live node; this can significantly reduce the time required for building indexes. In addition, to facilitate explicit locking of offline index build threads to specific CPUs, a new thread type (`idxbld`) is defined for the `ThreadConfig` configuration parameter.

As part of this work, NDB can now distinguish between execution thread types and other types of threads, and between types of threads which are permanently assigned to specific tasks, and those whose assignments are merely temporary.

NDB 7.6 also introduces the `nosend` parameter for `ThreadConfig`. By setting this to 1, you can keep a `main`, `ldm`, `rep`, or `tc` thread from assisting the send threads. This parameter is 0 by default, and cannot be used with I/O threads, send threads, index build threads, or watchdog threads.

For additional information, see the descriptions of the parameters.

- **Variable batch sizes for DDL bulk data operations.** As part of work ongoing to optimize bulk DDL performance by `ndbmtl`, it is now possible to obtain performance improvements by increasing the batch size for the bulk data parts of DDL operations processing data using scans. Batch sizes are now made configurable for unique index builds, foreign key builds, and online reorganization, by setting the respective data node configuration parameters listed here:
  - `MaxUIBuildBatchSize`: Maximum scan batch size used for building unique keys.
  - `MaxFKBuildBatchSize`: Maximum scan batch size used for building foreign keys.
  - `MaxReorgBuildBatchSize`: Maximum scan batch size used for reorganization of table partitions.

For each of the parameters just listed, the default value is 64, the minimum is 16, and the maximum is 512.

Increasing the appropriate batch size or sizes can help amortize inter-thread and inter-node latencies and make use of more parallel resources (local and remote) to help scale DDL performance. In each case there can be a tradeoff with ongoing traffic.

- **Partial LCPs.** NDB 7.6 implements partial local checkpoints. Formerly, an LCP always made a copy of the entire database. When working with terabytes of data this process could require a great deal of time, with an adverse impact on node and cluster restarts especially, as well as more space for the redo logs. It is now no longer strictly necessary for LCPs to do this—instead, an LCP now by default saves only a number of records that is based on the quantity of data changed since the previous LCP. This can vary between a full checkpoint and a checkpoint that changes nothing at all. In the event that the checkpoint reflects any changes, the minimum is to write one part of the 2048 making up a local LCP.

As part of this change, two new data node configuration parameters are introduced in this release: `EnablePartialLcp` (default `true`, or enabled) enables partial LCPs. `RecoveryWork` controls the percentage of space given over to LCPs; it increases with the amount of work which must be performed on LCPs during restarts as opposed to that performed during normal operations. Raising this value causes LCPs during normal operations to require writing fewer records and so decreases the usual workload. Raising this value also means that restarts can take longer.

You must disable partial LCPs explicitly by setting `EnablePartialLcp=false`. This uses the least amount of disk, but also tends to maximize the write load for LCPs. To optimize for the lowest workload on LCPs during normal operation, use `EnablePartialLcp=true` and `RecoveryWork=100`. To use the least disk space for partial LCPs, but with bounded writes, use

`EnablePartialLcp=true` and `RecoveryWork=25`, which is the minimum for `RecoveryWork`. The default is `EnablePartialLcp=true` with `RecoveryWork=50`, which means LCP files require approximately 1.5 times `DataMemory`; using `CompressedLcp=1`, this can be further reduced by half. Recovery times using the default settings should also be much faster than when `EnablePartialLcp` is set to `false`.



**Note**

The default value for `RecoveryWork` was increased from 50 to 60.

In addition the data node configuration parameters `BackupDataBufferSize`, `BackupWriteSize`, and `BackupMaxWriteSize` are all now deprecated, and subject to removal in a future release of MySQL NDB Cluster.

As part of this enhancement, work has been done to correct several issues with node restarts wherein it was possible to run out of undo log in various situations, most often when restoring a node that had been down for a long time during a period of intensive write activity.

Additional work was done to improve data node survival of long periods of synchronization without timing out, by updating the LCP watchdog during this process, and keeping better track of the progress of disk data synchronization. Previously, there was the possibility of spurious warnings or even node failures if synchronization took longer than the LCP watchdog timeout.



**Important**

When upgrading an NDB Cluster that uses disk data tables to NDB 7.6 or downgrading it from NDB 7.6, it is necessary to restart all data nodes with `--initial`.

- **Parallel undo log record processing.** Formerly, the data node `LGMAN` kernel block processed undo log records serially; now this is done in parallel. The rep thread, which hands off undo records to LDM threads, waited for an LDM to finish applying a record before fetching the next one; now the rep thread no longer waits, but proceeds immediately to the next record and LDM.

A count of the number of outstanding log records for each LDM in `LGMAN` is kept, and decremented whenever an LDM has completed the execution of a record. All the records belonging to a page are sent to the same LDM thread but are not guaranteed to be processed in order, so a hash map of pages that have outstanding records maintains a queue for each of these pages. When the page is available in the page cache, all records pending in the queue are applied in order.

A few types of records continue to be processed serially: `UNDO_LCP`, `UNDO_LCP_FIRST`, `UNDO_LOCAL_LCP`, `UNDO_LOCAL_LCP_FIRST`, `UNDO_DROP`, and `UNDO_END`.

There are no user-visible changes in functionality directly associated with this performance enhancement; it is part of work done to improve undo long handling in support of partial local checkpoints in NDB Cluster 7.6.

- **Reading table and fragment IDs from extent for undo log applier.** When applying an undo log, it is necessary to obtain the table ID and fragment ID from the page ID. This was done previously by reading the page from the `PGMAN` kernel block using an extra `PGMAN` worker thread, but when applying the undo log it was necessary to read the page again.

when using `O_DIRECT` this was very inefficient since the page was not cached in the OS kernel. To correct this issue, mapping from page ID to table ID and fragment ID is now done using information from the extent header the table IDs and fragment IDs for the pages used within a given extent. The extent



pages are always present in the page cache, so no extra reads from disk are required for performing the mapping. In addition, the information can already be read, using existing `TSMAN` kernel block data structures.

See the description of the `ODirect` data node configuration parameter, for more information.

- **Shared memory transporter.** User-defined shared memory (SHM) connections between a data node and an API node on the same host computer are fully supported in NDB 7.6, and are no longer considered experimental. You can enable an explicit shared memory connection by setting the `UseShm` configuration parameter to `1` for the relevant data node. When explicitly defining shared memory as the connection method, it is also necessary that both the data node and the API node are identified by `HostName`.

Performance of SHM connections can be enhanced through setting parameters such as `ShmSize`, `ShmSpintime`, and `SendBufferMemory` in an `[shm]` or `[shm default]` section of the cluster configuration file (`config.ini`). Configuration of SHM is otherwise similar to that of the TCP transporter.

The `SigNum` parameter is not used in the new SHM implementation, and any settings made for it are now ignored. [Section 21.4.3.12, “NDB Cluster Shared Memory Connections”](#), provides more information about these parameters. In addition, as part of this work, NDB code relating to the old SCI transporter has been removed.

For more information, see [Section 21.4.3.12, “NDB Cluster Shared Memory Connections”](#).

- **SPJ block inner join optimization.** In NDB 7.6, the `SPJ` kernel block can take into account when it is evaluating a join request in which at least some of the tables are INNER-joined. This means that it can eliminate requests for row, ranges, or both as soon as it becomes known that one or more of the preceding requests did not return any results for a parent row. This saves both the data nodes and the `SPJ` block from having to handle requests and result rows which never take part in an INNER-joined result row.

Consider this join query, where `pk` is the primary key on tables `t2`, `t3`, and `t4`, and columns `x`, `y`, and `z` are nonindexed columns:

```
SELECT * FROM t1
  JOIN t2 ON t2.pk = t1.x
  JOIN t3 ON t3.pk = t1.y
  JOIN t4 ON t4.pk = t1.z;
```

Previously, this resulted in an `SPJ` request including a scan on table `t1`, and lookups on each of the tables `t2`, `t3`, and `t4`; these were evaluated for every row returned from `t1`. For these, `SPJ` created `LQHKEYREQ` requests for tables `t2`, `t3`, and `t4`. Now `SPJ` takes into consideration the requirement that, to produce any result rows, an inner join must find a match in all tables joined; as soon as no matches are found for one of the tables, any further requests to tables having the same parent or tables are now skipped.



#### Note

This optimization cannot be applied until all of the data nodes and all of the API nodes in the cluster have been upgraded to NDB 7.6.

- **NDB wakeup thread.** NDB uses a poll receiver to read from sockets, to execute messages from the sockets, and to wake up other threads. When making only intermittent use of a receive thread, poll ownership is given up before starting to wake up other threads, which provides some degree of parallelism in the receive thread, but, when making constant use of the receive thread, the thread can be overburdened by tasks including wakeup of other threads.

NDB 7.6 supports offloading by the receiver thread of the task of waking up other threads to a new thread that wakes up other threads on request (and otherwise simply sleeps), making it possible to improve the capacity of a single cluster connection by roughly ten to twenty percent.

- **Adaptive LCP control.** NDB 7.6.7 implements an adaptive LCP control mechanism which acts in response to changes in redo log space usage. By controlling LCP disk write speed, you can help protect against a number of resource-related issues, including the following:
  - Insufficient CPU resources for traffic applications
  - Disk overload
  - Insufficient redo log buffer
  - GCP Stop conditions
  - Insufficient redo log space
  - Insufficient undo log space

This work includes the following changes relating to [NDB](#) configuration parameters:

- The default value of the [RecoveryWork](#) data node parameter is increased from 50 to 60; that is, [NDB](#) now uses 1.6 times the size of the data for storage of LCPs.
- A new data node configuration parameter [InsertRecoveryWork](#) provides additional tuning capabilities through controlling the percentage of [RecoveryWork](#) that is reserved for insert operations. The default value is 40 (that is, 40% of the storage space already reserved by [RecoveryWork](#)); the minimum and maximum are 0 and 70, respectively. Increasing this value allows for more writes to be performed during an LCP, while limiting the total size of the LCP. Decreasing [InsertRecoveryWork](#) limits the number of writes used during an LCP, but results in more space being used for the LCP, which means that recovery takes longer.

This work implements control of LCP speed chiefly to minimize the risk of running out of redo log. This is done in adaptive fashion, based on the amount of redo log space used, using the alert levels, with the responses taken when these levels are attained, shown here:

- **Low:** Redo log space usage is greater than 25%, or estimated usage shows insufficient redo log space at a very high transaction rate. In response, use of LCP data buffers is increased during LCP scans, priority of LCP scans is increased, and the amount of data that can be written per real-time break in an LCP scan is also increased.
- **High:** Redo log space usage is greater than 40%, or estimate to run out of redo log space at a high transaction rate. When this level of usage is reached, [MaxDiskWriteSpeed](#) is increased to the value of [MaxDiskWriteSpeedOtherNodeRestart](#). In addition, the minimum speed is doubled, and priority of LCP scans and what can be written per real-time break are both increased further.
- **Critical:** Redo log space usage is greater than 60%, or estimated usage shows insufficient redo log space at a normal transaction rate. At this level, [MaxDiskWriteSpeed](#) is increased to the value of [MaxDiskWriteSpeedOwnRestart](#); [MinDiskWriteSpeed](#) is also set to this value. Priority of LCP scans and the amount of data that can be written per real-time break are increased further, and the LCP data buffer is completely available during the LCP scan.

Raising the level also has the effect of increasing the calculated target checkpoint speed.

LCP control has the following benefits for [NDB](#) installations:

- Clusters should now survive very heavy loads using default configurations much better than previously.
- It should now be possible for NDB to run reliably on systems where the available disk space is (at a rough minimum) 2.1 times the amount of memory allocated to it ([DataMemory](#)). You should note that this figure does *not* include any disk space used for Disk Data tables.
- **ndb\_restore options.** Beginning with NDB 7.6.9, the `--nodeid` and `--backupid` options are both required when invoking `ndb_restore`.
- **Restoring by slices.** Beginning with NDB 7.6.13, it is possible to divide a backup into roughly equal portions (slices) and to restore these slices in parallel using two new options implemented for `ndb_restore`:
  - `--num-slices` determines the number of slices into which the backup should be divided.
  - `--slice-id` provides the ID of the slice to be restored by the current instance of `ndb_restore`.

This makes it possible to employ multiple instances of `ndb_restore` to restore subsets of the backup in parallel, potentially reducing the amount of time required to perform the restore operation.

For more information, see the description of the `ndb_restore --num-slices` option.

- **ndb\_restore: primary key schema changes.** NDB 7.6.14 (and later) supports different primary key definitions for source and target tables when restoring an NDB native backup with `ndb_restore` when it is run with the `--allow-pk-changes` option. Both increasing and decreasing the number of columns making up the original primary key are supported.

When the primary key is extended with an additional column or columns, any columns added must be defined as `NOT NULL`, and no values in any such columns may be changed during the time that the backup is being taken. Because some applications set all column values in a row when updating it, whether or not all values are actually changed, this can cause a restore operation to fail even if no values in the column to be added to the primary key have changed. You can override this behavior using the `--ignore-extended-pk-updates` option also added in NDB 7.6.14; in this case, you must ensure that no such values are changed.

A column can be removed from the table's primary key whether or not this column remains part of the table.

For more information, see the description of the `--allow-pk-changes` option for `ndb_restore`.

- **ndb\_blob\_tool enhancements.** Beginning with NDB 7.6.14, the `ndb_blob_tool` utility can detect missing blob parts for which inline parts exist and replace these with placeholder blob parts (consisting of space characters) of the correct length. To check whether there are missing blob parts, use the `--check-missing` option with this program. To replace any missing blob parts with placeholders, use the `--add-missing` option.

For more information, see [Section 21.5.6, “ndb\\_blob\\_tool — Check and Repair BLOB and TEXT columns of NDB Cluster Tables”](#).

- **Merging backups with ndb\_restore.** In some cases, it may be desirable to consolidate data originally stored in different instances of NDB Cluster (all using the same schema) into a single target NDB Cluster. This is now supported when using backups created in the `ndb_mgm` client (see [Section 21.6.8.2, “Using The NDB Cluster Management Client to Create a Backup”](#)) and restoring them with `ndb_restore`, using the `--remap-column` option added in NDB 7.6.14 along with `--restore-`

`data` (and possibly additional compatible options as needed or desired). `--remap-column` can be employed to handle cases in which primary and unique key values are overlapping between source clusters, and it is necessary that they do not overlap in the target cluster, as well as to preserve other relationships between tables such as foreign keys.

`--remap-column` takes as its argument a string having the format `db.tbl.col:fn:args`, where `db`, `tbl`, and `col` are, respectively, the names of the database, table, and column, `fn` is the name of a remapping function, and `args` is one or more arguments to `fn`. There is no default value. Only `offset` is supported as the function name, with `args` as the integer offset to be applied to the value of the column when inserting it into the target table from the backup. This column must be one of `INT` or `BIGINT`; the allowed range of the offset value is the same as the signed version of that type (this allows the offset to be negative if desired).

The new option can be used multiple times in the same invocation of `ndb_restore`, so that you can remap to new values multiple columns of the same table, different tables, or both. The offset value does not have to be the same for all instances of the option.

In addition, two new options are provided for `ndb_desc`, also beginning in NDB 7.6.14:

- `--auto-inc` (short form `-a`): Includes the next auto-increment value in the output, if the table has an `AUTO_INCREMENT` column.
- `--context` (short form `-x`): Provides extra information about the table, including the schema, database name, table name, and internal ID.

For more information and examples, see the description of the `--remap-column` option.

- **--ndb-log-fail-terminate option.** Beginning with NDB 7.6.14, you can cause the SQL node to terminate whenever it is unable to log all row events fully. This can be done by starting `mysqld` with the `--ndb-log-fail-terminate` option.
- **NDB programs—NDBT dependency removal.** The dependency of a number of NDB utility programs on the `NDBT` library has been removed. This library is used internally for development, and is not required for normal use; its inclusion in these programs could lead to unwanted issues when testing.

Affected programs are listed here, along with the NDB versions in which the dependency was removed:

- `ndb_restore`, in NDB 7.6.11
- `ndb_show_tables`, in NDB 7.6.14
- `ndb_waiter`, in NDB 7.6.14

The principal effect of this change for users is that these programs no longer print `NDBT_ProgramExit - status` following completion of a run. Applications that depend upon such behavior should be updated to reflect the change when upgrading to the indicated versions.

- **Auto-Installer deprecation and removal.** The MySQL NDB Cluster Auto-Installer web-based installation tool (`ndb_setup.py`) is deprecated in NDB 7.6.16, and is removed in NDB 7.6.17 and later. It is no longer supported.
- **ndbmemcache deprecation and removal.** `ndbmemcache` is no longer supported. `ndbmemcache` was deprecated in NDB 7.6.16, and removed in NDB 7.6.17.

- **Node.js support removed.** Beginning with the NDB Cluster 7.6.16 release, support for Node.js by NDB 7.6 has been removed.

Support for Node.js by NDB Cluster is maintained in NDB 8.0 only.

- **Conversion between NULL and NOT NULL during restore operations.** Beginning with NDB 7.6.19, `ndb_restore` can support restoring of `NULL` columns as `NOT NULL` and the reverse, using the options listed here:

- To restore a `NULL` column as `NOT NULL`, use the `--lossy-conversions` option.

The column originally declared as `NULL` must not contain any `NULL` rows; if it does, `ndb_restore` exits with an error.

- To restore a `NOT NULL` column as `NULL`, use the `--promote-attributes` option.

For more information, see the descriptions of the indicated `ndb_restore` options.

- **OpenSSL 3.0 support.** Beginning with NDB 7.6.27, all MySQL server and client binaries included in the NDB distribution are compiled with support for Open SSL 3.0

- **mysql client --commands option.** The `mysql` client `--commands` option, added in NDB 7.6.35, enables or disables most `mysql` client commands.

This option is enabled by default. To disable it, start the `mysql` client with `--commands=OFF` or `--skip-commands`.

For more information, see [Section 4.5.1.1, “mysql Client Options”](#).

## 21.2.5 NDB: Added, Deprecated, and Removed Options, Variables, and Parameters

### 21.2.5.1 Options, Variables, and Parameters Added, Deprecated or Removed in NDB 7.5

- [Parameters Introduced in NDB 7.5](#)
- [Parameters Deprecated in NDB 7.5](#)
- [Parameters Removed in NDB 7.5](#)
- [Options and Variables Introduced in NDB 7.5](#)
- [Options and Variables Deprecated in NDB 7.5](#)
- [Options and Variables Removed in NDB 7.5](#)

The next few sections contain information about NDB node configuration parameters and NDB-specific `mysqld` options and variables that have been added to, deprecated in, or removed from NDB 7.5.

#### Parameters Introduced in NDB 7.5

The following node configuration parameters have been added in NDB 7.5.

- `ApiVerbose`: Enable NDB API debugging; for NDB development. Added in NDB 7.5.2.

#### Parameters Deprecated in NDB 7.5

The following node configuration parameters have been deprecated in NDB 7.5.

- `ExecuteOnComputer`: String referencing earlier defined COMPUTER. Deprecated in NDB 7.5.0.
- `ExecuteOnComputer`: String referencing earlier defined COMPUTER. Deprecated in NDB 7.5.0.
- `ExecuteOnComputer`: String referencing earlier defined COMPUTER. Deprecated in NDB 7.5.0.

## Parameters Removed in NDB 7.5

The following node configuration parameters have been removed in NDB 7.5.

- `DiskCheckpointSpeed`: Bytes allowed to be written by checkpoint, per second. Removed in NDB 7.5.0.
- `DiskCheckpointSpeedInRestart`: Bytes allowed to be written by checkpoint during restart, per second. Removed in NDB 7.5.0.
- `Id`: Number identifying data node. Now deprecated; use `Nodeld` instead. Removed in NDB 7.5.0.
- `MaxNoOfSavedEvents`: Not used. Removed in NDB 7.5.0.
- `PortNumber`: Port used for SCI transporter. Removed in NDB 7.5.1.
- `PortNumber`: Port used for SHM transporter. Removed in NDB 7.5.1.
- `PortNumber`: Port used for TCP transporter. Removed in NDB 7.5.1.
- `ReservedSendBufferMemory`: This parameter is present in NDB code but is not enabled. Removed in NDB 7.5.2.

## Options and Variables Introduced in NDB 7.5

The following system variables, status variables, and server options have been added in NDB 7.5.

- `Ndb_system_name`: Configured cluster system name; empty if server not connected to NDB. Added in NDB 5.7.18-ndb-7.5.7.
- `ndb-allow-copying-alter-table`: Set to OFF to keep ALTER TABLE from using copying operations on NDB tables. Added in NDB 5.7.10-ndb-7.5.0.
- `ndb-cluster-connection-pool-nodeids`: Comma-separated list of node IDs for connections to cluster used by MySQL; number of nodes in list must match value set for `--ndb-cluster-connection-pool`. Added in NDB 5.7.10-ndb-7.5.0.
- `ndb-default-column-format`: Use this value (FIXED or DYNAMIC) by default for COLUMN\_FORMAT and ROW\_FORMAT options when creating or adding table columns. Added in NDB 5.7.11-ndb-7.5.1.
- `ndb-log-fail-terminate`: Terminate mysqld process if complete logging of all found row events is not possible. Added in NDB 5.7.29-ndb-7.5.18.
- `ndb-log-update-minimal`: Log updates in minimal format. Added in NDB 5.7.18-ndb-7.5.7.
- `ndb_data_node_neighbour`: Specifies cluster data node "closest" to this MySQL Server, for transaction hinting and fully replicated tables. Added in NDB 5.7.12-ndb-7.5.2.
- `ndb_default_column_format`: Sets default row format and column format (FIXED or DYNAMIC) used for new NDB tables. Added in NDB 5.7.11-ndb-7.5.1.

- [ndb\\_fully\\_replicated](#): Whether new NDB tables are fully replicated. Added in NDB 5.7.12-ndb-7.5.2.
- [ndb\\_read\\_backup](#): Enable read from any replica for all NDB tables; use `NDB_TABLE=READ_BACKUP={0|1}` with `CREATE TABLE` or `ALTER TABLE` to enable or disable for individual NDB tables. Added in NDB 5.7.12-ndb-7.5.2.

### Options and Variables Deprecated in NDB 7.5

No system variables, status variables, or server options have been deprecated in NDB 7.5.

### Options and Variables Removed in NDB 7.5

No system variables, status variables, or options have been removed in NDB 7.5.

## 21.2.5.2 Options, Variables, and Parameters Added, Deprecated or Removed in NDB 7.6

- [Parameters Introduced in NDB 7.6](#)
- [Parameters Deprecated in NDB 7.6](#)
- [Parameters Removed in NDB 7.6](#)
- [Options and Variables Introduced in NDB 7.6](#)
- [Options and Variables Deprecated in NDB 7.6](#)
- [Options and Variables Removed in NDB 7.6](#)

The next few sections contain information about [NDB](#) node configuration parameters and NDB-specific `mysqld` options and variables that have been added to, deprecated in, or removed from NDB 7.6.

### Parameters Introduced in NDB 7.6

The following node configuration parameters have been added in NDB 7.6.

- [ApiFailureHandlingTimeout](#): Maximum time for API node failure handling before escalating. 0 means no time limit; minimum usable value is 10. Added in NDB 7.6.34.
- [EnablePartialLcp](#): Enable partial LCP (true); if this is disabled (false), all LCPs write full checkpoints. Added in NDB 7.6.4.
- [EnableRedoControl](#): Enable adaptive checkpointing speed for controlling redo log usage. Added in NDB 7.6.7.
- [InsertRecoveryWork](#): Percentage of RecoveryWork used for inserted rows; has no effect unless partial local checkpoints are in use. Added in NDB 7.6.5.
- [LocationDomainId](#): Assign this API node to specific availability domain or zone. 0 (default) leaves this unset. Added in NDB 7.6.4.
- [LocationDomainId](#): Assign this management node to specific availability domain or zone. 0 (default) leaves this unset. Added in NDB 7.6.4.
- [LocationDomainId](#): Assign this data node to specific availability domain or zone. 0 (default) leaves this unset. Added in NDB 7.6.4.
- [MaxFKBuildBatchSize](#): Maximum scan batch size to use for building foreign keys. Increasing this value may speed up builds of foreign keys but impacts ongoing traffic as well. Added in NDB 7.6.4.

- [MaxReorgBuildBatchSize](#): Maximum scan batch size to use for reorganization of table partitions. Increasing this value may speed up table partition reorganization but impacts ongoing traffic as well. Added in NDB 7.6.4.
- [MaxUIBuildBatchSize](#): Maximum scan batch size to use for building unique keys. Increasing this value may speed up builds of unique keys but impacts ongoing traffic as well. Added in NDB 7.6.4.
- [ODirectSyncFlag](#): O\_DIRECT writes are treated as synchronized writes; ignored when ODirect is not enabled, InitFragmentLogFiles is set to SPARSE, or both. Added in NDB 7.6.4.
- [PreSendChecksum](#): If this parameter and Checksum are both enabled, perform pre-send checksum checks, and check all SHM signals between nodes for errors. Added in NDB 7.6.6.
- [PreSendChecksum](#): If this parameter and Checksum are both enabled, perform pre-send checksum checks, and check all TCP signals between nodes for errors. Added in NDB 7.6.6.
- [RecoveryWork](#): Percentage of storage overhead for LCP files: greater value means less work in normal operations, more work during recovery. Added in NDB 7.6.4.
- [SendBufferMemory](#): Bytes in shared memory buffer for signals sent from this node. Added in NDB 7.6.6.
- [ShmSpinTime](#): When receiving, number of microseconds to spin before sleeping. Added in NDB 7.6.6.
- [UseShm](#): Use shared memory connections between this data node and API node also running on this host. Added in NDB 7.6.6.
- [WatchDogImmediateKill](#): When true, threads are immediately killed whenever watchdog issues occur; used for testing and debugging. Added in NDB 7.6.7.

### Parameters Deprecated in NDB 7.6

The following node configuration parameters have been deprecated in NDB 7.6.

- [BackupDataBufferSize](#): Default size of databuffer for backup (in bytes). Deprecated in NDB 7.6.4.
- [BackupMaxWriteSize](#): Maximum size of file system writes made by backup (in bytes). Deprecated in NDB 7.6.4.
- [BackupWriteSize](#): Default size of file system writes made by backup (in bytes). Deprecated in NDB 7.6.4.
- [IndexMemory](#): Number of bytes on each data node allocated for storing indexes; subject to available system RAM and size of DataMemory. Deprecated in NDB 7.6.2.
- [Signal](#): Signal number to be used for signalling. Deprecated in NDB 7.6.6.

### Parameters Removed in NDB 7.6

No node configuration parameters have been removed in NDB 7.6.

### Options and Variables Introduced in NDB 7.6

The following system variables, status variables, and server options have been added in NDB 7.6.

- [Ndb\\_system\\_name](#): Configured cluster system name; empty if server not connected to NDB. Added in NDB 5.7.18-ndb-7.6.2.



- [ndb-log-fail-terminate](#): Terminate mysqld process if complete logging of all found row events is not possible. Added in NDB 5.7.29-ndb-7.6.14.
- [ndb-log-update-minimal](#): Log updates in minimal format. Added in NDB 5.7.18-ndb-7.6.3.
- [ndb\\_row\\_checksum](#): When enabled, set row checksums; enabled by default. Added in NDB 5.7.23-ndb-7.6.8.

### Options and Variables Deprecated in NDB 7.6

No system variables, status variables, or server options have been deprecated in NDB 7.6.

### Options and Variables Removed in NDB 7.6

No system variables, status variables, or options have been removed in NDB 7.6.

## 21.2.6 MySQL Server Using InnoDB Compared with NDB Cluster

MySQL Server offers a number of choices in storage engines. Since both [NDB](#) and [InnoDB](#) can serve as transactional MySQL storage engines, users of MySQL Server sometimes become interested in NDB Cluster. They see [NDB](#) as a possible alternative or upgrade to the default [InnoDB](#) storage engine in MySQL 5.7. While [NDB](#) and [InnoDB](#) share common characteristics, there are differences in architecture and implementation, so that some existing MySQL Server applications and usage scenarios can be a good fit for NDB Cluster, but not all of them.

In this section, we discuss and compare some characteristics of the [NDB](#) storage engine used by NDB 7.5 with [InnoDB](#) used in MySQL 5.7. The next few sections provide a technical comparison. In many instances, decisions about when and where to use NDB Cluster must be made on a case-by-case basis, taking all factors into consideration. While it is beyond the scope of this documentation to provide specifics for every conceivable usage scenario, we also attempt to offer some very general guidance on the relative suitability of some common types of applications for [NDB](#) as opposed to [InnoDB](#) back ends.

NDB Cluster 7.5 uses a [mysqld](#) based on MySQL 5.7, including support for [InnoDB](#) 1.1. While it is possible to use [InnoDB](#) tables with NDB Cluster, such tables are not clustered. It is also not possible to use programs or libraries from an NDB Cluster 7.5 distribution with MySQL Server 5.7, or the reverse.

While it is also true that some types of common business applications can be run either on NDB Cluster or on MySQL Server (most likely using the [InnoDB](#) storage engine), there are some important architectural and implementation differences. [Section 21.2.6.1, “Differences Between the NDB and InnoDB Storage Engines”](#), provides a summary of these differences. Due to the differences, some usage scenarios are clearly more suitable for one engine or the other; see [Section 21.2.6.2, “NDB and InnoDB Workloads”](#). This in turn has an impact on the types of applications that better suited for use with [NDB](#) or [InnoDB](#). See [Section 21.2.6.3, “NDB and InnoDB Feature Usage Summary”](#), for a comparison of the relative suitability of each for use in common types of database applications.

For information about the relative characteristics of the [NDB](#) and [MEMORY](#) storage engines, see [When to Use MEMORY or NDB Cluster](#).

See [Chapter 15, Alternative Storage Engines](#), for additional information about MySQL storage engines.

### 21.2.6.1 Differences Between the NDB and InnoDB Storage Engines

The [NDB](#) storage engine is implemented using a distributed, shared-nothing architecture, which causes it to behave differently from [InnoDB](#) in a number of ways. For those unaccustomed to working with [NDB](#),

unexpected behaviors can arise due to its distributed nature with regard to transactions, foreign keys, table limits, and other characteristics. These are shown in the following table:

**Table 21.1 Differences between InnoDB and NDB storage engines**

Feature	InnoDB (MySQL 5.7)	NDB 7.5/7.6
MySQL Server Version	5.7	5.7
InnoDB Version	InnoDB 5.7.44	InnoDB 5.7.44
NDB Cluster Version	N/A	NDB 7.5.36/7.6.36
Storage Limits	64TB	128TB (as of NDB 7.5.2)
Foreign Keys	Yes	Yes
Transactions	All standard types	READ COMMITTED
MVCC	Yes	No
Data Compression	Yes	No (NDB checkpoint and backup files can be compressed)
Large Row Support (> 14K)	Supported for VARBINARY, VARCHAR, BLOB, and TEXT columns	Supported for BLOB and TEXT columns only (Using these types to store very large amounts of data can lower NDB performance)
Replication Support	Asynchronous and semisynchronous replication using MySQL Replication; MySQL Group Replication	Automatic synchronous replication within an NDB Cluster; asynchronous replication between NDB Clusters, using MySQL Replication (Semisynchronous replication is not supported)
Scaleout for Read Operations	Yes (MySQL Replication)	Yes (Automatic partitioning in NDB Cluster; NDB Cluster Replication)
Scaleout for Write Operations	Requires application-level partitioning (sharding)	Yes (Automatic partitioning in NDB Cluster is transparent to applications)
High Availability (HA)	Built-in, from InnoDB cluster	Yes (Designed for 99.999% uptime)
Node Failure Recovery and Failover	From MySQL Group Replication	Automatic (Key element in NDB architecture)
Time for Node Failure Recovery	30 seconds or longer	Typically < 1 second
Real-Time Performance	No	Yes
In-Memory Tables	No	Yes (Some data can optionally be stored on disk; both in-memory and disk data storage are durable)
NoSQL Access to Storage Engine	Yes	Yes (Multiple APIs, including Memcached, Node.js/JavaScript, Java, JPA, C++, and HTTP/REST)
Concurrent and Parallel Writes	Yes	Up to 48 writers, optimized for concurrent writes
Conflict Detection and Resolution (Multiple Replication Surces)	Yes (MySQL Group Replication)	Yes

Feature	InnoDB (MySQL 5.7)	NDB 7.5/7.6
Hash Indexes	No	Yes
Online Addition of Nodes	Read/write replicas using MySQL Group Replication	Yes (all node types)
Online Upgrades	Yes (using replication)	Yes
Online Schema Modifications	Yes, as part of MySQL 5.7	Yes

### 21.2.6.2 NDB and InnoDB Workloads

NDB Cluster has a range of unique attributes that make it ideal to serve applications requiring high availability, fast failover, high throughput, and low latency. Due to its distributed architecture and multi-node implementation, NDB Cluster also has specific constraints that may keep some workloads from performing well. A number of major differences in behavior between the NDB and InnoDB storage engines with regard to some common types of database-driven application workloads are shown in the following table::

**Table 21.2 Differences between InnoDB and NDB storage engines, common types of data-driven application workloads.**

Workload	InnoDB	NDB Cluster (NDB)
High-Volume OLTP Applications	Yes	Yes
DSS Applications (data marts, analytics)	Yes	Limited (Join operations across OLTP datasets not exceeding 3TB in size)
Custom Applications	Yes	Yes
Packaged Applications	Yes	Limited (should be mostly primary key access); NDB Cluster 7.5 supports foreign keys
In-Network Telecoms Applications (HLR, HSS, SDP)	No	Yes
Session Management and Caching	Yes	Yes
E-Commerce Applications	Yes	Yes
User Profile Management, AAA Protocol	Yes	Yes

### 21.2.6.3 NDB and InnoDB Feature Usage Summary

When comparing application feature requirements to the capabilities of InnoDB with NDB, some are clearly more compatible with one storage engine than the other.

The following table lists supported application features according to the storage engine to which each feature is typically better suited.

**Table 21.3 Supported application features according to the storage engine to which each feature is typically better suited**

Preferred application requirements for InnoDB	Preferred application requirements for NDB
<ul style="list-style-type: none"> <li>Foreign keys</li> </ul>	<ul style="list-style-type: none"> <li>Write scaling</li> <li>99.999% uptime</li> </ul>

Preferred application requirements for <b>InnoDB</b>	Preferred application requirements for <b>NDB</b>
 <p><b>Note</b> NDB Cluster 7.5 supports foreign keys</p> <ul style="list-style-type: none"> <li>• Full table scans</li> <li>• Very large databases, rows, or transactions</li> <li>• Transactions other than <code>READ COMMITTED</code></li> </ul>	<ul style="list-style-type: none"> <li>• Online addition of nodes and online schema operations</li> <li>• Multiple SQL and NoSQL APIs (see <a href="#">NDB Cluster APIs: Overview and Concepts</a>)</li> <li>• Real-time performance</li> <li>• Limited use of <code>BLOB</code> columns</li> <li>• Foreign keys are supported, although their use may have an impact on performance at high throughput</li> </ul>

## 21.2.7 Known Limitations of NDB Cluster

In the sections that follow, we discuss known limitations in current releases of NDB Cluster as compared with the features available when using the `MyISAM` and `InnoDB` storage engines. If you check the “Cluster” category in the MySQL bugs database at <http://bugs.mysql.com>, you can find known bugs in the following categories under “MySQL Server:” in the MySQL bugs database at <http://bugs.mysql.com>, which we intend to correct in upcoming releases of NDB Cluster:

- NDB Cluster
- Cluster Direct API (NDBAPI)
- Cluster Disk Data
- Cluster Replication
- ClusterJ

This information is intended to be complete with respect to the conditions just set forth. You can report any discrepancies that you encounter to the MySQL bugs database using the instructions given in [Section 1.5, “How to Report Bugs or Problems”](#). Any problem which we do not plan to fix in NDB Cluster 7.5 is added to the list.

See [Previous NDB Cluster Issues Resolved in NDB Cluster 8.0](#) for a list of issues in earlier releases that have been resolved in NDB Cluster 7.5.



**Note**

Limitations and other issues specific to NDB Cluster Replication are described in [Section 21.7.3, “Known Issues in NDB Cluster Replication”](#).

### 21.2.7.1 Noncompliance with SQL Syntax in NDB Cluster

Some SQL statements relating to certain MySQL features produce errors when used with `NDB` tables, as described in the following list:

- **Temporary tables.** Temporary tables are not supported. Trying either to create a temporary table that uses the `NDB` storage engine or to alter an existing temporary table to use `NDB` fails with the error `Table storage engine 'ndbcluster' does not support the create option 'TEMPORARY'`.
- **Indexes and keys in NDB tables.** Keys and indexes on NDB Cluster tables are subject to the following limitations:

- **Column width.** Attempting to create an index on an NDB table column whose width is greater than 3072 bytes is rejected with `ER_TOO_LONG_KEY: Specified key was too long; max key length is 3072 bytes.`

Attempting to create an index on an NDB table column whose width is greater than 3056 bytes succeeds with a warning. In such cases, statistical information is not generated, which means a nonoptimal execution plan may be selected. For this reason, you should consider making the index length shorter than 3056 bytes if possible.

- **TEXT and BLOB columns.** You cannot create indexes on NDB table columns that use any of the `TEXT` or `BLOB` data types.
- **FULLTEXT indexes.** The NDB storage engine does not support `FULLTEXT` indexes, which are possible for `MyISAM` and `InnoDB` tables only.

However, you can create indexes on `VARCHAR` columns of NDB tables.

- **USING HASH keys and NULL.** Using nullable columns in unique keys and primary keys means that queries using these columns are handled as full table scans. To work around this issue, make the column `NOT NULL`, or re-create the index without the `USING HASH` option.
- **Prefixes.** There are no prefix indexes; only entire columns can be indexed. (The size of an NDB column index is always the same as the width of the column in bytes, up to and including 3072 bytes, as described earlier in this section. Also see [Section 21.2.7.6, “Unsupported or Missing Features in NDB Cluster”](#), for additional information.)
- **BIT columns.** A `BIT` column cannot be a primary key, unique key, or index, nor can it be part of a composite primary key, unique key, or index.
- **AUTO\_INCREMENT columns.** Like other MySQL storage engines, the NDB storage engine can handle a maximum of one `AUTO_INCREMENT` column per table, and this column must be indexed. However, in the case of an NDB table with no explicit primary key, an `AUTO_INCREMENT` column is automatically defined and used as a “hidden” primary key. For this reason, you cannot create an NDB table having an `AUTO_INCREMENT` column and no explicit primary key.

The following `CREATE TABLE` statements do not work, as shown here:

```
# No index on AUTO_INCREMENT column; table has no primary key
# Raises ER_WRONG_AUTO_KEY
mysql> CREATE TABLE n (
->   a INT,
->   b INT AUTO_INCREMENT
-> )
-> ENGINE=NDB;
ERROR 1075 (42000): Incorrect table definition; there can be only one auto
column and it must be defined as a key

# Index on AUTO_INCREMENT column; table has no primary key
# Raises NDB error 4335
mysql> CREATE TABLE n (
->   a INT,
->   b INT AUTO_INCREMENT,
->   KEY k (b)
-> )
-> ENGINE=NDB;
ERROR 1296 (HY000): Got error 4335 'Only one autoincrement column allowed per
```

table. Having a table without primary key uses an autoincr' from NDBCLUSTER

The following statement creates a table with a primary key, an `AUTO_INCREMENT` column, and an index on this column, and succeeds:

```
# Index on AUTO_INCREMENT column; table has a primary key
mysql> CREATE TABLE n (
->   a INT PRIMARY KEY,
->   b INT AUTO_INCREMENT,
->   KEY k (b)
-> )
-> ENGINE=NDB;
Query OK, 0 rows affected (0.38 sec)
```

- **Restrictions on foreign keys.** Support for foreign key constraints in NDB 7.5 is comparable to that provided by `InnoDB`, subject to the following restrictions:

- Every column referenced as a foreign key requires an explicit unique key, if it is not the table's primary key.
- `ON UPDATE CASCADE` is not supported when the reference is to the parent table's primary key.

This is because an update of a primary key is implemented as a delete of the old row (containing the old primary key) plus an insert of the new row (with a new primary key). This is not visible to the `NDB` kernel, which views these two rows as being the same, and thus has no way of knowing that this update should be cascaded.

- As of NDB 7.5.14 and NDB 7.6.10: `ON DELETE CASCADE` is not supported where the child table contains one or more columns of any of the `TEXT` or `BLOB` types. (Bug #89511, Bug #27484882)
- `SET DEFAULT` is not supported. (Also not supported by `InnoDB`.)
- The `NO ACTION` keywords are accepted but treated as `RESTRICT`. (Also the same as with `InnoDB`.)
- In earlier versions of NDB Cluster, when creating a table with foreign key referencing an index in another table, it sometimes appeared possible to create the foreign key even if the order of the columns in the indexes did not match, due to the fact that an appropriate error was not always returned internally. A partial fix for this issue improved the error used internally to work in most cases; however, it remains possible for this situation to occur in the event that the parent index is a unique index. (Bug #18094360)
- Prior to NDB 7.5.6, when adding or dropping a foreign key using `ALTER TABLE`, the parent table's metadata is not updated, which makes it possible subsequently to execute `ALTER TABLE` statements on the parent that should be invalid. To work around this issue, execute `SHOW CREATE TABLE` on the parent table immediately after adding or dropping the foreign key; this forces the parent's metadata to be reloaded.

This issue is fixed in NDB 7.5.6. (Bug #82989, Bug #24666177)

For more information, see [Section 13.1.18.5, "FOREIGN KEY Constraints"](#), and [Section 1.6.3.2, "FOREIGN KEY Constraints"](#).

- **NDB Cluster and geometry data types.** Geometry data types (`WKT` and `WKB`) are supported for `NDB` tables. However, spatial indexes are not supported.
- **Character sets and binary log files.** Currently, the `ndb_apply_status` and `ndb_binlog_index` tables are created using the `latin1` (ASCII) character set. Because names of binary logs are recorded

in this table, binary log files named using non-Latin characters are not referenced correctly in these tables. This is a known issue, which we are working to fix. (Bug #50226)

To work around this problem, use only Latin-1 characters when naming binary log files or setting any the `--basedir`, `--log-bin`, or `--log-bin-index` options.

- **Creating NDB tables with user-defined partitioning.** Support for user-defined partitioning in NDB Cluster is restricted to `[LINEAR] KEY` partitioning. Using any other partitioning type with `ENGINE=NDB` or `ENGINE=NDBCLUSTER` in a `CREATE TABLE` statement results in an error.

It is possible to override this restriction, but doing so is not supported for use in production settings. For details, see [User-defined partitioning and the NDB storage engine \(NDB Cluster\)](#).

**Default partitioning scheme.** All NDB Cluster tables are by default partitioned by `KEY` using the table's primary key as the partitioning key. If no primary key is explicitly set for the table, the “hidden” primary key automatically created by the NDB storage engine is used instead. For additional discussion of these and related issues, see [Section 22.2.5, “KEY Partitioning”](#).

`CREATE TABLE` and `ALTER TABLE` statements that would cause a user-partitioned `NDBCLUSTER` table not to meet either or both of the following two requirements are not permitted, and fail with an error:

1. The table must have an explicit primary key.
2. All columns listed in the table's partitioning expression must be part of the primary key.

**Exception.** If a user-partitioned `NDBCLUSTER` table is created using an empty column-list (that is, using `PARTITION BY [LINEAR] KEY()`), then no explicit primary key is required.

**Maximum number of partitions for NDBCLUSTER tables.** The maximum number of partitions that can be defined for a `NDBCLUSTER` table when employing user-defined partitioning is 8 per node group. (See [Section 21.2.2, “NDB Cluster Nodes, Node Groups, Fragment Replicas, and Partitions”](#), for more information about NDB Cluster node groups.

**DROP PARTITION not supported.** It is not possible to drop partitions from NDB tables using `ALTER TABLE ... DROP PARTITION`. The other partitioning extensions to `ALTER TABLE`—`ADD PARTITION`, `REORGANIZE PARTITION`, and `COALESCE PARTITION`—are supported for NDB tables, but use copying and so are not optimized. See [Section 22.3.1, “Management of RANGE and LIST Partitions”](#) and [Section 13.1.8, “ALTER TABLE Statement”](#).

**Partition selection.** Partition selection is not supported for NDB tables. See [Section 22.5, “Partition Selection”](#), for more information.

- **JSON data type.** The MySQL `JSON` data type is supported for NDB tables in the `mysqld` supplied with NDB 7.5.2 and later.

An NDB table can have a maximum of 3 `JSON` columns.

The NDB API has no special provision for working with `JSON` data, which it views simply as `BLOB` data. Handling data as `JSON` must be performed by the application.

- **CPU and thread info `ndbinfo` tables.** NDB 7.5.2 adds several new tables to the `ndbinfo` information database providing information about CPU and thread activity by node, thread ID, and thread type. The tables are listed here:
  - `cpustat`: Provides per-second, per-thread CPU statistics
  - `cpustat_50ms`: Raw per-thread CPU statistics data, gathered every 50ms

- `cpustat_1sec`: Raw per-thread CPU statistics data, gathered each second
- `cpustat_20sec`: Raw per-thread CPU statistics data, gathered every 20 seconds
- `threads`: Names and descriptions of thread types

For more information about these tables, see [Section 21.6.15, “ndbinfo: The NDB Cluster Information Database”](#).

- **Lock info ndbinfo tables.** NDB 7.5.3 adds new tables to the `ndbinfo` information database providing information about locks and lock attempts in a running NDB Cluster. These tables are listed here:
  - `cluster_locks`: Current lock requests which are waiting for or holding locks; this information can be useful when investigating stalls and deadlocks. Analogous to `cluster_operations`.
  - `locks_per_fragment`: Counts of lock claim requests, and their outcomes per fragment, as well as total time spent waiting for locks successfully and unsuccessfully. Analogous to `operations_per_fragment` and `memory_per_fragment`.
  - `server_locks`: Subset of cluster transactions—those running on the local `mysqld`, showing a connection id per transaction. Analogous to `server_operations`.

### 21.2.7.2 Limits and Differences of NDB Cluster from Standard MySQL Limits

In this section, we list limits found in NDB Cluster that either differ from limits found in, or that are not found in, standard MySQL.

**Memory usage and recovery.** Memory consumed when data is inserted into an `NDB` table is not automatically recovered when deleted, as it is with other storage engines. Instead, the following rules hold true:

- A `DELETE` statement on an `NDB` table makes the memory formerly used by the deleted rows available for re-use by inserts on the same table only. However, this memory can be made available for general re-use by performing `OPTIMIZE TABLE`.

A rolling restart of the cluster also frees any memory used by deleted rows. See [Section 21.6.5, “Performing a Rolling Restart of an NDB Cluster”](#).

- A `DROP TABLE` or `TRUNCATE TABLE` operation on an `NDB` table frees the memory that was used by this table for re-use by any `NDB` table, either by the same table or by another `NDB` table.



#### Note

Recall that `TRUNCATE TABLE` drops and re-creates the table. See [Section 13.1.34, “TRUNCATE TABLE Statement”](#).

- **Limits imposed by the cluster's configuration.** A number of hard limits exist which are configurable, but available main memory in the cluster sets limits. See the complete list of configuration parameters in [Section 21.4.3, “NDB Cluster Configuration Files”](#). Most configuration parameters can be upgraded online. These hard limits include:
  - Database memory size and index memory size (`DataMemory` and `IndexMemory`, respectively).  
`DataMemory` is allocated as 32KB pages. As each `DataMemory` page is used, it is assigned to a specific table; once allocated, this memory cannot be freed except by dropping the table.



See [Section 21.4.3.6, “Defining NDB Cluster Data Nodes”](#), for more information.

- The maximum number of operations that can be performed per transaction is set using the configuration parameters [MaxNoOfConcurrentOperations](#) and [MaxNoOfLocalOperations](#).



#### Note

Bulk loading, [TRUNCATE TABLE](#), and [ALTER TABLE](#) are handled as special cases by running multiple transactions, and so are not subject to this limitation.

- Different limits related to tables and indexes. For example, the maximum number of ordered indexes in the cluster is determined by [MaxNoOfOrderedIndexes](#), and the maximum number of ordered indexes per table is 16.
- **Node and data object maximums.** The following limits apply to numbers of cluster nodes and metadata objects:

- The maximum number of data nodes is 48.

A data node must have a node ID in the range of 1 to 48, inclusive. (Management and API nodes may use node IDs in the range 1 to 255, inclusive.)

- The total maximum number of nodes in an NDB Cluster is 255. This number includes all SQL nodes (MySQL Servers), API nodes (applications accessing the cluster other than MySQL servers), data nodes, and management servers.
- The maximum number of metadata objects in current versions of NDB Cluster is 20320. This limit is hard-coded.

See [Previous NDB Cluster Issues Resolved in NDB Cluster 8.0](#), for more information.

### 21.2.7.3 Limits Relating to Transaction Handling in NDB Cluster

A number of limitations exist in NDB Cluster with regard to the handling of transactions. These include the following:

- **Transaction isolation level.** The [NDBCLUSTER](#) storage engine supports only the [READ COMMITTED](#) transaction isolation level. ([InnoDB](#), for example, supports [READ COMMITTED](#), [READ UNCOMMITTED](#), [REPEATABLE READ](#), and [SERIALIZABLE](#).) You should keep in mind that [NDB](#) implements [READ COMMITTED](#) on a per-row basis; when a read request arrives at the data node storing the row, what is returned is the last committed version of the row at that time.

Uncommitted data is never returned, but when a transaction modifying a number of rows commits concurrently with a transaction reading the same rows, the transaction performing the read can observe “before” values, “after” values, or both, for different rows among these, due to the fact that a given row read request can be processed either before or after the commit of the other transaction.

To ensure that a given transaction reads only before or after values, you can impose row locks using [SELECT ... LOCK IN SHARE MODE](#). In such cases, the lock is held until the owning transaction is committed. Using row locks can also cause the following issues:

- Increased frequency of lock wait timeout errors, and reduced concurrency
- Increased transaction processing overhead due to reads requiring a commit phase

- Possibility of exhausting the available number of concurrent locks, which is limited by `MaxNoOfConcurrentOperations`

NDB uses `READ COMMITTED` for all reads unless a modifier such as `LOCK IN SHARE MODE` or `FOR UPDATE` is used. `LOCK IN SHARE MODE` causes shared row locks to be used; `FOR UPDATE` causes exclusive row locks to be used. Unique key reads have their locks upgraded automatically by NDB to ensure a self-consistent read; `BLOB` reads also employ extra locking for consistency.

See [Section 21.6.8.4, “NDB Cluster Backup Troubleshooting”](#), for information on how NDB Cluster's implementation of transaction isolation level can affect backup and restoration of NDB databases.

- **Transactions and BLOB or TEXT columns.** `NDBCLUSTER` stores only part of a column value that uses any of MySQL's `BLOB` or `TEXT` data types in the table visible to MySQL; the remainder of the `BLOB` or `TEXT` is stored in a separate internal table that is not accessible to MySQL. This gives rise to two related issues of which you should be aware whenever executing `SELECT` statements on tables that contain columns of these types:
  1. For any `SELECT` from an NDB Cluster table: If the `SELECT` includes a `BLOB` or `TEXT` column, the `READ COMMITTED` transaction isolation level is converted to a read with read lock. This is done to guarantee consistency.
  2. For any `SELECT` which uses a unique key lookup to retrieve any columns that use any of the `BLOB` or `TEXT` data types and that is executed within a transaction, a shared read lock is held on the table for the duration of the transaction—that is, until the transaction is either committed or aborted.

This issue does not occur for queries that use index or table scans, even against NDB tables having `BLOB` or `TEXT` columns.

For example, consider the table `t` defined by the following `CREATE TABLE` statement:

```
CREATE TABLE t (
  a INT NOT NULL AUTO_INCREMENT PRIMARY KEY,
  b INT NOT NULL,
  c INT NOT NULL,
  d TEXT,
  INDEX i(b),
  UNIQUE KEY u(c)
) ENGINE = NDB,
```

The following query on `t` causes a shared read lock, because it uses a unique key lookup:

```
SELECT * FROM t WHERE c = 1;
```

However, none of the four queries shown here causes a shared read lock:

```
SELECT * FROM t WHERE b = 1;

SELECT * FROM t WHERE d = '1';

SELECT * FROM t;
```

```
SELECT b,c WHERE a = 1;
```

This is because, of these four queries, the first uses an index scan, the second and third use table scans, and the fourth, while using a primary key lookup, does not retrieve the value of any `BLOB` or `TEXT` columns.

You can help minimize issues with shared read locks by avoiding queries that use unique key lookups that retrieve `BLOB` or `TEXT` columns, or, in cases where such queries are not avoidable, by committing transactions as soon as possible afterward.

- **Unique key lookups and transaction isolation.** Unique indexes are implemented in `NDB` using a hidden index table which is maintained internally. When a user-created `NDB` table is accessed using a unique index, the hidden index table is first read to find the primary key that is then used to read the user-created table. To avoid modification of the index during this double-read operation, the row found in the hidden index table is locked. When a row referenced by a unique index in the user-created `NDB` table is updated, the hidden index table is subject to an exclusive lock by the transaction in which the update is performed. This means that any read operation on the same (user-created) `NDB` table must wait for the update to complete. This is true even when the transaction level of the read operation is `READ COMMITTED`.

One workaround which can be used to bypass potentially blocking reads is to force the SQL node to ignore the unique index when performing the read. This can be done by using the `IGNORE INDEX` index hint as part of the `SELECT` statement reading the table (see [Section 8.9.4, “Index Hints”](#)). Because the MySQL server creates a shadowing ordered index for every unique index created in `NDB`, this lets the ordered index be read instead, and avoids unique index access locking. The resulting read is as consistent as a committed read by primary key, returning the last committed value at the time the row is read.

Reading via an ordered index makes less efficient use of resources in the cluster, and may have higher latency.

It is also possible to avoid using the unique index for access by querying for ranges rather than for unique values.

- **Rollbacks.** There are no partial transactions, and no partial rollbacks of transactions. A duplicate key or similar error causes the entire transaction to be rolled back.

This behavior differs from that of other transactional storage engines such as `InnoDB` that may roll back individual statements.

- **Transactions and memory usage.**

As noted elsewhere in this chapter, `NDB Cluster` does not handle large transactions well; it is better to perform a number of small transactions with a few operations each than to attempt a single large transaction containing a great many operations. Among other considerations, large transactions require very large amounts of memory. Because of this, the transactional behavior of a number of MySQL statements is affected as described in the following list:

- `TRUNCATE TABLE` is not transactional when used on `NDB` tables. If a `TRUNCATE TABLE` fails to empty the table, then it must be re-run until it is successful.
- `DELETE FROM` (even with no `WHERE` clause) is transactional. For tables containing a great many rows, you may find that performance is improved by using several `DELETE FROM ... LIMIT ...`

statements to “chunk” the delete operation. If your objective is to empty the table, then you may wish to use `TRUNCATE TABLE` instead.

- **LOAD DATA statements.** `LOAD DATA` is not transactional when used on `NDB` tables.



#### Important

When executing a `LOAD DATA` statement, the `NDB` engine performs commits at irregular intervals that enable better utilization of the communication network. It is not possible to know ahead of time when such commits take place.

- **ALTER TABLE and transactions.** When copying an `NDB` table as part of an `ALTER TABLE`, the creation of the copy is nontransactional. (In any case, this operation is rolled back when the copy is deleted.)
- **Transactions and the COUNT() function.** When using `NDB` Cluster Replication, it is not possible to guarantee the transactional consistency of the `COUNT()` function on the replica. In other words, when performing on the source a series of statements (`INSERT`, `DELETE`, or both) that changes the number of rows in a table within a single transaction, executing `SELECT COUNT(*) FROM table` queries on the replica may yield intermediate results. This is due to the fact that `SELECT COUNT(...)` may perform dirty reads, and is not a bug in the `NDB` storage engine. (See Bug #31321 for more information.)

### 21.2.7.4 NDB Cluster Error Handling

Starting, stopping, or restarting a node may give rise to temporary errors causing some transactions to fail. These include the following cases:

- **Temporary errors.** When first starting a node, it is possible that you may see Error 1204 `Temporary failure, distribution changed` and similar temporary errors.
- **Errors due to node failure.** The stopping or failure of any data node can result in a number of different node failure errors. (However, there should be no aborted transactions when performing a planned shutdown of the cluster.)

In either of these cases, any errors that are generated must be handled within the application. This should be done by retrying the transaction.

See also [Section 21.2.7.2, “Limits and Differences of NDB Cluster from Standard MySQL Limits”](#).

### 21.2.7.5 Limits Associated with Database Objects in NDB Cluster

Some database objects such as tables and indexes have different limitations when using the `NDBCLUSTER` storage engine:

- **Database and table names.** When using the `NDB` storage engine, the maximum allowed length both for database names and for table names is 63 characters. A statement using a database name or table name longer than this limit fails with an appropriate error.
- **Number of database objects.** The maximum number of *all* `NDB` database objects in a single `NDB` Cluster—including databases, tables, and indexes—is limited to 20320.
- **Attributes per table.** The maximum number of attributes (that is, columns and indexes) that can belong to a given table is 512.
- **Attributes per key.** The maximum number of attributes per key is 32.
- **Row size.** The maximum permitted size of any one row is 14000 bytes.

Each `BLOB` or `TEXT` column contributes  $256 + 8 = 264$  bytes to this total; this includes `JSON` columns. See [String Type Storage Requirements](#), as well as [JSON Storage Requirements](#), for more information relating to these types.

In addition, the maximum offset for a fixed-width column of an `NDB` table is 8188 bytes; attempting to create a table that violates this limitation fails with NDB error 851 `Maximum offset for fixed-size columns exceeded`. For memory-based columns, you can work around this limitation by using a variable-width column type such as `VARCHAR` or defining the column as `COLUMN_FORMAT=DYNAMIC`; this does not work with columns stored on disk. For disk-based columns, you may be able to do so by reordering one or more of the table's disk-based columns such that the combined width of all but the disk-based column defined last in the `CREATE TABLE` statement used to create the table does not exceed 8188 bytes, less any possible rounding performed for some data types such as `CHAR` or `VARCHAR`; otherwise it is necessary to use memory-based storage for one or more of the offending column or columns instead.

- **BIT column storage per table.** The maximum combined width for all `BIT` columns used in a given `NDB` table is 4096.
- **FIXED column storage.** `NDB` Cluster 7.5 and later supports a maximum of 128 TB per fragment of data in `FIXED` columns. (Previously, this was 16 GB.)

### 21.2.7.6 Unsupported or Missing Features in NDB Cluster

A number of features supported by other storage engines are not supported for `NDB` tables. Trying to use any of these features in `NDB` Cluster does not cause errors in or of itself; however, errors may occur in applications that expects the features to be supported or enforced. Statements referencing such features, even if effectively ignored by `NDB`, must be syntactically and otherwise valid.

- **Index prefixes.** Prefixes on indexes are not supported for `NDB` tables. If a prefix is used as part of an index specification in a statement such as `CREATE TABLE`, `ALTER TABLE`, or `CREATE INDEX`, the prefix is not created by `NDB`.

A statement containing an index prefix, and creating or modifying an `NDB` table, must still be syntactically valid. For example, the following statement always fails with Error 1089 `Incorrect prefix key; the used key part isn't a string, the used length is longer than the key part, or the storage engine does not support unique prefix keys`, regardless of storage engine:

```
CREATE TABLE t1 (
  c1 INT NOT NULL,
  c2 VARCHAR(100),
  INDEX i1 (c2(500))
);
```

This happens on account of the SQL syntax rule that no index may have a prefix larger than itself.

- **Savepoints and rollbacks.** Savepoints and rollbacks to savepoints are ignored as in `MyISAM`.
- **Durability of commits.** There are no durable commits on disk. Commits are replicated, but there is no guarantee that logs are flushed to disk on commit.
- **Replication.** Statement-based replication is not supported. Use `--binlog-format=ROW` (or `--binlog-format=MIXED`) when setting up cluster replication. See [Section 21.7, “NDB Cluster Replication”](#), for more information.

Replication using global transaction identifiers (GTIDs) is not compatible with NDB Cluster, and is not supported in NDB Cluster 7.5 or NDB Cluster 7.6. Do not enable GTIDs when using the [NDB](#) storage engine, as this is very likely to cause problems up to and including failure of NDB Cluster Replication.

Semisynchronous replication is not supported in NDB Cluster.

When replicating between clusters, it is possible to use IPv6 addresses between SQL nodes in different clusters, but all connections within a given cluster must use IPv4 addressing. For more information, see [NDB Cluster Replication and IPv6](#).

- **Generated columns.** The [NDB](#) storage engine does not support indexes on virtual generated columns.

As with other storage engines, you can create an index on a stored generated column, but you should bear in mind that [NDB](#) uses [DataMemory](#) for storage of the generated column as well as [IndexMemory](#) for the index. See [JSON columns and indirect indexing in NDB Cluster](#), for an example.

NDB Cluster writes changes in stored generated columns to the binary log, but does not log those made to virtual columns. This should not affect NDB Cluster Replication or replication between [NDB](#) and other MySQL storage engines.



### Note

See [Section 21.2.7.3, “Limits Relating to Transaction Handling in NDB Cluster”](#), for more information relating to limitations on transaction handling in [NDB](#).

### 21.2.7.7 Limitations Relating to Performance in NDB Cluster

The following performance issues are specific to or especially pronounced in NDB Cluster:

- **Range scans.** There are query performance issues due to sequential access to the [NDB](#) storage engine; it is also relatively more expensive to do many range scans than it is with either [MyISAM](#) or [InnoDB](#).
- **Reliability of Records in range.** The [Records in range](#) statistic is available but is not completely tested or officially supported. This may result in nonoptimal query plans in some cases. If necessary, you can employ [USE INDEX](#) or [FORCE INDEX](#) to alter the execution plan. See [Section 8.9.4, “Index Hints”](#), for more information on how to do this.
- **Unique hash indexes.** Unique hash indexes created with [USING HASH](#) cannot be used for accessing a table if [NULL](#) is given as part of the key.

### 21.2.7.8 Issues Exclusive to NDB Cluster

The following are limitations specific to the [NDB](#) storage engine:

- **Machine architecture.** All machines used in the cluster must have the same architecture. That is, all machines hosting nodes must be either big-endian or little-endian, and you cannot use a mixture of both. For example, you cannot have a management node running on a PowerPC which directs a data node that is running on an x86 machine. This restriction does not apply to machines simply running [mysql](#) or other clients that may be accessing the cluster's SQL nodes.
- **Binary logging.**  
NDB Cluster has the following limitations or restrictions with regard to binary logging:
  - NDB Cluster cannot produce a binary log for tables having [BLOB](#) columns but no primary key.

- Only the following schema operations are logged in a cluster binary log which is *not* on the `mysqld` executing the statement:
  - `CREATE TABLE`
  - `ALTER TABLE`
  - `DROP TABLE`
  - `CREATE DATABASE / CREATE SCHEMA`
  - `DROP DATABASE / DROP SCHEMA`
  - `CREATE TABLESPACE`
  - `ALTER TABLESPACE`
  - `DROP TABLESPACE`
  - `CREATE LOGFILE GROUP`
  - `ALTER LOGFILE GROUP`
  - `DROP LOGFILE GROUP`
- **Schema operations.** Schema operations (DDL statements) are rejected while any data node restarts. Schema operations are also not supported while performing an online upgrade or downgrade.
- **Number of fragment replicas.** The number of fragment replicas, as determined by the `NoOfReplicas` data node configuration parameter, is the number of copies of all data stored by NDB Cluster. Setting this parameter to 1 means there is only a single copy; in this case, no redundancy is provided, and the loss of a data node entails loss of data. To guarantee redundancy, and thus preservation of data even if a data node fails, set this parameter to 2, which is the default and recommended value in production.

Setting `NoOfReplicas` to a value greater than 2 is possible (to a maximum of 4) but unnecessary to guard against loss of data. In addition, *values greater than 2 for this parameter are not supported in production.*

See also [Section 21.2.7.10, “Limitations Relating to Multiple NDB Cluster Nodes”](#).

### 21.2.7.9 Limitations Relating to NDB Cluster Disk Data Storage

**Disk Data object maximums and minimums.** Disk data objects are subject to the following maximums and minimums:

- Maximum number of tablespaces:  $2^{32}$  (4294967296)
- Maximum number of data files per tablespace:  $2^{16}$  (65536)
- The minimum and maximum possible sizes of extents for tablespace data files are 32K and 2G, respectively. See [Section 13.1.19, “CREATE TABLESPACE Statement”](#), for more information.

In addition, when working with NDB Disk Data tables, you should be aware of the following issues regarding data files and extents:

- Data files use `DataMemory`. Usage is the same as for in-memory data.

- Data files use file descriptors. It is important to keep in mind that data files are always open, which means the file descriptors are always in use and cannot be re-used for other system tasks.
- Extents require sufficient `DiskPageBufferMemory`; you must reserve enough for this parameter to account for all memory used by all extents (number of extents times size of extents).

**Disk Data tables and diskless mode.** Use of Disk Data tables is not supported when running the cluster in diskless mode.

### 21.2.7.10 Limitations Relating to Multiple NDB Cluster Nodes

#### Multiple SQL nodes.

The following are issues relating to the use of multiple MySQL servers as NDB Cluster SQL nodes, and are specific to the `NDBCLUSTER` storage engine:

- **Stored programs not distributed.** Stored procedures, stored functions, triggers, and scheduled events are all supported by tables using the `NDB` storage engine, but these do *not* propagate automatically between MySQL Servers acting as Cluster SQL nodes, and must be re-created separately on each SQL node. See [Stored Programs in NDB Cluster](#).
- **No distributed table locks.** A `LOCK TABLES` statement or `GET_LOCK()` call works only for the SQL node on which the lock is issued; no other SQL node in the cluster “sees” this lock. This is true for a lock issued by any statement that locks tables as part of its operations. (See next item for an example.)

Implementing table locks in `NDBCLUSTER` can be done in an API application, and ensuring that all applications start by setting `LockMode` to `LM_Read` or `LM_Exclusive`. For more information about how to do this, see the description of `NdbOperation::getLockHandle()` in the *NDB Cluster API Guide*.

- **ALTER TABLE operations.** `ALTER TABLE` is not fully locking when running multiple MySQL servers (SQL nodes). (As discussed in the previous item, NDB Cluster does not support distributed table locks.)

#### Multiple management nodes.

When using multiple management servers:

- If any of the management servers are running on the same host, you must give nodes explicit IDs in connection strings because automatic allocation of node IDs does not work across multiple management servers on the same host. This is not required if every management server resides on a different host.
- When a management server starts, it first checks for any other management server in the same NDB Cluster, and upon successful connection to the other management server uses its configuration data. This means that the management server `--reload` and `--initial` startup options are ignored unless the management server is the only one running. It also means that, when performing a rolling restart of an NDB Cluster with multiple management nodes, the management server reads its own configuration file if (and only if) it is the only management server running in this NDB Cluster. See [Section 21.6.5, “Performing a Rolling Restart of an NDB Cluster”](#), for more information.

**Multiple network addresses.** Multiple network addresses per data node are not supported. Use of these is liable to cause problems: In the event of a data node failure, an SQL node waits for confirmation that the data node went down but never receives it because another route to that data node remains open. This can effectively make the cluster inoperable.



#### Note

It is possible to use multiple network hardware *interfaces* (such as Ethernet cards) for a single data node, but these must be bound to the same address. This also means that it not possible to use more than one `[tcp]` section per connection in



the `config.ini` file. See [Section 21.4.3.10, “NDB Cluster TCP/IP Connections”](#), for more information.

## 21.3 NDB Cluster Installation

This section describes the basics for planning, installing, configuring, and running an NDB Cluster. Whereas the examples in [Section 21.4, “Configuration of NDB Cluster”](#) provide more in-depth information on a variety of clustering options and configuration, the result of following the guidelines and procedures outlined here should be a usable NDB Cluster which meets the *minimum* requirements for availability and safeguarding of data.

For information about upgrading or downgrading an NDB Cluster between release versions, see [Section 21.3.7, “Upgrading and Downgrading NDB Cluster”](#).

This section covers hardware and software requirements; networking issues; installation of NDB Cluster; basic configuration issues; starting, stopping, and restarting the cluster; loading of a sample database; and performing queries.

**Assumptions.** The following sections make a number of assumptions regarding the cluster's physical and network configuration. These assumptions are discussed in the next few paragraphs.

**Cluster nodes and host computers.** The cluster consists of four nodes, each on a separate host computer, and each with a fixed network address on a typical Ethernet network as shown here:

**Table 21.4 Network addresses of nodes in example cluster**

Node	IP Address
Management node ( <code>mgmd</code> )	198.51.100.10
SQL node ( <code>mysqld</code> )	198.51.100.20
Data node "A" ( <code>ndbd</code> )	198.51.100.30
Data node "B" ( <code>ndbd</code> )	198.51.100.40

This setup is also shown in the following diagram:

Figure 21.4 NDB Cluster Multi-Computer Setup

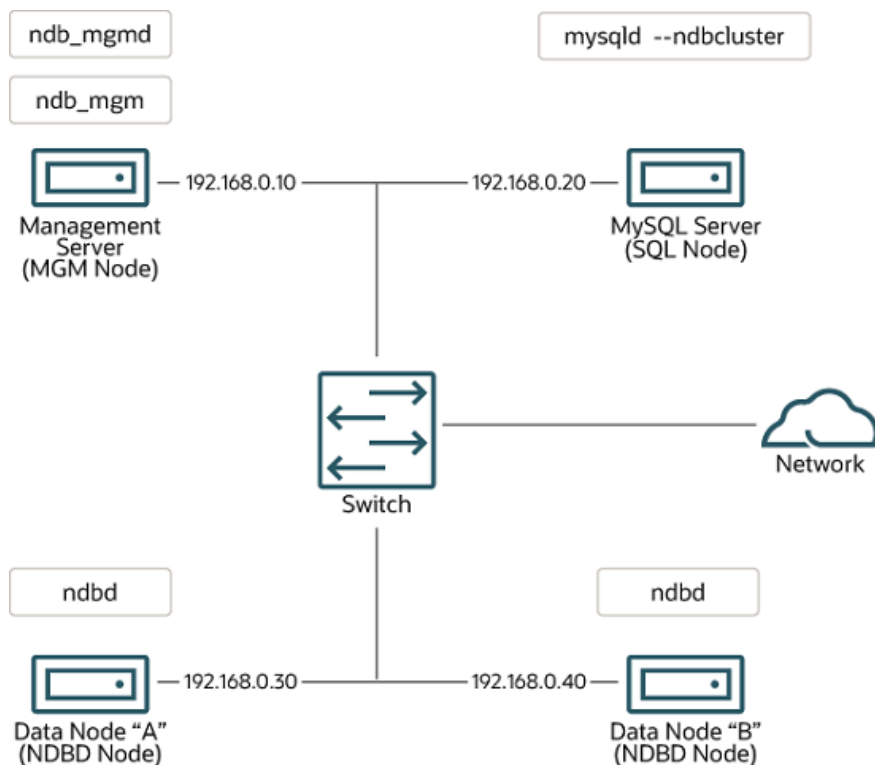

**Network addressing.** In the interest of simplicity (and reliability), this *How-To* uses only numeric IP addresses. However, if DNS resolution is available on your network, it is possible to use host names in lieu of IP addresses in configuring Cluster. Alternatively, you can use the `hosts` file (typically `/etc/hosts` for Linux and other Unix-like operating systems, `C:\WINDOWS\system32\drivers\etc\hosts` on Windows, or your operating system's equivalent) for providing a means to do host lookup if such is available.

**Potential hosts file issues.** A common problem when trying to use host names for Cluster nodes arises because of the way in which some operating systems (including some Linux distributions) set up the system's own host name in the `/etc/hosts` during installation. Consider two machines with the host names `ndb1` and `ndb2`, both in the `cluster` network domain. Red Hat Linux (including some derivatives such as CentOS and Fedora) places the following entries in these machines' `/etc/hosts` files:

```
# ndb1 /etc/hosts:
127.0.0.1 ndb1.cluster ndb1 localhost.localdomain localhost
```

```
# ndb2 /etc/hosts:
127.0.0.1 ndb2.cluster ndb2 localhost.localdomain localhost
```

SUSE Linux (including OpenSUSE) places these entries in the machines' `/etc/hosts` files:

```
# ndb1 /etc/hosts:
127.0.0.1 localhost
127.0.0.2 ndb1.cluster ndb1
```

```
# ndb2 /etc/hosts:
127.0.0.1 localhost
127.0.0.2 ndb2.cluster ndb2
```

In both instances, `ndb1` routes `ndb1.cluster` to a loopback IP address, but gets a public IP address from DNS for `ndb2.cluster`, while `ndb2` routes `ndb2.cluster` to a loopback address and obtains a

public address for `ndb1.cluster`. The result is that each data node connects to the management server, but cannot tell when any other data nodes have connected, and so the data nodes appear to hang while starting.



### Caution

You cannot mix `localhost` and other host names or IP addresses in `config.ini`. For these reasons, the solution in such cases (other than to use IP addresses for *all* `config.ini` `HostName` entries) is to remove the fully qualified host names from `/etc/hosts` and use these in `config.ini` for all cluster hosts.

**Host computer type.** Each host computer in our installation scenario is an Intel-based desktop PC running a supported operating system installed to disk in a standard configuration, and running no unnecessary services. The core operating system with standard TCP/IP networking capabilities should be sufficient. Also for the sake of simplicity, we also assume that the file systems on all hosts are set up identically. In the event that they are not, you should adapt these instructions accordingly.

**Network hardware.** Standard 100 Mbps or 1 gigabit Ethernet cards are installed on each machine, along with the proper drivers for the cards, and that all four hosts are connected through a standard-issue Ethernet networking appliance such as a switch. (All machines should use network cards with the same throughput. That is, all four machines in the cluster should have 100 Mbps cards *or* all four machines should have 1 Gbps cards.) NDB Cluster works in a 100 Mbps network; however, gigabit Ethernet provides better performance.



### Important

NDB Cluster is *not* intended for use in a network for which throughput is less than 100 Mbps or which experiences a high degree of latency. For this reason (among others), attempting to run an NDB Cluster over a wide area network such as the Internet is not likely to be successful, and is not supported in production.

**Sample data.** We use the `world` database which is available for download from the MySQL website (see <https://dev.mysql.com/doc/index-other.html>). We assume that each machine has sufficient memory for running the operating system, required NDB Cluster processes, and (on the data nodes) storing the database.

For general information about installing MySQL, see [Chapter 2, \*Installing and Upgrading MySQL\*](#). For information about installation of NDB Cluster on Linux and other Unix-like operating systems, see [Section 21.3.1, “Installation of NDB Cluster on Linux”](#). For information about installation of NDB Cluster on Windows operating systems, see [Section 21.3.2, “Installing NDB Cluster on Windows”](#).

For general information about NDB Cluster hardware, software, and networking requirements, see [Section 21.2.3, “NDB Cluster Hardware, Software, and Networking Requirements”](#).

## 21.3.1 Installation of NDB Cluster on Linux

This section covers installation methods for NDB Cluster on Linux and other Unix-like operating systems. While the next few sections refer to a Linux operating system, the instructions and procedures given there should be easily adaptable to other supported Unix-like platforms. For manual installation and setup instructions specific to Windows systems, see [Section 21.3.2, “Installing NDB Cluster on Windows”](#).

Each NDB Cluster host computer must have the correct executable programs installed. A host running an SQL node must have installed on it a MySQL Server binary (`mysqld`). Management nodes require the management server daemon (`ndb_mgmd`); data nodes require the data node daemon (`ndbd` or `ndbmt.d`). It is not necessary to install the MySQL Server binary on management node hosts and data node hosts. It is recommended that you also install the management client (`ndb_mgm`) on the management server host.

Installation of NDB Cluster on Linux can be done using precompiled binaries from Oracle (downloaded as a .tar.gz archive), with RPM packages (also available from Oracle), or from source code. All three of these installation methods are described in the section that follow.

Regardless of the method used, it is still necessary following installation of the NDB Cluster binaries to create configuration files for all cluster nodes, before you can start the cluster. See [Section 21.3.3, “Initial Configuration of NDB Cluster”](#).

### 21.3.1.1 Installing an NDB Cluster Binary Release on Linux

This section covers the steps necessary to install the correct executables for each type of Cluster node from precompiled binaries supplied by Oracle.

For setting up a cluster using precompiled binaries, the first step in the installation process for each cluster host is to download the binary archive from the [NDB Cluster downloads page](#). (For the most recent 64-bit NDB 7.6 release, this is `mysql-cluster-gpl-7.6.35-linux-glibc2.12-x86_64.tar.gz`.) We assume that you have placed this file in each machine's `/var/tmp` directory.

If you require a custom binary, see [Section 2.8.5, “Installing MySQL Using a Development Source Tree”](#).



#### Note

After completing the installation, do not yet start any of the binaries. We show you how to do so following the configuration of the nodes (see [Section 21.3.3, “Initial Configuration of NDB Cluster”](#)).

**SQL nodes.** On each of the machines designated to host SQL nodes, perform the following steps as the system `root` user:

1. Check your `/etc/passwd` and `/etc/group` files (or use whatever tools are provided by your operating system for managing users and groups) to see whether there is already a `mysql` group and `mysql` user on the system. Some OS distributions create these as part of the operating system installation process. If they are not already present, create a new `mysql` user group, and then add a `mysql` user to this group:

```
$> groupadd mysql
$> useradd -g mysql -s /bin/false mysql
```

The syntax for `useradd` and `groupadd` may differ slightly on different versions of Unix, or they may have different names such as `adduser` and `addgroup`.

2. Change location to the directory containing the downloaded file, unpack the archive, and create a symbolic link named `mysql` to the `mysql` directory.



#### Note

The actual file and directory names vary according to the NDB Cluster version number.

```
$> cd /var/tmp
$> tar -C /usr/local -xzf mysql-cluster-gpl-7.6.35-linux-glibc2.12-x86_64.tar.gz
$> ln -s /usr/local/mysql-cluster-gpl-7.6.35-linux-glibc2.12-x86_64 /usr/local/mysql
```

3. Change location to the `mysql` directory and set up the system databases using `mysqld --initialize` as shown here:

```
$> cd mysql
$> mysqld --initialize
```

This generates a random password for the MySQL `root` account. If you do *not* want the random password to be generated, you can substitute the `--initialize-insecure` option for `--initialize`. In either case, you should review [Section 2.9.1, “Initializing the Data Directory”](#), for additional information before performing this step. See also [Section 4.4.4, “mysql\\_secure\\_installation — Improve MySQL Installation Security”](#).

4. Set the necessary permissions for the MySQL server and data directories:

```
$> chown -R root .
$> chown -R mysql data
$> chgrp -R mysql .
```

5. Copy the MySQL startup script to the appropriate directory, make it executable, and set it to start when the operating system is booted up:

```
$> cp support-files/mysql.server /etc/rc.d/init.d/
$> chmod +x /etc/rc.d/init.d/mysql.server
$> chkconfig --add mysql.server
```

(The startup scripts directory may vary depending on your operating system and version—for example, in some Linux distributions, it is `/etc/init.d`.)

Here we use Red Hat's `chkconfig` for creating links to the startup scripts; use whatever means is appropriate for this purpose on your platform, such as `update-rc.d` on Debian.

Remember that the preceding steps must be repeated on each machine where an SQL node is to reside.

**Data nodes.** Installation of the data nodes does not require the `mysqld` binary. Only the NDB Cluster data node executable `ndbd` (single-threaded) or `ndbmtbd` (multithreaded) is required. These binaries can also be found in the `.tar.gz` archive. Again, we assume that you have placed this archive in `/var/tmp`.

As system `root` (that is, after using `sudo`, `su root`, or your system's equivalent for temporarily assuming the system administrator account's privileges), perform the following steps to install the data node binaries on the data node hosts:

1. Change location to the `/var/tmp` directory, and extract the `ndbd` and `ndbmtbd` binaries from the archive into a suitable directory such as `/usr/local/bin`:

```
$> cd /var/tmp
$> tar -zxvf mysql-cluster-gpl-7.6.35-linux-glibc2.12-x86_64.tar.gz
$> cd mysql-cluster-gpl-7.6.35-linux-glibc2.12-x86_64
$> cp bin/ndbd /usr/local/bin/ndbd
$> cp bin/ndbmtbd /usr/local/bin/ndbmtbd
```

(You can safely delete the directory created by unpacking the downloaded archive, and the files it contains, from `/var/tmp` once `ndb_mgm` and `ndb_mgmd` have been copied to the executables directory.)

2. Change location to the directory into which you copied the files, and then make both of them executable:

```
$> cd /usr/local/bin
$> chmod +x ndb*
```

The preceding steps should be repeated on each data node host.

Although only one of the data node executables is required to run an NDB Cluster data node, we have shown you how to install both `ndbd` and `ndbmtbd` in the preceding instructions. We recommend that you do

this when installing or upgrading NDB Cluster, even if you plan to use only one of them, since this should save time and trouble in the event that you later decide to change from one to the other.



### Note

The data directory on each machine hosting a data node is `/usr/local/mysql/data`. This piece of information is essential when configuring the management node. (See [Section 21.3.3, “Initial Configuration of NDB Cluster”](#).)

**Management nodes.** Installation of the management node does not require the `mysqld` binary. Only the NDB Cluster management server (`ndb_mgmd`) is required; you most likely want to install the management client (`ndb_mgm`) as well. Both of these binaries also be found in the `.tar.gz` archive. Again, we assume that you have placed this archive in `/var/tmp`.

As system `root`, perform the following steps to install `ndb_mgmd` and `ndb_mgm` on the management node host:

1. Change location to the `/var/tmp` directory, and extract the `ndb_mgm` and `ndb_mgmd` from the archive into a suitable directory such as `/usr/local/bin`:

```
$> cd /var/tmp
$> tar -zxvf mysql-cluster-gpl-7.6.35-linux-glibc2.12-x86_64.tar.gz
$> cd mysql-cluster-gpl-7.6.35-linux-glibc2.12-x86_64
$> cp bin/ndb_mgm* /usr/local/bin
```

(You can safely delete the directory created by unpacking the downloaded archive, and the files it contains, from `/var/tmp` once `ndb_mgm` and `ndb_mgmd` have been copied to the executables directory.)

2. Change location to the directory into which you copied the files, and then make both of them executable:

```
$> cd /usr/local/bin
$> chmod +x ndb_mgm*
```

In [Section 21.3.3, “Initial Configuration of NDB Cluster”](#), we create configuration files for all of the nodes in our example NDB Cluster.

### 21.3.1.2 Installing NDB Cluster from RPM

This section covers the steps necessary to install the correct executables for each type of NDB Cluster node using RPM packages supplied by Oracle.

As an alternative to the method described in this section, Oracle provides MySQL Repositories for NDB Cluster 7.5.6 and later that are compatible with many common Linux distributions. Two repositories, listed here, are available for RPM-based distributions:

- For distributions using `yum` or `dnf`, you can use the MySQL Yum Repository for NDB Cluster. See [Installing MySQL NDB Cluster Using the Yum Repository](#), for instructions and additional information.
- For SLES, you can use the MySQL SLES Repository for NDB Cluster. See [Installing MySQL NDB Cluster Using the SLES Repository](#), for instructions and additional information.

RPMs are available for both 32-bit and 64-bit Linux platforms. The filenames for these RPMs use the following pattern:

```
mysql-cluster-community-data-node-7.5.8-1.e17.x86_64.rpm
```

```
mysql-cluster-license-component-ver-rev.distro.arch.rpm

license:= {commercial | community}

component: {management-server | data-node | server | client | other-see text}

ver: major.minor.release

rev: major[.minor]

distro: {el6 | el7 | sles12}

arch: {i686 | x86_64}
```

*license* indicates whether the RPM is part of a Commercial or Community release of NDB Cluster. In the remainder of this section, we assume for the examples that you are installing a Community release.

Possible values for *component*, with descriptions, can be found in the following table:

**Table 21.5 Components of the NDB Cluster RPM distribution**

Component	Description
<code>auto-installer</code>	NDB Cluster Auto Installer program (DEPRECATED); see <a href="#">Section 21.3.8, “The NDB Cluster Auto-Installer (NDB 7.5) (NO LONGER SUPPORTED)”</a> , for usage
<code>client</code>	MySQL and NDB client programs; includes <code>mysql</code> client, <code>ndb_mgm</code> client, and other client tools
<code>common</code>	Character set and error message information needed by the MySQL server
<code>data-node</code>	<code>ndbd</code> and <code>ndbmt_d</code> data node binaries
<code>devel</code>	Headers and library files needed for MySQL client development
<code>embedded</code>	Embedded MySQL server
<code>embedded-compat</code>	Backwards-compatible embedded MySQL server
<code>embedded-devel</code>	Header and library files for developing applications for embedded MySQL
<code>java</code>	JAR files needed for support of ClusterJ applications
<code>libs</code>	MySQL client libraries
<code>libs-compat</code>	Backwards-compatible MySQL client libraries
<code>management-server</code>	The NDB Cluster management server ( <code>ndb_mgmd</code> )
<code>memcached</code>	Files needed to support <code>ndbmemcache</code>
<code>minimal-debuginfo</code>	Debug information for package server-minimal; useful when developing applications that use this package or when debugging this package
<code>ndbclient</code>	NDB client library for running NDB API and MGM API applications ( <code>libndbclient</code> )
<code>ndbclient-devel</code>	Header and other files needed for developing NDB API and MGM API applications
<code>nodejs</code>	Files needed to set up Node.JS support for NDB Cluster

Component	Description
<code>server</code>	The MySQL server ( <code>mysqld</code> ) with NDB storage engine support included, and associated MySQL server programs
<code>server-minimal</code>	Minimal installation of the MySQL server for NDB and related tools
<code>test</code>	<code>mysqltest</code> , other MySQL test programs, and support files

A single bundle (`.tar` file) of all NDB Cluster RPMs for a given platform and architecture is also available. The name of this file follows the pattern shown here:

```
mysql-cluster-license-ver-rev.distro.arch.rpm-bundle.tar
```

You can extract the individual RPM files from this file using `tar` or your preferred tool for extracting archives.

The components required to install the three major types of NDB Cluster nodes are given in the following list:

- *Management node*: `management-server`
- *Data node*: `data-node`
- *SQL node*: `server` and `common`

In addition, the `client` RPM should be installed to provide the `ndb_mgm` management client on at least one management node. You may also wish to install it on SQL nodes, to have `mysql` and other MySQL client programs available on these. We discuss installation of nodes by type later in this section.

`ver` represents the three-part NDB storage engine version number in `7.6.x` format, shown as `7.6.35` in the examples. `rev` provides the RPM revision number in `major.minor` format. In the examples shown in this section, we use `1.1` for this value.

The `distro` (Linux distribution) is one of `rhel5` (Oracle Linux 5, Red Hat Enterprise Linux 4 and 5), `e16` (Oracle Linux 6, Red Hat Enterprise Linux 6), `e17` (Oracle Linux 7, Red Hat Enterprise Linux 7), or `sles12` (SUSE Enterprise Linux 12). For the examples in this section, we assume that the host runs Oracle Linux 7, Red Hat Enterprise Linux 7, or the equivalent (`e17`).

`arch` is `i686` for 32-bit RPMs and `x86_64` for 64-bit versions. In the examples shown here, we assume a 64-bit platform.

The NDB Cluster version number in the RPM file names (shown here as `7.6.35`) can vary according to the version which you are actually using. *It is very important that all of the Cluster RPMs to be installed have the same version number.* The architecture should also be appropriate to the machine on which the RPM is to be installed; in particular, you should keep in mind that 64-bit RPMs (`x86_64`) cannot be used with 32-bit operating systems (use `i686` for the latter).

**Data nodes.** On a computer that is to host an NDB Cluster data node it is necessary to install only the `data-node` RPM. To do so, copy this RPM to the data node host, and run the following command as the system root user, replacing the name shown for the RPM as necessary to match that of the RPM downloaded from the MySQL website:

```
$> rpm -Uvh mysql-cluster-community-data-node-7.6.35-1.e17.x86_64.rpm
```



This installs the `ndb` and `ndbmysqld` data node binaries in `/usr/sbin`. Either of these can be used to run a data node process on this host.

**SQL nodes.** Copy the `server` and `common` RPMs to each machine to be used for hosting an NDB Cluster SQL node (`server` requires `common`). Install the `server` RPM by executing the following command as the system root user, replacing the name shown for the RPM as necessary to match the name of the RPM downloaded from the MySQL website:

```
$> rpm -Uvh mysql-cluster-community-server-7.6.35-1.el7.x86_64.rpm
```

This installs the MySQL server binary (`mysqld`), with NDB storage engine support, in the `/usr/sbin` directory. It also installs all needed MySQL Server support files and useful MySQL server programs, including the `mysql.server` and `mysqld_safe` startup scripts (in `/usr/share/mysql` and `/usr/bin`, respectively). The RPM installer should take care of general configuration issues (such as creating the `mysql` user and group, if needed) automatically.



### Important

You must use the versions of these RPMs released for NDB Cluster; those released for the standard MySQL server do not provide support for the NDB storage engine.

To administer the SQL node (MySQL server), you should also install the `client` RPM, as shown here:

```
$> rpm -Uvh mysql-cluster-community-client-7.6.35-1.el7.x86_64.rpm
```

This installs the `mysql` client and other MySQL client programs, such as `mysqladmin` and `mysqldump`, to `/usr/bin`.

**Management nodes.** To install the NDB Cluster management server, it is necessary only to use the `management-server` RPM. Copy this RPM to the computer intended to host the management node, and then install it by running the following command as the system root user (replace the name shown for the RPM as necessary to match that of the `management-server` RPM downloaded from the MySQL website):

```
$> rpm -Uvh mysql-cluster-community-management-server-7.6.35-1.el7.x86_64.rpm
```

This RPM installs the management server binary `ndb_mgmd` in the `/usr/sbin` directory. While this is the only program actually required for running a management node, it is also a good idea to have the `ndb_mgm` NDB Cluster management client available as well. You can obtain this program, as well as other NDB client programs such as `ndb_desc` and `ndb_config`, by installing the `client` RPM as described previously.



### Note

Previously, `ndb_mgm` was installed by the same RPM used to install the management server. In NDB 7.5 (and later), all NDB client programs are obtained from the same `client` RPM that installs `mysql` and other MySQL clients.

See [Section 2.5.5, “Installing MySQL on Linux Using RPM Packages from Oracle”](#), for general information about installing MySQL using RPMs supplied by Oracle.

After installing from RPM, you still need to configure the cluster; see [Section 21.3.3, “Initial Configuration of NDB Cluster”](#), for the relevant information.

See [Section 2.5.5, “Installing MySQL on Linux Using RPM Packages from Oracle”](#), for general information about installing MySQL using RPMs supplied by Oracle. See [Section 21.3.3, “Initial Configuration of NDB Cluster”](#), for information about required post-installation configuration.

## 21.3.1.3 Installing NDB Cluster Using .deb Files

The section provides information about installing NDB Cluster on Debian and related Linux distributions such as Ubuntu using the `.deb` files supplied by Oracle for this purpose.

For NDB Cluster 7.5.6 and later, Oracle also provides an APT repository for Debian and other distributions. See [Installing MySQL NDB Cluster Using the APT Repository](#), for instructions and additional information.

Oracle provides `.deb` installer files for NDB Cluster 7.5 and later for 32-bit and 64-bit platforms. For a Debian-based system, only a single installer file is necessary. This file is named using the pattern shown here, according to the applicable NDB Cluster version, Debian version, and architecture:

```
mysql-cluster-gpl-ndbver-debiandebianver-arch.deb
```

Here, `ndbver` is the 3-part NDB engine version number, `debianver` is the major version of Debian (8 or 9), and `arch` is one of `i686` or `x86_64`. In the examples that follow, we assume you wish to install NDB 7.6.35 on a 64-bit Debian 9 system; in this case, the installer file is named `mysql-cluster-gpl-7.6.35-debian9-x86_64.deb-bundle.tar`.

Once you have downloaded the appropriate `.deb` file, you can untar it, and then install it from the command line using `dpkg`, like this:

```
$> dpkg -i mysql-cluster-gpl-7.6.35-debian9-i686.deb
```

You can also remove it using `dpkg` as shown here:

```
$> dpkg -r mysql
```

The installer file should also be compatible with most graphical package managers that work with `.deb` files, such as `GDebi` for the GNOME desktop.

The `.deb` file installs NDB Cluster under `/opt/mysql/server-version/`, where `version` is the 2-part release series version for the included MySQL server. For NDB 7.5 and later, this is always `5.7`. The directory layout is the same as that for the generic Linux binary distribution (see [Table 2.3, “MySQL Installation Layout for Generic Unix/Linux Binary Package”](#)), with the exception that startup scripts and configuration files are found in `support-files` instead of `share`. All NDB Cluster executables, such as `ndb_mgm`, `ndbd`, and `ndb_mgmd`, are placed in the `bin` directory.

### 21.3.1.4 Building NDB Cluster from Source on Linux

This section provides information about compiling NDB Cluster on Linux and other Unix-like platforms. Building NDB Cluster from source is similar to building the standard MySQL Server, although it differs in a few key respects discussed here. For general information about building MySQL from source, see [Section 2.8, “Installing MySQL from Source”](#). For information about compiling NDB Cluster on Windows platforms, see [Section 21.3.2.2, “Compiling and Installing NDB Cluster from Source on Windows”](#).

Building NDB Cluster requires using the NDB Cluster sources. These are available from the NDB Cluster downloads page at <https://dev.mysql.com/downloads/cluster/>. The archived source file should have a name similar to `mysql-cluster-gpl-7.6.35.tar.gz`. You can also obtain NDB Cluster sources from GitHub at <https://github.com/mysql/mysql-server/tree/cluster-7.5> (NDB 7.5) and <https://github.com/mysql/mysql-server/tree/cluster-7.6> (NDB 7.6). *Building NDB Cluster 7.5 or 7.6 from standard MySQL Server 5.7 sources is not supported.*

The `WITH_NDBCLUSTER_STORAGE_ENGINE` option for `CMake` causes the binaries for the management nodes, data nodes, and other NDB Cluster programs to be built; it also causes `mysqld` to be compiled with NDB storage engine support. This option (or its alias `WITH_NDBCLUSTER`) is required when building NDB Cluster.

**Important**

The `WITH_NDB_JAVA` option is enabled by default. This means that, by default, if `CMake` cannot find the location of Java on your system, the configuration process fails; if you do not wish to enable Java and ClusterJ support, you must indicate this explicitly by configuring the build using `-DWITH_NDB_JAVA=OFF`. Use `WITH_CLASSPATH` to provide the Java classpath if needed.

For more information about `CMake` options specific to building NDB Cluster, see [CMake Options for Compiling NDB Cluster](#).

After you have run `make && make install` (or your system's equivalent), the result is similar to what is obtained by unpacking a precompiled binary to the same location.

**Management nodes.** When building from source and running the default `make install`, the management server and management client binaries (`ndb_mgmd` and `ndb_mgm`) can be found in `/usr/local/mysql/bin`. Only `ndb_mgmd` is required to be present on a management node host; however, it is also a good idea to have `ndb_mgm` present on the same host machine. Neither of these executables requires a specific location on the host machine's file system.

**Data nodes.** The only executable required on a data node host is the data node binary `ndbd` or `ndbmt.d`. (`mysqld`, for example, does not have to be present on the host machine.) By default, when building from source, this file is placed in the directory `/usr/local/mysql/bin`. For installing on multiple data node hosts, only `ndbd` or `ndbmt.d` need be copied to the other host machine or machines. (This assumes that all data node hosts use the same architecture and operating system; otherwise you may need to compile separately for each different platform.) The data node binary need not be in any particular location on the host's file system, as long as the location is known.

When compiling NDB Cluster from source, no special options are required for building multithreaded data node binaries. Configuring the build with NDB storage engine support causes `ndbmt.d` to be built automatically; `make install` places the `ndbmt.d` binary in the installation `bin` directory along with `mysqld`, `ndbd`, and `ndb_mgm`.

**SQL nodes.** If you compile MySQL with clustering support, and perform the default installation (using `make install` as the system `root` user), `mysqld` is placed in `/usr/local/mysql/bin`. Follow the steps given in [Section 2.8, "Installing MySQL from Source"](#) to make `mysqld` ready for use. If you want to run multiple SQL nodes, you can use a copy of the same `mysqld` executable and its associated support files on several machines. The easiest way to do this is to copy the entire `/usr/local/mysql` directory and all directories and files contained within it to the other SQL node host or hosts, then repeat the steps from [Section 2.8, "Installing MySQL from Source"](#) on each machine. If you configure the build with a nondefault `PREFIX` option, you must adjust the directory accordingly.

In [Section 21.3.3, "Initial Configuration of NDB Cluster"](#), we create configuration files for all of the nodes in our example NDB Cluster.

## 21.3.2 Installing NDB Cluster on Windows

This section describes installation procedures for NDB Cluster on Windows hosts. NDB Cluster 7.5 and 7.6 binaries for Windows can be obtained from <https://dev.mysql.com/downloads/cluster/>. For information about installing NDB Cluster on Windows from a binary release provided by Oracle, see [Section 21.3.2.1, "Installing NDB Cluster on Windows from a Binary Release"](#).

It is also possible to compile and install NDB Cluster from source on Windows using Microsoft Visual Studio. For more information, see [Section 21.3.2.2, "Compiling and Installing NDB Cluster from Source on Windows"](#).

### 21.3.2.1 Installing NDB Cluster on Windows from a Binary Release

This section describes a basic installation of NDB Cluster on Windows using a binary “no-install” NDB Cluster release provided by Oracle, using the same 4-node setup outlined in the beginning of this section (see [Section 21.3, “NDB Cluster Installation”](#)), as shown in the following table:

**Table 21.6 Network addresses of nodes in example cluster**

Node	IP Address
Management node ( <code>mgmd</code> )	198.51.100.10
SQL node ( <code>mysqld</code> )	198.51.100.20
Data node "A" ( <code>ndbd</code> )	198.51.100.30
Data node "B" ( <code>ndbd</code> )	198.51.100.40

As on other platforms, the NDB Cluster host computer running an SQL node must have installed on it a MySQL Server binary (`mysqld.exe`). You should also have the MySQL client (`mysql.exe`) on this host. For management nodes and data nodes, it is not necessary to install the MySQL Server binary; however, each management node requires the management server daemon (`ndb_mgmd.exe`); each data node requires the data node daemon (`ndbd.exe` or `ndbmttd.exe`). For this example, we refer to `ndbd.exe` as the data node executable, but you can install `ndbmttd.exe`, the multithreaded version of this program, instead, in exactly the same way. You should also install the management client (`ndb_mgm.exe`) on the management server host. This section covers the steps necessary to install the correct Windows binaries for each type of NDB Cluster node.



#### Note

As with other Windows programs, NDB Cluster executables are named with the `.exe` file extension. However, it is not necessary to include the `.exe` extension when invoking these programs from the command line. Therefore, we often simply refer to these programs in this documentation as `mysqld`, `mysql`, `ndb_mgmd`, and so on. You should understand that, whether we refer (for example) to `mysqld` or `mysqld.exe`, either name means the same thing (the MySQL Server program).

For setting up an NDB Cluster using Oracle's `no-install` binaries, the first step in the installation process is to download the latest NDB Cluster Windows ZIP binary archive from <https://dev.mysql.com/downloads/cluster/>. This archive has a filename of the `mysql-cluster-gpl-ver-winarch.zip`, where `ver` is the NDB storage engine version (such as `7.6.35`), and `arch` is the architecture (`32` for 32-bit binaries, and `64` for 64-bit binaries). For example, the NDB Cluster 7.6.35 archive for 64-bit Windows systems is named `mysql-cluster-gpl-7.6.35-win64.zip`.

You can run 32-bit NDB Cluster binaries on both 32-bit and 64-bit versions of Windows; however, 64-bit NDB Cluster binaries can be used only on 64-bit versions of Windows. If you are using a 32-bit version of Windows on a computer that has a 64-bit CPU, then you must use the 32-bit NDB Cluster binaries.

To minimize the number of files that need to be downloaded from the Internet or copied between machines, we start with the computer where you intend to run the SQL node.

**SQL node.** We assume that you have placed a copy of the archive in the directory `C:\Documents and Settings\username\My Documents\Downloads` on the computer having the IP address 198.51.100.20, where `username` is the name of the current user. (You can obtain this name using `ECHO %USERNAME%` on the command line.) To install and run NDB Cluster executables as Windows services, this user should be a member of the `Administrators` group.

Extract all the files from the archive. The Extraction Wizard integrated with Windows Explorer is adequate for this task. (If you use a different archive program, be sure that it extracts all files and directories from

the archive, and that it preserves the archive's directory structure.) When you are asked for a destination directory, enter `C:\`, which causes the Extraction Wizard to extract the archive to the directory `C:\mysql-cluster-gpl-ver-winarch`. Rename this directory to `C:\mysql`.

It is possible to install the NDB Cluster binaries to directories other than `C:\mysql\bin`; however, if you do so, you must modify the paths shown in this procedure accordingly. In particular, if the MySQL Server (SQL node) binary is installed to a location other than `C:\mysql` or `C:\Program Files\MySQL\MySQL Server 5.7`, or if the SQL node's data directory is in a location other than `C:\mysql\data` or `C:\Program Files\MySQL\MySQL Server 5.7\data`, extra configuration options must be used on the command line or added to the `my.ini` or `my.cnf` file when starting the SQL node. For more information about configuring a MySQL Server to run in a nonstandard location, see [Section 2.3.4, "Installing MySQL on Microsoft Windows Using a noinstall ZIP Archive"](#).

For a MySQL Server with NDB Cluster support to run as part of an NDB Cluster, it must be started with the options `--ndbcluster` and `--ndb-connectstring`. While you can specify these options on the command line, it is usually more convenient to place them in an option file. To do this, create a new text file in Notepad or another text editor. Enter the following configuration information into this file:

```
[mysqld]
# Options for mysqld process:
ndbcluster                # run NDB storage engine
ndb-connectstring=198.51.100.10 # location of management server
```

You can add other options used by this MySQL Server if desired (see [Section 2.3.4.2, "Creating an Option File"](#)), but the file must contain the options shown, at a minimum. Save this file as `C:\mysql\my.ini`. This completes the installation and setup for the SQL node.

**Data nodes.** An NDB Cluster data node on a Windows host requires only a single executable, one of either `ndbd.exe` or `ndbmtd.exe`. For this example, we assume that you are using `ndbd.exe`, but the same instructions apply when using `ndbmtd.exe`. On each computer where you wish to run a data node (the computers having the IP addresses 198.51.100.30 and 198.51.100.40), create the directories `C:\mysql`, `C:\mysql\bin`, and `C:\mysql\cluster-data`; then, on the computer where you downloaded and extracted the `no-install` archive, locate `ndbd.exe` in the `C:\mysql\bin` directory. Copy this file to the `C:\mysql\bin` directory on each of the two data node hosts.

To function as part of an NDB Cluster, each data node must be given the address or hostname of the management server. You can supply this information on the command line using the `--ndb-connectstring` or `-c` option when starting each data node process. However, it is usually preferable to put this information in an option file. To do this, create a new text file in Notepad or another text editor and enter the following text:

```
[mysql_cluster]
# Options for data node process:
ndb-connectstring=198.51.100.10 # location of management server
```

Save this file as `C:\mysql\my.ini` on the data node host. Create another text file containing the same information and save it on as `C:\mysql\my.ini` on the other data node host, or copy the `my.ini` file from the first data node host to the second one, making sure to place the copy in the second data node's `C:\mysql` directory. Both data node hosts are now ready to be used in the NDB Cluster, which leaves only the management node to be installed and configured.

**Management node.** The only executable program required on a computer used for hosting an NDB Cluster management node is the management server program `ndb_mgmd.exe`. However, in order to administer the NDB Cluster once it has been started, you should also install the NDB Cluster management client program `ndb_mgm.exe` on the same machine as the management server. Locate these two programs on the machine where you downloaded and extracted the `no-install` archive; this should be

the directory `C:\mysql\bin` on the SQL node host. Create the directory `C:\mysql\bin` on the computer having the IP address 198.51.100.10, then copy both programs to this directory.

You should now create two configuration files for use by `ndb_mgmd.exe`:

1. A local configuration file to supply configuration data specific to the management node itself. Typically, this file needs only to supply the location of the NDB Cluster global configuration file (see item 2).

To create this file, start a new text file in Notepad or another text editor, and enter the following information:

```
[mysql_cluster]
# Options for management node process
config-file=C:/mysql/bin/config.ini
```

Save this file as the text file `C:\mysql\bin\my.ini`.

2. A global configuration file from which the management node can obtain configuration information governing the NDB Cluster as a whole. At a minimum, this file must contain a section for each node in the NDB Cluster, and the IP addresses or hostnames for the management node and all data nodes (`HostName` configuration parameter). It is also advisable to include the following additional information:

- The IP address or hostname of any SQL nodes
- The data memory and index memory allocated to each data node (`DataMemory` and `IndexMemory` configuration parameters)
- The number of fragment replicas, using the `NoOfReplicas` configuration parameter (see [Section 21.2.2, "NDB Cluster Nodes, Node Groups, Fragment Replicas, and Partitions"](#))
- The directory where each data node stores its data and log file, and the directory where the management node keeps its log files (in both cases, the `DataDir` configuration parameter)

Create a new text file using a text editor such as Notepad, and input the following information:

```
[ndbd default]
# Options affecting ndbd processes on all data nodes:
NoOfReplicas=2           # Number of fragment replicas
DataDir=C:/mysql/cluster-data # Directory for each data node's data files
                           # Forward slashes used in directory path,
                           # rather than backslashes. This is correct;
                           # see Important note in text
DataMemory=80M          # Memory allocated to data storage
IndexMemory=18M         # Memory allocated to index storage
                           # For DataMemory and IndexMemory, we have used the
                           # default values. Since the "world" database takes up
                           # only about 500KB, this should be more than enough for
                           # this example Cluster setup.

[ndb_mgmd]
# Management process options:
HostName=198.51.100.10   # Hostname or IP address of management node
DataDir=C:/mysql/bin/cluster-logs # Directory for management node log files

[ndbd]
# Options for data node "A":
                           # (one [ndbd] section per data node)
HostName=198.51.100.30   # Hostname or IP address

[ndbd]
# Options for data node "B":
HostName=198.51.100.40   # Hostname or IP address
```

```
[mysqld]
# SQL node options:
HostName=198.51.100.20          # Hostname or IP address
```

Save this file as the text file `C:\mysql\bin\config.ini`.



### Important

A single backslash character (\) cannot be used when specifying directory paths in program options or configuration files used by NDB Cluster on Windows. Instead, you must either escape each backslash character with a second backslash (\\), or replace the backslash with a forward slash character (/). For example, the following line from the `[ndb_mgmd]` section of an NDB Cluster `config.ini` file does not work:

```
DataDir=C:\mysql\bin\cluster-logs
```

Instead, you may use either of the following:

```
DataDir=C:\\mysql\\bin\\cluster-logs # Escaped backslashes
```

```
DataDir=C:/mysql/bin/cluster-logs # Forward slashes
```

For reasons of brevity and legibility, we recommend that you use forward slashes in directory paths used in NDB Cluster program options and configuration files on Windows.

## 21.3.2.2 Compiling and Installing NDB Cluster from Source on Windows

Oracle provides precompiled NDB Cluster binaries for Windows which should be adequate for most users. However, if you wish, it is also possible to compile NDB Cluster for Windows from source code. The procedure for doing this is almost identical to the procedure used to compile the standard MySQL Server binaries for Windows, and uses the same tools. However, there are two major differences:

- Building NDB Cluster requires using the NDB Cluster sources. These are available from the NDB Cluster downloads page at <https://dev.mysql.com/downloads/cluster/>. The archived source file should have a name similar to `mysql-cluster-gpl-7.6.35.tar.gz`. You can also obtain NDB Cluster sources from GitHub at <https://github.com/mysql/mysql-server/tree/cluster-7.5> (NDB 7.5) and <https://github.com/mysql/mysql-server/tree/cluster-7.6> (NDB 7.6). *Building NDB Cluster 7.5 or 7.6 from standard MySQL Server 5.7 sources is not supported.*
- You must configure the build using the `WITH_NDBCLUSTER` option in addition to any other build options you wish to use with `CMake`. (`WITH_NDBCLUSTER_STORAGE_ENGINE` is supported as an alias.)



### Important

The `WITH_NDB_JAVA` option is enabled by default. This means that, by default, if `CMake` cannot find the location of Java on your system, the configuration process fails; if you do not wish to enable Java and ClusterJ support, you must indicate this explicitly by configuring the build using `-DWITH_NDB_JAVA=OFF`. (Bug #12379735) Use `WITH_CLASSPATH` to provide the Java classpath if needed.

For more information about `CMake` options specific to building NDB Cluster, see [CMake Options for Compiling NDB Cluster](#).

Once the build process is complete, you can create a Zip archive containing the compiled binaries; [Section 2.8.4, “Installing MySQL Using a Standard Source Distribution”](#) provides the commands needed to perform this task on Windows systems. The NDB Cluster binaries can be found in the `bin` directory

of the resulting archive, which is equivalent to the `no-install` archive, and which can be installed and configured in the same manner. For more information, see [Section 21.3.2.1, “Installing NDB Cluster on Windows from a Binary Release”](#).

### 21.3.2.3 Initial Startup of NDB Cluster on Windows

Once the NDB Cluster executables and needed configuration files are in place, performing an initial start of the cluster is simply a matter of starting the NDB Cluster executables for all nodes in the cluster. Each cluster node process must be started separately, and on the host computer where it resides. The management node should be started first, followed by the data nodes, and then finally by any SQL nodes.

1. On the management node host, issue the following command from the command line to start the management node process. The output should appear similar to what is shown here:

```
C:\mysql\bin> ndb_mgmd
2010-06-23 07:53:34 [MgmtSrvr] INFO -- NDB Cluster Management Server. mysql-5.7.44-ndb-7.6.36
2010-06-23 07:53:34 [MgmtSrvr] INFO -- Reading cluster configuration from 'config.ini'
```

The management node process continues to print logging output to the console. This is normal, because the management node is not running as a Windows service. (If you have used NDB Cluster on a Unix-like platform such as Linux, you may notice that the management node's default behavior in this regard on Windows is effectively the opposite of its behavior on Unix systems, where it runs by default as a Unix daemon process. This behavior is also true of NDB Cluster data node processes running on Windows.) For this reason, do not close the window in which `ndb_mgmd.exe` is running; doing so kills the management node process. (See [Section 21.3.2.4, “Installing NDB Cluster Processes as Windows Services”](#), where we show how to install and run NDB Cluster processes as Windows services.)

The required `-f` option tells the management node where to find the global configuration file (`config.ini`). The long form of this option is `--config-file`.



#### Important

An NDB Cluster management node caches the configuration data that it reads from `config.ini`; once it has created a configuration cache, it ignores the `config.ini` file on subsequent starts unless forced to do otherwise. This means that, if the management node fails to start due to an error in this file, you must make the management node re-read `config.ini` after you have corrected any errors in it. You can do this by starting `ndb_mgmd.exe` with the `--reload` or `--initial` option on the command line. Either of these options works to refresh the configuration cache.

It is not necessary or advisable to use either of these options in the management node's `my.ini` file.

2. On each of the data node hosts, run the command shown here to start the data node processes:

```
C:\mysql\bin> ndbd
2010-06-23 07:53:46 [ndbd] INFO -- Configuration fetched from 'localhost:1186', generation: 1
```

In each case, the first line of output from the data node process should resemble what is shown in the preceding example, and is followed by additional lines of logging output. As with the management node process, this is normal, because the data node is not running as a Windows service. For this reason, do not close the console window in which the data node process is running; doing so kills `ndbd.exe`. (For more information, see [Section 21.3.2.4, “Installing NDB Cluster Processes as Windows Services”](#).)

3. Do not start the SQL node yet; it cannot connect to the cluster until the data nodes have finished starting, which may take some time. Instead, in a new console window on the management node host,



start the NDB Cluster management client `ndb_mgm.exe`, which should be in `C:\mysql\bin` on the management node host. (Do not try to re-use the console window where `ndb_mgmd.exe` is running by typing **CTRL+C**, as this kills the management node.) The resulting output should look like this:

```
C:\mysql\bin> ndb_mgm
-- NDB Cluster -- Management Client --
ndb_mgm>
```

When the prompt `ndb_mgm>` appears, this indicates that the management client is ready to receive NDB Cluster management commands. You can observe the status of the data nodes as they start by entering `ALL STATUS` at the management client prompt. This command causes a running report of the data nodes's startup sequence, which should look something like this:

```
ndb_mgm> ALL STATUS
Connected to Management Server at: localhost:1186
Node 2: starting (Last completed phase 3) (mysql-5.7.44-ndb-7.6.36)
Node 3: starting (Last completed phase 3) (mysql-5.7.44-ndb-7.6.36)

Node 2: starting (Last completed phase 4) (mysql-5.7.44-ndb-7.6.36)
Node 3: starting (Last completed phase 4) (mysql-5.7.44-ndb-7.6.36)

Node 2: Started (version 7.6.36)
Node 3: Started (version 7.6.36)

ndb_mgm>
```



#### Note

Commands issued in the management client are not case-sensitive; we use uppercase as the canonical form of these commands, but you are not required to observe this convention when inputting them into the `ndb_mgm` client. For more information, see [Section 21.6.1, “Commands in the NDB Cluster Management Client”](#).

The output produced by `ALL STATUS` is likely to vary from what is shown here, according to the speed at which the data nodes are able to start, the release version number of the NDB Cluster software you are using, and other factors. What is significant is that, when you see that both data nodes have started, you are ready to start the SQL node.

You can leave `ndb_mgm.exe` running; it has no negative impact on the performance of the NDB Cluster, and we use it in the next step to verify that the SQL node is connected to the cluster after you have started it.

4. On the computer designated as the SQL node host, open a console window and navigate to the directory where you unpacked the NDB Cluster binaries (if you are following our example, this is `C:\mysql\bin`).

Start the SQL node by invoking `mysqld.exe` from the command line, as shown here:

```
C:\mysql\bin> mysqld --console
```

The `--console` option causes logging information to be written to the console, which can be helpful in the event of problems. (Once you are satisfied that the SQL node is running in a satisfactory manner, you can stop it and restart it out without the `--console` option, so that logging is performed normally.)

In the console window where the management client (`ndb_mgm.exe`) is running on the management node host, enter the `SHOW` command, which should produce output similar to what is shown here:

```
ndb_mgm> SHOW
Connected to Management Server at: localhost:1186
```

```
Cluster Configuration
-----
[ndbd(NDB)]      2 node(s)
id=2   @198.51.100.30 (Version: 5.7.44-ndb-7.6.36, Nodegroup: 0, *)
id=3   @198.51.100.40 (Version: 5.7.44-ndb-7.6.36, Nodegroup: 0)

[ndb_mgmd(MGM)] 1 node(s)
id=1   @198.51.100.10 (Version: 5.7.44-ndb-7.6.36)

[mysqld(API)]   1 node(s)
id=4   @198.51.100.20 (Version: 5.7.44-ndb-7.6.36)
```

You can also verify that the SQL node is connected to the NDB Cluster in the `mysql` client (`mysql.exe`) using the `SHOW ENGINE NDB STATUS` statement.

You should now be ready to work with database objects and data using NDB Cluster's `NDBCLUSTER` storage engine. See [Section 21.3.5, "NDB Cluster Example with Tables and Data"](#), for more information and examples.

You can also install `ndb_mgmd.exe`, `ndbd.exe`, and `ndbmtl.exe` as Windows services. For information on how to do this, see [Section 21.3.2.4, "Installing NDB Cluster Processes as Windows Services"](#).

### 21.3.2.4 Installing NDB Cluster Processes as Windows Services

Once you are satisfied that NDB Cluster is running as desired, you can install the management nodes and data nodes as Windows services, so that these processes are started and stopped automatically whenever Windows is started or stopped. This also makes it possible to control these processes from the command line with the appropriate `SC START` and `SC STOP` commands, or using the Windows graphical `Services` utility. `NET START` and `NET STOP` commands can also be used.

Installing programs as Windows services usually must be done using an account that has Administrator rights on the system.

To install the management node as a service on Windows, invoke `ndb_mgmd.exe` from the command line on the machine hosting the management node, using the `--install` option, as shown here:

```
C:\> C:\mysql\bin\ndb_mgmd.exe --install
Installing service 'NDB Cluster Management Server'
as '"C:\mysql\bin\ndbd.exe" "--service=ndb_mgmd"'
Service successfully installed.
```



#### Important

When installing an NDB Cluster program as a Windows service, you should always specify the complete path; otherwise the service installation may fail with the error `The system cannot find the file specified`.

The `--install` option must be used first, ahead of any other options that might be specified for `ndb_mgmd.exe`. However, it is preferable to specify such options in an options file instead. If your options file is not in one of the default locations as shown in the output of `ndb_mgmd.exe --help`, you can specify the location using the `--config-file` option.

Now you should be able to start and stop the management server like this:

```
C:\> SC START ndb_mgmd
C:\> SC STOP ndb_mgmd
```

**Note**

If using `NET` commands, you can also start or stop the management server as a Windows service using the descriptive name, as shown here:

```
C:\> NET START 'NDB Cluster Management Server'
The NDB Cluster Management Server service is starting.
The NDB Cluster Management Server service was started successfully.

C:\> NET STOP 'NDB Cluster Management Server'
The NDB Cluster Management Server service is stopping..
The NDB Cluster Management Server service was stopped successfully.
```

It is usually simpler to specify a short service name or to permit the default service name to be used when installing the service, and then reference that name when starting or stopping the service. To specify a service name other than `ndb_mgmd`, append it to the `--install` option, as shown in this example:

```
C:\> C:\mysql\bin\ndb_mgmd.exe --install=mgmdl
Installing service 'NDB Cluster Management Server'
as "C:\mysql\bin\ndb_mgmd.exe" "--service=mgmdl"
Service successfully installed.
```

Now you should be able to start or stop the service using the name you have specified, like this:

```
C:\> SC START mgmdl
C:\> SC STOP mgmdl
```

To remove the management node service, use `SC DELETE service_name`:

```
C:\> SC DELETE mgmdl
```

Alternatively, invoke `ndb_mgmd.exe` with the `--remove` option, as shown here:

```
C:\> C:\mysql\bin\ndb_mgmd.exe --remove
Removing service 'NDB Cluster Management Server'
Service successfully removed.
```

If you installed the service using a service name other than the default, pass the service name as the value of the `ndb_mgmd.exe --remove` option, like this:

```
C:\> C:\mysql\bin\ndb_mgmd.exe --remove=mgmdl
Removing service 'mgmdl'
Service successfully removed.
```

Installation of an NDB Cluster data node process as a Windows service can be done in a similar fashion, using the `--install` option for `ndbd.exe` (or `ndbmttd.exe`), as shown here:

```
C:\> C:\mysql\bin\ndbd.exe --install
Installing service 'NDB Cluster Data Node Daemon' as "C:\mysql\bin\ndbd.exe" "--service=ndbd"
Service successfully installed.
```

Now you can start or stop the data node as shown in the following example:

```
C:\> SC START ndbd
C:\> SC STOP ndbd
```

To remove the data node service, use `SC DELETE service_name`:

```
C:\> SC DELETE ndbd
```

Alternatively, invoke `ndbd.exe` with the `--remove` option, as shown here:

```
C:\> C:\mysql\bin\ndbd.exe --remove
Removing service 'NDB Cluster Data Node Daemon'
Service successfully removed.
```

As with `ndb_mgmd.exe` (and `mysqld.exe`), when installing `ndbd.exe` as a Windows service, you can also specify a name for the service as the value of `--install`, and then use it when starting or stopping the service, like this:

```
C:\> C:\mysql\bin\ndbd.exe --install=dnodel
Installing service 'dnodel' as '"C:\mysql\bin\ndbd.exe" "--service=dnodel"'
Service successfully installed.

C:\> SC START dnodel

C:\> SC STOP dnodel
```

If you specified a service name when installing the data node service, you can use this name when removing it as well, as shown here:

```
C:\> SC DELETE dnodel
```

Alternatively, you can pass the service name as the value of the `ndbd.exe --remove` option, as shown here:

```
C:\> C:\mysql\bin\ndbd.exe --remove=dnodel
Removing service 'dnodel'
Service successfully removed.
```

Installation of the SQL node as a Windows service, starting the service, stopping the service, and removing the service are done in a similar fashion, using `mysqld --install`, `SC START`, `SC STOP`, and `SC DELETE` (or `mysqld --remove`). `NET` commands can also be used to start or stop a service. For additional information, see [Section 2.3.4.8, “Starting MySQL as a Windows Service”](#).

### 21.3.3 Initial Configuration of NDB Cluster

In this section, we discuss manual configuration of an installed NDB Cluster by creating and editing configuration files.

For our four-node, four-host NDB Cluster (see [Cluster nodes and host computers](#)), it is necessary to write four configuration files, one per node host.

- Each data node or SQL node requires a `my.cnf` file that provides two pieces of information: a *connection string* that tells the node where to find the management node, and a line telling the MySQL server on this host (the machine hosting the data node) to enable the `NDBCLUSTER` storage engine.

For more information on connection strings, see [Section 21.4.3.3, “NDB Cluster Connection Strings”](#).

- The management node needs a `config.ini` file telling it how many fragment replicas to maintain, how much memory to allocate for data and indexes on each data node, where to find the data nodes, where to save data to disk on each data node, and where to find any SQL nodes.

**Configuring the data nodes and SQL nodes.** The `my.cnf` file needed for the data nodes is fairly simple. The configuration file should be located in the `/etc` directory and can be edited using any text editor. (Create the file if it does not exist.) For example:

```
$> vi /etc/my.cnf
```

**Note**

We show `vi` being used here to create the file, but any text editor should work just as well.

For each data node and SQL node in our example setup, `my.cnf` should look like this:

```
[mysqld]
# Options for mysqld process:
ndbcluster                # run NDB storage engine

[mysql_cluster]
# Options for NDB Cluster processes:
ndb-connectstring=198.51.100.10 # location of management server
```

After entering the preceding information, save this file and exit the text editor. Do this for the machines hosting data node “A”, data node “B”, and the SQL node.

**Important**

Once you have started a `mysqld` process with the `ndbcluster` and `ndb-connectstring` parameters in the `[mysqld]` and `[mysql_cluster]` sections of the `my.cnf` file as shown previously, you cannot execute any `CREATE TABLE` or `ALTER TABLE` statements without having actually started the cluster. Otherwise, these statements fail with an error. This is by design.

**Configuring the management node.** The first step in configuring the management node is to create the directory in which the configuration file can be found and then to create the file itself. For example (running as `root`):

```
$> mkdir /var/lib/mysql-cluster
$> cd /var/lib/mysql-cluster
$> vi config.ini
```

For our representative setup, the `config.ini` file should read as follows:

```
[ndbd default]
# Options affecting ndbd processes on all data nodes:
NoOfReplicas=2    # Number of fragment replicas
DataMemory=80M   # How much memory to allocate for data storage
IndexMemory=18M  # How much memory to allocate for index storage
                  # For DataMemory and IndexMemory, we have used the
                  # default values. Since the "world" database takes up
                  # only about 500KB, this should be more than enough for
                  # this example NDB Cluster setup.
                  # NOTE: IndexMemory is deprecated in NDB 7.6 and later; in
                  # these versions, resources for all data and indexes are
                  # allocated by DataMemory and any that are set for IndexMemory
                  # are added to the DataMemory resource pool

[ndb_mgmd]
# Management process options:
HostName=198.51.100.10 # Hostname or IP address of management node
DataDir=/var/lib/mysql-cluster # Directory for management node log files

[ndbd]
# Options for data node "A":
                               # (one [ndbd] section per data node)
HostName=198.51.100.30        # Hostname or IP address
NodeId=2                      # Node ID for this data node
DataDir=/usr/local/mysql/data # Directory for this data node's data files

[ndbd]
```

```
# Options for data node "B":
HostName=198.51.100.40      # Hostname or IP address
NodeId=3                   # Node ID for this data node
DataDir=/usr/local/mysql/data # Directory for this data node's data files

[mysqld]
# SQL node options:
HostName=198.51.100.20    # Hostname or IP address
                           # (additional mysqld connections can be
                           # specified for this node for various
                           # purposes such as running ndb_restore)
```



### Note

The `world` database can be downloaded from <https://dev.mysql.com/doc/index-other.html>.

After all the configuration files have been created and these minimal options have been specified, you are ready to proceed with starting the cluster and verifying that all processes are running. We discuss how this is done in [Section 21.3.4, “Initial Startup of NDB Cluster”](#).

For more detailed information about the available NDB Cluster configuration parameters and their uses, see [Section 21.4.3, “NDB Cluster Configuration Files”](#), and [Section 21.4, “Configuration of NDB Cluster”](#). For configuration of NDB Cluster as relates to making backups, see [Section 21.6.8.3, “Configuration for NDB Cluster Backups”](#).

The default port for Cluster management nodes is 1186. For data nodes, the cluster can automatically allocate ports from those that are already free.

## 21.3.4 Initial Startup of NDB Cluster

Starting the cluster is not very difficult after it has been configured. Each cluster node process must be started separately, and on the host where it resides. The management node should be started first, followed by the data nodes, and then finally by any SQL nodes:

1. On the management host, issue the following command from the system shell to start the management node process:

```
$> ndb_mgmd --initial -f /var/lib/mysql-cluster/config.ini
```

The first time that it is started, `ndb_mgmd` must be told where to find its configuration file, using the `-f` or `--config-file` option. This option requires that `--initial` or `--reload` also be specified; see [Section 21.5.4, “ndb\\_mgmd — The NDB Cluster Management Server Daemon”](#), for details.

2. On each of the data node hosts, run this command to start the `ndbd` process:

```
$> ndbd
```

3. If you used RPM files to install MySQL on the cluster host where the SQL node is to reside, you can (and should) use the supplied startup script to start the MySQL server process on the SQL node.

If all has gone well, and the cluster has been set up correctly, the cluster should now be operational. You can test this by invoking the `ndb_mgm` management node client. The output should look like that shown here, although you might see some slight differences in the output depending upon the exact version of MySQL that you are using:

```
$> ndb_mgm
-- NDB Cluster -- Management Client --
ndb_mgm> SHOW
```

```

Connected to Management Server at: localhost:1186
Cluster Configuration
-----
[ndbd(NDB)] 2 node(s)
id=2 @198.51.100.30 (Version: 5.7.44-ndb-7.6.36, Nodegroup: 0, *)
id=3 @198.51.100.40 (Version: 5.7.44-ndb-7.6.36, Nodegroup: 0)

[ndb_mgmd(MGM)] 1 node(s)
id=1 @198.51.100.10 (Version: 5.7.44-ndb-7.6.36)

[mysqld(API)] 1 node(s)
id=4 @198.51.100.20 (Version: 5.7.44-ndb-7.6.36)

```

The SQL node is referenced here as `[mysqld(API)]`, which reflects the fact that the `mysqld` process is acting as an NDB Cluster API node.



#### Note

The IP address shown for a given NDB Cluster SQL or other API node in the output of `SHOW` is the address used by the SQL or API node to connect to the cluster data nodes, and not to any management node.

You should now be ready to work with databases, tables, and data in NDB Cluster. See [Section 21.3.5, “NDB Cluster Example with Tables and Data”](#), for a brief discussion.

## 21.3.5 NDB Cluster Example with Tables and Data



#### Note

The information in this section applies to NDB Cluster running on both Unix and Windows platforms.

Working with database tables and data in NDB Cluster is not much different from doing so in standard MySQL. There are two key points to keep in mind:

- For a table to be replicated in the cluster, it must use the `NDBCLUSTER` storage engine. To specify this, use the `ENGINE=NDBCLUSTER` or `ENGINE=NDB` option when creating the table:

```
CREATE TABLE tbl_name (col_name column_definitions) ENGINE=NDBCLUSTER;
```

Alternatively, for an existing table that uses a different storage engine, use `ALTER TABLE` to change the table to use `NDBCLUSTER`:

```
ALTER TABLE tbl_name ENGINE=NDBCLUSTER;
```

- Every `NDBCLUSTER` table has a primary key. If no primary key is defined by the user when a table is created, the `NDBCLUSTER` storage engine automatically generates a hidden one. Such a key takes up space just as does any other table index. (It is not uncommon to encounter problems due to insufficient memory for accommodating these automatically created indexes.)

If you are importing tables from an existing database using the output of `mysqldump`, you can open the SQL script in a text editor and add the `ENGINE` option to any table creation statements, or replace any existing `ENGINE` options. Suppose that you have the `world` sample database on another MySQL server that does not support NDB Cluster, and you want to export the `City` table:

```
$> mysqldump --add-drop-table world City > city_table.sql
```

The resulting `city_table.sql` file contains this table creation statement (and the `INSERT` statements necessary to import the table data):

```

DROP TABLE IF EXISTS `City`;
CREATE TABLE `City` (
  `ID` int(11) NOT NULL auto_increment,
  `Name` char(35) NOT NULL default '',
  `CountryCode` char(3) NOT NULL default '',
  `District` char(20) NOT NULL default '',
  `Population` int(11) NOT NULL default '0',
  PRIMARY KEY (`ID`)
) ENGINE=MyISAM DEFAULT CHARSET=latin1;

INSERT INTO `City` VALUES (1,'Kabul','AFG','Kabol',1780000);
INSERT INTO `City` VALUES (2,'Qandahar','AFG','Qandahar',237500);
INSERT INTO `City` VALUES (3,'Herat','AFG','Herat',186800);
(remaining INSERT statements omitted)

```

You need to make sure that MySQL uses the `NDBCLUSTER` storage engine for this table. There are two ways that this can be accomplished. One of these is to modify the table definition *before* importing it into the Cluster database. Using the `City` table as an example, modify the `ENGINE` option of the definition as follows:

```

DROP TABLE IF EXISTS `City`;
CREATE TABLE `City` (
  `ID` int(11) NOT NULL auto_increment,
  `Name` char(35) NOT NULL default '',
  `CountryCode` char(3) NOT NULL default '',
  `District` char(20) NOT NULL default '',
  `Population` int(11) NOT NULL default '0',
  PRIMARY KEY (`ID`)
) ENGINE=NDBCLUSTER DEFAULT CHARSET=latin1;

INSERT INTO `City` VALUES (1,'Kabul','AFG','Kabol',1780000);
INSERT INTO `City` VALUES (2,'Qandahar','AFG','Qandahar',237500);
INSERT INTO `City` VALUES (3,'Herat','AFG','Herat',186800);
(remaining INSERT statements omitted)

```

This must be done for the definition of each table that is to be part of the clustered database. The easiest way to accomplish this is to do a search-and-replace on the file that contains the definitions and replace all instances of `TYPE=engine_name` or `ENGINE=engine_name` with `ENGINE=NDBCLUSTER`. If you do not want to modify the file, you can use the unmodified file to create the tables, and then use `ALTER TABLE` to change their storage engine. The particulars are given later in this section.

Assuming that you have already created a database named `world` on the SQL node of the cluster, you can then use the `mysql` command-line client to read `city_table.sql`, and create and populate the corresponding table in the usual manner:

```
$> mysql world < city_table.sql
```

It is very important to keep in mind that the preceding command must be executed on the host where the SQL node is running (in this case, on the machine with the IP address `198.51.100.20`).

To create a copy of the entire `world` database on the SQL node, use `mysqldump` on the noncluster server to export the database to a file named `world.sql` (for example, in the `/tmp` directory). Then modify the table definitions as just described and import the file into the SQL node of the cluster like this:

```
$> mysql world < /tmp/world.sql
```

If you save the file to a different location, adjust the preceding instructions accordingly.

Running `SELECT` queries on the SQL node is no different from running them on any other instance of a MySQL server. To run queries from the command line, you first need to log in to the MySQL Monitor in the usual way (specify the `root` password at the `Enter password:` prompt):



```

$> mysql -u root -p
Enter password:
Welcome to the MySQL monitor.  Commands end with ; or \g.
Your MySQL connection id is 1 to server version: 5.7.44-ndb-7.6.36

Type 'help;' or '\h' for help. Type '\c' to clear the buffer.

mysql>

```

We simply use the MySQL server's `root` account and assume that you have followed the standard security precautions for installing a MySQL server, including setting a strong `root` password. For more information, see [Section 2.9.4, “Securing the Initial MySQL Account”](#).

It is worth taking into account that Cluster nodes do *not* make use of the MySQL privilege system when accessing one another. Setting or changing MySQL user accounts (including the `root` account) effects only applications that access the SQL node, not interaction between nodes. See [Section 21.6.18.2, “NDB Cluster and MySQL Privileges”](#), for more information.

If you did not modify the `ENGINE` clauses in the table definitions prior to importing the SQL script, you should run the following statements at this point:

```

mysql> USE world;
mysql> ALTER TABLE City ENGINE=NDBCLUSTER;
mysql> ALTER TABLE Country ENGINE=NDBCLUSTER;
mysql> ALTER TABLE CountryLanguage ENGINE=NDBCLUSTER;

```

Selecting a database and running a `SELECT` query against a table in that database is also accomplished in the usual manner, as is exiting the MySQL Monitor:

```

mysql> USE world;
mysql> SELECT Name, Population FROM City ORDER BY Population DESC LIMIT 5;
+-----+-----+
| Name      | Population |
+-----+-----+
| Bombay    | 10500000  |
| Seoul     | 9981619   |
| São Paulo | 9968485   |
| Shanghai  | 9696300   |
| Jakarta   | 9604900   |
+-----+-----+
5 rows in set (0.34 sec)

mysql> \q
Bye

$>

```

Applications that use MySQL can employ standard APIs to access `NDB` tables. It is important to remember that your application must access the SQL node, and not the management or data nodes. This brief example shows how we might execute the `SELECT` statement just shown by using the PHP 5.X `mysqli` extension running on a Web server elsewhere on the network:

```

<!DOCTYPE HTML PUBLIC "-//W3C//DTD HTML 4.01 Transitional//EN"
"http://www.w3.org/TR/html4/loose.dtd">
<html>
<head>
  <meta http-equiv="Content-Type"
        content="text/html; charset=iso-8859-1">
  <title>SIMPLE mysqli SELECT</title>
</head>
<body>
<?php
# connect to SQL node:

```

```

$link = new mysqli('198.51.100.20', 'root', 'root_password', 'world');
# parameters for mysqli constructor are:
#   host, user, password, database

if( mysqli_connect_errno() )
    die("Connect failed: " . mysqli_connect_error());

$query = "SELECT Name, Population
        FROM City
        ORDER BY Population DESC
        LIMIT 5";

# if no errors...
if( $result = $link->query($query) )
{
?>
<table border="1" width="40%" cellpadding="4" cellspacing="1">
  <tbody>
    <tr>
      <th width="10%">City</th>
      <th>Population</th>
    </tr>
  <?
    # then display the results...
    while($row = $result->fetch_object())
      printf("<tr>\n  <td align=\"center\">%s</td><td>%d</td>\n</tr>\n",
            $row->Name, $row->Population);
?>
  </tbody>
</table>
<?
  # ...and verify the number of rows that were retrieved
  printf("<p>Affected rows: %d</p>\n", $link->affected_rows);
}
else
  # otherwise, tell us what went wrong
  echo mysqli_error();

# free the result set and the mysqli connection object
$result->close();
$link->close();
?>
</body>
</html>

```

We assume that the process running on the Web server can reach the IP address of the SQL node.

In a similar fashion, you can use the MySQL C API, Perl-DBI, Python-mysql, or MySQL Connectors to perform the tasks of data definition and manipulation just as you would normally with MySQL.

## 21.3.6 Safe Shutdown and Restart of NDB Cluster

To shut down the cluster, enter the following command in a shell on the machine hosting the management node:

```
$> ndb_mgm -e shutdown
```

The `-e` option here is used to pass a command to the `ndb_mgm` client from the shell. The command causes the `ndb_mgm`, `ndb_mgmd`, and any `ndbd` or `ndbmtbd` processes to terminate gracefully. Any SQL nodes can be terminated using `mysqladmin shutdown` and other means. On Windows platforms, assuming that you have installed the SQL node as a Windows service, you can use `SC STOP service_name` or `NET STOP service_name`.

To restart the cluster on Unix platforms, run these commands:

- On the management host (198.51.100.10 in our example setup):

```
$> ndb_mgmd -f /var/lib/mysql-cluster/config.ini
```

- On each of the data node hosts (198.51.100.30 and 198.51.100.40):

```
$> ndbd
```

- Use the `ndb_mgm` client to verify that both data nodes have started successfully.
- On the SQL host (198.51.100.20):

```
$> mysqld_safe &
```

On Windows platforms, assuming that you have installed all NDB Cluster processes as Windows services using the default service names (see [Section 21.3.2.4, “Installing NDB Cluster Processes as Windows Services”](#)), you can restart the cluster as follows:

- On the management host (198.51.100.10 in our example setup), execute the following command:

```
C:\> SC START ndb_mgmd
```

- On each of the data node hosts (198.51.100.30 and 198.51.100.40), execute the following command:

```
C:\> SC START ndbd
```

- On the management node host, use the `ndb_mgm` client to verify that the management node and both data nodes have started successfully (see [Section 21.3.2.3, “Initial Startup of NDB Cluster on Windows”](#)).
- On the SQL node host (198.51.100.20), execute the following command:

```
C:\> SC START mysql
```

In a production setting, it is usually not desirable to shut down the cluster completely. In many cases, even when making configuration changes, or performing upgrades to the cluster hardware or software (or both), which require shutting down individual host machines, it is possible to do so without shutting down the cluster as a whole by performing a *rolling restart* of the cluster. For more information about doing this, see [Section 21.6.5, “Performing a Rolling Restart of an NDB Cluster”](#).

## 21.3.7 Upgrading and Downgrading NDB Cluster

The following sections provide information about upgrading and downgrading NDB Cluster 7.5 and 7.6.

Schema operations, including SQL DDL statements, cannot be performed while any data nodes are restarting, and thus during an online upgrade or downgrade of the cluster. For other information regarding the rolling restart procedure used to perform an online upgrade, see [Section 21.6.5, “Performing a Rolling Restart of an NDB Cluster”](#).



### Important

Compatibility between release versions is taken into account only with regard to `NDBCLUSTER` in this section, and there are additional issues to be considered. See [Section 2.10, “Upgrading MySQL”](#).

*As with any other MySQL software upgrade or downgrade, you are strongly encouraged to review the relevant portions of the MySQL Manual for the MySQL*

versions from which and to which you intend to migrate, before attempting an upgrade or downgrade of the NDB Cluster software.

### 21.3.7.1 Upgrading and Downgrading NDB 7.5

This section provides information about compatibility between different NDB Cluster 7.5 releases with regard to performing upgrades and downgrades as well as compatibility matrices and notes. Additional information can also be found here regarding downgrades from NDB 7.5 to previous NDB release series. You should already be familiar with installing and configuring NDB Cluster prior to attempting an upgrade or downgrade. See [Section 21.4, “Configuration of NDB Cluster”](#).

The table shown here provides information on NDB Cluster upgrade and downgrade compatibility among different releases of NDB 7.5. Additional notes about upgrades and downgrades to, from, or within the NDB Cluster 7.5 release series can be found following the table.

**Figure 21.5 NDB Cluster Upgrade and Downgrade Compatibility, MySQL NDB Cluster 7.5**

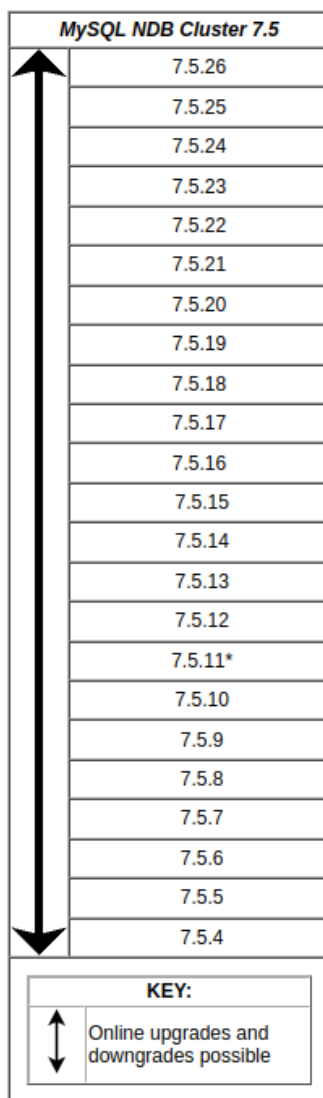

**Version support.** The following versions of NDB Cluster are supported for upgrades to GA releases of NDB Cluster 7.5 (7.5.4 and later):

- NDB Cluster 7.4 GA releases (7.4.4 and later)
- NDB Cluster 7.3 GA releases (7.3.2 and later)

**Known Issues When Upgrading or Downgrading NDB Cluster 7.5.** The following issues are known to occur when upgrading to or between NDB 7.5 releases:

- When run with `--initialize`, the server does not require NDB support; having NDB enabled at this time can cause problems with `ndbinfo` tables. To keep this from happening, the `--initialize` option now causes `mysqld` to ignore the `--ndbcluster` option if the latter is also specified.

A workaround for an upgrade that has failed for these reasons can be accomplished as follows:

1. Perform a rolling restart of the entire cluster
2. Delete all `.frm` files in the `data/ndbinfo` directory
3. Run `mysql_upgrade`.

(Bug #81689, Bug #82724, Bug #24521927, Bug #23518923)

- During an online upgrade from an NDB Cluster 7.3 release to an NDB 7.4 (or later) release, the failures of several data nodes running the lower version during local checkpoints (LCPs), and just prior to upgrading these nodes, led to additional node failures following the upgrade. This was due to lingering elements of the `EMPTY_LCP` protocol initiated by the older nodes as part of an LCP-plus-restart sequence, and which is no longer used in NDB 7.4 and later due to LCP optimizations implemented in those versions. This issue was fixed in NDB 7.5.4. (Bug #23129433)
- In NDB 7.5 (and later), the `ndb_binlog_index` table uses the InnoDB storage engine. Use of the MyISAM storage engine for this table continues to be supported for backward compatibility.

When upgrading a previous release to NDB 7.5 (or later), you can use the `--force --upgrade-system-tables` options with `mysql_upgrade` so that it performs `ALTER TABLE ... ENGINE=INNODB` on the `ndb_binlog_index` table.

For more information, see [Section 21.7.4, “NDB Cluster Replication Schema and Tables”](#).

### 21.3.7.2 Upgrading and Downgrading NDB 7.6

This section provides information about compatibility between different NDB Cluster 7.6 releases with regard to performing upgrades and downgrades as well as compatibility matrices and notes. Additional information can also be found here regarding downgrades from NDB 7.6 to previous NDB release series. You should already be familiar with installation and configuration of NDB Cluster prior to attempting an upgrade or downgrade. See [Section 21.4, “Configuration of NDB Cluster”](#).

The table shown here provides information on NDB Cluster upgrade and downgrade compatibility among different releases of NDB 7.6. Additional notes about upgrades and downgrades to, from, or within the NDB Cluster 7.6 release series can be found following the table.

Figure 21.6 NDB Cluster Upgrade and Downgrade Compatibility, MySQL NDB Cluster 7.6

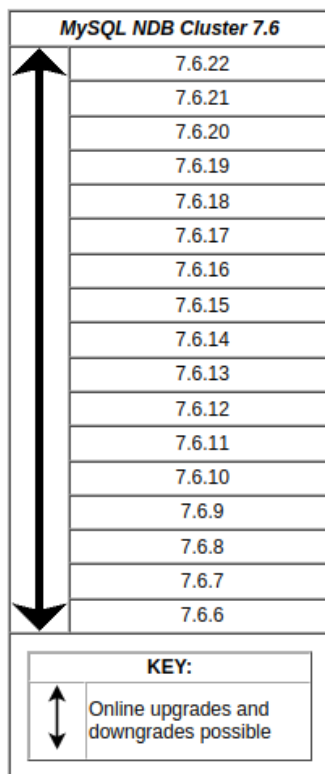

**Version support.** The following versions of NDB Cluster are supported for upgrades to GA releases of NDB Cluster 7.6 (7.6.6 and later):

- NDB Cluster 7.5 GA releases (7.5.4 and later)
- NDB Cluster 7.4 GA releases (7.4.4 and later)
- NDB Cluster 7.3 GA releases (7.3.2 and later)

**Known Issues When Upgrading or Downgrading NDB Cluster 7.6.** The following issues are known to occur when upgrading to, downgrading from, or between NDB 7.6 releases:

**Changes in Disk Data file format.** Due to changes in disk format, upgrading to or downgrading from either of the versions listed here requires an initial node restart of each data node:

- NDB 7.6.2
- NDB 7.6.4

To avoid problems relating to the old format, you should re-create any existing tablespaces and undo log file groups when upgrading. You can do this by performing an initial restart of each data node (that is, using the `--initial` option) as part of the upgrade process.

If you are using Disk Data tables, a downgrade from *any* NDB 7.6 release to any NDB 7.5 or earlier release requires that you restart all data nodes with `--initial` as part of the downgrade process. This is because NDB 7.5 and earlier release series are not able to read the new Disk Data file format.

**IndexMemory changes.** If you are downgrading from NDB 7.6 to NDB 7.5 (or earlier), you must set an explicit value for `IndexMemory` in the cluster configuration file if none is already present. This is because NDB 7.6 does not use this parameter and sets it to 0 by default, whereas it is required in NDB 7.5 and earlier releases, in which the cluster refuses to start with `Invalid configuration received from Management Server...` if `IndexMemory` is not set to a nonzero value.



### Important

Upgrading to NDB 7.6 from an earlier release, or downgrading from NDB 7.6 to an earlier release, requires purging then re-creating the `NDB` data node file system, which means that each data node must be restarted using the `--initial` option as part of the rolling restart or system restart normally required. (Starting a data node with no file system is already equivalent to an initial restart; in such cases, `--initial` is implied and not required. This is unchanged from previous releases of NDB Cluster.)

When such a restart is performed as part of an upgrade to NDB 7.6, any existing LCP files are checked for the presence of the LCP `Sysfile`, indicating that the existing data node file system was written using NDB 7.6. If such a node file system exists, but does not contain the `Sysfile`, and if any data nodes are restarted without the `--initial` option, `NDB` causes the restart to fail with an appropriate error message.

You should also be aware that no such protection is possible when downgrading from NDB 7.6 to a release previous to NDB 7.6.

## 21.3.8 The NDB Cluster Auto-Installer (NDB 7.5) (NO LONGER SUPPORTED)



### Note

This feature has been removed from NDB Cluster, and is no longer supported. See [Section 21.2.4, “What is New in MySQL NDB Cluster”](#), for more information.

The web-based graphical configuration installer (Auto-Installer) was removed in NDB 7.5.21, and is no longer included as part of the NDB Cluster distribution.

## 21.3.9 The NDB Cluster Auto-Installer (NO LONGER SUPPORTED)



### Note

This feature has been removed from NDB Cluster, and is no longer supported. See [Section 21.2.4, “What is New in MySQL NDB Cluster”](#), for more information.

The web-based graphical configuration installer (Auto-Installer) was removed in NDB 7.6.17, and is no longer included as part of the NDB Cluster distribution.

## 21.4 Configuration of NDB Cluster

A MySQL server that is part of an NDB Cluster differs in one chief respect from a normal (nonclustered) MySQL server, in that it employs the `NDB` storage engine. This engine is also referred to sometimes as `NDBCLUSTER`, although `NDB` is preferred.

To avoid unnecessary allocation of resources, the server is configured by default with the `NDB` storage engine disabled. To enable `NDB`, you must modify the server's `my.cnf` configuration file, or start the server with the `--ndbcluster` option.

This MySQL server is a part of the cluster, so it also must know how to access a management node to obtain the cluster configuration data. The default behavior is to look for the management node on `localhost`. However, should you need to specify that its location is elsewhere, this can be done in `my.cnf`, or with the `mysql` client. Before the NDB storage engine can be used, at least one management node must be operational, as well as any desired data nodes.

For more information about `--ndbcluster` and other `mysqld` options specific to NDB Cluster, see [MySQL Server Options for NDB Cluster](#).

For general information about installing NDB Cluster, see [Section 21.3, “NDB Cluster Installation”](#).

## 21.4.1 Quick Test Setup of NDB Cluster

To familiarize you with the basics, we describe the simplest possible configuration for a functional NDB Cluster. After this, you should be able to design your desired setup from the information provided in the other relevant sections of this chapter.

First, you need to create a configuration directory such as `/var/lib/mysql-cluster`, by executing the following command as the system `root` user:

```
$> mkdir /var/lib/mysql-cluster
```

In this directory, create a file named `config.ini` that contains the following information. Substitute appropriate values for `HostName` and `DataDir` as necessary for your system.

```
# file "config.ini" - showing minimal setup consisting of 1 data node,
# 1 management server, and 3 MySQL servers.
# The empty default sections are not required, and are shown only for
# the sake of completeness.
# Data nodes must provide a hostname but MySQL Servers are not required
# to do so.
# If you do not know the hostname for your machine, use localhost.
# The DataDir parameter also has a default value, but it is recommended to
# set it explicitly.
# [api] and [mgm] are aliases for [mysqld] and [ndb_mgmd], respectively.

[ndbd default]
NoOfReplicas= 1

[mysqld default]
[ndb_mgmd default]
[tcp default]

[ndb_mgmd]
HostName= myhost.example.com

[ndbd]
HostName= myhost.example.com
DataDir= /var/lib/mysql-cluster

[mysqld]
[mysqld]
[mysqld]
```

You can now start the `ndb_mgmd` management server. By default, it attempts to read the `config.ini` file in its current working directory, so change location into the directory where the file is located and then invoke `ndb_mgmd`:

```
$> cd /var/lib/mysql-cluster
$> ndb_mgmd
```

Then start a single data node by running `ndbd`:



```
$> ndbd
```

By default, `ndbd` looks for the management server at `localhost` on port 1186.



#### Note

If you have installed MySQL from a binary tarball, you must specify the path of the `ndb_mgmd` and `ndbd` servers explicitly. (Normally, these can be found in `/usr/local/mysql/bin`.)

Finally, change location to the MySQL data directory (usually `/var/lib/mysql` or `/usr/local/mysql/data`), and make sure that the `my.cnf` file contains the option necessary to enable the NDB storage engine:

```
[mysqld]
ndbcluster
```

You can now start the MySQL server as usual:

```
$> mysqld_safe --user=mysql &
```

Wait a moment to make sure the MySQL server is running properly. If you see the notice `mysql ended`, check the server's `.err` file to find out what went wrong.

If all has gone well so far, you now can start using the cluster. Connect to the server and verify that the `NDBCLUSTER` storage engine is enabled:

```
$> mysql
Welcome to the MySQL monitor.  Commands end with ; or \g.
Your MySQL connection id is 1 to server version: 5.7.44

Type 'help;' or '\h' for help. Type '\c' to clear the buffer.

mysql> SHOW ENGINES\G
...
***** 12. row *****
Engine: NDBCLUSTER
Support: YES
Comment: Clustered, fault-tolerant, memory-based tables
***** 13. row *****
Engine: NDB
Support: YES
Comment: Alias for NDBCLUSTER
...
```

The row numbers shown in the preceding example output may be different from those shown on your system, depending upon how your server is configured.

Try to create an `NDBCLUSTER` table:

```
$> mysql
mysql> USE test;
Database changed

mysql> CREATE TABLE ctest (i INT) ENGINE=NDBCLUSTER;
Query OK, 0 rows affected (0.09 sec)

mysql> SHOW CREATE TABLE ctest \G
***** 1. row *****
      Table: ctest
Create Table: CREATE TABLE `ctest` (
  `i` int(11) default NULL
) ENGINE=ndbcluster DEFAULT CHARSET=latin1
1 row in set (0.00 sec)
```

To check that your nodes were set up properly, start the management client:

```
$> ndb_mgm
```

Use the `SHOW` command from within the management client to obtain a report on the cluster's status:

```
ndb_mgm> SHOW
Cluster Configuration
-----
[ndbd(NDB)]      1 node(s)
id=2      @127.0.0.1  (Version: 5.7.44-ndb-7.5.36, Nodegroup: 0, *)

[ndb_mgmd(MGM)] 1 node(s)
id=1      @127.0.0.1  (Version: 5.7.44-ndb-7.5.36)

[mysqld(API)]   3 node(s)
id=3      @127.0.0.1  (Version: 5.7.44-ndb-7.5.36)
id=4 (not connected, accepting connect from any host)
id=5 (not connected, accepting connect from any host)
```

At this point, you have successfully set up a working NDB Cluster. You can now store data in the cluster by using any table created with `ENGINE=NDBCLUSTER` or its alias `ENGINE=NDB`.

## 21.4.2 Overview of NDB Cluster Configuration Parameters, Options, and Variables

The next several sections provide summary tables of NDB Cluster node configuration parameters used in the `config.ini` file to govern various aspects of node behavior, as well as of options and variables read by `mysqld` from a `my.cnf` file or from the command line when run as an NDB Cluster process. Each of the node parameter tables lists the parameters for a given type (`ndbd`, `ndb_mgmd`, `mysqld`, `computer`, `tcp`, or `shm`). All tables include the data type for the parameter, option, or variable, as well as its default, minimum, and maximum values as applicable.

**Considerations when restarting nodes.** For node parameters, these tables also indicate what type of restart is required (node restart or system restart)—and whether the restart must be done with `--initial`—to change the value of a given configuration parameter. When performing a node restart or an initial node restart, all of the cluster's data nodes must be restarted in turn (also referred to as a *rolling restart*). It is possible to update cluster configuration parameters marked as `node` online—that is, without shutting down the cluster—in this fashion. An initial node restart requires restarting each `ndbd` process with the `--initial` option.

A system restart requires a complete shutdown and restart of the entire cluster. An initial system restart requires taking a backup of the cluster, wiping the cluster file system after shutdown, and then restoring from the backup following the restart.

In any cluster restart, all of the cluster's management servers must be restarted for them to read the updated configuration parameter values.



### Important

Values for numeric cluster parameters can generally be increased without any problems, although it is advisable to do so progressively, making such adjustments in relatively small increments. Many of these can be increased online, using a rolling restart.

However, decreasing the values of such parameters—whether this is done using a node restart, node initial restart, or even a complete system restart of the cluster—is not to be undertaken lightly; it is recommended that you do so only

after careful planning and testing. This is especially true with regard to those parameters that relate to memory usage and disk space, such as `MaxNoOfTables`, `MaxNoOfOrderedIndexes`, and `MaxNoOfUniqueHashIndexes`. In addition, it is generally the case that configuration parameters relating to memory and disk usage can be raised using a simple node restart, but they require an initial node restart to be lowered.

Because some of these parameters can be used for configuring more than one type of cluster node, they may appear in more than one of the tables.



#### Note

`4294967039` often appears as a maximum value in these tables. This value is defined in the `NDBCLUSTER` sources as `MAX_INT_RNIL` and is equal to `0xFFFFFFFF`, or  $2^{32} - 2^8 - 1$ .

### 21.4.2.1 NDB Cluster Data Node Configuration Parameters

The listings in this section provide information about parameters used in the `[ndbd]` or `[ndbd default]` sections of a `config.ini` file for configuring NDB Cluster data nodes. For detailed descriptions and other additional information about each of these parameters, see [Section 21.4.3.6, “Defining NDB Cluster Data Nodes”](#).

These parameters also apply to `ndbmt`, the multithreaded version of `ndbd`. A separate listing of parameters specific to `ndbmt` follows.

- `ApiFailureHandlingTimeout`: Maximum time for API node failure handling before escalating. 0 means no time limit; minimum usable value is 10.
- `Arbitration`: How arbitration should be performed to avoid split-brain issues in event of node failure.
- `ArbitrationTimeout`: Maximum time (milliseconds) database partition waits for arbitration signal.
- `BackupDataBufferSize`: Default size of databuffer for backup (in bytes).
- `BackupDataDir`: Path to where to store backups. Note that string `'/BACKUP'` is always appended to this setting, so that *effective* default is `FileSystemPath/BACKUP`.
- `BackupDiskWriteSpeedPct`: Sets percentage of data node's allocated maximum write speed (`MaxDiskWriteSpeed`) to reserve for LCPs when starting backup.
- `BackupLogBufferSize`: Default size of log buffer for backup (in bytes).
- `BackupMaxWriteSize`: Maximum size of file system writes made by backup (in bytes).
- `BackupMemory`: Total memory allocated for backups per node (in bytes).
- `BackupReportFrequency`: Frequency of backup status reports during backup in seconds.
- `BackupWriteSize`: Default size of file system writes made by backup (in bytes).
- `BatchSizePerLocalScan`: Used to calculate number of lock records for scan with hold lock.
- `BuildIndexThreads`: Number of threads to use for building ordered indexes during system or node restart. Also applies when running `ndb_restore --rebuild-indexes`. Setting this parameter to 0 disables multithreaded building of ordered indexes.
- `CompressedBackup`: Use `zlib` to compress backups as they are written.

- `CompressedLCP`: Write compressed LCPs using zlib.
- `ConnectCheckIntervalDelay`: Time between data node connectivity check stages. Data node is considered suspect after 1 interval and dead after 2 intervals with no response.
- `CrashOnCorruptedTuple`: When enabled, forces node to shut down whenever it detects corrupted tuple.
- `DataDir`: Data directory for this node.
- `DataMemory`: Number of bytes on each data node allocated for storing data; subject to available system RAM and size of `IndexMemory`.
- `DefaultHashMapSize`: Set size (in buckets) to use for table hash maps. Three values are supported: 0, 240, and 3840.
- `DictTrace`: Enable DBDICT debugging; for NDB development.
- `DiskIOThreadPool`: Number of unbound threads for file access, applies to disk data only.
- `Diskless`: Run without using disk.
- `DiskPageBufferEntries`: Memory to allocate in `DiskPageBufferMemory`; very large disk transactions may require increasing this value.
- `DiskPageBufferMemory`: Number of bytes on each data node allocated for disk page buffer cache.
- `DiskSyncSize`: Amount of data written to file before synch is forced.
- `EnablePartialLcp`: Enable partial LCP (true); if this is disabled (false), all LCPs write full checkpoints.
- `EnableRedoControl`: Enable adaptive checkpointing speed for controlling redo log usage.
- `EventLogBufferSize`: Size of circular buffer for NDB log events within data nodes.
- `ExecuteOnComputer`: String referencing earlier defined `COMPUTER`.
- `ExtraSendBufferMemory`: Memory to use for send buffers in addition to any allocated by `TotalSendBufferMemory` or `SendBufferMemory`. Default (0) allows up to 16MB.
- `FileSystemPath`: Path to directory where data node stores its data (directory must exist).
- `FileSystemPathDataFiles`: Path to directory where data node stores its Disk Data files. Default value is `FileSystemPathDD`, if set; otherwise, `FileSystemPath` is used if it is set; otherwise, value of `DataDir` is used.
- `FileSystemPathDD`: Path to directory where data node stores its Disk Data and undo files. Default value is `FileSystemPath`, if set; otherwise, value of `DataDir` is used.
- `FileSystemPathUndoFiles`: Path to directory where data node stores its undo files for Disk Data. Default value is `FileSystemPathDD`, if set; otherwise, `FileSystemPath` is used if it is set; otherwise, value of `DataDir` is used.
- `FragmentLogFileSize`: Size of each redo log file.
- `HeartbeatIntervalDbApi`: Time between API node-data node heartbeats. (API connection closed after 3 missed heartbeats).
- `HeartbeatIntervalDbDb`: Time between data node-to-data node heartbeats; data node considered dead after 3 missed heartbeats.

- [HeartbeatOrder](#): Sets order in which data nodes check each others' heartbeats for determining whether given node is still active and connected to cluster. Must be zero for all data nodes or distinct nonzero values for all data nodes; see documentation for further guidance.
- [HostName](#): Host name or IP address for this data node.
- [IndexMemory](#): Number of bytes on each data node allocated for storing indexes; subject to available system RAM and size of DataMemory.
- [IndexStatAutoCreate](#): Enable/disable automatic statistics collection when indexes are created.
- [IndexStatAutoUpdate](#): Monitor indexes for changes and trigger automatic statistics updates.
- [IndexStatSaveScale](#): Scaling factor used in determining size of stored index statistics.
- [IndexStatSaveSize](#): Maximum size in bytes for saved statistics per index.
- [IndexStatTriggerPct](#): Threshold percent change in DML operations for index statistics updates. Value is scaled down by IndexStatTriggerScale.
- [IndexStatTriggerScale](#): Scale down IndexStatTriggerPct by this amount, multiplied by base 2 logarithm of index size, for large index. Set to 0 to disable scaling.
- [IndexStatUpdateDelay](#): Minimum delay between automatic index statistics updates for given index. 0 means no delay.
- [InitFragmentLogFiles](#): Initialize fragment log files, using sparse or full format.
- [InitialLogFileGroup](#): Describes log file group that is created during initial start. See documentation for format.
- [InitialNoOfOpenFiles](#): Initial number of files open per data node. (One thread is created per file).
- [InitialTablespace](#): Describes tablespace that is created during initial start. See documentation for format.
- [InsertRecoveryWork](#): Percentage of RecoveryWork used for inserted rows; has no effect unless partial local checkpoints are in use.
- [LateAlloc](#): Allocate memory after connection to management server has been established.
- [LcpScanProgressTimeout](#): Maximum time that local checkpoint fragment scan can be stalled before node is shut down to ensure systemwide LCP progress. Use 0 to disable.
- [LocationDomainId](#): Assign this data node to specific availability domain or zone. 0 (default) leaves this unset.
- [LockExecuteThreadToCPU](#): Comma-delimited list of CPU IDs.
- [LockMaintThreadsToCPU](#): CPU ID indicating which CPU runs maintenance threads.
- [LockPagesInMainMemory](#): 0=disable locking, 1=lock after memory allocation, 2=lock before memory allocation.
- [LogLevelCheckpoint](#): Log level of local and global checkpoint information printed to stdout.
- [LogLevelCongestion](#): Level of congestion information printed to stdout.
- [LogLevelConnection](#): Level of node connect/disconnect information printed to stdout.
- [LogLevelError](#): Transporter, heartbeat errors printed to stdout.

- `LogLevelInfo`: Heartbeat and log information printed to stdout.
- `LogLevelNodeRestart`: Level of node restart and node failure information printed to stdout.
- `LogLevelShutdown`: Level of node shutdown information printed to stdout.
- `LogLevelStartup`: Level of node startup information printed to stdout.
- `LogLevelStatistic`: Level of transaction, operation, and transporter information printed to stdout.
- `LongMessageBuffer`: Number of bytes allocated on each data node for internal long messages.
- `MaxAllocate`: No longer used; has no effect.
- `MaxBufferedEpochs`: Allowed number of epochs that subscribing node can lag behind (unprocessed epochs). Exceeding causes lagging subscribers to be disconnected.
- `MaxBufferedEpochBytes`: Total number of bytes allocated for buffering epochs.
- `MaxDiskWriteSpeed`: Maximum number of bytes per second that can be written by LCP and backup when no restarts are ongoing.
- `MaxDiskWriteSpeedOtherNodeRestart`: Maximum number of bytes per second that can be written by LCP and backup when another node is restarting.
- `MaxDiskWriteSpeedOwnRestart`: Maximum number of bytes per second that can be written by LCP and backup when this node is restarting.
- `MaxFKBuildBatchSize`: Maximum scan batch size to use for building foreign keys. Increasing this value may speed up builds of foreign keys but impacts ongoing traffic as well.
- `MaxDMLOperationsPerTransaction`: Limit size of transaction; aborts transaction if it requires more than this many DML operations.
- `MaxLCPStartDelay`: Time in seconds that LCP polls for checkpoint mutex (to allow other data nodes to complete metadata synchronization), before putting itself in lock queue for parallel recovery of table data.
- `MaxNoOfAttributes`: Suggests total number of attributes stored in database (sum over all tables).
- `MaxNoOfConcurrentIndexOperations`: Total number of index operations that can execute simultaneously on one data node.
- `MaxNoOfConcurrentOperations`: Maximum number of operation records in transaction coordinator.
- `MaxNoOfConcurrentScans`: Maximum number of scans executing concurrently on data node.
- `MaxNoOfConcurrentSubOperations`: Maximum number of concurrent subscriber operations.
- `MaxNoOfConcurrentTransactions`: Maximum number of transactions executing concurrently on this data node, total number of transactions that can be executed concurrently is this value times number of data nodes in cluster.
- `MaxNoOfFiredTriggers`: Total number of triggers that can fire simultaneously on one data node.
- `MaxNoOfLocalOperations`: Maximum number of operation records defined on this data node.
- `MaxNoOfLocalScans`: Maximum number of fragment scans in parallel on this data node.
- `MaxNoOfOpenFiles`: Maximum number of files open per data node. (One thread is created per file).
- `MaxNoOfOrderedIndexes`: Total number of ordered indexes that can be defined in system.

- **MaxNoOfSavedMessages**: Maximum number of error messages to write in error log and maximum number of trace files to retain.
- **MaxNoOfSubscribers**: Maximum number of subscribers.
- **MaxNoOfSubscriptions**: Maximum number of subscriptions (default 0 = MaxNoOfTables).
- **MaxNoOfTables**: Suggests total number of NDB tables stored in database.
- **MaxNoOfTriggers**: Total number of triggers that can be defined in system.
- **MaxNoOfUniqueHashIndexes**: Total number of unique hash indexes that can be defined in system.
- **MaxParallelCopyInstances**: Number of parallel copies during node restarts. Default is 0, which uses number of LDMs on both nodes, to maximum of 16.
- **MaxParallelScansPerFragment**: Maximum number of parallel scans per fragment. Once this limit is reached, scans are serialized.
- **MaxReorgBuildBatchSize**: Maximum scan batch size to use for reorganization of table partitions. Increasing this value may speed up table partition reorganization but impacts ongoing traffic as well.
- **MaxStartFailRetries**: Maximum retries when data node fails on startup, requires StopOnError = 0. Setting to 0 causes start attempts to continue indefinitely.
- **MaxUIBuildBatchSize**: Maximum scan batch size to use for building unique keys. Increasing this value may speed up builds of unique keys but impacts ongoing traffic as well.
- **MemReportFrequency**: Frequency of memory reports in seconds; 0 = report only when exceeding percentage limits.
- **MinDiskWriteSpeed**: Minimum number of bytes per second that can be written by LCP and backup.
- **MinFreePct**: Percentage of memory resources to keep in reserve for restarts.
- **NodeGroup**: Node group to which data node belongs; used only during initial start of cluster.
- **NodeId**: Number uniquely identifying data node among all nodes in cluster.
- **NoOfFragmentLogFiles**: Number of 16 MB redo log files in each of 4 file sets belonging to data node.
- **NoOfReplicas**: Number of copies of all data in database.
- **Numa**: (Linux only; requires libnuma) Controls NUMA support. Setting to 0 permits system to determine use of interleaving by data node process; 1 means that it is determined by data node.
- **ODirect**: Use O\_DIRECT file reads and writes when possible.
- **ODirectSyncFlag**: O\_DIRECT writes are treated as synchronized writes; ignored when ODirect is not enabled, InitFragmentLogFiles is set to SPARSE, or both.
- **RealtimeScheduler**: When true, data node threads are scheduled as real-time threads. Default is false.
- **RecoveryWork**: Percentage of storage overhead for LCP files: greater value means less work in normal operations, more work during recovery.
- **RedoBuffer**: Number of bytes on each data node allocated for writing redo logs.
- **RedoOverCommitCounter**: When RedoOverCommitLimit has been exceeded this many times, transactions are aborted, and operations are handled as specified by DefaultOperationRedoProblemAction.

- `RedoOverCommitLimit`: Each time that flushing current redo buffer takes longer than this many seconds, number of times that this has happened is compared to `RedoOverCommitCounter`.
- `ReservedSendBufferMemory`: This parameter is present in NDB code but is not enabled.
- `RestartOnErrorInsert`: Control type of restart caused by inserting error (when `StopOnError` is enabled).
- `RestartSubscriberConnectTimeout`: Amount of time for data node to wait for subscribing API nodes to connect. Set to 0 to disable timeout, which is always resolved to nearest full second.
- `SchedulerExecutionTimer`: Number of microseconds to execute in scheduler before sending.
- `SchedulerResponsiveness`: Set NDB scheduler response optimization 0-10; higher values provide better response time but lower throughput.
- `SchedulerSpinTimer`: Number of microseconds to execute in scheduler before sleeping.
- `ServerPort`: Port used to set up transporter for incoming connections from API nodes.
- `SharedGlobalMemory`: Total number of bytes on each data node allocated for any use.
- `StartFailRetryDelay`: Delay in seconds after start failure prior to retry; requires `StopOnError = 0`.
- `StartFailureTimeout`: Milliseconds to wait before terminating. (0=Wait forever).
- `StartNoNodeGroupTimeout`: Time to wait for nodes without nodegroup before trying to start (0=forever).
- `StartPartialTimeout`: Milliseconds to wait before trying to start without all nodes. (0=Wait forever).
- `StartPartitionedTimeout`: Milliseconds to wait before trying to start partitioned. (0=Wait forever).
- `StartupStatusReportFrequency`: Frequency of status reports during startup.
- `StopOnError`: When set to 0, data node automatically restarts and recovers following node failures.
- `StringMemory`: Default size of string memory (0 to 100 = % of maximum, 101+ = actual bytes).
- `TcpBind_INADDR_ANY`: Bind `IP_ADDR_ANY` so that connections can be made from anywhere (for autogenerated connections).
- `TimeBetweenEpochs`: Time between epochs (synchronization used for replication).
- `TimeBetweenEpochsTimeout`: Timeout for time between epochs. Exceeding causes node shutdown.
- `TimeBetweenGlobalCheckpoints`: Time between group commits of transactions to disk.
- `TimeBetweenGlobalCheckpointsTimeout`: Minimum timeout for group commit of transactions to disk.
- `TimeBetweenInactiveTransactionAbortCheck`: Time between checks for inactive transactions.
- `TimeBetweenLocalCheckpoints`: Time between taking snapshots of database (expressed in base-2 logarithm of bytes).
- `TimeBetweenWatchDogCheck`: Time between execution checks inside data node.
- `TimeBetweenWatchDogCheckInitial`: Time between execution checks inside data node (early start phases when memory is allocated).
- `TotalSendBufferMemory`: Total memory to use for all transporter send buffers..



- [TransactionBufferMemory](#): Dynamic buffer space (in bytes) for key and attribute data allocated for each data node.
- [TransactionDeadlockDetectionTimeout](#): Time transaction can spend executing within data node. This is time that transaction coordinator waits for each data node participating in transaction to execute request. If data node takes more than this amount of time, transaction is aborted.
- [TransactionInactiveTimeout](#): Milliseconds that application waits before executing another part of transaction. This is time transaction coordinator waits for application to execute or send another part (query, statement) of transaction. If application takes too much time, then transaction is aborted. Timeout = 0 means that application never times out.
- [TwoPassInitialNodeRestartCopy](#): Copy data in 2 passes during initial node restart, which enables multithreaded building of ordered indexes for such restarts.
- [UndoDataBuffer](#): Unused; has no effect.
- [UndoIndexBuffer](#): Unused; has no effect.
- [UseShm](#): Use shared memory connections between this data node and API node also running on this host.
- [WatchDogImmediateKill](#): When true, threads are immediately killed whenever watchdog issues occur; used for testing and debugging.

The following parameters are specific to `ndbmttd`:

- [MaxNoOfExecutionThreads](#): For `ndbmttd` only, specify maximum number of execution threads.
- [MaxSendDelay](#): Maximum number of microseconds to delay sending by `ndbmttd`.
- [NoOfFragmentLogParts](#): Number of redo log file groups belonging to this data node.
- [ThreadConfig](#): Used for configuration of multithreaded data nodes (`ndbmttd`). Default is empty string; see documentation for syntax and other information.

### 21.4.2.2 NDB Cluster Management Node Configuration Parameters

The listing in this section provides information about parameters used in the `[ndb_mgmd]` or `[mgm]` section of a `config.ini` file for configuring NDB Cluster management nodes. For detailed descriptions and other additional information about each of these parameters, see [Section 21.4.3.5, “Defining an NDB Cluster Management Server”](#).

- [ArbitrationDelay](#): When asked to arbitrate, arbitrator waits this long before voting (milliseconds).
- [ArbitrationRank](#): If 0, then management node is not arbitrator. Kernel selects arbitrators in order 1, 2.
- [DataDir](#): Data directory for this node.
- [ExecuteOnComputer](#): String referencing earlier defined COMPUTER.
- [ExtraSendBufferMemory](#): Memory to use for send buffers in addition to any allocated by `TotalSendBufferMemory` or `SendBufferMemory`. Default (0) allows up to 16MB.
- [HeartbeatIntervalMgmdMgmd](#): Time between management-node-to-management-node heartbeats; connection between management nodes is considered lost after 3 missed heartbeats.
- [HeartbeatThreadPriority](#): Set heartbeat thread policy and priority for management nodes; see manual for allowed values.

- **HostName**: Host name or IP address for this management node.
- **Id**: Number identifying management node. Now deprecated; use `NodId` instead.
- **LocationDomainId**: Assign this management node to specific availability domain or zone. 0 (default) leaves this unset.
- **LogDestination**: Where to send log messages: console, system log, or specified log file.
- **NodeId**: Number uniquely identifying management node among all nodes in cluster.
- **PortNumber**: Port number to send commands to and fetch configuration from management server.
- **PortNumberStats**: Port number used to get statistical information from management server.
- **TotalSendBufferMemory**: Total memory to use for all transporter send buffers.
- **wan**: Use WAN TCP setting as default.



#### Note

After making changes in a management node's configuration, it is necessary to perform a rolling restart of the cluster for the new configuration to take effect. See [Section 21.4.3.5, “Defining an NDB Cluster Management Server”](#), for more information.

To add new management servers to a running NDB Cluster, it is also necessary perform a rolling restart of all cluster nodes after modifying any existing `config.ini` files. For more information about issues arising when using multiple management nodes, see [Section 21.2.7.10, “Limitations Relating to Multiple NDB Cluster Nodes”](#).

### 21.4.2.3 NDB Cluster SQL Node and API Node Configuration Parameters

The listing in this section provides information about parameters used in the `[mysqld]` and `[api]` sections of a `config.ini` file for configuring NDB Cluster SQL nodes and API nodes. For detailed descriptions and other additional information about each of these parameters, see [Section 21.4.3.7, “Defining SQL and Other API Nodes in an NDB Cluster”](#).

- **ApiVerbose**: Enable NDB API debugging; for NDB development.
- **ArbitrationDelay**: When asked to arbitrate, arbitrator waits this many milliseconds before voting.
- **ArbitrationRank**: If 0, then API node is not arbitrator. Kernel selects arbitrators in order 1, 2.
- **AutoReconnect**: Specifies whether an API node should reconnect fully when disconnected from cluster.
- **BatchByteSize**: Default batch size in bytes.
- **BatchSize**: Default batch size in number of records.
- **ConnectBackoffMaxTime**: Specifies longest time in milliseconds (~100ms resolution) to allow between connection attempts to any given data node by this API node. Excludes time elapsed while connection attempts are ongoing, which in worst case can take several seconds. Disable by setting to 0. If no data nodes are currently connected to this API node, `StartConnectBackoffMaxTime` is used instead.
- **ConnectionMap**: Specifies which data nodes to connect.

- `DefaultHashMapSize`: Set size (in buckets) to use for table hash maps. Three values are supported: 0, 240, and 3840.
- `DefaultOperationRedoProblemAction`: How operations are handled in event that `RedoOverCommitCounter` is exceeded.
- `ExecuteOnComputer`: String referencing earlier defined COMPUTER.
- `ExtraSendBufferMemory`: Memory to use for send buffers in addition to any allocated by `TotalSendBufferMemory` or `SendBufferMemory`. Default (0) allows up to 16MB.
- `HeartbeatThreadPriority`: Set heartbeat thread policy and priority for API nodes; see manual for allowed values.
- `HostName`: Host name or IP address for this SQL or API node.
- `Id`: Number identifying MySQL server or API node (Id). Now deprecated; use `NodeId` instead.
- `LocationDomainId`: Assign this API node to specific availability domain or zone. 0 (default) leaves this unset.
- `MaxScanBatchSize`: Maximum collective batch size for one scan.
- `NodeId`: Number uniquely identifying SQL node or API node among all nodes in cluster.
- `StartConnectBackoffMaxTime`: Same as `ConnectBackoffMaxTime` except that this parameter is used in its place if no data nodes are connected to this API node.
- `TotalSendBufferMemory`: Total memory to use for all transporter send buffers.
- `wan`: Use WAN TCP setting as default.

For a discussion of MySQL server options for NDB Cluster, see [MySQL Server Options for NDB Cluster](#). For information about MySQL server system variables relating to NDB Cluster, see [NDB Cluster System Variables](#).



#### Note

To add new SQL or API nodes to the configuration of a running NDB Cluster, it is necessary to perform a rolling restart of all cluster nodes after adding new `[mysqld]` or `[api]` sections to the `config.ini` file (or files, if you are using more than one management server). This must be done before the new SQL or API nodes can connect to the cluster.

It is *not* necessary to perform any restart of the cluster if new SQL or API nodes can employ previously unused API slots in the cluster configuration to connect to the cluster.

### 21.4.2.4 Other NDB Cluster Configuration Parameters

The listings in this section provide information about parameters used in the `[computer]`, `[tcp]`, and `[shm]` sections of a `config.ini` file for configuring NDB Cluster. For detailed descriptions and additional information about individual parameters, see [Section 21.4.3.10, “NDB Cluster TCP/IP Connections”](#), or [Section 21.4.3.12, “NDB Cluster Shared Memory Connections”](#), as appropriate.

The following parameters apply to the `config.ini` file's `[computer]` section:

- `HostName`: Host name or IP address of this computer.
- `Id`: Unique identifier for this computer.

The following parameters apply to the `config.ini` file's `[tcp]` section:

- **Checksum**: If checksum is enabled, all signals between nodes are checked for errors.
- **Group**: Used for group proximity; smaller value is interpreted as being closer.
- **HostName1**: Name or IP address of first of two computers joined by TCP connection.
- **HostName2**: Name or IP address of second of two computers joined by TCP connection.
- **NodeId1**: ID of node (data node, API node, or management node) on one side of connection.
- **NodeId2**: ID of node (data node, API node, or management node) on one side of connection.
- **NodeIdServer**: Set server side of TCP connection.
- **OverloadLimit**: When more than this many unsent bytes are in send buffer, connection is considered overloaded.
- **PortNumber**: Port used for TCP transporter.
- **PreSendChecksum**: If this parameter and Checksum are both enabled, perform pre-send checksum checks, and check all TCP signals between nodes for errors.
- **Proxy**: ....
- **ReceiveBufferMemory**: Bytes of buffer for signals received by this node.
- **SendBufferMemory**: Bytes of TCP buffer for signals sent from this node.
- **SendSignalId**: Sends ID in each signal. Used in trace files. Defaults to true in debug builds.
- **TCP\_MAXSEG\_SIZE**: Value used for TCP\_MAXSEG.
- **TCP\_RCV\_BUF\_SIZE**: Value used for SO\_RCVBUF.
- **TCP\_SND\_BUF\_SIZE**: Value used for SO\_SNDBUF.
- **TcpBind\_INADDR\_ANY**: Bind InAddrAny instead of host name for server part of connection.

The following parameters apply to the `config.ini` file's `[shm]` section:

- **Checksum**: If checksum is enabled, all signals between nodes are checked for errors.
- **Group**: Used for group proximity; smaller value is interpreted as being closer.
- **HostName1**: Name or IP address of first of two computers joined by SHM connection.
- **HostName2**: Name or IP address of second of two computers joined by SHM connection.
- **NodeId1**: ID of node (data node, API node, or management node) on one side of connection.
- **NodeId2**: ID of node (data node, API node, or management node) on one side of connection.
- **NodeIdServer**: Set server side of SHM connection.
- **OverloadLimit**: When more than this many unsent bytes are in send buffer, connection is considered overloaded.
- **PortNumber**: Port used for SHM transporter.
- **PreSendChecksum**: If this parameter and Checksum are both enabled, perform pre-send checksum checks, and check all SHM signals between nodes for errors.

- [SendBufferMemory](#): Bytes in shared memory buffer for signals sent from this node.
- [SendSignalId](#): Sends ID in each signal. Used in trace files.
- [ShmKey](#): Shared memory key; when set to 1, this is calculated by NDB.
- [ShmSpinTime](#): When receiving, number of microseconds to spin before sleeping.
- [ShmSize](#): Size of shared memory segment.
- [Signum](#): Signal number to be used for signalling.

### 21.4.2.5 NDB Cluster `mysqld` Option and Variable Reference

The following list includes command-line options, system variables, and status variables applicable within `mysqld` when it is running as an SQL node in an NDB Cluster. For a reference to *all* command-line options, system variables, and status variables used with or relating to `mysqld`, see [Section 5.1.3, “Server Option, System Variable, and Status Variable Reference”](#).

- [Com\\_show\\_ndb\\_status](#): Count of SHOW NDB STATUS statements.
- [Handler\\_discover](#): Number of times that tables have been discovered.
- [ndb-batch-size](#): Size (in bytes) to use for NDB transaction batches.
- [ndb-blob-read-batch-bytes](#): Specifies size in bytes that large BLOB reads should be batched into. 0 = no limit.
- [ndb-blob-write-batch-bytes](#): Specifies size in bytes that large BLOB writes should be batched into. 0 = no limit.
- [ndb-cluster-connection-pool](#): Number of connections to cluster used by MySQL.
- [ndb-cluster-connection-pool-nodeids](#): Comma-separated list of node IDs for connections to cluster used by MySQL; number of nodes in list must match value set for `--ndb-cluster-connection-pool`.
- [ndb-connectstring](#): Address of NDB management server distributing configuration information for this cluster.
- [ndb-default-column-format](#): Use this value (FIXED or DYNAMIC) by default for COLUMN\_FORMAT and ROW\_FORMAT options when creating or adding table columns.
- [ndb-deferred-constraints](#): Specifies that constraint checks on unique indexes (where these are supported) should be deferred until commit time. Not normally needed or used; for testing purposes only.
- [ndb-distribution](#): Default distribution for new tables in NDBCLUSTER (KEYHASH or LINHASH, default is KEYHASH).
- [ndb-log-apply-status](#): Cause MySQL server acting as replica to log `mysql.ndb_apply_status` updates received from its immediate source in its own binary log, using its own server ID. Effective only if server is started with `--ndbcluster` option.
- [ndb-log-empty-epochs](#): When enabled, causes epochs in which there were no changes to be written to `ndb_apply_status` and `ndb_binlog_index` tables, even when `--log-slave-updates` is enabled.
- [ndb-log-empty-update](#): When enabled, causes updates that produced no changes to be written to `ndb_apply_status` and `ndb_binlog_index` tables, even when `--log-slave-updates` is enabled.
- [ndb-log-exclusive-reads](#): Log primary key reads with exclusive locks; allow conflict resolution based on read conflicts.

- `ndb-log-fail-terminate`: Terminate mysqld process if complete logging of all found row events is not possible.
- `ndb-log-orig`: Log originating server id and epoch in `mysql.ndb_binlog_index` table.
- `ndb-log-transaction-id`: Write NDB transaction IDs in binary log. Requires `--log-bin-v1-events=OFF`.
- `ndb-log-update-minimal`: Log updates in minimal format.
- `ndb-log-updated-only`: Log updates only (ON) or complete rows (OFF).
- `ndb-log-update-as-write`: Toggles logging of updates on source between updates (OFF) and writes (ON).
- `ndb-mgmd-host`: Set host (and port, if desired) for connecting to management server.
- `ndb-nodeid`: NDB Cluster node ID for this MySQL server.
- `ndb-optimized-node-selection`: Enable optimizations for selection of nodes for transactions. Enabled by default; use `--skip-ndb-optimized-node-selection` to disable.
- `ndb-transid-mysql-connection-map`: Enable or disable `ndb_transid_mysql_connection_map` plugin; that is, enable or disable `INFORMATION_SCHEMA` table having that name.
- `ndb-wait-connected`: Time (in seconds) for MySQL server to wait for connection to cluster management and data nodes before accepting MySQL client connections.
- `ndb-wait-setup`: Time (in seconds) for MySQL server to wait for NDB engine setup to complete.
- `ndb-allow-copying-alter-table`: Set to OFF to keep ALTER TABLE from using copying operations on NDB tables.
- `Ndb_api_adaptive_send_deferred_count`: Number of adaptive send calls not actually sent by this MySQL Server (SQL node).
- `Ndb_api_adaptive_send_deferred_count_session`: Number of adaptive send calls not actually sent in this client session.
- `Ndb_api_adaptive_send_deferred_count_slave`: Number of adaptive send calls not actually sent by this replica.
- `Ndb_api_adaptive_send_forced_count`: Number of adaptive sends with forced-send set sent by this MySQL Server (SQL node).
- `Ndb_api_adaptive_send_forced_count_session`: Number of adaptive sends with forced-send set in this client session.
- `Ndb_api_adaptive_send_forced_count_slave`: Number of adaptive sends with forced-send set sent by this replica.
- `Ndb_api_adaptive_send_unforced_count`: Number of adaptive sends without forced-send sent by this MySQL Server (SQL node).
- `Ndb_api_adaptive_send_unforced_count_session`: Number of adaptive sends without forced-send in this client session.
- `Ndb_api_adaptive_send_unforced_count_slave`: Number of adaptive sends without forced-send sent by this replica.

- [Ndb\\_api\\_bytes\\_received\\_count](#): Quantity of data (in bytes) received from data nodes by this MySQL Server (SQL node).
- [Ndb\\_api\\_bytes\\_received\\_count\\_session](#): Quantity of data (in bytes) received from data nodes in this client session.
- [Ndb\\_api\\_bytes\\_received\\_count\\_slave](#): Quantity of data (in bytes) received from data nodes by this replica.
- [Ndb\\_api\\_bytes\\_sent\\_count](#): Quantity of data (in bytes) sent to data nodes by this MySQL Server (SQL node).
- [Ndb\\_api\\_bytes\\_sent\\_count\\_session](#): Quantity of data (in bytes) sent to data nodes in this client session.
- [Ndb\\_api\\_bytes\\_sent\\_count\\_slave](#): Quantity of data (in bytes) sent to data nodes by this replica.
- [Ndb\\_api\\_event\\_bytes\\_count](#): Number of bytes of events received by this MySQL Server (SQL node).
- [Ndb\\_api\\_event\\_bytes\\_count\\_injector](#): Number of bytes of event data received by NDB binary log injector thread.
- [Ndb\\_api\\_event\\_data\\_count](#): Number of row change events received by this MySQL Server (SQL node).
- [Ndb\\_api\\_event\\_data\\_count\\_injector](#): Number of row change events received by NDB binary log injector thread.
- [Ndb\\_api\\_event\\_nondata\\_count](#): Number of events received, other than row change events, by this MySQL Server (SQL node).
- [Ndb\\_api\\_event\\_nondata\\_count\\_injector](#): Number of events received, other than row change events, by NDB binary log injector thread.
- [Ndb\\_api\\_pk\\_op\\_count](#): Number of operations based on or using primary keys by this MySQL Server (SQL node).
- [Ndb\\_api\\_pk\\_op\\_count\\_session](#): Number of operations based on or using primary keys in this client session.
- [Ndb\\_api\\_pk\\_op\\_count\\_slave](#): Number of operations based on or using primary keys by this replica.
- [Ndb\\_api\\_pruned\\_scan\\_count](#): Number of scans that have been pruned to one partition by this MySQL Server (SQL node).
- [Ndb\\_api\\_pruned\\_scan\\_count\\_session](#): Number of scans that have been pruned to one partition in this client session.
- [Ndb\\_api\\_pruned\\_scan\\_count\\_slave](#): Number of scans that have been pruned to one partition by this replica.
- [Ndb\\_api\\_range\\_scan\\_count](#): Number of range scans that have been started by this MySQL Server (SQL node).
- [Ndb\\_api\\_range\\_scan\\_count\\_session](#): Number of range scans that have been started in this client session.
- [Ndb\\_api\\_range\\_scan\\_count\\_slave](#): Number of range scans that have been started by this replica.

- `Ndb_api_read_row_count`: Total number of rows that have been read by this MySQL Server (SQL node).
- `Ndb_api_read_row_count_session`: Total number of rows that have been read in this client session.
- `Ndb_api_read_row_count_slave`: Total number of rows that have been read by this replica.
- `Ndb_api_scan_batch_count`: Number of batches of rows received by this MySQL Server (SQL node).
- `Ndb_api_scan_batch_count_session`: Number of batches of rows received in this client session.
- `Ndb_api_scan_batch_count_slave`: Number of batches of rows received by this replica.
- `Ndb_api_table_scan_count`: Number of table scans that have been started, including scans of internal tables, by this MySQL Server (SQL node).
- `Ndb_api_table_scan_count_session`: Number of table scans that have been started, including scans of internal tables, in this client session.
- `Ndb_api_table_scan_count_slave`: Number of table scans that have been started, including scans of internal tables, by this replica.
- `Ndb_api_trans_abort_count`: Number of transactions aborted by this MySQL Server (SQL node).
- `Ndb_api_trans_abort_count_session`: Number of transactions aborted in this client session.
- `Ndb_api_trans_abort_count_slave`: Number of transactions aborted by this replica.
- `Ndb_api_trans_close_count`: Number of transactions closed by this MySQL Server (SQL node); may be greater than sum of `TransCommitCount` and `TransAbortCount`.
- `Ndb_api_trans_close_count_session`: Number of transactions aborted (may be greater than sum of `TransCommitCount` and `TransAbortCount`) in this client session.
- `Ndb_api_trans_close_count_slave`: Number of transactions aborted (may be greater than sum of `TransCommitCount` and `TransAbortCount`) by this replica.
- `Ndb_api_trans_commit_count`: Number of transactions committed by this MySQL Server (SQL node).
- `Ndb_api_trans_commit_count_session`: Number of transactions committed in this client session.
- `Ndb_api_trans_commit_count_slave`: Number of transactions committed by this replica.
- `Ndb_api_trans_local_read_row_count`: Total number of rows that have been read by this MySQL Server (SQL node).
- `Ndb_api_trans_local_read_row_count_session`: Total number of rows that have been read in this client session.
- `Ndb_api_trans_local_read_row_count_slave`: Total number of rows that have been read by this replica.
- `Ndb_api_trans_start_count`: Number of transactions started by this MySQL Server (SQL node).
- `Ndb_api_trans_start_count_session`: Number of transactions started in this client session.
- `Ndb_api_trans_start_count_slave`: Number of transactions started by this replica.



- `Ndb_api_uk_op_count`: Number of operations based on or using unique keys by this MySQL Server (SQL node).
- `Ndb_api_uk_op_count_session`: Number of operations based on or using unique keys in this client session.
- `Ndb_api_uk_op_count_slave`: Number of operations based on or using unique keys by this replica.
- `Ndb_api_wait_exec_complete_count`: Number of times thread has been blocked while waiting for operation execution to complete by this MySQL Server (SQL node).
- `Ndb_api_wait_exec_complete_count_session`: Number of times thread has been blocked while waiting for operation execution to complete in this client session.
- `Ndb_api_wait_exec_complete_count_slave`: Number of times thread has been blocked while waiting for operation execution to complete by this replica.
- `Ndb_api_wait_meta_request_count`: Number of times thread has been blocked waiting for metadata-based signal by this MySQL Server (SQL node).
- `Ndb_api_wait_meta_request_count_session`: Number of times thread has been blocked waiting for metadata-based signal in this client session.
- `Ndb_api_wait_meta_request_count_slave`: Number of times thread has been blocked waiting for metadata-based signal by this replica.
- `Ndb_api_wait_nanos_count`: Total time (in nanoseconds) spent waiting for some type of signal from data nodes by this MySQL Server (SQL node).
- `Ndb_api_wait_nanos_count_session`: Total time (in nanoseconds) spent waiting for some type of signal from data nodes in this client session.
- `Ndb_api_wait_nanos_count_slave`: Total time (in nanoseconds) spent waiting for some type of signal from data nodes by this replica.
- `Ndb_api_wait_scan_result_count`: Number of times thread has been blocked while waiting for scan-based signal by this MySQL Server (SQL node).
- `Ndb_api_wait_scan_result_count_session`: Number of times thread has been blocked while waiting for scan-based signal in this client session.
- `Ndb_api_wait_scan_result_count_slave`: Number of times thread has been blocked while waiting for scan-based signal by this replica.
- `ndb_autoincrement_prefetch_sz`: NDB auto-increment prefetch size.
- `ndb_cache_check_time`: Number of milliseconds between checks of cluster SQL nodes made by MySQL query cache.
- `ndb_clear_apply_status`: Causes RESET SLAVE/RESET REPLICA to clear all rows from `ndb_apply_status` table; ON by default.
- `Ndb_cluster_node_id`: Node ID of this server when acting as NDB Cluster SQL node.
- `Ndb_config_from_host`: NDB Cluster management server host name or IP address.
- `Ndb_config_from_port`: Port for connecting to NDB Cluster management server.
- `Ndb_conflict_fn_epoch`: Number of rows that have been found in conflict by `NDB$EPOCH()` NDB replication conflict detection function.

- `Ndb_conflict_fn_epoch2`: Number of rows that have been found in conflict by NDB replication NDB\$EPOCH2() conflict detection function.
- `Ndb_conflict_fn_epoch2_trans`: Number of rows that have been found in conflict by NDB replication NDB\$EPOCH2\_TRANS() conflict detection function.
- `Ndb_conflict_fn_epoch_trans`: Number of rows that have been found in conflict by NDB\$EPOCH\_TRANS() conflict detection function.
- `Ndb_conflict_fn_max`: Number of times that NDB replication conflict resolution based on "greater timestamp wins" has been applied to update and delete operations.
- `Ndb_conflict_fn_max_del_win`: Number of times that NDB replication conflict resolution based on outcome of NDB\$MAX\_DELETE\_WIN() has been applied to update and delete operations.
- `Ndb_conflict_fn_old`: Number of times that NDB replication "same timestamp wins" conflict resolution has been applied.
- `Ndb_conflict_last_conflict_epoch`: Most recent NDB epoch on this replica in which some conflict was detected.
- `Ndb_conflict_last_stable_epoch`: Most recent epoch containing no conflicts.
- `Ndb_conflict_reflected_op_discard_count`: Number of reflected operations that were not applied due error during execution.
- `Ndb_conflict_reflected_op_prepare_count`: Number of reflected operations received that have been prepared for execution.
- `Ndb_conflict_refresh_op_count`: Number of refresh operations that have been prepared.
- `Ndb_conflict_trans_conflict_commit_count`: Number of epoch transactions committed after requiring transactional conflict handling.
- `Ndb_conflict_trans_detect_iter_count`: Number of internal iterations required to commit epoch transaction. Should be (slightly) greater than or equal to `Ndb_conflict_trans_conflict_commit_count`.
- `Ndb_conflict_trans_reject_count`: Number of transactions rejected after being found in conflict by transactional conflict function.
- `Ndb_conflict_trans_row_conflict_count`: Number of rows found in conflict by transactional conflict function. Includes any rows included in or dependent on conflicting transactions.
- `Ndb_conflict_trans_row_reject_count`: Total number of rows realigned after being found in conflict by transactional conflict function. Includes `Ndb_conflict_trans_row_conflict_count` and any rows included in or dependent on conflicting transactions.
- `ndb_data_node_neighbour`: Specifies cluster data node "closest" to this MySQL Server, for transaction hinting and fully replicated tables.
- `ndb_default_column_format`: Sets default row format and column format (FIXED or DYNAMIC) used for new NDB tables.
- `ndb_deferred_constraints`: Specifies that constraint checks should be deferred (where these are supported). Not normally needed or used; for testing purposes only.
- `ndb_distribution`: Default distribution for new tables in NDBCLUSTER (KEYHASH or LINHASH, default is KEYHASH).

- `Ndb_epoch_delete_delete_count`: Number of delete-delete conflicts detected (delete operation is applied, but row does not exist).
- `ndb_eventbuffer_free_percent`: Percentage of free memory that should be available in event buffer before resumption of buffering, after reaching limit set by `ndb_eventbuffer_max_alloc`.
- `ndb_eventbuffer_max_alloc`: Maximum memory that can be allocated for buffering events by NDB API. Defaults to 0 (no limit).
- `Ndb_execute_count`: Number of round trips to NDB kernel made by operations.
- `ndb_extra_logging`: Controls logging of NDB Cluster schema, connection, and data distribution events in MySQL error log.
- `ndb_force_send`: Forces sending of buffers to NDB immediately, without waiting for other threads.
- `ndb_fully_replicated`: Whether new NDB tables are fully replicated.
- `ndb_index_stat_enable`: Use NDB index statistics in query optimization.
- `ndb_index_stat_option`: Comma-separated list of tunable options for NDB index statistics; list should contain no spaces.
- `ndb_join_pushdown`: Enables pushing down of joins to data nodes.
- `Ndb_last_commit_epoch_server`: Epoch most recently committed by NDB.
- `Ndb_last_commit_epoch_session`: Epoch most recently committed by this NDB client.
- `ndb_log_apply_status`: Whether or not MySQL server acting as replica logs `mysql.ndb_apply_status` updates received from its immediate source in its own binary log, using its own server ID.
- `ndb_log_bin`: Write updates to NDB tables in binary log. Effective only if binary logging is enabled with `--log-bin`.
- `ndb_log_binlog_index`: Insert mapping between epochs and binary log positions into `ndb_binlog_index` table. Defaults to ON. Effective only if binary logging is enabled.
- `ndb_log_empty_epochs`: When enabled, epochs in which there were no changes are written to `ndb_apply_status` and `ndb_binlog_index` tables, even when `log_replica_updates` or `log_slave_updates` is enabled.
- `ndb_log_empty_update`: When enabled, updates which produce no changes are written to `ndb_apply_status` and `ndb_binlog_index` tables, even when `log_replica_updates` or `log_slave_updates` is enabled.
- `ndb_log_exclusive_reads`: Log primary key reads with exclusive locks; allow conflict resolution based on read conflicts.
- `ndb_log_orig`: Whether id and epoch of originating server are recorded in `mysql.ndb_binlog_index` table. Set using `--ndb-log-orig` option when starting `mysqld`.
- `ndb_log_transaction_id`: Whether NDB transaction IDs are written into binary log (Read-only).
- `Ndb_number_of_data_nodes`: Number of data nodes in this NDB cluster; set only if server participates in cluster.
- `ndb_optimization_delay`: Number of milliseconds to wait between processing sets of rows by `OPTIMIZE TABLE` on NDB tables.

- `ndb_optimized_node_selection`: Determines how SQL node chooses cluster data node to use as transaction coordinator.
- `Ndb_pruned_scan_count`: Number of scans executed by NDB since cluster was last started where partition pruning could be used.
- `Ndb_pushed_queries_defined`: Number of joins that API nodes have attempted to push down to data nodes.
- `Ndb_pushed_queries_dropped`: Number of joins that API nodes have tried to push down, but failed.
- `Ndb_pushed_queries_executed`: Number of joins successfully pushed down and executed on data nodes.
- `Ndb_pushed_reads`: Number of reads executed on data nodes by pushed-down joins.
- `ndb_read_backup`: Enable read from any replica for all NDB tables; use `NDB_TABLE=READ_BACKUP={0|1}` with `CREATE TABLE` or `ALTER TABLE` to enable or disable for individual NDB tables.
- `ndb_recv_thread_activation_threshold`: Activation threshold when receive thread takes over polling of cluster connection (measured in concurrently active threads).
- `ndb_recv_thread_cpu_mask`: CPU mask for locking receiver threads to specific CPUs; specified as hexadecimal. See documentation for details.
- `ndb_report_thresh_binlog_epoch_slip`: NDB 7.5 and later: Threshold for number of epochs completely buffered, but not yet consumed by binlog injector thread which when exceeded generates `BUFFERED_EPOCHS_OVER_THRESHOLD` event buffer status message; prior to NDB 7.5: Threshold for number of epochs to lag behind before reporting binary log status.
- `ndb_report_thresh_binlog_mem_usage`: Threshold for percentage of free memory remaining before reporting binary log status.
- `ndb_row_checksum`: When enabled, set row checksums; enabled by default.
- `Ndb_scan_count`: Total number of scans executed by NDB since cluster was last started.
- `ndb_show_foreign_key_mock_tables`: Show mock tables used to support `foreign_key_checks=0`.
- `ndb_slave_conflict_role`: Role for replica to play in conflict detection and resolution. Value is one of `PRIMARY`, `SECONDARY`, `PASS`, or `NONE` (default). Can be changed only when replication SQL thread is stopped. See documentation for further information.
- `Ndb_slave_max_replicated_epoch`: Most recently committed NDB epoch on this replica. When this value is greater than or equal to `Ndb_conflict_last_conflict_epoch`, no conflicts have yet been detected.
- `Ndb_system_name`: Configured cluster system name; empty if server not connected to NDB.
- `ndb_table_no_logging`: NDB tables created when this setting is enabled are not checkpointed to disk (although table schema files are created). Setting in effect when table is created with or altered to use `NDBCLUSTER` persists for table's lifetime.
- `ndb_table_temporary`: NDB tables are not persistent on disk: no schema files are created and tables are not logged.
- `ndb_use_copying_alter_table`: Use copying `ALTER TABLE` operations in NDB Cluster.
- `ndb_use_exact_count`: Forces NDB to use a count of records during `SELECT COUNT(*)` query planning to speed up this type of query.

- `ndb_use_transactions`: Set to OFF, to disable transaction support by NDB. Not recommended except in certain special cases; see documentation for details.
- `ndb_version`: Shows build and NDB engine version as an integer.
- `ndb_version_string`: Shows build information including NDB engine version in `ndb-x.y.z` format.
- `ndbcluster`: Enable NDB Cluster (if this version of MySQL supports it). Disabled by `--skip-ndbcluster`.
- `ndbinfo_database`: Name used for NDB information database; read only.
- `ndbinfo_max_bytes`: Used for debugging only.
- `ndbinfo_max_rows`: Used for debugging only.
- `ndbinfo_offline`: Put `ndbinfo` database into offline mode, in which no rows are returned from tables or views.
- `ndbinfo_show_hidden`: Whether to show `ndbinfo` internal base tables in `mysql` client; default is OFF.
- `ndbinfo_table_prefix`: Prefix to use for naming `ndbinfo` internal base tables; read only.
- `ndbinfo_version`: `ndbinfo` engine version; read only.
- `server_id_bits`: Number of least significant bits in `server_id` actually used for identifying server, permitting NDB API applications to store application data in most significant bits. `server_id` must be less than 2 to power of this value.
- `skip-ndbcluster`: Disable NDB Cluster storage engine.
- `slave_allow_batching`: Turns update batching on and off for replica.
- `transaction_allow_batching`: Allows batching of statements within one transaction. Disable AUTOCOMMIT to use.

### 21.4.3 NDB Cluster Configuration Files

Configuring NDB Cluster requires working with two files:

- `my.cnf`: Specifies options for all NDB Cluster executables. This file, with which you should be familiar with from previous work with MySQL, must be accessible by each executable running in the cluster.
- `config.ini`: This file, sometimes known as the *global configuration file*, is read only by the NDB Cluster management server, which then distributes the information contained therein to all processes participating in the cluster. `config.ini` contains a description of each node involved in the cluster. This includes configuration parameters for data nodes and configuration parameters for connections between all nodes in the cluster. For a quick reference to the sections that can appear in this file, and what sorts of configuration parameters may be placed in each section, see [Sections of the config.ini File](#).

**Caching of configuration data.** NDB uses *stateful configuration*. Rather than reading the global configuration file every time the management server is restarted, the management server caches the configuration the first time it is started, and thereafter, the global configuration file is read only when one of the following conditions is true:

- **The management server is started using the `--initial` option.** When `--initial` is used, the global configuration file is re-read, any existing cache files are deleted, and the management server creates a new configuration cache.

- **The management server is started using the `--reload` option.** The `--reload` option causes the management server to compare its cache with the global configuration file. If they differ, the management server creates a new configuration cache; any existing configuration cache is preserved, but not used. If the management server's cache and the global configuration file contain the same configuration data, then the existing cache is used, and no new cache is created.
- **The management server is started using `--config-cache=FALSE`.** This disables `--config-cache` (enabled by default), and can be used to force the management server to bypass configuration caching altogether. In this case, the management server ignores any configuration files that may be present, always reading its configuration data from the `config.ini` file instead.
- **No configuration cache is found.** In this case, the management server reads the global configuration file and creates a cache containing the same configuration data as found in the file.

**Configuration cache files.** The management server by default creates configuration cache files in a directory named `mysql-cluster` in the MySQL installation directory. (If you build NDB Cluster from source on a Unix system, the default location is `/usr/local/mysql-cluster`.) This can be overridden at runtime by starting the management server with the `--configdir` option. Configuration cache files are binary files named according to the pattern `ndb_node_id_config.bin.seq_id`, where `node_id` is the management server's node ID in the cluster, and `seq_id` is a cache identifier. Cache files are numbered sequentially using `seq_id`, in the order in which they are created. The management server uses the latest cache file as determined by the `seq_id`.



#### Note

It is possible to roll back to a previous configuration by deleting later configuration cache files, or by renaming an earlier cache file so that it has a higher `seq_id`. However, since configuration cache files are written in a binary format, you should not attempt to edit their contents by hand.

For more information about the `--configdir`, `--config-cache`, `--initial`, and `--reload` options for the NDB Cluster management server, see [Section 21.5.4, “ndb\\_mgmd — The NDB Cluster Management Server Daemon”](#).

We are continuously making improvements in Cluster configuration and attempting to simplify this process. Although we strive to maintain backward compatibility, there may be times when introduce an incompatible change. In such cases we try to let NDB Cluster users know in advance if a change is not backward compatible. If you find such a change and we have not documented it, please report it in the MySQL bugs database using the instructions given in [Section 1.5, “How to Report Bugs or Problems”](#).

### 21.4.3.1 NDB Cluster Configuration: Basic Example

To support NDB Cluster, you must to update `my.cnf` as shown in the following example. You may also specify these parameters on the command line when invoking the executables.



#### Note

The options shown here should not be confused with those that are used in `config.ini` global configuration files. Global configuration options are discussed later in this section.

```
# my.cnf
# example additions to my.cnf for NDB Cluster
# (valid in MySQL 5.7)

# enable ndbcluster storage engine, and provide connection string for
# management server host (default port is 1186)
```

```
[mysqld]
ndbcluster
ndb-connectstring=ndb_mgmd.mysql.com

# provide connection string for management server host (default port: 1186)
[ndbd]
connect-string=ndb_mgmd.mysql.com

# provide connection string for management server host (default port: 1186)
[ndb_mgm]
connect-string=ndb_mgmd.mysql.com

# provide location of cluster configuration file
# IMPORTANT: When starting the management server with this option in the
# configuration file, the use of --initial or --reload on the command line when
# invoking ndb_mgmd is also required.
[ndb_mgmd]
config-file=/etc/config.ini
```

(For more information on connection strings, see [Section 21.4.3.3, “NDB Cluster Connection Strings”](#).)

```
# my.cnf
# example additions to my.cnf for NDB Cluster
# (works on all versions)

# enable ndbcluster storage engine, and provide connection string for management
# server host to the default port 1186
[mysqld]
ndbcluster
ndb-connectstring=ndb_mgmd.mysql.com:1186
```



### Important

Once you have started a `mysqld` process with the `NDBCLUSTER` and `ndb-connectstring` parameters in the `[mysqld]` in the `my.cnf` file as shown previously, you cannot execute any `CREATE TABLE` or `ALTER TABLE` statements without having actually started the cluster. Otherwise, these statements fail with an error. *This is by design.*

You may also use a separate `[mysql_cluster]` section in the cluster `my.cnf` file for settings to be read and used by all executables:

```
# cluster-specific settings
[mysql_cluster]
ndb-connectstring=ndb_mgmd.mysql.com:1186
```

For additional [NDB](#) variables that can be set in the `my.cnf` file, see [NDB Cluster System Variables](#).

The NDB Cluster global configuration file is by convention named `config.ini` (but this is not required). If needed, it is read by `ndb_mgmd` at startup and can be placed in any location that can be read by it. The location and name of the configuration are specified using `--config-file=path_name` with `ndb_mgmd` on the command line. This option has no default value, and is ignored if `ndb_mgmd` uses the configuration cache.

The global configuration file for NDB Cluster uses INI format, which consists of sections preceded by section headings (surrounded by square brackets), followed by the appropriate parameter names and values. One deviation from the standard INI format is that the parameter name and value can be separated by a colon (`:`) as well as the equal sign (`=`); however, the equal sign is preferred. Another deviation is that sections are not uniquely identified by section name. Instead, unique sections (such as two different nodes of the same type) are identified by a unique ID specified as a parameter within the section.

Default values are defined for most parameters, and can also be specified in `config.ini`. To create a default value section, simply add the word `default` to the section name. For example, an `[ndbd]` section contains parameters that apply to a particular data node, whereas an `[ndbd default]` section contains parameters that apply to all data nodes. Suppose that all data nodes should use the same data memory size. To configure them all, create an `[ndbd default]` section that contains a `DataMemory` line to specify the data memory size.

If used, the `[ndbd default]` section must precede any `[ndbd]` sections in the configuration file. This is also true for `default` sections of any other type.



#### Note

In some older releases of NDB Cluster, there was no default value for `NoOfReplicas`, which always had to be specified explicitly in the `[ndbd default]` section. Although this parameter now has a default value of 2, which is the recommended setting in most common usage scenarios, it is still recommended practice to set this parameter explicitly.

The global configuration file must define the computers and nodes involved in the cluster and on which computers these nodes are located. An example of a simple configuration file for a cluster consisting of one management server, two data nodes and two MySQL servers is shown here:

```
# file "config.ini" - 2 data nodes and 2 SQL nodes
# This file is placed in the startup directory of ndb_mgmd (the
# management server)
# The first MySQL Server can be started from any host. The second
# can be started only on the host mysqld_5.mysql.com

[ndbd default]
NoOfReplicas= 2
DataDir= /var/lib/mysql-cluster

[ndb_mgmd]
Hostname= ndb_mgmd.mysql.com
DataDir= /var/lib/mysql-cluster

[ndbd]
HostName= ndbd_2.mysql.com

[ndbd]
HostName= ndbd_3.mysql.com

[mysqld]
[mysqld]
HostName= mysqld_5.mysql.com
```



#### Note

The preceding example is intended as a minimal starting configuration for purposes of familiarization with NDB Cluster, and is almost certain not to be sufficient for production settings. See [Section 21.4.3.2, "Recommended Starting Configuration for NDB Cluster"](#), which provides a more complete example starting configuration.

Each node has its own section in the `config.ini` file. For example, this cluster has two data nodes, so the preceding configuration file contains two `[ndbd]` sections defining these nodes.



#### Note

Do not place comments on the same line as a section heading in the `config.ini` file; this causes the management server not to start because it cannot parse the configuration file in such cases.



## Sections of the config.ini File

There are six different sections that you can use in the `config.ini` configuration file, as described in the following list:

- `[computer]`: Defines cluster hosts. This is not required to configure a viable NDB Cluster, but it may be used as a convenience when setting up a large cluster. See [Section 21.4.3.4, “Defining Computers in an NDB Cluster”](#), for more information.
- `[ndbd]`: Defines a cluster data node (`ndbd` process). See [Section 21.4.3.6, “Defining NDB Cluster Data Nodes”](#), for details.
- `[mysqld]`: Defines the cluster's MySQL server nodes (also called SQL or API nodes). For a discussion of SQL node configuration, see [Section 21.4.3.7, “Defining SQL and Other API Nodes in an NDB Cluster”](#).
- `[mgm]` or `[ndb_mgmd]`: Defines a cluster management server (MGM) node. For information concerning the configuration of management nodes, see [Section 21.4.3.5, “Defining an NDB Cluster Management Server”](#).
- `[tcp]`: Defines a TCP/IP connection between cluster nodes, with TCP/IP being the default transport protocol. Normally, `[tcp]` or `[tcp default]` sections are not required to set up an NDB Cluster, as the cluster handles this automatically; however, it may be necessary in some situations to override the defaults provided by the cluster. See [Section 21.4.3.10, “NDB Cluster TCP/IP Connections”](#), for information about available TCP/IP configuration parameters and how to use them. (You may also find [Section 21.4.3.11, “NDB Cluster TCP/IP Connections Using Direct Connections”](#) to be of interest in some cases.)
- `[shm]`: Defines shared-memory connections between nodes. In MySQL 5.7, it is enabled by default, but should still be considered experimental. For a discussion of SHM interconnects, see [Section 21.4.3.12, “NDB Cluster Shared Memory Connections”](#).
- `[sci]`: Defines Scalable Coherent Interface connections between cluster data nodes. Not supported in NDB 7.5 or 7.6.

You can define `default` values for each section. If used, a `default` section should come before any other sections of that type. For example, an `[ndbd default]` section should appear in the configuration file before any `[ndbd]` sections.

NDB Cluster parameter names are case-insensitive, unless specified in MySQL Server `my.cnf` or `my.ini` files.

### 21.4.3.2 Recommended Starting Configuration for NDB Cluster

Achieving the best performance from an NDB Cluster depends on a number of factors including the following:

- NDB Cluster software version
- Numbers of data nodes and SQL nodes
- Hardware
- Operating system
- Amount of data to be stored
- Size and type of load under which the cluster is to operate

Therefore, obtaining an optimum configuration is likely to be an iterative process, the outcome of which can vary widely with the specifics of each NDB Cluster deployment. Changes in configuration are also likely to be indicated when changes are made in the platform on which the cluster is run, or in applications that use the NDB Cluster's data. For these reasons, it is not possible to offer a single configuration that is ideal for all usage scenarios. However, in this section, we provide a recommended base configuration.

**Starting config.ini file.** The following `config.ini` file is a recommended starting point for configuring a cluster running NDB Cluster 7.5:

```
# TCP PARAMETERS

[tcp default]
SendBufferMemory=2M
ReceiveBufferMemory=2M

# Increasing the sizes of these 2 buffers beyond the default values
# helps prevent bottlenecks due to slow disk I/O.

# MANAGEMENT NODE PARAMETERS

[ndb_mgmd default]
DataDir=path/to/management/server/data/directory

# It is possible to use a different data directory for each management
# server, but for ease of administration it is preferable to be
# consistent.

[ndb_mgmd]
HostName=management-server-A-hostname
# NodeId=management-server-A-nodeid

[ndb_mgmd]
HostName=management-server-B-hostname
# NodeId=management-server-B-nodeid

# Using 2 management servers helps guarantee that there is always an
# arbitrator in the event of network partitioning, and so is
# recommended for high availability. Each management server must be
# identified by a HostName. You may for the sake of convenience specify
# a NodeId for any management server, although one is allocated
# for it automatically; if you do so, it must be in the range 1-255
# inclusive and must be unique among all IDs specified for cluster
# nodes.

# DATA NODE PARAMETERS

[ndbd default]
NoOfReplicas=2

# Using two fragment replicas is recommended to guarantee availability of data;
# using only one fragment replica does not provide any redundancy, which means
# that the failure of a single data node causes the entire cluster to
# shut down. We do not recommend using more than two fragment replicas, since
# two are sufficient to provide high availability, and we do not currently test
# with greater values for this parameter.

LockPagesInMainMemory=1

# On Linux and Solaris systems, setting this parameter locks data node
# processes into memory. Doing so prevents them from swapping to disk,
# which can severely degrade cluster performance.

DataMemory=3072M
IndexMemory=384M

# The values provided for DataMemory and IndexMemory assume 4 GB RAM
```

```
# per data node. However, for best results, you should first calculate
# the memory that would be used based on the data you actually plan to
# store (you may find the ndb\_size.pl utility helpful in estimating
# this), then allow an extra 20% over the calculated values. Naturally,
# you should ensure that each data node host has at least as much
# physical memory as the sum of these two values.
# NOTE: IndexMemory is deprecated in NDB 7.6 and later.

# ODirect=1

# Enabling this parameter causes NDBCLUSTER to try using O_DIRECT
# writes for local checkpoints and redo logs; this can reduce load on
# CPUs. We recommend doing so when using NDB Cluster on systems running
# Linux kernel 2.6 or later.

NoOfFragmentLogFiles=300
DataDir=path/to/data/node/data/directory
MaxNoOfConcurrentOperations=100000

SchedulerSpinTimer=400
SchedulerExecutionTimer=100
RealTimeScheduler=1
# Setting these parameters allows you to take advantage of real-time scheduling
# of NDB threads to achieve increased throughput when using ndbd. They
# are not needed when using ndbmt; in particular, you should not set
# RealTimeScheduler for ndbmt data nodes.

TimeBetweenGlobalCheckpoints=1000
TimeBetweenEpochs=200
RedoBuffer=32M

# CompressedLCP=1
# CompressedBackup=1
# Enabling CompressedLCP and CompressedBackup causes, respectively, local
# checkpoint files and backup files to be compressed, which can result in a space
# savings of up to 50% over noncompressed LCPs and backups.

# MaxNoOfLocalScans=64
MaxNoOfTables=1024
MaxNoOfOrderedIndexes=256

[ndbd]
HostName=data-node-A-hostname
# NodeId=data-node-A-nodeid

LockExecuteThreadToCPU=1
LockMaintThreadsToCPU=0
# On systems with multiple CPUs, these parameters can be used to lock NDBCLUSTER
# threads to specific CPUs

[ndbd]
HostName=data-node-B-hostname
# NodeId=data-node-B-nodeid

LockExecuteThreadToCPU=1
LockMaintThreadsToCPU=0

# You must have an [ndbd] section for every data node in the cluster;
# each of these sections must include a HostName. Each section may
# optionally include a NodeId for convenience, but in most cases, it is
# sufficient to allow the cluster to allocate node IDs dynamically. If
# you do specify the node ID for a data node, it must be in the range 1
# to 48 inclusive and must be unique among all IDs specified for
# cluster nodes.

# SQL NODE / API NODE PARAMETERS
```

```
[mysqld]
# HostName=sql-node-A-hostname
# NodeId=sql-node-A-nodeid

[mysqld]

[mysqld]

# Each API or SQL node that connects to the cluster requires a [mysqld]
# or [api] section of its own. Each such section defines a connection
# "slot"; you should have at least as many of these sections in the
# config.ini file as the total number of API nodes and SQL nodes that
# you wish to have connected to the cluster at any given time. There is
# no performance or other penalty for having extra slots available in
# case you find later that you want or need more API or SQL nodes to
# connect to the cluster at the same time.
# If no HostName is specified for a given [mysqld] or [api] section,
# then any API or SQL node may use that slot to connect to the
# cluster. You may wish to use an explicit HostName for one connection slot
# to guarantee that an API or SQL node from that host can always
# connect to the cluster. If you wish to prevent API or SQL nodes from
# connecting from other than a desired host or hosts, then use a
# HostName for every [mysqld] or [api] section in the config.ini file.
# You can if you wish define a node ID (NodeId parameter) for any API or
# SQL node, but this is not necessary; if you do so, it must be in the
# range 1 to 255 inclusive and must be unique among all IDs specified
# for cluster nodes.
```

**Required my.cnf options for SQL nodes.** MySQL servers acting as NDB Cluster SQL nodes must always be started with the `--ndbcluster` and `--ndb-connectstring` options, either on the command line or in `my.cnf`.

### 21.4.3.3 NDB Cluster Connection Strings

With the exception of the NDB Cluster management server (`ndb_mgmd`), each node that is part of an NDB Cluster requires a *connection string* that points to the management server's location. This connection string is used in establishing a connection to the management server as well as in performing other tasks depending on the node's role in the cluster. The syntax for a connection string is as follows:

```
[nodeid=node_id, ]host-definition[, host-definition[, ...]]

host-definition:
    host_name[:port_number]
```

`node_id` is an integer greater than or equal to 1 which identifies a node in `config.ini`. `host_name` is a string representing a valid Internet host name or IP address. `port_number` is an integer referring to a TCP/IP port number.

```
example 1 (long):    "nodeid=2,myhost1:1100,myhost2:1100,198.51.100.3:1200"
example 2 (short):  "myhost1"
```

`localhost:1186` is used as the default connection string value if none is provided. If `port_num` is omitted from the connection string, the default port is 1186. This port should always be available on the network because it has been assigned by IANA for this purpose (see <http://www.iana.org/assignments/port-numbers> for details).

By listing multiple host definitions, it is possible to designate several redundant management servers. An NDB Cluster data or API node attempts to contact successive management servers on each host in the order specified, until a successful connection has been established.

It is also possible to specify in a connection string one or more bind addresses to be used by nodes having multiple network interfaces for connecting to management servers. A bind address consists of a hostname

or network address and an optional port number. This enhanced syntax for connection strings is shown here:

```
[nodeid=node_id, ]
  [bind-address=host-definition, ]
  host-definition[; bind-address=host-definition]
  host-definition[; bind-address=host-definition]
  [, ...]]

host-definition:
  host_name[:port_number]
```

If a single bind address is used in the connection string *prior* to specifying any management hosts, then this address is used as the default for connecting to any of them (unless overridden for a given management server; see later in this section for an example). For example, the following connection string causes the node to use `198.51.100.242` regardless of the management server to which it connects:

```
bind-address=198.51.100.242, poseidon:1186, perch:1186
```

If a bind address is specified *following* a management host definition, then it is used only for connecting to that management node. Consider the following connection string:

```
poseidon:1186;bind-address=localhost, perch:1186;bind-address=198.51.100.242
```

In this case, the node uses `localhost` to connect to the management server running on the host named `poseidon` and `198.51.100.242` to connect to the management server running on the host named `perch`.

You can specify a default bind address and then override this default for one or more specific management hosts. In the following example, `localhost` is used for connecting to the management server running on host `poseidon`; since `198.51.100.242` is specified first (before any management server definitions), it is the default bind address and so is used for connecting to the management servers on hosts `perch` and `orca`:

```
bind-address=198.51.100.242,poseidon:1186;bind-address=localhost,perch:1186,orca:2200
```

There are a number of different ways to specify the connection string:

- Each executable has its own command-line option which enables specifying the management server at startup. (See the documentation for the respective executable.)
- It is also possible to set the connection string for all nodes in the cluster at once by placing it in a `[mysql_cluster]` section in the management server's `my.cnf` file.
- For backward compatibility, two other options are available, using the same syntax:
  1. Set the `NDB_CONNECTSTRING` environment variable to contain the connection string.
  2. Write the connection string for each executable into a text file named `Ndb.cfg` and place this file in the executable's startup directory.

These should be considered deprecated, and not used for new installations.

The recommended method for specifying the connection string is to set it on the command line or in the `my.cnf` file for each executable.

#### 21.4.3.4 Defining Computers in an NDB Cluster

The `[computer]` section has no real significance other than serving as a way to avoid the need of defining host names for each node in the system. All parameters mentioned here are required.

- [Id](#)

Version (or later)	NDB 7.5.0
Type or units	string
Default	[...]
Range	...
Restart Type	<b>Initial System Restart:</b> Requires a complete shutdown of the cluster, wiping and restoring the cluster file system from a <a href="#">backup</a> , and then restarting the cluster. (NDB 7.5.0)

This is a unique identifier, used to refer to the host computer elsewhere in the configuration file.



**Important**

The computer ID is *not* the same as the node ID used for a management, API, or data node. Unlike the case with node IDs, you cannot use `NodeId` in place of `Id` in the `[computer]` section of the `config.ini` file.

- [HostName](#)

Version (or later)	NDB 7.5.0
Type or units	name or IP address
Default	[...]
Range	...
Restart Type	<b>Node Restart:</b> Requires a <a href="#">rolling restart</a> of the cluster. (NDB 7.5.0)

This is the computer's hostname or IP address.

**Restart types.** Information about the restart types used by the parameter descriptions in this section is shown in the following table:

**Table 21.7 NDB Cluster restart types**

Symbol	Restart Type	Description
N	Node	The parameter can be updated using a rolling restart (see <a href="#">Section 21.6.5, "Performing</a>

Symbol	Restart Type	Description
		a Rolling Restart of an NDB Cluster")
S	System	All cluster nodes must be shut down completely, then restarted, to effect a change in this parameter
I	Initial	Data nodes must be restarted using the <code>--initial</code> option

### 21.4.3.5 Defining an NDB Cluster Management Server

The `[ndb_mgmd]` section is used to configure the behavior of the management server. If multiple management servers are employed, you can specify parameters common to all of them in an `[ndb_mgmd default]` section. `[mgm]` and `[mgm default]` are older aliases for these, supported for backward compatibility.

All parameters in the following list are optional and assume their default values if omitted.



**Note**

If neither the `ExecuteOnComputer` nor the `HostName` parameter is present, the default value `localhost` is assumed for both.

- `id`

Version (or later)	NDB 7.5.0
Type or units	unsigned
Default	[...]
Range	1 - 255
Restart Type	<b>Initial System Restart:</b> Requires a complete shutdown of the cluster, wiping and restoring the cluster file system from a <a href="#">backup</a> , and then restarting the cluster. (NDB 7.5.0)

Each node in the cluster has a unique identity. For a management node, this is represented by an integer value in the range 1 to 255, inclusive. This ID is used by all internal cluster messages for addressing the node, and so must be unique for each NDB Cluster node, regardless of the type of node.



**Note**

Data node IDs must be less than 49. If you plan to deploy a large number of data nodes, it is a good idea to limit the node IDs for management nodes (and API nodes) to values greater than 48.

The use of the `id` parameter for identifying management nodes is deprecated in favor of `NodeId`. Although `id` continues to be supported for backward compatibility, it now generates a warning and is subject to removal in a future version of NDB Cluster.

- `NodeId`

Version (or later)	NDB 7.5.0
Type or units	unsigned
Default	[...]
Range	1 - 255
Restart Type	<b>Initial System Restart:</b> Requires a complete shutdown of the cluster, wiping and restoring the cluster file system from a <a href="#">backup</a> , and then restarting the cluster. (NDB 7.5.0)

Each node in the cluster has a unique identity. For a management node, this is represented by an integer value in the range 1 to 255 inclusive. This ID is used by all internal cluster messages for addressing the node, and so must be unique for each NDB Cluster node, regardless of the type of node.



**Note**

Data node IDs must be less than 49. If you plan to deploy a large number of data nodes, it is a good idea to limit the node IDs for management nodes (and API nodes) to values greater than 48.

`NodeId` is the preferred parameter name to use when identifying management nodes. Although the older `id` continues to be supported for backward compatibility, it is now deprecated and generates a warning when used; it is also subject to removal in a future NDB Cluster release.

- `ExecuteOnComputer`

Version (or later)	NDB 7.5.0
Type or units	name
Default	[...]
Range	...
Deprecated	NDB 7.5.0
Restart Type	<b>System Restart:</b> Requires a complete shutdown and restart of the



	cluster. (NDB 7.5.0)
--	----------------------

This refers to the `Id` set for one of the computers defined in a `[computer]` section of the `config.ini` file.



**Important**

This parameter is deprecated as of NDB 7.5.0, and is subject to removal in a future release. Use the `HostName` parameter instead.

- `PortNumber`

Version (or later)	NDB 7.5.0
Type or units	unsigned
Default	1186
Range	0 - 64K
Restart Type	<b>System Restart:</b> Requires a complete shutdown and restart of the cluster. (NDB 7.5.0)

This is the port number on which the management server listens for configuration requests and management commands.

- `HostName`

Version (or later)	NDB 7.5.0
Type or units	name or IP address
Default	[...]
Range	...
Restart Type	<b>Node Restart:</b> Requires a <a href="#">rolling restart</a> of the cluster. (NDB 7.5.0)

Specifying this parameter defines the hostname of the computer on which the management node is to reside. Use `HostName` to specify a host name other than `localhost`.

- `LocationDomainId`

Version (or later)	NDB 7.6.4
Type or units	integer
Default	0
Range	0 - 16

Added	NDB 7.6.4
Restart Type	<b>System Restart:</b> Requires a complete shutdown and restart of the cluster. (NDB 7.5.0)

Assigns a management node to a specific [availability domain](#) (also known as an availability zone) within a cloud. By informing [NDB](#) which nodes are in which availability domains, performance can be improved in a cloud environment in the following ways:

- If requested data is not found on the same node, reads can be directed to another node in the same availability domain.
- Communication between nodes in different availability domains are guaranteed to use [NDB](#) transporters' WAN support without any further manual intervention.
- The transporter's group number can be based on which availability domain is used, such that also SQL and other API nodes communicate with local data nodes in the same availability domain whenever possible.
- The arbitrator can be selected from an availability domain in which no data nodes are present, or, if no such availability domain can be found, from a third availability domain.

[LocationDomainId](#) takes an integer value between 0 and 16 inclusive, with 0 being the default; using 0 is the same as leaving the parameter unset.

- [LogDestination](#)

Version (or later)	NDB 7.5.0
Type or units	{CONSOLE  SYSLOG FILE}
Default	FILE: filename=ndb_nodeid_cluster.log, maxsize=1000000, maxfiles=6
Range	...
Restart Type	<b>Node Restart:</b> Requires a <a href="#">rolling restart</a> of the cluster. (NDB 7.5.0)

This parameter specifies where to send cluster logging information. There are three options in this regard—[CONSOLE](#), [SYSLOG](#), and [FILE](#)—with [FILE](#) being the default:

- [CONSOLE](#) outputs the log to `stdout`:

```
CONSOLE
```

- `SYSLOG` sends the log to a `syslog` facility, possible values being one of `auth`, `authpriv`, `cron`, `daemon`, `ftp`, `kern`, `lpr`, `mail`, `news`, `syslog`, `user`, `uucp`, `local0`, `local1`, `local2`, `local3`, `local4`, `local5`, `local6`, or `local7`.



**Note**

Not every facility is necessarily supported by every operating system.

```
SYSLOG:facility=syslog
```

- `FILE` pipes the cluster log output to a regular file on the same machine. The following values can be specified:

- `filename`: The name of the log file.

The default log file name used in such cases is `ndb_nodeid_cluster.log`.

- `maxsize`: The maximum size (in bytes) to which the file can grow before logging rolls over to a new file. When this occurs, the old log file is renamed by appending `.N` to the file name, where `N` is the next number not yet used with this name.
- `maxfiles`: The maximum number of log files.

```
FILE:filename=cluster.log,maxsize=1000000,maxfiles=6
```

The default value for the `FILE` parameter is

`FILE:filename=ndb_node_id_cluster.log,maxsize=1000000,maxfiles=6`, where `node_id` is the ID of the node.

It is possible to specify multiple log destinations separated by semicolons as shown here:

```
CONSOLE;SYSLOG:facility=local0;FILE:filename=/var/log/mgmd
```

- `ArbitrationRank`

Version (or later)	NDB 7.5.0
Type or units	0-2
Default	1
Range	0 - 2
Restart Type	<b>Node Restart:</b> Requires a <a href="#">rolling restart</a> of the cluster. (NDB 7.5.0)

This parameter is used to define which nodes can act as arbitrators. Only management nodes and SQL nodes can be arbitrators. `ArbitrationRank` can take one of the following values:

- `0`: The node is never used as an arbitrator.
- `1`: The node has high priority; that is, it is preferred as an arbitrator over low-priority nodes.

- **2**: Indicates a low-priority node which is used as an arbitrator only if a node with a higher priority is not available for that purpose.

Normally, the management server should be configured as an arbitrator by setting its `ArbitrationRank` to 1 (the default for management nodes) and those for all SQL nodes to 0 (the default for SQL nodes).

You can disable arbitration completely either by setting `ArbitrationRank` to 0 on all management and SQL nodes, or by setting the `Arbitration` parameter in the `[ndbd default]` section of the `config.ini` global configuration file. Setting `Arbitration` causes any settings for `ArbitrationRank` to be disregarded.

- `ArbitrationDelay`

Version (or later)	NDB 7.5.0
Type or units	milliseconds
Default	0
Range	0 - 4294967039 (0xFFFFFFFF)
Restart Type	<b>Node Restart:</b> Requires a <a href="#">rolling restart</a> of the cluster. (NDB 7.5.0)

An integer value which causes the management server's responses to arbitration requests to be delayed by that number of milliseconds. By default, this value is 0; it is normally not necessary to change it.

- `DataDir`

Version (or later)	NDB 7.5.0
Type or units	path
Default	.
Range	...
Restart Type	<b>Node Restart:</b> Requires a <a href="#">rolling restart</a> of the cluster. (NDB 7.5.0)

This specifies the directory where output files from the management server are placed. These files include cluster log files, process output files, and the daemon's process ID (PID) file. (For log files, this location can be overridden by setting the `FILE` parameter for `LogDestination` as discussed previously in this section.)

The default value for this parameter is the directory in which `ndb_mgmd` is located.

- `PortNumberStats`

Version (or later)	NDB 7.5.0
Type or units	unsigned

Default	[...]
Range	0 - 64K
Restart Type	<b>Node Restart:</b> Requires a <a href="#">rolling restart</a> of the cluster. (NDB 7.5.0)

This parameter specifies the port number used to obtain statistical information from an NDB Cluster management server. It has no default value.

- [Wan](#)

Version (or later)	NDB 7.5.0
Type or units	boolean
Default	false
Range	true, false
Restart Type	<b>Node Restart:</b> Requires a <a href="#">rolling restart</a> of the cluster. (NDB 7.5.0)

Use WAN TCP setting as default.

- [HeartbeatThreadPriority](#)

Version (or later)	NDB 7.5.0
Type or units	string
Default	[...]
Range	...
Restart Type	<b>Node Restart:</b> Requires a <a href="#">rolling restart</a> of the cluster. (NDB 7.5.0)

Set the scheduling policy and priority of heartbeat threads for management and API nodes.

The syntax for setting this parameter is shown here:

```
HeartbeatThreadPriority = policy[, priority]

policy:
{FIFO | RR}
```

When setting this parameter, you must specify a policy. This is one of [FIFO](#) (first in, first out) or [RR](#) (round robin). The policy value is followed optionally by the priority (an integer).

- [ExtraSendBufferMemory](#)

Version (or later)	NDB 7.5.0
--------------------	-----------

Type or units	bytes
Default	0
Range	0 - 32G
Restart Type	<b>Node Restart:</b> Requires a <a href="#">rolling restart</a> of the cluster. (NDB 7.5.0)

This parameter specifies the amount of transporter send buffer memory to allocate in addition to any that has been set using [TotalSendBufferMemory](#), [SendBufferMemory](#), or both.

- [TotalSendBufferMemory](#)

Version (or later)	NDB 7.5.0
Type or units	bytes
Default	0
Range	256K - 4294967039 (0xFFFFFFFF)
Restart Type	<b>Node Restart:</b> Requires a <a href="#">rolling restart</a> of the cluster. (NDB 7.5.0)

This parameter is used to determine the total amount of memory to allocate on this node for shared send buffer memory among all configured transporters.

If this parameter is set, its minimum permitted value is 256KB; 0 indicates that the parameter has not been set. For more detailed information, see [Section 21.4.3.13, "Configuring NDB Cluster Send Buffer Parameters"](#).

- [HeartbeatIntervalMgmdMgmd](#)

Version (or later)	NDB 7.5.0
Type or units	milliseconds
Default	1500
Range	100 - 4294967039 (0xFFFFFFFF)
Restart Type	<b>Node Restart:</b> Requires a <a href="#">rolling restart</a> of the cluster. (NDB 7.5.0)

Specify the interval between heartbeat messages used to determine whether another management node is on contact with this one. The management node waits after 3 of these intervals to declare the

connection dead; thus, the default setting of 1500 milliseconds causes the management node to wait for approximately 1600 ms before timing out.



#### Note

After making changes in a management node's configuration, it is necessary to perform a rolling restart of the cluster for the new configuration to take effect.

To add new management servers to a running NDB Cluster, it is also necessary to perform a rolling restart of all cluster nodes after modifying any existing `config.ini` files. For more information about issues arising when using multiple management nodes, see [Section 21.2.7.10, "Limitations Relating to Multiple NDB Cluster Nodes"](#).

**Restart types.** Information about the restart types used by the parameter descriptions in this section is shown in the following table:

**Table 21.8 NDB Cluster restart types**

Symbol	Restart Type	Description
N	Node	The parameter can be updated using a rolling restart (see <a href="#">Section 21.6.5, "Performing a Rolling Restart of an NDB Cluster"</a> )
S	System	All cluster nodes must be shut down completely, then restarted, to effect a change in this parameter
I	Initial	Data nodes must be restarted using the <code>--initial</code> option

### 21.4.3.6 Defining NDB Cluster Data Nodes

The `[ndbd]` and `[ndbd default]` sections are used to configure the behavior of the cluster's data nodes.

`[ndbd]` and `[ndbd default]` are always used as the section names whether you are using `ndbd` or `ndbmt` binaries for the data node processes.

There are many parameters which control buffer sizes, pool sizes, timeouts, and so forth. The only mandatory parameter is `HostName`; this must be defined in the local `[ndbd]` section.

The parameter `NoOfReplicas` should be defined in the `[ndbd default]` section, as it is common to all Cluster data nodes. It is not strictly necessary to set `NoOfReplicas`, but it is good practice to set it explicitly.

Most data node parameters are set in the `[ndbd default]` section. Only those parameters explicitly stated as being able to set local values are permitted to be changed in the `[ndbd]` section. Where present, `HostName` and `NodeId` *must* be defined in the local `[ndbd]` section, and not in any other section of `config.ini`. In other words, settings for these parameters are specific to one data node.

For those parameters affecting memory usage or buffer sizes, it is possible to use `K`, `M`, or `G` as a suffix to indicate units of 1024, 1024×1024, or 1024×1024×1024. (For example, `100K` means 100 × 1024 = 102400.)

Parameter names and values are case-insensitive, unless used in a MySQL Server `my.cnf` or `my.ini` file, in which case they are case-sensitive.

Information about configuration parameters specific to NDB Cluster Disk Data tables can be found later in this section (see [Disk Data Configuration Parameters](#)).

All of these parameters also apply to `ndbmtd` (the multithreaded version of `ndbd`). Three additional data node configuration parameters—`MaxNoOfExecutionThreads`, `ThreadConfig`, and `NoOfFragmentLogParts`—apply to `ndbmtd` only; these have no effect when used with `ndbd`. For more information, see [Multi-Threading Configuration Parameters \(ndbmtd\)](#). See also [Section 21.5.3, “ndbmtd — The NDB Cluster Data Node Daemon \(Multi-Threaded\)”](#).

**Identifying data nodes.** The `NodeId` or `Id` value (that is, the data node identifier) can be allocated on the command line when the node is started or in the configuration file.

- `NodeId`

Version (or later)	NDB 7.5.0
Type or units	unsigned
Default	[...]
Range	1 - 48
Restart Type	<b>Initial System Restart:</b> Requires a complete shutdown of the cluster, wiping and restoring the cluster file system from a <a href="#">backup</a> , and then restarting the cluster. (NDB 7.5.0)

A unique node ID is used as the node's address for all cluster internal messages. For data nodes, this is an integer in the range 1 to 48 inclusive. Each node in the cluster must have a unique identifier.

`NodeId` is the only supported parameter name to use when identifying data nodes. (`Id` was removed in NDB 7.5.0.)

- `ExecuteOnComputer`

Version (or later)	NDB 7.5.0
Type or units	name
Default	[...]
Range	...
Deprecated	NDB 7.5.0
Restart Type	<b>System Restart:</b> Requires a complete shutdown and



	restart of the cluster. (NDB 7.5.0)
--	-------------------------------------

This refers to the `id` set for one of the computers defined in a `[computer]` section.



### Important

This parameter is deprecated as of NDB 7.5.0, and is subject to removal in a future release. Use the `HostName` parameter instead.

- `HostName`

Version (or later)	NDB 7.5.0
Type or units	name or IP address
Default	localhost
Range	...
Restart Type	<b>Node Restart:</b> Requires a <a href="#">rolling restart</a> of the cluster. (NDB 7.5.0)

Specifying this parameter defines the hostname of the computer on which the data node is to reside. Use `HostName` to specify a host name other than `localhost`.

- `ServerPort`

Version (or later)	NDB 7.5.0
Type or units	unsigned
Default	[...]
Range	1 - 64K
Restart Type	<b>System Restart:</b> Requires a complete shutdown and restart of the cluster. (NDB 7.5.0)

Each node in the cluster uses a port to connect to other nodes. By default, this port is allocated dynamically in such a way as to ensure that no two nodes on the same host computer receive the same port number, so it should normally not be necessary to specify a value for this parameter.

However, if you need to be able to open specific ports in a firewall to permit communication between data nodes and API nodes (including SQL nodes), you can set this parameter to the number of the desired port in an `[ndbd]` section or (if you need to do this for multiple data nodes) the `[ndbd`

`default]` section of the `config.ini` file, and then open the port having that number for incoming connections from SQL nodes, API nodes, or both.



**Note**

Connections from data nodes to management nodes is done using the `ndb_mgmd` management port (the management server's `PortNumber`) so outgoing connections to that port from any data nodes should always be permitted.

- `TcpBind_INADDR_ANY`

Setting this parameter to `TRUE` or `1` binds `IP_ADDR_ANY` so that connections can be made from anywhere (for autogenerated connections). The default is `FALSE` (`0`).

- `NodeGroup`

Version (or later)	NDB 7.5.0
Type or units	unsigned
Default	[...]
Range	0 - 65536
Restart Type	<b>Initial System Restart:</b> Requires a complete shutdown of the cluster, wiping and restoring the cluster file system from a <a href="#">backup</a> , and then restarting the cluster. (NDB 7.5.0)

This parameter can be used to assign a data node to a specific node group. It is read only when the cluster is started for the first time, and cannot be used to reassign a data node to a different node group online. It is generally not desirable to use this parameter in the `[ndbd default]` section of the `config.ini` file, and care must be taken not to assign nodes to node groups in such a way that an invalid numbers of nodes are assigned to any node groups.

The `NodeGroup` parameter is chiefly intended for use in adding a new node group to a running NDB Cluster without having to perform a rolling restart. For this purpose, you should set it to 65536 (the maximum value). You are not required to set a `NodeGroup` value for all cluster data nodes, only for those nodes which are to be started and added to the cluster as a new node group at a later time. For more information, see [Section 21.6.7.3, “Adding NDB Cluster Data Nodes Online: Detailed Example”](#).

- `LocationDomainId`

Version (or later)	NDB 7.6.4
Type or units	integer
Default	0

Range	0 - 16
Added	NDB 7.6.4
Restart Type	<b>System Restart:</b> Requires a complete shutdown and restart of the cluster. (NDB 7.5.0)

Assigns a data node to a specific [availability domain](#) (also known as an availability zone) within a cloud. By informing [NDB](#) which nodes are in which availability domains, performance can be improved in a cloud environment in the following ways:

- If requested data is not found on the same node, reads can be directed to another node in the same availability domain.
- Communication between nodes in different availability domains are guaranteed to use [NDB](#) transporters' WAN support without any further manual intervention.
- The transporter's group number can be based on which availability domain is used, such that also SQL and other API nodes communicate with local data nodes in the same availability domain whenever possible.
- The arbitrator can be selected from an availability domain in which no data nodes are present, or, if no such availability domain can be found, from a third availability domain.

[LocationDomainId](#) takes an integer value between 0 and 16 inclusive, with 0 being the default; using 0 is the same as leaving the parameter unset.

- [NoOfReplicas](#)

Version (or later)	NDB 7.5.0
Type or units	integer
Default	2
Range	1 - 2
Restart Type	<b>Initial System Restart:</b> Requires a complete shutdown of the cluster, wiping and restoring the cluster file system from a <a href="#">backup</a> , and then restarting

	the cluster. (NDB 7.5.0)
--	--------------------------

This global parameter can be set only in the `[ndbd default]` section, and defines the number of fragment replicas for each table stored in the cluster. This parameter also specifies the size of node groups. A node group is a set of nodes all storing the same information.

Node groups are formed implicitly. The first node group is formed by the set of data nodes with the lowest node IDs, the next node group by the set of the next lowest node identities, and so on. By way of example, assume that we have 4 data nodes and that `NoOfReplicas` is set to 2. The four data nodes have node IDs 2, 3, 4 and 5. Then the first node group is formed from nodes 2 and 3, and the second node group by nodes 4 and 5. It is important to configure the cluster in such a manner that nodes in the same node groups are not placed on the same computer because a single hardware failure would cause the entire cluster to fail.

If no node IDs are provided, the order of the data nodes is the determining factor for the node group. Whether or not explicit assignments are made, they can be viewed in the output of the management client's `SHOW` command.

The default and recommended maximum value for `NoOfReplicas` is 2. *This is the recommended value for most production environments.*



**Important**

While it is theoretically possible for the value of this parameter to be 3 or 4, **NDB Cluster 7.5 and NDB Cluster 7.6 do not support setting `NoOfReplicas` to a value greater than 2 in production.**



**Warning**

Setting `NoOfReplicas` to 1 means that there is only a single copy of all Cluster data; in this case, the loss of a single data node causes the cluster to fail because there are no additional copies of the data stored by that node.

The number of data nodes in the cluster must be evenly divisible by the value of this parameter. For example, if there are two data nodes, then `NoOfReplicas` must be equal to either 1 or 2, since 2/3 and 2/4 both yield fractional values; if there are four data nodes, then `NoOfReplicas` must be equal to 1, 2, or 4.

- [DataDir](#)

Version (or later)	NDB 7.5.0
Type or units	path
Default	.
Range	...
Restart Type	<b>Initial Node Restart:</b> Requires a <a href="#">rolling restart</a> of the cluster; each data node must be restarted with

	<code>--initial.</code> (NDB 7.5.0)
--	--

This parameter specifies the directory where trace files, log files, pid files and error logs are placed.

The default is the data node process working directory.

- [FileSystemPath](#)

Version (or later)	NDB 7.5.0
Type or units	path
Default	DataDir
Range	...
Restart Type	<b>Initial Node Restart:</b> Requires a <a href="#">rolling restart</a> of the cluster; each data node must be restarted with <code>--initial.</code> (NDB 7.5.0)

This parameter specifies the directory where all files created for metadata, REDO logs, UNDO logs (for Disk Data tables), and data files are placed. The default is the directory specified by [DataDir](#).



**Note**

This directory must exist before the `ndbd` process is initiated.

The recommended directory hierarchy for NDB Cluster includes `/var/lib/mysql-cluster`, under which a directory for the node's file system is created. The name of this subdirectory contains the node ID. For example, if the node ID is 2, this subdirectory is named `ndb_2_fs`.

- [BackupDataDir](#)

Version (or later)	NDB 7.5.0
Type or units	path
Default	FileSystemPath
Range	...
Restart Type	<b>Initial Node Restart:</b> Requires a <a href="#">rolling restart</a> of the cluster; each data node must be restarted with

	<code>--initial.</code> (NDB 7.5.0)
--	--

This parameter specifies the directory in which backups are placed.



**Important**

The string `'/BACKUP'` is always appended to this value. For example, if you set the value of `BackupDataDir` to `/var/lib/cluster-data`, then all backups are stored under `/var/lib/cluster-data/BACKUP`. This also means that the *effective* default backup location is the directory named `BACKUP` under the location specified by the `FileSystemPath` parameter.

**Data Memory, Index Memory, and String Memory**

`DataMemory` and `IndexMemory` are `[ndbd]` parameters specifying the size of memory segments used to store the actual records and their indexes. In setting values for these, it is important to understand how `DataMemory` and `IndexMemory` are used, as they usually need to be updated to reflect actual usage by the cluster.



**Note**

`IndexMemory` is deprecated in NDB 7.6, and subject to removal in a future version of NDB Cluster. See the descriptions that follow for further information.

- `DataMemory`

Version (or later)	NDB 7.5.0
Type or units	bytes
Default	80M
Range	1M - 1T
Version (or later)	NDB 7.6.2
Type or units	bytes
Default	98M
Range	1M - 1T
Restart Type	<b>Node Restart:</b> Requires a <a href="#">rolling restart</a> of the cluster. (NDB 7.5.0)

This parameter defines the amount of space (in bytes) available for storing database records. The entire amount specified by this value is allocated in memory, so it is extremely important that the machine has sufficient physical memory to accommodate it.

The memory allocated by `DataMemory` is used to store both the actual records and indexes. There is a 16-byte overhead on each record; an additional amount for each record is incurred because it is stored in a 32KB page with 128 byte page overhead (see below). There is also a small amount wasted per page due to the fact that each record is stored in only one page.

For variable-size table attributes, the data is stored on separate data pages, allocated from `DataMemory`. Variable-length records use a fixed-size part with an extra overhead of 4 bytes to reference the variable-size part. The variable-size part has 2 bytes overhead plus 2 bytes per attribute.

The maximum record size is 14000 bytes.

In NDB 7.5 (and earlier), the memory space defined by `DataMemory` is also used to store ordered indexes, which use about 10 bytes per record. Each table row is represented in the ordered index. A common error among users is to assume that all indexes are stored in the memory allocated by `IndexMemory`, but this is not the case: Only primary key and unique hash indexes use this memory; ordered indexes use the memory allocated by `DataMemory`. However, creating a primary key or unique hash index also creates an ordered index on the same keys, unless you specify `USING HASH` in the index creation statement. This can be verified by running `ndb_desc -d db_name table_name`.

In NDB 7.6, resources assigned to `DataMemory` are used for storing *all* data and indexes; any memory configured as `IndexMemory` is automatically added to that used by `DataMemory` to form a common resource pool.

The memory space allocated by `DataMemory` consists of 32KB pages, which are allocated to table fragments. Each table is normally partitioned into the same number of fragments as there are data nodes in the cluster. Thus, for each node, there are the same number of fragments as are set in `NoOfReplicas`.

Once a page has been allocated, it is currently not possible to return it to the pool of free pages, except by deleting the table. (This also means that `DataMemory` pages, once allocated to a given table, cannot be used by other tables.) Performing a data node recovery also compresses the partition because all records are inserted into empty partitions from other live nodes.

The `DataMemory` memory space also contains UNDO information: For each update, a copy of the unaltered record is allocated in the `DataMemory`. There is also a reference to each copy in the ordered table indexes. Unique hash indexes are updated only when the unique index columns are updated, in which case a new entry in the index table is inserted and the old entry is deleted upon commit. For this reason, it is also necessary to allocate enough memory to handle the largest transactions performed by applications using the cluster. In any case, performing a few large transactions holds no advantage over using many smaller ones, for the following reasons:

- Large transactions are not any faster than smaller ones
- Large transactions increase the number of operations that are lost and must be repeated in event of transaction failure
- Large transactions use more memory

In NDB 7.5 (and earlier), the default value for `DataMemory` is 80MB; in NDB 7.6, this is 98MB. The minimum value is 1MB. There is no maximum size, but in reality the maximum size has to be adapted so that the process does not start swapping when the limit is reached. This limit is determined by the amount of physical RAM available on the machine and by the amount of memory that the operating system may commit to any one process. 32-bit operating systems are generally limited to 2–4GB per process; 64-bit operating systems can use more. For large databases, it may be preferable to use a 64-bit operating system for this reason.

- `IndexMemory`

Version (or later)	NDB 7.5.0
Type or units	bytes
Default	18M
Range	1M - 1T

Version (or later)	NDB 7.6.2
Type or units	bytes
Default	0
Range	1M - 1T
Deprecated	NDB 7.6.2
Restart Type	<b>Node Restart:</b> Requires a <a href="#">rolling restart</a> of the cluster. (NDB 7.5.0)

In NDB 7.5 and earlier, this parameter controls the amount of storage used for hash indexes in NDB Cluster. Hash indexes are always used for primary key indexes, unique indexes, and unique constraints. When defining a primary key or a unique index, two indexes are created, one of which is a hash index used for all tuple accesses as well as lock handling. This index is also used to enforce unique constraints.

In NDB 7.6.2, the `IndexMemory` parameter is deprecated (and subject to future removal); any any memory assigned to `IndexMemory` is allocated instead to the same pool as `DataMemory`, which becomes solely responsible for all resources needed for storing data and indexes in memory. In NDB 7.6, the use of `IndexMemory` in the cluster configuration file triggers a warning from the management server.

You can estimate the size of a hash index using this formula:

```
size = ( (fragments * 32K) + (rows * 18) )
      * fragment_replicas
```

`fragments` is the number of fragments, `fragment_replicas` is the number of fragment replicas (normally two), and `rows` is the number of rows. If a table has one million rows, eight fragments, and two fragment replicas, the expected index memory usage is calculated as shown here:

```
((8 * 32K) + (1000000 * 18)) * 2 = ((8 * 32768) + (1000000 * 18)) * 2
= (262144 + 18000000) * 2
= 18262144 * 2 = 36524288 bytes = ~35MB
```

Index statistics for ordered indexes (when these are enabled) are stored in the `mysql.ndb_index_stat_sample` table. Since this table has a hash index, this adds to index memory usage. An upper bound to the number of rows for a given ordered index can be calculated as follows:

```
sample_size = key_size + ((key_attributes + 1) * 4)

sample_rows = IndexStatSaveSize
              * ((0.01 * IndexStatSaveScale * log2(rows * sample_size)) + 1)
              / sample_size
```

In the preceding formula, `key_size` is the size of the ordered index key in bytes, `key_attributes` is the number of attributes in the ordered index key, and `rows` is the number of rows in the base table.

Assume that table `t1` has 1 million rows and an ordered index named `ix1` on two four-byte integers. Assume in addition that `IndexStatSaveSize` and `IndexStatSaveScale` are set to their default values (32K and 100, respectively). Using the previous 2 formulas, we can calculate as follows:

```
sample_size = 8 + ((1 + 2) * 4) = 20 bytes
```



```
sample_rows = 32K
              * ((0.01 * 100 * log2(1000000*20)) + 1)
              / 20
              = 32768 * ((1 * ~16.811) + 1) / 20
              = 32768 * ~17.811 / 20
              = ~29182 rows
```

The expected index memory usage is thus  $2 * 18 * 29182 = \sim 1050550$  bytes.

Prior to NDB 7.6, the default value for `IndexMemory` is 18MB and the minimum is 1 MB; in NDB 7.6, the minimum and default value for this parameter is 0 (zero). This has implications for downgrades from NDB 7.6 to earlier versions of NDB Cluster; see [Section 21.3.7, “Upgrading and Downgrading NDB Cluster”](#), for more information.

- `StringMemory`

Version (or later)	NDB 7.5.0
Type or units	% or bytes
Default	25
Range	0 - 4294967039 (0xFFFFFFFF)
Restart Type	<b>System Restart:</b> Requires a complete shutdown and restart of the cluster. (NDB 7.5.0)

This parameter determines how much memory is allocated for strings such as table names, and is specified in an `[ndbd]` or `[ndbd default]` section of the `config.ini` file. A value between 0 and 100 inclusive is interpreted as a percent of the maximum default value, which is calculated based on a number of factors including the number of tables, maximum table name size, maximum size of `.FRM` files, `MaxNoOfTriggers`, maximum column name size, and maximum default column value.

A value greater than 100 is interpreted as a number of bytes.

The default value is 25—that is, 25 percent of the default maximum.

Under most circumstances, the default value should be sufficient, but when you have a great many NDB tables (1000 or more), it is possible to get Error 773 `Out of string memory, please modify StringMemory config parameter: Permanent error: Schema error`, in which case you should increase this value. 25 (25 percent) is not excessive, and should prevent this error from recurring in all but the most extreme conditions.

The following example illustrates how memory is used for a table. Consider this table definition:

```
CREATE TABLE example (
  a INT NOT NULL,
  b INT NOT NULL,
  c INT NOT NULL,
  PRIMARY KEY(a),
  UNIQUE(b)
) ENGINE=NDBCLUSTER;
```

For each record, there are 12 bytes of data plus 12 bytes overhead. Having no nullable columns saves 4 bytes of overhead. In addition, we have two ordered indexes on columns `a` and `b` consuming roughly 10 bytes each per record. There is a primary key hash index on the base table using roughly 29 bytes per record. The unique constraint is implemented by a separate table with `b` as primary key and `a` as a column. This other table consumes an additional 29 bytes of index memory per record in the `example` table as well 8 bytes of record data plus 12 bytes of overhead.

Thus, for one million records, we need 58MB for index memory to handle the hash indexes for the primary key and the unique constraint. We also need 64MB for the records of the base table and the unique index table, plus the two ordered index tables.

You can see that hash indexes takes up a fair amount of memory space; however, they provide very fast access to the data in return. They are also used in NDB Cluster to handle uniqueness constraints.

Currently, the only partitioning algorithm is hashing and ordered indexes are local to each node. Thus, ordered indexes cannot be used to handle uniqueness constraints in the general case.

An important point for both `IndexMemory` and `DataMemory` is that the total database size is the sum of all data memory and all index memory for each node group. Each node group is used to store replicated information, so if there are four nodes with two fragment replicas, there are two node groups. Thus, the total data memory available is  $2 \times \text{DataMemory}$  for each data node.

It is highly recommended that `DataMemory` and `IndexMemory` be set to the same values for all nodes. Data distribution is even over all nodes in the cluster, so the maximum amount of space available for any node can be no greater than that of the smallest node in the cluster.

`DataMemory` (and in NDB 7.5 and earlier `IndexMemory`) can be changed, but decreasing it can be risky; doing so can easily lead to a node or even an entire NDB Cluster that is unable to restart due to there being insufficient memory space. Increases should be acceptable, but it is recommended that such upgrades are performed in the same manner as a software upgrade, beginning with an update of the configuration file, and then restarting the management server followed by restarting each data node in turn.

**MinFreePct.** A proportion (5% by default) of data node resources including `DataMemory` (and in NDB 7.5 and earlier, `IndexMemory`) is kept in reserve to insure that the data node does not exhaust its memory when performing a restart. This can be adjusted using the `MinFreePct` data node configuration parameter (default 5).

Version (or later)	NDB 7.5.0
Type or units	unsigned
Default	5
Range	0 - 100
Restart Type	<b>Node Restart:</b> Requires a <a href="#">rolling restart</a> of the cluster. (NDB 7.5.0)

Updates do not increase the amount of index memory used. Inserts take effect immediately; however, rows are not actually deleted until the transaction is committed.

**Transaction parameters.** The next few `[ndbd]` parameters that we discuss are important because they affect the number of parallel transactions and the sizes of transactions that can be handled by the system. `MaxNoOfConcurrentTransactions` sets the number of parallel transactions possible in a node. `MaxNoOfConcurrentOperations` sets the number of records that can be in update phase or locked simultaneously.

Both of these parameters (especially `MaxNoOfConcurrentOperations`) are likely targets for users setting specific values and not using the default value. The default value is set for systems using small transactions, to ensure that these do not use excessive memory.

`MaxDMLOperationsPerTransaction` sets the maximum number of DML operations that can be performed in a given transaction.

- `MaxNoOfConcurrentTransactions`

Version (or later)	NDB 7.5.0
Type or units	integer
Default	4096
Range	32 - 4294967039 (0xFFFFFFFF)
Deprecated	Yes (in NDB 8.0)
Restart Type	<b>Node Restart:</b> Requires a <a href="#">rolling restart</a> of the cluster. (NDB 7.5.0)

Each cluster data node requires a transaction record for each active transaction in the cluster. The task of coordinating transactions is distributed among all of the data nodes. The total number of transaction records in the cluster is the number of transactions in any given node times the number of nodes in the cluster.

Transaction records are allocated to individual MySQL servers. Each connection to a MySQL server requires at least one transaction record, plus an additional transaction object per table accessed by that connection. This means that a reasonable minimum for the total number of transactions in the cluster can be expressed as

```
TotalNoOfConcurrentTransactions =
  (maximum number of tables accessed in any single transaction + 1)
  * number of SQL nodes
```

Suppose that there are 10 SQL nodes using the cluster. A single join involving 10 tables requires 11 transaction records; if there are 10 such joins in a transaction, then  $10 * 11 = 110$  transaction records are required for this transaction, per MySQL server, or  $110 * 10 = 1100$  transaction records total. Each data node can be expected to handle `TotalNoOfConcurrentTransactions` / number of data nodes. For an NDB Cluster having 4 data nodes, this would mean setting `MaxNoOfConcurrentTransactions` on each data node to  $1100 / 4 = 275$ . In addition, you should provide for failure recovery by ensuring that a single node group can accommodate all concurrent transactions; in other words, that each data node's `MaxNoOfConcurrentTransactions` is sufficient to cover a number of transactions equal to `TotalNoOfConcurrentTransactions` / number of node groups. If this cluster has a single node group, then `MaxNoOfConcurrentTransactions` should be set to 1100 (the same as the total number of concurrent transactions for the entire cluster).

In addition, each transaction involves at least one operation; for this reason, the value set for `MaxNoOfConcurrentTransactions` should always be no more than the value of `MaxNoOfConcurrentOperations`.

This parameter must be set to the same value for all cluster data nodes. This is due to the fact that, when a data node fails, the oldest surviving node re-creates the transaction state of all transactions that were ongoing in the failed node.

It is possible to change this value using a rolling restart, but the amount of traffic on the cluster must be such that no more transactions occur than the lower of the old and new levels while this is taking place.

The default value is 4096.

- [MaxNoOfConcurrentOperations](#)

Version (or later)	NDB 7.5.0
Type or units	integer
Default	32K
Range	32 - 4294967039 (0xFFFFFFFF)
Restart Type	<b>Node Restart:</b> Requires a <a href="#">rolling restart</a> of the cluster. (NDB 7.5.0)

It is a good idea to adjust the value of this parameter according to the size and number of transactions. When performing transactions which involve only a few operations and records, the default value for this parameter is usually sufficient. Performing large transactions involving many records usually requires that you increase its value.

Records are kept for each transaction updating cluster data, both in the transaction coordinator and in the nodes where the actual updates are performed. These records contain state information needed to find UNDO records for rollback, lock queues, and other purposes.

This parameter should be set at a minimum to the number of records to be updated simultaneously in transactions, divided by the number of cluster data nodes. For example, in a cluster which has four data nodes and which is expected to handle one million concurrent updates using transactions, you should set this value to  $1000000 / 4 = 250000$ . To help provide resiliency against failures, it is suggested that you set this parameter to a value that is high enough to permit an individual data node to handle the load for its node group. In other words, you should set the value equal to [total number of concurrent](#)

`operations / number of node groups`. (In the case where there is a single node group, this is the same as the total number of concurrent operations for the entire cluster.)

Because each transaction always involves at least one operation, the value of `MaxNoOfConcurrentOperations` should always be greater than or equal to the value of `MaxNoOfConcurrentTransactions`.

Read queries which set locks also cause operation records to be created. Some extra space is allocated within individual nodes to accommodate cases where the distribution is not perfect over the nodes.

When queries make use of the unique hash index, there are actually two operation records used per record in the transaction. The first record represents the read in the index table and the second handles the operation on the base table.

The default value is 32768.

This parameter actually handles two values that can be configured separately. The first of these specifies how many operation records are to be placed with the transaction coordinator. The second part specifies how many operation records are to be local to the database.

A very large transaction performed on an eight-node cluster requires as many operation records in the transaction coordinator as there are reads, updates, and deletes involved in the transaction. However, the operation records of the are spread over all eight nodes. Thus, if it is necessary to configure the system for one very large transaction, it is a good idea to configure the two parts separately. `MaxNoOfConcurrentOperations` is always used to calculate the number of operation records in the transaction coordinator portion of the node.

It is also important to have an idea of the memory requirements for operation records. These consume about 1KB per record.

- `MaxNoOfLocalOperations`

Version (or later)	NDB 7.5.0
Type or units	integer
Default	UNDEFINED
Range	32 - 4294967039 (0xFFFFFFFF)
Deprecated	Yes (in NDB 8.0)
Restart Type	<b>Node Restart:</b> Requires a <a href="#">rolling restart</a> of the cluster. (NDB 7.5.0)

By default, this parameter is calculated as  $1.1 \times \text{MaxNoOfConcurrentOperations}$ . This fits systems with many simultaneous transactions, none of them being very large. If there is a need to handle one very large transaction at a time and there are many nodes, it is a good idea to override the default value by explicitly specifying this parameter.

- `MaxDMLOperationsPerTransaction`

Version (or later)	NDB 7.5.0
--------------------	-----------

Type or units	operations (DML)
Default	4294967295
Range	32 - 4294967295
Restart Type	<b>Node Restart:</b> Requires a <a href="#">rolling restart</a> of the cluster. (NDB 7.5.0)

This parameter limits the size of a transaction. The transaction is aborted if it requires more than this many DML operations.

**Transaction temporary storage.** The next set of [[ndbd](#)] parameters is used to determine temporary storage when executing a statement that is part of a Cluster transaction. All records are released when the statement is completed and the cluster is waiting for the commit or rollback.

The default values for these parameters are adequate for most situations. However, users with a need to support transactions involving large numbers of rows or operations may need to increase these values to enable better parallelism in the system, whereas users whose applications require relatively small transactions can decrease the values to save memory.

- [MaxNoOfConcurrentIndexOperations](#)

Version (or later)	NDB 7.5.0
Type or units	integer
Default	8K
Range	0 - 4294967039 (0xFFFFFFFF)
Deprecated	Yes (in NDB 8.0)
Restart Type	<b>Node Restart:</b> Requires a <a href="#">rolling restart</a> of the cluster. (NDB 7.5.0)

For queries using a unique hash index, another temporary set of operation records is used during a query's execution phase. This parameter sets the size of that pool of records. Thus, this record is allocated only while executing a part of a query. As soon as this part has been executed, the record is released. The state needed to handle aborts and commits is handled by the normal operation records, where the pool size is set by the parameter [MaxNoOfConcurrentOperations](#).

The default value of this parameter is 8192. Only in rare cases of extremely high parallelism using unique hash indexes should it be necessary to increase this value. Using a smaller value is possible and can save memory if the DBA is certain that a high degree of parallelism is not required for the cluster.

- [MaxNoOfFiredTriggers](#)

Version (or later)	NDB 7.5.0
Type or units	integer
Default	4000

Range	0 - 4294967039 (0xFFFFFFFF)
Deprecated	Yes (in NDB 8.0)
Restart Type	<b>Node Restart:</b> Requires a <a href="#">rolling restart</a> of the cluster. (NDB 7.5.0)

The default value of `MaxNoOfFiredTriggers` is 4000, which is sufficient for most situations. In some cases it can even be decreased if the DBA feels certain the need for parallelism in the cluster is not high.

A record is created when an operation is performed that affects a unique hash index. Inserting or deleting a record in a table with unique hash indexes or updating a column that is part of a unique hash index fires an insert or a delete in the index table. The resulting record is used to represent this index table operation while waiting for the original operation that fired it to complete. This operation is short-lived but can still require a large number of records in its pool for situations with many parallel write operations on a base table containing a set of unique hash indexes.

- [TransactionBufferMemory](#)

Version (or later)	NDB 7.5.0
Type or units	bytes
Default	1M
Range	1K - 4294967039 (0xFFFFFFFF)
Restart Type	<b>Node Restart:</b> Requires a <a href="#">rolling restart</a> of the cluster. (NDB 7.5.0)

The memory affected by this parameter is used for tracking operations fired when updating index tables and reading unique indexes. This memory is used to store the key and column information for these operations. It is only very rarely that the value for this parameter needs to be altered from the default.

The default value for `TransactionBufferMemory` is 1MB.

Normal read and write operations use a similar buffer, whose usage is even more short-lived. The compile-time parameter `ZATTRBUF_FILESIZE` (found in `ndb/src/kernel/blocks/Dbtc/Dbtc.hpp`) set to  $4000 \times 128$  bytes (500KB). A similar buffer for key information, `ZDATABUF_FILESIZE` (also in `Dbtc.hpp`) contains  $4000 \times 16 = 62.5$ KB of buffer space. `Dbtc` is the module that handles transaction coordination.

**Scans and buffering.** There are additional `[ndbd]` parameters in the `Dblqh` module (in `ndb/src/kernel/blocks/Dblqh/Dblqh.hpp`) that affect reads and updates. These include `ZATTRINBUF_FILESIZE`, set by default to  $10000 \times 128$  bytes (1250KB) and `ZDATABUF_FILE_SIZE`, set by default to  $10000 \times 16$  bytes (roughly 156KB) of buffer space. To date, there have been neither any reports from users nor any results from our own extensive tests suggesting that either of these compile-time limits should be increased.

- [BatchSizePerLocalScan](#)

Version (or later)	NDB 7.5.0
Type or units	integer
Default	256
Range	1 - 992
Deprecated	Yes (in NDB 8.0)
Restart Type	<b>Node Restart:</b> Requires a <a href="#">rolling restart</a> of the cluster. (NDB 7.5.0)

This parameter is used to calculate the number of lock records used to handle concurrent scan operations.

[BatchSizePerLocalScan](#) has a strong connection to the [BatchSize](#) defined in the SQL nodes.

- [LongMessageBuffer](#)

Version (or later)	NDB 7.5.0
Type or units	bytes
Default	64M
Range	512K - 4294967039 (0xFFFFFFFF)
Restart Type	<b>Node Restart:</b> Requires a <a href="#">rolling restart</a> of the cluster. (NDB 7.5.0)

This is an internal buffer used for passing messages within individual nodes and between nodes. The default is 64MB.

This parameter seldom needs to be changed from the default.

- [MaxFKBuildBatchSize](#)

Version (or later)	NDB 7.6.4
Type or units	integer
Default	64
Range	16 - 512
Added	NDB 7.6.4
Restart Type	<b>Node Restart:</b> Requires a <a href="#">rolling restart</a> of



	the cluster. (NDB 7.5.0)
--	--------------------------

Maximum scan batch size used for building foreign keys. Increasing the value set for this parameter may speed up building of foreign key builds at the expense of greater impact to ongoing traffic.

- [MaxNoOfConcurrentScans](#)

Version (or later)	NDB 7.5.0
Type or units	integer
Default	256
Range	2 - 500
Restart Type	<b>Node Restart:</b> Requires a <a href="#">rolling restart</a> of the cluster. (NDB 7.5.0)

This parameter is used to control the number of parallel scans that can be performed in the cluster. Each transaction coordinator can handle the number of parallel scans defined for this parameter. Each scan query is performed by scanning all partitions in parallel. Each partition scan uses a scan record in the node where the partition is located, the number of records being the value of this parameter times the number of nodes. The cluster should be able to sustain [MaxNoOfConcurrentScans](#) scans concurrently from all nodes in the cluster.

Scans are actually performed in two cases. The first of these cases occurs when no hash or ordered indexes exists to handle the query, in which case the query is executed by performing a full table scan. The second case is encountered when there is no hash index to support the query but there is an ordered index. Using the ordered index means executing a parallel range scan. The order is kept on the local partitions only, so it is necessary to perform the index scan on all partitions.

The default value of [MaxNoOfConcurrentScans](#) is 256. The maximum value is 500.

- [MaxNoOfLocalScans](#)

Version (or later)	NDB 7.5.0
Type or units	integer
Default	4 * MaxNoOfConcurrentScans * [# of data nodes] + 2
Range	32 - 4294967039 (0xFFFFFFFF)
Deprecated	Yes (in NDB 8.0)
Restart Type	<b>Node Restart:</b> Requires a <a href="#">rolling restart</a> of

	the cluster. (NDB 7.5.0)
--	--------------------------

Specifies the number of local scan records if many scans are not fully parallelized. When the number of local scan records is not provided, it is calculated as shown here:

$$4 * \text{MaxNoOfConcurrentScans} * [\# \text{ data nodes}] + 2$$

The minimum value is 32.

- [MaxParallelCopyInstances](#)

Version (or later)	NDB 7.5.0
Type or units	integer
Default	0
Range	0 - 64
Restart Type	<b>Node Restart:</b> Requires a <a href="#">rolling restart</a> of the cluster. (NDB 7.5.0)

This parameter sets the parallelization used in the copy phase of a node restart or system restart, when a node that is currently just starting is synchronised with a node that already has current data by copying over any changed records from the node that is up to date. Because full parallelism in such cases can lead to overload situations, [MaxParallelCopyInstances](#) provides a means to decrease it. This parameter's default value 0. This value means that the effective parallelism is equal to the number of LDM instances in the node just starting as well as the node updating it.

- [MaxParallelScansPerFragment](#)

Version (or later)	NDB 7.5.0
Type or units	bytes
Default	256
Range	1 - 4294967039 (0xFFFFFFFF)
Restart Type	<b>Node Restart:</b> Requires a <a href="#">rolling restart</a> of the cluster. (NDB 7.5.0)

It is possible to configure the maximum number of parallel scans ([TUP](#) scans and [TUX](#) scans) allowed before they begin queuing for serial handling. You can increase this to take advantage of any unused CPU when performing large number of scans in parallel and improve their performance.

- [MaxReorgBuildBatchSize](#)

Version (or later)	NDB 7.6.4
Type or units	integer
Default	64

Range	16 - 512
Added	NDB 7.6.4
Restart Type	<b>Node Restart:</b> Requires a <a href="#">rolling restart</a> of the cluster. (NDB 7.5.0)

Maximum scan batch size used for reorganization of table partitions. Increasing the value set for this parameter may speed up reorganization at the expense of greater impact to ongoing traffic.

- [MaxUIBuildBatchSize](#)

Version (or later)	NDB 7.6.4
Type or units	integer
Default	64
Range	16 - 512
Added	NDB 7.6.4
Restart Type	<b>Node Restart:</b> Requires a <a href="#">rolling restart</a> of the cluster. (NDB 7.5.0)

Maximum scan batch size used for building unique keys. Increasing the value set for this parameter may speed up such builds at the expense of greater impact to ongoing traffic.

## Memory Allocation

### [MaxAllocate](#)

Version (or later)	NDB 7.5.0
Type or units	unsigned
Default	32M
Range	1M - 1G
Deprecated	Yes (in NDB 8.0)
Restart Type	<b>Node Restart:</b> Requires a <a href="#">rolling restart</a> of the cluster. (NDB 7.5.0)

This parameter was used in older versions of NDB Cluster, but has no effect in NDB 7.5 or NDB 7.6.

## Hash Map Size

### [DefaultHashMapSize](#)

Version (or later)	NDB 7.5.0
Type or units	LDM threads

Default	240
Range	0 - 3840
Restart Type	<b>Node Restart:</b> Requires a <a href="#">rolling restart</a> of the cluster. (NDB 7.5.0)

The size of the table hash maps used by NDB is configurable using this parameter. `DefaultHashMapSize` can take any of three possible values (0, 240, 3840).

The original intended use for this parameter was to facilitate upgrades and especially downgrades to and from very old releases with differing default hash map sizes. This is not an issue when upgrading from NDB Cluster 7.3 (or later) to later versions.

Decreasing this parameter online after any tables have been created or modified with `DefaultHashMapSize` equal to 3840 is not supported.

**Logging and checkpointing.** The following `[ndbd]` parameters control log and checkpoint behavior.

- `FragmentLogFileSize`

Version (or later)	NDB 7.5.0
Type or units	bytes
Default	16M
Range	4M - 1G
Restart Type	<b>Initial Node Restart:</b> Requires a <a href="#">rolling restart</a> of the cluster; each data node must be restarted with <code>--initial</code> . (NDB 7.5.0)

Setting this parameter enables you to control directly the size of redo log files. This can be useful in situations when NDB Cluster is operating under a high load and it is unable to close fragment log files quickly enough before attempting to open new ones (only 2 fragment log files can be open at one time); increasing the size of the fragment log files gives the cluster more time before having to open each new fragment log file. The default value for this parameter is 16M.

For more information about fragment log files, see the description for `NoOfFragmentLogFiles`.

- `InitialNoOfOpenFiles`

Version (or later)	NDB 7.5.0
Type or units	files
Default	27
Range	20 - 4294967039 (0xFFFFFFFF)

Restart Type	<b>Node Restart:</b> Requires a <a href="#">rolling restart</a> of the cluster. (NDB 7.5.0)
--------------	--

This parameter sets the initial number of internal threads to allocate for open files.

The default value is 27.

- [InitFragmentLogFiles](#)

Version (or later)	NDB 7.5.0
Type or units	[see values]
Default	SPARSE
Range	SPARSE, FULL
Restart Type	<b>Initial Node Restart:</b> Requires a <a href="#">rolling restart</a> of the cluster; each data node must be restarted with <code>--initial</code> . (NDB 7.5.0)

By default, fragment log files are created sparsely when performing an initial start of a data node—that is, depending on the operating system and file system in use, not all bytes are necessarily written to disk. However, it is possible to override this behavior and force all bytes to be written, regardless of the platform and file system type being used, by means of this parameter. [InitFragmentLogFiles](#) takes either of two values:

- [SPARSE](#). Fragment log files are created sparsely. This is the default value.
- [FULL](#). Force all bytes of the fragment log file to be written to disk.

Depending on your operating system and file system, setting [InitFragmentLogFiles=FULL](#) may help eliminate I/O errors on writes to the REDO log.

- [EnablePartialLcp](#)

Version (or later)	NDB 7.6.4
Type or units	boolean
Default	true
Range	...
Added	NDB 7.6.4
Restart Type	<b>Node Restart:</b> Requires a <a href="#">rolling restart</a> of

	the cluster. (NDB 7.5.0)
--	--------------------------

When `true`, enable partial local checkpoints: This means that each LCP records only part of the full database, plus any records containing rows changed since the last LCP; if no rows have changed, the LCP updates only the LCP control file and does not update any data files.

If `EnablePartialLcp` is disabled (`false`), each LCP uses only a single file and writes a full checkpoint; this requires the least amount of disk space for LCPs, but increases the write load for each LCP. The default value is enabled (`true`). The proportion of space used by partial LCPS can be modified by the setting for the `RecoveryWork` configuration parameter.

For more information about files and directories used for full and partial LCPs, see [NDB Cluster Data Node File System Directory](#).

In NDB 7.6.7 and later, setting this parameter to `false` also disables the calculation of disk write speed used by the adaptive LCP control mechanism.

- `LcpScanProgressTimeout`

Version (or later)	NDB 7.5.0
Type or units	second
Default	60
Range	0 - 4294967039 (0xFFFFFFFF)
Restart Type	<b>Node Restart:</b> Requires a <a href="#">rolling restart</a> of the cluster. (NDB 7.5.0)

A local checkpoint fragment scan watchdog checks periodically for no progress in each fragment scan performed as part of a local checkpoint, and shuts down the node if there is no progress after a given amount of time has elapsed. This interval can be set using the `LcpScanProgressTimeout` data node configuration parameter, which sets the maximum time for which the local checkpoint can be stalled before the LCP fragment scan watchdog shuts down the node.

The default value is 60 seconds (providing compatibility with previous releases). Setting this parameter to 0 disables the LCP fragment scan watchdog altogether.

- `MaxNoOfOpenFiles`

Version (or later)	NDB 7.5.0
Type or units	unsigned
Default	0
Range	20 - 4294967039 (0xFFFFFFFF)
Restart Type	<b>Node Restart:</b> Requires a <a href="#">rolling restart</a> of the cluster. (NDB 7.5.0)

This parameter sets a ceiling on how many internal threads to allocate for open files. *Any situation requiring a change in this parameter should be reported as a bug.*

The default value is 0. However, the minimum value to which this parameter can be set is 20.

- [MaxNoOfSavedMessages](#)

Version (or later)	NDB 7.5.0
Type or units	integer
Default	25
Range	0 - 4294967039 (0xFFFFFFFF)
Restart Type	<b>Node Restart:</b> Requires a <a href="#">rolling restart</a> of the cluster. (NDB 7.5.0)

This parameter sets the maximum number of errors written in the error log as well as the maximum number of trace files that are kept before overwriting the existing ones. Trace files are generated when, for whatever reason, the node crashes.

The default is 25, which sets these maximums to 25 error messages and 25 trace files.

- [MaxLCPStartDelay](#)

Version (or later)	NDB 7.5.0
Type or units	seconds
Default	0
Range	0 - 600
Restart Type	<b>Node Restart:</b> Requires a <a href="#">rolling restart</a> of the cluster. (NDB 7.5.0)

In parallel data node recovery, only table data is actually copied and synchronized in parallel; synchronization of metadata such as dictionary and checkpoint information is done in a serial fashion. In addition, recovery of dictionary and checkpoint information cannot be executed in parallel with performing of local checkpoints. This means that, when starting or restarting many data nodes concurrently, data nodes may be forced to wait while a local checkpoint is performed, which can result in longer node recovery times.

It is possible to force a delay in the local checkpoint to permit more (and possibly all) data nodes to complete metadata synchronization; once each data node's metadata synchronization is complete, all of the data nodes can recover table data in parallel, even while the local checkpoint is being executed. To force such a delay, set [MaxLCPStartDelay](#), which determines the number of seconds the cluster can wait to begin a local checkpoint while data nodes continue to synchronize metadata. This parameter should be set in the `[ndbd default]` section of the `config.ini` file, so that it is the same for all data nodes. The maximum value is 600; the default is 0.

- [NoOfFragmentLogFiles](#)

Version (or later)	NDB 7.5.0
Type or units	integer
Default	16
Range	3 - 4294967039 (0xFFFFFFFF)
Restart Type	<b>Initial Node Restart:</b> Requires a <a href="#">rolling restart</a> of the cluster; each data node must be restarted with <a href="#">--initial</a> . (NDB 7.5.0)

This parameter sets the number of REDO log files for the node, and thus the amount of space allocated to REDO logging. Because the REDO log files are organized in a ring, it is extremely important that the first and last log files in the set (sometimes referred to as the “head” and “tail” log files, respectively) do not meet. When these approach one another too closely, the node begins aborting all transactions encompassing updates due to a lack of room for new log records.

A [REDO](#) log record is not removed until both required local checkpoints have been completed since that log record was inserted. Checkpointing frequency is determined by its own set of configuration parameters discussed elsewhere in this chapter.

The default parameter value is 16, which by default means 16 sets of 4 16MB files for a total of 1024MB. The size of the individual log files is configurable using the [FragmentLogFileSize](#) parameter. In scenarios requiring a great many updates, the value for [NoOfFragmentLogFiles](#) may need to be set as high as 300 or even higher to provide sufficient space for REDO logs.

If the checkpointing is slow and there are so many writes to the database that the log files are full and the log tail cannot be cut without jeopardizing recovery, all updating transactions are aborted with internal error code 410 ([Out of log file space temporarily](#)). This condition prevails until a checkpoint has completed and the log tail can be moved forward.



**Important**

This parameter cannot be changed “on the fly”; you must restart the node using [--initial](#). If you wish to change this value for all data nodes in a running cluster, you can do so using a rolling node restart (using [--initial](#) when starting each data node).

- [RecoveryWork](#)

Version (or later)	NDB 7.6.4
Type or units	integer
Default	50
Range	25 - 100
Version (or later)	NDB 7.6.5



Type or units	integer
Default	60
Range	25 - 100
Added	NDB 7.6.4
Restart Type	<b>Node Restart:</b> Requires a <a href="#">rolling restart</a> of the cluster. (NDB 7.5.0)

Percentage of storage overhead for LCP files. This parameter has an effect only when [EnablePartialLcp](#) is true, that is, only when partial local checkpoints are enabled. A higher value means:

- Fewer records are written for each LCP, LCPs use more space
- More work is needed during restarts

A lower value for [RecoveryWork](#) means:

- More records are written during each LCP, but LCPs require less space on disk.
- Less work during restart and thus faster restarts, at the expense of more work during normal operations

For example, setting [RecoveryWork](#) to 60 means that the total size of an LCP is roughly  $1 + 0.6 = 1.6$  times the size of the data to be checkpointed. This means that 60% more work is required during the restore phase of a restart compared to the work done during a restart that uses full checkpoints. (This is more than compensated for during other phases of the restart such that the restart as a whole is still faster when using partial LCPs than when using full LCPs.) In order not to fill up the redo log, it is necessary to write at  $1 + (1 / \text{RecoveryWork})$  times the rate of data changes during checkpoints—thus, when [RecoveryWork](#) = 60, it is necessary to write at approximately  $1 + (1 / 0.6) = 2.67$  times the change rate. In other words, if changes are being written at 10 MByte per second, the checkpoint needs to be written at roughly 26.7 MByte per second.

Setting [RecoveryWork](#) = 40 means that only 1.4 times the total LCP size is needed (and thus the restore phase takes 10 to 15 percent less time. In this case, the checkpoint write rate is 3.5 times the rate of change.

The NDB source distribution includes a test program for simulating LCPs. [lcp\\_simulator.cc](#) can be found in [storage/ndb/src/kernel/blocks/backup/](#). To compile and run it on Unix platforms, execute the commands shown here:

```
$> gcc lcp_simulator.cc
$> ./a.out
```

This program has no dependencies other than [stdio.h](#), and does not require a connection to an NDB cluster or a MySQL server. By default, it simulates 300 LCPs (three sets of 100 LCPs, each consisting of inserts, updates, and deletes, in turn), reporting the size of the LCP after each one. You can alter the simulation by changing the values of [recovery\\_work](#), [insert\\_work](#), and [delete\\_work](#) in the source and recompiling. For more information, see the source of the program.

- [InsertRecoveryWork](#)

Version (or later)	NDB 7.6.5
Type or units	integer
Default	40
Range	0 - 70
Added	NDB 7.6.5
Restart Type	<b>Node Restart:</b> Requires a <a href="#">rolling restart</a> of the cluster. (NDB 7.5.0)

Percentage of [RecoveryWork](#) used for inserted rows. A higher value increases the number of writes during a local checkpoint, and decreases the total size of the LCP. A lower value decreases the number of writes during an LCP, but results in more space being used for the LCP, which means that recovery takes longer. This parameter has an effect only when [EnablePartialLcp](#) is true, that is, only when partial local checkpoints are enabled.

- [EnableRedoControl](#)

Version (or later)	NDB 7.6.7
Type or units	boolean
Default	false
Range	...
Added	NDB 7.6.7
Restart Type	<b>Node Restart:</b> Requires a <a href="#">rolling restart</a> of the cluster. (NDB 7.5.0)

Enable adaptive checkpointing speed for controlling redo log usage. Set to `false` to disable (the default). Setting [EnablePartialLcp](#) to `false` also disables the adaptive calculation.

When enabled, [EnableRedoControl](#) allows the data nodes greater flexibility with regard to the rate at which they write LCPs to disk. More specifically, enabling this parameter means that higher write rates can be employed, so that LCPs can complete and Redo logs be trimmed more quickly, thereby reducing recovery time and disk space requirements. This functionality allows data nodes to make better use of the higher rate of I/O and greater bandwidth available from modern solid-state storage devices and protocols, such as solid-state drives (SSDs) using Non-Volatile Memory Express (NVMe).

The parameter currently defaults to `false` (disabled) due to the fact that [NDB](#) is still deployed widely on systems whose I/O or bandwidth is constrained relative to those employing solid-state technology, such as those using conventional hard disks (HDDs). In settings such as these, the [EnableRedoControl](#) mechanism can easily cause the I/O subsystem to become saturated, increasing wait times for data node input and output. In particular, this can cause issues with NDB Disk Data tables which have tablespaces or log file groups sharing a constrained IO subsystem with data node LCP and redo log files; such problems potentially include node or cluster failure due to GCP stop errors.

**Metadata objects.** The next set of [ndbd] parameters defines pool sizes for metadata objects, used to define the maximum number of attributes, tables, indexes, and trigger objects used by indexes, events, and replication between clusters.



### Note

These act merely as “suggestions” to the cluster, and any that are not specified revert to the default values shown.

- [MaxNoOfAttributes](#)

Version (or later)	NDB 7.5.0
Type or units	integer
Default	1000
Range	32 - 4294967039 (0xFFFFFFFF)
Restart Type	<b>Node Restart:</b> Requires a <a href="#">rolling restart</a> of the cluster. (NDB 7.5.0)

This parameter sets a suggested maximum number of attributes that can be defined in the cluster; like [MaxNoOfTables](#), it is not intended to function as a hard upper limit.

(In older NDB Cluster releases, this parameter was sometimes treated as a hard limit for certain operations. This caused problems with NDB Cluster Replication, when it was possible to create more tables than could be replicated, and sometimes led to confusion when it was possible [or not possible, depending on the circumstances] to create more than [MaxNoOfAttributes](#) attributes.)

The default value is 1000, with the minimum possible value being 32. The maximum is 4294967039. Each attribute consumes around 200 bytes of storage per node due to the fact that all metadata is fully replicated on the servers.

When setting [MaxNoOfAttributes](#), it is important to prepare in advance for any [ALTER TABLE](#) statements that you might want to perform in the future. This is due to the fact, during the execution of [ALTER TABLE](#) on a Cluster table, 3 times the number of attributes as in the original table are used, and a good practice is to permit double this amount. For example, if the NDB Cluster table having the greatest number of attributes (*greatest\_number\_of\_attributes*) has 100 attributes, a good starting point for the value of [MaxNoOfAttributes](#) would be  $6 * \text{greatest\_number\_of\_attributes} = 600$ .

You should also estimate the average number of attributes per table and multiply this by [MaxNoOfTables](#). If this value is larger than the value obtained in the previous paragraph, you should use the larger value instead.

Assuming that you can create all desired tables without any problems, you should also verify that this number is sufficient by trying an actual [ALTER TABLE](#) after configuring the parameter. If this is not successful, increase [MaxNoOfAttributes](#) by another multiple of [MaxNoOfTables](#) and test it again.

- [MaxNoOfTables](#)

Version (or later)	NDB 7.5.0
--------------------	-----------

Type or units	integer
Default	128
Range	8 - 20320
Restart Type	<b>Node Restart:</b> Requires a <a href="#">rolling restart</a> of the cluster. (NDB 7.5.0)

A table object is allocated for each table and for each unique hash index in the cluster. This parameter sets a suggested maximum number of table objects for the cluster as a whole; like [MaxNoOfAttributes](#), it is not intended to function as a hard upper limit.

(In older NDB Cluster releases, this parameter was sometimes treated as a hard limit for certain operations. This caused problems with NDB Cluster Replication, when it was possible to create more tables than could be replicated, and sometimes led to confusion when it was possible [or not possible, depending on the circumstances] to create more than [MaxNoOfTables](#) tables.)

For each attribute that has a [BLOB](#) data type an extra table is used to store most of the [BLOB](#) data. These tables also must be taken into account when defining the total number of tables.

The default value of this parameter is 128. The minimum is 8 and the maximum is 20320. Each table object consumes approximately 20KB per node.



**Note**

The sum of [MaxNoOfTables](#), [MaxNoOfOrderedIndexes](#), and [MaxNoOfUniqueHashIndexes](#) must not exceed  $2^{32} - 2$  (4294967294).

- [MaxNoOfOrderedIndexes](#)

Version (or later)	NDB 7.5.0
Type or units	integer
Default	128
Range	0 - 4294967039 (0xFFFFFFFF)
Restart Type	<b>Node Restart:</b> Requires a <a href="#">rolling restart</a> of the cluster. (NDB 7.5.0)

For each ordered index in the cluster, an object is allocated describing what is being indexed and its storage segments. By default, each index so defined also defines an ordered index. Each unique index

and primary key has both an ordered index and a hash index. `MaxNoOfOrderedIndexes` sets the total number of ordered indexes that can be in use in the system at any one time.

The default value of this parameter is 128. Each index object consumes approximately 10KB of data per node.



**Note**

The sum of `MaxNoOfTables`, `MaxNoOfOrderedIndexes`, and `MaxNoOfUniqueHashIndexes` must not exceed  $2^{32} - 2$  (4294967294).

- `MaxNoOfUniqueHashIndexes`

Version (or later)	NDB 7.5.0
Type or units	integer
Default	64
Range	0 - 4294967039 (0xFFFFFFFF)
Restart Type	<b>Node Restart:</b> Requires a <a href="#">rolling restart</a> of the cluster. (NDB 7.5.0)

For each unique index that is not a primary key, a special table is allocated that maps the unique key to the primary key of the indexed table. By default, an ordered index is also defined for each unique index. To prevent this, you must specify the `USING HASH` option when defining the unique index.

The default value is 64. Each index consumes approximately 15KB per node.



**Note**

The sum of `MaxNoOfTables`, `MaxNoOfOrderedIndexes`, and `MaxNoOfUniqueHashIndexes` must not exceed  $2^{32} - 2$  (4294967294).

- `MaxNoOfTriggers`

Version (or later)	NDB 7.5.0
Type or units	integer
Default	768
Range	0 - 4294967039 (0xFFFFFFFF)
Restart Type	<b>Node Restart:</b> Requires a <a href="#">rolling restart</a> of

	the cluster. (NDB 7.5.0)
--	--------------------------

Internal update, insert, and delete triggers are allocated for each unique hash index. (This means that three triggers are created for each unique hash index.) However, an *ordered* index requires only a single trigger object. Backups also use three trigger objects for each normal table in the cluster.

Replication between clusters also makes use of internal triggers.

This parameter sets the maximum number of trigger objects in the cluster.

The default value is 768.

- [MaxNoOfSubscriptions](#)

Version (or later)	NDB 7.5.0
Type or units	unsigned
Default	0
Range	0 - 4294967039 (0xFFFFFFFF)
Restart Type	<b>Node Restart:</b> Requires a <a href="#">rolling restart</a> of the cluster. (NDB 7.5.0)

Each [NDB](#) table in an NDB Cluster requires a subscription in the NDB kernel. For some NDB API applications, it may be necessary or desirable to change this parameter. However, for normal usage with MySQL servers acting as SQL nodes, there is not any need to do so.

The default value for [MaxNoOfSubscriptions](#) is 0, which is treated as equal to [MaxNoOfTables](#). Each subscription consumes 108 bytes.

- [MaxNoOfSubscribers](#)

Version (or later)	NDB 7.5.0
Type or units	unsigned
Default	0
Range	0 - 4294967039 (0xFFFFFFFF)
Restart Type	<b>Node Restart:</b> Requires a <a href="#">rolling restart</a> of the cluster. (NDB 7.5.0)

This parameter is of interest only when using NDB Cluster Replication. The default value is 0, which is treated as  $2 * \text{MaxNoOfTables}$ ; that is, there is one subscription per [NDB](#) table for each of two MySQL

servers (one acting as the replication source and the other as the replica). Each subscriber uses 16 bytes of memory.

When using circular replication, multi-source replication, and other replication setups involving more than 2 MySQL servers, you should increase this parameter to the number of `mysqld` processes included in replication (this is often, but not always, the same as the number of clusters). For example, if you have a circular replication setup using three NDB Cluster s, with one `mysqld` attached to each cluster, and each of these `mysqld` processes acts as a source and as a replica, you should set `MaxNoOfSubscribers` equal to `3 * MaxNoOfTables`.

For more information, see [Section 21.7, “NDB Cluster Replication”](#).

- `MaxNoOfConcurrentSubOperations`

Version (or later)	NDB 7.5.0
Type or units	unsigned
Default	256
Range	0 - 4294967039 (0xFFFFFFFF)
Restart Type	<b>Node Restart:</b> Requires a <a href="#">rolling restart</a> of the cluster. (NDB 7.5.0)

This parameter sets a ceiling on the number of operations that can be performed by all API nodes in the cluster at one time. The default value (256) is sufficient for normal operations, and might need to be adjusted only in scenarios where there are a great many API nodes each performing a high volume of operations concurrently.

**Boolean parameters.** The behavior of data nodes is also affected by a set of `[ndbd]` parameters taking on boolean values. These parameters can each be specified as `TRUE` by setting them equal to `1` or `Y`, and as `FALSE` by setting them equal to `0` or `N`.

- `CompressedLCP`

Version (or later)	NDB 7.5.0
Type or units	boolean
Default	false
Range	true, false
Restart Type	<b>Node Restart:</b> Requires a <a href="#">rolling restart</a> of the cluster. (NDB 7.5.0)

Setting this parameter to `1` causes local checkpoint files to be compressed. The compression used is equivalent to `gzip --fast`, and can save 50% or more of the space required on the data node to store uncompressed checkpoint files. Compressed LCPs can be enabled for individual data nodes, or for all data nodes (by setting this parameter in the `[ndbd default]` section of the `config.ini` file).



### Important

You cannot restore a compressed local checkpoint to a cluster running a MySQL version that does not support this feature.

The default value is `0` (disabled).

On Windows platforms, this parameter has no effect in NDB 7.5 or NDB 7.6.

- [CrashOnCorruptedTuple](#)

Version (or later)	NDB 7.5.0
Type or units	boolean
Default	true
Range	true, false
Restart Type	<b>Node Restart:</b> Requires a <a href="#">rolling restart</a> of the cluster. (NDB 7.5.0)

When this parameter is enabled, it forces a data node to shut down whenever it encounters a corrupted tuple. In NDB 7.5, it is enabled by default.

- [Diskless](#)

Version (or later)	NDB 7.5.0
Type or units	true false (1 0)
Default	false
Range	true, false
Restart Type	<b>Initial System Restart:</b> Requires a complete shutdown of the cluster, wiping and restoring the cluster file system from a <a href="#">backup</a> , and then restarting the cluster. (NDB 7.5.0)

It is possible to specify NDB Cluster tables as *diskless*, meaning that tables are not checkpointed to disk and that no logging occurs. Such tables exist only in main memory. A consequence of using diskless



tables is that neither the tables nor the records in those tables survive a crash. However, when operating in diskless mode, it is possible to run `ndbd` on a diskless computer.



### Important

This feature causes the *entire* cluster to operate in diskless mode.

When this feature is enabled, Cluster online backup is disabled. In addition, a partial start of the cluster is not possible.

`Diskless` is disabled by default.

- `LateAlloc`

Version (or later)	NDB 7.5.0
Type or units	numeric
Default	1
Range	0 - 1
Restart Type	<b>Node Restart:</b> Requires a <a href="#">rolling restart</a> of the cluster. (NDB 7.5.0)

Allocate memory for this data node after a connection to the management server has been established. Enabled by default.

- `LockPagesInMainMemory`

Version (or later)	NDB 7.5.0
Type or units	numeric
Default	0
Range	0 - 2
Restart Type	<b>Node Restart:</b> Requires a <a href="#">rolling restart</a> of the cluster. (NDB 7.5.0)

For a number of operating systems, including Solaris and Linux, it is possible to lock a process into memory and so avoid any swapping to disk. This can be used to help guarantee the cluster's real-time characteristics.

This parameter takes one of the integer values `0`, `1`, or `2`, which act as shown in the following list:

- `0`: Disables locking. This is the default value.
- `1`: Performs the lock after allocating memory for the process.

- `2`: Performs the lock before memory for the process is allocated.

If the operating system is not configured to permit unprivileged users to lock pages, then the data node process making use of this parameter may have to be run as system root. (`LockPagesInMainMemory` uses the `mlockall` function. From Linux kernel 2.6.9, unprivileged users can lock memory as limited by `max locked memory`. For more information, see `ulimit -l` and <http://linux.die.net/man/2/mlock>).



**Note**

In older NDB Cluster releases, this parameter was a Boolean. `0` or `false` was the default setting, and disabled locking. `1` or `true` enabled locking of the process after its memory was allocated. NDB Cluster 7.5 treats `true` or `false` for the value of this parameter as an error.



**Important**

Beginning with `glibc` 2.10, `glibc` uses per-thread arenas to reduce lock contention on a shared pool, which consumes real memory. In general, a data node process does not need per-thread arenas, since it does not perform any memory allocation after startup. (This difference in allocators does not appear to affect performance significantly.)

The `glibc` behavior is intended to be configurable via the `MALLOC_ARENA_MAX` environment variable, but a bug in this mechanism prior to `glibc` 2.16 meant that this variable could not be set to less than 8, so that the wasted memory could not be reclaimed. (Bug #15907219; see also [http://sourceware.org/bugzilla/show\\_bug.cgi?id=13137](http://sourceware.org/bugzilla/show_bug.cgi?id=13137) for more information concerning this issue.)

One possible workaround for this problem is to use the `LD_PRELOAD` environment variable to preload a `jemalloc` memory allocation library to take the place of that supplied with `glibc`.

- `ODirect`

Version (or later)	NDB 7.5.0
Type or units	boolean
Default	false
Range	true, false
Restart Type	<b>Node Restart:</b> Requires a <a href="#">rolling restart</a> of the cluster. (NDB 7.5.0)

Enabling this parameter causes NDB to attempt using `O_DIRECT` writes for LCP, backups, and redo logs, often lowering `kswapd` and CPU usage. When using NDB Cluster on Linux, enable `ODirect` if you are using a 2.6 or later kernel.

`ODirect` is disabled by default.

- `ODirectSyncFlag`

Version (or later)	NDB 7.6.4
--------------------	-----------

Type or units	boolean
Default	false
Range	true, false
Added	NDB 7.6.4
Restart Type	<b>Node Restart:</b> Requires a <a href="#">rolling restart</a> of the cluster. (NDB 7.5.0)

When this parameter is enabled, redo log writes are performed such that each completed file system write is handled as a call to `fsync`. The setting for this parameter is ignored if at least one of the following conditions is true:

- `ODirect` is not enabled.
- `InitFragmentLogFiles` is set to `SPARSE`.

Disabled by default.

- `RestartOnErrorInsert`

Version (or later)	NDB 7.5.0
Type or units	error code
Default	2
Range	0 - 4
Restart Type	<b>Node Restart:</b> Requires a <a href="#">rolling restart</a> of the cluster. (NDB 7.5.0)

This feature is accessible only when building the debug version where it is possible to insert errors in the execution of individual blocks of code as part of testing.

This feature is disabled by default.

- `StopOnError`

Version (or later)	NDB 7.5.0
Type or units	boolean
Default	1
Range	0, 1
Restart Type	<b>Node Restart:</b> Requires a <a href="#">rolling restart</a> of

	the cluster. (NDB 7.5.0)
--	--------------------------

This parameter specifies whether a data node process should exit or perform an automatic restart when an error condition is encountered.

This parameter's default value is 1; this means that, by default, an error causes the data node process to halt.

When an error is encountered and `StopOnError` is 0, the data node process is restarted.

Prior to NDB Cluster 7.5.5, if the data node process exits in an uncontrolled fashion (due, for example, to performing `kill -9` on the data node process while performing a query, or to a segmentation fault), and `StopOnError` is set to 0, the angel process attempts to restart it in exactly the same way as it was started previously—that is, using the same startup options that were employed the last time the node was started. Thus, if the data node process was originally started using the `--initial` option, it is also restarted with `--initial`. This means that, in such cases, if the failure occurs on a sufficient number of data nodes in a very short interval, the effect is the same as if you had performed an initial restart of the entire cluster, leading to loss of all data. This issue is resolved in NDB Cluster 7.5.5 and later NDB 7.5 releases (Bug #83510, Bug #24945638).

Users of MySQL Cluster Manager should note that, when `StopOnError` equals 1, this prevents the MySQL Cluster Manager agent from restarting any data nodes after it has performed its own restart and recovery. See [Starting and Stopping the Agent on Linux](#), for more information.

- [UseShm](#)

Version (or later)	NDB 7.6.6
Type or units	boolean
Default	false
Range	true, false
Added	NDB 7.6.6
Restart Type	<b>Node Restart:</b> Requires a <a href="#">rolling restart</a> of the cluster. (NDB 7.5.0)

Use shared memory connections between this data node and the API node also running on this host. Set to 1 to enable.

See [Section 21.4.3.12, “NDB Cluster Shared Memory Connections”](#), for more information.

## Controlling Timeouts, Intervals, and Disk Paging

There are a number of `[ndbd]` parameters specifying timeouts and intervals between various actions in Cluster data nodes. Most of the timeout values are specified in milliseconds. Any exceptions to this are mentioned where applicable.

- [TimeBetweenWatchDogCheck](#)

Version (or later)	NDB 7.5.0
Type or units	milliseconds

Default	6000
Range	70 - 4294967039 (0xFFFFFFFF)
Restart Type	<b>Node Restart:</b> Requires a <a href="#">rolling restart</a> of the cluster. (NDB 7.5.0)

To prevent the main thread from getting stuck in an endless loop at some point, a “watchdog” thread checks the main thread. This parameter specifies the number of milliseconds between checks. If the process remains in the same state after three checks, the watchdog thread terminates it.

This parameter can easily be changed for purposes of experimentation or to adapt to local conditions. It can be specified on a per-node basis although there seems to be little reason for doing so.

The default timeout is 6000 milliseconds (6 seconds).

- [TimeBetweenWatchDogCheckInitial](#)

Version (or later)	NDB 7.5.0
Type or units	milliseconds
Default	6000
Range	70 - 4294967039 (0xFFFFFFFF)
Restart Type	<b>Node Restart:</b> Requires a <a href="#">rolling restart</a> of the cluster. (NDB 7.5.0)

This is similar to the [TimeBetweenWatchDogCheck](#) parameter, except that [TimeBetweenWatchDogCheckInitial](#) controls the amount of time that passes between execution checks inside a storage node in the early start phases during which memory is allocated.

The default timeout is 6000 milliseconds (6 seconds).

- [StartPartialTimeout](#)

Version (or later)	NDB 7.5.0
Type or units	milliseconds
Default	30000
Range	0 - 4294967039 (0xFFFFFFFF)
Restart Type	<b>Node Restart:</b> Requires a <a href="#">rolling restart</a> of

	the cluster. (NDB 7.5.0)
--	--------------------------

This parameter specifies how long the Cluster waits for all data nodes to come up before the cluster initialization routine is invoked. This timeout is used to avoid a partial Cluster startup whenever possible.

This parameter is overridden when performing an initial start or initial restart of the cluster.

The default value is 30000 milliseconds (30 seconds). 0 disables the timeout, in which case the cluster may start only if all nodes are available.

- [StartPartitionedTimeout](#)

Version (or later)	NDB 7.5.0
Type or units	milliseconds
Default	60000
Range	0 - 4294967039 (0xFFFFFFFF)
Version (or later)	NDB 7.6.4
Type or units	milliseconds
Default	0
Range	0 - 4294967039 (0xFFFFFFFF)
Restart Type	<b>Node Restart:</b> Requires a <a href="#">rolling restart</a> of the cluster. (NDB 7.5.0)

If the cluster is ready to start after waiting for [StartPartialTimeout](#) milliseconds but is still possibly in a partitioned state, the cluster waits until this timeout has also passed. If [StartPartitionedTimeout](#) is set to 0, the cluster waits indefinitely ( $2^{32}-1$  ms, or approximately 49.71 days).

This parameter is overridden when performing an initial start or initial restart of the cluster.

The default value in NDB 7.6 is 0; previously it was 60000 (60 seconds).

- [StartFailureTimeout](#)

Version (or later)	NDB 7.5.0
Type or units	milliseconds
Default	0
Range	0 - 4294967039 (0xFFFFFFFF)
Restart Type	<b>Node Restart:</b> Requires a <a href="#">rolling restart</a> of

	the cluster. (NDB 7.5.0)
--	--------------------------

If a data node has not completed its startup sequence within the time specified by this parameter, the node startup fails. Setting this parameter to 0 (the default value) means that no data node timeout is applied.

For nonzero values, this parameter is measured in milliseconds. For data nodes containing extremely large amounts of data, this parameter should be increased. For example, in the case of a data node containing several gigabytes of data, a period as long as 10–15 minutes (that is, 600000 to 1000000 milliseconds) might be required to perform a node restart.

- [StartNoNodeGroupTimeout](#)

Version (or later)	NDB 7.5.0
Type or units	milliseconds
Default	15000
Range	0 - 4294967039 (0xFFFFFFFF)
Restart Type	<b>Node Restart:</b> Requires a <a href="#">rolling restart</a> of the cluster. (NDB 7.5.0)

When a data node is configured with `Nodegroup = 65536`, is regarded as not being assigned to any node group. When that is done, the cluster waits `StartNoNodegroupTimeout` milliseconds, then treats such nodes as though they had been added to the list passed to the `--nowait-nodes` option, and starts. The default value is `15000` (that is, the management server waits 15 seconds). Setting this parameter equal to `0` means that the cluster waits indefinitely.

`StartNoNodegroupTimeout` must be the same for all data nodes in the cluster; for this reason, you should always set it in the `[ndbd default]` section of the `config.ini` file, rather than for individual data nodes.

See [Section 21.6.7, “Adding NDB Cluster Data Nodes Online”](#), for more information.

- [HeartbeatIntervalDbDb](#)

Version (or later)	NDB 7.5.0
Type or units	milliseconds
Default	5000
Range	10 - 4294967039 (0xFFFFFFFF)
Restart Type	<b>Node Restart:</b> Requires a <a href="#">rolling restart</a> of

	the cluster. (NDB 7.5.0)
--	--------------------------

One of the primary methods of discovering failed nodes is by the use of heartbeats. This parameter states how often heartbeat signals are sent and how often to expect to receive them. Heartbeats cannot be disabled.

After missing four heartbeat intervals in a row, the node is declared dead. Thus, the maximum time for discovering a failure through the heartbeat mechanism is five times the heartbeat interval.

The default heartbeat interval is 5000 milliseconds (5 seconds). This parameter must not be changed drastically and should not vary widely between nodes. If one node uses 5000 milliseconds and the node watching it uses 1000 milliseconds, obviously the node is declared dead very quickly. This parameter can be changed during an online software upgrade, but only in small increments.

See also [Network communication and latency](#), as well as the description of the [ConnectCheckIntervalDelay](#) configuration parameter.

- [HeartbeatIntervalDbApi](#)

Version (or later)	NDB 7.5.0
Type or units	milliseconds
Default	1500
Range	100 - 4294967039 (0xFFFFFFFF)
Restart Type	<b>Node Restart:</b> Requires a <a href="#">rolling restart</a> of the cluster. (NDB 7.5.0)

Each data node sends heartbeat signals to each MySQL server (SQL node) to ensure that it remains in contact. If a MySQL server fails to send a heartbeat in time it is declared “dead,” in which case all ongoing transactions are completed and all resources released. The SQL node cannot reconnect until all activities initiated by the previous MySQL instance have been completed. The three-heartbeat criteria for this determination are the same as described for [HeartbeatIntervalDbDb](#).

The default interval is 1500 milliseconds (1.5 seconds). This interval can vary between individual data nodes because each data node watches the MySQL servers connected to it, independently of all other data nodes.

For more information, see [Network communication and latency](#).

- [HeartbeatOrder](#)

Version (or later)	NDB 7.5.0
Type or units	numeric
Default	0
Range	0 - 65535
Restart Type	<b>System Restart:</b> Requires a



	complete shutdown and restart of the cluster. (NDB 7.5.0)
--	---

Data nodes send heartbeats to one another in a circular fashion whereby each data node monitors the previous one. If a heartbeat is not detected by a given data node, this node declares the previous data node in the circle “dead” (that is, no longer accessible by the cluster). The determination that a data node is dead is done globally; in other words; once a data node is declared dead, it is regarded as such by all nodes in the cluster.

It is possible for heartbeats between data nodes residing on different hosts to be too slow compared to heartbeats between other pairs of nodes (for example, due to a very low heartbeat interval or temporary connection problem), such that a data node is declared dead, even though the node can still function as part of the cluster. .

In this type of situation, it may be that the order in which heartbeats are transmitted between data nodes makes a difference as to whether or not a particular data node is declared dead. If this declaration occurs unnecessarily, this can in turn lead to the unnecessary loss of a node group and as thus to a failure of the cluster.

Consider a setup where there are 4 data nodes A, B, C, and D running on 2 host computers `host1` and `host2`, and that these data nodes make up 2 node groups, as shown in the following table:

**Table 21.9 Four data nodes A, B, C, D running on two host computers `host1`, `host2`; each data node belongs to one of two node groups.**

Node Group	Nodes Running on <code>host1</code>	Nodes Running on <code>host2</code>
Node Group 0:	Node A	Node B
Node Group 1:	Node C	Node D

Suppose the heartbeats are transmitted in the order A->B->C->D->A. In this case, the loss of the heartbeat between the hosts causes node B to declare node A dead and node C to declare node B dead. This results in loss of Node Group 0, and so the cluster fails. On the other hand, if the order of transmission is A->B->D->C->A (and all other conditions remain as previously stated), the loss of the heartbeat causes nodes A and D to be declared dead; in this case, each node group has one surviving node, and the cluster survives.

The `HeartbeatOrder` configuration parameter makes the order of heartbeat transmission user-configurable. The default value for `HeartbeatOrder` is zero; allowing the default value to be used on all data nodes causes the order of heartbeat transmission to be determined by `NDB`. If this parameter is used, it must be set to a nonzero value (maximum 65535) for every data node in the cluster, and this value must be unique for each data node; this causes the heartbeat transmission to proceed from data node to data node in the order of their `HeartbeatOrder` values from lowest to highest (and then directly from the data node having the highest `HeartbeatOrder` to the data node having the lowest value, to complete the circle). The values need not be consecutive. For example, to force the heartbeat transmission order A->B->D->C->A in the scenario outlined previously, you could set the `HeartbeatOrder` values as shown here:

**Table 21.10 `HeartbeatOrder` values to force a heartbeat transition order of A->B->D->C->A.**

Node	<code>HeartbeatOrder</code> Value
A	10

Node	HeartbeatOrder Value
B	20
C	30
D	25

To use this parameter to change the heartbeat transmission order in a running NDB Cluster, you must first set `HeartbeatOrder` for each data node in the cluster in the global configuration (`config.ini`) file (or files). To cause the change to take effect, you must perform either of the following:

- A complete shutdown and restart of the entire cluster.
- 2 rolling restarts of the cluster in succession. *All nodes must be restarted in the same order in both rolling restarts.*

You can use `DUMP 908` to observe the effect of this parameter in the data node logs.

- `ConnectCheckIntervalDelay`

Version (or later)	NDB 7.5.0
Type or units	milliseconds
Default	0
Range	0 - 4294967039 (0xFFFFFFFF)
Restart Type	<b>Node Restart:</b> Requires a <a href="#">rolling restart</a> of the cluster. (NDB 7.5.0)

This parameter enables connection checking between data nodes after one of them has failed heartbeat checks for 5 intervals of up to `HeartbeatIntervalDbDb` milliseconds.

Such a data node that further fails to respond within an interval of `ConnectCheckIntervalDelay` milliseconds is considered suspect, and is considered dead after two such intervals. This can be useful in setups with known latency issues.

The default value for this parameter is 0 (disabled).

- `TimeBetweenLocalCheckpoints`

Version (or later)	NDB 7.5.0
Type or units	number of 4-byte words, as base-2 logarithm
Default	20
Range	0 - 31
Restart Type	<b>Node Restart:</b> Requires a <a href="#">rolling restart</a> of

	the cluster. (NDB 7.5.0)
--	--------------------------

This parameter is an exception in that it does not specify a time to wait before starting a new local checkpoint; rather, it is used to ensure that local checkpoints are not performed in a cluster where relatively few updates are taking place. In most clusters with high update rates, it is likely that a new local checkpoint is started immediately after the previous one has been completed.

The size of all write operations executed since the start of the previous local checkpoints is added. This parameter is also exceptional in that it is specified as the base-2 logarithm of the number of 4-byte words, so that the default value 20 means 4MB ( $4 \times 2^{20}$ ) of write operations, 21 would mean 8MB, and so on up to a maximum value of 31, which equates to 8GB of write operations.

All the write operations in the cluster are added together. Setting [TimeBetweenLocalCheckpoints](#) to 6 or less means that local checkpoints are executed continuously without pause, independent of the cluster's workload.

- [TimeBetweenGlobalCheckpoints](#)

Version (or later)	NDB 7.5.0
Type or units	milliseconds
Default	2000
Range	20 - 32000
Restart Type	<b>Node Restart:</b> Requires a <a href="#">rolling restart</a> of the cluster. (NDB 7.5.0)

When a transaction is committed, it is committed in main memory in all nodes on which the data is mirrored. However, transaction log records are not flushed to disk as part of the commit. The reasoning behind this behavior is that having the transaction safely committed on at least two autonomous host machines should meet reasonable standards for durability.

It is also important to ensure that even the worst of cases—a complete crash of the cluster—is handled properly. To guarantee that this happens, all transactions taking place within a given interval are put into a global checkpoint, which can be thought of as a set of committed transactions that has been flushed to disk. In other words, as part of the commit process, a transaction is placed in a global checkpoint group. Later, this group's log records are flushed to disk, and then the entire group of transactions is safely committed to disk on all computers in the cluster.

This parameter defines the interval between global checkpoints. The default is 2000 milliseconds.

- [TimeBetweenGlobalCheckpointsTimeout](#)

Version (or later)	NDB 7.5.0
Type or units	milliseconds
Default	120000
Range	10 - 4294967039 (0xFFFFFFFF)
Restart Type	<b>Node Restart:</b> Requires a

	<a href="#">rolling restart</a> of the cluster. (NDB 7.5.0)
--	---

This parameter defines the minimum timeout between global checkpoints. The default is 120000 milliseconds.

- [TimeBetweenEpochs](#)

Version (or later)	NDB 7.5.0
Type or units	milliseconds
Default	100
Range	0 - 32000
Restart Type	<b>Node Restart:</b> Requires a <a href="#">rolling restart</a> of the cluster. (NDB 7.5.0)

This parameter defines the interval between synchronization epochs for NDB Cluster Replication. The default value is 100 milliseconds.

[TimeBetweenEpochs](#) is part of the implementation of “micro-GCPs”, which can be used to improve the performance of NDB Cluster Replication.

- [TimeBetweenEpochsTimeout](#)

Version (or later)	NDB 7.5.0
Type or units	milliseconds
Default	0
Range	0 - 256000
Restart Type	<b>Node Restart:</b> Requires a <a href="#">rolling restart</a> of the cluster. (NDB 7.5.0)

This parameter defines a timeout for synchronization epochs for NDB Cluster Replication. If a node fails to participate in a global checkpoint within the time determined by this parameter, the node is shut down. The default value is 0; in other words, the timeout is disabled.

[TimeBetweenEpochsTimeout](#) is part of the implementation of “micro-GCPs”, which can be used to improve the performance of NDB Cluster Replication.

The current value of this parameter and a warning are written to the cluster log whenever a GCP save takes longer than 1 minute or a GCP commit takes longer than 10 seconds.

Setting this parameter to zero has the effect of disabling GCP stops caused by save timeouts, commit timeouts, or both. The maximum possible value for this parameter is 256000 milliseconds.

- [MaxBufferedEpochs](#)

Version (or later)	NDB 7.5.0
Type or units	epochs
Default	100
Range	0 - 100000
Restart Type	<b>Node Restart:</b> Requires a <a href="#">rolling restart</a> of the cluster. (NDB 7.5.0)

The number of unprocessed epochs by which a subscribing node can lag behind. Exceeding this number causes a lagging subscriber to be disconnected.

The default value of 100 is sufficient for most normal operations. If a subscribing node does lag enough to cause disconnections, it is usually due to network or scheduling issues with regard to processes or threads. (In rare circumstances, the problem may be due to a bug in the [NDB](#) client.) It may be desirable to set the value lower than the default when epochs are longer.

Disconnection prevents client issues from affecting the data node service, running out of memory to buffer data, and eventually shutting down. Instead, only the client is affected as a result of the disconnect (by, for example gap events in the binary log), forcing the client to reconnect or restart the process.

- [MaxBufferedEpochBytes](#)

Version (or later)	NDB 7.5.0
Type or units	bytes
Default	26214400
Range	26214400 (0x01900000) - 4294967039 (0xFFFFFFFF)
Restart Type	<b>Node Restart:</b> Requires a <a href="#">rolling restart</a> of the cluster. (NDB 7.5.0)

The total number of bytes allocated for buffering epochs by this node.

- [TimeBetweenInactiveTransactionAbortCheck](#)

Version (or later)	NDB 7.5.0
Type or units	milliseconds
Default	1000
Range	1000 - 4294967039 (0xFFFFFFFF)

Restart Type	<b>Node Restart:</b> Requires a <a href="#">rolling restart</a> of the cluster. (NDB 7.5.0)
--------------	--

Timeout handling is performed by checking a timer on each transaction once for every interval specified by this parameter. Thus, if this parameter is set to 1000 milliseconds, every transaction is checked for timing out once per second.

The default value is 1000 milliseconds (1 second).

- [TransactionInactiveTimeout](#)

Version (or later)	NDB 7.5.0
Type or units	milliseconds
Default	4294967039 (0xFFFFFFFF)
Range	0 - 4294967039 (0xFFFFFFFF)
Restart Type	<b>Node Restart:</b> Requires a <a href="#">rolling restart</a> of the cluster. (NDB 7.5.0)

This parameter states the maximum time that is permitted to lapse between operations in the same transaction before the transaction is aborted.

The default for this parameter is 4G (also the maximum). For a real-time database that needs to ensure that no transaction keeps locks for too long, this parameter should be set to a relatively small value. Setting it to 0 means that the application never times out. The unit is milliseconds.

- [TransactionDeadlockDetectionTimeout](#)

Version (or later)	NDB 7.5.0
Type or units	milliseconds
Default	1200
Range	50 - 4294967039 (0xFFFFFFFF)
Restart Type	<b>Node Restart:</b> Requires a <a href="#">rolling restart</a> of the cluster. (NDB 7.5.0)

When a node executes a query involving a transaction, the node waits for the other nodes in the cluster to respond before continuing. This parameter sets the amount of time that the transaction can spend

executing within a data node, that is, the time that the transaction coordinator waits for each data node participating in the transaction to execute a request.

A failure to respond can occur for any of the following reasons:

- The node is “dead”
- The operation has entered a lock queue
- The node requested to perform the action could be heavily overloaded.

This timeout parameter states how long the transaction coordinator waits for query execution by another node before aborting the transaction, and is important for both node failure handling and deadlock detection.

The default timeout value is 1200 milliseconds (1.2 seconds).

The minimum for this parameter is 50 milliseconds.

- [DiskSyncSize](#)

Version (or later)	NDB 7.5.0
Type or units	bytes
Default	4M
Range	32K - 4294967039 (0xFFFFFFFF)
Restart Type	<b>Node Restart:</b> Requires a <a href="#">rolling restart</a> of the cluster. (NDB 7.5.0)

This is the maximum number of bytes to store before flushing data to a local checkpoint file. This is done to prevent write buffering, which can impede performance significantly. This parameter is *not* intended to take the place of [TimeBetweenLocalCheckpoints](#).



**Note**

When [ODirect](#) is enabled, it is not necessary to set [DiskSyncSize](#); in fact, in such cases its value is simply ignored.

The default value is 4M (4 megabytes).

- [MaxDiskWriteSpeed](#)

Version (or later)	NDB 7.5.0
Type or units	numeric
Default	20M
Range	1M - 1024G
Restart Type	<b>System Restart:</b> Requires a complete

	shutdown and restart of the cluster. (NDB 7.5.0)
--	--

Set the maximum rate for writing to disk, in bytes per second, by local checkpoints and backup operations when no restarts (by this data node or any other data node) are taking place in this NDB Cluster.

For setting the maximum rate of disk writes allowed while this data node is restarting, use [MaxDiskWriteSpeedOwnRestart](#). For setting the maximum rate of disk writes allowed while other data nodes are restarting, use [MaxDiskWriteSpeedOtherNodeRestart](#). The minimum speed for disk writes by all LCPs and backup operations can be adjusted by setting [MinDiskWriteSpeed](#).

- [MaxDiskWriteSpeedOtherNodeRestart](#)

Version (or later)	NDB 7.5.0
Type or units	numeric
Default	50M
Range	1M - 1024G
Restart Type	<b>System Restart:</b> Requires a complete shutdown and restart of the cluster. (NDB 7.5.0)

Set the maximum rate for writing to disk, in bytes per second, by local checkpoints and backup operations when one or more data nodes in this NDB Cluster are restarting, other than this node.

For setting the maximum rate of disk writes allowed while this data node is restarting, use [MaxDiskWriteSpeedOwnRestart](#). For setting the maximum rate of disk writes allowed when no data nodes are restarting anywhere in the cluster, use [MaxDiskWriteSpeed](#). The minimum speed for disk writes by all LCPs and backup operations can be adjusted by setting [MinDiskWriteSpeed](#).

- [MaxDiskWriteSpeedOwnRestart](#)

Version (or later)	NDB 7.5.0
Type or units	numeric
Default	200M
Range	1M - 1024G
Restart Type	<b>System Restart:</b> Requires a complete shutdown and restart of the



	cluster. (NDB 7.5.0)
--	----------------------

Set the maximum rate for writing to disk, in bytes per second, by local checkpoints and backup operations while this data node is restarting.

For setting the maximum rate of disk writes allowed while other data nodes are restarting, use [MaxDiskWriteSpeedOtherNodeRestart](#). For setting the maximum rate of disk writes allowed when no data nodes are restarting anywhere in the cluster, use [MaxDiskWriteSpeed](#). The minimum speed for disk writes by all LCPs and backup operations can be adjusted by setting [MinDiskWriteSpeed](#).

- [MinDiskWriteSpeed](#)

Version (or later)	NDB 7.5.0
Type or units	numeric
Default	10M
Range	1M - 1024G
Restart Type	<b>System Restart:</b> Requires a complete shutdown and restart of the cluster. (NDB 7.5.0)

Set the minimum rate for writing to disk, in bytes per second, by local checkpoints and backup operations.

The maximum rates of disk writes allowed for LCPs and backups under various conditions are adjustable using the parameters [MaxDiskWriteSpeed](#), [MaxDiskWriteSpeedOwnRestart](#), and [MaxDiskWriteSpeedOtherNodeRestart](#). See the descriptions of these parameters for more information.

- [ApiFailureHandlingTimeout](#)

Version (or later)	NDB 7.6.34
Type or units	seconds
Default	600
Range	0 - 4294967039 (0xFFFFFFFF)
Added	NDB 7.6.34
Restart Type	

Specifies the maximum time (in seconds) that the data node waits for API node failure handling to complete before escalating it to data node failure handling.

Added in NDB 7.6.34.

- [ArbitrationTimeout](#)

Version (or later)	NDB 7.5.0
--------------------	-----------

Type or units	milliseconds
Default	7500
Range	10 - 4294967039 (0xFFFFFFFF)
Restart Type	<b>Node Restart:</b> Requires a <a href="#">rolling restart</a> of the cluster. (NDB 7.5.0)

This parameter specifies how long data nodes wait for a response from the arbitrator to an arbitration message. If this is exceeded, the network is assumed to have split.

The default value is 7500 milliseconds (7.5 seconds).

- [Arbitration](#)

Version (or later)	NDB 7.5.0
Type or units	enumeration
Default	Default
Range	Default, Disabled, WaitExternal
Restart Type	<b>Node Restart:</b> Requires a <a href="#">rolling restart</a> of the cluster. (NDB 7.5.0)

The [Arbitration](#) parameter enables a choice of arbitration schemes, corresponding to one of 3 possible values for this parameter:

- **Default.** This enables arbitration to proceed normally, as determined by the [ArbitrationRank](#) settings for the management and API nodes. This is the default value.
- **Disabled.** Setting [Arbitration = Disabled](#) in the `[ndbd default]` section of the `config.ini` file to accomplish the same task as setting [ArbitrationRank](#) to 0 on all management and API nodes. When [Arbitration](#) is set in this way, any [ArbitrationRank](#) settings are ignored.
- **WaitExternal.** The [Arbitration](#) parameter also makes it possible to configure arbitration in such a way that the cluster waits until after the time determined by [ArbitrationTimeout](#) has passed for an external cluster manager application to perform arbitration instead of handling arbitration internally. This can be done by setting [Arbitration = WaitExternal](#) in the `[ndbd default]` section of the `config.ini` file. For best results with the [WaitExternal](#) setting, it is recommended that

`ArbitrationTimeout` be 2 times as long as the interval required by the external cluster manager to perform arbitration.



**Important**

This parameter should be used only in the `[ndbd default]` section of the cluster configuration file. The behavior of the cluster is unspecified when `Arbitration` is set to different values for individual data nodes.

- `RestartSubscriberConnectTimeout`

Version (or later)	NDB 7.5.0
Type or units	ms
Default	12000
Range	0 - 4294967039 (0xFFFFFFFF)
Restart Type	<b>Node Restart:</b> Requires a <a href="#">rolling restart</a> of the cluster. (NDB 7.5.0)

This parameter determines the time that a data node waits for subscribing API nodes to connect. Once this timeout expires, any “missing” API nodes are disconnected from the cluster. To disable this timeout, set `RestartSubscriberConnectTimeout` to 0.

While this parameter is specified in milliseconds, the timeout itself is resolved to the next-greatest whole second.

The heartbeat interval between management nodes and data nodes is always 100 milliseconds, and is not configurable.

**Buffering and logging.** Several `[ndbd]` configuration parameters enable the advanced user to have more control over the resources used by node processes and to adjust various buffer sizes at need.

These buffers are used as front ends to the file system when writing log records to disk. If the node is running in diskless mode, these parameters can be set to their minimum values without penalty due to the fact that disk writes are “faked” by the NDB storage engine’s file system abstraction layer.

- `UndoIndexBuffer`

Version (or later)	NDB 7.5.0
Type or units	unsigned
Default	2M
Range	1M - 4294967039 (0xFFFFFFFF)
Deprecated	Yes (in NDB 8.0)
Restart Type	<b>Node Restart:</b> Requires a <a href="#">rolling restart</a> of

	the cluster. (NDB 7.5.0)
--	--------------------------

This parameter formerly set the size of the undo index buffer, but has no effect in current versions of NDB Cluster.

- [UndoDataBuffer](#)

Version (or later)	NDB 7.5.0
Type or units	unsigned
Default	16M
Range	1M - 4294967039 (0xFFFFFFFF)
Deprecated	Yes (in NDB 8.0)
Restart Type	<b>Node Restart:</b> Requires a <a href="#">rolling restart</a> of the cluster. (NDB 7.5.0)

This parameter formerly set the size of the undo data buffer, but has no effect in current versions of NDB Cluster.

- [RedoBuffer](#)

Version (or later)	NDB 7.5.0
Type or units	bytes
Default	32M
Range	1M - 4294967039 (0xFFFFFFFF)
Restart Type	<b>Node Restart:</b> Requires a <a href="#">rolling restart</a> of the cluster. (NDB 7.5.0)

All update activities also need to be logged. The REDO log makes it possible to replay these updates whenever the system is restarted. The NDB recovery algorithm uses a “fuzzy” checkpoint of the

data together with the UNDO log, and then applies the REDO log to play back all changes up to the restoration point.

`RedoBuffer` sets the size of the buffer in which the REDO log is written. The default value is 32MB; the minimum value is 1MB.

If this buffer is too small, the NDB storage engine issues error code 1221 (`REDO log buffers overloaded`). For this reason, you should exercise care if you attempt to decrease the value of `RedoBuffer` as part of an online change in the cluster's configuration.

`ndbmt_d` allocates a separate buffer for each LDM thread (see `ThreadConfig`). For example, with 4 LDM threads, an `ndbmt_d` data node actually has 4 buffers and allocates `RedoBuffer` bytes to each one, for a total of  $4 * \text{RedoBuffer}$  bytes.

- `EventLogBufferSize`

Version (or later)	NDB 7.5.0
Type or units	bytes
Default	8192
Range	0 - 64K
Restart Type	<b>System Restart:</b> Requires a complete shutdown and restart of the cluster. (NDB 7.5.0)

Controls the size of the circular buffer used for NDB log events within data nodes.

**Controlling log messages.** In managing the cluster, it is very important to be able to control the number of log messages sent for various event types to `stdout`. For each event category, there are 16 possible event levels (numbered 0 through 15). Setting event reporting for a given event category to level 15 means all event reports in that category are sent to `stdout`; setting it to 0 means that there are no event reports made in that category.

By default, only the startup message is sent to `stdout`, with the remaining event reporting level defaults being set to 0. The reason for this is that these messages are also sent to the management server's cluster log.

An analogous set of levels can be set for the management client to determine which event levels to record in the cluster log.

- `LogLevelStartup`

Version (or later)	NDB 7.5.0
Type or units	integer
Default	1
Range	0 - 15
Restart Type	<b>Node Restart:</b> Requires a <a href="#">rolling restart</a> of

	the cluster. (NDB 7.5.0)
--	--------------------------

The reporting level for events generated during startup of the process.

The default level is 1.

- [LogLevelShutdown](#)

Version (or later)	NDB 7.5.0
Type or units	integer
Default	0
Range	0 - 15
Restart Type	<b>Node Restart:</b> Requires a <a href="#">rolling restart</a> of the cluster. (NDB 7.5.0)

The reporting level for events generated as part of graceful shutdown of a node.

The default level is 0.

- [LogLevelStatistic](#)

Version (or later)	NDB 7.5.0
Type or units	integer
Default	0
Range	0 - 15
Restart Type	<b>Node Restart:</b> Requires a <a href="#">rolling restart</a> of the cluster. (NDB 7.5.0)

The reporting level for statistical events such as number of primary key reads, number of updates, number of inserts, information relating to buffer usage, and so on.

The default level is 0.

- [LogLevelCheckpoint](#)

Version (or later)	NDB 7.5.0
Type or units	log level
Default	0
Range	0 - 15
Restart Type	<b>Node Restart:</b> Requires a <a href="#">rolling restart</a> of

	the cluster. (NDB 7.5.0)
--	--------------------------

The reporting level for events generated by local and global checkpoints.

The default level is 0.

- [LogLevelNodeRestart](#)

Version (or later)	NDB 7.5.0
Type or units	integer
Default	0
Range	0 - 15
Restart Type	<b>Node Restart:</b> Requires a <a href="#">rolling restart</a> of the cluster. (NDB 7.5.0)

The reporting level for events generated during node restart.

The default level is 0.

- [LogLevelConnection](#)

Version (or later)	NDB 7.5.0
Type or units	integer
Default	0
Range	0 - 15
Restart Type	<b>Node Restart:</b> Requires a <a href="#">rolling restart</a> of the cluster. (NDB 7.5.0)

The reporting level for events generated by connections between cluster nodes.

The default level is 0.

- [LogLevelError](#)

Version (or later)	NDB 7.5.0
Type or units	integer
Default	0
Range	0 - 15
Restart Type	<b>Node Restart:</b> Requires a <a href="#">rolling restart</a> of

	the cluster. (NDB 7.5.0)
--	--------------------------

The reporting level for events generated by errors and warnings by the cluster as a whole. These errors do not cause any node failure but are still considered worth reporting.

The default level is 0.

- [LogLevelCongestion](#)

Version (or later)	NDB 7.5.0
Type or units	level
Default	0
Range	0 - 15
Restart Type	<b>Node Restart:</b> Requires a <a href="#">rolling restart</a> of the cluster. (NDB 7.5.0)

The reporting level for events generated by congestion. These errors do not cause node failure but are still considered worth reporting.

The default level is 0.

- [LogLevelInfo](#)

Version (or later)	NDB 7.5.0
Type or units	integer
Default	0
Range	0 - 15
Restart Type	<b>Node Restart:</b> Requires a <a href="#">rolling restart</a> of the cluster. (NDB 7.5.0)

The reporting level for events generated for information about the general state of the cluster.

The default level is 0.

- [MemReportFrequency](#)

Version (or later)	NDB 7.5.0
Type or units	unsigned
Default	0
Range	0 - 4294967039 (0xFFFFFFFF)
Restart Type	<b>Node Restart:</b> Requires a



	<a href="#">rolling restart</a> of the cluster. (NDB 7.5.0)
--	---

This parameter controls how often data node memory usage reports are recorded in the cluster log; it is an integer value representing the number of seconds between reports.

Each data node's data memory and index memory usage is logged as both a percentage and a number of 32 KB pages of the `DataMemory` and (NDB 7.5 and earlier) `IndexMemory`, respectively, set in the `config.ini` file. For example, if `DataMemory` is equal to 100 MB, and a given data node is using 50 MB for data memory storage, the corresponding line in the cluster log might look like this:

```
2006-12-24 01:18:16 [MgmSrvr] INFO -- Node 2: Data usage is 50%(1280 32K pages of total 2560)
```

`MemReportFrequency` is not a required parameter. If used, it can be set for all cluster data nodes in the `[ndbd default]` section of `config.ini`, and can also be set or overridden for individual data nodes in the corresponding `[ndbd]` sections of the configuration file. The minimum value—which is also the default value—is 0, in which case memory reports are logged only when memory usage reaches certain percentages (80%, 90%, and 100%), as mentioned in the discussion of statistics events in [Section 21.6.3.2, “NDB Cluster Log Events”](#).

- [StartupStatusReportFrequency](#)

Version (or later)	NDB 7.5.0
Type or units	seconds
Default	0
Range	0 - 4294967039 (0xFFFFFFFF)
Restart Type	<b>Node Restart:</b> Requires a <a href="#">rolling restart</a> of the cluster. (NDB 7.5.0)

When a data node is started with the `--initial`, it initializes the redo log file during Start Phase 4 (see [Section 21.6.4, “Summary of NDB Cluster Start Phases”](#)). When very large values are set for `NoOfFragmentLogFiles`, `FragmentLogFileSize`, or both, this initialization can take a long time. You can force reports on the progress of this process to be logged periodically, by means of the `StartupStatusReportFrequency` configuration parameter. In this case, progress is reported in the cluster log, in terms of both the number of files and the amount of space that have been initialized, as shown here:

```
2009-06-20 16:39:23 [MgmSrvr] INFO -- Node 1: Local redo log file initialization status:
#Total files: 80, Completed: 60
#Total MBytes: 20480, Completed: 15557
2009-06-20 16:39:23 [MgmSrvr] INFO -- Node 2: Local redo log file initialization status:
#Total files: 80, Completed: 60
#Total MBytes: 20480, Completed: 15570
```

These reports are logged each `StartupStatusReportFrequency` seconds during Start Phase 4. If `StartupStatusReportFrequency` is 0 (the default), then reports are written to the cluster log only when at the beginning and at the completion of the redo log file initialization process.

## Data Node Debugging Parameters

The following parameters are intended for use during testing or debugging of data nodes, and not for use in production.

- [DictTrace](#)

Version (or later)	NDB 7.5.0
Type or units	bytes
Default	undefined
Range	0 - 100
Restart Type	<b>Node Restart:</b> Requires a <a href="#">rolling restart</a> of the cluster. (NDB 7.5.0)

It is possible to cause logging of traces for events generated by creating and dropping tables using [DictTrace](#). This parameter is useful only in debugging NDB kernel code. [DictTrace](#) takes an integer value. 0 disables logging; 1 enables it; setting this parameter to 2 enables logging of additional [DBDICT](#) debugging output (Bug #20368450).

- [WatchDogImmediateKill](#)

Version (or later)	NDB 7.6.7
Type or units	boolean
Default	false
Range	true, false
Added	NDB 7.6.7
Restart Type	<b>Node Restart:</b> Requires a <a href="#">rolling restart</a> of the cluster. (NDB 7.5.0)

In NDB 7.6.7 and later, you can cause threads to be killed immediately whenever watchdog issues occur by enabling the [WatchDogImmediateKill](#) data node configuration parameter. This parameter should be used only when debugging or troubleshooting, to obtain trace files reporting exactly what was occurring the instant that execution ceased.

**Backup parameters.** The `[ndbd]` parameters discussed in this section define memory buffers set aside for execution of online backups.

- [BackupDataBufferSize](#)

Version (or later)	NDB 7.5.0
Type or units	bytes
Default	16M

Range	2M - 4294967039 (0xFFFFFFFF)
Version (or later)	NDB 7.5.1
Type or units	bytes
Default	16M
Range	512K - 4294967039 (0xFFFFFFFF)
Deprecated	NDB 7.6.4
Restart Type	<b>Node Restart:</b> Requires a <a href="#">rolling restart</a> of the cluster. (NDB 7.5.0)

In creating a backup, there are two buffers used for sending data to the disk. The backup data buffer is used to fill in data recorded by scanning a node's tables. Once this buffer has been filled to the level specified as [BackupWriteSize](#), the pages are sent to disk. While flushing data to disk, the backup process can continue filling this buffer until it runs out of space. When this happens, the backup process pauses the scan and waits until some disk writes have completed freeing up memory so that scanning may continue.

- [BackupDiskWriteSpeedPct](#)

Version (or later)	NDB 7.5.0
Type or units	percent
Default	50
Range	0 - 90
Restart Type	<b>Node Restart:</b> Requires a <a href="#">rolling restart</a> of the cluster. (NDB 7.5.0)

During normal operation, data nodes attempt to maximize the disk write speed used for local checkpoints and backups while remaining within the bounds set by [MinDiskWriteSpeed](#) and [MaxDiskWriteSpeed](#). Disk write throttling gives each LDM thread an equal share of the total budget. This allows parallel LCPs to take place without exceeding the disk I/O budget. Because a backup is executed by only one LDM thread, this effectively caused a budget cut, resulting in longer backup completion times, and—if the rate of change is sufficiently high—in failure to complete the backup when the backup log buffer fill rate is higher than the achievable write rate.

This problem can be addressed by using the [BackupDiskWriteSpeedPct](#) configuration parameter, which takes a value in the range 0-90 (inclusive) which is interpreted as the percentage of the node's maximum write rate budget that is reserved prior to sharing out the remainder of the budget among LDM threads for LCPs. The LDM thread running the backup receives the whole write rate budget for the

backup, plus its (reduced) share of the write rate budget for local checkpoints. (This makes the disk write rate budget behave similarly to how it was handled in NDB Cluster 7.3 and earlier.)

The default value for this parameter is 50 (interpreted as 50%).

- [BackupLogBufferSize](#)

Version (or later)	NDB 7.5.0
Type or units	bytes
Default	16M
Range	2M - 4294967039 (0xFFFFFFFF)
Restart Type	<b>Node Restart:</b> Requires a <a href="#">rolling restart</a> of the cluster. (NDB 7.5.0)

The backup log buffer fulfills a role similar to that played by the backup data buffer, except that it is used for generating a log of all table writes made during execution of the backup. The same principles apply for writing these pages as with the backup data buffer, except that when there is no more space in the backup log buffer, the backup fails. For that reason, the size of the backup log buffer must be large enough to handle the load caused by write activities while the backup is being made. See [Section 21.6.8.3, "Configuration for NDB Cluster Backups"](#).

The default value for this parameter should be sufficient for most applications. In fact, it is more likely for a backup failure to be caused by insufficient disk write speed than it is for the backup log buffer to become full. If the disk subsystem is not configured for the write load caused by applications, the cluster is unlikely to be able to perform the desired operations.

It is preferable to configure cluster nodes in such a manner that the processor becomes the bottleneck rather than the disks or the network connections.

The default value for this parameter is 16MB.

- [BackupMemory](#)

Version (or later)	NDB 7.5.0
Type or units	bytes
Default	32M
Range	0 - 4294967039 (0xFFFFFFFF)
Deprecated	Yes (in NDB 7.4)
Restart Type	<b>Node Restart:</b> Requires a <a href="#">rolling restart</a> of

	the cluster. (NDB 7.5.0)
--	--------------------------

This parameter is deprecated, and subject to removal in a future version of NDB Cluster. Any setting made for it is ignored.

- [BackupReportFrequency](#)

Version (or later)	NDB 7.5.0
Type or units	seconds
Default	0
Range	0 - 4294967039 (0xFFFFFFFF)
Restart Type	<b>Node Restart:</b> Requires a <a href="#">rolling restart</a> of the cluster. (NDB 7.5.0)

This parameter controls how often backup status reports are issued in the management client during a backup, as well as how often such reports are written to the cluster log (provided cluster event logging is configured to permit it—see [Logging and checkpointing](#)). [BackupReportFrequency](#) represents the time in seconds between backup status reports.

The default value is 0.

- [BackupWriteSize](#)

Version (or later)	NDB 7.5.0
Type or units	bytes
Default	256K
Range	32K - 4294967039 (0xFFFFFFFF)
Deprecated	NDB 7.6.4
Restart Type	<b>Node Restart:</b> Requires a <a href="#">rolling restart</a> of the cluster. (NDB 7.5.0)

This parameter specifies the default size of messages written to disk by the backup log and backup data buffers.

The default value for this parameter is 256KB.

- [BackupMaxWriteSize](#)

Version (or later)	NDB 7.5.0
Type or units	bytes

Default	1M
Range	256K - 4294967039 (0xFFFFFFFF)
Deprecated	NDB 7.6.4
Restart Type	<b>Node Restart:</b> Requires a <a href="#">rolling restart</a> of the cluster. (NDB 7.5.0)

This parameter specifies the maximum size of messages written to disk by the backup log and backup data buffers.

The default value for this parameter is 1MB.

- [CompressedBackup](#)

Version (or later)	NDB 7.5.0
Type or units	boolean
Default	false
Range	true, false
Restart Type	<b>Node Restart:</b> Requires a <a href="#">rolling restart</a> of the cluster. (NDB 7.5.0)

Enabling this parameter causes backup files to be compressed. The compression used is equivalent to `gzip --fast`, and can save 50% or more of the space required on the data node to store uncompressed backup files. Compressed backups can be enabled for individual data nodes, or for all data nodes (by setting this parameter in the `[ndbd default]` section of the `config.ini` file).



### Important

You cannot restore a compressed backup to a cluster running a MySQL version that does not support this feature.

The default value is 0 (disabled).



### Note

The location of the backup files is determined by the `BackupDataDir` data node configuration parameter.

**Additional requirements.** When specifying these parameters, the following relationships must hold true. Otherwise, the data node cannot start.

- `BackupDataBufferSize >= BackupWriteSize + 188KB`
- `BackupLogBufferSize >= BackupWriteSize + 16KB`
- `BackupMaxWriteSize >= BackupWriteSize`

## NDB Cluster Realtime Performance Parameters

The `[ndbd]` parameters discussed in this section are used in scheduling and locking of threads to specific CPUs on multiprocessor data node hosts.



### Note

To make use of these parameters, the data node process must be run as system root.

- [BuildIndexThreads](#)

Version (or later)	NDB 7.5.0
Type or units	numeric
Default	0
Range	0 - 128
Version (or later)	NDB 7.6.4
Type or units	numeric
Default	128
Range	0 - 128
Restart Type	<b>Node Restart:</b> Requires a <a href="#">rolling restart</a> of the cluster. (NDB 7.5.0)

This parameter determines the number of threads to create when rebuilding ordered indexes during a system or node start, as well as when running `ndb_restore --rebuild-indexes`. It is supported only when there is more than one fragment for the table per data node (for example, when `COMMENT="NDB_TABLE=PARTITION_BALANCE=FOR_RA_BY_LDM_X_2"` is used with `CREATE TABLE`).

Setting this parameter to 0 (the default) disables multithreaded building of ordered indexes.

This parameter is supported when using `ndbd` or `ndbmt.d`.

You can enable multithreaded builds during data node initial restarts by setting the `TwoPassInitialNodeRestartCopy` data node configuration parameter to `TRUE`.

- [LockExecuteThreadToCPU](#)

Version (or later)	NDB 7.5.0
Type or units	set of CPU IDs
Default	0
Range	...
Restart Type	<b>Node Restart:</b> Requires a <a href="#">rolling restart</a> of the cluster. (NDB 7.5.0)

When used with `ndbd`, this parameter (now a string) specifies the ID of the CPU assigned to handle the `NDBCLUSTER` execution thread. When used with `ndbmt.d`, the value of this parameter is a comma-separated list of CPU IDs assigned to handle execution threads. Each CPU ID in the list should be an integer in the range 0 to 65535 (inclusive).

The number of IDs specified should match the number of execution threads determined by `MaxNoOfExecutionThreads`. However, there is no guarantee that threads are assigned to CPUs in any given order when using this parameter. You can obtain more finely-grained control of this type using `ThreadConfig`.

`LockExecuteThreadToCPU` has no default value.

- `LockMaintThreadsToCPU`

Version (or later)	NDB 7.5.0
Type or units	CPU ID
Default	0
Range	0 - 64K
Restart Type	<b>Node Restart:</b> Requires a <a href="#">rolling restart</a> of the cluster. (NDB 7.5.0)

This parameter specifies the ID of the CPU assigned to handle `NDBCLUSTER` maintenance threads.

The value of this parameter is an integer in the range 0 to 65535 (inclusive). *There is no default value.*

- `Numa`

Version (or later)	NDB 7.5.0
Type or units	numeric
Default	1
Range	...
Restart Type	<b>Node Restart:</b> Requires a <a href="#">rolling restart</a> of the cluster. (NDB 7.5.0)

This parameter determines whether Non-Uniform Memory Access (NUMA) is controlled by the operating system or by the data node process, whether the data node uses `ndbd` or `ndbmt.d`. By default, `NDB` attempts to use an interleaved NUMA memory allocation policy on any data node where the host operating system provides NUMA support.

Setting `Numa = 0` means that the datanode process does not itself attempt to set a policy for memory allocation, and permits this behavior to be determined by the operating system, which may be further guided by the separate `numactl` tool. That is, `Numa = 0` yields the system default behavior, which can be customised by `numactl`. For many Linux systems, the system default behavior is to allocate socket-local memory to any given process at allocation time. This can be problematic when using `ndbmt.d`; this



is because `nbdmtd` allocates all memory at startup, leading to an imbalance, giving different access speeds for different sockets, especially when locking pages in main memory.

Setting `Numa = 1` means that the data node process uses `libnuma` to request interleaved memory allocation. (This can also be accomplished manually, on the operating system level, using `numactl`.) Using interleaved allocation in effect tells the data node process to ignore non-uniform memory access but does not attempt to take any advantage of fast local memory; instead, the data node process tries to avoid imbalances due to slow remote memory. If interleaved allocation is not desired, set `Numa` to 0 so that the desired behavior can be determined on the operating system level.

The `Numa` configuration parameter is supported only on Linux systems where `libnuma.so` is available.

- `RealtimeScheduler`

Version (or later)	NDB 7.5.0
Type or units	boolean
Default	false
Range	true, false
Restart Type	<b>Node Restart:</b> Requires a <a href="#">rolling restart</a> of the cluster. (NDB 7.5.0)

Setting this parameter to 1 enables real-time scheduling of data node threads.

The default is 0 (scheduling disabled).

- `SchedulerExecutionTimer`

Version (or later)	NDB 7.5.0
Type or units	µs
Default	50
Range	0 - 11000
Restart Type	<b>Node Restart:</b> Requires a <a href="#">rolling restart</a> of the cluster. (NDB 7.5.0)

This parameter specifies the time in microseconds for threads to be executed in the scheduler before being sent. Setting it to 0 minimizes the response time; to achieve higher throughput, you can increase the value at the expense of longer response times.

The default is 50 µsec, which our testing shows to increase throughput slightly in high-load cases without materially delaying requests.

- `SchedulerResponsiveness`

Version (or later)	NDB 7.5.0
Type or units	integer

Default	5
Range	0 - 10
Restart Type	<b>Node Restart:</b> Requires a <a href="#">rolling restart</a> of the cluster. (NDB 7.5.0)

Set the balance in the NDB scheduler between speed and throughput. This parameter takes an integer whose value is in the range 0-10 inclusive, with 5 as the default. Higher values provide better response times relative to throughput. Lower values provide increased throughput at the expense of longer response times.

- [SchedulerSpinTimer](#)

Version (or later)	NDB 7.5.0
Type or units	µs
Default	0
Range	0 - 500
Restart Type	<b>Node Restart:</b> Requires a <a href="#">rolling restart</a> of the cluster. (NDB 7.5.0)

This parameter specifies the time in microseconds for threads to be executed in the scheduler before sleeping.

The default value is 0.

- [TwoPassInitialNodeRestartCopy](#)

Version (or later)	NDB 7.5.0
Type or units	boolean
Default	false
Range	true, false
Version (or later)	NDB 7.6.4
Type or units	boolean
Default	true
Range	true, false
Restart Type	<b>Node Restart:</b> Requires a <a href="#">rolling restart</a> of the cluster. (NDB 7.5.0)

Multithreaded building of ordered indexes can be enabled for initial restarts of data nodes by setting this configuration parameter to `true`, which enables two-pass copying of data during initial node restarts. In NDB 7.6, this is the default value (Bug #26704312, Bug #27109117).

You must also set `BuildIndexThreads` to a nonzero value.

**Multi-Threading Configuration Parameters (ndbmt).** `ndbmt` runs by default as a single-threaded process and must be configured to use multiple threads, using either of two methods, both of which require setting configuration parameters in the `config.ini` file. The first method is simply to set an appropriate value for the `MaxNoOfExecutionThreads` configuration parameter. A second method makes it possible to set up more complex rules for `ndbmt` multithreading using `ThreadConfig`. The next few paragraphs provide information about these parameters and their use with multithreaded data nodes.

- `MaxNoOfExecutionThreads`

Version (or later)	NDB 7.5.0
Type or units	integer
Default	2
Range	2 - 72
Restart Type	<p><b>Initial System Restart:</b> Requires a complete shutdown of the cluster, wiping and restoring the cluster file system from a <a href="#">backup</a>, and then restarting the cluster. (NDB 7.5.0)</p> <p><b>System Restart:</b> Requires a complete shutdown and restart of the cluster. (NDB 7.6.1)</p>

This parameter directly controls the number of execution threads used by `ndbmt`, up to a maximum of 72. Although this parameter is set in `[ndbd]` or `[ndbd default]` sections of the `config.ini` file, it is exclusive to `ndbmt` and does not apply to `ndbd`.

Setting `MaxNoOfExecutionThreads` sets the number of threads for each type as determined by a matrix in the file `storage/ndb/src/kernel/vm/mt_thr_config.cpp`. This table shows these numbers of threads for possible values of `MaxNoOfExecutionThreads`.

**Table 21.11** `MaxNoOfExecutionThreads` values and the corresponding number of threads by thread type (LQH, TC, Send, Receive).

<code>MaxNoOfExecutionThreads</code> Value	LDM Threads	TC Threads	Send Threads	Receive Threads
0 .. 3	1	0	0	1
4 .. 6	2	0	0	1

NDB Cluster Configuration Files

MaxNoOfExecutionThreads Value	DM Threads	TC Threads	Send Threads	Receive Threads
7 .. 8	4	0	0	1
9	4	2	0	1
10	4	2	1	1
11	4	3	1	1
12	6	2	1	1
13	6	3	1	1
14	6	3	1	2
15	6	3	2	2
16	8	3	1	2
17	8	4	1	2
18	8	4	2	2
19	8	5	2	2
20	10	4	2	2
21	10	5	2	2
22	10	5	2	3
23	10	6	2	3
24	12	5	2	3
25	12	6	2	3
26	12	6	3	3
27	12	7	3	3
28	12	7	3	4
29	12	8	3	4
30	12	8	4	4
31	12	9	4	4
32	16	8	3	3
33	16	8	3	4
34	16	8	4	4
35	16	9	4	4
36	16	10	4	4
37	16	10	4	5
38	16	11	4	5
39	16	11	5	5
40	20	10	4	4
41	20	10	4	5
42	20	11	4	5
43	20	11	5	5
44	20	12	5	5

MaxNoOfExecutionThreads Value	LDM Threads	TC Threads	Send Threads	Receive Threads
45	20	12	5	6
46	20	13	5	6
47	20	13	6	6
48	24	12	5	5
49	24	12	5	6
50	24	13	5	6
51	24	13	6	6
52	24	14	6	6
53	24	14	6	7
54	24	15	6	7
55	24	15	7	7
56	24	16	7	7
57	24	16	7	8
58	24	17	7	8
59	24	17	8	8
60	24	18	8	8
61	24	18	8	9
62	24	19	8	9
63	24	19	9	9
64	32	16	7	7
65	32	16	7	8
66	32	17	7	8
67	32	17	8	8
68	32	18	8	8
69	32	18	8	9
70	32	19	8	9
71	32	20	8	9
72	32	20	8	10

There is always one SUMA (replication) thread.

`NoOfFragmentLogParts` should be set equal to the number of LDM threads used by `ndbmt.d`, as determined by the setting for this parameter. This ratio should not be any greater than 4:1; beginning with NDB 7.5.7, a configuration in which this is the case is specifically disallowed. (Bug #25333414)

The number of LDM threads also determines the number of partitions used by an NDB table that is not explicitly partitioned; this is the number of LDM threads times the number of data nodes in the cluster. (If `ndbd` is used on the data nodes rather than `ndbmt.d`, then there is always a single LDM thread; in this case, the number of partitions created automatically is simply equal to the number of data nodes.

See [Section 21.2.2, “NDB Cluster Nodes, Node Groups, Fragment Replicas, and Partitions”](#), for more information.

Adding large tablespaces for Disk Data tables when using more than the default number of LDM threads may cause issues with resource and CPU usage if the disk page buffer is insufficiently large; see the description of the [DiskPageBufferMemory](#) configuration parameter, for more information.

The thread types are described later in this section (see [ThreadConfig](#)).

Setting this parameter outside the permitted range of values causes the management server to abort on startup with the error `Error line number: Illegal value value for parameter MaxNoOfExecutionThreads`.

For [MaxNoOfExecutionThreads](#), a value of 0 or 1 is rounded up internally by NDB to 2, so that 2 is considered this parameter's default and minimum value.

[MaxNoOfExecutionThreads](#) is generally intended to be set equal to the number of CPU threads available, and to allocate a number of threads of each type suitable to typical workloads. It does not assign particular threads to specified CPUs. For cases where it is desirable to vary from the settings provided, or to bind threads to CPUs, you should use [ThreadConfig](#) instead, which allows you to allocate each thread directly to a desired type, CPU, or both.

The multithreaded data node process always spawns, at a minimum, the threads listed here:

- 1 local query handler (LDM) thread
- 1 receive thread
- 1 subscription manager (SUMA or replication) thread

For a [MaxNoOfExecutionThreads](#) value of 8 or less, no TC threads are created, and TC handling is instead performed by the main thread.

Prior to NDB 7.6, changing the number of LDM threads always requires a system restart, whether it is changed using this parameter or [ThreadConfig](#). In NDB 7.6 and later it is possible to effect the change using a node initial restart (*N*) provided the following conditions are met:

- If, following the change, the number of LDM threads remains the same as before, nothing more than a simple node restart (rolling restart, or *N*) is required to implement the change.
- Otherwise (that is, if the number of LDM threads changes), it is still possible to effect the change using a node initial restart (*N*) provided the following two conditions are met:
  - a. Each LDM thread handles a maximum of 8 fragments, and
  - b. The total number of table fragments is an integer multiple of the number of LDM threads.

Prior to NDB 7.6, if the cluster's [IndexMemory](#) usage is greater than 50%, changing this requires an initial restart of the cluster. (A maximum of 30-35% [IndexMemory](#) usage is recommended in such cases.) Otherwise, resource usage and LDM thread allocation cannot be balanced between nodes, which can result in underutilized and overutilized LDM threads, and ultimately data node failures. In NDB 7.6 and later, an initial restart is *not* required to effect a change in this parameter.

- [MaxSendDelay](#)

Version (or later)	NDB 7.5.0
--------------------	-----------

Type or units	microseconds
Default	0
Range	0 - 11000
Restart Type	<b>Node Restart:</b> Requires a <a href="#">rolling restart</a> of the cluster. (NDB 7.5.0)

This parameter can be used to cause data nodes to wait momentarily before sending data to API nodes; in some circumstances, described in the following paragraphs, this can result in more efficient sending of larger volumes of data and higher overall throughput.

[MaxSendDelay](#) can be useful when there are a great many API nodes at saturation point or close to it, which can result in waves of increasing and decreasing performance. This occurs when the data nodes are able to send results back to the API nodes relatively quickly, with many small packets to process, which can take longer to process per byte compared to large packets, thus slowing down the API nodes; later, the data nodes start sending larger packets again.

To handle this type of scenario, you can set [MaxSendDelay](#) to a nonzero value, which helps to ensure that responses are not sent back to the API nodes so quickly. When this is done, responses are sent immediately when there is no other competing traffic, but when there is, setting [MaxSendDelay](#) causes the data nodes to wait long enough to ensure that they send larger packets. In effect, this introduces an artificial bottleneck into the send process, which can actually improve throughput significantly.

- [NoOfFragmentLogParts](#)

Version (or later)	NDB 7.5.0
Type or units	numeric
Default	4
Range	4, 6, 8, 10, 12, 16, 20, 24, 32
Restart Type	<b>Initial Node Restart:</b> Requires a <a href="#">rolling restart</a> of the cluster; each data node must be restarted with <code>--initial</code> . (NDB 7.5.0)

Set the number of log file groups for redo logs belonging to this `ndbmt.d`. The value of this parameter should be set equal to the number of LDM threads used by `ndbmt.d` as determined by the setting for [MaxNoOfExecutionThreads](#). Beginning with NDB 7.5.7, a configuration using more than 4 redo log parts per LDM is disallowed. (Bug #25333414)

See the description of [MaxNoOfExecutionThreads](#) for more information.

- [ThreadConfig](#)

Version (or later)	NDB 7.5.0
--------------------	-----------

Type or units	string
Default	"
Range	...
Restart Type	<p><b>Initial System Restart:</b> Requires a complete shutdown of the cluster, wiping and restoring the cluster file system from a <a href="#">backup</a>, and then restarting the cluster. (NDB 7.5.0)</p> <p><b>System Restart:</b> Requires a complete shutdown and restart of the cluster. (NDB 7.6.1)</p>

This parameter is used with `ndbmt` to assign threads of different types to different CPUs. Its value is a string whose format has the following syntax:

```
ThreadConfig := entry[,entry[,...]]
entry := type={param[,param[,...]]}
type := ldm | main | rcv | send | rep | io | tc | watchdog | idxbld
param := count=number
| cpubind=cpu_list
| cpuset=cpu_list
| spintime=number
| realtime={0|1}
| nosend={0|1}
| thread_prio={0..10}
| cpubind_exclusive=cpu_list
| cpuset_exclusive=cpu_list
```

The curly braces (`{...}`) surrounding the list of parameters are required, even if there is only one parameter in the list.

A `param` (parameter) specifies any or all of the following information:

- The number of threads of the given type (`count`).
- The set of CPUs to which the threads of the given type are to be nonexclusively bound. This is determined by either one of `cpubind` or `cpuset`). `cpubind` causes each thread to be bound



(nonexclusively) to a CPU in the set; `cpuset` means that each thread is bound (nonexclusively) to the set of CPUs specified.

On Solaris, you can instead specify a set of CPUs to which the threads of the given type are to be bound exclusively. `cpubind_exclusive` causes each thread to be bound exclusively to a CPU in the set; `cpuset_exclusive` means that each thread is bound exclusively to the set of CPUs specified.

Only one of `cpubind`, `cpuset`, `cpubind_exclusive`, or `cpuset_exclusive` can be provided in a single configuration.

- `spintime` determines the wait time in microseconds the thread spins before going to sleep.

The default value for `spintime` is the value of the `SchedulerSpinTimer` data node configuration parameter.

`spintime` does not apply to I/O threads, watchdog, or offline index build threads, and so cannot be set for these thread types.

- `realtime` can be set to 0 or 1. If it is set to 1, the threads run with real-time priority. This also means that `thread_prio` cannot be set.

The `realtime` parameter is set by default to the value of the `RealtimeScheduler` data node configuration parameter.

`realtime` cannot be set for offline index build threads.

- By setting `nosend` to 1, you can prevent a `main`, `ldm`, `rep`, or `tc` thread from assisting the send threads. This parameter is 0 by default, and cannot be used with other types of threads.
- `thread_prio` is a thread priority level that can be set from 0 to 10, with 10 representing the greatest priority. The default is 5. The precise effects of this parameter are platform-specific, and are described later in this section.

The thread priority level cannot be set for offline index build threads.

**thread\_prio settings and effects by platform.** The implementation of `thread_prio` differs between Linux/FreeBSD, Solaris, and Windows. In the following list, we discuss its effects on each of these platforms in turn:

- *Linux and FreeBSD:* We map `thread_prio` to a value to be supplied to the `nice` system call. Since a lower niceness value for a process indicates a higher process priority, increasing `thread_prio` has the effect of lowering the `nice` value.

**Table 21.12 Mapping of thread\_prio to nice values on Linux and FreeBSD**

<code>thread_prio</code> value	<code>nice</code> value
0	19
1	16
2	12
3	8
4	4
5	0
6	-4

<code>thread_prio</code> value	<code>nice</code> value
7	-8
8	-12
9	-16
10	-20

Some operating systems may provide for a maximum process niceness level of 20, but this is not supported by all targeted versions; for this reason, we choose 19 as the maximum `nice` value that can be set.

- *Solaris*: Setting `thread_prio` on Solaris sets the Solaris FX priority, with mappings as shown in the following table:

**Table 21.13 Mapping of `thread_prio` to FX priority on Solaris**

<code>thread_prio</code> value	Solaris FX priority
0	15
1	20
2	25
3	30
4	35
5	40
6	45
7	50
8	55
9	59
10	60

A `thread_prio` setting of 9 is mapped on Solaris to the special FX priority value 59, which means that the operating system also attempts to force the thread to run alone on its own CPU core.

- *Windows*: We map `thread_prio` to a Windows thread priority value passed to the Windows API `SetThreadPriority()` function. This mapping is shown in the following table:

**Table 21.14 Mapping of `thread_prio` to Windows thread priority**

<code>thread_prio</code> value	Windows thread priority
0 - 1	<code>THREAD_PRIORITY_LOWEST</code>
2 - 3	<code>THREAD_PRIORITY_BELOW_NORMAL</code>
4 - 5	<code>THREAD_PRIORITY_NORMAL</code>
6 - 7	<code>THREAD_PRIORITY_ABOVE_NORMAL</code>

<code>thread_prio</code> value	Windows thread priority
8 - 10	THREAD_PRIORITY_HIGHEST

The `type` attribute represents an NDB thread type. The thread types supported, and the range of permitted `count` values for each, are provided in the following list:

- `ldm`: Local query handler (`DBLQH` kernel block) that handles data. The more LDM threads that are used, the more highly partitioned the data becomes. Each LDM thread maintains its own sets of data and index partitions, as well as its own redo log. The value set for `ldm` must be one of the values 1, 2, 4, 6, 8, 12, 16, 24, or 32.

Changing the number of LDM threads normally requires an initial system restart to be effective and safe for cluster operations. This requirement is relaxed in NDB 7.6, as explained later in this section. (This is also true when this is done using `MaxNoOfExecutionThreads`.) *NDB 7.5 and earlier*: If `IndexMemory` usage is in excess of 50%, an initial restart of the cluster is required; a maximum of 30-35% `IndexMemory` usage is recommended in such cases. Otherwise, allocation of memory and LDM threads cannot be balanced between nodes, which can ultimately lead to data node failures.

Adding large tablespaces (hundreds of gigabytes or more) for Disk Data tables when using more than the default number of LDMs may cause issues with resource and CPU usage if `DiskPageBufferMemory` is not sufficiently large.

- `tc`: Transaction coordinator thread (`DBTC` kernel block) containing the state of an ongoing transaction. The maximum number of TC threads is 32.

Optimally, every new transaction can be assigned to a new TC thread. In most cases 1 TC thread per 2 LDM threads is sufficient to guarantee that this can happen. In cases where the number of writes is relatively small when compared to the number of reads, it is possible that only 1 TC thread per 4 LQH threads is required to maintain transaction states. Conversely, in applications that perform a great many updates, it may be necessary for the ratio of TC threads to LDM threads to approach 1 (for example, 3 TC threads to 4 LDM threads).

Setting `tc` to 0 causes TC handling to be done by the main thread. In most cases, this is effectively the same as setting it to 1.

Range: 0 - 32

- `main`: Data dictionary and transaction coordinator (`DBDIH` and `DBTC` kernel blocks), providing schema management. This is always handled by a single dedicated thread.

Range: 1 only.

- `recv`: Receive thread (`CMVMI` kernel block). Each receive thread handles one or more sockets for communicating with other nodes in an NDB Cluster, with one socket per node. NDB Cluster supports multiple receive threads; the maximum is 16 such threads.

Range: 1 - 16

- `send`: Send thread (`CMVMI` kernel block). To increase throughput, it is possible to perform sends from one or more separate, dedicated threads (maximum 8).

Previously, all threads handled their own sending directly; this can still be made to happen by setting the number of send threads to 0 (this also happens when `MaxNoOfExecutionThreads` is set less

than 10). While doing so can have an adverse impact on throughput, it can also in some cases provide decreased latency.

Range: 0 - 16

- `rep`: Replication thread (`SUMA` kernel block). Asynchronous replication operations are always handled by a single, dedicated thread.

Range: 1 only.

- `io`: File system and other miscellaneous operations. These are not demanding tasks, and are always handled as a group by a single, dedicated I/O thread.

Range: 1 only.

- `watchdog`: Parameters settings associated with this type are actually applied to several threads, each having a specific use. These threads include the `SocketServer` thread, which receives connection setups from other nodes; the `SocketClient` thread, which attempts to set up connections to other nodes; and the thread watchdog thread that checks that threads are progressing.

Range: 1 only.

- `idxbld`: Offline index build threads. Unlike the other thread types listed previously, which are permanent, these are temporary threads which are created and used only during node or system restarts, or when running `ndb_restore --rebuild-indexes`. They may be bound to CPU sets which overlap with CPU sets bound to permanent thread types.

`thread_prio`, `realtime`, and `spintime` values cannot be set for offline index build threads. In addition, `count` is ignored for this type of thread.

If `idxbld` is not specified, the default behavior is as follows:

- Offline index build threads are not bound if the I/O thread is also not bound, and these threads use any available cores.
- If the I/O thread is bound, then the offline index build threads are bound to the entire set of bound threads, due to the fact that there should be no other tasks for these threads to perform.

Range: 0 - 1.

This thread type was added in NDB 7.6. (Bug #25835748, Bug #26928111)

Prior to NDB 7.6, changing `ThreadConfig` requires a system initial restart. In NDB 7.6 (and later), this requirement can be relaxed under certain circumstances:

- If, following the change, the number of LDM threads remains the same as before, nothing more than a simple node restart (rolling restart, or *N*) is required to implement the change.

- Otherwise (that is, if the number of LDM threads changes), it is still possible to effect the change using a node initial restart (*NI*) provided the following two conditions are met:
  - a. Each LDM thread handles a maximum of 8 fragments, and
  - b. The total number of table fragments is an integer multiple of the number of LDM threads.

In any other case, a system initial restart is needed to change this parameter.

NDB 7.6 can distinguish between thread types by both of the following criteria:

- Whether the thread is an execution thread. Threads of type `main`, `ldm`, `recv`, `rep`, `tc`, and `send` are execution threads; `io`, `watchdog`, and `idxbld` threads are not considered execution threads.
- Whether the allocation of threads to a given task is permanent or temporary. Currently all thread types except `idxbld` are considered permanent; `idxbld` threads are regarded as temporary threads.

Simple examples:

```
# Example 1.
ThreadConfig=ldm={count=2,cpubind=1,2},main={cpubind=12},rep={cpubind=11}

# Example 2.
Threadconfig=main={cpubind=0},ldm={count=4,cpubind=1,2,5,6},io={cpubind=3}
```

It is usually desirable when configuring thread usage for a data node host to reserve one or more number of CPUs for operating system and other tasks. Thus, for a host machine with 24 CPUs, you might want to use 20 CPU threads (leaving 4 for other uses), with 8 LDM threads, 4 TC threads (half the number of LDM threads), 3 send threads, 3 receive threads, and 1 thread each for schema management, asynchronous replication, and I/O operations. (This is almost the same distribution of threads used when `MaxNoOfExecutionThreads` is set equal to 20.) The following `ThreadConfig` setting performs these assignments, additionally binding all of these threads to specific CPUs:

```
ThreadConfig=ldm{count=8,cpubind=1,2,3,4,5,6,7,8},main={cpubind=9},io={cpubind=9}, \
rep={cpubind=10},tc{count=4,cpubind=11,12,13,14},recv={count=3,cpubind=15,16,17}, \
send{count=3,cpubind=18,19,20}
```

It should be possible in most cases to bind the main (schema management) thread and the I/O thread to the same CPU, as we have done in the example just shown.

The following example incorporates groups of CPUs defined using both `cpuset` and `cpubind`, as well as use of thread prioritization.

```
ThreadConfig=ldm={count=4,cpuset=0-3,thread_prio=8,spintime=200}, \
ldm={count=4,cpubind=4-7,thread_prio=8,spintime=200}, \
tc={count=4,cpuset=8-9,thread_prio=6},send={count=2,thread_prio=10,cpubind=10-11}, \
main={count=1,cpubind=10},rep={count=1,cpubind=11}
```

In this case we create two LDM groups; the first uses `cpubind` and the second uses `cpuset`. `thread_prio` and `spintime` are set to the same values for each group. This means there are eight LDM threads in total. (You should ensure that `NoOfFragmentLogParts` is also set to 8.) The four TC threads use only two CPUs; it is possible when using `cpuset` to specify fewer CPUs than threads in the

group. (This is not true for `cpubind`.) The send threads use two threads using `cpubind` to bind these threads to CPUs 10 and 11. The main and rep threads can reuse these CPUs.

This example shows how `ThreadConfig` and `NoOfFragmentLogParts` might be set up for a 24-CPU host with hyperthreading, leaving CPUs 10, 11, 22, and 23 available for operating system functions and interrupts:

```
NoOfFragmentLogParts=10
ThreadConfig=ldm={count=10,cpubind=0-4,12-16,thread_prio=9,spintime=200}, \
tc={count=4,cpuset=6-7,18-19,thread_prio=8},send={count=1,cpuset=8}, \
recv={count=1,cpuset=20},main={count=1,cpuset=9,21},rep={count=1,cpuset=9,21}, \
io={count=1,cpuset=9,21,thread_prio=8},watchdog={count=1,cpuset=9,21,thread_prio=9}
```

The next few examples include settings for `idxbld`. The first two of these demonstrate how a CPU set defined for `idxbld` can overlap those specified for other (permanent) thread types, the first using `cpuset` and the second using `cpubind`:

```
ThreadConfig=main,ldm={count=4,cpuset=1-4},tc={count=4,cpuset=5,6,7}, \
io={cpubind=8},idxbld={cpuset=1-8}

ThreadConfig=main,ldm={count=1,cpubind=1},idxbld={count=1,cpubind=1}
```

The next example specifies a CPU for the I/O thread, but not for the index build threads:

```
ThreadConfig=main,ldm={count=4,cpuset=1-4},tc={count=4,cpuset=5,6,7}, \
io={cpubind=8}
```

Since the `ThreadConfig` setting just shown locks threads to eight cores numbered 1 through 8, it is equivalent to the setting shown here:

```
ThreadConfig=main,ldm={count=4,cpuset=1-4},tc={count=4,cpuset=5,6,7}, \
io={cpubind=8},idxbld={cpuset=1,2,3,4,5,6,7,8}
```

In order to take advantage of the enhanced stability that the use of `ThreadConfig` offers, it is necessary to insure that CPUs are isolated, and that they not subject to interrupts, or to being scheduled for other tasks by the operating system. On many Linux systems, you can do this by setting `IRQBALANCE_BANNED_CPUS` in `/etc/sysconfig/irqbalance` to `0xFFFFF0`, and by using the `isolcpus` boot option in `grub.conf`. For specific information, see your operating system or platform documentation.

**Disk Data Configuration Parameters.** Configuration parameters affecting Disk Data behavior include the following:

- `DiskPageBufferEntries`

Version (or later)	NDB 7.5.0
Type or units	32K pages
Default	10
Range	1 - 1000
Restart Type	<b>Node Restart:</b> Requires a <a href="#">rolling restart</a> of the cluster. (NDB 7.5.0)

This is the number of page entries (page references) to allocate. It is specified as a number of 32K pages in `DiskPageBufferMemory`. The default is sufficient for most cases but you may need to

increase the value of this parameter if you encounter problems with very large transactions on Disk Data tables. Each page entry requires approximately 100 bytes.

- [DiskPageBufferMemory](#)

Version (or later)	NDB 7.5.0
Type or units	bytes
Default	64M
Range	4M - 1T
Restart Type	<b>Node Restart:</b> Requires a <a href="#">rolling restart</a> of the cluster. (NDB 7.5.0)

This determines the amount of space used for caching pages on disk, and is set in the [\[ndbd\]](#) or [\[ndbd default\]](#) section of the `config.ini` file. It is measured in bytes. Each page takes up 32 KB. This means that NDB Cluster Disk Data storage always uses  $N * 32$  KB memory where  $N$  is some nonnegative integer.

The default value for this parameter is `64M` (2000 pages of 32 KB each).

If the value for [DiskPageBufferMemory](#) is set too low in conjunction with using more than the default number of LDM threads in [ThreadConfig](#) (for example `{ldm=6...}`), problems can arise when trying to add a large (for example 500G) data file to a disk-based NDB table, wherein the process takes indefinitely long while occupying one of the CPU cores.

This is due to the fact that, as part of adding a data file to a tablespace, extent pages are locked into memory in an extra PGMAN worker thread, for quick metadata access. When adding a large file, this worker has insufficient memory for all of the data file metadata. In such cases, you should either increase [DiskPageBufferMemory](#), or add smaller tablespace files. You may also need to adjust [DiskPageBufferEntries](#).

You can query the `ndbinfo.diskpagebuffer` table to help determine whether the value for this parameter should be increased to minimize unnecessary disk seeks. See [Section 21.6.15.20, "The ndbinfo diskpagebuffer Table"](#), for more information.

- [SharedGlobalMemory](#)

Version (or later)	NDB 7.5.0
Type or units	bytes
Default	128M
Range	0 - 64T
Restart Type	<b>Node Restart:</b> Requires a <a href="#">rolling restart</a> of the cluster. (NDB 7.5.0)

This parameter determines the amount of memory that is used for log buffers, disk operations (such as page requests and wait queues), and metadata for tablespaces, log file groups, [UNDO](#) files, and data files. The shared global memory pool also provides memory used for satisfying the memory

requirements of the `UNDO_BUFFER_SIZE` option used with `CREATE LOGFILE GROUP` and `ALTER LOGFILE GROUP` statements, including any default value implied for this options by the setting of the `InitialLogFileGroup` data node configuration parameter. `SharedGlobalMemory` can be set in the `[ndbd]` or `[ndbd default]` section of the `config.ini` configuration file, and is measured in bytes.

The default value is `128M`.

- `DiskIOThreadPool`

Version (or later)	NDB 7.5.0
Type or units	threads
Default	2
Range	0 - 4294967039 (0xFFFFFFFF)
Restart Type	<b>Node Restart:</b> Requires a <a href="#">rolling restart</a> of the cluster. (NDB 7.5.0)

This parameter determines the number of unbound threads used for Disk Data file access. Before `DiskIOThreadPool` was introduced, exactly one thread was spawned for each Disk Data file, which could lead to performance issues, particularly when using very large data files. With `DiskIOThreadPool`, you can—for example—access a single large data file using several threads working in parallel.

This parameter applies to Disk Data I/O threads only.

The optimum value for this parameter depends on your hardware and configuration, and includes these factors:

- **Physical distribution of Disk Data files.** You can obtain better performance by placing data files, undo log files, and the data node file system on separate physical disks. If you do this with some or all of these sets of files, then you can set `DiskIOThreadPool` higher to enable separate threads to handle the files on each disk.
- **Disk performance and types.** The number of threads that can be accommodated for Disk Data file handling is also dependent on the speed and throughput of the disks. Faster disks and higher throughput allow for more disk I/O threads. Our test results indicate that solid-state disk drives can handle many more disk I/O threads than conventional disks, and thus higher values for `DiskIOThreadPool`.

The default value for this parameter is 2.

- **Disk Data file system parameters.** The parameters in the following list make it possible to place NDB Cluster Disk Data files in specific directories without the need for using symbolic links.
- `FileSystemPathDD`

Version (or later)	NDB 7.5.0
Type or units	filename
Default	FileSystemPath



Range	...
Restart Type	<b>Initial Node Restart:</b> Requires a <a href="#">rolling restart</a> of the cluster; each data node must be restarted with <code>--initial</code> . (NDB 7.5.0)

If this parameter is specified, then NDB Cluster Disk Data data files and undo log files are placed in the indicated directory. This can be overridden for data files, undo log files, or both, by specifying values for `FileSystemPathDataFiles`, `FileSystemPathUndoFiles`, or both, as explained for these parameters. It can also be overridden for data files by specifying a path in the `ADD DATAFILE` clause of a `CREATE TABLESPACE` or `ALTER TABLESPACE` statement, and for undo log files by specifying a path in the `ADD UNDOFILE` clause of a `CREATE LOGFILE GROUP` or `ALTER LOGFILE GROUP` statement. If `FileSystemPathDD` is not specified, then `FileSystemPath` is used.

If a `FileSystemPathDD` directory is specified for a given data node (including the case where the parameter is specified in the `[ndbd default]` section of the `config.ini` file), then starting that data node with `--initial` causes all files in the directory to be deleted.

- `FileSystemPathDataFiles`

Version (or later)	NDB 7.5.0
Type or units	filename
Default	<code>FileSystemPathDD</code>
Range	...
Restart Type	<b>Initial Node Restart:</b> Requires a <a href="#">rolling restart</a> of the cluster; each data node must be restarted with <code>--initial</code> . (NDB 7.5.0)

If this parameter is specified, then NDB Cluster Disk Data data files are placed in the indicated directory. This overrides any value set for `FileSystemPathDD`. This parameter can be overridden for a given data file by specifying a path in the `ADD DATAFILE` clause of a `CREATE TABLESPACE` or `ALTER TABLESPACE` statement used to create that data file. If `FileSystemPathDataFiles` is not specified, then `FileSystemPathDD` is used (or `FileSystemPath`, if `FileSystemPathDD` has also not been set).

If a `FileSystemPathDataFiles` directory is specified for a given data node (including the case where the parameter is specified in the `[ndbd default]` section of the `config.ini` file), then starting that data node with `--initial` causes all files in the directory to be deleted.

- [FileSystemPathUndoFiles](#)

Version (or later)	NDB 7.5.0
Type or units	filename
Default	FileSystemPathDD
Range	...
Restart Type	<b>Initial Node Restart:</b> Requires a <a href="#">rolling restart</a> of the cluster; each data node must be restarted with <code>--initial</code> . (NDB 7.5.0)

If this parameter is specified, then NDB Cluster Disk Data undo log files are placed in the indicated directory. This overrides any value set for [FileSystemPathDD](#). This parameter can be overridden for a given data file by specifying a path in the `ADD UNDO` clause of a `CREATE LOGFILE GROUP` or `ALTER LOGFILE GROUP` statement used to create that data file. If [FileSystemPathUndoFiles](#) is not specified, then [FileSystemPathDD](#) is used (or [FileSystemPath](#), if [FileSystemPathDD](#) has also not been set).

If a [FileSystemPathUndoFiles](#) directory is specified for a given data node (including the case where the parameter is specified in the `[ndbd default]` section of the `config.ini` file), then starting that data node with `--initial` causes all files in the directory to be deleted.

For more information, see [Section 21.6.11.1, “NDB Cluster Disk Data Objects”](#).

- **Disk Data object creation parameters.** The next two parameters enable you—when starting the cluster for the first time—to cause a Disk Data log file group, tablespace, or both, to be created without the use of SQL statements.

- [InitialLogFileGroup](#)

Version (or later)	NDB 7.5.0
Type or units	string
Default	[see documentation]
Range	...
Restart Type	<b>System Restart:</b> Requires a complete shutdown and restart of the

	cluster. (NDB 7.5.0)
--	----------------------

This parameter can be used to specify a log file group that is created when performing an initial start of the cluster. `InitialLogFileGroup` is specified as shown here:

```
InitialLogFileGroup = [name=name]; [undo_buffer_size=size]; file-specification-list

file-specification-list:
    file-specification[; file-specification[; ...]]

file-specification:
    filename:size
```

The `name` of the log file group is optional and defaults to `DEFAULT-LG`. The `undo_buffer_size` is also optional; if omitted, it defaults to `64M`. Each `file-specification` corresponds to an undo log file, and at least one must be specified in the `file-specification-list`. Undo log files are placed according to any values that have been set for `FileSystemPath`, `FileSystemPathDD`, and `FileSystemPathUndoFiles`, just as if they had been created as the result of a `CREATE LOGFILE GROUP` or `ALTER LOGFILE GROUP` statement.

Consider the following:

```
InitialLogFileGroup = name=LG1; undo_buffer_size=128M; undo1.log:250M; undo2.log:150M
```

This is equivalent to the following SQL statements:

```
CREATE LOGFILE GROUP LG1
  ADD UNDOFILE 'undo1.log'
  INITIAL_SIZE 250M
  UNDO_BUFFER_SIZE 128M
  ENGINE NDBCLUSTER;

ALTER LOGFILE GROUP LG1
  ADD UNDOFILE 'undo2.log'
  INITIAL_SIZE 150M
  ENGINE NDBCLUSTER;
```

This logfile group is created when the data nodes are started with `--initial`.

Resources for the initial log file group are added to the global memory pool along with those indicated by the value of `SharedGlobalMemory`.

This parameter, if used, should always be set in the `[ndbd default]` section of the `config.ini` file. The behavior of an NDB Cluster when different values are set on different data nodes is not defined.

- `InitialTablespace`

Version (or later)	NDB 7.5.0
Type or units	string
Default	[see documentation]
Range	...
Restart Type	<b>System Restart:</b> Requires a

	complete shutdown and restart of the cluster. (NDB 7.5.0)
--	---

This parameter can be used to specify an NDB Cluster Disk Data tablespace that is created when performing an initial start of the cluster. `InitialTablespace` is specified as shown here:

```
InitialTablespace = [name=name;] [extent_size=size;] file-specification-list
```

The `name` of the tablespace is optional and defaults to `DEFAULT-TS`. The `extent_size` is also optional; it defaults to `1M`. The `file-specification-list` uses the same syntax as shown with the `InitialLogfileGroup` parameter, the only difference being that each `file-specification` used with `InitialTablespace` corresponds to a data file. At least one must be specified in the `file-specification-list`. Data files are placed according to any values that have been set for `FileSystemPath`, `FileSystemPathDD`, and `FileSystemPathDataFiles`, just as if they had been created as the result of a `CREATE TABLESPACE` or `ALTER TABLESPACE` statement.

For example, consider the following line specifying `InitialTablespace` in the `[ndbd default]` section of the `config.ini` file (as with `InitialLogfileGroup`, this parameter should always be set in the `[ndbd default]` section, as the behavior of an NDB Cluster when different values are set on different data nodes is not defined):

```
InitialTablespace = name=TS1; extent_size=8M; data1.dat:2G; data2.dat:4G
```

This is equivalent to the following SQL statements:

```
CREATE TABLESPACE TS1
  ADD DATAFILE 'data1.dat'
  EXTENT_SIZE 8M
  INITIAL_SIZE 2G
  ENGINE NDBCLUSTER;

ALTER TABLESPACE TS1
  ADD DATAFILE 'data2.dat'
  INITIAL_SIZE 4G
  ENGINE NDBCLUSTER;
```

This tablespace is created when the data nodes are started with `--initial`, and can be used whenever creating NDB Cluster Disk Data tables thereafter.

**Disk Data and GCP Stop errors.** Errors encountered when using Disk Data tables such as `Node nodeid killed this node because GCP stop was detected` (error 2303) are often referred to as “GCP stop errors”. Such errors occur when the redo log is not flushed to disk quickly enough; this is usually due to slow disks and insufficient disk throughput.

You can help prevent these errors from occurring by using faster disks, and by placing Disk Data files on a separate disk from the data node file system. Reducing the value of `TimeBetweenGlobalCheckpoints` tends to decrease the amount of data to be written for each global checkpoint, and so may provide some protection against redo log buffer overflows when trying to write a global checkpoint; however, reducing this value also permits less time in which to write the GCP, so this must be done with caution.

In addition to the considerations given for `DiskPageBufferMemory` as explained previously, it is also very important that the `DiskIOThreadPool` configuration parameter be set correctly; having `DiskIOThreadPool` set too high is very likely to cause GCP stop errors (Bug #37227).

GCP stops can be caused by save or commit timeouts; the `TimeBetweenEpochsTimeout` data node configuration parameter determines the timeout for commits. However, it is possible to disable both types of timeouts by setting this parameter to 0.

**Parameters for configuring send buffer memory allocation.** Send buffer memory is allocated dynamically from a memory pool shared between all transporters, which means that the size of the send buffer can be adjusted as necessary. (Previously, the NDB kernel used a fixed-size send buffer for every node in the cluster, which was allocated when the node started and could not be changed while the node was running.) The `TotalSendBufferMemory` and `OverLoadLimit` data node configuration parameters permit the setting of limits on this memory allocation. For more information about the use of these parameters (as well as `SendBufferMemory`), see [Section 21.4.3.13, “Configuring NDB Cluster Send Buffer Parameters”](#).

- `ExtraSendBufferMemory`

This parameter specifies the amount of transporter send buffer memory to allocate in addition to any set using `TotalSendBufferMemory`, `SendBufferMemory`, or both.

- `TotalSendBufferMemory`

This parameter is used to determine the total amount of memory to allocate on this node for shared send buffer memory among all configured transporters.

If this parameter is set, its minimum permitted value is 256KB; 0 indicates that the parameter has not been set. For more detailed information, see [Section 21.4.3.13, “Configuring NDB Cluster Send Buffer Parameters”](#).

See also [Section 21.6.7, “Adding NDB Cluster Data Nodes Online”](#).

**Redo log over-commit handling.** It is possible to control a data node's handling of operations when too much time is taken flushing redo logs to disk. This occurs when a given redo log flush takes longer than `RedoOverCommitLimit` seconds, more than `RedoOverCommitCounter` times, causing any pending transactions to be aborted. When this happens, the API node that sent the transaction can handle the operations that should have been committed either by queuing the operations and re-trying them, or by aborting them, as determined by `DefaultOperationRedoProblemAction`. The data node configuration parameters for setting the timeout and number of times it may be exceeded before the API node takes this action are described in the following list:

- `RedoOverCommitCounter`

Version (or later)	NDB 7.5.0
Type or units	numeric
Default	3
Range	0 - 4294967039 (0xFFFFFFFF)
Version (or later)	NDB 7.5.17
Type or units	numeric
Default	3
Range	1 - 4294967039 (0xFFFFFFFF)
Version (or later)	NDB 7.6.13
Type or units	numeric

Default	3
Range	1 - 4294967039 (0xFFFFFFFF)
Restart Type	<b>Node Restart:</b> Requires a <a href="#">rolling restart</a> of the cluster. (NDB 7.5.0)

When [RedoOverCommitLimit](#) is exceeded when trying to write a given redo log to disk this many times or more, any transactions that were not committed as a result are aborted, and an API node where any of these transactions originated handles the operations making up those transactions according to its value for [DefaultOperationRedoProblemAction](#) (by either queuing the operations to be re-tried, or aborting them).

- [RedoOverCommitLimit](#)

Version (or later)	NDB 7.5.0
Type or units	seconds
Default	20
Range	0 - 4294967039 (0xFFFFFFFF)
Version (or later)	NDB 7.5.17
Type or units	seconds
Default	20
Range	1 - 4294967039 (0xFFFFFFFF)
Version (or later)	NDB 7.6.13
Type or units	seconds
Default	20
Range	1 - 4294967039 (0xFFFFFFFF)
Restart Type	<b>Node Restart:</b> Requires a <a href="#">rolling restart</a> of the cluster. (NDB 7.5.0)

This parameter sets an upper limit in seconds for trying to write a given redo log to disk before timing out. The number of times the data node tries to flush this redo log, but takes longer than [RedoOverCommitLimit](#), is kept and compared with [RedoOverCommitCounter](#), and when flushing takes too long more times than the value of that parameter, any transactions that were not committed as a result of the flush timeout are aborted. When this occurs, the API node where any of these transactions originated handles the operations making up those transactions according to its [DefaultOperationRedoProblemAction](#) setting (it either queues the operations to be re-tried, or aborts them).

**Controlling restart attempts.** It is possible to exercise finely-grained control over restart attempts by data nodes when they fail to start using the `MaxStartFailRetries` and `StartFailRetryDelay` data node configuration parameters.

`MaxStartFailRetries` limits the total number of retries made before giving up on starting the data node, `StartFailRetryDelay` sets the number of seconds between retry attempts. These parameters are listed here:

- `StartFailRetryDelay`

Version (or later)	NDB 7.5.0
Type or units	unsigned
Default	0
Range	0 - 4294967039 (0xFFFFFFFF)
Restart Type	<b>Node Restart:</b> Requires a <a href="#">rolling restart</a> of the cluster. (NDB 7.5.0)

Use this parameter to set the number of seconds between restart attempts by the data node in the event on failure on startup. The default is 0 (no delay).

Both this parameter and `MaxStartFailRetries` are ignored unless `StopOnError` is equal to 0.

- `MaxStartFailRetries`

Version (or later)	NDB 7.5.0
Type or units	unsigned
Default	3
Range	0 - 4294967039 (0xFFFFFFFF)
Restart Type	<b>Node Restart:</b> Requires a <a href="#">rolling restart</a> of the cluster. (NDB 7.5.0)

Use this parameter to limit the number restart attempts made by the data node in the event that it fails on startup. The default is 3 attempts.

Both this parameter and `StartFailRetryDelay` are ignored unless `StopOnError` is equal to 0.

**NDB index statistics parameters.** The parameters in the following list relate to NDB index statistics generation.

- `IndexStatAutoCreate`

Version (or later)	NDB 7.5.0
Type or units	integer

Default	0
Range	0, 1
Restart Type	<b>Node Restart:</b> Requires a <a href="#">rolling restart</a> of the cluster. (NDB 7.5.0)

Enable (set equal to 1) or disable (set equal to 0) automatic statistics collection when indexes are created.

- [IndexStatAutoUpdate](#)

Version (or later)	NDB 7.5.0
Type or units	integer
Default	0
Range	0, 1
Restart Type	<b>Node Restart:</b> Requires a <a href="#">rolling restart</a> of the cluster. (NDB 7.5.0)

Enable (set equal to 1) or disable (set equal to 0) monitoring of indexes for changes, and trigger automatic statistics updates when these are detected. The degree of change needed to trigger the updates are determined by the settings for the [IndexStatTriggerPct](#) and [IndexStatTriggerScale](#) options.

- [IndexStatSaveSize](#)

Version (or later)	NDB 7.5.0
Type or units	bytes
Default	32768
Range	0 - 4294967039 (0xFFFFFFFF)
Restart Type	<b>Initial Node Restart:</b> Requires a <a href="#">rolling restart</a> of the cluster; each data node must be restarted with



	<code>--initial.</code> (NDB 7.5.0)
--	--

Maximum space in bytes allowed for the saved statistics of any given index in the NDB system tables and in the `mysqld` memory cache. In NDB 7.5 and earlier, this consumes `IndexMemory`.

At least one sample is always produced, regardless of any size limit. This size is scaled by `IndexStatSaveScale`.

The size specified by `IndexStatSaveSize` is scaled by the value of `IndexStatTriggerPct` for a large index, times 0.01. This is further multiplied by the logarithm to the base 2 of the index size. Setting `IndexStatTriggerPct` equal to 0 disables the scaling effect.

- `IndexStatSaveScale`

Version (or later)	NDB 7.5.0
Type or units	percentage
Default	100
Range	0 - 4294967039 (0xFFFFFFFF)
Restart Type	<b>Initial Node Restart:</b> Requires a <a href="#">rolling restart</a> of the cluster; each data node must be restarted with <code>--initial.</code> (NDB 7.5.0)

The size specified by `IndexStatSaveSize` is scaled by the value of `IndexStatTriggerPct` for a large index, times 0.01. This is further multiplied by the logarithm to the base 2 of the index size. Setting `IndexStatTriggerPct` equal to 0 disables the scaling effect.

- `IndexStatTriggerPct`

Version (or later)	NDB 7.5.0
Type or units	percentage
Default	100
Range	0 - 4294967039 (0xFFFFFFFF)
Restart Type	<b>Initial Node Restart:</b> Requires a <a href="#">rolling restart</a> of the cluster; each data node must be restarted with

	<code>--initial.</code> (NDB 7.5.0)
--	--

Percentage change in updates that triggers an index statistics update. The value is scaled by `IndexStatTriggerScale`. You can disable this trigger altogether by setting `IndexStatTriggerPct` to 0.

- `IndexStatTriggerScale`

Version (or later)	NDB 7.5.0
Type or units	percentage
Default	100
Range	0 - 4294967039 (0xFFFFFFFF)
Restart Type	<b>Initial Node Restart:</b> Requires a <a href="#">rolling restart</a> of the cluster; each data node must be restarted with <code>--initial.</code> (NDB 7.5.0)

Scale `IndexStatTriggerPct` by this amount times 0.01 for a large index. A value of 0 disables scaling.

- `IndexStatUpdateDelay`

Version (or later)	NDB 7.5.0
Type or units	seconds
Default	60
Range	0 - 4294967039 (0xFFFFFFFF)
Restart Type	<b>Initial Node Restart:</b> Requires a <a href="#">rolling restart</a> of the cluster; each data node must be restarted with <code>--initial.</code> (NDB 7.5.0)

Minimum delay in seconds between automatic index statistics updates for a given index. Setting this variable to 0 disables any delay. The default is 60 seconds.

**Restart types.** Information about the restart types used by the parameter descriptions in this section is shown in the following table:

**Table 21.15 NDB Cluster restart types**

Symbol	Restart Type	Description
N	Node	The parameter can be updated using a rolling restart (see <a href="#">Section 21.6.5, “Performing a Rolling Restart of an NDB Cluster”</a> )
S	System	All cluster nodes must be shut down completely, then restarted, to effect a change in this parameter
I	Initial	Data nodes must be restarted using the <code>--initial</code> option

### 21.4.3.7 Defining SQL and Other API Nodes in an NDB Cluster

The `[mysqld]` and `[api]` sections in the `config.ini` file define the behavior of the MySQL servers (SQL nodes) and other applications (API nodes) used to access cluster data. None of the parameters shown is required. If no computer or host name is provided, any host can use this SQL or API node.

Generally speaking, a `[mysqld]` section is used to indicate a MySQL server providing an SQL interface to the cluster, and an `[api]` section is used for applications other than `mysqld` processes accessing cluster data, but the two designations are actually synonymous; you can, for instance, list parameters for a MySQL server acting as an SQL node in an `[api]` section.



#### Note

For a discussion of MySQL server options for NDB Cluster, see [MySQL Server Options for NDB Cluster](#). For information about MySQL server system variables relating to NDB Cluster, see [NDB Cluster System Variables](#).

- `Id`

Version (or later)	NDB 7.5.0
Type or units	unsigned
Default	[...]
Range	1 - 255
Restart Type	<b>Initial System Restart:</b> Requires a complete shutdown of the cluster, wiping and restoring the cluster file system from a <a href="#">backup</a> , and then restarting the cluster. (NDB 7.5.0)

The `Id` is an integer value used to identify the node in all cluster internal messages. The permitted range of values is 1 to 255 inclusive. This value must be unique for each node in the cluster, regardless of the type of node.



**Note**

Data node IDs must be less than 49, regardless of the NDB Cluster version used. If you plan to deploy a large number of data nodes, it is a good idea to limit the node IDs for API nodes (and management nodes) to values greater than 48.

`NodeId` is the preferred parameter name to use when identifying API nodes. (`Id` continues to be supported for backward compatibility, but is now deprecated and generates a warning when used. It is also subject to future removal.)

- `ConnectionMap`

Version (or later)	NDB 7.5.0
Type or units	string
Default	[...]
Range	...
Restart Type	<b>Node Restart:</b> Requires a <a href="#">rolling restart</a> of the cluster. (NDB 7.5.0)

Specifies which data nodes to connect.

- `NodeId`

Version (or later)	NDB 7.5.0
Type or units	unsigned
Default	[...]
Range	1 - 255
Restart Type	<b>Initial System Restart:</b> Requires a complete shutdown of the cluster, wiping and restoring the cluster file system from a <a href="#">backup</a> , and then restarting the cluster. (NDB 7.5.0)

The `NodeId` is an integer value used to identify the node in all cluster internal messages. The permitted range of values is 1 to 255 inclusive. This value must be unique for each node in the cluster, regardless of the type of node.

**Note**

Data node IDs must be less than 49, regardless of the NDB Cluster version used. If you plan to deploy a large number of data nodes, it is a good idea to limit the node IDs for API nodes (and management nodes) to values greater than 48.

`NodeId` is the preferred parameter name to use when identifying management nodes. An alias, `Id`, was used for this purpose in very old versions of NDB Cluster, and continues to be supported for backward compatibility; it is now deprecated and generates a warning when used, and is subject to removal in a future release of NDB Cluster.

- [ExecuteOnComputer](#)

Version (or later)	NDB 7.5.0
Type or units	name
Default	[...]
Range	...
Deprecated	NDB 7.5.0
Restart Type	<b>System Restart:</b> Requires a complete shutdown and restart of the cluster. (NDB 7.5.0)

This refers to the `Id` set for one of the computers (hosts) defined in a `[computer]` section of the configuration file.

**Important**

This parameter is deprecated as of NDB 7.5.0, and is subject to removal in a future release. Use the [HostName](#) parameter instead.

- [HostName](#)

Version (or later)	NDB 7.5.0
Type or units	name or IP address
Default	[...]
Range	...
Restart Type	<b>Node Restart:</b> Requires a <a href="#">rolling restart</a> of

	the cluster. (NDB 7.5.0)
--	--------------------------

Specifying this parameter defines the host name of the computer on which the SQL node (API node) is to reside.

If no `HostName` is specified in a given `[mysql]` or `[api]` section of the `config.ini` file, then an SQL or API node may connect using the corresponding “slot” from any host which can establish a network connection to the management server host machine. *This differs from the default behavior for data nodes, where `localhost` is assumed for `HostName` unless otherwise specified.*

- `LocationDomainId`

Version (or later)	NDB 7.6.4
Type or units	integer
Default	0
Range	0 - 16
Added	NDB 7.6.4
Restart Type	<b>System Restart:</b> Requires a complete shutdown and restart of the cluster. (NDB 7.5.0)

Assigns an SQL or other API node to a specific `availability domain` (also known as an availability zone) within a cloud. By informing `NDB` which nodes are in which availability domains, performance can be improved in a cloud environment in the following ways:

- If requested data is not found on the same node, reads can be directed to another node in the same availability domain.
- Communication between nodes in different availability domains are guaranteed to use `NDB` transporters' WAN support without any further manual intervention.
- The transporter's group number can be based on which availability domain is used, such that also SQL and other API nodes communicate with local data nodes in the same availability domain whenever possible.
- The arbitrator can be selected from an availability domain in which no data nodes are present, or, if no such availability domain can be found, from a third availability domain.

`LocationDomainId` takes an integer value between 0 and 16 inclusive, with 0 being the default; using 0 is the same as leaving the parameter unset.

- `ArbitrationRank`

Version (or later)	NDB 7.5.0
Type or units	0-2
Default	0
Range	0 - 2

Restart Type	<b>Node Restart:</b> Requires a <a href="#">rolling restart</a> of the cluster. (NDB 7.5.0)
--------------	--

This parameter defines which nodes can act as arbitrators. Both management nodes and SQL nodes can be arbitrators. A value of 0 means that the given node is never used as an arbitrator, a value of 1 gives the node high priority as an arbitrator, and a value of 2 gives it low priority. A normal configuration uses the management server as arbitrator, setting its [ArbitrationRank](#) to 1 (the default for management nodes) and those for all SQL nodes to 0 (the default for SQL nodes).

By setting [ArbitrationRank](#) to 0 on all management and SQL nodes, you can disable arbitration completely. You can also control arbitration by overriding this parameter; to do so, set the [Arbitration](#) parameter in the `[ndbd default]` section of the `config.ini` global configuration file.

- [ArbitrationDelay](#)

Version (or later)	NDB 7.5.0
Type or units	milliseconds
Default	0
Range	0 - 4294967039 (0xFFFFFFFF)
Restart Type	<b>Node Restart:</b> Requires a <a href="#">rolling restart</a> of the cluster. (NDB 7.5.0)

Setting this parameter to any other value than 0 (the default) means that responses by the arbitrator to arbitration requests are delayed by the stated number of milliseconds. It is usually not necessary to change this value.

- [BatchByteSize](#)

Version (or later)	NDB 7.5.0
Type or units	bytes
Default	16K
Range	1K - 1M
Restart Type	<b>Node Restart:</b> Requires a <a href="#">rolling restart</a> of the cluster. (NDB 7.5.0)

For queries that are translated into full table scans or range scans on indexes, it is important for best performance to fetch records in properly sized batches. It is possible to set the proper size both in terms

of number of records ([BatchSize](#)) and in terms of bytes ([BatchByteSize](#)). The actual batch size is limited by both parameters.

The speed at which queries are performed can vary by more than 40% depending upon how this parameter is set.

This parameter is measured in bytes. The default value is 16K.

- [BatchSize](#)

Version (or later)	NDB 7.5.0
Type or units	records
Default	256
Range	1 - 992
Restart Type	<b>Node Restart:</b> Requires a <a href="#">rolling restart</a> of the cluster. (NDB 7.5.0)

This parameter is measured in number of records and is by default set to 256. The maximum size is 992.

- [ExtraSendBufferMemory](#)

Version (or later)	NDB 7.5.0
Type or units	bytes
Default	0
Range	0 - 4294967039 (0xFFFFFFFF)
Restart Type	<b>Node Restart:</b> Requires a <a href="#">rolling restart</a> of the cluster. (NDB 7.5.0)

This parameter specifies the amount of transporter send buffer memory to allocate in addition to any that has been set using [TotalSendBufferMemory](#), [SendBufferMemory](#), or both.

- [HeartbeatThreadPriority](#)

Version (or later)	NDB 7.5.0
Type or units	string
Default	[...]
Range	...
Restart Type	<b>Node Restart:</b> Requires a <a href="#">rolling restart</a> of



	the cluster. (NDB 7.5.0)
--	--------------------------

Use this parameter to set the scheduling policy and priority of heartbeat threads for management and API nodes. The syntax for setting this parameter is shown here:

```
HeartbeatThreadPriority = policy[, priority]
```

```
policy:  
{FIFO | RR}
```

When setting this parameter, you must specify a policy. This is one of [FIFO](#) (first in, first in) or [RR](#) (round robin). This followed optionally by the priority (an integer).

- [MaxScanBatchSize](#)

Version (or later)	NDB 7.5.0
Type or units	bytes
Default	256K
Range	32K - 16M
Restart Type	<b>Node Restart:</b> Requires a <a href="#">rolling restart</a> of the cluster. (NDB 7.5.0)

The batch size is the size of each batch sent from each data node. Most scans are performed in parallel to protect the MySQL Server from receiving too much data from many nodes in parallel; this parameter sets a limit to the total batch size over all nodes.

The default value of this parameter is set to 256KB. Its maximum size is 16MB.

- [TotalSendBufferMemory](#)

Version (or later)	NDB 7.5.0
Type or units	bytes
Default	0
Range	256K - 4294967039 (0xFFFFFFFF)
Restart Type	<b>Node Restart:</b> Requires a <a href="#">rolling restart</a> of the cluster. (NDB 7.5.0)

This parameter is used to determine the total amount of memory to allocate on this node for shared send buffer memory among all configured transporters.

If this parameter is set, its minimum permitted value is 256KB; 0 indicates that the parameter has not been set. For more detailed information, see [Section 21.4.3.13, “Configuring NDB Cluster Send Buffer Parameters”](#).

- [AutoReconnect](#)

Version (or later)	NDB 7.5.0
Type or units	boolean
Default	false
Range	true, false
Restart Type	<b>Node Restart:</b> Requires a <a href="#">rolling restart</a> of the cluster. (NDB 7.5.0)

This parameter is `false` by default. This forces disconnected API nodes (including MySQL Servers acting as SQL nodes) to use a new connection to the cluster rather than attempting to re-use an existing one, as re-use of connections can cause problems when using dynamically-allocated node IDs. (Bug #45921)



**Note**

This parameter can be overridden using the NDB API. For more information, see [Ndb\\_cluster\\_connection::set\\_auto\\_reconnect\(\)](#), and [Ndb\\_cluster\\_connection::get\\_auto\\_reconnect\(\)](#).

- [DefaultOperationRedoProblemAction](#)

Version (or later)	NDB 7.5.0
Type or units	enumeration
Default	QUEUE
Range	ABORT, QUEUE
Restart Type	<b>Node Restart:</b> Requires a <a href="#">rolling restart</a> of the cluster. (NDB 7.5.0)

This parameter (along with [RedoOverCommitLimit](#) and [RedoOverCommitCounter](#)) controls the data node's handling of operations when too much time is taken flushing redo logs to disk. This occurs when a given redo log flush takes longer than [RedoOverCommitLimit](#) seconds, more than [RedoOverCommitCounter](#) times, causing any pending transactions to be aborted.

When this happens, the node can respond in either of two ways, according to the value of [DefaultOperationRedoProblemAction](#), listed here:

- **ABORT:** Any pending operations from aborted transactions are also aborted.
- **QUEUE:** Pending operations from transactions that were aborted are queued up to be re-tried. This is the default. Pending operations are still aborted when the redo log runs out of space—that is, when [P\\_TAIL\\_PROBLEM](#) errors occur.

- [DefaultHashMapSize](#)

Version (or later)	NDB 7.5.0
--------------------	-----------

Type or units	buckets
Default	3840
Range	0 - 3840
Restart Type	<b>Node Restart:</b> Requires a <a href="#">rolling restart</a> of the cluster. (NDB 7.5.0)

The size of the table hash maps used by NDB is configurable using this parameter. [DefaultHashMapSize](#) can take any of three possible values (0, 240, 3840).

The original intended use for this parameter was to facilitate upgrades and especially downgrades to and from very old releases with differing default hash map sizes. This is not an issue when upgrading from NDB Cluster 7.3 (or later) to later versions.

Decreasing this parameter online after any tables have been created or modified with [DefaultHashMapSize](#) equal to 3840 is not currently supported.

- [Wan](#)

Version (or later)	NDB 7.5.0
Type or units	boolean
Default	false
Range	true, false
Restart Type	<b>Node Restart:</b> Requires a <a href="#">rolling restart</a> of the cluster. (NDB 7.5.0)

Use WAN TCP setting as default.

- [ConnectBackoffMaxTime](#)

Version (or later)	NDB 7.5.0
Type or units	integer
Default	0
Range	0 - 4294967039 (0xFFFFFFFF)
Restart Type	<b>Node Restart:</b> Requires a <a href="#">rolling restart</a> of the cluster. (NDB 7.5.0)

In an NDB Cluster with many unstarted data nodes, the value of this parameter can be raised to circumvent connection attempts to data nodes which have not yet begun to function in the cluster, as well as moderate high traffic to management nodes. As long as the API node is not connected to any new data nodes, the value of the [StartConnectBackoffMaxTime](#) parameter is applied; otherwise,

`ConnectBackoffMaxTime` is used to determine the length of time in milliseconds to wait between connection attempts.

Time elapsed *during* node connection attempts is not taken into account when calculating elapsed time for this parameter. The timeout is applied with approximately 100 ms resolution, starting with a 100 ms delay; for each subsequent attempt, the length of this period is doubled until it reaches `ConnectBackoffMaxTime` milliseconds, up to a maximum of 100000 ms (100s).

Once the API node is connected to a data node and that node reports (in a heartbeat message) that it has connected to other data nodes, connection attempts to those data nodes are no longer affected by this parameter, and are made every 100 ms thereafter until connected. Once a data node has started, it can take up `HeartbeatIntervalDbApi` for the API node to be notified that this has occurred.

- `StartConnectBackoffMaxTime`

Version (or later)	NDB 7.5.0
Type or units	integer
Default	0
Range	0 - 4294967039 (0xFFFFFFFF)
Restart Type	<b>Node Restart:</b> Requires a <a href="#">rolling restart</a> of the cluster. (NDB 7.5.0)

In an NDB Cluster with many unstarted data nodes, the value of this parameter can be raised to circumvent connection attempts to data nodes which have not yet begun to function in the cluster, as well as moderate high traffic to management nodes. As long as the API node is not connected to any new data nodes, the value of the `StartConnectBackoffMaxTime` parameter is applied; otherwise, `ConnectBackoffMaxTime` is used to determine the length of time in milliseconds to wait between connection attempts.

Time elapsed *during* node connection attempts is not taken into account when calculating elapsed time for this parameter. The timeout is applied with approximately 100 ms resolution, starting with a 100 ms delay; for each subsequent attempt, the length of this period is doubled until it reaches `StartConnectBackoffMaxTime` milliseconds, up to a maximum of 100000 ms (100s).

Once the API node is connected to a data node and that node reports (in a heartbeat message) that it has connected to other data nodes, connection attempts to those data nodes are no longer affected by this parameter, and are made every 100 ms thereafter until connected. Once a data node has started, it can take up `HeartbeatIntervalDbApi` for the API node to be notified that this has occurred.

**API Node Debugging Parameters.** You can use the `ApiVerbose` configuration parameter to enable debugging output from a given API node. This parameter takes an integer value. 0 is the default, and disables such debugging; 1 enables debugging output to the cluster log; 2 adds `DBDICT` debugging output as well. (Bug #20638450) See also [DUMP 1229](#).

You can also obtain information from a MySQL server running as an NDB Cluster SQL node using `SHOW STATUS` in the `mysql` client, as shown here:

```
mysql> SHOW STATUS LIKE 'ndb%';
+-----+-----+
| Variable_name | Value |
+-----+-----+
```

```

| Ndb_cluster_node_id | 5 |
| Ndb_config_from_host | 198.51.100.112 |
| Ndb_config_from_port | 1186 |
| Ndb_number_of_storage_nodes | 4 |
+-----+-----+
4 rows in set (0.02 sec)

```

For information about the status variables appearing in the output from this statement, see [NDB Cluster Status Variables](#).



**Note**

To add new SQL or API nodes to the configuration of a running NDB Cluster, it is necessary to perform a rolling restart of all cluster nodes after adding new `[mysqld]` or `[api]` sections to the `config.ini` file (or files, if you are using more than one management server). This must be done before the new SQL or API nodes can connect to the cluster.

It is *not* necessary to perform any restart of the cluster if new SQL or API nodes can employ previously unused API slots in the cluster configuration to connect to the cluster.

**Restart types.** Information about the restart types used by the parameter descriptions in this section is shown in the following table:

**Table 21.16 NDB Cluster restart types**

Symbol	Restart Type	Description
N	Node	The parameter can be updated using a rolling restart (see <a href="#">Section 21.6.5, “Performing a Rolling Restart of an NDB Cluster”</a> )
S	System	All cluster nodes must be shut down completely, then restarted, to effect a change in this parameter
I	Initial	Data nodes must be restarted using the <code>--initial</code> option

### 21.4.3.8 Defining the System

The `[system]` section is used for parameters applying to the cluster as a whole. The `Name` system parameter is used with MySQL Enterprise Monitor; `ConfigGenerationNumber` and `PrimaryMGMNode` are not used in production environments. Except when using NDB Cluster with MySQL Enterprise Monitor, is not necessary to have a `[system]` section in the `config.ini` file.

More information about these parameters can be found in the following list:

- [ConfigGenerationNumber](#)

Version (or later)	NDB 7.5.0
Type or units	unsigned
Default	0
Range	0 - 4294967039 (0xFFFFFFFF)

Restart Type	<b>Node Restart:</b> Requires a <a href="#">rolling restart</a> of the cluster. (NDB 7.5.0)
--------------	--

Configuration generation number. This parameter is currently unused.

- [Name](#)

Version (or later)	NDB 7.5.0
Type or units	string
Default	[...]
Range	...
Restart Type	<b>Node Restart:</b> Requires a <a href="#">rolling restart</a> of the cluster. (NDB 7.5.0)

Set a name for the cluster. This parameter is required for deployments with MySQL Enterprise Monitor; it is otherwise unused.

You can obtain the value of this parameter by checking the `Ndb_system_name` status variable. In NDB API applications, you can also retrieve it using `get_system_name()`.

- [PrimaryMGMNode](#)

Version (or later)	NDB 7.5.0
Type or units	unsigned
Default	0
Range	0 - 4294967039 (0xFFFFFFFF)
Restart Type	<b>Node Restart:</b> Requires a <a href="#">rolling restart</a> of the cluster. (NDB 7.5.0)

Node ID of the primary management node. This parameter is currently unused.

**Restart types.** Information about the restart types used by the parameter descriptions in this section is shown in the following table:

**Table 21.17 NDB Cluster restart types**

Symbol	Restart Type	Description
N	Node	The parameter can be updated using a rolling restart (see <a href="#">Section 21.6.5, “Performing a Rolling Restart of an NDB Cluster”</a> )

Symbol	Restart Type	Description
S	System	All cluster nodes must be shut down completely, then restarted, to effect a change in this parameter
I	Initial	Data nodes must be restarted using the <code>--initial</code> option

### 21.4.3.9 MySQL Server Options and Variables for NDB Cluster

This section provides information about MySQL server options, server and status variables that are specific to NDB Cluster. For general information on using these, and for other options and variables not specific to NDB Cluster, see [Section 5.1, “The MySQL Server”](#).

For NDB Cluster configuration parameters used in the cluster configuration file (usually named `config.ini`), see [Section 21.4, “Configuration of NDB Cluster”](#).

#### MySQL Server Options for NDB Cluster

This section provides descriptions of `mysqld` server options relating to NDB Cluster. For information about `mysqld` options not specific to NDB Cluster, and for general information about the use of options with `mysqld`, see [Section 5.1.6, “Server Command Options”](#).

For information about command-line options used with other NDB Cluster processes, see [Section 21.5, “NDB Cluster Programs”](#).

- `--ndbcluster`

Command-Line Format	<code>--ndbcluster[=value]</code>
Disabled by	<code>skip-ndbcluster</code>
Type	Boolean
Default Value	<code>OFF</code>

The `NDBCLUSTER` storage engine is necessary for using NDB Cluster. If a `mysqld` binary includes support for the `NDBCLUSTER` storage engine, the engine is disabled by default. Use the `--ndbcluster` option to enable it. Use `--skip-ndbcluster` to explicitly disable the engine.

It is not necessary or desirable to use this option together with `--initialize`. Beginning with NDB 7.5.4, `--ndbcluster` is ignored (and the `NDB` storage engine is *not* enabled) if `--initialize` is also used. (Bug #81689, Bug #23518923)

- `--ndb-allow-copying-alter-table=[ON|OFF]`

Command-Line Format	<code>--ndb-allow-copying-alter-table[={OFF ON}]</code>
Introduced	5.7.10-ndb-7.5.0
System Variable	<code>ndb_allow_copying_alter_table</code>
Scope	Global, Session
Dynamic	Yes
Type	Boolean

Default Value	ON
---------------	----

Let `ALTER TABLE` and other DDL statements use copying operations on NDB tables. Set to `OFF` to keep this from happening; doing so may improve performance of critical applications.

- `--ndb-batch-size=#`

Command-Line Format	<code>--ndb-batch-size</code>
System Variable	<code>ndb_batch_size</code>
Scope	Global, Session
Dynamic	Yes
Type	Integer
Default Value	32768
Minimum Value	0
Maximum Value (≥ 5.7.37-ndb-7.6.22)	2147483648
Maximum Value (≥ 5.7.37-ndb-7.5.26)	2147483648
Maximum Value (≤ 5.7.37-ndb-7.5.25)	31536000
Maximum Value (≤ 5.7.37-ndb-7.6.21)	31536000
Maximum Value	31536000
Unit	bytes

This sets the size in bytes that is used for NDB transaction batches.

- `--ndb-cluster-connection-pool=#`

Command-Line Format	<code>--ndb-cluster-connection-pool</code>
System Variable	<code>ndb_cluster_connection_pool</code>
System Variable	<code>ndb_cluster_connection_pool</code>
Scope	Global
Scope	Global
Dynamic	No
Dynamic	No
Type	Integer
Default Value	1
Minimum Value	1
Maximum Value	63

By setting this option to a value greater than 1 (the default), a `mysqld` process can use multiple connections to the cluster, effectively mimicking several SQL nodes. Each connection requires its own `[api]` or `[mysqld]` section in the cluster configuration (`config.ini`) file, and counts against the maximum number of API connections supported by the cluster.

Suppose that you have 2 cluster host computers, each running an SQL node whose `mysqld` process was started with `--ndb-cluster-connection-pool=4`; this means that the cluster must have 8 API slots available for these connections (instead of 2). All of these connections are set up when the SQL node connects to the cluster, and are allocated to threads in a round-robin fashion.



This option is useful only when running `mysqld` on host machines having multiple CPUs, multiple cores, or both. For best results, the value should be smaller than the total number of cores available on the host machine. Setting it to a value greater than this is likely to degrade performance severely.



### Important

Because each SQL node using connection pooling occupies multiple API node slots—each slot having its own node ID in the cluster—you must *not* use a node ID as part of the cluster connection string when starting any `mysqld` process that employs connection pooling.

Setting a node ID in the connection string when using the `--ndb-cluster-connection-pool` option causes node ID allocation errors when the SQL node attempts to connect to the cluster.

- `--ndb-cluster-connection-pool-nodeids=list`

Command-Line Format	<code>--ndb-cluster-connection-pool-nodeids</code>
Introduced	5.7.10-ndb-7.5.0
System Variable (≥ 5.7.10-ndb-7.5.0)	<code>ndb_cluster_connection_pool_nodeids</code>
Scope (≥ 5.7.10-ndb-7.5.0)	Global
Dynamic (≥ 5.7.10-ndb-7.5.0)	No
Type	Set
Default Value	

Specifies a comma-separated list of node IDs for connections to the cluster used by an SQL node. The number of nodes in this list must be the same as the value set for the `--ndb-cluster-connection-pool` option.

`--ndb-cluster-connection-pool-nodeids` was added in NDB 7.5.0.

- `--ndb-blob-read-batch-bytes=bytes`

Command-Line Format	<code>--ndb-blob-read-batch-bytes</code>
System Variable	<code>ndb_blob_read_batch_bytes</code>
Scope	Global, Session
Dynamic	Yes
Type	Integer
Default Value	65536
Minimum Value	0

Maximum Value	4294967295
---------------	------------

This option can be used to set the size (in bytes) for batching of **BLOB** data reads in NDB Cluster applications. When this batch size is exceeded by the amount of **BLOB** data to be read within the current transaction, any pending **BLOB** read operations are immediately executed.

The maximum value for this option is 4294967295; the default is 65536. Setting it to 0 has the effect of disabling **BLOB** read batching.



**Note**

In NDB API applications, you can control **BLOB** write batching with the `setMaxPendingBlobReadBytes()` and `getMaxPendingBlobReadBytes()` methods.

- `--ndb-blob-write-batch-bytes=bytes`

Command-Line Format	<code>--ndb-blob-write-batch-bytes</code>
System Variable	<code>ndb_blob_write_batch_bytes</code>
Scope	Global, Session
Dynamic	Yes
Type	Integer
Default Value	65536
Minimum Value	0
Maximum Value	4294967295
Unit	bytes

This option can be used to set the size (in bytes) for batching of **BLOB** data writes in NDB Cluster applications. When this batch size is exceeded by the amount of **BLOB** data to be written within the current transaction, any pending **BLOB** write operations are immediately executed.

The maximum value for this option is 4294967295; the default is 65536. Setting it to 0 has the effect of disabling **BLOB** write batching.



**Note**

In NDB API applications, you can control **BLOB** write batching with the `setMaxPendingBlobWriteBytes()` and `getMaxPendingBlobWriteBytes()` methods.

- `--ndb-connectstring=connection_string`

Command-Line Format	<code>--ndb-connectstring</code>
Type	String

When using the **NDBCLUSTER** storage engine, this option specifies the management server that distributes cluster configuration data. See [Section 21.4.3.3, “NDB Cluster Connection Strings”](#), for syntax.

- `--ndb-default-column-format={FIXED|DYNAMIC}`

Command-Line Format	<code>--ndb-default-column-format={FIXED DYNAMIC}</code>
Introduced	5.7.11-ndb-7.5.1
System Variable	<code>ndb_default_column_format</code>
Scope	Global
Dynamic	Yes
Type	Enumeration
Default Value ( $\geq$ 5.7.16-ndb-7.5.4)	<code>FIXED</code>
Default Value ( $\geq$ 5.7.11-ndb-7.5.1, $\leq$ 5.7.13-ndb-7.5.3)	<code>DYNAMIC</code>
Valid Values	<code>FIXED</code> <code>DYNAMIC</code>

In NDB 7.5.1 and later, sets the default `COLUMN_FORMAT` and `ROW_FORMAT` for new tables (see [Section 13.1.18, “CREATE TABLE Statement”](#)).

In NDB 7.5.1, the default for this option was `DYNAMIC`; in NDB 7.5.4, the default was changed to `FIXED` to maintain backwards compatibility with older release series (Bug #24487363).

- `--ndb-deferred-constraints=[0|1]`

Command-Line Format	<code>--ndb-deferred-constraints</code>
System Variable	<code>ndb_deferred_constraints</code>
Scope	Global, Session
Dynamic	Yes
Type	Integer
Default Value	0
Minimum Value	0
Maximum Value	1

Controls whether or not constraint checks on unique indexes are deferred until commit time, where such checks are supported. 0 is the default.

This option is not normally needed for operation of NDB Cluster or NDB Cluster Replication, and is intended primarily for use in testing.

- `--ndb-distribution={KEYHASH|LINHASH}`

Command-Line Format	<code>--ndb-distribution={KEYHASH LINHASH}</code>
System Variable	<code>ndb_distribution</code>
Scope	Global
Dynamic	Yes
Type	Enumeration
Default Value	<code>KEYHASH</code>

Valid Values	LINHASH KEYHASH
--------------	--------------------

Controls the default distribution method for NDB tables. Can be set to either of `KEYHASH` (key hashing) or `LINHASH` (linear hashing). `KEYHASH` is the default.

- `--ndb-log-apply-status`

Command-Line Format	<code>--ndb-log-apply-status[={OFF ON}]</code>
System Variable	<code>ndb_log_apply_status</code>
Scope	Global
Dynamic	No
Type	Boolean
Default Value	OFF

Causes a replica `mysqld` to log any updates received from its immediate source to the `mysql.ndb_apply_status` table in its own binary log using its own server ID rather than the server ID of the source. In a circular or chain replication setting, this allows such updates to propagate to the `mysql.ndb_apply_status` tables of any MySQL servers configured as replicas of the current `mysqld`.

In a chain replication setup, using this option allows downstream (replica) clusters to be aware of their positions relative to all of their upstream contributors (sources).

In a circular replication setup, this option causes changes to `ndb_apply_status` tables to complete the entire circuit, eventually propagating back to the originating NDB Cluster. This also allows a cluster acting as a source to see when its changes (epochs) have been applied to the other clusters in the circle.

This option has no effect unless the MySQL server is started with the `--ndbcluster` option.

- `--ndb-log-empty-epochs=[ON|OFF]`

Command-Line Format	<code>--ndb-log-empty-epochs[={OFF ON}]</code>
System Variable	<code>ndb_log_empty_epochs</code>
Scope	Global
Dynamic	Yes
Type	Boolean
Default Value	OFF

Causes epochs during which there were no changes to be written to the `ndb_apply_status` and `ndb_binlog_index` tables, even when `log_slave_updates` is enabled.

By default this option is disabled. Disabling `--ndb-log-empty-epochs` causes epoch transactions with no changes not to be written to the binary log, although a row is still written even for an empty epoch in `ndb_binlog_index`.

Because `--ndb-log-empty-epochs=1` causes the size of the `ndb_binlog_index` table to increase independently of the size of the binary log, users should be prepared to manage the growth of this table, even if they expect the cluster to be idle a large part of the time.

- `--ndb-log-empty-update={ON|OFF}`

Command-Line Format	<code>--ndb-log-empty-update[={OFF ON}]</code>
System Variable	<code>ndb_log_empty_update</code>
Scope	Global
Dynamic	Yes
Type	Boolean
Default Value	OFF

Causes updates that produced no changes to be written to the `ndb_apply_status` and `ndb_binlog_index` tables, when when `log_slave_updates` is enabled.

By default this option is disabled (OFF). Disabling `--ndb-log-empty-update` causes updates with no changes not to be written to the binary log.

- `--ndb-log-exclusive-reads={0|1}`

Command-Line Format	<code>--ndb-log-exclusive-reads[={OFF ON}]</code>
System Variable	<code>ndb_log_exclusive_reads</code>
Scope	Global, Session
Dynamic	Yes
Type	Boolean
Default Value	0

Starting the server with this option causes primary key reads to be logged with exclusive locks, which allows for NDB Cluster Replication conflict detection and resolution based on read conflicts. You can also enable and disable these locks at runtime by setting the value of the `ndb_log_exclusive_reads` system variable to 1 or 0, respectively. 0 (disable locking) is the default.

For more information, see [Read conflict detection and resolution](#).

- `--ndb-log-fail-terminate`

Command-Line Format	<code>--ndb-log-fail-terminate</code>
Introduced	5.7.29-ndb-7.6.14
System Variable	<code>ndb_log_fail_terminate</code>
Scope	Global
Dynamic	No
Type	Boolean
Default Value	FALSE

When this option is specified, and complete logging of all found row events is not possible, the `mysqld` process is terminated.

- `--ndb-log-orig`

Command-Line Format	<code>--ndb-log-orig[={OFF ON}]</code>	3511
System Variable	<code>ndb_log_orig</code>	

Scope	Global
Dynamic	No
Type	Boolean
Default Value	OFF

Log the originating server ID and epoch in the `ndb_binlog_index` table.



**Note**

This makes it possible for a given epoch to have multiple rows in `ndb_binlog_index`, one for each originating epoch.

For more information, see [Section 21.7.4, “NDB Cluster Replication Schema and Tables”](#).

- `--ndb-log-transaction-id`

Command-Line Format	<code>--ndb-log-transaction-id[={OFF ON}]</code>
System Variable	<code>ndb_log_transaction_id</code>
Scope	Global
Dynamic	No
Type	Boolean
Default Value	OFF

Causes a replica `mysqld` to write the NDB transaction ID in each row of the binary log. Such logging requires the use of the Version 2 event format for the binary log; thus, the `log_bin_use_v1_row_events` system variable must be disabled to use this option.

`--ndb-log-transaction-id` is required to enable NDB Cluster Replication conflict detection and resolution using the `NDB$EPOCH_TRANS()` function (see `NDB$EPOCH_TRANS()`).

For more information, see [Section 21.7.11, “NDB Cluster Replication Conflict Resolution”](#).

- `--ndb-log-update-as-write`

Command-Line Format	<code>--ndb-log-update-as-write[={OFF ON}]</code>
System Variable	<code>ndb_log_update_as_write</code>
Scope	Global
Dynamic	Yes
Type	Boolean

Default Value	ON
---------------	----

Whether updates on the source are written to the binary log as updates (`OFF`) or writes (`ON`). When this option is enabled, and both `--ndb-log-updated-only` and `--ndb-log-update-minimal` are disabled, operations of different types are logged as described in the following list:

- `INSERT`: Logged as a `WRITE_ROW` event with no before image; the after image is logged with all columns.
- `UPDATE`: Logged as a `WRITE_ROW` event with no before image; the after image is logged with all columns.
- `DELETE`: Logged as a `DELETE_ROW` event with all columns logged in the before image; the after image is not logged.

This option can be used for NDB Replication conflict resolution in combination with the other two NDB logging options mentioned previously; see [ndb\\_replication Table](#), for more information.

- `--ndb-log-updated-only`

Command-Line Format	<code>--ndb-log-updated-only[={OFF ON} ]</code>
System Variable	<code>ndb_log_updated_only</code>
Scope	Global
Dynamic	Yes
Type	Boolean
Default Value	ON

Whether `mysqld` writes updates only (`ON`) or complete rows (`OFF`) to the binary log. When this option is enabled, and both `--ndb-log-update-as-write` and `--ndb-log-update-minimal` are disabled, operations of different types are logged as described in the following list

- `INSERT`: Logged as a `WRITE_ROW` event with no before image; the after image is logged with all columns.
- `UPDATE`: Logged as an `UPDATE_ROW` event with primary key columns and updated columns present in both the before and after images.
- `DELETE`: Logged as a `DELETE_ROW` event with primary key columns included in the before image; the after image is not logged.

This option can be used for NDB Replication conflict resolution in combination with the other two NDB logging options mentioned previously; see [ndb\\_replication Table](#), for more information about how these options interact with one another.

- `--ndb-log-update-minimal`

Command-Line Format	<code>--ndb-log-update-minimal[={OFF ON} ]</code>
Introduced	5.7.18-ndb-7.6.3
System Variable	<code>ndb_log_update_minimal</code>
Scope	Global
Dynamic	Yes

Type	Boolean
Default Value	OFF

Log updates in a minimal fashion, by writing only the primary key values in the before image, and only the changed columns in the after image. This may cause compatibility problems if replicating to storage engines other than NDB. When this option is enabled, and both `--ndb-log-updated-only` and `--ndb-log-update-as-write` are disabled, operations of different types are logged as described in the following list:

- **INSERT**: Logged as a `WRITE_ROW` event with no before image; the after image is logged with all columns.
- **UPDATE**: Logged as an `UPDATE_ROW` event with primary key columns in the before image; all columns *except* primary key columns are logged in the after image.
- **DELETE**: Logged as a `DELETE_ROW` event with all columns in the before image; the after image is not logged.

This option can be used for NDB Replication conflict resolution in combination with the other two NDB logging options mentioned previously; see [ndb\\_replication Table](#), for more information.

- `--ndb-mgmd-host=host[:port]`

Command-Line Format	<code>--ndb-mgmd-host=host_name[:port_num]</code>
Type	String
Default Value	<code>localhost:1186</code>

Can be used to set the host and port number of a single management server for the program to connect to. If the program requires node IDs or references to multiple management servers (or both) in its connection information, use the `--ndb-connectstring` option instead.

- `--ndb-nodeid=#`

Command-Line Format	<code>--ndb-nodeid=#</code>
Status Variable	<code>Ndb_cluster_node_id</code>
Scope	Global
Dynamic	No
Type	Integer
Default Value	N/A
Minimum Value	1
Maximum Value	255
Maximum Value	63

Set this MySQL server's node ID in an NDB Cluster.

The `--ndb-nodeid` option overrides any node ID set with `--ndb-connectstring`, regardless of the order in which the two options are used.

In addition, if `--ndb-nodeid` is used, then either a matching node ID must be found in a `[mysqld]` or `[api]` section of `config.ini`, or there must be an "open" `[mysqld]` or `[api]` section in the file (that



is, a section without a `NodeId` or `Id` parameter specified). This is also true if the node ID is specified as part of the connection string.

Regardless of how the node ID is determined, its is shown as the value of the global status variable `Ndb_cluster_node_id` in the output of `SHOW STATUS`, and as `cluster_node_id` in the `connection` row of the output of `SHOW ENGINE NDBCLUSTER STATUS`.

For more information about node IDs for NDB Cluster SQL nodes, see [Section 21.4.3.7, “Defining SQL and Other API Nodes in an NDB Cluster”](#).

- `--ndb-optimization-delay=milliseconds`

Command-Line Format	<code>--ndb-optimization-delay=#</code>
System Variable	<code>ndb_optimization_delay</code>
Scope	Global
Dynamic	Yes
Type	Integer
Default Value	10
Minimum Value	0
Maximum Value	100000
Unit	milliseconds

Set the number of milliseconds to wait between sets of rows by `OPTIMIZE TABLE` statements on NDB tables. The default is 10.

- `--ndb-optimized-node-selection`

Command-Line Format	<code>--ndb-optimized-node-selection</code>
System Variable	<code>ndb_optimized_node_selection</code>
Scope	Global
Dynamic	Yes
Type	Integer
Default Value	3
Minimum Value	0
Maximum Value	3

Enable optimizations for selection of nodes for transactions. Enabled by default; use `--skip-ndb-optimized-node-selection` to disable.

- `--ndb-transid-mysql-connection-map=state`

Command-Line Format	<code>--ndb-transid-mysql-connection-map[=state]</code>
Type	Enumeration
Default Value	ON
Valid Values	ON
	OFF

	FORCE
--	-------

Enables or disables the plugin that handles the `ndb_transid_mysql_connection_map` table in the `INFORMATION_SCHEMA` database. Takes one of the values `ON`, `OFF`, or `FORCE`. `ON` (the default) enables the plugin. `OFF` disables the plugin, which makes `ndb_transid_mysql_connection_map` inaccessible. `FORCE` keeps the MySQL Server from starting if the plugin fails to load and start.

You can see whether the `ndb_transid_mysql_connection_map` table plugin is running by checking the output of `SHOW PLUGINS`.

- `--ndb-wait-connected=seconds`

Command-Line Format	<code>--ndb-wait-connected=#</code>
System Variable	<code>ndb_wait_connected</code>
Scope	Global
Dynamic	No
Type	Integer
Default Value	30
Minimum Value	0
Maximum Value	31536000
Unit	seconds

This option sets the period of time that the MySQL server waits for connections to NDB Cluster management and data nodes to be established before accepting MySQL client connections. The time is specified in seconds. The default value is 30.

- `--ndb-wait-setup=seconds`

Command-Line Format	<code>--ndb-wait-setup=#</code>
System Variable	<code>ndb_wait_setup</code>
Scope	Global
Dynamic	No
Type	Integer
Default Value	30
Default Value	30
Default Value	15
Default Value	15
Minimum Value	0
Maximum Value	31536000
Unit	seconds

This variable shows the period of time that the MySQL server waits for the `NDB` storage engine to complete setup before timing out and treating `NDB` as unavailable. The time is specified in seconds. The default value is 30.

- `--skip-ndbcluster`

Command-Line Format	<code>--skip-ndbcluster</code>
---------------------	--------------------------------

Disable the `NDBCLUSTER` storage engine. This is the default for binaries that were built with `NDBCLUSTER` storage engine support; the server allocates memory and other resources for this storage engine only if the `--ndbcluster` option is given explicitly. See [Section 21.4.1, “Quick Test Setup of NDB Cluster”](#), for an example.

## NDB Cluster System Variables

This section provides detailed information about MySQL server system variables that are specific to NDB Cluster and the `NDB` storage engine. For system variables not specific to NDB Cluster, see [Section 5.1.7, “Server System Variables”](#). For general information on using system variables, see [Section 5.1.8, “Using System Variables”](#).

- `ndb_autoincrement_prefetch_sz`

Command-Line Format	<code>--ndb-autoincrement-prefetch-sz=#</code>
System Variable	<code>ndb_autoincrement_prefetch_sz</code>
Scope	Global, Session
Dynamic	Yes
Type	Integer
Default Value	1
Minimum Value	1
Maximum Value	65536

Determines the probability of gaps in an autoincremented column. Set it to `1` to minimize this. Setting it to a high value for optimization makes inserts faster, but decreases the likelihood that consecutive autoincrement numbers are used in a batch of inserts.

This variable affects only the number of `AUTO_INCREMENT` IDs that are fetched between statements; within a given statement, at least 32 IDs are obtained at a time.



### Important

This variable does not affect inserts performed using `INSERT ... SELECT`.

- `ndb_cache_check_time`

Command-Line Format	<code>--ndb-cache-check-time=#</code>
Deprecated	5.7.20
System Variable	<code>ndb_cache_check_time</code>
Scope	Global
Dynamic	Yes
Type	Integer
Default Value	0
Minimum Value	0
Maximum Value	31536000

Unit	milliseconds
------	--------------

The number of milliseconds that elapse between checks of NDB Cluster SQL nodes by the MySQL query cache. Setting this to 0 (the default and minimum value) means that the query cache checks for validation on every query.

The recommended maximum value for this variable is 1000, which means that the check is performed once per second. A larger value means that the check is performed and possibly invalidated due to updates on different SQL nodes less often. It is generally not desirable to set this to a value greater than 2000.



**Note**

The query cache is deprecated as of MySQL 5.7.20, and is removed in MySQL 8.0. Deprecation includes `ndb_cache_check_time`.

- `ndb_clear_apply_status`

Command-Line Format	<code>--ndb-clear-apply-status[={OFF ON}]</code>
System Variable	<code>ndb_clear_apply_status</code>
Scope	Global
Dynamic	Yes
Type	Boolean
Default Value	ON

By the default, executing `RESET SLAVE` causes an NDB Cluster replica to purge all rows from its `ndb_apply_status` table. You can disable this by setting `ndb_clear_apply_status=OFF`.

- `ndb_data_node_neighbour`

Command-Line Format	<code>--ndb-data-node-neighbour=#</code>
Introduced	5.7.12-ndb-7.5.2
System Variable	<code>ndb_data_node_neighbour</code>
Scope	Global
Dynamic	Yes
Type	Integer
Default Value	0
Minimum Value	0
Maximum Value	255

Sets the ID of a “nearest” data node—that is, a preferred nonlocal data node is chosen to execute the transaction, rather than one running on the same host as the SQL or API node. This used to ensure that

when a fully replicated table is accessed, we access it on this data node, to ensure that the local copy of the table is always used whenever possible. This can also be used for providing hints for transactions.

This can improve data access times in the case of a node that is physically closer than and thus has higher network throughput than others on the same host.

See [Section 13.1.18.9, “Setting NDB Comment Options”](#), for further information.

Added in NDB 7.5.2.



#### Note

An equivalent method `set_data_node_neighbour()` is provided for use in NDB API applications.

- `ndb_default_column_format`

Command-Line Format	<code>--ndb-default-column-format={FIXED DYNAMIC}</code>
Introduced	5.7.11-ndb-7.5.1
System Variable	<code>ndb_default_column_format</code>
Scope	Global
Dynamic	Yes
Type	Enumeration
Default Value (≥ 5.7.16-ndb-7.5.4)	<code>FIXED</code>
Default Value (≥ 5.7.11-ndb-7.5.1, ≤ 5.7.13-ndb-7.5.3)	<code>DYNAMIC</code>
Valid Values	<code>FIXED</code> <code>DYNAMIC</code>

In NDB 7.5.1 and later, sets the default `COLUMN_FORMAT` and `ROW_FORMAT` for new tables (see [Section 13.1.18, “CREATE TABLE Statement”](#)).

In NDB 7.5.1, the default for this variable was `DYNAMIC`; in NDB 7.5.4, the default was changed to `FIXED` to maintain backwards compatibility with older release series (Bug #24487363).

- `ndb_deferred_constraints`

Command-Line Format	<code>--ndb-deferred-constraints=#</code>
System Variable	<code>ndb_deferred_constraints</code>
Scope	Global, Session
Dynamic	Yes
Type	Integer
Default Value	0
Minimum Value	0

Maximum Value	1
---------------	---

Controls whether or not constraint checks are deferred, where these are supported. 0 is the default.

This variable is not normally needed for operation of NDB Cluster or NDB Cluster Replication, and is intended primarily for use in testing.

- `ndb_distribution`

Command-Line Format	<code>--ndb-distribution={KEYHASH LINHASH}</code>
System Variable	<code>ndb_distribution</code>
Scope	Global
Dynamic	Yes
Type	Enumeration
Default Value	KEYHASH
Valid Values	LINHASH KEYHASH

Controls the default distribution method for NDB tables. Can be set to either of KEYHASH (key hashing) or LINHASH (linear hashing). KEYHASH is the default.

- `ndb_eventbuffer_free_percent`

Command-Line Format	<code>--ndb-eventbuffer-free-percent=#</code>
System Variable	<code>ndb_eventbuffer_free_percent</code>
Scope	Global
Dynamic	Yes
Type	Integer
Default Value	20
Minimum Value	1
Maximum Value	99

Sets the percentage of the maximum memory allocated to the event buffer (`ndb_eventbuffer_max_alloc`) that should be available in event buffer after reaching the maximum, before starting to buffer again.

- `ndb_eventbuffer_max_alloc`

Command-Line Format	<code>--ndb-eventbuffer-max-alloc=#</code>
System Variable	<code>ndb_eventbuffer_max_alloc</code>
Scope	Global
Dynamic	Yes
Type	Integer
Default Value	0
Minimum Value	0
Maximum Value (≥ 5.7.35-ndb-7.6.19)	9223372036854775807

Maximum Value (≥ 5.7.35-ndb-7.5.23)	9223372036854775807
Maximum Value (≤ 5.7.34-ndb-7.5.22)	4294967295
Maximum Value (≤ 5.7.34-ndb-7.6.18)	4294967295
Maximum Value	4294967295

Sets the maximum amount memory (in bytes) that can be allocated for buffering events by the NDB API. 0 means that no limit is imposed, and is the default.

- [ndb\\_extra\\_logging](#)

Command-Line Format	<code>ndb_extra_logging=#</code>
System Variable	<code>ndb_extra_logging</code>
Scope	Global
Dynamic	Yes
Type	Integer
Default Value	1
Minimum Value	0
Maximum Value	1

This variable enables recording in the MySQL error log of information specific to the [NDB](#) storage engine.

When this variable is set to 0, the only information specific to [NDB](#) that is written to the MySQL error log relates to transaction handling. If it set to a value greater than 0 but less than 10, [NDB](#) table schema and connection events are also logged, as well as whether or not conflict resolution is in use, and other [NDB](#) errors and information. If the value is set to 10 or more, information about [NDB](#) internals, such as the progress of data distribution among cluster nodes, is also written to the MySQL error log. The default is 1.

- [ndb\\_force\\_send](#)

Command-Line Format	<code>--ndb-force-send[={OFF ON}]</code>
System Variable	<code>ndb_force_send</code>
Scope	Global, Session
Dynamic	Yes
Type	Boolean
Default Value	ON

Forces sending of buffers to [NDB](#) immediately, without waiting for other threads. Defaults to [ON](#).

- [ndb\\_fully\\_replicated](#)

Command-Line Format	<code>--ndb-fully-replicated[={OFF ON}]</code>
Introduced	5.7.12-ndb-7.5.2
System Variable	<code>ndb_fully_replicated</code>
Scope	Global, Session
Dynamic	Yes
Type	Boolean

Default Value	OFF
---------------	-----

Determines whether new NDB tables are fully replicated. This setting can be overridden for an individual table using `COMMENT="NDB_TABLE=FULLY_REPLICATED=..."` in a `CREATE TABLE` or `ALTER TABLE` statement; see [Section 13.1.18.9, "Setting NDB Comment Options"](#), for syntax and other information.

Added in NDB 7.5.2.

- `ndb_index_stat_enable`

Command-Line Format	<code>--ndb-index-stat-enable[={OFF ON}]</code>
System Variable	<code>ndb_index_stat_enable</code>
Scope	Global, Session
Dynamic	Yes
Type	Boolean
Default Value	ON

Use NDB index statistics in query optimization. The default is ON.

- `ndb_index_stat_option`

Command-Line Format	<code>--ndb-index-stat-option=value</code>
System Variable	<code>ndb_index_stat_option</code>
Scope	Global, Session
Dynamic	Yes
Type	String
Default Value	<code>loop_checkon=1000ms,loop_idle=1000ms,loop_busy=update_batch=1,read_batch=4,idle_batch=32,check_delay=1m,delete_batch=8,clean_delay=0,erro</code>



```
error_delay=1m,evict_batch=8,evict_delay=1m,
cache_lowpct=90
```

This variable is used for providing tuning options for NDB index statistics generation. The list consist of comma-separated name-value pairs of option names and values, and this list must not contain any space characters.

Options not used when setting `ndb_index_stat_option` are not changed from their default values. For example, you can set `ndb_index_stat_option = 'loop_idle=1000ms,cache_limit=32M'`.

Time values can be optionally suffixed with `h` (hours), `m` (minutes), or `s` (seconds). Millisecond values can optionally be specified using `ms`; millisecond values cannot be specified using `h`, `m`, or `s`.) Integer values can be suffixed with `K`, `M`, or `G`.

The names of the options that can be set using this variable are shown in the table that follows. The table also provides brief descriptions of the options, their default values, and (where applicable) their minimum and maximum values.

**Table 21.18** `ndb_index_stat_option` options and values

Name	Description	Default/Units	Minimum/Maximum
<code>loop_enable</code>		1000 ms	0/4G
<code>loop_idle</code>	Time to sleep when idle	1000 ms	0/4G
<code>loop_busy</code>	Time to sleep when more work is waiting	100 ms	0/4G
<code>update_batch</code>		1	0/4G
<code>read_batch</code>		4	1/4G
<code>idle_batch</code>		32	1/4G
<code>check_batch</code>		8	1/4G
<code>check_delay</code>	How often to check for new statistics	10 m	1/4G
<code>delete_batch</code>		8	0/4G
<code>clean_delay</code>		1 m	0/4G
<code>error_batch</code>		4	1/4G
<code>error_delay</code>		1 m	1/4G
<code>evict_batch</code>		8	1/4G
<code>evict_delay</code>	Clean LRU cache, from read time	1 m	0/4G
<code>cache_limit</code>	Maximum amount of memory in bytes used for cached index statistics by this <code>mysqld</code> ; clean up the cache when this is exceeded.	32 M	0/4G
<code>cache_lowpct</code>		90	0/100

Name	Description	Default/Units	Minimum/Maximum
<code>zero_total</code>	Setting this to 1 resets all accumulating counters in <code>ndb_index_stat_status</code> to 0. This option value is also reset to 0 when this is done.	0	0/1

- `ndb_join_pushdown`

System Variable	<code>ndb_join_pushdown</code>
Scope	Global, Session
Dynamic	Yes
Type	Boolean
Default Value	ON

This variable controls whether joins on [NDB](#) tables are pushed down to the NDB kernel (data nodes). Previously, a join was handled using multiple accesses of [NDB](#) by the SQL node; however, when `ndb_join_pushdown` is enabled, a pushable join is sent in its entirety to the data nodes, where it can be distributed among the data nodes and executed in parallel on multiple copies of the data, with a single, merged result being returned to `mysqld`. This can reduce greatly the number of round trips between an SQL node and the data nodes required to handle such a join.

By default, `ndb_join_pushdown` is enabled.

**Conditions for NDB pushdown joins.** In order for a join to be pushable, it must meet the following conditions:

1. Only columns can be compared, and all columns to be joined must use *exactly* the same data type.  
This means that expressions such as `t1.a = t2.a + constant` cannot be pushed down, and that (for example) a join on an `INT` column and a `BIGINT` column also cannot be pushed down.
2. Queries referencing `BLOB` or `TEXT` columns are not supported.
3. Explicit locking is not supported; however, the [NDB](#) storage engine's characteristic implicit row-based locking is enforced.  
This means that a join using `FOR UPDATE` cannot be pushed down.
4. In order for a join to be pushed down, child tables in the join must be accessed using one of the `ref`, `eq_ref`, or `const` access methods, or some combination of these methods.  
Outer joined child tables can only be pushed using `eq_ref`.  
If the root of the pushed join is an `eq_ref` or `const`, only child tables joined by `eq_ref` can be appended. (A table joined by `ref` is likely to become the root of another pushed join.)  
If the query optimizer decides on `Using join cache` for a candidate child table, that table cannot be pushed as a child. However, it may be the root of another set of pushed tables.
5. Joins referencing tables explicitly partitioned by `[LINEAR] HASH`, `LIST`, or `RANGE` currently cannot be pushed down.

You can see whether a given join can be pushed down by checking it with `EXPLAIN`; when the join can be pushed down, you can see references to the `pushed join` in the `Extra` column of the output, as shown in this example:

```
mysql> EXPLAIN
->      SELECT e.first_name, e.last_name, t.title, d.dept_name
->      FROM employees e
->      JOIN dept_emp de ON e.emp_no=de.emp_no
->      JOIN departments d ON d.dept_no=de.dept_no
->      JOIN titles t ON e.emp_no=t.emp_no\G
***** 1. row *****
      id: 1
      select_type: SIMPLE
      table: d
      type: ALL
possible_keys: PRIMARY
      key: NULL
      key_len: NULL
      ref: NULL
      rows: 9
      Extra: Parent of 4 pushed join@1
***** 2. row *****
      id: 1
      select_type: SIMPLE
      table: de
      type: ref
possible_keys: PRIMARY,emp_no,dept_no
      key: dept_no
      key_len: 4
      ref: employees.d.dept_no
      rows: 5305
      Extra: Child of 'd' in pushed join@1
***** 3. row *****
      id: 1
      select_type: SIMPLE
      table: e
      type: eq_ref
possible_keys: PRIMARY
      key: PRIMARY
      key_len: 4
      ref: employees.de.emp_no
      rows: 1
      Extra: Child of 'de' in pushed join@1
***** 4. row *****
      id: 1
      select_type: SIMPLE
      table: t
      type: ref
possible_keys: PRIMARY,emp_no
      key: emp_no
      key_len: 4
      ref: employees.de.emp_no
      rows: 19
      Extra: Child of 'e' in pushed join@1
```

4 rows in set (0.00 sec)



**Note**

If inner joined child tables are joined by `ref`, and the result is ordered or grouped by a sorted index, this index cannot provide sorted rows, which forces writing to a sorted tempfile.

Two additional sources of information about pushed join performance are available:

1. The status variables `Ndb_pushed_queries_defined`, `Ndb_pushed_queries_dropped`, `Ndb_pushed_queries_executed`, and `Ndb_pushed_reads`.
2. The counters in the `ndbinfo.counters` table that belong to the `DBSPJ` kernel block.

- `ndb_log_apply_status`

Command-Line Format	<code>--ndb-log-apply-status[={OFF ON}]</code>
System Variable	<code>ndb_log_apply_status</code>
Scope	Global
Dynamic	No
Type	Boolean
Default Value	<code>OFF</code>

A read-only variable which shows whether the server was started with the `--ndb-log-apply-status` option.

- `ndb_log_bin`

Command-Line Format	<code>--ndb-log-bin[={OFF ON}]</code>
System Variable	<code>ndb_log_bin</code>
Scope	Global, Session
Dynamic	No
Type	Boolean
Default Value	<code>ON</code>

Causes updates to `NDB` tables to be written to the binary log. Setting this variable has no effect if binary logging is not already enabled for the server using `log_bin`. `ndb_log_bin` defaults to 1 (ON); normally, there is never any need to change this value in a production environment.

- `ndb_log_binlog_index`

Command-Line Format	<code>--ndb-log-binlog-index[={OFF ON}]</code>
System Variable	<code>ndb_log_binlog_index</code>
Scope	Global
Dynamic	Yes
Type	Boolean

Default Value	ON
---------------	----

Causes a mapping of epochs to positions in the binary log to be inserted into the `ndb_binlog_index` table. Setting this variable has no effect if binary logging is not already enabled for the server using `log_bin`. (In addition, `ndb_log_bin` must not be disabled.) `ndb_log_binlog_index` defaults to 1 (ON); normally, there is never any need to change this value in a production environment.

- `ndb_log_empty_epochs`

Command-Line Format	<code>--ndb-log-empty-epochs[={OFF ON} ]</code>
System Variable	<code>ndb_log_empty_epochs</code>
Scope	Global
Dynamic	Yes
Type	Boolean
Default Value	OFF

When this variable is set to 0, epoch transactions with no changes are not written to the binary log, although a row is still written even for an empty epoch in `ndb_binlog_index`.

- `ndb_log_empty_update`

Command-Line Format	<code>--ndb-log-empty-update[={OFF ON} ]</code>
System Variable	<code>ndb_log_empty_update</code>
Scope	Global
Dynamic	Yes
Type	Boolean
Default Value	OFF

When this variable is set to ON (1), update transactions with no changes are written to the binary log, even when `log_slave_updates` is enabled.

- `ndb_log_exclusive_reads`

Command-Line Format	<code>--ndb-log-exclusive-reads[={OFF ON} ]</code>
System Variable	<code>ndb_log_exclusive_reads</code>
Scope	Global, Session
Dynamic	Yes
Type	Boolean
Default Value	0

This variable determines whether primary key reads are logged with exclusive locks, which allows for NDB Cluster Replication conflict detection and resolution based on read conflicts. To enable these locks, set the value of `ndb_log_exclusive_reads` to 1. 0, which disables such locking, is the default.

For more information, see [Read conflict detection and resolution](#).

- `ndb_log_orig`

Command-Line Format	<code>--ndb-log-orig[={OFF ON} ]</code>
---------------------	---

System Variable	<code>ndb_log_orig</code>
Scope	Global
Dynamic	No
Type	Boolean
Default Value	OFF

Shows whether the originating server ID and epoch are logged in the `ndb_binlog_index` table. Set using the `--ndb-log-orig` server option.

- `ndb_log_transaction_id`

System Variable	<code>ndb_log_transaction_id</code>
Scope	Global
Dynamic	No
Type	Boolean
Default Value	OFF

This read-only, Boolean system variable shows whether a replica `mysqld` writes NDB transaction IDs in the binary log (required to use “active-active” NDB Cluster Replication with `NDB$EPOCH_TRANS()` conflict detection). To change the setting, use the `--ndb-log-transaction-id` option.

`ndb_log_transaction_id` is not supported in mainline MySQL Server 5.7.

For more information, see [Section 21.7.11, “NDB Cluster Replication Conflict Resolution”](#).

- `ndb_optimized_node_selection`

Command-Line Format	<code>--ndb-optimized-node-selection=#</code>
System Variable	<code>ndb_optimized_node_selection</code>
Scope	Global
Dynamic	No
Type	Integer
Default Value	3
Minimum Value	0
Maximum Value	3

There are two forms of optimized node selection, described here:

1. The SQL node uses *proximity* to determine the transaction coordinator; that is, the “closest” data node to the SQL node is chosen as the transaction coordinator. For this purpose, a data node having a shared memory connection with the SQL node is considered to be “closest” to the SQL node; the next closest (in order of decreasing proximity) are: TCP connection to `localhost`, followed by TCP connection from a host other than `localhost`.
2. The SQL thread uses *distribution awareness* to select the data node. That is, the data node housing the cluster partition accessed by the first statement of a given transaction is used as the transaction

coordinator for the entire transaction. (This is effective only if the first statement of the transaction accesses no more than one cluster partition.)

This option takes one of the integer values 0, 1, 2, or 3. 3 is the default. These values affect node selection as follows:

- 0: Node selection is not optimized. Each data node is employed as the transaction coordinator 8 times before the SQL thread proceeds to the next data node.
- 1: Proximity to the SQL node is used to determine the transaction coordinator.
- 2: Distribution awareness is used to select the transaction coordinator. However, if the first statement of the transaction accesses more than one cluster partition, the SQL node reverts to the round-robin behavior seen when this option is set to 0.
- 3: If distribution awareness can be employed to determine the transaction coordinator, then it is used; otherwise proximity is used to select the transaction coordinator. (This is the default behavior.)

Proximity is determined as follows:

1. Start with the value set for the `Group` parameter (default 55).
2. For an API node sharing the same host with other API nodes, decrement the value by 1. Assuming the default value for `Group`, the effective value for data nodes on same host as the API node is 54, and for remote data nodes 55.
3. (*NDB 7.5.2 and later:*) Setting `ndb_data_node_neighbour` further decreases the effective `Group` value by 50, causing this node to be regarded as the nearest node. This is needed only when all data nodes are on hosts other than that hosts the API node and it is desirable to dedicate one of them to the API node. In normal cases, the default adjustment described previously is sufficient.

Frequent changes in `ndb_data_node_neighbour` are not advisable, since this changes the state of the cluster connection and thus may disrupt the selection algorithm for new transactions from each thread until it stabilizes.

- `ndb_read_backup`

Command-Line Format	<code>--ndb-read-backup[={OFF ON}]</code>
Introduced	5.7.12-ndb-7.5.2
System Variable	<code>ndb_read_backup</code>
Scope	Global
Dynamic	Yes
Type	Boolean
Default Value	OFF

Enable read from any fragment replica for any NDB table subsequently created; doing so greatly improves the table read performance at a relatively small cost to writes.

If the SQL node and the data node use the same host name or IP address, this fact is detected automatically, so that the preference is to send reads to the same host. If these nodes are on the same

host but use different IP addresses, you can tell the SQL node to use the correct data node by setting the value of `ndb_data_node_neighbour` on the SQL node to the node ID of the data node.

To enable or disable read from any fragment replica for an individual table, you can set the `NDB_TABLE` option `READ_BACKUP` for the table accordingly, in a `CREATE TABLE` or `ALTER TABLE` statement; see [Section 13.1.18.9, “Setting NDB Comment Options”](#), for more information.

Added in NDB 7.5.2.

- `ndb_recv_thread_activation_threshold`

Command-Line Format	<code>--ndb-recv-thread-activation-threshold=#</code>
System Variable	<code>ndb_recv_thread_activation_threshold</code>
Scope	Global
Dynamic	Yes
Type	Integer
Default Value	8
Minimum Value	0 ( <code>MIN_ACTIVATION_THRESHOLD</code> )
Maximum Value	16 ( <code>MAX_ACTIVATION_THRESHOLD</code> )

When this number of concurrently active threads is reached, the receive thread takes over polling of the cluster connection.

This variable is global in scope. It can also be set at startup.

- `ndb_recv_thread_cpu_mask`

Command-Line Format	<code>--ndb-recv-thread-cpu-mask=mask</code>
System Variable	<code>ndb_recv_thread_cpu_mask</code>
Scope	Global
Dynamic	Yes
Type	Bitmap
Default Value	[empty]

CPU mask for locking receiver threads to specific CPUs. This is specified as a hexadecimal bitmask. For example, `0x33` means that one CPU is used per receiver thread. An empty string is the default; setting `ndb_recv_thread_cpu_mask` to this value removes any receiver thread locks previously set.

This variable is global in scope. It can also be set at startup.

- `ndb_report_thresh_binlog_epoch_slip`

Command-Line Format	<code>--ndb-report-thresh-binlog-epoch-slip=#</code>
System Variable	<code>ndb_report_thresh_binlog_epoch_slip</code>
Scope	Global
Dynamic	Yes
Type	Integer



Default Value (≥ 5.7.16-ndb-7.5.4)	10
Default Value (≤ 5.7.13-ndb-7.5.3)	3
Minimum Value	0
Maximum Value	256

In NDB 7.5.4 and later, this represents the threshold for the number of epochs completely buffered in the event buffer, but not yet consumed by the binlog injector thread. When this degree of slippage (lag) is exceeded, an event buffer status message is reported, with `BUFFERED_EPOCHS_OVER_THRESHOLD` supplied as the reason (see [Section 21.6.2.3, “Event Buffer Reporting in the Cluster Log”](#)). Slip is increased when an epoch is received from data nodes and buffered completely in the event buffer; it is decreased when an epoch is consumed by the binlog injector thread, it is reduced. Empty epochs are buffered and queued, and so included in this calculation only when this is enabled using the `Ndb::setEventBufferQueueEmptyEpoch()` method from the NDB API.

Prior to NDB 7.5.4, the value of this variable served as a threshold for the number of epochs to be behind before reporting binary log status. In these previous releases, a value of 3—the default—means that if the difference between which epoch has been received from the storage nodes and which epoch has been applied to the binary log is 3 or more, a status message is then sent to the cluster log.

- [ndb\\_report\\_thresh\\_binlog\\_mem\\_usage](#)

Command-Line Format	<code>--ndb-report-thresh-binlog-mem-usage=#</code>
System Variable	<a href="#">ndb_report_thresh_binlog_mem_usage</a>
Scope	Global
Dynamic	Yes
Type	Integer
Default Value	10
Minimum Value	0
Maximum Value	10

This is a threshold on the percentage of free memory remaining before reporting binary log status. For example, a value of 10 (the default) means that if the amount of available memory for receiving binary log data from the data nodes falls below 10%, a status message is sent to the cluster log.

- [ndb\\_row\\_checksum](#)

Introduced	5.7.23-ndb-7.6.8
System Variable	<a href="#">ndb_row_checksum</a>
Scope	Global, Session
Dynamic	Yes
Type	Integer
Default Value	1
Minimum Value	0
Maximum Value	1

Traditionally, NDB has created tables with row checksums, which checks for hardware issues at the expense of performance. Setting `ndb_row_checksum` to 0 means that row checksums are *not* used

for new or altered tables, which has a significant impact on performance for all types of queries. This variable is set to 1 by default, to provide backward-compatible behavior.

- `ndb_show_foreign_key_mock_tables`

Command-Line Format	<code>--ndb-show-foreign-key-mock-tables[={OFF ON}]</code>
System Variable	<code>ndb_show_foreign_key_mock_tables</code>
Scope	Global
Dynamic	Yes
Type	Boolean
Default Value	OFF

Show the mock tables used by NDB to support `foreign_key_checks=0`. When this is enabled, extra warnings are shown when creating and dropping the tables. The real (internal) name of the table can be seen in the output of `SHOW CREATE TABLE`.

- `ndb_slave_conflict_role`

Command-Line Format	<code>--ndb-slave-conflict-role=value</code>
System Variable	<code>ndb_slave_conflict_role</code>
Scope	Global
Dynamic	Yes
Type	Enumeration
Default Value	NONE
Valid Values	NONE  PRIMARY  SECONDARY  PASS

Determine the role of this SQL node (and NDB Cluster) in a circular (“active-active”) replication setup. `ndb_slave_conflict_role` can take any one of the values `PRIMARY`, `SECONDARY`, `PASS`, or `NULL` (the default). The replica SQL thread must be stopped before you can change `ndb_slave_conflict_role`. In addition, it is not possible to change directly between `PASS` and either of `PRIMARY` or `SECONDARY` directly; in such cases, you must ensure that the SQL thread is stopped, then execute `SET @@GLOBAL.ndb_slave_conflict_role = 'NONE'` first.

For more information, see [Section 21.7.11, “NDB Cluster Replication Conflict Resolution”](#).

- `ndb_table_no_logging`

System Variable	<code>ndb_table_no_logging</code>
Scope	Session
Dynamic	Yes
Type	Boolean

Default Value	OFF
---------------	-----

When this variable is set to `ON` or `1`, it causes all tables created or altered using `ENGINE NDB` to be nonlogging; that is, no data changes for this table are written to the redo log or checkpointed to disk, just as if the table had been created or altered using the `NOLOGGING` option for `CREATE TABLE` or `ALTER TABLE`.

For more information about nonlogging `NDB` tables, see [NDB\\_TABLE Options](#).

`ndb_table_no_logging` has no effect on the creation of `NDB` table schema files; to suppress these, use `ndb_table_temporary` instead.

- `ndb_table_temporary`

System Variable	<code>ndb_table_temporary</code>
Scope	Session
Dynamic	Yes
Type	Boolean
Default Value	OFF

When set to `ON` or `1`, this variable causes `NDB` tables not to be written to disk: This means that no table schema files are created, and that the tables are not logged.



#### Note

Setting this variable currently has no effect. This is a known issue; see Bug #34036.

- `ndb_use_copying_alter_table`

System Variable	<code>ndb_use_copying_alter_table</code>
Scope	Global, Session
Dynamic	No

Forces `NDB` to use copying of tables in the event of problems with online `ALTER TABLE` operations. The default value is `OFF`.

- `ndb_use_exact_count`

System Variable	<code>ndb_use_exact_count</code>
Scope	Global, Session
Dynamic	Yes
Type	Boolean
Default Value	OFF

Forces `NDB` to use a count of records during `SELECT COUNT(*)` query planning to speed up this type of query. The default value is `OFF`, which allows for faster queries overall.

- `ndb_use_transactions`

Command-Line Format	<code>--ndb-use-transactions[={OFF ON}]</code>
---------------------	--

System Variable	<code>ndb_use_transactions</code>
Scope	Global, Session
Dynamic	Yes
Type	Boolean
Default Value	<code>ON</code>

You can disable **NDB** transaction support by setting this variable's value to `OFF`. This is generally not recommended, although it may be useful to disable transaction support within a given client session when that session is used to import one or more dump files with large transactions; this allows a multi-row insert to be executed in parts, rather than as a single transaction. In such cases, once the import has been completed, you should either reset the variable value for this session to `ON`, or simply terminate the session.

- `ndb_version`

System Variable	<code>ndb_version</code>
Scope	Global
Dynamic	No
Type	String
Default Value	

**NDB** engine version, as a composite integer.

- `ndb_version_string`

System Variable	<code>ndb_version_string</code>
Scope	Global
Dynamic	No
Type	String
Default Value	

**NDB** engine version in `ndb-x.y.z` format.

- `server_id_bits`

Command-Line Format	<code>--server-id-bits=#</code>
System Variable	<code>server_id_bits</code>
Scope	Global
Dynamic	No
Type	Integer
Default Value	<code>32</code>
Minimum Value	<code>7</code>
Maximum Value	<code>32</code>

This variable indicates the number of least significant bits within the 32-bit `server_id` which actually identify the server. Indicating that the server is actually identified by fewer than 32 bits makes it possible for some of the remaining bits to be used for other purposes, such as storing user data generated by

applications using the NDB API's Event API within the `AnyValue` of an `OperationOptions` structure (NDB Cluster uses the `AnyValue` to store the server ID).

When extracting the effective server ID from `server_id` for purposes such as detection of replication loops, the server ignores the remaining bits. The `server_id_bits` variable is used to mask out any irrelevant bits of `server_id` in the I/O and SQL threads when deciding whether an event should be ignored based on the server ID.

This data can be read from the binary log by `mysqlbinlog`, provided that it is run with its own `server_id_bits` variable set to 32 (the default).

If the value of `server_id` greater than or equal to 2 to the power of `server_id_bits`; otherwise, `mysqld` refuses to start.

This system variable is supported only by NDB Cluster. It is not supported in the standard MySQL 5.7 Server.

- `slave_allow_batching`

Command-Line Format	<code>--slave-allow-batching[={OFF ON}]</code>
System Variable	<code>slave_allow_batching</code>
Scope	Global
Dynamic	Yes
Type	Boolean
Default Value	<code>OFF</code>

Whether or not batched updates are enabled on NDB Cluster replicas.

Allowing batched updates on the replica greatly improves performance, particularly when replicating `TEXT`, `BLOB`, and `JSON` columns. For this reason, you should always enable `slave_allow_batching` when using NDB replication. Beginning with NDB 7.6.23, a warning is issued whenever this variable is set to `OFF`.

Setting this variable has an effect only when using replication with the `NDB` storage engine; in MySQL Server 5.7, it is present but does nothing. For more information, see [Section 21.7.6, “Starting NDB Cluster Replication \(Single Replication Channel\)”](#).

- `transaction_allow_batching`

System Variable	<code>transaction_allow_batching</code>
Scope	Session
Dynamic	Yes
Type	Boolean

Default Value	OFF
---------------	-----

When set to `1` or `ON`, this variable enables batching of statements within the same transaction. To use this variable, `autocommit` must first be disabled by setting it to `0` or `OFF`; otherwise, setting `transaction_allow_batching` has no effect.

It is safe to use this variable with transactions that performs writes only, as having it enabled can lead to reads from the “before” image. You should ensure that any pending transactions are committed (using an explicit `COMMIT` if desired) before issuing a `SELECT`.



**Important**

`transaction_allow_batching` should not be used whenever there is the possibility that the effects of a given statement depend on the outcome of a previous statement within the same transaction.

This variable is currently supported for NDB Cluster only.

The system variables in the following list all relate to the `ndbinfo` information database.

- `ndbinfo_database`

System Variable	<code>ndbinfo_database</code>
Scope	Global
Dynamic	No
Type	String
Default Value	<code>ndbinfo</code>

Shows the name used for the `NDB` information database; the default is `ndbinfo`. This is a read-only variable whose value is determined at compile time.

- `ndbinfo_max_bytes`

Command-Line Format	<code>--ndbinfo-max-bytes=#</code>
System Variable	<code>ndbinfo_max_bytes</code>
Scope	Global, Session
Dynamic	Yes
Type	Integer
Default Value	<code>0</code>
Minimum Value	<code>0</code>
Maximum Value	<code>65535</code>

Used in testing and debugging only.

- `ndbinfo_max_rows`

Command-Line Format	<code>--ndbinfo-max-rows=#</code>
System Variable	<code>ndbinfo_max_rows</code>
Scope	Global, Session
Dynamic	Yes

Type	Integer
Default Value	10
Minimum Value	1
Maximum Value	256

Used in testing and debugging only.

- `ndbinfo_offline`

System Variable	<code>ndbinfo_offline</code>
Scope	Global
Dynamic	Yes
Type	Boolean
Default Value	<code>OFF</code>

Place the `ndbinfo` database into offline mode, in which tables and views can be opened even when they do not actually exist, or when they exist but have different definitions in `NDB`. No rows are returned from such tables (or views).

- `ndbinfo_show_hidden`

Command-Line Format	<code>--ndbinfo-show-hidden[={OFF ON}]</code>
System Variable	<code>ndbinfo_show_hidden</code>
Scope	Global, Session
Dynamic	Yes
Type	Boolean
Default Value	<code>OFF</code>
Valid Values	<code>ON</code> <code>OFF</code>

Whether or not the `ndbinfo` database's underlying internal tables are shown in the `mysql` client. The default is `OFF`.



**Note**

When `ndbinfo_show_hidden` is enabled, the internal tables are shown in the `ndbinfo` database only; they are not visible in `TABLES` or other `INFORMATION_SCHEMA` tables, regardless of the variable's setting.

- `ndbinfo_table_prefix`

System Variable	<code>ndbinfo_table_prefix</code>
Scope	Global
Dynamic	No
Type	String

Default Value	ndb\$
---------------	-------

The prefix used in naming the ndbinfo database's base tables (normally hidden, unless exposed by setting `ndbinfo_show_hidden`). This is a read-only variable whose default value is `ndb$`; the prefix itself is determined at compile time.

- `ndbinfo_version`

System Variable	<code>ndbinfo_version</code>
Scope	Global
Dynamic	No
Type	String
Default Value	

Shows the version of the `ndbinfo` engine in use; read-only.

## NDB Cluster Status Variables

This section provides detailed information about MySQL server status variables that relate to NDB Cluster and the `NDB` storage engine. For status variables not specific to NDB Cluster, and for general information on using status variables, see [Section 5.1.9, “Server Status Variables”](#).

- `Handler_discover`

The MySQL server can ask the `NDBCLUSTER` storage engine if it knows about a table with a given name. This is called discovery. `Handler_discover` indicates the number of times that tables have been discovered using this mechanism.

- `Ndb_api_adaptive_send_deferred_count`

Number of adaptive send calls that were not actually sent.

For more information, see [Section 21.6.14, “NDB API Statistics Counters and Variables”](#).

- `Ndb_api_adaptive_send_deferred_count_session`

Number of adaptive send calls that were not actually sent.

For more information, see [Section 21.6.14, “NDB API Statistics Counters and Variables”](#).

- `Ndb_api_adaptive_send_deferred_count_slave`

Number of adaptive send calls that were not actually sent by this replica.

For more information, see [Section 21.6.14, “NDB API Statistics Counters and Variables”](#).

- `Ndb_api_adaptive_send_forced_count`

Number of adaptive send calls using forced-send sent by this MySQL Server (SQL node).

For more information, see [Section 21.6.14, “NDB API Statistics Counters and Variables”](#).

- `Ndb_api_adaptive_send_forced_count_session`

Number of adaptive send calls using forced-send sent in this client session.



For more information, see [Section 21.6.14, “NDB API Statistics Counters and Variables”](#).

- `Ndb_api_adaptive_send_forced_count_slave`

Number of adaptive send calls using forced-send sent by this replica.

For more information, see [Section 21.6.14, “NDB API Statistics Counters and Variables”](#).

- `Ndb_api_adaptive_send_unforced_count`

Number of adaptive send calls without forced-send sent by this MySQL server (SQL node).

For more information, see [Section 21.6.14, “NDB API Statistics Counters and Variables”](#).

- `Ndb_api_adaptive_send_unforced_count_session`

Number of adaptive send calls without forced-send sent in this client session.

For more information, see [Section 21.6.14, “NDB API Statistics Counters and Variables”](#).

- `Ndb_api_adaptive_send_unforced_count_slave`

Number of adaptive send calls without forced-send sent by this replica.

For more information, see [Section 21.6.14, “NDB API Statistics Counters and Variables”](#).

- `Ndb_api_bytes_sent_count_session`

Amount of data (in bytes) sent to the data nodes in this client session.

Although this variable can be read using either `SHOW GLOBAL STATUS` or `SHOW SESSION STATUS`, it relates to the current session only, and is not affected by any other clients of this `mysqld`.

For more information, see [Section 21.6.14, “NDB API Statistics Counters and Variables”](#).

- `Ndb_api_bytes_sent_count_slave`

Amount of data (in bytes) sent to the data nodes by this replica.

Although this variable can be read using either `SHOW GLOBAL STATUS` or `SHOW SESSION STATUS`, it is effectively global in scope. If this MySQL server does not act as a replica, or does not use NDB tables, this value is always 0.

For more information, see [Section 21.6.14, “NDB API Statistics Counters and Variables”](#).

- `Ndb_api_bytes_sent_count`

Amount of data (in bytes) sent to the data nodes by this MySQL Server (SQL node).

Although this variable can be read using either `SHOW GLOBAL STATUS` or `SHOW SESSION STATUS`, it is effectively global in scope.

For more information, see [Section 21.6.14, “NDB API Statistics Counters and Variables”](#).

- `Ndb_api_bytes_received_count_session`

Amount of data (in bytes) received from the data nodes in this client session.

Although this variable can be read using either `SHOW GLOBAL STATUS` or `SHOW SESSION STATUS`, it relates to the current session only, and is not affected by any other clients of this `mysqld`.

For more information, see [Section 21.6.14, “NDB API Statistics Counters and Variables”](#).

- `Ndb_api_bytes_received_count_slave`

Amount of data (in bytes) received from the data nodes by this replica.

Although this variable can be read using either `SHOW GLOBAL STATUS` or `SHOW SESSION STATUS`, it is effectively global in scope. If this MySQL server does not act as a replica, or does not use NDB tables, this value is always 0.

For more information, see [Section 21.6.14, “NDB API Statistics Counters and Variables”](#).

- `Ndb_api_bytes_received_count`

Amount of data (in bytes) received from the data nodes by this MySQL Server (SQL node).

Although this variable can be read using either `SHOW GLOBAL STATUS` or `SHOW SESSION STATUS`, it is effectively global in scope.

For more information, see [Section 21.6.14, “NDB API Statistics Counters and Variables”](#).

- `Ndb_api_event_data_count_injector`

The number of row change events received by the NDB binlog injector thread.

Although this variable can be read using either `SHOW GLOBAL STATUS` or `SHOW SESSION STATUS`, it is effectively global in scope.

For more information, see [Section 21.6.14, “NDB API Statistics Counters and Variables”](#).

- `Ndb_api_event_data_count`

The number of row change events received by this MySQL Server (SQL node).

Although this variable can be read using either `SHOW GLOBAL STATUS` or `SHOW SESSION STATUS`, it is effectively global in scope.

For more information, see [Section 21.6.14, “NDB API Statistics Counters and Variables”](#).

- `Ndb_api_event_nondata_count_injector`

The number of events received, other than row change events, by the NDB binary log injector thread.

Although this variable can be read using either `SHOW GLOBAL STATUS` or `SHOW SESSION STATUS`, it is effectively global in scope.

For more information, see [Section 21.6.14, “NDB API Statistics Counters and Variables”](#).

- `Ndb_api_event_nondata_count`

The number of events received, other than row change events, by this MySQL Server (SQL node).

Although this variable can be read using either `SHOW GLOBAL STATUS` or `SHOW SESSION STATUS`, it is effectively global in scope.

For more information, see [Section 21.6.14, “NDB API Statistics Counters and Variables”](#).

- `Ndb_api_event_bytes_count_injector`

The number of bytes of events received by the NDB binlog injector thread.

Although this variable can be read using either `SHOW GLOBAL STATUS` or `SHOW SESSION STATUS`, it is effectively global in scope.

For more information, see [Section 21.6.14, “NDB API Statistics Counters and Variables”](#).

- `Ndb_api_event_bytes_count`

The number of bytes of events received by this MySQL Server (SQL node).

Although this variable can be read using either `SHOW GLOBAL STATUS` or `SHOW SESSION STATUS`, it is effectively global in scope.

For more information, see [Section 21.6.14, “NDB API Statistics Counters and Variables”](#).

- `Ndb_api_pk_op_count_session`

The number of operations in this client session based on or using primary keys. This includes operations on blob tables, implicit unlock operations, and auto-increment operations, as well as user-visible primary key operations.

Although this variable can be read using either `SHOW GLOBAL STATUS` or `SHOW SESSION STATUS`, it relates to the current session only, and is not affected by any other clients of this `mysqld`.

For more information, see [Section 21.6.14, “NDB API Statistics Counters and Variables”](#).

- `Ndb_api_pk_op_count_slave`

The number of operations by this replica based on or using primary keys. This includes operations on blob tables, implicit unlock operations, and auto-increment operations, as well as user-visible primary key operations.

Although this variable can be read using either `SHOW GLOBAL STATUS` or `SHOW SESSION STATUS`, it is effectively global in scope. If this MySQL server does not act as a replica, or does not use NDB tables, this value is always 0.

For more information, see [Section 21.6.14, “NDB API Statistics Counters and Variables”](#).

- `Ndb_api_pk_op_count`

The number of operations by this MySQL Server (SQL node) based on or using primary keys. This includes operations on blob tables, implicit unlock operations, and auto-increment operations, as well as user-visible primary key operations.

Although this variable can be read using either `SHOW GLOBAL STATUS` or `SHOW SESSION STATUS`, it is effectively global in scope.

For more information, see [Section 21.6.14, “NDB API Statistics Counters and Variables”](#).

- `Ndb_api_pruned_scan_count_session`

The number of scans in this client session that have been pruned to a single partition.

Although this variable can be read using either `SHOW GLOBAL STATUS` or `SHOW SESSION STATUS`, it relates to the current session only, and is not affected by any other clients of this `mysqld`.

For more information, see [Section 21.6.14, “NDB API Statistics Counters and Variables”](#).

- `Ndb_api_pruned_scan_count_slave`

The number of scans by this replica that have been pruned to a single partition.

Although this variable can be read using either `SHOW GLOBAL STATUS` or `SHOW SESSION STATUS`, it is effectively global in scope. If this MySQL server does not act as a replica, or does not use NDB tables, this value is always 0.

For more information, see [Section 21.6.14, “NDB API Statistics Counters and Variables”](#).

- `Ndb_api_pruned_scan_count`

The number of scans by this MySQL Server (SQL node) that have been pruned to a single partition.

Although this variable can be read using either `SHOW GLOBAL STATUS` or `SHOW SESSION STATUS`, it is effectively global in scope.

For more information, see [Section 21.6.14, “NDB API Statistics Counters and Variables”](#).

- `Ndb_api_range_scan_count_session`

The number of range scans that have been started in this client session.

Although this variable can be read using either `SHOW GLOBAL STATUS` or `SHOW SESSION STATUS`, it relates to the current session only, and is not affected by any other clients of this `mysqld`.

For more information, see [Section 21.6.14, “NDB API Statistics Counters and Variables”](#).

- `Ndb_api_range_scan_count_slave`

The number of range scans that have been started by this replica.

Although this variable can be read using either `SHOW GLOBAL STATUS` or `SHOW SESSION STATUS`, it is effectively global in scope. If this MySQL server does not act as a replica, or does not use NDB tables, this value is always 0.

For more information, see [Section 21.6.14, “NDB API Statistics Counters and Variables”](#).

- `Ndb_api_range_scan_count`

The number of range scans that have been started by this MySQL Server (SQL node).

Although this variable can be read using either `SHOW GLOBAL STATUS` or `SHOW SESSION STATUS`, it is effectively global in scope.

For more information, see [Section 21.6.14, “NDB API Statistics Counters and Variables”](#).

---

- `Ndb_api_read_row_count_session`

The total number of rows that have been read in this client session. This includes all rows read by any primary key, unique key, or scan operation made in this client session.

Although this variable can be read using either `SHOW GLOBAL STATUS` or `SHOW SESSION STATUS`, it relates to the current session only, and is not affected by any other clients of this `mysqld`.

For more information, see [Section 21.6.14, “NDB API Statistics Counters and Variables”](#).

- `Ndb_api_read_row_count_slave`

The total number of rows that have been read by this replica. This includes all rows read by any primary key, unique key, or scan operation made by this replica.

Although this variable can be read using either `SHOW GLOBAL STATUS` or `SHOW SESSION STATUS`, it is effectively global in scope. If this MySQL server does not act as a replica, or does not use NDB tables, this value is always 0.

For more information, see [Section 21.6.14, “NDB API Statistics Counters and Variables”](#).

- `Ndb_api_read_row_count`

The total number of rows that have been read by this MySQL Server (SQL node). This includes all rows read by any primary key, unique key, or scan operation made by this MySQL Server (SQL node).

You should be aware that this value may not be completely accurate with regard to rows read by `SELECT COUNT(*)` queries, due to the fact that, in this case, the MySQL server actually reads pseudo-rows in the form `[table fragment ID]:[number of rows in fragment]` and sums the rows per fragment for all fragments in the table to derive an estimated count for all rows. `Ndb_api_read_row_count` uses this estimate and not the actual number of rows in the table.

Although this variable can be read using either `SHOW GLOBAL STATUS` or `SHOW SESSION STATUS`, it is effectively global in scope.

For more information, see [Section 21.6.14, “NDB API Statistics Counters and Variables”](#).

- `Ndb_api_scan_batch_count_session`

The number of batches of rows received in this client session. 1 batch is defined as 1 set of scan results from a single fragment.

Although this variable can be read using either `SHOW GLOBAL STATUS` or `SHOW SESSION STATUS`, it relates to the current session only, and is not affected by any other clients of this `mysqld`.

For more information, see [Section 21.6.14, “NDB API Statistics Counters and Variables”](#).

- `Ndb_api_scan_batch_count_slave`

The number of batches of rows received by this replica. 1 batch is defined as 1 set of scan results from a single fragment.

Although this variable can be read using either `SHOW GLOBAL STATUS` or `SHOW SESSION STATUS`, it is effectively global in scope. If this MySQL server does not act as a replica, or does not use NDB tables, this value is always 0.

For more information, see [Section 21.6.14, “NDB API Statistics Counters and Variables”](#).

- `Ndb_api_scan_batch_count`

The number of batches of rows received by this MySQL Server (SQL node). 1 batch is defined as 1 set of scan results from a single fragment.

Although this variable can be read using either `SHOW GLOBAL STATUS` or `SHOW SESSION STATUS`, it is effectively global in scope.

For more information, see [Section 21.6.14, “NDB API Statistics Counters and Variables”](#).

- `Ndb_api_table_scan_count_session`

The number of table scans that have been started in this client session, including scans of internal tables,.

Although this variable can be read using either `SHOW GLOBAL STATUS` or `SHOW SESSION STATUS`, it relates to the current session only, and is not affected by any other clients of this `mysqld`.

For more information, see [Section 21.6.14, “NDB API Statistics Counters and Variables”](#).

- `Ndb_api_table_scan_count_slave`

The number of table scans that have been started by this replica, including scans of internal tables,.

Although this variable can be read using either `SHOW GLOBAL STATUS` or `SHOW SESSION STATUS`, it is effectively global in scope. If this MySQL server does not act as a replica, or does not use NDB tables, this value is always 0.

For more information, see [Section 21.6.14, “NDB API Statistics Counters and Variables”](#).

- `Ndb_api_table_scan_count`

The number of table scans that have been started by this MySQL Server (SQL node), including scans of internal tables,.

Although this variable can be read using either `SHOW GLOBAL STATUS` or `SHOW SESSION STATUS`, it is effectively global in scope.

For more information, see [Section 21.6.14, “NDB API Statistics Counters and Variables”](#).

- `Ndb_api_trans_abort_count_session`

The number of transactions aborted in this client session.

Although this variable can be read using either `SHOW GLOBAL STATUS` or `SHOW SESSION STATUS`, it relates to the current session only, and is not affected by any other clients of this `mysqld`.

For more information, see [Section 21.6.14, “NDB API Statistics Counters and Variables”](#).

- `Ndb_api_trans_abort_count_slave`

The number of transactions aborted by this replica.

Although this variable can be read using either `SHOW GLOBAL STATUS` or `SHOW SESSION STATUS`, it is effectively global in scope. If this MySQL server does not act as a replica, or does not use NDB tables, this value is always 0.

For more information, see [Section 21.6.14, “NDB API Statistics Counters and Variables”](#).

- `Ndb_api_trans_abort_count`

The number of transactions aborted by this MySQL Server (SQL node).

Although this variable can be read using either `SHOW GLOBAL STATUS` or `SHOW SESSION STATUS`, it is effectively global in scope.

For more information, see [Section 21.6.14, “NDB API Statistics Counters and Variables”](#).

- `Ndb_api_trans_close_count_session`

The number of transactions closed in this client session. This value may be greater than the sum of `Ndb_api_trans_commit_count_session` and `Ndb_api_trans_abort_count_session`, since some transactions may have been rolled back.

Although this variable can be read using either `SHOW GLOBAL STATUS` or `SHOW SESSION STATUS`, it relates to the current session only, and is not affected by any other clients of this `mysqld`.

For more information, see [Section 21.6.14, “NDB API Statistics Counters and Variables”](#).

- `Ndb_api_trans_close_count_slave`

The number of transactions closed by this replica. This value may be greater than the sum of `Ndb_api_trans_commit_count_slave` and `Ndb_api_trans_abort_count_slave`, since some transactions may have been rolled back.

Although this variable can be read using either `SHOW GLOBAL STATUS` or `SHOW SESSION STATUS`, it is effectively global in scope. If this MySQL server does not act as a replica, or does not use NDB tables, this value is always 0.

For more information, see [Section 21.6.14, “NDB API Statistics Counters and Variables”](#).

- `Ndb_api_trans_close_count`

The number of transactions closed by this MySQL Server (SQL node). This value may be greater than the sum of `Ndb_api_trans_commit_count` and `Ndb_api_trans_abort_count`, since some transactions may have been rolled back.

Although this variable can be read using either `SHOW GLOBAL STATUS` or `SHOW SESSION STATUS`, it is effectively global in scope.

For more information, see [Section 21.6.14, “NDB API Statistics Counters and Variables”](#).

- `Ndb_api_trans_commit_count_session`

The number of transactions committed in this client session.

Although this variable can be read using either `SHOW GLOBAL STATUS` or `SHOW SESSION STATUS`, it relates to the current session only, and is not affected by any other clients of this `mysqld`.

For more information, see [Section 21.6.14, “NDB API Statistics Counters and Variables”](#).

- `Ndb_api_trans_commit_count_slave`

The number of transactions committed by this replica.

Although this variable can be read using either `SHOW GLOBAL STATUS` or `SHOW SESSION STATUS`, it is effectively global in scope. If this MySQL server does not act as a replica, or does not use NDB tables, this value is always 0.

For more information, see [Section 21.6.14, “NDB API Statistics Counters and Variables”](#).

- `Ndb_api_trans_commit_count`

The number of transactions committed by this MySQL Server (SQL node).

Although this variable can be read using either `SHOW GLOBAL STATUS` or `SHOW SESSION STATUS`, it is effectively global in scope.

For more information, see [Section 21.6.14, “NDB API Statistics Counters and Variables”](#).

- `Ndb_api_trans_local_read_row_count_session`

The total number of rows that have been read in this client session. This includes all rows read by any primary key, unique key, or scan operation made in this client session.

Although this variable can be read using either `SHOW GLOBAL STATUS` or `SHOW SESSION STATUS`, it relates to the current session only, and is not affected by any other clients of this `mysqld`.

For more information, see [Section 21.6.14, “NDB API Statistics Counters and Variables”](#).

- `Ndb_api_trans_local_read_row_count_slave`

The total number of rows that have been read by this replica. This includes all rows read by any primary key, unique key, or scan operation made by this replica.

Although this variable can be read using either `SHOW GLOBAL STATUS` or `SHOW SESSION STATUS`, it is effectively global in scope. If this MySQL server does not act as a replica, or does not use NDB tables, this value is always 0.

For more information, see [Section 21.6.14, “NDB API Statistics Counters and Variables”](#).

- `Ndb_api_trans_local_read_row_count`

The total number of rows that have been read by this MySQL Server (SQL node). This includes all rows read by any primary key, unique key, or scan operation made by this MySQL Server (SQL node).

Although this variable can be read using either `SHOW GLOBAL STATUS` or `SHOW SESSION STATUS`, it is effectively global in scope.

For more information, see [Section 21.6.14, “NDB API Statistics Counters and Variables”](#).

- `Ndb_api_trans_start_count_session`

The number of transactions started in this client session.

Although this variable can be read using either `SHOW GLOBAL STATUS` or `SHOW SESSION STATUS`, it relates to the current session only, and is not affected by any other clients of this `mysqld`.

For more information, see [Section 21.6.14, “NDB API Statistics Counters and Variables”](#).



- `Ndb_api_trans_start_count_slave`

The number of transactions started by this replica.

Although this variable can be read using either `SHOW GLOBAL STATUS` or `SHOW SESSION STATUS`, it is effectively global in scope. If this MySQL server does not act as a replica, or does not use NDB tables, this value is always 0.

For more information, see [Section 21.6.14, “NDB API Statistics Counters and Variables”](#).

- `Ndb_api_trans_start_count`

The number of transactions started by this MySQL Server (SQL node).

Although this variable can be read using either `SHOW GLOBAL STATUS` or `SHOW SESSION STATUS`, it is effectively global in scope.

For more information, see [Section 21.6.14, “NDB API Statistics Counters and Variables”](#).

- `Ndb_api_uk_op_count_session`

The number of operations in this client session based on or using unique keys.

Although this variable can be read using either `SHOW GLOBAL STATUS` or `SHOW SESSION STATUS`, it relates to the current session only, and is not affected by any other clients of this `mysqld`.

For more information, see [Section 21.6.14, “NDB API Statistics Counters and Variables”](#).

- `Ndb_api_uk_op_count_slave`

The number of operations by this replica based on or using unique keys.

Although this variable can be read using either `SHOW GLOBAL STATUS` or `SHOW SESSION STATUS`, it is effectively global in scope. If this MySQL server does not act as a replica, or does not use NDB tables, this value is always 0.

For more information, see [Section 21.6.14, “NDB API Statistics Counters and Variables”](#).

- `Ndb_api_uk_op_count`

The number of operations by this MySQL Server (SQL node) based on or using unique keys.

Although this variable can be read using either `SHOW GLOBAL STATUS` or `SHOW SESSION STATUS`, it is effectively global in scope.

For more information, see [Section 21.6.14, “NDB API Statistics Counters and Variables”](#).

- `Ndb_api_wait_exec_complete_count_session`

The number of times a thread has been blocked in this client session while waiting for execution of an operation to complete. This includes all `execute()` calls as well as implicit executes for blob and auto-increment operations not visible to clients.

Although this variable can be read using either `SHOW GLOBAL STATUS` or `SHOW SESSION STATUS`, it relates to the current session only, and is not affected by any other clients of this `mysqld`.

For more information, see [Section 21.6.14, “NDB API Statistics Counters and Variables”](#).

- `Ndb_api_wait_exec_complete_count_slave`

The number of times a thread has been blocked by this replica while waiting for execution of an operation to complete. This includes all `execute()` calls as well as implicit executes for blob and auto-increment operations not visible to clients.

Although this variable can be read using either `SHOW GLOBAL STATUS` or `SHOW SESSION STATUS`, it is effectively global in scope. If this MySQL server does not act as a replica, or does not use NDB tables, this value is always 0.

For more information, see [Section 21.6.14, “NDB API Statistics Counters and Variables”](#).

- `Ndb_api_wait_exec_complete_count`

The number of times a thread has been blocked by this MySQL Server (SQL node) while waiting for execution of an operation to complete. This includes all `execute()` calls as well as implicit executes for blob and auto-increment operations not visible to clients.

Although this variable can be read using either `SHOW GLOBAL STATUS` or `SHOW SESSION STATUS`, it is effectively global in scope.

For more information, see [Section 21.6.14, “NDB API Statistics Counters and Variables”](#).

- `Ndb_api_wait_meta_request_count_session`

The number of times a thread has been blocked in this client session waiting for a metadata-based signal, such as is expected for DDL requests, new epochs, and seizure of transaction records.

Although this variable can be read using either `SHOW GLOBAL STATUS` or `SHOW SESSION STATUS`, it relates to the current session only, and is not affected by any other clients of this `mysqld`.

For more information, see [Section 21.6.14, “NDB API Statistics Counters and Variables”](#).

- `Ndb_api_wait_meta_request_count_slave`

The number of times a thread has been blocked by this replica waiting for a metadata-based signal, such as is expected for DDL requests, new epochs, and seizure of transaction records.

Although this variable can be read using either `SHOW GLOBAL STATUS` or `SHOW SESSION STATUS`, it is effectively global in scope. If this MySQL server does not act as a replica, or does not use NDB tables, this value is always 0.

For more information, see [Section 21.6.14, “NDB API Statistics Counters and Variables”](#).

- `Ndb_api_wait_meta_request_count`

The number of times a thread has been blocked by this MySQL Server (SQL node) waiting for a metadata-based signal, such as is expected for DDL requests, new epochs, and seizure of transaction records.

Although this variable can be read using either `SHOW GLOBAL STATUS` or `SHOW SESSION STATUS`, it is effectively global in scope.

For more information, see [Section 21.6.14, “NDB API Statistics Counters and Variables”](#).

- `Ndb_api_wait_nanos_count_session`

Total time (in nanoseconds) spent in this client session waiting for any type of signal from the data nodes.

Although this variable can be read using either `SHOW GLOBAL STATUS` or `SHOW SESSION STATUS`, it relates to the current session only, and is not affected by any other clients of this `mysqld`.

For more information, see [Section 21.6.14, “NDB API Statistics Counters and Variables”](#).

- `Ndb_api_wait_nanos_count_slave`

Total time (in nanoseconds) spent by this replica waiting for any type of signal from the data nodes.

Although this variable can be read using either `SHOW GLOBAL STATUS` or `SHOW SESSION STATUS`, it is effectively global in scope. If this MySQL server does not act as a replica, or does not use NDB tables, this value is always 0.

For more information, see [Section 21.6.14, “NDB API Statistics Counters and Variables”](#).

- `Ndb_api_wait_nanos_count`

Total time (in nanoseconds) spent by this MySQL Server (SQL node) waiting for any type of signal from the data nodes.

Although this variable can be read using either `SHOW GLOBAL STATUS` or `SHOW SESSION STATUS`, it is effectively global in scope.

For more information, see [Section 21.6.14, “NDB API Statistics Counters and Variables”](#).

- `Ndb_api_wait_scan_result_count_session`

The number of times a thread has been blocked in this client session while waiting for a scan-based signal, such as when waiting for more results from a scan, or when waiting for a scan to close.

Although this variable can be read using either `SHOW GLOBAL STATUS` or `SHOW SESSION STATUS`, it relates to the current session only, and is not affected by any other clients of this `mysqld`.

For more information, see [Section 21.6.14, “NDB API Statistics Counters and Variables”](#).

- `Ndb_api_wait_scan_result_count_slave`

The number of times a thread has been blocked by this replica while waiting for a scan-based signal, such as when waiting for more results from a scan, or when waiting for a scan to close.

Although this variable can be read using either `SHOW GLOBAL STATUS` or `SHOW SESSION STATUS`, it is effectively global in scope. If this MySQL server does not act as a replica, or does not use NDB tables, this value is always 0.

For more information, see [Section 21.6.14, “NDB API Statistics Counters and Variables”](#).

- `Ndb_api_wait_scan_result_count`

The number of times a thread has been blocked by this MySQL Server (SQL node) while waiting for a scan-based signal, such as when waiting for more results from a scan, or when waiting for a scan to close.

Although this variable can be read using either `SHOW GLOBAL STATUS` or `SHOW SESSION STATUS`, it is effectively global in scope.

For more information, see [Section 21.6.14, “NDB API Statistics Counters and Variables”](#).

- `Ndb_cluster_node_id`

If the server is acting as an NDB Cluster node, then the value of this variable is its node ID in the cluster.

If the server is not part of an NDB Cluster, then the value of this variable is 0.
- `Ndb_config_from_host`

If the server is part of an NDB Cluster, the value of this variable is the host name or IP address of the Cluster management server from which it gets its configuration data.

If the server is not part of an NDB Cluster, then the value of this variable is an empty string.
- `Ndb_config_from_port`

If the server is part of an NDB Cluster, the value of this variable is the number of the port through which it is connected to the Cluster management server from which it gets its configuration data.

If the server is not part of an NDB Cluster, then the value of this variable is 0.
- `Ndb_conflict_fn_epoch`

Used in NDB Cluster Replication conflict resolution, this variable shows the number of rows found to be in conflict using `NDB$EPOCH()` conflict resolution on a given `mysqld` since the last time it was restarted.

For more information, see [Section 21.7.11, “NDB Cluster Replication Conflict Resolution”](#).
- `Ndb_conflict_fn_epoch_trans`

Used in NDB Cluster Replication conflict resolution, this variable shows the number of rows found to be in conflict using `NDB$EPOCH_TRANS()` conflict resolution on a given `mysqld` since the last time it was restarted.

For more information, see [Section 21.7.11, “NDB Cluster Replication Conflict Resolution”](#).
- `Ndb_conflict_fn_epoch2`

Shows the number of rows found to be in conflict in NDB Cluster Replication conflict resolution, when using `NDB$EPOCH2()`, on the source designated as the primary since the last time it was restarted.

For more information, see `NDB$EPOCH2()`.
- `Ndb_conflict_fn_epoch2_trans`

Used in NDB Cluster Replication conflict resolution, this variable shows the number of rows found to be in conflict using `NDB$EPOCH_TRANS2()` conflict resolution on a given `mysqld` since the last time it was restarted.

For more information, see `NDB$EPOCH2_TRANS()`.
- `Ndb_conflict_fn_max`

Used in NDB Cluster Replication conflict resolution, this variable shows the number of times that a row was not applied on the current SQL node due to “greatest timestamp wins” conflict resolution since the last time that this `mysqld` was started.

For more information, see [Section 21.7.11, “NDB Cluster Replication Conflict Resolution”](#).
- `Ndb_conflict_fn_max_del_win`

Shows the number of times that a row was rejected on the current SQL node due to NDB Cluster Replication conflict resolution using `NDB$MAX_DELETE_WIN()`, since the last time that this `mysqld` was started.

For more information, see [Section 21.7.11, “NDB Cluster Replication Conflict Resolution”](#).

- `Ndb_conflict_fn_old`

Used in NDB Cluster Replication conflict resolution, this variable shows the number of times that a row was not applied as the result of “same timestamp wins” conflict resolution on a given `mysqld` since the last time it was restarted.

For more information, see [Section 21.7.11, “NDB Cluster Replication Conflict Resolution”](#).

- `Ndb_conflict_last_conflict_epoch`

The most recent epoch in which a conflict was detected on this replica. You can compare this value with `Ndb_slave_max_replicated_epoch`; if `Ndb_slave_max_replicated_epoch` is greater than `Ndb_conflict_last_conflict_epoch`, no conflicts have yet been detected.

See [Section 21.7.11, “NDB Cluster Replication Conflict Resolution”](#), for more information.

- `Ndb_conflict_reflected_op_discard_count`

When using NDB Cluster Replication conflict resolution, this is the number of reflected operations that were not applied on the secondary, due to encountering an error during execution.

See [Section 21.7.11, “NDB Cluster Replication Conflict Resolution”](#), for more information.

- `Ndb_conflict_reflected_op_prepare_count`

When using conflict resolution with NDB Cluster Replication, this status variable contains the number of reflected operations that have been defined (that is, prepared for execution on the secondary).

See [Section 21.7.11, “NDB Cluster Replication Conflict Resolution”](#).

- `Ndb_conflict_refresh_op_count`

When using conflict resolution with NDB Cluster Replication, this gives the number of refresh operations that have been prepared for execution on the secondary.

See [Section 21.7.11, “NDB Cluster Replication Conflict Resolution”](#), for more information.

- `Ndb_conflict_last_stable_epoch`

Number of rows found to be in conflict by a transactional conflict function

See [Section 21.7.11, “NDB Cluster Replication Conflict Resolution”](#), for more information.

- `Ndb_conflict_trans_row_conflict_count`

Used in NDB Cluster Replication conflict resolution, this status variable shows the number of rows found to be directly in-conflict by a transactional conflict function on a given `mysqld` since the last time it was restarted.

Currently, the only transactional conflict detection function supported by NDB Cluster is `NDB$EPOCH_TRANS()`, so this status variable is effectively the same as `Ndb_conflict_fn_epoch_trans`.

For more information, see [Section 21.7.11, “NDB Cluster Replication Conflict Resolution”](#).

- `Ndb_conflict_trans_row_reject_count`

Used in NDB Cluster Replication conflict resolution, this status variable shows the total number of rows realigned due to being determined as conflicting by a transactional conflict detection function. This includes not only `Ndb_conflict_trans_row_conflict_count`, but any rows in or dependent on conflicting transactions.

For more information, see [Section 21.7.11, “NDB Cluster Replication Conflict Resolution”](#).

- `Ndb_conflict_trans_reject_count`

Used in NDB Cluster Replication conflict resolution, this status variable shows the number of transactions found to be in conflict by a transactional conflict detection function.

For more information, see [Section 21.7.11, “NDB Cluster Replication Conflict Resolution”](#).

- `Ndb_conflict_trans_detect_iter_count`

Used in NDB Cluster Replication conflict resolution, this shows the number of internal iterations required to commit an epoch transaction. Should be (slightly) greater than or equal to `Ndb_conflict_trans_conflict_commit_count`.

For more information, see [Section 21.7.11, “NDB Cluster Replication Conflict Resolution”](#).

- `Ndb_conflict_trans_conflict_commit_count`

Used in NDB Cluster Replication conflict resolution, this shows the number of epoch transactions committed after they required transactional conflict handling.

For more information, see [Section 21.7.11, “NDB Cluster Replication Conflict Resolution”](#).

- `Ndb_epoch_delete_delete_count`

When using delete-delete conflict detection, this is the number of delete-delete conflicts detected, where a delete operation is applied, but the indicated row does not exist.

- `Ndb_execute_count`

Provides the number of round trips to the NDB kernel made by operations.

- `Ndb_last_commit_epoch_server`

The epoch most recently committed by NDB.

- `Ndb_last_commit_epoch_session`

The epoch most recently committed by this NDB client.

- `Ndb_number_of_data_nodes`

If the server is part of an NDB Cluster, the value of this variable is the number of data nodes in the cluster.

If the server is not part of an NDB Cluster, then the value of this variable is 0.

- `Ndb_pushed_queries_defined`

The total number of joins pushed down to the NDB kernel for distributed handling on the data nodes.



#### Note

Joins tested using [EXPLAIN](#) that can be pushed down contribute to this number.

- [Ndb\\_pushed\\_queries\\_dropped](#)

The number of joins that were pushed down to the NDB kernel but that could not be handled there.

- [Ndb\\_pushed\\_queries\\_executed](#)

The number of joins successfully pushed down to [NDB](#) and executed there.

- [Ndb\\_pushed\\_reads](#)

The number of rows returned to [mysqld](#) from the NDB kernel by joins that were pushed down.



#### Note

Executing [EXPLAIN](#) on joins that can be pushed down to [NDB](#) does not add to this number.

- [Ndb\\_pruned\\_scan\\_count](#)

This variable holds a count of the number of scans executed by [NDBCLUSTER](#) since the NDB Cluster was last started where [NDBCLUSTER](#) was able to use partition pruning.

Using this variable together with [Ndb\\_scan\\_count](#) can be helpful in schema design to maximize the ability of the server to prune scans to a single table partition, thereby involving only a single data node.

- [Ndb\\_scan\\_count](#)

This variable holds a count of the total number of scans executed by [NDBCLUSTER](#) since the NDB Cluster was last started.

- [Ndb\\_slave\\_max\\_replicated\\_epoch](#)

The most recently committed epoch on this replica. You can compare this value with [Ndb\\_conflict\\_last\\_conflict\\_epoch](#); if [Ndb\\_slave\\_max\\_replicated\\_epoch](#) is the greater of the two, no conflicts have yet been detected.

For more information, see [Section 21.7.11, “NDB Cluster Replication Conflict Resolution”](#).

- [Ndb\\_system\\_name](#)

If this MySQL Server is connected to an NDB cluster, this read-only variable shows the cluster system name. Otherwise, the value is an empty string.

### 21.4.3.10 NDB Cluster TCP/IP Connections

TCP/IP is the default transport mechanism for all connections between nodes in an NDB Cluster. Normally it is not necessary to define TCP/IP connections; NDB Cluster automatically sets up such connections for all data nodes, management nodes, and SQL or API nodes.

**Note**

For an exception to this rule, see [Section 21.4.3.11, “NDB Cluster TCP/IP Connections Using Direct Connections”](#).

To override the default connection parameters, it is necessary to define a connection using one or more `[tcp]` sections in the `config.ini` file. Each `[tcp]` section explicitly defines a TCP/IP connection between two NDB Cluster nodes, and must contain at a minimum the parameters `NodeId1` and `NodeId2`, as well as any connection parameters to override.

It is also possible to change the default values for these parameters by setting them in the `[tcp default]` section.

**Important**

Any `[tcp]` sections in the `config.ini` file should be listed *last*, following all other sections in the file. However, this is not required for a `[tcp default]` section. This requirement is a known issue with the way in which the `config.ini` file is read by the NDB Cluster management server.

Connection parameters which can be set in `[tcp]` and `[tcp default]` sections of the `config.ini` file are listed here:

- [Checksum](#)

Version (or later)	NDB 7.5.0
Type or units	boolean
Default	false
Range	true, false
Restart Type	<b>Node Restart:</b> Requires a <a href="#">rolling restart</a> of the cluster. (NDB 7.5.0)

This parameter is a boolean parameter (enabled by setting it to `Y` or `1`, disabled by setting it to `N` or `0`). It is disabled by default. When it is enabled, checksums for all messages are calculated before they placed in the send buffer. This feature ensures that messages are not corrupted while waiting in the send buffer, or by the transport mechanism.

- [Group](#)

When `ndb_optimized_node_selection` is enabled, node proximity is used in some cases to select which node to connect to. This parameter can be used to influence proximity by setting it to a lower value, which is interpreted as “closer”. See the description of the system variable for more information.

- [HostName1](#)

Version (or later)	NDB 7.5.0
Type or units	name or IP address
Default	[...]
Range	...



Restart Type	<b>Node Restart:</b> Requires a <a href="#">rolling restart</a> of the cluster. (NDB 7.5.0)
--------------	--

The [HostName1](#) and [HostName2](#) parameters can be used to specify specific network interfaces to be used for a given TCP connection between two nodes. The values used for these parameters can be host names or IP addresses.

- [HostName2](#)

Version (or later)	NDB 7.5.0
Type or units	name or IP address
Default	[...]
Range	...
Restart Type	<b>Node Restart:</b> Requires a <a href="#">rolling restart</a> of the cluster. (NDB 7.5.0)

The [HostName1](#) and [HostName2](#) parameters can be used to specify specific network interfaces to be used for a given TCP connection between two nodes. The values used for these parameters can be host names or IP addresses.

- [NodeId1](#)

Version (or later)	NDB 7.5.0
Type or units	numeric
Default	[none]
Range	1 - 255
Restart Type	<b>Node Restart:</b> Requires a <a href="#">rolling restart</a> of the cluster. (NDB 7.5.0)

To identify a connection between two nodes it is necessary to provide their node IDs in the [\[tcp\]](#) section of the configuration file as the values of [NodeId1](#) and [NodeId2](#). These are the same unique [Id](#) values for each of these nodes as described in [Section 21.4.3.7, "Defining SQL and Other API Nodes in an NDB Cluster"](#).

- [NodeId2](#)

Version (or later)	NDB 7.5.0
Type or units	numeric
Default	[none]
Range	1 - 255

Restart Type	<b>Node Restart:</b> Requires a <a href="#">rolling restart</a> of the cluster. (NDB 7.5.0)
--------------	--

To identify a connection between two nodes it is necessary to provide their node IDs in the `[tcp]` section of the configuration file as the values of `NodeId1` and `NodeId2`. These are the same unique `Id` values for each of these nodes as described in [Section 21.4.3.7, “Defining SQL and Other API Nodes in an NDB Cluster”](#).

- [NodeIdServer](#)

Version (or later)	NDB 7.5.0
Type or units	numeric
Default	[none]
Range	1 - 63
Restart Type	<b>Node Restart:</b> Requires a <a href="#">rolling restart</a> of the cluster. (NDB 7.5.0)

Set the server side of a TCP connection.

- [OverloadLimit](#)

Version (or later)	NDB 7.5.0
Type or units	bytes
Default	0
Range	0 - 4294967039 (0xFFFFFFFF)
Restart Type	<b>Node Restart:</b> Requires a <a href="#">rolling restart</a> of the cluster. (NDB 7.5.0)

When more than this many unsent bytes are in the send buffer, the connection is considered overloaded.

This parameter can be used to determine the amount of unsent data that must be present in the send buffer before the connection is considered overloaded. See [Section 21.4.3.13, “Configuring NDB Cluster Send Buffer Parameters”](#), for more information.

- [PortNumber](#) (*OBSOLETE*)

This parameter formerly specified the port number to be used for listening for connections from other nodes. It is now deprecated (and removed in NDB Cluster 7.5); use the `ServerPort` data node configuration parameter for this purpose instead (Bug #77405, Bug #21280456).

- [PreSendChecksum](#)

Version (or later)	NDB 7.6.6
Type or units	boolean
Default	false
Range	true, false
Added	NDB 7.6.6
Restart Type	<b>Node Restart:</b> Requires a <a href="#">rolling restart</a> of the cluster. (NDB 7.5.0)

If this parameter and [Checksum](#) are both enabled, perform pre-send checksum checks, and check all TCP signals between nodes for errors. Has no effect if [Checksum](#) is not also enabled.

- [Proxy](#)

Version (or later)	NDB 7.5.0
Type or units	string
Default	[...]
Range	...
Restart Type	<b>Node Restart:</b> Requires a <a href="#">rolling restart</a> of the cluster. (NDB 7.5.0)

Set a proxy for the TCP connection.

- [ReceiveBufferMemory](#)

Version (or later)	NDB 7.5.0
Type or units	bytes
Default	2M
Range	16K - 4294967039 (0xFFFFFFFF)
Restart Type	<b>Node Restart:</b> Requires a <a href="#">rolling restart</a> of the cluster. (NDB 7.5.0)

Specifies the size of the buffer used when receiving data from the TCP/IP socket.

The default value of this parameter is 2MB. The minimum possible value is 16KB; the theoretical maximum is 4GB.

- [SendBufferMemory](#)

Version (or later)	NDB 7.5.0
Type or units	unsigned
Default	2M
Range	256K - 4294967039 (0xFFFFFFFF)
Restart Type	<b>Node Restart:</b> Requires a <a href="#">rolling restart</a> of the cluster. (NDB 7.5.0)

TCP transporters use a buffer to store all messages before performing the send call to the operating system. When this buffer reaches 64KB its contents are sent; these are also sent when a round of messages have been executed. To handle temporary overload situations it is also possible to define a bigger send buffer.

If this parameter is set explicitly, then the memory is not dedicated to each transporter; instead, the value used denotes the hard limit for how much memory (out of the total available memory—that is, [TotalSendBufferMemory](#)) that may be used by a single transporter. For more information about configuring dynamic transporter send buffer memory allocation in NDB Cluster, see [Section 21.4.3.13, “Configuring NDB Cluster Send Buffer Parameters”](#).

The default size of the send buffer is 2MB, which is the size recommended in most situations. The minimum size is 64 KB; the theoretical maximum is 4 GB.

- [SendSignalId](#)

Version (or later)	NDB 7.5.0
Type or units	boolean
Default	false (debug builds: true)
Range	true, false
Restart Type	<b>Node Restart:</b> Requires a <a href="#">rolling restart</a> of the cluster. (NDB 7.5.0)

To be able to retrace a distributed message datagram, it is necessary to identify each message. When this parameter is set to [Y](#), message IDs are transported over the network. This feature is disabled by default in production builds, and enabled in [-debug](#) builds.

- [TcpBind\\_INADDR\\_ANY](#)

Setting this parameter to [TRUE](#) or [1](#) binds [IP\\_ADDR\\_ANY](#) so that connections can be made from anywhere (for autogenerated connections). The default is [FALSE](#) ([0](#)).

- [TCP\\_MAXSEG\\_SIZE](#)

Version (or later)	NDB 7.5.0
--------------------	-----------

Type or units	unsigned
Default	0
Range	0 - 2G
Restart Type	<b>Node Restart:</b> Requires a <a href="#">rolling restart</a> of the cluster. (NDB 7.5.0)

Determines the size of the memory set during TCP transporter initialization. The default is recommended for most common usage cases.

- [TCP\\_RCV\\_BUF\\_SIZE](#)

Version (or later)	NDB 7.5.0
Type or units	unsigned
Default	0
Range	0 - 2G
Restart Type	<b>Node Restart:</b> Requires a <a href="#">rolling restart</a> of the cluster. (NDB 7.5.0)

Determines the size of the receive buffer set during TCP transporter initialization. The default and minimum value is 0, which allows the operating system or platform to set this value. The default is recommended for most common usage cases.

- [TCP\\_SND\\_BUF\\_SIZE](#)

Version (or later)	NDB 7.5.0
Type or units	unsigned
Default	0
Range	0 - 2G
Restart Type	<b>Node Restart:</b> Requires a <a href="#">rolling restart</a> of the cluster. (NDB 7.5.0)

Determines the size of the send buffer set during TCP transporter initialization. The default and minimum value is 0, which allows the operating system or platform to set this value. The default is recommended for most common usage cases.

**Restart types.** Information about the restart types used by the parameter descriptions in this section is shown in the following table:

**Table 21.19 NDB Cluster restart types**

Symbol	Restart Type	Description
N	Node	The parameter can be updated using a rolling restart (see <a href="#">Section 21.6.5, “Performing a Rolling Restart of an NDB Cluster”</a> )
S	System	All cluster nodes must be shut down completely, then restarted, to effect a change in this parameter
I	Initial	Data nodes must be restarted using the <code>--initial</code> option

### 21.4.3.11 NDB Cluster TCP/IP Connections Using Direct Connections

Setting up a cluster using direct connections between data nodes requires specifying explicitly the crossover IP addresses of the data nodes so connected in the `[tcp]` section of the cluster `config.ini` file.

In the following example, we envision a cluster with at least four hosts, one each for a management server, an SQL node, and two data nodes. The cluster as a whole resides on the `172.23.72.*` subnet of a LAN. In addition to the usual network connections, the two data nodes are connected directly using a standard crossover cable, and communicate with one another directly using IP addresses in the `1.1.0.*` address range as shown:

```
# Management Server
[ndb_mgmd]
Id=1
HostName=172.23.72.20

# SQL Node
[mysqld]
Id=2
HostName=172.23.72.21

# Data Nodes
[ndbd]
Id=3
HostName=172.23.72.22

[ndbd]
Id=4
HostName=172.23.72.23

# TCP/IP Connections
[tcp]
NodeId1=3
NodeId2=4
HostName1=1.1.0.1
HostName2=1.1.0.2
```

The `HostName1` and `HostName2` parameters are used only when specifying direct connections.

The use of direct TCP connections between data nodes can improve the cluster's overall efficiency by enabling the data nodes to bypass an Ethernet device such as a switch, hub, or router, thus cutting down on the cluster's latency.

**Note**

To take the best advantage of direct connections in this fashion with more than two data nodes, you must have a direct connection between each data node and every other data node in the same node group.

**21.4.3.12 NDB Cluster Shared Memory Connections**

Communications between NDB cluster nodes are normally handled using TCP/IP. The shared memory (SHM) transporter is distinguished by the fact that signals are transmitted by writing in memory rather than on a socket. The shared-memory transporter (SHM) can improve performance by negating up to 20% of the overhead required by a TCP connection when running an API node (usually an SQL node) and a data node together on the same host. You can enable a shared memory connection in either of the two ways listed here:

- By setting the `UseShm` data node configuration parameter to `1`, and setting `HostName` for the data node and `HostName` for the API node to the same value.
- By using `[shm]` sections in the cluster configuration file, each containing settings for `NodeId1` and `NodeId2`. This method is described in more detail later in this section.

Suppose a cluster is running a data node which has node ID 1 and an SQL node having node ID 51 on the same host computer at 10.0.0.1. To enable an SHM connection between these two nodes, all that is necessary is to insure that the following entries are included in the cluster configuration file:

```
[ndbd]
NodeId=1
HostName=10.0.0.1
UseShm=1

[mysqld]
NodeId=51
HostName=10.0.0.1
```

**Important**

The two entries just shown are in addition to any other entries and parameter settings needed by the cluster. A more complete example is shown later in this section.

Before starting data nodes that use SHM connections, it is also necessary to make sure that the operating system on each computer hosting such a data node has sufficient memory allocated to shared memory segments. See the documentation for your operating platform for information regarding this. In setups where multiple hosts are each running a data node and an API node, it is possible to enable shared memory on all such hosts by setting `UseShm` in the `[ndbd default]` section of the configuration file. This is shown in the example later in this section.

While not strictly required, tuning for all SHM connections in the cluster can be done by setting one or more of the following parameters in the `[shm default]` section of the cluster configuration (`config.ini`) file:

- `ShmSize`: Shared memory size
- `ShmSpinTime`: Time in  $\mu$ s to spin before sleeping
- `SendBufferMemory`: Size of buffer for signals sent from this node, in bytes.
- `SendSignalId`: Indicates that a signal ID is included in each signal sent through the transporter.
- `Checksum`: Indicates that a checksum is included in each signal sent through the transporter.

- `PreSendChecksum`: Checks of the checksum are made prior to sending the signal; Checksum must also be enabled for this to work

This example shows a simple setup with SHM connections defined on multiple hosts, in an NDB Cluster using 3 computers listed here by host name, hosting the node types shown:

1. `10.0.0.0`: The management server
2. `10.0.0.1`: A data node and an SQL node
3. `10.0.0.2`: A data node and an SQL node

In this scenario, each data node communicates with both the management server and the other data node using TCP transporters; each SQL node uses a shared memory transporter to communicate with the data nodes that is local to it, and a TCP transporter to communicate with the remote data node. A basic configuration reflecting this setup is enabled by the `config.ini` file whose contents are shown here:

```
[ndbd default]
DataDir=/path/to/datadir
UseShm=1

[shm default]
ShmSize=8M
ShmSpintime=200
SendBufferMemory=4M

[tcp default]
SendBufferMemory=8M

[ndb_mgmd]
NodeId=49
Hostname=10.0.0.0
DataDir=/path/to/datadir

[ndbd]
NodeId=1
Hostname=10.0.0.1
DataDir=/path/to/datadir

[ndbd]
NodeId=2
Hostname=10.0.0.2
DataDir=/path/to/datadir

[mysqld]
NodeId=51
Hostname=10.0.0.1

[mysqld]
NodeId=52
Hostname=10.0.0.2

[api]
[api]
```

Parameters affecting all shared memory transporters are set in the `[shm default]` section; these can be overridden on a per-connection basis in one or more `[shm]` sections. Each such section must be associated with a given SHM connection using `NodeId1` and `NodeId2`; the values required for these parameters are the node IDs of the two nodes connected by the transporter. You can also identify the nodes by host name using `HostName1` and `HostName2`, but these parameters are not required.

The API nodes for which no host names are set use the TCP transporter to communicate with data nodes independent of the hosts on which they are started; the parameters and values set in the `[tcp default]` section of the configuration file apply to all TCP transporters in the cluster.



For optimum performance, you can define a spin time for the SHM transporter ([ShmSpinTime](#) parameter); this affects both the data node receiver thread and the poll owner (receive thread or user thread) in [NDB](#).

- [Checksum](#)

Version (or later)	NDB 7.5.0
Type or units	boolean
Default	true
Range	true, false
Restart Type	<b>Node Restart:</b> Requires a <a href="#">rolling restart</a> of the cluster. (NDB 7.5.0)

This parameter is a boolean ([Y/N](#)) parameter which is disabled by default. When it is enabled, checksums for all messages are calculated before being placed in the send buffer.

This feature prevents messages from being corrupted while waiting in the send buffer. It also serves as a check against data being corrupted during transport.

- [Group](#)

Version (or later)	NDB 7.5.0
Type or units	unsigned
Default	35
Range	0 - 200
Restart Type	<b>Node Restart:</b> Requires a <a href="#">rolling restart</a> of the cluster. (NDB 7.5.0)

Determines the group proximity; a smaller value is interpreted as being closer. The default value is sufficient for most conditions.

- [HostName1](#)

Version (or later)	NDB 7.5.0
Type or units	name or IP address
Default	[...]
Range	...
Restart Type	<b>Node Restart:</b> Requires a <a href="#">rolling restart</a> of

	the cluster. (NDB 7.5.0)
--	--------------------------

The `HostName1` and `HostName2` parameters can be used to specify specific network interfaces to be used for a given SHM connection between two nodes. The values used for these parameters can be host names or IP addresses.

- `HostName2`

Version (or later)	NDB 7.5.0
Type or units	name or IP address
Default	[...]
Range	...
Restart Type	<b>Node Restart:</b> Requires a <a href="#">rolling restart</a> of the cluster. (NDB 7.5.0)

The `HostName1` and `HostName2` parameters can be used to specify specific network interfaces to be used for a given SHM connection between two nodes. The values used for these parameters can be host names or IP addresses.

- `NodeId1`

Version (or later)	NDB 7.5.0
Type or units	numeric
Default	[none]
Range	1 - 255
Restart Type	<b>Node Restart:</b> Requires a <a href="#">rolling restart</a> of the cluster. (NDB 7.5.0)

To identify a connection between two nodes it is necessary to provide node identifiers for each of them, as `NodeId1` and `NodeId2`.

- `NodeId2`

Version (or later)	NDB 7.5.0
Type or units	numeric
Default	[none]
Range	1 - 255
Restart Type	<b>Node Restart:</b> Requires a <a href="#">rolling restart</a> of the cluster. (NDB 7.5.0)

To identify a connection between two nodes it is necessary to provide node identifiers for each of them, as `NodeId1` and `NodeId2`.

- `NodeIdServer`

Version (or later)	NDB 7.5.0
Type or units	numeric
Default	[none]
Range	1 - 63
Restart Type	<b>Node Restart:</b> Requires a <a href="#">rolling restart</a> of the cluster. (NDB 7.5.0)

Identify the server end of a shared memory connection. By default, this is the node ID of the data node.

- `OverloadLimit`

Version (or later)	NDB 7.5.0
Type or units	bytes
Default	0
Range	0 - 4294967039 (0xFFFFFFFF)
Restart Type	<b>Node Restart:</b> Requires a <a href="#">rolling restart</a> of the cluster. (NDB 7.5.0)

When more than this many unsend bytes are in the send buffer, the connection is considered overloaded.

This parameter can be used to determine the amount of unsend data that must be present in the send buffer before the connection is considered overloaded. See [Section 21.4.3.13, “Configuring NDB Cluster Send Buffer Parameters”](#), and [Section 21.6.15.44, “The ndbinfo transporters Table”](#), for more information.

- `PortNumber`

Version (or later)	NDB 7.5.0
Type or units	unsigned
Default	[...]
Range	0 - 64K
Removed	NDB 7.5.1
Restart Type	<b>System Restart:</b> Requires a complete shutdown and restart of the

	cluster. (NDB 7.5.0)
--	----------------------

Set the port to be used by the SHM transporter.

- [PreSendChecksum](#)

Version (or later)	NDB 7.6.6
Type or units	boolean
Default	false
Range	true, false
Added	NDB 7.6.6
Restart Type	<b>Node Restart:</b> Requires a <a href="#">rolling restart</a> of the cluster. (NDB 7.5.0)

If this parameter and [Checksum](#) are both enabled, perform pre-send checksum checks, and check all SHM signals between nodes for errors. Has no effect if [Checksum](#) is not also enabled.

- [SendBufferMemory](#)

Version (or later)	NDB 7.6.6
Type or units	integer
Default	2M
Range	256K - 4294967039 (0xFFFFFFFF)
Added	NDB 7.6.6
Restart Type	<b>Node Restart:</b> Requires a <a href="#">rolling restart</a> of the cluster. (NDB 7.5.0)

Size (in bytes) of the shared memory buffer for signals sent from this node using a shared memory connection.

- [SendSignalId](#)

Version (or later)	NDB 7.5.0
Type or units	boolean
Default	false
Range	true, false
Restart Type	<b>Node Restart:</b> Requires a <a href="#">rolling restart</a> of

	the cluster. (NDB 7.5.0)
--	--------------------------

To retrace the path of a distributed message, it is necessary to provide each message with a unique identifier. Setting this parameter to `Y` causes these message IDs to be transported over the network as well. This feature is disabled by default in production builds, and enabled in `-debug` builds.

- [ShmKey](#)

Version (or later)	NDB 7.5.0
Type or units	unsigned
Default	0
Range	0 - 4294967039 (0xFFFFFFFF)
Restart Type	<b>Node Restart:</b> Requires a <a href="#">rolling restart</a> of the cluster. (NDB 7.5.0)

When setting up shared memory segments, a node ID, expressed as an integer, is used to identify uniquely the shared memory segment to use for the communication. There is no default value. If [UseShm](#) is enabled, the shared memory key is calculated automatically by [NDB](#).

- [ShmSize](#)

Version (or later)	NDB 7.5.0
Type or units	bytes
Default	1M
Range	64K - 4294967039 (0xFFFFFFFF)
Version (or later)	NDB 7.6.6
Type or units	bytes
Default	4M
Range	64K - 4294967039 (0xFFFFFFFF)
Restart Type	<b>Node Restart:</b> Requires a <a href="#">rolling restart</a> of the cluster. (NDB 7.5.0)

Each SHM connection has a shared memory segment where messages between nodes are placed by the sender and read by the reader. The size of this segment is defined by [ShmSize](#). The default value in NDB 7.6 is 4MB.

- [ShmSpinTime](#)

Version (or later)	NDB 7.6.6
Type or units	integer
Default	0
Range	0 - 2000
Added	NDB 7.6.6
Restart Type	<b>Node Restart:</b> Requires a <a href="#">rolling restart</a> of the cluster. (NDB 7.5.0)

When receiving, the time to wait before sleeping, in microseconds.

- [SigNum](#)

Version (or later)	NDB 7.5.0
Type or units	unsigned
Default	[...]
Range	0 - 4294967039 (0xFFFFFFFF)
Deprecated	NDB 7.6.6
Restart Type	<b>Node Restart:</b> Requires a <a href="#">rolling restart</a> of the cluster. (NDB 7.5.0)

This parameter is no longer used in NDB 7.6, in which any setting for it is ignored.

The following applies only in NDB 7.5 (and earlier):

When using the shared memory transporter, a process sends an operating system signal to the other process when there is new data available in the shared memory. Should that signal conflict with an existing signal, this parameter can be used to change it. This is a possibility when using SHM due to the fact that different operating systems use different signal numbers.

The default value of [SigNum](#) is 0; therefore, it must be set to avoid errors in the cluster log when using the shared memory transporter. Typically, this parameter is set to 10 in the `[shm default]` section of the `config.ini` file.

**Restart types.** Information about the restart types used by the parameter descriptions in this section is shown in the following table:

**Table 21.20 NDB Cluster restart types**

Symbol	Restart Type	Description
N	Node	The parameter can be updated using a rolling restart (see <a href="#">Section 21.6.5, "Performing</a>

Symbol	Restart Type	Description
		a Rolling Restart of an NDB Cluster")
S	System	All cluster nodes must be shut down completely, then restarted, to effect a change in this parameter
I	Initial	Data nodes must be restarted using the <code>--initial</code> option

### 21.4.3.13 Configuring NDB Cluster Send Buffer Parameters

The NDB kernel employs a unified send buffer whose memory is allocated dynamically from a pool shared by all transporters. This means that the size of the send buffer can be adjusted as necessary. Configuration of the unified send buffer can be accomplished by setting the following parameters:

- **TotalSendBufferMemory.** This parameter can be set for all types of NDB Cluster nodes—that is, it can be set in the `[ndbd]`, `[mgm]`, and `[api]` (or `[mysql]`) sections of the `config.ini` file. It represents the total amount of memory (in bytes) to be allocated by each node for which it is set for use among all configured transporters. If set, its minimum is 256KB; the maximum is 4294967039.

To be backward-compatible with existing configurations, this parameter takes as its default value the sum of the maximum send buffer sizes of all configured transporters, plus an additional 32KB (one page) per transporter. The maximum depends on the type of transporter, as shown in the following table:

**Table 21.21 Transporter types with maximum send buffer sizes**

Transporter	Maximum Send Buffer Size (bytes)
TCP	<code>SendBufferMemory</code> (default = 2M)
SHM	20K

This enables existing configurations to function in close to the same way as they did with NDB Cluster 6.3 and earlier, with the same amount of memory and send buffer space available to each transporter. However, memory that is unused by one transporter is not available to other transporters.

- **OverloadLimit.** This parameter is used in the `config.ini` file `[tcp]` section, and denotes the amount of unsent data (in bytes) that must be present in the send buffer before the connection is considered overloaded. When such an overload condition occurs, transactions that affect the overloaded connection fail with NDB API Error 1218 (`Send Buffers overloaded in NDB kernel`) until the overload status passes. The default value is 0, in which case the effective overload limit is calculated as `SendBufferMemory * 0.8` for a given connection. The maximum value for this parameter is 4G.
- **SendBufferMemory.** This value denotes a hard limit for the amount of memory that may be used by a single transporter out of the entire pool specified by `TotalSendBufferMemory`. However, the sum of `SendBufferMemory` for all configured transporters may be greater than the `TotalSendBufferMemory` that is set for a given node. This is a way to save memory when many nodes are in use, as long as the maximum amount of memory is never required by all transporters at the same time.
- **ReservedSendBufferMemory.** Removed prior to NDB 7.5 GA.

Version (or later)	NDB 7.5.0
Type or units	bytes

Default	256K
Range	0 - 4294967039 (0xFFFFFFFF)
Removed	NDB 7.5.2
Restart Type	<b>Node Restart:</b> Requires a <a href="#">rolling restart</a> of the cluster. (NDB 7.5.0)

Previously, this data node parameter was present, but not actually used (Bug #77404, Bug #21280428).

You can use the `ndbinfo.transporters` table to monitor send buffer memory usage, and to detect slowdown and overload conditions that can adversely affect performance.

## 21.4.4 Using High-Speed Interconnects with NDB Cluster

Even before design of `NDBCLUSTER` began in 1996, it was evident that one of the major problems to be encountered in building parallel databases would be communication between the nodes in the network. For this reason, `NDBCLUSTER` was designed from the very beginning to permit the use of a number of different data transport mechanisms, or transporters.

NDB Cluster 7.5 and 7.6 support three of these (see [Section 21.2.1, “NDB Cluster Core Concepts”](#)). A fourth transporter, Scalable Coherent Interface (SCI), was also supported in very old versions of `NDB`. This required specialized hardware, software, and MySQL binaries that are no longer available.

## 21.5 NDB Cluster Programs

Using and managing an NDB Cluster requires several specialized programs, which we describe in this chapter. We discuss the purposes of these programs in an NDB Cluster, how to use the programs, and what startup options are available for each of them.

These programs include the NDB Cluster data, management, and SQL node processes (`ndbd`, `ndbmt`, `ndb_mgmd`, and `mysqld`) and the management client (`ndb_mgm`).

For information about using `mysqld` as an NDB Cluster process, see [Section 21.6.10, “MySQL Server Usage for NDB Cluster”](#).

Other `NDB` utility, diagnostic, and example programs are included with the NDB Cluster distribution. These include `ndb_restore`, `ndb_show_tables`, and `ndb_config`. These programs are also covered in this section.

The final portion of this section contains tables of options that are common to all the various NDB Cluster programs.

### 21.5.1 `ndbd` — The NDB Cluster Data Node Daemon

The `ndbd` binary provides the single-threaded version of the process that is used to handle all the data in tables employing the `NDBCLUSTER` storage engine. This data node process enables a data node to accomplish distributed transaction handling, node recovery, checkpointing to disk, online backup, and related tasks. In NDB 7.6.31 and later, when started, `ndbd` logs a warning similar to that shown here:

```
2024-05-28 13:32:16 [ndbd] WARNING -- Running ndbd with a single thread of
signal execution. For multi-threaded signal execution run the ndbmt binary.
```

`ndbmt` is the multi-threaded version of this binary.



In an NDB Cluster, a set of `ndbd` processes cooperate in handling data. These processes can execute on the same computer (host) or on different computers. The correspondences between data nodes and Cluster hosts is completely configurable.

Options that can be used with `ndbd` are shown in the following table. Additional descriptions follow the table.

**Table 21.22 Command-line options used with the program `ndbd`**

Format	Description	Added, Deprecated, or Removed
<code>--bind-address=name</code>	Local bind address	(Supported in all NDB releases based on MySQL 5.7)
<code>--character-sets-dir=path</code>	Directory containing character sets	(Supported in all NDB releases based on MySQL 5.7)
<code>--connect-delay=#</code>	Obsolete synonym for <code>--connect-retry-delay</code> , which should be used instead of this option	REMOVED: NDB 7.5.25, NDB 7.6.21
<code>--connect-retries=#</code>	Set the number of times to retry a connection before giving up; 0 means 1 attempt only (and no retries); -1 means continue retrying indefinitely	(Supported in all NDB releases based on MySQL 5.7)
<code>--connect-retry-delay=#</code>	Time to wait between attempts to contact a management server, in seconds; 0 means do not wait between attempts	(Supported in all NDB releases based on MySQL 5.7)
<code>--connect-string=connection_string,</code> <code>-c connection_string</code>	Same as <code>--ndb-connectstring</code>	(Supported in all NDB releases based on MySQL 5.7)
<code>--core-file</code>	Write core file on error; used in debugging	(Supported in all NDB releases based on MySQL 5.7)
<code>--daemon,</code> <code>-d</code>	Start <code>ndbd</code> as daemon (default); override with <code>--nodaemon</code>	(Supported in all NDB releases based on MySQL 5.7)
<code>--defaults-extra-file=path</code>	Read given file after global files are read	(Supported in all NDB releases based on MySQL 5.7)
<code>--defaults-file=path</code>	Read default options from given file only	(Supported in all NDB releases based on MySQL 5.7)
<code>--defaults-group-suffix=string</code>	Also read groups with <code>concat(group, suffix)</code>	(Supported in all NDB releases based on MySQL 5.7)
<code>--foreground</code>	Run <code>ndbd</code> in foreground, provided for debugging purposes (implies <code>--nodaemon</code> )	(Supported in all NDB releases based on MySQL 5.7)
<code>--help,</code> <code>-?</code>	Display help text and exit	(Supported in all NDB releases based on MySQL 5.7)
<code>--initial</code>	Perform initial start of <code>ndbd</code> , including file system cleanup;	(Supported in all NDB releases based on MySQL 5.7)

Format	Description	Added, Deprecated, or Removed
	consult documentation before using this option	
<code>--initial-start</code>	Perform partial initial start (requires <code>--nowait-nodes</code> )	(Supported in all NDB releases based on MySQL 5.7)
<code>--install[=name]</code>	Used to install data node process as Windows service; does not apply on other platforms	(Supported in all NDB releases based on MySQL 5.7)
<code>--logbuffer-size=#</code>	Control size of log buffer; for use when debugging with many log messages being generated; default is sufficient for normal operations	ADDED: NDB 7.6.6
<code>--login-path=path</code>	Read given path from login file	(Supported in all NDB releases based on MySQL 5.7)
<code>--ndb-connectstring=connection_string</code> <code>-c connection_string</code>	Set connect string for connecting to <code>ndb_mgmd</code> . Syntax: "[nodeid=id;][host=]hostname[:port]". Overrides entries in <code>NDB_CONNECTSTRING</code> and <code>my.cnf</code>	(Supported in all NDB releases based on MySQL 5.7)
<code>--ndb-mgmd-host=connection_string,</code> <code>-c connection_string</code>	Same as <code>--ndb-connectstring</code>	(Supported in all NDB releases based on MySQL 5.7)
<code>--ndb-nodeid=#</code>	Set node ID for this node, overriding any ID set by <code>--ndb-connectstring</code>	(Supported in all NDB releases based on MySQL 5.7)
<code>--nodaemon</code>	Do not start <code>ndbd</code> as daemon; provided for testing purposes	(Supported in all NDB releases based on MySQL 5.7)
<code>--no-defaults</code>	Do not read default options from any option file other than login file	(Supported in all NDB releases based on MySQL 5.7)
<code>--nostart,</code> <code>-n</code>	Do not start <code>ndbd</code> immediately; <code>ndbd</code> waits for command to start from <code>ndb_mgm</code>	(Supported in all NDB releases based on MySQL 5.7)
<code>--nowait-nodes=list</code>	Do not wait for these data nodes to start (takes comma-separated list of node IDs); requires <code>--ndb-nodeid</code>	(Supported in all NDB releases based on MySQL 5.7)
<code>--ndb-optimized-node-selection</code>	Enable optimizations for selection of nodes for transactions. Enabled by default; use <code>--skip-ndb-optimized-node-selection</code> to disable	(Supported in all NDB releases based on MySQL 5.7)
<code>--print-defaults</code>	Print program argument list and exit	(Supported in all NDB releases based on MySQL 5.7)

Format	Description	Added, Deprecated, or Removed
<code>--remove[=name]</code>	Used to remove data node process that was previously installed as Windows service; does not apply on other platforms	(Supported in all NDB releases based on MySQL 5.7)
<code>--usage,</code> <code>-?</code>	Display help text and exit; same as <code>--help</code>	(Supported in all NDB releases based on MySQL 5.7)
<code>--verbose,</code> <code>-v</code>	Write extra debugging information to node log	(Supported in all NDB releases based on MySQL 5.7)
<code>--version,</code> <code>-V</code>	Display version information and exit	(Supported in all NDB releases based on MySQL 5.7)



**Note**

All of these options also apply to the multithreaded version of this program (`ndbmtbd`) and you may substitute “`ndbmtbd`” for “`ndbd`” wherever the latter occurs in this section.

- `--bind-address`

Command-Line Format	<code>--bind-address=name</code>
Type	String
Default Value	

Causes `ndbd` to bind to a specific network interface (host name or IP address). This option has no default value.

- `--character-sets-dir`

Command-Line Format	<code>--character-sets-dir=path</code>
---------------------	--

Directory containing character sets.

- `--connect-delay=#`

Command-Line Format	<code>--connect-delay=#</code>
Deprecated	Yes (removed in 5.7.36-ndb-7.6.21)
Type	Numeric
Default Value	5
Minimum Value	0
Maximum Value	3600

Determines the time to wait between attempts to contact a management server when starting (the number of attempts is controlled by the `--connect-retries` option). The default is 5 seconds.

This option is deprecated, and is subject to removal in a future release of NDB Cluster. Use `--connect-retry-delay` instead.

- `--connect-retries=#`

Command-Line Format	<code>--connect-retries=#</code>
Type	Numeric
Default Value	12
Minimum Value (≥ 5.7.36-ndb-7.6.21)	-1
Minimum Value (≥ 5.7.36-ndb-7.5.25)	-1
Minimum Value (≤ 5.7.36-ndb-7.5.24)	0
Minimum Value (≤ 5.7.36-ndb-7.6.20)	0
Minimum Value	0
Maximum Value	65535

Set the number of times to retry a connection before giving up; 0 means 1 attempt only (and no retries). The default is 12 attempts. The time to wait between attempts is controlled by the `--connect-retry-delay` option.

Beginning with NDB 7.5.25 and NDB 7.6.21, you can set this option to -1, in which case, the data node process continues indefinitely to try to connect.

- `--connect-retry-delay=#`

Command-Line Format	<code>--connect-retry-delay=#</code>
Type	Numeric
Default Value	5
Minimum Value	0
Maximum Value	4294967295

Determines the time to wait between attempts to contact a management server when starting (the time between attempts is controlled by the `--connect-retries` option). The default is 5 seconds.

This option takes the place of the `--connect-delay` option, which is now deprecated and subject to removal in a future release of NDB Cluster.

The short form `-r` for this option is deprecated as of NDB 7.5.25 and NDB 7.6.21, and subject to removal in a future release of NDB Cluster. Use the long form instead.

- `--connect-string`

Command-Line Format	<code>--connect-string=connection_string</code>
Type	String
Default Value	[none]

Same as `--ndb-connectstring`.

- `--core-file`

Command-Line Format	<code>--core-file</code>
---------------------	--------------------------

Write core file on error; used in debugging.

- `--daemon, -d`

Command-Line Format	<code>--daemon</code>
---------------------	-----------------------

Instructs `ndbd` or `ndbmt` to execute as a daemon process. This is the default behavior. `--nodaemon` can be used to prevent the process from running as a daemon.

This option has no effect when running `ndbd` or `ndbmt` on Windows platforms.

- `--defaults-extra-file`

Command-Line Format	<code>--defaults-extra-file=path</code>
Type	String
Default Value	[none]

Read given file after global files are read.

- `--defaults-file`

Command-Line Format	<code>--defaults-file=path</code>
Type	String
Default Value	[none]

Read default options from given file only.

- `--defaults-group-suffix`

Command-Line Format	<code>--defaults-group-suffix=string</code>
Type	String
Default Value	[none]

Also read groups with `concat(group, suffix)`.

- `--foreground`

Command-Line Format	<code>--foreground</code>
---------------------	---------------------------

Causes `ndbd` or `ndbmt` to execute as a foreground process, primarily for debugging purposes. This option implies the `--nodaemon` option.

This option has no effect when running `ndbd` or `ndbmt` on Windows platforms.

- `--help`

Command-Line Format	<code>--help</code>
---------------------	---------------------

Display help text and exit.

- `--initial`

Command-Line Format	<code>--initial</code>
---------------------	------------------------

Instructs `ndbd` to perform an initial start. An initial start erases any files created for recovery purposes by earlier instances of `ndbd`. It also re-creates recovery log files. On some operating systems, this process can take a substantial amount of time.

An `--initial` start is to be used *only* when starting the `ndbd` process under very special circumstances; this is because this option causes all files to be removed from the NDB Cluster file system and all redo log files to be re-created. These circumstances are listed here:

- When performing a software upgrade which has changed the contents of any files.
- When restarting the node with a new version of `ndbd`.
- As a measure of last resort when for some reason the node restart or system restart repeatedly fails. In this case, be aware that this node can no longer be used to restore data due to the destruction of the data files.



### Warning

To avoid the possibility of eventual data loss, it is recommended that you *not* use the `--initial` option together with `StopOnError = 0`. Instead, set `StopOnError` to 0 in `config.ini` only after the cluster has been started, then restart the data nodes normally—that is, without the `--initial` option. See the description of the `StopOnError` parameter for a detailed explanation of this issue. (Bug #24945638)

Use of this option prevents the `StartPartialTimeout` and `StartPartitionedTimeout` configuration parameters from having any effect.



### Important

This option does *not* affect either of the following types of files:

- Backup files that have already been created by the affected node
- NDB Cluster Disk Data files (see [Section 21.6.11, “NDB Cluster Disk Data Tables”](#)).

This option also has no effect on recovery of data by a data node that is just starting (or restarting) from data nodes that are already running. This recovery of data occurs automatically, and requires no user intervention in an NDB Cluster that is running normally.

It is permissible to use this option when starting the cluster for the very first time (that is, before any data node files have been created); however, it is *not* necessary to do so.

- `--initial-start`

Command-Line Format	<code>--initial-start</code>
---------------------	------------------------------

This option is used when performing a partial initial start of the cluster. Each node should be started with this option, as well as `--nowait-nodes`.

Suppose that you have a 4-node cluster whose data nodes have the IDs 2, 3, 4, and 5, and you wish to perform a partial initial start using only nodes 2, 4, and 5—that is, omitting node 3:

```
$> ndbd --ndb-nodeid=2 --nowait-nodes=3 --initial-start
$> ndbd --ndb-nodeid=4 --nowait-nodes=3 --initial-start
$> ndbd --ndb-nodeid=5 --nowait-nodes=3 --initial-start
```

When using this option, you must also specify the node ID for the data node being started with the `--ndb-nodeid` option.



**Important**

Do not confuse this option with the `--nowait-nodes` option for `ndb_mgmd`, which can be used to enable a cluster configured with multiple management servers to be started without all management servers being online.

- `--install[=name]`

Command-Line Format	<code>--install[=name]</code>
Platform Specific	Windows
Type	String
Default Value	<code>ndbd</code>

Causes `ndbd` to be installed as a Windows service. Optionally, you can specify a name for the service; if not set, the service name defaults to `ndbd`. Although it is preferable to specify other `ndbd` program options in a `my.ini` or `my.cnf` configuration file, it is possible to use together with `--install`. However, in such cases, the `--install` option must be specified first, before any other options are given, for the Windows service installation to succeed.

It is generally not advisable to use this option together with the `--initial` option, since this causes the data node file system to be wiped and rebuilt every time the service is stopped and started. Extreme care should also be taken if you intend to use any of the other `ndbd` options that affect the starting of data nodes—including `--initial-start`, `--nostart`, and `--nowait-nodes`—together with `--install`, and you should make absolutely certain you fully understand and allow for any possible consequences of doing so.

The `--install` option has no effect on non-Windows platforms.

- `--logbuffer-size=#`

Command-Line Format	<code>--logbuffer-size=#</code>
Introduced	5.7.22-ndb-7.6.6
Type	Integer
Default Value	32768
Minimum Value	2048
Maximum Value	4294967295

Sets the size of the data node log buffer. When debugging with high amounts of extra logging, it is possible for the log buffer to run out of space if there are too many log messages, in which case some log messages can be lost. This should not occur during normal operations.

- `--login-path`

Command-Line Format	<code>--login-path=path</code>
Type	String
Default Value	[none]

Read given path from login file.

- `--ndb-connectstring`

Command-Line Format	<code>--ndb-connectstring=connection_string</code>
Type	String
Default Value	[none]

Set connect string for connecting to `ndb_mgmd`. Syntax: "[nodeid=id;][host=]hostname[:port]". Overrides entries in `NDB_CONNECTSTRING` and `my.cnf`.

- `--ndb-mgmd-host`

Command-Line Format	<code>--ndb-mgmd-host=connection_string</code>
Type	String
Default Value	[none]

Same as `--ndb-connectstring`.

- `--ndb-nodeid`

Command-Line Format	<code>--ndb-nodeid=#</code>
Type	Integer
Default Value	[none]

Set node ID for this node, overriding any ID set by `--ndb-connectstring`.

- `--ndb-optimized-node-selection`

Command-Line Format	<code>--ndb-optimized-node-selection</code>
---------------------	---

Enable optimizations for selection of nodes for transactions. Enabled by default; use `--skip-ndb-optimized-node-selection` to disable.



- `--nodaemon`

Command-Line Format	<code>--nodaemon</code>
---------------------	-------------------------

Prevents `ndbd` or `ndbmt` from executing as a daemon process. This option overrides the `--daemon` option. This is useful for redirecting output to the screen when debugging the binary.

The default behavior for `ndbd` and `ndbmt` on Windows is to run in the foreground, making this option unnecessary on Windows platforms, where it has no effect.

- `--no-defaults`

Command-Line Format	<code>--no-defaults</code>
---------------------	----------------------------

Do not read default options from any option file other than login file.

- `--nostart, -n`

Command-Line Format	<code>--nostart</code>
---------------------	------------------------

Instructs `ndbd` not to start automatically. When this option is used, `ndbd` connects to the management server, obtains configuration data from it, and initializes communication objects. However, it does not actually start the execution engine until specifically requested to do so by the management server. This can be accomplished by issuing the proper `START` command in the management client (see [Section 21.6.1, “Commands in the NDB Cluster Management Client”](#)).

- `--nowait-nodes=node_id_1[, node_id_2[, ...]]`

Command-Line Format	<code>--nowait-nodes=list</code>
Type	String
Default Value	

This option takes a list of data nodes which for which the cluster does not wait for before starting.

This can be used to start the cluster in a partitioned state. For example, to start the cluster with only half of the data nodes (nodes 2, 3, 4, and 5) running in a 4-node cluster, you can start each `ndbd` process with `--nowait-nodes=3,5`. In this case, the cluster starts as soon as nodes 2 and 4 connect, and does *not* wait `StartPartitionedTimeout` milliseconds for nodes 3 and 5 to connect as it would otherwise.

If you wanted to start up the same cluster as in the previous example without one `ndbd` (say, for example, that the host machine for node 3 has suffered a hardware failure) then start nodes 2, 4, and 5 with `--nowait-nodes=3`. Then the cluster starts as soon as nodes 2, 4, and 5 connect and does not wait for node 3 to start.

- `--print-defaults`

Command-Line Format	<code>--print-defaults</code>
---------------------	-------------------------------

Print program argument list and exit.

- `--remove[=name]`

Command-Line Format	<code>--remove[=name]</code>
---------------------	------------------------------

Platform Specific	Windows
Type	String
Default Value	ndbd

Causes an `ndbd` process that was previously installed as a Windows service to be removed. Optionally, you can specify a name for the service to be uninstalled; if not set, the service name defaults to `ndbd`.

The `--remove` option has no effect on non-Windows platforms.

- `--usage`

Command-Line Format	<code>--usage</code>
---------------------	----------------------

Display help text and exit; same as `--help`.

- `--verbose, -v`

Causes extra debug output to be written to the node log.

In NDB 7.6, you can also use `NODELOG DEBUG ON` and `NODELOG DEBUG OFF` to enable and disable this extra logging while the data node is running.

- `--version`

Command-Line Format	<code>--version</code>
---------------------	------------------------

Display version information and exit.

`ndbd` generates a set of log files which are placed in the directory specified by `DataDir` in the `config.ini` configuration file.

These log files are listed below. `node_id` is and represents the node's unique identifier. For example, `ndb_2_error.log` is the error log generated by the data node whose node ID is `2`.

- `ndb_node_id_error.log` is a file containing records of all crashes which the referenced `ndbd` process has encountered. Each record in this file contains a brief error string and a reference to a trace file for this crash. A typical entry in this file might appear as shown here:

```
Date/Time: Saturday 30 July 2004 - 00:20:01
Type of error: error
Message: Internal program error (failed ndbrequire)
Fault ID: 2341
Problem data: DbtupFixAlloc.cpp
Object of reference: DBTUP (Line: 173)
ProgramName: NDB Kernel
ProcessID: 14909
TraceFile: ndb_2_trace.log.2
***EOM***
```

Listings of possible `ndbd` exit codes and messages generated when a data node process shuts down prematurely can be found in [Data Node Error Messages](#).



### Important

*The last entry in the error log file is not necessarily the newest one (nor is it likely to be). Entries in the error log are *not* listed in chronological order;*

rather, they correspond to the order of the trace files as determined in the `ndb_node_id_trace.log.next` file (see below). Error log entries are thus overwritten in a cyclical and not sequential fashion.

- `ndb_node_id_trace.log.trace_id` is a trace file describing exactly what happened just before the error occurred. This information is useful for analysis by the NDB Cluster development team.

It is possible to configure the number of these trace files that are created before old files are overwritten. `trace_id` is a number which is incremented for each successive trace file.

- `ndb_node_id_trace.log.next` is the file that keeps track of the next trace file number to be assigned.
- `ndb_node_id_out.log` is a file containing any data output by the `ndbd` process. This file is created only if `ndbd` is started as a daemon, which is the default behavior.
- `ndb_node_id.pid` is a file containing the process ID of the `ndbd` process when started as a daemon. It also functions as a lock file to avoid the starting of nodes with the same identifier.
- `ndb_node_id_signal.log` is a file used only in debug versions of `ndbd`, where it is possible to trace all incoming, outgoing, and internal messages with their data in the `ndbd` process.

It is recommended not to use a directory mounted through NFS because in some environments this can cause problems whereby the lock on the `.pid` file remains in effect even after the process has terminated.

To start `ndbd`, it may also be necessary to specify the host name of the management server and the port on which it is listening. Optionally, one may also specify the node ID that the process is to use.

```
$> ndbd --connect-string="nodeid=2;host=ndb_mgmd.mysql.com:1186"
```

See [Section 21.4.3.3, “NDB Cluster Connection Strings”](#), for additional information about this issue. For more information about data node configuration parameters, see [Section 21.4.3.6, “Defining NDB Cluster Data Nodes”](#).

When `ndbd` starts, it actually initiates two processes. The first of these is called the “angel process”; its only job is to discover when the execution process has been completed, and then to restart the `ndbd` process if it is configured to do so. Thus, if you attempt to kill `ndbd` using the Unix `kill` command, it is necessary to kill both processes, beginning with the angel process. The preferred method of terminating an `ndbd` process is to use the management client and stop the process from there.

The execution process uses one thread for reading, writing, and scanning data, as well as all other activities. This thread is implemented asynchronously so that it can easily handle thousands of concurrent actions. In addition, a watch-dog thread supervises the execution thread to make sure that it does not hang in an endless loop. A pool of threads handles file I/O, with each thread able to handle one open file. Threads can also be used for transporter connections by the transporters in the `ndbd` process. In a multi-processor system performing a large number of operations (including updates), the `ndbd` process can consume up to 2 CPUs if permitted to do so.

For a machine with many CPUs it is possible to use several `ndbd` processes which belong to different node groups; however, such a configuration is still considered experimental and is not supported for MySQL 5.7 in a production setting. See [Section 21.2.7, “Known Limitations of NDB Cluster”](#).

## 21.5.2 ndbinfo\_select\_all — Select From ndbinfo Tables

`ndbinfo_select_all` is a client program that selects all rows and columns from one or more tables in the `ndbinfo` database

Not all `ndbinfo` tables available in the `mysql` client can be read by this program (see later in this section). In addition, `ndbinfo_select_all` can show information about some tables internal to `ndbinfo` which cannot be accessed using SQL, including the `tables` and `columns` metadata tables.

To select from one or more `ndbinfo` tables using `ndbinfo_select_all`, it is necessary to supply the names of the tables when invoking the program as shown here:

```
$> ndbinfo_select_all table_name1 [table_name2] [...]
```

For example:

```
$> ndbinfo_select_all logbuffers logspaces
== logbuffers ==
node_id log_type      log_id  log_part      total  used  high
5      0      0      0      33554432    262144  0
6      0      0      0      33554432    262144  0
7      0      0      0      33554432    262144  0
8      0      0      0      33554432    262144  0
== logspaces ==
node_id log_type      log_id  log_part      total  used  high
5      0      0      0      268435456    0      0
5      0      0      1      268435456    0      0
5      0      0      2      268435456    0      0
5      0      0      3      268435456    0      0
6      0      0      0      268435456    0      0
6      0      0      1      268435456    0      0
6      0      0      2      268435456    0      0
6      0      0      3      268435456    0      0
7      0      0      0      268435456    0      0
7      0      0      1      268435456    0      0
7      0      0      2      268435456    0      0
7      0      0      3      268435456    0      0
8      0      0      0      268435456    0      0
8      0      0      1      268435456    0      0
8      0      0      2      268435456    0      0
8      0      0      3      268435456    0      0
$>
```

Options that can be used with `ndbinfo_select_all` are shown in the following table. Additional descriptions follow the table.

**Table 21.23 Command-line options used with the program `ndbinfo_select_all`**

Format	Description	Added, Deprecated, or Removed
<code>--character-sets-dir=path</code>	Directory containing character sets	(Supported in all NDB releases based on MySQL 5.7)
<code>--connect-retries=#</code>	Number of times to retry connection before giving up	(Supported in all NDB releases based on MySQL 5.7)
<code>--connect-retry-delay=#</code>	Number of seconds to wait between attempts to contact management server	(Supported in all NDB releases based on MySQL 5.7)
<code>--connect-string=connection-string,</code> <code>-c connection_string</code>	Same as <code>--ndb-connectstring</code>	(Supported in all NDB releases based on MySQL 5.7)
<code>--core-file</code>	Write core file on error; used in debugging	(Supported in all NDB releases based on MySQL 5.7)

Format	Description	Added, Deprecated, or Removed
<code>--database=db_name,</code> <code>-d</code>	Name of database where table is located	(Supported in all NDB releases based on MySQL 5.7)
<code>--defaults-extra-file=path</code>	Read given file after global files are read	(Supported in all NDB releases based on MySQL 5.7)
<code>--defaults-file=path</code>	Read default options from given file only	(Supported in all NDB releases based on MySQL 5.7)
<code>--defaults-group-suffix=string</code>	Also read groups with <code>concat(group, suffix)</code>	(Supported in all NDB releases based on MySQL 5.7)
<code>--delay=#</code>	Set delay in seconds between loops	(Supported in all NDB releases based on MySQL 5.7)
<code>--help,</code> <code>-?</code>	Display help text and exit	(Supported in all NDB releases based on MySQL 5.7)
<code>--login-path=path</code>	Read given path from login file	(Supported in all NDB releases based on MySQL 5.7)
<code>--loops=#,</code> <code>-l</code>	Set number of times to perform select	(Supported in all NDB releases based on MySQL 5.7)
<code>--ndb-connectstring=connection-string,</code> <code>-c</code>	Set connect string for connecting to <code>ndb_mgmd</code> . Syntax: "[nodeid=id;][host=]hostname[:port]". Overrides entries in <code>NDB_CONNECTSTRING</code> and <code>my.cnf</code>	(Supported in all NDB releases based on MySQL 5.7)
<code>--ndb-mgmd-host=connection-string,</code> <code>-c</code>	Same as <code>--ndb-connectstring</code>	(Supported in all NDB releases based on MySQL 5.7)
<code>--ndb-nodeid=#</code>	Set node ID for this node, overriding any ID set by <code>--ndb-connectstring</code>	(Supported in all NDB releases based on MySQL 5.7)
<code>--no-defaults</code>	Do not read default options from any option file other than login file	(Supported in all NDB releases based on MySQL 5.7)
<code>--ndb-optimized-node-selection</code>	Enable optimizations for selection of nodes for transactions. Enabled by default; use <code>--skip-ndb-optimized-node-selection</code> to disable	(Supported in all NDB releases based on MySQL 5.7)
<code>--parallelism=#,</code> <code>-p</code>	Set degree of parallelism	(Supported in all NDB releases based on MySQL 5.7)
<code>--print-defaults</code>	Print program argument list and exit	(Supported in all NDB releases based on MySQL 5.7)
<code>--usage,</code>	Display help text and exit; same as <code>--help</code>	(Supported in all NDB releases based on MySQL 5.7)

Format	Description	Added, Deprecated, or Removed
-? --version, -V	Display version information and exit	(Supported in all NDB releases based on MySQL 5.7)

- `--character-sets-dir`

Command-Line Format	<code>--character-sets-dir=path</code>
---------------------	--

Directory containing character sets.

- `--connect-retries`

Command-Line Format	<code>--connect-retries=#</code>
Type	Integer
Default Value	12
Minimum Value	0
Maximum Value	12

Number of times to retry connection before giving up.

- `--connect-retry-delay`

Command-Line Format	<code>--connect-retry-delay=#</code>
Type	Integer
Default Value	5
Minimum Value	0
Maximum Value	5

Number of seconds to wait between attempts to contact management server.

- `--connect-string`

Command-Line Format	<code>--connect-string=connection-string</code>
Type	String
Default Value	[none]

Same as `--ndb-connectstring`.

- `--core-file`

Command-Line Format	<code>--core-file</code>
---------------------	--------------------------

Write core file on error; used in debugging.

- `--defaults-extra-file`

Command-Line Format	<code>--defaults-extra-file=path</code>
---------------------	---

Type	String
Default Value	[none]

Read given file after global files are read.

- `--defaults-file`

Command-Line Format	<code>--defaults-file=path</code>
Type	String
Default Value	[none]

Read default options from given file only.

- `--defaults-group-suffix`

Command-Line Format	<code>--defaults-group-suffix=string</code>
Type	String
Default Value	[none]

Also read groups with `concat(group, suffix)`.

- `--delay=seconds`

Command-Line Format	<code>--delay=#</code>
Type	Numeric
Default Value	5
Minimum Value	0
Maximum Value	MAX_INT

This option sets the number of seconds to wait between executing loops. Has no effect if `--loops` is set to 0 or 1.

- `--help`

Command-Line Format	<code>--help</code>
---------------------	---------------------

Display help text and exit.

- `--login-path`

Command-Line Format	<code>--login-path=path</code>
Type	String
Default Value	[none]

Read given path from login file.

- `--loops=number, -l number`

Command-Line Format	<code>--loops=#</code>
Type	Numeric

Default Value	1
Minimum Value	0
Maximum Value	MAX_INT

This option sets the number of times to execute the select. Use `--delay` to set the time between loops.

- `--ndb-connectstring`

Command-Line Format	<code>--ndb-connectstring=connection-string</code>
Type	String
Default Value	[none]

Set connect string for connecting to `ndb_mgmd`. Syntax: "[nodeid=id;][host=]hostname[:port]". Overrides entries in `NDB_CONNECTSTRING` and `my.cnf`.

- `--ndb-mgmd-host`

Command-Line Format	<code>--ndb-mgmd-host=connection-string</code>
Type	String
Default Value	[none]

Same as `--ndb-connectstring`.

- `--ndb-nodeid`

Command-Line Format	<code>--ndb-nodeid=#</code>
Type	Integer
Default Value	[none]

Set node ID for this node, overriding any ID set by `--ndb-connectstring`.

- `--ndb-optimized-node-selection`

Command-Line Format	<code>--ndb-optimized-node-selection</code>
---------------------	---

Enable optimizations for selection of nodes for transactions. Enabled by default; use `--skip-ndb-optimized-node-selection` to disable.

- `--no-defaults`

Command-Line Format	<code>--no-defaults</code>
---------------------	----------------------------

Do not read default options from any option file other than login file.

- `--print-defaults`

Command-Line Format	<code>--print-defaults</code>
---------------------	-------------------------------



- `--usage`

Command-Line Format	<code>--usage</code>
---------------------	----------------------

Display help text and exit; same as `--help`.

- `--version`

Command-Line Format	<code>--version</code>
---------------------	------------------------

Display version information and exit.

`ndbinfo_select_all` is unable to read the following tables:

- `arbitrator_validity_detail`
- `arbitrator_validity_summary`
- `cluster_locks`
- `cluster_operations`
- `cluster_transactions`
- `disk_write_speed_aggregate_node`
- `locks_per_fragment`
- `memory_per_fragment`
- `memoryusage`
- `operations_per_fragment`
- `server_locks`
- `server_operations`
- `server_transactions`
- `table_info`

### 21.5.3 ndbmt d — The NDB Cluster Data Node Daemon (Multi-Threaded)

`ndbmt d` is a multithreaded version of `ndbd`, the process that is used to handle all the data in tables using the `NDBCLUSTER` storage engine. `ndbmt d` is intended for use on host computers having multiple CPU cores. Except where otherwise noted, `ndbmt d` functions in the same way as `ndbd`; therefore, in this section, we concentrate on the ways in which `ndbmt d` differs from `ndbd`, and you should consult [Section 21.5.1, “ndbd — The NDB Cluster Data Node Daemon”](#), for additional information about running NDB Cluster data nodes that apply to both the single-threaded and multithreaded versions of the data node process.

Command-line options and configuration parameters used with `ndbd` also apply to `ndbmt d`. For more information about these options and parameters, see [Section 21.5.1, “ndbd — The NDB Cluster Data Node Daemon”](#), and [Section 21.4.3.6, “Defining NDB Cluster Data Nodes”](#), respectively.

`ndbmt d` is also file system-compatible with `ndbd`. In other words, a data node running `ndbd` can be stopped, the binary replaced with `ndbmt d`, and then restarted without any loss of data. (However,

when doing this, you must make sure that `MaxNoOfExecutionThreads` is set to an appropriate value before restarting the node if you wish for `ndbmttd` to run in multithreaded fashion.) Similarly, an `ndbmttd` binary can be replaced with `ndbd` simply by stopping the node and then starting `ndbd` in place of the multithreaded binary. It is not necessary when switching between the two to start the data node binary using `--initial`.

Using `ndbmttd` differs from using `ndbd` in two key respects:

1. Because `ndbmttd` runs by default in single-threaded mode (that is, it behaves like `ndbd`), you must configure it to use multiple threads. This can be done by setting an appropriate value in the `config.ini` file for the `MaxNoOfExecutionThreads` configuration parameter or the `ThreadConfig` configuration parameter. Using `MaxNoOfExecutionThreads` is simpler, but `ThreadConfig` offers more flexibility. For more information about these configuration parameters and their use, see [Multi-Threading Configuration Parameters \(ndbmttd\)](#).
2. Trace files are generated by critical errors in `ndbmttd` processes in a somewhat different fashion from how these are generated by `ndbd` failures. These differences are discussed in more detail in the next few paragraphs.

Like `ndbd`, `ndbmttd` generates a set of log files which are placed in the directory specified by `DataDir` in the `config.ini` configuration file. Except for trace files, these are generated in the same way and have the same names as those generated by `ndbd`.

In the event of a critical error, `ndbmttd` generates trace files describing what happened just prior to the error's occurrence. These files, which can be found in the data node's `DataDir`, are useful for analysis of problems by the NDB Cluster Development and Support teams. One trace file is generated for each `ndbmttd` thread. The names of these files have the following pattern:

```
ndb_node_id_trace.log.trace_id_tthread_id,
```

In this pattern, `node_id` stands for the data node's unique node ID in the cluster, `trace_id` is a trace sequence number, and `thread_id` is the thread ID. For example, in the event of the failure of an `ndbmttd` process running as an NDB Cluster data node having the node ID 3 and with `MaxNoOfExecutionThreads` equal to 4, four trace files are generated in the data node's data directory. If this is the first time this node has failed, then these files are named `ndb_3_trace.log.1_t1`, `ndb_3_trace.log.1_t2`, `ndb_3_trace.log.1_t3`, and `ndb_3_trace.log.1_t4`. Internally, these trace files follow the same format as `ndbd` trace files.

The `ndbd` exit codes and messages that are generated when a data node process shuts down prematurely are also used by `ndbmttd`. See [Data Node Error Messages](#), for a listing of these.



#### Note

It is possible to use `ndbd` and `ndbmttd` concurrently on different data nodes in the same NDB Cluster. However, such configurations have not been tested extensively; thus, we cannot recommend doing so in a production setting at this time.

## 21.5.4 ndb\_mgmd — The NDB Cluster Management Server Daemon

The management server is the process that reads the cluster configuration file and distributes this information to all nodes in the cluster that request it. It also maintains a log of cluster activities. Management clients can connect to the management server and check the cluster's status.

Options that can be used with `ndb_mgmd` are shown in the following table. Additional descriptions follow the table.

**Table 21.24 Command-line options used with the program ndb\_mgmd**

Format	Description	Added, Deprecated, or Removed
<code>--bind-address=host</code>	Local bind address	(Supported in all NDB releases based on MySQL 5.7)
<code>--character-sets-dir=path</code>	Directory containing character sets	(Supported in all NDB releases based on MySQL 5.7)
<code>--config-cache[=TRUE FALSE]</code>	Enable management server configuration cache; true by default	(Supported in all NDB releases based on MySQL 5.7)
<code>--config-file=file,</code> <code>-f file</code>	Specify cluster configuration file; also specify <code>--reload</code> or <code>--initial</code> to override configuration cache if present	(Supported in all NDB releases based on MySQL 5.7)
<code>--configdir=directory,</code> <code>--config-dir=directory</code>	Specify cluster management server configuration cache directory	(Supported in all NDB releases based on MySQL 5.7)
<code>--connect-retries=#</code>	Number of times to retry connection before giving up	(Supported in all NDB releases based on MySQL 5.7)
<code>--connect-retry-delay=#</code>	Number of seconds to wait between attempts to contact management server	(Supported in all NDB releases based on MySQL 5.7)
<code>--connect-string=connection_string,</code> <code>-c connection_string</code>	Same as <code>--ndb-connectstring</code>	(Supported in all NDB releases based on MySQL 5.7)
<code>--core-file</code>	Write core file on error; used in debugging	(Supported in all NDB releases based on MySQL 5.7)
<code>--daemon,</code> <code>-d</code>	Run <code>ndb_mgmd</code> in daemon mode (default)	(Supported in all NDB releases based on MySQL 5.7)
<code>--defaults-extra-file=path</code>	Read given file after global files are read	(Supported in all NDB releases based on MySQL 5.7)
<code>--defaults-file=path</code>	Read default options from given file only	(Supported in all NDB releases based on MySQL 5.7)
<code>--defaults-group-suffix=string</code>	Also read groups with <code>concat(group, suffix)</code>	(Supported in all NDB releases based on MySQL 5.7)
<code>--help,</code> <code>-?</code>	Display help text and exit	(Supported in all NDB releases based on MySQL 5.7)
<code>--initial</code>	Causes management server to reload configuration data from configuration file, bypassing configuration cache	(Supported in all NDB releases based on MySQL 5.7)
<code>--install[=name]</code>	Used to install management server process as Windows service; does not apply on other platforms	(Supported in all NDB releases based on MySQL 5.7)

Format	Description	Added, Deprecated, or Removed
<code>--interactive</code>	Run ndb_mgmd in interactive mode (not officially supported in production; for testing purposes only)	(Supported in all NDB releases based on MySQL 5.7)
<code>--log-name=name</code>	Name to use when writing cluster log messages applying to this node	(Supported in all NDB releases based on MySQL 5.7)
<code>--login-path=path</code>	Read given path from login file	(Supported in all NDB releases based on MySQL 5.7)
<code>--mycnf</code>	Read cluster configuration data from my.cnf file	(Supported in all NDB releases based on MySQL 5.7)
<code>--ndb-connectstring=connection_string</code> <code>-c connection_string</code>	Set connect string for connecting to ndb_mgmd. Syntax: "[nodeid=id;][host=]hostname[:port]". Overrides entries in NDB_CONNECTSTRING and my.cnf	(Supported in all NDB releases based on MySQL 5.7)
<code>--ndb-mgmd-host=connection_string,</code> <code>-c connection_string</code>	Same as --ndb-connectstring	(Supported in all NDB releases based on MySQL 5.7)
<code>--ndb-nodeid=#</code>	Set node ID for this node, overriding any ID set by --ndb-connectstring	(Supported in all NDB releases based on MySQL 5.7)
<code>--ndb-optimized-node-selection</code>	Enable optimizations for selection of nodes for transactions. Enabled by default; use --skip-ndb-optimized-node-selection to disable	(Supported in all NDB releases based on MySQL 5.7)
<code>--no-defaults</code>	Do not read default options from any option file other than login file	(Supported in all NDB releases based on MySQL 5.7)
<code>--no-nodeid-checks</code>	Do not perform any node ID checks	(Supported in all NDB releases based on MySQL 5.7)
<code>--nodaemon</code>	Do not run ndb_mgmd as a daemon	(Supported in all NDB releases based on MySQL 5.7)
<code>--nowait-nodes=list</code>	Do not wait for management nodes specified when starting this management server; requires --ndb-nodeid option	(Supported in all NDB releases based on MySQL 5.7)
<code>--print-defaults</code>	Print program argument list and exit	(Supported in all NDB releases based on MySQL 5.7)
<code>--print-full-config,</code> <code>-P</code>	Print full configuration and exit	(Supported in all NDB releases based on MySQL 5.7)

Format	Description	Added, Deprecated, or Removed
<code>--reload</code>	Causes management server to compare configuration file with configuration cache	(Supported in all NDB releases based on MySQL 5.7)
<code>--remove[=name]</code>	Used to remove management server process that was previously installed as Windows service, optionally specifying name of service to be removed; does not apply on other platforms	(Supported in all NDB releases based on MySQL 5.7)
<code>--skip-config-file</code>	Do not use configuration file	(Supported in all NDB releases based on MySQL 5.7)
<code>--usage,</code> <code>-?</code>	Display help text and exit; same as <code>--help</code>	(Supported in all NDB releases based on MySQL 5.7)
<code>--verbose,</code> <code>-v</code>	Write additional information to log	(Supported in all NDB releases based on MySQL 5.7)
<code>--version,</code> <code>-V</code>	Display version information and exit	(Supported in all NDB releases based on MySQL 5.7)

- `--bind-address=host`

Command-Line Format	<code>--bind-address=host</code>
Type	String
Default Value	[none]

Causes the management server to bind to a specific network interface (host name or IP address). This option has no default value.

- `--character-sets-dir`

Command-Line Format	<code>--character-sets-dir=path</code>
---------------------	--

Directory containing character sets.

- `--config-cache`

Command-Line Format	<code>--config-cache[=TRUE FALSE]</code>
Type	Boolean
Default Value	TRUE

This option, whose default value is 1 (or TRUE, or ON), can be used to disable the management server's configuration cache, so that it reads its configuration from `config.ini` every time it starts (see

Section 21.4.3, “NDB Cluster Configuration Files”). You can do this by starting the `ndb_mgmd` process with any one of the following options:

- `--config-cache=0`
- `--config-cache=FALSE`
- `--config-cache=OFF`
- `--skip-config-cache`

Using one of the options just listed is effective only if the management server has no stored configuration at the time it is started. If the management server finds any configuration cache files, then the `--config-cache` option or the `--skip-config-cache` option is ignored. Therefore, to disable configuration caching, the option should be used the *first* time that the management server is started. Otherwise—that is, if you wish to disable configuration caching for a management server that has *already* created a configuration cache—you must stop the management server, delete any existing configuration cache files manually, then restart the management server with `--skip-config-cache` (or with `--config-cache` set equal to 0, `OFF`, or `FALSE`).

Configuration cache files are normally created in a directory named `mysql-cluster` under the installation directory (unless this location has been overridden using the `--configdir` option). Each time the management server updates its configuration data, it writes a new cache file. The files are named sequentially in order of creation using the following format:

```
ndb_node-id_config.bin.seq-number
```

`node-id` is the management server's node ID; `seq-number` is a sequence number, beginning with 1. For example, if the management server's node ID is 5, then the first three configuration cache files would, when they are created, be named `ndb_5_config.bin.1`, `ndb_5_config.bin.2`, and `ndb_5_config.bin.3`.

If your intent is to purge or reload the configuration cache without actually disabling caching, you should start `ndb_mgmd` with one of the options `--reload` or `--initial` instead of `--skip-config-cache`.

To re-enable the configuration cache, simply restart the management server, but without the `--config-cache` or `--skip-config-cache` option that was used previously to disable the configuration cache.

`ndb_mgmd` does not check for the configuration directory (`--configdir`) or attempts to create one when `--skip-config-cache` is used. (Bug #13428853)

- `--config-file=filename, -f filename`

Command-Line Format	<code>--config-file=file</code>
Disabled by	<code>skip-config-file</code>
Type	File name

Default Value	[none]
---------------	--------

Instructs the management server as to which file it should use for its configuration file. By default, the management server looks for a file named `config.ini` in the same directory as the `ndb_mgmd` executable; otherwise the file name and location must be specified explicitly.

This option has no default value, and is ignored unless the management server is forced to read the configuration file, either because `ndb_mgmd` was started with the `--reload` or `--initial` option, or because the management server could not find any configuration cache.

The `--config-file` option is also read if `ndb_mgmd` was started with `--config-cache=OFF`. See [Section 21.4.3, “NDB Cluster Configuration Files”](#), for more information.

- `--configdir=dir_name`

Command-Line Format	<code>--configdir=directory</code> <code>--config-dir=directory</code>
Type	File name
Default Value	<code>\$INSTALLDIR/mysql-cluster</code>

Specifies the cluster management server's configuration cache directory. `--config-dir` is an alias for this option.

- `--connect-retries`

Command-Line Format	<code>--connect-retries=#</code>
Type	Integer
Default Value	12
Minimum Value	0
Maximum Value	12

Number of times to retry connection before giving up.

- `--connect-retry-delay`

Command-Line Format	<code>--connect-retry-delay=#</code>
Type	Integer
Default Value	5
Minimum Value	0
Maximum Value	5

Number of seconds to wait between attempts to contact management server.

- `--connect-string`

Command-Line Format	<code>--connect-string=connection_string</code>
Type	String

Default Value	[none]
---------------	--------

Same as `--ndb-connectstring`.

- `--core-file`

Command-Line Format	<code>--core-file</code>
---------------------	--------------------------

Write core file on error; used in debugging.

- `--daemon, -d`

Command-Line Format	<code>--daemon</code>
---------------------	-----------------------

Instructs `ndb_mgmd` to start as a daemon process. This is the default behavior.

This option has no effect when running `ndb_mgmd` on Windows platforms.

- `--defaults-extra-file`

Command-Line Format	<code>--defaults-extra-file=path</code>
Type	String
Default Value	[none]

Read given file after global files are read.

- `--defaults-file`

Command-Line Format	<code>--defaults-file=path</code>
Type	String
Default Value	[none]

Read default options from given file only.

- `--defaults-group-suffix`

Command-Line Format	<code>--defaults-group-suffix=string</code>
Type	String
Default Value	[none]

Also read groups with `concat(group, suffix)`.

- `--help`

Command-Line Format	<code>--help</code>
---------------------	---------------------

Display help text and exit.



- `--initial`

Command-Line Format	<code>--initial</code>
---------------------	------------------------

Configuration data is cached internally, rather than being read from the cluster global configuration file each time the management server is started (see [Section 21.4.3, “NDB Cluster Configuration Files”](#)). Using the `--initial` option overrides this behavior, by forcing the management server to delete any existing cache files, and then to re-read the configuration data from the cluster configuration file and to build a new cache.

This differs in two ways from the `--reload` option. First, `--reload` forces the server to check the configuration file against the cache and reload its data only if the contents of the file are different from the cache. Second, `--reload` does not delete any existing cache files.

If `ndb_mgmd` is invoked with `--initial` but cannot find a global configuration file, the management server cannot start.

When a management server starts, it checks for another management server in the same NDB Cluster and tries to use the other management server's configuration data. This behavior has implications when performing a rolling restart of an NDB Cluster with multiple management nodes. See [Section 21.6.5, “Performing a Rolling Restart of an NDB Cluster”](#), for more information.

When used together with the `--config-file` option, the cache is cleared only if the configuration file is actually found.

- `--install[=name]`

Command-Line Format	<code>--install[=name]</code>
Platform Specific	Windows
Type	String
Default Value	<code>ndb_mgmd</code>

Causes `ndb_mgmd` to be installed as a Windows service. Optionally, you can specify a name for the service; if not set, the service name defaults to `ndb_mgmd`. Although it is preferable to specify other `ndb_mgmd` program options in a `my.ini` or `my.cnf` configuration file, it is possible to use them together with `--install`. However, in such cases, the `--install` option must be specified first, before any other options are given, for the Windows service installation to succeed.

It is generally not advisable to use this option together with the `--initial` option, since this causes the configuration cache to be wiped and rebuilt every time the service is stopped and started. Care should also be taken if you intend to use any other `ndb_mgmd` options that affect the starting of the management server, and you should make absolutely certain you fully understand and allow for any possible consequences of doing so.

The `--install` option has no effect on non-Windows platforms.

- `--interactive`

Command-Line Format	<code>--interactive</code>
---------------------	----------------------------

Starts `ndb_mgmd` in interactive mode; that is, an `ndb_mgm` client session is started as soon as the management server is running. This option does not start any other NDB Cluster nodes.

- `--login-path`

Command-Line Format	<code>--login-path=path</code>
Type	String
Default Value	[none]

Read given path from login file.

- `--log-name=name`

Command-Line Format	<code>--log-name=name</code>
Type	String
Default Value	MgmtSrvr

Provides a name to be used for this node in the cluster log.

- `--mycnf`

Command-Line Format	<code>--mycnf</code>
---------------------	----------------------

Read configuration data from the `my.cnf` file.

- `--ndb-connectstring`

Command-Line Format	<code>--ndb-connectstring=connection_string</code>
Type	String
Default Value	[none]

Set connection string. Syntax: `[nodeid=id;][host=]hostname[:port]`. Overrides entries in `NDB_CONNECTSTRING` and `my.cnf`; ignored if `--config-file` is specified.

- `--ndb-mgmd-host`

Command-Line Format	<code>--ndb-mgmd-host=connection_string</code>
Type	String
Default Value	[none]

Same as `--ndb-connectstring`.

- `--ndb-nodeid`

Command-Line Format	<code>--ndb-nodeid=#</code>
Type	Integer
Default Value	[none]

Set node ID for this node, overriding any ID set by `--ndb-connectstring`.

- `--ndb-optimized-node-selection`

Command-Line Format	<code>--ndb-optimized-node-selection</code>
---------------------	---

Enable optimizations for selection of nodes for transactions. Enabled by default; use `--skip-ndb-optimized-node-selection` to disable.

- `--no-defaults`

Command-Line Format	<code>--no-defaults</code>
---------------------	----------------------------

Do not read default options from any option file other than login file.

- `--no-nodeid-checks`

Command-Line Format	<code>--no-nodeid-checks</code>
---------------------	---------------------------------

Do not perform any checks of node IDs.

- `--nodaemon`

Command-Line Format	<code>--nodaemon</code>
---------------------	-------------------------

Instructs `ndb_mgmd` not to start as a daemon process.

The default behavior for `ndb_mgmd` on Windows is to run in the foreground, making this option unnecessary on Windows platforms.

- `--nowait-nodes`

Command-Line Format	<code>--nowait-nodes=list</code>
Type	Numeric
Default Value	[none]
Minimum Value	1
Maximum Value	255

When starting an NDB Cluster is configured with two management nodes, each management server normally checks to see whether the other `ndb_mgmd` is also operational and whether the other management server's configuration is identical to its own. However, it is sometimes desirable to start the cluster with only one management node (and perhaps to allow the other `ndb_mgmd` to be started later). This option causes the management node to bypass any checks for any other management nodes whose node IDs are passed to this option, permitting the cluster to start as though configured to use only the management node that was started.

For purposes of illustration, consider the following portion of a `config.ini` file (where we have omitted most of the configuration parameters that are not relevant to this example):

```
[ndbd]
NodeId = 1
HostName = 198.51.100.101

[ndbd]
NodeId = 2
HostName = 198.51.100.102

[ndbd]
```

```

NodeId = 3
HostName = 198.51.100.103

[ndbd]
NodeId = 4
HostName = 198.51.100.104

[ndb_mgmd]
NodeId = 10
HostName = 198.51.100.150

[ndb_mgmd]
NodeId = 11
HostName = 198.51.100.151

[api]
NodeId = 20
HostName = 198.51.100.200

[api]
NodeId = 21
HostName = 198.51.100.201

```

Assume that you wish to start this cluster using only the management server having node ID 10 and running on the host having the IP address 198.51.100.150. (Suppose, for example, that the host computer on which you intend to the other management server is temporarily unavailable due to a hardware failure, and you are waiting for it to be repaired.) To start the cluster in this way, use a command line on the machine at 198.51.100.150 to enter the following command:

```
$> ndb_mgmd --ndb-nodeid=10 --nowait-nodes=11
```

As shown in the preceding example, when using `--nowait-nodes`, you must also use the `--ndb-nodeid` option to specify the node ID of this `ndb_mgmd` process.

You can then start each of the cluster's data nodes in the usual way. If you wish to start and use the second management server in addition to the first management server at a later time without restarting the data nodes, you must start each data node with a connection string that references both management servers, like this:

```
$> ndbd -c 198.51.100.150,198.51.100.151
```

The same is true with regard to the connection string used with any `mysqld` processes that you wish to start as NDB Cluster SQL nodes connected to this cluster. See [Section 21.4.3.3, “NDB Cluster Connection Strings”](#), for more information.

When used with `ndb_mgmd`, this option affects the behavior of the management node with regard to other management nodes only. Do not confuse it with the `--nowait-nodes` option used with `ndbd` or `ndbmt` to permit a cluster to start with fewer than its full complement of data nodes; when used with data nodes, this option affects their behavior only with regard to other data nodes.

Multiple management node IDs may be passed to this option as a comma-separated list. Each node ID must be no less than 1 and no greater than 255. In practice, it is quite rare to use more than two management servers for the same NDB Cluster (or to have any need for doing so); in most cases you need to pass to this option only the single node ID for the one management server that you do not wish to use when starting the cluster.



#### Note

When you later start the “missing” management server, its configuration must match that of the management server that is already in use by the cluster.

Otherwise, it fails the configuration check performed by the existing management server, and does not start.

- `--print-defaults`

Command-Line Format	<code>--print-defaults</code>
---------------------	-------------------------------

Print program argument list and exit.

- `--print-full-config, -P`

Command-Line Format	<code>--print-full-config</code>
---------------------	----------------------------------

Shows extended information regarding the configuration of the cluster. With this option on the command line the `ndb_mgmd` process prints information about the cluster setup including an extensive list of the cluster configuration sections as well as parameters and their values. Normally used together with the `--config-file (-f)` option.

- `--reload`

Command-Line Format	<code>--reload</code>
---------------------	-----------------------

NDB Cluster configuration data is stored internally rather than being read from the cluster global configuration file each time the management server is started (see [Section 21.4.3, “NDB Cluster Configuration Files”](#)). Using this option forces the management server to check its internal data store against the cluster configuration file and to reload the configuration if it finds that the configuration file does not match the cache. Existing configuration cache files are preserved, but not used.

This differs in two ways from the `--initial` option. First, `--initial` causes all cache files to be deleted. Second, `--initial` forces the management server to re-read the global configuration file and construct a new cache.

If the management server cannot find a global configuration file, then the `--reload` option is ignored.

When `--reload` is used, the management server must be able to communicate with data nodes and any other management servers in the cluster before it attempts to read the global configuration file; otherwise, the management server fails to start. This can happen due to changes in the networking environment, such as new IP addresses for nodes or an altered firewall configuration. In such cases, you must use `--initial` instead to force the existing cached configuration to be discarded and reloaded from the file. See [Section 21.6.5, “Performing a Rolling Restart of an NDB Cluster”](#), for additional information.

- `--remove[=name]`

Command-Line Format	<code>--remove[=name]</code>
Platform Specific	Windows
Type	String
Default Value	<code>ndb_mgmd</code>

Remove a management server process that has been installed as a Windows service, optionally specifying the name of the service to be removed. Applies only to Windows platforms.

- `--skip-config-file`

Command-Line Format	<code>--skip-config-file</code>
---------------------	---------------------------------

Do not read cluster configuration file; ignore `--initial` and `--reload` options if specified.

- `--usage`

Command-Line Format	<code>--usage</code>
---------------------	----------------------

Display help text and exit; same as `--help`.

- `--verbose, -v`

Command-Line Format	<code>--verbose</code>
---------------------	------------------------

Remove a management server process that has been installed as a Windows service, optionally specifying the name of the service to be removed. Applies only to Windows platforms.

- `--version`

Command-Line Format	<code>--version</code>
---------------------	------------------------

Display version information and exit.

It is not strictly necessary to specify a connection string when starting the management server. However, if you are using more than one management server, a connection string should be provided and each node in the cluster should specify its node ID explicitly.

See [Section 21.4.3.3, “NDB Cluster Connection Strings”](#), for information about using connection strings. [Section 21.5.4, “ndb\\_mgmd — The NDB Cluster Management Server Daemon”](#), describes other options for `ndb_mgmd`.

The following files are created or used by `ndb_mgmd` in its starting directory, and are placed in the `DataDir` as specified in the `config.ini` configuration file. In the list that follows, `node_id` is the unique node identifier.

- `config.ini` is the configuration file for the cluster as a whole. This file is created by the user and read by the management server. [Section 21.4, “Configuration of NDB Cluster”](#), discusses how to set up this file.
- `ndb_node_id_cluster.log` is the cluster events log file. Examples of such events include checkpoint startup and completion, node startup events, node failures, and levels of memory usage. A complete listing of cluster events with descriptions may be found in [Section 21.6, “Management of NDB Cluster”](#).

By default, when the size of the cluster log reaches one million bytes, the file is renamed to `ndb_node_id_cluster.log.seq_id`, where `seq_id` is the sequence number of the cluster log file. (For example: If files with the sequence numbers 1, 2, and 3 already exist, the next log file is named using the number 4.) You can change the size and number of files, and other characteristics of the cluster log, using the `LogDestination` configuration parameter.

- `ndb_node_id_out.log` is the file used for `stdout` and `stderr` when running the management server as a daemon.
- `ndb_node_id.pid` is the process ID file used when running the management server as a daemon.

## 21.5.5 ndb\_mgm — The NDB Cluster Management Client

The `ndb_mgm` management client process is actually not needed to run the cluster. Its value lies in providing a set of commands for checking the cluster's status, starting backups, and performing other administrative functions. The management client accesses the management server using a C API. Advanced users can also employ this API for programming dedicated management processes to perform tasks similar to those performed by `ndb_mgm`.

To start the management client, it is necessary to supply the host name and port number of the management server:

```
$> ndb_mgm [host_name [port_num]]
```

For example:

```
$> ndb_mgm ndb_mgmd.mysql.com 1186
```

The default host name and port number are `localhost` and 1186, respectively.

Options that can be used with `ndb_mgm` are shown in the following table. Additional descriptions follow the table.

**Table 21.25 Command-line options used with the program `ndb_mgm`**

Format	Description	Added, Deprecated, or Removed
<code>--character-sets-dir=path</code>	Directory containing character sets	(Supported in all NDB releases based on MySQL 5.7)
<code>--connect-retry-delay=#</code>	Number of seconds to wait between attempts to contact management server	(Supported in all NDB releases based on MySQL 5.7)
<code>--connect-string=connection_string,</code> <code>-c connection_string</code>	Same as <code>--ndb-connectstring</code>	(Supported in all NDB releases based on MySQL 5.7)
<code>--core-file</code>	Write core file on error; used in debugging	(Supported in all NDB releases based on MySQL 5.7)
<code>--defaults-extra-file=path</code>	Read given file after global files are read	(Supported in all NDB releases based on MySQL 5.7)
<code>--defaults-file=path</code>	Read default options from given file only	(Supported in all NDB releases based on MySQL 5.7)
<code>--defaults-group-suffix=string</code>	Also read groups with <code>concat(group, suffix)</code>	(Supported in all NDB releases based on MySQL 5.7)
<code>--execute=command,</code> <code>-e command</code>	Execute command and exit	(Supported in all NDB releases based on MySQL 5.7)
<code>--help,</code> <code>-?</code>	Display help text and exit	(Supported in all NDB releases based on MySQL 5.7)
<code>--login-path=path</code>	Read given path from login file	(Supported in all NDB releases based on MySQL 5.7)
<code>--ndb-connectstring=connection_string</code>	Set connect string for connecting to <code>ndb_mgmd</code> .	(Supported in all NDB releases based on MySQL 5.7)

Format	Description	Added, Deprecated, or Removed
<code>-c connection_string</code>	Syntax: "[nodeid=id;] [host=]hostname[:port]". Overrides entries in NDB_CONNECTSTRING and my.cnf	
<code>--ndb-mgmd- host=connection_string,</code>	Same as <code>--ndb-connectstring</code>	(Supported in all NDB releases based on MySQL 5.7)
<code>-c connection_string --ndb-nodeid=#</code>	Set node ID for this node, overriding any ID set by <code>--ndb-connectstring</code>	(Supported in all NDB releases based on MySQL 5.7)
<code>--ndb-optimized-node- selection</code>	Enable optimizations for selection of nodes for transactions. Enabled by default; use <code>--skip-ndb- optimized-node-selection</code> to disable	(Supported in all NDB releases based on MySQL 5.7)
<code>--no-defaults</code>	Do not read default options from any option file other than login file	(Supported in all NDB releases based on MySQL 5.7)
<code>--print-defaults</code>	Print program argument list and exit	(Supported in all NDB releases based on MySQL 5.7)
<code>--try-reconnect=#,</code>	Set number of times to retry connection before giving up; synonym for <code>--connect-retries</code>	(Supported in all NDB releases based on MySQL 5.7)
<code>-t #</code>		
<code>--usage,</code>	Display help text and exit; same as <code>--help</code>	(Supported in all NDB releases based on MySQL 5.7)
<code>-?</code>		
<code>--version,</code>	Display version information and exit	(Supported in all NDB releases based on MySQL 5.7)
<code>-V</code>		

- `--character-sets-dir`

Command-Line Format	<code>--character-sets-dir=path</code>
---------------------	--

Directory containing character sets.

- `--connect-retries=#`

Command-Line Format	<code>--connect-retries=#</code>
Type	Numeric
Default Value	3
Minimum Value	0
Maximum Value	4294967295

This option specifies the number of times following the first attempt to retry a connection before giving up (the client always tries the connection at least once). The length of time to wait per attempt is set using `--connect-retry-delay`.



This option is synonymous with the `--try-reconnect` option, which is now deprecated.

- `--connect-retry-delay`

Command-Line Format	<code>--connect-retry-delay=#</code>
Type	Integer
Default Value	5
Minimum Value	0
Maximum Value	5

Number of seconds to wait between attempts to contact management server.

- `--connect-string`

Command-Line Format	<code>--connect-string=connection_string</code>
Type	String
Default Value	[none]

Same as `--ndb-connectstring`.

- `--core-file`

Command-Line Format	<code>--core-file</code>
---------------------	--------------------------

Write core file on error; used in debugging.

- `--defaults-extra-file`

Command-Line Format	<code>--defaults-extra-file=path</code>
Type	String
Default Value	[none]

Read given file after global files are read.

- `--defaults-file`

Command-Line Format	<code>--defaults-file=path</code>
Type	String
Default Value	[none]

Read default options from given file only.

- `--defaults-group-suffix`

Command-Line Format	<code>--defaults-group-suffix=string</code>
Type	String
Default Value	[none]

Also read groups with `concat(group, suffix)`.

- `--execute=command`, `-e command`

Command-Line Format	<code>--execute=command</code>
---------------------	--------------------------------

This option can be used to send a command to the NDB Cluster management client from the system shell. For example, either of the following is equivalent to executing `SHOW` in the management client:

```
$> ndb_mgm -e "SHOW"
$> ndb_mgm --execute="SHOW"
```

This is analogous to how the `--execute` or `-e` option works with the `mysql` command-line client. See [Section 4.2.2.1, “Using Options on the Command Line”](#).



**Note**

If the management client command to be passed using this option contains any space characters, then the command *must* be enclosed in quotation marks. Either single or double quotation marks may be used. If the management client command contains no space characters, the quotation marks are optional.

- `--help`

Command-Line Format	<code>--help</code>
---------------------	---------------------

Display help text and exit.

- `--login-path`

Command-Line Format	<code>--login-path=path</code>
Type	String
Default Value	[none]

Read given path from login file.

- `--ndb-connectstring`

Command-Line Format	<code>--ndb-connectstring=connection_string</code>
Type	String
Default Value	[none]

Set connect string for connecting to `ndb_mgmd`. Syntax: `[nodeid=id;][host=]hostname[:port]`. Overrides entries in `NDB_CONNECTSTRING` and `my.cnf`.

- `--ndb-mgmd-host`

Command-Line Format	<code>--ndb-mgmd-host=connection_string</code>
Type	String
Default Value	[none]

- `--ndb-nodeid`

Command-Line Format	<code>--ndb-nodeid=#</code>
Type	Integer
Default Value	[none]

Set node ID for this node, overriding any ID set by `--ndb-connectstring`.

- `--ndb-optimized-node-selection`

Command-Line Format	<code>--ndb-optimized-node-selection</code>
---------------------	---

Enable optimizations for selection of nodes for transactions. Enabled by default; use `--skip-ndb-optimized-node-selection` to disable.

- `--no-defaults`

Command-Line Format	<code>--no-defaults</code>
---------------------	----------------------------

Do not read default options from any option file other than login file.

- `--print-defaults`

Command-Line Format	<code>--print-defaults</code>
---------------------	-------------------------------

Print program argument list and exit.

- `--try-reconnect=number`

Command-Line Format	<code>--try-reconnect=#</code>
Deprecated	Yes
Type (≥ 5.7.10-ndb-7.5.0)	Numeric
Type	Integer
Default Value (≥ 5.7.10-ndb-7.5.0)	12
Default Value	3
Minimum Value	0
Maximum Value	4294967295

If the connection to the management server is broken, the node tries to reconnect to it every 5 seconds until it succeeds. By using this option, it is possible to limit the number of attempts to *number* before giving up and reporting an error instead.

This option is deprecated and subject to removal in a future release. Use `--connect-retries`, instead.

- `--usage`

Command-Line Format	<code>--usage</code>
---------------------	----------------------

Display help text and exit; same as `--help`.

- `--version`

Command-Line Format	<code>--version</code>
---------------------	------------------------

Display version information and exit.

Additional information about using `ndb_mgm` can be found in [Section 21.6.1, “Commands in the NDB Cluster Management Client”](#).

## 21.5.6 ndb\_blob\_tool — Check and Repair BLOB and TEXT columns of NDB Cluster Tables

This tool can be used to check for and remove orphaned BLOB column parts from NDB tables, as well as to generate a file listing any orphaned parts. It is sometimes useful in diagnosing and repairing corrupted or damaged NDB tables containing BLOB or TEXT columns.

The basic syntax for `ndb_blob_tool` is shown here:

```
ndb_blob_tool [options] table [column, ...]
```

Unless you use the `--help` option, you must specify an action to be performed by including one or more of the options `--check-orphans`, `--delete-orphans`, or `--dump-file`. These options cause `ndb_blob_tool` to check for orphaned BLOB parts, remove any orphaned BLOB parts, and generate a dump file listing orphaned BLOB parts, respectively, and are described in more detail later in this section.

You must also specify the name of a table when invoking `ndb_blob_tool`. In addition, you can optionally follow the table name with the (comma-separated) names of one or more BLOB or TEXT columns from that table. If no columns are listed, the tool works on all of the table's BLOB and TEXT columns. If you need to specify a database, use the `--database (-d)` option.

The `--verbose` option provides additional information in the output about the tool's progress.

Options that can be used with `ndb_blob_tool` are shown in the following table. Additional descriptions follow the table.

**Table 21.26 Command-line options used with the program `ndb_blob_tool`**

Format	Description	Added, Deprecated, or Removed
<code>--add-missing</code>	Write dummy blob parts to take place of those which are missing	ADDED: NDB 7.5.18, NDB 7.6.14
<code>--character-sets-dir=path</code>	Directory containing character sets	(Supported in all NDB releases based on MySQL 5.7)
<code>--check-missing</code>	Check for blobs having inline parts but missing one or more parts from parts table	ADDED: NDB 7.5.18, NDB 7.6.14
<code>--check-orphans</code>	Check for blob parts having no corresponding inline parts	(Supported in all NDB releases based on MySQL 5.7)
<code>--connect-retries=#</code>	Number of times to retry connection before giving up	(Supported in all NDB releases based on MySQL 5.7)
<code>--connect-retry-delay=#</code>	Number of seconds to wait between attempts to contact management server	(Supported in all NDB releases based on MySQL 5.7)
<code>--connect-string=connection_string,</code>	Same as <code>--ndb-connectstring</code>	(Supported in all NDB releases based on MySQL 5.7)

Format	Description	Added, Deprecated, or Removed
<code>-c connection_string</code>		
<code>--core-file</code>	Write core file on error; used in debugging	(Supported in all NDB releases based on MySQL 5.7)
<code>--database=name,</code>	Database to find the table in	(Supported in all NDB releases based on MySQL 5.7)
<code>-d name</code>		
<code>--defaults-extra-file=path</code>	Read given file after global files are read	(Supported in all NDB releases based on MySQL 5.7)
<code>--defaults-file=path</code>	Read default options from given file only	(Supported in all NDB releases based on MySQL 5.7)
<code>--defaults-group-suffix=string</code>	Also read groups with concat(group, suffix)	(Supported in all NDB releases based on MySQL 5.7)
<code>--delete-orphans</code>	Delete blob parts having no corresponding inline parts	(Supported in all NDB releases based on MySQL 5.7)
<code>--dump-file=file</code>	Write orphan keys to specified file	(Supported in all NDB releases based on MySQL 5.7)
<code>--help,</code>	Display help text and exit	(Supported in all NDB releases based on MySQL 5.7)
<code>-?</code>		
<code>--login-path=path</code>	Read given path from login file	(Supported in all NDB releases based on MySQL 5.7)
<code>--ndb-connectstring=connection_string</code>	Set connect string for connecting to ndb_mgmd. Syntax: "[nodeid=id;][host=]hostname[:port]". Overrides entries in NDB_CONNECTSTRING and my.cnf	(Supported in all NDB releases based on MySQL 5.7)
<code>-c connection_string</code>		
<code>--ndb-mgmd-host=connection_string,</code>	Same as --ndb-connectstring	(Supported in all NDB releases based on MySQL 5.7)
<code>-c connection_string</code>		
<code>--ndb-nodeid=#</code>	Set node ID for this node, overriding any ID set by --ndb-connectstring	(Supported in all NDB releases based on MySQL 5.7)
<code>--ndb-optimized-node-selection</code>	Enable optimizations for selection of nodes for transactions. Enabled by default; use --skip-ndb-optimized-node-selection to disable	(Supported in all NDB releases based on MySQL 5.7)
<code>--no-defaults</code>	Do not read default options from any option file other than login file	(Supported in all NDB releases based on MySQL 5.7)
<code>--print-defaults</code>	Print program argument list and exit	(Supported in all NDB releases based on MySQL 5.7)
<code>--usage,</code>	Display help text and exit; same as --help	(Supported in all NDB releases based on MySQL 5.7)

Format	Description	Added, Deprecated, or Removed
-?		
--verbose, -v	Verbose output	(Supported in all NDB releases based on MySQL 5.7)
--version, -V	Display version information and exit	(Supported in all NDB releases based on MySQL 5.7)

- `--add-missing`

Command-Line Format	<code>--add-missing</code>
Introduced	5.7.29-ndb-7.6.14

For each inline part in NDB Cluster tables which has no corresponding BLOB part, write a dummy BLOB part of the required length, consisting of spaces.

- `--character-sets-dir`

Command-Line Format	<code>--character-sets-dir=path</code>
---------------------	--

Directory containing character sets.

- `--check-missing`

Command-Line Format	<code>--check-missing</code>
Introduced	5.7.29-ndb-7.6.14

Check for inline parts in NDB Cluster tables which have no corresponding BLOB parts.

- `--check-orphans`

Command-Line Format	<code>--check-orphans</code>
---------------------	------------------------------

Check for BLOB parts in NDB Cluster tables which have no corresponding inline parts.

- `--connect-retries`

Command-Line Format	<code>--connect-retries=#</code>
Type	Integer
Default Value	12
Minimum Value	0
Maximum Value	12

Number of times to retry connection before giving up.

- `--connect-retry-delay`

Command-Line Format	<code>--connect-retry-delay=#</code>
Type	Integer

Default Value	5
Minimum Value	0
Maximum Value	5

Number of seconds to wait between attempts to contact management server.

- `--connect-string`

Command-Line Format	<code>--connect-string=connection_string</code>
Type	String
Default Value	[none]

Same as `--ndb-connectstring`.

- `--core-file`

Command-Line Format	<code>--core-file</code>
---------------------	--------------------------

Write core file on error; used in debugging.

- `--database=db_name, -d`

Command-Line Format	<code>--database=name</code>
Type	String
Default Value	[none]

Specify the database to find the table in.

- `--defaults-extra-file`

Command-Line Format	<code>--defaults-extra-file=path</code>
Type	String
Default Value	[none]

Read given file after global files are read.

- `--defaults-file`

Command-Line Format	<code>--defaults-file=path</code>
Type	String
Default Value	[none]

Read default options from given file only.

- `--defaults-group-suffix`

Command-Line Format	<code>--defaults-group-suffix=string</code>
Type	String
Default Value	[none]

Also read groups with `concat(group, suffix)`.

- `--delete-orphans`

Command-Line Format	<code>--delete-orphans</code>
---------------------	-------------------------------

Remove BLOB parts from NDB Cluster tables which have no corresponding inline parts.

- `--dump-file=file`

Command-Line Format	<code>--dump-file=file</code>
Type	File name
Default Value	[none]

Writes a list of orphaned BLOB column parts to *file*. The information written to the file includes the table key and BLOB part number for each orphaned BLOB part.

- `--help`

Command-Line Format	<code>--help</code>
---------------------	---------------------

Display help text and exit.

- `--login-path`

Command-Line Format	<code>--login-path=path</code>
Type	String
Default Value	[none]

Read given path from login file.

- `--ndb-connectstring`

Command-Line Format	<code>--ndb-connectstring=connection_string</code>
Type	String
Default Value	[none]

Set connect string for connecting to ndb\_mgmd. Syntax: "[nodeid=id;][host=]hostname[:port]". Overrides entries in NDB\_CONNECTSTRING and my.cnf.

- `--ndb-mgmd-host`

Command-Line Format	<code>--ndb-mgmd-host=connection_string</code>
Type	String
Default Value	[none]

Same as `--ndb-connectstring`.

- `--ndb-nodeid`

Command-Line Format	<code>--ndb-nodeid=#</code>
Type	Integer
Default Value	[none]



Set node ID for this node, overriding any ID set by `--ndb-connectstring`.

- `--ndb-optimized-node-selection`

Command-Line Format	<code>--ndb-optimized-node-selection</code>
---------------------	---

Enable optimizations for selection of nodes for transactions. Enabled by default; use `--skip-ndb-optimized-node-selection` to disable.

- `--no-defaults`

Command-Line Format	<code>--no-defaults</code>
---------------------	----------------------------

Do not read default options from any option file other than login file.

- `--print-defaults`

Command-Line Format	<code>--print-defaults</code>
---------------------	-------------------------------

Print program argument list and exit.

- `--usage`

Command-Line Format	<code>--usage</code>
---------------------	----------------------

Display help text and exit; same as `--help`.

- `--verbose`

Command-Line Format	<code>--verbose</code>
---------------------	------------------------

Provide extra information in the tool's output regarding its progress.

- `--version`

Command-Line Format	<code>--version</code>
---------------------	------------------------

Display version information and exit.

## Example

First we create an NDB table in the `test` database, using the `CREATE TABLE` statement shown here:

```
USE test;

CREATE TABLE btest (
  c0 BIGINT UNSIGNED NOT NULL AUTO_INCREMENT PRIMARY KEY,
  c1 TEXT,
  c2 BLOB
) ENGINE=NDB;
```

Then we insert a few rows into this table, using a series of statements similar to this one:

```
INSERT INTO btest VALUES (NULL, 'x', REPEAT('x', 1000));
```

When run with `--check-orphans` against this table, `ndb_blob_tool` generates the following output:

```
$> ndb_blob_tool --check-orphans --verbose -d test btest
connected
```

```

processing 2 blobs
processing blob #0 c1 NDB$BLOB_19_1
NDB$BLOB_19_1: nextResult: res=1
total parts: 0
orphan parts: 0
processing blob #1 c2 NDB$BLOB_19_2
NDB$BLOB_19_2: nextResult: res=0
NDB$BLOB_19_2: nextResult: res=0
NDB$BLOB_19_2: nextResult: res=0
NDB$BLOB_19_2: nextResult: res=0
NDB$BLOB_19_2: nextResult: res=0
NDB$BLOB_19_2: nextResult: res=0
NDB$BLOB_19_2: nextResult: res=0
NDB$BLOB_19_2: nextResult: res=0
NDB$BLOB_19_2: nextResult: res=0
NDB$BLOB_19_2: nextResult: res=0
NDB$BLOB_19_2: nextResult: res=1
total parts: 10
orphan parts: 0
disconnected

NDBT_ProgramExit: 0 - OK

```

The tool reports that there are no NDB BLOB column parts associated with column `c1`, even though `c1` is a `TEXT` column. This is due to the fact that, in an NDB table, only the first 256 bytes of a `BLOB` or `TEXT` column value are stored inline, and only the excess, if any, is stored separately; thus, if there are no values using more than 256 bytes in a given column of one of these types, no `BLOB` column parts are created by NDB for this column. See [Section 11.7, “Data Type Storage Requirements”](#), for more information.

## 21.5.7 ndb\_config — Extract NDB Cluster Configuration Information

This tool extracts current configuration information for data nodes, SQL nodes, and API nodes from one of a number of sources: an NDB Cluster management node, or its `config.ini` or `my.cnf` file. By default, the management node is the source for the configuration data; to override the default, execute `ndb_config` with the `--config-file` or `--mycnf` option. It is also possible to use a data node as the source by specifying its node ID with `--config_from_node=node_id`.

`ndb_config` can also provide an offline dump of all configuration parameters which can be used, along with their default, maximum, and minimum values and other information. The dump can be produced in either text or XML format; for more information, see the discussion of the `--configinfo` and `--xml` options later in this section).

You can filter the results by section (`DB`, `SYSTEM`, or `CONNECTIONS`) using one of the options `--nodes`, `--system`, or `--connections`.

Options that can be used with `ndb_config` are shown in the following table. Additional descriptions follow the table.

**Table 21.27 Command-line options used with the program `ndb_config`**

Format	Description	Added, Deprecated, or Removed
<code>--character-sets-dir=path</code>	Directory containing character sets	(Supported in all NDB releases based on MySQL 5.7)
<code>--config-file=file_name</code>	Set the path to config.ini file	(Supported in all NDB releases based on MySQL 5.7)
<code>--config-from-node=#</code>	Obtain configuration data from the node having this ID (must be a data node)	(Supported in all NDB releases based on MySQL 5.7)

Format	Description	Added, Deprecated, or Removed
<code>--configinfo</code>	Dumps information about all NDB configuration parameters in text format with default, maximum, and minimum values. Use with <code>--xml</code> to obtain XML output	(Supported in all NDB releases based on MySQL 5.7)
<code>--connections</code>	Print information only about connections specified in <code>[tcp]</code> , <code>[tcp default]</code> , <code>[sci]</code> , <code>[sci default]</code> , <code>[shm]</code> , or <code>[shm default]</code> sections of cluster configuration file. Cannot be used with <code>--system</code> or <code>--nodes</code>	(Supported in all NDB releases based on MySQL 5.7)
<code>--connect-retries=#</code>	Number of times to retry connection before giving up	(Supported in all NDB releases based on MySQL 5.7)
<code>--connect-retry-delay=#</code>	Number of seconds to wait between attempts to contact management server	(Supported in all NDB releases based on MySQL 5.7)
<code>--connect-string=connection_string,</code> <code>-c connection_string</code>	Same as <code>--ndb-connectstring</code>	(Supported in all NDB releases based on MySQL 5.7)
<code>--core-file</code>	Write core file on error; used in debugging	(Supported in all NDB releases based on MySQL 5.7)
<code>--defaults-extra-file=path</code>	Read given file after global files are read	(Supported in all NDB releases based on MySQL 5.7)
<code>--defaults-file=path</code>	Read default options from given file only	(Supported in all NDB releases based on MySQL 5.7)
<code>--defaults-group-suffix=string</code>	Also read groups with <code>concat(group, suffix)</code>	(Supported in all NDB releases based on MySQL 5.7)
<code>--diff-default</code>	Print only configuration parameters that have non-default values	ADDED: NDB 7.5.7, NDB 7.6.3
<code>--fields=string,</code> <code>-f</code>	Field separator	(Supported in all NDB releases based on MySQL 5.7)
<code>--help,</code> <code>-?</code>	Display help text and exit	(Supported in all NDB releases based on MySQL 5.7)
<code>--host=name</code>	Specify host	(Supported in all NDB releases based on MySQL 5.7)
<code>--login-path=path</code>	Read given path from login file	(Supported in all NDB releases based on MySQL 5.7)
<code>--mycnf</code>	Read configuration data from <code>my.cnf</code> file	(Supported in all NDB releases based on MySQL 5.7)
<code>--ndb-connectstring=connection_string,</code> <code>-c connection_string</code>	Set connect string for connecting to <code>ndb_mgmd</code> . Syntax: "[nodeid=id;]	(Supported in all NDB releases based on MySQL 5.7)

Format	Description	Added, Deprecated, or Removed
<code>--ndb-mgmd-host=connection_string,</code> <code>-c connection_string</code>	[host=]hostname[:port]". Overrides entries in NDB_CONNECTSTRING and my.cnf Same as --ndb-connectstring	(Supported in all NDB releases based on MySQL 5.7)
<code>--ndb-nodeid=#</code>	Set node ID for this node, overriding any ID set by --ndb-connectstring	(Supported in all NDB releases based on MySQL 5.7)
<code>--ndb-optimized-node-selection</code>	Enable optimizations for selection of nodes for transactions. Enabled by default; use --skip-ndb-optimized-node-selection to disable	(Supported in all NDB releases based on MySQL 5.7)
<code>--no-defaults</code>	Do not read default options from any option file other than login file	(Supported in all NDB releases based on MySQL 5.7)
<code>--nodeid=#</code>	Get configuration of node with this ID	(Supported in all NDB releases based on MySQL 5.7)
<code>--nodes</code>	Print node information ([ndbd] or [ndbd default] section of cluster configuration file) only. Cannot be used with --system or --connections	(Supported in all NDB releases based on MySQL 5.7)
<code>--query=string,</code> <code>-q string</code>	One or more query options (attributes)	(Supported in all NDB releases based on MySQL 5.7)
<code>--query-all,</code> <code>-a</code>	Dumps all parameters and values to a single comma-delimited string	ADDED: NDB 7.4.16, NDB 7.5.7
<code>--print-defaults</code>	Print program argument list and exit	(Supported in all NDB releases based on MySQL 5.7)
<code>--rows=string,</code> <code>-r string</code>	Row separator	(Supported in all NDB releases based on MySQL 5.7)
<code>--system</code>	Print SYSTEM section information only (see ndb_config --configinfo output). Cannot be used with --nodes or --connections	(Supported in all NDB releases based on MySQL 5.7)
<code>--type=name</code>	Specify node type	(Supported in all NDB releases based on MySQL 5.7)
<code>--usage,</code> <code>-?</code>	Display help text and exit; same as --help	(Supported in all NDB releases based on MySQL 5.7)
<code>--version,</code>	Display version information and exit	(Supported in all NDB releases based on MySQL 5.7)

Format	Description	Added, Deprecated, or Removed
<code>-V</code> <code>--configinfo --xml</code>	Use <code>--xml</code> with <code>--configinfo</code> to obtain a dump of all NDB configuration parameters in XML format with default, maximum, and minimum values	(Supported in all NDB releases based on MySQL 5.7)

- `--character-sets-dir`

Command-Line Format	<code>--character-sets-dir=path</code>
---------------------	--

Directory containing character sets.

- `--configinfo`

The `--configinfo` option causes `ndb_config` to dump a list of each NDB Cluster configuration parameter supported by the NDB Cluster distribution of which `ndb_config` is a part, including the following information:

- A brief description of each parameter's purpose, effects, and usage
- The section of the `config.ini` file where the parameter may be used
- The parameter's data type or unit of measurement
- Where applicable, the parameter's default, minimum, and maximum values
- NDB Cluster release version and build information

By default, this output is in text format. Part of this output is shown here:

```
$> ndb_config --configinfo

***** SYSTEM *****

Name (String)
Name of system (NDB Cluster)
MANDATORY

PrimaryMGMNode (Non-negative Integer)
Node id of Primary ndb_mgmd(MGM) node
Default: 0 (Min: 0, Max: 4294967039)

ConfigGenerationNumber (Non-negative Integer)
Configuration generation number
Default: 0 (Min: 0, Max: 4294967039)

***** DB *****

MaxNoOfSubscriptions (Non-negative Integer)
Max no of subscriptions (default 0 == MaxNoOfTables)
Default: 0 (Min: 0, Max: 4294967039)

MaxNoOfSubscribers (Non-negative Integer)
Max no of subscribers (default 0 == 2 * MaxNoOfTables)
Default: 0 (Min: 0, Max: 4294967039)
```

...

Use this option together with the `--xml` option to obtain output in XML format.

- `--config-file=path-to-file`

Command-Line Format	<code>--config-file=file_name</code>
Type	File name
Default Value	

Gives the path to the management server's configuration file (`config.ini`). This may be a relative or absolute path. If the management node resides on a different host from the one on which `ndb_config` is invoked, then an absolute path must be used.

- `--config_from_node=#`

Command-Line Format	<code>--config-from-node=#</code>
Type	Numeric
Default Value	<code>none</code>
Minimum Value	<code>1</code>
Maximum Value	<code>48</code>

Obtain the cluster's configuration data from the data node that has this ID.

If the node having this ID is not a data node, `ndb_config` fails with an error. (To obtain configuration data from the management node instead, simply omit this option.)

- `--connections`

Command-Line Format	<code>--connections</code>
---------------------	----------------------------

Tells `ndb_config` to print `CONNECTIONS` information only—that is, information about parameters found in the `[tcp]`, `[tcp default]`, `[shm]`, or `[shm default]` sections of the cluster configuration file (see [Section 21.4.3.10, “NDB Cluster TCP/IP Connections”](#), and [Section 21.4.3.12, “NDB Cluster Shared Memory Connections”](#), for more information).

This option is mutually exclusive with `--nodes` and `--system`; only one of these 3 options can be used.

- `--connect-retries`

Command-Line Format	<code>--connect-retries=#</code>
Type	Integer
Default Value	<code>12</code>
Minimum Value	<code>0</code>
Maximum Value	<code>12</code>

Number of times to retry connection before giving up.

- `--connect-retry-delay`

Command-Line Format	<code>--connect-retry-delay=#</code>
---------------------	--------------------------------------

Type	Integer
Default Value	5
Minimum Value	0
Maximum Value	5

Number of seconds to wait between attempts to contact management server.

- `--connect-string`

Command-Line Format	<code>--connect-string=connection_string</code>
Type	String
Default Value	[none]

Same as `--ndb-connectstring`.

- `--core-file`

Command-Line Format	<code>--core-file</code>
---------------------	--------------------------

Write core file on error; used in debugging.

- `--defaults-extra-file`

Command-Line Format	<code>--defaults-extra-file=path</code>
Type	String
Default Value	[none]

Read given file after global files are read.

- `--defaults-file`

Command-Line Format	<code>--defaults-file=path</code>
Type	String
Default Value	[none]

Read default options from given file only.

- `--defaults-group-suffix`

Command-Line Format	<code>--defaults-group-suffix=string</code>
Type	String
Default Value	[none]

Also read groups with `concat(group, suffix)`.

- `--diff-default`

Command-Line Format	<code>--diff-default</code>
Introduced	5.7.18-ndb-7.6.3

Print only configuration parameters that have non-default values.

- `--fields=delimiter, -f delimiter`

Command-Line Format	<code>--fields=string</code>
Type	String
Default Value	

Specifies a *delimiter* string used to separate the fields in the result. The default is `,` (the comma character).



**Note**

If the *delimiter* contains spaces or escapes (such as `\n` for the linefeed character), then it must be quoted.

- `--help`

Command-Line Format	<code>--help</code>
---------------------	---------------------

Display help text and exit.

- `--host=hostname`

Command-Line Format	<code>--host=name</code>
Type	String
Default Value	

Specifies the host name of the node for which configuration information is to be obtained.



**Note**

While the hostname `localhost` usually resolves to the IP address `127.0.0.1`, this may not necessarily be true for all operating platforms and configurations. This means that it is possible, when `localhost` is used in `config.ini`, for `ndb_config --host=localhost` to fail if `ndb_config` is run on a different host where `localhost` resolves to a different address (for example, on some versions of SUSE Linux, this is `127.0.0.2`). In general, for best results, you should use numeric IP addresses for all NDB Cluster configuration values relating to hosts, or verify that all NDB Cluster hosts handle `localhost` in the same fashion.

- `--login-path`

Command-Line Format	<code>--login-path=path</code>
Type	String
Default Value	<code>[none]</code>

Read given path from login file.

- `--mycnf`

Command-Line Format	<code>--mycnf</code>
---------------------	----------------------

Read configuration data from the `my.cnf` file.



- `--ndb-connectstring=connection_string, -c connection_string`

Command-Line Format	<code>--ndb-connectstring=connection_string</code>
Type	String
Default Value	[none]

Specifies the connection string to use in connecting to the management server. The format for the connection string is the same as described in [Section 21.4.3.3, “NDB Cluster Connection Strings”](#), and defaults to `localhost:1186`.

- `--ndb-mgmd-host`

Command-Line Format	<code>--ndb-mgmd-host=connection_string</code>
Type	String
Default Value	[none]

Same as `--ndb-connectstring`.

- `--ndb-nodeid`

Command-Line Format	<code>--ndb-nodeid=#</code>
Type	Integer
Default Value	[none]

Set node ID for this node, overriding any ID set by `--ndb-connectstring`.

- `--ndb-optimized-node-selection`

Command-Line Format	<code>--ndb-optimized-node-selection</code>
---------------------	---

Enable optimizations for selection of nodes for transactions. Enabled by default; use `--skip-ndb-optimized-node-selection` to disable.

- `--no-defaults`

Command-Line Format	<code>--no-defaults</code>
---------------------	----------------------------

Do not read default options from any option file other than login file.

- `--nodeid=node_id`

Command-Line Format	<code>--ndb-nodeid=#</code>
Type	Integer
Default Value	[none]

Specify the node ID of the node for which configuration information is to be obtained. Formerly, `--id` could be used as a synonym for this option; in NDB 7.5 and later, the only form accepted is `--nodeid`.

- `--nodes`

Command-Line Format	<code>--nodes</code>
---------------------	----------------------

Tells `ndb_config` to print information relating only to parameters defined in an `[ndbd]` or `[ndbd default]` section of the cluster configuration file (see [Section 21.4.3.6, “Defining NDB Cluster Data Nodes”](#)).

This option is mutually exclusive with `--connections` and `--system`; only one of these 3 options can be used.

- `--query=query-options, -q query-options`

Command-Line Format	<code>--query=string</code>
Type	String
Default Value	

This is a comma-delimited list of *query options*—that is, a list of one or more node attributes to be returned. These include `nodeid` (node ID), `type` (node type—that is, `ndbd`, `mysqld`, or `ndb_mgmd`), and any configuration parameters whose values are to be obtained.

For example, `--query=nodeid,type,datamemory,datadir` returns the node ID, node type, `DataMemory`, and `DataDir` for each node.

Formerly, `id` was accepted as a synonym for `nodeid`, but has been removed in NDB 7.5 and later.



**Note**

If a given parameter is not applicable to a certain type of node, then an empty string is returned for the corresponding value. See the examples later in this section for more information.

- `--query-all, -a`

Command-Line Format	<code>--query-all</code>
Introduced	5.7.18-ndb-7.5.7
Type	String
Default Value	

Returns a comma-delimited list of all query options (node attributes; note that this list is a single string).

This option was introduced in NDB 7.5.7 (Bug #60095, Bug #11766869).

- `--print-defaults`

Command-Line Format	<code>--print-defaults</code>
---------------------	-------------------------------

Print program argument list and exit.

- `--rows=separator, -r separator`

Command-Line Format	<code>--rows=string</code>
Type	String

Default Value	
---------------	--

Specifies a *separator* string used to separate the rows in the result. The default is a space character.



**Note**

If the *separator* contains spaces or escapes (such as `\n` for the linefeed character), then it must be quoted.

- `--system`

Command-Line Format	<code>--system</code>
---------------------	-----------------------

Tells `ndb_config` to print `SYSTEM` information only. This consists of system variables that cannot be changed at run time; thus, there is no corresponding section of the cluster configuration file for them. They can be seen (prefixed with `***** SYSTEM *****`) in the output of `ndb_config --configinfo`.

This option is mutually exclusive with `--nodes` and `--connections`; only one of these 3 options can be used.

- `--type=node_type`

Command-Line Format	<code>--type=name</code>
Type	Enumeration
Default Value	<code>[none]</code>
Valid Values	<code>ndbd</code> <code>mysqld</code> <code>ndb_mgmd</code>

Filters results so that only configuration values applying to nodes of the specified *node\_type* (`ndbd`, `mysqld`, or `ndb_mgmd`) are returned.

- `--usage`, `--help`, or `-?`

Command-Line Format	<code>--help</code>
---------------------	---------------------

Causes `ndb_config` to print a list of available options, and then exit. Synonym for `--help`.

- `--version`, `-V`

Command-Line Format	<code>--version</code>
---------------------	------------------------

Causes `ndb_config` to print a version information string, and then exit.

- `--configinfo --xml`

Command-Line Format	<code>--configinfo --xml</code>
---------------------	---------------------------------

Cause `ndb_config --configinfo` to provide output as XML by adding this option. A portion of such output is shown in this example:

```
$> ndb_config --configinfo --xml
```

```

<configvariables protocolversion="1" ndbversionstring="5.7.44-ndb-7.5.36"
    ndbversion="460032" ndbversionmajor="7" ndbversionminor="5"
    ndbversionbuild="0">
  <section name="SYSTEM">
    <param name="Name" comment="Name of system (NDB Cluster)" type="string"
      mandatory="true"/>
    <param name="PrimaryMGMDNode" comment="Node id of Primary ndb_mgmd(MGM) node"
      type="unsigned" default="0" min="0" max="4294967039"/>
    <param name="ConfigGenerationNumber" comment="Configuration generation number"
      type="unsigned" default="0" min="0" max="4294967039"/>
  </section>
  <section name="MYSQLD" primarykeys="NodeId">
    <param name="wan" comment="Use WAN TCP setting as default" type="bool"
      default="false"/>
    <param name="HostName" comment="Name of computer for this node"
      type="string" default=""/>
    <param name="Id" comment="NodeId" type="unsigned" mandatory="true"
      min="1" max="255" deprecated="true"/>
    <param name="NodeId" comment="Number identifying application node (mysqld(API))"
      type="unsigned" mandatory="true" min="1" max="255"/>
    <param name="ExecuteOnComputer" comment="HostName" type="string"
      deprecated="true"/>
    ...
  </section>
  ...
</configvariables>
    
```



### Note

Normally, the XML output produced by `ndb_config --configinfo --xml` is formatted using one line per element; we have added extra whitespace in the previous example, as well as the next one, for reasons of legibility. This should not make any difference to applications using this output, since most XML processors either ignore nonessential whitespace as a matter of course, or can be instructed to do so.

The XML output also indicates when changing a given parameter requires that data nodes be restarted using the `--initial` option. This is shown by the presence of an `initial="true"` attribute in the corresponding `<param>` element. In addition, the restart type (`system` or `node`) is also shown; if a given parameter requires a system restart, this is indicated by the presence of a `restart="system"` attribute in the corresponding `<param>` element. For example, changing the value set for the `Diskless` parameter requires a system initial restart, as shown here (with the `restart` and `initial` attributes highlighted for visibility):

```

<param name="Diskless" comment="Run wo/ disk" type="bool" default="false"
  restart="system" initial="true"/>
    
```

Currently, no `initial` attribute is included in the XML output for `<param>` elements corresponding to parameters which do not require initial restarts; in other words, `initial="false"` is the default, and the value `false` should be assumed if the attribute is not present. Similarly, the default restart type is `node` (that is, an online or “rolling” restart of the cluster), but the `restart` attribute is included only if

the restart type is `system` (meaning that all cluster nodes must be shut down at the same time, then restarted).

Deprecated parameters are indicated in the XML output by the `deprecated` attribute, as shown here:

```
<param name="NoOfDiskPagesToDiskAfterRestartACC" comment="DiskCheckpointSpeed"
  type="unsigned" default="20" min="1" max="4294967039" deprecated="true"/>
```

In such cases, the `comment` refers to one or more parameters that supersede the deprecated parameter. Similarly to `initial`, the `deprecated` attribute is indicated only when the parameter is deprecated, with `deprecated="true"`, and does not appear at all for parameters which are not deprecated. (Bug #21127135)

Beginning with NDB 7.5.0, parameters that are required are indicated with `mandatory="true"`, as shown here:

```
<param name="NodeId"
  comment="Number identifying application node (mysqld(API))"
  type="unsigned" mandatory="true" min="1" max="255"/>
```

In much the same way that the `initial` or `deprecated` attribute is displayed only for a parameter that requires an initial restart or that is deprecated, the `mandatory` attribute is included only if the given parameter is actually required.



### Important

The `--xml` option can be used only with the `--configinfo` option. Using `--xml` without `--configinfo` fails with an error.

Unlike the options used with this program to obtain current configuration data, `--configinfo` and `--xml` use information obtained from the NDB Cluster sources when `ndb_config` was compiled. For this reason, no connection to a running NDB Cluster or access to a `config.ini` or `my.cnf` file is required for these two options.

Combining other `ndb_config` options (such as `--query` or `--type`) with `--configinfo` (with or without the `--xml` option) is not supported. Currently, if you attempt to do so, the usual result is that all other options besides `--configinfo` or `--xml` are simply ignored. *However, this behavior is not guaranteed and is subject to change at any time.* In addition, since `ndb_config`, when used with the `--configinfo` option, does not access the NDB Cluster or read any files, trying to specify additional options such as `--ndb-connectstring` or `--config-file` with `--configinfo` serves no purpose.

## Examples

1. To obtain the node ID and type of each node in the cluster:

```
$> ./ndb_config --query=nodeid,type --fields=':' --rows='\n'
1:ndbd
2:ndbd
3:ndbd
4:ndbd
5:ndb_mgmd
6:mysqld
7:mysqld
8:mysqld
9:mysqld
```

In this example, we used the `--fields` options to separate the ID and type of each node with a colon character (:), and the `--rows` options to place the values for each node on a new line in the output.

- To produce a connection string that can be used by data, SQL, and API nodes to connect to the management server:

```
$> ./ndb_config --config-file=usr/local/mysql/cluster-data/config.ini \
--query=hostname,portnumber --fields=: --rows=, --type=ndb_mgmd
198.51.100.179:1186
```

- This invocation of `ndb_config` checks only data nodes (using the `--type` option), and shows the values for each node's ID and host name, as well as the values set for its `DataMemory` and `DataDir` parameters:

```
$> ./ndb_config --type=ndbd --query=nodeid,host,datamemory,datadir -f ' : ' -r '\n'
1 : 198.51.100.193 : 83886080 : /usr/local/mysql/cluster-data
2 : 198.51.100.112 : 83886080 : /usr/local/mysql/cluster-data
3 : 198.51.100.176 : 83886080 : /usr/local/mysql/cluster-data
4 : 198.51.100.119 : 83886080 : /usr/local/mysql/cluster-data
```

In this example, we used the short options `-f` and `-r` for setting the field delimiter and row separator, respectively, as well as the short option `-q` to pass a list of parameters to be obtained.

- To exclude results from any host except one in particular, use the `--host` option:

```
$> ./ndb_config --host=198.51.100.176 -f : -r '\n' -q id,type
3:ndbd
5:ndb_mgmd
```

In this example, we also used the short form `-q` to determine the attributes to be queried.

Similarly, you can limit results to a node with a specific ID using the `--nodeid` option.

## 21.5.8 ndb\_cpdc — Automate Testing for NDB Development

A utility having this name was formerly part of an internal automated test framework used in testing and debugging NDB Cluster. It is no longer included in NDB Cluster distributions provided by Oracle.

## 21.5.9 ndb\_delete\_all — Delete All Rows from an NDB Table

`ndb_delete_all` deletes all rows from the given NDB table. In some cases, this can be much faster than `DELETE` or even `TRUNCATE TABLE`.

### Usage

```
ndb_delete_all -c connection_string tbl_name -d db_name
```

This deletes all rows from the table named `tbl_name` in the database named `db_name`. It is exactly equivalent to executing `TRUNCATE db_name.tbl_name` in MySQL.

Options that can be used with `ndb_delete_all` are shown in the following table. Additional descriptions follow the table.

**Table 21.28 Command-line options used with the program `ndb_delete_all`**

Format	Description	Added, Deprecated, or Removed
<code>--character-sets-dir=path</code>	Directory containing character sets	(Supported in all NDB releases based on MySQL 5.7)
<code>--connect-retries=#</code>	Number of times to retry connection before giving up	(Supported in all NDB releases based on MySQL 5.7)

Format	Description	Added, Deprecated, or Removed
<code>--connect-retry-delay=#</code>	Number of seconds to wait between attempts to contact management server	(Supported in all NDB releases based on MySQL 5.7)
<code>--connect-string=connection_string,</code> <code>-c connection_string</code>	Same as <code>--ndb-connectstring</code>	(Supported in all NDB releases based on MySQL 5.7)
<code>--core-file</code>	Write core file on error; used in debugging	(Supported in all NDB releases based on MySQL 5.7)
<code>--database=name,</code> <code>-d name</code>	Name of the database in which the table is found	(Supported in all NDB releases based on MySQL 5.7)
<code>--defaults-extra-file=path</code>	Read given file after global files are read	(Supported in all NDB releases based on MySQL 5.7)
<code>--defaults-file=path</code>	Read default options from given file only	(Supported in all NDB releases based on MySQL 5.7)
<code>--defaults-group-suffix=string</code>	Also read groups with <code>concat(group, suffix)</code>	(Supported in all NDB releases based on MySQL 5.7)
<code>--diskscan</code>	Perform disk scan	(Supported in all NDB releases based on MySQL 5.7)
<code>--help,</code> <code>-?</code>	Display help text and exit	(Supported in all NDB releases based on MySQL 5.7)
<code>--login-path=path</code>	Read given path from login file	(Supported in all NDB releases based on MySQL 5.7)
<code>--ndb-connectstring=connection_string,</code> <code>-c connection_string</code>	Set connect string for connecting to <code>ndb_mgmd</code> . Syntax: "[nodeid=id;][host=]hostname[:port]". Overrides entries in <code>NDB_CONNECTSTRING</code> and <code>my.cnf</code>	(Supported in all NDB releases based on MySQL 5.7)
<code>--ndb-mgmd-host=connection_string,</code> <code>-c connection_string</code>	Same as <code>--ndb-connectstring</code>	(Supported in all NDB releases based on MySQL 5.7)
<code>--ndb-nodeid=#</code>	Set node ID for this node, overriding any ID set by <code>--ndb-connectstring</code>	(Supported in all NDB releases based on MySQL 5.7)
<code>--ndb-optimized-node-selection</code>	Enable optimizations for selection of nodes for transactions. Enabled by default; use <code>--skip-ndb-optimized-node-selection</code> to disable	(Supported in all NDB releases based on MySQL 5.7)
<code>--no-defaults</code>	Do not read default options from any option file other than login file	(Supported in all NDB releases based on MySQL 5.7)

Format	Description	Added, Deprecated, or Removed
<code>--print-defaults</code>	Print program argument list and exit	(Supported in all NDB releases based on MySQL 5.7)
<code>--transactional,</code> <code>-t</code>	Perform delete in one single transaction; possible to run out of operations when used	(Supported in all NDB releases based on MySQL 5.7)
<code>--tupscan</code>	Perform tuple scan	(Supported in all NDB releases based on MySQL 5.7)
<code>--usage,</code> <code>-?</code>	Display help text and exit; same as <code>--help</code>	(Supported in all NDB releases based on MySQL 5.7)
<code>--version,</code> <code>-V</code>	Display version information and exit	(Supported in all NDB releases based on MySQL 5.7)

- `--character-sets-dir`

Command-Line Format	<code>--character-sets-dir=path</code>
---------------------	--

Directory containing character sets.

- `--connect-retries`

Command-Line Format	<code>--connect-retries=#</code>
Type	Integer
Default Value	12
Minimum Value	0
Maximum Value	12

Number of times to retry connection before giving up.

- `--connect-retry-delay`

Command-Line Format	<code>--connect-retry-delay=#</code>
Type	Integer
Default Value	5
Minimum Value	0
Maximum Value	5

Number of seconds to wait between attempts to contact management server.

- `--connect-string`

Command-Line Format	<code>--connect-string=connection_string</code>
Type	String
Default Value	[none]

Same as `--ndb-connectstring`.



- `--core-file`

Command-Line Format	<code>--core-file</code>
---------------------	--------------------------

Write core file on error; used in debugging.

- `--database, -d`

Command-Line Format	<code>--database=name</code>
Type	String
Default Value	<code>TEST_DB</code>

Name of the database containing the table to delete from.

- `--defaults-extra-file`

Command-Line Format	<code>--defaults-extra-file=path</code>
Type	String
Default Value	<code>[none]</code>

Read given file after global files are read.

- `--defaults-file`

Command-Line Format	<code>--defaults-file=path</code>
Type	String
Default Value	<code>[none]</code>

Read default options from given file only.

- `--defaults-group-suffix`

Command-Line Format	<code>--defaults-group-suffix=string</code>
Type	String
Default Value	<code>[none]</code>

Also read groups with `concat(group, suffix)`.

- `--diskscan`

Command-Line Format	<code>--diskscan</code>
---------------------	-------------------------

Run a disk scan.

- `--help`

Command-Line Format	<code>--help</code>
---------------------	---------------------

Display help text and exit.

- `--login-path`

Command-Line Format	<code>--login-path=path</code>
Type	String
Default Value	[none]

Read given path from login file.

- `--ndb-connectstring`

Command-Line Format	<code>--ndb-connectstring=connection_string</code>
Type	String
Default Value	[none]

Set connect string for connecting to ndb\_mgmd. Syntax: "[nodeid=id;][host=]hostname[:port]". Overrides entries in NDB\_CONNECTSTRING and my.cnf.

- `--ndb-mgmd-host`

Command-Line Format	<code>--ndb-mgmd-host=connection_string</code>
Type	String
Default Value	[none]

Same as `--ndb-connectstring`.

- `--ndb-nodeid`

Command-Line Format	<code>--ndb-nodeid=#</code>
Type	Integer
Default Value	[none]

Set node ID for this node, overriding any ID set by `--ndb-connectstring`.

- `--ndb-optimized-node-selection`

Command-Line Format	<code>--ndb-optimized-node-selection</code>
---------------------	---

Enable optimizations for selection of nodes for transactions. Enabled by default; use `--skip-ndb-optimized-node-selection` to disable.

- `--no-defaults`

Command-Line Format	<code>--no-defaults</code>
---------------------	----------------------------

Do not read default options from any option file other than login file.

- `--print-defaults`

Command-Line Format	<code>--print-defaults</code>
---------------------	-------------------------------

Print program argument list and exit.

- `--transactional, -t`

Use of this option causes the delete operation to be performed as a single transaction.



**Warning**

With very large tables, using this option may cause the number of operations available to the cluster to be exceeded.

- `--tupscan`

Run a tuple scan.

- `--usage`

Command-Line Format	<code>--usage</code>
---------------------	----------------------

Display help text and exit; same as `--help`.

- `--version`

Command-Line Format	<code>--version</code>
---------------------	------------------------

Display version information and exit.

## 21.5.10 ndb\_desc — Describe NDB Tables

`ndb_desc` provides a detailed description of one or more [NDB](#) tables.

### Usage

```
ndb_desc -c connection_string tbl_name -d db_name [options]
ndb_desc -c connection_string index_name -d db_name -t tbl_name
```

Additional options that can be used with `ndb_desc` are listed later in this section.

### Sample Output

MySQL table creation and population statements:

```
USE test;

CREATE TABLE fish (
  id INT(11) NOT NULL AUTO_INCREMENT,
  name VARCHAR(20) NOT NULL,
  length_mm INT(11) NOT NULL,
  weight_gm INT(11) NOT NULL,

  PRIMARY KEY pk (id),
  UNIQUE KEY uk (name)
) ENGINE=NDB;

INSERT INTO fish VALUES
  (NULL, 'guppy', 35, 2), (NULL, 'tuna', 2500, 150000),
  (NULL, 'shark', 3000, 110000), (NULL, 'manta ray', 1500, 50000),
  (NULL, 'grouper', 900, 125000), (NULL, 'puffer', 250, 2500);
```

Output from `ndb_desc`:

```
$> ./ndb_desc -c localhost fish -d test -p
-- fish --
Version: 2
```

```

Fragment type: HashMapPartition
K Value: 6
Min load factor: 78
Max load factor: 80
Temporary table: no
Number of attributes: 4
Number of primary keys: 1
Length of frm data: 337
Max Rows: 0
Row Checksum: 1
Row GCI: 1
SingleUserMode: 0
ForceVarPart: 1
PartitionCount: 2
FragmentCount: 2
PartitionBalance: FOR_RP_BY_LDM
ExtraRowGciBits: 0
ExtraRowAuthorBits: 0
TableStatus: Retrieved
Table options:
HashMap: DEFAULT-HASHMAP-3840-2
-- Attributes --
id Int PRIMARY KEY DISTRIBUTION KEY AT=FIXED ST=MEMORY AUTO_INCR
name Varchar(20;latin1_swedish_ci) NOT NULL AT=SHORT_VAR ST=MEMORY DYNAMIC
length_mm Int NOT NULL AT=FIXED ST=MEMORY DYNAMIC
weight_gm Int NOT NULL AT=FIXED ST=MEMORY DYNAMIC
-- Indexes --
PRIMARY KEY(id) - UniqueHashIndex
PRIMARY(id) - OrderedIndex
uk(name) - OrderedIndex
uk$unique(name) - UniqueHashIndex
-- Per partition info --
Partition      Row count      Commit count      Frag fixed memory      Frag var sized memory      Extent_space
0                2                2                32768                  32768                      0
1                4                4                32768                  32768                      0

NDBT_ProgramExit: 0 - OK

```

Information about multiple tables can be obtained in a single invocation of `ndb_desc` by using their names, separated by spaces. All of the tables must be in the same database.

You can obtain additional information about a specific index using the `--table` (short form: `-t`) option and supplying the name of the index as the first argument to `ndb_desc`, as shown here:

```

$> ./ndb_desc uk -d test -t fish
-- uk --
Version: 2
Base table: fish
Number of attributes: 1
Logging: 0
Index type: OrderedIndex
Index status: Retrieved
-- Attributes --
name Varchar(20;latin1_swedish_ci) NOT NULL AT=SHORT_VAR ST=MEMORY
-- IndexTable 10/uk --
Version: 2
Fragment type: FragUndefined
K Value: 6
Min load factor: 78
Max load factor: 80
Temporary table: yes
Number of attributes: 2
Number of primary keys: 1
Length of frm data: 0
Max Rows: 0

```

```

Row Checksum: 1
Row GCI: 1
SingleUserMode: 2
ForceVarPart: 0
PartitionCount: 2
FragmentCount: 2
FragmentCountType: ONE_PER_LDM_PER_NODE
ExtraRowGciBits: 0
ExtraRowAuthorBits: 0
TableStatus: Retrieved
Table options:
-- Attributes --
name Varchar(20;latin1_swedish_ci) NOT NULL AT=SHORT_VAR ST=MEMORY
NDB$TNODE Unsigned [64] PRIMARY KEY DISTRIBUTION KEY AT=FIXED ST=MEMORY
-- Indexes --
PRIMARY KEY(NDB$TNODE) - UniqueHashIndex

NDBT_ProgramExit: 0 - OK

```

When an index is specified in this way, the `--extra-partition-info` and `--extra-node-info` options have no effect.

The `Version` column in the output contains the table's schema object version. For information about interpreting this value, see [NDB Schema Object Versions](#).

Three of the table properties that can be set using `NDB_TABLE` comments embedded in `CREATE TABLE` and `ALTER TABLE` statements are also visible in `ndb_desc` output. The table's `FRAGMENT_COUNT_TYPE` is always shown in the `FragmentCountType` column. `READ_ONLY` and `FULLY_REPLICATED`, if set to 1, are shown in the `Table options` column. You can see this after executing the following `ALTER TABLE` statement in the `mysql` client:

```

mysql> ALTER TABLE fish COMMENT='NDB_TABLE=READ_ONLY=1,FULLY_REPLICATED=1';
1 row in set, 1 warning (0.00 sec)

mysql> SHOW WARNINGS\G
+-----+-----+-----+-----+-----+-----+
| Level  | Code | Message                                                                                               |
+-----+-----+-----+-----+-----+-----+
| Warning | 1296 | Got error 4503 'Table property is FRAGMENT_COUNT_TYPE=ONE_PER_LDM_PER_NODE but not in c
+-----+-----+-----+-----+-----+-----+
1 row in set (0.00 sec)

```

The warning is issued because `READ_ONLY=1` requires that the table's fragment count type is (or be set to) `ONE_PER_LDM_PER_NODE_GROUP`; NDB sets this automatically in such cases. You can check that the `ALTER TABLE` statement has the desired effect using `SHOW CREATE TABLE`:

```

mysql> SHOW CREATE TABLE fish\G
***** 1. row *****
      Table: fish
Create Table: CREATE TABLE `fish` (
  `id` int(11) NOT NULL AUTO_INCREMENT,
  `name` varchar(20) NOT NULL,
  `length_mm` int(11) NOT NULL,
  `weight_gm` int(11) NOT NULL,
  PRIMARY KEY (`id`),
  UNIQUE KEY `uk` (`name`)
) ENGINE=ndbcluster DEFAULT CHARSET=latin1
COMMENT='NDB_TABLE=READ_BACKUP=1,FULLY_REPLICATED=1'
1 row in set (0.01 sec)

```

Because `FRAGMENT_COUNT_TYPE` was not set explicitly, its value is not shown in the comment text printed by `SHOW CREATE TABLE`. `ndb_desc`, however, displays the updated value for this attribute. The `Table options` column shows the binary properties just enabled. You can see this in the output shown here (emphasized text):

```

$> ./ndb_desc -c localhost fish -d test -p
-- fish --
Version: 4
Fragment type: HashMapPartition
K Value: 6
Min load factor: 78
Max load factor: 80
Temporary table: no
Number of attributes: 4
Number of primary keys: 1
Length of frm data: 380
Max Rows: 0
Row Checksum: 1
Row GCI: 1
SingleUserMode: 0
ForceVarPart: 1
PartitionCount: 1
FragmentCount: 1
FragmentCountType: ONE_PER_LDM_PER_NODE_GROUP
ExtraRowGciBits: 0
ExtraRowAuthorBits: 0
TableStatus: Retrieved
Table options: readbackup, fullyreplicated
HashMap: DEFAULT-HASHMAP-3840-1
-- Attributes --
id Int PRIMARY KEY DISTRIBUTION KEY AT=FIXED ST=MEMORY AUTO_INCR
name Varchar(20;latin1_swedish_ci) NOT NULL AT=SHORT_VAR ST=MEMORY DYNAMIC
length_mm Int NOT NULL AT=FIXED ST=MEMORY DYNAMIC
weight_gm Int NOT NULL AT=FIXED ST=MEMORY DYNAMIC
-- Indexes --
PRIMARY KEY(id) - UniqueHashIndex
PRIMARY(id) - OrderedIndex
uk(name) - OrderedIndex
uk$unique(name) - UniqueHashIndex
-- Per partition info --
Partition          Row count          Commit count          Frag fixed memory          Frag var sized memory          Extent_space
NDBT_ProgramExit: 0 - OK

```

For more information about these table properties, see [Section 13.1.18.9, “Setting NDB Comment Options”](#).

The `Extent_space` and `Free extent_space` columns are applicable only to NDB tables having columns on disk; for tables having only in-memory columns, these columns always contain the value 0.

To illustrate their use, we modify the previous example. First, we must create the necessary Disk Data objects, as shown here:

```

CREATE LOGFILE GROUP lg_1
  ADD UNDOFILE 'undo_1.log'
  INITIAL_SIZE 16M
  UNDO_BUFFER_SIZE 2M
  ENGINE NDB;

ALTER LOGFILE GROUP lg_1
  ADD UNDOFILE 'undo_2.log'
  INITIAL_SIZE 12M
  ENGINE NDB;

CREATE TABLESPACE ts_1
  ADD DATAFILE 'data_1.dat'
  USE LOGFILE GROUP lg_1
  INITIAL_SIZE 32M
  ENGINE NDB;

ALTER TABLESPACE ts_1

```

```
ADD DATAFILE 'data_2.dat'
INITIAL_SIZE 48M
ENGINE NDB;
```

(For more information on the statements just shown and the objects created by them, see [Section 21.6.11.1, “NDB Cluster Disk Data Objects”](#), as well as [Section 13.1.15, “CREATE LOGFILE GROUP Statement”](#), and [Section 13.1.19, “CREATE TABLESPACE Statement”](#).)

Now we can create and populate a version of the `fish` table that stores 2 of its columns on disk (deleting the previous version of the table first, if it already exists):

```
CREATE TABLE fish (
  id INT(11) NOT NULL AUTO_INCREMENT,
  name VARCHAR(20) NOT NULL,
  length_mm INT(11) NOT NULL,
  weight_gm INT(11) NOT NULL,

  PRIMARY KEY pk (id),
  UNIQUE KEY uk (name)
) TABLESPACE ts_1 STORAGE DISK
ENGINE=NDB;

INSERT INTO fish VALUES
  (NULL, 'guppy', 35, 2), (NULL, 'tuna', 2500, 150000),
  (NULL, 'shark', 3000, 110000), (NULL, 'manta ray', 1500, 50000),
  (NULL, 'grouper', 900, 125000), (NULL, 'puffer', 250, 2500);
```

When run against this version of the table, `ndb_desc` displays the following output:

```
$> ./ndb_desc -c localhost fish -d test -p
-- fish --
Version: 1
Fragment type: HashMapPartition
K Value: 6
Min load factor: 78
Max load factor: 80
Temporary table: no
Number of attributes: 4
Number of primary keys: 1
Length of frm data: 346
Max Rows: 0
Row Checksum: 1
Row GCI: 1
SingleUserMode: 0
ForceVarPart: 1
PartitionCount: 2
FragmentCount: 2
FragmentCountType: ONE_PER_LDM_PER_NODE
ExtraRowGciBits: 0
ExtraRowAuthorBits: 0
TableStatus: Retrieved
Table options:
HashMap: DEFAULT-HASHMAP-3840-2
-- Attributes --
id Int PRIMARY KEY DISTRIBUTION KEY AT=FIXED ST=MEMORY AUTO_INCR
name Varchar(20;latin1_swedish_ci) NOT NULL AT=SHORT_VAR ST=MEMORY
length_mm Int NOT NULL AT=FIXED ST=DISK
weight_gm Int NOT NULL AT=FIXED ST=DISK
-- Indexes --
PRIMARY KEY(id) - UniqueHashIndex
PRIMARY(id) - OrderedIndex
uk(name) - OrderedIndex
uk$unique(name) - UniqueHashIndex
-- Per partition info --
Partition      Row count      Commit count      Frag fixed memory      Frag var sized memory      Extent spa
0              2              2              32768              32768              1048576
```

1	4	4	32768	32768	1048576
NDBT_ProgramExit: 0 - OK					

This means that 1048576 bytes are allocated from the tablespace for this table on each partition, of which 1044440 bytes remain free for additional storage. In other words,  $1048576 - 1044440 = 4136$  bytes per partition is currently being used to store the data from this table's disk-based columns. The number of bytes shown as `Free extent space` is available for storing on-disk column data from the `fish` table only; for this reason, it is not visible when selecting from the Information Schema `FILES` table.

For fully replicated tables, `ndb_desc` shows only the nodes holding primary partition fragment replicas; nodes with copy fragment replicas (only) are ignored. Beginning with NDB 7.5.4, you can obtain such information, using the `mysql` client, from the `table_distribution_status`, `table_fragments`, `table_info`, and `table_replicas` tables in the `ndbinfo` database.

Options that can be used with `ndb_desc` are shown in the following table. Additional descriptions follow the table.

**Table 21.29 Command-line options used with the program `ndb_desc`**

Format	Description	Added, Deprecated, or Removed
<code>--auto-inc,</code> <code>-a</code>	Show next value for AUTO_INCREMENT oolumn if table has one	ADDED: NDB 7.6.14
<code>--blob-info,</code> <code>-b</code>	Include partition information for BLOB tables in output. Requires that the <code>-p</code> option also be used	(Supported in all NDB releases based on MySQL 5.7)
<code>--character-sets-dir=path</code>	Directory containing character sets	(Supported in all NDB releases based on MySQL 5.7)
<code>--connect-retries=#</code>	Number of times to retry connection before giving up	(Supported in all NDB releases based on MySQL 5.7)
<code>--connect-retry-delay=#</code>	Number of seconds to wait between attempts to contact management server	(Supported in all NDB releases based on MySQL 5.7)
<code>--connect-string=connection_string,</code> <code>-c connection_string</code>	Same as <code>--ndb-connectstring</code>	(Supported in all NDB releases based on MySQL 5.7)
<code>--context,</code> <code>-x</code>	Show extra information for table such as database, schema, name, and internal ID	ADDED: NDB 7.6.14
<code>--core-file</code>	Write core file on error; used in debugging	(Supported in all NDB releases based on MySQL 5.7)
<code>--database=name,</code> <code>-d name</code>	Name of database containing table	(Supported in all NDB releases based on MySQL 5.7)
<code>--defaults-extra-file=path</code>	Read given file after global files are read	(Supported in all NDB releases based on MySQL 5.7)
<code>--defaults-file=path</code>	Read default options from given file only	(Supported in all NDB releases based on MySQL 5.7)



Format	Description	Added, Deprecated, or Removed
<code>--defaults-group-suffix=string</code>	Also read groups with <code>concat(group, suffix)</code>	(Supported in all NDB releases based on MySQL 5.7)
<code>--extra-node-info,</code> <code>-n</code>	Include partition-to-data-node mappings in output; requires <code>--extra-partition-info</code>	(Supported in all NDB releases based on MySQL 5.7)
<code>--extra-partition-info,</code> <code>-p</code>	Display information about partitions	(Supported in all NDB releases based on MySQL 5.7)
<code>--help,</code> <code>-?</code>	Display help text and exit	(Supported in all NDB releases based on MySQL 5.7)
<code>--login-path=path</code>	Read given path from login file	(Supported in all NDB releases based on MySQL 5.7)
<code>--ndb-connectstring=connection_string</code> <code>-c connection_string</code>	Set connect string for connecting to <code>ndb_mgmd</code> . Syntax: "[nodeid=id;][host=]hostname[:port]". Overrides entries in <code>NDB_CONNECTSTRING</code> and <code>my.cnf</code>	(Supported in all NDB releases based on MySQL 5.7)
<code>--ndb-mgmd-host=connection_string,</code> <code>-c connection_string</code>	Same as <code>--ndb-connectstring</code>	(Supported in all NDB releases based on MySQL 5.7)
<code>--ndb-nodeid=#</code>	Set node ID for this node, overriding any ID set by <code>--ndb-connectstring</code>	(Supported in all NDB releases based on MySQL 5.7)
<code>--ndb-optimized-node-selection</code>	Enable optimizations for selection of nodes for transactions. Enabled by default; use <code>--skip-ndb-optimized-node-selection</code> to disable	(Supported in all NDB releases based on MySQL 5.7)
<code>--no-defaults</code>	Do not read default options from any option file other than login file	(Supported in all NDB releases based on MySQL 5.7)
<code>--print-defaults</code>	Print program argument list and exit	(Supported in all NDB releases based on MySQL 5.7)
<code>--retries=#,</code> <code>-r #</code>	Number of times to retry the connection (once per second)	(Supported in all NDB releases based on MySQL 5.7)
<code>--table=name,</code> <code>-t name</code>	Specify the table in which to find an index. When this option is used, <code>-p</code> and <code>-n</code> have no effect and are ignored	(Supported in all NDB releases based on MySQL 5.7)
<code>--unqualified,</code> <code>-u</code>	Use unqualified table names	(Supported in all NDB releases based on MySQL 5.7)

Format	Description	Added, Deprecated, or Removed
<code>--usage</code> , <code>-?</code>	Display help text and exit; same as <code>--help</code>	(Supported in all NDB releases based on MySQL 5.7)
<code>--version</code> , <code>-V</code>	Display version information and exit	(Supported in all NDB releases based on MySQL 5.7)

- `--auto-inc`, `-a`

Show the next value for a table's `AUTO_INCREMENT` column, if it has one.

- `--blob-info`, `-b`

Include information about subordinate `BLOB` and `TEXT` columns.

Use of this option also requires the use of the `--extra-partition-info` (`-p`) option.

- `--character-sets-dir`

Command-Line Format	<code>--character-sets-dir=path</code>
---------------------	--

Directory containing character sets.

- `--connect-retries`

Command-Line Format	<code>--connect-retries=#</code>
Type	Integer
Default Value	12
Minimum Value	0
Maximum Value	12

Number of times to retry connection before giving up.

- `--connect-retry-delay`

Command-Line Format	<code>--connect-retry-delay=#</code>
Type	Integer
Default Value	5
Minimum Value	0
Maximum Value	5

Number of seconds to wait between attempts to contact management server.

- `--connect-string`

Command-Line Format	<code>--connect-string=connection_string</code>
Type	String

Default Value	[none]
---------------	--------

Same as `--ndb-connectstring`.

- `--context, -x`

Show additional contextual information for the table such as schema, database name, table name, and the table's internal ID.

- `--core-file`

Command-Line Format	<code>--core-file</code>
---------------------	--------------------------

Write core file on error; used in debugging.

- `--database=db_name, -d`

Specify the database in which the table should be found.

- `--defaults-extra-file`

Command-Line Format	<code>--defaults-extra-file=path</code>
Type	String
Default Value	[none]

Read given file after global files are read.

- `--defaults-file`

Command-Line Format	<code>--defaults-file=path</code>
Type	String
Default Value	[none]

Read default options from given file only.

- `--defaults-group-suffix`

Command-Line Format	<code>--defaults-group-suffix=string</code>
Type	String
Default Value	[none]

Also read groups with `concat(group, suffix)`.

- `--extra-node-info, -n`

Include information about the mappings between table partitions and the data nodes upon which they reside. This information can be useful for verifying distribution awareness mechanisms and supporting more efficient application access to the data stored in NDB Cluster.

Use of this option also requires the use of the `--extra-partition-info (-p)` option.

- `--extra-partition-info, -p`

Print additional information about the table's partitions.

- `--help`

Command-Line Format	<code>--help</code>
---------------------	---------------------

Display help text and exit.

- `--login-path`

Command-Line Format	<code>--login-path=path</code>
Type	String
Default Value	[none]

Read given path from login file.

- `--ndb-connectstring`

Command-Line Format	<code>--ndb-connectstring=connection_string</code>
Type	String
Default Value	[none]

Set connect string for connecting to ndb\_mgmd. Syntax: "[nodeid=id;][host=]hostname[:port]". Overrides entries in NDB\_CONNECTSTRING and my.cnf.

- `--ndb-mgmd-host`

Command-Line Format	<code>--ndb-mgmd-host=connection_string</code>
Type	String
Default Value	[none]

Same as `--ndb-connectstring`.

- `--ndb-nodeid`

Command-Line Format	<code>--ndb-nodeid=#</code>
Type	Integer
Default Value	[none]

Set node ID for this node, overriding any ID set by `--ndb-connectstring`.

- `--ndb-optimized-node-selection`

Command-Line Format	<code>--ndb-optimized-node-selection</code>
---------------------	---

Enable optimizations for selection of nodes for transactions. Enabled by default; use `--skip-ndb-optimized-node-selection` to disable.

- `--no-defaults`

Command-Line Format	<code>--no-defaults</code>
---------------------	----------------------------

Do not read default options from any option file other than login file.

- `--print-defaults`

Command-Line Format	<code>--print-defaults</code>
---------------------	-------------------------------

Print program argument list and exit.

- `--retries=#, -r`  
Try to connect this many times before giving up. One connect attempt is made per second.
- `--table=tbl_name, -t`  
Specify the table in which to look for an index.
- `--unqualified, -u`  
Use unqualified table names.
- `--usage`

Command-Line Format	<code>--usage</code>
---------------------	----------------------

Display help text and exit; same as `--help`.

- `--version`

Command-Line Format	<code>--version</code>
---------------------	------------------------

Display version information and exit.

In NDB 7.5.3 and later, table indexes listed in the output are ordered by ID. Previously, this was not deterministic and could vary between platforms. (Bug #81763, Bug #23547742)

## 21.5.11 ndb\_drop\_index — Drop Index from an NDB Table

`ndb_drop_index` drops the specified index from an NDB table. *It is recommended that you use this utility only as an example for writing NDB API applications*—see the Warning later in this section for details.

### Usage

```
ndb_drop_index -c connection_string table_name index -d db_name
```

The statement shown above drops the index named `index` from the `table` in the `database`.

Options that can be used with `ndb_drop_index` are shown in the following table. Additional descriptions follow the table.

**Table 21.30 Command-line options used with the program `ndb_drop_index`**

Format	Description	Added, Deprecated, or Removed
<code>--character-sets-dir=path</code>	Directory containing character sets	(Supported in all NDB releases based on MySQL 5.7)
<code>--connect-retries=#</code>	Number of times to retry connection before giving up	(Supported in all NDB releases based on MySQL 5.7)
<code>--connect-retry-delay=#</code>	Number of seconds to wait between attempts to contact management server	(Supported in all NDB releases based on MySQL 5.7)

Format	Description	Added, Deprecated, or Removed
<code>--connect-string=connection_string,</code> <code>-c connection_string</code>	Same as <code>--ndb-connectstring</code>	(Supported in all NDB releases based on MySQL 5.7)
<code>--core-file</code>	Write core file on error; used in debugging	(Supported in all NDB releases based on MySQL 5.7)
<code>--database=name,</code> <code>-d name</code>	Name of database in which table is found	(Supported in all NDB releases based on MySQL 5.7)
<code>--defaults-extra-file=path</code> <code>--defaults-file=path</code>	Read given file after global files are read Read default options from given file only	(Supported in all NDB releases based on MySQL 5.7) (Supported in all NDB releases based on MySQL 5.7)
<code>--defaults-group-suffix=string</code> <code>--help,</code> <code>-?</code>	Also read groups with <code>concat(group, suffix)</code> Display help text and exit	(Supported in all NDB releases based on MySQL 5.7) (Supported in all NDB releases based on MySQL 5.7)
<code>--login-path=path</code>	Read given path from login file	(Supported in all NDB releases based on MySQL 5.7)
<code>--ndb-connectstring=connection_string</code> <code>-c connection_string</code>	Set connect string for connecting to <code>ndb_mgmd</code> . Syntax: "[nodeid=id;][host=]hostname[:port]". Overrides entries in <code>NDB_CONNECTSTRING</code> and <code>my.cnf</code>	(Supported in all NDB releases based on MySQL 5.7)
<code>--ndb-mgmd-host=connection_string,</code> <code>-c connection_string</code>	Same as <code>--ndb-connectstring</code>	(Supported in all NDB releases based on MySQL 5.7)
<code>--ndb-nodeid=#</code>	Set node ID for this node, overriding any ID set by <code>--ndb-connectstring</code>	(Supported in all NDB releases based on MySQL 5.7)
<code>--ndb-optimized-node-selection</code>	Enable optimizations for selection of nodes for transactions. Enabled by default; use <code>--skip-ndb-optimized-node-selection</code> to disable	(Supported in all NDB releases based on MySQL 5.7)
<code>--no-defaults</code>	Do not read default options from any option file other than login file	(Supported in all NDB releases based on MySQL 5.7)
<code>--print-defaults</code>	Print program argument list and exit	(Supported in all NDB releases based on MySQL 5.7)
<code>--usage,</code> <code>-?</code>	Display help text and exit; same as <code>--help</code>	(Supported in all NDB releases based on MySQL 5.7)

Format	Description	Added, Deprecated, or Removed
<code>--version</code> , <code>-V</code>	Display version information and exit	(Supported in all NDB releases based on MySQL 5.7)

- `--character-sets-dir`

Command-Line Format	<code>--character-sets-dir=path</code>
---------------------	--

Directory containing character sets.

- `--connect-retries`

Command-Line Format	<code>--connect-retries=#</code>
Type	Integer
Default Value	12
Minimum Value	0
Maximum Value	12

Number of times to retry connection before giving up.

- `--connect-retry-delay`

Command-Line Format	<code>--connect-retry-delay=#</code>
Type	Integer
Default Value	5
Minimum Value	0
Maximum Value	5

Number of seconds to wait between attempts to contact management server.

- `--connect-string`

Command-Line Format	<code>--connect-string=connection_string</code>
Type	String
Default Value	[none]

Same as `--ndb-connectstring`.

- `--core-file`

Command-Line Format	<code>--core-file</code>
---------------------	--------------------------

Write core file on error; used in debugging.

- `--database, -d`

Command-Line Format	<code>--database=name</code>
Type	String

Default Value	TEST_DB
---------------	---------

Name of the database in which the table resides.

- `--defaults-extra-file`

Command-Line Format	<code>--defaults-extra-file=path</code>
Type	String
Default Value	[none]

Read given file after global files are read.

- `--defaults-file`

Command-Line Format	<code>--defaults-file=path</code>
Type	String
Default Value	[none]

Read default options from given file only.

- `--defaults-group-suffix`

Command-Line Format	<code>--defaults-group-suffix=string</code>
Type	String
Default Value	[none]

Also read groups with `concat(group, suffix)`.

- `--help`

Command-Line Format	<code>--help</code>
---------------------	---------------------

Display help text and exit.

- `--login-path`

Command-Line Format	<code>--login-path=path</code>
Type	String
Default Value	[none]

Read given path from login file.

- `--ndb-connectstring`

Command-Line Format	<code>--ndb-connectstring=connection_string</code>
Type	String
Default Value	[none]

Set connect string for connecting to `ndb_mgmd`. Syntax: "[nodeid=id;][host=]hostname[:port]". Overrides entries in `NDB_CONNECTSTRING` and `my.cnf`.

- `--ndb-mgmd-host`



Command-Line Format	<code>--ndb-mgmd-host=connection_string</code>
Type	String
Default Value	[none]

Same as `--ndb-connectstring`.

- `--ndb-nodeid`

Command-Line Format	<code>--ndb-nodeid=#</code>
Type	Integer
Default Value	[none]

Set node ID for this node, overriding any ID set by `--ndb-connectstring`.

- `--ndb-optimized-node-selection`

Command-Line Format	<code>--ndb-optimized-node-selection</code>
---------------------	---

Enable optimizations for selection of nodes for transactions. Enabled by default; use `--skip-ndb-optimized-node-selection` to disable.

- `--no-defaults`

Command-Line Format	<code>--no-defaults</code>
---------------------	----------------------------

Do not read default options from any option file other than login file.

- `--print-defaults`

Command-Line Format	<code>--print-defaults</code>
---------------------	-------------------------------

Print program argument list and exit.

- `--usage`

Command-Line Format	<code>--usage</code>
---------------------	----------------------

Display help text and exit; same as `--help`.

- `--version`

Command-Line Format	<code>--version</code>
---------------------	------------------------

Display version information and exit.



### Warning

*Operations performed on Cluster table indexes using the NDB API are not visible to MySQL and make the table unusable by a MySQL server. If you use this program to drop an index, then try to access the table from an SQL node, an error results, as shown here:*

```
$> ./ndb_drop_index -c localhost dogs ix -d ctest1
Dropping index dogs/idx...OK
```

```
NDBT_ProgramExit: 0 - OK

$> ./mysql -u jon -p ctest1
Enter password: *****
Reading table information for completion of table and column names
You can turn off this feature to get a quicker startup with -A

Welcome to the MySQL monitor.  Commands end with ; or \g.
Your MySQL connection id is 7 to server version: 5.7.44-ndb-7.5.36

Type 'help;' or '\h' for help. Type '\c' to clear the buffer.

mysql> SHOW TABLES;
+-----+
| Tables_in_ctest1 |
+-----+
| a                |
| bt1              |
| bt2              |
| dogs             |
| employees        |
| fish             |
+-----+
6 rows in set (0.00 sec)

mysql> SELECT * FROM dogs;
ERROR 1296 (HY000): Got error 4243 'Index not found' from NDBCLUSTER
```

In such a case, your *only* option for making the table available to MySQL again is to drop the table and re-create it. You can use either the SQL statement `DROP TABLE` or the `ndb_drop_table` utility (see [Section 21.5.12, “ndb\\_drop\\_table — Drop an NDB Table”](#)) to drop the table.

## 21.5.12 ndb\_drop\_table — Drop an NDB Table

`ndb_drop_table` drops the specified `NDB` table. (If you try to use this on a table created with a storage engine other than `NDB`, the attempt fails with the error `723: No such table exists`.) This operation is extremely fast; in some cases, it can be an order of magnitude faster than using a MySQL `DROP TABLE` statement on an `NDB` table.

### Usage

```
ndb_drop_table -c connection_string tbl_name -d db_name
```

Options that can be used with `ndb_drop_table` are shown in the following table. Additional descriptions follow the table.

**Table 21.31 Command-line options used with the program `ndb_drop_table`**

Format	Description	Added, Deprecated, or Removed
<code>--character-sets-dir=path</code>	Directory containing character sets	(Supported in all NDB releases based on MySQL 5.7)
<code>--connect-retries=#</code>	Number of times to retry connection before giving up	(Supported in all NDB releases based on MySQL 5.7)
<code>--connect-retry-delay=#</code>	Number of seconds to wait between attempts to contact management server	(Supported in all NDB releases based on MySQL 5.7)
<code>--connect-string=connection_string,</code>	Same as <code>--ndb-connectstring</code>	(Supported in all NDB releases based on MySQL 5.7)

Format	Description	Added, Deprecated, or Removed
-c connection_string		
--core-file	Write core file on error; used in debugging	(Supported in all NDB releases based on MySQL 5.7)
--database=name,	Name of database in which table is found	(Supported in all NDB releases based on MySQL 5.7)
-d name		
--defaults-extra-file=path	Read given file after global files are read	(Supported in all NDB releases based on MySQL 5.7)
--defaults-file=path	Read default options from given file only	(Supported in all NDB releases based on MySQL 5.7)
--defaults-group-suffix=string	Also read groups with concat(group, suffix)	(Supported in all NDB releases based on MySQL 5.7)
--help,	Display help text and exit	(Supported in all NDB releases based on MySQL 5.7)
-?		
--login-path=path	Read given path from login file	(Supported in all NDB releases based on MySQL 5.7)
--ndb-connectstring=connection_string	Set connect string for connecting to ndb_mgmd. Syntax: "[nodeid=id;][host=]hostname[:port]". Overrides entries in NDB_CONNECTSTRING and my.cnf	(Supported in all NDB releases based on MySQL 5.7)
-c connection_string		
--ndb-mgmd-host=connection_string,	Same as --ndb-connectstring	(Supported in all NDB releases based on MySQL 5.7)
-c connection_string		
--ndb-nodeid=#	Set node ID for this node, overriding any ID set by --ndb-connectstring	(Supported in all NDB releases based on MySQL 5.7)
--ndb-optimized-node-selection	Enable optimizations for selection of nodes for transactions. Enabled by default; use --skip-ndb-optimized-node-selection to disable	(Supported in all NDB releases based on MySQL 5.7)
--no-defaults	Do not read default options from any option file other than login file	(Supported in all NDB releases based on MySQL 5.7)
--print-defaults	Print program argument list and exit	(Supported in all NDB releases based on MySQL 5.7)
--usage,	Display help text and exit; same as --help	(Supported in all NDB releases based on MySQL 5.7)
-?		
--version,	Display version information and exit	(Supported in all NDB releases based on MySQL 5.7)
-V		

- `--character-sets-dir`

Command-Line Format	<code>--character-sets-dir=path</code>
---------------------	--

Directory containing character sets.

- `--connect-retries`

Command-Line Format	<code>--connect-retries=#</code>
Type	Integer
Default Value	12
Minimum Value	0
Maximum Value	12

Number of times to retry connection before giving up.

- `--connect-retry-delay`

Command-Line Format	<code>--connect-retry-delay=#</code>
Type	Integer
Default Value	5
Minimum Value	0
Maximum Value	5

Number of seconds to wait between attempts to contact management server.

- `--connect-string`

Command-Line Format	<code>--connect-string=connection_string</code>
Type	String
Default Value	[none]

Same as `--ndb-connectstring`.

- `--core-file`

Command-Line Format	<code>--core-file</code>
---------------------	--------------------------

Write core file on error; used in debugging.

- `--database, -d`

Command-Line Format	<code>--database=name</code>
Type	String
Default Value	TEST_DB

Name of the database in which the table resides.

- `--defaults-extra-file`

Command-Line Format	<code>--defaults-extra-file=path</code>
---------------------	---

Type	String
Default Value	[none]

Read given file after global files are read.

- `--defaults-file`

Command-Line Format	<code>--defaults-file=path</code>
Type	String
Default Value	[none]

Read default options from given file only.

- `--defaults-group-suffix`

Command-Line Format	<code>--defaults-group-suffix=string</code>
Type	String
Default Value	[none]

Also read groups with `concat(group, suffix)`.

- `--help`

Command-Line Format	<code>--help</code>
---------------------	---------------------

Display help text and exit.

- `--login-path`

Command-Line Format	<code>--login-path=path</code>
Type	String
Default Value	[none]

Read given path from login file.

- `--ndb-connectstring`

Command-Line Format	<code>--ndb-connectstring=connection_string</code>
Type	String
Default Value	[none]

Set connect string for connecting to `ndb_mgmd`. Syntax: "[nodeid=id;][host=]hostname[:port]". Overrides entries in `NDB_CONNECTSTRING` and `my.cnf`.

- `--ndb-mgmd-host`

Command-Line Format	<code>--ndb-mgmd-host=connection_string</code>
Type	String
Default Value	[none]

Same as `--ndb-connectstring`.

- `--ndb-nodeid`

Command-Line Format	<code>--ndb-nodeid=#</code>
Type	Integer
Default Value	[none]

Set node ID for this node, overriding any ID set by `--ndb-connectstring`.

- `--ndb-optimized-node-selection`

Command-Line Format	<code>--ndb-optimized-node-selection</code>
---------------------	---

Enable optimizations for selection of nodes for transactions. Enabled by default; use `--skip-ndb-optimized-node-selection` to disable.

- `--no-defaults`

Command-Line Format	<code>--no-defaults</code>
---------------------	----------------------------

Do not read default options from any option file other than login file.

- `--print-defaults`

Command-Line Format	<code>--print-defaults</code>
---------------------	-------------------------------

Print program argument list and exit.

- `--usage`

Command-Line Format	<code>--usage</code>
---------------------	----------------------

Display help text and exit; same as `--help`.

- `--version`

Command-Line Format	<code>--version</code>
---------------------	------------------------

Display version information and exit.

## 21.5.13 ndb\_error\_reporter — NDB Error-Reporting Utility

`ndb_error_reporter` creates an archive from data node and management node log files that can be used to help diagnose bugs or other problems with a cluster. *It is highly recommended that you make use of this utility when filing reports of bugs in NDB Cluster.*

Options that can be used with `ndb_error_reporter` are shown in the following table. Additional descriptions follow the table.

**Table 21.32 Command-line options used with the program `ndb_error_reporter`**

Format	Description	Added, Deprecated, or Removed
<code>--connection-timeout=#</code>	Number of seconds to wait when connecting to nodes before timing out	(Supported in all NDB releases based on MySQL 5.7)

Format	Description	Added, Deprecated, or Removed
<code>--dry-scp</code>	Disable scp with remote hosts; used in testing only	(Supported in all NDB releases based on MySQL 5.7)
<code>--fs</code>	Include file system data in error report; can use a large amount of disk space	(Supported in all NDB releases based on MySQL 5.7)
<code>--help</code> , <code>-?</code>	Display help text and exit	(Supported in all NDB releases based on MySQL 5.7)
<code>--skip-nodegroup=#</code>	Skip all nodes in the node group having this ID	(Supported in all NDB releases based on MySQL 5.7)

## Usage

```
ndb_error_reporter path/to/config-file [username] [options]
```

This utility is intended for use on a management node host, and requires the path to the management host configuration file (usually named `config.ini`). Optionally, you can supply the name of a user that is able to access the cluster's data nodes using SSH, to copy the data node log files. `ndb_error_reporter` then includes all of these files in archive that is created in the same directory in which it is run. The archive is named `ndb_error_report_YYYYMMDDhhmmss.tar.bz2`, where `YYYYMMDDhhmmss` is a datetime string.

`ndb_error_reporter` also accepts the options listed here:

- `--connection-timeout=timeout`

Command-Line Format	<code>--connection-timeout=#</code>
Type	Integer
Default Value	0

Wait this many seconds when trying to connect to nodes before timing out.

- `--dry-scp`

Command-Line Format	<code>--dry-scp</code>
---------------------	------------------------

Run `ndb_error_reporter` without using scp from remote hosts. Used for testing only.

- `--fs`

Command-Line Format	<code>--fs</code>
---------------------	-------------------

Copy the data node file systems to the management host and include them in the archive.

Because data node file systems can be extremely large, even after being compressed, we ask that you please do *not* send archives created using this option to Oracle unless you are specifically requested to do so.

- `--help`

Command-Line Format	<code>--help</code>
---------------------	---------------------

Display help text and exit.

- `--skip-nodgroup=nodgroup_id`

Command-Line Format	<code>--connection-timeout=#</code>
Type	Integer
Default Value	0

Skip all nodes belong to the node group having the supplied node group ID.

## 21.5.14 ndb\_import — Import CSV Data Into NDB

`ndb_import` imports CSV-formatted data, such as that produced by `mysqldump --tab`, directly into NDB using the NDB API. `ndb_import` requires a connection to an NDB management server (`ndb_mgmd`) to function; it does not require a connection to a MySQL Server.

### Usage

```
ndb_import db_name file_name options
```

`ndb_import` requires two arguments. `db_name` is the name of the database where the table into which to import the data is found; `file_name` is the name of the CSV file from which to read the data; this must include the path to this file if it is not in the current directory. The name of the file must match that of the table; the file's extension, if any, is not taken into consideration. Options supported by `ndb_import` include those for specifying field separators, escapes, and line terminators, and are described later in this section.

`ndb_import` rejects any empty lines read from the CSV file.

`ndb_import` must be able to connect to an NDB Cluster management server; for this reason, there must be an unused `[api]` slot in the cluster `config.ini` file.

To duplicate an existing table that uses a different storage engine, such as `InnoDB`, as an `NDB` table, use the `mysql` client to perform a `SELECT INTO OUTFILE` statement to export the existing table to a CSV file, then to execute a `CREATE TABLE LIKE` statement to create a new table having the same structure as the existing table, then perform `ALTER TABLE ... ENGINE=NDB` on the new table; after this, from the system shell, invoke `ndb_import` to load the data into the new `NDB` table. For example, an existing `InnoDB` table named `myinnodb_table` in a database named `myinnodb` can be exported into an `NDB` table named `myndb_table` in a database named `myndb` as shown here, assuming that you are already logged in as a MySQL user with the appropriate privileges:

1. In the `mysql` client:

```
mysql> USE myinnodb;

mysql> SELECT * INTO OUTFILE '/tmp/myndb_table.csv'
> FIELDS TERMINATED BY ',' OPTIONALLY ENCLOSED BY '"' ESCAPED BY '\\'
> LINES TERMINATED BY '\n'
> FROM myinnodbttable;

mysql> CREATE DATABASE myndb;

mysql> USE myndb;

mysql> CREATE TABLE myndb_table LIKE myinnodb.myinnodb_table;

mysql> ALTER TABLE myndb_table ENGINE=NDB;
```



```
mysql> EXIT;
Bye
$>
```

Once the target database and table have been created, a running `mysqld` is no longer required. You can stop it using `mysqladmin shutdown` or another method before proceeding, if you wish.

2. In the system shell:

```
# if you are not already in the MySQL bin directory:
$> cd path-to-mysql-bin-dir

$> ndb_import myndb /tmp/myndb_table.csv --fields-optionally-enclosed-by=''' \
--fields-terminated-by="," --fields-escaped-by='\\'
```

The output should resemble what is shown here:

```
job-1 import myndb.myndb_table from /tmp/myndb_table.csv
job-1 [running] import myndb.myndb_table from /tmp/myndb_table.csv
job-1 [success] import myndb.myndb_table from /tmp/myndb_table.csv
job-1 imported 19984 rows in 0h0m9s at 2277 rows/s
jobs summary: defined: 1 run: 1 with success: 1 with failure: 0
$>
```

Options that can be used with `ndb_import` are shown in the following table. Additional descriptions follow the table.

**Table 21.33 Command-line options used with the program `ndb_import`**

Format	Description	Added, Deprecated, or Removed
<code>--abort-on-error</code>	Dump core on any fatal error; used for debugging	ADDED: NDB 7.6.2
<code>--ai-increment=#</code>	For table with hidden PK, specify autoincrement increment. See <code>mysqld</code>	ADDED: NDB 7.6.2
<code>--ai-offset=#</code>	For table with hidden PK, specify autoincrement offset. See <code>mysqld</code>	ADDED: NDB 7.6.2
<code>--ai-prefetch-sz=#</code>	For table with hidden PK, specify number of autoincrement values that are prefetched. See <code>mysqld</code>	ADDED: NDB 7.6.2
<code>--character-sets-dir=path</code>	Directory containing character sets	ADDED: NDB 7.6.2
<code>--connect-retries=#</code>	Number of times to retry connection before giving up	(Supported in all NDB releases based on MySQL 5.7)
<code>--connect-retry-delay=#</code>	Number of seconds to wait between attempts to contact management server	ADDED: NDB 7.6.2
<code>--connect-string=connection_string,</code> <code>-c connection_string</code>	Same as <code>--ndb-connectstring</code>	ADDED: NDB 7.6.2
<code>--connections=#</code>	Number of cluster connections to create	ADDED: NDB 7.6.2

Format	Description	Added, Deprecated, or Removed
<code>--continue</code>	When job fails, continue to next job	ADDED: NDB 7.6.2
<code>--core-file</code>	Write core file on error; used in debugging	ADDED: NDB 7.6.2
<code>--csvopt=opts</code>	Shorthand option for setting typical CSV option values. See documentation for syntax and other information	ADDED: NDB 7.6.2
<code>--db-workers=#</code>	Number of threads, per data node, executing database operations	ADDED: NDB 7.6.2
<code>--defaults-extra-file=path</code>	Read given file after global files are read	ADDED: NDB 7.6.2
<code>--defaults-file=path</code>	Read default options from given file only	ADDED: NDB 7.6.2
<code>--defaults-group-suffix=string</code>	Also read groups with <code>concat(group, suffix)</code>	ADDED: NDB 7.6.2
<code>--errins-type=name</code>	Error insert type, for testing purposes; use "list" to obtain all possible values	ADDED: NDB 7.6.2
<code>--errins-delay=#</code>	Error insert delay in milliseconds; random variation is added	ADDED: NDB 7.6.2
<code>--fields-enclosed-by=char</code>	Same as FIELDS ENCLOSED BY option for LOAD DATA statements. For CSV input this is same as using <code>--fields-optionally-enclosed-by</code>	ADDED: NDB 7.6.2
<code>--fields-escaped-by=char</code>	Same as FIELDS ESCAPED BY option for LOAD DATA statements	ADDED: NDB 7.6.2
<code>--fields-optionally-enclosed-by=char</code>	Same as FIELDS OPTIONALLY ENCLOSED BY option for LOAD DATA statements	ADDED: NDB 7.6.2
<code>--fields-terminated-by=char</code>	Same as FIELDS TERMINATED BY option for LOAD DATA statements	ADDED: NDB 7.6.2
<code>--help,</code> <code>-?</code>	Display help text and exit	ADDED: NDB 7.6.2
<code>--idlesleep=#</code>	Number of milliseconds to sleep waiting for more to do	ADDED: NDB 7.6.2
<code>--idlespin=#</code>	Number of times to retry before idlesleep	ADDED: NDB 7.6.2
<code>--ignore-lines=#</code>	Ignore first # lines in input file. Used to skip a non-data header	ADDED: NDB 7.6.2
<code>--input-type=name</code>	Input type: random or csv	ADDED: NDB 7.6.2

Format	Description	Added, Deprecated, or Removed
<code>--input-workers=#</code>	Number of threads processing input. Must be 2 or more if <code>--input-type</code> is <code>csv</code>	ADDED: NDB 7.6.2
<code>--keep-state</code>	State files (except non-empty <code>*.rej</code> files) are normally removed on job completion. Using this option causes all state files to be preserved instead	ADDED: NDB 7.6.4
<code>--lines-terminated-by=char</code>	Same as <code>LINES TERMINATED BY</code> option for <code>LOAD DATA</code> statements	ADDED: NDB 7.6.2
<code>--login-path=path</code>	Read given path from login file	ADDED: NDB 7.6.2
<code>--max-rows=#</code>	Import only this number of input data rows; default is 0, which imports all rows	ADDED: NDB 7.6.2
<code>--monitor=#</code>	Periodically print status of running job if something has changed (status, rejected rows, temporary errors). Value 0 disables. Value 1 prints any change seen. Higher values reduce status printing exponentially up to some pre-defined limit	ADDED: NDB 7.6.2
<code>--ndb-connectstring=connection_string</code> <code>-c connection_string</code>	Set connect string for connecting to <code>ndb_mgmd</code> . Syntax: "[nodeid=id;][host=]hostname[:port]". Overrides entries in <code>NDB_CONNECTSTRING</code> and <code>my.cnf</code>	ADDED: NDB 7.6.2
<code>--ndb-mgmd-host=connection_string,</code> <code>-c connection_string</code>	Same as <code>--ndb-connectstring</code>	ADDED: NDB 7.6.2
<code>--ndb-nodeid=#</code>	Set node ID for this node, overriding any ID set by <code>--ndb-connectstring</code>	ADDED: NDB 7.6.2
<code>--ndb-optimized-node-selection</code>	Enable optimizations for selection of nodes for transactions. Enabled by default; use <code>--skip-ndb-optimized-node-selection</code> to disable	(Supported in all NDB releases based on MySQL 5.7)
<code>--no-asynch</code>	Run database operations as batches, in single transactions	ADDED: NDB 7.6.2
<code>--no-defaults</code>	Do not read default options from any option file other than login file	ADDED: NDB 7.6.2

Format	Description	Added, Deprecated, or Removed
<code>--no-hint</code>	Tells transaction coordinator not to use distribution key hint when selecting data node	ADDED: NDB 7.6.2
<code>--opbatch=#</code>	A db execution batch is a set of transactions and operations sent to NDB kernel. This option limits NDB operations (including blob operations) in a db execution batch. Therefore it also limits number of asynch transactions. Value 0 is not valid	ADDED: NDB 7.6.2
<code>--opbytes=#</code>	Limit bytes in execution batch (default 0 = no limit)	ADDED: NDB 7.6.2
<code>--output-type=name</code>	Output type: ndb is default, null used for testing	ADDED: NDB 7.6.2
<code>--output-workers=#</code>	Number of threads processing output or relaying database operations	ADDED: NDB 7.6.2
<code>--pagesize=#</code>	Align I/O buffers to given size	ADDED: NDB 7.6.2
<code>--pagecnt=#</code>	Size of I/O buffers as multiple of page size. CSV input worker allocates double-sized buffer	ADDED: NDB 7.6.2
<code>--polltimeout=#</code>	Timeout per poll for completed asynchronous transactions; polling continues until all polls are completed, or error occurs	ADDED: NDB 7.6.2
<code>--print-defaults</code>	Print program argument list and exit	ADDED: NDB 7.6.2
<code>--rejects=#</code>	Limit number of rejected rows (rows with permanent error) in data load. Default is 0 which means that any rejected row causes a fatal error. The row exceeding the limit is also added to *.rej	ADDED: NDB 7.6.2
<code>--resume</code>	If job aborted (temporary error, user interrupt), resume with rows not yet processed	ADDED: NDB 7.6.2
<code>--rowbatch=#</code>	Limit rows in row queues (default 0 = no limit); must be 1 or more if --input-type is random	ADDED: NDB 7.6.2
<code>--rowbytes=#</code>	Limit bytes in row queues (0 = no limit)	ADDED: NDB 7.6.2
<code>--state-dir=path</code>	Where to write state files; current directory is default	ADDED: NDB 7.6.2

Format	Description	Added, Deprecated, or Removed
<code>--stats</code>	Save performance related options and internal statistics in *.sto and *.stt files. These files are kept on successful completion even if --keep-state is not used	ADDED: NDB 7.6.4
<code>--tempdelay=#</code>	Number of milliseconds to sleep between temporary errors	ADDED: NDB 7.6.2
<code>--temperrors=#</code>	Number of times a transaction can fail due to a temporary error, per execution batch; 0 means any temporary error is fatal. Such errors do not cause any rows to be written to .rej file	ADDED: NDB 7.6.2
<code>--usage,</code> <code>-?</code>	Display help text and exit; same as --help	ADDED: NDB 7.6.2
<code>--verbose[=#],</code> <code>-v [#]</code>	Enable verbose output	ADDED: NDB 7.6.2
<code>--version,</code> <code>-V</code>	Display version information and exit	ADDED: NDB 7.6.2

- `--abort-on-error`

Command-Line Format	<code>--abort-on-error</code>
Introduced	5.7.18-ndb-7.6.2

Dump core on any fatal error; used for debugging only.

- `--ai-increment=#`

Command-Line Format	<code>--ai-increment=#</code>
Introduced	5.7.18-ndb-7.6.2
Type	Integer
Default Value	1
Minimum Value	1
Maximum Value	4294967295

For a table with a hidden primary key, specify the autoincrement increment, like the `auto_increment_increment` system variable does in the MySQL Server.

- `--ai-offset=#`

Command-Line Format	<code>--ai-offset=#</code>
Introduced	5.7.18-ndb-7.6.2
Type	Integer

Default Value	1
Minimum Value	1
Maximum Value	4294967295

For a table with hidden primary key, specify the autoincrement offset. Similar to the `auto_increment_offset` system variable.

- `--ai-prefetch-sz=#`

Command-Line Format	<code>--ai-prefetch-sz=#</code>
Introduced	5.7.18-ndb-7.6.2
Type	Integer
Default Value	1024
Minimum Value	1
Maximum Value	4294967295

For a table with a hidden primary key, specify the number of autoincrement values that are prefetched. Behaves like the `ndb_autoincrement_prefetch_sz` system variable does in the MySQL Server.

- `--character-sets-dir`

Command-Line Format	<code>--character-sets-dir=path</code>
Introduced	5.7.18-ndb-7.6.2

Directory containing character sets.

- `--connect-retries`

Command-Line Format	<code>--connect-retries=#</code>
Type	Integer
Default Value	12
Minimum Value	0
Maximum Value	12

Number of times to retry connection before giving up.

- `--connect-retry-delay`

Command-Line Format	<code>--connect-retry-delay=#</code>
Introduced	5.7.18-ndb-7.6.2
Type	Integer
Default Value	5
Minimum Value	0
Maximum Value	5

Number of seconds to wait between attempts to contact management server.

- `--connections=#`

Command-Line Format	<code>--connections=#</code>
Introduced	5.7.18-ndb-7.6.2
Type	Integer
Default Value	1
Minimum Value	1
Maximum Value	4294967295

Number of cluster connections to create.

- `--connect-string`

Command-Line Format	<code>--connect-string=connection_string</code>
Introduced	5.7.18-ndb-7.6.2
Type	String
Default Value	[none]

Same as `--ndb-connectstring`.

- `--continue`

Command-Line Format	<code>--continue</code>
Introduced	5.7.18-ndb-7.6.2

When a job fails, continue to the next job.

- `--core-file`

Command-Line Format	<code>--core-file</code>
Introduced	5.7.18-ndb-7.6.2

Write core file on error; used in debugging.

- `--csvopt=string`

Command-Line Format	<code>--csvopt=opts</code>
Introduced	5.7.18-ndb-7.6.2
Type	String

Default Value	[none]
---------------	--------

Provides a shortcut method for setting typical CSV import options. The argument to this option is a string consisting of one or more of the following parameters:

- `c`: Fields terminated by comma
- `d`: Use defaults, except where overridden by another parameter
- `n`: Lines terminated by `\n`
- `q`: Fields optionally enclosed by double quote characters (")
- `r`: Line terminated by `\r`

The order of the parameters makes no difference, except that if both `n` and `r` are specified, the one occurring last is the parameter which takes effect.

This option is intended for use in testing under conditions in which it is difficult to transmit escapes or quotation marks.

- `--db-workers=#`

Command-Line Format	<code>--db-workers=#</code>
Introduced	5.7.18-ndb-7.6.2
Type	Integer
Default Value (≥ 5.7.20-ndb-7.6.4)	4
Default Value (≥ 5.7.18-ndb-7.6.2, ≤ 5.7.18-ndb-7.6.3)	1
Minimum Value	1
Maximum Value	4294967295

Number of threads, per data node, executing database operations.

- `--defaults-extra-file`

Command-Line Format	<code>--defaults-extra-file=path</code>
Introduced	5.7.18-ndb-7.6.2
Type	String
Default Value	[none]

Read given file after global files are read.

- `--defaults-file`

Command-Line Format	<code>--defaults-file=path</code>
Introduced	5.7.18-ndb-7.6.2
Type	String
Default Value	[none]

Read default options from given file only.



- `--defaults-group-suffix`

Command-Line Format	<code>--defaults-group-suffix=string</code>
Introduced	5.7.18-ndb-7.6.2
Type	String
Default Value	[none]

Also read groups with `concat(group, suffix)`.

- `--errins-type=name`

Command-Line Format	<code>--errins-type=name</code>
Introduced	5.7.18-ndb-7.6.2
Type	Enumeration
Default Value	[none]
Valid Values	<code>stopjob</code> <code>stopall</code> <code>sighup</code> <code>sigint</code> <code>list</code>

Error insert type; use `list` as the `name` value to obtain all possible values. This option is used for testing purposes only.

- `--errins-delay=#`

Command-Line Format	<code>--errins-delay=#</code>
Introduced	5.7.18-ndb-7.6.2
Type	Integer
Default Value	1000
Minimum Value	0
Maximum Value	4294967295
Unit	ms

Error insert delay in milliseconds; random variation is added. This option is used for testing purposes only.

- `--fields-enclosed-by=char`

Command-Line Format	<code>--fields-enclosed-by=char</code>
Introduced	5.7.18-ndb-7.6.2
Type	String

Default Value	[none]
---------------	--------

This works in the same way as the `FIELDS ENCLOSED BY` option does for the `LOAD DATA` statement, specifying a character to be interpreted as quoting field values. For CSV input, this is the same as `--fields-optionally-enclosed-by`.

- `--fields-escaped-by=name`

Command-Line Format	<code>--fields-escaped-by=char</code>
Introduced	5.7.18-ndb-7.6.2
Type	String
Default Value	\

Specify an escape character in the same way as the `FIELDS ESCAPED BY` option does for the SQL `LOAD DATA` statement.

- `--fields-optionally-enclosed-by=char`

Command-Line Format	<code>--fields-optionally-enclosed-by=char</code>
Introduced	5.7.18-ndb-7.6.2
Type	String
Default Value	[none]

This works in the same way as the `FIELDS OPTIONALLY ENCLOSED BY` option does for the `LOAD DATA` statement, specifying a character to be interpreted as optionally quoting field values. For CSV input, this is the same as `--fields-enclosed-by`.

- `--fields-terminated-by=char`

Command-Line Format	<code>--fields-terminated-by=char</code>
Introduced	5.7.18-ndb-7.6.2
Type	String
Default Value	\t

This works in the same way as the `FIELDS TERMINATED BY` option does for the `LOAD DATA` statement, specifying a character to be interpreted as the field separator.

- `--help`

Command-Line Format	<code>--help</code>
Introduced	5.7.18-ndb-7.6.2

Display help text and exit.

- `--idlesleep=#`

Command-Line Format	<code>--idlesleep=#</code>
Introduced	5.7.18-ndb-7.6.2
Type	Integer
Default Value	1

Minimum Value	1
Maximum Value	4294967295
Unit	ms

Number of milliseconds to sleep waiting for more work to perform.

- `--idlespin=#`

Command-Line Format	<code>--idlespin=#</code>
Introduced	5.7.18-ndb-7.6.2
Type	Integer
Default Value	0
Minimum Value	0
Maximum Value	4294967295

Number of times to retry before sleeping.

- `--ignore-lines=#`

Command-Line Format	<code>--ignore-lines=#</code>
Introduced	5.7.18-ndb-7.6.2
Type	Integer
Default Value	0
Minimum Value	0
Maximum Value	4294967295

Cause `ndb_import` to ignore the first `#` lines of the input file. This can be employed to skip a file header that does not contain any data.

- `--input-type=name`

Command-Line Format	<code>--input-type=name</code>
Introduced	5.7.18-ndb-7.6.2
Type	Enumeration
Default Value	<code>csv</code>
Valid Values	<code>random</code> <code>csv</code>

Set the type of input type. The default is `csv`; `random` is intended for testing purposes only. .

- `--input-workers=#`

Command-Line Format	<code>--input-workers=#</code>
Introduced	5.7.18-ndb-7.6.2
Type	Integer
Default Value (≥ 5.7.20-ndb-7.6.4)	4

Default Value (≥ 5.7.18-ndb-7.6.2, ≤ 5.7.18-ndb-7.6.3)	2
Minimum Value	1
Maximum Value	4294967295

Set the number of threads processing input.

- `--keep-state`

Command-Line Format	<code>--keep-state</code>
Introduced	5.7.20-ndb-7.6.4

By default, `ndb_import` removes all state files (except non-empty `*.rej` files) when it completes a job. Specify this option (nor argument is required) to force the program to retain all state files instead.

- `--lines-terminated-by=name`

Command-Line Format	<code>--lines-terminated-by=char</code>
Introduced	5.7.18-ndb-7.6.2
Type	String
Default Value	<code>\n</code>

This works in the same way as the `LINES TERMINATED BY` option does for the `LOAD DATA` statement, specifying a character to be interpreted as end-of-line.

- `--login-path`

Command-Line Format	<code>--login-path=path</code>
Introduced	5.7.18-ndb-7.6.2
Type	String
Default Value	<code>[none]</code>

Read given path from login file.

- `--log-level=#`

Command-Line Format	<code>--log-level=#</code>
Type	Integer
Default Value	0
Minimum Value	0
Maximum Value	2

Performs internal logging at the given level. This option is intended primarily for internal and development use.

In debug builds of NDB only, the logging level can be set using this option to a maximum of 4.

- `--max-rows=#`

Command-Line Format	<code>--max-rows=#</code>
---------------------	---------------------------

Introduced	5.7.18-ndb-7.6.2
Type	Integer
Default Value	0
Minimum Value	0
Maximum Value	4294967295
Unit	bytes

Import only this number of input data rows; the default is 0, which imports all rows.

- `--monitor=#`

Command-Line Format	<code>--monitor=#</code>
Introduced	5.7.18-ndb-7.6.2
Type	Integer
Default Value	2
Minimum Value	0
Maximum Value	4294967295
Unit	bytes

Periodically print the status of a running job if something has changed (status, rejected rows, temporary errors). Set to 0 to disable this reporting. Setting to 1 prints any change that is seen. Higher values reduce the frequency of this status reporting.

- `--ndb-connectstring`

Command-Line Format	<code>--ndb-connectstring=connection_string</code>
Introduced	5.7.18-ndb-7.6.2
Type	String
Default Value	[none]

Set connect string for connecting to ndb\_mgmd. Syntax: "[nodeid=id;][host=]hostname[:port]". Overrides entries in NDB\_CONNECTSTRING and my.cnf.

- `--ndb-mgmd-host`

Command-Line Format	<code>--ndb-mgmd-host=connection_string</code>
Introduced	5.7.18-ndb-7.6.2
Type	String
Default Value	[none]

Same as `--ndb-connectstring`.

- `--ndb-nodeid`

Command-Line Format	<code>--ndb-nodeid=#</code>
Introduced	5.7.18-ndb-7.6.2
Type	Integer

Default Value	[none]
---------------	--------

Set node ID for this node, overriding any ID set by `--ndb-connectstring`.

- `--ndb-optimized-node-selection`

Command-Line Format	<code>--ndb-optimized-node-selection</code>
---------------------	---

Enable optimizations for selection of nodes for transactions. Enabled by default; use `--skip-ndb-optimized-node-selection` to disable.

- `--no-asynch`

Command-Line Format	<code>--no-asynch</code>
Introduced	5.7.18-ndb-7.6.2

Run database operations as batches, in single transactions.

- `--no-defaults`

Command-Line Format	<code>--no-defaults</code>
Introduced	5.7.18-ndb-7.6.2

Do not read default options from any option file other than login file.

- `--no-hint`

Command-Line Format	<code>--no-hint</code>
Introduced	5.7.18-ndb-7.6.2

Do not use distribution key hinting to select a data node.

- `--opbatch=#`

Command-Line Format	<code>--opbatch=#</code>
Introduced	5.7.18-ndb-7.6.2
Type	Integer
Default Value	256
Minimum Value	1
Maximum Value	4294967295
Unit	bytes

Set a limit on the number of operations (including blob operations), and thus the number of asynchronous transactions, per execution batch.

- `--opbytes=#`

Command-Line Format	<code>--opbytes=#</code>
Introduced	5.7.18-ndb-7.6.2
Type	Integer

Default Value	0
Minimum Value	0
Maximum Value	4294967295
Unit	bytes

Set a limit on the number of bytes per execution batch. Use 0 for no limit.

- `--output-type=name`

Command-Line Format	<code>--output-type=name</code>
Introduced	5.7.18-ndb-7.6.2
Type	Enumeration
Default Value	<code>ndb</code>
Valid Values	<code>null</code>

Set the output type. `ndb` is the default. `null` is used only for testing.

- `--output-workers=#`

Command-Line Format	<code>--output-workers=#</code>
Introduced	5.7.18-ndb-7.6.2
Type	Integer
Default Value	2
Minimum Value	1
Maximum Value	4294967295

Set the number of threads processing output or relaying database operations.

- `--pagesize=#`

Command-Line Format	<code>--pagesize=#</code>
Introduced	5.7.18-ndb-7.6.2
Type	Integer
Default Value	4096
Minimum Value	1
Maximum Value	4294967295
Unit	bytes

Align I/O buffers to the given size.

- `--pagecnt=#`

Command-Line Format	<code>--pagecnt=#</code>
Introduced	5.7.18-ndb-7.6.2
Type	Integer
Default Value	64

Minimum Value	1
Maximum Value	4294967295

Set the size of I/O buffers as multiple of page size. The CSV input worker allocates buffer that is doubled in size.

- `--polltimeout=#`

Command-Line Format	<code>--polltimeout=#</code>
Introduced	5.7.18-ndb-7.6.2
Type	Integer
Default Value	1000
Minimum Value	1
Maximum Value	4294967295
Unit	ms

Set a timeout per poll for completed asynchronous transactions; polling continues until all polls are completed, or until an error occurs.

- `--print-defaults`

Command-Line Format	<code>--print-defaults</code>
Introduced	5.7.18-ndb-7.6.2

Print program argument list and exit.

- `--rejects=#`

Command-Line Format	<code>--rejects=#</code>
Introduced	5.7.18-ndb-7.6.2
Type	Integer
Default Value	0
Minimum Value	0
Maximum Value	4294967295

Limit the number of rejected rows (rows with permanent errors) in the data load. The default is 0, which means that any rejected row causes a fatal error. Any rows causing the limit to be exceeded are added to the `.rej` file.

The limit imposed by this option is effective for the duration of the current run. A run restarted using `--resume` is considered a “new” run for this purpose.

- `--resume`

Command-Line Format	<code>--resume</code>
Introduced	5.7.18-ndb-7.6.2



- `--rowbatch=#`

Command-Line Format	<code>--rowbatch=#</code>
Introduced	5.7.18-ndb-7.6.2
Type	Integer
Default Value	0
Minimum Value	0
Maximum Value	4294967295
Unit	rows

Set a limit on the number of rows per row queue. Use 0 for no limit.

- `--rowbytes=#`

Command-Line Format	<code>--rowbytes=#</code>
Introduced	5.7.18-ndb-7.6.2
Type	Integer
Default Value	262144
Minimum Value	0
Maximum Value	4294967295
Unit	bytes

Set a limit on the number of bytes per row queue. Use 0 for no limit.

- `--stats`

Command-Line Format	<code>--stats</code>
Introduced	5.7.20-ndb-7.6.4

Save information about options related to performance and other internal statistics in files named `*.sto` and `*.stt`. These files are always kept on successful completion (even if `--keep-state` is not also specified).

- `--state-dir=name`

Command-Line Format	<code>--state-dir=path</code>
Introduced	5.7.18-ndb-7.6.2
Type	String
Default Value	.

Where to write the state files (`tbl_name.map`, `tbl_name.rej`, `tbl_name.res`, and `tbl_name.stt`) produced by a run of the program; the default is the current directory.

- `--tempdelay=#`

Command-Line Format	<code>--tempdelay=#</code>
Introduced	5.7.18-ndb-7.6.2
Type	Integer

Default Value	10
Minimum Value	0
Maximum Value	4294967295
Unit	ms

Number of milliseconds to sleep between temporary errors.

- `--temperrors=#`

Command-Line Format	<code>--temperrors=#</code>
Introduced	5.7.18-ndb-7.6.2
Type	Integer
Default Value	0
Minimum Value	0
Maximum Value	4294967295

Number of times a transaction can fail due to a temporary error, per execution batch. The default is 0, which means that any temporary error is fatal. Temporary errors do not cause any rows to be added to the `.rej` file.

- `--usage`

Command-Line Format	<code>--usage</code>
Introduced	5.7.18-ndb-7.6.2

Display help text and exit; same as `--help`.

- `--verbose, -v`

Command-Line Format	<code>--verbose[=#]</code>
Introduced	5.7.18-ndb-7.6.2
Type (≥ 5.7.20-ndb-7.6.4)	Boolean
Type (≥ 5.7.18-ndb-7.6.2, ≤ 5.7.18-ndb-7.6.3)	Integer
Default Value (≥ 5.7.20-ndb-7.6.4)	<code>false</code>
Default Value (≥ 5.7.18-ndb-7.6.2, ≤ 5.7.18-ndb-7.6.3)	0
Minimum Value	0
Maximum Value	2

Enable verbose output.



**Note**

Previously, this option controlled the internal logging level for debugging messages. In NDB 7.6, use the `--log-level` option for this purpose instead.

- `--version`

Command-Line Format	<code>--version</code>
---------------------	------------------------

Introduced	5.7.18-ndb-7.6.2
------------	------------------

Display version information and exit.

As with `LOAD DATA`, options for field and line formatting much match those used to create the CSV file, whether this was done using `SELECT INTO ... OUTFILE`, or by some other means. There is no equivalent to the `LOAD DATA` statement `STARTING WITH` option.

`ndb_import` was added in NDB 7.6.

## 21.5.15 ndb\_index\_stat — NDB Index Statistics Utility

`ndb_index_stat` provides per-fragment statistical information about indexes on NDB tables. This includes cache version and age, number of index entries per partition, and memory consumption by indexes.

### Usage

To obtain basic index statistics about a given NDB table, invoke `ndb_index_stat` as shown here, with the name of the table as the first argument and the name of the database containing this table specified immediately following it, using the `--database` (`-d`) option:

```
ndb_index_stat table -d database
```

In this example, we use `ndb_index_stat` to obtain such information about an NDB table named `mytable` in the `test` database:

```
$> ndb_index_stat -d test mytable
table:City index:PRIMARY fragCount:2
sampleVersion:3 loadTime:1399585986 sampleCount:1994 keyBytes:7976
query cache: valid:1 sampleCount:1994 totalBytes:27916
times in ms: save: 7.133 sort: 1.974 sort per sample: 0.000

NDBT_ProgramExit: 0 - OK
```

`sampleVersion` is the version number of the cache from which the statistics data is taken. Running `ndb_index_stat` with the `--update` option causes `sampleVersion` to be incremented.

`loadTime` shows when the cache was last updated. This is expressed as seconds since the Unix Epoch.

`sampleCount` is the number of index entries found per partition. You can estimate the total number of entries by multiplying this by the number of fragments (shown as `fragCount`).

`sampleCount` can be compared with the cardinality of `SHOW INDEX` or `INFORMATION_SCHEMA.STATISTICS`, although the latter two provide a view of the table as a whole, while `ndb_index_stat` provides a per-fragment average.

`keyBytes` is the number of bytes used by the index. In this example, the primary key is an integer, which requires four bytes for each index, so `keyBytes` can be calculated in this case as shown here:

```
keyBytes = sampleCount * (4 bytes per index) = 1994 * 4 = 7976
```

This information can also be obtained using the corresponding column definitions from the Information Schema `COLUMNS` table (this requires a MySQL Server and a MySQL client application).

`totalBytes` is the total memory consumed by all indexes on the table, in bytes.

Timings shown in the preceding examples are specific to each invocation of `ndb_index_stat`.

The `--verbose` option provides some additional output, as shown here:

```
$> ndb_index_stat -d test mytable --verbose
random seed 1337010518
```

```

connected
loop 1 of 1
table:mytable index:PRIMARY fragCount:4
sampleVersion:2 loadTime:1336751773 sampleCount:0 keyBytes:0
read stats
query cache created
query cache: valid:1 sampleCount:0 totalBytes:0
times in ms: save: 20.766 sort: 0.001
disconnected

NDBT_ProgramExit: 0 - OK

$>

```

If the only output from the program is `NDBT_ProgramExit: 0 - OK`, this may indicate that no statistics yet exist. To force them to be created (or updated if they already exist), invoke `ndb_index_stat` with the `--update` option, or execute `ANALYZE TABLE` on the table in the `mysql` client.

## Options

The following table includes options that are specific to the NDB Cluster `ndb_index_stat` utility. Additional descriptions are listed following the table.

**Table 21.34 Command-line options used with the program `ndb_index_stat`**

Format	Description	Added, Deprecated, or Removed
<code>--character-sets-dir=path</code>	Directory containing character sets	(Supported in all NDB releases based on MySQL 5.7)
<code>--connect-retries=#</code>	Number of times to retry connection before giving up	(Supported in all NDB releases based on MySQL 5.7)
<code>--connect-retry-delay=#</code>	Number of seconds to wait between attempts to contact management server	(Supported in all NDB releases based on MySQL 5.7)
<code>--connect-string=connection_string,</code> <code>-c connection_string</code>	Same as <code>--ndb-connectstring</code>	(Supported in all NDB releases based on MySQL 5.7)
<code>--core-file</code>	Write core file on error; used in debugging	(Supported in all NDB releases based on MySQL 5.7)
<code>--database=name,</code> <code>-d name</code>	Name of database containing table	(Supported in all NDB releases based on MySQL 5.7)
<code>--defaults-extra-file=path</code>	Read given file after global files are read	(Supported in all NDB releases based on MySQL 5.7)
<code>--defaults-file=path</code>	Read default options from given file only	(Supported in all NDB releases based on MySQL 5.7)
<code>--defaults-group-suffix=string</code>	Also read groups with <code>concat(group, suffix)</code>	(Supported in all NDB releases based on MySQL 5.7)
<code>--delete</code>	Delete index statistics for table, stopping any auto-update previously configured	(Supported in all NDB releases based on MySQL 5.7)
<code>--dump</code>	Print query cache	(Supported in all NDB releases based on MySQL 5.7)

Format	Description	Added, Deprecated, or Removed
<code>--help,</code> <code>-?</code>	Display help text and exit	(Supported in all NDB releases based on MySQL 5.7)
<code>--login-path=path</code>	Read given path from login file	(Supported in all NDB releases based on MySQL 5.7)
<code>--loops=#</code>	Set the number of times to perform given command; default is 0	(Supported in all NDB releases based on MySQL 5.7)
<code>--ndb-connectstring=connection_string</code> <code>-c connection_string</code>	Set connect string for connecting to ndb_mgmd. Syntax: "[nodeid=id;][host=]hostname[:port]". Overrides entries in NDB_CONNECTSTRING and my.cnf	(Supported in all NDB releases based on MySQL 5.7)
<code>--ndb-mgmd-host=connection_string,</code> <code>-c connection_string</code>	Same as <code>--ndb-connectstring</code>	(Supported in all NDB releases based on MySQL 5.7)
<code>--ndb-nodeid=#</code>	Set node ID for this node, overriding any ID set by <code>--ndb-connectstring</code>	(Supported in all NDB releases based on MySQL 5.7)
<code>--ndb-optimized-node-selection</code>	Enable optimizations for selection of nodes for transactions. Enabled by default; use <code>--skip-ndb-optimized-node-selection</code> to disable	(Supported in all NDB releases based on MySQL 5.7)
<code>--no-defaults</code>	Do not read default options from any option file other than login file	(Supported in all NDB releases based on MySQL 5.7)
<code>--print-defaults</code>	Print program argument list and exit	(Supported in all NDB releases based on MySQL 5.7)
<code>--query=#</code>	Perform random range queries on first key attr (must be int unsigned)	(Supported in all NDB releases based on MySQL 5.7)
<code>--sys-drop</code>	Drop any statistics tables and events in NDB kernel (all statistics are lost)	(Supported in all NDB releases based on MySQL 5.7)
<code>--sys-create</code>	Create all statistics tables and events in NDB kernel, if none of them already exist	(Supported in all NDB releases based on MySQL 5.7)
<code>--sys-create-if-not-exist</code>	Create any statistics tables and events in NDB kernel that do not already exist	(Supported in all NDB releases based on MySQL 5.7)
<code>--sys-create-if-not-valid</code>	Create any statistics tables or events that do not already exist in the NDB kernel, after dropping any that are invalid	(Supported in all NDB releases based on MySQL 5.7)

Format	Description	Added, Deprecated, or Removed
<code>--sys-check</code>	Verify that NDB system index statistics and event tables exist	(Supported in all NDB releases based on MySQL 5.7)
<code>--sys-skip-tables</code>	Do not apply sys-* options to tables	(Supported in all NDB releases based on MySQL 5.7)
<code>--sys-skip-events</code>	Do not apply sys-* options to events	(Supported in all NDB releases based on MySQL 5.7)
<code>--update</code>	Update index statistics for table, restarting any auto-update previously configured	(Supported in all NDB releases based on MySQL 5.7)
<code>--usage,</code> <code>-?</code>	Display help text and exit; same as <code>--help</code>	(Supported in all NDB releases based on MySQL 5.7)
<code>--verbose,</code> <code>-v</code>	Turn on verbose output	(Supported in all NDB releases based on MySQL 5.7)
<code>--version,</code> <code>-V</code>	Display version information and exit	(Supported in all NDB releases based on MySQL 5.7)

- `--character-sets-dir`

Command-Line Format	<code>--character-sets-dir=path</code>
---------------------	--

Directory containing character sets.

- `--connect-retries`

Command-Line Format	<code>--connect-retries=#</code>
Type	Integer
Default Value	12
Minimum Value	0
Maximum Value	12

Number of times to retry connection before giving up.

- `--connect-retry-delay`

Command-Line Format	<code>--connect-retry-delay=#</code>
Type	Integer
Default Value	5
Minimum Value	0
Maximum Value	5

Number of seconds to wait between attempts to contact management server.

- `--connect-string`

Command-Line Format	<code>--connect-string=connection_string</code>
Type	String
Default Value	[none]

Same as `--ndb-connectstring`.

- `--core-file`

Command-Line Format	<code>--core-file</code>
---------------------	--------------------------

Write core file on error; used in debugging.

- `--database=name, -d name`

Command-Line Format	<code>--database=name</code>
Type	String
Default Value	[none]
Minimum Value	
Maximum Value	

The name of the database that contains the table being queried.

- `--defaults-extra-file`

Command-Line Format	<code>--defaults-extra-file=path</code>
Type	String
Default Value	[none]

Read given file after global files are read.

- `--defaults-file`

Command-Line Format	<code>--defaults-file=path</code>
Type	String
Default Value	[none]

Read default options from given file only.

- `--defaults-group-suffix`

Command-Line Format	<code>--defaults-group-suffix=string</code>
Type	String
Default Value	[none]

Also read groups with `concat(group, suffix)`.

- `--delete`

Command-Line Format	<code>--delete</code>
---------------------	-----------------------

Delete the index statistics for the given table, stopping any auto-update that was previously configured.

- `--dump`

Command-Line Format	<code>--dump</code>
---------------------	---------------------

Dump the contents of the query cache.

- `--help`

Command-Line Format	<code>--help</code>
---------------------	---------------------

Display help text and exit.

- `--login-path`

Command-Line Format	<code>--login-path=path</code>
Type	String
Default Value	[none]

Read given path from login file.

- `--loops=#`

Command-Line Format	<code>--loops=#</code>
Type	Numeric
Default Value	0
Minimum Value	0
Maximum Value	MAX_INT

Repeat commands this number of times (for use in testing).

- `--ndb-connectstring`

Command-Line Format	<code>--ndb-connectstring=connection_string</code>
Type	String
Default Value	[none]

Set connect string for connecting to ndb\_mgmd. Syntax: "[nodeid=id;][host=]hostname[:port]". Overrides entries in NDB\_CONNECTSTRING and my.cnf.

- `--ndb-mgmd-host`

Command-Line Format	<code>--ndb-mgmd-host=connection_string</code>
Type	String
Default Value	[none]



- `--ndb-nodeid`

Command-Line Format	<code>--ndb-nodeid=#</code>
Type	Integer
Default Value	[none]

Set node ID for this node, overriding any ID set by `--ndb-connectstring`.

- `--ndb-optimized-node-selection`

Command-Line Format	<code>--ndb-optimized-node-selection</code>
---------------------	---

Enable optimizations for selection of nodes for transactions. Enabled by default; use `--skip-ndb-optimized-node-selection` to disable.

- `--no-defaults`

Command-Line Format	<code>--no-defaults</code>
---------------------	----------------------------

Do not read default options from any option file other than login file.

- `--print-defaults`

Command-Line Format	<code>--print-defaults</code>
---------------------	-------------------------------

Print program argument list and exit.

- `--query=#`

Command-Line Format	<code>--query=#</code>
Type	Numeric
Default Value	0
Minimum Value	0
Maximum Value	<code>MAX_INT</code>

Perform random range queries on first key attribute (must be int unsigned).

- `--sys-drop`

Command-Line Format	<code>--sys-drop</code>
---------------------	-------------------------

Drop all statistics tables and events in the NDB kernel. *This causes all statistics to be lost.*

- `--sys-create`

Command-Line Format	<code>--sys-create</code>
---------------------	---------------------------

Create all statistics tables and events in the NDB kernel. This works only if none of them exist previously.

- `--sys-create-if-not-exist`

Command-Line Format	<code>--sys-create-if-not-exist</code>
---------------------	--

Create any NDB system statistics tables or events (or both) that do not already exist when the program is invoked.

- `--sys-create-if-not-valid`

Command-Line Format	<code>--sys-create-if-not-valid</code>
---------------------	--

Create any NDB system statistics tables or events that do not already exist, after dropping any that are invalid.

- `--sys-check`

Command-Line Format	<code>--sys-check</code>
---------------------	--------------------------

Verify that all required system statistics tables and events exist in the NDB kernel.

- `--sys-skip-tables`

Command-Line Format	<code>--sys-skip-tables</code>
---------------------	--------------------------------

Do not apply any `--sys-*` options to any statistics tables.

- `--sys-skip-events`

Command-Line Format	<code>--sys-skip-events</code>
---------------------	--------------------------------

Do not apply any `--sys-*` options to any events.

- `--update`

Command-Line Format	<code>--update</code>
---------------------	-----------------------

Update the index statistics for the given table, and restart any auto-update that was previously configured.

- `--usage`

Command-Line Format	<code>--usage</code>
---------------------	----------------------

Display help text and exit; same as `--help`.

- `--verbose`

Command-Line Format	<code>--verbose</code>
---------------------	------------------------

Turn on verbose output.

- `--version`

Command-Line Format	<code>--version</code>
---------------------	------------------------

Display version information and exit.

**ndb\_index\_stat system options.** The following options are used to generate and update the statistics tables in the NDB kernel. None of these options can be mixed with statistics options (see [ndb\\_index\\_stat statistics options](#)).

- `--sys-drop`
- `--sys-create`
- `--sys-create-if-not-exist`
- `--sys-create-if-not-valid`
- `--sys-check`
- `--sys-skip-tables`
- `--sys-skip-events`

**ndb\_index\_stat statistics options.** The options listed here are used to generate index statistics. They work with a given table and database. They cannot be mixed with system options (see [ndb\\_index\\_stat system options](#)).

- `--database`
- `--delete`
- `--update`
- `--dump`
- `--query`

## 21.5.16 ndb\_move\_data — NDB Data Copy Utility

`ndb_move_data` copies data from one NDB table to another.

### Usage

The program is invoked with the names of the source and target tables; either or both of these may be qualified optionally with the database name. Both tables must use the NDB storage engine.

```
ndb_move_data options source target
```

Options that can be used with `ndb_move_data` are shown in the following table. Additional descriptions follow the table.

**Table 21.35 Command-line options used with the program `ndb_move_data`**

Format	Description	Added, Deprecated, or Removed
<code>--abort-on-error</code>	Dump core on permanent error (debug option)	(Supported in all NDB releases based on MySQL 5.7)
<code>--character-sets-dir=path</code>	Directory where character sets are	(Supported in all NDB releases based on MySQL 5.7)
<code>--connect-retries=#</code>	Number of times to retry connection before giving up	(Supported in all NDB releases based on MySQL 5.7)
<code>--connect-retry-delay=#</code>	Number of seconds to wait between attempts to contact management server	(Supported in all NDB releases based on MySQL 5.7)

Format	Description	Added, Deprecated, or Removed
<code>--connect-string=connection_string,</code> <code>-c connection_string</code>	Same as <code>--ndb-connectstring</code>	(Supported in all NDB releases based on MySQL 5.7)
<code>--core-file</code>	Write core file on error; used in debugging	(Supported in all NDB releases based on MySQL 5.7)
<code>--database=name,</code> <code>-d name</code>	Name of database in which table is found	(Supported in all NDB releases based on MySQL 5.7)
<code>--defaults-extra-file=path</code>	Read given file after global files are read	(Supported in all NDB releases based on MySQL 5.7)
<code>--defaults-file=path</code>	Read default options from given file only	(Supported in all NDB releases based on MySQL 5.7)
<code>--defaults-group-suffix=string</code>	Also read groups with <code>concat(group, suffix)</code>	(Supported in all NDB releases based on MySQL 5.7)
<code>--drop-source</code>	Drop source table after all rows have been moved	(Supported in all NDB releases based on MySQL 5.7)
<code>--error-insert</code>	Insert random temporary errors (used in testing)	(Supported in all NDB releases based on MySQL 5.7)
<code>--exclude-missing-columns</code>	Ignore extra columns in source or target table	(Supported in all NDB releases based on MySQL 5.7)
<code>--help,</code> <code>-?</code>	Display help text and exit	(Supported in all NDB releases based on MySQL 5.7)
<code>--login-path=path</code>	Read given path from login file	(Supported in all NDB releases based on MySQL 5.7)
<code>--lossy-conversions,</code> <code>-l</code>	Allow attribute data to be truncated when converted to smaller type	(Supported in all NDB releases based on MySQL 5.7)
<code>--ndb-connectstring=connection_string,</code> <code>-c connection_string</code>	Set connect string for connecting to <code>ndb_mgmd</code> . Syntax: "[nodeid=id;][host=]hostname[:port]". Overrides entries in <code>NDB_CONNECTSTRING</code> and <code>my.cnf</code>	(Supported in all NDB releases based on MySQL 5.7)
<code>--ndb-mgmd-host=connection_string,</code> <code>-c connection_string</code>	Same as <code>--ndb-connectstring</code>	(Supported in all NDB releases based on MySQL 5.7)
<code>--ndb-nodeid=#</code>	Set node ID for this node, overriding any ID set by <code>--ndb-connectstring</code>	(Supported in all NDB releases based on MySQL 5.7)
<code>--ndb-optimized-node-selection</code>	Enable optimizations for selection of nodes for transactions. Enabled by default; use <code>--skip-ndb-</code>	(Supported in all NDB releases based on MySQL 5.7)

Format	Description	Added, Deprecated, or Removed
<code>--no-defaults</code>	optimized-node-selection to disable	(Supported in all NDB releases based on MySQL 5.7)
<code>--print-defaults</code>	Do not read default options from any option file other than login file	(Supported in all NDB releases based on MySQL 5.7)
<code>--promote-attributes,</code> <code>-A</code>	Print program argument list and exit	(Supported in all NDB releases based on MySQL 5.7)
<code>--staging-tries=x[,y[,z]]</code>	Allow attribute data to be converted to larger type	(Supported in all NDB releases based on MySQL 5.7)
<code>--usage,</code> <code>-?</code>	Specify tries on temporary errors; format is x[,y[,z]] where x=max tries (0=no limit), y=min delay (ms), z=max delay (ms)	(Supported in all NDB releases based on MySQL 5.7)
<code>--verbose</code>	Display help text and exit; same as --help	(Supported in all NDB releases based on MySQL 5.7)
<code>--version,</code> <code>-V</code>	Enable verbose messages	(Supported in all NDB releases based on MySQL 5.7)
	Display version information and exit	(Supported in all NDB releases based on MySQL 5.7)

- `--abort-on-error`

Command-Line Format	<code>--abort-on-error</code>
---------------------	-------------------------------

Dump core on permanent error (debug option).

- `--character-sets-dir=name`

Command-Line Format	<code>--character-sets-dir=path</code>
Type	String
Default Value	[none]

Directory where character sets are.

- `--connect-retry-delay`

Command-Line Format	<code>--connect-retry-delay=#</code>
Type	Integer
Default Value	5
Minimum Value	0
Maximum Value	5

Number of seconds to wait between attempts to contact management server.

- `--connect-retries`

Command-Line Format	<code>--connect-retries=#</code>
Type	Integer
Default Value	12
Minimum Value	0
Maximum Value	12

Number of times to retry connection before giving up.

- `--connect-string`

Command-Line Format	<code>--connect-string=connection_string</code>
Type	String
Default Value	[none]

Same as `--ndb-connectstring`.

- `--core-file`

Command-Line Format	<code>--core-file</code>
---------------------	--------------------------

Write core file on error; used in debugging.

- `--database=dbname, -d`

Command-Line Format	<code>--database=name</code>
Type	String
Default Value	TEST_DB

Name of the database in which the table is found.

- `--defaults-extra-file`

Command-Line Format	<code>--defaults-extra-file=path</code>
Type	String
Default Value	[none]

Read given file after global files are read.

- `--defaults-file`

Command-Line Format	<code>--defaults-file=path</code>
Type	String
Default Value	[none]

Read default options from given file only.

- `--defaults-group-suffix`

Command-Line Format	<code>--defaults-group-suffix=string</code>
---------------------	---

Type	String
Default Value	[none]

Also read groups with concat(group, suffix).

- `--drop-source`

Command-Line Format	<code>--drop-source</code>
---------------------	----------------------------

Drop source table after all rows have been moved.

- `--error-insert`

Command-Line Format	<code>--error-insert</code>
---------------------	-----------------------------

Insert random temporary errors (testing option).

- `--exclude-missing-columns`

Command-Line Format	<code>--exclude-missing-columns</code>
---------------------	--

Ignore extra columns in source or target table.

- `--help`

Command-Line Format	<code>--help</code>
---------------------	---------------------

Display help text and exit.

- `--login-path`

Command-Line Format	<code>--login-path=path</code>
Type	String
Default Value	[none]

Read given path from login file.

- `--lossy-conversions, -l`

Command-Line Format	<code>--lossy-conversions</code>
---------------------	----------------------------------

Allow attribute data to be truncated when converted to a smaller type.

- `--ndb-connectstring`

Command-Line Format	<code>--ndb-connectstring=connection_string</code>
Type	String
Default Value	[none]

Set connect string for connecting to ndb\_mgmd. Syntax: "[nodeid=id;][host=]hostname[:port]". Overrides entries in NDB\_CONNECTSTRING and my.cnf.

- `--ndb-mgmd-host`

Command-Line Format	<code>--ndb-mgmd-host=connection_string</code>
Type	String
Default Value	[none]

Same as `--ndb-connectstring`.

- `--ndb-nodeid`

Command-Line Format	<code>--ndb-nodeid=#</code>
Type	Integer
Default Value	[none]

Set node ID for this node, overriding any ID set by `--ndb-connectstring`.

- `--ndb-optimized-node-selection`

Command-Line Format	<code>--ndb-optimized-node-selection</code>
---------------------	---

Enable optimizations for selection of nodes for transactions. Enabled by default; use `--skip-ndb-optimized-node-selection` to disable.

- `--no-defaults`

Command-Line Format	<code>--no-defaults</code>
---------------------	----------------------------

Do not read default options from any option file other than login file.

- `--print-defaults`

Command-Line Format	<code>--print-defaults</code>
---------------------	-------------------------------

Print program argument list and exit.

- `--promote-attributes, -A`

Command-Line Format	<code>--promote-attributes</code>
---------------------	-----------------------------------

Allow attribute data to be converted to a larger type.

- `--staging-tries=x[,y[,z]]`

Command-Line Format	<code>--staging-tries=x[,y[,z]]</code>
Type	String
Default Value	0,1000,60000

Specify tries on temporary errors. Format is x[,y[,z]] where x=max tries (0=no limit), y=min delay (ms), z=max delay (ms).



- `--usage`

Command-Line Format	<code>--usage</code>
---------------------	----------------------

Display help text and exit; same as `--help`.

- `--verbose`

Command-Line Format	<code>--verbose</code>
---------------------	------------------------

Enable verbose messages.

- `--version`

Command-Line Format	<code>--version</code>
---------------------	------------------------

Display version information and exit.

## 21.5.17 ndb\_perror — Obtain NDB Error Message Information

`ndb_perror` shows information about an NDB error, given its error code. This includes the error message, the type of error, and whether the error is permanent or temporary. Added to the MySQL NDB Cluster distribution in NDB 7.6, it is intended as a drop-in replacement for `pererror --ndb`.

### Usage

```
ndb_perror [options] error_code
```

`ndb_perror` does not need to access a running NDB Cluster, or any nodes (including SQL nodes). To view information about a given NDB error, invoke the program, using the error code as an argument, like this:

```
$> ndb_perror 323
NDB error code 323: Invalid nodegroup id, nodegroup already existing: Permanent error: Application error
```

To display only the error message, invoke `ndb_perror` with the `--silent` option (short form `-s`), as shown here:

```
$> ndb_perror -s 323
Invalid nodegroup id, nodegroup already existing: Permanent error: Application error
```

Like `pererror`, `ndb_perror` accepts multiple error codes:

```
$> ndb_perror 321 1001
NDB error code 321: Invalid nodegroup id: Permanent error: Application error
NDB error code 1001: Illegal connect string
```

Additional program options for `ndb_perror` are described later in this section.

`ndb_perror` replaces `pererror --ndb`, which is deprecated in NDB 7.6 and subject to removal in a future release of MySQL NDB Cluster. To make substitution easier in scripts and other applications that might depend on `pererror` for obtaining NDB error information, `ndb_perror` supports its own “dummy” `--ndb` option, which does nothing.

The following table includes all options that are specific to the NDB Cluster program `ndb_perror`. Additional descriptions follow the table.

**Table 21.36 Command-line options used with the program ndb\_perror**

Format	Description	Added, Deprecated, or Removed
<code>--defaults-extra-file=path</code>	Read given file after global files are read	(Supported in all NDB releases based on MySQL 5.7)
<code>--defaults-file=path</code>	Read default options from given file only	(Supported in all NDB releases based on MySQL 5.7)
<code>--defaults-group-suffix=string</code>	Also read groups with concat(group, suffix)	(Supported in all NDB releases based on MySQL 5.7)
<code>--help,</code> <code>-?</code>	Display help text	ADDED: NDB 7.6.4
<code>--login-path=path</code>	Read given path from login file	(Supported in all NDB releases based on MySQL 5.7)
<code>--ndb</code>	For compatibility with applications depending on old versions of perror; does nothing	ADDED: NDB 7.6.4
<code>--no-defaults</code>	Do not read default options from any option file other than login file	(Supported in all NDB releases based on MySQL 5.7)
<code>--print-defaults</code>	Print program argument list and exit	(Supported in all NDB releases based on MySQL 5.7)
<code>--silent,</code> <code>-s</code>	Show error message only	ADDED: NDB 7.6.4
<code>--version,</code> <code>-V</code>	Print program version information and exit	ADDED: NDB 7.6.4
<code>--verbose,</code> <code>-v</code>	Verbose output; disable with --silent	ADDED: NDB 7.6.4

## Additional Options

- `--help, -?`

Command-Line Format	<code>--help</code>
Introduced	5.7.19-ndb-7.6.4

Display program help text and exit.

- `--ndb`

Command-Line Format	<code>--ndb</code>
Introduced	5.7.19-ndb-7.6.4

For compatibility with applications depending on old versions of `perror` that use that program's `--ndb` option. The option when used with `ndb_perror` does nothing, and is ignored by it.

- `--silent, -s`

Command-Line Format	<code>--silent</code>
Introduced	5.7.19-ndb-7.6.4

Show error message only.

- `--version, -V`

Command-Line Format	<code>--version</code>
Introduced	5.7.19-ndb-7.6.4

Print program version information and exit.

- `--verbose, -v`

Command-Line Format	<code>--verbose</code>
Introduced	5.7.19-ndb-7.6.4

Verbose output; disable with `--silent`.

## 21.5.18 ndb\_print\_backup\_file — Print NDB Backup File Contents

`ndb_print_backup_file` obtains diagnostic information from a cluster backup file.

### Usage

```
ndb_print_backup_file file_name
```

*file\_name* is the name of a cluster backup file. This can be any of the files (`.Data`, `.ctl`, or `.log` file) found in a cluster backup directory. These files are found in the data node's backup directory under the subdirectory `BACKUP-#`, where `#` is the sequence number for the backup. For more information about cluster backup files and their contents, see [Section 21.6.8.1, “NDB Cluster Backup Concepts”](#).

Like `ndb_print_schema_file` and `ndb_print_sys_file` (and unlike most of the other `NDB` utilities that are intended to be run on a management server host or to connect to a management server) `ndb_print_backup_file` must be run on a cluster data node, since it accesses the data node file system directly. Because it does not make use of the management server, this utility can be used when the management server is not running, and even when the cluster has been completely shut down.

### Additional Options

None.

## 21.5.19 ndb\_print\_file — Print NDB Disk Data File Contents

`ndb_print_file` obtains information from an NDB Cluster Disk Data file.

### Usage

```
ndb_print_file [-v] [-q] file_name+
```

*file\_name* is the name of an NDB Cluster Disk Data file. Multiple filenames are accepted, separated by spaces.

Like `ndb_print_schema_file` and `ndb_print_sys_file` (and unlike most of the other `NDB` utilities that are intended to be run on a management server host or to connect to a management server)

`ndb_print_file` must be run on an NDB Cluster data node, since it accesses the data node file system directly. Because it does not make use of the management server, this utility can be used when the management server is not running, and even when the cluster has been completely shut down.

## Additional Options

`ndb_print_file` supports the following options:

- `-v`: Make output verbose.
- `-q`: Suppress output (quiet mode).
- `--help, -h, -?`: Print help message.

For more information, see [Section 21.6.11, “NDB Cluster Disk Data Tables”](#).

## 21.5.20 ndb\_print\_frag\_file — Print NDB Fragment List File Contents

`ndb_print_frag_file` obtains information from a cluster fragment list file. It is intended for use in helping to diagnose issues with data node restarts.

## Usage

```
ndb_print_frag_file file_name
```

`file_name` is the name of a cluster fragment list file, which matches the pattern `SX.FragList`, where `X` is a digit in the range 2-9 inclusive, and are found in the data node file system of the data node having the node ID `nodeid`, in directories named `ndb_nodeid_fs/DN/DBDIH/`, where `N` is 1 or 2. Each fragment file contains records of the fragments belonging to each NDB table. For more information about cluster fragment files, see [NDB Cluster Data Node File System Directory](#).

Like `ndb_print_backup_file`, `ndb_print_sys_file`, and `ndb_print_schema_file` (and unlike most of the other NDB utilities that are intended to be run on a management server host or to connect to a management server), `ndb_print_frag_file` must be run on a cluster data node, since it accesses the data node file system directly. Because it does not make use of the management server, this utility can be used when the management server is not running, and even when the cluster has been completely shut down.

## Additional Options

None.

## Sample Output

```
$> ndb_print_frag_file /usr/local/mysql/data/ndb_3_fs/D1/DBDIH/S2.FragList
Filename: /usr/local/mysql/data/ndb_3_fs/D1/DBDIH/S2.FragList with size 8192
noOfPages = 1 noOfWords = 182
Table Data
-----
Num Frags: 2 NoOfReplicas: 2 hashpointer: 4294967040
kvalue: 6 mask: 0x00000000 method: HashMap
Storage is on Logged and checkpointed, survives SR
----- Fragment with FragId: 0 -----
Preferred Primary: 2 numStoredReplicas: 2 numOldStoredReplicas: 0 distKey: 0 LogPartId: 0
-----Stored Replica-----
Replica node is: 2 initialGci: 2 numCrashedReplicas = 0 nextLcpNo = 1
LcpNo[0]: maxGciCompleted: 1 maxGciStarted: 2 lcpId: 1 lcpStatus: valid
LcpNo[1]: maxGciCompleted: 0 maxGciStarted: 0 lcpId: 0 lcpStatus: invalid
-----Stored Replica-----
Replica node is: 3 initialGci: 2 numCrashedReplicas = 0 nextLcpNo = 1
```

```
LcpNo[0]: maxGciCompleted: 1 maxGciStarted: 2 lcpId: 1 lcpStatus: valid
LcpNo[1]: maxGciCompleted: 0 maxGciStarted: 0 lcpId: 0 lcpStatus: invalid
----- Fragment with FragId: 1 -----
Preferred Primary: 3 numStoredReplicas: 2 numOldStoredReplicas: 0 distKey: 0 LogPartId: 1
-----Stored Replica-----
Replica node is: 3 initialGci: 2 numCrashedReplicas = 0 nextLcpNo = 1
LcpNo[0]: maxGciCompleted: 1 maxGciStarted: 2 lcpId: 1 lcpStatus: valid
LcpNo[1]: maxGciCompleted: 0 maxGciStarted: 0 lcpId: 0 lcpStatus: invalid
-----Stored Replica-----
Replica node is: 2 initialGci: 2 numCrashedReplicas = 0 nextLcpNo = 1
LcpNo[0]: maxGciCompleted: 1 maxGciStarted: 2 lcpId: 1 lcpStatus: valid
LcpNo[1]: maxGciCompleted: 0 maxGciStarted: 0 lcpId: 0 lcpStatus: invalid
```

## 21.5.21 ndb\_print\_schema\_file — Print NDB Schema File Contents

`ndb_print_schema_file` obtains diagnostic information from a cluster schema file.

### Usage

```
ndb_print_schema_file file_name
```

*file\_name* is the name of a cluster schema file. For more information about cluster schema files, see [NDB Cluster Data Node File System Directory](#).

Like `ndb_print_backup_file` and `ndb_print_sys_file` (and unlike most of the other NDB utilities that are intended to be run on a management server host or to connect to a management server) `ndb_print_schema_file` must be run on a cluster data node, since it accesses the data node file system directly. Because it does not make use of the management server, this utility can be used when the management server is not running, and even when the cluster has been completely shut down.

### Additional Options

None.

## 21.5.22 ndb\_print\_sys\_file — Print NDB System File Contents

`ndb_print_sys_file` obtains diagnostic information from an NDB Cluster system file.

### Usage

```
ndb_print_sys_file file_name
```

*file\_name* is the name of a cluster system file (sysfile). Cluster system files are located in a data node's data directory (`DataDir`); the path under this directory to system files matches the pattern `ndb_#_fs/D#/DBDIH/P#.sysfile`. In each case, the # represents a number (not necessarily the same number). For more information, see [NDB Cluster Data Node File System Directory](#).

Like `ndb_print_backup_file` and `ndb_print_schema_file` (and unlike most of the other NDB utilities that are intended to be run on a management server host or to connect to a management server) `ndb_print_backup_file` must be run on a cluster data node, since it accesses the data node file system directly. Because it does not make use of the management server, this utility can be used when the management server is not running, and even when the cluster has been completely shut down.

### Additional Options

None.

## 21.5.23 ndb\_redo\_log\_reader — Check and Print Content of Cluster Redo Log

Reads a redo log file, checking it for errors, printing its contents in a human-readable format, or both. `ndb_redo_log_reader` is intended for use primarily by NDB Cluster developers and Support personnel in debugging and diagnosing problems.

This utility remains under development, and its syntax and behavior are subject to change in future NDB Cluster releases.

The C++ source files for `ndb_redo_log_reader` can be found in the directory `/storage/ndb/src/kernel/blocks/dblqh/redoLogReader`.

Options that can be used with `ndb_redo_log_reader` are shown in the following table. Additional descriptions follow the table.

**Table 21.37 Command-line options used with the program `ndb_redo_log_reader`**

Format	Description	Added, Deprecated, or Removed
<code>-dump</code>	Print dump info	(Supported in all NDB releases based on MySQL 5.7)
<code>-filedescriptors</code>	Print file descriptors only	(Supported in all NDB releases based on MySQL 5.7)
<code>--help</code>	Print usage information (has no short form)	(Supported in all NDB releases based on MySQL 5.7)
<code>-lap</code>	Provide lap info, with max GCI started and completed	(Supported in all NDB releases based on MySQL 5.7)
<code>-mbyte #</code>	Starting megabyte	(Supported in all NDB releases based on MySQL 5.7)
<code>-mbyteheaders</code>	Show only first page header of each megabyte in file	(Supported in all NDB releases based on MySQL 5.7)
<code>-nocheck</code>	Do not check records for errors	(Supported in all NDB releases based on MySQL 5.7)
<code>-noprint</code>	Do not print records	(Supported in all NDB releases based on MySQL 5.7)
<code>-page #</code>	Start with this page	(Supported in all NDB releases based on MySQL 5.7)
<code>-pageheaders</code>	Show page headers only	(Supported in all NDB releases based on MySQL 5.7)
<code>-pageindex #</code>	Start with this page index	(Supported in all NDB releases based on MySQL 5.7)
<code>-twiddle</code>	Bit-shifted dump	(Supported in all NDB releases based on MySQL 5.7)

## Usage

```
ndb_redo_log_reader file_name [options]
```

*file\_name* is the name of a cluster redo log file. redo log files are located in the numbered directories under the data node's data directory (`DataDir`); the path under this directory to the redo log files matches the pattern `ndb_nodeid_fs/D#/DBLQH/S#.FragLog`. *nodeid* is the data node's node ID. The two instances of # each represent a number (not necessarily the same number); the number following `D` is in the range 8-39 inclusive; the range of the number following `S` varies according to the value of the

`NoOfFragmentLogFiles` configuration parameter, whose default value is 16; thus, the default range of the number in the file name is 0-15 inclusive. For more information, see [NDB Cluster Data Node File System Directory](#).

The name of the file to be read may be followed by one or more of the options listed here:

- `-dump`

Command-Line Format	<code>-dump</code>
---------------------	--------------------

Print dump info.

- |                     |                               |
|---------------------|-------------------------------|
| Command-Line Format | <code>-filedescriptors</code> |
|---------------------|-------------------------------|

`-filedescriptors`: Print file descriptors only.

- |                     |                     |
|---------------------|---------------------|
| Command-Line Format | <code>--help</code> |
|---------------------|---------------------|

`--help`: Print usage information.

- `-lap`

Command-Line Format	<code>-lap</code>
---------------------	-------------------

Provide lap info, with max GCI started and completed.

- |                     |                       |
|---------------------|-----------------------|
| Command-Line Format | <code>-mbyte #</code> |
| Type                | Numeric               |
| Default Value       | 0                     |
| Minimum Value       | 0                     |
| Maximum Value       | 15                    |

`-mbyte #`: Starting megabyte.

`#` is an integer in the range 0 to 15, inclusive.

- |                     |                            |
|---------------------|----------------------------|
| Command-Line Format | <code>-mbyteheaders</code> |
|---------------------|----------------------------|

`-mbyteheaders`: Show only the first page header of every megabyte in the file.

- |                     |                       |
|---------------------|-----------------------|
| Command-Line Format | <code>-noprint</code> |
|---------------------|-----------------------|

`-noprint`: Do not print the contents of the log file.

- |                     |                       |
|---------------------|-----------------------|
| Command-Line Format | <code>-nocheck</code> |
|---------------------|-----------------------|

`-nocheck`: Do not check the log file for errors.

- |                     |                      |
|---------------------|----------------------|
| Command-Line Format | <code>-page #</code> |
| Type                | Integer              |
| Default Value       | 0                    |
| Minimum Value       | 0                    |

Maximum Value	31
---------------	----

`-page #`: Start at this page.

`#` is an integer in the range 0 to 31, inclusive.

- |                     |                           |
|---------------------|---------------------------|
| Command-Line Format | <code>-pageheaders</code> |
|---------------------|---------------------------|

`-pageheaders`: Show page headers only.

- |                     |                           |
|---------------------|---------------------------|
| Command-Line Format | <code>-pageindex #</code> |
| Type                | Integer                   |
| Default Value       | 12                        |
| Minimum Value       | 12                        |
| Maximum Value       | 8191                      |

`-pageindex #`: Start at this page index.

`#` is an integer between 12 and 8191, inclusive.

- `-twiddle`

Command-Line Format	<code>-twiddle</code>
---------------------	-----------------------

Bit-shifted dump.

Like `ndb_print_backup_file` and `ndb_print_schema_file` (and unlike most of the NDB utilities that are intended to be run on a management server host or to connect to a management server) `ndb_redo_log_reader` must be run on a cluster data node, since it accesses the data node file system directly. Because it does not make use of the management server, this utility can be used when the management server is not running, and even when the cluster has been completely shut down.

## 21.5.24 ndb\_restore — Restore an NDB Cluster Backup

The NDB Cluster restoration program is implemented as a separate command-line utility `ndb_restore`, which can normally be found in the MySQL `bin` directory. This program reads the files created as a result of the backup and inserts the stored information into the database.



### Note

Beginning with NDB 7.5.15 and 7.6.11, this program no longer prints `NDBT_ProgramExit: ...` when it finishes its run. Applications depending on this behavior should be modified accordingly when upgrading from earlier releases.

`ndb_restore` must be executed once for each of the backup files that were created by the `START BACKUP` command used to create the backup (see [Section 21.6.8.2, “Using The NDB Cluster Management Client to Create a Backup”](#)). This is equal to the number of data nodes in the cluster at the time that the backup was created.



### Note

Before using `ndb_restore`, it is recommended that the cluster be running in single user mode, unless you are restoring multiple data nodes in parallel. See [Section 21.6.6, “NDB Cluster Single User Mode”](#), for more information.



Options that can be used with `ndb_restore` are shown in the following table. Additional descriptions follow the table.

**Table 21.38 Command-line options used with the program `ndb_restore`**

Format	Description	Added, Deprecated, or Removed
<code>--allow-pk-changes[=0 1]</code>	Allow changes to set of columns making up table's primary key	ADDED: NDB 7.6.14
<code>--append</code>	Append data to tab-delimited file	(Supported in all NDB releases based on MySQL 5.7)
<code>--backup-path=path</code>	Path to backup files directory	(Supported in all NDB releases based on MySQL 5.7)
<code>--backupid=#,</code> <code>-b #</code>	Restore from backup having this ID	(Supported in all NDB releases based on MySQL 5.7)
<code>--character-sets-dir=path</code>	Directory containing character sets	(Supported in all NDB releases based on MySQL 5.7)
<code>--</code> <code>connect=connection_string,</code> <code>-c connection_string</code>	Alias for <code>--connectstring</code>	(Supported in all NDB releases based on MySQL 5.7)
<code>--connect-retries=#</code>	Number of times to retry connection before giving up	(Supported in all NDB releases based on MySQL 5.7)
<code>--connect-retry-delay=#</code>	Number of seconds to wait between attempts to contact management server	(Supported in all NDB releases based on MySQL 5.7)
<code>--connect-string=connection_string,</code> <code>-c connection_string</code>	Same as <code>--ndb-connectstring</code>	(Supported in all NDB releases based on MySQL 5.7)
<code>--core-file</code>	Write core file on error; used in debugging	(Supported in all NDB releases based on MySQL 5.7)
<code>--defaults-extra-file=path</code>	Read given file after global files are read	(Supported in all NDB releases based on MySQL 5.7)
<code>--defaults-file=path</code>	Read default options from given file only	(Supported in all NDB releases based on MySQL 5.7)
<code>--defaults-group-suffix=string</code>	Also read groups with <code>concat(group, suffix)</code>	(Supported in all NDB releases based on MySQL 5.7)
<code>--disable-indexes</code>	Causes indexes from backup to be ignored; may decrease time needed to restore data	(Supported in all NDB releases based on MySQL 5.7)
<code>--dont-ignore-systab-0,</code> <code>-f</code>	Do not ignore system table during restore; experimental only; not for production use	(Supported in all NDB releases based on MySQL 5.7)
<code>--exclude-databases=list</code>	List of one or more databases to exclude (includes those not named)	(Supported in all NDB releases based on MySQL 5.7)

Format	Description	Added, Deprecated, or Removed
<code>--exclude-intermediate-sql-tables[=TRUE FALSE]</code>	Do not restore any intermediate tables (having names prefixed with '#sql-') that were left over from copying ALTER TABLE operations; specify FALSE to restore such tables	(Supported in all NDB releases based on MySQL 5.7)
<code>--exclude-missing-columns</code>	Causes columns from backup version of table that are missing from version of table in database to be ignored	(Supported in all NDB releases based on MySQL 5.7)
<code>--exclude-missing-tables</code>	Causes tables from backup that are missing from database to be ignored	(Supported in all NDB releases based on MySQL 5.7)
<code>--exclude-tables=list</code>	List of one or more tables to exclude (includes those in same database that are not named); each table reference must include database name	(Supported in all NDB releases based on MySQL 5.7)
<code>--fields-enclosed-by=char</code>	Fields are enclosed by this character	(Supported in all NDB releases based on MySQL 5.7)
<code>--fields-optionally-enclosed-by</code>	Fields are optionally enclosed by this character	(Supported in all NDB releases based on MySQL 5.7)
<code>--fields-terminated-by=char</code>	Fields are terminated by this character	(Supported in all NDB releases based on MySQL 5.7)
<code>--help,</code>	Display help text and exit	(Supported in all NDB releases based on MySQL 5.7)
<code>-?</code>		
<code>--hex</code>	Print binary types in hexadecimal format	(Supported in all NDB releases based on MySQL 5.7)
<code>--ignore-extended-pk-updates[=0 1]</code>	Ignore log entries containing updates to columns now included in extended primary key	ADDED: NDB 7.6.14
<code>--include-databases=list</code>	List of one or more databases to restore (excludes those not named)	(Supported in all NDB releases based on MySQL 5.7)
<code>--include-tables=list</code>	List of one or more tables to restore (excludes those in same database that are not named); each table reference must include database name	(Supported in all NDB releases based on MySQL 5.7)
<code>--lines-terminated-by=char</code>	Lines are terminated by this character	(Supported in all NDB releases based on MySQL 5.7)
<code>--login-path=path</code>	Read given path from login file	(Supported in all NDB releases based on MySQL 5.7)
<code>--lossy-conversions,</code>	Allow lossy conversions of column values (type demotions or	(Supported in all NDB releases based on MySQL 5.7)
<code>-L</code>		

Format	Description	Added, Deprecated, or Removed
	changes in sign) when restoring data from backup	
<code>--no-binlog</code>	If mysqld is connected and using binary logging, do not log restored data	(Supported in all NDB releases based on MySQL 5.7)
<code>--no-defaults</code>	Do not read default options from any option file other than login file	(Supported in all NDB releases based on MySQL 5.7)
<code>--no-restore-disk-objects,</code> <code>-d</code>	Do not restore objects relating to Disk Data	(Supported in all NDB releases based on MySQL 5.7)
<code>--no-upgrade,</code> <code>-u</code>	Do not upgrade array type for varsize attributes which do not already resize VAR data, and do not change column attributes	(Supported in all NDB releases based on MySQL 5.7)
<code>--ndb-connectstring=connection_string</code> <code>-c connection_string</code>	Set connect string for connecting to ndb_mgmd. Syntax: "[nodeid=id;][host=]hostname[:port]". Overrides entries in NDB_CONNECTSTRING and my.cnf	(Supported in all NDB releases based on MySQL 5.7)
<code>--ndb-mgmd-host=connection_string,</code> <code>-c connection_string</code>	Same as <code>--ndb-connectstring</code>	(Supported in all NDB releases based on MySQL 5.7)
<code>--ndb-nodegroup-map=map,</code> <code>-z</code>	Specify node group map; unused, unsupported	(Supported in all NDB releases based on MySQL 5.7)
<code>--ndb-nodeid=#</code>	Set node ID for this node, overriding any ID set by <code>--ndb-connectstring</code>	(Supported in all NDB releases based on MySQL 5.7)
<code>--ndb-optimized-node-selection</code>	Enable optimizations for selection of nodes for transactions. Enabled by default; use <code>--skip-ndb-optimized-node-selection</code> to disable	(Supported in all NDB releases based on MySQL 5.7)
<code>--nodeid=#,</code> <code>-n #</code>	ID of node where backup was taken	(Supported in all NDB releases based on MySQL 5.7)
<code>--num-slices=#</code>	Number of slices to apply when restoring by slice	ADDED: NDB 7.6.13
<code>--parallelism=#,</code> <code>-p #</code>	Number of parallel transactions to use while restoring data	(Supported in all NDB releases based on MySQL 5.7)
<code>--preserve-trailing-spaces,</code> <code>-P</code>	Allow preservation of trailing spaces (including padding) when	(Supported in all NDB releases based on MySQL 5.7)

Format	Description	Added, Deprecated, or Removed
	promoting fixed-width string types to variable-width types	
<code>--print</code>	Print metadata, data, and log to stdout (equivalent to <code>--print-meta --print-data --print-log</code> )	(Supported in all NDB releases based on MySQL 5.7)
<code>--print-data</code>	Print data to stdout	(Supported in all NDB releases based on MySQL 5.7)
<code>--print-defaults</code>	Print program argument list and exit	(Supported in all NDB releases based on MySQL 5.7)
<code>--print-log</code>	Print log to stdout	(Supported in all NDB releases based on MySQL 5.7)
<code>--print-meta</code>	Print metadata to stdout	(Supported in all NDB releases based on MySQL 5.7)
<code>--print-sql-log</code>	Write SQL log to stdout	ADDED: NDB 7.5.4
<code>--progress-frequency=#</code>	Print status of restore each given number of seconds	(Supported in all NDB releases based on MySQL 5.7)
<code>--promote-attributes,</code> <code>-A</code>	Allow attributes to be promoted when restoring data from backup	(Supported in all NDB releases based on MySQL 5.7)
<code>--rebuild-indexes</code>	Causes multithreaded rebuilding of ordered indexes found in backup; number of threads used is determined by setting <code>BuildIndexThreads</code>	(Supported in all NDB releases based on MySQL 5.7)
<code>--remap-column=string</code>	Apply offset to value of specified column using indicated function and arguments. Format is <code>[db].[tbl].[col]:[fn]:[args]</code> ; see documentation for details	ADDED: NDB 7.6.14
<code>--restore-data,</code> <code>-r</code>	Restore table data and logs into NDB Cluster using NDB API	(Supported in all NDB releases based on MySQL 5.7)
<code>--restore-epoch,</code> <code>-e</code>	Restore epoch info into status table; useful on replica cluster for starting replication; updates or inserts row in <code>mysql.ndb_apply_status</code> with ID 0	(Supported in all NDB releases based on MySQL 5.7)
<code>--restore-meta,</code> <code>-m</code>	Restore metadata to NDB Cluster using NDB API	(Supported in all NDB releases based on MySQL 5.7)
<code>--restore-privilege-tables</code>	Restore MySQL privilege tables that were previously moved to NDB	(Supported in all NDB releases based on MySQL 5.7)
<code>--rewrite-database=string</code>	Restore to differently named database; format is <code>olddb,newdb</code>	(Supported in all NDB releases based on MySQL 5.7)

Format	Description	Added, Deprecated, or Removed
<code>--skip-broken-objects</code>	Ignore missing blob tables in backup file	(Supported in all NDB releases based on MySQL 5.7)
<code>--skip-table-check,</code> <code>-s</code>	Skip table structure check during restore	(Supported in all NDB releases based on MySQL 5.7)
<code>--skip-unknown-objects</code>	Causes schema objects not recognized by <code>ndb_restore</code> to be ignored when restoring backup made from newer NDB version to older version	(Supported in all NDB releases based on MySQL 5.7)
<code>--slice-id=#</code>	Slice ID, when restoring by slices	ADDED: NDB 7.6.13
<code>--tab=path,</code> <code>-T path</code>	Creates a tab-separated .txt file for each table in path provided	(Supported in all NDB releases based on MySQL 5.7)
<code>--timestamp-printouts{=true false}</code>	Prefix all info, error, and debug log messages with timestamps	ADDED: NDB 7.5.30, 5.7.41-ndb-7.6.26
<code>--usage,</code> <code>-?</code>	Display help text and exit; same as <code>--help</code>	(Supported in all NDB releases based on MySQL 5.7)
<code>--verbose=#</code>	Level of verbosity in output	(Supported in all NDB releases based on MySQL 5.7)
<code>--version,</code> <code>-V</code>	Display version information and exit	(Supported in all NDB releases based on MySQL 5.7)

- `--allow-pk-changes`

Command-Line Format	<code>--allow-pk-changes[=0 1]</code>
Introduced	5.7.29-ndb-7.6.14
Type	Integer
Default Value	0
Minimum Value	0
Maximum Value	1

When this option is set to `1`, `ndb_restore` allows the primary keys in a table definition to differ from that of the same table in the backup. This may be desirable when backing up and restoring between different schema versions with primary key changes on one or more tables, and it appears that performing

the restore operation using `ndb_restore` is simpler or more efficient than issuing many `ALTER TABLE` statements after restoring table schemas and data.

The following changes in primary key definitions are supported by `--allow-pk-changes`:

- **Extending the primary key:** A non-nullable column that exists in the table schema in the backup becomes part of the table's primary key in the database.



#### Important

When extending a table's primary key, any columns which become part of primary key must not be updated while the backup is being taken; any such updates discovered by `ndb_restore` cause the restore operation to fail, even when no change in value takes place. In some cases, it may be possible to override this behavior using the `--ignore-extended-pk-updates` option; see the description of this option for more information.

- **Contracting the primary key (1):** A column that is already part of the table's primary key in the backup schema is no longer part of the primary key, but remains in the table.
- **Contracting the primary key (2):** A column that is already part of the table's primary key in the backup schema is removed from the table entirely.

These differences can be combined with other schema differences supported by `ndb_restore`, including changes to blob and text columns requiring the use of staging tables.

Basic steps in a typical scenario using primary key schema changes are listed here:

1. Restore table schemas using `ndb_restore --restore-meta`
2. Alter schema to that desired, or create it
3. Back up the desired schema
4. Run `ndb_restore --disable-indexes` using the backup from the previous step, to drop indexes and constraints
5. Run `ndb_restore --allow-pk-changes` (possibly along with `--ignore-extended-pk-updates`, `--disable-indexes`, and possibly other options as needed) to restore all data
6. Run `ndb_restore --rebuild-indexes` using the backup made with the desired schema, to rebuild indexes and constraints

When extending the primary key, it may be necessary for `ndb_restore` to use a temporary secondary unique index during the restore operation to map from the old primary key to the new one. Such an index is created only when necessary to apply events from the backup log to a table which has an extended primary key. This index is named `NDB$RESTORE_PK_MAPPING`, and is created on each table requiring it; it can be shared, if necessary, by multiple instances of `ndb_restore` instances running in parallel. (Running `ndb_restore --rebuild-indexes` at the end of the restore process causes this index to be dropped.)

- `--append`

Command-Line Format	<code>--append</code>
---------------------	-----------------------

When used with the `--tab` and `--print-data` options, this causes the data to be appended to any existing files having the same names.

- `--backup-path=dir_name`

Command-Line Format	<code>--backup-path=path</code>
Type	Directory name
Default Value	<code>./</code>

The path to the backup directory is required; this is supplied to `ndb_restore` using the `--backup-path` option, and must include the subdirectory corresponding to the ID backup of the backup to be restored. For example, if the data node's `DataDir` is `/var/lib/mysql-cluster`, then the backup directory is `/var/lib/mysql-cluster/BACKUP`, and the backup files for the backup with the ID 3 can be found in `/var/lib/mysql-cluster/BACKUP/BACKUP-3`. The path may be absolute or relative to the directory in which the `ndb_restore` executable is located, and may be optionally prefixed with `backup-path=`.

It is possible to restore a backup to a database with a different configuration than it was created from. For example, suppose that a backup with backup ID 12, created in a cluster with two storage nodes having the node IDs 2 and 3, is to be restored to a cluster with four nodes. Then `ndb_restore` must be run twice—once for each storage node in the cluster where the backup was taken. However, `ndb_restore` cannot always restore backups made from a cluster running one version of MySQL to a cluster running a different MySQL version. See [Section 21.3.7, “Upgrading and Downgrading NDB Cluster”](#), for more information.



### Important

It is not possible to restore a backup made from a newer version of NDB Cluster using an older version of `ndb_restore`. You can restore a backup made from a newer version of MySQL to an older cluster, but you must use a copy of `ndb_restore` from the newer NDB Cluster version to do so.

For example, to restore a cluster backup taken from a cluster running NDB Cluster 7.6.36 to a cluster running NDB Cluster 7.5.36, you must use the `ndb_restore` that comes with the NDB Cluster 7.6.36 distribution.

For more rapid restoration, the data may be restored in parallel, provided that there is a sufficient number of cluster connections available. That is, when restoring to multiple nodes in parallel, you must have an `[api]` or `[mysqld]` section in the cluster `config.ini` file available for each concurrent `ndb_restore` process. However, the data files must always be applied before the logs.

- `--backupid=#, -b`

Command-Line Format	<code>--backupid=#</code>
Type	Numeric
Default Value	<code>none</code>

This option is used to specify the ID or sequence number of the backup, and is the same number shown by the management client in the `Backup backup_id completed` message displayed upon 3697

completion of a backup. (See [Section 21.6.8.2, “Using The NDB Cluster Management Client to Create a Backup”](#).)



**Important**

When restoring cluster backups, you must be sure to restore all data nodes from backups having the same backup ID. Using files from different backups can at best result in restoring the cluster to an inconsistent state, and may fail altogether.

In NDB 7.5.13 and later, and in NDB 7.6.9 and later, this option is required.

- `--character-sets-dir`

Command-Line Format	<code>--character-sets-dir=path</code>
---------------------	--

Directory containing character sets.

- `--connect, -c`

Command-Line Format	<code>--connect=connection_string</code>
Type	String
Default Value	<code>localhost:1186</code>

Alias for `--ndb-connectstring`.

- `--connect-retries`

Command-Line Format	<code>--connect-retries=#</code>
Type	Integer
Default Value	12
Minimum Value	0
Maximum Value	12

Number of times to retry connection before giving up.

- `--connect-retry-delay`

Command-Line Format	<code>--connect-retry-delay=#</code>
Type	Integer
Default Value	5
Minimum Value	0
Maximum Value	5

Number of seconds to wait between attempts to contact management server.

- `--connect-string`

Command-Line Format	<code>--connect-string=connection_string</code>
Type	String
Default Value	<code>[none]</code>



Same as `--ndb-connectstring`.

- `--core-file`

Command-Line Format	<code>--core-file</code>
---------------------	--------------------------

Write core file on error; used in debugging.

- `--defaults-extra-file`

Command-Line Format	<code>--defaults-extra-file=path</code>
Type	String
Default Value	[none]

Read given file after global files are read.

- `--defaults-file`

Command-Line Format	<code>--defaults-file=path</code>
Type	String
Default Value	[none]

Read default options from given file only.

- `--defaults-group-suffix`

Command-Line Format	<code>--defaults-group-suffix=string</code>
Type	String
Default Value	[none]

Also read groups with `concat(group, suffix)`.

- `--disable-indexes`

Command-Line Format	<code>--disable-indexes</code>
---------------------	--------------------------------

Disable restoration of indexes during restoration of the data from a native NDB backup. Afterwards, you can restore indexes for all tables at once with multithreaded building of indexes using `--rebuild-indexes`, which should be faster than rebuilding indexes concurrently for very large tables.

Beginning with NDB 7.5.24 and NDB 7.6.20, this option also drops any foreign keys specified in the backup.

- `--dont-ignore-systab-0, -f`

Command-Line Format	<code>--dont-ignore-systab-0</code>
---------------------	-------------------------------------

Normally, when restoring table data and metadata, `ndb_restore` ignores the copy of the NDB system table that is present in the backup. `--dont-ignore-systab-0` causes the system table to be restored. *This option is intended for experimental and development use only, and is not recommended in a production environment.*

- `--exclude-databases=db-list`

Command-Line Format	<code>--exclude-databases=list</code>
Type	String
Default Value	

Comma-delimited list of one or more databases which should not be restored.

This option is often used in combination with `--exclude-tables`; see that option's description for further information and examples.

- `--exclude-intermediate-sql-tables[=TRUE|FALSE]`

Command-Line Format	<code>--exclude-intermediate-sql-tables[=TRUE FALSE]</code>
Type	Boolean
Default Value	TRUE

When performing copying `ALTER TABLE` operations, `mysqld` creates intermediate tables (whose names are prefixed with `#sql-`). When `TRUE`, the `--exclude-intermediate-sql-tables` option keeps `ndb_restore` from restoring such tables that may have been left over from these operations. This option is `TRUE` by default.

- `--exclude-missing-columns`

Command-Line Format	<code>--exclude-missing-columns</code>
---------------------	--

It is possible to restore only selected table columns using this option, which causes `ndb_restore` to ignore any columns missing from tables being restored as compared to the versions of those tables found in the backup. This option applies to all tables being restored. If you wish to apply this option only to selected tables or databases, you can use it in combination with one or more of the `--include-*` or `--exclude-*` options described elsewhere in this section to do so, then restore data to the remaining tables using a complementary set of these options.

- `--exclude-missing-tables`

Command-Line Format	<code>--exclude-missing-tables</code>
---------------------	---------------------------------------

It is possible to restore only selected tables using this option, which causes `ndb_restore` to ignore any tables from the backup that are not found in the target database.

- `--exclude-tables=table-list`

Command-Line Format	<code>--exclude-tables=list</code>
Type	String

Default Value	
---------------	--

List of one or more tables to exclude; each table reference must include the database name. Often used together with `--exclude-databases`.

When `--exclude-databases` or `--exclude-tables` is used, only those databases or tables named by the option are excluded; all other databases and tables are restored by `ndb_restore`.

This table shows several invocations of `ndb_restore` using `--exclude-*` options (other options possibly required have been omitted for clarity), and the effects these options have on restoring from an NDB Cluster backup:

**Table 21.39** Several invocations of `ndb_restore` using `--exclude-*` options, and the effects these options have on restoring from an NDB Cluster backup.

Option	Result
<code>--exclude-databases=db1</code>	All tables in all databases except <code>db1</code> are restored; no tables in <code>db1</code> are restored
<code>--exclude-databases=db1,db2</code> (or <code>--exclude-databases=db1 --exclude-databases=db2</code> )	All tables in all databases except <code>db1</code> and <code>db2</code> are restored; no tables in <code>db1</code> or <code>db2</code> are restored
<code>--exclude-tables=db1.t1</code>	All tables except <code>t1</code> in database <code>db1</code> are restored; all other tables in <code>db1</code> are restored; all tables in all other databases are restored
<code>--exclude-tables=db1.t2,db2.t1</code> (or <code>--exclude-tables=db1.t2 --exclude-tables=db2.t1</code> )	All tables in database <code>db1</code> except for <code>t2</code> and all tables in database <code>db2</code> except for table <code>t1</code> are restored; no other tables in <code>db1</code> or <code>db2</code> are

Option	Result
	restored; all tables in all other databases are restored

You can use these two options together. For example, the following causes all tables in all databases *except for* databases `db1` and `db2`, and tables `t1` and `t2` in database `db3`, to be restored:

```
$> ndb_restore [...] --exclude-databases=db1,db2 --exclude-tables=db3.t1,db3.t2
```

(Again, we have omitted other possibly necessary options in the interest of clarity and brevity from the example just shown.)

You can use `--include-*` and `--exclude-*` options together, subject to the following rules:

- The actions of all `--include-*` and `--exclude-*` options are cumulative.
- All `--include-*` and `--exclude-*` options are evaluated in the order passed to `ndb_restore`, from right to left.
- In the event of conflicting options, the first (rightmost) option takes precedence. In other words, the first option (going from right to left) that matches against a given database or table “wins”.

For example, the following set of options causes `ndb_restore` to restore all tables from database `db1` except `db1.t1`, while restoring no other tables from any other databases:

```
--include-databases=db1 --exclude-tables=db1.t1
```

However, reversing the order of the options just given simply causes all tables from database `db1` to be restored (including `db1.t1`, but no tables from any other database), because the `--include-databases` option, being farthest to the right, is the first match against database `db1` and thus takes precedence over any other option that matches `db1` or any tables in `db1`:

```
--exclude-tables=db1.t1 --include-databases=db1
```

- `--fields-enclosed-by=char`

Command-Line Format	<code>--fields-enclosed-by=char</code>
Type	String
Default Value	

Each column value is enclosed by the string passed to this option (regardless of data type; see the description of `--fields-optionally-enclosed-by`).

- `--fields-optionally-enclosed-by`

Command-Line Format	<code>--fields-optionally-enclosed-by</code>
Type	String
Default Value	

The string passed to this option is used to enclose column values containing character data (such as `CHAR`, `VARCHAR`, `BINARY`, `TEXT`, or `ENUM`).

- `--fields-terminated-by=char`

Command-Line Format	<code>--fields-terminated-by=char</code>
---------------------	--

Type	String
Default Value	\t (tab)

The string passed to this option is used to separate column values. The default value is a tab character (\t).

- `--help`

Command-Line Format	<code>--help</code>
---------------------	---------------------

Display help text and exit.

- `--hex`

Command-Line Format	<code>--hex</code>
---------------------	--------------------

If this option is used, all binary values are output in hexadecimal format.

- `--ignore-extended-pk-updates`

Command-Line Format	<code>--ignore-extended-pk-updates[=0 1]</code>
Introduced	5.7.29-ndb-7.6.14
Type	Integer
Default Value	0
Minimum Value	0
Maximum Value	1

When using the `--allow-pk-changes` option, columns which become part of a table's primary key must not be updated while the backup is being taken; such columns should keep the same values from the time values are inserted into them until the rows containing the values are deleted. If `ndb_restore` encounters updates to these columns when restoring a backup, the restore fails. Because some applications may set values for all columns when updating a row, even when some column values are not changed, the backup may include log events appearing to update columns which are not in fact modified. In such cases you can set `--ignore-extended-pk-updates` to 1, forcing `ndb_restore` to ignore such updates.



**Important**

When causing these updates to be ignored, the user is responsible for ensuring that there are no updates to the values of any columns that become part of the primary key.

For more information, see the description of `--allow-pk-changes`.

- `--include-databases=db-list`

Command-Line Format	<code>--include-databases=list</code>
Type	String
Default Value	

Comma-delimited list of one or more databases to restore. Often used together with `--include-tables`; see the description of that option for further information and examples.

- `--include-tables=table-list`

Command-Line Format	<code>--include-tables=list</code>
Type	String
Default Value	

Comma-delimited list of tables to restore; each table reference must include the database name.

When `--include-databases` or `--include-tables` is used, only those databases or tables named by the option are restored; all other databases and tables are excluded by `ndb_restore`, and are not restored.

The following table shows several invocations of `ndb_restore` using `--include-*` options (other options possibly required have been omitted for clarity), and the effects these have on restoring from an NDB Cluster backup:

**Table 21.40** Several invocations of `ndb_restore` using `--include-*` options, and their effects on restoring from an NDB Cluster backup.

Option	Result
<code>--include-databases=db1</code>	Only tables in database <code>db1</code> are restored; all tables in all other databases are ignored
<code>--include-databases=db1,db2</code> (or <code>--include-databases=db1 --include-databases=db2</code> )	Only tables in databases <code>db1</code> and <code>db2</code> are restored; all tables in all other databases are ignored
<code>--include-tables=db1.t1</code>	Only table <code>t1</code> in database <code>db1</code> is restored; no other tables in <code>db1</code> or in any other database are restored
<code>--include-tables=db1.t2,db2.t1</code> (or <code>--include-tables=db1.t2 --include-tables=db2.t1</code> )	Only the table <code>t2</code> in database <code>db1</code> and the table <code>t1</code> in database <code>db2</code> are restored; no other tables in <code>db1</code> , <code>db2</code> , or any other database are restored

You can also use these two options together. For example, the following causes all tables in databases `db1` and `db2`, together with the tables `t1` and `t2` in database `db3`, to be restored (and no other databases or tables):

```
$> ndb_restore [...] --include-databases=db1,db2 --include-tables=db3.t1,db3.t2
```

(Again we have omitted other, possibly required, options in the example just shown.)

It also possible to restore only selected databases, or selected tables from a single database, without any `--include-*` (or `--exclude-*`) options, using the syntax shown here:

```
ndb_restore other_options db_name,[db_name[,...]] | tbl_name[,tbl_name][,...]]
```

In other words, you can specify either of the following to be restored:

- All tables from one or more databases
- One or more tables from a single database
- `--lines-terminated-by=char`

Type	String
Default Value	\n (linebreak)

Specifies the string used to end each line of output. The default is a linefeed character (\n).

- `--login-path`

Command-Line Format	<code>--login-path=path</code>
Type	String
Default Value	[none]

Read given path from login file.

- `--lossy-conversions, -L`

Command-Line Format	<code>--lossy-conversions</code>
---------------------	----------------------------------

This option is intended to complement the `--promote-attributes` option. Using `--lossy-conversions` allows lossy conversions of column values (type demotions or changes in sign) when restoring data from backup. With some exceptions, the rules governing demotion are the same as for MySQL replication; see [Replication of Columns Having Different Data Types](#), for information about specific type conversions currently supported by attribute demotion.

Beginning with NDB 7.5.23 and NDB 7.6.19, this option also makes it possible to restore a `NULL` column as `NOT NULL`. The column must not contain any `NULL` entries; otherwise `ndb_restore` stops with an error.

`ndb_restore` reports any truncation of data that it performs during lossy conversions once per attribute and column.

- `--ndb-connectstring`

Command-Line Format	<code>--ndb-connectstring=connection_string</code>
Type	String
Default Value	[none]

Set connect string for connecting to `ndb_mgmd`. Syntax: "[nodeid=id;][host=]hostname[:port]". Overrides entries in `NDB_CONNECTSTRING` and `my.cnf`.

- `--ndb-mgmd-host`

Command-Line Format	<code>--ndb-mgmd-host=connection_string</code>
Type	String
Default Value	[none]

Same as `--ndb-connectstring`.

- `--ndb-nodegroup-map=map, -z`

Command-Line Format	<code>--ndb-nodegroup-map=map</code>
---------------------	--------------------------------------

Intended for restoring a backup taken from one node group to a different node group, but never completely implemented; unsupported.

- `--ndb-nodeid`

Command-Line Format	<code>--ndb-nodeid=#</code>
Type	Integer
Default Value	[none]

Set node ID for this node, overriding any ID set by `--ndb-connectstring`.

- `--ndb-optimized-node-selection`

Command-Line Format	<code>--ndb-optimized-node-selection</code>
---------------------	---

Enable optimizations for selection of nodes for transactions. Enabled by default; use `--skip-ndb-optimized-node-selection` to disable.

- `--no-binlog`

Command-Line Format	<code>--no-binlog</code>
---------------------	--------------------------

This option prevents any connected SQL nodes from writing data restored by `ndb_restore` to their binary logs.

- `--no-defaults`

Command-Line Format	<code>--no-defaults</code>
---------------------	----------------------------

Do not read default options from any option file other than login file.

- `--no-restore-disk-objects, -d`

Command-Line Format	<code>--no-restore-disk-objects</code>
---------------------	--

This option stops `ndb_restore` from restoring any NDB Cluster Disk Data objects, such as tablespaces and log file groups; see [Section 21.6.11, "NDB Cluster Disk Data Tables"](#), for more information about these.

- `--no-upgrade, -u`

Command-Line Format	<code>--no-upgrade</code>
---------------------	---------------------------

When using `ndb_restore` to restore a backup, `VARCHAR` columns created using the old fixed format are resized and recreated using the variable-width format now employed. This behavior can be overridden by specifying `--no-upgrade`.

- `--nodeid=#, -n`

Command-Line Format	<code>--nodeid=#</code>
---------------------	-------------------------



Type	Numeric
Default Value	<code>none</code>

Specify the node ID of the data node on which the backup was taken.

When restoring to a cluster with different number of data nodes from that where the backup was taken, this information helps identify the correct set or sets of files to be restored to a given node. (In such cases, multiple files usually need to be restored to a single data node.) See [Section 21.5.24.2, “Restoring to a different number of data nodes”](#), for additional information and examples.

In NDB 7.5.13 and later, and in NDB 7.6.9 and later, this option is required.

- `--num-slices=#`

Command-Line Format	<code>--num-slices=#</code>
Introduced	5.7.29-ndb-7.6.13
Type	Integer
Default Value	<code>1</code>
Minimum Value	<code>1</code>
Maximum Value	<code>1024</code>

When restoring a backup by slices, this option sets the number of slices into which to divide the backup. This allows multiple instances of `ndb_restore` to restore disjoint subsets in parallel, potentially reducing the amount of time required to perform the restore operation.

A *slice* is a subset of the data in a given backup; that is, it is a set of fragments having the same slice ID, specified using the `--slice-id` option. The two options must always be used together, and the value set by `--slice-id` must always be less than the number of slices.

`ndb_restore` encounters fragments and assigns each one a fragment counter. When restoring by slices, a slice ID is assigned to each fragment; this slice ID is in the range 0 to 1 less than the number of slices. For a table that is not a **BLOB** table, the slice to which a given fragment belongs is determined using the formula shown here:

$$[slice\_ID] = [fragment\_counter] \% [number\_of\_slices]$$

For a **BLOB** table, a fragment counter is not used; the fragment number is used instead, along with the ID of the main table for the **BLOB** table (recall that **NDB** stores **BLOB** values in a separate table internally). In this case, the slice ID for a given fragment is calculated as shown here:

$$[slice\_ID] = ([main\_table\_ID] + [fragment\_ID]) \% [number\_of\_slices]$$

Thus, restoring by *N* slices means running *N* instances of `ndb_restore`, all with `--num-slices=N` (along with any other necessary options) and one each with `--slice-id=1`, `--slice-id=2`, `--slice-id=3`, and so on through `slice-id=N-1`.

- `--parallelism=#, -p`

Command-Line Format	<code>--parallelism=#</code>
Type	Numeric
Default Value	<code>128</code>

Minimum Value	1
Maximum Value	1024

`ndb_restore` uses single-row transactions to apply many rows concurrently. This parameter determines the number of parallel transactions (concurrent rows) that an instance of `ndb_restore` tries to use. By default, this is 128; the minimum is 1, and the maximum is 1024.

The work of performing the inserts is parallelized across the threads in the data nodes involved. This mechanism is employed for restoring bulk data from the `.Data` file—that is, the fuzzy snapshot of the data; it is not used for building or rebuilding indexes. The change log is applied serially; index drops and builds are DDL operations and handled separately. There is no thread-level parallelism on the client side of the restore.

- `--preserve-trailing-spaces, -P`

Command-Line Format	<code>--preserve-trailing-spaces</code>
---------------------	---

Cause trailing spaces to be preserved when promoting a fixed-width character data type to its variable-width equivalent—that is, when promoting a `CHAR` column value to `VARCHAR`, or a `BINARY` column value to `VARBINARY`. Otherwise, any trailing spaces are dropped from such column values when they are inserted into the new columns.



**Note**

Although you can promote `CHAR` columns to `VARCHAR` and `BINARY` columns to `VARBINARY`, you cannot promote `VARCHAR` columns to `CHAR` or `VARBINARY` columns to `BINARY`.

- `--print`

Command-Line Format	<code>--print</code>
---------------------	----------------------

Causes `ndb_restore` to print all data, metadata, and logs to `stdout`. Equivalent to using the `--print-data`, `--print-meta`, and `--print-log` options together.



**Note**

Use of `--print` or any of the `--print_*` options is in effect performing a dry run. Including one or more of these options causes any output to be redirected to `stdout`; in such cases, `ndb_restore` makes no attempt to restore data or metadata to an NDB Cluster.

- `--print-data`

Command-Line Format	<code>--print-data</code>
---------------------	---------------------------

Cause `ndb_restore` to direct its output to `stdout`. Often used together with one or more of `--tab`, `--fields-enclosed-by`, `--fields-optionally-enclosed-by`, `--fields-terminated-by`, `--hex`, and `--append`.

`TEXT` and `BLOB` column values are always truncated. Such values are truncated to the first 256 bytes in the output. This cannot currently be overridden when using `--print-data`.

- `--print-defaults`

Command-Line Format	<code>--print-defaults</code>
---------------------	-------------------------------

Print program argument list and exit.

- `--print-log`

Command-Line Format	<code>--print-log</code>
---------------------	--------------------------

Cause `ndb_restore` to output its log to `stdout`.

- `--print-meta`

Command-Line Format	<code>--print-meta</code>
---------------------	---------------------------

Print all metadata to `stdout`.

- `print-sql-log`

Command-Line Format	<code>--print-sql-log</code>
Introduced	5.7.16-ndb-7.5.4

Log SQL statements to `stdout`. Use the option to enable; normally this behavior is disabled. The option checks before attempting to log whether all the tables being restored have explicitly defined primary keys; queries on a table having only the hidden primary key implemented by NDB cannot be converted to valid SQL.

This option does not work with tables having `BLOB` columns.

The `--print-sql-log` option was added in NDB 7.5.4. (Bug #13511949)

- `--progress-frequency=N`

Command-Line Format	<code>--progress-frequency=#</code>
Type	Numeric
Default Value	0
Minimum Value	0
Maximum Value	65535

Print a status report each `N` seconds while the backup is in progress. 0 (the default) causes no status reports to be printed. The maximum is 65535.

- `--promote-attributes, -A`

Command-Line Format	<code>--promote-attributes</code>
---------------------	-----------------------------------

`ndb_restore` supports limited *attribute promotion* in much the same way that it is supported by MySQL replication; that is, data backed up from a column of a given type can generally be restored to a column using a “larger, similar” type. For example, data from a `CHAR(20)` column can be restored to a column declared as `VARCHAR(20)`, `VARCHAR(30)`, or `CHAR(30)`; data from a `MEDIUMINT` column can be

restored to a column of type `INT` or `BIGINT`. See [Replication of Columns Having Different Data Types](#), for a table of type conversions currently supported by attribute promotion.

Beginning with NDB 7.5.23 and NDB 7.6.19, this option also makes it possible to restore a `NOT NULL` column as `NULL`.

Attribute promotion by `ndb_restore` must be enabled explicitly, as follows:

1. Prepare the table to which the backup is to be restored. `ndb_restore` cannot be used to re-create the table with a different definition from the original; this means that you must either create the table manually, or alter the columns which you wish to promote using `ALTER TABLE` after restoring the table metadata but before restoring the data.
2. Invoke `ndb_restore` with the `--promote-attributes` option (short form `-A`) when restoring the table data. Attribute promotion does not occur if this option is not used; instead, the restore operation fails with an error.

When converting between character data types and `TEXT` or `BLOB`, only conversions between character types (`CHAR` and `VARCHAR`) and binary types (`BINARY` and `VARBINARY`) can be performed at the same time. For example, you cannot promote an `INT` column to `BIGINT` while promoting a `VARCHAR` column to `TEXT` in the same invocation of `ndb_restore`.

Converting between `TEXT` columns using different character sets is not supported, and is expressly disallowed.

When performing conversions of character or binary types to `TEXT` or `BLOB` with `ndb_restore`, you may notice that it creates and uses one or more staging tables named `table_name$Tnode_id`. These tables are not needed afterwards, and are normally deleted by `ndb_restore` following a successful restoration.

- `--rebuild-indexes`

Command-Line Format	<code>--rebuild-indexes</code>
---------------------	--------------------------------

Enable multithreaded rebuilding of the ordered indexes while restoring a native NDB backup. The number of threads used for building ordered indexes by `ndb_restore` with this option is controlled by the `BuildIndexThreads` data node configuration parameter and the number of LDMs.

It is necessary to use this option only for the first run of `ndb_restore`; this causes all ordered indexes to be rebuilt without using `--rebuild-indexes` again when restoring subsequent nodes. You should use this option prior to inserting new rows into the database; otherwise, it is possible for a row to be inserted that later causes a unique constraint violation when trying to rebuild the indexes.

Building of ordered indices is parallelized with the number of LDMs by default. Offline index builds performed during node and system restarts can be made faster using the `BuildIndexThreads` data node configuration parameter; this parameter has no effect on dropping and rebuilding of indexes by `ndb_restore`, which is performed online.

Rebuilding of unique indexes uses disk write bandwidth for redo logging and local checkpointing. An insufficient amount of this bandwidth can lead to redo buffer overload or log overload errors. In such cases you can run `ndb_restore --rebuild-indexes` again; the process resumes at the point where the error occurred. You can also do this when you have encountered temporary errors. You can repeat execution of `ndb_restore --rebuild-indexes` indefinitely; you may be able to stop such errors by reducing the value of `--parallelism`. If the problem is insufficient space, you can increase the size of the redo log (`FragmentLogFileSize` node configuration parameter), or you can increase the speed at

which LCPs are performed (`MaxDiskWriteSpeed` and related parameters), in order to free space more quickly.

- `--remap-column=db.tbl.col:fn:args`

Command-Line Format	<code>--remap-column=string</code>
Introduced	5.7.29-ndb-7.6.14
Type	String
Default Value	[none]

When used together with `--restore-data`, this option applies a function to the value of the indicated column. Values in the argument string are listed here:

- `db`: Database name, following any renames performed by `--rewrite-database`.
- `tbl`: Table name.
- `col`: Name of the column to be updated. This column must be of type `INT` or `BIGINT`. The column can also be but is not required to be `UNSIGNED`.
- `fn`: Function name; currently, the only supported name is `offset`.
- `args`: Arguments supplied to the function. Currently, only a single argument, the size of the offset to be added by the `offset` function, is supported. Negative values are supported. The size of the argument cannot exceed that of the signed variant of the column's type; for example, if `col` is an `INT` column, then the allowed range of the argument passed to the `offset` function is `-2147483648` to `2147483647` (see [Section 11.1.2, "Integer Types \(Exact Value\) - INTEGER, INT, SMALLINT, TINYINT, MEDIUMINT, BIGINT"](#)).

If applying the offset value to the column would cause an overflow or underflow, the restore operation fails. This could happen, for example, if the column is a `BIGINT`, and the option attempts to apply an offset value of 8 on a row in which the column value is 4294967291, since  $4294967291 + 8 = 4294967299 > 4294967295$ .

This option can be useful when you wish to merge data stored in multiple source instances of NDB Cluster (all using the same schema) into a single destination NDB Cluster, using NDB native backup (see [Section 21.6.8.2, "Using The NDB Cluster Management Client to Create a Backup"](#)) and `ndb_restore` to merge the data, where primary and unique key values are overlapping between source clusters, and it is necessary as part of the process to remap these values to ranges that do not overlap. It may also be necessary to preserve other relationships between tables. To fulfill such requirements, it is possible to use the option multiple times in the same invocation of `ndb_restore` to remap columns of different tables, as shown here:

```
$> ndb_restore --restore-data --remap-column=hr.employee.id:offset:1000 \
--remap-column=hr.manager.id:offset:1000 --remap-column=hr.firstaiders.id:offset:1000
```

(Other options not shown here may also be used.)

`--remap-column` can also be used to update multiple columns of the same table. Combinations of multiple tables and columns are possible. Different offset values can also be used for different columns of the same table, like this:

```
$> ndb_restore --restore-data --remap-column=hr.employee.salary:offset:10000 \
```

```
--remap-column=hr.employee.hours:offset:-10
```

When source backups contain duplicate tables which should not be merged, you can handle this by using `--exclude-tables`, `--exclude-databases`, or by some other means in your application.

Information about the structure and other characteristics of tables to be merged can be obtained using `SHOW CREATE TABLE`; the `ndb_desc` tool; and `MAX()`, `MIN()`, `LAST_INSERT_ID()`, and other MySQL functions.

Replication of changes from merged to unmerged tables, or from unmerged to merged tables, in separate instances of NDB Cluster is not supported.

- `--restore-data, -r`

Command-Line Format	<code>--restore-data</code>
---------------------	-----------------------------

Output NDB table data and logs.

- `--restore-epoch, -e`

Command-Line Format	<code>--restore-epoch</code>
---------------------	------------------------------

Add (or restore) epoch information to the cluster replication status table. This is useful for starting replication on an NDB replica cluster. When this option is used, the row in the `mysql.ndb_apply_status` having 0 in the `id` column is updated if it already exists; such a row is inserted if it does not already exist. (See [Section 21.7.9, “NDB Cluster Backups With NDB Cluster Replication”](#).)

- `--restore-meta, -m`

Command-Line Format	<code>--restore-meta</code>
---------------------	-----------------------------

This option causes `ndb_restore` to print NDB table metadata.

The first time you run the `ndb_restore` restoration program, you also need to restore the metadata. In other words, you must re-create the database tables—this can be done by running it with the `--restore-meta (-m)` option. Restoring the metadata need be done only on a single data node; this is sufficient to restore it to the entire cluster.

In older versions of NDB Cluster, tables whose schemas were restored using this option used the same number of partitions as they did on the original cluster, even if it had a differing number of data nodes from the new cluster. In NDB 7.5.2 and later, when restoring metadata, this is no longer an issue; `ndb_restore` now uses the default number of partitions for the target cluster, unless the number of local data manager threads is also changed from what it was for data nodes in the original cluster.



**Note**

The cluster should have an empty database when starting to restore a backup. (In other words, you should start the data nodes with `--initial` prior to performing the restore.)

- `--restore-privilege-tables`

Command-Line Format	<code>--restore-privilege-tables</code>
---------------------	---

`ndb_restore` does not by default restore distributed MySQL privilege tables. This option causes `ndb_restore` to restore the privilege tables.

This works only if the privilege tables were converted to `NDB` before the backup was taken. For more information, see [Section 21.6.13, “Distributed Privileges Using Shared Grant Tables”](#).

- `--rewrite-database=olddb,newdb`

Command-Line Format	<code>--rewrite-database=string</code>
Type	String
Default Value	<code>none</code>

This option makes it possible to restore to a database having a different name from that used in the backup. For example, if a backup is made of a database named `products`, you can restore the data it contains to a database named `inventory`, use this option as shown here (omitting any other options that might be required):

```
$> ndb_restore --rewrite-database=product,inventory
```

The option can be employed multiple times in a single invocation of `ndb_restore`. Thus it is possible to restore simultaneously from a database named `db1` to a database named `db2` and from a database named `db3` to one named `db4` using `--rewrite-database=db1,db2 --rewrite-database=db3,db4`. Other `ndb_restore` options may be used between multiple occurrences of `--rewrite-database`.

In the event of conflicts between multiple `--rewrite-database` options, the last `--rewrite-database` option used, reading from left to right, is the one that takes effect. For example, if `--rewrite-database=db1,db2 --rewrite-database=db1,db3` is used, only `--rewrite-database=db1,db3` is honored, and `--rewrite-database=db1,db2` is ignored. It is also possible to restore from multiple databases to a single database, so that `--rewrite-database=db1,db3 --rewrite-database=db2,db3` restores all tables and data from databases `db1` and `db2` into database `db3`.



### Important

When restoring from multiple backup databases into a single target database using `--rewrite-database`, no check is made for collisions between table or other object names, and the order in which rows are restored is not guaranteed. This means that it is possible in such cases for rows to be overwritten and updates to be lost.

- `--skip-broken-objects`

Command-Line Format	<code>--skip-broken-objects</code>
---------------------	------------------------------------

This option causes `ndb_restore` to ignore corrupt tables while reading a native `NDB` backup, and to continue restoring any remaining tables (that are not also corrupted). Currently, the `--skip-broken-objects` option works only in the case of missing blob parts tables.

- `--skip-table-check, -s`

Command-Line Format	<code>--skip-table-check</code>
---------------------	---------------------------------

It is possible to restore data without restoring table metadata. By default when doing this, `ndb_restore` fails with an error if a mismatch is found between the table data and the table schema; this option overrides that behavior.

Some of the restrictions on mismatches in column definitions when restoring data using `ndb_restore` are relaxed; when one of these types of mismatches is encountered, `ndb_restore` does not stop with an error as it did previously, but rather accepts the data and inserts it into the target table while issuing a warning to the user that this is being done. This behavior occurs whether or not either of the options `--skip-table-check` or `--promote-attributes` is in use. These differences in column definitions are of the following types:

- Different `COLUMN_FORMAT` settings (`FIXED`, `DYNAMIC`, `DEFAULT`)
  - Different `STORAGE` settings (`MEMORY`, `DISK`)
  - Different default values
  - Different distribution key settings
- `--skip-unknown-objects`

Command-Line Format	<code>--skip-unknown-objects</code>
---------------------	-------------------------------------

This option causes `ndb_restore` to ignore any schema objects it does not recognize while reading a native `NDB` backup. This can be used for restoring a backup made from a cluster running (for example) `NDB 7.6` to a cluster running `NDB Cluster 7.5`.

- `--slice-id=#`

Command-Line Format	<code>--slice-id=#</code>
Introduced	5.7.29-ndb-7.6.13
Type	Integer
Default Value	0
Minimum Value	0
Maximum Value	1023

When restoring by slices, this is the ID of the slice to restore. This option is always used together with `--num-slices`, and its value must be always less than that of `--num-slices`.

For more information, see the description of the `--num-slices` elsewhere in this section.

- `--tab=dir_name, -T dir_name`

Command-Line Format	<code>--tab=path</code>
Type	Directory name

Causes `--print-data` to create dump files, one per table, each named `tbl_name.txt`. It requires as its argument the path to the directory where the files should be saved; use `.` for the current directory.



- `--timestamp-printouts`

Command-Line Format	<code>--timestamp-printouts{=true false}</code>
Introduced	5.7.41-ndb-7.5.30, 5.7.41-ndb-7.6.26
Type	Boolean
Default Value	<code>false</code>

Causes info, error, and debug log messages to be prefixed with timestamps.

This option is disabled by default in NDB 7.5 and NDB 7.6. Set it explicitly to `true` to enable.

- `--usage`

Command-Line Format	<code>--usage</code>
---------------------	----------------------

Display help text and exit; same as `--help`.

- `--verbose=#`

Command-Line Format	<code>--verbose=#</code>
Type	Numeric
Default Value	1
Minimum Value	0
Maximum Value	255

Sets the level for the verbosity of the output. The minimum is 0; the maximum is 255. The default value is 1.

- `--version`

Command-Line Format	<code>--version</code>
---------------------	------------------------

Display version information and exit.

Typical options for this utility are shown here:

```
ndb_restore [-c connection_string] -n node_id -b backup_id \
  [-m] -r --backup-path=/path/to/backup/files
```

Normally, when restoring from an NDB Cluster backup, `ndb_restore` requires at a minimum the `--nodeid` (short form: `-n`), `--backupid` (short form: `-b`), and `--backup-path` options. In addition, when `ndb_restore` is used to restore any tables containing unique indexes, you must include `--disable-indexes` or `--rebuild-indexes`. (Bug #57782, Bug #11764893)

The `-c` option is used to specify a connection string which tells `ndb_restore` where to locate the cluster management server (see [Section 21.4.3.3, “NDB Cluster Connection Strings”](#)). If this option is not used, then `ndb_restore` attempts to connect to a management server on `localhost:1186`. This utility acts as a cluster API node, and so requires a free connection “slot” to connect to the cluster management server. This means that there must be at least one `[api]` or `[mysqld]` section that can be used by it in the cluster `config.ini` file. It is a good idea to keep at least one empty `[api]` or `[mysqld]` section in `config.ini` that is not being used for a MySQL server or other application for this reason (see [Section 21.4.3.7, “Defining SQL and Other API Nodes in an NDB Cluster”](#)).

You can verify that `ndb_restore` is connected to the cluster by using the `SHOW` command in the `ndb_mgm` management client. You can also accomplish this from a system shell, as shown here:

```
$> ndb_mgm -e "SHOW"
```

### Error reporting.

`ndb_restore` reports both temporary and permanent errors. In the case of temporary errors, it may be able to recover from them, and reports `Restore successful, but encountered temporary error, please look at configuration` in such cases.



### Important

After using `ndb_restore` to initialize an NDB Cluster for use in circular replication, binary logs on the SQL node acting as the replica are not automatically created, and you must cause them to be created manually. To cause the binary logs to be created, issue a `SHOW TABLES` statement on that SQL node before running `START SLAVE`. This is a known issue in NDB Cluster.

## 21.5.24.1 Restoring an NDB Backup to a Different Version of NDB Cluster

The following two sections provide information about restoring a native NDB backup to a different version of NDB Cluster from the version in which the backup was taken.

In addition, you should consult [Section 21.3.7, “Upgrading and Downgrading NDB Cluster”](#), for other issues you may encounter when attempting to restore an NDB backup to a cluster running a different version of the NDB software.

It is also advisable to review [What is New in NDB Cluster 8.0](#), as well as [Section 2.10.3, “Changes in MySQL 5.7”](#), for other changes between NDB 8.0 and previous versions of NDB Cluster that may be relevant to your particular circumstances.

### Restoring an NDB backup to a previous version of NDB Cluster

You may encounter issues when restoring a backup taken from a later version of NDB Cluster to a previous one, due to the use of features which do not exist in the earlier version. Some of these issues are listed here:

- Tables created in NDB 8.0 by default use the `utf8mb4_ai_ci` character set, which is not available in NDB 7.6 and earlier, and so cannot be read by an `ndb_restore` binary from one of these earlier versions. In such cases, it is necessary to alter any tables using `utf8mb4_ai_ci` so that they use a character set supported in the older version prior to performing the backup.
- Due to changes in how the MySQL Server and NDB handle table metadata, tables created or altered using the included MySQL server binary from NDB 8.0.14 or later cannot be restored using `ndb_restore` to an earlier version of NDB Cluster. Such tables use `.sdi` files which are not understood by older versions of `mysqld`.

A backup taken in NDB 8.0.14 or later of tables which were created in NDB 8.0.13 or earlier, and which have not been altered since upgrading to NDB 8.0.14 or later, should be restorable to older versions of NDB Cluster.

Since it is possible to restore metadata and table data separately, you can in such cases restore the table schemas from a dump made using `mysqldump`, or by executing the necessary `CREATE TABLE` statements manually, then import only the table data using `ndb_restore` with the `--restore-data` option.

- Encrypted backups created in NDB 8.0.22 and later cannot be restored using `ndb_restore` from NDB 8.0.21 or earlier.
- The `NDB_STORED_USER` privilege is not supported prior to NDB 8.0.18.
- NDB Cluster 8.0.18 and later supports up to 144 data nodes, while earlier versions support a maximum of only 48 data nodes. See [Restoring to Fewer Nodes Than the Original](#), for information with situations in which this incompatibility causes an issue.

## Restoring an NDB backup to a later version of NDB Cluster

In general, it should be possible to restore a backup created using the `ndb_mgm` client `START BACKUP` command in an older version of NDB to a newer version, provided that you use the `ndb_restore` binary that comes with the newer version. (It may be possible to use the older version of `ndb_restore`, but this is not recommended.) Additional potential issues are listed here:

- When restoring the metadata from a backup (`--restore-meta` option), `ndb_restore` normally attempts to reproduce the captured table schema exactly as it was when the backup was taken.

Tables created in versions of NDB prior to 8.0.14 use `.frm` files for their metadata. These files can be read by the `mysqld` in NDB 8.0.14 and later, which can use the information contained therein to create the `.sdi` files used by the MySQL data dictionary in later versions.

- When restoring an older backup to a newer version of NDB, it may not be possible to take advantage of newer features such as hashmap partitioning, greater number of hashmap buckets, read backup, and different partitioning layouts. For this reason, it may be preferable to restore older schemas using `mysqldump` and the `mysql` client, which allows NDB to make use of the new schema features.
- Tables using the old temporal types which did not support fractional seconds (used prior to MySQL 5.6.4 and NDB 7.3.31) cannot be restored to NDB 8.0 using `ndb_restore`. You can check such tables using `CHECK TABLE`, and then upgrade them to the newer temporal column format, if necessary, using `REPAIR TABLE` in the `mysql` client; this must be done prior to taking the backup. See [Preparing Your Installation for Upgrade](#), for more information.

You also restore such tables using a dump created with `mysqldump`.

- Distributed grant tables created in NDB 7.6 and earlier are not supported in NDB 8.0. Such tables can be restored to an NDB 8.0 cluster, but they have no effect on access control.

### 21.5.24.2 Restoring to a different number of data nodes

It is possible to restore from an NDB backup to a cluster having a different number of data nodes than the original from which the backup was taken. The following two sections discuss, respectively, the cases where the target cluster has a lesser or greater number of data nodes than the source of the backup.

#### Restoring to Fewer Nodes Than the Original

You can restore to a cluster having fewer data nodes than the original provided that the larger number of nodes is an even multiple of the smaller number. In the following example, we use a backup taken on a cluster having four data nodes to a cluster having two data nodes.

1. The management server for the original cluster is on host `host10`. The original cluster has four data nodes, with the node IDs and host names shown in the following extract from the management server's `config.ini` file:

```
[ndbd]
NodeId=2
```

```

HostName=host2

[ndbd]
NodeId=4
HostName=host4

[ndbd]
NodeId=6
HostName=host6

[ndbd]
NodeId=8
HostName=host8
    
```

We assume that each data node was originally started with `ndbmtid --ndb-connectstring=host10` or the equivalent.

2. Perform a backup in the normal manner. See [Section 21.6.8.2, “Using The NDB Cluster Management Client to Create a Backup”](#), for information about how to do this.
3. The files created by the backup on each data node are listed here, where *N* is the node ID and *B* is the backup ID.
  - `BACKUP-B-0.N.Data`
  - `BACKUP-B.N.ctl`
  - `BACKUP-B.N.log`

These files are found under `BackupDataDir/BACKUP/BACKUP-B`, on each data node. For the rest of this example, we assume that the backup ID is 1.

Have all of these files available for later copying to the new data nodes (where they can be accessed on the data node's local file system by `ndb_restore`). It is simplest to copy them all to a single location; we assume that this is what you have done.

4. The management server for the target cluster is on host `host20`, and the target has two data nodes, with the node IDs and host names shown, from the management server `config.ini` file on `host20`:

```

[ndbd]
NodeId=3
hostname=host3

[ndbd]
NodeId=5
hostname=host5
    
```

Each of the data node processes on `host3` and `host5` should be started with `ndbmtid -c host20 --initial` or the equivalent, so that the new (target) cluster starts with clean data node file systems.

5. Copy two different sets of two backup files to each of the target data nodes. For this example, copy the backup files from nodes 2 and 4 from the original cluster to node 3 in the target cluster. These files are listed here:
  - `BACKUP-1-0.2.Data`
  - `BACKUP-1.2.ctl`
  - `BACKUP-1.2.log`
  - `BACKUP-1-0.4.Data`

- `BACKUP-1.4.ct1`
- `BACKUP-1.4.log`

Then copy the backup files from nodes 6 and 8 to node 5; these files are shown in the following list:

- `BACKUP-1-0.6.Data`
- `BACKUP-1.6.ct1`
- `BACKUP-1.6.log`
- `BACKUP-1-0.8.Data`
- `BACKUP-1.8.ct1`
- `BACKUP-1.8.log`

For the remainder of this example, we assume that the respective backup files have been saved to the directory `/BACKUP-1` on each of nodes 3 and 5.

6. On each of the two target data nodes, you must restore from both sets of backups. First, restore the backups from nodes 2 and 4 to node 3 by invoking `ndb_restore` on `host3` as shown here:

```
$> ndb_restore -c host20 --nodeid=2 --backupid=1 --restore-data --backup-path=/BACKUP-1
$> ndb_restore -c host20 --nodeid=4 --backupid=1 --restore-data --backup-path=/BACKUP-1
```

Then restore the backups from nodes 6 and 8 to node 5 by invoking `ndb_restore` on `host5`, like this:

```
$> ndb_restore -c host20 --nodeid=6 --backupid=1 --restore-data --backup-path=/BACKUP-1
$> ndb_restore -c host20 --nodeid=8 --backupid=1 --restore-data --backup-path=/BACKUP-1
```

## Restoring to More Nodes Than the Original

The node ID specified for a given `ndb_restore` command is that of the node in the original backup and not that of the data node to restore it to. When performing a backup using the method described in this section, `ndb_restore` connects to the management server and obtains a list of data nodes in the cluster the backup is being restored to. The restored data is distributed accordingly, so that the number of nodes in the target cluster does not need to be known or calculated when performing the backup.



### Note

When changing the total number of LCP threads or LQH threads per node group, you should recreate the schema from backup created using `mysqldump`.

1. *Create the backup of the data.* You can do this by invoking the `ndb_mgm` client `START BACKUP` command from the system shell, like this:

```
$> ndb_mgm -e "START BACKUP 1"
```

This assumes that the desired backup ID is 1.

2. *Create a backup of the schema.* In NDB 7.5.2 and later, this step is necessary only if the total number of LCP threads or LQH threads per node group is changed.

```
$> mysqldump --no-data --routines --events --triggers --databases > myschema.sql
```



### Important

Once you have created the NDB native backup using `ndb_mgm`, you must not make any schema changes before creating the backup of the schema, if you do so.

- Copy the backup directory to the new cluster. For example if the backup you want to restore has ID 1 and `BackupDataDir = /backups/node_nodeid`, then the path to the backup on this node is `/backups/node_1/BACKUP/BACKUP-1`. Inside this directory there are three files, listed here:

- `BACKUP-1-0.1.Data`
- `BACKUP-1.1.ct1`
- `BACKUP-1.1.log`

You should copy the entire directory to the new node.

If you needed to create a schema file, copy this to a location on an SQL node where it can be read by `mysqld`.

There is no requirement for the backup to be restored from a specific node or nodes.

To restore from the backup just created, perform the following steps:

- Restore the schema.*

- If you created a separate schema backup file using `mysqldump`, import this file using the `mysql` client, similar to what is shown here:

```
$> mysql < myschema.sql
```

When importing the schema file, you may need to specify the `--user` and `--password` options (and possibly others) in addition to what is shown, in order for the `mysql` client to be able to connect to the MySQL server.

- If you did *not* need to create a schema file, you can re-create the schema using `ndb_restore --restore-meta` (short form `-m`), similar to what is shown here:

```
$> ndb_restore --nodeid=1 --backupid=1 --restore-meta --backup-path=/backups/node_1/BACKUP/BACKUP-1
```

`ndb_restore` must be able to contact the management server; add the `--ndb-connectstring` option if and as needed to make this possible.

- Restore the data.* This needs to be done once for each data node in the original cluster, each time using that data node's node ID. Assuming that there were 4 data nodes originally, the set of commands required would look something like this:

```
ndb_restore --nodeid=1 --backupid=1 --restore-data --backup-path=/backups/node_1/BACKUP/BACKUP-1 --disable-
ndb_restore --nodeid=2 --backupid=1 --restore-data --backup-path=/backups/node_2/BACKUP/BACKUP-1 --disable-
ndb_restore --nodeid=3 --backupid=1 --restore-data --backup-path=/backups/node_3/BACKUP/BACKUP-1 --disable-
ndb_restore --nodeid=4 --backupid=1 --restore-data --backup-path=/backups/node_4/BACKUP/BACKUP-1 --disable-
```

These can be run in parallel.

Be sure to add the `--ndb-connectstring` option as needed.

3. *Rebuild the indexes.* These were disabled by the `--disable-indexes` option used in the commands just shown. Recreating the indexes avoids errors due to the restore not being consistent at all points. Rebuilding the indexes can also improve performance in some cases. To rebuild the indexes, execute the following command once, on a single node:

```
$> ndb_restore --nodeid=1 --backupid=1 --backup-path=/backups/node_1/BACKUP/BACKUP-1 --rebuild-indexes
```

As mentioned previously, you may need to add the `--ndb-connectstring` option, so that `ndb_restore` can contact the management server.

## 21.5.25 ndb\_select\_all — Print Rows from an NDB Table

`ndb_select_all` prints all rows from an NDB table to `stdout`.

### Usage

```
ndb_select_all -c connection_string tbl_name -d db_name [> file_name]
```

Options that can be used with `ndb_select_all` are shown in the following table. Additional descriptions follow the table.

**Table 21.41 Command-line options used with the program `ndb_select_all`**

Format	Description	Added, Deprecated, or Removed
<code>--character-sets-dir=path</code>	Directory containing character sets	(Supported in all NDB releases based on MySQL 5.7)
<code>--connect-retries=#</code>	Number of times to retry connection before giving up	(Supported in all NDB releases based on MySQL 5.7)
<code>--connect-retry-delay=#</code>	Number of seconds to wait between attempts to contact management server	(Supported in all NDB releases based on MySQL 5.7)
<code>--connect-string=connection_string,</code> <code>-c connection_string</code>	Same as <code>--ndb-connectstring</code>	(Supported in all NDB releases based on MySQL 5.7)
<code>--core-file</code>	Write core file on error; used in debugging	(Supported in all NDB releases based on MySQL 5.7)
<code>--database=name,</code> <code>-d name</code>	Name of database in which table is found	(Supported in all NDB releases based on MySQL 5.7)
<code>--defaults-extra-file=path</code>	Read given file after global files are read	(Supported in all NDB releases based on MySQL 5.7)
<code>--defaults-file=path</code>	Read default options from given file only	(Supported in all NDB releases based on MySQL 5.7)
<code>--defaults-group-suffix=string</code>	Also read groups with <code>concat(group, suffix)</code>	(Supported in all NDB releases based on MySQL 5.7)
<code>--delimiter=char,</code> <code>-D char</code>	Set column delimiter	(Supported in all NDB releases based on MySQL 5.7)
<code>--descending,</code> <code>-z</code>	Sort resultset in descending order (requires <code>--order</code> )	(Supported in all NDB releases based on MySQL 5.7)

Format	Description	Added, Deprecated, or Removed
<code>--disk</code>	Print disk references (useful only for Disk Data tables having unindexed columns)	(Supported in all NDB releases based on MySQL 5.7)
<code>--gci</code>	Include GCI in output	(Supported in all NDB releases based on MySQL 5.7)
<code>--gci64</code>	Include GCI and row epoch in output	(Supported in all NDB releases based on MySQL 5.7)
<code>--header[=value],</code> <code>-h</code>	Print header (set to 0 FALSE to disable headers in output)	(Supported in all NDB releases based on MySQL 5.7)
<code>--lock=#,</code>	Lock type	(Supported in all NDB releases based on MySQL 5.7)
<code>-l #</code> <code>--login-path=path</code>	Read given path from login file	(Supported in all NDB releases based on MySQL 5.7)
<code>--help,</code> <code>-?</code>	Display help text and exit	(Supported in all NDB releases based on MySQL 5.7)
<code>--ndb-connectstring=connection_string</code> <code>-c connection_string</code>	Set connect string for connecting to ndb_mgmd. Syntax: "[nodeid=id;][host=]hostname[:port]". Overrides entries in NDB_CONNECTSTRING and my.cnf	(Supported in all NDB releases based on MySQL 5.7)
<code>--ndb-mgmd-host=connection_string,</code> <code>-c connection_string</code>	Same as <code>--ndb-connectstring</code>	(Supported in all NDB releases based on MySQL 5.7)
<code>--ndb-nodeid=#</code>	Set node ID for this node, overriding any ID set by <code>--ndb-connectstring</code>	(Supported in all NDB releases based on MySQL 5.7)
<code>--ndb-optimized-node-selection</code>	Enable optimizations for selection of nodes for transactions. Enabled by default; use <code>--skip-ndb-optimized-node-selection</code> to disable	(Supported in all NDB releases based on MySQL 5.7)
<code>--no-defaults</code>	Do not read default options from any option file other than login file	(Supported in all NDB releases based on MySQL 5.7)
<code>--nodata</code>	Do not print table column data	(Supported in all NDB releases based on MySQL 5.7)
<code>--order=index,</code> <code>-o index</code>	Sort resultset according to index having this name	(Supported in all NDB releases based on MySQL 5.7)
<code>--parallelism=#,</code> <code>-p #</code>	Degree of parallelism	(Supported in all NDB releases based on MySQL 5.7)



Format	Description	Added, Deprecated, or Removed
<code>--print-defaults</code>	Print program argument list and exit	(Supported in all NDB releases based on MySQL 5.7)
<code>--rowid</code>	Print row ID	(Supported in all NDB releases based on MySQL 5.7)
<code>--tupscan,</code> <code>-t</code>	Scan in tup order	(Supported in all NDB releases based on MySQL 5.7)
<code>--usage,</code> <code>-?</code>	Display help text and exit; same as <code>--help</code>	(Supported in all NDB releases based on MySQL 5.7)
<code>--useHexFormat,</code> <code>-x</code>	Output numbers in hexadecimal format	(Supported in all NDB releases based on MySQL 5.7)
<code>--version,</code> <code>-V</code>	Display version information and exit	(Supported in all NDB releases based on MySQL 5.7)

- `--character-sets-dir`

Command-Line Format	<code>--character-sets-dir=path</code>
---------------------	--

Directory containing character sets.

- `--connect-retries`

Command-Line Format	<code>--connect-retries=#</code>
Type	Integer
Default Value	12
Minimum Value	0
Maximum Value	12

Number of times to retry connection before giving up.

- `--connect-retry-delay`

Command-Line Format	<code>--connect-retry-delay=#</code>
Type	Integer
Default Value	5
Minimum Value	0
Maximum Value	5

Number of seconds to wait between attempts to contact management server.

- `--connect-string`

Command-Line Format	<code>--connect-string=connection_string</code>
Type	String

Default Value	[none]
---------------	--------

Same as `--ndb-connectstring`.

- `--core-file`

Command-Line Format	<code>--core-file</code>
---------------------	--------------------------

Write core file on error; used in debugging.

- `--database=dbname, -d dbname`

Name of the database in which the table is found. The default value is `TEST_DB`.

- `--descending, -z`

Sorts the output in descending order. This option can be used only in conjunction with the `-o` (`--order`) option.

- `--defaults-extra-file`

Command-Line Format	<code>--defaults-extra-file=path</code>
Type	String
Default Value	[none]

Read given file after global files are read.

- `--defaults-file`

Command-Line Format	<code>--defaults-file=path</code>
Type	String
Default Value	[none]

Read default options from given file only.

- `--defaults-group-suffix`

Command-Line Format	<code>--defaults-group-suffix=string</code>
Type	String
Default Value	[none]

Also read groups with `concat(group, suffix)`.

- `--delimiter=character, -D character`

Causes the `character` to be used as a column delimiter. Only table data columns are separated by this delimiter.

The default delimiter is the tab character.

- `--disk`

Adds a disk reference column to the output. The column is nonempty only for Disk Data tables having nonindexed columns.

- `--gci`

Adds a `GCI` column to the output showing the global checkpoint at which each row was last updated. See [Section 21.2, “NDB Cluster Overview”](#), and [Section 21.6.3.2, “NDB Cluster Log Events”](#), for more information about checkpoints.

- `--gci64`

Adds a `ROW$GCI64` column to the output showing the global checkpoint at which each row was last updated, as well as the number of the epoch in which this update occurred.

- `--help`

Command-Line Format	<code>--help</code>
---------------------	---------------------

Display help text and exit.

- `--lock=lock_type, -l lock_type`

Employs a lock when reading the table. Possible values for `lock_type` are:

- `0`: Read lock
- `1`: Read lock with hold
- `2`: Exclusive read lock

There is no default value for this option.

- `--login-path`

Command-Line Format	<code>--login-path=path</code>
Type	String
Default Value	[none]

Read given path from login file.

- `--header=FALSE`

Excludes column headers from the output.

- `--nodata`

Causes any table data to be omitted.

- `--ndb-connectstring`

Command-Line Format	<code>--ndb-connectstring=connection_string</code>
Type	String
Default Value	[none]

Set connect string for connecting to `ndb_mgmd`. Syntax: "[nodeid=id;][host=]hostname[:port]". Overrides entries in `NDB_CONNECTSTRING` and `my.cnf`.

- `--ndb-mgmd-host`

Command-Line Format	<code>--ndb-mgmd-host=connection_string</code>
Type	String
Default Value	[none]

Same as `--ndb-connectstring`.

- `--ndb-nodeid`

Command-Line Format	<code>--ndb-nodeid=#</code>
Type	Integer
Default Value	[none]

Set node ID for this node, overriding any ID set by `--ndb-connectstring`.

- `--ndb-optimized-node-selection`

Command-Line Format	<code>--ndb-optimized-node-selection</code>
---------------------	---

Enable optimizations for selection of nodes for transactions. Enabled by default; use `--skip-ndb-optimized-node-selection` to disable.

- `--no-defaults`

Command-Line Format	<code>--no-defaults</code>
---------------------	----------------------------

Do not read default options from any option file other than login file.

- `--order=index_name, -o index_name`

Orders the output according to the index named `index_name`.



**Note**

This is the name of an index, not of a column; the index must have been explicitly named when created.

- `parallelism=#, -p #`

Specifies the degree of parallelism.

- `--print-defaults`

Command-Line Format	<code>--print-defaults</code>
---------------------	-------------------------------

Print program argument list and exit.

- `--rowid`

Adds a `ROWID` column providing information about the fragments in which rows are stored.

- `--tupscan, -t`

Scan the table in the order of the tuples.

- `--usage`

Command-Line Format	<code>--usage</code>
---------------------	----------------------

Display help text and exit; same as `--help`.

- `--useHexFormat -x`

Causes all numeric values to be displayed in hexadecimal format. This does not affect the output of numerals contained in strings or datetime values.

- `--version`

Command-Line Format	<code>--version</code>
---------------------	------------------------

Display version information and exit.

## Sample Output

Output from a MySQL `SELECT` statement:

```
mysql> SELECT * FROM ctest1.fish;
+----+-----+
| id | name   |
+----+-----+
| 3  | shark  |
| 6  | puffer |
| 2  | tuna   |
| 4  | manta ray |
| 5  | grouper |
| 1  | guppy  |
+----+-----+
6 rows in set (0.04 sec)
```

Output from the equivalent invocation of `ndb_select_all`:

```
$> ./ndb_select_all -c localhost fish -d ctest1
id      name
3       [shark]
6       [puffer]
2       [tuna]
4       [manta ray]
5       [grouper]
1       [guppy]
6 rows returned

NDBT_ProgramExit: 0 - OK
```

All string values are enclosed by square brackets (`[...]`) in the output of `ndb_select_all`. For another example, consider the table created and populated as shown here:

```
CREATE TABLE dogs (
  id INT(11) NOT NULL AUTO_INCREMENT,
  name VARCHAR(25) NOT NULL,
  breed VARCHAR(50) NOT NULL,
  PRIMARY KEY pk (id),
  KEY ix (name)
)
TABLESPACE ts STORAGE DISK
ENGINE=NDBCLUSTER;

INSERT INTO dogs VALUES
  ('', 'Lassie', 'collie'),
  ('', 'Scooby-Doo', 'Great Dane'),
```

```
('', 'Rin-Tin-Tin', 'Alsatian'),
('', 'Rosscoe', 'Mutt');
```

This demonstrates the use of several additional `ndb_select_all` options:

```
$> ./ndb_select_all -d ctest1 dogs -o ix -z --gci --disk
GCI      id name      breed      DISK_REF
834461   2 [Scooby-Doo] [Great Dane] [ m_file_no: 0 m_page: 98 m_page_idx: 0 ]
834878   4 [Rosscoe]    [Mutt]      [ m_file_no: 0 m_page: 98 m_page_idx: 16 ]
834463   3 [Rin-Tin-Tin] [Alsatian]  [ m_file_no: 0 m_page: 34 m_page_idx: 0 ]
835657   1 [Lassie]     [Collie]    [ m_file_no: 0 m_page: 66 m_page_idx: 0 ]
4 rows returned

NDBT_ProgramExit: 0 - OK
```

## 21.5.26 ndb\_select\_count — Print Row Counts for NDB Tables

`ndb_select_count` prints the number of rows in one or more NDB tables. With a single table, the result is equivalent to that obtained by using the MySQL statement `SELECT COUNT(*) FROM tbl_name`.

### Usage

```
ndb_select_count [-c connection_string] -ddb_name tbl_name[, tbl_name2[, ...]]
```

Options that can be used with `ndb_select_count` are shown in the following table. Additional descriptions follow the table.

**Table 21.42 Command-line options used with the program `ndb_select_count`**

Format	Description	Added, Deprecated, or Removed
<code>--character-sets-dir=path</code>	Directory containing character sets	(Supported in all NDB releases based on MySQL 5.7)
<code>--connect-retries=#</code>	Number of times to retry connection before giving up	(Supported in all NDB releases based on MySQL 5.7)
<code>--connect-retry-delay=#</code>	Number of seconds to wait between attempts to contact management server	(Supported in all NDB releases based on MySQL 5.7)
<code>--connect-string=connection_string,</code> <code>-c connection_string</code>	Same as <code>--ndb-connectstring</code>	(Supported in all NDB releases based on MySQL 5.7)
<code>--core-file</code>	Write core file on error; used in debugging	(Supported in all NDB releases based on MySQL 5.7)
<code>--database=name,</code> <code>-d name</code>	Name of database in which table is found	(Supported in all NDB releases based on MySQL 5.7)
<code>--defaults-extra-file=path</code>	Read given file after global files are read	(Supported in all NDB releases based on MySQL 5.7)
<code>--defaults-file=path</code>	Read default options from given file only	(Supported in all NDB releases based on MySQL 5.7)
<code>--defaults-group-suffix=string</code>	Also read groups with <code>concat(group, suffix)</code>	(Supported in all NDB releases based on MySQL 5.7)
<code>--help,</code> <code>-?</code>	Display help text and exit	(Supported in all NDB releases based on MySQL 5.7)

Format	Description	Added, Deprecated, or Removed
<code>--lock=#,</code> <code>-l #</code>	Lock type	(Supported in all NDB releases based on MySQL 5.7)
<code>--login-path=path</code>	Read given path from login file	(Supported in all NDB releases based on MySQL 5.7)
<code>--ndb-connectstring=connection_string</code> <code>-c connection_string</code>	Set connect string for connecting to ndb_mgmd. Syntax: "[nodeid=id;][host=]hostname[:port]". Overrides entries in NDB_CONNECTSTRING and my.cnf	(Supported in all NDB releases based on MySQL 5.7)
<code>--ndb-mgmd-host=connection_string,</code> <code>-c connection_string</code>	Same as <code>--ndb-connectstring</code>	(Supported in all NDB releases based on MySQL 5.7)
<code>--ndb-nodeid=#</code>	Set node ID for this node, overriding any ID set by <code>--ndb-connectstring</code>	(Supported in all NDB releases based on MySQL 5.7)
<code>--ndb-optimized-node-selection</code>	Enable optimizations for selection of nodes for transactions. Enabled by default; use <code>--skip-ndb-optimized-node-selection</code> to disable	(Supported in all NDB releases based on MySQL 5.7)
<code>--no-defaults</code>	Do not read default options from any option file other than login file	(Supported in all NDB releases based on MySQL 5.7)
<code>--parallelism=#,</code> <code>-p #</code>	Degree of parallelism	(Supported in all NDB releases based on MySQL 5.7)
<code>--print-defaults</code>	Print program argument list and exit	(Supported in all NDB releases based on MySQL 5.7)
<code>--usage,</code> <code>-?</code>	Display help text and exit; same as <code>--help</code>	(Supported in all NDB releases based on MySQL 5.7)
<code>--version,</code> <code>-V</code>	Display version information and exit	(Supported in all NDB releases based on MySQL 5.7)

- `--character-sets-dir`

Command-Line Format	<code>--character-sets-dir=path</code>
---------------------	--

Directory containing character sets.

- `--connect-retries`

Command-Line Format	<code>--connect-retries=#</code>
Type	Integer

Default Value	12
Minimum Value	0
Maximum Value	12

Number of times to retry connection before giving up.

- `--connect-retry-delay`

Command-Line Format	<code>--connect-retry-delay=#</code>
Type	Integer
Default Value	5
Minimum Value	0
Maximum Value	5

Number of seconds to wait between attempts to contact management server.

- `--connect-string`

Command-Line Format	<code>--connect-string=connection_string</code>
Type	String
Default Value	[none]

Same as `--ndb-connectstring`.

- `--core-file`

Command-Line Format	<code>--core-file</code>
---------------------	--------------------------

Write core file on error; used in debugging.

- `--defaults-file`

Command-Line Format	<code>--defaults-file=path</code>
Type	String
Default Value	[none]

Read default options from given file only.

- `--defaults-extra-file`

Command-Line Format	<code>--defaults-extra-file=path</code>
Type	String
Default Value	[none]

Read given file after global files are read.

- `--defaults-group-suffix`

Command-Line Format	<code>--defaults-group-suffix=string</code>
Type	String



Default Value	[none]
---------------	--------

Also read groups with `concat(group, suffix)`.

- `--login-path`

Command-Line Format	<code>--login-path=path</code>
Type	String
Default Value	[none]

Read given path from login file.

- `--help`

Command-Line Format	<code>--help</code>
---------------------	---------------------

Display help text and exit.

- `--ndb-connectstring`

Command-Line Format	<code>--ndb-connectstring=connection_string</code>
Type	String
Default Value	[none]

Set connect string for connecting to `ndb_mgmd`. Syntax: "[nodeid=id;][host=]hostname[:port]". Overrides entries in `NDB_CONNECTSTRING` and `my.cnf`.

- `--ndb-mgmd-host`

Command-Line Format	<code>--ndb-mgmd-host=connection_string</code>
Type	String
Default Value	[none]

Same as `--ndb-connectstring`.

- `--ndb-optimized-node-selection`

Command-Line Format	<code>--ndb-optimized-node-selection</code>
---------------------	---

Enable optimizations for selection of nodes for transactions. Enabled by default; use `--skip-ndb-optimized-node-selection` to disable.

- `--ndb-nodeid`

Command-Line Format	<code>--ndb-nodeid=#</code>
Type	Integer
Default Value	[none]

Set node ID for this node, overriding any ID set by `--ndb-connectstring`.

- `--no-defaults`

Command-Line Format	<code>--no-defaults</code>
---------------------	----------------------------

Do not read default options from any option file other than login file.

- `--print-defaults`

Command-Line Format	<code>--print-defaults</code>
---------------------	-------------------------------

Print program argument list and exit.

- `--usage`

Command-Line Format	<code>--usage</code>
---------------------	----------------------

Display help text and exit; same as `--help`.

- `--version`

Command-Line Format	<code>--version</code>
---------------------	------------------------

Display version information and exit.

You can obtain row counts from multiple tables in the same database by listing the table names separated by spaces when invoking this command, as shown under **Sample Output**.

## Sample Output

```
$> ./ndb_select_count -c localhost -d ctest1 fish dogs
6 records in table fish
4 records in table dogs

NDBT_ProgramExit: 0 - OK
```

## 21.5.27 ndb\_show\_tables — Display List of NDB Tables

`ndb_show_tables` displays a list of all NDB database objects in the cluster. By default, this includes not only both user-created tables and NDB system tables, but NDB-specific indexes, internal triggers, and NDB Cluster Disk Data objects as well.

Options that can be used with `ndb_show_tables` are shown in the following table. Additional descriptions follow the table.

**Table 21.43 Command-line options used with the program `ndb_show_tables`**

Format	Description	Added, Deprecated, or Removed
<code>--character-sets-dir=path</code>	Directory containing character sets	(Supported in all NDB releases based on MySQL 5.7)
<code>--connect-retries=#</code>	Number of times to retry connection before giving up	(Supported in all NDB releases based on MySQL 5.7)
<code>--connect-retry-delay=#</code>	Number of seconds to wait between attempts to contact management server	(Supported in all NDB releases based on MySQL 5.7)

Format	Description	Added, Deprecated, or Removed
<code>--connect-string=connection_string,</code> <code>-c connection_string</code>	Same as <code>--ndb-connectstring</code>	(Supported in all NDB releases based on MySQL 5.7)
<code>--core-file</code>	Write core file on error; used in debugging	(Supported in all NDB releases based on MySQL 5.7)
<code>--database=name,</code> <code>-d name</code>	Specifies database in which table is found; database name must be followed by table name	(Supported in all NDB releases based on MySQL 5.7)
<code>--defaults-extra-file=path</code>	Read given file after global files are read	(Supported in all NDB releases based on MySQL 5.7)
<code>--defaults-file=path</code>	Read default options from given file only	(Supported in all NDB releases based on MySQL 5.7)
<code>--defaults-group-suffix=string</code>	Also read groups with <code>concat(group, suffix)</code>	(Supported in all NDB releases based on MySQL 5.7)
<code>--login-path=path</code>	Read given path from login file	(Supported in all NDB releases based on MySQL 5.7)
<code>--loops=#,</code> <code>-l #</code>	Number of times to repeat output	(Supported in all NDB releases based on MySQL 5.7)
<code>--help,</code> <code>-?</code>	Display help text and exit	(Supported in all NDB releases based on MySQL 5.7)
<code>--ndb-connectstring=connection_string,</code> <code>-c connection_string</code>	Set connect string for connecting to <code>ndb_mgmd</code> . Syntax: "[nodeid=id;][host=]hostname[:port]". Overrides entries in <code>NDB_CONNECTSTRING</code> and <code>my.cnf</code>	(Supported in all NDB releases based on MySQL 5.7)
<code>--ndb-mgmd-host=connection_string,</code> <code>-c connection_string</code>	Same as <code>--ndb-connectstring</code>	(Supported in all NDB releases based on MySQL 5.7)
<code>--ndb-nodeid=#</code>	Set node ID for this node, overriding any ID set by <code>--ndb-connectstring</code>	(Supported in all NDB releases based on MySQL 5.7)
<code>--ndb-optimized-node-selection</code>	Enable optimizations for selection of nodes for transactions. Enabled by default; use <code>--skip-ndb-optimized-node-selection</code> to disable	(Supported in all NDB releases based on MySQL 5.7)
<code>--no-defaults</code>	Do not read default options from any option file other than login file	(Supported in all NDB releases based on MySQL 5.7)
<code>--parsable,</code> <code>-p</code>	Return output suitable for MySQL LOAD DATA statement	(Supported in all NDB releases based on MySQL 5.7)

Format	Description	Added, Deprecated, or Removed
<code>--print-defaults</code>	Print program argument list and exit	(Supported in all NDB releases based on MySQL 5.7)
<code>--show-temp-status</code>	Show table temporary flag	(Supported in all NDB releases based on MySQL 5.7)
<code>--type=#,</code> <code>-t #</code>	Limit output to objects of this type	(Supported in all NDB releases based on MySQL 5.7)
<code>--unqualified,</code> <code>-u</code>	Do not qualify table names	(Supported in all NDB releases based on MySQL 5.7)
<code>--usage,</code> <code>-?</code>	Display help text and exit; same as <code>--help</code>	(Supported in all NDB releases based on MySQL 5.7)
<code>--version,</code> <code>-V</code>	Display version information and exit	(Supported in all NDB releases based on MySQL 5.7)

## Usage

```
ndb_show_tables [-c connection_string]
```

- `--character-sets-dir`

Command-Line Format	<code>--character-sets-dir=path</code>
---------------------	--

Directory containing character sets.

- `--connect-retries`

Command-Line Format	<code>--connect-retries=#</code>
Type	Integer
Default Value	12
Minimum Value	0
Maximum Value	12

Number of times to retry connection before giving up.

- `--connect-retry-delay`

Command-Line Format	<code>--connect-retry-delay=#</code>
Type	Integer
Default Value	5
Minimum Value	0
Maximum Value	5

Number of seconds to wait between attempts to contact management server.

- `--connect-string`

Command-Line Format	<code>--connect-string=connection_string</code>
Type	String
Default Value	[none]

Same as `--ndb-connectstring`.

- `--core-file`

Command-Line Format	<code>--core-file</code>
---------------------	--------------------------

Write core file on error; used in debugging.

- `--database, -d`

Specifies the name of the database in which the desired table is found. If this option is given, the name of a table must follow the database name.

If this option has not been specified, and no tables are found in the `TEST_DB` database, `ndb_show_tables` issues a warning.

- `--defaults-extra-file`

Command-Line Format	<code>--defaults-extra-file=path</code>
Type	String
Default Value	[none]

Read given file after global files are read.

- `--defaults-file`

Command-Line Format	<code>--defaults-file=path</code>
Type	String
Default Value	[none]

Read default options from given file only.

- `--defaults-group-suffix`

Command-Line Format	<code>--defaults-group-suffix=string</code>
Type	String
Default Value	[none]

Also read groups with `concat(group, suffix)`.

- `--help`

Command-Line Format	<code>--help</code>
---------------------	---------------------

Display help text and exit.

- `--login-path`

Command-Line Format	<code>--login-path=path</code>
Type	String
Default Value	[none]

Read given path from login file.

- `--loops, -l`

Specifies the number of times the utility should execute. This is 1 when this option is not specified, but if you do use the option, you must supply an integer argument for it.

- `--ndb-connectstring`

Command-Line Format	<code>--ndb-connectstring=connection_string</code>
Type	String
Default Value	[none]

Set connect string for connecting to ndb\_mgmd. Syntax: "[nodeid=id;][host=]hostname[:port]". Overrides entries in NDB\_CONNECTSTRING and my.cnf.

- `--ndb-mgmd-host`

Command-Line Format	<code>--ndb-mgmd-host=connection_string</code>
Type	String
Default Value	[none]

Same as `--ndb-connectstring`.

- `--ndb-nodeid`

Command-Line Format	<code>--ndb-nodeid=#</code>
Type	Integer
Default Value	[none]

Set node ID for this node, overriding any ID set by `--ndb-connectstring`.

- `--ndb-optimized-node-selection`

Command-Line Format	<code>--ndb-optimized-node-selection</code>
---------------------	---

Enable optimizations for selection of nodes for transactions. Enabled by default; use `--skip-ndb-optimized-node-selection` to disable.

- `--no-defaults`

Command-Line Format	<code>--no-defaults</code>
---------------------	----------------------------

Do not read default options from any option file other than login file.

- `--parsable, -p`

Using this option causes the output to be in a format suitable for use with `LOAD DATA`.

- `--print-defaults`

Command-Line Format	<code>--print-defaults</code>
---------------------	-------------------------------

Print program argument list and exit.

- `--show-temp-status`

If specified, this causes temporary tables to be displayed.

- `--type, -t`

Can be used to restrict the output to one type of object, specified by an integer type code as shown here:

- 1: System table
- 2: User-created table
- 3: Unique hash index

Any other value causes all `NDB` database objects to be listed (the default).

- `--unqualified, -u`

If specified, this causes unqualified object names to be displayed.

- `--usage`

Command-Line Format	<code>--usage</code>
---------------------	----------------------

Display help text and exit; same as `--help`.

- `--version`

Command-Line Format	<code>--version</code>
---------------------	------------------------

Display version information and exit.



**Note**

Only user-created `NDB` Cluster tables may be accessed from `MySQL`; system tables such as `SYSTAB_0` are not visible to `mysqld`. However, you can examine the contents of system tables using `NDB` API applications such as `ndb_select_all` (see [Section 21.5.25, “ndb\\_select\\_all — Print Rows from an NDB Table”](#)).

Prior to `NDB 7.5.18` and `7.6.14`, this program printed `NDBT_ProgramExit - status` upon completion of its run, due to an unnecessary dependency on the `NDBT` testing library. This dependency is has now been removed, eliminating the extraneous output.

## 21.5.28 ndb\_size.pl — NDBCLUSTER Size Requirement Estimator

This is a `Perl` script that can be used to estimate the amount of space that would be required by a `MySQL` database if it were converted to use the `NDBCLUSTER` storage engine. Unlike the other utilities discussed

in this section, it does not require access to an NDB Cluster (in fact, there is no reason for it to do so). However, it does need to access the MySQL server on which the database to be tested resides.

## Requirements

- A running MySQL server. The server instance does not have to provide support for NDB Cluster.
- A working installation of Perl.
- The `DBI` module, which can be obtained from CPAN if it is not already part of your Perl installation. (Many Linux and other operating system distributions provide their own packages for this library.)
- A MySQL user account having the necessary privileges. If you do not wish to use an existing account, then creating one using `GRANT USAGE ON db_name.*`—where `db_name` is the name of the database to be examined—is sufficient for this purpose.

`ndb_size.pl` can also be found in the MySQL sources in `storage/ndb/tools`.

Options that can be used with `ndb_size.pl` are shown in the following table. Additional descriptions follow the table.

**Table 21.44 Command-line options used with the program `ndb_size.pl`**

Format	Description	Added, Deprecated, or Removed
<code>--database=string</code>	Database or databases to examine; a comma-delimited list; default is ALL (use all databases found on server)	(Supported in all NDB releases based on MySQL 5.7)
<code>--hostname=string</code>	Specify host and optional port in host[:port] format	(Supported in all NDB releases based on MySQL 5.7)
<code>--socket=path</code>	Specify socket to connect to	(Supported in all NDB releases based on MySQL 5.7)
<code>--user=string</code>	Specify MySQL user name	(Supported in all NDB releases based on MySQL 5.7)
<code>--password=password</code>	Specify MySQL user password	(Supported in all NDB releases based on MySQL 5.7)
<code>--format=string</code>	Set output format (text or HTML)	(Supported in all NDB releases based on MySQL 5.7)
<code>--excludetables=list</code>	Skip any tables in comma-separated list	(Supported in all NDB releases based on MySQL 5.7)
<code>--excludedbs=list</code>	Skip any databases in comma-separated list	(Supported in all NDB releases based on MySQL 5.7)
<code>--savequeries=path</code>	Saves all queries on database into file specified	(Supported in all NDB releases based on MySQL 5.7)
<code>--loadqueries=path</code>	Loads all queries from file specified; does not connect to database	(Supported in all NDB releases based on MySQL 5.7)
<code>--real_table_name=string</code>	Designates table to handle unique index size calculations	(Supported in all NDB releases based on MySQL 5.7)

## Usage

```
perl ndb_size.pl [--database={db_name|ALL}] [--hostname=host[:port]] [--socket=socket] \
```



```
[--user=user] [--password=password] \  
[--help|-h] [--format={html|text}] \  
[--loadqueries=file_name] [--savequeries=file_name]
```

By default, this utility attempts to analyze all databases on the server. You can specify a single database using the `--database` option; the default behavior can be made explicit by using `ALL` for the name of the database. You can also exclude one or more databases by using the `--excludedbs` option with a comma-separated list of the names of the databases to be skipped. Similarly, you can cause specific tables to be skipped by listing their names, separated by commas, following the optional `--excludetables` option. A host name can be specified using `--hostname`; the default is `localhost`. You can specify a port in addition to the host using `host:port` format for the value of `--hostname`. The default port number is 3306. If necessary, you can also specify a socket; the default is `/var/lib/mysql.sock`. A MySQL user name and password can be specified the corresponding options shown. It also possible to control the format of the output using the `--format` option; this can take either of the values `html` or `text`, with `text` being the default. An example of the text output is shown here:

```
$> ndb_size.pl --database=test --socket=/tmp/mysql.sock  
ndb_size.pl report for database: 'test' (1 tables)  
-----  
Connected to: DBI:mysql:host=localhost;mysql_socket=/tmp/mysql.sock  
  
Including information for versions: 4.1, 5.0, 5.1  
  
test.tl  
-----  
DataMemory for Columns (* means var sized DataMemory):  
  Column Name      Type  Var sized  Key  4.1  5.0  5.1  
  -----  
  HIDDEN_NDB_PKEY  bigint  PRI      8    8    8  
  c2                varchar(50)  Y    52  52  4*  
  c1                int(11)      4    4    4  
  -----  
  Fixed Size Columns DM/Row      64  64  12  
  Var size Columns DM/Row       0   0   4  
  
DataMemory for Indexes:  
  Index Name      Type      4.1      5.0      5.1  
  -----  
  PRIMARY        BTREE     16       16       16  
  -----  
  Total Index DM/Row      16      16      16  
  
IndexMemory for Indexes:  
  Index Name      4.1      5.0      5.1  
  -----  
  PRIMARY        33       16       16  
  -----  
  Indexes IM/Row      33       16       16  
  
Summary (for THIS table):  
  4.1      5.0      5.1  
  -----  
  Fixed Overhead DM/Row      12      12      16  
  NULL Bytes/Row            4        4        4  
  DataMemory/Row           96       96       48  
  (Includes overhead, bitmap and indexes)  
  
  Var size Overhead DM/Row      0        0        8  
  Var size NULL Bytes/Row      0        0        4  
  Avg Var side DM/Row         0        0       16  
  
  No. Rows                0        0        0  
  
  Rows/32kb DM Page       340      340      680  
  Fixedsize DataMemory (KB)  0        0        0  
  
  Rows/32kb Var size DM Page  0        0      2040  
  Var size DataMemory (KB)  0        0        0
```

Rows/8kb IM Page	248	512	512	
IndexMemory (KB)	0	0	0	
Parameter Minimum Requirements				
-----				
* indicates greater than default				
Parameter	Default	4.1	5.0	5.1
DataMemory (KB)	81920	0	0	0
NoOfOrderedIndexes	128	1	1	1
NoOfTables	128	1	1	1
IndexMemory (KB)	18432	0	0	0
NoOfUniqueHashIndexes	64	0	0	0
NoOfAttributes	1000	3	3	3
NoOfTriggers	768	5	5	5

For debugging purposes, the Perl arrays containing the queries run by this script can be read from the file specified using `--savequeries`; a file containing such arrays to be read during script execution can be specified using `--loadqueries`. Neither of these options has a default value.

To produce output in HTML format, use the `--format` option and redirect the output to a file, as shown here:

```
$> ndb_size.pl --database=test --socket=/tmp/mysql.sock --format=html > ndb_size.html
```

(Without the redirection, the output is sent to `stdout`.)

The output from this script includes the following information:

- Minimum values for the `DataMemory`, `IndexMemory`, `MaxNoOfTables`, `MaxNoOfAttributes`, `MaxNoOfOrderedIndexes`, and `MaxNoOfTriggers` configuration parameters required to accommodate the tables analyzed.
- Memory requirements for all of the tables, attributes, ordered indexes, and unique hash indexes defined in the database.
- The `IndexMemory` and `DataMemory` required per table and table row.

## 21.5.29 ndb\_top — View CPU usage information for NDB threads

`ndb_top` displays running information in the terminal about CPU usage by NDB threads on an NDB Cluster data node. Each thread is represented by two rows in the output, the first showing system statistics, the second showing the measured statistics for the thread.

`ndb_top` is available in MySQL NDB Cluster 7.6 (and later).

### Usage

```
ndb_top [-h hostname] [-t port] [-u user] [-p pass] [-n node_id]
```

`ndb_top` connects to a MySQL Server running as an SQL node of the cluster. By default, it attempts to connect to a `mysqld` running on `localhost` and port 3306, as the MySQL `root` user with no password specified. You can override the default host and port using, respectively, `--host` (`-h`) and `--port` (`-t`). To specify a MySQL user and password, use the `--user` (`-u`) and `--passwd` (`-p`) options. This user must be able to read tables in the `ndbinfo` database (`ndb_top` uses information from `ndbinfo.cpusstat` and related tables).

For more information about MySQL user accounts and passwords, see [Section 6.2, “Access Control and Account Management”](#).

Output is available as plain text or an ASCII graph; you can specify this using the `--text (-x)` and `--graph (-g)` options, respectively. These two display modes provide the same information; they can be used concurrently. At least one display mode must be in use.

Color display of the graph is supported and enabled by default (`--color` or `-c` option). With color support enabled, the graph display shows OS user time in blue, OS system time in green, and idle time as blank. For measured load, blue is used for execution time, yellow for send time, red for time spent in send buffer full waits, and blank spaces for idle time. The percentage shown in the graph display is the sum of percentages for all threads which are not idle. Colors are not currently configurable; you can use grayscale instead by using `--skip-color`.

The sorted view (`--sort, -r`) is based on the maximum of the measured load and the load reported by the OS. Display of these can be enabled and disabled using the `--measured-load (-m)` and `--os-load (-o)` options. Display of at least one of these loads must be enabled.

The program tries to obtain statistics from a data node having the node ID given by the `--node-id (-n)` option; if unspecified, this is 1. `ndb_top` cannot provide information about other types of nodes.

The view adjusts itself to the height and width of the terminal window; the minimum supported width is 76 characters.

Once started, `ndb_top` runs continuously until forced to exit; you can quit the program using `Ctrl-C`. The display updates once per second; to set a different delay interval, use `--sleep-time (-s)`.



**Note**

`ndb_top` is available on macOS, Linux, and Solaris. It is not currently supported on Windows platforms.

The following table includes all options that are specific to the NDB Cluster program `ndb_top`. Additional descriptions follow the table.

**Table 21.45 Command-line options used with the program `ndb_top`**

Format	Description	Added, Deprecated, or Removed
<code>--color,</code> <code>-c</code>	Show ASCII graphs in color; use <code>--skip-colors</code> to disable	ADDED: NDB 7.6.3
<code>--defaults-extra-file=path</code>	Read given file after global files are read	(Supported in all NDB releases based on MySQL 5.7)
<code>--defaults-file=path</code>	Read default options from given file only	(Supported in all NDB releases based on MySQL 5.7)
<code>--defaults-group-suffix=string</code>	Also read groups with <code>concat(group, suffix)</code>	(Supported in all NDB releases based on MySQL 5.7)
<code>--graph,</code> <code>-g</code>	Display data using graphs; use <code>--skip-graphs</code> to disable	ADDED: NDB 7.6.3
<code>--help</code>	Show program usage information	ADDED: NDB 7.6.3
<code>--host=string,</code> <code>-h string</code>	Host name or IP address of MySQL Server to connect to	ADDED: NDB 7.6.3
<code>--login-path=path</code>	Read given path from login file	(Supported in all NDB releases based on MySQL 5.7)

Format	Description	Added, Deprecated, or Removed
<code>--measured-load,</code> <code>-m</code> <code>--no-defaults</code> <code>--node-id=#,</code> <code>-n #</code> <code>--os-load,</code> <code>-o</code> <code>--passwd=password,</code> <code>-p password</code> <code>--password=password,</code> <code>-p password</code> <code>--port=#,</code> <code>-t # (&lt;=7.6.5),</code> <code>-P # (&gt;=7.6.6)</code> <code>--print-defaults</code> <code>--sleep-time=#,</code> <code>-s #</code> <code>--socket=path,</code> <code>-S path</code> <code>--sort,</code> <code>-r</code> <code>--text,</code> <code>-x (&lt;=7.6.5),</code> <code>-t (&gt;=7.6.6)</code> <code>--usage</code> <code>--user=name,</code> <code>-u name</code>	Show measured load by thread  Do not read default options from any option file other than login file  Watch node having this node ID  Show load measured by operating system  Connect using this password (same as --password option)  Connect using this password  Port number to use when connecting to MySQL Server  Print program argument list and exit  Time to wait between display refreshes, in seconds  Socket file to use for connection  Sort threads by usage; use --skip-sort to disable  Display data using text  Show program usage information; same as --help  Connect as this MySQL user	ADDED: NDB 7.6.3  (Supported in all NDB releases based on MySQL 5.7) ADDED: NDB 7.6.3  ADDED: NDB 7.6.3  ADDED: NDB 7.6.3 REMOVED: NDB 7.6.4 ADDED: NDB 7.6.6  ADDED: NDB 7.6.3  (Supported in all NDB releases based on MySQL 5.7) ADDED: NDB 7.6.3  ADDED: NDB 7.6.6  ADDED: NDB 7.6.3  ADDED: NDB 7.6.3  ADDED: NDB 7.6.3

## Additional Options

- `--color, -c`

Command-Line Format	<code>--color</code>
---------------------	----------------------

Introduced	5.7.19-ndb-7.6.3
------------	------------------

Show ASCII graphs in color; use `--skip-colors` to disable.

- `--defaults-extra-file`

Command-Line Format	<code>--defaults-extra-file=path</code>
Type	String
Default Value	[none]

Read given file after global files are read.

- `--defaults-file`

Command-Line Format	<code>--defaults-file=path</code>
Type	String
Default Value	[none]

Read default options from given file only.

- `--defaults-group-suffix`

Command-Line Format	<code>--defaults-group-suffix=string</code>
Type	String
Default Value	[none]

Also read groups with `concat(group, suffix)`.

- `--graph, -g`

Command-Line Format	<code>--graph</code>
Introduced	5.7.19-ndb-7.6.3

Display data using graphs; use `--skip-graphs` to disable. This option or `--text` must be true; both options may be true.

- `--help, -?`

Command-Line Format	<code>--help</code>
Introduced	5.7.19-ndb-7.6.3

Show program usage information.

- `--host[=name], -h`

Command-Line Format	<code>--host=string</code>
Introduced	5.7.19-ndb-7.6.3
Type	String
Default Value	localhost

Host name or IP address of MySQL Server to connect to.

- `--login-path`

Command-Line Format	<code>--login-path=path</code>
Type	String
Default Value	[none]

Read given path from login file.

- `--measured-load, -m`

Command-Line Format	<code>--measured-load</code>
Introduced	5.7.19-ndb-7.6.3

Show measured load by thread. This option or `--os-load` must be true; both options may be true.

- `--no-defaults`

Command-Line Format	<code>--no-defaults</code>
---------------------	----------------------------

Do not read default options from any option file other than login file.

- `--node-id[=#], -n`

Command-Line Format	<code>--node-id=#</code>
Introduced	5.7.19-ndb-7.6.3
Type	Integer
Default Value	1

Watch the data node having this node ID.

- `--os-load, -o`

Command-Line Format	<code>--os-load</code>
Introduced	5.7.19-ndb-7.6.3

Show load measured by operating system. This option or `--measured-load` must be true; both options may be true.

- `--passwd[=password], -p`

Command-Line Format	<code>--passwd=password</code>
Introduced	5.7.19-ndb-7.6.3
Removed	5.7.20-ndb-7.6.4
Type	String
Default Value	NULL

Connect to a MySQL Server using this password and the MySQL user specified by `--user`. Synonym for `--password`.

This password is associated with a MySQL user account only, and is not related in any way to the password used with encrypted NDB backups.

- `--password[=password], -p`

Command-Line Format	<code>--password=<i>password</i></code>
Introduced	5.7.22-ndb-7.6.6
Type	String
Default Value	NULL

Connect to a MySQL Server using this password and the MySQL user specified by `--user`.

This password is associated with a MySQL user account only, and is not related in any way to the password used with encrypted NDB backups.

- `--port[=#], -P`

Command-Line Format	<code>--port=#</code>
Introduced	5.7.19-ndb-7.6.3
Type	Integer
Default Value	3306

Port number to use when connecting to MySQL Server.

(Formerly, the short form for this option was `-t`, which was repurposed as the short form of `--text`.)

- `--print-defaults`

Command-Line Format	<code>--print-defaults</code>
---------------------	-------------------------------

Print program argument list and exit.

- `--sleep-time[=seconds], -s`

Command-Line Format	<code>--sleep-time=#</code>
Introduced	5.7.19-ndb-7.6.3
Type	Integer
Default Value	1

Time to wait between display refreshes, in seconds.

- `--socket=path/to/file, -S`

Command-Line Format	<code>--socket=<i>path</i></code>
Introduced	5.7.22-ndb-7.6.6
Type	Path name
Default Value	[none]

Use the specified socket file for the connection.

- `--sort, -r`

Command-Line Format	<code>--sort</code>
---------------------	---------------------

Introduced	5.7.19-ndb-7.6.3
------------	------------------

Sort threads by usage; use `--skip-sort` to disable.

- `--text, -t`

Command-Line Format	<code>--text</code>
Introduced	5.7.19-ndb-7.6.3

Display data using text. This option or `--graph` must be true; both options may be true.

(The short form for this option was `-x` in previous versions of NDB Cluster, but this is no longer supported.)

- `--usage`

Command-Line Format	<code>--usage</code>
Introduced	5.7.19-ndb-7.6.3

Display help text and exit; same as `--help`.

- `--user[=name], -u`

Command-Line Format	<code>--user=name</code>
Introduced	5.7.19-ndb-7.6.3
Type	String
Default Value	<code>root</code>

Connect as this MySQL user. Normally requires a password supplied by the `--password` option.

**Sample Output.** The next figure shows `ndb_top` running in a terminal window on a Linux system with an `ndbmta` data node under a moderate load. Here, the program has been invoked using `ndb_top -n8 -x` to provide both text and graph output:



Figure 21.7 ndb\_top Running in Terminal

```

jon@valhaj:....7-cluster-7.6/bin
ldm thr_no 2 OS view [user: 24%, system: 13%, idle: 63%] 37%
ldm thr_no 2 OS view [user: 24%, system: 13%, idle: 63%] 37%
main thr_no 0 OS view [user: 5%, system: 11%, idle: 84%] 16%
main thr_no 0 OS view [user: 5%, system: 11%, idle: 84%] 16%
recv thr_no 3 OS view [user: 3%, system: 10%, idle: 87%] 13%
recv thr_no 3 OS view [user: 3%, system: 10%, idle: 87%] 13%
rep thr_no 1 OS view [user: 0%, system: 0%, idle: 100%] 0%
rep thr_no 1 OS view [user: 0%, system: 0%, idle: 100%] 0%

```

### 21.5.30 ndb\_waiter — Wait for NDB Cluster to Reach a Given Status

`ndb_waiter` repeatedly (each 100 milliseconds) prints out the status of all cluster data nodes until either the cluster reaches a given status or the `--timeout` limit is exceeded, then exits. By default, it waits for the cluster to achieve `STARTED` status, in which all nodes have started and connected to the cluster. This can be overridden using the `--no-contact` and `--not-started` options.

The node states reported by this utility are as follows:

- `NO_CONTACT`: The node cannot be contacted.
- `UNKNOWN`: The node can be contacted, but its status is not yet known. Usually, this means that the node has received a `START` or `RESTART` command from the management server, but has not yet acted on it.
- `NOT_STARTED`: The node has stopped, but remains in contact with the cluster. This is seen when restarting the node using the management client's `RESTART` command.
- `STARTING`: The node's `ndbd` process has started, but the node has not yet joined the cluster.

- **STARTED**: The node is operational, and has joined the cluster.
- **SHUTTING\_DOWN**: The node is shutting down.
- **SINGLE USER MODE**: This is shown for all cluster data nodes when the cluster is in single user mode.

Options that can be used with `ndb_waiter` are shown in the following table. Additional descriptions follow the table.

**Table 21.46 Command-line options used with the program `ndb_waiter`**

Format	Description	Added, Deprecated, or Removed
<code>--character-sets-dir=path</code>	Directory containing character sets	(Supported in all NDB releases based on MySQL 5.7)
<code>--connect-retries=#</code>	Number of times to retry connection before giving up	(Supported in all NDB releases based on MySQL 5.7)
<code>--connect-retry-delay=#</code>	Number of seconds to wait between attempts to contact management server	(Supported in all NDB releases based on MySQL 5.7)
<code>--connect-string=connection_string,</code> <code>-c connection_string</code>	Same as <code>--ndb-connectstring</code>	(Supported in all NDB releases based on MySQL 5.7)
<code>--core-file</code>	Write core file on error; used in debugging	(Supported in all NDB releases based on MySQL 5.7)
<code>--defaults-extra-file=path</code>	Read given file after global files are read	(Supported in all NDB releases based on MySQL 5.7)
<code>--defaults-file=path</code>	Read default options from given file only	(Supported in all NDB releases based on MySQL 5.7)
<code>--defaults-group-suffix=string</code>	Also read groups with <code>concat(group, suffix)</code>	(Supported in all NDB releases based on MySQL 5.7)
<code>--help,</code> <code>-?</code>	Display help text and exit	(Supported in all NDB releases based on MySQL 5.7)
<code>--login-path=path</code>	Read given path from login file	(Supported in all NDB releases based on MySQL 5.7)
<code>--ndb-connectstring=connection_string,</code> <code>-c connection_string</code>	Set connect string for connecting to <code>ndb_mgmd</code> . Syntax: "[nodeid=id;] [host=]hostname[:port]". Overrides entries in <code>NDB_CONNECTSTRING</code> and <code>my.cnf</code>	(Supported in all NDB releases based on MySQL 5.7)
<code>--ndb-mgmd-host=connection_string,</code> <code>-c connection_string</code>	Same as <code>--ndb-connectstring</code>	(Supported in all NDB releases based on MySQL 5.7)
<code>--ndb-nodeid=#</code>	Set node ID for this node, overriding any ID set by <code>--ndb-connectstring</code>	(Supported in all NDB releases based on MySQL 5.7)

Format	Description	Added, Deprecated, or Removed
<code>--ndb-optimized-node-selection</code>	Enable optimizations for selection of nodes for transactions. Enabled by default; use <code>--skip-ndb-optimized-node-selection</code> to disable	(Supported in all NDB releases based on MySQL 5.7)
<code>--no-contact,</code> <code>-n</code>	Wait for cluster to reach NO CONTACT state	(Supported in all NDB releases based on MySQL 5.7)
<code>--no-defaults</code>	Do not read default options from any option file other than login file	(Supported in all NDB releases based on MySQL 5.7)
<code>--not-started</code>	Wait for cluster to reach NOT STARTED state	(Supported in all NDB releases based on MySQL 5.7)
<code>--nowait-nodes=list</code>	List of nodes not to be waited for	(Supported in all NDB releases based on MySQL 5.7)
<code>--print-defaults</code>	Print program argument list and exit	(Supported in all NDB releases based on MySQL 5.7)
<code>--single-user</code>	Wait for cluster to enter single user mode	(Supported in all NDB releases based on MySQL 5.7)
<code>--timeout=#,</code> <code>-t #</code>	Wait this many seconds, then exit whether or not cluster has reached desired state	(Supported in all NDB releases based on MySQL 5.7)
<code>--usage,</code> <code>-?</code>	Display help text and exit; same as <code>--help</code>	(Supported in all NDB releases based on MySQL 5.7)
<code>--version,</code> <code>-V</code>	Display version information and exit	(Supported in all NDB releases based on MySQL 5.7)
<code>--wait-nodes=list,</code> <code>-w list</code>	List of nodes to be waited for	(Supported in all NDB releases based on MySQL 5.7)

## Usage

```
ndb_waiter [-c connection_string]
```

## Additional Options

- `--character-sets-dir`

Command-Line Format	<code>--character-sets-dir=path</code>
---------------------	--

Directory containing character sets.

- `--connect-retries`

Command-Line Format	<code>--connect-retries=#</code>
Type	Integer
Default Value	12

Minimum Value	0
Maximum Value	12

Number of times to retry connection before giving up.

- `--connect-retry-delay`

Command-Line Format	<code>--connect-retry-delay=#</code>
Type	Integer
Default Value	5
Minimum Value	0
Maximum Value	5

Number of seconds to wait between attempts to contact management server.

- `--connect-string`

Command-Line Format	<code>--connect-string=connection_string</code>
Type	String
Default Value	[none]

Same as `--ndb-connectstring`.

- `--core-file`

Command-Line Format	<code>--core-file</code>
---------------------	--------------------------

Write core file on error; used in debugging.

- `--defaults-extra-file`

Command-Line Format	<code>--defaults-extra-file=path</code>
Type	String
Default Value	[none]

Read given file after global files are read.

- `--defaults-file`

Command-Line Format	<code>--defaults-file=path</code>
Type	String
Default Value	[none]

Read default options from given file only.

- `--defaults-group-suffix`

Command-Line Format	<code>--defaults-group-suffix=string</code>
Type	String
Default Value	[none]

Also read groups with `concat(group, suffix)`.

- `--login-path`

Command-Line Format	<code>--login-path=path</code>
Type	String
Default Value	[none]

Read given path from login file.

- `--help`

Command-Line Format	<code>--help</code>
---------------------	---------------------

Display help text and exit.

- `--ndb-connectstring`

Command-Line Format	<code>--ndb-connectstring=connection_string</code>
Type	String
Default Value	[none]

Set connect string for connecting to `ndb_mgmd`. Syntax: "[nodeid=id;][host=]hostname[:port]". Overrides entries in `NDB_CONNECTSTRING` and `my.cnf`.

- `--ndb-mgmd-host`

Command-Line Format	<code>--ndb-mgmd-host=connection_string</code>
Type	String
Default Value	[none]

Same as `--ndb-connectstring`.

- `--ndb-nodeid`

Command-Line Format	<code>--ndb-nodeid=#</code>
Type	Integer
Default Value	[none]

Set node ID for this node, overriding any ID set by `--ndb-connectstring`.

- `--ndb-optimized-node-selection`

Command-Line Format	<code>--ndb-optimized-node-selection</code>
---------------------	---

Enable optimizations for selection of nodes for transactions. Enabled by default; use `--skip-ndb-optimized-node-selection` to disable.

- `--no-contact, -n`

Instead of waiting for the `STARTED` state, `ndb_waiter` continues running until the cluster reaches `NO_CONTACT` status before exiting.

- `--no-defaults`

Command-Line Format	<code>--no-defaults</code>
---------------------	----------------------------

Do not read default options from any option file other than login file.

- `--not-started`

Instead of waiting for the `STARTED` state, `ndb_waiter` continues running until the cluster reaches `NOT_STARTED` status before exiting.

- `--nowait-nodes=list`

When this option is used, `ndb_waiter` does not wait for the nodes whose IDs are listed. The list is comma-delimited; ranges can be indicated by dashes, as shown here:

```
$> ndb_waiter --nowait-nodes=1,3,7-9
```



### Important

Do *not* use this option together with the `--wait-nodes` option.

- `--print-defaults`

Command-Line Format	<code>--print-defaults</code>
---------------------	-------------------------------

Print program argument list and exit.

- `--timeout=seconds, -t seconds`

Time to wait. The program exits if the desired state is not achieved within this number of seconds. The default is 120 seconds (1200 reporting cycles).

- `--single-user`

The program waits for the cluster to enter single user mode.

- `--usage`

Command-Line Format	<code>--usage</code>
---------------------	----------------------

Display help text and exit; same as `--help`.

- `--version`

Command-Line Format	<code>--version</code>
---------------------	------------------------

Display version information and exit.

- `--wait-nodes=list, -w list`

When this option is used, `ndb_waiter` waits only for the nodes whose IDs are listed. The list is comma-delimited; ranges can be indicated by dashes, as shown here:

```
$> ndb_waiter --wait-nodes=2,4-6,10
```



### Important

Do *not* use this option together with the `--nowait-nodes` option.

**Sample Output.** Shown here is the output from `ndb_waiter` when run against a 4-node cluster in which two nodes have been shut down and then started again manually. Duplicate reports (indicated by `...`) are omitted.

```
$> ./ndb_waiter -c localhost

Connecting to mgmsrv at (localhost)
State node 1 STARTED
State node 2 NO_CONTACT
State node 3 STARTED
State node 4 NO_CONTACT
Waiting for cluster enter state STARTED

...

State node 1 STARTED
State node 2 UNKNOWN
State node 3 STARTED
State node 4 NO_CONTACT
Waiting for cluster enter state STARTED

...

State node 1 STARTED
State node 2 STARTING
State node 3 STARTED
State node 4 NO_CONTACT
Waiting for cluster enter state STARTED

...

State node 1 STARTED
State node 2 STARTING
State node 3 STARTED
State node 4 UNKNOWN
Waiting for cluster enter state STARTED

...

State node 1 STARTED
State node 2 STARTING
State node 3 STARTED
State node 4 STARTING
Waiting for cluster enter state STARTED

...

State node 1 STARTED
State node 2 STARTED
State node 3 STARTED
State node 4 STARTING
Waiting for cluster enter state STARTED

...
```

```
State node 1 STARTED
State node 2 STARTED
State node 3 STARTED
State node 4 STARTED
Waiting for cluster enter state STARTED
```



### Note

If no connection string is specified, then `ndb_waiter` tries to connect to a management on `localhost`, and reports `Connecting to mgmsrv at (null)`.

Prior to NDB 7.5.18 and 7.6.14, this program printed `NDBT_ProgramExit - status` upon completion of its run, due to an unnecessary dependency on the `NDBT` testing library. This dependency is has now been removed, eliminating the extraneous output.

## 21.6 Management of NDB Cluster

Managing an NDB Cluster involves a number of tasks, the first of which is to configure and start NDB Cluster. This is covered in [Section 21.4, “Configuration of NDB Cluster”](#), and [Section 21.5, “NDB Cluster Programs”](#).

The next few sections cover the management of a running NDB Cluster.

For information about security issues relating to management and deployment of an NDB Cluster, see [Section 21.6.18, “NDB Cluster Security Issues”](#).

There are essentially two methods of actively managing a running NDB Cluster. The first of these is through the use of commands entered into the management client whereby cluster status can be checked, log levels changed, backups started and stopped, and nodes stopped and started. The second method involves studying the contents of the cluster log `ndb_node_id_cluster.log`; this is usually found in the management server's `DataDir` directory, but this location can be overridden using the `LogDestination` option. (Recall that `node_id` represents the unique identifier of the node whose activity is being logged.) The cluster log contains event reports generated by `ndbd`. It is also possible to send cluster log entries to a Unix system log.

Some aspects of the cluster's operation can be also be monitored from an SQL node using the `SHOW ENGINE NDB STATUS` statement.

More detailed information about NDB Cluster operations is available in real time through an SQL interface using the `ndbinfo` database. For more information, see [Section 21.6.15, “ndbinfo: The NDB Cluster Information Database”](#).

NDB statistics counters provide improved monitoring using the `mysql` client. These counters, implemented in the NDB kernel, relate to operations performed by or affecting `Ndb` objects, such as starting, closing, and aborting transactions; primary key and unique key operations; table, range, and pruned scans; blocked threads waiting for various operations to complete; and data and events sent and received by NDB Cluster. The counters are incremented by the NDB kernel whenever NDB API calls are made or data is sent to or received by the data nodes.

`mysqld` exposes the NDB API statistics counters as system status variables, which can be identified from the prefix common to all of their names (`Ndb_api_`). The values of these variables can be read in the `mysql` client from the output of a `SHOW STATUS` statement, or by querying either the `SESSION_STATUS` table or the `GLOBAL_STATUS` table (in the `INFORMATION_SCHEMA` database). By comparing the values of the status variables before and after the execution of an SQL statement that acts on NDB tables, you can observe the actions taken on the NDB API level that correspond to this statement, which can be beneficial for monitoring and performance tuning of NDB Cluster.



MySQL Cluster Manager provides an advanced command-line interface that simplifies many otherwise complex NDB Cluster management tasks, such as starting, stopping, or restarting an NDB Cluster with a large number of nodes. The MySQL Cluster Manager client also supports commands for getting and setting the values of most node configuration parameters as well as `mysqld` server options and variables relating to NDB Cluster. See [MySQL Cluster Manager 1.4.8 User Manual](#), for more information.

## 21.6.1 Commands in the NDB Cluster Management Client

In addition to the central configuration file, a cluster may also be controlled through a command-line interface available through the management client `ndb_mgm`. This is the primary administrative interface to a running cluster.

Commands for the event logs are given in [Section 21.6.3, “Event Reports Generated in NDB Cluster”](#); commands for creating backups and restoring from them are provided in [Section 21.6.8, “Online Backup of NDB Cluster”](#).

**Using `ndb_mgm` with MySQL Cluster Manager.** MySQL Cluster Manager handles starting and stopping processes and tracks their states internally, so it is not necessary to use `ndb_mgm` for these tasks for an NDB Cluster that is under MySQL Cluster Manager control. It is recommended *not* to use the `ndb_mgm` command-line client that comes with the NDB Cluster distribution to perform operations that involve starting or stopping nodes. These include but are not limited to the `START`, `STOP`, `RESTART`, and `SHUTDOWN` commands. For more information, see [MySQL Cluster Manager Process Commands](#).

The management client has the following basic commands. In the listing that follows, `node_id` denotes either a data node ID or the keyword `ALL`, which indicates that the command should be applied to all of the cluster's data nodes.

- `CONNECT` *connection-string*

Connects to the management server indicated by the connection string. If the client is already connected to this server, the client reconnects.

- `CREATE NODEGROUP` *nodeid*[, *nodeid*, ...]

Creates a new NDB Cluster node group and causes data nodes to join it.

This command is used after adding new data nodes online to an NDB Cluster, and causes them to join a new node group and thus to begin participating fully in the cluster. The command takes as its sole parameter a comma-separated list of node IDs—these are the IDs of the nodes just added and started, and that are to join the new node group. The list must contain no duplicate IDs; beginning with NDB 7.5.23 and NDB 7.6.19, the presence of any duplicates causes the command to return an error. The number of nodes in the list must be the same as the number of nodes in each node group that is already part of the cluster (each NDB Cluster node group must have the same number of nodes). In other words, if the NDB Cluster consists of 2 node groups having 2 data nodes each, then the new node group must also have 2 data nodes.

The node group ID of the new node group created by this command is determined automatically, and always the next highest unused node group ID in the cluster; it is not possible to set it manually.

For more information, see [Section 21.6.7, “Adding NDB Cluster Data Nodes Online”](#).

- `DROP NODEGROUP` *nodegroup\_id*

Drops the NDB Cluster node group with the given *nodegroup\_id*.

This command can be used to drop a node group from an NDB Cluster. `DROP NODEGROUP` takes as its sole argument the node group ID of the node group to be dropped.

`DROP NODEGROUP` acts only to remove the data nodes in the effected node group from that node group. It does not stop data nodes, assign them to a different node group, or remove them from the cluster's configuration. A data node that does not belong to a node group is indicated in the output of the management client `SHOW` command with `no nodegroup` in place of the node group ID, like this (indicated using bold text):

```
id=3 @10.100.2.67 (5.7.44-ndb-7.5.36, no nodegroup)
```

`DROP NODEGROUP` works only when all data nodes in the node group to be dropped are completely empty of any table data and table definitions. Since there is currently no way using `ndb_mgm` or the `mysql` client to remove all data from a specific data node or node group, this means that the command succeeds only in the two following cases:

1. After issuing `CREATE NODEGROUP` in the `ndb_mgm` client, but before issuing any `ALTER TABLE ... REORGANIZE PARTITION` statements in the `mysql` client.
2. After dropping all `NDBCLUSTER` tables using `DROP TABLE`.

`TRUNCATE TABLE` does not work for this purpose because this removes only the table data; the data nodes continue to store an `NDBCLUSTER` table's definition until a `DROP TABLE` statement is issued that causes the table metadata to be dropped.

For more information about `DROP NODEGROUP`, see [Section 21.6.7, "Adding NDB Cluster Data Nodes Online"](#).

- `ENTER SINGLE USER MODE node_id`

Enters single user mode, whereby only the MySQL server identified by the node ID `node_id` is permitted to access the database.

- `EXIT SINGLE USER MODE`

Exits single user mode, enabling all SQL nodes (that is, all running `mysqld` processes) to access the database.



#### Note

It is possible to use `EXIT SINGLE USER MODE` even when not in single user mode, although the command has no effect in this case.

- `HELP`

Displays information on all available commands.

- `node_id NODELOG DEBUG {ON|OFF}`

Toggles debug logging in the node log, as though the effected data node or nodes had been started with the `--verbose` option. `NODELOG DEBUG ON` starts debug logging; `NODELOG DEBUG OFF` switches debug logging off.

This command was added in NDB 7.6.

- `PROMPT [prompt]`

Changes the prompt shown by `ndb_mgm` to the string literal `prompt`.

`prompt` should not be quoted (unless you want the prompt to include the quotation marks). Unlike the case with the `mysql` client, special character sequences and escapes are not recognized. If called without an argument, the command resets the prompt to the default value (`ndb_mgm>`).

Some examples are shown here:

```
ndb_mgm> PROMPT mgm#1:
mgm#1: SHOW
Cluster Configuration
...
mgm#1: PROMPT mymgm >
mymgm > PROMPT 'mymgm:'
'mymgm:' PROMPT mymgm:
mymgm: PROMPT
ndb_mgm> EXIT
$>
```

Note that leading spaces and spaces within the `prompt` string are not trimmed. Trailing spaces are removed.

The `PROMPT` command was added in NDB 7.5.0.

- `QUIT, EXIT`

Terminates the management client.

This command does not affect any nodes connected to the cluster.

- `node_id REPORT report-type`

Displays a report of type `report-type` for the data node identified by `node_id`, or for all data nodes using `ALL`.

Currently, there are three accepted values for `report-type`:

- `BackupStatus` provides a status report on a cluster backup in progress
- `MemoryUsage` displays how much data memory and index memory is being used by each data node as shown in this example:

```
ndb_mgm> ALL REPORT MEMORY
Node 1: Data usage is 5%(177 32K pages of total 3200)
Node 1: Index usage is 0%(108 8K pages of total 12832)
Node 2: Data usage is 5%(177 32K pages of total 3200)
Node 2: Index usage is 0%(108 8K pages of total 12832)
```

This information is also available from the `ndbinfo.memoryusage` table.

- `EventLog` reports events from the event log buffers of one or more data nodes.

`report-type` is case-insensitive and “fuzzy”; for `MemoryUsage`, you can use `MEMORY` (as shown in the prior example), `memory`, or even simply `MEM` (or `mem`). You can abbreviate `BackupStatus` in a similar fashion.

- `node_id RESTART [-n] [-i] [-a] [-f]`

Restarts the data node identified by `node_id` (or all data nodes).

Using the `-i` option with `RESTART` causes the data node to perform an initial restart; that is, the node's file system is deleted and recreated. The effect is the same as that obtained from stopping the data node process and then starting it again using `ndbd --initial` from the system shell.



**Note**

Backup files and Disk Data files are not removed when this option is used.

Using the `-n` option causes the data node process to be restarted, but the data node is not actually brought online until the appropriate `START` command is issued. The effect of this option is the same as that obtained from stopping the data node and then starting it again using `ndbd --nostart` or `ndbd -n` from the system shell.

Using the `-a` causes all current transactions relying on this node to be aborted. No GCP check is done when the node rejoins the cluster.

Normally, `RESTART` fails if taking the node offline would result in an incomplete cluster. The `-f` option forces the node to restart without checking for this. If this option is used and the result is an incomplete cluster, the entire cluster is restarted.

- `SHOW`

Displays basic information about the cluster and cluster nodes. For all nodes, the output includes the node's ID, type, and `NDB` software version. If the node is connected, its IP address is also shown; otherwise the output shows `not connected, accepting connect from ip_address`, with `any host` used for nodes that are permitted to connect from any address.

In addition, for data nodes, the output includes `starting` if the node has not yet started, and shows the node group of which the node is a member. If the data node is acting as the master node, this is indicated with an asterisk (\*).

Consider a cluster whose configuration file includes the information shown here (possible additional settings are omitted for clarity):

```
[ndbd default]
DataMemory= 128G
NoOfReplicas= 2

[ndb_mgmd]
NodeId=50
HostName=198.51.100.150

[ndbd]
NodeId=5
HostName=198.51.100.10
DataDir=/var/lib/mysql-cluster

[ndbd]
NodeId=6
HostName=198.51.100.20
DataDir=/var/lib/mysql-cluster

[ndbd]
NodeId=7
HostName=198.51.100.30
DataDir=/var/lib/mysql-cluster
```

```
[ndbd]
NodeId=8
HostName=198.51.100.40
DataDir=/var/lib/mysql-cluster

[mysqld]
NodeId=100
HostName=198.51.100.100

[api]
NodeId=101
```

After this cluster (including one SQL node) has been started, `SHOW` displays the following output:

```
ndb_mgm> SHOW
Connected to Management Server at: localhost:1186
Cluster Configuration
-----
[ndbd(NDB)] 4 node(s)
id=5 @198.51.100.10 (5.7.44-ndb-7.6.36, Nodegroup: 0, *)
id=6 @198.51.100.20 (5.7.44-ndb-7.6.36, Nodegroup: 0)
id=7 @198.51.100.30 (5.7.44-ndb-7.6.36, Nodegroup: 1)
id=8 @198.51.100.40 (5.7.44-ndb-7.6.36, Nodegroup: 1)

[ndb_mgmd(MGM)] 1 node(s)
id=50 @198.51.100.150 (5.7.44-ndb-7.6.36)

[mysqld(API)] 2 node(s)
id=100 @198.51.100.100 (5.7.44-ndb-7.6.36)
id=101 (not connected, accepting connect from any host)
```

The output from this command also indicates when the cluster is in single user mode (see the description of the `ENTER SINGLE USER MODE` command, as well as [Section 21.6.6, "NDB Cluster Single User Mode"](#)).

- `SHUTDOWN`

Shuts down all cluster data nodes and management nodes. To exit the management client after this has been done, use `EXIT` or `QUIT`.

This command does *not* shut down any SQL nodes or API nodes that are connected to the cluster.

- `node_id STATUS`

Displays status information for the data node identified by `node_id` (or for all data nodes).

Possible node status values include `UNKNOWN`, `NO_CONTACT`, `NOT_STARTED`, `STARTING`, `STARTED`, `SHUTTING_DOWN`, and `RESTARTING`.

The output from this command also indicates when the cluster is in single user mode (status `SINGLE USER MODE`).

- `node_id START`

Brings online the data node identified by `node_id` (or all data nodes).

`ALL START` works on all data nodes only, and does not affect management nodes.



### Important

To use this command to bring a data node online, the data node must have been started using `--nostart` or `-n`.

- `node_id STOP [-a] [-f]`

Stops the data or management node identified by `node_id`.



### Note

`ALL STOP` works to stop all data nodes only, and does not affect management nodes.

A node affected by this command disconnects from the cluster, and its associated `ndbd` or `ndb_mgmd` process terminates.

The `-a` option causes the node to be stopped immediately, without waiting for the completion of any pending transactions.

Normally, `STOP` fails if the result would cause an incomplete cluster. The `-f` option forces the node to shut down without checking for this. If this option is used and the result is an incomplete cluster, the cluster immediately shuts down.



### Warning

Use of the `-a` option also disables the safety check otherwise performed when `STOP` is invoked to insure that stopping the node does not cause an incomplete cluster. In other words, you should exercise extreme care when using the `-a` option with the `STOP` command, due to the fact that this option makes it possible for the cluster to undergo a forced shutdown because it no longer has a complete copy of all data stored in `NDB`.

**Additional commands.** A number of other commands available in the `ndb_mgm` client are described elsewhere, as shown in the following list:

- `START BACKUP` is used to perform an online backup in the `ndb_mgm` client; the `ABORT BACKUP` command is used to cancel a backup already in progress. For more information, see [Section 21.6.8, “Online Backup of NDB Cluster”](#).
- The `CLUSTERLOG` command is used to perform various logging functions. See [Section 21.6.3, “Event Reports Generated in NDB Cluster”](#), for more information and examples. NDB 7.6 adds `NODELOG DEBUG` to activate or deactivate debug printouts in node logs, as described previously in this section.
- For testing and diagnostics work, the client supports a `DUMP` command which can be used to execute internal commands on the cluster. It should never be used in a production setting unless directed to do so by MySQL Support. For more information, see [NDB Cluster Management Client DUMP Commands](#).

## 21.6.2 NDB Cluster Log Messages

This section contains information about the messages written to the cluster log in response to different cluster log events. It provides additional, more specific information on [NDB transporter errors](#).

### 21.6.2.1 NDB Cluster: Messages in the Cluster Log

The following table lists the most common [NDB](#) cluster log messages. For information about the cluster log, log events, and event types, see [Section 21.6.3, “Event Reports Generated in NDB Cluster”](#). These log messages also correspond to log event types in the MGM API; see [The Ndb\\_logevent\\_type Type](#), for related information of interest to Cluster API developers.

**Table 21.47 Common NDB cluster log messages**

Log Message	Description	Event Name	Event Type	Priority	Severity
Node mgm_node_id: Node data_node_id Connected	The data node having node ID <i>node_id</i> has connected to the management server (node <i>mgm_node_id</i> ).	Connected	Connection	8	INFO
Node mgm_node_id: Node data_node_id Disconnected	The data node having node ID <i>data_node_id</i> has disconnected from the management server (node <i>mgm_node_id</i> ).	Disconnected	Connection	8	ALERT
Node data_node_id: Communication to Node api_node_id closed	The API node or SQL node having node ID <i>api_node_id</i> is no longer communicating with data node <i>data_node_id</i> .	CommunicationClosed	Communication	8	INFO
Node data_node_id: Communication to Node api_node_id opened	The API node or SQL node having node ID <i>api_node_id</i> is now communicating with data node <i>data_node_id</i> .	CommunicationOpened	Communication	8	INFO
Node mgm_node_id: Node api_node_id: API version	The API node having node ID <i>api_node_id</i> has connected to management node	ConnectedApiVersion	Connection	8	INFO

NDB Cluster Log Messages

Log Message	Description	Event Name	Event Type	Priority	Severity
	<i>mgm_node_id</i> using NDB API version <i>version</i> (generally the same as the MySQL version number).				
Node <i>node_id</i> : Global checkpoint <i>gci</i> started	A global checkpoint with the ID <i>gci</i> has been started; node <i>node_id</i> is the master responsible for this global checkpoint.	GlobalCheckpointStarted	GlobalCheckpoint	9	INFO
Node <i>node_id</i> : Global checkpoint <i>gci</i> completed	The global checkpoint having the ID <i>gci</i> has been completed; node <i>node_id</i> was the master responsible for this global checkpoint.	GlobalCheckpointCompleted	GlobalCheckpoint	10	INFO
Node <i>node_id</i> : Local checkpoint <i>lcp</i> started. Keep GCI = <i>current_gci</i> oldest restorable GCI = <i>old_gci</i>	The local checkpoint having sequence ID <i>lcp</i> has been started on node <i>node_id</i> . The most recent GCI that can be used has the index <i>current_gci</i> , and the oldest GCI from which the cluster can be restored has the index <i>old_gci</i> .	LocalCheckpointStarted	LocalCheckpoint	7	INFO
Node <i>node_id</i> : Local checkpoint <i>lcp</i> completed	The local checkpoint having sequence ID <i>lcp</i> on node	LocalCheckpointCompleted	LocalCheckpoint	8	INFO



NDB Cluster Log Messages

Log Message	Description	Event Name	Event Type	Priority	Severity
	<i>node_id</i> has been completed.				
Node <i>node_id</i> : Local Checkpoint stopped in CALCULATED_KEEP_GCI	The node was unable to determine the most recent usable GCI.	LCPStoppedInCheckpoint	Checkpoint	0	ALERT
Node <i>node_id</i> : Table ID = <i>table_id</i> , fragment ID = <i>fragment_id</i> has completed LCP on Node <i>node_id</i> maxGciStarted <i>started_gci</i> maxGciCompleted <i>completed_gci</i>	A table fragment has been checkpointed to disk on node <i>node_id</i> . The GCI in progress has the index <i>started_gci</i> , and the most recent GCI to have been completed has the index <i>completed_gci</i> .	LCPFragmentCompleted	Checkpoint	11	INFO
Node <i>node_id</i> : ACC Blocked <i>num_1</i> and TUP Blocked <i>num_2</i> times last second	Undo logging is blocked because the log buffer is close to overflowing.	UndoLogBlocked	Checkpoint	7	INFO
Node <i>node_id</i> : Start initiated <i>version</i>	Data node <i>node_id</i> , running NDB version <i>version</i> , is beginning its startup process.	NDBStartStarted	Startup	1	INFO
Node <i>node_id</i> : Started <i>version</i>	Data node <i>node_id</i> , running NDB version <i>version</i> , has started successfully.	NDBStartCompleted	Startup	1	INFO
Node <i>node_id</i> : STTORY received after	The node has received a signal indicating that a cluster restart has completed.	STTORYReceived	Startup	15	INFO

NDB Cluster Log Messages

Log Message	Description	Event Name	Event Type	Priority	Severity
restart finished					
Node <i>node_id</i> : Start phase <i>phase</i> completed ( <i>type</i> )	The node has completed start phase <i>phase</i> of a <i>type</i> start. For a listing of start phases, see <a href="#">Section 21.6.4, "Summary of NDB Cluster Start Phases"</a> . ( <i>type</i> is one of <i>initial</i> , <i>system</i> , <i>node</i> , <i>initial node</i> , or <i>&lt;Unknown&gt;</i> .)	StartPhaseCompleted	Startup	4	INFO
Node <i>node_id</i> : CM_REGCONF president = <i>president_id</i> , own Node = <i>own_id</i> , our dynamic id = <i>dynamic_id</i>	Node <i>president_id</i> has been selected as "president". <i>own_id</i> and <i>dynamic_id</i> should always be the same as the ID ( <i>node_id</i> ) of the reporting node.	CM_REGCONF	Startup	3	INFO
Node <i>node_id</i> : CM_REGREF from Node <i>president_id</i> to our Node <i>node_id</i> . Cause = <i>cause</i>	The reporting node (ID <i>node_id</i> ) was unable to accept node <i>president_id</i> as president. The <i>cause</i> of the problem is given as one of <i>Busy</i> , <i>Election with wait = false</i> , <i>Not president</i> , <i>Election without selecting new</i>	CM_REGREF	Startup	8	INFO

Log Message	Description	Event Name	Event Type	Priority	Severity
	<code>candidate,</code> or <code>No</code> such cause.				
Node <code>node_id:</code> We are Node <code>own_id</code> with dynamic ID <code>dynamic_id,</code> our left neighbor is Node <code>id_1,</code> our right is Node <code>id_2</code>	The node has discovered its neighboring nodes in the cluster (node <code>id_1</code> and node <code>id_2</code> ). <code>node_id,</code> <code>own_id,</code> and <code>dynamic_id</code> should always be the same; if they are not, this indicates a serious misconfiguration of the cluster nodes.	FIND_NEIGHBOU	StartUp	8	INFO
Node <code>node_id:</code> <code>type</code> shutdown initiated	The node has received a shutdown signal. The <code>type</code> of shutdown is either <code>Cluster</code> or <code>Node</code> .	NDBStopStarte	StartUp	1	INFO
Node <code>node_id:</code> Node shutdown completed [, <code>action</code> ] [Initiated by signal <code>signal</code> .]	The node has been shut down. This report may include an <code>action</code> , which if present is one of <code>restarting,</code> <code>no start,</code> or <code>initial</code> . The report may also include a reference to an NDB Protocol <code>signal</code> ; for possible signals, refer to <a href="#">Operations and Signals</a> .	NDBStopComple	StartUp	1	INFO
Node <code>node_id:</code> Forced node shutdown completed	The node has been forcibly shut down. The <code>action</code> (one of <code>restarting,</code>	NDBStopForced	StartUp	1	ALERT

NDB Cluster Log Messages

Log Message	Description	Event Name	Event Type	Priority	Severity
[, action]. [Occurred during startphase start_phase.] [ Initiated by signal.] [Caused by error error_code: 'error_message' error_status' [(extra info extra_code)]]	no start, or initial) subsequently being taken, if any, is also reported. If the shutdown occurred while the node was starting, the report includes the start_phase during which the node failed. If this was a result of a signal sent to the node, this information is also provided (see <a href="#">Operations and Signals</a> , for more information). If the error causing the failure is known, this is also included; for more information about NDB error messages and classifications, see <a href="#">NDB Cluster API Errors</a> .				
Node node_id: Node shutdown aborted	The node shutdown process was aborted by the user.	NDBStopAborted	StartUp	1	INFO
Node node_id: StartLog: [GCI Keep: keep_pos LastCompleted last_pos NewestRestore keep_pos restore_pos]	This reports global checkpoints referenced during a node start. The redo log prior to keep_pos is dropped. last_pos is	StartREDOLog	StartUp	4	INFO

Log Message	Description	Event Name	Event Type	Priority	Severity
	the last global checkpoint in which data node the participated; <i>restore_pos</i> is the global checkpoint which is actually used to restore all data nodes.				
<i>startup_message</i> [Listed separately; see below.]	There are a number of possible startup messages that can be logged under different circumstances. These are listed separately; see <a href="#">Section 21.6.2.2, "NDB Cluster Log Startup Messages"</a> .	StartReport	StartUp	4	INFO
Node <i>node_id</i> : Node restart completed copy of dictionary information	Copying of data dictionary information to the restarted node has been completed.	NR_CopyDict	NodeRestart	8	INFO
Node <i>node_id</i> : Node restart completed copy of distribution information	Copying of data distribution information to the restarted node has been completed.	NR_CopyDistr	NodeRestart	8	INFO
Node <i>node_id</i> : Node restart starting to copy the fragments to Node <i>node_id</i>	Copy of fragments to starting data node <i>node_id</i> has begun	NR_CopyFragStart	NodeRestart	8	INFO
Node <i>node_id</i> : Table ID = <i>table_id</i> , fragment ID =	Fragment <i>fragment_id</i> from table <i>table_id</i> has been copied	NR_CopyFragDone	NodeRestart	10	INFO

NDB Cluster Log Messages

Log Message	Description	Event Name	Event Type	Priority	Severity
<i>fragment_id</i> have been copied to Node <i>node_id</i>	to data node <i>node_id</i>				
Node <i>node_id</i> : Node restart completed copying the fragments to Node <i>node_id</i>	Copying of all table fragments to restarting data node <i>node_id</i> has been completed	NR_CopyFragComp	NodeRestart	8	INFO
Node <i>node_id</i> : Node <i>node1_id</i> completed failure of Node <i>node2_id</i>	Data node <i>node1_id</i> has detected the failure of data node <i>node2_id</i>	NodeFailComp	NodeRestart	8	ALERT
All nodes completed failure of Node <i>node_id</i>	All (remaining) data nodes have detected the failure of data node <i>node_id</i>	NodeFailComp	NodeRestart	8	ALERT
Node failure of <i>node_id</i> block completed	The failure of data node <i>node_id</i> has been detected in the <i>block</i> NDB kernel block, where <i>block</i> is 1 of DBTC, DBDICT, DBDIH, or DBLQH; for more information, see <a href="#">NDB Kernel Blocks</a>	NodeFailComp	NodeRestart	8	ALERT
Node <i>mgm_node_id</i> : Node <i>data_node_id</i> has failed. The Node state at failure was <i>state_code</i>	A data node has failed. Its state at the time of failure is described by an arbitration state code <i>state_code</i> : possible state code values can be found in the file <code>include/</code>	NODE_FAILREP	NodeRestart	8	ALERT

Log Message	Description	Event Name	Event Type	Priority	Severity
	kernel/ signaldata/ ArbitSignalData.hpp.				
President restarts arbitration thread [state=state_ or Prepare arbitrator node node_id [ticket=ticke or Receive arbitrator node node_id [ticket=ticke or Started arbitrator node node_id [ticket=ticke or Lost arbitrator node node_id - process failure [state=state_ or Lost arbitrator node node_id - process exit [state=state_ or Lost arbitrator node node_id - error_message [state=state_	This is a report on the current state and progress of arbitration in the cluster. <code>node_id</code> is the node ID of the management node or SQL node selected as the arbitrator. <code>state_code</code> is an arbitration state code, as found in <code>include/kernel/signaldata/ArbitSignalData.hpp</code> . When an error has occurred, an <code>error_message</code> , also defined in <code>ArbitSignalData.hpp</code> , is provided. <code>ticket_id</code> is a unique identifier handed out by the arbitrator when it is selected to all the nodes that participated in its selection; this is used to ensure that each node requesting arbitration was one of the nodes that took part in the selection process.	ArbitState	NodeRestart	6	INFO
Arbitration check lost - less than 1/2 nodes left or	This message reports on the result of arbitration. In the event	ArbitResult	NodeRestart	2	ALERT

NDB Cluster Log Messages

Log Message	Description	Event Name	Event Type	Priority	Severity
Arbitration check won - all node groups and more than 1/2 nodes left or Arbitration check won - node group majority or Arbitration check lost - missing node group or Network partitioning - arbitration required or Arbitration won - positive reply from node <i>node_id</i> or Arbitration lost - negative reply from node <i>node_id</i> or Network partitioning - no arbitrator available or Network partitioning - no arbitrator configured or Arbitration failure - <i>error_message</i> [state= <i>state_code</i> ]	of arbitration failure, an <i>error_message</i> and an arbitration <i>state_code</i> are provided; definitions for both of these are found in include/kernel/signaldata/ArbitSignalData.hpp.				
Node <i>node_id</i> : GCP Take over started	This node is attempting to assume responsibility for the next global checkpoint (that is, it is becoming	GCP_Takeovers	NodeStart	7	INFO



NDB Cluster Log Messages

Log Message	Description	Event Name	Event Type	Priority	Severity
	the master node)				
Node <i>node_id</i> : GCP Take over completed	This node has become the master, and has assumed responsibility for the next global checkpoint	GCP_TakeoverCompleted	NodeRestart	7	INFO
Node <i>node_id</i> : LCP Take over started	This node is attempting to assume responsibility for the next set of local checkpoints (that is, it is becoming the master node)	LCP_TakeoverStarted	NodeRestart	7	INFO
Node <i>node_id</i> : LCP Take over completed	This node has become the master, and has assumed responsibility for the next set of local checkpoints	LCP_TakeoverCompleted	NodeRestart	7	INFO
Node <i>node_id</i> : Trans. Count = <i>transactions</i> , Commit Count = <i>commits</i> , Read Count = <i>reads</i> , Simple Read Count = <i>simple_reads</i> , Write Count = <i>writes</i> , AttrInfo Count = <i>AttrInfo_objects</i> , Concurrent Operations = <i>concurrent_operations</i> , Abort Count = <i>aborts</i> , Scans = <i>scans</i> , Range	This report of transaction activity is given approximately once every 10 seconds	TransReportComplete	Statistic	8	INFO

NDB Cluster Log Messages

Log Message	Description	Event Name	Event Type	Priority	Severity
scans = range_scans					
Node node_id: Operations=op	Number of operations performed by this node, provided approximately once every 10 seconds	OperationReport@clusters	Statistic	8	INFO
Node node_id: Table with ID = table_id created	A table having the table ID shown has been created	TableCreated	Statistic	7	INFO
Node node_id: Mean loop Counter in doJob last 8192 times = count		JobStatistic	Statistic	9	INFO
Mean send size to Node = node_id last 4096 sends = bytes bytes	This node is sending an average of bytes bytes per send to node node_id	SendBytesStatistic	Statistic	9	INFO
Mean receive size to Node = node_id last 4096 sends = bytes bytes	This node is receiving an average of bytes of data each time it receives data from node node_id	ReceiveBytesStatistic	Statistic	9	INFO
Node node_id: Data usage is data_memory_percent% (data_pages_used 32K pages of total data_pages_total) /Node node_id: Index usage is	This report is generated when a DUMP 1000 command is issued in the cluster management client	MemoryUsage	Statistic	5	INFO

Log Message	Description	Event Name	Event Type	Priority	Severity
<code>index_memory_percentage%</code> <code>(index_pages_used</code> 8K pages of total <code>index_pages_total)</code>					
Node <code>node1_id:</code> Transporter to node <code>node2_id</code> reported error <code>error_code:</code> <code>error_message</code>	A transporter error occurred while communicating with node <code>node2_id</code> ; for a listing of transporter error codes and messages, see <a href="#">NDB Transporter Errors</a> , in <a href="#">MySQL NDB Cluster Internals Manual</a>	TransporterError	Error	2	ERROR
Node <code>node1_id:</code> Transporter to node <code>node2_id</code> reported error <code>error_code:</code> <code>error_message</code>	A warning of a potential transporter problem while communicating with node <code>node2_id</code> ; for a listing of transporter error codes and messages, see <a href="#">NDB Transporter Errors</a> , for more information	TransporterWarning	Warning	8	WARNING
Node <code>node1_id:</code> Node <code>node2_id</code> missed heartbeat <code>heartbeat_id</code>	This node missed a heartbeat from node <code>node2_id</code>	MissedHeartbeat	Error	8	WARNING
Node <code>node1_id:</code> Node <code>node2_id</code> declared dead due	This node has missed at least 3 heartbeats from node <code>node2_id</code> , and so has declared that node "dead"	DeadDueToHeartbeat	Error	8	ALERT

NDB Cluster Log Messages

Log Message	Description	Event Name	Event Type	Priority	Severity
to missed heartbeat					
Node <i>node1_id</i> : Node Sent Heartbeat to node = <i>node2_id</i>	This node has sent a heartbeat to node <i>node2_id</i>	SentHeartbeat	Info	12	INFO
(NDB 7.5.0 and earlier.) Node <i>node_id</i> : Event buffer status: used=bytes_used (percent_used) alloc=bytes_allocated (percent_available) max=bytes_available apply_epoch=latest_epoch	This report is seen during heavy event buffer usage, for example, when many updates are being applied in a relatively short period of time; the report shows the number of bytes and the percentage of event buffer memory used, the bytes allocated and percentage still available, and the latest and latest restorable epochs	EventBufferStatus	Info	7	INFO
(NDB 7.5.1 and later.) Node <i>node_id</i> : Event buffer status ( <i>object_id</i> ): used=bytes_used (percent_used of alloc) alloc=bytes_allocated max=bytes_available latest_consumed_epoch latest_buffered_epoch report_reason=	This report is seen during heavy event buffer usage, for example, when many updates are being applied in a relatively short period of time; the report shows the number of bytes and the percentage of event buffer memory used, the bytes allocated and percentage still available,	EventBufferStatus2	Info	7	INFO

Log Message	Description	Event Name	Event Type	Priority	Severity
	and the latest buffered and consumed epochs; for more information, see <a href="#">Section 21.6.2.3, "Event Buffer Reporting in the Cluster Log"</a>				
Node <i>node_id</i> : Entering single user mode, Node <i>node_id</i> : Entered single user mode Node <i>API_node_id</i> has exclusive access, Node <i>node_id</i> : Entering single user mode	These reports are written to the cluster log when entering and exiting single user mode; <i>API_node_id</i> is the node ID of the API or SQL having exclusive access to the cluster (for more information, see <a href="#">Section 21.6.6, "NDB Cluster Single User Mode"</a> ); the message <code>Unknown single user report <i>API_node_id</i></code> indicates an error has taken place and should never be seen in normal operation	SingleUser	Info	7	INFO
Node <i>node_id</i> : Backup <i>backup_id</i> started from node <i>mgm_node_id</i>	A backup has been started using the management node having <i>mgm_node_id</i> ; this message is also displayed in the cluster management client when the <code>START BACKUP</code> command is	BackupStarted	Backup	7	INFO

NDB Cluster Log Messages

Log Message	Description	Event Name	Event Type	Priority	Severity
	issued; for more information, see <a href="#">Section 21.6.8.2, "Using The NDB Cluster Management Client to Create a Backup"</a>				
Node <i>node_id</i> : Backup <i>backup_id</i> started from node <i>mgm_node_id</i> completed. StartGCP: <i>start_gcp</i> StopGCP: <i>stop_gcp</i> #Records: <i>records</i> #LogRecords: <i>log_records</i> Data: <i>data_bytes</i> bytes Log: <i>log_bytes</i> bytes	The backup having the ID <i>backup_id</i> has been completed; for more information, see <a href="#">Section 21.6.8.2, "Using The NDB Cluster Management Client to Create a Backup"</a>	BackupCompleted	Backup	7	INFO
Node <i>node_id</i> : Backup request from <i>mgm_node_id</i> failed to start. Error: <i>error_code</i>	The backup failed to start; for error codes, see <a href="#">MGM API Errors</a>	BackupFailedToStart	Backup	7	ALERT
Node <i>node_id</i> : Backup <i>backup_id</i> started from <i>mgm_node_id</i> has been aborted. Error: <i>error_code</i>	The backup was terminated after starting, possibly due to user intervention	BackupAborted	Backup	7	ALERT

### 21.6.2.2 NDB Cluster Log Startup Messages

Possible startup messages with descriptions are provided in the following list:

- Initial start, waiting for %s to connect, nodes [ all: %s connected: %s no-wait: %s ]
- Waiting until nodes: %s connects, nodes [ all: %s connected: %s no-wait: %s ]
- Waiting %u sec for nodes %s to connect, nodes [ all: %s connected: %s no-wait: %s ]
- Waiting for non partitioned start, nodes [ all: %s connected: %s missing: %s no-wait: %s ]
- Waiting %u sec for non partitioned start, nodes [ all: %s connected: %s missing: %s no-wait: %s ]
- Initial start with nodes %s [ missing: %s no-wait: %s ]
- Start with all nodes %s
- Start with nodes %s [ missing: %s no-wait: %s ]
- Start potentially partitioned with nodes %s [ missing: %s no-wait: %s ]
- Unknown startreport: 0x%x [ %s %s %s %s ]

### 21.6.2.3 Event Buffer Reporting in the Cluster Log

NDB uses one or more memory buffers for events received from the data nodes. There is one such buffer for each Ndb object subscribing to table events, which means that there are usually two buffers for each mysqld performing binary logging (one buffer for schema events, and one for data events). Each buffer contains epochs made up of events. These events consist of operation types (insert, update, delete) and row data (before and after images plus metadata).

NDB generates messages in the cluster log to describe the state of these buffers. Although these reports appear in the cluster log, they refer to buffers on API nodes (unlike most other cluster log messages, which are generated by data nodes). These messages and the data structures underlying them were changed significantly in NDB 7.5.1, with the addition of the NDB\_LE\_EventBufferStatus2 event type and the ndb\_logevent\_EventBufferStatus2 data structure (see [The Ndb\\_logevent\\_type Type](#)). The remainder of this discussion focuses on the implementation based on NDB\_LE\_EventBufferStatus2.

Event buffer logging reports in the cluster log use the format shown here:

```
Node node_id: Event buffer status (object_id):
used=bytes_used (percent_used% of alloc)
alloc=bytes_allocated (percent_alloc% of max) max=bytes_available
latest_consumed_epoch=latest_consumed_epoch
latest_buffered_epoch=latest_buffered_epoch
report_reason=report_reason
```

The fields making up this report are listed here, with descriptions:

- *node\_id*: ID of the node where the report originated.
- *object\_id*: ID of the Ndb object where the report originated.
- *bytes\_used*: Number of bytes used by the buffer.

- *percent\_used*: Percentage of allocated bytes used.
- *bytes\_allocated*: Number of bytes allocated to this buffer.
- *percent\_alloc*: Percentage of available bytes used; not printed if `ndb_eventbuffer_max_alloc` is equal to 0 (unlimited).
- *bytes\_available*: Number of bytes available; this is 0 if `ndb_eventbuffer_max_alloc` is 0 (unlimited).
- *latest\_consumed\_epoch*: The epoch most recently consumed to completion. (In NDB API applications, this is done by calling `nextEvent()`.)
- *latest\_buffered\_epoch*: The epoch most recently buffered (completely) in the event buffer.
- *report\_reason*: The reason for making the report. Possible reasons are shown later in this section.

The `latest_consumed_epoch` and `latest_buffered_epoch` fields correspond, respectively, to the `apply_gci` and `latest_gci` fields of the old-style event buffer logging messages used prior to NDB 7.5.1.

Possible reasons for reporting are described in the following list:

- `ENOUGH_FREE_EVENTBUFFER`: The event buffer has sufficient space.  
`LOW_FREE_EVENTBUFFER`: The event buffer is running low on free space.  
The threshold free percentage level triggering these reports can be adjusted by setting the `ndb_report_thresh_binlog_mem_usage` server variable.
- `BUFFERED_EPOCHS_OVER_THRESHOLD`: Whether the number of buffered epochs has exceeded the configured threshold. This number is the difference between the latest epoch that has been received in its entirety and the epoch that has most recently been consumed (in NDB API applications, this is done by calling `nextEvent()` or `nextEvent2()`). The report is generated every second until the number of buffered epochs goes below the threshold, which can be adjusted by setting the `ndb_report_thresh_binlog_epoch_slip` server variable. You can also adjust the threshold in NDB API applications by calling `setEventBufferQueueEmptyEpoch()`.
- `PARTIALLY_DISCARDING`: Event buffer memory is exhausted—that is, 100% of `ndb_eventbuffer_max_alloc` has been used. Any partially buffered epoch is buffered to completion even if usage exceeds 100%, but any new epochs received are discarded. This means that a gap has occurred in the event stream.
- `COMPLETELY_DISCARDING`: No epochs are buffered.
- `PARTIALLY_BUFFERING`: The buffer free percentage following the gap has risen to the threshold, which can be set in the `mysql` client using the `ndb_eventbuffer_free_percent` server system variable or in NDB API applications by calling `set_eventbuffer_free_percent()`. New epochs are buffered. Epochs that could not be completed due to the gap are discarded.
- `COMPLETELY_BUFFERING`: All epochs received are being buffered, which means that there is sufficient event buffer memory. The gap in the event stream has been closed.

#### 21.6.2.4 NDB Cluster: NDB Transporter Errors

This section lists error codes, names, and messages that are written to the cluster log in the event of transporter errors.



## NDB Cluster Log Messages

---

0x00	<b>TE_NO_ERROR</b> No error
0x01	<b>TE_ERROR_CLOSING_SOCKET</b> Error found during closing of socket
0x02	<b>TE_ERROR_IN_SELECT_BEFORE_ACCEPT</b> Error found before accept. The transporter will retry
0x03	<b>TE_INVALID_MESSAGE_LENGTH</b> Error found in message (invalid message length)
0x04	<b>TE_INVALID_CHECKSUM</b> Error found in message (checksum)
0x05	<b>TE_COULD_NOT_CREATE_SOCKET</b> Error found while creating socket(can't create socket)
0x06	<b>TE_COULD_NOT_BIND_SOCKET</b> Error found while binding server socket
0x07	<b>TE_LISTEN_FAILED</b> Error found while listening to server socket
0x08	<b>TE_ACCEPT_RETURN_ERROR</b> Error found during accept(accept return error)
0x0b	<b>TE_SHM_DISCONNECT</b> The remote node has disconnected
0x0c	<b>TE_SHM_IPC_STAT</b> Unable to check shm segment
0x0d	<b>TE_SHM_UNABLE_TO_CREATE_SEGMENT</b> Unable to create shm segment
0x0e	<b>TE_SHM_UNABLE_TO_ATTACH_SEGMENT</b> Unable to attach shm segment
0x0f	<b>TE_SHM_UNABLE_TO_REMOVE_SEGMENT</b> Unable to remove shm segment
0x10	<b>TE_TOO_SMALL_SIGID</b> Sig ID too small

0x11	<b>TE_TOO_LARGE_SIGID</b> Sig ID too large
0x12	<b>TE_WAIT_STACK_FULL</b> Wait stack was full
0x13	<b>TE_RECEIVE_BUFFER_FULL</b> Receive buffer was full
0x14	<b>TE_SIGNAL_LOST_SEND_BUFFER_FULL</b> Send buffer was full, and trying to force send fails
0x15	<b>TE_SIGNAL_LOST</b> Send failed for unknown reason(signal lost)
0x16	<b>TE_SEND_BUFFER_FULL</b> The send buffer was full, but sleeping for a while solved
0x21	<b>TE_SHM_IPC_PERMANENT</b> Shm ipc Permanent error



**Note**

Transporter error codes 0x17 through 0x20 and 0x22 are reserved for SCI connections, which are not supported in this version of NDB Cluster, and so are not included here.

### 21.6.3 Event Reports Generated in NDB Cluster

In this section, we discuss the types of event logs provided by NDB Cluster, and the types of events that are logged.

NDB Cluster provides two types of event log:

- The *cluster log*, which includes events generated by all cluster nodes. The cluster log is the log recommended for most uses because it provides logging information for an entire cluster in a single location.

By default, the cluster log is saved to a file named `ndb_node_id_cluster.log`, (where *node\_id* is the node ID of the management server) in the management server's `DataDir`.

Cluster logging information can also be sent to `stdout` or a `syslog` facility in addition to or instead of being saved to a file, as determined by the values set for the `DataDir` and `LogDestination` configuration parameters. See [Section 21.4.3.5, “Defining an NDB Cluster Management Server”](#), for more information about these parameters.

- *Node logs* are local to each node.

Output generated by node event logging is written to the file `ndb_node_id_out.log` (where *node\_id* is the node's node ID) in the node's `DataDir`. Node event logs are generated for both management nodes and data nodes.

Node logs are intended to be used only during application development, or for debugging application code.

Each reportable event can be distinguished according to three different criteria:

- **Category:** This can be any one of the following values: [STARTUP](#), [SHUTDOWN](#), [STATISTICS](#), [CHECKPOINT](#), [NODERESTART](#), [CONNECTION](#), [ERROR](#), or [INFO](#).
- **Priority:** This is represented by one of the numbers from 0 to 15 inclusive, where 0 indicates “most important” and 15 “least important.”
- **Severity Level:** This can be any one of the following values: [ALERT](#), [CRITICAL](#), [ERROR](#), [WARNING](#), [INFO](#), or [DEBUG](#).

The cluster log can be filtered on these properties using the NDB management client [CLUSTERLOG](#) command. This command affects the cluster log only, and has no effect on the node logs; debug logging in one or more node logs can be turned on and off using the `ndb_mgm NODELOG DEBUG` command.

The format used in the cluster log is as shown here:

```
2007-01-26 19:35:55 [MgmSrvr] INFO -- Node 1: Data usage is 2%(60 32K pages of total 2560)
2007-01-26 19:35:55 [MgmSrvr] INFO -- Node 1: Index usage is 1%(24 8K pages of total 2336)
2007-01-26 19:35:55 [MgmSrvr] INFO -- Node 1: Resource 0 min: 0 max: 639 curr: 0
2007-01-26 19:35:55 [MgmSrvr] INFO -- Node 2: Data usage is 2%(76 32K pages of total 2560)
2007-01-26 19:35:55 [MgmSrvr] INFO -- Node 2: Index usage is 1%(24 8K pages of total 2336)
2007-01-26 19:35:55 [MgmSrvr] INFO -- Node 2: Resource 0 min: 0 max: 639 curr: 0
2007-01-26 19:35:55 [MgmSrvr] INFO -- Node 3: Data usage is 2%(58 32K pages of total 2560)
2007-01-26 19:35:55 [MgmSrvr] INFO -- Node 3: Index usage is 1%(25 8K pages of total 2336)
2007-01-26 19:35:55 [MgmSrvr] INFO -- Node 3: Resource 0 min: 0 max: 639 curr: 0
2007-01-26 19:35:55 [MgmSrvr] INFO -- Node 4: Data usage is 2%(74 32K pages of total 2560)
2007-01-26 19:35:55 [MgmSrvr] INFO -- Node 4: Index usage is 1%(25 8K pages of total 2336)
2007-01-26 19:35:55 [MgmSrvr] INFO -- Node 4: Resource 0 min: 0 max: 639 curr: 0
2007-01-26 19:39:42 [MgmSrvr] INFO -- Node 4: Node 9 Connected
2007-01-26 19:39:42 [MgmSrvr] INFO -- Node 1: Node 9 Connected
2007-01-26 19:39:42 [MgmSrvr] INFO -- Node 1: Node 9: API 5.7.44-ndb-7.5.36
2007-01-26 19:39:42 [MgmSrvr] INFO -- Node 2: Node 9 Connected
2007-01-26 19:39:42 [MgmSrvr] INFO -- Node 2: Node 9: API 5.7.44-ndb-7.5.36
2007-01-26 19:39:42 [MgmSrvr] INFO -- Node 3: Node 9 Connected
2007-01-26 19:39:42 [MgmSrvr] INFO -- Node 3: Node 9: API 5.7.44-ndb-7.5.36
2007-01-26 19:39:42 [MgmSrvr] INFO -- Node 4: Node 9: API 5.7.44-ndb-7.5.36
2007-01-26 19:59:22 [MgmSrvr] ALERT -- Node 2: Node 7 Disconnected
2007-01-26 19:59:22 [MgmSrvr] ALERT -- Node 2: Node 7 Disconnected
```

Each line in the cluster log contains the following information:

- A timestamp in `YYYY-MM-DD HH:MM:SS` format.
- The type of node which is performing the logging. In the cluster log, this is always `[MgmSrvr]`.
- The severity of the event.
- The ID of the node reporting the event.
- A description of the event. The most common types of events to appear in the log are connections and disconnections between different nodes in the cluster, and when checkpoints occur. In some cases, the description may contain status information.

For additional information, see [Section 21.6.3.2, “NDB Cluster Log Events”](#).

### 21.6.3.1 NDB Cluster Logging Management Commands

`ndb_mgm` supports a number of management commands related to the cluster log and node logs. In the listing that follows, `node_id` denotes either a storage node ID or the keyword `ALL`, which indicates that the command should be applied to all of the cluster's data nodes.

- `CLUSTERLOG ON`  
Turns the cluster log on.
- `CLUSTERLOG OFF`  
Turns the cluster log off.
- `CLUSTERLOG INFO`  
Provides information about cluster log settings.
- `node_id CLUSTERLOG category=threshold`  
Logs `category` events with priority less than or equal to `threshold` in the cluster log.
- `CLUSTERLOG TOGGLE severity_level`  
Toggles cluster logging of events of the specified `severity_level`.

The following table describes the default setting (for all data nodes) of the cluster log category threshold. If an event has a priority with a value lower than or equal to the priority threshold, it is reported in the cluster log.



#### Note

Events are reported per data node, and that the threshold can be set to different values on different nodes.

**Table 21.48 Cluster log categories, with default threshold setting**

Category	Default threshold (All data nodes)
<code>STARTUP</code>	7
<code>SHUTDOWN</code>	7
<code>STATISTICS</code>	7
<code>CHECKPOINT</code>	7
<code>NODERESTART</code>	7
<code>CONNECTION</code>	8
<code>ERROR</code>	15
<code>INFO</code>	7
<code>BACKUP</code>	15
<code>CONGESTION</code>	7
<code>SCHEMA</code>	7

The `STATISTICS` category can provide a great deal of useful data. See [Section 21.6.3.3, “Using CLUSTERLOG STATISTICS in the NDB Cluster Management Client”](#), for more information.

Thresholds are used to filter events within each category. For example, a `STARTUP` event with a priority of 3 is not logged unless the threshold for `STARTUP` is set to 3 or higher. Only events with priority 3 or lower are sent if the threshold is 3.

The following table shows the event severity levels.



#### Note

These correspond to Unix `syslog` levels, except for `LOG_EMERG` and `LOG_NOTICE`, which are not used or mapped.

**Table 21.49 Event severity levels**

Severity Level Value	Severity	Description
1	<code>ALERT</code>	A condition that should be corrected immediately, such as a corrupted system database
2	<code>CRITICAL</code>	Critical conditions, such as device errors or insufficient resources
3	<code>ERROR</code>	Conditions that should be corrected, such as configuration errors
4	<code>WARNING</code>	Conditions that are not errors, but that might require special handling
5	<code>INFO</code>	Informational messages
6	<code>DEBUG</code>	Debugging messages used for <code>NDBCLUSTER</code> development

Event severity levels can be turned on or off using `CLUSTERLOG TOGGLE`. If a severity level is turned on, then all events with a priority less than or equal to the category thresholds are logged. If the severity level is turned off then no events belonging to that severity level are logged.



#### Important

Cluster log levels are set on a per `ndb_mgmd`, per subscriber basis. This means that, in an NDB Cluster with multiple management servers, using a `CLUSTERLOG` command in an instance of `ndb_mgm` connected to one management server affects only logs generated by that management server but not by any of the others. This also means that, should one of the management servers be restarted, only logs generated by that management server are affected by the resetting of log levels caused by the restart.

### 21.6.3.2 NDB Cluster Log Events

An event report reported in the event logs has the following format:

```
datetime [string] severity -- message
```

For example:

```
09:19:30 2005-07-24 [NDB] INFO -- Node 4 Start phase 4 completed
```

This section discusses all reportable events, ordered by category and severity level within each category.

In the event descriptions, GCP and LCP mean “Global Checkpoint” and “Local Checkpoint”, respectively.

#### CONNECTION Events

These events are associated with connections between Cluster nodes.

**Table 21.50 Events associated with connections between cluster nodes**

Event	Priority	Severity Level	Description
Connected	8	INFO	Data nodes connected
Disconnected	8	ALERT	Data nodes disconnected
CommunicationClosed	8	INFO	SQL node or data node connection closed
CommunicationOpened	8	INFO	SQL node or data node connection open
ConnectedApiVersion	8	INFO	Connection using API version

## CHECKPOINT Events

The logging messages shown here are associated with checkpoints.

**Table 21.51 Events associated with checkpoints**

Event	Priority	Severity Level	Description
GlobalCheckpointStarted	9	INFO	Start of GCP: REDO log is written to disk
GlobalCheckpointCompleted	10	INFO	GCP finished
LocalCheckpointStarted	7	INFO	Start of LCP: data written to disk
LocalCheckpointCompleted	7	INFO	LCP completed normally
LCPStoppedInCalcKeepCci	0	ALERT	LCP stopped
LCPFragmentCompleted	11	INFO	LCP on a fragment has been completed
UndoLogBlocked	7	INFO	UNDO logging blocked; buffer near overflow
RedoStatus	7	INFO	Redo status

## STARTUP Events

The following events are generated in response to the startup of a node or of the cluster and of its success or failure. They also provide information relating to the progress of the startup process, including information concerning logging activities.

**Table 21.52 Events relating to the startup of a node or cluster**

Event	Priority	Severity Level	Description
NDBStartStarted	1	INFO	Data node start phases initiated (all nodes starting)
NDBStartCompleted	1	INFO	Start phases completed, all data nodes
STTORYRYRecieved	15	INFO	Blocks received after completion of restart

Event	Priority	Severity Level	Description
StartPhaseCompleted	4	INFO	Data node start phase <i>X</i> completed
CM_REGCONF	3	INFO	Node has been successfully included into the cluster; shows the node, managing node, and dynamic ID
CM_REGREF	8	INFO	Node has been refused for inclusion in the cluster; cannot be included in cluster due to misconfiguration, inability to establish communication, or other problem
FIND_NEIGHBOURS	8	INFO	Shows neighboring data nodes
NDBStopStarted	1	INFO	Data node shutdown initiated
NDBStopCompleted	1	INFO	Data node shutdown complete
NDBStopForced	1	ALERT	Forced shutdown of data node
NDBStopAborted	1	INFO	Unable to shut down data node normally
StartREDOLog	4	INFO	New redo log started; GCI keep <i>X</i> , newest restorable GCI <i>Y</i>
StartLog	10	INFO	New log started; log part <i>X</i> , start MB <i>Y</i> , stop MB <i>Z</i>
UNDORecordsExecuted	15	INFO	Undo records executed
StartReport	4	INFO	Report started
LogFileInitStatus	7	INFO	Log file initialization status
LogFileInitCompStatus	7	INFO	Log file completion status
StartReadLCP	10	INFO	Start read for local checkpoint
ReadLCPComplete	10	INFO	Read for local checkpoint completed
RunRedo	8	INFO	Running the redo log
RebuildIndex	10	INFO	Rebuilding indexes

## NODERESTART Events

The following events are generated when restarting a node and relate to the success or failure of the node restart process.

Table 21.53 Events relating to restarting a node

Event	Priority	Severity Level	Description
NR_CopyDict	7	INFO	Completed copying of dictionary information
NR_CopyDistr	7	INFO	Completed copying distribution information
NR_CopyFragStarted	7	INFO	Starting to copy fragments
NR_CopyFragDone	10	INFO	Completed copying a fragment
NR_CopyFragCompleted	7	INFO	Completed copying all fragments
NodeFailCompleted	8	ALERT	Node failure phase completed
NODE_FAILREP	8	ALERT	Reports that a node has failed
ArbitState	6	INFO	Report whether an arbitrator is found or not; there are seven different possible outcomes when seeking an arbitrator, listed here: <ul style="list-style-type: none"> <li>• Management server restarts arbitration thread [state=<i>x</i>]</li> <li>• Prepare arbitrator node <i>x</i> [ticket=<i>y</i>]</li> <li>• Receive arbitrator node <i>x</i> [ticket=<i>y</i>]</li> <li>• Started arbitrator node <i>x</i> [ticket=<i>y</i>]</li> <li>• Lost arbitrator node <i>x</i> - process failure [state=<i>y</i>]</li> <li>• Lost arbitrator node <i>x</i> - process exit [state=<i>y</i>]</li> <li>• Lost arbitrator node <i>x</i> &lt;error msg&gt; [state=<i>y</i>]</li> </ul>
ArbitResult	2	ALERT	Report arbitrator results; there are eight different possible results for arbitration attempts, listed here:



Event	Priority	Severity Level	Description
			<ul style="list-style-type: none"> <li>• Arbitration check failed: less than 1/2 nodes left</li> <li>• Arbitration check succeeded: node group majority</li> <li>• Arbitration check failed: missing node group</li> <li>• Network partitioning: arbitration required</li> <li>• Arbitration succeeded: affirmative response from node <i>x</i></li> <li>• Arbitration failed: negative response from node <i>x</i></li> <li>• Network partitioning: no arbitrator available</li> <li>• Network partitioning: no arbitrator configured</li> </ul>
GCP_TakeoverStarted	7	INFO	GCP takeover started
GCP_TakeoverCompleted	7	INFO	GCP takeover complete
LCP_TakeoverStarted	7	INFO	LCP takeover started
LCP_TakeoverCompleted	7	INFO	LCP takeover complete (state = <i>x</i> )
ConnectCheckStarted	6	INFO	Connection check started
ConnectCheckCompleted	6	INFO	Connection check completed
NodeFailRejected	6	ALERT	Node failure phase failed

## STATISTICS Events

The following events are of a statistical nature. They provide information such as numbers of transactions and other operations, amount of data sent or received by individual nodes, and memory usage.

**Table 21.54 Events of a statistical nature**

Event	Priority	Severity Level	Description
TransReportCounters	8	INFO	Report transaction statistics, including numbers of transactions, commits, reads, simple reads, writes, concurrent operations, attribute information, and aborts

Event	Priority	Severity Level	Description
OperationReportCounters	8	INFO	Number of operations
TableCreated	7	INFO	Report number of tables created
JobStatistic	9	INFO	Mean internal job scheduling statistics
ThreadConfigLoop	9	INFO	Number of thread configuration loops
SendBytesStatistic	9	INFO	Mean number of bytes sent to node <i>x</i>
ReceiveBytesStatistic	9	INFO	Mean number of bytes received from node <i>x</i>
MemoryUsage	5	INFO	Data and index memory usage (80%, 90%, and 100%)
MtSignalStatistics	9	INFO	Multithreaded signals

## SCHEMA Events

These events relate to NDB Cluster schema operations.

**Table 21.55 Events relating to NDB Cluster schema operations**

Event	Priority	Severity Level	Description
CreateSchemaObject	8	INFO	Schema object created
AlterSchemaObject	8	INFO	Schema object updated
DropSchemaObject	8	INFO	Schema object dropped

## ERROR Events

These events relate to Cluster errors and warnings. The presence of one or more of these generally indicates that a major malfunction or failure has occurred.

**Table 21.56 Events relating to cluster errors and warnings**

Event	Priority	Severity Level	Description
TransporterError	2	ERROR	Transporter error
TransporterWarning	8	WARNING	Transporter warning
MissedHeartbeat	8	WARNING	Node <i>x</i> missed heartbeat number <i>y</i>
DeadDueToHeartbeat	8	ALERT	Node <i>x</i> declared “dead” due to missed heartbeat
WarningEvent	2	WARNING	General warning event
SubscriptionStatus	4	WARNING	Change in subscription status

## INFO Events

These events provide general information about the state of the cluster and activities associated with Cluster maintenance, such as logging and heartbeat transmission.

**Table 21.57 Information events**

Event	Priority	Severity Level	Description
<code>SentHeartbeat</code>	12	INFO	Sent heartbeat
<code>CreateLogBytes</code>	11	INFO	Create log: Log part, log file, size in MB
<code>InfoEvent</code>	2	INFO	General informational event
<code>EventBufferStatus</code>	7	INFO	Event buffer status
<code>EventBufferStatus2</code>	7	INFO	Improved event buffer status information; added in NDB 7.5.1



**Note**

`SentHeartbeat` events are available only if NDB Cluster was compiled with `VM_TRACE` enabled.

## SINGLEUSER Events

These events are associated with entering and exiting single user mode.

**Table 21.58 Events relating to single user mode**

Event	Priority	Severity Level	Description
<code>SingleUser</code>	7	INFO	Entering or exiting single user mode

## BACKUP Events

These events provide information about backups being created or restored.

**Table 21.59 Backup events**

Event	Priority	Severity Level	Description
<code>BackupStarted</code>	7	INFO	Backup started
<code>BackupStatus</code>	7	INFO	Backup status
<code>BackupCompleted</code>	7	INFO	Backup completed
<code>BackupFailedToStart</code>	7	ALERT	Backup failed to start
<code>BackupAborted</code>	7	ALERT	Backup aborted by user
<code>RestoreStarted</code>	7	INFO	Started restoring from backup
<code>RestoreMetaData</code>	7	INFO	Restoring metadata
<code>RestoreData</code>	7	INFO	Restoring data

Event	Priority	Severity Level	Description
<code>RestoreLog</code>	7	INFO	Restoring log files
<code>RestoreCompleted</code>	7	INFO	Completed restoring from backup
<code>SavedEvent</code>	7	INFO	Event saved

### 21.6.3.3 Using CLUSTERLOG STATISTICS in the NDB Cluster Management Client

The NDB management client's `CLUSTERLOG STATISTICS` command can provide a number of useful statistics in its output. Counters providing information about the state of the cluster are updated at 5-second reporting intervals by the transaction coordinator (TC) and the local query handler (LQH), and written to the cluster log.

**Transaction coordinator statistics.** Each transaction has one transaction coordinator, which is chosen by one of the following methods:

- In a round-robin fashion
- By communication proximity
- By supplying a data placement hint when the transaction is started



#### Note

You can determine which TC selection method is used for transactions started from a given SQL node using the `ndb_optimized_node_selection` system variable.

All operations within the same transaction use the same transaction coordinator, which reports the following statistics:

- **Trans count.** This is the number transactions started in the last interval using this TC as the transaction coordinator. Any of these transactions may have committed, have been aborted, or remain uncommitted at the end of the reporting interval.



#### Note

Transactions do not migrate between TCs.

- **Commit count.** This is the number of transactions using this TC as the transaction coordinator that were committed in the last reporting interval. Because some transactions committed in this reporting interval may have started in a previous reporting interval, it is possible for `Commit count` to be greater than `Trans count`.
- **Read count.** This is the number of primary key read operations using this TC as the transaction coordinator that were started in the last reporting interval, including simple reads. This count also includes reads performed as part of unique index operations. A unique index read operation generates 2 primary key read operations—1 for the hidden unique index table, and 1 for the table on which the read takes place.
- **Simple read count.** This is the number of simple read operations using this TC as the transaction coordinator that were started in the last reporting interval.
- **Write count.** This is the number of primary key write operations using this TC as the transaction coordinator that were started in the last reporting interval. This includes all inserts, updates, writes and deletes, as well as writes performed as part of unique index operations.

**Note**

A unique index update operation can generate multiple PK read and write operations on the index table and on the base table.

- **AttrInfoCount.** This is the number of 32-bit data words received in the last reporting interval for primary key operations using this TC as the transaction coordinator. For reads, this is proportional to the number of columns requested. For inserts and updates, this is proportional to the number of columns written, and the size of their data. For delete operations, this is usually zero.

Unique index operations generate multiple PK operations and so increase this count. However, data words sent to describe the PK operation itself, and the key information sent, are *not* counted here. Attribute information sent to describe columns to read for scans, or to describe ScanFilters, is also not counted in `AttrInfoCount`.

- **Concurrent Operations.** This is the number of primary key or scan operations using this TC as the transaction coordinator that were started during the last reporting interval but that were not completed. Operations increment this counter when they are started and decrement it when they are completed; this occurs after the transaction commits. Dirty reads and writes—as well as failed operations—decrement this counter.

The maximum value that `Concurrent Operations` can have is the maximum number of operations that a TC block can support; currently, this is  $(2 * \text{MaxNoOfConcurrentOperations}) + 16 + \text{MaxNoOfConcurrentTransactions}$ . (For more information about these configuration parameters, see the *Transaction Parameters* section of [Section 21.4.3.6, “Defining NDB Cluster Data Nodes”](#).)

- **Abort count.** This is the number of transactions using this TC as the transaction coordinator that were aborted during the last reporting interval. Because some transactions that were aborted in the last reporting interval may have started in a previous reporting interval, `Abort count` can sometimes be greater than `Trans count`.
- **Scans.** This is the number of table scans using this TC as the transaction coordinator that were started during the last reporting interval. This does not include range scans (that is, ordered index scans).
- **Range scans.** This is the number of ordered index scans using this TC as the transaction coordinator that were started in the last reporting interval.
- **Local reads.** This is the number of primary-key read operations performed using a transaction coordinator on a node that also holds the primary fragment replica of the record. This count can also be obtained from the `LOCAL_READS` counter in the `ndbinfo.counters` table.
- **Local writes.** This contains the number of primary-key read operations that were performed using a transaction coordinator on a node that also holds the primary fragment replica of the record. This count can also be obtained from the `LOCAL_WRITES` counter in the `ndbinfo.counters` table.

**Local query handler statistics (Operations).** There is 1 cluster event per local query handler block (that is, 1 per data node process). Operations are recorded in the LQH where the data they are operating on resides.

**Note**

A single transaction may operate on data stored in multiple LQH blocks.

The `Operations` statistic provides the number of local operations performed by this LQH block in the last reporting interval, and includes all types of read and write operations (insert, update, write, and delete

operations). This also includes operations used to replicate writes. For example, in a cluster having two fragment replicas, the write to the primary fragment replica is recorded in the primary LQH, and the write to the backup is recorded in the backup LQH. Unique key operations may result in multiple local operations; however, this does *not* include local operations generated as a result of a table scan or ordered index scan, which are not counted.

**Process scheduler statistics.** In addition to the statistics reported by the transaction coordinator and local query handler, each `ndbd` process has a scheduler which also provides useful metrics relating to the performance of an NDB Cluster. This scheduler runs in an infinite loop; during each loop the scheduler performs the following tasks:

1. Read any incoming messages from sockets into a job buffer.
2. Check whether there are any timed messages to be executed; if so, put these into the job buffer as well.
3. Execute (in a loop) any messages in the job buffer.
4. Send any distributed messages that were generated by executing the messages in the job buffer.
5. Wait for any new incoming messages.

Process scheduler statistics include the following:

- **Mean Loop Counter.** This is the number of loops executed in the third step from the preceding list. This statistic increases in size as the utilization of the TCP/IP buffer improves. You can use this to monitor changes in performance as you add new data node processes.
- **Mean send size and Mean receive size.** These statistics enable you to gauge the efficiency of, respectively writes and reads between nodes. The values are given in bytes. Higher values mean a lower cost per byte sent or received; the maximum value is 64K.

To cause all cluster log statistics to be logged, you can use the following command in the `NDB` management client:

```
ndb_mgm> ALL CLUSTERLOG STATISTICS=15
```



#### Note

Setting the threshold for `STATISTICS` to 15 causes the cluster log to become very verbose, and to grow quite rapidly in size, in direct proportion to the number of cluster nodes and the amount of activity in the NDB Cluster.

For more information about NDB Cluster management client commands relating to logging and reporting, see [Section 21.6.3.1, “NDB Cluster Logging Management Commands”](#).

## 21.6.4 Summary of NDB Cluster Start Phases

This section provides a simplified outline of the steps involved when NDB Cluster data nodes are started. More complete information can be found in [NDB Cluster Start Phases](#), in the *NDB Internals Guide*.

These phases are the same as those reported in the output from the `node_id STATUS` command in the management client (see [Section 21.6.1, “Commands in the NDB Cluster Management Client”](#)). These start phases are also reported in the `start_phase` column of the `ndbinfo.nodes` table.

**Start types.** There are several different startup types and modes, as shown in the following list:

- **Initial start.** The cluster starts with a clean file system on all data nodes. This occurs either when the cluster started for the very first time, or when all data nodes are restarted using the `--initial` option.

**Note**

Disk Data files are not removed when restarting a node using `--initial`.

- **System restart.** The cluster starts and reads data stored in the data nodes. This occurs when the cluster has been shut down after having been in use, when it is desired for the cluster to resume operations from the point where it left off.
- **Node restart.** This is the online restart of a cluster node while the cluster itself is running.
- **Initial node restart.** This is the same as a node restart, except that the node is reinitialized and started with a clean file system.

**Setup and initialization (phase -1).** Prior to startup, each data node (`ndbd` process) must be initialized. Initialization consists of the following steps:

1. Obtain a node ID
2. Fetch configuration data
3. Allocate ports to be used for inter-node communications
4. Allocate memory according to settings obtained from the configuration file

When a data node or SQL node first connects to the management node, it reserves a cluster node ID. To make sure that no other node allocates the same node ID, this ID is retained until the node has managed to connect to the cluster and at least one `ndbd` reports that this node is connected. This retention of the node ID is guarded by the connection between the node in question and `ndb_mgmd`.

After each data node has been initialized, the cluster startup process can proceed. The stages which the cluster goes through during this process are listed here:

- **Phase 0.** The `NDBFS` and `NDBCNTR` blocks start. Data node file systems are cleared on those data nodes that were started with `--initial` option.
- **Phase 1.** In this stage, all remaining `NDB` kernel blocks are started. NDB Cluster connections are set up, inter-block communications are established, and heartbeats are started. In the case of a node restart, API node connections are also checked.

**Note**

When one or more nodes hang in Phase 1 while the remaining node or nodes hang in Phase 2, this often indicates network problems. One possible cause of such issues is one or more cluster hosts having multiple network interfaces. Another common source of problems causing this condition is the blocking of TCP/IP ports needed for communications between cluster nodes. In the latter case, this is often due to a misconfigured firewall.

- **Phase 2.** The `NDBCNTR` kernel block checks the states of all existing nodes. The master node is chosen, and the cluster schema file is initialized.
- **Phase 3.** The `DBLQH` and `DBTC` kernel blocks set up communications between them. The startup type is determined; if this is a restart, the `DBDIH` block obtains permission to perform the restart.
- **Phase 4.** For an initial start or initial node restart, the redo log files are created. The number of these files is equal to `NoOfFragmentLogFiles`.

For a system restart:

- Read schema or schemas.
- Read data from the local checkpoint.
- Apply all redo information until the latest restorable global checkpoint has been reached.

For a node restart, find the tail of the redo log.

- **Phase 5.** Most of the database-related portion of a data node start is performed during this phase. For an initial start or system restart, a local checkpoint is executed, followed by a global checkpoint. Periodic checks of memory usage begin during this phase, and any required node takeovers are performed.
- **Phase 6.** In this phase, node groups are defined and set up.
- **Phase 7.** The arbitrator node is selected and begins to function. The next backup ID is set, as is the backup disk write speed. Nodes reaching this start phase are marked as `Started`. It is now possible for API nodes (including SQL nodes) to connect to the cluster.
- **Phase 8.** If this is a system restart, all indexes are rebuilt (by `DBDIH`).
- **Phase 9.** The node internal startup variables are reset.
- **Phase 100 (OBSOLETE).** Formerly, it was at this point during a node restart or initial node restart that API nodes could connect to the node and begin to receive events. Currently, this phase is empty.
- **Phase 101.** At this point in a node restart or initial node restart, event delivery is handed over to the node joining the cluster. The newly-joined node takes over responsibility for delivering its primary data to subscribers. This phase is also referred to as *SUMA handover phase*.

After this process is completed for an initial start or system restart, transaction handling is enabled. For a node restart or initial node restart, completion of the startup process means that the node may now act as a transaction coordinator.

### 21.6.5 Performing a Rolling Restart of an NDB Cluster

This section discusses how to perform a *rolling restart* of an NDB Cluster installation, so called because it involves stopping and starting (or restarting) each node in turn, so that the cluster itself remains operational. This is often done as part of a *rolling upgrade* or *rolling downgrade*, where high availability of the cluster is mandatory and no downtime of the cluster as a whole is permissible. Where we refer to upgrades, the information provided here also generally applies to downgrades as well.

There are a number of reasons why a rolling restart might be desirable. These are described in the next few paragraphs.

#### **Configuration change.**

To make a change in the cluster's configuration, such as adding an SQL node to the cluster, or setting a configuration parameter to a new value.

**NDB Cluster software upgrade or downgrade.** To upgrade the cluster to a newer version of the NDB Cluster software (or to downgrade it to an older version). This is usually referred to as a “rolling upgrade” (or “rolling downgrade”, when reverting to an older version of NDB Cluster).

**Change on node host.** To make changes in the hardware or operating system on which one or more NDB Cluster node processes are running.



**System reset (cluster reset).**

To reset the cluster because it has reached an undesirable state. In such cases it is often desirable to reload the data and metadata of one or more data nodes. This can be done in any of three ways:

- Start each data node process (`ndbd` or possibly `ndbmtbd`) with the `--initial` option, which forces the data node to clear its file system and to reload all NDB Cluster data and metadata from the other data nodes.
- Create a backup using the `ndb_mgm` client `START BACKUP` command prior to performing the restart. Following the upgrade, restore the node or nodes using `ndb_restore`.

See [Section 21.6.8, “Online Backup of NDB Cluster”](#), and [Section 21.5.24, “ndb\\_restore — Restore an NDB Cluster Backup”](#), for more information.

- Use `mysqldump` to create a backup prior to the upgrade; afterward, restore the dump using `LOAD DATA`.

**Resource Recovery.**

To free memory previously allocated to a table by successive `INSERT` and `DELETE` operations, for re-use by other NDB Cluster tables.

The process for performing a rolling restart may be generalized as follows:

1. Stop all cluster management nodes (`ndb_mgmd` processes), reconfigure them, then restart them. (See [Rolling restarts with multiple management servers](#).)
2. Stop, reconfigure, then restart each cluster data node (`ndbd` process) in turn.

Some node configuration parameters can be updated by issuing `RESTART` for each of the data nodes in the `ndb_mgm` client following the previous step. Other parameters require that the data node be stopped completely using the management client `STOP` command, then started again from a system shell by invoking the `ndbd` or `ndbmtbd` executable as appropriate. (A shell command such as `kill` can also be used on most Unix systems to stop a data node process, but the `STOP` command is preferred and usually simpler.)

**Note**

On Windows, you can also use `SC STOP` and `SC START` commands, `NET STOP` and `NET START` commands, or the Windows Service Manager to stop and start nodes which have been installed as Windows services (see [Section 21.3.2.4, “Installing NDB Cluster Processes as Windows Services”](#)).

The type of restart required is indicated in the documentation for each node configuration parameter. See [Section 21.4.3, “NDB Cluster Configuration Files”](#).

3. Stop, reconfigure, then restart each cluster SQL node (`mysqld` process) in turn.

NDB Cluster supports a somewhat flexible order for upgrading nodes. When upgrading an NDB Cluster, you may upgrade API nodes (including SQL nodes) before upgrading the management nodes, data nodes, or both. In other words, you are permitted to upgrade the API and SQL nodes in any order. This is subject to the following provisions:

- This functionality is intended for use as part of an online upgrade only. A mix of node binaries from different NDB Cluster releases is neither intended nor supported for continuous, long-term use in a production setting.

- You must upgrade all nodes of the same type (management, data, or API node) before upgrading any nodes of a different type. This remains true regardless of the order in which the nodes are upgraded.
- You must upgrade all management nodes before upgrading any data nodes. This remains true regardless of the order in which you upgrade the cluster's API and SQL nodes.
- Features specific to the “new” version must not be used until all management nodes and data nodes have been upgraded.

This also applies to any MySQL Server version change that may apply, in addition to the NDB engine version change, so do not forget to take this into account when planning the upgrade. (This is true for online upgrades of NDB Cluster in general.)

It is not possible for any API node to perform schema operations (such as data definition statements) during a node restart. Due in part to this limitation, schema operations are also not supported during an online upgrade or downgrade. In addition, it is not possible to perform native backups while an upgrade or downgrade is ongoing.

**Rolling restarts with multiple management servers.** When performing a rolling restart of an NDB Cluster with multiple management nodes, you should keep in mind that `ndb_mgmd` checks to see if any other management node is running, and, if so, tries to use that node's configuration data. To keep this from occurring, and to force `ndb_mgmd` to re-read its configuration file, perform the following steps:

1. Stop all NDB Cluster `ndb_mgmd` processes.
2. Update all `config.ini` files.
3. Start a single `ndb_mgmd` with `--reload`, `--initial`, or both options as desired.
4. If you started the first `ndb_mgmd` with the `--initial` option, you must also start any remaining `ndb_mgmd` processes using `--initial`.

Regardless of any other options used when starting the first `ndb_mgmd`, you should not start any remaining `ndb_mgmd` processes after the first one using `--reload`.

5. Complete the rolling restarts of the data nodes and API nodes as normal.

When performing a rolling restart to update the cluster's configuration, you can use the `config_generation` column of the `ndbinfo.nodes` table to keep track of which data nodes have been successfully restarted with the new configuration. See [Section 21.6.15.28, “The ndbinfo nodes Table”](#).

## 21.6.6 NDB Cluster Single User Mode

*Single user mode* enables the database administrator to restrict access to the database system to a single API node, such as a MySQL server (SQL node) or an instance of `ndb_restore`. When entering single user mode, connections to all other API nodes are closed gracefully and all running transactions are aborted. No new transactions are permitted to start.

Once the cluster has entered single user mode, only the designated API node is granted access to the database.

You can use the `ALL STATUS` command in the `ndb_mgm` client to see when the cluster has entered single user mode. You can also check the `status` column of the `ndbinfo.nodes` table (see [Section 21.6.15.28, “The ndbinfo nodes Table”](#), for more information).

Example:

```
ndb_mgm> ENTER SINGLE USER MODE 5
```

After this command has executed and the cluster has entered single user mode, the API node whose node ID is 5 becomes the cluster's only permitted user.

The node specified in the preceding command must be an API node; attempting to specify any other type of node is rejected.



#### Note

When the preceding command is invoked, all transactions running on the designated node are aborted, the connection is closed, and the server must be restarted.

The command `EXIT SINGLE USER MODE` changes the state of the cluster's data nodes from single user mode to normal mode. API nodes—such as MySQL Servers—waiting for a connection (that is, waiting for the cluster to become ready and available), are again permitted to connect. The API node denoted as the single-user node continues to run (if still connected) during and after the state change.

Example:

```
ndb_mgm> EXIT SINGLE USER MODE
```

There are two recommended ways to handle a node failure when running in single user mode:

- Method 1:
  1. Finish all single user mode transactions
  2. Issue the `EXIT SINGLE USER MODE` command
  3. Restart the cluster's data nodes
- Method 2:
 

Restart storage nodes prior to entering single user mode.

## 21.6.7 Adding NDB Cluster Data Nodes Online

This section describes how to add NDB Cluster data nodes “online”—that is, without needing to shut down the cluster completely and restart it as part of the process.



#### Important

Currently, you must add new data nodes to an NDB Cluster as part of a new node group. In addition, it is not possible to change the number of fragment replicas (or the number of nodes per node group) online.

### 21.6.7.1 Adding NDB Cluster Data Nodes Online: General Issues

This section provides general information about the behavior of and current limitations in adding NDB Cluster nodes online.

**Redistribution of Data.** The ability to add new nodes online includes a means to reorganize `NDBCLUSTER` table data and indexes so that they are distributed across all data nodes, including the new ones, by means of the `ALTER TABLE ... REORGANIZE PARTITION` statement. Table reorganization

of both in-memory and Disk Data tables is supported. This redistribution does not currently include unique indexes (only ordered indexes are redistributed).

The redistribution for `NDBCLUSTER` tables already existing before the new data nodes were added is not automatic, but can be accomplished using simple SQL statements in `mysql` or another MySQL client application. However, all data and indexes added to tables created after a new node group has been added are distributed automatically among all cluster data nodes, including those added as part of the new node group.

**Partial starts.** It is possible to add a new node group without all of the new data nodes being started. It is also possible to add a new node group to a degraded cluster—that is, a cluster that is only partially started, or where one or more data nodes are not running. In the latter case, the cluster must have enough nodes running to be viable before the new node group can be added.

**Effects on ongoing operations.** Normal DML operations using NDB Cluster data are not prevented by the creation or addition of a new node group, or by table reorganization. However, it is not possible to perform DDL concurrently with table reorganization—that is, no other DDL statements can be issued while an `ALTER TABLE ... REORGANIZE PARTITION` statement is executing. In addition, during the execution of `ALTER TABLE ... REORGANIZE PARTITION` (or the execution of any other DDL statement), it is not possible to restart cluster data nodes.

**Failure handling.** Failures of data nodes during node group creation and table reorganization are handled as shown in the following table:

**Table 21.60 Data node failure handling during node group creation and table reorganization**

Failure during	Failure in “Old” data node	Failure in “New” data node	System Failure
Node group creation	<ul style="list-style-type: none"> <li>• <b>If a node other than the master fails:</b> The creation of the node group is always rolled forward.</li> <li>• <b>If the master fails:</b> <ul style="list-style-type: none"> <li>• <b>If the internal commit point has been reached:</b> The creation of the node group is rolled forward.</li> <li>• <b>If the internal commit point has not yet been reached.</b> The creation of the node group is rolled back</li> </ul> </li> </ul>	<ul style="list-style-type: none"> <li>• <b>If a node other than the master fails:</b> The creation of the node group is always rolled forward.</li> <li>• <b>If the master fails:</b> <ul style="list-style-type: none"> <li>• <b>If the internal commit point has been reached:</b> The creation of the node group is rolled forward.</li> <li>• <b>If the internal commit point has not yet been reached.</b> The creation of the node group is rolled back</li> </ul> </li> </ul>	<ul style="list-style-type: none"> <li>• <b>If the execution of CREATE NODEGROUP has reached the internal commit point:</b> When restarted, the cluster includes the new node group. Otherwise it without.</li> <li>• <b>If the execution of CREATE NODEGROUP has not yet reached the internal commit point:</b> When restarted, the cluster does not include the new node group.</li> </ul>
Table reorganization	<ul style="list-style-type: none"> <li>• <b>If a node other than the master fails:</b> The table reorganization is always rolled forward.</li> </ul>	<ul style="list-style-type: none"> <li>• <b>If a node other than the master fails:</b> The table reorganization is always rolled forward.</li> </ul>	<ul style="list-style-type: none"> <li>• <b>If the execution of an ALTER TABLE ... REORGANIZE PARTITION statement has reached the</b></li> </ul>

Failure during	Failure in “Old” data node	Failure in “New” data node	System Failure
	<ul style="list-style-type: none"> <li>• <b>If the master fails:</b></li> <li>• <b>If the internal commit point has been reached:</b> The table reorganization is rolled forward.</li> <li>• <b>If the internal commit point has not yet been reached.</b> The table reorganization is rolled back.</li> </ul>	<ul style="list-style-type: none"> <li>• <b>If the master fails:</b></li> <li>• <b>If the internal commit point has been reached:</b> The table reorganization is rolled forward.</li> <li>• <b>If the internal commit point has not yet been reached.</b> The table reorganization is rolled back.</li> </ul>	<ul style="list-style-type: none"> <li>• <b>internal commit point:</b> When the cluster is restarted, the data and indexes belonging to <i>table</i> are distributed using the “new” data nodes.</li> <li>• <b>If the execution of an ALTER TABLE ... REORGANIZE PARTITION statement has not yet reached the internal commit point:</b> When the cluster is restarted, the data and indexes belonging to <i>table</i> are distributed using only the “old” data nodes.</li> </ul>

**Dropping node groups.** The `ndb_mgm` client supports a `DROP NODEGROUP` command, but it is possible to drop a node group only when no data nodes in the node group contain any data. Since there is currently no way to “empty” a specific data node or node group, this command works only the following two cases:

1. After issuing `CREATE NODEGROUP` in the `ndb_mgm` client, but before issuing any `ALTER TABLE ... REORGANIZE PARTITION` statements in the `mysql` client.
2. After dropping all `NDBCLUSTER` tables using `DROP TABLE`.

`TRUNCATE TABLE` does not work for this purpose because the data nodes continue to store the table definitions.

### 21.6.7.2 Adding NDB Cluster Data Nodes Online: Basic procedure

In this section, we list the basic steps required to add new data nodes to an NDB Cluster. This procedure applies whether you are using `ndbd` or `ndbmtbd` binaries for the data node processes. For a more detailed example, see [Section 21.6.7.3, “Adding NDB Cluster Data Nodes Online: Detailed Example”](#).

Assuming that you already have a running NDB Cluster, adding data nodes online requires the following steps:

1. Edit the cluster configuration `config.ini` file, adding new `[ndbd]` sections corresponding to the nodes to be added. In the case where the cluster uses multiple management servers, these changes need to be made to all `config.ini` files used by the management servers.

You must be careful that node IDs for any new data nodes added in the `config.ini` file do not overlap node IDs used by existing nodes. In the event that you have API nodes using dynamically allocated node IDs and these IDs match node IDs that you want to use for new data nodes, it is possible to force any such API nodes to “migrate”, as described later in this procedure.

2. Perform a rolling restart of all NDB Cluster management servers.

**Important**

All management servers must be restarted with the `--reload` or `--initial` option to force the reading of the new configuration.

3. Perform a rolling restart of all existing NDB Cluster data nodes. It is not necessary (or usually even desirable) to use `--initial` when restarting the existing data nodes.

If you are using API nodes with dynamically allocated IDs matching any node IDs that you wish to assign to new data nodes, you must restart all API nodes (including SQL nodes) before restarting any of the data nodes processes in this step. This causes any API nodes with node IDs that were previously not explicitly assigned to relinquish those node IDs and acquire new ones.

4. Perform a rolling restart of any SQL or API nodes connected to the NDB Cluster.
5. Start the new data nodes.

The new data nodes may be started in any order. They can also be started concurrently, as long as they are started after the rolling restarts of all existing data nodes have been completed, and before proceeding to the next step.

6. Execute one or more `CREATE NODEGROUP` commands in the NDB Cluster management client to create the new node group or node groups to which the new data nodes belong.
7. Redistribute the cluster's data among all data nodes, including the new ones. Normally this is done by issuing an `ALTER TABLE ... ALGORITHM=INPLACE, REORGANIZE PARTITION` statement in the `mysql` client for each `NDBCLUSTER` table.

*Exception:* For tables created using the `MAX_ROWS` option, this statement does not work; instead, use `ALTER TABLE ... ALGORITHM=INPLACE MAX_ROWS=...` to reorganize such tables. You should also bear in mind that using `MAX_ROWS` to set the number of partitions in this fashion is deprecated in NDB 7.5.4 and later, where you should use `PARTITION_BALANCE` instead; see [Section 13.1.18.9, "Setting NDB Comment Options"](#), for more information.

**Note**

This needs to be done only for tables already existing at the time the new node group is added. Data in tables created after the new node group is added is distributed automatically; however, data added to any given table `tbl` that existed before the new nodes were added is not distributed using the new nodes until that table has been reorganized.

8. `ALTER TABLE ... REORGANIZE PARTITION ALGORITHM=INPLACE` reorganizes partitions but does not reclaim the space freed on the "old" nodes. You can do this by issuing, for each `NDBCLUSTER` table, an `OPTIMIZE TABLE` statement in the `mysql` client.

This works for space used by variable-width columns of in-memory NDB tables. `OPTIMIZE TABLE` is not supported for fixed-width columns of in-memory tables; it is also not supported for Disk Data tables.

You can add all the nodes desired, then issue several `CREATE NODEGROUP` commands in succession to add the new node groups to the cluster.

### 21.6.7.3 Adding NDB Cluster Data Nodes Online: Detailed Example

In this section we provide a detailed example illustrating how to add new NDB Cluster data nodes online, starting with an NDB Cluster having 2 data nodes in a single node group and concluding with a cluster having 4 data nodes in 2 node groups.

**Starting configuration.** For purposes of illustration, we assume a minimal configuration, and that the cluster uses a `config.ini` file containing only the following information:

```
[ndbd default]
DataMemory = 100M
IndexMemory = 100M
NoOfReplicas = 2
DataDir = /usr/local/mysql/var/mysql-cluster

[ndbd]
Id = 1
HostName = 198.51.100.1

[ndbd]
Id = 2
HostName = 198.51.100.2

[mgm]
HostName = 198.51.100.10
Id = 10

[api]
Id=20
HostName = 198.51.100.20

[api]
Id=21
HostName = 198.51.100.21
```



### Note

We have left a gap in the sequence between data node IDs and other nodes. This make it easier later to assign node IDs that are not already in use to data nodes which are newly added.

We also assume that you have already started the cluster using the appropriate command line or `my.cnf` options, and that running `SHOW` in the management client produces output similar to what is shown here:

```
-- NDB Cluster -- Management Client --
ndb_mgm> SHOW
Connected to Management Server at: 198.51.100.10:1186
Cluster Configuration
-----
[ndbd(NDB)] 2 node(s)
id=1 @198.51.100.1 (5.7.44-ndb-7.5.36, Nodegroup: 0, *)
id=2 @198.51.100.2 (5.7.44-ndb-7.5.36, Nodegroup: 0)

[ndb_mgmd(MGM)] 1 node(s)
id=10 @198.51.100.10 (5.7.44-ndb-7.5.36)

[mysqld(API)] 2 node(s)
id=20 @198.51.100.20 (5.7.44-ndb-7.5.36)
id=21 @198.51.100.21 (5.7.44-ndb-7.5.36)
```

Finally, we assume that the cluster contains a single `NDBCLUSTER` table created as shown here:

```
USE n;

CREATE TABLE ips (
  id BIGINT NOT NULL AUTO_INCREMENT PRIMARY KEY,
  country_code CHAR(2) NOT NULL,
  type CHAR(4) NOT NULL,
  ip_address VARCHAR(15) NOT NULL,
  addresses BIGINT UNSIGNED DEFAULT NULL,
  date BIGINT UNSIGNED DEFAULT NULL
```

```
) ENGINE NDBCLUSTER;
```

The memory usage and related information shown later in this section was generated after inserting approximately 50000 rows into this table.



### Note

In this example, we show the single-threaded `ndbd` being used for the data node processes. You can also apply this example, if you are using the multithreaded `ndbmt` by substituting `ndbmt` for `ndbd` wherever it appears in the steps that follow.

**Step 1: Update configuration file.** Open the cluster global configuration file in a text editor and add `[ndbd]` sections corresponding to the 2 new data nodes. (We give these data nodes IDs 3 and 4, and assume that they are to be run on host machines at addresses 198.51.100.3 and 198.51.100.4, respectively.) After you have added the new sections, the contents of the `config.ini` file should look like what is shown here, where the additions to the file are shown in bold type:

```
[ndbd default]
DataMemory = 100M
IndexMemory = 100M
NoOfReplicas = 2
DataDir = /usr/local/mysql/var/mysql-cluster

[ndbd]
Id = 1
HostName = 198.51.100.1

[ndbd]
Id = 2
HostName = 198.51.100.2

[ndbd]
Id = 3
HostName = 198.51.100.3

[ndbd]
Id = 4
HostName = 198.51.100.4

[mgm]
HostName = 198.51.100.10
Id = 10

[api]
Id=20
HostName = 198.51.100.20

[api]
Id=21
HostName = 198.51.100.21
```

Once you have made the necessary changes, save the file.

**Step 2: Restart the management server.** Restarting the cluster management server requires that you issue separate commands to stop the management server and then to start it again, as follows:

1. Stop the management server using the management client `STOP` command, as shown here:

```
ndb_mgm> 10 STOP
Node 10 has shut down.
Disconnecting to allow Management Server to shutdown
$>
```



- Because shutting down the management server causes the management client to terminate, you must start the management server from the system shell. For simplicity, we assume that `config.ini` is in the same directory as the management server binary, but in practice, you must supply the correct path to the configuration file. You must also supply the `--reload` or `--initial` option so that the management server reads the new configuration from the file rather than its configuration cache. If your shell's current directory is also the same as the directory where the management server binary is located, then you can invoke the management server as shown here:

```
$> ndb_mgmd -f config.ini --reload
2008-12-08 17:29:23 [MgmSrvr] INFO      -- NDB Cluster Management Server. 5.7.44-ndb-7.5.36
2008-12-08 17:29:23 [MgmSrvr] INFO      -- Reading cluster configuration from 'config.ini'
```

If you check the output of `SHOW` in the management client after restarting the `ndb_mgm` process, you should now see something like this:

```
-- NDB Cluster -- Management Client --
ndb_mgm> SHOW
Connected to Management Server at: 198.51.100.10:1186
Cluster Configuration
-----
[ndbd(NDB)]      2 node(s)
id=1   @198.51.100.1  (5.7.44-ndb-7.5.36, Nodegroup: 0, *)
id=2   @198.51.100.2  (5.7.44-ndb-7.5.36, Nodegroup: 0)
id=3   (not connected, accepting connect from 198.51.100.3)
id=4   (not connected, accepting connect from 198.51.100.4)

[ndb_mgmd(MGM)] 1 node(s)
id=10  @198.51.100.10  (5.7.44-ndb-7.5.36)

[mysqld(API)]   2 node(s)
id=20  @198.51.100.20  (5.7.44-ndb-7.5.36)
id=21  @198.51.100.21  (5.7.44-ndb-7.5.36)
```

**Step 3: Perform a rolling restart of the existing data nodes.** This step can be accomplished entirely within the cluster management client using the `RESTART` command, as shown here:

```
ndb_mgm> 1 RESTART
Node 1: Node shutdown initiated
Node 1: Node shutdown completed, restarting, no start.
Node 1 is being restarted

ndb_mgm> Node 1: Start initiated (version 7.5.36)
Node 1: Started (version 7.5.36)

ndb_mgm> 2 RESTART
Node 2: Node shutdown initiated
Node 2: Node shutdown completed, restarting, no start.
Node 2 is being restarted

ndb_mgm> Node 2: Start initiated (version 7.5.36)

ndb_mgm> Node 2: Started (version 7.5.36)
```



### Important

After issuing each `X RESTART` command, wait until the management client reports `Node X: Started (version ...)` before proceeding any further.

You can verify that all existing data nodes were restarted using the updated configuration by checking the `ndbinfo.nodes` table in the `mysql` client.

**Step 4: Perform a rolling restart of all cluster API nodes.** Shut down and restart each MySQL server acting as an SQL node in the cluster using `mysqladmin shutdown` followed by `mysqld_safe` (or

another startup script). This should be similar to what is shown here, where `password` is the MySQL `root` password for a given MySQL server instance:

```
$> mysqladmin -uroot -ppassword shutdown
081208 20:19:56 mysqld_safe mysqld from pid file
/usr/local/mysql/var/tonfisk.pid ended
$> mysqld_safe --ndbcluster --ndb-connectstring=198.51.100.10 &
081208 20:20:06 mysqld_safe Logging to '/usr/local/mysql/var/tonfisk.err'.
081208 20:20:06 mysqld_safe Starting mysqld daemon with databases
from /usr/local/mysql/var
```

Of course, the exact input and output depend on how and where MySQL is installed on the system, as well as which options you choose to start it (and whether or not some or all of these options are specified in a `my.cnf` file).

**Step 5: Perform an initial start of the new data nodes.** From a system shell on each of the hosts for the new data nodes, start the data nodes as shown here, using the `--initial` option:

```
$> ndbd -c 198.51.100.10 --initial
```



#### Note

Unlike the case with restarting the existing data nodes, you can start the new data nodes concurrently; you do not need to wait for one to finish starting before starting the other.

*Wait until both of the new data nodes have started before proceeding with the next step.* Once the new data nodes have started, you can see in the output of the management client `SHOW` command that they do not yet belong to any node group (as indicated with bold type here):

```
ndb_mgm> SHOW
Connected to Management Server at: 198.51.100.10:1186
Cluster Configuration
-----
[ndbd(NDB)] 2 node(s)
id=1 @198.51.100.1 (5.7.44-ndb-7.5.36, Nodegroup: 0, *)
id=2 @198.51.100.2 (5.7.44-ndb-7.5.36, Nodegroup: 0)
id=3 @198.51.100.3 (5.7.44-ndb-7.5.36, no nodegroup)
id=4 @198.51.100.4 (5.7.44-ndb-7.5.36, no nodegroup)

[ndb_mgmd(MGM)] 1 node(s)
id=10 @198.51.100.10 (5.7.44-ndb-7.5.36)

[mysqld(API)] 2 node(s)
id=20 @198.51.100.20 (5.7.44-ndb-7.5.36)
id=21 @198.51.100.21 (5.7.44-ndb-7.5.36)
```

**Step 6: Create a new node group.** You can do this by issuing a `CREATE NODEGROUP` command in the cluster management client. This command takes as its argument a comma-separated list of the node IDs of the data nodes to be included in the new node group, as shown here:

```
ndb_mgm> CREATE NODEGROUP 3,4
Nodegroup 1 created
```

By issuing `SHOW` again, you can verify that data nodes 3 and 4 have joined the new node group (again indicated in bold type):

```
ndb_mgm> SHOW
Connected to Management Server at: 198.51.100.10:1186
Cluster Configuration
-----
```

```
[ndbd(NDB)] 2 node(s)
id=1 @198.51.100.1 (5.7.44-ndb-7.5.36, Nodegroup: 0, *)
id=2 @198.51.100.2 (5.7.44-ndb-7.5.36, Nodegroup: 0)
id=3 @198.51.100.3 (5.7.44-ndb-7.5.36, Nodegroup: 1)
id=4 @198.51.100.4 (5.7.44-ndb-7.5.36, Nodegroup: 1)

[ndb_mgmd(MGM)] 1 node(s)
id=10 @198.51.100.10 (5.7.44-ndb-7.5.36)

[mysqld(API)] 2 node(s)
id=20 @198.51.100.20 (5.7.44-ndb-7.5.36)
id=21 @198.51.100.21 (5.7.44-ndb-7.5.36)
```

**Step 7: Redistribute cluster data.** When a node group is created, existing data and indexes are not automatically distributed to the new node group's data nodes, as you can see by issuing the appropriate `REPORT` command in the management client:

```
ndb_mgm> ALL REPORT MEMORY

Node 1: Data usage is 5%(177 32K pages of total 3200)
Node 1: Index usage is 0%(108 8K pages of total 12832)
Node 2: Data usage is 5%(177 32K pages of total 3200)
Node 2: Index usage is 0%(108 8K pages of total 12832)
Node 3: Data usage is 0%(0 32K pages of total 3200)
Node 3: Index usage is 0%(0 8K pages of total 12832)
Node 4: Data usage is 0%(0 32K pages of total 3200)
Node 4: Index usage is 0%(0 8K pages of total 12832)
```

By using `ndb_desc` with the `-p` option, which causes the output to include partitioning information, you can see that the table still uses only 2 partitions (in the `Per partition info` section of the output, shown here in bold text):

```
$> ndb_desc -c 198.51.100.10 -d n ips -p
-- ips --
Version: 1
Fragment type: 9
K Value: 6
Min load factor: 78
Max load factor: 80
Temporary table: no
Number of attributes: 6
Number of primary keys: 1
Length of frm data: 340
Row Checksum: 1
Row GCI: 1
SingleUserMode: 0
ForceVarPart: 1
FragmentCount: 2
TableStatus: Retrieved
-- Attributes --
id Bigint PRIMARY KEY DISTRIBUTION KEY AT=FIXED ST=MEMORY AUTO_INCR
country_code Char(2;latin1_swedish_ci) NOT NULL AT=FIXED ST=MEMORY
type Char(4;latin1_swedish_ci) NOT NULL AT=FIXED ST=MEMORY
ip_address Varchar(15;latin1_swedish_ci) NOT NULL AT=SHORT_VAR ST=MEMORY
addresses Bigunsigned NULL AT=FIXED ST=MEMORY
date Bigunsigned NULL AT=FIXED ST=MEMORY

-- Indexes --
PRIMARY KEY(id) - UniqueHashIndex
PRIMARY(id) - OrderedIndex

-- Per partition info --
Partition  Row count  Commit count  Frag fixed memory  Frag varsized memory
0          26086      26086         1572864             557056
1          26329      26329         1605632             557056
```

```
NDBT_ProgramExit: 0 - OK
```

You can cause the data to be redistributed among all of the data nodes by performing, for each NDB table, an `ALTER TABLE ... ALGORITHM=INPLACE, REORGANIZE PARTITION` statement in the `mysql` client.



### Important

`ALTER TABLE ... ALGORITHM=INPLACE, REORGANIZE PARTITION` does not work on tables that were created with the `MAX_ROWS` option. Instead, use `ALTER TABLE ... ALGORITHM=INPLACE, MAX_ROWS=...` to reorganize such tables.

Keep in mind that using `MAX_ROWS` to set the number of partitions per table is deprecated in NDB 7.5.4 and later, where you should use `PARTITION_BALANCE` instead; see [Section 13.1.18.9, “Setting NDB Comment Options”](#), for more information.

After issuing the statement `ALTER TABLE ips ALGORITHM=INPLACE, REORGANIZE PARTITION`, you can see using `ndb_desc` that the data for this table is now stored using 4 partitions, as shown here (with the relevant portions of the output in bold type):

```
$> ndb_desc -c 198.51.100.10 -d n ips -p
-- ips --
Version: 16777217
Fragment type: 9
K Value: 6
Min load factor: 78
Max load factor: 80
Temporary table: no
Number of attributes: 6
Number of primary keys: 1
Length of frm data: 341
Row Checksum: 1
Row GCI: 1
SingleUserMode: 0
ForceVarPart: 1
FragmentCount: 4
TableStatus: Retrieved
-- Attributes --
id Bigint PRIMARY KEY DISTRIBUTION KEY AT=FIXED ST=MEMORY AUTO_INCR
country_code Char(2;latin1_swedish_ci) NOT NULL AT=FIXED ST=MEMORY
type Char(4;latin1_swedish_ci) NOT NULL AT=FIXED ST=MEMORY
ip_address Varchar(15;latin1_swedish_ci) NOT NULL AT=SHORT_VAR ST=MEMORY
addresses Bigunsigned NULL AT=FIXED ST=MEMORY
date Bigunsigned NULL AT=FIXED ST=MEMORY

-- Indexes --
PRIMARY KEY(id) - UniqueHashIndex
PRIMARY(id) - OrderedIndex

-- Per partition info --
Partition  Row count  Commit count  Frag fixed memory  Frag var sized memory
0          12981      52296         1572864             557056
1          13236      52515         1605632             557056
2          13105      13105         819200              294912
3          13093      13093         819200              294912

NDBT_ProgramExit: 0 - OK
```



### Note

Normally, `ALTER TABLE table_name [ALGORITHM=INPLACE,] REORGANIZE PARTITION` is used with a list of partition identifiers and a set of partition definitions

to create a new partitioning scheme for a table that has already been explicitly partitioned. Its use here to redistribute data onto a new NDB Cluster node group is an exception in this regard; when used in this way, no other keywords or identifiers follow `REORGANIZE PARTITION`.

For more information, see [Section 13.1.8, “ALTER TABLE Statement”](#).

In addition, for each table, the `ALTER TABLE` statement should be followed by an `OPTIMIZE TABLE` to reclaim wasted space. You can obtain a list of all `NDBCLUSTER` tables using the following query against the Information Schema `TABLES` table:

```
SELECT TABLE_SCHEMA, TABLE_NAME
FROM INFORMATION_SCHEMA.TABLES
WHERE ENGINE = 'NDBCLUSTER';
```



#### Note

The `INFORMATION_SCHEMA.TABLES.ENGINE` value for an NDB Cluster table is always `NDBCLUSTER`, regardless of whether the `CREATE TABLE` statement used to create the table (or `ALTER TABLE` statement used to convert an existing table from a different storage engine) used `NDB` or `NDBCLUSTER` in its `ENGINE` option.

You can see after performing these statements in the output of `ALL REPORT MEMORY` that the data and indexes are now redistributed between all cluster data nodes, as shown here:

```
ndb_mgm> ALL REPORT MEMORY

Node 1: Data usage is 5%(176 32K pages of total 3200)
Node 1: Index usage is 0%(76 8K pages of total 12832)
Node 2: Data usage is 5%(176 32K pages of total 3200)
Node 2: Index usage is 0%(76 8K pages of total 12832)
Node 3: Data usage is 2%(80 32K pages of total 3200)
Node 3: Index usage is 0%(51 8K pages of total 12832)
Node 4: Data usage is 2%(80 32K pages of total 3200)
Node 4: Index usage is 0%(50 8K pages of total 12832)
```



#### Note

Since only one DDL operation on `NDBCLUSTER` tables can be executed at a time, you must wait for each `ALTER TABLE ... REORGANIZE PARTITION` statement to finish before issuing the next one.

It is not necessary to issue `ALTER TABLE ... REORGANIZE PARTITION` statements for `NDBCLUSTER` tables created *after* the new data nodes have been added; data added to such tables is distributed among all data nodes automatically. However, in `NDBCLUSTER` tables that existed *prior* to the addition of the new nodes, neither existing nor new data is distributed using the new nodes until these tables have been reorganized using `ALTER TABLE ... REORGANIZE PARTITION`.

**Alternative procedure, without rolling restart.** It is possible to avoid the need for a rolling restart by configuring the extra data nodes, but not starting them, when first starting the cluster. We assume, as before, that you wish to start with two data nodes—nodes 1 and 2—in one node group and later to expand the cluster to four data nodes, by adding a second node group consisting of nodes 3 and 4:

```
[ndbd default]
DataMemory = 100M
IndexMemory = 100M
NoOfReplicas = 2
DataDir = /usr/local/mysql/var/mysql-cluster

[ndbd]
Id = 1
```

```

HostName = 198.51.100.1

[ndbd]
Id = 2
HostName = 198.51.100.2

[ndbd]
Id = 3
HostName = 198.51.100.3
Nodegroup = 65536

[ndbd]
Id = 4
HostName = 198.51.100.4
Nodegroup = 65536

[mgm]
HostName = 198.51.100.10
Id = 10

[api]
Id=20
HostName = 198.51.100.20

[api]
Id=21
HostName = 198.51.100.21

```

The data nodes to be brought online at a later time (nodes 3 and 4) can be configured with `NodeGroup = 65536`, in which case nodes 1 and 2 can each be started as shown here:

```
$> ndbd -c 198.51.100.10 --initial
```

The data nodes configured with `NodeGroup = 65536` are treated by the management server as though you had started nodes 1 and 2 using `--nowait-nodes=3,4` after waiting for a period of time determined by the setting for the `StartNoNodeGroupTimeout` data node configuration parameter. By default, this is 15 seconds (15000 milliseconds).



#### Note

`StartNoNodegroupTimeout` must be the same for all data nodes in the cluster; for this reason, you should always set it in the `[ndbd default]` section of the `config.ini` file, rather than for individual data nodes.

When you are ready to add the second node group, you need only perform the following additional steps:

1. Start data nodes 3 and 4, invoking the data node process once for each new node:

```
$> ndbd -c 198.51.100.10 --initial
```

2. Issue the appropriate `CREATE NODEGROUP` command in the management client:

```
ndb_mgm> CREATE NODEGROUP 3,4
```

3. In the `mysql` client, issue `ALTER TABLE ... REORGANIZE PARTITION` and `OPTIMIZE TABLE` statements for each existing `NDBCLUSTER` table. (As noted elsewhere in this section, existing NDB Cluster tables cannot use the new nodes for data distribution until this has been done.)

## 21.6.8 Online Backup of NDB Cluster

The next few sections describe how to prepare for and then to create an NDB Cluster backup using the functionality for this purpose found in the `ndb_mgm` management client. To distinguish this type of backup

from a backup made using `mysqldump`, we sometimes refer to it as a “native” NDB Cluster backup. (For information about the creation of backups with `mysqldump`, see [Section 4.5.4, “mysqldump — A Database Backup Program”](#).) Restoration of NDB Cluster backups is done using the `ndb_restore` utility provided with the NDB Cluster distribution; for information about `ndb_restore` and its use in restoring NDB Cluster backups, see [Section 21.5.24, “ndb\\_restore — Restore an NDB Cluster Backup”](#).

### 21.6.8.1 NDB Cluster Backup Concepts

A backup is a snapshot of the database at a given time. The backup consists of three main parts:

- **Metadata.** The names and definitions of all database tables
- **Table records.** The data actually stored in the database tables at the time that the backup was made
- **Transaction log.** A sequential record telling how and when data was stored in the database

Each of these parts is saved on all nodes participating in the backup. During backup, each node saves these three parts into three files on disk:

- `BACKUP-backup_id.node_id.ctl`

A control file containing control information and metadata. Each node saves the same table definitions (for all tables in the cluster) to its own version of this file.

- `BACKUP-backup_id-0.node_id.data`

A data file containing the table records, which are saved on a per-fragment basis. That is, different nodes save different fragments during the backup. The file saved by each node starts with a header that states the tables to which the records belong. Following the list of records there is a footer containing a checksum for all records.

- `BACKUP-backup_id.node_id.log`

A log file containing records of committed transactions. Only transactions on tables stored in the backup are stored in the log. Nodes involved in the backup save different records because different nodes host different database fragments.

In the listing just shown, `backup_id` stands for the backup identifier and `node_id` is the unique identifier for the node creating the file.

The location of the backup files is determined by the `BackupDataDir` parameter.

### 21.6.8.2 Using The NDB Cluster Management Client to Create a Backup

Before starting a backup, make sure that the cluster is properly configured for performing one. (See [Section 21.6.8.3, “Configuration for NDB Cluster Backups”](#).)

The `START BACKUP` command is used to create a backup:

```
START BACKUP [backup_id] [wait_option] [snapshot_option]
wait_option:
WAIT {STARTED | COMPLETED} | NOWAIT
snapshot_option:
SNAPSHOTSTART | SNAPSHOTEND
```

Successive backups are automatically identified sequentially, so the `backup_id`, an integer greater than or equal to 1, is optional; if it is omitted, the next available value is used. If an existing `backup_id`

value is used, the backup fails with the error `Backup failed: file already exists`. If used, the `backup_id` must follow `START BACKUP` immediately, before any other options are used.

The `wait_option` can be used to determine when control is returned to the management client after a `START BACKUP` command is issued, as shown in the following list:

- If `NOWAIT` is specified, the management client displays a prompt immediately, as seen here:

```
ndb_mgm> START BACKUP NOWAIT
ndb_mgm>
```

In this case, the management client can be used even while it prints progress information from the backup process.

- With `WAIT STARTED` the management client waits until the backup has started before returning control to the user, as shown here:

```
ndb_mgm> START BACKUP WAIT STARTED
Waiting for started, this may take several minutes
Node 2: Backup 3 started from node 1
ndb_mgm>
```

- `WAIT COMPLETED` causes the management client to wait until the backup process is complete before returning control to the user.

`WAIT COMPLETED` is the default.

A `snapshot_option` can be used to determine whether the backup matches the state of the cluster when `START BACKUP` was issued, or when it was completed. `SNAPSHOTSTART` causes the backup to match the state of the cluster when the backup began; `SNAPSHOTEND` causes the backup to reflect the state of the cluster when the backup was finished. `SNAPSHOTEND` is the default, and matches the behavior found in previous NDB Cluster releases.



#### Note

If you use the `SNAPSHOTSTART` option with `START BACKUP`, and the `CompressedBackup` parameter is enabled, only the data and control files are compressed—the log file is not compressed.

If both a `wait_option` and a `snapshot_option` are used, they may be specified in either order. For example, all of the following commands are valid, assuming that there is no existing backup having 4 as its ID:

```
START BACKUP WAIT STARTED SNAPSHOTSTART
START BACKUP SNAPSHOTSTART WAIT STARTED
START BACKUP 4 WAIT COMPLETED SNAPSHOTSTART
START BACKUP SNAPSHOTEND WAIT COMPLETED
START BACKUP 4 NOWAIT SNAPSHOTSTART
```

The procedure for creating a backup consists of the following steps:

1. Start the management client (`ndb_mgm`), if it not running already.
2. Execute the `START BACKUP` command. This produces several lines of output indicating the progress of the backup, as shown here:

```
ndb_mgm> START BACKUP
Waiting for completed, this may take several minutes
Node 2: Backup 1 started from node 1
```



```
Node 2: Backup 1 started from node 1 completed
StartGCP: 177 StopGCP: 180
#Records: 7362 #LogRecords: 0
Data: 453648 bytes Log: 0 bytes
ndb_mgm>
```

- When the backup has started the management client displays this message:

```
Backup backup_id started from node node_id
```

*backup\_id* is the unique identifier for this particular backup. This identifier is saved in the cluster log, if it has not been configured otherwise. *node\_id* is the identifier of the management server that is coordinating the backup with the data nodes. At this point in the backup process the cluster has received and processed the backup request. It does not mean that the backup has finished. An example of this statement is shown here:

```
Node 2: Backup 1 started from node 1
```

- The management client indicates with a message like this one that the backup has started:

```
Backup backup_id started from node node_id completed
```

As is the case for the notification that the backup has started, *backup\_id* is the unique identifier for this particular backup, and *node\_id* is the node ID of the management server that is coordinating the backup with the data nodes. This output is accompanied by additional information including relevant global checkpoints, the number of records backed up, and the size of the data, as shown here:

```
Node 2: Backup 1 started from node 1 completed
StartGCP: 177 StopGCP: 180
#Records: 7362 #LogRecords: 0
Data: 453648 bytes Log: 0 bytes
```

It is also possible to perform a backup from the system shell by invoking `ndb_mgm` with the `-e` or `--execute` option, as shown in this example:

```
$> ndb_mgm -e "START BACKUP 6 WAIT COMPLETED SNAPSHOTSTART"
```

When using `START BACKUP` in this way, you must specify the backup ID.

Cluster backups are created by default in the `BACKUP` subdirectory of the `DataDir` on each data node. This can be overridden for one or more data nodes individually, or for all cluster data nodes in the `config.ini` file using the `BackupDataDir` configuration parameter. The backup files created for a backup with a given *backup\_id* are stored in a subdirectory named `BACKUP-backup_id` in the backup directory.

**Cancelling backups.** To cancel or abort a backup that is already in progress, perform the following steps:

- Start the management client.
- Execute this command:

```
ndb_mgm> ABORT BACKUP backup_id
```

The number *backup\_id* is the identifier of the backup that was included in the response of the management client when the backup was started (in the message `Backup backup_id started from node management_node_id`).

- The management client acknowledges the abort request with `Abort of backup backup_id ordered.`

**Note**

At this point, the management client has not yet received a response from the cluster data nodes to this request, and the backup has not yet actually been aborted.

4. After the backup has been aborted, the management client reports this fact in a manner similar to what is shown here:

```
Node 1: Backup 3 started from 5 has been aborted.
  Error: 1321 - Backup aborted by user request: Permanent error: User defined error
Node 3: Backup 3 started from 5 has been aborted.
  Error: 1323 - 1323: Permanent error: Internal error
Node 2: Backup 3 started from 5 has been aborted.
  Error: 1323 - 1323: Permanent error: Internal error
Node 4: Backup 3 started from 5 has been aborted.
  Error: 1323 - 1323: Permanent error: Internal error
```

In this example, we have shown sample output for a cluster with 4 data nodes, where the sequence number of the backup to be aborted is 3, and the management node to which the cluster management client is connected has the node ID 5. The first node to complete its part in aborting the backup reports that the reason for the abort was due to a request by the user. (The remaining nodes report that the backup was aborted due to an unspecified internal error.)

**Note**

There is no guarantee that the cluster nodes respond to an `ABORT BACKUP` command in any particular order.

The `Backup backup_id started from node management_node_id has been aborted` messages mean that the backup has been terminated and that all files relating to this backup have been removed from the cluster file system.

It is also possible to abort a backup in progress from a system shell using this command:

```
$> ndb_mgm -e "ABORT BACKUP backup_id"
```

**Note**

If there is no backup having the ID `backup_id` running when an `ABORT BACKUP` is issued, the management client makes no response, nor is it indicated in the cluster log that an invalid abort command was sent.

### 21.6.8.3 Configuration for NDB Cluster Backups

Five configuration parameters are essential for backup:

- `BackupDataBufferSize`

The amount of memory used to buffer data before it is written to disk.

- `BackupLogBufferSize`

The amount of memory used to buffer log records before these are written to disk.

- `BackupMemory`

The total memory allocated in a data node for backups. This should be the sum of the memory allocated for the backup data buffer and the backup log buffer.

- [BackupWriteSize](#)

The default size of blocks written to disk. This applies for both the backup data buffer and the backup log buffer.

- [BackupMaxWriteSize](#)

The maximum size of blocks written to disk. This applies for both the backup data buffer and the backup log buffer.

In addition, [CompressedBackup](#) causes [NDB](#) to use compression when creating and writing to backup files.

More detailed information about these parameters can be found in [Backup Parameters](#).

You can also set a location for the backup files using the [BackupDataDir](#) configuration parameter. The default is `FileSystemPath/BACKUP/BACKUP-backup_id`.

#### 21.6.8.4 NDB Cluster Backup Troubleshooting

If an error code is returned when issuing a backup request, the most likely cause is insufficient memory or disk space. You should check that there is enough memory allocated for the backup.



#### Important

If you have set [BackupDataBufferSize](#) and [BackupLogBufferSize](#) and their sum is greater than 4MB, then you must also set [BackupMemory](#) as well.

You should also make sure that there is sufficient space on the hard drive partition of the backup target.

[NDB](#) does not support repeatable reads, which can cause problems with the restoration process. Although the backup process is “hot”, restoring an [NDB Cluster](#) from backup is not a 100% “hot” process. This is due to the fact that, for the duration of the restore process, running transactions get nonrepeatable reads from the restored data. This means that the state of the data is inconsistent while the restore is in progress.

### 21.6.9 Importing Data Into MySQL Cluster

It is common when setting up a new instance of [NDB Cluster](#) to need to import data from an existing [NDB Cluster](#), instance of [MySQL](#), or other source. This data is most often available in one or more of the following formats:

- An SQL dump file such as produced by [mysqldump](#) or [mysqlpump](#). This can be imported using the [mysql](#) client, as shown later in this section.
- A CSV file produced by [mysqldump](#) or other export program. Such files can be imported into [NDB](#) using `LOAD DATA INFILE` in the [mysql](#) client, or with the [ndb\\_import](#) utility provided with the [NDB Cluster](#) distribution. For more information about the latter, see [Section 21.5.14, “ndb\\_import — Import CSV Data Into NDB”](#).
- A native [NDB](#) backup produced using `START BACKUP` in the [NDB](#) management client. To import a native backup, you must use the [ndb\\_restore](#) program that comes as part of [NDB Cluster](#). See [Section 21.5.24, “ndb\\_restore — Restore an NDB Cluster Backup”](#), for more about using this program.

When importing data from an SQL file, it is often not necessary to enforce transactions or foreign keys, and temporarily disabling these features can speed up the import process greatly. This can be done using the [mysql](#) client, either from a client session, or by invoking it on the command line. Within a [mysql](#) client session, you can perform the import using the following SQL statements:

```
SET ndb_use_transactions=0;
SET foreign_key_checks=0;

source path/to/dumpfile;

SET ndb_use_transactions=1;
SET foreign_key_checks=1;
```

When performing the import in this fashion, you *must* enable `ndb_use_transaction` and `foreign_key_checks` again following execution of the `mysql` client's `source` command. Otherwise, it is possible for later statements in same session may also be executed without enforcing transactions or foreign key constraints, and which could lead to data inconsistency.

From the system shell, you can import the SQL file while disabling enforcement of transaction and foreign keys by using the `mysql` client with the `--init-command` option, like this:

```
$> mysql --init-command='SET ndb_use_transactions=0; SET foreign_key_checks=0' < path/to/dumpfile
```

It is also possible to load the data into an `InnoDB` table, and convert it to use the NDB storage engine afterwards using `ALTER TABLE ... ENGINE NDB`). You should take into account, especially for many tables, that this may require a number of such operations; in addition, if foreign keys are used, you must mind the order of the `ALTER TABLE` statements carefully, due to the fact that foreign keys do not work between tables using different MySQL storage engines.

You should be aware that the methods described previously in this section are not optimized for very large data sets or large transactions. Should an application really need big transactions or many concurrent transactions as part of normal operation, you may wish to increase the value of the `MaxNoOfConcurrentOperations` data node configuration parameter, which reserves more memory to allow a data node to take over a transaction if its transaction coordinator stops unexpectedly.

You may also wish to do this when performing bulk `DELETE` or `UPDATE` operations on NDB Cluster tables. If possible, try to have applications perform these operations in chunks, for example, by adding `LIMIT` to such statements.

If a data import operation does not complete successfully, for whatever reason, you should be prepared to perform any necessary cleanup including possibly one or more `DROP TABLE` statements, `DROP DATABASE` statements, or both. Failing to do so may leave the database in an inconsistent state.

## 21.6.10 MySQL Server Usage for NDB Cluster

`mysqld` is the traditional MySQL server process. To be used with NDB Cluster, `mysqld` needs to be built with support for the `NDB` storage engine, as it is in the precompiled binaries available from <https://dev.mysql.com/downloads/>. If you build MySQL from source, you must invoke `CMake` with the `-DWITH_NDBCLUSTER=1` option to include support for `NDB`.

For more information about compiling NDB Cluster from source, see [Section 21.3.1.4, “Building NDB Cluster from Source on Linux”](#), and [Section 21.3.2.2, “Compiling and Installing NDB Cluster from Source on Windows”](#).

(For information about `mysqld` options and variables, in addition to those discussed in this section, which are relevant to NDB Cluster, see [Section 21.4.3.9, “MySQL Server Options and Variables for NDB Cluster”](#).)

If the `mysqld` binary has been built with Cluster support, the `NDBCLUSTER` storage engine is still disabled by default. You can use either of two possible options to enable this engine:

- Use `--ndbcluster` as a startup option on the command line when starting `mysqld`.

- Insert a line containing `ndbcluster` in the `[mysqld]` section of your `my.cnf` file.

An easy way to verify that your server is running with the `NDBCLUSTER` storage engine enabled is to issue the `SHOW ENGINES` statement in the MySQL Monitor (`mysql`). You should see the value `YES` as the `Support` value in the row for `NDBCLUSTER`. If you see `NO` in this row or if there is no such row displayed in the output, you are not running an NDB-enabled version of MySQL. If you see `DISABLED` in this row, you need to enable it in either one of the two ways just described.

To read cluster configuration data, the MySQL server requires at a minimum three pieces of information:

- The MySQL server's own cluster node ID
- The host name or IP address for the management server
- The number of the TCP/IP port on which it can connect to the management server

Node IDs can be allocated dynamically, so it is not strictly necessary to specify them explicitly.

The `mysqld` parameter `ndb-connectstring` is used to specify the connection string either on the command line when starting `mysqld` or in `my.cnf`. The connection string contains the host name or IP address where the management server can be found, as well as the TCP/IP port it uses.

In the following example, `ndb_mgmd.mysql.com` is the host where the management server resides, and the management server listens for cluster messages on port 1186:

```
$> mysqld --ndbcluster --ndb-connectstring=ndb_mgmd.mysql.com:1186
```

See [Section 21.4.3.3, “NDB Cluster Connection Strings”](#), for more information on connection strings.

Given this information, the MySQL server can act as a full participant in the cluster. (We often refer to a `mysqld` process running in this manner as an SQL node.) It is fully aware of all cluster data nodes as well as their status, and establishes connections to all data nodes. In this case, it is able to use any data node as a transaction coordinator and to read and update node data.

You can see in the `mysql` client whether a MySQL server is connected to the cluster using `SHOW PROCESSLIST`. If the MySQL server is connected to the cluster, and you have the `PROCESS` privilege, then the first row of the output is as shown here:

```
mysql> SHOW PROCESSLIST \G
***** 1. row *****
  Id: 1
  User: system user
  Host:
  db:
Command: Daemon
  Time: 1
  State: Waiting for event from ndbcluster
  Info: NULL
```



### Important

To participate in an NDB Cluster, the `mysqld` process must be started with *both* the options `--ndbcluster` and `--ndb-connectstring` (or their equivalents in `my.cnf`). If `mysqld` is started with only the `--ndbcluster` option, or if it is unable to contact the cluster, it is not possible to work with NDB tables, *nor is it possible to create any new tables regardless of storage engine*. The latter restriction is a safety measure intended to prevent the creation of tables having the same names as NDB tables while the SQL node is not connected to the cluster. If you wish to create

tables using a different storage engine while the `mysqld` process is not participating in an NDB Cluster, you must restart the server *without* the `--ndbcluster` option.

## 21.6.11 NDB Cluster Disk Data Tables

It is possible to store the nonindexed columns of NDB tables on disk, rather than in RAM.

As part of implementing NDB Cluster Disk Data work, a number of improvements were made in NDB Cluster for the efficient handling of very large amounts (terabytes) of data during node recovery and restart. These include a “no-steal” algorithm for synchronizing a starting node with very large data sets. For more information, see the paper [Recovery Principles of NDB Cluster 5.1](#), by NDB Cluster developers Mikael Ronström and Jonas Orelund.

NDB Cluster Disk Data performance can be influenced by a number of configuration parameters. For information about these parameters and their effects, see [NDB Cluster Disk Data configuration parameters](#) and [NDB Cluster Disk Data storage and GCP Stop errors](#)

The performance of an NDB Cluster that uses Disk Data storage can also be greatly improved by separating data node file systems from undo log files and tablespace data files, which can be done using symbolic links. For more information, see [Section 21.6.11.2, “Using Symbolic Links with Disk Data Objects”](#).

### 21.6.11.1 NDB Cluster Disk Data Objects

NDB Cluster Disk Data storage is implemented using a number of *Disk Data objects*. These include the following:

- *Tablespaces* act as containers for other Disk Data objects.
- *Undo log files* undo information required for rolling back transactions.
- One or more undo log files are assigned to a *log file group*, which is then assigned to a tablespace.
- *Data files* store Disk Data table data. A data file is assigned directly to a tablespace.

Undo log files and data files are actual files in the file system of each data node; by default they are placed in `ndb_node_id_fs` in the *DataDir* specified in the NDB Cluster `config.ini` file, and where `node_id` is the data node's node ID. It is possible to place these elsewhere by specifying either an absolute or relative path as part of the filename when creating the undo log or data file. Statements that create these files are shown later in this section.

NDB Cluster tablespaces and log file groups are not implemented as files.



#### Important

Although not all Disk Data objects are implemented as files, they all share the same namespace. This means that *each Disk Data object* must be uniquely named (and not merely each Disk Data object of a given type). For example, you cannot have a tablespace and a log file group both named `ddl`.

Assuming that you have already set up an NDB Cluster with all nodes (including management and SQL nodes), the basic steps for creating an NDB Cluster table on disk are as follows:

1. Create a log file group, and assign one or more undo log files to it (an undo log file is also sometimes referred to as an *undofile*).

**Note**

Undo log files are necessary only for Disk Data tables; they are not used for [NDBCLUSTER](#) tables that are stored only in memory.

2. Create a tablespace; assign the log file group, as well as one or more data files, to the tablespace.
3. Create a Disk Data table that uses this tablespace for data storage.

Each of these tasks can be accomplished using SQL statements in the `mysql` client or other MySQL client application, as shown in the example that follows.

1. We create a log file group named `lg_1` using `CREATE LOGFILE GROUP`. This log file group is to be made up of two undo log files, which we name `undo_1.log` and `undo_2.log`, whose initial sizes are 16 MB and 12 MB, respectively. (The default initial size for an undo log file is 128 MB.) Optionally, you can also specify a size for the log file group's undo buffer, or permit it to assume the default value of 8 MB. In this example, we set the UNDO buffer's size at 2 MB. A log file group must be created with an undo log file; so we add `undo_1.log` to `lg_1` in this `CREATE LOGFILE GROUP` statement:

```
CREATE LOGFILE GROUP lg_1
  ADD UNDOFILE 'undo_1.log'
  INITIAL_SIZE 16M
  UNDO_BUFFER_SIZE 2M
  ENGINE NDBCLUSTER;
```

To add `undo_2.log` to the log file group, use the following `ALTER LOGFILE GROUP` statement:

```
ALTER LOGFILE GROUP lg_1
  ADD UNDOFILE 'undo_2.log'
  INITIAL_SIZE 12M
  ENGINE NDBCLUSTER;
```

Some items of note:

- The `.log` file extension used here is not required. We use it merely to make the log files easily recognizable.
- Every `CREATE LOGFILE GROUP` and `ALTER LOGFILE GROUP` statement must include an `ENGINE` option. The only permitted values for this option are `NDBCLUSTER` and `NDB`.

**Important**

There can exist at most one log file group in the same NDB Cluster at any given time.

- When you add an undo log file to a log file group using `ADD UNDOFILE 'filename'`, a file with the name `filename` is created in the `ndb_node_id_fs` directory within the `DataDir` of each data node in the cluster, where `node_id` is the node ID of the data node. Each undo log file is of the size specified in the SQL statement. For example, if an NDB Cluster has 4 data nodes, then the `ALTER LOGFILE GROUP` statement just shown creates 4 undo log files, 1 each on in the data directory of each of the 4 data nodes; each of these files is named `undo_2.log` and each file is 12 MB in size.
- `UNDO_BUFFER_SIZE` is limited by the amount of system memory available.
- For more information about the `CREATE LOGFILE GROUP` statement, see [Section 13.1.15, "CREATE LOGFILE GROUP Statement"](#). For more information about `ALTER LOGFILE GROUP`, see [Section 13.1.5, "ALTER LOGFILE GROUP Statement"](#).

2. Now we can create a tablespace, which contains files to be used by NDB Cluster Disk Data tables for storing their data. A tablespace is also associated with a particular log file group. When creating a new tablespace, you must specify the log file group which it is to use for undo logging; you must also specify a data file. You can add more data files to the tablespace after the tablespace is created; it is also possible to drop data files from a tablespace (an example of dropping data files is provided later in this section).

Assume that we wish to create a tablespace named `ts_1` which uses `lg_1` as its log file group. This tablespace is to contain two data files named `data_1.dat` and `data_2.dat`, whose initial sizes are 32 MB and 48 MB, respectively. (The default value for `INITIAL_SIZE` is 128 MB.) We can do this using two SQL statements, as shown here:

```
CREATE TABLESPACE ts_1
  ADD DATAFILE 'data_1.dat'
  USE LOGFILE GROUP lg_1
  INITIAL_SIZE 32M
  ENGINE NDBCLUSTER;

ALTER TABLESPACE ts_1
  ADD DATAFILE 'data_2.dat'
  INITIAL_SIZE 48M
  ENGINE NDBCLUSTER;
```

The `CREATE TABLESPACE` statement creates a tablespace `ts_1` with the data file `data_1.dat`, and associates `ts_1` with log file group `lg_1`. The `ALTER TABLESPACE` adds the second data file (`data_2.dat`).

Some items of note:

- As is the case with the `.log` file extension used in this example for undo log files, there is no special significance for the `.dat` file extension; it is used merely for easy recognition of data files.
  - When you add a data file to a tablespace using `ADD DATAFILE 'filename'`, a file with the name `filename` is created in the `ndb_node_id_fs` directory within the `DataDir` of each data node in the cluster, where `node_id` is the node ID of the data node. Each data file is of the size specified in the SQL statement. For example, if an NDB Cluster has 4 data nodes, then the `ALTER TABLESPACE` statement just shown creates 4 data files, 1 each in the data directory of each of the 4 data nodes; each of these files is named `data_2.dat` and each file is 48 MB in size.
  - NDB 7.6 (and later) reserves 4% of each tablespace for use during data node restarts. This space is not available for storing data.
  - All `CREATE TABLESPACE` and `ALTER TABLESPACE` statements must contain an `ENGINE` clause; only tables using the same storage engine as the tablespace can be created in the tablespace. For NDB Cluster tablespaces, the only permitted values for this option are `NDBCLUSTER` and `NDB`.
  - For more information about the `CREATE TABLESPACE` and `ALTER TABLESPACE` statements, see [Section 13.1.19, “CREATE TABLESPACE Statement”](#), and [Section 13.1.9, “ALTER TABLESPACE Statement”](#).
3. Now it is possible to create a table whose nonindexed columns are stored on disk in the tablespace `ts_1`:

```
CREATE TABLE dt_1 (
  member_id INT UNSIGNED NOT NULL AUTO_INCREMENT PRIMARY KEY,
  last_name VARCHAR(50) NOT NULL,
  first_name VARCHAR(50) NOT NULL,
  dob DATE NOT NULL,
  joined DATE NOT NULL,
```



```
INDEX(last_name, first_name)
)
TABLESPACE ts_1 STORAGE DISK
ENGINE NDBCLUSTER;
```

The `TABLESPACE ... STORAGE DISK` option tells the `NDBCLUSTER` storage engine to use tablespace `ts_1` for disk data storage.

Once table `ts_1` has been created as shown, you can perform `INSERT`, `SELECT`, `UPDATE`, and `DELETE` statements on it just as you would with any other MySQL table.

It is also possible to specify whether an individual column is stored on disk or in memory by using a `STORAGE` clause as part of the column's definition in a `CREATE TABLE` or `ALTER TABLE` statement. `STORAGE DISK` causes the column to be stored on disk, and `STORAGE MEMORY` causes in-memory storage to be used. See [Section 13.1.18, "CREATE TABLE Statement"](#), for more information.

**Indexing of columns implicitly stored on disk.** For table `dt_1` as defined in the example just shown, only the `dob` and `joined` columns are stored on disk. This is because there are indexes on the `id`, `last_name`, and `first_name` columns, and so data belonging to these columns is stored in RAM. Only nonindexed columns can be held on disk; indexes and indexed column data continue to be stored in memory. This tradeoff between the use of indexes and conservation of RAM is something you must keep in mind as you design Disk Data tables.

You cannot add an index to a column that has been explicitly declared `STORAGE DISK`, without first changing its storage type to `MEMORY`; any attempt to do so fails with an error. A column which *implicitly* uses disk storage can be indexed; when this is done, the column's storage type is changed to `MEMORY` automatically. By "implicitly", we mean a column whose storage type is not declared, but which is which inherited from the parent table. In the following `CREATE TABLE` statement (using the tablespace `ts_1` defined previously), columns `c2` and `c3` use disk storage implicitly:

```
mysql> CREATE TABLE ti (
->   c1 INT PRIMARY KEY,
->   c2 INT,
->   c3 INT,
->   c4 INT
-> )
->   STORAGE DISK
->   TABLESPACE ts_1
->   ENGINE NDBCLUSTER;
Query OK, 0 rows affected (1.31 sec)
```

Because `c2`, `c3`, and `c4` are themselves not declared with `STORAGE DISK`, it is possible to index them. Here, we add indexes to `c2` and `c3`, using, respectively, `CREATE INDEX` and `ALTER TABLE`:

```
mysql> CREATE INDEX i1 ON ti(c2);
Query OK, 0 rows affected (2.72 sec)
Records: 0 Duplicates: 0 Warnings: 0

mysql> ALTER TABLE ti ADD INDEX i2(c3);
Query OK, 0 rows affected (0.92 sec)
Records: 0 Duplicates: 0 Warnings: 0
```

`SHOW CREATE TABLE` confirms that the indexes were added.

```
mysql> SHOW CREATE TABLE ti\G
***** 1. row *****
      Table: ti
Create Table: CREATE TABLE `ti` (
  `c1` int(11) NOT NULL,
  `c2` int(11) DEFAULT NULL,
  `c3` int(11) DEFAULT NULL,
```

```

`c4` int(11) DEFAULT NULL,
PRIMARY KEY (`c1`),
KEY `i1` (`c2`),
KEY `i2` (`c3`)
) /*!50100 TABLESPACE `ts_1` STORAGE DISK */ ENGINE=ndbcluster DEFAULT CHARSET=latin1
1 row in set (0.00 sec)

```

You can see using `ndb_desc` that the indexed columns (emphasized text) now use in-memory rather than on-disk storage:

```

$> ./ndb_desc -d test t1
-- t1 --
Version: 33554433
Fragment type: HashMapPartition
K Value: 6
Min load factor: 78
Max load factor: 80
Temporary table: no
Number of attributes: 4
Number of primary keys: 1
Length of frm data: 317
Max Rows: 0
Row Checksum: 1
Row GCI: 1
SingleUserMode: 0
ForceVarPart: 1
PartitionCount: 4
FragmentCount: 4
PartitionBalance: FOR_RP_BY_LDM
ExtraRowGciBits: 0
ExtraRowAuthorBits: 0
TableStatus: Retrieved
Table options:
HashMap: DEFAULT-HASHMAP-3840-4
-- Attributes --
c1 Int PRIMARY KEY DISTRIBUTION KEY AT=FIXED ST=MEMORY
c2 Int NULL AT=FIXED ST=MEMORY
c3 Int NULL AT=FIXED ST=MEMORY
c4 Int NULL AT=FIXED ST=DISK
-- Indexes --
PRIMARY KEY(c1) - UniqueHashIndex
i2(c3) - OrderedIndex
PRIMARY(c1) - OrderedIndex
i1(c2) - OrderedIndex

NDBT_ProgramExit: 0 - OK

```

**Performance note.** The performance of a cluster using Disk Data storage is greatly improved if Disk Data files are kept on a separate physical disk from the data node file system. This must be done for each data node in the cluster to derive any noticeable benefit.

You may use absolute and relative file system paths with [ADD UNDOFILE](#) and [ADD DATAFILE](#). Relative paths are calculated relative to the data node's data directory. You may also use symbolic links; see [Section 21.6.11.2, "Using Symbolic Links with Disk Data Objects"](#), for more information and examples.

A log file group, a tablespace, and any Disk Data tables using these must be created in a particular order. The same is true for dropping any of these objects:

- A log file group cannot be dropped as long as any tablespaces are using it.
- A tablespace cannot be dropped as long as it contains any data files.
- You cannot drop any data files from a tablespace as long as there remain any tables which are using the tablespace.

- It is not possible to drop files created in association with a different tablespace than the one with which the files were created. (Bug #20053)

For example, to drop all the objects created so far in this section, you would use the following statements:

```
mysql> DROP TABLE dt_1;

mysql> ALTER TABLESPACE ts_1
-> DROP DATAFILE 'data_2.dat'
-> ENGINE NDBCLUSTER;

mysql> ALTER TABLESPACE ts_1
-> DROP DATAFILE 'data_1.dat'
-> ENGINE NDBCLUSTER;

mysql> DROP TABLESPACE ts_1
-> ENGINE NDBCLUSTER;

mysql> DROP LOGFILE GROUP lg_1
-> ENGINE NDBCLUSTER;
```

These statements must be performed in the order shown, except that the two `ALTER TABLESPACE ... DROP DATAFILE` statements may be executed in either order.

You can obtain information about data files used by Disk Data tables by querying the `FILES` table in the `INFORMATION_SCHEMA` database. An extra “NULL row” provides additional information about undo log files. For more information and examples, see [Section 24.3.9, “The INFORMATION\\_SCHEMA FILES Table”](#).

### 21.6.11.2 Using Symbolic Links with Disk Data Objects

The performance of an NDB Cluster that uses Disk Data storage can be greatly improved by separating the data node file system from any tablespace files (undo log files and data files), and placing these on different disks. In early versions of NDB Cluster, there was no direct support for this in NDB Cluster, and it was necessary to achieve this separation using symbolic links. NDB Cluster now supports the data node configuration parameters `FileSystemPathDD`, `FileSystemPathDataFiles`, and `FileSystemPathUndoFiles`, which make the use of symbolic links for this purpose unnecessary. For more information about these parameters, see [Disk Data file system parameters](#).

### 21.6.11.3 NDB Cluster Disk Data Storage Requirements

The following items apply to Disk Data storage requirements:

- Variable-length columns of Disk Data tables take up a fixed amount of space. For each row, this is equal to the space required to store the largest possible value for that column.

For general information about calculating these values, see [Section 11.7, “Data Type Storage Requirements”](#).

You can obtain an estimate the amount of space available in data files and undo log files by querying the Information Schema `FILES` table. For more information and examples, see [Section 24.3.9, “The INFORMATION\\_SCHEMA FILES Table”](#).



#### Note

The `OPTIMIZE TABLE` statement does not have any effect on Disk Data tables.

- In a Disk Data table, the first 256 bytes of a `TEXT` or `BLOB` column are stored in memory; only the remainder is stored on disk.

- Each row in a Disk Data table uses 8 bytes in memory to point to the data stored on disk. This means that, in some cases, converting an in-memory column to the disk-based format can actually result in greater memory usage. For example, converting a `CHAR(4)` column from memory-based to disk-based format increases the amount of `DataMemory` used per row from 4 to 8 bytes.



### Important

Starting the cluster with the `--initial` option does *not* remove Disk Data files. You must remove these manually prior to performing an initial restart of the cluster.

Performance of Disk Data tables can be improved by minimizing the number of disk seeks by making sure that `DiskPageBufferMemory` is of sufficient size. You can query the `diskpagebuffer` table to help determine whether the value for this parameter needs to be increased.

## 21.6.12 Online Operations with ALTER TABLE in NDB Cluster

MySQL NDB Cluster 7.5 and 7.6 support online table schema changes using `ALTER TABLE ... ALGORITHM=DEFAULT | INPLACE | COPY`. NDB Cluster handles `COPY` and `INPLACE` as described in the next few paragraphs.

For `ALGORITHM=COPY`, the `mysqld` NDB Cluster handler performs the following actions:

- Tells the data nodes to create an empty copy of the table, and to make the required schema changes to this copy.
- Reads rows from the original table, and writes them to the copy.
- Tells the data nodes to drop the original table and then to rename the copy.

We sometimes refer to this as a “copying” or “offline” `ALTER TABLE`.

DML operations are not permitted concurrently with a copying `ALTER TABLE`.

The `mysqld` on which the copying `ALTER TABLE` statement is issued takes a metadata lock, but this is in effect only on that `mysqld`. Other NDB clients can modify row data during a copying `ALTER TABLE`, resulting in inconsistency.

For `ALGORITHM=INPLACE`, the NDB Cluster handler tells the data nodes to make the required changes, and does not perform any copying of data.

We also refer to this as a “non-copying” or “online” `ALTER TABLE`.

A non-copying `ALTER TABLE` allows concurrent DML operations.

Regardless of the algorithm used, the `mysqld` takes a Global Schema Lock (GSL) while executing `ALTER TABLE`; this prevents execution of any (other) DDL or backups concurrently on this or any other SQL node in the cluster. This is normally not problematic, unless the `ALTER TABLE` takes a very long time.



### Note

Some older releases of NDB Cluster used a syntax specific to NDB for online `ALTER TABLE` operations. That syntax has since been removed.

Operations that add and drop indexes on variable-width columns of NDB tables occur online. Online operations are noncopying; that is, they do not require that indexes be re-created. They do not lock the table being altered from access by other API nodes in an NDB Cluster (but see [Limitations of NDB online operations](#), later in this section). Such operations do not require single user mode for NDB table alterations

made in an NDB cluster with multiple API nodes; transactions can continue uninterrupted during online DDL operations.

`ALGORITHM=INPLACE` can be used to perform online `ADD COLUMN`, `ADD INDEX` (including `CREATE INDEX` statements), and `DROP INDEX` operations on NDB tables. Online renaming of NDB tables is also supported.

Disk-based columns cannot be added to NDB tables online. This means that, if you wish to add an in-memory column to an NDB table that uses a table-level `STORAGE DISK` option, you must declare the new column as using memory-based storage explicitly. For example—assuming that you have already created tablespace `ts1`—suppose that you create table `t1` as follows:

```
mysql> CREATE TABLE t1 (
>   c1 INT NOT NULL PRIMARY KEY,
>   c2 VARCHAR(30)
> )
> TABLESPACE ts1 STORAGE DISK
> ENGINE NDB;
Query OK, 0 rows affected (1.73 sec)
Records: 0 Duplicates: 0 Warnings: 0
```

You can add a new in-memory column to this table online as shown here:

```
mysql> ALTER TABLE t1
>   ADD COLUMN c3 INT COLUMN_FORMAT DYNAMIC STORAGE MEMORY,
>   ALGORITHM=INPLACE;
Query OK, 0 rows affected (1.25 sec)
Records: 0 Duplicates: 0 Warnings: 0
```

This statement fails if the `STORAGE MEMORY` option is omitted:

```
mysql> ALTER TABLE t1
>   ADD COLUMN c4 INT COLUMN_FORMAT DYNAMIC,
>   ALGORITHM=INPLACE;
ERROR 1846 (0A000): ALGORITHM=INPLACE is not supported. Reason:
Adding column(s) or add/reorganize partition not supported online. Try
ALGORITHM=COPY.
```

If you omit the `COLUMN_FORMAT DYNAMIC` option, the dynamic column format is employed automatically, but a warning is issued, as shown here:

```
mysql> ALTER ONLINE TABLE t1 ADD COLUMN c4 INT STORAGE MEMORY;
Query OK, 0 rows affected, 1 warning (1.17 sec)
Records: 0 Duplicates: 0 Warnings: 0

mysql> SHOW WARNINGS\G
***** 1. row *****
Level: Warning
Code: 1478
Message: DYNAMIC column c4 with STORAGE DISK is not supported, column will
become FIXED

mysql> SHOW CREATE TABLE t1\G
***** 1. row *****
Table: t1
Create Table: CREATE TABLE `t1` (
  `c1` int(11) NOT NULL,
  `c2` varchar(30) DEFAULT NULL,
  `c3` int(11) /*!50606 STORAGE MEMORY */ /*!50606 COLUMN_FORMAT DYNAMIC */ DEFAULT NULL,
  `c4` int(11) /*!50606 STORAGE MEMORY */ DEFAULT NULL,
  PRIMARY KEY (`c1`)
) /*!50606 TABLESPACE ts_1 STORAGE DISK */ ENGINE=ndbcluster DEFAULT CHARSET=latin1
1 row in set (0.03 sec)
```

**Note**

The `STORAGE` and `COLUMN_FORMAT` keywords are supported only in NDB Cluster; in any other version of MySQL, attempting to use either of these keywords in a `CREATE TABLE` or `ALTER TABLE` statement results in an error.

It is also possible to use the statement `ALTER TABLE ... REORGANIZE PARTITION, ALGORITHM=INPLACE` with no `partition_names INTO (partition_definitions)` option on NDB tables. This can be used to redistribute NDB Cluster data among new data nodes that have been added to the cluster online. This does *not* perform any defragmentation, which requires an `OPTIMIZE TABLE` or null `ALTER TABLE` statement. For more information, see [Section 21.6.7, “Adding NDB Cluster Data Nodes Online”](#).

## Limitations of NDB online operations

Online `DROP COLUMN` operations are not supported.

Online `ALTER TABLE`, `CREATE INDEX`, or `DROP INDEX` statements that add columns or add or drop indexes are subject to the following limitations:

- A given online `ALTER TABLE` can use only one of `ADD COLUMN`, `ADD INDEX`, or `DROP INDEX`. One or more columns can be added online in a single statement; only one index may be created or dropped online in a single statement.
- The table being altered is not locked with respect to API nodes other than the one on which an online `ALTER TABLE ADD COLUMN`, `ADD INDEX`, or `DROP INDEX` operation (or `CREATE INDEX` or `DROP INDEX` statement) is run. However, the table is locked against any other operations originating on the *same* API node while the online operation is being executed.
- The table to be altered must have an explicit primary key; the hidden primary key created by the NDB storage engine is not sufficient for this purpose.
- The storage engine used by the table cannot be changed online.
- The tablespace used by the table cannot be changed online. (Bug #99269, Bug #31180526)
- When used with NDB Cluster Disk Data tables, it is not possible to change the storage type (`DISK` or `MEMORY`) of a column online. This means, that when you add or drop an index in such a way that the operation would be performed online, and you want the storage type of the column or columns to be changed, you must use `ALGORITHM=COPY` in the statement that adds or drops the index.

Columns to be added online cannot use the `BLOB` or `TEXT` type, and must meet the following criteria:

- The columns must be dynamic; that is, it must be possible to create them using `COLUMN_FORMAT DYNAMIC`. If you omit the `COLUMN_FORMAT DYNAMIC` option, the dynamic column format is employed automatically.
- The columns must permit `NULL` values and not have any explicit default value other than `NULL`. Columns added online are automatically created as `DEFAULT NULL`, as can be seen here:

```
mysql> CREATE TABLE t2 (
>     c1 INT NOT NULL AUTO_INCREMENT PRIMARY KEY
> ) ENGINE=NDB;
Query OK, 0 rows affected (1.44 sec)

mysql> ALTER TABLE t2
>     ADD COLUMN c2 INT,
>     ADD COLUMN c3 INT,
>     ALGORITHM=INPLACE;
```

```
Query OK, 0 rows affected, 2 warnings (0.93 sec)

mysql> SHOW CREATE TABLE t1\G
***** 1. row *****
      Table: t1
Create Table: CREATE TABLE `t2` (
  `c1` int(11) NOT NULL AUTO_INCREMENT,
  `c2` int(11) DEFAULT NULL,
  `c3` int(11) DEFAULT NULL,
  PRIMARY KEY (`c1`)
) ENGINE=ndbcluster DEFAULT CHARSET=latin1
1 row in set (0.00 sec)
```

- The columns must be added following any existing columns. If you attempt to add a column online before any existing columns or using the `FIRST` keyword, the statement fails with an error.
- Existing table columns cannot be reordered online.

For online `ALTER TABLE` operations on `NDB` tables, fixed-format columns are converted to dynamic when they are added online, or when indexes are created or dropped online, as shown here (repeating the `CREATE TABLE` and `ALTER TABLE` statements just shown for the sake of clarity):

```
mysql> CREATE TABLE t2 (
>   c1 INT NOT NULL AUTO_INCREMENT PRIMARY KEY
> ) ENGINE=NDB;
Query OK, 0 rows affected (1.44 sec)

mysql> ALTER TABLE t2
>   ADD COLUMN c2 INT,
>   ADD COLUMN c3 INT,
>   ALGORITHM=INPLACE;
Query OK, 0 rows affected, 2 warnings (0.93 sec)

mysql> SHOW WARNINGS;
***** 1. row *****
      Level: Warning
      Code: 1478
Message: Converted FIXED field 'c2' to DYNAMIC to enable online ADD COLUMN
***** 2. row *****
      Level: Warning
      Code: 1478
Message: Converted FIXED field 'c3' to DYNAMIC to enable online ADD COLUMN
2 rows in set (0.00 sec)
```

Only the column or columns to be added online must be dynamic. Existing columns need not be; this includes the table's primary key, which may also be `FIXED`, as shown here:

```
mysql> CREATE TABLE t3 (
>   c1 INT NOT NULL AUTO_INCREMENT PRIMARY KEY COLUMN_FORMAT FIXED
> ) ENGINE=NDB;
Query OK, 0 rows affected (2.10 sec)

mysql> ALTER TABLE t3 ADD COLUMN c2 INT, ALGORITHM=INPLACE;
Query OK, 0 rows affected, 1 warning (0.78 sec)
Records: 0 Duplicates: 0 Warnings: 0

mysql> SHOW WARNINGS;
***** 1. row *****
      Level: Warning
      Code: 1478
Message: Converted FIXED field 'c2' to DYNAMIC to enable online ADD COLUMN
1 row in set (0.00 sec)
```

Columns are not converted from `FIXED` to `DYNAMIC` column format by renaming operations. For more information about `COLUMN_FORMAT`, see [Section 13.1.18, "CREATE TABLE Statement"](#).

The `KEY`, `CONSTRAINT`, and `IGNORE` keywords are supported in `ALTER TABLE` statements using `ALGORITHM=INPLACE`.

Beginning with NDB Cluster 7.5.7, setting `MAX_ROWS` to 0 using an online `ALTER TABLE` statement is disallowed. You must use a copying `ALTER TABLE` to perform this operation. (Bug #21960004)

## 21.6.13 Distributed Privileges Using Shared Grant Tables

NDB Cluster supports distribution of MySQL users and privileges across all SQL nodes in an NDB Cluster. This support is not enabled by default; you should follow the procedure outlined in this section in order to do so.

Normally, each MySQL server's user privilege tables in the `mysql` database must use the `MyISAM` storage engine, which means that a user account and its associated privileges created on one SQL node are not available on the cluster's other SQL nodes. An SQL file `ndb_dist_priv.sql` provided with the NDB Cluster distribution can be found in the `share` directory in the MySQL installation directory.

The first step in enabling distributed privileges is to load this script into a MySQL Server that functions as an SQL node (which we refer to after this as the *target* SQL node or MySQL Server). You can do this by executing the following command from the system shell on the target SQL node after changing to its MySQL installation directory (where `options` stands for any additional options needed to connect to this SQL node):

```
$> mysql options -uroot < share/ndb_dist_priv.sql
```

Importing `ndb_dist_priv.sql` creates a number of stored routines (six stored procedures and one stored function) in the `mysql` database on the target SQL node. After connecting to the SQL node in the `mysql` client (as the MySQL `root` user), you can verify that these were created as shown here:

```
mysql> SELECT ROUTINE_NAME, ROUTINE_SCHEMA, ROUTINE_TYPE
-> FROM INFORMATION_SCHEMA.ROUTINES
-> WHERE ROUTINE_NAME LIKE 'mysql_cluster%'
-> ORDER BY ROUTINE_TYPE;
```

ROUTINE_NAME	ROUTINE_SCHEMA	ROUTINE_TYPE
mysql_cluster_privileges_are_distributed	mysql	FUNCTION
mysql_cluster_backup_privileges	mysql	PROCEDURE
mysql_cluster_move_grant_tables	mysql	PROCEDURE
mysql_cluster_move_privileges	mysql	PROCEDURE
mysql_cluster_restore_local_privileges	mysql	PROCEDURE
mysql_cluster_restore_privileges	mysql	PROCEDURE
mysql_cluster_restore_privileges_from_local	mysql	PROCEDURE

```
7 rows in set (0.01 sec)
```

The stored procedure named `mysql_cluster_move_privileges` creates backup copies of the existing privilege tables, then converts them to `NDB`.

`mysql_cluster_move_privileges` performs the backup and conversion in two steps. The first step is to call `mysql_cluster_backup_privileges`, which creates two sets of copies in the `mysql` database:

- A set of local copies that use the `MyISAM` storage engine. Their names are generated by adding the suffix `_backup` to the original privilege table names.
- A set of distributed copies that use the `NDBCLUSTER` storage engine. These tables are named by prefixing `ndb_` and appending `_backup` to the names of the original tables.



After the copies are created, `mysql_cluster_move_privileges` invokes `mysql_cluster_move_grant_tables`, which contains the `ALTER TABLE ... ENGINE = NDB` statements that convert the `mysql` system tables to `NDB`.

Normally, you should not invoke either `mysql_cluster_backup_privileges` or `mysql_cluster_move_grant_tables` manually; these stored procedures are intended only for use by `mysql_cluster_move_privileges`.

Although the original privilege tables are backed up automatically, it is always a good idea to create backups manually of the existing privilege tables on all affected SQL nodes before proceeding. You can do this using `mysqldump` in a manner similar to what is shown here:

```
$> mysqldump options -uroot \
      mysql user db tables_priv columns_priv procs_priv proxies_priv > backup_file
```

To perform the conversion, you must be connected to the target SQL node using the `mysql` client (again, as the MySQL `root` user). Invoke the stored procedure like this:

```
mysql> CALL mysql.mysql_cluster_move_privileges();
Query OK, 0 rows affected (22.32 sec)
```

Depending on the number of rows in the privilege tables, this procedure may take some time to execute. If some of the privilege tables are empty, you may see one or more `No data - zero rows fetched, selected, or processed` warnings when `mysql_cluster_move_privileges` returns. In such cases, the warnings may be safely ignored. To verify that the conversion was successful, you can use the stored function `mysql_cluster_privileges_are_distributed` as shown here:

```
mysql> SELECT CONCAT(
->   'Conversion ',
->   IF(mysql.mysql_cluster_privileges_are_distributed(), 'succeeded', 'failed'),
->   '.')
-> AS Result;
+-----+
| Result |
+-----+
| Conversion succeeded. |
+-----+
1 row in set (0.00 sec)
```

`mysql_cluster_privileges_are_distributed` checks for the existence of the distributed privilege tables and returns `1` if all of the privilege tables are distributed; otherwise, it returns `0`.

You can verify that the backups have been created using a query such as this one:

```
mysql> SELECT TABLE_NAME, ENGINE FROM INFORMATION_SCHEMA.TABLES
->   WHERE TABLE_SCHEMA = 'mysql' AND TABLE_NAME LIKE '%backup'
->   ORDER BY ENGINE;
+-----+-----+
| TABLE_NAME | ENGINE |
+-----+-----+
| db_backup | MyISAM |
| user_backup | MyISAM |
| columns_priv_backup | MyISAM |
| tables_priv_backup | MyISAM |
| proxies_priv_backup | MyISAM |
| procs_priv_backup | MyISAM |
| ndb_columns_priv_backup | ndbcluster |
| ndb_user_backup | ndbcluster |
| ndb_tables_priv_backup | ndbcluster |
| ndb_proxies_priv_backup | ndbcluster |
| ndb_procs_priv_backup | ndbcluster |
| ndb_db_backup | ndbcluster |
```

```
+-----+
12 rows in set (0.00 sec)
```

Once the conversion to distributed privileges has been made, any time a MySQL user account is created, dropped, or has its privileges updated on any SQL node, the changes take effect immediately on all other MySQL servers attached to the cluster. Once privileges are distributed, any new MySQL Servers that connect to the cluster automatically participate in the distribution.



### Note

For clients connected to SQL nodes at the time that `mysql_cluster_move_privileges` is executed, you may need to execute `FLUSH PRIVILEGES` on those SQL nodes, or to disconnect and then reconnect the clients, in order for those clients to be able to see the changes in privileges.

All MySQL user privileges are distributed across all connected MySQL Servers. This includes any privileges associated with views and stored routines, even though distribution of views and stored routines themselves is not currently supported.

In the event that an SQL node becomes disconnected from the cluster while `mysql_cluster_move_privileges` is running, you must drop its privilege tables after reconnecting to the cluster, using a statement such as `DROP TABLE IF EXISTS mysql.user mysql.db mysql.tables_priv mysql.columns_priv mysql.procs_priv`. This causes the SQL node to use the shared privilege tables rather than its own local versions of them. This is not needed when connecting a new SQL node to the cluster for the first time.

In the event of an initial restart of the entire cluster (all data nodes shut down, then started again with `--initial`), the shared privilege tables are lost. If this happens, you can restore them using the original target SQL node either from the backups made by `mysql_cluster_move_privileges` or from a dump file created with `mysqldump`. If you need to use a new MySQL Server to perform the restoration, you should start it with `--skip-grant-tables` when connecting to the cluster for the first time; after this, you can restore the privilege tables locally, then distribute them again using `mysql_cluster_move_privileges`. After restoring and distributing the tables, you should restart this MySQL Server without the `--skip-grant-tables` option.

You can also restore the distributed tables using `ndb_restore --restore-privilege-tables` from a backup made using `START BACKUP` in the `ndb_mgm` client. (The MyISAM tables created by `mysql_cluster_move_privileges` are not backed up by the `START BACKUP` command.) `ndb_restore` does not restore the privilege tables by default; the `--restore-privilege-tables` option causes it to do so.

You can restore the SQL node's local privileges using either of two procedures. `mysql_cluster_restore_privileges` works as follows:

1. If copies of the `mysql.ndb*_backup` tables are available, attempt to restore the system tables from these.
2. Otherwise, attempt to restore the system tables from the local backups named `*_backup` (without the `ndb_` prefix).

The other procedure, named `mysql_cluster_restore_local_privileges`, restores the system tables from the local backups only, without checking the `ndb_*` backups.

The system tables re-created by `mysql_cluster_restore_privileges` or `mysql_cluster_restore_local_privileges` use the MySQL server default storage engine; they are not shared or distributed in any way, and do not use NDB Cluster's NDB storage engine.

The additional stored procedure `mysql_cluster_restore_privileges_from_local` is intended for the use of `mysql_cluster_restore_privileges` and `mysql_cluster_restore_local_privileges`. It should not be invoked directly.



### Important

Applications that access NDB Cluster data directly, including NDB API and ClusterJ applications, are not subject to the MySQL privilege system. This means that, once you have distributed the grant tables, they can be freely accessed by such applications, just as they can any other NDB tables. In particular, you should keep in mind that *NDB API and ClusterJ applications can read and write user names, host names, password hashes, and any other contents of the distributed grant tables without any restrictions.*

## 21.6.14 NDB API Statistics Counters and Variables

A number of types of statistical counters relating to actions performed by or affecting Ndb objects are available. Such actions include starting and closing (or aborting) transactions; primary key and unique key operations; table, range, and pruned scans; threads blocked while waiting for the completion of various operations; and data and events sent and received by NDBCLUSTER. The counters are incremented inside the NDB kernel whenever NDB API calls are made or data is sent to or received by the data nodes. `mysqld` exposes these counters as system status variables; their values can be read in the output of `SHOW STATUS`, or by querying the Information Schema `SESSION_STATUS` or `GLOBAL_STATUS` table. By comparing the values before and after statements operating on NDB tables, you can observe the corresponding actions taken on the API level, and thus the cost of performing the statement.

You can list all of these status variables using the following `SHOW STATUS` statement:

```
mysql> SHOW STATUS LIKE 'ndb_api%';
```

Variable_name	Value
Ndb_api_wait_exec_complete_count	2
Ndb_api_wait_scan_result_count	3
Ndb_api_wait_meta_request_count	101
Ndb_api_wait_nanos_count	83664697215
Ndb_api_bytes_sent_count	13608
Ndb_api_bytes_received_count	142800
Ndb_api_trans_start_count	2
Ndb_api_trans_commit_count	1
Ndb_api_trans_abort_count	0
Ndb_api_trans_close_count	2
Ndb_api_pk_op_count	1
Ndb_api_uk_op_count	0
Ndb_api_table_scan_count	1
Ndb_api_range_scan_count	0
Ndb_api_pruned_scan_count	0
Ndb_api_scan_batch_count	0
Ndb_api_read_row_count	1
Ndb_api_trans_local_read_row_count	1
Ndb_api_adaptive_send_forced_count	0
Ndb_api_adaptive_send_unforced_count	3
Ndb_api_adaptive_send_deferred_count	0
Ndb_api_event_data_count	0
Ndb_api_event_nodata_count	0
Ndb_api_event_bytes_count	0
Ndb_api_wait_exec_complete_count_slave	0
Ndb_api_wait_scan_result_count_slave	0
Ndb_api_wait_meta_request_count_slave	0
Ndb_api_wait_nanos_count_slave	0
Ndb_api_bytes_sent_count_slave	0
Ndb_api_bytes_received_count_slave	0

## NDB API Statistics Counters and Variables

Ndb_api_trans_start_count_slave	0
Ndb_api_trans_commit_count_slave	0
Ndb_api_trans_abort_count_slave	0
Ndb_api_trans_close_count_slave	0
Ndb_api_pk_op_count_slave	0
Ndb_api_uk_op_count_slave	0
Ndb_api_table_scan_count_slave	0
Ndb_api_range_scan_count_slave	0
Ndb_api_pruned_scan_count_slave	0
Ndb_api_scan_batch_count_slave	0
Ndb_api_read_row_count_slave	0
Ndb_api_trans_local_read_row_count_slave	0
Ndb_api_adaptive_send_forced_count_slave	0
Ndb_api_adaptive_send_unforced_count_slave	0
Ndb_api_adaptive_send_deferred_count_slave	0
Ndb_api_event_data_count_injector	0
Ndb_api_event_nodata_count_injector	0
Ndb_api_event_bytes_count_injector	0
Ndb_api_wait_exec_complete_count_session	0
Ndb_api_wait_scan_result_count_session	0
Ndb_api_wait_meta_request_count_session	0
Ndb_api_wait_nanos_count_session	0
Ndb_api_bytes_sent_count_session	0
Ndb_api_bytes_received_count_session	0
Ndb_api_trans_start_count_session	0
Ndb_api_trans_commit_count_session	0
Ndb_api_trans_abort_count_session	0
Ndb_api_trans_close_count_session	0
Ndb_api_pk_op_count_session	0
Ndb_api_uk_op_count_session	0
Ndb_api_table_scan_count_session	0
Ndb_api_range_scan_count_session	0
Ndb_api_pruned_scan_count_session	0
Ndb_api_scan_batch_count_session	0
Ndb_api_read_row_count_session	0
Ndb_api_trans_local_read_row_count_session	0
Ndb_api_adaptive_send_forced_count_session	0
Ndb_api_adaptive_send_unforced_count_session	0
Ndb_api_adaptive_send_deferred_count_session	0

-----+-----+-----  
69 rows in set (0.00 sec)

These status variables are also available from the [SESSION\\_STATUS](#) and [GLOBAL\\_STATUS](#) tables of the [INFORMATION\\_SCHEMA](#) database, as shown here:

```
mysql> SELECT * FROM INFORMATION_SCHEMA.SESSION_STATUS
-> WHERE VARIABLE_NAME LIKE 'ndb_api%';
```

VARIABLE_NAME	VARIABLE_VALUE
Ndb_api_wait_exec_complete_count	2
Ndb_api_wait_scan_result_count	3
Ndb_api_wait_meta_request_count	101
Ndb_api_wait_nanos_count	74890499869
Ndb_api_bytes_sent_count	13608
Ndb_api_bytes_received_count	142800
Ndb_api_trans_start_count	2
Ndb_api_trans_commit_count	1
Ndb_api_trans_abort_count	0
Ndb_api_trans_close_count	2
Ndb_api_pk_op_count	1
Ndb_api_uk_op_count	0
Ndb_api_table_scan_count	1
Ndb_api_range_scan_count	0
Ndb_api_pruned_scan_count	0
Ndb_api_scan_batch_count	0
Ndb_api_read_row_count	1

## NDB API Statistics Counters and Variables

Ndb_api_trans_local_read_row_count	1
Ndb_api_adaptive_send_forced_count	0
Ndb_api_adaptive_send_unforced_count	3
Ndb_api_adaptive_send_deferred_count	0
Ndb_api_event_data_count	0
Ndb_api_event_nodata_count	0
Ndb_api_event_bytes_count	0
Ndb_api_wait_exec_complete_count_slave	0
Ndb_api_wait_scan_result_count_slave	0
Ndb_api_wait_meta_request_count_slave	0
Ndb_api_wait_nanos_count_slave	0
Ndb_api_bytes_sent_count_slave	0
Ndb_api_bytes_received_count_slave	0
Ndb_api_trans_start_count_slave	0
Ndb_api_trans_commit_count_slave	0
Ndb_api_trans_abort_count_slave	0
Ndb_api_trans_close_count_slave	0
Ndb_api_pk_op_count_slave	0
Ndb_api_uk_op_count_slave	0
Ndb_api_table_scan_count_slave	0
Ndb_api_range_scan_count_slave	0
Ndb_api_pruned_scan_count_slave	0
Ndb_api_scan_batch_count_slave	0
Ndb_api_read_row_count_slave	0
Ndb_api_trans_local_read_row_count_slave	0
Ndb_api_adaptive_send_forced_count_slave	0
Ndb_api_adaptive_send_unforced_count_slave	0
Ndb_api_adaptive_send_deferred_count_slave	0
Ndb_api_event_data_count_injector	0
Ndb_api_event_nodata_count_injector	0
Ndb_api_event_bytes_count_injector	0
Ndb_api_wait_exec_complete_count_session	0
Ndb_api_wait_scan_result_count_session	0
Ndb_api_wait_meta_request_count_session	0
Ndb_api_wait_nanos_count_session	0
Ndb_api_bytes_sent_count_session	0
Ndb_api_bytes_received_count_session	0
Ndb_api_trans_start_count_session	0
Ndb_api_trans_commit_count_session	0
Ndb_api_trans_abort_count_session	0
Ndb_api_trans_close_count_session	0
Ndb_api_pk_op_count_session	0
Ndb_api_uk_op_count_session	0
Ndb_api_table_scan_count_session	0
Ndb_api_range_scan_count_session	0
Ndb_api_pruned_scan_count_session	0
Ndb_api_scan_batch_count_session	0
Ndb_api_read_row_count_session	0
Ndb_api_trans_local_read_row_count_session	0
Ndb_api_adaptive_send_forced_count_session	0
Ndb_api_adaptive_send_unforced_count_session	0
Ndb_api_adaptive_send_deferred_count_session	0

+-----+  
69 rows in set (0.00 sec)

```
mysql> SELECT * FROM INFORMATION_SCHEMA.GLOBAL_STATUS
      -> WHERE VARIABLE_NAME LIKE 'ndb_api%';
```

VARIABLE_NAME	VARIABLE_VALUE
Ndb_api_wait_exec_complete_count	2
Ndb_api_wait_scan_result_count	3
Ndb_api_wait_meta_request_count	101
Ndb_api_wait_nanos_count	13640285623
Ndb_api_bytes_sent_count	13608
Ndb_api_bytes_received_count	142800
Ndb_api_trans_start_count	2

## NDB API Statistics Counters and Variables

Ndb_api_trans_commit_count	1
Ndb_api_trans_abort_count	0
Ndb_api_trans_close_count	2
Ndb_api_pk_op_count	1
Ndb_api_uk_op_count	0
Ndb_api_table_scan_count	1
Ndb_api_range_scan_count	0
Ndb_api_pruned_scan_count	0
Ndb_api_scan_batch_count	0
Ndb_api_read_row_count	1
Ndb_api_trans_local_read_row_count	1
Ndb_api_adaptive_send_forced_count	0
Ndb_api_adaptive_send_unforced_count	3
Ndb_api_adaptive_send_deferred_count	0
Ndb_api_event_data_count	0
Ndb_api_event_nodata_count	0
Ndb_api_event_bytes_count	0
Ndb_api_wait_exec_complete_count_slave	0
Ndb_api_wait_scan_result_count_slave	0
Ndb_api_wait_meta_request_count_slave	0
Ndb_api_wait_nanos_count_slave	0
Ndb_api_bytes_sent_count_slave	0
Ndb_api_bytes_received_count_slave	0
Ndb_api_trans_start_count_slave	0
Ndb_api_trans_commit_count_slave	0
Ndb_api_trans_abort_count_slave	0
Ndb_api_trans_close_count_slave	0
Ndb_api_pk_op_count_slave	0
Ndb_api_uk_op_count_slave	0
Ndb_api_table_scan_count_slave	0
Ndb_api_range_scan_count_slave	0
Ndb_api_pruned_scan_count_slave	0
Ndb_api_scan_batch_count_slave	0
Ndb_api_read_row_count_slave	0
Ndb_api_trans_local_read_row_count_slave	0
Ndb_api_adaptive_send_forced_count_slave	0
Ndb_api_adaptive_send_unforced_count_slave	0
Ndb_api_adaptive_send_deferred_count_slave	0
Ndb_api_event_data_count_injector	0
Ndb_api_event_nodata_count_injector	0
Ndb_api_event_bytes_count_injector	0
Ndb_api_wait_exec_complete_count_session	0
Ndb_api_wait_scan_result_count_session	0
Ndb_api_wait_meta_request_count_session	0
Ndb_api_wait_nanos_count_session	0
Ndb_api_bytes_sent_count_session	0
Ndb_api_bytes_received_count_session	0
Ndb_api_trans_start_count_session	0
Ndb_api_trans_commit_count_session	0
Ndb_api_trans_abort_count_session	0
Ndb_api_trans_close_count_session	0
Ndb_api_pk_op_count_session	0
Ndb_api_uk_op_count_session	0
Ndb_api_table_scan_count_session	0
Ndb_api_range_scan_count_session	0
Ndb_api_pruned_scan_count_session	0
Ndb_api_scan_batch_count_session	0
Ndb_api_read_row_count_session	0
Ndb_api_trans_local_read_row_count_session	0
Ndb_api_adaptive_send_forced_count_session	0
Ndb_api_adaptive_send_unforced_count_session	0
Ndb_api_adaptive_send_deferred_count_session	0

+-----+-----+  
69 rows in set (0.01 sec)

Each `Ndb` object has its own counters. NDB API applications can read the values of the counters for use in optimization or monitoring. For multithreaded clients which use more than one `Ndb` object concurrently, it is also possible to obtain a summed view of counters from all `Ndb` objects belonging to a given `Ndb_cluster_connection`.

Four sets of these counters are exposed. One set applies to the current session only; the other 3 are global. *This is in spite of the fact that their values can be obtained as either session or global status variables in the `mysql` client.* This means that specifying the `SESSION` or `GLOBAL` keyword with `SHOW STATUS` has no effect on the values reported for NDB API statistics status variables, and the value for each of these variables is the same whether the value is obtained from the equivalent column of the `SESSION_STATUS` or the `GLOBAL_STATUS` table.

- *Session counters (session specific)*

Session counters relate to the `Ndb` objects in use by (only) the current session. Use of such objects by other MySQL clients does not influence these counts.

In order to minimize confusion with standard MySQL session variables, we refer to the variables that correspond to these NDB API session counters as “`_session` variables”, with a leading underscore.

- *Replica counters (global)*

This set of counters relates to the `Ndb` objects used by the replicat SQL thread, if any. If this `mysqld` does not act as a replica, or does not use `NDB` tables, then all of these counts are 0.

We refer to the related status variables as “`_slave` variables” (with a leading underscore).

- *Injector counters (global)*

Injector counters relate to the `Ndb` object used to listen to cluster events by the binary log injector thread. Even when not writing a binary log, `mysqld` processes attached to an NDB Cluster continue to listen for some events, such as schema changes.

We refer to the status variables that correspond to NDB API injector counters as “`_injector` variables” (with a leading underscore).

- *Server (Global) counters (global)*

This set of counters relates to all `Ndb` objects currently used by this `mysqld`. This includes all MySQL client applications, the replica SQL thread (if any), the binlog injector, and the `NDB` utility thread.

We refer to the status variables that correspond to these counters as “global variables” or “`mysqld`-level variables”.

You can obtain values for a particular set of variables by additionally filtering for the substring `session`, `slave`, or `injector` in the variable name (along with the common prefix `Ndb_api`). For `_session` variables, this can be done as shown here:

```
mysql> SHOW STATUS LIKE 'ndb_api%session';
+-----+-----+
| Variable_name | Value |
+-----+-----+
| Ndb_api_wait_exec_complete_count_session | 2 |
| Ndb_api_wait_scan_result_count_session | 0 |
| Ndb_api_wait_meta_request_count_session | 1 |
| Ndb_api_wait_nanos_count_session | 8144375 |
| Ndb_api_bytes_sent_count_session | 68 |
| Ndb_api_bytes_received_count_session | 84 |
| Ndb_api_trans_start_count_session | 1 |
+-----+-----+
```

## NDB API Statistics Counters and Variables

```

| Ndb_api_trans_commit_count_session      | 1 |
| Ndb_api_trans_abort_count_session      | 0 |
| Ndb_api_trans_close_count_session      | 1 |
| Ndb_api_pk_op_count_session            | 1 |
| Ndb_api_uk_op_count_session            | 0 |
| Ndb_api_table_scan_count_session       | 0 |
| Ndb_api_range_scan_count_session       | 0 |
| Ndb_api_pruned_scan_count_session      | 0 |
| Ndb_api_scan_batch_count_session       | 0 |
| Ndb_api_read_row_count_session         | 1 |
| Ndb_api_trans_local_read_row_count_session | 1 |
+-----+-----+
18 rows in set (0.50 sec)

```

To obtain a listing of the NDB API `mysqld`-level status variables, filter for variable names beginning with `ndb_api` and ending in `_count`, like this:

```

mysql> SELECT * FROM INFORMATION_SCHEMA.SESSION_STATUS
-> WHERE VARIABLE_NAME LIKE 'ndb_api%count';
+-----+-----+
| VARIABLE_NAME                | VARIABLE_VALUE |
+-----+-----+
| NDB_API_WAIT_EXEC_COMPLETE_COUNT | 4              |
| NDB_API_WAIT_SCAN_RESULT_COUNT   | 3              |
| NDB_API_WAIT_META_REQUEST_COUNT  | 28             |
| NDB_API_WAIT_NANOS_COUNT         | 53756398      |
| NDB_API_BYTES_SENT_COUNT         | 1060           |
| NDB_API_BYTES_RECEIVED_COUNT     | 9724           |
| NDB_API_TRANS_START_COUNT        | 3              |
| NDB_API_TRANS_COMMIT_COUNT       | 2              |
| NDB_API_TRANS_ABORT_COUNT        | 0              |
| NDB_API_TRANS_CLOSE_COUNT        | 3              |
| NDB_API_PK_OP_COUNT              | 2              |
| NDB_API_UK_OP_COUNT              | 0              |
| NDB_API_TABLE_SCAN_COUNT         | 1              |
| NDB_API_RANGE_SCAN_COUNT         | 0              |
| NDB_API_PRUNED_SCAN_COUNT        | 0              |
| NDB_API_SCAN_BATCH_COUNT         | 0              |
| NDB_API_READ_ROW_COUNT           | 2              |
| NDB_API_TRANS_LOCAL_READ_ROW_COUNT | 2              |
| NDB_API_EVENT_DATA_COUNT         | 0              |
| NDB_API_EVENT_NONDATA_COUNT      | 0              |
| NDB_API_EVENT_BYTES_COUNT        | 0              |
+-----+-----+
21 rows in set (0.09 sec)

```

Not all counters are reflected in all 4 sets of status variables. For the event counters `DataEventsRecvdCount`, `NondataEventsRecvdCount`, and `EventBytesRecvdCount`, only `_injector` and `mysqld`-level NDB API status variables are available:

```

mysql> SHOW STATUS LIKE 'ndb_api%event%';
+-----+-----+
| Variable_name                | Value |
+-----+-----+
| Ndb_api_event_data_count_injector | 0     |
| Ndb_api_event_nondata_count_injector | 0     |
| Ndb_api_event_bytes_count_injector | 0     |
| Ndb_api_event_data_count         | 0     |
| Ndb_api_event_nondata_count      | 0     |
| Ndb_api_event_bytes_count        | 0     |
+-----+-----+
6 rows in set (0.00 sec)

```

`_injector` status variables are not implemented for any other NDB API counters, as shown here:

```

mysql> SHOW STATUS LIKE 'ndb_api%injector%';

```



```

+-----+-----+
| Variable_name | Value |
+-----+-----+
| Ndb_api_event_data_count_injector | 0 |
| Ndb_api_event_nondata_count_injector | 0 |
| Ndb_api_event_bytes_count_injector | 0 |
+-----+-----+
3 rows in set (0.00 sec)

```

The names of the status variables can easily be associated with the names of the corresponding counters. Each NDB API statistics counter is listed in the following table with a description as well as the names of any MySQL server status variables corresponding to this counter.

**Table 21.61 NDB API statistics counters**

Counter Name	Description	Status Variables (by statistic type):
		<ul style="list-style-type: none"> <li>• Session</li> <li>• Slave (replica)</li> <li>• Injector</li> <li>• Server</li> </ul>
<code>WaitExecCompleteCount</code>	Number of times thread has been blocked while waiting for execution of an operation to complete. Includes all <code>execute()</code> calls as well as implicit executes for blob operations and auto-increment not visible to clients.	<ul style="list-style-type: none"> <li>• <code>Ndb_api_wait_exec_complete_count_session</code></li> <li>• <code>Ndb_api_wait_exec_complete_count_slave</code></li> <li>• [none]</li> <li>• <code>Ndb_api_wait_exec_complete_count_injector</code></li> <li>• <code>Ndb_api_wait_exec_complete_count_server</code></li> </ul>
<code>WaitScanResultCount</code>	Number of times thread has been blocked while waiting for a scan-based signal, such waiting for additional results, or for a scan to close.	<ul style="list-style-type: none"> <li>• <code>Ndb_api_wait_scan_result_count_session</code></li> <li>• <code>Ndb_api_wait_scan_result_count_slave</code></li> <li>• [none]</li> <li>• <code>Ndb_api_wait_scan_result_count_injector</code></li> <li>• <code>Ndb_api_wait_scan_result_count_server</code></li> </ul>
<code>WaitMetaRequestCount</code>	Number of times thread has been blocked waiting for a metadata-based signal; this can occur when waiting for a DDL operation or for an epoch to be started (or ended).	<ul style="list-style-type: none"> <li>• <code>Ndb_api_wait_meta_request_count_session</code></li> <li>• <code>Ndb_api_wait_meta_request_count_slave</code></li> <li>• [none]</li> <li>• <code>Ndb_api_wait_meta_request_count_injector</code></li> <li>• <code>Ndb_api_wait_meta_request_count_server</code></li> </ul>
<code>WaitNanosCount</code>	Total time (in nanoseconds) spent waiting for some type of signal from the data nodes.	<ul style="list-style-type: none"> <li>• <code>Ndb_api_wait_nanos_count_session</code></li> <li>• <code>Ndb_api_wait_nanos_count_slave</code></li> <li>• [none]</li> <li>• <code>Ndb_api_wait_nanos_count_injector</code></li> <li>• <code>Ndb_api_wait_nanos_count_server</code></li> </ul>
<code>BytesSentCount</code>	Amount of data (in bytes) sent to the data nodes	<ul style="list-style-type: none"> <li>• <code>Ndb_api_bytes_sent_count_session</code></li> <li>• <code>Ndb_api_bytes_sent_count_slave</code></li> </ul>

Counter Name	Description	Status Variables (by statistic type):
		<ul style="list-style-type: none"> <li>• <b>Session</b></li> <li>• <b>Slave (replica)</b></li> <li>• <b>Injector</b></li> <li>• <b>Server</b></li> </ul>
BytesRecvdCount	Amount of data (in bytes) received from the data nodes	<ul style="list-style-type: none"> <li>• [none]</li> <li>• Ndb_api_bytes_sent_count</li> <li>• Ndb_api_bytes_received_count_session</li> <li>• Ndb_api_bytes_received_count_slave</li> <li>• [none]</li> <li>• Ndb_api_bytes_received_count</li> </ul>
TransStartCount	Number of transactions started.	<ul style="list-style-type: none"> <li>• Ndb_api_trans_start_count_session</li> <li>• Ndb_api_trans_start_count_slave</li> <li>• [none]</li> <li>• Ndb_api_trans_start_count</li> </ul>
TransCommitCount	Number of transactions committed.	<ul style="list-style-type: none"> <li>• Ndb_api_trans_commit_count_session</li> <li>• Ndb_api_trans_commit_count_slave</li> <li>• [none]</li> <li>• Ndb_api_trans_commit_count</li> </ul>
TransAbortCount	Number of transactions aborted.	<ul style="list-style-type: none"> <li>• Ndb_api_trans_abort_count_session</li> <li>• Ndb_api_trans_abort_count_slave</li> <li>• [none]</li> <li>• Ndb_api_trans_abort_count</li> </ul>
TransCloseCount	Number of transactions aborted. (This value may be greater than the sum of TransCommitCount and TransAbortCount.)	<ul style="list-style-type: none"> <li>• Ndb_api_trans_close_count_session</li> <li>• Ndb_api_trans_close_count_slave</li> <li>• [none]</li> <li>• Ndb_api_trans_close_count</li> </ul>
PkOpCount	Number of operations based on or using primary keys. This count includes blob-part table operations, implicit unlocking operations, and auto-increment operations, as well as primary	<ul style="list-style-type: none"> <li>• Ndb_api_pk_op_count_session</li> <li>• Ndb_api_pk_op_count_slave</li> <li>• [none]</li> <li>• Ndb_api_pk_op_count</li> </ul>

Counter Name	Description	Status Variables (by statistic type):
	key operations normally visible to MySQL clients.	<ul style="list-style-type: none"> <li>• <b>Session</b></li> <li>• <b>Slave (replica)</b></li> <li>• <b>Injector</b></li> <li>• <b>Server</b></li> </ul>
UkOpCount	Number of operations based on or using unique keys.	<ul style="list-style-type: none"> <li>• <code>Ndb_api_uk_op_count_session</code></li> <li>• <code>Ndb_api_uk_op_count_slave</code></li> <li>• <code>[none]</code></li> <li>• <code>Ndb_api_uk_op_count</code></li> </ul>
TableScanCount	Number of table scans that have been started. This includes scans of internal tables.	<ul style="list-style-type: none"> <li>• <code>Ndb_api_table_scan_count_session</code></li> <li>• <code>Ndb_api_table_scan_count_slave</code></li> <li>• <code>[none]</code></li> <li>• <code>Ndb_api_table_scan_count</code></li> </ul>
RangeScanCount	Number of range scans that have been started.	<ul style="list-style-type: none"> <li>• <code>Ndb_api_range_scan_count_session</code></li> <li>• <code>Ndb_api_range_scan_count_slave</code></li> <li>• <code>[none]</code></li> <li>• <code>Ndb_api_range_scan_count</code></li> </ul>
PrunedScanCount	Number of scans that have been pruned to a single partition.	<ul style="list-style-type: none"> <li>• <code>Ndb_api_pruned_scan_count_session</code></li> <li>• <code>Ndb_api_pruned_scan_count_slave</code></li> <li>• <code>[none]</code></li> <li>• <code>Ndb_api_pruned_scan_count</code></li> </ul>
ScanBatchCount	Number of batches of rows received. (A <i>batch</i> in this context is a set of scan results from a single fragment.)	<ul style="list-style-type: none"> <li>• <code>Ndb_api_scan_batch_count_session</code></li> <li>• <code>Ndb_api_scan_batch_count_slave</code></li> <li>• <code>[none]</code></li> <li>• <code>Ndb_api_scan_batch_count</code></li> </ul>
ReadRowCount	Total number of rows that have been read. Includes rows read using primary key, unique key, and scan operations.	<ul style="list-style-type: none"> <li>• <code>Ndb_api_read_row_count_session</code></li> <li>• <code>Ndb_api_read_row_count_slave</code></li> <li>• <code>[none]</code></li> <li>• <code>Ndb_api_read_row_count</code></li> </ul>

Counter Name	Description	Status Variables (by statistic type):
		<ul style="list-style-type: none"> <li>• <b>Session</b></li> <li>• <b>Slave (replica)</b></li> <li>• <b>Injector</b></li> <li>• <b>Server</b></li> </ul>
<code>TransLocalReadRowCount</code>	Number of rows read from the data same node on which the transaction was being run.	<ul style="list-style-type: none"> <li>• <code>Ndb_api_trans_local_read_row_count</code></li> <li>• <code>Ndb_api_trans_local_read_row_count</code></li> <li>• [none]</li> <li>• <code>Ndb_api_trans_local_read_row_count</code></li> </ul>
<code>DataEventsRecvdCount</code>	Number of row change events received.	<ul style="list-style-type: none"> <li>• [none]</li> <li>• [none]</li> <li>• <code>Ndb_api_event_data_count_injector</code></li> <li>• <code>Ndb_api_event_data_count</code></li> </ul>
<code>NondataEventsRecvdCount</code>	Number of events received, other than row change events.	<ul style="list-style-type: none"> <li>• [none]</li> <li>• [none]</li> <li>• <code>Ndb_api_event_nondata_count_injector</code></li> <li>• <code>Ndb_api_event_nondata_count</code></li> </ul>
<code>EventBytesRecvdCount</code>	Number of bytes of events received.	<ul style="list-style-type: none"> <li>• [none]</li> <li>• [none]</li> <li>• <code>Ndb_api_event_bytes_count_injector</code></li> <li>• <code>Ndb_api_event_bytes_count</code></li> </ul>

To see all counts of committed transactions—that is, all `TransCommitCount` counter status variables—you can filter the results of `SHOW STATUS` for the substring `trans_commit_count`, like this:

```
mysql> SHOW STATUS LIKE '%trans_commit_count%';
+-----+-----+
| Variable_name | Value |
+-----+-----+
| Ndb_api_trans_commit_count_session | 1 |
| Ndb_api_trans_commit_count_slave | 0 |
| Ndb_api_trans_commit_count | 2 |
+-----+-----+
3 rows in set (0.00 sec)
```

From this you can determine that 1 transaction has been committed in the current `mysql` client session, and 2 transactions have been committed on this `mysqld` since it was last restarted.

You can see how various NDB API counters are incremented by a given SQL statement by comparing the values of the corresponding `_session` status variables immediately before and after performing the

statement. In this example, after getting the initial values from `SHOW STATUS`, we create in the `test` database an NDB table, named `t`, that has a single column:

```
mysql> SHOW STATUS LIKE 'ndb_api%session%';
+-----+-----+
| Variable_name | Value |
+-----+-----+
| Ndb_api_wait_exec_complete_count_session | 2 |
| Ndb_api_wait_scan_result_count_session | 0 |
| Ndb_api_wait_meta_request_count_session | 3 |
| Ndb_api_wait_nanos_count_session | 820705 |
| Ndb_api_bytes_sent_count_session | 132 |
| Ndb_api_bytes_received_count_session | 372 |
| Ndb_api_trans_start_count_session | 1 |
| Ndb_api_trans_commit_count_session | 1 |
| Ndb_api_trans_abort_count_session | 0 |
| Ndb_api_trans_close_count_session | 1 |
| Ndb_api_pk_op_count_session | 1 |
| Ndb_api_uk_op_count_session | 0 |
| Ndb_api_table_scan_count_session | 0 |
| Ndb_api_range_scan_count_session | 0 |
| Ndb_api_pruned_scan_count_session | 0 |
| Ndb_api_scan_batch_count_session | 0 |
| Ndb_api_read_row_count_session | 1 |
| Ndb_api_trans_local_read_row_count_session | 1 |
+-----+-----+
18 rows in set (0.00 sec)

mysql> USE test;
Database changed
mysql> CREATE TABLE t (c INT) ENGINE NDBCLUSTER;
Query OK, 0 rows affected (0.85 sec)
```

Now you can execute a new `SHOW STATUS` statement and observe the changes, as shown here (with the changed rows highlighted in the output):

```
mysql> SHOW STATUS LIKE 'ndb_api%session%';
+-----+-----+
| Variable_name | Value |
+-----+-----+
| Ndb_api_wait_exec_complete_count_session | 8 |
| Ndb_api_wait_scan_result_count_session | 0 |
| Ndb_api_wait_meta_request_count_session | 17 |
| Ndb_api_wait_nanos_count_session | 706871709 |
| Ndb_api_bytes_sent_count_session | 2376 |
| Ndb_api_bytes_received_count_session | 3844 |
| Ndb_api_trans_start_count_session | 4 |
| Ndb_api_trans_commit_count_session | 4 |
| Ndb_api_trans_abort_count_session | 0 |
| Ndb_api_trans_close_count_session | 4 |
| Ndb_api_pk_op_count_session | 6 |
| Ndb_api_uk_op_count_session | 0 |
| Ndb_api_table_scan_count_session | 0 |
| Ndb_api_range_scan_count_session | 0 |
| Ndb_api_pruned_scan_count_session | 0 |
| Ndb_api_scan_batch_count_session | 0 |
| Ndb_api_read_row_count_session | 2 |
| Ndb_api_trans_local_read_row_count_session | 1 |
+-----+-----+
18 rows in set (0.00 sec)
```

Similarly, you can see the changes in the NDB API statistics counters caused by inserting a row into `t`: Insert the row, then run the same `SHOW STATUS` statement used in the previous example, as shown here:

```
mysql> INSERT INTO t VALUES (100);
Query OK, 1 row affected (0.00 sec)
```

```
mysql> SHOW STATUS LIKE 'ndb_api%session%';
+-----+-----+
| Variable_name | Value |
+-----+-----+
| Ndb_api_wait_exec_complete_count_session | 11 |
| Ndb_api_wait_scan_result_count_session | 6 |
| Ndb_api_wait_meta_request_count_session | 20 |
| Ndb_api_wait_nanos_count_session | 707370418 |
| Ndb_api_bytes_sent_count_session | 2724 |
| Ndb_api_bytes_received_count_session | 4116 |
| Ndb_api_trans_start_count_session | 7 |
| Ndb_api_trans_commit_count_session | 6 |
| Ndb_api_trans_abort_count_session | 0 |
| Ndb_api_trans_close_count_session | 7 |
| Ndb_api_pk_op_count_session | 8 |
| Ndb_api_uk_op_count_session | 0 |
| Ndb_api_table_scan_count_session | 1 |
| Ndb_api_range_scan_count_session | 0 |
| Ndb_api_pruned_scan_count_session | 0 |
| Ndb_api_scan_batch_count_session | 0 |
| Ndb_api_read_row_count_session | 3 |
| Ndb_api_trans_local_read_row_count_session | 2 |
+-----+-----+
18 rows in set (0.00 sec)
```

We can make a number of observations from these results:

- Although we created `t` with no explicit primary key, 5 primary key operations were performed in doing so (the difference in the “before” and “after” values of `Ndb_api_pk_op_count_session`, or 6 minus 1). This reflects the creation of the hidden primary key that is a feature of all tables using the NDB storage engine.
- By comparing successive values for `Ndb_api_wait_nanos_count_session`, we can see that the NDB API operations implementing the `CREATE TABLE` statement waited much longer ( $706871709 - 820705 = 706051004$  nanoseconds, or approximately 0.7 second) for responses from the data nodes than those executed by the `INSERT` ( $707370418 - 706871709 = 498709$  ns or roughly .0005 second). The execution times reported for these statements in the `mysql` client correlate roughly with these figures.

On platforms without sufficient (nanosecond) time resolution, small changes in the value of the `WaitNanosCount` NDB API counter due to SQL statements that execute very quickly may not always be visible in the values of `Ndb_api_wait_nanos_count_session`, `Ndb_api_wait_nanos_count_slave`, or `Ndb_api_wait_nanos_count`.

- The `INSERT` statement incremented both the `ReadRowCount` and `TransLocalReadRowCount` NDB API statistics counters, as reflected by the increased values of `Ndb_api_read_row_count_session` and `Ndb_api_trans_local_read_row_count_session`.

## 21.6.15 ndbinfo: The NDB Cluster Information Database

`ndbinfo` is a database containing information specific to NDB Cluster.

This database contains a number of tables, each providing a different sort of data about NDB Cluster node status, resource usage, and operations. You can find more detailed information about each of these tables in the next several sections.

`ndbinfo` is included with NDB Cluster support in the MySQL Server; no special compilation or configuration steps are required; the tables are created by the MySQL Server when it connects to the cluster. You can verify that `ndbinfo` support is active in a given MySQL Server instance using `SHOW`

`PLUGINS`; if `ndbinfo` support is enabled, you should see a row containing `ndbinfo` in the `Name` column and `ACTIVE` in the `Status` column, as shown here (emphasized text):

```
mysql> SHOW PLUGINS;
```

Name	Status	Type	Library	License
binlog	ACTIVE	STORAGE ENGINE	NULL	GPL
mysql_native_password	ACTIVE	AUTHENTICATION	NULL	GPL
sha256_password	ACTIVE	AUTHENTICATION	NULL	GPL
MRG_MYISAM	ACTIVE	STORAGE ENGINE	NULL	GPL
MEMORY	ACTIVE	STORAGE ENGINE	NULL	GPL
CSV	ACTIVE	STORAGE ENGINE	NULL	GPL
MyISAM	ACTIVE	STORAGE ENGINE	NULL	GPL
InnoDB	ACTIVE	STORAGE ENGINE	NULL	GPL
INNODB_TRX	ACTIVE	INFORMATION SCHEMA	NULL	GPL
INNODB_LOCKS	ACTIVE	INFORMATION SCHEMA	NULL	GPL
INNODB_LOCK_WAITS	ACTIVE	INFORMATION SCHEMA	NULL	GPL
INNODB_CMP	ACTIVE	INFORMATION SCHEMA	NULL	GPL
INNODB_CMP_RESET	ACTIVE	INFORMATION SCHEMA	NULL	GPL
INNODB_CMPMEM	ACTIVE	INFORMATION SCHEMA	NULL	GPL
INNODB_CMPMEM_RESET	ACTIVE	INFORMATION SCHEMA	NULL	GPL
INNODB_CMP_PER_INDEX	ACTIVE	INFORMATION SCHEMA	NULL	GPL
INNODB_CMP_PER_INDEX_RESET	ACTIVE	INFORMATION SCHEMA	NULL	GPL
INNODB_BUFFER_PAGE	ACTIVE	INFORMATION SCHEMA	NULL	GPL
INNODB_BUFFER_PAGE_LRU	ACTIVE	INFORMATION SCHEMA	NULL	GPL
INNODB_BUFFER_POOL_STATS	ACTIVE	INFORMATION SCHEMA	NULL	GPL
INNODB_TEMP_TABLE_INFO	ACTIVE	INFORMATION SCHEMA	NULL	GPL
INNODB_METRICS	ACTIVE	INFORMATION SCHEMA	NULL	GPL
INNODB_FT_DEFAULT_STOPWORD	ACTIVE	INFORMATION SCHEMA	NULL	GPL
INNODB_FT_DELETED	ACTIVE	INFORMATION SCHEMA	NULL	GPL
INNODB_FT_BEING_DELETED	ACTIVE	INFORMATION SCHEMA	NULL	GPL
INNODB_FT_CONFIG	ACTIVE	INFORMATION SCHEMA	NULL	GPL
INNODB_FT_INDEX_CACHE	ACTIVE	INFORMATION SCHEMA	NULL	GPL
INNODB_FT_INDEX_TABLE	ACTIVE	INFORMATION SCHEMA	NULL	GPL
INNODB_SYS_TABLES	ACTIVE	INFORMATION SCHEMA	NULL	GPL
INNODB_SYS_TABLESTATS	ACTIVE	INFORMATION SCHEMA	NULL	GPL
INNODB_SYS_INDEXES	ACTIVE	INFORMATION SCHEMA	NULL	GPL
INNODB_SYS_COLUMNS	ACTIVE	INFORMATION SCHEMA	NULL	GPL
INNODB_SYS_FIELDS	ACTIVE	INFORMATION SCHEMA	NULL	GPL
INNODB_SYS_FOREIGN	ACTIVE	INFORMATION SCHEMA	NULL	GPL
INNODB_SYS_FOREIGN_COLS	ACTIVE	INFORMATION SCHEMA	NULL	GPL
INNODB_SYS_TABLESPACES	ACTIVE	INFORMATION SCHEMA	NULL	GPL
INNODB_SYS_DATAFILES	ACTIVE	INFORMATION SCHEMA	NULL	GPL
INNODB_SYS_VIRTUAL	ACTIVE	INFORMATION SCHEMA	NULL	GPL
PERFORMANCE_SCHEMA	ACTIVE	STORAGE ENGINE	NULL	GPL
<b>ndbCluster</b>	<b>ACTIVE</b>	<b>STORAGE ENGINE</b>	<b>NULL</b>	<b>GPL</b>
<b>/ ndbinfo</b>	<b>/ ACTIVE</b>	<b>/ STORAGE ENGINE</b>	<b>/ NULL</b>	<b>/ GPL</b>
ndb_transid_mysql_connection_map	ACTIVE	INFORMATION SCHEMA	NULL	GPL
BLACKHOLE	ACTIVE	STORAGE ENGINE	NULL	GPL
ARCHIVE	ACTIVE	STORAGE ENGINE	NULL	GPL
partition	ACTIVE	STORAGE ENGINE	NULL	GPL
ngram	ACTIVE	FTPARSER	NULL	GPL

46 rows in set (0.00 sec)

You can also do this by checking the output of `SHOW ENGINES` for a line including `ndbinfo` in the `Engine` column and `YES` in the `Support` column, as shown here (emphasized text):

```
mysql> SHOW ENGINES\G
***** 1. row *****
  Engine: ndbcluster
  Support: YES
  Comment: Clustered, fault-tolerant tables
  Transactions: YES
    XA: NO
  Savepoints: NO
```

```

***** 2. row *****
  Engine: CSV
  Support: YES
  Comment: CSV storage engine
Transactions: NO
  XA: NO
  Savepoints: NO
***** 3. row *****
  Engine: InnoDB
  Support: DEFAULT
  Comment: Supports transactions, row-level locking, and foreign keys
Transactions: YES
  XA: YES
  Savepoints: YES
***** 4. row *****
  Engine: BLACKHOLE
  Support: YES
  Comment: /dev/null storage engine (anything you write to it disappears)
Transactions: NO
  XA: NO
  Savepoints: NO
***** 5. row *****
  Engine: MyISAM
  Support: YES
  Comment: MyISAM storage engine
Transactions: NO
  XA: NO
  Savepoints: NO
***** 6. row *****
  Engine: MRG_MYISAM
  Support: YES
  Comment: Collection of identical MyISAM tables
Transactions: NO
  XA: NO
  Savepoints: NO
***** 7. row *****
  Engine: ARCHIVE
  Support: YES
  Comment: Archive storage engine
Transactions: NO
  XA: NO
  Savepoints: NO
***** 8. row *****
  Engine: ndbinfo
  Support: YES
  Comment: NDB Cluster system information storage engine
Transactions: NO
  XA: NO
  Savepoints: NO
***** 9. row *****
  Engine: PERFORMANCE_SCHEMA
  Support: YES
  Comment: Performance Schema
Transactions: NO
  XA: NO
  Savepoints: NO
***** 10. row *****
  Engine: MEMORY
  Support: YES
  Comment: Hash based, stored in memory, useful for temporary tables
Transactions: NO
  XA: NO
  Savepoints: NO
10 rows in set (0.00 sec)

```



If `ndbinfo` support is enabled, then you can access `ndbinfo` using SQL statements in `mysql` or another MySQL client. For example, you can see `ndbinfo` listed in the output of `SHOW DATABASES`, as shown here (emphasized text):

```
mysql> SHOW DATABASES;
+-----+
| Database |
+-----+
| information_schema |
| mysql |
| ndbinfo |
| performance_schema |
| sys |
+-----+
5 rows in set (0.04 sec)
```

If the `mysqld` process was not started with the `--ndbcluster` option, `ndbinfo` is not available and is not displayed by `SHOW DATABASES`. If `mysqld` was formerly connected to an NDB Cluster but the cluster becomes unavailable (due to events such as cluster shutdown, loss of network connectivity, and so forth), `ndbinfo` and its tables remain visible, but an attempt to access any tables (other than `blocks` or `config_params`) fails with Got error 157 'Connection to NDB failed' from NDBINFO.

With the exception of the `blocks` and `config_params` tables, what we refer to as `ndbinfo` “tables” are actually views generated from internal NDB tables not normally visible to the MySQL Server. You can make these tables visible by setting the `ndbinfo_show_hidden` system variable to `ON` (or `1`), but this is normally not necessary.

All `ndbinfo` tables are read-only, and are generated on demand when queried. Because many of them are generated in parallel by the data nodes while other are specific to a given SQL node, they are not guaranteed to provide a consistent snapshot.

In addition, pushing down of joins is not supported on `ndbinfo` tables; so joining large `ndbinfo` tables can require transfer of a large amount of data to the requesting API node, even when the query makes use of a `WHERE` clause.

`ndbinfo` tables are not included in the query cache. (Bug #59831)

You can select the `ndbinfo` database with a `USE` statement, and then issue a `SHOW TABLES` statement to obtain a list of tables, just as for any other database, like this:

```
mysql> USE ndbinfo;
Database changed

mysql> SHOW TABLES;
+-----+
| Tables_in_ndbinfo |
+-----+
| arbitrator_validity_detail |
| arbitrator_validity_summary |
| blocks |
| cluster_locks |
| cluster_operations |
| cluster_transactions |
| config_nodes |
| config_params |
| config_values |
| counters |
| cpustat |
| cpustat_1sec |
| cpustat_20sec |
| cpustat_50ms |
+-----+
```

```

| dict_obj_info
| dict_obj_types
| disk_write_speed_aggregate
| disk_write_speed_aggregate_node
| disk_write_speed_base
| diskpagebuffer
| error_messages
| locks_per_fragment
| logbuffers
| logspaces
| membership
| memory_per_fragment
| memoryusage
| nodes
| operations_per_fragment
| processes
| resources
| restart_info
| server_locks
| server_operations
| server_transactions
| table_distribution_status
| table_fragments
| table_info
| table_replicas
| tc_time_track_stats
| threadblocks
| threads
| threadstat
| transporters
+-----+
44 rows in set (0.00 sec)

```

In NDB 7.5.0 (and later), all `ndbinfo` tables use the `NDB` storage engine; however, an `ndbinfo` entry still appears in the output of `SHOW ENGINES` and `SHOW PLUGINS` as described previously.

The `config_values` table was added in NDB 7.5.0.

The `cpustat`, `cpustat_50ms`, `cpustat_1sec`, `cpustat_20sec`, and `threads` tables were added in NDB 7.5.2.

The `cluster_locks`, `locks_per_fragment`, and `server_locks` tables were added in NDB 7.5.3.

The `dict_obj_info`, `table_distribution_status`, `table_fragments`, `table_info`, and `table_replicas` tables were added in NDB 7.5.4.

The `config_nodes` and `processes` tables were added in NDB 7.5.7.

The `error_messages` table was added in NDB 7.6.

You can execute `SELECT` statements against these tables, just as you would normally expect:

```

mysql> SELECT * FROM memoryusage;
+-----+-----+-----+-----+-----+-----+
| node_id | memory_type          | used   | used_pages | total   | total_pages |
+-----+-----+-----+-----+-----+-----+
| 5       | Data memory         | 753664 | 23         | 1073741824 | 32768       |
| 5       | Index memory        | 163840 | 20         | 1074003968 | 131104      |
| 5       | Long message buffer | 2304   | 9          | 67108864   | 262144      |
| 6       | Data memory         | 753664 | 23         | 1073741824 | 32768       |
| 6       | Index memory        | 163840 | 20         | 1074003968 | 131104      |
| 6       | Long message buffer | 2304   | 9          | 67108864   | 262144      |
+-----+-----+-----+-----+-----+-----+
6 rows in set (0.02 sec)

```

More complex queries, such as the two following `SELECT` statements using the `memoryusage` table, are possible:

```
mysql> SELECT SUM(used) as 'Data Memory Used, All Nodes'
> FROM memoryusage
> WHERE memory_type = 'Data memory';
+-----+
| Data Memory Used, All Nodes |
+-----+
|                               6460 |
+-----+
1 row in set (0.37 sec)

mysql> SELECT SUM(max) as 'Total IndexMemory Available'
> FROM memoryusage
> WHERE memory_type = 'Index memory';
+-----+
| Total IndexMemory Available |
+-----+
|                               25664 |
+-----+
1 row in set (0.33 sec)
```

`ndbinfo` table and column names are case-sensitive (as is the name of the `ndbinfo` database itself). These identifiers are in lowercase. Trying to use the wrong lettercase results in an error, as shown in this example:

```
mysql> SELECT * FROM nodes;
+-----+-----+-----+-----+
| node_id | uptime | status | start_phase |
+-----+-----+-----+-----+
| 1 | 13602 | STARTED | 0 |
| 2 | 16 | STARTED | 0 |
+-----+-----+-----+-----+
2 rows in set (0.04 sec)

mysql> SELECT * FROM Nodes;
ERROR 1146 (42S02): Table 'ndbinfo.Nodes' doesn't exist
```

`mysqldump` ignores the `ndbinfo` database entirely, and excludes it from any output. This is true even when using the `--databases` or `--all-databases` option.

NDB Cluster also maintains tables in the `INFORMATION_SCHEMA` information database, including the `FILES` table which contains information about files used for NDB Cluster Disk Data storage, and the `ndb_transid_mysql_connection_map` table, which shows the relationships between transactions, transaction coordinators, and NDB Cluster API nodes. For more information, see the descriptions of the tables or [Section 21.6.16, “INFORMATION\\_SCHEMA Tables for NDB Cluster”](#).

### 21.6.15.1 The `ndbinfo` `arbitrator_validity_detail` Table

The `arbitrator_validity_detail` table shows the view that each data node in the cluster has of the arbitrator. It is a subset of the `membership` table.

The `arbitrator_validity_detail` table contains the following columns:

- `node_id`  
This node's node ID
- `arbitrator`  
Node ID of arbitrator

- `arb_ticket`

Internal identifier used to track arbitration

- `arb_connected`

Whether this node is connected to the arbitrator; either of `Yes` or `No`

- `arb_state`

Arbitration state

## Notes

The node ID is the same as that reported by `ndb_mgm -e "SHOW"`.

All nodes should show the same `arb_ticket` and `arb_state` values as well as the same `arb_state` value. Possible `arb_state` values are `ARBIT_NULL`, `ARBIT_INIT`, `ARBIT_FIND`, `ARBIT_PREP1`, `ARBIT_PREP2`, `ARBIT_START`, `ARBIT_RUN`, `ARBIT_CHOOSE`, `ARBIT_CRASH`, and `UNKNOWN`.

`arb_connected` shows whether the current node is connected to the `arb_ticket`.

### 21.6.15.2 The `ndbinfo arbitrator_validity_summary` Table

The `arbitrator_validity_summary` table provides a composite view of the arbitrator with regard to the cluster's data nodes.

The `arbitrator_validity_summary` table contains the following columns:

- `arb_ticket`

Node ID of arbitrator

- `arb_connected`

Whether this arbitrator is connected to the cluster; either of `Yes` or `No`

- `consensus_count`

Number of data nodes that see this node as arbitrator

## Notes

In normal operations, this table should have only 1 row for any appreciable length of time. If it has more than 1 row for longer than a few moments, then either not all nodes are connected to the arbitrator, or all nodes are connected, but do not agree on the same arbitrator.

The `arb_ticket` column shows the arbitrator's node ID.

`arb_connected` is the internal identifier used by this arbitrator.

`consensus_count` shows whether this node is connected to the cluster as an arbitrator.

### 21.6.15.3 The `ndbinfo blocks` Table

The `blocks` table is a static table which simply contains the names and internal IDs of all NDB kernel blocks (see [NDB Kernel Blocks](#)). It is for use by the other `ndbinfo` tables (most of which are actually views) in mapping block numbers to block names for producing human-readable output.

The `blocks` table contains the following columns:

- `block_number`  
Block number
- `block_name`  
Block name

## Notes

To obtain a list of all block names, simply execute `SELECT block_name FROM ndbinfo.blocks`. Although this is a static table, its content can vary between different NDB Cluster releases.

### 21.6.15.4 The `ndbinfo cluster_locks` Table

The `cluster_locks` table provides information about current lock requests holding and waiting for locks on `NDB` tables in an NDB Cluster, and is intended as a companion table to `cluster_operations`. Information obtain from the `cluster_locks` table may be useful in investigating stalls and deadlocks.

The `cluster_locks` table contains the following columns:

- `node_id`  
ID of reporting node
- `block_instance`  
ID of reporting LDM instance
- `tableid`  
ID of table containing this row
- `fragmentid`  
ID of fragment containing locked row
- `rowid`  
ID of locked row
- `transid`  
Transaction ID
- `mode`  
Lock request mode
- `state`  
Lock state

- `detail`  
Whether this is first holding lock in row lock queue
- `op`  
Operation type
- `duration_millis`  
Milliseconds spent waiting or holding lock
- `lock_num`  
ID of lock object
- `waiting_for`  
Waiting for lock with this ID

## Notes

The table ID (`tableid` column) is assigned internally, and is the same as that used in other `ndbinfo` tables. It is also shown in the output of `ndb_show_tables`.

The transaction ID (`transid` column) is the identifier generated by the NDB API for the transaction requesting or holding the current lock.

The `mode` column shows the lock mode; this is always one of `S` (indicating a shared lock) or `X` (an exclusive lock). If a transaction holds an exclusive lock on a given row, all other locks on that row have the same transaction ID.

The `state` column shows the lock state. Its value is always one of `H` (holding) or `W` (waiting). A waiting lock request waits for a lock held by a different transaction.

When the `detail` column contains a `*` (asterisk character), this means that this lock is the first holding lock in the affected row's lock queue; otherwise, this column is empty. This information can be used to help identify the unique entries in a list of lock requests.

The `op` column shows the type of operation requesting the lock. This is always one of the values `READ`, `INSERT`, `UPDATE`, `DELETE`, `SCAN`, or `REFRESH`.

The `duration_millis` column shows the number of milliseconds for which this lock request has been waiting or holding the lock. This is reset to 0 when a lock is granted for a waiting request.

The lock ID (`lockid` column) is unique to this node and block instance.

The lock state is shown in the `lock_state` column; if this is `W`, the lock is waiting to be granted, and the `waiting_for` column shows the lock ID of the lock object this request is waiting for. Otherwise, the `waiting_for` column is empty. `waiting_for` can refer only to locks on the same row, as identified by `node_id`, `block_instance`, `tableid`, `fragmentid`, and `rowid`.

The `cluster_locks` table was added in NDB 7.5.3.

### 21.6.15.5 The `ndbinfo cluster_operations` Table

The `cluster_operations` table provides a per-operation (stateful primary key `op`) view of all activity in the NDB Cluster from the point of view of the local data management (LQH) blocks (see [The DBLQH Block](#)).

The `cluster_operations` table contains the following columns:

- `node_id`  
Node ID of reporting LQH block
- `block_instance`  
LQH block instance
- `transid`  
Transaction ID
- `operation_type`  
Operation type (see text for possible values)
- `state`  
Operation state (see text for possible values)
- `tableid`  
Table ID
- `fragmentid`  
Fragment ID
- `client_node_id`  
Client node ID
- `client_block_ref`  
Client block reference
- `tc_node_id`  
Transaction coordinator node ID
- `tc_block_no`  
Transaction coordinator block number
- `tc_block_instance`  
Transaction coordinator block instance

## Notes

The transaction ID is a unique 64-bit number which can be obtained using the NDB API's `getTransactionId()` method. (Currently, the MySQL Server does not expose the NDB API transaction ID of an ongoing transaction.)

The `operation_type` column can take any one of the values `READ`, `READ-SH`, `READ-EX`, `INSERT`, `UPDATE`, `DELETE`, `WRITE`, `UNLOCK`, `REFRESH`, `SCAN`, `SCAN-SH`, `SCAN-EX`, or `<unknown>`.

The `state` column can have any one of the values `ABORT_QUEUED`, `ABORT_STOPPED`, `COMMITTED`, `COMMIT_QUEUED`, `COMMIT_STOPPED`, `COPY_CLOSE_STOPPED`, `COPY_FIRST_STOPPED`, `COPY_STOPPED`, `COPY_TUPKEY`, `IDLE`, `LOG_ABORT_QUEUED`, `LOG_COMMIT_QUEUED`, `LOG_COMMIT_QUEUED_WAIT_SIGNAL`, `LOG_COMMIT_WRITTEN`, `LOG_COMMIT_WRITTEN_WAIT_SIGNAL`, `LOG_QUEUED`, `PREPARED`, `PREPARED_RECEIVED_COMMIT`, `SCAN_CHECK_STOPPED`, `SCAN_CLOSE_STOPPED`, `SCAN_FIRST_STOPPED`, `SCAN_RELEASE_STOPPED`, `SCAN_STATE_USED`, `SCAN_STOPPED`, `SCAN_TUPKEY`, `STOPPED`, `TC_NOT_CONNECTED`, `WAIT_ACC`, `WAIT_ACC_ABORT`, `WAIT_AI_AFTER_ABORT`, `WAIT_ATTR`, `WAIT_SCAN_AI`, `WAIT_TUP`, `WAIT_TUPKEYINFO`, `WAIT_TUP_COMMIT`, or `WAIT_TUP_TO_ABORT`. (If the MySQL Server is running with `ndbinfo_show_hidden` enabled, you can view this list of states by selecting from the `ndb $dbldqh_tcconnect_state` table, which is normally hidden.)

You can obtain the name of an NDB table from its table ID by checking the output of `ndb_show_tables`.

The `fragid` is the same as the partition number seen in the output of `ndb_desc --extra-partition-info` (short form `-p`).

In `client_node_id` and `client_block_ref`, `client` refers to an NDB Cluster API or SQL node (that is, an NDB API client or a MySQL Server attached to the cluster).

The `block_instance` and `tc_block_instance` column provide, respectively, the `DBLQH` and `DBTC` block instance numbers. You can use these along with the block names to obtain information about specific threads from the `threadblocks` table.

### 21.6.15.6 The `ndbinfo cluster_transactions` Table

The `cluster_transactions` table shows information about all ongoing transactions in an NDB Cluster.

The `cluster_transactions` table contains the following columns:

- `node_id`  
Node ID of transaction coordinator
- `block_instance`  
TC block instance
- `transid`  
Transaction ID
- `state`  
Operation state (see text for possible values)
- `count_operations`  
Number of stateful primary key operations in transaction (includes reads with locks, as well as DML operations)
- `outstanding_operations`  
Operations still being executed in local data management blocks
- `inactive_seconds`  
Time spent waiting for API



- `client_node_id`  
Client node ID
- `client_block_ref`  
Client block reference

## Notes

The transaction ID is a unique 64-bit number which can be obtained using the NDB API's `getTransactionId()` method. (Currently, the MySQL Server does not expose the NDB API transaction ID of an ongoing transaction.)

`block_instance` refers to an instance of a kernel block. Together with the block name, this number can be used to look up a given instance in the `threadblocks` table.

The `state` column can have any one of the values `CS_ABORTING`, `CS_COMMITTING`, `CS_COMMIT_SENT`, `CS_COMPLETE_SENT`, `CS_COMPLETING`, `CS_CONNECTED`, `CS_DISCONNECTED`, `CS_FAIL_ABORTED`, `CS_FAIL_ABORTING`, `CS_FAIL_COMMITTED`, `CS_FAIL_COMMITTING`, `CS_FAIL_COMPLETED`, `CS_FAIL_PREPARED`, `CS_PREPARE_TO_COMMIT`, `CS_RECEIVING`, `CS_REC_COMMITTING`, `CS_RESTART`, `CS_SEND_FIRE_TRIG_REQ`, `CS_STARTED`, `CS_START_COMMITTING`, `CS_START_SCAN`, `CS_WAIT_ABORT_CONF`, `CS_WAIT_COMMIT_CONF`, `CS_WAIT_COMPLETE_CONF`, `CS_WAIT_FIRE_TRIG_REQ`. (If the MySQL Server is running with `ndbinfo_show_hidden` enabled, you can view this list of states by selecting from the `ndb$dbtc_apiconnect_state` table, which is normally hidden.)

In `client_node_id` and `client_block_ref`, `client` refers to an NDB Cluster API or SQL node (that is, an NDB API client or a MySQL Server attached to the cluster).

The `tc_block_instance` column provides the `DBTC` block instance number. You can use this along with the block name to obtain information about specific threads from the `threadblocks` table.

### 21.6.15.7 The `ndbinfo config_nodes` Table

The `config_nodes` table shows nodes configured in an NDB Cluster `config.ini` file. For each node, the table displays a row containing the node ID, the type of node (management node, data node, or API node), and the name or IP address of the host on which the node is configured to run.

This table does not indicate whether a given node is actually running, or whether it is currently connected to the cluster. Information about nodes connected to an NDB Cluster can be obtained from the `nodes` and `processes` table.

The `config_nodes` table contains the following columns:

- `node_id`  
The node's ID
- `node_type`  
The type of node
- `node_hostname`  
The name or IP address of the host on which the node resides

---

## Notes

The `node_id` column shows the node ID used in the `config.ini` file for this node; if none is specified, the node ID that would be assigned automatically to this node is displayed.

The `node_type` column displays one of the following three values:

- `MGM`: Management node.
- `NDB`: Data node.
- `API`: API node; this includes SQL nodes.

The `node_hostname` column shows the node host as specified in the `config.ini` file. This can be empty for an API node, if `HostName` has not been set in the cluster configuration file. If `HostName` has not been set for a data node in the configuration file, `localhost` is used here. `localhost` is also used if `HostName` has not been specified for a management node.

The `config_nodes` table was added in NDB 7.5.7.

### 21.6.15.8 The `ndbinfo config_params` Table

The `config_params` table is a static table which provides the names and internal ID numbers of and other information about NDB Cluster configuration parameters.

The `config_params` table contains the following columns:

- `param_number`  
The parameter's internal ID number
- `param_name`  
The name of the parameter
- `param_description`  
A brief description of the parameter
- `param_type`  
The parameter's data type
- `param_default`  
The parameter's default value, if any
- `param_min`  
The parameter's maximum value, if any
- `param_max`  
The parameter's minimum value, if any
- `param_mandatory`  
This is 1 if the parameter is required, otherwise 0

- `param_status`

Currently unused

## Notes

In NDB Cluster 7.5 (and later), this table is read-only. The `param_description`, `param_type`, `param_default`, `param_min`, `param_max`, `param_mandatory`, and `param_status` columns were all added in NDB 7.5.0.

Although this is a static table, its content can vary between NDB Cluster installations, since supported parameters can vary due to differences between software releases, cluster hardware configurations, and other factors.

### 21.6.15.9 The `ndbinfo config_values` Table

The `config_values` table, implemented in NDB 7.5.0, provides information about the current state of node configuration parameter values. Each row in the table corresponds to the current value of a parameter on a given node.

- `node_id`

ID of the node in the cluster

- `config_param`

The parameter's internal ID number

- `config_value`

Current value of the parameter

## Notes

This table's `config_param` column and the `config_params` table's `param_number` column use the same parameter identifiers. By joining the two tables on these columns, you can obtain detailed information about desired node configuration parameters. The query shown here provides the current values for all parameters on each data node in the cluster, ordered by node ID and parameter name:

```
SELECT  v.node_id AS 'Node Id',
        p.param_name AS 'Parameter',
        v.config_value AS 'Value'
FROM    config_values v
JOIN    config_params p
ON      v.config_param=p.param_number
WHERE   p.param_name NOT LIKE '\\\__%'
ORDER BY v.node_id, p.param_name;
```

Partial output from the previous query when run on a small example cluster used for simple testing:

Node Id	Parameter	Value
2	Arbitration	1
2	ArbitrationTimeout	7500
2	BackupDataBufferSize	16777216
2	BackupDataDir	/home/jon/data
2	BackupDiskWriteSpeedPct	50
2	BackupLogBufferSize	16777216

```
...
```

3	TotalSendBufferMemory	0
3	TransactionBufferMemory	1048576
3	TransactionDeadlockDetectionTimeout	1200
3	TransactionInactiveTimeout	4294967039
3	TwoPassInitialNodeRestartCopy	0
3	UndoDataBuffer	16777216
3	UndoIndexBuffer	2097152

-----

248 rows in set (0.02 sec)

The **WHERE** clause filters out parameters whose names begin with a double underscore (`__`); these parameters are reserved for testing and other internal uses by the NDB developers, and are not intended for use in a production NDB Cluster.

You can obtain output that is more specific, more detailed, or both by issuing the proper queries. This example provides all types of available information about the `NodeId`, `NoOfReplicas`, `HostName`, `DataMemory`, `IndexMemory`, and `TotalSendBufferMemory` parameters as currently set for all data nodes in the cluster:

```
SELECT  p.param_name AS Name,
        v.node_id AS Node,
        p.param_type AS Type,
        p.param_default AS 'Default',
        p.param_min AS Minimum,
        p.param_max AS Maximum,
        CASE p.param_mandatory WHEN 1 THEN 'Y' ELSE 'N' END AS 'Required',
        v.config_value AS Current
FROM    config_params p
JOIN    config_values v
ON      p.param_number = v.config_param
WHERE   p.param_name
        IN ('NodeId', 'NoOfReplicas', 'HostName',
            'DataMemory', 'IndexMemory', 'TotalSendBufferMemory')\G
```

The output from this query when run on a small NDB Cluster with 2 data nodes used for simple testing is shown here:

```
***** 1. row *****
      Name: NodeId
      Node: 2
      Type: unsigned
      Default:
      Minimum: 1
      Maximum: 48
      Required: Y
      Current: 2
***** 2. row *****
      Name: HostName
      Node: 2
      Type: string
      Default: localhost
      Minimum:
      Maximum:
      Required: N
      Current: 127.0.0.1
***** 3. row *****
      Name: TotalSendBufferMemory
      Node: 2
      Type: unsigned
      Default: 0
      Minimum: 262144
      Maximum: 4294967039
      Required: N
```

```

Current: 0
***** 4. row *****
  Name: NoOfReplicas
  Node: 2
  Type: unsigned
  Default: 2
  Minimum: 1
  Maximum: 4
  Required: N
  Current: 2
***** 5. row *****
  Name: DataMemory
  Node: 2
  Type: unsigned
  Default: 102760448
  Minimum: 1048576
  Maximum: 109951162776
  Required: N
  Current: 524288000
***** 6. row *****
  Name: NodeId
  Node: 3
  Type: unsigned
  Default:
  Minimum: 1
  Maximum: 48
  Required: Y
  Current: 3
***** 7. row *****
  Name: HostName
  Node: 3
  Type: string
  Default: localhost
  Minimum:
  Maximum:
  Required: N
  Current: 127.0.0.1
***** 8. row *****
  Name: TotalSendBufferMemory
  Node: 3
  Type: unsigned
  Default: 0
  Minimum: 262144
  Maximum: 4294967039
  Required: N
  Current: 0
***** 9. row *****
  Name: NoOfReplicas
  Node: 3
  Type: unsigned
  Default: 2
  Minimum: 1
  Maximum: 4
  Required: N
  Current: 2
***** 10. row *****
  Name: DataMemory
  Node: 3
  Type: unsigned
  Default: 102760448
  Minimum: 1048576
  Maximum: 109951162776
  Required: N
  Current: 524288000
10 rows in set (0.01 sec)

```

### 21.6.15.10 The ndbinfo counters Table

The `counters` table provides running totals of events such as reads and writes for specific kernel blocks and data nodes. Counts are kept from the most recent node start or restart; a node start or restart resets all counters on that node. Not all kernel blocks have all types of counters.

The `counters` table contains the following columns:

- `node_id`

The data node ID

- `block_name`

Name of the associated NDB kernel block (see [NDB Kernel Blocks](#)).

- `block_instance`

Block instance

- `counter_id`

The counter's internal ID number; normally an integer between 1 and 10, inclusive.

- `counter_name`

The name of the counter. See text for names of individual counters and the NDB kernel block with which each counter is associated.

- `val`

The counter's value

## Notes

Each counter is associated with a particular NDB kernel block.

The `OPERATIONS` counter is associated with the `DBLQH` (local query handler) kernel block (see [The DBLQH Block](#)). A primary-key read counts as one operation, as does a primary-key update. For reads, there is one operation in `DBLQH` per operation in `DBTC`. For writes, there is one operation counted per fragment replica.

The `ATTRINFO`, `TRANSACTIONS`, `COMMITTS`, `READS`, `LOCAL_READS`, `SIMPLE_READS`, `WRITES`, `LOCAL_WRITES`, `ABORTS`, `TABLE_SCANS`, and `RANGE_SCANS` counters are associated with the `DBTC` (transaction co-ordinator) kernel block (see [The DBTC Block](#)).

`LOCAL_WRITES` and `LOCAL_READS` are primary-key operations using a transaction coordinator in a node that also holds the primary fragment replica of the record.

The `READS` counter includes all reads. `LOCAL_READS` includes only those reads of the primary fragment replica on the same node as this transaction coordinator. `SIMPLE_READS` includes only those reads in which the read operation is the beginning and ending operation for a given transaction. Simple reads do not hold locks but are part of a transaction, in that they observe uncommitted changes made by the transaction containing them but not of any other uncommitted transactions. Such reads are “simple” from the point of view of the TC block; since they hold no locks they are not durable, and once `DBTC` has routed them to the relevant LQH block, it holds no state for them.

`ATTRINFO` keeps a count of the number of times an interpreted program is sent to the data node. See [NDB Protocol Messages](#), for more information about `ATTRINFO` messages in the `NDB` kernel.

The `LOCAL_TABLE_SCANS_SENT`, `READS_RECEIVED`, `PRUNED_RANGE_SCANS_RECEIVED`, `RANGE_SCANS_RECEIVED`, `LOCAL_READS_SENT`, `CONST_PRUNED_RANGE_SCANS_RECEIVED`, `LOCAL_RANGE_SCANS_SENT`, `REMOTE_READS_SENT`, `REMOTE_RANGE_SCANS_SENT`, `READS_NOT_FOUND`, `SCAN_BATCHES_RETURNED`, `TABLE_SCANS_RECEIVED`, and `SCAN_ROWS_RETURNED` counters are associated with the `DBSPJ` (select push-down join) kernel block (see [The DBSPJ Block](#)).

The `block_name` and `block_instance` columns provide, respectively, the applicable NDB kernel block name and instance number. You can use these to obtain information about specific threads from the `threadblocks` table.

A number of counters provide information about transporter overload and send buffer sizing when troubleshooting such issues. For each LQH instance, there is one instance of each counter in the following list:

- `LQHKEY_OVERLOAD`: Number of primary key requests rejected at the LQH block instance due to transporter overload
- `LQHKEY_OVERLOAD_TC`: Count of instances of `LQHKEY_OVERLOAD` where the TC node transporter was overloaded
- `LQHKEY_OVERLOAD_READER`: Count of instances of `LQHKEY_OVERLOAD` where the API reader (reads only) node was overloaded.
- `LQHKEY_OVERLOAD_NODE_PEER`: Count of instances of `LQHKEY_OVERLOAD` where the next backup data node (writes only) was overloaded
- `LQHKEY_OVERLOAD_SUBSCRIBER`: Count of instances of `LQHKEY_OVERLOAD` where a event subscriber (writes only) was overloaded.
- `LQHSCAN_SLOWDOWNS`: Count of instances where a fragment scan batch size was reduced due to scanning API transporter overload.

### 21.6.15.11 The `ndbinfo cpustat` Table

The `cpustat` table provides per-thread CPU statistics gathered each second, for each thread running in the NDB kernel.

The `cpustat` table contains the following columns:

- `node_id`  
ID of the node where the thread is running
- `thr_no`  
Thread ID (specific to this node)
- `OS_user`  
OS user time
- `OS_system`  
OS system time
- `OS_idle`

OS idle time

- `thread_exec`

Thread execution time

- `thread_sleeping`

Thread sleep time

- `thread_spinning`

Thread spin time

- `thread_send`

Thread send time

- `thread_buffer_full`

Thread buffer full time

- `elapsed_time`

Elapsed time

## Notes

This table was added in NDB 7.5.2.

### 21.6.15.12 The `ndbinfo cpustat_50ms` Table

The `cpustat_50ms` table provides raw, per-thread CPU data obtained each 50 milliseconds for each thread running in the `NDB` kernel.

Like `cpustat_1sec` and `cpustat_20sec`, this table shows 20 measurement sets per thread, each referencing a period of the named duration. Thus, `cpustat_50ms` provides 1 second of history.

The `cpustat_50ms` table contains the following columns:

- `node_id`

ID of the node where the thread is running

- `thr_no`

Thread ID (specific to this node)

- `OS_user_time`

OS user time

- `OS_system_time`

OS system time

- `OS_idle_time`



OS idle time

- `exec_time`

Thread execution time

- `sleep_time`

Thread sleep time

- `spin_time`

Thread spin time

- `send_time`

Thread send time

- `buffer_full_time`

Thread buffer full time

- `elapsed_time`

Elapsed time

## Notes

This table was added in NDB 7.5.2.

### 21.6.15.13 The `ndbinfo cpustat_1sec` Table

The `cpustat-1sec` table provides raw, per-thread CPU data obtained each second for each thread running in the NDB kernel.

Like `cpustat_50ms` and `cpustat_20sec`, this table shows 20 measurement sets per thread, each referencing a period of the named duration. Thus, `cpustat_1sec` provides 20 seconds of history.

The `cpustat_1sec` table contains the following columns:

- `node_id`

ID of the node where the thread is running

- `thr_no`

Thread ID (specific to this node)

- `OS_user_time`

OS user time

- `OS_system_time`

OS system time

- `OS_idle_time`

OS idle time

- `exec_time`

Thread execution time

- `sleep_time`

Thread sleep time

- `spin_time`

Thread spin time

- `send_time`

Thread send time

- `buffer_full_time`

Thread buffer full time

- `elapsed_time`

Elapsed time

## Notes

This table was added in NDB 7.5.2.

### 21.6.15.14 The `ndbinfo cpustat_20sec` Table

The `cpustat_20sec` table provides raw, per-thread CPU data obtained each 20 seconds, for each thread running in the NDB kernel.

Like `cpustat_50ms` and `cpustat_1sec`, this table shows 20 measurement sets per thread, each referencing a period of the named duration. Thus, `cpustat_20sec` provides 400 seconds of history.

The `cpustat_20sec` table contains the following columns:

- `node_id`

ID of the node where the thread is running

- `thr_no`

Thread ID (specific to this node)

- `OS_user_time`

OS user time

- `OS_system_time`

OS system time

- `OS_idle_time`

OS idle time

- `exec_time`

Thread execution time

- `sleep_time`

Thread sleep time

- `spin_time`

Thread spin time

- `send_time`

Thread send time

- `buffer_full_time`

Thread buffer full time

- `elapsed_time`

Elapsed time

## Notes

This table was added in NDB 7.5.2.

### 21.6.15.15 The `ndbinfo dict_obj_info` Table

The `dict_obj_info` table provides information about NDB data dictionary (`DICT`) objects such as tables and indexes. (The `dict_obj_types` table can be queried for a list of all the types.) This information includes the object's type, state, parent object (if any), and fully qualified name.

The `dict_obj_info` table contains the following columns:

- `type`

Type of `DICT` object; join on `dict_obj_types` to obtain the name

- `id`

Object identifier; for Disk Data undo log files and data files, this is the same as the value shown in the `LOGFILE_GROUP_NUMBER` column of the Information Schema `FILES` table

- `version`

Object version

- `state`

Object state

- `parent_obj_type`

Parent object's type (a `dict_obj_types` type ID); 0 indicates that the object has no parent

- `parent_obj_id`

Parent object ID (such as a base table); 0 indicates that the object has no parent

- `fq_name`

Fully qualified object name; for a table, this has the form `database_name/def/table_name`, for a primary key, the form is `sys/def/table_id/PRIMARY`, and for a unique key it is `sys/def/table_id/uk_name$unique`

## Notes

This table was added in NDB 7.5.4.

### 21.6.15.16 The `ndbinfo dict_obj_types` Table

The `dict_obj_types` table is a static table listing possible dictionary object types used in the NDB kernel. These are the same types defined by `Object::Type` in the NDB API.

The `dict_obj_types` table contains the following columns:

- `type_id`

The type ID for this type

- `type_name`

The name of this type

### 21.6.15.17 The `ndbinfo disk_write_speed_base` Table

The `disk_write_speed_base` table provides base information about the speed of disk writes during LCP, backup, and restore operations.

The `disk_write_speed_base` table contains the following columns:

- `node_id`

Node ID of this node

- `thr_no`

Thread ID of this LDM thread

- `millis_ago`

Milliseconds since this reporting period ended

- `millis_passed`

Milliseconds elapsed in this reporting period

- `backup_lcp_bytes_written`

Number of bytes written to disk by local checkpoints and backup processes during this period

- `redo_bytes_written`

Number of bytes written to REDO log during this period

- `target_disk_write_speed`

Actual speed of disk writes per LDM thread (base data)

### 21.6.15.18 The `ndbinfo disk_write_speed_aggregate` Table

The `disk_write_speed_aggregate` table provides aggregated information about the speed of disk writes during LCP, backup, and restore operations.

The `disk_write_speed_aggregate` table contains the following columns:

- `node_id`

Node ID of this node

- `thr_no`

Thread ID of this LDM thread

- `backup_lcp_speed_last_sec`

Number of bytes written to disk by backup and LCP processes in the last second

- `redo_speed_last_sec`

Number of bytes written to REDO log in the last second

- `backup_lcp_speed_last_10sec`

Number of bytes written to disk by backup and LCP processes per second, averaged over the last 10 seconds

- `redo_speed_last_10sec`

Number of bytes written to REDO log per second, averaged over the last 10 seconds

- `std_dev_backup_lcp_speed_last_10sec`

Standard deviation in number of bytes written to disk by backup and LCP processes per second, averaged over the last 10 seconds

- `std_dev_redo_speed_last_10sec`

Standard deviation in number of bytes written to REDO log per second, averaged over the last 10 seconds

- `backup_lcp_speed_last_60sec`

Number of bytes written to disk by backup and LCP processes per second, averaged over the last 60 seconds

- `redo_speed_last_60sec`

Number of bytes written to REDO log per second, averaged over the last 10 seconds

- `std_dev_backup_lcp_speed_last_60sec`

Standard deviation in number of bytes written to disk by backup and LCP processes per second, averaged over the last 60 seconds

- `std_dev_redo_speed_last_60sec`

Standard deviation in number of bytes written to REDO log per second, averaged over the last 60 seconds

- `slowdowns_due_to_io_lag`

Number of seconds since last node start that disk writes were slowed due to REDO log I/O lag

- `slowdowns_due_to_high_cpu`

Number of seconds since last node start that disk writes were slowed due to high CPU usage

- `disk_write_speed_set_to_min`

Number of seconds since last node start that disk write speed was set to minimum

- `current_target_disk_write_speed`

Actual speed of disk writes per LDM thread (aggregated)

### 21.6.15.19 The `ndbinfo disk_write_speed_aggregate_node` Table

The `disk_write_speed_aggregate_node` table provides aggregated information per node about the speed of disk writes during LCP, backup, and restore operations.

The `disk_write_speed_aggregate_node` table contains the following columns:

- `node_id`

Node ID of this node

- `backup_lcp_speed_last_sec`

Number of bytes written to disk by backup and LCP processes in the last second

- `redo_speed_last_sec`

Number of bytes written to the redo log in the last second

- `backup_lcp_speed_last_10sec`

Number of bytes written to disk by backup and LCP processes per second, averaged over the last 10 seconds

- `redo_speed_last_10sec`

Number of bytes written to the redo log each second, averaged over the last 10 seconds

- `backup_lcp_speed_last_60sec`

Number of bytes written to disk by backup and LCP processes per second, averaged over the last 60 seconds

- `redo_speed_last_60sec`

Number of bytes written to the redo log each second, averaged over the last 60 seconds

### 21.6.15.20 The `ndbinfo diskpagebuffer` Table

The `diskpagebuffer` table provides statistics about disk page buffer usage by NDB Cluster Disk Data tables.

The `diskpagebuffer` table contains the following columns:

- `node_id`  
The data node ID
- `block_instance`  
Block instance
- `pages_written`  
Number of pages written to disk.
- `pages_written_lcp`  
Number of pages written by local checkpoints.
- `pages_read`  
Number of pages read from disk
- `log_waits`  
Number of page writes waiting for log to be written to disk
- `page_requests_direct_return`  
Number of requests for pages that were available in buffer
- `page_requests_wait_queue`  
Number of requests that had to wait for pages to become available in buffer
- `page_requests_wait_io`  
Number of requests that had to be read from pages on disk (pages were unavailable in buffer)

## Notes

You can use this table with NDB Cluster Disk Data tables to determine whether `DiskPageBufferMemory` is sufficiently large to allow data to be read from the buffer rather from disk; minimizing disk seeks can help improve performance of such tables.

You can determine the proportion of reads from `DiskPageBufferMemory` to the total number of reads using a query such as this one, which obtains this ratio as a percentage:

```
SELECT
  node_id,
  100 * page_requests_direct_return /
    (page_requests_direct_return + page_requests_wait_io)
  AS hit_ratio
FROM ndbinfo.diskpagebuffer;
```

The result from this query should be similar to what is shown here, with one row for each data node in the cluster (in this example, the cluster has 4 data nodes):

```
+-----+-----+
```

```
| node_id | hit_ratio |
+-----+-----+
|      5 | 97.6744 |
|      6 | 97.6879 |
|      7 | 98.1776 |
|      8 | 98.1343 |
+-----+-----+
4 rows in set (0.00 sec)
```

`hit_ratio` values approaching 100% indicate that only a very small number of reads are being made from disk rather than from the buffer, which means that Disk Data read performance is approaching an optimum level. If any of these values are less than 95%, this is a strong indicator that the setting for `DiskPageBufferMemory` needs to be increased in the `config.ini` file.



**Note**

A change in `DiskPageBufferMemory` requires a rolling restart of all of the cluster's data nodes before it takes effect.

`block_instance` refers to an instance of a kernel block. Together with the block name, this number can be used to look up a given instance in the `threadblocks` table. Using this information, you can obtain information about disk page buffer metrics relating to individual threads; an example query using `LIMIT 1` to limit the output to a single thread is shown here:

```
mysql> SELECT
>   node_id, thr_no, block_name, thread_name, pages_written,
>   pages_written_lcp, pages_read, log_waits,
>   page_requests_direct_return, page_requests_wait_queue,
>   page_requests_wait_io
> FROM ndbinfo.diskpagebuffer
>   INNER JOIN ndbinfo.threadblocks USING (node_id, block_instance)
>   INNER JOIN ndbinfo.threads USING (node_id, thr_no)
> WHERE block_name = 'PGMAN' LIMIT 1\G
***** 1. row *****
      node_id: 1
      thr_no: 1
      block_name: PGMAN
      thread_name: rep
      pages_written: 0
      pages_written_lcp: 0
      pages_read: 1
      log_waits: 0
page_requests_direct_return: 4
      page_requests_wait_queue: 0
      page_requests_wait_io: 1
1 row in set (0.01 sec)
```

### 21.6.15.21 The ndbinfo error\_messages Table

The `error_messages` table provides information about

The `error_messages` table contains the following columns:

- `error_code`  
 Numeric error code
- `error_description`  
 Description of error
- `error_status`



Error status code

- `error_classification`

Error classification code

## Notes

`error_code` is a numeric NDB error code. This is the same error code that can be supplied to `ndb_perror` or `perror --ndb`.

`error_description` provides a basic description of the condition causing the error.

The `error_status` column provides status information relating to the error. Possible values for this column are listed here:

- No error
- Illegal connect string
- Illegal server handle
- Illegal reply from server
- Illegal number of nodes
- Illegal node status
- Out of memory
- Management server not connected
- Could not connect to socket
- Start failed
- Stop failed
- Restart failed
- Could not start backup
- Could not abort backup
- Could not enter single user mode
- Could not exit single user mode
- Failed to complete configuration change
- Failed to get configuration
- Usage error
- Success
- Permanent error
- Temporary error
- Unknown result

- `Temporary error, restart node`
- `Permanent error, external action needed`
- `Ndbd file system error, restart node initial`
- `Unknown`

The `error_classification` column shows the error classification. See [NDB Error Classifications](#), for information about classification codes and their meanings.

The `error_messages` table was added in NDB 7.6.

### 21.6.15.22 The `ndbinfo locks_per_fragment` Table

The `locks_per_fragment` table provides information about counts of lock claim requests, and the outcomes of these requests on a per-fragment basis, serving as a companion table to `operations_per_fragment` and `memory_per_fragment`. This table also shows the total time spent waiting for locks successfully and unsuccessfully since fragment or table creation, or since the most recent restart.

The `locks_per_fragment` table contains the following columns:

- `fq_name`  
Fully qualified table name
- `parent_fq_name`  
Fully qualified name of parent object
- `type`  
Table type; see text for possible values
- `table_id`  
Table ID
- `node_id`  
Reporting node ID
- `block_instance`  
LDM instance ID
- `fragment_num`  
Fragment identifier
- `ex_req`  
Exclusive lock requests started
- `ex_imm_ok`  
Exclusive lock requests immediately granted
- `ex_wait_ok`

Exclusive lock requests granted following wait

- `ex_wait_fail`

Exclusive lock requests not granted

- `sh_req`

Shared lock requests started

- `sh_imm_ok`

Shared lock requests immediately granted

- `sh_wait_ok`

Shared lock requests granted following wait

- `sh_wait_fail`

Shared lock requests not granted

- `wait_ok_millis`

Time spent waiting for lock requests that were granted, in milliseconds

- `wait_fail_millis`

Time spent waiting for lock requests that failed, in milliseconds

## Notes

`block_instance` refers to an instance of a kernel block. Together with the block name, this number can be used to look up a given instance in the `threadblocks` table.

`fq_name` is a fully qualified database object name in `database/schema/name` format, such as `test/def/t1` or `sys/def/10/b$unique`.

`parent_fq_name` is the fully qualified name of this object's parent object (table).

`table_id` is the table's internal ID generated by NDB. This is the same internal table ID shown in other `ndbinfo` tables; it is also visible in the output of `ndb_show_tables`.

The `type` column shows the type of table. This is always one of `System table`, `User table`, `Unique hash index`, `Hash index`, `Unique ordered index`, `Ordered index`, `Hash index trigger`, `Subscription trigger`, `Read only constraint`, `Index trigger`, `Reorganize trigger`, `Tablespace`, `Log file group`, `Data file`, `Undo file`, `Hash map`, `Foreign key definition`, `Foreign key parent trigger`, `Foreign key child trigger`, or `Schema transaction`.

The values shown in all of the columns `ex_req`, `ex_req_imm_ok`, `ex_wait_ok`, `ex_wait_fail`, `sh_req`, `sh_req_imm_ok`, `sh_wait_ok`, and `sh_wait_fail` represent cumulative numbers of requests since the table or fragment was created, or since the last restart of this node, whichever of these occurred later. This is also true for the time values shown in the `wait_ok_millis` and `wait_fail_millis` columns.

Every lock request is considered either to be in progress, or to have completed in some way (that is, to have succeeded or failed). This means that the following relationships are true:

```
ex_req >= (ex_req_imm_ok + ex_wait_ok + ex_wait_fail)
```

```
sh_req >= (sh_req_imm_ok + sh_wait_ok + sh_wait_fail)
```

The number of requests currently in progress is the current number of incomplete requests, which can be found as shown here:

```
[exclusive lock requests in progress] =
  ex_req - (ex_req_imm_ok + ex_wait_ok + ex_wait_fail)

[shared lock requests in progress] =
  sh_req - (sh_req_imm_ok + sh_wait_ok + sh_wait_fail)
```

A failed wait indicates an aborted transaction, but the abort may or may not be caused by a lock wait timeout. You can obtain the total number of aborts while waiting for locks as shown here:

```
[aborts while waiting for locks] = ex_wait_fail + sh_wait_fail
```

The `locks_per_fragment` table was added in NDB 7.5.3.

### 21.6.15.23 The ndbinfo logbuffers Table

The `logbuffer` table provides information on NDB Cluster log buffer usage.

The `logbuffers` table contains the following columns:

- `node_id`

The ID of this data node.

- `log_type`

Type of log. In NDB 7.5, one of: `REDO` or `DD-UNDO`. In NDB 7.6, one of: `REDO`, `DD-UNDO`, `BACKUP-DATA`, or `BACKUP-LOG`.

- `log_id`

The log ID; for Disk Data undo log files, this is the same as the value shown in the `LOGFILE_GROUP_NUMBER` column of the Information Schema `FILES` table as well as the value shown for the `log_id` column of the `ndbinfo logspaces` table

- `log_part`

The log part number

- `total`

Total space available for this log

- `used`

Space used by this log

### Notes

NDB 7.6.6 makes available `logbuffers` table rows reflecting two additional log types when performing an NDB backup. One of these rows has the log type `BACKUP-DATA`, which shows the amount of data buffer used during backup to copy fragments to backup files. The other row has the log type `BACKUP-LOG`, which displays the amount of log buffer used during the backup to record changes made after the backup has started. One each of these `log_type` rows is shown in the `logbuffers` table for each data node in the cluster. These rows are not present unless an NDB backup is currently being performed. (Bug #25822988)

### 21.6.15.24 The ndbinfo logspaces Table

This table provides information about NDB Cluster log space usage.

The `logspaces` table contains the following columns:

- `node_id`

The ID of this data node.

- `log_type`

Type of log; one of: `REDO` or `DD-UNDO`.

- `log_id`

The log ID; for Disk Data undo log files, this is the same as the value shown in the `LOGFILE_GROUP_NUMBER` column of the Information Schema `FILES` table as well as the value shown for the `log_id` column of the `ndbinfo logbuffers` table

- `log_part`

The log part number.

- `total`

Total space available for this log.

- `used`

Space used by this log.

### 21.6.15.25 The ndbinfo membership Table

The `membership` table describes the view that each data node has of all the others in the cluster, including node group membership, president node, arbitrator, arbitrator successor, arbitrator connection states, and other information.

The `membership` table contains the following columns:

- `node_id`

This node's node ID

- `group_id`

Node group to which this node belongs

- `left_node`

Node ID of the previous node

- `right_node`

Node ID of the next node

- `president`

President's node ID

- `successor`  
Node ID of successor to president
- `succession_order`  
Order in which this node succeeds to presidency
- `Conf_HB_order`  
-
- `arbiterator`  
Node ID of arbiterator
- `arb_ticket`  
Internal identifier used to track arbitration
- `arb_state`  
Arbitration state
- `arb_connected`  
Whether this node is connected to the arbiterator; either of `Yes` or `No`
- `connected_rank1_arbs`  
Connected arbiterators of rank 1
- `connected_rank2_arbs`  
Connected arbiterators of rank 1

## Notes

The node ID and node group ID are the same as reported by `ndb_mgm -e "SHOW"`.

`left_node` and `right_node` are defined in terms of a model that connects all data nodes in a circle, in order of their node IDs, similar to the ordering of the numbers on a clock dial, as shown here:

**Figure 21.8 Circular Arrangement of NDB Cluster Nodes**

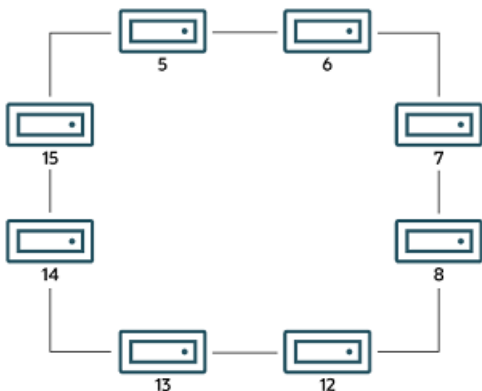

In this example, we have 8 data nodes, numbered 5, 6, 7, 8, 12, 13, 14, and 15, ordered clockwise in a circle. We determine “left” and “right” from the interior of the circle. The node to the left of node 5 is node 15, and the node to the right of node 5 is node 6. You can see all these relationships by running the following query and observing the output:

```
mysql> SELECT node_id,left_node,right_node
-> FROM ndbinfo.membership;
```

node_id	left_node	right_node
5	15	6
6	5	7
7	6	8
8	7	12
12	8	13
13	12	14
14	13	15
15	14	5

```
8 rows in set (0.00 sec)
```

The designations “left” and “right” are used in the event log in the same way.

The `president` node is the node viewed by the current node as responsible for setting an arbitrator (see [NDB Cluster Start Phases](#)). If the president fails or becomes disconnected, the current node expects the node whose ID is shown in the `successor` column to become the new president. The `succession_order` column shows the place in the succession queue that the current node views itself as having.

In a normal NDB Cluster, all data nodes should see the same node as `president`, and the same node (other than the president) as its `successor`. In addition, the current president should see itself as `1` in the order of succession, the `successor` node should see itself as `2`, and so on.

All nodes should show the same `arb_ticket` values as well as the same `arb_state` values. Possible `arb_state` values are `ARBIT_NULL`, `ARBIT_INIT`, `ARBIT_FIND`, `ARBIT_PREP1`, `ARBIT_PREP2`, `ARBIT_START`, `ARBIT_RUN`, `ARBIT_CHOOSE`, `ARBIT_CRASH`, and `UNKNOWN`.

`arb_connected` shows whether this node is connected to the node shown as this node's `arbitorator`.

The `connected_rank1_arbs` and `connected_rank2_arbs` columns each display a list of 0 or more arbitrators having an `ArbitrationRank` equal to 1, or to 2, respectively.



#### Note

Both management nodes and API nodes are eligible to become arbitrators.

### 21.6.15.26 The `ndbinfo memoryusage` Table

Querying this table provides information similar to that provided by the `ALL REPORT MemoryUsage` command in the `ndb_mgm` client, or logged by `ALL DUMP 1000`.

The `memoryusage` table contains the following columns:

- `node_id`

The node ID of this data node.

- `memory_type`

One of [Data memory](#), [Index memory](#), or [Long message buffer](#).

- [used](#)

Number of bytes currently used for data memory or index memory by this data node.

- [used\\_pages](#)

Number of pages currently used for data memory or index memory by this data node; see text.

- [total](#)

Total number of bytes of data memory or index memory available for this data node; see text.

- [total\\_pages](#)

Total number of memory pages available for data memory or index memory on this data node; see text.

## Notes

The [total](#) column represents the total amount of memory in bytes available for the given resource (data memory or index memory) on a particular data node. This number should be approximately equal to the setting of the corresponding configuration parameter in the [config.ini](#) file.

Suppose that the cluster has 2 data nodes having node IDs [5](#) and [6](#), and the [config.ini](#) file contains the following:

```
[ndbd default]
DataMemory = 1G
IndexMemory = 1G
```

Suppose also that the value of the [LongMessageBuffer](#) configuration parameter is allowed to assume its default (64 MB).

The following query shows approximately the same values:

```
mysql> SELECT node_id, memory_type, total
> FROM ndbinfo.memoryusage;
+-----+-----+-----+
| node_id | memory_type      | total      |
+-----+-----+-----+
| 5       | Data memory      | 1073741824 |
| 5       | Index memory     | 1074003968 |
| 5       | Long message buffer | 67108864  |
| 6       | Data memory      | 1073741824 |
| 6       | Index memory     | 1074003968 |
| 6       | Long message buffer | 67108864  |
+-----+-----+-----+
6 rows in set (0.00 sec)
```

In this case, the [total](#) column values for index memory are slightly higher than the value set of [IndexMemory](#) due to internal rounding.

For the [used\\_pages](#) and [total\\_pages](#) columns, resources are measured in pages, which are 32K in size for [DataMemory](#) and 8K for [IndexMemory](#). For long message buffer memory, the page size is 256 bytes.

### 21.6.15.27 The ndbinfo memory\_per\_fragment Table

- [memory\\_per\\_fragment Table: Notes](#)



- [memory\\_per\\_fragment Table: Examples](#)

The `memory_per_fragment` table provides information about the usage of memory by individual fragments. See the [Notes](#) later in this section to see how you can use this to find out how much memory is used by NDB tables.

The `memory_per_fragment` table contains the following columns:

- `fq_name`

Name of this fragment

- `parent_fq_name`

Name of this fragment's parent

- `type`

Dictionary object type (`Object::Type`, in the NDB API) used for this fragment; one of `System table`, `User table`, `Unique hash index`, `Hash index`, `Unique ordered index`, `Ordered index`, `Hash index trigger`, `Subscription trigger`, `Read only constraint`, `Index trigger`, `Reorganize trigger`, `Tablespace`, `Log file group`, `Data file`, `Undo file`, `Hash map`, `Foreign key definition`, `Foreign key parent trigger`, `Foreign key child trigger`, or `Schema transaction`.

You can also obtain this list by executing `TABLE ndbinfo.dict_obj_types` in the `mysql` client.

- `table_id`

Table ID for this table

- `node_id`

Node ID for this node

- `block_instance`

NDB kernel block instance ID; you can use this number to obtain information about specific threads from the `threadblocks` table.

- `fragment_num`

Fragment ID (number)

- `fixed_elem_alloc_bytes`

Number of bytes allocated for fixed-sized elements

- `fixed_elem_free_bytes`

Free bytes remaining in pages allocated to fixed-size elements

- `fixed_elem_size_bytes`

Length of each fixed-size element in bytes

- `fixed_elem_count`

Number of fixed-size elements

- `fixed_elem_free_count`  
Number of free rows for fixed-size elements
- `var_elem_alloc_bytes`  
Number of bytes allocated for variable-size elements
- `var_elem_free_bytes`  
Free bytes remaining in pages allocated to variable-size elements
- `var_elem_count`  
Number of variable-size elements
- `hash_index_alloc_bytes`  
Number of bytes allocated to hash indexes

### memory\_per\_fragment Table: Notes

The `memory_per_fragment` table contains one row for every table fragment replica and every index fragment replica in the system; this means that, for example, when `NoOfReplicas=2`, there are normally two fragment replicas for each fragment. This is true as long as all data nodes are running and connected to the cluster; for a data node that is missing, there are no rows for the fragment replicas that it hosts.

The columns of the `memory_per_fragment` table can be grouped according to their function or purpose as follows:

- *Key columns:* `fq_name`, `type`, `table_id`, `node_id`, `block_instance`, and `fragment_num`
- *Relationship column:* `parent_fq_name`
- *Fixed-size storage columns:* `fixed_elem_alloc_bytes`, `fixed_elem_free_bytes`, `fixed_elem_size_bytes`, `fixed_elem_count`, and `fixed_elem_free_count`
- *Variable-sized storage columns:* `var_elem_alloc_bytes`, `var_elem_free_bytes`, and `var_elem_count`
- *Hash index column:* `hash_index_alloc_bytes`

The `parent_fq_name` and `fq_name` columns can be used to identify indexes associated with a table. Similar schema object hierarchy information is available in other `ndbinfo` tables.

Table and index fragment replicas allocate `DataMemory` in 32KB pages. These memory pages are managed as listed here:

- *Fixed-size pages:* These store the fixed-size parts of rows stored in a given fragment. Every row has a fixed-size part.
- *Variable-sized pages:* These store variable-sized parts for rows in the fragment. Every row having one or more variable-sized, one or more dynamic columns (or both) has a variable-sized part.
- *Hash index pages:* These are allocated as 8 KB subpages, and store the primary key hash index structure.

Each row in an `NDB` table has a fixed-size part, consisting of a row header, and one or more fixed-size columns. The row may also contain one or more variable-size part references, one or more disk part

references, or both. Each row also has a primary key hash index entry (corresponding to the hidden primary key that is part of every NDB table).

From the foregoing we can see that each table fragment and index fragment together allocate the amount of `DataMemory` calculated as shown here:

```
DataMemory =
  (number_of_fixed_pages + number_of_var_pages) * 32KB
  + number_of_hash_pages * 8KB
```

Since `fixed_elem_alloc_bytes` and `var_elem_alloc_bytes` are always multiples of 32768 bytes, we can further determine that `number_of_fixed_pages = fixed_elem_alloc_bytes / 32768` and `number_of_var_pages = var_elem_alloc_bytes / 32768`. `hash_index_alloc_bytes` is always a multiple of 8192 bytes, so `number_of_hash_pages = hash_index_alloc_bytes / 8192`.

A fixed size page has an internal header and a number of fixed-size slots, each of which can contain one row's fixed-size part. The size of a given row's fixed size part is schema-dependent, and is provided by the `fixed_elem_size_bytes` column; the number of fixed-size slots per page can be determined by calculating the total number of slots and the total number of pages, like this:

```
fixed_slots = fixed_elem_count + fixed_elem_free_count

fixed_pages = fixed_elem_alloc_bytes / 32768

slots_per_page = total_slots / total_pages
```

`fixed_elem_count` is in effect the row count for a given table fragment, since each row has 1 fixed element, `fixed_elem_free_count` is the total number of free fixed-size slots across the allocated pages. `fixed_elem_free_bytes` is equal to `fixed_elem_free_count * fixed_elem_size_bytes`.

A fragment can have any number of fixed-size pages; when the last row on a fixed-size page is deleted, the page is released to the `DataMemory` page pool. Fixed-size pages can be fragmented, with more pages allocated than is required by the number of fixed-size slots in use. You can check whether this is the case by comparing the pages required to the pages allocated, which you can calculate like this:

```
fixed_pages_required = 1 + (fixed_elem_count / slots_per_page)

fixed_page_utilization = fixed_pages_required / fixed_pages
```

A variable-sized page has an internal header and uses the remaining space to store one or more variable-sized row parts; the number of parts stored depends on the schema and the actual data stored. Since not all schemas or rows have a variable-sized part, `var_elem_count` can be less than `fixed_elem_count`. The total free space available on all variable-sized pages in the fragment is shown by the `var_elem_free_bytes` column; because this space may be spread over multiple pages, it cannot necessarily be used to store an entry of a particular size. Each variable-sized page is reorganized as needed to fit the changing size of variable-sized row parts as they are inserted, updated, and deleted; if a given row part grows too large for the page it is in, it can be moved to a different page.

Variable-sized page utilisation can be calculated as shown here:

```
var_page_used_bytes = var_elem_alloc_bytes - var_elem_free_bytes

var_page_utilisation = var_page_used_bytes / var_elem_alloc_bytes

avg_row_var_part_size = var_page_used_bytes / fixed_elem_count
```

We can obtain the average variable part size per row like this:

```
avg_row_var_part_size = var_page_used_bytes / fixed_elem_count
```

---

Secondary unique indexes are implemented internally as independent tables with the following schema:

- *Primary key*: Indexed columns in base table.
- *Values*: Primary key columns from base table.

These tables are distributed and fragmented as normal. This means that their fragment replicas use fixed, variable, and hash index pages as with any other [NDB](#) table.

Secondary ordered indexes are fragmented and distributed in the same way as the base table. Ordered index fragments are T-tree structures which maintain a balanced tree containing row references in the order implied by the indexed columns. Since the tree contains references rather than actual data, the T-tree storage cost is not dependent on the size or number of indexed columns, but is rather a function of the number of rows. The tree is constructed using fixed-size node structures, each of which may contain a number of row references; the number of nodes required depends on the number of rows in the table, and the tree structure necessary to represent the ordering. In the [memory\\_per\\_fragment](#) table, we can see that ordered indexes allocate only fixed-size pages, so as usual the relevant columns from this table are as listed here:

- [fixed\\_elem\\_alloc\\_bytes](#): This is equal to 32768 times the number of fixed-size pages.
- [fixed\\_elem\\_count](#): The number of T-tree nodes in use.
- [fixed\\_elem\\_size\\_bytes](#): The number of bytes per T-tree node.
- [fixed\\_elem\\_free\\_count](#): The number of T-tree node slots available in the pages allocated.
- [fixed\\_elem\\_free\\_bytes](#): This is equal to `fixed_elem_free_count * fixed_elem_size_bytes`.

If free space in a page is fragmented, the page is defragmented. `OPTIMIZE TABLE` can be used to defragment a table's variable-sized pages; this moves row variable-sized parts between pages so that some whole pages can be freed for re-use.

### **memory\_per\_fragment Table: Examples**

- [Getting general information about fragments and memory usage](#)
- [Finding a table and its indexes](#)
- [Finding the memory allocated by schema elements](#)
- [Finding the memory allocated for a table and all indexes](#)
- [Finding the memory allocated per row](#)
- [Finding the total memory in use per row](#)
- [Finding the memory allocated per element](#)
- [Finding the average memory allocated per row, by element](#)
- [Finding the average memory allocated per row](#)
- [Finding the average memory allocated per row for a table](#)
- [Finding the memory in use by each schema element](#)
- [Finding the average memory in use by each schema element](#)

- Finding the average memory in use per row, by element
- Finding the total average memory in use per row

For the following examples, we create a simple table with three integer columns, one of which has a primary key, one having a unique index, and one with no indexes, as well as one `VARCHAR` column with no indexes, as shown here:

```
mysql> CREATE DATABASE IF NOT EXISTS test;
Query OK, 1 row affected (0.06 sec)

mysql> USE test;
Database changed

mysql> CREATE TABLE t1 (
  ->   c1 BIGINT NOT NULL AUTO_INCREMENT PRIMARY KEY,
  ->   c2 INT,
  ->   c3 INT UNIQUE,
  -> ) ENGINE=NDBCLUSTER;
Query OK, 0 rows affected (0.27 sec)
```

Following creation of the table, we insert 50,000 rows containing random data; the precise method of generating and inserting these rows makes no practical difference, and we leave the method of accomplishing as an exercise for the user.

### Getting general information about fragments and memory usage

This query shows general information about memory usage for each fragment:

```
mysql> SELECT
  ->   fq_name, node_id, block_instance, fragment_num, fixed_elem_alloc_bytes,
  ->   fixed_elem_free_bytes, fixed_elem_size_bytes, fixed_elem_count,
  ->   fixed_elem_free_count, var_elem_alloc_bytes, var_elem_free_bytes,
  ->   var_elem_count
  -> FROM ndbinfo.memory_per_fragment
  -> WHERE fq_name = "test/def/t1"\G
***** 1. row *****
      fq_name: test/def/t1
      node_id: 5
      block_instance: 1
      fragment_num: 0
fixed_elem_alloc_bytes: 1114112
fixed_elem_free_bytes: 11836
fixed_elem_size_bytes: 44
      fixed_elem_count: 24925
fixed_elem_free_count: 269
var_elem_alloc_bytes: 1245184
var_elem_free_bytes: 32552
      var_elem_count: 24925
***** 2. row *****
      fq_name: test/def/t1
      node_id: 5
      block_instance: 1
      fragment_num: 1
fixed_elem_alloc_bytes: 1114112
fixed_elem_free_bytes: 5236
fixed_elem_size_bytes: 44
      fixed_elem_count: 25075
fixed_elem_free_count: 119
var_elem_alloc_bytes: 1277952
var_elem_free_bytes: 54232
      var_elem_count: 25075
***** 3. row *****
      fq_name: test/def/t1
      node_id: 6
```

```

        block_instance: 1
        fragment_num: 0
fixed_elem_alloc_bytes: 1114112
fixed_elem_free_bytes: 11836
fixed_elem_size_bytes: 44
        fixed_elem_count: 24925
fixed_elem_free_count: 269
var_elem_alloc_bytes: 1245184
var_elem_free_bytes: 32552
var_elem_count: 24925
***** 4. row *****
        fq_name: test/def/t1
        node_id: 6
        block_instance: 1
        fragment_num: 1
fixed_elem_alloc_bytes: 1114112
fixed_elem_free_bytes: 5236
fixed_elem_size_bytes: 44
        fixed_elem_count: 25075
fixed_elem_free_count: 119
var_elem_alloc_bytes: 1277952
var_elem_free_bytes: 54232
var_elem_count: 25075
4 rows in set (0.12 sec)

```

### Finding a table and its indexes

This query can be used to find a specific table and its indexes:

```

mysql> SELECT fq_name
-> FROM ndbinfo.memory_per_fragment
-> WHERE fq_name = 'test/def/t1' OR parent_fq_name='test/def/t1'
-> GROUP BY fq_name;
+-----+
| fq_name          |
+-----+
| test/def/t1     |
| sys/def/13/PRIMARY |
| sys/def/13/c3   |
| sys/def/13/c3$unique |
+-----+
4 rows in set (0.13 sec)

mysql> SELECT COUNT(*) FROM t1;
+-----+
| COUNT(*) |
+-----+
| 50000 |
+-----+
1 row in set (0.00 sec)

```

### Finding the memory allocated by schema elements

This query shows the memory allocated by each schema element (in total across all replicas):

```

mysql> SELECT
-> fq_name AS Name,
-> SUM(fixed_elem_alloc_bytes) AS Fixed,
-> SUM(var_elem_alloc_bytes) AS Var,
-> SUM(hash_index_alloc_bytes) AS Hash,
-> SUM(fixed_elem_alloc_bytes+var_elem_alloc_bytes+hash_index_alloc_bytes) AS Total
-> FROM ndbinfo.memory_per_fragment
-> WHERE fq_name = 'test/def/t1' OR parent_fq_name='test/def/t1'
-> GROUP BY fq_name;
+-----+-----+-----+-----+
| Name          | Fixed | Var   | Hash  | Total |
+-----+-----+-----+-----+

```

```

+-----+-----+-----+-----+-----+
| test/def/t1 | 4456448 | 5046272 | 1425408 | 10928128 |
| sys/def/13/PRIMARY | 1966080 | 0 | 0 | 1966080 |
| sys/def/13/c3 | 1441792 | 0 | 0 | 1441792 |
| sys/def/13/c3$unique | 3276800 | 0 | 1425408 | 4702208 |
+-----+-----+-----+-----+-----+
4 rows in set (0.11 sec)

```

### Finding the memory allocated for a table and all indexes

The sum of memory allocated for the table and all its indexes (in total across all replicas) can be obtained using the query shown here:

```

mysql> SELECT
->   SUM(fixed_elem_alloc_bytes) AS Fixed,
->   SUM(var_elem_alloc_bytes) AS Var,
->   SUM(hash_index_alloc_bytes) AS Hash,
->   SUM(fixed_elem_alloc_bytes+var_elem_alloc_bytes+hash_index_alloc_bytes) AS Total
-> FROM ndbinfo.memory_per_fragment
-> WHERE fq_name = 'test/def/t1' OR parent_fq_name='test/def/t1';
+-----+-----+-----+-----+
| Fixed | Var | Hash | Total |
+-----+-----+-----+-----+
| 11141120 | 5046272 | 2850816 | 19038208 |
+-----+-----+-----+-----+
1 row in set (0.12 sec)

```

This is an abbreviated version of the previous query which shows only the total memory used by the table:

```

mysql> SELECT
->   SUM(fixed_elem_alloc_bytes+var_elem_alloc_bytes+hash_index_alloc_bytes) AS Total
-> FROM ndbinfo.memory_per_fragment
-> WHERE fq_name = 'test/def/t1' OR parent_fq_name='test/def/t1';
+-----+
| Total |
+-----+
| 19038208 |
+-----+
1 row in set (0.12 sec)

```

### Finding the memory allocated per row

The following query shows the total memory allocated per row (across all replicas):

```

mysql> SELECT
->   SUM(fixed_elem_alloc_bytes+var_elem_alloc_bytes+hash_index_alloc_bytes)
->   /
->   SUM(fixed_elem_count) AS Total_alloc_per_row
-> FROM ndbinfo.memory_per_fragment
-> WHERE fq_name = 'test/def/t1';
+-----+
| Total_alloc_per_row |
+-----+
| 109.2813 |
+-----+
1 row in set (0.12 sec)

```

### Finding the total memory in use per row

To obtain the total memory in use per row (across all replicas), we need the total memory used divided by the row count, which is the `fixed_elem_count` for the base table like this:

```

mysql> SELECT

```

```

-> SUM(
->   (fixed_elem_alloc_bytes - fixed_elem_free_bytes)
->   + (var_elem_alloc_bytes - var_elem_free_bytes)
->   + hash_index_alloc_bytes
-> )
-> /
-> SUM(fixed_elem_count)
-> AS total_in_use_per_row
-> FROM ndbinfo.memory_per_fragment
-> WHERE fq_name = 'test/def/t1';
+-----+
| total_in_use_per_row |
+-----+
|          107.2042 |
+-----+
1 row in set (0.12 sec)

```

### Finding the memory allocated per element

The memory allocated by each schema element (in total across all replicas) can be found using the following query:

```

mysql> SELECT
->   fq_name AS Name,
->   SUM(fixed_elem_alloc_bytes) AS Fixed,
->   SUM(var_elem_alloc_bytes) AS Var,
->   SUM(hash_index_alloc_bytes) AS Hash,
->   SUM(fixed_elem_alloc_bytes + var_elem_alloc_bytes + hash_index_alloc_bytes)
->   AS Total_alloc
-> FROM ndbinfo.memory_per_fragment
-> WHERE fq_name = 'test/def/t1' OR parent_fq_name='test/def/t1'
-> GROUP BY fq_name;
+-----+-----+-----+-----+-----+
| Name                | Fixed  | Var    | Hash   | Total_alloc |
+-----+-----+-----+-----+-----+
| test/def/t1         | 4456448 | 5046272 | 1425408 | 10928128 |
| sys/def/13/PRIMARY | 1966080 | 0       | 0       | 1966080 |
| sys/def/13/c3       | 1441792 | 0       | 0       | 1441792 |
| sys/def/13/c3$unique | 3276800 | 0       | 1425408 | 4702208 |
+-----+-----+-----+-----+-----+
4 rows in set (0.11 sec)

```

### Finding the average memory allocated per row, by element

To obtain the average memory allocated per row by each schema element (in total across all replicas), we use a subquery to get the base table fixed element count each time to get an average per row since `fixed_elem_count` for the indexes is not necessarily the same as for the base table, as shown here:

```

mysql> SELECT
->   fq_name AS Name,
->   ( SELECT SUM(fixed_elem_count)
->     FROM ndbinfo.memory_per_fragment
->     WHERE fq_name='test/def/t1') AS Table_rows,
->
->   SUM(fixed_elem_alloc_bytes)
->   /
->   ( SELECT SUM(fixed_elem_count)
->     FROM ndbinfo.memory_per_fragment
->     WHERE fq_name='test/def/t1') AS Avg_fixed_alloc,
->
->   SUM(var_elem_alloc_bytes)
->   /
->   ( SELECT SUM(fixed_elem_count)
->     FROM ndbinfo.memory_per_fragment
->     WHERE fq_name='test/def/t1') as Avg_var_alloc,

```



```

->
-> SUM(hash_index_alloc_bytes)
-> /
-> ( SELECT SUM(fixed_elem_count)
-> FROM ndbinfo.memory_per_fragment
-> WHERE fq_name='test/def/t1') as Avg_hash_alloc,
->
-> SUM(fixed_elem_alloc_bytes+var_elem_alloc_bytes+hash_index_alloc_bytes)
-> /
-> ( SELECT SUM(fixed_elem_count)
-> FROM ndbinfo.memory_per_fragment
-> WHERE fq_name='test/def/t1') as Avg_total_alloc
->
-> FROM ndbinfo.memory_per_fragment
-> WHERE fq_name = 'test/def/t1' or parent_fq_name='test/def/t1'
-> GROUP BY fq_name;

```

Name	Table_rows	Avg_fixed_alloc	Avg_var_alloc	Avg_hash_alloc	Avg_total_alloc
test/def/t1	100000	44.5645	50.4627	14.2541	109.2813
sys/def/13/PRIMARY	100000	19.6608	0.0000	0.0000	19.6608
sys/def/13/c3	100000	14.4179	0.0000	0.0000	14.4179
sys/def/13/c3\$unique	100000	32.7680	0.0000	14.2541	47.0221

4 rows in set (0.70 sec)

### Finding the average memory allocated per row

Average memory allocated per row (in total across all replicas):

```

mysql> SELECT
-> ( SELECT SUM(fixed_elem_count)
-> FROM ndbinfo.memory_per_fragment
-> WHERE fq_name='test/def/t1') AS Table_rows,
->
-> SUM(fixed_elem_alloc_bytes)
-> /
-> ( SELECT SUM(fixed_elem_count)
-> FROM ndbinfo.memory_per_fragment
-> WHERE fq_name='test/def/t1') AS Avg_fixed_alloc,
->
-> SUM(var_elem_alloc_bytes)
-> /
-> ( SELECT SUM(fixed_elem_count)
-> FROM ndbinfo.memory_per_fragment
-> WHERE fq_name='test/def/t1') AS Avg_var_alloc,
->
-> SUM(hash_index_alloc_bytes)
-> /
-> ( SELECT SUM(fixed_elem_count)
-> FROM ndbinfo.memory_per_fragment
-> WHERE fq_name='test/def/t1') AS Avg_hash_alloc,
->
-> SUM(fixed_elem_alloc_bytes + var_elem_alloc_bytes + hash_index_alloc_bytes)
-> /
-> ( SELECT SUM(fixed_elem_count)
-> FROM ndbinfo.memory_per_fragment
-> WHERE fq_name='test/def/t1') AS Avg_total_alloc
->
-> FROM ndbinfo.memory_per_fragment
-> WHERE fq_name = 'test/def/t1' OR parent_fq_name='test/def/t1';

```

Table_rows	Avg_fixed_alloc	Avg_var_alloc	Avg_hash_alloc	Avg_total_alloc
100000	111.4112	50.4627	28.5082	190.3821

1 row in set (0.71 sec)

## Finding the average memory allocated per row for a table

To get the average amount of memory allocated per row for the entire table across all replicas, we can use the query shown here:

```
mysql> SELECT
->   ( SELECT SUM(fixed_elem_count)
->     FROM ndbinfo.memory_per_fragment
->     WHERE fq_name='test/def/t1') AS table_rows,
->
->   SUM(fixed_elem_alloc_bytes + var_elem_alloc_bytes + hash_index_alloc_bytes)
->   /
->   ( SELECT SUM(fixed_elem_count)
->     FROM ndbinfo.memory_per_fragment
->     WHERE fq_name='test/def/t1') AS avg_total_alloc
->
-> FROM ndbinfo.memory_per_fragment
-> WHERE fq_name = 'test/def/t1' OR parent_fq_name='test/def/t1';
+-----+-----+
| table_rows | avg_total_alloc |
+-----+-----+
|      100000 |          190.3821 |
+-----+-----+
1 row in set (0.33 sec)
```

## Finding the memory in use by each schema element

To obtain the memory in use per schema element across all replicas, we need to sum the difference between allocated and free memory for each element, like this:

```
mysql> SELECT
->   fq_name AS Name,
->   SUM(fixed_elem_alloc_bytes - fixed_elem_free_bytes) AS fixed_inuse,
->   SUM(var_elem_alloc_bytes - var_elem_free_bytes) AS var_inuse,
->   SUM(hash_index_alloc_bytes) AS hash_memory,
->   SUM( (fixed_elem_alloc_bytes - fixed_elem_free_bytes)
->     + (var_elem_alloc_bytes - var_elem_free_bytes)
->     + hash_index_alloc_bytes) AS total_alloc
-> FROM ndbinfo.memory_per_fragment
-> WHERE fq_name = 'test/def/t1' OR parent_fq_name='test/def/t1'
-> GROUP BY fq_name;
+-----+-----+-----+-----+-----+
| fq_name          | fixed_inuse | var_inuse | hash  | total_alloc |
+-----+-----+-----+-----+-----+
| test/def/t1      | 4422304    | 4872704   | 1425408 | 10720416    |
| sys/def/13/PRIMARY | 1950848    | 0         | 0       | 1950848     |
| sys/def/13/c3    | 1428736    | 0         | 0       | 1428736     |
| sys/def/13/c3$unique | 3212800    | 0         | 1425408 | 4638208     |
+-----+-----+-----+-----+-----+
4 rows in set (0.13 sec)
```

## Finding the average memory in use by each schema element

This query gets the average memory in use per schema element across all replicas:

```
mysql> SELECT
->   fq_name AS Name,
->
->   ( SELECT SUM(fixed_elem_count)
->     FROM ndbinfo.memory_per_fragment
->     WHERE fq_name='test/def/t1') AS table_rows,
->
->   SUM(fixed_elem_alloc_bytes - fixed_elem_free_bytes)
->   /
```

```

-> ( SELECT SUM(fixed_elem_count)
-> FROM ndbinfo.memory_per_fragment
-> WHERE fq_name='test/def/t1') AS avg_fixed_inuse,
->
-> SUM(var_elem_alloc_bytes - var_elem_free_bytes)
-> /
-> ( SELECT SUM(fixed_elem_count)
-> FROM ndbinfo.memory_per_fragment
-> WHERE fq_name='test/def/t1') AS avg_var_inuse,
->
-> SUM(hash_index_alloc_bytes)
-> /
-> ( SELECT SUM(fixed_elem_count)
-> FROM ndbinfo.memory_per_fragment
-> WHERE fq_name='test/def/t1') AS avg_hash,
->
-> SUM(
-> (fixed_elem_alloc_bytes - fixed_elem_free_bytes)
-> + (var_elem_alloc_bytes - var_elem_free_bytes) + hash_index_alloc_bytes)
-> /
-> ( SELECT SUM(fixed_elem_count)
-> FROM ndbinfo.memory_per_fragment
-> WHERE fq_name='test/def/t1') AS avg_total_inuse
->
-> FROM ndbinfo.memory_per_fragment
-> WHERE fq_name = 'test/def/t1' OR parent_fq_name='test/def/t1'
-> GROUP BY fq_name;
-----+-----+-----+-----+-----+-----+
| Name                | table_rows | avg_fixed_inuse | avg_var_inuse | avg_hash | avg_total_inuse |
-----+-----+-----+-----+-----+-----+
| test/def/t1         | 100000    | 44.2230         | 48.7270       | 14.2541  | 107.2042        |
| sys/def/13/PRIMARY  | 100000    | 19.5085         | 0.0000        | 0.0000   | 19.5085         |
| sys/def/13/c3       | 100000    | 14.2874         | 0.0000        | 0.0000   | 14.2874         |
| sys/def/13/c3$unique | 100000    | 32.1280         | 0.0000        | 14.2541  | 46.3821         |
-----+-----+-----+-----+-----+-----+
4 rows in set (0.72 sec)

```

### Finding the average memory in use per row, by element

This query gets the average memory in use per row, by element, across all replicas:

```

mysql> SELECT
-> ( SELECT SUM(fixed_elem_count)
-> FROM ndbinfo.memory_per_fragment
-> WHERE fq_name='test/def/t1') AS table_rows,
->
-> SUM(fixed_elem_alloc_bytes - fixed_elem_free_bytes)
-> /
-> ( SELECT SUM(fixed_elem_count)
-> FROM ndbinfo.memory_per_fragment
-> WHERE fq_name='test/def/t1') AS avg_fixed_inuse,
->
-> SUM(var_elem_alloc_bytes - var_elem_free_bytes)
-> /
-> ( SELECT SUM(fixed_elem_count)
-> FROM ndbinfo.memory_per_fragment
-> WHERE fq_name='test/def/t1') AS avg_var_inuse,
->
-> SUM(hash_index_alloc_bytes)
-> /
-> ( SELECT SUM(fixed_elem_count)
-> FROM ndbinfo.memory_per_fragment
-> WHERE fq_name='test/def/t1') AS avg_hash,
->
-> SUM(
-> (fixed_elem_alloc_bytes - fixed_elem_free_bytes)
-> + (var_elem_alloc_bytes - var_elem_free_bytes)

```

```

-> + hash_index_alloc_bytes)
-> /
-> ( SELECT SUM(fixed_elem_count)
-> FROM ndbinfo.memory_per_fragment
-> WHERE fq_name='test/def/t1') AS avg_total_inuse
->
-> FROM ndbinfo.memory_per_fragment
-> WHERE fq_name = 'test/def/t1' OR parent_fq_name='test/def/t1';
+-----+-----+-----+-----+-----+
| table_rows | avg_fixed_inuse | avg_var_inuse | avg_hash | avg_total_inuse |
+-----+-----+-----+-----+-----+
| 100000 | 110.1469 | 48.7270 | 28.5082 | 187.3821 |
+-----+-----+-----+-----+-----+
1 row in set (0.68 sec)

```

### Finding the total average memory in use per row

This query obtains the total average memory in use, per row:

```

mysql> SELECT
-> SUM(
-> (fixed_elem_alloc_bytes - fixed_elem_free_bytes)
-> + (var_elem_alloc_bytes - var_elem_free_bytes)
-> + hash_index_alloc_bytes)
-> /
-> ( SELECT
-> SUM(fixed_elem_count)
-> FROM ndbinfo.memory_per_fragment
-> WHERE fq_name='test/def/t1') AS avg_total_in_use
-> FROM ndbinfo.memory_per_fragment
-> WHERE fq_name = 'test/def/t1' OR parent_fq_name='test/def/t1';
+-----+
| avg_total_in_use |
+-----+
| 187.3821 |
+-----+
1 row in set (0.24 sec)

```

### 21.6.15.28 The ndbinfo nodes Table

This table contains information on the status of data nodes. For each data node that is running in the cluster, a corresponding row in this table provides the node's node ID, status, and uptime. For nodes that are starting, it also shows the current start phase.

The `nodes` table contains the following columns:

- `node_id`  
The data node's unique node ID in the cluster.
- `uptime`  
Time since the node was last started, in seconds.
- `status`  
Current status of the data node; see text for possible values.
- `start_phase`  
If the data node is starting, the current start phase.
- `config_generation`

The version of the cluster configuration file in use on this data node.

## Notes

The `uptime` column shows the time in seconds that this node has been running since it was last started or restarted. This is a `BIGINT` value. This figure includes the time actually needed to start the node; in other words, this counter starts running the moment that `ndbd` or `ndbmtid` is first invoked; thus, even for a node that has not yet finished starting, `uptime` may show a nonzero value.

The `status` column shows the node's current status. This is one of: `NOTHING`, `CMVMI`, `STARTING`, `STARTED`, `SINGLEUSER`, `STOPPING_1`, `STOPPING_2`, `STOPPING_3`, or `STOPPING_4`. When the status is `STARTING`, you can see the current start phase in the `start_phase` column (see later in this section). `SINGLEUSER` is displayed in the `status` column for all data nodes when the cluster is in single user mode (see [Section 21.6.6, "NDB Cluster Single User Mode"](#)). Seeing one of the `STOPPING` states does not necessarily mean that the node is shutting down but can mean rather that it is entering a new state. For example, if you put the cluster in single user mode, you can sometimes see data nodes report their state briefly as `STOPPING_2` before the status changes to `SINGLEUSER`.

The `start_phase` column uses the same range of values as those used in the output of the `ndb_mgm` client `node_id STATUS` command (see [Section 21.6.1, "Commands in the NDB Cluster Management Client"](#)). If the node is not currently starting, then this column shows `0`. For a listing of NDB Cluster start phases with descriptions, see [Section 21.6.4, "Summary of NDB Cluster Start Phases"](#).

The `config_generation` column shows which version of the cluster configuration is in effect on each data node. This can be useful when performing a rolling restart of the cluster in order to make changes in configuration parameters. For example, from the output of the following `SELECT` statement, you can see that node 3 is not yet using the latest version of the cluster configuration (`6`) although nodes 1, 2, and 4 are doing so:

```
mysql> USE ndbinfo;
Database changed
mysql> SELECT * FROM nodes;
+-----+-----+-----+-----+-----+
| node_id | uptime | status | start_phase | config_generation |
+-----+-----+-----+-----+-----+
| 1 | 10462 | STARTED | 0 | 6 |
| 2 | 10460 | STARTED | 0 | 6 |
| 3 | 10457 | STARTED | 0 | 5 |
| 4 | 10455 | STARTED | 0 | 6 |
+-----+-----+-----+-----+-----+
2 rows in set (0.04 sec)
```

Therefore, for the case just shown, you should restart node 3 to complete the rolling restart of the cluster.

Nodes that are stopped are not accounted for in this table. Suppose that you have an NDB Cluster with 4 data nodes (node IDs 1, 2, 3 and 4), and all nodes are running normally, then this table contains 4 rows, 1 for each data node:

```
mysql> USE ndbinfo;
Database changed
mysql> SELECT * FROM nodes;
+-----+-----+-----+-----+-----+
| node_id | uptime | status | start_phase | config_generation |
+-----+-----+-----+-----+-----+
| 1 | 11776 | STARTED | 0 | 6 |
| 2 | 11774 | STARTED | 0 | 6 |
| 3 | 11771 | STARTED | 0 | 6 |
| 4 | 11769 | STARTED | 0 | 6 |
+-----+-----+-----+-----+-----+
4 rows in set (0.04 sec)
```

If you shut down one of the nodes, only the nodes that are still running are represented in the output of this `SELECT` statement, as shown here:

```
ndb_mgm> 2 STOP
```

```
Node 2: Node shutdown initiated
```

```
Node 2: Node shutdown completed.
```

```
Node 2 has shutdown.
```

```
mysql> SELECT * FROM nodes;
```

```
+-----+-----+-----+-----+-----+
| node_id | uptime | status | start_phase | config_generation |
+-----+-----+-----+-----+-----+
|      1 | 11807 | STARTED |          0 |          6 |
|      3 | 11802 | STARTED |          0 |          6 |
|      4 | 11800 | STARTED |          0 |          6 |
+-----+-----+-----+-----+-----+
3 rows in set (0.02 sec)
```

### 21.6.15.29 The ndbinfo operations\_per\_fragment Table

The `operations_per_fragment` table provides information about the operations performed on individual fragments and fragment replicas, as well as about some of the results from these operations.

The `operations_per_fragment` table contains the following columns:

- `fq_name`  
Name of this fragment
- `parent_fq_name`  
Name of this fragment's parent
- `type`  
Type of object; see text for possible values
- `table_id`  
Table ID for this table
- `node_id`  
Node ID for this node
- `block_instance`  
Kernel block instance ID
- `fragment_num`  
Fragment ID (number)
- `tot_key_reads`  
Total number of key reads for this fragment replica
- `tot_key_inserts`  
Total number of key inserts for this fragment replica

- `tot_key_updates`  
total number of key updates for this fragment replica
- `tot_key_writes`  
Total number of key writes for this fragment replica
- `tot_key_deletes`  
Total number of key deletes for this fragment replica
- `tot_key_refs`  
Number of key operations refused
- `tot_key_attrinfo_bytes`  
Total size of all `attrinfo` attributes
- `tot_key_keyinfo_bytes`  
Total size of all `keyinfo` attributes
- `tot_key_prog_bytes`  
Total size of all interpreted programs carried by `attrinfo` attributes
- `tot_key_inst_exec`  
Total number of instructions executed by interpreted programs for key operations
- `tot_key_bytes_returned`  
Total size of all data and metadata returned from key read operations
- `tot_frag_scans`  
Total number of scans performed on this fragment replica
- `tot_scan_rows_examined`  
Total number of rows examined by scans
- `tot_scan_rows_returned`  
Total number of rows returned to client
- `tot_scan_bytes_returned`  
Total size of data and metadata returned to the client
- `tot_scan_prog_bytes`  
Total size of interpreted programs for scan operations
- `tot_scan_bound_bytes`  
Total size of all bounds used in ordered index scans

- `tot_scan_inst_exec`  
Total number of instructions executed for scans
- `tot_qd_frag_scans`  
Number of times that scans of this fragment replica have been queued
- `conc_frag_scans`  
Number of scans currently active on this fragment replica (excluding queued scans)
- `conc_qd_frag_scans`  
Number of scans currently queued for this fragment replica
- `tot_commits`  
Total number of row changes committed to this fragment replica

## Notes

The `fq_name` contains the fully qualified name of the schema object to which this fragment replica belongs. This currently has the following formats:

- Base table: `DbName/def/TblName`
- BLOB table: `DbName/def/NDB$BLOB_BaseTblId_ColNo`
- Ordered index: `sys/def/BaseTblId/IndexName`
- Unique index: `sys/def/BaseTblId/IndexName$unique`

The `$unique` suffix shown for unique indexes is added by `mysqld`; for an index created by a different NDB API client application, this may differ, or not be present.

The syntax just shown for fully qualified object names is an internal interface which is subject to change in future releases.

Consider a table `t1` created and modified by the following SQL statements:

```
CREATE DATABASE mydb;

USE mydb;

CREATE TABLE t1 (
  a INT NOT NULL,
  b INT NOT NULL,
  t TEXT NOT NULL,
  PRIMARY KEY (b)
) ENGINE=ndbcluster;

CREATE UNIQUE INDEX ix1 ON t1(b) USING HASH;
```

If `t1` is assigned table ID 11, this yields the `fq_name` values shown here:

- Base table: `mydb/def/t1`
- BLOB table: `mydb/def/NDB$BLOB_11_2`
- Ordered index (primary key): `sys/def/11/PRIMARY`



- Unique index: `sys/def/11/ix1$unique`

For indexes or BLOB tables, the `parent_fq_name` column contains the `fq_name` of the corresponding base table. For base tables, this column is always `NULL`.

The `type` column shows the schema object type used for this fragment, which can take any one of the values `System table`, `User table`, `Unique hash index`, or `Ordered index`. BLOB tables are shown as `User table`.

The `table_id` column value is unique at any given time, but can be reused if the corresponding object has been deleted. The same ID can be seen using the `ndb_show_tables` utility.

The `block_instance` column shows which LDM instance this fragment replica belongs to. You can use this to obtain information about specific threads from the `threadblocks` table. The first such instance is always numbered 0.

Since there are typically two replicas, and assuming that this is so, each `fragment_num` value should appear twice in the table, on two different data nodes from the same node group.

Since NDB does not use single-key access for ordered indexes, the counts for `tot_key_reads`, `tot_key_inserts`, `tot_key_updates`, `tot_key_writes`, and `tot_key_deletes` are not incremented by ordered index operations.



#### Note

When using `tot_key_writes`, you should keep in mind that a write operation in this context updates the row if the key exists, and inserts a new row otherwise. (One use of this is in the NDB implementation of the `REPLACE` SQL statement.)

The `tot_key_refs` column shows the number of key operations refused by the LDM. Generally, such a refusal is due to duplicate keys (inserts), `Key not found` errors (updates, deletes, and reads), or the operation was rejected by an interpreted program used as a predicate on the row matching the key.

The `attrinfo` and `keyinfo` attributes counted by the `tot_key_attrinfo_bytes` and `tot_key_keyinfo_bytes` columns are attributes of an `LQHKEYREQ` signal (see [The NDB Communication Protocol](#)) used to initiate a key operation by the LDM. An `attrinfo` typically contains tuple field values (inserts and updates) or projection specifications (for reads); `keyinfo` contains the primary or unique key needed to locate a given tuple in this schema object.

The value shown by `tot_frag_scans` includes both full scans (that examine every row) and scans of subsets. Unique indexes and BLOB tables are never scanned, so this value, like other scan-related counts, is 0 for fragment replicas of these.

`tot_scan_rows_examined` may display less than the total number of rows in a given fragment replica, since ordered index scans can be limited by bounds. In addition, a client may choose to end a scan before all potentially matching rows have been examined; this occurs when using an SQL statement containing a `LIMIT` or `EXISTS` clause, for example. `tot_scan_rows_returned` is always less than or equal to `tot_scan_rows_examined`.

`tot_scan_bytes_returned` includes, in the case of pushed joins, projections returned to the `DBSPJ` block in the NDB kernel.

`tot_qd_frag_scans` can be effected by the setting for the `MaxParallelScansPerFragment` data node configuration parameter, which limits the number of scans that may execute concurrently on a single fragment replica.

### 21.6.15.30 The ndbinfo processes Table

---

This table contains information about NDB Cluster node processes; each node is represented by the row in the table. Only nodes that are connected to the cluster are shown in this table. You can obtain information about nodes that are configured but not connected to the cluster from the [nodes](#) and [config\\_nodes](#) tables.

The [processes](#) table contains the following columns:

- [node\\_id](#)  
The node's unique node ID in the cluster
- [node\\_type](#)  
Type of node (management, data, or API node; see text)
- [node\\_version](#)  
Version of the NDB software program running on this node.
- [process\\_id](#)  
This node's process ID
- [angel\\_process\\_id](#)  
Process ID of this node's angel process
- [process\\_name](#)  
Name of the executable
- [service\\_URI](#)  
Service URI of this node (see text)

## Notes

[node\\_id](#) is the ID assigned to this node in the cluster.

The [node\\_type](#) column displays one of the following three values:

- **MGM**: Management node.
- **NDB**: Data node.
- **API**: API or SQL node.

For an executable shipped with the NDB Cluster distribution, [node\\_version](#) shows the two-part MySQL NDB Cluster version string, such as `5.7.44-ndb-7.5.36` or `5.7.44-ndb-7.6.36`, that it was compiled with. See [Version strings used in NDB Cluster software](#), for more information.

[process\\_id](#) is the node executable's process ID as shown by the host operating system using a process display application such as `top` on Linux, or the Task Manager on Windows platforms.

[angel\\_process\\_id](#) is the system process ID for the node's angel process, which ensures that a data node or SQL is automatically restarted in cases of failures. For management nodes and API nodes other than SQL nodes, the value of this column is `NULL`.

The [process\\_name](#) column shows the name of the running executable. For management nodes, this is `ndb_mgmd`. For data nodes, this is `ndbd` (single-threaded) or `ndbmttd` (multithreaded).

For SQL nodes, this is `mysqld`. For other types of API nodes, it is the name of the executable program connected to the cluster; NDB API applications can set a custom value for this using `Ndb_cluster_connection::set_name()`.

`service_URI` shows the service network address. For management nodes and data nodes, the scheme used is `ndb://`. For SQL nodes, this is `mysql://`. By default, API nodes other than SQL nodes use `ndb://` for the scheme; NDB API applications can set this to a custom value using `Ndb_cluster_connection::set_service_uri()`. regardless of the node type, the scheme is followed by the IP address used by the NDB transporter for the node in question. For management nodes and SQL nodes, this address includes the port number (usually 1186 for management nodes and 3306 for SQL nodes). If the SQL node was started with the `bind_address` system variable set, this address is used instead of the transporter address, unless the bind address is set to `*`, `0.0.0.0`, or `::`.

Additional path information may be included in the `service_URI` value for an SQL node reflecting various configuration options. For example, `mysql://198.51.100.3/tmp/mysql.sock` indicates that the SQL node was started with the `skip_networking` system variable enabled, and `mysql://198.51.100.3:3306/?server-id=1` shows that replication is enabled for this SQL node.

The `processes` table was added in NDB 7.5.7.

### 21.6.15.31 The ndbinfo resources Table

This table provides information about data node resource availability and usage.

These resources are sometimes known as *super-pools*.

The `resources` table contains the following columns:

- `node_id`

The unique node ID of this data node.

- `resource_name`

Name of the resource; see text.

- `reserved`

The amount reserved for this resource, as a number of 32KB pages.

- `used`

The amount actually used by this resource, as a number of 32KB pages.

- `max`

The maximum amount (number of 32KB pages) of this resource that is available to this data node. 0 in this column indicates that the resource is unlimited, which means the effective maximum is 4294967295 ( $2^{32}-1$ ).

#### Notes

The `resource_name` can be any one of the names shown in the following table:

- `RESERVED`: Reserved by the system; cannot be overridden.
- `TRANSACTION_MEMORY`: Memory allocated for transactions on this data node.

- **DISK\_OPERATIONS**: If a log file group is allocated, the size of the undo log buffer is used to set the size of this resource. This resource is used only to allocate the undo log buffer for an undo log file group; there can only be one such group. Overallocation occurs as needed by `CREATE LOGFILE GROUP`.
- **DISK\_RECORDS**: Records allocated for Disk Data operations.
- **DATA\_MEMORY**: Used for main memory tuples, indexes, and hash indexes. Sum of DataMemory and IndexMemory, plus 8 pages of 32 KB each if IndexMemory has been set. Cannot be overallocated.
- **JOBBUFFER**: Used for allocating job buffers by the NDB scheduler; cannot be overallocated. This is approximately 2 MB per thread plus a 1 MB buffer in both directions for all threads that can communicate. For large configurations this consume several GB.
- **FILE\_BUFFERS**: Used by the redo log handler in the `DBLQH` kernel block; cannot be overallocated. Size is `NoOfFragmentLogParts * RedoBuffer`, plus 1 MB per log file part.
- **TRANSPORTER\_BUFFERS**: Used for send buffers by `ndbmt`; the sum of `TotalSendBufferMemory` and `ExtraSendBufferMemory`. This resource that can be overallocated by up to 25 percent. `TotalSendBufferMemory` is calculated by summing the send buffer memory per node, the default value of which is 2 MB. Thus, in a system having four data nodes and eight API nodes, the data nodes have  $12 * 2$  MB send buffer memory. `ExtraSendBufferMemory` is used by `ndbmt` and amounts to 2 MB extra memory per thread. Thus, with 4 LDM threads, 2 TC threads, 1 main thread, 1 replication thread, and 2 receive threads, `ExtraSendBufferMemory` is  $10 * 2$  MB. Overallocation of this resource can be performed by setting the `SharedGlobalMemory` data node configuration parameter.
- **DISK\_PAGE\_BUFFER**: Used for the disk page buffer; determined by the `DiskPageBufferMemory` configuration parameter. Cannot be overallocated.
- **QUERY\_MEMORY**: Used by the `DBSPJ` kernel block.
- **SCHEMA\_TRANS\_MEMORY**: Minimum is 2 MB; can be overallocated to use any remaining available memory.

### 21.6.15.32 The `ndbinfo restart_info` Table

The `restart_info` table contains information about node restart operations. Each entry in the table corresponds to a node restart status report in real time from a data node with the given node ID. Only the most recent report for any given node is shown.

The `restart_info` table contains the following columns:

- `node_id`  
Node ID in the cluster
- `node_restart_status`  
Node status; see text for values. Each of these corresponds to a possible value of `node_restart_status_int`.
- `node_restart_status_int`  
Node status code; see text for values.
- `secs_to_complete_node_failure`  
Time in seconds to complete node failure handling

- `secs_to_allocate_node_id`  
Time in seconds from node failure completion to allocation of node ID
- `secs_to_include_in_heartbeat_protocol`  
Time in seconds from allocation of node ID to inclusion in heartbeat protocol
- `secs_until_wait_for_ndbcntr_master`  
Time in seconds from being included in heartbeat protocol until waiting for `NDBCNTR` master began
- `secs_wait_for_ndbcntr_master`  
Time in seconds spent waiting to be accepted by `NDBCNTR` master for starting
- `secs_to_get_start_permitted`  
Time in seconds elapsed from receiving of permission for start from master until all nodes have accepted start of this node
- `secs_to_wait_for_lcp_for_copy_meta_data`  
Time in seconds spent waiting for LCP completion before copying metadata
- `secs_to_copy_meta_data`  
Time in seconds required to copy metadata from master to newly starting node
- `secs_to_include_node`  
Time in seconds waited for GCP and inclusion of all nodes into protocols
- `secs_starting_node_to_request_local_recovery`  
Time in seconds that the node just starting spent waiting to request local recovery
- `secs_for_local_recovery`  
Time in seconds required for local recovery by node just starting
- `secs_restore_fragments`  
Time in seconds required to restore fragments from LCP files
- `secs_undo_disk_data`  
Time in seconds required to execute undo log on disk data part of records
- `secs_exec_redo_log`  
Time in seconds required to execute redo log on all restored fragments
- `secs_index_rebuild`  
Time in seconds required to rebuild indexes on restored fragments
- `secs_to_synchronize_starting_node`  
Time in seconds required to synchronize starting node from live nodes

- `secs_wait_lcp_for_restart`  
Time in seconds required for LCP start and completion before restart was completed
- `secs_wait_subscription_handover`  
Time in seconds spent waiting for handover of replication subscriptions
- `total_restart_secs`  
Total number of seconds from node failure until node is started again

## Notes

The following list contains values defined for the `node_restart_status_int` column with their internal status names (in parentheses), and the corresponding messages shown in the `node_restart_status` column:

- 0 (`ALLOCATED_NODE_ID`)  
Allocated node id
- 1 (`INCLUDED_IN_HB_PROTOCOL`)  
Included in heartbeat protocol
- 2 (`NDBCNTR_START_WAIT`)  
Wait for NDBCNTR master to permit us to start
- 3 (`NDBCNTR_STARTED`)  
NDBCNTR master permitted us to start
- 4 (`START_PERMITTED`)  
All nodes permitted us to start
- 5 (`WAIT_LCP_TO_COPY_DICT`)  
Wait for LCP completion to start copying metadata
- 6 (`COPY_DICT_TO_STARTING_NODE`)  
Copying metadata to starting node
- 7 (`INCLUDE_NODE_IN_LCP_AND_GCP`)  
Include node in LCP and GCP protocols
- 8 (`LOCAL_RECOVERY_STARTED`)  
Restore fragments ongoing
- 9 (`COPY_FRAGMENTS_STARTED`)  
Synchronizing starting node with live nodes
- 10 (`WAIT_LCP_FOR_RESTART`)

- Wait for LCP to ensure durability

  - 11 (WAIT\_SUMA\_HANOVER)

Wait for handover of subscriptions

  - 12 (RESTART\_COMPLETED)

Restart completed

  - 13 (NODE\_FAILED)

Node failed, failure handling in progress

  - 14 (NODE\_FAILURE\_COMPLETED)

Node failure handling completed

  - 15 (NODE\_GETTING\_PERMIT)

All nodes permitted us to start

  - 16 (NODE\_GETTING\_INCLUDED)

Include node in LCP and GCP protocols

  - 17 (NODE\_GETTING\_SYNCED)

Synchronizing starting node with live nodes

  - 18 (NODE\_GETTING\_LCP\_WAITED)

[none]

  - 19 (NODE\_ACTIVE)

Restart completed

  - 20 (NOT\_DEFINED\_IN\_CLUSTER)

[none]

  - 21 (NODE\_NOT\_RESTARTED\_YET)

Initial state

Status numbers 0 through 12 apply on master nodes only; the remainder of those shown in the table apply to all restarting data nodes. Status numbers 13 and 14 define node failure states; 20 and 21 occur when no information about the restart of a given node is available.

See also [Section 21.6.4, “Summary of NDB Cluster Start Phases”](#).

### 21.6.15.33 The ndbinfo server\_locks Table

The `server_locks` table is similar in structure to the `cluster_locks` table, and provides a subset of the information found in the latter table, but which is specific to the SQL node (MySQL server) where it resides. (The `cluster_locks` table provides information about all locks in the cluster.) More precisely,

`server_locks` contains information about locks requested by threads belonging to the current `mysqld` instance, and serves as a companion table to `server_operations`. This may be useful for correlating locking patterns with specific MySQL user sessions, queries, or use cases.

The `server_locks` table contains the following columns:

- `mysql_connection_id`  
MySQL connection ID
- `node_id`  
ID of reporting node
- `block_instance`  
ID of reporting LDM instance
- `tableid`  
ID of table containing this row
- `fragmentid`  
ID of fragment containing locked row
- `rowid`  
ID of locked row
- `transid`  
Transaction ID
- `mode`  
Lock request mode
- `state`  
Lock state
- `detail`  
Whether this is first holding lock in row lock queue
- `op`  
Operation type
- `duration_millis`  
Milliseconds spent waiting or holding lock
- `lock_num`  
ID of lock object
- `waiting_for`



Waiting for lock with this ID

## Notes

The `mysql_connection_id` column shows the MySQL connection or thread ID as shown by `SHOW PROCESSLIST`.

`block_instance` refers to an instance of a kernel block. Together with the block name, this number can be used to look up a given instance in the `threadblocks` table.

The `tableid` is assigned to the table by NDB; the same ID is used for this table in other `ndbinfo` tables, as well as in the output of `ndb_show_tables`.

The transaction ID shown in the `transid` column is the identifier generated by the NDB API for the transaction requesting or holding the current lock.

The `mode` column shows the lock mode, which is always one of `S` (shared lock) or `X` (exclusive lock). If a transaction has an exclusive lock on a given row, all other locks on that row have the same transaction ID.

The `state` column shows the lock state. Its value is always one of `H` (holding) or `W` (waiting). A waiting lock request waits for a lock held by a different transaction.

The `detail` column indicates whether this lock is the first holding lock in the affected row's lock queue, in which case it contains a `*` (asterisk character); otherwise, this column is empty. This information can be used to help identify the unique entries in a list of lock requests.

The `op` column shows the type of operation requesting the lock. This is always one of the values `READ`, `INSERT`, `UPDATE`, `DELETE`, `SCAN`, or `REFRESH`.

The `duration_millis` column shows the number of milliseconds for which this lock request has been waiting or holding the lock. This is reset to 0 when a lock is granted for a waiting request.

The lock ID (`lockid` column) is unique to this node and block instance.

If the `lock_state` column's value is `w`, this lock is waiting to be granted, and the `waiting_for` column shows the lock ID of the lock object this request is waiting for. Otherwise, `waiting_for` is empty. `waiting_for` can refer only to locks on the same row (as identified by `node_id`, `block_instance`, `tableid`, `fragmentid`, and `rowid`).

The `server_locks` table was added in NDB 7.5.3.

### 21.6.15.34 The `ndbinfo server_operations` Table

The `server_operations` table contains entries for all ongoing NDB operations that the current SQL node (MySQL Server) is currently involved in. It effectively is a subset of the `cluster_operations` table, in which operations for other SQL and API nodes are not shown.

The `server_operations` table contains the following columns:

- `mysql_connection_id`  
MySQL Server connection ID
- `node_id`  
Node ID

- `block_instance`  
Block instance
- `transid`  
Transaction ID
- `operation_type`  
Operation type (see text for possible values)
- `state`  
Operation state (see text for possible values)
- `tableid`  
Table ID
- `fragmentid`  
Fragment ID
- `client_node_id`  
Client node ID
- `client_block_ref`  
Client block reference
- `tc_node_id`  
Transaction coordinator node ID
- `tc_block_no`  
Transaction coordinator block number
- `tc_block_instance`  
Transaction coordinator block instance

## Notes

The `mysql_connection_id` is the same as the connection or session ID shown in the output of `SHOW PROCESSLIST`. It is obtained from the `INFORMATION_SCHEMA` table `NDB_TRANSID_MYSQL_CONNECTION_MAP`.

`block_instance` refers to an instance of a kernel block. Together with the block name, this number can be used to look up a given instance in the `threadblocks` table.

The transaction ID (`transid`) is a unique 64-bit number which can be obtained using the NDB API's `getTransactionId()` method. (Currently, the MySQL Server does not expose the NDB API transaction ID of an ongoing transaction.)

The `operation_type` column can take any one of the values `READ`, `READ-SH`, `READ-EX`, `INSERT`, `UPDATE`, `DELETE`, `WRITE`, `UNLOCK`, `REFRESH`, `SCAN`, `SCAN-SH`, `SCAN-EX`, or `<unknown>`.

The `state` column can have any one of the values `ABORT_QUEUED`, `ABORT_STOPPED`, `COMMITTED`, `COMMIT_QUEUED`, `COMMIT_STOPPED`, `COPY_CLOSE_STOPPED`, `COPY_FIRST_STOPPED`, `COPY_STOPPED`, `COPY_TUPKEY`, `IDLE`, `LOG_ABORT_QUEUED`, `LOG_COMMIT_QUEUED`, `LOG_COMMIT_QUEUED_WAIT_SIGNAL`, `LOG_COMMIT_WRITTEN`, `LOG_COMMIT_WRITTEN_WAIT_SIGNAL`, `LOG_QUEUED`, `PREPARED`, `PREPARED_RECEIVED_COMMIT`, `SCAN_CHECK_STOPPED`, `SCAN_CLOSE_STOPPED`, `SCAN_FIRST_STOPPED`, `SCAN_RELEASE_STOPPED`, `SCAN_STATE_USED`, `SCAN_STOPPED`, `SCAN_TUPKEY`, `STOPPED`, `TC_NOT_CONNECTED`, `WAIT_ACC`, `WAIT_ACC_ABORT`, `WAIT_AI_AFTER_ABORT`, `WAIT_ATTR`, `WAIT_SCAN_AI`, `WAIT_TUP`, `WAIT_TUPKEYINFO`, `WAIT_TUP_COMMIT`, or `WAIT_TUP_TO_ABORT`. (If the MySQL Server is running with `ndbinfo_show_hidden` enabled, you can view this list of states by selecting from the `ndb $dbldqh_tcconnect_state` table, which is normally hidden.)

You can obtain the name of an NDB table from its table ID by checking the output of `ndb_show_tables`.

The `fragid` is the same as the partition number seen in the output of `ndb_desc --extra-partition-info` (short form `-p`).

In `client_node_id` and `client_block_ref`, `client` refers to an NDB Cluster API or SQL node (that is, an NDB API client or a MySQL Server attached to the cluster).

The `block_instance` and `tc_block_instance` column provide NDB kernel block instance numbers. You can use these to obtain information about specific threads from the `threadblocks` table.

### 21.6.15.35 The `ndbinfo server_transactions` Table

The `server_transactions` table is subset of the `cluster_transactions` table, but includes only those transactions in which the current SQL node (MySQL Server) is a participant, while including the relevant connection IDs.

The `server_transactions` table contains the following columns:

- `mysql_connection_id`  
MySQL Server connection ID
- `node_id`  
Transaction coordinator node ID
- `block_instance`  
Transaction coordinator block instance
- `transid`  
Transaction ID
- `state`  
Operation state (see text for possible values)
- `count_operations`  
Number of stateful operations in the transaction
- `outstanding_operations`  
Operations still being executed by local data management layer (LQH blocks)

- `inactive_seconds`  
Time spent waiting for API
- `client_node_id`  
Client node ID
- `client_block_ref`  
Client block reference

## Notes

The `mysql_connection_id` is the same as the connection or session ID shown in the output of `SHOW PROCESSLIST`. It is obtained from the `INFORMATION_SCHEMA` table `NDB_TRANSID_MYSQL_CONNECTION_MAP`.

`block_instance` refers to an instance of a kernel block. Together with the block name, this number can be used to look up a given instance in the `threadblocks` table.

The transaction ID (`transid`) is a unique 64-bit number which can be obtained using the NDB API's `getTransactionId()` method. (Currently, the MySQL Server does not expose the NDB API transaction ID of an ongoing transaction.)

The `state` column can have any one of the values `CS_ABORTING`, `CS_COMMITTING`, `CS_COMMIT_SENT`, `CS_COMPLETE_SENT`, `CS_COMPLETING`, `CS_CONNECTED`, `CS_DISCONNECTED`, `CS_FAIL_ABORTED`, `CS_FAIL_ABORTING`, `CS_FAIL_COMMITTED`, `CS_FAIL_COMMITTING`, `CS_FAIL_COMPLETED`, `CS_FAIL_PREPARED`, `CS_PREPARE_TO_COMMIT`, `CS_RECEIVING`, `CS_REC_COMMITTING`, `CS_RESTART`, `CS_SEND_FIRE_TRIG_REQ`, `CS_STARTED`, `CS_START_COMMITTING`, `CS_START_SCAN`, `CS_WAIT_ABORT_CONF`, `CS_WAIT_COMMIT_CONF`, `CS_WAIT_COMPLETE_CONF`, `CS_WAIT_FIRE_TRIG_REQ`. (If the MySQL Server is running with `ndbinfo_show_hidden` enabled, you can view this list of states by selecting from the `ndb$dbtc_apiconnect_state` table, which is normally hidden.)

In `client_node_id` and `client_block_ref`, `client` refers to an NDB Cluster API or SQL node (that is, an NDB API client or a MySQL Server attached to the cluster).

The `block_instance` column provides the `DBTC` kernel block instance number. You can use this to obtain information about specific threads from the `threadblocks` table.

### 21.6.15.36 The `ndbinfo` table `distribution_status` Table

The `table_distribution_status` table provides information about the progress of table distribution for `NDB` tables.

The `table_distribution_status` table contains the following columns:

- `node_id`  
Node id
- `table_id`  
Table ID
- `tab_copy_status`

Status of copying of table distribution data to disk; one of `IDLE`, `SR_PHASE1_READ_PAGES`, `SR_PHASE2_READ_TABLE`, `SR_PHASE3_COPY_TABLE`, `REMOVE_NODE`, `LCP_READ_TABLE`, `COPY_TAB_REQ`, `COPY_NODE_STATE`, `ADD_TABLE_MASTER`, `ADD_TABLE_SLAVE`, `INVALIDATE_NODE_LCP`, `ALTER_TABLE`, `COPY_TO_SAVE`, or `GET_TABINFO`

- `tab_update_status`

Status of updating of table distribution data; one of `IDLE`, `LOCAL_CHECKPOINT`, `LOCAL_CHECKPOINT_QUEUED`, `REMOVE_NODE`, `COPY_TAB_REQ`, `ADD_TABLE_MASTER`, `ADD_TABLE_SLAVE`, `INVALIDATE_NODE_LCP`, or `CALLBACK`

- `tab_lcp_status`

Status of table LCP; one of `ACTIVE` (waiting for local checkpoint to be performed), `WRITING_TO_FILE` (checkpoint performed but not yet written to disk), or `COMPLETED` (checkpoint performed and persisted to disk)

- `tab_status`

Table internal status; one of `ACTIVE` (table exists), `CREATING` (table is being created), or `DROPPING` (table is being dropped)

- `tab_storage`

Table recoverability; one of `NORMAL` (fully recoverable with redo logging and checkpointing), `NOLOGGING` (recoverable from node crash, empty following cluster crash), or `TEMPORARY` (not recoverable)

- `tab_partitions`

Number of partitions in table

- `tab_fragments`

Number of fragments in table; normally same as `tab_partitions`; for fully replicated tables equal to `tab_partitions * [number of node groups]`

- `current_scan_count`

Current number of active scans

- `scan_count_wait`

Current number of scans waiting to be performed before `ALTER TABLE` can complete.

- `is_reorg_ongoing`

Whether table is currently being reorganized (1 if true)

## Notes

The `table_distribution_status` table was added in NDB 7.5.4.

### 21.6.15.37 The ndbinfo table\_fragments Table

The `table_fragments` table provides information about the fragmentation, partitioning, distribution, and (internal) replication of NDB tables.

The `table_fragments` table contains the following columns:

- `node_id`  
Node ID (DIH master)
- `table_id`  
Table ID
- `partition_id`  
Partition ID
- `fragment_id`  
Fragment ID (same as partition ID unless table is fully replicated)
- `partition_order`  
Order of fragment in partition
- `log_part_id`  
Log part ID of fragment
- `no_of_replicas`  
Number of fragment replicas
- `current_primary`  
Current primary node ID
- `preferred_primary`  
Preferred primary node ID
- `current_first_backup`  
Current first backup node ID
- `current_second_backup`  
Current second backup node ID
- `current_third_backup`  
Current third backup node ID
- `num_alive_replicas`  
Current number of live fragment replicas
- `num_dead_replicas`  
Current number of dead fragment replicas
- `num_lcp_replicas`  
Number of fragment replicas remaining to be checkpointed

## Notes

The `table_fragments` table was added in NDB 7.5.4.

### 21.6.15.38 The `ndbinfo table_info` Table

The `table_info` table provides information about logging, checkpointing, distribution, and storage options in effect for individual `NDB` tables.

The `table_info` table contains the following columns:

- `table_id`  
Table ID
- `logged_table`  
Whether table is logged (1) or not (0)
- `row_contains_gci`  
Whether table rows contain GCI (1 true, 0 false)
- `row_contains_checksum`  
Whether table rows contain checksum (1 true, 0 false)
- `read_backup`  
If backup fragment replicas are read this is 1, otherwise 0
- `fully_replicated`  
If table is fully replicated this is 1, otherwise 0
- `storage_type`  
Table storage type; one of `MEMORY` or `DISK`
- `hashmap_id`  
Hashmap ID
- `partition_balance`  
Partition balance (fragment count type) used for table; one of `FOR_RP_BY_NODE`, `FOR_RA_BY_NODE`, `FOR_RP_BY_LDM`, or `FOR_RA_BY_LDM`
- `create_gci`  
GCI in which table was created

## Notes

The `table_info` table was added in NDB 7.5.4.

### 21.6.15.39 The `ndbinfo table_replicas` Table

The `table_replicas` table provides information about the copying, distribution, and checkpointing of `NDB` table fragments and fragment replicas.

The `table_replicas` table contains the following columns:

- `node_id`  
ID of the node from which data is fetched (DIH master)
- `table_id`  
Table ID
- `fragment_id`  
Fragment ID
- `initial_gci`  
Initial GCI for table
- `replica_node_id`  
ID of node where fragment replica is stored
- `is_lcp_ongoing`  
Is 1 if LCP is ongoing on this fragment, 0 otherwise
- `num_crashed_replicas`  
Number of crashed fragment replica instances
- `last_max_gci_started`  
Highest GCI started in most recent LCP
- `last_max_gci_completed`  
Highest GCI completed in most recent LCP
- `last_lcp_id`  
ID of most recent LCP
- `prev_lcp_id`  
ID of previous LCP
- `prev_max_gci_started`  
Highest GCI started in previous LCP
- `prev_max_gci_completed`  
Highest GCI completed in previous LCP
- `last_create_gci`  
Last Create GCI of last crashed fragment replica instance
- `last_replica_gci`



Last GCI of last crashed fragment replica instance

- `is_replica_alive`

1 if this fragment replica is alive, 0 otherwise

## Notes

The `table_replicas` table was added in NDB 7.5.4.

### 21.6.15.40 The `ndbinfo tc_time_track_stats` Table

The `tc_time_track_stats` table provides time-tracking information obtained from the `DBTC` block (TC) instances in the data nodes, through API nodes access `NDB`. Each TC instance tracks latencies for a set of activities it undertakes on behalf of API nodes or other data nodes; these activities include transactions, transaction errors, key reads, key writes, unique index operations, failed key operations of any type, scans, failed scans, fragment scans, and failed fragment scans.

A set of counters is maintained for each activity, each counter covering a range of latencies less than or equal to an upper bound. At the conclusion of each activity, its latency is determined and the appropriate counter incremented. `tc_time_track_stats` presents this information as rows, with a row for each instance of the following:

- Data node, using its ID
- TC block instance
- Other communicating data node or API node, using its ID
- Upper bound value

## Notes

Each row contains a value for each activity type. This is the number of times that this activity occurred with a latency within the range specified by the row (that is, where the latency does not exceed the upper bound).

The `tc_time_track_stats` table contains the following columns:

- `node_id`  
Requesting node ID
- `block_number`  
TC block number
- `block_instance`  
TC block instance number
- `comm_node_id`  
Node ID of communicating API or data node
- `upper_bound`  
Upper bound of interval (in microseconds)

- `scans`

Based on duration of successful scans from opening to closing, tracked against the API or data nodes requesting them.

- `scan_errors`

Based on duration of failed scans from opening to closing, tracked against the API or data nodes requesting them.

- `scan_fragments`

Based on duration of successful fragment scans from opening to closing, tracked against the data nodes executing them

- `scan_fragment_errors`

Based on duration of failed fragment scans from opening to closing, tracked against the data nodes executing them

- `transactions`

Based on duration of successful transactions from beginning until sending of commit `ACK`, tracked against the API or data nodes requesting them. Stateless transactions are not included.

- `transaction_errors`

Based on duration of failing transactions from start to point of failure, tracked against the API or data nodes requesting them.

- `read_key_ops`

Based on duration of successful primary key reads with locks. Tracked against both the API or data node requesting them and the data node executing them.

- `write_key_ops`

Based on duration of successful primary key writes, tracked against both the API or data node requesting them and the data node executing them.

- `index_key_ops`

Based on duration of successful unique index key operations, tracked against both the API or data node requesting them and the data node executing reads of base tables.

- `key_op_errors`

Based on duration of all unsuccessful key read or write operations, tracked against both the API or data node requesting them and the data node executing them.

The `block_instance` column provides the `DBTC` kernel block instance number. You can use this together with the block name to obtain information about specific threads from the `threadblocks` table.

### 21.6.15.41 The `ndbinfo threadblocks` Table

The `threadblocks` table associates data nodes, threads, and instances of `NDB` kernel blocks.

The `threadblocks` table contains the following columns:

- `node_id`  
Node ID
- `thr_no`  
Thread ID
- `block_name`  
Block name
- `block_instance`  
Block instance number

## Notes

The value of the `block_name` in this table is one of the values found in the `block_name` column when selecting from the `ndbinfo.blocks` table. Although the list of possible values is static for a given NDB Cluster release, the list may vary between releases.

The `block_instance` column provides the kernel block instance number.

### 21.6.15.42 The `ndbinfo threads` Table

The `threads` table provides information about threads running in the NDB kernel.

The `threads` table contains the following columns:

- `node_id`  
ID of the node where the thread is running
- `thr_no`  
Thread ID (specific to this node)
- `thread_name`  
Thread name (type of thread)
- `thread_description`  
Thread (type) description

## Notes

Sample output from a 2-node example cluster, including thread descriptions, is shown here:

```
mysql> SELECT * FROM threads;
+-----+-----+-----+-----+
| node_id | thr_no | thread_name | thread_description |
+-----+-----+-----+-----+
| 5 | 0 | main | main thread, schema and distribution handling |
| 5 | 1 | rep | rep thread, asynch replication and proxy block handling |
| 5 | 2 | ldm | ldm thread, handling a set of data partitions |
| 5 | 3 | recv | receive thread, performing receive and polling for new receives |
| 6 | 0 | main | main thread, schema and distribution handling |
```

6	1	rep	rep thread, asynch replication and proxy block handling
6	2	ldm	ldm thread, handling a set of data partitions
6	3	recv	receive thread, performing receive and polling for new receives

8 rows in set (0.01 sec)

This table was added in NDB 7.5.2.

### 21.6.15.43 The ndbinfo threadstat Table

The `threadstat` table provides a rough snapshot of statistics for threads running in the NDB kernel.

The `threadstat` table contains the following columns:

- `node_id`  
Node ID
- `thr_no`  
Thread ID
- `thr_nm`  
Thread name
- `c_loop`  
Number of loops in main loop
- `c_exec`  
Number of signals executed
- `c_wait`  
Number of times waiting for additional input
- `c_l_sent_prioa`  
Number of priority A signals sent to own node
- `c_l_sent_priob`  
Number of priority B signals sent to own node
- `c_r_sent_prioa`  
Number of priority A signals sent to remote node
- `c_r_sent_priob`  
Number of priority B signals sent to remote node
- `os_tid`  
OS thread ID
- `os_now`

OS time (ms)

- `os_ru_utime`

OS user CPU time ( $\mu$ s)

- `os_ru_stime`

OS system CPU time ( $\mu$ s)

- `os_ru_minflt`

OS page reclaims (soft page faults)

- `os_ru_majflt`

OS page faults (hard page faults)

- `os_ru_nvcsw`

OS voluntary context switches

- `os_ru_nivcsw`

OS involuntary context switches

## Notes

`os_time` uses the system `gettimeofday()` call.

The values of the `os_ru_utime`, `os_ru_stime`, `os_ru_minflt`, `os_ru_majflt`, `os_ru_nvcsw`, and `os_ru_nivcsw` columns are obtained using the system `getrusage()` call, or the equivalent.

Since this table contains counts taken at a given point in time, for best results it is necessary to query this table periodically and store the results in an intermediate table or tables. The MySQL Server's Event Scheduler can be employed to automate such monitoring. For more information, see [Section 23.4, "Using the Event Scheduler"](#).

### 21.6.15.44 The ndbinfo transporters Table

This table contains information about NDB transporters.

The `transporters` table contains the following columns:

- `node_id`

This data node's unique node ID in the cluster

- `remote_node_id`

The remote data node's node ID

- `status`

Status of the connection

- `remote_address`

Name or IP address of the remote host

- `bytes_sent`  
Number of bytes sent using this connection
- `bytes_received`  
Number of bytes received using this connection
- `connect_count`  
Number of times connection established on this transporter
- `overloaded`  
1 if this transporter is currently overloaded, otherwise 0
- `overload_count`  
Number of times this transporter has entered overload state since connecting
- `slowdown`  
1 if this transporter is in slowdown state, otherwise 0
- `slowdown_count`  
Number of times this transporter has entered slowdown state since connecting

## Notes

For each running data node in the cluster, the `transporters` table displays a row showing the status of each of that node's connections with all nodes in the cluster, *including itself*. This information is shown in the table's `status` column, which can have any one of the following values: `CONNECTING`, `CONNECTED`, `DISCONNECTING`, or `DISCONNECTED`.

Connections to API and management nodes which are configured but not currently connected to the cluster are shown with status `DISCONNECTED`. Rows where the `node_id` is that of a data node which is not currently connected are not shown in this table. (This is similar omission of disconnected nodes in the `ndbinfo.nodes` table.)

The `remote_address` is the host name or address for the node whose ID is shown in the `remote_node_id` column. The `bytes_sent` from this node and `bytes_received` by this node are the numbers, respectively, of bytes sent and received by the node using this connection since it was established. For nodes whose status is `CONNECTING` or `DISCONNECTED`, these columns always display 0.

Assume you have a 5-node cluster consisting of 2 data nodes, 2 SQL nodes, and 1 management node, as shown in the output of the `SHOW` command in the `ndb_mgm` client:

```
ndb_mgm> SHOW
Connected to Management Server at: localhost:1186
Cluster Configuration
-----
[ndbd(NDB)] 2 node(s)
id=1 @10.100.10.1 (5.7.44-ndb-7.6.36, Nodegroup: 0, *)
id=2 @10.100.10.2 (5.7.44-ndb-7.6.36, Nodegroup: 0)

[ndb_mgmd(MGM)] 1 node(s)
id=10 @10.100.10.10 (5.7.44-ndb-7.6.36)
```

```
[mysqld(API)] 2 node(s)
id=20 @10.100.10.20 (5.7.44-ndb-7.6.36)
id=21 @10.100.10.21 (5.7.44-ndb-7.6.36)
```

There are 10 rows in the `transporters` table—5 for the first data node, and 5 for the second—assuming that all data nodes are running, as shown here:

```
mysql> SELECT node_id, remote_node_id, status
-> FROM ndbinfo.transporters;
```

node_id	remote_node_id	status
1	1	DISCONNECTED
1	2	CONNECTED
1	10	CONNECTED
1	20	CONNECTED
1	21	CONNECTED
2	1	CONNECTED
2	2	DISCONNECTED
2	10	CONNECTED
2	20	CONNECTED
2	21	CONNECTED

```
10 rows in set (0.04 sec)
```

If you shut down one of the data nodes in this cluster using the command `2 STOP` in the `ndb_mgm` client, then repeat the previous query (again using the `mysql` client), this table now shows only 5 rows—1 row for each connection from the remaining management node to another node, including both itself and the data node that is currently offline—and displays `CONNECTING` for the status of each remaining connection to the data node that is currently offline, as shown here:

```
mysql> SELECT node_id, remote_node_id, status
-> FROM ndbinfo.transporters;
```

node_id	remote_node_id	status
1	1	DISCONNECTED
1	2	CONNECTING
1	10	CONNECTED
1	20	CONNECTED
1	21	CONNECTED

```
5 rows in set (0.02 sec)
```

The `connect_count`, `overloaded`, `overload_count`, `slowdown`, and `slowdown_count` counters are reset on connection, and retain their values after the remote node disconnects. The `bytes_sent` and `bytes_received` counters are also reset on connection, and so retain their values following disconnection (until the next connection resets them).

The *overload* state referred to by the `overloaded` and `overload_count` columns occurs when this transporter's send buffer contains more than `OVERloadLimit` bytes (default is 80% of `SendBufferMemory`, that is,  $0.8 * 2097152 = 1677721$  bytes). When a given transporter is in a state of overload, any new transaction that tries to use this transporter fails with Error 1218 (`Send Buffers overloaded in NDB kernel`). This affects both scans and primary key operations.

The *slowdown* state referenced by the `slowdown` and `slowdown_count` columns of this table occurs when the transporter's send buffer contains more than 60% of the overload limit (equal to  $0.6 * 2097152 = 1258291$  bytes by default). In this state, any new scan using this transporter has its batch size reduced to minimize the load on the transporter.

Common causes of send buffer slowdown or overloading include the following:

- Data size, in particular the quantity of data stored in `TEXT` columns or `BLOB` columns (or both types of columns)
- Having a data node (ndbd or ndbmtd) on the same host as an SQL node that is engaged in binary logging
- Large number of rows per transaction or transaction batch
- Configuration issues such as insufficient `SendBufferMemory`
- Hardware issues such as insufficient RAM or poor network connectivity

See also [Section 21.4.3.13, “Configuring NDB Cluster Send Buffer Parameters”](#).

## 21.6.16 INFORMATION\_SCHEMA Tables for NDB Cluster

Two `INFORMATION_SCHEMA` tables provide information that is of particular use when managing an NDB Cluster. The `FILES` table provides information about NDB Cluster Disk Data files. The `ndb_transid_mysql_connection_map` table provides a mapping between transactions, transaction coordinators, and API nodes.

Additional statistical and other data about NDB Cluster transactions, operations, threads, blocks, and other aspects of performance can be obtained from the tables in the `ndbinfo` database. For information about these tables, see [Section 21.6.15, “ndbinfo: The NDB Cluster Information Database”](#).

## 21.6.17 Quick Reference: NDB Cluster SQL Statements

This section discusses several SQL statements that can prove useful in managing and monitoring a MySQL server that is connected to an NDB Cluster, and in some cases provide information about the cluster itself.

- `SHOW ENGINE NDB STATUS, SHOW ENGINE NDBCLUSTER STATUS`

The output of this statement contains information about the server's connection to the cluster, creation and usage of NDB Cluster objects, and binary logging for NDB Cluster replication.

See [Section 13.7.5.15, “SHOW ENGINE Statement”](#), for a usage example and more detailed information.

- `SHOW ENGINES`

This statement can be used to determine whether or not clustering support is enabled in the MySQL server, and if so, whether it is active.

See [Section 13.7.5.16, “SHOW ENGINES Statement”](#), for more detailed information.



### Note

This statement does not support a `LIKE` clause. However, you can use `LIKE` to filter queries against the Information Schema `ENGINES` table, as discussed in the next item.

- `SELECT * FROM INFORMATION_SCHEMA.ENGINES [WHERE ENGINE LIKE 'NDB%']`

This is the equivalent of `SHOW ENGINES`, but uses the `ENGINES` table of the `INFORMATION_SCHEMA` database. Unlike the case with the `SHOW ENGINES` statement, it is possible to filter the results using a `LIKE` clause, and to select specific columns to obtain information that may be of use in scripts. For



example, the following query shows whether the server was built with [NDB](#) support and, if so, whether it is enabled:

```
mysql> SELECT SUPPORT FROM INFORMATION_SCHEMA.ENGINES
-> WHERE ENGINE LIKE 'NDB%';
+-----+
| support |
+-----+
| ENABLED |
+-----+
```

See [Section 24.3.7, “The INFORMATION\\_SCHEMA ENGINES Table”](#), for more information.

- `SHOW VARIABLES LIKE 'NDB%'`

This statement provides a list of most server system variables relating to the [NDB](#) storage engine, and their values, as shown here, using [NDB 7.6](#):

```
mysql> SHOW VARIABLES LIKE 'NDB%';
+-----+-----+
| Variable_name | Value |
+-----+-----+
| ndb_allow_copying_alter_table | ON |
| ndb_autoincrement_prefetch_sz | 1 |
| ndb_batch_size | 32768 |
| ndb_blob_read_batch_bytes | 65536 |
| ndb_blob_write_batch_bytes | 65536 |
| ndb_cache_check_time | 0 |
| ndb_clear_apply_status | ON |
| ndb_cluster_connection_pool | 1 |
| ndb_cluster_connection_pool_nodeids | |
| ndb_connectstring | 127.0.0.1 |
| ndb_data_node_neighbour | 0 |
| ndb_default_column_format | FIXED |
| ndb_deferred_constraints | 0 |
| ndb_distribution | KEYHASH |
| ndb_eventbuffer_free_percent | 20 |
| ndb_eventbuffer_max_alloc | 0 |
| ndb_extra_logging | 1 |
| ndb_force_send | ON |
| ndb_fully_replicated | OFF |
| ndb_index_stat_enable | ON |
| ndb_index_stat_option | loop_enable=1000ms,loop_idle=1000ms,
loop_busy=100ms,update_batch=1,read_batch=4,idle_batch=32,check_batch=8,
check_delay=10m,delete_batch=8,clean_delay=1m,error_batch=4,error_delay=1m,
evict_batch=8,evict_delay=1m,cache_limit=32M,cache_lowpct=90,zero_total=0 |
| ndb_join_pushdown | ON |
| ndb_log_apply_status | OFF |
| ndb_log_bin | ON |
| ndb_log_binlog_index | ON |
| ndb_log_empty_epochs | OFF |
| ndb_log_empty_update | OFF |
| ndb_log_exclusive_reads | OFF |
| ndb_log_orig | OFF |
| ndb_log_transaction_id | OFF |
| ndb_log_update_as_write | ON |
| ndb_log_update_minimal | OFF |
| ndb_log_updated_only | ON |
| ndb_mgmd_host | 127.0.0.1 |
| ndb_nodeid | 0 |
| ndb_optimization_delay | 10 |
| ndb_optimized_node_selection | 3 |
| ndb_read_backup | OFF |
| ndb_recv_thread_activation_threshold | 8 |
| ndb_recv_thread_cpu_mask | |
| ndb_report_thresh_binlog_epoch_slip | 10 |
+-----+-----+
```

```

| ndb_report_thresh_binlog_mem_usage | 10
| ndb_row_checksum | 1
| ndb_show_foreign_key_mock_tables | OFF
| ndb_slave_conflict_role | NONE
| ndb_table_no_logging | OFF
| ndb_table_temporary | OFF
| ndb_use_copying_alter_table | OFF
| ndb_use_exact_count | OFF
| ndb_use_transactions | ON
| ndb_version | 460301
| ndb_version_string | ndb-7.6.36
| ndb_wait_connected | 30
| ndb_wait_setup | 30
| ndbinfo_database | ndbinfo
| ndbinfo_max_bytes | 0
| ndbinfo_max_rows | 10
| ndbinfo_offline | OFF
| ndbinfo_show_hidden | OFF
| ndbinfo_table_prefix | ndb$
| ndbinfo_version | 460301
+-----+-----+
61 rows in set (0.02 sec)

```

See [Section 5.1.7, “Server System Variables”](#), for more information.

- `SELECT * FROM INFORMATION_SCHEMA.GLOBAL_VARIABLES WHERE VARIABLE_NAME LIKE 'NDB%';`

Although it is deprecated in NDB 7.5 and NDB 7.6, you can use this statement (and others accessing the `INFORMATION_SCHEMA.GLOBAL_VARIABLES` table) if `show_compatibility_56` is enabled. (Querying the `performance_schema.global_variables` table is preferred; see next item.) It is equivalent to the `SHOW VARIABLES` statement described in the previous item, and provides almost identical output, as shown here:

```

mysql> SET @@global.show_compatibility_56=ON;
Query OK, 0 rows affected (0.00 sec)

mysql> SELECT * FROM INFORMATION_SCHEMA.GLOBAL_VARIABLES
-> WHERE VARIABLE_NAME LIKE 'NDB%';

mysql> SELECT * FROM INFORMATION_SCHEMA.GLOBAL_VARIABLES WHERE VARIABLE_NAME LIKE 'NDB%';
+-----+-----+
| VARIABLE_NAME | VARIABLE_VALUE |
+-----+-----+
| NDB_CLUSTER_CONNECTION_POOL_NODEIDS |
| NDB_LOG_BINLOG_INDEX | ON
| NDB_WAIT_SETUP | 30
| NDB_ROW_CHECKSUM | 1
| NDB_WAIT_CONNECTED | 30
| NDB_USE_EXACT_COUNT | OFF
| NDB_RECV_THREAD_ACTIVATION_THRESHOLD | 8
| NDB_READ_BACKUP | OFF
| NDB_EVENTBUFFER_MAX_ALLOC | 0
| NDBINFO_DATABASE | ndbinfo
| NDB_LOG_APPLY_STATUS | OFF
| NDB_JOIN_PUSHDOWN | ON
| NDB_RECV_THREAD_CPU_MASK |
| NDBINFO_VERSION | 460301
| NDB_CONNECTSTRING | 127.0.0.1
| NDB_TABLE_NO_LOGGING | OFF
| NDB_LOG_UPDATED_ONLY | ON
| NDB_VERSION | 460301
| NDB_LOG_UPDATE_MINIMAL | OFF
| NDB_OPTIMIZATION_DELAY | 10
| NDB_DEFAULT_COLUMN_FORMAT | FIXED

```

```

| NDB_LOG_UPDATE_AS_WRITE | ON |
| NDB_SHOW_FOREIGN_KEY MOCK TABLES | OFF |
| NDB_VERSION_STRING | ndb-7.6.36 |
| NDBINFO_OFFLINE | OFF |
| NDB_INDEX_STAT_OPTION | loop_enable=1000ms,loop_idle=1000ms,
loop_busy=100ms,update_batch=1,read_batch=4,idle_batch=32,check_batch=8,
check_delay=10m,delete_batch=8,clear_delay=1m,error_batch=4,error_delay=1m,
evict_batch=8,evict_delay=1m,cache_limit=32M,cache_lowpct=90,zero_total=0
| NDBINFO_MAX_ROWS | 10 |
| NDB_BATCH_SIZE | 32768 |
| NDB_USE_TRANSACTIONS | ON |
| NDB_NODEID | 0 |
| NDB_ALLOW_COPYING_ALTER_TABLE | ON |
| NDB_SLAVE_CONFLICT_ROLE | NONE |
| NDB_REPORT_THRESH_BINLOG_MEM_USAGE | 10 |
| NDB_FULLY_REPLICATED | OFF |
| NDB_MGMD_HOST | 127.0.0.1 |
| NDB_REPORT_THRESH_BINLOG_EPOCH_SLIP | 10 |
| NDBINFO_MAX_BYTES | 0 |
| NDB_LOG_BIN | ON |
| NDBINFO_TABLE_PREFIX | ndb$ |
| NDB_LOG_EMPTY_EPOCHS | OFF |
| NDB_LOG_ORIG | OFF |
| NDB_LOG_EXCLUSIVE_READS | OFF |
| NDB_LOG_TRANSACTION_ID | OFF |
| NDB_DATA_NODE_NEIGHBOUR | 0 |
| NDB_CLEAR_APPLY_STATUS | ON |
| NDBINFO_SHOW_HIDDEN | OFF |
| NDB_INDEX_STAT_ENABLE | ON |
| NDB_DISTRIBUTION | KEYHASH |
| NDB_BLOB_WRITE_BATCH_BYTES | 65536 |
| NDB_DEFERRED_CONSTRAINTS | 0 |
| NDB_TABLE_TEMPORARY | OFF |
| NDB_EXTRA_LOGGING | 1 |
| NDB_AUTOINCREMENT_PREFETCH_SZ | 1 |
| NDB_FORCE_SEND | ON |
| NDB_OPTIMIZED_NODE_SELECTION | 3 |
| NDB_CLUSTER_CONNECTION_POOL | 1 |
| NDB_EVENTBUFFER_FREE_PERCENT | 20 |
| NDB_USE_COPYING_ALTER_TABLE | OFF |
| NDB_CACHE_CHECK_TIME | 0 |
| NDB_BLOB_READ_BATCH_BYTES | 65536 |
| NDB_LOG_EMPTY_UPDATE | OFF |

```

61 rows in set, 1 warning (0.00 sec)

```
mysql> SHOW WARNINGS;
```

```

+-----+-----+-----+
| Level | Code | Message |
+-----+-----+-----+
| Warning | 1287 | 'INFORMATION_SCHEMA.GLOBAL_VARIABLES' is deprecated and will
be removed in a future release. Please use performance_schema.global_variables
instead |
+-----+-----+-----+

```

Unlike the case with the `SHOW VARIABLES` statement, it is possible to select individual columns. For example:

```

mysql> SELECT VARIABLE_VALUE
-> FROM INFORMATION_SCHEMA.GLOBAL_VARIABLES
-> WHERE VARIABLE_NAME = 'ndb_force_send';
+-----+
| VARIABLE_VALUE |
+-----+
| ON |

```

See [Section 24.3.11, “The INFORMATION\\_SCHEMA GLOBAL\\_VARIABLES and SESSION\\_VARIABLES Tables”](#), and [Section 5.1.7, “Server System Variables”](#), for more information. See also [Section 25.20, “Migrating to Performance Schema System and Status Variable Tables”](#).

- `SELECT * FROM performance_schema.global_variables WHERE VARIABLE_NAME LIKE 'NDB%'`

This statement is the equivalent of the `SHOW VARIABLES` statement described in the previous item, and is preferred in NDB 7.5 and NDB 7.6 to querying the `INFORMATION_SCHEMA.GLOBAL_VARIABLES` table (now deprecated; see previous item). It provides output almost identical to that produced by `SHOW VARIABLES`, as shown here:

```
mysql> SELECT * FROM performance_schema.global_variables
-> WHERE VARIABLE_NAME LIKE 'NDB%';
```

VARIABLE_NAME	VARIABLE_VALUE
ndb_allow_copying_alter_table	ON
ndb_autoincrement_prefetch_sz	1
ndb_batch_size	32768
ndb_blob_read_batch_bytes	65536
ndb_blob_write_batch_bytes	65536
ndb_cache_check_time	0
ndb_clear_apply_status	ON
ndb_cluster_connection_pool	1
ndb_cluster_connection_pool_nodeids	
ndb_connectstring	127.0.0.1
ndb_data_node_neighbour	0
ndb_default_column_format	FIXED
ndb_deferred_constraints	0
ndb_distribution	KEYHASH
ndb_eventbuffer_free_percent	20
ndb_eventbuffer_max_alloc	0
ndb_extra_logging	1
ndb_force_send	ON
ndb_fully_replicated	OFF
ndb_index_stat_enable	ON
ndb_index_stat_option	loop_enable=1000ms,loop_idle=1000ms, loop_busy=100ms,update_batch=1,read_batch=4,idle_batch=32,check_batch=8, check_delay=10m,delete_batch=8,clean_delay=1m,error_batch=4,error_delay=1m, evict_batch=8,evict_delay=1m,cache_limit=32M,cache_lowpct=90,zero_total=0
ndb_join_pushdown	ON
ndb_log_apply_status	OFF
ndb_log_bin	ON
ndb_log_binlog_index	ON
ndb_log_empty_epochs	OFF
ndb_log_empty_update	OFF
ndb_log_exclusive_reads	OFF
ndb_log_orig	OFF
ndb_log_transaction_id	OFF
ndb_log_update_as_write	ON
ndb_log_update_minimal	OFF
ndb_log_updated_only	ON
ndb_mgmd_host	127.0.0.1
ndb_nodeid	0
ndb_optimization_delay	10
ndb_optimized_node_selection	3
ndb_read_backup	OFF
ndb_recv_thread_activation_threshold	8
ndb_recv_thread_cpu_mask	
ndb_report_thresh_binlog_epoch_slip	10
ndb_report_thresh_binlog_mem_usage	10
ndb_row_checksum	1

ndb_show_foreign_key_mock_tables	OFF
ndb_slave_conflict_role	NONE
ndb_table_no_logging	OFF
ndb_table_temporary	OFF
ndb_use_copying_alter_table	OFF
ndb_use_exact_count	OFF
ndb_use_transactions	ON
ndb_version	460301
ndb_version_string	ndb-7.6.36
ndb_wait_connected	30
ndb_wait_setup	30
ndbinfo_database	ndbinfo
ndbinfo_max_bytes	0
ndbinfo_max_rows	10
ndbinfo_offline	OFF
ndbinfo_show_hidden	OFF
ndbinfo_table_prefix	ndb\$
ndbinfo_version	460301

Unlike the case with the `SHOW VARIABLES` statement, it is possible to select individual columns. For example:

```
mysql> SELECT VARIABLE_VALUE
  -> FROM performance_schema.global_variables
  -> WHERE VARIABLE_NAME = 'ndb_force_send';
+-----+
| VARIABLE_VALUE |
+-----+
| ON              |
+-----+
```

A more useful query is shown here:

```
mysql> SELECT VARIABLE_NAME AS Name, VARIABLE_VALUE AS Value
  > FROM performance_schema.global_variables
  > WHERE VARIABLE_NAME
  > IN ('version', 'ndb_version',
  >     'ndb_version_string', 'ndbinfo_version');
```

Name	Value
ndb_version	460301
ndb_version_string	ndb-7.6.36
ndbinfo_version	460301
version	5.7.44-ndb-7.6.36

See [Section 25.12.13, “Performance Schema System Variable Tables”](#), and [Section 5.1.7, “Server System Variables”](#), for more information.

- `SHOW STATUS LIKE 'NDB%'`

This statement shows at a glance whether or not the MySQL server is acting as a cluster SQL node, and if so, it provides the MySQL server's cluster node ID, the host name and port for the cluster management server to which it is connected, and the number of data nodes in the cluster, as shown here:

```
mysql> SHOW STATUS LIKE 'NDB%';
+-----+-----+
| Variable_name | Value |
+-----+-----+
| Ndb_api_wait_exec_complete_count | 2     |
| Ndb_api_wait_scan_result_count   | 5     |
| Ndb_api_wait_meta_request_count  | 54    |
+-----+-----+
```

## Quick Reference: NDB Cluster SQL Statements

Ndb_api_wait_nanos_count	1849442202547
Ndb_api_bytes_sent_count	2044
Ndb_api_bytes_received_count	81384
Ndb_api_trans_start_count	2
Ndb_api_trans_commit_count	1
Ndb_api_trans_abort_count	0
Ndb_api_trans_close_count	2
Ndb_api_pk_op_count	1
Ndb_api_uk_op_count	0
Ndb_api_table_scan_count	1
Ndb_api_range_scan_count	0
Ndb_api_pruned_scan_count	0
Ndb_api_scan_batch_count	2
Ndb_api_read_row_count	4
Ndb_api_trans_local_read_row_count	2
Ndb_api_adaptive_send_forced_count	0
Ndb_api_adaptive_send_unforced_count	3
Ndb_api_adaptive_send_deferred_count	0
Ndb_api_event_data_count	0
Ndb_api_event_nondata_count	0
Ndb_api_event_bytes_count	0
Ndb_api_wait_exec_complete_count_slave	0
Ndb_api_wait_scan_result_count_slave	0
Ndb_api_wait_meta_request_count_slave	0
Ndb_api_wait_nanos_count_slave	0
Ndb_api_bytes_sent_count_slave	0
Ndb_api_bytes_received_count_slave	0
Ndb_api_trans_start_count_slave	0
Ndb_api_trans_commit_count_slave	0
Ndb_api_trans_abort_count_slave	0
Ndb_api_trans_close_count_slave	0
Ndb_api_pk_op_count_slave	0
Ndb_api_uk_op_count_slave	0
Ndb_api_table_scan_count_slave	0
Ndb_api_range_scan_count_slave	0
Ndb_api_pruned_scan_count_slave	0
Ndb_api_scan_batch_count_slave	0
Ndb_api_read_row_count_slave	0
Ndb_api_trans_local_read_row_count_slave	0
Ndb_api_adaptive_send_forced_count_slave	0
Ndb_api_adaptive_send_unforced_count_slave	0
Ndb_api_adaptive_send_deferred_count_slave	0
Ndb_slave_max_replicated_epoch	0
Ndb_api_event_data_count_injector	0
Ndb_api_event_nondata_count_injector	0
Ndb_api_event_bytes_count_injector	0
Ndb_cluster_node_id	100
Ndb_config_from_host	127.0.0.1
Ndb_config_from_port	1186
Ndb_number_of_data_nodes	2
Ndb_number_of_ready_data_nodes	2
Ndb_connect_count	0
Ndb_execute_count	0
Ndb_scan_count	0
Ndb_pruned_scan_count	0
Ndb_schema_locks_count	0
Ndb_api_wait_exec_complete_count_session	0
Ndb_api_wait_scan_result_count_session	0
Ndb_api_wait_meta_request_count_session	0
Ndb_api_wait_nanos_count_session	0
Ndb_api_bytes_sent_count_session	0
Ndb_api_bytes_received_count_session	0
Ndb_api_trans_start_count_session	0
Ndb_api_trans_commit_count_session	0
Ndb_api_trans_abort_count_session	0
Ndb_api_trans_close_count_session	0
Ndb_api_pk_op_count_session	0

Ndb_api_uk_op_count_session	0
Ndb_api_table_scan_count_session	0
Ndb_api_range_scan_count_session	0
Ndb_api_pruned_scan_count_session	0
Ndb_api_scan_batch_count_session	0
Ndb_api_read_row_count_session	0
Ndb_api_trans_local_read_row_count_session	0
Ndb_api_adaptive_send_forced_count_session	0
Ndb_api_adaptive_send_unforced_count_session	0
Ndb_api_adaptive_send_deferred_count_session	0
Ndb_sorted_scan_count	0
Ndb_pushed_queries_defined	0
Ndb_pushed_queries_dropped	0
Ndb_pushed_queries_executed	0
Ndb_pushed_reads	0
Ndb_last_commit_epoch_server	29347511533580
Ndb_last_commit_epoch_session	0
Ndb_system_name	MC_20191209172820
Ndb_conflict_fn_max	0
Ndb_conflict_fn_old	0
Ndb_conflict_fn_max_del_win	0
Ndb_conflict_fn_epoch	0
Ndb_conflict_fn_epoch_trans	0
Ndb_conflict_fn_epoch2	0
Ndb_conflict_fn_epoch2_trans	0
Ndb_conflict_trans_row_conflict_count	0
Ndb_conflict_trans_row_reject_count	0
Ndb_conflict_trans_reject_count	0
Ndb_conflict_trans_detect_iter_count	0
Ndb_conflict_trans_conflict_commit_count	0
Ndb_conflict_epoch_delete_delete_count	0
Ndb_conflict_reflected_op_prepare_count	0
Ndb_conflict_reflected_op_discard_count	0
Ndb_conflict_refresh_op_count	0
Ndb_conflict_last_conflict_epoch	0
Ndb_conflict_last_stable_epoch	0
Ndb_index_stat_status	allow:1,enable:1,busy:0, loop:1000,list:(new:0,update:0,read:0,idle:0,check:0,delete:0,error:0,total:0), analyze:(queue:0,wait:0),stats:(nostats:0,wait:0),total:(analyze:(all:0,error:0), query:(all:0,nostats:0,error:0),event:(act:0,skip:0,miss:0), cache:(refresh:0,clean:0,pinned:0,drop:0,evict:0)), cache:(query:0,clean:0,drop:0,evict:0,usedpct:0.00,highpct:0.00)
Ndb_index_stat_cache_query	0
Ndb_index_stat_cache_clean	0

If the MySQL server was built with clustering support, but it is not connected to a cluster, all rows in the output of this statement contain a zero or an empty string.

See also [Section 13.7.5.35, “SHOW STATUS Statement”](#).

- `SELECT * FROM INFORMATION_SCHEMA.GLOBAL_STATUS WHERE VARIABLE_NAME LIKE 'NDB %';`

This statement, although deprecated in NDB 7.5 and NDB 7.6, can be used if [show\\_compatibility\\_56](#) is enabled to obtain similar output to the `SHOW STATUS` statement discussed in the previous item; the preferred method is to query the `performance_schema.global_status` table (see next item). Unlike the case with `SHOW STATUS`,

it is possible using the `SELECT` to extract values in SQL for use in scripts for monitoring and automation purposes.

See [Section 24.3.10, “The INFORMATION\\_SCHEMA GLOBAL\\_STATUS and SESSION\\_STATUS Tables”](#), as well as [Section 25.20, “Migrating to Performance Schema System and Status Variable Tables”](#), for more information.

- `SELECT * FROM performance_schema.global_status WHERE VARIABLE_NAME LIKE 'NDB%'`

This statement provides similar output to the `SHOW STATUS` statement discussed previously. Unlike the case with `SHOW STATUS`, it is possible using `SELECT` statements to extract values in SQL for use in scripts for monitoring and automation purposes.

See [Section 25.12.14, “Performance Schema Status Variable Tables”](#), for more information.

- `SELECT * FROM INFORMATION_SCHEMA.PLUGINS WHERE PLUGIN_NAME LIKE 'NDB%'`

This statement displays information from the Information Schema `PLUGINS` table about plugins associated with NDB Cluster, such as version, author, and license, as shown here:

```
mysql> SELECT * FROM INFORMATION_SCHEMA.PLUGINS
> WHERE PLUGIN_NAME LIKE 'NDB%'\G
***** 1. row *****
      PLUGIN_NAME: ndbcluster
      PLUGIN_VERSION: 1.0
      PLUGIN_STATUS: ACTIVE
      PLUGIN_TYPE: STORAGE ENGINE
      PLUGIN_TYPE_VERSION: 50729.0
      PLUGIN_LIBRARY: NULL
      PLUGIN_LIBRARY_VERSION: NULL
      PLUGIN_AUTHOR: MySQL AB
      PLUGIN_DESCRIPTION: Clustered, fault-tolerant tables
      PLUGIN_LICENSE: GPL
      LOAD_OPTION: ON
***** 2. row *****
      PLUGIN_NAME: ndbinfo
      PLUGIN_VERSION: 0.1
      PLUGIN_STATUS: ACTIVE
      PLUGIN_TYPE: STORAGE ENGINE
      PLUGIN_TYPE_VERSION: 50744.0
      PLUGIN_LIBRARY: NULL
      PLUGIN_LIBRARY_VERSION: NULL
      PLUGIN_AUTHOR: Sun Microsystems Inc.
      PLUGIN_DESCRIPTION: MySQL Cluster system information storage engine
      PLUGIN_LICENSE: GPL
      LOAD_OPTION: ON
***** 3. row *****
      PLUGIN_NAME: ndb_transid_mysql_connection_map
      PLUGIN_VERSION: 0.1
      PLUGIN_STATUS: ACTIVE
      PLUGIN_TYPE: INFORMATION SCHEMA
      PLUGIN_TYPE_VERSION: 50744.0
      PLUGIN_LIBRARY: NULL
      PLUGIN_LIBRARY_VERSION: NULL
      PLUGIN_AUTHOR: Oracle Corporation
      PLUGIN_DESCRIPTION: Map between mysql connection id and ndb transaction id
      PLUGIN_LICENSE: GPL
      LOAD_OPTION: ON
```

You can also use the `SHOW PLUGINS` statement to display this information, but the output from that statement cannot easily be filtered. See also [The MySQL Plugin API](#), which describes where and how the information in the `PLUGINS` table is obtained.



You can also query the tables in the `ndbinfo` information database for real-time data about many NDB Cluster operations. See [Section 21.6.15, “ndbinfo: The NDB Cluster Information Database”](#).

## 21.6.18 NDB Cluster Security Issues

This section discusses security considerations to take into account when setting up and running NDB Cluster.

Topics covered in this section include the following:

- NDB Cluster and network security issues
- Configuration issues relating to running NDB Cluster securely
- NDB Cluster and the MySQL privilege system
- MySQL standard security procedures as applicable to NDB Cluster

### 21.6.18.1 NDB Cluster Security and Networking Issues

In this section, we discuss basic network security issues as they relate to NDB Cluster. It is extremely important to remember that NDB Cluster “out of the box” is not secure; you or your network administrator must take the proper steps to ensure that your cluster cannot be compromised over the network.

Cluster communication protocols are inherently insecure, and no encryption or similar security measures are used in communications between nodes in the cluster. Because network speed and latency have a direct impact on the cluster's efficiency, it is also not advisable to employ SSL or other encryption to network connections between nodes, as such schemes effectively slow communications.

It is also true that no authentication is used for controlling API node access to an NDB Cluster. As with encryption, the overhead of imposing authentication requirements would have an adverse impact on Cluster performance.

In addition, there is no checking of the source IP address for either of the following when accessing the cluster:

- SQL or API nodes using “free slots” created by empty `[mysqld]` or `[api]` sections in the `config.ini` file

This means that, if there are any empty `[mysqld]` or `[api]` sections in the `config.ini` file, then any API nodes (including SQL nodes) that know the management server's host name (or IP address) and port can connect to the cluster and access its data without restriction. (See [Section 21.6.18.2, “NDB Cluster and MySQL Privileges”](#), for more information about this and related issues.)



#### Note

You can exercise some control over SQL and API node access to the cluster by specifying a `HostName` parameter for all `[mysqld]` and `[api]` sections in the `config.ini` file. However, this also means that, should you wish to connect an API node to the cluster from a previously unused host, you need to add an `[api]` section containing its host name to the `config.ini` file.

More information is available [elsewhere in this chapter](#) about the `HostName` parameter. Also see [Section 21.4.1, “Quick Test Setup of NDB Cluster”](#), for configuration examples using `HostName` with API nodes.

- Any `ndb_mgm` client

This means that any cluster management client that is given the management server's host name (or IP address) and port (if not the standard port) can connect to the cluster and execute any management client command. This includes commands such as `ALL STOP` and `SHUTDOWN`.

For these reasons, it is necessary to protect the cluster on the network level. The safest network configuration for Cluster is one which isolates connections between Cluster nodes from any other network communications. This can be accomplished by any of the following methods:

1. Keeping Cluster nodes on a network that is physically separate from any public networks. This option is the most dependable; however, it is the most expensive to implement.

We show an example of an NDB Cluster setup using such a physically segregated network here:

**Figure 21.9 NDB Cluster with Hardware Firewall**

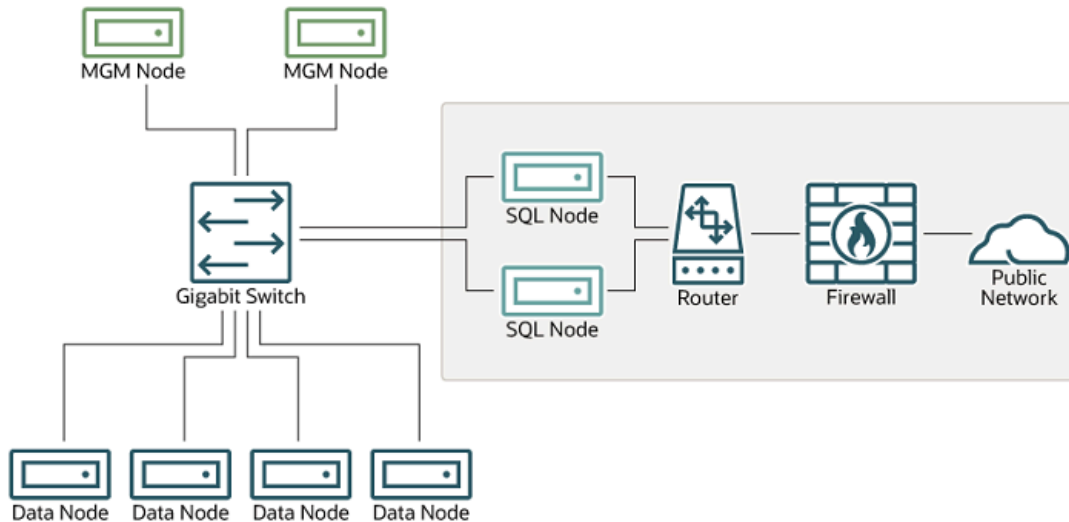

This setup has two networks, one private (solid box) for the Cluster management servers and data nodes, and one public (dotted box) where the SQL nodes reside. (We show the management and data nodes connected using a gigabit switch since this provides the best performance.) Both networks are protected from the outside by a hardware firewall, sometimes also known as a *network-based firewall*.

This network setup is safest because no packets can reach the cluster's management or data nodes from outside the network—and none of the cluster's internal communications can reach the outside—without going through the SQL nodes, as long as the SQL nodes do not permit any packets to be forwarded. This means, of course, that all SQL nodes must be secured against hacking attempts.



### Important

With regard to potential security vulnerabilities, an SQL node is no different from any other MySQL server. See [Section 6.1.3, “Making MySQL Secure Against Attackers”](#), for a description of techniques you can use to secure MySQL servers.

2. Using one or more software firewalls (also known as *host-based firewalls*) to control which packets pass through to the cluster from portions of the network that do not require access to it. In this type of setup, a software firewall must be installed on every host in the cluster which might otherwise be accessible from outside the local network.

The host-based option is the least expensive to implement, but relies purely on software to provide protection and so is the most difficult to keep secure.

This type of network setup for NDB Cluster is illustrated here:

**Figure 21.10 NDB Cluster with Software Firewalls**

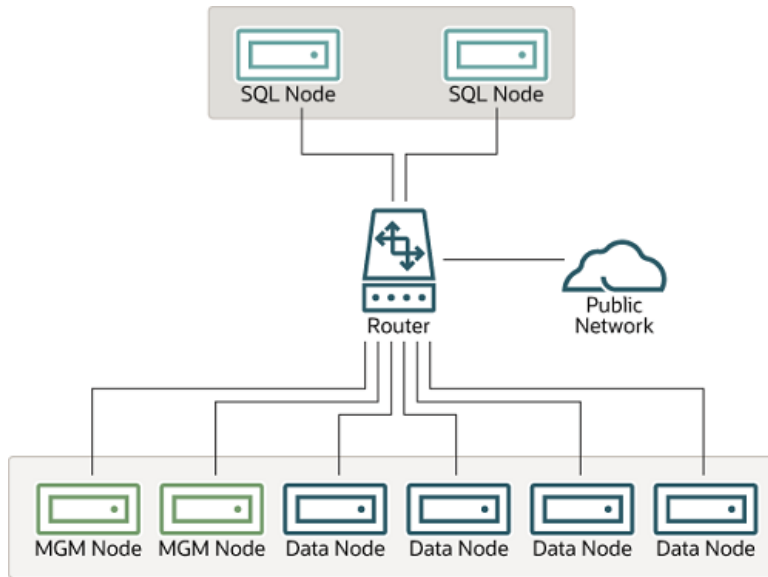

Using this type of network setup means that there are two zones of NDB Cluster hosts. Each cluster host must be able to communicate with all of the other machines in the cluster, but only those hosting SQL nodes (dotted box) can be permitted to have any contact with the outside, while those in the zone containing the data nodes and management nodes (solid box) must be isolated from any machines that are not part of the cluster. Applications using the cluster and user of those applications must *not* be permitted to have direct access to the management and data node hosts.

To accomplish this, you must set up software firewalls that limit the traffic to the type or types shown in the following table, according to the type of node that is running on each cluster host computer:

**Table 21.62 Node types in a host-based firewall cluster configuration**

Node Type	Permitted Traffic
SQL or API node	<ul style="list-style-type: none"> <li>It originates from the IP address of a management or data node (using any TCP or UDP port).</li> <li>It originates from within the network in which the cluster resides and is on the port that your application is using.</li> </ul>
Data node or Management node	<ul style="list-style-type: none"> <li>It originates from the IP address of a management or data node (using any TCP or UDP port).</li> </ul>

Node Type	Permitted Traffic
	<ul style="list-style-type: none"> <li>It originates from the IP address of an SQL or API node.</li> </ul>

Any traffic other than that shown in the table for a given node type should be denied.

The specifics of configuring a firewall vary from firewall application to firewall application, and are beyond the scope of this Manual. `iptables` is a very common and reliable firewall application, which is often used with `APF` as a front end to make configuration easier. You can (and should) consult the documentation for the software firewall that you employ, should you choose to implement an NDB Cluster network setup of this type, or of a “mixed” type as discussed under the next item.

- It is also possible to employ a combination of the first two methods, using both hardware and software to secure the cluster—that is, using both network-based and host-based firewalls. This is between the first two schemes in terms of both security level and cost. This type of network setup keeps the cluster behind the hardware firewall, but permits incoming packets to travel beyond the router connecting all cluster hosts to reach the SQL nodes.

One possible network deployment of an NDB Cluster using hardware and software firewalls in combination is shown here:

**Figure 21.11 NDB Cluster with a Combination of Hardware and Software Firewalls**

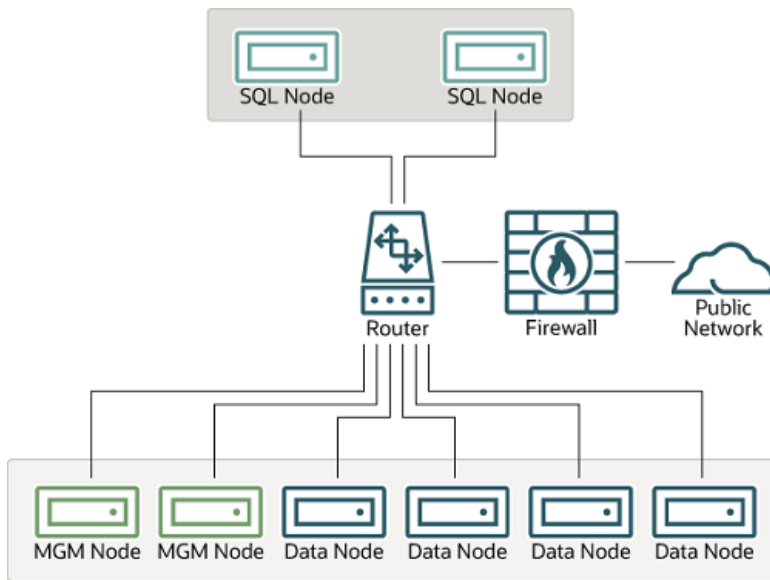

In this case, you can set the rules in the hardware firewall to deny any external traffic except to SQL nodes and API nodes, and then permit traffic to them only on the ports required by your application.

Whatever network configuration you use, remember that your objective from the viewpoint of keeping the cluster secure remains the same—to prevent any unessential traffic from reaching the cluster while ensuring the most efficient communication between the nodes in the cluster.

Because NDB Cluster requires large numbers of ports to be open for communications between nodes, the recommended option is to use a segregated network. This represents the simplest way to prevent unwanted traffic from reaching the cluster.

**Note**

If you wish to administer an NDB Cluster remotely (that is, from outside the local network), the recommended way to do this is to use `ssh` or another secure login shell to access an SQL node host. From this host, you can then run the management client to access the management server safely, from within the cluster's own local network.

Even though it is possible to do so in theory, it is *not* recommended to use `ndb_mgm` to manage a Cluster directly from outside the local network on which the Cluster is running. Since neither authentication nor encryption takes place between the management client and the management server, this represents an extremely insecure means of managing the cluster, and is almost certain to be compromised sooner or later.

### 21.6.18.2 NDB Cluster and MySQL Privileges

In this section, we discuss how the MySQL privilege system works in relation to NDB Cluster and the implications of this for keeping an NDB Cluster secure.

Standard MySQL privileges apply to NDB Cluster tables. This includes all MySQL privilege types (`SELECT` privilege, `UPDATE` privilege, `DELETE` privilege, and so on) granted on the database, table, and column level. As with any other MySQL Server, user and privilege information is stored in the `mysql` system database. The SQL statements used to grant and revoke privileges on NDB tables, databases containing such tables, and columns within such tables are identical in all respects with the `GRANT` and `REVOKE` statements used in connection with database objects involving any (other) MySQL storage engine. The same thing is true with respect to the `CREATE USER` and `DROP USER` statements.

It is important to keep in mind that, by default, the MySQL grant tables use the `MyISAM` storage engine. Because of this, those tables are not normally duplicated or shared among MySQL servers acting as SQL nodes in an NDB Cluster. In other words, changes in users and their privileges do not automatically propagate between SQL nodes by default. If you wish, you can enable automatic distribution of MySQL users and privileges across NDB Cluster SQL nodes; see [Section 21.6.13, “Distributed Privileges Using Shared Grant Tables”](#), for details.

Conversely, because there is no way in MySQL to deny privileges (privileges can either be revoked or not granted in the first place, but not denied as such), there is no special protection for NDB tables on one SQL node from users that have privileges on another SQL node; (This is true even if you are not using automatic distribution of user privileges. The definitive example of this is the MySQL `root` account, which can perform any action on any database object. In combination with empty `[mysqld]` or `[api]` sections of the `config.ini` file, this account can be especially dangerous. To understand why, consider the following scenario:

- The `config.ini` file contains at least one empty `[mysqld]` or `[api]` section. This means that the NDB Cluster management server performs no checking of the host from which a MySQL Server (or other API node) accesses the NDB Cluster.
- There is no firewall, or the firewall fails to protect against access to the NDB Cluster from hosts external to the network.
- The host name or IP address of the NDB Cluster management server is known or can be determined from outside the network.

If these conditions are true, then anyone, anywhere can start a MySQL Server with `--ndbcluster --ndb-connectstring=management_host` and access this NDB Cluster. Using the MySQL `root` account, this person can then perform the following actions:

- Execute metadata statements such as `SHOW DATABASES` statement (to obtain a list of all `NDB` databases on the server) or `SHOW TABLES FROM some_ndb_database` statement to obtain a list of all `NDB` tables in a given database
- Run any legal MySQL statements on any of the discovered tables, such as:
  - `SELECT * FROM some_table` to read all the data from any table
  - `DELETE FROM some_table` to delete all the data from a table
  - `DESCRIBE some_table` or `SHOW CREATE TABLE some_table` to determine the table schema
  - `UPDATE some_table SET column1 = some_value` to fill a table column with “garbage” data; this could actually cause much greater damage than simply deleting all the data

More insidious variations might include statements like these:

```
UPDATE some_table SET an_int_column = an_int_column + 1
```

or

```
UPDATE some_table SET a_varchar_column = REVERSE(a_varchar_column)
```

Such malicious statements are limited only by the imagination of the attacker.

The only tables that would be safe from this sort of mayhem would be those tables that were created using storage engines other than `NDB`, and so not visible to a “rogue” SQL node.

A user who can log in as `root` can also access the `INFORMATION_SCHEMA` database and its tables, and so obtain information about databases, tables, stored routines, scheduled events, and any other database objects for which metadata is stored in `INFORMATION_SCHEMA`.

It is also a very good idea to use different passwords for the `root` accounts on different `NDB` Cluster SQL nodes unless you are using distributed privileges.

In sum, you cannot have a safe `NDB` Cluster if it is directly accessible from outside your local network.



### Important

*Never leave the MySQL root account password empty.* This is just as true when running MySQL as an `NDB` Cluster SQL node as it is when running it as a standalone (non-Cluster) MySQL Server, and should be done as part of the MySQL installation process before configuring the MySQL Server as an SQL node in an `NDB` Cluster.

If you wish to employ `NDB` Cluster's distributed privilege capabilities, you should not simply convert the system tables in the `mysql` database to use the `NDB` storage engine manually. Use the stored procedure provided for this purpose instead; see [Section 21.6.13, “Distributed Privileges Using Shared Grant Tables”](#).

Otherwise, if you need to synchronize `mysql` system tables between SQL nodes, you can use standard MySQL replication to do so, or employ a script to copy table entries between the MySQL servers.

**Summary.** The most important points to remember regarding the MySQL privilege system with regard to `NDB` Cluster are listed here:

1. Users and privileges established on one SQL node do not automatically exist or take effect on other SQL nodes in the cluster. Conversely, removing a user or privilege on one SQL node in the cluster does not remove the user or privilege from any other SQL nodes.

2. You can distribute MySQL users and privileges among SQL nodes using the SQL script, and the stored procedures it contains, that are supplied for this purpose in the NDB Cluster distribution.
3. Once a MySQL user is granted privileges on an NDB table from one SQL node in an NDB Cluster, that user can “see” any data in that table regardless of the SQL node from which the data originated, even if you are not using privilege distribution.

### 21.6.18.3 NDB Cluster and MySQL Security Procedures

In this section, we discuss MySQL standard security procedures as they apply to running NDB Cluster.

In general, any standard procedure for running MySQL securely also applies to running a MySQL Server as part of an NDB Cluster. First and foremost, you should always run a MySQL Server as the `mysql` operating system user; this is no different from running MySQL in a standard (non-Cluster) environment. The `mysql` system account should be uniquely and clearly defined. Fortunately, this is the default behavior for a new MySQL installation. You can verify that the `mysqld` process is running as the `mysql` operating system user by using the system command such as the one shown here:

```
$> ps aux | grep mysql
root      10467  0.0  0.1   3616  1380 pts/3    S      11:53   0:00 \
/bin/sh ./mysqld_safe --ndbcluster --ndb-connectstring=localhost:1186
mysql     10512  0.2  2.5  58528 26636 pts/3    Sl     11:53   0:00 \
/usr/local/mysql/libexec/mysqld --basedir=/usr/local/mysql \
--datadir=/usr/local/mysql/var --user=mysql --ndbcluster \
--ndb-connectstring=localhost:1186 --pid-file=/usr/local/mysql/var/mothra.pid \
--log-error=/usr/local/mysql/var/mothra.err
jon       10579  0.0  0.0   2736   688 pts/0     S+    11:54   0:00 grep mysql
```

If the `mysqld` process is running as any other user than `mysql`, you should immediately shut it down and restart it as the `mysql` user. If this user does not exist on the system, the `mysql` user account should be created, and this user should be part of the `mysql` user group; in this case, you should also make sure that the MySQL data directory on this system (as set using the `--datadir` option for `mysqld`) is owned by the `mysql` user, and that the SQL node's `my.cnf` file includes `user=mysql` in the `[mysqld]` section. Alternatively, you can start the MySQL server process with `--user=mysql` on the command line, but it is preferable to use the `my.cnf` option, since you might forget to use the command-line option and so have `mysqld` running as another user unintentionally. The `mysqld_safe` startup script forces MySQL to run as the `mysql` user.



#### Important

Never run `mysqld` as the system root user. Doing so means that potentially any file on the system can be read by MySQL, and thus—should MySQL be compromised—by an attacker.

As mentioned in the previous section (see [Section 21.6.18.2, “NDB Cluster and MySQL Privileges”](#)), you should always set a root password for the MySQL Server as soon as you have it running. You should also delete the anonymous user account that is installed by default. You can accomplish these tasks using the following statements:

```
$> mysql -u root

mysql> UPDATE mysql.user
->   SET Password=PASSWORD('secure_password')
->   WHERE User='root';

mysql> DELETE FROM mysql.user
->   WHERE User='';

mysql> FLUSH PRIVILEGES;
```

Be very careful when executing the `DELETE` statement not to omit the `WHERE` clause, or you risk deleting *all* MySQL users. Be sure to run the `FLUSH PRIVILEGES` statement as soon as you have modified the `mysql.user` table, so that the changes take immediate effect. Without `FLUSH PRIVILEGES`, the changes do not take effect until the next time that the server is restarted.

**Note**

Many of the NDB Cluster utilities such as `ndb_show_tables`, `ndb_desc`, and `ndb_select_all` also work without authentication and can reveal table names, schemas, and data. By default these are installed on Unix-style systems with the permissions `wxr-xr-x` (755), which means they can be executed by any user that can access the `mysql/bin` directory.

See [Section 21.5, “NDB Cluster Programs”](#), for more information about these utilities.

## 21.7 NDB Cluster Replication

NDB Cluster supports *asynchronous replication*, more usually referred to simply as “replication”. This section explains how to set up and manage a configuration in which one group of computers operating as an NDB Cluster replicates to a second computer or group of computers. We assume some familiarity on the part of the reader with standard MySQL replication as discussed elsewhere in this Manual. (See [Chapter 16, Replication](#)).

**Note**

NDB Cluster does not support replication using GTIDs; semisynchronous replication and group replication are also not supported by the `NDB` storage engine.

Normal (non-clustered) replication involves a source server (formerly called a “master”) and a replica server (formerly referred to as a “slave”), the source being so named because operations and data to be replicated originate with it, and the replica being the recipient of these. In NDB Cluster, replication is conceptually very similar but can be more complex in practice, as it may be extended to cover a number of different configurations including replicating between two complete clusters. Although an NDB Cluster itself depends on the `NDB` storage engine for clustering functionality, it is not necessary to use `NDB` as the storage engine for the replica's copies of the replicated tables (see [Replication from NDB to other storage engines](#)). However, for maximum availability, it is possible (and preferable) to replicate from one NDB Cluster to another, and it is this scenario that we discuss, as shown in the following figure:



Figure 21.12 NDB Cluster-to-Cluster Replication Layout

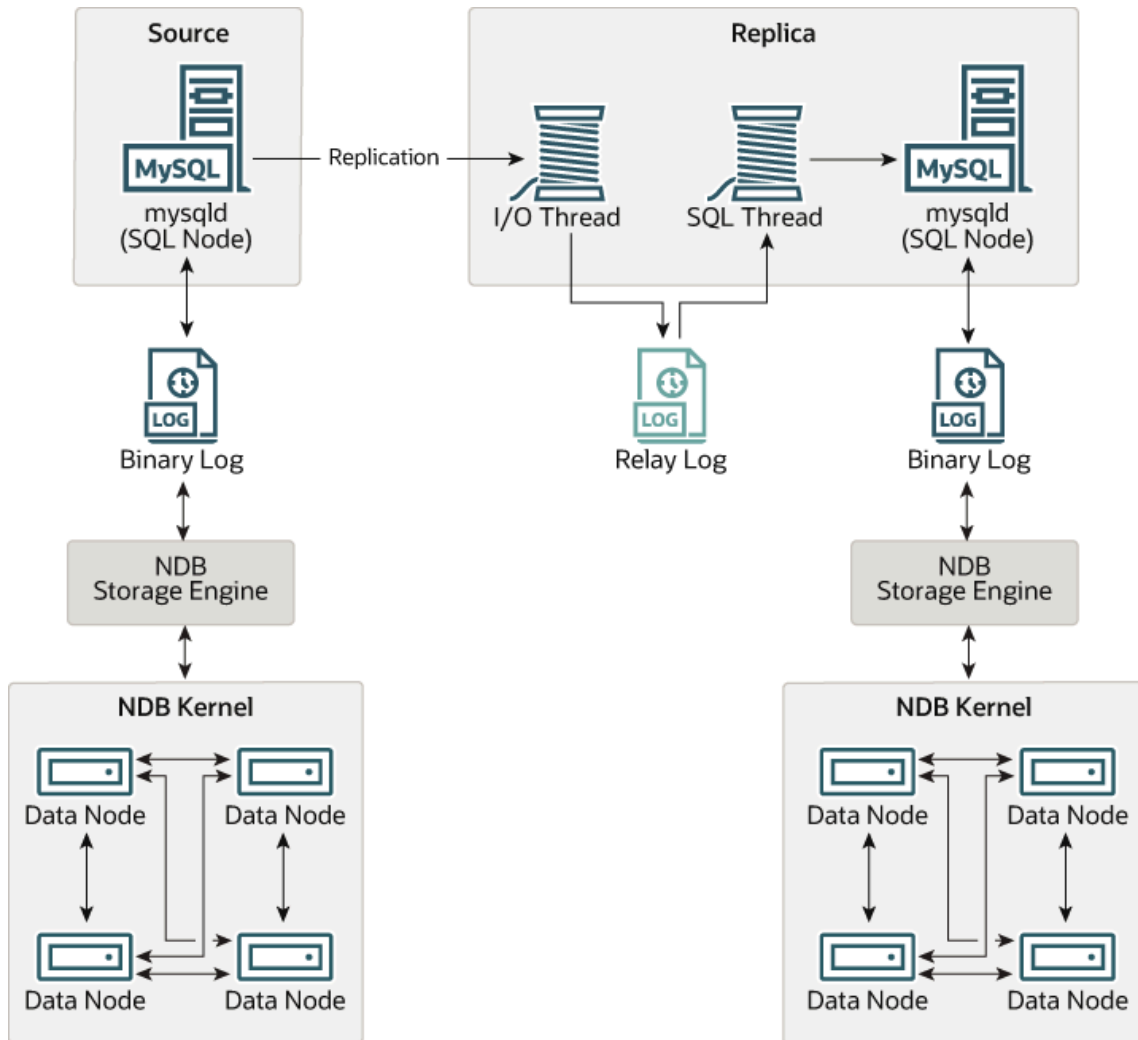

In this scenario, the replication process is one in which successive states of a source cluster are logged and saved to a replica cluster. This process is accomplished by a special thread known as the NDB binary log injector thread, which runs on each MySQL server and produces a binary log (`binlog`). This thread ensures that all changes in the cluster producing the binary log—and not just those changes that are effected through the MySQL Server—are inserted into the binary log with the correct serialization order. We refer to the MySQL source and replica servers as replication servers or replication nodes, and the data flow or line of communication between them as a *replication channel*.

For information about performing point-in-time recovery with NDB Cluster and NDB Cluster Replication, see [Section 21.7.9.2, “Point-In-Time Recovery Using NDB Cluster Replication”](#).

**NDB API replica status variables.** NDB API counters can provide enhanced monitoring capabilities on replica clusters. These counters are implemented as NDB statistics `_slave` status variables, as seen in the output of `SHOW STATUS`, or in the results of queries against the `SESSION_STATUS` or `GLOBAL_STATUS` table in a `mysql` client session connected to a MySQL Server that is acting as a replica in NDB Cluster Replication. By comparing the values of these status variables before and after the execution of statements affecting replicated NDB tables, you can observe the corresponding actions taken on the NDB API level by the replica, which can be useful when monitoring or troubleshooting NDB Cluster Replication. [Section 21.6.14, “NDB API Statistics Counters and Variables”](#), provides additional information.

**Replication from NDB to non-NDB tables.** It is possible to replicate [NDB](#) tables from an NDB Cluster acting as the replication source to tables using other MySQL storage engines such as [InnoDB](#) or [MyISAM](#) on a replica `mysqld`. This is subject to a number of conditions; see [Replication from NDB to other storage engines](#), and [Replication from NDB to a nontransactional storage engine](#), for more information.

## 21.7.1 NDB Cluster Replication: Abbreviations and Symbols

Throughout this section, we use the following abbreviations or symbols for referring to the source and replica clusters, and to processes and commands run on the clusters or cluster nodes:

**Table 21.63 Abbreviations used throughout this section referring to source and replica clusters, and to processes and commands run on cluster nodes**

Symbol or Abbreviation	Description (Refers to...)
<code>S</code>	The cluster serving as the (primary) replication source
<code>R</code>	The cluster acting as the (primary) replica
<code>shellS&gt;</code>	Shell command to be issued on the source cluster
<code>mysqlS&gt;</code>	MySQL client command issued on a single MySQL server running as an SQL node on the source cluster
<code>mysqlS*&gt;</code>	MySQL client command to be issued on all SQL nodes participating in the replication source cluster
<code>shellR&gt;</code>	Shell command to be issued on the replica cluster
<code>mysqlR&gt;</code>	MySQL client command issued on a single MySQL server running as an SQL node on the replica cluster
<code>mysqlR*&gt;</code>	MySQL client command to be issued on all SQL nodes participating in the replica cluster
<code>C</code>	Primary replication channel
<code>C'</code>	Secondary replication channel
<code>S'</code>	Secondary replication source
<code>R'</code>	Secondary replica

## 21.7.2 General Requirements for NDB Cluster Replication

A replication channel requires two MySQL servers acting as replication servers (one each for the source and replica). For example, this means that in the case of a replication setup with two replication channels (to provide an extra channel for redundancy), there should be a total of four replication nodes, two per cluster.

Replication of an NDB Cluster as described in this section and those following is dependent on row-based replication. This means that the replication source MySQL server must be running with `--binlog-format=ROW` or `--binlog-format=MIXED`, as described in [Section 21.7.6, “Starting NDB Cluster Replication \(Single Replication Channel\)”](#). For general information about row-based replication, see [Section 16.2.1, “Replication Formats”](#).



### Important

If you attempt to use NDB Cluster Replication with `--binlog-format=STATEMENT`, replication fails to work properly because the

`ndb_binlog_index` table on the source cluster and the `epoch` column of the `ndb_apply_status` table on the replica cluster are not updated (see [Section 21.7.4, “NDB Cluster Replication Schema and Tables”](#)). Instead, only updates on the MySQL server acting as the replication source propagate to the replica, and no updates from any other SQL nodes in the source cluster are replicated.

The default value for the `--binlog-format` option is `MIXED`.

Each MySQL server used for replication in either cluster must be uniquely identified among all the MySQL replication servers participating in either cluster (you cannot have replication servers on both the source and replica clusters sharing the same ID). This can be done by starting each SQL node using the `--server-id=id` option, where `id` is a unique integer. Although it is not strictly necessary, we assume for purposes of this discussion that all NDB Cluster binaries are of the same release version.

It is generally true in MySQL Replication that both MySQL servers (`mysqld` processes) involved must be compatible with one another with respect to both the version of the replication protocol used and the SQL feature sets which they support (see [Section 16.4.2, “Replication Compatibility Between MySQL Versions”](#)). It is due to such differences between the binaries in the NDB Cluster and MySQL Server 5.7 distributions that NDB Cluster Replication has the additional requirement that both `mysqld` binaries come from an NDB Cluster distribution. The simplest and easiest way to assure that the `mysqld` servers are compatible is to use the same NDB Cluster distribution for all source and replica `mysqld` binaries.

We assume that the replica server or cluster is dedicated to replication of the source cluster, and that no other data is being stored on it.

All NDB tables being replicated must be created using a MySQL server and client. Tables and other database objects created using the NDB API (with, for example, `Dictionary::createTable()`) are not visible to a MySQL server and so are not replicated. Updates by NDB API applications to existing tables that were created using a MySQL server can be replicated.



#### Note

It is possible to replicate an NDB Cluster using statement-based replication. However, in this case, the following restrictions apply:

- All updates to data rows on the cluster acting as the source must be directed to a single MySQL server.
- It is not possible to replicate a cluster using multiple simultaneous MySQL replication processes.
- Only changes made at the SQL level are replicated.

These are in addition to the other limitations of statement-based replication as opposed to row-based replication; see [Section 16.2.1.1, “Advantages and Disadvantages of Statement-Based and Row-Based Replication”](#), for more specific information concerning the differences between the two replication formats.

### 21.7.3 Known Issues in NDB Cluster Replication

This section discusses known problems or issues when using replication with NDB Cluster.

**Loss of connection between source and replica.** A loss of connection can occur either between the source cluster SQL node and the replica cluster SQL node, or between the source SQL node and the

data nodes of the source cluster. In the latter case, this can occur not only as a result of loss of physical connection (for example, a broken network cable), but due to the overflow of data node event buffers; if the SQL node is too slow to respond, it may be dropped by the cluster (this is controllable to some degree by adjusting the `MaxBufferedEpochs` and `TimeBetweenEpochs` configuration parameters). If this occurs, *it is entirely possible for new data to be inserted into the source cluster without being recorded in the source SQL node's binary log*. For this reason, to guarantee high availability, it is extremely important to maintain a backup replication channel, to monitor the primary channel, and to fail over to the secondary replication channel when necessary to keep the replica cluster synchronized with the source. NDB Cluster is not designed to perform such monitoring on its own; for this, an external application is required.

The source SQL node issues a “gap” event when connecting or reconnecting to the source cluster. (A gap event is a type of “incident event,” which indicates an incident that occurs that affects the contents of the database but that cannot easily be represented as a set of changes. Examples of incidents are server failures, database resynchronization, some software updates, and some hardware changes.) When the replica encounters a gap in the replication log, it stops with an error message. This message is available in the output of `SHOW SLAVE STATUS`, and indicates that the SQL thread has stopped due to an incident registered in the replication stream, and that manual intervention is required. See [Section 21.7.8, “Implementing Failover with NDB Cluster Replication”](#), for more information about what to do in such circumstances.



### Important

Because NDB Cluster is not designed on its own to monitor replication status or provide failover, if high availability is a requirement for the replica server or cluster, then you must set up multiple replication lines, monitor the source `mysqld` on the primary replication line, and be prepared fail over to a secondary line if and as necessary. This must be done manually, or possibly by means of a third-party application. For information about implementing this type of setup, see [Section 21.7.7, “Using Two Replication Channels for NDB Cluster Replication”](#), and [Section 21.7.8, “Implementing Failover with NDB Cluster Replication”](#).

If you are replicating from a standalone MySQL server to an NDB Cluster, one channel is usually sufficient.

**Circular replication.** NDB Cluster Replication supports circular replication, as shown in the next example. The replication setup involves three NDB Clusters numbered 1, 2, and 3, in which Cluster 1 acts as the replication source for Cluster 2, Cluster 2 acts as the source for Cluster 3, and Cluster 3 acts as the source for Cluster 1, thus completing the circle. Each NDB Cluster has two SQL nodes, with SQL nodes A and B belonging to Cluster 1, SQL nodes C and D belonging to Cluster 2, and SQL nodes E and F belonging to Cluster 3.

Circular replication using these clusters is supported as long as the following conditions are met:

- The SQL nodes on all source and replica clusters are the same.
- All SQL nodes acting as sources and replicas are started with the `log_slave_updates` system variable enabled.

This type of circular replication setup is shown in the following diagram:

**Figure 21.13 NDB Cluster Circular Replication With All Sources As Replicas**

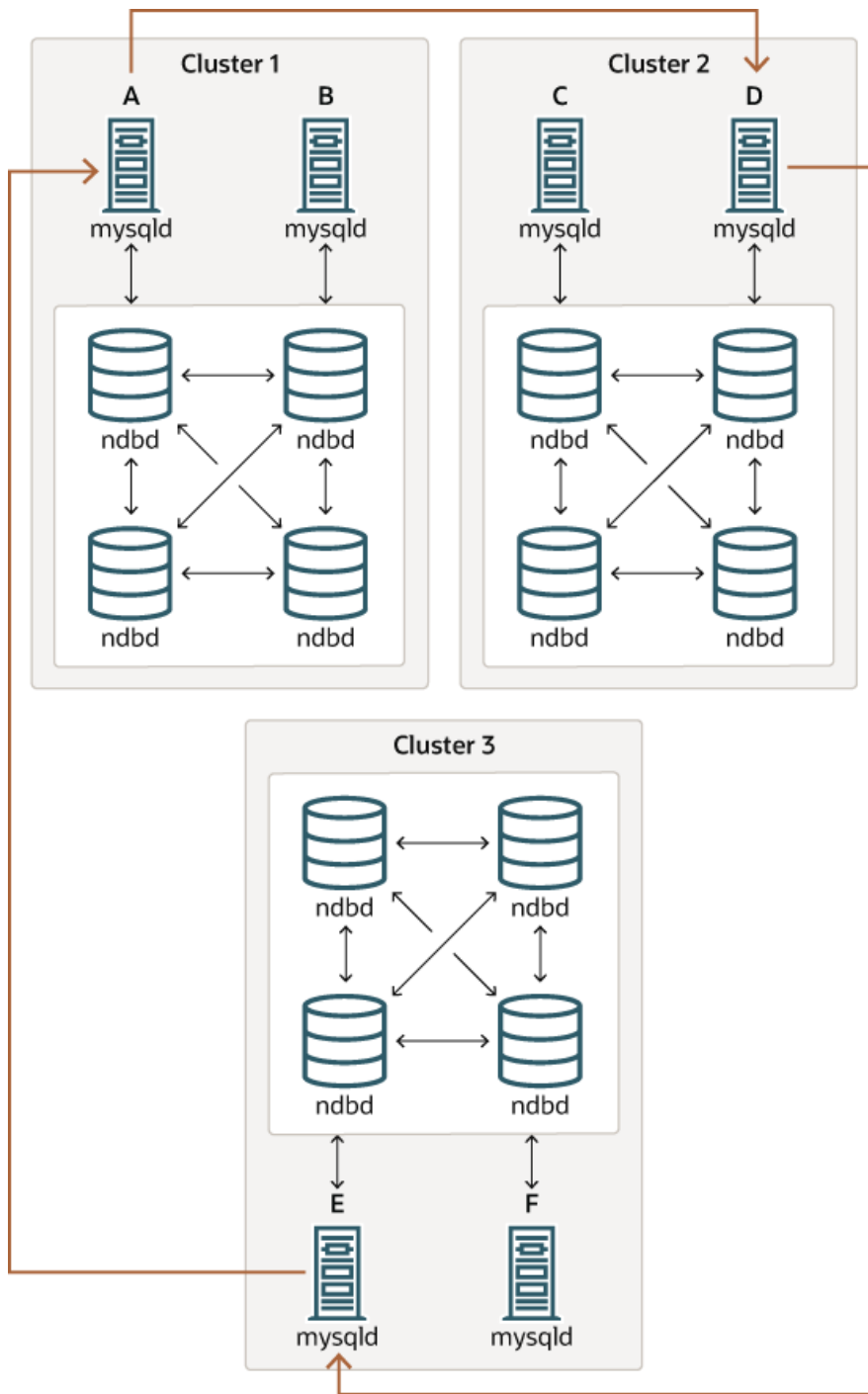

In this scenario, SQL node A in Cluster 1 replicates to SQL node C in Cluster 2; SQL node C replicates to SQL node E in Cluster 3; SQL node E replicates to SQL node A. In other words, the replication line (indicated by the curved arrows in the diagram) directly connects all SQL nodes used as sources and replicas.

It should also be possible to set up circular replication in which not all source SQL nodes are also replicas, as shown here:

Figure 21.14 NDB Cluster Circular Replication Where Not All Sources Are Replicas

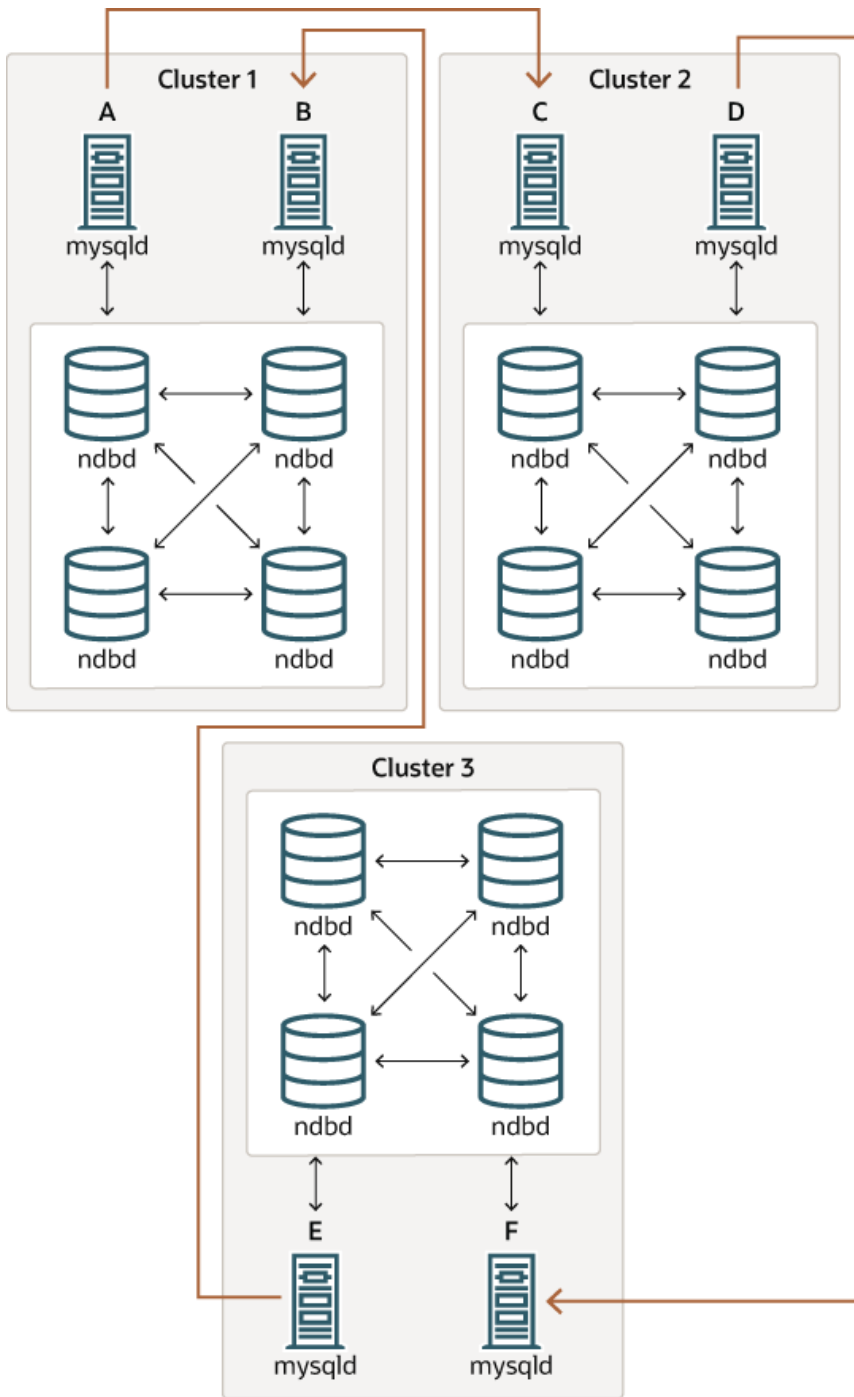

In this case, different SQL nodes in each cluster are used as sources and replicas. However, you must *not* start any of the SQL nodes with the `log_slave_updates` system variable enabled. This type of circular replication scheme for NDB Cluster, in which the line of replication (again indicated by the curved arrows in the diagram) is discontinuous, should be possible, but it should be noted that it has not yet been thoroughly tested and must therefore still be considered experimental.

**Note**

The [NDB](#) storage engine uses *idempotent execution mode*, which suppresses duplicate-key and other errors that otherwise break circular replication of NDB Cluster. This is equivalent to setting the global `slave_exec_mode` system variable to `IDEMPOTENT`, although this is not necessary in NDB Cluster replication, since NDB Cluster sets this variable automatically and ignores any attempts to set it explicitly.

**NDB Cluster replication and primary keys.** In the event of a node failure, errors in replication of [NDB](#) tables without primary keys can still occur, due to the possibility of duplicate rows being inserted in such cases. For this reason, it is highly recommended that all [NDB](#) tables being replicated have explicit primary keys.

**NDB Cluster Replication and Unique Keys.** In older versions of NDB Cluster, operations that updated values of unique key columns of [NDB](#) tables could result in duplicate-key errors when replicated. This issue is solved for replication between [NDB](#) tables by deferring unique key checks until after all table row updates have been performed.

Deferring constraints in this way is currently supported only by [NDB](#). Thus, updates of unique keys when replicating from [NDB](#) to a different storage engine such as [InnoDB](#) or [MyISAM](#) are still not supported.

The problem encountered when replicating without deferred checking of unique key updates can be illustrated using [NDB](#) table such as `t`, is created and populated on the source (and transmitted to a replica that does not support deferred unique key updates) as shown here:

```
CREATE TABLE t (
  p INT PRIMARY KEY,
  c INT,
  UNIQUE KEY u (c)
) ENGINE NDB;

INSERT INTO t
VALUES (1,1), (2,2), (3,3), (4,4), (5,5);
```

The following `UPDATE` statement on `t` succeeds on the source, since the rows affected are processed in the order determined by the `ORDER BY` option, performed over the entire table:

```
UPDATE t SET c = c - 1 ORDER BY p;
```

The same statement fails with a duplicate key error or other constraint violation on the replica, because the ordering of the row updates is performed for one partition at a time, rather than for the table as a whole.

**Note**

Every [NDB](#) table is implicitly partitioned by key when it is created. See [Section 22.2.5, “KEY Partitioning”](#), for more information.

**GTIDs not supported.** Replication using global transaction IDs is not compatible with the [NDB](#) storage engine, and is not supported. Enabling GTIDs is likely to cause NDB Cluster Replication to fail.

**Multithreaded replicas not supported.** NDB Cluster does not support multithreaded replicas. This is because the replica may not be able to separate transactions occurring in one database from those in another if they are written within the same epoch. In addition, every transaction handled by the [NDB](#) storage engine involves at least two databases—the target database and the `mysql` system database—due to the requirement for updating the `mysql.ndb_apply_status` table (see [Section 21.7.4, “NDB Cluster Replication Schema and Tables”](#)). This in turn breaks the requirement for multithreading that the transaction is specific to a given database.

Prior to NDB 7.5.7 and NDB 7.6.3, setting any system variables relating to multithreaded slaves such as `slave_parallel_workers` and `slave_checkpoint_group` (or the equivalent `mysqld` startup options) was completely ignored, and had no effect.

Beginning with NDB 7.5.7 and NDB 7.6.3, `slave_parallel_workers` is always 0. If set to any other value on startup, NDB changes it to 0, and writes a message to the `mysqld` server log file.

**Restarting with `--initial`.** Restarting the cluster with the `--initial` option causes the sequence of GCI and epoch numbers to start over from 0. (This is generally true of NDB Cluster and not limited to replication scenarios involving Cluster.) The MySQL servers involved in replication should in this case be restarted. After this, you should use the `RESET MASTER` and `RESET SLAVE` statements to clear the invalid `ndb_binlog_index` and `ndb_apply_status` tables, respectively.

**Replication from NDB to other storage engines.** It is possible to replicate an NDB table on the source to a table using a different storage engine on the replica, taking into account the restrictions listed here:

- Multi-source and circular replication are not supported (tables on both the source and the replica must use the NDB storage engine for this to work).
- Using a storage engine which does not perform binary logging for tables on the replica requires special handling.
- Use of a nontransactional storage engine for tables on the replica also requires special handling.
- The source `mysqld` must be started with `--ndb-log-update-as-write=0` or `--ndb-log-update-as-write=OFF`.

The next few paragraphs provide additional information about each of the issues just described.

**Multiple sources not supported when replicating NDB to other storage engines.** For replication from NDB to a different storage engine, the relationship between the two databases must be one-to-one. This means that bidirectional or circular replication is not supported between NDB Cluster and other storage engines.

In addition, it is not possible to configure more than one replication channel when replicating between NDB and a different storage engine. (An NDB Cluster database *can* simultaneously replicate to multiple NDB Cluster databases.) If the source uses NDB tables, it is still possible to have more than one MySQL Server maintain a binary log of all changes, but for the replica to change sources (fail over), the new source-replica relationship must be explicitly defined on the replica.

**Replicating NDB tables to a storage engine that does not perform binary logging.** If you attempt to replicate from an NDB Cluster to a replica that uses a storage engine that does not handle its own binary logging, the replication process aborts with the error `Binary logging not possible ... Statement cannot be written atomically since more than one engine involved and at least one engine is self-logging` (Error 1595). It is possible to work around this issue in one of the following ways:

- **Turn off binary logging on the replica.** This can be accomplished by setting `sql_log_bin = 0`.
- **Change the storage engine used for the `mysql.ndb_apply_status` table.** Causing this table to use an engine that does not handle its own binary logging can also eliminate the conflict. This can be done by issuing a statement such as `ALTER TABLE mysql.ndb_apply_status ENGINE=MyISAM` on the replica. It is safe to do this when using a storage engine other than NDB on the replica, since you do not need to worry about keeping multiple replicas synchronized.
- **Filter out changes to the `mysql.ndb_apply_status` table on the replica.** This can be done by starting the replica with `--replicate-ignore-table=mysql.ndb_apply_status`. If you need for



other tables to be ignored by replication, you might wish to use an appropriate `--replicate-wild-ignore-table` option instead.



### Important

You should *not* disable replication or binary logging of `mysql.ndb_apply_status` or change the storage engine used for this table when replicating from one NDB Cluster to another. See [Replication and binary log filtering rules with replication between NDB Clusters](#), for details.

**Replication from NDB to a nontransactional storage engine.** When replicating from NDB to a nontransactional storage engine such as MyISAM, you may encounter unnecessary duplicate key errors when replicating `INSERT ... ON DUPLICATE KEY UPDATE` statements. You can suppress these by using `--ndb-log-update-as-write=0`, which forces updates to be logged as writes, rather than as updates.

**Replication and binary log filtering rules with replication between NDB Clusters.** If you are using any of the options `--replicate-do-*`, `--replicate-ignore-*`, `--binlog-do-db`, or `--binlog-ignore-db` to filter databases or tables being replicated, you must take care not to block replication or binary logging of the `mysql.ndb_apply_status`, which is required for replication between NDB Clusters to operate properly. In particular, you must keep in mind the following:

1. Using `--replicate-do-db=db_name` (and no other `--replicate-do-*` or `--replicate-ignore-*` options) means that *only* tables in database `db_name` are replicated. In this case, you should also use `--replicate-do-db=mysql`, `--binlog-do-db=mysql`, or `--replicate-do-table=mysql.ndb_apply_status` to ensure that `mysql.ndb_apply_status` is populated on replicas.

Using `--binlog-do-db=db_name` (and no other `--binlog-do-db` options) means that changes *only* to tables in database `db_name` are written to the binary log. In this case, you should also use `--replicate-do-db=mysql`, `--binlog-do-db=mysql`, or `--replicate-do-table=mysql.ndb_apply_status` to ensure that `mysql.ndb_apply_status` is populated on replicas.

2. Using `--replicate-ignore-db=mysql` means that no tables in the `mysql` database are replicated. In this case, you should also use `--replicate-do-table=mysql.ndb_apply_status` to ensure that `mysql.ndb_apply_status` is replicated.

Using `--binlog-ignore-db=mysql` means that no changes to tables in the `mysql` database are written to the binary log. In this case, you should also use `--replicate-do-table=mysql.ndb_apply_status` to ensure that `mysql.ndb_apply_status` is replicated.

You should also remember that each replication rule requires the following:

1. Its own `--replicate-do-*` or `--replicate-ignore-*` option, and that multiple rules cannot be expressed in a single replication filtering option. For information about these rules, see [Section 16.1.6, “Replication and Binary Logging Options and Variables”](#).
2. Its own `--binlog-do-db` or `--binlog-ignore-db` option, and that multiple rules cannot be expressed in a single binary log filtering option. For information about these rules, see [Section 5.4.4, “The Binary Log”](#).

If you are replicating an NDB Cluster to a replica that uses a storage engine other than NDB, the considerations just given previously may not apply, as discussed elsewhere in this section.

**NDB Cluster Replication and IPv6.** While the NDB API and MGM API (and thus data nodes and management nodes) do not support IPv6 in NDB 7.5 and 7.6, MySQL Servers—including those acting as

SQL nodes in an NDB Cluster—can use IPv6 to contact other MySQL Servers. This means that you can replicate between NDB Clusters using IPv6 to connect the source and replica SQL nodes as shown by the dotted arrow in the following diagram:

**Figure 21.15 Replication Between SQL Nodes Connected Using IPv6**

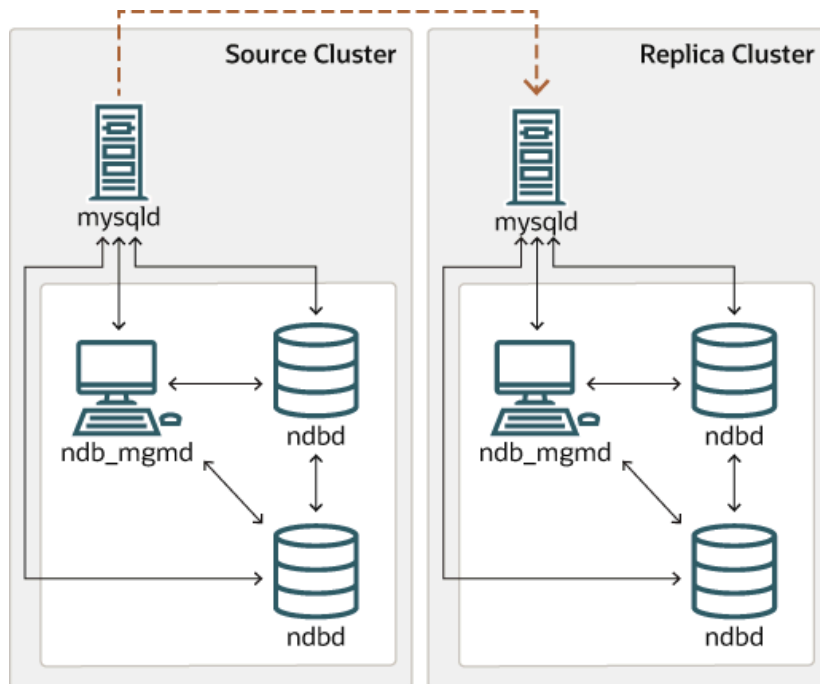

All connections originating *within* the NDB Cluster —represented in the preceding diagram by solid arrows—must use IPv4. In other words, all NDB Cluster data nodes, management servers, and management clients must be accessible from one another using IPv4. In addition, SQL nodes must use IPv4 to communicate with the cluster.

Since there is currently no support in the NDB and MGM APIs for IPv6, any applications written using these APIs must also make all connections using IPv4.

**Attribute promotion and demotion.** NDB Cluster Replication includes support for attribute promotion and demotion. The implementation of the latter distinguishes between lossy and non-lossy type conversions, and their use on the replica can be controlled by setting the `slave_type_conversions` global server system variable.

For more information about attribute promotion and demotion in NDB Cluster, see [Row-based replication: attribute promotion and demotion](#).

NDB, unlike `InnoDB` or `MyISAM`, does not write changes to virtual columns to the binary log; however, this has no detrimental effects on NDB Cluster Replication or replication between NDB and other storage engines. Changes to stored generated columns are logged.

## 21.7.4 NDB Cluster Replication Schema and Tables

- [ndb\\_apply\\_status](#) Table
- [ndb\\_binlog\\_index](#) Table
- [ndb\\_replication](#) Table

Replication in NDB Cluster makes use of a number of dedicated tables in the `mysql` database on each MySQL Server instance acting as an SQL node in both the cluster being replicated and in the replica. This is true regardless of whether the replica is a single server or a cluster.

The `ndb_binlog_index` and `ndb_apply_status` tables are created in the `mysql` database. They should not be explicitly replicated by the user. User intervention is normally not required to create or maintain either of these tables, since both are maintained by the NDB binary log (binlog) injector thread. This keeps the source `mysqld` process updated to changes performed by the NDB storage engine. The *NDB binlog injector thread* receives events directly from the NDB storage engine. The NDB injector is responsible for capturing all the data events within the cluster, and ensures that all events which change, insert, or delete data are recorded in the `ndb_binlog_index` table. The replica I/O thread transfers the events from the source's binary log to the replica's relay log.

The `ndb_replication` table must be created manually. This table can be updated by the user to perform filtering by database or table. See [ndb\\_replication Table](#), for more information. `ndb_replication` is also used in NDB Replication conflict detection and resolution for conflict resolution control; see [Conflict Resolution Control](#).

Even though `ndb_binlog_index` and `ndb_apply_status` are created and maintained automatically, it is advisable to check for the existence and integrity of these tables as an initial step in preparing an NDB Cluster for replication. It is possible to view event data recorded in the binary log by querying the `mysql.ndb_binlog_index` table directly on the source. This can be also be accomplished using the `SHOW BINLOG EVENTS` statement on either the source or replica SQL node. (See [Section 13.7.5.2, "SHOW BINLOG EVENTS Statement"](#).)

You can also obtain useful information from the output of `SHOW ENGINE NDB STATUS`.



#### Note

When performing schema changes on NDB tables, applications should wait until the `ALTER TABLE` statement has returned in the MySQL client connection that issued the statement before attempting to use the updated definition of the table.

## ndb\_apply\_status Table

`ndb_apply_status` is used to keep a record of the operations that have been replicated from the source to the replica. If the `ndb_apply_status` table does not exist on the replica, `ndb_restore` re-creates it.

Unlike the case with `ndb_binlog_index`, the data in this table is not specific to any one SQL node in the (replica) cluster, and so `ndb_apply_status` can use the `NDBCLUSTER` storage engine, as shown here:

```
CREATE TABLE `ndb_apply_status` (
  `server_id` INT(10) UNSIGNED NOT NULL,
  `epoch` BIGINT(20) UNSIGNED NOT NULL,
  `log_name` VARCHAR(255) CHARACTER SET latin1 COLLATE latin1_bin NOT NULL,
  `start_pos` BIGINT(20) UNSIGNED NOT NULL,
  `end_pos` BIGINT(20) UNSIGNED NOT NULL,
  PRIMARY KEY (`server_id`) USING HASH
) ENGINE=NDBCLUSTER DEFAULT CHARSET=latin1;
```

The `ndb_apply_status` table is populated only on replicas, which means that, on the source, this table never contains any rows; thus, there is no need to allot any `DataMemory` to `ndb_apply_status` there.

Because this table is populated from data originating on the source, it should be allowed to replicate; any replication filtering or binary log filtering rules that inadvertently prevent the replica from updating `ndb_apply_status`, or that prevent the source from writing into the binary log may prevent replication

between clusters from operating properly. For more information about potential problems arising from such filtering rules, see [Replication and binary log filtering rules with replication between NDB Clusters](#).

0 in the `epoch` column of this table indicates a transaction originating from a storage engine other than NDB.

## ndb\_binlog\_index Table

NDB Cluster Replication uses the `ndb_binlog_index` table for storing the binary log's indexing data. Since this table is local to each MySQL server and does not participate in clustering, it uses the `InnoDB` storage engine. This means that it must be created separately on each `mysqld` participating in the source cluster. (The binary log itself contains updates from all MySQL servers in the cluster.) This table is defined as follows:

```
CREATE TABLE `ndb_binlog_index` (
  `Position` BIGINT(20) UNSIGNED NOT NULL,
  `File` VARCHAR(255) NOT NULL,
  `epoch` BIGINT(20) UNSIGNED NOT NULL,
  `inserts` INT(10) UNSIGNED NOT NULL,
  `updates` INT(10) UNSIGNED NOT NULL,
  `deletes` INT(10) UNSIGNED NOT NULL,
  `schemaops` INT(10) UNSIGNED NOT NULL,
  `orig_server_id` INT(10) UNSIGNED NOT NULL,
  `orig_epoch` BIGINT(20) UNSIGNED NOT NULL,
  `gci` INT(10) UNSIGNED NOT NULL,
  `next_position` bigint(20) unsigned NOT NULL,
  `next_file` varchar(255) NOT NULL,
  PRIMARY KEY (`epoch`,`orig_server_id`,`orig_epoch`)
) ENGINE=InnoDB DEFAULT CHARSET=latin1;
```



### Note

Prior to NDB 7.5.2, this table always used the `MyISAM` storage engine. If you are upgrading from an earlier release, you can use `mysql_upgrade` with the `--force` and `--upgrade-system-tables` options after starting the server.) The system table upgrade causes an `ALTER TABLE ... ENGINE=INNODB` statement to be executed for this table. Use of the `MyISAM` storage engine for this table continues to be supported for backward compatibility.

`ndb_binlog_index` may require additional disk space after being converted to `InnoDB`. If this becomes an issue, you may be able to conserve space by using an `InnoDB` tablespace for this table, changing its `ROW_FORMAT` to `COMPRESSED`, or both. For more information, see [Section 13.1.19, “CREATE TABLESPACE Statement”](#), and [Section 13.1.18, “CREATE TABLE Statement”](#), as well as [Section 14.6.3, “Tablespaces”](#).

The size of the `ndb_binlog_index` table is dependent on the number of epochs per binary log file and the number of binary log files. The number of epochs per binary log file normally depends on the amount of binary log generated per epoch and the size of the binary log file, with smaller epochs resulting in more epochs per file. You should be aware that empty epochs produce inserts to the `ndb_binlog_index` table, even when the `--ndb-log-empty-epochs` option is `OFF`, meaning that the number of entries per file depends on the length of time that the file is in use; this relationship can be represented by the formula shown here:

$$[\text{number of epochs per file}] = [\text{time spent per file}] / \text{TimeBetweenEpochs}$$

A busy NDB Cluster writes to the binary log regularly and presumably rotates binary log files more quickly than a quiet one. This means that a “quiet” NDB Cluster with `--ndb-log-empty-epochs=ON` can

actually have a much higher number of `ndb_binlog_index` rows per file than one with a great deal of activity.

When `mysqld` is started with the `--ndb-log-orig` option, the `orig_server_id` and `orig_epoch` columns store, respectively, the ID of the server on which the event originated and the epoch in which the event took place on the originating server, which is useful in NDB Cluster replication setups employing multiple sources. The `SELECT` statement used to find the closest binary log position to the highest applied epoch on the replica in a multi-source setup (see [Section 21.7.10, “NDB Cluster Replication: Bidirectional and Circular Replication”](#)) employs these two columns, which are not indexed. This can lead to performance issues when trying to fail over, since the query must perform a table scan, especially when the source has been running with `--ndb-log-empty-epochs=ON`. You can improve multi-source failover times by adding an index to these columns, as shown here:

```
ALTER TABLE mysql.ndb_binlog_index
  ADD INDEX orig_lookup USING BTREE (orig_server_id, orig_epoch);
```

Adding this index provides no benefit when replicating from a single source to a single replica, since the query used to get the binary log position in such cases makes no use of `orig_server_id` or `orig_epoch`.

See [Section 21.7.8, “Implementing Failover with NDB Cluster Replication”](#), for more information about using the `next_position` and `next_file` columns.

The following figure shows the relationship of the NDB Cluster replication source server, its binary log injector thread, and the `mysql.ndb_binlog_index` table.

**Figure 21.16 The Replication Source Cluster**

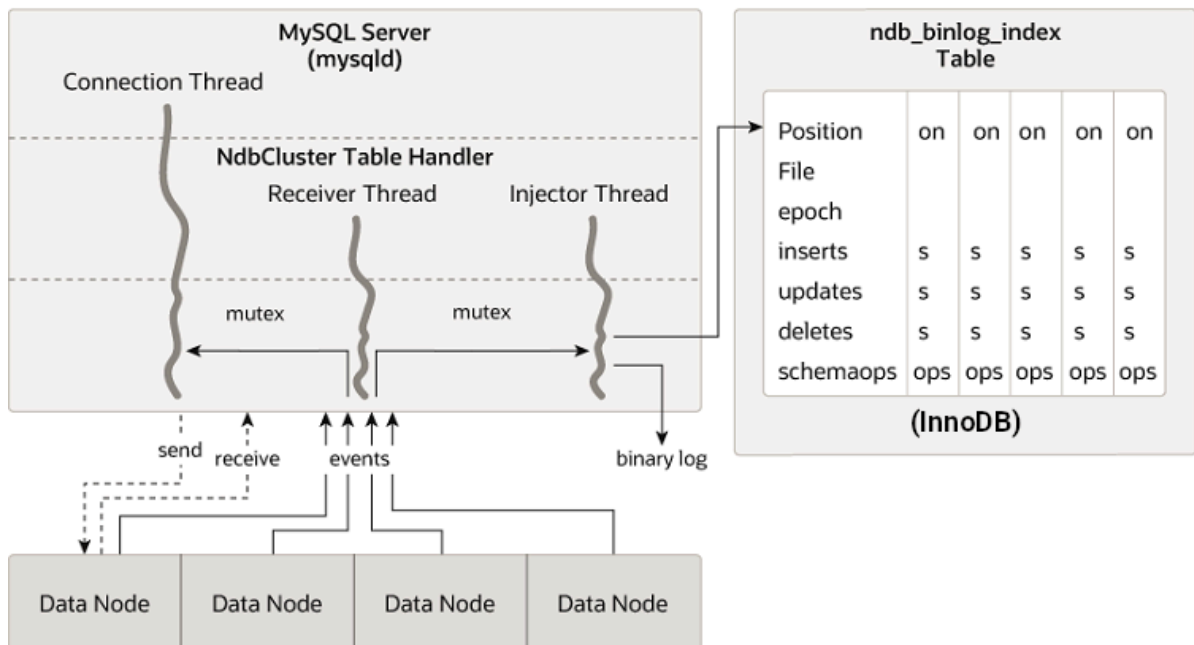

## ndb\_replication Table

The `ndb_replication` table is used to control binary logging and conflict resolution, and acts on a per-table basis. Each row in this table corresponds to a table being replicated, determines how to log changes to the table and, if a conflict resolution function is specified, and determines how to resolve conflicts for that table.

Unlike the `ndb_apply_status` and `ndb_replication` tables, the `ndb_replication` table must be created manually, using the SQL statement shown here:

```
CREATE TABLE mysql.ndb_replication (
  db VARBINARY(63),
  table_name VARBINARY(63),
  server_id INT UNSIGNED,
  binlog_type INT UNSIGNED,
  conflict_fn VARBINARY(128),
  PRIMARY KEY USING HASH (db, table_name, server_id)
) ENGINE=NDB
PARTITION BY KEY(db,table_name);
```

The columns of this table are listed here, with descriptions:

- `db` column

The name of the database containing the table to be replicated.

You may employ either or both of the wildcards `_` and `%` as part of the database name. (See [Matching with wildcards](#), later in this section.)

- `table_name` column

The name of the table to be replicated.

The table name may include either or both of the wildcards `_` and `%`. See [Matching with wildcards](#), later in this section.

- `server_id` column

The unique server ID of the MySQL instance (SQL node) where the table resides.

`0` in this column acts like a wildcard equivalent to `%`, and matches any server ID. (See [Matching with wildcards](#), later in this section.)

- `binlog_type` column

The type of binary logging to be employed. See text for values and descriptions.

- `conflict_fn` column

The conflict resolution function to be applied; one of [NDB\\$OLD\(\)](#), [NDB\\$MAX\(\)](#), [NDB\\$MAX\\_DELETE\\_WIN\(\)](#), [NDB\\$EPOCH\(\)](#), [NDB\\$EPOCH\\_TRANS\(\)](#), [NDB\\$EPOCH2\(\)](#), [NDB\\$EPOCH2\\_TRANS\(\)](#); `NULL` indicates that conflict resolution is not used for this table.

See [Conflict Resolution Functions](#), for more information about these functions and their uses in NDB Replication conflict resolution.

Some conflict resolution functions ([NDB\\$OLD\(\)](#), [NDB\\$EPOCH\(\)](#), [NDB\\$EPOCH\\_TRANS\(\)](#)) require the use of one or more user-created exceptions tables. See [Conflict Resolution Exceptions Table](#).

To enable conflict resolution with NDB Replication, it is necessary to create and populate this table with control information on the SQL node or nodes on which the conflict should be resolved. Depending on the conflict resolution type and method to be employed, this may be the source, the replica, or both servers. In a simple source-replica setup where data can also be changed locally on the replica this is typically the replica. In a more complex replication scheme, such as bidirectional replication, this is usually all of the sources involved. See [Section 21.7.11, “NDB Cluster Replication Conflict Resolution”](#), for more information.

The `ndb_replication` table allows table-level control over binary logging outside the scope of conflict resolution, in which case `conflict_fn` is specified as `NULL`, while the remaining column values are used to control binary logging for a given table or set of tables matching a wildcard expression. By setting the proper value for the `binlog_type` column, you can make logging for a given table or tables use a desired binary log format, or disabling binary logging altogether. Possible values for this column, with values and descriptions, are shown in the following table:

**Table 21.64 binlog\_type values, with values and descriptions**

Value	Description
0	Use server default
1	Do not log this table in the binary log (same effect as <code>sql_log_bin = 0</code> , but applies to one or more specified tables only)
2	Log updated attributes only; log these as <code>WRITE_ROW</code> events
3	Log full row, even if not updated (MySQL server default behavior)
6	Use updated attributes, even if values are unchanged
7	Log full row, even if no values are changed; log updates as <code>UPDATE_ROW</code> events
8	Log update as <code>UPDATE_ROW</code> ; log only primary key columns in before image, and only updated columns in after image (same effect as <code>--ndb-log-update-minimal</code> , but applies to one or more specified tables only)
9	Log update as <code>UPDATE_ROW</code> ; log only primary key columns in before image, and all columns other than primary key columns in after image



**Note**

`binlog_type` values 4 and 5 are not used, and so are omitted from the table just shown, as well as from the next table.

Several `binlog_type` values are equivalent to various combinations of the `mysqld` logging options `--ndb-log-updated-only`, `--ndb-log-update-as-write`, and `--ndb-log-update-minimal`, as shown in the following table:

**Table 21.65 binlog\_type values with equivalent combinations of NDB logging options**

Value	<code>--ndb-log-updated-only</code> Value	<code>--ndb-log-update-as-write</code> Value	<code>--ndb-log-update-minimal</code> Value
0	--	--	--
1	--	--	--
2	ON	ON	OFF
3	OFF	ON	OFF
6	ON	OFF	OFF
7	OFF	OFF	OFF
8	ON	OFF	ON

Value	--ndb-log-updated-only Value	--ndb-log-update-as-write Value	--ndb-log-update-minimal Value
9	OFF	OFF	ON

Binary logging can be set to different formats for different tables by inserting rows into the `ndb_replication` table using the appropriate `db`, `table_name`, and `binlog_type` column values. The internal integer value shown in the preceding table should be used when setting the binary logging format. The following two statements set binary logging to logging of full rows (value 3) for table `test.a`, and to logging of updates only (value 2) for table `test.b`:

```
# Table test.a: Log full rows
INSERT INTO mysql.ndb_replication VALUES("test", "a", 0, 3, NULL);

# Table test.b: log updates only
INSERT INTO mysql.ndb_replication VALUES("test", "b", 0, 2, NULL);
```

To disable logging for one or more tables, use 1 for `binlog_type`, as shown here:

```
# Disable binary logging for table test.t1
INSERT INTO mysql.ndb_replication VALUES("test", "t1", 0, 1, NULL);

# Disable binary logging for any table in 'test' whose name begins with 't'
INSERT INTO mysql.ndb_replication VALUES("test", "t%", 0, 1, NULL);
```

Disabling logging for a given table is the equivalent of setting `sql_log_bin = 0`, except that it applies to one or more tables individually. If an SQL node is not performing binary logging for a given table, it is not sent the row change events for those tables. This means that it is not receiving all changes and discarding some, but rather it is not subscribing to these changes.

Disabling logging can be useful for a number of reasons, including those listed here:

- Not sending changes across the network generally saves bandwidth, buffering, and CPU resources.
- Not logging changes to tables with very frequent updates but whose value is not great is a good fit for transient data (such as session data) that may be relatively unimportant in the event of a complete failure of the cluster.
- Using a session variable (or `sql_log_bin`) and application code, it is also possible to log (or not to log) certain SQL statements or types of SQL statements; for example, it may be desirable in some cases not to record DDL statements on one or more tables.
- Splitting replication streams into two (or more) binary logs can be done for reasons of performance, a need to replicate different databases to different places, use of different binary logging types for different databases, and so on.

**Matching with wildcards.** In order not to make it necessary to insert a row in the `ndb_replication` table for each and every combination of database, table, and SQL node in your replication setup, NDB supports wildcard matching on the this table's `db`, `table_name`, and `server_id` columns. Database and table names used in, respectively, `db` and `table_name` may contain either or both of the following wildcards:

- `_` (underscore character): matches zero or more characters
- `%` (percent sign): matches a single character

(These are the same wildcards as supported by the MySQL `LIKE` operator.)

The `server_id` column supports 0 as a wildcard equivalent to `_` (matches anything). This is used in the examples shown previously.



A given row in the `ndb_replication` table can use wildcards to match any of the database name, table name, and server ID in any combination. Where there are multiple potential matches in the table, the best match is chosen, according to the table shown here, where *W* represents a wildcard match, *E* an exact match, and the greater the value in the *Quality* column, the better the match:

**Table 21.66 Weights of different combinations of wildcard and exact matches on columns in the `mysql.ndb_replication` table**

db	table_name	server_id	Quality
W	W	W	1
W	W	E	2
W	E	W	3
W	E	E	4
E	W	W	5
E	W	E	6
E	E	W	7
E	E	E	8

Thus, an exact match on database name, table name, and server ID is considered best (strongest), while the weakest (worst) match is a wildcard match on all three columns. Only the strength of the match is considered when choosing which rule to apply; the order in which the rows occur in the table has no effect on this determination.

**Logging Full or Partial Rows.** There are two basic methods of logging rows, as determined by the setting of the `--ndb-log-updated-only` option for `mysqld`:

- Log complete rows (option set to `ON`)
- Log only column data that has been updated—that is, column data whose value has been set, regardless of whether or not this value was actually changed. This is the default behavior (option set to `OFF`).

It is usually sufficient—and more efficient—to log updated columns only; however, if you need to log full rows, you can do so by setting `--ndb-log-updated-only` to `0` or `OFF`.

**Logging Changed Data as Updates.** The setting of the MySQL Server's `--ndb-log-update-as-write` option determines whether logging is performed with or without the “before” image.

Because conflict resolution for updates and delete operations is done in the MySQL Server's update handler, it is necessary to control the logging performed by the replication source such that updates are updates and not writes; that is, such that updates are treated as changes in existing rows rather than the writing of new rows, even though these replace existing rows.

This option is turned on by default; in other words, updates are treated as writes. That is, updates are by default written as `write_row` events in the binary log, rather than as `update_row` events.

To disable the option, start the source `mysqld` with `--ndb-log-update-as-write=0` or `--ndb-log-update-as-write=OFF`. You must do this when replicating from NDB tables to tables using a different storage engine; see [Replication from NDB to other storage engines](#), and [Replication from NDB to a nontransactional storage engine](#), for more information.

## 21.7.5 Preparing the NDB Cluster for Replication

Preparing the NDB Cluster for replication consists of the following steps:

1. Check all MySQL servers for version compatibility (see [Section 21.7.2, “General Requirements for NDB Cluster Replication”](#)).
2. Create a replication account on the source Cluster with the appropriate privileges, using the following two SQL statements:

```
mysqlS> CREATE USER 'replica_user'@'replica_host'
        -> IDENTIFIED BY 'replica_password';

mysqlS> GRANT REPLICATION SLAVE ON *.*
        -> TO 'replica_user'@'replica_host';
```

In the previous statement, *replica\_user* is the replication account user name, *replica\_host* is the host name or IP address of the replica, and *replica\_password* is the password to assign to this account.

For example, to create a replica user account with the name *myreplica*, logging in from the host named *replica-host*, and using the password *53cr37*, use the following `CREATE USER` and `GRANT` statements:

```
mysqlS> CREATE USER 'myreplica'@'replica-host'
        -> IDENTIFIED BY '53cr37';

mysqlS> GRANT REPLICATION SLAVE ON *.*
        -> TO 'myreplica'@'replica-host';
```

For security reasons, it is preferable to use a unique user account—not employed for any other purpose—for the replication account.

3. Set up the replica to use the source. Using the `mysql` client, this can be accomplished with the following `CHANGE MASTER TO` statement:

```
mysqlR> CHANGE MASTER TO
        -> MASTER_HOST='source_host',
        -> MASTER_PORT=source_port,
        -> MASTER_USER='replica_user',
        -> MASTER_PASSWORD='replica_password';
```

In the previous statement, *source\_host* is the host name or IP address of the replication source, *source\_port* is the port for the replica to use when connecting to the source, *replica\_user* is the user name set up for the replica on the source, and *replica\_password* is the password set for that user account in the previous step.

For example, to tell the replica to use the MySQL server whose host name is *rep-source* with the replication account created in the previous step, use the following statement:

```
mysqlR> CHANGE MASTER TO
        -> MASTER_HOST='rep-source',
        -> MASTER_PORT=3306,
        -> MASTER_USER='myreplica',
        -> MASTER_PASSWORD='53cr37';
```

For a complete list of options that can be used with this statement, see [Section 13.4.2.1, “CHANGE MASTER TO Statement”](#).

To provide replication backup capability, you also need to add an `--ndb-connectstring` option to the replica's `my.cnf` file prior to starting the replication process. See [Section 21.7.9, “NDB Cluster Backups With NDB Cluster Replication”](#), for details.

For additional options that can be set in `my.cnf` for replicas, see [Section 16.1.6, “Replication and Binary Logging Options and Variables”](#).

4. If the source cluster is already in use, you can create a backup of the source and load this onto the replica to cut down on the amount of time required for the replica to synchronize itself with the source. If the replica is also running NDB Cluster, this can be accomplished using the backup and restore procedure described in [Section 21.7.9, “NDB Cluster Backups With NDB Cluster Replication”](#).

```
ndb-connectstring=management_host[:port]
```

In the event that you are *not* using NDB Cluster on the replica, you can create a backup with this command on the source:

```
shellS> mysqldump --master-data=1
```

Then import the resulting data dump onto the replica by copying the dump file over to it. After this, you can use the `mysql` client to import the data from the dumpfile into the replica database as shown here, where `dump_file` is the name of the file that was generated using `mysqldump` on the source, and `db_name` is the name of the database to be replicated:

```
shellR> mysql -u root -p db_name < dump_file
```

For a complete list of options to use with `mysqldump`, see [Section 4.5.4, “mysqldump — A Database Backup Program”](#).



#### Note

If you copy the data to the replica in this fashion, you should make sure that the replica is started with the `--skip-slave-start` option on the command line, or else include `skip-slave-start` in the replica's `my.cnf` file to keep it from trying to connect to the source to begin replicating before all the data has been loaded. Once the data loading has completed, follow the additional steps outlined in the next two sections.

5. Ensure that each MySQL server acting as a replication source is assigned a unique server ID, and has binary logging enabled, using the row-based format. (See [Section 16.2.1, “Replication Formats”](#).) In addition, we recommend enabling the `slave_allow_batching` system variable; beginning with NDB 7.6.23, a warning is issued if this variable is set to `OFF`. You should also consider increasing the values used with the `--ndb-batch-size` and `--ndb-blob-write-batch-bytes` options as well. All of these options can be set either in the source server's `my.cnf` file, or on the command line when starting the source `mysqld` process. See [Section 21.7.6, “Starting NDB Cluster Replication \(Single Replication Channel\)”](#), for more information.

## 21.7.6 Starting NDB Cluster Replication (Single Replication Channel)

This section outlines the procedure for starting NDB Cluster replication using a single replication channel.

1. Start the MySQL replication source server by issuing this command, where `id` is this server's unique ID (see [Section 21.7.2, “General Requirements for NDB Cluster Replication”](#)):

```
shellS> mysqld --ndbcluster --server-id=id \
--log-bin --ndb-log-bin &
```

This starts the server's `mysqld` process with binary logging enabled using the proper logging format.

**Note**

You can also start the source with `--binlog-format=MIXED`, in which case row-based replication is used automatically when replicating between clusters. Statement-based binary logging is not supported for NDB Cluster Replication (see [Section 21.7.2, “General Requirements for NDB Cluster Replication”](#)).

2. Start the MySQL replica server as shown here:

```
shellR> mysqld --ndbcluster --server-id=id &
```

In the command just shown, `id` is the replica server's unique ID. It is not necessary to enable logging on the replica.

**Note**

You should use the `--skip-slave-start` option with this command or else you should include `skip-slave-start` in the replica server's `my.cnf` file, unless you want replication to begin immediately. With the use of this option, the start of replication is delayed until the appropriate `START SLAVE` statement has been issued, as explained in Step 4 below.

3. It is necessary to synchronize the replica server with the source server's replication binary log. If binary logging has not previously been running on the source, run the following statement on the replica:

```
mysqlR> CHANGE MASTER TO
-> MASTER_LOG_FILE='',
-> MASTER_LOG_POS=4;
```

This instructs the replica to begin reading the source server's binary log from the log's starting point. Otherwise—that is, if you are loading data from the source using a backup—see [Section 21.7.8, “Implementing Failover with NDB Cluster Replication”](#), for information on how to obtain the correct values to use for `MASTER_LOG_FILE` and `MASTER_LOG_POS` in such cases.

4. Finally, instruct the replica to begin applying replication by issuing this command from the `mysql` client on the replica:

```
mysqlR> START SLAVE;
```

This also initiates the transmission of data and changes from the source to the replica.

It is also possible to use two replication channels, in a manner similar to the procedure described in the next section; the differences between this and using a single replication channel are covered in [Section 21.7.7, “Using Two Replication Channels for NDB Cluster Replication”](#).

It is also possible to improve cluster replication performance by enabling *batched updates*. This can be accomplished by setting the `slave_allow_batching` system variable on the replicas' `mysqld` processes. Normally, updates are applied as soon as they are received. However, the use of batching causes updates to be applied in batches of 32 KB each; this can result in higher throughput and less CPU usage, particularly where individual updates are relatively small.

**Note**

Batching works on a per-epoch basis; updates belonging to more than one transaction can be sent as part of the same batch.

All outstanding updates are applied when the end of an epoch is reached, even if the updates total less than 32 KB.

Batching can be turned on and off at runtime. To activate it at runtime, you can use either of these two statements:

```
SET GLOBAL slave_allow_batching = 1;
SET GLOBAL slave_allow_batching = ON;
```

If a particular batch causes problems (such as a statement whose effects do not appear to be replicated correctly), batching can be deactivated using either of the following statements:

```
SET GLOBAL slave_allow_batching = 0;
SET GLOBAL slave_allow_batching = OFF;
```

You can check whether batching is currently being used by means of an appropriate `SHOW VARIABLES` statement, like this one:

```
mysql> SHOW VARIABLES LIKE 'slave%';
+-----+-----+
| Variable_name | Value |
+-----+-----+
| slave_allow_batching | ON |
| slave_compressed_protocol | OFF |
| slave_load_tmpdir | /tmp |
| slave_net_timeout | 3600 |
| slave_skip_errors | OFF |
| slave_transaction_retries | 10 |
+-----+-----+
6 rows in set (0.00 sec)
```

## 21.7.7 Using Two Replication Channels for NDB Cluster Replication

In a more complete example scenario, we envision two replication channels to provide redundancy and thereby guard against possible failure of a single replication channel. This requires a total of four replication servers, two source servers on the source cluster and two replica servers on the replica cluster. For purposes of the discussion that follows, we assume that unique identifiers are assigned as shown here:

**Table 21.67 NDB Cluster replication servers described in the text**

Server ID	Description
1	Source - primary replication channel (S)
2	Source - secondary replication channel (S)
3	Replica - primary replication channel (R)
4	replica - secondary replication channel (R)

Setting up replication with two channels is not radically different from setting up a single replication channel. First, the `mysqld` processes for the primary and secondary replication source servers must be started, followed by those for the primary and secondary replicas. The replication processes can be initiated by issuing the `START SLAVE` statement on each of the replicas. The commands and the order in which they need to be issued are shown here:

1. Start the primary replication source:

```
shellS> mysqld --ndbcluster --server-id=1 \
--log-bin &
```

2. Start the secondary replication source:

```
shellS'> mysqld --ndbcluster --server-id=2 \
--log-bin &
```

3. Start the primary replica server:

```
shellR> mysqld --ndbcluster --server-id=3 \
            --skip-slave-start &
```

4. Start the secondary replica server:

```
shellR'> mysqld --ndbcluster --server-id=4 \
            --skip-slave-start &
```

5. Finally, initiate replication on the primary channel by executing the `START SLAVE` statement on the primary replica as shown here:

```
mysqlR> START SLAVE;
```



### Warning

Only the primary channel must be started at this point. The secondary replication channel needs to be started only in the event that the primary replication channel fails, as described in [Section 21.7.8, “Implementing Failover with NDB Cluster Replication”](#). Running multiple replication channels simultaneously can result in unwanted duplicate records being created on the replicas.

As mentioned previously, it is not necessary to enable binary logging on the replicas.

## 21.7.8 Implementing Failover with NDB Cluster Replication

In the event that the primary Cluster replication process fails, it is possible to switch over to the secondary replication channel. The following procedure describes the steps required to accomplish this.

1. Obtain the time of the most recent global checkpoint (GCP). That is, you need to determine the most recent epoch from the `ndb_apply_status` table on the replica cluster, which can be found using the following query:

```
mysqlR'> SELECT @latest:=MAX(epoch)
->         FROM mysql.ndb_apply_status;
```

In a circular replication topology, with a source and a replica running on each host, when you are using `ndb_log_apply_status=1`, NDB Cluster epochs are written in the replicas' binary logs. This means that the `ndb_apply_status` table contains information for the replica on this host as well as for any other host which acts as a replica of the replication source server running on this host.

In this case, you need to determine the latest epoch on this replica to the exclusion of any epochs from any other replicas in this replica's binary log that were not listed in the `IGNORE_SERVER_IDS` options of the `CHANGE MASTER TO` statement used to set up this replica. The reason for excluding such epochs is that rows in the `mysql.ndb_apply_status` table whose server IDs have a match in the `IGNORE_SERVER_IDS` list from the `CHANGE MASTER TO` statement used to prepare this replica's source are also considered to be from local servers, in addition to those having the replica's own server ID. You can retrieve this list as `Replicate_Ignore_Server_Ids` from the output of `SHOW SLAVE STATUS`. We assume that you have obtained this list and are substituting it for `ignore_server_ids` in the query shown here, which like the previous version of the query, selects the greatest epoch into a variable named `@latest`:

```
mysqlR'> SELECT @latest:=MAX(epoch)
->         FROM mysql.ndb_apply_status
->         WHERE server_id NOT IN (ignore_server_ids);
```

In some cases, it may be simpler or more efficient (or both) to use a list of the server IDs to be included and `server_id IN server_id_list` in the `WHERE` condition of the preceding query.

- Using the information obtained from the query shown in Step 1, obtain the corresponding records from the `ndb_binlog_index` table on the source cluster.

You can use the following query to obtain the needed records from the `ndb_binlog_index` table on the source:

```
mysqlS'> SELECT
->     @file:=SUBSTRING_INDEX(next_file, '/', -1),
->     @pos:=next_position
-> FROM mysql.ndb_binlog_index
-> WHERE epoch = @latest;
```

These are the records saved on the source since the failure of the primary replication channel. We have employed a user variable `@latest` here to represent the value obtained in Step 1. Of course, it is not possible for one `mysqld` instance to access user variables set on another server instance directly. These values must be “plugged in” to the second query manually or by an application.



### Important

You must ensure that the replica `mysqld` is started with `--slave-skip-errors=ddl_exist_errors` before executing `START SLAVE`. Otherwise, replication may stop with duplicate DDL errors.

- Now it is possible to synchronize the secondary channel by running the following query on the secondary replica server:

```
mysqlR'> CHANGE MASTER TO
->     MASTER_LOG_FILE='@file',
->     MASTER_LOG_POS=@pos;
```

Again we have employed user variables (in this case `@file` and `@pos`) to represent the values obtained in Step 2 and applied in Step 3; in practice these values must be inserted manually or using an application that can access both of the servers involved.



### Note

`@file` is a string value such as `'/var/log/mysql/replication-source-bin.00001'`, and so must be quoted when used in SQL or application code. However, the value represented by `@pos` must *not* be quoted. Although MySQL normally attempts to convert strings to numbers, this case is an exception.

- You can now initiate replication on the secondary channel by issuing the appropriate statement on the secondary replica `mysqld`:

```
mysqlR'> START SLAVE;
```

Once the secondary replication channel is active, you can investigate the failure of the primary and effect repairs. The precise actions required to do this depend upon the reasons for which the primary channel failed.



### Warning

The secondary replication channel is to be started only if and when the primary replication channel has failed. Running multiple replication channels simultaneously can result in unwanted duplicate records being created on the replicas.

If the failure is limited to a single server, it should in theory be possible to replicate from `S` to `R'`, or from `S'` to `R`.

## 21.7.9 NDB Cluster Backups With NDB Cluster Replication

This section discusses making backups and restoring from them using NDB Cluster replication. We assume that the replication servers have already been configured as covered previously (see [Section 21.7.5, “Preparing the NDB Cluster for Replication”](#), and the sections immediately following). This having been done, the procedure for making a backup and then restoring from it is as follows:

1. There are two different methods by which the backup may be started.

- **Method A.** This method requires that the cluster backup process was previously enabled on the source server, prior to starting the replication process. This can be done by including the following line in a `[mysql_cluster]` section in the `my.cnf` file, where `management_host` is the IP address or host name of the NDB management server for the source cluster, and `port` is the management server's port number:

```
ndb-connectstring=management_host[:port]
```



### Note

The port number needs to be specified only if the default port (1186) is not being used. See [Section 21.3.3, “Initial Configuration of NDB Cluster”](#), for more information about ports and port allocation in NDB Cluster.

In this case, the backup can be started by executing this statement on the replication source:

```
shellS> ndb_mgm -e "START BACKUP"
```

- **Method B.** If the `my.cnf` file does not specify where to find the management host, you can start the backup process by passing this information to the NDB management client as part of the `START BACKUP` command. This can be done as shown here, where `management_host` and `port` are the host name and port number of the management server:

```
shellS> ndb_mgm management_host:port -e "START BACKUP"
```

In our scenario as outlined earlier (see [Section 21.7.5, “Preparing the NDB Cluster for Replication”](#)), this would be executed as follows:

```
shellS> ndb_mgm rep-source:1186 -e "START BACKUP"
```

2. Copy the cluster backup files to the replica that is being brought on line. Each system running an `ndbd` process for the source cluster has cluster backup files located on it, and *all* of these files must be copied to the replica to ensure a successful restore. The backup files can be copied into any directory on the computer where the replica's management host resides, as long as the MySQL and NDB binaries have read permissions in that directory. In this case, we assume that these files have been copied into the directory `/var/BACKUPS/BACKUP-1`.

While it is not necessary that the replica cluster have the same number of `ndbd` processes (data nodes) as the source, it is highly recommended this number be the same. It is necessary that the replica be started with the `--skip-slave-start` option, to prevent premature startup of the replication process.

3. Create any databases on the replica cluster that are present on the source cluster and that are to be replicated.



**Important**

A `CREATE DATABASE` (or `CREATE SCHEMA`) statement corresponding to each database to be replicated must be executed on each SQL node in the replica cluster.

- Reset the replica cluster using this statement in the `mysql` client:

```
mysqlR> RESET SLAVE;
```

- You can now start the cluster restoration process on the replica using the `ndb_restore` command for each backup file in turn. For the first of these, it is necessary to include the `-m` option to restore the cluster metadata, as shown here:

```
shellR> ndb_restore -c replica_host:port -n node-id \
          -b backup-id -m -r dir
```

`dir` is the path to the directory where the backup files have been placed on the replica. For the `ndb_restore` commands corresponding to the remaining backup files, the `-m` option should *not* be used.

For restoring from a source cluster with four data nodes (as shown in the figure in [Section 21.7, “NDB Cluster Replication”](#)) where the backup files have been copied to the directory `/var/BACKUPS/BACKUP-1`, the proper sequence of commands to be executed on the replica might look like this:

```
shellR> ndb_restore -c replica-host:1186 -n 2 -b 1 -m \
          -r ./var/BACKUPS/BACKUP-1
shellR> ndb_restore -c replica-host:1186 -n 3 -b 1 \
          -r ./var/BACKUPS/BACKUP-1
shellR> ndb_restore -c replica-host:1186 -n 4 -b 1 \
          -r ./var/BACKUPS/BACKUP-1
shellR> ndb_restore -c replica-host:1186 -n 5 -b 1 -e \
          -r ./var/BACKUPS/BACKUP-1
```

**Important**

The `-e` (or `--restore-epoch`) option in the final invocation of `ndb_restore` in this example is required to make sure that the epoch is written to the replica's `mysql.ndb_apply_status` table. Without this information, the replica cannot synchronize properly with the source. (See [Section 21.5.24, “ndb\\_restore — Restore an NDB Cluster Backup”](#).)

- Now you need to obtain the most recent epoch from the `ndb_apply_status` table on the replica (as discussed in [Section 21.7.8, “Implementing Failover with NDB Cluster Replication”](#)):

```
mysqlR> SELECT @latest:=MAX(epoch)
          FROM mysql.ndb_apply_status;
```

- Using `@latest` as the epoch value obtained in the previous step, you can obtain the correct starting position `@pos` in the correct binary log file `@file` from the `mysql.ndb_binlog_index` table on the source. The query shown here gets these from the `next_position` and `next_file` columns from the last epoch applied before the logical restore position:

```
mysqlS> SELECT
->     @file:=SUBSTRING_INDEX(next_file, '/', -1),
->     @pos:=next_position
-> FROM mysql.ndb_binlog_index
-> WHERE epoch > @latest
```

```
-> ORDER BY epoch ASC LIMIT 1;
```

In the event that there is currently no replication traffic, you can get similar information by running `SHOW MASTER STATUS` on the source and using the value shown in the `Position` column of the output for the file whose name has the suffix with the greatest value for all files shown in the `File` column. In this case, you must determine which file this is and supply the name in the next step manually or by parsing the output with a script.

- Using the values obtained in the previous step, you can now issue the appropriate `CHANGE MASTER TO` statement in the replica's `mysql` client:

```
mysqlR> CHANGE MASTER TO
->     MASTER_LOG_FILE='@file',
->     MASTER_LOG_POS=@pos;
```

- Now that the replica knows from what point in which binary log file to start reading data from the source, you can cause the replica to begin replicating with this statement:

```
mysqlR> START SLAVE;
```

To perform a backup and restore on a second replication channel, it is necessary only to repeat these steps, substituting the host names and IDs of the secondary source and replica for those of the primary source and replica servers where appropriate, and running the preceding statements on them.

For additional information on performing Cluster backups and restoring Cluster from backups, see [Section 21.6.8, “Online Backup of NDB Cluster”](#).

### 21.7.9.1 NDB Cluster Replication: Automating Synchronization of the Replica to the Source Binary Log

It is possible to automate much of the process described in the previous section (see [Section 21.7.9, “NDB Cluster Backups With NDB Cluster Replication”](#)). The following Perl script `reset-replica.pl` serves as an example of how you can do this.

```
#!/user/bin/perl -w

# file: reset-replica.pl

# Copyright (c) 2005, 2020, Oracle and/or its affiliates. All rights reserved.

# This program is free software; you can redistribute it and/or modify
# it under the terms of the GNU General Public License as published by
# the Free Software Foundation; either version 2 of the License, or
# (at your option) any later version.

# This program is distributed in the hope that it will be useful,
# but WITHOUT ANY WARRANTY; without even the implied warranty of
# MERCHANTABILITY or FITNESS FOR A PARTICULAR PURPOSE. See the
# GNU General Public License for more details.

# You should have received a copy of the GNU General Public License
# along with this program; if not, write to:
# Free Software Foundation, Inc.
# 59 Temple Place, Suite 330
# Boston, MA 02111-1307 USA
#
# Version 1.1

##### Includes #####

use DBI;
```

```
##### Globals #####

my $m_host='';
my $m_port='';
my $m_user='';
my $m_pass='';
my $s_host='';
my $s_port='';
my $s_user='';
my $s_pass='';
my $dbhM='';
my $dbhS='';

##### Sub Prototypes #####

sub CollectCommandPromptInfo;
sub ConnectToDatabases;
sub DisconnectFromDatabases;
sub GetReplicaEpoch;
sub GetSourceInfo;
sub UpdateReplica;

##### Program Main #####

CollectCommandPromptInfo;
ConnectToDatabases;
GetReplicaEpoch;
GetSourceInfo;
UpdateReplica;
DisconnectFromDatabases;

##### Collect Command Prompt Info #####

sub CollectCommandPromptInfo
{
  ### Check that user has supplied correct number of command line args
  die "Usage:\n
      reset-replica >source MySQL host< >source MySQL port< \n
          >source user< >source pass< >replica MySQL host< \n
          >replica MySQL port< >replica user< >replica pass< \n
  All 8 arguments must be passed. Use BLANK for NULL passwords\n"
  unless @ARGV == 8;

  $m_host = $ARGV[0];
  $m_port = $ARGV[1];
  $m_user = $ARGV[2];
  $m_pass = $ARGV[3];
  $s_host = $ARGV[4];
  $s_port = $ARGV[5];
  $s_user = $ARGV[6];
  $s_pass = $ARGV[7];

  if ($m_pass eq "BLANK") { $m_pass = '';}
  if ($s_pass eq "BLANK") { $s_pass = '';}
}

##### Make connections to both databases #####

sub ConnectToDatabases
{
  ### Connect to both source and replica cluster databases

  ### Connect to source
  $dbhM
    = DBI->connect(
      "dbi:mysql:database=mysql;host=$m_host;port=$m_port",
      "$m_user", "$m_pass")
}
```

```

    or die "Can't connect to source cluster MySQL process!
        Error: $DBI::errstr\n";

### Connect to replica
$dbhS
= DBI->connect(
    "dbi:mysql:database=mysql;host=$s_host",
    "$s_user", "$s_pass")
    or die "Can't connect to replica cluster MySQL process!
        Error: $DBI::errstr\n";
}

##### Disconnect from both databases #####

sub DisconnectFromDatabases
{
    ### Disconnect from source

    $dbhM->disconnect
    or warn " Disconnection failed: $DBI::errstr\n";

    ### Disconnect from replica

    $dbhS->disconnect
    or warn " Disconnection failed: $DBI::errstr\n";
}

##### Find the last good GCI #####

sub GetReplicaEpoch
{
    $sth = $dbhS->prepare("SELECT MAX(epoch)
        FROM mysql.ndb_apply_status;")
        or die "Error while preparing to select epoch from replica: ",
            $dbhS->errstr;

    $sth->execute
        or die "Selecting epoch from replica error: ", $sth->errstr;

    $sth->bind_col (1, \$epoch);
    $sth->fetch;
    print "\tReplica epoch = $epoch\n";
    $sth->finish;
}

##### Find the position of the last GCI in the binary log #####

sub GetSourceInfo
{
    $sth = $dbhM->prepare("SELECT
        SUBSTRING_INDEX(File, '/', -1), Position
        FROM mysql.ndb_binlog_index
        WHERE epoch > $epoch
        ORDER BY epoch ASC LIMIT 1;")
        or die "Prepare to select from source error: ", $dbhM->errstr;

    $sth->execute
        or die "Selecting from source error: ", $sth->errstr;

    $sth->bind_col (1, \$binlog);
    $sth->bind_col (2, \$binpos);
    $sth->fetch;
    print "\tSource binary log file = $binlog\n";
    print "\tSource binary log position = $binpos\n";
    $sth->finish;
}

```

```
##### Set the replica to process from that location #####
sub UpdateReplica
{
  $sth = $dbhS->prepare("CHANGE MASTER TO
                        MASTER_LOG_FILE='$binlog',
                        MASTER_LOG_POS=$binpos;")
    or die "Prepare to CHANGE MASTER error: ", $dbhS->errstr;

  $sth->execute
    or die "CHANGE MASTER on replica error: ", $sth->errstr;
  $sth->finish;
  print "\tReplica has been updated. You may now start the replica.\n";
}
# end reset-replica.pl
```

### 21.7.9.2 Point-In-Time Recovery Using NDB Cluster Replication

*Point-in-time* recovery—that is, recovery of data changes made since a given point in time—is performed after restoring a full backup that returns the server to its state when the backup was made. Performing point-in-time recovery of NDB Cluster tables with NDB Cluster and NDB Cluster Replication can be accomplished using a native [NDB](#) data backup (taken by issuing `CREATE BACKUP` in the `ndb_mgm` client) and restoring the `ndb_binlog_index` table (from a dump made using `mysqldump`).

To perform point-in-time recovery of NDB Cluster, it is necessary to follow the steps shown here:

1. Back up all [NDB](#) databases in the cluster, using the `START BACKUP` command in the `ndb_mgm` client (see [Section 21.6.8, “Online Backup of NDB Cluster”](#)).
2. At some later point, prior to restoring the cluster, make a backup of the `mysql.ndb_binlog_index` table. It is probably simplest to use `mysqldump` for this task. Also back up the binary log files at this time.

This backup should be updated regularly—perhaps even hourly—depending on your needs.

3. (*Catastrophic failure or error occurs.*)
4. Locate the last known good backup.
5. Clear the data node file systems (using `ndbd --initial` or `ndbmtl --initial`).



#### Note

NDB Cluster Disk Data tablespace and log files are not removed by `--initial`. You must delete these manually.

6. Use `DROP TABLE` or `TRUNCATE TABLE` with the `mysql.ndb_binlog_index` table.
7. Execute `ndb_restore`, restoring all data. You must include the `--restore-epoch` option when you run `ndb_restore`, so that the `ndb_apply_status` table is populated correctly. (See [Section 21.5.24, “ndb\\_restore — Restore an NDB Cluster Backup”](#), for more information.)
8. Restore the `ndb_binlog_index` table from the output of `mysqldump` and restore the binary log files from backup, if necessary.
9. Find the epoch applied most recently—that is, the maximum `epoch` column value in the `ndb_apply_status` table—as the user variable `@LATEST_EPOCH` (emphasized):

```
SELECT @LATEST_EPOCH:=MAX(epoch)
```

```
FROM mysql.ndb_apply_status;
```

10. Find the latest binary log file (`@FIRST_FILE`) and position (`Position` column value) within this file that correspond to `@LATEST_EPOCH` in the `ndb_binlog_index` table:

```
SELECT Position, @FIRST_FILE:=File
FROM mysql.ndb_binlog_index
WHERE epoch > @LATEST_EPOCH ORDER BY epoch ASC LIMIT 1;
```

11. Using `mysqlbinlog`, replay the binary log events from the given file and position up to the point of the failure. (See [Section 4.6.7, “mysqlbinlog — Utility for Processing Binary Log Files”](#).)

See also [Section 7.5, “Point-in-Time \(Incremental\) Recovery”](#), for more information about the binary log, replication, and incremental recovery.

### 21.7.10 NDB Cluster Replication: Bidirectional and Circular Replication

It is possible to use NDB Cluster for bidirectional replication between two clusters, as well as for circular replication between any number of clusters.

**Circular replication example.** In the next few paragraphs we consider the example of a replication setup involving three NDB Clusters numbered 1, 2, and 3, in which Cluster 1 acts as the replication source for Cluster 2, Cluster 2 acts as the source for Cluster 3, and Cluster 3 acts as the source for Cluster 1. Each cluster has two SQL nodes, with SQL nodes A and B belonging to Cluster 1, SQL nodes C and D belonging to Cluster 2, and SQL nodes E and F belonging to Cluster 3.

Circular replication using these clusters is supported as long as the following conditions are met:

- The SQL nodes on all sources and replicas are the same.
- All SQL nodes acting as sources and replicas are started with the `log_slave_updates` system variable enabled.

This type of circular replication setup is shown in the following diagram:

Figure 21.17 NDB Cluster Circular Replication with All Sources As Replicas

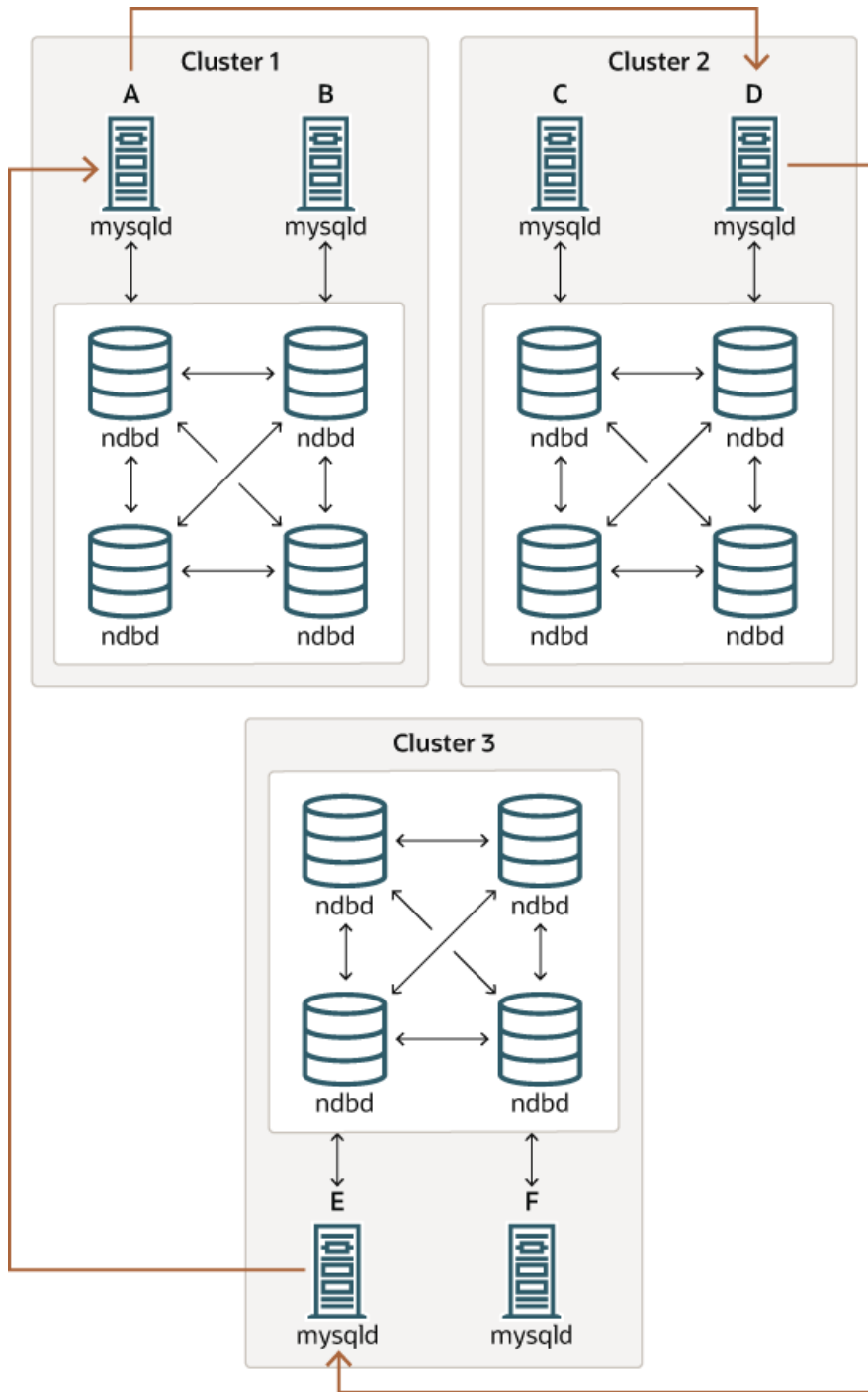

In this scenario, SQL node A in Cluster 1 replicates to SQL node C in Cluster 2; SQL node C replicates to SQL node E in Cluster 3; SQL node E replicates to SQL node A. In other words, the replication line (indicated by the curved arrows in the diagram) directly connects all SQL nodes used as replication sources and replicas.

It is also possible to set up circular replication in such a way that not all source SQL nodes are also replicas, as shown here:

Figure 21.18 NDB Cluster Circular Replication Where Not All Sources Are Replicas

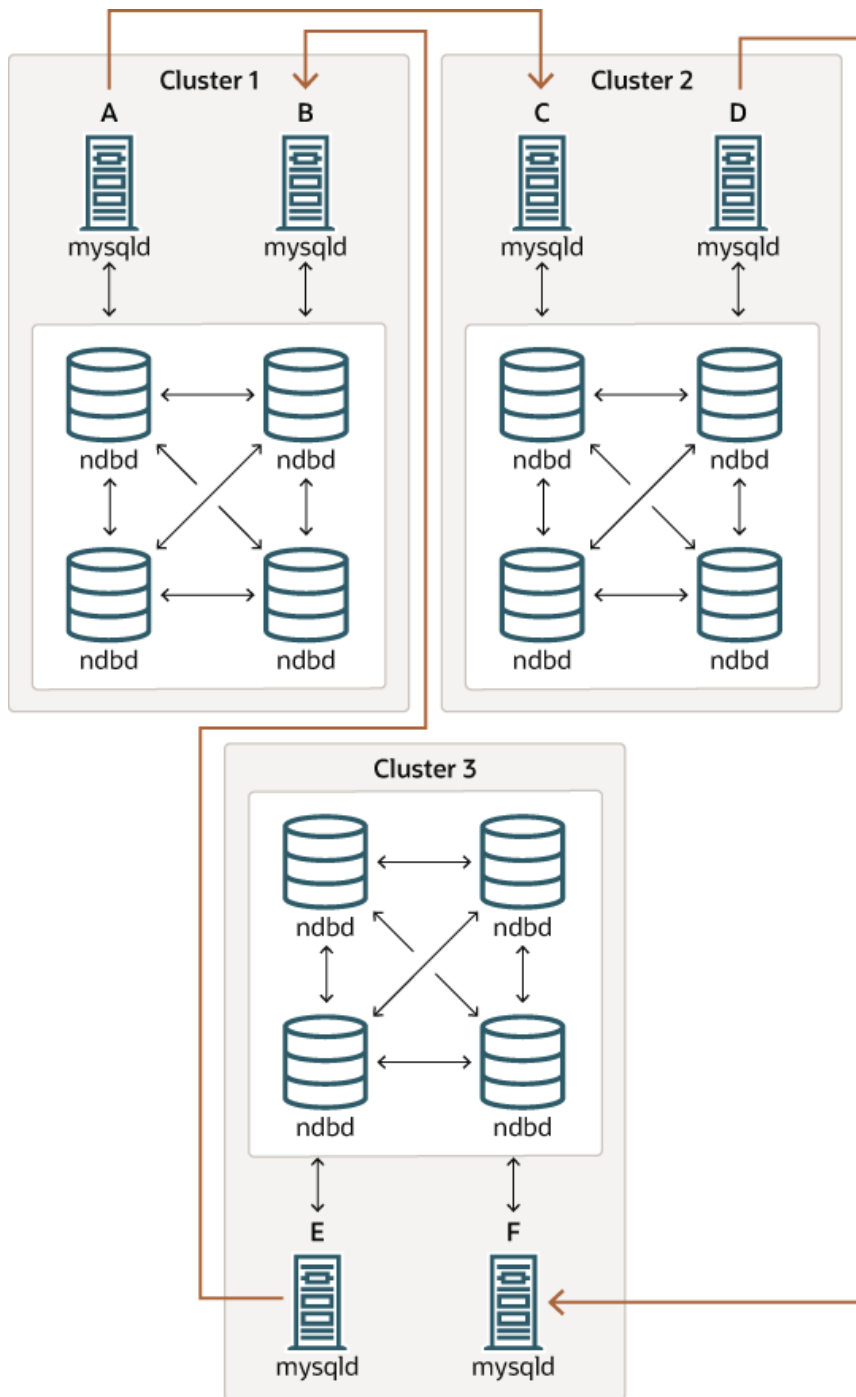

In this case, different SQL nodes in each cluster are used as replication sources and replicas. You must *not* start any of the SQL nodes with the `log_slave_updates` system variable enabled. This type of circular replication scheme for NDB Cluster, in which the line of replication (again indicated by the curved arrows in the diagram) is discontinuous, should be possible, but it should be noted that it has not yet been thoroughly tested and must therefore still be considered experimental.

**Using NDB-native backup and restore to initialize a replica cluster.** When setting up circular replication, it is possible to initialize the replica cluster by using the management client `START BACKUP`



command on one NDB Cluster to create a backup and then applying this backup on another NDB Cluster using `ndb_restore`. This does not automatically create binary logs on the second NDB Cluster's SQL node acting as the replica; in order to cause the binary logs to be created, you must issue a `SHOW TABLES` statement on that SQL node; this should be done prior to running `START SLAVE`. This is a known issue.

**Multi-source failover example.** In this section, we discuss failover in a multi-source NDB Cluster replication setup with three NDB Clusters having server IDs 1, 2, and 3. In this scenario, Cluster 1 replicates to Clusters 2 and 3; Cluster 2 also replicates to Cluster 3. This relationship is shown here:

**Figure 21.19 NDB Cluster Multi-Master Replication With 3 Sources**

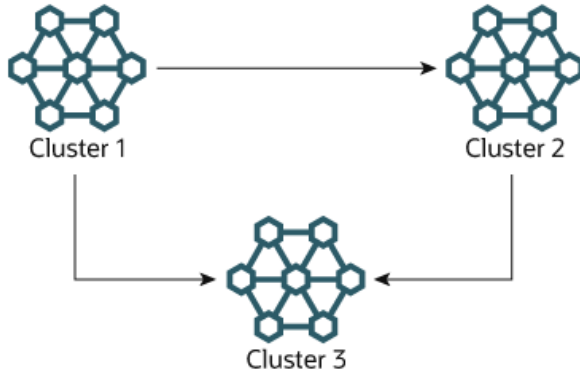

In other words, data replicates from Cluster 1 to Cluster 3 through 2 different routes: directly, and by way of Cluster 2.

Not all MySQL servers taking part in multi-source replication must act as both source and replica, and a given NDB Cluster might use different SQL nodes for different replication channels. Such a case is shown here:

Figure 21.20 NDB Cluster Multi-Source Replication, With MySQL Servers

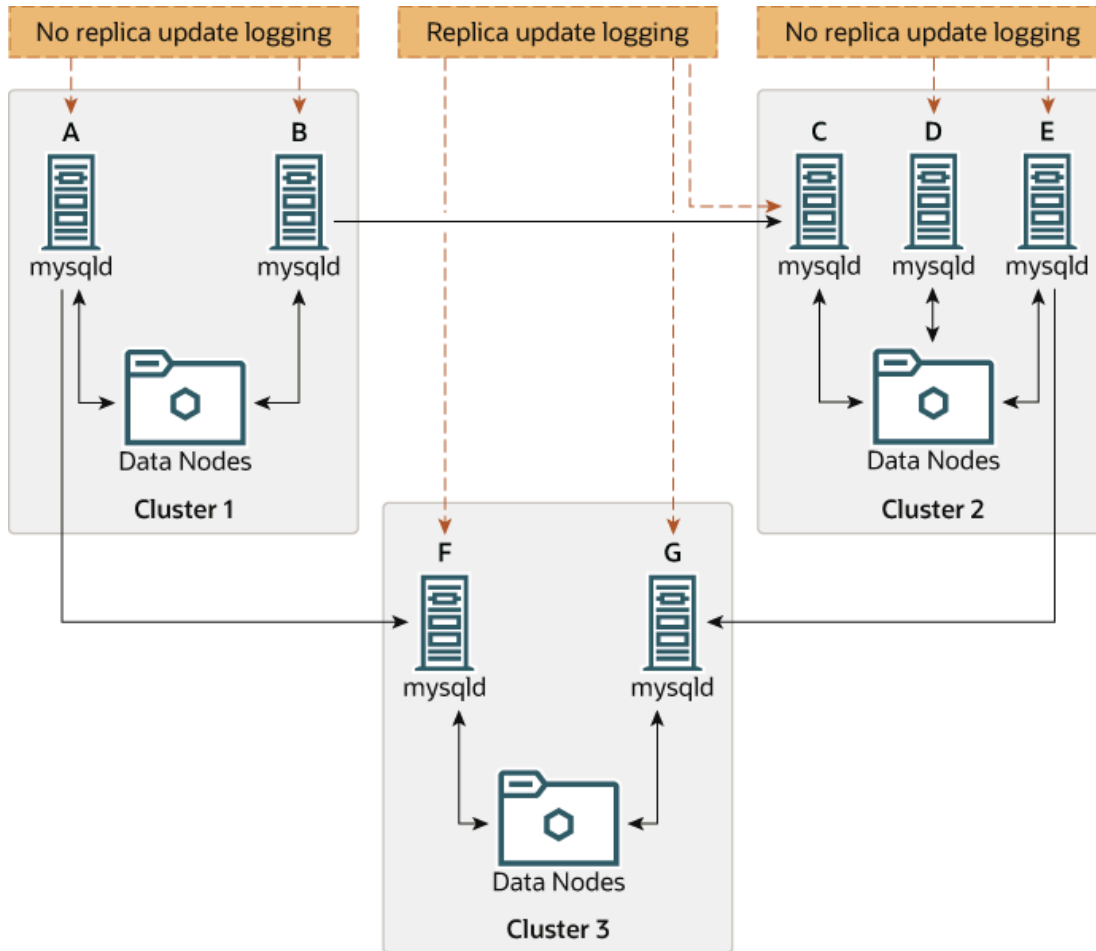

MySQL servers acting as replicas must be run with the `log_slave_updates` system variable enabled. Which `mysqld` processes require this option is also shown in the preceding diagram.



**Note**

Using the `log_slave_updates` system variable has no effect on servers not being run as replicas.

The need for failover arises when one of the replicating clusters goes down. In this example, we consider the case where Cluster 1 is lost to service, and so Cluster 3 loses 2 sources of updates from Cluster 1. Because replication between NDB Clusters is asynchronous, there is no guarantee that Cluster 3's updates originating directly from Cluster 1 are more recent than those received through Cluster 2. You can handle this by ensuring that Cluster 3 catches up to Cluster 2 with regard to updates from Cluster 1. In terms of MySQL servers, this means that you need to replicate any outstanding updates from MySQL server C to server F.

On server C, perform the following queries:

```
mysqlC> SELECT @latest:=MAX(epoch)
-> FROM mysql.ndb_apply_status
-> WHERE server_id=1;

mysqlC> SELECT
-> @file:=SUBSTRING_INDEX(File, '/', -1),
```

```

-> @pos:=Position
-> FROM mysql.ndb_binlog_index
-> WHERE orig_epoch >= @latest
-> AND orig_server_id = 1
-> ORDER BY epoch ASC LIMIT 1;

```



### Note

You can improve the performance of this query, and thus likely speed up failover times significantly, by adding the appropriate index to the `ndb_binlog_index` table. See [Section 21.7.4, “NDB Cluster Replication Schema and Tables”](#), for more information.

Copy over the values for `@file` and `@pos` manually from server C to server F (or have your application perform the equivalent). Then, on server F, execute the following `CHANGE MASTER TO` statement:

```

mysqlF> CHANGE MASTER TO
-> MASTER_HOST = 'serverC'
-> MASTER_LOG_FILE='@file',
-> MASTER_LOG_POS=@pos;

```

Once this has been done, you can issue a `START SLAVE` statement on MySQL server F; this causes any missing updates originating from server B to be replicated to server F.

The `CHANGE MASTER TO` statement also supports an `IGNORE_SERVER_IDS` option which takes a comma-separated list of server IDs and causes events originating from the corresponding servers to be ignored. For more information, see [Section 13.4.2.1, “CHANGE MASTER TO Statement”](#), and [Section 13.7.5.34, “SHOW SLAVE STATUS Statement”](#). For information about how this option interacts with the `ndb_log_apply_status` variable, see [Section 21.7.8, “Implementing Failover with NDB Cluster Replication”](#).

## 21.7.11 NDB Cluster Replication Conflict Resolution

- [Requirements](#)
- [Source Column Control](#)
- [Conflict Resolution Control](#)
- [Conflict Resolution Functions](#)
- [Conflict Resolution Exceptions Table](#)
- [Conflict Detection Status Variables](#)
- [Examples](#)

When using a replication setup involving multiple sources (including circular replication), it is possible that different sources may try to update the same row on the replica with different data. Conflict resolution in NDB Cluster Replication provides a means of resolving such conflicts by permitting a user-defined resolution column to be used to determine whether or not an update on a given source should be applied on the replica.

Some types of conflict resolution supported by NDB Cluster (`NDB$OLD()`, `NDB$MAX()`, `NDB$MAX_DELETE_WIN()`) implement this user-defined column as a “timestamp” column (although its type cannot be `TIMESTAMP`, as explained later in this section). These types of conflict resolution are always applied a row-by-row basis rather than a transactional basis. The epoch-based conflict resolution functions `NDB$EPOCH()` and `NDB$EPOCH_TRANS()` compare the order in which epochs are replicated (and thus

these functions are transactional). Different methods can be used to compare resolution column values on the replica when conflicts occur, as explained later in this section; the method used can be set to act on a single table, database, or server, or on a set of one or more tables using pattern matching. See [Matching with wildcards](#), for information about using pattern matches in the `db`, `table_name`, and `server_id` columns of the `mysql.ndb_replication` table.

You should also keep in mind that it is the application's responsibility to ensure that the resolution column is correctly populated with relevant values, so that the resolution function can make the appropriate choice when determining whether to apply an update.

## Requirements

Preparations for conflict resolution must be made on both the source and the replica. These tasks are described in the following list:

- On the source writing the binary logs, you must determine which columns are sent (all columns or only those that have been updated). This is done for the MySQL Server as a whole by applying the `mysqld` startup option `--ndb-log-updated-only` (described later in this section), or on one or more specific tables by placing the proper entries in the `mysql.ndb_replication` table (see [ndb\\_replication Table](#)).



### Note

If you are replicating tables with very large columns (such as `TEXT` or `BLOB` columns), `--ndb-log-updated-only` can also be useful for reducing the size of the binary logs and avoiding possible replication failures due to exceeding `max_allowed_packet`.

See [Section 16.4.1.19, “Replication and max\\_allowed\\_packet”](#), for more information about this issue.

- On the replica, you must determine which type of conflict resolution to apply (“latest timestamp wins”, “same timestamp wins”, “primary wins”, “primary wins, complete transaction”, or none). This is done using the `mysql.ndb_replication` system table, and applies to one or more specific tables (see [ndb\\_replication Table](#)).
- NDB Cluster also supports read conflict detection, that is, detecting conflicts between reads of a given row in one cluster and updates or deletes of the same row in another cluster. This requires exclusive read locks obtained by setting `ndb_log_exclusive_reads` equal to 1 on the replica. All rows read by a conflicting read are logged in the exceptions table. For more information, see [Read conflict detection and resolution](#).
- NDB applies `WRITE_ROW` events strictly as inserts, requiring that there is not already any such row; that is, an incoming write is always rejected if the row already exists.

When using the functions `NDB$OLD()`, `NDB$MAX()`, and `NDB$MAX_DELETE_WIN()` for timestamp-based conflict resolution, we often refer to the column used for determining updates as a “timestamp” column. However, the data type of this column is never `TIMESTAMP`; instead, its data type should be `INT` (`INTEGER`) or `BIGINT`. The “timestamp” column should also be `UNSIGNED` and `NOT NULL`.

The `NDB$EPOCH()` and `NDB$EPOCH_TRANS()` functions discussed later in this section work by comparing the relative order of replication epochs applied on a primary and secondary NDB Cluster, and do not make use of timestamps.

## Source Column Control

We can see update operations in terms of “before” and “after” images—that is, the states of the table before and after the update is applied. Normally, when updating a table with a primary key, the “before”

image is not of great interest; however, when we need to determine on a per-update basis whether or not to use the updated values on a replica, we need to make sure that both images are written to the source's binary log. This is done with the `--ndb-log-update-as-write` option for `mysqld`, as described later in this section.



### Important

Whether logging of complete rows or of updated columns only is done is decided when the MySQL server is started, and cannot be changed online; you must either restart `mysqld`, or start a new `mysqld` instance with different logging options.

## Conflict Resolution Control

Conflict resolution is usually enabled on the server where conflicts can occur. Like logging method selection, it is enabled by entries in the `mysql.ndb_replication` table.

`NBT_UPDATED_ONLY_MINIMAL` and `NBT_UPDATED_FULL_MINIMAL` can be used with `NDB$EPOCH()`, `NDB$EPOCH2()`, and `NDB$EPOCH_TRANS()`, because these do not require “before” values of columns which are not primary keys. Conflict resolution algorithms requiring the old values, such as `NDB$MAX()` and `NDB$OLD()`, do not work correctly with these `binlog_type` values.

## Conflict Resolution Functions

This section provides detailed information about the functions which can be used for conflict detection and resolution with NDB Replication. These functions are listed here in alphabetical order:

- [NDB\\$OLD\(\)](#)
- [NDB\\$MAX\(\)](#)
- [NDB\\$MAX\\_DELETE\\_WIN\(\)](#)
- [NDB\\$EPOCH\(\)](#)
- [NDB\\$EPOCH\\_TRANS\(\)](#)
- [NDB\\$EPOCH2\(\)](#)
- [NDB\\$EPOCH2\\_TRANS\(\)](#)

### NDB\$OLD()

If the value of `column_name` is the same on both the source and the replica, then the update is applied; otherwise, the update is not applied on the replica and an exception is written to the log. This is illustrated by the following pseudocode:

```
if (source_old_column_value == replica_current_column_value)
    apply_update();
else
    log_exception();
```

This function can be used for “same value wins” conflict resolution. This type of conflict resolution ensures that updates are not applied on the replica from the wrong source.



### Important

The column value from the source's “before” image is used by this function.

## NDB\$MAX()

If the “timestamp” column value for a given row coming from the source is higher than that on the replica, it is applied; otherwise it is not applied on the replica. This is illustrated by the following pseudocode:

```
if (source_new_column_value > replica_current_column_value)
    apply_update();
```

This function can be used for “greatest timestamp wins” conflict resolution. This type of conflict resolution ensures that, in the event of a conflict, the version of the row that was most recently updated is the version that persists.



### Important

The column value from the source's “after” image is used by this function.

## NDB\$MAX\_DELETE\_WIN()

This is a variation on `NDB$MAX()`. Due to the fact that no timestamp is available for a delete operation, a delete using `NDB$MAX()` is in fact processed as `NDB$OLD`, but for some use cases, this is not optimal. For `NDB$MAX_DELETE_WIN()`, if the “timestamp” column value for a given row adding or updating an existing row coming from the source is higher than that on the replica, it is applied. However, delete operations are treated as always having the higher value. This is illustrated by the following pseudocode:

```
if ( (source_new_column_value > replica_current_column_value)
    ||
    operation.type == "delete")
    apply_update();
```

This function can be used for “greatest timestamp, delete wins” conflict resolution. This type of conflict resolution ensures that, in the event of a conflict, the version of the row that was deleted or (otherwise) most recently updated is the version that persists.



### Note

As with `NDB$MAX()`, the column value from the source's “after” image is the value used by this function.

## NDB\$EPOCH()

The `NDB$EPOCH()` function tracks the order in which replicated epochs are applied on a replica cluster relative to changes originating on the replica. This relative ordering is used to determine whether changes originating on the replica are concurrent with any changes that originate locally, and are therefore potentially in conflict.

Most of what follows in the description of `NDB$EPOCH()` also applies to `NDB$EPOCH_TRANS()`. Any exceptions are noted in the text.

`NDB$EPOCH()` is asymmetric, operating on one NDB Cluster in a bidirectional replication configuration (sometimes referred to as “active-active” replication). We refer here to cluster on which it operates as the primary, and the other as the secondary. The replica on the primary is responsible for detecting and handling conflicts, while the replica on the secondary is not involved in any conflict detection or handling.

When the replica on the primary detects conflicts, it injects events into its own binary log to compensate for these; this ensures that the secondary NDB Cluster eventually realigns itself with the primary and so keeps the primary and secondary from diverging. This compensation and realignment mechanism requires that

the primary NDB Cluster always wins any conflicts with the secondary—that is, that the primary's changes are always used rather than those from the secondary in event of a conflict. This “primary always wins” rule has the following implications:

- Operations that change data, once committed on the primary, are fully persistent and are not undone or rolled back by conflict detection and resolution.
- Data read from the primary is fully consistent. Any changes committed on the Primary (locally or from the replica) are not reverted later.
- Operations that change data on the secondary may later be reverted if the primary determines that they are in conflict.
- Individual rows read on the secondary are self-consistent at all times, each row always reflecting either a state committed by the secondary, or one committed by the primary.
- Sets of rows read on the secondary may not necessarily be consistent at a given single point in time. For `NDB$EPOCH_TRANS()`, this is a transient state; for `NDB$EPOCH()`, it can be a persistent state.
- Assuming a period of sufficient length without any conflicts, all data on the secondary NDB Cluster (eventually) becomes consistent with the primary's data.

`NDB$EPOCH()` and `NDB$EPOCH_TRANS()` do not require any user schema modifications, or application changes to provide conflict detection. However, careful thought must be given to the schema used, and the access patterns used, to verify that the complete system behaves within specified limits.

Each of the `NDB$EPOCH()` and `NDB$EPOCH_TRANS()` functions can take an optional parameter; this is the number of bits to use to represent the lower 32 bits of the epoch, and should be set to no less than the value calculated as shown here:

```
CEIL( LOG2( TimeBetweenGlobalCheckpoints / TimeBetweenEpochs ), 1)
```

For the default values of these configuration parameters (2000 and 100 milliseconds, respectively), this gives a value of 5 bits, so the default value (6) should be sufficient, unless other values are used for `TimeBetweenGlobalCheckpoints`, `TimeBetweenEpochs`, or both. A value that is too small can result in false positives, while one that is too large could lead to excessive wasted space in the database.

Both `NDB$EPOCH()` and `NDB$EPOCH_TRANS()` insert entries for conflicting rows into the relevant exceptions tables, provided that these tables have been defined according to the same exceptions table schema rules as described elsewhere in this section (see `NDB$OLD()`). You must create any exceptions table before creating the data table with which it is to be used.

As with the other conflict detection functions discussed in this section, `NDB$EPOCH()` and `NDB$EPOCH_TRANS()` are activated by including relevant entries in the `mysql.ndb_replication` table (see `ndb_replication Table`). The roles of the primary and secondary NDB Clusters in this scenario are fully determined by `mysql.ndb_replication` table entries.

Because the conflict detection algorithms employed by `NDB$EPOCH()` and `NDB$EPOCH_TRANS()` are asymmetric, you must use different values for the `server_id` entries of the primary and secondary replicas.

A conflict between `DELETE` operations alone is not sufficient to trigger a conflict using `NDB$EPOCH()` or `NDB$EPOCH_TRANS()`, and the relative placement within epochs does not matter.

### Limitations on NDB\$EPOCH()

The following limitations currently apply when using `NDB$EPOCH()` to perform conflict detection:

- Conflicts are detected using NDB Cluster epoch boundaries, with granularity proportional to `TimeBetweenEpochs` (default: 100 milliseconds). The minimum conflict window is the minimum time during which concurrent updates to the same data on both clusters always report a conflict. This is always a nonzero length of time, and is roughly proportional to  $2 * (\text{latency} + \text{queueing} + \text{TimeBetweenEpochs})$ . This implies that—assuming the default for `TimeBetweenEpochs` and ignoring any latency between clusters (as well as any queuing delays)—the minimum conflict window size is approximately 200 milliseconds. This minimum window should be considered when looking at expected application “race” patterns.
- Additional storage is required for tables using the `NDB$EPOCH()` and `NDB$EPOCH_TRANS()` functions; from 1 to 32 bits extra space per row is required, depending on the value passed to the function.
- Conflicts between delete operations may result in divergence between the primary and secondary. When a row is deleted on both clusters concurrently, the conflict can be detected, but is not recorded, since the row is deleted. This means that further conflicts during the propagation of any subsequent realignment operations are not detected, which can lead to divergence.

Deletes should be externally serialized, or routed to one cluster only. Alternatively, a separate row should be updated transactionally with such deletes and any inserts that follow them, so that conflicts can be tracked across row deletes. This may require changes in applications.

- Only two NDB Clusters in a bidirectional “active-active” configuration are currently supported when using `NDB$EPOCH()` or `NDB$EPOCH_TRANS()` for conflict detection.
- Tables having `BLOB` or `TEXT` columns are not currently supported with `NDB$EPOCH()` or `NDB$EPOCH_TRANS()`.

## NDB\$EPOCH\_TRANS()

`NDB$EPOCH_TRANS()` extends the `NDB$EPOCH()` function. Conflicts are detected and handled in the same way using the “primary wins all” rule (see `NDB$EPOCH()`) but with the extra condition that any other rows updated in the same transaction in which the conflict occurred are also regarded as being in conflict. In other words, where `NDB$EPOCH()` realigns individual conflicting rows on the secondary, `NDB$EPOCH_TRANS()` realigns conflicting transactions.

In addition, any transactions which are detectably dependent on a conflicting transaction are also regarded as being in conflict, these dependencies being determined by the contents of the secondary cluster's binary log. Since the binary log contains only data modification operations (inserts, updates, and deletes), only overlapping data modifications are used to determine dependencies between transactions.

`NDB$EPOCH_TRANS()` is subject to the same conditions and limitations as `NDB$EPOCH()`, and in addition requires that Version 2 binary log row events are used (`log_bin_use_v1_row_events` equal to 0), which adds a storage overhead of 2 bytes per event in the binary log. In addition, all transaction IDs must be recorded in the secondary's binary log, using `--ndb-log-transaction-id` set to `ON`. This adds a variable amount of overhead (up to 13 bytes per row).

See `NDB$EPOCH()`.

## NDB\$EPOCH2()

The `NDB$EPOCH2()` function is similar to `NDB$EPOCH()`, except that `NDB$EPOCH2()` provides for delete-delete handling with a bidirectional replication topology. In this scenario, primary and secondary roles are assigned to the two sources by setting the `ndb_slave_conflict_role` system variable to the appropriate value on each source (usually one each of `PRIMARY`, `SECONDARY`). When this is done, modifications made by the secondary are reflected by the primary back to the secondary which then conditionally applies them.



## NDB\$EPOCH2\_TRANS()

`NDB$EPOCH2_TRANS()` extends the `NDB$EPOCH2()` function. Conflicts are detected and handled in the same way, and assigning primary and secondary roles to the replicating clusters, but with the extra condition that any other rows updated in the same transaction in which the conflict occurred are also regarded as being in conflict. That is, `NDB$EPOCH2()` realigns individual conflicting rows on the secondary, while `NDB$EPOCH_TRANS()` realigns conflicting transactions.

Where `NDB$EPOCH()` and `NDB$EPOCH_TRANS()` use metadata that is specified per row, per last modified epoch, to determine on the primary whether an incoming replicated row change from the secondary is concurrent with a locally committed change; concurrent changes are regarded as conflicting, with subsequent exceptions table updates and realignment of the secondary. A problem arises when a row is deleted on the primary so there is no longer any last-modified epoch available to determine whether any replicated operations conflict, which means that conflicting delete operations are not detected. This can result in divergence, an example being a delete on one cluster which is concurrent with a delete and insert on the other; this is why delete operations can be routed to only one cluster when using `NDB$EPOCH()` and `NDB$EPOCH_TRANS()`.

`NDB$EPOCH2()` bypasses the issue just described—storing information about deleted rows on the PRIMARY—by ignoring any delete-delete conflict, and by avoiding any potential resultant divergence as well. This is accomplished by reflecting any operation successfully applied on and replicated from the secondary back to the secondary. On its return to the secondary, it can be used to reapply an operation on the secondary which was deleted by an operation originating from the primary.

When using `NDB$EPOCH2()`, you should keep in mind that the secondary applies the delete from the primary, removing the new row until it is restored by a reflected operation. In theory, the subsequent insert or update on the secondary conflicts with the delete from the primary, but in this case, we choose to ignore this and allow the secondary to “win”, in the interest of preventing divergence between the clusters. In other words, after a delete, the primary does not detect conflicts, and instead adopts the secondary's following changes immediately. Because of this, the secondary's state can revisit multiple previous committed states as it progresses to a final (stable) state, and some of these may be visible.

You should also be aware that reflecting all operations from the secondary back to the primary increases the size of the primary's logbinary log, as well as demands on bandwidth, CPU usage, and disk I/O.

Application of reflected operations on the secondary depends on the state of the target row on the secondary. Whether or not reflected changes are applied on the secondary can be tracked by checking the `Ndb_conflict_reflected_op_prepare_count` and `Ndb_conflict_reflected_op_discard_count` status variables. The number of changes applied is simply the difference between these two values (note that `Ndb_conflict_reflected_op_prepare_count` is always greater than or equal to `Ndb_conflict_reflected_op_discard_count`).

Events are applied if and only if both of the following conditions are true:

- The existence of the row—that is, whether or not it exists—is in accordance with the type of event. For delete and update operations, the row must already exist. For insert operations, the row must *not* exist.
- The row was last modified by the primary. It is possible that the modification was accomplished through the execution of a reflected operation.

If both of these conditions are not met, the reflected operation is discarded by the secondary.

## Conflict Resolution Exceptions Table

To use the `NDB$OLD()` conflict resolution function, it is also necessary to create an exceptions table corresponding to each NDB table for which this type of conflict resolution is to be employed. This is also

true when using `NDB$EPOCH()` or `NDB$EPOCH_TRANS()`. The name of this table is that of the table for which conflict resolution is to be applied, with the string `$EX` appended. (For example, if the name of the original table is `mytable`, the name of the corresponding exceptions table name should be `mytable$EX`.) The syntax for creating the exceptions table is as shown here:

```
CREATE TABLE original_table$EX (
  [NDB$]server_id INT UNSIGNED,
  [NDB$]source_server_id INT UNSIGNED,
  [NDB$]source_epoch BIGINT UNSIGNED,
  [NDB$]count INT UNSIGNED,

  [NDB$OP_TYPE ENUM('WRITE_ROW', 'UPDATE_ROW', 'DELETE_ROW',
    'REFRESH_ROW', 'READ_ROW') NOT NULL,]
  [NDB$CFT_CAUSE ENUM('ROW_DOES_NOT_EXIST', 'ROW_ALREADY_EXISTS',
    'DATA_IN_CONFLICT', 'TRANS_IN_CONFLICT') NOT NULL,]
  [NDB$ORIG_TRANSID BIGINT UNSIGNED NOT NULL,]

  original_table_pk_columns,

  [orig_table_column|orig_table_column$OLD|orig_table_column$NEW,]

  [additional_columns,]

  PRIMARY KEY([NDB$]server_id, [NDB$]source_server_id, [NDB$]source_epoch, [NDB$]count)
) ENGINE=NDB;
```

The first four columns are required. The names of the first four columns and the columns matching the original table's primary key columns are not critical; however, we suggest for reasons of clarity and consistency, that you use the names shown here for the `server_id`, `source_server_id`, `source_epoch`, and `count` columns, and that you use the same names as in the original table for the columns matching those in the original table's primary key.

If the exceptions table uses one or more of the optional columns `NDB$OP_TYPE`, `NDB$CFT_CAUSE`, or `NDB$ORIG_TRANSID` discussed later in this section, then each of the required columns must also be named using the prefix `NDB$`. If desired, you can use the `NDB$` prefix to name the required columns even if you do not define any optional columns, but in this case, all four of the required columns must be named using the prefix.

Following these columns, the columns making up the original table's primary key should be copied in the order in which they are used to define the primary key of the original table. The data types for the columns duplicating the primary key columns of the original table should be the same as (or larger than) those of the original columns. A subset of the primary key columns may be used.

The exceptions table must use the `NDB` storage engine. (An example that uses `NDB$OLD()` with an exceptions table is shown later in this section.)

Additional columns may optionally be defined following the copied primary key columns, but not before any of them; any such extra columns cannot be `NOT NULL`. `NDB` Cluster supports three additional, predefined optional columns `NDB$OP_TYPE`, `NDB$CFT_CAUSE`, and `NDB$ORIG_TRANSID`, which are described in the next few paragraphs.

**`NDB$OP_TYPE`:** This column can be used to obtain the type of operation causing the conflict. If you use this column, define it as shown here:

```
NDB$OP_TYPE ENUM('WRITE_ROW', 'UPDATE_ROW', 'DELETE_ROW',
  'REFRESH_ROW', 'READ_ROW') NOT NULL
```

The `WRITE_ROW`, `UPDATE_ROW`, and `DELETE_ROW` operation types represent user-initiated operations. `REFRESH_ROW` operations are operations generated by conflict resolution in compensating transactions

sent back to the originating cluster from the cluster that detected the conflict. [READ\\_ROW](#) operations are user-initiated read tracking operations defined with exclusive row locks.

[NDB\\$CFT\\_CAUSE](#): You can define an optional column [NDB\\$CFT\\_CAUSE](#) which provides the cause of the registered conflict. This column, if used, is defined as shown here:

```
NDB$CFT_CAUSE ENUM('ROW_DOES_NOT_EXIST', 'ROW_ALREADY_EXISTS',
'DATA_IN_CONFLICT', 'TRANS_IN_CONFLICT') NOT NULL
```

[ROW\\_DOES\\_NOT\\_EXIST](#) can be reported as the cause for [UPDATE\\_ROW](#) and [WRITE\\_ROW](#) operations; [ROW\\_ALREADY\\_EXISTS](#) can be reported for [WRITE\\_ROW](#) events. [DATA\\_IN\\_CONFLICT](#) is reported when a row-based conflict function detects a conflict; [TRANS\\_IN\\_CONFLICT](#) is reported when a transactional conflict function rejects all of the operations belonging to a complete transaction.

[NDB\\$ORIG\\_TRANSID](#): The [NDB\\$ORIG\\_TRANSID](#) column, if used, contains the ID of the originating transaction. This column should be defined as follows:

```
NDB$ORIG_TRANSID BIGINT UNSIGNED NOT NULL
```

[NDB\\$ORIG\\_TRANSID](#) is a 64-bit value generated by [NDB](#). This value can be used to correlate multiple exceptions table entries belonging to the same conflicting transaction from the same or different exceptions tables.

Additional reference columns which are not part of the original table's primary key can be named [colname\\$OLD](#) or [colname\\$NEW](#). [colname\\$OLD](#) references old values in update and delete operations—that is, operations containing [DELETE\\_ROW](#) events. [colname\\$NEW](#) can be used to reference new values in insert and update operations—in other words, operations using [WRITE\\_ROW](#) events, [UPDATE\\_ROW](#) events, or both types of events. Where a conflicting operation does not supply a value for a given reference column that is not a primary key, the exceptions table row contains either [NULL](#), or a defined default value for that column.



### Important

The [mysql.ndb\\_replication](#) table is read when a data table is set up for replication, so the row corresponding to a table to be replicated must be inserted into [mysql.ndb\\_replication](#) *before* the table to be replicated is created.

## Conflict Detection Status Variables

Several status variables can be used to monitor conflict detection. You can see how many rows have been found in conflict by [NDB\\$EPOCH\(\)](#) since this replica was last restarted from the current value of the [Ndb\\_conflict\\_fn\\_epoch](#) system status variable.

[Ndb\\_conflict\\_fn\\_epoch\\_trans](#) provides the number of rows that have been found directly in conflict by [NDB\\$EPOCH\\_TRANS\(\)](#). [Ndb\\_conflict\\_fn\\_epoch2](#) and [Ndb\\_conflict\\_fn\\_epoch2\\_trans](#) show the number of rows found in conflict by [NDB\\$EPOCH2\(\)](#) and [NDB\\$EPOCH2\\_TRANS\(\)](#), respectively. The number of rows actually realigned, including those affected due to their membership in or dependency on the same transactions as other conflicting rows, is given by [Ndb\\_conflict\\_trans\\_row\\_reject\\_count](#).

Another server status variable [Ndb\\_conflict\\_fn\\_max](#) provides a count of the number of times that a row was not applied on the current SQL node due to “greatest timestamp wins” conflict resolution since the last time that [mysqld](#) was started. [Ndb\\_conflict\\_fn\\_max\\_del\\_win](#) provides a count of the number of times that conflict resolution based on the outcome of [NDB\\$MAX\\_DELETE\\_WIN\(\)](#) has been applied.

The number of times that a row was not applied as the result of “same timestamp wins” conflict resolution on a given [mysqld](#) since the last time it was restarted is given by the global status variable

`Ndb_conflict_fn_old`. In addition to incrementing `Ndb_conflict_fn_old`, the primary key of the row that was not used is inserted into an *exceptions table*, as explained elsewhere in this section.

See also [NDB Cluster Status Variables](#).

## Examples

The following examples assume that you have already a working NDB Cluster replication setup, as described in [Section 21.7.5, “Preparing the NDB Cluster for Replication”](#), and [Section 21.7.6, “Starting NDB Cluster Replication \(Single Replication Channel\)”](#).

**NDB\$MAX() example.** Suppose you wish to enable “greatest timestamp wins” conflict resolution on table `test.t1`, using column `mycol` as the “timestamp”. This can be done using the following steps:

1. Make sure that you have started the source `mysqld` with `--ndb-log-update-as-write=OFF`.
2. On the source, perform this `INSERT` statement:

```
INSERT INTO mysql.ndb_replication
VALUES ('test', 't1', 0, NULL, 'NDB$MAX(mycol)');
```



### Note

If the `ndb_replication` table does not already exist, you must create it. See [ndb\\_replication Table](#).

Inserting a 0 into the `server_id` column indicates that all SQL nodes accessing this table should use conflict resolution. If you want to use conflict resolution on a specific `mysqld` only, use the actual server ID.

Inserting `NULL` into the `binlog_type` column has the same effect as inserting 0 (`NBT_DEFAULT`); the server default is used.

3. Create the `test.t1` table:

```
CREATE TABLE test.t1 (
  columns
  mycol INT UNSIGNED,
  columns
) ENGINE=NDB;
```

Now, when updates are performed on this table, conflict resolution is applied, and the version of the row having the greatest value for `mycol` is written to the replica.



### Note

Other `binlog_type` options such as `NBT_UPDATED_ONLY_USE_UPDATE (6)` should be used to control logging on the source using the `ndb_replication` table rather than by using command-line options.

**NDB\$OLD() example.** Suppose an NDB table such as the one defined here is being replicated, and you wish to enable “same timestamp wins” conflict resolution for updates to this table:

```
CREATE TABLE test.t2 (
  a INT UNSIGNED NOT NULL,
  b CHAR(25) NOT NULL,
  columns,
  mycol INT UNSIGNED NOT NULL,
  columns,
  PRIMARY KEY pk (a, b)
) ENGINE=NDB;
```

The following steps are required, in the order shown:

1. First—and *prior* to creating `test.t2`—you must insert a row into the `mysql.ndb_replication` table, as shown here:

```
INSERT INTO mysql.ndb_replication
VALUES ('test', 't2', 0, 0, 'NDB$OLD(mycol)');
```

Possible values for the `binlog_type` column are shown earlier in this section; in this case, we use `0` to specify that the server default logging behavior be used. The value `'NDB$OLD(mycol)'` should be inserted into the `conflict_fn` column.

2. Create an appropriate exceptions table for `test.t2`. The table creation statement shown here includes all required columns; any additional columns must be declared following these columns, and before the definition of the table's primary key.

```
CREATE TABLE test.t2$EX (
  server_id INT UNSIGNED,
  source_server_id INT UNSIGNED,
  source_epoch BIGINT UNSIGNED,
  count INT UNSIGNED,
  a INT UNSIGNED NOT NULL,
  b CHAR(25) NOT NULL,

  [additional_columns,]

  PRIMARY KEY(server_id, source_server_id, source_epoch, count)
) ENGINE=NDB;
```

We can include additional columns for information about the type, cause, and originating transaction ID for a given conflict. We are also not required to supply matching columns for all primary key columns in the original table. This means you can create the exceptions table like this:

```
CREATE TABLE test.t2$EX (
  NDB$server_id INT UNSIGNED,
  NDB$source_server_id INT UNSIGNED,
  NDB$source_epoch BIGINT UNSIGNED,
  NDB$count INT UNSIGNED,
  a INT UNSIGNED NOT NULL,

  NDB$OP_TYPE ENUM('WRITE_ROW', 'UPDATE_ROW', 'DELETE_ROW',
  'REFRESH_ROW', 'READ_ROW') NOT NULL,
  NDB$CFT_CAUSE ENUM('ROW_DOES_NOT_EXIST', 'ROW_ALREADY_EXISTS',
  'DATA_IN_CONFLICT', 'TRANS_IN_CONFLICT') NOT NULL,
  NDB$ORIG_TRANSID BIGINT UNSIGNED NOT NULL,

  [additional_columns,]

  PRIMARY KEY(NDB$server_id, NDB$source_server_id, NDB$source_epoch, NDB$count)
) ENGINE=NDB;
```



#### Note

The `NDB$` prefix is required for the four required columns since we included at least one of the columns `NDB$OP_TYPE`, `NDB$CFT_CAUSE`, or `NDB$ORIG_TRANSID` in the table definition.

3. Create the table `test.t2` as shown previously.

These steps must be followed for every table for which you wish to perform conflict resolution using `NDB$OLD()`. For each such table, there must be a corresponding row in `mysql.ndb_replication`, and there must be an exceptions table in the same database as the table being replicated.

**Read conflict detection and resolution.** NDB Cluster also supports tracking of read operations, which makes it possible in circular replication setups to manage conflicts between reads of a given row in one cluster and updates or deletes of the same row in another. This example uses `employee` and `department` tables to model a scenario in which an employee is moved from one department to another on the source cluster (which we refer to hereafter as cluster *A*) while the replica cluster (hereafter *B*) updates the employee count of the employee's former department in an interleaved transaction.

The data tables have been created using the following SQL statements:

```
# Employee table
CREATE TABLE employee (
  id INT PRIMARY KEY,
  name VARCHAR(2000),
  dept INT NOT NULL
) ENGINE=NDB;

# Department table
CREATE TABLE department (
  id INT PRIMARY KEY,
  name VARCHAR(2000),
  members INT
) ENGINE=NDB;
```

The contents of the two tables include the rows shown in the (partial) output of the following `SELECT` statements:

```
mysql> SELECT id, name, dept FROM employee;
+-----+-----+-----+
| id  | name  | dept |
+-----+-----+-----+
...
| 998 | Mike  | 3    |
| 999 | Joe   | 3    |
| 1000| Mary  | 3    |
...
+-----+-----+-----+

mysql> SELECT id, name, members FROM department;
+-----+-----+-----+
| id  | name          | members |
+-----+-----+-----+
...
| 3   | Old project  | 24      |
...
+-----+-----+-----+
```

We assume that we are already using an exceptions table that includes the four required columns (and these are used for this table's primary key), the optional columns for operation type and cause, and the original table's primary key column, created using the SQL statement shown here:

```
CREATE TABLE employee$EX (
  NDB$server_id INT UNSIGNED,
  NDB$source_server_id INT UNSIGNED,
  NDB$source_epoch BIGINT UNSIGNED,
  NDB$count INT UNSIGNED,

  NDB$OP_TYPE ENUM( 'WRITE_ROW', 'UPDATE_ROW', 'DELETE_ROW',
                   'REFRESH_ROW', 'READ_ROW') NOT NULL,
  NDB$CFT_CAUSE ENUM( 'ROW_DOES_NOT_EXIST',
                     'ROW_ALREADY_EXISTS',
                     'DATA_IN_CONFLICT',
                     'TRANS_IN_CONFLICT') NOT NULL,

  id INT NOT NULL,
```

```
PRIMARY KEY(NDB$server_id, NDB$source_server_id, NDB$source_epoch, NDB$count)
)
ENGINE=NDB;
```

Suppose there occur the two simultaneous transactions on the two clusters. On cluster *A*, we create a new department, then move employee number 999 into that department, using the following SQL statements:

```
BEGIN;
INSERT INTO department VALUES (4, "New project", 1);
UPDATE employee SET dept = 4 WHERE id = 999;
COMMIT;
```

At the same time, on cluster *B*, another transaction reads from `employee`, as shown here:

```
BEGIN;
SELECT name FROM employee WHERE id = 999;
UPDATE department SET members = members - 1 WHERE id = 3;
commit;
```

The conflicting transactions are not normally detected by the conflict resolution mechanism, since the conflict is between a read (`SELECT`) and an update operation. You can circumvent this issue by executing `SET ndb_log_exclusive_reads = 1` on the replica cluster. Acquiring exclusive read locks in this way causes any rows read on the source to be flagged as needing conflict resolution on the replica cluster. If we enable exclusive reads in this way prior to the logging of these transactions, the read on cluster *B* is tracked and sent to cluster *A* for resolution; the conflict on the employee row is subsequently detected and the transaction on cluster *B* is aborted.

The conflict is registered in the exceptions table (on cluster *A*) as a `READ_ROW` operation (see [Conflict Resolution Exceptions Table](#), for a description of operation types), as shown here:

```
mysql> SELECT id, NDB$OP_TYPE, NDB$CFT_CAUSE FROM employee$EX;
+-----+-----+-----+
| id    | NDB$OP_TYPE | NDB$CFT_CAUSE |
+-----+-----+-----+
...
| 999   | READ_ROW    | TRANS_IN_CONFLICT |
+-----+-----+-----+
```

Any existing rows found in the read operation are flagged. This means that multiple rows resulting from the same conflict may be logged in the exception table, as shown by examining the effects a conflict between an update on cluster *A* and a read of multiple rows on cluster *B* from the same table in simultaneous transactions. The transaction executed on cluster *A* is shown here:

```
BEGIN;
INSERT INTO department VALUES (4, "New project", 0);
UPDATE employee SET dept = 4 WHERE dept = 3;
SELECT COUNT(*) INTO @count FROM employee WHERE dept = 4;
UPDATE department SET members = @count WHERE id = 4;
COMMIT;
```

Concurrently a transaction containing the statements shown here runs on cluster *B*:

```
SET ndb_log_exclusive_reads = 1; # Must be set if not already enabled
...
BEGIN;
SELECT COUNT(*) INTO @count FROM employee WHERE dept = 3 FOR UPDATE;
UPDATE department SET members = @count WHERE id = 3;
COMMIT;
```

In this case, all three rows matching the `WHERE` condition in the second transaction's `SELECT` are read, and are thus flagged in the exceptions table, as shown here:

```
mysql> SELECT id, NDB$OP_TYPE, NDB$CFT_CAUSE FROM employee$EX;
+-----+-----+-----+
| id    | NDB$OP_TYPE | NDB$CFT_CAUSE |
+-----+-----+-----+
...
| 998   | READ_ROW    | TRANS_IN_CONFLICT |
| 999   | READ_ROW    | TRANS_IN_CONFLICT |
| 1000  | READ_ROW    | TRANS_IN_CONFLICT |
...
+-----+-----+-----+
```

Read tracking is performed on the basis of existing rows only. A read based on a given condition track conflicts only of any rows that are *found* and not of any rows that are inserted in an interleaved transaction. This is similar to how exclusive row locking is performed in a single instance of NDB Cluster.

## 21.8 NDB Cluster Release Notes

Changes in NDB Cluster releases are documented separately from this reference manual; you can find release notes for the changes in each NDB Cluster 7.5 release at [NDB 7.5 Release Notes](#), and for each NDB Cluster 7.6 release at [NDB 7.6 Release Notes](#).

You can obtain release notes for older versions of NDB Cluster from [NDB Cluster Release Notes](#).



---

# Chapter 22 Partitioning

## Table of Contents

22.1 Overview of Partitioning in MySQL .....	3981
22.2 Partitioning Types .....	3984
22.2.1 RANGE Partitioning .....	3986
22.2.2 LIST Partitioning .....	3990
22.2.3 COLUMNS Partitioning .....	3992
22.2.4 HASH Partitioning .....	4000
22.2.5 KEY Partitioning .....	4003
22.2.6 Subpartitioning .....	4005
22.2.7 How MySQL Partitioning Handles NULL .....	4009
22.3 Partition Management .....	4013
22.3.1 Management of RANGE and LIST Partitions .....	4014
22.3.2 Management of HASH and KEY Partitions .....	4020
22.3.3 Exchanging Partitions and Subpartitions with Tables .....	4021
22.3.4 Maintenance of Partitions .....	4029
22.3.5 Obtaining Information About Partitions .....	4030
22.4 Partition Pruning .....	4032
22.5 Partition Selection .....	4035
22.6 Restrictions and Limitations on Partitioning .....	4041
22.6.1 Partitioning Keys, Primary Keys, and Unique Keys .....	4049
22.6.2 Partitioning Limitations Relating to Storage Engines .....	4052
22.6.3 Partitioning Limitations Relating to Functions .....	4053
22.6.4 Partitioning and Locking .....	4055

This chapter discusses MySQL's implementation of *user-defined partitioning*.



### Note

As of MySQL 5.7.17, the generic partitioning handler in the MySQL server is deprecated, and is removed in MySQL 8.0, when the storage engine used for a given table is expected to provide its own (“native”) partitioning handler. Currently, only the [InnoDB](#) and [NDB](#) storage engines do this.

Use of tables with nonnative partitioning results in an [ER\\_WARN\\_DEPRECATED\\_SYNTAX](#) warning. In MySQL 5.7.17 through 5.7.20, the server automatically performs a check at startup to identify tables that use nonnative partitioning; for any that are found, the server writes a message to its error log. To disable this check, use the `--disable-partition-engine-check` option. In MySQL 5.7.21 and later, this check is *not* performed; in these versions, you must start the server with `--disable-partition-engine-check=false`, if you wish for the server to check for tables using the generic partitioning handler (Bug #85830, Bug #25846957).

To prepare for migration to MySQL 8.0, any table with nonnative partitioning should be changed to use an engine that provides native partitioning, or be made nonpartitioned. For example, to change a table to [InnoDB](#), execute this statement:

```
ALTER TABLE table_name ENGINE = INNODB;
```

You can determine whether your MySQL Server supports partitioning by checking the output of the `SHOW PLUGINS` statement, like this:

```
mysql> SHOW PLUGINS;
```

Name	Status	Type	Library	License
binlog	ACTIVE	STORAGE ENGINE	NULL	GPL
<b>partition</b>	<b>ACTIVE</b>	<b>STORAGE ENGINE</b>	<b>NULL</b>	<b>GPL</b>
ARCHIVE	ACTIVE	STORAGE ENGINE	NULL	GPL
BLACKHOLE	ACTIVE	STORAGE ENGINE	NULL	GPL
CSV	ACTIVE	STORAGE ENGINE	NULL	GPL
FEDERATED	DISABLED	STORAGE ENGINE	NULL	GPL
MEMORY	ACTIVE	STORAGE ENGINE	NULL	GPL
InnoDB	ACTIVE	STORAGE ENGINE	NULL	GPL
MRG_MYISAM	ACTIVE	STORAGE ENGINE	NULL	GPL
MyISAM	ACTIVE	STORAGE ENGINE	NULL	GPL
ndbcluster	DISABLED	STORAGE ENGINE	NULL	GPL

```
11 rows in set (0.00 sec)
```

You can also check the Information Schema `PLUGINS` table with a query similar to this one:

```
mysql> SELECT
->     PLUGIN_NAME as Name,
->     PLUGIN_VERSION as Version,
->     PLUGIN_STATUS as Status
-> FROM INFORMATION_SCHEMA.PLUGINS
-> WHERE PLUGIN_TYPE='STORAGE ENGINE';
```

Name	Version	Status
binlog	1.0	ACTIVE
CSV	1.0	ACTIVE
MEMORY	1.0	ACTIVE
MRG_MYISAM	1.0	ACTIVE
MyISAM	1.0	ACTIVE
PERFORMANCE_SCHEMA	0.1	ACTIVE
BLACKHOLE	1.0	ACTIVE
ARCHIVE	3.0	ACTIVE
InnoDB	5.7	ACTIVE
<b>partition</b>	<b>1.0</b>	<b>ACTIVE</b>

```
10 rows in set (0.00 sec)
```

In either case, if you do not see the `partition` plugin listed with the value `ACTIVE` for the `Status` column in the output (shown in bold text in each of the examples just given), then your version of MySQL was not built with partitioning support.

MySQL 5.7 Community binaries provided by Oracle include partitioning support. For information about partitioning support offered in MySQL Enterprise Edition binaries, see [Chapter 28, MySQL Enterprise Edition](#).

To enable partitioning if you are compiling MySQL 5.7 from source, the build must be configured with the `--DWITH_PARTITION_STORAGE_ENGINE` option. For more information, see [Section 2.8, "Installing MySQL from Source"](#).

If your MySQL binary is built with partitioning support, nothing further needs to be done to enable it (for example, no special entries are required in your `my.cnf` file).

If you want to disable partitioning support, you can start the MySQL Server with the `--skip-partition` option. When partitioning support is disabled, you can see any existing partitioned tables and drop them (although doing this is not advised), but you cannot otherwise manipulate them or access their data.

See [Section 22.1, “Overview of Partitioning in MySQL”](#), for an introduction to partitioning and partitioning concepts.

MySQL supports several types of partitioning as well as subpartitioning; see [Section 22.2, “Partitioning Types”](#), and [Section 22.2.6, “Subpartitioning”](#).

[Section 22.3, “Partition Management”](#), covers methods of adding, removing, and altering partitions in existing partitioned tables.

[Section 22.3.4, “Maintenance of Partitions”](#), discusses table maintenance commands for use with partitioned tables.

The `PARTITIONS` table in the `INFORMATION_SCHEMA` database provides information about partitions and partitioned tables. See [Section 24.3.16, “The INFORMATION\\_SCHEMA PARTITIONS Table”](#), for more information; for some examples of queries against this table, see [Section 22.2.7, “How MySQL Partitioning Handles NULL”](#).

For known issues with partitioning in MySQL 5.7, see [Section 22.6, “Restrictions and Limitations on Partitioning”](#).

You may also find the following resources to be useful when working with partitioned tables.

**Additional Resources.** Other sources of information about user-defined partitioning in MySQL include the following:

- [MySQL Partitioning Forum](#)

This is the official discussion forum for those interested in or experimenting with MySQL Partitioning technology. It features announcements and updates from MySQL developers and others. It is monitored by members of the Partitioning Development and Documentation Teams.

- [PlanetMySQL](#)

A MySQL news site featuring MySQL-related blogs, which should be of interest to anyone using my MySQL. We encourage you to check here for links to blogs kept by those working with MySQL Partitioning, or to have your own blog added to those covered.

MySQL 5.7 binaries are available from <https://dev.mysql.com/downloads/mysql/5.7.html>. However, for the latest partitioning bugfixes and feature additions, you can obtain the source from our GitHub repository. To enable partitioning, the build must be configured with the `-DWITH_PARTITION_STORAGE_ENGINE` option. For more information about building MySQL, see [Section 2.8, “Installing MySQL from Source”](#). If you have problems compiling a partitioning-enabled MySQL 5.7 build, check the [MySQL Partitioning Forum](#) and ask for assistance there if you do not find a solution to your problem already posted.

## 22.1 Overview of Partitioning in MySQL

This section provides a conceptual overview of partitioning in MySQL 5.7.

For information on partitioning restrictions and feature limitations, see [Section 22.6, “Restrictions and Limitations on Partitioning”](#).

The SQL standard does not provide much in the way of guidance regarding the physical aspects of data storage. The SQL language itself is intended to work independently of any data structures or media underlying the schemas, tables, rows, or columns with which it works. Nonetheless, most advanced database management systems have evolved some means of determining the physical location to be

used for storing specific pieces of data in terms of the file system, hardware or even both. In MySQL, the [InnoDB](#) storage engine has long supported the notion of a tablespace, and the MySQL Server, even prior to the introduction of partitioning, could be configured to employ different physical directories for storing different databases (see [Section 8.12.3, “Using Symbolic Links”](#), for an explanation of how this is done).

*Partitioning* takes this notion a step further, by enabling you to distribute portions of individual tables across a file system according to rules which you can set largely as needed. In effect, different portions of a table are stored as separate tables in different locations. The user-selected rule by which the division of data is accomplished is known as a *partitioning function*, which in MySQL can be the modulus, simple matching against a set of ranges or value lists, an internal hashing function, or a linear hashing function. The function is selected according to the partitioning type specified by the user, and takes as its parameter the value of a user-supplied expression. This expression can be a column value, a function acting on one or more column values, or a set of one or more column values, depending on the type of partitioning that is used.

In the case of [RANGE](#), [LIST](#), and [\[LINEAR\] HASH](#) partitioning, the value of the partitioning column is passed to the partitioning function, which returns an integer value representing the number of the partition in which that particular record should be stored. This function must be nonconstant and nonrandom. It may not contain any queries, but may use an SQL expression that is valid in MySQL, as long as that expression returns either `NULL` or an integer *intval* such that

```
-MAXVALUE <= intval <= MAXVALUE
```

(`MAXVALUE` is used to represent the least upper bound for the type of integer in question. `-MAXVALUE` represents the greatest lower bound.)

For [\[LINEAR\] KEY](#), [RANGE COLUMNS](#), and [LIST COLUMNS](#) partitioning, the partitioning expression consists of a list of one or more columns.

For [\[LINEAR\] KEY](#) partitioning, the partitioning function is supplied by MySQL.

For more information about permitted partitioning column types and partitioning functions, see [Section 22.2, “Partitioning Types”](#), as well as [Section 13.1.18, “CREATE TABLE Statement”](#), which provides partitioning syntax descriptions and additional examples. For information about restrictions on partitioning functions, see [Section 22.6.3, “Partitioning Limitations Relating to Functions”](#).

This is known as *horizontal partitioning*—that is, different rows of a table may be assigned to different physical partitions. MySQL 5.7 does not support *vertical partitioning*, in which different columns of a table are assigned to different physical partitions. There are no plans at this time to introduce vertical partitioning into MySQL.

For information about determining whether your MySQL Server binary supports user-defined partitioning, see [Chapter 22, Partitioning](#).

For creating partitioned tables, you can use most storage engines that are supported by your MySQL server; the MySQL partitioning engine runs in a separate layer and can interact with any of these. In MySQL 5.7, all partitions of the same partitioned table must use the same storage engine; for example, you cannot use [MyISAM](#) for one partition and [InnoDB](#) for another. However, there is nothing preventing you from using different storage engines for different partitioned tables on the same MySQL server or even in the same database.

MySQL partitioning cannot be used with the [MERGE](#), [CSV](#), or [FEDERATED](#) storage engines.

Partitioning by [KEY](#) or [LINEAR KEY](#) is possible with [NDB](#), but other types of user-defined partitioning are not supported for tables using this storage engine. In addition, an [NDB](#) table that employs user-defined partitioning must have an explicit primary key, and any columns referenced in the table’s partitioning expression must be part of the primary key. However, if no columns are listed in the [PARTITION BY KEY](#)

or `PARTITION BY LINEAR KEY` clause of the `CREATE TABLE` or `ALTER TABLE` statement used to create or modify a user-partitioned NDB table, then the table is not required to have an explicit primary key. For more information, see [Section 21.2.7.1, “Noncompliance with SQL Syntax in NDB Cluster”](#).

To employ a particular storage engine for a partitioned table, it is necessary only to use the `[STORAGE] ENGINE` option just as you would for a nonpartitioned table. However, you should keep in mind that `[STORAGE] ENGINE` (and other table options) need to be listed *before* any partitioning options are used in a `CREATE TABLE` statement. This example shows how to create a table that is partitioned by hash into 6 partitions and which uses the InnoDB storage engine:

```
CREATE TABLE ti (id INT, amount DECIMAL(7,2), tr_date DATE)
ENGINE=INNODB
PARTITION BY HASH( MONTH(tr_date) )
PARTITIONS 6;
```

Each `PARTITION` clause can include a `[STORAGE] ENGINE` option, but in MySQL 5.7 this has no effect.



### Important

Partitioning applies to all data and indexes of a table; you cannot partition only the data and not the indexes, or vice versa, nor can you partition only a portion of the table.

Data and indexes for each partition can be assigned to a specific directory using the `DATA DIRECTORY` and `INDEX DIRECTORY` options for the `PARTITION` clause of the `CREATE TABLE` statement used to create the partitioned table.

`DATA DIRECTORY` and `INDEX DIRECTORY` are not supported for individual partitions or subpartitions of MyISAM tables on Windows.

Only the `DATA DIRECTORY` option is supported for individual partitions and subpartitions of InnoDB tables.

All columns used in the table's partitioning expression must be part of every unique key that the table may have, including any primary key. This means that a table such as this one, created by the following SQL statement, cannot be partitioned:

```
CREATE TABLE tnp (
  id INT NOT NULL AUTO_INCREMENT,
  ref BIGINT NOT NULL,
  name VARCHAR(255),
  PRIMARY KEY pk (id),
  UNIQUE KEY uk (name)
);
```

Because the keys `pk` and `uk` have no columns in common, there are no columns available for use in a partitioning expression. Possible workarounds in this situation include adding the `name` column to the table's primary key, adding the `id` column to `uk`, or simply removing the unique key altogether. See [Section 22.6.1, “Partitioning Keys, Primary Keys, and Unique Keys”](#), for more information.

In addition, `MAX_ROWS` and `MIN_ROWS` can be used to determine the maximum and minimum numbers of rows, respectively, that can be stored in each partition. See [Section 22.3, “Partition Management”](#), for more information on these options.

The `MAX_ROWS` option can also be useful for creating NDB Cluster tables with extra partitions, thus allowing for greater storage of hash indexes. See the documentation for the `DataMemory` data node configuration parameter, as well as [Section 21.2.2, “NDB Cluster Nodes, Node Groups, Fragment Replicas, and Partitions”](#), for more information.

Some advantages of partitioning are listed here:

- Partitioning makes it possible to store more data in one table than can be held on a single disk or file system partition.
- Data that loses its usefulness can often be easily removed from a partitioned table by dropping the partition (or partitions) containing only that data. Conversely, the process of adding new data can in some cases be greatly facilitated by adding one or more new partitions for storing specifically that data.
- Some queries can be greatly optimized in virtue of the fact that data satisfying a given `WHERE` clause can be stored only on one or more partitions, which automatically excludes any remaining partitions from the search. Because partitions can be altered after a partitioned table has been created, you can reorganize your data to enhance frequent queries that may not have been often used when the partitioning scheme was first set up. This ability to exclude non-matching partitions (and thus any rows they contain) is often referred to as *partition pruning*. For more information, see [Section 22.4, “Partition Pruning”](#).

In addition, MySQL supports explicit partition selection for queries. For example, `SELECT * FROM t PARTITION (p0,p1) WHERE c < 5` selects only those rows in partitions `p0` and `p1` that match the `WHERE` condition. In this case, MySQL does not check any other partitions of table `t`; this can greatly speed up queries when you already know which partition or partitions you wish to examine. Partition selection is also supported for the data modification statements `DELETE`, `INSERT`, `REPLACE`, `UPDATE`, and `LOAD DATA`, `LOAD XML`. See the descriptions of these statements for more information and examples.

## 22.2 Partitioning Types

This section discusses the types of partitioning which are available in MySQL 5.7. These include the types listed here:

- **RANGE partitioning.** This type of partitioning assigns rows to partitions based on column values falling within a given range. See [Section 22.2.1, “RANGE Partitioning”](#). For information about an extension to this type, `RANGE COLUMNS`, see [Section 22.2.3.1, “RANGE COLUMNS partitioning”](#).
- **LIST partitioning.** Similar to partitioning by `RANGE`, except that the partition is selected based on columns matching one of a set of discrete values. See [Section 22.2.2, “LIST Partitioning”](#). For information about an extension to this type, `LIST COLUMNS`, see [Section 22.2.3.2, “LIST COLUMNS partitioning”](#).
- **HASH partitioning.** With this type of partitioning, a partition is selected based on the value returned by a user-defined expression that operates on column values in rows to be inserted into the table. The function may consist of any expression valid in MySQL that yields an integer value. See [Section 22.2.4, “HASH Partitioning”](#).

An extension to this type, `LINEAR HASH`, is also available, see [Section 22.2.4.1, “LINEAR HASH Partitioning”](#).

- **KEY partitioning.** This type of partitioning is similar to partitioning by `HASH`, except that only one or more columns to be evaluated are supplied, and the MySQL server provides its own hashing function. These columns can contain other than integer values, since the hashing function supplied by MySQL guarantees an integer result regardless of the column data type. An extension to this type, `LINEAR KEY`, is also available. See [Section 22.2.5, “KEY Partitioning”](#).

A very common use of database partitioning is to segregate data by date. Some database systems support explicit date partitioning, which MySQL does not implement in 5.7. However, it is not difficult in MySQL

to create partitioning schemes based on [DATE](#), [TIME](#), or [DATETIME](#) columns, or based on expressions making use of such columns.

When partitioning by [KEY](#) or [LINEAR KEY](#), you can use a [DATE](#), [TIME](#), or [DATETIME](#) column as the partitioning column without performing any modification of the column value. For example, this table creation statement is perfectly valid in MySQL:

```
CREATE TABLE members (
  firstname VARCHAR(25) NOT NULL,
  lastname VARCHAR(25) NOT NULL,
  username VARCHAR(16) NOT NULL,
  email VARCHAR(35),
  joined DATE NOT NULL
)
PARTITION BY KEY(joined)
PARTITIONS 6;
```

In MySQL 5.7, it is also possible to use a [DATE](#) or [DATETIME](#) column as the partitioning column using [RANGE COLUMNS](#) and [LIST COLUMNS](#) partitioning.

MySQL's other partitioning types, however, require a partitioning expression that yields an integer value or [NULL](#). If you wish to use date-based partitioning by [RANGE](#), [LIST](#), [HASH](#), or [LINEAR HASH](#), you can simply employ a function that operates on a [DATE](#), [TIME](#), or [DATETIME](#) column and returns such a value, as shown here:

```
CREATE TABLE members (
  firstname VARCHAR(25) NOT NULL,
  lastname VARCHAR(25) NOT NULL,
  username VARCHAR(16) NOT NULL,
  email VARCHAR(35),
  joined DATE NOT NULL
)
PARTITION BY RANGE( YEAR(joined) ) (
  PARTITION p0 VALUES LESS THAN (1960),
  PARTITION p1 VALUES LESS THAN (1970),
  PARTITION p2 VALUES LESS THAN (1980),
  PARTITION p3 VALUES LESS THAN (1990),
  PARTITION p4 VALUES LESS THAN MAXVALUE
);
```

Additional examples of partitioning using dates may be found in the following sections of this chapter:

- [Section 22.2.1, “RANGE Partitioning”](#)
- [Section 22.2.4, “HASH Partitioning”](#)
- [Section 22.2.4.1, “LINEAR HASH Partitioning”](#)

For more complex examples of date-based partitioning, see the following sections:

- [Section 22.4, “Partition Pruning”](#)
- [Section 22.2.6, “Subpartitioning”](#)

MySQL partitioning is optimized for use with the [TO\\_DAYS\(\)](#), [YEAR\(\)](#), and [TO\\_SECONDS\(\)](#) functions. However, you can use other date and time functions that return an integer or [NULL](#), such as [WEEKDAY\(\)](#), [DAYOFYEAR\(\)](#), or [MONTH\(\)](#). See [Section 12.7, “Date and Time Functions”](#), for more information about such functions.

It is important to remember—regardless of the type of partitioning that you use—that partitions are always numbered automatically and in sequence when created, starting with 0. When a new row is inserted into a

partitioned table, it is these partition numbers that are used in identifying the correct partition. For example, if your table uses 4 partitions, these partitions are numbered 0, 1, 2, and 3. For the [RANGE](#) and [LIST](#) partitioning types, it is necessary to ensure that there is a partition defined for each partition number. For [HASH](#) partitioning, the user-supplied expression must evaluate to an integer value. For [KEY](#) partitioning, this issue is taken care of automatically by the hashing function which the MySQL server employs internally.

Names of partitions generally follow the rules governing other MySQL identifiers, such as those for tables and databases. However, you should note that partition names are not case-sensitive. For example, the following [CREATE TABLE](#) statement fails as shown:

```
mysql> CREATE TABLE t2 (val INT)
-> PARTITION BY LIST(val)(
->     PARTITION mypart VALUES IN (1,3,5),
->     PARTITION MyPart VALUES IN (2,4,6)
-> );
ERROR 1488 (HY000): Duplicate partition name mypart
```

Failure occurs because MySQL sees no difference between the partition names `mypart` and `MyPart`.

When you specify the number of partitions for the table, this must be expressed as a positive, nonzero integer literal with no leading zeros, and may not be an expression such as `0.8E+01` or `6-2`, even if it evaluates to an integer value. Decimal fractions are not permitted.

In the sections that follow, we do not necessarily provide all possible forms for the syntax that can be used for creating each partition type; this information may be found in [Section 13.1.18, “CREATE TABLE Statement”](#).

## 22.2.1 RANGE Partitioning

A table that is partitioned by range is partitioned in such a way that each partition contains rows for which the partitioning expression value lies within a given range. Ranges should be contiguous but not overlapping, and are defined using the [VALUES LESS THAN](#) operator. For the next few examples, suppose that you are creating a table such as the following to hold personnel records for a chain of 20 video stores, numbered 1 through 20:

```
CREATE TABLE employees (
  id INT NOT NULL,
  fname VARCHAR(30),
  lname VARCHAR(30),
  hired DATE NOT NULL DEFAULT '1970-01-01',
  separated DATE NOT NULL DEFAULT '9999-12-31',
  job_code INT NOT NULL,
  store_id INT NOT NULL
);
```



### Note

The `employees` table used here has no primary or unique keys. While the examples work as shown for purposes of the present discussion, you should keep in mind that tables are extremely likely in practice to have primary keys, unique keys, or both, and that allowable choices for partitioning columns depend on the columns used for these keys, if any are present. For a discussion of these issues, see [Section 22.6.1, “Partitioning Keys, Primary Keys, and Unique Keys”](#).

This table can be partitioned by range in a number of ways, depending on your needs. One way would be to use the `store_id` column. For instance, you might decide to partition the table 4 ways by adding a [PARTITION BY RANGE](#) clause as shown here:

```
CREATE TABLE employees (
```



```

    id INT NOT NULL,
    fname VARCHAR(30),
    lname VARCHAR(30),
    hired DATE NOT NULL DEFAULT '1970-01-01',
    separated DATE NOT NULL DEFAULT '9999-12-31',
    job_code INT NOT NULL,
    store_id INT NOT NULL
)
PARTITION BY RANGE (store_id) (
    PARTITION p0 VALUES LESS THAN (6),
    PARTITION p1 VALUES LESS THAN (11),
    PARTITION p2 VALUES LESS THAN (16),
    PARTITION p3 VALUES LESS THAN (21)
);

```

In this partitioning scheme, all rows corresponding to employees working at stores 1 through 5 are stored in partition `p0`, to those employed at stores 6 through 10 are stored in partition `p1`, and so on. Note that each partition is defined in order, from lowest to highest. This is a requirement of the `PARTITION BY RANGE` syntax; you can think of it as being analogous to a series of `if ... elseif ...` statements in C or Java in this regard.

It is easy to determine that a new row containing the data `(72, 'Mitchell', 'Wilson', '1998-06-25', DEFAULT, 7, 13)` is inserted into partition `p2`, but what happens when your chain adds a 21<sup>st</sup> store? Under this scheme, there is no rule that covers a row whose `store_id` is greater than 20, so an error results because the server does not know where to place it. You can keep this from occurring by using a “catchall” `VALUES LESS THAN` clause in the `CREATE TABLE` statement that provides for all values greater than the highest value explicitly named:

```

CREATE TABLE employees (
    id INT NOT NULL,
    fname VARCHAR(30),
    lname VARCHAR(30),
    hired DATE NOT NULL DEFAULT '1970-01-01',
    separated DATE NOT NULL DEFAULT '9999-12-31',
    job_code INT NOT NULL,
    store_id INT NOT NULL
)
PARTITION BY RANGE (store_id) (
    PARTITION p0 VALUES LESS THAN (6),
    PARTITION p1 VALUES LESS THAN (11),
    PARTITION p2 VALUES LESS THAN (16),
    PARTITION p3 VALUES LESS THAN MAXVALUE
);

```

Another way to avoid an error when no matching value is found is to use the `IGNORE` keyword as part of the `INSERT` statement. For an example, see [Section 22.2.2, “LIST Partitioning”](#).

`MAXVALUE` represents an integer value that is always greater than the largest possible integer value (in mathematical language, it serves as a *least upper bound*). Now, any rows whose `store_id` column value is greater than or equal to 16 (the highest value defined) are stored in partition `p3`. At some point in the future—when the number of stores has increased to 25, 30, or more—you can use an `ALTER TABLE` statement to add new partitions for stores 21-25, 26-30, and so on (see [Section 22.3, “Partition Management”](#), for details of how to do this).

In much the same fashion, you could partition the table based on employee job codes—that is, based on ranges of `job_code` column values. For example—assuming that two-digit job codes are used for regular (in-store) workers, three-digit codes are used for office and support personnel, and four-digit codes are used for management positions—you could create the partitioned table using the following statement:

```

CREATE TABLE employees (
    id INT NOT NULL,

```

## RANGE Partitioning

```
fname VARCHAR(30),
lname VARCHAR(30),
hired DATE NOT NULL DEFAULT '1970-01-01',
separated DATE NOT NULL DEFAULT '9999-12-31',
job_code INT NOT NULL,
store_id INT NOT NULL
)
PARTITION BY RANGE (job_code) (
PARTITION p0 VALUES LESS THAN (100),
PARTITION p1 VALUES LESS THAN (1000),
PARTITION p2 VALUES LESS THAN (10000)
);
```

In this instance, all rows relating to in-store workers would be stored in partition `p0`, those relating to office and support staff in `p1`, and those relating to managers in partition `p2`.

It is also possible to use an expression in `VALUES LESS THAN` clauses. However, MySQL must be able to evaluate the expression's return value as part of a `LESS THAN (<)` comparison.

Rather than splitting up the table data according to store number, you can use an expression based on one of the two `DATE` columns instead. For example, let us suppose that you wish to partition based on the year that each employee left the company; that is, the value of `YEAR(separated)`. An example of a `CREATE TABLE` statement that implements such a partitioning scheme is shown here:

```
CREATE TABLE employees (
  id INT NOT NULL,
  fname VARCHAR(30),
  lname VARCHAR(30),
  hired DATE NOT NULL DEFAULT '1970-01-01',
  separated DATE NOT NULL DEFAULT '9999-12-31',
  job_code INT,
  store_id INT
)
PARTITION BY RANGE ( YEAR(separated) ) (
PARTITION p0 VALUES LESS THAN (1991),
PARTITION p1 VALUES LESS THAN (1996),
PARTITION p2 VALUES LESS THAN (2001),
PARTITION p3 VALUES LESS THAN MAXVALUE
);
```

In this scheme, for all employees who left before 1991, the rows are stored in partition `p0`; for those who left in the years 1991 through 1995, in `p1`; for those who left in the years 1996 through 2000, in `p2`; and for any workers who left after the year 2000, in `p3`.

It is also possible to partition a table by `RANGE`, based on the value of a `TIMESTAMP` column, using the `UNIX_TIMESTAMP()` function, as shown in this example:

```
CREATE TABLE quarterly_report_status (
  report_id INT NOT NULL,
  report_status VARCHAR(20) NOT NULL,
  report_updated TIMESTAMP NOT NULL DEFAULT CURRENT_TIMESTAMP ON UPDATE CURRENT_TIMESTAMP
)
PARTITION BY RANGE ( UNIX_TIMESTAMP(report_updated) ) (
PARTITION p0 VALUES LESS THAN ( UNIX_TIMESTAMP('2008-01-01 00:00:00') ),
PARTITION p1 VALUES LESS THAN ( UNIX_TIMESTAMP('2008-04-01 00:00:00') ),
PARTITION p2 VALUES LESS THAN ( UNIX_TIMESTAMP('2008-07-01 00:00:00') ),
PARTITION p3 VALUES LESS THAN ( UNIX_TIMESTAMP('2008-10-01 00:00:00') ),
PARTITION p4 VALUES LESS THAN ( UNIX_TIMESTAMP('2009-01-01 00:00:00') ),
PARTITION p5 VALUES LESS THAN ( UNIX_TIMESTAMP('2009-04-01 00:00:00') ),
PARTITION p6 VALUES LESS THAN ( UNIX_TIMESTAMP('2009-07-01 00:00:00') ),
PARTITION p7 VALUES LESS THAN ( UNIX_TIMESTAMP('2009-10-01 00:00:00') ),
PARTITION p8 VALUES LESS THAN ( UNIX_TIMESTAMP('2010-01-01 00:00:00') ),
PARTITION p9 VALUES LESS THAN (MAXVALUE)
);
```

```
);
```

Any other expressions involving `TIMESTAMP` values are not permitted. (See Bug #42849.)

Range partitioning is particularly useful when one or more of the following conditions is true:

- You want or need to delete “old” data. If you are using the partitioning scheme shown previously for the `employees` table, you can simply use `ALTER TABLE employees DROP PARTITION p0;` to delete all rows relating to employees who stopped working for the firm prior to 1991. (See [Section 13.1.8, “ALTER TABLE Statement”](#), and [Section 22.3, “Partition Management”](#), for more information.) For a table with a great many rows, this can be much more efficient than running a `DELETE` query such as `DELETE FROM employees WHERE YEAR(separated) <= 1990;`.
- You want to use a column containing date or time values, or containing values arising from some other series.
- You frequently run queries that depend directly on the column used for partitioning the table. For example, when executing a query such as `EXPLAIN SELECT COUNT(*) FROM employees WHERE separated BETWEEN '2000-01-01' AND '2000-12-31' GROUP BY store_id;` MySQL can quickly determine that only partition `p2` needs to be scanned because the remaining partitions cannot contain any records satisfying the `WHERE` clause. See [Section 22.4, “Partition Pruning”](#), for more information about how this is accomplished.

A variant on this type of partitioning is `RANGE COLUMNS` partitioning. Partitioning by `RANGE COLUMNS` makes it possible to employ multiple columns for defining partitioning ranges that apply both to placement of rows in partitions and for determining the inclusion or exclusion of specific partitions when performing partition pruning. See [Section 22.2.3.1, “RANGE COLUMNS partitioning”](#), for more information.

**Partitioning schemes based on time intervals.** If you wish to implement a partitioning scheme based on ranges or intervals of time in MySQL 5.7, you have two options:

1. Partition the table by `RANGE`, and for the partitioning expression, employ a function operating on a `DATE`, `TIME`, or `DATETIME` column and returning an integer value, as shown here:

```
CREATE TABLE members (
  firstname VARCHAR(25) NOT NULL,
  lastname VARCHAR(25) NOT NULL,
  username VARCHAR(16) NOT NULL,
  email VARCHAR(35),
  joined DATE NOT NULL
)
PARTITION BY RANGE( YEAR(joined) ) (
  PARTITION p0 VALUES LESS THAN (1960),
  PARTITION p1 VALUES LESS THAN (1970),
  PARTITION p2 VALUES LESS THAN (1980),
  PARTITION p3 VALUES LESS THAN (1990),
  PARTITION p4 VALUES LESS THAN MAXVALUE
);
```

In MySQL 5.7, it is also possible to partition a table by `RANGE` based on the value of a `TIMESTAMP` column, using the `UNIX_TIMESTAMP()` function, as shown in this example:

```
CREATE TABLE quarterly_report_status (
  report_id INT NOT NULL,
  report_status VARCHAR(20) NOT NULL,
  report_updated TIMESTAMP NOT NULL DEFAULT CURRENT_TIMESTAMP ON UPDATE CURRENT_TIMESTAMP
)
PARTITION BY RANGE ( UNIX_TIMESTAMP(report_updated) ) (
  PARTITION p0 VALUES LESS THAN ( UNIX_TIMESTAMP('2008-01-01 00:00:00') ),
  PARTITION p1 VALUES LESS THAN ( UNIX_TIMESTAMP('2008-04-01 00:00:00') ),
```

```

PARTITION p2 VALUES LESS THAN ( UNIX_TIMESTAMP('2008-07-01 00:00:00') ),
PARTITION p3 VALUES LESS THAN ( UNIX_TIMESTAMP('2008-10-01 00:00:00') ),
PARTITION p4 VALUES LESS THAN ( UNIX_TIMESTAMP('2009-01-01 00:00:00') ),
PARTITION p5 VALUES LESS THAN ( UNIX_TIMESTAMP('2009-04-01 00:00:00') ),
PARTITION p6 VALUES LESS THAN ( UNIX_TIMESTAMP('2009-07-01 00:00:00') ),
PARTITION p7 VALUES LESS THAN ( UNIX_TIMESTAMP('2009-10-01 00:00:00') ),
PARTITION p8 VALUES LESS THAN ( UNIX_TIMESTAMP('2010-01-01 00:00:00') ),
PARTITION p9 VALUES LESS THAN (MAXVALUE)
);

```

In MySQL 5.7, any other expressions involving `TIMESTAMP` values are not permitted. (See Bug #42849.)



#### Note

It is also possible in MySQL 5.7 to use `UNIX_TIMESTAMP(timestamp_column)` as a partitioning expression for tables that are partitioned by `LIST`. However, it is usually not practical to do so.

- Partition the table by `RANGE COLUMNS`, using a `DATE` or `DATETIME` column as the partitioning column. For example, the `members` table could be defined using the `joined` column directly, as shown here:

```

CREATE TABLE members (
  firstname VARCHAR(25) NOT NULL,
  lastname VARCHAR(25) NOT NULL,
  username VARCHAR(16) NOT NULL,
  email VARCHAR(35),
  joined DATE NOT NULL
)
PARTITION BY RANGE COLUMNS(joined) (
  PARTITION p0 VALUES LESS THAN ('1960-01-01'),
  PARTITION p1 VALUES LESS THAN ('1970-01-01'),
  PARTITION p2 VALUES LESS THAN ('1980-01-01'),
  PARTITION p3 VALUES LESS THAN ('1990-01-01'),
  PARTITION p4 VALUES LESS THAN MAXVALUE
);

```



#### Note

The use of partitioning columns employing date or time types other than `DATE` or `DATETIME` is not supported with `RANGE COLUMNS`.

## 22.2.2 LIST Partitioning

List partitioning in MySQL is similar to range partitioning in many ways. As in partitioning by `RANGE`, each partition must be explicitly defined. The chief difference between the two types of partitioning is that, in list partitioning, each partition is defined and selected based on the membership of a column value in one of a set of value lists, rather than in one of a set of contiguous ranges of values. This is done by using `PARTITION BY LIST(expr)` where `expr` is a column value or an expression based on a column value and returning an integer value, and then defining each partition by means of a `VALUES IN (value_list)`, where `value_list` is a comma-separated list of integers.



#### Note

In MySQL 5.7, it is possible to match against only a list of integers (and possibly `NULL`—see Section 22.2.7, “How MySQL Partitioning Handles NULL”) when partitioning by `LIST`.

However, other column types may be used in value lists when employing `LIST COLUMN` partitioning, which is described later in this section.

Unlike the case with partitions defined by range, list partitions do not need to be declared in any particular order. For more detailed syntactical information, see [Section 13.1.18, “CREATE TABLE Statement”](#).

For the examples that follow, we assume that the basic definition of the table to be partitioned is provided by the `CREATE TABLE` statement shown here:

```
CREATE TABLE employees (
  id INT NOT NULL,
  fname VARCHAR(30),
  lname VARCHAR(30),
  hired DATE NOT NULL DEFAULT '1970-01-01',
  separated DATE NOT NULL DEFAULT '9999-12-31',
  job_code INT,
  store_id INT
);
```

(This is the same table used as a basis for the examples in [Section 22.2.1, “RANGE Partitioning”](#).)

Suppose that there are 20 video stores distributed among 4 franchises as shown in the following table.

Region	Store ID Numbers
North	3, 5, 6, 9, 17
East	1, 2, 10, 11, 19, 20
West	4, 12, 13, 14, 18
Central	7, 8, 15, 16

To partition this table in such a way that rows for stores belonging to the same region are stored in the same partition, you could use the `CREATE TABLE` statement shown here:

```
CREATE TABLE employees (
  id INT NOT NULL,
  fname VARCHAR(30),
  lname VARCHAR(30),
  hired DATE NOT NULL DEFAULT '1970-01-01',
  separated DATE NOT NULL DEFAULT '9999-12-31',
  job_code INT,
  store_id INT
)
PARTITION BY LIST(store_id) (
  PARTITION pNorth VALUES IN (3,5,6,9,17),
  PARTITION pEast VALUES IN (1,2,10,11,19,20),
  PARTITION pWest VALUES IN (4,12,13,14,18),
  PARTITION pCentral VALUES IN (7,8,15,16)
);
```

This makes it easy to add or drop employee records relating to specific regions to or from the table. For instance, suppose that all stores in the West region are sold to another company. In MySQL 5.7, all rows relating to employees working at stores in that region can be deleted with the query `ALTER TABLE employees TRUNCATE PARTITION pWest`, which can be executed much more efficiently than the equivalent `DELETE` statement `DELETE FROM employees WHERE store_id IN (4,12,13,14,18);`. (Using `ALTER TABLE employees DROP PARTITION pWest` would also delete all of these rows, but would also remove the partition `pWest` from the definition of the table; you would need to use an `ALTER TABLE ... ADD PARTITION` statement to restore the table's original partitioning scheme.)

As with [RANGE](#) partitioning, it is possible to combine [LIST](#) partitioning with partitioning by hash or key to produce a composite partitioning (subpartitioning). See [Section 22.2.6, “Subpartitioning”](#).

Unlike the case with [RANGE](#) partitioning, there is no “catch-all” such as `MAXVALUE`; all expected values for the partitioning expression should be covered in `PARTITION ... VALUES IN (...)` clauses. An

`INSERT` statement containing an unmatched partitioning column value fails with an error, as shown in this example:

```
mysql> CREATE TABLE h2 (
->   c1 INT,
->   c2 INT
-> )
-> PARTITION BY LIST(c1) (
->   PARTITION p0 VALUES IN (1, 4, 7),
->   PARTITION p1 VALUES IN (2, 5, 8)
-> );
Query OK, 0 rows affected (0.11 sec)

mysql> INSERT INTO h2 VALUES (3, 5);
ERROR 1525 (HY000): Table has no partition for value 3
```

When inserting multiple rows using a single `INSERT` statement the behavior depends on whether the table uses a transactional storage engine. For an `InnoDB` table, the statement is considered a single transaction, so the presence of any unmatched values causes the statement to fail completely, and no rows are inserted. For a table using a nontransactional storage engine such as `MyISAM`, any rows coming before the row containing the unmatched value are inserted, but any coming after it are not.

You can cause this type of error to be ignored by using the `IGNORE` keyword, although a warning is issued for each row containing unmatched partitioning column values, as shown here.

```
mysql> TRUNCATE h2;
Query OK, 1 row affected (0.00 sec)

mysql> TABLE h2;
Empty set (0.00 sec)

mysql> INSERT IGNORE INTO h2 VALUES (2, 5), (6, 10), (7, 5), (3, 1), (1, 9);
Query OK, 3 rows affected, 2 warnings (0.01 sec)
Records: 5  Duplicates: 2  Warnings: 2

mysql> SHOW WARNINGS;
+-----+-----+-----+
| Level | Code | Message                                     |
+-----+-----+-----+
| Warning | 1526 | Table has no partition for value 6 |
| Warning | 1526 | Table has no partition for value 3 |
+-----+-----+-----+
2 rows in set (0.00 sec)
```

You can see in the output of the following `TABLE` statement that rows containing unmatched partitioning column values were silently rejected, while rows containing no unmatched values were inserted into the table:

```
mysql> TABLE h2;
+-----+-----+
| c1 | c2 |
+-----+-----+
| 7 | 5 |
| 1 | 9 |
| 2 | 5 |
+-----+-----+
3 rows in set (0.00 sec)
```

MySQL also provides support for `LIST COLUMNS` partitioning, a variant of `LIST` partitioning that enables you to use columns of types other than integer for partitioning columns, and to use multiple columns as partitioning keys. For more information, see [Section 22.2.3.2, “LIST COLUMNS partitioning”](#).

## 22.2.3 COLUMNS Partitioning

The next two sections discuss *COLUMNS partitioning*, which are variants on [RANGE](#) and [LIST](#) partitioning. *COLUMNS* partitioning enables the use of multiple columns in partitioning keys. All of these columns are taken into account both for the purpose of placing rows in partitions and for the determination of which partitions are to be checked for matching rows in partition pruning.

In addition, both [RANGE COLUMNS](#) partitioning and [LIST COLUMNS](#) partitioning support the use of non-integer columns for defining value ranges or list members. The permitted data types are shown in the following list:

- All integer types: [TINYINT](#), [SMALLINT](#), [MEDIUMINT](#), [INT \(INTEGER\)](#), and [BIGINT](#). (This is the same as with partitioning by [RANGE](#) and [LIST](#).)

Other numeric data types (such as [DECIMAL](#) or [FLOAT](#)) are not supported as partitioning columns.

- [DATE](#) and [DATETIME](#).

Columns using other data types relating to dates or times are not supported as partitioning columns.

- The following string types: [CHAR](#), [VARCHAR](#), [BINARY](#), and [VARBINARY](#).

[TEXT](#) and [BLOB](#) columns are not supported as partitioning columns.

The discussions of [RANGE COLUMNS](#) and [LIST COLUMNS](#) partitioning in the next two sections assume that you are already familiar with partitioning based on ranges and lists as supported in MySQL 5.1 and later; for more information about these, see [Section 22.2.1, “RANGE Partitioning”](#), and [Section 22.2.2, “LIST Partitioning”](#), respectively.

### 22.2.3.1 RANGE COLUMNS partitioning

Range columns partitioning is similar to range partitioning, but enables you to define partitions using ranges based on multiple column values. In addition, you can define the ranges using columns of types other than integer types.

[RANGE COLUMNS](#) partitioning differs significantly from [RANGE](#) partitioning in the following ways:

- [RANGE COLUMNS](#) does not accept expressions, only names of columns.
- [RANGE COLUMNS](#) accepts a list of one or more columns.

[RANGE COLUMNS](#) partitions are based on comparisons between *tuples* (lists of column values) rather than comparisons between scalar values. Placement of rows in [RANGE COLUMNS](#) partitions is also based on comparisons between tuples; this is discussed further later in this section.

- [RANGE COLUMNS](#) partitioning columns are not restricted to integer columns; string, [DATE](#) and [DATETIME](#) columns can also be used as partitioning columns. (See [Section 22.2.3, “COLUMNS Partitioning”](#), for details.)

The basic syntax for creating a table partitioned by [RANGE COLUMNS](#) is shown here:

```
CREATE TABLE table_name
PARTITION BY RANGE COLUMNS(column_list) (
    PARTITION partition_name VALUES LESS THAN (value_list)[,
    PARTITION partition_name VALUES LESS THAN (value_list)][,
    ...]
)
column_list:
    column_name[, column_name][, ...]
```

```
value_list:
    value[, value][, ...]
```

**Note**

Not all `CREATE TABLE` options that can be used when creating partitioned tables are shown here. For complete information, see [Section 13.1.18, “CREATE TABLE Statement”](#).

In the syntax just shown, *column\_list* is a list of one or more columns (sometimes called a *partitioning column list*), and *value\_list* is a list of values (that is, it is a *partition definition value list*). A *value\_list* must be supplied for each partition definition, and each *value\_list* must have the same number of values as the *column\_list* has columns. Generally speaking, if you use *N* columns in the `COLUMNS` clause, then each `VALUES LESS THAN` clause must also be supplied with a list of *N* values.

The elements in the partitioning column list and in the value list defining each partition must occur in the same order. In addition, each element in the value list must be of the same data type as the corresponding element in the column list. However, the order of the column names in the partitioning column list and the value lists does not have to be the same as the order of the table column definitions in the main part of the `CREATE TABLE` statement. As with table partitioned by `RANGE`, you can use `MAXVALUE` to represent a value such that any legal value inserted into a given column is always less than this value. Here is an example of a `CREATE TABLE` statement that helps to illustrate all of these points:

```
mysql> CREATE TABLE rcx (
->     a INT,
->     b INT,
->     c CHAR(3),
->     d INT
-> )
-> PARTITION BY RANGE COLUMNS(a,d,c) (
->     PARTITION p0 VALUES LESS THAN (5,10,'ggg'),
->     PARTITION p1 VALUES LESS THAN (10,20,'mmm'),
->     PARTITION p2 VALUES LESS THAN (15,30,'sss'),
->     PARTITION p3 VALUES LESS THAN (MAXVALUE,MAXVALUE,MAXVALUE)
-> );
Query OK, 0 rows affected (0.15 sec)
```

Table `rcx` contains the columns `a`, `b`, `c`, `d`. The partitioning column list supplied to the `COLUMNS` clause uses 3 of these columns, in the order `a`, `d`, `c`. Each value list used to define a partition contains 3 values in the same order; that is, each value list tuple has the form `(INT, INT, CHAR(3))`, which corresponds to the data types used by columns `a`, `d`, and `c` (in that order).

Placement of rows into partitions is determined by comparing the tuple from a row to be inserted that matches the column list in the `COLUMNS` clause with the tuples used in the `VALUES LESS THAN` clauses to define partitions of the table. Because we are comparing tuples (that is, lists or sets of values) rather than scalar values, the semantics of `VALUES LESS THAN` as used with `RANGE COLUMNS` partitions differs somewhat from the case with simple `RANGE` partitions. In `RANGE` partitioning, a row generating an expression value that is equal to a limiting value in a `VALUES LESS THAN` is never placed in the corresponding partition; however, when using `RANGE COLUMNS` partitioning, it is sometimes possible for a row whose partitioning column list's first element is equal in value to the that of the first element in a `VALUES LESS THAN` value list to be placed in the corresponding partition.

Consider the `RANGE` partitioned table created by this statement:

```
CREATE TABLE r1 (
    a INT,
    b INT
)
PARTITION BY RANGE (a) (
```



```

PARTITION p0 VALUES LESS THAN (5),
PARTITION p1 VALUES LESS THAN (MAXVALUE)
);

```

If we insert 3 rows into this table such that the column value for `a` is 5 for each row, all 3 rows are stored in partition `p1` because the `a` column value is in each case not less than 5, as we can see by executing the proper query against the Information Schema `PARTITIONS` table:

```

mysql> INSERT INTO r1 VALUES (5,10), (5,11), (5,12);
Query OK, 3 rows affected (0.00 sec)
Records: 3 Duplicates: 0 Warnings: 0

mysql> SELECT PARTITION_NAME, TABLE_ROWS
  ->     FROM INFORMATION_SCHEMA.PARTITIONS
  ->     WHERE TABLE_NAME = 'r1';
+-----+-----+
| PARTITION_NAME | TABLE_ROWS |
+-----+-----+
| p0             |            0 |
| p1             |            3 |
+-----+-----+
2 rows in set (0.00 sec)

```

Now consider a similar table `rc1` that uses `RANGE COLUMNS` partitioning with both columns `a` and `b` referenced in the `COLUMNS` clause, created as shown here:

```

CREATE TABLE rc1 (
  a INT,
  b INT
)
PARTITION BY RANGE COLUMNS(a, b) (
  PARTITION p0 VALUES LESS THAN (5, 12),
  PARTITION p3 VALUES LESS THAN (MAXVALUE, MAXVALUE)
);

```

If we insert exactly the same rows into `rc1` as we just inserted into `r1`, the distribution of the rows is quite different:

```

mysql> INSERT INTO rc1 VALUES (5,10), (5,11), (5,12);
Query OK, 3 rows affected (0.00 sec)
Records: 3 Duplicates: 0 Warnings: 0

mysql> SELECT PARTITION_NAME, TABLE_ROWS
  ->     FROM INFORMATION_SCHEMA.PARTITIONS
  ->     WHERE TABLE_NAME = 'rc1';
+-----+-----+
| PARTITION_NAME | TABLE_ROWS |
+-----+-----+
| p0             |            2 |
| p3             |            1 |
+-----+-----+
2 rows in set (0.00 sec)

```

This is because we are comparing rows rather than scalar values. We can compare the row values inserted with the limiting row value from the `VALUES THAN LESS THAN` clause used to define partition `p0` in table `rc1`, like this:

```

mysql> SELECT (5,10) < (5,12), (5,11) < (5,12), (5,12) < (5,12);
+-----+-----+-----+
| (5,10) < (5,12) | (5,11) < (5,12) | (5,12) < (5,12) |
+-----+-----+-----+
|            1 |            1 |            0 |
+-----+-----+-----+
1 row in set (0.00 sec)

```

The 2 tuples (5,10) and (5,11) evaluate as less than (5,12), so they are stored in partition p0. Since 5 is not less than 5 and 12 is not less than 12, (5,12) is considered not less than (5,12), and is stored in partition p1.

The `SELECT` statement in the preceding example could also have been written using explicit row constructors, like this:

```
SELECT ROW(5,10) < ROW(5,12), ROW(5,11) < ROW(5,12), ROW(5,12) < ROW(5,12);
```

For more information about the use of row constructors in MySQL, see [Section 13.2.10.5, “Row Subqueries”](#).

For a table partitioned by `RANGE COLUMNS` using only a single partitioning column, the storing of rows in partitions is the same as that of an equivalent table that is partitioned by `RANGE`. The following `CREATE TABLE` statement creates a table partitioned by `RANGE COLUMNS` using 1 partitioning column:

```
CREATE TABLE rx (
  a INT,
  b INT
)
PARTITION BY RANGE COLUMNS (a) (
  PARTITION p0 VALUES LESS THAN (5),
  PARTITION p1 VALUES LESS THAN (MAXVALUE)
);
```

If we insert the rows (5,10), (5,11), and (5,12) into this table, we can see that their placement is the same as it is for the table `r` we created and populated earlier:

```
mysql> INSERT INTO rx VALUES (5,10), (5,11), (5,12);
Query OK, 3 rows affected (0.00 sec)
Records: 3 Duplicates: 0 Warnings: 0
```

```
mysql> SELECT PARTITION_NAME, TABLE_ROWS
-> FROM INFORMATION_SCHEMA.PARTITIONS
-> WHERE TABLE_NAME = 'rx';
```

PARTITION_NAME	TABLE_ROWS
p0	0
p1	3

2 rows in set (0.00 sec)

It is also possible to create tables partitioned by `RANGE COLUMNS` where limiting values for one or more columns are repeated in successive partition definitions. You can do this as long as the tuples of column values used to define the partitions are strictly increasing. For example, each of the following `CREATE TABLE` statements is valid:

```
CREATE TABLE rc2 (
  a INT,
  b INT
)
PARTITION BY RANGE COLUMNS(a,b) (
  PARTITION p0 VALUES LESS THAN (0,10),
  PARTITION p1 VALUES LESS THAN (10,20),
  PARTITION p2 VALUES LESS THAN (10,30),
  PARTITION p3 VALUES LESS THAN (MAXVALUE,MAXVALUE)
);

CREATE TABLE rc3 (
  a INT,
  b INT
)
PARTITION BY RANGE COLUMNS(a,b) (
```

```

PARTITION p0 VALUES LESS THAN (0,10),
PARTITION p1 VALUES LESS THAN (10,20),
PARTITION p2 VALUES LESS THAN (10,30),
PARTITION p3 VALUES LESS THAN (10,35),
PARTITION p4 VALUES LESS THAN (20,40),
PARTITION p5 VALUES LESS THAN (MAXVALUE,MAXVALUE)
);

```

The following statement also succeeds, even though it might appear at first glance that it would not, since the limiting value of column `b` is 25 for partition `p0` and 20 for partition `p1`, and the limiting value of column `c` is 100 for partition `p1` and 50 for partition `p2`:

```

CREATE TABLE rc4 (
  a INT,
  b INT,
  c INT
)
PARTITION BY RANGE COLUMNS(a,b,c) (
  PARTITION p0 VALUES LESS THAN (0,25,50),
  PARTITION p1 VALUES LESS THAN (10,20,100),
  PARTITION p2 VALUES LESS THAN (10,30,50),
  PARTITION p3 VALUES LESS THAN (MAXVALUE,MAXVALUE,MAXVALUE)
);

```

When designing tables partitioned by `RANGE COLUMNS`, you can always test successive partition definitions by comparing the desired tuples using the `mysql` client, like this:

```

mysql> SELECT (0,25,50) < (10,20,100), (10,20,100) < (10,30,50);
+-----+-----+
| (0,25,50) < (10,20,100) | (10,20,100) < (10,30,50) |
+-----+-----+
| 1 | 1 |
+-----+-----+
1 row in set (0.00 sec)

```

If a `CREATE TABLE` statement contains partition definitions that are not in strictly increasing order, it fails with an error, as shown in this example:

```

mysql> CREATE TABLE rcf (
->   a INT,
->   b INT,
->   c INT
-> )
-> PARTITION BY RANGE COLUMNS(a,b,c) (
->   PARTITION p0 VALUES LESS THAN (0,25,50),
->   PARTITION p1 VALUES LESS THAN (20,20,100),
->   PARTITION p2 VALUES LESS THAN (10,30,50),
->   PARTITION p3 VALUES LESS THAN (MAXVALUE,MAXVALUE,MAXVALUE)
-> );
ERROR 1493 (HY000): VALUES LESS THAN value must be strictly increasing for each partition

```

When you get such an error, you can deduce which partition definitions are invalid by making “less than” comparisons between their column lists. In this case, the problem is with the definition of partition `p2` because the tuple used to define it is not less than the tuple used to define partition `p3`, as shown here:

```

mysql> SELECT (0,25,50) < (20,20,100), (20,20,100) < (10,30,50);
+-----+-----+
| (0,25,50) < (20,20,100) | (20,20,100) < (10,30,50) |
+-----+-----+
| 1 | 0 |
+-----+-----+
1 row in set (0.00 sec)

```

It is also possible for `MAXVALUE` to appear for the same column in more than one `VALUES LESS THAN` clause when using `RANGE COLUMNS`. However, the limiting values for individual columns in successive

partition definitions should otherwise be increasing, there should be no more than one partition defined where `MAXVALUE` is used as the upper limit for all column values, and this partition definition should appear last in the list of `PARTITION ... VALUES LESS THAN` clauses. In addition, you cannot use `MAXVALUE` as the limiting value for the first column in more than one partition definition.

As stated previously, it is also possible with `RANGE COLUMNS` partitioning to use non-integer columns as partitioning columns. (See [Section 22.2.3, “COLUMNS Partitioning”](#), for a complete listing of these.) Consider a table named `employees` (which is not partitioned), created using the following statement:

```
CREATE TABLE employees (
  id INT NOT NULL,
  fname VARCHAR(30),
  lname VARCHAR(30),
  hired DATE NOT NULL DEFAULT '1970-01-01',
  separated DATE NOT NULL DEFAULT '9999-12-31',
  job_code INT NOT NULL,
  store_id INT NOT NULL
);
```

Using `RANGE COLUMNS` partitioning, you can create a version of this table that stores each row in one of four partitions based on the employee's last name, like this:

```
CREATE TABLE employees_by_lname (
  id INT NOT NULL,
  fname VARCHAR(30),
  lname VARCHAR(30),
  hired DATE NOT NULL DEFAULT '1970-01-01',
  separated DATE NOT NULL DEFAULT '9999-12-31',
  job_code INT NOT NULL,
  store_id INT NOT NULL
)
PARTITION BY RANGE COLUMNS (lname) (
  PARTITION p0 VALUES LESS THAN ('g'),
  PARTITION p1 VALUES LESS THAN ('m'),
  PARTITION p2 VALUES LESS THAN ('t'),
  PARTITION p3 VALUES LESS THAN (MAXVALUE)
);
```

Alternatively, you could cause the `employees` table as created previously to be partitioned using this scheme by executing the following `ALTER TABLE` statement:

```
ALTER TABLE employees PARTITION BY RANGE COLUMNS (lname) (
  PARTITION p0 VALUES LESS THAN ('g'),
  PARTITION p1 VALUES LESS THAN ('m'),
  PARTITION p2 VALUES LESS THAN ('t'),
  PARTITION p3 VALUES LESS THAN (MAXVALUE)
);
```



### Note

Because different character sets and collations have different sort orders, the character sets and collations in use may effect which partition of a table partitioned by `RANGE COLUMNS` a given row is stored in when using string columns as partitioning columns. In addition, changing the character set or collation for a given database, table, or column after such a table is created may cause changes in how rows are distributed. For example, when using a case-sensitive collation, `'and'` sorts before `'Andersen'`, but when using a collation that is case-insensitive, the reverse is true.

For information about how MySQL handles character sets and collations, see [Chapter 10, Character Sets, Collations, Unicode](#).

Similarly, you can cause the `employees` table to be partitioned in such a way that each row is stored in one of several partitions based on the decade in which the corresponding employee was hired using the `ALTER TABLE` statement shown here:

```
ALTER TABLE employees PARTITION BY RANGE COLUMNS (hired) (
  PARTITION p0 VALUES LESS THAN ('1970-01-01'),
  PARTITION p1 VALUES LESS THAN ('1980-01-01'),
  PARTITION p2 VALUES LESS THAN ('1990-01-01'),
  PARTITION p3 VALUES LESS THAN ('2000-01-01'),
  PARTITION p4 VALUES LESS THAN ('2010-01-01'),
  PARTITION p5 VALUES LESS THAN (MAXVALUE)
);
```

See [Section 13.1.18, “CREATE TABLE Statement”](#), for additional information about `PARTITION BY RANGE COLUMNS` syntax.

### 22.2.3.2 LIST COLUMNS partitioning

MySQL 5.7 provides support for `LIST COLUMNS` partitioning. This is a variant of `LIST` partitioning that enables the use of multiple columns as partition keys, and for columns of data types other than integer types to be used as partitioning columns; you can use string types, `DATE`, and `DATETIME` columns. (For more information about permitted data types for `COLUMNS` partitioning columns, see [Section 22.2.3, “COLUMNS Partitioning”](#).)

Suppose that you have a business that has customers in 12 cities which, for sales and marketing purposes, you organize into 4 regions of 3 cities each as shown in the following table:

Region	Cities
1	Oskarshamn, Högsby, Mönsterås
2	Vimmerby, Hultsfred, Västervik
3	Nässjö, Eksjö, Vetlanda
4	Uppvidinge, Alvesta, Växjö

With `LIST COLUMNS` partitioning, you can create a table for customer data that assigns a row to any of 4 partitions corresponding to these regions based on the name of the city where a customer resides, as shown here:

```
CREATE TABLE customers_1 (
  first_name VARCHAR(25),
  last_name VARCHAR(25),
  street_1 VARCHAR(30),
  street_2 VARCHAR(30),
  city VARCHAR(15),
  renewal DATE
)
PARTITION BY LIST COLUMNS(city) (
  PARTITION pRegion_1 VALUES IN('Oskarshamn', 'Högsby', 'Mönsterås'),
  PARTITION pRegion_2 VALUES IN('Vimmerby', 'Hultsfred', 'Västervik'),
  PARTITION pRegion_3 VALUES IN('Nässjö', 'Eksjö', 'Vetlanda'),
  PARTITION pRegion_4 VALUES IN('Uppvidinge', 'Alvesta', 'Växjö')
);
```

As with partitioning by `RANGE COLUMNS`, you do not need to use expressions in the `COLUMNS()` clause to convert column values into integers. (In fact, the use of expressions other than column names is not permitted with `COLUMNS()`.)

It is also possible to use `DATE` and `DATETIME` columns, as shown in the following example that uses the same name and columns as the `customers_1` table shown previously, but employs `LIST COLUMNS`

partitioning based on the `renewal` column to store rows in one of 4 partitions depending on the week in February 2010 the customer's account is scheduled to renew:

```
CREATE TABLE customers_2 (
  first_name VARCHAR(25),
  last_name VARCHAR(25),
  street_1 VARCHAR(30),
  street_2 VARCHAR(30),
  city VARCHAR(15),
  renewal DATE
)
PARTITION BY LIST COLUMNS(renewal) (
  PARTITION pWeek_1 VALUES IN('2010-02-01', '2010-02-02', '2010-02-03',
    '2010-02-04', '2010-02-05', '2010-02-06', '2010-02-07'),
  PARTITION pWeek_2 VALUES IN('2010-02-08', '2010-02-09', '2010-02-10',
    '2010-02-11', '2010-02-12', '2010-02-13', '2010-02-14'),
  PARTITION pWeek_3 VALUES IN('2010-02-15', '2010-02-16', '2010-02-17',
    '2010-02-18', '2010-02-19', '2010-02-20', '2010-02-21'),
  PARTITION pWeek_4 VALUES IN('2010-02-22', '2010-02-23', '2010-02-24',
    '2010-02-25', '2010-02-26', '2010-02-27', '2010-02-28')
);
```

This works, but becomes cumbersome to define and maintain if the number of dates involved grows very large; in such cases, it is usually more practical to employ `RANGE` or `RANGE COLUMNS` partitioning instead. In this case, since the column we wish to use as the partitioning key is a `DATE` column, we use `RANGE COLUMNS` partitioning, as shown here:

```
CREATE TABLE customers_3 (
  first_name VARCHAR(25),
  last_name VARCHAR(25),
  street_1 VARCHAR(30),
  street_2 VARCHAR(30),
  city VARCHAR(15),
  renewal DATE
)
PARTITION BY RANGE COLUMNS(renewal) (
  PARTITION pWeek_1 VALUES LESS THAN('2010-02-09'),
  PARTITION pWeek_2 VALUES LESS THAN('2010-02-15'),
  PARTITION pWeek_3 VALUES LESS THAN('2010-02-22'),
  PARTITION pWeek_4 VALUES LESS THAN('2010-03-01')
);
```

See [Section 22.2.3.1, “RANGE COLUMNS partitioning”](#), for more information.

In addition (as with `RANGE COLUMNS` partitioning), you can use multiple columns in the `COLUMNS()` clause.

See [Section 13.1.18, “CREATE TABLE Statement”](#), for additional information about `PARTITION BY LIST COLUMNS()` syntax.

## 22.2.4 HASH Partitioning

Partitioning by `HASH` is used primarily to ensure an even distribution of data among a predetermined number of partitions. With range or list partitioning, you must specify explicitly into which partition a given column value or set of column values is to be stored; with hash partitioning, MySQL takes care of this for you, and you need only specify a column value or expression based on a column value to be hashed and the number of partitions into which the partitioned table is to be divided.

To partition a table using `HASH` partitioning, it is necessary to append to the `CREATE TABLE` statement a `PARTITION BY HASH (expr)` clause, where `expr` is an expression that returns an integer. This can simply be the name of a column whose type is one of MySQL's integer types. In addition, you most likely

want to follow this with `PARTITIONS num`, where `num` is a positive integer representing the number of partitions into which the table is to be divided.



### Note

For simplicity, the tables in the examples that follow do not use any keys. You should be aware that, if a table has any unique keys, every column used in the partitioning expression for this table must be part of every unique key, including the primary key. See [Section 22.6.1, “Partitioning Keys, Primary Keys, and Unique Keys”](#), for more information.

The following statement creates a table that uses hashing on the `store_id` column and is divided into 4 partitions:

```
CREATE TABLE employees (
  id INT NOT NULL,
  fname VARCHAR(30),
  lname VARCHAR(30),
  hired DATE NOT NULL DEFAULT '1970-01-01',
  separated DATE NOT NULL DEFAULT '9999-12-31',
  job_code INT,
  store_id INT
)
PARTITION BY HASH(store_id)
PARTITIONS 4;
```

If you do not include a `PARTITIONS` clause, the number of partitions defaults to 1.

Using the `PARTITIONS` keyword without a number following it results in a syntax error.

You can also use an SQL expression that returns an integer for `expr`. For instance, you might want to partition based on the year in which an employee was hired. This can be done as shown here:

```
CREATE TABLE employees (
  id INT NOT NULL,
  fname VARCHAR(30),
  lname VARCHAR(30),
  hired DATE NOT NULL DEFAULT '1970-01-01',
  separated DATE NOT NULL DEFAULT '9999-12-31',
  job_code INT,
  store_id INT
)
PARTITION BY HASH( YEAR(hired) )
PARTITIONS 4;
```

`expr` must return a nonconstant, nonrandom integer value (in other words, it should be varying but deterministic), and must not contain any prohibited constructs as described in [Section 22.6, “Restrictions and Limitations on Partitioning”](#). You should also keep in mind that this expression is evaluated each time a row is inserted or updated (or possibly deleted); this means that very complex expressions may give rise to performance issues, particularly when performing operations (such as batch inserts) that affect a great many rows at one time.

The most efficient hashing function is one which operates upon a single table column and whose value increases or decreases consistently with the column value, as this allows for “pruning” on ranges of partitions. That is, the more closely that the expression varies with the value of the column on which it is based, the more efficiently MySQL can use the expression for hash partitioning.

For example, where `date_col` is a column of type `DATE`, then the expression `TO_DAYS(date_col)` is said to vary directly with the value of `date_col`, because for every change in the value of `date_col`, the value of the expression changes in a consistent manner. The variance of the expression `YEAR(date_col)` with respect to `date_col` is not quite as direct as that of `TO_DAYS(date_col)`,

because not every possible change in `date_col` produces an equivalent change in `YEAR(date_col)`. Even so, `YEAR(date_col)` is a good candidate for a hashing function, because it varies directly with a portion of `date_col` and there is no possible change in `date_col` that produces a disproportionate change in `YEAR(date_col)`.

By way of contrast, suppose that you have a column named `int_col` whose type is `INT`. Now consider the expression `POW(5-int_col,3) + 6`. This would be a poor choice for a hashing function because a change in the value of `int_col` is not guaranteed to produce a proportional change in the value of the expression. Changing the value of `int_col` by a given amount can produce widely differing changes in the value of the expression. For example, changing `int_col` from 5 to 6 produces a change of `-1` in the value of the expression, but changing the value of `int_col` from 6 to 7 produces a change of `-7` in the expression value.

In other words, the more closely the graph of the column value versus the value of the expression follows a straight line as traced by the equation  $y=cx$  where  $c$  is some nonzero constant, the better the expression is suited to hashing. This has to do with the fact that the more nonlinear an expression is, the more uneven the distribution of data among the partitions it tends to produce.

In theory, pruning is also possible for expressions involving more than one column value, but determining which of such expressions are suitable can be quite difficult and time-consuming. For this reason, the use of hashing expressions involving multiple columns is not particularly recommended.

When `PARTITION BY HASH` is used, MySQL determines which partition of `num` partitions to use based on the modulus of the result of the expression. In other words, for a given expression `expr`, the partition in which the record is stored is partition number  $N$ , where  $N = \text{MOD}(\text{expr}, \text{num})$ . Suppose that table `t1` is defined as follows, so that it has 4 partitions:

```
CREATE TABLE t1 (col1 INT, col2 CHAR(5), col3 DATE)
PARTITION BY HASH( YEAR(col3) )
PARTITIONS 4;
```

If you insert a record into `t1` whose `col3` value is `'2005-09-15'`, then the partition in which it is stored is determined as follows:

```
MOD(YEAR('2005-09-01'),4)
= MOD(2005,4)
= 1
```

MySQL 5.7 also supports a variant of `HASH` partitioning known as *linear hashing* which employs a more complex algorithm for determining the placement of new rows inserted into the partitioned table. See [Section 22.2.4.1, “LINEAR HASH Partitioning”](#), for a description of this algorithm.

The user-supplied expression is evaluated each time a record is inserted or updated. It may also—depending on the circumstances—be evaluated when records are deleted.

### 22.2.4.1 LINEAR HASH Partitioning

MySQL also supports linear hashing, which differs from regular hashing in that linear hashing utilizes a linear powers-of-two algorithm whereas regular hashing employs the modulus of the hashing function's value.

Syntactically, the only difference between linear-hash partitioning and regular hashing is the addition of the `LINEAR` keyword in the `PARTITION BY` clause, as shown here:

```
CREATE TABLE employees (
  id INT NOT NULL,
  fname VARCHAR(30),
  lname VARCHAR(30),
  hired DATE NOT NULL DEFAULT '1970-01-01',
```



```

    separated DATE NOT NULL DEFAULT '9999-12-31',
    job_code INT,
    store_id INT
)
PARTITION BY LINEAR HASH( YEAR(hired) )
PARTITIONS 4;

```

Given an expression *expr*, the partition in which the record is stored when linear hashing is used is partition number *N* from among *num* partitions, where *N* is derived according to the following algorithm:

1. Find the next power of 2 greater than *num*. We call this value *V*; it can be calculated as:

```
V = POWER(2, CEILING(LOG(2, num)))
```

(Suppose that *num* is 13. Then `LOG(2, 13)` is 3.7004397181411. `CEILING(3.7004397181411)` is 4, and `V = POWER(2, 4)`, which is 16.)

2. Set  $N = F(\text{column\_list}) \& (V - 1)$ .

3. While  $N \geq \text{num}$ :

- Set  $V = V / 2$
- Set  $N = N \& (V - 1)$

Suppose that the table `t1`, using linear hash partitioning and having 6 partitions, is created using this statement:

```

CREATE TABLE t1 (col1 INT, col2 CHAR(5), col3 DATE)
PARTITION BY LINEAR HASH( YEAR(col3) )
PARTITIONS 6;

```

Now assume that you want to insert two records into `t1` having the `col3` column values `'2003-04-14'` and `'1998-10-19'`. The partition number for the first of these is determined as follows:

```

V = POWER(2, CEILING( LOG(2,6) )) = 8
N = YEAR('2003-04-14') & (8 - 1)
  = 2003 & 7
  = 3
(3 >= 6 is FALSE: record stored in partition #3)

```

The number of the partition where the second record is stored is calculated as shown here:

```

V = 8
N = YEAR('1998-10-19') & (8 - 1)
  = 1998 & 7
  = 6
(6 >= 6 is TRUE: additional step required)
N = 6 & ((8 / 2) - 1)
  = 6 & 3
  = 2
(2 >= 6 is FALSE: record stored in partition #2)

```

The advantage in partitioning by linear hash is that the adding, dropping, merging, and splitting of partitions is made much faster, which can be beneficial when dealing with tables containing extremely large amounts (terabytes) of data. The disadvantage is that data is less likely to be evenly distributed between partitions as compared with the distribution obtained using regular hash partitioning.

## 22.2.5 KEY Partitioning

Partitioning by key is similar to partitioning by hash, except that where hash partitioning employs a user-defined expression, the hashing function for key partitioning is supplied by the MySQL server. NDB Cluster uses `MD5()` for this purpose; for tables using other storage engines, the server employs its own internal hashing function which is based on the same algorithm as `PASSWORD()`.

The syntax rules for `CREATE TABLE ... PARTITION BY KEY` are similar to those for creating a table that is partitioned by hash. The major differences are listed here:

- `KEY` is used rather than `HASH`.
- `KEY` takes only a list of zero or more column names. Any columns used as the partitioning key must comprise part or all of the table's primary key, if the table has one. Where no column name is specified as the partitioning key, the table's primary key is used, if there is one. For example, the following `CREATE TABLE` statement is valid in MySQL 5.7:

```
CREATE TABLE k1 (
  id INT NOT NULL PRIMARY KEY,
  name VARCHAR(20)
)
PARTITION BY KEY()
PARTITIONS 2;
```

If there is no primary key but there is a unique key, then the unique key is used for the partitioning key:

```
CREATE TABLE k1 (
  id INT NOT NULL,
  name VARCHAR(20),
  UNIQUE KEY (id)
)
PARTITION BY KEY()
PARTITIONS 2;
```

However, if the unique key column were not defined as `NOT NULL`, then the previous statement would fail.

In both of these cases, the partitioning key is the `id` column, even though it is not shown in the output of `SHOW CREATE TABLE` or in the `PARTITION_EXPRESSION` column of the Information Schema `PARTITIONS` table.

Unlike the case with other partitioning types, columns used for partitioning by `KEY` are not restricted to integer or `NULL` values. For example, the following `CREATE TABLE` statement is valid:

```
CREATE TABLE tm1 (
  s1 CHAR(32) PRIMARY KEY
)
PARTITION BY KEY(s1)
PARTITIONS 10;
```

The preceding statement would *not* be valid, were a different partitioning type to be specified. (In this case, simply using `PARTITION BY KEY()` would also be valid and have the same effect as `PARTITION BY KEY(s1)`, since `s1` is the table's primary key.)

For additional information about this issue, see [Section 22.6, “Restrictions and Limitations on Partitioning”](#).

Columns with index prefixes are not supported in partitioning keys. This means that `CHAR`, `VARCHAR`, `BINARY`, and `VARBINARY` columns can be used in a partitioning key, as long as they do not employ prefixes; because a prefix must be specified for `BLOB` and `TEXT` columns in index definitions, it is not possible to use columns of these two types in partitioning keys. In MySQL 5.7, columns using prefixes

are permitted when creating, altering, or upgrading partitioned tables, even though they are not included in the table's partitioning key. This is a known issue in MySQL 5.7 which is addressed in MySQL 8.0, where this permissive behavior is deprecated, and the server displays appropriate warnings or errors when attempting to use such columns in these cases. See [Column index prefixes not supported for key partitioning](#), for more information and examples.



### Note

Tables using the [NDB](#) storage engine are implicitly partitioned by [KEY](#), using the table's primary key as the partitioning key (as with other MySQL storage engines). In the event that the NDB Cluster table has no explicit primary key, the “hidden” primary key generated by the [NDB](#) storage engine for each NDB Cluster table is used as the partitioning key.

If you define an explicit partitioning scheme for an [NDB](#) table, the table must have an explicit primary key, and any columns used in the partitioning expression must be part of this key. However, if the table uses an “empty” partitioning expression—that is, `PARTITION BY KEY()` with no column references—then no explicit primary key is required.

You can observe this partitioning using the `ndb_desc` utility (with the `-p` option).



### Important

For a key-partitioned table, you cannot execute an `ALTER TABLE DROP PRIMARY KEY`, as doing so generates the error `ERROR 1466 (HY000): Field in list of fields for partition function not found in table`. This is not an issue for NDB Cluster tables which are partitioned by [KEY](#); in such cases, the table is reorganized using the “hidden” primary key as the table's new partitioning key. See [Chapter 21, MySQL NDB Cluster 7.5 and NDB Cluster 7.6](#).

It is also possible to partition a table by linear key. Here is a simple example:

```
CREATE TABLE tk (
  col1 INT NOT NULL,
  col2 CHAR(5),
  col3 DATE
)
PARTITION BY LINEAR KEY (col1)
PARTITIONS 3;
```

Using [LINEAR](#) has the same effect on [KEY](#) partitioning as it does on [HASH](#) partitioning, with the partition number being derived using a powers-of-two algorithm rather than modulo arithmetic. See [Section 22.2.4.1, “LINEAR HASH Partitioning”](#), for a description of this algorithm and its implications.

## 22.2.6 Subpartitioning

Subpartitioning—also known as *composite partitioning*—is the further division of each partition in a partitioned table. Consider the following `CREATE TABLE` statement:

```
CREATE TABLE ts (id INT, purchased DATE)
PARTITION BY RANGE( YEAR(purchased) )
SUBPARTITION BY HASH( TO_DAYS(purchased) )
SUBPARTITIONS 2 (
  PARTITION p0 VALUES LESS THAN (1990),
  PARTITION p1 VALUES LESS THAN (2000),
```

```

PARTITION p2 VALUES LESS THAN MAXVALUE
);

```

Table `ts` has 3 [RANGE](#) partitions. Each of these partitions—`p0`, `p1`, and `p2`—is further divided into 2 subpartitions. In effect, the entire table is divided into  $3 * 2 = 6$  partitions. However, due to the action of the [PARTITION BY RANGE](#) clause, the first 2 of these store only those records with a value less than 1990 in the `purchased` column.

In MySQL 5.7, it is possible to subpartition tables that are partitioned by [RANGE](#) or [LIST](#). Subpartitions may use either [HASH](#) or [KEY](#) partitioning. This is also known as *composite partitioning*.



### Note

[SUBPARTITION BY HASH](#) and [SUBPARTITION BY KEY](#) generally follow the same syntax rules as [PARTITION BY HASH](#) and [PARTITION BY KEY](#), respectively. An exception to this is that [SUBPARTITION BY KEY](#) (unlike [PARTITION BY KEY](#)) does not currently support a default column, so the column used for this purpose must be specified, even if the table has an explicit primary key. This is a known issue which we are working to address; see [Issues with subpartitions](#), for more information and an example.

It is also possible to define subpartitions explicitly using [SUBPARTITION](#) clauses to specify options for individual subpartitions. For example, a more verbose fashion of creating the same table `ts` as shown in the previous example would be:

```

CREATE TABLE ts (id INT, purchased DATE)
PARTITION BY RANGE( YEAR(purchased) )
SUBPARTITION BY HASH( TO_DAYS(purchased) ) (
  PARTITION p0 VALUES LESS THAN (1990) (
    SUBPARTITION s0,
    SUBPARTITION s1
  ),
  PARTITION p1 VALUES LESS THAN (2000) (
    SUBPARTITION s2,
    SUBPARTITION s3
  ),
  PARTITION p2 VALUES LESS THAN MAXVALUE (
    SUBPARTITION s4,
    SUBPARTITION s5
  )
);

```

Some syntactical items of note are listed here:

- Each partition must have the same number of subpartitions.
- If you explicitly define any subpartitions using [SUBPARTITION](#) on any partition of a partitioned table, you must define them all. In other words, the following statement fails:

```

CREATE TABLE ts (id INT, purchased DATE)
PARTITION BY RANGE( YEAR(purchased) )
SUBPARTITION BY HASH( TO_DAYS(purchased) ) (
  PARTITION p0 VALUES LESS THAN (1990) (
    SUBPARTITION s0,
    SUBPARTITION s1
  ),
  PARTITION p1 VALUES LESS THAN (2000),
  PARTITION p2 VALUES LESS THAN MAXVALUE (
    SUBPARTITION s2,
    SUBPARTITION s3
  )
);

```

```
);
```

This statement would still fail even if it included a `SUBPARTITIONS 2` clause.

- Each `SUBPARTITION` clause must include (at a minimum) a name for the subpartition. Otherwise, you may set any desired option for the subpartition or allow it to assume its default setting for that option.
- Subpartition names must be unique across the entire table. For example, the following `CREATE TABLE` statement is valid in MySQL 5.7:

```
CREATE TABLE ts (id INT, purchased DATE)
PARTITION BY RANGE( YEAR(purchased) )
SUBPARTITION BY HASH( TO_DAYS(purchased) ) (
  PARTITION p0 VALUES LESS THAN (1990) (
    SUBPARTITION s0,
    SUBPARTITION s1
  ),
  PARTITION p1 VALUES LESS THAN (2000) (
    SUBPARTITION s2,
    SUBPARTITION s3
  ),
  PARTITION p2 VALUES LESS THAN MAXVALUE (
    SUBPARTITION s4,
    SUBPARTITION s5
  )
);
```

Subpartitions can be used with especially large `MyISAM` tables to distribute data and indexes across many disks. Suppose that you have 6 disks mounted as `/disk0`, `/disk1`, `/disk2`, and so on. Now consider the following example:

```
CREATE TABLE ts (id INT, purchased DATE)
ENGINE = MYISAM
PARTITION BY RANGE( YEAR(purchased) )
SUBPARTITION BY HASH( TO_DAYS(purchased) ) (
  PARTITION p0 VALUES LESS THAN (1990) (
    SUBPARTITION s0
      DATA DIRECTORY = '/disk0/data'
      INDEX DIRECTORY = '/disk0/idx',
    SUBPARTITION s1
      DATA DIRECTORY = '/disk1/data'
      INDEX DIRECTORY = '/disk1/idx'
  ),
  PARTITION p1 VALUES LESS THAN (2000) (
    SUBPARTITION s2
      DATA DIRECTORY = '/disk2/data'
      INDEX DIRECTORY = '/disk2/idx',
    SUBPARTITION s3
      DATA DIRECTORY = '/disk3/data'
      INDEX DIRECTORY = '/disk3/idx'
  ),
  PARTITION p2 VALUES LESS THAN MAXVALUE (
    SUBPARTITION s4
      DATA DIRECTORY = '/disk4/data'
      INDEX DIRECTORY = '/disk4/idx',
    SUBPARTITION s5
      DATA DIRECTORY = '/disk5/data'
      INDEX DIRECTORY = '/disk5/idx'
  )
);
```

In this case, a separate disk is used for the data and for the indexes of each `RANGE`. Many other variations are possible; another example might be:

```
CREATE TABLE ts (id INT, purchased DATE)
```

## Subpartitioning

```
ENGINE = MYISAM
PARTITION BY RANGE(YEAR(purchased))
SUBPARTITION BY HASH( TO_DAYS(purchased) ) (
  PARTITION p0 VALUES LESS THAN (1990) (
    SUBPARTITION s0a
      DATA DIRECTORY = '/disk0'
      INDEX DIRECTORY = '/disk1',
    SUBPARTITION s0b
      DATA DIRECTORY = '/disk2'
      INDEX DIRECTORY = '/disk3'
  ),
  PARTITION p1 VALUES LESS THAN (2000) (
    SUBPARTITION s1a
      DATA DIRECTORY = '/disk4/data'
      INDEX DIRECTORY = '/disk4/idx',
    SUBPARTITION s1b
      DATA DIRECTORY = '/disk5/data'
      INDEX DIRECTORY = '/disk5/idx'
  ),
  PARTITION p2 VALUES LESS THAN MAXVALUE (
    SUBPARTITION s2a,
    SUBPARTITION s2b
  )
);
```

Here, the storage is as follows:

- Rows with `purchased` dates from before 1990 take up a vast amount of space, so are split up 4 ways, with a separate disk dedicated to the data and to the indexes for each of the two subpartitions (`s0a` and `s0b`) making up partition `p0`. In other words:
  - The data for subpartition `s0a` is stored on `/disk0`.
  - The indexes for subpartition `s0a` are stored on `/disk1`.
  - The data for subpartition `s0b` is stored on `/disk2`.
  - The indexes for subpartition `s0b` are stored on `/disk3`.
- Rows containing dates ranging from 1990 to 1999 (partition `p1`) do not require as much room as those from before 1990. These are split between 2 disks (`/disk4` and `/disk5`) rather than 4 disks as with the legacy records stored in `p0`:
  - Data and indexes belonging to `p1`'s first subpartition (`s1a`) are stored on `/disk4`—the data in `/disk4/data`, and the indexes in `/disk4/idx`.
  - Data and indexes belonging to `p1`'s second subpartition (`s1b`) are stored on `/disk5`—the data in `/disk5/data`, and the indexes in `/disk5/idx`.
- Rows reflecting dates from the year 2000 to the present (partition `p2`) do not take up as much space as required by either of the two previous ranges. Currently, it is sufficient to store all of these in the default location.

In future, when the number of purchases for the decade beginning with the year 2000 grows to a point where the default location no longer provides sufficient space, the corresponding rows can be moved using an `ALTER TABLE ... REORGANIZE PARTITION` statement. See [Section 22.3, “Partition Management”](#), for an explanation of how this can be done.

The `DATA DIRECTORY` and `INDEX DIRECTORY` options are not permitted in partition definitions when the `NO_DIR_IN_CREATE` server SQL mode is in effect. In MySQL 5.7, these options are also not permitted when defining subpartitions (Bug #42954).

## 22.2.7 How MySQL Partitioning Handles NULL

Partitioning in MySQL does nothing to disallow `NULL` as the value of a partitioning expression, whether it is a column value or the value of a user-supplied expression. Even though it is permitted to use `NULL` as the value of an expression that must otherwise yield an integer, it is important to keep in mind that `NULL` is not a number. MySQL's partitioning implementation treats `NULL` as being less than any non-`NULL` value, just as `ORDER BY` does.

This means that treatment of `NULL` varies between partitioning of different types, and may produce behavior which you do not expect if you are not prepared for it. This being the case, we discuss in this section how each MySQL partitioning type handles `NULL` values when determining the partition in which a row should be stored, and provide examples for each.

**Handling of NULL with RANGE partitioning.** If you insert a row into a table partitioned by `RANGE` such that the column value used to determine the partition is `NULL`, the row is inserted into the lowest partition. Consider these two tables in a database named `p`, created as follows:

```
mysql> CREATE TABLE t1 (
->   c1 INT,
->   c2 VARCHAR(20)
-> )
-> PARTITION BY RANGE(c1) (
->   PARTITION p0 VALUES LESS THAN (0),
->   PARTITION p1 VALUES LESS THAN (10),
->   PARTITION p2 VALUES LESS THAN MAXVALUE
-> );
```

Query OK, 0 rows affected (0.09 sec)

```
mysql> CREATE TABLE t2 (
->   c1 INT,
->   c2 VARCHAR(20)
-> )
-> PARTITION BY RANGE(c1) (
->   PARTITION p0 VALUES LESS THAN (-5),
->   PARTITION p1 VALUES LESS THAN (0),
->   PARTITION p2 VALUES LESS THAN (10),
->   PARTITION p3 VALUES LESS THAN MAXVALUE
-> );
```

Query OK, 0 rows affected (0.09 sec)

You can see the partitions created by these two `CREATE TABLE` statements using the following query against the `PARTITIONS` table in the `INFORMATION_SCHEMA` database:

```
mysql> SELECT TABLE_NAME, PARTITION_NAME, TABLE_ROWS, AVG_ROW_LENGTH, DATA_LENGTH
> FROM INFORMATION_SCHEMA.PARTITIONS
> WHERE TABLE_SCHEMA = 'p' AND TABLE_NAME LIKE 't_';
```

TABLE_NAME	PARTITION_NAME	TABLE_ROWS	AVG_ROW_LENGTH	DATA_LENGTH
t1	p0	0	0	0
t1	p1	0	0	0
t1	p2	0	0	0
t2	p0	0	0	0
t2	p1	0	0	0
t2	p2	0	0	0
t2	p3	0	0	0

7 rows in set (0.00 sec)

(For more information about this table, see [Section 24.3.16, “The INFORMATION\\_SCHEMA PARTITIONS Table”](#).) Now let us populate each of these tables with a single row containing a `NULL` in the column used as the partitioning key, and verify that the rows were inserted using a pair of `SELECT` statements:

## How MySQL Partitioning Handles NULL

```
mysql> INSERT INTO t1 VALUES (NULL, 'mothra');
Query OK, 1 row affected (0.00 sec)

mysql> INSERT INTO t2 VALUES (NULL, 'mothra');
Query OK, 1 row affected (0.00 sec)

mysql> SELECT * FROM t1;
+-----+-----+
| id   | name  |
+-----+-----+
| NULL | mothra |
+-----+-----+
1 row in set (0.00 sec)

mysql> SELECT * FROM t2;
+-----+-----+
| id   | name  |
+-----+-----+
| NULL | mothra |
+-----+-----+
1 row in set (0.00 sec)
```

You can see which partitions are used to store the inserted rows by rerunning the previous query against `INFORMATION_SCHEMA.PARTITIONS` and inspecting the output:

```
mysql> SELECT TABLE_NAME, PARTITION_NAME, TABLE_ROWS, AVG_ROW_LENGTH, DATA_LENGTH
> FROM INFORMATION_SCHEMA.PARTITIONS
> WHERE TABLE_SCHEMA = 'p' AND TABLE_NAME LIKE 't_';
+-----+-----+-----+-----+-----+
| TABLE_NAME | PARTITION_NAME | TABLE_ROWS | AVG_ROW_LENGTH | DATA_LENGTH |
+-----+-----+-----+-----+-----+
| t1          | p0             | 1           | 20             | 20           |
| t1          | p1             | 0           | 0              | 0            |
| t1          | p2             | 0           | 0              | 0            |
| t2          | p0             | 1           | 20             | 20           |
| t2          | p1             | 0           | 0              | 0            |
| t2          | p2             | 0           | 0              | 0            |
| t2          | p3             | 0           | 0              | 0            |
+-----+-----+-----+-----+-----+
7 rows in set (0.01 sec)
```

You can also demonstrate that these rows were stored in the lowest partition of each table by dropping these partitions, and then re-running the `SELECT` statements:

```
mysql> ALTER TABLE t1 DROP PARTITION p0;
Query OK, 0 rows affected (0.16 sec)

mysql> ALTER TABLE t2 DROP PARTITION p0;
Query OK, 0 rows affected (0.16 sec)

mysql> SELECT * FROM t1;
Empty set (0.00 sec)

mysql> SELECT * FROM t2;
Empty set (0.00 sec)
```

(For more information on `ALTER TABLE ... DROP PARTITION`, see [Section 13.1.8, “ALTER TABLE Statement”](#).)

`NULL` is also treated in this way for partitioning expressions that use SQL functions. Suppose that we define a table using a `CREATE TABLE` statement such as this one:

```
CREATE TABLE tndate (
  id INT,
  dt DATE
```



```
)
PARTITION BY RANGE( YEAR(dt) ) (
  PARTITION p0 VALUES LESS THAN (1990),
  PARTITION p1 VALUES LESS THAN (2000),
  PARTITION p2 VALUES LESS THAN MAXVALUE
);
```

As with other MySQL functions, `YEAR(NULL)` returns `NULL`. A row with a `dt` column value of `NULL` is treated as though the partitioning expression evaluated to a value less than any other value, and so is inserted into partition `p0`.

**Handling of NULL with LIST partitioning.** A table that is partitioned by `LIST` admits `NULL` values if and only if one of its partitions is defined using that value-list that contains `NULL`. The converse of this is that a table partitioned by `LIST` which does not explicitly use `NULL` in a value list rejects rows resulting in a `NULL` value for the partitioning expression, as shown in this example:

```
mysql> CREATE TABLE ts1 (
->   c1 INT,
->   c2 VARCHAR(20)
-> )
-> PARTITION BY LIST(c1) (
->   PARTITION p0 VALUES IN (0, 3, 6),
->   PARTITION p1 VALUES IN (1, 4, 7),
->   PARTITION p2 VALUES IN (2, 5, 8)
-> );
Query OK, 0 rows affected (0.01 sec)

mysql> INSERT INTO ts1 VALUES (9, 'mothra');
ERROR 1504 (HY000): Table has no partition for value 9

mysql> INSERT INTO ts1 VALUES (NULL, 'mothra');
ERROR 1504 (HY000): Table has no partition for value NULL
```

Only rows having a `c1` value between 0 and 8 inclusive can be inserted into `ts1`. `NULL` falls outside this range, just like the number 9. We can create tables `ts2` and `ts3` having value lists containing `NULL`, as shown here:

```
mysql> CREATE TABLE ts2 (
->   c1 INT,
->   c2 VARCHAR(20)
-> )
-> PARTITION BY LIST(c1) (
->   PARTITION p0 VALUES IN (0, 3, 6),
->   PARTITION p1 VALUES IN (1, 4, 7),
->   PARTITION p2 VALUES IN (2, 5, 8),
->   PARTITION p3 VALUES IN (NULL)
-> );
Query OK, 0 rows affected (0.01 sec)

mysql> CREATE TABLE ts3 (
->   c1 INT,
->   c2 VARCHAR(20)
-> )
-> PARTITION BY LIST(c1) (
->   PARTITION p0 VALUES IN (0, 3, 6),
->   PARTITION p1 VALUES IN (1, 4, 7, NULL),
->   PARTITION p2 VALUES IN (2, 5, 8)
-> );
Query OK, 0 rows affected (0.01 sec)
```

When defining value lists for partitioning, you can (and should) treat `NULL` just as you would any other value. For example, both `VALUES IN (NULL)` and `VALUES IN (1, 4, 7, NULL)` are valid, as are `VALUES IN (1, NULL, 4, 7)`, `VALUES IN (NULL, 1, 4, 7)`, and so on. You can insert a row having `NULL` for column `c1` into each of the tables `ts2` and `ts3`:

## How MySQL Partitioning Handles NULL

```
mysql> INSERT INTO ts2 VALUES (NULL, 'mothra');
Query OK, 1 row affected (0.00 sec)

mysql> INSERT INTO ts3 VALUES (NULL, 'mothra');
Query OK, 1 row affected (0.00 sec)
```

By issuing the appropriate query against the Information Schema `PARTITIONS` table, you can determine which partitions were used to store the rows just inserted (we assume, as in the previous examples, that the partitioned tables were created in the `p` database):

```
mysql> SELECT TABLE_NAME, PARTITION_NAME, TABLE_ROWS, AVG_ROW_LENGTH, DATA_LENGTH
> FROM INFORMATION_SCHEMA.PARTITIONS
> WHERE TABLE_SCHEMA = 'p' AND TABLE_NAME LIKE 'ts_';
+-----+-----+-----+-----+-----+
| TABLE_NAME | PARTITION_NAME | TABLE_ROWS | AVG_ROW_LENGTH | DATA_LENGTH |
+-----+-----+-----+-----+-----+
| ts2         | p0              | 0           | 0              | 0           |
| ts2         | p1              | 0           | 0              | 0           |
| ts2         | p2              | 0           | 0              | 0           |
| / ts2       | / p3            | / 1         | / 20           | / 20        |
| ts3         | p0              | 0           | 0              | 0           |
| / ts3       | / p1            | / 1         | / 20           | / 20        |
| ts3         | p2              | 0           | 0              | 0           |
+-----+-----+-----+-----+-----+
7 rows in set (0.01 sec)
```

As shown earlier in this section, you can also verify which partitions were used for storing the rows by deleting these partitions and then performing a `SELECT`.

**Handling of NULL with HASH and KEY partitioning.** `NULL` is handled somewhat differently for tables partitioned by `HASH` or `KEY`. In these cases, any partition expression that yields a `NULL` value is treated as though its return value were zero. We can verify this behavior by examining the effects on the file system of creating a table partitioned by `HASH` and populating it with a record containing appropriate values. Suppose that you have a table `th` (also in the `p` database) created using the following statement:

```
mysql> CREATE TABLE th (
->   c1 INT,
->   c2 VARCHAR(20)
-> )
-> PARTITION BY HASH(c1)
-> PARTITIONS 2;
Query OK, 0 rows affected (0.00 sec)
```

The partitions belonging to this table can be viewed using the query shown here:

```
mysql> SELECT TABLE_NAME, PARTITION_NAME, TABLE_ROWS, AVG_ROW_LENGTH, DATA_LENGTH
> FROM INFORMATION_SCHEMA.PARTITIONS
> WHERE TABLE_SCHEMA = 'p' AND TABLE_NAME = 'th';
+-----+-----+-----+-----+-----+
| TABLE_NAME | PARTITION_NAME | TABLE_ROWS | AVG_ROW_LENGTH | DATA_LENGTH |
+-----+-----+-----+-----+-----+
| th          | p0              | 0           | 0              | 0           |
| th          | p1              | 0           | 0              | 0           |
+-----+-----+-----+-----+-----+
2 rows in set (0.00 sec)
```

`TABLE_ROWS` for each partition is 0. Now insert two rows into `th` whose `c1` column values are `NULL` and 0, and verify that these rows were inserted, as shown here:

```
mysql> INSERT INTO th VALUES (NULL, 'mothra'), (0, 'gigan');
Query OK, 1 row affected (0.00 sec)

mysql> SELECT * FROM th;
+-----+-----+-----+-----+-----+
| c1      | c2      |
+-----+-----+
| NULL    | mothra  |
| 0       | gigan   |
+-----+-----+
```

```

+-----+-----+
| c1    | c2    |
+-----+-----+
| NULL  | mothra|
+-----+-----+
| 0     | gigan |
+-----+-----+
2 rows in set (0.01 sec)

```

Recall that for any integer  $N$ , the value of `NULL MOD N` is always `NULL`. For tables that are partitioned by `HASH` or `KEY`, this result is treated for determining the correct partition as `0`. Checking the Information Schema `PARTITIONS` table once again, we can see that both rows were inserted into partition `p0`:

```

mysql> SELECT TABLE_NAME, PARTITION_NAME, TABLE_ROWS, AVG_ROW_LENGTH, DATA_LENGTH
> FROM INFORMATION_SCHEMA.PARTITIONS
> WHERE TABLE_SCHEMA = 'p' AND TABLE_NAME = 'th';
+-----+-----+-----+-----+-----+
| TABLE_NAME | PARTITION_NAME | TABLE_ROWS | AVG_ROW_LENGTH | DATA_LENGTH |
+-----+-----+-----+-----+-----+
| th          | p0             | 2           | 20             | 20           |
| th          | p1             | 0           | 0              | 0            |
+-----+-----+-----+-----+-----+
2 rows in set (0.00 sec)

```

By repeating the last example using `PARTITION BY KEY` in place of `PARTITION BY HASH` in the definition of the table, you can verify that `NULL` is also treated like `0` for this type of partitioning.

## 22.3 Partition Management

MySQL 5.7 provides a number of ways to modify partitioned tables. It is possible to add, drop, redefine, merge, or split existing partitions. All of these actions can be carried out using the partitioning extensions to the `ALTER TABLE` statement. There are also ways to obtain information about partitioned tables and partitions. We discuss these topics in the sections that follow.

- For information about partition management in tables partitioned by `RANGE` or `LIST`, see [Section 22.3.1, “Management of RANGE and LIST Partitions”](#).
- For a discussion of managing `HASH` and `KEY` partitions, see [Section 22.3.2, “Management of HASH and KEY Partitions”](#).
- See [Section 22.3.5, “Obtaining Information About Partitions”](#), for a discussion of mechanisms provided in MySQL 5.7 for obtaining information about partitioned tables and partitions.
- For a discussion of performing maintenance operations on partitions, see [Section 22.3.4, “Maintenance of Partitions”](#).



### Note

In MySQL 5.7, all partitions of a partitioned table must have the same number of subpartitions, and it is not possible to change the subpartitioning once the table has been created.

To change a table's partitioning scheme, it is necessary only to use the `ALTER TABLE` statement with a `partition_options` clause. This clause has the same syntax as that as used with `CREATE TABLE` for creating a partitioned table, and always begins with the keywords `PARTITION BY`. Suppose that you have a table partitioned by range using the following `CREATE TABLE` statement:

```

CREATE TABLE trb3 (id INT, name VARCHAR(50), purchased DATE)
PARTITION BY RANGE( YEAR(purchased) ) (
PARTITION p0 VALUES LESS THAN (1990),
PARTITION p1 VALUES LESS THAN (1995),
PARTITION p2 VALUES LESS THAN (2000),

```

```

PARTITION p3 VALUES LESS THAN (2005)
);

```

To repartition this table so that it is partitioned by key into two partitions using the `id` column value as the basis for the key, you can use this statement:

```
ALTER TABLE trb3 PARTITION BY KEY(id) PARTITIONS 2;
```

This has the same effect on the structure of the table as dropping the table and re-creating it using `CREATE TABLE trb3 PARTITION BY KEY(id) PARTITIONS 2;`

`ALTER TABLE ... ENGINE = ...` changes only the storage engine used by the table, and leaves the table's partitioning scheme intact. Use `ALTER TABLE ... REMOVE PARTITIONING` to remove a table's partitioning. See [Section 13.1.8, “ALTER TABLE Statement”](#).



### Important

Only a single `PARTITION BY`, `ADD PARTITION`, `DROP PARTITION`, `REORGANIZE PARTITION`, or `COALESCE PARTITION` clause can be used in a given `ALTER TABLE` statement. If you (for example) wish to drop a partition and reorganize a table's remaining partitions, you must do so in two separate `ALTER TABLE` statements (one using `DROP PARTITION` and then a second one using `REORGANIZE PARTITION`).

In MySQL 5.7, it is possible to delete all rows from one or more selected partitions using `ALTER TABLE ... TRUNCATE PARTITION`.

## 22.3.1 Management of RANGE and LIST Partitions

Adding and dropping of range and list partitions are handled in a similar fashion, so we discuss the management of both sorts of partitioning in this section. For information about working with tables that are partitioned by hash or key, see [Section 22.3.2, “Management of HASH and KEY Partitions”](#).

Dropping a partition from a table that is partitioned by either `RANGE` or by `LIST` can be accomplished using the `ALTER TABLE` statement with the `DROP PARTITION` option. Suppose that you have created a table that is partitioned by range and then populated with 10 records using the following `CREATE TABLE` and `INSERT` statements:

```

mysql> CREATE TABLE tr (id INT, name VARCHAR(50), purchased DATE)
->     PARTITION BY RANGE( YEAR(purchased) ) (
->         PARTITION p0 VALUES LESS THAN (1990),
->         PARTITION p1 VALUES LESS THAN (1995),
->         PARTITION p2 VALUES LESS THAN (2000),
->         PARTITION p3 VALUES LESS THAN (2005),
->         PARTITION p4 VALUES LESS THAN (2010),
->         PARTITION p5 VALUES LESS THAN (2015)
->     );

```

Query OK, 0 rows affected (0.28 sec)

```

mysql> INSERT INTO tr VALUES
->     (1, 'desk organiser', '2003-10-15'),
->     (2, 'alarm clock', '1997-11-05'),
->     (3, 'chair', '2009-03-10'),
->     (4, 'bookcase', '1989-01-10'),
->     (5, 'exercise bike', '2014-05-09'),
->     (6, 'sofa', '1987-06-05'),
->     (7, 'espresso maker', '2011-11-22'),
->     (8, 'aquarium', '1992-08-04'),
->     (9, 'study desk', '2006-09-16'),
->     (10, 'lava lamp', '1998-12-25');

```

Query OK, 10 rows affected (0.05 sec)

```
Records: 10 Duplicates: 0 Warnings: 0
```

You can see which items should have been inserted into partition `p2` as shown here:

```
mysql> SELECT * FROM tr
-> WHERE purchased BETWEEN '1995-01-01' AND '1999-12-31';
+-----+-----+-----+
| id  | name      | purchased |
+-----+-----+-----+
|  2  | alarm clock | 1997-11-05 |
| 10  | lava lamp  | 1998-12-25 |
+-----+-----+-----+
2 rows in set (0.00 sec)
```

You can also get this information using partition selection, as shown here:

```
mysql> SELECT * FROM tr PARTITION (p2);
+-----+-----+-----+
| id  | name      | purchased |
+-----+-----+-----+
|  2  | alarm clock | 1997-11-05 |
| 10  | lava lamp  | 1998-12-25 |
+-----+-----+-----+
2 rows in set (0.00 sec)
```

See [Section 22.5, “Partition Selection”](#), for more information.

To drop the partition named `p2`, execute the following command:

```
mysql> ALTER TABLE tr DROP PARTITION p2;
Query OK, 0 rows affected (0.03 sec)
```



#### Note

The `NDBCLUSTER` storage engine does not support `ALTER TABLE ... DROP PARTITION`. It does, however, support the other partitioning-related extensions to `ALTER TABLE` that are described in this chapter.

It is very important to remember that, *when you drop a partition, you also delete all the data that was stored in that partition*. You can see that this is the case by re-running the previous `SELECT` query:

```
mysql> SELECT * FROM tr WHERE purchased
-> BETWEEN '1995-01-01' AND '1999-12-31';
Empty set (0.00 sec)
```

Because of this, you must have the `DROP` privilege for a table before you can execute `ALTER TABLE ... DROP PARTITION` on that table.

If you wish to drop all data from all partitions while preserving the table definition and its partitioning scheme, use the `TRUNCATE TABLE` statement. (See [Section 13.1.34, “TRUNCATE TABLE Statement”](#).)

If you intend to change the partitioning of a table *without* losing data, use `ALTER TABLE ... REORGANIZE PARTITION` instead. See below or in [Section 13.1.8, “ALTER TABLE Statement”](#), for information about `REORGANIZE PARTITION`.

If you now execute a `SHOW CREATE TABLE` statement, you can see how the partitioning makeup of the table has been changed:

```
mysql> SHOW CREATE TABLE tr\G
***** 1. row *****
      Table: tr
Create Table: CREATE TABLE `tr` (
  `id` int(11) DEFAULT NULL,
  `name` varchar(50) DEFAULT NULL,
```

```

`purchased` date DEFAULT NULL
) ENGINE=InnoDB DEFAULT CHARSET=latin1
/*!50100 PARTITION BY RANGE ( YEAR(purchased))
(PARTITION p0 VALUES LESS THAN (1990) ENGINE = InnoDB,
PARTITION p1 VALUES LESS THAN (1995) ENGINE = InnoDB,
PARTITION p3 VALUES LESS THAN (2005) ENGINE = InnoDB,
PARTITION p4 VALUES LESS THAN (2010) ENGINE = InnoDB,
PARTITION p5 VALUES LESS THAN (2015) ENGINE = InnoDB) */
1 row in set (0.00 sec)

```

When you insert new rows into the changed table with `purchased` column values between `'1995-01-01'` and `'2004-12-31'` inclusive, those rows are stored in partition `p3`. You can verify this as follows:

```

mysql> INSERT INTO tr VALUES (11, 'pencil holder', '1995-07-12');
Query OK, 1 row affected (0.00 sec)

mysql> SELECT * FROM tr WHERE purchased
-> BETWEEN '1995-01-01' AND '2004-12-31';
+-----+-----+-----+
| id  | name           | purchased |
+-----+-----+-----+
|  1  | desk organiser | 2003-10-15 |
| 11  | pencil holder  | 1995-07-12 |
+-----+-----+-----+
2 rows in set (0.00 sec)

mysql> ALTER TABLE tr DROP PARTITION p3;
Query OK, 0 rows affected (0.03 sec)

mysql> SELECT * FROM tr WHERE purchased
-> BETWEEN '1995-01-01' AND '2004-12-31';
Empty set (0.00 sec)

```

The number of rows dropped from the table as a result of `ALTER TABLE ... DROP PARTITION` is not reported by the server as it would be by the equivalent `DELETE` query.

Dropping `LIST` partitions uses exactly the same `ALTER TABLE ... DROP PARTITION` syntax as used for dropping `RANGE` partitions. However, there is one important difference in the effect this has on your use of the table afterward: You can no longer insert into the table any rows having any of the values that were included in the value list defining the deleted partition. (See [Section 22.2.2, “LIST Partitioning”](#), for an example.)

To add a new range or list partition to a previously partitioned table, use the `ALTER TABLE ... ADD PARTITION` statement. For tables which are partitioned by `RANGE`, this can be used to add a new range to the end of the list of existing partitions. Suppose that you have a partitioned table containing membership data for your organization, which is defined as follows:

```

CREATE TABLE members (
  id INT,
  fname VARCHAR(25),
  lname VARCHAR(25),
  dob DATE
)
PARTITION BY RANGE( YEAR(dob) ) (
  PARTITION p0 VALUES LESS THAN (1980),
  PARTITION p1 VALUES LESS THAN (1990),
  PARTITION p2 VALUES LESS THAN (2000)
);

```

Suppose further that the minimum age for members is 16. As the calendar approaches the end of 2015, you realize that you are soon going to be admitting members who were born in 2000 (and later). You can modify the `members` table to accommodate new members born in the years 2000 to 2010 as shown here:

```
ALTER TABLE members ADD PARTITION (PARTITION p3 VALUES LESS THAN (2010));
```

With tables that are partitioned by range, you can use `ADD PARTITION` to add new partitions to the high end of the partitions list only. Trying to add a new partition in this manner between or before existing partitions results in an error as shown here:

```
mysql> ALTER TABLE members
>     ADD PARTITION (
>     PARTITION n VALUES LESS THAN (1970));
ERROR 1463 (HY000): VALUES LESS THAN value must be strictly »
increasing for each partition
```

You can work around this problem by reorganizing the first partition into two new ones that split the range between them, like this:

```
ALTER TABLE members
REORGANIZE PARTITION p0 INTO (
PARTITION n0 VALUES LESS THAN (1970),
PARTITION n1 VALUES LESS THAN (1980)
);
```

Using `SHOW CREATE TABLE` you can see that the `ALTER TABLE` statement has had the desired effect:

```
mysql> SHOW CREATE TABLE members\G
***** 1. row *****
Table: members
Create Table: CREATE TABLE `members` (
  `id` int(11) DEFAULT NULL,
  `fname` varchar(25) DEFAULT NULL,
  `lname` varchar(25) DEFAULT NULL,
  `dob` date DEFAULT NULL
) ENGINE=InnoDB DEFAULT CHARSET=latin1
/*!50100 PARTITION BY RANGE ( YEAR(dob))
(PARTITION n0 VALUES LESS THAN (1970) ENGINE = InnoDB,
PARTITION n1 VALUES LESS THAN (1980) ENGINE = InnoDB,
PARTITION p1 VALUES LESS THAN (1990) ENGINE = InnoDB,
PARTITION p2 VALUES LESS THAN (2000) ENGINE = InnoDB,
PARTITION p3 VALUES LESS THAN (2010) ENGINE = InnoDB) */
1 row in set (0.00 sec)
```

See also [Section 13.1.8.1, “ALTER TABLE Partition Operations”](#).

You can also use `ALTER TABLE ... ADD PARTITION` to add new partitions to a table that is partitioned by `LIST`. Suppose a table `tt` is defined using the following `CREATE TABLE` statement:

```
CREATE TABLE tt (
  id INT,
  data INT
)
PARTITION BY LIST(data) (
  PARTITION p0 VALUES IN (5, 10, 15),
  PARTITION p1 VALUES IN (6, 12, 18)
);
```

You can add a new partition in which to store rows having the `data` column values `7`, `14`, and `21` as shown:

```
ALTER TABLE tt ADD PARTITION (PARTITION p2 VALUES IN (7, 14, 21));
```

Keep in mind that you *cannot* add a new `LIST` partition encompassing any values that are already included in the value list of an existing partition. If you attempt to do so, an error results:

```
mysql> ALTER TABLE tt ADD PARTITION
```

```
> (PARTITION np VALUES IN (4, 8, 12));
ERROR 1465 (HY000): Multiple definition of same constant »
      in list partitioning
```

Because any rows with the `data` column value `12` have already been assigned to partition `p1`, you cannot create a new partition on table `tt` that includes `12` in its value list. To accomplish this, you could drop `p1`, and add `np` and then a new `p1` with a modified definition. However, as discussed earlier, this would result in the loss of all data stored in `p1`—and it is often the case that this is not what you really want to do. Another solution might appear to be to make a copy of the table with the new partitioning and to copy the data into it using `CREATE TABLE ... SELECT ...`, then drop the old table and rename the new one, but this could be very time-consuming when dealing with a large amounts of data. This also might not be feasible in situations where high availability is a requirement.

You can add multiple partitions in a single `ALTER TABLE ... ADD PARTITION` statement as shown here:

```
CREATE TABLE employees (
  id INT NOT NULL,
  fname VARCHAR(50) NOT NULL,
  lname VARCHAR(50) NOT NULL,
  hired DATE NOT NULL
)
PARTITION BY RANGE( YEAR(hired) ) (
  PARTITION p1 VALUES LESS THAN (1991),
  PARTITION p2 VALUES LESS THAN (1996),
  PARTITION p3 VALUES LESS THAN (2001),
  PARTITION p4 VALUES LESS THAN (2005)
);

ALTER TABLE employees ADD PARTITION (
  PARTITION p5 VALUES LESS THAN (2010),
  PARTITION p6 VALUES LESS THAN MAXVALUE
);
```

Fortunately, MySQL's partitioning implementation provides ways to redefine partitions without losing data. Let us look first at a couple of simple examples involving `RANGE` partitioning. Recall the `members` table which is now defined as shown here:

```
mysql> SHOW CREATE TABLE members\G
***** 1. row *****
      Table: members
Create Table: CREATE TABLE `members` (
  `id` int(11) DEFAULT NULL,
  `fname` varchar(25) DEFAULT NULL,
  `lname` varchar(25) DEFAULT NULL,
  `dob` date DEFAULT NULL
) ENGINE=InnoDB DEFAULT CHARSET=latin1
/*150100 PARTITION BY RANGE ( YEAR(dob))
(PARTITION n0 VALUES LESS THAN (1970) ENGINE = InnoDB,
PARTITION n1 VALUES LESS THAN (1980) ENGINE = InnoDB,
PARTITION p1 VALUES LESS THAN (1990) ENGINE = InnoDB,
PARTITION p2 VALUES LESS THAN (2000) ENGINE = InnoDB,
PARTITION p3 VALUES LESS THAN (2010) ENGINE = InnoDB) */
1 row in set (0.00 sec)
```

Suppose that you would like to move all rows representing members born before 1960 into a separate partition. As we have already seen, this cannot be done using `ALTER TABLE ... ADD PARTITION`. However, you can use another partition-related extension to `ALTER TABLE` to accomplish this:

```
ALTER TABLE members REORGANIZE PARTITION n0 INTO (
  PARTITION s0 VALUES LESS THAN (1960),
  PARTITION s1 VALUES LESS THAN (1970)
);
```



In effect, this command splits partition `n0` into two new partitions `s0` and `s1`. It also moves the data that was stored in `n0` into the new partitions according to the rules embodied in the two `PARTITION ... VALUES ...` clauses, so that `s0` contains only those records for which `YEAR(dob)` is less than 1960 and `s1` contains those rows in which `YEAR(dob)` is greater than or equal to 1960 but less than 1970.

A `REORGANIZE PARTITION` clause may also be used for merging adjacent partitions. You can reverse the effect of the previous statement on the `members` table as shown here:

```
ALTER TABLE members REORGANIZE PARTITION s0,s1 INTO (
    PARTITION p0 VALUES LESS THAN (1970)
);
```

No data is lost in splitting or merging partitions using `REORGANIZE PARTITION`. In executing the above statement, MySQL moves all of the records that were stored in partitions `s0` and `s1` into partition `p0`.

The general syntax for `REORGANIZE PARTITION` is shown here:

```
ALTER TABLE tbl_name
    REORGANIZE PARTITION partition_list
    INTO (partition_definitions);
```

Here, `tbl_name` is the name of the partitioned table, and `partition_list` is a comma-separated list of names of one or more existing partitions to be changed. `partition_definitions` is a comma-separated list of new partition definitions, which follow the same rules as for the `partition_definitions` list used in `CREATE TABLE`. You are not limited to merging several partitions into one, or to splitting one partition into many, when using `REORGANIZE PARTITION`. For example, you can reorganize all four partitions of the `members` table into two, like this:

```
ALTER TABLE members REORGANIZE PARTITION p0,p1,p2,p3 INTO (
    PARTITION m0 VALUES LESS THAN (1980),
    PARTITION m1 VALUES LESS THAN (2000)
);
```

You can also use `REORGANIZE PARTITION` with tables that are partitioned by `LIST`. Let us return to the problem of adding a new partition to the list-partitioned `tt` table and failing because the new partition had a value that was already present in the value-list of one of the existing partitions. We can handle this by adding a partition that contains only nonconflicting values, and then reorganizing the new partition and the existing one so that the value which was stored in the existing one is now moved to the new one:

```
ALTER TABLE tt ADD PARTITION (PARTITION np VALUES IN (4, 8));
ALTER TABLE tt REORGANIZE PARTITION p1,np INTO (
    PARTITION p1 VALUES IN (6, 18),
    PARTITION np VALUES in (4, 8, 12)
);
```

Here are some key points to keep in mind when using `ALTER TABLE ... REORGANIZE PARTITION` to repartition tables that are partitioned by `RANGE` or `LIST`:

- The `PARTITION` options used to determine the new partitioning scheme are subject to the same rules as those used with a `CREATE TABLE` statement.

A new `RANGE` partitioning scheme cannot have any overlapping ranges; a new `LIST` partitioning scheme cannot have any overlapping sets of values.

- The combination of partitions in the `partition_definitions` list should account for the same range or set of values overall as the combined partitions named in the `partition_list`.

For example, partitions `p1` and `p2` together cover the years 1980 through 1999 in the `members` table used as an example in this section. Any reorganization of these two partitions should cover the same range of years overall.

- For tables partitioned by [RANGE](#), you can reorganize only adjacent partitions; you cannot skip range partitions.

For instance, you could not reorganize the example `members` table using a statement beginning with `ALTER TABLE members REORGANIZE PARTITION p0,p2 INTO ...` because `p0` covers the years prior to 1970 and `p2` the years from 1990 through 1999 inclusive, so these are not adjacent partitions. (You cannot skip partition `p1` in this case.)

- You cannot use `REORGANIZE PARTITION` to change the type of partitioning used by the table (for example, you cannot change `RANGE` partitions to `HASH` partitions or the reverse). You also cannot use this statement to change the partitioning expression or column. To accomplish either of these tasks without dropping and re-creating the table, you can use `ALTER TABLE ... PARTITION BY ...`, as shown here:

```
ALTER TABLE members
PARTITION BY HASH( YEAR(dob) )
PARTITIONS 8;
```

## 22.3.2 Management of HASH and KEY Partitions

Tables which are partitioned by hash or by key are very similar to one another with regard to making changes in a partitioning setup, and both differ in a number of ways from tables which have been partitioned by range or list. For that reason, this section addresses the modification of tables partitioned by hash or by key only. For a discussion of adding and dropping of partitions of tables that are partitioned by range or list, see [Section 22.3.1, “Management of RANGE and LIST Partitions”](#).

You cannot drop partitions from tables that are partitioned by `HASH` or `KEY` in the same way that you can from tables that are partitioned by `RANGE` or `LIST`. However, you can merge `HASH` or `KEY` partitions using the `ALTER TABLE ... COALESCE PARTITION` statement. Suppose that you have a table containing data about clients, which is divided into twelve partitions. The `clients` table is defined as shown here:

```
CREATE TABLE clients (
  id INT,
  fname VARCHAR(30),
  lname VARCHAR(30),
  signed DATE
)
PARTITION BY HASH( MONTH(signed) )
PARTITIONS 12;
```

To reduce the number of partitions from twelve to eight, execute the following `ALTER TABLE` command:

```
mysql> ALTER TABLE clients COALESCE PARTITION 4;
Query OK, 0 rows affected (0.02 sec)
```

`COALESCE` works equally well with tables that are partitioned by `HASH`, `KEY`, `LINEAR HASH`, or `LINEAR KEY`. Here is an example similar to the previous one, differing only in that the table is partitioned by `LINEAR KEY`:

```
mysql> CREATE TABLE clients_lk (
->   id INT,
->   fname VARCHAR(30),
->   lname VARCHAR(30),
->   signed DATE
-> )
-> PARTITION BY LINEAR KEY(signed)
-> PARTITIONS 12;
Query OK, 0 rows affected (0.03 sec)

mysql> ALTER TABLE clients_lk COALESCE PARTITION 4;
Query OK, 0 rows affected (0.06 sec)
```

```
Records: 0 Duplicates: 0 Warnings: 0
```

The number following `COALESCE PARTITION` is the number of partitions to merge into the remainder—in other words, it is the number of partitions to remove from the table.

If you attempt to remove more partitions than the table has, the result is an error like the one shown:

```
mysql> ALTER TABLE clients COALESCE PARTITION 18;
ERROR 1478 (HY000): Cannot remove all partitions, use DROP TABLE instead
```

To increase the number of partitions for the `clients` table from 12 to 18, use `ALTER TABLE ... ADD PARTITION` as shown here:

```
ALTER TABLE clients ADD PARTITION PARTITIONS 6;
```

### 22.3.3 Exchanging Partitions and Subpartitions with Tables

In MySQL 5.7, it is possible to exchange a table partition or subpartition with a table using `ALTER TABLE pt EXCHANGE PARTITION p WITH TABLE nt`, where *pt* is the partitioned table and *p* is the partition or subpartition of *pt* to be exchanged with unpartitioned table *nt*, provided that the following statements are true:

1. Table *nt* is not itself partitioned.
2. Table *nt* is not a temporary table.
3. The structures of tables *pt* and *nt* are otherwise identical.
4. Table *nt* contains no foreign key references, and no other table has any foreign keys that refer to *nt*.
5. There are no rows in *nt* that lie outside the boundaries of the partition definition for *p*. This condition does not apply if the `WITHOUT VALIDATION` option is used. The `[{WITH|WITHOUT} VALIDATION]` option was added in MySQL 5.7.5.
6. Both tables must use the same character set and collation.
7. For `InnoDB` tables, both tables must use the same row format. To determine the row format of an `InnoDB` table, query the Information Schema `INNODB_SYS_TABLES` table.
8. Any partition-level `MAX_ROWS` setting for *p* must be the same as the table-level `MAX_ROWS` value set for *nt*. The setting for any partition-level `MIN_ROWS` setting for *p* must also be the same any table-level `MIN_ROWS` value set for *nt*.  
  
This is true in either case whether not *pt* has an explicit table-level `MAX_ROWS` or `MIN_ROWS` option in effect.
9. The `AVG_ROW_LENGTH` cannot differ between the two tables *pt* and *nt*.
10. *pt* does not have any partitions that use the `DATA DIRECTORY` option. This restriction is lifted for `InnoDB` tables in MySQL 5.7.25 and later.
11. `INDEX DIRECTORY` cannot differ between the table and the partition to be exchanged with it.
12. No table or partition `TABLESPACE` options can be used in either of the tables.

In addition to the `ALTER`, `INSERT`, and `CREATE` privileges usually required for `ALTER TABLE` statements, you must have the `DROP` privilege to perform `ALTER TABLE ... EXCHANGE PARTITION`.

You should also be aware of the following effects of `ALTER TABLE ... EXCHANGE PARTITION`:

- Executing `ALTER TABLE ... EXCHANGE PARTITION` does not invoke any triggers on either the partitioned table or the table to be exchanged.
- Any `AUTO_INCREMENT` columns in the exchanged table are reset.
- The `IGNORE` keyword has no effect when used with `ALTER TABLE ... EXCHANGE PARTITION`.

The syntax of the `ALTER TABLE ... EXCHANGE PARTITION` statement is shown here, where `pt` is the partitioned table, `p` is the partition or subpartition to be exchanged, and `nt` is the nonpartitioned table to be exchanged with `p`:

```
ALTER TABLE pt
  EXCHANGE PARTITION p
  WITH TABLE nt;
```

Optionally, you can append a `WITH VALIDATION` or `WITHOUT VALIDATION` clause. When `WITHOUT VALIDATION` is specified, the `ALTER TABLE ... EXCHANGE PARTITION` operation does not perform row-by-row validation when exchanging a partition a nonpartitioned table, allowing database administrators to assume responsibility for ensuring that rows are within the boundaries of the partition definition. `WITH VALIDATION` is the default behavior and need not be specified explicitly. The `[ {WITH|WITHOUT} VALIDATION ]` option was added in MySQL 5.7.5.

One and only one partition or subpartition may be exchanged with one and only one nonpartitioned table in a single `ALTER TABLE EXCHANGE PARTITION` statement. To exchange multiple partitions or subpartitions, use multiple `ALTER TABLE EXCHANGE PARTITION` statements. `EXCHANGE PARTITION` may not be combined with other `ALTER TABLE` options. The partitioning and (if applicable) subpartitioning used by the partitioned table may be of any type or types supported in MySQL 5.7.

## Exchanging a Partition with a Nonpartitioned Table

Suppose that a partitioned table `e` has been created and populated using the following SQL statements:

```
CREATE TABLE e (
  id INT NOT NULL,
  fname VARCHAR(30),
  lname VARCHAR(30)
)
PARTITION BY RANGE (id) (
  PARTITION p0 VALUES LESS THAN (50),
  PARTITION p1 VALUES LESS THAN (100),
  PARTITION p2 VALUES LESS THAN (150),
  PARTITION p3 VALUES LESS THAN (MAXVALUE)
);

INSERT INTO e VALUES
(1669, "Jim", "Smith"),
(337, "Mary", "Jones"),
(16, "Frank", "White"),
(2005, "Linda", "Black");
```

Now we create a nonpartitioned copy of `e` named `e2`. This can be done using the `mysql` client as shown here:

```
mysql> CREATE TABLE e2 LIKE e;
Query OK, 0 rows affected (1.34 sec)

mysql> ALTER TABLE e2 REMOVE PARTITIONING;
Query OK, 0 rows affected (0.90 sec)
Records: 0 Duplicates: 0 Warnings: 0
```

You can see which partitions in table `e` contain rows by querying the Information Schema `PARTITIONS` table, like this:

```
mysql> SELECT PARTITION_NAME, TABLE_ROWS
-> FROM INFORMATION_SCHEMA.PARTITIONS
-> WHERE TABLE_NAME = 'e';
+-----+-----+
| PARTITION_NAME | TABLE_ROWS |
+-----+-----+
| p0              |            1 |
| p1              |            0 |
| p2              |            0 |
| p3              |            3 |
+-----+-----+
4 rows in set (0.00 sec)
```



### Note

For partitioned InnoDB tables, the row count given in the `TABLE_ROWS` column of the Information Schema `PARTITIONS` table is only an estimated value used in SQL optimization, and is not always exact.

To exchange partition `p0` in table `e` with table `e2`, you can use the `ALTER TABLE` statement shown here:

```
mysql> ALTER TABLE e EXCHANGE PARTITION p0 WITH TABLE e2;
Query OK, 0 rows affected (0.28 sec)
```

More precisely, the statement just issued causes any rows found in the partition to be swapped with those found in the table. You can observe how this has happened by querying the Information Schema `PARTITIONS` table, as before. The table row that was previously found in partition `p0` is no longer present:

```
mysql> SELECT PARTITION_NAME, TABLE_ROWS
-> FROM INFORMATION_SCHEMA.PARTITIONS
-> WHERE TABLE_NAME = 'e';
+-----+-----+
| PARTITION_NAME | TABLE_ROWS |
+-----+-----+
| p0              |            0 |
| p1              |            0 |
| p2              |            0 |
| p3              |            3 |
+-----+-----+
4 rows in set (0.00 sec)
```

If you query table `e2`, you can see that the “missing” row can now be found there:

```
mysql> SELECT * FROM e2;
+-----+-----+
| id | fname | lname |
+-----+-----+
| 16 | Frank | White |
+-----+-----+
1 row in set (0.00 sec)
```

The table to be exchanged with the partition does not necessarily have to be empty. To demonstrate this, we first insert a new row into table `e`, making sure that this row is stored in partition `p0` by choosing an `id` column value that is less than 50, and verifying this afterward by querying the `PARTITIONS` table:

```
mysql> INSERT INTO e VALUES (41, "Michael", "Green");
Query OK, 1 row affected (0.05 sec)

mysql> SELECT PARTITION_NAME, TABLE_ROWS
-> FROM INFORMATION_SCHEMA.PARTITIONS
-> WHERE TABLE_NAME = 'e';
+-----+-----+
| PARTITION_NAME | TABLE_ROWS |
+-----+-----+
| p0              |            1 |
```

```

| p1 | 0 |
| p2 | 0 |
| p3 | 3 |
+-----+
4 rows in set (0.00 sec)

```

Now we once again exchange partition `p0` with table `e2` using the same `ALTER TABLE` statement as previously:

```

mysql> ALTER TABLE e EXCHANGE PARTITION p0 WITH TABLE e2;
Query OK, 0 rows affected (0.28 sec)

```

The output of the following queries shows that the table row that was stored in partition `p0` and the table row that was stored in table `e2`, prior to issuing the `ALTER TABLE` statement, have now switched places:

```

mysql> SELECT * FROM e;
+-----+-----+-----+
| id | fname | lname |
+-----+-----+-----+
| 16 | Frank | White |
| 1669 | Jim | Smith |
| 337 | Mary | Jones |
| 2005 | Linda | Black |
+-----+-----+-----+
4 rows in set (0.00 sec)

mysql> SELECT PARTITION_NAME, TABLE_ROWS
-> FROM INFORMATION_SCHEMA.PARTITIONS
-> WHERE TABLE_NAME = 'e';
+-----+-----+
| PARTITION_NAME | TABLE_ROWS |
+-----+-----+
| p0 | 1 |
| p1 | 0 |
| p2 | 0 |
| p3 | 3 |
+-----+-----+
4 rows in set (0.00 sec)

mysql> SELECT * FROM e2;
+-----+-----+-----+
| id | fname | lname |
+-----+-----+-----+
| 41 | Michael | Green |
+-----+-----+-----+
1 row in set (0.00 sec)

```

## Nonmatching Rows

You should keep in mind that any rows found in the nonpartitioned table prior to issuing the `ALTER TABLE ... EXCHANGE PARTITION` statement must meet the conditions required for them to be stored in the target partition; otherwise, the statement fails. To see how this occurs, first insert a row into `e2` that is outside the boundaries of the partition definition for partition `p0` of table `e`. For example, insert a row with an `id` column value that is too large; then, try to exchange the table with the partition again:

```

mysql> INSERT INTO e2 VALUES (51, "Ellen", "McDonald");
Query OK, 1 row affected (0.08 sec)

mysql> ALTER TABLE e EXCHANGE PARTITION p0 WITH TABLE e2;
ERROR 1707 (HY000): Found row that does not match the partition

```

Only the `WITHOUT VALIDATION` option would permit this operation to succeed:

```

mysql> ALTER TABLE e EXCHANGE PARTITION p0 WITH TABLE e2 WITHOUT VALIDATION;
Query OK, 0 rows affected (0.02 sec)

```

When a partition is exchanged with a table that contains rows that do not match the partition definition, it is the responsibility of the database administrator to fix the non-matching rows, which can be performed using `REPAIR TABLE` or `ALTER TABLE ... REPAIR PARTITION`.

## Exchanging Partitions Without Row-By-Row Validation

To avoid time consuming validation when exchanging a partition with a table that has many rows, it is possible to skip the row-by-row validation step by appending `WITHOUT VALIDATION` to the `ALTER TABLE ... EXCHANGE PARTITION` statement.

The following example compares the difference between execution times when exchanging a partition with a nonpartitioned table, with and without validation. The partitioned table (table `e`) contains two partitions of 1 million rows each. The rows in `p0` of table `e` are removed and `p0` is exchanged with a nonpartitioned table of 1 million rows. The `WITH VALIDATION` operation takes 0.74 seconds. By comparison, the `WITHOUT VALIDATION` operation takes 0.01 seconds.

```
# Create a partitioned table with 1 million rows in each partition

CREATE TABLE e (
  id INT NOT NULL,
  fname VARCHAR(30),
  lname VARCHAR(30)
)
PARTITION BY RANGE (id) (
  PARTITION p0 VALUES LESS THAN (1000001),
  PARTITION p1 VALUES LESS THAN (2000001),
);

SELECT COUNT(*) FROM e;
+-----+
| COUNT(*) |
+-----+
| 2000000 |
+-----+
1 row in set (0.27 sec)

# View the rows in each partition

SELECT PARTITION_NAME, TABLE_ROWS FROM INFORMATION_SCHEMA.PARTITIONS WHERE TABLE_NAME = 'e';
+-----+-----+
| PARTITION_NAME | TABLE_ROWS |
+-----+-----+
| p0              | 1000000     |
| p1              | 1000000     |
+-----+-----+
2 rows in set (0.00 sec)

# Create a nonpartitioned table of the same structure and populate it with 1 million rows

CREATE TABLE e2 (
  id INT NOT NULL,
  fname VARCHAR(30),
  lname VARCHAR(30)
);

mysql> SELECT COUNT(*) FROM e2;
+-----+
| COUNT(*) |
+-----+
| 1000000 |
+-----+
1 row in set (0.24 sec)

# Create another nonpartitioned table of the same structure and populate it with 1 million rows
```

## Exchanging Partitions and Subpartitions with Tables

```
CREATE TABLE e3 (
  id INT NOT NULL,
  fname VARCHAR(30),
  lname VARCHAR(30)
);

mysql> SELECT COUNT(*) FROM e3;
+-----+
| COUNT(*) |
+-----+
| 1000000 |
+-----+
1 row in set (0.25 sec)

# Drop the rows from p0 of table e

mysql> DELETE FROM e WHERE id < 1000001;
Query OK, 1000000 rows affected (5.55 sec)

# Confirm that there are no rows in partition p0

mysql> SELECT PARTITION_NAME, TABLE_ROWS FROM INFORMATION_SCHEMA.PARTITIONS WHERE TABLE_NAME = 'e';
+-----+-----+
| PARTITION_NAME | TABLE_ROWS |
+-----+-----+
| p0              | 0           |
| p1              | 1000000    |
+-----+-----+
2 rows in set (0.00 sec)

# Exchange partition p0 of table e with the table e2 'WITH VALIDATION'

mysql> ALTER TABLE e EXCHANGE PARTITION p0 WITH TABLE e2 WITH VALIDATION;
Query OK, 0 rows affected (0.74 sec)

# Confirm that the partition was exchanged with table e2

mysql> SELECT PARTITION_NAME, TABLE_ROWS FROM INFORMATION_SCHEMA.PARTITIONS WHERE TABLE_NAME = 'e';
+-----+-----+
| PARTITION_NAME | TABLE_ROWS |
+-----+-----+
| p0              | 1000000    |
| p1              | 1000000    |
+-----+-----+
2 rows in set (0.00 sec)

# Once again, drop the rows from p0 of table e

mysql> DELETE FROM e WHERE id < 1000001;
Query OK, 1000000 rows affected (5.55 sec)

# Confirm that there are no rows in partition p0

mysql> SELECT PARTITION_NAME, TABLE_ROWS FROM INFORMATION_SCHEMA.PARTITIONS WHERE TABLE_NAME = 'e';
+-----+-----+
| PARTITION_NAME | TABLE_ROWS |
+-----+-----+
| p0              | 0           |
| p1              | 1000000    |
+-----+-----+
2 rows in set (0.00 sec)

# Exchange partition p0 of table e with the table e3 'WITHOUT VALIDATION'

mysql> ALTER TABLE e EXCHANGE PARTITION p0 WITH TABLE e3 WITHOUT VALIDATION;
Query OK, 0 rows affected (0.01 sec)
```



```
# Confirm that the partition was exchanged with table e3

mysql> SELECT PARTITION_NAME, TABLE_ROWS FROM INFORMATION_SCHEMA.PARTITIONS WHERE TABLE_NAME = 'e';
+-----+-----+
| PARTITION_NAME | TABLE_ROWS |
+-----+-----+
| p0              | 1000000     |
| p1              | 1000000     |
+-----+-----+
2 rows in set (0.00 sec)
```

If a partition is exchanged with a table that contains rows that do not match the partition definition, it is the responsibility of the database administrator to fix the non-matching rows, which can be performed using `REPAIR TABLE` or `ALTER TABLE ... REPAIR PARTITION`.

## Exchanging a Subpartition with a Nonpartitioned Table

You can also exchange a subpartition of a subpartitioned table (see [Section 22.2.6, “Subpartitioning”](#)) with a nonpartitioned table using an `ALTER TABLE ... EXCHANGE PARTITION` statement. In the following example, we first create a table `es` that is partitioned by `RANGE` and subpartitioned by `KEY`, populate this table as we did table `e`, and then create an empty, nonpartitioned copy `es2` of the table, as shown here:

```
mysql> CREATE TABLE es (
->   id INT NOT NULL,
->   fname VARCHAR(30),
->   lname VARCHAR(30)
-> )
-> PARTITION BY RANGE (id)
-> SUBPARTITION BY KEY (lname)
-> SUBPARTITIONS 2 (
->   PARTITION p0 VALUES LESS THAN (50),
->   PARTITION p1 VALUES LESS THAN (100),
->   PARTITION p2 VALUES LESS THAN (150),
->   PARTITION p3 VALUES LESS THAN (MAXVALUE)
-> );
Query OK, 0 rows affected (2.76 sec)

mysql> INSERT INTO es VALUES
->   (1669, "Jim", "Smith"),
->   (337, "Mary", "Jones"),
->   (16, "Frank", "White"),
->   (2005, "Linda", "Black");
Query OK, 4 rows affected (0.04 sec)
Records: 4 Duplicates: 0 Warnings: 0

mysql> CREATE TABLE es2 LIKE es;
Query OK, 0 rows affected (1.27 sec)

mysql> ALTER TABLE es2 REMOVE PARTITIONING;
Query OK, 0 rows affected (0.70 sec)
Records: 0 Duplicates: 0 Warnings: 0
```

Although we did not explicitly name any of the subpartitions when creating table `es`, we can obtain generated names for these by including the `SUBPARTITION_NAME` of the `PARTITIONS` table from `INFORMATION_SCHEMA` when selecting from that table, as shown here:

```
mysql> SELECT PARTITION_NAME, SUBPARTITION_NAME, TABLE_ROWS
->   FROM INFORMATION_SCHEMA.PARTITIONS
->   WHERE TABLE_NAME = 'es';
+-----+-----+-----+
| PARTITION_NAME | SUBPARTITION_NAME | TABLE_ROWS |
+-----+-----+-----+
| p0              | p0sp0              | 1           |
+-----+-----+-----+
```

## Exchanging Partitions and Subpartitions with Tables

```
| p0 | p0sp1 | 0 |
| p1 | p1sp0 | 0 |
| p1 | p1sp1 | 0 |
| p2 | p2sp0 | 0 |
| p2 | p2sp1 | 0 |
| p3 | p3sp0 | 3 |
| p3 | p3sp1 | 0 |
+-----+-----+-----+
8 rows in set (0.00 sec)
```

The following `ALTER TABLE` statement exchanges subpartition `p3sp0` table `es` with the nonpartitioned table `es2`:

```
mysql> ALTER TABLE es EXCHANGE PARTITION p3sp0 WITH TABLE es2;
Query OK, 0 rows affected (0.29 sec)
```

You can verify that the rows were exchanged by issuing the following queries:

```
mysql> SELECT PARTITION_NAME, SUBPARTITION_NAME, TABLE_ROWS
-> FROM INFORMATION_SCHEMA.PARTITIONS
-> WHERE TABLE_NAME = 'es';
+-----+-----+-----+
| PARTITION_NAME | SUBPARTITION_NAME | TABLE_ROWS |
+-----+-----+-----+
| p0 | p0sp0 | 1 |
| p0 | p0sp1 | 0 |
| p1 | p1sp0 | 0 |
| p1 | p1sp1 | 0 |
| p2 | p2sp0 | 0 |
| p2 | p2sp1 | 0 |
| p3 | p3sp0 | 0 |
| p3 | p3sp1 | 0 |
+-----+-----+-----+
8 rows in set (0.00 sec)
```

```
mysql> SELECT * FROM es2;
+-----+-----+-----+
| id | fname | lname |
+-----+-----+-----+
| 1669 | Jim | Smith |
| 337 | Mary | Jones |
| 2005 | Linda | Black |
+-----+-----+-----+
3 rows in set (0.00 sec)
```

If a table is subpartitioned, you can exchange only a subpartition of the table—not an entire partition—with an unpartitioned table, as shown here:

```
mysql> ALTER TABLE es EXCHANGE PARTITION p3 WITH TABLE es2;
ERROR 1704 (HY000): Subpartitioned table, use subpartition instead of partition
```

The comparison of table structures used by MySQL is very strict. The number, order, names, and types of columns and indexes of the partitioned table and the nonpartitioned table must match exactly. In addition, both tables must use the same storage engine:

```
mysql> CREATE TABLE es3 LIKE e;
Query OK, 0 rows affected (1.31 sec)

mysql> ALTER TABLE es3 REMOVE PARTITIONING;
Query OK, 0 rows affected (0.53 sec)
Records: 0 Duplicates: 0 Warnings: 0

mysql> SHOW CREATE TABLE es3\G
***** 1. row *****
Table: es3
```

```

Create Table: CREATE TABLE `es3` (
  `id` int(11) NOT NULL,
  `fname` varchar(30) DEFAULT NULL,
  `lname` varchar(30) DEFAULT NULL
) ENGINE=InnoDB DEFAULT CHARSET=latin1
1 row in set (0.00 sec)

mysql> ALTER TABLE es3 ENGINE = MyISAM;
Query OK, 0 rows affected (0.15 sec)
Records: 0 Duplicates: 0 Warnings: 0

mysql> ALTER TABLE es EXCHANGE PARTITION p3sp0 WITH TABLE es3;
ERROR 1497 (HY000): The mix of handlers in the partitions is not allowed in this version of MySQL

```

## 22.3.4 Maintenance of Partitions

A number of table and partition maintenance tasks can be carried out using SQL statements intended for such purposes on partitioned tables in MySQL 5.7.

Table maintenance of partitioned tables can be accomplished using the statements [CHECK TABLE](#), [OPTIMIZE TABLE](#), [ANALYZE TABLE](#), and [REPAIR TABLE](#), which are supported for partitioned tables.

You can use a number of extensions to [ALTER TABLE](#) for performing operations of this type on one or more partitions directly, as described in the following list:

- **Rebuilding partitions.** Rebuilds the partition; this has the same effect as dropping all records stored in the partition, then reinserting them. This can be useful for purposes of defragmentation.

Example:

```
ALTER TABLE t1 REBUILD PARTITION p0, p1;
```

- **Optimizing partitions.** If you have deleted a large number of rows from a partition or if you have made many changes to a partitioned table with variable-length rows (that is, having [VARCHAR](#), [BLOB](#), or [TEXT](#) columns), you can use [ALTER TABLE ... OPTIMIZE PARTITION](#) to reclaim any unused space and to defragment the partition data file.

Example:

```
ALTER TABLE t1 OPTIMIZE PARTITION p0, p1;
```

Using [OPTIMIZE PARTITION](#) on a given partition is equivalent to running [CHECK PARTITION](#), [ANALYZE PARTITION](#), and [REPAIR PARTITION](#) on that partition.

Some MySQL storage engines, including [InnoDB](#), do not support per-partition optimization; in these cases, [ALTER TABLE ... OPTIMIZE PARTITION](#) analyzes and rebuilds the entire table, and causes an appropriate warning to be issued. (Bug #11751825, Bug #42822) Use [ALTER TABLE ... REBUILD PARTITION](#) and [ALTER TABLE ... ANALYZE PARTITION](#) instead, to avoid this issue.

- **Analyzing partitions.** This reads and stores the key distributions for partitions.

Example:

```
ALTER TABLE t1 ANALYZE PARTITION p3;
```

- **Repairing partitions.** This repairs corrupted partitions.

Example:

```
ALTER TABLE t1 REPAIR PARTITION p0,p1;
```

Normally, `REPAIR PARTITION` fails when the partition contains duplicate key errors. In MySQL 5.7.2 and later, you can use `ALTER IGNORE TABLE` with this option, in which case all rows that cannot be moved due to the presence of duplicate keys are removed from the partition (Bug #16900947).

- **Checking partitions.** You can check partitions for errors in much the same way that you can use `CHECK TABLE` with nonpartitioned tables.

Example:

```
ALTER TABLE trb3 CHECK PARTITION p1;
```

This command tells you if the data or indexes in partition `p1` of table `t1` are corrupted. If this is the case, use `ALTER TABLE ... REPAIR PARTITION` to repair the partition.

Normally, `CHECK PARTITION` fails when the partition contains duplicate key errors. In MySQL 5.7.2 and later, you can use `ALTER IGNORE TABLE` with this option, in which case the statement returns the contents of each row in the partition where a duplicate key violation is found. Only the values for the columns in the partitioning expression for the table are reported. (Bug #16900947)

Each of the statements in the list just shown also supports the keyword `ALL` in place of the list of partition names. Using `ALL` causes the statement to act on all partitions in the table.

The use of `mysqlcheck` and `myisamchk` is not supported with partitioned tables.

In MySQL 5.7, you can also truncate partitions using `ALTER TABLE ... TRUNCATE PARTITION`. This statement can be used to delete all rows from one or more partitions in much the same way that `TRUNCATE TABLE` deletes all rows from a table.

`ALTER TABLE ... TRUNCATE PARTITION ALL` truncates all partitions in the table.

Prior to MySQL 5.7.2, `ANALYZE`, `CHECK`, `OPTIMIZE`, `REBUILD`, `REPAIR`, and `TRUNCATE` operations were not permitted on subpartitions (Bug #14028340, Bug #65184).

## 22.3.5 Obtaining Information About Partitions

This section discusses obtaining information about existing partitions, which can be done in a number of ways. Methods of obtaining such information include the following:

- Using the `SHOW CREATE TABLE` statement to view the partitioning clauses used in creating a partitioned table.
- Using the `SHOW TABLE STATUS` statement to determine whether a table is partitioned.
- Querying the Information Schema `PARTITIONS` table.
- Using the statement `EXPLAIN SELECT` to see which partitions are used by a given `SELECT`.

As discussed elsewhere in this chapter, `SHOW CREATE TABLE` includes in its output the `PARTITION BY` clause used to create a partitioned table. For example:

```
mysql> SHOW CREATE TABLE trb3\G
***** 1. row *****
      Table: trb3
Create Table: CREATE TABLE `trb3` (
  `id` int(11) default NULL,
  `name` varchar(50) default NULL,
  `purchased` date default NULL
) ENGINE=MyISAM DEFAULT CHARSET=latin1
```

```

PARTITION BY RANGE (YEAR(purchased)) (
  PARTITION p0 VALUES LESS THAN (1990) ENGINE = MyISAM,
  PARTITION p1 VALUES LESS THAN (1995) ENGINE = MyISAM,
  PARTITION p2 VALUES LESS THAN (2000) ENGINE = MyISAM,
  PARTITION p3 VALUES LESS THAN (2005) ENGINE = MyISAM
)
1 row in set (0.00 sec)
    
```

The output from `SHOW TABLE STATUS` for partitioned tables is the same as that for nonpartitioned tables, except that the `Create_options` column contains the string `partitioned`. The `Engine` column contains the name of the storage engine used by all partitions of the table. (See [Section 13.7.5.36, “SHOW TABLE STATUS Statement”](#), for more information about this statement.)

You can also obtain information about partitions from `INFORMATION_SCHEMA`, which contains a `PARTITIONS` table. See [Section 24.3.16, “The INFORMATION\\_SCHEMA PARTITIONS Table”](#).

It is possible to determine which partitions of a partitioned table are involved in a given `SELECT` query using `EXPLAIN`. The `partitions` column in the `EXPLAIN` output lists the partitions from which records would be matched by the query.

Suppose that you have a table `trb1` created and populated as follows:

```

CREATE TABLE trb1 (id INT, name VARCHAR(50), purchased DATE)
PARTITION BY RANGE(id)
(
  PARTITION p0 VALUES LESS THAN (3),
  PARTITION p1 VALUES LESS THAN (7),
  PARTITION p2 VALUES LESS THAN (9),
  PARTITION p3 VALUES LESS THAN (11)
);

INSERT INTO trb1 VALUES
(1, 'desk organiser', '2003-10-15'),
(2, 'CD player', '1993-11-05'),
(3, 'TV set', '1996-03-10'),
(4, 'bookcase', '1982-01-10'),
(5, 'exercise bike', '2004-05-09'),
(6, 'sofa', '1987-06-05'),
(7, 'popcorn maker', '2001-11-22'),
(8, 'aquarium', '1992-08-04'),
(9, 'study desk', '1984-09-16'),
(10, 'lava lamp', '1998-12-25');
    
```

You can see which partitions are used in a query such as `SELECT * FROM trb1;`, as shown here:

```

mysql> EXPLAIN SELECT * FROM trb1\G
***** 1. row *****
      id: 1
  select_type: SIMPLE
        table: trb1
   partitions: p0,p1,p2,p3
         type: ALL
possible_keys: NULL
          key: NULL
        key_len: NULL
         ref: NULL
         rows: 10
      Extra: Using filesort
    
```

In this case, all four partitions are searched. However, when a limiting condition making use of the partitioning key is added to the query, you can see that only those partitions containing matching values are scanned, as shown here:

```

mysql> EXPLAIN SELECT * FROM trb1 WHERE id < 5\G
    
```

```
***** 1. row *****
      id: 1
      select_type: SIMPLE
      table: trb1
      partitions: p0,p1
      type: ALL
      possible_keys: NULL
      key: NULL
      key_len: NULL
      ref: NULL
      rows: 10
      Extra: Using where
```

`EXPLAIN` also provides information about keys used and possible keys:

```
mysql> ALTER TABLE trb1 ADD PRIMARY KEY (id);
Query OK, 10 rows affected (0.03 sec)
Records: 10 Duplicates: 0 Warnings: 0

mysql> EXPLAIN SELECT * FROM trb1 WHERE id < 5\G
***** 1. row *****
      id: 1
      select_type: SIMPLE
      table: trb1
      partitions: p0,p1
      type: range
      possible_keys: PRIMARY
      key: PRIMARY
      key_len: 4
      ref: NULL
      rows: 7
      Extra: Using where
```

If `EXPLAIN PARTITIONS` is used to examine a query against a nonpartitioned table, no error is produced, but the value of the `partitions` column is always `NULL`.

The `rows` column of `EXPLAIN` output displays the total number of rows in the table.

See also [Section 13.8.2, “EXPLAIN Statement”](#).

## 22.4 Partition Pruning

This section discusses an optimization known as *partition pruning*. The core concept behind partition pruning is relatively simple, and can be described as “Do not scan partitions where there can be no matching values”. Suppose that you have a partitioned table `t1` defined by this statement:

```
CREATE TABLE t1 (
  fname VARCHAR(50) NOT NULL,
  lname VARCHAR(50) NOT NULL,
  region_code TINYINT UNSIGNED NOT NULL,
  dob DATE NOT NULL
)
PARTITION BY RANGE( region_code ) (
  PARTITION p0 VALUES LESS THAN (64),
  PARTITION p1 VALUES LESS THAN (128),
  PARTITION p2 VALUES LESS THAN (192),
  PARTITION p3 VALUES LESS THAN MAXVALUE
);
```

Consider the case where you wish to obtain results from a `SELECT` statement such as this one:

```
SELECT fname, lname, region_code, dob
FROM t1
WHERE region_code > 125 AND region_code < 130;
```

It is easy to see that none of the rows which ought to be returned are in either of the partitions `p0` or `p3`; that is, we need to search only in partitions `p1` and `p2` to find matching rows. By doing so, it is possible to expend much less time and effort in finding matching rows than would be required to scan all partitions in the table. This “cutting away” of unneeded partitions is known as *pruning*. When the optimizer can make use of partition pruning in performing this query, execution of the query can be an order of magnitude faster than the same query against a nonpartitioned table containing the same column definitions and data.



### Note

When pruning is performed on a partitioned `MyISAM` table, all partitions are opened, whether or not they are examined, due to the design of the `MyISAM` storage engine. This means that you must have a sufficient number of file descriptors available to cover all partitions of the table. See [MyISAM and partition file descriptor usage](#).

This limitation does not apply to partitioned tables using other MySQL storage engines such as `InnoDB`.

The optimizer can perform pruning whenever a `WHERE` condition can be reduced to either one of the following two cases:

- `partition_column = constant`
- `partition_column IN (constant1, constant2, ..., constantN)`

In the first case, the optimizer simply evaluates the partitioning expression for the value given, determines which partition contains that value, and scans only this partition. In many cases, the equal sign can be replaced with another arithmetic comparison, including `<`, `>`, `<=`, `>=`, and `<>`. Some queries using `BETWEEN` in the `WHERE` clause can also take advantage of partition pruning. See the examples later in this section.

In the second case, the optimizer evaluates the partitioning expression for each value in the list, creates a list of matching partitions, and then scans only the partitions in this partition list.

MySQL can apply partition pruning to `SELECT`, `DELETE`, and `UPDATE` statements. An `INSERT` statement also accesses only one partition per inserted row; this is true even for a table that is partitioned by `HASH` or `KEY` although this is not currently shown in the output of `EXPLAIN`.

Pruning can also be applied to short ranges, which the optimizer can convert into equivalent lists of values. For instance, in the previous example, the `WHERE` clause can be converted to `WHERE region_code IN (126, 127, 128, 129)`. Then the optimizer can determine that the first two values in the list are found in partition `p1`, the remaining two values in partition `p2`, and that the other partitions contain no relevant values and so do not need to be searched for matching rows.

The optimizer can also perform pruning for `WHERE` conditions that involve comparisons of the preceding types on multiple columns for tables that use `RANGE COLUMNS` or `LIST COLUMNS` partitioning.

This type of optimization can be applied whenever the partitioning expression consists of an equality or a range which can be reduced to a set of equalities, or when the partitioning expression represents an increasing or decreasing relationship. Pruning can also be applied for tables partitioned on a `DATE` or `DATETIME` column when the partitioning expression uses the `YEAR()` or `TO_DAYS()` function. In addition, in MySQL 5.7, pruning can be applied for such tables when the partitioning expression uses the `TO_SECONDS()` function.

Suppose that table `t2`, defined as shown here, is partitioned on a `DATE` column:

```
CREATE TABLE t2 (
  fname VARCHAR(50) NOT NULL,
  lname VARCHAR(50) NOT NULL,
  region_code TINYINT UNSIGNED NOT NULL,
```

```

    dob DATE NOT NULL
)
PARTITION BY RANGE( YEAR(dob) ) (
    PARTITION d0 VALUES LESS THAN (1970),
    PARTITION d1 VALUES LESS THAN (1975),
    PARTITION d2 VALUES LESS THAN (1980),
    PARTITION d3 VALUES LESS THAN (1985),
    PARTITION d4 VALUES LESS THAN (1990),
    PARTITION d5 VALUES LESS THAN (2000),
    PARTITION d6 VALUES LESS THAN (2005),
    PARTITION d7 VALUES LESS THAN MAXVALUE
);

```

The following statements using `t2` can make use of partition pruning:

```

SELECT * FROM t2 WHERE dob = '1982-06-23';

UPDATE t2 SET region_code = 8 WHERE dob BETWEEN '1991-02-15' AND '1997-04-25';

DELETE FROM t2 WHERE dob >= '1984-06-21' AND dob <= '1999-06-21'

```

In the case of the last statement, the optimizer can also act as follows:

1. Find the partition containing the low end of the range.

`YEAR( '1984-06-21' )` yields the value `1984`, which is found in partition `d3`.

2. Find the partition containing the high end of the range.

`YEAR( '1999-06-21' )` evaluates to `1999`, which is found in partition `d5`.

3. Scan only these two partitions and any partitions that may lie between them.

In this case, this means that only partitions `d3`, `d4`, and `d5` are scanned. The remaining partitions may be safely ignored (and are ignored).



### Important

Invalid `DATE` and `DATETIME` values referenced in the `WHERE` condition of a statement against a partitioned table are treated as `NULL`. This means that a query such as `SELECT * FROM partitioned_table WHERE date_column < '2008-12-00'` does not return any values (see Bug #40972).

So far, we have looked only at examples using `RANGE` partitioning, but pruning can be applied with other partitioning types as well.

Consider a table that is partitioned by `LIST`, where the partitioning expression is increasing or decreasing, such as the table `t3` shown here. (In this example, we assume for the sake of brevity that the `region_code` column is limited to values between 1 and 10 inclusive.)

```

CREATE TABLE t3 (
    fname VARCHAR(50) NOT NULL,
    lname VARCHAR(50) NOT NULL,
    region_code TINYINT UNSIGNED NOT NULL,
    dob DATE NOT NULL
)
PARTITION BY LIST(region_code) (
    PARTITION r0 VALUES IN (1, 3),
    PARTITION r1 VALUES IN (2, 5, 8),
    PARTITION r2 VALUES IN (4, 9),
    PARTITION r3 VALUES IN (6, 7, 10)
);

```



For a statement such as `SELECT * FROM t3 WHERE region_code BETWEEN 1 AND 3`, the optimizer determines in which partitions the values 1, 2, and 3 are found (`r0` and `r1`) and skips the remaining ones (`r2` and `r3`).

For tables that are partitioned by `HASH` or `[LINEAR] KEY`, partition pruning is also possible in cases in which the `WHERE` clause uses a simple `=` relation against a column used in the partitioning expression. Consider a table created like this:

```
CREATE TABLE t4 (
  fname VARCHAR(50) NOT NULL,
  lname VARCHAR(50) NOT NULL,
  region_code TINYINT UNSIGNED NOT NULL,
  dob DATE NOT NULL
)
PARTITION BY KEY(region_code)
PARTITIONS 8;
```

A statement that compares a column value with a constant can be pruned:

```
UPDATE t4 WHERE region_code = 7;
```

Pruning can also be employed for short ranges, because the optimizer can turn such conditions into `IN` relations. For example, using the same table `t4` as defined previously, queries such as these can be pruned:

```
SELECT * FROM t4 WHERE region_code > 2 AND region_code < 6;
SELECT * FROM t4 WHERE region_code BETWEEN 3 AND 5;
```

In both these cases, the `WHERE` clause is transformed by the optimizer into `WHERE region_code IN (3, 4, 5)`.



### Important

This optimization is used only if the range size is smaller than the number of partitions. Consider this statement:

```
DELETE FROM t4 WHERE region_code BETWEEN 4 AND 12;
```

The range in the `WHERE` clause covers 9 values (4, 5, 6, 7, 8, 9, 10, 11, 12), but `t4` has only 8 partitions. This means that the `DELETE` cannot be pruned.

When a table is partitioned by `HASH` or `[LINEAR] KEY`, pruning can be used only on integer columns. For example, this statement cannot use pruning because `dob` is a `DATE` column:

```
SELECT * FROM t4 WHERE dob >= '2001-04-14' AND dob <= '2005-10-15';
```

However, if the table stores year values in an `INT` column, then a query having `WHERE year_col >= 2001 AND year_col <= 2005` can be pruned.

Prior to MySQL 5.7.1, partition pruning was disabled for all tables using a storage engine that provides automatic partitioning, such as the `NDB` storage engine used by `NDB Cluster`. (Bug #14672885) Beginning with MySQL 5.7.1, such tables can be pruned if they are explicitly partitioned. (Bug #14827952)

## 22.5 Partition Selection

MySQL 5.7 supports explicit selection of partitions and subpartitions that, when executing a statement, should be checked for rows matching a given `WHERE` condition. Partition selection is similar to partition pruning, in that only specific partitions are checked for matches, but differs in two key respects:

1. The partitions to be checked are specified by the issuer of the statement, unlike partition pruning, which is automatic.
2. Whereas partition pruning applies only to queries, explicit selection of partitions is supported for both queries and a number of DML statements.

SQL statements supporting explicit partition selection are listed here:

- `SELECT`
- `DELETE`
- `INSERT`
- `REPLACE`
- `UPDATE`
- `LOAD DATA`.
- `LOAD XML`.

The remainder of this section discusses explicit partition selection as it applies generally to the statements just listed, and provides some examples.

Explicit partition selection is implemented using a `PARTITION` option. For all supported statements, this option uses the syntax shown here:

```
PARTITION (partition_names)

partition_names:
    partition_name, ...
```

This option always follows the name of the table to which the partition or partitions belong.

`partition_names` is a comma-separated list of partitions or subpartitions to be used. Each name in this list must be the name of an existing partition or subpartition of the specified table; if any of the partitions or subpartitions are not found, the statement fails with an error (`partition 'partition_name' does not exist`). Partitions and subpartitions named in `partition_names` may be listed in any order, and may overlap.

When the `PARTITION` option is used, only the partitions and subpartitions listed are checked for matching rows. This option can be used in a `SELECT` statement to determine which rows belong to a given partition. Consider a partitioned table named `employees`, created and populated using the statements shown here:

```
SET @@SQL_MODE = '';

CREATE TABLE employees (
    id INT NOT NULL AUTO_INCREMENT PRIMARY KEY,
    fname VARCHAR(25) NOT NULL,
    lname VARCHAR(25) NOT NULL,
    store_id INT NOT NULL,
    department_id INT NOT NULL
)
PARTITION BY RANGE(id) (
    PARTITION p0 VALUES LESS THAN (5),
    PARTITION p1 VALUES LESS THAN (10),
    PARTITION p2 VALUES LESS THAN (15),
    PARTITION p3 VALUES LESS THAN MAXVALUE
);

INSERT INTO employees VALUES
    ('', 'Bob', 'Taylor', 3, 2), ('', 'Frank', 'Williams', 1, 2),
    ('', 'Ellen', 'Johnson', 3, 4), ('', 'Jim', 'Smith', 2, 4),
```

```
(', 'Mary', 'Jones', 1, 1), ('', 'Linda', 'Black', 2, 3),
('', 'Ed', 'Jones', 2, 1), ('', 'June', 'Wilson', 3, 1),
('', 'Andy', 'Smith', 1, 3), ('', 'Lou', 'Waters', 2, 4),
('', 'Jill', 'Stone', 1, 4), ('', 'Roger', 'White', 3, 2),
('', 'Howard', 'Andrews', 1, 2), ('', 'Fred', 'Goldberg', 3, 3),
('', 'Barbara', 'Brown', 2, 3), ('', 'Alice', 'Rogers', 2, 2),
('', 'Mark', 'Morgan', 3, 3), ('', 'Karen', 'Cole', 3, 2);
```

You can see which rows are stored in partition `p1` like this:

```
mysql> SELECT * FROM employees PARTITION (p1);
+-----+-----+-----+-----+-----+
| id | fname | lname | store_id | department_id |
+-----+-----+-----+-----+-----+
| 5 | Mary | Jones | 1 | 1 |
| 6 | Linda | Black | 2 | 3 |
| 7 | Ed | Jones | 2 | 1 |
| 8 | June | Wilson | 3 | 1 |
| 9 | Andy | Smith | 1 | 3 |
+-----+-----+-----+-----+-----+
5 rows in set (0.00 sec)
```

The result is the same as obtained by the query `SELECT * FROM employees WHERE id BETWEEN 5 AND 9`.

To obtain rows from multiple partitions, supply their names as a comma-delimited list. For example, `SELECT * FROM employees PARTITION (p1, p2)` returns all rows from partitions `p1` and `p2` while excluding rows from the remaining partitions.

Any valid query against a partitioned table can be rewritten with a `PARTITION` option to restrict the result to one or more desired partitions. You can use `WHERE` conditions, `ORDER BY` and `LIMIT` options, and so on. You can also use aggregate functions with `HAVING` and `GROUP BY` options. Each of the following queries produces a valid result when run on the `employees` table as previously defined:

```
mysql> SELECT * FROM employees PARTITION (p0, p2)
-> WHERE lname LIKE 'S%';
+-----+-----+-----+-----+-----+
| id | fname | lname | store_id | department_id |
+-----+-----+-----+-----+-----+
| 4 | Jim | Smith | 2 | 4 |
| 11 | Jill | Stone | 1 | 4 |
+-----+-----+-----+-----+-----+
2 rows in set (0.00 sec)

mysql> SELECT id, CONCAT(fname, ' ', lname) AS name
-> FROM employees PARTITION (p0) ORDER BY lname;
+-----+-----+
| id | name |
+-----+-----+
| 3 | Ellen Johnson |
| 4 | Jim Smith |
| 1 | Bob Taylor |
| 2 | Frank Williams |
+-----+-----+
4 rows in set (0.06 sec)

mysql> SELECT store_id, COUNT(department_id) AS c
-> FROM employees PARTITION (p1,p2,p3)
-> GROUP BY store_id HAVING c > 4;
+-----+-----+
| c | store_id |
+-----+-----+
| 5 | 2 |
| 5 | 3 |
+-----+-----+
```

2 rows in set (0.00 sec)

Statements using partition selection can be employed with tables using any of the partitioning types supported in MySQL 5.7. When a table is created using `[LINEAR] HASH` or `[LINEAR] KEY` partitioning and the names of the partitions are not specified, MySQL automatically names the partitions `p0`, `p1`, `p2`, ..., `pN-1`, where `N` is the number of partitions. For subpartitions not explicitly named, MySQL assigns automatically to the subpartitions in each partition `pX` the names `pXsp0`, `pXsp1`, `pXsp2`, ..., `pXspM-1`, where `M` is the number of subpartitions. When executing against this table a `SELECT` (or other SQL statement for which explicit partition selection is allowed), you can use these generated names in a `PARTITION` option, as shown here:

```
mysql> CREATE TABLE employees_sub (
->     id INT NOT NULL AUTO_INCREMENT,
->     fname VARCHAR(25) NOT NULL,
->     lname VARCHAR(25) NOT NULL,
->     store_id INT NOT NULL,
->     department_id INT NOT NULL,
->     PRIMARY KEY pk (id, lname)
-> )
->     PARTITION BY RANGE(id)
->     SUBPARTITION BY KEY (lname)
->     SUBPARTITIONS 2 (
->         PARTITION p0 VALUES LESS THAN (5),
->         PARTITION p1 VALUES LESS THAN (10),
->         PARTITION p2 VALUES LESS THAN (15),
->         PARTITION p3 VALUES LESS THAN MAXVALUE
-> );
Query OK, 0 rows affected (1.14 sec)

mysql> INSERT INTO employees_sub # re-use data in employees table
->     SELECT * FROM employees;
Query OK, 18 rows affected (0.09 sec)
Records: 18 Duplicates: 0 Warnings: 0

mysql> SELECT id, CONCAT(fname, ' ', lname) AS name
->     FROM employees_sub PARTITION (p2sp1);
+-----+
| id | name          |
+-----+
| 10 | Lou Waters   |
| 14 | Fred Goldberg|
+-----+
2 rows in set (0.00 sec)
```

You may also use a `PARTITION` option in the `SELECT` portion of an `INSERT ... SELECT` statement, as shown here:

```
mysql> CREATE TABLE employees_copy LIKE employees;
Query OK, 0 rows affected (0.28 sec)

mysql> INSERT INTO employees_copy
->     SELECT * FROM employees PARTITION (p2);
Query OK, 5 rows affected (0.04 sec)
Records: 5 Duplicates: 0 Warnings: 0

mysql> SELECT * FROM employees_copy;
+-----+-----+-----+-----+-----+
| id | fname | lname  | store_id | department_id |
+-----+-----+-----+-----+-----+
| 10 | Lou   | Waters | 2        | 4              |
| 11 | Jill  | Stone  | 1        | 4              |
| 12 | Roger | White  | 3        | 2              |
| 13 | Howard| Andrews| 1        | 2              |
| 14 | Fred  | Goldberg| 3        | 3              |
+-----+-----+-----+-----+-----+
```

5 rows in set (0.00 sec)

Partition selection can also be used with joins. Suppose we create and populate two tables using the statements shown here:

```
CREATE TABLE stores (
  id INT NOT NULL AUTO_INCREMENT PRIMARY KEY,
  city VARCHAR(30) NOT NULL
)
PARTITION BY HASH(id)
PARTITIONS 2;

INSERT INTO stores VALUES
  ('', 'Nambucca'), ('', 'Uranga'),
  ('', 'Bellinghen'), ('', 'Grafton');

CREATE TABLE departments (
  id INT NOT NULL AUTO_INCREMENT PRIMARY KEY,
  name VARCHAR(30) NOT NULL
)
PARTITION BY KEY(id)
PARTITIONS 2;

INSERT INTO departments VALUES
  ('', 'Sales'), ('', 'Customer Service'),
  ('', 'Delivery'), ('', 'Accounting');
```

You can explicitly select partitions (or subpartitions, or both) from any or all of the tables in a join. (The `PARTITION` option used to select partitions from a given table immediately follows the name of the table, before all other options, including any table alias.) For example, the following query gets the name, employee ID, department, and city of all employees who work in the Sales or Delivery department (partition `p1` of the `departments` table) at the stores in either of the cities of Nambucca and Bellinghen (partition `p0` of the `stores` table):

```
mysql> SELECT
->   e.id AS 'Employee ID', CONCAT(e.fname, ' ', e.lname) AS Name,
->   s.city AS City, d.name AS department
-> FROM employees AS e
-> JOIN stores PARTITION (p1) AS s ON e.store_id=s.id
-> JOIN departments PARTITION (p0) AS d ON e.department_id=d.id
-> ORDER BY e.lname;
+-----+-----+-----+-----+
| Employee ID | Name          | City      | department |
+-----+-----+-----+-----+
|          14 | Fred Goldberg | Bellinghen | Delivery   |
|           5 | Mary Jones    | Nambucca   | Sales      |
|          17 | Mark Morgan   | Bellinghen | Delivery   |
|           9 | Andy Smith    | Nambucca   | Delivery   |
|           8 | June Wilson   | Bellinghen | Sales      |
+-----+-----+-----+-----+
5 rows in set (0.00 sec)
```

For general information about joins in MySQL, see [Section 13.2.9.2, “JOIN Clause”](#).

When the `PARTITION` option is used with `DELETE` statements, only those partitions (and subpartitions, if any) listed with the option are checked for rows to be deleted. Any other partitions are ignored, as shown here:

```
mysql> SELECT * FROM employees WHERE fname LIKE 'j%';
+-----+-----+-----+-----+-----+
| id | fname | lname | store_id | department_id |
+-----+-----+-----+-----+-----+
|  4 | Jim   | Smith |         2 |              4 |
|  8 | June  | Wilson |         3 |              1 |
| 11 | Jill  | Stone |         1 |              4 |
+-----+-----+-----+-----+-----+
```

## Partition Selection

```
+-----+-----+-----+-----+-----+
3 rows in set (0.00 sec)

mysql> DELETE FROM employees PARTITION (p0, p1)
->     WHERE fname LIKE 'j%';
Query OK, 2 rows affected (0.09 sec)

mysql> SELECT * FROM employees WHERE fname LIKE 'j%';
+-----+-----+-----+-----+-----+
| id | fname | lname | store_id | department_id |
+-----+-----+-----+-----+-----+
| 11 | Jill  | Stone |         1 |              4 |
+-----+-----+-----+-----+-----+
1 row in set (0.00 sec)
```

Only the two rows in partitions `p0` and `p1` matching the `WHERE` condition were deleted. As you can see from the result when the `SELECT` is run a second time, there remains a row in the table matching the `WHERE` condition, but residing in a different partition (`p2`).

`UPDATE` statements using explicit partition selection behave in the same way; only rows in the partitions referenced by the `PARTITION` option are considered when determining the rows to be updated, as can be seen by executing the following statements:

```
mysql> UPDATE employees PARTITION (p0)
->     SET store_id = 2 WHERE fname = 'Jill';
Query OK, 0 rows affected (0.00 sec)
Rows matched: 0  Changed: 0  Warnings: 0

mysql> SELECT * FROM employees WHERE fname = 'Jill';
+-----+-----+-----+-----+-----+
| id | fname | lname | store_id | department_id |
+-----+-----+-----+-----+-----+
| 11 | Jill  | Stone |         1 |              4 |
+-----+-----+-----+-----+-----+
1 row in set (0.00 sec)

mysql> UPDATE employees PARTITION (p2)
->     SET store_id = 2 WHERE fname = 'Jill';
Query OK, 1 row affected (0.09 sec)
Rows matched: 1  Changed: 1  Warnings: 0

mysql> SELECT * FROM employees WHERE fname = 'Jill';
+-----+-----+-----+-----+-----+
| id | fname | lname | store_id | department_id |
+-----+-----+-----+-----+-----+
| 11 | Jill  | Stone |         2 |              4 |
+-----+-----+-----+-----+-----+
1 row in set (0.00 sec)
```

In the same way, when `PARTITION` is used with `DELETE`, only rows in the partition or partitions named in the partition list are checked for deletion.

For statements that insert rows, the behavior differs in that failure to find a suitable partition causes the statement to fail. This is true for both `INSERT` and `REPLACE` statements, as shown here:

```
mysql> INSERT INTO employees PARTITION (p2) VALUES (20, 'Jan', 'Jones', 1, 3);
ERROR 1729 (HY000): Found a row not matching the given partition set
mysql> INSERT INTO employees PARTITION (p3) VALUES (20, 'Jan', 'Jones', 1, 3);
Query OK, 1 row affected (0.07 sec)

mysql> REPLACE INTO employees PARTITION (p0) VALUES (20, 'Jan', 'Jones', 3, 2);
ERROR 1729 (HY000): Found a row not matching the given partition set

mysql> REPLACE INTO employees PARTITION (p3) VALUES (20, 'Jan', 'Jones', 3, 2);
Query OK, 2 rows affected (0.09 sec)
```

For statements that write multiple rows to a partitioned table that uses the [InnoDB](#) storage engine: If any row in the list following [VALUES](#) cannot be written to one of the partitions specified in the [partition\\_names](#) list, the entire statement fails and no rows are written. This is shown for [INSERT](#) statements in the following example, reusing the [employees](#) table created previously:

```
mysql> ALTER TABLE employees
->     REORGANIZE PARTITION p3 INTO (
->         PARTITION p3 VALUES LESS THAN (20),
->         PARTITION p4 VALUES LESS THAN (25),
->         PARTITION p5 VALUES LESS THAN MAXVALUE
->     );
Query OK, 6 rows affected (2.09 sec)
Records: 6 Duplicates: 0 Warnings: 0

mysql> SHOW CREATE TABLE employees\G
***** 1. row *****
      Table: employees
Create Table: CREATE TABLE `employees` (
  `id` int(11) NOT NULL AUTO_INCREMENT,
  `fname` varchar(25) NOT NULL,
  `lname` varchar(25) NOT NULL,
  `store_id` int(11) NOT NULL,
  `department_id` int(11) NOT NULL,
  PRIMARY KEY (`id`)
) ENGINE=InnoDB AUTO_INCREMENT=27 DEFAULT CHARSET=latin1
/*!50100 PARTITION BY RANGE (id)
(PARTITION p0 VALUES LESS THAN (5) ENGINE = InnoDB,
PARTITION p1 VALUES LESS THAN (10) ENGINE = InnoDB,
PARTITION p2 VALUES LESS THAN (15) ENGINE = InnoDB,
PARTITION p3 VALUES LESS THAN (20) ENGINE = InnoDB,
PARTITION p4 VALUES LESS THAN (25) ENGINE = InnoDB,
PARTITION p5 VALUES LESS THAN MAXVALUE ENGINE = InnoDB) */
1 row in set (0.00 sec)

mysql> INSERT INTO employees PARTITION (p3, p4) VALUES
->     (24, 'Tim', 'Greene', 3, 1), (26, 'Linda', 'Mills', 2, 1);
ERROR 1729 (HY000): Found a row not matching the given partition set

mysql> INSERT INTO employees PARTITION (p3, p4, p5) VALUES
->     (24, 'Tim', 'Greene', 3, 1), (26, 'Linda', 'Mills', 2, 1);
Query OK, 2 rows affected (0.06 sec)
Records: 2 Duplicates: 0 Warnings: 0
```

The preceding is true for both [INSERT](#) statements and [REPLACE](#) statements that write multiple rows.

In MySQL 5.7.1 and later, partition selection is disabled for tables employing a storage engine that supplies automatic partitioning, such as [NDB](#). (Bug #14827952)

## 22.6 Restrictions and Limitations on Partitioning

This section discusses current restrictions and limitations on MySQL partitioning support.

**Prohibited constructs.** The following constructs are not permitted in partitioning expressions:

- Stored procedures, stored functions, loadable functions, or plugins.
- Declared variables or user variables.

For a list of SQL functions which are permitted in partitioning expressions, see [Section 22.6.3, “Partitioning Limitations Relating to Functions”](#).

**Arithmetic and logical operators.** Use of the arithmetic operators [+](#), [-](#), and [\\*](#) is permitted in partitioning expressions. However, the result must be an integer value or [NULL](#) (except in the case of

[[LINEAR](#)] [KEY](#) partitioning, as discussed elsewhere in this chapter; see [Section 22.2](#), “[Partitioning Types](#)”, for more information).

The [DIV](#) operator is also supported, and the [/](#) operator is not permitted. (Bug #30188, Bug #33182)

The bit operators [|](#), [&](#), [^](#), [<<](#), [>>](#), and [~](#) are not permitted in partitioning expressions.

**HANDLER statements.** Previously, the [HANDLER](#) statement was not supported with partitioned tables. This limitation is removed beginning with MySQL 5.7.1.

**Server SQL mode.** Tables employing user-defined partitioning do not preserve the SQL mode in effect at the time that they were created. As discussed in [Section 5.1.10](#), “[Server SQL Modes](#)”, the results of many MySQL functions and operators may change according to the server SQL mode. Therefore, a change in the SQL mode at any time after the creation of partitioned tables may lead to major changes in the behavior of such tables, and could easily lead to corruption or loss of data. For these reasons, *it is strongly recommended that you never change the server SQL mode after creating partitioned tables.*

**Examples.** The following examples illustrate some changes in behavior of partitioned tables due to a change in the server SQL mode:

1. **Error handling.** Suppose that you create a partitioned table whose partitioning expression is one such as `column DIV 0` or `column MOD 0`, as shown here:

```
mysql> CREATE TABLE tn (c1 INT)
->     PARTITION BY LIST(1 DIV c1) (
->     PARTITION p0 VALUES IN (NULL),
->     PARTITION p1 VALUES IN (1)
-> );
Query OK, 0 rows affected (0.05 sec)
```

The default behavior for MySQL is to return [NULL](#) for the result of a division by zero, without producing any errors:

```
mysql> SELECT @@sql_mode;
+-----+
| @@sql_mode |
+-----+
|             |
+-----+
1 row in set (0.00 sec)

mysql> INSERT INTO tn VALUES (NULL), (0), (1);
Query OK, 3 rows affected (0.00 sec)
Records: 3 Duplicates: 0 Warnings: 0
```

However, changing the server SQL mode to treat division by zero as an error and to enforce strict error handling causes the same [INSERT](#) statement to fail, as shown here:

```
mysql> SET sql_mode='STRICT_ALL_TABLES,ERROR_FOR_DIVISION_BY_ZERO';
Query OK, 0 rows affected (0.00 sec)

mysql> INSERT INTO tn VALUES (NULL), (0), (1);
ERROR 1365 (22012): Division by 0
```

2. **Table accessibility.** Sometimes a change in the server SQL mode can make partitioned tables unusable. The following [CREATE TABLE](#) statement can be executed successfully only if the [NO\\_UNSIGNED\\_SUBTRACTION](#) mode is in effect:

```
mysql> SELECT @@sql_mode;
+-----+
| @@sql_mode |
```



```

+-----+
|       |
+-----+
1 row in set (0.00 sec)

mysql> CREATE TABLE tu (c1 BIGINT UNSIGNED)
-> PARTITION BY RANGE(c1 - 10) (
-> PARTITION p0 VALUES LESS THAN (-5),
-> PARTITION p1 VALUES LESS THAN (0),
-> PARTITION p2 VALUES LESS THAN (5),
-> PARTITION p3 VALUES LESS THAN (10),
-> PARTITION p4 VALUES LESS THAN (MAXVALUE)
-> );
ERROR 1563 (HY000): Partition constant is out of partition function domain

mysql> SET sql_mode='NO_UNSIGNED_SUBTRACTION';
Query OK, 0 rows affected (0.00 sec)

mysql> SELECT @@sql_mode;
+-----+
| @@sql_mode          |
+-----+
| NO_UNSIGNED_SUBTRACTION |
+-----+
1 row in set (0.00 sec)

mysql> CREATE TABLE tu (c1 BIGINT UNSIGNED)
-> PARTITION BY RANGE(c1 - 10) (
-> PARTITION p0 VALUES LESS THAN (-5),
-> PARTITION p1 VALUES LESS THAN (0),
-> PARTITION p2 VALUES LESS THAN (5),
-> PARTITION p3 VALUES LESS THAN (10),
-> PARTITION p4 VALUES LESS THAN (MAXVALUE)
-> );
Query OK, 0 rows affected (0.05 sec)

```

If you remove the `NO_UNSIGNED_SUBTRACTION` server SQL mode after creating `tu`, you may no longer be able to access this table:

```

mysql> SET sql_mode='';
Query OK, 0 rows affected (0.00 sec)

mysql> SELECT * FROM tu;
ERROR 1563 (HY000): Partition constant is out of partition function domain
mysql> INSERT INTO tu VALUES (20);
ERROR 1563 (HY000): Partition constant is out of partition function domain

```

See also [Section 5.1.10, “Server SQL Modes”](#).

Server SQL modes also impact replication of partitioned tables. Disparate SQL modes on source and replica can lead to partitioning expressions being evaluated differently; this can cause the distribution of data among partitions to be different in the source's and replica's copies of a given table, and may even cause inserts into partitioned tables that succeed on the source to fail on the replica. For best results, you should always use the same server SQL mode on the source and on the replica.

**Performance considerations.** Some effects of partitioning operations on performance are given in the following list:

- **File system operations.** Partitioning and repartitioning operations (such as `ALTER TABLE` with `PARTITION BY ...`, `REORGANIZE PARTITION`, or `REMOVE PARTITIONING`) depend on file system operations for their implementation. This means that the speed of these operations is affected by such factors as file system type and characteristics, disk speed, swap space, file handling efficiency of the operating system, and MySQL server options and variables that relate to

file handling. In particular, you should make sure that `large_files_support` is enabled and that `open_files_limit` is set properly. For partitioned tables using the `MyISAM` storage engine, increasing `myisam_max_sort_file_size` may improve performance; partitioning and repartitioning operations involving `InnoDB` tables may be made more efficient by enabling `innodb_file_per_table`.

See also [Maximum number of partitions](#).

- **MyISAM and partition file descriptor usage.**

For a partitioned `MyISAM` table, MySQL uses 2 file descriptors for each partition, for each such table that is open. This means that you need many more file descriptors to perform operations on a partitioned `MyISAM` table than on a table which is identical to it except that the latter table is not partitioned, particularly when performing `ALTER TABLE` operations.

Assume a `MyISAM` table `t` with 100 partitions, such as the table created by this SQL statement:

```
CREATE TABLE t (c1 VARCHAR(50))
PARTITION BY KEY (c1) PARTITIONS 100
ENGINE=MYISAM;
```



#### Note

For brevity, we use `KEY` partitioning for the table shown in this example, but file descriptor usage as described here applies to all partitioned `MyISAM` tables, regardless of the type of partitioning that is employed. Partitioned tables using other storage engines such as `InnoDB` are not affected by this issue.

Now assume that you wish to repartition `t` so that it has 101 partitions, using the statement shown here:

```
ALTER TABLE t PARTITION BY KEY (c1) PARTITIONS 101;
```

To process this `ALTER TABLE` statement, MySQL uses 402 file descriptors—that is, two for each of the 100 original partitions, plus two for each of the 101 new partitions. This is because all partitions (old and new) must be opened concurrently during the reorganization of the table data. It is recommended that, if you expect to perform such operations, you should make sure that the `open_files_limit` system variable is not set too low to accommodate them.

- **Table locks.** Generally, the process executing a partitioning operation on a table takes a write lock on the table. Reads from such tables are relatively unaffected; pending `INSERT` and `UPDATE` operations are performed as soon as the partitioning operation has completed. For `InnoDB`-specific exceptions to this limitation, see [Partitioning Operations](#).
- **Storage engine.** Partitioning operations, queries, and update operations generally tend to be faster with `MyISAM` tables than with `InnoDB` or `NDB` tables.
- **Indexes; partition pruning.** As with nonpartitioned tables, proper use of indexes can speed up queries on partitioned tables significantly. In addition, designing partitioned tables and queries on these tables to take advantage of *partition pruning* can improve performance dramatically. See [Section 22.4, “Partition Pruning”](#), for more information.

Previously, index condition pushdown was not supported for partitioned tables. This limitation was removed in MySQL 5.7.3. See [Section 8.2.1.5, “Index Condition Pushdown Optimization”](#).

- **Performance with LOAD DATA.** In MySQL 5.7, `LOAD DATA` uses buffering to improve performance. You should be aware that the buffer uses 130 KB memory per partition to achieve this.

#### Maximum number of partitions.

The maximum possible number of partitions for a given table not using the `NDB` storage engine is 8192. This number includes subpartitions.

The maximum possible number of user-defined partitions for a table using the [NDB](#) storage engine is determined according to the version of the NDB Cluster software being used, the number of data nodes, and other factors. See [NDB and user-defined partitioning](#), for more information.

If, when creating tables with a large number of partitions (but less than the maximum), you encounter an error message such as `Got error ... from storage engine: Out of resources when opening file`, you may be able to address the issue by increasing the value of the `open_files_limit` system variable. However, this is dependent on the operating system, and may not be possible or advisable on all platforms; see [Section B.3.2.16, "File Not Found and Similar Errors"](#), for more information. In some cases, using large numbers (hundreds) of partitions may also not be advisable due to other concerns, so using more partitions does not automatically lead to better results.

See also [File system operations](#).

#### **Query cache not supported.**

The query cache is not supported for partitioned tables, and is automatically disabled for queries involving partitioned tables. The query cache cannot be enabled for such queries.

#### **Per-partition key caches.**

In MySQL 5.7, key caches are supported for partitioned [MyISAM](#) tables, using the `CACHE INDEX` and `LOAD INDEX INTO CACHE` statements. Key caches may be defined for one, several, or all partitions, and indexes for one, several, or all partitions may be preloaded into key caches.

#### **Foreign keys not supported for partitioned InnoDB tables.**

Partitioned tables using the [InnoDB](#) storage engine do not support foreign keys. More specifically, this means that the following two statements are true:

1. No definition of an [InnoDB](#) table employing user-defined partitioning may contain foreign key references; no [InnoDB](#) table whose definition contains foreign key references may be partitioned.
2. No [InnoDB](#) table definition may contain a foreign key reference to a user-partitioned table; no [InnoDB](#) table with user-defined partitioning may contain columns referenced by foreign keys.

The scope of the restrictions just listed includes all tables that use the [InnoDB](#) storage engine. `CREATE TABLE` and `ALTER TABLE` statements that would result in tables violating these restrictions are not allowed.

**ALTER TABLE ... ORDER BY.** An `ALTER TABLE ... ORDER BY column` statement run against a partitioned table causes ordering of rows only within each partition.

**Effects on REPLACE statements by modification of primary keys.** It can be desirable in some cases (see [Section 22.6.1, "Partitioning Keys, Primary Keys, and Unique Keys"](#)) to modify a table's primary key. Be aware that, if your application uses `REPLACE` statements and you do this, the results of these statements can be drastically altered. See [Section 13.2.8, "REPLACE Statement"](#), for more information and an example.

#### **FULLTEXT indexes.**

Partitioned tables do not support [FULLTEXT](#) indexes or searches, even for partitioned tables employing the [InnoDB](#) or [MyISAM](#) storage engine.

**Spatial columns.** Columns with spatial data types such as [POINT](#) or [GEOMETRY](#) cannot be used in partitioned tables.

#### **Temporary tables.**

Temporary tables cannot be partitioned. (Bug #17497)

**Log tables.** It is not possible to partition the log tables; an `ALTER TABLE ... PARTITION BY ...` statement on such a table fails with an error.

**Data type of partitioning key.**

A partitioning key must be either an integer column or an expression that resolves to an integer. Expressions employing `ENUM` columns cannot be used. The column or expression value may also be `NULL`. (See [Section 22.2.7](#), “How MySQL Partitioning Handles `NULL`”.)

There are two exceptions to this restriction:

1. When partitioning by `[LINEAR] KEY`, it is possible to use columns of any valid MySQL data type other than `TEXT` or `BLOB` as partitioning keys, because MySQL's internal key-hashing functions produce the correct data type from these types. For example, the following two `CREATE TABLE` statements are valid:

```
CREATE TABLE tkc (c1 CHAR)
PARTITION BY KEY(c1)
PARTITIONS 4;

CREATE TABLE tke
  ( c1 ENUM('red', 'orange', 'yellow', 'green', 'blue', 'indigo', 'violet') )
PARTITION BY LINEAR KEY(c1)
PARTITIONS 6;
```

2. When partitioning by `RANGE COLUMNS` or `LIST COLUMNS`, it is possible to use string, `DATE`, and `DATETIME` columns. For example, each of the following `CREATE TABLE` statements is valid:

```
CREATE TABLE rc (c1 INT, c2 DATE)
PARTITION BY RANGE COLUMNS(c2) (
  PARTITION p0 VALUES LESS THAN('1990-01-01'),
  PARTITION p1 VALUES LESS THAN('1995-01-01'),
  PARTITION p2 VALUES LESS THAN('2000-01-01'),
  PARTITION p3 VALUES LESS THAN('2005-01-01'),
  PARTITION p4 VALUES LESS THAN(MAXVALUE)
);

CREATE TABLE lc (c1 INT, c2 CHAR(1))
PARTITION BY LIST COLUMNS(c2) (
  PARTITION p0 VALUES IN('a', 'd', 'g', 'j', 'm', 'p', 's', 'v', 'y'),
  PARTITION p1 VALUES IN('b', 'e', 'h', 'k', 'n', 'q', 't', 'w', 'z'),
  PARTITION p2 VALUES IN('c', 'f', 'i', 'l', 'o', 'r', 'u', 'x', NULL)
);
```

Neither of the preceding exceptions applies to `BLOB` or `TEXT` column types.

**Subqueries.**

A partitioning key may not be a subquery, even if that subquery resolves to an integer value or `NULL`.

**Column index prefixes not supported for key partitioning.** When creating a table that is partitioned by key, any columns in the partitioning key which use column prefixes are not used in the table's partitioning function. Consider the following `CREATE TABLE` statement, which has three `VARCHAR` columns, and whose primary key uses all three columns and specifies prefixes for two of them:

```
CREATE TABLE t1 (
  a VARCHAR(10000),
  b VARCHAR(25),
  c VARCHAR(10),
  PRIMARY KEY (a(10), b, c(2))
) PARTITION BY KEY() PARTITIONS 2;
```

This statement is accepted, but the resulting table is actually created as if you had issued the following statement, using only the primary key column which does not include a prefix (column `b`) for the partitioning key:

```
CREATE TABLE t1 (
```

```

a VARCHAR(10000),
b VARCHAR(25),
c VARCHAR(10),
PRIMARY KEY (a(10), b, c(2))
) PARTITION BY KEY(b) PARTITIONS 2;

```

No warning is issued or any other indication provided that this has occurred, except in the event that all columns specified for the partitioning key use prefixes, in which case the statement fails with the error message shown here:

```

mysql> CREATE TABLE t2 (
->   a VARCHAR(10000),
->   b VARCHAR(25),
->   c VARCHAR(10),
->   PRIMARY KEY (a(10), b(5), c(2))
-> ) PARTITION BY KEY() PARTITIONS 2;
ERROR 1503 (HY000): A PRIMARY KEY must include all columns in the
table's partitioning function

```

This also occurs when altering or upgrading such tables, and includes cases in which the columns used in the partitioning function are defined implicitly as those in the table's primary key by employing an empty `PARTITION BY KEY()` clause.

This is a known issue which is addressed in MySQL 8.0 by deprecating the permissive behavior; in MySQL 8.0, if any columns using prefixes are included in a table's partitioning function, the server logs an appropriate warning for each such column, or raises a descriptive error if necessary. (Allowing the use of columns with prefixes in partitioning keys is subject to removal altogether in a future version of MySQL.)

For general information about partitioning tables by key, see [Section 22.2.5, “KEY Partitioning”](#).

### Issues with subpartitions.

Subpartitions must use `HASH` or `KEY` partitioning. Only `RANGE` and `LIST` partitions may be subpartitioned; `HASH` and `KEY` partitions cannot be subpartitioned.

`SUBPARTITION BY KEY` requires that the subpartitioning column or columns be specified explicitly, unlike the case with `PARTITION BY KEY`, where it can be omitted (in which case the table's primary key column is used by default). Consider the table created by this statement:

```

CREATE TABLE ts (
  id INT NOT NULL AUTO_INCREMENT PRIMARY KEY,
  name VARCHAR(30)
);

```

You can create a table having the same columns, partitioned by `KEY`, using a statement such as this one:

```

CREATE TABLE ts (
  id INT NOT NULL AUTO_INCREMENT PRIMARY KEY,
  name VARCHAR(30)
)
PARTITION BY KEY()
PARTITIONS 4;

```

The previous statement is treated as though it had been written like this, with the table's primary key column used as the partitioning column:

```

CREATE TABLE ts (
  id INT NOT NULL AUTO_INCREMENT PRIMARY KEY,
  name VARCHAR(30)
)
PARTITION BY KEY(id)
PARTITIONS 4;

```

However, the following statement that attempts to create a subpartitioned table using the default column as the subpartitioning column fails, and the column must be specified for the statement to succeed, as shown here:

```
mysql> CREATE TABLE ts (
->     id INT NOT NULL AUTO_INCREMENT PRIMARY KEY,
->     name VARCHAR(30)
-> )
-> PARTITION BY RANGE(id)
-> SUBPARTITION BY KEY()
-> SUBPARTITIONS 4
-> (
->     PARTITION p0 VALUES LESS THAN (100),
->     PARTITION p1 VALUES LESS THAN (MAXVALUE)
-> );
ERROR 1064 (42000): You have an error in your SQL syntax; check the manual that
corresponds to your MySQL server version for the right syntax to use near ''

mysql> CREATE TABLE ts (
->     id INT NOT NULL AUTO_INCREMENT PRIMARY KEY,
->     name VARCHAR(30)
-> )
-> PARTITION BY RANGE(id)
-> SUBPARTITION BY KEY(id)
-> SUBPARTITIONS 4
-> (
->     PARTITION p0 VALUES LESS THAN (100),
->     PARTITION p1 VALUES LESS THAN (MAXVALUE)
-> );
Query OK, 0 rows affected (0.07 sec)
```

This is a known issue (see Bug #51470).

**DATA DIRECTORY and INDEX DIRECTORY options.** [DATA DIRECTORY](#) and [INDEX DIRECTORY](#) are subject to the following restrictions when used with partitioned tables:

- Table-level [DATA DIRECTORY](#) and [INDEX DIRECTORY](#) options are ignored (see Bug #32091).
- On Windows, the [DATA DIRECTORY](#) and [INDEX DIRECTORY](#) options are not supported for individual partitions or subpartitions of [MyISAM](#) tables. However, you can use [DATA DIRECTORY](#) for individual partitions or subpartitions of [InnoDB](#) tables.

**Repairing and rebuilding partitioned tables.** The statements [CHECK TABLE](#), [OPTIMIZE TABLE](#), [ANALYZE TABLE](#), and [REPAIR TABLE](#) are supported for partitioned tables.

In addition, you can use [ALTER TABLE ... REBUILD PARTITION](#) to rebuild one or more partitions of a partitioned table; [ALTER TABLE ... REORGANIZE PARTITION](#) also causes partitions to be rebuilt. See [Section 13.1.8, “ALTER TABLE Statement”](#), for more information about these two statements.

Starting in MySQL 5.7.2, [ANALYZE](#), [CHECK](#), [OPTIMIZE](#), [REPAIR](#), and [TRUNCATE](#) operations are supported with subpartitions. [REBUILD](#) was also accepted syntax prior to MySQL 5.7.5, although this had no effect. (Bug #19075411, Bug #73130) See also [Section 13.1.8.1, “ALTER TABLE Partition Operations”](#).

[mysqlcheck](#), [myisamchk](#), and [myisampack](#) are not supported with partitioned tables.

**FOR EXPORT option (FLUSH TABLES).** The [FLUSH TABLES](#) statement's [FOR EXPORT](#) option is not supported for partitioned [InnoDB](#) tables in MySQL 5.7.4 and earlier. (Bug #16943907)

**File name delimiters for partitions and subpartitions.** Table partition and subpartition file names include generated delimiters such as [#P#](#) and [#SP#](#). The lettercase of such delimiters can vary and should not be depended upon.

## 22.6.1 Partitioning Keys, Primary Keys, and Unique Keys

This section discusses the relationship of partitioning keys with primary keys and unique keys. The rule governing this relationship can be expressed as follows: All columns used in the partitioning expression for a partitioned table must be part of every unique key that the table may have.

In other words, *every unique key on the table must use every column in the table's partitioning expression.* (This also includes the table's primary key, since it is by definition a unique key. This particular case is discussed later in this section.) For example, each of the following table creation statements is invalid:

```
CREATE TABLE t1 (  
  col1 INT NOT NULL,  
  col2 DATE NOT NULL,  
  col3 INT NOT NULL,  
  col4 INT NOT NULL,  
  UNIQUE KEY (col1, col2)  
)  
PARTITION BY HASH(col3)  
PARTITIONS 4;  
  
CREATE TABLE t2 (  
  col1 INT NOT NULL,  
  col2 DATE NOT NULL,  
  col3 INT NOT NULL,  
  col4 INT NOT NULL,  
  UNIQUE KEY (col1),  
  UNIQUE KEY (col3)  
)  
PARTITION BY HASH(col1 + col3)  
PARTITIONS 4;
```

In each case, the proposed table would have at least one unique key that does not include all columns used in the partitioning expression.

Each of the following statements is valid, and represents one way in which the corresponding invalid table creation statement could be made to work:

```
CREATE TABLE t1 (  
  col1 INT NOT NULL,  
  col2 DATE NOT NULL,  
  col3 INT NOT NULL,  
  col4 INT NOT NULL,  
  UNIQUE KEY (col1, col2, col3)  
)  
PARTITION BY HASH(col3)  
PARTITIONS 4;  
  
CREATE TABLE t2 (  
  col1 INT NOT NULL,  
  col2 DATE NOT NULL,  
  col3 INT NOT NULL,  
  col4 INT NOT NULL,  
  UNIQUE KEY (col1, col3)  
)  
PARTITION BY HASH(col1 + col3)  
PARTITIONS 4;
```

This example shows the error produced in such cases:

```
mysql> CREATE TABLE t3 (  
->   col1 INT NOT NULL,  
->   col2 DATE NOT NULL,  
->   col3 INT NOT NULL,  
->   col4 INT NOT NULL,
```

```
->     UNIQUE KEY (col1, col2),
->     UNIQUE KEY (col3)
-> )
-> PARTITION BY HASH(col1 + col3)
-> PARTITIONS 4;
ERROR 1491 (HY000): A PRIMARY KEY must include all columns in the table's partitioning function
```

The `CREATE TABLE` statement fails because both `col1` and `col3` are included in the proposed partitioning key, but neither of these columns is part of both of unique keys on the table. This shows one possible fix for the invalid table definition:

```
mysql> CREATE TABLE t3 (
->     col1 INT NOT NULL,
->     col2 DATE NOT NULL,
->     col3 INT NOT NULL,
->     col4 INT NOT NULL,
->     UNIQUE KEY (col1, col2, col3),
->     UNIQUE KEY (col3)
-> )
-> PARTITION BY HASH(col3)
-> PARTITIONS 4;
Query OK, 0 rows affected (0.05 sec)
```

In this case, the proposed partitioning key `col3` is part of both unique keys, and the table creation statement succeeds.

The following table cannot be partitioned at all, because there is no way to include in a partitioning key any columns that belong to both unique keys:

```
CREATE TABLE t4 (
    col1 INT NOT NULL,
    col2 INT NOT NULL,
    col3 INT NOT NULL,
    col4 INT NOT NULL,
    UNIQUE KEY (col1, col3),
    UNIQUE KEY (col2, col4)
);
```

Since every primary key is by definition a unique key, this restriction also includes the table's primary key, if it has one. For example, the next two statements are invalid:

```
CREATE TABLE t5 (
    col1 INT NOT NULL,
    col2 DATE NOT NULL,
    col3 INT NOT NULL,
    col4 INT NOT NULL,
    PRIMARY KEY(col1, col2)
)
PARTITION BY HASH(col3)
PARTITIONS 4;

CREATE TABLE t6 (
    col1 INT NOT NULL,
    col2 DATE NOT NULL,
    col3 INT NOT NULL,
    col4 INT NOT NULL,
    PRIMARY KEY(col1, col3),
    UNIQUE KEY(col2)
)
PARTITION BY HASH( YEAR(col2) )
PARTITIONS 4;
```

In both cases, the primary key does not include all columns referenced in the partitioning expression. However, both of the next two statements are valid:



```

CREATE TABLE t7 (
  col1 INT NOT NULL,
  col2 DATE NOT NULL,
  col3 INT NOT NULL,
  col4 INT NOT NULL,
  PRIMARY KEY(col1, col2)
)
PARTITION BY HASH(col1 + YEAR(col2))
PARTITIONS 4;

CREATE TABLE t8 (
  col1 INT NOT NULL,
  col2 DATE NOT NULL,
  col3 INT NOT NULL,
  col4 INT NOT NULL,
  PRIMARY KEY(col1, col2, col4),
  UNIQUE KEY(col2, col1)
)
PARTITION BY HASH(col1 + YEAR(col2))
PARTITIONS 4;
    
```

If a table has no unique keys—this includes having no primary key—then this restriction does not apply, and you may use any column or columns in the partitioning expression as long as the column type is compatible with the partitioning type.

For the same reason, you cannot later add a unique key to a partitioned table unless the key includes all columns used by the table's partitioning expression. Consider the partitioned table created as shown here:

```

mysql> CREATE TABLE t_no_pk (c1 INT, c2 INT)
->     PARTITION BY RANGE(c1) (
->         PARTITION p0 VALUES LESS THAN (10),
->         PARTITION p1 VALUES LESS THAN (20),
->         PARTITION p2 VALUES LESS THAN (30),
->         PARTITION p3 VALUES LESS THAN (40)
->     );
Query OK, 0 rows affected (0.12 sec)
    
```

It is possible to add a primary key to `t_no_pk` using either of these `ALTER TABLE` statements:

```

# possible PK
mysql> ALTER TABLE t_no_pk ADD PRIMARY KEY(c1);
Query OK, 0 rows affected (0.13 sec)
Records: 0 Duplicates: 0 Warnings: 0

# drop this PK
mysql> ALTER TABLE t_no_pk DROP PRIMARY KEY;
Query OK, 0 rows affected (0.10 sec)
Records: 0 Duplicates: 0 Warnings: 0

# use another possible PK
mysql> ALTER TABLE t_no_pk ADD PRIMARY KEY(c1, c2);
Query OK, 0 rows affected (0.12 sec)
Records: 0 Duplicates: 0 Warnings: 0

# drop this PK
mysql> ALTER TABLE t_no_pk DROP PRIMARY KEY;
Query OK, 0 rows affected (0.09 sec)
Records: 0 Duplicates: 0 Warnings: 0
    
```

However, the next statement fails, because `c1` is part of the partitioning key, but is not part of the proposed primary key:

```

# fails with error 1503
mysql> ALTER TABLE t_no_pk ADD PRIMARY KEY(c2);
ERROR 1503 (HY000): A PRIMARY KEY must include all columns in the table's partitioning function
    
```

Since `t_no_pk` has only `c1` in its partitioning expression, attempting to adding a unique key on `c2` alone fails. However, you can add a unique key that uses both `c1` and `c2`.

These rules also apply to existing nonpartitioned tables that you wish to partition using `ALTER TABLE ... PARTITION BY`. Consider a table `np_pk` created as shown here:

```
mysql> CREATE TABLE np_pk (
->   id INT NOT NULL AUTO_INCREMENT,
->   name VARCHAR(50),
->   added DATE,
->   PRIMARY KEY (id)
-> );
Query OK, 0 rows affected (0.08 sec)
```

The following `ALTER TABLE` statement fails with an error, because the `added` column is not part of any unique key in the table:

```
mysql> ALTER TABLE np_pk
->   PARTITION BY HASH( TO_DAYS(added) )
->   PARTITIONS 4;
ERROR 1503 (HY000): A PRIMARY KEY must include all columns in the table's partitioning function
```

However, this statement using the `id` column for the partitioning column is valid, as shown here:

```
mysql> ALTER TABLE np_pk
->   PARTITION BY HASH(id)
->   PARTITIONS 4;
Query OK, 0 rows affected (0.11 sec)
Records: 0 Duplicates: 0 Warnings: 0
```

In the case of `np_pk`, the only column that may be used as part of a partitioning expression is `id`; if you wish to partition this table using any other column or columns in the partitioning expression, you must first modify the table, either by adding the desired column or columns to the primary key, or by dropping the primary key altogether.

## 22.6.2 Partitioning Limitations Relating to Storage Engines

The following limitations apply to the use of storage engines with user-defined partitioning of tables.

**MERGE storage engine.** User-defined partitioning and the `MERGE` storage engine are not compatible. Tables using the `MERGE` storage engine cannot be partitioned. Partitioned tables cannot be merged.

**FEDERATED storage engine.** Partitioning of `FEDERATED` tables is not supported; it is not possible to create partitioned `FEDERATED` tables.

**CSV storage engine.** Partitioned tables using the `CSV` storage engine are not supported; it is not possible to create partitioned `CSV` tables.

**InnoDB storage engine.** `InnoDB` foreign keys and MySQL partitioning are not compatible. Partitioned `InnoDB` tables cannot have foreign key references, nor can they have columns referenced by foreign keys. `InnoDB` tables which have or which are referenced by foreign keys cannot be partitioned.

`InnoDB` does not support the use of multiple disks for subpartitions. (This is currently supported only by `MyISAM`.)

In addition, `ALTER TABLE ... OPTIMIZE PARTITION` does not work correctly with partitioned tables that use the `InnoDB` storage engine. Use `ALTER TABLE ... REBUILD PARTITION` and `ALTER TABLE ... ANALYZE PARTITION`, instead, for such tables. For more information, see [Section 13.1.8.1, “ALTER TABLE Partition Operations”](#).

**User-defined partitioning and the NDB storage engine (NDB Cluster).** Partitioning by `KEY` (including `LINEAR KEY`) is the only type of partitioning supported for the NDB storage engine. It is not possible under normal circumstances in NDB Cluster to create an NDB Cluster table using any partitioning type other than `[LINEAR] KEY`, and attempting to do so fails with an error.

*Exception (not for production):* It is possible to override this restriction by setting the `new` system variable on NDB Cluster SQL nodes to `ON`. If you choose to do this, you should be aware that tables using partitioning types other than `[LINEAR] KEY` are not supported in production. *In such cases, you can create and use tables with partitioning types other than `KEY` or `LINEAR KEY`, but you do this entirely at your own risk.* You should also be aware that this functionality is now deprecated and subject to removal without further notice in a future release of NDB Cluster.

The maximum number of partitions that can be defined for an NDB table depends on the number of data nodes and node groups in the cluster, the version of the NDB Cluster software in use, and other factors. See [NDB and user-defined partitioning](#), for more information.

As of MySQL NDB Cluster 7.5.2, the maximum amount of fixed-size data that can be stored per partition in an NDB table is 128 TB. Previously, this was 16 GB.

`CREATE TABLE` and `ALTER TABLE` statements that would cause a user-partitioned NDB table not to meet either or both of the following two requirements are not permitted, and fail with an error:

1. The table must have an explicit primary key.
2. All columns listed in the table's partitioning expression must be part of the primary key.

**Exception.** If a user-partitioned NDB table is created using an empty column-list (that is, using `PARTITION BY KEY()` or `PARTITION BY LINEAR KEY()`), then no explicit primary key is required.

**Partition selection.** Partition selection is not supported for NDB tables. See [Section 22.5, "Partition Selection"](#), for more information.

**Upgrading partitioned tables.** When performing an upgrade, tables which are partitioned by `KEY` and which use any storage engine other than NDB must be dumped and reloaded.

**Same storage engine for all partitions.** All partitions of a partitioned table must use the same storage engine and it must be the same storage engine used by the table as a whole. In addition, if one does not specify an engine on the table level, then one must do either of the following when creating or altering a partitioned table:

- Do *not* specify any engine for *any* partition or subpartition
- Specify the engine for *all* partitions or subpartitions

### 22.6.3 Partitioning Limitations Relating to Functions

This section discusses limitations in MySQL Partitioning relating specifically to functions used in partitioning expressions.

Only the MySQL functions shown in the following list are allowed in partitioning expressions:

- `ABS()`
- `CEILING()` (see [CEILING\(\)](#) and [FLOOR\(\)](#))
- `DATEDIFF()`

- DAY ( )
- DAYOFMONTH ( )
- DAYOFWEEK ( )
- DAYOFYEAR ( )
- EXTRACT ( ) (see [EXTRACT\(\)](#) function with WEEK specifier)
- FLOOR ( ) (see [CEILING\(\)](#) and [FLOOR\(\)](#))
- HOUR ( )
- MICROSECOND ( )
- MINUTE ( )
- MOD ( )
- MONTH ( )
- QUARTER ( )
- SECOND ( )
- TIME\_TO\_SEC ( )
- TO\_DAYS ( )
- TO\_SECONDS ( )
- UNIX\_TIMESTAMP ( ) (with [TIMESTAMP](#) columns)
- WEEKDAY ( )
- YEAR ( )
- YEARWEEK ( )

In MySQL 5.7, partition pruning is supported for the [TO\\_DAYS\(\)](#), [TO\\_SECONDS\(\)](#), [YEAR\(\)](#), and [UNIX\\_TIMESTAMP\(\)](#) functions. See [Section 22.4, “Partition Pruning”](#), for more information.

**CEILING() and FLOOR().** Each of these functions returns an integer only if it is passed an argument of an exact numeric type, such as one of the [INT](#) types or [DECIMAL](#). This means, for example, that the following [CREATE TABLE](#) statement fails with an error, as shown here:

```
mysql> CREATE TABLE t (c FLOAT) PARTITION BY LIST( FLOOR(c) )(
->     PARTITION p0 VALUES IN (1,3,5),
->     PARTITION p1 VALUES IN (2,4,6)
-> );
ERROR 1490 (HY000): The PARTITION function returns the wrong type
```

**EXTRACT() function with WEEK specifier.** The value returned by the [EXTRACT\(\)](#) function, when used as [EXTRACT\(WEEK FROM col\)](#), depends on the value of the `default_week_format` system variable. For this reason, [EXTRACT\(\)](#) is not permitted as a partitioning function when it specifies the unit as [WEEK](#). (Bug #54483)

See [Section 12.6.2, “Mathematical Functions”](#), for more information about the return types of these functions, as well as [Section 11.1, “Numeric Data Types”](#).

## 22.6.4 Partitioning and Locking

For storage engines such as `MyISAM` that actually execute table-level locks when executing DML or DDL statements, such a statement in older versions of MySQL (5.6.5 and earlier) that affected a partitioned table imposed a lock on the table as a whole; that is, all partitions were locked until the statement was finished. In MySQL 5.7, *partition lock pruning* eliminates unneeded locks in many cases, and most statements reading from or updating a partitioned `MyISAM` table cause only the effected partitions to be locked. For example, a `SELECT` from a partitioned `MyISAM` table locks only those partitions actually containing rows that satisfy the `SELECT` statement's `WHERE` condition are locked.

For statements affecting partitioned tables using storage engines such as `InnoDB`, that employ row-level locking and do not actually perform (or need to perform) the locks prior to partition pruning, this is not an issue.

The next few paragraphs discuss the effects of partition lock pruning for various MySQL statements on tables using storage engines that employ table-level locks.

### Effects on DML statements

`SELECT` statements (including those containing unions or joins) lock only those partitions that actually need to be read. This also applies to `SELECT ... PARTITION`.

An `UPDATE` prunes locks only for tables on which no partitioning columns are updated.

`REPLACE` and `INSERT` lock only those partitions having rows to be inserted or replaced. However, if an `AUTO_INCREMENT` value is generated for any partitioning column then all partitions are locked.

`INSERT ... ON DUPLICATE KEY UPDATE` is pruned as long as no partitioning column is updated.

`INSERT ... SELECT` locks only those partitions in the source table that need to be read, although all partitions in the target table are locked.

Locks imposed by `LOAD DATA` statements on partitioned tables cannot be pruned.

The presence of `BEFORE INSERT` or `BEFORE UPDATE` triggers using any partitioning column of a partitioned table means that locks on `INSERT` and `UPDATE` statements updating this table cannot be pruned, since the trigger can alter its values: A `BEFORE INSERT` trigger on any of the table's partitioning columns means that locks set by `INSERT` or `REPLACE` cannot be pruned, since the `BEFORE INSERT` trigger may change a row's partitioning columns before the row is inserted, forcing the row into a different partition than it would be otherwise. A `BEFORE UPDATE` trigger on a partitioning column means that locks imposed by `UPDATE` or `INSERT ... ON DUPLICATE KEY UPDATE` cannot be pruned.

### Affected DDL statements

`CREATE VIEW` does not cause any locks.

`ALTER TABLE ... EXCHANGE PARTITION` prunes locks; only the exchanged table and the exchanged partition are locked.

`ALTER TABLE ... TRUNCATE PARTITION` prunes locks; only the partitions to be emptied are locked.

In addition, `ALTER TABLE` statements take metadata locks on the table level.

### Other statements

`LOCK TABLES` cannot prune partition locks.

`CALL stored_procedure(expr)` supports lock pruning, but evaluating `expr` does not.

`DO` and `SET` statements do not support partitioning lock pruning.

---

# Chapter 23 Stored Objects

## Table of Contents

23.1 Defining Stored Programs .....	4058
23.2 Using Stored Routines .....	4059
23.2.1 Stored Routine Syntax .....	4060
23.2.2 Stored Routines and MySQL Privileges .....	4061
23.2.3 Stored Routine Metadata .....	4061
23.2.4 Stored Procedures, Functions, Triggers, and LAST_INSERT_ID() .....	4061
23.3 Using Triggers .....	4062
23.3.1 Trigger Syntax and Examples .....	4062
23.3.2 Trigger Metadata .....	4066
23.4 Using the Event Scheduler .....	4067
23.4.1 Event Scheduler Overview .....	4067
23.4.2 Event Scheduler Configuration .....	4068
23.4.3 Event Syntax .....	4070
23.4.4 Event Metadata .....	4070
23.4.5 Event Scheduler Status .....	4071
23.4.6 The Event Scheduler and MySQL Privileges .....	4072
23.5 Using Views .....	4075
23.5.1 View Syntax .....	4075
23.5.2 View Processing Algorithms .....	4075
23.5.3 Updatable and Insertable Views .....	4077
23.5.4 The View WITH CHECK OPTION Clause .....	4079
23.5.5 View Metadata .....	4080
23.6 Stored Object Access Control .....	4081
23.7 Stored Program Binary Logging .....	4084
23.8 Restrictions on Stored Programs .....	4090
23.9 Restrictions on Views .....	4094

This chapter discusses stored database objects that are defined in terms of SQL code that is stored on the server for later execution.

Stored objects include these object types:

- **Stored procedure:** An object created with `CREATE PROCEDURE` and invoked using the `CALL` statement. A procedure does not have a return value but can modify its parameters for later inspection by the caller. It can also generate result sets to be returned to the client program.
- **Stored function:** An object created with `CREATE FUNCTION` and used much like a built-in function. You invoke it in an expression and it returns a value during expression evaluation.
- **Trigger:** An object created with `CREATE TRIGGER` that is associated with a table. A trigger is activated when a particular event occurs for the table, such as an insert or update.
- **Event:** An object created with `CREATE EVENT` and invoked by the server according to schedule.
- **View:** An object created with `CREATE VIEW` that when referenced produces a result set. A view acts as a virtual table.

Terminology used in this document reflects the stored object hierarchy:

- Stored routines include stored procedures and functions.
- Stored programs include stored routines, triggers, and events.
- Stored objects include stored programs and views.

This chapter describes how to use stored objects. The following sections provide additional information about SQL syntax for statements related to these objects, and about object processing:

- For each object type, there are `CREATE`, `ALTER`, and `DROP` statements that control which objects exist and how they are defined. See [Section 13.1, “Data Definition Statements”](#).
- The `CALL` statement is used to invoke stored procedures. See [Section 13.2.1, “CALL Statement”](#).
- Stored program definitions include a body that may use compound statements, loops, conditionals, and declared variables. See [Section 13.6, “Compound Statements”](#).
- Metadata changes to objects referred to by stored programs are detected and cause automatic reparsing of the affected statements when the program is next executed. For more information, see [Section 8.10.4, “Caching of Prepared Statements and Stored Programs”](#).

## 23.1 Defining Stored Programs

Each stored program contains a body that consists of an SQL statement. This statement may be a compound statement made up of several statements separated by semicolon (`;`) characters. For example, the following stored procedure has a body made up of a `BEGIN . . . END` block that contains a `SET` statement and a `REPEAT` loop that itself contains another `SET` statement:

```
CREATE PROCEDURE dorepeat(p1 INT)
BEGIN
  SET @x = 0;
  REPEAT SET @x = @x + 1; UNTIL @x > p1 END REPEAT;
END;
```

If you use the `mysql` client program to define a stored program containing semicolon characters, a problem arises. By default, `mysql` itself recognizes the semicolon as a statement delimiter, so you must redefine the delimiter temporarily to cause `mysql` to pass the entire stored program definition to the server.

To redefine the `mysql` delimiter, use the `delimiter` command. The following example shows how to do this for the `dorepeat()` procedure just shown. The delimiter is changed to `//` to enable the entire definition to be passed to the server as a single statement, and then restored to `;` before invoking the procedure. This enables the `;` delimiter used in the procedure body to be passed through to the server rather than being interpreted by `mysql` itself.

```
mysql> delimiter //

mysql> CREATE PROCEDURE dorepeat(p1 INT)
-> BEGIN
->   SET @x = 0;
->   REPEAT SET @x = @x + 1; UNTIL @x > p1 END REPEAT;
-> END
-> //
Query OK, 0 rows affected (0.00 sec)

mysql> delimiter ;

mysql> CALL dorepeat(1000);
Query OK, 0 rows affected (0.00 sec)

mysql> SELECT @x;
```



```
+-----+
| @x   |
+-----+
| 1001 |
+-----+
1 row in set (0.00 sec)
```

You can redefine the delimiter to a string other than `//`, and the delimiter can consist of a single character or multiple characters. You should avoid the use of the backslash (`\`) character because that is the escape character for MySQL.

The following is an example of a function that takes a parameter, performs an operation using an SQL function, and returns the result. In this case, it is unnecessary to use `delimiter` because the function definition contains no internal `;` statement delimiters:

```
mysql> CREATE FUNCTION hello (s CHAR(20))
mysql> RETURNS CHAR(50) DETERMINISTIC
-> RETURN CONCAT('Hello, ',s,'!');
Query OK, 0 rows affected (0.00 sec)

mysql> SELECT hello('world');
+-----+
| hello('world') |
+-----+
| Hello, world!  |
+-----+
1 row in set (0.00 sec)
```

## 23.2 Using Stored Routines

MySQL supports stored routines (procedures and functions). A stored routine is a set of SQL statements that can be stored in the server. Once this has been done, clients don't need to keep reissuing the individual statements but can refer to the stored routine instead.

Stored routines require the `proc` table in the `mysql` database. This table is created during the MySQL installation procedure. If you are upgrading to MySQL 5.7 from an earlier version, be sure to update your grant tables to make sure that the `proc` table exists. See [Section 4.4.7, “mysql\\_upgrade — Check and Upgrade MySQL Tables”](#).

Stored routines can be particularly useful in certain situations:

- When multiple client applications are written in different languages or work on different platforms, but need to perform the same database operations.
- When security is paramount. Banks, for example, use stored procedures and functions for all common operations. This provides a consistent and secure environment, and routines can ensure that each operation is properly logged. In such a setup, applications and users would have no access to the database tables directly, but can only execute specific stored routines.

Stored routines can provide improved performance because less information needs to be sent between the server and the client. The tradeoff is that this does increase the load on the database server because more of the work is done on the server side and less is done on the client (application) side. Consider this if many client machines (such as Web servers) are serviced by only one or a few database servers.

Stored routines also enable you to have libraries of functions in the database server. This is a feature shared by modern application languages that enable such design internally (for example, by using classes). Using these client application language features is beneficial for the programmer even outside the scope of database use.

MySQL follows the SQL:2003 syntax for stored routines, which is also used by IBM's DB2. All syntax described here is supported and any limitations and extensions are documented where appropriate.

## Additional Resources

- You may find the [Stored Procedures User Forum](#) of use when working with stored procedures and functions.
- For answers to some commonly asked questions regarding stored routines in MySQL, see [Section A.4, "MySQL 5.7 FAQ: Stored Procedures and Functions"](#).
- There are some restrictions on the use of stored routines. See [Section 23.8, "Restrictions on Stored Programs"](#).
- Binary logging for stored routines takes place as described in [Section 23.7, "Stored Program Binary Logging"](#).

### 23.2.1 Stored Routine Syntax

A stored routine is either a procedure or a function. Stored routines are created with the `CREATE PROCEDURE` and `CREATE FUNCTION` statements (see [Section 13.1.16, "CREATE PROCEDURE and CREATE FUNCTION Statements"](#)). A procedure is invoked using a `CALL` statement (see [Section 13.2.1, "CALL Statement"](#)), and can only pass back values using output variables. A function can be called from inside a statement just like any other function (that is, by invoking the function's name), and can return a scalar value. The body of a stored routine can use compound statements (see [Section 13.6, "Compound Statements"](#)).

Stored routines can be dropped with the `DROP PROCEDURE` and `DROP FUNCTION` statements (see [Section 13.1.27, "DROP PROCEDURE and DROP FUNCTION Statements"](#)), and altered with the `ALTER PROCEDURE` and `ALTER FUNCTION` statements (see [Section 13.1.6, "ALTER PROCEDURE Statement"](#)).

A stored procedure or function is associated with a particular database. This has several implications:

- When the routine is invoked, an implicit `USE db_name` is performed (and undone when the routine terminates). `USE` statements within stored routines are not permitted.
- You can qualify routine names with the database name. This can be used to refer to a routine that is not in the current database. For example, to invoke a stored procedure `p` or function `f` that is associated with the `test` database, you can say `CALL test.p()` or `test.f()`.
- When a database is dropped, all stored routines associated with it are dropped as well.

Stored functions cannot be recursive.

Recursion in stored procedures is permitted but disabled by default. To enable recursion, set the `max_sp_recursion_depth` server system variable to a value greater than zero. Stored procedure recursion increases the demand on thread stack space. If you increase the value of `max_sp_recursion_depth`, it may be necessary to increase thread stack size by increasing the value of `thread_stack` at server startup. See [Section 5.1.7, "Server System Variables"](#), for more information.

MySQL supports a very useful extension that enables the use of regular `SELECT` statements (that is, without using cursors or local variables) inside a stored procedure. The result set of such a query is simply sent directly to the client. Multiple `SELECT` statements generate multiple result sets, so the client must use a MySQL client library that supports multiple result sets. This means the client must use a client library from a version of MySQL at least as recent as 4.1. The client should also specify the `CLIENT_MULTI_RESULTS` option when it connects. For C programs, this can be done with the

`mysql_real_connect()` C API function. See [mysql\\_real\\_connect\(\)](#), and [Multiple Statement Execution Support](#).

## 23.2.2 Stored Routines and MySQL Privileges

The MySQL grant system takes stored routines into account as follows:

- The `CREATE ROUTINE` privilege is needed to create stored routines.
- The `ALTER ROUTINE` privilege is needed to alter or drop stored routines. This privilege is granted automatically to the creator of a routine if necessary, and dropped from the creator when the routine is dropped.
- The `EXECUTE` privilege is required to execute stored routines. However, this privilege is granted automatically to the creator of a routine if necessary (and dropped from the creator when the routine is dropped). Also, the default `SQL SECURITY` characteristic for a routine is `DEFINER`, which enables users who have access to the database with which the routine is associated to execute the routine.
- If the `automatic_sp_privileges` system variable is 0, the `EXECUTE` and `ALTER ROUTINE` privileges are not automatically granted to and dropped from the routine creator.
- The creator of a routine is the account used to execute the `CREATE` statement for it. This might not be the same as the account named as the `DEFINER` in the routine definition.

The server manipulates the `mysql.proc` table in response to statements that create, alter, or drop stored routines. Manual manipulation of this table is not supported.

## 23.2.3 Stored Routine Metadata

To obtain metadata about stored routines:

- Query the `ROUTINES` table of the `INFORMATION_SCHEMA` database. See [Section 24.3.21, “The INFORMATION\\_SCHEMA ROUTINES Table”](#).
- Use the `SHOW CREATE PROCEDURE` and `SHOW CREATE FUNCTION` statements to see routine definitions. See [Section 13.7.5.9, “SHOW CREATE PROCEDURE Statement”](#).
- Use the `SHOW PROCEDURE STATUS` and `SHOW FUNCTION STATUS` statements to see routine characteristics. See [Section 13.7.5.28, “SHOW PROCEDURE STATUS Statement”](#).
- Use the `SHOW PROCEDURE CODE` and `SHOW FUNCTION CODE` statements to see a representation of the internal implementation of the routine. See [Section 13.7.5.27, “SHOW PROCEDURE CODE Statement”](#).

## 23.2.4 Stored Procedures, Functions, Triggers, and LAST\_INSERT\_ID()

Within the body of a stored routine (procedure or function) or a trigger, the value of `LAST_INSERT_ID()` changes the same way as for statements executed outside the body of these kinds of objects (see [Section 12.15, “Information Functions”](#)). The effect of a stored routine or trigger upon the value of `LAST_INSERT_ID()` that is seen by following statements depends on the kind of routine:

- If a stored procedure executes statements that change the value of `LAST_INSERT_ID()`, the changed value is seen by statements that follow the procedure call.
- For stored functions and triggers that change the value, the value is restored when the function or trigger ends, so following statements do not see a changed value.

## 23.3 Using Triggers

A trigger is a named database object that is associated with a table, and that activates when a particular event occurs for the table. Some uses for triggers are to perform checks of values to be inserted into a table or to perform calculations on values involved in an update.

A trigger is defined to activate when a statement inserts, updates, or deletes rows in the associated table. These row operations are trigger events. For example, rows can be inserted by `INSERT` or `LOAD DATA` statements, and an insert trigger activates for each inserted row. A trigger can be set to activate either before or after the trigger event. For example, you can have a trigger activate before each row that is inserted into a table or after each row that is updated.



### Important

MySQL triggers activate only for changes made to tables by SQL statements. This includes changes to base tables that underlie updatable views. Triggers do not activate for changes to tables made by APIs that do not transmit SQL statements to the MySQL Server. This means that triggers are not activated by updates made using the `NDB` API.

Triggers are not activated by changes in `INFORMATION_SCHEMA` or `performance_schema` tables. Those tables are actually views and triggers are not permitted on views.

The following sections describe the syntax for creating and dropping triggers, show some examples of how to use them, and indicate how to obtain trigger metadata.

### Additional Resources

- You may find the [MySQL User Forums](#) helpful when working with triggers.
- For answers to commonly asked questions regarding triggers in MySQL, see [Section A.5, “MySQL 5.7 FAQ: Triggers”](#).
- There are some restrictions on the use of triggers; see [Section 23.8, “Restrictions on Stored Programs”](#).
- Binary logging for triggers takes place as described in [Section 23.7, “Stored Program Binary Logging”](#).

### 23.3.1 Trigger Syntax and Examples

To create a trigger or drop a trigger, use the `CREATE TRIGGER` or `DROP TRIGGER` statement, described in [Section 13.1.20, “CREATE TRIGGER Statement”](#), and [Section 13.1.31, “DROP TRIGGER Statement”](#).

Here is a simple example that associates a trigger with a table, to activate for `INSERT` operations. The trigger acts as an accumulator, summing the values inserted into one of the columns of the table.

```
mysql> CREATE TABLE account (acct_num INT, amount DECIMAL(10,2));
Query OK, 0 rows affected (0.03 sec)

mysql> CREATE TRIGGER ins_sum BEFORE INSERT ON account
FOR EACH ROW SET @sum = @sum + NEW.amount;
Query OK, 0 rows affected (0.01 sec)
```

The `CREATE TRIGGER` statement creates a trigger named `ins_sum` that is associated with the `account` table. It also includes clauses that specify the trigger action time, the triggering event, and what to do when the trigger activates:

- The keyword `BEFORE` indicates the trigger action time. In this case, the trigger activates before each row inserted into the table. The other permitted keyword here is `AFTER`.
- The keyword `INSERT` indicates the trigger event; that is, the type of operation that activates the trigger. In the example, `INSERT` operations cause trigger activation. You can also create triggers for `DELETE` and `UPDATE` operations.
- The statement following `FOR EACH ROW` defines the trigger body; that is, the statement to execute each time the trigger activates, which occurs once for each row affected by the triggering event. In the example, the trigger body is a simple `SET` that accumulates into a user variable the values inserted into the `amount` column. The statement refers to the column as `NEW.amount` which means “the value of the `amount` column to be inserted into the new row.”

To use the trigger, set the accumulator variable to zero, execute an `INSERT` statement, and then see what value the variable has afterward:

```
mysql> SET @sum = 0;
mysql> INSERT INTO account VALUES(137,14.98),(141,1937.50),(97,-100.00);
mysql> SELECT @sum AS 'Total amount inserted';
+-----+
| Total amount inserted |
+-----+
|           1852.48    |
+-----+
```

In this case, the value of `@sum` after the `INSERT` statement has executed is  $14.98 + 1937.50 - 100$ , or `1852.48`.

To destroy the trigger, use a `DROP TRIGGER` statement. You must specify the schema name if the trigger is not in the default schema:

```
mysql> DROP TRIGGER test.ins_sum;
```

If you drop a table, any triggers for the table are also dropped.

Trigger names exist in the schema namespace, meaning that all triggers must have unique names within a schema. Triggers in different schemas can have the same name.

As of MySQL 5.7.2, it is possible to define multiple triggers for a given table that have the same trigger event and action time. For example, you can have two `BEFORE UPDATE` triggers for a table. By default, triggers that have the same trigger event and action time activate in the order they were created. To affect trigger order, specify a clause after `FOR EACH ROW` that indicates `FOLLOWS` or `PRECEDES` and the name of an existing trigger that also has the same trigger event and action time. With `FOLLOWS`, the new trigger activates after the existing trigger. With `PRECEDES`, the new trigger activates before the existing trigger.

For example, the following trigger definition defines another `BEFORE INSERT` trigger for the `account` table:

```
mysql> CREATE TRIGGER ins_transaction BEFORE INSERT ON account
      FOR EACH ROW PRECEDES ins_sum
      SET
        @deposits = @deposits + IF(NEW.amount>0,NEW.amount,0),
        @withdrawals = @withdrawals + IF(NEW.amount<0,-NEW.amount,0);
Query OK, 0 rows affected (0.01 sec)
```

This trigger, `ins_transaction`, is similar to `ins_sum` but accumulates deposits and withdrawals separately. It has a `PRECEDES` clause that causes it to activate before `ins_sum`; without that clause, it would activate after `ins_sum` because it is created after `ins_sum`.

Before MySQL 5.7.2, there cannot be multiple triggers for a given table that have the same trigger event and action time. For example, you cannot have two `BEFORE UPDATE` triggers for a table. To work around this, you can define a trigger that executes multiple statements by using the `BEGIN ... END` compound statement construct after `FOR EACH ROW`. (An example appears later in this section.)

Within the trigger body, the `OLD` and `NEW` keywords enable you to access columns in the rows affected by a trigger. `OLD` and `NEW` are MySQL extensions to triggers; they are not case-sensitive.

In an `INSERT` trigger, only `NEW.col_name` can be used; there is no old row. In a `DELETE` trigger, only `OLD.col_name` can be used; there is no new row. In an `UPDATE` trigger, you can use `OLD.col_name` to refer to the columns of a row before it is updated and `NEW.col_name` to refer to the columns of the row after it is updated.

A column named with `OLD` is read only. You can refer to it (if you have the `SELECT` privilege), but not modify it. You can refer to a column named with `NEW` if you have the `SELECT` privilege for it. In a `BEFORE` trigger, you can also change its value with `SET NEW.col_name = value` if you have the `UPDATE` privilege for it. This means you can use a trigger to modify the values to be inserted into a new row or used to update a row. (Such a `SET` statement has no effect in an `AFTER` trigger because the row change has already occurred.)

In a `BEFORE` trigger, the `NEW` value for an `AUTO_INCREMENT` column is 0, not the sequence number that is generated automatically when the new row actually is inserted.

By using the `BEGIN ... END` construct, you can define a trigger that executes multiple statements. Within the `BEGIN` block, you also can use other syntax that is permitted within stored routines such as conditionals and loops. However, just as for stored routines, if you use the `mysql` program to define a trigger that executes multiple statements, it is necessary to redefine the `mysql` statement delimiter so that you can use the `;` statement delimiter within the trigger definition. The following example illustrates these points. It defines an `UPDATE` trigger that checks the new value to be used for updating each row, and modifies the value to be within the range from 0 to 100. This must be a `BEFORE` trigger because the value must be checked before it is used to update the row:

```
mysql> delimiter //
mysql> CREATE TRIGGER upd_check BEFORE UPDATE ON account
FOR EACH ROW
BEGIN
    IF NEW.amount < 0 THEN
        SET NEW.amount = 0;
    ELSEIF NEW.amount > 100 THEN
        SET NEW.amount = 100;
    END IF;
END;//
mysql> delimiter ;
```

It can be easier to define a stored procedure separately and then invoke it from the trigger using a simple `CALL` statement. This is also advantageous if you want to execute the same code from within several triggers.

There are limitations on what can appear in statements that a trigger executes when activated:

- The trigger cannot use the `CALL` statement to invoke stored procedures that return data to the client or that use dynamic SQL. (Stored procedures are permitted to return data to the trigger through `OUT` or `INOUT` parameters.)
- The trigger cannot use statements that explicitly or implicitly begin or end a transaction, such as `START TRANSACTION`, `COMMIT`, or `ROLLBACK`. (`ROLLBACK to SAVEPOINT` is permitted because it does not end a transaction.)

See also [Section 23.8, “Restrictions on Stored Programs”](#).

MySQL handles errors during trigger execution as follows:

- If a `BEFORE` trigger fails, the operation on the corresponding row is not performed.
- A `BEFORE` trigger is activated by the *attempt* to insert or modify the row, regardless of whether the attempt subsequently succeeds.
- An `AFTER` trigger is executed only if any `BEFORE` triggers and the row operation execute successfully.
- An error during either a `BEFORE` or `AFTER` trigger results in failure of the entire statement that caused trigger invocation.
- For transactional tables, failure of a statement should cause rollback of all changes performed by the statement. Failure of a trigger causes the statement to fail, so trigger failure also causes rollback. For nontransactional tables, such rollback cannot be done, so although the statement fails, any changes performed prior to the point of the error remain in effect.

Triggers can contain direct references to tables by name, such as the trigger named `testref` shown in this example:

```
CREATE TABLE test1(a1 INT);
CREATE TABLE test2(a2 INT);
CREATE TABLE test3(a3 INT NOT NULL AUTO_INCREMENT PRIMARY KEY);
CREATE TABLE test4(
  a4 INT NOT NULL AUTO_INCREMENT PRIMARY KEY,
  b4 INT DEFAULT 0
);

delimiter |

CREATE TRIGGER testref BEFORE INSERT ON test1
FOR EACH ROW
BEGIN
  INSERT INTO test2 SET a2 = NEW.a1;
  DELETE FROM test3 WHERE a3 = NEW.a1;
  UPDATE test4 SET b4 = b4 + 1 WHERE a4 = NEW.a1;
END;
|

delimiter ;

INSERT INTO test3 (a3) VALUES
  (NULL), (NULL), (NULL), (NULL), (NULL),
  (NULL), (NULL), (NULL), (NULL), (NULL);

INSERT INTO test4 (a4) VALUES
  (0), (0), (0), (0), (0), (0), (0), (0), (0), (0), (0);
```

Suppose that you insert the following values into table `test1` as shown here:

```
mysql> INSERT INTO test1 VALUES
  (1), (3), (1), (7), (1), (8), (4), (4);
Query OK, 8 rows affected (0.01 sec)
Records: 8 Duplicates: 0 Warnings: 0
```

As a result, the four tables contain the following data:

```
mysql> SELECT * FROM test1;
+-----+
| a1    |
+-----+
| 1    |
```

```

| 3 |
| 1 |
| 7 |
| 1 |
| 8 |
| 4 |
| 4 |
+-----+
8 rows in set (0.00 sec)

mysql> SELECT * FROM test2;
+-----+
| a2 |
+-----+
| 1 |
| 3 |
| 1 |
| 7 |
| 1 |
| 8 |
| 4 |
| 4 |
+-----+
8 rows in set (0.00 sec)

mysql> SELECT * FROM test3;
+-----+
| a3 |
+-----+
| 2 |
| 5 |
| 6 |
| 9 |
| 10 |
+-----+
5 rows in set (0.00 sec)

mysql> SELECT * FROM test4;
+-----+-----+
| a4 | b4 |
+-----+-----+
| 1 | 3 |
| 2 | 0 |
| 3 | 1 |
| 4 | 2 |
| 5 | 0 |
| 6 | 0 |
| 7 | 1 |
| 8 | 1 |
| 9 | 0 |
| 10 | 0 |
+-----+-----+
10 rows in set (0.00 sec)

```

### 23.3.2 Trigger Metadata

To obtain metadata about triggers:

- Query the `TRIGGERS` table of the `INFORMATION_SCHEMA` database. See [Section 24.3.29, “The INFORMATION\\_SCHEMA TRIGGERS Table”](#).
- Use the `SHOW CREATE TRIGGER` statement. See [Section 13.7.5.11, “SHOW CREATE TRIGGER Statement”](#).
- Use the `SHOW TRIGGERS` statement. See [Section 13.7.5.38, “SHOW TRIGGERS Statement”](#).



## 23.4 Using the Event Scheduler

The *MySQL Event Scheduler* manages the scheduling and execution of events, that is, tasks that run according to a schedule. The following discussion covers the Event Scheduler and is divided into the following sections:

- [Section 23.4.1, “Event Scheduler Overview”](#), provides an introduction to and conceptual overview of MySQL Events.
- [Section 23.4.3, “Event Syntax”](#), discusses the SQL statements for creating, altering, and dropping MySQL Events.
- [Section 23.4.4, “Event Metadata”](#), shows how to obtain information about events and how this information is stored by the MySQL Server.
- [Section 23.4.6, “The Event Scheduler and MySQL Privileges”](#), discusses the privileges required to work with events and the ramifications that events have with regard to privileges when executing.

Stored routines require the `event` table in the `mysql` database. This table is created during the MySQL 5.7 installation procedure. If you are upgrading to MySQL 5.7 from an earlier version, be sure to update your grant tables to make sure that the `event` table exists. See [Section 2.10, “Upgrading MySQL”](#).

### Additional Resources

- There are some restrictions on the use of events; see [Section 23.8, “Restrictions on Stored Programs”](#).
- Binary logging for events takes place as described in [Section 23.7, “Stored Program Binary Logging”](#).
- You may also find the [MySQL User Forums](#) to be helpful.

### 23.4.1 Event Scheduler Overview

MySQL Events are tasks that run according to a schedule. Therefore, we sometimes refer to them as *scheduled* events. When you create an event, you are creating a named database object containing one or more SQL statements to be executed at one or more regular intervals, beginning and ending at a specific date and time. Conceptually, this is similar to the idea of the Unix `crontab` (also known as a “cron job”) or the Windows Task Scheduler.

Scheduled tasks of this type are also sometimes known as “temporal triggers”, implying that these are objects that are triggered by the passage of time. While this is essentially correct, we prefer to use the term *events* to avoid confusion with triggers of the type discussed in [Section 23.3, “Using Triggers”](#). Events should more specifically not be confused with “temporary triggers”. Whereas a trigger is a database object whose statements are executed in response to a specific type of event that occurs on a given table, a (scheduled) event is an object whose statements are executed in response to the passage of a specified time interval.

While there is no provision in the SQL Standard for event scheduling, there are precedents in other database systems, and you may notice some similarities between these implementations and that found in the MySQL Server.

MySQL Events have the following major features and properties:

- In MySQL, an event is uniquely identified by its name and the schema to which it is assigned.
- An event performs a specific action according to a schedule. This action consists of an SQL statement, which can be a compound statement in a `BEGIN . . . END` block if desired (see [Section 13.6](#),

“[Compound Statements](#)”). An event's timing can be either *one-time* or *recurrent*. A one-time event executes one time only. A recurrent event repeats its action at a regular interval, and the schedule for a recurring event can be assigned a specific start day and time, end day and time, both, or neither. (By default, a recurring event's schedule begins as soon as it is created, and continues indefinitely, until it is disabled or dropped.)

If a repeating event does not terminate within its scheduling interval, the result may be multiple instances of the event executing simultaneously. If this is undesirable, you should institute a mechanism to prevent simultaneous instances. For example, you could use the `GET_LOCK( )` function, or row or table locking.

- Users can create, modify, and drop scheduled events using SQL statements intended for these purposes. Syntactically invalid event creation and modification statements fail with an appropriate error message. *A user may include statements in an event's action which require privileges that the user does not actually have.* The event creation or modification statement succeeds but the event's action fails. See [Section 23.4.6, “The Event Scheduler and MySQL Privileges”](#) for details.
- Many of the properties of an event can be set or modified using SQL statements. These properties include the event's name, timing, persistence (that is, whether it is preserved following the expiration of its schedule), status (enabled or disabled), action to be performed, and the schema to which it is assigned. See [Section 13.1.2, “ALTER EVENT Statement”](#).

The default definer of an event is the user who created the event, unless the event has been altered, in which case the definer is the user who issued the last `ALTER EVENT` statement affecting that event. An event can be modified by any user having the `EVENT` privilege on the database for which the event is defined. See [Section 23.4.6, “The Event Scheduler and MySQL Privileges”](#).

- An event's action statement may include most SQL statements permitted within stored routines. For restrictions, see [Section 23.8, “Restrictions on Stored Programs”](#).

## 23.4.2 Event Scheduler Configuration

Events are executed by a special *event scheduler thread*; when we refer to the Event Scheduler, we actually refer to this thread. When running, the event scheduler thread and its current state can be seen by users having the `PROCESS` privilege in the output of `SHOW PROCESSLIST`, as shown in the discussion that follows.

The global `event_scheduler` system variable determines whether the Event Scheduler is enabled and running on the server. It has one of the following values, which affect event scheduling as described:

- **OFF**: The Event Scheduler is stopped. The event scheduler thread does not run, is not shown in the output of `SHOW PROCESSLIST`, and no scheduled events execute. **OFF** is the default `event_scheduler` value.

When the Event Scheduler is stopped (`event_scheduler` is **OFF**), it can be started by setting the value of `event_scheduler` to **ON**. (See next item.)

- **ON**: The Event Scheduler is started; the event scheduler thread runs and executes all scheduled events.

When the Event Scheduler is **ON**, the event scheduler thread is listed in the output of `SHOW PROCESSLIST` as a daemon process, and its state is represented as shown here:

```
mysql> SHOW PROCESSLIST\G
***** 1. row *****
  Id: 1
  User: root
  Host: localhost
  db: NULL
```

```

Command: Query
Time: 0
State: NULL
Info: show processlist
***** 2. row *****
  Id: 2
  User: event_scheduler
  Host: localhost
  db: NULL
Command: Daemon
Time: 3
State: Waiting for next activation
Info: NULL
2 rows in set (0.00 sec)

```

Event scheduling can be stopped by setting the value of `event_scheduler` to `OFF`.

- **DISABLED**: This value renders the Event Scheduler nonoperational. When the Event Scheduler is **DISABLED**, the event scheduler thread does not run (and so does not appear in the output of `SHOW PROCESSLIST`). In addition, the Event Scheduler state cannot be changed at runtime.

If the Event Scheduler status has not been set to **DISABLED**, `event_scheduler` can be toggled between **ON** and **OFF** (using `SET`). It is also possible to use `0` for **OFF**, and `1` for **ON** when setting this variable. Thus, any of the following 4 statements can be used in the `mysql` client to turn on the Event Scheduler:

```

SET GLOBAL event_scheduler = ON;
SET @@GLOBAL.event_scheduler = ON;
SET GLOBAL event_scheduler = 1;
SET @@GLOBAL.event_scheduler = 1;

```

Similarly, any of these 4 statements can be used to turn off the Event Scheduler:

```

SET GLOBAL event_scheduler = OFF;
SET @@GLOBAL.event_scheduler = OFF;
SET GLOBAL event_scheduler = 0;
SET @@GLOBAL.event_scheduler = 0;

```

Although **ON** and **OFF** have numeric equivalents, the value displayed for `event_scheduler` by `SELECT` or `SHOW VARIABLES` is always one of **OFF**, **ON**, or **DISABLED**. **DISABLED** has no numeric equivalent. For this reason, **ON** and **OFF** are usually preferred over `1` and `0` when setting this variable.

Note that attempting to set `event_scheduler` without specifying it as a global variable causes an error:

```

mysql> SET @@event_scheduler = OFF;
ERROR 1229 (HY000): Variable 'event_scheduler' is a GLOBAL
variable and should be set with SET GLOBAL

```



### Important

It is possible to set the Event Scheduler to **DISABLED** only at server startup. If `event_scheduler` is **ON** or **OFF**, you cannot set it to **DISABLED** at runtime. Also, if the Event Scheduler is set to **DISABLED** at startup, you cannot change the value of `event_scheduler` at runtime.

To disable the event scheduler, use one of the following two methods:

- As a command-line option when starting the server:

```
--event-scheduler=DISABLED
```

- In the server configuration file (`my.cnf`, or `my.ini` on Windows systems), include the line where it can be read by the server (for example, in a `[mysqld]` section):

```
event_scheduler=DISABLED
```

To enable the Event Scheduler, restart the server without the `--event-scheduler=DISABLED` command-line option, or after removing or commenting out the line containing `event_scheduler=DISABLED` in the server configuration file, as appropriate. Alternatively, you can use `ON` (or `1`) or `OFF` (or `0`) in place of the `DISABLED` value when starting the server.



#### Note

You can issue event-manipulation statements when `event_scheduler` is set to `DISABLED`. No warnings or errors are generated in such cases (provided that the statements are themselves valid). However, scheduled events cannot execute until this variable is set to `ON` (or `1`). Once this has been done, the event scheduler thread executes all events whose scheduling conditions are satisfied.

Starting the MySQL server with the `--skip-grant-tables` option causes `event_scheduler` to be set to `DISABLED`, overriding any other value set either on the command line or in the `my.cnf` or `my.ini` file (Bug #26807).

For SQL statements used to create, alter, and drop events, see [Section 23.4.3, “Event Syntax”](#).

MySQL provides an `EVENTS` table in the `INFORMATION_SCHEMA` database. This table can be queried to obtain information about scheduled events which have been defined on the server. See [Section 23.4.4, “Event Metadata”](#), and [Section 24.3.8, “The INFORMATION\\_SCHEMA EVENTS Table”](#), for more information.

For information regarding event scheduling and the MySQL privilege system, see [Section 23.4.6, “The Event Scheduler and MySQL Privileges”](#).

### 23.4.3 Event Syntax

MySQL provides several SQL statements for working with scheduled events:

- New events are defined using the `CREATE EVENT` statement. See [Section 13.1.12, “CREATE EVENT Statement”](#).
- The definition of an existing event can be changed by means of the `ALTER EVENT` statement. See [Section 13.1.2, “ALTER EVENT Statement”](#).
- When a scheduled event is no longer wanted or needed, it can be deleted from the server by its definer using the `DROP EVENT` statement. See [Section 13.1.23, “DROP EVENT Statement”](#). Whether an event persists past the end of its schedule also depends on its `ON COMPLETION` clause, if it has one. See [Section 13.1.12, “CREATE EVENT Statement”](#).

An event can be dropped by any user having the `EVENT` privilege for the database on which the event is defined. See [Section 23.4.6, “The Event Scheduler and MySQL Privileges”](#).

### 23.4.4 Event Metadata

To obtain metadata about events:

- Query the `event` table of the `mysql` database.
- Query the `EVENTS` table of the `INFORMATION_SCHEMA` database. See [Section 24.3.8, “The INFORMATION\\_SCHEMA EVENTS Table”](#).

- Use the `SHOW CREATE EVENT` statement. See [Section 13.7.5.7, “SHOW CREATE EVENT Statement”](#).
- Use the `SHOW EVENTS` statement. See [Section 13.7.5.18, “SHOW EVENTS Statement”](#).

### Event Scheduler Time Representation

Each session in MySQL has a session time zone (STZ). This is the session `time_zone` value that is initialized from the server's global `time_zone` value when the session begins but may be changed during the session.

The session time zone that is current when a `CREATE EVENT` or `ALTER EVENT` statement executes is used to interpret times specified in the event definition. This becomes the event time zone (ETZ); that is, the time zone that is used for event scheduling and is in effect within the event as it executes.

For representation of event information in the `mysql.event` table, the `execute_at`, `starts`, and `ends` times are converted to UTC and stored along with the event time zone. This enables event execution to proceed as defined regardless of any subsequent changes to the server time zone or daylight saving time effects. The `last_executed` time is also stored in UTC.

If you select information from `mysql.event`, the times just mentioned are retrieved as UTC values. These times can also be obtained by selecting from the Information Schema `EVENTS` table or from `SHOW EVENTS`, but they are reported as ETZ values. Other times available from these sources indicate when an event was created or last altered; these are displayed as STZ values. The following table summarizes representation of event times.

Value	<code>mysql.event</code>	<code>EVENTS</code> Table	<code>SHOW EVENTS</code>
Execute at	UTC	ETZ	ETZ
Starts	UTC	ETZ	ETZ
Ends	UTC	ETZ	ETZ
Last executed	UTC	ETZ	n/a
Created	STZ	STZ	n/a
Last altered	STZ	STZ	n/a

## 23.4.5 Event Scheduler Status

The Event Scheduler writes information about event execution that terminates with an error or warning to the MySQL Server's error log. See [Section 23.4.6, “The Event Scheduler and MySQL Privileges”](#) for an example.

To obtain information about the state of the Event Scheduler for debugging and troubleshooting purposes, run `mysqladmin debug` (see [Section 4.5.2, “mysqladmin — A MySQL Server Administration Program”](#)); after running this command, the server's error log contains output relating to the Event Scheduler, similar to what is shown here:

```
Events status:
LLA = Last Locked At   LUA = Last Unlocked At
WOC = Waiting On Condition  DL = Data Locked

Event scheduler status:
State      : INITIALIZED
Thread id  : 0
LLA       : n/a:0
LUA       : n/a:0
WOC       : NO
```

```

Workers      : 0
Executed     : 0
Data locked: NO

Event queue status:
Element count : 0
Data locked   : NO
Attempting lock : NO
LLA          : init_queue:95
LUA          : init_queue:103
WOC          : NO
Next activation : never

```

In statements that occur as part of events executed by the Event Scheduler, diagnostics messages (not only errors, but also warnings) are written to the error log, and, on Windows, to the application event log. For frequently executed events, it is possible for this to result in many logged messages. For example, for `SELECT ... INTO var_list` statements, if the query returns no rows, a warning with error code 1329 occurs (`No data`), and the variable values remain unchanged. If the query returns multiple rows, error 1172 occurs (`Result consisted of more than one row`). For either condition, you can avoid having the warnings be logged by declaring a condition handler; see [Section 13.6.7.2, “DECLARE ... HANDLER Statement”](#). For statements that may retrieve multiple rows, another strategy is to use `LIMIT 1` to limit the result set to a single row.

## 23.4.6 The Event Scheduler and MySQL Privileges

To enable or disable the execution of scheduled events, it is necessary to set the value of the global `event_scheduler` system variable. This requires privileges sufficient to set global system variables. See [Section 5.1.8.1, “System Variable Privileges”](#).

The `EVENT` privilege governs the creation, modification, and deletion of events. This privilege can be bestowed using `GRANT`. For example, this `GRANT` statement confers the `EVENT` privilege for the schema named `myschema` on the user `jon@ghidora`:

```
GRANT EVENT ON myschema.* TO jon@ghidora;
```

(We assume that this user account already exists, and that we wish for it to remain unchanged otherwise.)

To grant this same user the `EVENT` privilege on all schemas, use the following statement:

```
GRANT EVENT ON *.* TO jon@ghidora;
```

The `EVENT` privilege has global or schema-level scope. Therefore, trying to grant it on a single table results in an error as shown:

```
mysql> GRANT EVENT ON myschema.mytable TO jon@ghidora;
ERROR 1144 (42000): Illegal GRANT/REVOKE command; please
consult the manual to see which privileges can be used
```

It is important to understand that an event is executed with the privileges of its definer, and that it cannot perform any actions for which its definer does not have the requisite privileges. For example, suppose that `jon@ghidora` has the `EVENT` privilege for `myschema`. Suppose also that this user has the `SELECT` privilege for `myschema`, but no other privileges for this schema. It is possible for `jon@ghidora` to create a new event such as this one:

```
CREATE EVENT e_store_ts
ON SCHEDULE
EVERY 10 SECOND
DO
INSERT INTO myschema.mytable VALUES (UNIX_TIMESTAMP());
```

The user waits for a minute or so, and then performs a `SELECT * FROM mytable;` query, expecting to see several new rows in the table. Instead, the table is empty. Since the user does not have the `INSERT` privilege for the table in question, the event has no effect.

If you inspect the MySQL error log (`hostname.err`), you can see that the event is executing, but the action it is attempting to perform fails:

```
2013-09-24T12:41:31.261992Z 25 [ERROR] Event Scheduler:
[jon@ghidora][cookbook.e_store_ts] INSERT command denied to user
'jon'@'ghidora' for table 'mytable'
2013-09-24T12:41:31.262022Z 25 [Note] Event Scheduler:
[jon@ghidora].[myschema.e_store_ts] event execution failed.
2013-09-24T12:41:41.271796Z 26 [ERROR] Event Scheduler:
[jon@ghidora][cookbook.e_store_ts] INSERT command denied to user
'jon'@'ghidora' for table 'mytable'
2013-09-24T12:41:41.272761Z 26 [Note] Event Scheduler:
[jon@ghidora].[myschema.e_store_ts] event execution failed.
```

Since this user very likely does not have access to the error log, it is possible to verify whether the event's action statement is valid by executing it directly:

```
mysql> INSERT INTO myschema.mytable VALUES (UNIX_TIMESTAMP());
ERROR 1142 (42000): INSERT command denied to user
'jon'@'ghidora' for table 'mytable'
```

Inspection of the Information Schema `EVENTS` table shows that `e_store_ts` exists and is enabled, but its `LAST_EXECUTED` column is `NULL`:

```
mysql> SELECT * FROM INFORMATION_SCHEMA.EVENTS
> WHERE EVENT_NAME='e_store_ts'
> AND EVENT_SCHEMA='myschema'\G
***** 1. row *****
EVENT_CATALOG: NULL
EVENT_SCHEMA: myschema
EVENT_NAME: e_store_ts
DEFINER: jon@ghidora
EVENT_BODY: SQL
EVENT_DEFINITION: INSERT INTO myschema.mytable VALUES (UNIX_TIMESTAMP())
EVENT_TYPE: RECURRING
EXECUTE_AT: NULL
INTERVAL_VALUE: 5
INTERVAL_FIELD: SECOND
SQL_MODE: NULL
STARTS: 0000-00-00 00:00:00
ENDS: 0000-00-00 00:00:00
STATUS: ENABLED
ON_COMPLETION: NOT PRESERVE
CREATED: 2006-02-09 22:36:06
LAST_ALTERED: 2006-02-09 22:36:06
LAST_EXECUTED: NULL
EVENT_COMMENT:
1 row in set (0.00 sec)
```

To rescind the `EVENT` privilege, use the `REVOKE` statement. In this example, the `EVENT` privilege on the schema `myschema` is removed from the `jon@ghidora` user account:

```
REVOKE EVENT ON myschema.* FROM jon@ghidora;
```



### Important

Revoking the `EVENT` privilege from a user does not delete or disable any events that may have been created by that user.

An event is not migrated or dropped as a result of renaming or dropping the user who created it.

Suppose that the user `jon@ghidora` has been granted the `EVENT` and `INSERT` privileges on the `myschema` schema. This user then creates the following event:

```
CREATE EVENT e_insert
ON SCHEDULE
  EVERY 7 SECOND
DO
  INSERT INTO myschema.mytable;
```

After this event has been created, `root` revokes the `EVENT` privilege for `jon@ghidora`. However, `e_insert` continues to execute, inserting a new row into `mytable` each seven seconds. The same would be true if `root` had issued either of these statements:

- `DROP USER jon@ghidora;`
- `RENAME USER jon@ghidora TO someotherguy@ghidora;`

You can verify that this is true by examining the `mysql.event` table (discussed later in this section) or the Information Schema `EVENTS` table before and after issuing a `DROP USER` or `RENAME USER` statement.

Event definitions are stored in the `mysql.event` table. To drop an event created by another user account, the MySQL `root` user (or another user with the necessary privileges) can delete rows from this table. For example, to remove the event `e_insert` shown previously, `root` can use the following statement:

```
DELETE FROM mysql.event
WHERE db = 'myschema'
AND name = 'e_insert';
```

It is very important to match the event name and database schema name when deleting rows from the `mysql.event` table. This is because different events of the same name can exist in different schemas.

Users' `EVENT` privileges are stored in the `Event_priv` columns of the `mysql.user` and `mysql.db` tables. In both cases, this column holds one of the values 'Y' or 'N'. 'N' is the default. `mysql.user.Event_priv` is set to 'Y' for a given user only if that user has the global `EVENT` privilege (that is, if the privilege was bestowed using `GRANT EVENT ON *.*`). For a schema-level `EVENT` privilege, `GRANT` creates a row in `mysql.db` and sets that row's `Db` column to the name of the schema, the `User` column to the name of the user, and the `Event_priv` column to 'Y'. There should never be any need to manipulate these tables directly, since the `GRANT EVENT` and `REVOKE EVENT` statements perform the required operations on them.

Five status variables provide counts of event-related operations (but *not* of statements executed by events; see [Section 23.8, "Restrictions on Stored Programs"](#)). These are:

- `Com_create_event`: The number of `CREATE EVENT` statements executed since the last server restart.
- `Com_alter_event`: The number of `ALTER EVENT` statements executed since the last server restart.
- `Com_drop_event`: The number of `DROP EVENT` statements executed since the last server restart.
- `Com_show_create_event`: The number of `SHOW CREATE EVENT` statements executed since the last server restart.
- `Com_show_events`: The number of `SHOW EVENTS` statements executed since the last server restart.

You can view current values for all of these at one time by running the statement `SHOW STATUS LIKE '%event%';`



## 23.5 Using Views

MySQL supports views, including updatable views. Views are stored queries that when invoked produce a result set. A view acts as a virtual table.

The following discussion describes the syntax for creating and dropping views, and shows some examples of how to use them.

### Additional Resources

- You may find the [MySQL User Forums](#) helpful when working with views.
- For answers to some commonly asked questions regarding views in MySQL, see [Section A.6, “MySQL 5.7 FAQ: Views”](#).
- There are some restrictions on the use of views; see [Section 23.9, “Restrictions on Views”](#).

### 23.5.1 View Syntax

The `CREATE VIEW` statement creates a new view (see [Section 13.1.21, “CREATE VIEW Statement”](#)). To alter the definition of a view or drop a view, use `ALTER VIEW` (see [Section 13.1.10, “ALTER VIEW Statement”](#)), or `DROP VIEW` (see [Section 13.1.32, “DROP VIEW Statement”](#)).

A view can be created from many kinds of `SELECT` statements. It can refer to base tables or other views. It can use joins, `UNION`, and subqueries. The `SELECT` need not even refer to any tables. The following example defines a view that selects two columns from another table, as well as an expression calculated from those columns:

```
mysql> CREATE TABLE t (qty INT, price INT);
mysql> INSERT INTO t VALUES(3, 50), (5, 60);
mysql> CREATE VIEW v AS SELECT qty, price, qty*price AS value FROM t;
mysql> SELECT * FROM v;
+-----+-----+-----+
| qty  | price | value |
+-----+-----+-----+
| 3    | 50    | 150   |
| 5    | 60    | 300   |
+-----+-----+-----+
mysql> SELECT * FROM v WHERE qty = 5;
+-----+-----+-----+
| qty  | price | value |
+-----+-----+-----+
| 5    | 60    | 300   |
+-----+-----+-----+
```

### 23.5.2 View Processing Algorithms

The optional `ALGORITHM` clause for `CREATE VIEW` or `ALTER VIEW` is a MySQL extension to standard SQL. It affects how MySQL processes the view. `ALGORITHM` takes three values: `MERGE`, `TEMPTABLE`, or `UNDEFINED`.

- For `MERGE`, the text of a statement that refers to the view and the view definition are merged such that parts of the view definition replace corresponding parts of the statement.
- For `TEMPTABLE`, the results from the view are retrieved into a temporary table, which then is used to execute the statement.
- For `UNDEFINED`, MySQL chooses which algorithm to use. It prefers `MERGE` over `TEMPTABLE` if possible, because `MERGE` is usually more efficient and because a view cannot be updated if a temporary table is used.

- If no `ALGORITHM` clause is present, the default algorithm is determined by the value of the `derived_merge` flag of the `optimizer_switch` system variable. For additional discussion, see [Section 8.2.2.4, “Optimizing Derived Tables and View References with Merging or Materialization”](#).

A reason to specify `TEMPTABLE` explicitly is that locks can be released on underlying tables after the temporary table has been created and before it is used to finish processing the statement. This might result in quicker lock release than the `MERGE` algorithm so that other clients that use the view are not blocked as long.

A view algorithm can be `UNDEFINED` for three reasons:

- No `ALGORITHM` clause is present in the `CREATE VIEW` statement.
- The `CREATE VIEW` statement has an explicit `ALGORITHM = UNDEFINED` clause.
- `ALGORITHM = MERGE` is specified for a view that can be processed only with a temporary table. In this case, MySQL generates a warning and sets the algorithm to `UNDEFINED`.

As mentioned earlier, `MERGE` is handled by merging corresponding parts of a view definition into the statement that refers to the view. The following examples briefly illustrate how the `MERGE` algorithm works. The examples assume that there is a view `v_merge` that has this definition:

```
CREATE ALGORITHM = MERGE VIEW v_merge (vc1, vc2) AS
SELECT c1, c2 FROM t WHERE c3 > 100;
```

Example 1: Suppose that we issue this statement:

```
SELECT * FROM v_merge;
```

MySQL handles the statement as follows:

- `v_merge` becomes `t`
- `*` becomes `vc1, vc2`, which corresponds to `c1, c2`
- The view `WHERE` clause is added

The resulting statement to be executed becomes:

```
SELECT c1, c2 FROM t WHERE c3 > 100;
```

Example 2: Suppose that we issue this statement:

```
SELECT * FROM v_merge WHERE vc1 < 100;
```

This statement is handled similarly to the previous one, except that `vc1 < 100` becomes `c1 < 100` and the view `WHERE` clause is added to the statement `WHERE` clause using an `AND` connective (and parentheses are added to make sure the parts of the clause are executed with correct precedence). The resulting statement to be executed becomes:

```
SELECT c1, c2 FROM t WHERE (c3 > 100) AND (c1 < 100);
```

Effectively, the statement to be executed has a `WHERE` clause of this form:

```
WHERE (select WHERE) AND (view WHERE)
```

If the `MERGE` algorithm cannot be used, a temporary table must be used instead. Constructs that prevent merging are the same as those that prevent merging in derived tables. Examples are `SELECT DISTINCT`

or `LIMIT` in the subquery. For details, see [Section 8.2.2.4, “Optimizing Derived Tables and View References with Merging or Materialization”](#).

### 23.5.3 Updatable and Insertable Views

Some views are updatable and references to them can be used to specify tables to be updated in data change statements. That is, you can use them in statements such as `UPDATE`, `DELETE`, or `INSERT` to update the contents of the underlying table. Derived tables can also be specified in multiple-table `UPDATE` and `DELETE` statements, but can only be used for reading data to specify rows to be updated or deleted. Generally, the view references must be updatable, meaning that they may be merged and not materialized. Composite views have more complex rules.

For a view to be updatable, there must be a one-to-one relationship between the rows in the view and the rows in the underlying table. There are also certain other constructs that make a view nonupdatable. To be more specific, a view is not updatable if it contains any of the following:

- Aggregate functions (`SUM()`, `MIN()`, `MAX()`, `COUNT()`, and so forth)
- `DISTINCT`
- `GROUP BY`
- `HAVING`
- `UNION` or `UNION ALL`
- Subquery in the select list

Before MySQL 5.7.11, subqueries in the select list fail for `INSERT`, but are okay for `UPDATE`, `DELETE`. As of MySQL 5.7.11, that is still true for nondependent subqueries. For dependent subqueries in the select list, no data change statements are permitted.

- Certain joins (see additional join discussion later in this section)
- Reference to nonupdatable view in the `FROM` clause
- Subquery in the `WHERE` clause that refers to a table in the `FROM` clause
- Refers only to literal values (in this case, there is no underlying table to update)
- `ALGORITHM = TEMPTABLE` (use of a temporary table always makes a view nonupdatable)
- Multiple references to any column of a base table (fails for `INSERT`, okay for `UPDATE`, `DELETE`)

A generated column in a view is considered updatable because it is possible to assign to it. However, if such a column is updated explicitly, the only permitted value is `DEFAULT`. For information about generated columns, see [Section 13.1.18.7, “CREATE TABLE and Generated Columns”](#).

It is sometimes possible for a multiple-table view to be updatable, assuming that it can be processed with the `MERGE` algorithm. For this to work, the view must use an inner join (not an outer join or a `UNION`). Also, only a single table in the view definition can be updated, so the `SET` clause must name only columns from one of the tables in the view. Views that use `UNION ALL` are not permitted even though they might be theoretically updatable.

With respect to insertability (being updatable with `INSERT` statements), an updatable view is insertable if it also satisfies these additional requirements for the view columns:

- There must be no duplicate view column names.
- The view must contain all columns in the base table that do not have a default value.
- The view columns must be simple column references. They must not be expressions, such as these:

```
3.14159
col1 + 3
UPPER(col2)
col3 / col4
(subquery)
```

MySQL sets a flag, called the view updatability flag, at `CREATE VIEW` time. The flag is set to `YES` (true) if `UPDATE` and `DELETE` (and similar operations) are legal for the view. Otherwise, the flag is set to `NO` (false). The `IS_UPDATABLE` column in the Information Schema `VIEWS` table displays the status of this flag.

If a view is not updatable, statements such `UPDATE`, `DELETE`, and `INSERT` are illegal and are rejected. (Even if a view is updatable, it might not be possible to insert into it, as described elsewhere in this section.)

The `IS_UPDATABLE` flag may be unreliable if a view depends on one or more other views, and one of these underlying views is updated. Regardless of the `IS_UPDATABLE` value, the server keeps track of the updatability of a view and correctly rejects data change operations to views that are not updatable. If the `IS_UPDATABLE` value for a view has become inaccurate to due to changes to underlying views, the value can be updated by deleting and re-creating the view.

The updatability of views may be affected by the value of the `updatable_views_with_limit` system variable. See [Section 5.1.7, “Server System Variables”](#).

For the following discussion, suppose that these tables and views exist:

```
CREATE TABLE t1 (x INTEGER);
CREATE TABLE t2 (c INTEGER);
CREATE VIEW vmat AS SELECT SUM(x) AS s FROM t1;
CREATE VIEW vup AS SELECT * FROM t2;
CREATE VIEW vjoin AS SELECT * FROM vmat JOIN vup ON vmat.s=vup.c;
```

`INSERT`, `UPDATE`, and `DELETE` statements are permitted as follows:

- **INSERT:** The insert table of an `INSERT` statement may be a view reference that is merged. If the view is a join view, all components of the view must be updatable (not materialized). For a multiple-table updatable view, `INSERT` can work if it inserts into a single table.

This statement is invalid because one component of the join view is nonupdatable:

```
INSERT INTO vjoin (c) VALUES (1);
```

This statement is valid; the view contains no materialized components:

```
INSERT INTO vup (c) VALUES (1);
```

- **UPDATE:** The table or tables to be updated in an `UPDATE` statement may be view references that are merged. If a view is a join view, at least one component of the view must be updatable (this differs from `INSERT`).

In a multiple-table `UPDATE` statement, the updated table references of the statement must be base tables or updatable view references. Nonupdated table references may be materialized views or derived tables.

This statement is valid; column `c` is from the updatable part of the join view:

```
UPDATE vjoin SET c=c+1;
```

This statement is invalid; column `x` is from the nonupdatable part:

```
UPDATE vjoin SET x=x+1;
```

This statement is valid; the updated table reference of the multiple-table `UPDATE` is an updatable view (`vup`):

```
UPDATE vup JOIN (SELECT SUM(x) AS s FROM t1) AS dt ON ...
SET c=c+1;
```

This statement is invalid; it tries to update a materialized derived table:

```
UPDATE vup JOIN (SELECT SUM(x) AS s FROM t1) AS dt ON ...
SET s=s+1;
```

- `DELETE`: The table or tables to be deleted from in a `DELETE` statement must be merged views. Join views are not allowed (this differs from `INSERT` and `UPDATE`).

This statement is invalid because the view is a join view:

```
DELETE vjoin WHERE ...;
```

This statement is valid because the view is a merged (updatable) view:

```
DELETE vup WHERE ...;
```

This statement is valid because it deletes from a merged (updatable) view:

```
DELETE vup FROM vup JOIN (SELECT SUM(x) AS s FROM t1) AS dt ON ...;
```

Additional discussion and examples follow.

Earlier discussion in this section pointed out that a view is not insertable if not all columns are simple column references (for example, if it contains columns that are expressions or composite expressions). Although such a view is not insertable, it can be updatable if you update only columns that are not expressions. Consider this view:

```
CREATE VIEW v AS SELECT col1, 1 AS col2 FROM t;
```

This view is not insertable because `col2` is an expression. But it is updatable if the update does not try to update `col2`. This update is permissible:

```
UPDATE v SET col1 = 0;
```

This update is not permissible because it attempts to update an expression column:

```
UPDATE v SET col2 = 0;
```

If a table contains an `AUTO_INCREMENT` column, inserting into an insertable view on the table that does not include the `AUTO_INCREMENT` column does not change the value of `LAST_INSERT_ID()`, because the side effects of inserting default values into columns not part of the view should not be visible.

## 23.5.4 The View WITH CHECK OPTION Clause

The `WITH CHECK OPTION` clause can be given for an updatable view to prevent inserts to rows for which the `WHERE` clause in the `select_statement` is not true. It also prevents updates to rows for which the

`WHERE` clause is true but the update would cause it to be not true (in other words, it prevents visible rows from being updated to nonvisible rows).

In a `WITH CHECK OPTION` clause for an updatable view, the `LOCAL` and `CASCADDED` keywords determine the scope of check testing when the view is defined in terms of another view. When neither keyword is given, the default is `CASCADDED`.

Before MySQL 5.7.6, `WITH CHECK OPTION` testing works like this:

- With `LOCAL`, the view `WHERE` clause is checked, but no underlying views are checked.
- With `CASCADDED`, the view `WHERE` clause is checked, then checking recurses to underlying views, adds `WITH CASCADDED CHECK OPTION` to them (for purposes of the check; their definitions remain unchanged), and applies the same rules.
- With no check option, the view `WHERE` clause is not checked, and no underlying views are checked.

As of MySQL 5.7.6, `WITH CHECK OPTION` testing is standard-compliant (with changed semantics from previously for `LOCAL` and no check clause):

- With `LOCAL`, the view `WHERE` clause is checked, then checking recurses to underlying views and applies the same rules.
- With `CASCADDED`, the view `WHERE` clause is checked, then checking recurses to underlying views, adds `WITH CASCADDED CHECK OPTION` to them (for purposes of the check; their definitions remain unchanged), and applies the same rules.
- With no check option, the view `WHERE` clause is not checked, then checking recurses to underlying views, and applies the same rules.

Consider the definitions for the following table and set of views:

```
CREATE TABLE t1 (a INT);
CREATE VIEW v1 AS SELECT * FROM t1 WHERE a < 2
WITH CHECK OPTION;
CREATE VIEW v2 AS SELECT * FROM v1 WHERE a > 0
WITH LOCAL CHECK OPTION;
CREATE VIEW v3 AS SELECT * FROM v1 WHERE a > 0
WITH CASCADDED CHECK OPTION;
```

Here the `v2` and `v3` views are defined in terms of another view, `v1`. Before MySQL 5.7.6, because `v2` has a `LOCAL` check option, inserts are tested only against the `v2` check. `v3` has a `CASCADDED` check option, so inserts are tested not only against the `v3` check, but against those of underlying views. The following statements illustrate these differences:

```
mysql> INSERT INTO v2 VALUES (2);
Query OK, 1 row affected (0.00 sec)
mysql> INSERT INTO v3 VALUES (2);
ERROR 1369 (HY000): CHECK OPTION failed 'test.v3'
```

As of MySQL 5.7.6, the semantics for `LOCAL` differ from previously: Inserts for `v2` are checked against its `LOCAL` check option, then (unlike before 5.7.6), the check recurses to `v1` and the rules are applied again. The rules for `v1` cause a check failure. The check for `v3` fails as before:

```
mysql> INSERT INTO v2 VALUES (2);
ERROR 1369 (HY000): CHECK OPTION failed 'test.v2'
mysql> INSERT INTO v3 VALUES (2);
ERROR 1369 (HY000): CHECK OPTION failed 'test.v3'
```

## 23.5.5 View Metadata

To obtain metadata about views:

- Query the `VIEWS` table of the `INFORMATION_SCHEMA` database. See [Section 24.3.31, “The INFORMATION\\_SCHEMA VIEWS Table”](#).
- Use the `SHOW CREATE VIEW` statement. See [Section 13.7.5.13, “SHOW CREATE VIEW Statement”](#).

## 23.6 Stored Object Access Control

Stored programs (procedures, functions, triggers, and events) and views are defined prior to use and, when referenced, execute within a security context that determines their privileges. The privileges applicable to execution of a stored object are controlled by its `DEFINER` attribute and `SQL SECURITY` characteristic.

- [The DEFINER Attribute](#)
- [The SQL SECURITY Characteristic](#)
- [Examples](#)
- [Orphan Stored Objects](#)
- [Risk-Minimization Guidelines](#)

### The DEFINER Attribute

A stored object definition can include a `DEFINER` attribute that names a MySQL account. If a definition omits the `DEFINER` attribute, the default object definer is the user who creates it.

The following rules determine which accounts you can specify as the `DEFINER` attribute for a stored object:

- If you have the `SUPER` privilege, you can specify any account as the `DEFINER` attribute. If the account does not exist, a warning is generated.
- Otherwise, the only permitted account is your own, specified either literally or as `CURRENT_USER` or `CURRENT_USER()`. You cannot set the definer to any other account.

Creating a stored object with a nonexistent `DEFINER` account creates an orphan object, which may have negative consequences; see [Orphan Stored Objects](#).

### The SQL SECURITY Characteristic

For stored routines (procedures and functions) and views, the object definition can include an `SQL SECURITY` characteristic with a value of `DEFINER` or `INVOKER` to specify whether the object executes in definer or invoker context. If the definition omits the `SQL SECURITY` characteristic, the default is definer context.

Triggers and events have no `SQL SECURITY` characteristic and always execute in definer context. The server invokes these objects automatically as necessary, so there is no invoking user.

Definer and invoker security contexts differ as follows:

- A stored object that executes in definer security context executes with the privileges of the account named by its `DEFINER` attribute. These privileges may be entirely different from those of the invoking user. The invoker must have appropriate privileges to reference the object (for example, `EXECUTE` to call a stored procedure or `SELECT` to select from a view), but during object execution, the invoker's privileges

are ignored and only the `DEFINER` account privileges matter. If the `DEFINER` account has few privileges, the object is correspondingly limited in the operations it can perform. If the `DEFINER` account is highly privileged (such as an administrative account), the object can perform powerful operations *no matter who invokes it*.

- A stored routine or view that executes in invoker security context can perform only operations for which the invoker has privileges. The `DEFINER` attribute has no effect on object execution.

## Examples

Consider the following stored procedure, which is declared with `SQL SECURITY DEFINER` to execute in definer security context:

```
CREATE DEFINER = 'admin'@'localhost' PROCEDURE p1()
SQL SECURITY DEFINER
BEGIN
    UPDATE t1 SET counter = counter + 1;
END;
```

Any user who has the `EXECUTE` privilege for `p1` can invoke it with a `CALL` statement. However, when `p1` executes, it does so in definer security context and thus executes with the privileges of `'admin'@'localhost'`, the account named as its `DEFINER` attribute. This account must have the `EXECUTE` privilege for `p1` as well as the `UPDATE` privilege for the table `t1` referenced within the object body. Otherwise, the procedure fails.

Now consider this stored procedure, which is identical to `p1` except that its `SQL SECURITY` characteristic is `INVOKER`:

```
CREATE DEFINER = 'admin'@'localhost' PROCEDURE p2()
SQL SECURITY INVOKER
BEGIN
    UPDATE t1 SET counter = counter + 1;
END;
```

Unlike `p1`, `p2` executes in invoker security context and thus with the privileges of the invoking user regardless of the `DEFINER` attribute value. `p2` fails if the invoker lacks the `EXECUTE` privilege for `p2` or the `UPDATE` privilege for the table `t1`.

## Orphan Stored Objects

An orphan stored object is one for which its `DEFINER` attribute names a nonexistent account:

- An orphan stored object can be created by specifying a nonexistent `DEFINER` account at object-creation time.
- An existing stored object can become orphaned through execution of a `DROP USER` statement that drops the object `DEFINER` account, or a `RENAME USER` statement that renames the object `DEFINER` account.

An orphan stored object may be problematic in these ways:

- Because the `DEFINER` account does not exist, the object may not work as expected if it executes in definer security context:
  - For a stored routine, an error occurs at routine execution time if the `SQL SECURITY` value is `DEFINER` but the definer account does not exist.
  - For a trigger, it is not a good idea for trigger activation to occur until the account actually does exist. Otherwise, the behavior with respect to privilege checking is undefined.



- For an event, an error occurs at event execution time if the account does not exist.
- For a view, an error occurs when the view is referenced if the `SQL SECURITY` value is `DEFINER` but the definer account does not exist.
- The object may present a security risk if the nonexistent `DEFINER` account is subsequently re-created for a purpose unrelated to the object. In this case, the account “adopts” the object and, with the appropriate privileges, is able to execute it even if that is not intended.

To obtain information about the accounts used as stored object definers in a MySQL installation, query the `INFORMATION_SCHEMA`.

This query identifies which `INFORMATION_SCHEMA` tables describe objects that have a `DEFINER` attribute:

```
mysql> SELECT TABLE_SCHEMA, TABLE_NAME FROM INFORMATION_SCHEMA.COLUMNS
        WHERE COLUMN_NAME = 'DEFINER';
+-----+-----+
| TABLE_SCHEMA | TABLE_NAME |
+-----+-----+
| information_schema | EVENTS      |
| information_schema | ROUTINES   |
| information_schema | TRIGGERS   |
| information_schema | VIEWS      |
+-----+-----+
```

The result tells you which tables to query to discover which stored object `DEFINER` values exist and which objects have a particular `DEFINER` value:

- To identify which `DEFINER` values exist in each table, use these queries:

```
SELECT DISTINCT DEFINER FROM INFORMATION_SCHEMA.EVENTS;
SELECT DISTINCT DEFINER FROM INFORMATION_SCHEMA.ROUTINES;
SELECT DISTINCT DEFINER FROM INFORMATION_SCHEMA.TRIGGERS;
SELECT DISTINCT DEFINER FROM INFORMATION_SCHEMA.VIEWS;
```

The query results are significant for any account displayed as follows:

- If the account exists, dropping or renaming it causes stored objects to become orphaned. If you plan to drop or rename the account, consider first dropping its associated stored objects or redefining them to have a different definer.
- If the account does not exist, creating it causes it to adopt currently orphaned stored objects. If you plan to create the account, consider whether the orphaned objects should be associated with it. If not, redefine them to have a different definer.

To redefine an object with a different definer, you can use `ALTER EVENT` or `ALTER VIEW` to directly modify the `DEFINER` account of events and views. For stored procedures and functions and for triggers, you must drop the object and re-create it with a different `DEFINER` account

- To identify which objects have a given `DEFINER` account, use these queries, substituting the account of interest for `user_name@host_name`:

```
SELECT EVENT_SCHEMA, EVENT_NAME FROM INFORMATION_SCHEMA.EVENTS
WHERE DEFINER = 'user_name@host_name';
SELECT ROUTINE_SCHEMA, ROUTINE_NAME, ROUTINE_TYPE
FROM INFORMATION_SCHEMA.ROUTINES
WHERE DEFINER = 'user_name@host_name';
SELECT TRIGGER_SCHEMA, TRIGGER_NAME FROM INFORMATION_SCHEMA.TRIGGERS
WHERE DEFINER = 'user_name@host_name';
SELECT TABLE_SCHEMA, TABLE_NAME FROM INFORMATION_SCHEMA.VIEWS
WHERE DEFINER = 'user_name@host_name';
```

For the `ROUTINES` table, the query includes the `ROUTINE_TYPE` column so that output rows distinguish whether the `DEFINER` is for a stored procedure or stored function.

If the account you are searching for does not exist, any objects displayed by those queries are orphan objects.

## Risk-Minimization Guidelines

To minimize the risk potential for stored object creation and use, follow these guidelines:

- Do not create orphan stored objects; that is, objects for which the `DEFINER` attribute names a nonexistent account. Do not cause stored objects to become orphaned by dropping or renaming an account named by the `DEFINER` attribute of any existing object.
- For a stored routine or view, use `SQL SECURITY INVOKER` in the object definition when possible so that it can be used only by users with permissions appropriate for the operations performed by the object.
- If you create definer-context stored objects while using an account that has the `SUPER` privilege, specify an explicit `DEFINER` attribute that names an account possessing only the privileges required for the operations performed by the object. Specify a highly privileged `DEFINER` account only when absolutely necessary.
- Administrators can prevent users from creating stored objects that specify highly privileged `DEFINER` accounts by not granting them the `SUPER` privilege.
- Definer-context objects should be written keeping in mind that they may be able to access data for which the invoking user has no privileges. In some cases, you can prevent references to these objects by not granting unauthorized users particular privileges:
  - A stored routine cannot be referenced by a user who does not have the `EXECUTE` privilege for it.
  - A view cannot be referenced by a user who does not have the appropriate privilege for it (`SELECT` to select from it, `INSERT` to insert into it, and so forth).

However, no such control exists for triggers and events because they always execute in definer context. The server invokes these objects automatically as necessary, and users do not reference them directly:

- A trigger is activated by access to the table with which it is associated, even ordinary table accesses by users with no special privileges.
- An event is executed by the server on a scheduled basis.

In both cases, if the `DEFINER` account is highly privileged, the object may be able to perform sensitive or dangerous operations. This remains true if the privileges needed to create the object are revoked from the account of the user who created it. Administrators should be especially careful about granting users object-creation privileges.

## 23.7 Stored Program Binary Logging

The binary log contains information about SQL statements that modify database contents. This information is stored in the form of “events” that describe the modifications. (Binary log events differ from scheduled event stored objects.) The binary log has two important purposes:

- For replication, the binary log is used on source replication servers as a record of the statements to be sent to replica servers. The source sends the events contained in its binary log to its replicas, which

execute those events to make the same data changes that were made on the source. See [Section 16.2, “Replication Implementation”](#).

- Certain data recovery operations require use of the binary log. After a backup file has been restored, the events in the binary log that were recorded after the backup was made are re-executed. These events bring databases up to date from the point of the backup. See [Section 7.3.2, “Using Backups for Recovery”](#).

However, if logging occurs at the statement level, there are certain binary logging issues with respect to stored programs (stored procedures and functions, triggers, and events):

- In some cases, a statement might affect different sets of rows on source and replica.
- Replicated statements executed on a replica are processed by the replica SQL thread, which has full privileges. It is possible for a procedure to follow different execution paths on source and replica servers, so a user can write a routine containing a dangerous statement that executes only on the replica where it is processed by a thread that has full privileges.
- If a stored program that modifies data is nondeterministic, it is not repeatable. This can result in different data on source and replica, or cause restored data to differ from the original data.

This section describes how MySQL handles binary logging for stored programs. It states the current conditions that the implementation places on the use of stored programs, and what you can do to avoid logging problems. It also provides additional information about the reasons for these conditions.

Unless noted otherwise, the remarks here assume that binary logging is enabled on the server (see [Section 5.4.4, “The Binary Log”](#).) If the binary log is not enabled, replication is not possible, nor is the binary log available for data recovery. In MySQL 5.7, binary logging is not enabled by default, and you enable it using the `--log-bin` option.

In general, the issues described here result when binary logging occurs at the SQL statement level (statement-based binary logging). If you use row-based binary logging, the log contains changes made to individual rows as a result of executing SQL statements. When routines or triggers execute, row changes are logged, not the statements that make the changes. For stored procedures, this means that the `CALL` statement is not logged. For stored functions, row changes made within the function are logged, not the function invocation. For triggers, row changes made by the trigger are logged. On the replica side, only the row changes are seen, not the stored program invocation.

Mixed format binary logging (`binlog_format=MIXED`) uses statement-based binary logging, except for cases where only row-based binary logging is guaranteed to lead to proper results. With mixed format, when a stored function, stored procedure, trigger, event, or prepared statement contains anything that is not safe for statement-based binary logging, the entire statement is marked as unsafe and logged in row format. The statements used to create and drop procedures, functions, triggers, and events are always safe, and are logged in statement format. For more information about row-based, mixed, and statement-based logging, and how safe and unsafe statements are determined, see [Section 16.2.1, “Replication Formats”](#).

The conditions on the use of stored functions in MySQL can be summarized as follows. These conditions do not apply to stored procedures or Event Scheduler events and they do not apply unless binary logging is enabled.

- To create or alter a stored function, you must have the `SUPER` privilege, in addition to the `CREATE ROUTINE` or `ALTER ROUTINE` privilege that is normally required. (Depending on the `DEFINER` value in the function definition, `SUPER` might be required regardless of whether binary logging is enabled. See [Section 13.1.16, “CREATE PROCEDURE and CREATE FUNCTION Statements”](#).)

- When you create a stored function, you must declare either that it is deterministic or that it does not modify data. Otherwise, it may be unsafe for data recovery or replication.

By default, for a `CREATE FUNCTION` statement to be accepted, at least one of `DETERMINISTIC`, `NO SQL`, or `READS SQL DATA` must be specified explicitly. Otherwise an error occurs:

```
ERROR 1418 (HY000): This function has none of DETERMINISTIC, NO SQL,
or READS SQL DATA in its declaration and binary logging is enabled
(you *might* want to use the less safe log_bin_trust_function_creators
variable)
```

This function is deterministic (and does not modify data), so it is safe:

```
CREATE FUNCTION f1(i INT)
RETURNS INT
DETERMINISTIC
READS SQL DATA
BEGIN
    RETURN i;
END;
```

This function uses `UUID()`, which is not deterministic, so the function also is not deterministic and is not safe:

```
CREATE FUNCTION f2()
RETURNS CHAR(36) CHARACTER SET utf8
BEGIN
    RETURN UUID();
END;
```

This function modifies data, so it may not be safe:

```
CREATE FUNCTION f3(p_id INT)
RETURNS INT
BEGIN
    UPDATE t SET modtime = NOW() WHERE id = p_id;
    RETURN ROW_COUNT();
END;
```

Assessment of the nature of a function is based on the “honesty” of the creator. MySQL does not check that a function declared `DETERMINISTIC` is free of statements that produce nondeterministic results.

- When you attempt to execute a stored function, if `binlog_format=STATEMENT` is set, the `DETERMINISTIC` keyword must be specified in the function definition. If this is not the case, an error is generated and the function does not run, unless `log_bin_trust_function_creators=1` is specified to override this check (see below). For recursive function calls, the `DETERMINISTIC` keyword is required on the outermost call only. If row-based or mixed binary logging is in use, the statement is accepted and replicated even if the function was defined without the `DETERMINISTIC` keyword.
- Because MySQL does not check if a function really is deterministic at creation time, the invocation of a stored function with the `DETERMINISTIC` keyword might carry out an action that is unsafe for statement-based logging, or invoke a function or procedure containing unsafe statements. If this occurs when `binlog_format=STATEMENT` is set, a warning message is issued. If row-based or mixed binary logging is in use, no warning is issued, and the statement is replicated in row-based format.
- To relax the preceding conditions on function creation (that you must have the `SUPER` privilege and that a function must be declared deterministic or to not modify data), set the global `log_bin_trust_function_creators` system variable to 1. By default, this variable has a value of 0, but you can change it like this:

```
mysql> SET GLOBAL log_bin_trust_function_creators = 1;
```

You can also set this variable at server startup.

If binary logging is not enabled, `log_bin_trust_function_creators` does not apply. `SUPER` is not required for function creation unless, as described previously, the `DEFINER` value in the function definition requires it.

- For information about built-in functions that may be unsafe for replication (and thus cause stored functions that use them to be unsafe as well), see [Section 16.4.1, “Replication Features and Issues”](#).

Triggers are similar to stored functions, so the preceding remarks regarding functions also apply to triggers with the following exception: `CREATE TRIGGER` does not have an optional `DETERMINISTIC` characteristic, so triggers are assumed to be always deterministic. However, this assumption might be invalid in some cases. For example, the `UUID()` function is nondeterministic (and does not replicate). Be careful about using such functions in triggers.

Triggers can update tables, so error messages similar to those for stored functions occur with `CREATE TRIGGER` if you do not have the required privileges. On the replica side, the replica uses the trigger `DEFINER` attribute to determine which user is considered to be the creator of the trigger.

The rest of this section provides additional detail about the logging implementation and its implications. You need not read it unless you are interested in the background on the rationale for the current logging-related conditions on stored routine use. This discussion applies only for statement-based logging, and not for row-based logging, with the exception of the first item: `CREATE` and `DROP` statements are logged as statements regardless of the logging mode.

- The server writes `CREATE EVENT`, `CREATE PROCEDURE`, `CREATE FUNCTION`, `ALTER EVENT`, `ALTER PROCEDURE`, `ALTER FUNCTION`, `DROP EVENT`, `DROP PROCEDURE`, and `DROP FUNCTION` statements to the binary log.
- A stored function invocation is logged as a `SELECT` statement if the function changes data and occurs within a statement that would not otherwise be logged. This prevents nonreplication of data changes that result from use of stored functions in nonlogged statements. For example, `SELECT` statements are not written to the binary log, but a `SELECT` might invoke a stored function that makes changes. To handle this, a `SELECT func_name()` statement is written to the binary log when the given function makes a change. Suppose that the following statements are executed on the source server:

```
CREATE FUNCTION f1(a INT) RETURNS INT
BEGIN
  IF (a < 3) THEN
    INSERT INTO t2 VALUES (a);
  END IF;
  RETURN 0;
END;

CREATE TABLE t1 (a INT);
INSERT INTO t1 VALUES (1),(2),(3);

SELECT f1(a) FROM t1;
```

When the `SELECT` statement executes, the function `f1()` is invoked three times. Two of those invocations insert a row, and MySQL logs a `SELECT` statement for each of them. That is, MySQL writes the following statements to the binary log:

```
SELECT f1(1);
SELECT f1(2);
```

The server also logs a `SELECT` statement for a stored function invocation when the function invokes a stored procedure that causes an error. In this case, the server writes the `SELECT` statement to the log

along with the expected error code. On the replica, if the same error occurs, that is the expected result and replication continues. Otherwise, replication stops.

- Logging stored function invocations rather than the statements executed by a function has a security implication for replication, which arises from two factors:
  - It is possible for a function to follow different execution paths on source and replica servers.
  - Statements executed on a replica are processed by the replica SQL thread which has full privileges.

The implication is that although a user must have the `CREATE ROUTINE` privilege to create a function, the user can write a function containing a dangerous statement that executes only on the replica where it is processed by a thread that has full privileges. For example, if the source and replica servers have server ID values of 1 and 2, respectively, a user on the source server could create and invoke an unsafe function `unsafe_func()` as follows:

```
mysql> delimiter //
mysql> CREATE FUNCTION unsafe_func () RETURNS INT
-> BEGIN
->   IF @@server_id=2 THEN dangerous_statement; END IF;
->   RETURN 1;
-> END;
-> //
mysql> delimiter ;
mysql> INSERT INTO t VALUES(unsafe_func());
```

The `CREATE FUNCTION` and `INSERT` statements are written to the binary log, so the replica executes them. Because the replica SQL thread has full privileges, it executes the dangerous statement. Thus, the function invocation has different effects on the source and replica and is not replication-safe.

To guard against this danger for servers that have binary logging enabled, stored function creators must have the `SUPER` privilege, in addition to the usual `CREATE ROUTINE` privilege that is required. Similarly, to use `ALTER FUNCTION`, you must have the `SUPER` privilege in addition to the `ALTER ROUTINE` privilege. Without the `SUPER` privilege, an error occurs:

```
ERROR 1419 (HY000): You do not have the SUPER privilege and
binary logging is enabled (you *might* want to use the less safe
log_bin_trust_function_creators variable)
```

If you do not want to require function creators to have the `SUPER` privilege (for example, if all users with the `CREATE ROUTINE` privilege on your system are experienced application developers), set the global `log_bin_trust_function_creators` system variable to 1. You can also set this variable at server startup. If binary logging is not enabled, `log_bin_trust_function_creators` does not apply. `SUPER` is not required for function creation unless, as described previously, the `DEFINER` value in the function definition requires it.

- If a function that performs updates is nondeterministic, it is not repeatable. This can have two undesirable effects:
  - It makes a replica different from the source.
  - Restored data is different from the original data.

To deal with these problems, MySQL enforces the following requirement: On a source server, creation and alteration of a function is refused unless you declare the function to be deterministic or to not modify data. Two sets of function characteristics apply here:

- The `DETERMINISTIC` and `NOT DETERMINISTIC` characteristics indicate whether a function always produces the same result for given inputs. The default is `NOT DETERMINISTIC` if neither

characteristic is given. To declare that a function is deterministic, you must specify `DETERMINISTIC` explicitly.

- The `CONTAINS SQL`, `NO SQL`, `READS SQL DATA`, and `MODIFIES SQL DATA` characteristics provide information about whether the function reads or writes data. Either `NO SQL` or `READS SQL DATA` indicates that a function does not change data, but you must specify one of these explicitly because the default is `CONTAINS SQL` if no characteristic is given.

By default, for a `CREATE FUNCTION` statement to be accepted, at least one of `DETERMINISTIC`, `NO SQL`, or `READS SQL DATA` must be specified explicitly. Otherwise an error occurs:

```
ERROR 1418 (HY000): This function has none of DETERMINISTIC, NO SQL,
or READS SQL DATA in its declaration and binary logging is enabled
(you *might* want to use the less safe log_bin_trust_function_creators
variable)
```

If you set `log_bin_trust_function_creators` to 1, the requirement that functions be deterministic or not modify data is dropped.

- Stored procedure calls are logged at the statement level rather than at the `CALL` level. That is, the server does not log the `CALL` statement, it logs those statements within the procedure that actually execute. As a result, the same changes that occur on the source server are observed on replicas. This prevents problems that could result from a procedure having different execution paths on different machines.

In general, statements executed within a stored procedure are written to the binary log using the same rules that would apply were the statements to be executed in standalone fashion. Some special care is taken when logging procedure statements because statement execution within procedures is not quite the same as in nonprocedure context:

- A statement to be logged might contain references to local procedure variables. These variables do not exist outside of stored procedure context, so a statement that refers to such a variable cannot be logged literally. Instead, each reference to a local variable is replaced by this construct for logging purposes:

```
NAME_CONST(var_name, var_value)
```

`var_name` is the local variable name, and `var_value` is a constant indicating the value that the variable has at the time the statement is logged. `NAME_CONST()` has a value of `var_value`, and a “name” of `var_name`. Thus, if you invoke this function directly, you get a result like this:

```
mysql> SELECT NAME_CONST('myname', 14);
+-----+
| myname |
+-----+
|      14 |
+-----+
```

`NAME_CONST()` enables a logged standalone statement to be executed on a replica with the same effect as the original statement that was executed on the source within a stored procedure.

The use of `NAME_CONST()` can result in a problem for `CREATE TABLE ... SELECT` statements when the source column expressions refer to local variables. Converting these references to `NAME_CONST()` expressions can result in column names that are different on the source and replica

servers, or names that are too long to be legal column identifiers. A workaround is to supply aliases for columns that refer to local variables. Consider this statement when `myvar` has a value of 1:

```
CREATE TABLE t1 SELECT myvar;
```

That is rewritten as follows:

```
CREATE TABLE t1 SELECT NAME_CONST(myvar, 1);
```

To ensure that the source and replica tables have the same column names, write the statement like this:

```
CREATE TABLE t1 SELECT myvar AS myvar;
```

The rewritten statement becomes:

```
CREATE TABLE t1 SELECT NAME_CONST(myvar, 1) AS myvar;
```

- A statement to be logged might contain references to user-defined variables. To handle this, MySQL writes a `SET` statement to the binary log to make sure that the variable exists on the replica with the same value as on the source. For example, if a statement refers to a variable `@my_var`, that statement is preceded in the binary log by the following statement, where `value` is the value of `@my_var` on the source:

```
SET @my_var = value;
```

- Procedure calls can occur within a committed or rolled-back transaction. Transactional context is accounted for so that the transactional aspects of procedure execution are replicated correctly. That is, the server logs those statements within the procedure that actually execute and modify data, and also logs `BEGIN`, `COMMIT`, and `ROLLBACK` statements as necessary. For example, if a procedure updates only transactional tables and is executed within a transaction that is rolled back, those updates are not logged. If the procedure occurs within a committed transaction, `BEGIN` and `COMMIT` statements are logged with the updates. For a procedure that executes within a rolled-back transaction, its statements are logged using the same rules that would apply if the statements were executed in standalone fashion:
  - Updates to transactional tables are not logged.
  - Updates to nontransactional tables are logged because rollback does not cancel them.
  - Updates to a mix of transactional and nontransactional tables are logged surrounded by `BEGIN` and `ROLLBACK` so that replicas make the same changes and rollbacks as on the source.
- A stored procedure call is *not* written to the binary log at the statement level if the procedure is invoked from within a stored function. In that case, the only thing logged is the statement that invokes the function (if it occurs within a statement that is logged) or a `DO` statement (if it occurs within a statement that is not logged). For this reason, care should be exercised in the use of stored functions that invoke a procedure, even if the procedure is otherwise safe in itself.

## 23.8 Restrictions on Stored Programs

- [SQL Statements Not Permitted in Stored Routines](#)
- [Restrictions for Stored Functions](#)
- [Restrictions for Triggers](#)
- [Name Conflicts within Stored Routines](#)



- [Replication Considerations](#)
- [Debugging Considerations](#)
- [Unsupported Syntax from the SQL:2003 Standard](#)
- [Stored Routine Concurrency Considerations](#)
- [Event Scheduler Restrictions](#)
- [Stored Programs in NDB Cluster](#)

These restrictions apply to the features described in [Chapter 23, \*Stored Objects\*](#).

Some of the restrictions noted here apply to all stored routines; that is, both to stored procedures and stored functions. There are also some [restrictions specific to stored functions](#) but not to stored procedures.

The restrictions for stored functions also apply to triggers. There are also some [restrictions specific to triggers](#).

The restrictions for stored procedures also apply to the `DO` clause of Event Scheduler event definitions. There are also some [restrictions specific to events](#).

## SQL Statements Not Permitted in Stored Routines

Stored routines cannot contain arbitrary SQL statements. The following statements are not permitted:

- The locking statements `LOCK TABLES` and `UNLOCK TABLES`.
- `ALTER VIEW`.
- `LOAD DATA` and `LOAD XML`.
- SQL prepared statements (`PREPARE`, `EXECUTE`, `DEALLOCATE PREPARE`) can be used in stored procedures, but not in stored functions or triggers. Thus, stored functions and triggers cannot use dynamic SQL (where you construct statements as strings and then execute them).
- Generally, statements not permitted in SQL prepared statements are also not permitted in stored programs. For a list of statements supported as prepared statements, see [Section 13.5, “Prepared Statements”](#). Exceptions are `SIGNAL`, `RESIGNAL`, and `GET DIAGNOSTICS`, which are not permissible as prepared statements but are permitted in stored programs.
- Because local variables are in scope only during stored program execution, references to them are not permitted in prepared statements created within a stored program. Prepared statement scope is the current session, not the stored program, so the statement could be executed after the program ends, at which point the variables would no longer be in scope. For example, `SELECT ... INTO local_var` cannot be used as a prepared statement. This restriction also applies to stored procedure and function parameters. See [Section 13.5.1, “PREPARE Statement”](#).
- Within all stored programs (stored procedures and functions, triggers, and events), the parser treats `BEGIN [WORK]` as the beginning of a `BEGIN ... END` block.

To begin a transaction within a stored procedure or event, use `START TRANSACTION` instead.

`START TRANSACTION` cannot be used within a stored function or trigger.

## Restrictions for Stored Functions

The following additional statements or operations are not permitted within stored functions. They are permitted within stored procedures, except stored procedures that are invoked from within a stored function

or trigger. For example, if you use `FLUSH` in a stored procedure, that stored procedure cannot be called from a stored function or trigger.

- Statements that perform explicit or implicit commit or rollback. Support for these statements is not required by the SQL standard, which states that each DBMS vendor may decide whether to permit them.
- Statements that return a result set. This includes `SELECT` statements that do not have an `INTO var_list` clause and other statements such as `SHOW`, `EXPLAIN`, and `CHECK TABLE`. A function can process a result set either with `SELECT ... INTO var_list` or by using a cursor and `FETCH` statements. See [Section 13.2.9.1, “SELECT ... INTO Statement”](#), and [Section 13.6.6, “Cursors”](#).
- `FLUSH` statements.
- Stored functions cannot be used recursively.
- A stored function or trigger cannot modify a table that is already being used (for reading or writing) by the statement that invoked the function or trigger.
- If you refer to a temporary table multiple times in a stored function under different aliases, a `Can't reopen table: 'tbl_name'` error occurs, even if the references occur in different statements within the function.
- `HANDLER ... READ` statements that invoke stored functions can cause replication errors and are disallowed.

## Restrictions for Triggers

For triggers, the following additional restrictions apply:

- Triggers are not activated by foreign key actions.
- When using row-based replication, triggers on the replica are not activated by statements originating on the source. The triggers on the replica are activated when using statement-based replication. For more information, see [Section 16.4.1.34, “Replication and Triggers”](#).
- The `RETURN` statement is not permitted in triggers, which cannot return a value. To exit a trigger immediately, use the `LEAVE` statement.
- Triggers are not permitted on tables in the `mysql` database. Nor are they permitted on `INFORMATION_SCHEMA` or `performance_schema` tables. Those tables are actually views and triggers are not permitted on views.
- The trigger cache does not detect when metadata of the underlying objects has changed. If a trigger uses a table and the table has changed since the trigger was loaded into the cache, the trigger operates using the outdated metadata.

## Name Conflicts within Stored Routines

The same identifier might be used for a routine parameter, a local variable, and a table column. Also, the same local variable name can be used in nested blocks. For example:

```
CREATE PROCEDURE p (i INT)
BEGIN
  DECLARE i INT DEFAULT 0;
  SELECT i FROM t;
  BEGIN
    DECLARE i INT DEFAULT 1;
    SELECT i FROM t;
```

```
END ;  
END ;
```

In such cases, the identifier is ambiguous and the following precedence rules apply:

- A local variable takes precedence over a routine parameter or table column.
- A routine parameter takes precedence over a table column.
- A local variable in an inner block takes precedence over a local variable in an outer block.

The behavior that variables take precedence over table columns is nonstandard.

## Replication Considerations

Use of stored routines can cause replication problems. This issue is discussed further in [Section 23.7, “Stored Program Binary Logging”](#).

The `--replicate-wild-do-table=db_name.tbl_name` option applies to tables, views, and triggers. It does not apply to stored procedures and functions, or events. To filter statements operating on the latter objects, use one or more of the `--replicate-*-db` options.

## Debugging Considerations

There are no stored routine debugging facilities.

## Unsupported Syntax from the SQL:2003 Standard

The MySQL stored routine syntax is based on the SQL:2003 standard. The following items from that standard are not currently supported:

- `UNDO` handlers
- `FOR` loops

## Stored Routine Concurrency Considerations

To prevent problems of interaction between sessions, when a client issues a statement, the server uses a snapshot of routines and triggers available for execution of the statement. That is, the server calculates a list of procedures, functions, and triggers that may be used during execution of the statement, loads them, and then proceeds to execute the statement. While the statement executes, it does not see changes to routines performed by other sessions.

For maximum concurrency, stored functions should minimize their side-effects; in particular, updating a table within a stored function can reduce concurrent operations on that table. A stored function acquires table locks before executing, to avoid inconsistency in the binary log due to mismatch of the order in which statements execute and when they appear in the log. When statement-based binary logging is used, statements that invoke a function are recorded rather than the statements executed within the function. Consequently, stored functions that update the same underlying tables do not execute in parallel. In contrast, stored procedures do not acquire table-level locks. All statements executed within stored procedures are written to the binary log, even for statement-based binary logging. See [Section 23.7, “Stored Program Binary Logging”](#).

## Event Scheduler Restrictions

The following limitations are specific to the Event Scheduler:

- Event names are handled in case-insensitive fashion. For example, you cannot have two events in the same database with the names `anEvent` and `AnEvent`.
- An event may not be created, altered, or dropped from within a stored program, if the event name is specified by means of a variable. An event also may not create, alter, or drop stored routines or triggers.
- DDL statements on events are prohibited while a `LOCK TABLES` statement is in effect.
- Event timings using the intervals `YEAR`, `QUARTER`, `MONTH`, and `YEAR_MONTH` are resolved in months; those using any other interval are resolved in seconds. There is no way to cause events scheduled to occur at the same second to execute in a given order. In addition—due to rounding, the nature of threaded applications, and the fact that a nonzero length of time is required to create events and to signal their execution—events may be delayed by as much as 1 or 2 seconds. However, the time shown in the Information Schema `EVENTS` table's `LAST_EXECUTED` column or the `mysql.event` table's `last_executed` column is always accurate to within one second of the actual event execution time. (See also Bug #16522.)
- Each execution of the statements contained in the body of an event takes place in a new connection; thus, these statements have no effect in a given user session on the server's statement counts such as `Com_select` and `Com_insert` that are displayed by `SHOW STATUS`. However, such counts are updated in the global scope. (Bug #16422)
- Events do not support times later than the end of the Unix Epoch; this is approximately the beginning of the year 2038. Such dates are specifically not permitted by the Event Scheduler. (Bug #16396)
- References to stored functions, loadable functions, and tables in the `ON SCHEDULE` clauses of `CREATE EVENT` and `ALTER EVENT` statements are not supported. These sorts of references are not permitted. (See Bug #22830 for more information.)

## Stored Programs in NDB Cluster

While stored procedures, stored functions, triggers, and scheduled events are all supported by tables using the `NDB` storage engine, you must keep in mind that these do *not* propagate automatically between MySQL Servers acting as Cluster SQL nodes. This is because of the following:

- Stored routine definitions are kept in tables in the `mysql` system database using the `MyISAM` storage engine, and so do not participate in clustering.
- The `.TRN` and `.TRG` files containing trigger definitions are not read by the `NDB` storage engine, and are not copied between Cluster nodes.

Any stored routine or trigger that interacts with `NDB` Cluster tables must be re-created by running the appropriate `CREATE PROCEDURE`, `CREATE FUNCTION`, or `CREATE TRIGGER` statements on each MySQL Server that participates in the cluster where you wish to use the stored routine or trigger. Similarly, any changes to existing stored routines or triggers must be carried out explicitly on all Cluster SQL nodes, using the appropriate `ALTER` or `DROP` statements on each MySQL Server accessing the cluster.



### Warning

Do *not* attempt to work around the issue described in the first item mentioned previously by converting any `mysql` database tables to use the `NDB` storage engine. *Altering the system tables in the `mysql` database is not supported* and is very likely to produce undesirable results.

## 23.9 Restrictions on Views

The maximum number of tables that can be referenced in the definition of a view is 61.

View processing is not optimized:

- It is not possible to create an index on a view.
- Indexes can be used for views processed using the merge algorithm. However, a view that is processed with the temptable algorithm is unable to take advantage of indexes on its underlying tables (although indexes can be used during generation of the temporary tables).

Before MySQL 5.7.7, subqueries cannot be used in the `FROM` clause of a view.

There is a general principle that you cannot modify a table and select from the same table in a subquery. See [Section 13.2.10.12, “Restrictions on Subqueries”](#).

The same principle also applies if you select from a view that selects from the table, if the view selects from the table in a subquery and the view is evaluated using the merge algorithm. Example:

```
CREATE VIEW v1 AS
SELECT * FROM t2 WHERE EXISTS (SELECT 1 FROM t1 WHERE t1.a = t2.a);

UPDATE t1, v2 SET t1.a = 1 WHERE t1.b = v2.b;
```

If the view is evaluated using a temporary table, you *can* select from the table in the view subquery and still modify that table in the outer query. In this case the view is stored in a temporary table and thus you are not really selecting from the table in a subquery and modifying it “at the same time.” (This is another reason you might wish to force MySQL to use the temptable algorithm by specifying `ALGORITHM = TEMPTABLE` in the view definition.)

You can use `DROP TABLE` or `ALTER TABLE` to drop or alter a table that is used in a view definition. No warning results from the `DROP` or `ALTER` operation, even though this invalidates the view. Instead, an error occurs later, when the view is used. `CHECK TABLE` can be used to check for views that have been invalidated by `DROP` or `ALTER` operations.

With regard to view updatability, the overall goal for views is that if any view is theoretically updatable, it should be updatable in practice. Many theoretically updatable views can be updated now, but limitations still exist. For details, see [Section 23.5.3, “Updatable and Insertable Views”](#).

There exists a shortcoming with the current implementation of views. If a user is granted the basic privileges necessary to create a view (the `CREATE VIEW` and `SELECT` privileges), that user cannot call `SHOW CREATE VIEW` on that object unless the user is also granted the `SHOW VIEW` privilege.

That shortcoming can lead to problems backing up a database with `mysqldump`, which may fail due to insufficient privileges. This problem is described in Bug #22062.

The workaround to the problem is for the administrator to manually grant the `SHOW VIEW` privilege to users who are granted `CREATE VIEW`, since MySQL does not grant it implicitly when views are created.

Views do not have indexes, so index hints do not apply. Use of index hints when selecting from a view is not permitted.

`SHOW CREATE VIEW` displays view definitions using an `AS alias_name` clause for each column. If a column is created from an expression, the default alias is the expression text, which can be quite long. Aliases for column names in `CREATE VIEW` statements are checked against the maximum column length of 64 characters (not the maximum alias length of 256 characters). As a result, views created from the output of `SHOW CREATE VIEW` fail if any column alias exceeds 64 characters. This can cause problems in the following circumstances for views with too-long aliases:

- View definitions fail to replicate to newer replicas that enforce the column-length restriction.
- Dump files created with `mysqldump` cannot be loaded into servers that enforce the column-length restriction.

A workaround for either problem is to modify each problematic view definition to use aliases that provide shorter column names. Then the view replicates properly, and can be dumped and reloaded without causing an error. To modify the definition, drop and create the view again with `DROP VIEW` and `CREATE VIEW`, or replace the definition with `CREATE OR REPLACE VIEW`.

For problems that occur when reloading view definitions in dump files, another workaround is to edit the dump file to modify its `CREATE VIEW` statements. However, this does not change the original view definitions, which may cause problems for subsequent dump operations.

---

# Chapter 24 INFORMATION\_SCHEMA Tables

## Table of Contents

24.1 Introduction .....	4098
24.2 INFORMATION_SCHEMA Table Reference .....	4101
24.3 INFORMATION_SCHEMA General Tables .....	4105
24.3.1 INFORMATION_SCHEMA General Table Reference .....	4105
24.3.2 The INFORMATION_SCHEMA CHARACTER_SETS Table .....	4106
24.3.3 The INFORMATION_SCHEMA COLLATIONS Table .....	4106
24.3.4 The INFORMATION_SCHEMA COLLATION_CHARACTER_SET_APPLICABILITY Table .....	4107
24.3.5 The INFORMATION_SCHEMA COLUMNS Table .....	4107
24.3.6 The INFORMATION_SCHEMA COLUMN_PRIVILEGES Table .....	4110
24.3.7 The INFORMATION_SCHEMA ENGINES Table .....	4111
24.3.8 The INFORMATION_SCHEMA EVENTS Table .....	4112
24.3.9 The INFORMATION_SCHEMA FILES Table .....	4116
24.3.10 The INFORMATION_SCHEMA GLOBAL_STATUS and SESSION_STATUS Tables ....	4123
24.3.11 The INFORMATION_SCHEMA GLOBAL_VARIABLES and SESSION_VARIABLES Tables .....	4123
24.3.12 The INFORMATION_SCHEMA KEY_COLUMN_USAGE Table .....	4124
24.3.13 The INFORMATION_SCHEMA ndb_transid_mysql_connection_map Table .....	4125
24.3.14 The INFORMATION_SCHEMA OPTIMIZER_TRACE Table .....	4126
24.3.15 The INFORMATION_SCHEMA PARAMETERS Table .....	4127
24.3.16 The INFORMATION_SCHEMA PARTITIONS Table .....	4128
24.3.17 The INFORMATION_SCHEMA PLUGINS Table .....	4132
24.3.18 The INFORMATION_SCHEMA PROCESSLIST Table .....	4133
24.3.19 The INFORMATION_SCHEMA PROFILING Table .....	4134
24.3.20 The INFORMATION_SCHEMA REFERENTIAL_CONSTRAINTS Table .....	4135
24.3.21 The INFORMATION_SCHEMA ROUTINES Table .....	4136
24.3.22 The INFORMATION_SCHEMA SCHEMATA Table .....	4139
24.3.23 The INFORMATION_SCHEMA SCHEMA_PRIVILEGES Table .....	4140
24.3.24 The INFORMATION_SCHEMA STATISTICS Table .....	4141
24.3.25 The INFORMATION_SCHEMA TABLES Table .....	4142
24.3.26 The INFORMATION_SCHEMA TABLESPACES Table .....	4146
24.3.27 The INFORMATION_SCHEMA TABLE_CONSTRAINTS Table .....	4146
24.3.28 The INFORMATION_SCHEMA TABLE_PRIVILEGES Table .....	4147
24.3.29 The INFORMATION_SCHEMA TRIGGERS Table .....	4148
24.3.30 The INFORMATION_SCHEMA USER_PRIVILEGES Table .....	4150
24.3.31 The INFORMATION_SCHEMA VIEWS Table .....	4150
24.4 INFORMATION_SCHEMA InnoDB Tables .....	4152
24.4.1 INFORMATION_SCHEMA InnoDB Table Reference .....	4152
24.4.2 The INFORMATION_SCHEMA INNODB_BUFFER_PAGE Table .....	4154
24.4.3 The INFORMATION_SCHEMA INNODB_BUFFER_PAGE_LRU Table .....	4157
24.4.4 The INFORMATION_SCHEMA INNODB_BUFFER_POOL_STATS Table .....	4160
24.4.5 The INFORMATION_SCHEMA INNODB_CMP and INNODB_CMP_RESET Tables .....	4163
24.4.6 The INFORMATION_SCHEMA INNODB_CMPMEM and INNODB_CMPMEM_RESET Tables .....	4164
24.4.7 The INFORMATION_SCHEMA INNODB_CMP_PER_INDEX and INNODB_CMP_PER_INDEX_RESET Tables .....	4166
24.4.8 The INFORMATION_SCHEMA INNODB_FT_BEING_DELETED Table .....	4167
24.4.9 The INFORMATION_SCHEMA INNODB_FT_CONFIG Table .....	4168

24.4.10	The INFORMATION_SCHEMA INNODB_FT_DEFAULT_STOPWORD Table .....	4169
24.4.11	The INFORMATION_SCHEMA INNODB_FT_DELETED Table .....	4170
24.4.12	The INFORMATION_SCHEMA INNODB_FT_INDEX_CACHE Table .....	4171
24.4.13	The INFORMATION_SCHEMA INNODB_FT_INDEX_TABLE Table .....	4173
24.4.14	The INFORMATION_SCHEMA INNODB_LOCKS Table .....	4174
24.4.15	The INFORMATION_SCHEMA INNODB_LOCK_WAITS Table .....	4176
24.4.16	The INFORMATION_SCHEMA INNODB_METRICS Table .....	4177
24.4.17	The INFORMATION_SCHEMA INNODB_SYS_COLUMNS Table .....	4179
24.4.18	The INFORMATION_SCHEMA INNODB_SYS_DATAFILES Table .....	4180
24.4.19	The INFORMATION_SCHEMA INNODB_SYS_FIELDS Table .....	4181
24.4.20	The INFORMATION_SCHEMA INNODB_SYS_FOREIGN Table .....	4182
24.4.21	The INFORMATION_SCHEMA INNODB_SYS_FOREIGN_COLS Table .....	4183
24.4.22	The INFORMATION_SCHEMA INNODB_SYS_INDEXES Table .....	4183
24.4.23	The INFORMATION_SCHEMA INNODB_SYS_TABLES Table .....	4185
24.4.24	The INFORMATION_SCHEMA INNODB_SYS_TABLESPACES Table .....	4186
24.4.25	The INFORMATION_SCHEMA INNODB_SYS_TABLESTATS View .....	4188
24.4.26	The INFORMATION_SCHEMA INNODB_SYS_VIRTUAL Table .....	4189
24.4.27	The INFORMATION_SCHEMA INNODB_TEMP_TABLE_INFO Table .....	4190
24.4.28	The INFORMATION_SCHEMA INNODB_TRX Table .....	4192
24.5	INFORMATION_SCHEMA Thread Pool Tables .....	4194
24.5.1	INFORMATION_SCHEMA Thread Pool Table Reference .....	4195
24.5.2	The INFORMATION_SCHEMA TP_THREAD_GROUP_STATE Table .....	4195
24.5.3	The INFORMATION_SCHEMA TP_THREAD_GROUP_STATS Table .....	4197
24.5.4	The INFORMATION_SCHEMA TP_THREAD_STATE Table .....	4199
24.6	INFORMATION_SCHEMA Connection Control Tables .....	4199
24.6.1	INFORMATION_SCHEMA Connection Control Table Reference .....	4199
24.6.2	The INFORMATION_SCHEMA CONNECTION_CONTROL_FAILED_LOGIN_ATTEMPTS Table .....	4200
24.7	INFORMATION_SCHEMA MySQL Enterprise Firewall Tables .....	4200
24.7.1	INFORMATION_SCHEMA Firewall Table Reference .....	4200
24.7.2	The INFORMATION_SCHEMA MYSQL_FIREWALL_USERS Table .....	4201
24.7.3	The INFORMATION_SCHEMA MYSQL_FIREWALL_WHITELIST Table .....	4201
24.8	Extensions to SHOW Statements .....	4201

[INFORMATION\\_SCHEMA](#) provides access to database *metadata*, information about the MySQL server such as the name of a database or table, the data type of a column, or access privileges. Other terms that are sometimes used for this information are *data dictionary* and *system catalog*.

## 24.1 Introduction

[INFORMATION\\_SCHEMA](#) provides access to database *metadata*, information about the MySQL server such as the name of a database or table, the data type of a column, or access privileges. Other terms that are sometimes used for this information are *data dictionary* and *system catalog*.

- [INFORMATION\\_SCHEMA Usage Notes](#)
- [Character Set Considerations](#)
- [INFORMATION\\_SCHEMA as Alternative to SHOW Statements](#)
- [INFORMATION\\_SCHEMA and Privileges](#)
- [Performance Considerations](#)
- [Standards Considerations](#)



- [Conventions in the INFORMATION\\_SCHEMA Reference Sections](#)
- [Related Information](#)

## INFORMATION\_SCHEMA Usage Notes

`INFORMATION_SCHEMA` is a database within each MySQL instance, the place that stores information about all the other databases that the MySQL server maintains. The `INFORMATION_SCHEMA` database contains several read-only tables. They are actually views, not base tables, so there are no files associated with them, and you cannot set triggers on them. Also, there is no database directory with that name.

Although you can select `INFORMATION_SCHEMA` as the default database with a `USE` statement, you can only read the contents of tables, not perform `INSERT`, `UPDATE`, or `DELETE` operations on them.

Here is an example of a statement that retrieves information from `INFORMATION_SCHEMA`:

```
mysql> SELECT table_name, table_type, engine
FROM information_schema.tables
WHERE table_schema = 'db5'
ORDER BY table_name;
```

table_name	table_type	engine
fk	BASE TABLE	InnoDB
fk2	BASE TABLE	InnoDB
goto	BASE TABLE	MyISAM
into	BASE TABLE	MyISAM
k	BASE TABLE	MyISAM
kurs	BASE TABLE	MyISAM
loop	BASE TABLE	MyISAM
pk	BASE TABLE	InnoDB
t	BASE TABLE	MyISAM
t2	BASE TABLE	MyISAM
t3	BASE TABLE	MyISAM
t7	BASE TABLE	MyISAM
tables	BASE TABLE	MyISAM
v	VIEW	NULL
v2	VIEW	NULL
v3	VIEW	NULL
v56	VIEW	NULL

17 rows in set (0.01 sec)

Explanation: The statement requests a list of all the tables in database `db5`, showing just three pieces of information: the name of the table, its type, and its storage engine.

## Character Set Considerations

The definition for character columns (for example, `TABLES.TABLE_NAME`) is generally `VARCHAR(N) CHARACTER SET utf8` where `N` is at least 64. MySQL uses the default collation for this character set (`utf8_general_ci`) for all searches, sorts, comparisons, and other string operations on such columns.

Because some MySQL objects are represented as files, searches in `INFORMATION_SCHEMA` string columns can be affected by file system case sensitivity. For more information, see [Section 10.8.7, “Using Collation in INFORMATION\\_SCHEMA Searches”](#).

## INFORMATION\_SCHEMA as Alternative to SHOW Statements

The `SELECT ... FROM INFORMATION_SCHEMA` statement is intended as a more consistent way to provide access to the information provided by the various `SHOW` statements that MySQL supports (`SHOW DATABASES`, `SHOW TABLES`, and so forth). Using `SELECT` has these advantages, compared to `SHOW`:

- It conforms to Codd's rules, because all access is done on tables.
- You can use the familiar syntax of the `SELECT` statement, and only need to learn some table and column names.
- The implementor need not worry about adding keywords.
- You can filter, sort, concatenate, and transform the results from `INFORMATION_SCHEMA` queries into whatever format your application needs, such as a data structure or a text representation to parse.
- This technique is more interoperable with other database systems. For example, Oracle Database users are familiar with querying tables in the Oracle data dictionary.

Because `SHOW` is familiar and widely used, the `SHOW` statements remain as an alternative. In fact, along with the implementation of `INFORMATION_SCHEMA`, there are enhancements to `SHOW` as described in [Section 24.8, “Extensions to SHOW Statements”](#).

## INFORMATION\_SCHEMA and Privileges

For most `INFORMATION_SCHEMA` tables, each MySQL user has the right to access them, but can see only the rows in the tables that correspond to objects for which the user has the proper access privileges. In some cases (for example, the `ROUTINE_DEFINITION` column in the `INFORMATION_SCHEMA ROUTINES` table), users who have insufficient privileges see `NULL`. Some tables have different privilege requirements; for these, the requirements are mentioned in the applicable table descriptions. For example, InnoDB tables (tables with names that begin with `INNODB_`) require the `PROCESS` privilege.

The same privileges apply to selecting information from `INFORMATION_SCHEMA` and viewing the same information through `SHOW` statements. In either case, you must have some privilege on an object to see information about it.

## Performance Considerations

`INFORMATION_SCHEMA` queries that search for information from more than one database might take a long time and impact performance. To check the efficiency of a query, you can use `EXPLAIN`. For information about using `EXPLAIN` output to tune `INFORMATION_SCHEMA` queries, see [Section 8.2.3, “Optimizing INFORMATION\\_SCHEMA Queries”](#).

## Standards Considerations

The implementation for the `INFORMATION_SCHEMA` table structures in MySQL follows the ANSI/ISO SQL:2003 standard Part 11 *Schemata*. Our intent is approximate compliance with SQL:2003 core feature F021 *Basic information schema*.

Users of SQL Server 2000 (which also follows the standard) may notice a strong similarity. However, MySQL has omitted many columns that are not relevant for our implementation, and added columns that are MySQL-specific. One such added column is the `ENGINE` column in the `INFORMATION_SCHEMA TABLES` table.

Although other DBMSs use a variety of names, like `syscat` or `system`, the standard name is `INFORMATION_SCHEMA`.

To avoid using any name that is reserved in the standard or in DB2, SQL Server, or Oracle, we changed the names of some columns marked “MySQL extension”. (For example, we changed `COLLATION` to `TABLE_COLLATION` in the `TABLES` table.) See the list of reserved words near the end of this article: <https://web.archive.org/web/20070428032454/http://www.dbazine.com/db2/db2-disarticles/gulutzan5>.

## Conventions in the INFORMATION\_SCHEMA Reference Sections

The following sections describe each of the tables and columns in `INFORMATION_SCHEMA`. For each column, there are three pieces of information:

- “`INFORMATION_SCHEMA` Name” indicates the name for the column in the `INFORMATION_SCHEMA` table. This corresponds to the standard SQL name unless the “Remarks” field says “MySQL extension.”
- “`SHOW` Name” indicates the equivalent field name in the closest `SHOW` statement, if there is one.
- “Remarks” provides additional information where applicable. If this field is `NULL`, it means that the value of the column is always `NULL`. If this field says “MySQL extension,” the column is a MySQL extension to standard SQL.

Many sections indicate what `SHOW` statement is equivalent to a `SELECT` that retrieves information from `INFORMATION_SCHEMA`. For `SHOW` statements that display information for the default database if you omit a `FROM db_name` clause, you can often select information for the default database by adding an `AND TABLE_SCHEMA = SCHEMA()` condition to the `WHERE` clause of a query that retrieves information from an `INFORMATION_SCHEMA` table.

## Related Information

These sections discuss additional `INFORMATION_SCHEMA`-related topics:

- information about `INFORMATION_SCHEMA` tables specific to the InnoDB storage engine: [Section 24.4, “INFORMATION\\_SCHEMA InnoDB Tables”](#)
- information about `INFORMATION_SCHEMA` tables specific to the thread pool plugin: [Section 24.5, “INFORMATION\\_SCHEMA Thread Pool Tables”](#)
- information about `INFORMATION_SCHEMA` tables specific to the `CONNECTION_CONTROL` plugin: [Section 24.6, “INFORMATION\\_SCHEMA Connection Control Tables”](#)
- Answers to questions that are often asked concerning the `INFORMATION_SCHEMA` database: [Section A.7, “MySQL 5.7 FAQ: INFORMATION\\_SCHEMA”](#)
- `INFORMATION_SCHEMA` queries and the optimizer: [Section 8.2.3, “Optimizing INFORMATION\\_SCHEMA Queries”](#)
- The effect of collation on `INFORMATION_SCHEMA` comparisons: [Section 10.8.7, “Using Collation in INFORMATION\\_SCHEMA Searches”](#)

## 24.2 INFORMATION\_SCHEMA Table Reference

The following table summarizes all available `INFORMATION_SCHEMA` tables. For greater detail, see the individual table descriptions.

**Table 24.1 INFORMATION\_SCHEMA Tables**

Table Name	Description	Introduced	Deprecated
<code>CHARACTER_SETS</code>	Available character sets		
<code>COLLATION_CHARACTER</code>	Character set applicable to each collation		
<code>COLLATIONS</code>	Collations for each character set		

INFORMATION\_SCHEMA Table Reference

Table Name	Description	Introduced	Deprecated
<a href="#">COLUMN_PRIVILEGES</a>	Privileges defined on columns		
<a href="#">COLUMNS</a>	Columns in each table		
<a href="#">CONNECTION_CONTROL_FAILED_ATTEMPTS</a>	Current number of consecutive failed connection attempts per account	5.7.17	
<a href="#">ENGINES</a>	Storage engine properties		
<a href="#">EVENTS</a>	Event Manager events		
<a href="#">FILES</a>	Files that store tablespace data		
<a href="#">GLOBAL_STATUS</a>	Global status variables		
<a href="#">GLOBAL_VARIABLES</a>	Global system variables		
<a href="#">INNODB_BUFFER_PAGE</a>	Pages in InnoDB buffer pool		
<a href="#">INNODB_BUFFER_PAGE_LRU</a>	LRU ordering of pages in InnoDB buffer pool		
<a href="#">INNODB_BUFFER_POOL_STATS</a>	InnoDB buffer pool statistics		
<a href="#">INNODB_CMP</a>	Status for operations related to compressed InnoDB tables		
<a href="#">INNODB_CMP_PER_INDEX</a>	Status for operations related to compressed InnoDB tables and indexes		
<a href="#">INNODB_CMP_PER_INDEX_STATS</a>	Status for operations related to compressed InnoDB tables and indexes		
<a href="#">INNODB_CMP_RESET</a>	Status for operations related to compressed InnoDB tables		
<a href="#">INNODB_CMPMEM</a>	Status for compressed pages within InnoDB buffer pool		
<a href="#">INNODB_CMPMEM_RESET</a>	Status for compressed pages within InnoDB buffer pool		
<a href="#">INNODB_FT_BEING_DELETED</a>	Snapshot of INNODB_FT_DELETED table		
<a href="#">INNODB_FT_CONFIG</a>	Metadata for InnoDB table FULLTEXT		

Table Name	Description	Introduced	Deprecated
	index and associated processing		
INNODB_FT_DEFAULT_STOPWORDS	Default list of stopwords for InnoDB FULLTEXT indexes		
INNODB_FT_DELETED	Rows deleted from InnoDB table FULLTEXT index		
INNODB_FT_INDEX_CACHE	Token information for newly inserted rows in InnoDB FULLTEXT index		
INNODB_FT_INDEX_TABLE	Inverted index information for processing text searches against InnoDB table FULLTEXT index		
INNODB_LOCK_WAITS	InnoDB transaction lock-wait information		5.7.14
INNODB_LOCKS	InnoDB transaction lock information		5.7.14
INNODB_METRICS	InnoDB performance information		
INNODB_SYS_COLUMNS	Columns in each InnoDB table		
INNODB_SYS_DATAFILES	Data file path information for InnoDB file-per-table and general tablespaces		
INNODB_SYS_FIELDS	Key columns of InnoDB indexes		
INNODB_SYS_FOREIGN	InnoDB foreign-key metadata		
INNODB_SYS_FOREIGN_COLUMNS	InnoDB foreign-key column status information		
INNODB_SYS_INDEXES	InnoDB index metadata		
INNODB_SYS_TABLES	InnoDB table metadata		
INNODB_SYS_TABLESPACES	InnoDB file-per-table, general, and undo tablespace metadata		
INNODB_SYS_TABLESTATS	InnoDB table low-level status information		
INNODB_SYS_VIRTUAL	InnoDB virtual generated column metadata		
INNODB_TEMP_TABLE_INFO	Information about active user-created InnoDB temporary tables		

INFORMATION\_SCHEMA Table Reference

Table Name	Description	Introduced	Deprecated
INNODB_TRX	Active InnoDB transaction information		
KEY_COLUMN_USAGE	Which key columns have constraints		
MYSQL_FIREWALL_USERS	Firewall in-memory data for account profiles		
MYSQL_FIREWALL_WHITELIST	Firewall in-memory data for account profile allowlists		
ndb_transid_mysql_connections	NDB transaction information		
OPTIMIZER_TRACE	Information produced by optimizer trace activity		
PARAMETERS	Stored routine parameters and stored function return values		
PARTITIONS	Table partition information		
PLUGINS	Plugin information		
PROCESSLIST	Information about currently executing threads		
PROFILING	Statement profiling information		
REFERENTIAL_CONSTRAINTS	Foreign key information		
ROUTINES	Stored routine information		
SCHEMA_PRIVILEGES	Privileges defined on schemas		
SCHEMATA	Schema information		
SESSION_STATUS	Status variables for current session		
SESSION_VARIABLES	System variables for current session		
STATISTICS	Table index statistics		
TABLE_CONSTRAINTS	Which tables have constraints		
TABLE_PRIVILEGES	Privileges defined on tables		
TABLES	Table information		
TABLESPACES	Tablespace information		
TP_THREAD_GROUP_STATES	Thread pool thread group states		

Table Name	Description	Introduced	Deprecated
<a href="#">TP_THREAD_GROUP_STATISTICS</a>	Thread pool thread group statistics		
<a href="#">TP_THREAD_STATE</a>	Thread pool thread information		
<a href="#">TRIGGERS</a>	Trigger information		
<a href="#">USER_PRIVILEGES</a>	Privileges defined globally per user		
<a href="#">VIEWS</a>	View information		

## 24.3 INFORMATION\_SCHEMA General Tables

The following sections describe what may be denoted as the “general” set of [INFORMATION\\_SCHEMA](#) tables. These are the tables not associated with particular storage engines, components, or plugins.

### 24.3.1 INFORMATION\_SCHEMA General Table Reference

The following table summarizes [INFORMATION\\_SCHEMA](#) general tables. For greater detail, see the individual table descriptions.

**Table 24.2 INFORMATION\_SCHEMA General Tables**

Table Name	Description
<a href="#">CHARACTER_SETS</a>	Available character sets
<a href="#">COLLATION_CHARACTER_SET_APPLICABILITY</a>	Character set applicable to each collation
<a href="#">COLLATIONS</a>	Collations for each character set
<a href="#">COLUMN_PRIVILEGES</a>	Privileges defined on columns
<a href="#">COLUMNS</a>	Columns in each table
<a href="#">ENGINES</a>	Storage engine properties
<a href="#">EVENTS</a>	Event Manager events
<a href="#">FILES</a>	Files that store tablespace data
<a href="#">GLOBAL_STATUS</a>	Global status variables
<a href="#">GLOBAL_VARIABLES</a>	Global system variables
<a href="#">KEY_COLUMN_USAGE</a>	Which key columns have constraints
<a href="#">ndb_transid_mysql_connection_map</a>	NDB transaction information
<a href="#">OPTIMIZER_TRACE</a>	Information produced by optimizer trace activity
<a href="#">PARAMETERS</a>	Stored routine parameters and stored function return values
<a href="#">PARTITIONS</a>	Table partition information
<a href="#">PLUGINS</a>	Plugin information
<a href="#">PROCESSLIST</a>	Information about currently executing threads
<a href="#">PROFILING</a>	Statement profiling information
<a href="#">REFERENTIAL_CONSTRAINTS</a>	Foreign key information
<a href="#">ROUTINES</a>	Stored routine information

Table Name	Description
<a href="#">SCHEMA_PRIVILEGES</a>	Privileges defined on schemas
<a href="#">SCHEMATA</a>	Schema information
<a href="#">SESSION_STATUS</a>	Status variables for current session
<a href="#">SESSION_VARIABLES</a>	System variables for current session
<a href="#">STATISTICS</a>	Table index statistics
<a href="#">TABLE_CONSTRAINTS</a>	Which tables have constraints
<a href="#">TABLE_PRIVILEGES</a>	Privileges defined on tables
<a href="#">TABLES</a>	Table information
<a href="#">TABLESPACES</a>	Tablespace information
<a href="#">TRIGGERS</a>	Trigger information
<a href="#">USER_PRIVILEGES</a>	Privileges defined globally per user
<a href="#">VIEWS</a>	View information

### 24.3.2 The INFORMATION\_SCHEMA CHARACTER\_SETS Table

The [CHARACTER\\_SETS](#) table provides information about available character sets.

The [CHARACTER\\_SETS](#) table has these columns:

- [CHARACTER\\_SET\\_NAME](#)

The character set name.

- [DEFAULT\\_COLLATE\\_NAME](#)

The default collation for the character set.

- [DESCRIPTION](#)

A description of the character set.

- [MAXLEN](#)

The maximum number of bytes required to store one character.

#### Notes

Character set information is also available from the [SHOW CHARACTER SET](#) statement. See [Section 13.7.5.3, “SHOW CHARACTER SET Statement”](#). The following statements are equivalent:

```
SELECT * FROM INFORMATION_SCHEMA.CHARACTER_SETS
  [WHERE CHARACTER_SET_NAME LIKE 'wild']

SHOW CHARACTER SET
  [LIKE 'wild']
```

### 24.3.3 The INFORMATION\_SCHEMA COLLATIONS Table

The [COLLATIONS](#) table provides information about collations for each character set.

The [COLLATIONS](#) table has these columns:



- [COLLATION\\_NAME](#)  
The collation name.
- [CHARACTER\\_SET\\_NAME](#)  
The name of the character set with which the collation is associated.
- [ID](#)  
The collation ID.
- [IS\\_DEFAULT](#)  
Whether the collation is the default for its character set.
- [IS\\_COMPILED](#)  
Whether the character set is compiled into the server.
- [SORTLEN](#)  
This is related to the amount of memory required to sort strings expressed in the character set.

## Notes

Collation information is also available from the [SHOW COLLATION](#) statement. See [Section 13.7.5.4, “SHOW COLLATION Statement”](#). The following statements are equivalent:

```
SELECT COLLATION_NAME FROM INFORMATION_SCHEMA.COLLATIONS
  [WHERE COLLATION_NAME LIKE 'wild']

SHOW COLLATION
  [LIKE 'wild']
```

## 24.3.4 The INFORMATION\_SCHEMA COLLATION\_CHARACTER\_SET\_APPLICABILITY Table

The [COLLATION\\_CHARACTER\\_SET\\_APPLICABILITY](#) table indicates what character set is applicable for what collation.

The [COLLATION\\_CHARACTER\\_SET\\_APPLICABILITY](#) table has these columns:

- [COLLATION\\_NAME](#)  
The collation name.
- [CHARACTER\\_SET\\_NAME](#)  
The name of the character set with which the collation is associated.

## Notes

The [COLLATION\\_CHARACTER\\_SET\\_APPLICABILITY](#) columns are equivalent to the first two columns displayed by the [SHOW COLLATION](#) statement.

## 24.3.5 The INFORMATION\_SCHEMA COLUMNS Table

The [COLUMNS](#) table provides information about columns in tables.

The `COLUMNS` table has these columns:

- `TABLE_CATALOG`

The name of the catalog to which the table containing the column belongs. This value is always `def`.

- `TABLE_SCHEMA`

The name of the schema (database) to which the table containing the column belongs.

- `TABLE_NAME`

The name of the table containing the column.

- `COLUMN_NAME`

The name of the column.

- `ORDINAL_POSITION`

The position of the column within the table. `ORDINAL_POSITION` is necessary because you might want to say `ORDER BY ORDINAL_POSITION`. Unlike `SHOW COLUMNS`, `SELECT` from the `COLUMNS` table does not have automatic ordering.

- `COLUMN_DEFAULT`

The default value for the column. This is `NULL` if the column has an explicit default of `NULL`, or if the column definition includes no `DEFAULT` clause.

- `IS_NULLABLE`

The column nullability. The value is `YES` if `NULL` values can be stored in the column, `NO` if not.

- `DATA_TYPE`

The column data type.

The `DATA_TYPE` value is the type name only with no other information. The `COLUMN_TYPE` value contains the type name and possibly other information such as the precision or length.

- `CHARACTER_MAXIMUM_LENGTH`

For string columns, the maximum length in characters.

- `CHARACTER_OCTET_LENGTH`

For string columns, the maximum length in bytes.

- `NUMERIC_PRECISION`

For numeric columns, the numeric precision.

- `NUMERIC_SCALE`

For numeric columns, the numeric scale.

- `DATETIME_PRECISION`

For temporal columns, the fractional seconds precision.

- `CHARACTER_SET_NAME`

For character string columns, the character set name.

- `COLLATION_NAME`

For character string columns, the collation name.

- `COLUMN_TYPE`

The column data type.

The `DATA_TYPE` value is the type name only with no other information. The `COLUMN_TYPE` value contains the type name and possibly other information such as the precision or length.

- `COLUMN_KEY`

Whether the column is indexed:

- If `COLUMN_KEY` is empty, the column either is not indexed or is indexed only as a secondary column in a multiple-column, nonunique index.
- If `COLUMN_KEY` is `PRI`, the column is a `PRIMARY KEY` or is one of the columns in a multiple-column `PRIMARY KEY`.
- If `COLUMN_KEY` is `UNI`, the column is the first column of a `UNIQUE` index. (A `UNIQUE` index permits multiple `NULL` values, but you can tell whether the column permits `NULL` by checking the `Null` column.)
- If `COLUMN_KEY` is `MUL`, the column is the first column of a nonunique index in which multiple occurrences of a given value are permitted within the column.

If more than one of the `COLUMN_KEY` values applies to a given column of a table, `COLUMN_KEY` displays the one with the highest priority, in the order `PRI`, `UNI`, `MUL`.

A `UNIQUE` index may be displayed as `PRI` if it cannot contain `NULL` values and there is no `PRIMARY KEY` in the table. A `UNIQUE` index may display as `MUL` if several columns form a composite `UNIQUE` index; although the combination of the columns is unique, each column can still hold multiple occurrences of a given value.

- `EXTRA`

Any additional information that is available about a given column. The value is nonempty in these cases:

- `auto_increment` for columns that have the `AUTO_INCREMENT` attribute.
- `on update CURRENT_TIMESTAMP` for `TIMESTAMP` or `DATETIME` columns that have the `ON UPDATE CURRENT_TIMESTAMP` attribute.
- `STORED GENERATED` or `VIRTUAL GENERATED` for generated columns.

- `PRIVILEGES`

The privileges you have for the column.

- `COLUMN_COMMENT`

Any comment included in the column definition.

- [GENERATION\\_EXPRESSION](#)

For generated columns, displays the expression used to compute column values. Empty for nongenerated columns. For information about generated columns, see [Section 13.1.18.7, “CREATE TABLE and Generated Columns”](#).

## Notes

- In `SHOW COLUMNS`, the `Type` display includes values from several different `COLUMNS` columns.
- `CHARACTER_OCTET_LENGTH` should be the same as `CHARACTER_MAXIMUM_LENGTH`, except for multibyte character sets.
- `CHARACTER_SET_NAME` can be derived from `COLLATION_NAME`. For example, if you say `SHOW FULL COLUMNS FROM t`, and you see in the `COLLATION_NAME` column a value of `latin1_swedish_ci`, the character set is what is before the first underscore: `latin1`.

Column information is also available from the `SHOW COLUMNS` statement. See [Section 13.7.5.5, “SHOW COLUMNS Statement”](#). The following statements are nearly equivalent:

```
SELECT COLUMN_NAME, DATA_TYPE, IS_NULLABLE, COLUMN_DEFAULT
FROM INFORMATION_SCHEMA.COLUMNS
WHERE table_name = 'tbl_name'
[AND table_schema = 'db_name']
[AND column_name LIKE 'wild']

SHOW COLUMNS
FROM tbl_name
[FROM db_name]
[LIKE 'wild']
```

## 24.3.6 The INFORMATION\_SCHEMA COLUMN\_PRIVILEGES Table

The `COLUMN_PRIVILEGES` table provides information about column privileges. It takes its values from the `mysql.columns_priv` system table.

The `COLUMN_PRIVILEGES` table has these columns:

- [GRANTEE](#)

The name of the account to which the privilege is granted, in `'user_name'@'host_name'` format.

- [TABLE\\_CATALOG](#)

The name of the catalog to which the table containing the column belongs. This value is always `def`.

- [TABLE\\_SCHEMA](#)

The name of the schema (database) to which the table containing the column belongs.

- [TABLE\\_NAME](#)

The name of the table containing the column.

- [COLUMN\\_NAME](#)

The name of the column.

- [PRIVILEGE\\_TYPE](#)

The privilege granted. The value can be any privilege that can be granted at the column level; see [Section 13.7.1.4, “GRANT Statement”](#). Each row lists a single privilege, so there is one row per column privilege held by the grantee.

In the output from `SHOW FULL COLUMNS`, the privileges are all in one column and in lowercase, for example, `select,insert,update,references`. In `COLUMN_PRIVILEGES`, there is one privilege per row, in uppercase.

- `IS_GRANTABLE`

`YES` if the user has the `GRANT OPTION` privilege, `NO` otherwise. The output does not list `GRANT OPTION` as a separate row with `PRIVILEGE_TYPE='GRANT OPTION'`.

## Notes

- `COLUMN_PRIVILEGES` is a nonstandard `INFORMATION_SCHEMA` table.

The following statements are *not* equivalent:

```
SELECT ... FROM INFORMATION_SCHEMA.COLUMN_PRIVILEGES
SHOW GRANTS ...
```

## 24.3.7 The INFORMATION\_SCHEMA ENGINES Table

The `ENGINES` table provides information about storage engines. This is particularly useful for checking whether a storage engine is supported, or to see what the default engine is.

The `ENGINES` table has these columns:

- `ENGINE`

The name of the storage engine.

- `SUPPORT`

The server's level of support for the storage engine, as shown in the following table.

Value	Meaning
<code>YES</code>	The engine is supported and is active
<code>DEFAULT</code>	Like <code>YES</code> , plus this is the default engine
<code>NO</code>	The engine is not supported
<code>DISABLED</code>	The engine is supported but has been disabled

A value of `NO` means that the server was compiled without support for the engine, so it cannot be enabled at runtime.

A value of `DISABLED` occurs either because the server was started with an option that disables the engine, or because not all options required to enable it were given. In the latter case, the error log should contain a reason indicating why the option is disabled. See [Section 5.4.2, “The Error Log”](#).

You might also see `DISABLED` for a storage engine if the server was compiled to support it, but was started with a `--skip-engine_name` option. For the `NDB` storage engine, `DISABLED` means the server was compiled with support for `NDB Cluster`, but was not started with the `--ndbcluster` option.

All MySQL servers support `MyISAM` tables. It is not possible to disable `MyISAM`.

- `COMMENT`  
A brief description of the storage engine.
- `TRANSACTIONS`  
Whether the storage engine supports transactions.
- `XA`  
Whether the storage engine supports XA transactions.
- `SAVEPOINTS`  
Whether the storage engine supports savepoints.

## Notes

- `ENGINES` is a nonstandard `INFORMATION_SCHEMA` table.
- Storage engine information is also available from the `SHOW ENGINES` statement. See [Section 13.7.5.16, “SHOW ENGINES Statement”](#). The following statements are equivalent:

```
SELECT * FROM INFORMATION_SCHEMA.ENGINES
SHOW ENGINES
```

## 24.3.8 The INFORMATION\_SCHEMA EVENTS Table

The `EVENTS` table provides information about Event Manager events, which are discussed in [Section 23.4, “Using the Event Scheduler”](#).

The `EVENTS` table has these columns:

- `EVENT_CATALOG`  
The name of the catalog to which the event belongs. This value is always `def`.
- `EVENT_SCHEMA`  
The name of the schema (database) to which the event belongs.
- `EVENT_NAME`  
The name of the event.
- `DEFINER`  
The account named in the `DEFINER` clause (often the user who created the event), in `'user_name'@'host_name'` format.
- `TIME_ZONE`  
The event time zone, which is the time zone used for scheduling the event and that is in effect within the event as it executes. The default value is `SYSTEM`.
- `EVENT_BODY`  
The language used for the statements in the event's `DO` clause. The value is always `SQL`.
- `EVENT_DEFINITION`

The text of the SQL statement making up the event's `DO` clause; in other words, the statement executed by this event.

- `EVENT_TYPE`

The event repetition type, either `ONE TIME` (transient) or `RECURRING` (repeating).

- `EXECUTE_AT`

For a one-time event, this is the `DATETIME` value specified in the `AT` clause of the `CREATE EVENT` statement used to create the event, or of the last `ALTER EVENT` statement that modified the event. The value shown in this column reflects the addition or subtraction of any `INTERVAL` value included in the event's `AT` clause. For example, if an event is created using `ON SCHEDULE AT CURRENT_TIMESTAMP + '1:6' DAY_HOUR`, and the event was created at 2018-02-09 14:05:30, the value shown in this column would be `'2018-02-10 20:05:30'`. If the event's timing is determined by an `EVERY` clause instead of an `AT` clause (that is, if the event is recurring), the value of this column is `NULL`.

- `INTERVAL_VALUE`

For a recurring event, the number of intervals to wait between event executions. For a transient event, the value is always `NULL`.

- `INTERVAL_FIELD`

The time units used for the interval which a recurring event waits before repeating. For a transient event, the value is always `NULL`.

- `SQL_MODE`

The SQL mode in effect when the event was created or altered, and under which the event executes. For the permitted values, see [Section 5.1.10, "Server SQL Modes"](#).

- `STARTS`

The start date and time for a recurring event. This is displayed as a `DATETIME` value, and is `NULL` if no start date and time are defined for the event. For a transient event, this column is always `NULL`. For a recurring event whose definition includes a `STARTS` clause, this column contains the corresponding `DATETIME` value. As with the `EXECUTE_AT` column, this value resolves any expressions used. If there is no `STARTS` clause affecting the timing of the event, this column is `NULL`.

- `ENDS`

For a recurring event whose definition includes a `ENDS` clause, this column contains the corresponding `DATETIME` value. As with the `EXECUTE_AT` column, this value resolves any expressions used. If there is no `ENDS` clause affecting the timing of the event, this column is `NULL`.

- `STATUS`

The event status. One of `ENABLED`, `DISABLED`, or `SLAVESIDE_DISABLED`. `SLAVESIDE_DISABLED` indicates that the creation of the event occurred on another MySQL server acting as a replication source and replicated to the current MySQL server which is acting as a replica, but the event is not presently being executed on the replica. For more information, see [Section 16.4.1.16, "Replication of Invoked Features"](#). information.

- `ON_COMPLETION`

One of the two values `PRESERVE` or `NOT PRESERVE`.

- **CREATED**

The date and time when the event was created. This is a **TIMESTAMP** value.

- **LAST\_ALTERED**

The date and time when the event was last modified. This is a **TIMESTAMP** value. If the event has not been modified since its creation, this value is the same as the **CREATED** value.

- **LAST\_EXECUTED**

The date and time when the event last executed. This is a **DATETIME** value. If the event has never executed, this column is **NULL**.

**LAST\_EXECUTED** indicates when the event started. As a result, the **ENDS** column is never less than **LAST\_EXECUTED**.

- **EVENT\_COMMENT**

The text of the comment, if the event has one. If not, this value is empty.

- **ORIGINATOR**

The server ID of the MySQL server on which the event was created; used in replication. This value may be updated by **ALTER EVENT** to the server ID of the server on which that statement occurs, if executed on a replication source. The default value is 0.

- **CHARACTER\_SET\_CLIENT**

The session value of the `character_set_client` system variable when the event was created.

- **COLLATION\_CONNECTION**

The session value of the `collation_connection` system variable when the event was created.

- **DATABASE\_COLLATION**

The collation of the database with which the event is associated.

## Notes

- **EVENTS** is a nonstandard **INFORMATION\_SCHEMA** table.
- Times in the **EVENTS** table are displayed using the event time zone, the current session time zone, or UTC, as described in [Section 23.4.4, “Event Metadata”](#).
- For more information about **SLAVESIDE\_DISABLED** and the **ORIGINATOR** column, see [Section 16.4.1.16, “Replication of Invoked Features”](#).

## Example

Suppose that the user 'jon'@'ghidora' creates an event named `e_daily`, and then modifies it a few minutes later using an **ALTER EVENT** statement, as shown here:

```
DELIMITER |  
  
CREATE EVENT e_daily  
  ON SCHEDULE  
    EVERY 1 DAY  
  COMMENT 'Saves total number of sessions then clears the table each day'  
  DO
```



```

BEGIN
  INSERT INTO site_activity.totals (time, total)
    SELECT CURRENT_TIMESTAMP, COUNT(*)
      FROM site_activity.sessions;
  DELETE FROM site_activity.sessions;
END |

DELIMITER ;

ALTER EVENT e_daily
  ENABLE;

```

(Note that comments can span multiple lines.)

This user can then run the following `SELECT` statement, and obtain the output shown:

```

mysql> SELECT * FROM INFORMATION_SCHEMA.EVENTS
  WHERE EVENT_NAME = 'e_daily'
  AND EVENT_SCHEMA = 'myschema'\G
***** 1. row *****
EVENT_CATALOG: def
EVENT_SCHEMA: myschema
EVENT_NAME: e_daily
DEFINER: jon@ghidora
TIME_ZONE: SYSTEM
EVENT_BODY: SQL
EVENT_DEFINITION: BEGIN
  INSERT INTO site_activity.totals (time, total)
    SELECT CURRENT_TIMESTAMP, COUNT(*)
      FROM site_activity.sessions;
  DELETE FROM site_activity.sessions;
END
EVENT_TYPE: RECURRING
EXECUTE_AT: NULL
INTERVAL_VALUE: 1
INTERVAL_FIELD: DAY
SQL_MODE: ONLY_FULL_GROUP_BY,STRICT_TRANS_TABLES,
NO_ZERO_IN_DATE,NO_ZERO_DATE,
ERROR_FOR_DIVISION_BY_ZERO,
NO_AUTO_CREATE_USER,NO_ENGINE_SUBSTITUTION
STARTS: 2018-08-08 11:06:34
ENDS: NULL
STATUS: ENABLED
ON_COMPLETION: NOT PRESERVE
CREATED: 2018-08-08 11:06:34
LAST_ALTERED: 2018-08-08 11:06:34
LAST_EXECUTED: 2018-08-08 16:06:34
EVENT_COMMENT: Saves total number of sessions then clears the
table each day
ORIGINATOR: 1
CHARACTER_SET_CLIENT: utf8
COLLATION_CONNECTION: utf8_general_ci
DATABASE_COLLATION: latin1_swedish_ci

```

Event information is also available from the `SHOW EVENTS` statement. See [Section 13.7.5.18, “SHOW EVENTS Statement”](#). The following statements are equivalent:

```

SELECT
  EVENT_SCHEMA, EVENT_NAME, DEFINER, TIME_ZONE, EVENT_TYPE, EXECUTE_AT,
  INTERVAL_VALUE, INTERVAL_FIELD, STARTS, ENDS, STATUS, ORIGINATOR,
  CHARACTER_SET_CLIENT, COLLATION_CONNECTION, DATABASE_COLLATION
FROM INFORMATION_SCHEMA.EVENTS
WHERE table_schema = 'db_name'
[AND column_name LIKE 'wild']

SHOW EVENTS
[FROM db_name]

```

[LIKE 'wild']

## 24.3.9 The INFORMATION\_SCHEMA FILES Table

The `FILES` table provides information about the files in which MySQL tablespace data is stored.

The `FILES` table provides information about `InnoDB` data files. In NDB Cluster, this table also provides information about the files in which NDB Cluster Disk Data tables are stored. For additional information specific to `InnoDB`, see [InnoDB Notes](#), later in this section; for additional information specific to NDB Cluster, see [NDB Notes](#).

The `FILES` table has these columns:

- `FILE_ID`

For `InnoDB`: The tablespace ID, also referred to as the `space_id` or `fil_space_t::id`.

For `NDB`: A file identifier. `FILE_ID` column values are auto-generated.

- `FILE_NAME`

For `InnoDB`: The name of the data file. File-per-table and general tablespaces have an `.ibd` file name extension. Undo tablespaces are prefixed by `undo`. The system tablespace is prefixed by `ibdata`. Temporary tablespaces are prefixed by `ibttmp`. The file name includes the file path, which may be relative to the MySQL data directory (the value of the `datadir` system variable).

For `NDB`: The name of an `UNDO` log file created by `CREATE LOGFILE GROUP` or `ALTER LOGFILE GROUP`, or of a data file created by `CREATE TABLESPACE` or `ALTER TABLESPACE`.

- `FILE_TYPE`

For `InnoDB`: The tablespace file type. There are three possible file types for `InnoDB` files. `TABLESPACE` is the file type for any system, general, or file-per-table tablespace file that holds tables, indexes, or other forms of user data. `TEMPORARY` is the file type for temporary tablespaces. `UNDO LOG` is the file type for undo tablespaces, which hold undo records.

For `NDB`: One of the values `UNDO LOG`, `DATAFILE`, or `TABLESPACE`.

- `TABLESPACE_NAME`

The name of the tablespace with which the file is associated.

- `TABLE_CATALOG`

This value is always empty.

- `TABLE_SCHEMA`

This is always `NULL`.

- `TABLE_NAME`

This is always `NULL`.

- `LOGFILE_GROUP_NAME`

For `InnoDB`: This is always `NULL`.

For `NDB`: The name of the log file group to which the log file or data file belongs.

- `LOGFILE_GROUP_NUMBER`

For `InnoDB`: This is always `NULL`.

For `NDB`: For a Disk Data undo log file, the auto-generated ID number of the log file group to which the log file belongs. This is the same as the value shown for the `id` column in the `ndbinfo.dict_obj_info` table and the `log_id` column in the `ndbinfo.logspaces` and `ndbinfo.logspaces` tables for this undo log file.

- `ENGINE`

For `InnoDB`: This is always `InnoDB`.

For `NDB`: This is always `ndbcluster`.

- `FULLTEXT_KEYS`

This is always `NULL`.

- `DELETED_ROWS`

This is always `NULL`.

- `UPDATE_COUNT`

This is always `NULL`.

- `FREE_EXTENTS`

For `InnoDB`: The number of fully free extents in the current data file.

For `NDB`: The number of extents which have not yet been used by the file.

- `TOTAL_EXTENTS`

For `InnoDB`: The number of full extents used in the current data file. Any partial extent at the end of the file is not counted.

For `NDB`: The total number of extents allocated to the file.

- `EXTENT_SIZE`

For `InnoDB`: Extent size is 1048576 (1MB) for files with a 4KB, 8KB, or 16KB page size. Extent size is 2097152 bytes (2MB) for files with a 32KB page size, and 4194304 (4MB) for files with a 64KB page size. `FILES` does not report `InnoDB` page size. Page size is defined by the `innodb_page_size` system variable. Extent size information can also be retrieved from the `INNODB_SYS_TABLESPACES` table where `FILES.FILE_ID = INNODB_SYS_TABLESPACES.SPACE`.

For `NDB`: The size of an extent for the file in bytes.

- `INITIAL_SIZE`

For `InnoDB`: The initial size of the file in bytes.

For `NDB`: The size of the file in bytes. This is the same value that was used in the `INITIAL_SIZE` clause of the `CREATE LOGFILE GROUP`, `ALTER LOGFILE GROUP`, `CREATE TABLESPACE`, or `ALTER TABLESPACE` statement used to create the file.

- `MAXIMUM_SIZE`

For **InnoDB**: The maximum number of bytes permitted in the file. The value is **NULL** for all data files except for predefined system tablespace data files. Maximum system tablespace file size is defined by `innodb_data_file_path`. Maximum temporary tablespace file size is defined by `innodb_temp_data_file_path`. A **NULL** value for a predefined system tablespace data file indicates that a file size limit was not defined explicitly.

For **NDB**: This value is always the same as the `INITIAL_SIZE` value.

- `AUTOEXTEND_SIZE`

The auto-extend size of the tablespace. For **NDB**, `AUTOEXTEND_SIZE` is always **NULL**.

- `CREATION_TIME`

This is always **NULL**.

- `LAST_UPDATE_TIME`

This is always **NULL**.

- `LAST_ACCESS_TIME`

This is always **NULL**.

- `RECOVER_TIME`

This is always **NULL**.

- `TRANSACTION_COUNTER`

This is always **NULL**.

- `VERSION`

For **InnoDB**: This is always **NULL**.

For **NDB**: The version number of the file.

- `ROW_FORMAT`

For **InnoDB**: This is always **NULL**.

For **NDB**: One of `FIXED` or `DYNAMIC`.

- `TABLE_ROWS`

This is always **NULL**.

- `AVG_ROW_LENGTH`

This is always **NULL**.

- `DATA_LENGTH`

This is always **NULL**.

- `MAX_DATA_LENGTH`

This is always **NULL**.

- [INDEX\\_LENGTH](#)

This is always `NULL`.

- [DATA\\_FREE](#)

For `InnoDB`: The total amount of free space (in bytes) for the entire tablespace. Predefined system tablespaces, which include the system tablespace and temporary table tablespaces, may have one or more data files.

For `NDB`: This is always `NULL`.

- [CREATE\\_TIME](#)

This is always `NULL`.

- [UPDATE\\_TIME](#)

This is always `NULL`.

- [CHECK\\_TIME](#)

This is always `NULL`.

- [CHECKSUM](#)

This is always `NULL`.

- [STATUS](#)

For `InnoDB`: This value is `NORMAL` by default. `InnoDB` file-per-table tablespaces may report `IMPORTING`, which indicates that the tablespace is not yet available.

For `NDB`: This is always `NORMAL`.

- [EXTRA](#)

For `InnoDB`: This is always `NULL`.

For `NDB`: This column shows which data node the data file or undo log file belongs to (each data node having its own copy of each file); for an undo log files, it also shows the size of the undo log buffer. Suppose that you use this statement on an `NDB` Cluster with four data nodes:

```
CREATE LOGFILE GROUP mygroup
  ADD UNDOFILE 'new_undo.dat'
  INITIAL_SIZE 2G
  ENGINE NDB;
```

After running the `CREATE LOGFILE GROUP` statement successfully, you should see a result similar to the one shown here for this query against the `FILES` table:

```
mysql> SELECT LOGFILE_GROUP_NAME, FILE_TYPE, EXTRA
  FROM INFORMATION_SCHEMA.FILES
  WHERE FILE_NAME = 'new_undo.dat';
```

LOGFILE_GROUP_NAME	FILE_TYPE	EXTRA
mygroup	UNDO LOG	CLUSTER_NODE=5;UNDO_BUFFER_SIZE=8388608
mygroup	UNDO LOG	CLUSTER_NODE=6;UNDO_BUFFER_SIZE=8388608
mygroup	UNDO LOG	CLUSTER_NODE=7;UNDO_BUFFER_SIZE=8388608

```
| mygroup | UNDO LOG | CLUSTER_NODE=8;UNDO_BUFFER_SIZE=8388608 |
+-----+-----+-----+
```

## Notes

- `FILES` is a nonstandard `INFORMATION_SCHEMA` table.

## InnoDB Notes

The following notes apply to `InnoDB` data files.

- Data reported by `FILES` is reported from the `InnoDB` in-memory cache for open files. By comparison, `INNODB_SYS_DATAFILES` reports data from the `InnoDB SYS_DATAFILES` internal data dictionary table.
- The data reported by `FILES` includes temporary tablespace data. This data is not available in the `InnoDB SYS_DATAFILES` internal data dictionary table, and is therefore not reported by `INNODB_SYS_DATAFILES`.
- Undo tablespace data is reported by `FILES`.
- The following query returns all data pertinent to `InnoDB` tablespaces.

```
SELECT
  FILE_ID, FILE_NAME, FILE_TYPE, TABLESPACE_NAME, FREE_EXTENTS,
  TOTAL_EXTENTS, EXTENT_SIZE, INITIAL_SIZE, MAXIMUM_SIZE,
  AUTOEXTEND_SIZE, DATA_FREE, STATUS
FROM INFORMATION_SCHEMA.FILES WHERE ENGINE='InnoDB'\G
```

## NDB Notes

- The `FILES` table provides information about Disk Data *files* only; you cannot use it for determining disk space allocation or availability for individual `NDB` tables. However, it is possible to see how much space is allocated for each `NDB` table having data stored on disk—as well as how much remains available for storage of data on disk for that table—using `ndb_desc`.
- The `CREATION_TIME`, `LAST_UPDATE_TIME`, and `LAST_ACCESSED` values are as reported by the operating system, and are not supplied by the `NDB` storage engine. Where no value is provided by the operating system, these columns display `NULL`.
- The difference between the `TOTAL_EXTENTS` and `FREE_EXTENTS` columns is the number of extents currently in use by the file:

```
SELECT TOTAL_EXTENTS - FREE_EXTENTS AS extents_used
FROM INFORMATION_SCHEMA.FILES
WHERE FILE_NAME = 'myfile.dat';
```

To approximate the amount of disk space in use by the file, multiply that difference by the value of the `EXTENT_SIZE` column, which gives the size of an extent for the file in bytes:

```
SELECT (TOTAL_EXTENTS - FREE_EXTENTS) * EXTENT_SIZE AS bytes_used
FROM INFORMATION_SCHEMA.FILES
WHERE FILE_NAME = 'myfile.dat';
```

Similarly, you can estimate the amount of space that remains available in a given file by multiplying `FREE_EXTENTS` by `EXTENT_SIZE`:

```
SELECT FREE_EXTENTS * EXTENT_SIZE AS bytes_free
FROM INFORMATION_SCHEMA.FILES
WHERE FILE_NAME = 'myfile.dat';
```



### Important

The byte values produced by the preceding queries are approximations only, and their precision is inversely proportional to the value of `EXTENT_SIZE`. That is, the larger `EXTENT_SIZE` becomes, the less accurate the approximations are.

It is also important to remember that once an extent is used, it cannot be freed again without dropping the data file of which it is a part. This means that deletes from a Disk Data table do *not* release disk space.

The extent size can be set in a `CREATE TABLESPACE` statement. For more information, see [Section 13.1.19, “CREATE TABLESPACE Statement”](#).

- An additional row is present in the `FILES` table following the creation of a logfile group. This row has `NULL` for the value of the `FILE_NAME` column and `0` for the value of the `FILE_ID` column; the value of the `FILE_TYPE` column is always `UNDO LOG`, and that of the `STATUS` column is always `NORMAL`. The value of the `ENGINE` column for this row is always `ndbcluster`.

The `FREE_EXTENTS` column in this row shows the total number of free extents available to all undo files belonging to a given log file group whose name and number are shown in the `LOGFILE_GROUP_NAME` and `LOGFILE_GROUP_NUMBER` columns, respectively.

Suppose there are no existing log file groups on your NDB Cluster, and you create one using the following statement:

```
mysql> CREATE LOGFILE GROUP lg1
      ADD UNDOFILE 'undofile.dat'
      INITIAL_SIZE = 16M
      UNDO_BUFFER_SIZE = 1M
      ENGINE = NDB;
```

You can now see this `NULL` row when you query the `FILES` table:

```
mysql> SELECT DISTINCT
      FILE_NAME AS File,
      FREE_EXTENTS AS Free,
      TOTAL_EXTENTS AS Total,
      EXTENT_SIZE AS Size,
      INITIAL_SIZE AS Initial
      FROM INFORMATION_SCHEMA.FILES;
```

File	Free	Total	Size	Initial
undofile.dat	NULL	4194304	4	16777216
NULL	4184068	NULL	4	NULL

The total number of free extents available for undo logging is always somewhat less than the sum of the `TOTAL_EXTENTS` column values for all undo files in the log file group due to overhead required for maintaining the undo files. This can be seen by adding a second undo file to the log file group, then repeating the previous query against the `FILES` table:

```
mysql> ALTER LOGFILE GROUP lg1
      ADD UNDOFILE 'undofile02.dat'
      INITIAL_SIZE = 4M
      ENGINE = NDB;

mysql> SELECT DISTINCT
      FILE_NAME AS File,
      FREE_EXTENTS AS Free,
```

```
TOTAL_EXTENTS AS Total,
EXTENT_SIZE AS Size,
INITIAL_SIZE AS Initial
FROM INFORMATION_SCHEMA.FILES;
```

File	Free	Total	Size	Initial
undofile.dat	NULL	4194304	4	16777216
undofile02.dat	NULL	1048576	4	4194304
NULL	5223944	NULL	4	NULL

The amount of free space in bytes which is available for undo logging by Disk Data tables using this log file group can be approximated by multiplying the number of free extents by the initial size:

```
mysql> SELECT
    FREE_EXTENTS AS 'Free Extents',
    FREE_EXTENTS * EXTENT_SIZE AS 'Free Bytes'
    FROM INFORMATION_SCHEMA.FILES
    WHERE LOGFILE_GROUP_NAME = 'lg1'
    AND FILE_NAME IS NULL;
```

Free Extents	Free Bytes
5223944	20895776

If you create an NDB Cluster Disk Data table and then insert some rows into it, you can see approximately how much space remains for undo logging afterward, for example:

```
mysql> CREATE TABLESPACE ts1
    ADD DATAFILE 'data1.dat'
    USE LOGFILE GROUP lg1
    INITIAL_SIZE 512M
    ENGINE = NDB;

mysql> CREATE TABLE dd (
    c1 INT NOT NULL PRIMARY KEY,
    c2 INT,
    c3 DATE
)
    TABLESPACE ts1 STORAGE DISK
    ENGINE = NDB;

mysql> INSERT INTO dd VALUES
    (NULL, 1234567890, '2007-02-02'),
    (NULL, 1126789005, '2007-02-03'),
    (NULL, 1357924680, '2007-02-04'),
    (NULL, 1642097531, '2007-02-05');

mysql> SELECT
    FREE_EXTENTS AS 'Free Extents',
    FREE_EXTENTS * EXTENT_SIZE AS 'Free Bytes'
    FROM INFORMATION_SCHEMA.FILES
    WHERE LOGFILE_GROUP_NAME = 'lg1'
    AND FILE_NAME IS NULL;
```

Free Extents	Free Bytes
5207565	20830260

- An additional row is present in the `FILES` table for any NDB Cluster tablespace, whether or not any data files are associated with the tablespace. This row has `NULL` for the value of the `FILE_NAME` column, and the value of the `FILE_ID` column is always 0. The value shown in the `FILE_TYPE` column is always



`TABLESPACE`, and that of the `STATUS` column is always `NORMAL`. The value of the `ENGINE` column for this row is always `ndbcluster`.

- For additional information, and examples of creating and dropping NDB Cluster Disk Data objects, see [Section 21.6.11, “NDB Cluster Disk Data Tables”](#).
- As of MySQL 5.7.31, you must have the `PROCESS` privilege to query this table.

### 24.3.10 The INFORMATION\_SCHEMA GLOBAL\_STATUS and SESSION\_STATUS Tables



#### Note

The value of the `show_compatibility_56` system variable affects the information available from the tables described here. For details, see the description of that variable in [Section 5.1.7, “Server System Variables”](#).



#### Note

Information available from the tables described here is also available from the Performance Schema. The `INFORMATION_SCHEMA` tables are deprecated in preference to the Performance Schema tables and are removed in MySQL 8.0. For advice on migrating away from the `INFORMATION_SCHEMA` tables to the Performance Schema tables, see [Section 25.20, “Migrating to Performance Schema System and Status Variable Tables”](#).

The `GLOBAL_STATUS` and `SESSION_STATUS` tables provide information about server status variables. Their contents correspond to the information produced by the `SHOW GLOBAL STATUS` and `SHOW SESSION STATUS` statements (see [Section 13.7.5.35, “SHOW STATUS Statement”](#)).

#### Notes

- The `VARIABLE_VALUE` column for each of these tables is defined as `VARCHAR(1024)`.

### 24.3.11 The INFORMATION\_SCHEMA GLOBAL\_VARIABLES and SESSION\_VARIABLES Tables



#### Note

The value of the `show_compatibility_56` system variable affects the information available from the tables described here. For details, see the description of that variable in [Section 5.1.7, “Server System Variables”](#).



#### Note

Information available from the tables described here is also available from the Performance Schema. The `INFORMATION_SCHEMA` tables are deprecated in preference to the Performance Schema tables and are removed in MySQL 8.0. For advice on migrating away from the `INFORMATION_SCHEMA` tables to the Performance Schema tables, see [Section 25.20, “Migrating to Performance Schema System and Status Variable Tables”](#).

The `GLOBAL_VARIABLES` and `SESSION_VARIABLES` tables provide information about server status variables. Their contents correspond to the information produced by the `SHOW GLOBAL VARIABLES` and `SHOW SESSION VARIABLES` statements (see [Section 13.7.5.39, “SHOW VARIABLES Statement”](#)).

## Notes

- The `VARIABLE_VALUE` column for each of these tables is defined as `VARCHAR(1024)`. For variables with very long values that are not completely displayed, use `SELECT` as a workaround. For example:

```
SELECT @@GLOBAL.innodb_data_file_path;
```

### 24.3.12 The INFORMATION\_SCHEMA KEY\_COLUMN\_USAGE Table

The `KEY_COLUMN_USAGE` table describes which key columns have constraints.

The `KEY_COLUMN_USAGE` table has these columns:

- `CONSTRAINT_CATALOG`

The name of the catalog to which the constraint belongs. This value is always `def`.

- `CONSTRAINT_SCHEMA`

The name of the schema (database) to which the constraint belongs.

- `CONSTRAINT_NAME`

The name of the constraint.

- `TABLE_CATALOG`

The name of the catalog to which the table belongs. This value is always `def`.

- `TABLE_SCHEMA`

The name of the schema (database) to which the table belongs.

- `TABLE_NAME`

The name of the table that has the constraint.

- `COLUMN_NAME`

The name of the column that has the constraint.

If the constraint is a foreign key, then this is the column of the foreign key, not the column that the foreign key references.

- `ORDINAL_POSITION`

The column's position within the constraint, not the column's position within the table. Column positions are numbered beginning with 1.

- `POSITION_IN_UNIQUE_CONSTRAINT`

`NULL` for unique and primary-key constraints. For foreign-key constraints, this column is the ordinal position in key of the table that is being referenced.

- `REFERENCED_TABLE_SCHEMA`

The name of the schema (database) referenced by the constraint.

- `REFERENCED_TABLE_NAME`

The name of the table referenced by the constraint.

- `REFERENCED_COLUMN_NAME`

The name of the column referenced by the constraint.

Suppose that there are two tables name `t1` and `t3` that have the following definitions:

```
CREATE TABLE t1
(
  s1 INT,
  s2 INT,
  s3 INT,
  PRIMARY KEY(s3)
) ENGINE=InnoDB;

CREATE TABLE t3
(
  s1 INT,
  s2 INT,
  s3 INT,
  KEY(s1),
  CONSTRAINT CO FOREIGN KEY (s2) REFERENCES t1(s3)
) ENGINE=InnoDB;
```

For those two tables, the `KEY_COLUMN_USAGE` table has two rows:

- One row with `CONSTRAINT_NAME = 'PRIMARY'`, `TABLE_NAME = 't1'`, `COLUMN_NAME = 's3'`, `ORDINAL_POSITION = 1`, `POSITION_IN_UNIQUE_CONSTRAINT = NULL`.
- One row with `CONSTRAINT_NAME = 'CO'`, `TABLE_NAME = 't3'`, `COLUMN_NAME = 's2'`, `ORDINAL_POSITION = 1`, `POSITION_IN_UNIQUE_CONSTRAINT = 1`.

### 24.3.13 The INFORMATION\_SCHEMA ndb\_transid\_mysql\_connection\_map Table

The `ndb_transid_mysql_connection_map` table provides a mapping between NDB transactions, NDB transaction coordinators, and MySQL Servers attached to an NDB Cluster as API nodes. This information is used when populating the `server_operations` and `server_transactions` tables of the `ndbinfo` NDB Cluster information database.

The `ndb_transid_mysql_connection_map` table has these columns:

- `mysql_connection_id`  
The MySQL server connection ID.
- `node_id`  
The transaction coordinator node ID.
- `ndb_transid`  
The NDB transaction ID.

#### Notes

The `mysql_connection_id` value is the same as the connection or session ID shown in the output of `SHOW PROCESSLIST`.

There are no `SHOW` statements associated with this table.

This is a nonstandard table, specific to NDB Cluster. It is implemented as an `INFORMATION_SCHEMA` plugin; you can verify that it is supported by checking the output of `SHOW PLUGINS`. If `ndb_transid_mysql_connection_map` support is enabled, the output from this statement includes a plugin having this name, of type `INFORMATION_SCHEMA`, and having status `ACTIVE`, as shown here (using emphasized text):

```
mysql> SHOW PLUGINS;
+-----+-----+-----+-----+-----+-----+
| Name                               | Status | Type           | Library | License |
+-----+-----+-----+-----+-----+-----+
| binlog                             | ACTIVE | STORAGE ENGINE | NULL    | GPL     |
| mysql_native_password              | ACTIVE | AUTHENTICATION | NULL    | GPL     |
| CSV                                | ACTIVE | STORAGE ENGINE | NULL    | GPL     |
| MEMORY                             | ACTIVE | STORAGE ENGINE | NULL    | GPL     |
| MRG_MYISAM                         | ACTIVE | STORAGE ENGINE | NULL    | GPL     |
| MyISAM                             | ACTIVE | STORAGE ENGINE | NULL    | GPL     |
| PERFORMANCE_SCHEMA               | ACTIVE | STORAGE ENGINE | NULL    | GPL     |
| BLACKHOLE                         | ACTIVE | STORAGE ENGINE | NULL    | GPL     |
| ARCHIVE                           | ACTIVE | STORAGE ENGINE | NULL    | GPL     |
| ndbcluster                        | ACTIVE | STORAGE ENGINE | NULL    | GPL     |
| ndbinfo                           | ACTIVE | STORAGE ENGINE | NULL    | GPL     |
| ndb_transid_mysql_connection_map | ACTIVE | INFORMATION_SCHEMA | NULL | GPL |
| InnoDB                            | ACTIVE | STORAGE ENGINE | NULL    | GPL     |
| INNODB_TRX                        | ACTIVE | INFORMATION SCHEMA | NULL    | GPL     |
| INNODB_LOCKS                      | ACTIVE | INFORMATION SCHEMA | NULL    | GPL     |
| INNODB_LOCK_WAITS                 | ACTIVE | INFORMATION SCHEMA | NULL    | GPL     |
| INNODB_CMP                        | ACTIVE | INFORMATION SCHEMA | NULL    | GPL     |
| INNODB_CMP_RESET                  | ACTIVE | INFORMATION SCHEMA | NULL    | GPL     |
| INNODB_CMPMEM                     | ACTIVE | INFORMATION SCHEMA | NULL    | GPL     |
| INNODB_CMPMEM_RESET               | ACTIVE | INFORMATION SCHEMA | NULL    | GPL     |
| partition                          | ACTIVE | STORAGE ENGINE | NULL    | GPL     |
+-----+-----+-----+-----+-----+-----+
22 rows in set (0.00 sec)
```

The plugin is enabled by default. You can disable it (or force the server not to run unless the plugin starts) by starting the server with the `--ndb-transid-mysql-connection-map` option. If the plugin is disabled, the status is shown by `SHOW PLUGINS` as `DISABLED`. The plugin cannot be enabled or disabled at runtime.

Although the names of this table and its columns are displayed using lowercase, you can use uppercase or lowercase when referring to them in SQL statements.

For this table to be created, the MySQL Server must be a binary supplied with the NDB Cluster distribution, or one built from the NDB Cluster sources with `NDB` storage engine support enabled. It is not available in the standard MySQL 5.7 Server.

### 24.3.14 The INFORMATION\_SCHEMA OPTIMIZER\_TRACE Table

The `OPTIMIZER_TRACE` table provides information produced by the optimizer tracing capability for traced statements. To enable tracking, use the `optimizer_trace` system variable. For details, see [Section 8.15, “Tracing the Optimizer”](#).

The `OPTIMIZER_TRACE` table has these columns:

- `QUERY`

The text of the traced statement.

- `TRACE`

The trace, in `JSON` format.

- `MISSING_BYTES_BEYOND_MAX_MEM_SIZE`

Each remembered trace is a string that is extended as optimization progresses and appends data to it. The `optimizer_trace_max_mem_size` variable sets a limit on the total amount of memory used by all currently remembered traces. If this limit is reached, the current trace is not extended (and thus is incomplete), and the `MISSING_BYTES_BEYOND_MAX_MEM_SIZE` column shows the number of bytes missing from the trace.

- `INSUFFICIENT_PRIVILEGES`

If a traced query uses views or stored routines that have `SQL SECURITY` with a value of `DEFINER`, it may be that a user other than the definer is denied from seeing the trace of the query. In that case, the trace is shown as empty and `INSUFFICIENT_PRIVILEGES` has a value of 1. Otherwise, the value is 0.

### 24.3.15 The INFORMATION\_SCHEMA PARAMETERS Table

The `PARAMETERS` table provides information about parameters for stored routines (stored procedures and stored functions), and about return values for stored functions. The `PARAMETERS` table does not include built-in (native) functions or loadable functions. Parameter information is similar to the contents of the `param_list` column in the `mysql.proc` table.

The `PARAMETERS` table has these columns:

- `SPECIFIC_CATALOG`

The name of the catalog to which the routine containing the parameter belongs. This value is always `def`.

- `SPECIFIC_SCHEMA`

The name of the schema (database) to which the routine containing the parameter belongs.

- `SPECIFIC_NAME`

The name of the routine containing the parameter.

- `ORDINAL_POSITION`

For successive parameters of a stored procedure or function, the `ORDINAL_POSITION` values are 1, 2, 3, and so forth. For a stored function, there is also a row that applies to the function return value (as described by the `RETURNS` clause). The return value is not a true parameter, so the row that describes it has these unique characteristics:

- The `ORDINAL_POSITION` value is 0.
- The `PARAMETER_NAME` and `PARAMETER_MODE` values are `NULL` because the return value has no name and the mode does not apply.

- `PARAMETER_MODE`

The mode of the parameter. This value is one of `IN`, `OUT`, or `INOUT`. For a stored function return value, this value is `NULL`.

- `PARAMETER_NAME`

The name of the parameter. For a stored function return value, this value is `NULL`.

- `DATA_TYPE`

The parameter data type.

The `DATA_TYPE` value is the type name only with no other information. The `DTD_IDENTIFIER` value contains the type name and possibly other information such as the precision or length.

- `CHARACTER_MAXIMUM_LENGTH`

For string parameters, the maximum length in characters.

- `CHARACTER_OCTET_LENGTH`

For string parameters, the maximum length in bytes.

- `NUMERIC_PRECISION`

For numeric parameters, the numeric precision.

- `NUMERIC_SCALE`

For numeric parameters, the numeric scale.

- `DATETIME_PRECISION`

For temporal parameters, the fractional seconds precision.

- `CHARACTER_SET_NAME`

For character string parameters, the character set name.

- `COLLATION_NAME`

For character string parameters, the collation name.

- `DTD_IDENTIFIER`

The parameter data type.

The `DATA_TYPE` value is the type name only with no other information. The `DTD_IDENTIFIER` value contains the type name and possibly other information such as the precision or length.

- `ROUTINE_TYPE`

`PROCEDURE` for stored procedures, `FUNCTION` for stored functions.

## 24.3.16 The INFORMATION\_SCHEMA PARTITIONS Table

The `PARTITIONS` table provides information about table partitions. Each row in this table corresponds to an individual partition or subpartition of a partitioned table. For more information about partitioning tables, see [Chapter 22, Partitioning](#).

The `PARTITIONS` table has these columns:

- `TABLE_CATALOG`

The name of the catalog to which the table belongs. This value is always `def`.

- [TABLE\\_SCHEMA](#)

The name of the schema (database) to which the table belongs.

- [TABLE\\_NAME](#)

The name of the table containing the partition.

- [PARTITION\\_NAME](#)

The name of the partition.

- [SUBPARTITION\\_NAME](#)

If the [PARTITIONS](#) table row represents a subpartition, the name of subpartition; otherwise [NULL](#).

- [PARTITION\\_ORDINAL\\_POSITION](#)

All partitions are indexed in the same order as they are defined, with 1 being the number assigned to the first partition. The indexing can change as partitions are added, dropped, and reorganized; the number shown in this column reflects the current order, taking into account any indexing changes.

- [SUBPARTITION\\_ORDINAL\\_POSITION](#)

Subpartitions within a given partition are also indexed and reindexed in the same manner as partitions are indexed within a table.

- [PARTITION\\_METHOD](#)

One of the values [RANGE](#), [LIST](#), [HASH](#), [LINEAR HASH](#), [KEY](#), or [LINEAR KEY](#); that is, one of the available partitioning types as discussed in [Section 22.2, "Partitioning Types"](#).

- [SUBPARTITION\\_METHOD](#)

One of the values [HASH](#), [LINEAR HASH](#), [KEY](#), or [LINEAR KEY](#); that is, one of the available subpartitioning types as discussed in [Section 22.2.6, "Subpartitioning"](#).

- [PARTITION\\_EXPRESSION](#)

The expression for the partitioning function used in the [CREATE TABLE](#) or [ALTER TABLE](#) statement that created the table's current partitioning scheme.

For example, consider a partitioned table created in the `test` database using this statement:

```
CREATE TABLE tp (
  c1 INT,
  c2 INT,
  c3 VARCHAR(25)
)
PARTITION BY HASH(c1 + c2)
PARTITIONS 4;
```

The [PARTITION\\_EXPRESSION](#) column in a [PARTITIONS](#) table row for a partition from this table displays `c1 + c2`, as shown here:

```
mysql> SELECT DISTINCT PARTITION_EXPRESSION
FROM INFORMATION_SCHEMA.PARTITIONS
WHERE TABLE_NAME='tp' AND TABLE_SCHEMA='test';
+-----+
| PARTITION_EXPRESSION |
```

```
+-----+
| c1 + c2 |
+-----+
```

For an [NDB](#) table that is not explicitly partitioned, this column is empty. For tables using other storage engines and which are not partitioned, this column is [NULL](#).

- [SUBPARTITION\\_EXPRESSION](#)

This works in the same fashion for the subpartitioning expression that defines the subpartitioning for a table as [PARTITION\\_EXPRESSION](#) does for the partitioning expression used to define a table's partitioning.

If the table has no subpartitions, this column is [NULL](#).

- [PARTITION\\_DESCRIPTION](#)

This column is used for [RANGE](#) and [LIST](#) partitions. For a [RANGE](#) partition, it contains the value set in the partition's [VALUES LESS THAN](#) clause, which can be either an integer or [MAXVALUE](#). For a [LIST](#) partition, this column contains the values defined in the partition's [VALUES IN](#) clause, which is a list of comma-separated integer values.

For partitions whose [PARTITION\\_METHOD](#) is other than [RANGE](#) or [LIST](#), this column is always [NULL](#).

- [TABLE\\_ROWS](#)

The number of table rows in the partition.

For partitioned [InnoDB](#) tables, the row count given in the [TABLE\\_ROWS](#) column is only an estimated value used in SQL optimization, and may not always be exact.

For [NDB](#) tables, you can also obtain this information using the [ndb\\_desc](#) utility.

- [AVG\\_ROW\\_LENGTH](#)

The average length of the rows stored in this partition or subpartition, in bytes. This is the same as [DATA\\_LENGTH](#) divided by [TABLE\\_ROWS](#).

For [NDB](#) tables, you can also obtain this information using the [ndb\\_desc](#) utility.

- [DATA\\_LENGTH](#)

The total length of all rows stored in this partition or subpartition, in bytes; that is, the total number of bytes stored in the partition or subpartition.

For [NDB](#) tables, you can also obtain this information using the [ndb\\_desc](#) utility.

- [MAX\\_DATA\\_LENGTH](#)

The maximum number of bytes that can be stored in this partition or subpartition.

For [NDB](#) tables, you can also obtain this information using the [ndb\\_desc](#) utility.

- [INDEX\\_LENGTH](#)

The length of the index file for this partition or subpartition, in bytes.

For partitions of [NDB](#) tables, whether the tables use implicit or explicit partitioning, the [INDEX\\_LENGTH](#) column value is always 0. However, you can obtain equivalent information using the [ndb\\_desc](#) utility.



- `DATA_FREE`

The number of bytes allocated to the partition or subpartition but not used.

For `NDB` tables, you can also obtain this information using the `ndb_desc` utility.

- `CREATE_TIME`

The time that the partition or subpartition was created.

- `UPDATE_TIME`

The time that the partition or subpartition was last modified.

- `CHECK_TIME`

The last time that the table to which this partition or subpartition belongs was checked.

For partitioned `InnoDB` tables, the value is always `NULL`.

- `CHECKSUM`

The checksum value, if any; otherwise `NULL`.

- `PARTITION_COMMENT`

The text of the comment, if the partition has one. If not, this value is empty.

The maximum length for a partition comment is defined as 1024 characters, and the display width of the `PARTITION_COMMENT` column is also 1024, characters to match this limit.

- `NODEGROUP`

This is the nodegroup to which the partition belongs. For `NDB` Cluster tables, this is always `default`.

For partitioned tables using storage engines other than `NDB`, the value is also `default`. Otherwise, this column is empty.

- `TABLESPACE_NAME`

The name of the tablespace to which the partition belongs. The value is always `DEFAULT`, unless the table uses the `NDB` storage engine (see the *Notes* at the end of this section).

## Notes

- `PARTITIONS` is a nonstandard `INFORMATION_SCHEMA` table.
- A table using any storage engine other than `NDB` and which is not partitioned has one row in the `PARTITIONS` table. However, the values of the `PARTITION_NAME`, `SUBPARTITION_NAME`, `PARTITION_ORDINAL_POSITION`, `SUBPARTITION_ORDINAL_POSITION`, `PARTITION_METHOD`, `SUBPARTITION_METHOD`, `PARTITION_EXPRESSION`, `SUBPARTITION_EXPRESSION`, and `PARTITION_DESCRIPTION` columns are all `NULL`. Also, the `PARTITION_COMMENT` column in this case is blank.
- An `NDB` table which is not explicitly partitioned has one row in the `PARTITIONS` table for each data node in the `NDB` cluster. For each such row:
  - The `SUBPARTITION_NAME`, `SUBPARTITION_ORDINAL_POSITION`, `SUBPARTITION_METHOD`, `SUBPARTITION_EXPRESSION`, `CREATE_TIME`, `UPDATE_TIME`, `CHECK_TIME`, `CHECKSUM`, and `TABLESPACE_NAME` columns are all `NULL`.

- The `PARTITION_METHOD` is always `KEY`.
- The `NODEGROUP` column is `default`.
- The `PARTITION_EXPRESSION` and `PARTITION_COMMENT` columns are empty.

### 24.3.17 The INFORMATION\_SCHEMA PLUGINS Table

The `PLUGINS` table provides information about server plugins.

The `PLUGINS` table has these columns:

- `PLUGIN_NAME`

The name used to refer to the plugin in statements such as `INSTALL PLUGIN` and `UNINSTALL PLUGIN`.

- `PLUGIN_VERSION`

The version from the plugin's general type descriptor.

- `PLUGIN_STATUS`

The plugin status, one of `ACTIVE`, `INACTIVE`, `DISABLED`, or `DELETED`.

- `PLUGIN_TYPE`

The type of plugin, such as `STORAGE ENGINE`, `INFORMATION_SCHEMA`, or `AUTHENTICATION`.

- `PLUGIN_TYPE_VERSION`

The version from the plugin's type-specific descriptor.

- `PLUGIN_LIBRARY`

The name of the plugin shared library file. This is the name used to refer to the plugin file in statements such as `INSTALL PLUGIN` and `UNINSTALL PLUGIN`. This file is located in the directory named by the `plugin_dir` system variable. If the library name is `NULL`, the plugin is compiled in and cannot be uninstalled with `UNINSTALL PLUGIN`.

- `PLUGIN_LIBRARY_VERSION`

The plugin API interface version.

- `PLUGIN_AUTHOR`

The plugin author.

- `PLUGIN_DESCRIPTION`

A short description of the plugin.

- `PLUGIN_LICENSE`

How the plugin is licensed (for example, `GPL`).

- `LOAD_OPTION`

How the plugin was loaded. The value is `OFF`, `ON`, `FORCE`, or `FORCE_PLUS_PERMANENT`. See [Section 5.5.1, “Installing and Uninstalling Plugins”](#).

## Notes

- `PLUGINS` is a nonstandard `INFORMATION_SCHEMA` table.
- For plugins installed with `INSTALL PLUGIN`, the `PLUGIN_NAME` and `PLUGIN_LIBRARY` values are also registered in the `mysql.plugin` table.
- For information about plugin data structures that form the basis of the information in the `PLUGINS` table, see [The MySQL Plugin API](#).

Plugin information is also available from the `SHOW PLUGINS` statement. See [Section 13.7.5.25, “SHOW PLUGINS Statement”](#). These statements are equivalent:

```
SELECT
  PLUGIN_NAME, PLUGIN_STATUS, PLUGIN_TYPE,
  PLUGIN_LIBRARY, PLUGIN_LICENSE
FROM INFORMATION_SCHEMA.PLUGINS;

SHOW PLUGINS;
```

## 24.3.18 The INFORMATION\_SCHEMA PROCESSLIST Table

The MySQL process list indicates the operations currently being performed by the set of threads executing within the server. The `PROCESSLIST` table is one source of process information. For a comparison of this table with other sources, see [Sources of Process Information](#).

The `PROCESSLIST` table has these columns:

- `ID`

The connection identifier. This is the same value displayed in the `Id` column of the `SHOW PROCESSLIST` statement, displayed in the `PROCESSLIST_ID` column of the Performance Schema `threads` table, and returned by the `CONNECTION_ID()` function within the thread.

- `USER`

The MySQL user who issued the statement. A value of `system user` refers to a nonclient thread spawned by the server to handle tasks internally, for example, a delayed-row handler thread or an I/O or SQL thread used on replica hosts. For `system user`, there is no host specified in the `Host` column. `unauthenticated user` refers to a thread that has become associated with a client connection but for which authentication of the client user has not yet occurred. `event_scheduler` refers to the thread that monitors scheduled events (see [Section 23.4, “Using the Event Scheduler”](#)).

- `HOST`

The host name of the client issuing the statement (except for `system user`, for which there is no host). The host name for TCP/IP connections is reported in `host_name:client_port` format to make it easier to determine which client is doing what.

- `DB`

The default database for the thread, or `NULL` if none has been selected.

- `COMMAND`

The type of command the thread is executing on behalf of the client, or `Sleep` if the session is idle. For descriptions of thread commands, see [Section 8.14, “Examining Server Thread \(Process\) Information”](#). The value of this column corresponds to the `COM_xxx` commands of the client/server protocol and `Com_xxx` status variables. See [Section 5.1.9, “Server Status Variables”](#).

- `TIME`

The time in seconds that the thread has been in its current state. For a replica SQL thread, the value is the number of seconds between the timestamp of the last replicated event and the real time of the replica host. See [Section 16.2.3, “Replication Threads”](#).

- `STATE`

An action, event, or state that indicates what the thread is doing. For descriptions of `STATE` values, see [Section 8.14, “Examining Server Thread \(Process\) Information”](#).

Most states correspond to very quick operations. If a thread stays in a given state for many seconds, there might be a problem that needs to be investigated.

- `INFO`

The statement the thread is executing, or `NULL` if it is executing no statement. The statement might be the one sent to the server, or an innermost statement if the statement executes other statements. For example, if a `CALL` statement executes a stored procedure that is executing a `SELECT` statement, the `INFO` value shows the `SELECT` statement.

## Notes

- `PROCESSLIST` is a nonstandard `INFORMATION_SCHEMA` table.
- Like the output from the `SHOW PROCESSLIST` statement, the `PROCESSLIST` table provides information about all threads, even those belonging to other users, if you have the `PROCESS` privilege. Otherwise (without the `PROCESS` privilege), nonanonymous users have access to information about their own threads but not threads for other users, and anonymous users have no access to thread information.
- If an SQL statement refers to the `PROCESSLIST` table, MySQL populates the entire table once, when statement execution begins, so there is read consistency during the statement. There is no read consistency for a multi-statement transaction.

The following statements are equivalent:

```
SELECT * FROM INFORMATION_SCHEMA.PROCESSLIST
SHOW FULL PROCESSLIST
```

## 24.3.19 The INFORMATION\_SCHEMA PROFILING Table

The `PROFILING` table provides statement profiling information. Its contents correspond to the information produced by the `SHOW PROFILE` and `SHOW PROFILES` statements (see [Section 13.7.5.30, “SHOW PROFILE Statement”](#)). The table is empty unless the `profiling` session variable is set to 1.



### Note

This table is deprecated; expect it to be removed in a future release of MySQL. Use the [Performance Schema](#) instead; see [Section 25.19.1, “Query Profiling Using Performance Schema”](#).

The `PROFILING` table has these columns:

- `QUERY_ID`  
A numeric statement identifier.
- `SEQ`  
A sequence number indicating the display order for rows with the same `QUERY_ID` value.
- `STATE`  
The profiling state to which the row measurements apply.
- `DURATION`  
How long statement execution remained in the given state, in seconds.
- `CPU_USER`, `CPU_SYSTEM`  
User and system CPU use, in seconds.
- `CONTEXT_VOLUNTARY`, `CONTEXT_INVOLUNTARY`  
How many voluntary and involuntary context switches occurred.
- `BLOCK_OPS_IN`, `BLOCK_OPS_OUT`  
The number of block input and output operations.
- `MESSAGES_SENT`, `MESSAGES_RECEIVED`  
The number of communication messages sent and received.
- `PAGE_FAULTS_MAJOR`, `PAGE_FAULTS_MINOR`  
The number of major and minor page faults.
- `SWAPS`  
How many swaps occurred.
- `SOURCE_FUNCTION`, `SOURCE_FILE`, and `SOURCE_LINE`  
Information indicating where in the source code the profiled state executes.

## Notes

- `PROFILING` is a nonstandard `INFORMATION_SCHEMA` table.

Profiling information is also available from the `SHOW PROFILE` and `SHOW PROFILES` statements. See [Section 13.7.5.30, “SHOW PROFILE Statement”](#). For example, the following queries are equivalent:

```
SHOW PROFILE FOR QUERY 2;  
  
SELECT STATE, FORMAT(DURATION, 6) AS DURATION  
FROM INFORMATION_SCHEMA.PROFILING  
WHERE QUERY_ID = 2 ORDER BY SEQ;
```

## 24.3.20 The INFORMATION\_SCHEMA REFERENTIAL\_CONSTRAINTS Table

The [REFERENTIAL\\_CONSTRAINTS](#) table provides information about foreign keys.

The [REFERENTIAL\\_CONSTRAINTS](#) table has these columns:

- [CONSTRAINT\\_CATALOG](#)

The name of the catalog to which the constraint belongs. This value is always `def`.

- [CONSTRAINT\\_SCHEMA](#)

The name of the schema (database) to which the constraint belongs.

- [CONSTRAINT\\_NAME](#)

The name of the constraint.

- [UNIQUE\\_CONSTRAINT\\_CATALOG](#)

The name of the catalog containing the unique constraint that the constraint references. This value is always `def`.

- [UNIQUE\\_CONSTRAINT\\_SCHEMA](#)

The name of the schema (database) containing the unique constraint that the constraint references.

- [UNIQUE\\_CONSTRAINT\\_NAME](#)

The name of the unique constraint that the constraint references.

- [MATCH\\_OPTION](#)

The value of the constraint `MATCH` attribute. The only valid value at this time is `NONE`.

- [UPDATE\\_RULE](#)

The value of the constraint `ON UPDATE` attribute. The possible values are `CASCADE`, `SET NULL`, `SET DEFAULT`, `RESTRICT`, `NO ACTION`.

- [DELETE\\_RULE](#)

The value of the constraint `ON DELETE` attribute. The possible values are `CASCADE`, `SET NULL`, `SET DEFAULT`, `RESTRICT`, `NO ACTION`.

- [TABLE\\_NAME](#)

The name of the table. This value is the same as in the [TABLE\\_CONSTRAINTS](#) table.

- [REFERENCED\\_TABLE\\_NAME](#)

The name of the table referenced by the constraint.

### 24.3.21 The INFORMATION\_SCHEMA ROUTINES Table

The [ROUTINES](#) table provides information about stored routines (stored procedures and stored functions). The [ROUTINES](#) table does not include built-in (native) functions or loadable functions.

The column named “`mysql.proc Name`” indicates the `mysql.proc` table column that corresponds to the [INFORMATION\\_SCHEMA ROUTINES](#) table column, if any.

The [ROUTINES](#) table has these columns:

- [SPECIFIC\\_NAME](#)  
The name of the routine.
- [ROUTINE\\_CATALOG](#)  
The name of the catalog to which the routine belongs. This value is always `def`.
- [ROUTINE\\_SCHEMA](#)  
The name of the schema (database) to which the routine belongs.
- [ROUTINE\\_NAME](#)  
The name of the routine.
- [ROUTINE\\_TYPE](#)  
`PROCEDURE` for stored procedures, `FUNCTION` for stored functions.
- [DATA\\_TYPE](#)  
If the routine is a stored function, the return value data type. If the routine is a stored procedure, this value is empty.  
  
The [DATA\\_TYPE](#) value is the type name only with no other information. The [DTD\\_IDENTIFIER](#) value contains the type name and possibly other information such as the precision or length.
- [CHARACTER\\_MAXIMUM\\_LENGTH](#)  
For stored function string return values, the maximum length in characters. If the routine is a stored procedure, this value is `NULL`.
- [CHARACTER\\_OCTET\\_LENGTH](#)  
For stored function string return values, the maximum length in bytes. If the routine is a stored procedure, this value is `NULL`.
- [NUMERIC\\_PRECISION](#)  
For stored function numeric return values, the numeric precision. If the routine is a stored procedure, this value is `NULL`.
- [NUMERIC\\_SCALE](#)  
For stored function numeric return values, the numeric scale. If the routine is a stored procedure, this value is `NULL`.
- [DATETIME\\_PRECISION](#)  
For stored function temporal return values, the fractional seconds precision. If the routine is a stored procedure, this value is `NULL`.
- [CHARACTER\\_SET\\_NAME](#)  
For stored function character string return values, the character set name. If the routine is a stored procedure, this value is `NULL`.
- [COLLATION\\_NAME](#)

For stored function character string return values, the collation name. If the routine is a stored procedure, this value is `NULL`.

- `DTD_IDENTIFIER`

If the routine is a stored function, the return value data type. If the routine is a stored procedure, this value is empty.

The `DATA_TYPE` value is the type name only with no other information. The `DTD_IDENTIFIER` value contains the type name and possibly other information such as the precision or length.

- `ROUTINE_BODY`

The language used for the routine definition. This value is always `SQL`.

- `ROUTINE_DEFINITION`

The text of the SQL statement executed by the routine.

- `EXTERNAL_NAME`

This value is always `NULL`.

- `EXTERNAL_LANGUAGE`

The language of the stored routine. MySQL calculates `EXTERNAL_LANGUAGE` thus:

- If `mysql.proc.language='SQL'`, `EXTERNAL_LANGUAGE` is `NULL`
- Otherwise, `EXTERNAL_LANGUAGE` is what is in `mysql.proc.language`. However, we do not have external languages yet, so it is always `NULL`.

- `PARAMETER_STYLE`

This value is always `SQL`.

- `IS_DETERMINISTIC`

`YES` or `NO`, depending on whether the routine is defined with the `DETERMINISTIC` characteristic.

- `SQL_DATA_ACCESS`

The data access characteristic for the routine. The value is one of `CONTAINS SQL`, `NO SQL`, `READS SQL DATA`, or `MODIFIES SQL DATA`.

- `SQL_PATH`

This value is always `NULL`.

- `SECURITY_TYPE`

The routine `SQL SECURITY` characteristic. The value is one of `DEFINER` or `INVOKER`.

- `CREATED`

The date and time when the routine was created. This is a `TIMESTAMP` value.

- `LAST_ALTERED`



The date and time when the routine was last modified. This is a [TIMESTAMP](#) value. If the routine has not been modified since its creation, this value is the same as the [CREATED](#) value.

- [SQL\\_MODE](#)

The SQL mode in effect when the routine was created or altered, and under which the routine executes. For the permitted values, see [Section 5.1.10, “Server SQL Modes”](#).

- [ROUTINE\\_COMMENT](#)

The text of the comment, if the routine has one. If not, this value is empty.

- [DEFINER](#)

The account named in the [DEFINER](#) clause (often the user who created the routine), in `'user_name'@'host_name'` format.

- [CHARACTER\\_SET\\_CLIENT](#)

The session value of the `character_set_client` system variable when the routine was created.

- [COLLATION\\_CONNECTION](#)

The session value of the `collation_connection` system variable when the routine was created.

- [DATABASE\\_COLLATION](#)

The collation of the database with which the routine is associated.

## Notes

- To see information about a routine, you must be the user named in the routine [DEFINER](#) clause or have [SELECT](#) access to the `mysql.proc` table. If you do not have privileges for the routine itself, the value displayed for the [ROUTINE\\_DEFINITION](#) column is `NULL`.
- Information about stored function return values is also available in the [PARAMETERS](#) table. The return value row for a stored function can be identified as the row that has an [ORDINAL\\_POSITION](#) value of 0.

## 24.3.22 The INFORMATION\_SCHEMA SCHEMATA Table

A schema is a database, so the [SCHEMATA](#) table provides information about databases.

The [SCHEMATA](#) table has these columns:

- [CATALOG\\_NAME](#)

The name of the catalog to which the schema belongs. This value is always `def`.

- [SCHEMA\\_NAME](#)

The name of the schema.

- [DEFAULT\\_CHARACTER\\_SET\\_NAME](#)

The schema default character set.

- [DEFAULT\\_COLLATION\\_NAME](#)

The schema default collation.

- `SQL_PATH`

This value is always `NULL`.

Schema names are also available from the `SHOW DATABASES` statement. See [Section 13.7.5.14, “SHOW DATABASES Statement”](#). The following statements are equivalent:

```
SELECT SCHEMA_NAME AS `Database`
FROM INFORMATION_SCHEMA.SCHEMATA
[WHERE SCHEMA_NAME LIKE 'wild']

SHOW DATABASES
[LIKE 'wild']
```

You see only those databases for which you have some kind of privilege, unless you have the global `SHOW DATABASES` privilege.



### Caution

Because a global privilege is considered a privilege for all databases, *any* global privilege enables a user to see all database names with `SHOW DATABASES` or by examining the `INFORMATION_SCHEMA.SCHEMATA` table.

## 24.3.23 The INFORMATION\_SCHEMA SCHEMA\_PRIVILEGES Table

The `SCHEMA_PRIVILEGES` table provides information about schema (database) privileges. It takes its values from the `mysql.db` system table.

The `SCHEMA_PRIVILEGES` table has these columns:

- `GRANTEE`

The name of the account to which the privilege is granted, in '`user_name`'@'`host_name`' format.

- `TABLE_CATALOG`

The name of the catalog to which the schema belongs. This value is always `def`.

- `TABLE_SCHEMA`

The name of the schema.

- `PRIVILEGE_TYPE`

The privilege granted. The value can be any privilege that can be granted at the schema level; see [Section 13.7.1.4, “GRANT Statement”](#). Each row lists a single privilege, so there is one row per schema privilege held by the grantee.

- `IS_GRANTABLE`

`YES` if the user has the `GRANT OPTION` privilege, `NO` otherwise. The output does not list `GRANT OPTION` as a separate row with `PRIVILEGE_TYPE='GRANT OPTION'`.

### Notes

- `SCHEMA_PRIVILEGES` is a nonstandard `INFORMATION_SCHEMA` table.

The following statements are *not* equivalent:

```
SELECT ... FROM INFORMATION_SCHEMA.SCHEMA_PRIVILEGES
SHOW GRANTS ...
```

## 24.3.24 The INFORMATION\_SCHEMA STATISTICS Table

The `STATISTICS` table provides information about table indexes.

The `STATISTICS` table has these columns:

- `TABLE_CATALOG`

The name of the catalog to which the table containing the index belongs. This value is always `def`.

- `TABLE_SCHEMA`

The name of the schema (database) to which the table containing the index belongs.

- `TABLE_NAME`

The name of the table containing the index.

- `NON_UNIQUE`

0 if the index cannot contain duplicates, 1 if it can.

- `INDEX_SCHEMA`

The name of the schema (database) to which the index belongs.

- `INDEX_NAME`

The name of the index. If the index is the primary key, the name is always `PRIMARY`.

- `SEQ_IN_INDEX`

The column sequence number in the index, starting with 1.

- `COLUMN_NAME`

The column name. See also the description for the `EXPRESSION` column.

- `COLLATION`

How the column is sorted in the index. This can have values `A` (ascending), `D` (descending), or `NULL` (not sorted).

- `CARDINALITY`

An estimate of the number of unique values in the index. To update this number, run `ANALYZE TABLE` or (for `MyISAM` tables) `myisamchk -a`.

`CARDINALITY` is counted based on statistics stored as integers, so the value is not necessarily exact even for small tables. The higher the cardinality, the greater the chance that MySQL uses the index when doing joins.

- `SUB_PART`

The index prefix. That is, the number of indexed characters if the column is only partly indexed, `NULL` if the entire column is indexed.



#### Note

Prefix *limits* are measured in bytes. However, prefix *lengths* for index specifications in `CREATE TABLE`, `ALTER TABLE`, and `CREATE INDEX` statements are interpreted as number of characters for nonbinary string types (`CHAR`, `VARCHAR`, `TEXT`) and number of bytes for binary string types (`BINARY`, `VARBINARY`, `BLOB`). Take this into account when specifying a prefix length for a nonbinary string column that uses a multibyte character set.

For additional information about index prefixes, see [Section 8.3.4, “Column Indexes”](#), and [Section 13.1.14, “CREATE INDEX Statement”](#).

- `PACKED`

Indicates how the key is packed. `NULL` if it is not.

- `NULLABLE`

Contains `YES` if the column may contain `NULL` values and `' '` if not.

- `INDEX_TYPE`

The index method used (`BTREE`, `FULLTEXT`, `HASH`, `RTREE`).

- `COMMENT`

Information about the index not described in its own column, such as `disabled` if the index is disabled.

- `INDEX_COMMENT`

Any comment provided for the index with a `COMMENT` attribute when the index was created.

## Notes

- There is no standard `INFORMATION_SCHEMA` table for indexes. The MySQL column list is similar to what SQL Server 2000 returns for `sp_statistics`, except that `QUALIFIER` and `OWNER` are replaced with `CATALOG` and `SCHEMA`, respectively.

Information about table indexes is also available from the `SHOW INDEX` statement. See [Section 13.7.5.22, “SHOW INDEX Statement”](#). The following statements are equivalent:

```
SELECT * FROM INFORMATION_SCHEMA.STATISTICS
  WHERE table_name = 'tbl_name'
  AND table_schema = 'db_name'

SHOW INDEX
  FROM tbl_name
  FROM db_name
```

## 24.3.25 The INFORMATION\_SCHEMA TABLES Table

The `TABLES` table provides information about tables in databases.

The `TABLES` table has these columns:

- [TABLE\\_CATALOG](#)

The name of the catalog to which the table belongs. This value is always `def`.

- [TABLE\\_SCHEMA](#)

The name of the schema (database) to which the table belongs.

- [TABLE\\_NAME](#)

The name of the table.

- [TABLE\\_TYPE](#)

`BASE TABLE` for a table, `VIEW` for a view, or `SYSTEM VIEW` for an `INFORMATION_SCHEMA` table.

The `TABLES` table does not list `TEMPORARY` tables.

- [ENGINE](#)

The storage engine for the table. See [Chapter 14, The InnoDB Storage Engine](#), and [Chapter 15, Alternative Storage Engines](#).

For partitioned tables, `ENGINE` shows the name of the storage engine used by all partitions.

- [VERSION](#)

The version number of the table's `.frm` file.

- [ROW\\_FORMAT](#)

The row-storage format (`Fixed`, `Dynamic`, `Compressed`, `Redundant`, `Compact`). For `MyISAM` tables, `Dynamic` corresponds to what `myisamchk -dvv` reports as `Packed`. `InnoDB` table format is either `Redundant` or `Compact` when using the `Antelope` file format, or `Compressed` or `Dynamic` when using the `Barracuda` file format.

- [TABLE\\_ROWS](#)

The number of rows. Some storage engines, such as `MyISAM`, store the exact count. For other storage engines, such as `InnoDB`, this value is an approximation, and may vary from the actual value by as much as 40% to 50%. In such cases, use `SELECT COUNT(*)` to obtain an accurate count.

`TABLE_ROWS` is `NULL` for `INFORMATION_SCHEMA` tables.

For `InnoDB` tables, the row count is only a rough estimate used in SQL optimization. (This is also true if the `InnoDB` table is partitioned.)

- [AVG\\_ROW\\_LENGTH](#)

The average row length.

Refer to the notes at the end of this section for related information.

- [DATA\\_LENGTH](#)

For `MyISAM`, `DATA_LENGTH` is the length of the data file, in bytes.

For `InnoDB`, `DATA_LENGTH` is the approximate amount of space allocated for the clustered index, in bytes. Specifically, it is the clustered index size, in pages, multiplied by the `InnoDB` page size.

Refer to the notes at the end of this section for information regarding other storage engines.

- [MAX\\_DATA\\_LENGTH](#)

For [MyISAM](#), [MAX\\_DATA\\_LENGTH](#) is maximum length of the data file. This is the total number of bytes of data that can be stored in the table, given the data pointer size used.

Unused for [InnoDB](#).

Refer to the notes at the end of this section for information regarding other storage engines.

- [INDEX\\_LENGTH](#)

For [MyISAM](#), [INDEX\\_LENGTH](#) is the length of the index file, in bytes.

For [InnoDB](#), [INDEX\\_LENGTH](#) is the approximate amount of space allocated for non-clustered indexes, in bytes. Specifically, it is the sum of non-clustered index sizes, in pages, multiplied by the [InnoDB](#) page size.

Refer to the notes at the end of this section for information regarding other storage engines.

- [DATA\\_FREE](#)

The number of allocated but unused bytes.

[InnoDB](#) tables report the free space of the tablespace to which the table belongs. For a table located in the shared tablespace, this is the free space of the shared tablespace. If you are using multiple tablespaces and the table has its own tablespace, the free space is for only that table. Free space means the number of bytes in completely free extents minus a safety margin. Even if free space displays as 0, it may be possible to insert rows as long as new extents need not be allocated.

For NDB Cluster, [DATA\\_FREE](#) shows the space allocated on disk for, but not used by, a Disk Data table or fragment on disk. (In-memory data resource usage is reported by the [DATA\\_LENGTH](#) column.)

For partitioned tables, this value is only an estimate and may not be absolutely correct. A more accurate method of obtaining this information in such cases is to query the [INFORMATION\\_SCHEMA PARTITIONS](#) table, as shown in this example:

```
SELECT SUM(DATA_FREE)
  FROM INFORMATION_SCHEMA.PARTITIONS
 WHERE TABLE_SCHEMA = 'mydb'
 AND   TABLE_NAME   = 'mytable';
```

For more information, see [Section 24.3.16, “The INFORMATION\\_SCHEMA PARTITIONS Table”](#).

- [AUTO\\_INCREMENT](#)

The next [AUTO\\_INCREMENT](#) value.

- [CREATE\\_TIME](#)

When the table was created.

- [UPDATE\\_TIME](#)

When the data file was last updated. For some storage engines, this value is [NULL](#). For example, [InnoDB](#) stores multiple tables in its [system tablespace](#) and the data file timestamp does not apply. Even with [file-per-table](#) mode with each [InnoDB](#) table in a separate `.ibd` file, [change buffering](#) can delay the

write to the data file, so the file modification time is different from the time of the last insert, update, or delete. For `MyISAM`, the data file timestamp is used; however, on Windows the timestamp is not updated by updates, so the value is inaccurate.

`UPDATE_TIME` displays a timestamp value for the last `UPDATE`, `INSERT`, or `DELETE` performed on `InnoDB` tables that are not partitioned. For MVCC, the timestamp value reflects the `COMMIT` time, which is considered the last update time. Timestamps are not persisted when the server is restarted or when the table is evicted from the `InnoDB` data dictionary cache.

The `UPDATE_TIME` column also shows this information for partitioned `InnoDB` tables.

- `CHECK_TIME`

When the table was last checked. Not all storage engines update this time, in which case, the value is always `NULL`.

For partitioned `InnoDB` tables, `CHECK_TIME` is always `NULL`.

- `TABLE_COLLATION`

The table default collation. The output does not explicitly list the table default character set, but the collation name begins with the character set name.

- `CHECKSUM`

The live checksum value, if any.

- `CREATE_OPTIONS`

Extra options used with `CREATE TABLE`.

`CREATE_OPTIONS` shows `partitioned` if the table is partitioned.

`CREATE_OPTIONS` shows the `ENCRYPTION` clause specified for tables created in file-per-table tablespaces.

When creating a table with `strict mode` disabled, the storage engine's default row format is used if the specified row format is not supported. The actual row format of the table is reported in the `ROW_FORMAT` column. `CREATE_OPTIONS` shows the row format that was specified in the `CREATE TABLE` statement.

When altering the storage engine of a table, table options that are not applicable to the new storage engine are retained in the table definition to enable reverting the table with its previously defined options to the original storage engine, if necessary. The `CREATE_OPTIONS` column may show retained options.

- `TABLE_COMMENT`

The comment used when creating the table (or information as to why MySQL could not access the table information).

## Notes

- For `NDB` tables, the output of this statement shows appropriate values for the `AVG_ROW_LENGTH` and `DATA_LENGTH` columns, with the exception that `BLOB` columns are not taken into account.
- For `NDB` tables, `DATA_LENGTH` includes data stored in main memory only; the `MAX_DATA_LENGTH` and `DATA_FREE` columns apply to Disk Data.

- For NDB Cluster Disk Data tables, [MAX\\_DATA\\_LENGTH](#) shows the space allocated for the disk part of a Disk Data table or fragment. (In-memory data resource usage is reported by the [DATA\\_LENGTH](#) column.)
- For MEMORY tables, the [DATA\\_LENGTH](#), [MAX\\_DATA\\_LENGTH](#), and [INDEX\\_LENGTH](#) values approximate the actual amount of allocated memory. The allocation algorithm reserves memory in large amounts to reduce the number of allocation operations.
- For views, all [TABLES](#) columns are [NULL](#) except that [TABLE\\_NAME](#) indicates the view name and [TABLE\\_COMMENT](#) says [VIEW](#).

Table information is also available from the [SHOW TABLE STATUS](#) and [SHOW TABLES](#) statements. See [Section 13.7.5.36, “SHOW TABLE STATUS Statement”](#), and [Section 13.7.5.37, “SHOW TABLES Statement”](#). The following statements are equivalent:

```
SELECT
  TABLE_NAME, ENGINE, VERSION, ROW_FORMAT, TABLE_ROWS, AVG_ROW_LENGTH,
  DATA_LENGTH, MAX_DATA_LENGTH, INDEX_LENGTH, DATA_FREE, AUTO_INCREMENT,
  CREATE_TIME, UPDATE_TIME, CHECK_TIME, TABLE_COLLATION, CHECKSUM,
  CREATE_OPTIONS, TABLE_COMMENT
FROM INFORMATION_SCHEMA.TABLES
WHERE table_schema = 'db_name'
[AND table_name LIKE 'wild']

SHOW TABLE STATUS
FROM db_name
[LIKE 'wild']
```

The following statements are equivalent:

```
SELECT
  TABLE_NAME, TABLE_TYPE
FROM INFORMATION_SCHEMA.TABLES
WHERE table_schema = 'db_name'
[AND table_name LIKE 'wild']

SHOW FULL TABLES
FROM db_name
[LIKE 'wild']
```

### 24.3.26 The INFORMATION\_SCHEMA TABLESPACES Table

This table is unused. Other [INFORMATION\\_SCHEMA](#) tables may provide related information:

- For NDB, the [INFORMATION\\_SCHEMA FILES](#) table provides tablespace-related information.
- For InnoDB, the [INFORMATION\\_SCHEMA INNODB\\_SYS\\_TABLESPACES](#) and [INNODB\\_SYS\\_DATAFILES](#) tables provide tablespace metadata.

### 24.3.27 The INFORMATION\_SCHEMA TABLE\_CONSTRAINTS Table

The [TABLE\\_CONSTRAINTS](#) table describes which tables have constraints.

The [TABLE\\_CONSTRAINTS](#) table has these columns:

- [CONSTRAINT\\_CATALOG](#)

The name of the catalog to which the constraint belongs. This value is always [def](#).

- [CONSTRAINT\\_SCHEMA](#)

The name of the schema (database) to which the constraint belongs.



- [CONSTRAINT\\_NAME](#)  
The name of the constraint.
- [TABLE\\_SCHEMA](#)  
The name of the schema (database) to which the table belongs.
- [TABLE\\_NAME](#)  
The name of the table.
- [CONSTRAINT\\_TYPE](#)  
The type of constraint. The value can be [UNIQUE](#), [PRIMARY KEY](#), [FOREIGN KEY](#), or [CHECK](#). This is a [CHAR](#) (not [ENUM](#)) column. The [CHECK](#) value is not available until MySQL supports [CHECK](#).  
  
The [UNIQUE](#) and [PRIMARY KEY](#) information is about the same as what you get from the [Key\\_name](#) column in the output from [SHOW INDEX](#) when the [Non\\_unique](#) column is 0.

### 24.3.28 The INFORMATION\_SCHEMA TABLE\_PRIVILEGES Table

The [TABLE\\_PRIVILEGES](#) table provides information about table privileges. It takes its values from the [mysql.tables\\_priv](#) system table.

The [TABLE\\_PRIVILEGES](#) table has these columns:

- [GRANTEE](#)  
The name of the account to which the privilege is granted, in '[user\\_name](#)'@'[host\\_name](#)' format.
- [TABLE\\_CATALOG](#)  
The name of the catalog to which the table belongs. This value is always [def](#).
- [TABLE\\_SCHEMA](#)  
The name of the schema (database) to which the table belongs.
- [TABLE\\_NAME](#)  
The name of the table.
- [PRIVILEGE\\_TYPE](#)  
The privilege granted. The value can be any privilege that can be granted at the table level; see [Section 13.7.1.4, "GRANT Statement"](#). Each row lists a single privilege, so there is one row per table privilege held by the grantee.
- [IS\\_GRANTABLE](#)  
[YES](#) if the user has the [GRANT OPTION](#) privilege, [NO](#) otherwise. The output does not list [GRANT OPTION](#) as a separate row with [PRIVILEGE\\_TYPE='GRANT OPTION'](#).

#### Notes

- [TABLE\\_PRIVILEGES](#) is a nonstandard [INFORMATION\\_SCHEMA](#) table.

The following statements are *not* equivalent:

```
SELECT ... FROM INFORMATION_SCHEMA.TABLE_PRIVILEGES
SHOW GRANTS ...
```

## 24.3.29 The INFORMATION\_SCHEMA TRIGGERS Table

The `TRIGGERS` table provides information about triggers. To see information about a table's triggers, you must have the `TRIGGER` privilege for the table.

The `TRIGGERS` table has these columns:

- `TRIGGER_CATALOG`

The name of the catalog to which the trigger belongs. This value is always `def`.

- `TRIGGER_SCHEMA`

The name of the schema (database) to which the trigger belongs.

- `TRIGGER_NAME`

The name of the trigger.

- `EVENT_MANIPULATION`

The trigger event. This is the type of operation on the associated table for which the trigger activates. The value is `INSERT` (a row was inserted), `DELETE` (a row was deleted), or `UPDATE` (a row was modified).

- `EVENT_OBJECT_CATALOG`, `EVENT_OBJECT_SCHEMA`, and `EVENT_OBJECT_TABLE`

As noted in [Section 23.3, "Using Triggers"](#), every trigger is associated with exactly one table. These columns indicate the catalog and schema (database) in which this table occurs, and the table name, respectively. The `EVENT_OBJECT_CATALOG` value is always `def`.

- `ACTION_ORDER`

The ordinal position of the trigger's action within the list of triggers on the same table with the same `EVENT_MANIPULATION` and `ACTION_TIMING` values.

- `ACTION_CONDITION`

This value is always `NULL`.

- `ACTION_STATEMENT`

The trigger body; that is, the statement executed when the trigger activates. This text uses UTF-8 encoding.

- `ACTION_ORIENTATION`

This value is always `ROW`.

- `ACTION_TIMING`

Whether the trigger activates before or after the triggering event. The value is `BEFORE` or `AFTER`.

- `ACTION_REFERENCE_OLD_TABLE`

This value is always `NULL`.

- [ACTION\\_REFERENCE\\_NEW\\_TABLE](#)

This value is always `NULL`.

- [ACTION\\_REFERENCE\\_OLD\\_ROW](#) and [ACTION\\_REFERENCE\\_NEW\\_ROW](#)

The old and new column identifiers, respectively. The [ACTION\\_REFERENCE\\_OLD\\_ROW](#) value is always `OLD` and the [ACTION\\_REFERENCE\\_NEW\\_ROW](#) value is always `NEW`.

- [CREATED](#)

The date and time when the trigger was created. This is a `TIMESTAMP(2)` value (with a fractional part in hundredths of seconds) for triggers created in MySQL 5.7.2 or later, `NULL` for triggers created prior to 5.7.2.

- [SQL\\_MODE](#)

The SQL mode in effect when the trigger was created, and under which the trigger executes. For the permitted values, see [Section 5.1.10, “Server SQL Modes”](#).

- [DEFINER](#)

The account named in the [DEFINER](#) clause (often the user who created the trigger), in `'user_name'@'host_name'` format.

- [CHARACTER\\_SET\\_CLIENT](#)

The session value of the `character_set_client` system variable when the trigger was created.

- [COLLATION\\_CONNECTION](#)

The session value of the `collation_connection` system variable when the trigger was created.

- [DATABASE\\_COLLATION](#)

The collation of the database with which the trigger is associated.

## Example

The following example uses the `ins_sum` trigger defined in [Section 23.3, “Using Triggers”](#):

```
mysql> SELECT * FROM INFORMATION_SCHEMA.TRIGGERS
      WHERE TRIGGER_SCHEMA='test' AND TRIGGER_NAME='ins_sum'\G
***** 1. row *****
      TRIGGER_CATALOG: def
      TRIGGER_SCHEMA: test
      TRIGGER_NAME: ins_sum
      EVENT_MANIPULATION: INSERT
EVENT_OBJECT_CATALOG: def
EVENT_OBJECT_SCHEMA: test
      EVENT_OBJECT_TABLE: account
      ACTION_ORDER: 1
      ACTION_CONDITION: NULL
      ACTION_STATEMENT: SET @sum = @sum + NEW.amount
      ACTION_ORIENTATION: ROW
      ACTION_TIMING: BEFORE
ACTION_REFERENCE_OLD_TABLE: NULL
ACTION_REFERENCE_NEW_TABLE: NULL
      ACTION_REFERENCE_OLD_ROW: OLD
      ACTION_REFERENCE_NEW_ROW: NEW
      CREATED: 2018-08-08 10:10:12.61
      SQL_MODE: ONLY_FULL_GROUP_BY,STRICT_TRANS_TABLES,
```

```

NO_ZERO_IN_DATE,NO_ZERO_DATE,
ERROR_FOR_DIVISION_BY_ZERO,
NO_AUTO_CREATE_USER,NO_ENGINE_SUBSTITUTION
DEFINER: me@localhost
CHARACTER_SET_CLIENT: utf8
COLLATION_CONNECTION: utf8_general_ci
DATABASE_COLLATION: latin1_swedish_ci

```

Trigger information is also available from the `SHOW TRIGGERS` statement. See [Section 13.7.5.38, “SHOW TRIGGERS Statement”](#).

### 24.3.30 The INFORMATION\_SCHEMA USER\_PRIVILEGES Table

The `USER_PRIVILEGES` table provides information about global privileges. It takes its values from the `mysql.user` system table.

The `USER_PRIVILEGES` table has these columns:

- `GRANTEE`

The name of the account to which the privilege is granted, in '`user_name`'@'`host_name`' format.

- `TABLE_CATALOG`

The name of the catalog. This value is always `def`.

- `PRIVILEGE_TYPE`

The privilege granted. The value can be any privilege that can be granted at the global level; see [Section 13.7.1.4, “GRANT Statement”](#). Each row lists a single privilege, so there is one row per global privilege held by the grantee.

- `IS_GRANTABLE`

`YES` if the user has the `GRANT OPTION` privilege, `NO` otherwise. The output does not list `GRANT OPTION` as a separate row with `PRIVILEGE_TYPE='GRANT OPTION'`.

#### Notes

- `USER_PRIVILEGES` is a nonstandard `INFORMATION_SCHEMA` table.

The following statements are *not* equivalent:

```

SELECT ... FROM INFORMATION_SCHEMA.USER_PRIVILEGES
SHOW GRANTS ...

```

### 24.3.31 The INFORMATION\_SCHEMA VIEWS Table

The `VIEWS` table provides information about views in databases. You must have the `SHOW VIEW` privilege to access this table.

The `VIEWS` table has these columns:

- `TABLE_CATALOG`

The name of the catalog to which the view belongs. This value is always `def`.

- `TABLE_SCHEMA`

The name of the schema (database) to which the view belongs.

- [TABLE\\_NAME](#)

The name of the view.

- [VIEW\\_DEFINITION](#)

The [SELECT](#) statement that provides the definition of the view. This column has most of what you see in the [Create Table](#) column that [SHOW CREATE VIEW](#) produces. Skip the words before [SELECT](#) and skip the words [WITH CHECK OPTION](#). Suppose that the original statement was:

```
CREATE VIEW v AS
  SELECT s2,s1 FROM t
  WHERE s1 > 5
  ORDER BY s1
  WITH CHECK OPTION;
```

Then the view definition looks like this:

```
SELECT s2,s1 FROM t WHERE s1 > 5 ORDER BY s1
```

- [CHECK\\_OPTION](#)

The value of the [CHECK\\_OPTION](#) attribute. The value is one of [NONE](#), [CASCADE](#), or [LOCAL](#).

- [IS\\_UPDATABLE](#)

MySQL sets a flag, called the view updatability flag, at [CREATE VIEW](#) time. The flag is set to [YES](#) (true) if [UPDATE](#) and [DELETE](#) (and similar operations) are legal for the view. Otherwise, the flag is set to [NO](#) (false). The [IS\\_UPDATABLE](#) column in the [VIEWS](#) table displays the status of this flag.

If a view is not updatable, statements such [UPDATE](#), [DELETE](#), and [INSERT](#) are illegal and are rejected. (Even if a view is updatable, it might not be possible to insert into it; for details, refer to [Section 23.5.3](#), “[Updatable and Insertable Views](#)”.)

The [IS\\_UPDATABLE](#) flag may be unreliable if a view depends on one or more other views, and one of these underlying views is updated. Regardless of the [IS\\_UPDATABLE](#) value, the server keeps track of the updatability of a view and correctly rejects data change operations to views that are not updatable. If the [IS\\_UPDATABLE](#) value for a view has become inaccurate due to changes to underlying views, the value can be updated by deleting and re-creating the view.

- [DEFINER](#)

The account of the user who created the view, in '[user\\_name](#)'@'[host\\_name](#)' format.

- [SECURITY\\_TYPE](#)

The view [SQL SECURITY](#) characteristic. The value is one of [DEFINER](#) or [INVOKER](#).

- [CHARACTER\\_SET\\_CLIENT](#)

The session value of the [character\\_set\\_client](#) system variable when the view was created.

- [COLLATION\\_CONNECTION](#)

The session value of the [collation\\_connection](#) system variable when the view was created.

## Notes

MySQL permits different [sql\\_mode](#) settings to tell the server the type of SQL syntax to support. For example, you might use the [ANSI](#) SQL mode to ensure MySQL correctly interprets the standard SQL

concatenation operator, the double bar ( || ), in your queries. If you then create a view that concatenates items, you might worry that changing the `sql_mode` setting to a value different from `ANSI` could cause the view to become invalid. But this is not the case. No matter how you write out a view definition, MySQL always stores it the same way, in a canonical form. Here is an example that shows how the server changes a double bar concatenation operator to a `CONCAT()` function:

```
mysql> SET sql_mode = 'ANSI';
Query OK, 0 rows affected (0.00 sec)

mysql> CREATE VIEW test.v AS SELECT 'a' || 'b' as coll;
Query OK, 0 rows affected (0.00 sec)

mysql> SELECT VIEW_DEFINITION FROM INFORMATION_SCHEMA.VIEWS
       WHERE TABLE_SCHEMA = 'test' AND TABLE_NAME = 'v';
+-----+
| VIEW_DEFINITION |
+-----+
| select concat('a','b') AS `coll` |
+-----+
1 row in set (0.00 sec)
```

The advantage of storing a view definition in canonical form is that changes made later to the value of `sql_mode` do not affect the results from the view. However, an additional consequence is that comments prior to `SELECT` are stripped from the definition by the server.

## 24.4 INFORMATION\_SCHEMA InnoDB Tables

This section provides table definitions for `INFORMATION_SCHEMA` InnoDB tables. For related information and examples, see [Section 14.16, “InnoDB INFORMATION\\_SCHEMA Tables”](#).

`INFORMATION_SCHEMA` InnoDB tables can be used to monitor ongoing InnoDB activity, to detect inefficiencies before they turn into issues, or to troubleshoot performance and capacity issues. As your database becomes bigger and busier, running up against the limits of your hardware capacity, you monitor and tune these aspects to keep the database running smoothly.

### 24.4.1 INFORMATION\_SCHEMA InnoDB Table Reference

The following table summarizes `INFORMATION_SCHEMA` InnoDB tables. For greater detail, see the individual table descriptions.

**Table 24.3 INFORMATION\_SCHEMA InnoDB Tables**

Table Name	Description	Deprecated
<code>INNODB_BUFFER_PAGE</code>	Pages in InnoDB buffer pool	
<code>INNODB_BUFFER_PAGE_LRU</code>	LRU ordering of pages in InnoDB buffer pool	
<code>INNODB_BUFFER_POOL_STATS</code>	InnoDB buffer pool statistics	
<code>INNODB_CMP</code>	Status for operations related to compressed InnoDB tables	
<code>INNODB_CMP_PER_INDEX</code>	Status for operations related to compressed InnoDB tables and indexes	
<code>INNODB_CMP_PER_INDEX_RESET</code>	Status for operations related to compressed InnoDB tables and indexes	

Table Name	Description	Deprecated
INNODB_CMP_RESET	Status for operations related to compressed InnoDB tables	
INNODB_CMPMEM	Status for compressed pages within InnoDB buffer pool	
INNODB_CMPMEM_RESET	Status for compressed pages within InnoDB buffer pool	
INNODB_FT_BEING_DELETED	Snapshot of INNODB_FT_DELETED table	
INNODB_FT_CONFIG	Metadata for InnoDB table FULLTEXT index and associated processing	
INNODB_FT_DEFAULT_STOPWORD	Default list of stopwords for InnoDB FULLTEXT indexes	
INNODB_FT_DELETED	Rows deleted from InnoDB table FULLTEXT index	
INNODB_FT_INDEX_CACHE	Token information for newly inserted rows in InnoDB FULLTEXT index	
INNODB_FT_INDEX_TABLE	Inverted index information for processing text searches against InnoDB table FULLTEXT index	
INNODB_LOCK_WAITS	InnoDB transaction lock-wait information	5.7.14
INNODB_LOCKS	InnoDB transaction lock information	5.7.14
INNODB_METRICS	InnoDB performance information	
INNODB_SYS_COLUMNS	Columns in each InnoDB table	
INNODB_SYS_DATAFILES	Data file path information for InnoDB file-per-table and general tablespaces	
INNODB_SYS_FIELDS	Key columns of InnoDB indexes	
INNODB_SYS_FOREIGN	InnoDB foreign-key metadata	
INNODB_SYS_FOREIGN_COLS	InnoDB foreign-key column status information	
INNODB_SYS_INDEXES	InnoDB index metadata	
INNODB_SYS_TABLES	InnoDB table metadata	
INNODB_SYS_TABLESPACES	InnoDB file-per-table, general, and undo tablespace metadata	
INNODB_SYS_TABLESTATS	InnoDB table low-level status information	
INNODB_SYS_VIRTUAL	InnoDB virtual generated column metadata	
INNODB_TEMP_TABLE_INFO	Information about active user-created InnoDB temporary tables	

Table Name	Description	Deprecated
<a href="#">INNODB_TRX</a>	Active InnoDB transaction information	

## 24.4.2 The INFORMATION\_SCHEMA INNODB\_BUFFER\_PAGE Table

The [INNODB\\_BUFFER\\_PAGE](#) table provides information about each [page](#) in the [InnoDB buffer pool](#).

For related usage information and examples, see [Section 14.16.5, “InnoDB INFORMATION\\_SCHEMA Buffer Pool Tables”](#).



### Warning

Querying the [INNODB\\_BUFFER\\_PAGE](#) table can affect performance. Do not query this table on a production system unless you are aware of the performance impact and have determined it to be acceptable. To avoid impacting performance on a production system, reproduce the issue you want to investigate and query buffer pool statistics on a test instance.

The [INNODB\\_BUFFER\\_PAGE](#) table has these columns:

- [POOL\\_ID](#)

The buffer pool ID. This is an identifier to distinguish between multiple buffer pool instances.

- [BLOCK\\_ID](#)

The buffer pool block ID.

- [SPACE](#)

The tablespace ID; the same value as [INNODB\\_SYS\\_TABLES . SPACE](#).

- [PAGE\\_NUMBER](#)

The page number.

- [PAGE\\_TYPE](#)

The page type. The following table shows the permitted values.

**Table 24.4 INNODB\_BUFFER\_PAGE.PAGE\_TYPE Values**

Page Type	Description
<a href="#">ALLOCATED</a>	Freshly allocated page
<a href="#">BLOB</a>	Uncompressed BLOB page
<a href="#">COMPRESSED_BLOB2</a>	Subsequent comp BLOB page
<a href="#">COMPRESSED_BLOB</a>	First compressed BLOB page
<a href="#">EXTENT_DESCRIPTOR</a>	Extent descriptor page
<a href="#">FILE_SPACE_HEADER</a>	File space header
<a href="#">IBUF_BITMAP</a>	Insert buffer bitmap
<a href="#">IBUF_FREE_LIST</a>	Insert buffer free list



Page Type	Description
IBUF_INDEX	Insert buffer index
INDEX	B-tree node
INODE	Index node
RTREE_INDEX	R-tree index
SYSTEM	System page
TRX_SYSTEM	Transaction system data
UNDO_LOG	Undo log page
UNKNOWN	Unknown

- [FLUSH\\_TYPE](#)

The flush type.

- [FIX\\_COUNT](#)

The number of threads using this block within the buffer pool. When zero, the block is eligible to be evicted.

- [IS\\_HASHED](#)

Whether a hash index has been built on this page.

- [NEWEST\\_MODIFICATION](#)

The Log Sequence Number of the youngest modification.

- [OLDEST\\_MODIFICATION](#)

The Log Sequence Number of the oldest modification.

- [ACCESS\\_TIME](#)

An abstract number used to judge the first access time of the page.

- [TABLE\\_NAME](#)

The name of the table the page belongs to. This column is applicable only to pages with a [PAGE\\_TYPE](#) value of [INDEX](#).

- [INDEX\\_NAME](#)

The name of the index the page belongs to. This can be the name of a clustered index or a secondary index. This column is applicable only to pages with a [PAGE\\_TYPE](#) value of [INDEX](#).

- [NUMBER\\_RECORDS](#)

The number of records within the page.

- [DATA\\_SIZE](#)

The sum of the sizes of the records. This column is applicable only to pages with a [PAGE\\_TYPE](#) value of [INDEX](#).

- [COMPRESSED\\_SIZE](#)

The compressed page size. `NULL` for pages that are not compressed.

- `PAGE_STATE`

The page state. The following table shows the permitted values.

**Table 24.5 INNODB\_BUFFER\_PAGE.PAGE\_STATE Values**

Page State	Description
<code>FILE_PAGE</code>	A buffered file page
<code>MEMORY</code>	Contains a main memory object
<code>NOT_USED</code>	In the free list
<code>NULL</code>	Clean compressed pages, compressed pages in the flush list, pages used as buffer pool watch sentinels
<code>READY_FOR_USE</code>	A free page
<code>REMOVE_HASH</code>	Hash index should be removed before placing in the free list

- `IO_FIX`

Whether any I/O is pending for this page: `IO_NONE` = no pending I/O, `IO_READ` = read pending, `IO_WRITE` = write pending.

- `IS_OLD`

Whether the block is in the sublist of old blocks in the LRU list.

- `FREE_PAGE_CLOCK`

The value of the `freed_page_clock` counter when the block was the last placed at the head of the LRU list. The `freed_page_clock` counter tracks the number of blocks removed from the end of the LRU list.

## Example

```
mysql> SELECT * FROM INFORMATION_SCHEMA.INNODB_BUFFER_PAGE LIMIT 1\G
***** 1. row *****
      POOL_ID: 0
      BLOCK_ID: 0
      SPACE: 97
      PAGE_NUMBER: 2473
      PAGE_TYPE: INDEX
      FLUSH_TYPE: 1
      FIX_COUNT: 0
      IS_HASHED: YES
NEWEST_MODIFICATION: 733855581
OLDEST_MODIFICATION: 0
      ACCESS_TIME: 3378385672
      TABLE_NAME: `employees`.`salaries`
      INDEX_NAME: PRIMARY
      NUMBER_RECORDS: 468
      DATA_SIZE: 14976
      COMPRESSED_SIZE: 0
      PAGE_STATE: FILE_PAGE
      IO_FIX: IO_NONE
      IS_OLD: YES
```

FREE\_PAGE\_CLOCK: 66

## Notes

- This table is useful primarily for expert-level performance monitoring, or when developing performance-related extensions for MySQL.
- You must have the `PROCESS` privilege to query this table.
- Use the `INFORMATION_SCHEMA COLUMNS` table or the `SHOW COLUMNS` statement to view additional information about the columns of this table, including data types and default values.
- When tables, table rows, partitions, or indexes are deleted, associated pages remain in the buffer pool until space is required for other data. The `INNODB_BUFFER_PAGE` table reports information about these pages until they are evicted from the buffer pool. For more information about how the `InnoDB` manages buffer pool data, see [Section 14.5.1, “Buffer Pool”](#).

### 24.4.3 The INFORMATION\_SCHEMA INNODB\_BUFFER\_PAGE\_LRU Table

The `INNODB_BUFFER_PAGE_LRU` table provides information about the pages in the `InnoDB` buffer pool; in particular, how they are ordered in the LRU list that determines which pages to `evict` from the buffer pool when it becomes full.

The `INNODB_BUFFER_PAGE_LRU` table has the same columns as the `INNODB_BUFFER_PAGE` table, except that the `INNODB_BUFFER_PAGE_LRU` table has `LRU_POSITION` and `COMPRESSED` columns instead of `BLOCK_ID` and `PAGE_STATE` columns.

For related usage information and examples, see [Section 14.16.5, “InnoDB INFORMATION\\_SCHEMA Buffer Pool Tables”](#).



#### Warning

Querying the `INNODB_BUFFER_PAGE_LRU` table can affect performance. Do not query this table on a production system unless you are aware of the performance impact and have determined it to be acceptable. To avoid impacting performance on a production system, reproduce the issue you want to investigate and query buffer pool statistics on a test instance.

The `INNODB_BUFFER_PAGE_LRU` table has these columns:

- `POOL_ID`  
The buffer pool ID. This is an identifier to distinguish between multiple buffer pool instances.
- `LRU_POSITION`  
The position of the page in the LRU list.
- `SPACE`  
The tablespace ID; the same value as `INNODB_SYS_TABLES.SPACE`.
- `PAGE_NUMBER`  
The page number.
- `PAGE_TYPE`  
The page type. The following table shows the permitted values.

**Table 24.6 INNODB\_BUFFER\_PAGE\_LRU.PAGE\_TYPE Values**

Page Type	Description
ALLOCATED	Freshly allocated page
BLOB	Uncompressed BLOB page
COMPRESSED_BLOB2	Subsequent comp BLOB page
COMPRESSED_BLOB	First compressed BLOB page
EXTENT_DESCRIPTOR	Extent descriptor page
FILE_SPACE_HEADER	File space header
IBUF_BITMAP	Insert buffer bitmap
IBUF_FREE_LIST	Insert buffer free list
IBUF_INDEX	Insert buffer index
INDEX	B-tree node
INODE	Index node
RTREE_INDEX	R-tree index
SYSTEM	System page
TRX_SYSTEM	Transaction system data
UNDO_LOG	Undo log page
UNKNOWN	Unknown

- `FLUSH_TYPE`

The flush type.

- `FIX_COUNT`

The number of threads using this block within the buffer pool. When zero, the block is eligible to be evicted.

- `IS_HASHED`

Whether a hash index has been built on this page.

- `NEWEST_MODIFICATION`

The Log Sequence Number of the youngest modification.

- `OLDEST_MODIFICATION`

The Log Sequence Number of the oldest modification.

- `ACCESS_TIME`

An abstract number used to judge the first access time of the page.

- `TABLE_NAME`

The name of the table the page belongs to. This column is applicable only to pages with a `PAGE_TYPE` value of `INDEX`.

- `INDEX_NAME`

The name of the index the page belongs to. This can be the name of a clustered index or a secondary index. This column is applicable only to pages with a `PAGE_TYPE` value of `INDEX`.

- `NUMBER_RECORDS`

The number of records within the page.

- `DATA_SIZE`

The sum of the sizes of the records. This column is applicable only to pages with a `PAGE_TYPE` value of `INDEX`.

- `COMPRESSED_SIZE`

The compressed page size. `NULL` for pages that are not compressed.

- `COMPRESSED`

Whether the page is compressed.

- `IO_FIX`

Whether any I/O is pending for this page: `IO_NONE` = no pending I/O, `IO_READ` = read pending, `IO_WRITE` = write pending.

- `IS_OLD`

Whether the block is in the sublist of old blocks in the LRU list.

- `FREE_PAGE_CLOCK`

The value of the `freed_page_clock` counter when the block was the last placed at the head of the LRU list. The `freed_page_clock` counter tracks the number of blocks removed from the end of the LRU list.

## Example

```
mysql> SELECT * FROM INFORMATION_SCHEMA.INNODB_BUFFER_PAGE_LRU LIMIT 1\G
***** 1. row *****
      POOL_ID: 0
     LRU_POSITION: 0
           SPACE: 97
    PAGE_NUMBER: 1984
     PAGE_TYPE: INDEX
     FLUSH_TYPE: 1
     FIX_COUNT: 0
     IS_HASHED: YES
NEWEST_MODIFICATION: 719490396
OLDEST_MODIFICATION: 0
     ACCESS_TIME: 3378383796
     TABLE_NAME: `employees`.`salaries`
     INDEX_NAME: PRIMARY
NUMBER_RECORDS: 468
     DATA_SIZE: 14976
COMPRESSED_SIZE: 0
     COMPRESSED: NO
           IO_FIX: IO_NONE
           IS_OLD: YES
     FREE_PAGE_CLOCK: 0
```

## Notes

- This table is useful primarily for expert-level performance monitoring, or when developing performance-related extensions for MySQL.
- You must have the [PROCESS](#) privilege to query this table.
- Use the [INFORMATION\\_SCHEMA COLUMNS](#) table or the [SHOW COLUMNS](#) statement to view additional information about the columns of this table, including data types and default values.
- Querying this table can require MySQL to allocate a large block of contiguous memory, more than 64 bytes times the number of active pages in the buffer pool. This allocation could potentially cause an out-of-memory error, especially for systems with multi-gigabyte buffer pools.
- Querying this table requires MySQL to lock the data structure representing the buffer pool while traversing the LRU list, which can reduce concurrency, especially for systems with multi-gigabyte buffer pools.
- When tables, table rows, partitions, or indexes are deleted, associated pages remain in the buffer pool until space is required for other data. The [INNODB\\_BUFFER\\_PAGE\\_LRU](#) table reports information about these pages until they are evicted from the buffer pool. For more information about how the [InnoDB](#) manages buffer pool data, see [Section 14.5.1, “Buffer Pool”](#).

## 24.4.4 The INFORMATION\_SCHEMA INNODB\_BUFFER\_POOL\_STATS Table

The [INNODB\\_BUFFER\\_POOL\\_STATS](#) table provides much of the same buffer pool information provided in [SHOW ENGINE INNODB STATUS](#) output. Much of the same information may also be obtained using [InnoDB](#) buffer pool [server status variables](#).

The idea of making pages in the buffer pool “young” or “not young” refers to transferring them between the [sublists](#) at the head and tail of the buffer pool data structure. Pages made “young” take longer to age out of the buffer pool, while pages made “not young” are moved much closer to the point of [eviction](#).

For related usage information and examples, see [Section 14.16.5, “InnoDB INFORMATION\\_SCHEMA Buffer Pool Tables”](#).

The [INNODB\\_BUFFER\\_POOL\\_STATS](#) table has these columns:

- [POOL\\_ID](#)

The buffer pool ID. This is an identifier to distinguish between multiple buffer pool instances.

- [POOL\\_SIZE](#)

The [InnoDB](#) buffer pool size in pages.

- [FREE\\_BUFFERS](#)

The number of free pages in the [InnoDB](#) buffer pool.

- [DATABASE\\_PAGES](#)

The number of pages in the [InnoDB](#) buffer pool containing data. This number includes both dirty and clean pages.

- [OLD\\_DATABASE\\_PAGES](#)

The number of pages in the `old` buffer pool sublist.

- [MODIFIED\\_DATABASE\\_PAGES](#)  
The number of modified (dirty) database pages.
- [PENDING\\_DECOMPRESS](#)  
The number of pages pending decompression.
- [PENDING\\_READS](#)  
The number of pending reads.
- [PENDING\\_FLUSH\\_LRU](#)  
The number of pages pending flush in the LRU.
- [PENDING\\_FLUSH\\_LIST](#)  
The number of pages pending flush in the flush list.
- [PAGES\\_MADE\\_YOUNG](#)  
The number of pages made young.
- [PAGES\\_NOT\\_MADE\\_YOUNG](#)  
The number of pages not made young.
- [PAGES\\_MADE\\_YOUNG\\_RATE](#)  
The number of pages made young per second (pages made young since the last printout / time elapsed).
- [PAGES\\_MADE\\_NOT\\_YOUNG\\_RATE](#)  
The number of pages not made per second (pages not made young since the last printout / time elapsed).
- [NUMBER\\_PAGES\\_READ](#)  
The number of pages read.
- [NUMBER\\_PAGES\\_CREATED](#)  
The number of pages created.
- [NUMBER\\_PAGES\\_WRITTEN](#)  
The number of pages written.
- [PAGES\\_READ\\_RATE](#)  
The number of pages read per second (pages read since the last printout / time elapsed).
- [PAGES\\_CREATE\\_RATE](#)  
The number of pages created per second (pages created since the last printout / time elapsed).
- [PAGES\\_WRITTEN\\_RATE](#)  
The number of pages written per second (pages written since the last printout / time elapsed).

- [NUMBER\\_PAGES\\_GET](#)  
The number of logical read requests.
- [HIT\\_RATE](#)  
The buffer pool hit rate.
- [YOUNG\\_MAKE\\_PER\\_THOUSAND\\_GETS](#)  
The number of pages made young per thousand gets.
- [NOT\\_YOUNG\\_MAKE\\_PER\\_THOUSAND\\_GETS](#)  
The number of pages not made young per thousand gets.
- [NUMBER\\_PAGES\\_READ\\_AHEAD](#)  
The number of pages read ahead.
- [NUMBER\\_READ\\_AHEAD\\_EVICTED](#)  
The number of pages read into the `InnoDB` buffer pool by the read-ahead background thread that were subsequently evicted without having been accessed by queries.
- [READ\\_AHEAD\\_RATE](#)  
The read-ahead rate per second (pages read ahead since the last printout / time elapsed).
- [READ\\_AHEAD\\_EVICTED\\_RATE](#)  
The number of read-ahead pages evicted without access per second (read-ahead pages not accessed since the last printout / time elapsed).
- [LRU\\_IO\\_TOTAL](#)  
Total LRU I/O.
- [LRU\\_IO\\_CURRENT](#)  
LRU I/O for the current interval.
- [UNCOMPRESS\\_TOTAL](#)  
The total number of pages decompressed.
- [UNCOMPRESS\\_CURRENT](#)  
The number of pages decompressed in the current interval.

## Example

```
mysql> SELECT * FROM INFORMATION_SCHEMA.INNODB_BUFFER_POOL_STATS\G
***** 1. row *****
          POOL_ID: 0
          POOL_SIZE: 8192
          FREE_BUFFERS: 1
          DATABASE_PAGES: 8085
          OLD_DATABASE_PAGES: 2964
          MODIFIED_DATABASE_PAGES: 0
          PENDING_DECOMPRESS: 0
          PENDING_READS: 0
```



```

PENDING_FLUSH_LRU: 0
PENDING_FLUSH_LIST: 0
PAGES_MADE_YOUNG: 22821
PAGES_NOT_MADE_YOUNG: 3544303
PAGES_MADE_YOUNG_RATE: 357.62602199870594
PAGES_MADE_NOT_YOUNG_RATE: 0
NUMBER_PAGES_READ: 2389
NUMBER_PAGES_CREATED: 12385
NUMBER_PAGES_WRITTEN: 13111
PAGES_READ_RATE: 0
PAGES_CREATE_RATE: 0
PAGES_WRITTEN_RATE: 0
NUMBER_PAGES_GET: 33322210
HIT_RATE: 1000
YOUNG_MAKE_PER_THOUSAND_GETS: 18
NOT_YOUNG_MAKE_PER_THOUSAND_GETS: 0
NUMBER_PAGES_READ_AHEAD: 2024
NUMBER_READ_AHEAD_EVICTED: 0
READ_AHEAD_RATE: 0
READ_AHEAD_EVICTED_RATE: 0
LRU_IO_TOTAL: 0
LRU_IO_CURRENT: 0
UNCOMPRESS_TOTAL: 0
UNCOMPRESS_CURRENT: 0

```

## Notes

- This table is useful primarily for expert-level performance monitoring, or when developing performance-related extensions for MySQL.
- You must have the [PROCESS](#) privilege to query this table.
- Use the [INFORMATION\\_SCHEMA COLUMNS](#) table or the [SHOW COLUMNS](#) statement to view additional information about the columns of this table, including data types and default values.

## 24.4.5 The INFORMATION\_SCHEMA INNODB\_CMP and INNODB\_CMP\_RESET Tables

The [INNODB\\_CMP](#) and [INNODB\\_CMP\\_RESET](#) tables provide status information on operations related to [compressed InnoDB](#) tables.

The [INNODB\\_CMP](#) and [INNODB\\_CMP\\_RESET](#) tables have these columns:

- [PAGE\\_SIZE](#)

The compressed page size in bytes.

- [COMPRESS\\_OPS](#)

The number of times a B-tree page of size [PAGE\\_SIZE](#) has been compressed. Pages are compressed whenever an empty page is created or the space for the uncompressed modification log runs out.

- [COMPRESS\\_OPS\\_OK](#)

The number of times a B-tree page of size [PAGE\\_SIZE](#) has been successfully compressed. This count should never exceed [COMPRESS\\_OPS](#).

- [COMPRESS\\_TIME](#)

The total time in seconds used for attempts to compress B-tree pages of size [PAGE\\_SIZE](#).

- [UNCOMPRESS\\_OPS](#)

The number of times a B-tree page of size `PAGE_SIZE` has been uncompressed. B-tree pages are uncompressed whenever compression fails or at first access when the uncompressed page does not exist in the buffer pool.

- `UNCOMPRESS_TIME`

The total time in seconds used for uncompressing B-tree pages of the size `PAGE_SIZE`.

## Example

```
mysql> SELECT * FROM INFORMATION_SCHEMA.INNODB_CMP\G
***** 1. row *****
      page_size: 1024
      compress_ops: 0
compress_ops_ok: 0
      compress_time: 0
      uncompress_ops: 0
      uncompress_time: 0
***** 2. row *****
      page_size: 2048
      compress_ops: 0
compress_ops_ok: 0
      compress_time: 0
      uncompress_ops: 0
      uncompress_time: 0
***** 3. row *****
      page_size: 4096
      compress_ops: 0
compress_ops_ok: 0
      compress_time: 0
      uncompress_ops: 0
      uncompress_time: 0
***** 4. row *****
      page_size: 8192
      compress_ops: 86955
compress_ops_ok: 81182
      compress_time: 27
      uncompress_ops: 26828
      uncompress_time: 5
***** 5. row *****
      page_size: 16384
      compress_ops: 0
compress_ops_ok: 0
      compress_time: 0
      uncompress_ops: 0
      uncompress_time: 0
```

## Notes

- Use these tables to measure the effectiveness of [InnoDB table compression](#) in your database.
- You must have the `PROCESS` privilege to query this table.
- Use the `INFORMATION_SCHEMA COLUMNS` table or the `SHOW COLUMNS` statement to view additional information about the columns of this table, including data types and default values.
- For usage information, see [Section 14.9.1.4, “Monitoring InnoDB Table Compression at Runtime”](#) and [Section 14.16.1.3, “Using the Compression Information Schema Tables”](#). For general information about [InnoDB table compression](#), see [Section 14.9, “InnoDB Table and Page Compression”](#).

## 24.4.6 The INFORMATION\_SCHEMA INNODB\_CMPMEM and INNODB\_CMPMEM\_RESET Tables

The `INNODB_CMPMEM` and `INNODB_CMPMEM_RESET` tables provide status information on compressed pages within the `InnoDB` buffer pool.

The `INNODB_CMPMEM` and `INNODB_CMPMEM_RESET` tables have these columns:

- `PAGE_SIZE`

The block size in bytes. Each record of this table describes blocks of this size.

- `BUFFER_POOL_INSTANCE`

A unique identifier for the buffer pool instance.

- `PAGES_USED`

The number of blocks of size `PAGE_SIZE` that are currently in use.

- `PAGES_FREE`

The number of blocks of size `PAGE_SIZE` that are currently available for allocation. This column shows the external fragmentation in the memory pool. Ideally, these numbers should be at most 1.

- `RELOCATION_OPS`

The number of times a block of size `PAGE_SIZE` has been relocated. The buddy system can relocate the allocated “buddy neighbor” of a freed block when it tries to form a bigger freed block. Reading from the `INNODB_CMPMEM_RESET` table resets this count.

- `RELOCATION_TIME`

The total time in microseconds used for relocating blocks of size `PAGE_SIZE`. Reading from the table `INNODB_CMPMEM_RESET` resets this count.

## Example

```
mysql> SELECT * FROM INFORMATION_SCHEMA.INNODB_CMPMEM\G
***** 1. row *****
      page_size: 1024
buffer_pool_instance: 0
      pages_used: 0
      pages_free: 0
      relocation_ops: 0
      relocation_time: 0
***** 2. row *****
      page_size: 2048
buffer_pool_instance: 0
      pages_used: 0
      pages_free: 0
      relocation_ops: 0
      relocation_time: 0
***** 3. row *****
      page_size: 4096
buffer_pool_instance: 0
      pages_used: 0
      pages_free: 0
      relocation_ops: 0
      relocation_time: 0
***** 4. row *****
      page_size: 8192
buffer_pool_instance: 0
      pages_used: 7673
      pages_free: 15
```

```

relocation_ops: 4638
relocation_time: 0
***** 5. row *****
page_size: 16384
buffer_pool_instance: 0
pages_used: 0
pages_free: 0
relocation_ops: 0
relocation_time: 0
    
```

## Notes

- Use these tables to measure the effectiveness of [InnoDB table compression](#) in your database.
- You must have the [PROCESS](#) privilege to query this table.
- Use the [INFORMATION\\_SCHEMA COLUMNS](#) table or the [SHOW COLUMNS](#) statement to view additional information about the columns of this table, including data types and default values.
- For usage information, see [Section 14.9.1.4, “Monitoring InnoDB Table Compression at Runtime”](#) and [Section 14.16.1.3, “Using the Compression Information Schema Tables”](#). For general information about [InnoDB table compression](#), see [Section 14.9, “InnoDB Table and Page Compression”](#).

## 24.4.7 The INFORMATION\_SCHEMA INNODB\_CMP\_PER\_INDEX and INNODB\_CMP\_PER\_INDEX\_RESET Tables

The [INNODB\\_CMP\\_PER\\_INDEX](#) and [INNODB\\_CMP\\_PER\\_INDEX\\_RESET](#) tables provide status information on operations related to [compressed InnoDB tables and indexes](#), with separate statistics for each combination of database, table, and index, to help you evaluate the performance and usefulness of compression for specific tables.

For a compressed [InnoDB table](#), both the table data and all the [secondary indexes](#) are compressed. In this context, the table data is treated as just another index, one that happens to contain all the columns: the [clustered index](#).

The [INNODB\\_CMP\\_PER\\_INDEX](#) and [INNODB\\_CMP\\_PER\\_INDEX\\_RESET](#) tables have these columns:

- [DATABASE\\_NAME](#)

The schema (database) containing the applicable table.

- [TABLE\\_NAME](#)

The table to monitor for compression statistics.

- [INDEX\\_NAME](#)

The index to monitor for compression statistics.

- [COMPRESS\\_OPS](#)

The number of compression operations attempted. [Pages](#) are compressed whenever an empty page is created or the space for the uncompressed modification log runs out.

- [COMPRESS\\_OPS\\_OK](#)

The number of successful compression operations. Subtract from the [COMPRESS\\_OPS](#) value to get the number of [compression failures](#). Divide by the [COMPRESS\\_OPS](#) value to get the percentage of compression failures.

- [COMPRESS\\_TIME](#)

The total time in seconds used for compressing data in this index.

- [UNCOMPRESS\\_OPS](#)

The number of uncompression operations performed. Compressed [InnoDB](#) pages are uncompressed whenever compression [fails](#), or the first time a compressed page is accessed in the [buffer pool](#) and the uncompressed page does not exist.

- [UNCOMPRESS\\_TIME](#)

The total time in seconds used for uncompressing data in this index.

## Example

```
mysql> SELECT * FROM INFORMATION_SCHEMA.INNODB_CMP_PER_INDEX\G
***** 1. row *****
  database_name: employees
    table_name: salaries
    index_name: PRIMARY
    compress_ops: 0
compress_ops_ok: 0
  compress_time: 0
uncompress_ops: 23451
uncompress_time: 4
***** 2. row *****
  database_name: employees
    table_name: salaries
    index_name: emp_no
    compress_ops: 0
compress_ops_ok: 0
  compress_time: 0
uncompress_ops: 1597
uncompress_time: 0
```

## Notes

- Use these tables to measure the effectiveness of [InnoDB](#) table [compression](#) for specific tables, indexes, or both.
- You must have the [PROCESS](#) privilege to query these tables.
- Use the [INFORMATION\\_SCHEMA COLUMNS](#) table or the [SHOW COLUMNS](#) statement to view additional information about the columns of these tables, including data types and default values.
- Because collecting separate measurements for every index imposes substantial performance overhead, [INNODB\\_CMP\\_PER\\_INDEX](#) and [INNODB\\_CMP\\_PER\\_INDEX\\_RESET](#) statistics are not gathered by default. You must enable the [innodb\\_cmp\\_per\\_index\\_enabled](#) system variable before performing the operations on compressed tables that you want to monitor.
- For usage information, see [Section 14.9.1.4, “Monitoring InnoDB Table Compression at Runtime”](#) and [Section 14.16.1.3, “Using the Compression Information Schema Tables”](#). For general information about [InnoDB](#) table compression, see [Section 14.9, “InnoDB Table and Page Compression”](#).

## 24.4.8 The INFORMATION\_SCHEMA INNODB\_FT\_BEING\_DELETED Table

The [INNODB\\_FT\\_BEING\\_DELETED](#) table provides a snapshot of the [INNODB\\_FT\\_DELETED](#) table; it is used only during an [OPTIMIZE TABLE](#) maintenance operation. When [OPTIMIZE TABLE](#) is run, the [INNODB\\_FT\\_BEING\\_DELETED](#) table is emptied, and [DOC\\_ID](#) values are removed from the

`INNODB_FT_DELETED` table. Because the contents of `INNODB_FT_BEING_DELETED` typically have a short lifetime, this table has limited utility for monitoring or debugging. For information about running `OPTIMIZE TABLE` on tables with `FULLTEXT` indexes, see [Section 12.9.6, “Fine-Tuning MySQL Full-Text Search”](#).

This table is empty initially. Before querying it, set the value of the `innodb_ft_aux_table` system variable to the name (including the database name) of the table that contains the `FULLTEXT` index; for example `test/articles`. The output appears similar to the example provided for the `INNODB_FT_DELETED` table.

For related usage information and examples, see [Section 14.16.4, “InnoDB INFORMATION\\_SCHEMA FULLTEXT Index Tables”](#).

The `INNODB_FT_BEING_DELETED` table has these columns:

- `DOC_ID`

The document ID of the row that is in the process of being deleted. This value might reflect the value of an ID column that you defined for the underlying table, or it can be a sequence value generated by `InnoDB` when the table contains no suitable column. This value is used when you do text searches, to skip rows in the `INNODB_FT_INDEX_TABLE` table before data for deleted rows is physically removed from the `FULLTEXT` index by an `OPTIMIZE TABLE` statement. For more information, see [Optimizing InnoDB Full-Text Indexes](#).

## Notes

- You must have the `PROCESS` privilege to query this table.
- Use the `INFORMATION_SCHEMA COLUMNS` table or the `SHOW COLUMNS` statement to view additional information about the columns of this table, including data types and default values.
- For more information about `InnoDB FULLTEXT` search, see [Section 14.6.2.4, “InnoDB Full-Text Indexes”](#), and [Section 12.9, “Full-Text Search Functions”](#).

## 24.4.9 The INFORMATION\_SCHEMA INNODB\_FT\_CONFIG Table

The `INNODB_FT_CONFIG` table provides metadata about the `FULLTEXT` index and associated processing for an `InnoDB` table.

This table is empty initially. Before querying it, set the value of the `innodb_ft_aux_table` system variable to the name (including the database name) of the table that contains the `FULLTEXT` index; for example `test/articles`.

For related usage information and examples, see [Section 14.16.4, “InnoDB INFORMATION\\_SCHEMA FULLTEXT Index Tables”](#).

The `INNODB_FT_CONFIG` table has these columns:

- `KEY`

The name designating an item of metadata for an `InnoDB` table containing a `FULLTEXT` index.

The values for this column might change, depending on the needs for performance tuning and debugging for `InnoDB` full-text processing. The key names and their meanings include:

- `optimize_checkpoint_limit`: The number of seconds after which an `OPTIMIZE TABLE` run stops.

- `synced_doc_id`: The next `DOC_ID` to be issued.
- `stopword_table_name`: The *database/table* name for a user-defined stopword table. The `VALUE` column is empty if there is no user-defined stopword table.
- `use_stopword`: Indicates whether a stopword table is used, which is defined when the `FULLTEXT` index is created.
- `VALUE`  
The value associated with the corresponding `KEY` column, reflecting some limit or current value for an aspect of a `FULLTEXT` index for an `InnoDB` table.

## Example

```
mysql> SELECT * FROM INFORMATION_SCHEMA.INNODB_FT_CONFIG;
+-----+-----+
| KEY                | VALUE                |
+-----+-----+
| optimize_checkpoint_limit | 180                |
| synced_doc_id       | 0                   |
| stopword_table_name | test/my_stopwords  |
| use_stopword       | 1                   |
+-----+-----+
```

## Notes

- This table is intended only for internal configuration. It is not intended for statistical information purposes.
- You must have the `PROCESS` privilege to query this table.
- Use the `INFORMATION_SCHEMA COLUMNS` table or the `SHOW COLUMNS` statement to view additional information about the columns of this table, including data types and default values.
- For more information about `InnoDB FULLTEXT` search, see [Section 14.6.2.4, “InnoDB Full-Text Indexes”](#), and [Section 12.9, “Full-Text Search Functions”](#).

## 24.4.10 The INFORMATION\_SCHEMA INNODB\_FT\_DEFAULT\_STOPWORD Table

The `INNODB_FT_DEFAULT_STOPWORD` table holds a list of `stopwords` that are used by default when creating a `FULLTEXT` index on `InnoDB` tables. For information about the default `InnoDB` stopword list and how to define your own stopword lists, see [Section 12.9.4, “Full-Text Stopwords”](#).

For related usage information and examples, see [Section 14.16.4, “InnoDB INFORMATION\\_SCHEMA FULLTEXT Index Tables”](#).

The `INNODB_FT_DEFAULT_STOPWORD` table has these columns:

- `value`

A word that is used by default as a stopword for `FULLTEXT` indexes on `InnoDB` tables. This is not used if you override the default stopword processing with either the `innodb_ft_server_stopword_table` or the `innodb_ft_user_stopword_table` system variable.

## Example

```
mysql> SELECT * FROM INFORMATION_SCHEMA.INNODB_FT_DEFAULT_STOPWORD;
```

```

+-----+
| value |
+-----+
| a     |
| about |
| an    |
| are   |
| as    |
| at    |
| be    |
| by    |
| com   |
| de    |
| en    |
| for   |
| from  |
| how   |
| i     |
| in    |
| is    |
| it    |
| la    |
| of    |
| on    |
| or    |
| that  |
| the   |
| this  |
| to    |
| was   |
| what  |
| when  |
| where |
| who   |
| will  |
| with  |
| und   |
| the   |
| www   |
+-----+
36 rows in set (0.00 sec)

```

## Notes

- You must have the [PROCESS](#) privilege to query this table.
- Use the [INFORMATION\\_SCHEMA COLUMNS](#) table or the [SHOW COLUMNS](#) statement to view additional information about the columns of this table, including data types and default values.
- For more information about [InnoDB FULLTEXT](#) search, see [Section 14.6.2.4, “InnoDB Full-Text Indexes”](#), and [Section 12.9, “Full-Text Search Functions”](#).

### 24.4.11 The INFORMATION\_SCHEMA INNODB\_FT\_DELETED Table

The [INNODB\\_FT\\_DELETED](#) table stores rows that are deleted from the [FULLTEXT](#) index for an [InnoDB](#) table. To avoid expensive index reorganization during DML operations for an [InnoDB FULLTEXT](#) index, the information about newly deleted words is stored separately, filtered out of search results when you do a text search, and removed from the main search index only when you issue an [OPTIMIZE TABLE](#) statement for the [InnoDB](#) table. For more information, see [Optimizing InnoDB Full-Text Indexes](#).

This table is empty initially. Before querying it, set the value of the [innodb\\_ft\\_aux\\_table](#) system variable to the name (including the database name) of the table that contains the [FULLTEXT](#) index; for example [test/articles](#).



For related usage information and examples, see [Section 14.16.4, “InnoDB INFORMATION\\_SCHEMA FULLTEXT Index Tables”](#).

The `INNODB_FT_DELETED` table has these columns:

- `DOC_ID`

The document ID of the newly deleted row. This value might reflect the value of an ID column that you defined for the underlying table, or it can be a sequence value generated by `InnoDB` when the table contains no suitable column. This value is used when you do text searches, to skip rows in the `INNODB_FT_INDEX_TABLE` table before data for deleted rows is physically removed from the `FULLTEXT` index by an `OPTIMIZE TABLE` statement. For more information, see [Optimizing InnoDB Full-Text Indexes](#).

## Example

```
mysql> SELECT * FROM INFORMATION_SCHEMA.INNODB_FT_DELETED;
+-----+
| DOC_ID |
+-----+
|      6 |
|      7 |
|      8 |
+-----+
```

## Notes

- You must have the `PROCESS` privilege to query this table.
- Use the `INFORMATION_SCHEMA.COLUMNS` table or the `SHOW COLUMNS` statement to view additional information about the columns of this table, including data types and default values.
- For more information about `InnoDB FULLTEXT` search, see [Section 14.6.2.4, “InnoDB Full-Text Indexes”](#), and [Section 12.9, “Full-Text Search Functions”](#).

## 24.4.12 The INFORMATION\_SCHEMA INNODB\_FT\_INDEX\_CACHE Table

The `INNODB_FT_INDEX_CACHE` table provides token information about newly inserted rows in a `FULLTEXT` index. To avoid expensive index reorganization during DML operations, the information about newly indexed words is stored separately, and combined with the main search index only when `OPTIMIZE TABLE` is run, when the server is shut down, or when the cache size exceeds a limit defined by the `innodb_ft_cache_size` or `innodb_ft_total_cache_size` system variable.

This table is empty initially. Before querying it, set the value of the `innodb_ft_aux_table` system variable to the name (including the database name) of the table that contains the `FULLTEXT` index; for example `test/articles`.

For related usage information and examples, see [Section 14.16.4, “InnoDB INFORMATION\\_SCHEMA FULLTEXT Index Tables”](#).

The `INNODB_FT_INDEX_CACHE` table has these columns:

- `WORD`

A word extracted from the text of a newly inserted row.

- `FIRST_DOC_ID`

The first document ID in which this word appears in the `FULLTEXT` index.

- `LAST_DOC_ID`

The last document ID in which this word appears in the `FULLTEXT` index.

- `DOC_COUNT`

The number of rows in which this word appears in the `FULLTEXT` index. The same word can occur several times within the cache table, once for each combination of `DOC_ID` and `POSITION` values.

- `DOC_ID`

The document ID of the newly inserted row. This value might reflect the value of an ID column that you defined for the underlying table, or it can be a sequence value generated by `InnoDB` when the table contains no suitable column.

- `POSITION`

The position of this particular instance of the word within the relevant document identified by the `DOC_ID` value. The value does not represent an absolute position; it is an offset added to the `POSITION` of the previous instance of that word.

## Notes

- This table is empty initially. Before querying it, set the value of the `innodb_ft_aux_table` system variable to the name (including the database name) of the table that contains the `FULLTEXT` index; for example `test/articles`. The following example demonstrates how to use the `innodb_ft_aux_table` system variable to show information about a `FULLTEXT` index for a specified table.

```
mysql> USE test;

mysql> CREATE TABLE articles (
  id INT UNSIGNED AUTO_INCREMENT NOT NULL PRIMARY KEY,
  title VARCHAR(200),
  body TEXT,
  FULLTEXT (title,body)
) ENGINE=InnoDB;

mysql> INSERT INTO articles (title,body) VALUES
('MySQL Tutorial','DBMS stands for DataBase ...'),
('How To Use MySQL Well','After you went through a ...'),
('Optimizing MySQL','In this tutorial we show ...'),
('1001 MySQL Tricks','1. Never run mysql as root. 2. ...'),
('MySQL vs. YourSQL','In the following database comparison ...'),
('MySQL Security','When configured properly, MySQL ...');

mysql> SET GLOBAL innodb_ft_aux_table = 'test/articles';

mysql> SELECT WORD, DOC_COUNT, DOC_ID, POSITION
FROM INFORMATION_SCHEMA.INNODB_FT_INDEX_CACHE LIMIT 5;
```

WORD	DOC_COUNT	DOC_ID	POSITION
1001	1	4	0
after	1	2	22
comparison	1	5	44
configured	1	6	20
database	2	1	31

- You must have the [PROCESS](#) privilege to query this table.
- Use the [INFORMATION\\_SCHEMA COLUMNS](#) table or the [SHOW COLUMNS](#) statement to view additional information about the columns of this table, including data types and default values.
- For more information about [InnoDB FULLTEXT](#) search, see [Section 14.6.2.4, “InnoDB Full-Text Indexes”](#), and [Section 12.9, “Full-Text Search Functions”](#).

### 24.4.13 The INFORMATION\_SCHEMA INNODB\_FT\_INDEX\_TABLE Table

The [INNODB\\_FT\\_INDEX\\_TABLE](#) table provides information about the inverted index used to process text searches against the [FULLTEXT](#) index of an [InnoDB](#) table.

This table is empty initially. Before querying it, set the value of the [innodb\\_ft\\_aux\\_table](#) system variable to the name (including the database name) of the table that contains the [FULLTEXT](#) index; for example `test/articles`.

For related usage information and examples, see [Section 14.16.4, “InnoDB INFORMATION\\_SCHEMA FULLTEXT Index Tables”](#).

The [INNODB\\_FT\\_INDEX\\_TABLE](#) table has these columns:

- [WORD](#)

A word extracted from the text of the columns that are part of a [FULLTEXT](#).

- [FIRST\\_DOC\\_ID](#)

The first document ID in which this word appears in the [FULLTEXT](#) index.

- [LAST\\_DOC\\_ID](#)

The last document ID in which this word appears in the [FULLTEXT](#) index.

- [DOC\\_COUNT](#)

The number of rows in which this word appears in the [FULLTEXT](#) index. The same word can occur several times within the cache table, once for each combination of [DOC\\_ID](#) and [POSITION](#) values.

- [DOC\\_ID](#)

The document ID of the row containing the word. This value might reflect the value of an ID column that you defined for the underlying table, or it can be a sequence value generated by [InnoDB](#) when the table contains no suitable column.

- [POSITION](#)

The position of this particular instance of the word within the relevant document identified by the [DOC\\_ID](#) value.

#### Notes

- This table is empty initially. Before querying it, set the value of the [innodb\\_ft\\_aux\\_table](#) system variable to the name (including the database name) of the table that contains the [FULLTEXT](#) index; for example `test/articles`. The following example demonstrates how to use the [innodb\\_ft\\_aux\\_table](#) system variable to show information about a [FULLTEXT](#) index for a specified table. Before information for newly inserted rows appears in [INNODB\\_FT\\_INDEX\\_TABLE](#), the [FULLTEXT](#) index cache must be flushed to disk. This is accomplished by running an [OPTIMIZE TABLE](#) operation

on the indexed table with the `innodb_optimize_fulltext_only` system variable enabled. (The example disables that variable again at the end because it is intended to be enabled only temporarily.)

```
mysql> USE test;

mysql> CREATE TABLE articles (
    id INT UNSIGNED AUTO_INCREMENT NOT NULL PRIMARY KEY,
    title VARCHAR(200),
    body TEXT,
    FULLTEXT (title,body)
) ENGINE=InnoDB;

mysql> INSERT INTO articles (title,body) VALUES
('MySQL Tutorial','DBMS stands for DataBase ...'),
('How To Use MySQL Well','After you went through a ...'),
('Optimizing MySQL','In this tutorial we show ...'),
('1001 MySQL Tricks','1. Never run mysqld as root. 2. ...'),
('MySQL vs. YourSQL','In the following database comparison ...'),
('MySQL Security','When configured properly, MySQL ...');

mysql> SET GLOBAL innodb_optimize_fulltext_only=ON;

mysql> OPTIMIZE TABLE articles;
+-----+-----+-----+-----+
| Table          | Op      | Msg_type | Msg_text |
+-----+-----+-----+-----+
| test.articles | optimize | status   | OK       |
+-----+-----+-----+-----+

mysql> SET GLOBAL innodb_ft_aux_table = 'test/articles';

mysql> SELECT WORD, DOC_COUNT, DOC_ID, POSITION
FROM INFORMATION_SCHEMA.INNODB_FT_INDEX_TABLE LIMIT 5;
+-----+-----+-----+-----+
| WORD          | DOC_COUNT | DOC_ID | POSITION |
+-----+-----+-----+-----+
| 1001          | 1         | 4      | 0       |
| after         | 1         | 2      | 22      |
| comparison    | 1         | 5      | 44      |
| configured    | 1         | 6      | 20      |
| database      | 2         | 1      | 31      |
+-----+-----+-----+-----+

mysql> SET GLOBAL innodb_optimize_fulltext_only=OFF;
```

- You must have the `PROCESS` privilege to query this table.
- Use the `INFORMATION_SCHEMA COLUMNS` table or the `SHOW COLUMNS` statement to view additional information about the columns of this table, including data types and default values.
- For more information about `InnoDB FULLTEXT` search, see [Section 14.6.2.4, “InnoDB Full-Text Indexes”](#), and [Section 12.9, “Full-Text Search Functions”](#).

## 24.4.14 The INFORMATION\_SCHEMA INNODB\_LOCKS Table

The `INNODB_LOCKS` table provides information about each lock that an `InnoDB` transaction has requested but not yet acquired, and each lock that a transaction holds that is blocking another transaction.



### Note

This table is deprecated as of MySQL 5.7.14 and is removed in MySQL 8.0.

The `INNODB_LOCKS` table has these columns:

- [LOCK\\_ID](#)

A unique lock ID number, internal to [InnoDB](#). Treat it as an opaque string. Although [LOCK\\_ID](#) currently contains [TRX\\_ID](#), the format of the data in [LOCK\\_ID](#) is subject to change at any time. Do not write applications that parse the [LOCK\\_ID](#) value.

- [LOCK\\_TRX\\_ID](#)

The ID of the transaction holding the lock. To obtain details about the transaction, join this column with the [TRX\\_ID](#) column of the [INNODB\\_TRX](#) table.

- [LOCK\\_MODE](#)

How the lock is requested. Permitted lock mode descriptors are [S](#), [X](#), [IS](#), [IX](#), [GAP](#), [AUTO\\_INC](#), and [UNKNOWN](#). Lock mode descriptors may be used in combination to identify particular lock modes. For information about [InnoDB](#) lock modes, see [Section 14.7.1, “InnoDB Locking”](#).

- [LOCK\\_TYPE](#)

The type of lock. Permitted values are [RECORD](#) for a row-level lock, [TABLE](#) for a table-level lock.

- [LOCK\\_TABLE](#)

The name of the table that has been locked or contains locked records.

- [LOCK\\_INDEX](#)

The name of the index, if [LOCK\\_TYPE](#) is [RECORD](#); otherwise [NULL](#).

- [LOCK\\_SPACE](#)

The tablespace ID of the locked record, if [LOCK\\_TYPE](#) is [RECORD](#); otherwise [NULL](#).

- [LOCK\\_PAGE](#)

The page number of the locked record, if [LOCK\\_TYPE](#) is [RECORD](#); otherwise [NULL](#).

- [LOCK\\_REC](#)

The heap number of the locked record within the page, if [LOCK\\_TYPE](#) is [RECORD](#); otherwise [NULL](#).

- [LOCK\\_DATA](#)

The data associated with the lock, if any. A value is shown if the [LOCK\\_TYPE](#) is [RECORD](#), otherwise the value is [NULL](#). Primary key values of the locked record are shown for a lock placed on the primary key index. Secondary index values of the locked record are shown for a lock placed on a unique secondary index. Secondary index values are shown with primary key values appended if the secondary index is not unique. If there is no primary key, [LOCK\\_DATA](#) shows either the key values of a selected unique index or the unique [InnoDB](#) internal row ID number, according to the rules governing [InnoDB](#) clustered index use (see [Section 14.6.2.1, “Clustered and Secondary Indexes”](#)). [LOCK\\_DATA](#) reports “supremum pseudo-record” for a lock taken on a supremum pseudo-record. If the page containing the locked record is not in the buffer pool because it was written to disk while the lock was held, [InnoDB](#) does not fetch the page from disk. Instead, [LOCK\\_DATA](#) reports [NULL](#).

## Example

```
mysql> SELECT * FROM INFORMATION_SCHEMA.INNODB_LOCKS\G
***** 1. row *****
```

```

lock_id: 3723:72:3:2
lock_trx_id: 3723
lock_mode: X
lock_type: RECORD
lock_table: `mysql`.`t`
lock_index: PRIMARY
lock_space: 72
lock_page: 3
lock_rec: 2
lock_data: 1, 9
***** 2. row *****
lock_id: 3722:72:3:2
lock_trx_id: 3722
lock_mode: S
lock_type: RECORD
lock_table: `mysql`.`t`
lock_index: PRIMARY
lock_space: 72
lock_page: 3
lock_rec: 2
lock_data: 1, 9

```

## Notes

- Use this table to help diagnose performance problems that occur during times of heavy concurrent load. Its contents are updated as described in [Section 14.16.2.3, “Persistence and Consistency of InnoDB Transaction and Locking Information”](#).
- You must have the `PROCESS` privilege to query this table.
- Use the `INFORMATION_SCHEMA COLUMNS` table or the `SHOW COLUMNS` statement to view additional information about the columns of this table, including data types and default values.
- For usage information, see [Section 14.16.2.1, “Using InnoDB Transaction and Locking Information”](#).

## 24.4.15 The INFORMATION\_SCHEMA INNODB\_LOCK\_WAITS Table

The `INNODB_LOCK_WAITS` table contains one or more rows for each blocked `InnoDB` transaction, indicating the lock it has requested and any locks that are blocking that request.



### Note

This table is deprecated as of MySQL 5.7.14 and is removed in MySQL 8.0.

The `INNODB_LOCK_WAITS` table has these columns:

- `REQUESTING_TRX_ID`

The ID of the requesting (blocked) transaction.

- `REQUESTED_LOCK_ID`

The ID of the lock for which a transaction is waiting. To obtain details about the lock, join this column with the `LOCK_ID` column of the `INNODB_LOCKS` table.

- `BLOCKING_TRX_ID`

The ID of the blocking transaction.

- `BLOCKING_LOCK_ID`

The ID of a lock held by a transaction blocking another transaction from proceeding. To obtain details about the lock, join this column with the `LOCK_ID` column of the `INNODB_LOCKS` table.

## Example

```
mysql> SELECT * FROM INFORMATION_SCHEMA.INNODB_LOCK_WAITS\G
***** 1. row *****
requesting_trx_id: 3396
requested_lock_id: 3396:91:3:2
  blocking_trx_id: 3395
  blocking_lock_id: 3395:91:3:2
```

## Notes

- Use this table to help diagnose performance problems that occur during times of heavy concurrent load. Its contents are updated as described in [Section 14.16.2.3, “Persistence and Consistency of InnoDB Transaction and Locking Information”](#).
- You must have the `PROCESS` privilege to query this table.
- Use the `INFORMATION_SCHEMA.COLUMNS` table or the `SHOW COLUMNS` statement to view additional information about the columns of this table, including data types and default values.
- For usage information, see [Section 14.16.2.1, “Using InnoDB Transaction and Locking Information”](#).

## 24.4.16 The INFORMATION\_SCHEMA INNODB\_METRICS Table

The `INNODB_METRICS` table provides a wide variety of `InnoDB` performance information, complementing the specific focus areas of the Performance Schema tables for `InnoDB`. With simple queries, you can check the overall health of the system. With more detailed queries, you can diagnose issues such as performance bottlenecks, resource shortages, and application issues.

Each monitor represents a point within the `InnoDB` source code that is instrumented to gather counter information. Each counter can be started, stopped, and reset. You can also perform these actions for a group of counters using their common module name.

By default, relatively little data is collected. To start, stop, and reset counters, set one of the system variables `innodb_monitor_enable`, `innodb_monitor_disable`, `innodb_monitor_reset`, or `innodb_monitor_reset_all`, using the name of the counter, the name of the module, a wildcard match for such a name using the “%” character, or the special keyword `all`.

For usage information, see [Section 14.16.6, “InnoDB INFORMATION\\_SCHEMA Metrics Table”](#).

The `INNODB_METRICS` table has these columns:

- `NAME`  
A unique name for the counter.
- `SUBSYSTEM`  
The aspect of `InnoDB` that the metric applies to.
- `COUNT`  
The value since the counter was enabled.
- `MAX_COUNT`

The maximum value since the counter was enabled.

- `MIN_COUNT`

The minimum value since the counter was enabled.

- `AVG_COUNT`

The average value since the counter was enabled.

- `COUNT_RESET`

The counter value since it was last reset. (The `_RESET` columns act like the lap counter on a stopwatch: you can measure the activity during some time interval, while the cumulative figures are still available in `COUNT`, `MAX_COUNT`, and so on.)

- `MAX_COUNT_RESET`

The maximum counter value since it was last reset.

- `MIN_COUNT_RESET`

The minimum counter value since it was last reset.

- `AVG_COUNT_RESET`

The average counter value since it was last reset.

- `TIME_ENABLED`

The timestamp of the last start.

- `TIME_DISABLED`

The timestamp of the last stop.

- `TIME_ELAPSED`

The elapsed time in seconds since the counter started.

- `TIME_RESET`

The timestamp of the last reset.

- `STATUS`

Whether the counter is still running (`enabled`) or stopped (`disabled`).

- `TYPE`

Whether the item is a cumulative counter, or measures the current value of some resource.

- `COMMENT`

The counter description.

## Example

```
mysql> SELECT * FROM INFORMATION_SCHEMA.INNODB_METRICS WHERE NAME='dml_inserts'\G
```



```

***** 1. row *****
      NAME: dml_inserts
      SUBSYSTEM: dml
      COUNT: 3
      MAX_COUNT: 3
      MIN_COUNT: NULL
      AVG_COUNT: 0.046153846153846156
      COUNT_RESET: 3
MAX_COUNT_RESET: 3
MIN_COUNT_RESET: NULL
AVG_COUNT_RESET: NULL
      TIME_ENABLED: 2014-12-04 14:18:28
      TIME_DISABLED: NULL
      TIME_ELAPSED: 65
      TIME_RESET: NULL
      STATUS: enabled
      TYPE: status_counter
      COMMENT: Number of rows inserted

```

## Notes

- You must have the [PROCESS](#) privilege to query this table.
- Use the [INFORMATION\\_SCHEMA COLUMNS](#) table or the [SHOW COLUMNS](#) statement to view additional information about the columns of this table, including data types and default values.
- Transaction counter [COUNT](#) values may differ from the number of transaction events reported in Performance Schema [EVENTS\\_TRANSACTIONS\\_SUMMARY](#) tables. [InnoDB](#) counts only those transactions that it executes, whereas Performance Schema collects events for all non-aborted transactions initiated by the server, including empty transactions.

## 24.4.17 The INFORMATION\_SCHEMA INNODB\_SYS\_COLUMNS Table

The [INNODB\\_SYS\\_COLUMNS](#) table provides metadata about [InnoDB](#) table columns, equivalent to the information from the [SYS\\_COLUMNS](#) table in the [InnoDB](#) data dictionary.

For related usage information and examples, see [Section 14.16.3, “InnoDB INFORMATION\\_SCHEMA System Tables”](#).

The [INNODB\\_SYS\\_COLUMNS](#) table has these columns:

- [TABLE\\_ID](#)

An identifier representing the table associated with the column; the same value as [INNODB\\_SYS\\_TABLES.TABLE\\_ID](#).

- [NAME](#)

The name of the column. These names can be uppercase or lowercase depending on the [lower\\_case\\_table\\_names](#) setting. There are no special system-reserved names for columns.

- [POS](#)

The ordinal position of the column within the table, starting from 0 and incrementing sequentially. When a column is dropped, the remaining columns are reordered so that the sequence has no gaps. The [POS](#) value for a virtual generated column encodes the column sequence number and ordinal position of the column. For more information, see the [POS](#) column description in [Section 24.4.26, “The INFORMATION\\_SCHEMA INNODB\\_SYS\\_VIRTUAL Table”](#).

- [MTYPE](#)

Stands for “main type”. A numeric identifier for the column type. 1 = [VARCHAR](#), 2 = [CHAR](#), 3 = [FIXBINARY](#), 4 = [BINARY](#), 5 = [BLOB](#), 6 = [INT](#), 7 = [SYS\\_CHILD](#), 8 = [SYS](#), 9 = [FLOAT](#), 10 = [DOUBLE](#), 11 = [DECIMAL](#), 12 = [VARMYSQL](#), 13 = [MYSQL](#), 14 = [GEOMETRY](#).

- [PRTYPE](#)

The [InnoDB](#) “precise type”, a binary value with bits representing MySQL data type, character set code, and nullability.

- [LEN](#)

The column length, for example 4 for [INT](#) and 8 for [BIGINT](#). For character columns in multibyte character sets, this length value is the maximum length in bytes needed to represent a definition such as [VARCHAR\(N\)](#); that is, it might be  $2*N$ ,  $3*N$ , and so on depending on the character encoding.

## Example

```
mysql> SELECT * FROM INFORMATION_SCHEMA.INNODB_SYS_COLUMNS where TABLE_ID = 71\G
***** 1. row *****
TABLE_ID: 71
  NAME: col1
  POS: 0
  MTYPE: 6
  PRTYPE: 1027
  LEN: 4
***** 2. row *****
TABLE_ID: 71
  NAME: col2
  POS: 1
  MTYPE: 2
  PRTYPE: 524542
  LEN: 10
***** 3. row *****
TABLE_ID: 71
  NAME: col3
  POS: 2
  MTYPE: 1
  PRTYPE: 524303
  LEN: 10
```

## Notes

- You must have the [PROCESS](#) privilege to query this table.
- Use the [INFORMATION\\_SCHEMA COLUMNS](#) table or the [SHOW COLUMNS](#) statement to view additional information about the columns of this table, including data types and default values.

## 24.4.18 The INFORMATION\_SCHEMA INNODB\_SYS\_DATAFILES Table

The [INNODB\\_SYS\\_DATAFILES](#) table provides data file path information for [InnoDB](#) file-per-table and general tablespaces, equivalent to the information in the [SYS\\_DATAFILES](#) table in the [InnoDB](#) data dictionary.

For related usage information and examples, see [Section 14.16.3, “InnoDB INFORMATION\\_SCHEMA System Tables”](#).

**Note**

The `INFORMATION_SCHEMA.FILES` table reports metadata for all InnoDB tablespace types including file-per-table tablespaces, general tablespaces, the system tablespace, the temporary tablespace, and undo tablespaces, if present.

The `INNODB_SYS_DATAFILES` table has these columns:

- `SPACE`

The tablespace ID.

- `PATH`

The tablespace data file path. If a `file-per-table` tablespace is created in a location outside the MySQL data directory, the path value is a fully qualified directory path. Otherwise, the path is relative to the data directory.

**Example**

```
mysql> SELECT * FROM INFORMATION_SCHEMA.INNODB_SYS_DATAFILES WHERE SPACE = 57\G
***** 1. row *****
SPACE: 57
PATH: ./test/t1.ibd
```

**Notes**

- You must have the `PROCESS` privilege to query this table.
- Use the `INFORMATION_SCHEMA.COLUMNS` table or the `SHOW COLUMNS` statement to view additional information about the columns of this table, including data types and default values.

**24.4.19 The INFORMATION\_SCHEMA INNODB\_SYS\_FIELDS Table**

The `INNODB_SYS_FIELDS` table provides metadata about the key columns (fields) of InnoDB indexes, equivalent to the information from the `SYS_FIELDS` table in the InnoDB data dictionary.

For related usage information and examples, see [Section 14.16.3, “InnoDB INFORMATION\\_SCHEMA System Tables”](#).

The `INNODB_SYS_FIELDS` table has these columns:

- `INDEX_ID`

An identifier for the index associated with this key field; the same value as `INNODB_SYS_INDEXES.INDEX_ID`.

- `NAME`

The name of the original column from the table; the same value as `INNODB_SYS_COLUMNS.NAME`.

- `POS`

The ordinal position of the key field within the index, starting from 0 and incrementing sequentially. When a column is dropped, the remaining columns are reordered so that the sequence has no gaps.

**Example**

```
mysql> SELECT * FROM INFORMATION_SCHEMA.INNODB_SYS_FIELDS WHERE INDEX_ID = 117\G
```

```
***** 1. row *****
INDEX_ID: 117
NAME: coll
POS: 0
```

## Notes

- You must have the [PROCESS](#) privilege to query this table.
- Use the [INFORMATION\\_SCHEMA COLUMNS](#) table or the [SHOW COLUMNS](#) statement to view additional information about the columns of this table, including data types and default values.

## 24.4.20 The INFORMATION\_SCHEMA INNODB\_SYS\_FOREIGN Table

The [INNODB\\_SYS\\_FOREIGN](#) table provides metadata about [InnoDB foreign keys](#), equivalent to the information from the [SYS\\_FOREIGN](#) table in the [InnoDB](#) data dictionary.

For related usage information and examples, see [Section 14.16.3, “InnoDB INFORMATION\\_SCHEMA System Tables”](#).

The [INNODB\\_SYS\\_FOREIGN](#) table has these columns:

- [ID](#)

The name (not a numeric value) of the foreign key index, preceded by the schema (database) name (for example, [test/products\\_fk](#)).

- [FOR\\_NAME](#)

The name of the [child table](#) in this foreign key relationship.

- [REF\\_NAME](#)

The name of the [parent table](#) in this foreign key relationship.

- [N\\_COLS](#)

The number of columns in the foreign key index.

- [TYPE](#)

A collection of bit flags with information about the foreign key column, ORed together. 0 = [ON DELETE/UPDATE RESTRICT](#), 1 = [ON DELETE CASCADE](#), 2 = [ON DELETE SET NULL](#), 4 = [ON UPDATE CASCADE](#), 8 = [ON UPDATE SET NULL](#), 16 = [ON DELETE NO ACTION](#), 32 = [ON UPDATE NO ACTION](#).

## Example

```
mysql> SELECT * FROM INFORMATION_SCHEMA.INNODB_SYS_FOREIGN\G
***** 1. row *****
      ID: test/fkl
FOR_NAME: test/child
REF_NAME: test/parent
  N_COLS: 1
     TYPE: 1
```

## Notes

- You must have the [PROCESS](#) privilege to query this table.

- Use the [INFORMATION\\_SCHEMA COLUMNS](#) table or the `SHOW COLUMNS` statement to view additional information about the columns of this table, including data types and default values.

### 24.4.21 The INFORMATION\_SCHEMA INNODB\_SYS\_FOREIGN\_COLS Table

The [INNODB\\_SYS\\_FOREIGN\\_COLS](#) table provides status information about the columns of [InnoDB](#) foreign keys, equivalent to the information from the [SYS\\_FOREIGN\\_COLS](#) table in the [InnoDB](#) data dictionary.

For related usage information and examples, see [Section 14.16.3, “InnoDB INFORMATION\\_SCHEMA System Tables”](#).

The [INNODB\\_SYS\\_FOREIGN\\_COLS](#) table has these columns:

- [ID](#)

The foreign key index associated with this index key field, using the same value as [INNODB\\_SYS\\_FOREIGN.ID](#).

- [FOR\\_COL\\_NAME](#)

The name of the associated column in the child table.

- [REF\\_COL\\_NAME](#)

The name of the associated column in the parent table.

- [POS](#)

The ordinal position of this key field within the foreign key index, starting from 0.

### Example

```
mysql> SELECT * FROM INFORMATION_SCHEMA.INNODB_SYS_FOREIGN_COLS WHERE ID = 'test/fk1'\G
***** 1. row *****
      ID: test/fk1
FOR_COL_NAME: parent_id
REF_COL_NAME: id
      POS: 0
```

### Notes

- You must have the [PROCESS](#) privilege to query this table.
- Use the [INFORMATION\\_SCHEMA COLUMNS](#) table or the `SHOW COLUMNS` statement to view additional information about the columns of this table, including data types and default values.

### 24.4.22 The INFORMATION\_SCHEMA INNODB\_SYS\_INDEXES Table

The [INNODB\\_SYS\\_INDEXES](#) table provides metadata about [InnoDB](#) indexes, equivalent to the information in the internal [SYS\\_INDEXES](#) table in the [InnoDB](#) data dictionary.

For related usage information and examples, see [Section 14.16.3, “InnoDB INFORMATION\\_SCHEMA System Tables”](#).

The [INNODB\\_SYS\\_INDEXES](#) table has these columns:

- [INDEX\\_ID](#)

An identifier for the index. Index identifiers are unique across all the databases in an instance.

- [NAME](#)

The name of the index. Most indexes created implicitly by [InnoDB](#) have consistent names but the index names are not necessarily unique. Examples: [PRIMARY](#) for a primary key index, [GEN\\_CLUST\\_INDEX](#) for the index representing a primary key when one is not specified, and [ID\\_IND](#), [FOR\\_IND](#), and [REF\\_IND](#) for foreign key constraints.

- [TABLE\\_ID](#)

An identifier representing the table associated with the index; the same value as [INNODB\\_SYS\\_TABLES.TABLE\\_ID](#).

- [TYPE](#)

A numeric value derived from bit-level information that identifies the index type. 0 = nonunique secondary index; 1 = automatically generated clustered index ([GEN\\_CLUST\\_INDEX](#)); 2 = unique nonclustered index; 3 = clustered index; 32 = full-text index; 64 = spatial index; 128 = secondary index on a [virtual generated column](#).

- [N\\_FIELDS](#)

The number of columns in the index key. For [GEN\\_CLUST\\_INDEX](#) indexes, this value is 0 because the index is created using an artificial value rather than a real table column.

- [PAGE\\_NO](#)

The root page number of the index B-tree. For full-text indexes, the [PAGE\\_NO](#) column is unused and set to -1 ([FIL\\_NULL](#)) because the full-text index is laid out in several B-trees (auxiliary tables).

- [SPACE](#)

An identifier for the tablespace where the index resides. 0 means the [InnoDB system tablespace](#). Any other number represents a table created with a separate [.ibd](#) file in [file-per-table](#) mode. This identifier stays the same after a [TRUNCATE TABLE](#) statement. Because all indexes for a table reside in the same tablespace as the table, this value is not necessarily unique.

- [MERGE\\_THRESHOLD](#)

The merge threshold value for index pages. If the amount of data in an index page falls below the [MERGE\\_THRESHOLD](#) value when a row is deleted or when a row is shortened by an update operation, [InnoDB](#) attempts to merge the index page with the neighboring index page. The default threshold value is 50%. For more information, see [Section 14.8.12, “Configuring the Merge Threshold for Index Pages”](#).

## Example

```
mysql> SELECT * FROM INFORMATION_SCHEMA.INNODB_SYS_INDEXES WHERE TABLE_ID = 34\G
***** 1. row *****
INDEX_ID: 39
NAME: GEN_CLUST_INDEX
TABLE_ID: 34
TYPE: 1
N_FIELDS: 0
PAGE_NO: 3
SPACE: 23
MERGE_THRESHOLD: 50
***** 2. row *****
INDEX_ID: 40
```

```

NAME: i1
TABLE_ID: 34
TYPE: 0
N_FIELDS: 1
PAGE_NO: 4
SPACE: 23
MERGE_THRESHOLD: 50

```

## Notes

- You must have the [PROCESS](#) privilege to query this table.
- Use the [INFORMATION\\_SCHEMA COLUMNS](#) table or the [SHOW COLUMNS](#) statement to view additional information about the columns of this table, including data types and default values.

### 24.4.23 The INFORMATION\_SCHEMA INNODB\_SYS\_TABLES Table

The [INNODB\\_SYS\\_TABLES](#) table provides metadata about [InnoDB](#) tables, equivalent to the information from the [SYS\\_TABLES](#) table in the [InnoDB](#) data dictionary.

For related usage information and examples, see [Section 14.16.3, “InnoDB INFORMATION\\_SCHEMA System Tables”](#).

The [INNODB\\_SYS\\_TABLES](#) table has these columns:

- [TABLE\\_ID](#)

An identifier for the [InnoDB](#) table. This value is unique across all databases in the instance.

- [NAME](#)

The name of the table, preceded by the schema (database) name where appropriate (for example, [test/t1](#)). Names of databases and user tables are in the same case as they were originally defined, possibly influenced by the [lower\\_case\\_table\\_names](#) setting.

- [FLAG](#)

A numeric value that represents bit-level information about table format and storage characteristics.

- [N\\_COLS](#)

The number of columns in the table. The number reported includes three hidden columns that are created by [InnoDB](#) ([DB\\_ROW\\_ID](#), [DB\\_TRX\\_ID](#), and [DB\\_ROLL\\_PTR](#)). The number reported also includes [virtual generated columns](#), if present.

- [SPACE](#)

An identifier for the tablespace where the table resides. 0 means the [InnoDB system tablespace](#). Any other number represents either a [file-per-table](#) tablespace or a general tablespace. This identifier stays the same after a [TRUNCATE TABLE](#) statement. For file-per-table tablespaces, this identifier is unique for tables across all databases in the instance.

- [FILE\\_FORMAT](#)

The table's file format ([Antelope](#) or [Barracuda](#)).

- [ROW\\_FORMAT](#)

The table's row format ([Compact](#), [Redundant](#), [Dynamic](#), or [Compressed](#)).

- [ZIP\\_PAGE\\_SIZE](#)

The zip page size. Applies only to tables with a row format of [Compressed](#).

- [SPACE\\_TYPE](#)

The type of tablespace to which the table belongs. Possible values include [System](#) for the system tablespace, [General](#) for general tablespaces, and [Single](#) for file-per-table tablespaces. Tables assigned to the system tablespace using [CREATE TABLE](#) or [ALTER TABLE TABLESPACE=innodb\\_system](#) have a [SPACE\\_TYPE](#) of [General](#). For more information, see [CREATE TABLESPACE](#).

## Example

```
mysql> SELECT * FROM INFORMATION_SCHEMA.INNODB_SYS_TABLES WHERE TABLE_ID = 214\G
***** 1. row *****
TABLE_ID: 214
NAME: test/t1
FLAG: 129
N_COLS: 4
SPACE: 233
FILE_FORMAT: Antelope
ROW_FORMAT: Compact
ZIP_PAGE_SIZE: 0
SPACE_TYPE: General
```

## Notes

- You must have the [PROCESS](#) privilege to query this table.
- Use the [INFORMATION\\_SCHEMA COLUMNS](#) table or the [SHOW COLUMNS](#) statement to view additional information about the columns of this table, including data types and default values.

## 24.4.24 The INFORMATION\_SCHEMA INNODB\_SYS\_TABLESPACES Table

The [INNODB\\_SYS\\_TABLESPACES](#) table provides metadata about [InnoDB](#) file-per-table and general tablespaces, equivalent to the information in the [SYS\\_TABLESPACES](#) table in the [InnoDB](#) data dictionary.

For related usage information and examples, see [Section 14.16.3, “InnoDB INFORMATION\\_SCHEMA System Tables”](#).



### Note

The [INFORMATION\\_SCHEMA FILES](#) table reports metadata for all [InnoDB](#) tablespace types including file-per-table tablespaces, general tablespaces, the system tablespace, the temporary tablespace, and undo tablespaces, if present.

The [INNODB\\_SYS\\_TABLESPACES](#) table has these columns:

- [SPACE](#)

The tablespace ID.

- [NAME](#)

The schema (database) and table name.

- [FLAG](#)



A numeric value that represents bit-level information about tablespace format and storage characteristics.

- `FILE_FORMAT`

The tablespace file format. For example, `Antelope`, `Barracuda`, or `Any` (general tablespaces support any row format). The data in this field is interpreted from the tablespace flags information that resides in the `.ibd` file. For more information about InnoDB file formats, see [Section 14.10, “InnoDB File-Format Management”](#).

- `ROW_FORMAT`

The tablespace row format (`Compact or Redundant`, `Dynamic`, or `Compressed`). The data in this column is interpreted from the tablespace flags information that resides in the `.ibd` file.

- `PAGE_SIZE`

The tablespace page size. The data in this column is interpreted from the tablespace flags information that resides in the `.ibd` file.

- `ZIP_PAGE_SIZE`

The tablespace zip page size. The data in this column is interpreted from the tablespace flags information that resides in the `.ibd` file.

- `SPACE_TYPE`

The type of tablespace. Possible values include `General` for general tablespaces and `Single` for file-per-table tablespaces.

- `FS_BLOCK_SIZE`

The file system block size, which is the unit size used for hole punching. This column pertains to the InnoDB [transparent page compression](#) feature.

- `FILE_SIZE`

The apparent size of the file, which represents the maximum size of the file, uncompressed. This column pertains to the InnoDB [transparent page compression](#) feature.

- `ALLOCATED_SIZE`

The actual size of the file, which is the amount of space allocated on disk. This column pertains to the InnoDB [transparent page compression](#) feature.

## Example

```
mysql> SELECT * FROM INFORMATION_SCHEMA.INNODB_SYS_TABLESPACES WHERE SPACE = 26\G
***** 1. row *****
      SPACE: 26
      NAME: test/t1
      FLAG: 0
      FILE_FORMAT: Antelope
      ROW_FORMAT: Compact or Redundant
      PAGE_SIZE: 16384
      ZIP_PAGE_SIZE: 0
      SPACE_TYPE: Single
      FS_BLOCK_SIZE: 4096
      FILE_SIZE: 98304
```

```
ALLOCATED_SIZE: 65536
```

## Notes

- You must have the [PROCESS](#) privilege to query this table.
- Use the [INFORMATION\\_SCHEMA COLUMNS](#) table or the [SHOW COLUMNS](#) statement to view additional information about the columns of this table, including data types and default values.
- Because tablespace flags are always zero for all Antelope file formats (unlike table flags), there is no way to determine from this flag integer if the tablespace row format is Redundant or Compact. As a result, the possible values for the [ROW\\_FORMAT](#) field are “Compact or Redundant”, “Compressed”, or “Dynamic.”
- With the introduction of general tablespaces, [InnoDB](#) system tablespace data (for SPACE 0) is exposed in [INNODB\\_SYS\\_TABLESPACES](#).

### 24.4.25 The INFORMATION\_SCHEMA INNODB\_SYS\_TABLESTATS View

The [INNODB\\_SYS\\_TABLESTATS](#) table provides a view of low-level status information about [InnoDB](#) tables. This data is used by the MySQL optimizer to calculate which index to use when querying an [InnoDB](#) table. This information is derived from in-memory data structures rather than data stored on disk. There is no corresponding internal [InnoDB](#) system table.

[InnoDB](#) tables are represented in this view if they have been opened since the last server restart and have not aged out of the table cache. Tables for which persistent stats are available are always represented in this view.

Table statistics are updated only for [DELETE](#) or [UPDATE](#) operations that modify indexed columns. Statistics are not updated by operations that modify only nonindexed columns.

[ANALYZE TABLE](#) clears table statistics and sets the [STATS\\_INITIALIZED](#) column to [Uninitialized](#). Statistics are collected again the next time the table is accessed.

For related usage information and examples, see [Section 14.16.3, “InnoDB INFORMATION\\_SCHEMA System Tables”](#).

The [INNODB\\_SYS\\_TABLESTATS](#) table has these columns:

- [TABLE\\_ID](#)

An identifier representing the table for which statistics are available; the same value as [INNODB\\_SYS\\_TABLES.TABLE\\_ID](#).

- [NAME](#)

The name of the table; the same value as [INNODB\\_SYS\\_TABLES.NAME](#).

- [STATS\\_INITIALIZED](#)

The value is [Initialized](#) if the statistics are already collected, [Uninitialized](#) if not.

- [NUM\\_ROWS](#)

The current estimated number of rows in the table. Updated after each DML operation. The value could be imprecise if uncommitted transactions are inserting into or deleting from the table.

- [CLUST\\_INDEX\\_SIZE](#)

The number of pages on disk that store the clustered index, which holds the [InnoDB](#) table data in primary key order. This value might be null if no statistics are collected yet for the table.

- [OTHER\\_INDEX\\_SIZE](#)

The number of pages on disk that store all secondary indexes for the table. This value might be null if no statistics are collected yet for the table.

- [MODIFIED\\_COUNTER](#)

The number of rows modified by DML operations, such as [INSERT](#), [UPDATE](#), [DELETE](#), and also cascade operations from foreign keys. This column is reset each time table statistics are recalculated

- [AUTOINC](#)

The next number to be issued for any auto-increment-based operation. The rate at which the [AUTOINC](#) value changes depends on how many times auto-increment numbers have been requested and how many numbers are granted per request.

- [REF\\_COUNT](#)

When this counter reaches zero, the table metadata can be evicted from the table cache.

## Example

```
mysql> SELECT * FROM INFORMATION_SCHEMA.INNODB_SYS_TABLESTATS where TABLE_ID = 71\G
***** 1. row *****
      TABLE_ID: 71
          NAME: test/t1
STATS_INITIALIZED: Initialized
          NUM_ROWS: 1
      CLUST_INDEX_SIZE: 1
      OTHER_INDEX_SIZE: 0
      MODIFIED_COUNTER: 1
          AUTOINC: 0
          REF_COUNT: 1
```

## Notes

- This table is useful primarily for expert-level performance monitoring, or when developing performance-related extensions for MySQL.
- You must have the [PROCESS](#) privilege to query this table.
- Use the [INFORMATION\\_SCHEMA COLUMNS](#) table or the [SHOW COLUMNS](#) statement to view additional information about the columns of this table, including data types and default values.

### 24.4.26 The INFORMATION\_SCHEMA INNODB\_SYS\_VIRTUAL Table

The [INNODB\\_SYS\\_VIRTUAL](#) table provides metadata about [InnoDB virtual generated columns](#) and columns upon which virtual generated columns are based, equivalent to information in the [SYS\\_VIRTUAL](#) table in the [InnoDB](#) data dictionary.

A row appears in the [INNODB\\_SYS\\_VIRTUAL](#) table for each column upon which a virtual generated column is based.

The [INNODB\\_SYS\\_VIRTUAL](#) table has these columns:

- [TABLE\\_ID](#)

An identifier representing the table associated with the virtual column; the same value as `INNODB_SYS_TABLES.TABLE_ID`.

- `POS`

The position value of the [virtual generated column](#). The value is large because it encodes the column sequence number and ordinal position. The formula used to calculate the value uses a bitwise operation:

```
((nth virtual generated column for the InnoDB instance + 1) << 16)
+ the ordinal position of the virtual generated column
```

For example, if the first virtual generated column in the `InnoDB` instance is the third column of the table, the formula is  $(0 + 1) \ll 16) + 2$ . The first virtual generated column in the `InnoDB` instance is always number 0. As the third column in the table, the ordinal position of the virtual generated column is 2. Ordinal positions are counted from 0.

- `BASE_POS`

The ordinal position of the columns upon which a virtual generated column is based.

## Example

```
mysql> CREATE TABLE `t1` (
  `a` int(11) DEFAULT NULL,
  `b` int(11) DEFAULT NULL,
  `c` int(11) GENERATED ALWAYS AS (a+b) VIRTUAL,
  `h` varchar(10) DEFAULT NULL
) ENGINE=InnoDB DEFAULT CHARSET=utf8mb4;

mysql> SELECT * FROM INFORMATION_SCHEMA.INNODB_VIRTUAL
WHERE TABLE_ID IN
  (SELECT TABLE_ID FROM INFORMATION_SCHEMA.INNODB_TABLES
   WHERE NAME LIKE "test/t1");
```

TABLE_ID	POS	BASE_POS
95	65538	0
95	65538	1

## Notes

- If a constant value is assigned to a [virtual generated column](#), as in the following table, an entry for the column does not appear in the `INNODB_SYS_VIRTUAL` table. For an entry to appear, a virtual generated column must have a base column.

```
CREATE TABLE `t1` (
  `a` int(11) DEFAULT NULL,
  `b` int(11) DEFAULT NULL,
  `c` int(11) GENERATED ALWAYS AS (5) VIRTUAL
) ENGINE=InnoDB DEFAULT CHARSET=utf8mb4;
```

However, metadata for such a column does appear in the `INNODB_SYS_COLUMNS` table.

- You must have the `PROCESS` privilege to query this table.
- Use the `INFORMATION_SCHEMA COLUMNS` table or the `SHOW COLUMNS` statement to view additional information about the columns of this table, including data types and default values.

## 24.4.27 The INFORMATION\_SCHEMA INNODB\_TEMP\_TABLE\_INFO Table

The `INNODB_TEMP_TABLE_INFO` table provides information about user-created `InnoDB` temporary tables that are active in an `InnoDB` instance. It does not provide information about internal `InnoDB` temporary tables used by the optimizer. The `INNODB_TEMP_TABLE_INFO` table is created when first queried, exists only in memory, and is not persisted to disk.

For usage information and examples, see [Section 14.16.7, “InnoDB INFORMATION\\_SCHEMA Temporary Table Info Table”](#).

The `INNODB_TEMP_TABLE_INFO` table has these columns:

- `TABLE_ID`

The table ID of the temporary table.

- `NAME`

The name of the temporary table.

- `N_COLS`

The number of columns in the temporary table. The number includes three hidden columns created by `InnoDB` (`DB_ROW_ID`, `DB_TRX_ID`, and `DB_ROLL_PTR`).

- `SPACE`

The ID of the temporary tablespace where the temporary table resides. In 5.7, non-compressed `InnoDB` temporary tables reside in a shared temporary tablespace. The data file for the shared temporary tablespace is defined by the `innodb_temp_data_file_path` system variable. By default, there is a single data file for the shared temporary tablespace named `ibtmp1`, which is located in the data directory. Compressed temporary tables reside in separate file-per-table tablespaces located in the temporary file directory defined by `tmpdir`. The temporary tablespace ID is a nonzero value that is dynamically generated on server restart.

- `PER_TABLE_TABLESPACE`

A value of `TRUE` indicates that the temporary table resides in a separate file-per-table tablespace. A value of `FALSE` indicates that the temporary table resides in the shared temporary tablespace.

- `IS_COMPRESSED`

A value of `TRUE` indicates that the temporary table is compressed.

## Example

```
mysql> CREATE TEMPORARY TABLE t1 (c1 INT PRIMARY KEY) ENGINE=INNODB;

mysql> SELECT * FROM INFORMATION_SCHEMA.INNODB_TEMP_TABLE_INFO\G
***** 1. row *****
      TABLE_ID: 38
         NAME: #sql26cf_6_0
        N_COLS: 4
         SPACE: 52
PER_TABLE_TABLESPACE: FALSE
      IS_COMPRESSED: FALSE
```

## Notes

- This table is useful primarily for expert-level monitoring.
- You must have the `PROCESS` privilege to query this table.

- Use the [INFORMATION\\_SCHEMA COLUMNS](#) table or the `SHOW COLUMNS` statement to view additional information about the columns of this table, including data types and default values.

## 24.4.28 The INFORMATION\_SCHEMA INNODB\_TRX Table

The `INNODB_TRX` table provides information about every transaction currently executing inside `InnoDB`, including whether the transaction is waiting for a lock, when the transaction started, and the SQL statement the transaction is executing, if any.

For usage information, see [Section 14.16.2.1, “Using InnoDB Transaction and Locking Information”](#).

The `INNODB_TRX` table has these columns:

- `TRX_ID`

A unique transaction ID number, internal to `InnoDB`. These IDs are not created for transactions that are read only and nonlocking. For details, see [Section 8.5.3, “Optimizing InnoDB Read-Only Transactions”](#).

- `TRX_WEIGHT`

The weight of a transaction, reflecting (but not necessarily the exact count of) the number of rows altered and the number of rows locked by the transaction. To resolve a deadlock, `InnoDB` selects the transaction with the smallest weight as the “victim” to roll back. Transactions that have changed nontransactional tables are considered heavier than others, regardless of the number of altered and locked rows.

- `TRX_STATE`

The transaction execution state. Permitted values are `RUNNING`, `LOCK WAIT`, `ROLLING BACK`, and `COMMITTING`.

- `TRX_STARTED`

The transaction start time.

- `TRX_REQUESTED_LOCK_ID`

The ID of the lock the transaction is currently waiting for, if `TRX_STATE` is `LOCK WAIT`; otherwise `NULL`. To obtain details about the lock, join this column with the `LOCK_ID` column of the `INNODB_LOCKS` table.

- `TRX_WAIT_STARTED`

The time when the transaction started waiting on the lock, if `TRX_STATE` is `LOCK WAIT`; otherwise `NULL`.

- `TRX_MYSQL_THREAD_ID`

The MySQL thread ID. To obtain details about the thread, join this column with the `ID` column of the `INFORMATION_SCHEMA PROCESSLIST` table, but see [Section 14.16.2.3, “Persistence and Consistency of InnoDB Transaction and Locking Information”](#).

- `TRX_QUERY`

The SQL statement that is being executed by the transaction.

- `TRX_OPERATION_STATE`

The transaction's current operation, if any; otherwise `NULL`.

- [TRX\\_TABLES\\_IN\\_USE](#)

The number of [InnoDB](#) tables used while processing the current SQL statement of this transaction.
- [TRX\\_TABLES\\_LOCKED](#)

The number of [InnoDB](#) tables that the current SQL statement has row locks on. (Because these are row locks, not table locks, the tables can usually still be read from and written to by multiple transactions, despite some rows being locked.)
- [TRX\\_LOCK\\_STRUCTS](#)

The number of locks reserved by the transaction.
- [TRX\\_LOCK\\_MEMORY\\_BYTES](#)

The total size taken up by the lock structures of this transaction in memory.
- [TRX\\_ROWS\\_LOCKED](#)

The approximate number of rows locked by this transaction. The value might include delete-marked rows that are physically present but not visible to the transaction.
- [TRX\\_ROWS\\_MODIFIED](#)

The number of modified and inserted rows in this transaction.
- [TRX\\_CONCURRENCY\\_TICKETS](#)

A value indicating how much work the current transaction can do before being swapped out, as specified by the [innodb\\_concurrency\\_tickets](#) system variable.
- [TRX\\_ISOLATION\\_LEVEL](#)

The isolation level of the current transaction.
- [TRX\\_UNIQUE\\_CHECKS](#)

Whether unique checks are turned on or off for the current transaction. For example, they might be turned off during a bulk data load.
- [TRX\\_FOREIGN\\_KEY\\_CHECKS](#)

Whether foreign key checks are turned on or off for the current transaction. For example, they might be turned off during a bulk data load.
- [TRX\\_LAST\\_FOREIGN\\_KEY\\_ERROR](#)

The detailed error message for the last foreign key error, if any; otherwise [NULL](#).
- [TRX\\_ADAPTIVE\\_HASH\\_LATCHED](#)

Whether the adaptive hash index is locked by the current transaction. When the adaptive hash index search system is partitioned, a single transaction does not lock the entire adaptive hash index. Adaptive hash index partitioning is controlled by [innodb\\_adaptive\\_hash\\_index\\_parts](#), which is set to 8 by default.
- [TRX\\_ADAPTIVE\\_HASH\\_TIMEOUT](#)

Deprecated in MySQL 5.7.8. Always returns 0.

Whether to relinquish the search latch immediately for the adaptive hash index, or reserve it across calls from MySQL. When there is no adaptive hash index contention, this value remains zero and statements reserve the latch until they finish. During times of contention, it counts down to zero, and statements release the latch immediately after each row lookup. When the adaptive hash index search system is partitioned (controlled by `innodb_adaptive_hash_index_parts`), the value remains 0.

- `TRX_IS_READ_ONLY`

A value of 1 indicates the transaction is read only.

- `TRX_AUTOCOMMIT_NON_LOCKING`

A value of 1 indicates the transaction is a `SELECT` statement that does not use the `FOR UPDATE` or `LOCK IN SHARED MODE` clauses, and is executing with `autocommit` enabled so that the transaction contains only this one statement. When this column and `TRX_IS_READ_ONLY` are both 1, `InnoDB` optimizes the transaction to reduce the overhead associated with transactions that change table data.

## Example

```
mysql> SELECT * FROM INFORMATION_SCHEMA.INNODB_TRX\G
***** 1. row *****
      trx_id: 1510
      trx_state: RUNNING
      trx_started: 2014-11-19 13:24:40
      trx_requested_lock_id: NULL
      trx_wait_started: NULL
      trx_weight: 586739
      trx_mysql_thread_id: 2
      trx_query: DELETE FROM employees.salaries WHERE salary > 65000
      trx_operation_state: updating or deleting
      trx_tables_in_use: 1
      trx_tables_locked: 1
      trx_lock_structs: 3003
      trx_lock_memory_bytes: 450768
      trx_rows_locked: 1407513
      trx_rows_modified: 583736
      trx_concurrency_tickets: 0
      trx_isolation_level: REPEATABLE READ
      trx_unique_checks: 1
      trx_foreign_key_checks: 1
      trx_last_foreign_key_error: NULL
      trx_adaptive_hash_latched: 0
      trx_adaptive_hash_timeout: 10000
      trx_is_read_only: 0
      trx_autocommit_non_locking: 0
```

## Notes

- Use this table to help diagnose performance problems that occur during times of heavy concurrent load. Its contents are updated as described in [Section 14.16.2.3, “Persistence and Consistency of InnoDB Transaction and Locking Information”](#).
- You must have the `PROCESS` privilege to query this table.
- Use the `INFORMATION_SCHEMA COLUMNS` table or the `SHOW COLUMNS` statement to view additional information about the columns of this table, including data types and default values.

## 24.5 INFORMATION\_SCHEMA Thread Pool Tables



The following sections describe the `INFORMATION_SCHEMA` tables associated with the thread pool plugin (see [Section 5.5.3, “MySQL Enterprise Thread Pool”](#)). They provide information about thread pool operation:

- `TP_THREAD_GROUP_STATE`: Information about thread pool thread group states
- `TP_THREAD_GROUP_STATS`: Thread group statistics
- `TP_THREAD_STATE`: Information about thread pool thread states

Rows in these tables represent snapshots in time. In the case of `TP_THREAD_STATE`, all rows for a thread group comprise a snapshot in time. Thus, the MySQL server holds the mutex of the thread group while producing the snapshot. But it does not hold mutexes on all thread groups at the same time, to prevent a statement against `TP_THREAD_STATE` from blocking the entire MySQL server.

The thread pool `INFORMATION_SCHEMA` tables are implemented by individual plugins and the decision whether to load one can be made independently of the others (see [Section 5.5.3.2, “Thread Pool Installation”](#)). However, the content of all the tables depends on the thread pool plugin being enabled. If a table plugin is enabled but the thread pool plugin is not, the table becomes visible and can be accessed, but is empty.

## 24.5.1 INFORMATION\_SCHEMA Thread Pool Table Reference

The following table summarizes `INFORMATION_SCHEMA` thread pool tables. For greater detail, see the individual table descriptions.

**Table 24.7 INFORMATION\_SCHEMA Thread Pool Tables**

Table Name	Description
<code>TP_THREAD_GROUP_STATE</code>	Thread pool thread group states
<code>TP_THREAD_GROUP_STATS</code>	Thread pool thread group statistics
<code>TP_THREAD_STATE</code>	Thread pool thread information

## 24.5.2 The INFORMATION\_SCHEMA TP\_THREAD\_GROUP\_STATE Table

The `TP_THREAD_GROUP_STATE` table has one row per thread group in the thread pool. Each row provides information about the current state of a group.

The `TP_THREAD_GROUP_STATE` table has these columns:

- `TP_GROUP_ID`

The thread group ID. This is a unique key within the table.

- `CONSUMER_THREADS`

The number of consumer threads. There is at most one thread ready to start executing if the active threads become stalled or blocked.

- `RESERVE_THREADS`

The number of threads in the reserved state. This means that they are not started until there is a need to wake a new thread and there is no consumer thread. This is where most threads end up when the thread group has created more threads than needed for normal operation. Often a thread group needs additional threads for a short while and then does not need them again for a while. In this case, they go

into the reserved state and remain until needed again. They take up some extra memory resources, but no extra computing resources.

- [CONNECT\\_THREAD\\_COUNT](#)

The number of threads that are processing or waiting to process connection initialization and authentication. There can be a maximum of four connection threads per thread group; these threads expire after a period of inactivity.

This column was added in MySQL 5.7.18.

- [CONNECTION\\_COUNT](#)

The number of connections using this thread group.

- [QUEUED\\_QUERIES](#)

The number of statements waiting in the high-priority queue.

- [QUEUED\\_TRANSACTIONS](#)

The number of statements waiting in the low-priority queue. These are the initial statements for transactions that have not started, so they also represent queued transactions.

- [STALL\\_LIMIT](#)

The value of the `thread_pool_stall_limit` system variable for the thread group. This is the same value for all thread groups.

- [PRIO\\_KICKUP\\_TIMER](#)

The value of the `thread_pool_prio_kickup_timer` system variable for the thread group. This is the same value for all thread groups.

- [ALGORITHM](#)

The value of the `thread_pool_algorithm` system variable for the thread group. This is the same value for all thread groups.

- [THREAD\\_COUNT](#)

The number of threads started in the thread pool as part of this thread group.

- [ACTIVE\\_THREAD\\_COUNT](#)

The number of threads active in executing statements.

- [STALLED\\_THREAD\\_COUNT](#)

The number of stalled statements in the thread group. A stalled statement could be executing, but from a thread pool perspective it is stalled and making no progress. A long-running statement quickly ends up in this category.

- [WAITING\\_THREAD\\_NUMBER](#)

If there is a thread handling the polling of statements in the thread group, this specifies the thread number within this thread group. It is possible that this thread could be executing a statement.

- [OLDEST\\_QUEUED](#)

How long in milliseconds the oldest queued statement has been waiting for execution.

- `MAX_THREAD_IDS_IN_GROUP`

The maximum thread ID of the threads in the group. This is the same as `MAX(TP_THREAD_NUMBER)` for the threads when selected from the `TP_THREAD_STATE` table. That is, these two queries are equivalent:

```
SELECT TP_GROUP_ID, MAX_THREAD_IDS_IN_GROUP
FROM TP_THREAD_GROUP_STATE;

SELECT TP_GROUP_ID, MAX(TP_THREAD_NUMBER)
FROM TP_THREAD_STATE GROUP BY TP_GROUP_ID;
```

### 24.5.3 The INFORMATION\_SCHEMA TP\_THREAD\_GROUP\_STATS Table

The `TP_THREAD_GROUP_STATS` table reports statistics per thread group. There is one row per group.

The `TP_THREAD_GROUP_STATS` table has these columns:

- `TP_GROUP_ID`

The thread group ID. This is a unique key within the table.

- `CONNECTIONS_STARTED`

The number of connections started.

- `CONNECTIONS_CLOSED`

The number of connections closed.

- `QUERIES_EXECUTED`

The number of statements executed. This number is incremented when a statement starts executing, not when it finishes.

- `QUERIES_QUEUED`

The number of statements received that were queued for execution. This does not count statements that the thread group was able to begin executing immediately without queuing, which can happen under the conditions described in [Section 5.5.3.3, “Thread Pool Operation”](#).

- `THREADS_STARTED`

The number of threads started.

- `PRIO_KICKUPS`

The number of statements that have been moved from low-priority queue to high-priority queue based on the value of the `thread_pool_prio_kickup_timer` system variable. If this number increases quickly, consider increasing the value of that variable. A quickly increasing counter means that the priority system is not keeping transactions from starting too early. For `InnoDB`, this most likely means deteriorating performance due to too many concurrent transactions..

- `STALLED_QUERIES_EXECUTED`

The number of statements that have become defined as stalled due to executing for longer than the value of the `thread_pool_stall_limit` system variable.

- [BECOME\\_CONSUMER\\_THREAD](#)

The number of times thread have been assigned the consumer thread role.

- [BECOME\\_RESERVE\\_THREAD](#)

The number of times threads have been assigned the reserve thread role.

- [BECOME\\_WAITING\\_THREAD](#)

The number of times threads have been assigned the waiter thread role. When statements are queued, this happens very often, even in normal operation, so rapid increases in this value are normal in the case of a highly loaded system where statements are queued up.

- [WAKE\\_THREAD\\_STALL\\_CHECKER](#)

The number of times the stall check thread decided to wake or create a thread to possibly handle some statements or take care of the waiter thread role.

- [SLEEP\\_WAITS](#)

The number of [THD\\_WAIT\\_SLEEP](#) waits. These occur when threads go to sleep; for example, by calling the [SLEEP\(\)](#) function.

- [DISK\\_IO\\_WAITS](#)

The number of [THD\\_WAIT\\_DISKIO](#) waits. These occur when threads perform disk I/O that is likely to not hit the file system cache. Such waits occur when the buffer pool reads and writes data to disk, not for normal reads from and writes to files.

- [ROW\\_LOCK\\_WAITS](#)

The number of [THD\\_WAIT\\_ROW\\_LOCK](#) waits for release of a row lock by another transaction.

- [GLOBAL\\_LOCK\\_WAITS](#)

The number of [THD\\_WAIT\\_GLOBAL\\_LOCK](#) waits for a global lock to be released.

- [META\\_DATA\\_LOCK\\_WAITS](#)

The number of [THD\\_WAIT\\_META\\_DATA\\_LOCK](#) waits for a metadata lock to be released.

- [TABLE\\_LOCK\\_WAITS](#)

The number of [THD\\_WAIT\\_TABLE\\_LOCK](#) waits for a table to be unlocked that the statement needs to access.

- [USER\\_LOCK\\_WAITS](#)

The number of [THD\\_WAIT\\_USER\\_LOCK](#) waits for a special lock constructed by the user thread.

- [BINLOG\\_WAITS](#)

The number of [THD\\_WAIT\\_BINLOG\\_WAITS](#) waits for the binary log to become free.

- [GROUP\\_COMMIT\\_WAITS](#)

The number of [THD\\_WAIT\\_GROUP\\_COMMIT](#) waits. These occur when a group commit must wait for the other parties to complete their part of a transaction.

- `FSYNC_WAITS`

The number of `THD_WAIT_SYNC` waits for a file sync operation.

## 24.5.4 The INFORMATION\_SCHEMA TP\_THREAD\_STATE Table

The `TP_THREAD_STATE` table has one row per thread created by the thread pool to handle connections.

The `TP_THREAD_STATE` table has these columns:

- `TP_GROUP_ID`

The thread group ID.

- `TP_THREAD_NUMBER`

The ID of the thread within its thread group. `TP_GROUP_ID` and `TP_THREAD_NUMBER` together provide a unique key within the table.

- `PROCESS_COUNT`

The 10ms interval in which the statement that uses this thread is currently executing. 0 means no statement is executing, 1 means it is in the first 10ms, and so forth.

- `WAIT_TYPE`

The type of wait for the thread. `NULL` means the thread is not blocked. Otherwise, the thread is blocked by a call to `thd_wait_begin()` and the value specifies the type of wait. The `xxx_WAIT` columns of the `TP_THREAD_GROUP_STATS` table accumulate counts for each wait type.

The `WAIT_TYPE` value is a string that describes the type of wait, as shown in the following table.

**Table 24.8 TP\_THREAD\_STATE Table WAIT\_TYPE Values**

Wait Type	Meaning
<code>THD_WAIT_SLEEP</code>	Waiting for sleep
<code>THD_WAIT_DISKIO</code>	Waiting for Disk IO
<code>THD_WAIT_ROW_LOCK</code>	Waiting for row lock
<code>THD_WAIT_GLOBAL_LOCK</code>	Waiting for global lock
<code>THD_WAIT_META_DATA_LOCK</code>	Waiting for metadata lock
<code>THD_WAIT_TABLE_LOCK</code>	Waiting for table lock
<code>THD_WAIT_USER_LOCK</code>	Waiting for user lock
<code>THD_WAIT_BINLOG</code>	Waiting for binlog
<code>THD_WAIT_GROUP_COMMIT</code>	Waiting for group commit
<code>THD_WAIT_SYNC</code>	Waiting for fsync

## 24.6 INFORMATION\_SCHEMA Connection Control Tables

The following sections describe the `INFORMATION_SCHEMA` tables associated with the `connection_control` plugin.

### 24.6.1 INFORMATION\_SCHEMA Connection Control Table Reference

The following table summarizes [INFORMATION\\_SCHEMA](#) connection control tables. For greater detail, see the individual table descriptions.

**Table 24.9 INFORMATION\_SCHEMA Connection Control Tables**

Table Name	Description	Introduced
<a href="#">CONNECTION_CONTROL_FAILED_LOGIN_ATTEMPTS</a>	Current number of consecutive failed connection attempts per account	5.7.17

## 24.6.2 The INFORMATION\_SCHEMA CONNECTION\_CONTROL\_FAILED\_LOGIN\_ATTEMPTS Table

This table provides information about the current number of consecutive failed connection attempts per account (user/host combination). The table was added in MySQL 5.7.17.

[CONNECTION\\_CONTROL\\_FAILED\\_LOGIN\\_ATTEMPTS](#) has these columns:

- [USERHOST](#)

The user/host combination indicating an account that has failed connection attempts, in `'user_name'@'host_name'` format.

- [FAILED\\_ATTEMPTS](#)

The current number of consecutive failed connection attempts for the [USERHOST](#) value. This counts all failed attempts, regardless of whether they were delayed. The number of attempts for which the server added a delay to its response is the difference between the [FAILED\\_ATTEMPTS](#) value and the [connection\\_control\\_failed\\_connections\\_threshold](#) system variable value.

### Notes

- The [CONNECTION\\_CONTROL\\_FAILED\\_LOGIN\\_ATTEMPTS](#) plugin must be activated for this table to be available, and the [CONNECTION\\_CONTROL](#) plugin must be activated or the table contents are always empty. See [Section 6.4.2, “Connection Control Plugins”](#).
- The table contains rows only for accounts that have had one or more consecutive failed connection attempts without a subsequent successful attempt. When an account connects successfully, its failed-connection count is reset to zero and the server removes any row corresponding to the account.
- Assigning a value to the [connection\\_control\\_failed\\_connections\\_threshold](#) system variable at runtime resets all accumulated failed-connection counters to zero, which causes the table to become empty.

## 24.7 INFORMATION\_SCHEMA MySQL Enterprise Firewall Tables

The following sections describe the [INFORMATION\\_SCHEMA](#) tables associated with MySQL Enterprise Firewall (see [Section 6.4.6, “MySQL Enterprise Firewall”](#)). They provide views into the firewall in-memory data cache. These tables are available only if the appropriate firewall plugins are enabled.

### 24.7.1 INFORMATION\_SCHEMA Firewall Table Reference

The following table summarizes [INFORMATION\\_SCHEMA](#) firewall tables. For greater detail, see the individual table descriptions.

**Table 24.10 INFORMATION\_SCHEMA Firewall Tables**

Table Name	Description
<code>MYSQL_FIREWALL_USERS</code>	Firewall in-memory data for account profiles
<code>MYSQL_FIREWALL_WHITELIST</code>	Firewall in-memory data for account profile allowlists

## 24.7.2 The INFORMATION\_SCHEMA MYSQL\_FIREWALL\_USERS Table

The `MYSQL_FIREWALL_USERS` table provides a view into the in-memory data cache for MySQL Enterprise Firewall. It lists names and operational modes of registered firewall account profiles. It is used in conjunction with the `mysql.firewall_users` system table that provides persistent storage of firewall data; see [MySQL Enterprise Firewall Tables](#).

The `MYSQL_FIREWALL_USERS` table has these columns:

- `USERHOST`

The account profile name. Each account name has the format `user_name@host_name`.

- `MODE`

The current operational mode for the profile. Permitted mode values are `OFF`, `DETECTING`, `PROTECTING`, `RECORDING`, and `RESET`. For details about their meanings, see [Firewall Concepts](#).

## 24.7.3 The INFORMATION\_SCHEMA MYSQL\_FIREWALL\_WHITELIST Table

The `MYSQL_FIREWALL_WHITELIST` table provides a view into the in-memory data cache for MySQL Enterprise Firewall. It lists allowlist rules of registered firewall account profiles. It is used in conjunction with the `mysql.firewall_whitelist` system table that provides persistent storage of firewall data; see [MySQL Enterprise Firewall Tables](#).

The `MYSQL_FIREWALL_WHITELIST` table has these columns:

- `USERHOST`

The account profile name. Each account name has the format `user_name@host_name`.

- `RULE`

A normalized statement indicating an acceptable statement pattern for the profile. A profile allowlist is the union of its rules.

## 24.8 Extensions to SHOW Statements

Some extensions to `SHOW` statements accompany the implementation of `INFORMATION_SCHEMA`:

- `SHOW` can be used to get information about the structure of `INFORMATION_SCHEMA` itself.
- Several `SHOW` statements accept a `WHERE` clause that provides more flexibility in specifying which rows to display.

The `IS_UPDATABLE` flag may be unreliable if a view depends on one or more other views, and one of these underlying views is updated. Regardless of the `IS_UPDATABLE` value, the server keeps track of the updatability of a view and correctly rejects data change operations to views that are not updatable. If the `IS_UPDATABLE` value for a view has become inaccurate due to changes to underlying views, the value can be updated by deleting and recreating the view.

`INFORMATION_SCHEMA` is an information database, so its name is included in the output from `SHOW DATABASES`. Similarly, `SHOW TABLES` can be used with `INFORMATION_SCHEMA` to obtain a list of its tables:

```
mysql> SHOW TABLES FROM INFORMATION_SCHEMA;
+-----+
| Tables_in_INFORMATION_SCHEMA |
+-----+
| CHARACTER_SETS                |
| COLLATIONS                    |
| COLLATION_CHARACTER_SET_APPLICABILITY |
| COLUMNS                      |
| COLUMN_PRIVILEGES             |
| ENGINES                      |
| EVENTS                       |
| FILES                        |
| GLOBAL_STATUS                 |
| GLOBAL_VARIABLES              |
| KEY_COLUMN_USAGE              |
| PARTITIONS                    |
| PLUGINS                      |
| PROCESSLIST                   |
| REFERENTIAL_CONSTRAINTS      |
| ROUTINES                      |
| SCHEMATA                      |
| SCHEMA_PRIVILEGES             |
| SESSION_STATUS                |
| SESSION_VARIABLES             |
| STATISTICS                    |
| TABLES                       |
| TABLE_CONSTRAINTS           |
| TABLE_PRIVILEGES             |
| TRIGGERS                      |
| USER_PRIVILEGES               |
| VIEWS                         |
+-----+
```

`SHOW COLUMNS` and `DESCRIBE` can display information about the columns in individual `INFORMATION_SCHEMA` tables.

`SHOW` statements that accept a `LIKE` clause to limit the rows displayed also permit a `WHERE` clause that specifies more general conditions that selected rows must satisfy:

```
SHOW CHARACTER SET
SHOW COLLATION
SHOW COLUMNS
SHOW DATABASES
SHOW FUNCTION STATUS
SHOW INDEX
SHOW OPEN TABLES
SHOW PROCEDURE STATUS
SHOW STATUS
SHOW TABLE STATUS
SHOW TABLES
SHOW TRIGGERS
SHOW VARIABLES
```

The `WHERE` clause, if present, is evaluated against the column names displayed by the `SHOW` statement. For example, the `SHOW CHARACTER SET` statement produces these output columns:

```
mysql> SHOW CHARACTER SET;
+-----+-----+-----+-----+
| Charset | Description | Default collation | Maxlen |
+-----+-----+-----+-----+
| big5    | Big5 Traditional Chinese | big5_chinese_ci | 2 |
+-----+-----+-----+-----+
```



dec8	DEC West European	dec8_swedish_ci	1
cp850	DOS West European	cp850_general_ci	1
hp8	HP West European	hp8_english_ci	1
koi8r	KOI8-R Relcom Russian	koi8r_general_ci	1
latin1	cp1252 West European	latin1_swedish_ci	1
latin2	ISO 8859-2 Central European	latin2_general_ci	1
...			

To use a `WHERE` clause with `SHOW CHARACTER SET`, you would refer to those column names. As an example, the following statement displays information about character sets for which the default collation contains the string `'japanese'`:

```
mysql> SHOW CHARACTER SET WHERE `Default collation` LIKE '%japanese%';
```

Charset	Description	Default collation	Maxlen
ujis	EUC-JP Japanese	ujis_japanese_ci	3
sjis	Shift-JIS Japanese	sjis_japanese_ci	2
cp932	SJIS for Windows Japanese	cp932_japanese_ci	2
eucjpms	UJIS for Windows Japanese	eucjpms_japanese_ci	3

This statement displays the multibyte character sets:

```
mysql> SHOW CHARACTER SET WHERE Maxlen > 1;
```

Charset	Description	Default collation	Maxlen
big5	Big5 Traditional Chinese	big5_chinese_ci	2
ujis	EUC-JP Japanese	ujis_japanese_ci	3
sjis	Shift-JIS Japanese	sjis_japanese_ci	2
euckr	EUC-KR Korean	euckr_korean_ci	2
gb2312	GB2312 Simplified Chinese	gb2312_chinese_ci	2
gbk	GBK Simplified Chinese	gbk_chinese_ci	2
utf8	UTF-8 Unicode	utf8_general_ci	3
ucs2	UCS-2 Unicode	ucs2_general_ci	2
cp932	SJIS for Windows Japanese	cp932_japanese_ci	2
eucjpms	UJIS for Windows Japanese	eucjpms_japanese_ci	3



---

# Chapter 25 MySQL Performance Schema

## Table of Contents

25.1 Performance Schema Quick Start .....	4207
25.2 Performance Schema Build Configuration .....	4213
25.3 Performance Schema Startup Configuration .....	4214
25.4 Performance Schema Runtime Configuration .....	4216
25.4.1 Performance Schema Event Timing .....	4217
25.4.2 Performance Schema Event Filtering .....	4220
25.4.3 Event Pre-Filtering .....	4222
25.4.4 Pre-Filtering by Instrument .....	4223
25.4.5 Pre-Filtering by Object .....	4224
25.4.6 Pre-Filtering by Thread .....	4226
25.4.7 Pre-Filtering by Consumer .....	4228
25.4.8 Example Consumer Configurations .....	4231
25.4.9 Naming Instruments or Consumers for Filtering Operations .....	4236
25.4.10 Determining What Is Instrumented .....	4237
25.5 Performance Schema Queries .....	4237
25.6 Performance Schema Instrument Naming Conventions .....	4238
25.7 Performance Schema Status Monitoring .....	4241
25.8 Performance Schema Atom and Molecule Events .....	4244
25.9 Performance Schema Tables for Current and Historical Events .....	4245
25.10 Performance Schema Statement Digests .....	4246
25.11 Performance Schema General Table Characteristics .....	4250
25.12 Performance Schema Table Descriptions .....	4251
25.12.1 Performance Schema Table Reference .....	4251
25.12.2 Performance Schema Setup Tables .....	4255
25.12.3 Performance Schema Instance Tables .....	4260
25.12.4 Performance Schema Wait Event Tables .....	4265
25.12.5 Performance Schema Stage Event Tables .....	4271
25.12.6 Performance Schema Statement Event Tables .....	4277
25.12.7 Performance Schema Transaction Tables .....	4288
25.12.8 Performance Schema Connection Tables .....	4296
25.12.9 Performance Schema Connection Attribute Tables .....	4299
25.12.10 Performance Schema User-Defined Variable Tables .....	4302
25.12.11 Performance Schema Replication Tables .....	4303
25.12.12 Performance Schema Lock Tables .....	4314
25.12.13 Performance Schema System Variable Tables .....	4318
25.12.14 Performance Schema Status Variable Tables .....	4319
25.12.15 Performance Schema Summary Tables .....	4321
25.12.16 Performance Schema Miscellaneous Tables .....	4341
25.13 Performance Schema Option and Variable Reference .....	4353
25.14 Performance Schema Command Options .....	4357
25.15 Performance Schema System Variables .....	4358
25.16 Performance Schema Status Variables .....	4376
25.17 The Performance Schema Memory-Allocation Model .....	4379
25.18 Performance Schema and Plugins .....	4380
25.19 Using the Performance Schema to Diagnose Problems .....	4380
25.19.1 Query Profiling Using Performance Schema .....	4381
25.20 Migrating to Performance Schema System and Status Variable Tables .....	4383
25.21 Restrictions on Performance Schema .....	4385

---

The MySQL Performance Schema is a feature for monitoring MySQL Server execution at a low level. The Performance Schema has these characteristics:

- The Performance Schema provides a way to inspect internal execution of the server at runtime. It is implemented using the `PERFORMANCE_SCHEMA` storage engine and the `performance_schema` database. The Performance Schema focuses primarily on performance data. This differs from `INFORMATION_SCHEMA`, which serves for inspection of metadata.
- The Performance Schema monitors server events. An “event” is anything the server does that takes time and has been instrumented so that timing information can be collected. In general, an event could be a function call, a wait for the operating system, a stage of an SQL statement execution such as parsing or sorting, or an entire statement or group of statements. Event collection provides access to information about synchronization calls (such as for mutexes) file and table I/O, table locks, and so forth for the server and for several storage engines.
- Performance Schema events are distinct from events written to the server's binary log (which describe data modifications) and Event Scheduler events (which are a type of stored program).
- Performance Schema events are specific to a given instance of the MySQL Server. Performance Schema tables are considered local to the server, and changes to them are not replicated or written to the binary log.
- Current events are available, as well as event histories and summaries. This enables you to determine how many times instrumented activities were performed and how much time they took. Event information is available to show the activities of specific threads, or activity associated with particular objects such as a mutex or file.
- The `PERFORMANCE_SCHEMA` storage engine collects event data using “instrumentation points” in server source code.
- Collected events are stored in tables in the `performance_schema` database. These tables can be queried using `SELECT` statements like other tables.
- Performance Schema configuration can be modified dynamically by updating tables in the `performance_schema` database through SQL statements. Configuration changes affect data collection immediately.
- Tables in the Performance Schema are in-memory tables that use no persistent on-disk storage. The contents are repopulated beginning at server startup and discarded at server shutdown.
- Monitoring is available on all platforms supported by MySQL.

Some limitations might apply: The types of timers might vary per platform. Instruments that apply to storage engines might not be implemented for all storage engines. Instrumentation of each third-party engine is the responsibility of the engine maintainer. See also [Section 25.21, “Restrictions on Performance Schema”](#).

- Data collection is implemented by modifying the server source code to add instrumentation. There are no separate threads associated with the Performance Schema, unlike other features such as replication or the Event Scheduler.

The Performance Schema is intended to provide access to useful information about server execution while having minimal impact on server performance. The implementation follows these design goals:

- Activating the Performance Schema causes no changes in server behavior. For example, it does not cause thread scheduling to change, and it does not cause query execution plans (as shown by `EXPLAIN`) to change.

- Server monitoring occurs continuously and unobtrusively with very little overhead. Activating the Performance Schema does not make the server unusable.
- The parser is unchanged. There are no new keywords or statements.
- Execution of server code proceeds normally even if the Performance Schema fails internally.
- When there is a choice between performing processing during event collection initially or during event retrieval later, priority is given to making collection faster. This is because collection is ongoing whereas retrieval is on demand and might never happen at all.
- It is easy to add new instrumentation points.
- Instrumentation is versioned. If the instrumentation implementation changes, previously instrumented code continues to work. This benefits developers of third-party plugins because it is not necessary to upgrade each plugin to stay synchronized with the latest Performance Schema changes.



### Note

The MySQL `sys` schema is a set of objects that provides convenient access to data collected by the Performance Schema. The `sys` schema is installed by default. For usage instructions, see [Chapter 26, MySQL sys Schema](#).

## 25.1 Performance Schema Quick Start

This section briefly introduces the Performance Schema with examples that show how to use it. For additional examples, see [Section 25.19, “Using the Performance Schema to Diagnose Problems”](#).

The Performance Schema is enabled by default. To enable or disable it explicitly, start the server with the `performance_schema` variable set to an appropriate value. For example, use these lines in the server `my.cnf` file:

```
[mysqld]
performance_schema=ON
```

When the server starts, it sees `performance_schema` and attempts to initialize the Performance Schema. To verify successful initialization, use this statement:

```
mysql> SHOW VARIABLES LIKE 'performance_schema';
+-----+-----+
| Variable_name | Value |
+-----+-----+
| performance_schema | ON |
+-----+-----+
```

A value of `ON` means that the Performance Schema initialized successfully and is ready for use. A value of `OFF` means that some error occurred. Check the server error log for information about what went wrong.

The Performance Schema is implemented as a storage engine. If this engine is available (which you should already have checked earlier), you should see it listed with a `SUPPORT` value of `YES` in the output from the Information Schema `ENGINES` table or the `SHOW ENGINES` statement:

```
mysql> SELECT * FROM INFORMATION_SCHEMA.ENGINES
WHERE ENGINE='PERFORMANCE_SCHEMA'\G
***** 1. row *****
ENGINE: PERFORMANCE_SCHEMA
SUPPORT: YES
COMMENT: Performance Schema
TRANSACTIONS: NO
XA: NO
```

```

SAVEPOINTS: NO

mysql> SHOW ENGINES\G
...
  Engine: PERFORMANCE_SCHEMA
  Support: YES
  Comment: Performance Schema
Transactions: NO
          XA: NO
  Savepoints: NO
...

```

The `PERFORMANCE_SCHEMA` storage engine operates on tables in the `performance_schema` database. You can make `performance_schema` the default database so that references to its tables need not be qualified with the database name:

```
mysql> USE performance_schema;
```

Performance Schema tables are stored in the `performance_schema` database. Information about the structure of this database and its tables can be obtained, as for any other database, by selecting from the `INFORMATION_SCHEMA` database or by using `SHOW` statements. For example, use either of these statements to see what Performance Schema tables exist:

```

mysql> SELECT TABLE_NAME FROM INFORMATION_SCHEMA.TABLES
       WHERE TABLE_SCHEMA = 'performance_schema';
+-----+
| TABLE_NAME |
+-----+
| accounts    |
| cond_instances |
...
| events_stages_current |
| events_stages_history |
| events_stages_history_long |
| events_stages_summary_by_account_by_event_name |
| events_stages_summary_by_host_by_event_name |
| events_stages_summary_by_thread_by_event_name |
| events_stages_summary_by_user_by_event_name |
| events_stages_summary_global_by_event_name |
| events_statements_current |
| events_statements_history |
| events_statements_history_long |
...
| file_instances |
| file_summary_by_event_name |
| file_summary_by_instance |
| host_cache |
| hosts |
| memory_summary_by_account_by_event_name |
| memory_summary_by_host_by_event_name |
| memory_summary_by_thread_by_event_name |
| memory_summary_by_user_by_event_name |
| memory_summary_global_by_event_name |
| metadata_locks |
| mutex_instances |
| objects_summary_global_by_type |
| performance_timers |
| replication_connection_configuration |
| replication_connection_status |
| replication_applier_configuration |
| replication_applier_status |
| replication_applier_status_by_coordinator |
| replication_applier_status_by_worker |
| rwlock_instances |
| session_account_connect_attrs |
| session_connect_attrs |

```

```

| setup_actors
| setup_consumers
| setup_instruments
| setup_objects
| setup_timers
| socket_instances
| socket_summary_by_event_name
| socket_summary_by_instance
| table_handles
| table_io_waits_summary_by_index_usage
| table_io_waits_summary_by_table
| table_lock_waits_summary_by_table
| threads
| users
+-----+

mysql> SHOW TABLES FROM performance_schema;
+-----+
| Tables_in_performance_schema
+-----+
| accounts
| cond_instances
| events_stages_current
| events_stages_history
| events_stages_history_long
| ...

```

The number of Performance Schema tables increases over time as implementation of additional instrumentation proceeds.

The name of the `performance_schema` database is lowercase, as are the names of tables within it. Queries should specify the names in lowercase.

To see the structure of individual tables, use `SHOW CREATE TABLE`:

```

mysql> SHOW CREATE TABLE performance_schema.setup_consumers\G
***** 1. row *****
      Table: setup_consumers
Create Table: CREATE TABLE `setup_consumers` (
  `NAME` varchar(64) NOT NULL,
  `ENABLED` enum('YES','NO') NOT NULL
) ENGINE=PERFORMANCE_SCHEMA DEFAULT CHARSET=utf8

```

Table structure is also available by selecting from tables such as `INFORMATION_SCHEMA.COLUMNS` or by using statements such as `SHOW COLUMNS`.

Tables in the `performance_schema` database can be grouped according to the type of information in them: Current events, event histories and summaries, object instances, and setup (configuration) information. The following examples illustrate a few uses for these tables. For detailed information about the tables in each group, see [Section 25.12, “Performance Schema Table Descriptions”](#).

Initially, not all instruments and consumers are enabled, so the performance schema does not collect all events. To turn all of these on and enable event timing, execute two statements (the row counts may differ depending on MySQL version):

```

mysql> UPDATE performance_schema.setup_instruments
      SET ENABLED = 'YES', TIMED = 'YES';
Query OK, 560 rows affected (0.04 sec)
mysql> UPDATE performance_schema.setup_consumers
      SET ENABLED = 'YES';
Query OK, 10 rows affected (0.00 sec)

```

To see what the server is doing at the moment, examine the `events_waits_current` table. It contains one row per thread showing each thread's most recent monitored event:

```
mysql> SELECT *
      FROM performance_schema.events_waits_current\G
***** 1. row *****
      THREAD_ID: 0
      EVENT_ID: 5523
      END_EVENT_ID: 5523
      EVENT_NAME: wait/synch/mutex/mysys/THR_LOCK::mutex
      SOURCE: thr_lock.c:525
      TIMER_START: 201660494489586
      TIMER_END: 201660494576112
      TIMER_WAIT: 86526
      SPINS: NULL
      OBJECT_SCHEMA: NULL
      OBJECT_NAME: NULL
      INDEX_NAME: NULL
      OBJECT_TYPE: NULL
      OBJECT_INSTANCE_BEGIN: 142270668
      NESTING_EVENT_ID: NULL
      NESTING_EVENT_TYPE: NULL
      OPERATION: lock
      NUMBER_OF_BYTES: NULL
      FLAGS: 0
      ...
```

This event indicates that thread 0 was waiting for 86,526 picoseconds to acquire a lock on `THR_LOCK::mutex`, a mutex in the `mysys` subsystem. The first few columns provide the following information:

- The ID columns indicate which thread the event comes from and the event number.
- `EVENT_NAME` indicates what was instrumented and `SOURCE` indicates which source file contains the instrumented code.
- The timer columns show when the event started and stopped and how long it took. If an event is still in progress, the `TIMER_END` and `TIMER_WAIT` values are `NULL`. Timer values are approximate and expressed in picoseconds. For information about timers and event time collection, see [Section 25.4.1](#), “Performance Schema Event Timing”.

The history tables contain the same kind of rows as the current-events table but have more rows and show what the server has been doing “recently” rather than “currently.” The `events_waits_history` and `events_waits_history_long` tables contain the most recent 10 events per thread and most recent 10,000 events, respectively. For example, to see information for recent events produced by thread 13, do this:

```
mysql> SELECT EVENT_ID, EVENT_NAME, TIMER_WAIT
      FROM performance_schema.events_waits_history
      WHERE THREAD_ID = 13
      ORDER BY EVENT_ID;
```

EVENT_ID	EVENT_NAME	TIMER_WAIT
86	wait/synch/mutex/mysys/THR_LOCK::mutex	686322
87	wait/synch/mutex/mysys/THR_LOCK_malloc	320535
88	wait/synch/mutex/mysys/THR_LOCK_malloc	339390
89	wait/synch/mutex/mysys/THR_LOCK_malloc	377100
90	wait/synch/mutex/sql/LOCK_plugin	614673
91	wait/synch/mutex/sql/LOCK_open	659925
92	wait/synch/mutex/sql/THD::LOCK_thd_data	494001
93	wait/synch/mutex/mysys/THR_LOCK_malloc	222489
94	wait/synch/mutex/mysys/THR_LOCK_malloc	214947
95	wait/synch/mutex/mysys/LOCK_alarm	312993

As new events are added to a history table, older events are discarded if the table is full.



Summary tables provide aggregated information for all events over time. The tables in this group summarize event data in different ways. To see which instruments have been executed the most times or have taken the most wait time, sort the `events_waits_summary_global_by_event_name` table on the `COUNT_STAR` or `SUM_TIMER_WAIT` column, which correspond to a `COUNT(*)` or `SUM(TIMER_WAIT)` value, respectively, calculated over all events:

```
mysql> SELECT EVENT_NAME, COUNT_STAR
FROM performance_schema.events_waits_summary_global_by_event_name
ORDER BY COUNT_STAR DESC LIMIT 10;
```

EVENT_NAME	COUNT_STAR
wait/synch/mutex/mysys/THR_LOCK_malloc	6419
wait/io/file/sql/FRM	452
wait/synch/mutex/sql/LOCK_plugin	337
wait/synch/mutex/mysys/THR_LOCK_open	187
wait/synch/mutex/mysys/LOCK_alarm	147
wait/synch/mutex/sql/THD::LOCK_thd_data	115
wait/io/file/myisam/kfile	102
wait/synch/mutex/sql/LOCK_global_system_variables	89
wait/synch/mutex/mysys/THR_LOCK::mutex	89
wait/synch/mutex/sql/LOCK_open	88

```
mysql> SELECT EVENT_NAME, SUM_TIMER_WAIT
FROM performance_schema.events_waits_summary_global_by_event_name
ORDER BY SUM_TIMER_WAIT DESC LIMIT 10;
```

EVENT_NAME	SUM_TIMER_WAIT
wait/io/file/sql/MYSQL_LOG	1599816582
wait/synch/mutex/mysys/THR_LOCK_malloc	1530083250
wait/io/file/sql/binlog_index	1385291934
wait/io/file/sql/FRM	1292823243
wait/io/file/myisam/kfile	411193611
wait/io/file/myisam/dfile	322401645
wait/synch/mutex/mysys/LOCK_alarm	145126935
wait/io/file/sql/casetest	104324715
wait/synch/mutex/sql/LOCK_plugin	86027823
wait/io/file/sql/pid	72591750

These results show that the `THR_LOCK_malloc` mutex is “hot,” both in terms of how often it is used and amount of time that threads wait attempting to acquire it.



#### Note

The `THR_LOCK_malloc` mutex is used only in debug builds. In production builds it is not hot because it is nonexistent.

Instance tables document what types of objects are instrumented. An instrumented object, when used by the server, produces an event. These tables provide event names and explanatory notes or status information. For example, the `file_instances` table lists instances of instruments for file I/O operations and their associated files:

```
mysql> SELECT *
FROM performance_schema.file_instances\G
***** 1. row *****
FILE_NAME: /opt/mysql-log/60500/binlog.000007
EVENT_NAME: wait/io/file/sql/binlog
OPEN_COUNT: 0
***** 2. row *****
FILE_NAME: /opt/mysql/60500/data/mysql/tables_priv.MYI
EVENT_NAME: wait/io/file/myisam/kfile
```

```

OPEN_COUNT: 1
***** 3. row *****
FILE_NAME: /opt/mysql/60500/data/mysql/columns_priv.MYI
EVENT_NAME: wait/io/file/myisam/kfile
OPEN_COUNT: 1
...

```

Setup tables are used to configure and display monitoring characteristics. For example, [setup\\_instruments](#) lists the set of instruments for which events can be collected and shows which of them are enabled:

```

mysql> SELECT * FROM performance_schema.setup_instruments;
+-----+-----+-----+
| NAME                                | ENABLED | TIMED |
+-----+-----+-----+
...
| stage/sql/end                       | NO      | NO    |
| stage/sql/executing                 | NO      | NO    |
| stage/sql/init                      | NO      | NO    |
| stage/sql/insert                    | NO      | NO    |
...
| statement/sql/load                  | YES     | YES   |
| statement/sql/grant                 | YES     | YES   |
| statement/sql/check                 | YES     | YES   |
| statement/sql/flush                 | YES     | YES   |
...
| wait/synch/mutex/sql/LOCK_global_read_lock | YES     | YES   |
| wait/synch/mutex/sql/LOCK_global_system_variables | YES     | YES   |
| wait/synch/mutex/sql/LOCK_lock_db   | YES     | YES   |
| wait/synch/mutex/sql/LOCK_manager   | YES     | YES   |
...
| wait/synch/rwlock/sql/LOCK_grant    | YES     | YES   |
| wait/synch/rwlock/sql/LOGGER::LOCK_logger | YES     | YES   |
| wait/synch/rwlock/sql/LOCK_sys_init_connect | YES     | YES   |
| wait/synch/rwlock/sql/LOCK_sys_init_slave | YES     | YES   |
...
| wait/io/file/sql/binlog             | YES     | YES   |
| wait/io/file/sql/binlog_index       | YES     | YES   |
| wait/io/file/sql/casetest           | YES     | YES   |
| wait/io/file/sql/dbopt              | YES     | YES   |
...

```

To understand how to interpret instrument names, see [Section 25.6, “Performance Schema Instrument Naming Conventions”](#).

To control whether events are collected for an instrument, set its `ENABLED` value to `YES` or `NO`. For example:

```

mysql> UPDATE performance_schema.setup_instruments
      SET ENABLED = 'NO'
      WHERE NAME = 'wait/synch/mutex/sql/LOCK_mysql_create_db';

```

The Performance Schema uses collected events to update tables in the `performance_schema` database, which act as “consumers” of event information. The `setup_consumers` table lists the available consumers and which are enabled:

```

mysql> SELECT * FROM performance_schema.setup_consumers;
+-----+-----+
| NAME                                | ENABLED |
+-----+-----+
| events_stages_current               | NO      |
| events_stages_history               | NO      |
| events_stages_history_long          | NO      |
| events_statements_current           | YES     |
| events_statements_history           | YES     |

```

events_statements_history_long	NO
events_transactions_current	NO
events_transactions_history	NO
events_transactions_history_long	NO
events_waits_current	NO
events_waits_history	NO
events_waits_history_long	NO
global_instrumentation	YES
thread_instrumentation	YES
statements_digest	YES

To control whether the Performance Schema maintains a consumer as a destination for event information, set its `ENABLED` value.

For more information about the setup tables and how to use them to control event collection, see [Section 25.4.2, “Performance Schema Event Filtering”](#).

There are some miscellaneous tables that do not fall into any of the previous groups. For example, `performance_timers` lists the available event timers and their characteristics. For information about timers, see [Section 25.4.1, “Performance Schema Event Timing”](#).

## 25.2 Performance Schema Build Configuration

The Performance Schema is mandatory and always compiled in. It is possible to exclude certain parts of the Performance Schema instrumentation. For example, to exclude stage and statement instrumentation, do this:

```
$> cmake . \
      -DDISABLE_PSI_STAGE=1 \
      -DDISABLE_PSI_STATEMENT=1
```

For more information, see the descriptions of the `DISABLE_PSI_XXX` CMake options in [Section 2.8.7, “MySQL Source-Configuration Options”](#).

If you install MySQL over a previous installation that was configured without the Performance Schema (or with an older version of the Performance Schema that has missing or out-of-date tables). One indication of this issue is the presence of messages such as the following in the error log:

```
[ERROR] Native table 'performance_schema`.`events_waits_history'
has the wrong structure
[ERROR] Native table 'performance_schema`.`events_waits_history_long'
has the wrong structure
...
```

To correct that problem, perform the MySQL upgrade procedure. See [Section 2.10, “Upgrading MySQL”](#).

To verify whether a server was built with Performance Schema support, check its help output. If the Performance Schema is available, the output mentions several variables with names that begin with `performance_schema`:

```
$> mysqld --verbose --help
...
--performance_schema
           Enable the performance schema.
--performance_schema_events_waits_history_long_size=#
           Number of rows in events_waits_history_long.
...
```

You can also connect to the server and look for a line that names the `PERFORMANCE_SCHEMA` storage engine in the output from `SHOW ENGINES`:

```
mysql> SHOW ENGINES\G
...
  Engine: PERFORMANCE_SCHEMA
  Support: YES
  Comment: Performance Schema
Transactions: NO
  XA: NO
  Savepoints: NO
...
```

If the Performance Schema was not configured into the server at build time, no row for `PERFORMANCE_SCHEMA` appears in the output from `SHOW ENGINES`. You might see `performance_schema` listed in the output from `SHOW DATABASES`, but it has no tables and cannot be used.

A line for `PERFORMANCE_SCHEMA` in the `SHOW ENGINES` output means that the Performance Schema is available, not that it is enabled. To enable it, you must do so at server startup, as described in the next section.

## 25.3 Performance Schema Startup Configuration

To use the MySQL Performance Schema, it must be enabled at server startup to enable event collection to occur.

Assuming that the Performance Schema is available, it is enabled by default. To enable or disable it explicitly, start the server with the `performance_schema` variable set to an appropriate value. For example, use these lines in your `my.cnf` file:

```
[mysqld]
performance_schema=ON
```

If the server is unable to allocate any internal buffer during Performance Schema initialization, the Performance Schema disables itself and sets `performance_schema` to `OFF`, and the server runs without instrumentation.

The Performance Schema also permits instrument and consumer configuration at server startup.

To control an instrument at server startup, use an option of this form:

```
--performance-schema-instrument='instrument_name=value'
```

Here, `instrument_name` is an instrument name such as `wait/synch/mutex/sql/LOCK_open`, and `value` is one of these values:

- `OFF`, `FALSE`, or `0`: Disable the instrument
- `ON`, `TRUE`, or `1`: Enable and time the instrument
- `COUNTED`: Enable and count (rather than time) the instrument

Each `--performance-schema-instrument` option can specify only one instrument name, but multiple instances of the option can be given to configure multiple instruments. In addition, patterns are permitted in instrument names to configure instruments that match the pattern. To configure all condition synchronization instruments as enabled and counted, use this option:

```
--performance-schema-instrument='wait/synch/cond/%=COUNTED'
```

To disable all instruments, use this option:

```
--performance-schema-instrument='%=OFF'
```

Exception: The `memory/performance_schema/%` instruments are built in and cannot be disabled at startup.

Longer instrument name strings take precedence over shorter pattern names, regardless of order. For information about specifying patterns to select instruments, see [Section 25.4.9, “Naming Instruments or Consumers for Filtering Operations”](#).

An unrecognized instrument name is ignored. It is possible that a plugin installed later may create the instrument, at which time the name is recognized and configured.

To control a consumer at server startup, use an option of this form:

```
--performance-schema-consumer-consumer_name=value
```

Here, `consumer_name` is a consumer name such as `events_waits_history`, and `value` is one of these values:

- `OFF`, `FALSE`, or `0`: Do not collect events for the consumer
- `ON`, `TRUE`, or `1`: Collect events for the consumer

For example, to enable the `events_waits_history` consumer, use this option:

```
--performance-schema-consumer-events-waits-history=ON
```

The permitted consumer names can be found by examining the `setup_consumers` table. Patterns are not permitted. Consumer names in the `setup_consumers` table use underscores, but for consumers set at startup, dashes and underscores within the name are equivalent.

The Performance Schema includes several system variables that provide configuration information:

```
mysql> SHOW VARIABLES LIKE 'perf%';
```

Variable_name	Value
performance_schema	ON
performance_schema_accounts_size	100
performance_schema_digests_size	200
performance_schema_events_stages_history_long_size	10000
performance_schema_events_stages_history_size	10
performance_schema_events_statements_history_long_size	10000
performance_schema_events_statements_history_size	10
performance_schema_events_waits_history_long_size	10000
performance_schema_events_waits_history_size	10
performance_schema_hosts_size	100
performance_schema_max_cond_classes	80
performance_schema_max_cond_instances	1000
...	

The `performance_schema` variable is `ON` or `OFF` to indicate whether the Performance Schema is enabled or disabled. The other variables indicate table sizes (number of rows) or memory allocation values.



#### Note

With the Performance Schema enabled, the number of Performance Schema instances affects the server memory footprint, perhaps to a large extent. The Performance Schema autoscales many parameters to use memory only as required; see [Section 25.17, “The Performance Schema Memory-Allocation Model”](#).

To change the value of Performance Schema system variables, set them at server startup. For example, put the following lines in a `my.cnf` file to change the sizes of the history tables for wait events:

```
[mysqld]
performance_schema
performance_schema_events_waits_history_size=20
performance_schema_events_waits_history_long_size=15000
```

The Performance Schema automatically sizes the values of several of its parameters at server startup if they are not set explicitly. For example, it sizes the parameters that control the sizes of the events waits tables this way. The Performance Schema allocates memory incrementally, scaling its memory use to actual server load, instead of allocating all the memory it needs during server startup. Consequently, many sizing parameters need not be set at all. To see which parameters are autosized or autoscaled, use `mysqld --verbose --help` and examine the option descriptions, or see [Section 25.15, “Performance Schema System Variables”](#).

For each autosized parameter that is not set at server startup, the Performance Schema determines how to set its value based on the value of the following system values, which are considered as “hints” about how you have configured your MySQL server:

```
max_connections
open_files_limit
table_definition_cache
table_open_cache
```

To override autosizing or autoscaling for a given parameter, set it to a value other than `-1` at startup. In this case, the Performance Schema assigns it the specified value.

At runtime, `SHOW VARIABLES` displays the actual values that autosized parameters were set to. Autoscaled parameters display with a value of `-1`.

If the Performance Schema is disabled, its autosized and autoscaled parameters remain set to `-1` and `SHOW VARIABLES` displays `-1`.

## 25.4 Performance Schema Runtime Configuration

Specific Performance Schema features can be enabled at runtime to control which types of event collection occur.

Performance Schema setup tables contain information about monitoring configuration:

```
mysql> SELECT TABLE_NAME FROM INFORMATION_SCHEMA.TABLES
        WHERE TABLE_SCHEMA = 'performance_schema'
        AND TABLE_NAME LIKE 'setup%';
+-----+
| TABLE_NAME |
+-----+
| setup_actors |
| setup_consumers |
| setup_instruments |
| setup_objects |
| setup_timers |
+-----+
```

You can examine the contents of these tables to obtain information about Performance Schema monitoring characteristics. If you have the `UPDATE` privilege, you can change Performance Schema operation by modifying setup tables to affect how monitoring occurs. For additional details about these tables, see [Section 25.12.2, “Performance Schema Setup Tables”](#).

To see which event timers are selected, query the `setup_timers` tables:

```
mysql> SELECT * FROM performance_schema.setup_timers;
+-----+-----+
| NAME | TIMER_NAME |
+-----+-----+
```

idle	MICROSECOND
wait	CYCLE
stage	NANOSECOND
statement	NANOSECOND
transaction	NANOSECOND

The `NAME` value indicates the type of instrument to which the timer applies, and `TIMER_NAME` indicates which timer applies to those instruments. The timer applies to instruments where their name begins with an element matching the `NAME` value.

To change the timer, update the `NAME` value. For example, to use the `NANOSECOND` timer for the `wait` timer:

```
mysql> UPDATE performance_schema.setup_timers
      SET TIMER_NAME = 'NANOSECOND'
      WHERE NAME = 'wait';
mysql> SELECT * FROM performance_schema.setup_timers;
```

NAME	TIMER_NAME
idle	MICROSECOND
wait	NANOSECOND
stage	NANOSECOND
statement	NANOSECOND
transaction	NANOSECOND

For discussion of timers, see [Section 25.4.1, “Performance Schema Event Timing”](#).

The `setup_instruments` and `setup_consumers` tables list the instruments for which events can be collected and the types of consumers for which event information actually is collected, respectively. Other setup tables enable further modification of the monitoring configuration. [Section 25.4.2, “Performance Schema Event Filtering”](#), discusses how you can modify these tables to affect event collection.

If there are Performance Schema configuration changes that must be made at runtime using SQL statements and you would like these changes to take effect each time the server starts, put the statements in a file and start the server with the `init_file` system variable set to name the file. This strategy can also be useful if you have multiple monitoring configurations, each tailored to produce a different kind of monitoring, such as casual server health monitoring, incident investigation, application behavior troubleshooting, and so forth. Put the statements for each monitoring configuration into their own file and specify the appropriate file as the `init_file` value when you start the server.

## 25.4.1 Performance Schema Event Timing

Events are collected by means of instrumentation added to the server source code. Instruments time events, which is how the Performance Schema provides an idea of how long events take. It is also possible to configure instruments not to collect timing information. This section discusses the available timers and their characteristics, and how timing values are represented in events.

### Performance Schema Timers

Two Performance Schema tables provide timer information:

- `performance_timers` lists the available timers and their characteristics.
- `setup_timers` indicates which timers are used for which instruments.

Each timer row in `setup_timers` must refer to one of the timers listed in `performance_timers`.

Timers vary in precision and amount of overhead. To see what timers are available and their characteristics, check the `performance_timers` table:

```
mysql> SELECT * FROM performance_schema.performance_timers;
```

TIMER_NAME	TIMER_FREQUENCY	TIMER_RESOLUTION	TIMER_OVERHEAD
CYCLE	2389029850	1	72
NANOSECOND	1000000000	1	112
MICROSECOND	1000000	1	136
MILLISECOND	1036	1	168
TICK	105	1	2416

If the values associated with a given timer name are `NULL`, that timer is not supported on your platform. The rows that do not contain `NULL` indicate which timers you can use in `setup_timers`.

The columns have these meanings:

- The `TIMER_NAME` column shows the names of the available timers. `CYCLE` refers to the timer that is based on the CPU (processor) cycle counter. The timers in `setup_timers` that you can use are those that do not have `NULL` in the other columns. If the values associated with a given timer name are `NULL`, that timer is not supported on your platform.
- `TIMER_FREQUENCY` indicates the number of timer units per second. For a cycle timer, the frequency is generally related to the CPU speed. The value shown was obtained on a system with a 2.4GHz processor. The other timers are based on fixed fractions of seconds. For `TICK`, the frequency may vary by platform (for example, some use 100 ticks/second, others 1000 ticks/second).
- `TIMER_RESOLUTION` indicates the number of timer units by which timer values increase at a time. If a timer has a resolution of 10, its value increases by 10 each time.
- `TIMER_OVERHEAD` is the minimal number of cycles of overhead to obtain one timing with the given timer. The overhead per event is twice the value displayed because the timer is invoked at the beginning and end of the event.

To see which timers are in effect or to change timers, access the `setup_timers` table:

```
mysql> SELECT * FROM performance_schema.setup_timers;
```

NAME	TIMER_NAME
idle	MICROSECOND
wait	CYCLE
stage	NANOSECOND
statement	NANOSECOND
transaction	NANOSECOND

```
mysql> UPDATE performance_schema.setup_timers
SET TIMER_NAME = 'MICROSECOND'
WHERE NAME = 'idle';
```

```
mysql> SELECT * FROM performance_schema.setup_timers;
```

NAME	TIMER_NAME
idle	MICROSECOND
wait	CYCLE
stage	NANOSECOND
statement	NANOSECOND
transaction	NANOSECOND



By default, the Performance Schema uses the best timer available for each instrument type, but you can select a different one.

To time wait events, the most important criterion is to reduce overhead, at the possible expense of the timer accuracy, so using the `CYCLE` timer is the best.

The time a statement (or stage) takes to execute is in general orders of magnitude larger than the time it takes to execute a single wait. To time statements, the most important criterion is to have an accurate measure, which is not affected by changes in processor frequency, so using a timer which is not based on cycles is the best. The default timer for statements is `NANOSECOND`. The extra “overhead” compared to the `CYCLE` timer is not significant, because the overhead caused by calling a timer twice (once when the statement starts, once when it ends) is orders of magnitude less compared to the CPU time used to execute the statement itself. Using the `CYCLE` timer has no benefit here, only drawbacks.

The precision offered by the cycle counter depends on processor speed. If the processor runs at 1 GHz (one billion cycles/second) or higher, the cycle counter delivers sub-nanosecond precision. Using the cycle counter is much cheaper than getting the actual time of day. For example, the standard `gettimeofday()` function can take hundreds of cycles, which is an unacceptable overhead for data gathering that may occur thousands or millions of times per second.

Cycle counters also have disadvantages:

- End users expect to see timings in wall-clock units, such as fractions of a second. Converting from cycles to fractions of seconds can be expensive. For this reason, the conversion is a quick and fairly rough multiplication operation.
- Processor cycle rate might change, such as when a laptop goes into power-saving mode or when a CPU slows down to reduce heat generation. If a processor's cycle rate fluctuates, conversion from cycles to real-time units is subject to error.
- Cycle counters might be unreliable or unavailable depending on the processor or the operating system. For example, on Pentiums, the instruction is `RDTSC` (an assembly-language rather than a C instruction) and it is theoretically possible for the operating system to prevent user-mode programs from using it.
- Some processor details related to out-of-order execution or multiprocessor synchronization might cause the counter to seem fast or slow by up to 1000 cycles.

MySQL works with cycle counters on x386 (Windows, macOS, Linux, Solaris, and other Unix flavors), PowerPC, and IA-64.

## Performance Schema Timer Representation in Events

Rows in Performance Schema tables that store current events and historical events have three columns to represent timing information: `TIMER_START` and `TIMER_END` indicate when an event started and finished, and `TIMER_WAIT` indicates event duration.

The `setup_instruments` table has an `ENABLED` column to indicate the instruments for which to collect events. The table also has a `TIMED` column to indicate which instruments are timed. If an instrument is not enabled, it produces no events. If an enabled instrument is not timed, events produced by the instrument have `NULL` for the `TIMER_START`, `TIMER_END`, and `TIMER_WAIT` timer values. This in turn causes those values to be ignored when calculating aggregate time values in summary tables (sum, minimum, maximum, and average).

Internally, times within events are stored in units given by the timer in effect when event timing begins. For display when events are retrieved from Performance Schema tables, times are shown in picoseconds (trillionths of a second) to normalize them to a standard unit, regardless of which timer is selected.

Modifications to the `setup_timers` table affect monitoring immediately. Events already in progress may use the original timer for the begin time and the new timer for the end time. To avoid unpredictable results after you make timer changes, use `TRUNCATE TABLE` to reset Performance Schema statistics.

The timer baseline (“time zero”) occurs at Performance Schema initialization during server startup. `TIMER_START` and `TIMER_END` values in events represent picoseconds since the baseline. `TIMER_WAIT` values are durations in picoseconds.

Picosecond values in events are approximate. Their accuracy is subject to the usual forms of error associated with conversion from one unit to another. If the `CYCLE` timer is used and the processor rate varies, there might be drift. For these reasons, it is not reasonable to look at the `TIMER_START` value for an event as an accurate measure of time elapsed since server startup. On the other hand, it is reasonable to use `TIMER_START` or `TIMER_WAIT` values in `ORDER BY` clauses to order events by start time or duration.

The choice of picoseconds in events rather than a value such as microseconds has a performance basis. One implementation goal was to show results in a uniform time unit, regardless of the timer. In an ideal world this time unit would look like a wall-clock unit and be reasonably precise; in other words, microseconds. But to convert cycles or nanoseconds to microseconds, it would be necessary to perform a division for every instrumentation. Division is expensive on many platforms. Multiplication is not expensive, so that is what is used. Therefore, the time unit is an integer multiple of the highest possible `TIMER_FREQUENCY` value, using a multiplier large enough to ensure that there is no major precision loss. The result is that the time unit is “picoseconds.” This precision is spurious, but the decision enables overhead to be minimized.

While a wait, stage, statement, or transaction event is executing, the respective current-event tables display current-event timing information:

```
events_waits_current
events_stages_current
events_statements_current
events_transactions_current
```

To make it possible to determine how long a not-yet-completed event has been running, the timer columns are set as follows:

- `TIMER_START` is populated.
- `TIMER_END` is populated with the current timer value.
- `TIMER_WAIT` is populated with the time elapsed so far (`TIMER_END - TIMER_START`).

Events that have not yet completed have an `END_EVENT_ID` value of `NULL`. To assess time elapsed so far for an event, use the `TIMER_WAIT` column. Therefore, to identify events that have not yet completed and have taken longer than `N` picoseconds thus far, monitoring applications can use this expression in queries:

```
WHERE END_EVENT_ID IS NULL AND TIMER_WAIT > N
```

Event identification as just described assumes that the corresponding instruments have `ENABLED` and `TIMED` set to `YES` and that the relevant consumers are enabled.

## 25.4.2 Performance Schema Event Filtering

Events are processed in a producer/consumer fashion:

- Instrumented code is the source for events and produces events to be collected. The `setup_instruments` table lists the instruments for which events can be collected, whether they are enabled, and (for enabled instruments) whether to collect timing information:

```
mysql> SELECT * FROM performance_schema.setup_instruments;
+-----+-----+-----+
| NAME                                     | ENABLED | TIMED |
+-----+-----+-----+
...
| wait/synch/mutex/sql/LOCK_global_read_lock | YES     | YES   |
| wait/synch/mutex/sql/LOCK_global_system_variables | YES     | YES   |
| wait/synch/mutex/sql/LOCK_lock_db          | YES     | YES   |
| wait/synch/mutex/sql/LOCK_manager         | YES     | YES   |
...

```

The `setup_instruments` table provides the most basic form of control over event production. To further refine event production based on the type of object or thread being monitored, other tables may be used as described in [Section 25.4.3, “Event Pre-Filtering”](#).

- Performance Schema tables are the destinations for events and consume events. The `setup_consumers` table lists the types of consumers to which event information can be sent and whether they are enabled:

```
mysql> SELECT * FROM performance_schema.setup_consumers;
+-----+-----+
| NAME                                     | ENABLED |
+-----+-----+
| events_stages_current                   | NO      |
| events_stages_history                   | NO      |
| events_stages_history_long              | NO      |
| events_statements_current               | YES     |
| events_statements_history               | YES     |
| events_statements_history_long          | NO      |
| events_transactions_current             | NO      |
| events_transactions_history             | NO      |
| events_transactions_history_long        | NO      |
| events_waits_current                    | NO      |
| events_waits_history                    | NO      |
| events_waits_history_long               | NO      |
| global_instrumentation                  | YES     |
| thread_instrumentation                  | YES     |
| statements_digest                       | YES     |
+-----+-----+

```

Filtering can be done at different stages of performance monitoring:

- **Pre-filtering.** This is done by modifying Performance Schema configuration so that only certain types of events are collected from producers, and collected events update only certain consumers. To do this, enable or disable instruments or consumers. Pre-filtering is done by the Performance Schema and has a global effect that applies to all users.

Reasons to use pre-filtering:

- To reduce overhead. Performance Schema overhead should be minimal even with all instruments enabled, but perhaps you want to reduce it further. Or you do not care about timing events and want to disable the timing code to eliminate timing overhead.
- To avoid filling the current-events or history tables with events in which you have no interest. Pre-filtering leaves more “room” in these tables for instances of rows for enabled instrument types. If you enable only file instruments with pre-filtering, no rows are collected for nonfile instruments. With post-filtering, nonfile events are collected, leaving fewer rows for file events.
- To avoid maintaining some kinds of event tables. If you disable a consumer, the server does not spend time maintaining destinations for that consumer. For example, if you do not care about event histories, you can disable the history table consumers to improve performance.

- **Post-filtering.** This involves the use of `WHERE` clauses in queries that select information from Performance Schema tables, to specify which of the available events you want to see. Post-filtering is performed on a per-user basis because individual users select which of the available events are of interest.

Reasons to use post-filtering:

- To avoid making decisions for individual users about which event information is of interest.
- To use the Performance Schema to investigate a performance issue when the restrictions to impose using pre-filtering are not known in advance.

The following sections provide more detail about pre-filtering and provide guidelines for naming instruments or consumers in filtering operations. For information about writing queries to retrieve information (post-filtering), see [Section 25.5, “Performance Schema Queries”](#).

### 25.4.3 Event Pre-Filtering

Pre-filtering is done by the Performance Schema and has a global effect that applies to all users. Pre-filtering can be applied to either the producer or consumer stage of event processing:

- To configure pre-filtering at the producer stage, several tables can be used:
  - `setup_instruments` indicates which instruments are available. An instrument disabled in this table produces no events regardless of the contents of the other production-related setup tables. An instrument enabled in this table is permitted to produce events, subject to the contents of the other tables.
  - `setup_objects` controls whether the Performance Schema monitors particular table and stored program objects.
  - `threads` indicates whether monitoring is enabled for each server thread.
  - `setup_actors` determines the initial monitoring state for new foreground threads.
- To configure pre-filtering at the consumer stage, modify the `setup_consumers` table. This determines the destinations to which events are sent. `setup_consumers` also implicitly affects event production. If a given event is not sent to any destination (is not consumed), the Performance Schema does not produce it.

Modifications to any of these tables affect monitoring immediately, with some exceptions:

- Modifications to some instruments in the `setup_instruments` table are effective only at server startup; changing them at runtime has no effect. This affects primarily mutexes, conditions, and rwlocks in the server, although there may be other instruments for which this is true. This restriction is lifted as of MySQL 5.7.12.
- Modifications to the `setup_actors` table affect only foreground threads created subsequent to the modification, not existing threads.

When you change the monitoring configuration, the Performance Schema does not flush the history tables. Events already collected remain in the current-events and history tables until displaced by newer events. If you disable instruments, you might need to wait a while before events for them are displaced by newer events of interest. Alternatively, use `TRUNCATE TABLE` to empty the history tables.

After making instrumentation changes, you might want to truncate the summary tables. Generally, the effect is to reset the summary columns to 0 or `NULL`, not to remove rows. This enables you to clear

collected values and restart aggregation. That might be useful, for example, after you have made a runtime configuration change. Exceptions to this truncation behavior are noted in individual summary table sections.

The following sections describe how to use specific tables to control Performance Schema pre-filtering.

## 25.4.4 Pre-Filtering by Instrument

The `setup_instruments` table lists the available instruments:

```
mysql> SELECT * FROM performance_schema.setup_instruments;
```

NAME	ENABLED	TIMED
...		
stage/sql/end	NO	NO
stage/sql/executing	NO	NO
stage/sql/init	NO	NO
stage/sql/insert	NO	NO
...		
statement/sql/load	YES	YES
statement/sql/grant	YES	YES
statement/sql/check	YES	YES
statement/sql/flush	YES	YES
...		
wait/synch/mutex/sql/LOCK_global_read_lock	YES	YES
wait/synch/mutex/sql/LOCK_global_system_variables	YES	YES
wait/synch/mutex/sql/LOCK_lock_db	YES	YES
wait/synch/mutex/sql/LOCK_manager	YES	YES
...		
wait/synch/rwlock/sql/LOCK_grant	YES	YES
wait/synch/rwlock/sql/LOGGER::LOCK_logger	YES	YES
wait/synch/rwlock/sql/LOCK_sys_init_connect	YES	YES
wait/synch/rwlock/sql/LOCK_sys_init_slave	YES	YES
...		
wait/io/file/sql/binlog	YES	YES
wait/io/file/sql/binlog_index	YES	YES
wait/io/file/sql/casetest	YES	YES
wait/io/file/sql/dbopt	YES	YES
...		

To control whether an instrument is enabled, set its `ENABLED` column to `YES` or `NO`. To configure whether to collect timing information for an enabled instrument, set its `TIMED` value to `YES` or `NO`. Setting the `TIMED` column affects Performance Schema table contents as described in [Section 25.4.1, “Performance Schema Event Timing”](#).

Modifications to most `setup_instruments` rows affect monitoring immediately. For some instruments, modifications are effective only at server startup; changing them at runtime has no effect. This affects primarily mutexes, conditions, and rwlocks in the server, although there may be other instruments for which this is true.

The `setup_instruments` table provides the most basic form of control over event production. To further refine event production based on the type of object or thread being monitored, other tables may be used as described in [Section 25.4.3, “Event Pre-Filtering”](#).

The following examples demonstrate possible operations on the `setup_instruments` table. These changes, like other pre-filtering operations, affect all users. Some of these queries use the `LIKE` operator and a pattern match instrument names. For additional information about specifying patterns to select instruments, see [Section 25.4.9, “Naming Instruments or Consumers for Filtering Operations”](#).

- Disable all instruments:

```
UPDATE performance_schema.setup_instruments
SET ENABLED = 'NO';
```

Now no events are collected.

- Disable all file instruments, adding them to the current set of disabled instruments:

```
UPDATE performance_schema.setup_instruments
SET ENABLED = 'NO'
WHERE NAME LIKE 'wait/io/file/%';
```

- Disable only file instruments, enable all other instruments:

```
UPDATE performance_schema.setup_instruments
SET ENABLED = IF(NAME LIKE 'wait/io/file/%', 'NO', 'YES');
```

- Enable all but those instruments in the `mysys` library:

```
UPDATE performance_schema.setup_instruments
SET ENABLED = CASE WHEN NAME LIKE '%/mysys/%' THEN 'YES' ELSE 'NO' END;
```

- Disable a specific instrument:

```
UPDATE performance_schema.setup_instruments
SET ENABLED = 'NO'
WHERE NAME = 'wait/synch/mutex/mysys/TMPDIR_mutex';
```

- To toggle the state of an instrument, “flip” its `ENABLED` value:

```
UPDATE performance_schema.setup_instruments
SET ENABLED = IF(ENABLED = 'YES', 'NO', 'YES')
WHERE NAME = 'wait/synch/mutex/mysys/TMPDIR_mutex';
```

- Disable timing for all events:

```
UPDATE performance_schema.setup_instruments
SET TIMED = 'NO';
```

## 25.4.5 Pre-Filtering by Object

The `setup_objects` table controls whether the Performance Schema monitors particular table and stored program objects. The initial `setup_objects` contents look like this:

```
mysql> SELECT * FROM performance_schema.setup_objects;
```

OBJECT_TYPE	OBJECT_SCHEMA	OBJECT_NAME	ENABLED	TIMED
EVENT	mysql	%	NO	NO
EVENT	performance_schema	%	NO	NO
EVENT	information_schema	%	NO	NO
EVENT	%	%	YES	YES
FUNCTION	mysql	%	NO	NO
FUNCTION	performance_schema	%	NO	NO
FUNCTION	information_schema	%	NO	NO
FUNCTION	%	%	YES	YES
PROCEDURE	mysql	%	NO	NO
PROCEDURE	performance_schema	%	NO	NO
PROCEDURE	information_schema	%	NO	NO
PROCEDURE	%	%	YES	YES
TABLE	mysql	%	NO	NO
TABLE	performance_schema	%	NO	NO
TABLE	information_schema	%	NO	NO
TABLE	%	%	YES	YES

TRIGGER	mysql	%	NO	NO
TRIGGER	performance_schema	%	NO	NO
TRIGGER	information_schema	%	NO	NO
TRIGGER	%	%	YES	YES

Modifications to the `setup_objects` table affect object monitoring immediately.

The `OBJECT_TYPE` column indicates the type of object to which a row applies. `TABLE` filtering affects table I/O events (`wait/io/table/sql/handler` instrument) and table lock events (`wait/lock/table/sql/handler` instrument).

The `OBJECT_SCHEMA` and `OBJECT_NAME` columns should contain a literal schema or object name, or `'%'` to match any name.

The `ENABLED` column indicates whether matching objects are monitored, and `TIMED` indicates whether to collect timing information. Setting the `TIMED` column affects Performance Schema table contents as described in [Section 25.4.1, “Performance Schema Event Timing”](#).

The effect of the default object configuration is to instrument all objects except those in the `mysql`, `INFORMATION_SCHEMA`, and `performance_schema` databases. (Tables in the `INFORMATION_SCHEMA` database are not instrumented regardless of the contents of `setup_objects`; the row for `information_schema.%` simply makes this default explicit.)

When the Performance Schema checks for a match in `setup_objects`, it tries to find more specific matches first. For rows that match a given `OBJECT_TYPE`, the Performance Schema checks rows in this order:

- Rows with `OBJECT_SCHEMA='literal'` and `OBJECT_NAME='literal'`.
- Rows with `OBJECT_SCHEMA='literal'` and `OBJECT_NAME='%'`.
- Rows with `OBJECT_SCHEMA='%'` and `OBJECT_NAME='%'`.

For example, with a table `db1.t1`, the Performance Schema looks in `TABLE` rows for a match for `'db1'` and `'t1'`, then for `'db1'` and `'%'`, then for `'%'` and `'%'`. The order in which matching occurs matters because different matching `setup_objects` rows can have different `ENABLED` and `TIMED` values.

For table-related events, the Performance Schema combines the contents of `setup_objects` with `setup_instruments` to determine whether to enable instruments and whether to time enabled instruments:

- For tables that match a row in `setup_objects`, table instruments produce events only if `ENABLED` is `YES` in both `setup_instruments` and `setup_objects`.
- The `TIMED` values in the two tables are combined, so that timing information is collected only when both values are `YES`.

For stored program objects, the Performance Schema takes the `ENABLED` and `TIMED` columns directly from the `setup_objects` row. There is no combining of values with `setup_instruments`.

Suppose that `setup_objects` contains the following `TABLE` rows that apply to `db1`, `db2`, and `db3`:

OBJECT_TYPE	OBJECT_SCHEMA	OBJECT_NAME	ENABLED	TIMED
TABLE	db1	t1	YES	YES
TABLE	db1	t2	NO	NO
TABLE	db2	%	YES	YES
TABLE	db3	%	NO	NO

TABLE	%	%	YES	YES
-------	---	---	-----	-----

If an object-related instrument in `setup_instruments` has an `ENABLED` value of `NO`, events for the object are not monitored. If the `ENABLED` value is `YES`, event monitoring occurs according to the `ENABLED` value in the relevant `setup_objects` row:

- `db1.t1` events are monitored
- `db1.t2` events are not monitored
- `db2.t3` events are monitored
- `db3.t4` events are not monitored
- `db4.t5` events are monitored

Similar logic applies for combining the `TIMED` columns from the `setup_instruments` and `setup_objects` tables to determine whether to collect event timing information.

If a persistent table and a temporary table have the same name, matching against `setup_objects` rows occurs the same way for both. It is not possible to enable monitoring for one table but not the other. However, each table is instrumented separately.

## 25.4.6 Pre-Filtering by Thread

The `threads` table contains a row for each server thread. Each row contains information about a thread and indicates whether monitoring is enabled for it. For the Performance Schema to monitor a thread, these things must be true:

- The `thread_instrumentation` consumer in the `setup_consumers` table must be `YES`.
- The `threads.INSTRUMENTED` column must be `YES`.
- Monitoring occurs only for those thread events produced from instruments that are enabled in the `setup_instruments` table.

The `threads` table also indicates for each server thread whether to perform historical event logging. This includes wait, stage, statement, and transaction events and affects logging to these tables:

```
events_waits_history
events_waits_history_long
events_stages_history
events_stages_history_long
events_statements_history
events_statements_history_long
events_transactions_history
events_transactions_history_long
```

For historical event logging to occur, these things must be true:

- The appropriate history-related consumers in the `setup_consumers` table must be enabled. For example, wait event logging in the `events_waits_history` and `events_waits_history_long` tables requires the corresponding `events_waits_history` and `events_waits_history_long` consumers to be `YES`.
- The `threads.HISTORY` column must be `YES`.
- Logging occurs only for those thread events produced from instruments that are enabled in the `setup_instruments` table.



For foreground threads (resulting from client connections), the initial values of the `INSTRUMENTED` and `HISTORY` columns in `threads` table rows are determined by whether the user account associated with a thread matches any row in the `setup_actors` table. The values come from the `ENABLED` and `HISTORY` columns of the matching `setup_actors` table row.

For background threads, there is no associated user. `INSTRUMENTED` and `HISTORY` are `YES` by default and `setup_actors` is not consulted.

The initial `setup_actors` contents look like this:

```
mysql> SELECT * FROM performance_schema.setup_actors;
+-----+-----+-----+-----+-----+
| HOST | USER | ROLE | ENABLED | HISTORY |
+-----+-----+-----+-----+-----+
| %    | %    | %    | YES     | YES     |
+-----+-----+-----+-----+-----+
```

The `HOST` and `USER` columns should contain a literal host or user name, or `'%'` to match any name.

The `ENABLED` and `HISTORY` columns indicate whether to enable instrumentation and historical event logging for matching threads, subject to the other conditions described previously.

When the Performance Schema checks for a match for each new foreground thread in `setup_actors`, it tries to find more specific matches first, using the `USER` and `HOST` columns (`ROLE` is unused):

- Rows with `USER='literal'` and `HOST='literal'`.
- Rows with `USER='literal'` and `HOST='%'`.
- Rows with `USER='%'` and `HOST='literal'`.
- Rows with `USER='%'` and `HOST='%'`.

The order in which matching occurs matters because different matching `setup_actors` rows can have different `USER` and `HOST` values. This enables instrumenting and historical event logging to be applied selectively per host, user, or account (user and host combination), based on the `ENABLED` and `HISTORY` column values:

- When the best match is a row with `ENABLED=YES`, the `INSTRUMENTED` value for the thread becomes `YES`. When the best match is a row with `HISTORY=YES`, the `HISTORY` value for the thread becomes `YES`.
- When the best match is a row with `ENABLED=NO`, the `INSTRUMENTED` value for the thread becomes `NO`. When the best match is a row with `HISTORY=NO`, the `HISTORY` value for the thread becomes `NO`.
- When no match is found, the `INSTRUMENTED` and `HISTORY` values for the thread become `NO`.

The `ENABLED` and `HISTORY` columns in `setup_actors` rows can be set to `YES` or `NO` independent of one another. This means you can enable instrumentation separately from whether you collect historical events.

By default, monitoring and historical event collection are enabled for all new foreground threads because the `setup_actors` table initially contains a row with `'%'` for both `HOST` and `USER`. To perform more limited matching such as to enable monitoring only for some foreground threads, you must change this row because it matches any connection, and add rows for more specific `HOST/USER` combinations.

Suppose that you modify `setup_actors` as follows:

```
UPDATE performance_schema.setup_actors
SET ENABLED = 'NO', HISTORY = 'NO'
WHERE HOST = '%' AND USER = '%';
INSERT INTO performance_schema.setup_actors
```

```
(HOST,USER,ROLE,ENABLED,HISTORY)
VALUES('localhost','joe','%','YES','YES');
INSERT INTO performance_schema.setup_actors
(HOST,USER,ROLE,ENABLED,HISTORY)
VALUES('hosta.example.com','joe','%','YES','NO');
INSERT INTO performance_schema.setup_actors
(HOST,USER,ROLE,ENABLED,HISTORY)
VALUES('%','sam','%','NO','YES');
```

The `UPDATE` statement changes the default match to disable instrumentation and historical event collection. The `INSERT` statements add rows for more specific matches.

Now the Performance Schema determines how to set the `INSTRUMENTED` and `HISTORY` values for new connection threads as follows:

- If `joe` connects from the local host, the connection matches the first inserted row. The `INSTRUMENTED` and `HISTORY` values for the thread become `YES`.
- If `joe` connects from `hosta.example.com`, the connection matches the second inserted row. The `INSTRUMENTED` value for the thread becomes `YES` and the `HISTORY` value becomes `NO`.
- If `joe` connects from any other host, there is no match. The `INSTRUMENTED` and `HISTORY` values for the thread become `NO`.
- If `sam` connects from any host, the connection matches the third inserted row. The `INSTRUMENTED` value for the thread becomes `NO` and the `HISTORY` value becomes `YES`.
- For any other connection, the row with `HOST` and `USER` set to `'%'` matches. This row now has `ENABLED` and `HISTORY` set to `NO`, so the `INSTRUMENTED` and `HISTORY` values for the thread become `NO`.

Modifications to the `setup_actors` table affect only foreground threads created subsequent to the modification, not existing threads. To affect existing threads, modify the `INSTRUMENTED` and `HISTORY` columns of `threads` table rows.

## 25.4.7 Pre-Filtering by Consumer

The `setup_consumers` table lists the available consumer types and which are enabled:

```
mysql> SELECT * FROM performance_schema.setup_consumers;
+-----+
| NAME                                | ENABLED |
+-----+
| events_stages_current               | NO      |
| events_stages_history               | NO      |
| events_stages_history_long          | NO      |
| events_statements_current           | YES     |
| events_statements_history           | YES     |
| events_statements_history_long      | NO      |
| events_transactions_current         | NO      |
| events_transactions_history         | NO      |
| events_transactions_history_long    | NO      |
| events_waits_current                | NO      |
| events_waits_history                | NO      |
| events_waits_history_long           | NO      |
| global_instrumentation              | YES     |
| thread_instrumentation              | YES     |
| statements_digest                   | YES     |
+-----+

```

Modify the `setup_consumers` table to affect pre-filtering at the consumer stage and determine the destinations to which events are sent. To enable or disable a consumer, set its `ENABLED` value to `YES` or `NO`.

Modifications to the `setup_consumers` table affect monitoring immediately.

If you disable a consumer, the server does not spend time maintaining destinations for that consumer. For example, if you do not care about historical event information, disable the history consumers:

```
UPDATE performance_schema.setup_consumers
SET ENABLED = 'NO'
WHERE NAME LIKE '%history%';
```

The consumer settings in the `setup_consumers` table form a hierarchy from higher levels to lower. The following principles apply:

- Destinations associated with a consumer receive no events unless the Performance Schema checks the consumer and the consumer is enabled.
- A consumer is checked only if all consumers it depends on (if any) are enabled.
- If a consumer is not checked, or is checked but is disabled, other consumers that depend on it are not checked.
- Dependent consumers may have their own dependent consumers.
- If an event would not be sent to any destination, the Performance Schema does not produce it.

The following lists describe the available consumer values. For discussion of several representative consumer configurations and their effect on instrumentation, see [Section 25.4.8, “Example Consumer Configurations”](#).

- [Global and Thread Consumers](#)
- [Wait Event Consumers](#)
- [Stage Event Consumers](#)
- [Statement Event Consumers](#)
- [Transaction Event Consumers](#)
- [Statement Digest Consumer](#)

### Global and Thread Consumers

- `global_instrumentation` is the highest level consumer. If `global_instrumentation` is `NO`, it disables global instrumentation. All other settings are lower level and are not checked; it does not matter what they are set to. No global or per thread information is maintained and no individual events are collected in the current-events or event-history tables. If `global_instrumentation` is `YES`, the Performance Schema maintains information for global states and also checks the `thread_instrumentation` consumer.
- `thread_instrumentation` is checked only if `global_instrumentation` is `YES`. Otherwise, if `thread_instrumentation` is `NO`, it disables thread-specific instrumentation and all lower-level settings are ignored. No information is maintained per thread and no individual events are collected in the current-events or event-history tables. If `thread_instrumentation` is `YES`, the Performance Schema maintains thread-specific information and also checks `events_xxx_current` consumers.

### Wait Event Consumers

These consumers require both `global_instrumentation` and `thread_instrumentation` to be `YES` or they are not checked. If checked, they act as follows:

- `events_waits_current`, if `NO`, disables collection of individual wait events in the `events_waits_current` table. If `YES`, it enables wait event collection and the Performance Schema checks the `events_waits_history` and `events_waits_history_long` consumers.
- `events_waits_history` is not checked if `event_waits_current` is `NO`. Otherwise, an `events_waits_history` value of `NO` or `YES` disables or enables collection of wait events in the `events_waits_history` table.
- `events_waits_history_long` is not checked if `event_waits_current` is `NO`. Otherwise, an `events_waits_history_long` value of `NO` or `YES` disables or enables collection of wait events in the `events_waits_history_long` table.

### Stage Event Consumers

These consumers require both `global_instrumentation` and `thread_instrumentation` to be `YES` or they are not checked. If checked, they act as follows:

- `events_stages_current`, if `NO`, disables collection of individual stage events in the `events_stages_current` table. If `YES`, it enables stage event collection and the Performance Schema checks the `events_stages_history` and `events_stages_history_long` consumers.
- `events_stages_history` is not checked if `event_stages_current` is `NO`. Otherwise, an `events_stages_history` value of `NO` or `YES` disables or enables collection of stage events in the `events_stages_history` table.
- `events_stages_history_long` is not checked if `event_stages_current` is `NO`. Otherwise, an `events_stages_history_long` value of `NO` or `YES` disables or enables collection of stage events in the `events_stages_history_long` table.

### Statement Event Consumers

These consumers require both `global_instrumentation` and `thread_instrumentation` to be `YES` or they are not checked. If checked, they act as follows:

- `events_statements_current`, if `NO`, disables collection of individual statement events in the `events_statements_current` table. If `YES`, it enables statement event collection and the Performance Schema checks the `events_statements_history` and `events_statements_history_long` consumers.
- `events_statements_history` is not checked if `events_statements_current` is `NO`. Otherwise, an `events_statements_history` value of `NO` or `YES` disables or enables collection of statement events in the `events_statements_history` table.
- `events_statements_history_long` is not checked if `events_statements_current` is `NO`. Otherwise, an `events_statements_history_long` value of `NO` or `YES` disables or enables collection of statement events in the `events_statements_history_long` table.

### Transaction Event Consumers

These consumers require both `global_instrumentation` and `thread_instrumentation` to be `YES` or they are not checked. If checked, they act as follows:

- `events_transactions_current`, if `NO`, disables collection of individual transaction events in the `events_transactions_current` table. If `YES`, it enables transaction event collection and the Performance Schema checks the `events_transactions_history` and `events_transactions_history_long` consumers.

- `events_transactions_history` is not checked if `events_transactions_current` is `NO`. Otherwise, an `events_transactions_history` value of `NO` or `YES` disables or enables collection of transaction events in the `events_transactions_history` table.
- `events_transactions_history_long` is not checked if `events_transactions_current` is `NO`. Otherwise, an `events_transactions_history_long` value of `NO` or `YES` disables or enables collection of transaction events in the `events_transactions_history_long` table.

## Statement Digest Consumer

The `statements_digest` consumer requires `global_instrumentation` to be `YES` or it is not checked. There is no dependency on the statement event consumers, so you can obtain statistics per digest without having to collect statistics in `events_statements_current`, which is advantageous in terms of overhead. Conversely, you can get detailed statements in `events_statements_current` without digests (the `DIGEST` and `DIGEST_TEXT` columns are `NULL`).

For more information about statement digesting, see [Section 25.10, “Performance Schema Statement Digests”](#).

## 25.4.8 Example Consumer Configurations

The consumer settings in the `setup_consumers` table form a hierarchy from higher levels to lower. The following discussion describes how consumers work, showing specific configurations and their effects as consumer settings are enabled progressively from high to low. The consumer values shown are representative. The general principles described here apply to other consumer values that may be available.

The configuration descriptions occur in order of increasing functionality and overhead. If you do not need the information provided by enabling lower-level settings, disable them and the Performance Schema executes less code on your behalf and you have less information to sift through.

The `setup_consumers` table contains the following hierarchy of values:

```
global_instrumentation
thread_instrumentation
  events_waits_current
  events_waits_history
  events_waits_history_long
events_stages_current
  events_stages_history
  events_stages_history_long
events_statements_current
  events_statements_history
  events_statements_history_long
events_transactions_current
  events_transactions_history
  events_transactions_history_long
statements_digest
```



### Note

In the consumer hierarchy, the consumers for waits, stages, statements, and transactions are all at the same level. This differs from the event nesting hierarchy, for which wait events nest within stage events, which nest within statement events, which nest within transaction events.

If a given consumer setting is `NO`, the Performance Schema disables the instrumentation associated with the consumer and ignores all lower-level settings. If a given setting is `YES`, the Performance Schema

enables the instrumentation associated with it and checks the settings at the next lowest level. For a description of the rules for each consumer, see [Section 25.4.7, “Pre-Filtering by Consumer”](#).

For example, if `global_instrumentation` is enabled, `thread_instrumentation` is checked. If `thread_instrumentation` is enabled, the `events_xxx_current` consumers are checked. If of these `events_waits_current` is enabled, `events_waits_history` and `events_waits_history_long` are checked.

Each of the following configuration descriptions indicates which setup elements the Performance Schema checks and which output tables it maintains (that is, for which tables it collects information).

- [No Instrumentation](#)
- [Global Instrumentation Only](#)
- [Global and Thread Instrumentation Only](#)
- [Global, Thread, and Current-Event Instrumentation](#)
- [Global, Thread, Current-Event, and Event-History instrumentation](#)

## No Instrumentation

Server configuration state:

```
mysql> SELECT * FROM performance_schema.setup_consumers;
+-----+-----+
| NAME                | ENABLED |
+-----+-----+
| global_instrumentation | NO      |
| ...                 |         |
+-----+-----+
```

In this configuration, nothing is instrumented.

Setup elements checked:

- Table `setup_consumers`, consumer `global_instrumentation`

Output tables maintained:

- None

## Global Instrumentation Only

Server configuration state:

```
mysql> SELECT * FROM performance_schema.setup_consumers;
+-----+-----+
| NAME                | ENABLED |
+-----+-----+
| global_instrumentation | YES     |
| thread_instrumentation  | NO      |
| ...                 |         |
+-----+-----+
```

In this configuration, instrumentation is maintained only for global states. Per-thread instrumentation is disabled.

Additional setup elements checked, relative to the preceding configuration:

- Table `setup_consumers`, consumer `thread_instrumentation`
- Table `setup_instruments`
- Table `setup_objects`
- Table `setup_timers`

Additional output tables maintained, relative to the preceding configuration:

- `mutex_instances`
- `rwlock_instances`
- `cond_instances`
- `file_instances`
- `users`
- `hosts`
- `accounts`
- `socket_summary_by_event_name`
- `file_summary_by_instance`
- `file_summary_by_event_name`
- `objects_summary_global_by_type`
- `memory_summary_global_by_event_name`
- `table_lock_waits_summary_by_table`
- `table_io_waits_summary_by_index_usage`
- `table_io_waits_summary_by_table`
- `events_waits_summary_by_instance`
- `events_waits_summary_global_by_event_name`
- `events_stages_summary_global_by_event_name`
- `events_statements_summary_global_by_event_name`
- `events_transactions_summary_global_by_event_name`

## Global and Thread Instrumentation Only

Server configuration state:

```
mysql> SELECT * FROM performance_schema.setup_consumers;
+-----+-----+
| NAME                                | ENABLED |
+-----+-----+
| global_instrumentation              | YES     |
| thread_instrumentation              | YES     |
| events_waits_current                | NO      |
```

```

...
| events_stages_current          | NO      |
...
| events_statements_current     | NO      |
...
| events_transactions_current   | NO      |
...
+-----+-----+

```

In this configuration, instrumentation is maintained globally and per thread. No individual events are collected in the current-events or event-history tables.

Additional setup elements checked, relative to the preceding configuration:

- Table `setup_consumers`, consumers `events_xxx_current`, where `xxx` is `waits`, `stages`, `statements`, `transactions`
- Table `setup_actors`
- Column `threads.instrumented`

Additional output tables maintained, relative to the preceding configuration:

- `events_xxx_summary_by_yyy_by_event_name`, where `xxx` is `waits`, `stages`, `statements`, `transactions`; and `yyy` is `thread`, `user`, `host`, `account`

## Global, Thread, and Current-Event Instrumentation

Server configuration state:

```

mysql> SELECT * FROM performance_schema.setup_consumers;
+-----+-----+
| NAME                                | ENABLED |
+-----+-----+
| global_instrumentation              | YES     |
| thread_instrumentation              | YES     |
| events_waits_current                | YES     |
| events_waits_history                | NO      |
| events_waits_history_long           | NO      |
| events_stages_current                | YES     |
| events_stages_history                | NO      |
| events_stages_history_long          | NO      |
| events_statements_current            | YES     |
| events_statements_history            | NO      |
| events_statements_history_long       | NO      |
| events_transactions_current          | YES     |
| events_transactions_history          | NO      |
| events_transactions_history_long     | NO      |
...
+-----+-----+

```

In this configuration, instrumentation is maintained globally and per thread. Individual events are collected in the current-events table, but not in the event-history tables.

Additional setup elements checked, relative to the preceding configuration:

- Consumers `events_xxx_history`, where `xxx` is `waits`, `stages`, `statements`, `transactions`
- Consumers `events_xxx_history_long`, where `xxx` is `waits`, `stages`, `statements`, `transactions`

Additional output tables maintained, relative to the preceding configuration:



- `events_xxx_current`, where `xxx` is `waits`, `stages`, `statements`, `transactions`

## Global, Thread, Current-Event, and Event-History instrumentation

The preceding configuration collects no event history because the `events_xxx_history` and `events_xxx_history_long` consumers are disabled. Those consumers can be enabled separately or together to collect event history per thread, globally, or both.

This configuration collects event history per thread, but not globally:

```
mysql> SELECT * FROM performance_schema.setup_consumers;
```

NAME	ENABLED
global_instrumentation	YES
thread_instrumentation	YES
events_waits_current	YES
events_waits_history	YES
events_waits_history_long	NO
events_stages_current	YES
events_stages_history	YES
events_stages_history_long	NO
events_statements_current	YES
events_statements_history	YES
events_statements_history_long	NO
events_transactions_current	YES
events_transactions_history	YES
events_transactions_history_long	NO
...	

Event-history tables maintained for this configuration:

- `events_xxx_history`, where `xxx` is `waits`, `stages`, `statements`, `transactions`

This configuration collects event history globally, but not per thread:

```
mysql> SELECT * FROM performance_schema.setup_consumers;
```

NAME	ENABLED
global_instrumentation	YES
thread_instrumentation	YES
events_waits_current	YES
events_waits_history	NO
events_waits_history_long	YES
events_stages_current	YES
events_stages_history	NO
events_stages_history_long	YES
events_statements_current	YES
events_statements_history	NO
events_statements_history_long	YES
events_transactions_current	YES
events_transactions_history	NO
events_transactions_history_long	YES
...	

Event-history tables maintained for this configuration:

- `events_xxx_history_long`, where `xxx` is `waits`, `stages`, `statements`, `transactions`

This configuration collects event history per thread and globally:

```
mysql> SELECT * FROM performance_schema.setup_consumers;
```

NAME	ENABLED
global_instrumentation	YES
thread_instrumentation	YES
events_waits_current	YES
events_waits_history	YES
events_waits_history_long	YES
events_stages_current	YES
events_stages_history	YES
events_stages_history_long	YES
events_statements_current	YES
events_statements_history	YES
events_statements_history_long	YES
events_transactions_current	YES
events_transactions_history	YES
events_transactions_history_long	YES
...	

Event-history tables maintained for this configuration:

- `events_xxx_history`, where `xxx` is `waits`, `stages`, `statements`, `transactions`
- `events_xxx_history_long`, where `xxx` is `waits`, `stages`, `statements`, `transactions`

## 25.4.9 Naming Instruments or Consumers for Filtering Operations

Names given for filtering operations can be as specific or general as required. To indicate a single instrument or consumer, specify its name in full:

```
UPDATE performance_schema.setup_instruments
SET ENABLED = 'NO'
WHERE NAME = 'wait/synch/mutex/myisammrgr/MYRG_INFO::mutex';

UPDATE performance_schema.setup_consumers
SET ENABLED = 'NO'
WHERE NAME = 'events_waits_current';
```

To specify a group of instruments or consumers, use a pattern that matches the group members:

```
UPDATE performance_schema.setup_instruments
SET ENABLED = 'NO'
WHERE NAME LIKE 'wait/synch/mutex/%';

UPDATE performance_schema.setup_consumers
SET ENABLED = 'NO'
WHERE NAME LIKE '%history%';
```

If you use a pattern, it should be chosen so that it matches all the items of interest and no others. For example, to select all file I/O instruments, it is better to use a pattern that includes the entire instrument name prefix:

```
... WHERE NAME LIKE 'wait/io/file/%';
```

The pattern `'%/file/%'` matches other instruments that have an element of `'/file/'` anywhere in the name. Even less suitable is the pattern `'%file%'` because it matches instruments with `'file'` anywhere in the name, such as `wait/synch/mutex/innodb/file_open_mutex`.

To check which instrument or consumer names a pattern matches, perform a simple test:

```
SELECT NAME FROM performance_schema.setup_instruments
WHERE NAME LIKE 'pattern';
```

```
SELECT NAME FROM performance_schema.setup_consumers
WHERE NAME LIKE 'pattern';
```

For information about the types of names that are supported, see [Section 25.6, “Performance Schema Instrument Naming Conventions”](#).

## 25.4.10 Determining What Is Instrumented

It is always possible to determine what instruments the Performance Schema includes by checking the `setup_instruments` table. For example, to see what file-related events are instrumented for the `InnoDB` storage engine, use this query:

```
mysql> SELECT * FROM performance_schema.setup_instruments
      WHERE NAME LIKE 'wait/io/file/innodb/%';
```

NAME	ENABLED	TIMED
wait/io/file/innodb/innodb_data_file	YES	YES
wait/io/file/innodb/innodb_log_file	YES	YES
wait/io/file/innodb/innodb_temp_file	YES	YES

An exhaustive description of precisely what is instrumented is not given in this documentation, for several reasons:

- What is instrumented is the server code. Changes to this code occur often, which also affects the set of instruments.
- It is not practical to list all the instruments because there are hundreds of them.
- As described earlier, it is possible to find out by querying the `setup_instruments` table. This information is always up to date for your version of MySQL, also includes instrumentation for instrumented plugins you might have installed that are not part of the core server, and can be used by automated tools.

## 25.5 Performance Schema Queries

Pre-filtering limits which event information is collected and is independent of any particular user. By contrast, post-filtering is performed by individual users through the use of queries with appropriate `WHERE` clauses that restrict what event information to select from the events available after pre-filtering has been applied.

In [Section 25.4.3, “Event Pre-Filtering”](#), an example showed how to pre-filter for file instruments. If the event tables contain both file and nonfile information, post-filtering is another way to see information only for file events. Add a `WHERE` clause to queries to restrict event selection appropriately:

```
mysql> SELECT THREAD_ID, NUMBER_OF_BYTES
      FROM performance_schema.events_waits_history
      WHERE EVENT_NAME LIKE 'wait/io/file/%'
      AND NUMBER_OF_BYTES IS NOT NULL;
```

THREAD_ID	NUMBER_OF_BYTES
11	66
11	47
11	139
5	24
5	834

## 25.6 Performance Schema Instrument Naming Conventions

An instrument name consists of a sequence of elements separated by '/' characters. Example names:

```
wait/io/file/myisam/log
wait/io/file/mysys/charset
wait/lock/table/sql/handler
wait/synch/cond/mysys/COND_alarm
wait/synch/cond/sql/BINLOG::update_cond
wait/synch/mutex/mysys/BITMAP_mutex
wait/synch/mutex/sql/LOCK_delete
wait/synch/rwlock/sql/Query_cache_query::lock
stage/sql/closing_tables
stage/sql/Sorting_result
statement/com/Execute
statement/com/Query
statement/sql/create_table
statement/sql/lock_tables
```

The instrument name space has a tree-like structure. The elements of an instrument name from left to right provide a progression from more general to more specific. The number of elements a name has depends on the type of instrument.

The interpretation of a given element in a name depends on the elements to the left of it. For example, `myisam` appears in both of the following names, but `myisam` in the first name is related to file I/O, whereas in the second it is related to a synchronization instrument:

```
wait/io/file/myisam/log
wait/synch/cond/myisam/MI_SORT_INFO::cond
```

Instrument names consist of a prefix with a structure defined by the Performance Schema implementation and a suffix defined by the developer implementing the instrument code. The top-level element of an instrument prefix indicates the type of instrument. This element also determines which event timer in the `setup_timers` table applies to the instrument. For the prefix part of instrument names, the top level indicates the type of instrument.

The suffix part of instrument names comes from the code for the instruments themselves. Suffixes may include levels such as these:

- A name for the major element (a server module such as `myisam`, `innodb`, `mysys`, or `sql`) or a plugin name.
- The name of a variable in the code, in the form `XXX` (a global variable) or `CCC::MMM` (a member `MMM` in class `CCC`). Examples: `COND_thread_cache`, `THR_LOCK_myisam`, `BINLOG::LOCK_index`.
- [Top-Level Instrument Elements](#)
- [Idle Instrument Elements](#)
- [Memory Instrument Elements](#)
- [Stage Instrument Elements](#)
- [Statement Instrument Elements](#)
- [Wait Instrument Elements](#)

### Top-Level Instrument Elements

- `idle`: An instrumented idle event. This instrument has no further elements.

- `memory`: An instrumented memory event.
- `stage`: An instrumented stage event.
- `statement`: An instrumented statement event.
- `transaction`: An instrumented transaction event. This instrument has no further elements.
- `wait`: An instrumented wait event.

## Idle Instrument Elements

The `idle` instrument is used for idle events, which The Performance Schema generates as discussed in the description of the `socket_instances.STATE` column in [Section 25.12.3.5, “The `socket\_instances` Table”](#).

## Memory Instrument Elements

Most memory instrumentation is disabled by default, and can be enabled or disabled at startup, or dynamically at runtime by updating the `ENABLED` column of the relevant instruments in the `setup_instruments` table. Memory instruments have names of the form `memory/code_area/instrument_name` where `code_area` is a value such as `sql` or `myisam`, and `instrument_name` is the instrument detail.

Instruments named with the prefix `memory/performance_schema/` expose how much memory is allocated for internal buffers in the Performance Schema. The `memory/performance_schema/` instruments are built in, always enabled, and cannot be disabled at startup or runtime. Built-in memory instruments are displayed only in the `memory_summary_global_by_event_name` table. For more information, see [Section 25.17, “The Performance Schema Memory-Allocation Model”](#).

## Stage Instrument Elements

Stage instruments have names of the form `stage/code_area/stage_name`, where `code_area` is a value such as `sql` or `myisam`, and `stage_name` indicates the stage of statement processing, such as `Sorting result` or `Sending data`. Stages correspond to the thread states displayed by `SHOW PROCESSLIST` or that are visible in the Information Schema `PROCESSLIST` table.

## Statement Instrument Elements

- `statement/abstract/*`: An abstract instrument for statement operations. Abstract instruments are used during the early stages of statement classification before the exact statement type is known, then changed to a more specific statement instrument when the type is known. For a description of this process, see [Section 25.12.6, “Performance Schema Statement Event Tables”](#).
- `statement/com`: An instrumented command operation. These have names corresponding to `COM_xxx` operations (see the `mysql_com.h` header file and `sql/sql_parse.cc`). For example, the `statement/com/Connect` and `statement/com/Init DB` instruments correspond to the `COM_CONNECT` and `COM_INIT_DB` commands.
- `statement/scheduler/event`: A single instrument to track all events executed by the Event Scheduler. This instrument comes into play when a scheduled event begins executing.
- `statement/sp`: An instrumented internal instruction executed by a stored program. For example, the `statement/sp/cfetch` and `statement/sp/freturn` instruments are used cursor fetch and function return instructions.

- `statement/sql`: An instrumented SQL statement operation. For example, the `statement/sql/create_db` and `statement/sql/select` instruments are used for `CREATE DATABASE` and `SELECT` statements.

## Wait Instrument Elements

- `wait/io`

An instrumented I/O operation.

- `wait/io/file`

An instrumented file I/O operation. For files, the wait is the time waiting for the file operation to complete (for example, a call to `fwrite()`). Due to caching, the physical file I/O on the disk might not happen within this call.

- `wait/io/socket`

An instrumented socket operation. Socket instruments have names of the form `wait/io/socket/sql/socket_type`. The server has a listening socket for each network protocol that it supports. The instruments associated with listening sockets for TCP/IP or Unix socket file connections have a `socket_type` value of `server_tcpip_socket` or `server_unix_socket`, respectively. When a listening socket detects a connection, the server transfers the connection to a new socket managed by a separate thread. The instrument for the new connection thread has a `socket_type` value of `client_connection`.

- `wait/io/table`

An instrumented table I/O operation. These include row-level accesses to persistent base tables or temporary tables. Operations that affect rows are fetch, insert, update, and delete. For a view, waits are associated with base tables referenced by the view.

Unlike most waits, a table I/O wait can include other waits. For example, table I/O might include file I/O or memory operations. Thus, `events_waits_current` for a table I/O wait usually has two rows. For more information, see [Section 25.8, “Performance Schema Atom and Molecule Events”](#).

Some row operations might cause multiple table I/O waits. For example, an insert might activate a trigger that causes an update.

- `wait/lock`

An instrumented lock operation.

- `wait/lock/table`

An instrumented table lock operation.

- `wait/lock/metadata/sql/mdl`

An instrumented metadata lock operation.

- `wait/synch`

An instrumented synchronization object. For synchronization objects, the `TIMER_WAIT` time includes the amount of time blocked while attempting to acquire a lock on the object, if any.

- `wait/synch/cond`

A condition is used by one thread to signal to other threads that something they were waiting for has happened. If a single thread was waiting for a condition, it can wake up and proceed with its execution. If several threads were waiting, they can all wake up and compete for the resource for which they were waiting.

- `wait/synch/mutex`

A mutual exclusion object used to permit access to a resource (such as a section of executable code) while preventing other threads from accessing the resource.

- `wait/synch/rwlock`

A [read/write lock](#) object used to lock a specific variable for access while preventing its use by other threads. A shared read lock can be acquired simultaneously by multiple threads. An exclusive write lock can be acquired by only one thread at a time.

- `wait/synch/sxlock`

A shared-exclusive (SX) lock is a type of [rwlock](#) lock object that provides write access to a common resource while permitting inconsistent reads by other threads. `sxlocks` optimize concurrency and improve scalability for read-write workloads.

## 25.7 Performance Schema Status Monitoring

There are several status variables associated with the Performance Schema:

```
mysql> SHOW STATUS LIKE 'perf%';
```

Variable_name	Value
Performance_schema_accounts_lost	0
Performance_schema_cond_classes_lost	0
Performance_schema_cond_instances_lost	0
Performance_schema_digest_lost	0
Performance_schema_file_classes_lost	0
Performance_schema_file_handles_lost	0
Performance_schema_file_instances_lost	0
Performance_schema_hosts_lost	0
Performance_schema_locker_lost	0
Performance_schema_memory_classes_lost	0
Performance_schema_metadata_lock_lost	0
Performance_schema_mutex_classes_lost	0
Performance_schema_mutex_instances_lost	0
Performance_schema_nested_statement_lost	0
Performance_schema_program_lost	0
Performance_schema_rwlock_classes_lost	0
Performance_schema_rwlock_instances_lost	0
Performance_schema_session_connect_attrs_lost	0
Performance_schema_socket_classes_lost	0
Performance_schema_socket_instances_lost	0
Performance_schema_stage_classes_lost	0
Performance_schema_statement_classes_lost	0
Performance_schema_table_handles_lost	0
Performance_schema_table_instances_lost	0
Performance_schema_thread_classes_lost	0
Performance_schema_thread_instances_lost	0
Performance_schema_users_lost	0

The Performance Schema status variables provide information about instrumentation that could not be loaded or created due to memory constraints. Names for these variables have several forms:

- `Performance_schema_xxx_classes_lost` indicates how many instruments of type `xxx` could not be loaded.
- `Performance_schema_xxx_instances_lost` indicates how many instances of object type `xxx` could not be created.
- `Performance_schema_xxx_handles_lost` indicates how many instances of object type `xxx` could not be opened.
- `Performance_schema_locker_lost` indicates how many events are “lost” or not recorded.

For example, if a mutex is instrumented in the server source but the server cannot allocate memory for the instrumentation at runtime, it increments `Performance_schema_mutex_classes_lost`. The mutex still functions as a synchronization object (that is, the server continues to function normally), but performance data for it is not collected. If the instrument can be allocated, it can be used for initializing instrumented mutex instances. For a singleton mutex such as a global mutex, there is only one instance. Other mutexes have an instance per connection, or per page in various caches and data buffers, so the number of instances varies over time. Increasing the maximum number of connections or the maximum size of some buffers increases the maximum number of instances that might be allocated at once. If the server cannot create a given instrumented mutex instance, it increments `Performance_schema_mutex_instances_lost`.

Suppose that the following conditions hold:

- The server was started with the `--performance_schema_max_mutex_classes=200` option and thus has room for 200 mutex instruments.
- 150 mutex instruments have been loaded already.
- The plugin named `plugin_a` contains 40 mutex instruments.
- The plugin named `plugin_b` contains 20 mutex instruments.

The server allocates mutex instruments for the plugins depending on how many they need and how many are available, as illustrated by the following sequence of statements:

```
INSTALL PLUGIN plugin_a
```

The server now has  $150+40 = 190$  mutex instruments.

```
UNINSTALL PLUGIN plugin_a;
```

The server still has 190 instruments. All the historical data generated by the plugin code is still available, but new events for the instruments are not collected.

```
INSTALL PLUGIN plugin_a;
```

The server detects that the 40 instruments are already defined, so no new instruments are created, and previously assigned internal memory buffers are reused. The server still has 190 instruments.

```
INSTALL PLUGIN plugin_b;
```

The server has room for  $200-190 = 10$  instruments (in this case, mutex classes), and sees that the plugin contains 20 new instruments. 10 instruments are loaded, and 10 are discarded or “lost.” The `Performance_schema_mutex_classes_lost` indicates the number of instruments (mutex classes) lost:

```
mysql> SHOW STATUS LIKE "perf%mutex_classes_lost";
+-----+-----+
```



```

+-----+-----+
| Variable_name | Value |
+-----+-----+
| Performance_schema_mutex_classes_lost | 10 |
+-----+-----+
1 row in set (0.10 sec)

```

The instrumentation still works and collects (partial) data for `plugin_b`.

When the server cannot create a mutex instrument, these results occur:

- No row for the instrument is inserted into the `setup_instruments` table.
- `Performance_schema_mutex_classes_lost` increases by 1.
- `Performance_schema_mutex_instances_lost` does not change. (When the mutex instrument is not created, it cannot be used to create instrumented mutex instances later.)

The pattern just described applies to all types of instruments, not just mutexes.

A value of `Performance_schema_mutex_classes_lost` greater than 0 can happen in two cases:

- To save a few bytes of memory, you start the server with `--performance_schema_max_mutex_classes=N`, where `N` is less than the default value. The default value is chosen to be sufficient to load all the plugins provided in the MySQL distribution, but this can be reduced if some plugins are never loaded. For example, you might choose not to load some of the storage engines in the distribution.
- You load a third-party plugin that is instrumented for the Performance Schema but do not allow for the plugin's instrumentation memory requirements when you start the server. Because it comes from a third party, the instrument memory consumption of this engine is not accounted for in the default value chosen for `performance_schema_max_mutex_classes`.

If the server has insufficient resources for the plugin's instruments and you do not explicitly allocate more using `--performance_schema_max_mutex_classes=N`, loading the plugin leads to starvation of instruments.

If the value chosen for `performance_schema_max_mutex_classes` is too small, no error is reported in the error log and there is no failure at runtime. However, the content of the tables in the `performance_schema` database misses events. The `Performance_schema_mutex_classes_lost` status variable is the only visible sign to indicate that some events were dropped internally due to failure to create instruments.

If an instrument is not lost, it is known to the Performance Schema, and is used when instrumenting instances. For example, `wait/synch/mutex/sql/LOCK_delete` is the name of a mutex instrument in the `setup_instruments` table. This single instrument is used when creating a mutex in the code (in `THD::LOCK_delete`) however many instances of the mutex are needed as the server runs. In this case, `LOCK_delete` is a mutex that is per connection (`THD`), so if a server has 1000 connections, there are 1000 threads, and 1000 instrumented `LOCK_delete` mutex instances (`THD::LOCK_delete`).

If the server does not have room for all these 1000 instrumented mutexes (instances), some mutexes are created with instrumentation, and some are created without instrumentation. If the server can create only 800 instances, 200 instances are lost. The server continues to run, but increments `Performance_schema_mutex_instances_lost` by 200 to indicate that instances could not be created.

A value of `Performance_schema_mutex_instances_lost` greater than 0 can happen when the code initializes more mutexes at runtime than were allocated for `--performance_schema_max_mutex_instances=N`.

The bottom line is that if `SHOW STATUS LIKE 'perf%'` says that nothing was lost (all values are zero), the Performance Schema data is accurate and can be relied upon. If something was lost, the data is incomplete, and the Performance Schema could not record everything given the insufficient amount of memory it was given to use. In this case, the specific `Performance_schema_xxx_lost` variable indicates the problem area.

It might be appropriate in some cases to cause deliberate instrument starvation. For example, if you do not care about performance data for file I/O, you can start the server with all Performance Schema parameters related to file I/O set to 0. No memory is allocated for file-related classes, instances, or handles, and all file events are lost.

Use `SHOW ENGINE PERFORMANCE_SCHEMA STATUS` to inspect the internal operation of the Performance Schema code:

```
mysql> SHOW ENGINE PERFORMANCE_SCHEMA STATUS\G
...
***** 3. row *****
  Type: performance_schema
  Name: events_waits_history.size
Status: 76
***** 4. row *****
  Type: performance_schema
  Name: events_waits_history.count
Status: 10000
***** 5. row *****
  Type: performance_schema
  Name: events_waits_history.memory
Status: 760000
...
***** 57. row *****
  Type: performance_schema
  Name: performance_schema.memory
Status: 26459600
...
```

This statement is intended to help the DBA understand the effects that different Performance Schema options have on memory requirements. For a description of the field meanings, see [Section 13.7.5.15, “SHOW ENGINE Statement”](#).

## 25.8 Performance Schema Atom and Molecule Events

For a table I/O event, there are usually two rows in `events_waits_current`, not one. For example, a row fetch might result in rows like this:

Row#	EVENT_NAME	TIMER_START	TIMER_END
1	wait/io/file/myisam/dfile	10001	10002
2	wait/io/table/sql/handler	10000	NULL

The row fetch causes a file read. In the example, the table I/O fetch event started before the file I/O event but has not finished (its `TIMER_END` value is `NULL`). The file I/O event is “nested” within the table I/O event.

This occurs because, unlike other “atomic” wait events such as for mutexes or file I/O, table I/O events are “molecular” and include (overlap with) other events. In `events_waits_current`, the table I/O event usually has two rows:

- One row for the most recent table I/O wait event
- One row for the most recent wait event of any kind

Usually, but not always, the “of any kind” wait event differs from the table I/O event. As each subsidiary event completes, it disappears from `events_waits_current`. At this point, and until the next subsidiary event begins, the table I/O wait is also the most recent wait of any kind.

## 25.9 Performance Schema Tables for Current and Historical Events

For wait, stage, statement, and transaction events, the Performance Schema can monitor and store current events. In addition, when events end, the Performance Schema can store them in history tables. For each event type, the Performance Schema uses three tables for storing current and historical events. The tables have names of the following forms, where `xxx` indicates the event type (`waits`, `stages`, `statements`, `transactions`):

- `events_xxx_current`: The “current events” table stores the current monitored event for each thread (one row per thread).
- `events_xxx_history`: The “recent history” table stores the most recent events that have ended per thread (up to a maximum number of rows per thread).
- `events_xxx_history_long`: The “long history” table stores the most recent events that have ended globally (across all threads, up to a maximum number of rows per table).

The `_current` table for each event type contains one row per thread, so there is no system variable for configuring its maximum size. The Performance Schema autosizes the history tables, or the sizes can be configured explicitly at server startup using table-specific system variables, as indicated in the sections that describe the individual history tables. Typical autosized values are 10 rows per thread for `_history` tables, and 10,000 rows total for `_history_long` tables.

For each event type, the `_current`, `_history`, and `_history_long` tables have the same columns.

The `_current` tables show what is currently happening within the server. When a current event ends, it is removed from its `_current` table.

The `_history` and `_history_long` tables show what has happened in the recent past. When the history tables become full, old events are discarded as new events are added. Rows expire from the `_history` and `_history_long` tables in different ways because the tables serve different purposes:

- `_history` is meant to investigate individual threads, independently of the global server load.
- `_history_long` is meant to investigate the server globally, not each thread.

The difference between the two types of history tables relates to the data retention policy. Both tables contains the same data when an event is first seen. However, data within each table expires differently over time, so that data might be preserved for a longer or shorter time in each table:

- For `_history`, when the table contains the maximum number of rows for a given thread, the oldest thread row is discarded when a new row for that thread is added.
- For `_history_long`, when the table becomes full, the oldest row is discarded when a new row is added, regardless of which thread generated either row.

When a thread ends, all its rows are discarded from the `_history` table but not from the `_history_long` table.

The following example illustrates the differences in how events are added to and discarded from the two types of history tables. The principles apply equally to all event types. The example is based on these assumptions:

- The Performance Schema is configured to retain 10 rows per thread in the `_history` table and 10,000 rows total in the `_history_long` table.

- Thread A generates 1 event per second.

Thread B generates 100 events per second.

- No other threads are running.

After 5 seconds of execution:

- A and B have generated 5 and 500 events, respectively.
- `_history` contains 5 rows for A and 10 rows for B. Because storage per thread is limited to 10 rows, no rows have been discarded for A, whereas 490 rows have been discarded for B.
- `_history_long` contains 5 rows for A and 500 rows for B. Because the table has a maximum size of 10,000 rows, no rows have been discarded for either thread.

After 5 minutes (300 seconds) of execution:

- A and B have generated 300 and 30,000 events, respectively.
- `_history` contains 10 rows for A and 10 rows for B. Because storage per thread is limited to 10 rows, 290 rows have been discarded for A, whereas 29,990 rows have been discarded for B. Rows for A include data up to 10 seconds old, whereas rows for B include data up to only .1 seconds old.
- `_history_long` contains 10,000 rows. Because A and B together generate 101 events per second, the table contains data up to approximately  $10,000/101 = 99$  seconds old, with a mix of rows approximately 100 to 1 from B as opposed to A.

## 25.10 Performance Schema Statement Digests

The MySQL server is capable of maintaining statement digest information. The digesting process converts each SQL statement to normalized form (the statement digest) and computes an MD5 hash value (the digest hash value) from the normalized result. Normalization permits statements that are similar to be grouped and summarized to expose information about the types of statements the server is executing and how often they occur. This section describes how statement digesting occurs and how it can be useful.

Digesting occurs in the parser regardless of whether the Performance Schema is available, so that other server components such as MySQL Enterprise Firewall and query rewrite plugins have access to statement digests.

- [Statement Digest General Concepts](#)
- [Statement Digests in the Performance Schema](#)
- [Statement Digest Memory Use](#)

### Statement Digest General Concepts

When the parser receives an SQL statement, it computes a statement digest if that digest is needed, which is true if any of the following conditions are true:

- Performance Schema digest instrumentation is enabled
- MySQL Enterprise Firewall is enabled

- A query rewrite plugin is enabled

The `max_digest_length` system variable value determines the maximum number of bytes available per session for computation of normalized statement digests. Once that amount of space is used during digest computation, truncation occurs: no further tokens from a parsed statement are collected or figure into its digest value. Statements that differ only after that many bytes of parsed tokens produce the same normalized statement digest and are considered identical if compared or if aggregated for digest statistics.



### Warning

Setting the `max_digest_length` system variable to zero disables digest production, which also disables server functionality that requires digests.

After the normalized statement has been computed, an MD5 hash value is computed from it. In addition:

- If MySQL Enterprise Firewall is enabled, it is called and the digest as computed is available to it.
- If any query rewrite plugin is enabled, it is called and the statement digest and digest value are available to it.
- If the Performance Schema has digest instrumentation enabled, it makes a copy of the normalized statement digest, allocating a maximum of `performance_schema_max_digest_length` bytes for it. Consequently, if `performance_schema_max_digest_length` is less than `max_digest_length`, the copy is truncated relative to the original. The copy of the normalized statement digest is stored in the appropriate Performance Schema tables, along with the MD5 hash value computed from the original normalized statement. (If the Performance Schema truncates its copy of the normalized statement digest relative to the original, it does not recompute the MD5 hash value.)

Statement normalization transforms the statement text to a more standardized digest string representation that preserves the general statement structure while removing information not essential to the structure:

- Object identifiers such as database and table names are preserved.
- Literal values are converted to parameter markers. A normalized statement does not retain information such as names, passwords, dates, and so forth.
- Comments are removed and whitespace is adjusted.

Consider these statements:

```
SELECT * FROM orders WHERE customer_id=10 AND quantity>20
SELECT * FROM orders WHERE customer_id = 20 AND quantity > 100
```

To normalize these statements, the parser replaces data values by `?` and adjusts whitespace. Both statements yield the same normalized form and thus are considered “the same”:

```
SELECT * FROM orders WHERE customer_id = ? AND quantity > ?
```

The normalized statement contains less information but is still representative of the original statement. Other similar statements that have different data values have the same normalized form.

Now consider these statements:

```
SELECT * FROM customers WHERE customer_id = 1000
SELECT * FROM orders WHERE customer_id = 1000
```

In this case, the normalized statements differ because the object identifiers differ:

```
SELECT * FROM customers WHERE customer_id = ?
```

```
SELECT * FROM orders WHERE customer_id = ?
```

If normalization produces a statement that exceeds the space available in the digest buffer (as determined by `max_digest_length`), truncation occurs and the text ends with "...". Long normalized statements that differ only in the part that occurs following the "..." are considered the same. Consider these statements:

```
SELECT * FROM mytable WHERE cola = 10 AND colb = 20
SELECT * FROM mytable WHERE cola = 10 AND colc = 20
```

If the cutoff happens to be right after the `AND`, both statements have this normalized form:

```
SELECT * FROM mytable WHERE cola = ? AND ...
```

In this case, the difference in the second column name is lost and both statements are considered the same.

## Statement Digests in the Performance Schema

In the Performance Schema, statement digesting involves these elements:

- A `statements_digest` consumer in the `setup_consumers` table controls whether the Performance Schema maintains digest information. See [Statement Digest Consumer](#).
- The statement event tables (`events_statements_current`, `events_statements_history`, and `events_statements_history_long`) have columns for storing normalized statement digests and the corresponding digest MD5 hash values:
  - `DIGEST_TEXT` is the text of the normalized statement digest. This is a copy of the original normalized statement that was computed to a maximum of `max_digest_length` bytes, further truncated as necessary to `performance_schema_max_digest_length` bytes.
  - `DIGEST` is the digest MD5 hash value computed from the original normalized statement.

See [Section 25.12.6, "Performance Schema Statement Event Tables"](#).

- The `events_statements_summary_by_digest` summary table provides aggregated statement digest information. This table aggregates information for statements per `SCHEMA_NAME` and `DIGEST` combination. The Performance Schema uses MD5 hash values for aggregation because they are fast to compute and have a favorable statistical distribution that minimizes collisions. See [Section 25.12.15.3, "Statement Summary Tables"](#).

The statement event tables also have an `SQL_TEXT` column that contains the original SQL statement. The maximum space available for statement display is 1024 bytes by default. To change this value, set the `performance_schema_max_sql_text_length` system variable at server startup.

The `performance_schema_max_digest_length` system variable determines the maximum number of bytes available per statement for digest value storage in the Performance Schema. However, the display length of statement digests may be longer than the available buffer size due to internal encoding of statement elements such as keywords and literal values. Consequently, values selected from the `DIGEST_TEXT` column of statement event tables may appear to exceed the `performance_schema_max_digest_length` value.

The `events_statements_summary_by_digest` summary table provides a profile of the statements executed by the server. It shows what kinds of statements an application is executing and how often. An application developer can use this information together with other information in the table to assess the application's performance characteristics. For example, table columns that show wait times, lock times, or index use may highlight types of queries that are inefficient. This gives the developer insight into which parts of the application need attention.

The `events_statements_summary_by_digest` summary table has a fixed size. By default the Performance Schema estimates the size to use at startup. To specify the table size explicitly, set the `performance_schema_digests_size` system variable at server startup. If the table becomes full, the Performance Schema groups statements that have `SCHEMA_NAME` and `DIGEST` values not matching existing values in the table in a special row with `SCHEMA_NAME` and `DIGEST` set to `NULL`. This permits all statements to be counted. However, if the special row accounts for a significant percentage of the statements executed, it might be desirable to increase the summary table size by increasing `performance_schema_digests_size`.

## Statement Digest Memory Use

For applications that generate very long statements that differ only at the end, increasing `max_digest_length` enables computation of digests that distinguish statements that would otherwise aggregate to the same digest. Conversely, decreasing `max_digest_length` causes the server to devote less memory to digest storage but increases the likelihood of longer statements aggregating to the same digest. Administrators should keep in mind that larger values result in correspondingly increased memory requirements, particularly for workloads that involve large numbers of simultaneous sessions (the server allocates `max_digest_length` bytes per session).

As described previously, normalized statement digests as computed by the parser are constrained to a maximum of `max_digest_length` bytes, whereas normalized statement digests stored in the Performance Schema use `performance_schema_max_digest_length` bytes. The following memory-use considerations apply regarding the relative values of `max_digest_length` and `performance_schema_max_digest_length`:

- If `max_digest_length` is less than `performance_schema_max_digest_length`:
  - Server components other than the Performance Schema use normalized statement digests that take up to `max_digest_length` bytes.
  - The Performance Schema does not further truncate normalized statement digests that it stores, but allocates more memory than `max_digest_length` bytes per digest, which is unnecessary.
- If `max_digest_length` equals `performance_schema_max_digest_length`:
  - Server components other than the Performance Schema use normalized statement digests that take up to `max_digest_length` bytes.
  - The Performance Schema does not further truncate normalized statement digests that it stores, and allocates the same amount of memory as `max_digest_length` bytes per digest.
- If `max_digest_length` is greater than `performance_schema_max_digest_length`:
  - Server components other than the Performance Schema use normalized statement digests that take up to `max_digest_length` bytes.
  - The Performance Schema further truncates normalized statement digests that it stores, and allocates less memory than `max_digest_length` bytes per digest.

Because the Performance Schema statement event tables might store many digests, setting `performance_schema_max_digest_length` smaller than `max_digest_length` enables administrators to balance these factors:

- The need to have long normalized statement digests available for server components outside the Performance Schema
- Many concurrent sessions, each of which allocates digest-computation memory

- The need to limit memory consumption by the Performance Schema statement event tables when storing many statement digests

The `performance_schema_max_digest_length` setting is not per session, it is per statement, and a session can store multiple statements in the `events_statements_history` table. A typical number of statements in this table is 10 per session, so each session consumes 10 times the memory indicated by the `performance_schema_max_digest_length` value, for this table alone.

Also, there are many statements (and digests) collected globally, most notably in the `events_statements_history_long` table. Here, too,  $N$  statements stored consume  $N$  times the memory indicated by the `performance_schema_max_digest_length` value.

To assess the amount of memory used for SQL statement storage and digest computation, use the `SHOW ENGINE PERFORMANCE_SCHEMA STATUS` statement, or monitor these instruments:

```
mysql> SELECT NAME
        FROM performance_schema.setup_instruments
        WHERE NAME LIKE '%.sqltext';
+-----+-----+
| NAME                                     |
+-----+-----+
| memory/performance_schema/events_statements_history.sqltext |
| memory/performance_schema/events_statements_current.sqltext |
| memory/performance_schema/events_statements_history_long.sqltext |
+-----+-----+

mysql> SELECT NAME
        FROM performance_schema.setup_instruments
        WHERE NAME LIKE 'memory/performance_schema/%.tokens';
+-----+-----+
| NAME                                     |
+-----+-----+
| memory/performance_schema/events_statements_history.tokens |
| memory/performance_schema/events_statements_current.tokens |
| memory/performance_schema/events_statements_summary_by_digest.tokens |
| memory/performance_schema/events_statements_history_long.tokens |
+-----+-----+
```

## 25.11 Performance Schema General Table Characteristics

The name of the `performance_schema` database is lowercase, as are the names of tables within it. Queries should specify the names in lowercase.

Many tables in the `performance_schema` database are read only and cannot be modified:

```
mysql> TRUNCATE TABLE performance_schema.setup_instruments;
ERROR 1683 (HY000): Invalid performance_schema usage.
```

Some of the setup tables have columns that can be modified to affect Performance Schema operation; some also permit rows to be inserted or deleted. Truncation is permitted to clear collected events, so `TRUNCATE TABLE` can be used on tables containing those kinds of information, such as tables named with a prefix of `events_waits_`.

Summary tables can be truncated with `TRUNCATE TABLE`. Generally, the effect is to reset the summary columns to 0 or `NULL`, not to remove rows. This enables you to clear collected values and restart aggregation. That might be useful, for example, after you have made a runtime configuration change. Exceptions to this truncation behavior are noted in individual summary table sections.

Privileges are as for other databases and tables:

- To retrieve from `performance_schema` tables, you must have the `SELECT` privilege.



- To change those columns that can be modified, you must have the [UPDATE](#) privilege.
- To truncate tables that can be truncated, you must have the [DROP](#) privilege.

Because only a limited set of privileges apply to Performance Schema tables, attempts to use [GRANT ALL](#) as shorthand for granting privileges at the database or table level fail with an error:

```
mysql> GRANT ALL ON performance_schema.*
      TO 'u1'@'localhost';
ERROR 1044 (42000): Access denied for user 'root'@'localhost'
to database 'performance_schema'
mysql> GRANT ALL ON performance_schema.setup_instruments
      TO 'u2'@'localhost';
ERROR 1044 (42000): Access denied for user 'root'@'localhost'
to database 'performance_schema'
```

Instead, grant exactly the desired privileges:

```
mysql> GRANT SELECT ON performance_schema.*
      TO 'u1'@'localhost';
Query OK, 0 rows affected (0.03 sec)

mysql> GRANT SELECT, UPDATE ON performance_schema.setup_instruments
      TO 'u2'@'localhost';
Query OK, 0 rows affected (0.02 sec)
```

## 25.12 Performance Schema Table Descriptions

Tables in the [performance\\_schema](#) database can be grouped as follows:

- Setup tables. These tables are used to configure and display monitoring characteristics.
- Current events tables. The [events\\_waits\\_current](#) table contains the most recent event for each thread. Other similar tables contain current events at different levels of the event hierarchy: [events\\_stages\\_current](#) for stage events, [events\\_statements\\_current](#) for statement events, and [events\\_transactions\\_current](#) for transaction events.
- History tables. These tables have the same structure as the current events tables, but contain more rows. For example, for wait events, [events\\_waits\\_history](#) table contains the most recent 10 events per thread. [events\\_waits\\_history\\_long](#) contains the most recent 10,000 events. Other similar tables exist for stage, statement, and transaction histories.

To change the sizes of the history tables, set the appropriate system variables at server startup. For example, to set the sizes of the wait event history tables, set [performance\\_schema\\_events\\_waits\\_history\\_size](#) and [performance\\_schema\\_events\\_waits\\_history\\_long\\_size](#).

- Summary tables. These tables contain information aggregated over groups of events, including those that have been discarded from the history tables.
- Instance tables. These tables document what types of objects are instrumented. An instrumented object, when used by the server, produces an event. These tables provide event names and explanatory notes or status information.
- Miscellaneous tables. These do not fall into any of the other table groups.

### 25.12.1 Performance Schema Table Reference

The following table summarizes all available Performance Schema tables. For greater detail, see the individual table descriptions.

**Table 25.1 Performance Schema Tables**

Table Name	Description	Deprecated
<code>accounts</code>	Connection statistics per client account	
<code>cond_instances</code>	Synchronization object instances	
<code>events_stages_current</code>	Current stage events	
<code>events_stages_history</code>	Most recent stage events per thread	
<code>events_stages_history_long</code>	Most recent stage events overall	
<code>events_stages_summary_by_account</code>	Stage events per account and event name	
<code>events_stages_summary_by_host</code>	Stage events per host name and event name	
<code>events_stages_summary_by_thread</code>	Stage waits per thread and event name	
<code>events_stages_summary_by_user</code>	Stage events per user name and event name	
<code>events_stages_summary_global</code>	Stage waits per event name	
<code>events_statements_current</code>	Current statement events	
<code>events_statements_history</code>	Most recent statement events per thread	
<code>events_statements_history_long</code>	Most recent statement events overall	
<code>events_statements_summary_by_account</code>	Statement events per account and event name	
<code>events_statements_summary_by_statement</code>	Statement events per schema and digest value	
<code>events_statements_summary_by_host</code>	Statement events per host name and event name	
<code>events_statements_summary_by_program</code>	Statement events per stored program	
<code>events_statements_summary_by_thread</code>	Statement events per thread and event name	
<code>events_statements_summary_by_user</code>	Statement events per user name and event name	
<code>events_statements_summary_by_event</code>	Statement events per event name	
<code>events_transactions_current</code>	Current transaction events	
<code>events_transactions_history</code>	Most recent transaction events per thread	
<code>events_transactions_history_long</code>	Most recent transaction events overall	
<code>events_transactions_summary_by_account</code>	Transaction events per account and event name	

Performance Schema Table Reference

Table Name	Description	Deprecated
<a href="#">events_transactions_summary_by_host</a>	Transaction events per host name and event name	
<a href="#">events_transactions_summary_by_thread</a>	Transaction events per thread and event name	
<a href="#">events_transactions_summary_by_user</a>	Transaction events per user name and event name	
<a href="#">events_transactions_summary_by_event</a>	Transaction events per event name	
<a href="#">events_waits_current</a>	Current wait events	
<a href="#">events_waits_history</a>	Most recent wait events per thread	
<a href="#">events_waits_history_long</a>	Most recent wait events overall	
<a href="#">events_waits_summary_by_account</a>	Wait events per account and event name	
<a href="#">events_waits_summary_by_host</a>	Wait events per host name and event name	
<a href="#">events_waits_summary_by_instance</a>	Wait events per instance	
<a href="#">events_waits_summary_by_thread</a>	Wait events per thread and event name	
<a href="#">events_waits_summary_by_user</a>	Wait events per user name and event name	
<a href="#">events_waits_summary_global_by_event</a>	Wait events per event name	
<a href="#">file_instances</a>	File instances	
<a href="#">file_summary_by_event_name</a>	File events per event name	
<a href="#">file_summary_by_instance</a>	File events per file instance	
<a href="#">global_status</a>	Global status variables	
<a href="#">global_variables</a>	Global system variables	
<a href="#">host_cache</a>	Information from internal host cache	
<a href="#">hosts</a>	Connection statistics per client host name	
<a href="#">memory_summary_by_account</a>	Memory operations per account and event name	
<a href="#">memory_summary_by_host_by_event</a>	Memory operations per host and event name	
<a href="#">memory_summary_by_thread_by_event</a>	Memory operations per thread and event name	
<a href="#">memory_summary_by_user_by_event</a>	Memory operations per user and event name	
<a href="#">memory_summary_global_by_event</a>	Memory operations globally per event name	
<a href="#">metadata_locks</a>	Metadata locks and lock requests	

Performance Schema Table Reference

Table Name	Description	Deprecated
<code>mutex_instances</code>	Mutex synchronization object instances	
<code>objects_summary_global_by_type</code>	Object summaries	
<code>performance_timers</code>	Which event timers are available	
<code>prepared_statements_instances</code>	Prepared statement instances and statistics	
<code>replication_applier_configuration</code>	Configuration parameters for replication applier on replica	
<code>replication_applier_status</code>	Current status of replication applier on replica	
<code>replication_applier_status_by_coordinator</code>	SQL or coordinator thread applier status	
<code>replication_applier_status_by_worker</code>	Worker thread applier status	
<code>replication_connection_configuration</code>	Configuration parameters for connecting to source	
<code>replication_connection_status</code>	Current status of connection to source	
<code>replication_group_member_statistics</code>	Replication group member statistics	
<code>replication_group_members</code>	Replication group member network and status	
<code>rwlock_instances</code>	Lock synchronization object instances	
<code>session_account_connect_attributes</code>	Connection attributes per for current session	
<code>session_connect_attrs</code>	Connection attributes for all sessions	
<code>session_status</code>	Status variables for current session	
<code>session_variables</code>	System variables for current session	
<code>setup_actors</code>	How to initialize monitoring for new foreground threads	
<code>setup_consumers</code>	Consumers for which event information can be stored	
<code>setup_instruments</code>	Classes of instrumented objects for which events can be collected	
<code>setup_objects</code>	Which objects should be monitored	
<code>setup_timers</code>	Currently selected event timers	5.7.21
<code>socket_instances</code>	Active connection instances	
<code>socket_summary_by_event_name</code>	Socket waits and I/O per event name	

Table Name	Description	Deprecated
<code>socket_summary_by_instance</code>	Socket waits and I/O per instance	
<code>status_by_account</code>	Session status variables per account	
<code>status_by_host</code>	Session status variables per host name	
<code>status_by_thread</code>	Session status variables per session	
<code>status_by_user</code>	Session status variables per user name	
<code>table_handles</code>	Table locks and lock requests	
<code>table_io_waits_summary_by_index</code>	Table I/O waits per index	
<code>table_io_waits_summary_by_table</code>	Table I/O waits per table	
<code>table_lock_waits_summary_by_table</code>	Table lock waits per table	
<code>threads</code>	Information about server threads	
<code>user_variables_by_thread</code>	User-defined variables per thread	
<code>users</code>	Connection statistics per client user name	
<code>variables_by_thread</code>	Session system variables per session	

## 25.12.2 Performance Schema Setup Tables

The setup tables provide information about the current instrumentation and enable the monitoring configuration to be changed. For this reason, some columns in these tables can be changed if you have the `UPDATE` privilege.

The use of tables rather than individual variables for setup information provides a high degree of flexibility in modifying Performance Schema configuration. For example, you can use a single statement with standard SQL syntax to make multiple simultaneous configuration changes.

These setup tables are available:

- `setup_actors`: How to initialize monitoring for new foreground threads
- `setup_consumers`: The destinations to which event information can be sent and stored
- `setup_instruments`: The classes of instrumented objects for which events can be collected
- `setup_objects`: Which objects should be monitored
- `setup_timers`: The current event timer

### 25.12.2.1 The `setup_actors` Table

The `setup_actors` table contains information that determines whether to enable monitoring and historical event logging for new foreground server threads (threads associated with client connections). This table has a maximum size of 100 rows by default. To change the table size, modify the `performance_schema_setup_actors_size` system variable at server startup.

For each new foreground thread, the Performance Schema matches the user and host for the thread against the rows of the `setup_actors` table. If a row from that table matches, its `ENABLED` and `HISTORY`

column values are used to set the `INSTRUMENTED` and `HISTORY` columns, respectively, of the `threads` table row for the thread. This enables instrumenting and historical event logging to be applied selectively per host, user, or account (user and host combination). If there is no match, the `INSTRUMENTED` and `HISTORY` columns for the thread are set to `NO`.

For background threads, there is no associated user. `INSTRUMENTED` and `HISTORY` are `YES` by default and `setup_actors` is not consulted.

The initial contents of the `setup_actors` table match any user and host combination, so monitoring and historical event collection are enabled by default for all foreground threads:

```
mysql> SELECT * FROM performance_schema.setup_actors;
+-----+-----+-----+-----+-----+
| HOST | USER | ROLE | ENABLED | HISTORY |
+-----+-----+-----+-----+-----+
| %    | %    | %    | YES     | YES     |
+-----+-----+-----+-----+-----+
```

For information about how to use the `setup_actors` table to affect event monitoring, see [Section 25.4.6, “Pre-Filtering by Thread”](#).

Modifications to the `setup_actors` table affect only foreground threads created subsequent to the modification, not existing threads. To affect existing threads, modify the `INSTRUMENTED` and `HISTORY` columns of `threads` table rows.

The `setup_actors` table has these columns:

- `HOST`

The host name. This should be a literal name, or `'%'` to mean “any host.”

- `USER`

The user name. This should be a literal name, or `'%'` to mean “any user.”

- `ROLE`

Unused.

- `ENABLED`

Whether to enable instrumentation for foreground threads matched by the row. The value is `YES` or `NO`.

- `HISTORY`

Whether to log historical events for foreground threads matched by the row. The value is `YES` or `NO`.

`TRUNCATE TABLE` is permitted for the `setup_actors` table. It removes the rows.

### 25.12.2.2 The `setup_consumers` Table

The `setup_consumers` table lists the types of consumers for which event information can be stored and which are enabled:

```
mysql> SELECT * FROM performance_schema.setup_consumers;
+-----+-----+
| NAME                                | ENABLED |
+-----+-----+
| events_stages_current               | NO      |
| events_stages_history               | NO      |
| events_stages_history_long         | NO      |
+-----+-----+
```

events_statements_current	YES
events_statements_history	YES
events_statements_history_long	NO
events_transactions_current	NO
events_transactions_history	NO
events_transactions_history_long	NO
events_waits_current	NO
events_waits_history	NO
events_waits_history_long	NO
global_instrumentation	YES
thread_instrumentation	YES
statements_digest	YES

The consumer settings in the `setup_consumers` table form a hierarchy from higher levels to lower. For detailed information about the effect of enabling different consumers, see [Section 25.4.7, “Pre-Filtering by Consumer”](#).

Modifications to the `setup_consumers` table affect monitoring immediately.

The `setup_consumers` table has these columns:

- **NAME**

The consumer name.

- **ENABLED**

Whether the consumer is enabled. The value is **YES** or **NO**. This column can be modified. If you disable a consumer, the server does not spend time adding event information to it.

**TRUNCATE TABLE** is not permitted for the `setup_consumers` table.

### 25.12.2.3 The `setup_instruments` Table

The `setup_instruments` table lists classes of instrumented objects for which events can be collected:

```
mysql> SELECT * FROM performance_schema.setup_instruments;
```

NAME	ENABLED	TIMED
...		
stage/sql/end	NO	NO
stage/sql/executing	NO	NO
stage/sql/init	NO	NO
stage/sql/insert	NO	NO
...		
statement/sql/load	YES	YES
statement/sql/grant	YES	YES
statement/sql/check	YES	YES
statement/sql/flush	YES	YES
...		
wait/synch/mutex/sql/LOCK_global_read_lock	YES	YES
wait/synch/mutex/sql/LOCK_global_system_variables	YES	YES
wait/synch/mutex/sql/LOCK_lock_db	YES	YES
wait/synch/mutex/sql/LOCK_manager	YES	YES
...		
wait/synch/rwlock/sql/LOCK_grant	YES	YES
wait/synch/rwlock/sql/LOGGER::LOCK_logger	YES	YES
wait/synch/rwlock/sql/LOCK_sys_init_connect	YES	YES
wait/synch/rwlock/sql/LOCK_sys_init_slave	YES	YES
...		
wait/io/file/sql/binlog	YES	YES
wait/io/file/sql/binlog_index	YES	YES
wait/io/file/sql/casetest	YES	YES

```
| wait/io/file/sql/dbopt          | YES | YES |
...
```

Each instrument added to the source code provides a row for the `setup_instruments` table, even when the instrumented code is not executed. When an instrument is enabled and executed, instrumented instances are created, which are visible in the `xxx_instances` tables, such as `file_instances` or `rwlock_instances`.

Modifications to most `setup_instruments` rows affect monitoring immediately. For some instruments, modifications are effective only at server startup; changing them at runtime has no effect. This affects primarily mutexes, conditions, and rwlocks in the server, although there may be other instruments for which this is true.

For more information about the role of the `setup_instruments` table in event filtering, see [Section 25.4.3, “Event Pre-Filtering”](#).

The `setup_instruments` table has these columns:

- `NAME`

The instrument name. Instrument names may have multiple parts and form a hierarchy, as discussed in [Section 25.6, “Performance Schema Instrument Naming Conventions”](#). Events produced from execution of an instrument have an `EVENT_NAME` value that is taken from the instrument `NAME` value. (Events do not really have a “name,” but this provides a way to associate events with instruments.)

- `ENABLED`

Whether the instrument is enabled. The value is `YES` or `NO`. A disabled instrument produces no events. This column can be modified, although setting `ENABLED` has no effect for instruments that have already been created.

- `TIMED`

Whether the instrument is timed. The value is `YES` or `NO`. This column can be modified, although setting `TIMED` has no effect for instruments that have already been created.

For memory instruments, the `TIMED` column in `setup_instruments` is ignored because memory operations are not timed.

If an enabled instrument is not timed, the instrument code is enabled, but the timer is not. Events produced by the instrument have `NULL` for the `TIMER_START`, `TIMER_END`, and `TIMER_WAIT` timer values. This in turn causes those values to be ignored when calculating the sum, minimum, maximum, and average time values in summary tables.

`TRUNCATE TABLE` is not permitted for the `setup_instruments` table.

### 25.12.2.4 The `setup_objects` Table

The `setup_objects` table controls whether the Performance Schema monitors particular objects. This table has a maximum size of 100 rows by default. To change the table size, modify the `performance_schema_setup_objects_size` system variable at server startup.

The initial `setup_objects` contents look like this:

```
mysql> SELECT * FROM performance_schema.setup_objects;
+-----+-----+-----+-----+-----+
| OBJECT_TYPE | OBJECT_SCHEMA | OBJECT_NAME | ENABLED | TIMED |
+-----+-----+-----+-----+-----+
| EVENT      | mysql        | %          | NO     | NO    |
```



EVENT	performance_schema	%	NO	NO
EVENT	information_schema	%	NO	NO
EVENT	%	%	YES	YES
FUNCTION	mysql	%	NO	NO
FUNCTION	performance_schema	%	NO	NO
FUNCTION	information_schema	%	NO	NO
FUNCTION	%	%	YES	YES
PROCEDURE	mysql	%	NO	NO
PROCEDURE	performance_schema	%	NO	NO
PROCEDURE	information_schema	%	NO	NO
PROCEDURE	%	%	YES	YES
TABLE	mysql	%	NO	NO
TABLE	performance_schema	%	NO	NO
TABLE	information_schema	%	NO	NO
TABLE	%	%	YES	YES
TRIGGER	mysql	%	NO	NO
TRIGGER	performance_schema	%	NO	NO
TRIGGER	information_schema	%	NO	NO
TRIGGER	%	%	YES	YES

Modifications to the `setup_objects` table affect object monitoring immediately.

For object types listed in `setup_objects`, the Performance Schema uses the table to how to monitor them. Object matching is based on the `OBJECT_SCHEMA` and `OBJECT_NAME` columns. Objects for which there is no match are not monitored.

The effect of the default object configuration is to instrument all tables except those in the `mysql`, `INFORMATION_SCHEMA`, and `performance_schema` databases. (Tables in the `INFORMATION_SCHEMA` database are not instrumented regardless of the contents of `setup_objects`; the row for `information_schema.%` simply makes this default explicit.)

When the Performance Schema checks for a match in `setup_objects`, it tries to find more specific matches first. For example, with a table `db1.t1`, it looks for a match for `'db1'` and `'t1'`, then for `'db1'` and `'%'`, then for `'%'` and `'%'`. The order in which matching occurs matters because different matching `setup_objects` rows can have different `ENABLED` and `TIMED` values.

Rows can be inserted into or deleted from `setup_objects` by users with the `INSERT` or `DELETE` privilege on the table. For existing rows, only the `ENABLED` and `TIMED` columns can be modified, by users with the `UPDATE` privilege on the table.

For more information about the role of the `setup_objects` table in event filtering, see [Section 25.4.3, “Event Pre-Filtering”](#).

The `setup_objects` table has these columns:

- `OBJECT_TYPE`

The type of object to instrument. The value is one of `'EVENT'` (Event Scheduler event), `'FUNCTION'` (stored function), `'PROCEDURE'` (stored procedure), `'TABLE'` (base table), or `'TRIGGER'` (trigger).

`TABLE` filtering affects table I/O events (`wait/io/table/sql/handler` instrument) and table lock events (`wait/lock/table/sql/handler` instrument).

- `OBJECT_SCHEMA`

The schema that contains the object. This should be a literal name, or `'%'` to mean “any schema.”

- `OBJECT_NAME`

The name of the instrumented object. This should be a literal name, or `'%'` to mean “any object.”

- [ENABLED](#)

Whether events for the object are instrumented. The value is [YES](#) or [NO](#). This column can be modified.

- [TIMED](#)

Whether events for the object are timed. The value is [YES](#) or [NO](#). This column can be modified.

`TRUNCATE TABLE` is permitted for the `setup_objects` table. It removes the rows.

### 25.12.2.5 The `setup_timers` Table

The `setup_timers` table shows the currently selected event timers:

```
mysql> SELECT * FROM performance_schema.setup_timers;
```

NAME	TIMER_NAME
idle	MICROSECOND
wait	CYCLE
stage	NANOSECOND
statement	NANOSECOND
transaction	NANOSECOND



#### Note

As of MySQL 5.7.21, the Performance Schema `setup_timers` table is deprecated and is removed in MySQL 8.0, as is the `TICKS` row in the `performance_timers` table.

The `setup_timers.TIMER_NAME` value can be changed to select a different timer. The value can be any of the values in the `performance_timers.TIMER_NAME` column. For an explanation of how event timing occurs, see [Section 25.4.1, “Performance Schema Event Timing”](#).

Modifications to the `setup_timers` table affect monitoring immediately. Events already in progress may use the original timer for the begin time and the new timer for the end time. To avoid unpredictable results after you make timer changes, use `TRUNCATE TABLE` to reset Performance Schema statistics.

The `setup_timers` table has these columns:

- [NAME](#)

The type of instrument the timer is used for.

- [TIMER\\_NAME](#)

The timer that applies to the instrument type. This column can be modified.

`TRUNCATE TABLE` is not permitted for the `setup_timers` table.

### 25.12.3 Performance Schema Instance Tables

Instance tables document what types of objects are instrumented. They provide event names and explanatory notes or status information:

- `cond_instances`: Condition synchronization object instances
- `file_instances`: File instances

- `mutex_instances`: Mutex synchronization object instances
- `rwlock_instances`: Lock synchronization object instances
- `socket_instances`: Active connection instances

These tables list instrumented synchronization objects, files, and connections. There are three types of synchronization objects: `cond`, `mutex`, and `rwlock`. Each instance table has an `EVENT_NAME` or `NAME` column to indicate the instrument associated with each row. Instrument names may have multiple parts and form a hierarchy, as discussed in [Section 25.6, “Performance Schema Instrument Naming Conventions”](#).

The `mutex_instances.LOCKED_BY_THREAD_ID` and `rwlock_instances.WRITE_LOCKED_BY_THREAD_ID` columns are extremely important for investigating performance bottlenecks or deadlocks. For examples of how to use them for this purpose, see [Section 25.19, “Using the Performance Schema to Diagnose Problems”](#)

### 25.12.3.1 The `cond_instances` Table

The `cond_instances` table lists all the conditions seen by the Performance Schema while the server executes. A condition is a synchronization mechanism used in the code to signal that a specific event has happened, so that a thread waiting for this condition can resume work.

When a thread is waiting for something to happen, the condition name is an indication of what the thread is waiting for, but there is no immediate way to tell which other threads cause the condition to happen.

The `cond_instances` table has these columns:

- `NAME`

The instrument name associated with the condition.

- `OBJECT_INSTANCE_BEGIN`

The address in memory of the instrumented condition.

`TRUNCATE TABLE` is not permitted for the `cond_instances` table.

### 25.12.3.2 The `file_instances` Table

The `file_instances` table lists all the files seen by the Performance Schema when executing file I/O instrumentation. If a file on disk has never been opened, it is not in `file_instances`. When a file is deleted from the disk, it is also removed from the `file_instances` table.

The `file_instances` table has these columns:

- `FILE_NAME`

The file name.

- `EVENT_NAME`

The instrument name associated with the file.

- `OPEN_COUNT`

The count of open handles on the file. If a file was opened and then closed, it was opened 1 time, but `OPEN_COUNT` is 0. To list all the files currently opened by the server, use `WHERE OPEN_COUNT > 0`.

---

`TRUNCATE TABLE` is not permitted for the `file_instances` table.

### 25.12.3.3 The `mutex_instances` Table

The `mutex_instances` table lists all the mutexes seen by the Performance Schema while the server executes. A mutex is a synchronization mechanism used in the code to enforce that only one thread at a given time can have access to some common resource. The resource is said to be “protected” by the mutex.

When two threads executing in the server (for example, two user sessions executing a query simultaneously) do need to access the same resource (a file, a buffer, or some piece of data), these two threads compete against each other, so that the first query to obtain a lock on the mutex causes the other query to wait until the first is done and unlocks the mutex.

The work performed while holding a mutex is said to be in a “critical section,” and multiple queries do execute this critical section in a serialized way (one at a time), which is a potential bottleneck.

The `mutex_instances` table has these columns:

- `NAME`

The instrument name associated with the mutex.

- `OBJECT_INSTANCE_BEGIN`

The address in memory of the instrumented mutex.

- `LOCKED_BY_THREAD_ID`

When a thread currently has a mutex locked, `LOCKED_BY_THREAD_ID` is the `THREAD_ID` of the locking thread, otherwise it is `NULL`.

`TRUNCATE TABLE` is not permitted for the `mutex_instances` table.

For every mutex instrumented in the code, the Performance Schema provides the following information.

- The `setup_instruments` table lists the name of the instrumentation point, with the prefix `wait/synch/mutex/`.
- When some code creates a mutex, a row is added to the `mutex_instances` table. The `OBJECT_INSTANCE_BEGIN` column is a property that uniquely identifies the mutex.
- When a thread attempts to lock a mutex, the `events_waits_current` table shows a row for that thread, indicating that it is waiting on a mutex (in the `EVENT_NAME` column), and indicating which mutex is waited on (in the `OBJECT_INSTANCE_BEGIN` column).
- When a thread succeeds in locking a mutex:
  - `events_waits_current` shows that the wait on the mutex is completed (in the `TIMER_END` and `TIMER_WAIT` columns)
  - The completed wait event is added to the `events_waits_history` and `events_waits_history_long` tables
  - `mutex_instances` shows that the mutex is now owned by the thread (in the `THREAD_ID` column).
- When a thread unlocks a mutex, `mutex_instances` shows that the mutex now has no owner (the `THREAD_ID` column is `NULL`).

- When a mutex object is destroyed, the corresponding row is removed from `mutex_instances`.

By performing queries on both of the following tables, a monitoring application or a DBA can detect bottlenecks or deadlocks between threads that involve mutexes:

- `events_waits_current`, to see what mutex a thread is waiting for
- `mutex_instances`, to see which other thread currently owns a mutex

### 25.12.3.4 The `rwlock_instances` Table

The `rwlock_instances` table lists all the `rwlock` (read write lock) instances seen by the Performance Schema while the server executes. An `rwlock` is a synchronization mechanism used in the code to enforce that threads at a given time can have access to some common resource following certain rules. The resource is said to be “protected” by the `rwlock`. The access is either shared (many threads can have a read lock at the same time), exclusive (only one thread can have a write lock at a given time), or shared-exclusive (a thread can have a write lock while permitting inconsistent reads by other threads). Shared-exclusive access is otherwise known as an `sxlock` and optimizes concurrency and improves scalability for read-write workloads.

Depending on how many threads are requesting a lock, and the nature of the locks requested, access can be either granted in shared mode, exclusive mode, shared-exclusive mode or not granted at all, waiting for other threads to finish first.

The `rwlock_instances` table has these columns:

- `NAME`

The instrument name associated with the lock.

- `OBJECT_INSTANCE_BEGIN`

The address in memory of the instrumented lock.

- `WRITE_LOCKED_BY_THREAD_ID`

When a thread currently has an `rwlock` locked in exclusive (write) mode, `WRITE_LOCKED_BY_THREAD_ID` is the `THREAD_ID` of the locking thread, otherwise it is `NULL`.

- `READ_LOCKED_BY_COUNT`

When a thread currently has an `rwlock` locked in shared (read) mode, `READ_LOCKED_BY_COUNT` is incremented by 1. This is a counter only, so it cannot be used directly to find which thread holds a read lock, but it can be used to see whether there is a read contention on an `rwlock`, and see how many readers are currently active.

`TRUNCATE TABLE` is not permitted for the `rwlock_instances` table.

By performing queries on both of the following tables, a monitoring application or a DBA may detect some bottlenecks or deadlocks between threads that involve locks:

- `events_waits_current`, to see what `rwlock` a thread is waiting for
- `rwlock_instances`, to see which other thread currently owns an `rwlock`

There is a limitation: The `rwlock_instances` can be used only to identify the thread holding a write lock, but not the threads holding a read lock.

### 25.12.3.5 The `socket_instances` Table

The `socket_instances` table provides a real-time snapshot of the active connections to the MySQL server. The table contains one row per TCP/IP or Unix socket file connection. Information available in this table provides a real-time snapshot of the active connections to the server. (Additional information is available in socket summary tables, including network activity such as socket operations and number of bytes transmitted and received; see [Section 25.12.15.8, “Socket Summary Tables”](#)).

```
mysql> SELECT * FROM performance_schema.socket_instances\G
***** 1. row *****
EVENT_NAME: wait/io/socket/sql/server_unix_socket
OBJECT_INSTANCE_BEGIN: 4316619408
THREAD_ID: 1
SOCKET_ID: 16
IP:
PORT: 0
STATE: ACTIVE
***** 2. row *****
EVENT_NAME: wait/io/socket/sql/client_connection
OBJECT_INSTANCE_BEGIN: 4316644608
THREAD_ID: 21
SOCKET_ID: 39
IP: 127.0.0.1
PORT: 55233
STATE: ACTIVE
***** 3. row *****
EVENT_NAME: wait/io/socket/sql/server_tcpip_socket
OBJECT_INSTANCE_BEGIN: 4316699040
THREAD_ID: 1
SOCKET_ID: 14
IP: 0.0.0.0
PORT: 50603
STATE: ACTIVE
```

Socket instruments have names of the form `wait/io/socket/sql/socket_type` and are used like this:

1. The server has a listening socket for each network protocol that it supports. The instruments associated with listening sockets for TCP/IP or Unix socket file connections have a `socket_type` value of `server_tcpip_socket` or `server_unix_socket`, respectively.
2. When a listening socket detects a connection, the server transfers the connection to a new socket managed by a separate thread. The instrument for the new connection thread has a `socket_type` value of `client_connection`.
3. When a connection terminates, the row in `socket_instances` corresponding to it is deleted.

The `socket_instances` table has these columns:

- `EVENT_NAME`

The name of the `wait/io/socket/*` instrument that produced the event. This is a `NAME` value from the `setup_instruments` table. Instrument names may have multiple parts and form a hierarchy, as discussed in [Section 25.6, “Performance Schema Instrument Naming Conventions”](#).

- `OBJECT_INSTANCE_BEGIN`

This column uniquely identifies the socket. The value is the address of an object in memory.

- `THREAD_ID`

The internal thread identifier assigned by the server. Each socket is managed by a single thread, so each socket can be mapped to a thread which can be mapped to a server process.

- `SOCKET_ID`

The internal file handle assigned to the socket.

- `IP`

The client IP address. The value may be either an IPv4 or IPv6 address, or blank to indicate a Unix socket file connection.

- `PORT`

The TCP/IP port number, in the range from 0 to 65535.

- `STATE`

The socket status, either `IDLE` or `ACTIVE`. Wait times for active sockets are tracked using the corresponding socket instrument. Wait times for idle sockets are tracked using the `idle` instrument.

A socket is idle if it is waiting for a request from the client. When a socket becomes idle, the event row in `socket_instances` that is tracking the socket switches from a status of `ACTIVE` to `IDLE`. The `EVENT_NAME` value remains `wait/io/socket/*`, but timing for the instrument is suspended. Instead, an event is generated in the `events_waits_current` table with an `EVENT_NAME` value of `idle`.

When the next request is received, the `idle` event terminates, the socket instance switches from `IDLE` to `ACTIVE`, and timing of the socket instrument resumes.

`TRUNCATE TABLE` is not permitted for the `socket_instances` table.

The `IP:PORT` column combination value identifies the connection. This combination value is used in the `OBJECT_NAME` column of the `events_waits_xxx` tables, to identify the connection from which socket events come:

- For the Unix domain listener socket (`server_unix_socket`), the port is 0, and the IP is ''.
- For client connections via the Unix domain listener (`client_connection`), the port is 0, and the IP is ''.
- For the TCP/IP server listener socket (`server_tcpip_socket`), the port is always the master port (for example, 3306), and the IP is always 0.0.0.0.
- For client connections via the TCP/IP listener (`client_connection`), the port is whatever the server assigns, but never 0. The IP is the IP of the originating host (127.0.0.1 or ::1 for the local host)

## 25.12.4 Performance Schema Wait Event Tables

The Performance Schema instruments waits, which are events that take time. Within the event hierarchy, wait events nest within stage events, which nest within statement events, which nest within transaction events.

These tables store wait events:

- `events_waits_current`: The current wait event for each thread.
- `events_waits_history`: The most recent wait events that have ended per thread.
- `events_waits_history_long`: The most recent wait events that have ended globally (across all threads).

The following sections describe the wait event tables. There are also summary tables that aggregate information about wait events; see [Section 25.12.15.1](#), “Wait Event Summary Tables”.

For more information about the relationship between the three wait event tables, see [Section 25.9](#), “Performance Schema Tables for Current and Historical Events”.

## Configuring Wait Event Collection

To control whether to collect wait events, set the state of the relevant instruments and consumers:

- The `setup_instruments` table contains instruments with names that begin with `wait`. Use these instruments to enable or disable collection of individual wait event classes.
- The `setup_consumers` table contains consumer values with names corresponding to the current and historical wait event table names. Use these consumers to filter collection of wait events.

Some wait instruments are enabled by default; others are disabled. For example:

```
mysql> SELECT * FROM performance_schema.setup_instruments
      WHERE NAME LIKE 'wait/io/file/innodb%';
+-----+-----+-----+
| NAME                                     | ENABLED | TIMED |
+-----+-----+-----+
| wait/io/file/innodb/innodb_data_file    | YES     | YES   |
| wait/io/file/innodb/innodb_log_file    | YES     | YES   |
| wait/io/file/innodb/innodb_temp_file    | YES     | YES   |
+-----+-----+-----+
mysql> SELECT *
      FROM performance_schema.setup_instruments WHERE
      NAME LIKE 'wait/io/socket/%';
+-----+-----+-----+
| NAME                                     | ENABLED | TIMED |
+-----+-----+-----+
| wait/io/socket/sql/server_tcpip_socket  | NO      | NO    |
| wait/io/socket/sql/server_unix_socket   | NO      | NO    |
| wait/io/socket/sql/client_connection    | NO      | NO    |
+-----+-----+-----+
```

The wait consumers are disabled by default:

```
mysql> SELECT *
      FROM performance_schema.setup_consumers
      WHERE NAME LIKE 'events_waits%';
+-----+-----+
| NAME                                     | ENABLED |
+-----+-----+
| events_waits_current                    | NO      |
| events_waits_history                    | NO      |
| events_waits_history_long               | NO      |
+-----+-----+
```

To control wait event collection at server startup, use lines like these in your `my.cnf` file:

- Enable:

```
[mysqld]
performance-schema-instrument='wait/%=ON'
performance-schema-consumer-events-waits-current=ON
performance-schema-consumer-events-waits-history=ON
performance-schema-consumer-events-waits-history-long=ON
```

- Disable:

```
[mysqld]
performance-schema-instrument='wait/%=OFF'
```



```
performance-schema-consumer-events-waits-current=OFF
performance-schema-consumer-events-waits-history=OFF
performance-schema-consumer-events-waits-history-long=OFF
```

To control wait event collection at runtime, update the `setup_instruments` and `setup_consumers` tables:

- Enable:

```
UPDATE performance_schema.setup_instruments
SET ENABLED = 'YES', TIMED = 'YES'
WHERE NAME LIKE 'wait/%';

UPDATE performance_schema.setup_consumers
SET ENABLED = 'YES'
WHERE NAME LIKE 'events_waits%';
```

- Disable:

```
UPDATE performance_schema.setup_instruments
SET ENABLED = 'NO', TIMED = 'NO'
WHERE NAME LIKE 'wait/%';

UPDATE performance_schema.setup_consumers
SET ENABLED = 'NO'
WHERE NAME LIKE 'events_waits%';
```

To collect only specific wait events, enable only the corresponding wait instruments. To collect wait events only for specific wait event tables, enable the wait instruments but only the wait consumers corresponding to the desired tables.

The `setup_timers` table contains a row with a `NAME` value of `wait` that indicates the unit for wait event timing. The default unit is `CYCLE`:

```
mysql> SELECT *
      FROM performance_schema.setup_timers
      WHERE NAME = 'wait';
+-----+-----+
| NAME | TIMER_NAME |
+-----+-----+
| wait | CYCLE      |
+-----+-----+
```

To change the timing unit, modify the `TIMER_NAME` value:

```
UPDATE performance_schema.setup_timers
SET TIMER_NAME = 'NANOSECOND'
WHERE NAME = 'wait';
```

For additional information about configuring event collection, see [Section 25.3, “Performance Schema Startup Configuration”](#), and [Section 25.4, “Performance Schema Runtime Configuration”](#).

### 25.12.4.1 The `events_waits_current` Table

The `events_waits_current` table contains current wait events. The table stores one row per thread showing the current status of the thread's most recent monitored wait event, so there is no system variable for configuring the table size.

Of the tables that contain wait event rows, `events_waits_current` is the most fundamental. Other tables that contain wait event rows are logically derived from the current events. For example, the `events_waits_history` and `events_waits_history_long` tables are collections of the most recent wait events that have ended, up to a maximum number of rows per thread and globally across all threads, respectively.

---

For more information about the relationship between the three wait event tables, see [Section 25.9, “Performance Schema Tables for Current and Historical Events”](#).

For information about configuring whether to collect wait events, see [Section 25.12.4, “Performance Schema Wait Event Tables”](#).

The `events_waits_current` table has these columns:

- `THREAD_ID`, `EVENT_ID`

The thread associated with the event and the thread current event number when the event starts. The `THREAD_ID` and `EVENT_ID` values taken together uniquely identify the row. No two rows have the same pair of values.

- `END_EVENT_ID`

This column is set to `NULL` when the event starts and updated to the thread current event number when the event ends.

- `EVENT_NAME`

The name of the instrument that produced the event. This is a `NAME` value from the `setup_instruments` table. Instrument names may have multiple parts and form a hierarchy, as discussed in [Section 25.6, “Performance Schema Instrument Naming Conventions”](#).

- `SOURCE`

The name of the source file containing the instrumented code that produced the event and the line number in the file at which the instrumentation occurs. This enables you to check the source to determine exactly what code is involved. For example, if a mutex or lock is being blocked, you can check the context in which this occurs.

- `TIMER_START`, `TIMER_END`, `TIMER_WAIT`

Timing information for the event. The unit for these values is picoseconds (trillionths of a second). The `TIMER_START` and `TIMER_END` values indicate when event timing started and ended. `TIMER_WAIT` is the event elapsed time (duration).

If an event has not finished, `TIMER_END` is the current timer value and `TIMER_WAIT` is the time elapsed so far (`TIMER_END - TIMER_START`).

If an event is produced from an instrument that has `TIMED = NO`, timing information is not collected, and `TIMER_START`, `TIMER_END`, and `TIMER_WAIT` are all `NULL`.

For discussion of picoseconds as the unit for event times and factors that affect time values, see [Section 25.4.1, “Performance Schema Event Timing”](#).

- `SPINS`

For a mutex, the number of spin rounds. If the value is `NULL`, the code does not use spin rounds or spinning is not instrumented.

- `OBJECT_SCHEMA`, `OBJECT_NAME`, `OBJECT_TYPE`, `OBJECT_INSTANCE_BEGIN`

These columns identify the object “being acted on.” What that means depends on the object type.

For a synchronization object (`cond`, `mutex`, `rwlock`):

- `OBJECT_SCHEMA`, `OBJECT_NAME`, and `OBJECT_TYPE` are `NULL`.
- `OBJECT_INSTANCE_BEGIN` is the address of the synchronization object in memory.

For a file I/O object:

- `OBJECT_SCHEMA` is `NULL`.
- `OBJECT_NAME` is the file name.
- `OBJECT_TYPE` is `FILE`.
- `OBJECT_INSTANCE_BEGIN` is an address in memory.

For a socket object:

- `OBJECT_NAME` is the `IP:PORT` value for the socket.
- `OBJECT_INSTANCE_BEGIN` is an address in memory.

For a table I/O object:

- `OBJECT_SCHEMA` is the name of the schema that contains the table.
- `OBJECT_NAME` is the table name.
- `OBJECT_TYPE` is `TABLE` for a persistent base table or `TEMPORARY TABLE` for a temporary table.
- `OBJECT_INSTANCE_BEGIN` is an address in memory.

An `OBJECT_INSTANCE_BEGIN` value itself has no meaning, except that different values indicate different objects. `OBJECT_INSTANCE_BEGIN` can be used for debugging. For example, it can be used with `GROUP BY OBJECT_INSTANCE_BEGIN` to see whether the load on 1,000 mutexes (that protect, say, 1,000 pages or blocks of data) is spread evenly or just hitting a few bottlenecks. This can help you correlate with other sources of information if you see the same object address in a log file or another debugging or performance tool.

- `INDEX_NAME`

The name of the index used. `PRIMARY` indicates the table primary index. `NULL` means that no index was used.

- `NESTING_EVENT_ID`

The `EVENT_ID` value of the event within which this event is nested.

- `NESTING_EVENT_TYPE`

The nesting event type. The value is `TRANSACTION`, `STATEMENT`, `STAGE`, or `WAIT`.

- `OPERATION`

The type of operation performed, such as `lock`, `read`, or `write`.

- `NUMBER_OF_BYTES`

The number of bytes read or written by the operation. For table I/O waits (events for the `wait/io/table/sql/handler` instrument), `NUMBER_OF_BYTES` indicates the number of rows. If the value is

greater than 1, the event is for a batch I/O operation. The following discussion describes the difference between exclusively single-row reporting and reporting that reflects batch I/O.

MySQL executes joins using a nested-loop implementation. The job of the Performance Schema instrumentation is to provide row count and accumulated execution time per table in the join. Assume a join query of the following form that is executed using a table join order of `t1`, `t2`, `t3`:

```
SELECT ... FROM t1 JOIN t2 ON ... JOIN t3 ON ...
```

Table “fanout” is the increase or decrease in number of rows from adding a table during join processing. If the fanout for table `t3` is greater than 1, the majority of row-fetch operations are for that table. Suppose that the join accesses 10 rows from `t1`, 20 rows from `t2` per row from `t1`, and 30 rows from `t3` per row of table `t2`. With single-row reporting, the total number of instrumented operations is:

```
10 + (10 * 20) + (10 * 20 * 30) = 6210
```

A significant reduction in the number of instrumented operations is achievable by aggregating them per scan (that is, per unique combination of rows from `t1` and `t2`). With batch I/O reporting, the Performance Schema produces an event for each scan of the innermost table `t3` rather than for each row, and the number of instrumented row operations reduces to:

```
10 + (10 * 20) + (10 * 20) = 410
```

That is a reduction of 93%, illustrating how the batch-reporting strategy significantly reduces Performance Schema overhead for table I/O by reducing the number of reporting calls. The tradeoff is lesser accuracy for event timing. Rather than time for an individual row operation as in per-row reporting, timing for batch I/O includes time spent for operations such as join buffering, aggregation, and returning rows to the client.

For batch I/O reporting to occur, these conditions must be true:

- Query execution accesses the innermost table of a query block (for a single-table query, that table counts as innermost)
- Query execution does not request a single row from the table (so, for example, `eq_ref` access prevents use of batch reporting)
- Query execution does not evaluate a subquery containing table access for the table
- `FLAGS`

Reserved for future use.

`TRUNCATE TABLE` is permitted for the `events_waits_current` table. It removes the rows.

### 25.12.4.2 The `events_waits_history` Table

The `events_waits_history` table contains the `N` most recent wait events that have ended per thread. Wait events are not added to the table until they have ended. When the table contains the maximum number of rows for a given thread, the oldest thread row is discarded when a new row for that thread is added. When a thread ends, all its rows are discarded.

The Performance Schema autosizes the value of `N` during server startup. To set the number of rows per thread explicitly, set the `performance_schema_events_waits_history_size` system variable at server startup.

The `events_waits_history` table has the same columns as `events_waits_current`. See [Section 25.12.4.1, “The `events\_waits\_current` Table”](#).

`TRUNCATE TABLE` is permitted for the `events_waits_history` table. It removes the rows.

For more information about the relationship between the three wait event tables, see [Section 25.9, “Performance Schema Tables for Current and Historical Events”](#).

For information about configuring whether to collect wait events, see [Section 25.12.4, “Performance Schema Wait Event Tables”](#).

### 25.12.4.3 The `events_waits_history_long` Table

The `events_waits_history_long` table contains  $N$  the most recent wait events that have ended globally, across all threads. Wait events are not added to the table until they have ended. When the table becomes full, the oldest row is discarded when a new row is added, regardless of which thread generated either row.

The Performance Schema autosizes the value of  $N$  during server startup. To set the table size explicitly, set the `performance_schema_events_waits_history_long_size` system variable at server startup.

The `events_waits_history_long` table has the same columns as `events_waits_current`. See [Section 25.12.4.1, “The `events\_waits\_current` Table”](#).

`TRUNCATE TABLE` is permitted for the `events_waits_history_long` table. It removes the rows.

For more information about the relationship between the three wait event tables, see [Section 25.9, “Performance Schema Tables for Current and Historical Events”](#).

For information about configuring whether to collect wait events, see [Section 25.12.4, “Performance Schema Wait Event Tables”](#).

## 25.12.5 Performance Schema Stage Event Tables

The Performance Schema instruments stages, which are steps during the statement-execution process, such as parsing a statement, opening a table, or performing a `filesort` operation. Stages correspond to the thread states displayed by `SHOW PROCESSLIST` or that are visible in the Information Schema `PROCESSLIST` table. Stages begin and end when state values change.

Within the event hierarchy, wait events nest within stage events, which nest within statement events, which nest within transaction events.

These tables store stage events:

- `events_stages_current`: The current stage event for each thread.
- `events_stages_history`: The most recent stage events that have ended per thread.
- `events_stages_history_long`: The most recent stage events that have ended globally (across all threads).

The following sections describe the stage event tables. There are also summary tables that aggregate information about stage events; see [Section 25.12.15.2, “Stage Summary Tables”](#).

For more information about the relationship between the three stage event tables, see [Section 25.9, “Performance Schema Tables for Current and Historical Events”](#).

- [Configuring Stage Event Collection](#)
- [Stage Event Progress Information](#)

## Configuring Stage Event Collection

To control whether to collect stage events, set the state of the relevant instruments and consumers:

- The `setup_instruments` table contains instruments with names that begin with `stage`. Use these instruments to enable or disable collection of individual stage event classes.
- The `setup_consumers` table contains consumer values with names corresponding to the current and historical stage event table names. Use these consumers to filter collection of stage events.

Other than those instruments that provide statement progress information, the stage instruments are disabled by default. For example:

```
mysql> SELECT *
      FROM performance_schema.setup_instruments
      WHERE NAME RLIKE 'stage/sql/[a-c]';
```

NAME	ENABLED	TIMED
stage/sql/After create	NO	NO
stage/sql/allocating local table	NO	NO
stage/sql/altering table	NO	NO
stage/sql/committing alter table to storage engine	NO	NO
stage/sql/Changing master	NO	NO
stage/sql/Checking master version	NO	NO
stage/sql/checking permissions	NO	NO
stage/sql/checking privileges on cached query	NO	NO
stage/sql/checking query cache for query	NO	NO
stage/sql/cleaning up	NO	NO
stage/sql/closing tables	NO	NO
stage/sql/Connecting to master	NO	NO
stage/sql/converting HEAP to MyISAM	NO	NO
stage/sql/Copying to group table	NO	NO
stage/sql/Copying to tmp table	NO	NO
stage/sql/copy to tmp table	NO	NO
stage/sql/Creating sort index	NO	NO
stage/sql/creating table	NO	NO
stage/sql/Creating tmp table	NO	NO

Stage event instruments that provide statement progress information are enabled and timed by default:

```
mysql> SELECT *
      FROM performance_schema.setup_instruments
      WHERE ENABLED='YES' AND NAME LIKE "stage/%";
```

NAME	ENABLED	TIMED
stage/sql/copy to tmp table	YES	YES
stage/innodb/alter table (end)	YES	YES
stage/innodb/alter table (flush)	YES	YES
stage/innodb/alter table (insert)	YES	YES
stage/innodb/alter table (log apply index)	YES	YES
stage/innodb/alter table (log apply table)	YES	YES
stage/innodb/alter table (merge sort)	YES	YES
stage/innodb/alter table (read PK and internal sort)	YES	YES
stage/innodb/buffer pool load	YES	YES

The stage consumers are disabled by default:

```
mysql> SELECT *
      FROM performance_schema.setup_consumers
      WHERE NAME LIKE 'events_stages%';
```

NAME	ENABLED
events_stages_current	NO
events_stages_history	NO
events_stages_history_long	NO

To control stage event collection at server startup, use lines like these in your `my.cnf` file:

- Enable:

```
[mysqld]
performance-schema-instrument='stage/%=ON'
performance-schema-consumer-events-stages-current=ON
performance-schema-consumer-events-stages-history=ON
performance-schema-consumer-events-stages-history-long=ON
```

- Disable:

```
[mysqld]
performance-schema-instrument='stage/%=OFF'
performance-schema-consumer-events-stages-current=OFF
performance-schema-consumer-events-stages-history=OFF
performance-schema-consumer-events-stages-history-long=OFF
```

To control stage event collection at runtime, update the `setup_instruments` and `setup_consumers` tables:

- Enable:

```
UPDATE performance_schema.setup_instruments
SET ENABLED = 'YES', TIMED = 'YES'
WHERE NAME LIKE 'stage/%';

UPDATE performance_schema.setup_consumers
SET ENABLED = 'YES'
WHERE NAME LIKE 'events_stages%';
```

- Disable:

```
UPDATE performance_schema.setup_instruments
SET ENABLED = 'NO', TIMED = 'NO'
WHERE NAME LIKE 'stage/%';

UPDATE performance_schema.setup_consumers
SET ENABLED = 'NO'
WHERE NAME LIKE 'events_stages%';
```

To collect only specific stage events, enable only the corresponding stage instruments. To collect stage events only for specific stage event tables, enable the stage instruments but only the stage consumers corresponding to the desired tables.

The `setup_timers` table contains a row with a `NAME` value of `stage` that indicates the unit for stage event timing. The default unit is `NANOSECOND`:

```
mysql> SELECT *
FROM performance_schema.setup_timers
WHERE NAME = 'stage';
+-----+-----+
| NAME | TIMER_NAME |
+-----+-----+
| stage | NANOSECOND |
+-----+-----+
```

To change the timing unit, modify the `TIMER_NAME` value:

```
UPDATE performance_schema.setup_timers
SET TIMER_NAME = 'MICROSECOND'
WHERE NAME = 'stage';
```

For additional information about configuring event collection, see [Section 25.3, “Performance Schema Startup Configuration”](#), and [Section 25.4, “Performance Schema Runtime Configuration”](#).

## Stage Event Progress Information

The Performance Schema stage event tables contain two columns that, taken together, provide a stage progress indicator for each row:

- `WORK_COMPLETED`: The number of work units completed for the stage
- `WORK_ESTIMATED`: The number of work units expected for the stage

Each column is `NULL` if no progress information is provided for an instrument. Interpretation of the information, if it is available, depends entirely on the instrument implementation. The Performance Schema tables provide a container to store progress data, but make no assumptions about the semantics of the metric itself:

- A “work unit” is an integer metric that increases over time during execution, such as the number of bytes, rows, files, or tables processed. The definition of “work unit” for a particular instrument is left to the instrumentation code providing the data.
- The `WORK_COMPLETED` value can increase one or many units at a time, depending on the instrumented code.
- The `WORK_ESTIMATED` value can change during the stage, depending on the instrumented code.

Instrumentation for a stage event progress indicator can implement any of the following behaviors:

- No progress instrumentation

This is the most typical case, where no progress data is provided. The `WORK_COMPLETED` and `WORK_ESTIMATED` columns are both `NULL`.

- Unbounded progress instrumentation

Only the `WORK_COMPLETED` column is meaningful. No data is provided for the `WORK_ESTIMATED` column, which displays 0.

By querying the `events_stages_current` table for the monitored session, a monitoring application can report how much work has been performed so far, but cannot report whether the stage is near completion. Currently, no stages are instrumented like this.

- Bounded progress instrumentation

The `WORK_COMPLETED` and `WORK_ESTIMATED` columns are both meaningful.

This type of progress indicator is appropriate for an operation with a defined completion criterion, such as the table-copy instrument described later. By querying the `events_stages_current` table for the monitored session, a monitoring application can report how much work has been performed so far, and can report the overall completion percentage for the stage, by computing the `WORK_COMPLETED / WORK_ESTIMATED` ratio.



The `stage/sql/copy to tmp table` instrument illustrates how progress indicators work. During execution of an `ALTER TABLE` statement, the `stage/sql/copy to tmp table` stage is used, and this stage can execute potentially for a long time, depending on the size of the data to copy.

The table-copy task has a defined termination (all rows copied), and the `stage/sql/copy to tmp table` stage is instrumented to provide bounded progress information: The work unit used is number of rows copied, `WORK_COMPLETED` and `WORK_ESTIMATED` are both meaningful, and their ratio indicates task percentage complete.

To enable the instrument and the relevant consumers, execute these statements:

```
UPDATE performance_schema.setup_instruments
SET ENABLED='YES'
WHERE NAME='stage/sql/copy to tmp table';

UPDATE performance_schema.setup_consumers
SET ENABLED='YES'
WHERE NAME LIKE 'events_stages_%';
```

To see the progress of an ongoing `ALTER TABLE` statement, select from the `events_stages_current` table.

### 25.12.5.1 The `events_stages_current` Table

The `events_stages_current` table contains current stage events. The table stores one row per thread showing the current status of the thread's most recent monitored stage event, so there is no system variable for configuring the table size.

Of the tables that contain stage event rows, `events_stages_current` is the most fundamental. Other tables that contain stage event rows are logically derived from the current events. For example, the `events_stages_history` and `events_stages_history_long` tables are collections of the most recent stage events that have ended, up to a maximum number of rows per thread and globally across all threads, respectively.

For more information about the relationship between the three stage event tables, see [Section 25.9, “Performance Schema Tables for Current and Historical Events”](#).

For information about configuring whether to collect stage events, see [Section 25.12.5, “Performance Schema Stage Event Tables”](#).

The `events_stages_current` table has these columns:

- `THREAD_ID`, `EVENT_ID`

The thread associated with the event and the thread current event number when the event starts. The `THREAD_ID` and `EVENT_ID` values taken together uniquely identify the row. No two rows have the same pair of values.

- `END_EVENT_ID`

This column is set to `NULL` when the event starts and updated to the thread current event number when the event ends.

- `EVENT_NAME`

The name of the instrument that produced the event. This is a `NAME` value from the `setup_instruments` table. Instrument names may have multiple parts and form a hierarchy, as discussed in [Section 25.6, “Performance Schema Instrument Naming Conventions”](#).

- [SOURCE](#)

The name of the source file containing the instrumented code that produced the event and the line number in the file at which the instrumentation occurs. This enables you to check the source to determine exactly what code is involved.

- [TIMER\\_START](#), [TIMER\\_END](#), [TIMER\\_WAIT](#)

Timing information for the event. The unit for these values is picoseconds (trillionths of a second). The [TIMER\\_START](#) and [TIMER\\_END](#) values indicate when event timing started and ended. [TIMER\\_WAIT](#) is the event elapsed time (duration).

If an event has not finished, [TIMER\\_END](#) is the current timer value and [TIMER\\_WAIT](#) is the time elapsed so far ( $\text{TIMER\_END} - \text{TIMER\_START}$ ).

If an event is produced from an instrument that has [TIMED = NO](#), timing information is not collected, and [TIMER\\_START](#), [TIMER\\_END](#), and [TIMER\\_WAIT](#) are all [NULL](#).

For discussion of picoseconds as the unit for event times and factors that affect time values, see [Section 25.4.1, “Performance Schema Event Timing”](#).

- [WORK\\_COMPLETED](#), [WORK\\_ESTIMATED](#)

These columns provide stage progress information, for instruments that have been implemented to produce such information. [WORK\\_COMPLETED](#) indicates how many work units have been completed for the stage, and [WORK\\_ESTIMATED](#) indicates how many work units are expected for the stage. For more information, see [Stage Event Progress Information](#).

- [NESTING\\_EVENT\\_ID](#)

The [EVENT\\_ID](#) value of the event within which this event is nested. The nesting event for a stage event is usually a statement event.

- [NESTING\\_EVENT\\_TYPE](#)

The nesting event type. The value is [TRANSACTION](#), [STATEMENT](#), [STAGE](#), or [WAIT](#).

[TRUNCATE TABLE](#) is permitted for the [events\\_stages\\_current](#) table. It removes the rows.

### 25.12.5.2 The [events\\_stages\\_history](#) Table

The [events\\_stages\\_history](#) table contains the *N* most recent stage events that have ended per thread. Stage events are not added to the table until they have ended. When the table contains the maximum number of rows for a given thread, the oldest thread row is discarded when a new row for that thread is added. When a thread ends, all its rows are discarded.

The Performance Schema autosizes the value of *N* during server startup. To set the number of rows per thread explicitly, set the [performance\\_schema\\_events\\_stages\\_history\\_size](#) system variable at server startup.

The [events\\_stages\\_history](#) table has the same columns as [events\\_stages\\_current](#). See [Section 25.12.5.1, “The \[events\\\_stages\\\_current\]\(#\) Table”](#).

[TRUNCATE TABLE](#) is permitted for the [events\\_stages\\_history](#) table. It removes the rows.

For more information about the relationship between the three stage event tables, see [Section 25.9, “Performance Schema Tables for Current and Historical Events”](#).

For information about configuring whether to collect stage events, see [Section 25.12.5, “Performance Schema Stage Event Tables”](#).

### 25.12.5.3 The `events_stages_history_long` Table

The `events_stages_history_long` table contains the *N* most recent stage events that have ended globally, across all threads. Stage events are not added to the table until they have ended. When the table becomes full, the oldest row is discarded when a new row is added, regardless of which thread generated either row.

The Performance Schema autosizes the value of *N* during server startup. To set the table size explicitly, set the `performance_schema_events_stages_history_long_size` system variable at server startup.

The `events_stages_history_long` table has the same columns as `events_stages_current`. See [Section 25.12.5.1, “The `events\_stages\_current` Table”](#).

`TRUNCATE TABLE` is permitted for the `events_stages_history_long` table. It removes the rows.

For more information about the relationship between the three stage event tables, see [Section 25.9, “Performance Schema Tables for Current and Historical Events”](#).

For information about configuring whether to collect stage events, see [Section 25.12.5, “Performance Schema Stage Event Tables”](#).

## 25.12.6 Performance Schema Statement Event Tables

The Performance Schema instruments statement execution. Statement events occur at a high level of the event hierarchy. Within the event hierarchy, wait events nest within stage events, which nest within statement events, which nest within transaction events.

These tables store statement events:

- `events_statements_current`: The current statement event for each thread.
- `events_statements_history`: The most recent statement events that have ended per thread.
- `events_statements_history_long`: The most recent statement events that have ended globally (across all threads).
- `prepared_statements_instances`: Prepared statement instances and statistics

The following sections describe the statement event tables. There are also summary tables that aggregate information about statement events; see [Section 25.12.15.3, “Statement Summary Tables”](#).

For more information about the relationship between the three `events_statements_xxx` event tables, see [Section 25.9, “Performance Schema Tables for Current and Historical Events”](#).

- [Configuring Statement Event Collection](#)
- [Statement Monitoring](#)

### Configuring Statement Event Collection

To control whether to collect statement events, set the state of the relevant instruments and consumers:

- The `setup_instruments` table contains instruments with names that begin with `statement`. Use these instruments to enable or disable collection of individual statement event classes.

- The `setup_consumers` table contains consumer values with names corresponding to the current and historical statement event table names, and the statement digest consumer. Use these consumers to filter collection of statement events and statement digesting.

The statement instruments are enabled by default, and the `events_statements_current`, `events_statements_history`, and `statements_digest` statement consumers are enabled by default:

```
mysql> SELECT *
      FROM performance_schema.setup_instruments
      WHERE NAME LIKE 'statement/%';
```

NAME	ENABLED	TIMED
statement/sql/select	YES	YES
statement/sql/create_table	YES	YES
statement/sql/create_index	YES	YES
...		
statement/sp/stmt	YES	YES
statement/sp/set	YES	YES
statement/sp/set_trigger_field	YES	YES
statement/scheduler/event	YES	YES
statement/com/Sleep	YES	YES
statement/com/Quit	YES	YES
statement/com/Init DB	YES	YES
...		
statement/abstract/Query	YES	YES
statement/abstract/new_packet	YES	YES
statement/abstract/relay_log	YES	YES

```
mysql> SELECT *
      FROM performance_schema.setup_consumers
      WHERE NAME LIKE '%statements%';
```

NAME	ENABLED
events_statements_current	YES
events_statements_history	YES
events_statements_history_long	NO
statements_digest	YES

To control statement event collection at server startup, use lines like these in your `my.cnf` file:

- Enable:

```
[mysqld]
performance-schema-instrument='statement/%=ON'
performance-schema-consumer-events-statements-current=ON
performance-schema-consumer-events-statements-history=ON
performance-schema-consumer-events-statements-history-long=ON
performance-schema-consumer-statements-digest=ON
```

- Disable:

```
[mysqld]
performance-schema-instrument='statement/%=OFF'
performance-schema-consumer-events-statements-current=OFF
performance-schema-consumer-events-statements-history=OFF
performance-schema-consumer-events-statements-history-long=OFF
performance-schema-consumer-statements-digest=OFF
```

To control statement event collection at runtime, update the `setup_instruments` and `setup_consumers` tables:

- Enable:

```
UPDATE performance_schema.setup_instruments
SET ENABLED = 'YES', TIMED = 'YES'
WHERE NAME LIKE 'statement/%';

UPDATE performance_schema.setup_consumers
SET ENABLED = 'YES'
WHERE NAME LIKE '%statements%';
```

- Disable:

```
UPDATE performance_schema.setup_instruments
SET ENABLED = 'NO', TIMED = 'NO'
WHERE NAME LIKE 'statement/%';

UPDATE performance_schema.setup_consumers
SET ENABLED = 'NO'
WHERE NAME LIKE '%statements%';
```

To collect only specific statement events, enable only the corresponding statement instruments. To collect statement events only for specific statement event tables, enable the statement instruments but only the statement consumers corresponding to the desired tables.

The `setup_timers` table contains a row with a `NAME` value of `statement` that indicates the unit for statement event timing. The default unit is `NANOSECOND`:

```
mysql> SELECT *
      FROM performance_schema.setup_timers
      WHERE NAME = 'statement';
+-----+-----+
| NAME      | TIMER_NAME |
+-----+-----+
| statement | NANOSECOND |
+-----+-----+
```

To change the timing unit, modify the `TIMER_NAME` value:

```
UPDATE performance_schema.setup_timers
SET TIMER_NAME = 'MICROSECOND'
WHERE NAME = 'statement';
```

For additional information about configuring event collection, see [Section 25.3, “Performance Schema Startup Configuration”](#), and [Section 25.4, “Performance Schema Runtime Configuration”](#).

## Statement Monitoring

Statement monitoring begins from the moment the server sees that activity is requested on a thread, to the moment when all activity has ceased. Typically, this means from the time the server gets the first packet from the client to the time the server has finished sending the response. Statements within stored programs are monitored like other statements.

When the Performance Schema instruments a request (server command or SQL statement), it uses instrument names that proceed in stages from more general (or “abstract”) to more specific until it arrives at a final instrument name.

Final instrument names correspond to server commands and SQL statements:

- Server commands correspond to the `COM_xxx` codes defined in the `mysql_com.h` header file and processed in `sql/sql_parse.cc`. Examples are `COM_PING` and `COM_QUIT`. Instruments for commands have names that begin with `statement/com`, such as `statement/com/Ping` and `statement/com/Quit`.

- SQL statements are expressed as text, such as `DELETE FROM t1` or `SELECT * FROM t2`. Instruments for SQL statements have names that begin with `statement/sql`, such as `statement/sql/delete` and `statement/sql/select`.

Some final instrument names are specific to error handling:

- `statement/com/Error` accounts for messages received by the server that are out of band. It can be used to detect commands sent by clients that the server does not understand. This may be helpful for purposes such as identifying clients that are misconfigured or using a version of MySQL more recent than that of the server, or clients that are attempting to attack the server.
- `statement/sql/error` accounts for SQL statements that fail to parse. It can be used to detect malformed queries sent by clients. A query that fails to parse differs from a query that parses but fails due to an error during execution. For example, `SELECT * FROM` is malformed, and the `statement/sql/error` instrument is used. By contrast, `SELECT *` parses but fails with a `No tables used` error. In this case, `statement/sql/select` is used and the statement event contains information to indicate the nature of the error.

A request can be obtained from any of these sources:

- As a command or statement request from a client, which sends the request as packets
- As a statement string read from the relay log on a replica
- As an event from the Event Scheduler

The details for a request are not initially known and the Performance Schema proceeds from abstract to specific instrument names in a sequence that depends on the source of the request.

For a request received from a client:

1. When the server detects a new packet at the socket level, a new statement is started with an abstract instrument name of `statement/abstract/new_packet`.
2. When the server reads the packet number, it knows more about the type of request received, and the Performance Schema refines the instrument name. For example, if the request is a `COM_PING` packet, the instrument name becomes `statement/com/Ping` and that is the final name. If the request is a `COM_QUERY` packet, it is known to correspond to an SQL statement but not the particular type of statement. In this case, the instrument changes from one abstract name to a more specific but still abstract name, `statement/abstract/Query`, and the request requires further classification.
3. If the request is a statement, the statement text is read and given to the parser. After parsing, the exact statement type is known. If the request is, for example, an `INSERT` statement, the Performance Schema refines the instrument name from `statement/abstract/Query` to `statement/sql/insert`, which is the final name.

For a request read as a statement from the relay log on a replica:

1. Statements in the relay log are stored as text and are read as such. There is no network protocol, so the `statement/abstract/new_packet` instrument is not used. Instead, the initial instrument is `statement/abstract/relay_log`.
2. When the statement is parsed, the exact statement type is known. If the request is, for example, an `INSERT` statement, the Performance Schema refines the instrument name from `statement/abstract/Query` to `statement/sql/insert`, which is the final name.

The preceding description applies only for statement-based replication. For row-based replication, table I/O done on the replica as it processes row changes can be instrumented, but row events in the relay log do not appear as discrete statements.

For a request received from the Event Scheduler:

The event execution is instrumented using the name `statement/scheduler/event`. This is the final name.

Statements executed within the event body are instrumented using `statement/sql/*` names, without use of any preceding abstract instrument. An event is a stored program, and stored programs are precompiled in memory before execution. Consequently, there is no parsing at runtime and the type of each statement is known by the time it executes.

Statements executed within the event body are child statements. For example, if an event executes an `INSERT` statement, execution of the event itself is the parent, instrumented using `statement/scheduler/event`, and the `INSERT` is the child, instrumented using `statement/sql/insert`. The parent/child relationship holds *between* separate instrumented operations. This differs from the sequence of refinement that occurs *within* a single instrumented operation, from abstract to final instrument names.

For statistics to be collected for statements, it is not sufficient to enable only the final `statement/sql/*` instruments used for individual statement types. The abstract `statement/abstract/*` instruments must be enabled as well. This should not normally be an issue because all statement instruments are enabled by default. However, an application that enables or disables statement instruments selectively must take into account that disabling abstract instruments also disables statistics collection for the individual statement instruments. For example, to collect statistics for `INSERT` statements, `statement/sql/insert` must be enabled, but also `statement/abstract/new_packet` and `statement/abstract/Query`. Similarly, for replicated statements to be instrumented, `statement/abstract/relay_log` must be enabled.

No statistics are aggregated for abstract instruments such as `statement/abstract/Query` because no statement is ever classified with an abstract instrument as the final statement name.

### 25.12.6.1 The `events_statements_current` Table

The `events_statements_current` table contains current statement events. The table stores one row per thread showing the current status of the thread's most recent monitored statement event, so there is no system variable for configuring the table size.

Of the tables that contain statement event rows, `events_statements_current` is the most fundamental. Other tables that contain statement event rows are logically derived from the current events. For example, the `events_statements_history` and `events_statements_history_long` tables are collections of the most recent statement events that have ended, up to a maximum number of rows per thread and globally across all threads, respectively.

For more information about the relationship between the three `events_statements_xxx` event tables, see [Section 25.9, “Performance Schema Tables for Current and Historical Events”](#).

For information about configuring whether to collect statement events, see [Section 25.12.6, “Performance Schema Statement Event Tables”](#).

The `events_statements_current` table has these columns:

- `THREAD_ID`, `EVENT_ID`

The thread associated with the event and the thread current event number when the event starts. The `THREAD_ID` and `EVENT_ID` values taken together uniquely identify the row. No two rows have the same pair of values.

- `END_EVENT_ID`

This column is set to `NULL` when the event starts and updated to the thread current event number when the event ends.

- `EVENT_NAME`

The name of the instrument from which the event was collected. This is a `NAME` value from the `setup_instruments` table. Instrument names may have multiple parts and form a hierarchy, as discussed in [Section 25.6, “Performance Schema Instrument Naming Conventions”](#).

For SQL statements, the `EVENT_NAME` value initially is `statement/com/Query` until the statement is parsed, then changes to a more appropriate value, as described in [Section 25.12.6, “Performance Schema Statement Event Tables”](#).

- `SOURCE`

The name of the source file containing the instrumented code that produced the event and the line number in the file at which the instrumentation occurs. This enables you to check the source to determine exactly what code is involved.

- `TIMER_START`, `TIMER_END`, `TIMER_WAIT`

Timing information for the event. The unit for these values is picoseconds (trillionths of a second). The `TIMER_START` and `TIMER_END` values indicate when event timing started and ended. `TIMER_WAIT` is the event elapsed time (duration).

If an event has not finished, `TIMER_END` is the current timer value and `TIMER_WAIT` is the time elapsed so far (`TIMER_END - TIMER_START`).

If an event is produced from an instrument that has `TIMED = NO`, timing information is not collected, and `TIMER_START`, `TIMER_END`, and `TIMER_WAIT` are all `NULL`.

For discussion of picoseconds as the unit for event times and factors that affect time values, see [Section 25.4.1, “Performance Schema Event Timing”](#).

- `LOCK_TIME`

The time spent waiting for table locks. This value is computed in microseconds but normalized to picoseconds for easier comparison with other Performance Schema timers.

- `SQL_TEXT`

The text of the SQL statement. For a command not associated with an SQL statement, the value is `NULL`.

The maximum space available for statement display is 1024 bytes by default. To change this value, set the `performance_schema_max_sql_text_length` system variable at server startup.

- `DIGEST`

The statement digest MD5 value as a string of 32 hexadecimal characters, or `NULL` if the `statements_digest` consumer is `no`. For more information about statement digesting, see [Section 25.10, “Performance Schema Statement Digests”](#).

- `DIGEST_TEXT`

The normalized statement digest text, or `NULL` if the `statements_digest` consumer is `no`. For more information about statement digesting, see [Section 25.10, “Performance Schema Statement Digests”](#).



The `performance_schema_max_digest_length` system variable determines the maximum number of bytes available per session for digest value storage. However, the display length of statement digests may be longer than the available buffer size due to encoding of statement elements such as keywords and literal values in digest buffer. Consequently, values selected from the `DIGEST_TEXT` column of statement event tables may appear to exceed the `performance_schema_max_digest_length` value.

- `CURRENT_SCHEMA`

The default database for the statement, `NULL` if there is none.

- `OBJECT_SCHEMA`, `OBJECT_NAME`, `OBJECT_TYPE`

For nested statements (stored programs), these columns contain information about the parent statement. Otherwise they are `NULL`.

- `OBJECT_INSTANCE_BEGIN`

This column identifies the statement. The value is the address of an object in memory.

- `MYSQL_ERRNO`

The statement error number, from the statement diagnostics area.

- `RETURNED_SQLSTATE`

The statement SQLSTATE value, from the statement diagnostics area.

- `MESSAGE_TEXT`

The statement error message, from the statement diagnostics area.

- `ERRORS`

Whether an error occurred for the statement. The value is 0 if the SQLSTATE value begins with `00` (completion) or `01` (warning). The value is 1 if the SQLSTATE value is anything else.

- `WARNINGS`

The number of warnings, from the statement diagnostics area.

- `ROWS_AFFECTED`

The number of rows affected by the statement. For a description of the meaning of “affected,” see [mysql\\_affected\\_rows\(\)](#).

- `ROWS_SENT`

The number of rows returned by the statement.

- `ROWS_EXAMINED`

The number of rows examined by the server layer (not counting any processing internal to storage engines).

- `CREATED_TMP_DISK_TABLES`

Like the `Created_tmp_disk_tables` status variable, but specific to the statement.

- `CREATED_TMP_TABLES`

Like the `Created_tmp_tables` status variable, but specific to the statement.

- `SELECT_FULL_JOIN`

Like the `Select_full_join` status variable, but specific to the statement.

- `SELECT_FULL_RANGE_JOIN`

Like the `Select_full_range_join` status variable, but specific to the statement.

- `SELECT_RANGE`

Like the `Select_range` status variable, but specific to the statement.

- `SELECT_RANGE_CHECK`

Like the `Select_range_check` status variable, but specific to the statement.

- `SELECT_SCAN`

Like the `Select_scan` status variable, but specific to the statement.

- `SORT_MERGE_PASSES`

Like the `Sort_merge_passes` status variable, but specific to the statement.

- `SORT_RANGE`

Like the `Sort_range` status variable, but specific to the statement.

- `SORT_ROWS`

Like the `Sort_rows` status variable, but specific to the statement.

- `SORT_SCAN`

Like the `Sort_scan` status variable, but specific to the statement.

- `NO_INDEX_USED`

1 if the statement performed a table scan without using an index, 0 otherwise.

- `NO_GOOD_INDEX_USED`

1 if the server found no good index to use for the statement, 0 otherwise. For additional information, see the description of the `Extra` column from `EXPLAIN` output for the `Range checked for each record` value in [Section 8.8.2, “EXPLAIN Output Format”](#).

- `NESTING_EVENT_ID`, `NESTING_EVENT_TYPE`, `NESTING_EVENT_LEVEL`

These three columns are used with other columns to provide information as follows for top-level (unnested) statements and nested statements (executed within a stored program).

For top level statements:

```
OBJECT_TYPE = NULL
OBJECT_SCHEMA = NULL
```

```
OBJECT_NAME = NULL
NESTING_EVENT_ID = NULL
NESTING_EVENT_TYPE = NULL
NESTING_LEVEL = 0
```

For nested statements:

```
OBJECT_TYPE = the parent statement object type
OBJECT_SCHEMA = the parent statement object schema
OBJECT_NAME = the parent statement object name
NESTING_EVENT_ID = the parent statement EVENT_ID
NESTING_EVENT_TYPE = 'STATEMENT'
NESTING_LEVEL = the parent statement NESTING_LEVEL plus one
```

`TRUNCATE TABLE` is permitted for the `events_statements_current` table. It removes the rows.

### 25.12.6.2 The `events_statements_history` Table

The `events_statements_history` table contains the *N* most recent statement events that have ended per thread. Statement events are not added to the table until they have ended. When the table contains the maximum number of rows for a given thread, the oldest thread row is discarded when a new row for that thread is added. When a thread ends, all its rows are discarded.

The Performance Schema autosizes the value of *N* during server startup. To set the number of rows per thread explicitly, set the `performance_schema_events_statements_history_size` system variable at server startup.

The `events_statements_history` table has the same columns as `events_statements_current`. See [Section 25.12.6.1, “The `events\_statements\_current` Table”](#).

`TRUNCATE TABLE` is permitted for the `events_statements_history` table. It removes the rows.

For more information about the relationship between the three `events_statements_xxx` event tables, see [Section 25.9, “Performance Schema Tables for Current and Historical Events”](#).

For information about configuring whether to collect statement events, see [Section 25.12.6, “Performance Schema Statement Event Tables”](#).

### 25.12.6.3 The `events_statements_history_long` Table

The `events_statements_history_long` table contains the *N* most recent statement events that have ended globally, across all threads. Statement events are not added to the table until they have ended. When the table becomes full, the oldest row is discarded when a new row is added, regardless of which thread generated either row.

The value of *N* is autosized at server startup. To set the table size explicitly, set the `performance_schema_events_statements_history_long_size` system variable at server startup.

The `events_statements_history_long` table has the same columns as `events_statements_current`. See [Section 25.12.6.1, “The `events\_statements\_current` Table”](#).

`TRUNCATE TABLE` is permitted for the `events_statements_history_long` table. It removes the rows.

For more information about the relationship between the three `events_statements_xxx` event tables, see [Section 25.9, “Performance Schema Tables for Current and Historical Events”](#).

For information about configuring whether to collect statement events, see [Section 25.12.6, “Performance Schema Statement Event Tables”](#).

### 25.12.6.4 The `prepared_statements_instances` Table

The Performance Schema provides instrumentation for prepared statements, for which there are two protocols:

- The binary protocol. This is accessed through the MySQL C API and maps onto underlying server commands as shown in the following table.

C API Function	Corresponding Server Command
<code>mysql_stmt_prepare()</code>	<code>COM_STMT_PREPARE</code>
<code>mysql_stmt_execute()</code>	<code>COM_STMT_EXECUTE</code>
<code>mysql_stmt_close()</code>	<code>COM_STMT_CLOSE</code>

- The text protocol. This is accessed using SQL statements and maps onto underlying server commands as shown in the following table.

SQL Statement	Corresponding Server Command
<code>PREPARE</code>	<code>SQLCOM_PREPARE</code>
<code>EXECUTE</code>	<code>SQLCOM_EXECUTE</code>
<code>DEALLOCATE PREPARE, DROP PREPARE</code>	<code>SQLCOM_DEALLOCATE PREPARE</code>

Performance Schema prepared statement instrumentation covers both protocols. The following discussion refers to the server commands rather than the C API functions or SQL statements.

Information about prepared statements is available in the `prepared_statements_instances` table. This table enables inspection of prepared statements used in the server and provides aggregated statistics about them. To control the size of this table, set the `performance_schema_max_prepared_statements_instances` system variable at server startup.

Collection of prepared statement information depends on the statement instruments shown in the following table. These instruments are enabled by default. To modify them, update the `setup_instruments` table.

Instrument	Server Command
<code>statement/com/Prepare</code>	<code>COM_STMT_PREPARE</code>
<code>statement/com/Execute</code>	<code>COM_STMT_EXECUTE</code>
<code>statement/sql/prepare_sql</code>	<code>SQLCOM_PREPARE</code>
<code>statement/sql/execute_sql</code>	<code>SQLCOM_EXECUTE</code>

The Performance Schema manages the contents of the `prepared_statements_instances` table as follows:

- Statement preparation

A `COM_STMT_PREPARE` or `SQLCOM_PREPARE` command creates a prepared statement in the server. If the statement is successfully instrumented, a new row is added to the `prepared_statements_instances` table. If the statement cannot be instrumented, `Performance_schema_prepared_statements_lost` status variable is incremented.

- Prepared statement execution

Execution of a `COM_STMT_EXECUTE` or `SQLCOM_EXECUTE` command for an instrumented prepared statement instance updates the corresponding `prepared_statements_instances` table row.

- Prepared statement deallocation

Execution of a `COM_STMT_CLOSE` or `SQLCOM_DEALLOCATE_PREPARE` command for an instrumented prepared statement instance removes the corresponding `prepared_statements_instances` table row. To avoid resource leaks, removal occurs even if the prepared statement instruments described previously are disabled.

The `prepared_statements_instances` table has these columns:

- `OBJECT_INSTANCE_BEGIN`

The address in memory of the instrumented prepared statement.

- `STATEMENT_ID`

The internal statement ID assigned by the server. The text and binary protocols both use statement IDs.

- `STATEMENT_NAME`

For the binary protocol, this column is `NULL`. For the text protocol, this column is the external statement name assigned by the user. For example, for the following SQL statement, the name of the prepared statement is `stmt`:

```
PREPARE stmt FROM 'SELECT 1';
```

- `SQL_TEXT`

The prepared statement text, with `?` placeholder markers.

- `OWNER_THREAD_ID`, `OWNER_EVENT_ID`

These columns indicate the event that created the prepared statement.

- `OWNER_OBJECT_TYPE`, `OWNER_OBJECT_SCHEMA`, `OWNER_OBJECT_NAME`

For a prepared statement created by a client session, these columns are `NULL`. For a prepared statement created by a stored program, these columns point to the stored program. A typical user error is forgetting to deallocate prepared statements. These columns can be used to find stored programs that leak prepared statements:

```
SELECT
  OWNER_OBJECT_TYPE, OWNER_OBJECT_SCHEMA, OWNER_OBJECT_NAME,
  STATEMENT_NAME, SQL_TEXT
FROM performance_schema.prepared_statements_instances
WHERE OWNER_OBJECT_TYPE IS NOT NULL;
```

- `TIMER_PREPARE`

The time spent executing the statement preparation itself.

- `COUNT_REPREPARE`

The number of times the statement was reprepared internally (see [Section 8.10.4, “Caching of Prepared Statements and Stored Programs”](#)). Timing statistics for reparation are not available because it is counted as part of statement execution, not as a separate operation.

- `COUNT_EXECUTE`, `SUM_TIMER_EXECUTE`, `MIN_TIMER_EXECUTE`, `AVG_TIMER_EXECUTE`, `MAX_TIMER_EXECUTE`

Aggregated statistics for executions of the prepared statement.

- `SUM_xxx`

The remaining `SUM_xxx` columns are the same as for the statement summary tables (see [Section 25.12.15.3, “Statement Summary Tables”](#)).

`TRUNCATE TABLE` resets the statistics columns of the `prepared_statements_instances` table.

## 25.12.7 Performance Schema Transaction Tables

The Performance Schema instruments transactions. Within the event hierarchy, wait events nest within stage events, which nest within statement events, which nest within transaction events.

These tables store transaction events:

- `events_transactions_current`: The current transaction event for each thread.
- `events_transactions_history`: The most recent transaction events that have ended per thread.
- `events_transactions_history_long`: The most recent transaction events that have ended globally (across all threads).

The following sections describe the transaction event tables. There are also summary tables that aggregate information about transaction events; see [Section 25.12.15.4, “Transaction Summary Tables”](#).

For more information about the relationship between the three transaction event tables, see [Section 25.9, “Performance Schema Tables for Current and Historical Events”](#).

- [Configuring Transaction Event Collection](#)
- [Transaction Boundaries](#)
- [Transaction Instrumentation](#)
- [Transactions and Nested Events](#)
- [Transactions and Stored Programs](#)
- [Transactions and Savepoints](#)
- [Transactions and Errors](#)

### Configuring Transaction Event Collection

To control whether to collect transaction events, set the state of the relevant instruments and consumers:

- The `setup_instruments` table contains an instrument named `transaction`. Use this instrument to enable or disable collection of individual transaction event classes.
- The `setup_consumers` table contains consumer values with names corresponding to the current and historical transaction event table names. Use these consumers to filter collection of transaction events.

The `transaction` instrument and the transaction consumers are disabled by default:

```
mysql> SELECT *
      FROM performance_schema.setup_instruments
      WHERE NAME = 'transaction';
+-----+-----+-----+
| NAME          | ENABLED | TIMED |
+-----+-----+-----+
| transaction   | NO      | NO    |
```

```

+-----+-----+-----+
mysql> SELECT *
      FROM performance_schema.setup_consumers
      WHERE NAME LIKE 'events_transactions%';
+-----+-----+-----+
| NAME                                | ENABLED |
+-----+-----+-----+
| events_transactions_current         | NO      |
| events_transactions_history         | NO      |
| events_transactions_history_long    | NO      |
+-----+-----+-----+

```

To control transaction event collection at server startup, use lines like these in your `my.cnf` file:

- Enable:

```

[mysqld]
performance-schema-instrument='transaction=ON'
performance-schema-consumer-events-transactions-current=ON
performance-schema-consumer-events-transactions-history=ON
performance-schema-consumer-events-transactions-history-long=ON

```

- Disable:

```

[mysqld]
performance-schema-instrument='transaction=OFF'
performance-schema-consumer-events-transactions-current=OFF
performance-schema-consumer-events-transactions-history=OFF
performance-schema-consumer-events-transactions-history-long=OFF

```

To control transaction event collection at runtime, update the `setup_instruments` and `setup_consumers` tables:

- Enable:

```

UPDATE performance_schema.setup_instruments
SET ENABLED = 'YES', TIMED = 'YES'
WHERE NAME = 'transaction';

UPDATE performance_schema.setup_consumers
SET ENABLED = 'YES'
WHERE NAME LIKE 'events_transactions%';

```

- Disable:

```

UPDATE performance_schema.setup_instruments
SET ENABLED = 'NO', TIMED = 'NO'
WHERE NAME = 'transaction';

UPDATE performance_schema.setup_consumers
SET ENABLED = 'NO'
WHERE NAME LIKE 'events_transactions%';

```

To collect transaction events only for specific transaction event tables, enable the `transaction` instrument but only the transaction consumers corresponding to the desired tables.

The `setup_timers` table contains a row with a `NAME` value of `transaction` that indicates the unit for transaction event timing. The default unit is `NANOSECOND`:

```

mysql> SELECT *
      FROM performance_schema.setup_timers
      WHERE NAME = 'transaction';
+-----+-----+
| NAME          | TIMER_NAME |
+-----+-----+

```

```
+-----+
| transaction | NANOSECOND |
+-----+
```

To change the timing unit, modify the `TIMER_NAME` value:

```
UPDATE performance_schema.setup_timers
SET TIMER_NAME = 'MICROSECOND'
WHERE NAME = 'transaction';
```

For additional information about configuring event collection, see [Section 25.3, “Performance Schema Startup Configuration”](#), and [Section 25.4, “Performance Schema Runtime Configuration”](#).

## Transaction Boundaries

In MySQL Server, transactions start explicitly with these statements:

```
START TRANSACTION | BEGIN | XA START | XA BEGIN
```

Transactions also start implicitly. For example, when the `autocommit` system variable is enabled, the start of each statement starts a new transaction.

When `autocommit` is disabled, the first statement following a committed transaction marks the start of a new transaction. Subsequent statements are part of the transaction until it is committed.

Transactions explicitly end with these statements:

```
COMMIT | ROLLBACK | XA COMMIT | XA ROLLBACK
```

Transactions also end implicitly, by execution of DDL statements, locking statements, and server administration statements.

In the following discussion, references to `START TRANSACTION` also apply to `BEGIN`, `XA START`, and `XA BEGIN`. Similarly, references to `COMMIT` and `ROLLBACK` apply to `XA COMMIT` and `XA ROLLBACK`, respectively.

The Performance Schema defines transaction boundaries similarly to that of the server. The start and end of a transaction event closely match the corresponding state transitions in the server:

- For an explicitly started transaction, the transaction event starts during processing of the `START TRANSACTION` statement.
- For an implicitly started transaction, the transaction event starts on the first statement that uses a transactional engine after the previous transaction has ended.
- For any transaction, whether explicitly or implicitly ended, the transaction event ends when the server transitions out of the active transaction state during the processing of `COMMIT` or `ROLLBACK`.

There are subtle implications to this approach:

- Transaction events in the Performance Schema do not fully include the statement events associated with the corresponding `START TRANSACTION`, `COMMIT`, or `ROLLBACK` statements. There is a trivial amount of timing overlap between the transaction event and these statements.
- Statements that work with nontransactional engines have no effect on the transaction state of the connection. For implicit transactions, the transaction event begins with the first statement that uses a transactional engine. This means that statements operating exclusively on nontransactional tables are ignored, even following `START TRANSACTION`.

To illustrate, consider the following scenario:



```

1. SET autocommit = OFF;
2. CREATE TABLE t1 (a INT) ENGINE = InnoDB;
3. START TRANSACTION; -- Transaction 1 START
4. INSERT INTO t1 VALUES (1), (2), (3);
5. CREATE TABLE t2 (a INT) ENGINE = MyISAM; -- Transaction 1 COMMIT
-- (implicit; DDL forces commit)
6. INSERT INTO t2 VALUES (1), (2), (3); -- Update nontransactional table
7. UPDATE t2 SET a = a + 1; -- ... and again
8. INSERT INTO t1 VALUES (4), (5), (6); -- Write to transactional table
-- Transaction 2 START (implicit)
9. COMMIT; -- Transaction 2 COMMIT

```

From the perspective of the server, Transaction 1 ends when table `t2` is created. Transaction 2 does not start until a transactional table is accessed, despite the intervening updates to nontransactional tables.

From the perspective of the Performance Schema, Transaction 2 starts when the server transitions into an active transaction state. Statements 6 and 7 are not included within the boundaries of Transaction 2, which is consistent with how the server writes transactions to the binary log.

## Transaction Instrumentation

Three attributes define transactions:

- Access mode (read only, read write)
- Isolation level ([SERIALIZABLE](#), [REPEATABLE READ](#), and so forth)
- Implicit (`autocommit` enabled) or explicit (`autocommit` disabled)

To reduce complexity of the transaction instrumentation and to ensure that the collected transaction data provides complete, meaningful results, all transactions are instrumented independently of access mode, isolation level, or autocommit mode.

To selectively examine transaction history, use the attribute columns in the transaction event tables: [ACCESS\\_MODE](#), [ISOLATION\\_LEVEL](#), and [AUTOCOMMIT](#).

The cost of transaction instrumentation can be reduced various ways, such as enabling or disabling transaction instrumentation according to user, account, host, or thread (client connection).

## Transactions and Nested Events

The parent of a transaction event is the event that initiated the transaction. For an explicitly started transaction, this includes the [START TRANSACTION](#) and [COMMIT AND CHAIN](#) statements. For an implicitly started transaction, it is the first statement that uses a transactional engine after the previous transaction ends.

In general, a transaction is the top-level parent to all events initiated during the transaction, including statements that explicitly end the transaction such as [COMMIT](#) and [ROLLBACK](#). Exceptions are statements that implicitly end a transaction, such as DDL statements, in which case the current transaction must be committed before the new statement is executed.

## Transactions and Stored Programs

Transactions and stored program events are related as follows:

- Stored Procedures

Stored procedures operate independently of transactions. A stored procedure can be started within a transaction, and a transaction can be started or ended from within a stored procedure. If called from

within a transaction, a stored procedure can execute statements that force a commit of the parent transaction and then start a new transaction.

If a stored procedure is started within a transaction, that transaction is the parent of the stored procedure event.

If a transaction is started by a stored procedure, the stored procedure is the parent of the transaction event.

- Stored Functions

Stored functions are restricted from causing an explicit or implicit commit or rollback. Stored function events can reside within a parent transaction event.

- Triggers

Triggers activate as part of a statement that accesses the table with which it is associated, so the parent of a trigger event is always the statement that activates it.

Triggers cannot issue statements that cause an explicit or implicit commit or rollback of a transaction.

- Scheduled Events

The execution of the statements in the body of a scheduled event takes place in a new connection. Nesting of a scheduled event within a parent transaction is not applicable.

## Transactions and Savepoints

Savepoint statements are recorded as separate statement events. Transaction events include separate counters for `SAVEPOINT`, `ROLLBACK TO SAVEPOINT`, and `RELEASE SAVEPOINT` statements issued during the transaction.

## Transactions and Errors

Errors and warnings that occur within a transaction are recorded in statement events, but not in the corresponding transaction event. This includes transaction-specific errors and warnings, such as a rollback on a nontransactional table or GTID consistency errors.

### 25.12.7.1 The `events_transactions_current` Table

The `events_transactions_current` table contains current transaction events. The table stores one row per thread showing the current status of the thread's most recent monitored transaction event, so there is no system variable for configuring the table size. For example:

```
mysql> SELECT *
      FROM performance_schema.events_transactions_current LIMIT 1\G
***** 1. row *****
          THREAD_ID: 26
          EVENT_ID: 7
      END_EVENT_ID: NULL
      EVENT_NAME: transaction
          STATE: ACTIVE
          TRX_ID: NULL
          GTID: 3E11FA47-71CA-11E1-9E33-C80AA9429562:56
          XID: NULL
          XA_STATE: NULL
          SOURCE: transaction.cc:150
      TIMER_START: 420833537900000
      TIMER_END: NULL
```

```

TIMER_WAIT: NULL
ACCESS_MODE: READ WRITE
ISOLATION_LEVEL: REPEATABLE READ
AUTOCOMMIT: NO
NUMBER_OF_SAVEPOINTS: 0
NUMBER_OF_ROLLBACK_TO_SAVEPOINT: 0
NUMBER_OF_RELEASE_SAVEPOINT: 0
OBJECT_INSTANCE_BEGIN: NULL
NESTING_EVENT_ID: 6
NESTING_EVENT_TYPE: STATEMENT

```

Of the tables that contain transaction event rows, `events_transactions_current` is the most fundamental. Other tables that contain transaction event rows are logically derived from the current events. For example, the `events_transactions_history` and `events_transactions_history_long` tables are collections of the most recent transaction events that have ended, up to a maximum number of rows per thread and globally across all threads, respectively.

For more information about the relationship between the three transaction event tables, see [Section 25.9, “Performance Schema Tables for Current and Historical Events”](#).

For information about configuring whether to collect transaction events, see [Section 25.12.7, “Performance Schema Transaction Tables”](#).

The `events_transactions_current` table has these columns:

- `THREAD_ID, EVENT_ID`

The thread associated with the event and the thread current event number when the event starts. The `THREAD_ID` and `EVENT_ID` values taken together uniquely identify the row. No two rows have the same pair of values.

- `END_EVENT_ID`

This column is set to `NULL` when the event starts and updated to the thread current event number when the event ends.

- `EVENT_NAME`

The name of the instrument from which the event was collected. This is a `NAME` value from the `setup_instruments` table. Instrument names may have multiple parts and form a hierarchy, as discussed in [Section 25.6, “Performance Schema Instrument Naming Conventions”](#).

- `STATE`

The current transaction state. The value is `ACTIVE` (after `START TRANSACTION` or `BEGIN`), `COMMITTED` (after `COMMIT`), or `ROLLED BACK` (after `ROLLBACK`).

- `TRX_ID`

Unused.

- `GTID`

The GTID column contains the value of `gtid_next`, which can be one of `ANONYMOUS`, `AUTOMATIC`, or a GTID using the format `UUID:NUMBER`. For transactions that use `gtid_next=AUTOMATIC`, which is all normal client transactions, the GTID column changes when the transaction commits and the actual GTID is assigned. If `gtid_mode` is either `ON` or `ON_PERMISSIVE`, the GTID column changes to the transaction's GTID. If `gtid_mode` is either `OFF` or `OFF_PERMISSIVE`, the GTID column changes to `ANONYMOUS`.

- `XID_FORMAT_ID`, `XID_GTRID`, and `XID_BQUAL`

The elements of the XA transaction identifier. They have the format described in [Section 13.3.7.1, “XA Transaction SQL Statements”](#).

- `XA_STATE`

The state of the XA transaction. The value is `ACTIVE` (after `XA START`), `IDLE` (after `XA END`), `PREPARED` (after `XA PREPARE`), `ROLLED BACK` (after `XA ROLLBACK`), or `COMMITTED` (after `XA COMMIT`).

On a replica, the same XA transaction can appear in the `events_transactions_current` table with different states on different threads. This is because immediately after the XA transaction is prepared, it is detached from the replication applier thread, and can be committed or rolled back by any thread on the replica. The `events_transactions_current` table displays the current status of the most recent monitored transaction event on the thread, and does not update this status when the thread is idle. So the XA transaction can still be displayed in the `PREPARED` state for the original applier thread, after it has been processed by another thread. To positively identify XA transactions that are still in the `PREPARED` state and need to be recovered, use the `XA RECOVER` statement rather than the Performance Schema transaction tables.

- `SOURCE`

The name of the source file containing the instrumented code that produced the event and the line number in the file at which the instrumentation occurs. This enables you to check the source to determine exactly what code is involved.

- `TIMER_START`, `TIMER_END`, `TIMER_WAIT`

Timing information for the event. The unit for these values is picoseconds (trillionths of a second). The `TIMER_START` and `TIMER_END` values indicate when event timing started and ended. `TIMER_WAIT` is the event elapsed time (duration).

If an event has not finished, `TIMER_END` is the current timer value and `TIMER_WAIT` is the time elapsed so far (`TIMER_END - TIMER_START`).

If an event is produced from an instrument that has `TIMED = NO`, timing information is not collected, and `TIMER_START`, `TIMER_END`, and `TIMER_WAIT` are all `NULL`.

For discussion of picoseconds as the unit for event times and factors that affect time values, see [Section 25.4.1, “Performance Schema Event Timing”](#).

- `ACCESS_MODE`

The transaction access mode. The value is `READ WRITE` or `READ ONLY`.

- `ISOLATION_LEVEL`

The transaction isolation level. The value is `REPEATABLE READ`, `READ COMMITTED`, `READ UNCOMMITTED`, or `SERIALIZABLE`.

- `AUTOCOMMIT`

Whether autocommit mode was enabled when the transaction started.

- `NUMBER_OF_SAVEPOINTS`, `NUMBER_OF_ROLLBACK_TO_SAVEPOINT`,  
`NUMBER_OF_RELEASE_SAVEPOINT`

The number of `SAVEPOINT`, `ROLLBACK TO SAVEPOINT`, and `RELEASE SAVEPOINT` statements issued during the transaction.

- `OBJECT_INSTANCE_BEGIN`

Unused.

- `NESTING_EVENT_ID`

The `EVENT_ID` value of the event within which this event is nested.

- `NESTING_EVENT_TYPE`

The nesting event type. The value is `TRANSACTION`, `STATEMENT`, `STAGE`, or `WAIT`. (`TRANSACTION` does not appear because transactions cannot be nested.)

`TRUNCATE TABLE` is permitted for the `events_transactions_current` table. It removes the rows.

### 25.12.7.2 The `events_transactions_history` Table

The `events_transactions_history` table contains the  $N$  most recent transaction events that have ended per thread. Transaction events are not added to the table until they have ended. When the table contains the maximum number of rows for a given thread, the oldest thread row is discarded when a new row for that thread is added. When a thread ends, all its rows are discarded.

The Performance Schema autosizes the value of  $N$  during server startup. To set the number of rows per thread explicitly, set the `performance_schema_events_transactions_history_size` system variable at server startup.

The `events_transactions_history` table has the same columns as `events_transactions_current`. See [Section 25.12.7.1, “The `events\_transactions\_current` Table”](#).

`TRUNCATE TABLE` is permitted for the `events_transactions_history` table. It removes the rows.

For more information about the relationship between the three transaction event tables, see [Section 25.9, “Performance Schema Tables for Current and Historical Events”](#).

For information about configuring whether to collect transaction events, see [Section 25.12.7, “Performance Schema Transaction Tables”](#).

### 25.12.7.3 The `events_transactions_history_long` Table

The `events_transactions_history_long` table contains the  $N$  most recent transaction events that have ended globally, across all threads. Transaction events are not added to the table until they have ended. When the table becomes full, the oldest row is discarded when a new row is added, regardless of which thread generated either row.

The Performance Schema autosizes the value of  $N$  is autosized at server startup. To set the table size explicitly, set the `performance_schema_events_transactions_history_long_size` system variable at server startup.

The `events_transactions_history_long` table has the same columns as `events_transactions_current`. See [Section 25.12.7.1, “The `events\_transactions\_current` Table”](#).

`TRUNCATE TABLE` is permitted for the `events_transactions_history_long` table. It removes the rows.

For more information about the relationship between the three transaction event tables, see [Section 25.9, “Performance Schema Tables for Current and Historical Events”](#).

For information about configuring whether to collect transaction events, see [Section 25.12.7, “Performance Schema Transaction Tables”](#).

## 25.12.8 Performance Schema Connection Tables

When a client connects to the MySQL server, it does so under a particular user name and from a particular host. The Performance Schema provides statistics about these connections, tracking them per account (user and host combination) as well as separately per user name and host name, using these tables:

- `accounts`: Connection statistics per client account
- `hosts`: Connection statistics per client host name
- `users`: Connection statistics per client user name

The meaning of “account” in the connection tables is similar to its meaning in the MySQL grant tables in the `mysql` system database, in the sense that the term refers to a combination of user and host values. They differ in that, for grant tables, the host part of an account can be a pattern, whereas for Performance Schema tables, the host value is always a specific nonpattern host name.

Each connection table has `CURRENT_CONNECTIONS` and `TOTAL_CONNECTIONS` columns to track the current and total number of connections per “tracking value” on which its statistics are based. The tables differ in what they use for the tracking value. The `accounts` table has `USER` and `HOST` columns to track connections per user and host combination. The `users` and `hosts` tables have a `USER` and `HOST` column, respectively, to track connections per user name and host name.

The Performance Schema also counts internal threads and threads for user sessions that failed to authenticate, using rows with `USER` and `HOST` column values of `NULL`.

Suppose that clients named `user1` and `user2` each connect one time from `hosta` and `hostb`. The Performance Schema tracks the connections as follows:

- The `accounts` table has four rows, for the `user1/hosta`, `user1/hostb`, `user2/hosta`, and `user2/hostb` account values, each row counting one connection per account.
- The `hosts` table has two rows, for `hosta` and `hostb`, each row counting two connections per host name.
- The `users` table has two rows, for `user1` and `user2`, each row counting two connections per user name.

When a client connects, the Performance Schema determines which row in each connection table applies, using the tracking value appropriate to each table. If there is no such row, one is added. Then the Performance Schema increments by one the `CURRENT_CONNECTIONS` and `TOTAL_CONNECTIONS` columns in that row.

When a client disconnects, the Performance Schema decrements by one the `CURRENT_CONNECTIONS` column in the row and leaves the `TOTAL_CONNECTIONS` column unchanged.

`TRUNCATE TABLE` is permitted for connection tables. It has these effects:

- Rows are removed for accounts, hosts, or users that have no current connections (rows with `CURRENT_CONNECTIONS = 0`).

- Nonremoved rows are reset to count only current connections: For rows with `CURRENT_CONNECTIONS > 0`, `TOTAL_CONNECTIONS` is reset to `CURRENT_CONNECTIONS`.
- Summary tables that depend on the connection table are implicitly truncated, as described later in this section.

The Performance Schema maintains summary tables that aggregate connection statistics for various event types by account, host, or user. These tables have `_summary_by_account`, `_summary_by_host`, or `_summary_by_user` in the name. To identify them, use this query:

```
mysql> SELECT TABLE_NAME FROM INFORMATION_SCHEMA.TABLES
WHERE TABLE_SCHEMA = 'performance_schema'
AND TABLE_NAME REGEXP '_summary_by_(account|host|user) '
ORDER BY TABLE_NAME;
```

```
+-----+
| TABLE_NAME |
+-----+
| events_stages_summary_by_account_by_event_name |
| events_stages_summary_by_host_by_event_name |
| events_stages_summary_by_user_by_event_name |
| events_statements_summary_by_account_by_event_name |
| events_statements_summary_by_host_by_event_name |
| events_statements_summary_by_user_by_event_name |
| events_transactions_summary_by_account_by_event_name |
| events_transactions_summary_by_host_by_event_name |
| events_transactions_summary_by_user_by_event_name |
| events_waits_summary_by_account_by_event_name |
| events_waits_summary_by_host_by_event_name |
| events_waits_summary_by_user_by_event_name |
| memory_summary_by_account_by_event_name |
| memory_summary_by_host_by_event_name |
| memory_summary_by_user_by_event_name |
+-----+
```

For details about individual connection summary tables, consult the section that describes tables for the summarized event type:

- Wait event summaries: [Section 25.12.15.1, “Wait Event Summary Tables”](#)
- Stage event summaries: [Section 25.12.15.2, “Stage Summary Tables”](#)
- Statement event summaries: [Section 25.12.15.3, “Statement Summary Tables”](#)
- Transaction event summaries: [Section 25.12.15.4, “Transaction Summary Tables”](#)
- Memory event summaries: [Section 25.12.15.9, “Memory Summary Tables”](#)

`TRUNCATE TABLE` is permitted for connection summary tables. It removes rows for accounts, hosts, or users with no connections, and resets the summary columns to zero for the remaining rows. In addition, each summary table that is aggregated by account, host, user, or thread is implicitly truncated by truncation of the connection table on which it depends. The following table describes the relationship between connection table truncation and implicitly truncated tables.

**Table 25.2 Implicit Effects of Connection Table Truncation**

Truncated Connection Table	Implicitly Truncated Summary Tables
<code>accounts</code>	Tables with names containing <code>_summary_by_account</code> , <code>_summary_by_thread</code>
<code>hosts</code>	Tables with names containing <code>_summary_by_account</code> , <code>_summary_by_host</code> , <code>_summary_by_thread</code>

Truncated Connection Table	Implicitly Truncated Summary Tables
<code>users</code>	Tables with names containing <code>_summary_by_account</code> , <code>_summary_by_user</code> , <code>_summary_by_thread</code>

Truncating a `_summary_global` summary table also implicitly truncates its corresponding connection and thread summary tables. For example, truncating `events_waits_summary_global_by_event_name` implicitly truncates the wait event summary tables that are aggregated by account, host, user, or thread.

### 25.12.8.1 The accounts Table

The `accounts` table contains a row for each account that has connected to the MySQL server. For each account, the table counts the current and total number of connections. The table size is autosized at server startup. To set the table size explicitly, set the `performance_schema_accounts_size` system variable at server startup. To disable account statistics, set this variable to 0.

The `accounts` table has the following columns. For a description of how the Performance Schema maintains rows in this table, including the effect of `TRUNCATE TABLE`, see [Section 25.12.8, “Performance Schema Connection Tables”](#).

- `USER`

The client user name for the connection. This is `NULL` for an internal thread, or for a user session that failed to authenticate.

- `HOST`

The host from which the client connected. This is `NULL` for an internal thread, or for a user session that failed to authenticate.

- `CURRENT_CONNECTIONS`

The current number of connections for the account.

- `TOTAL_CONNECTIONS`

The total number of connections for the account.

### 25.12.8.2 The hosts Table

The `hosts` table contains a row for each host from which clients have connected to the MySQL server. For each host name, the table counts the current and total number of connections. The table size is autosized at server startup. To set the table size explicitly, set the `performance_schema_hosts_size` system variable at server startup. To disable host statistics, set this variable to 0.

The `hosts` table has the following columns. For a description of how the Performance Schema maintains rows in this table, including the effect of `TRUNCATE TABLE`, see [Section 25.12.8, “Performance Schema Connection Tables”](#).

- `HOST`

The host from which the client connected. This is `NULL` for an internal thread, or for a user session that failed to authenticate.

- `CURRENT_CONNECTIONS`

The current number of connections for the host.



- [TOTAL\\_CONNECTIONS](#)

The total number of connections for the host.

### 25.12.8.3 The users Table

The `users` table contains a row for each user who has connected to the MySQL server. For each user name, the table counts the current and total number of connections. The table size is autosized at server startup. To set the table size explicitly, set the `performance_schema_users_size` system variable at server startup. To disable user statistics, set this variable to 0.

The `users` table has the following columns. For a description of how the Performance Schema maintains rows in this table, including the effect of `TRUNCATE TABLE`, see [Section 25.12.8, “Performance Schema Connection Tables”](#).

- [USER](#)

The client user name for the connection. This is `NULL` for an internal thread, or for a user session that failed to authenticate.

- [CURRENT\\_CONNECTIONS](#)

The current number of connections for the user.

- [TOTAL\\_CONNECTIONS](#)

The total number of connections for the user.

## 25.12.9 Performance Schema Connection Attribute Tables

Connection attributes are key-value pairs that application programs can pass to the server at connect time. For applications based on the C API implemented by the `libmysqlclient` client library, the `mysql_options()` and `mysql_options4()` functions define the connection attribute set. Other MySQL Connectors may provide their own attribute-definition methods.

These Performance Schema tables expose attribute information:

- [session\\_account\\_connect\\_attrs](#): Connection attributes for the current session, and other sessions associated with the session account
- [session\\_connect\\_attrs](#): Connection attributes for all sessions

Attribute names that begin with an underscore (`_`) are reserved for internal use and should not be created by application programs. This convention permits new attributes to be introduced by MySQL without colliding with application attributes, and enables application programs to define their own attributes that do not collide with internal attributes.

- [Available Connection Attributes](#)
- [Connection Attribute Limits](#)

### Available Connection Attributes

The set of connection attributes visible within a given connection varies depending on factors such as your platform, MySQL Connector used to establish the connection, or client program.

The `libmysqlclient` client library sets these attributes:

- `_client_name`: The client name (`libmysql` for the client library).
- `_client_version`: The client library version.
- `_os`: The operating system (for example, `Linux`, `Win64`).
- `_pid`: The client process ID.
- `_platform`: The machine platform (for example, `x86_64`).
- `_thread`: The client thread ID (Windows only).

Other MySQL Connectors may define their own connection attributes.

MySQL Connector/J defines these attributes:

- `_client_license`: The connector license type.
- `_runtime_vendor`: The Java runtime environment (JRE) vendor.
- `_runtime_version`: The Java runtime environment (JRE) version.

MySQL Connector/NET defines these attributes:

- `_client_version`: The client library version.
- `_os`: The operating system (for example, `Linux`, `Win64`).
- `_pid`: The client process ID.
- `_platform`: The machine platform (for example, `x86_64`).
- `_program_name`: The client name.
- `_thread`: The client thread ID (Windows only).

PHP defines attributes that depend on how it was compiled:

- Compiled using `libmysqlclient`: The standard `libmysqlclient` attributes, described previously.
- Compiled using `mysqlnd`: Only the `_client_name` attribute, with a value of `mysqlnd`.

Many MySQL client programs set a `program_name` attribute with a value equal to the client name. For example, `mysqladmin` and `mysqldump` set `program_name` to `mysqladmin` and `mysqldump`, respectively.

Some MySQL client programs define additional attributes:

- `mysqlbinlog`:
  - `_client_role`: `binary_log_listener`
- Replica connections:
  - `program_name`: `mysqld`
  - `_client_role`: `binary_log_listener`
  - `_client_replication_channel_name`: The channel name.
- `FEDERATED` storage engine connections:

- `program_name: mysqld`
- `_client_role: federated_storage`

## Connection Attribute Limits

There are limits on the amount of connection attribute data transmitted from client to server:

- A fixed limit imposed by the client prior to connect time.
- A fixed limit imposed by the server at connect time.
- A configurable limit imposed by the Performance Schema at connect time.

For connections initiated using the C API, the `libmysqlclient` library imposes a limit of 64KB on the aggregate size of connection attribute data on the client side: Calls to `mysql_options()` that cause this limit to be exceeded produce a `CR_INVALID_PARAMETER_NO` error. Other MySQL Connectors may impose their own client-side limits on how much connection attribute data can be transmitted to the server.

On the server side, these size checks on connection attribute data occur:

- The server imposes a limit of 64KB on the aggregate size of connection attribute data it can accept. If a client attempts to send more than 64KB of attribute data, the server rejects the connection.
- For accepted connections, the Performance Schema checks aggregate attribute size against the value of the `performance_schema_session_connect_attrs_size` system variable. If attribute size exceeds this value, these actions take place:
  - The Performance Schema truncates the attribute data and increments the `Performance_schema_session_connect_attrs_lost` status variable, which indicates the number of connections for which attribute truncation occurred.
  - The Performance Schema writes a message to the error log if the `log_error_verbosity` system variable is greater than 1:

```
[Warning] Connection attributes of length N were truncated
```

### 25.12.9.1 The `session_account_connect_attrs` Table

Application programs can provide key-value connection attributes to be passed to the server at connect time. For descriptions of common attributes, see [Section 25.12.9, “Performance Schema Connection Attribute Tables”](#).

The `session_account_connect_attrs` table contains connection attributes only for the current session, and other sessions associated with the session account. To see connection attributes for all sessions, use the `session_connect_attrs` table.

The `session_account_connect_attrs` table has these columns:

- `PROCESSLIST_ID`

The connection identifier for the session.

- `ATTR_NAME`

The attribute name.

- `ATTR_VALUE`

The attribute value.

- `ORDINAL_POSITION`

The order in which the attribute was added to the set of connection attributes.

`TRUNCATE TABLE` is not permitted for the `session_account_connect_attrs` table.

### 25.12.9.2 The `session_connect_attrs` Table

Application programs can provide key-value connection attributes to be passed to the server at connect time. For descriptions of common attributes, see [Section 25.12.9, “Performance Schema Connection Attribute Tables”](#).

The `session_connect_attrs` table contains connection attributes for all sessions. To see connection attributes only for the current session, and other sessions associated with the session account, use the `session_account_connect_attrs` table.

The `session_connect_attrs` table has these columns:

- `PROCESSLIST_ID`

The connection identifier for the session.

- `ATTR_NAME`

The attribute name.

- `ATTR_VALUE`

The attribute value.

- `ORDINAL_POSITION`

The order in which the attribute was added to the set of connection attributes.

`TRUNCATE TABLE` is not permitted for the `session_connect_attrs` table.

### 25.12.10 Performance Schema User-Defined Variable Tables

The Performance Schema provides a `user_variables_by_thread` table that exposes user-defined variables. These are variables defined within a specific session and include a `@` character preceding the name; see [Section 9.4, “User-Defined Variables”](#).

The `user_variables_by_thread` table has these columns:

- `THREAD_ID`

The thread identifier of the session in which the variable is defined.

- `VARIABLE_NAME`

The variable name, without the leading `@` character.

- `VARIABLE_VALUE`

The variable value.

`TRUNCATE TABLE` is not permitted for the `user_variables_by_thread` table.

## 25.12.11 Performance Schema Replication Tables

The Performance Schema provides tables that expose replication information. This is similar to the information available from the `SHOW SLAVE STATUS` statement, but representation in table form is more accessible and has usability benefits:

- `SHOW SLAVE STATUS` output is useful for visual inspection, but not so much for programmatic use. By contrast, using the Performance Schema tables, information about replica status can be searched using general `SELECT` queries, including complex `WHERE` conditions, joins, and so forth.
- Query results can be saved in tables for further analysis, or assigned to variables and thus used in stored procedures.
- The replication tables provide better diagnostic information. For multithreaded replica operation, `SHOW SLAVE STATUS` reports all coordinator and worker thread errors using the `Last_SQL_Errno` and `Last_SQL_Error` fields, so only the most recent of those errors is visible and information can be lost. The replication tables store errors on a per-thread basis without loss of information.
- The last seen transaction is visible in the replication tables on a per-worker basis. This is information not available from `SHOW SLAVE STATUS`.
- Developers familiar with the Performance Schema interface can extend the replication tables to provide additional information by adding rows to the tables.

### Replication Table Descriptions

The Performance Schema provides the following replication-related tables:

- Tables that contain information about the connection of a replica to the replication source server:
  - `replication_connection_configuration`: Configuration parameters for connecting to the source
  - `replication_connection_status`: Current status of the connection to the source
- Tables that contain general (not thread-specific) information about the transaction applier:
  - `replication_applier_configuration`: Configuration parameters for the transaction applier on the replica.
  - `replication_applier_status`: Current status of the transaction applier on the replica.
- Tables that contain information about specific threads responsible for applying transactions received from the source:
  - `replication_applier_status_by_coordinator`: Status of the coordinator thread (empty unless the replica is multithreaded).
  - `replication_applier_status_by_worker`: Status of the applier thread or worker threads if the replica is multithreaded.
- Tables that contain information about replication group members:
  - `replication_group_members`: Provides network and status information for group members.
  - `replication_group_member_stats`: Provides statistical information about group members and transaction in which they participate.

The following sections describe each replication table in more detail, including the correspondence between the columns produced by `SHOW SLAVE STATUS` and the replication table columns in which the same information appears.

The remainder of this introduction to the replication tables describes how the Performance Schema populates them and which fields from `SHOW SLAVE STATUS` are not represented in the tables.

## Replication Table Life Cycle

The Performance Schema populates the replication tables as follows:

- Prior to execution of `CHANGE MASTER TO`, the tables are empty.
- After `CHANGE MASTER TO`, the configuration parameters can be seen in the tables. At this time, there are no active replica threads, so the `THREAD_ID` columns are `NULL` and the `SERVICE_STATE` columns have a value of `OFF`.
- After `START SLAVE`, non-`NULL` `THREAD_ID` values can be seen. Threads that are idle or active have a `SERVICE_STATE` value of `ON`. The thread that connects to the source has a value of `CONNECTING` while it establishes the connection, and `ON` thereafter as long as the connection lasts.
- After `STOP SLAVE`, the `THREAD_ID` columns become `NULL` and the `SERVICE_STATE` columns for threads that no longer exist have a value of `OFF`.
- The tables are preserved after `STOP SLAVE` or threads dying due to an error.
- The `replication_applier_status_by_worker` table is nonempty only when the replica is operating in multithreaded mode. That is, if the `slave_parallel_workers` system variable is greater than 0, this table is populated when `START SLAVE` is executed, and the number of rows shows the number of workers.

## SHOW SLAVE STATUS Information Not In the Replication Tables

The information in the Performance Schema replication tables differs somewhat from the information available from `SHOW SLAVE STATUS` because the tables are oriented toward use of global transaction identifiers (GTIDs), not file names and positions, and they represent server UUID values, not server ID values. Due to these differences, several `SHOW SLAVE STATUS` columns are not preserved in the Performance Schema replication tables, or are represented a different way:

- The following fields refer to file names and positions and are not preserved:

```
Master_Log_File
Read_Master_Log_Pos
Relay_Log_File
Relay_Log_Pos
Relay_Master_Log_File
Exec_Master_Log_Pos
Until_Condition
Until_Log_File
Until_Log_Pos
```

- The `Master_Info_File` field is not preserved. It refers to the `master.info` file, which has been superseded by crash-safe tables.
- The following fields are based on `server_id`, not `server_uuid`, and are not preserved:

```
Master_Server_Id
Replicate_Ignore_Server_Ids
```

- The `Skip_Counter` field is based on event counts, not GTIDs, and is not preserved.
- These error fields are aliases for `Last_SQL_Errno` and `Last_SQL_Error`, so they are not preserved:

```
Last_Errno
Last_Error
```

In the Performance Schema, this error information is available in the `LAST_ERROR_NUMBER` and `LAST_ERROR_MESSAGE` columns of the `replication_applier_status_by_worker` table (and `replication_applier_status_by_coordinator` if the replica is multithreaded). Those tables provide more specific per-thread error information than is available from `Last_Errno` and `Last_Error`.

- Fields that provide information about command-line filtering options is not preserved:

```
Replicate_Do_DB
Replicate_Ignore_DB
Replicate_Do_Table
Replicate_Ignore_Table
Replicate_Wild_Do_Table
Replicate_Wild_Ignore_Table
```

- The `Slave_IO_State` and `Slave_SQL_Running_State` fields are not preserved. If needed, these values can be obtained from the process list by using the `THREAD_ID` column of the appropriate replication table and joining it with the `ID` column in the `INFORMATION_SCHEMA.PROCESSLIST` table to select the `STATE` column of the latter table.
- The `Executed_Gtid_Set` field can show a large set with a great deal of text. Instead, the Performance Schema tables show GTIDs of transactions that are currently being applied by the replica. Alternatively, the set of executed GTIDs can be obtained from the value of the `gtid_executed` system variable.
- The `Seconds_Behind_Master` and `Relay_Log_Space` fields are in to-be-decided status and are not preserved.

## Status Variables Moved to Replication Tables

As of MySQL version 5.7.5, the following status variables (previously monitored using `SHOW STATUS`) were moved to the Performance Schema replication tables:

- `Slave_retried_transactions`
- `Slave_last_heartbeat`
- `Slave_received_heartbeats`
- `Slave_heartbeat_period`
- `Slave_running`

These status variables are now only relevant when a single replication channel is being used because they *only* report the status of the default replication channel. When multiple replication channels exist, use the Performance Schema replication tables described in this section, which report these variables for each existing replication channel.

## Replication Channels

The first column of the replication Performance Schema tables is `CHANNEL_NAME`. This enables the tables to be viewed per replication channel. In a non-multisource replication setup there is a single default

replication channel. When you are using multiple replication channels on a replica, you can filter the tables per replication channel to monitor a specific replication channel. See [Section 16.2.2, “Replication Channels”](#) and [Section 16.1.5.8, “Multi-Source Replication Monitoring”](#) for more information.

### 25.12.11.1 The replication\_connection\_configuration Table

This table shows the configuration parameters used by the replica for connecting to the source. Parameters stored in the table can be changed at runtime with the `CHANGE MASTER TO` statement, as indicated in the column descriptions.

Compared to the `replication_connection_status` table, `replication_connection_configuration` changes less frequently. It contains values that define how the replica connects to the source and that remain constant during the connection, whereas `replication_connection_status` contains values that change during the connection.

The `replication_connection_configuration` table has the following columns. The column descriptions indicate the corresponding `CHANGE MASTER TO` options from which the column values are taken, and the table given later in this section shows the correspondence between `replication_connection_configuration` columns and `SHOW SLAVE STATUS` columns.

- `CHANNEL_NAME`

The replication channel which this row is displaying. There is always a default replication channel, and more replication channels can be added. See [Section 16.2.2, “Replication Channels”](#) for more information. (`CHANGE MASTER TO` option: `FOR CHANNEL`)

- `HOST`

The replication source server that the replica is connected to. (`CHANGE MASTER TO` option: `MASTER_HOST`)

- `PORT`

The port used to connect to the replication source server. (`CHANGE MASTER TO` option: `MASTER_PORT`)

- `USER`

The user name of the account used to connect to the replication source server. (`CHANGE MASTER TO` option: `MASTER_USER`)

- `NETWORK_INTERFACE`

The network interface that the replica is bound to, if any. (`CHANGE MASTER TO` option: `MASTER_BIND`)

- `AUTO_POSITION`

1 if autopositioning is in use; otherwise 0. (`CHANGE MASTER TO` option: `MASTER_AUTO_POSITION`)

- `SSL_ALLOWED`, `SSL_CA_FILE`, `SSL_CA_PATH`, `SSL_CERTIFICATE`, `SSL_CIPHER`, `SSL_KEY`, `SSL_VERIFY_SERVER_CERTIFICATE`, `SSL_CRL_FILE`, `SSL_CRL_PATH`

These columns show the SSL parameters used by the replica to connect to the replication source server, if any.

`SSL_ALLOWED` has these values:

- `Yes` if an SSL connection to the source is permitted



- `No` if an SSL connection to the source is not permitted
- `Ignored` if an SSL connection is permitted but the replica does not have SSL support enabled

`CHANGE MASTER TO` options for the other SSL columns: `MASTER_SSL_CA`, `MASTER_SSL_CAPATH`, `MASTER_SSL_CERT`, `MASTER_SSL_CIPHER`, `MASTER_SSL_CRL`, `MASTER_SSL_CRLPATH`, `MASTER_SSL_KEY`, `MASTER_SSL_VERIFY_SERVER_CERT`.

- `CONNECTION_RETRY_INTERVAL`

The number of seconds between connect retries. (`CHANGE MASTER TO` option: `MASTER_CONNECT_RETRY`)

- `CONNECTION_RETRY_COUNT`

The number of times the replica can attempt to reconnect to the source in the event of a lost connection. (`CHANGE MASTER TO` option: `MASTER_RETRY_COUNT`)

- `HEARTBEAT_INTERVAL`

The replication heartbeat interval on a replica, measured in seconds. (`CHANGE MASTER TO` option: `MASTER_HEARTBEAT_PERIOD`)

- `TLS_VERSION`

The TLS version used on the source. For TLS version information, see [Section 6.3.2, “Encrypted Connection TLS Protocols and Ciphers”](#). (`CHANGE MASTER TO` option: `MASTER_TLS_VERSION`)

This column was added in MySQL 5.7.10.

`TRUNCATE TABLE` is not permitted for the `replication_connection_configuration` table.

The following table shows the correspondence between `replication_connection_configuration` columns and `SHOW SLAVE STATUS` columns.

<code>replication_connection_configuration</code> Column	<code>SHOW SLAVE STATUS</code> Column
<code>CHANNEL_NAME</code>	<code>Channel_name</code>
<code>HOST</code>	<code>Master_Host</code>
<code>PORT</code>	<code>Master_Port</code>
<code>USER</code>	<code>Master_User</code>
<code>NETWORK_INTERFACE</code>	<code>Master_Bind</code>
<code>AUTO_POSITION</code>	<code>Auto_Position</code>
<code>SSL_ALLOWED</code>	<code>Master_SSL_Allowed</code>
<code>SSL_CA_FILE</code>	<code>Master_SSL_CA_File</code>
<code>SSL_CA_PATH</code>	<code>Master_SSL_CA_Path</code>
<code>SSL_CERTIFICATE</code>	<code>Master_SSL_Cert</code>
<code>SSL_CIPHER</code>	<code>Master_SSL_Cipher</code>
<code>SSL_KEY</code>	<code>Master_SSL_Key</code>
<code>SSL_VERIFY_SERVER_CERTIFICATE</code>	<code>Master_SSL_Verify_Server_Cert</code>

<code>replication_connection_configuration</code> Column	SHOW SLAVE STATUS Column
<code>SSL_CRL_FILE</code>	<code>Master_SSL_Crl</code>
<code>SSL_CRL_PATH</code>	<code>Master_SSL_Crlpath</code>
<code>CONNECTION_RETRY_INTERVAL</code>	<code>Connect_Retry</code>
<code>CONNECTION_RETRY_COUNT</code>	<code>Master_Retry_Count</code>
<code>HEARTBEAT_INTERVAL</code>	<code>None</code>
<code>TLS_VERSION</code>	<code>Master_TLS_Version</code>

### 25.12.11.2 The `replication_connection_status` Table

This table shows the current status of the replication I/O thread that handles the replica's connection to the source.

Compared to the `replication_connection_configuration` table, `replication_connection_status` changes more frequently. It contains values that change during the connection, whereas `replication_connection_configuration` contains values which define how the replica connects to the source and that remain constant during the connection.

The `replication_connection_status` table has these columns:

- `CHANNEL_NAME`

The replication channel which this row is displaying. There is always a default replication channel, and more replication channels can be added. See [Section 16.2.2, “Replication Channels”](#) for more information.

- `GROUP_NAME`

If this server is a member of a group, shows the name of the group the server belongs to.

- `SOURCE_UUID`

The `server_uuid` value from the source.

- `THREAD_ID`

The I/O thread ID.

- `SERVICE_STATE`

`ON` (thread exists and is active or idle), `OFF` (thread no longer exists), or `CONNECTING` (thread exists and is connecting to the source).

- `RECEIVED_TRANSACTION_SET`

The set of global transaction IDs (GTIDs) corresponding to all transactions received by this replica. Empty if GTIDs are not in use. See [GTID Sets](#) for more information.

- `LAST_ERROR_NUMBER`, `LAST_ERROR_MESSAGE`

The error number and error message of the most recent error that caused the I/O thread to stop. An error number of 0 and message of the empty string mean “no error.” If the `LAST_ERROR_MESSAGE` value is not empty, the error values also appear in the replica's error log.

Issuing `RESET MASTER` or `RESET SLAVE` resets the values shown in these columns.

- `LAST_ERROR_TIMESTAMP`

A timestamp in `YYMMDD hh:mm:ss` format that shows when the most recent I/O error took place.

- `LAST_HEARTBEAT_TIMESTAMP`

A timestamp in `YYMMDD hh:mm:ss` format that shows when the most recent heartbeat signal was received by a replica.

- `COUNT_RECEIVED_HEARTBEATS`

The total number of heartbeat signals that a replica received since the last time it was restarted or reset, or a `CHANGE MASTER TO` statement was issued.

`TRUNCATE TABLE` is not permitted for the `replication_connection_status` table.

The following table shows the correspondence between `replication_connection_status` columns and `SHOW SLAVE STATUS` columns.

<code>replication_connection_status</code> Column	<code>SHOW SLAVE STATUS</code> Column
<code>SOURCE_UUID</code>	<code>Master_UUID</code>
<code>THREAD_ID</code>	None
<code>SERVICE_STATE</code>	<code>Slave_IO_Running</code>
<code>RECEIVED_TRANSACTION_SET</code>	<code>Retrieved_Gtid_Set</code>
<code>LAST_ERROR_NUMBER</code>	<code>Last_IO_Errno</code>
<code>LAST_ERROR_MESSAGE</code>	<code>Last_IO_Error</code>
<code>LAST_ERROR_TIMESTAMP</code>	<code>Last_IO_Error_Timestamp</code>

### 25.12.11.3 The `replication_applier_configuration` Table

This table shows the configuration parameters that affect transactions applied by the replica. Parameters stored in the table can be changed at runtime with the `CHANGE MASTER TO` statement, as indicated in the column descriptions.

The `replication_applier_configuration` table has these columns:

- `CHANNEL_NAME`

The replication channel which this row is displaying. There is always a default replication channel, and more replication channels can be added. See [Section 16.2.2, “Replication Channels”](#) for more information.

- `DESIRED_DELAY`

The number of seconds that the replica must lag the source. (`CHANGE MASTER TO` option: `MASTER_DELAY`)

`TRUNCATE TABLE` is not permitted for the `replication_applier_configuration` table.

The following table shows the correspondence between `replication_applier_configuration` columns and `SHOW SLAVE STATUS` columns.

<code>replication_applier_configuration</code> Column	SHOW SLAVE STATUS Column
<code>DESIRED_DELAY</code>	<code>SQL_Delay</code>

#### 25.12.11.4 The `replication_applier_status` Table

This table shows the current general transaction execution status on the replica. The table provides information about general aspects of transaction applier status that are not specific to any thread involved. Thread-specific status information is available in the `replication_applier_status_by_coordinator` table (and `replication_applier_status_by_worker` if the replica is multithreaded).

The `replication_applier_status` table has these columns:

- `CHANNEL_NAME`

The replication channel which this row is displaying. There is always a default replication channel, and more replication channels can be added. See [Section 16.2.2, “Replication Channels”](#) for more information.

- `SERVICE_STATE`

Shows `ON` when the replication channel's applier threads are active or idle, `OFF` means that the applier threads are not active.

- `REMAINING_DELAY`

If the replica is waiting for `DESIRED_DELAY` seconds to pass since the source applied an event, this field contains the number of delay seconds remaining. At other times, this field is `NULL`. (The `DESIRED_DELAY` value is stored in the `replication_applier_configuration` table.)

- `COUNT_TRANSACTIONS_RETRIES`

Shows the number of retries that were made because the replication SQL thread failed to apply a transaction. The maximum number of retries for a given transaction is set by the `slave_transaction_retries` system variable.

`TRUNCATE TABLE` is not permitted for the `replication_applier_status` table.

The following table shows the correspondence between `replication_applier_status` columns and `SHOW SLAVE STATUS` columns.

<code>replication_applier_status</code> Column	SHOW SLAVE STATUS Column
<code>SERVICE_STATE</code>	None
<code>REMAINING_DELAY</code>	<code>SQL_Remaining_Delay</code>

#### 25.12.11.5 The `replication_applier_status_by_coordinator` Table

For a multithreaded replica, the replica uses multiple worker threads and a coordinator thread to manage them, and this table shows the status of the coordinator thread. For a single-threaded replica, this table is empty. For a multithreaded replica, the `replication_applier_status_by_worker` table shows the status of the worker threads.

The `replication_applier_status_by_coordinator` table has these columns:

- `CHANNEL_NAME`

The replication channel which this row is displaying. There is always a default replication channel, and more replication channels can be added. See [Section 16.2.2, “Replication Channels”](#) for more information.

- `THREAD_ID`

The SQL/coordinator thread ID.

- `SERVICE_STATE`

`ON` (thread exists and is active or idle) or `OFF` (thread no longer exists).

- `LAST_ERROR_NUMBER`, `LAST_ERROR_MESSAGE`

The error number and error message of the most recent error that caused the SQL/coordinator thread to stop. An error number of 0 and message which is an empty string means “no error”. If the `LAST_ERROR_MESSAGE` value is not empty, the error values also appear in the replica's error log.

Issuing `RESET MASTER` or `RESET SLAVE` resets the values shown in these columns.

All error codes and messages displayed in the `LAST_ERROR_NUMBER` and `LAST_ERROR_MESSAGE` columns correspond to error values listed in [Server Error Message Reference](#).

- `LAST_ERROR_TIMESTAMP`

A timestamp in `YYMMDD hh:mm:ss` format that shows when the most recent SQL/coordinator error occurred.

`TRUNCATE TABLE` is not permitted for the `replication_applier_status_by_coordinator` table.

The following table shows the correspondence between `replication_applier_status_by_coordinator` columns and `SHOW SLAVE STATUS` columns.

<code>replication_applier_status_by_coordinator</code> Column	<code>SHOW SLAVE STATUS</code> Column
<code>THREAD_ID</code>	None
<code>SERVICE_STATE</code>	<code>Slave_SQL_Running</code>
<code>LAST_ERROR_NUMBER</code>	<code>Last_SQL_Errno</code>
<code>LAST_ERROR_MESSAGE</code>	<code>Last_SQL_Error</code>
<code>LAST_ERROR_TIMESTAMP</code>	<code>Last_SQL_Error_Timestamp</code>

### 25.12.11.6 The `replication_applier_status_by_worker` Table

If the replica is not multithreaded, this table shows the status of the applier thread. Otherwise, the replica uses multiple worker threads and a coordinator thread to manage them, and this table shows the status of the worker threads. For a multithreaded replica, the `replication_applier_status_by_coordinator` table shows the status of the coordinator thread.

The `replication_applier_status_by_worker` table has these columns:

- `CHANNEL_NAME`

The replication channel which this row is displaying. There is always a default replication channel, and more replication channels can be added. See [Section 16.2.2, “Replication Channels”](#) for more information.

- `WORKER_ID`

The worker identifier (same value as the `id` column in the `mysql.slave_worker_info` table). After `STOP SLAVE`, the `THREAD_ID` column becomes `NULL`, but the `WORKER_ID` value is preserved.

- `THREAD_ID`

The worker thread identifier.

- `SERVICE_STATE`

`ON` (thread exists and is active or idle) or `OFF` (thread no longer exists).

- `LAST_SEEN_TRANSACTION`

The transaction that the worker has last seen. The worker has not necessarily applied this transaction because it could still be in the process of doing so.

If the `gtid_mode` system variable value is `OFF`, this column is `ANONYMOUS`, indicating that transactions do not have global transaction identifiers (GTIDs) and are identified by file and position only.

If `gtid_mode` is `ON`, the column value is defined as follows:

- If no transaction has executed, the column is empty.
- When a transaction has executed, the column is set from `gtid_next` as soon as `gtid_next` is set. From this moment, the column always shows a GTID.
- The GTID is preserved until the next transaction is executed. If an error occurs, the column value is the GTID of the transaction being executed by the worker when the error occurred. The following statement shows whether or not that transaction has been committed:

```
SELECT GTID_SUBSET(LAST_SEEN_TRANSACTION, @@GLOBAL.GTID_EXECUTED)
FROM performance_schema.replication_applier_status_by_worker;
```

If the statement returns zero, the transaction has not yet been committed, either because it is still being processed, or because the worker thread was stopped while it was being processed. If the statement returns nonzero, the transaction has been committed.

- `LAST_ERROR_NUMBER`, `LAST_ERROR_MESSAGE`

The error number and error message of the most recent error that caused the worker thread to stop. An error number of 0 and message of the empty string mean “no error”. If the `LAST_ERROR_MESSAGE` value is not empty, the error values also appear in the replica's error log.

Issuing `RESET MASTER` or `RESET SLAVE` resets the values shown in these columns.

All error codes and messages displayed in the `LAST_ERROR_NUMBER` and `LAST_ERROR_MESSAGE` columns correspond to error values listed in [Server Error Message Reference](#).

- `LAST_ERROR_TIMESTAMP`

A timestamp in `YYMMDD hh:mm:ss` format that shows when the most recent worker error occurred.

`TRUNCATE TABLE` is not permitted for the `replication_applier_status_by_worker` table.

The following table shows the correspondence between `replication_applier_status_by_worker` columns and `SHOW SLAVE STATUS` columns.

<code>replication_applier_status_by_worker</code> Column	SHOW SLAVE STATUS Column
<code>WORKER_ID</code>	None
<code>THREAD_ID</code>	None
<code>SERVICE_STATE</code>	None
<code>LAST_SEEN_TRANSACTION</code>	None
<code>LAST_ERROR_NUMBER</code>	<code>Last_SQL_Errno</code>
<code>LAST_ERROR_MESSAGE</code>	<code>Last_SQL_Error</code>
<code>LAST_ERROR_TIMESTAMP</code>	<code>Last_SQL_Error_Timestamp</code>

### 25.12.11.7 The `replication_group_member_stats` Table

This table shows statistical information for MySQL Group Replication members. It is populated only when Group Replication is running.

The `replication_group_member_stats` table has these columns:

- `CHANNEL_NAME`  
Name of the Group Replication channel.
- `VIEW_ID`  
Current view identifier for this group.
- `MEMBER_ID`  
The member server UUID. This has a different value for each member in the group. This also serves as a key because it is unique to each member.
- `COUNT_TRANSACTIONS_IN_QUEUE`  
The number of transactions in the queue pending conflict detection checks. Once the transactions have been checked for conflicts, if they pass the check, they are queued to be applied as well.
- `COUNT_TRANSACTIONS_CHECKED`  
The number of transactions that have been checked for conflicts.
- `COUNT_CONFLICTS_DETECTED`  
The number of transactions that have not passed the conflict detection check.
- `COUNT_TRANSACTIONS_ROWS_VALIDATING`  
Number of transaction rows which can be used for certification, but have not been garbage collected. Can be thought of as the current size of the conflict detection database against which each transaction is certified.
- `TRANSACTIONS_COMMITTED_ALL_MEMBERS`  
The transactions that have been successfully committed on all members of the replication group, shown as [GTID Sets](#). This is updated at a fixed time interval.
- `LAST_CONFLICT_FREE_TRANSACTION`

The transaction identifier of the last conflict free transaction which was checked.

`TRUNCATE TABLE` is not permitted for the `replication_group_member_stats` table.

### 25.12.11.8 The `replication_group_members` Table

This table shows network and status information for replication group members. The network addresses shown are the addresses used to connect clients to the group, and should not be confused with the member's internal group communication address specified by `group_replication_local_address`.

The `replication_group_members` table has these columns:

- `CHANNEL_NAME`

Name of the Group Replication channel.

- `MEMBER_ID`

Identifier for this member; the same as the server UUID.

- `MEMBER_HOST`

Network address of this member (host name or IP address). Retrieved from the member's `hostname` variable.

- `MEMBER_PORT`

Port on which the server is listening. Retrieved from the member's `port` variable.

- `MEMBER_STATE`

Current state of this member; can be any one of the following:

- `OFFLINE`: The Group Replication plugin is installed but has not been started.
- `RECOVERING`: The server has joined a group from which it is retrieving data.
- `ONLINE`: The member is in a fully functioning state.
- `ERROR`: The member has encountered an error, either during applying transactions or during the recovery phase, and is not participating in the group's transactions.
- `UNREACHABLE`: The failure detection process suspects that this member cannot be contacted, because the group messages have timed out.

`TRUNCATE TABLE` is not permitted for the `replication_group_members` table.

## 25.12.12 Performance Schema Lock Tables

The Performance Schema exposes lock information through these tables:

- `metadata_locks`: Metadata locks held and requested
- `table_handles`: Table locks held and requested

The following sections describe these tables in more detail.

### 25.12.12.1 The `metadata_locks` Table



MySQL uses metadata locking to manage concurrent access to database objects and to ensure data consistency; see [Section 8.11.4, “Metadata Locking”](#). Metadata locking applies not just to tables, but also to schemas, stored programs (procedures, functions, triggers, scheduled events), tablespaces, user locks acquired with the `GET_LOCK()` function (see [Section 12.14, “Locking Functions”](#)), and locks acquired with the locking service described in [Section 5.5.6.1, “The Locking Service”](#).

The Performance Schema exposes metadata lock information through the `metadata_locks` table:

- Locks that have been granted (shows which sessions own which current metadata locks).
- Locks that have been requested but not yet granted (shows which sessions are waiting for which metadata locks).
- Lock requests that have been killed by the deadlock detector.
- Lock requests that have timed out and are waiting for the requesting session's lock request to be discarded.

This information enables you to understand metadata lock dependencies between sessions. You can see not only which lock a session is waiting for, but which session currently holds that lock.

The `metadata_locks` table is read only and cannot be updated. It is autosized by default; to configure the table size, set the `performance_schema_max_metadata_locks` system variable at server startup.

Metadata lock instrumentation uses the `wait/lock/metadata/sql/mdl` instrument, which is disabled by default.

To control metadata lock instrumentation state at server startup, use lines like these in your `my.cnf` file:

- Enable:

```
[mysqld]
performance-schema-instrument='wait/lock/metadata/sql/mdl=ON'
```

- Disable:

```
[mysqld]
performance-schema-instrument='wait/lock/metadata/sql/mdl=OFF'
```

To control metadata lock instrumentation state at runtime, update the `setup_instruments` table:

- Enable:

```
UPDATE performance_schema.setup_instruments
SET ENABLED = 'YES', TIMED = 'YES'
WHERE NAME = 'wait/lock/metadata/sql/mdl';
```

- Disable:

```
UPDATE performance_schema.setup_instruments
SET ENABLED = 'NO', TIMED = 'NO'
WHERE NAME = 'wait/lock/metadata/sql/mdl';
```

The Performance Schema maintains `metadata_locks` table content as follows, using the `LOCK_STATUS` column to indicate the status of each lock:

- When a metadata lock is requested and obtained immediately, a row with a status of `GRANTED` is inserted.

- When a metadata lock is requested and not obtained immediately, a row with a status of `PENDING` is inserted.
- When a metadata lock previously requested is granted, its row status is updated to `GRANTED`.
- When a metadata lock is released, its row is deleted.
- When a pending lock request is canceled by the deadlock detector to break a deadlock (`ER_LOCK_DEADLOCK`), its row status is updated from `PENDING` to `VICTIM`.
- When a pending lock request times out (`ER_LOCK_WAIT_TIMEOUT`), its row status is updated from `PENDING` to `TIMEOUT`.
- When granted lock or pending lock request is killed, its row status is updated from `GRANTED` or `PENDING` to `KILLED`.
- The `VICTIM`, `TIMEOUT`, and `KILLED` status values are brief and signify that the lock row is about to be deleted.
- The `PRE_ACQUIRE_NOTIFY` and `POST_RELEASE_NOTIFY` status values are brief and signify that the metadata locking subsystem is notifying interested storage engines while entering lock acquisition operations or leaving lock release operations. These status values were added in MySQL 5.7.11.

The `metadata_locks` table has these columns:

- `OBJECT_TYPE`

The type of lock used in the metadata lock subsystem. The value is one of `GLOBAL`, `SCHEMA`, `TABLE`, `FUNCTION`, `PROCEDURE`, `TRIGGER` (currently unused), `EVENT`, `COMMIT`, `USER_LEVEL_LOCK`, `TABLESPACE`, or `LOCKING_SERVICE`.

A value of `USER_LEVEL_LOCK` indicates a lock acquired with `GET_LOCK()`. A value of `LOCKING_SERVICE` indicates a lock acquired with the locking service described in [Section 5.5.6.1, “The Locking Service”](#).

- `OBJECT_SCHEMA`

The schema that contains the object.

- `OBJECT_NAME`

The name of the instrumented object.

- `OBJECT_INSTANCE_BEGIN`

The address in memory of the instrumented object.

- `LOCK_TYPE`

The lock type from the metadata lock subsystem. The value is one of `INTENTION_EXCLUSIVE`, `SHARED`, `SHARED_HIGH_PRIO`, `SHARED_READ`, `SHARED_WRITE`, `SHARED_UPGRADABLE`, `SHARED_NO_WRITE`, `SHARED_NO_READ_WRITE`, or `EXCLUSIVE`.

- `LOCK_DURATION`

The lock duration from the metadata lock subsystem. The value is one of `STATEMENT`, `TRANSACTION`, or `EXPLICIT`. The `STATEMENT` and `TRANSACTION` values signify locks that are released implicitly at statement or transaction end, respectively. The `EXPLICIT` value signifies locks that survive statement or

transaction end and are released by explicit action, such as global locks acquired with `FLUSH TABLES WITH READ LOCK`.

- `LOCK_STATUS`

The lock status from the metadata lock subsystem. The value is one of `PENDING`, `GRANTED`, `VICTIM`, `TIMEOUT`, `KILLED`, `PRE_ACQUIRE_NOTIFY`, or `POST_RELEASE_NOTIFY`. The Performance Schema assigns these values as described previously.

- `SOURCE`

The name of the source file containing the instrumented code that produced the event and the line number in the file at which the instrumentation occurs. This enables you to check the source to determine exactly what code is involved.

- `OWNER_THREAD_ID`

The thread requesting a metadata lock.

- `OWNER_EVENT_ID`

The event requesting a metadata lock.

`TRUNCATE TABLE` is not permitted for the `metadata_locks` table.

### 25.12.12.2 The `table_handles` Table

The Performance Schema exposes table lock information through the `table_handles` table to show the table locks currently in effect for each opened table handle. `table_handles` reports what is recorded by the table lock instrumentation. This information shows which table handles the server has open, how they are locked, and by which sessions.

The `table_handles` table is read only and cannot be updated. It is autosized by default; to configure the table size, set the `performance_schema_max_table_handles` system variable at server startup.

Table lock instrumentation uses the `wait/lock/table/sql/handler` instrument, which is enabled by default.

To control table lock instrumentation state at server startup, use lines like these in your `my.cnf` file:

- Enable:

```
[mysqld]
performance-schema-instrument='wait/lock/table/sql/handler=ON'
```

- Disable:

```
[mysqld]
performance-schema-instrument='wait/lock/table/sql/handler=OFF'
```

To control table lock instrumentation state at runtime, update the `setup_instruments` table:

- Enable:

```
UPDATE performance_schema.setup_instruments
SET ENABLED = 'YES', TIMED = 'YES'
WHERE NAME = 'wait/lock/table/sql/handler';
```

- Disable:

```
UPDATE performance_schema.setup_instruments
SET ENABLED = 'NO', TIMED = 'NO'
WHERE NAME = 'wait/lock/table/sql/handler';
```

The `table_handles` table has these columns:

- `OBJECT_TYPE`

The table opened by a table handle.

- `OBJECT_SCHEMA`

The schema that contains the object.

- `OBJECT_NAME`

The name of the instrumented object.

- `OBJECT_INSTANCE_BEGIN`

The table handle address in memory.

- `OWNER_THREAD_ID`

The thread owning the table handle.

- `OWNER_EVENT_ID`

The event which caused the table handle to be opened.

- `INTERNAL_LOCK`

The table lock used at the SQL level. The value is one of `READ`, `READ WITH SHARED LOCKS`, `READ HIGH PRIORITY`, `READ NO INSERT`, `WRITE ALLOW WRITE`, `WRITE CONCURRENT INSERT`, `WRITE LOW PRIORITY`, or `WRITE`. For information about these lock types, see the `include/thr_lock.h` source file.

- `EXTERNAL_LOCK`

The table lock used at the storage engine level. The value is one of `READ EXTERNAL` or `WRITE EXTERNAL`.

`TRUNCATE TABLE` is not permitted for the `table_handles` table.

## 25.12.13 Performance Schema System Variable Tables



### Note

The value of the `show_compatibility_56` system variable affects the information available from the tables described here. For details, see the description of that variable in [Section 5.1.7, “Server System Variables”](#).

The MySQL server maintains many system variables that indicate how it is configured (see [Section 5.1.7, “Server System Variables”](#)). System variable information is available in these Performance Schema tables:

- `global_variables`: Global system variables. An application that wants only global values should use this table.

- `session_variables`: System variables for the current session. An application that wants all system variable values for its own session should use this table. It includes the session variables for its session, as well as the values of global variables that have no session counterpart.
- `variables_by_thread`: Session system variables for each active session. An application that wants to know the session variable values for specific sessions should use this table. It includes session variables only, identified by thread ID.

The session variable tables (`session_variables`, `variables_by_thread`) contain information only for active sessions, not terminated sessions.

The `global_variables` and `session_variables` tables have these columns:

- `VARIABLE_NAME`

The system variable name.

- `VARIABLE_VALUE`

The system variable value. For `global_variables`, this column contains the global value. For `session_variables`, this column contains the variable value in effect for the current session.

The `variables_by_thread` table has these columns:

- `THREAD_ID`

The thread identifier of the session in which the system variable is defined.

- `VARIABLE_NAME`

The system variable name.

- `VARIABLE_VALUE`

The session variable value for the session named by the `THREAD_ID` column.

The `variables_by_thread` table contains system variable information only about foreground threads. If not all threads are instrumented by the Performance Schema, this table may miss some rows. In this case, the `Performance_schema_thread_instances_lost` status variable is greater than zero.

`TRUNCATE TABLE` is not supported for Performance Schema system variable tables.

## 25.12.14 Performance Schema Status Variable Tables



### Note

The value of the `show_compatibility_56` system variable affects the information available from the tables described here. For details, see the description of that variable in [Section 5.1.7, “Server System Variables”](#).

The MySQL server maintains many status variables that provide information about its operation (see [Section 5.1.9, “Server Status Variables”](#)). Status variable information is available in these Performance Schema tables:

- `global_status`: Global status variables. An application that wants only global values should use this table.

- `session_status`: Status variables for the current session. An application that wants all status variable values for its own session should use this table. It includes the session variables for its session, as well as the values of global variables that have no session counterpart.
- `status_by_thread`: Session status variables for each active session. An application that wants to know the session variable values for specific sessions should use this table. It includes session variables only, identified by thread ID.

There are also summary tables that provide status variable information aggregated by account, host name, and user name. See [Section 25.12.15.10, “Status Variable Summary Tables”](#).

The session variable tables (`session_status`, `status_by_thread`) contain information only for active sessions, not terminated sessions.

The Performance Schema collects statistics for global status variables only for threads for which the `INSTRUMENTED` value is `YES` in the `threads` table. Statistics for session status variables are always collected, regardless of the `INSTRUMENTED` value.

The Performance Schema does not collect statistics for `Com_***` status variables in the status variable tables. To obtain global and per-session statement execution counts, use the `events_statements_summary_global_by_event_name` and `events_statements_summary_by_thread_by_event_name` tables, respectively. For example:

```
SELECT EVENT_NAME, COUNT_STAR
FROM performance_schema.events_statements_summary_global_by_event_name
WHERE EVENT_NAME LIKE 'statement/sql/%';
```

The `global_status` and `session_status` tables have these columns:

- `VARIABLE_NAME`

The status variable name.

- `VARIABLE_VALUE`

The status variable value. For `global_status`, this column contains the global value. For `session_status`, this column contains the variable value for the current session.

The `status_by_thread` table contains the status of each active thread. It has these columns:

- `THREAD_ID`

The thread identifier of the session in which the status variable is defined.

- `VARIABLE_NAME`

The status variable name.

- `VARIABLE_VALUE`

The session variable value for the session named by the `THREAD_ID` column.

The `status_by_thread` table contains status variable information only about foreground threads. If the `performance_schema_max_thread_instances` system variable is not autoscaled (signified by a value of `-1`) and the maximum permitted number of instrumented thread objects is not greater than the number of background threads, the table is empty.

The Performance Schema supports `TRUNCATE TABLE` for status variable tables as follows:

- `global_status`: Resets thread, account, host, and user status. Resets global status variables except those that the server never resets.
- `session_status`: Not supported.
- `status_by_thread`: Aggregates status for all threads to the global status and account status, then resets thread status. If account statistics are not collected, the session status is added to host and user status, if host and user status are collected.

Account, host, and user statistics are not collected if the `performance_schema_accounts_size`, `performance_schema_hosts_size`, and `performance_schema_users_size` system variables, respectively, are set to 0.

`FLUSH STATUS` adds the session status from all active sessions to the global status variables, resets the status of all active sessions, and resets account, host, and user status values aggregated from disconnected sessions.

## 25.12.15 Performance Schema Summary Tables

Summary tables provide aggregated information for terminated events over time. The tables in this group summarize event data in different ways.

Each summary table has grouping columns that determine how to group the data to be aggregated, and summary columns that contain the aggregated values. Tables that summarize events in similar ways often have similar sets of summary columns and differ only in the grouping columns used to determine how events are aggregated.

Summary tables can be truncated with `TRUNCATE TABLE`. Generally, the effect is to reset the summary columns to 0 or `NULL`, not to remove rows. This enables you to clear collected values and restart aggregation. That might be useful, for example, after you have made a runtime configuration change. Exceptions to this truncation behavior are noted in individual summary table sections.

### Wait Event Summaries

**Table 25.3 Performance Schema Wait Event Summary Tables**

Table Name	Description
<code>events_waits_summary_by_account_by_event_name</code>	Wait events per account and event name
<code>events_waits_summary_by_host_by_event_name</code>	Wait events per host name and event name
<code>events_waits_summary_by_instance</code>	Wait events per instance
<code>events_waits_summary_by_thread_by_event_name</code>	Wait events per thread and event name
<code>events_waits_summary_by_user_by_event_name</code>	Wait events per user name and event name
<code>events_waits_summary_global_by_event_name</code>	Wait events per event name

### Stage Summaries

**Table 25.4 Performance Schema Stage Event Summary Tables**

Table Name	Description
<code>events_stages_summary_by_account_by_event_name</code>	Stage events per account and event name
<code>events_stages_summary_by_host_by_event_name</code>	Stage events per host name and event name
<code>events_stages_summary_by_thread_by_event_name</code>	Stage events per thread and event name
<code>events_stages_summary_by_user_by_event_name</code>	Stage events per user name and event name

Table Name	Description
<code>events_stages_summary_global_by_event_name</code>	Stage waits per event name

## Statement Summaries

**Table 25.5 Performance Schema Statement Event Summary Tables**

Table Name	Description
<code>events_statements_summary_by_account_by_event_name</code>	Statement events per account and event name
<code>events_statements_summary_by_digest</code>	Statement events per schema and digest value
<code>events_statements_summary_by_host_by_event_name</code>	Statement events per host name and event name
<code>events_statements_summary_by_program</code>	Statement events per stored program
<code>events_statements_summary_by_thread_by_event_name</code>	Statement events per thread and event name
<code>events_statements_summary_by_user_by_event_name</code>	Statement events per user name and event name
<code>events_statements_summary_global_by_event_name</code>	Statement events per event name
<code>prepared_statements_instances</code>	Prepared statement instances and statistics

## Transaction Summaries

**Table 25.6 Performance Schema Transaction Event Summary Tables**

Table Name	Description
<code>events_transactions_summary_by_account_by_event_name</code>	Transaction events per account and event name
<code>events_transactions_summary_by_host_by_event_name</code>	Transaction events per host name and event name
<code>events_transactions_summary_by_thread_by_event_name</code>	Transaction events per thread and event name
<code>events_transactions_summary_by_user_by_event_name</code>	Transaction events per user name and event name
<code>events_transactions_summary_global_by_event_name</code>	Transaction events per event name

## Object Wait Summaries

**Table 25.7 Performance Schema Object Event Summary Tables**

Table Name	Description
<code>objects_summary_global_by_type</code>	Object summaries

## File I/O Summaries

**Table 25.8 Performance Schema File I/O Event Summary Tables**

Table Name	Description
<code>file_summary_by_event_name</code>	File events per event name
<code>file_summary_by_instance</code>	File events per file instance

## Table I/O and Lock Wait Summaries

**Table 25.9 Performance Schema Table I/O and Lock Wait Event Summary Tables**

Table Name	Description
<code>table_io_waits_summary_by_index_usage</code>	Table I/O waits per index



Table Name	Description
<code>table_io_waits_summary_by_table</code>	Table I/O waits per table
<code>table_lock_waits_summary_by_table</code>	Table lock waits per table

## Socket Summaries

**Table 25.10 Performance Schema Socket Event Summary Tables**

Table Name	Description
<code>socket_summary_by_event_name</code>	Socket waits and I/O per event name
<code>socket_summary_by_instance</code>	Socket waits and I/O per instance

## Memory Summaries

**Table 25.11 Performance Schema Memory Operation Summary Tables**

Table Name	Description
<code>memory_summary_by_account_by_event_name</code>	Memory operations per account and event name
<code>memory_summary_by_host_by_event_name</code>	Memory operations per host and event name
<code>memory_summary_by_thread_by_event_name</code>	Memory operations per thread and event name
<code>memory_summary_by_user_by_event_name</code>	Memory operations per user and event name
<code>memory_summary_global_by_event_name</code>	Memory operations globally per event name

## Status Variable Summaries

**Table 25.12 Performance Schema Error Status Variable Summary Tables**

Table Name	Description
<code>status_by_account</code>	Session status variables per account
<code>status_by_host</code>	Session status variables per host name
<code>status_by_user</code>	Session status variables per user name

### 25.12.15.1 Wait Event Summary Tables

The Performance Schema maintains tables for collecting current and recent wait events, and aggregates that information in summary tables. [Section 25.12.4, “Performance Schema Wait Event Tables”](#) describes the events on which wait summaries are based. See that discussion for information about the content of wait events, the current and recent wait event tables, and how to control wait event collection, which is disabled by default.

Example wait event summary information:

```
mysql> SELECT *
        FROM performance_schema.events_waits_summary_global_by_event_name\G
...
***** 6. row *****
      EVENT_NAME: wait/synch/mutex/sql/BINARY_LOG::LOCK_index
      COUNT_STAR: 8
      SUM_TIMER_WAIT: 2119302
      MIN_TIMER_WAIT: 196092
      AVG_TIMER_WAIT: 264912
```

```

MAX_TIMER_WAIT: 569421
...
***** 9. row *****
EVENT_NAME: wait/synch/mutex/sql/hash_filo::lock
COUNT_STAR: 69
SUM_TIMER_WAIT: 16848828
MIN_TIMER_WAIT: 0
AVG_TIMER_WAIT: 244185
MAX_TIMER_WAIT: 735345
...

```

Each wait event summary table has one or more grouping columns to indicate how the table aggregates events. Event names refer to names of event instruments in the `setup_instruments` table:

- `events_waits_summary_by_account_by_event_name` has `EVENT_NAME`, `USER`, and `HOST` columns. Each row summarizes events for a given account (user and host combination) and event name.
- `events_waits_summary_by_host_by_event_name` has `EVENT_NAME` and `HOST` columns. Each row summarizes events for a given host and event name.
- `events_waits_summary_by_instance` has `EVENT_NAME` and `OBJECT_INSTANCE_BEGIN` columns. Each row summarizes events for a given event name and object. If an instrument is used to create multiple instances, each instance has a unique `OBJECT_INSTANCE_BEGIN` value and is summarized separately in this table.
- `events_waits_summary_by_thread_by_event_name` has `THREAD_ID` and `EVENT_NAME` columns. Each row summarizes events for a given thread and event name.
- `events_waits_summary_by_user_by_event_name` has `EVENT_NAME` and `USER` columns. Each row summarizes events for a given user and event name.
- `events_waits_summary_global_by_event_name` has an `EVENT_NAME` column. Each row summarizes events for a given event name. An instrument might be used to create multiple instances of the instrumented object. For example, if there is an instrument for a mutex that is created for each connection, there are as many instances as there are connections. The summary row for the instrument summarizes over all these instances.

Each wait event summary table has these summary columns containing aggregated values:

- `COUNT_STAR`  
The number of summarized events. This value includes all events, whether timed or nontimed.
- `SUM_TIMER_WAIT`  
The total wait time of the summarized timed events. This value is calculated only for timed events because nontimed events have a wait time of `NULL`. The same is true for the other `xxx_TIMER_WAIT` values.
- `MIN_TIMER_WAIT`  
The minimum wait time of the summarized timed events.
- `AVG_TIMER_WAIT`  
The average wait time of the summarized timed events.
- `MAX_TIMER_WAIT`

The maximum wait time of the summarized timed events.

`TRUNCATE TABLE` is permitted for wait summary tables. It has these effects:

- For summary tables not aggregated by account, host, or user, truncation resets the summary columns to zero rather than removing rows.
- For summary tables aggregated by account, host, or user, truncation removes rows for accounts, hosts, or users with no connections, and resets the summary columns to zero for the remaining rows.

In addition, each wait summary table that is aggregated by account, host, user, or thread is implicitly truncated by truncation of the connection table on which it depends, or truncation of `events_waits_summary_global_by_event_name`. For details, see [Section 25.12.8, “Performance Schema Connection Tables”](#).

### 25.12.15.2 Stage Summary Tables

The Performance Schema maintains tables for collecting current and recent stage events, and aggregates that information in summary tables. [Section 25.12.5, “Performance Schema Stage Event Tables”](#) describes the events on which stage summaries are based. See that discussion for information about the content of stage events, the current and historical stage event tables, and how to control stage event collection, which is disabled by default.

Example stage event summary information:

```
mysql> SELECT *
      FROM performance_schema.events_stages_summary_global_by_event_name\G
...
***** 5. row *****
      EVENT_NAME: stage/sql/checking permissions
      COUNT_STAR: 57
      SUM_TIMER_WAIT: 26501888880
      MIN_TIMER_WAIT: 7317456
      AVG_TIMER_WAIT: 464945295
      MAX_TIMER_WAIT: 12858936792
...
***** 9. row *****
      EVENT_NAME: stage/sql/closing tables
      COUNT_STAR: 37
      SUM_TIMER_WAIT: 662606568
      MIN_TIMER_WAIT: 1593864
      AVG_TIMER_WAIT: 17907891
      MAX_TIMER_WAIT: 437977248
...
```

Each stage summary table has one or more grouping columns to indicate how the table aggregates events. Event names refer to names of event instruments in the `setup_instruments` table:

- `events_stages_summary_by_account_by_event_name` has `EVENT_NAME`, `USER`, and `HOST` columns. Each row summarizes events for a given account (user and host combination) and event name.
- `events_stages_summary_by_host_by_event_name` has `EVENT_NAME` and `HOST` columns. Each row summarizes events for a given host and event name.
- `events_stages_summary_by_thread_by_event_name` has `THREAD_ID` and `EVENT_NAME` columns. Each row summarizes events for a given thread and event name.
- `events_stages_summary_by_user_by_event_name` has `EVENT_NAME` and `USER` columns. Each row summarizes events for a given user and event name.

- `events_stages_summary_global_by_event_name` has an `EVENT_NAME` column. Each row summarizes events for a given event name.

Each stage summary table has these summary columns containing aggregated values: `COUNT_STAR`, `SUM_TIMER_WAIT`, `MIN_TIMER_WAIT`, `AVG_TIMER_WAIT`, and `MAX_TIMER_WAIT`. These columns are analogous to the columns of the same names in the wait event summary tables (see [Section 25.12.15.1, “Wait Event Summary Tables”](#)), except that the stage summary tables aggregate events from `events_stages_current` rather than `events_waits_current`.

`TRUNCATE TABLE` is permitted for stage summary tables. It has these effects:

- For summary tables not aggregated by account, host, or user, truncation resets the summary columns to zero rather than removing rows.
- For summary tables aggregated by account, host, or user, truncation removes rows for accounts, hosts, or users with no connections, and resets the summary columns to zero for the remaining rows.

In addition, each stage summary table that is aggregated by account, host, user, or thread is implicitly truncated by truncation of the connection table on which it depends, or truncation of `events_stages_summary_global_by_event_name`. For details, see [Section 25.12.8, “Performance Schema Connection Tables”](#).

### 25.12.15.3 Statement Summary Tables

The Performance Schema maintains tables for collecting current and recent statement events, and aggregates that information in summary tables. [Section 25.12.6, “Performance Schema Statement Event Tables”](#) describes the events on which statement summaries are based. See that discussion for information about the content of statement events, the current and historical statement event tables, and how to control statement event collection, which is partially disabled by default.

Example statement event summary information:

```
mysql> SELECT *
      FROM performance_schema.events_statements_summary_global_by_event_name\G
***** 1. row *****
      EVENT_NAME: statement/sql/select
      COUNT_STAR: 25
      SUM_TIMER_WAIT: 1535983999000
      MIN_TIMER_WAIT: 209823000
      AVG_TIMER_WAIT: 61439359000
      MAX_TIMER_WAIT: 1363397650000
      SUM_LOCK_TIME: 20186000000
      SUM_ERRORS: 0
      SUM_WARNINGS: 0
      SUM_ROWS_AFFECTED: 0
      SUM_ROWS_SENT: 388
      SUM_ROWS_EXAMINED: 370
SUM_CREATED_TMP_DISK_TABLES: 0
SUM_CREATED_TMP_TABLES: 0
SUM_SELECT_FULL_JOIN: 0
SUM_SELECT_FULL_RANGE_JOIN: 0
SUM_SELECT_RANGE: 0
SUM_SELECT_RANGE_CHECK: 0
SUM_SELECT_SCAN: 6
SUM_SORT_MERGE_PASSES: 0
SUM_SORT_RANGE: 0
SUM_SORT_ROWS: 0
SUM_SORT_SCAN: 0
SUM_NO_INDEX_USED: 6
SUM_NO_GOOD_INDEX_USED: 0
...

```

Each statement summary table has one or more grouping columns to indicate how the table aggregates events. Event names refer to names of event instruments in the `setup_instruments` table:

- `events_statements_summary_by_account_by_event_name` has `EVENT_NAME`, `USER`, and `HOST` columns. Each row summarizes events for a given account (user and host combination) and event name.
- `events_statements_summary_by_digest` has `SCHEMA_NAME` and `DIGEST` columns. Each row summarizes events per schema and digest value. (The `DIGEST_TEXT` column contains the corresponding normalized statement digest text, but is neither a grouping nor a summary column.)

The maximum number of rows in the table is autosized at server startup. To set this maximum explicitly, set the `performance_schema_digests_size` system variable at server startup.

- `events_statements_summary_by_host_by_event_name` has `EVENT_NAME` and `HOST` columns. Each row summarizes events for a given host and event name.
- `events_statements_summary_by_program` has `OBJECT_TYPE`, `OBJECT_SCHEMA`, and `OBJECT_NAME` columns. Each row summarizes events for a given stored program (stored procedure or function, trigger, or event).
- `events_statements_summary_by_thread_by_event_name` has `THREAD_ID` and `EVENT_NAME` columns. Each row summarizes events for a given thread and event name.
- `events_statements_summary_by_user_by_event_name` has `EVENT_NAME` and `USER` columns. Each row summarizes events for a given user and event name.
- `events_statements_summary_global_by_event_name` has an `EVENT_NAME` column. Each row summarizes events for a given event name.
- `prepared_statements_instances` has an `OBJECT_INSTANCE_BEGIN` column. Each row summarizes events for a given prepared statement.

Each statement summary table has these summary columns containing aggregated values (with exceptions as noted):

- `COUNT_STAR`, `SUM_TIMER_WAIT`, `MIN_TIMER_WAIT`, `AVG_TIMER_WAIT`, `MAX_TIMER_WAIT`

These columns are analogous to the columns of the same names in the wait event summary tables (see [Section 25.12.15.1, "Wait Event Summary Tables"](#)), except that the statement summary tables aggregate events from `events_statements_current` rather than `events_waits_current`.

The `prepared_statements_instances` table does not have these columns.

- `SUM_xxx`

The aggregate of the corresponding `xxx` column in the `events_statements_current` table. For example, the `SUM_LOCK_TIME` and `SUM_ERRORS` columns in statement summary tables are the aggregates of the `LOCK_TIME` and `ERRORS` columns in `events_statements_current` table.

The `events_statements_summary_by_digest` table has these additional summary columns:

- `FIRST_SEEN`, `LAST_SEEN`

Timestamps indicating when statements with the given digest value were first seen and most recently seen.

The `events_statements_summary_by_program` table has these additional summary columns:

- `COUNT_STATEMENTS`, `SUM_STATEMENTS_WAIT`, `MIN_STATEMENTS_WAIT`, `AVG_STATEMENTS_WAIT`, `MAX_STATEMENTS_WAIT`

Statistics about nested statements invoked during stored program execution.

The `prepared_statements_instances` table has these additional summary columns:

- `COUNT_EXECUTE`, `SUM_TIMER_EXECUTE`, `MIN_TIMER_EXECUTE`, `AVG_TIMER_EXECUTE`, `MAX_TIMER_EXECUTE`

Aggregated statistics for executions of the prepared statement.

`TRUNCATE TABLE` is permitted for statement summary tables. It has these effects:

- For `events_statements_summary_by_digest`, it removes the rows.
- For other summary tables not aggregated by account, host, or user, truncation resets the summary columns to zero rather than removing rows.
- For other summary tables aggregated by account, host, or user, truncation removes rows for accounts, hosts, or users with no connections, and resets the summary columns to zero for the remaining rows.

In addition, each statement summary table that is aggregated by account, host, user, or thread is implicitly truncated by truncation of the connection table on which it depends, or truncation of `events_statements_summary_global_by_event_name`. For details, see [Section 25.12.8, “Performance Schema Connection Tables”](#).

### Statement Digest Aggregation Rules

If the `statements_digest` consumer is enabled, aggregation into `events_statements_summary_by_digest` occurs as follows when a statement completes. Aggregation is based on the `DIGEST` value computed for the statement.

- If a `events_statements_summary_by_digest` row already exists with the digest value for the statement that just completed, statistics for the statement are aggregated to that row. The `LAST_SEEN` column is updated to the current time.
- If no row has the digest value for the statement that just completed, and the table is not full, a new row is created for the statement. The `FIRST_SEEN` and `LAST_SEEN` columns are initialized with the current time.
- If no row has the statement digest value for the statement that just completed, and the table is full, the statistics for the statement that just completed are added to a special “catch-all” row with `DIGEST = NULL`, which is created if necessary. If the row is created, the `FIRST_SEEN` and `LAST_SEEN` columns are initialized with the current time. Otherwise, the `LAST_SEEN` column is updated with the current time.

The row with `DIGEST = NULL` is maintained because Performance Schema tables have a maximum size due to memory constraints. The `DIGEST = NULL` row permits digests that do not match other rows to be counted even if the summary table is full, using a common “other” bucket. This row helps you estimate whether the digest summary is representative:

- A `DIGEST = NULL` row that has a `COUNT_STAR` value that represents 5% of all digests shows that the digest summary table is very representative; the other rows cover 95% of the statements seen.
- A `DIGEST = NULL` row that has a `COUNT_STAR` value that represents 50% of all digests shows that the digest summary table is not very representative; the other rows cover only half the statements seen. Most likely the DBA should increase the maximum table size so that more of the rows counted in the `DIGEST = NULL` row would be counted using more specific rows instead. By default, the table is

autosized, but if this size is too small, set the `performance_schema_digests_size` system variable to a larger value at server startup.

## Stored Program Instrumentation Behavior

For stored program types for which instrumentation is enabled in the `setup_objects` table, `events_statements_summary_by_program` maintains statistics for stored programs as follows:

- A row is added for an object when it is first used in the server.
- The row for an object is removed when the object is dropped.
- Statistics are aggregated in the row for an object as it executes.

See also [Section 25.4.3, “Event Pre-Filtering”](#).

## 25.12.15.4 Transaction Summary Tables

The Performance Schema maintains tables for collecting current and recent transaction events, and aggregates that information in summary tables. [Section 25.12.7, “Performance Schema Transaction Tables”](#) describes the events on which transaction summaries are based. See that discussion for information about the content of transaction events, the current and historical transaction event tables, and how to control transaction event collection, which is disabled by default.

Example transaction event summary information:

```
mysql> SELECT *
      FROM performance_schema.events_transactions_summary_global_by_event_name
      LIMIT 1\G
***** 1. row *****
      EVENT_NAME: transaction
      COUNT_STAR: 5
      SUM_TIMER_WAIT: 19550092000
      MIN_TIMER_WAIT: 2954148000
      AVG_TIMER_WAIT: 3910018000
      MAX_TIMER_WAIT: 5486275000
      COUNT_READ_WRITE: 5
      SUM_TIMER_READ_WRITE: 19550092000
      MIN_TIMER_READ_WRITE: 2954148000
      AVG_TIMER_READ_WRITE: 3910018000
      MAX_TIMER_READ_WRITE: 5486275000
      COUNT_READ_ONLY: 0
      SUM_TIMER_READ_ONLY: 0
      MIN_TIMER_READ_ONLY: 0
      AVG_TIMER_READ_ONLY: 0
      MAX_TIMER_READ_ONLY: 0
```

Each transaction summary table has one or more grouping columns to indicate how the table aggregates events. Event names refer to names of event instruments in the `setup_instruments` table:

- `events_transactions_summary_by_account_by_event_name` has `USER`, `HOST`, and `EVENT_NAME` columns. Each row summarizes events for a given account (user and host combination) and event name.
- `events_transactions_summary_by_host_by_event_name` has `HOST` and `EVENT_NAME` columns. Each row summarizes events for a given host and event name.
- `events_transactions_summary_by_thread_by_event_name` has `THREAD_ID` and `EVENT_NAME` columns. Each row summarizes events for a given thread and event name.
- `events_transactions_summary_by_user_by_event_name` has `USER` and `EVENT_NAME` columns. Each row summarizes events for a given user and event name.

- `events_transactions_summary_global_by_event_name` has an `EVENT_NAME` column. Each row summarizes events for a given event name.

Each transaction summary table has these summary columns containing aggregated values:

- `COUNT_STAR`, `SUM_TIMER_WAIT`, `MIN_TIMER_WAIT`, `AVG_TIMER_WAIT`, `MAX_TIMER_WAIT`

These columns are analogous to the columns of the same names in the wait event summary tables (see [Section 25.12.15.1, “Wait Event Summary Tables”](#)), except that the transaction summary tables aggregate events from `events_transactions_current` rather than `events_waits_current`. These columns summarize read-write and read-only transactions.

- `COUNT_READ_WRITE`, `SUM_TIMER_READ_WRITE`, `MIN_TIMER_READ_WRITE`, `AVG_TIMER_READ_WRITE`, `MAX_TIMER_READ_WRITE`

These are similar to the `COUNT_STAR` and `xxx_TIMER_WAIT` columns, but summarize read-write transactions only. The transaction access mode specifies whether transactions operate in read/write or read-only mode.

- `COUNT_READ_ONLY`, `SUM_TIMER_READ_ONLY`, `MIN_TIMER_READ_ONLY`, `AVG_TIMER_READ_ONLY`, `MAX_TIMER_READ_ONLY`

These are similar to the `COUNT_STAR` and `xxx_TIMER_WAIT` columns, but summarize read-only transactions only. The transaction access mode specifies whether transactions operate in read/write or read-only mode.

`TRUNCATE TABLE` is permitted for transaction summary tables. It has these effects:

- For summary tables not aggregated by account, host, or user, truncation resets the summary columns to zero rather than removing rows.
- For summary tables aggregated by account, host, or user, truncation removes rows for accounts, hosts, or users with no connections, and resets the summary columns to zero for the remaining rows.

In addition, each transaction summary table that is aggregated by account, host, user, or thread is implicitly truncated by truncation of the connection table on which it depends, or truncation of `events_transactions_summary_global_by_event_name`. For details, see [Section 25.12.8, “Performance Schema Connection Tables”](#).

### Transaction Aggregation Rules

Transaction event collection occurs without regard to isolation level, access mode, or autocommit mode.

Transaction event collection occurs for all non-aborted transactions initiated by the server, including empty transactions.

Read-write transactions are generally more resource intensive than read-only transactions, therefore transaction summary tables include separate aggregate columns for read-write and read-only transactions.

Resource requirements may also vary with transaction isolation level. However, presuming that only one isolation level would be used per server, aggregation by isolation level is not provided.

### 25.12.15.5 Object Wait Summary Table

The Performance Schema maintains the `objects_summary_global_by_type` table for aggregating object wait events.



Example object wait event summary information:

```
mysql> SELECT * FROM performance_schema.objects_summary_global_by_type\G
...
***** 3. row *****
OBJECT_TYPE: TABLE
OBJECT_SCHEMA: test
OBJECT_NAME: t
COUNT_STAR: 3
SUM_TIMER_WAIT: 263126976
MIN_TIMER_WAIT: 1522272
AVG_TIMER_WAIT: 87708678
MAX_TIMER_WAIT: 258428280
...
***** 10. row *****
OBJECT_TYPE: TABLE
OBJECT_SCHEMA: mysql
OBJECT_NAME: user
COUNT_STAR: 14
SUM_TIMER_WAIT: 365567592
MIN_TIMER_WAIT: 1141704
AVG_TIMER_WAIT: 26111769
MAX_TIMER_WAIT: 334783032
...
```

The `objects_summary_global_by_type` table has these grouping columns to indicate how the table aggregates events: `OBJECT_TYPE`, `OBJECT_SCHEMA`, and `OBJECT_NAME`. Each row summarizes events for the given object.

`objects_summary_global_by_type` has the same summary columns as the `events_waits_summary_by_XXX` tables. See [Section 25.12.15.1, “Wait Event Summary Tables”](#).

`TRUNCATE TABLE` is permitted for the object summary table. It resets the summary columns to zero rather than removing rows.

### 25.12.15.6 File I/O Summary Tables

The Performance Schema maintains file I/O summary tables that aggregate information about I/O operations.

Example file I/O event summary information:

```
mysql> SELECT * FROM performance_schema.file_summary_by_event_name\G
...
***** 2. row *****
EVENT_NAME: wait/io/file/sql/binlog
COUNT_STAR: 31
SUM_TIMER_WAIT: 8243784888
MIN_TIMER_WAIT: 0
AVG_TIMER_WAIT: 265928484
MAX_TIMER_WAIT: 6490658832
...
mysql> SELECT * FROM performance_schema.file_summary_by_instance\G
...
***** 2. row *****
FILE_NAME: /var/mysql/share/english/errmsg.sys
EVENT_NAME: wait/io/file/sql/ERRMSG
EVENT_NAME: wait/io/file/sql/ERRMSG
OBJECT_INSTANCE_BEGIN: 4686193384
COUNT_STAR: 5
SUM_TIMER_WAIT: 13990154448
MIN_TIMER_WAIT: 26349624
AVG_TIMER_WAIT: 2798030607
MAX_TIMER_WAIT: 8150662536
```

Each file I/O summary table has one or more grouping columns to indicate how the table aggregates events. Event names refer to names of event instruments in the `setup_instruments` table:

- `file_summary_by_event_name` has an `EVENT_NAME` column. Each row summarizes events for a given event name.
- `file_summary_by_instance` has `FILE_NAME`, `EVENT_NAME`, and `OBJECT_INSTANCE_BEGIN` columns. Each row summarizes events for a given file and event name.

Each file I/O summary table has the following summary columns containing aggregated values. Some columns are more general and have values that are the same as the sum of the values of more fine-grained columns. In this way, aggregations at higher levels are available directly without the need for user-defined views that sum lower-level columns.

- `COUNT_STAR`, `SUM_TIMER_WAIT`, `MIN_TIMER_WAIT`, `AVG_TIMER_WAIT`, `MAX_TIMER_WAIT`

These columns aggregate all I/O operations.

- `COUNT_READ`, `SUM_TIMER_READ`, `MIN_TIMER_READ`, `AVG_TIMER_READ`, `MAX_TIMER_READ`, `SUM_NUMBER_OF_BYTES_READ`

These columns aggregate all read operations, including `FGETS`, `FGETC`, `FREAD`, and `READ`.

- `COUNT_WRITE`, `SUM_TIMER_WRITE`, `MIN_TIMER_WRITE`, `AVG_TIMER_WRITE`, `MAX_TIMER_WRITE`, `SUM_NUMBER_OF_BYTES_WRITE`

These columns aggregate all write operations, including `FPUTS`, `FPUTC`, `FPRINTF`, `VFPRINTF`, `FWRITE`, and `PWRITE`.

- `COUNT_MISC`, `SUM_TIMER_MISC`, `MIN_TIMER_MISC`, `AVG_TIMER_MISC`, `MAX_TIMER_MISC`

These columns aggregate all other I/O operations, including `CREATE`, `DELETE`, `OPEN`, `CLOSE`, `STREAM_OPEN`, `STREAM_CLOSE`, `SEEK`, `TELL`, `FLUSH`, `STAT`, `FSTAT`, `CHSIZE`, `RENAME`, and `SYNC`. There are no byte counts for these operations.

`TRUNCATE TABLE` is permitted for file I/O summary tables. It resets the summary columns to zero rather than removing rows.

The MySQL server uses several techniques to avoid I/O operations by caching information read from files, so it is possible that statements you might expect to result in I/O events do not do so. You may be able to ensure that I/O does occur by flushing caches or restarting the server to reset its state.

### 25.12.15.7 Table I/O and Lock Wait Summary Tables

The following sections describe the table I/O and lock wait summary tables:

- `table_io_waits_summary_by_index_usage`: Table I/O waits per index
- `table_io_waits_summary_by_table`: Table I/O waits per table
- `table_lock_waits_summary_by_table`: Table lock waits per table

#### The `table_io_waits_summary_by_table` Table

The `table_io_waits_summary_by_table` table aggregates all table I/O wait events, as generated by the `wait/io/table/sql/handler` instrument. The grouping is by table.

The `table_io_waits_summary_by_table` table has these grouping columns to indicate how the table aggregates events: `OBJECT_TYPE`, `OBJECT_SCHEMA`, and `OBJECT_NAME`. These columns have the same meaning as in the `events_waits_current` table. They identify the table to which the row applies.

`table_io_waits_summary_by_table` has the following summary columns containing aggregated values. As indicated in the column descriptions, some columns are more general and have values that are the same as the sum of the values of more fine-grained columns. For example, columns that aggregate all writes hold the sum of the corresponding columns that aggregate inserts, updates, and deletes. In this way, aggregations at higher levels are available directly without the need for user-defined views that sum lower-level columns.

- `COUNT_STAR`, `SUM_TIMER_WAIT`, `MIN_TIMER_WAIT`, `AVG_TIMER_WAIT`, `MAX_TIMER_WAIT`

These columns aggregate all I/O operations. They are the same as the sum of the corresponding `xxx_READ` and `xxx_WRITE` columns.

- `COUNT_READ`, `SUM_TIMER_READ`, `MIN_TIMER_READ`, `AVG_TIMER_READ`, `MAX_TIMER_READ`

These columns aggregate all read operations. They are the same as the sum of the corresponding `xxx_FETCH` columns.

- `COUNT_WRITE`, `SUM_TIMER_WRITE`, `MIN_TIMER_WRITE`, `AVG_TIMER_WRITE`, `MAX_TIMER_WRITE`

These columns aggregate all write operations. They are the same as the sum of the corresponding `xxx_INSERT`, `xxx_UPDATE`, and `xxx_DELETE` columns.

- `COUNT_FETCH`, `SUM_TIMER_FETCH`, `MIN_TIMER_FETCH`, `AVG_TIMER_FETCH`, `MAX_TIMER_FETCH`

These columns aggregate all fetch operations.

- `COUNT_INSERT`, `SUM_TIMER_INSERT`, `MIN_TIMER_INSERT`, `AVG_TIMER_INSERT`, `MAX_TIMER_INSERT`

These columns aggregate all insert operations.

- `COUNT_UPDATE`, `SUM_TIMER_UPDATE`, `MIN_TIMER_UPDATE`, `AVG_TIMER_UPDATE`, `MAX_TIMER_UPDATE`

These columns aggregate all update operations.

- `COUNT_DELETE`, `SUM_TIMER_DELETE`, `MIN_TIMER_DELETE`, `AVG_TIMER_DELETE`, `MAX_TIMER_DELETE`

These columns aggregate all delete operations.

`TRUNCATE TABLE` is permitted for table I/O summary tables. It resets the summary columns to zero rather than removing rows. Truncating this table also truncates the `table_io_waits_summary_by_index_usage` table.

### The `table_io_waits_summary_by_index_usage` Table

The `table_io_waits_summary_by_index_usage` table aggregates all table index I/O wait events, as generated by the `wait/io/table/sql/handler` instrument. The grouping is by table index.

The columns of `table_io_waits_summary_by_index_usage` are nearly identical to `table_io_waits_summary_by_table`. The only difference is the additional group column, `INDEX_NAME`, which corresponds to the name of the index that was used when the table I/O wait event was recorded:

- A value of `PRIMARY` indicates that table I/O used the primary index.
- A value of `NULL` means that table I/O used no index.
- Inserts are counted against `INDEX_NAME = NULL`.

`TRUNCATE TABLE` is permitted for table I/O summary tables. It resets the summary columns to zero rather than removing rows. This table is also truncated by truncation of the `table_io_waits_summary_by_table` table. A DDL operation that changes the index structure of a table may cause the per-index statistics to be reset.

## The `table_lock_waits_summary_by_table` Table

The `table_lock_waits_summary_by_table` table aggregates all table lock wait events, as generated by the `wait/lock/table/sql/handler` instrument. The grouping is by table.

This table contains information about internal and external locks:

- An internal lock corresponds to a lock in the SQL layer. This is currently implemented by a call to `thr_lock()`. In event rows, these locks are distinguished by the `OPERATION` column, which has one of these values:

```
read normal
read with shared locks
read high priority
read no insert
write allow write
write concurrent insert
write delayed
write low priority
write normal
```

- An external lock corresponds to a lock in the storage engine layer. This is currently implemented by a call to `handler::external_lock()`. In event rows, these locks are distinguished by the `OPERATION` column, which has one of these values:

```
read external
write external
```

The `table_lock_waits_summary_by_table` table has these grouping columns to indicate how the table aggregates events: `OBJECT_TYPE`, `OBJECT_SCHEMA`, and `OBJECT_NAME`. These columns have the same meaning as in the `events_waits_current` table. They identify the table to which the row applies.

`table_lock_waits_summary_by_table` has the following summary columns containing aggregated values. As indicated in the column descriptions, some columns are more general and have values that are the same as the sum of the values of more fine-grained columns. For example, columns that aggregate all locks hold the sum of the corresponding columns that aggregate read and write locks. In this way, aggregations at higher levels are available directly without the need for user-defined views that sum lower-level columns.

- `COUNT_STAR`, `SUM_TIMER_WAIT`, `MIN_TIMER_WAIT`, `AVG_TIMER_WAIT`, `MAX_TIMER_WAIT`

These columns aggregate all lock operations. They are the same as the sum of the corresponding `xxx_READ` and `xxx_WRITE` columns.

- `COUNT_READ`, `SUM_TIMER_READ`, `MIN_TIMER_READ`, `AVG_TIMER_READ`, `MAX_TIMER_READ`

These columns aggregate all read-lock operations. They are the same as the sum of the corresponding `xxx_READ_NORMAL`, `xxx_READ_WITH_SHARED_LOCKS`, `xxx_READ_HIGH_PRIORITY`, and `xxx_READ_NO_INSERT` columns.

- COUNT\_WRITE, SUM\_TIMER\_WRITE, MIN\_TIMER\_WRITE, AVG\_TIMER\_WRITE, MAX\_TIMER\_WRITE

These columns aggregate all write-lock operations. They are the same as the sum of the corresponding xxx\_WRITE\_ALLOW\_WRITE, xxx\_WRITE\_CONCURRENT\_INSERT, xxx\_WRITE\_LOW\_PRIORITY, and xxx\_WRITE\_NORMAL columns.

- COUNT\_READ\_NORMAL, SUM\_TIMER\_READ\_NORMAL, MIN\_TIMER\_READ\_NORMAL, AVG\_TIMER\_READ\_NORMAL, MAX\_TIMER\_READ\_NORMAL

These columns aggregate internal read locks.

- COUNT\_READ\_WITH\_SHARED\_LOCKS, SUM\_TIMER\_READ\_WITH\_SHARED\_LOCKS, MIN\_TIMER\_READ\_WITH\_SHARED\_LOCKS, AVG\_TIMER\_READ\_WITH\_SHARED\_LOCKS, MAX\_TIMER\_READ\_WITH\_SHARED\_LOCKS

These columns aggregate internal read locks.

- COUNT\_READ\_HIGH\_PRIORITY, SUM\_TIMER\_READ\_HIGH\_PRIORITY, MIN\_TIMER\_READ\_HIGH\_PRIORITY, AVG\_TIMER\_READ\_HIGH\_PRIORITY, MAX\_TIMER\_READ\_HIGH\_PRIORITY

These columns aggregate internal read locks.

- COUNT\_READ\_NO\_INSERT, SUM\_TIMER\_READ\_NO\_INSERT, MIN\_TIMER\_READ\_NO\_INSERT, AVG\_TIMER\_READ\_NO\_INSERT, MAX\_TIMER\_READ\_NO\_INSERT

These columns aggregate internal read locks.

- COUNT\_READ\_EXTERNAL, SUM\_TIMER\_READ\_EXTERNAL, MIN\_TIMER\_READ\_EXTERNAL, AVG\_TIMER\_READ\_EXTERNAL, MAX\_TIMER\_READ\_EXTERNAL

These columns aggregate external read locks.

- COUNT\_WRITE\_ALLOW\_WRITE, SUM\_TIMER\_WRITE\_ALLOW\_WRITE, MIN\_TIMER\_WRITE\_ALLOW\_WRITE, AVG\_TIMER\_WRITE\_ALLOW\_WRITE, MAX\_TIMER\_WRITE\_ALLOW\_WRITE

These columns aggregate internal write locks.

- COUNT\_WRITE\_CONCURRENT\_INSERT, SUM\_TIMER\_WRITE\_CONCURRENT\_INSERT, MIN\_TIMER\_WRITE\_CONCURRENT\_INSERT, AVG\_TIMER\_WRITE\_CONCURRENT\_INSERT, MAX\_TIMER\_WRITE\_CONCURRENT\_INSERT

These columns aggregate internal write locks.

- COUNT\_WRITE\_LOW\_PRIORITY, SUM\_TIMER\_WRITE\_LOW\_PRIORITY, MIN\_TIMER\_WRITE\_LOW\_PRIORITY, AVG\_TIMER\_WRITE\_LOW\_PRIORITY, MAX\_TIMER\_WRITE\_LOW\_PRIORITY

These columns aggregate internal write locks.

- COUNT\_WRITE\_NORMAL, SUM\_TIMER\_WRITE\_NORMAL, MIN\_TIMER\_WRITE\_NORMAL, AVG\_TIMER\_WRITE\_NORMAL, MAX\_TIMER\_WRITE\_NORMAL

These columns aggregate internal write locks.

- COUNT\_WRITE\_EXTERNAL, SUM\_TIMER\_WRITE\_EXTERNAL, MIN\_TIMER\_WRITE\_EXTERNAL, AVG\_TIMER\_WRITE\_EXTERNAL, MAX\_TIMER\_WRITE\_EXTERNAL

These columns aggregate external write locks.

`TRUNCATE TABLE` is permitted for table lock summary tables. It resets the summary columns to zero rather than removing rows.

### 25.12.15.8 Socket Summary Tables

These socket summary tables aggregate timer and byte count information for socket operations:

- `socket_summary_by_event_name`: Aggregate timer and byte count statistics generated by the `wait/io/socket/*` instruments for all socket I/O operations, per socket instrument.
- `socket_summary_by_instance`: Aggregate timer and byte count statistics generated by the `wait/io/socket/*` instruments for all socket I/O operations, per socket instance. When a connection terminates, the row in `socket_summary_by_instance` corresponding to it is deleted.

The socket summary tables do not aggregate waits generated by `idle` events while sockets are waiting for the next request from the client. For `idle` event aggregations, use the wait-event summary tables; see [Section 25.12.15.1, “Wait Event Summary Tables”](#).

Each socket summary table has one or more grouping columns to indicate how the table aggregates events. Event names refer to names of event instruments in the `setup_instruments` table:

- `socket_summary_by_event_name` has an `EVENT_NAME` column. Each row summarizes events for a given event name.
- `socket_summary_by_instance` has an `OBJECT_INSTANCE_BEGIN` column. Each row summarizes events for a given object.

Each socket summary table has these summary columns containing aggregated values:

- `COUNT_STAR`, `SUM_TIMER_WAIT`, `MIN_TIMER_WAIT`, `AVG_TIMER_WAIT`, `MAX_TIMER_WAIT`

These columns aggregate all operations.

- `COUNT_READ`, `SUM_TIMER_READ`, `MIN_TIMER_READ`, `AVG_TIMER_READ`, `MAX_TIMER_READ`, `SUM_NUMBER_OF_BYTES_READ`

These columns aggregate all receive operations (`RECV`, `RECVFROM`, and `RECVMSG`).

- `COUNT_WRITE`, `SUM_TIMER_WRITE`, `MIN_TIMER_WRITE`, `AVG_TIMER_WRITE`, `MAX_TIMER_WRITE`, `SUM_NUMBER_OF_BYTES_WRITE`

These columns aggregate all send operations (`SEND`, `SENDTO`, and `SENDMSG`).

- `COUNT_MISC`, `SUM_TIMER_MISC`, `MIN_TIMER_MISC`, `AVG_TIMER_MISC`, `MAX_TIMER_MISC`

These columns aggregate all other socket operations, such as `CONNECT`, `LISTEN`, `ACCEPT`, `CLOSE`, and `SHUTDOWN`. There are no byte counts for these operations.

The `socket_summary_by_instance` table also has an `EVENT_NAME` column that indicates the class of the socket: `client_connection`, `server_tcpip_socket`, `server_unix_socket`. This column can be grouped on to isolate, for example, client activity from that of the server listening sockets.

`TRUNCATE TABLE` is permitted for socket summary tables. Except for `events_statements_summary_by_digest`, it resets the summary columns to zero rather than removing rows.

## 25.12.15.9 Memory Summary Tables

The Performance Schema instruments memory usage and aggregates memory usage statistics, detailed by these factors:

- Type of memory used (various caches, internal buffers, and so forth)
- Thread, account, user, host indirectly performing the memory operation

The Performance Schema instruments the following aspects of memory use

- Memory sizes used
- Operation counts
- Low and high water marks

Memory sizes help to understand or tune the memory consumption of the server.

Operation counts help to understand or tune the overall pressure the server is putting on the memory allocator, which has an impact on performance. Allocating a single byte one million times is not the same as allocating one million bytes a single time; tracking both sizes and counts can expose the difference.

Low and high water marks are critical to detect workload spikes, overall workload stability, and possible memory leaks.

Memory summary tables do not contain timing information because memory events are not timed.

For information about collecting memory usage data, see [Memory Instrumentation Behavior](#).

Example memory event summary information:

```
mysql> SELECT *
      FROM performance_schema.memory_summary_global_by_event_name
      WHERE EVENT_NAME = 'memory/sql/TABLE'\G
***** 1. row *****
          EVENT_NAME: memory/sql/TABLE
          COUNT_ALLOC: 1381
          COUNT_FREE: 924
SUM_NUMBER_OF_BYTES_ALLOC: 2059873
SUM_NUMBER_OF_BYTES_FREE: 1407432
          LOW_COUNT_USED: 0
          CURRENT_COUNT_USED: 457
          HIGH_COUNT_USED: 461
          LOW_NUMBER_OF_BYTES_USED: 0
CURRENT_NUMBER_OF_BYTES_USED: 652441
          HIGH_NUMBER_OF_BYTES_USED: 669269
```

Each memory summary table has one or more grouping columns to indicate how the table aggregates events. Event names refer to names of event instruments in the [setup\\_instruments](#) table:

- [memory\\_summary\\_by\\_account\\_by\\_event\\_name](#) has `USER`, `HOST`, and `EVENT_NAME` columns. Each row summarizes events for a given account (user and host combination) and event name.
- [memory\\_summary\\_by\\_host\\_by\\_event\\_name](#) has `HOST` and `EVENT_NAME` columns. Each row summarizes events for a given host and event name.
- [memory\\_summary\\_by\\_thread\\_by\\_event\\_name](#) has `THREAD_ID` and `EVENT_NAME` columns. Each row summarizes events for a given thread and event name.

- `memory_summary_by_user_by_event_name` has `USER` and `EVENT_NAME` columns. Each row summarizes events for a given user and event name.
- `memory_summary_global_by_event_name` has an `EVENT_NAME` column. Each row summarizes events for a given event name.

Each memory summary table has these summary columns containing aggregated values:

- `COUNT_ALLOC`, `COUNT_FREE`

The aggregated numbers of calls to memory-allocation and memory-free functions.

- `SUM_NUMBER_OF_BYTES_ALLOC`, `SUM_NUMBER_OF_BYTES_FREE`

The aggregated sizes of allocated and freed memory blocks.

- `CURRENT_COUNT_USED`

The aggregated number of currently allocated blocks that have not been freed yet. This is a convenience column, equal to `COUNT_ALLOC - COUNT_FREE`.

- `CURRENT_NUMBER_OF_BYTES_USED`

The aggregated size of currently allocated memory blocks that have not been freed yet. This is a convenience column, equal to `SUM_NUMBER_OF_BYTES_ALLOC - SUM_NUMBER_OF_BYTES_FREE`.

- `LOW_COUNT_USED`, `HIGH_COUNT_USED`

The low and high water marks corresponding to the `CURRENT_COUNT_USED` column.

- `LOW_NUMBER_OF_BYTES_USED`, `HIGH_NUMBER_OF_BYTES_USED`

The low and high water marks corresponding to the `CURRENT_NUMBER_OF_BYTES_USED` column.

`TRUNCATE TABLE` is permitted for memory summary tables. It has these effects:

- In general, truncation resets the baseline for statistics, but does not change the server state. That is, truncating a memory table does not free memory.
- `COUNT_ALLOC` and `COUNT_FREE` are reset to a new baseline, by reducing each counter by the same value.
- Likewise, `SUM_NUMBER_OF_BYTES_ALLOC` and `SUM_NUMBER_OF_BYTES_FREE` are reset to a new baseline.
- `LOW_COUNT_USED` and `HIGH_COUNT_USED` are reset to `CURRENT_COUNT_USED`.
- `LOW_NUMBER_OF_BYTES_USED` and `HIGH_NUMBER_OF_BYTES_USED` are reset to `CURRENT_NUMBER_OF_BYTES_USED`.

In addition, each memory summary table that is aggregated by account, host, user, or thread is implicitly truncated by truncation of the connection table on which it depends, or truncation of `memory_summary_global_by_event_name`. For details, see [Section 25.12.8, “Performance Schema Connection Tables”](#).

### Memory Instrumentation Behavior

Memory instruments are listed in the `setup_instruments` table and have names of the form `memory/code_area/instrument_name`. Most memory instrumentation is disabled by default.



Instruments named with the prefix `memory/performance_schema/` expose how much memory is allocated for internal buffers in the Performance Schema itself. The `memory/performance_schema/` instruments are built in, always enabled, and cannot be disabled at startup or runtime. Built-in memory instruments are displayed only in the `memory_summary_global_by_event_name` table.

To control memory instrumentation state at server startup, use lines like these in your `my.cnf` file:

- Enable:

```
[mysqld]
performance-schema-instrument='memory/%=ON'
```

- Disable:

```
[mysqld]
performance-schema-instrument='memory/%=OFF'
```

To control memory instrumentation state at runtime, update the `ENABLED` column of the relevant instruments in the `setup_instruments` table:

- Enable:

```
UPDATE performance_schema.setup_instruments
SET ENABLED = 'YES'
WHERE NAME LIKE 'memory/%';
```

- Disable:

```
UPDATE performance_schema.setup_instruments
SET ENABLED = 'NO'
WHERE NAME LIKE 'memory/%';
```

For memory instruments, the `TIMED` column in `setup_instruments` is ignored because memory operations are not timed.

When a thread in the server executes a memory allocation that has been instrumented, these rules apply:

- If the thread is not instrumented or the memory instrument is not enabled, the memory block allocated is not instrumented.
- Otherwise (that is, both the thread and the instrument are enabled), the memory block allocated is instrumented.

For deallocation, these rules apply:

- If a memory allocation operation was instrumented, the corresponding free operation is instrumented, regardless of the current instrument or thread enabled status.
- If a memory allocation operation was not instrumented, the corresponding free operation is not instrumented, regardless of the current instrument or thread enabled status.

For the per-thread statistics, the following rules apply.

When an instrumented memory block of size `N` is allocated, the Performance Schema makes these updates to memory summary table columns:

- `COUNT_ALLOC`: Increased by 1
- `CURRENT_COUNT_USED`: Increased by 1
- `HIGH_COUNT_USED`: Increased if `CURRENT_COUNT_USED` is a new maximum

- `SUM_NUMBER_OF_BYTES_ALLOC`: Increased by *N*
- `CURRENT_NUMBER_OF_BYTES_USED`: Increased by *N*
- `HIGH_NUMBER_OF_BYTES_USED`: Increased if `CURRENT_NUMBER_OF_BYTES_USED` is a new maximum

When an instrumented memory block is deallocated, the Performance Schema makes these updates to memory summary table columns:

- `COUNT_FREE`: Increased by 1
- `CURRENT_COUNT_USED`: Decreased by 1
- `LOW_COUNT_USED`: Decreased if `CURRENT_COUNT_USED` is a new minimum
- `SUM_NUMBER_OF_BYTES_FREE`: Increased by *N*
- `CURRENT_NUMBER_OF_BYTES_USED`: Decreased by *N*
- `LOW_NUMBER_OF_BYTES_USED`: Decreased if `CURRENT_NUMBER_OF_BYTES_USED` is a new minimum

For higher-level aggregates (global, by account, by user, by host), the same rules apply as expected for low and high water marks.

- `LOW_COUNT_USED` and `LOW_NUMBER_OF_BYTES_USED` are lower estimates. The value reported by the Performance Schema is guaranteed to be less than or equal to the lowest count or size of memory effectively used at runtime.
- `HIGH_COUNT_USED` and `HIGH_NUMBER_OF_BYTES_USED` are higher estimates. The value reported by the Performance Schema is guaranteed to be greater than or equal to the highest count or size of memory effectively used at runtime.

For lower estimates in summary tables other than `memory_summary_global_by_event_name`, it is possible for values to go negative if memory ownership is transferred between threads.

Here is an example of estimate computation; but note that estimate implementation is subject to change:

Thread 1 uses memory in the range from 1MB to 2MB during execution, as reported by the `LOW_NUMBER_OF_BYTES_USED` and `HIGH_NUMBER_OF_BYTES_USED` columns of the `memory_summary_by_thread_by_event_name` table.

Thread 2 uses memory in the range from 10MB to 12MB during execution, as reported likewise.

When these two threads belong to the same user account, the per-account summary estimates that this account used memory in the range from 11MB to 14MB. That is, the `LOW_NUMBER_OF_BYTES_USED` for the higher level aggregate is the sum of each `LOW_NUMBER_OF_BYTES_USED` (assuming the worst case). Likewise, the `HIGH_NUMBER_OF_BYTES_USED` for the higher level aggregate is the sum of each `HIGH_NUMBER_OF_BYTES_USED` (assuming the worst case).

11MB is a lower estimate that can occur only if both threads hit the low usage mark at the same time.

14MB is a higher estimate that can occur only if both threads hit the high usage mark at the same time.

The real memory usage for this account could have been in the range from 11.5MB to 13.5MB.

For capacity planning, reporting the worst case is actually the desired behavior, as it shows what can potentially happen when sessions are uncorrelated, which is typically the case.

## 25.12.15.10 Status Variable Summary Tables



### Note

The value of the `show_compatibility_56` system variable affects the information available from the tables described here. For details, see the description of that variable in [Section 5.1.7, “Server System Variables”](#).

The Performance Schema makes status variable information available in the tables described in [Section 25.12.14, “Performance Schema Status Variable Tables”](#). It also makes aggregated status variable information available in summary tables, described here. Each status variable summary table has one or more grouping columns to indicate how the table aggregates status values:

- `status_by_account` has `USER`, `HOST`, and `VARIABLE_NAME` columns to summarize status variables by account.
- `status_by_host` has `HOST` and `VARIABLE_NAME` columns to summarize status variables by the host from which clients connected.
- `status_by_user` has `USER` and `VARIABLE_NAME` columns to summarize status variables by client user name.

Each status variable summary table has this summary column containing aggregated values:

- `VARIABLE_VALUE`

The aggregated status variable value for active and terminated sessions.

The meaning of “account” in these tables is similar to its meaning in the MySQL grant tables in the `mysql` system database, in the sense that the term refers to a combination of user and host values. They differ in that, for grant tables, the host part of an account can be a pattern, whereas for Performance Schema tables, the host value is always a specific nonpattern host name.

Account status is collected when sessions terminate. The session status counters are added to the global status counters and the corresponding account status counters. If account statistics are not collected, the session status is added to host and user status, if host and user status are collected.

Account, host, and user statistics are not collected if the `performance_schema_accounts_size`, `performance_schema_hosts_size`, and `performance_schema_users_size` system variables, respectively, are set to 0.

The Performance Schema supports `TRUNCATE TABLE` for status variable summary tables as follows; in all cases, status for active sessions is unaffected:

- `status_by_account`: Aggregates account status from terminated sessions to user and host status, then resets account status.
- `status_by_host`: Resets aggregated host status from terminated sessions.
- `status_by_user`: Resets aggregated user status from terminated sessions.

`FLUSH STATUS` adds the session status from all active sessions to the global status variables, resets the status of all active sessions, and resets account, host, and user status values aggregated from disconnected sessions.

## 25.12.16 Performance Schema Miscellaneous Tables

The following sections describe tables that do not fall into the table categories discussed in the preceding sections:

- `host_cache`: Information from the internal host cache.
- `performance_timers`: Which event timers are available.
- `threads`: Information about server threads.

### 25.12.16.1 The `host_cache` Table

The MySQL server maintains an in-memory host cache that contains client host name and IP address information and is used to avoid Domain Name System (DNS) lookups. The `host_cache` table exposes the contents of this cache. The `host_cache_size` system variable controls the size of the host cache, as well as the size of the `host_cache` table. For operational and configuration information about the host cache, see [Section 5.1.11.2, “DNS Lookups and the Host Cache”](#).

Because the `host_cache` table exposes the contents of the host cache, it can be examined using `SELECT` statements. This may help you diagnose the causes of connection problems. The Performance Schema must be enabled or this table is empty.

The `host_cache` table has these columns:

- `IP`

The IP address of the client that connected to the server, expressed as a string.

- `HOST`

The resolved DNS host name for that client IP, or `NULL` if the name is unknown.

- `HOST_VALIDATED`

Whether the IP-to-host name-to-IP DNS resolution was performed successfully for the client IP. If `HOST_VALIDATED` is `YES`, the `HOST` column is used as the host name corresponding to the IP so that additional calls to DNS can be avoided. While `HOST_VALIDATED` is `NO`, DNS resolution is attempted for each connection attempt, until it eventually completes with either a valid result or a permanent error. This information enables the server to avoid caching bad or missing host names during temporary DNS failures, which would negatively affect clients forever.

- `SUM_CONNECT_ERRORS`

The number of connection errors that are deemed “blocking” (assessed against the `max_connect_errors` system variable). Only protocol handshake errors are counted, and only for hosts that passed validation (`HOST_VALIDATED = YES`).

Once `SUM_CONNECT_ERRORS` for a given host reaches the value of `max_connect_errors`, new connections from that host are blocked. The `SUM_CONNECT_ERRORS` value can exceed the `max_connect_errors` value because multiple connection attempts from a host can occur simultaneously while the host is not blocked. Any or all of them can fail, independently incrementing `SUM_CONNECT_ERRORS`, possibly beyond the value of `max_connect_errors`.

Suppose that `max_connect_errors` is 200 and `SUM_CONNECT_ERRORS` for a given host is 199. If 10 clients attempt to connect from that host simultaneously, none of them are blocked because `SUM_CONNECT_ERRORS` has not reached 200. If blocking errors occur for five of the clients, `SUM_CONNECT_ERRORS` is increased by one for each client, for a resulting `SUM_CONNECT_ERRORS` value of 204. The other five clients succeed and are not blocked because the value of `SUM_CONNECT_ERRORS` when their connection attempts began had not reached 200. New connections from the host that begin after `SUM_CONNECT_ERRORS` reaches 200 are blocked.

- `COUNT_HOST_BLOCKED_ERRORS`

The number of connections that were blocked because `SUM_CONNECT_ERRORS` exceeded the value of the `max_connect_errors` system variable.

- `COUNT_NAMEINFO_TRANSIENT_ERRORS`

The number of transient errors during IP-to-host name DNS resolution.

- `COUNT_NAMEINFO_PERMANENT_ERRORS`

The number of permanent errors during IP-to-host name DNS resolution.

- `COUNT_FORMAT_ERRORS`

The number of host name format errors. MySQL does not perform matching of `Host` column values in the `mysql.user` system table against host names for which one or more of the initial components of the name are entirely numeric, such as `1.2.example.com`. The client IP address is used instead. For the rationale why this type of matching does not occur, see [Section 6.2.4, “Specifying Account Names”](#).

- `COUNT_ADDRINFO_TRANSIENT_ERRORS`

The number of transient errors during host name-to-IP reverse DNS resolution.

- `COUNT_ADDRINFO_PERMANENT_ERRORS`

The number of permanent errors during host name-to-IP reverse DNS resolution.

- `COUNT_FCRDNS_ERRORS`

The number of forward-confirmed reverse DNS errors. These errors occur when IP-to-host name-to-IP DNS resolution produces an IP address that does not match the client originating IP address.

- `COUNT_HOST_ACL_ERRORS`

The number of errors that occur because no users are permitted to connect from the client host. In such cases, the server returns `ER_HOST_NOT_PRIVILEGED` and does not even ask for a user name or password.

- `COUNT_NO_AUTH_PLUGIN_ERRORS`

The number of errors due to requests for an unavailable authentication plugin. A plugin can be unavailable if, for example, it was never loaded or a load attempt failed.

- `COUNT_AUTH_PLUGIN_ERRORS`

The number of errors reported by authentication plugins.

An authentication plugin can report different error codes to indicate the root cause of a failure. Depending on the type of error, one of these columns is incremented: `COUNT_AUTHENTICATION_ERRORS`, `COUNT_AUTH_PLUGIN_ERRORS`, `COUNT_HANDSHAKE_ERRORS`. New return codes are an optional extension to the existing plugin API. Unknown or unexpected plugin errors are counted in the `COUNT_AUTH_PLUGIN_ERRORS` column.

- `COUNT_HANDSHAKE_ERRORS`

The number of errors detected at the wire protocol level.

- `COUNT_PROXY_USER_ERRORS`

---

The number of errors detected when proxy user A is proxied to another user B who does not exist.

- `COUNT_PROXY_USER_ACL_ERRORS`

The number of errors detected when proxy user A is proxied to another user B who does exist but for whom A does not have the `PROXY` privilege.

- `COUNT_AUTHENTICATION_ERRORS`

The number of errors caused by failed authentication.

- `COUNT_SSL_ERRORS`

The number of errors due to SSL problems.

- `COUNT_MAX_USER_CONNECTIONS_ERRORS`

The number of errors caused by exceeding per-user connection quotas. See [Section 6.2.16, “Setting Account Resource Limits”](#).

- `COUNT_MAX_USER_CONNECTIONS_PER_HOUR_ERRORS`

The number of errors caused by exceeding per-user connections-per-hour quotas. See [Section 6.2.16, “Setting Account Resource Limits”](#).

- `COUNT_DEFAULT_DATABASE_ERRORS`

The number of errors related to the default database. For example, the database does not exist or the user has no privileges to access it.

- `COUNT_INIT_CONNECT_ERRORS`

The number of errors caused by execution failures of statements in the `init_connect` system variable value.

- `COUNT_LOCAL_ERRORS`

The number of errors local to the server implementation and not related to the network, authentication, or authorization. For example, out-of-memory conditions fall into this category.

- `COUNT_UNKNOWN_ERRORS`

The number of other, unknown errors not accounted for by other columns in this table. This column is reserved for future use, in case new error conditions must be reported, and if preserving the backward compatibility and structure of the `host_cache` table is required.

- `FIRST_SEEN`

The timestamp of the first connection attempt seen from the client in the `IP` column.

- `LAST_SEEN`

The timestamp of the most recent connection attempt seen from the client in the `IP` column.

- `FIRST_ERROR_SEEN`

The timestamp of the first error seen from the client in the `IP` column.

- `LAST_ERROR_SEEN`

The timestamp of the most recent error seen from the client in the `IP` column.

`TRUNCATE TABLE` is permitted for the `host_cache` table. It requires the `DROP` privilege for the table. Truncating the table flushes the host cache, which has the effects described in [Flushing the Host Cache](#).

### 25.12.16.2 The `performance_timers` Table

The `performance_timers` table shows which event timers are available:

```
mysql> SELECT * FROM performance_schema.performance_timers;
```

TIMER_NAME	TIMER_FREQUENCY	TIMER_RESOLUTION	TIMER_OVERHEAD
CYCLE	2389029850	1	72
NANOSECOND	1000000000	1	112
MICROSECOND	1000000	1	136
MILLISECOND	1036	1	168
TICK	105	1	2416

If the values associated with a given timer name are `NULL`, that timer is not supported on your platform. The rows that do not contain `NULL` indicate which timers you can use in `setup_timers`. For an explanation of how event timing occurs, see [Section 25.4.1, “Performance Schema Event Timing”](#).



#### Note

As of MySQL 5.7.21, the Performance Schema `setup_timers` table is deprecated and is removed in MySQL 8.0, as is the `TICKS` row in the `performance_timers` table.

The `performance_timers` table has these columns:

- `TIMER_NAME`

The name by which to refer to the timer when configuring the `setup_timers` table.

- `TIMER_FREQUENCY`

The number of timer units per second. For a cycle timer, the frequency is generally related to the CPU speed. For example, on a system with a 2.4GHz processor, the `CYCLE` may be close to 2400000000.

- `TIMER_RESOLUTION`

Indicates the number of timer units by which timer values increase. If a timer has a resolution of 10, its value increases by 10 each time.

- `TIMER_OVERHEAD`

The minimal number of cycles of overhead to obtain one timing with the given timer. The Performance Schema determines this value by invoking the timer 20 times during initialization and picking the smallest value. The total overhead really is twice this amount because the instrumentation invokes the timer at the start and end of each event. The timer code is called only for timed events, so this overhead does not apply for nontimed events.

`TRUNCATE TABLE` is not permitted for the `performance_timers` table.

### 25.12.16.3 The `processlist` Table

**Note**

The `processlist` table is automatically created in the Performance Schema for new installations of MySQL 5.7.39, or higher. It is also created automatically by an upgrade.

The MySQL process list indicates the operations currently being performed by the set of threads executing within the server. The `processlist` table is one source of process information. For a comparison of this table with other sources, see [Sources of Process Information](#).

The `processlist` table can be queried directly. If you have the `PROCESS` privilege, you can see all threads, even those belonging to other users. Otherwise (without the `PROCESS` privilege), nonanonymous users have access to information about their own threads but not threads for other users, and anonymous users have no access to thread information.

**Note**

If the `performance_schema_show_processlist` system variable is enabled, the `processlist` table also serves as the basis for an alternative implementation underlying the `SHOW PROCESSLIST` statement. For details, see later in this section.

The `processlist` table contains a row for each server process:

```
mysql> SELECT * FROM performance_schema.processlist\G
***** 1. row *****
      ID: 5
      USER: event_scheduler
      HOST: localhost
      DB: NULL
COMMAND: Daemon
      TIME: 137
      STATE: Waiting on empty queue
      INFO: NULL
***** 2. row *****
      ID: 9
      USER: me
      HOST: localhost:58812
      DB: NULL
COMMAND: Sleep
      TIME: 95
      STATE:
      INFO: NULL
***** 3. row *****
      ID: 10
      USER: me
      HOST: localhost:58834
      DB: test
COMMAND: Query
      TIME: 0
      STATE: executing
      INFO: SELECT * FROM performance_schema.processlist
...

```

The `processlist` table has these columns:

- `ID`

The connection identifier. This is the same value displayed in the `Id` column of the `SHOW PROCESSLIST` statement, displayed in the `PROCESSLIST_ID` column of the Performance Schema `threads` table, and returned by the `CONNECTION_ID()` function within the thread.

- `USER`



The MySQL user who issued the statement. A value of `system user` refers to a nonclient thread spawned by the server to handle tasks internally, for example, a delayed-row handler thread or an I/O or SQL thread used on replica hosts. For `system user`, there is no host specified in the `Host` column. `unauthenticated user` refers to a thread that has become associated with a client connection but for which authentication of the client user has not yet occurred. `event_scheduler` refers to the thread that monitors scheduled events (see [Section 23.4, “Using the Event Scheduler”](#)).



### Note

A `USER` value of `system user` is distinct from the `SYSTEM_USER` privilege. The former designates internal threads. The latter distinguishes the system user and regular user account categories (see [Account Categories](#)).

- `HOST`

The host name of the client issuing the statement (except for `system user`, for which there is no host). The host name for TCP/IP connections is reported in `host_name:client_port` format to make it easier to determine which client is doing what.

- `DB`

The default database for the thread, or `NULL` if none has been selected.

- `COMMAND`

The type of command the thread is executing on behalf of the client, or `Sleep` if the session is idle. For descriptions of thread commands, see [Section 8.14, “Examining Server Thread \(Process\) Information”](#). The value of this column corresponds to the `COM_xxxx` commands of the client/server protocol and `Com_xxxx` status variables. See [Section 5.1.9, “Server Status Variables”](#)

- `TIME`

The time in seconds that the thread has been in its current state. For a replica SQL thread, the value is the number of seconds between the timestamp of the last replicated event and the real time of the replica host. See [Section 16.2.3, “Replication Threads”](#).

- `STATE`

An action, event, or state that indicates what the thread is doing. For descriptions of `STATE` values, see [Section 8.14, “Examining Server Thread \(Process\) Information”](#).

Most states correspond to very quick operations. If a thread stays in a given state for many seconds, there might be a problem that needs to be investigated.

- `INFO`

The statement the thread is executing, or `NULL` if it is executing no statement. The statement might be the one sent to the server, or an innermost statement if the statement executes other statements. For example, if a `CALL` statement executes a stored procedure that is executing a `SELECT` statement, the `INFO` value shows the `SELECT` statement.

- `EXECUTION_ENGINE`

The query execution engine. The value is either `PRIMARY` or `SECONDARY`. For use with MySQL HeatWave Service and MySQL HeatWave, where the `PRIMARY` engine is `InnoDB` and the `SECONDARY` engine is MySQL HeatWave (`RAPID`). For MySQL Community Edition Server, MySQL Enterprise Edition

Server (on-premise), and MySQL HeatWave Service without MySQL HeatWave, the value is always `PRIMARY`. This column was added in MySQL 8.0.29.

`TRUNCATE TABLE` is not permitted for the `processlist` table.

As mentioned previously, if the `performance_schema_show_processlist` system variable is enabled, the `processlist` table serves as the basis for an alternative implementation of other process information sources:

- The `SHOW PROCESSLIST` statement.
- The `mysqladmin processlist` command (which uses `SHOW PROCESSLIST` statement).

The default `SHOW PROCESSLIST` implementation iterates across active threads from within the thread manager while holding a global mutex. This has negative performance consequences, particularly on busy systems. The alternative `SHOW PROCESSLIST` implementation is based on the Performance Schema `processlist` table. This implementation queries active thread data from the Performance Schema rather than the thread manager and does not require a mutex.

MySQL configuration affects `processlist` table contents as follows:

- Minimum required configuration:
  - The MySQL server must be configured and built with thread instrumentation enabled. This is true by default; it is controlled using the `DISABLE_PSI_THREAD` CMake option.
  - The Performance Schema must be enabled at server startup. This is true by default; it is controlled using the `performance_schema` system variable.

With that configuration satisfied, `performance_schema_show_processlist` enables or disables the alternative `SHOW PROCESSLIST` implementation. If the minimum configuration is not satisfied, the `processlist` table (and thus `SHOW PROCESSLIST`) may not return all data.

- Recommended configuration:
  - To avoid having some threads ignored:
    - Leave the `performance_schema_max_thread_instances` system variable set to its default or set it at least as great as the `max_connections` system variable.
    - Leave the `performance_schema_max_thread_classes` system variable set to its default.
  - To avoid having some `STATE` column values be empty, leave the `performance_schema_max_stage_classes` system variable set to its default.

The default for those configuration parameters is `-1`, which causes the Performance Schema to autosize them at server startup. With the parameters set as indicated, the `processlist` table (and thus `SHOW PROCESSLIST`) produce complete process information.

The preceding configuration parameters affect the contents of the `processlist` table. For a given configuration, however, the `processlist` contents are unaffected by the `performance_schema_show_processlist` setting.

The alternative process list implementation does not apply to the `INFORMATION_SCHEMA PROCESSLIST` table or the `COM_PROCESS_INFO` command of the MySQL client/server protocol.

#### 25.12.16.4 The threads Table

The `threads` table contains a row for each server thread. Each row contains information about a thread and indicates whether monitoring and historical event logging are enabled for it:

```
mysql> SELECT * FROM performance_schema.threads\G
***** 1. row *****
      THREAD_ID: 1
        NAME: thread/sql/main
         TYPE: BACKGROUND
PROCESSLIST_ID: NULL
PROCESSLIST_USER: NULL
PROCESSLIST_HOST: NULL
PROCESSLIST_DB: NULL
PROCESSLIST_COMMAND: NULL
PROCESSLIST_TIME: 80284
PROCESSLIST_STATE: NULL
PROCESSLIST_INFO: NULL
PARENT_THREAD_ID: NULL
          ROLE: NULL
INSTRUMENTED: YES
      HISTORY: YES
CONNECTION_TYPE: NULL
      THREAD_OS_ID: 489803
...
***** 4. row *****
      THREAD_ID: 51
        NAME: thread/sql/one_connection
         TYPE: FOREGROUND
PROCESSLIST_ID: 34
PROCESSLIST_USER: isabella
PROCESSLIST_HOST: localhost
PROCESSLIST_DB: performance_schema
PROCESSLIST_COMMAND: Query
PROCESSLIST_TIME: 0
PROCESSLIST_STATE: Sending data
PROCESSLIST_INFO: SELECT * FROM performance_schema.threads
PARENT_THREAD_ID: 1
          ROLE: NULL
INSTRUMENTED: YES
      HISTORY: YES
CONNECTION_TYPE: SSL/TLS
      THREAD_OS_ID: 755399
...
```

When the Performance Schema initializes, it populates the `threads` table based on the threads in existence then. Thereafter, a new row is added each time the server creates a thread.

The `INSTRUMENTED` and `HISTORY` column values for new threads are determined by the contents of the `setup_actors` table. For information about how to use the `setup_actors` table to control these columns, see [Section 25.4.6, “Pre-Filtering by Thread”](#).

Removal of rows from the `threads` table occurs when threads end. For a thread associated with a client session, removal occurs when the session ends. If a client has auto-reconnect enabled and the session reconnects after a disconnect, the session becomes associated with a new row in the `threads` table that has a different `PROCESSLIST_ID` value. The initial `INSTRUMENTED` and `HISTORY` values for the new thread may be different from those of the original thread: The `setup_actors` table may have changed in the meantime, and if the `INSTRUMENTED` or `HISTORY` value for the original thread was changed after the row was initialized, the change does not carry over to the new thread.

You can enable or disable thread monitoring (that is, whether events executed by the thread are instrumented) and historical event logging. To control the initial `INSTRUMENTED` and `HISTORY` values for new foreground threads, use the `setup_actors` table. To control these aspects of existing threads, set the `INSTRUMENTED` and `HISTORY` columns of `threads` table rows. (For more information about the

conditions under which thread monitoring and historical event logging occur, see the descriptions of the `INSTRUMENTED` and `HISTORY` columns.)

For a comparison of the `threads` table columns with names having a prefix of `PROCESSLIST_` to other process information sources, see [Sources of Process Information](#).



### Important

For thread information sources other than the `threads` table, information about threads for other users is shown only if the current user has the `PROCESS` privilege. That is not true of the `threads` table; all rows are shown to any user who has the `SELECT` privilege for the table. Users who should not be able to see threads for other users by accessing the `threads` table should not be given the `SELECT` privilege for it.

The `threads` table has these columns:

- `THREAD_ID`

A unique thread identifier.

- `NAME`

The name associated with the thread instrumentation code in the server. For example, `thread/sql/one_connection` corresponds to the thread function in the code responsible for handling a user connection, and `thread/sql/main` stands for the `main()` function of the server.

- `TYPE`

The thread type, either `FOREGROUND` or `BACKGROUND`. User connection threads are foreground threads. Threads associated with internal server activity are background threads. Examples are internal `InnoDB` threads, “binlog dump” threads sending information to replicas, and replication I/O and SQL threads.

- `PROCESSLIST_ID`

For a foreground thread (associated with a user connection), this is the connection identifier. This is the same value displayed in the `ID` column of the `INFORMATION_SCHEMA.PROCESSLIST` table, displayed in the `Id` column of `SHOW PROCESSLIST` output, and returned by the `CONNECTION_ID()` function within the thread.

For a background thread (not associated with a user connection), `PROCESSLIST_ID` is `NULL`, so the values are not unique.

- `PROCESSLIST_USER`

The user associated with a foreground thread, `NULL` for a background thread.

- `PROCESSLIST_HOST`

The host name of the client associated with a foreground thread, `NULL` for a background thread.

Unlike the `HOST` column of the `INFORMATION_SCHEMA.PROCESSLIST` table or the `Host` column of `SHOW PROCESSLIST` output, the `PROCESSLIST_HOST` column does not include the port number for TCP/IP connections. To obtain this information from the Performance Schema, enable the socket instrumentation (which is not enabled by default) and examine the `socket_instances` table:

```
mysql> SELECT * FROM performance_schema.setup_instruments
        WHERE NAME LIKE 'wait/io/socket%';
```

```

+-----+-----+-----+
| NAME                                     | ENABLED | TIMED |
+-----+-----+-----+
| wait/io/socket/sql/server_tcpip_socket | NO      | NO    |
| wait/io/socket/sql/server_unix_socket  | NO      | NO    |
| wait/io/socket/sql/client_connection   | NO      | NO    |
+-----+-----+-----+
3 rows in set (0.01 sec)

mysql> UPDATE performance_schema.setup_instruments
      SET ENABLED='YES'
      WHERE NAME LIKE 'wait/io/socket%';
Query OK, 3 rows affected (0.00 sec)
Rows matched: 3  Changed: 3  Warnings: 0

mysql> SELECT * FROM performance_schema.socket_instances\G
***** 1. row *****
EVENT_NAME: wait/io/socket/sql/client_connection
OBJECT_INSTANCE_BEGIN: 140612577298432
  THREAD_ID: 31
  SOCKET_ID: 53
      IP: ::ffff:127.0.0.1
      PORT: 55642
      STATE: ACTIVE
...

```

- [PROCESSLIST\\_DB](#)

The default database for the thread, or `NULL` if none has been selected.

- [PROCESSLIST\\_COMMAND](#)

For foreground threads, the type of command the thread is executing on behalf of the client, or `Sleep` if the session is idle. For descriptions of thread commands, see [Section 8.14, “Examining Server Thread \(Process\) Information”](#). The value of this column corresponds to the `COM_xxx` commands of the client/server protocol and `Com_xxx` status variables. See [Section 5.1.9, “Server Status Variables”](#)

Background threads do not execute commands on behalf of clients, so this column may be `NULL`.

- [PROCESSLIST\\_TIME](#)

The time in seconds that the thread has been in its current state. For a replica SQL thread, the value is the number of seconds between the timestamp of the last replicated event and the real time of the replica host. See [Section 16.2.3, “Replication Threads”](#).

- [PROCESSLIST\\_STATE](#)

An action, event, or state that indicates what the thread is doing. For descriptions of `PROCESSLIST_STATE` values, see [Section 8.14, “Examining Server Thread \(Process\) Information”](#). If the value is `NULL`, the thread may correspond to an idle client session or the work it is doing is not instrumented with stages.

Most states correspond to very quick operations. If a thread stays in a given state for many seconds, there might be a problem that bears investigation.

- [PROCESSLIST\\_INFO](#)

The statement the thread is executing, or `NULL` if it is executing no statement. The statement might be the one sent to the server, or an innermost statement if the statement executes other statements. For example, if a `CALL` statement executes a stored procedure that is executing a `SELECT` statement, the `PROCESSLIST_INFO` value shows the `SELECT` statement.

- [PARENT\\_THREAD\\_ID](#)

If this thread is a subthread (spawned by another thread), this is the [THREAD\\_ID](#) value of the spawning thread.

- [ROLE](#)

Unused.

- [INSTRUMENTED](#)

Whether events executed by the thread are instrumented. The value is [YES](#) or [NO](#).

- For foreground threads, the initial [INSTRUMENTED](#) value is determined by whether the user account associated with the thread matches any row in the [setup\\_actors](#) table. Matching is based on the values of the [PROCESSLIST\\_USER](#) and [PROCESSLIST\\_HOST](#) columns.

If the thread spawns a subthread, matching occurs again for the [threads](#) table row created for the subthread.

- For background threads, [INSTRUMENTED](#) is [YES](#) by default. [setup\\_actors](#) is not consulted because there is no associated user for background threads.
- For any thread, its [INSTRUMENTED](#) value can be changed during the lifetime of the thread.

For monitoring of events executed by the thread to occur, these things must be true:

- The [thread\\_instrumentation](#) consumer in the [setup\\_consumers](#) table must be [YES](#).
- The [threads.INSTRUMENTED](#) column must be [YES](#).
- Monitoring occurs only for those thread events produced from instruments that have the [ENABLED](#) column set to [YES](#) in the [setup\\_instruments](#) table.

- [HISTORY](#)

Whether to log historical events for the thread. The value is [YES](#) or [NO](#).

- For foreground threads, the initial [HISTORY](#) value is determined by whether the user account associated with the thread matches any row in the [setup\\_actors](#) table. Matching is based on the values of the [PROCESSLIST\\_USER](#) and [PROCESSLIST\\_HOST](#) columns.

If the thread spawns a subthread, matching occurs again for the [threads](#) table row created for the subthread.

- For background threads, [HISTORY](#) is [YES](#) by default. [setup\\_actors](#) is not consulted because there is no associated user for background threads.
- For any thread, its [HISTORY](#) value can be changed during the lifetime of the thread.

For historical event logging for the thread to occur, these things must be true:

- The appropriate history-related consumers in the [setup\\_consumers](#) table must be enabled. For example, wait event logging in the [events\\_waits\\_history](#) and [events\\_waits\\_history\\_long](#) tables requires the corresponding [events\\_waits\\_history](#) and [events\\_waits\\_history\\_long](#) consumers to be [YES](#).
- The [threads.HISTORY](#) column must be [YES](#).

- Logging occurs only for those thread events produced from instruments that have the `ENABLED` column set to `YES` in the `setup_instruments` table.

- `CONNECTION_TYPE`

The protocol used to establish the connection, or `NULL` for background threads. Permitted values are `TCP/IP` (TCP/IP connection established without encryption), `SSL/TLS` (TCP/IP connection established with encryption), `Socket` (Unix socket file connection), `Named Pipe` (Windows named pipe connection), and `Shared Memory` (Windows shared memory connection).

- `THREAD_OS_ID`

The thread or task identifier as defined by the underlying operating system, if there is one:

- When a MySQL thread is associated with the same operating system thread for its lifetime, `THREAD_OS_ID` contains the operating system thread ID.
- When a MySQL thread is not associated with the same operating system thread for its lifetime, `THREAD_OS_ID` contains `NULL`. This is typical for user sessions when the thread pool plugin is used (see [Section 5.5.3, “MySQL Enterprise Thread Pool”](#)).

For Windows, `THREAD_OS_ID` corresponds to the thread ID visible in Process Explorer (<https://technet.microsoft.com/en-us/sysinternals/bb896653.aspx>).

For Linux, `THREAD_OS_ID` corresponds to the value of the `gettid()` function. This value is exposed, for example, using the `perf` or `ps -L` commands, or in the `proc` file system (`/proc/[pid]/task/[tid]`). For more information, see the `perf-stat(1)`, `ps(1)`, and `proc(5)` man pages.

`TRUNCATE TABLE` is not permitted for the `threads` table.

## 25.13 Performance Schema Option and Variable Reference

**Table 25.13 Performance Schema Variable Reference**

Name	Cmd-Line	Option File	System Var	Status Var	Var Scope	Dynamic
<code>performance_schema</code>	Yes	Yes	Yes		Global	No
<code>Performance_schema_accounts_lost</code>				Yes	Global	No
<code>performance_schema_accounts_size</code>	Yes	Yes	Yes		Global	No
<code>Performance_schema_cond_classes_lost</code>				Yes	Global	No
<code>Performance_schema_cond_instances_lost</code>				Yes	Global	No
<code>performance-schema-consumer-events-stages-current</code>	Yes	Yes				
<code>performance-schema-consumer-events-stages-history</code>	Yes	Yes				

Performance Schema Option and Variable Reference

Name	Cmd-Line	Option File	System Var	Status Var	Var Scope	Dynamic
performance-schema-consumer-events-stages-history-long	Yes	Yes				
performance-schema-consumer-events-statements-current	Yes	Yes				
performance-schema-consumer-events-statements-history	Yes	Yes				
performance-schema-consumer-events-statements-history-long	Yes	Yes				
performance-schema-consumer-events-transactions-current	Yes	Yes				
performance-schema-consumer-events-transactions-history	Yes	Yes				
performance-schema-consumer-events-transactions-history-long	Yes	Yes				
performance-schema-consumer-events-waits-current	Yes	Yes				
performance-schema-	Yes	Yes				



Name	Cmd-Line	Option File	System Var	Status Var	Var Scope	Dynamic
consumer-events-waits-history						
performance-schema-consumer-events-waits-history-long	Yes	Yes				
performance-schema-consumer-global-instrumentation	Yes	Yes				
performance-schema-consumer-statements-digest	Yes	Yes				
performance-schema-consumer-thread-instrumentation	Yes	Yes				
Performance_schema_digest_lost				Yes	Global	No
performance_schema_digests	Yes	Yes	Yes		Global	No
performance_schema_events_history_size	Yes	Yes	Yes		Global	No
performance_schema_events_history_size_long	Yes	Yes	Yes		Global	No
performance_schema_events_statements_history_size	Yes	Yes	Yes		Global	No
performance_schema_events_statements_history_size_long	Yes	Yes	Yes		Global	No
performance_schema_events_transactions_history_size	Yes	Yes	Yes		Global	No
performance_schema_events_transactions_history_size_long	Yes	Yes	Yes		Global	No
performance_schema_events_waits_history_size	Yes	Yes	Yes		Global	No
performance_schema_events_waits_history_size_long	Yes	Yes	Yes		Global	No
Performance_schema_file_classes_lost				Yes	Global	No
Performance_schema_file_handles_lost				Yes	Global	No
Performance_schema_file_instances_lost				Yes	Global	No
Performance_schema_hosts_lost				Yes	Global	No
performance_schema_hosts_size	Yes	Yes	Yes		Global	No
performance-schema-instrument	Yes	Yes				
Performance_schema_locker_lost				Yes	Global	No
performance_schema_max_classes	Yes	Yes	Yes		Global	No

Performance Schema Option and Variable Reference

Name	Cmd-Line	Option File	System Var	Status Var	Var Scope	Dynamic	
performance_schema_max_connections	Yes	Yes	instances	Yes		Global	No
performance_schema_max_digest_length	Yes	Yes	length	Yes		Global	No
performance_schema_max_file_classes	Yes	Yes	classes	Yes		Global	No
performance_schema_max_file_handles	Yes	Yes	handles	Yes		Global	No
performance_schema_max_file_instances	Yes	Yes	instances	Yes		Global	No
performance_schema_max_metadata_classes	Yes	Yes	classes	Yes		Global	No
performance_schema_max_metadata_locks	Yes	Yes	locks	Yes		Global	No
performance_schema_max_mutex_classes	Yes	Yes	classes	Yes		Global	No
performance_schema_max_mutex_instances	Yes	Yes	instances	Yes		Global	No
performance_schema_max_prepared_statements_instances	Yes	Yes	instances	Yes		Global	No
performance_schema_max_program_instances	Yes	Yes	instances	Yes		Global	No
performance_schema_max_rwlock_classes	Yes	Yes	classes	Yes		Global	No
performance_schema_max_rwlock_instances	Yes	Yes	instances	Yes		Global	No
performance_schema_max_socket_classes	Yes	Yes	classes	Yes		Global	No
performance_schema_max_socket_instances	Yes	Yes	instances	Yes		Global	No
performance_schema_max_stage_classes	Yes	Yes	classes	Yes		Global	No
performance_schema_max_statement_classes	Yes	Yes	classes	Yes		Global	No
performance_schema_max_statement_stack	Yes	Yes	stack	Yes		Global	No
performance_schema_max_table_handles	Yes	Yes	handles	Yes		Global	No
performance_schema_max_table_instances	Yes	Yes	instances	Yes		Global	No
performance_schema_max_thread_classes	Yes	Yes	classes	Yes		Global	No
performance_schema_max_thread_instances	Yes	Yes	instances	Yes		Global	No
Performance_schema_memory_classes_lost					Yes	Global	No
Performance_schema_metadata_lock_lost					Yes	Global	No
Performance_schema_mutex_classes_lost					Yes	Global	No
Performance_schema_mutex_instances_lost					Yes	Global	No
Performance_schema_nested_statement_lost					Yes	Global	No
Performance_schema_prepared_statements_lost					Yes	Global	No
Performance_schema_program_lost					Yes	Global	No
Performance_schema_rwlock_classes_lost					Yes	Global	No
Performance_schema_rwlock_instances_lost					Yes	Global	No
Performance_schema_session_connect_attrs_lost					Yes	Global	No
performance_schema_session_connect_attrs	Yes	Yes	connect_attrs	Yes		Global	No
performance_schema_setup_actors_size	Yes	Yes	size	Yes		Global	No
performance_schema_setup_objects_size	Yes	Yes	size	Yes		Global	No
Performance_schema_socket_classes_lost					Yes	Global	No
Performance_schema_socket_instances_lost					Yes	Global	No
Performance_schema_stage_classes_lost					Yes	Global	No

Name	Cmd-Line	Option File	System Var	Status Var	Var Scope	Dynamic
<a href="#">Performance_schema_statement_classes_lost</a>				Yes	Global	No
<a href="#">Performance_schema_table_handles_lost</a>				Yes	Global	No
<a href="#">Performance_schema_table_instances_lost</a>				Yes	Global	No
<a href="#">Performance_schema_thread_classes_lost</a>				Yes	Global	No
<a href="#">Performance_schema_thread_instances_lost</a>				Yes	Global	No
<a href="#">Performance_schema_users_lost</a>				Yes	Global	No
<a href="#">performance_schema_users_size</a>	Yes	Yes	Yes		Global	No

## 25.14 Performance Schema Command Options

Performance Schema parameters can be specified at server startup on the command line or in option files to configure Performance Schema instruments and consumers. Runtime configuration is also possible in many cases (see [Section 25.4, “Performance Schema Runtime Configuration”](#)), but startup configuration must be used when runtime configuration is too late to affect instruments that have already been initialized during the startup process.

Performance Schema consumers and instruments can be configured at startup using the following syntax. For additional details, see [Section 25.3, “Performance Schema Startup Configuration”](#).

- `--performance-schema-consumer-consumer_name=value`

Configure a Performance Schema consumer. Consumer names in the `setup_consumers` table use underscores, but for consumers set at startup, dashes and underscores within the name are equivalent. Options for configuring individual consumers are detailed later in this section.

- `--performance-schema-instrument=instrument_name=value`

Configure a Performance Schema instrument. The name may be given as a pattern to configure instruments that match the pattern.

The following items configure individual consumers:

- `--performance-schema-consumer-events-stages-current=value`

Configure the `events-stages-current` consumer.

- `--performance-schema-consumer-events-stages-history=value`

Configure the `events-stages-history` consumer.

- `--performance-schema-consumer-events-stages-history-long=value`

Configure the `events-stages-history-long` consumer.

- `--performance-schema-consumer-events-statements-current=value`

Configure the `events-statements-current` consumer.

- `--performance-schema-consumer-events-statements-history=value`

Configure the `events-statements-history` consumer.

- `--performance-schema-consumer-events-statements-history-long=value`

Configure the `events-statements-history-long` consumer.

- `--performance-schema-consumer-events-transactions-current=value`

Configure the Performance Schema `events-transactions-current` consumer.

- `--performance-schema-consumer-events-transactions-history=value`

Configure the Performance Schema `events-transactions-history` consumer.

- `--performance-schema-consumer-events-transactions-history-long=value`

Configure the Performance Schema `events-transactions-history-long` consumer.

- `--performance-schema-consumer-events-waits-current=value`

Configure the `events-waits-current` consumer.

- `--performance-schema-consumer-events-waits-history=value`

Configure the `events-waits-history` consumer.

- `--performance-schema-consumer-events-waits-history-long=value`

Configure the `events-waits-history-long` consumer.

- `--performance-schema-consumer-global-instrumentation=value`

Configure the `global-instrumentation` consumer.

- `--performance-schema-consumer-statements-digest=value`

Configure the `statements-digest` consumer.

- `--performance-schema-consumer-thread-instrumentation=value`

Configure the `thread-instrumentation` consumer.

## 25.15 Performance Schema System Variables

The Performance Schema implements several system variables that provide configuration information:

```
mysql> SHOW VARIABLES LIKE 'perf%';
```

Variable_name	Value
<code>performance_schema</code>	ON
<code>performance_schema_accounts_size</code>	-1
<code>performance_schema_digests_size</code>	10000
<code>performance_schema_events_stages_history_long_size</code>	10000
<code>performance_schema_events_stages_history_size</code>	10
<code>performance_schema_events_statements_history_long_size</code>	10000
<code>performance_schema_events_statements_history_size</code>	10
<code>performance_schema_events_transactions_history_long_size</code>	10000
<code>performance_schema_events_transactions_history_size</code>	10
<code>performance_schema_events_waits_history_long_size</code>	10000
<code>performance_schema_events_waits_history_size</code>	10
<code>performance_schema_hosts_size</code>	-1
<code>performance_schema_max_cond_classes</code>	80
<code>performance_schema_max_cond_instances</code>	-1
<code>performance_schema_max_digest_length</code>	1024
<code>performance_schema_max_file_classes</code>	50

performance_schema_max_file_handles	32768
performance_schema_max_file_instances	-1
performance_schema_max_index_stat	-1
performance_schema_max_memory_classes	320
performance_schema_max_metadata_locks	-1
performance_schema_max_mutex_classes	200
performance_schema_max_mutex_instances	-1
performance_schema_max_prepared_statements_instances	-1
performance_schema_max_program_instances	-1
performance_schema_max_rwlock_classes	40
performance_schema_max_rwlock_instances	-1
performance_schema_max_socket_classes	10
performance_schema_max_socket_instances	-1
performance_schema_max_sql_text_length	1024
performance_schema_max_stage_classes	150
performance_schema_max_statement_classes	192
performance_schema_max_statement_stack	10
performance_schema_max_table_handles	-1
performance_schema_max_table_instances	-1
performance_schema_max_table_lock_stat	-1
performance_schema_max_thread_classes	50
performance_schema_max_thread_instances	-1
performance_schema_session_connect_attrs_size	512
performance_schema_setup_actors_size	-1
performance_schema_setup_objects_size	-1
performance_schema_users_size	-1

Performance Schema system variables can be set at server startup on the command line or in option files, and many can be set at runtime. See [Section 25.13, “Performance Schema Option and Variable Reference”](#).

The Performance Schema automatically sizes the values of several of its parameters at server startup if they are not set explicitly. For more information, see [Section 25.3, “Performance Schema Startup Configuration”](#).

Performance Schema system variables have the following meanings:

- [performance\\_schema](#)

Command-Line Format	<code>--performance-schema [= {OFF   ON} ]</code>
System Variable	<a href="#">performance_schema</a>
Scope	Global
Dynamic	No
Type	Boolean
Default Value	ON

The value of this variable is `ON` or `OFF` to indicate whether the Performance Schema is enabled. By default, the value is `ON`. At server startup, you can specify this variable with no value or a value of `ON` or `1` to enable it, or with a value of `OFF` or `0` to disable it.

Even when the Performance Schema is disabled, it continues to populate the [global\\_variables](#), [session\\_variables](#), [global\\_status](#), and [session\\_status](#) tables. This occurs as necessary to permit the results for the `SHOW VARIABLES` and `SHOW STATUS` statements to be drawn from those tables, depending on the setting of the [show\\_compatibility\\_56](#) system variable.

- [performance\\_schema\\_accounts\\_size](#)

Command-Line Format	<code>--performance-schema-accounts-size=#</code>
---------------------	---

## Performance Schema System Variables

System Variable	<a href="#">performance_schema_accounts_size</a>
Scope	Global
Dynamic	No
Type	Integer
Default Value	-1 (signifies autoscaling; do not assign this literal value)
Minimum Value	-1 (signifies autoscaling; do not assign this literal value)
Maximum Value	1048576

The number of rows in the [accounts](#) table. If this variable is 0, the Performance Schema does not maintain connection statistics in the [accounts](#) table or status variable information in the [status\\_by\\_account](#) table.

- [performance\\_schema\\_digests\\_size](#)

Command-Line Format	<code>--performance-schema-digests-size=#</code>
System Variable	<a href="#">performance_schema_digests_size</a>
Scope	Global
Dynamic	No
Type	Integer
Default Value	-1 (signifies autosizing; do not assign this literal value)
Minimum Value	-1 (signifies autoscaling; do not assign this literal value)
Maximum Value	1048576

The maximum number of rows in the [events\\_statements\\_summary\\_by\\_digest](#) table. If this maximum is exceeded such that a digest cannot be instrumented, the Performance Schema increments the [Performance\\_schema\\_digest\\_lost](#) status variable.

For more information about statement digesting, see [Section 25.10, “Performance Schema Statement Digests”](#).

- [performance\\_schema\\_events\\_stages\\_history\\_long\\_size](#)

Command-Line Format	<code>--performance-schema-events-stages-history-long-size=#</code>
System Variable	<a href="#">performance_schema_events_stages_history_long_size</a>
Scope	Global
Dynamic	No
Type	Integer
Default Value	-1 (signifies autosizing; do not assign this literal value)
Minimum Value	-1 (signifies autoscaling; do not assign this literal value)

Maximum Value	1048576
---------------	---------

The number of rows in the `events_stages_history_long` table.

- `performance_schema_events_stages_history_size`

Command-Line Format	<code>--performance-schema-events-stages-history-size=#</code>
System Variable	<code>performance_schema_events_stages_history_size</code>
Scope	Global
Dynamic	No
Type	Integer
Default Value	-1 (signifies autosizing; do not assign this literal value)
Minimum Value	-1 (signifies autoscaling; do not assign this literal value)
Maximum Value	1024

The number of rows per thread in the `events_stages_history` table.

- `performance_schema_events_statements_history_long_size`

Command-Line Format	<code>--performance-schema-events-statements-history-long-size=#</code>
System Variable	<code>performance_schema_events_statements_history_long_size</code>
Scope	Global
Dynamic	No
Type	Integer
Default Value	-1 (signifies autosizing; do not assign this literal value)
Minimum Value	-1 (signifies autoscaling; do not assign this literal value)
Maximum Value	1048576

The number of rows in the `events_statements_history_long` table.

- `performance_schema_events_statements_history_size`

Command-Line Format	<code>--performance-schema-events-statements-history-size=#</code>
System Variable	<code>performance_schema_events_statements_history_size</code>
Scope	Global
Dynamic	No
Type	Integer
Default Value	-1 (signifies autosizing; do not assign this literal value)

## Performance Schema System Variables

Minimum Value	-1 (signifies autoscaling; do not assign this literal value)
Maximum Value	1024

The number of rows per thread in the `events_statements_history` table.

- [performance\\_schema\\_events\\_transactions\\_history\\_long\\_size](#)

Command-Line Format	<code>--performance-schema-events-transactions-history-long-size=#</code>
System Variable	<a href="#">performance_schema_events_transactions_history_</a>
Scope	Global
Dynamic	No
Type	Integer
Default Value	-1 (signifies autosizing; do not assign this literal value)
Minimum Value	-1 (signifies autoscaling; do not assign this literal value)
Maximum Value	1048576

The number of rows in the `events_transactions_history_long` table.

- [performance\\_schema\\_events\\_transactions\\_history\\_size](#)

Command-Line Format	<code>--performance-schema-events-transactions-history-size=#</code>
System Variable	<a href="#">performance_schema_events_transactions_history_</a>
Scope	Global
Dynamic	No
Type	Integer
Default Value	-1 (signifies autosizing; do not assign this literal value)
Minimum Value	-1 (signifies autoscaling; do not assign this literal value)
Maximum Value	1024

The number of rows per thread in the `events_transactions_history` table.

- [performance\\_schema\\_events\\_waits\\_history\\_long\\_size](#)

Command-Line Format	<code>--performance-schema-events-waits-history-long-size=#</code>
System Variable	<a href="#">performance_schema_events_waits_history_long_si</a>
Scope	Global
Dynamic	No
Type	Integer



Default Value	-1 (signifies autosizing; do not assign this literal value)
Minimum Value	-1 (signifies autoscaling; do not assign this literal value)
Maximum Value	1048576

The number of rows in the `events_waits_history_long` table.

- `performance_schema_events_waits_history_size`

Command-Line Format	<code>--performance-schema-events-waits-history-size=#</code>
System Variable	<code>performance_schema_events_waits_history_size</code>
Scope	Global
Dynamic	No
Type	Integer
Default Value	-1 (signifies autosizing; do not assign this literal value)
Minimum Value	-1 (signifies autoscaling; do not assign this literal value)
Maximum Value	1024

The number of rows per thread in the `events_waits_history` table.

- `performance_schema_hosts_size`

Command-Line Format	<code>--performance-schema-hosts-size=#</code>
System Variable	<code>performance_schema_hosts_size</code>
Scope	Global
Dynamic	No
Type	Integer
Default Value	-1 (signifies autoscaling; do not assign this literal value)
Minimum Value	-1 (signifies autoscaling; do not assign this literal value)
Maximum Value	1048576

The number of rows in the `hosts` table. If this variable is 0, the Performance Schema does not maintain connection statistics in the `hosts` table or status variable information in the `status_by_host` table.

- `performance_schema_max_cond_classes`

Command-Line Format	<code>--performance-schema-max-cond-classes=#</code>
System Variable	<code>performance_schema_max_cond_classes</code>
Scope	Global
Dynamic	No

## Performance Schema System Variables

Type	Integer
Default Value	80
Minimum Value	0
Maximum Value	256

The maximum number of condition instruments. For information about how to set and use this variable, see [Section 25.7, “Performance Schema Status Monitoring”](#).

- [performance\\_schema\\_max\\_cond\\_instances](#)

Command-Line Format	<code>--performance-schema-max-cond-instances=#</code>
System Variable	<a href="#">performance_schema_max_cond_instances</a>
Scope	Global
Dynamic	No
Type	Integer
Default Value	-1 (signifies autoscaling; do not assign this literal value)
Minimum Value	-1 (signifies autoscaling; do not assign this literal value)
Maximum Value	1048576

The maximum number of instrumented condition objects. For information about how to set and use this variable, see [Section 25.7, “Performance Schema Status Monitoring”](#).

- [performance\\_schema\\_max\\_digest\\_length](#)

Command-Line Format	<code>--performance-schema-max-digest-length=#</code>
System Variable	<a href="#">performance_schema_max_digest_length</a>
Scope	Global
Dynamic	No
Type	Integer
Default Value	1024
Minimum Value	0
Maximum Value	1048576
Unit	bytes

The maximum number of bytes of memory reserved per statement for computation of normalized statement digest values in the Performance Schema. This variable is related to [max\\_digest\\_length](#); see the description of that variable in [Section 5.1.7, “Server System Variables”](#).

For more information about statement digesting, including considerations regarding memory use, see [Section 25.10, “Performance Schema Statement Digests”](#).

- `performance_schema_max_file_classes`

Command-Line Format	<code>--performance-schema-max-file-classes=#</code>
System Variable	<code>performance_schema_max_file_classes</code>
Scope	Global
Dynamic	No
Type	Integer
Default Value	80
Minimum Value	0
Maximum Value	256

The maximum number of file instruments. For information about how to set and use this variable, see [Section 25.7, “Performance Schema Status Monitoring”](#).

- `performance_schema_max_file_handles`

Command-Line Format	<code>--performance-schema-max-file-handles=#</code>
System Variable	<code>performance_schema_max_file_handles</code>
Scope	Global
Dynamic	No
Type	Integer
Default Value	32768
Minimum Value	0
Maximum Value	1048576

The maximum number of opened file objects. For information about how to set and use this variable, see [Section 25.7, “Performance Schema Status Monitoring”](#).

The value of `performance_schema_max_file_handles` should be greater than the value of `open_files_limit`: `open_files_limit` affects the maximum number of open file handles the server can support and `performance_schema_max_file_handles` affects how many of these file handles can be instrumented.

- `performance_schema_max_file_instances`

Command-Line Format	<code>--performance-schema-max-file-instances=#</code>
System Variable	<code>performance_schema_max_file_instances</code>
Scope	Global
Dynamic	No
Type	Integer
Default Value	-1 (signifies autoscaling; do not assign this literal value)
Minimum Value	-1 (signifies autoscaling; do not assign this literal value)

## Performance Schema System Variables

Maximum Value	1048576
---------------	---------

The maximum number of instrumented file objects. For information about how to set and use this variable, see [Section 25.7, “Performance Schema Status Monitoring”](#).

- [performance\\_schema\\_max\\_index\\_stat](#)

Command-Line Format	<code>--performance-schema-max-index-stat=#</code>
System Variable	<a href="#">performance_schema_max_index_stat</a>
Scope	Global
Dynamic	No
Type	Integer
Default Value	-1 (signifies autosizing; do not assign this literal value)
Minimum Value	-1 (signifies autoscaling; do not assign this literal value)
Maximum Value	1048576

The maximum number of indexes for which the Performance Schema maintains statistics. If this maximum is exceeded such that index statistics are lost, the Performance Schema increments the [Performance\\_schema\\_index\\_stat\\_lost](#) status variable. The default value is autosized using the value of [performance\\_schema\\_max\\_table\\_instances](#).

- [performance\\_schema\\_max\\_memory\\_classes](#)

Command-Line Format	<code>--performance-schema-max-memory-classes=#</code>
System Variable	<a href="#">performance_schema_max_memory_classes</a>
Scope	Global
Dynamic	No
Type	Integer
Default Value	320
Minimum Value	0
Maximum Value	1024

The maximum number of memory instruments. For information about how to set and use this variable, see [Section 25.7, “Performance Schema Status Monitoring”](#).

- [performance\\_schema\\_max\\_metadata\\_locks](#)

Command-Line Format	<code>--performance-schema-max-metadata-locks=#</code>
System Variable	<a href="#">performance_schema_max_metadata_locks</a>
Scope	Global
Dynamic	No
Type	Integer

Default Value	-1 (signifies autoscaling; do not assign this literal value)
Minimum Value	-1 (signifies autoscaling; do not assign this literal value)
Maximum Value	10485760

The maximum number of metadata lock instruments. This value controls the size of the `metadata_locks` table. If this maximum is exceeded such that a metadata lock cannot be instrumented, the Performance Schema increments the `Performance_schema_metadata_lock_lost` status variable.

- `performance_schema_max_mutex_classes`

Command-Line Format	<code>--performance-schema-max-mutex-classes=#</code>
System Variable	<code>performance_schema_max_mutex_classes</code>
Scope	Global
Dynamic	No
Type	Integer
Default Value	200
Minimum Value	0
Maximum Value	256

The maximum number of mutex instruments. For information about how to set and use this variable, see [Section 25.7, “Performance Schema Status Monitoring”](#).

- `performance_schema_max_mutex_instances`

Command-Line Format	<code>--performance-schema-max-mutex-instances=#</code>
System Variable	<code>performance_schema_max_mutex_instances</code>
Scope	Global
Dynamic	No
Type	Integer
Default Value	-1 (signifies autoscaling; do not assign this literal value)
Minimum Value	-1 (signifies autoscaling; do not assign this literal value)
Maximum Value	104857600

The maximum number of instrumented mutex objects. For information about how to set and use this variable, see [Section 25.7, “Performance Schema Status Monitoring”](#).

- `performance_schema_max_prepared_statements_instances`

Command-Line Format	<code>--performance-schema-max-prepared-statements-instances=#</code>
System Variable	<code>performance_schema_max_prepared_statements_instances</code>

## Performance Schema System Variables

Scope	Global
Dynamic	No
Type	Integer
Default Value	-1 (signifies autoscaling; do not assign this literal value)
Minimum Value	-1 (signifies autoscaling; do not assign this literal value)
Maximum Value	4194304

The maximum number of rows in the `prepared_statements_instances` table. If this maximum is exceeded such that a prepared statement cannot be instrumented, the Performance Schema increments the `Performance_schema_prepared_statements_lost` status variable. For information about how to set and use this variable, see [Section 25.7, “Performance Schema Status Monitoring”](#).

The default value of this variable is autosized based on the value of the `max_prepared_stmt_count` system variable.

- `performance_schema_max_rwlock_classes`

Command-Line Format	<code>--performance-schema-max-rwlock-classes=#</code>
System Variable	<code>performance_schema_max_rwlock_classes</code>
Scope	Global
Dynamic	No
Type	Integer
Default Value (≥ 5.7.25)	50
Default Value (≤ 5.7.24)	40
Minimum Value	0
Maximum Value	256

The maximum number of rwlock instruments. For information about how to set and use this variable, see [Section 25.7, “Performance Schema Status Monitoring”](#).

- `performance_schema_max_program_instances`

Command-Line Format	<code>--performance-schema-max-program-instances=#</code>
System Variable	<code>performance_schema_max_program_instances</code>
Scope	Global
Dynamic	No
Type	Integer
Default Value	-1 (signifies autoscaling; do not assign this literal value)
Minimum Value	-1 (signifies autoscaling; do not assign this literal value)

Maximum Value	1048576
---------------	---------

The maximum number of stored programs for which the Performance Schema maintains statistics. If this maximum is exceeded, the Performance Schema increments the [Performance\\_schema\\_program\\_lost](#) status variable. For information about how to set and use this variable, see [Section 25.7, “Performance Schema Status Monitoring”](#).

- [performance\\_schema\\_max\\_rwlock\\_instances](#)

Command-Line Format	<code>--performance-schema-max-rwlock-instances=#</code>
System Variable	<a href="#">performance_schema_max_rwlock_instances</a>
Scope	Global
Dynamic	No
Type	Integer
Default Value	-1 (signifies autosizing; do not assign this literal value)
Minimum Value	-1 (signifies autosizing; do not assign this literal value)
Maximum Value	104857600

The maximum number of instrumented rwlock objects. For information about how to set and use this variable, see [Section 25.7, “Performance Schema Status Monitoring”](#).

- [performance\\_schema\\_max\\_socket\\_classes](#)

Command-Line Format	<code>--performance-schema-max-socket-classes=#</code>
System Variable	<a href="#">performance_schema_max_socket_classes</a>
Scope	Global
Dynamic	No
Type	Integer
Default Value	10
Minimum Value	0
Maximum Value	256

The maximum number of socket instruments. For information about how to set and use this variable, see [Section 25.7, “Performance Schema Status Monitoring”](#).

- [performance\\_schema\\_max\\_socket\\_instances](#)

Command-Line Format	<code>--performance-schema-max-socket-instances=#</code>
System Variable	<a href="#">performance_schema_max_socket_instances</a>
Scope	Global
Dynamic	No
Type	Integer

## Performance Schema System Variables

Default Value	-1 (signifies autoscaling; do not assign this literal value)
Minimum Value	-1 (signifies autoscaling; do not assign this literal value)
Maximum Value	1048576

The maximum number of instrumented socket objects. For information about how to set and use this variable, see [Section 25.7, “Performance Schema Status Monitoring”](#).

- [performance\\_schema\\_max\\_sql\\_text\\_length](#)

Command-Line Format	<code>--performance-schema-max-sql-text-length=#</code>
System Variable	<code>performance_schema_max_sql_text_length</code>
Scope	Global
Dynamic	No
Type	Integer
Default Value	1024
Minimum Value	0
Maximum Value	1048576
Unit	bytes

The maximum number of bytes used to store SQL statements in the `SQL_TEXT` column of the `events_statements_current`, `events_statements_history`, and `events_statements_history_long` statement event tables. Any bytes in excess of `performance_schema_max_sql_text_length` are discarded and do not appear in the `SQL_TEXT` column. Statements differing only after that many initial bytes are indistinguishable in this column.

Decreasing the `performance_schema_max_sql_text_length` value reduces memory use but causes more statements to become indistinguishable if they differ only at the end. Increasing the value increases memory use but permits longer statements to be distinguished.

- [performance\\_schema\\_max\\_stage\\_classes](#)

Command-Line Format	<code>--performance-schema-max-stage-classes=#</code>
System Variable	<code>performance_schema_max_stage_classes</code>
Scope	Global
Dynamic	No
Type	Integer
Default Value	150
Minimum Value	0
Maximum Value	256

The maximum number of stage instruments. For information about how to set and use this variable, see [Section 25.7, “Performance Schema Status Monitoring”](#).

- [performance\\_schema\\_max\\_statement\\_classes](#)



Command-Line Format	<code>--performance-schema-max-statement-classes=#</code>
System Variable	<a href="#">performance_schema_max_statement_classes</a>
Scope	Global
Dynamic	No
Type	Integer
Minimum Value	0
Maximum Value	256

The maximum number of statement instruments. For information about how to set and use this variable, see [Section 25.7, “Performance Schema Status Monitoring”](#).

The default value is calculated at server build time based on the number of commands in the client/server protocol and the number of SQL statement types supported by the server.

This variable should not be changed, unless to set it to 0 to disable all statement instrumentation and save all memory associated with it. Setting the variable to nonzero values other than the default has no benefit; in particular, values larger than the default cause more memory to be allocated than is needed.

- [performance\\_schema\\_max\\_statement\\_stack](#)

Command-Line Format	<code>--performance-schema-max-statement-stack=#</code>
System Variable	<a href="#">performance_schema_max_statement_stack</a>
Scope	Global
Dynamic	No
Type	Integer
Default Value	10
Minimum Value	1
Maximum Value	256

The maximum depth of nested stored program calls for which the Performance Schema maintains statistics. When this maximum is exceeded, the Performance Schema increments the [Performance\\_schema\\_nested\\_statement\\_lost](#) status variable for each stored program statement executed.

- [performance\\_schema\\_max\\_table\\_handles](#)

Command-Line Format	<code>--performance-schema-max-table-handles=#</code>
System Variable	<a href="#">performance_schema_max_table_handles</a>
Scope	Global
Dynamic	No
Type	Integer
Default Value	-1 (signifies autoscaling; do not assign this literal value)

## Performance Schema System Variables

Minimum Value	-1 (signifies autoscaling; do not assign this literal value)
Maximum Value	1048576

The maximum number of opened table objects. This value controls the size of the `table_handles` table. If this maximum is exceeded such that a table handle cannot be instrumented, the Performance Schema increments the `Performance_schema_table_handles_lost` status variable. For information about how to set and use this variable, see [Section 25.7, “Performance Schema Status Monitoring”](#).

- `performance_schema_max_table_instances`

Command-Line Format	<code>--performance-schema-max-table-instances=#</code>
System Variable	<code>performance_schema_max_table_instances</code>
Scope	Global
Dynamic	No
Type	Integer
Default Value	-1 (signifies autoscaling; do not assign this literal value)
Minimum Value	-1 (signifies autoscaling; do not assign this literal value)
Maximum Value	1048576

The maximum number of instrumented table objects. For information about how to set and use this variable, see [Section 25.7, “Performance Schema Status Monitoring”](#).

- `performance_schema_max_table_lock_stat`

Command-Line Format	<code>--performance-schema-max-table-lock-stat=#</code>
System Variable	<code>performance_schema_max_table_lock_stat</code>
Scope	Global
Dynamic	No
Type	Integer
Default Value	-1 (signifies autosizing; do not assign this literal value)
Minimum Value	-1 (signifies autoscaling; do not assign this literal value)
Maximum Value	1048576

The maximum number of tables for which the Performance Schema maintains lock statistics. If this maximum is exceeded such that table lock statistics are lost, the Performance Schema increments the `Performance_schema_table_lock_stat_lost` status variable.

- `performance_schema_max_thread_classes`

Command-Line Format	<code>--performance-schema-max-thread-classes=#</code>
System Variable	<code>performance_schema_max_thread_classes</code>
Scope	Global
Dynamic	No
Type	Integer
Default Value	50
Minimum Value	0
Maximum Value	256

The maximum number of thread instruments. For information about how to set and use this variable, see [Section 25.7, “Performance Schema Status Monitoring”](#).

- `performance_schema_max_thread_instances`

Command-Line Format	<code>--performance-schema-max-thread-instances=#</code>
System Variable	<code>performance_schema_max_thread_instances</code>
Scope	Global
Dynamic	No
Type	Integer
Default Value	-1 (signifies autosizing; do not assign this literal value)
Minimum Value	-1 (signifies autoscaling; do not assign this literal value)
Maximum Value	1048576

The maximum number of instrumented thread objects. The value controls the size of the `threads` table. If this maximum is exceeded such that a thread cannot be instrumented, the Performance Schema increments the `performance_schema_thread_instances_lost` status variable. For information about how to set and use this variable, see [Section 25.7, “Performance Schema Status Monitoring”](#).

The `max_connections` system variable affects how many threads can run in the server. `performance_schema_max_thread_instances` affects how many of these running threads can be instrumented.

The `variables_by_thread` and `status_by_thread` tables contain system and status variable information only about foreground threads. If not all threads are instrumented by the Performance Schema, this table may miss some rows. In this case, the `performance_schema_thread_instances_lost` status variable is greater than zero.

- `performance_schema_session_connect_attrs_size`

Command-Line Format	<code>--performance-schema-session-connect-attrs-size=#</code>
System Variable	<code>performance_schema_session_connect_attrs_size</code>

## Performance Schema System Variables

Scope	Global
Dynamic	No
Type	Integer
Default Value	-1 (signifies autosizing; do not assign this literal value)
Minimum Value	-1 (signifies autosizing; do not assign this literal value)
Maximum Value	1048576
Unit	bytes

The amount of preallocated memory per thread reserved to hold connection attribute key-value pairs. If the aggregate size of connection attribute data sent by a client is larger than this amount, the Performance Schema truncates the attribute data, increments the `performance_schema_session_connect_attrs_lost` status variable, and writes a message to the error log indicating that truncation occurred if the `log_error_verbosity` system variable value is greater than 1.

The default value of `performance_schema_session_connect_attrs_size` is autosized at server startup. This value may be small, so if truncation occurs (`performance_schema_session_connect_attrs_lost` becomes nonzero), you may wish to set `performance_schema_session_connect_attrs_size` explicitly to a larger value.

Although the maximum permitted `performance_schema_session_connect_attrs_size` value is 1MB, the effective maximum is 64KB because the server imposes a limit of 64KB on the aggregate size of connection attribute data it can accept. If a client attempts to send more than 64KB of attribute data, the server rejects the connection. For more information, see [Section 25.12.9, “Performance Schema Connection Attribute Tables”](#).

- `performance_schema_setup_actors_size`

Command-Line Format	<code>--performance-schema-setup-actors-size=#</code>
System Variable	<code>performance_schema_setup_actors_size</code>
Scope	Global
Dynamic	No
Type	Integer
Default Value	-1 (signifies autoscaling; do not assign this literal value)
Minimum Value	-1 (signifies autosizing; do not assign this literal value)
Maximum Value	1048576

The number of rows in the `setup_actors` table.

- `performance_schema_setup_objects_size`

Command-Line Format	<code>--performance-schema-setup-objects-size=#</code>
System Variable	<code>performance_schema_setup_objects_size</code>

Scope	Global
Dynamic	No
Type	Integer
Default Value	-1 (signifies autoscaling; do not assign this literal value)
Minimum Value	-1 (signifies autoscaling; do not assign this literal value)
Maximum Value	1048576

The number of rows in the `setup_objects` table.

- `performance_schema_show_processlist`

Command-Line Format	<code>--performance-schema-show-processlist[={OFF ON}]</code>
Introduced	5.7.39
System Variable	<code>performance_schema_show_processlist</code>
Scope	Global
Dynamic	Yes
Type	Boolean
Default Value	OFF

The `SHOW PROCESSLIST` statement provides process information by collecting thread data from all active threads. The `performance_schema_show_processlist` variable determines which `SHOW PROCESSLIST` implementation to use:

- The default implementation iterates across active threads from within the thread manager while holding a global mutex. This has negative performance consequences, particularly on busy systems.
- The alternative `SHOW PROCESSLIST` implementation is based on the Performance Schema `processlist` table. This implementation queries active thread data from the Performance Schema rather than the thread manager and does not require a mutex.

To enable the alternative implementation, enable the `performance_schema_show_processlist` system variable. To ensure that the default and alternative implementations yield the same information, certain configuration requirements must be met; see [Section 25.12.16.3, “The processlist Table”](#).

- `performance_schema_users_size`

Command-Line Format	<code>--performance-schema-users-size=#</code>
System Variable	<code>performance_schema_users_size</code>
Scope	Global
Dynamic	No
Type	Integer
Default Value	-1 (signifies autoscaling; do not assign this literal value)
Minimum Value	-1 (signifies autoscaling; do not assign this literal value)

Maximum Value	1048576
---------------	---------

The number of rows in the `users` table. If this variable is 0, the Performance Schema does not maintain connection statistics in the `users` table or status variable information in the `status_by_user` table.

## 25.16 Performance Schema Status Variables

The Performance Schema implements several status variables that provide information about instrumentation that could not be loaded or created due to memory constraints:

```
mysql> SHOW STATUS LIKE 'perf%';
+-----+-----+
| Variable_name | Value |
+-----+-----+
| Performance_schema_accounts_lost | 0 |
| Performance_schema_cond_classes_lost | 0 |
| Performance_schema_cond_instances_lost | 0 |
| Performance_schema_file_classes_lost | 0 |
| Performance_schema_file_handles_lost | 0 |
| Performance_schema_file_instances_lost | 0 |
| Performance_schema_hosts_lost | 0 |
| Performance_schema_locker_lost | 0 |
| Performance_schema_mutex_classes_lost | 0 |
| Performance_schema_mutex_instances_lost | 0 |
| Performance_schema_rwlock_classes_lost | 0 |
| Performance_schema_rwlock_instances_lost | 0 |
| Performance_schema_socket_classes_lost | 0 |
| Performance_schema_socket_instances_lost | 0 |
| Performance_schema_stage_classes_lost | 0 |
| Performance_schema_statement_classes_lost | 0 |
| Performance_schema_table_handles_lost | 0 |
| Performance_schema_table_instances_lost | 0 |
| Performance_schema_thread_classes_lost | 0 |
| Performance_schema_thread_instances_lost | 0 |
| Performance_schema_users_lost | 0 |
+-----+-----+
```

For information on using these variables to check Performance Schema status, see [Section 25.7, “Performance Schema Status Monitoring”](#).

Performance Schema status variables have the following meanings:

- `Performance_schema_accounts_lost`

The number of times a row could not be added to the `accounts` table because it was full.

- `Performance_schema_cond_classes_lost`

How many condition instruments could not be loaded.

- `Performance_schema_cond_instances_lost`

How many condition instrument instances could not be created.

- `Performance_schema_digest_lost`

The number of digest instances that could not be instrumented in the `events_statements_summary_by_digest` table. This can be nonzero if the value of `performance_schema_digests_size` is too small.

- `Performance_schema_file_classes_lost`

How many file instruments could not be loaded.

- `Performance_schema_file_handles_lost`

How many file instrument instances could not be opened.

- `Performance_schema_file_instances_lost`

How many file instrument instances could not be created.

- `Performance_schema_hosts_lost`

The number of times a row could not be added to the `hosts` table because it was full.

- `Performance_schema_index_stat_lost`

The number of indexes for which statistics were lost. This can be nonzero if the value of `performance_schema_max_index_stat` is too small.

- `Performance_schema_locker_lost`

How many events are “lost” or not recorded, due to the following conditions:

- Events are recursive (for example, waiting for A caused a wait on B, which caused a wait on C).
- The depth of the nested events stack is greater than the limit imposed by the implementation.

Events recorded by the Performance Schema are not recursive, so this variable should always be 0.

- `Performance_schema_memory_classes_lost`

The number of times a memory instrument could not be loaded.

- `Performance_schema_metadata_lock_lost`

The number of metadata locks that could not be instrumented in the `metadata_locks` table. This can be nonzero if the value of `performance_schema_max_metadata_locks` is too small.

- `Performance_schema_mutex_classes_lost`

How many mutex instruments could not be loaded.

- `Performance_schema_mutex_instances_lost`

How many mutex instrument instances could not be created.

- `Performance_schema_nested_statement_lost`

The number of stored program statements for which statistics were lost. This can be nonzero if the value of `performance_schema_max_statement_stack` is too small.

- `Performance_schema_prepared_statements_lost`

The number of prepared statements that could not be instrumented in the `prepared_statements_instances` table. This can be nonzero if the value of `performance_schema_max_prepared_statements_instances` is too small.

- `Performance_schema_program_lost`

The number of stored programs for which statistics were lost. This can be nonzero if the value of `performance_schema_max_program_instances` is too small.

- `Performance_schema_rwlock_classes_lost`

How many rwlock instruments could not be loaded.

- `Performance_schema_rwlock_instances_lost`

How many rwlock instrument instances could not be created.

- `Performance_schema_session_connect_attrs_lost`

The number of connections for which connection attribute truncation has occurred.

For a given connection, if the client sends connection attribute key-value pairs for which the aggregate size is larger than the reserved storage permitted by the value of the `performance_schema_session_connect_attrs_size` system variable, the Performance Schema truncates the attribute data and increments `Performance_schema_session_connect_attrs_lost`. If this value is nonzero, you may wish to set `performance_schema_session_connect_attrs_size` to a larger value.

For more information about connection attributes, see [Section 25.12.9, “Performance Schema Connection Attribute Tables”](#).

- `Performance_schema_socket_classes_lost`

How many socket instruments could not be loaded.

- `Performance_schema_socket_instances_lost`

How many socket instrument instances could not be created.

- `Performance_schema_stage_classes_lost`

How many stage instruments could not be loaded.

- `Performance_schema_statement_classes_lost`

How many statement instruments could not be loaded.

- `Performance_schema_table_handles_lost`

How many table instrument instances could not be opened. This can be nonzero if the value of `performance_schema_max_table_handles` is too small.

- `Performance_schema_table_instances_lost`

How many table instrument instances could not be created.

- `Performance_schema_table_lock_stat_lost`

The number of tables for which lock statistics were lost. This can be nonzero if the value of `performance_schema_max_table_lock_stat` is too small.

- `Performance_schema_thread_classes_lost`

How many thread instruments could not be loaded.



- `Performance_schema_thread_instances_lost`

The number of thread instances that could not be instrumented in the `threads` table. This can be nonzero if the value of `performance_schema_max_thread_instances` is too small.

- `Performance_schema_users_lost`

The number of times a row could not be added to the `users` table because it was full.

## 25.17 The Performance Schema Memory-Allocation Model

The Performance Schema uses this memory allocation model:

- May allocate memory at server startup
- May allocate additional memory during server operation
- Never free memory during server operation (although it might be recycled)
- Free all memory used at shutdown

The result is to relax memory constraints so that the Performance Schema can be used with less configuration, and to decrease the memory footprint so that consumption scales with server load. Memory used depends on the load actually seen, not the load estimated or explicitly configured for.

Several Performance Schema sizing parameters are autoscaled and need not be configured explicitly unless you want to establish an explicit limit on memory allocation:

```
performance_schema_accounts_size
performance_schema_hosts_size
performance_schema_max_cond_instances
performance_schema_max_file_instances
performance_schema_max_index_stat
performance_schema_max_metadata_locks
performance_schema_max_mutex_instances
performance_schema_max_prepared_statements_instances
performance_schema_max_program_instances
performance_schema_max_rwlock_instances
performance_schema_max_socket_instances
performance_schema_max_table_handles
performance_schema_max_table_instances
performance_schema_max_table_lock_stat
performance_schema_max_thread_instances
performance_schema_users_size
```

For an autoscaled parameter, configuration works like this:

- With the value set to -1 (the default), the parameter is autoscaled:
  - The corresponding internal buffer is empty initially and no memory is allocated.
  - As the Performance Schema collects data, memory is allocated in the corresponding buffer. The buffer size is unbounded, and may grow with the load.
- With the value set to 0:
  - The corresponding internal buffer is empty initially and no memory is allocated.
- With the value set to  $N > 0$ :
  - The corresponding internal buffer is empty initially and no memory is allocated.

- As the Performance Schema collects data, memory is allocated in the corresponding buffer, until the buffer size reaches  $N$ .
- Once the buffer size reaches  $N$ , no more memory is allocated. Data collected by the Performance Schema for this buffer is lost, and any corresponding “lost instance” counters are incremented.

To see how much memory the Performance Schema is using, check the instruments designed for that purpose. The Performance Schema allocates memory internally and associates each buffer with a dedicated instrument so that memory consumption can be traced to individual buffers. Instruments named with the prefix `memory/performance_schema/` expose how much memory is allocated for these internal buffers. The buffers are global to the server, so the instruments are displayed only in the `memory_summary_global_by_event_name` table, and not in other `memory_summary_by_XXX_by_event_name` tables.

This query shows the information associated with the memory instruments:

```
SELECT * FROM performance_schema.memory_summary_global_by_event_name
WHERE EVENT_NAME LIKE 'memory/performance_schema/%';
```

## 25.18 Performance Schema and Plugins

Removing a plugin with `UNINSTALL PLUGIN` does not affect information already collected for code in that plugin. Time spent executing the code while the plugin was loaded was still spent even if the plugin is unloaded later. The associated event information, including aggregate information, remains readable in `performance_schema` database tables. For additional information about the effect of plugin installation and removal, see [Section 25.7, “Performance Schema Status Monitoring”](#).

A plugin implementor who instruments plugin code should document its instrumentation characteristics to enable those who load the plugin to account for its requirements. For example, a third-party storage engine should include in its documentation how much memory the engine needs for mutex and other instruments.

## 25.19 Using the Performance Schema to Diagnose Problems

The Performance Schema is a tool to help a DBA do performance tuning by taking real measurements instead of “wild guesses.” This section demonstrates some ways to use the Performance Schema for this purpose. The discussion here relies on the use of event filtering, which is described in [Section 25.4.2, “Performance Schema Event Filtering”](#).

The following example provides one methodology that you can use to analyze a repeatable problem, such as investigating a performance bottleneck. To begin, you should have a repeatable use case where performance is deemed “too slow” and needs optimization, and you should enable all instrumentation (no pre-filtering at all).

1. Run the use case.
2. Using the Performance Schema tables, analyze the root cause of the performance problem. This analysis relies heavily on post-filtering.
3. For problem areas that are ruled out, disable the corresponding instruments. For example, if analysis shows that the issue is not related to file I/O in a particular storage engine, disable the file I/O instruments for that engine. Then truncate the history and summary tables to remove previously collected events.
4. Repeat the process at step 1.

At each iteration, the Performance Schema output, particularly the `events_waits_history_long` table, contains less and less “noise” caused by nonsignificant instruments, and given that this table has a fixed size, contains more and more data relevant to the analysis of the problem at hand.

At each iteration, investigation should lead closer and closer to the root cause of the problem, as the signal-to-noise ratio improves, making analysis easier.

5. Once a root cause of performance bottleneck is identified, take the appropriate corrective action, such as:
  - Tune the server parameters (cache sizes, memory, and so forth).
  - Tune a query by writing it differently,
  - Tune the database schema (tables, indexes, and so forth).
  - Tune the code (this applies to storage engine or server developers only).
6. Start again at step 1, to see the effects of the changes on performance.

The `mutex_instances.LOCKED_BY_THREAD_ID` and `rwlock_instances.WRITE_LOCKED_BY_THREAD_ID` columns are extremely important for investigating performance bottlenecks or deadlocks. This is made possible by Performance Schema instrumentation as follows:

1. Suppose that thread 1 is stuck waiting for a mutex.
2. You can determine what the thread is waiting for:

```
SELECT * FROM performance_schema.events_waits_current
WHERE THREAD_ID = thread_1;
```

Say the query result identifies that the thread is waiting for mutex A, found in `events_waits_current.OBJECT_INSTANCE_BEGIN`.

3. You can determine which thread is holding mutex A:

```
SELECT * FROM performance_schema.mutex_instances
WHERE OBJECT_INSTANCE_BEGIN = mutex_A;
```

Say the query result identifies that it is thread 2 holding mutex A, as found in `mutex_instances.LOCKED_BY_THREAD_ID`.

4. You can see what thread 2 is doing:

```
SELECT * FROM performance_schema.events_waits_current
WHERE THREAD_ID = thread_2;
```

## 25.19.1 Query Profiling Using Performance Schema

The following example demonstrates how to use Performance Schema statement events and stage events to retrieve data comparable to profiling information provided by `SHOW PROFILES` and `SHOW PROFILE` statements.

The `setup_actors` table can be used to limit the collection of historical events by host, user, or account to reduce runtime overhead and the amount of data collected in history tables. The first step of the example shows how to limit collection of historical events to a specific user.

Performance Schema displays event timer information in picoseconds (trillionths of a second) to normalize timing data to a standard unit. In the following example, `TIMER_WAIT` values are divided by 100000000000 to show data in units of seconds. Values are also truncated to 6 decimal places to display data in the same format as `SHOW PROFILES` and `SHOW PROFILE` statements.

1. Limit the collection of historical events to the user running the query. By default, `setup_actors` is configured to allow monitoring and historical event collection for all foreground threads:

```
mysql> SELECT * FROM performance_schema.setup_actors;
+-----+-----+-----+-----+-----+
| HOST | USER | ROLE | ENABLED | HISTORY |
+-----+-----+-----+-----+-----+
| %    | %    | %    | YES     | YES     |
+-----+-----+-----+-----+-----+
```

Update the default row in the `setup_actors` table to disable historical event collection and monitoring for all foreground threads, and insert a new row that enables monitoring and historical event collection for the user running the query:

```
mysql> UPDATE performance_schema.setup_actors
      SET ENABLED = 'NO', HISTORY = 'NO'
      WHERE HOST = '%' AND USER = '%';

mysql> INSERT INTO performance_schema.setup_actors
      (HOST,USER,ROLE,ENABLED,HISTORY)
      VALUES('localhost','test_user','%','YES','YES');
```

Data in the `setup_actors` table should now appear similar to the following:

```
mysql> SELECT * FROM performance_schema.setup_actors;
+-----+-----+-----+-----+-----+
| HOST      | USER      | ROLE | ENABLED | HISTORY |
+-----+-----+-----+-----+-----+
| %         | %         | %    | NO      | NO      |
| localhost | test_user | %    | YES     | YES     |
+-----+-----+-----+-----+-----+
```

2. Ensure that statement and stage instrumentation is enabled by updating the `setup_instruments` table. Some instruments may already be enabled by default.

```
mysql> UPDATE performance_schema.setup_instruments
      SET ENABLED = 'YES', TIMED = 'YES'
      WHERE NAME LIKE '%statement/%';

mysql> UPDATE performance_schema.setup_instruments
      SET ENABLED = 'YES', TIMED = 'YES'
      WHERE NAME LIKE '%stage/%';
```

3. Ensure that `events_statements_*` and `events_stages_*` consumers are enabled. Some consumers may already be enabled by default.

```
mysql> UPDATE performance_schema.setup_consumers
      SET ENABLED = 'YES'
      WHERE NAME LIKE '%events_statements_%';

mysql> UPDATE performance_schema.setup_consumers
      SET ENABLED = 'YES'
      WHERE NAME LIKE '%events_stages_%';
```

4. Under the user account you are monitoring, run the statement that you want to profile. For example:

```
mysql> SELECT * FROM employees.employees WHERE emp_no = 10001;
+-----+-----+-----+-----+-----+-----+
| emp_no | birth_date | first_name | last_name | gender | hire_date |
+-----+-----+-----+-----+-----+-----+
```

10001	1953-09-02	Georgi	Facello	M	1986-06-26
-------	------------	--------	---------	---	------------

- Identify the `EVENT_ID` of the statement by querying the `events_statements_history_long` table. This step is similar to running `SHOW PROFILES` to identify the `Query_ID`. The following query produces output similar to `SHOW PROFILES`:

```
mysql> SELECT EVENT_ID, TRUNCATE(TIMER_WAIT/1000000000000,6) as Duration, SQL_TEXT
FROM performance_schema.events_statements_history_long WHERE SQL_TEXT like '%10001%';
```

event_id	duration	sql_text
31	0.028310	SELECT * FROM employees.employees WHERE emp_no = 10001

- Query the `events_stages_history_long` table to retrieve the statement's stage events. Stages are linked to statements using event nesting. Each stage event record has a `NESTING_EVENT_ID` column that contains the `EVENT_ID` of the parent statement.

```
mysql> SELECT event_name AS Stage, TRUNCATE(TIMER_WAIT/1000000000000,6) AS Duration
FROM performance_schema.events_stages_history_long WHERE NESTING_EVENT_ID=31;
```

Stage	Duration
stage/sql/starting	0.000080
stage/sql/checking permissions	0.000005
stage/sql/Opening tables	0.027759
stage/sql/init	0.000052
stage/sql/System lock	0.000009
stage/sql/optimizing	0.000006
stage/sql/statistics	0.000082
stage/sql/preparing	0.000008
stage/sql/executing	0.000000
stage/sql/Sending data	0.000017
stage/sql/end	0.000001
stage/sql/query end	0.000004
stage/sql/closing tables	0.000006
stage/sql/freeing items	0.000272
stage/sql/cleaning up	0.000001

## 25.20 Migrating to Performance Schema System and Status Variable Tables

The `INFORMATION_SCHEMA` has tables that contain system and status variable information (see [Section 24.3.11](#), “The `INFORMATION_SCHEMA` `GLOBAL_VARIABLES` and `SESSION_VARIABLES` Tables”, and [Section 24.3.10](#), “The `INFORMATION_SCHEMA` `GLOBAL_STATUS` and `SESSION_STATUS` Tables”). The Performance Schema also contains system and status variable tables (see [Section 25.12.13](#), “Performance Schema System Variable Tables”, and [Section 25.12.14](#), “Performance Schema Status Variable Tables”). The Performance Schema tables are intended to replace the `INFORMATION_SCHEMA` tables, which are deprecated as of MySQL 5.7.6 and are removed in MySQL 8.0.

This section describes the intended migration path away from the `INFORMATION_SCHEMA` system and status variable tables to the corresponding Performance Schema tables. Application developers should use this information as guidance regarding the changes required to access system and status variables in MySQL 5.7.6 and up as the `INFORMATION_SCHEMA` tables become deprecated and eventually are removed.

### MySQL 5.6

In MySQL 5.6, system and status variable information is available from these `SHOW` statements:

```
SHOW VARIABLES
SHOW STATUS
```

And from these `INFORMATION_SCHEMA` tables:

```
INFORMATION_SCHEMA.GLOBAL_VARIABLES
INFORMATION_SCHEMA.SESSION_VARIABLES

INFORMATION_SCHEMA.GLOBAL_STATUS
INFORMATION_SCHEMA.SESSION_STATUS
```

### MySQL 5.7

As of MySQL 5.7.6, the Performance Schema includes these tables as new sources of system and status variable information:

```
performance_schema.global_variables
performance_schema.session_variables
performance_schema.variables_by_thread

performance_schema.global_status
performance_schema.session_status
performance_schema.status_by_thread
performance_schema.status_by_account
performance_schema.status_by_host
performance_schema.status_by_user
```

MySQL 5.7.6 also adds a `show_compatibility_56` system variable to control how the server makes system and status variable information available.

When `show_compatibility_56` is `ON`, compatibility with MySQL 5.6 is enabled. The older system and status variable sources (`SHOW` statements, `INFORMATION_SCHEMA` tables) are available with semantics identical to MySQL 5.6. Applications should run as is, with no code changes, and should see the same variable names and values as in MySQL 5.6. Warnings occur under these circumstances:

- A deprecation warning is raised when selecting from the `INFORMATION_SCHEMA` tables.
- In MySQL 5.7.6 and 5.7.7, a deprecation warning is raised when using a `WHERE` clause with the `SHOW` statements. This behavior does not occur as of MySQL 5.7.8.

When `show_compatibility_56` is `OFF`, compatibility with MySQL 5.6 is disabled and several changes result. Applications must be revised as follows to run properly:

- Selecting from the `INFORMATION_SCHEMA` tables produces an error. Applications that access the `INFORMATION_SCHEMA` tables should be revised to use the corresponding Performance Schema tables instead.

Before MySQL 5.7.9, selecting from the `INFORMATION_SCHEMA` tables produces an empty result set plus a deprecation warning. This was not sufficient notice to signal the need to migrate to the corresponding Performance Schema system and status variable tables for the case that `show_compatibility_56=OFF`. Producing an error in MySQL 5.7.9 and higher makes it more evident that an application is operating under conditions that require modification, as well as where the problem lies.

In MySQL 5.7.6 and 5.7.7, the Performance Schema `session_variables` and `session_status` tables do not fully reflect all variable values in effect for the current session; they include no rows for global variables that have no session counterpart. This is corrected in MySQL 5.7.8.

- Output for the `SHOW` statements is produced using the underlying Performance Schema tables. Applications written to use these statements can still use them, but it is best to use MySQL 5.7.8 or higher. In MySQL 5.7.6 and 5.7.7, the results may differ:
  - `SHOW [SESSION] VARIABLES` output does not include global variables that have no session counterpart.
  - Using a `WHERE` clause with the `SHOW` statements produces an error.
- These `Slave_xxx` status variables become unavailable through `SHOW STATUS`:

```
Slave_heartbeat_period
Slave_last_heartbeat
Slave_received_heartbeats
Slave_retried_transactions
Slave_running
```

Applications that use these status variables should be revised to obtain this information using the replication-related Performance Schema tables. For details, see [Effect of show\\_compatibility\\_56 on Slave Status Variables](#).

- The Performance Schema does not collect statistics for `Com_xxx` status variables in the status variable tables. To obtain global and per-session statement execution counts, use the `events_statements_summary_global_by_event_name` and `events_statements_summary_by_thread_by_event_name` tables, respectively.

### Migration and Privileges

Initially, with the introduction of Performance Schema system and status variable tables in MySQL 5.7.6, access to those tables required the `SELECT` privilege, just as for other Performance Schema tables. However, this had the consequence that when `show_compatibility_56=OFF`, the `SHOW VARIABLES` and `SHOW STATUS` statements also required the `SELECT` privilege: With compatibility disabled, output for those statements was taken from the Performance Schema `global_variables`, `session_variables`, `global_status`, and `session_status` tables.

As of MySQL 5.7.9, those Performance Schema tables are world readable and accessible without the `SELECT` privilege. Consequently, `SHOW VARIABLES` and `SHOW STATUS` do not require privileges on the underlying Performance Schema tables from which their output is produced when `show_compatibility_56=OFF`.

### Beyond MySQL 5.7

In a MySQL 8.0, the `INFORMATION_SCHEMA` variable tables and the `show_compatibility_56` system variable are removed, and output from the `SHOW` statements is always based on the underlying Performance Schema tables.

Applications that have been revised to work in MySQL 5.7 when `show_compatibility_56=OFF` should work without further changes, except that it is not possible to test or set `show_compatibility_56` because it does not exist.

## 25.21 Restrictions on Performance Schema

The Performance Schema avoids using mutexes to collect or produce data, so there are no guarantees of consistency and results can sometimes be incorrect. Event values in `performance_schema` tables are nondeterministic and nonrepeatable.

If you save event information in another table, you should not assume that the original events are still available later. For example, if you select events from a `performance_schema` table into a temporary table, intending to join that table with the original table later, there might be no matches.

`mysqldump` and `BACKUP DATABASE` ignore tables in the `performance_schema` database.

Tables in the `performance_schema` database cannot be locked with `LOCK TABLES`, except the `setup_XXX` tables.

Tables in the `performance_schema` database cannot be indexed.

Results for queries that refer to tables in the `performance_schema` database are not saved in the query cache.

Tables in the `performance_schema` database are not replicated.

The Performance Schema is not available in `libmysqld`, the embedded server.

The types of timers might vary per platform. The `performance_timers` table shows which event timers are available. If the values in this table for a given timer name are `NULL`, that timer is not supported on your platform.

Instruments that apply to storage engines might not be implemented for all storage engines. Instrumentation of each third-party engine is the responsibility of the engine maintainer.



---

# Chapter 26 MySQL sys Schema

## Table of Contents

26.1 Prerequisites for Using the sys Schema .....	4387
26.2 Using the sys Schema .....	4388
26.3 sys Schema Progress Reporting .....	4389
26.4 sys Schema Object Reference .....	4390
26.4.1 sys Schema Object Index .....	4390
26.4.2 sys Schema Tables and Triggers .....	4395
26.4.3 sys Schema Views .....	4398
26.4.4 sys Schema Stored Procedures .....	4439
26.4.5 sys Schema Stored Functions .....	4459

MySQL 5.7 includes the `sys` schema, a set of objects that helps DBAs and developers interpret data collected by the Performance Schema. `sys` schema objects can be used for typical tuning and diagnosis use cases. Objects in this schema include:

- Views that summarize Performance Schema data into more easily understandable form.
- Stored procedures that perform operations such as Performance Schema configuration and generating diagnostic reports.
- Stored functions that query Performance Schema configuration and provide formatting services.

For new installations, the `sys` schema is installed by default during data directory initialization if you use `mysqld` with the `--initialize` or `--initialize-insecure` option. You can drop the `sys` schema manually after initialization if it is unneeded.

For upgrades, `mysql_upgrade` installs the `sys` schema if it is not installed, and upgrades it to the current version otherwise. To permit this behavior to be suppressed, `mysql_upgrade` has a `--skip-sys-schema` option.

`mysql_upgrade` returns an error if a `sys` schema exists but has no `version` view, on the assumption that absence of this view indicates a user-created `sys` schema. To upgrade in this case, remove or rename the existing `sys` schema first.

`sys` schema objects have a `DEFINER` of `'mysql.sys'@'localhost'`. Use of the dedicated `mysql.sys` account avoids problems that occur if a DBA renames or removes the `root` account.

## 26.1 Prerequisites for Using the sys Schema

Before using the `sys` schema, the prerequisites described in this section must be satisfied.

Because the `sys` schema provides an alternative means of accessing the Performance Schema, the Performance Schema must be enabled for the `sys` schema to work. See [Section 25.3, “Performance Schema Startup Configuration”](#).

For full access to the `sys` schema, a user must have these privileges:

- `SELECT` on all `sys` tables and views
- `EXECUTE` on all `sys` stored procedures and functions
- `INSERT` and `UPDATE` for the `sys_config` table, if changes are to be made to it

- Additional privileges for certain `sys` schema stored procedures and functions, as noted in their descriptions (for example, the `ps_setup_save()` procedure)

It is also necessary to have privileges for the objects underlying the `sys` schema objects:

- `SELECT` on any Performance Schema tables accessed by `sys` schema objects, and `UPDATE` for any tables to be updated using `sys` schema objects
- `PROCESS` for the `INFORMATION_SCHEMA INNODB_BUFFER_PAGE` table

Certain Performance Schema instruments and consumers must be enabled and (for instruments) timed to take full advantage of `sys` schema capabilities:

- All `wait` instruments
- All `stage` instruments
- All `statement` instruments
- `xxx_current` and `xxx_history_long` consumers for all events

You can use the `sys` schema itself to enable all of the additional instruments and consumers:

```
CALL sys.ps_setup_enable_instrument('wait');
CALL sys.ps_setup_enable_instrument('stage');
CALL sys.ps_setup_enable_instrument('statement');
CALL sys.ps_setup_enable_consumer('current');
CALL sys.ps_setup_enable_consumer('history_long');
```



#### Note

For many uses of the `sys` schema, the default Performance Schema is sufficient for data collection. Enabling all the instruments and consumers just mentioned has a performance impact, so it is preferable to enable only the additional configuration you need. Also, remember that if you enable additional configuration, you can easily restore the default configuration like this:

```
CALL sys.ps_setup_reset_to_default(TRUE);
```

## 26.2 Using the sys Schema

You can make the `sys` schema the default schema so that references to its objects need not be qualified with the schema name:

```
mysql> USE sys;
Database changed
mysql> SELECT * FROM version;
+-----+-----+
| sys_version | mysql_version |
+-----+-----+
| 1.5.1       | 5.7.24-debug-log |
+-----+-----+
```

(The `version` view shows the `sys` schema and MySQL server versions.)

To access `sys` schema objects while a different schema is the default (or simply to be explicit), qualify object references with the schema name:

```
mysql> SELECT * FROM sys.version;
+-----+-----+
| sys_version | mysql_version |
+-----+-----+
```

```
| 1.5.1 | 5.7.24-debug-log |
+-----+-----+
```

The `sys` schema contains many views that summarize Performance Schema tables in various ways. Most of these views come in pairs, such that one member of the pair has the same name as the other member, plus a `x$` prefix. For example, the `host_summary_by_file_io` view summarizes file I/O grouped by host and displays latencies converted from picoseconds to more readable values (with units);

```
mysql> SELECT * FROM sys.host_summary_by_file_io;
+-----+-----+-----+
| host      | ios   | io_latency |
+-----+-----+-----+
| localhost | 67570 | 5.38 s     |
| background | 3468  | 4.18 s     |
+-----+-----+-----+
```

The `x$host_summary_by_file_io` view summarizes the same data but displays unformatted picosecond latencies:

```
mysql> SELECT * FROM sys.x$host_summary_by_file_io;
+-----+-----+-----+
| host      | ios   | io_latency |
+-----+-----+-----+
| localhost | 67574 | 5380678125144 |
| background | 3474  | 4758696829416 |
+-----+-----+-----+
```

The view without the `x$` prefix is intended to provide output that is more user friendly and easier for humans to read. The view with the `x$` prefix that displays the same values in raw form is intended more for use with other tools that perform their own processing on the data. For additional information about the differences between non-`x$` and `x$` views, see [Section 26.4.3, “sys Schema Views”](#).

To examine `sys` schema object definitions, use the appropriate `SHOW` statement or `INFORMATION_SCHEMA` query. For example, to examine the definitions of the `session` view and `format_bytes()` function, use these statements:

```
mysql> SHOW CREATE VIEW sys.session;
mysql> SHOW CREATE FUNCTION sys.format_bytes;
```

However, those statements display the definitions in relatively unformatted form. To view object definitions with more readable formatting, access the individual `.sql` files found under the `scripts/sys_schema` in MySQL source distributions. Prior to MySQL 5.7.28, the sources are maintained in a separate distribution available from the `sys` schema development website at <https://github.com/mysql/mysql-sys>.

Neither `mysqldump` nor `mysqlpump` dump the `sys` schema by default. To generate a dump file, name the `sys` schema explicitly on the command line using either of these commands:

```
mysqldump --databases --routines sys > sys_dump.sql
mysqlpump sys > sys_dump.sql
```

To reinstall the schema from the dump file, use this command:

```
mysql < sys_dump.sql
```

## 26.3 sys Schema Progress Reporting

The following `sys` schema views provide progress reporting for long-running transactions:

```
processlist
session
x$processlist
x$session
```

Assuming that the required instruments and consumers are enabled, the `progress` column of these views shows the percentage of work completed for stages that support progress reporting.

Stage progress reporting requires that the `events_stages_current` consumer be enabled, as well as the instruments for which progress information is desired. Instruments for these stages currently support progress reporting:

```
stage/sql/Copying to tmp table
stage/innodb/alter table (end)
stage/innodb/alter table (flush)
stage/innodb/alter table (insert)
stage/innodb/alter table (log apply index)
stage/innodb/alter table (log apply table)
stage/innodb/alter table (merge sort)
stage/innodb/alter table (read PK and internal sort)
stage/innodb/buffer pool load
```

For stages that do not support estimated and completed work reporting, or if the required instruments or consumers are not enabled, the `progress` column is `NULL`.

## 26.4 sys Schema Object Reference

The `sys` schema includes tables and triggers, views, and stored procedures and functions. The following sections provide details for each of these objects.

### 26.4.1 sys Schema Object Index

The following tables list `sys` schema objects and provide a short description of each one.

**Table 26.1 sys Schema Tables and Triggers**

Table or Trigger Name	Description
<code>sys_config</code>	sys schema configuration options table
<code>sys_config_insert_set_user</code>	sys_config insert trigger
<code>sys_config_update_set_user</code>	sys_config update trigger

**Table 26.2 sys Schema Views**

View Name	Description	Deprecated
<code>host_summary, x</code> <code>\$host_summary</code>	Statement activity, file I/O, and connections, grouped by host	
<code>host_summary_by_file_io, x</code> <code>\$host_summary_by_file_io</code>	File I/O, grouped by host	
<code>host_summary_by_file_io_type, x</code> <code>\$host_summary_by_file_io_type</code>	File I/O, grouped by host and event type	
<code>host_summary_by_stages, x</code> <code>\$host_summary_by_stages</code>	Statement stages, grouped by host	
<code>host_summary_by_statement_latency, x</code> <code>\$host_summary_by_statement_latency</code>	Statement statistics, grouped by host	
<code>host_summary_by_statement_type, x</code> <code>\$host_summary_by_statement_type</code>	Statements executed, grouped by host and statement type	

View Name	Description	Deprecated
<code>innodb_buffer_stats_by_schema, x</code> <code>\$innodb_buffer_stats_by_schema</code>	InnoDB buffer information, grouped by schema	
<code>innodb_buffer_stats_by_table, x</code> <code>\$innodb_buffer_stats_by_table</code>	InnoDB buffer information, grouped by schema and table	
<code>innodb_lock_waits, x</code> <code>\$innodb_lock_waits</code>	InnoDB lock information	
<code>io_by_thread_by_latency, x</code> <code>\$io_by_thread_by_latency</code>	I/O consumers, grouped by thread	
<code>io_global_by_file_by_bytes, x</code> <code>\$io_global_by_file_by_bytes</code>	Global I/O consumers, grouped by file and bytes	
<code>io_global_by_file_by_latency, x</code> <code>\$io_global_by_file_by_latency</code>	Global I/O consumers, grouped by file and latency	
<code>io_global_by_wait_by_bytes, x</code> <code>\$io_global_by_wait_by_bytes</code>	Global I/O consumers, grouped by bytes	
<code>io_global_by_wait_by_latency, x</code> <code>\$io_global_by_wait_by_latency</code>	Global I/O consumers, grouped by latency	
<code>latest_file_io, x</code> <code>\$latest_file_io</code>	Most recent I/O, grouped by file and thread	
<code>memory_by_host_by_current_bytes, x</code> <code>\$memory_by_host_by_current_bytes</code>	Memory use, grouped by host	
<code>memory_by_thread_by_current_bytes, x</code> <code>\$memory_by_thread_by_current_bytes</code>	Memory use, grouped by thread	
<code>memory_by_user_by_current_bytes, x</code> <code>\$memory_by_user_by_current_bytes</code>	Memory use, grouped by user	
<code>memory_global_by_current_by_allocation_type, x</code> <code>\$memory_global_by_current_by_allocation_type</code>	Memory use, grouped by allocation type	
<code>memory_global_total, x</code> <code>\$memory_global_total</code>	Total memory use	
<code>metrics</code>	Server metrics	
<code>processlist, x</code> <code>\$processlist</code>	Processlist information	
<code>ps_check_lost_instrumentation</code>	Variables that have lost instruments	
<code>schema_auto_increment_columns</code>	AUTO_INCREMENT column information	

View Name	Description	Deprecated
<code>schema_index_statistics, x</code> <code>\$schema_index_statistics</code>	Index statistics	
<code>schema_object_overview</code>	Types of objects within each schema	
<code>schema_redundant_indexes</code>	Duplicate or redundant indexes	
<code>schema_table_lock_waits, x</code> <code>\$schema_table_lock_waits</code>	Sessions waiting for metadata locks	
<code>schema_table_statistics, x</code> <code>\$schema_table_statistics</code>	Table statistics	
<code>schema_table_statistics_with_buffer, x</code> <code>\$schema_table_statistics_with_buffer</code>	Table statistics, including InnoDB buffer pool statistics	
<code>schema_tables_with_full_table_scans, x</code> <code>\$schema_tables_with_full_table_scans</code>	Tables being accessed with full scans	
<code>schema_unused_indexes</code>	Indexes not in active use	
<code>session, x</code> <code>\$session</code>	Processlist information for user sessions	
<code>session_ssl_status</code>	Connection SSL information	
<code>statement_analysis, x</code> <code>\$statement_analysis</code>	Statement aggregate statistics	
<code>statements_with_errors_or_warnings, x</code> <code>\$statements_with_errors_or_warnings</code>	Statements that have produced errors or warnings	
<code>statements_with_full_table_scans, x</code> <code>\$statements_with_full_table_scans</code>	Statements that have done full table scans	
<code>statements_with_runtime_in_95th_percentile, x</code> <code>\$statements_with_runtime_in_95th_percentile</code>	Statements with highest average runtime	
<code>statements_with_sorting, x</code> <code>\$statements_with_sorting</code>	Statements that performed sorts	
<code>statements_with_temp_tables, x</code> <code>\$statements_with_temp_tables</code>	Statements that used temporary tables	
<code>user_summary, x</code> <code>\$user_summary</code>	User statement and connection activity	
<code>user_summary_by_file_io, x</code> <code>\$user_summary_by_file_io</code>	File I/O, grouped by user	
<code>user_summary_by_file_io_type, x</code> <code>\$user_summary_by_file_io_type</code>	File I/O, grouped by user and event	
<code>user_summary_by_stages, x</code> <code>\$user_summary_by_stages</code>	Stage events, grouped by user	

View Name	Description	Deprecated
<code>user_summary_by_statement_latency</code> x \$ <code>user_summary_by_statement_latency</code>	Statement statistics, grouped by user	
<code>user_summary_by_statement_type</code> x \$ <code>user_summary_by_statement_type</code>	Statements executed, grouped by user and statement	
<code>version</code>	Current sys schema and MySQL server versions	5.7.28
<code>wait_classes_global_by_avg_latency</code> x \$ <code>wait_classes_global_by_avg_latency</code>	Wait class, average latency, grouped by event class	
<code>wait_classes_global_by_latency</code> x \$ <code>wait_classes_global_by_latency</code>	Wait class total latency, grouped by event class	
<code>waits_by_host_by_latency</code> x \$ <code>waits_by_host_by_latency</code>	Wait events, grouped by host and event	
<code>waits_by_user_by_latency</code> x \$ <code>waits_by_user_by_latency</code>	Wait events, grouped by user and event	
<code>waits_global_by_latency</code> x \$ <code>waits_global_by_latency</code>	Wait events, grouped by event	
x \$ <code>ps_digest_95th_percentile_by_avg_us</code>	Helper view for 95th-percentile views	
x \$ <code>ps_digest_avg_latency_distribution</code>	Helper view for 95th-percentile views	
x \$ <code>ps_schema_table_statistics</code>	Helper view for table-statistics views	
x \$ <code>schema_flattened_keys</code>	Helper view for schema_redundant_indexes	

**Table 26.3 sys Schema Stored Procedures**

Procedure Name	Description
<code>create_synonym_db()</code>	Create synonym for schema
<code>diagnostics()</code>	Collect system diagnostic information
<code>execute_prepared_stmt()</code>	Execute prepared statement
<code>ps_setup_disable_background_threads()</code>	Disable background thread instrumentation
<code>ps_setup_disable_consumer()</code>	Disable consumers
<code>ps_setup_disable_instrument()</code>	Disable instruments
<code>ps_setup_disable_thread()</code>	Disable instrumentation for thread
<code>ps_setup_enable_background_threads()</code>	Enable background thread instrumentation
<code>ps_setup_enable_consumer()</code>	Enable consumers
<code>ps_setup_enable_instrument()</code>	Enable instruments

Procedure Name	Description
<code>ps_setup_enable_thread()</code>	Enable instrumentation for thread
<code>ps_setup_reload_saved()</code>	Reload saved Performance Schema configuration
<code>ps_setup_reset_to_default()</code>	Reset saved Performance Schema configuration
<code>ps_setup_save()</code>	Save Performance Schema configuration
<code>ps_setup_show_disabled()</code>	Display disabled Performance Schema configuration
<code>ps_setup_show_disabled_consumers()</code>	Display disabled Performance Schema consumers
<code>ps_setup_show_disabled_instruments()</code>	Display disabled Performance Schema instruments
<code>ps_setup_show_enabled()</code>	Display enabled Performance Schema configuration
<code>ps_setup_show_enabled_consumers()</code>	Display enabled Performance Schema consumers
<code>ps_setup_show_enabled_instruments()</code>	Display enabled Performance Schema instruments
<code>ps_statement_avg_latency_histogram()</code>	Display statement latency histogram
<code>ps_trace_statement_digest()</code>	Trace Performance Schema instrumentation for digest
<code>ps_trace_thread()</code>	Dump Performance Schema data for thread
<code>ps_truncate_all_tables()</code>	Truncate Performance Schema summary tables
<code>statement_performance_analyzer()</code>	Report of statements running on server
<code>table_exists()</code>	Whether a table exists

**Table 26.4 sys Schema Stored Functions**

Function Name	Description	Introduced
<code>extract_schema_from_file_name()</code>	Extract schema name part of file name	
<code>extract_table_from_file_name()</code>	Extract table name part of file name	
<code>format_bytes()</code>	Convert byte count to value with units	
<code>format_path()</code>	Replace directories in path name with symbolic system variable names	
<code>format_statement()</code>	Truncate long statement to fixed length	
<code>format_time()</code>	Convert picoseconds time to value with units	
<code>list_add()</code>	Add item to list	
<code>list_drop()</code>	Remove item from list	
<code>ps_is_account_enabled()</code>	Whether Performance Schema instrumentation for account is enabled	
<code>ps_is_consumer_enabled()</code>	Whether Performance Schema consumer is enabled	
<code>ps_is_instrument_default_enabled()</code>	Whether Performance Schema instrument is enabled by default	



Function Name	Description	Introduced
<code>ps_is_instrument_default_t</code>	Whether Performance Schema instrument is timed by default	
<code>ps_is_thread_instrumented()</code>	Whether Performance Schema instrumentation for connection ID is enabled	
<code>ps_thread_account()</code>	Account associated with Performance Schema thread ID	
<code>ps_thread_id()</code>	Performance Schema thread ID associated with connection ID	
<code>ps_thread_stack()</code>	Event information for connection ID	
<code>ps_thread_trx_info()</code>	Transaction information for thread ID	
<code>quote_identifier()</code>	Quote string as identifier	5.7.14
<code>sys_get_config()</code>	sys schema configuration option value	
<code>version_major()</code>	MySQL server major version number	
<code>version_minor()</code>	MySQL server minor version number	
<code>version_patch()</code>	MySQL server patch release version number	

## 26.4.2 sys Schema Tables and Triggers

The following sections describe `sys` schema tables and triggers.

### 26.4.2.1 The `sys_config` Table

This table contains `sys` schema configuration options, one row per option. Configuration changes made by updating this table persist across client sessions and server restarts.

The `sys_config` table has these columns:

- `variable`

The configuration option name.

- `value`

The configuration option value.

- `set_time`

The timestamp of the most recent modification to the row.

- `set_by`

The account that made the most recent modification to the row. The value is `NULL` if the row has not been changed since the `sys` schema was installed.

As an efficiency measure to minimize the number of direct reads from the `sys_config` table, `sys` schema functions that use a value from this table check for a user-defined variable with a corresponding name, which is the user-defined variable having the same name plus a `@sys.` prefix. (For example, the variable corresponding to the `diagnostics.include_raw` option is `@sys.diagnostics.include_raw`.) If the user-defined variable exists in the current session and is non-`NULL`, the function uses its value in preference to the value in the `sys_config` table. Otherwise, the function reads and uses the value from the table. In the latter case, the calling function conventionally also sets the corresponding user-defined variable to the table value so that further references to the configuration option within the same session use the variable and need not read the table again.

For example, the `statement_truncate_len` option controls the maximum length of statements returned by the `format_statement()` function. The default is 64. To temporarily change the value to 32 for your current session, set the corresponding `@sys.statement_truncate_len` user-defined variable:

```
mysql> SET @stmt = 'SELECT variable, value, set_time, set_by FROM sys_config';
mysql> SELECT sys.format_statement(@stmt);
+-----+
| sys.format_statement(@stmt) |
+-----+
| SELECT variable, value, set_time, set_by FROM sys_config |
+-----+
mysql> SET @sys.statement_truncate_len = 32;
mysql> SELECT sys.format_statement(@stmt);
+-----+
| sys.format_statement(@stmt) |
+-----+
| SELECT variabl ... ROM sys_config |
+-----+
```

Subsequent invocations of `format_statement()` within the session continue to use the user-defined variable value (32), rather than the value stored in the table (64).

To stop using the user-defined variable and revert to using the value in the table, set the variable to `NULL` within your session:

```
mysql> SET @sys.statement_truncate_len = NULL;
mysql> SELECT sys.format_statement(@stmt);
+-----+
| sys.format_statement(@stmt) |
+-----+
| SELECT variable, value, set_time, set_by FROM sys_config |
+-----+
```

Alternatively, end your current session (causing the user-defined variable to no longer exist) and begin a new session.

The conventional relationship just described between options in the `sys_config` table and user-defined variables can be exploited to make temporary configuration changes that end when your session ends. However, if you set a user-defined variable and then subsequently change the corresponding table value within the same session, the changed table value is not used in that session as long as the user-defined variable exists and is not `NULL`. (The changed table value *is* used in other sessions that do not have the user-defined variable assigned.)

The following list describes the options in the `sys_config` table and the corresponding user-defined variables:

- `diagnostics.allow_i_s_tables`, `@sys.diagnostics.allow_i_s_tables`

If this option is `ON`, the `diagnostics()` procedure is permitted to perform table scans on the Information Schema `TABLES` table. This can be expensive if there are many tables. The default is `OFF`.

- `diagnostics.include_raw, @sys.diagnostics.include_raw`

If this option is `ON`, the `diagnostics()` procedure includes the raw output from querying the `metrics` view. The default is `OFF`.

- `ps_thread_trx_info.max_length, @sys.ps_thread_trx_info.max_length`

The maximum length for JSON output produced by the `ps_thread_trx_info()` function. The default is 65535.

- `statement_performance_analyzer.limit, @sys.statement_performance_analyzer.limit`

The maximum number of rows to return for views that have no built-in limit. (For example, the `statements_with_runtimes_in_95th_percentile` view has a built-in limit in the sense that it returns only statements with average execution time in the 95th percentile.) The default is 100.

- `statement_performance_analyzer.view, @sys.statement_performance_analyzer.view`

The custom query or view to be used by the `statement_performance_analyzer()` procedure (which is itself invoked by the `diagnostics()` procedure). If the option value contains a space, it is interpreted as a query. Otherwise, it must be the name of an existing view that queries the Performance Schema `events_statements_summary_by_digest` table. There cannot be any `LIMIT` clause in the query or view definition if the `statement_performance_analyzer.limit` configuration option is greater than 0. The default is `NULL` (no custom view defined).

- `statement_truncate_len, @sys.statement_truncate_len`

The maximum length of statements returned by the `format_statement()` function. Longer statements are truncated to this length. The default is 64.

Other options can be added to the `sys_config` table. For example, the `diagnostics()` and `execute_prepared_stmt()` procedures use the `debug` option if it exists, but this option is not part of the `sys_config` table by default because debug output normally is enabled only temporarily, by setting the corresponding `@sys.debug` user-defined variable. To enable debug output without having to set that variable in individual sessions, add the option to the table:

```
mysql> INSERT INTO sys.sys_config (variable, value) VALUES('debug', 'ON');
```

To change the debug setting in the table, do two things. First, modify the value in the table itself:

```
mysql> UPDATE sys.sys_config
      SET value = 'OFF'
      WHERE variable = 'debug';
```

Second, to also ensure that procedure invocations within the current session use the changed value from the table, set the corresponding user-defined variable to `NULL`:

```
mysql> SET @sys.debug = NULL;
```

### 26.4.2.2 The `sys_config_insert_set_user` Trigger

For rows added to the `sys_config` table by `INSERT` statements, the `sys_config_insert_set_user` trigger sets the `set_by` column to the current user.

### 26.4.2.3 The `sys_config_update_set_user` Trigger

The `sys_config_update_set_user` trigger for the `sys_config` table is similar to the `sys_config_insert_set_user` trigger, but for `UPDATE` statements.

## 26.4.3 sys Schema Views

The following sections describe `sys` schema views.

The `sys` schema contains many views that summarize Performance Schema tables in various ways. Most of these views come in pairs, such that one member of the pair has the same name as the other member, plus a `x$` prefix. For example, the `host_summary_by_file_io` view summarizes file I/O grouped by host and displays latencies converted from picoseconds to more readable values (with units);

```
mysql> SELECT * FROM sys.host_summary_by_file_io;
+-----+-----+-----+
| host          | ios    | io_latency |
+-----+-----+-----+
| localhost     | 67570  | 5.38 s     |
| background    | 3468   | 4.18 s     |
+-----+-----+-----+
```

The `x$host_summary_by_file_io` view summarizes the same data but displays unformatted picosecond latencies:

```
mysql> SELECT * FROM sys.x$host_summary_by_file_io;
+-----+-----+-----+
| host          | ios    | io_latency |
+-----+-----+-----+
| localhost     | 67574  | 5380678125144 |
| background    | 3474   | 4758696829416 |
+-----+-----+-----+
```

The view without the `x$` prefix is intended to provide output that is more user friendly and easier to read. The view with the `x$` prefix that displays the same values in raw form is intended more for use with other tools that perform their own processing on the data.

Views without the `x$` prefix differ from the corresponding `x$` views in these ways:

- Byte counts are formatted with size units using `format_bytes()`.
- Time values are formatted with temporal units using `format_time()`.
- SQL statements are truncated to a maximum display width using `format_statement()`.
- Path name are shortened using `format_path()`.

### 26.4.3.1 The `host_summary` and `x$host_summary` Views

These views summarize statement activity, file I/O, and connections, grouped by host.

The `host_summary` and `x$host_summary` views have these columns:

- `host`

The host from which the client connected. Rows for which the `HOST` column in the underlying Performance Schema table is `NULL` are assumed to be for background threads and are reported with a host name of `background`.

- `statements`

The total number of statements for the host.

- `statement_latency`

The total wait time of timed statements for the host.

- `statement_avg_latency`  
The average wait time per timed statement for the host.
- `table_scans`  
The total number of table scans for the host.
- `file_ios`  
The total number of file I/O events for the host.
- `file_io_latency`  
The total wait time of timed file I/O events for the host.
- `current_connections`  
The current number of connections for the host.
- `total_connections`  
The total number of connections for the host.
- `unique_users`  
The number of distinct users for the host.
- `current_memory`  
The current amount of allocated memory for the host.
- `total_memory_allocated`  
The total amount of allocated memory for the host.

### 26.4.3.2 The `host_summary_by_file_io` and `x$host_summary_by_file_io` Views

These views summarize file I/O, grouped by host. By default, rows are sorted by descending total file I/O latency.

The `host_summary_by_file_io` and `x$host_summary_by_file_io` views have these columns:

- `host`  
The host from which the client connected. Rows for which the `HOST` column in the underlying Performance Schema table is `NULL` are assumed to be for background threads and are reported with a host name of `background`.
- `ios`  
The total number of file I/O events for the host.
- `io_latency`  
The total wait time of timed file I/O events for the host.

### 26.4.3.3 The `host_summary_by_file_io_type` and `x$host_summary_by_file_io_type` Views

These views summarize file I/O, grouped by host and event type. By default, rows are sorted by host and descending total I/O latency.

The `host_summary_by_file_io_type` and `x$host_summary_by_file_io_type` views have these columns:

- `host`

The host from which the client connected. Rows for which the `HOST` column in the underlying Performance Schema table is `NULL` are assumed to be for background threads and are reported with a host name of `background`.

- `event_name`

The file I/O event name.

- `total`

The total number of occurrences of the file I/O event for the host.

- `total_latency`

The total wait time of timed occurrences of the file I/O event for the host.

- `max_latency`

The maximum single wait time of timed occurrences of the file I/O event for the host.

#### 26.4.3.4 The `host_summary_by_stages` and `x$host_summary_by_stages` Views

These views summarize statement stages, grouped by host. By default, rows are sorted by host and descending total latency.

The `host_summary_by_stages` and `x$host_summary_by_stages` views have these columns:

- `host`

The host from which the client connected. Rows for which the `HOST` column in the underlying Performance Schema table is `NULL` are assumed to be for background threads and are reported with a host name of `background`.

- `event_name`

The stage event name.

- `total`

The total number of occurrences of the stage event for the host.

- `total_latency`

The total wait time of timed occurrences of the stage event for the host.

- `avg_latency`

The average wait time per timed occurrence of the stage event for the host.

#### 26.4.3.5 The `host_summary_by_statement_latency` and `x$host_summary_by_statement_latency` Views

These views summarize overall statement statistics, grouped by host. By default, rows are sorted by descending total latency.

The `host_summary_by_statement_latency` and `x$host_summary_by_statement_latency` views have these columns:

- `host`

The host from which the client connected. Rows for which the `HOST` column in the underlying Performance Schema table is `NULL` are assumed to be for background threads and are reported with a host name of `background`.

- `total`

The total number of statements for the host.

- `total_latency`

The total wait time of timed statements for the host.

- `max_latency`

The maximum single wait time of timed statements for the host.

- `lock_latency`

The total time waiting for locks by timed statements for the host.

- `rows_sent`

The total number of rows returned by statements for the host.

- `rows_examined`

The total number of rows read from storage engines by statements for the host.

- `rows_affected`

The total number of rows affected by statements for the host.

- `full_scans`

The total number of full table scans by statements for the host.

### 26.4.3.6 The `host_summary_by_statement_type` and `x$host_summary_by_statement_type` Views

These views summarize information about statements executed, grouped by host and statement type. By default, rows are sorted by host and descending total latency.

The `host_summary_by_statement_type` and `x$host_summary_by_statement_type` views have these columns:

- `host`

The host from which the client connected. Rows for which the `HOST` column in the underlying Performance Schema table is `NULL` are assumed to be for background threads and are reported with a host name of `background`.

- `statement`

The final component of the statement event name.

- `total`

The total number of occurrences of the statement event for the host.

- `total_latency`

The total wait time of timed occurrences of the statement event for the host.

- `max_latency`

The maximum single wait time of timed occurrences of the statement event for the host.

- `lock_latency`

The total time waiting for locks by timed occurrences of the statement event for the host.

- `rows_sent`

The total number of rows returned by occurrences of the statement event for the host.

- `rows_examined`

The total number of rows read from storage engines by occurrences of the statement event for the host.

- `rows_affected`

The total number of rows affected by occurrences of the statement event for the host.

- `full_scans`

The total number of full table scans by occurrences of the statement event for the host.

### 26.4.3.7 The `innodb_buffer_stats_by_schema` and `x$innodb_buffer_stats_by_schema` Views

These views summarize the information in the `INFORMATION_SCHEMA.INNODB_BUFFER_PAGE` table, grouped by schema. By default, rows are sorted by descending buffer size.



#### Warning

Querying views that access the `INNODB_BUFFER_PAGE` table can affect performance. Do not query these views on a production system unless you are aware of the performance impact and have determined it to be acceptable. To avoid impacting performance on a production system, reproduce the issue you want to investigate and query buffer pool statistics on a test instance.

The `innodb_buffer_stats_by_schema` and `x$innodb_buffer_stats_by_schema` views have these columns:

- `object_schema`

The schema name for the object, or `InnoDB System` if the table belongs to the `InnoDB` storage engine.

- `allocated`



The total number of bytes allocated for the schema.

- `data`

The total number of data bytes allocated for the schema.

- `pages`

The total number of pages allocated for the schema.

- `pages_hashed`

The total number of hashed pages allocated for the schema.

- `pages_old`

The total number of old pages allocated for the schema.

- `rows_cached`

The total number of cached rows for the schema.

### 26.4.3.8 The `innodb_buffer_stats_by_table` and `x$innodb_buffer_stats_by_table` Views

These views summarize the information in the `INFORMATION_SCHEMA.INNODB_BUFFER_PAGE` table, grouped by schema and table. By default, rows are sorted by descending buffer size.



#### Warning

Querying views that access the `INNODB_BUFFER_PAGE` table can affect performance. Do not query these views on a production system unless you are aware of the performance impact and have determined it to be acceptable. To avoid impacting performance on a production system, reproduce the issue you want to investigate and query buffer pool statistics on a test instance.

The `innodb_buffer_stats_by_table` and `x$innodb_buffer_stats_by_table` views have these columns:

- `object_schema`

The schema name for the object, or `InnoDB System` if the table belongs to the `InnoDB` storage engine.

- `object_name`

The table name.

- `allocated`

The total number of bytes allocated for the table.

- `data`

The number of data bytes allocated for the table.

- `pages`

The total number of pages allocated for the table.

- `pages_hashed`  
The number of hashed pages allocated for the table.
- `pages_old`  
The number of old pages allocated for the table.
- `rows_cached`  
The number of cached rows for the table.

### 26.4.3.9 The `innodb_lock_waits` and `x$innodb_lock_waits` Views

These views summarize the `InnoDB` locks that transactions are waiting for. By default, rows are sorted by descending lock age.

The `innodb_lock_waits` and `x$innodb_lock_waits` views have these columns:

- `wait_started`  
The time at which the lock wait started.
- `wait_age`  
How long the lock has been waited for, as a `TIME` value.
- `wait_age_secs`  
How long the lock has been waited for, in seconds.
- `locked_table`  
The name of the locked table. This column contains combined schema/table name values.
- `locked_index`  
The name of the locked index.
- `locked_type`  
The type of the waiting lock.
- `waiting_trx_id`  
The ID of the waiting transaction.
- `waiting_trx_started`  
The time at which the waiting transaction started.
- `waiting_trx_age`  
How long the waiting transaction has been waiting, as a `TIME` value.
- `waiting_trx_rows_locked`  
The number of rows locked by the waiting transaction.
- `waiting_trx_rows_modified`

The number of rows modified by the waiting transaction.

- `waiting_pid`

The processlist ID of the waiting transaction.

- `waiting_query`

The statement that is waiting for the lock.

- `waiting_lock_id`

The ID of the waiting lock.

- `waiting_lock_mode`

The mode of the waiting lock.

- `blocking_trx_id`

The ID of the transaction that is blocking the waiting lock.

- `blocking_pid`

The processlist ID of the blocking transaction.

- `blocking_query`

The statement the blocking transaction is executing. This field reports NULL if the session that issued the blocking query becomes idle. For more information, see [Identifying a Blocking Query After the Issuing Session Becomes Idle](#).

- `blocking_lock_id`

The ID of the lock that is blocking the waiting lock.

- `blocking_lock_mode`

The mode of the lock that is blocking the waiting lock.

- `blocking_trx_started`

The time at which the blocking transaction started.

- `blocking_trx_age`

How long the blocking transaction has been executing, as a `TIME` value.

- `blocking_trx_rows_locked`

The number of rows locked by the blocking transaction.

- `blocking_trx_rows_modified`

The number of rows modified by the blocking transaction.

- `sql_kill_blocking_query`

The `KILL` statement to execute to kill the blocking statement.

- `sql_kill_blocking_connection`

The `KILL` statement to execute to kill the session running the blocking statement.

### 26.4.3.10 The `io_by_thread_by_latency` and `x$io_by_thread_by_latency` Views

These views summarize I/O consumers to display time waiting for I/O, grouped by thread. By default, rows are sorted by descending total I/O latency.

The `io_by_thread_by_latency` and `x$io_by_thread_by_latency` views have these columns:

- `user`

For foreground threads, the account associated with the thread. For background threads, the thread name.

- `total`

The total number of I/O events for the thread.

- `total_latency`

The total wait time of timed I/O events for the thread.

- `min_latency`

The minimum single wait time of timed I/O events for the thread.

- `avg_latency`

The average wait time per timed I/O event for the thread.

- `max_latency`

The maximum single wait time of timed I/O events for the thread.

- `thread_id`

The thread ID.

- `processlist_id`

For foreground threads, the processlist ID of the thread. For background threads, `NULL`.

### 26.4.3.11 The `io_global_by_file_by_bytes` and `x$io_global_by_file_by_bytes` Views

These views summarize global I/O consumers to display amount of I/O, grouped by file. By default, rows are sorted by descending total I/O (bytes read and written).

The `io_global_by_file_by_bytes` and `x$io_global_by_file_by_bytes` views have these columns:

- `file`

The file path name.

- `count_read`

The total number of read events for the file.

- `total_read`  
The total number of bytes read from the file.
- `avg_read`  
The average number of bytes per read from the file.
- `count_write`  
The total number of write events for the file.
- `total_written`  
The total number of bytes written to the file.
- `avg_write`  
The average number of bytes per write to the file.
- `total`  
The total number of bytes read and written for the file.
- `write_pct`  
The percentage of total bytes of I/O that were writes.

#### 26.4.3.12 The `io_global_by_file_by_latency` and `x$io_global_by_file_by_latency` Views

These views summarize global I/O consumers to display time waiting for I/O, grouped by file. By default, rows are sorted by descending total latency.

The `io_global_by_file_by_latency` and `x$io_global_by_file_by_latency` views have these columns:

- `file`  
The file path name.
- `total`  
The total number of I/O events for the file.
- `total_latency`  
The total wait time of timed I/O events for the file.
- `count_read`  
The total number of read I/O events for the file.
- `read_latency`  
The total wait time of timed read I/O events for the file.
- `count_write`  
The total number of write I/O events for the file.

- `write_latency`  
The total wait time of timed write I/O events for the file.
- `count_misc`  
The total number of other I/O events for the file.
- `misc_latency`  
The total wait time of timed other I/O events for the file.

### 26.4.3.13 The `io_global_by_wait_by_bytes` and `x$io_global_by_wait_by_bytes` Views

These views summarize global I/O consumers to display amount of I/O and time waiting for I/O, grouped by event. By default, rows are sorted by descending total I/O (bytes read and written).

The `io_global_by_wait_by_bytes` and `x$io_global_by_wait_by_bytes` views have these columns:

- `event_name`  
The I/O event name, with the `wait/io/file/` prefix stripped.
- `total`  
The total number of occurrences of the I/O event.
- `total_latency`  
The total wait time of timed occurrences of the I/O event.
- `min_latency`  
The minimum single wait time of timed occurrences of the I/O event.
- `avg_latency`  
The average wait time per timed occurrence of the I/O event.
- `max_latency`  
The maximum single wait time of timed occurrences of the I/O event.
- `count_read`  
The number of read requests for the I/O event.
- `total_read`  
The number of bytes read for the I/O event.
- `avg_read`  
The average number of bytes per read for the I/O event.
- `count_write`  
The number of write requests for the I/O event.

- `total_written`  
The number of bytes written for the I/O event.
- `avg_written`  
The average number of bytes per write for the I/O event.
- `total_requested`  
The total number of bytes read and written for the I/O event.

#### 26.4.3.14 The `io_global_by_wait_by_latency` and `x$io_global_by_wait_by_latency` Views

These views summarize global I/O consumers to display amount of I/O and time waiting for I/O, grouped by event. By default, rows are sorted by descending total latency.

The `io_global_by_wait_by_latency` and `x$io_global_by_wait_by_latency` views have these columns:

- `event_name`  
The I/O event name, with the `wait/io/file/` prefix stripped.
- `total`  
The total number of occurrences of the I/O event.
- `total_latency`  
The total wait time of timed occurrences of the I/O event.
- `avg_latency`  
The average wait time per timed occurrence of the I/O event.
- `max_latency`  
The maximum single wait time of timed occurrences of the I/O event.
- `read_latency`  
The total wait time of timed read occurrences of the I/O event.
- `write_latency`  
The total wait time of timed write occurrences of the I/O event.
- `misc_latency`  
The total wait time of timed other occurrences of the I/O event.
- `count_read`  
The number of read requests for the I/O event.
- `total_read`  
The number of bytes read for the I/O event.

- `avg_read`  
The average number of bytes per read for the I/O event.
- `count_write`  
The number of write requests for the I/O event.
- `total_written`  
The number of bytes written for the I/O event.
- `avg_written`  
The average number of bytes per write for the I/O event.

#### 26.4.3.15 The `latest_file_io` and `x$latest_file_io` Views

These views summarize file I/O activity, grouped by file and thread. By default, rows are sorted with most recent I/O first.

The `latest_file_io` and `x$latest_file_io` views have these columns:

- `thread`  
For foreground threads, the account associated with the thread (and port number for TCP/IP connections). For background threads, the thread name and thread ID
- `file`  
The file path name.
- `latency`  
The wait time of the file I/O event.
- `operation`  
The type of operation.
- `requested`  
The number of data bytes requested for the file I/O event.

#### 26.4.3.16 The `memory_by_host_by_current_bytes` and `x$memory_by_host_by_current_bytes` Views

These views summarize memory use, grouped by host. By default, rows are sorted by descending amount of memory used.

The `memory_by_host_by_current_bytes` and `x$memory_by_host_by_current_bytes` views have these columns:

- `host`  
The host from which the client connected. Rows for which the `HOST` column in the underlying Performance Schema table is `NULL` are assumed to be for background threads and are reported with a host name of `background`.



- `current_count_used`  
The current number of allocated memory blocks that have not been freed yet for the host.
- `current_allocated`  
The current number of allocated bytes that have not been freed yet for the host.
- `current_avg_alloc`  
The current number of allocated bytes per memory block for the host.
- `current_max_alloc`  
The largest single current memory allocation in bytes for the host.
- `total_allocated`  
The total memory allocation in bytes for the host.

#### **26.4.3.17 The `memory_by_thread_by_current_bytes` and `x$memory_by_thread_by_current_bytes` Views**

These views summarize memory use, grouped by thread. By default, rows are sorted by descending amount of memory used.

The `memory_by_thread_by_current_bytes` and `x$memory_by_thread_by_current_bytes` views have these columns:

- `thread_id`  
The thread ID.
- `user`  
The thread user or thread name.
- `current_count_used`  
The current number of allocated memory blocks that have not been freed yet for the thread.
- `current_allocated`  
The current number of allocated bytes that have not been freed yet for the thread.
- `current_avg_alloc`  
The current number of allocated bytes per memory block for the thread.
- `current_max_alloc`  
The largest single current memory allocation in bytes for the thread.
- `total_allocated`  
The total memory allocation in bytes for the thread.

#### **26.4.3.18 The `memory_by_user_by_current_bytes` and `x$memory_by_user_by_current_bytes` Views**

These views summarize memory use, grouped by user. By default, rows are sorted by descending amount of memory used.

The `memory_by_user_by_current_bytes` and `x$memory_by_user_by_current_bytes` views have these columns:

- `user`

The client user name. Rows for which the `USER` column in the underlying Performance Schema table is `NULL` are assumed to be for background threads and are reported with a host name of `background`.

- `current_count_used`

The current number of allocated memory blocks that have not been freed yet for the user.

- `current_allocated`

The current number of allocated bytes that have not been freed yet for the user.

- `current_avg_alloc`

The current number of allocated bytes per memory block for the user.

- `current_max_alloc`

The largest single current memory allocation in bytes for the user.

- `total_allocated`

The total memory allocation in bytes for the user.

### 26.4.3.19 The `memory_global_by_current_bytes` and `x$memory_global_by_current_bytes` Views

These views summarize memory use, grouped by allocation type (that is, by event). By default, rows are sorted by descending amount of memory used.

The `memory_global_by_current_bytes` and `x$memory_global_by_current_bytes` views have these columns:

- `event_name`

The memory event name.

- `current_count`

The total number of occurrences of the event.

- `current_alloc`

The current number of allocated bytes that have not been freed yet for the event.

- `current_avg_alloc`

The current number of allocated bytes per memory block for the event.

- `high_count`

The high-water mark for number of memory blocks allocated for the event.

- `high_alloc`

The high-water mark for number of bytes allocated for the event.

- `high_avg_alloc`

The high-water mark for average number of bytes per memory block allocated for the event.

### 26.4.3.20 The `memory_global_total` and `x$memory_global_total` Views

These views summarize total memory use within the server.

The `memory_global_total` and `x$memory_global_total` views have these columns:

- `total_allocated`

The total bytes of memory allocated within the server.

### 26.4.3.21 The `metrics` View

This view summarizes MySQL server metrics to show variable names, values, types, and whether they are enabled. By default, rows are sorted by variable type and name.

The `metrics` view includes this information:

- Global status variables from the Performance Schema `global_status` table
- InnoDB metrics from the `INFORMATION_SCHEMA INNODB_METRICS` table
- Current and total memory allocation, based on the Performance Schema memory instrumentation
- The current time (human readable and Unix timestamp formats)

There is some duplication of information between the `global_status` and `INNODB_METRICS` tables, which the `metrics` view eliminates.

The `metrics` view has these columns:

- `Variable_name`

The metric name. The metric type determines the source from which the name is taken:

- For global status variables: The `VARIABLE_NAME` column of the `global_status` table
- For InnoDB metrics: The `NAME` column of the `INNODB_METRICS` table
- For other metrics: A view-provided descriptive string

- `Variable_value`

The metric value. The metric type determines the source from which the value is taken:

- For global status variables: The `VARIABLE_VALUE` column of the `global_status` table
- For InnoDB metrics: The `COUNT` column of the `INNODB_METRICS` table
- For memory metrics: The relevant column from the Performance Schema `memory_summary_global_by_event_name` table

- For the current time: The value of `NOW(3)` or `UNIX_TIMESTAMP(NOW(3))`
- `Type`

The metric type:

- For global status variables: `Global Status`
- For InnoDB metrics: `InnoDB Metrics - %`, where `%` is replaced by the value of the `SUBSYSTEM` column of the `INNODB_METRICS` table
- For memory metrics: `Performance Schema`
- For the current time: `System Time`
- `Enabled`

Whether the metric is enabled:

- For global status variables: `YES`
- For InnoDB metrics: `YES` if the `STATUS` column of the `INNODB_METRICS` table is `enabled`, `NO` otherwise
- For memory metrics: `NO`, `YES`, or `PARTIAL` (currently, `PARTIAL` occurs only for memory metrics and indicates that not all `memory/%` instruments are enabled; Performance Schema memory instruments are always enabled)
- For the current time: `YES`

### 26.4.3.22 The processlist and x\$processlist Views

The MySQL process list indicates the operations currently being performed by the set of threads executing within the server. The `processlist` and `x$processlist` views summarize process information. They provide more complete information than the `SHOW PROCESSLIST` statement and the `INFORMATION_SCHEMA.PROCESSLIST` table, and are also nonblocking. By default, rows are sorted by descending process time and descending wait time. For a comparison of process information sources, see [Sources of Process Information](#).

The column descriptions here are brief. For additional information, see the description of the Performance Schema `threads` table at [Section 25.12.16.4, “The threads Table”](#).

The `processlist` and `x$processlist` views have these columns:

- `thd_id`  
The thread ID.
- `conn_id`  
The connection ID.
- `user`  
The thread user or thread name.
- `db`

The default database for the thread, or `NULL` if there is none.

- `command`

For foreground threads, the type of command the thread is executing on behalf of the client, or `Sleep` if the session is idle.

- `state`

An action, event, or state that indicates what the thread is doing.

- `time`

The time in seconds that the thread has been in its current state.

- `current_statement`

The statement the thread is executing, or `NULL` if it is not executing any statement.

- `statement_latency`

How long the statement has been executing.

- `progress`

The percentage of work completed for stages that support progress reporting. See [Section 26.3, "sys Schema Progress Reporting"](#).

- `lock_latency`

The time spent waiting for locks by the current statement.

- `rows_examined`

The number of rows read from storage engines by the current statement.

- `rows_sent`

The number of rows returned by the current statement.

- `rows_affected`

The number of rows affected by the current statement.

- `tmp_tables`

The number of internal in-memory temporary tables created by the current statement.

- `tmp_disk_tables`

The number of internal on-disk temporary tables created by the current statement.

- `full_scan`

The number of full table scans performed by the current statement.

- `last_statement`

The last statement executed by the thread, if there is no currently executing statement or wait.

- `last_statement_latency`  
How long the last statement executed.
- `current_memory`  
The number of bytes allocated by the thread.
- `last_wait`  
The name of the most recent wait event for the thread.
- `last_wait_latency`  
The wait time of the most recent wait event for the thread.
- `source`  
The source file and line number containing the instrumented code that produced the event.
- `trx_latency`  
The wait time of the current transaction for the thread.
- `trx_state`  
The state for the current transaction for the thread.
- `trx_autocommit`  
Whether autocommit mode was enabled when the current transaction started.
- `pid`  
The client process ID.
- `program_name`  
The client program name.

### 26.4.3.23 The `ps_check_lost_instrumentation` View

This view returns information about lost Performance Schema instruments, to indicate whether the Performance Schema is unable to monitor all runtime data.

The `ps_check_lost_instrumentation` view has these columns:

- `variable_name`  
The Performance Schema status variable name indicating which type of instrument was lost.
- `variable_value`  
The number of instruments lost.

### 26.4.3.24 The `schema_auto_increment_columns` View

This view indicates which tables have `AUTO_INCREMENT` columns and provides information about those columns, such as the current and maximum column values and the usage ratio (ratio of used to possible values). By default, rows are sorted by descending usage ratio and maximum column value.

Tables in these schemas are excluded from view output: `mysql`, `sys`, `INFORMATION_SCHEMA`, `performance_schema`.

The `schema_auto_increment_columns` view has these columns:

- `table_schema`

The schema that contains the table.

- `table_name`

The table that contains the `AUTO_INCREMENT` column.

- `column_name`

The name of the `AUTO_INCREMENT` column.

- `data_type`

The data type of the column.

- `column_type`

The column type of the column, which is the data type plus possibly other information. For example, for a column with a `bigint(20) unsigned` column type, the data type is just `bigint`.

- `is_signed`

Whether the column type is signed.

- `is_unsigned`

Whether the column type is unsigned.

- `max_value`

The maximum permitted value for the column.

- `auto_increment`

The current `AUTO_INCREMENT` value for the column.

- `auto_increment_ratio`

The ratio of used to permitted values for the column. This indicates how much of the sequence of values is “used up.”

### 26.4.3.25 The `schema_index_statistics` and `x$schema_index_statistics` Views

These views provide index statistics. By default, rows are sorted by descending total index latency.

The `schema_index_statistics` and `x$schema_index_statistics` views have these columns:

- `table_schema`

The schema that contains the table.

- `table_name`

The table that contains the index.

- `index_name`  
The name of the index.
- `rows_selected`  
The total number of rows read using the index.
- `select_latency`  
The total wait time of timed reads using the index.
- `rows_inserted`  
The total number of rows inserted into the index.
- `insert_latency`  
The total wait time of timed inserts into the index.
- `rows_updated`  
The total number of rows updated in the index.
- `update_latency`  
The total wait time of timed updates in the index.
- `rows_deleted`  
The total number of rows deleted from the index.
- `delete_latency`  
The total wait time of timed deletes from the index.

### 26.4.3.26 The `schema_object_overview` View

This view summarizes the types of objects within each schema. By default, rows are sorted by schema and object type.

**Note**

For MySQL instances with a large number of objects, this view might take a long time to execute.

The `schema_object_overview` view has these columns:

- `db`  
The schema name.
- `object_type`  
The object type: `BASE TABLE`, `INDEX (index_type)`, `EVENT`, `FUNCTION`, `PROCEDURE`, `TRIGGER`, `VIEW`.
- `count`



The number of objects in the schema of the given type.

### 26.4.3.27 The `schema_redundant_indexes` and `x$schema_flattened_keys` Views

The `schema_redundant_indexes` view displays indexes that duplicate other indexes or are made redundant by them. The `x$schema_flattened_keys` view is a helper view for `schema_redundant_indexes`.

In the following column descriptions, the dominant index is the one that makes the redundant index redundant.

The `schema_redundant_indexes` view has these columns:

- `table_schema`  
The schema that contains the table.
- `table_name`  
The table that contains the index.
- `redundant_index_name`  
The name of the redundant index.
- `redundant_index_columns`  
The names of the columns in the redundant index.
- `redundant_index_non_unique`  
The number of nonunique columns in the redundant index.
- `dominant_index_name`  
The name of the dominant index.
- `dominant_index_columns`  
The names of the columns in the dominant index.
- `dominant_index_non_unique`  
The number of nonunique columns in the dominant index.
- `subpart_exists`  
Whether the index indexes only part of a column.
- `sql_drop_index`  
The statement to execute to drop the redundant index.

The `x$schema_flattened_keys` view has these columns:

- `table_schema`  
The schema that contains the table.

- `table_name`  
The table that contains the index.
- `index_name`  
An index name.
- `non_unique`  
The number of nonunique columns in the index.
- `subpart_exists`  
Whether the index indexes only part of a column.
- `index_columns`  
The name of the columns in the index.

### 26.4.3.28 The `schema_table_lock_waits` and `x$schema_table_lock_waits` Views

These views display which sessions are blocked waiting on metadata locks, and what is blocking them.

The column descriptions here are brief. For additional information, see the description of the Performance Schema `metadata_locks` table at [Section 25.12.12.1, “The `metadata\_locks` Table”](#).

The `schema_table_lock_waits` and `x$schema_table_lock_waits` views have these columns:

- `object_schema`  
The schema containing the object to be locked.
- `object_name`  
The name of the instrumented object.
- `waiting_thread_id`  
The thread ID of the thread that is waiting for the lock.
- `waiting_pid`  
The processlist ID of the thread that is waiting for the lock.
- `waiting_account`  
The account associated with the session that is waiting for the lock.
- `waiting_lock_type`  
The type of the waiting lock.
- `waiting_lock_duration`  
How long the waiting lock has been waiting.
- `waiting_query`  
The statement that is waiting for the lock.

- `waiting_query_secs`  
How long the statement has been waiting, in seconds.
- `waiting_query_rows_affected`  
The number of rows affected by the statement.
- `waiting_query_rows_examined`  
The number of rows read from storage engines by the statement.
- `blocking_thread_id`  
The thread ID of the thread that is blocking the waiting lock.
- `blocking_pid`  
The processlist ID of the thread that is blocking the waiting lock.
- `blocking_account`  
The account associated with the thread that is blocking the waiting lock.
- `blocking_lock_type`  
The type of lock that is blocking the waiting lock.
- `blocking_lock_duration`  
How long the blocking lock has been held.
- `sql_kill_blocking_query`  
The `KILL` statement to execute to kill the blocking statement.
- `sql_kill_blocking_connection`  
The `KILL` statement to execute to kill the session running the blocking statement.

#### 26.4.3.29 The `schema_table_statistics` and `x$schema_table_statistics` Views

These views summarize table statistics. By default, rows are sorted by descending total wait time (tables with most contention first).

These views use a helper view, `x$ps_schema_table_statistics_io`.

The `schema_table_statistics` and `x$schema_table_statistics` views have these columns:

- `table_schema`  
The schema that contains the table.
- `table_name`  
The table name.
- `total_latency`  
The total wait time of timed I/O events for the table.

- `rows_fetched`  
The total number of rows read from the table.
- `fetch_latency`  
The total wait time of timed read I/O events for the table.
- `rows_inserted`  
The total number of rows inserted into the table.
- `insert_latency`  
The total wait time of timed insert I/O events for the table.
- `rows_updated`  
The total number of rows updated in the table.
- `update_latency`  
The total wait time of timed update I/O events for the table.
- `rows_deleted`  
The total number of rows deleted from the table.
- `delete_latency`  
The total wait time of timed delete I/O events for the table.
- `io_read_requests`  
The total number of read requests for the table.
- `io_read`  
The total number of bytes read from the table.
- `io_read_latency`  
The total wait time of reads from the table.
- `io_write_requests`  
The total number of write requests for the table.
- `io_write`  
The total number of bytes written to the table.
- `io_write_latency`  
The total wait time of writes to the table.
- `io_misc_requests`  
The total number of miscellaneous I/O requests for the table.

- `io_misc_latency`

The total wait time of miscellaneous I/O requests for the table.

### 26.4.3.30 The `schema_table_statistics_with_buffer` and `x$ $schema_table_statistics_with_buffer` Views

These views summarize table statistics, including InnoDB buffer pool statistics. By default, rows are sorted by descending total wait time (tables with most contention first).

These views use a helper view, `x$ps_schema_table_statistics_io`.

The `schema_table_statistics_with_buffer` and `x$  
$schema_table_statistics_with_buffer` views have these columns:

- `table_schema`

The schema that contains the table.

- `table_name`

The table name.

- `rows_fetched`

The total number of rows read from the table.

- `fetch_latency`

The total wait time of timed read I/O events for the table.

- `rows_inserted`

The total number of rows inserted into the table.

- `insert_latency`

The total wait time of timed insert I/O events for the table.

- `rows_updated`

The total number of rows updated in the table.

- `update_latency`

The total wait time of timed update I/O events for the table.

- `rows_deleted`

The total number of rows deleted from the table.

- `delete_latency`

The total wait time of timed delete I/O events for the table.

- `io_read_requests`

The total number of read requests for the table.

- `io_read`  
The total number of bytes read from the table.
- `io_read_latency`  
The total wait time of reads from the table.
- `io_write_requests`  
The total number of write requests for the table.
- `io_write`  
The total number of bytes written to the table.
- `io_write_latency`  
The total wait time of writes to the table.
- `io_misc_requests`  
The total number of miscellaneous I/O requests for the table.
- `io_misc_latency`  
The total wait time of miscellaneous I/O requests for the table.
- `innodb_buffer_allocated`  
The total number of InnoDB buffer bytes allocated for the table.
- `innodb_buffer_data`  
The total number of InnoDB data bytes allocated for the table.
- `innodb_buffer_free`  
The total number of InnoDB nondata bytes allocated for the table (`innodb_buffer_allocated - innodb_buffer_data`).
- `innodb_buffer_pages`  
The total number of InnoDB pages allocated for the table.
- `innodb_buffer_pages_hashed`  
The total number of InnoDB hashed pages allocated for the table.
- `innodb_buffer_pages_old`  
The total number of InnoDB old pages allocated for the table.
- `innodb_buffer_rows_cached`  
The total number of InnoDB cached rows for the table.

### 26.4.3.31 The `schema_tables_with_full_table_scans` and `x$schema_tables_with_full_table_scans` Views

These views display which tables are being accessed with full table scans. By default, rows are sorted by descending rows scanned.

The `schema_tables_with_full_table_scans` and `x$schema_tables_with_full_table_scans` views have these columns:

- `object_schema`  
The schema name.
- `object_name`  
The table name.
- `rows_full_scanned`  
The total number of rows scanned by full scans of the table.
- `latency`  
The total wait time of full scans of the table.

#### 26.4.3.32 The `schema_unused_indexes` View

These views display indexes for which there are no events, which indicates that they are not being used. By default, rows are sorted by schema and table.

This view is most useful when the server has been up and processing long enough that its workload is representative. Otherwise, presence of an index in this view may not be meaningful.

The `schema_unused_indexes` view has these columns:

- `object_schema`  
The schema name.
- `object_name`  
The table name.
- `index_name`  
The unused index name.

#### 26.4.3.33 The `session` and `x$session` Views

These views are similar to `processlist` and `x$processlist`, but they filter out background processes to display only user sessions. For descriptions of the columns, see [Section 26.4.3.22, “The `processlist` and `x\$processlist` Views”](#).

#### 26.4.3.34 The `session_ssl_status` View

For each connection, this view displays the SSL version, cipher, and count of reused SSL sessions.

The `session_ssl_status` view has these columns:

- `thread_id`  
The thread ID for the connection.

- `ssl_version`  
The version of SSL used for the connection.
- `ssl_cipher`  
The SSL cipher used for the connection.
- `ssl_sessions_reused`  
The number of reused SSL sessions for the connection.

### 26.4.3.35 The `statement_analysis` and `x$statement_analysis` Views

These views list normalized statements with aggregated statistics. The content mimics the MySQL Enterprise Monitor Query Analysis view. By default, rows are sorted by descending total latency.

The `statement_analysis` and `x$statement_analysis` views have these columns:

- `query`  
The normalized statement string.
- `db`  
The default database for the statement, or `NULL` if there is none.
- `full_scan`  
The total number of full table scans performed by occurrences of the statement.
- `exec_count`  
The total number of times the statement has executed.
- `err_count`  
The total number of errors produced by occurrences of the statement.
- `warn_count`  
The total number of warnings produced by occurrences of the statement.
- `total_latency`  
The total wait time of timed occurrences of the statement.
- `max_latency`  
The maximum single wait time of timed occurrences of the statement.
- `avg_latency`  
The average wait time per timed occurrence of the statement.
- `lock_latency`  
The total time waiting for locks by timed occurrences of the statement.
- `rows_sent`



The total number of rows returned by occurrences of the statement.

- `rows_sent_avg`

The average number of rows returned per occurrence of the statement.

- `rows_examined`

The total number of rows read from storage engines by occurrences of the statement.

- `rows_examined_avg`

The average number of rows read from storage engines per occurrence of the statement.

- `rows_affected`

The total number of rows affected by occurrences of the statement.

- `rows_affected_avg`

The average number of rows affected per occurrence of the statement.

- `tmp_tables`

The total number of internal in-memory temporary tables created by occurrences of the statement.

- `tmp_disk_tables`

The total number of internal on-disk temporary tables created by occurrences of the statement.

- `rows_sorted`

The total number of rows sorted by occurrences of the statement.

- `sort_merge_passes`

The total number of sort merge passes by occurrences of the statement.

- `digest`

The statement digest.

- `first_seen`

The time at which the statement was first seen.

- `last_seen`

The time at which the statement was most recently seen.

### **26.4.3.36 The `statements_with_errors_or_warnings` and `x$statements_with_errors_or_warnings` Views**

These views display normalized statements that have produced errors or warnings. By default, rows are sorted by descending error and warning counts.

The `statements_with_errors_or_warnings` and `x$statements_with_errors_or_warnings` views have these columns:

- `query`  
The normalized statement string.
- `db`  
The default database for the statement, or `NULL` if there is none.
- `exec_count`  
The total number of times the statement has executed.
- `errors`  
The total number of errors produced by occurrences of the statement.
- `error_pct`  
The percentage of statement occurrences that produced errors.
- `warnings`  
The total number of warnings produced by occurrences of the statement.
- `warning_pct`  
The percentage of statement occurrences that produced warnings.
- `first_seen`  
The time at which the statement was first seen.
- `last_seen`  
The time at which the statement was most recently seen.
- `digest`  
The statement digest.

### 26.4.3.37 The `statements_with_full_table_scans` and `x$statements_with_full_table_scans` Views

These views display normalized statements that have done full table scans. By default, rows are sorted by descending percentage of time a full scan was done and descending total latency.

The `statements_with_full_table_scans` and `x$statements_with_full_table_scans` views have these columns:

- `query`  
The normalized statement string.
- `db`  
The default database for the statement, or `NULL` if there is none.
- `exec_count`

The total number of times the statement has executed.

- `total_latency`

The total wait time of timed statement events for the statement.

- `no_index_used_count`

The total number of times no index was used to scan the table.

- `no_good_index_used_count`

The total number of times no good index was used to scan the table.

- `no_index_used_pct`

The percentage of the time no index was used to scan the table.

- `rows_sent`

The total number of rows returned from the table.

- `rows_examined`

The total number of rows read from the storage engine for the table.

- `rows_sent_avg`

The average number of rows returned from the table.

- `rows_examined_avg`

The average number of rows read from the storage engine for the table.

- `first_seen`

The time at which the statement was first seen.

- `last_seen`

The time at which the statement was most recently seen.

- `digest`

The statement digest.

### **26.4.3.38 The `statements_with_runtimes_in_95th_percentile` and `x$statements_with_runtimes_in_95th_percentile` Views**

These views list statements with runtimes in the 95th percentile. By default, rows are sorted by descending average latency.

Both views use two helper views, `x$ps_digest_avg_latency_distribution` and `x$ps_digest_95th_percentile_by_avg_us`.

The `statements_with_runtimes_in_95th_percentile` and `x$statements_with_runtimes_in_95th_percentile` views have these columns:

- `query`  
The normalized statement string.
- `db`  
The default database for the statement, or `NULL` if there is none.
- `full_scan`  
The total number of full table scans performed by occurrences of the statement.
- `exec_count`  
The total number of times the statement has executed.
- `err_count`  
The total number of errors produced by occurrences of the statement.
- `warn_count`  
The total number of warnings produced by occurrences of the statement.
- `total_latency`  
The total wait time of timed occurrences of the statement.
- `max_latency`  
The maximum single wait time of timed occurrences of the statement.
- `avg_latency`  
The average wait time per timed occurrence of the statement.
- `rows_sent`  
The total number of rows returned by occurrences of the statement.
- `rows_sent_avg`  
The average number of rows returned per occurrence of the statement.
- `rows_examined`  
The total number of rows read from storage engines by occurrences of the statement.
- `rows_examined_avg`  
The average number of rows read from storage engines per occurrence of the statement.
- `first_seen`  
The time at which the statement was first seen.
- `last_seen`  
The time at which the statement was most recently seen.

- `digest`

The statement digest.

### 26.4.3.39 The `statements_with_sorting` and `x$statements_with_sorting` Views

These views list normalized statements that have performed sorts. By default, rows are sorted by descending total latency.

The `statements_with_sorting` and `x$statements_with_sorting` views have these columns:

- `query`

The normalized statement string.

- `db`

The default database for the statement, or `NULL` if there is none.

- `exec_count`

The total number of times the statement has executed.

- `total_latency`

The total wait time of timed occurrences of the statement.

- `sort_merge_passes`

The total number of sort merge passes by occurrences of the statement.

- `avg_sort_merges`

The average number of sort merge passes per occurrence of the statement.

- `sorts_using_scans`

The total number of sorts using table scans by occurrences of the statement.

- `sort_using_range`

The total number of sorts using range accesses by occurrences of the statement.

- `rows_sorted`

The total number of rows sorted by occurrences of the statement.

- `avg_rows_sorted`

The average number of rows sorted per occurrence of the statement.

- `first_seen`

The time at which the statement was first seen.

- `last_seen`

The time at which the statement was most recently seen.

- `digest`

The statement digest.

#### 26.4.3.40 The `statements_with_temp_tables` and `x$statements_with_temp_tables` Views

These views list normalized statements that have used temporary tables. By default, rows are sorted by descending number of on-disk temporary tables used and descending number of in-memory temporary tables used.

The `statements_with_temp_tables` and `x$statements_with_temp_tables` views have these columns:

- `query`

The normalized statement string.

- `db`

The default database for the statement, or `NULL` if there is none.

- `exec_count`

The total number of times the statement has executed.

- `total_latency`

The total wait time of timed occurrences of the statement.

- `memory_tmp_tables`

The total number of internal in-memory temporary tables created by occurrences of the statement.

- `disk_tmp_tables`

The total number of internal on-disk temporary tables created by occurrences of the statement.

- `avg_tmp_tables_per_query`

The average number of internal temporary tables created per occurrence of the statement.

- `tmp_tables_to_disk_pct`

The percentage of internal in-memory temporary tables that were converted to on-disk tables.

- `first_seen`

The time at which the statement was first seen.

- `last_seen`

The time at which the statement was most recently seen.

- `digest`

The statement digest.

#### 26.4.3.41 The `user_summary` and `x$user_summary` Views

These views summarize statement activity, file I/O, and connections, grouped by user. By default, rows are sorted by descending total latency.

The `user_summary` and `x$user_summary` views have these columns:

- `user`

The client user name. Rows for which the `USER` column in the underlying Performance Schema table is `NULL` are assumed to be for background threads and are reported with a host name of `background`.

- `statements`

The total number of statements for the user.

- `statement_latency`

The total wait time of timed statements for the user.

- `statement_avg_latency`

The average wait time per timed statement for the user.

- `table_scans`

The total number of table scans for the user.

- `file_ios`

The total number of file I/O events for the user.

- `file_io_latency`

The total wait time of timed file I/O events for the user.

- `current_connections`

The current number of connections for the user.

- `total_connections`

The total number of connections for the user.

- `unique_hosts`

The number of distinct hosts from which connections for the user have originated.

- `current_memory`

The current amount of allocated memory for the user.

- `total_memory_allocated`

The total amount of allocated memory for the user.

#### 26.4.3.42 The `user_summary_by_file_io` and `x$user_summary_by_file_io` Views

These views summarize file I/O, grouped by user. By default, rows are sorted by descending total file I/O latency.

The `user_summary_by_file_io` and `x$user_summary_by_file_io` views have these columns:

- `user`

The client user name. Rows for which the `USER` column in the underlying Performance Schema table is `NULL` are assumed to be for background threads and are reported with a host name of `background`.

- `ios`

The total number of file I/O events for the user.

- `io_latency`

The total wait time of timed file I/O events for the user.

#### 26.4.3.43 The `user_summary_by_file_io_type` and `x$user_summary_by_file_io_type` Views

These views summarize file I/O, grouped by user and event type. By default, rows are sorted by user and descending total latency.

The `user_summary_by_file_io_type` and `x$user_summary_by_file_io_type` views have these columns:

- `user`

The client user name. Rows for which the `USER` column in the underlying Performance Schema table is `NULL` are assumed to be for background threads and are reported with a host name of `background`.

- `event_name`

The file I/O event name.

- `total`

The total number of occurrences of the file I/O event for the user.

- `latency`

The total wait time of timed occurrences of the file I/O event for the user.

- `max_latency`

The maximum single wait time of timed occurrences of the file I/O event for the user.

#### 26.4.3.44 The `user_summary_by_stages` and `x$user_summary_by_stages` Views

These views summarize stages, grouped by user. By default, rows are sorted by user and descending total stage latency.

The `user_summary_by_stages` and `x$user_summary_by_stages` views have these columns:

- `user`

The client user name. Rows for which the `USER` column in the underlying Performance Schema table is `NULL` are assumed to be for background threads and are reported with a host name of `background`.

- `event_name`

The stage event name.

- `total`



The total number of occurrences of the stage event for the user.

- `total_latency`

The total wait time of timed occurrences of the stage event for the user.

- `avg_latency`

The average wait time per timed occurrence of the stage event for the user.

#### **26.4.3.45 The `user_summary_by_statement_latency` and `x$user_summary_by_statement_latency` Views**

These views summarize overall statement statistics, grouped by user. By default, rows are sorted by descending total latency.

The `user_summary_by_statement_latency` and `x$user_summary_by_statement_latency` views have these columns:

- `user`

The client user name. Rows for which the `USER` column in the underlying Performance Schema table is `NULL` are assumed to be for background threads and are reported with a host name of `background`.

- `total`

The total number of statements for the user.

- `total_latency`

The total wait time of timed statements for the user.

- `max_latency`

The maximum single wait time of timed statements for the user.

- `lock_latency`

The total time waiting for locks by timed statements for the user.

- `rows_sent`

The total number of rows returned by statements for the user.

- `rows_examined`

The total number of rows read from storage engines by statements for the user.

- `rows_affected`

The total number of rows affected by statements for the user.

- `full_scans`

The total number of full table scans by statements for the user.

#### **26.4.3.46 The `user_summary_by_statement_type` and `x$user_summary_by_statement_type` Views**

These views summarize information about statements executed, grouped by user and statement type. By default, rows are sorted by user and descending total latency.

The `user_summary_by_statement_type` and `x$user_summary_by_statement_type` views have these columns:

- `user`

The client user name. Rows for which the `USER` column in the underlying Performance Schema table is `NULL` are assumed to be for background threads and are reported with a host name of `background`.

- `statement`

The final component of the statement event name.

- `total`

The total number of occurrences of the statement event for the user.

- `total_latency`

The total wait time of timed occurrences of the statement event for the user.

- `max_latency`

The maximum single wait time of timed occurrences of the statement event for the user.

- `lock_latency`

The total time waiting for locks by timed occurrences of the statement event for the user.

- `rows_sent`

The total number of rows returned by occurrences of the statement event for the user.

- `rows_examined`

The total number of rows read from storage engines by occurrences of the statement event for the user.

- `rows_affected`

The total number of rows affected by occurrences of the statement event for the user.

- `full_scans`

The total number of full table scans by occurrences of the statement event for the user.

### 26.4.3.47 The version View

This view provides the current `sys` schema and MySQL server versions.



#### Note

As of MySQL 5.7.28, this view is deprecated and subject to removal in a future MySQL version. Applications that use it should be migrated to use an alternative instead. For example, use the `VERSION()` function to retrieve the MySQL server version.

The `version` view has these columns:

- `sys_version`

The `sys` schema version.

- `mysql_version`

The MySQL server version.

### 26.4.3.48 The `wait_classes_global_by_avg_latency` and `x$wait_classes_global_by_avg_latency` Views

These views summarize wait class average latencies, grouped by event class. By default, rows are sorted by descending average latency. Idle events are ignored.

An event class is determined by stripping from the event name everything after the first three components. For example, the class for `wait/io/file/sql/slow_log` is `wait/io/file`.

The `wait_classes_global_by_avg_latency` and `x$wait_classes_global_by_avg_latency` views have these columns:

- `event_class`

The event class.

- `total`

The total number of occurrences of events in the class.

- `total_latency`

The total wait time of timed occurrences of events in the class.

- `min_latency`

The minimum single wait time of timed occurrences of events in the class.

- `avg_latency`

The average wait time per timed occurrence of events in the class.

- `max_latency`

The maximum single wait time of timed occurrences of events in the class.

### 26.4.3.49 The `wait_classes_global_by_latency` and `x$wait_classes_global_by_latency` Views

These views summarize wait class total latencies, grouped by event class. By default, rows are sorted by descending total latency. Idle events are ignored.

An event class is determined by stripping from the event name everything after the first three components. For example, the class for `wait/io/file/sql/slow_log` is `wait/io/file`.

The `wait_classes_global_by_latency` and `x$wait_classes_global_by_latency` views have these columns:

- `event_class`

The event class.

- `total`

The total number of occurrences of events in the class.

- `total_latency`

The total wait time of timed occurrences of events in the class.

- `min_latency`

The minimum single wait time of timed occurrences of events in the class.

- `avg_latency`

The average wait time per timed occurrence of events in the class.

- `max_latency`

The maximum single wait time of timed occurrences of events in the class.

#### **26.4.3.50 The `waits_by_host_by_latency` and `x$waits_by_host_by_latency` Views**

These views summarize wait events, grouped by host and event. By default, rows are sorted by host and descending total latency. Idle events are ignored.

The `waits_by_host_by_latency` and `x$waits_by_host_by_latency` views have these columns:

- `host`

The host from which the connection originated.

- `event`

The event name.

- `total`

The total number of occurrences of the event for the host.

- `total_latency`

The total wait time of timed occurrences of the event for the host.

- `avg_latency`

The average wait time per timed occurrence of the event for the host.

- `max_latency`

The maximum single wait time of timed occurrences of the event for the host.

#### **26.4.3.51 The `waits_by_user_by_latency` and `x$waits_by_user_by_latency` Views**

These views summarize wait events, grouped by user and event. By default, rows are sorted by user and descending total latency. Idle events are ignored.

The `waits_by_user_by_latency` and `x$waits_by_user_by_latency` views have these columns:

- `user`  
The user associated with the connection.
- `event`  
The event name.
- `total`  
The total number of occurrences of the event for the user.
- `total_latency`  
The total wait time of timed occurrences of the event for the user.
- `avg_latency`  
The average wait time per timed occurrence of the event for the user.
- `max_latency`  
The maximum single wait time of timed occurrences of the event for the user.

#### 26.4.3.52 The `waits_global_by_latency` and `x$waits_global_by_latency` Views

These views summarize wait events, grouped by event. By default, rows are sorted by descending total latency. Idle events are ignored.

The `waits_global_by_latency` and `x$waits_global_by_latency` views have these columns:

- `events`  
The event name.
- `total`  
The total number of occurrences of the event.
- `total_latency`  
The total wait time of timed occurrences of the event.
- `avg_latency`  
The average wait time per timed occurrence of the event.
- `max_latency`  
The maximum single wait time of timed occurrences of the event.

### 26.4.4 sys Schema Stored Procedures

The following sections describe `sys` schema stored procedures.

#### 26.4.4.1 The `create_synonym_db()` Procedure

Given a schema name, this procedure creates a synonym schema containing views that refer to all the tables and views in the original schema. This can be used, for example, to create a shorter name by which to refer to a schema with a long name (such as `info` rather than `INFORMATION_SCHEMA`).

## Parameters

- `in_db_name` `VARCHAR(64)`: The name of the schema for which to create the synonym.
- `in_synonym` `VARCHAR(64)`: The name to use for the synonym schema. This schema must not already exist.

## Example

```
mysql> SHOW DATABASES;
+-----+
| Database |
+-----+
| information_schema |
| mysql |
| performance_schema |
| sys |
| world |
+-----+
mysql> CALL sys.create_synonym_db('INFORMATION_SCHEMA', 'info');
+-----+
| summary |
+-----+
| Created 63 views in the info database |
+-----+
mysql> SHOW DATABASES;
+-----+
| Database |
+-----+
| information_schema |
| info |
| mysql |
| performance_schema |
| sys |
| world |
+-----+
mysql> SHOW FULL TABLES FROM info;
+-----+-----+
| Tables_in_info | Table_type |
+-----+-----+
| character_sets | VIEW |
| collation_character_set_applicability | VIEW |
| collations | VIEW |
| column_privileges | VIEW |
| columns | VIEW |
| ... |
```

### 26.4.4.2 The `diagnostics()` Procedure

Creates a report of the current server status for diagnostic purposes.

This procedure disables binary logging during its execution by manipulating the session value of the `sql_log_bin` system variable. That is a restricted operation, so the procedure requires privileges sufficient to set restricted session variables. See [Section 5.1.8.1, “System Variable Privileges”](#).

Data collected for `diagnostics()` includes this information:

- Information from the `metrics` view (see [Section 26.4.3.21, “The metrics View”](#))

- Information from other relevant `sys` schema views, such as the one that determines queries in the 95th percentile
- Information from the `ndbinfo` schema, if the MySQL server is part of NDB Cluster
- Replication status (both source and replica)

Some of the `sys` schema views are calculated as initial (optional), overall, and delta values:

- The initial view is the content of the view at the start of the `diagnostics()` procedure. This output is the same as the start values used for the delta view. The initial view is included if the `diagnostics.include_raw` configuration option is `ON`.
- The overall view is the content of the view at the end of the `diagnostics()` procedure. This output is the same as the end values used for the delta view. The overall view is always included.
- The delta view is the difference from the beginning to the end of procedure execution. The minimum and maximum values are the minimum and maximum values from the end view, respectively. They do not necessarily reflect the minimum and maximum values in the monitored period. Except for the `metrics` view, the delta is calculated only between the first and last outputs.

## Parameters

- `in_max_runtime` `INT UNSIGNED`: The maximum data collection time in seconds. Use `NULL` to collect data for the default of 60 seconds. Otherwise, use a value greater than 0.
- `in_interval` `INT UNSIGNED`: The sleep time between data collections in seconds. Use `NULL` to sleep for the default of 30 seconds. Otherwise, use a value greater than 0.
- `in_auto_config` `ENUM('current', 'medium', 'full')`: The Performance Schema configuration to use. Permitted values are:
  - `current`: Use the current instrument and consumer settings.
  - `medium`: Enable some instruments and consumers.
  - `full`: Enable all instruments and consumers.



### Note

The more instruments and consumers enabled, the more impact on MySQL server performance. Be careful with the `medium` setting and especially the `full` setting, which has a large performance impact.

Use of the `medium` or `full` setting requires the `SUPER` privilege.

If a setting other than `current` is chosen, the current settings are restored at the end of the procedure.

## Configuration Options

`diagnostics()` operation can be modified using the following configuration options or their corresponding user-defined variables (see [Section 26.4.2.1, “The sys\\_config Table”](#)):

- `debug`, `@sys.debug`

If this option is `ON`, produce debugging output. The default is `OFF`.

- `diagnostics.allow_i_s_tables`, `@sys.diagnostics.allow_i_s_tables`

If this option is `ON`, the `diagnostics()` procedure is permitted to perform table scans on the Information Schema `TABLES` table. This can be expensive if there are many tables. The default is `OFF`.

- `diagnostics.include_raw, @sys.diagnostics.include_raw`

If this option is `ON`, the `diagnostics()` procedure output includes the raw output from querying the `metrics` view. The default is `OFF`.

- `statement_truncate_len, @sys.statement_truncate_len`

The maximum length of statements returned by the `format_statement()` function. Longer statements are truncated to this length. The default is 64.

## Example

Create a diagnostics report that starts an iteration every 30 seconds and runs for at most 120 seconds using the current Performance Schema settings:

```
mysql> CALL sys.diagnostics(120, 30, 'current');
```

To capture the output from the `diagnostics()` procedure in a file as it runs, use the `mysql` client `tee filename` and `notee` commands (see [Section 4.5.1.2, “mysql Client Commands”](#)):

```
mysql> tee diag.out;
mysql> CALL sys.diagnostics(120, 30, 'current');
mysql> notee;
```

### 26.4.4.3 The `execute_prepared_stmt()` Procedure

Given an SQL statement as a string, executes it as a prepared statement. The prepared statement is deallocated after execution, so it is not subject to reuse. Thus, this procedure is useful primarily for executing dynamic statements on a one-time basis.

This procedure uses `sys_execute_prepared_stmt` as the prepared statement name. If that statement name exists when the procedure is called, its previous content is destroyed.

## Parameters

- `in_query LONGTEXT CHARACTER SET utf8`: The statement string to execute.

## Configuration Options

`execute_prepared_stmt()` operation can be modified using the following configuration options or their corresponding user-defined variables (see [Section 26.4.2.1, “The sys\\_config Table”](#)):

- `debug, @sys.debug`

If this option is `ON`, produce debugging output. The default is `OFF`.

## Example

```
mysql> CALL sys.execute_prepared_stmt('SELECT COUNT(*) FROM mysql.user');
+-----+
| COUNT(*) |
+-----+
|         15 |
+-----+
```

### 26.4.4.4 The `ps_setup_disable_background_threads()` Procedure



Disables Performance Schema instrumentation for all background threads. Produces a result set indicating how many background threads were disabled. Already disabled threads do not count.

### Parameters

None.

### Example

```
mysql> CALL sys.ps_setup_disable_background_threads();
+-----+
| summary |
+-----+
| Disabled 24 background threads |
+-----+
```

#### 26.4.4.5 The ps\_setup\_disable\_consumer() Procedure

Disables Performance Schema consumers with names that contain the argument. Produces a result set indicating how many consumers were disabled. Already disabled consumers do not count.

### Parameters

- `consumer VARCHAR(128)`: The value used to match consumer names, which are identified by using `%consumer%` as an operand for a `LIKE` pattern match.

A value of `' '` matches all consumers.

### Example

Disable all statement consumers:

```
mysql> CALL sys.ps_setup_disable_consumer('statement');
+-----+
| summary |
+-----+
| Disabled 4 consumers |
+-----+
```

#### 26.4.4.6 The ps\_setup\_disable\_instrument() Procedure

Disables Performance Schema instruments with names that contain the argument. Produces a result set indicating how many instruments were disabled. Already disabled instruments do not count.

### Parameters

- `in_pattern VARCHAR(128)`: The value used to match instrument names, which are identified by using `%in_pattern%` as an operand for a `LIKE` pattern match.

A value of `' '` matches all instruments.

### Example

Disable a specific instrument:

```
mysql> CALL sys.ps_setup_disable_instrument('wait/lock/metadata/sql/mdl');
```

```

+-----+
| summary |
+-----+
| Disabled 1 instrument |
+-----+
    
```

Disable all mutex instruments:

```

mysql> CALL sys.ps_setup_disable_instrument('mutex');
+-----+
| summary |
+-----+
| Disabled 177 instruments |
+-----+
    
```

### 26.4.4.7 The ps\_setup\_disable\_thread() Procedure

Given a connection ID, disables Performance Schema instrumentation for the thread. Produces a result set indicating how many threads were disabled. Already disabled threads do not count.

#### Parameters

- `in_connection_id` `BIGINT`: The connection ID. This is a value of the type given in the `PROCESSLIST_ID` column of the Performance Schema `threads` table or the `Id` column of `SHOW PROCESSLIST` output.

#### Example

Disable a specific connection by its connection ID:

```

mysql> CALL sys.ps_setup_disable_thread(225);
+-----+
| summary |
+-----+
| Disabled 1 thread |
+-----+
    
```

Disable the current connection:

```

mysql> CALL sys.ps_setup_disable_thread(CONNECTION_ID());
+-----+
| summary |
+-----+
| Disabled 1 thread |
+-----+
    
```

### 26.4.4.8 The ps\_setup\_enable\_background\_threads() Procedure

Enables Performance Schema instrumentation for all background threads. Produces a result set indicating how many background threads were enabled. Already enabled threads do not count.

#### Parameters

None.

#### Example

```
mysql> CALL sys.ps_setup_enable_background_threads();
+-----+
| summary |
+-----+
| Enabled 24 background threads |
+-----+
```

#### 26.4.4.9 The ps\_setup\_enable\_consumer() Procedure

Enables Performance Schema consumers with names that contain the argument. Produces a result set indicating how many consumers were enabled. Already enabled consumers do not count.

##### Parameters

- `consumer VARCHAR(128)`: The value used to match consumer names, which are identified by using `%consumer%` as an operand for a `LIKE` pattern match.

A value of `' '` matches all consumers.

##### Example

Enable all statement consumers:

```
mysql> CALL sys.ps_setup_enable_consumer('statement');
+-----+
| summary |
+-----+
| Enabled 4 consumers |
+-----+
```

#### 26.4.4.10 The ps\_setup\_enable\_instrument() Procedure

Enables Performance Schema instruments with names that contain the argument. Produces a result set indicating how many instruments were enabled. Already enabled instruments do not count.

##### Parameters

- `in_pattern VARCHAR(128)`: The value used to match instrument names, which are identified by using `%in_pattern%` as an operand for a `LIKE` pattern match.

A value of `' '` matches all instruments.

##### Example

Enable a specific instrument:

```
mysql> CALL sys.ps_setup_enable_instrument('wait/lock/metadata/sql/mdl');
+-----+
| summary |
+-----+
| Enabled 1 instrument |
+-----+
```

Enable all mutex instruments:

```
mysql> CALL sys.ps_setup_enable_instrument('mutex');
+-----+
```

```
| summary |
+-----+
| Enabled 177 instruments |
+-----+
```

#### 26.4.4.11 The `ps_setup_enable_thread()` Procedure

Given a connection ID, enables Performance Schema instrumentation for the thread. Produces a result set indicating how many threads were enabled. Already enabled threads do not count.

##### Parameters

- `in_connection_id` `BIGINT`: The connection ID. This is a value of the type given in the `PROCESSLIST_ID` column of the Performance Schema `threads` table or the `Id` column of `SHOW PROCESSLIST` output.

##### Example

Enable a specific connection by its connection ID:

```
mysql> CALL sys.ps_setup_enable_thread(225);
+-----+
| summary |
+-----+
| Enabled 1 thread |
+-----+
```

Enable the current connection:

```
mysql> CALL sys.ps_setup_enable_thread(CONNECTION_ID());
+-----+
| summary |
+-----+
| Enabled 1 thread |
+-----+
```

#### 26.4.4.12 The `ps_setup_reload_saved()` Procedure

Reloads a Performance Schema configuration saved earlier within the same session using `ps_setup_save()`. For more information, see the description of `ps_setup_save()`.

This procedure disables binary logging during its execution by manipulating the session value of the `sql_log_bin` system variable. That is a restricted operation, so the procedure requires privileges sufficient to set restricted session variables. See [Section 5.1.8.1, “System Variable Privileges”](#).

##### Parameters

None.

#### 26.4.4.13 The `ps_setup_reset_to_default()` Procedure

Resets the Performance Schema configuration to its default settings.

##### Parameters

- `in_verbose` `BOOLEAN`: Whether to display information about each setup stage during procedure execution. This includes the SQL statements executed.

## Example

```
mysql> CALL sys.ps_setup_reset_to_default(TRUE)\G
***** 1. row *****
status: Resetting: setup_actors
DELETE
FROM performance_schema.setup_actors
WHERE NOT (HOST = '%' AND USER = '%' AND ROLE = '%')

***** 1. row *****
status: Resetting: setup_actors
INSERT IGNORE INTO performance_schema.setup_actors
VALUES ('%', '%', '%')

...

```

### 26.4.4.14 The `ps_setup_save()` Procedure

Saves the current Performance Schema configuration. This enables you to alter the configuration temporarily for debugging or other purposes, then restore it to the previous state by invoking the `ps_setup_reload_saved()` procedure.

To prevent other simultaneous calls to save the configuration, `ps_setup_save()` acquires an advisory lock named `sys.ps_setup_save` by calling the `GET_LOCK()` function. `ps_setup_save()` takes a timeout parameter to indicate how many seconds to wait if the lock already exists (which indicates that some other session has a saved configuration outstanding). If the timeout expires without obtaining the lock, `ps_setup_save()` fails.

It is intended you call `ps_setup_reload_saved()` later within the *same* session as `ps_setup_save()` because the configuration is saved in `TEMPORARY` tables. `ps_setup_save()` drops the temporary tables and releases the lock. If you end your session without invoking `ps_setup_save()`, the tables and lock disappear automatically.

This procedure disables binary logging during its execution by manipulating the session value of the `sql_log_bin` system variable. That is a restricted operation, so the procedure requires privileges sufficient to set restricted session variables. See [Section 5.1.8.1, “System Variable Privileges”](#).

#### Parameters

- `in_timeout` `INT`: How many seconds to wait to obtain the `sys.ps_setup_save` lock. A negative timeout value means infinite timeout.

#### Example

```
mysql> CALL sys.ps_setup_save(10);
... make Performance Schema configuration changes ...
mysql> CALL sys.ps_setup_reload_saved();

```

### 26.4.4.15 The `ps_setup_show_disabled()` Procedure

Displays all currently disabled Performance Schema configuration.

#### Parameters

- `in_show_instruments` `BOOLEAN`: Whether to display disabled instruments. This might be a long list.
- `in_show_threads` `BOOLEAN`: Whether to display disabled threads.

## Example

```
mysql> CALL sys.ps_setup_show_disabled(TRUE, TRUE);
+-----+
| performance_schema_enabled |
+-----+
| 1 |
+-----+

+-----+
| enabled_users |
+-----+
| '%@%' |
+-----+

+-----+-----+-----+-----+
| object_type | objects | enabled | timed |
+-----+-----+-----+-----+
| EVENT | mysql.% | NO | NO |
| EVENT | performance_schema.% | NO | NO |
| EVENT | information_schema.% | NO | NO |
| FUNCTION | mysql.% | NO | NO |
| FUNCTION | performance_schema.% | NO | NO |
| FUNCTION | information_schema.% | NO | NO |
| PROCEDURE | mysql.% | NO | NO |
| PROCEDURE | performance_schema.% | NO | NO |
| PROCEDURE | information_schema.% | NO | NO |
| TABLE | mysql.% | NO | NO |
| TABLE | performance_schema.% | NO | NO |
| TABLE | information_schema.% | NO | NO |
| TRIGGER | mysql.% | NO | NO |
| TRIGGER | performance_schema.% | NO | NO |
| TRIGGER | information_schema.% | NO | NO |
+-----+-----+-----+-----+
...

```

### 26.4.4.16 The ps\_setup\_show\_disabled\_consumers() Procedure

Displays all currently disabled Performance Schema consumers.

#### Parameters

None.

#### Example

```
mysql> CALL sys.ps_setup_show_disabled_consumers();
+-----+
| disabled_consumers |
+-----+
| events_stages_current |
| events_stages_history |
| events_stages_history_long |
| events_statements_history |
| events_statements_history_long |
| events_transactions_history |
| events_transactions_history_long |
| events_waits_current |
| events_waits_history |
| events_waits_history_long |
+-----+

```

### 26.4.4.17 The ps\_setup\_show\_disabled\_instruments() Procedure

Displays all currently disabled Performance Schema instruments. This might be a long list.

### Parameters

None.

### Example

```
mysql> CALL sys.ps_setup_show_disabled_instruments()\G
***** 1. row *****
disabled_instruments: wait/synch/mutex/sql/TC_LOG_MMAP::LOCK_tc
                    timed: NO
***** 2. row *****
disabled_instruments: wait/synch/mutex/sql/THD::LOCK_query_plan
                    timed: NO
***** 3. row *****
disabled_instruments: wait/synch/mutex/sql/MYSQL_BIN_LOG::LOCK_commit
                    timed: NO
...

```

### 26.4.4.18 The ps\_setup\_show\_enabled() Procedure

Displays all currently enabled Performance Schema configuration.

### Parameters

- `in_show_instruments` `BOOLEAN`: Whether to display enabled instruments. This might be a long list.
- `in_show_threads` `BOOLEAN`: Whether to display enabled threads.

### Example

```
mysql> CALL sys.ps_setup_show_enabled(FALSE, FALSE);
+-----+
| performance_schema_enabled |
+-----+
| 1 |
+-----+
1 row in set (0.00 sec)

+-----+
| enabled_users |
+-----+
| '%@'%' |
+-----+
1 row in set (0.00 sec)

+-----+-----+-----+-----+
| object_type | objects | enabled | timed |
+-----+-----+-----+-----+
| EVENT       | %.%    | YES     | YES   |
| FUNCTION    | %.%    | YES     | YES   |
| PROCEDURE   | %.%    | YES     | YES   |
| TABLE      | %.%    | YES     | YES   |
| TRIGGER     | %.%    | YES     | YES   |
+-----+-----+-----+-----+
5 rows in set (0.00 sec)

+-----+
| enabled_consumers |
+-----+
| events_statements_current |

```

```

| events_statements_history |
| global_instrumentation   |
| statements_digest        |
| thread_instrumentation   |
+-----+

```

### 26.4.4.19 The `ps_setup_show_enabled_consumers()` Procedure

Displays all currently enabled Performance Schema consumers.

#### Parameters

None.

#### Example

```

mysql> CALL sys.ps_setup_show_enabled_consumers();
+-----+
| enabled_consumers |
+-----+
| events_statements_current |
| events_statements_history |
| global_instrumentation   |
| statements_digest        |
| thread_instrumentation   |
+-----+

```

### 26.4.4.20 The `ps_setup_show_enabled_instruments()` Procedure

Displays all currently enabled Performance Schema instruments. This might be a long list.

#### Parameters

None.

#### Example

```

mysql> CALL sys.ps_setup_show_enabled_instruments()\G
***** 1. row *****
enabled_instruments: wait/io/file/sql/map
                    timed: YES
***** 2. row *****
enabled_instruments: wait/io/file/sql/binlog
                    timed: YES
***** 3. row *****
enabled_instruments: wait/io/file/sql/binlog_cache
                    timed: YES
...

```

### 26.4.4.21 The `ps_statement_avg_latency_histogram()` Procedure

Displays a textual histogram graph of the average latency values across all normalized statements tracked within the Performance Schema `events_statements_summary_by_digest` table.

This procedure can be used to display a very high-level picture of the latency distribution of statements running within this MySQL instance.

#### Parameters

None.



## Example

The histogram output in statement units. For example, `* = 2 units` in the histogram legend means that each `*` character represents 2 statements.

```
mysql> CALL sys.ps_statement_avg_latency_histogram()\G
***** 1. row *****
Performance Schema Statement Digest Average Latency Histogram:

. = 1 unit
* = 2 units
# = 3 units

(0 - 66ms)      88 | #####
(66 - 133ms)   14 | .....
(133 - 199ms)   4  | ....
(199 - 265ms)   5  | **
(265 - 332ms)   1  | .
(332 - 398ms)   0  |
(398 - 464ms)   1  | .
(464 - 531ms)   0  |
(531 - 597ms)   0  |
(597 - 663ms)   0  |
(663 - 730ms)   0  |
(730 - 796ms)   0  |
(796 - 863ms)   0  |
(863 - 929ms)   0  |
(929 - 995ms)   0  |
(995 - 1062ms)  0  |

Total Statements: 114; Buckets: 16; Bucket Size: 66 ms;
```

### 26.4.4.22 The `ps_trace_statement_digest()` Procedure

Traces all Performance Schema instrumentation for a specific statement digest.

If you find a statement of interest within the Performance Schema `events_statements_summary_by_digest` table, specify its `DIGEST` column MD5 value to this procedure and indicate the polling duration and interval. The result is a report of all statistics tracked within Performance Schema for that digest for the interval.

The procedure also attempts to execute `EXPLAIN` for the longest running example of the digest during the interval. This attempt might fail because the Performance Schema truncates long `SQL_TEXT` values. Consequently, `EXPLAIN` fails due to parse errors.

This procedure disables binary logging during its execution by manipulating the session value of the `sql_log_bin` system variable. That is a restricted operation, so the procedure requires privileges sufficient to set restricted session variables. See [Section 5.1.8.1, “System Variable Privileges”](#).

#### Parameters

- `in_digest` `VARCHAR(32)`: The statement digest identifier to analyze.
- `in_runtime` `INT`: How long to run the analysis in seconds.
- `in_interval` `DECIMAL(2,2)`: The analysis interval in seconds (which can be fractional) at which to try to take snapshots.
- `in_start_fresh` `BOOLEAN`: Whether to truncate the Performance Schema `events_statements_history_long` and `events_stages_history_long` tables before starting.

- `in_auto_enable` `BOOLEAN`: Whether to automatically enable required consumers.

**Example**

```
mysql> CALL sys.ps_trace_statement_digest('891ec6860f98ba46d89dd20b0c03652c', 10, 0.1, TRUE, TRUE);
+-----+
| SUMMARY STATISTICS |
+-----+
| SUMMARY STATISTICS |
+-----+
1 row in set (9.11 sec)

+-----+-----+-----+-----+-----+-----+-----+
| executions | exec_time | lock_time | rows_sent | rows_examined | tmp_tables | full_scans |
+-----+-----+-----+-----+-----+-----+-----+
|          21 | 4.11 ms  | 2.00 ms  |          0 |             21 |           0 |           0 |
+-----+-----+-----+-----+-----+-----+-----+
1 row in set (9.11 sec)

+-----+-----+-----+-----+
| event_name                | count | latency |
+-----+-----+-----+-----+
| stage/sql/checking query cache for query |     16 | 724.37 us |
| stage/sql/statistics          |     16 | 546.92 us |
| stage/sql/freeing items       |     18 | 520.11 us |
| stage/sql/init                |     51 | 466.80 us |
...
| stage/sql/cleaning up        |     18 | 11.92 us  |
| stage/sql/executing          |     16 | 6.95 us   |
+-----+-----+-----+-----+
17 rows in set (9.12 sec)

+-----+
| LONGEST RUNNING STATEMENT |
+-----+
| LONGEST RUNNING STATEMENT |
+-----+
1 row in set (9.16 sec)

+-----+-----+-----+-----+-----+-----+-----+
| thread_id | exec_time | lock_time | rows_sent | rows_examined | tmp_tables | full_scan |
+-----+-----+-----+-----+-----+-----+-----+
|    166646 | 618.43 us | 1.00 ms  |          0 |             1 |           0 |           0 |
+-----+-----+-----+-----+-----+-----+-----+
1 row in set (9.16 sec)

# Truncated for clarity...
+-----+
| sql_text
+-----+
| select hibeventhe0_.id as id1382_, hibeventhe0_.createdTime ... |
+-----+
1 row in set (9.17 sec)

+-----+-----+-----+-----+
| event_name                | latency |
+-----+-----+-----+-----+
| stage/sql/init            | 8.61 us |
| stage/sql/Waiting for query cache lock | 453.23 us |
| stage/sql/init            | 331.07 ns |
| stage/sql/checking query cache for query | 43.04 us |
...
| stage/sql/freeing items   | 30.46 us |
| stage/sql/cleaning up    | 662.13 ns |
+-----+-----+-----+-----+
18 rows in set (9.23 sec)
```

```

+-----+-----+-----+-----+-----+-----+-----+-----+-----+-----+
| id | select_type | table          | type | possible_keys | key          | key_len | ref          | rows | Ext:
+-----+-----+-----+-----+-----+-----+-----+-----+-----+-----+
| 1 | SIMPLE      | hibeventhe0_  | const | fixedTime     | fixedTime   | 775     | const,const | 1 | NUL
+-----+-----+-----+-----+-----+-----+-----+-----+-----+-----+
1 row in set (9.27 sec)

Query OK, 0 rows affected (9.28 sec)

```

### 26.4.4.23 The `ps_trace_thread()` Procedure

Dumps all Performance Schema data for an instrumented thread to a `.dot` formatted graph file (for the DOT graph description language). Each result set returned from the procedure should be used for a complete graph.

This procedure disables binary logging during its execution by manipulating the session value of the `sql_log_bin` system variable. That is a restricted operation, so the procedure requires privileges sufficient to set restricted session variables. See [Section 5.1.8.1, “System Variable Privileges”](#).

#### Parameters

- `in_thread_id` `INT`: The thread to trace.
- `in_outfile` `VARCHAR(255)`: The name to use for the `.dot` output file.
- `in_max_runtime` `DECIMAL(20,2)`: The maximum number of seconds (which can be fractional) to collect data. Use `NULL` to collect data for the default of 60 seconds.
- `in_interval` `DECIMAL(20,2)`: The number of seconds (which can be fractional) to sleep between data collections. Use `NULL` to sleep for the default of 1 second.
- `in_start_fresh` `BOOLEAN`: Whether to reset all Performance Schema data before tracing.
- `in_auto_setup` `BOOLEAN`: Whether to disable all other threads and enable all instruments and consumers. This also resets the settings at the end of the run.
- `in_debug` `BOOLEAN`: Whether to include `file:lineno` information in the graph.

#### Example

```

mysql> CALL sys.ps_trace_thread(25, CONCAT('/tmp/stack-', REPLACE(NOW(), ' ', '-'), '.dot'), NULL, NULL, T
+-----+-----+
| summary |
+-----+-----+
| Disabled 1 thread |
+-----+-----+
1 row in set (0.00 sec)

+-----+-----+
| Info |
+-----+-----+
| Data collection starting for THREAD_ID = 25 |
+-----+-----+
1 row in set (0.03 sec)

+-----+-----+
| Info |
+-----+-----+
| Stack trace written to /tmp/stack-2014-02-16-21:18:41.dot |
+-----+-----+
1 row in set (60.07 sec)

```

```

+-----+
| Convert to PDF |
+-----+
| dot -Tpdf -o /tmp/stack_25.pdf /tmp/stack-2014-02-16-21:18:41.dot |
+-----+
1 row in set (60.07 sec)

+-----+
| Convert to PNG |
+-----+
| dot -Tpng -o /tmp/stack_25.png /tmp/stack-2014-02-16-21:18:41.dot |
+-----+
1 row in set (60.07 sec)

+-----+
| summary |
+-----+
| Enabled 1 thread |
+-----+
1 row in set (60.32 sec)

```

#### 26.4.4.24 The `ps_truncate_all_tables()` Procedure

Truncates all Performance Schema summary tables, resetting all aggregated instrumentation as a snapshot. Produces a result set indicating how many tables were truncated.

##### Parameters

- `in_verbose` **BOOLEAN**: Whether to display each `TRUNCATE TABLE` statement before executing it.

##### Example

```

mysql> CALL sys.ps_truncate_all_tables(FALSE);
+-----+
| summary |
+-----+
| Truncated 44 tables |
+-----+

```

#### 26.4.4.25 The `statement_performance_analyzer()` Procedure

Creates a report of the statements running on the server. The views are calculated based on the overall and/or delta activity.

This procedure disables binary logging during its execution by manipulating the session value of the `sql_log_bin` system variable. That is a restricted operation, so the procedure requires privileges sufficient to set restricted session variables. See [Section 5.1.8.1, “System Variable Privileges”](#).

##### Parameters

- `in_action` **ENUM('snapshot', 'overall', 'delta', 'create\_tmp', 'create\_table', 'save', 'cleanup')**: The action to take. These values are permitted:
  - `snapshot`: Store a snapshot. The default is to make a snapshot of the current content of the Performance Schema `events_statements_summary_by_digest` table. By setting `in_table`, this can be overwritten to copy the content of the specified table. The snapshot is stored in the `sys` schema `tmp_digests` temporary table.
  - `overall`: Generate an analysis based on the content of the table specified by `in_table`. For the overall analysis, `in_table` can be `NOW()` to use a fresh snapshot. This overwrites an existing snapshot. Use `NULL` for `in_table` to use the existing snapshot. If `in_table` is

NULL and no snapshot exists, a new snapshot is created. The `in_views` parameter and the `statement_performance_analyzer.limit` configuration option affect the operation of this procedure.

- `delta`: Generate a delta analysis. The delta is calculated between the reference table specified by `in_table` and the snapshot, which must exist. This action uses the `sys` schema `tmp_digests_delta` temporary table. The `in_views` parameter and the `statement_performance_analyzer.limit` configuration option affect the operation of this procedure.
- `create_table`: Create a regular table suitable for storing the snapshot for later use (for example, for calculating deltas).
- `create_tmp`: Create a temporary table suitable for storing the snapshot for later use (for example, for calculating deltas).
- `save`: Save the snapshot in the table specified by `in_table`. The table must exist and have the correct structure. If no snapshot exists, a new snapshot is created.
- `cleanup`: Remove the temporary tables used for the snapshot and delta.
- `in_table` VARCHAR(129): The table parameter used for some of the actions specified by the `in_action` parameter. Use the format `db_name.tbl_name` or `tbl_name` without using any backtick ( ` ) identifier-quoting characters. Periods ( . ) are not supported in database and table names.

The meaning of the `in_table` value for each `in_action` value is detailed in the individual `in_action` value descriptions.

- `in_views` SET ( 'with\_runtimes\_in\_95th\_percentile', 'analysis', 'with\_errors\_or\_warnings', 'with\_full\_table\_scans', 'with\_sorting', 'with\_temp\_tables', 'custom' ): Which views to include. This parameter is a SET value, so it can contain multiple view names, separated by commas. The default is to include all views except `custom`. The following values are permitted:
  - `with_runtimes_in_95th_percentile`: Use the `statements_with_runtimes_in_95th_percentile` view.
  - `analysis`: Use the `statement_analysis` view.
  - `with_errors_or_warnings`: Use the `statements_with_errors_or_warnings` view.
  - `with_full_table_scans`: Use the `statements_with_full_table_scans` view.
  - `with_sorting`: Use the `statements_with_sorting` view.
  - `with_temp_tables`: Use the `statements_with_temp_tables` view.
  - `custom`: Use a custom view. This view must be specified using the `statement_performance_analyzer.view` configuration option to name a query or an existing view.

## Configuration Options

`statement_performance_analyzer()` operation can be modified using the following configuration options or their corresponding user-defined variables (see [Section 26.4.2.1, “The sys\\_config Table”](#)):

- `debug`, `@sys.debug`

If this option is `ON`, produce debugging output. The default is `OFF`.

- `statement_performance_analyzer.limit`,  
`@sys.statement_performance_analyzer.limit`

The maximum number of rows to return for views that have no built-in limit. The default is 100.

- `statement_performance_analyzer.view`, `@sys.statement_performance_analyzer.view`

The custom query or view to be used. If the option value contains a space, it is interpreted as a query. Otherwise, it must be the name of an existing view that queries the Performance Schema `events_statements_summary_by_digest` table. There cannot be any `LIMIT` clause in the query or view definition if the `statement_performance_analyzer.limit` configuration option is greater than 0. If specifying a view, use the same format as for the `in_table` parameter. The default is `NULL` (no custom view defined).

## Example

To create a report with the queries in the 95th percentile since the last truncation of `events_statements_summary_by_digest` and with a one-minute delta period:

1. Create a temporary table to store the initial snapshot.
2. Create the initial snapshot.
3. Save the initial snapshot in the temporary table.
4. Wait one minute.
5. Create a new snapshot.
6. Perform analysis based on the new snapshot.
7. Perform analysis based on the delta between the initial and new snapshots.

```
mysql> CALL sys.statement_performance_analyzer('create_tmp', 'mydb.tmp_digests_ini', NULL);
Query OK, 0 rows affected (0.08 sec)

mysql> CALL sys.statement_performance_analyzer('snapshot', NULL, NULL);
Query OK, 0 rows affected (0.02 sec)

mysql> CALL sys.statement_performance_analyzer('save', 'mydb.tmp_digests_ini', NULL);
Query OK, 0 rows affected (0.00 sec)

mysql> DO SLEEP(60);
Query OK, 0 rows affected (1 min 0.00 sec)

mysql> CALL sys.statement_performance_analyzer('snapshot', NULL, NULL);
Query OK, 0 rows affected (0.02 sec)

mysql> CALL sys.statement_performance_analyzer('overall', NULL, 'with_runtimes_in_95th_percentile');
+-----+
| Next Output                                |
+-----+
| Queries with Runtime in 95th Percentile |
+-----+
1 row in set (0.05 sec)

...

mysql> CALL sys.statement_performance_analyzer('delta', 'mydb.tmp_digests_ini', 'with_runtimes_in_95th_percentile');
```

```

+-----+
| Next Output |
+-----+
| Queries with Runtime in 95th Percentile |
+-----+
1 row in set (0.03 sec)
...

```

Create an overall report of the 95th percentile queries and the top 10 queries with full table scans:

```

mysql> CALL sys.statement_performance_analyzer('snapshot', NULL, NULL);
Query OK, 0 rows affected (0.01 sec)

mysql> SET @sys.statement_performance_analyzer.limit = 10;
Query OK, 0 rows affected (0.00 sec)

mysql> CALL sys.statement_performance_analyzer('overall', NULL, 'with_runtimes_in_95th_percentile,with_full_table_scans');
+-----+
| Next Output |
+-----+
| Queries with Runtime in 95th Percentile |
+-----+
1 row in set (0.01 sec)
...

+-----+
| Next Output |
+-----+
| Top 10 Queries with Full Table Scan |
+-----+
1 row in set (0.09 sec)
...

```

Use a custom view showing the top 10 queries sorted by total execution time, refreshing the view every minute using the `watch` command in Linux:

```

mysql> CREATE OR REPLACE VIEW mydb.my_statements AS
  SELECT sys.format_statement(DIGEST_TEXT) AS query,
         SCHEMA_NAME AS db,
         COUNT_STAR AS exec_count,
         sys.format_time(SUM_TIMER_WAIT) AS total_latency,
         sys.format_time(AVG_TIMER_WAIT) AS avg_latency,
         ROUND(IFNULL(SUM_ROWS_SENT / NULLIF(COUNT_STAR, 0), 0)) AS rows_sent_avg,
         ROUND(IFNULL(SUM_ROWS_EXAMINED / NULLIF(COUNT_STAR, 0), 0)) AS rows_examined_avg,
         ROUND(IFNULL(SUM_ROWS_AFFECTED / NULLIF(COUNT_STAR, 0), 0)) AS rows_affected_avg,
         DIGEST AS digest
  FROM performance_schema.events_statements_summary_by_digest
  ORDER BY SUM_TIMER_WAIT DESC;
Query OK, 0 rows affected (0.10 sec)

mysql> CALL sys.statement_performance_analyzer('create_table', 'mydb.digests_prev', NULL);
Query OK, 0 rows affected (0.10 sec)

$> watch -n 60 "mysql sys --table -e \"
> SET @sys.statement_performance_analyzer.view = 'mydb.my_statements';
> SET @sys.statement_performance_analyzer.limit = 10;
> CALL statement_performance_analyzer('snapshot', NULL, NULL);
> CALL statement_performance_analyzer('delta', 'mydb.digests_prev', 'custom');
> CALL statement_performance_analyzer('save', 'mydb.digests_prev', NULL);
> \""

Every 60.0s: mysql sys --table -e "          ... Mon Dec 22 10:58:51 2014
+-----+

```

Next Output							
Top 10 Queries Using Custom View							
query	db	exec_count	total_latency	avg_latency	rows_sent_avg	rows_examined_avg	r
...							

### 26.4.4.26 The table\_exists() Procedure

Tests whether a given table exists as a regular table, a `TEMPORARY` table, or a view. The procedure returns the table type in an `OUT` parameter. If both a temporary and a permanent table exist with the given name, `TEMPORARY` is returned.

#### Parameters

- `in_db` `VARCHAR(64)`: The name of the database in which to check for table existence.
- `in_table` `VARCHAR(64)`: The name of the table to check the existence of.
- `out_exists` `ENUM('', 'BASE TABLE', 'VIEW', 'TEMPORARY')`: The return value. This is an `OUT` parameter, so it must be a variable into which the table type can be stored. When the procedure returns, the variable has one of the following values to indicate whether the table exists:
  - `''`: The table name does not exist as a base table, `TEMPORARY` table, or view.
  - `BASE TABLE`: The table name exists as a base (permanent) table.
  - `VIEW`: The table name exists as a view.
  - `TEMPORARY`: The table name exists as a `TEMPORARY` table.

#### Example

```
mysql> CREATE DATABASE db1;
Query OK, 1 row affected (0.01 sec)

mysql> USE db1;
Database changed

mysql> CREATE TABLE t1 (id INT PRIMARY KEY);
Query OK, 0 rows affected (0.03 sec)

mysql> CREATE TABLE t2 (id INT PRIMARY KEY);
Query OK, 0 rows affected (0.20 sec)

mysql> CREATE view v_t1 AS SELECT * FROM t1;
Query OK, 0 rows affected (0.02 sec)

mysql> CREATE TEMPORARY TABLE t1 (id INT PRIMARY KEY);
Query OK, 0 rows affected (0.00 sec)

mysql> CALL sys.table_exists('db1', 't1', @exists); SELECT @exists;
Query OK, 0 rows affected (0.01 sec)

+-----+
| @exists |
+-----+
| TEMPORARY |
+-----+
1 row in set (0.00 sec)
```



```

mysql> CALL sys.table_exists('db1', 't2', @exists); SELECT @exists;
Query OK, 0 rows affected (0.02 sec)

+-----+
| @exists |
+-----+
| BASE TABLE |
+-----+
1 row in set (0.00 sec)

mysql> CALL sys.table_exists('db1', 'v_t1', @exists); SELECT @exists;
Query OK, 0 rows affected (0.02 sec)

+-----+
| @exists |
+-----+
| VIEW |
+-----+
1 row in set (0.00 sec)

mysql> CALL sys.table_exists('db1', 't3', @exists); SELECT @exists;
Query OK, 0 rows affected (0.00 sec)

+-----+
| @exists |
+-----+
| |
+-----+
1 row in set (0.00 sec)

```

## 26.4.5 sys Schema Stored Functions

The following sections describe `sys` schema stored functions.

### 26.4.5.1 The `extract_schema_from_file_name()` Function

Given a file path name, returns the path component that represents the schema name. This function assumes that the file name lies within the schema directory. For this reason, it does not work with partitions or tables defined using their own `DATA_DIRECTORY` table option.

This function is useful when extracting file I/O information from the Performance Schema that includes file path names. It provides a convenient way to display schema names, which can be more easily understood than full path names, and can be used in joins against object schema names.

#### Parameters

- `path VARCHAR(512)`: The full path to a data file from which to extract the schema name.

#### Return Value

A `VARCHAR(64)` value.

#### Example

```

mysql> SELECT sys.extract_schema_from_file_name('/usr/local/mysql/data/world/City.ibd');
+-----+
| sys.extract_schema_from_file_name('/usr/local/mysql/data/world/City.ibd') |
+-----+
| world |
+-----+

```

### 26.4.5.2 The `extract_table_from_file_name()` Function

Given a file path name, returns the path component that represents the table name.

This function is useful when extracting file I/O information from the Performance Schema that includes file path names. It provides a convenient way to display table names, which can be more easily understood than full path names, and can be used in joins against object table names.

### Parameters

- `path VARCHAR(512)`: The full path to a data file from which to extract the table name.

### Return Value

A `VARCHAR(64)` value.

### Example

```
mysql> SELECT sys.extract_table_from_file_name('/usr/local/mysql/data/world/City.ibd');
+-----+
| sys.extract_table_from_file_name('/usr/local/mysql/data/world/City.ibd') |
+-----+
| City |
+-----+
```

## 26.4.5.3 The `format_bytes()` Function

Given a byte count, converts it to human-readable format and returns a string consisting of a value and a units indicator. Depending on the size of the value, the units part is `bytes`, `KiB` (kibibytes), `MiB` (mebibytes), `GiB` (gibibytes), `TiB` (tebibytes), or `PiB` (pebibytes).

### Parameters

- `bytes TEXT`: The byte count to format.

### Return Value

A `TEXT` value.

### Example

```
mysql> SELECT sys.format_bytes(512), sys.format_bytes(18446644073709551615);
+-----+-----+
| sys.format_bytes(512) | sys.format_bytes(18446644073709551615) |
+-----+-----+
| 512 bytes | 16383.91 PiB |
+-----+-----+
```

## 26.4.5.4 The `format_path()` Function

Given a path name, returns the modified path name after replacing subpaths that match the values of the following system variables, in order:

```
datadir
tmpdir
slave_load_tmpdir
innodb_data_home_dir
innodb_log_group_home_dir
innodb_undo_directory
basedir
```

A value that matches the value of system variable `sysvar` is replaced with the string `@GLOBAL.sysvar`.

Prior to MySQL 5.7.14, backslashes in Windows path names are converted to forward slashes in the result.

## Parameters

- `path` `VARCHAR(512)`: The path name to format.

## Return Value

A `VARCHAR(512) CHARACTER SET utf8` value.

## Example

```
mysql> SELECT sys.format_path('/usr/local/mysql/data/world/City.ibd');
+-----+
| sys.format_path('/usr/local/mysql/data/world/City.ibd') |
+-----+
| @@datadir/world/City.ibd                               |
+-----+
```

### 26.4.5.5 The `format_statement()` Function

Given a string (normally representing an SQL statement), reduces it to the length given by the `statement_truncate_len` configuration option, and returns the result. No truncation occurs if the string is shorter than `statement_truncate_len`. Otherwise, the middle part of the string is replaced by an ellipsis (...).

This function is useful for formatting possibly lengthy statements retrieved from Performance Schema tables to a known fixed maximum length.

## Parameters

- `statement` `LONGTEXT`: The statement to format.

## Configuration Options

`format_statement()` operation can be modified using the following configuration options or their corresponding user-defined variables (see [Section 26.4.2.1, “The `sys\_config` Table](#)”):

- `statement_truncate_len`, `@sys.statement_truncate_len`

The maximum length of statements returned by the `format_statement()` function. Longer statements are truncated to this length. The default is 64.

## Return Value

A `LONGTEXT` value.

## Example

By default, `format_statement()` truncates statements to be no more than 64 characters. Setting `@sys.statement_truncate_len` changes the truncation length for the current session:

```
mysql> SET @stmt = 'SELECT variable, value, set_time, set_by FROM sys_config';
mysql> SELECT sys.format_statement(@stmt);
+-----+
| sys.format_statement(@stmt) |
+-----+
| SELECT variable, value, set_time, set_by FROM sys_config |
+-----+
```

```
mysql> SET @sys.statement_truncate_len = 32;
mysql> SELECT sys.format_statement(@stmt);
+-----+
| sys.format_statement(@stmt) |
+-----+
| SELECT variabl ... ROM sys_config |
+-----+
```

### 26.4.5.6 The format\_time() Function

Given a Performance Schema latency or wait time in picoseconds, converts it to human-readable format and returns a string consisting of a value and a units indicator. Depending on the size of the value, the units part is `ps` (picoseconds), `ns` (nanoseconds), `us` (microseconds), `ms` (milliseconds), `s` (seconds), `m` (minutes), `h` (hours), `d` (days), or `w` (weeks).

#### Parameters

- `picoseconds` `TEXT`: The picoseconds value to format.

#### Return Value

A `TEXT` value.

#### Example

```
mysql> SELECT sys.format_time(3501), sys.format_time(188732396662000);
+-----+-----+
| sys.format_time(3501) | sys.format_time(188732396662000) |
+-----+-----+
| 3.50 ns                | 3.15 m                            |
+-----+-----+
```

### 26.4.5.7 The list\_add() Function

Adds a value to a comma-separated list of values and returns the result.

This function and `list_drop()` can be useful for manipulating the value of system variables such as `sql_mode` and `optimizer_switch` that take a comma-separated list of values.

#### Parameters

- `in_list` `TEXT`: The list to be modified.
- `in_add_value` `TEXT`: The value to add to the list.

#### Return Value

A `TEXT` value.

#### Example

```
mysql> SELECT @@sql_mode;
+-----+
| @@sql_mode |
+-----+
| ONLY_FULL_GROUP_BY,STRICT_TRANS_TABLES |
+-----+
mysql> SET @@sql_mode = sys.list_add(@@sql_mode, 'NO_ENGINE_SUBSTITUTION');
mysql> SELECT @@sql_mode;
+-----+
```

```

| @@sql_mode |
+-----+
| ONLY_FULL_GROUP_BY,STRICT_TRANS_TABLES,NO_ENGINE_SUBSTITUTION |
+-----+
mysql> SET @@sql_mode = sys.list_drop(@@sql_mode, 'ONLY_FULL_GROUP_BY');
mysql> SELECT @@sql_mode;
+-----+
| @@sql_mode |
+-----+
| STRICT_TRANS_TABLES,NO_ENGINE_SUBSTITUTION |
+-----+

```

### 26.4.5.8 The list\_drop() Function

Removes a value from a comma-separated list of values and returns the result. For more information, see the description of [list\\_add\(\)](#)

#### Parameters

- `in_list` `TEXT`: The list to be modified.
- `in_drop_value` `TEXT`: The value to drop from the list.

#### Return Value

A `TEXT` value.

### 26.4.5.9 The ps\_is\_account\_enabled() Function

Returns `YES` or `NO` to indicate whether Performance Schema instrumentation for a given account is enabled.

#### Parameters

- `in_host` `VARCHAR(60)`: The host name of the account to check.
- `in_user` `VARCHAR(32)`: The user name of the account to check.

#### Return Value

An `ENUM('YES', 'NO')` value.

#### Example

```

mysql> SELECT sys.ps_is_account_enabled('localhost', 'root');
+-----+
| sys.ps_is_account_enabled('localhost', 'root') |
+-----+
| YES |
+-----+

```

### 26.4.5.10 The ps\_is\_consumer\_enabled() Function

Returns `YES` or `NO` to indicate whether a given Performance Schema consumer is enabled, or `NULL` if the argument is `NULL`. If the argument is not a valid consumer name, an error occurs. (Prior to MySQL 5.7.28, the function returns `NULL` if the argument is not a valid consumer name.)

This function accounts for the consumer hierarchy, so a consumer is not considered enabled unless all consumers on which depends are also enabled. For information about the consumer hierarchy, see [Section 25.4.7, “Pre-Filtering by Consumer”](#).

## Parameters

- `in_consumer VARCHAR(64)`: The name of the consumer to check.

## Return Value

An `ENUM('YES', 'NO')` value.

## Example

```
mysql> SELECT sys.ps_is_consumer_enabled('thread_instrumentation');
+-----+
| sys.ps_is_consumer_enabled('thread_instrumentation') |
+-----+
| YES |
+-----+
```

### 26.4.5.11 The `ps_is_instrument_default_enabled()` Function

Returns `YES` or `NO` to indicate whether a given Performance Schema instrument is enabled by default.

## Parameters

- `in_instrument VARCHAR(128)`: The name of the instrument to check.

## Return Value

An `ENUM('YES', 'NO')` value.

## Example

```
mysql> SELECT sys.ps_is_instrument_default_enabled('memory/innodb/row_log_buf');
+-----+
| sys.ps_is_instrument_default_enabled('memory/innodb/row_log_buf') |
+-----+
| NO |
+-----+
mysql> SELECT sys.ps_is_instrument_default_enabled('statement/sql/alter_user');
+-----+
| sys.ps_is_instrument_default_enabled('statement/sql/alter_user') |
+-----+
| YES |
+-----+
```

### 26.4.5.12 The `ps_is_instrument_default_timed()` Function

Returns `YES` or `NO` to indicate whether a given Performance Schema instrument is timed by default.

## Parameters

- `in_instrument VARCHAR(128)`: The name of the instrument to check.

## Return Value

An `ENUM('YES', 'NO')` value.

## Example

```
mysql> SELECT sys.ps_is_instrument_default_timed('memory/innodb/row_log_buf');
+-----+
```

```

| sys.ps_is_instrument_default_timed('memory/innodb/row_log_buf') |
+-----+
| NO |
+-----+
mysql> SELECT sys.ps_is_instrument_default_timed('statement/sql/alter_user');
+-----+
| sys.ps_is_instrument_default_timed('statement/sql/alter_user') |
+-----+
| YES |
+-----+

```

### 26.4.5.13 The `ps_is_thread_instrumented()` Function

Returns `YES` or `NO` to indicate whether Performance Schema instrumentation for a given connection ID is enabled, `UNKNOWN` if the ID is unknown, or `NULL` if the ID is `NULL`.

#### Parameters

- `in_connection_id` `BIGINT UNSIGNED`: The connection ID. This is a value of the type given in the `PROCESSLIST_ID` column of the Performance Schema `threads` table or the `Id` column of `SHOW PROCESSLIST` output.

#### Return Value

An `ENUM('YES', 'NO', 'UNKNOWN')` value.

#### Example

```

mysql> SELECT sys.ps_is_thread_instrumented(43);
+-----+
| sys.ps_is_thread_instrumented(43) |
+-----+
| UNKNOWN |
+-----+
mysql> SELECT sys.ps_is_thread_instrumented(CONNECTION_ID());
+-----+
| sys.ps_is_thread_instrumented(CONNECTION_ID()) |
+-----+
| YES |
+-----+

```

### 26.4.5.14 The `ps_thread_account()` Function

Given a Performance Schema thread ID, returns the `user_name@host_name` account associated with the thread.

#### Parameters

- `in_thread_id` `BIGINT UNSIGNED`: The thread ID for which to return the account. The value should match the `THREAD_ID` column from some Performance Schema `threads` table row.

#### Return Value

A `TEXT` value.

#### Example

```

mysql> SELECT sys.ps_thread_account(sys.ps_thread_id(CONNECTION_ID()));
+-----+
| sys.ps_thread_account(sys.ps_thread_id(CONNECTION_ID())) |
+-----+

```

```

+-----+
| root@localhost |
+-----+

```

### 26.4.5.15 The `ps_thread_id()` Function

Returns the Performance Schema thread ID assigned to a given connection ID, or the thread ID for the current connection if the connection ID is `NULL`.

#### Parameters

- `in_connection_id` `BIGINT UNSIGNED`: The ID of the connection for which to return the thread ID. This is a value of the type given in the `PROCESLIST_ID` column of the Performance Schema `threads` table or the `Id` column of `SHOW PROCESSLIST` output.

#### Return Value

A `BIGINT UNSIGNED` value.

#### Example

```

mysql> SELECT sys.ps_thread_id(260);
+-----+
| sys.ps_thread_id(260) |
+-----+
|                285 |
+-----+

```

### 26.4.5.16 The `ps_thread_stack()` Function

Returns a JSON formatted stack of all statements, stages, and events within the Performance Schema for a given thread ID.

#### Parameters

- `in_thread_id` `BIGINT`: The ID of the thread to trace. The value should match the `THREAD_ID` column from some Performance Schema `threads` table row.
- `in_verbose` `BOOLEAN`: Whether to include `file:lineno` information in the events.

#### Return Value

A `LONGTEXT CHARACTER SET latin1` value.

#### Example

```

mysql> SELECT sys.ps_thread_stack(37, FALSE) AS thread_stack\G
***** 1. row *****
thread_stack: {"rankdir": "LR", "nodesep": "0.10",
"stack_created": "2014-02-19 13:39:03", "mysql_version": "5.7.3-m13",
"mysql_user": "root@localhost", "events": [{"nesting_event_id": "0",
"event_id": "10", "timer_wait": 256.35, "event_info": "sql/select",
"wait_info": "select @@version_comment limit 1\nerrors: 0\nwarnings: 0\nlock time:
...

```

### 26.4.5.17 The `ps_thread_trx_info()` Function

Returns a JSON object containing information about a given thread. The information includes the current transaction, and the statements it has already executed, derived from the Performance Schema



`events_transactions_current` and `events_statements_history` tables. (The consumers for those tables must be enabled to obtain full data in the JSON object.)

If the output exceeds the truncation length (65535 by default), a JSON error object is returned, such as:

```
{ "error": "Trx info truncated: Row 6 was cut by GROUP_CONCAT()" }
```

Similar error objects are returned for other warnings and exceptions raised during function execution.

## Parameters

- `in_thread_id` `BIGINT UNSIGNED`: The thread ID for which to return transaction information. The value should match the `THREAD_ID` column from some Performance Schema `threads` table row.

## Configuration Options

`ps_thread_trx_info()` operation can be modified using the following configuration options or their corresponding user-defined variables (see [Section 26.4.2.1, “The sys\\_config Table”](#)):

- `ps_thread_trx_info.max_length`, `@sys.ps_thread_trx_info.max_length`

The maximum length of the output. The default is 65535.

## Return Value

A `LONGTEXT` value.

## Example

```
mysql> SELECT sys.ps_thread_trx_info(48)\G
***** 1. row *****
sys.ps_thread_trx_info(48): [
  {
    "time": "790.70 us",
    "state": "COMMITTED",
    "mode": "READ WRITE",
    "autocommitted": "NO",
    "gtid": "AUTOMATIC",
    "isolation": "REPEATABLE READ",
    "statements_executed": [
      {
        "sql_text": "INSERT INTO info VALUES (1, \'foo\')",
        "time": "471.02 us",
        "schema": "trx",
        "rows_examined": 0,
        "rows_affected": 1,
        "rows_sent": 0,
        "tmp_tables": 0,
        "tmp_disk_tables": 0,
        "sort_rows": 0,
        "sort_merge_passes": 0
      },
      {
        "sql_text": "COMMIT",
        "time": "254.42 us",
        "schema": "trx",
        "rows_examined": 0,
        "rows_affected": 0,
        "rows_sent": 0,
        "tmp_tables": 0,
        "tmp_disk_tables": 0,
        "sort_rows": 0,
        "sort_merge_passes": 0
      }
    ]
  }
]
```

```

    }
  ]
},
{
  "time": "426.20 us",
  "state": "COMMITTED",
  "mode": "READ WRITE",
  "autocommitted": "NO",
  "gtid": "AUTOMATIC",
  "isolation": "REPEATABLE READ",
  "statements_executed": [
    {
      "sql_text": "INSERT INTO info VALUES (2, \'bar\')",
      "time": "107.33 us",
      "schema": "trx",
      "rows_examined": 0,
      "rows_affected": 1,
      "rows_sent": 0,
      "tmp_tables": 0,
      "tmp_disk_tables": 0,
      "sort_rows": 0,
      "sort_merge_passes": 0
    },
    {
      "sql_text": "COMMIT",
      "time": "213.23 us",
      "schema": "trx",
      "rows_examined": 0,
      "rows_affected": 0,
      "rows_sent": 0,
      "tmp_tables": 0,
      "tmp_disk_tables": 0,
      "sort_rows": 0,
      "sort_merge_passes": 0
    }
  ]
}
]
]

```

### 26.4.5.18 The `quote_identifier()` Function

Given a string argument, this function produces a quoted identifier suitable for inclusion in SQL statements. This is useful when a value to be used as an identifier is a reserved word or contains backtick (``) characters. It was added in MySQL 5.7.14.

#### Parameters

`in_identifier` **TEXT**: The identifier to quote.

#### Return Value

A **TEXT** value.

#### Example

```

mysql> SELECT sys.quote_identifier('plain');
+-----+
| sys.quote_identifier('plain') |
+-----+
| `plain`                       |
+-----+
mysql> SELECT sys.quote_identifier('trick`ier');
+-----+
| sys.quote_identifier('trick`ier') |

```

```

+-----+
| `trick` `ier` |
+-----+
mysql> SELECT sys.quote_identifier('integer');
+-----+
| sys.quote_identifier('integer') |
+-----+
| `integer` |
+-----+

```

### 26.4.5.19 The `sys_get_config()` Function

Given a configuration option name, returns the option value from the `sys_config` table, or the provided default value (which may be `NULL`) if the option does not exist in the table.

If `sys_get_config()` returns the default value and that value is `NULL`, it is expected that the caller is able to handle `NULL` for the given configuration option.

By convention, routines that call `sys_get_config()` first check whether the corresponding user-defined variable exists and is non-`NULL`. If so, the routine uses the variable value without reading the `sys_config` table. If the variable does not exist or is `NULL`, the routine reads the option value from the table and sets the user-defined variable to that value. For more information about the relationship between configuration options and their corresponding user-defined variables, see [Section 26.4.2.1, “The `sys\_config` Table”](#).

If you want to check whether the configuration option has already been set and, if not, use the return value of `sys_get_config()`, you can use `IFNULL(...)` (see example later). However, this should not be done inside a loop (for example, for each row in a result set) because for repeated calls where the assignment is needed only in the first iteration, using `IFNULL(...)` is expected to be significantly slower than using an `IF (...) THEN ... END IF;` block (see example later).

#### Parameters

- `in_variable_name` `VARCHAR(128)`: The name of the configuration option for which to return the value.
- `in_default_value` `VARCHAR(128)`: The default value to return if the configuration option is not found in the `sys_config` table.

#### Return Value

A `VARCHAR(128)` value.

#### Example

Get a configuration value from the `sys_config` table, falling back to 128 as the default if the option is not present in the table:

```

mysql> SELECT sys.sys_get_config('statement_truncate_len', 128) AS Value;
+-----+
| Value |
+-----+
| 64    |
+-----+

```

One-liner example: Check whether the option is already set; if not, assign the `IFNULL(...)` result (using the value from the `sys_config` table):

```

mysql> SET @sys.statement_truncate_len =
        IFNULL(@sys.statement_truncate_len,
              sys.sys_get_config('statement_truncate_len', 64));

```

`IF (...) THEN ... END IF;` block example: Check whether the option is already set; if not, assign the value from the `sys_config` table:

```
IF (@sys.statement_truncate_len IS NULL) THEN
  SET @sys.statement_truncate_len = sys.sys_get_config('statement_truncate_len', 64);
END IF;
```

### 26.4.5.20 The `version_major()` Function

This function returns the major version of the MySQL server.

#### Parameters

None.

#### Return Value

A `TINYINT UNSIGNED` value.

#### Example

```
mysql> SELECT VERSION(), sys.version_major();
+-----+-----+
| VERSION() | sys.version_major() |
+-----+-----+
| 5.7.24-debug-log | 5 |
+-----+-----+
```

### 26.4.5.21 The `version_minor()` Function

This function returns the minor version of the MySQL server.

#### Parameters

None.

#### Return Value

A `TINYINT UNSIGNED` value.

#### Example

```
mysql> SELECT VERSION(), sys.version_minor();
+-----+-----+
| VERSION() | sys.version_minor() |
+-----+-----+
| 5.7.24-debug-log | 7 |
+-----+-----+
```

### 26.4.5.22 The `version_patch()` Function

This function returns the patch release version of the MySQL server.

#### Parameters

None.

#### Return Value

A `TINYINT UNSIGNED` value.

**Example**

```
mysql> SELECT VERSION(), sys.version_patch();
+-----+-----+
| VERSION()          | sys.version_patch() |
+-----+-----+
| 5.7.24-debug-log  |          24         |
+-----+-----+
```



---

# Chapter 27 Connectors and APIs

## Table of Contents

27.1 MySQL Connector/C++ .....	4476
27.2 MySQL Connector/J .....	4476
27.3 MySQL Connector/NET .....	4476
27.4 MySQL Connector/ODBC .....	4476
27.5 MySQL Connector/Python .....	4476
27.6 libmysqld, the Embedded MySQL Server Library .....	4476
27.6.1 Compiling Programs with libmysqld .....	4477
27.6.2 Restrictions When Using the Embedded MySQL Server .....	4478
27.6.3 Options with the Embedded Server .....	4478
27.6.4 Embedded Server Examples .....	4479
27.7 MySQL C API .....	4482
27.8 MySQL PHP API .....	4482
27.9 MySQL Perl API .....	4482
27.10 MySQL Python API .....	4483
27.11 MySQL Ruby APIs .....	4483
27.11.1 The MySQL/Ruby API .....	4484
27.11.2 The Ruby/MySQL API .....	4484
27.12 MySQL Tcl API .....	4484
27.13 MySQL Eiffel Wrapper .....	4484

MySQL Connectors provide connectivity to the MySQL server for client programs. APIs provide low-level access to MySQL resources using either the classic MySQL protocol or X Protocol. Both Connectors and the APIs enable you to connect and execute MySQL statements from another language or environment, including ODBC, Java (JDBC), C++, Python, PHP, Perl, Ruby, and native C and embedded MySQL instances.

## MySQL Connectors

Oracle develops a number of connectors:

- [Connector/C++](#) enables C++ applications to connect to MySQL.
- [Connector/J](#) provides driver support for connecting to MySQL from Java applications using the standard Java Database Connectivity (JDBC) API.
- [Connector/NET](#) enables developers to create .NET applications that connect to MySQL. Connector/NET implements a fully functional ADO.NET interface and provides support for use with ADO.NET aware tools. Applications that use Connector/NET can be written in any supported .NET language.
- [Connector/ODBC](#) provides driver support for connecting to MySQL using the Open Database Connectivity (ODBC) API. Support is available for ODBC connectivity from Windows, Unix, and macOS platforms.
- [Connector/Python](#) provides driver support for connecting to MySQL from Python applications using an API that is compliant with the [Python DB API version 2.0](#). No additional Python modules or MySQL client libraries are required.

## The MySQL C API

For direct access to using MySQL natively within a C application, there are two methods:

- The [C API](#) provides low-level access to the MySQL client/server protocol through the `libmysqlclient` client library. This is the primary method used to connect to an instance of the MySQL server, and is used both by MySQL command-line clients and many of the MySQL Connectors and third-party APIs detailed here.

`libmysqlclient` is included in MySQL distributions.

- `libmysqld` is an embedded MySQL server library that enables you to embed an instance of the MySQL server into your C applications.

`libmysqld` is included in MySQL distributions.



#### Note

The `libmysqld` embedded server library is deprecated as of MySQL 5.7.19 and is removed in MySQL 8.0.

See also [MySQL C API Implementations](#).

To access MySQL from a C application, or to build an interface to MySQL for a language not supported by the Connectors or APIs in this chapter, the [C API](#) is where to start. A number of programmer's utilities are available to help with the process; see [Section 4.7, "Program Development Utilities"](#).

## Third-Party MySQL APIs

The remaining APIs described in this chapter provide an interface to MySQL from specific application languages. These third-party solutions are not developed or supported by Oracle. Basic information on their usage and abilities is provided here for reference purposes only.

All the third-party language APIs are developed using one of two methods, using `libmysqlclient` or by implementing a *native driver*. The two solutions offer different benefits:

- Using `libmysqlclient` offers complete compatibility with MySQL because it uses the same libraries as the MySQL client applications. However, the feature set is limited to the implementation and interfaces exposed through `libmysqlclient` and the performance may be lower as data is copied between the native language, and the MySQL API components.
- *Native drivers* are an implementation of the MySQL network protocol entirely within the host language or environment. Native drivers are fast, as there is less copying of data between components, and they can offer advanced functionality not available through the standard MySQL API. Native drivers are also easier for end users to build and deploy because no copy of the MySQL client libraries is needed to build the native driver components.

[Table 27.1, "MySQL APIs and Interfaces"](#) lists many of the libraries and interfaces available for MySQL.

**Table 27.1 MySQL APIs and Interfaces**

Environment	API	Type	Notes
Ada	GNU Ada MySQL Bindings	<code>libmysqlclient</code>	See <a href="#">MySQL Bindings for GNU Ada</a>
C	C API	<code>libmysqlclient</code>	See <a href="#">MySQL 5.7 C API Developer Guide</a> .
C++	Connector/C++	<code>libmysqlclient</code>	See <a href="#">MySQL Connector/C++ 9.5 Developer Guide</a> .
	MySQL++	<code>libmysqlclient</code>	See <a href="#">MySQL++ website</a> .



Environment	API	Type	Notes
	MySQL wrapped	<code>libmysqlclient</code>	See <a href="#">MySQL wrapped</a> .
Cocoa	MySQL-Cocoa	<code>libmysqlclient</code>	Compatible with the Objective-C Cocoa environment. See <a href="http://mysql-cocoa.sourceforge.net/">http://mysql-cocoa.sourceforge.net/</a>
D	MySQL for D	<code>libmysqlclient</code>	See <a href="#">MySQL for D</a> .
Eiffel	Eiffel MySQL	<code>libmysqlclient</code>	See <a href="#">Section 27.13, "MySQL Eiffel Wrapper"</a> .
Erlang	<code>erlang-mysql-driver</code>	<code>libmysqlclient</code>	See <a href="#">erlang-mysql-driver</a> .
Haskell	Haskell MySQL Bindings	Native Driver	See <a href="#">Brian O'Sullivan's pure Haskell MySQL bindings</a> .
	<code>hsqldb-mysql</code>	<code>libmysqlclient</code>	See <a href="#">MySQL driver for Haskell</a> .
Java/JDBC	Connector/J	Native Driver	See <a href="#">MySQL Connector/J Developer Guide</a> .
Kaya	MyDB	<code>libmysqlclient</code>	See <a href="#">MyDB</a> .
Lua	LuaSQL	<code>libmysqlclient</code>	See <a href="#">LuaSQL</a> .
.NET/Mono	Connector/NET	Native Driver	See <a href="#">MySQL Connector/NET Developer Guide</a> .
Objective Caml	OBjective Caml MySQL Bindings	<code>libmysqlclient</code>	See <a href="#">MySQL Bindings for Objective Caml</a> .
Octave	Database bindings for GNU Octave	<code>libmysqlclient</code>	See <a href="#">Database bindings for GNU Octave</a> .
ODBC	Connector/ODBC	<code>libmysqlclient</code>	See <a href="#">MySQL Connector/ODBC Developer Guide</a> .
Perl	<code>DBI/DBD::mysql</code>	<code>libmysqlclient</code>	See <a href="#">Section 27.9, "MySQL Perl API"</a> .
	<code>Net::MySQL</code>	Native Driver	See <a href="#">Net::MySQL at CPAN</a>
PHP	<code>mysql</code> , <code>ext/mysql</code> interface (deprecated)	<code>libmysqlclient</code>	See <a href="#">MySQL and PHP</a> .
	<code>mysqli</code> , <code>ext/mysqli</code> interface	<code>libmysqlclient</code>	See <a href="#">MySQL and PHP</a> .
	<code>PDO_MYSQL</code>	<code>libmysqlclient</code>	See <a href="#">MySQL and PHP</a> .
	PDO mysqlnd	Native Driver	
Python	Connector/Python	Native Driver	See <a href="#">MySQL Connector/Python Developer Guide</a> .
Python	Connector/Python C Extension	<code>libmysqlclient</code>	See <a href="#">MySQL Connector/Python Developer Guide</a> .
	MySQLdb	<code>libmysqlclient</code>	See <a href="#">Section 27.10, "MySQL Python API"</a> .

Environment	API	Type	Notes
Ruby	mysql2	libmysqlclient	Uses libmysqlclient. See <a href="#">Section 27.11</a> , “MySQL Ruby APIs”.
Scheme	Myscsh	libmysqlclient	See Myscsh.
SPL	sql_mysql	libmysqlclient	See <a href="#">sql_mysql</a> for SPL.
Tcl	MySQLtcl	libmysqlclient	See <a href="#">Section 27.12</a> , “MySQL Tcl API”.

## 27.1 MySQL Connector/C++

The MySQL Connector/C++ manual is published in standalone form, not as part of the MySQL Reference Manual. For information, see these documents:

- Main manual: [MySQL Connector/C++ 9.5 Developer Guide](#)
- Release notes: [MySQL Connector/C++ Release Notes](#)

## 27.2 MySQL Connector/J

The MySQL Connector/J manual is published in standalone form, not as part of the MySQL Reference Manual. For information, see these documents:

- Main manual: [MySQL Connector/J Developer Guide](#)
- Release notes: [MySQL Connector/J Release Notes](#)

## 27.3 MySQL Connector/NET

The MySQL Connector/NET manual is published in standalone form, not as part of the MySQL Reference Manual. For information, see these documents:

- Main manual: [MySQL Connector/NET Developer Guide](#)
- Release notes: [MySQL Connector/NET Release Notes](#)

## 27.4 MySQL Connector/ODBC

The MySQL Connector/ODBC manual is published in standalone form, not as part of the MySQL Reference Manual. For information, see these documents:

- Main manual: [MySQL Connector/ODBC Developer Guide](#)
- Release notes: [MySQL Connector/ODBC Release Notes](#)

## 27.5 MySQL Connector/Python

The MySQL Connector/Python manual is published in standalone form, not as part of the MySQL Reference Manual. For information, see these documents:

- Main manual: [MySQL Connector/Python Developer Guide](#)
- Release notes: [MySQL Connector/Python Release Notes](#)

## 27.6 libmysqld, the Embedded MySQL Server Library

The embedded MySQL server library makes it possible to run a full-featured MySQL server inside a client application. The main benefits are increased speed and more simple management for embedded applications.



#### Note

The `libmysqld` embedded server library is deprecated as of MySQL 5.7.19 and is removed in MySQL 8.0.

The embedded server library is based on the client/server version of MySQL, which is written in C/C++. Consequently, the embedded server also is written in C/C++. There is no embedded server available in other languages.

The API is identical for the embedded MySQL version and the client/server version. To change a threaded application to use the embedded library, you normally only have to add calls to the following functions.

**Table 27.2 MySQL Embedded Server Library Functions**

Function	When to Call
<code>mysql_library_init()</code>	Call it before any other MySQL function is called, preferably early in the <code>main()</code> function.
<code>mysql_library_end()</code>	Call it before your program exits.
<code>mysql_thread_init()</code>	Call it in each thread you create that accesses MySQL.
<code>mysql_thread_end()</code>	Call it before calling <code>pthread_exit()</code> .

Then, link your code with `libmysqld.a` instead of `libmysqlclient.a`. To ensure binary compatibility between your application and the server library, always compile your application against headers for the same series of MySQL that was used to compile the server library. For example, if `libmysqld` was compiled against MySQL 5.6 headers, do not compile your application against MySQL 5.7 headers, or vice versa.

Because the `mysql_library_xxx()` functions are also included in `libmysqlclient.a`, you can change between the embedded and the client/server version by just linking your application with the right library. See `mysql_library_init()`.

One difference between the embedded server and the standalone server is that for the embedded server, authentication for connections is disabled by default.

## 27.6.1 Compiling Programs with libmysqld

In precompiled binary MySQL distributions that include `libmysqld`, the embedded server library, MySQL builds the library using the appropriate vendor compiler if there is one.

To get a `libmysqld` library if you build MySQL from source yourself, you should configure MySQL with the `-DWITH_EMBEDDED_SERVER=1` option. See [Section 2.8.7, “MySQL Source-Configuration Options”](#).

When you link your program with `libmysqld`, you must also include the system-specific `pthread` libraries and some libraries that the MySQL server uses. You can get the full list of libraries by executing `mysql_config --libmysqld-libs`.

The correct flags for compiling and linking a threaded program must be used, even if you do not directly call any thread functions in your code.

To compile a C program to include the necessary files to embed the MySQL server library into an executable version of a program, the compiler needs to know where to find various files and needs

instructions on how to compile the program. The following example shows how a program could be compiled from the command line, assuming that you are using `gcc`, use the GNU C compiler:

```
gcc mysql_test.c -o mysql_test \  
`/usr/local/mysql/bin/mysql_config --include --libmysqld-libs`
```

Immediately following the `gcc` command is the name of the C program source file. After it, the `-o` option is given to indicate that the file name that follows is the name that the compiler is to give to the output file, the compiled program. The next line of code tells the compiler to obtain the location of the include files and libraries and other settings for the system on which it is compiled. The `mysql_config` command is contained in backticks, not single quotation marks.

On some non-`gcc` platforms, the embedded library depends on C++ runtime libraries and linking against the embedded library might result in missing-symbol errors. To solve this, link using a C++ compiler or explicitly list the required libraries on the link command line.

## 27.6.2 Restrictions When Using the Embedded MySQL Server

The embedded server has the following limitations:

- No loadable functions.
- No stack trace on core dump.
- You cannot set this up as a source or a replica (no replication).
- Very large result sets may be unusable on low memory systems.
- You cannot connect to an embedded server from an outside process with sockets or TCP/IP. However, you can connect to an intermediate application, which in turn can connect to an embedded server on the behalf of a remote client or outside process.
- `libmysqld` does not support encrypted connections. An implication is that if an application linked against `libmysqld` establishes a connection to a remote server, the connection cannot be encrypted.
- `InnoDB` is not reentrant in the embedded server and cannot be used for multiple connections, either successively or simultaneously.
- The Event Scheduler is not available. Because of this, the `event_scheduler` system variable is disabled.
- The Performance Schema is not available.
- The embedded server cannot share the same `secure_file_priv` directory with another server. As of MySQL 5.7.8, the default value for this directory can be set at build time with the `INSTALL_SECURE_FILE_PRIV_EMBEDDEDIR` CMake option.

Some of these limitations can be changed by editing the `mysql_embed.h` include file and recompiling MySQL.

## 27.6.3 Options with the Embedded Server

Any options that may be given with the `mysqld` server daemon, may be used with an embedded server library. Server options may be given in an array as an argument to the `mysql_library_init()`, which initializes the server. They also may be given in an option file like `my.cnf`. To specify an option file for a C program, use the `--defaults-file` option as one of the elements of the second argument of the `mysql_library_init()` function. See `mysql_library_init()`, for more information on the `mysql_library_init()` function.

Using option files can make it easier to switch between a client/server application and one where MySQL is embedded. Put common options under the `[server]` group. These are read by both MySQL versions. Client/server-specific options should go under the `[mysqld]` section. Put options specific to the embedded MySQL server library in the `[embedded]` section. Options specific to applications go under section labeled `[ApplicationName_SERVER]`. See [Section 4.2.2.2, "Using Option Files"](#).

## 27.6.4 Embedded Server Examples

These two example programs should work without any changes on a Linux or FreeBSD system. For other operating systems, minor changes are needed, mostly with file paths. These examples are designed to give enough details for you to understand the problem, without the clutter that is a necessary part of a real application. The first example is very straightforward. The second example is a little more advanced with some error checking. The first is followed by a command-line entry for compiling the program. The second is followed by a GNUmake file that may be used for compiling instead.

### Example 1

`test1_libmysqld.c`

```
#include <stdio.h>
#include <stdlib.h>
#include <stdarg.h>
#include "mysql.h"

MYSQL *mysql;
MYSQL_RES *results;
MYSQL_ROW record;

static char *server_options[] = \
    { "mysql_test", "--defaults-file=my.cnf", NULL };
int num_elements = (sizeof(server_options) / sizeof(char *)) - 1;

static char *server_groups[] = { "libmysqld_server",
    "libmysqld_client", NULL };

int main(void)
{
    mysql_library_init(num_elements, server_options, server_groups);
    mysql = mysql_init(NULL);
    mysql_options(mysql, MYSQL_READ_DEFAULT_GROUP, "libmysqld_client");
    mysql_options(mysql, MYSQL_OPT_USE_EMBEDDED_CONNECTION, NULL);

    mysql_real_connect(mysql, NULL, NULL, NULL, "database1", 0, NULL, 0);

    mysql_query(mysql, "SELECT column1, column2 FROM table1");

    results = mysql_store_result(mysql);

    while((record = mysql_fetch_row(results))) {
        printf("%s - %s\n", record[0], record[1]);
    }

    mysql_free_result(results);
    mysql_close(mysql);
    mysql_library_end();

    return 0;
}
```

Here is the command line for compiling the above program:

```
gcc test1_libmysqld.c -o test1_libmysqld \
    `/usr/local/mysql/bin/mysql_config --include --libmysqld-libs`
```

**Example 2**

To try the example, create an `test2_libmysqld` directory at the same level as the MySQL source directory. Save the `test2_libmysqld.c` source and the `GNUmakefile` in the directory, and run GNU `make` from inside the `test2_libmysqld` directory.

`test2_libmysqld.c`

```

/*
 * A simple example client, using the embedded MySQL server library
 */

#include <mysql.h>
#include <stdarg.h>
#include <stdio.h>
#include <stdlib.h>

MYSQL *db_connect(const char *dbname);
void db_disconnect(MYSQL *db);
void db_do_query(MYSQL *db, const char *query);

const char *server_groups[] = {
    "test2_libmysqld_SERVER", "embedded", "server", NULL
};

int
main(int argc, char **argv)
{
    MYSQL *one, *two;

    /* mysql_library_init() must be called before any other mysql
     * functions.
     *
     * You can use mysql_library_init(0, NULL, NULL), and it
     * initializes the server using groups = {
     *   "server", "embedded", NULL
     * }.
     *
     * In your $HOME/.my.cnf file, you probably want to put:
     [test2_libmysqld_SERVER]
     language = /path/to/source/of/mysql/sql/share/english
     *
     * You could, of course, modify argc and argv before passing
     * them to this function. Or you could create new ones in any
     * way you like. But all of the arguments in argv (except for
     * argv[0], which is the program name) should be valid options
     * for the MySQL server.
     *
     * If you link this client against the normal mysqlclient
     * library, this function is just a stub that does nothing.
     */
    mysql_library_init(argc, argv, (char **)server_groups);

    one = db_connect("test");
    two = db_connect(NULL);

    db_do_query(one, "SHOW TABLE STATUS");
    db_do_query(two, "SHOW DATABASES");

    mysql_close(two);
    mysql_close(one);

    /* This must be called after all other mysql functions */
    mysql_library_end();

```

```

    exit(EXIT_SUCCESS);
}

static void
die(MYSQL *db, char *fmt, ...)
{
    va_list ap;
    va_start(ap, fmt);
    vfprintf(stderr, fmt, ap);
    va_end(ap);
    (void)putc('\n', stderr);
    if (db)
        db_disconnect(db);
    exit(EXIT_FAILURE);
}

MYSQL *
db_connect(const char *dbname)
{
    MYSQL *db = mysql_init(NULL);
    if (!db)
        die(db, "mysql_init failed: no memory");
    /*
     * Notice that the client and server use separate group names.
     * This is critical, because the server does not accept the
     * client's options, and vice versa.
     */
    mysql_options(db, MYSQL_READ_DEFAULT_GROUP, "test2_libmysqld_CLIENT");
    if (!mysql_real_connect(db, NULL, NULL, NULL, dbname, 0, NULL, 0))
        die(db, "mysql_real_connect failed: %s", mysql_error(db));

    return db;
}

void
db_disconnect(MYSQL *db)
{
    mysql_close(db);
}

void
db_do_query(MYSQL *db, const char *query)
{
    if (mysql_query(db, query) != 0)
        goto err;

    if (mysql_field_count(db) > 0)
    {
        MYSQL_RES *res;
        MYSQL_ROW row, end_row;
        int num_fields;

        if (!(res = mysql_store_result(db)))
            goto err;
        num_fields = mysql_num_fields(res);
        while ((row = mysql_fetch_row(res)))
        {
            (void)fputs(">> ", stdout);
            for (end_row = row + num_fields; row < end_row; ++row)
                (void)printf("%s\t", row ? (char*)*row : "NULL");
            (void)fputc('\n', stdout);
        }
        (void)fputc('\n', stdout);
        mysql_free_result(res);
    }
    else
        (void)printf("Affected rows: %lld\n", mysql_affected_rows(db));
}

```

```

return;

err:
    die(db, "db_do_query failed: %s [%s]", mysql_error(db), query);
}

```

### GNUmakefile

```

# This assumes the MySQL software is installed in /usr/local/mysql
inc      := /usr/local/mysql/include/mysql
lib      := /usr/local/mysql/lib

# If you have not installed the MySQL software yet, try this instead
#inc     := $(HOME)/mysql-5.7/include
#lib     := $(HOME)/mysql-5.7/libmysqld

CC       := gcc
CPPFLAGS := -I$(inc) -D_THREAD_SAFE -D_REENTRANT
CFLAGS   := -g -W -Wall
LDFLAGS  := -static
# You can change -lmysqld to -mysqlclient to use the
# client/server library
LDLIBS   = -L$(lib) -lmysqld -lm -ldl -lcrypt

ifneq (,$(shell grep FreeBSD /COPYRIGHT 2>/dev/null))
# FreeBSD
LDFLAGS += -pthread
else
# Assume Linux
LDLIBS += -lpthread
endif

# This works for simple one-file test programs
sources := $(wildcard *.c)
objects := $(patsubst %c,%o,$(sources))
targets := $(basename $(sources))

all: $(targets)

clean:
    rm -f $(targets) $(objects) *.core

```

## 27.7 MySQL C API

The MySQL C API Developer Guide is published in standalone form, not as part of the MySQL Reference Manual. See [MySQL 5.7 C API Developer Guide](#).

## 27.8 MySQL PHP API

The MySQL PHP API manual is now published in standalone form, not as part of the MySQL Reference Manual. See [MySQL and PHP](#).

## 27.9 MySQL Perl API

The Perl [DBI](#) module provides a generic interface for database access. You can write a DBI script that works with many different database engines without change. To use DBI with MySQL, install the following:

1. The [DBI](#) module.
2. The `DBD::mysql` module. This is the DataBase Driver (DBD) module for Perl.



3. Optionally, the DBD module for any other type of database server you want to access.

Perl DBI is the recommended Perl interface. It replaces an older interface called `mysqlperl`, which should be considered obsolete.

These sections contain information about using Perl with MySQL and writing MySQL applications in Perl:

- For installation instructions for Perl DBI support, see [Section 2.12, “Perl Installation Notes”](#).
- For an example of reading options from option files, see [Section 5.7.4, “Using Client Programs in a Multiple-Server Environment”](#).
- For secure coding tips, see [Section 6.1.1, “Security Guidelines”](#).
- For debugging tips, see [Section 5.8.1.4, “Debugging mysqld under gdb”](#).
- For some Perl-specific environment variables, see [Section 4.9, “Environment Variables”](#).
- For considerations for running on macOS, see [Section 2.4, “Installing MySQL on macOS”](#).
- For ways to quote string literals, see [Section 9.1.1, “String Literals”](#).

DBI information is available at the command line, online, or in printed form:

- Once you have the `DBI` and `DBD:mysql` modules installed, you can get information about them at the command line with the `perldoc` command:

```
$> perldoc DBI
$> perldoc DBI::FAQ
$> perldoc DBD:mysql
```

You can also use `pod2man`, `pod2html`, and so on to translate this information into other formats.

- For online information about Perl DBI, visit the DBI website, <http://dbi.perl.org/>. That site hosts a general DBI mailing list.
- For printed information, the official DBI book is *Programming the Perl DBI* (Alligator Descartes and Tim Bunce, O'Reilly & Associates, 2000). Information about the book is available at the DBI website, <http://dbi.perl.org/>.

## 27.10 MySQL Python API

`MySQLLdb` is a third-party driver that provides MySQL support for Python, compliant with the Python DB API version 2.0. It can be found at <http://sourceforge.net/projects/mysql-python/>.

The new MySQL Connector/Python component provides an interface to the same Python API, and is built into the MySQL Server and supported by Oracle. See [MySQL Connector/Python Developer Guide](#) for details on the Connector, as well as coding guidelines for Python applications and sample Python code.

## 27.11 MySQL Ruby APIs

The `mysql2` Ruby gem provides an API for connecting to MySQL, performing queries, and iterating through results; it is intended to support MySQL 5.7 and MySQL 8.0. For more information, see the [mysql2 page at RubyGems.org](#) or the project's [GitHub page](#).

For background and syntax information about the Ruby language, see [Ruby Programming Language](#).

### 27.11.1 The MySQL/Ruby API

The MySQL/Ruby module provides access to MySQL databases using Ruby through [libmysqlclient](#).

For information on installing the module, and the functions exposed, see [MySQL/Ruby](#).

### 27.11.2 The Ruby/MySQL API

The Ruby/MySQL module provides access to MySQL databases using Ruby through a native driver interface using the MySQL network protocol.

For information on installing the module, and the functions exposed, see [Ruby/MySQL](#).

## 27.12 MySQL Tcl API

[MySQLtcl](#) is a simple API for accessing a MySQL database server from the [Tcl programming language](#). It can be found at <http://www.xdobry.de/mysqltcl/>.

## 27.13 MySQL Eiffel Wrapper

Eiffel MySQL is an interface to the MySQL database server using the [Eiffel programming language](#), written by Michael Ravits. It can be found at <http://efsa.sourceforge.net/archive/ravits/mysql.htm>.

---

# Chapter 28 MySQL Enterprise Edition

## Table of Contents

28.1 MySQL Enterprise Backup Overview .....	4485
28.2 MySQL Enterprise Security Overview .....	4486
28.3 MySQL Enterprise Encryption Overview .....	4486
28.4 MySQL Enterprise Audit Overview .....	4487
28.5 MySQL Enterprise Firewall Overview .....	4487
28.6 MySQL Enterprise Thread Pool Overview .....	4487
28.7 MySQL Enterprise Data Masking and De-Identification Overview .....	4487
28.8 MySQL Telemetry .....	4488

MySQL Enterprise Edition is a commercial product. Like MySQL Community Edition, MySQL Enterprise Edition includes MySQL Server, a fully integrated transaction-safe, ACID-compliant database with full commit, rollback, crash-recovery, and row-level locking capabilities. In addition, MySQL Enterprise Edition includes the following components designed to provide monitoring and online backup, as well as improved security and scalability:

The following sections briefly discuss each of these components and indicate where to find more detailed information. To learn more about commercial products, see <https://www.mysql.com/products/>.

- [MySQL Enterprise Backup](#)
- [MySQL Enterprise Security](#)
- [MySQL Enterprise Encryption](#)
- [MySQL Enterprise Audit](#)
- [MySQL Enterprise Firewall](#)
- [MySQL Enterprise Thread Pool](#)
- [MySQL Enterprise Data Masking and De-Identification](#)

## 28.1 MySQL Enterprise Backup Overview

MySQL Enterprise Backup performs hot backup operations for MySQL databases. The product is architected for efficient and reliable backups of tables created by the InnoDB storage engine. For completeness, it can also back up tables from MyISAM and other storage engines.

The following discussion briefly summarizes MySQL Enterprise Backup. For more information, see the MySQL Enterprise Backup manual, available at <https://dev.mysql.com/doc/mysql-enterprise-backup/en/>.

Hot backups are performed while the database is running and applications are reading and writing to it. This type of backup does not block normal database operations, and it captures even changes that occur while the backup is happening. For these reasons, hot backups are desirable when your database “grows up” -- when the data is large enough that the backup takes significant time, and when your data is important enough to your business that you must capture every last change, without taking your application, website, or web service offline.

MySQL Enterprise Backup does a hot backup of all tables that use the InnoDB storage engine. For tables using MyISAM or other non-InnoDB storage engines, it does a “warm” backup, where the database

continues to run, but those tables cannot be modified while being backed up. For efficient backup operations, you can designate InnoDB as the default storage engine for new tables, or convert existing tables to use the InnoDB storage engine.

## 28.2 MySQL Enterprise Security Overview

MySQL Enterprise Edition provides plugins that implement security features using external services:

- MySQL Enterprise Edition includes an authentication plugin that enables MySQL Server to use LDAP (Lightweight Directory Access Protocol) to authenticate MySQL users. LDAP Authentications supports user name and password, SASL, and GSSAPI/Kerberos authentication methods to LDAP services. For more information, see [Section 6.4.1.9, “LDAP Pluggable Authentication”](#).
- MySQL Enterprise Edition includes an authentication plugin that enables MySQL Server to use Native Kerberos to authenticate MySQL users using their Kerberos Principals. For more information, see [Kerberos Pluggable Authentication](#).
- MySQL Enterprise Edition includes an authentication plugin that enables MySQL Server to use PAM (Pluggable Authentication Modules) to authenticate MySQL users. PAM enables a system to use a standard interface to access various kinds of authentication methods, such as Unix passwords or an LDAP directory. For more information, see [Section 6.4.1.7, “PAM Pluggable Authentication”](#).
- MySQL Enterprise Edition includes an authentication plugin that performs external authentication on Windows, enabling MySQL Server to use native Windows services to authenticate client connections. Users who have logged in to Windows can connect from MySQL client programs to the server based on the information in their environment without specifying an additional password. For more information, see [Section 6.4.1.8, “Windows Pluggable Authentication”](#).
- MySQL Enterprise Edition includes a suite of masking and de-identification functions that perform subsetting, random generation, and dictionary replacement to de-identify strings, numerics, phone numbers, emails and more. These functions enable masking existing data using several methods such as obfuscation (removing identifying characteristics), generation of formatted random data, and data replacement or substitution. For more information, see [Section 6.5, “MySQL Enterprise Data Masking and De-Identification”](#).
- MySQL Enterprise Edition includes a set of encryption functions based on the OpenSSL library that expose OpenSSL capabilities at the SQL level. For more information, see [Section 28.3, “MySQL Enterprise Encryption Overview”](#).
- MySQL Enterprise Edition 5.7 and higher includes a keyring plugin that uses Oracle Key Vault as a backend for keyring storage. For more information, see [Section 6.4.4, “The MySQL Keyring”](#).
- MySQL Transparent Data Encryption (TDE) provides at-rest encryption for MySQL Server for all files that might contain sensitive data. For more information, see [Section 14.14, “InnoDB Data-at-Rest Encryption”](#), [Encrypting Binary Log Files and Relay Log Files](#), and [Encrypting Audit Log Files](#).

For other related Enterprise security features, see [Section 28.3, “MySQL Enterprise Encryption Overview”](#).

## 28.3 MySQL Enterprise Encryption Overview

MySQL Enterprise Edition includes a set of encryption functions based on the OpenSSL library that expose OpenSSL capabilities at the SQL level. These functions enable Enterprise applications to perform the following operations:

- Implement added data protection using public-key asymmetric cryptography

- Create public and private keys and digital signatures
- Perform asymmetric encryption and decryption
- Use cryptographic hashing for digital signing and data verification and validation

For more information, see [Section 6.6, “MySQL Enterprise Encryption”](#).

For other related Enterprise security features, see [Section 28.2, “MySQL Enterprise Security Overview”](#).

## 28.4 MySQL Enterprise Audit Overview

MySQL Enterprise Edition includes MySQL Enterprise Audit, implemented using a server plugin. MySQL Enterprise Audit uses the open MySQL Audit API to enable standard, policy-based monitoring and logging of connection and query activity executed on specific MySQL servers. Designed to meet the Oracle audit specification, MySQL Enterprise Audit provides an out of box, easy to use auditing and compliance solution for applications that are governed by both internal and external regulatory guidelines.

When installed, the audit plugin enables MySQL Server to produce a log file containing an audit record of server activity. The log contents include when clients connect and disconnect, and what actions they perform while connected, such as which databases and tables they access.

For more information, see [Section 6.4.5, “MySQL Enterprise Audit”](#).

## 28.5 MySQL Enterprise Firewall Overview

MySQL Enterprise Edition includes MySQL Enterprise Firewall, an application-level firewall that enables database administrators to permit or deny SQL statement execution based on matching against allowlists of accepted statement patterns. This helps harden MySQL Server against attacks such as SQL injection or attempts to exploit applications by using them outside of their legitimate query workload characteristics.

Each MySQL account registered with the firewall has its own statement allowlist, enabling protection to be tailored per account. For a given account, the firewall can operate in recording or protecting mode, for training in the accepted statement patterns or protection against unacceptable statements.

For more information, see [Section 6.4.6, “MySQL Enterprise Firewall”](#).

## 28.6 MySQL Enterprise Thread Pool Overview

MySQL Enterprise Edition includes MySQL Enterprise Thread Pool, implemented using a server plugin. The default thread-handling model in MySQL Server executes statements using one thread per client connection. As more clients connect to the server and execute statements, overall performance degrades. In MySQL Enterprise Edition, a thread pool plugin provides an alternative thread-handling model designed to reduce overhead and improve performance. The plugin implements a thread pool that increases server performance by efficiently managing statement execution threads for large numbers of client connections.

For more information, see [Section 5.5.3, “MySQL Enterprise Thread Pool”](#).

## 28.7 MySQL Enterprise Data Masking and De-Identification Overview

MySQL Enterprise Edition 5.7 and higher includes MySQL Enterprise Data Masking and De-Identification, implemented as a plugin library containing a plugin and several loadable functions. Data masking hides sensitive information by replacing real values with substitutes. MySQL Enterprise Data Masking and De-Identification functions enable masking existing data using several methods such as obfuscation (removing identifying characteristics), generation of formatted random data, and data replacement or substitution.

For more information, see [Section 6.5, “MySQL Enterprise Data Masking and De-Identification”](#).

## 28.8 MySQL Telemetry

The MySQL telemetry component is based on the OpenTelemetry (OTel) project, an open-source, vendor-neutral observability framework providing a common observability standard. It enables users to instrument their applications in order to export observability data: traces, metrics and logs, enabling increased granularity of debugging and testing.

For more information, see [Telemetry](#).

---

## Chapter 29 MySQL Workbench

MySQL Workbench provides a graphical tool for working with MySQL servers and databases. MySQL Workbench is developed and tested with MySQL Server 8.0. MySQL Workbench may connect to MySQL Server 8.4 and higher but some MySQL Workbench features may not function with those newer server versions.

The following discussion briefly describes MySQL Workbench capabilities. For more information, see the MySQL Workbench manual, available at <https://dev.mysql.com/doc/workbench/en/>.

MySQL Workbench provides five main areas of functionality:

- **SQL Development:** Enables you to create and manage connections to database servers. As well as enabling you to configure connection parameters, MySQL Workbench provides the capability to execute SQL queries on the database connections using the built-in SQL Editor. This functionality replaces that previously provided by the Query Browser standalone application.
- **Data Modeling:** Enables you to create models of your database schema graphically, reverse and forward engineer between a schema and a live database, and edit all aspects of your database using the comprehensive Table Editor. The Table Editor provides easy-to-use facilities for editing Tables, Columns, Indexes, Triggers, Partitioning, Options, Inserts and Privileges, Routines and Views.
- **Server Administration:** Enables you to create and administer server instances.
- **Data Migration:** Allows you to migrate from Microsoft SQL Server, Sybase ASE, SQLite, SQL Anywhere, PostgreSQL, and other RDBMS tables, objects and data to MySQL. Migration also supports migrating from earlier versions of MySQL to the latest releases.
- **MySQL Enterprise Support:** Support for Enterprise products such as MySQL Enterprise Backup and MySQL Audit.

MySQL Workbench is available in two editions, the Community Edition and the Commercial Edition. The Community Edition is available free of charge. The Commercial Edition provides additional Enterprise features, such as database documentation generation, at low cost.





---

# Appendix A MySQL 5.7 Frequently Asked Questions

## Table of Contents

A.1 MySQL 5.7 FAQ: General .....	4491
A.2 MySQL 5.7 FAQ: Storage Engines .....	4493
A.3 MySQL 5.7 FAQ: Server SQL Mode .....	4494
A.4 MySQL 5.7 FAQ: Stored Procedures and Functions .....	4495
A.5 MySQL 5.7 FAQ: Triggers .....	4499
A.6 MySQL 5.7 FAQ: Views .....	4501
A.7 MySQL 5.7 FAQ: INFORMATION_SCHEMA .....	4502
A.8 MySQL 5.7 FAQ: Migration .....	4502
A.9 MySQL 5.7 FAQ: Security .....	4503
A.10 MySQL 5.7 FAQ: NDB Cluster .....	4505
A.11 MySQL 5.7 FAQ: MySQL Chinese, Japanese, and Korean Character Sets .....	4518
A.12 MySQL 5.7 FAQ: Connectors & APIs .....	4531
A.13 MySQL 5.7 FAQ: C API, libmysql .....	4531
A.14 MySQL 5.7 FAQ: Replication .....	4532
A.15 MySQL 5.7 FAQ: MySQL Enterprise Thread Pool .....	4536
A.16 MySQL 5.7 FAQ: InnoDB Change Buffer .....	4538
A.17 MySQL 5.7 FAQ: InnoDB Data-at-Rest Encryption .....	4539
A.18 MySQL 5.7 FAQ: Virtualization Support .....	4542

## A.1 MySQL 5.7 FAQ: General

A.1.1 Which version of MySQL is production-ready (GA)? .....	4491
A.1.2 Can MySQL do subqueries? .....	4492
A.1.3 Can MySQL perform multiple-table inserts, updates, and deletes? .....	4492
A.1.4 Does MySQL 5.7 have a Query Cache? Does it work on Server, Instance or Database? .....	4492
A.1.5 Does MySQL have Sequences? .....	4492
A.1.6 Does MySQL have a <code>NOW()</code> function with fractions of seconds? .....	4492
A.1.7 Does MySQL work with multi-core processors? .....	4492
A.1.8 Why do I see multiple processes for <code>mysqld</code> ? .....	4493
A.1.9 Can MySQL perform ACID transactions? .....	4493

### A.1.1. Which version of MySQL is production-ready (GA)?

MySQL 9.6, 8.4, and 8.0 are actively supported for production use.

The MySQL 9 Innovation series began with the MySQL 9.0.0 release on 01 July 2024.

The MySQL 8.4 LTS series began with the MySQL 8.4.0 release on 30 April 2024.

The MySQL 8 Innovation series began with the MySQL 8.1.0 release on 18 July 2023. Active development ended on 2024-01-16 with the MySQL 8.3.0 release.

MySQL 8.0 achieved General Availability (GA) status with MySQL 8.0.11, which was released for production use on 19 April 2018. It became a bugfix series as of MySQL 8.0.34 with the introduction of the [Innovation and LTS release model](#).

MySQL 5.7 achieved General Availability (GA) status with MySQL 5.7.9, which was released for production use on 21 October 2015. Active development for MySQL 5.7 ended on 25 October 2023 with the MySQL 5.7.44 release.

MySQL 5.6 achieved General Availability (GA) status with MySQL 5.6.10, which was released for production use on 5 February 2013. Active development for MySQL 5.6 has ended.

MySQL 5.5 achieved General Availability (GA) status with MySQL 5.5.8, which was released for production use on 3 December 2010. Active development for MySQL 5.5 has ended.

MySQL 5.1 achieved General Availability (GA) status with MySQL 5.1.30, which was released for production use on 14 November 2008. Active development for MySQL 5.1 has ended.

MySQL 5.0 achieved General Availability (GA) status with MySQL 5.0.15, which was released for production use on 19 October 2005. Active development for MySQL 5.0 has ended.

**A.1.2.** Can MySQL do subqueries?

Yes. See [Section 13.2.10, “Subqueries”](#).

**A.1.3.** Can MySQL perform multiple-table inserts, updates, and deletes?

Yes. For the syntax required to perform multiple-table updates, see [Section 13.2.11, “UPDATE Statement”](#); for that required to perform multiple-table deletes, see [Section 13.2.2, “DELETE Statement”](#).

A multiple-table insert can be accomplished using a trigger whose `FOR EACH ROW` clause contains multiple `INSERT` statements within a `BEGIN . . . END` block. See [Section 23.3, “Using Triggers”](#).

**A.1.4.** Does MySQL 5.7 have a Query Cache? Does it work on Server, Instance or Database?

Yes. (However, the query cache is deprecated as of MySQL 5.7.20, and is removed in MySQL 8.0.) The query cache operates on the server level, caching complete result sets matched with the original query string. If an exactly identical query is made (which often happens, particularly in web applications), no parsing or execution is necessary; the result is sent directly from the cache. Various tuning options are available. See [Section 8.10.3, “The MySQL Query Cache”](#).

**A.1.5.** Does MySQL have Sequences?

No. However, MySQL has an `AUTO_INCREMENT` system, which can also handle inserts in a multi-source replication setup. With the `auto_increment_increment` and `auto_increment_offset` system variables, you can set each server to generate auto-increment values that don't conflict with other servers. The `auto_increment_increment` value should be greater than the number of servers, and each server should have a unique offset.

**A.1.6.** Does MySQL have a `NOW( )` function with fractions of seconds?

Yes, see [Section 11.2.7, “Fractional Seconds in Time Values”](#).

**A.1.7.** Does MySQL work with multi-core processors?

Yes. MySQL is fully multithreaded, and makes use of all CPUs made available to it. Not all CPUs may be available; modern operating systems should be able to utilize all underlying CPUs, but also make it possible to restrict a process to a specific CPU or sets of CPUs.

On Windows, there is currently a limit to the number of (logical) processors that `mysqld` can use: a single processor group, which is limited to a maximum of 64 logical processors.

Use of multiple cores may be seen in these ways:

- A single core is usually used to service the commands issued from one session.

- A few background threads make limited use of extra cores; for example, to keep background I/O tasks moving.
- If the database is I/O-bound (indicated by CPU consumption less than capacity), adding more CPUs is futile. If the database is partitioned into an I/O-bound part and a CPU-bound part, adding CPUs may still be useful.

#### A.1.8. Why do I see multiple processes for `mysqld`?

`mysqld` is a single-process program, not a multi-process program, and does not fork or launch other processes. However, `mysqld` is multithreaded and some process-reporting system utilities display separate entries for each thread of multithreaded processes, which may lead to the appearance of multiple `mysqld` processes when in fact there is only one.

#### A.1.9. Can MySQL perform ACID transactions?

Yes. All current MySQL versions support transactions. The `InnoDB` storage engine offers full ACID transactions with row-level locking, multi-versioning, nonlocking repeatable reads, and all four SQL standard isolation levels.

The `NDB` storage engine supports the `READ COMMITTED` transaction isolation level only.

## A.2 MySQL 5.7 FAQ: Storage Engines

A.2.1 Where can I obtain complete documentation for MySQL storage engines? .....	4493
A.2.2 Are there any new storage engines in MySQL 5.7? .....	4493
A.2.3 Have any storage engines been removed in MySQL 5.7? .....	4493
A.2.4 Can I prevent the use of a particular storage engine? .....	4493
A.2.5 Is there an advantage to using the <code>InnoDB</code> storage engine exclusively, as opposed to a combination of <code>InnoDB</code> and non- <code>InnoDB</code> storage engines? .....	4493
A.2.6 What are the unique benefits of the <code>ARCHIVE</code> storage engine? .....	4494

#### A.2.1. Where can I obtain complete documentation for MySQL storage engines?

See [Chapter 15, \*Alternative Storage Engines\*](#). That chapter contains information about all MySQL storage engines except for the `InnoDB` storage engine and the `NDB` storage engine (used for MySQL Cluster). `InnoDB` is covered in [Chapter 14, \*The InnoDB Storage Engine\*](#). `NDB` is covered in [Chapter 21, \*MySQL NDB Cluster 7.5 and NDB Cluster 7.6\*](#).

#### A.2.2. Are there any new storage engines in MySQL 5.7?

No. `InnoDB` is the default storage engine for new tables. See [Section 14.1, "Introduction to InnoDB"](#) for details.

#### A.2.3. Have any storage engines been removed in MySQL 5.7?

No.

#### A.2.4. Can I prevent the use of a particular storage engine?

Yes. The `disabled_storage_engines` configuration option defines which storage engines cannot be used to create tables or tablespaces. By default, `disabled_storage_engines` is empty (no engines disabled), but it can be set to a comma-separated list of one or more engines.

#### A.2.5. Is there an advantage to using the `InnoDB` storage engine exclusively, as opposed to a combination of `InnoDB` and non-`InnoDB` storage engines?

Yes. Using `InnoDB` tables exclusively can simplify backup and recovery operations. MySQL Enterprise Backup does a [hot backup](#) of all tables that use the `InnoDB` storage engine. For tables using `MyISAM` or other non-`InnoDB` storage engines, it does a “warm” backup, where the database continues to run, but those tables cannot be modified while being backed up. See [Section 28.1](#), “MySQL Enterprise Backup Overview”.

#### A.2.6. What are the unique benefits of the `ARCHIVE` storage engine?

The `ARCHIVE` storage engine stores large amounts of data without indexes; it has a small footprint, and performs selects using table scans. See [Section 15.5](#), “The `ARCHIVE` Storage Engine”, for details.

## A.3 MySQL 5.7 FAQ: Server SQL Mode

A.3.1 What are server SQL modes? .....	4494
A.3.2 How many server SQL modes are there? .....	4494
A.3.3 How do you determine the server SQL mode? .....	4494
A.3.4 Is the mode dependent on the database or connection? .....	4494
A.3.5 Can the rules for strict mode be extended? .....	4494
A.3.6 Does strict mode impact performance? .....	4494
A.3.7 What is the default server SQL mode when MySQL 5.7 is installed? .....	4495

#### A.3.1. What are server SQL modes?

Server SQL modes define what SQL syntax MySQL should support and what kind of data validation checks it should perform. This makes it easier to use MySQL in different environments and to use MySQL together with other database servers. The MySQL Server apply these modes individually to different clients. For more information, see [Section 5.1.10](#), “Server SQL Modes”.

#### A.3.2. How many server SQL modes are there?

Each mode can be independently switched on and off. See [Section 5.1.10](#), “Server SQL Modes”, for a complete list of available modes.

#### A.3.3. How do you determine the server SQL mode?

You can set the default SQL mode (for `mysqld` startup) with the `--sql-mode` option. Using the statement `SET [GLOBAL|SESSION] sql_mode='modes'`, you can change the settings from within a connection, either locally to the connection, or to take effect globally. You can retrieve the current mode by issuing a `SELECT @@sql_mode` statement.

#### A.3.4. Is the mode dependent on the database or connection?

A mode is not linked to a particular database. Modes can be set locally to the session (connection), or globally for the server. you can change these settings using `SET [GLOBAL|SESSION] sql_mode='modes'`.

#### A.3.5. Can the rules for strict mode be extended?

When we refer to *strict mode*, we mean a mode where at least one of the modes `TRADITIONAL`, `STRICT_TRANS_TABLES`, or `STRICT_ALL_TABLES` is enabled. Options can be combined, so you can add restrictions to a mode. See [Section 5.1.10](#), “Server SQL Modes”, for more information.

#### A.3.6. Does strict mode impact performance?

The intensive validation of input data that some settings requires more time than if the validation is not done. While the performance impact is not that great, if you do not require such validation

(perhaps your application already handles all of this), then MySQL gives you the option of leaving strict mode disabled. However, if you do require it, strict mode can provide such validation.

**A.3.7.** What is the default server SQL mode when MySQL 5.7 is installed?

The default SQL mode in MySQL 5.7 includes these modes: [ONLY\\_FULL\\_GROUP\\_BY](#), [STRICT\\_TRANS\\_TABLES](#), [NO\\_ZERO\\_IN\\_DATE](#), [NO\\_ZERO\\_DATE](#), [ERROR\\_FOR\\_DIVISION\\_BY\\_ZERO](#), [NO\\_AUTO\\_CREATE\\_USER](#), and [NO\\_ENGINE\\_SUBSTITUTION](#).

For information about all available modes and default MySQL behavior, see [Section 5.1.10](#), “[Server SQL Modes](#)”.

## A.4 MySQL 5.7 FAQ: Stored Procedures and Functions

A.4.1 Does MySQL support stored procedures and functions? .....	4495
A.4.2 Where can I find documentation for MySQL stored procedures and stored functions? .....	4495
A.4.3 Is there a discussion forum for MySQL stored procedures? .....	4495
A.4.4 Where can I find the ANSI SQL 2003 specification for stored procedures? .....	4496
A.4.5 How do you manage stored routines? .....	4496
A.4.6 Is there a way to view all stored procedures and stored functions in a given database? .....	4496
A.4.7 Where are stored procedures stored? .....	4496
A.4.8 Is it possible to group stored procedures or stored functions into packages? .....	4496
A.4.9 Can a stored procedure call another stored procedure? .....	4496
A.4.10 Can a stored procedure call a trigger? .....	4496
A.4.11 Can a stored procedure access tables? .....	4496
A.4.12 Do stored procedures have a statement for raising application errors? .....	4497
A.4.13 Do stored procedures provide exception handling? .....	4497
A.4.14 Can MySQL stored routines return result sets? .....	4497
A.4.15 Is <a href="#">WITH RECOMPILE</a> supported for stored procedures? .....	4497
A.4.16 Is there a MySQL equivalent to using <a href="#">mod_plsql</a> as a gateway on Apache to talk directly to a stored procedure in the database? .....	4497
A.4.17 Can I pass an array as input to a stored procedure? .....	4497
A.4.18 Can I pass a cursor as an <a href="#">IN</a> parameter to a stored procedure? .....	4497
A.4.19 Can I return a cursor as an <a href="#">OUT</a> parameter from a stored procedure? .....	4497
A.4.20 Can I print out a variable's value within a stored routine for debugging purposes? .....	4497
A.4.21 Can I commit or roll back transactions inside a stored procedure? .....	4497
A.4.22 Do MySQL stored procedures and functions work with replication? .....	4497
A.4.23 Are stored procedures and functions created on a replication source server replicated to a replica? .....	4497
A.4.24 How are actions that take place inside stored procedures and functions replicated? .....	4498
A.4.25 Are there special security requirements for using stored procedures and functions together with replication? .....	4498
A.4.26 What limitations exist for replicating stored procedure and function actions? .....	4498
A.4.27 Do the preceding limitations affect the ability of MySQL to do point-in-time recovery? .....	4498
A.4.28 What is being done to correct the aforementioned limitations? .....	4498

**A.4.1.** Does MySQL support stored procedures and functions?

Yes. MySQL supports two types of stored routines, stored procedures, and stored functions.

**A.4.2.** Where can I find documentation for MySQL stored procedures and stored functions?

See [Section 23.2](#), “[Using Stored Routines](#)”.

**A.4.3.** Is there a discussion forum for MySQL stored procedures?

Yes. See <https://forums.mysql.com/list.php?98>.

**A.4.4.** Where can I find the ANSI SQL 2003 specification for stored procedures?

Unfortunately, the official specifications are not freely available (ANSI makes them available for purchase). However, there are books, such as *SQL-99 Complete, Really* by Peter Gultzan and Trudy Pelzer, that provide a comprehensive overview of the standard, including coverage of stored procedures.

**A.4.5.** How do you manage stored routines?

It is always good practice to use a clear naming scheme for your stored routines. You can manage stored procedures with `CREATE [FUNCTION|PROCEDURE]`, `ALTER [FUNCTION|PROCEDURE]`, `DROP [FUNCTION|PROCEDURE]`, and `SHOW CREATE [FUNCTION|PROCEDURE]`. You can obtain information about existing stored procedures using the `ROUTINES` table in the `INFORMATION_SCHEMA` database (see [Section 24.3.21](#), “The `INFORMATION_SCHEMA ROUTINES` Table”).

**A.4.6.** Is there a way to view all stored procedures and stored functions in a given database?

Yes. For a database named `dbname`, use this query on the `INFORMATION_SCHEMA.ROUTINES` table:

```
SELECT ROUTINE_TYPE, ROUTINE_NAME
FROM INFORMATION_SCHEMA.ROUTINES
WHERE ROUTINE_SCHEMA = 'dbname' ;
```

For more information, see [Section 24.3.21](#), “The `INFORMATION_SCHEMA ROUTINES` Table”.

The body of a stored routine can be viewed using `SHOW CREATE FUNCTION` (for a stored function) or `SHOW CREATE PROCEDURE` (for a stored procedure). See [Section 13.7.5.9](#), “`SHOW CREATE PROCEDURE Statement`”, for more information.

**A.4.7.** Where are stored procedures stored?

In the `proc` table of the `mysql` system database. However, you should not access the tables in the system database directly. Instead, query the `INFORMATION_SCHEMA ROUTINES` and `PARAMETERS` tables. See [Section 24.3.21](#), “The `INFORMATION_SCHEMA ROUTINES` Table”, and [Section 24.3.15](#), “The `INFORMATION_SCHEMA PARAMETERS` Table”.

You can also use `SHOW CREATE FUNCTION` to obtain information about stored functions, and `SHOW CREATE PROCEDURE` to obtain information about stored procedures. See [Section 13.7.5.9](#), “`SHOW CREATE PROCEDURE Statement`”.

**A.4.8.** Is it possible to group stored procedures or stored functions into packages?

No. This is not supported in MySQL.

**A.4.9.** Can a stored procedure call another stored procedure?

Yes.

**A.4.10** Can a stored procedure call a trigger?

A stored procedure can execute an SQL statement, such as an `UPDATE`, that causes a trigger to activate.

**A.4.11** Can a stored procedure access tables?

Yes. A stored procedure can access one or more tables as required.

**A.4.12** Do stored procedures have a statement for raising application errors?

Yes. MySQL implements the SQL standard [SIGNAL](#) and [RESIGNAL](#) statements. See [Section 13.6.7, “Condition Handling”](#).

**A.4.13** Do stored procedures provide exception handling?

MySQL implements [HANDLER](#) definitions according to the SQL standard. See [Section 13.6.7.2, “DECLARE ... HANDLER Statement”](#), for details.

**A.4.14** Can MySQL stored routines return result sets?

*Stored procedures* can, but stored functions cannot. If you perform an ordinary [SELECT](#) inside a stored procedure, the result set is returned directly to the client. You need to use the MySQL 4.1 (or higher) client/server protocol for this to work. This means that, for example, in PHP, you need to use the [mysqli](#) extension rather than the old [mysql](#) extension.

**A.4.15** Is [WITH RECOMPILE](#) supported for stored procedures?

No.

**A.4.16** Is there a MySQL equivalent to using [mod\\_php5](#) as a gateway on Apache to talk directly to a stored procedure in the database?

There is no equivalent in MySQL.

**A.4.17** Can I pass an array as input to a stored procedure?

No.

**A.4.18** Can I pass a cursor as an [IN](#) parameter to a stored procedure?

Cursors are only available inside stored procedures.

**A.4.19** Can I return a cursor as an [OUT](#) parameter from a stored procedure?

Cursors are only available inside stored procedures. However, if you do not open a cursor on a [SELECT](#), the result is sent directly to the client. You can also [SELECT INTO](#) variables. See [Section 13.2.9, “SELECT Statement”](#).

**A.4.20** Can I print out a variable's value within a stored routine for debugging purposes?

Yes, you can do this in a *stored procedure*, but not in a stored function. If you perform an ordinary [SELECT](#) inside a stored procedure, the result set is returned directly to the client. You must use the MySQL 4.1 (or above) client/server protocol for this to work. This means that, for example, in PHP, you need to use the [mysqli](#) extension rather than the old [mysql](#) extension.

**A.4.21** Can I commit or roll back transactions inside a stored procedure?

Yes. However, you cannot perform transactional operations within a stored function.

**A.4.22** Do MySQL stored procedures and functions work with replication?

Yes, standard actions carried out in stored procedures and functions are replicated from a replication source server to a replica. There are a few limitations that are described in detail in [Section 23.7, “Stored Program Binary Logging”](#).

**A.4.23** Are stored procedures and functions created on a replication source server replicated to a replica?

Yes, creation of stored procedures and functions carried out through normal DDL statements on a replication source server are replicated to a replica, so that the objects exist on both servers. `ALTER` and `DROP` statements for stored procedures and functions are also replicated.

**A.4.24**How are actions that take place inside stored procedures and functions replicated?

MySQL records each DML event that occurs in a stored procedure and replicates those individual actions to a replica. The actual calls made to execute stored procedures are not replicated.

Stored functions that change data are logged as function invocations, not as the DML events that occur inside each function.

**A.4.25**Are there special security requirements for using stored procedures and functions together with replication?

Yes. Because a replica has authority to execute any statement read from a source's binary log, special security constraints exist for using stored functions with replication. If replication or binary logging in general (for the purpose of point-in-time recovery) is active, then MySQL DBAs have two security options open to them:

1. Any user wishing to create stored functions must be granted the `SUPER` privilege.
2. Alternatively, a DBA can set the `log_bin_trust_function_creators` system variable to 1, which enables anyone with the standard `CREATE ROUTINE` privilege to create stored functions.

**A.4.26**What limitations exist for replicating stored procedure and function actions?

Nondeterministic (random) or time-based actions embedded in stored procedures may not replicate properly. By their very nature, randomly produced results are not predictable and cannot be exactly reproduced; therefore, random actions replicated to a replica do not mirror those performed on a source. Declaring stored functions to be `DETERMINISTIC` or setting the `log_bin_trust_function_creators` system variable to 0 keeps random operations producing random values from being invoked.

In addition, time-based actions cannot be reproduced on a replica because the timing of such actions in a stored procedure is not reproducible through the binary log used for replication. It records only DML events and does not factor in timing constraints.

Finally, nontransactional tables for which errors occur during large DML actions (such as bulk inserts) may experience replication issues in that a source may be partially updated from DML activity, but no updates are done to the replica because of the errors that occurred. A workaround is for a function's DML actions to be carried out with the `IGNORE` keyword so that updates on the source that cause errors are ignored and updates that do not cause errors are replicated to the replica.

**A.4.27**Do the preceding limitations affect the ability of MySQL to do point-in-time recovery?

The same limitations that affect replication do affect point-in-time recovery.

**A.4.28**What is being done to correct the aforementioned limitations?

You can choose either statement-based replication or row-based replication. The original replication implementation is based on statement-based binary logging. Row-based binary logging resolves the limitations mentioned earlier.

*Mixed* replication is also available (by starting the server with `--binlog-format=mixed`). This hybrid form of replication “knows” whether statement-level replication can safely be used, or row-level replication is required.



For additional information, see [Section 16.2.1, “Replication Formats”](#).

## A.5 MySQL 5.7 FAQ: Triggers

A.5.1 Where can I find the documentation for MySQL 5.7 triggers? .....	4499
A.5.2 Is there a discussion forum for MySQL Triggers? .....	4499
A.5.3 Does MySQL have statement-level or row-level triggers? .....	4499
A.5.4 Are there any default triggers? .....	4499
A.5.5 How are triggers managed in MySQL? .....	4499
A.5.6 Is there a way to view all triggers in a given database? .....	4499
A.5.7 Where are triggers stored? .....	4500
A.5.8 Can a trigger call a stored procedure? .....	4500
A.5.9 Can triggers access tables? .....	4500
A.5.10 Can a table have multiple triggers with the same trigger event and action time? .....	4500
A.5.11 Is it possible for a trigger to update tables on a remote server? .....	4500
A.5.12 Do triggers work with replication? .....	4500
A.5.13 How are actions carried out through triggers on a source replicated to a replica? .....	4500

### A.5.1. Where can I find the documentation for MySQL 5.7 triggers?

See [Section 23.3, “Using Triggers”](#).

### A.5.2. Is there a discussion forum for MySQL Triggers?

Yes. It is available at <https://forums.mysql.com/list.php?99>.

### A.5.3. Does MySQL have statement-level or row-level triggers?

All triggers are `FOR EACH ROW`; that is, the trigger is activated for each row that is inserted, updated, or deleted. MySQL does not support triggers using `FOR EACH STATEMENT`.

### A.5.4. Are there any default triggers?

Not explicitly. MySQL does have specific special behavior for some `TIMESTAMP` columns, as well as for columns which are defined using `AUTO_INCREMENT`.

### A.5.5. How are triggers managed in MySQL?

Triggers can be created using the `CREATE TRIGGER` statement, and dropped using `DROP TRIGGER`. See [Section 13.1.20, “CREATE TRIGGER Statement”](#), and [Section 13.1.31, “DROP TRIGGER Statement”](#), for more about these statements.

Information about triggers can be obtained by querying the `INFORMATION_SCHEMA.TRIGGERS` table. See [Section 24.3.29, “The INFORMATION\\_SCHEMA TRIGGERS Table”](#).

### A.5.6. Is there a way to view all triggers in a given database?

Yes. You can obtain a listing of all triggers defined on database `dbname` using a query on the `INFORMATION_SCHEMA.TRIGGERS` table such as the one shown here:

```
SELECT TRIGGER_NAME, EVENT_MANIPULATION, EVENT_OBJECT_TABLE, ACTION_STATEMENT
FROM INFORMATION_SCHEMA.TRIGGERS
WHERE TRIGGER_SCHEMA='dbname' ;
```

For more information about this table, see [Section 24.3.29, “The INFORMATION\\_SCHEMA TRIGGERS Table”](#).

You can also use the [SHOW TRIGGERS](#) statement, which is specific to MySQL. See [Section 13.7.5.38, "SHOW TRIGGERS Statement"](#).

**A.5.7.** Where are triggers stored?

Triggers are stored in `.TRG` files, with one such file one per table.

**A.5.8.** Can a trigger call a stored procedure?

Yes.

**A.5.9.** Can triggers access tables?

A trigger can access both old and new data in its own table. A trigger can also affect other tables, but it is not permitted to modify a table that is already being used (for reading or writing) by the statement that invoked the function or trigger.

**A.5.10** Can a table have multiple triggers with the same trigger event and action time?

It is possible to define multiple triggers for a given table that have the same trigger event and action time. For example, you can have two `BEFORE UPDATE` triggers for a table. By default, triggers that have the same trigger event and action time activate in the order they were created. To affect trigger order, specify a clause after `FOR EACH ROW` that indicates `FOLLOWS` or `PRECEDES` and the name of an existing trigger that also has the same trigger event and action time. With `FOLLOWS`, the new trigger activates after the existing trigger. With `PRECEDES`, the new trigger activates before the existing trigger.

**A.5.11** Is it possible for a trigger to update tables on a remote server?

Yes. A table on a remote server could be updated using the `FEDERATED` storage engine. (See [Section 15.8, "The FEDERATED Storage Engine"](#)).

**A.5.12** Do triggers work with replication?

Yes. However, the way in which they work depends whether you are using MySQL's "classic" statement-based or row-based replication format.

When using statement-based replication, triggers on the replica are executed by statements that are executed on the source (and replicated to the replica).

When using row-based replication, triggers are not executed on the replica due to statements that were run on the source and then replicated to the replica. Instead, when using row-based replication, the changes caused by executing the trigger on the source are applied on the replica.

For more information, see [Section 16.4.1.34, "Replication and Triggers"](#).

**A.5.13** How are actions carried out through triggers on a source replicated to a replica?

Again, this depends on whether you are using statement-based or row-based replication.

**Statement-based replication.** First, the triggers that exist on a source must be re-created on the replica server. Once this is done, the replication flow works as any other standard DML statement that participates in replication. For example, consider a table `EMP` that has an `AFTER` insert trigger, which exists on a replication source server. The same `EMP` table and `AFTER` insert trigger exist on the replica server as well. The replication flow would be:

1. An `INSERT` statement is made to `EMP`.

2. The [AFTER](#) trigger on [EMP](#) activates.
3. The [INSERT](#) statement is written to the binary log.
4. The replica picks up the [INSERT](#) statement to [EMP](#) and executes it.
5. The [AFTER](#) trigger on [EMP](#) that exists on the replica activates.

**Row-based replication.** When you use row-based replication, the changes caused by executing the trigger on the source are applied on the replica. However, the triggers themselves are not actually executed on the replica under row-based replication. This is because, if both the source and the replica applied the changes from the source and, in addition, the trigger causing these changes were applied on the replica, the changes would in effect be applied twice on the replica, leading to different data on the source and the replica.

In most cases, the outcome is the same for both row-based and statement-based replication. However, if you use different triggers on the source and replica, you cannot use row-based replication. (This is because the row-based format replicates the changes made by triggers executing on the source to the replicas, rather than the statements that caused the triggers to execute, and the corresponding triggers on the replica are not executed.) Instead, any statements causing such triggers to be executed must be replicated using statement-based replication.

For more information, see [Section 16.4.1.34, “Replication and Triggers”](#).

## A.6 MySQL 5.7 FAQ: Views

A.6.1 Where can I find documentation covering MySQL Views? .....	4501
A.6.2 Is there a discussion forum for MySQL Views? .....	4501
A.6.3 What happens to a view if an underlying table is dropped or renamed? .....	4501
A.6.4 Does MySQL have table snapshots? .....	4501
A.6.5 Does MySQL have materialized views? .....	4501
A.6.6 Can you insert into views that are based on joins? .....	4502

### A.6.1. Where can I find documentation covering MySQL Views?

See [Section 23.5, “Using Views”](#).

You may also find the [MySQL User Forums](#) to be helpful.

### A.6.2. Is there a discussion forum for MySQL Views?

See the [MySQL User Forums](#).

### A.6.3. What happens to a view if an underlying table is dropped or renamed?

After a view has been created, it is possible to drop or alter a table or view to which the definition refers. To check a view definition for problems of this kind, use the [CHECK TABLE](#) statement. (See [Section 13.7.2.2, “CHECK TABLE Statement”](#).)

### A.6.4. Does MySQL have table snapshots?

No.

### A.6.5. Does MySQL have materialized views?

No.

**A.6.6. Can you insert into views that are based on joins?**

It is possible, provided that your `INSERT` statement has a column list that makes it clear there is only one table involved.

You *cannot* insert into multiple tables with a single insert on a view.

**A.7 MySQL 5.7 FAQ: INFORMATION\_SCHEMA**

A.7.1 Where can I find documentation for the MySQL <code>INFORMATION_SCHEMA</code> database? .....	4502
A.7.2 Is there a discussion forum for <code>INFORMATION_SCHEMA</code> ? .....	4502
A.7.3 Where can I find the ANSI SQL 2003 specification for <code>INFORMATION_SCHEMA</code> ? .....	4502
A.7.4 What is the difference between the Oracle Data Dictionary and MySQL <code>INFORMATION_SCHEMA</code> ? .....	4502
A.7.5 Can I add to or otherwise modify the tables found in the <code>INFORMATION_SCHEMA</code> database? ....	4502

**A.7.1. Where can I find documentation for the MySQL `INFORMATION_SCHEMA` database?**

See [Chapter 24, `INFORMATION\_SCHEMA` Tables](#).

You may also find the [MySQL User Forums](#) to be helpful.

**A.7.2. Is there a discussion forum for `INFORMATION_SCHEMA`?**

See the [MySQL User Forums](#).

**A.7.3. Where can I find the ANSI SQL 2003 specification for `INFORMATION_SCHEMA`?**

Unfortunately, the official specifications are not freely available. (ANSI makes them available for purchase.) However, there are books available, such as *SQL-99 Complete, Really* by Peter Gulutzan and Trudy Pelzer, that provide a comprehensive overview of the standard, including `INFORMATION_SCHEMA`.

**A.7.4. What is the difference between the Oracle Data Dictionary and MySQL `INFORMATION_SCHEMA`?**

Both Oracle and MySQL provide metadata in tables. However, Oracle and MySQL use different table names and column names. The MySQL implementation is more similar to those found in DB2 and SQL Server, which also support `INFORMATION_SCHEMA` as defined in the SQL standard.

**A.7.5. Can I add to or otherwise modify the tables found in the `INFORMATION_SCHEMA` database?**

No. Since applications may rely on a certain standard structure, this should not be modified. For this reason, *we cannot support bugs or other issues which result from modifying `INFORMATION_SCHEMA` tables or data.*

**A.8 MySQL 5.7 FAQ: Migration**

A.8.1 Where can I find information on how to upgrade or downgrade MySQL? .....	4502
A.8.2 How has storage engine (table type) support changed in MySQL 5.7 from previous versions? ...	4502

**A.8.1. Where can I find information on how to upgrade or downgrade MySQL?**

For detailed upgrade information, see [Section 2.10, “Upgrading MySQL”](#). Do not skip a major version when upgrading, but rather complete the process in steps, upgrading from one major version to the next in each step. This may seem more complicated, but ultimately saves time and trouble. If you encounter problems during the upgrade, their origin is easier to identify, either by you or, if you have a MySQL Enterprise subscription, by MySQL support.

**A.8.2. How has storage engine (table type) support changed in MySQL 5.7 from previous versions?**

Storage engine support has changed as follows:

- Support for [ISAM](#) tables was removed in MySQL 5.0 and you should now use the [MyISAM](#) storage engine in place of [ISAM](#). To convert a table `tblname` from [ISAM](#) to [MyISAM](#), simply issue a statement such as this one:

```
ALTER TABLE tblname ENGINE=MYISAM;
```

- Internal [RAID](#) for [MyISAM](#) tables was also removed in MySQL 5.0. This was formerly used to allow large tables in file systems that did not support file sizes greater than 2GB. All modern file systems allow for larger tables; in addition, there are now other solutions such as [MERGE](#) tables and views.
- The [VARCHAR](#) column type now retains trailing spaces in all storage engines.
- [MEMORY](#) tables (formerly known as [HEAP](#) tables) can also contain [VARCHAR](#) columns.

## A.9 MySQL 5.7 FAQ: Security

A.9.1 Where can I find documentation that addresses security issues for MySQL? .....	4503
A.9.2 What is the default authentication plugin in MySQL 5.7? .....	4503
A.9.3 Does MySQL have native support for SSL? .....	4504
A.9.4 Is SSL support built into MySQL binaries, or must I recompile the binary myself to enable it? ....	4504
A.9.5 Does MySQL have built-in authentication against LDAP directories? .....	4504
A.9.6 Does MySQL include support for Roles Based Access Control (RBAC)? .....	4504
A.9.7 Does MySQL support TLS 1.0 and 1.1? .....	4504

### A.9.1. Where can I find documentation that addresses security issues for MySQL?

The best place to start is [Chapter 6, Security](#).

Other portions of the MySQL Documentation which you may find useful with regard to specific security concerns include the following:

- [Section 6.1.1, “Security Guidelines”](#).
- [Section 6.1.3, “Making MySQL Secure Against Attackers”](#).
- [Section B.3.3.2, “How to Reset the Root Password”](#).
- [Section 6.1.5, “How to Run MySQL as a Normal User”](#).
- [Section 6.1.4, “Security-Related mysqld Options and Variables”](#).
- [Section 6.1.6, “Security Considerations for LOAD DATA LOCAL”](#).
- [Section 2.9, “Postinstallation Setup and Testing”](#).
- [Section 6.3, “Using Encrypted Connections”](#).
- [Loadable Function Security Precautions](#).

There is also the [Secure Deployment Guide](#), which provides procedures for deploying a generic binary distribution of MySQL Enterprise Edition Server with features for managing the security of your MySQL installation.

### A.9.2. What is the default authentication plugin in MySQL 5.7?

The default authentication plugin in MySQL 5.7 is `mysql_native_password`. For information about this plugin, see [Section 6.4.1.1, “Native Pluggable Authentication”](#). For general information about pluggable authentication and other available authentication plugins, see [Section 6.2.13, “Pluggable Authentication”](#), and [Section 6.4.1, “Authentication Plugins”](#).

**A.9.3.** Does MySQL have native support for SSL?

Yes, the binaries have support for SSL connections between the client and server. See [Section 6.3, “Using Encrypted Connections”](#).

You can also tunnel a connection using SSH, if (for example) the client application does not support SSL connections. For an example, see [Section 6.3.5, “Connecting to MySQL Remotely from Windows with SSH”](#).

**A.9.4.** Is SSL support built into MySQL binaries, or must I recompile the binary myself to enable it?

Yes, the binaries have SSL enabled for client/server connections that are secured, authenticated, or both. See [Section 6.3, “Using Encrypted Connections”](#).

**A.9.5.** Does MySQL have built-in authentication against LDAP directories?

The Enterprise edition includes a [PAM Authentication Plugin](#) that supports authentication against an LDAP directory.

**A.9.6.** Does MySQL include support for Roles Based Access Control (RBAC)?

Not at this time.

**A.9.7.** Does MySQL support TLS 1.0 and 1.1?

Support for the TLSv1 and TLSv1.1 connection protocols is removed as of MySQL 8.0.28. The protocols were deprecated from MySQL 8.0.26. For the consequences of that removal, see [Deprecated TLS Protocols](#).

Support for TLS versions 1.0 and 1.1 is removed because those protocol versions are old, released in 1996 and 2006, respectively. The algorithms used are weak and outdated.

Unless you are using very old versions of MySQL Server or connectors, you are unlikely to have connections using TLS 1.0 or 1.1. MySQL connectors and clients select the highest TLS version available by default.

*When was support for TLS 1.2 added to MySQL Server?* MySQL Community Server added TLS 1.2 support when the community server switched to OpenSSL for MySQL 5.6, 5.7, and 8.0 in 2019. For MySQL Enterprise Edition, OpenSSL added TLS 1.2 support in 2015, in MySQL Server 5.7.10.

*How can one view which TLS versions are in active use?* For MySQL 5.7 or 8.0, review whether TLS 1.0 or 1.1 is in use by running this query:

```
SELECT
  `session_ssl_status`.`thread_id`, `session_ssl_status`.`ssl_version`,
  `session_ssl_status`.`ssl_cipher`, `session_ssl_status`.`ssl_sessions_reused`
FROM `sys`.`session_ssl_status`
WHERE ssl_version NOT IN ('TLSv1.3','TLSv1.2');
```

If a thread using TLSv1.0 or TLSv1.1 is listed, you can determine where this connection is coming from by running this query:

```
SELECT thd_id,conn_id, user, db, current_statement, program_name
FROM sys.processlist
WHERE thd_id IN (
    SELECT `session_ssl_status`.`thread_id`
    FROM `sys`.`session_ssl_status`
    WHERE ssl_version NOT IN ('TLSv1.3','TLSv1.2')
);
```

Alternatively, you can run this query:

```
SELECT *
FROM sys.session
WHERE thd_id IN (
    SELECT `session_ssl_status`.`thread_id`
    FROM `sys`.`session_ssl_status`
    WHERE ssl_version NOT IN ('TLSv1.3','TLSv1.2')
);
```

These queries provide details needed to determine which application is not supporting TLS 1.2 or 1.3, and target upgrades for those.

*Are there other options for testing for TLS 1.0 or 1.1?* Yes, you can disable those versions prior to upgrading your server to a newer version. Explicitly specify which version to use, either in `mysql.cnf` (or `mysql.ini`) or by using `SET PERSIST`, for example: `--tls-version=TLSv1.2`.

*Do all MySQL Connectors (5.7 and 8.0) support TLS 1.2 and higher? What about C and C++ applications using `libmysql`?* For C and C++ applications using the community `libmysqlclient` library, use an OpenSSL-based library (that is, do *not* use YaSSL). Usage of OpenSSL was unified in 2018 (in MySQL 8.0.4 and 5.7.28, respectively). The same applies for Connector/ODBC and Connector/C++. To determine what library dependencies are used, run the following commands to see if OpenSSL is listed. On Linux, use this command:

```
$> sudo ldd /usr/local/mysql/lib/libmysqlclient.a | grep -i openssl
```

On MacOS, use this command:

```
$> sudo otool -l /usr/local/mysql/lib/libmysqlclient.a | grep -i openssl
```

Check the documentation for each connector, but they do support TLS 1.2 and TLS 1.3.

## A.10 MySQL 5.7 FAQ: NDB Cluster

In the following section, we answer questions that are frequently asked about NDB Cluster and the `NDB` storage engine.

A.10.1 Which versions of the MySQL software support NDB Cluster? Do I have to compile from source? .....	4506
A.10.2 What do “NDB” and “NDBCLUSTER” mean? .....	4507
A.10.3 What is the difference between using NDB Cluster versus using MySQL Replication? .....	4507
A.10.4 Do I need any special networking to run NDB Cluster? How do computers in a cluster communicate? .....	4507
A.10.5 How many computers do I need to run an NDB Cluster, and why? .....	4508
A.10.6 What do the different computers do in an NDB Cluster? .....	4508
A.10.7 When I run the <code>SHOW</code> command in the NDB Cluster management client, I see a line of output that looks like this: .....	4508
A.10.8 With which operating systems can I use NDB Cluster? .....	4509
A.10.9 What are the hardware requirements for running NDB Cluster? .....	4509
A.10.10 How much RAM do I need to use NDB Cluster? Is it possible to use disk memory at all? .....	4509

A.10.11 What file systems can I use with NDB Cluster? What about network file systems or network shares? .....	4510
A.10.12 Can I run NDB Cluster nodes inside virtual machines (such as those created by VMWare, VirtualBox, Parallels, or Xen)? .....	4511
A.10.13 I am trying to populate an NDB Cluster database. The loading process terminates prematurely and I get an error message like this one: .....	4511
A.10.14 NDB Cluster uses TCP/IP. Does this mean that I can run it over the Internet, with one or more nodes in remote locations? .....	4511
A.10.15 Do I have to learn a new programming or query language to use NDB Cluster? .....	4512
A.10.16 What programming languages and APIs are supported by NDB Cluster? .....	4512
A.10.17 Does NDB Cluster include any management tools? .....	4512
A.10.18 How do I find out what an error or warning message means when using NDB Cluster? .....	4512
A.10.19 Is NDB Cluster transaction-safe? What isolation levels are supported? .....	4513
A.10.20 What storage engines are supported by NDB Cluster? .....	4513
A.10.21 In the event of a catastrophic failure—for example, the whole city loses power <i>and</i> my UPS fails—would I lose all my data? .....	4513
A.10.22 Is it possible to use <code>FULLTEXT</code> indexes with NDB Cluster? .....	4513
A.10.23 Can I run multiple nodes on a single computer? .....	4513
A.10.24 Can I add data nodes to an NDB Cluster without restarting it? .....	4514
A.10.25 Are there any limitations that I should be aware of when using NDB Cluster? .....	4514
A.10.26 Does NDB Cluster support foreign keys? .....	4514
A.10.27 How do I import an existing MySQL database into an NDB Cluster? .....	4514
A.10.28 How do NDB Cluster nodes communicate with one another? .....	4515
A.10.29 What is an <i>arbiter</i> ? .....	4515
A.10.30 What data types are supported by NDB Cluster? .....	4515
A.10.31 How do I start and stop NDB Cluster? .....	4516
A.10.32 What happens to NDB Cluster data when the cluster is shut down? .....	4516
A.10.33 Is it a good idea to have more than one management node for an NDB Cluster? .....	4517
A.10.34 Can I mix different kinds of hardware and operating systems in one NDB Cluster? .....	4517
A.10.35 Can I run two data nodes on a single host? Two SQL nodes? .....	4517
A.10.36 Can I use host names with NDB Cluster? .....	4517
A.10.37 Does NDB Cluster support IPv6? .....	4517
A.10.38 How do I handle MySQL users in an NDB Cluster having multiple MySQL servers? .....	4517
A.10.39 How do I continue to send queries in the event that one of the SQL nodes fails? .....	4517
A.10.40 How do I back up and restore an NDB Cluster? .....	4518
A.10.41 What is an “angel process”? .....	4518

#### A.10.1 Which versions of the MySQL software support NDB Cluster? Do I have to compile from source?

NDB Cluster is not supported in standard MySQL Server releases. Instead, MySQL NDB Cluster is provided as a separate product. Available NDB Cluster release series include the following:

- **NDB Cluster 7.3 / NDB Cluster 7.4.** These two series are no longer maintained or supported for new deployments. Users of NDB Cluster 7.3 or 7.4 should upgrade to NDB 7.5 or newer as soon as possible. We recommend that new deployments use the latest NDB Cluster 8.0 release.
- **NDB Cluster 7.5.** This series is a previous General Availability (GA) version of NDB Cluster, still available for production use, although we recommend that new deployments use the latest NDB Cluster 8.0 release. The latest NDB Cluster 7.5 releases can be obtained from <https://dev.mysql.com/downloads/cluster/>.
- **NDB Cluster 7.6.** This series is a previous General Availability (GA) version of NDB Cluster, still available for production use, although we recommend that new deployments use the latest NDB Cluster 8.0 release. The latest NDB Cluster 7.6 releases can be obtained from <https://dev.mysql.com/downloads/cluster/>.



- **NDB Cluster 8.0.** This series is the most recent General Availability (GA) version of NDB Cluster, based on version 8.0 of the [NDB](#) storage engine and MySQL Server 8.0. NDB Cluster 8.0 is available for production use; new deployments intended for production should use the latest GA release in this series, which is currently NDB Cluster 8.0.44. You can obtain the most recent NDB Cluster 8.0 release from <https://dev.mysql.com/downloads/cluster/>. For information about new features and other important changes in this series, see [What is New in MySQL NDB Cluster 8.0](#).

You can obtain and compile NDB Cluster from source (see [Section 21.3.1.4, “Building NDB Cluster from Source on Linux”](#), and [Section 21.3.2.2, “Compiling and Installing NDB Cluster from Source on Windows”](#)), but for all but the most specialized cases, we recommend using one of the following installers provided by Oracle that is appropriate to your operating platform and circumstances:

- Linux [binary release](#) (`tar.gz` file)
- Linux [RPM package](#)
- Linux [.deb file](#)
- Windows [binary “no-install” release](#)
- Windows [MSI Installer](#)

Installation packages may also be available from your platform's package management system.

You can determine whether your MySQL Server has [NDB](#) support using one of the statements `SHOW VARIABLES LIKE 'have_%'`, `SHOW ENGINES`, or `SHOW PLUGINS`.

#### A.10.2 What do “NDB” and “NDBCLUSTER” mean?

“NDB” stands for “**N**etwork **D**atabase”. [NDB](#) and [NDBCLUSTER](#) are both names for the storage engine that enables clustering support with MySQL. [NDB](#) is preferred, but either name is correct.

#### A.10.3 What is the difference between using NDB Cluster versus using MySQL Replication?

In traditional MySQL replication, a source MySQL server updates one or more replicas. Transactions are committed sequentially, and a slow transaction can cause the replica to lag behind the source. This means that if the source fails, it is possible that the replica might not have recorded the last few transactions. If a transaction-safe engine such as [InnoDB](#) is being used, a transaction is either completed on the replica or not applied at all, but replication does not guarantee that all data on the source and the replica remains consistent at all times. In NDB Cluster, all data nodes are kept in synchrony, and a transaction committed by any one data node is committed for all data nodes. In the event of a data node failure, all remaining data nodes remain in a consistent state.

In short, whereas standard MySQL replication is *asynchronous*, NDB Cluster is *synchronous*.

Asynchronous replication is also available in NDB Cluster. *NDB Cluster Replication* (also sometimes known as “geo-replication”) includes the capability to replicate both between two NDB Clusters, and from an NDB Cluster to a non-Cluster MySQL server. See [Section 21.7, “NDB Cluster Replication”](#).

#### A.10.4 Do I need any special networking to run NDB Cluster? How do computers in a cluster communicate?

NDB Cluster is intended to be used in a high-bandwidth environment, with computers connecting using TCP/IP. Its performance depends directly upon the connection speed between the cluster's computers. The minimum connectivity requirements for NDB Cluster include a typical 100-megabit Ethernet network or the equivalent. We recommend you use gigabit Ethernet whenever available.

**A.10.5** How many computers do I need to run an NDB Cluster, and why?

A minimum of three computers is required to run a viable cluster. However, the minimum *recommended* number of computers in an NDB Cluster is four: one each to run the management and SQL nodes, and two computers to serve as data nodes. The purpose of the two data nodes is to provide redundancy; the management node must run on a separate machine to guarantee continued arbitration services in the event that one of the data nodes fails.

To provide increased throughput and high availability, you should use multiple SQL nodes (MySQL Servers connected to the cluster). It is also possible (although not strictly necessary) to run multiple management servers.

**A.10.6** What do the different computers do in an NDB Cluster?

An NDB Cluster has both a physical and logical organization, with computers being the physical elements. The logical or functional elements of a cluster are referred to as *nodes*, and a computer housing a cluster node is sometimes referred to as a *cluster host*. There are three types of nodes, each corresponding to a specific role within the cluster. These are:

- **Management node.** This node provides management services for the cluster as a whole, including startup, shutdown, backups, and configuration data for the other nodes. The management node server is implemented as the application `ndb_mgmd`; the management client used to control NDB Cluster is `ndb_mgm`. See [Section 21.5.4, “ndb\\_mgmd — The NDB Cluster Management Server Daemon”](#), and [Section 21.5.5, “ndb\\_mgm — The NDB Cluster Management Client”](#), for information about these programs.
- **Data node.** This type of node stores and replicates data. Data node functionality is handled by instances of the NDB data node process `ndbd`. For more information, see [Section 21.5.1, “ndbd — The NDB Cluster Data Node Daemon”](#).
- **SQL node.** This is simply an instance of MySQL Server (`mysqld`) that is built with support for the `NDBCLUSTER` storage engine and started with the `--ndb-cluster` option to enable the engine and the `--ndb-connectstring` option to enable it to connect to an NDB Cluster management server. For more about these options, see [MySQL Server Options for NDB Cluster](#).

**Note**

An *API node* is any application that makes direct use of Cluster data nodes for data storage and retrieval. An SQL node can thus be considered a type of API node that uses a MySQL Server to provide an SQL interface to the Cluster. You can write such applications (that do not depend on a MySQL Server) using the NDB API, which supplies a direct, object-oriented transaction and scanning interface to NDB Cluster data; see [NDB Cluster API Overview: The NDB API](#), for more information.

**A.10.7** When I run the `SHOW` command in the NDB Cluster management client, I see a line of output that looks like this:

```
id=2      @10.100.10.32  (Version: 8.0.44-ndb-8.0.44 Nodegroup: 0, *)
```

What does the `*` mean? How is this node different from the others?

The simplest answer is, “It’s not something you can control, and it’s nothing that you need to worry about in any case, unless you’re a software engineer writing or analyzing the NDB Cluster source code”.

If you don’t find that answer satisfactory, here’s a longer and more technical version:

A number of mechanisms in NDB Cluster require distributed coordination among the data nodes. These distributed algorithms and protocols include global checkpointing, DDL (schema) changes, and node restart handling. To make this coordination simpler, the data nodes “elect” one of their number to act as leader. There is no user-facing mechanism for influencing this selection, which is completely automatic; the fact that it *is* automatic is a key part of NDB Cluster’s internal architecture.

When a node acts as the “leader” for any of these mechanisms, it is usually the point of coordination for the activity, and the other nodes act as “followers”, carrying out their parts of the activity as directed by the leader. If the node acting as leader fails, then the remaining nodes elect a new leader. Tasks in progress that were being coordinated by the old leader may either fail or be continued by the new leader, depending on the actual mechanism involved.

It is possible for some of these different mechanisms and protocols to have different leader nodes, but in general the same leader is chosen for all of them. The node indicated as the leader in the output of `SHOW` in the management client is known internally as the `DICT` manager, responsible for coordinating DDL and metadata activity.

NDB Cluster is designed in such a way that the choice of leader has no discernible effect outside the cluster itself. For example, the current leader does not have significantly higher CPU or resource usage than the other data nodes, and failure of the leader should not have a significantly different impact on the cluster than the failure of any other data node.

#### A.10.8 With which operating systems can I use NDB Cluster?

NDB Cluster is supported on most Unix-like operating systems. NDB Cluster is also supported in production settings on Microsoft Windows operating systems.

For more detailed information concerning the level of support which is offered for NDB Cluster on various operating system versions, operating system distributions, and hardware platforms, please refer to <https://www.mysql.com/support/supportedplatforms/cluster.html>.

#### A.10.9 What are the hardware requirements for running NDB Cluster?

NDB Cluster should run on any platform for which `NDB-enabled` binaries are available. For data nodes and API nodes, faster CPUs and more memory are likely to improve performance, and 64-bit CPUs are likely to be more effective than 32-bit processors. There must be sufficient memory on machines used for data nodes to hold each node’s share of the database (see *How much RAM do I Need?* for more information). For a computer which is used only for running the NDB Cluster management server, the requirements are minimal; a common desktop PC (or the equivalent) is generally sufficient for this task. Nodes can communicate through the standard TCP/IP network and hardware. They can also use the high-speed SCI protocol; however, special networking hardware and software are required to use SCI (see [Section 21.4.4, “Using High-Speed Interconnects with NDB Cluster”](#)).

#### A.10.10 How much RAM do I need to use NDB Cluster? Is it possible to use disk memory at all?

NDB Cluster was originally implemented as in-memory only, but all versions currently available also provide the ability to store NDB Cluster on disk. See [Section 21.6.11, “NDB Cluster Disk Data Tables”](#), for more information.

For in-memory `NDB` tables, you can use the following formula for obtaining a rough estimate of how much RAM is needed for each data node in the cluster:

$$(\text{SizeofDatabase} \times \text{NumberOfReplicas} \times 1.1) / \text{NumberOfDataNodes}$$

To calculate the memory requirements more exactly requires determining, for each table in the cluster database, the storage space required per row (see [Section 11.7, “Data Type Storage Requirements”](#), for details), and multiplying this by the number of rows. You must also remember to account for any column indexes as follows:

- Each primary key or hash index created for an `NDBCLUSTER` table requires 21–25 bytes per record. These indexes use `IndexMemory`.
- Each ordered index requires 10 bytes storage per record, using `DataMemory`.
- Creating a primary key or unique index also creates an ordered index, unless this index is created with `USING HASH`. In other words:
  - A primary key or unique index on a Cluster table normally takes up 31 to 35 bytes per record.
  - However, if the primary key or unique index is created with `USING HASH`, then it requires only 21 to 25 bytes per record.

Creating NDB Cluster tables with `USING HASH` for all primary keys and unique indexes generally causes table updates to run more quickly—in some cases by as much as 20 to 30 percent faster than updates on tables where `USING HASH` was not used in creating primary and unique keys. This is due to the fact that less memory is required (because no ordered indexes are created), and that less CPU must be utilized (because fewer indexes must be read and possibly updated). However, it also means that queries that could otherwise use range scans must be satisfied by other means, which can result in slower selects.

When calculating Cluster memory requirements, you may find useful the `ndb_size.pl` utility which is available in recent MySQL 5.7 releases. This Perl script connects to a current (non-Cluster) MySQL database and creates a report on how much space that database would require if it used the `NDBCLUSTER` storage engine. For more information, see [Section 21.5.28, “ndb\\_size.pl — NDBCLUSTER Size Requirement Estimator”](#).

It is especially important to keep in mind that *every NDB Cluster table must have a primary key*. The `NDB` storage engine creates a primary key automatically if none is defined; this primary key is created without `USING HASH`.

You can determine how much memory is being used for storage of NDB Cluster data and indexes at any given time using the `REPORT MEMORYUSAGE` command in the `ndb_mgm` client; see [Section 21.6.1, “Commands in the NDB Cluster Management Client”](#), for more information. In addition, warnings are written to the cluster log when 80% of available `DataMemory` or (prior to NDB 7.6) `IndexMemory` is in use, and again when usage reaches 90%, 99%, and 100%.

#### **A.10.1** What file systems can I use with NDB Cluster? What about network file systems or network shares?

Generally, any file system that is native to the host operating system should work well with NDB Cluster. If you find that a given file system works particularly well (or not so especially well) with NDB Cluster, we invite you to discuss your findings in the [NDB Cluster Forums](#).

For Windows, we recommend that you use `NTFS` file systems for NDB Cluster, just as we do for standard MySQL. We do not test NDB Cluster with `FAT` or `VFAT` file systems. Because of this, we do not recommend their use with MySQL or NDB Cluster.

NDB Cluster is implemented as a shared-nothing solution; the idea behind this is that the failure of a single piece of hardware should not cause the failure of multiple cluster nodes, or possibly even the

failure of the cluster as a whole. For this reason, the use of network shares or network file systems is not supported for NDB Cluster. This also applies to shared storage devices such as SANs.

**A.10.12** Can I run NDB Cluster nodes inside virtual machines (such as those created by VMWare, VirtualBox, Parallels, or Xen)?

NDB Cluster is supported for use in virtual machines. We currently support and test using [Oracle VM](#).

Some NDB Cluster users have successfully deployed NDB Cluster using other virtualization products; in such cases, Oracle can provide NDB Cluster support, but issues specific to the virtual environment must be referred to that product's vendor.

**A.10.13** I am trying to populate an NDB Cluster database. The loading process terminates prematurely and I get an error message like this one:

```
ERROR 1114: The table 'my_cluster_table' is full
```

Why is this happening?

The cause is very likely to be that your setup does not provide sufficient RAM for all table data and all indexes, *including the primary key required by the NDB storage engine and automatically created in the event that the table definition does not include the definition of a primary key.*

It is also worth noting that all data nodes should have the same amount of RAM, since no data node in a cluster can use more memory than the least amount available to any individual data node. For example, if there are four computers hosting Cluster data nodes, and three of these have 3GB of RAM available to store Cluster data while the remaining data node has only 1GB RAM, then each data node can devote at most 1GB to NDB Cluster data and indexes.

In some cases it is possible to get `Table is full` errors in MySQL client applications even when `ndb_mgm -e "ALL REPORT MEMORYUSAGE"` shows significant free `DataMemory`. You can force NDB to create extra partitions for NDB Cluster tables and thus have more memory available for hash indexes by using the `MAX_ROWS` option for `CREATE TABLE`. In general, setting `MAX_ROWS` to twice the number of rows that you expect to store in the table should be sufficient.

For similar reasons, you can also sometimes encounter problems with data node restarts on nodes that are heavily loaded with data. The `MinFreePct` parameter can help with this issue by reserving a portion (5% by default) of `DataMemory` and (prior to NDB 7.6) `IndexMemory` for use in restarts. This reserved memory is not available for storing NDB tables or data.

**A.10.14** NDB Cluster uses TCP/IP. Does this mean that I can run it over the Internet, with one or more nodes in remote locations?

It is very unlikely that a cluster would perform reliably under such conditions, as NDB Cluster was designed and implemented with the assumption that it would be run under conditions guaranteeing dedicated high-speed connectivity such as that found in a LAN setting using 100 Mbps or gigabit Ethernet—preferably the latter. We neither test nor warrant its performance using anything slower than this.

Also, it is extremely important to keep in mind that communications between the nodes in an NDB Cluster are not secure; they are neither encrypted nor safeguarded by any other protective mechanism. The most secure configuration for a cluster is in a private network behind a firewall, with no direct access to any Cluster data or management nodes from outside. (For SQL nodes, you should take the same precautions as you would with any other instance of the MySQL server.) For more information, see [Section 21.6.18, "NDB Cluster Security Issues"](#).

**A.10.15** Do I have to learn a new programming or query language to use NDB Cluster?

No. Although some specialized commands are used to manage and configure the cluster itself, only standard (My)SQL statements are required for the following operations:

- Creating, altering, and dropping tables
- Inserting, updating, and deleting table data
- Creating, changing, and dropping primary and unique indexes

Some specialized configuration parameters and files are required to set up an NDB Cluster—see [Section 21.4.3, “NDB Cluster Configuration Files”](#), for information about these.

A few simple commands are used in the NDB Cluster management client (`ndb_mgm`) for tasks such as starting and stopping cluster nodes. See [Section 21.6.1, “Commands in the NDB Cluster Management Client”](#).

**A.10.16** What programming languages and APIs are supported by NDB Cluster?

NDB Cluster supports the same programming APIs and languages as the standard MySQL Server, including ODBC, .Net, the MySQL C API, and numerous drivers for popular scripting languages such as PHP, Perl, and Python. NDB Cluster applications written using these APIs behave similarly to other MySQL applications; they transmit SQL statements to a MySQL Server (in the case of NDB Cluster, an SQL node), and receive responses containing rows of data. For more information about these APIs, see [Chapter 27, Connectors and APIs](#).

NDB Cluster also supports application programming using the NDB API, which provides a low-level C++ interface to NDB Cluster data without needing to go through a MySQL Server. See [The NDB API](#). In addition, many `NDBCLUSTER` management functions are exposed by the C-language MGM API; see [The MGM API](#), for more information.

NDB Cluster also supports Java application programming using ClusterJ, which supports a domain object model of data using sessions and transactions. See [Java and NDB Cluster](#), for more information.

NDB Cluster 8.0 also includes adapters supporting NoSQL applications written against `Node.js`, with NDB Cluster as the data store. See [MySQL NoSQL Connector for JavaScript](#), for more information.

**A.10.17** Does NDB Cluster include any management tools?

NDB Cluster includes a command line client for performing basic management functions. See [Section 21.5.5, “ndb\\_mgm — The NDB Cluster Management Client”](#), and [Section 21.6.1, “Commands in the NDB Cluster Management Client”](#).

NDB Cluster is also supported by MySQL Cluster Manager, a separate product providing an advanced command line interface that can automate many NDB Cluster management tasks such as rolling restarts and configuration changes. For more information about MySQL Cluster Manager, see [MySQL Cluster Manager 1.4.8 User Manual](#).

**A.10.18** How do I find out what an error or warning message means when using NDB Cluster?

There are two ways in which this can be done:

- From within the `mysql` client, use `SHOW ERRORS` or `SHOW WARNINGS` immediately upon being notified of the error or warning condition.

- From a system shell prompt, use `pererror --ndb error_code`.

**A.10.19** NDB Cluster transaction-safe? What isolation levels are supported?

Yes. For tables created with the [NDB](#) storage engine, transactions are supported. Currently, NDB Cluster supports only the [READ COMMITTED](#) transaction isolation level.

**A.10.20** What storage engines are supported by NDB Cluster?

NDB Cluster requires the [NDB](#) storage engine. That is, in order for a table to be shared between nodes in an NDB Cluster, the table must be created using `ENGINE=NDB` (or the equivalent option `ENGINE=NDBCLUSTER`).

It is possible to create tables using other storage engines (such as [InnoDB](#) or [MyISAM](#)) on a MySQL server being used with NDB Cluster, but since these tables do not use [NDB](#), they do not participate in clustering; each such table is strictly local to the individual MySQL server instance on which it is created.

NDB Cluster is quite different from [InnoDB](#) clustering with regard to architecture, requirements, and implementation; despite any similarity in their names, the two are not compatible. For more information about [InnoDB](#) clustering, see [MySQL AdminAPI](#). See also [Section 21.2.6, “MySQL Server Using InnoDB Compared with NDB Cluster”](#), for information about the differences between the [NDB](#) and [InnoDB](#) storage engines.

**A.10.21** In the event of a catastrophic failure—for example, the whole city loses power *and* my UPS fails—would I lose all my data?

All committed transactions are logged. Therefore, although it is possible that some data could be lost in the event of a catastrophe, this should be quite limited. Data loss can be further reduced by minimizing the number of operations per transaction. (It is not a good idea to perform large numbers of operations per transaction in any case.)

**A.10.22** Is it possible to use [FULLTEXT](#) indexes with NDB Cluster?

[FULLTEXT](#) indexing is currently supported only by the [InnoDB](#) and [MyISAM](#) storage engines. See [Section 12.9, “Full-Text Search Functions”](#), for more information.

**A.10.23** Can I run multiple nodes on a single computer?

It is possible but not always advisable. One of the chief reasons to run a cluster is to provide redundancy. To obtain the full benefits of this redundancy, each node should reside on a separate machine. If you place multiple nodes on a single machine and that machine fails, you lose all of those nodes. For this reason, if you do run multiple data nodes on a single machine, it is *extremely* important that they be set up in such a way that the failure of this machine does not cause the loss of all the data nodes in a given node group.

Given that NDB Cluster can be run on commodity hardware loaded with a low-cost (or even no-cost) operating system, the expense of an extra machine or two is well worth it to safeguard mission-critical data. It is also worth noting that the requirements for a cluster host running a management node are minimal. This task can be accomplished with a 300 MHz Pentium or equivalent CPU and sufficient RAM for the operating system, plus a small amount of overhead for the `ndb_mgmd` and `ndb_mgm` processes.

It is acceptable to run multiple cluster data nodes on a single host that has multiple CPUs, cores, or both. The NDB Cluster distribution also provides a multithreaded version of the data node binary intended for use on such systems. For more information, see [Section 21.5.3, “ndbmtid — The NDB Cluster Data Node Daemon \(Multi-Threaded\)”](#).

It is also possible in some cases to run data nodes and SQL nodes concurrently on the same machine; how well such an arrangement performs is dependent on a number of factors such as number of cores and CPUs as well as the amount of disk and memory available to the data node and SQL node processes, and you must take these factors into account when planning such a configuration.

**A.10.24** Can I add data nodes to an NDB Cluster without restarting it?

It is possible to add new data nodes to a running NDB Cluster without taking the cluster offline. For more information, see [Section 21.6.7, “Adding NDB Cluster Data Nodes Online”](#).

For other types of NDB Cluster nodes, a rolling restart is all that is required (see [Section 21.6.5, “Performing a Rolling Restart of an NDB Cluster”](#)).

**A.10.25** Are there any limitations that I should be aware of when using NDB Cluster?

Limitations on [NDB](#) tables in MySQL NDB Cluster include the following:

- Temporary tables are not supported; a `CREATE TEMPORARY TABLE` statement using `ENGINE=NDB` or `ENGINE=NDBCLUSTER` fails with an error.
- The only types of user-defined partitioning supported for `NDBCLUSTER` tables are `KEY` and `LINEAR KEY`. Trying to create an `NDB` table using any other partitioning type fails with an error.
- `FULLTEXT` indexes are not supported.
- Index prefixes are not supported. Only complete columns may be indexed.
- Spatial indexes are not supported (although spatial columns can be used). See [Section 11.4, “Spatial Data Types”](#).
- Support for partial transactions and partial rollbacks is comparable to that of other transactional storage engines such as `InnoDB` that can roll back individual statements.
- The maximum number of attributes allowed per table is 512. Attribute names cannot be any longer than 31 characters. For each table, the maximum combined length of the table and database names is 122 characters.
- Prior to NDB 8.0, the maximum size for a table row is 14 kilobytes, not counting `BLOB` values. In NDB 8.0, this maximum is increased to 30000 bytes. See [Section 21.2.7.5, “Limits Associated with Database Objects in NDB Cluster”](#), for more information.

There is no set limit for the number of rows per `NDB` table. Limits on table size depend on a number of factors, in particular on the amount of RAM available to each data node.

For a complete listing of limitations in NDB Cluster, see [Section 21.2.7, “Known Limitations of NDB Cluster”](#). See also [Previous NDB Cluster Issues Resolved in NDB Cluster 8.0](#).

**A.10.26** Does NDB Cluster support foreign keys?

NDB Cluster provides support for foreign key constraints which is comparable to that found in the `InnoDB` storage engine; see [Section 1.6.3.2, “FOREIGN KEY Constraints”](#), for more detailed information, as well as [Section 13.1.18.5, “FOREIGN KEY Constraints”](#). Applications requiring foreign key support should use NDB Cluster 7.3, 7.4, 7.5, or later.

**A.10.27** How do I import an existing MySQL database into an NDB Cluster?



You can import databases into NDB Cluster much as you would with any other version of MySQL. Other than the limitations mentioned elsewhere in this FAQ, the only other special requirement is that any tables to be included in the cluster must use the `NDB` storage engine. This means that the tables must be created with `ENGINE=NDB` or `ENGINE=NDBCLUSTER`.

It is also possible to convert existing tables that use other storage engines to `NDBCLUSTER` using one or more `ALTER TABLE` statement. However, the definition of the table must be compatible with the `NDBCLUSTER` storage engine prior to making the conversion. In MySQL 5.7, an additional workaround is also required; see [Section 21.2.7, “Known Limitations of NDB Cluster”](#), for details.

#### A.10.28 How do NDB Cluster nodes communicate with one another?

Cluster nodes can communicate through any of three different transport mechanisms: TCP/IP, SHM (shared memory), and SCI (Scalable Coherent Interface). Where available, SHM is used by default between nodes residing on the same cluster host; however, this is considered experimental. SCI is a high-speed (1 gigabit per second and higher), high-availability protocol used in building scalable multi-processor systems; it requires special hardware and drivers. See [Section 21.4.4, “Using High-Speed Interconnects with NDB Cluster”](#), for more about using SCI as a transport mechanism for NDB Cluster.

#### A.10.29 What is an *arbiter*?

If one or more data nodes in a cluster fail, it is possible that not all cluster data nodes are able to “see” one another. In fact, it is possible that two sets of data nodes might become isolated from one another in a network partitioning, also known as a “split-brain” scenario. This type of situation is undesirable because each set of data nodes tries to behave as though it is the entire cluster. An arbiter is required to decide between the competing sets of data nodes.

When all data nodes in at least one node group are alive, network partitioning is not an issue, because no single subset of the cluster can form a functional cluster on its own. The real problem arises when no single node group has all its nodes alive, in which case network partitioning (the “split-brain” scenario) becomes possible. Then an arbiter is required. All cluster nodes recognize the same node as the arbiter, which is normally the management server; however, it is possible to configure any of the MySQL Servers in the cluster to act as the arbiter instead. The arbiter accepts the first set of cluster nodes to contact it, and tells the remaining set to shut down. Arbiter selection is controlled by the `ArbitrationRank` configuration parameter for MySQL Server and management server nodes. You can also use the `ArbitrationRank` configuration parameter to control the arbiter selection process. For more information about these parameters, see [Section 21.4.3.5, “Defining an NDB Cluster Management Server”](#).

The role of arbiter does not in and of itself impose any heavy demands upon the host so designated, and thus the arbiter host does not need to be particularly fast or to have extra memory especially for this purpose.

#### A.10.30 What data types are supported by NDB Cluster?

NDB Cluster supports all of the usual MySQL data types, including those associated with MySQL's spatial extensions; however, the `NDB` storage engine does not support spatial indexes. (Spatial indexes are supported only by `MyISAM`; see [Section 11.4, “Spatial Data Types”](#), for more information.) In addition, there are some differences with regard to indexes when used with `NDB` tables.



#### Note

NDB Cluster Disk Data tables (that is, tables created with `TABLESPACE ... STORAGE DISK ENGINE=NDB` or `TABLESPACE ... STORAGE DISK`

`ENGINE=NDBCLUSTER`) have only fixed-width rows. This means that (for example) each Disk Data table record containing a `VARCHAR(255)` column requires space for 255 characters (as required for the character set and collation being used for the table), regardless of the actual number of characters stored therein.

See [Section 21.2.7, “Known Limitations of NDB Cluster”](#), for more information about these issues.

### A.10.31 How do I start and stop NDB Cluster?

It is necessary to start each node in the cluster separately, in the following order:

1. Start the management node, using the `ndb_mgmd` command.

When starting the cluster for the first time, you must include the `-f` or `--config-file` option to tell the management node where its configuration file can be found.

2. Start each data node with the `ndbd` command.

Each data node must be started with the `-c` or `--ndb-connectstring` option so that the data node knows how to connect to the management server.

3. Start each MySQL Server (SQL node) using your preferred startup script, such as `mysqld_safe`.

Each MySQL Server must be started with the `--ndbcluster` and `--ndb-connectstring` options. These options cause `mysqld` to enable `NDBCLUSTER` storage engine support and how to connect to the management server.

Each of these commands must be run from a system shell on the machine housing the affected node. (You do not have to be physically present at the machine—a remote login shell can be used for this purpose.) You can verify that the cluster is running by starting the `NDB` management client `ndb_mgm` on the machine housing the management node and issuing the `SHOW` or `ALL STATUS` command.

To shut down a running cluster, issue the command `SHUTDOWN` in the management client. Alternatively, you may enter the following command in a system shell:

```
$> ndb_mgm -e "SHUTDOWN"
```

(The quotation marks in this example are optional, since there are no spaces in the command string following the `-e` option; in addition, the `SHUTDOWN` command, like other management client commands, is not case-sensitive.)

Either of these commands causes the `ndb_mgm`, `ndb_mgm`, and any `ndbd` processes to terminate gracefully. MySQL servers running as SQL nodes can be stopped using `mysqladmin shutdown`.

For more information, see [Section 21.6.1, “Commands in the NDB Cluster Management Client”](#), and [Section 21.3.6, “Safe Shutdown and Restart of NDB Cluster”](#).

MySQL Cluster Manager provides additional ways to handle starting and stopping of NDB Cluster nodes. See [MySQL Cluster Manager 1.4.8 User Manual](#), for more information about this tool.

### A.10.32 What happens to NDB Cluster data when the cluster is shut down?

The data that was held in memory by the cluster's data nodes is written to disk, and is reloaded into memory the next time that the cluster is started.

**A.10.33** Is it a good idea to have more than one management node for an NDB Cluster?

It can be helpful as a fail-safe. Only one management node controls the cluster at any given time, but it is possible to configure one management node as primary, and one or more additional management nodes to take over in the event that the primary management node fails.

See [Section 21.4.3, “NDB Cluster Configuration Files”](#), for information on how to configure NDB Cluster management nodes.

**A.10.34** Can I mix different kinds of hardware and operating systems in one NDB Cluster?

Yes, as long as all machines and operating systems have the same “endianness” (all big-endian or all little-endian).

It is also possible to use software from different NDB Cluster releases on different nodes. However, we support such use only as part of a rolling upgrade procedure (see [Section 21.6.5, “Performing a Rolling Restart of an NDB Cluster”](#)).

**A.10.35** Can I run two data nodes on a single host? Two SQL nodes?

Yes, it is possible to do this. In the case of multiple data nodes, it is advisable (but not required) for each node to use a different data directory. If you want to run multiple SQL nodes on one machine, each instance of `mysqld` must use a different TCP/IP port.

Running data nodes and SQL nodes together on the same host is possible, but you should be aware that the `ndbd` or `ndbmtl` processes may compete for memory with `mysqld`.

**A.10.36** Can I use host names with NDB Cluster?

Yes, it is possible to use DNS and DHCP for cluster hosts. However, if your application requires “five nines” availability, you should use fixed (numeric) IP addresses, since making communication between Cluster hosts dependent on services such as DNS and DHCP introduces additional potential points of failure.

**A.10.37** Does NDB Cluster support IPv6?

IPv6 is supported for connections between SQL nodes (MySQL servers), but connections between all other types of NDB Cluster nodes must use IPv4.

In practical terms, this means that you can use IPv6 for replication between NDB Clusters, but connections between nodes in the same NDB Cluster must use IPv4. For more information, see [Section 21.7.3, “Known Issues in NDB Cluster Replication”](#).

**A.10.38** How do I handle MySQL users in an NDB Cluster having multiple MySQL servers?

MySQL user accounts and privileges are normally not automatically propagated between different MySQL servers accessing the same NDB Cluster. MySQL NDB Cluster provides support for distributed privileges, which you can enable by following a procedure provided in the documentation; see [Section 21.6.13, “Distributed Privileges Using Shared Grant Tables”](#), for more information.

**Important**

The mechanism for handling users distributed or shared between NDB Cluster SQL nodes changed significantly in NDB 8.0; this implementation is not compatible with that in NDB 7.6 and earlier. See [Privilege Synchronization and NDB\\_STORED\\_USER](#), for details.

**A.10.39** How do I continue to send queries in the event that one of the SQL nodes fails?

MySQL NDB Cluster does not provide any sort of automatic failover between SQL nodes. Your application must be prepared to handle the loss of SQL nodes and to fail over between them.

#### A.10.40 How do I back up and restore an NDB Cluster?

You can use the NDB Cluster native backup and restore functionality in the NDB management client and the `ndb_restore` program. See [Section 21.6.8, “Online Backup of NDB Cluster”](#), and [Section 21.5.24, “ndb\\_restore — Restore an NDB Cluster Backup”](#).

You can also use the traditional functionality provided for this purpose in `mysqldump` and the MySQL server. See [Section 4.5.4, “mysqldump — A Database Backup Program”](#), for more information.

#### A.10.41 What is an “angel process”?

This process monitors and, if necessary, attempts to restart the data node process. If you check the list of active processes on your system after starting `ndbd`, you can see that there are actually 2 processes running by that name, as shown here (we omit the output from `ndb_mgmd` and `ndbd` for brevity):

```
$> ./ndb_mgmd

$> ps aux | grep ndb
me      23002  0.0  0.0 122948  3104 ?          Ss1  14:14   0:00 ./ndb_mgmd
me      23025  0.0  0.0   5284   820 pts/2    S+   14:14   0:00 grep ndb

$> ./ndbd -c 127.0.0.1 --initial

$> ps aux | grep ndb
me      23002  0.0  0.0 123080  3356 ?          Ss1  14:14   0:00 ./ndb_mgmd
me      23096  0.0  0.0  35876  2036 ?          Ss   14:14   0:00 ./ndbmtd -c 127.0.0.1 --initial
me      23097  1.0  2.4 524116 91096 ?          S1   14:14   0:00 ./ndbmtd -c 127.0.0.1 --initial
me      23168  0.0  0.0   5284   812 pts/2    R+   14:15   0:00 grep ndb
```

The `ndbd` process showing `0.0` for both memory and CPU usage is the angel process (although it actually does use a very small amount of each). This process merely checks to see if the main `ndbd` or `ndbmtd` process (the primary data node process which actually handles the data) is running. If permitted to do so (for example, if the `StopOnError` configuration parameter is set to `false`), the angel process tries to restart the primary data node process.

## A.11 MySQL 5.7 FAQ: MySQL Chinese, Japanese, and Korean Character Sets

This set of Frequently Asked Questions derives from the experience of MySQL's Support and Development groups in handling many inquiries about CJK (Chinese-Japanese-Korean) issues.

A.11.1 What CJK character sets are available in MySQL? .....	4519
A.11.2 I have inserted CJK characters into my table. Why does <code>SELECT</code> display them as “?” characters? .....	4520
A.11.3 What problems should I be aware of when working with the Big5 Chinese character set? .....	4522
A.11.4 Why do Japanese character set conversions fail? .....	4522
A.11.5 What should I do if I want to convert SJIS 81CA to cp932? .....	4523
A.11.6 How does MySQL represent the Yen (¥) sign? .....	4523
A.11.7 Of what issues should I be aware when working with Korean character sets in MySQL? .....	4524
A.11.8 Why do I get <code>Incorrect string value</code> error messages? .....	4524
A.11.9 Why does my GUI front end or browser display CJK characters incorrectly in my application using Access, PHP, or another API? .....	4525

A.11.10 I've upgraded to MySQL 5.7. How can I revert to behavior like that in MySQL 4.0 with regard to character sets? .....	4525
A.11.11 Why do some <code>LIKE</code> and <code>FULLTEXT</code> searches with CJK characters fail? .....	4527
A.11.12 How do I know whether character <code>x</code> is available in all character sets? .....	4527
A.11.13 Why do CJK strings sort incorrectly in Unicode? (I) .....	4528
A.11.14 Why do CJK strings sort incorrectly in Unicode? (II) .....	4529
A.11.15 Why are my supplementary characters rejected by MySQL? .....	4530
A.11.16 Should “CJK” be “CJKV”? .....	4531
A.11.17 Does MySQL permit CJK characters to be used in database and table names? .....	4531
A.11.18 Where can I find translations of the MySQL Manual into Chinese, Japanese, and Korean? ...	4531
A.11.19 Where can I get help with CJK and related issues in MySQL? .....	4531

### A.11.1 What CJK character sets are available in MySQL?

The list of CJK character sets may vary depending on your MySQL version. For example, the `gb18030` character set is not supported prior to MySQL 5.7.4. However, since the name of the applicable language appears in the `DESCRIPTION` column for every entry in the `INFORMATION_SCHEMA.CHARACTER_SETS` table, you can obtain a current list of all the non-Unicode CJK character sets using this query:

```
mysql> SELECT CHARACTER_SET_NAME, DESCRIPTION
FROM INFORMATION_SCHEMA.CHARACTER_SETS
WHERE DESCRIPTION LIKE '%Chin%'
OR DESCRIPTION LIKE '%Japanese%'
OR DESCRIPTION LIKE '%Korean%'
ORDER BY CHARACTER_SET_NAME;
```

CHARACTER_SET_NAME	DESCRIPTION
big5	Big5 Traditional Chinese
cp932	SJIS for Windows Japanese
ujis	UJIS for Windows Japanese
euckr	EUC-KR Korean
gb18030	China National Standard GB18030
gb2312	GB2312 Simplified Chinese
gbk	GBK Simplified Chinese
sjis	Shift-JIS Japanese
ujis	EUC-JP Japanese

(For more information, see [Section 24.3.2, “The INFORMATION\\_SCHEMA.CHARACTER\\_SETS Table”](#).)

MySQL supports three variants of the *GB* (*Guojia Biaozhun*, or *National Standard*, or *Simplified Chinese*) character sets which are official in the People's Republic of China: `gb2312`, `gbk`, and (as of MySQL 5.7.4) `gb18030`.

Sometimes people try to insert `gbk` characters into `gb2312`, and it works most of the time because `gbk` is a superset of `gb2312`. But eventually they try to insert a rarer Chinese character and it does not work. (For an example, see [Bug #16072](#)).

Here, we try to clarify exactly what characters are legitimate in `gb2312` or `gbk`, with reference to the official documents. Please check these references before reporting `gb2312` or `gbk` bugs:

- The MySQL `gbk` character set is in reality “Microsoft code page 936”. This differs from the official `gbk` for characters `A1A4` (middle dot), `A1AA` (em dash), `A6E0–A6F5`, and `A8BB–A8C0`.
- For a listing of `gbk`/Unicode mappings, see <http://www.unicode.org/Public/MAPPINGS/VENDORS/MICSFT/WINDOWS/CP936.TXT>.

It is also possible to store CJK characters in Unicode character sets, although the available collations may not sort characters quite as you expect:

- The `utf8` and `ucs2` character sets support the characters from Unicode Basic Multilingual Plane (BMP). These characters have code point values between `U+0000` and `U+FFFF`.
- The `utf8mb4`, `utf16`, `utf16le`, and `utf32` character sets support BMP characters, as well as supplementary characters that lie outside the BMP. Supplementary characters have code point values between `U+10000` and `U+10FFFF`.

The collation used for a Unicode character set determines the ability to sort (that is, distinguish) characters in the set:

- Collations based on Unicode Collation Algorithm (UCA) 4.0.0 distinguish only BMP characters.
- Collations based on UCA 5.2.0 or 9.0.0 distinguish BMP and supplementary characters.
- Non-UCA collations may not distinguish all Unicode characters. For example, the `utf8mb4` default collation is `utf8mb4_general_ci`, which distinguishes only BMP characters.

Moreover, distinguishing characters is not the same as ordering them per the conventions of a given CJK language. Currently, MySQL has only one CJK-specific UCA collation, `gb18030_unicode_520_ci` (which requires use of the non-Unicode `gb18030` character set).

For information about Unicode collations and their differentiating properties, including collation properties for supplementary characters, see [Section 10.10.1, “Unicode Character Sets”](#).

#### A.11.2I have inserted CJK characters into my table. Why does `SELECT` display them as “?” characters?

This problem is usually due to a setting in MySQL that does not match the settings for the application program or the operating system. Here are some common steps for correcting these types of issues:

- *Be certain of what MySQL version you are using.*

Use the statement `SELECT VERSION();` to determine this.

- *Make sure that the database is actually using the desired character set.*

People often think that the client character set is always the same as either the server character set or the character set used for display purposes. However, both of these are false assumptions. You can make sure by checking the result of `SHOW CREATE TABLE tablename` or, better yet, by using this statement:

```
SELECT character_set_name, collation_name
FROM information_schema.columns
WHERE table_schema = your_database_name
AND table_name = your_table_name
AND column_name = your_column_name;
```

- *Determine the hexadecimal value of the character or characters that are not being displayed correctly.*

You can obtain this information for a column `column_name` in the table `table_name` using the following query:

```
SELECT HEX(column_name)
```

```
FROM table_name;
```

`3F` is the encoding for the `?` character; this means that `?` is the character actually stored in the column. This most often happens because of a problem converting a particular character from your client character set to the target character set.

- *Make sure that a round trip is possible. When you select `literal` (or `_introducer hexadecimal-value`), do you obtain `literal` as a result?*

For example, the Japanese Katakana character *Pe* (ペ) exists in all CJK character sets, and has the code point value (hexadecimal coding) `0x30da`. To test a round trip for this character, use this query:

```
SELECT 'ペ' AS `ペ`;          /* or SELECT _ucs2 0x30da; */
```

If the result is not also ペ, the round trip failed.

For bug reports regarding such failures, we might ask you to follow up with `SELECT HEX('ペ');`. Then we can determine whether the client encoding is correct.

- *Make sure that the problem is not with the browser or other application, rather than with MySQL.*

Use the `mysql` client program to accomplish this task. If `mysql` displays characters correctly but your application does not, your problem is probably due to system settings.

To determine your settings, use the `SHOW VARIABLES` statement, whose output should resemble what is shown here:

```
mysql> SHOW VARIABLES LIKE 'char%';
+-----+-----+
| Variable_name | Value |
+-----+-----+
| character_set_client | utf8 |
| character_set_connection | utf8 |
| character_set_database | latin1 |
| character_set_filesystem | binary |
| character_set_results | utf8 |
| character_set_server | latin1 |
| character_set_system | utf8 |
| character_sets_dir | /usr/local/mysql/share/mysqlCharsets/ |
+-----+-----+
```

These are typical character-set settings for an international-oriented client (notice the use of `utf8` Unicode) connected to a server in the West (`latin1` is a West Europe character set).

Although Unicode (usually the `utf8` variant on Unix, and the `ucs2` variant on Windows) is preferable to Latin, it is often not what your operating system utilities support best. Many Windows users find that a Microsoft character set, such as `cp932` for Japanese Windows, is suitable.

If you cannot control the server settings, and you have no idea what setting your underlying computer uses, try changing to a common character set for the country that you're in (`euckr` = Korea; `gb18030`, `gb2312` or `gbk` = People's Republic of China; `big5` = Taiwan; `sjis`, `ujis`, `cp932`, or `eucjpms` = Japan; `ucs2` or `utf8` = anywhere). Usually it is necessary to change only

the client and connection and results settings. The `SET NAMES` statement changes all three at once. For example:

```
SET NAMES 'big5';
```

Once the setting is correct, you can make it permanent by editing `my.cnf` or `my.ini`. For example you might add lines looking like these:

```
[mysqld]
character-set-server=big5
[client]
default-character-set=big5
```

It is also possible that there are issues with the API configuration setting being used in your application; see *Why does my GUI front end or browser not display CJK characters correctly...?* for more information.

#### A.11.3 What problems should I be aware of when working with the Big5 Chinese character set?

MySQL supports the Big5 character set which is common in Hong Kong and Taiwan (Republic of China). The MySQL `big5` character set is in reality Microsoft code page 950, which is very similar to the original `big5` character set.

A feature request for adding `HKSCS` extensions has been filed. People who need this extension may find the suggested patch for Bug #13577 to be of interest.

#### A.11.4 Why do Japanese character set conversions fail?

MySQL supports the `sjis`, `ujis`, `cp932`, and `eucjpm` character sets, as well as Unicode. A common need is to convert between character sets. For example, there might be a Unix server (typically with `sjis` or `ujis`) and a Windows client (typically with `cp932`).

In the following conversion table, the `ucs2` column represents the source, and the `sjis`, `cp932`, `ujis`, and `eucjpm` columns represent the destinations; that is, the last 4 columns provide the hexadecimal result when we use `CONVERT(ucs2)` or we assign a `ucs2` column containing the value to an `sjis`, `cp932`, `ujis`, or `eucjpm` column.

Character Name	ucs2	sjis	cp932	ujis	eucjpm
BROKEN BAR	00A6	3F	3F	8FA2C3	3F
FULLWIDTH BROKEN BAR	FFE4	3F	FA55	3F	8FA2
YEN SIGN	00A5	3F	3F	20	3F
FULLWIDTH YEN SIGN	FFE5	818F	818F	A1EF	3F
TILDE	007E	7E	7E	7E	7E
OVERLINE	203E	3F	3F	20	3F
HORIZONTAL BAR	2015	815C	815C	A1BD	A1BD
EM DASH	2014	3F	3F	3F	3F
REVERSE SOLIDUS	005C	815F	5C	5C	5C



Character Name	ucs2	sjis	cp932	ujis	ejcjpms
FULLWIDTH REVERSE SOLIDUS	FF3C	3F	815F	3F	A1C0
WAVE DASH	301C	8160	3F	A1C1	3F
FULLWIDTH TILDE	FF5E	3F	8160	3F	A1C1
DOUBLE VERTICAL LINE	2016	8161	3F	A1C2	3F
PARALLEL TO	2225	3F	8161	3F	A1C2
MINUS SIGN	2212	817C	3F	A1DD	3F
FULLWIDTH HYPHEN-MINUS	FF0D	3F	817C	3F	A1DD
CENT SIGN	00A2	8191	3F	A1F1	3F
FULLWIDTH CENT SIGN	FFE0	3F	8191	3F	A1F1
POUND SIGN	00A3	8192	3F	A1F2	3F
FULLWIDTH POUND SIGN	FFE1	3F	8192	3F	A1F2
NOT SIGN	00AC	81CA	3F	A2CC	3F
FULLWIDTH NOT SIGN	FFE2	3F	81CA	3F	A2CC

Now consider the following portion of the table.

	ucs2	sjis	cp932
NOT SIGN	00AC	81CA	3F
FULLWIDTH NOT SIGN	FFE2	3F	81CA

This means that MySQL converts the `NOT SIGN` (Unicode `U+00AC`) to `sjis` code point `0x81CA` and to `cp932` code point `3F`. (`3F` is the question mark (“?”). This is what is always used when the conversion cannot be performed.)

#### A.11.5 What should I do if I want to convert SJIS `81CA` to `cp932`?

Our answer is: “?”. There are disadvantages to this, and many people would prefer a “loose” conversion, so that `81CA` (`NOT SIGN`) in `sjis` becomes `81CA` (`FULLWIDTH NOT SIGN`) in `cp932`.

#### A.11.6 How does MySQL represent the Yen (¥) sign?

A problem arises because some versions of Japanese character sets (both `sjis` and `ejc`) treat `5C` as a *reverse solidus* (`\`, also known as a backslash), whereas others treat it as a yen sign (¥).

MySQL follows only one version of the JIS (Japanese Industrial Standards) standard description. In MySQL, *5C* is always the reverse solidus (`\`).

#### A.11.7 Of what issues should I be aware when working with Korean character sets in MySQL?

In theory, while there have been several versions of the `euckr` (*Extended Unix Code Korea*) character set, only one problem has been noted. We use the “ASCII” variant of EUC-KR, in which the code point `0x5c` is REVERSE SOLIDUS, that is `\`, instead of the “KS-Roman” variant of EUC-KR, in which the code point `0x5c` is WON SIGN (₩). This means that you cannot convert Unicode `U+20A9` to `euckr`:

```
mysql> SELECT
        CONVERT('₩' USING euckr) AS euckr,
        HEX(CONVERT('₩' USING euckr)) AS hexeuckr;
+-----+-----+
| euckr | hexeuckr |
+-----+-----+
| ?     | 3F       |
+-----+-----+
```

#### A.11.8 Why do I get `Incorrect string value` error messages?

To see the problem, create a table with one Unicode (`ucs2`) column and one Chinese (`gb2312`) column.

```
mysql> CREATE TABLE ch
        (ucs2 CHAR(3) CHARACTER SET ucs2,
         gb2312 CHAR(3) CHARACTER SET gb2312);
```

In nonstrict SQL mode, try to place the rare character `ㄸ` in both columns.

```
mysql> SET sql_mode = '';
mysql> INSERT INTO ch VALUES ('AㄸB', 'AㄸB');
Query OK, 1 row affected, 1 warning (0.00 sec)
```

The `INSERT` produces a warning. Use the following statement to see what it is:

```
mysql> SHOW WARNINGS\G
***** 1. row *****
Level: Warning
Code: 1366
Message: Incorrect string value: '\xE6\xB1\x8CB' for column 'gb2312' at row 1
```

So it is a warning about the `gb2312` column only.

```
mysql> SELECT ucs2,HEX(ucs2),gb2312,HEX(gb2312) FROM ch;
+-----+-----+-----+-----+
| ucs2 | HEX(ucs2) | gb2312 | HEX(gb2312) |
+-----+-----+-----+-----+
| AㄸB | 00416C4C0042 | A?B | 413F42 |
+-----+-----+-----+-----+
```

Several things need explanation here:

1. The `ㄸ` character is not in the `gb2312` character set, as described earlier.
2. If you are using an old version of MySQL, you may see a different message.
3. A warning occurs rather than an error because MySQL is not set to use strict SQL mode. In nonstrict mode, MySQL tries to do what it can, to get the best fit, rather than give up. With

strict SQL mode, the `Incorrect string value` message occurs as an error rather than a warning, and the `INSERT` fails.

**A.11.9** Why does my GUI front end or browser display CJK characters incorrectly in my application using Access, PHP, or another API?

Obtain a direct connection to the server using the `mysql` client, and try the same query there. If `mysql` responds correctly, the trouble may be that your application interface requires initialization. Use `mysql` to tell you what character set or sets it uses with the statement `SHOW VARIABLES LIKE 'char%'`. If you are using Access, you are most likely connecting with Connector/ODBC. In this case, you should check [Configuring Connector/ODBC](#). If, for example, you use `big5`, you would enter `SET NAMES 'big5'`. (In this case, no `;` character is required.) If you are using ASP, you might need to add `SET NAMES` in the code. Here is an example that has worked in the past:

```
<%
Session.CodePage=0
Dim strConnection
Dim Conn
strConnection="driver={MySQL ODBC 3.51 Driver};server=server;uid=username;" \
& "pwd=password;database=database;stmt=SET NAMES 'big5';"
Set Conn = Server.CreateObject("ADODB.Connection")
Conn.Open strConnection
%>
```

In much the same way, if you are using any character set other than `latin1` with Connector/NET, you must specify the character set in the connection string. See [Connector/NET Connections](#), for more information.

If you are using PHP, try this:

```
<?php
$link = new mysqli($host, $usr, $pwd, $db);

if( mysqli_connect_errno() )
{
    printf("Connect failed: %s\n", mysqli_connect_error());
    exit();
}

$link->query("SET NAMES 'utf8'");
?>
```

In this case, we used `SET NAMES` to change `character_set_client`, `character_set_connection`, and `character_set_results`.

Another issue often encountered in PHP applications has to do with assumptions made by the browser. Sometimes adding or changing a `<meta>` tag suffices to correct the problem: for example, to insure that the user agent interprets page content as UTF-8, include `<meta http-equiv="Content-Type" content="text/html; charset=utf-8">` in the `<head>` section of the HTML page.

If you are using Connector/J, see [Using Character Sets and Unicode](#).

**A.11.10** I've upgraded to MySQL 5.7. How can I revert to behavior like that in MySQL 4.0 with regard to character sets?

In MySQL Version 4.0, there was a single “global” character set for both server and client, and the decision as to which character to use was made by the server administrator. This changed starting with MySQL Version 4.1. What happens now is a “handshake”, as described in [Section 10.4, “Connection Character Sets and Collations”](#):

When a client connects, it sends to the server the name of the character set that it wants to use. The server uses the name to set the `character_set_client`, `character_set_results`, and `character_set_connection` system variables. In effect, the server performs a `SET NAMES` operation using the character set name.

The effect of this is that you cannot control the client character set by starting `mysqld` with `--character-set-server=utf8`. However, some Asian customers prefer the MySQL 4.0 behavior. To make it possible to retain this behavior, we added a `mysqld` switch, `--character-set-client-handshake`, which can be turned off with `--skip-character-set-client-handshake`. If you start `mysqld` with `--skip-character-set-client-handshake`, then, when a client connects, it sends to the server the name of the character set that it wants to use. However, *the server ignores this request from the client*.

By way of example, suppose that your favorite server character set is `latin1`. Suppose further that the client uses `utf8` because this is what the client's operating system supports. Start the server with `latin1` as its default character set:

```
mysqld --character-set-server=latin1
```

And then start the client with the default character set `utf8`:

```
mysql --default-character-set=utf8
```

The resulting settings can be seen by viewing the output of `SHOW VARIABLES`:

```
mysql> SHOW VARIABLES LIKE 'char%';
+-----+-----+
| Variable_name | Value |
+-----+-----+
| character_set_client | utf8 |
| character_set_connection | utf8 |
| character_set_database | latin1 |
| character_set_filesystem | binary |
| character_set_results | utf8 |
| character_set_server | latin1 |
| character_set_system | utf8 |
| character_sets_dir | /usr/local/mysql/share/mysql/charsets/ |
+-----+-----+
```

Now stop the client, and stop the server using `mysqladmin`. Then start the server again, but this time tell it to skip the handshake like so:

```
mysqld --character-set-server=utf8 --skip-character-set-client-handshake
```

Start the client with `utf8` once again as the default character set, then display the resulting settings:

```
mysql> SHOW VARIABLES LIKE 'char%';
+-----+-----+
| Variable_name | Value |
+-----+-----+
| character_set_client | latin1 |
| character_set_connection | latin1 |
| character_set_database | latin1 |
| character_set_filesystem | binary |
| character_set_results | latin1 |
| character_set_server | latin1 |
| character_set_system | utf8 |
| character_sets_dir | /usr/local/mysql/share/mysql/charsets/ |
+-----+-----+
```

As you can see by comparing the differing results from `SHOW VARIABLES`, the server ignores the client's initial settings if the `--skip-character-set-client-handshake` option is used.

#### A.11.1 Why do some `LIKE` and `FULLTEXT` searches with CJK characters fail?

For `LIKE` searches, there is a very simple problem with binary string column types such as `BINARY` and `BLOB`: we must know where characters end. With multibyte character sets, different characters might have different octet lengths. For example, in `utf8`, `A` requires one byte but `^` requires three bytes, as shown here:

```
+-----+-----+
| OCTET_LENGTH(_utf8 'A') | OCTET_LENGTH(_utf8 '^') |
+-----+-----+
|                1 |                3 |
+-----+-----+
```

If we do not know where the first character in a string ends, we do not know where the second character begins, in which case even very simple searches such as `LIKE '_A%'` fail. The solution is to use a nonbinary string column type defined to have the proper CJK character set. For example: `mycol TEXT CHARACTER SET sjis`. Alternatively, convert to a CJK character set before comparing.

This is one reason why MySQL cannot permit encodings of nonexistent characters. If it is not strict about rejecting bad input, it has no way of knowing where characters end.

For `FULLTEXT` searches, we must know where words begin and end. With Western languages, this is rarely a problem because most (if not all) of these use an easy-to-identify word boundary: the space character. However, this is not usually the case with Asian writing. We could use arbitrary halfway measures, like assuming that all Han characters represent words, or (for Japanese) depending on changes from Katakana to Hiragana due to grammatical endings. However, the only sure solution requires a comprehensive word list, which means that we would have to include a dictionary in the server for each Asian language supported. This is simply not feasible.

#### A.11.2 How do I know whether character `x` is available in all character sets?

The majority of simplified Chinese and basic nonhalfwidth Japanese Kana characters appear in all CJK character sets. The following stored procedure accepts a `UCS-2` Unicode character, converts it to other character sets, and displays the results in hexadecimal.

```
DELIMITER //

CREATE PROCEDURE p_convert(ucs2_char CHAR(1) CHARACTER SET ucs2)
BEGIN

CREATE TABLE tj
    (ucs2 CHAR(1) character set ucs2,
    utf8 CHAR(1) character set utf8,
    big5 CHAR(1) character set big5,
    cp932 CHAR(1) character set cp932,
    eucjpms CHAR(1) character set eucjpms,
    euckr CHAR(1) character set euckr,
    gb2312 CHAR(1) character set gb2312,
    gbk CHAR(1) character set gbk,
    sjis CHAR(1) character set sjis,
    ujis CHAR(1) character set ujis);

INSERT INTO tj (ucs2) VALUES (ucs2_char);

UPDATE tj SET utf8=ucs2,
    big5=ucs2,
```

```

        cp932=ucs2,
        eucjpms=ucs2,
        euckr=ucs2,
        gb2312=ucs2,
        gbk=ucs2,
        sjis=ucs2,
        ujis=ucs2;

/* If there are conversion problems, UPDATE produces warnings. */

SELECT hex(ucs2) AS ucs2,
       hex(utf8) AS utf8,
       hex(big5) AS big5,
       hex(cp932) AS cp932,
       hex(eucjpms) AS eucjpms,
       hex(euckr) AS euckr,
       hex(gb2312) AS gb2312,
       hex(gbk) AS gbk,
       hex(sjis) AS sjis,
       hex(ujis) AS ujis
FROM tj;

DROP TABLE tj;

END//

DELIMITER ;

```

The input can be any single `ucs2` character, or it can be the code value (hexadecimal representation) of that character. For example, from Unicode's list of `ucs2` encodings and names (<http://www.unicode.org/Public/UNIDATA/UnicodeData.txt>), we know that the Katakana character *Pe* appears in all CJK character sets, and that its code value is `X'30DA'`. If we use this value as the argument to `p_convert()`, the result is as shown here:

```

mysql> CALL p_convert(X'30DA');
+-----+-----+-----+-----+-----+-----+-----+-----+-----+-----+
| ucs2 | utf8   | big5   | cp932 | eucjpms | euckr  | gb2312 | gbk    | sjis    | ujis    |
+-----+-----+-----+-----+-----+-----+-----+-----+-----+-----+
| 30DA | E3839A | C772   | 8379  | A5DA    | ABDA   | A5DA    | A5DA   | 8379    | A5DA    |
+-----+-----+-----+-----+-----+-----+-----+-----+-----+-----+

```

Since none of the column values is `3F` (that is, the question mark character, `?`), we know that every conversion worked.

#### A.11.13 Why do CJK strings sort incorrectly in Unicode? (I)



##### Note

The CJK sorting problems described here can occur for MySQL versions prior to MySQL 8.0. As of MySQL 8.0, they can be solved by using the `utf8mb4` character set and the `utf8mb4_ja_0900_as_cs` collation.

Sometimes people observe that the result of a `utf8_unicode_ci` or `ucs2_unicode_ci` search, or of an `ORDER BY` sort is not what they think a native would expect. Although we never rule out the possibility that there is a bug, we have found in the past that many people do not correctly read the standard table of weights for the Unicode Collation Algorithm. MySQL uses the tables found under <http://www.unicode.org/Public/UCA/>:

- UCA 4.0.0 table: <http://www.unicode.org/Public/UCA/4.0.0/allkeys-4.0.0.txt>

This includes `xxx_unicode_ci` collations with no version number in the collation name.

- UCA 5.2.0 table: <http://www.unicode.org/Public/UCA/5.2.0/allkeys.txt>

This includes collations with `_520_` in the collation name.

- UCA 9.0.0 table: <http://www.unicode.org/Public/UCA/9.0.0/allkeys.txt>

This includes collations with `_0900_` in the collation name.

To handle newer UCA versions, we create new collations. We are very wary about changing ordering of existing collations because that affects indexes, which can bring about situations such as that reported in Bug #16526, illustrated as follows:

```
mysql> CREATE TABLE tj (s1 CHAR(1) CHARACTER SET utf8 COLLATE utf8_unicode_ci);
Query OK, 0 rows affected (0.05 sec)

mysql> INSERT INTO tj VALUES ('が'),('か');
Query OK, 2 rows affected (0.00 sec)
Records: 2 Duplicates: 0 Warnings: 0

mysql> SELECT * FROM tj WHERE s1 = 'か';
+-----+
| s1    |
+-----+
| が    |
| か    |
+-----+
```

The character in the first result row is not the one that we searched for. Why did MySQL retrieve it? First we look for the Unicode code point value, which is possible by reading the hexadecimal number for the `ucs2` version of the characters:

```
mysql> SELECT s1, HEX(CONVERT(s1 USING ucs2)) FROM tj;
+-----+-----+
| s1    | HEX(CONVERT(s1 USING ucs2)) |
+-----+-----+
| が    | 304C                         |
| か    | 304B                         |
+-----+-----+
```

Now we search for `304B` and `304C` in the `4.0.0 allkeys` table, and find these lines:

```
304B ; [.1E57.0020.000E.304B] # HIRAGANA LETTER KA
304C ; [.1E57.0020.000E.304B][.0000.0140.0002.3099] # HIRAGANA LETTER GA; QQCM
```

The official Unicode names (following the “#” mark) tell us the Japanese syllabary (Hiragana), the informal classification (letter, digit, or punctuation mark), and the Western identifier (*KA* or *GA*, which happen to be voiced and unvoiced components of the same letter pair). More importantly, the *primary weight* (the first hexadecimal number inside the square brackets) is `1E57` on both lines. For comparisons in both searching and sorting, MySQL pays attention to the primary weight only, ignoring all the other numbers. This means that we are sorting `が` and `か` correctly according to the Unicode specification. If we wanted to distinguish them, we'd have to use a non-UCA (Unicode Collation Algorithm) collation (`utf8_bin` or `utf8_general_ci`), or to compare the `HEX()` values, or use `ORDER BY CONVERT(s1 USING sjis)`. Being correct “according to Unicode” is not enough, of course: the person who submitted the bug was equally correct. To solve this, we need another collation for Japanese according to the JIS X 4061 standard, in which voiced/unvoiced letter pairs like *KA/GA* are distinguishable for ordering purposes.

#### A.11.14 Why do CJK strings sort incorrectly in Unicode? (II)

**Note**

The CJK sorting problems described here can occur for MySQL versions prior to MySQL 8.0. As of MySQL 8.0, they can be solved by using the `utf8mb4` character set and the `utf8mb4_ja_0900_as_cs` collation.

If you are using Unicode (`ucs2` or `utf8`), and you know what the Unicode sort order is (see [Section A.11, “MySQL 5.7 FAQ: MySQL Chinese, Japanese, and Korean Character Sets”](#)), but MySQL still seems to sort your table incorrectly, first verify the character set in the table definition:

```
mysql> SHOW CREATE TABLE t\G
***** 1. row *****
Table: t
Create Table: CREATE TABLE `t` (
`s1` char(1) CHARACTER SET ucs2 DEFAULT NULL
) ENGINE=MyISAM DEFAULT CHARSET=latin1
```

Since the character set for the column `s1` appears to be correct (`ucs2`), check what information the `INFORMATION_SCHEMA.COLUMNS` table can provide about this column:

```
mysql> SELECT COLUMN_NAME, CHARACTER_SET_NAME, COLLATION_NAME
FROM INFORMATION_SCHEMA.COLUMNS
WHERE COLUMN_NAME = 's1'
AND TABLE_NAME = 't';
```

COLUMN_NAME	CHARACTER_SET_NAME	COLLATION_NAME
s1	ucs2	ucs2_general_ci

(See [Section 24.3.5, “The INFORMATION\\_SCHEMA COLUMNS Table”](#), for more information.)

You can see that the collation is `ucs2_general_ci` instead of `ucs2_unicode_ci`. The reason why this is so can be found using `SHOW CHARACTER SET`, as shown here:

```
mysql> SHOW CHARACTER SET LIKE 'ucs2%';
```

Charset	Description	Default collation	Maxlen
ucs2	UCS-2 Unicode	ucs2_general_ci	2

For `ucs2` and `utf8`, the default collation is “general”. To specify a Unicode UCA collation, use `COLLATE ucs2_unicode_ci`, as shown in the preceding item.

**A.11.15** Why are my supplementary characters rejected by MySQL?

Supplementary characters lie outside the Unicode *Basic Multilingual Plane / Plane 0*. BMP characters have code point values between `U+0000` and `U+FFFF`. Supplementary characters have code point values between `U+10000` and `U+10FFFF`.

To store supplementary characters, you must use a character set that permits them:

- The `utf8` and `ucs2` character sets support BMP characters only.

The `utf8` character set permits only `UTF-8` characters that take up to three bytes. This has led to reports such as that found in [Bug #12600](#), which we rejected as “not a bug”. With `utf8`, MySQL



must truncate an input string when it encounters bytes that it does not understand. Otherwise, it is unknown how long the bad multibyte character is.

One possible workaround is to use `ucs2` instead of `utf8`, in which case the “bad” characters are changed to question marks. However, no truncation takes place. You can also change the data type to `BLOB` or `BINARY`, which perform no validity checking.

- The `utf8mb4`, `utf16`, `utf16le`, and `utf32` character sets support BMP characters, as well as supplementary characters outside the BMP.

#### A.11.16 Should “CJK” be “CJKV”?

No. The term “CJKV” (*Chinese Japanese Korean Vietnamese*) refers to Vietnamese character sets which contain Han (originally Chinese) characters. MySQL supports the modern Vietnamese script with Western characters, but does not support the old Vietnamese script using Han characters.

As of MySQL 5.6, there are Vietnamese collations for Unicode character sets, as described in [Section 10.10.1, “Unicode Character Sets”](#).

#### A.11.17 Does MySQL permit CJK characters to be used in database and table names?

Yes.

#### A.11.18 Where can I find translations of the MySQL Manual into Chinese, Japanese, and Korean?

The Japanese translation of the MySQL 5.6 manual can be downloaded from <https://dev.mysql.com/doc/>.

#### A.11.19 Where can I get help with CJK and related issues in MySQL?

The following resources are available:

- A listing of MySQL user groups can be found at <https://wikis.oracle.com/display/mysql/List+of+MySQL+User+Groups>.
- View feature requests relating to character set issues at <http://tinyurl.com/y6xcuf>.
- Visit the MySQL [Character Sets, Collation, Unicode Forum](#). <http://forums.mysql.com/> also provides foreign-language forums.

## A.12 MySQL 5.7 FAQ: Connectors & APIs

For common questions, issues, and answers relating to the MySQL Connectors and other APIs, see the following areas of the Manual:

- [Using C API Features](#)
- [Connector/ODBC Notes and Tips](#)
- [Connector/NET Programming](#)
- [MySQL Connector/J Developer Guide](#)

## A.13 MySQL 5.7 FAQ: C API, libmysql

Frequently asked questions about MySQL C API and libmysql.

A.13.1 What is “MySQL Native C API”? What are typical benefits and use cases? ..... 4532

A.13.2 Which version of libmysql should I use? .....	4532
A.13.3 What if I want to use the “NoSQL” X DevAPI? .....	4532
A.13.4 How to I download libmysql? .....	4532
A.13.5 Where is the documentation? .....	4532
A.13.6 How do I report bugs? .....	4532
A.13.7 Is it possible to compile the library myself? .....	4532

**A.13.1**What is “MySQL Native C API”? What are typical benefits and use cases?

libmysql is a C-based API that you can use in C applications to connect with the MySQL database server. It is also itself used as the foundation for drivers for standard database APIs like ODBC, Perl's DBI, and Python's DB API.

**A.13.2**Which version of libmysql should I use?

For MySQL 8.0 and 5.7 we recommend libmysql 8.0.

**A.13.3**What if I want to use the “NoSQL” X DevAPI?

For C-language and X DevApi Document Store for MySQL, we recommend MySQL Connector/C++. Connector/C++ has compatible C headers. (This is not applicable to MySQL 5.7 or before.)

**A.13.4**How to I download libmysql?

- Linux: The Client Utilities Package is available from the [MySQL Community Server](#) download page.
- Repos: The Client Utilities Package is available from the [Yum](#), [APT](#), [SuSE repositories](#).
- Windows: The Client Utilities Package is available from [Windows Installer](#).

**A.13.5**Where is the documentation?

See [MySQL 5.7 C API Developer Guide](#).

**A.13.6**How do I report bugs?

Please report any bugs or inconsistencies you observe to our [Bugs Database](#). Select the C API Client as shown.

**A.13.7**Is it possible to compile the library myself?

Compiling MySQL Server also compiles libmysqlclient; there is not a way to only compile libmysqlclient. For related information, see [MySQL C API Implementations](#).

## A.14 MySQL 5.7 FAQ: Replication

In the following section, we provide answers to questions that are most frequently asked about MySQL Replication.

A.14.1 Must the replica be connected to the source all the time? .....	4533
A.14.2 Must I enable networking on my source and replica to enable replication? .....	4533
A.14.3 How do I know how late a replica is compared to the source? In other words, how do I know the date of the last statement replicated by the replica? .....	4533
A.14.4 How do I force the source to block updates until the replica catches up? .....	4533
A.14.5 What issues should I be aware of when setting up two-way replication? .....	4534

A.14.6 How can I use replication to improve performance of my system? .....	4534
A.14.7 What should I do to prepare client code in my own applications to use performance-enhancing replication? .....	4534
A.14.8 When and how much can MySQL replication improve the performance of my system? .....	4534
A.14.9 How can I use replication to provide redundancy or high availability? .....	4535
A.14.10 How do I tell whether a replication source server is using statement-based or row-based binary logging format? .....	4536
A.14.11 How do I tell a replica to use row-based replication? .....	4536
A.14.12 How do I prevent <code>GRANT</code> and <code>REVOKE</code> statements from replicating to replica machines? .....	4536
A.14.13 Does replication work on mixed operating systems (for example, the source runs on Linux while replicas run on macOS and Windows)? .....	4536
A.14.14 Does replication work on mixed hardware architectures (for example, the source runs on a 64-bit machine while replicas run on 32-bit machines)? .....	4536

#### A.14.1 Must the replica be connected to the source all the time?

No, it does not. The replica can go down or stay disconnected for hours or even days, and then reconnect and catch up on updates. For example, you can set up a source/replica relationship over a dial-up link where the link is up only sporadically and for short periods of time. The implication of this is that, at any given time, the replica is not guaranteed to be in synchrony with the source unless you take some special measures.

To ensure that catchup can occur for a replica that has been disconnected, you must not remove binary log files from the source that contain information that has not yet been replicated to the replicas. Asynchronous replication can work only if the replica is able to continue reading the binary log from the point where it last read events.

#### A.14.2 Must I enable networking on my source and replica to enable replication?

Yes, networking must be enabled on the source and replica. If networking is not enabled, the replica cannot connect to the source and transfer the binary log. Verify that the `skip_networking` system variable has not been enabled in the configuration file for either server.

#### A.14.3 How do I know how late a replica is compared to the source? In other words, how do I know the date of the last statement replicated by the replica?

Check the `Seconds_Behind_Master` column in the output from `SHOW REPLICATION | SLAVE STATUS`. See [Section 16.1.7.1, “Checking Replication Status”](#).

When the replication SQL thread executes an event read from the source, it modifies its own time to the event timestamp. (This is why `TIMESTAMP` is well replicated.) In the `Time` column in the output of `SHOW PROCESSLIST`, the number of seconds displayed for the replication SQL thread is the number of seconds between the timestamp of the last replicated event and the real time of the replica machine. You can use this to determine the date of the last replicated event. Note that if your replica has been disconnected from the source for one hour, and then reconnects, you may immediately see large `Time` values such as 3600 for the replication SQL thread in `SHOW PROCESSLIST`. This is because the replica is executing statements that are one hour old. See [Section 16.2.3, “Replication Threads”](#).

#### A.14.4 How do I force the source to block updates until the replica catches up?

Use the following procedure:

1. On the source, execute these statements:

```
mysql> FLUSH TABLES WITH READ LOCK;
mysql> SHOW MASTER STATUS;
```

Record the replication coordinates (the current binary log file name and position) from the output of the `SHOW` statement.

2. On the replica, issue the following statement, where the arguments to the `SOURCE_POS_WAIT()` or `MASTER_POS_WAIT()` function are the replication coordinate values obtained in the previous step:

```
mysql> SELECT MASTER_POS_WAIT('log_name', log_pos);  
  
Or from MySQL 8.0.26:  
mysql> SELECT SOURCE_POS_WAIT('log_name', log_pos);
```

The `SELECT` statement blocks until the replica reaches the specified log file and position. At that point, the replica is in synchrony with the source and the statement returns.

3. On the source, issue the following statement to enable the source to begin processing updates again:

```
mysql> UNLOCK TABLES;
```

#### A.14.5 What issues should I be aware of when setting up two-way replication?

MySQL replication currently does not support any locking protocol between source and replica to guarantee the atomicity of a distributed (cross-server) update. In other words, it is possible for client A to make an update to co-source 1, and in the meantime, before it propagates to co-source 2, client B could make an update to co-source 2 that makes the update of client A work differently than it did on co-source 1. Thus, when the update of client A makes it to co-source 2, it produces tables that are different from what you have on co-source 1, even after all the updates from co-source 2 have also propagated. This means that you should not chain two servers together in a two-way replication relationship unless you are sure that your updates can safely happen in any order, or unless you take care of mis-ordered updates somehow in the client code.

You should also realize that two-way replication actually does not improve performance very much (if at all) as far as updates are concerned. Each server must do the same number of updates, just as you would have a single server do. The only difference is that there is a little less lock contention because the updates originating on another server are serialized in one replication thread. Even this benefit might be offset by network delays.

#### A.14.6 How can I use replication to improve performance of my system?

Set up one server as the source and direct all writes to it. Then configure as many replicas as you have the budget and rackspace for, and distribute the reads among the source and the replicas. You can also start the replicas with the `--skip-innodb` option, enable the `low_priority_updates` system variable, and set the `delay_key_write` system variable to `ALL` to get speed improvements on the replica end. In this case, the replica uses nontransactional `MyISAM` tables instead of `InnoDB` tables to get more speed by eliminating transactional overhead.

#### A.14.7 What should I do to prepare client code in my own applications to use performance-enhancing replication?

See the guide to using replication as a scale-out solution, [Section 16.3.4, "Using Replication for Scale-Out"](#).

#### A.14.8 When and how much can MySQL replication improve the performance of my system?

MySQL replication is most beneficial for a system that processes frequent reads and infrequent writes. In theory, by using a single-source/multiple-replica setup, you can scale the system by

adding more replicas until you either run out of network bandwidth, or your update load grows to the point that the source cannot handle it.

To determine how many replicas you can use before the added benefits begin to level out, and how much you can improve performance of your site, you must know your query patterns, and determine empirically by benchmarking the relationship between the throughput for reads and writes on a typical source and a typical replica. The example here shows a rather simplified calculation of what you can get with replication for a hypothetical system. Let `reads` and `writes` denote the number of reads and writes per second, respectively.

Let's say that system load consists of 10% writes and 90% reads, and we have determined by benchmarking that `reads` is  $1200 - 2 * \text{writes}$ . In other words, the system can do 1,200 reads per second with no writes, the average write is twice as slow as the average read, and the relationship is linear. Suppose that the source and each replica have the same capacity, and that we have one source and  $N$  replicas. Then we have for each server (source or replica):

$$\text{reads} = 1200 - 2 * \text{writes}$$

$$\text{reads} = 9 * \text{writes} / (N + 1) \text{ (reads are split, but writes replicated to all replicas)}$$

$$9 * \text{writes} / (N + 1) + 2 * \text{writes} = 1200$$

$$\text{writes} = 1200 / (2 + 9/(N + 1))$$

The last equation indicates the maximum number of writes for  $N$  replicas, given a maximum possible read rate of 1,200 per second and a ratio of nine reads per write.

This analysis yields the following conclusions:

- If  $N = 0$  (which means we have no replication), our system can handle about  $1200/11 = 109$  writes per second.
- If  $N = 1$ , we get up to 184 writes per second.
- If  $N = 8$ , we get up to 400 writes per second.
- If  $N = 17$ , we get up to 480 writes per second.
- Eventually, as  $N$  approaches infinity (and our budget negative infinity), we can get very close to 600 writes per second, increasing system throughput about 5.5 times. However, with only eight servers, we increase it nearly four times.

These computations assume infinite network bandwidth and neglect several other factors that could be significant on your system. In many cases, you may not be able to perform a computation similar to the one just shown that accurately predicts what happens on your system if you add  $N$  replicas. However, answering the following questions should help you decide whether and by how much replication may improve the performance of your system:

- What is the read/write ratio on your system?
- How much more write load can one server handle if you reduce the reads?
- For how many replicas do you have bandwidth available on your network?

#### **A.14.9**How can I use replication to provide redundancy or high availability?

How you implement redundancy is entirely dependent on your application and circumstances. High-availability solutions (with automatic failover) require active monitoring and either custom scripts or third party tools to provide the failover support from the original MySQL server to the replica.

To handle the process manually, you should be able to switch from a failed source to a pre-configured replica by altering your application to talk to the new server or by adjusting the DNS for the MySQL server from the failed server to the new server.

For more information and some example solutions, see [Section 16.3.7, “Switching Sources During Failover”](#).

**A.14.10** How do I tell whether a replication source server is using statement-based or row-based binary logging format?

Check the value of the `binlog_format` system variable:

```
mysql> SHOW VARIABLES LIKE 'binlog_format';
```

The value shown is always one of `STATEMENT`, `ROW`, or `MIXED`. For `MIXED` mode, statement-based logging is used by default but replication switches automatically to row-based logging under certain conditions, such as unsafe statements. For information about when this may occur, see [Section 5.4.4.3, “Mixed Binary Logging Format”](#).

**A.14.11** How do I tell a replica to use row-based replication?

Replicas automatically know which format to use.

**A.14.12** How do I prevent `GRANT` and `REVOKE` statements from replicating to replica machines?

Start the server with the `--replicate-wild-ignore-table=mysql.%` option to ignore replication for tables in the `mysql` database.

**A.14.13** Does replication work on mixed operating systems (for example, the source runs on Linux while replicas run on macOS and Windows)?

Yes.

**A.14.14** Does replication work on mixed hardware architectures (for example, the source runs on a 64-bit machine while replicas run on 32-bit machines)?

Yes.

## A.15 MySQL 5.7 FAQ: MySQL Enterprise Thread Pool

A.15.1 What is the Thread Pool and what problem does it solve? .....	4536
A.15.2 How does the Thread Pool limit and manage concurrent sessions and transactions for optimal performance and throughput? .....	4537
A.15.3 How is the Thread Pool different from the client side Connection Pool? .....	4537
A.15.4 When should I use the Thread Pool? .....	4537
A.15.5 Are there recommended Thread Pool configurations? .....	4537

**A.15.1** What is the Thread Pool and what problem does it solve?

The MySQL Thread Pool is a MySQL server plugin that extends the default connection-handling capabilities of the MySQL server to limit the number of concurrently executing statements/queries and transactions to ensure that each has sufficient CPU and memory resources to fulfill its task. For MySQL 5.7, the Thread Pool plugin is included in MySQL Enterprise Edition, a commercial product.

The default thread-handling model in MySQL Server executes statements using one thread per client connection. As more clients connect to the server and execute statements, overall performance degrades. The Thread Pool plugin provides an alternative thread-handling model designed to reduce overhead and improve performance. The Thread Pool plugin increases server performance by efficiently managing statement execution threads for large numbers of client connections, especially on modern multi-CPU/Core systems.

For more information, see [Section 5.5.3, “MySQL Enterprise Thread Pool”](#).

**A.15.2**How does the Thread Pool limit and manage concurrent sessions and transactions for optimal performance and throughput?

The Thread Pool uses a “divide and conquer” approach to limiting and balancing concurrency. Unlike the default connection handling of the MySQL Server, the Thread Pool separates connections and threads, so there is no fixed relationship between connections and the threads that execute statements received from those connections. The Thread Pool then manages client connections within configurable thread groups, where they are prioritized and queued based on the nature of the work they were submitted to accomplish.

For more information, see [Section 5.5.3.3, “Thread Pool Operation”](#).

**A.15.3**How is the Thread Pool different from the client side Connection Pool?

The MySQL Connection Pool operates on the client side to ensure that a MySQL client does not constantly connect to and disconnect from the MySQL server. It is designed to cache idle connections in the MySQL client for use by other users as they are needed. This minimizes the overhead and expense of establishing and tearing down connections as queries are submitted to the MySQL server. The MySQL Connection Pool has no visibility as to the query handling capabilities or load of the back-end MySQL server. By contrast, the Thread Pool operates on the MySQL server side and is designed to manage the execution of inbound concurrent connections and queries as they are received from the client connections accessing the back-end MySQL database. Because of the separation of duties, the MySQL Connection Pool and Thread Pool are orthogonal and can be used independent of each other.

MySQL Connection Pooling via the MySQL Connectors is covered in [Chapter 27, Connectors and APIs](#).

**A.15.4**When should I use the Thread Pool?

There are a few rules of thumb to consider for optimal Thread Pool use cases:

The MySQL `Threads_running` variable keeps track of the number of concurrent statements currently executing in the MySQL Server. If this variable consistently exceeds a region where the server won't operate optimally (usually going beyond 40 for InnoDB workloads), the Thread Pool should be beneficial, especially in extreme parallel overload situations.

If you are using the `innodb_thread_concurrency` to limit the number of concurrently executing statements, you should find that the Thread Pool solves the same problem, only better, by assigning connections to thread groups, then queuing executions based on transactional content, user defined designations, and so forth.

Lastly, if your workload comprises mainly short queries, the Thread Pool should be beneficial.

To learn more, see [Section 5.5.3.4, “Thread Pool Tuning”](#).

**A.15.5**Are there recommended Thread Pool configurations?

The Thread Pool has a number of user case driven configuration parameters that affect its performance. To learn about these and tips on tuning, see [Section 5.5.3.4, “Thread Pool Tuning”](#).

## A.16 MySQL 5.7 FAQ: InnoDB Change Buffer

A.16.1 What types of operations modify secondary indexes and result in change buffering? .....	4538
A.16.2 What is the benefit of the <a href="#">InnoDB</a> change buffer? .....	4538
A.16.3 Does the change buffer support other types of indexes? .....	4538
A.16.4 How much space does <a href="#">InnoDB</a> use for the change buffer? .....	4538
A.16.5 How do I determine the current size of the change buffer? .....	4538
A.16.6 When does change buffer merging occur? .....	4539
A.16.7 When is the change buffer flushed? .....	4539
A.16.8 When should the change buffer be used? .....	4539
A.16.9 When should the change buffer not be used? .....	4539
A.16.10 Where can I find additional information about the change buffer? .....	4539

### A.16.1 What types of operations modify secondary indexes and result in change buffering?

[INSERT](#), [UPDATE](#), and [DELETE](#) operations can modify secondary indexes. If an affected index page is not in the buffer pool, the changes can be buffered in the change buffer.

### A.16.2 What is the benefit of the [InnoDB](#) change buffer?

Buffering secondary index changes when secondary index pages are not in the buffer pool avoids expensive random access I/O operations that would be required to immediately read in affected index pages from disk. Buffered changes can be applied later, in batches, as pages are read into the buffer pool by other read operations.

### A.16.3 Does the change buffer support other types of indexes?

No. The change buffer only supports secondary indexes. Clustered indexes, full-text indexes, and spatial indexes are not supported. Full-text indexes have their own caching mechanism.

### A.16.4 How much space does [InnoDB](#) use for the change buffer?

Prior to the introduction of the [innodb\\_change\\_buffer\\_max\\_size](#) configuration option in MySQL 5.6, the maximum size of the on-disk change buffer in the system tablespace was 1/3 of the [InnoDB](#) buffer pool size.

In MySQL 5.6 and later, the [innodb\\_change\\_buffer\\_max\\_size](#) configuration option defines the maximum size of the change buffer as a percentage of the total buffer pool size. By default, [innodb\\_change\\_buffer\\_max\\_size](#) is set to 25. The maximum setting is 50.

[InnoDB](#) does not buffer an operation if it would cause the on-disk change buffer to exceed the defined limit.

Change buffer pages are not required to persist in the buffer pool and may be evicted by LRU operations.

### A.16.5 How do I determine the current size of the change buffer?

The current size of the change buffer is reported by [SHOW ENGINE INNODB STATUS \G](#), under the [INSERT BUFFER AND ADAPTIVE HASH INDEX](#) heading. For example:

```
-----
INSERT BUFFER AND ADAPTIVE HASH INDEX
-----
Ibuf: size 1, free list len 0, seg size 2, 0 merges
```



Relevant data points include:

- `size`: The number of pages used within the change buffer. Change buffer size is equal to `seg size - (1 + free list len)`. The `1 +` value represents the change buffer header page.
- `seg size`: The size of the change buffer, in pages.

For information about monitoring change buffer status, see [Section 14.5.2, “Change Buffer”](#).

#### A.16.6 When does change buffer merging occur?

- When a page is read into the buffer pool, buffered changes are merged upon completion of the read, before the page is made available.
- Change buffer merging is performed as a background task. The `innodb_io_capacity` parameter sets an upper limit on the I/O activity performed by InnoDB background tasks such as merging data from the change buffer.
- A change buffer merge is performed during crash recovery. Changes are applied from the change buffer (in the system tablespace) to leaf pages of secondary indexes as index pages are read into the buffer pool.
- The change buffer is fully durable and can survive a system crash. Upon restart, change buffer merge operations resume as part of normal operations.
- A full merge of the change buffer can be forced as part of a slow server shutdown using `--innodb-fast-shutdown=0`.

#### A.16.7 When is the change buffer flushed?

Updated pages are flushed by the same flushing mechanism that flushes the other pages that occupy the buffer pool.

#### A.16.8 When should the change buffer be used?

The change buffer is a feature designed to reduce random I/O to secondary indexes as indexes grow larger and no longer fit in the InnoDB buffer pool. Generally, the change buffer should be used when the entire data set does not fit into the buffer pool, when there is substantial DML activity that modifies secondary index pages, or when there are lots of secondary indexes that are regularly changed by DML activity.

#### A.16.9 When should the change buffer not be used?

You might consider disabling the change buffer if the entire data set fits within the InnoDB buffer pool, if you have relatively few secondary indexes, or if you are using solid-state storage, where random reads are about as fast as sequential reads. Before making configuration changes, it is recommended that you run tests using a representative workload to determine if disabling the change buffer provides any benefit.

#### A.16.10 Where can I find additional information about the change buffer?

See [Section 14.5.2, “Change Buffer”](#).

## A.17 MySQL 5.7 FAQ: InnoDB Data-at-Rest Encryption

A.17.1 Is data decrypted for users who are authorized to see it? ..... 4540

A.17.2 What is the overhead associated with <a href="#">InnoDB</a> data-at-rest encryption? .....	4540
A.17.3 What are the encryption algorithms used with <a href="#">InnoDB</a> data-at-rest encryption? .....	4540
A.17.4 Is it possible to use 3rd party encryption algorithms in place of the one provided by the <a href="#">InnoDB</a> data-at-rest encryption feature? .....	4540
A.17.5 Can indexed columns be encrypted? .....	4540
A.17.6 What data types and data lengths does <a href="#">InnoDB</a> data-at-rest encryption support? .....	4540
A.17.7 Does data remain encrypted on the network? .....	4540
A.17.8 Does database memory contain cleartext or encrypted data? .....	4541
A.17.9 How do I know which data to encrypt? .....	4541
A.17.10 How is <a href="#">InnoDB</a> data-at-rest encryption different from encryption functions MySQL already provides? .....	4541
A.17.11 Does the transportable tablespaces feature work with <a href="#">InnoDB</a> data-at-rest encryption? .....	4541
A.17.12 Does compression work with <a href="#">InnoDB</a> data-at-rest encryption? .....	4541
A.17.13 Can I use <a href="#">mysqldump</a> with encrypted tables? .....	4541
A.17.14 How do I change (rotate, re-key) the master encryption key? .....	4541
A.17.15 How do I migrate data from a cleartext <a href="#">InnoDB</a> tablespace to an encrypted <a href="#">InnoDB</a> tablespace? .....	4541
A.17.16 Can the <a href="#">InnoDB</a> data-at-rest feature store the master encryption key in an external device using the PKSC11 interface? .....	4542

#### A.17.1 Is data decrypted for users who are authorized to see it?

Yes. [InnoDB](#) data-at-rest encryption is designed to transparently apply encryption within the database without impacting existing applications. Returning data in encrypted format would break most existing applications. [InnoDB](#) data-at-rest encryption provides the benefit of encryption without the overhead associated with traditional database encryption solutions, which would typically require expensive and substantial changes to applications, database triggers, and views.

#### A.17.2 What is the overhead associated with [InnoDB](#) data-at-rest encryption?

There is no additional storage overhead. According to internal benchmarks, performance overhead amounts to a single digit percentage difference.

#### A.17.3 What are the encryption algorithms used with [InnoDB](#) data-at-rest encryption?

[InnoDB](#) data-at-rest encryption supports the Advanced Encryption Standard (AES256) block-based encryption algorithm. It uses Electronic Codebook (ECB) block encryption mode for tablespace key encryption and Cipher Block Chaining (CBC) block encryption mode for data encryption.

#### A.17.4 Is it possible to use 3rd party encryption algorithms in place of the one provided by the [InnoDB](#) data-at-rest encryption feature?

No, it is not possible to use other encryption algorithms. The provided encryption algorithm is broadly accepted.

#### A.17.5 Can indexed columns be encrypted?

[InnoDB](#) data-at-rest encryption supports all indexes transparently.

#### A.17.6 What data types and data lengths does [InnoDB](#) data-at-rest encryption support?

[InnoDB](#) data-at-rest encryption supports all supported data types. There is no data length limitation.

#### A.17.7 Does data remain encrypted on the network?

Data encrypted by the [InnoDB](#) data-at-rest feature is decrypted when it is read from the tablespace file. Thus, if the data is on the network, it is in cleartext form. However, data on the network can be

encrypted using MySQL network encryption, which encrypts data traveling to and from a database using SSL/TLS.

**A.17.8** Does database memory contain cleartext or encrypted data?

With [InnoDB](#) data-at-rest encryption, in-memory data is decrypted, which provides complete transparency.

**A.17.9** How do I know which data to encrypt?

Compliance with the PCI-DSS standard requires that credit card numbers (Primary Account Number, or 'PAN') be stored in encrypted form. Breach Notification Laws (for example, CA SB 1386, CA AB 1950, and similar laws in 43+ more US states) require encryption of first name, last name, driver license number, and other PII data. In early 2008, CA AB 1298 added medical and health insurance information to PII data. Additionally, industry specific privacy and security standards may require encryption of certain assets. For example, assets such as pharmaceutical research results, oil field exploration results, financial contracts, or personal data of law enforcement informants may require encryption. In the health care industry, the privacy of patient data, health records and X-ray images is of the highest importance.

**A.17.10** How is [InnoDB](#) data-at-rest encryption different from encryption functions MySQL already provides?

There are symmetric and asymmetric encryption APIs in MySQL that can be used to manually encrypt data within the database. However, the application must manage encryption keys and perform required encryption and decryption operations by calling API functions. [InnoDB](#) data-at-rest encryption requires no application changes, is transparent to end users, and provides automated, built-in key management.

**A.17.11** Does the transportable tablespaces feature work with [InnoDB](#) data-at-rest encryption?

Yes. It is supported for encrypted file-per-table tablespaces. For more information, see [Exporting Encrypted Tablespaces](#).

**A.17.12** Does compression work with [InnoDB](#) data-at-rest encryption?

Customers using [InnoDB](#) data-at-rest encryption receive the full benefit of compression because compression is applied before data blocks are encrypted.

**A.17.13** Can I use `mysqldump` with encrypted tables?

Yes. Because these utilities create logical backups, the data dumped from encrypted tables is not encrypted.

**A.17.14** How do I change (rotate, re-key) the master encryption key?

[InnoDB](#) data-at-rest encryption uses a two tier key mechanism. When data-at-rest encryption is used, individual tablespace keys are stored in the header of the underlying tablespace data file. Tablespace keys are encrypted using the master encryption key. The master encryption key is generated when tablespace encryption is enabled, and is stored outside the database. The master encryption key is rotated using the `ALTER INSTANCE ROTATE INNODB MASTER KEY` statement, which generates a new master encryption key, stores the key, and rotates the key into use.

**A.17.15** How do I migrate data from a cleartext [InnoDB](#) tablespace to an encrypted [InnoDB](#) tablespace?

Transferring data from one tablespace to another is not required. To encrypt data in an [InnoDB](#) file-per-table tablespace, run `ALTER TABLE tbl_name ENCRYPTION = 'Y'`. To encrypt a general tablespace or the `mysql` tablespace, run `ALTER TABLESPACE tablespace_name ENCRYPTION`

= 'Y'. Encryption support for general tablespaces was introduced in MySQL 8.0.13. Encryption support for the [mysql](#) system tablespace is available as of MySQL 8.0.16.

**A.17.16** Can the [InnoDB](#) data-at-rest feature store the master encryption key in an external device using the PKSC11 interface?

Not at this time. Currently, the KMIP 1.1 protocol is supported with the [keyring\\_okv](#) plugin, which is available with MySQL Enterprise Edition.

## A.18 MySQL 5.7 FAQ: Virtualization Support

A.18.1 Is MySQL supported on virtualized environments such as Oracle VM, VMWare, Docker, Microsoft Hyper-V, or others? ..... 4542

**A.18.1** Is MySQL supported on virtualized environments such as Oracle VM, VMWare, Docker, Microsoft Hyper-V, or others?

MySQL is supported on virtualized environments, but is certified only for [Oracle VM](#). Contact Oracle Support for more information.

Be aware of potential problems when using virtualization software. The usual ones are related to performance, performance degradations, slowness, or unpredictability of disk, I/O, network, and memory.

---

# Appendix B Error Messages and Common Problems

## Table of Contents

B.1 Error Message Sources and Elements .....	4543
B.2 Error Information Interfaces .....	4545
B.3 Problems and Common Errors .....	4547
B.3.1 How to Determine What Is Causing a Problem .....	4547
B.3.2 Common Errors When Using MySQL Programs .....	4548
B.3.3 Administration-Related Issues .....	4559
B.3.4 Query-Related Issues .....	4568
B.3.5 Optimizer-Related Issues .....	4575
B.3.6 Table Definition-Related Issues .....	4575
B.3.7 Known Issues in MySQL .....	4577

This appendix describes the types of error information MySQL provides and how to obtain information about them. The final section is for troubleshooting. It describes common problems and errors that may occur and potential resolutions.

## Additional Resources

Other error-related documentation includes:

- Information about configuring where and how the server writes the error log: [Section 5.4.2, “The Error Log”](#)
- Information about the character set used for error messages: [Section 10.6, “Error Message Character Set”](#)
- Information about the language used for error messages: [Section 10.12, “Setting the Error Message Language”](#)
- Information about errors related to [InnoDB](#): [Section 14.22.4, “InnoDB Error Handling”](#)
- Information about errors specific to NDB Cluster: [NDB Cluster API Errors](#); see also [NDB API Errors and Error Handling](#), and [MGM API Errors](#)
- Descriptions of the error messages that the MySQL server and client programs generate: [MySQL 5.7 Error Message Reference](#)

## B.1 Error Message Sources and Elements

This section discusses how error messages originate within MySQL and the elements they contain.

- [Error Message Sources](#)
- [Error Message Elements](#)

### Error Message Sources

Error messages can originate on the server side or the client side:

- On the server side, error messages may occur during the startup and shutdown processes, as a result of issues that occur during SQL statement execution, and so forth.

- The MySQL server writes some error messages to its error log. These indicate issues of interest to database administrators or that require DBA action.
- The server sends other error messages to client programs. These indicate issues pertaining only to a particular client. The MySQL client library takes errors received from the server and makes them available to the host client program.
- Client-side error messages are generated from within the MySQL client library, usually involving problems communicating with the server.

Example server-side error messages written to the error log:

- This message produced during the startup process provides a status or progress indicator:

```
2018-09-26T14:46:06.326016Z 0 [Note] Skipping generation of SSL
certificates as options related to SSL are specified.
```

- This message indicates an issue that requires DBA action:

```
2018-10-02T03:20:39.410387Z 0 [ERROR] Plugin 'InnoDB'
registration as a STORAGE ENGINE failed.
```

Example server-side error message sent to client programs, as displayed by the `mysql` client:

```
mysql> SELECT * FROM no_such_table;
ERROR 1146 (42S02): Table 'test.no_such_table' doesn't exist
```

Example client-side error message originating from within the client library, as displayed by the `mysql` client:

```
$> mysql -h no-such-host
ERROR 2005 (HY000): Unknown MySQL server host 'no-such-host' (0)
```

Whether an error originates from within the client library or is received from the server, a MySQL client program may respond in varying ways. As just illustrated, the client may display the error message so the user can take corrective measures. The client may instead internally attempt to resolve or retry a failed operation, or take other action.

## Error Message Elements

When an error occurs, error information includes several elements: an error code, SQLSTATE value, and message string. These elements have the following characteristics:

- Error code: This value is numeric. It is MySQL-specific and is not portable to other database systems.

Each error number has a corresponding symbolic value. Examples:

- The symbol for server error number 1146 is `ER_NO_SUCH_TABLE`.
- The symbol for client error number 2005 is `CR_UNKNOWN_HOST`.

Error codes are stable across General Availability (GA) releases of a given MySQL series. Before a series reaches GA status, new codes may still be under development and are subject to change.

- SQLSTATE value: This value is a five-character string (for example, '42S02'). SQLSTATE values are taken from ANSI SQL and ODBC and are more standardized than the numeric error codes. The first two characters of an SQLSTATE value indicate the error class:
  - Class = '00' indicates success.

- Class = '01' indicates a warning.
- Class = '02' indicates “not found.” This is relevant within the context of cursors and is used to control what happens when a cursor reaches the end of a data set. This condition also occurs for `SELECT ... INTO var_list` statements that retrieve no rows.
- Class > '02' indicates an exception.

For server-side errors, not all MySQL error numbers have corresponding SQLSTATE values. In these cases, 'HY000' (general error) is used.

For client-side errors, the SQLSTATE value is always 'HY000' (general error), so it is not meaningful for distinguishing one client error from another.

- Message string: This string provides a textual description of the error.

## B.2 Error Information Interfaces

Error messages can originate on the server side or the client side, and each error message includes an error code, SQLSTATE value, and message string, as described in [Section B.1, “Error Message Sources and Elements”](#). For lists of server-side, client-side, and global (shared between server and clients) errors, see [MySQL 5.7 Error Message Reference](#).

For error checking from within programs, use error code numbers or symbols, not error message strings. Message strings do not change often, but it is possible. Also, if the database administrator changes the language setting, that affects the language of message strings; see [Section 10.12, “Setting the Error Message Language”](#).

Error information in MySQL is available in the server error log, at the SQL level, from within client programs, and at the command line.

- [Error Log](#)
- [SQL Error Message Interface](#)
- [Client Error Message Interface](#)
- [Command-Line Error Message Interface](#)

### Error Log

On the server side, some messages are intended for the error log. For information about configuring where and how the server writes the log, see [Section 5.4.2, “The Error Log”](#).

Other server error messages are intended to be sent to client programs and are available as described in [Client Error Message Interface](#).

### SQL Error Message Interface

At the SQL level, there are several sources of error information in MySQL:

- SQL statement warning and error information is available through the `SHOW WARNINGS` and `SHOW ERRORS` statements. The `warning_count` system variable indicates the number of errors, warnings, and notes (with notes excluded if the `sql_notes` system variable is disabled). The `error_count` system variable indicates the number of errors. Its value excludes warnings and notes.

- The `GET DIAGNOSTICS` statement may be used to inspect the diagnostic information in the diagnostics area. See [Section 13.6.7.3, “GET DIAGNOSTICS Statement”](#).
- `SHOW SLAVE STATUS` statement output includes information about replication errors occurring on replica servers.
- `SHOW ENGINE INNODB STATUS` statement output includes information about the most recent foreign key error if a `CREATE TABLE` statement for an `InnoDB` table fails.

## Client Error Message Interface

Client programs receive errors from two sources:

- Errors that originate on the client side from within the MySQL client library.
- Errors that originate on the server side and are sent to the client by the server. These are received within the client library, which makes them available to the host client program.

Regardless of whether an error originates from within the client library or is received from the server, a MySQL client program obtains the error code, SQLSTATE value, message string, and other related information by calling C API functions in the client library:

- `mysql_errno()` returns the MySQL error code.
- `mysql_sqlstate()` returns the SQLSTATE value.
- `mysql_error()` returns the message string.
- `mysql_stmt_errno()`, `mysql_stmt_sqlstate()`, and `mysql_stmt_error()` are the corresponding error functions for prepared statements.
- `mysql_warning_count()` returns the number of errors, warnings, and notes for the most recent statement.

For descriptions of the client library error functions, see [MySQL 5.7 C API Developer Guide](#).

A MySQL client program may respond to an error in varying ways. The client may display the error message so the user can take corrective measures, internally attempt to resolve or retry a failed operation, or take other action. For example, (using the `mysql` client), a failure to connect to the server might result in this message:

```
$> mysql -h no-such-host
ERROR 2005 (HY000): Unknown MySQL server host 'no-such-host' (0)
```

## Command-Line Error Message Interface

The `pererror` program provides information from the command line about error numbers. See [Section 4.8.2, “pererror — Display MySQL Error Message Information”](#).

```
$> pererror 1231
MySQL error code 1231 (ER_WRONG_VALUE_FOR_VAR): Variable '%-.64s' can't
be set to the value of '%-.200s'
```

For MySQL NDB Cluster errors, use `ndb_pererror`. See [Section 21.5.17, “ndb\\_pererror — Obtain NDB Error Message Information”](#).

```
$> ndb_pererror 323
NDB error code 323: Invalid nodegroup id, nodegroup already existing:
Permanent error: Application error
```



## B.3 Problems and Common Errors

This section lists some common problems and error messages that you may encounter. It describes how to determine the causes of the problems and what to do to solve them.

### B.3.1 How to Determine What Is Causing a Problem

When you run into a problem, the first thing you should do is to find out which program or piece of equipment is causing it:

- If you have one of the following symptoms, then it is probably a hardware problem (such as memory, motherboard, CPU, or hard disk) or kernel problem:
  - The keyboard does not work. This can normally be checked by pressing the Caps Lock key. If the Caps Lock light does not change, you have to replace your keyboard. (Before doing this, you should try to restart your computer and check all cables to the keyboard.)
  - The mouse pointer does not move.
  - The machine does not answer to a remote machine's pings.
  - Other programs that are not related to MySQL do not behave correctly.
  - Your system restarted unexpectedly. (A faulty user-level program should never be able to take down your system.)

In this case, you should start by checking all your cables and run some diagnostic tool to check your hardware! You should also check whether there are any patches, updates, or service packs for your operating system that could likely solve your problem. Check also that all your libraries (such as `glibc`) are up to date.

It is always good to use a machine with ECC memory to discover memory problems early.

- If your keyboard is locked up, you may be able to recover by logging in to your machine from another machine and executing `kbd_mode -a`.
- Please examine your system log file (`/var/log/messages` or similar) for reasons for your problem. If you think the problem is in MySQL, you should also examine MySQL's log files. See [Section 5.4, "MySQL Server Logs"](#).
- If you do not think you have hardware problems, you should try to find out which program is causing problems. Try using `top`, `ps`, Task Manager, or some similar program, to check which program is taking all CPU or is locking the machine.
- Use `top`, `df`, or a similar program to check whether you are out of memory, disk space, file descriptors, or some other critical resource.
- If the problem is some runaway process, you can always try to kill it. If it does not want to die, there is probably a bug in the operating system.

If you have examined all other possibilities and concluded that the MySQL server or a MySQL client is causing the problem, it is time to create a bug report, see [Section 1.5, "How to Report Bugs or Problems"](#). In the bug report, try to give a complete description of how the system is behaving and what you think is happening. Also state why you think that MySQL is causing the problem. Take into consideration all the situations described in this chapter. State any problems exactly how they appear when you examine your system. Use the "copy and paste" method for any output and error messages from programs and log files.

Try to describe in detail which program is not working and all symptoms you see. We have in the past received many bug reports that state only “the system does not work.” This provides us with no information about what could be the problem.

If a program fails, it is always useful to know the following information:

- Has the program in question made a segmentation fault (did it dump core)?
- Is the program taking up all available CPU time? Check with `top`. Let the program run for a while, it may simply be evaluating something computationally intensive.
- If the `mysqld` server is causing problems, can you get any response from it with `mysqladmin -u root ping` or `mysqladmin -u root processlist`?
- What does a client program say when you try to connect to the MySQL server? (Try with `mysql`, for example.) Does the client jam? Do you get any output from the program?

When sending a bug report, you should follow the outline described in [Section 1.5, “How to Report Bugs or Problems”](#).

## B.3.2 Common Errors When Using MySQL Programs

This section lists some errors that users frequently encounter when running MySQL programs. Although the problems show up when you try to run client programs, the solutions to many of the problems involves changing the configuration of the MySQL server.

### B.3.2.1 Access denied

An `Access denied` error can have many causes. Often the problem is related to the MySQL accounts that the server permits client programs to use when connecting. See [Section 6.2, “Access Control and Account Management”](#), and [Section 6.2.17, “Troubleshooting Problems Connecting to MySQL”](#).

### B.3.2.2 Can't connect to [local] MySQL server

A MySQL client on Unix can connect to the `mysqld` server in two different ways: By using a Unix socket file to connect through a file in the file system (default `/tmp/mysql.sock`), or by using TCP/IP, which connects through a port number. A Unix socket file connection is faster than TCP/IP, but can be used only when connecting to a server on the same computer. A Unix socket file is used if you do not specify a host name or if you specify the special host name `localhost`.

If the MySQL server is running on Windows, you can connect using TCP/IP. If the server is started with the `named_pipe` system variable enabled, you can also connect with named pipes if you run the client on the host where the server is running. The name of the named pipe is `MySQL` by default. If you do not give a host name when connecting to `mysqld`, a MySQL client first tries to connect to the named pipe. If that does not work, it connects to the TCP/IP port. You can force the use of named pipes on Windows by using `.` as the host name.

The error (2002) `Can't connect to ...` normally means that there is no MySQL server running on the system or that you are using an incorrect Unix socket file name or TCP/IP port number when trying to connect to the server. You should also check that the TCP/IP port you are using has not been blocked by a firewall or port blocking service.

The error (2003) `Can't connect to MySQL server on 'server' (10061)` indicates that the network connection has been refused. You should check that there is a MySQL server running, that it has network connections enabled, and that the network port you specified is the one configured on the server.

Start by checking whether there is a process named `mysqld` running on your server host. (Use `ps xa | grep mysqld` on Unix or the Task Manager on Windows.) If there is no such process, you should start the server. See [Section 2.9.2, “Starting the Server”](#).

If a `mysqld` process is running, you can check it by trying the following commands. The port number or Unix socket file name might be different in your setup. `host_ip` represents the IP address of the machine where the server is running.

```
$> mysqladmin version
$> mysqladmin variables
$> mysqladmin -h `hostname` version variables
$> mysqladmin -h `hostname` --port=3306 version
$> mysqladmin -h host_ip version
$> mysqladmin --protocol=SOCKET --socket=/tmp/mysql.sock version
```

Note the use of backticks rather than forward quotation marks with the `hostname` command; these cause the output of `hostname` (that is, the current host name) to be substituted into the `mysqladmin` command. If you have no `hostname` command or are running on Windows, you can manually type the host name of your machine (without backticks) following the `-h` option. You can also try `-h 127.0.0.1` to connect with TCP/IP to the local host.

Make sure that the server has not been configured to ignore network connections or (if you are attempting to connect remotely) that it has not been configured to listen only locally on its network interfaces. If the server was started with the `skip_networking` system variable enabled, it does not accept TCP/IP connections at all. If the server was started with the `bind_address` system variable set to `127.0.0.1`, it listens for TCP/IP connections only locally on the loopback interface and does not accept remote connections.

Check to make sure that there is no firewall blocking access to MySQL. Your firewall may be configured on the basis of the application being executed, or the port number used by MySQL for communication (3306 by default). Under Linux or Unix, check your IP tables (or similar) configuration to ensure that the port has not been blocked. Under Windows, applications such as ZoneAlarm or Windows Firewall may need to be configured not to block the MySQL port.

Here are some reasons the [Can't connect to local MySQL server](#) error might occur:

- `mysqld` is not running on the local host. Check your operating system's process list to ensure the `mysqld` process is present.
- You're running a MySQL server on Windows with many TCP/IP connections to it. If you're experiencing that quite often your clients get that error, you can find a workaround here: [Connection to MySQL Server Failing on Windows](#).
- Someone has removed the Unix socket file that `mysqld` uses (`/tmp/mysql.sock` by default). For example, you might have a `cron` job that removes old files from the `/tmp` directory. You can always run `mysqladmin version` to check whether the Unix socket file that `mysqladmin` is trying to use really exists. The fix in this case is to change the `cron` job to not remove `mysql.sock` or to place the socket file somewhere else. See [Section B.3.3.6, “How to Protect or Change the MySQL Unix Socket File”](#).
- You have started the `mysqld` server with the `--socket=/path/to/socket` option, but forgotten to tell client programs the new name of the socket file. If you change the socket path name for the server, you must also notify the MySQL clients. You can do this by providing the same `--socket` option when you run client programs. You also need to ensure that clients have permission to access the `mysql.sock` file. To find out where the socket file is, you can do:

```
$> netstat -ln | grep mysql
```

See [Section B.3.3.6, “How to Protect or Change the MySQL Unix Socket File”](#).

- You are using Linux and one server thread has died (dumped core). In this case, you must kill the other `mysqld` threads (for example, with `kill`) before you can restart the MySQL server. See [Section B.3.3.3, “What to Do If MySQL Keeps Crashing”](#).
- The server or client program might not have the proper access privileges for the directory that holds the Unix socket file or the socket file itself. In this case, you must either change the access privileges for the directory or socket file so that the server and clients can access them, or restart `mysqld` with a `--socket` option that specifies a socket file name in a directory where the server can create it and where client programs can access it.

If you get the error message `Can't connect to MySQL server on some_host`, you can try the following things to find out what the problem is:

- Check whether the server is running on that host by executing `telnet some_host 3306` and pressing the Enter key a couple of times. (3306 is the default MySQL port number. Change the value if your server is listening to a different port.) If there is a MySQL server running and listening to the port, you should get a response that includes the server's version number. If you get an error such as `telnet: Unable to connect to remote host: Connection refused`, then there is no server running on the given port.
- If the server is running on the local host, try using `mysqladmin -h localhost variables` to connect using the Unix socket file. Verify the TCP/IP port number that the server is configured to listen to (it is the value of the `port` variable.)
- If you are running under Linux and Security-Enhanced Linux (SELinux) is enabled, see [Section 6.7, “SELinux”](#).

## Connection to MySQL Server Failing on Windows

When you're running a MySQL server on Windows with many TCP/IP connections to it, and you're experiencing that quite often your clients get a `Can't connect to MySQL server` error, the reason might be that Windows does not allow for enough ephemeral (short-lived) ports to serve those connections.

The purpose of `TIME_WAIT` is to keep a connection accepting packets even after the connection has been closed. This is because Internet routing can cause a packet to take a slow route to its destination and it may arrive after both sides have agreed to close. If the port is in use for a new connection, that packet from the old connection could break the protocol or compromise personal information from the original connection. The `TIME_WAIT` delay prevents this by ensuring that the port cannot be reused until after some time has been permitted for those delayed packets to arrive.

It is safe to reduce `TIME_WAIT` greatly on LAN connections because there is little chance of packets arriving at very long delays, as they could through the Internet with its comparatively large distances and latencies.

Windows permits ephemeral (short-lived) TCP ports to the user. After any port is closed it remains in `TIME_WAIT` status for 120 seconds. The port is not available again until this time expires. The default range of port numbers depends on the version of Windows, with a more limited number of ports in older versions:

- Windows through Server 2003: Ports in range 1025–5000
- Windows Vista, Server 2008, and newer: Ports in range 49152–65535

With a small stack of available TCP ports (5000) and a high number of TCP ports being open and closed over a short period of time along with the `TIME_WAIT` status you have a good chance for running out of ports. There are two ways to address this problem:

- Reduce the number of TCP ports consumed quickly by investigating connection pooling or persistent connections where possible
- Tune some settings in the Windows registry (see below)



### Important

The following procedure involves modifying the Windows registry. Before you modify the registry, make sure to back it up and make sure that you understand how to restore it if a problem occurs. For information about how to back up, restore, and edit the registry, view the following article in the Microsoft Knowledge Base: <http://support.microsoft.com/kb/256986/EN-US/>.

1. Start Registry Editor ([Regedt32.exe](#)).
2. Locate the following key in the registry:

```
HKEY_LOCAL_MACHINE\SYSTEM\CurrentControlSet\Services\Tcpip\Parameters
```

3. On the **Edit** menu, click **Add Value**, and then add the following registry value:

```
Value Name: MaxUserPort  
Data Type: REG_DWORD  
Value: 65534
```

This sets the number of ephemeral ports available to any user. The valid range is between 5000 and 65534 (decimal). The default value is 0x1388 (5000 decimal).

4. On the **Edit** menu, click **Add Value**, and then add the following registry value:

```
Value Name: TcpTimedWaitDelay  
Data Type: REG_DWORD  
Value: 30
```

This sets the number of seconds to hold a TCP port connection in **TIME\_WAIT** state before closing. The valid range is between 30 and 300 decimal, although you may wish to check with Microsoft for the latest permitted values. The default value is 0x78 (120 decimal).

5. Quit Registry Editor.
6. Reboot the machine.

Note: Undoing the above should be as simple as deleting the registry entries you've created.

### B.3.2.3 Lost connection to MySQL server

There are three likely causes for this error message.

Usually it indicates network connectivity trouble and you should check the condition of your network if this error occurs frequently. If the error message includes “during query,” this is probably the case you are experiencing.

Sometimes the “during query” form happens when millions of rows are being sent as part of one or more queries. If you know that this is happening, you should try increasing `net_read_timeout` from its default of 30 seconds to 60 seconds or longer, sufficient for the data transfer to complete.

More rarely, it can happen when the client is attempting the initial connection to the server. In this case, if your `connect_timeout` value is set to only a few seconds, you may be able to resolve the problem by increasing it to ten seconds, perhaps more if you have a very long distance or slow connection. You can

determine whether you are experiencing this more uncommon cause by using `SHOW GLOBAL STATUS LIKE 'Aborted_connects'`. It increases by one for each initial connection attempt that the server aborts. You may see “reading authorization packet” as part of the error message; if so, that also suggests that this is the solution that you need.

If the cause is none of those just described, you may be experiencing a problem with `BLOB` values that are larger than `max_allowed_packet`, which can cause this error with some clients. Sometime you may see an `ER_NET_PACKET_TOO_LARGE` error, and that confirms that you need to increase `max_allowed_packet`.

### B.3.2.4 Password Fails When Entered Interactively

MySQL client programs prompt for a password when invoked with a `--password` or `-p` option that has no following password value:

```
$> mysql -u user_name -p
Enter password:
```

On some systems, you may find that your password works when specified in an option file or on the command line, but not when you enter it interactively at the `Enter password:` prompt. This occurs when the library provided by the system to read passwords limits password values to a small number of characters (typically eight). That is a problem with the system library, not with MySQL. To work around it, change your MySQL password to a value that is eight or fewer characters long, or put your password in an option file.

### B.3.2.5 Too many connections

If clients encounter `Too many connections` errors when attempting to connect to the `mysqld` server, all available connections are in use by other clients.

The permitted number of connections is controlled by the `max_connections` system variable. To support more connections, set `max_connections` to a larger value.

`mysqld` actually permits `max_connections + 1` client connections. The extra connection is reserved for use by accounts that have the `SUPER` privilege. By granting the privilege to administrators and not to normal users (who should not need it), an administrator who also has the `PROCESS` privilege can connect to the server and use `SHOW PROCESSLIST` to diagnose problems even if the maximum number of unprivileged clients are connected. See [Section 13.7.5.29, “SHOW PROCESSLIST Statement”](#).

For more information about how the server handles client connections, see [Section 5.1.11.1, “Connection Interfaces”](#).

### B.3.2.6 Out of memory

If you issue a query using the `mysql` client program and receive an error like the following one, it means that `mysql` does not have enough memory to store the entire query result:

```
mysql: Out of memory at line 42, 'malloc.c'
mysql: needed 8136 byte (8k), memory in use: 12481367 bytes (12189k)
ERROR 2008: MySQL client ran out of memory
```

To remedy the problem, first check whether your query is correct. Is it reasonable that it should return so many rows? If not, correct the query and try again. Otherwise, you can invoke `mysql` with the `--quick` option. This causes it to use the `mysql_use_result()` C API function to retrieve the result set, which places less of a load on the client (but more on the server).

### B.3.2.7 MySQL server has gone away

This section also covers the related `Lost connection to server during query` error.

The most common reason for the `MySQL server has gone away` error is that the server timed out and closed the connection. In this case, you normally get one of the following error codes (which one you get is operating system-dependent).

Error Code	Description
<code>CR_SERVER_GONE_ERROR</code>	The client couldn't send a question to the server.
<code>CR_SERVER_LOST</code>	The client didn't get an error when writing to the server, but it didn't get a full answer (or any answer) to the question.

By default, the server closes the connection after eight hours if nothing has happened. You can change the time limit by setting the `wait_timeout` variable when you start `mysqld`. See [Section 5.1.7, “Server System Variables”](#).

If you have a script, you just have to issue the query again for the client to do an automatic reconnection. This assumes that you have automatic reconnection in the client enabled (which is the default for the `mysql` command-line client).

Some other common reasons for the `MySQL server has gone away` error are:

- You (or the db administrator) has killed the running thread with a `KILL` statement or a `mysqladmin kill` command.
- You tried to run a query after closing the connection to the server. This indicates a logic error in the application that should be corrected.
- A client application running on a different host does not have the necessary privileges to connect to the MySQL server from that host.
- You got a timeout from the TCP/IP connection on the client side. This may happen if you have been using the commands: `mysql_options(..., MYSQL_OPT_READ_TIMEOUT,...)` or `mysql_options(..., MYSQL_OPT_WRITE_TIMEOUT,...)`. In this case increasing the timeout may help solve the problem.
- You have encountered a timeout on the server side and the automatic reconnection in the client is disabled (the `reconnect` flag in the `MYSQL` structure is equal to 0).
- You are using a Windows client and the server had dropped the connection (probably because `wait_timeout` expired) before the command was issued.

The problem on Windows is that in some cases MySQL does not get an error from the OS when writing to the TCP/IP connection to the server, but instead gets the error when trying to read the answer from the connection.

The solution to this is to either do a `mysql_ping()` on the connection if there has been a long time since the last query (this is what Connector/ODBC does) or set `wait_timeout` on the `mysqld` server so high that it in practice never times out.

- You can also get these errors if you send a query to the server that is incorrect or too large. If `mysqld` receives a packet that is too large or out of order, it assumes that something has gone wrong with the client and closes the connection. If you need big queries (for example, if you are working with big `BLOB` columns), you can increase the query limit by setting the server's `max_allowed_packet` variable,

which has a default value of 4MB. You may also need to increase the maximum packet size on the client end. More information on setting the packet size is given in [Section B.3.2.8, “Packet Too Large”](#).

An `INSERT` or `REPLACE` statement that inserts a great many rows can also cause these sorts of errors. Either one of these statements sends a single request to the server irrespective of the number of rows to be inserted; thus, you can often avoid the error by reducing the number of rows sent per `INSERT` or `REPLACE`.

- It is also possible to see this error if host name lookups fail (for example, if the DNS server on which your server or network relies goes down). This is because MySQL is dependent on the host system for name resolution, but has no way of knowing whether it is working—from MySQL's point of view the problem is indistinguishable from any other network timeout.

You may also see the `MySQL server has gone away` error if MySQL is started with the `skip_networking` system variable enabled.

Another networking issue that can cause this error occurs if the MySQL port (default 3306) is blocked by your firewall, thus preventing any connections at all to the MySQL server.

- You can also encounter this error with applications that fork child processes, all of which try to use the same connection to the MySQL server. This can be avoided by using a separate connection for each child process.
- You have encountered a bug where the server died while executing the query.

You can check whether the MySQL server died and restarted by executing `mysqladmin version` and examining the server's uptime. If the client connection was broken because `mysqld` crashed and restarted, you should concentrate on finding the reason for the crash. Start by checking whether issuing the query again kills the server again. See [Section B.3.3.3, “What to Do If MySQL Keeps Crashing”](#).

You can obtain more information about lost connections by starting `mysqld` with the `log_error_verbosity` system variable set to 3. This logs some of the disconnection messages in the `hostname.err` file. See [Section 5.4.2, “The Error Log”](#).

If you want to create a bug report regarding this problem, be sure that you include the following information:

- Indicate whether the MySQL server died. You can find information about this in the server error log. See [Section B.3.3.3, “What to Do If MySQL Keeps Crashing”](#).
- If a specific query kills `mysqld` and the tables involved were checked with `CHECK TABLE` before you ran the query, can you provide a reproducible test case? See [Section 5.8, “Debugging MySQL”](#).
- What is the value of the `wait_timeout` system variable in the MySQL server? (`mysqladmin variables` gives you the value of this variable.)
- Have you tried to run `mysqld` with the general query log enabled to determine whether the problem query appears in the log? (See [Section 5.4.3, “The General Query Log”](#).)

See also [Section B.3.2.9, “Communication Errors and Aborted Connections”](#), and [Section 1.5, “How to Report Bugs or Problems”](#).

### B.3.2.8 Packet Too Large

A communication packet is a single SQL statement sent to the MySQL server, a single row that is sent to the client, or a binary log event sent from a replication source server to a replica.



The largest possible packet that can be transmitted to or from a MySQL 5.7 server or client is 1GB.

When a MySQL client or the `mysqld` server receives a packet bigger than `max_allowed_packet` bytes, it issues an `ER_NET_PACKET_TOO_LARGE` error and closes the connection. With some clients, you may also get a `Lost connection to MySQL server during query` error if the communication packet is too large.

Both the client and the server have their own `max_allowed_packet` variable, so if you want to handle big packets, you must increase this variable both in the client and in the server.

If you are using the `mysql` client program, its default `max_allowed_packet` variable is 16MB. To set a larger value, start `mysql` like this:

```
$> mysql --max_allowed_packet=32M
```

That sets the packet size to 32MB.

The server's default `max_allowed_packet` value is 4MB. You can increase this if the server needs to handle big queries (for example, if you are working with big `BLOB` columns). For example, to set the variable to 16MB, start the server like this:

```
$> mysqld --max_allowed_packet=16M
```

You can also use an option file to set `max_allowed_packet`. For example, to set the size for the server to 16MB, add the following lines in an option file:

```
[mysqld]
max_allowed_packet=16M
```

It is safe to increase the value of this variable because the extra memory is allocated only when needed. For example, `mysqld` allocates more memory only when you issue a long query or when `mysqld` must return a large result row. The small default value of the variable is a precaution to catch incorrect packets between the client and server and also to ensure that you do not run out of memory by using large packets accidentally.

You can also get strange problems with large packets if you are using large `BLOB` values but have not given `mysqld` access to enough memory to handle the query. If you suspect this is the case, try adding `ulimit -d 256000` to the beginning of the `mysqld_safe` script and restarting `mysqld`.

### B.3.2.9 Communication Errors and Aborted Connections

If connection problems occur such as communication errors or aborted connections, use these sources of information to diagnose problems:

- The error log. See [Section 5.4.2, “The Error Log”](#).
- The general query log. See [Section 5.4.3, “The General Query Log”](#).
- The `Aborted_xxx` and `Connection_errors_xxx` status variables. See [Section 5.1.9, “Server Status Variables”](#).
- The host cache, which is accessible using the Performance Schema `host_cache` table. See [Section 5.1.11.2, “DNS Lookups and the Host Cache”](#), and [Section 25.12.16.1, “The host\\_cache Table”](#).

If the `log_error_verbosity` system variable is set to 3, you might find messages like this in your error log:

```
[Note] Aborted connection 854 to db: 'employees' user: 'josh'
```

If a client is unable even to connect, the server increments the `Aborted_connects` status variable. Unsuccessful connection attempts can occur for the following reasons:

- A client attempts to access a database but has no privileges for it.
- A client uses an incorrect password.
- A connection packet does not contain the right information.
- It takes more than `connect_timeout` seconds to obtain a connect packet. See [Section 5.1.7, “Server System Variables”](#).

If these kinds of things happen, it might indicate that someone is trying to break into your server! If the general query log is enabled, messages for these types of problems are logged to it.

If a client successfully connects but later disconnects improperly or is terminated, the server increments the `Aborted_clients` status variable, and logs an `Aborted connection` message to the error log. The cause can be any of the following:

- The client program did not call `mysql_close()` before exiting.
- The client had been sleeping more than `wait_timeout` or `interactive_timeout` seconds without issuing any requests to the server. See [Section 5.1.7, “Server System Variables”](#).
- The client program ended abruptly in the middle of a data transfer.

Other reasons for problems with aborted connections or aborted clients:

- The `max_allowed_packet` variable value is too small or queries require more memory than you have allocated for `mysqld`. See [Section B.3.2.8, “Packet Too Large”](#).
- Use of Ethernet protocol with Linux, both half and full duplex. Some Linux Ethernet drivers have this bug. You should test for this bug by transferring a huge file using FTP between the client and server machines. If a transfer goes in burst-pause-burst-pause mode, you are experiencing a Linux duplex syndrome. Switch the duplex mode for both your network card and hub/switch to either full duplex or to half duplex and test the results to determine the best setting.
- A problem with the thread library that causes interrupts on reads.
- Badly configured TCP/IP.
- Faulty Ethernets, hubs, switches, cables, and so forth. This can be diagnosed properly only by replacing hardware.

See also [Section B.3.2.7, “MySQL server has gone away”](#).

### B.3.2.10 The table is full

If a table-full error occurs, it may be that the disk is full or that the table has reached its maximum size. The effective maximum table size for MySQL databases is usually determined by operating system constraints on file sizes, not by MySQL internal limits. See [Section 8.4.6, “Limits on Table Size”](#).

### B.3.2.11 Can't create/write to file

If you get an error of the following type for some queries, it means that MySQL cannot create a temporary file for the result set in the temporary directory:

```
Can't create/write to file '...\sqla3fe_0.ism'.
```

The preceding error is a typical message for Windows; the Unix message is similar.

One fix is to start `mysqld` with the `--tmpdir` option or to add the option to the `[mysqld]` section of your option file. For example, to specify a directory of `C:\temp`, use these lines:

```
[mysqld]
tmpdir=C:/temp
```

The `C:\temp` directory must exist and have sufficient space for the MySQL server to write to. See [Section 4.2.2.2, "Using Option Files"](#).

Another cause of this error can be permissions issues. Make sure that the MySQL server can write to the `tmpdir` directory.

Check also the error code that you get with  `perror`. One reason the server cannot write to a table is that the file system is full:

```
$> perror 28
OS error code 28: No space left on device
```

If you get an error of the following type during startup, it indicates that the file system or directory used for storing data files is write protected. Provided that the write error is to a test file, the error is not serious and can be safely ignored.

```
Can't create test file /usr/local/mysql/data/master.lower-test
```

### B.3.2.12 Commands out of sync

If you get `Commands out of sync; you can't run this command now` in your client code, you are calling client functions in the wrong order.

This can happen, for example, if you are using `mysql_use_result()` and try to execute a new query before you have called `mysql_free_result()`. It can also happen if you try to execute two queries that return data without calling `mysql_use_result()` or `mysql_store_result()` in between.

### B.3.2.13 Ignoring user

If you get the following error, it means that when `mysqld` was started or when it reloaded the grant tables, it found an account in the `user` table that had an invalid password.

```
Found wrong password for user 'some_user'@'some_host'; ignoring user
```

As a result, the account is simply ignored by the permission system.

The following list indicates possible causes of and fixes for this problem:

- You may be running a new version of `mysqld` with an old `user` table. Check whether the `Password` column of that table is shorter than 16 characters. If so, correct this condition by running `mysql_upgrade`.
- The account has an old password (eight characters long). Update the account in the `user` table to have a new password.
- You have specified a password in the `user` table without using the `PASSWORD()` function. Use `mysql` to update the account in the `user` table with a new password, making sure to use the `PASSWORD()` function:

```
mysql> UPDATE user SET Password=PASSWORD('new_password')
-> WHERE User='some_user' AND Host='some_host';
```

### B.3.2.14 Table 'tbl\_name' doesn't exist

If you get either of the following errors, it usually means that no table exists in the default database with the given name:

```
Table 'tbl_name' doesn't exist
Can't find file: 'tbl_name' (errno: 2)
```

In some cases, it may be that the table does exist but that you are referring to it incorrectly:

- Because MySQL uses directories and files to store databases and tables, database and table names are case-sensitive if they are located on a file system that has case-sensitive file names.
- Even for file systems that are not case-sensitive, such as on Windows, all references to a given table within a query must use the same lettercase.

You can check which tables are in the default database with `SHOW TABLES`. See [Section 13.7.5, “SHOW Statements”](#).

### B.3.2.15 Can't initialize character set

You might see an error like this if you have character set problems:

```
MySQL Connection Failed: Can't initialize character set charset_name
```

This error can have any of the following causes:

- The character set is a multibyte character set and you have no support for the character set in the client. In this case, you need to recompile the client by running `CMake` with the `-DDEFAULT_CHARSET=charset_name` or `-DWITH_EXTRA_CHARSETS=charset_name` option. See [Section 2.8.7, “MySQL Source-Configuration Options”](#).

All standard MySQL binaries are compiled with `-DWITH_EXTRA_CHARSETS=complex`, which enables support for all multibyte character sets. See [Section 2.8.7, “MySQL Source-Configuration Options”](#).

- The character set is a simple character set that is not compiled into `mysqld`, and the character set definition files are not in the place where the client expects to find them.

In this case, you need to use one of the following methods to solve the problem:

- Recompile the client with support for the character set. See [Section 2.8.7, “MySQL Source-Configuration Options”](#).
- Specify to the client the directory where the character set definition files are located. For many clients, you can do this with the `--character-sets-dir` option.
- Copy the character definition files to the path where the client expects them to be.

### B.3.2.16 File Not Found and Similar Errors

If you get `ERROR 'file_name' not found (errno: 23)`, `Can't open file: file_name (errno: 24)`, or any other error with `errno 23` or `errno 24` from MySQL, it means that you have not allocated enough file descriptors for the MySQL server. You can use the `pererror` utility to get a description of what the error number means:

```
$> pererror 23
OS error code 23: File table overflow
$> pererror 24
OS error code 24: Too many open files
```

```
$> perror 11
OS error code 11: Resource temporarily unavailable
```

The problem here is that `mysqld` is trying to keep open too many files simultaneously. You can either tell `mysqld` not to open so many files at once or increase the number of file descriptors available to `mysqld`.

To tell `mysqld` to keep open fewer files at a time, you can make the table cache smaller by reducing the value of the `table_open_cache` system variable (the default value is 64). This may not entirely prevent running out of file descriptors because in some circumstances the server may attempt to extend the cache size temporarily, as described in [Section 8.4.3.1, “How MySQL Opens and Closes Tables”](#). Reducing the value of `max_connections` also reduces the number of open files (the default value is 100).

To change the number of file descriptors available to `mysqld`, you can use the `--open-files-limit` option to `mysqld_safe` or set the `open_files_limit` system variable. See [Section 5.1.7, “Server System Variables”](#). The easiest way to set these values is to add an option to your option file. See [Section 4.2.2.2, “Using Option Files”](#). If you have an old version of `mysqld` that does not support setting the open files limit, you can edit the `mysqld_safe` script. There is a commented-out line `ulimit -n 256` in the script. You can remove the `#` character to uncomment this line, and change the number 256 to set the number of file descriptors to be made available to `mysqld`.

`--open-files-limit` and `ulimit` can increase the number of file descriptors, but only up to the limit imposed by the operating system. There is also a “hard” limit that can be overridden only if you start `mysqld_safe` or `mysqld` as `root` (just remember that you also need to start the server with the `--user` option in this case so that it does not continue to run as `root` after it starts up). If you need to increase the operating system limit on the number of file descriptors available to each process, consult the documentation for your system.



#### Note

If you run the `tcsh` shell, `ulimit` does not work! `tcsh` also reports incorrect values when you ask for the current limits. In this case, you should start `mysqld_safe` using `sh`.

### B.3.2.17 Table-Corruption Issues

If you have started `mysqld` with the `myisam_recover_options` system variable set, MySQL automatically checks and tries to repair MyISAM tables if they are marked as 'not closed properly' or 'crashed'. If this happens, MySQL writes an entry in the `hostname.err` file 'Warning: Checking table ...' which is followed by `Warning: Repairing table` if the table needs to be repaired. If you get a lot of these errors, without `mysqld` having died unexpectedly just before, then something is wrong and needs to be investigated further.

When the server detects MyISAM table corruption, it writes additional information to the error log, such as the name and line number of the source file, and the list of threads accessing the table. Example: `Got an error from thread_id=1, mi_dynrec.c:368`. This is useful information to include in bug reports.

See also [Section 5.1.6, “Server Command Options”](#), and [Section 5.8.1.7, “Making a Test Case If You Experience Table Corruption”](#).

## B.3.3 Administration-Related Issues

### B.3.3.1 Problems with File Permissions

If you have problems with file permissions, the `UMASK` or `UMASK_DIR` environment variable might be set incorrectly when `mysqld` starts. For example, `mysqld` might issue the following error message when you create a table:

```
ERROR: Can't find file: 'path/with/filename.frm' (Errcode: 13)
```

The default `UMASK` and `UMASK_DIR` values are `0640` and `0750`, respectively. `mysqld` assumes that the value for `UMASK` or `UMASK_DIR` is in octal if it starts with a zero. For example, setting `UMASK=0600` is equivalent to `UMASK=384` because `0600` octal is `384` decimal.

Assuming that you start `mysqld` using `mysqld_safe`, change the default `UMASK` value as follows:

```
UMASK=384 # = 600 in octal
export UMASK
mysqld_safe &
```



#### Note

An exception applies for the error log file if you start `mysqld` using `mysqld_safe`, which does not respect `UMASK`: `mysqld_safe` may create the error log file if it does not exist prior to starting `mysqld`, and `mysqld_safe` uses a umask set to a strict value of `0137`. If this is unsuitable, create the error file manually with the desired access mode prior to executing `mysqld_safe`.

By default, `mysqld` creates database directories with an access permission value of `0750`. To modify this behavior, set the `UMASK_DIR` variable. If you set its value, new directories are created with the combined `UMASK` and `UMASK_DIR` values. For example, to give group access to all new directories, start `mysqld_safe` as follows:

```
UMASK_DIR=504 # = 770 in octal
export UMASK_DIR
mysqld_safe &
```

For additional details, see [Section 4.9, “Environment Variables”](#).

### B.3.3.2 How to Reset the Root Password

If you have never assigned a `root` password for MySQL, the server does not require a password at all for connecting as `root`. However, this is insecure. For instructions on assigning a password, see [Section 2.9.4, “Securing the Initial MySQL Account”](#).

If you know the `root` password and want to change it, see [Section 13.7.1.1, “ALTER USER Statement”](#), and [Section 13.7.1.7, “SET PASSWORD Statement”](#).

If you assigned a `root` password previously but have forgotten it, you can assign a new password. The following sections provide instructions for Windows and Unix and Unix-like systems, as well as generic instructions that apply to any system.

#### Resetting the Root Password: Windows Systems

On Windows, use the following procedure to reset the password for the MySQL `'root'@'localhost'` account. To change the password for a `root` account with a different host name part, modify the instructions to use that host name.

1. Log on to your system as Administrator.
2. Stop the MySQL server if it is running. For a server that is running as a Windows service, go to the Services manager: From the **Start** menu, select **Control Panel**, then **Administrative Tools**, then **Services**. Find the MySQL service in the list and stop it.

If your server is not running as a service, you may need to use the Task Manager to force it to stop.

3. Create a text file containing the password-assignment statement on a single line. Replace the password with the password that you want to use.

```
ALTER USER 'root'@'localhost' IDENTIFIED BY 'MyNewPass' ;
```

4. Save the file. This example assumes that you name the file `C:\mysql-init.txt`.
5. Open a console window to get to the command prompt: From the **Start** menu, select **Run**, then enter `cmd` as the command to be run.
6. Start the MySQL server with the `init_file` system variable set to name the file (notice that the backslash in the option value is doubled):

```
C:\> cd "C:\Program Files\MySQL\MySQL Server 5.7\bin"
C:\> mysqld --init-file=C:\\mysql-init.txt
```

If you installed MySQL to a different location, adjust the `cd` command accordingly.

The server executes the contents of the file named by the `init_file` system variable at startup, changing the `'root'@'localhost'` account password.

To have server output to appear in the console window rather than in a log file, add the `--console` option to the `mysqld` command.

If you installed MySQL using the MySQL Installation Wizard, you may need to specify a `--defaults-file` option. For example:

```
C:\> mysqld
      --defaults-file="C:\\ProgramData\\MySQL\\MySQL Server 5.7\\my.ini"
      --init-file=C:\\mysql-init.txt
```

The appropriate `--defaults-file` setting can be found using the Services Manager: From the **Start** menu, select **Control Panel**, then **Administrative Tools**, then **Services**. Find the MySQL service in the list, right-click it, and choose the `Properties` option. The `Path to executable` field contains the `--defaults-file` setting.

7. After the server has started successfully, delete `C:\mysql-init.txt`.

You should now be able to connect to the MySQL server as `root` using the new password. Stop the MySQL server and restart it normally. If you run the server as a service, start it from the Windows Services window. If you start the server manually, use whatever command you normally use.

If the `ALTER USER` statement fails to reset the password, try repeating the procedure using the following statements to modify the `user` table directly:

```
UPDATE mysql.user
  SET authentication_string = PASSWORD('MyNewPass'), password_expired = 'N'
  WHERE User = 'root' AND Host = 'localhost';
FLUSH PRIVILEGES;
```

## Resetting the Root Password: Unix and Unix-Like Systems

On Unix, use the following procedure to reset the password for the MySQL `'root'@'localhost'` account. To change the password for a `root` account with a different host name part, modify the instructions to use that host name.

The instructions assume that you start the MySQL server from the Unix login account that you normally use for running it. For example, if you run the server using the `mysql` login account, you should log in as `mysql` before using the instructions. Alternatively, you can log in as `root`, but in this case you *must* start

`mysqld` with the `--user=mysql` option. If you start the server as `root` without using `--user=mysql`, the server may create `root`-owned files in the data directory, such as log files, and these may cause permission-related problems for future server startups. If that happens, you must either change the ownership of the files to `mysql` or remove them.

1. Log on to your system as the Unix user that the MySQL server runs as (for example, `mysql`).
2. Stop the MySQL server if it is running. Locate the `.pid` file that contains the server's process ID. The exact location and name of this file depend on your distribution, host name, and configuration. Common locations are `/var/lib/mysql/`, `/var/run/mysqld/`, and `/usr/local/mysql/data/`. Generally, the file name has an extension of `.pid` and begins with either `mysqld` or your system's host name.

Stop the MySQL server by sending a normal `kill` (not `kill -9`) to the `mysqld` process. Use the actual path name of the `.pid` file in the following command:

```
$> kill `cat /mysql-data-directory/host_name.pid`
```

Use backticks (not forward quotation marks) with the `cat` command. These cause the output of `cat` to be substituted into the `kill` command.

3. Create a text file containing the password-assignment statement on a single line. Replace the password with the password that you want to use.

```
ALTER USER 'root'@'localhost' IDENTIFIED BY 'MyNewPass';
```

4. Save the file. This example assumes that you name the file `/home/me/mysql-init`. The file contains the password, so do not save it where it can be read by other users. If you are not logged in as `mysql` (the user the server runs as), make sure that the file has permissions that permit `mysql` to read it.
5. Start the MySQL server with the `init_file` system variable set to name the file:

```
$> mysqld --init-file=/home/me/mysql-init &
```

The server executes the contents of the file named by the `init_file` system variable at startup, changing the `'root'@'localhost'` account password.

Other options may be necessary as well, depending on how you normally start your server. For example, `--defaults-file` may be needed before the `init_file` argument.

6. After the server has started successfully, delete `/home/me/mysql-init`.

You should now be able to connect to the MySQL server as `root` using the new password. Stop the server and restart it normally.

If the `ALTER USER` statement fails to reset the password, try repeating the procedure using the following statements to modify the `user` table directly:

```
UPDATE mysql.user
  SET authentication_string = PASSWORD('MyNewPass'), password_expired = 'N'
  WHERE User = 'root' AND Host = 'localhost';
FLUSH PRIVILEGES;
```

## Resetting the Root Password: Generic Instructions

The preceding sections provide password-resetting instructions specifically for Windows and Unix and Unix-like systems. Alternatively, on any platform, you can reset the password using the `mysql` client (but this approach is less secure):



1. Stop the MySQL server if necessary, then restart it with the `--skip-grant-tables` option. This enables anyone to connect without a password and with all privileges, and disables account-management statements such as `ALTER USER` and `SET PASSWORD`. Because this is insecure, you might want to use `--skip-grant-tables` in conjunction with enabling the `skip_networking` system variable to prevent remote clients from connecting. On Windows platforms, if you enable `skip_networking`, you must also enable `shared_memory` or `named_pipe`; otherwise the server cannot start.
2. Connect to the MySQL server using the `mysql` client; no password is necessary because the server was started with `--skip-grant-tables`:

```
$> mysql
```

3. In the `mysql` client, tell the server to reload the grant tables so that account-management statements work:

```
mysql> FLUSH PRIVILEGES;
```

Then change the `'root'@'localhost'` account password. Replace the password with the password that you want to use. To change the password for a `root` account with a different host name part, modify the instructions to use that host name.

```
mysql> ALTER USER 'root'@'localhost' IDENTIFIED BY 'MyNewPass';
```

You should now be able to connect to the MySQL server as `root` using the new password. Stop the server and restart it normally (without the `--skip-grant-tables` option and without enabling the `skip_networking` system variable).

If the `ALTER USER` statement fails to reset the password, try repeating the procedure using the following statements to modify the `user` table directly:

```
UPDATE mysql.user SET authentication_string = PASSWORD('MyNewPass')
WHERE User = 'root' AND Host = 'localhost';
FLUSH PRIVILEGES;
```

### B.3.3.3 What to Do If MySQL Keeps Crashing

Each MySQL version is tested on many platforms before it is released. This does not mean that there are no bugs in MySQL, but if there are bugs, they should be very few and can be hard to find. If you have a problem, it always helps if you try to find out exactly what crashes your system, because you have a much better chance of getting the problem fixed quickly.

First, you should try to find out whether the problem is that the `mysqld` server dies or whether your problem has to do with your client. You can check how long your `mysqld` server has been up by executing `mysqladmin version`. If `mysqld` has died and restarted, you may find the reason by looking in the server's error log. See [Section 5.4.2, "The Error Log"](#).

On some systems, you can find in the error log a stack trace of where `mysqld` died that you can resolve with the `resolve_stack_dump` program. See [Section 5.8, "Debugging MySQL"](#). Note that the variable values written in the error log may not always be 100% correct.

Many unexpected server exits are caused by corrupted data files or index files. MySQL updates the files on disk with the `write()` system call after every SQL statement and before the client is notified about the result. (This is not true if you are running with the `delay_key_write` system variable enabled, in which case data files are written but not index files.) This means that data file contents are safe even if `mysqld` crashes, because the operating system ensures that the unflushed data is written to disk. You can force MySQL to flush everything to disk after every SQL statement by starting `mysqld` with the `--flush` option.

The preceding means that normally you should not get corrupted tables unless one of the following happens:

- The MySQL server or the server host was killed in the middle of an update.
- You have found a bug in `mysqld` that caused it to die in the middle of an update.
- Some external program is manipulating data files or index files at the same time as `mysqld` without locking the table properly.
- You are running many `mysqld` servers using the same data directory on a system that does not support good file system locks (normally handled by the `lockd` lock manager), or you are running multiple servers with external locking disabled.
- You have a crashed data file or index file that contains very corrupt data that confused `mysqld`.
- You have found a bug in the data storage code. This is not likely, but it is at least possible. In this case, you can try to change the storage engine to another engine by using `ALTER TABLE` on a repaired copy of the table.

Because it is very difficult to know why something is crashing, first try to check whether things that work for others result in an unexpected exit for you. Try the following things:

- Stop the `mysqld` server with `mysqladmin shutdown`, run `myisamchk --silent --force */*.MYI` from the data directory to check all MyISAM tables, and restart `mysqld`. This ensures that you are running from a clean state. See [Chapter 5, MySQL Server Administration](#).
- Start `mysqld` with the general query log enabled (see [Section 5.4.3, “The General Query Log”](#)). Then try to determine from the information written to the log whether some specific query kills the server. About 95% of all bugs are related to a particular query. Normally, this is one of the last queries in the log file just before the server restarts. See [Section 5.4.3, “The General Query Log”](#). If you can repeatedly kill MySQL with a specific query, even when you have checked all tables just before issuing it, then you have isolated the bug and should submit a bug report for it. See [Section 1.5, “How to Report Bugs or Problems”](#).
- Try to make a test case that we can use to repeat the problem. See [Section 5.8, “Debugging MySQL”](#).
- Try the `fork_big.pl` script. (It is located in the `tests` directory of source distributions.)
- Configuring MySQL for debugging makes it much easier to gather information about possible errors if something goes wrong. Reconfigure MySQL with the `-DWITH_DEBUG=1` option to `CMake` and then recompile. See [Section 5.8, “Debugging MySQL”](#).
- Make sure that you have applied the latest patches for your operating system.
- Use the `--skip-external-locking` option to `mysqld`. On some systems, the `lockd` lock manager does not work properly; the `--skip-external-locking` option tells `mysqld` not to use external locking. (This means that you cannot run two `mysqld` servers on the same data directory and that you must be careful if you use `myisamchk`. Nevertheless, it may be instructive to try the option as a test.)
- If `mysqld` appears to be running but not responding, try `mysqladmin -u root processlist`. Sometimes `mysqld` is not hung even though it seems unresponsive. The problem may be that all connections are in use, or there may be some internal lock problem. `mysqladmin -u root processlist` usually is able to make a connection even in these cases, and can provide useful information about the current number of connections and their status.
- Run the command `mysqladmin -i 5 status` or `mysqladmin -i 5 -r status` in a separate window to produce statistics while running other queries.

- Try the following:
  1. Start `mysqld` from `gdb` (or another debugger). See [Section 5.8, “Debugging MySQL”](#).
  2. Run your test scripts.
  3. Print the backtrace and the local variables at the three lowest levels. In `gdb`, you can do this with the following commands when `mysqld` has crashed inside `gdb`:

```
backtrace
info local
up
info local
up
info local
```

With `gdb`, you can also examine which threads exist with `info threads` and switch to a specific thread with `thread N`, where `N` is the thread ID.

- Try to simulate your application with a Perl script to force MySQL to exit or misbehave.
- Send a normal bug report. See [Section 1.5, “How to Report Bugs or Problems”](#). Be even more detailed than usual. Because MySQL works for many people, the crash might result from something that exists only on your computer (for example, an error that is related to your particular system libraries).
- If you have a problem with tables containing dynamic-length rows and you are using only `VARCHAR` columns (not `BLOB` or `TEXT` columns), you can try to change all `VARCHAR` to `CHAR` with `ALTER TABLE`. This forces MySQL to use fixed-size rows. Fixed-size rows take a little extra space, but are much more tolerant to corruption.

The current dynamic row code has been in use for several years with very few problems, but dynamic-length rows are by nature more prone to errors, so it may be a good idea to try this strategy to see whether it helps.

- Consider the possibility of hardware faults when diagnosing problems. Defective hardware can be the cause of data corruption. Pay particular attention to your memory and disk subsystems when troubleshooting hardware.

### B.3.3.4 How MySQL Handles a Full Disk

This section describes how MySQL responds to disk-full errors (such as “no space left on device”), and to quota-exceeded errors (such as “write failed” or “user block limit reached”).

This section is relevant for writes to `MyISAM` tables. It also applies for writes to binary log files and binary log index file, except that references to “row” and “record” should be understood to mean “event.”

When a disk-full condition occurs, MySQL does the following:

- It checks once every minute to see whether there is enough space to write the current row. If there is enough space, it continues as if nothing had happened.
- Every 10 minutes it writes an entry to the log file, warning about the disk-full condition.

To alleviate the problem, take the following actions:

- To continue, you only have to free enough disk space to insert all records.
- Alternatively, to abort the thread, use `mysqladmin kill`. The thread is aborted the next time it checks the disk (in one minute).

- Other threads might be waiting for the table that caused the disk-full condition. If you have several “locked” threads, killing the one thread that is waiting on the disk-full condition enables the other threads to continue.

Exceptions to the preceding behavior are when you use `REPAIR TABLE` or `OPTIMIZE TABLE` or when the indexes are created in a batch after `LOAD DATA` or after an `ALTER TABLE` statement. All of these statements may create large temporary files that, if left to themselves, would cause big problems for the rest of the system. If the disk becomes full while MySQL is doing any of these operations, it removes the big temporary files and mark the table as crashed. The exception is that for `ALTER TABLE`, the old table is left unchanged.

### B.3.3.5 Where MySQL Stores Temporary Files

On Unix, MySQL uses the value of the `TMPDIR` environment variable as the path name of the directory in which to store temporary files. If `TMPDIR` is not set, MySQL uses the system default, which is usually `/tmp`, `/var/tmp`, or `/usr/tmp`.

On Windows, MySQL checks in order the values of the `TMPDIR`, `TEMP`, and `TMP` environment variables. For the first one found to be set, MySQL uses it and does not check those remaining. If none of `TMPDIR`, `TEMP`, or `TMP` are set, MySQL uses the Windows system default, which is usually `C:\windows\temp\`.

If the file system containing your temporary file directory is too small, you can use the `mysqld --tmpdir` option to specify a directory in a file system where you have enough space.

The `--tmpdir` option can be set to a list of several paths that are used in round-robin fashion. Paths should be separated by colon characters (`:`) on Unix and semicolon characters (`;`) on Windows.



#### Note

To spread the load effectively, these paths should be located on different *physical* disks, not different partitions of the same disk.

If the MySQL server is acting as a replica, you can set the `slave_load_tmpdir` system variable to specify a separate directory for holding temporary files when replicating `LOAD DATA` statements. This directory should be in a disk-based file system (not a memory-based file system) so that the temporary files used to replicate `LOAD DATA` can survive machine restarts. The directory also should not be one that is cleared by the operating system during the system startup process. However, replication can now continue after a restart if the temporary files have been removed.

MySQL arranges that temporary files are removed if `mysqld` is terminated. On platforms that support it (such as Unix), this is done by unlinking the file after opening it. The disadvantage of this is that the name does not appear in directory listings and you do not see a big temporary file that fills up the file system in which the temporary file directory is located. (In such cases, `ls -l +L` may be helpful in identifying large files associated with `mysqld`.)

When sorting (`ORDER BY` or `GROUP BY`), MySQL normally uses one or two temporary files. The maximum disk space required is determined by the following expression:

```
(length of what is sorted + sizeof(row pointer))
* number of matched rows
* 2
```

The row pointer size is usually four bytes, but may grow in the future for really big tables.

For some statements, MySQL creates temporary SQL tables that are not hidden and have names that begin with `#sql`.

Some `SELECT` queries creates temporary SQL tables to hold intermediate results.

DDL operations that rebuild the table and are not performed online using the `ALGORITHM=INPLACE` technique create a temporary copy of the original table in the same directory as the original table.

Online DDL operations may use temporary log files for recording concurrent DML, temporary sort files when creating an index, and temporary intermediate tables files when rebuilding the table. For more information, see [Section 14.13.3, “Online DDL Space Requirements”](#).

InnoDB non-compressed, user-created temporary tables and on-disk internal temporary tables are created in a temporary tablespace file named `ibtmp1` in the MySQL data directory. For more information, see [Section 14.6.3.5, “The Temporary Tablespace”](#).

See also [Section 14.16.7, “InnoDB INFORMATION\\_SCHEMA Temporary Table Info Table”](#). [Orphan Temporary Tables](#).

### B.3.3.6 How to Protect or Change the MySQL Unix Socket File

The default location for the Unix socket file that the server uses for communication with local clients is `/tmp/mysql.sock`. (For some distribution formats, the directory might be different, such as `/var/lib/mysql` for RPMs.)

On some versions of Unix, anyone can delete files in the `/tmp` directory or other similar directories used for temporary files. If the socket file is located in such a directory on your system, this might cause problems.

On most versions of Unix, you can protect your `/tmp` directory so that files can be deleted only by their owners or the superuser (`root`). To do this, set the `sticky` bit on the `/tmp` directory by logging in as `root` and using the following command:

```
$> chmod +t /tmp
```

You can check whether the `sticky` bit is set by executing `ls -ld /tmp`. If the last permission character is `t`, the bit is set.

Another approach is to change the place where the server creates the Unix socket file. If you do this, you should also let client programs know the new location of the file. You can specify the file location in several ways:

- Specify the path in a global or local option file. For example, put the following lines in `/etc/my.cnf`:

```
[mysqld]
socket=/path/to/socket

[client]
socket=/path/to/socket
```

See [Section 4.2.2.2, “Using Option Files”](#).

- Specify a `--socket` option on the command line to `mysqld_safe` and when you run client programs.
- Set the `MYSQL_UNIX_PORT` environment variable to the path of the Unix socket file.
- Recompile MySQL from source to use a different default Unix socket file location. Define the path to the file with the `MYSQL_UNIX_ADDR` option when you run `CMake`. See [Section 2.8.7, “MySQL Source-Configuration Options”](#).

You can test whether the new socket location works by attempting to connect to the server with this command:

```
$> mysqladmin --socket=/path/to/socket version
```

### B.3.3.7 Time Zone Problems

If you have a problem with `SELECT NOW()` returning values in UTC and not your local time, you have to tell the server your current time zone. The same applies if `UNIX_TIMESTAMP()` returns the wrong value. This should be done for the environment in which the server runs (for example, in `mysqld_safe` or `mysql.server`). See [Section 4.9, “Environment Variables”](#).

You can set the time zone for the server with the `--timezone=timezone_name` option to `mysqld_safe`. You can also set it by setting the `TZ` environment variable before you start `mysqld`.

The permissible values for `--timezone` or `TZ` are system dependent. Consult your operating system documentation to see what values are acceptable.

## B.3.4 Query-Related Issues

### B.3.4.1 Case Sensitivity in String Searches

For nonbinary strings (`CHAR`, `VARCHAR`, `TEXT`), string searches use the collation of the comparison operands. For binary strings (`BINARY`, `VARBINARY`, `BLOB`), comparisons use the numeric values of the bytes in the operands; this means that for alphabetic characters, comparisons are case-sensitive.

A comparison between a nonbinary string and binary string is treated as a comparison of binary strings.

Simple comparison operations (`>=`, `>`, `=`, `<`, `<=`, sorting, and grouping) are based on each character's “sort value.” Characters with the same sort value are treated as the same character. For example, if `e` and `é` have the same sort value in a given collation, they compare as equal.

The default character set and collation are `latin1` and `latin1_swedish_ci`, so nonbinary string comparisons are case-insensitive by default. This means that if you search with `col_name LIKE 'a%'`, you get all column values that start with `A` or `a`. To make this search case-sensitive, make sure that one of the operands has a case-sensitive or binary collation. For example, if you are comparing a column and a string that both have the `latin1` character set, you can use the `COLLATE` operator to cause either operand to have the `latin1_general_cs` or `latin1_bin` collation:

```
col_name COLLATE latin1_general_cs LIKE 'a%'
col_name LIKE 'a%' COLLATE latin1_general_cs
col_name COLLATE latin1_bin LIKE 'a%'
col_name LIKE 'a%' COLLATE latin1_bin
```

If you want a column always to be treated in case-sensitive fashion, declare it with a case-sensitive or binary collation. See [Section 13.1.18, “CREATE TABLE Statement”](#).

To cause a case-sensitive comparison of nonbinary strings to be case-insensitive, use `COLLATE` to name a case-insensitive collation. The strings in the following example normally are case-sensitive, but `COLLATE` changes the comparison to be case-insensitive:

```
mysql> SET @s1 = 'MySQL' COLLATE latin1_bin,
->      @s2 = 'mysql' COLLATE latin1_bin;
mysql> SELECT @s1 = @s2;
+-----+
| @s1 = @s2 |
+-----+
|          0 |
+-----+
mysql> SELECT @s1 COLLATE latin1_swedish_ci = @s2;
+-----+
| @s1 COLLATE latin1_swedish_ci = @s2 |
+-----+
|                                     1 |
```

A binary string is case-sensitive in comparisons. To compare the string as case-insensitive, convert it to a nonbinary string and use `COLLATE` to name a case-insensitive collation:

```
mysql> SET @s = BINARY 'MySQL';
mysql> SELECT @s = 'mysql';
+-----+
| @s = 'mysql' |
+-----+
|             0 |
+-----+
mysql> SELECT CONVERT(@s USING latin1) COLLATE latin1_swedish_ci = 'mysql';
+-----+
| CONVERT(@s USING latin1) COLLATE latin1_swedish_ci = 'mysql' |
+-----+
|                                                                 1 |
+-----+
```

To determine whether a value compares as a nonbinary or binary string, use the `COLLATION()` function. This example shows that `VERSION()` returns a string that has a case-insensitive collation, so comparisons are case-insensitive:

```
mysql> SELECT COLLATION(VERSION());
+-----+
| COLLATION(VERSION()) |
+-----+
| utf8_general_ci      |
+-----+
```

For binary strings, the collation value is `binary`, so comparisons are case-sensitive. One context in which you may see `binary` is for compression functions, which return binary strings as a general rule:

```
mysql> SELECT COLLATION(COMPRESS('x'));
+-----+
| COLLATION(COMPRESS('x')) |
+-----+
| binary                   |
+-----+
```

To check the sort value of a string, the `WEIGHT_STRING()` may be helpful. See [Section 12.8, “String Functions and Operators”](#).

### B.3.4.2 Problems Using DATE Columns

The format of a `DATE` value is `'YYYY-MM-DD'`. According to standard SQL, no other format is permitted. You should use this format in `UPDATE` expressions and in the `WHERE` clause of `SELECT` statements. For example:

```
SELECT * FROM t1 WHERE date >= '2003-05-05';
```

As a convenience, MySQL automatically converts a date to a number if the date is used in numeric context and vice versa. MySQL also permits a “relaxed” string format when updating and in a `WHERE` clause that compares a date to a `DATE`, `DATETIME`, or `TIMESTAMP` column. “Relaxed” format means that any punctuation character may be used as the separator between parts. For example, `'2004-08-15'` and `'2004#08#15'` are equivalent. MySQL can also convert a string containing no separators (such as `'20040815'`), provided it makes sense as a date.

When you compare a `DATE`, `TIME`, `DATETIME`, or `TIMESTAMP` to a constant string with the `<`, `<=`, `=`, `>=`, `>`, or `BETWEEN` operators, MySQL normally converts the string to an internal long integer for faster comparison (and also for a bit more “relaxed” string checking). However, this conversion is subject to the following exceptions:

- When you compare two columns
- When you compare a `DATE`, `TIME`, `DATETIME`, or `TIMESTAMP` column to an expression
- When you use any comparison method other than those just listed, such as `IN` or `STRCMP()`.

For those exceptions, the comparison is done by converting the objects to strings and performing a string comparison.

To be on the safe side, assume that strings are compared as strings and use the appropriate string functions if you want to compare a temporal value to a string.

The special “zero” date `'0000-00-00'` can be stored and retrieved as `'0000-00-00'`. When a `'0000-00-00'` date is used through Connector/ODBC, it is automatically converted to `NULL` because ODBC cannot handle that kind of date.

Because MySQL performs the conversions just described, the following statements work (assume that `idate` is a `DATE` column):

```
INSERT INTO t1 (idate) VALUES (19970505);
INSERT INTO t1 (idate) VALUES ('19970505');
INSERT INTO t1 (idate) VALUES ('97-05-05');
INSERT INTO t1 (idate) VALUES ('1997.05.05');
INSERT INTO t1 (idate) VALUES ('1997 05 05');
INSERT INTO t1 (idate) VALUES ('0000-00-00');

SELECT idate FROM t1 WHERE idate >= '1997-05-05';
SELECT idate FROM t1 WHERE idate >= 19970505;
SELECT MOD(idate,100) FROM t1 WHERE idate >= 19970505;
SELECT idate FROM t1 WHERE idate >= '19970505';
```

However, the following statement does not work:

```
SELECT idate FROM t1 WHERE STRCMP(idate,'20030505')=0;
```

`STRCMP()` is a string function, so it converts `idate` to a string in `'YYYY-MM-DD'` format and performs a string comparison. It does not convert `'20030505'` to the date `'2003-05-05'` and perform a date comparison.

If you enable the `ALLOW_INVALID_DATES` SQL mode, MySQL permits you to store dates that are given only limited checking: MySQL requires only that the day is in the range from 1 to 31 and the month is in the range from 1 to 12. This makes MySQL very convenient for Web applications where you obtain year, month, and day in three different fields and you want to store exactly what the user inserted (without date validation).

MySQL permits you to store dates where the day or month and day are zero. This is convenient if you want to store a birthdate in a `DATE` column and you know only part of the date. To disallow zero month or day parts in dates, enable the `NO_ZERO_IN_DATE` mode.

MySQL permits you to store a “zero” value of `'0000-00-00'` as a “dummy date.” This is in some cases more convenient than using `NULL` values. If a date to be stored in a `DATE` column cannot be converted to any reasonable value, MySQL stores `'0000-00-00'`. To disallow `'0000-00-00'`, enable the `NO_ZERO_DATE` mode.

To have MySQL check all dates and accept only legal dates (unless overridden by `IGNORE`), set the `sql_mode` system variable to `"NO_ZERO_IN_DATE,NO_ZERO_DATE"`.

### B.3.4.3 Problems with NULL Values



The concept of the `NULL` value is a common source of confusion for newcomers to SQL, who often think that `NULL` is the same thing as an empty string `' '`. This is not the case. For example, the following statements are completely different:

```
mysql> INSERT INTO my_table (phone) VALUES (NULL);
mysql> INSERT INTO my_table (phone) VALUES ('');
```

Both statements insert a value into the `phone` column, but the first inserts a `NULL` value and the second inserts an empty string. The meaning of the first can be regarded as “phone number is not known” and the meaning of the second can be regarded as “the person is known to have no phone, and thus no phone number.”

To help with `NULL` handling, you can use the `IS NULL` and `IS NOT NULL` operators and the `IFNULL()` function.

In SQL, the `NULL` value is never true in comparison to any other value, even `NULL`. An expression that contains `NULL` always produces a `NULL` value unless otherwise indicated in the documentation for the operators and functions involved in the expression. All columns in the following example return `NULL`:

```
mysql> SELECT NULL, 1+NULL, CONCAT('Invisible',NULL);
```

To search for column values that are `NULL`, you cannot use an `expr = NULL` test. The following statement returns no rows, because `expr = NULL` is never true for any expression:

```
mysql> SELECT * FROM my_table WHERE phone = NULL;
```

To look for `NULL` values, you must use the `IS NULL` test. The following statements show how to find the `NULL` phone number and the empty phone number:

```
mysql> SELECT * FROM my_table WHERE phone IS NULL;
mysql> SELECT * FROM my_table WHERE phone = '';
```

See [Section 3.3.4.6, “Working with NULL Values”](#), for additional information and examples.

You can add an index on a column that can have `NULL` values if you are using the `MyISAM`, `InnoDB`, or `MEMORY` storage engine. Otherwise, you must declare an indexed column `NOT NULL`, and you cannot insert `NULL` into the column.

When reading data with `LOAD DATA`, empty or missing columns are updated with `' '`. To load a `NULL` value into a column, use `\N` in the data file. The literal word `NULL` may also be used under some circumstances. See [Section 13.2.6, “LOAD DATA Statement”](#).

When using `DISTINCT`, `GROUP BY`, or `ORDER BY`, all `NULL` values are regarded as equal.

When using `ORDER BY`, `NULL` values are presented first, or last if you specify `DESC` to sort in descending order.

Aggregate (group) functions such as `COUNT()`, `MIN()`, and `SUM()` ignore `NULL` values. The exception to this is `COUNT(*)`, which counts rows and not individual column values. For example, the following statement produces two counts. The first is a count of the number of rows in the table, and the second is a count of the number of non-`NULL` values in the `age` column:

```
mysql> SELECT COUNT(*), COUNT(age) FROM person;
```

For some data types, MySQL handles `NULL` values specially. For example, if you insert `NULL` into an integer or floating-point column that has the `AUTO_INCREMENT` attribute, the next number in the sequence is inserted. Under certain conditions, if you insert `NULL` into a `TIMESTAMP` column, the current date and time is inserted; this behavior depends in part on the server SQL mode (see [Section 5.1.10, “Server SQL Modes”](#)) as well as the value of the `explicit_defaults_for_timestamp` system variable.

### B.3.4.4 Problems with Column Aliases

An alias can be used in a query select list to give a column a different name. You can use the alias in `GROUP BY`, `ORDER BY`, or `HAVING` clauses to refer to the column:

```
SELECT SQRT(a*b) AS root FROM tbl_name
  GROUP BY root HAVING root > 0;
SELECT id, COUNT(*) AS cnt FROM tbl_name
  GROUP BY id HAVING cnt > 0;
SELECT id AS 'Customer identity' FROM tbl_name;
```

Standard SQL disallows references to column aliases in a `WHERE` clause. This restriction is imposed because when the `WHERE` clause is evaluated, the column value may not yet have been determined. For example, the following query is illegal:

```
SELECT id, COUNT(*) AS cnt FROM tbl_name
  WHERE cnt > 0 GROUP BY id;
```

The `WHERE` clause determines which rows should be included in the `GROUP BY` clause, but it refers to the alias of a column value that is not known until after the rows have been selected, and grouped by the `GROUP BY`.

In the select list of a query, a quoted column alias can be specified using identifier or string quoting characters:

```
SELECT 1 AS `one`, 2 AS 'two';
```

Elsewhere in the statement, quoted references to the alias must use identifier quoting or the reference is treated as a string literal. For example, this statement groups by the values in column `id`, referenced using the alias ``a``:

```
SELECT id AS 'a', COUNT(*) AS cnt FROM tbl_name
  GROUP BY `a`;
```

This statement groups by the literal string `'a'` and does not work as expected:

```
SELECT id AS 'a', COUNT(*) AS cnt FROM tbl_name
  GROUP BY 'a';
```

### B.3.4.5 Rollback Failure for Nontransactional Tables

If you receive the following message when trying to perform a `ROLLBACK`, it means that one or more of the tables you used in the transaction do not support transactions:

```
Warning: Some non-transactional changed tables couldn't be rolled back
```

These nontransactional tables are not affected by the `ROLLBACK` statement.

If you were not deliberately mixing transactional and nontransactional tables within the transaction, the most likely cause for this message is that a table you thought was transactional actually is not. This can happen if you try to create a table using a transactional storage engine that is not supported by your `mysqld` server (or that was disabled with a startup option). If `mysqld` does not support a storage engine, it instead creates the table as a `MyISAM` table, which is nontransactional.

You can check the storage engine for a table by using either of these statements:

```
SHOW TABLE STATUS LIKE 'tbl_name';
SHOW CREATE TABLE tbl_name;
```

See [Section 13.7.5.36, “SHOW TABLE STATUS Statement”](#), and [Section 13.7.5.10, “SHOW CREATE TABLE Statement”](#).

To check which storage engines your `mysqld` server supports, use this statement:

```
SHOW ENGINES;
```

See [Section 13.7.5.16, “SHOW ENGINES Statement”](#) for full details.

### B.3.4.6 Deleting Rows from Related Tables

If the total length of the `DELETE` statement for `related_table` is more than 1MB (the default value of the `max_allowed_packet` system variable), you should split it into smaller parts and execute multiple `DELETE` statements. You probably get the fastest `DELETE` by specifying only 100 to 1,000 `related_column` values per statement if the `related_column` is indexed. If the `related_column` is not indexed, the speed is independent of the number of arguments in the `IN` clause.

### B.3.4.7 Solving Problems with No Matching Rows

If you have a complicated query that uses many tables but that returns no rows, you should use the following procedure to find out what is wrong:

1. Test the query with `EXPLAIN` to check whether you can find something that is obviously wrong. See [Section 13.8.2, “EXPLAIN Statement”](#).
2. Select only those columns that are used in the `WHERE` clause.
3. Remove one table at a time from the query until it returns some rows. If the tables are large, it is a good idea to use `LIMIT 10` with the query.
4. Issue a `SELECT` for the column that should have matched a row against the table that was last removed from the query.
5. If you are comparing `FLOAT` or `DOUBLE` columns with numbers that have decimals, you cannot use equality (`=`) comparisons. This problem is common in most computer languages because not all floating-point values can be stored with exact precision. In some cases, changing the `FLOAT` to a `DOUBLE` fixes this. See [Section B.3.4.8, “Problems with Floating-Point Values”](#).
6. If you still cannot figure out what is wrong, create a minimal test that can be run with `mysql test < query.sql` that shows your problems. You can create a test file by dumping the tables with `mysqldump --quick db_name tbl_name_1 ... tbl_name_n > query.sql`. Open the file in an editor, remove some insert lines (if there are more than needed to demonstrate the problem), and add your `SELECT` statement at the end of the file.

Verify that the test file demonstrates the problem by executing these commands:

```
$> mysqladmin create test2
$> mysql test2 < query.sql
```

Attach the test file to a bug report, which you can file using the instructions in [Section 1.5, “How to Report Bugs or Problems”](#).

### B.3.4.8 Problems with Floating-Point Values

Floating-point numbers sometimes cause confusion because they are approximate and not stored as exact values. A floating-point value as written in an SQL statement may not be the same as the value represented internally. Attempts to treat floating-point values as exact in comparisons may lead to problems. They are also subject to platform or implementation dependencies. The `FLOAT` and `DOUBLE` data types are subject to these issues. For `DECIMAL` columns, MySQL performs operations with a precision of 65 decimal digits, which should solve most common inaccuracy problems.

The following example uses `DOUBLE` to demonstrate how calculations that are done using floating-point operations are subject to floating-point error.

```
mysql> CREATE TABLE t1 (i INT, d1 DOUBLE, d2 DOUBLE);
mysql> INSERT INTO t1 VALUES (1, 101.40, 21.40), (1, -80.00, 0.00),
-> (2, 0.00, 0.00), (2, -13.20, 0.00), (2, 59.60, 46.40),
-> (2, 30.40, 30.40), (3, 37.00, 7.40), (3, -29.60, 0.00),
-> (4, 60.00, 15.40), (4, -10.60, 0.00), (4, -34.00, 0.00),
-> (5, 33.00, 0.00), (5, -25.80, 0.00), (5, 0.00, 7.20),
-> (6, 0.00, 0.00), (6, -51.40, 0.00);

mysql> SELECT i, SUM(d1) AS a, SUM(d2) AS b
-> FROM t1 GROUP BY i HAVING a <> b;
```

i	a	b
1	21.4	21.4
2	76.8	76.8
3	7.4	7.4
4	15.4	15.4
5	7.2	7.2
6	-51.4	0

The result is correct. Although the first five records look like they should not satisfy the comparison (the values of `a` and `b` do not appear to be different), they may do so because the difference between the numbers shows up around the tenth decimal or so, depending on factors such as computer architecture or the compiler version or optimization level. For example, different CPUs may evaluate floating-point numbers differently.

If columns `d1` and `d2` had been defined as `DECIMAL` rather than `DOUBLE`, the result of the `SELECT` query would have contained only one row—the last one shown above.

The correct way to do floating-point number comparison is to first decide on an acceptable tolerance for differences between the numbers and then do the comparison against the tolerance value. For example, if we agree that floating-point numbers should be regarded the same if they are same within a precision of one in ten thousand (0.0001), the comparison should be written to find differences larger than the tolerance value:

```
mysql> SELECT i, SUM(d1) AS a, SUM(d2) AS b FROM t1
-> GROUP BY i HAVING ABS(a - b) > 0.0001;

+-----+-----+-----+
| i     | a     | b     |
+-----+-----+-----+
| 6     | -51.4 | 0     |
+-----+-----+-----+
1 row in set (0.00 sec)
```

Conversely, to get rows where the numbers are the same, the test should find differences within the tolerance value:

```
mysql> SELECT i, SUM(d1) AS a, SUM(d2) AS b FROM t1
-> GROUP BY i HAVING ABS(a - b) <= 0.0001;

+-----+-----+-----+
| i     | a     | b     |
+-----+-----+-----+
| 1     | 21.4  | 21.4  |
| 2     | 76.8  | 76.8  |
| 3     | 7.4   | 7.4   |
| 4     | 15.4  | 15.4  |
| 5     | 7.2   | 7.2   |
+-----+-----+-----+
5 rows in set (0.03 sec)
```

Floating-point values are subject to platform or implementation dependencies. Suppose that you execute the following statements:

```
CREATE TABLE t1(c1 FLOAT(53,0), c2 FLOAT(53,0));
INSERT INTO t1 VALUES('1e+52','-1e+52');
SELECT * FROM t1;
```

On some platforms, the `SELECT` statement returns `inf` and `-inf`. On others, it returns `0` and `-0`.

An implication of the preceding issues is that if you attempt to create a replica by dumping table contents with `mysqldump` on the source and reloading the dump file into the replica, tables containing floating-point columns might differ between the two hosts.

## B.3.5 Optimizer-Related Issues

MySQL uses a cost-based optimizer to determine the best way to resolve a query. In many cases, MySQL can calculate the best possible query plan, but sometimes MySQL does not have enough information about the data at hand and has to make “educated” guesses about the data.

For the cases when MySQL does not do the “right” thing, tools that you have available to help MySQL are:

- Use the `EXPLAIN` statement to get information about how MySQL processes a query. To use it, just add the keyword `EXPLAIN` to the front of your `SELECT` statement:

```
mysql> EXPLAIN SELECT * FROM t1, t2 WHERE t1.i = t2.i;
```

`EXPLAIN` is discussed in more detail in [Section 13.8.2, “EXPLAIN Statement”](#).

- Use `ANALYZE TABLE tbl_name` to update the key distributions for the scanned table. See [Section 13.7.2.1, “ANALYZE TABLE Statement”](#).
- Use `FORCE INDEX` for the scanned table to tell MySQL that table scans are very expensive compared to using the given index:

```
SELECT * FROM t1, t2 FORCE INDEX (index_for_column)
WHERE t1.col_name=t2.col_name;
```

`USE INDEX` and `IGNORE INDEX` may also be useful. See [Section 8.9.4, “Index Hints”](#).

- Global and table-level `STRAIGHT_JOIN`. See [Section 13.2.9, “SELECT Statement”](#).
- You can tune global or thread-specific system variables. For example, start `mysqld` with the `--max-seeks-for-key=1000` option or use `SET max_seeks_for_key=1000` to tell the optimizer to assume that no key scan causes more than 1,000 key seeks. See [Section 5.1.7, “Server System Variables”](#).

## B.3.6 Table Definition-Related Issues

### B.3.6.1 Problems with ALTER TABLE

If you get a duplicate-key error when using `ALTER TABLE` to change the character set or collation of a character column, the cause is either that the new column collation maps two keys to the same value or that the table is corrupted. In the latter case, you should run `REPAIR TABLE` on the table. `REPAIR TABLE` works for `MyISAM`, `ARCHIVE`, and `CSV` tables.

If `ALTER TABLE` dies with the following error, the problem may be that MySQL crashed during an earlier `ALTER TABLE` operation and there is an old table named `A-xxx` or `B-xxx` lying around:

```
Error on rename of './database/name.frm'
```

```
to './database/B-xxx.frm' (Errcode: 17)
```

In this case, go to the MySQL data directory and delete all files that have names starting with `A-` or `B-`. (You may want to move them elsewhere instead of deleting them.)

`ALTER TABLE` works in the following way:

- Create a new table named `A-xxx` with the requested structural changes.
- Copy all rows from the original table to `A-xxx`.
- Rename the original table to `B-xxx`.
- Rename `A-xxx` to your original table name.
- Delete `B-xxx`.

If something goes wrong with the renaming operation, MySQL tries to undo the changes. If something goes seriously wrong (although this shouldn't happen), MySQL may leave the old table as `B-xxx`. A simple rename of the table files at the system level should get your data back.

If you use `ALTER TABLE` on a transactional table or if you are using Windows, `ALTER TABLE` unlocks the table if you had done a `LOCK TABLE` on it. This is done because `InnoDB` and these operating systems cannot drop a table that is in use.

### B.3.6.2 TEMPORARY Table Problems

Temporary tables created with `CREATE TEMPORARY TABLE` have the following limitations:

- `TEMPORARY` tables are supported only by the `InnoDB`, `MEMORY`, `MyISAM`, and `MERGE` storage engines.
- Temporary tables are not supported for NDB Cluster.
- The `SHOW TABLES` statement does not list `TEMPORARY` tables.
- To rename `TEMPORARY` tables, `RENAME TABLE` does not work. Use `ALTER TABLE` instead:

```
ALTER TABLE old_name RENAME new_name;
```

- You cannot refer to a `TEMPORARY` table more than once in the same query. For example, the following does not work:

```
SELECT * FROM temp_table JOIN temp_table AS t2;
```

The statement produces this error:

```
ERROR 1137: Can't reopen table: 'temp_table'
```

- The `Can't reopen table` error also occurs if you refer to a temporary table multiple times in a stored function under different aliases, even if the references occur in different statements within the function. It may occur for temporary tables created outside stored functions and referred to across multiple calling and callee functions.
- If a `TEMPORARY` is created with the same name as an existing non-`TEMPORARY` table, the non-`TEMPORARY` table is hidden until the `TEMPORARY` table is dropped, even if the tables use different storage engines.
- There are known issues in using temporary tables with replication. See [Section 16.4.1.29, “Replication and Temporary Tables”](#), for more information.

## B.3.7 Known Issues in MySQL

This section lists known issues in recent versions of MySQL.

For information about platform-specific issues, see the installation and debugging instructions in [Section 2.1, “General Installation Guidance”](#), and [Section 5.8, “Debugging MySQL”](#).

The following problems are known:

- Subquery optimization for `IN` is not as effective as for `=`.
- Even if you use `lower_case_table_names=2` (which enables MySQL to remember the case used for databases and table names), MySQL does not remember the case used for database names for the function `DATABASE()` or within the various logs (on case-insensitive systems).
- Dropping a `FOREIGN KEY` constraint does not work in replication because the constraint may have another name on the replica.
- `REPLACE` (and `LOAD DATA` with the `REPLACE` option) does not trigger `ON DELETE CASCADE`.
- `DISTINCT` with `ORDER BY` does not work inside `GROUP_CONCAT()` if you do not use all and only those columns that are in the `DISTINCT` list.
- When inserting a big integer value (between  $2^{63}$  and  $2^{64}-1$ ) into a decimal or string column, it is inserted as a negative value because the number is evaluated in signed integer context.
- With statement-based binary logging, the source server writes the executed queries to the binary log. This is a very fast, compact, and efficient logging method that works perfectly in most cases. However, it is possible for the data on the source and replica to become different if a query is designed in such a way that the data modification is nondeterministic (generally not a recommended practice, even outside of replication).

For example:

- `CREATE TABLE ... SELECT` or `INSERT ... SELECT` statements that insert zero or `NULL` values into an `AUTO_INCREMENT` column.
- `DELETE` if you are deleting rows from a table that has foreign keys with `ON DELETE CASCADE` properties.
- `REPLACE ... SELECT, INSERT IGNORE ... SELECT` if you have duplicate key values in the inserted data.

**If and only if the preceding queries have no `ORDER BY` clause guaranteeing a deterministic order.**

For example, for `INSERT ... SELECT` with no `ORDER BY`, the `SELECT` may return rows in a different order (which results in a row having different ranks, hence getting a different number in the `AUTO_INCREMENT` column), depending on the choices made by the optimizers on the source and replica.

A query is optimized differently on the source and replica only if:

- The table is stored using a different storage engine on the source than on the replica. (It is possible to use different storage engines on the source and replica. For example, you can use `InnoDB` on the source, but `MyISAM` on the replica if the replica has less available disk space.)
- MySQL buffer sizes (`key_buffer_size`, and so on) are different on the source and replica.

- The source and replica run different MySQL versions, and the optimizer code differs between these versions.

This problem may also affect database restoration using `mysqlbinlog|mysql`.

The easiest way to avoid this problem is to add an `ORDER BY` clause to the aforementioned nondeterministic queries to ensure that the rows are always stored or modified in the same order. Using row-based or mixed logging format also avoids the problem.

- Log file names are based on the server host name if you do not specify a file name with the startup option. To retain the same log file names if you change your host name to something else, you must explicitly use options such as `--log-bin=old_host_name-bin`. See [Section 5.1.6, “Server Command Options”](#). Alternatively, rename the old files to reflect your host name change. If these are binary logs, you must edit the binary log index file and fix the binary log file names there as well. (The same is true for the relay logs on a replica.)
- `mysqlbinlog` does not delete temporary files left after a `LOAD DATA` statement. See [Section 4.6.7, “mysqlbinlog — Utility for Processing Binary Log Files”](#).
- `RENAME` does not work with `TEMPORARY` tables or tables used in a `MERGE` table.
- When using `SET CHARACTER SET`, you cannot use translated characters in database, table, and column names.
- You cannot use `_` or `%` with `ESCAPE` in `LIKE ... ESCAPE`.
- The server uses only the first `max_sort_length` bytes when comparing data values. This means that values cannot reliably be used in `GROUP BY`, `ORDER BY`, or `DISTINCT` if they differ only after the first `max_sort_length` bytes. To work around this, increase the variable value. The default value of `max_sort_length` is 1024 and can be changed at server startup time or at runtime.
- Numeric calculations are done with `BIGINT` or `DOUBLE` (both are normally 64 bits long). Which precision you get depends on the function. The general rule is that bit functions are performed with `BIGINT` precision, `IF()` and `ELT()` with `BIGINT` or `DOUBLE` precision, and the rest with `DOUBLE` precision. You should try to avoid using unsigned long long values if they resolve to be larger than 63 bits (9223372036854775807) for anything other than bit fields.
- You can have up to 255 `ENUM` and `SET` columns in one table.
- In `MIN()`, `MAX()`, and other aggregate functions, MySQL currently compares `ENUM` and `SET` columns by their string value rather than by the string's relative position in the set.
- In an `UPDATE` statement, columns are updated from left to right. If you refer to an updated column, you get the updated value instead of the original value. For example, the following statement increments `KEY` by 2, **not** 1:
 

```
mysql> UPDATE tbl_name SET KEY=KEY+1,KEY=KEY+1;
```
- You can refer to multiple temporary tables in the same query, but you cannot refer to any given temporary table more than once. For example, the following does not work:
 

```
mysql> SELECT * FROM temp_table, temp_table AS t2;
ERROR 1137: Can't reopen table: 'temp_table'
```
- The optimizer may handle `DISTINCT` differently when you are using “hidden” columns in a join than when you are not. In a join, hidden columns are counted as part of the result (even if they are not shown), whereas in normal queries, hidden columns do not participate in the `DISTINCT` comparison.



An example of this is:

```
SELECT DISTINCT mp3id FROM band_downloads
WHERE userid = 9 ORDER BY id DESC;
```

and

```
SELECT DISTINCT band_downloads.mp3id
FROM band_downloads,band_mp3
WHERE band_downloads.userid = 9
AND band_mp3.id = band_downloads.mp3id
ORDER BY band_downloads.id DESC;
```

In the second case, you may get two identical rows in the result set (because the values in the hidden `id` column may differ).

Note that this happens only for queries that do not have the `ORDER BY` columns in the result.

- If you execute a `PROCEDURE` on a query that returns an empty set, in some cases the `PROCEDURE` does not transform the columns.
- Creation of a table of type `MERGE` does not check whether the underlying tables are compatible types.
- If you use `ALTER TABLE` to add a `UNIQUE` index to a table used in a `MERGE` table and then add a normal index on the `MERGE` table, the key order is different for the tables if there was an old, non-`UNIQUE` key in the table. This is because `ALTER TABLE` puts `UNIQUE` indexes before normal indexes to be able to detect duplicate keys as early as possible.
- An `UPDATE` statement involving a temporary table with a join on a non-temporary table having a trigger defined on it can result in an error, even though the update statement reads only the non-temporary table, in the following cases:
  - With read-only mode enabled (by using `SET GLOBAL read_only = 1`).
  - With the transaction level set to `READ_ONLY` (that is, using `SET GLOBAL TRANSACTION READ ONLY` or `SET SESSION TRANSACTION READ ONLY`).



---

# Appendix C Indexes

## Table of Contents

General Index .....	4581
C Function Index .....	4848
Command Index .....	4852
Function Index .....	4900
INFORMATION_SCHEMA Index .....	4945
Join Types Index .....	4957
Operator Index .....	4959
Option Index .....	4968
Privileges Index .....	5078
SQL Modes Index .....	5088
Statement/Syntax Index .....	5093
Status Variable Index .....	5183
System Variable Index .....	5214
Transaction Isolation Level Index .....	5297

## General Index

### Symbols

! (logical NOT), 1906  
!= (not equal), 1900  
", 1661  
#mysql50 identifier prefix, 1662, 1668  
%, 1913  
% (modulo), 1918  
% (wildcard character), 1653  
& (bitwise AND), 2019  
&& (logical AND), 1906  
( ) (parentheses), 1898  
(Control+Z) \Z, 1653, 2295  
\* (multiplication), 1913  
+ (addition), 1912  
- (subtraction), 1912  
- (unary minus), 1912  
--basedir  
    removed features, 24  
--bootstrap  
    deprecated features, 22  
--comments  
    deprecated features, 22  
--datadir  
    removed features, 24  
--des-key-file  
    deprecated features, 21  
--fix-db-names  
    deprecated features, 22

---

- fix-table-names
  - deprecated features, 22
- ignore-db-dir
  - deprecated features, 21
- log-warnings
  - deprecated features, 20
- password option, 1078
- secure-auth
  - removed features, 23
- skip-comments
  - deprecated features, 22
- skip-innodb
  - deprecated features, 20
- skip-secure-auth
  - removed features, 23
- ssl
  - deprecated features, 20
- ssl-verify-server-cert
  - deprecated features, 20
- temp-pool
  - deprecated features, 20
- tmpdir
  - removed features, 24
- >, 2090
- >>, 2092
- c option (ndb\_mgmd) (OBSOLETE), 3592
- d option
  - ndb\_index\_stat, 3673
  - ndb\_mgmd, 3594
- e option
  - ndb\_mgm, 3604
- f option
  - ndb\_mgmd, 3592
- l option
  - ndbinfo\_select\_all, 3585
- myisam\_repair\_threads
  - removed features, 25
- n option
  - ndbd, 3579
  - ndbmtd, 3579
- p option, 1078
- P option
  - ndb\_mgmd, 3599
- v option
  - ndb\_mgmd, 3600
- .frm file, 2228
- .ibd file, 2228
- .my.cnf option file, 311, 313, 337, 1045, 1079, 1143
- .MYD file, 2228
- .MYI file, 2228
- .mylogin.cnf option file, 311, 605
- .mysql\_history file, 426, 1079
- .mysql\_secret file, 162, 362
- .pid (process ID) file, 1438

---

/ (division), 1913  
/etc/passwd, 1088, 2318  
3306 port, 211, 756  
33060 port, 211  
:= (assignment operator), 1907  
:= (assignment), 1697  
< (less than), 1901  
<< (left shift), 299, 2019  
<= (less than or equal), 1901  
<=> (equal to), 1900  
<> (not equal), 1900  
= (assignment operator), 1908  
= (assignment), 1697  
= (equal), 1900  
> (greater than), 1901  
>= (greater than or equal), 1901  
>> (right shift), 2019  
[api] (NDB Cluster), 3372  
[computer] (NDB Cluster), 3373  
[mgm] (NDB Cluster), 3371  
[mysqld] (NDB Cluster), 3372  
[ndbd default] (NDB Cluster), 3365  
[ndbd] (NDB Cluster), 3365  
[ndb\_mgmd] (NDB Cluster), 3371  
[shm] (NDB Cluster), 3373  
[tcp] (NDB Cluster), 3373  
\" (double quote), 1653, 2106  
' (single quote), 1653  
\. (mysql client command), 293, 430  
\0 (ASCII NUL), 1652, 2295  
\b (backspace), 1653, 2106, 2295  
\f (formfeed), 2106  
\n (linefeed), 1653, 2106, 2295  
\n (newline), 1653, 2106, 2295  
\N (NULL), 2295  
\N as NULL  
    deprecated features, 21  
\r (carriage return), 1653, 2106, 2295  
\t (tab), 1653, 2106, 2295  
\u (Unicode character), 2106  
\Z (Control+Z) ASCII 26, 1653, 2295  
\ (escape), 1653, 2106  
^ (bitwise XOR), 2019  
\_ (wildcard character), 1653  
\_ai collation suffix, 1716  
\_as collation suffix, 1716  
\_bin collation suffix, 1716, 1739  
\_ci collation suffix, 1716  
\_cs collation suffix, 1716  
\_rowid  
    SELECT statements, 2190, 2210, 2210  
, 1661  
| (bitwise OR), 2018  
|| (logical OR), 1906

---

~ (invert bits), 2019

## A

abort-on-error option  
  ndb\_import, 3655  
  ndb\_move\_data, 3679  
abort-slave-event-count option  
  mysqld, 3025  
aborted clients, 4555  
aborted connection, 4555  
Aborted\_clients status variable, 910  
Aborted\_connects status variable, 910  
ABS(), 1914  
abstract-numbers option  
  mysqldumpslow, 643  
access control, 1094, 1113  
access denied errors, 4548  
access privileges, 1094  
account  
  default, 233  
  root, 233  
account locking, 1108, 1139  
  ALTER USER, 2432  
  CREATE USER statement, 2439  
  Locked\_connects status variable, 920  
account management, 1094  
account names, 1111  
accounts  
  adding privileges, 1118  
  creating, 1118  
  deleting, 1121  
  reserved, 1121  
accounts table  
  performance\_schema, 4298  
account\_locked column  
  user table, 1108  
ACID, 2545, 2549, 5301  
ACLs, 1094  
ACOS(), 1915  
activating plugins, 996  
ActiveState Perl, 266  
adaptive flushing, 5301  
adaptive hash index, 2561, 5301  
add-drop-database option  
  mysqldump, 481  
  mysqlpump, 520  
add-drop-table option  
  mysqldump, 481  
  mysqlpump, 521  
add-drop-trigger option  
  mysqldump, 481  
add-drop-user option  
  mysqlpump, 521

---

- add-locks option
  - mysqldump, 497
  - mysqlpump, 521
- add-missing option
  - ndb\_blob\_tool, 3608
- ADDDATE(), 1925
- adding
  - character sets, 1768
  - new account privileges, 1118
  - new user privileges, 1118
- addition (+), 1912
- ADDTIME(), 1925
- admin-auth-plugin option
  - mysql\_install\_db, 365
- admin-host option
  - mysql\_install\_db, 365
- admin-require-ssl option
  - mysql\_install\_db, 365
- admin-user option
  - mysql\_install\_db, 366
- administration
  - server, 435
- administration of NDB Cluster, 3601
- administrative programs, 306
- ADO.NET, 5302
- AES\_DECRYPT(), 2023
- AES\_ENCRYPT(), 2023
- After create
  - thread state, 1623
- age
  - calculating, 282
- aggregate functions, 2115
- ai-increment option
  - ndb\_import, 3655
- ai-offset option
  - ndb\_import, 3655
- ai-prefetch-sz option
  - ndb\_import, 3656
- AIO, 5302
- alias names
  - case sensitivity, 1665
- aliases
  - for expressions, 2129
  - for tables, 2313
  - in GROUP BY clauses, 2129
  - names, 1660
  - on expressions, 2312
- ALL, 2330
  - SELECT modifier, 2316
- ALL join type
  - optimizer, 1555
- ALL privilege, 1099
- ALL PRIVILEGES privilege, 1099
- all-databases option

---

- mysqlcheck, 455
- mysqldump, 493
- mysqlpump, 521
- all-in-1 option
  - mysqlcheck, 455
- all-tablespaces option
  - mysqldump, 481
- Alliance Key Manager
  - keyring\_okv keyring plugin, 1267
- allow-keywords option
  - mysqldump, 482
- allow-mismatches option
  - innochecksum, 571
- allow-pk-changes option
  - ndb\_restore, 3695
- allow-suspicious-udfs option
  - mysqld, 739
- ALLOW\_INVALID\_DATES SQL mode, 934
- ALTER COLUMN, 2167
- ALTER DATABASE, 2152
  - deprecated features, 22
- ALTER EVENT, 2154
  - and replication, 3144
- ALTER FUNCTION, 2155
- ALTER IGNORE TABLE
  - removed features, 24
- ALTER INSTANCE, 2155
- ALTER LOGFILE GROUP, 2156
  - (see also [NDB Cluster Disk Data](#))
- ALTER privilege, 1099
- ALTER PROCEDURE, 2157
- ALTER ROUTINE privilege, 1099
- ALTER SCHEMA, 2152
- ALTER SERVER, 2157
- ALTER TABLE, 2158, 2168, 4575
  - and replication metadata repositories, 3098
  - monitoring, 2851
  - ROW\_FORMAT, 2701
- ALTER TABLE partition validation
  - new features, 17
- ALTER TABLESPACE
  - NDB Cluster Disk Data, 2181
- ALTER USER statement, 1122, 2425
- ALTER VIEW, 2183
- altering
  - database, 2152
  - schema, 2152
- altering table
  - thread state, 1623
- altering user accounts, 2425
- MySQL Enterprise Backup, 5304
- ANALYSE()
  - PROCEDURE, 1524
- analyze option



---

- myisamchk, 588
- mysqlcheck, 455
- ANALYZE TABLE
  - and partitioning, 4029
- ANALYZE TABLE statement, 2454
- Analyzing
  - thread state, 1623
- AND
  - bitwise, 2019
  - logical, 1906
- anonymous user, 1113, 1116
- ANSI, 5302
- ANSI mode
  - running, 47
- ansi option
  - mysqld, 739
- ANSI SQL mode, 933, 940
- ANSI\_QUOTES SQL mode, 934
- Antelope, 5302
- Antelope file format, 2691, 2763
- ANY, 2330
- ANY\_VALUE(), 2133
- Apache, 302
- API, 5302
- API node (NDB Cluster)
  - defined, 3287
- API nodes (see SQL nodes)
- ApiFailureHandlingTimeout, 3451
- APIs, 4473
  - Perl, 4482
- append option
  - ndb\_restore, 3697
- application error handling, 1094
- application programming interface (API), 5302
- apply, 5302
- apply-slave-statements option
  - mysqldump, 485
- apply\_status table (OBSOLETE), 3941
  - (see also [NDB Cluster replication](#))
- approximate-value literals, 2141
- approximate-value numeric literals, 1654, 2142
- Arbitration, 3452
- ArbitrationDelay, 3398, 3497
- ArbitrationRank, 3397, 3496
- ArbitrationTimeout, 3451
- arbitrator\_validity\_detail
  - ndbinfo table, 3845
- arbitrator\_validity\_summary
  - ndbinfo table, 3846
- ARCHIVE storage engine, 2915, 2934
- Area(), 2066
- arithmetic expressions, 1912
- arithmetic functions, 2018
- arithmetic operators, 2018

---

- .ARM file, 5301
- array
  - JSON, 1847
- .ARZ file, 5301
- AS, 2313, 2319
- AsBinary(), 2059
- ASCII(), 1946
- ASIN(), 1915
- ASP.net, 5302
- assembly, 5302
- assignment operator
  - :=, 1907
  - =, 1908
- assignment operators, 1907
- AsText(), 2059
- asymmetric\_decrypt(), 1404
- asymmetric\_derive(), 1404
- asymmetric\_encrypt(), 1404
- asymmetric\_sign(), 1405
- asymmetric\_verify(), 1406
- asynchronous I/O, 2654, 5303
- asynchronous replication (see [NDB Cluster replication](#))
- ATAN(), 1915
- ATAN2(), 1915
- atomic, 5303
- atomic DDL, 5303
- atomic instruction, 5303
- attackers
  - security against, 1087
- attribute demotion
  - replication, 3138
- attribute promotion
  - replication, 3137
- audit log encryption functions
  - audit\_log\_encryption\_password\_get(), 1320, 1348
  - audit\_log\_encryption\_password\_set(), 1320, 1349
- audit log filtering
  - legacy mode, 1329, 1340, 1345
  - rule based, 1327
- audit log filtering functions
  - audit\_log\_filter\_flush(), 1349
  - audit\_log\_filter\_remove\_filter(), 1350
  - audit\_log\_filter\_remove\_user(), 1350
  - audit\_log\_filter\_set\_filter(), 1351
  - audit\_log\_filter\_set\_user(), 1351
- audit log reading functions
  - audit\_log\_read(), 1324, 1352
  - audit\_log\_read\_bookmark(), 1324, 1353
- audit-log option
  - mysqld, 1354
- audit\_log plugin, 1294
  - and Group Replication, 1364, 3187
  - installing, 1295
- audit\_log\_buffer\_size system variable, 1355

---

audit\_log\_compression system variable, 1355  
audit\_log\_connection\_policy system variable, 1356  
audit\_log\_current\_session system variable, 1356  
Audit\_log\_current\_size status variable, 1363  
audit\_log\_disable variable, 1357  
audit\_log\_encryption system variable, 1357  
audit\_log\_encryption\_password\_get() audit log encryption function, 1320, 1348  
audit\_log\_encryption\_password\_set() audit log encryption function, 1320, 1349  
Audit\_log\_events status variable, 1364  
Audit\_log\_events\_filtered status variable, 1364  
Audit\_log\_events\_lost status variable, 1364  
Audit\_log\_events\_written status variable, 1364  
Audit\_log\_event\_max\_drop\_size status variable, 1363  
audit\_log\_exclude\_accounts system variable, 1357  
audit\_log\_file system variable, 1324, 1358  
audit\_log\_filter table  
    system table, 970  
audit\_log\_filter\_flush() audit log filtering function, 1349  
audit\_log\_filter\_id system variable, 1358  
audit\_log\_filter\_remove\_filter() audit log filtering function, 1350  
audit\_log\_filter\_remove\_user() audit log filtering function, 1350  
audit\_log\_filter\_set\_filter() audit log filtering function, 1351  
audit\_log\_filter\_set\_user() audit log filtering function, 1351  
audit\_log\_flush system variable, 1359  
audit\_log\_format system variable, 1359  
audit\_log\_format\_unix\_timestamp system variable, 1359  
audit\_log\_include\_accounts system variable, 1360  
audit\_log\_policy system variable, 1360  
audit\_log\_read() audit log reading function, 1324, 1352  
audit\_log\_read\_bookmark() audit log reading function, 1324, 1353  
audit\_log\_read\_buffer\_size system variable, 1327, 1361  
audit\_log\_rotate\_on\_size system variable, 1362  
audit\_log\_statement\_policy system variable, 1362  
audit\_log\_strategy system variable, 1363  
Audit\_log\_total\_size status variable, 1364  
audit\_log\_user table  
    system table, 970  
Audit\_log\_write\_waits status variable, 1364  
authentication  
    for the InnoDB memcached interface, 2879  
    LDAP, 1206  
    SASL, 1206  
authentication plugin  
    authentication\_ldap\_sasl, 1206  
    authentication\_ldap\_sasl\_client, 1206  
    authentication\_ldap\_simple, 1206  
    authentication\_pam, 1190  
    authentication\_windows, 1201  
    authentication\_windows\_client, 1201  
    auth\_socket, 1222  
    auth\_test\_plugin, 1224  
    caching\_sha2\_password, 1179  
    mysql\_clear\_password, 1189  
    mysql\_clear\_plugin, 1206

---

mysql\_native\_password, 1174  
mysql\_no\_login, 1219  
mysql\_old\_password, 1175  
sha256\_password, 1184  
test\_plugin\_server, 1224  
AUTHENTICATION\_LDAP\_CLIENT\_LOG environment variable, 651, 1232  
authentication\_ldap\_sasl\_auth\_method\_name system variable, 1227  
authentication\_ldap\_sasl\_bind\_base\_dn system variable, 1228  
authentication\_ldap\_sasl\_bind\_root\_dn system variable, 1228  
authentication\_ldap\_sasl\_bind\_root\_pwd system variable, 1229  
authentication\_ldap\_sasl\_ca\_path system variable, 1229  
authentication\_ldap\_sasl\_group\_search\_attr system variable, 1229  
authentication\_ldap\_sasl\_group\_search\_filter system variable, 1230  
authentication\_ldap\_sasl\_init\_pool\_size system variable, 1231  
authentication\_ldap\_sasl\_log\_status system variable, 1232  
authentication\_ldap\_sasl\_max\_pool\_size system variable, 1232  
authentication\_ldap\_sasl\_server\_host system variable, 1233  
authentication\_ldap\_sasl\_server\_port system variable, 1233  
authentication\_ldap\_sasl\_tls system variable, 1233  
authentication\_ldap\_sasl\_user\_search\_attr system variable, 1234  
authentication\_ldap\_simple\_auth\_method\_name system variable, 1234  
authentication\_ldap\_simple\_bind\_base\_dn system variable, 1235  
authentication\_ldap\_simple\_bind\_root\_dn system variable, 1236  
authentication\_ldap\_simple\_bind\_root\_pwd system variable, 1237  
authentication\_ldap\_simple\_ca\_path system variable, 1237  
authentication\_ldap\_simple\_group\_search\_attr system variable, 1237  
authentication\_ldap\_simple\_group\_search\_filter system variable, 1238  
authentication\_ldap\_simple\_init\_pool\_size system variable, 1238  
authentication\_ldap\_simple\_log\_status system variable, 1239  
authentication\_ldap\_simple\_max\_pool\_size system variable, 1240  
authentication\_ldap\_simple\_server\_host system variable, 1240  
authentication\_ldap\_simple\_server\_port system variable, 1242  
authentication\_ldap\_simple\_tls system variable, 1242  
authentication\_ldap\_simple\_user\_search\_attr system variable, 1242  
authentication\_pam authentication plugin, 1190  
AUTHENTICATION\_PAM\_LOG environment variable, 651, 1200  
authentication\_windows authentication plugin, 1201  
authentication\_windows\_client authentication plugin, 1201  
authentication\_windows\_log\_level system variable, 768  
authentication\_windows\_use\_principal\_name system variable, 768  
auth\_socket authentication plugin, 1222  
auth\_test\_plugin authentication plugin, 1224  
auto-generate-sql option  
    mysqlslap, 556  
auto-generate-sql-add-autoincrement option  
    mysqlslap, 556  
auto-generate-sql-execute-number option  
    mysqlslap, 556  
auto-generate-sql-guid-primary option  
    mysqlslap, 556  
auto-generate-sql-load-type option  
    mysqlslap, 556  
auto-generate-sql-secondary-indexes option  
    mysqlslap, 557

---

- auto-generate-sql-unique-query-number option
  - mysqslap, 557
- auto-generate-sql-unique-write-number option
  - mysqslap, 557
- auto-generate-sql-write-number option
  - mysqslap, 557
- auto-inc lock, 2612
- auto-inc option
  - ndb\_desc, 3636
- auto-increment, 2580, 2580, 2586, 2586, 5303
- auto-increment locking, 5303
- auto-rehash option
  - mysql, 399
- auto-repair option
  - mysqlcheck, 455
- auto-vertical-output option
  - mysql, 400
- auto.cnf file, 2999
  - and SHOW SLAVE HOSTS statement, 2507
- autocommit, 5304
- autocommit mode, 2620
- autocommit system variable, 769
- automatic\_sp\_privileges system variable, 769
- AutoReconnect
  - API and SQL nodes, 3500
- autowrapped JSON values, 1851
- auto\_generate\_certs system variable, 770
- AUTO\_INCREMENT, 299, 1797
  - and NULL values, 4571
  - and replication, 3133
- auto\_increment\_increment system variable, 3007
- auto\_increment\_offset system variable, 3010
- availability, 5304
- AVG(), 2117
- AVG(DISTINCT), 2117
- avoid\_temporal\_upgrade system variable, 770

## **B**

- B-tree, 5304
- B-tree indexes, 1514, 2587
- background threads, 2655
  - read, 2653
  - write, 2653
- backslash
  - escape character, 1651
- backspace (b), 1653, 2106, 2295
- backticks, 5304
- backup, 5305
- BACKUP Events (NDB Cluster), 3789
- backup identifiers
  - native backup and restore, 3811
- backup option
  - myisamchk, 585

---

- myisampack, 598
- backup-path option
  - ndb\_restore, 3697
- BackupDataBufferSize, 3460, 3812
- BackupDataDir, 3407
- BackupDiskWriteSpeedPct, 3461
- backupid option
  - ndb\_restore, 3697
- BackupLogBufferSize, 3462, 3812
- BackupMaxWriteSize, 3463, 3813
- BackupMemory, 3462, 3812
- BackupReportFrequency, 3463
- backups, 1415, 4485
  - databases and tables, 465, 515
  - in NDB Cluster, 3690, 3808, 3809, 3809, 3812
  - in NDB Cluster replication, 3954
  - InnoDB, 2864
  - with mysqldump, 1425
- backups, troubleshooting
  - in NDB Cluster, 3813
- BackupWriteSize, 3463, 3813
- back\_log system variable, 770
- Barracuda, 5305
- Barracuda file format, 2673, 2691, 2763
- base column, 5305
- base64-output option
  - mysqlbinlog, 617
- basedir option
  - mysql.server, 353
  - mysqld, 740
  - mysqld\_safe, 344
  - mysql\_install\_db, 366
  - mysql\_plugin, 372
- basedir system variable, 771
- batch mode, 292
- batch option
  - mysql, 400
- batch SQL files, 393
- BatchByteSize, 3497
- Batched Key Access
  - optimization, 1470, 1472
- batched updates (NDB Cluster Replication), 3950
- BatchSize, 3498
- BatchSizePerLocalScan, 3417
- BEGIN, 2344, 2387
  - labels, 2387
  - XA transactions, 2359
- BENCHMARK(), 2036
- benchmarks, 1618
- beta, 5305
- BETWEEN ... AND, 1901
- bidirectional replication
  - in NDB Cluster, 3960
  - NDB Cluster, 3965

---

big5, 4518  
BIGINT data type, 1794  
big\_tables system variable, 771  
BIN(), 1947  
BINARY, 2001  
binary collation, 1739  
BINARY data type, 1818, 1821  
binary distributions  
    installing, 81  
binary log, 978, 5305  
    event groups, 2376, 3083  
binary logging  
    and NDB Cluster, 3328  
binary-as-hex option  
    mysql, 400  
binary-configure.sh  
    removed features, 25  
binary-mode option  
    mysql, 401  
bind-address option  
    mysql, 401  
    mysqladmin, 441  
    mysqlbinlog, 618  
    mysqlcheck, 455  
    mysqldump, 474  
    mysqlimport, 505  
    mysqlpump, 521  
    mysqlshow, 543  
    mysql\_upgrade, 387  
    ndb\_mgmd, 3591  
bind\_address system variable, 772  
binlog, 5305  
Binlog Dump  
    thread command, 1621  
BINLOG statement, 2526  
    mysqlbinlog output, 635  
binlog-checksum option  
    mysqld, 3052  
binlog-do-db option  
    mysqld, 3049  
binlog-ignore-db option  
    mysqld, 3051  
binlog-row-event-max-size option  
    mysqlbinlog, 618  
    mysqld, 3048  
Binlog\_cache\_disk\_use status variable, 910  
binlog\_cache\_size system variable, 3053  
Binlog\_cache\_use status variable, 910  
binlog\_checksum system variable, 3053  
binlog\_direct\_non\_transactional\_updates system variable, 3054  
binlog\_error\_action system variable, 3055  
binlog\_format  
    BLACKHOLE, 3133  
binlog\_format system variable, 3055

---

binlog\_group\_commit\_sync\_delay, 3056  
binlog\_group\_commit\_sync\_no\_delay\_count, 3057  
binlog\_gtid\_simple\_recovery, 3071  
binlog\_index table (OBSOLETE) (see [NDB Cluster replication](#))  
binlog\_max\_flush\_queue\_time  
    deprecated features, 20  
binlog\_max\_flush\_queue\_time system variable, 3058  
binlog\_order\_commits system variable, 3058  
binlog\_rows\_query\_log\_events system variable, 3060  
binlog\_row\_image system variable, 3059  
Binlog\_stmt\_cache\_disk\_use status variable, 910  
binlog\_stmt\_cache\_size system variable, 3061  
Binlog\_stmt\_cache\_use status variable, 910  
binlog\_transaction\_dependency\_history\_size system variable, 3062  
binlog\_transaction\_dependency\_tracking system variable, 3061  
BIT data type, 1793  
bit functions, 2018  
    example, 299  
bit operators, 2018  
bit-value literal introducer, 1659  
bit-value literals, 1659  
BIT\_AND(), 2117  
BIT\_COUNT, 299  
BIT\_COUNT(), 2019  
BIT\_LENGTH(), 1947  
BIT\_OR, 299  
BIT\_OR(), 2117  
BIT\_XOR(), 2117  
BLACKHOLE  
    binlog\_format, 3133  
    replication, 3133  
BLACKHOLE storage engine, 2915, 2936  
blind query expansion, 1983, 5306  
BLOB, 5306  
BLOB columns  
    default values, 1823  
    indexing, 1509, 2206  
    inserting binary data, 1654  
    size, 1865  
BLOB data type, 1818, 1822  
blob-info option  
    ndb\_desc, 3636  
Block Nested-Loop  
    optimization, 1470, 1471  
Block Nested-Loop join algorithm, 1459  
block-search option  
    myisamchk, 588  
blocked hosts  
    unblocking, 952  
blocks  
    ndbinfo table, 3846  
block\_encryption\_mode system variable, 773  
BOOL data type, 1793  
BOOLEAN data type, 1793



---

boolean literals, 1660  
boolean options, 319  
Boolean search, 1977  
bootstrap option  
  mysqld, 740  
bottleneck, 5306  
bounce, 5306  
brackets  
  square, 1792  
buddy allocator, 2816, 5306  
buffer, 5306  
buffer pool, 1583, 2639, 2644, 2644, 2645, 2646, 2648, 5306  
  and compressed tables, 2682  
  monitoring, 2555, 2643, 2650  
buffer pool instance, 5307  
buffer sizes, 1583, 2639  
  client, 4473  
Buffer(), 2069  
bugs  
  known, 4577  
  NDB Cluster  
    reporting, 3648  
  reporting, 2, 41  
bugs database, 41  
bugs.mysql.com, 41  
builddir option  
  mysql\_install\_db, 366  
BuildIndexThreads, 3465  
BUILD\_CONFIG option  
  CMake, 203  
built-in, 5307  
built-in functions  
  reference, 1871  
built-in operators  
  reference, 1871  
bulk loading  
  for InnoDB tables, 1536  
  for MyISAM tables, 1544  
bulk\_insert\_buffer\_size system variable, 773, 2922  
business rules, 5307  
Bytes\_received status variable, 911  
Bytes\_sent status variable, 911

## C

C, 5307  
C API, 4473, 4482, 5307  
  FAQ, 4531  
C#, 5308  
C++, 4476, 5308  
C:\my.cnf option file, 1045  
cache, 5308  
CACHE INDEX  
  and partitioning, 4045

---

CACHE INDEX statement, 2526  
caches  
  clearing, 2527  
cache\_policies table, 2897  
caching\_sha2\_password authentication plugin, 1179  
calculating  
  aggregate value for a set of rows, 2115  
  cardinality, 2495  
  dates, 282  
calendar, 1813  
CALL, 2273  
can't create/write to file, 4556  
Can't reopen table  
  error message, 4576  
cardinality, 1488, 5308  
carriage return (r), 1653, 2106, 2295  
CASE, 1909, 2390  
case sensitivity  
  access checking, 1110  
  account names, 1111  
  in identifiers, 1665  
  in names, 1665  
  in searches, 4568  
  in string comparisons, 1962  
  of database names, 47  
  of replication filtering options, 3105  
  of table names, 47  
CAST, 2002  
cast functions, 2000  
cast operators, 2000  
casts, 1893, 1899, 2000  
CC environment variable, 220, 651  
CEIL(), 1915  
CEILING(), 1916  
Centroid(), 2066  
.cfg file, 5307  
cflags option  
  mysql\_config, 644  
change buffer, 2557, 5308  
  monitoring, 2560  
change buffering, 5309  
  disabling, 2558  
CHANGE MASTER TO, 2366  
  in NDB Cluster, 3948  
CHANGE REPLICATION FILTER, 2372  
Change user  
  thread command, 1621  
changes to privileges, 1121  
changing  
  column, 2165  
  field, 2166  
  socket location, 353, 4567  
  table, 2158, 2168, 4575  
Changing master

---

- thread state, 1633
- channel
  - commands, 3092
  - replication, 3091
- CHAR data type, 1815, 1817
- CHAR VARYING data type, 1817
- CHAR(), 1947
- CHARACTER data type, 1817
- character set introducer, 1723
- character set repertoire, 1747
- character sets, 1710
  - adding, 1768
  - and replication, 3134
  - Asian, 1762
  - Baltic, 1761
  - binary, 1766
  - Central European, 1759
  - Cyrillic, 1761
  - Middle East, 1760
  - new features, 17
  - repertoire, 1713
  - restrictions, 1767
  - South European, 1760
  - Unicode, 1752
  - West European, 1758
- CHARACTER VARYING data type, 1817
- character-set-client-handshake option
  - mysqld, 740
- character-sets-dir option
  - myisamchk, 586
  - myisampack, 599
  - mysql, 401
  - mysqladmin, 441
  - mysqlbinlog, 618
  - mysqlcheck, 456
  - mysqldump, 485
  - mysqlimport, 505
  - mysqlpump, 521
  - mysqlshow, 543
  - mysql\_upgrade, 387
  - ndbd, 3573
  - ndbinfo\_select\_all, 3584
  - ndb\_blob\_tool, 3608
  - ndb\_config, 3615
  - ndb\_delete\_all, 3626
  - ndb\_desc, 3636
  - ndb\_drop\_index, 3641
  - ndb\_drop\_table, 3646
  - ndb\_import, 3656
  - ndb\_index\_stat, 3672
  - ndb\_mgm, 3602
  - ndb\_mgmd, 3591
  - ndb\_move\_data, 3679
  - ndb\_restore, 3698

---

- ndb\_select\_all, 3723
- ndb\_select\_count, 3729
- ndb\_show\_tables, 3734
- ndb\_waiter, 3749
- characters
  - multibyte, 1771
- CHARACTER\_LENGTH(), 1948
- CHARACTER\_SETS
  - INFORMATION\_SCHEMA table, 4106
- character\_sets\_dir system variable, 776
- character\_set\_client system variable, 774
- character\_set\_connection system variable, 774
- character\_set\_database
  - deprecated features, 20
- character\_set\_database system variable, 774
- character\_set\_filesystem system variable, 775
- character\_set\_results system variable, 775
- character\_set\_server system variable, 775
- character\_set\_system system variable, 776
- charset command
  - mysql, 421
- charset option
  - comp\_err, 360
- CHARSET(), 2036
- CHAR\_LENGTH(), 1948
- check option
  - myisamchk, 584
  - mysqlcheck, 456
- check options
  - myisamchk, 584
- CHECK TABLE
  - and partitioning, 4029
- CHECK TABLE statement, 2455
- check-missing option
  - ndb\_blob\_tool, 3608
- check-only-changed option
  - myisamchk, 584
  - mysqlcheck, 456
- check-orphans option
  - ndb\_blob\_tool, 3608
- check-upgrade option
  - mysqlcheck, 456
- checking
  - tables for errors, 1435
- Checking master version
  - thread state, 1630
- checking permissions
  - thread state, 1623
- checking privileges on cached query
  - thread state, 1629
- checking query cache for query
  - thread state, 1630
- Checking table
  - thread state, 1623

---

checkpoint, 5309  
CHECKPOINT Events (NDB Cluster), 3784  
Checksum, 3554  
checksum, 5309  
Checksum (NDB Cluster), 3563  
checksum errors, 183  
CHECKSUM TABLE  
    and replication, 3134  
CHECKSUM TABLE statement, 2460  
check\_proxy\_users system variable, 776, 1138  
child table, 5309  
Chinese, Japanese, Korean character sets  
    frequently asked questions, 4518  
choosing  
    a MySQL version, 62  
    data types, 1866  
chroot option  
    mysqld, 741  
circular replication  
    in NDB Cluster, 3934, 3960, 3965  
CJK (Chinese, Japanese, Korean)  
    Access, PHP, etc., 4518  
    availability of specific characters, 4518  
    big5, 4518  
    character sets available, 4518  
    characters displayed as question marks, 4518  
    CJKV, 4518  
    collations, 4518, 4518  
    conversion problems with Japanese character sets, 4518  
    data truncation, 4518  
    Database and table names, 4518  
    documentation in Chinese, 4518  
    documentation in Japanese, 4518  
    documentation in Korean, 4518  
    FAQ, 4518  
    gb2312, gbk, 4518  
    Japanese character sets, 4518  
    Korean character set, 4518  
    LIKE and FULLTEXT, 4518  
    MySQL 4.0 behavior, 4518  
    ORDER BY treatment, 4518, 4518  
    problems with Access, PHP, etc., 4518  
    problems with Big5 character sets (Chinese), 4518  
    problems with data truncation, 4518  
    problems with euckr character set (Korean), 4518  
    problems with GB character sets (Chinese), 4518  
    problems with LIKE and FULLTEXT, 4518  
    problems with Yen sign (Japanese), 4518  
    rejected characters, 4518  
    sort order problems, 4518, 4518  
    sorting problems, 4518, 4518  
    testing availability of characters, 4518  
    Unicode collations, 4518  
    Vietnamese, 4518

---

- Yen sign, 4518
- clean page, 5309
- clean shutdown, 965, 1040, 3149, 5309
- cleaning up
  - thread state, 1623
- clear command
  - mysql, 421
- Clearing
  - thread state, 1634
- clearing
  - cached, 2527
- client, 5309
  - signal handling, 655
- client connections, 947
- client libraries, 5310
- client programs, 305
- client tools, 4473
- client-side prepared statement, 5310
- clients
  - debugging, 1052
- CLOB, 5310
- cloning tables, 2230
- CLOSE, 2395
- Close stmt
  - thread command, 1621
- closing
  - tables, 1525
- closing tables
  - thread state, 1623
- cluster database (OBSOLETE) (see [NDB Cluster replication](#))
- cluster logs, 3780, 3781
- clustered index, 5310
  - InnoDB, 2587
- Clustering (see [NDB Cluster](#))
- CLUSTERLOG commands (NDB Cluster), 3782
- CLUSTERLOG STATISTICS command (NDB Cluster), 3790
- cluster\_locks
  - ndbinfo table, 3847
- cluster\_operations
  - ndbinfo table, 3848
- cluster\_replication database (OBSOLETE) (see [NDB Cluster replication](#))
- cluster\_transactions
  - ndbinfo table, 3850
- CMake
  - BUILD\_CONFIG option, 203
  - CMAKE\_BUILD\_TYPE option, 203
  - CMAKE\_CXX\_FLAGS option, 218
  - CMAKE\_C\_FLAGS option, 218
  - CMAKE\_INSTALL\_PREFIX option, 204
  - COMPILATION\_COMMENT option, 208
  - CPACK\_MONOLITHIC\_INSTALL option, 203
  - DEFAULT\_CHARSET option, 208
  - DEFAULT\_COLLATION option, 208
  - DISABLE\_PSI\_COND option, 208

---

DISABLE\_PSI\_FILE option, 208  
DISABLE\_PSI\_IDLE option, 208  
DISABLE\_PSI\_MEMORY option, 208  
DISABLE\_PSI\_METADATA option, 208  
DISABLE\_PSI\_MUTEX option, 208  
DISABLE\_PSI\_PS option, 209  
DISABLE\_PSI\_RWLOCK option, 208  
DISABLE\_PSI\_SOCKET option, 208  
DISABLE\_PSI\_SP option, 208  
DISABLE\_PSI\_STAGE option, 209  
DISABLE\_PSI\_STATEMENT option, 209  
DISABLE\_PSI\_STATEMENT\_DIGEST option, 209  
DISABLE\_PSI\_TABLE option, 209  
DISABLE\_PSI\_THREAD option, 209  
DISABLE\_PSI\_TRANSACTION option, 209  
DOWNLOAD\_BOOST option, 209  
DOWNLOAD\_BOOST\_TIMEOUT option, 209  
ENABLED\_LOCAL\_INFILE option, 210, 1091  
ENABLED\_PROFILING option, 210  
ENABLE\_DOWNLOADS option, 209  
ENABLE\_DTRACE option, 210  
ENABLE\_GCOV option, 210  
ENABLE\_GPROF option, 210  
FORCE\_UNSUPPORTED\_COMPILER option, 210  
IGNORE\_AIO\_CHECK option, 210  
INSTALL\_BINDIR option, 204  
INSTALL\_DOCDIR option, 204  
INSTALL\_DOCREADMEDIR option, 204  
INSTALL\_INCLUDEDIR option, 204  
INSTALL\_INFODIR option, 204  
INSTALL\_LAYOUT option, 204  
INSTALL\_LIBDIR option, 204  
INSTALL\_MANDIR option, 205  
INSTALL\_MYSQLKEYRINGDIR option, 205  
INSTALL\_MYSQLSHAREDIR option, 205  
INSTALL\_MYSQLTESTDIR option, 205  
INSTALL\_PKGCONFIGDIR option, 205  
INSTALL\_PLUGINDIR option, 205  
INSTALL\_SBINDIR option, 205  
INSTALL\_SCRIPTDIR option, 205  
INSTALL\_SECURE\_FILE\_PRIVDIR option, 205  
INSTALL\_SECURE\_FILE\_PRIV\_EMBEDDEDIR option, 205  
INSTALL\_SHAREDIR option, 205  
INSTALL\_SUPPORTFILESDIR option, 206  
MAX\_INDEXES option, 210  
MEMCACHED\_HOME option, 218  
MUTEX\_TYPE option, 211  
MYSQLX\_TCP\_PORT option, 211  
MYSQLX\_UNIX\_ADDR option, 211  
MYSQL\_DATADIR option, 206  
MYSQL\_MAINTAINER\_MODE option, 211  
MYSQL\_PROJECT\_NAME option, 211  
MYSQL\_TCP\_PORT option, 211  
MYSQL\_UNIX\_ADDR option, 211

---

ODBC\_INCLUDES option, 206  
ODBC\_LIB\_DIR option, 206  
OPTIMIZER\_TRACE option, 211  
options, 194  
REPRODUCIBLE\_BUILD option, 211  
running after prior invocation, 190, 220  
SUNPRO\_CXX\_LIBRARY option, 218  
SYSCONFDIR option, 206  
SYSTEMD\_PID\_DIR option, 206  
SYSTEMD\_SERVICE\_NAME option, 206  
TMPDIR option, 206  
VERSION file, 221  
WIN\_DEBUG\_NO\_INLINE option, 211  
WITHOUT\_SERVER option, 217  
WITH\_ASAN option, 212  
WITH\_ASAN\_SCOPE option, 212  
WITH\_AUTHENTICATION\_LDAP option, 212  
WITH\_AUTHENTICATION\_PAM option, 212  
WITH\_AWS\_SDK option, 212  
WITH\_BOOST option, 212  
WITH\_BUNDLED\_LIBEVENT option, 219  
WITH\_BUNDLED\_MEMCACHED option, 219  
WITH\_CLASSPATH option, 219  
WITH\_CLIENT\_PROTOCOL\_TRACING option, 213  
WITH\_CURL option, 213  
WITH\_DEBUG option, 213  
WITH\_DEFAULT\_COMPILER\_OPTIONS option, 218  
WITH\_DEFAULT\_FEATURE\_SET option, 213  
WITH\_EDITLINE option, 213  
WITH\_EMBEDDED\_SERVER option, 214  
WITH\_EMBEDDED\_SHARED\_LIBRARY option, 214  
WITH\_ERROR\_INSERT option, 219  
WITH\_EXTRA\_CHARSETS option, 214  
WITH\_GMOCK option, 214  
WITH\_INNODB\_EXTRA\_DEBUG option, 214  
WITH\_INNODB\_MEMCACHED option, 214  
WITH\_KEYRING\_TEST option, 214  
WITH\_LDAP option, 214  
WITH\_LIBEVENT option, 215  
WITH\_LIBWRAP option, 215  
WITH\_LZ4 option, 215  
WITH\_MECAB option, 215  
WITH\_MSAN option, 215  
WITH\_MSCRT\_DEBUG option, 215  
WITH\_NDBAPI\_EXAMPLES option, 219  
WITH\_NDBCLUSTER option, 219  
WITH\_NDBCLUSTER\_STORAGE\_ENGINE option, 219  
WITH\_NDBMTD option, 219  
WITH\_NDB\_BINLOG option, 219  
WITH\_NDB\_DEBUG option, 219  
WITH\_NDB\_JAVA option, 219  
WITH\_NDB\_PORT option, 219  
WITH\_NDB\_TEST option, 220  
WITH\_NUMA option, 215



---

- WITH\_PROTOBUF option, 216
- WITH\_RAPID option, 216
- WITH\_SASL option, 216
- WITH\_SSL option, 216
- WITH\_SYSTEMD option, 216
- WITH\_TEST\_TRACE\_PLUGIN option, 217
- WITH\_UBSAN option, 217
- WITH\_UNIT\_TESTS option, 217
- WITH\_UNIXODBC option, 217
- WITH\_VALGRIND option, 217
- WITH\_ZLIB option, 217
- CMakeCache.txt file, 220
- CMAKE\_BUILD\_TYPE option
  - CMake, 203
- CMAKE\_CXX\_FLAGS option
  - CMake, 218
- CMAKE\_C\_FLAGS option
  - CMake, 218
- CMAKE\_INSTALL\_PREFIX option
  - CMake, 204
- COALESCE(), 1902
- code injection
  - XPath, 2016
- coercibility
  - collation, 1737
- COERCIBILITY(), 2037
- cold backup, 5310
- collating
  - strings, 1771
- collation
  - adding, 1772
  - coercibility, 1737
  - INFORMATION\_SCHEMA, 1742
  - modifying, 1773
- COLLATION(), 2037
- collations, 1710
  - Asian, 1762
  - Baltic, 1761
  - binary, 1739, 1766
  - Central European, 1759
  - Cyrillic, 1761
  - Middle East, 1760
  - naming conventions, 1716
  - PAD SPACE, 1740, 1820
  - South European, 1760
  - Unicode, 1752
  - West European, 1758
  - \_ai suffix, 1716
  - \_as suffix, 1716
  - \_bin suffix, 1716, 1739
  - \_ci suffix, 1716
  - \_ss suffix, 1716
- COLLATIONS
  - INFORMATION\_SCHEMA table, 4106

---

## COLLATION\_CHARACTER\_SET\_APPLICABILITY

INFORMATION\_SCHEMA table, 4107

collation\_connection system variable, 777

collation\_database

depreciated features, 20

collation\_database system variable, 777

collation\_server system variable, 777

color option

ndb\_top, 3742

column, 5310

changing, 2166

types, 1792

column alias

problems, 4572

quoting, 1662, 4572

column comment options (NDB), 2246

column comments, 2208

column format, 2208

column index, 5310

column names

case sensitivity, 1665

column prefix, 5310

column storage, 2208

column-names option

mysql, 401

column-type-info option

mysql, 402

columns

displaying, 540

indexes, 1509

names, 1660

other types, 1867

selecting, 280

storage requirements, 1862

## COLUMNS

INFORMATION\_SCHEMA table, 4107

columns option

mysqlimport, 505

columns partitioning, 3993

columns per table

maximum, 1530

columns\_priv table

system table, 968, 1105

## COLUMN\_PRIVILEGES

INFORMATION\_SCHEMA table, 4110

comma-separated values data, reading, 2294, 2319

command interceptor, 5311

command option precedence, 309

command options

mysql, 394

mysqladmin, 438

mysqld, 738

command options (NDB Cluster)

mysqld, 3505

---

- ndbd, 3571
- ndbinfo\_select\_all, 3582
- ndb\_mgm, 3601
- ndb\_mgmd, 3588
- command syntax, 4
- command-line history
  - mysql, 426
- command-line tool, 110, 393
- commands
  - for binary distribution, 82
- commands option
  - mysql, 403
- commands out of sync, 4557
- comment stripping
  - deprecated features, 22
- comment syntax, 1705
- comments
  - adding, 1705
  - starting, 53
- comments option
  - mysql, 404
  - mysqldump, 482
- COMMIT, 2344
  - XA transactions, 2359
- commit, 5311
- commit option
  - mysqlslap, 557
- committing alter table to storage engine
  - thread state, 1623
- Committing events to binlog
  - thread state, 1633
- compact option
  - mysqldump, 489
- compact row format, 2699, 5311
- comparison operators, 1899
- comparisons
  - access checking, 1110
  - account names, 1111
- compatibility
  - with ODBC, 867, 1664, 1795, 1893, 1904, 2208, 2322
  - with Oracle, 48, 2122, 2166, 2538
  - with PostgreSQL, 49
  - with standard SQL, 46
- compatible option
  - mysqldump, 489
- COMPILATION\_COMMENT option
  - CMake, 208
- compiling
  - optimizing, 1606
- compiling MySQL server
  - problems, 220
- complete-insert option
  - mysqldump, 489
  - mysqlpump, 522

---

- completion\_type system variable, 777
- composite index, 5311
- composite partitioning, 4006
- compound statements, 2387
- compress option
  - mysql, 404
  - mysqladmin, 442
  - mysqlcheck, 456
  - mysqldump, 475
  - mysqlimport, 505
  - mysqlpump, 522
  - mysqlshow, 543
  - mysqslap, 558
  - mysql\_upgrade, 387
- COMPRESS(), 2027
- compress-output option
  - mysqlpump, 522
- compressed backup, 5311
- compressed row format, 2701, 5312
- compressed table, 5312
- compressed tables, 598, 2926
- CompressedBackup, 3464
- CompressedLCP, 3433
- compression, 2672, 2687, 5312
  - algorithms, 2680
  - application and schema design, 2677
  - BLOBs, VARCHAR and TEXT, 2681
  - buffer pool considerations, 2682
  - compressed page size, 2678
  - configuration characteristics, 2678
  - connection, 339
  - data and indexes, 2680
  - data characteristics, 2676
  - enabling for a table, 2673
  - implementation, 2680
  - information schema, 2815
  - KEY\_BLOCK\_SIZE, 2678
  - log file format, 2683
  - modification log, 2681
  - monitoring, 2679
  - overflow pages, 2681
  - overview, 2673
  - tuning, 2675
  - workload characteristics, 2678
- compression failure, 5312
- Compression status variable, 912
- comp\_err, 305, 359
  - charset option, 360
  - debug option, 360
  - debug-info option, 360
  - header-file option, 360
  - help option, 359
  - in-file option, 361
  - name-file option, 361

---

- out-dir option, 361
- out-file option, 361
- state-file option, 361
- version option, 361
- COM\_FIELD\_LIST
  - deprecated features, 22
- COM\_PROCESS\_INFO
  - deprecated features, 22
- COM\_PROCESS\_KILL
  - deprecated features, 22
- COM\_REFRESH
  - deprecated features, 22
- CONCAT(), 1948
- concatenation
  - string, 1651, 1948
- CONCAT\_WS(), 1948
- concurrency, 2545, 5312
  - of commits, 2756
  - of threads, 2808
  - tickets, 2758
- concurrency option
  - mysqlslap, 558
- concurrent inserts, 1598, 1601
- concurrent\_insert system variable, 778
- condition handling
  - INOUT parameters, 2424
  - new features, 15
  - OUT parameters, 2424
- Conditions, 2397
- conditions, 2490, 2523
- cond\_instances table
  - performance\_schema, 4261
- config-cache option
  - ndb\_mgmd, 3591
- config-file option
  - my\_print\_defaults, 646
  - ndb\_config, 3616
  - ndb\_mgmd, 3592
- config.ini (NDB Cluster), 3350, 3383, 3384, 3600
- configdir option
  - ndb\_mgmd, 3593
- ConfigGenerationNumber, 3503
- configinfo option
  - ndb\_config, 3615
- configuration
  - NDB Cluster, 3364
  - server, 658
- configuration file, 5312
- configuration files, 1143
- configure action
  - MySQLInstallerConsole, 112
- configuring backups
  - in NDB Cluster, 3812
- configuring NDB Cluster, 3331, 3361, 3600, 3815

---

Configuring NDB Cluster (concepts), 3287  
config\_from\_node option  
    ndb\_config, 3616  
config\_nodes  
    ndbinfo table, 3851  
config\_options table, 2897  
config\_params  
    ndbinfo table, 3852  
config\_values  
    ndbinfo table, 3853  
conflict detection status variables  
    NDB Cluster Replication, 3973  
conflict resolution  
    enabling, 3967  
    NDB Cluster Replication, 3965  
    ndb\_replication table, 3943  
Connect  
    thread command, 1621  
connect command  
    mysql, 421  
CONNECT command (NDB Cluster), 3755  
connect option  
    ndb\_restore, 3698  
Connect Out  
    thread command, 1621  
connect-delay option  
    ndbd, 3573  
    ndbmtd, 3573  
connect-expired-password option  
    mysql, 404  
connect-retries option  
    ndbd, 3574  
    ndbinfo\_select\_all, 3584  
    ndbmtd, 3574  
    ndb\_blob\_tool, 3608  
    ndb\_config, 3616  
    ndb\_delete\_all, 3626  
    ndb\_desc, 3636  
    ndb\_drop\_index, 3641  
    ndb\_drop\_table, 3646  
    ndb\_import, 3656  
    ndb\_index\_stat, 3672  
    ndb\_mgm, 3602  
    ndb\_mgmd, 3593  
    ndb\_move\_data, 3680  
    ndb\_restore, 3698  
    ndb\_select\_all, 3723  
    ndb\_select\_count, 3729  
    ndb\_show\_tables, 3734  
    ndb\_waiter, 3749  
connect-retry-delay option  
    ndbd, 3574  
    ndbinfo\_select\_all, 3584  
    ndbmtd, 3574

---

- ndb\_blob\_tool, 3608
- ndb\_config, 3616
- ndb\_delete\_all, 3626
- ndb\_desc, 3636
- ndb\_drop\_index, 3641
- ndb\_drop\_table, 3646
- ndb\_import, 3656
- ndb\_index\_stat, 3672
- ndb\_mgm, 3603
- ndb\_mgmd, 3593
- ndb\_move\_data, 3679
- ndb\_restore, 3698
- ndb\_select\_all, 3723
- ndb\_select\_count, 3730
- ndb\_show\_tables, 3734
- ndb\_waiter, 3750
- connect-string option
  - ndbd, 3574
  - ndbinfo\_select\_all, 3584
  - ndb\_blob\_tool, 3609
  - ndb\_config, 3617
  - ndb\_delete\_all, 3626
  - ndb\_desc, 3636
  - ndb\_drop\_index, 3641
  - ndb\_drop\_table, 3646
  - ndb\_import, 3657
  - ndb\_index\_stat, 3673
  - ndb\_mgm, 3603
  - ndb\_mgmd, 3593
  - ndb\_move\_data, 3680
  - ndb\_restore, 3698
  - ndb\_select\_all, 3723
  - ndb\_select\_count, 3730
  - ndb\_show\_tables, 3734
  - ndb\_waiter, 3750
- connect-timeout option
  - mysql, 405
  - mysqladmin, 442
- ConnectBackoffMaxTime, 3501
- ConnectCheckIntervalDelay, 3444
- connecting
  - remotely with SSH, 1173
  - to the server, 269, 335
  - verification, 1113
- Connecting to master
  - thread state, 1631
- connection, 5313
  - aborted, 4555
- connection compression, 339
- connection control table reference
  - INFORMATION\_SCHEMA, 4200
- CONNECTION Events (NDB Cluster), 3783
- connection management, 947
- connection pool, 5313

---

connection string, 5313 (see [NDB Cluster](#))  
connection-server-id option  
  mysqlbinlog, 619  
connection-timeout option  
  ndb\_error\_reporter, 3649  
ConnectionMap, 3494  
connections option  
  ndb\_config, 3616  
  ndb\_import, 3657  
Connections status variable, 912  
CONNECTION\_CONTROL plugin  
  installing, 1243  
  status variables, 1249  
  system variables, 1247  
Connection\_control\_delay\_generated status variable, 1249  
connection\_control\_failed\_connections\_threshold system variable, 1247  
CONNECTION\_CONTROL\_FAILED\_LOGIN\_ATTEMPTS  
  INFORMATION\_SCHEMA table, 4200  
CONNECTION\_CONTROL\_FAILED\_LOGIN\_ATTEMPTS plugin  
  installing, 1243  
connection\_control\_max\_connection\_delay system variable, 1248  
connection\_control\_min\_connection\_delay system variable, 1248  
Connection\_errors\_accept status variable, 912  
Connection\_errors\_internal status variable, 912  
Connection\_errors\_max\_connections status variable, 912  
Connection\_errors\_peer\_address status variable, 912  
Connection\_errors\_select status variable, 912  
Connection\_errors\_tcpwrap status variable, 912  
CONNECTION\_ID(), 2037  
connector, 5313  
Connector/C++, 4473, 4476, 5313  
Connector/J, 4473, 4476, 5313  
Connector/NET, 4473, 4476, 5313  
Connector/ODBC, 4473, 4476, 5314  
Connector/PHP, 5314  
Connector/Python, 4473, 4476  
Connectors, 4473  
connect\_timeout system variable, 779  
consistent read, 5314  
consistent reads, 2621  
console option  
  mysqld, 741  
const table  
  optimizer, 1553, 2316  
constant table, 1446  
constraint, 5314  
constraints, 53  
  foreign keys, 2232  
containers table, 2897  
Contains(), 2077  
context option  
  ndb\_desc, 3637  
continue option  
  ndb\_import, 3657



---

Control+C  
  statement termination, 394, 416  
CONV(), 1916  
conventions  
  syntax, 2  
  typographical, 2  
CONVERT, 2003  
CONVERT TO, 2169  
converting HEAP to ondisk  
  thread state, 1623  
CONVERT\_TZ(), 1925  
ConvexHull(), 2069  
copy to tmp table  
  thread state, 1624  
copying databases, 257  
copying tables, 2231  
Copying to group table  
  thread state, 1624  
Copying to tmp table  
  thread state, 1624  
Copying to tmp table on disk  
  thread state, 1624  
core-file option  
  mysqld, 741  
  ndbd, 3574  
  ndbinfo\_select\_all, 3584  
  ndb\_blob\_tool, 3609  
  ndb\_config, 3617  
  ndb\_delete\_all, 3627  
  ndb\_desc, 3637  
  ndb\_drop\_index, 3641  
  ndb\_drop\_table, 3646  
  ndb\_import, 3657  
  ndb\_index\_stat, 3673  
  ndb\_mgm, 3603  
  ndb\_mgmd, 3594  
  ndb\_move\_data, 3680  
  ndb\_restore, 3699  
  ndb\_select\_all, 3724  
  ndb\_select\_count, 3730  
  ndb\_show\_tables, 3735  
  ndb\_waiter, 3750  
core-file-size option  
  mysqld\_safe, 344  
core\_file system variable, 779  
correct-checksum option  
  myisamchk, 586  
correlated subqueries, 2332  
corruption, 2905  
  InnoDB, 2865  
COS(), 1916  
cost model  
  optimizer, 1580  
COT(), 1916

---

- count option
  - innochecksum, 569
  - myisam\_ftdump, 576
  - mysqladmin, 442
  - mysqlshow, 543
- COUNT(), 2117
- COUNT(DISTINCT), 2118
- counter, 5314
- counters
  - ndbinfo table, 3855
- counting
  - table rows, 287
- covering index, 5314
- CPACK\_MONOLITHIC\_INSTALL option
  - CMake, 203
- CPU-bound, 5315
- cpustat
  - ndbinfo table, 3857
- cpustat\_1sec
  - ndbinfo table, 3859
- cpustat\_20sec
  - ndbinfo table, 3860
- cpustat\_50ms
  - ndbinfo table, 3858
- crash, 1045, 5315
  - recovery, 1434
  - repeated, 4563
  - replication, 3149
- crash recovery, 5315
  - InnoDB, 2866, 2867
- crash-safe replication, 3030, 3114
- CrashOnCorruptedTuple, 3434
- CRC32(), 1916
- CREATE ... IF NOT EXISTS
  - and replication, 3134
- CREATE DATABASE, 2183
- Create DB
  - thread command, 1621
- CREATE EVENT, 2184
  - and replication, 3144
- CREATE FUNCTION, 2196
- CREATE FUNCTION statement, 2465
- CREATE INDEX, 2188
- CREATE LOGFILE GROUP, 2194
  - (see also [NDB Cluster Disk Data](#))
- CREATE NODEGROUP command (NDB Cluster), 3755
- create option
  - mysqlslap, 558
- CREATE privilege, 1099
- CREATE PROCEDURE, 2196
- CREATE ROUTINE privilege, 1099
- CREATE SCHEMA, 2183
- CREATE SERVER, 2201
- CREATE TABLE, 2202

---

- DIRECTORY options
  - and replication, 3140
- KEY\_BLOCK\_SIZE, 2678
- NDB\_COLUMN options, 2247
- NDB\_TABLE options, 2249
- options for table compression, 2673
- ROW\_FORMAT, 2701
- CREATE TABLE ... SELECT
  - and replication, 3134
- CREATE TABLESPACE, 2252
  - general tablespace, 2252
- CREATE TABLESPACE privilege, 1099
- CREATE TEMPORARY TABLE
  - deprecated features, 23
- CREATE TEMPORARY TABLES privilege, 1099
- CREATE TRIGGER, 2258
- CREATE USER privilege, 1099
- CREATE USER statement, 1118, 1122, 2432
- CREATE VIEW, 2260
- CREATE VIEW privilege, 1099
- create-options option
  - mysqldump, 489
- create-schema option
  - mysqlslap, 558
- Created\_tmp\_disk\_tables status variable, 913
- Created\_tmp\_files status variable, 913
- Created\_tmp\_tables status variable, 913
- create\_asymmetric\_priv\_key(), 1406
- create\_asymmetric\_pub\_key(), 1407
- create\_dh\_parameters(), 1407
- create\_digest(), 1407
- create\_synonym\_db() procedure
  - sys schema, 4439
- creating
  - bug reports, 41
  - database, 2183
  - databases, 273
  - default startup options, 311
  - loadable function, 2465
  - schema, 2183
  - tables, 275
- Creating index
  - thread state, 1624
- Creating sort index
  - thread state, 1624
- creating table
  - thread state, 1624
- Creating tmp table
  - thread state, 1624
- creating user accounts, 2432
- CROSS JOIN, 2319
- Crosses(), 2073
- CRUD, 5315
- CR\_SERVER\_GONE\_ERROR, 4552

---

CR\_SERVER\_LOST\_ERROR, 4553  
CSV data, reading, 2294, 2319  
csv option  
    mysqslap, 558  
CSV storage engine, 2915, 2933  
csvopt option  
    ndb\_import, 3657  
CURDATE(), 1926  
CURRENT\_DATE, 1926  
CURRENT\_TIME, 1926  
CURRENT\_TIMESTAMP, 1926  
CURRENT\_USER(), 2038  
cursor, 5315  
Cursors, 2395  
CURTIME(), 1926  
CXX environment variable, 220, 651  
cxxflags option  
    mysql\_config, 645

## D

Daemon  
    thread command, 1621  
daemon option  
    ndb\_mgmd, 3594  
daemonize option  
    mysqld, 741  
daemon\_memcached\_enable\_binlog system variable, 2738  
daemon\_memcached\_engine\_lib\_name system variable, 2738  
daemon\_memcached\_engine\_lib\_path system variable, 2739  
daemon\_memcached\_option system variable, 2739  
daemon\_memcached\_r\_batch\_size system variable, 2740  
daemon\_memcached\_w\_batch\_size system variable, 2740  
data  
    importing, 430, 501  
    loading into tables, 277  
    retrieving, 278  
    size, 1521  
data dictionary, 5315  
data directory, 5316  
    mysql\_upgrade\_info file, 384  
DATA DIRECTORY  
    and replication, 3140  
data encryption, 2726  
data files, 5316  
Data Masking plugin  
    installing, 1383  
    uninstalling, 1383  
data node (NDB Cluster)  
    defined, 3287  
data nodes  
    memory allocation, 3466  
data nodes (NDB Cluster), 3570, 3587  
Data on disk (NDB Cluster)

---

and INFORMATION\_SCHEMA.FILES table, 4116

Data truncation with CJK characters, 4518

data type

BIGINT, 1794  
BINARY, 1818, 1821  
BIT, 1793  
BLOB, 1818, 1822  
BOOL, 1793, 1867  
BOOLEAN, 1793, 1867  
CHAR, 1815, 1817  
CHAR VARYING, 1817  
CHARACTER, 1817  
CHARACTER VARYING, 1817  
DATE, 1802, 1803  
DATETIME, 1802, 1803  
DEC, 1795  
DECIMAL, 1794, 2141  
DOUBLE, 1795  
DOUBLE PRECISION, 1796  
ENUM, 1819, 1824  
FIXED, 1795  
FLOAT, 1795, 1795, 1795  
GEOMETRY, 1831  
GEOMETRYCOLLECTION, 1831  
INT, 1794  
INTEGER, 1794  
LINESTRING, 1831  
LONG, 1822  
LONGBLOB, 1819  
LONGTEXT, 1819  
MEDIUMBLOB, 1818  
MEDIUMINT, 1794  
MEDIUMTEXT, 1818  
MULTILINESTRING, 1831  
MULTIPOINT, 1831  
MULTIPOLYGON, 1831  
NATIONAL CHAR, 1817  
NATIONAL VARCHAR, 1817  
NCHAR, 1817  
NUMERIC, 1795  
NVARCHAR, 1817  
POINT, 1831  
POLYGON, 1831  
REAL, 1796  
SET, 1819, 1827  
SMALLINT, 1794  
TEXT, 1818, 1822  
TIME, 1803, 1805  
TIMESTAMP, 1802, 1803  
TINYBLOB, 1818  
TINYINT, 1793  
TINYTEXT, 1818  
VARBINARY, 1818, 1821  
VARCHAR, 1815, 1817

---

- VARCHARACTER, 1817
- YEAR, 1803, 1806
- data types, 1792
  - date and time, 1800
  - numeric, 1792
  - string, 1815
- data warehouse, 5316
- data-at-rest encryption, 2726
- data-file-length option
  - myisamchk, 586
- database, 5316
  - altering, 2152
  - creating, 2183
  - deleting, 2265
  - renaming, 2271
- Database information
  - obtaining, 2473
- database metadata, 4098
- database names
  - case sensitivity, 47, 1665
- database objects
  - metadata, 1714
- database option
  - mysql, 405
  - mysqlbinlog, 619
  - ndb\_blob\_tool, 3609
  - ndb\_delete\_all, 3627
  - ndb\_desc, 3637
  - ndb\_drop\_index, 3641
  - ndb\_drop\_table, 3646
  - ndb\_index\_stat, 3673
  - ndb\_move\_data, 3680
  - ndb\_show\_tables, 3735
- database symlinking
  - removed features, 24
- DATABASE(), 2039
- databases
  - backups, 1415
  - copying, 257
  - creating, 273, 2183
  - defined, 4
  - displaying, 540
  - dumping, 465, 515
  - information about, 291
  - names, 1660
  - replicating, 2953
  - selecting, 275, 2542
  - symbolic links, 1608
  - using, 273
- databases option
  - mysqlcheck, 456
  - mysqldump, 493
  - mysqlpump, 522
- DataDir, 3398, 3406

---

datadir option  
  mysql.server, 353  
  mysqld, 742  
  mysqld\_safe, 344  
  mysql\_install\_db, 366  
  mysql\_plugin, 372  
  mysql\_ssl\_rsa\_setup, 381  
datadir system variable, 780  
DataMemory, 3408  
DATE, 4569  
date and time data types, 1800  
date and time functions, 1922  
date calculations, 282  
DATE columns  
  problems, 4569  
DATE data type, 1802, 1803  
date data types  
  storage requirements, 1863  
date literals, 1655  
date values  
  problems, 1804  
DATE(), 1926  
DATEDIFF(), 1927  
dates  
  used with partitioning, 3984  
  used with partitioning (examples), 3988, 4001, 4006, 4033  
DATETIME data type, 1802, 1803  
datetime\_format system variable, 780  
DATE\_ADD(), 1927  
date\_format system variable, 780  
DATE\_FORMAT(), 1928  
DATE\_SUB(), 1927, 1929  
DAY(), 1929  
Daylight Saving Time, 959, 1519, 1941  
DAYNAME(), 1930  
DAYOFMONTH(), 1930  
DAYOFWEEK(), 1930  
DAYOFYEAR(), 1930  
db table  
  sorting, 1117  
  system table, 233, 968, 1105  
db-workers option  
  ndb\_import, 3658  
DB2  
  deprecated features, 19  
DB2 SQL mode, 940  
DBI interface, 4482  
DBI->quote, 1654  
DBI->trace, 1048  
DBI/DBD interface, 4482  
DBI\_TRACE environment variable, 651, 1048  
DBI\_USER environment variable, 651  
DEBUG package, 1052  
DCL, 2440, 2451, 5316

---

DDEX provider, 5316  
DDL, 2152, 5316  
DDL log, 993  
deadlock, 1597, 2352, 2624, 2629, 2629, 2630, 2630, 2794, 3151, 4380, 5317  
deadlock detection, 5317  
DEALLOCATE PREPARE, 2382, 2386  
deb file  
    MySQL APT Repository, 157  
    MySQL SLES Repository, 157  
Debug  
    thread command, 1621  
debug option  
    comp\_err, 360  
    myisamchk, 580  
    myisampack, 599  
    mysql, 405  
    mysqladmin, 442  
    mysqlbinlog, 620  
    mysqlcheck, 456  
    mysqld, 742  
    mysqldump, 482  
    mysqldumpslow, 642  
    mysqlimport, 506  
    mysqlpump, 523  
    mysqlshow, 544  
    mysqlslap, 559  
    mysql\_config\_editor, 608  
    mysql\_upgrade, 387  
    my\_print\_defaults, 646  
debug system variable, 780  
debug-check option  
    mysql, 405  
    mysqladmin, 442  
    mysqlbinlog, 620  
    mysqlcheck, 457  
    mysqldump, 483  
    mysqlimport, 506  
    mysqlpump, 523  
    mysqlshow, 544  
    mysqlslap, 559  
    mysql\_upgrade, 387  
debug-info option  
    comp\_err, 360  
    mysql, 405  
    mysqladmin, 443  
    mysqlbinlog, 621  
    mysqlcheck, 457  
    mysqldump, 483  
    mysqlimport, 506  
    mysqlpump, 523  
    mysqlshow, 544  
    mysqlslap, 559  
    mysql\_upgrade, 388  
debug-sync-timeout option



---

- mysqld, 742
- debugging
  - client, 1052
  - MySQL, 1045
  - server, 1045
- debugging support, 194
- debug\_sync system variable, 781
- DEC data type, 1795
- decimal arithmetic, 2141
- DECIMAL data type, 1794, 2141
- decimal point, 1792
- DECLARE, 2388
- DECODE(), 2027
  - deprecated features, 21
- decode\_bits myisamchk variable, 582
- DEFAULT
  - constraint, 55
- default
  - privileges, 233
- default account, 233
- default host name, 335
- default installation location, 80
- default options, 311
- default proxy user, 1135
- DEFAULT value clause, 1860, 2207
- default values, 1860, 2207, 2282
  - BLOB and TEXT columns, 1823
  - explicit, 1860
  - implicit, 1860
  - suppression, 55
- DEFAULT(), 2134
- default-auth option, 324
  - mysql, 406
  - mysqladmin, 443
  - mysqlbinlog, 621
  - mysqlcheck, 458
  - mysqldump, 475
  - mysqlimport, 506
  - mysqlpump, 523
  - mysqlshow, 544
  - mysqlslap, 559
  - mysql\_upgrade, 388
- default-character-set option
  - mysql, 406
  - mysqladmin, 443
  - mysqlcheck, 457
  - mysqldump, 485
  - mysqlimport, 506
  - mysqlpump, 524
  - mysqlshow, 544
  - mysql\_upgrade, 388
- default-parallelism option
  - mysqlpump, 524
- default-time-zone option

---

- mysqld, 743
- DefaultHashMapSize, 3421, 3500
- DefaultOperationRedoProblemAction
  - API and SQL nodes, 3500
- defaults
  - embedded, 4478
- defaults option
  - mysql\_install\_db, 366
- defaults-extra-file option, 317
  - myisamchk, 581
  - mysql, 406
  - mysqladmin, 443
  - mysqlbinlog, 621
  - mysqlcheck, 457
  - mysqld, 743
  - mysqldump, 479
  - mysqld\_multi, 355
  - mysqld\_safe, 344
  - mysqlimport, 507
  - mysqlpump, 524
  - mysqlshow, 545
  - mysqslap, 559
  - mysql\_install\_db, 367
  - mysql\_secure\_installation, 375
  - mysql\_upgrade, 388
  - my\_print\_defaults, 646
- ndbd, 3575
  - ndbinfo\_select\_all, 3584
  - ndb\_blob\_tool, 3609
  - ndb\_config, 3617
  - ndb\_delete\_all, 3627
  - ndb\_desc, 3637
  - ndb\_drop\_index, 3642
  - ndb\_drop\_table, 3646
  - ndb\_import, 3658
  - ndb\_index\_stat, 3673
  - ndb\_mgm, 3603
  - ndb\_mgmd, 3594
  - ndb\_move\_data, 3680
  - ndb\_restore, 3699
  - ndb\_select\_all, 3724
  - ndb\_select\_count, 3730
  - ndb\_show\_tables, 3735
  - ndb\_top, 3743
  - ndb\_waiter, 3750
- defaults-file option, 317
  - myisamchk, 581
  - mysql, 406
  - mysqladmin, 443
  - mysqlbinlog, 621
  - mysqlcheck, 457
  - mysqld, 743
  - mysqldump, 480
  - mysqld\_multi, 355

---

mysqld\_safe, 345  
mysqlimport, 507  
mysqlpump, 524  
mysqlshow, 545  
mysqlslap, 560  
mysql\_install\_db, 367  
mysql\_secure\_installation, 376  
mysql\_upgrade, 388  
my\_print\_defaults, 646  
ndbd, 3575  
ndbinfo\_select\_all, 3585  
ndb\_blob\_tool, 3609  
ndb\_config, 3617  
ndb\_delete\_all, 3627  
ndb\_desc, 3637  
ndb\_drop\_index, 3642  
ndb\_drop\_table, 3647  
ndb\_import, 3658  
ndb\_index\_stat, 3673  
ndb\_mgm, 3603  
ndb\_mgmd, 3594  
ndb\_move\_data, 3680  
ndb\_restore, 3699  
ndb\_select\_all, 3724  
ndb\_select\_count, 3730  
ndb\_show\_tables, 3735  
ndb\_top, 3743  
ndb\_waiter, 3750  
defaults-group-suffix option, 317  
myisamchk, 581  
mysql, 407  
mysqladmin, 444  
mysqlbinlog, 621  
mysqlcheck, 458  
mysqld, 743  
mysqldump, 480  
mysqlimport, 507  
mysqlpump, 525  
mysqlshow, 545  
mysqlslap, 560  
mysql\_secure\_installation, 376  
mysql\_upgrade, 388  
my\_print\_defaults, 646  
ndbd, 3575  
ndbinfo\_select\_all, 3585  
ndb\_blob\_tool, 3609  
ndb\_config, 3617  
ndb\_delete\_all, 3627  
ndb\_desc, 3637  
ndb\_drop\_index, 3642  
ndb\_drop\_table, 3647  
ndb\_import, 3659  
ndb\_index\_stat, 3673  
ndb\_mgm, 3603

---

- ndb\_mgmd, 3594
- ndb\_move\_data, 3680
- ndb\_restore, 3699
- ndb\_select\_all, 3724
- ndb\_select\_count, 3730
- ndb\_show\_tables, 3735
- ndb\_top, 3743
- ndb\_waiter, 3750
- default\_authentication\_plugin system variable, 781
- DEFAULT\_CHARSET option
  - CMake, 208
- DEFAULT\_COLLATION option
  - CMake, 208
- default\_password\_lifetime system variable, 782
- default\_storage\_engine system variable, 783
- default\_tmp\_storage\_engine system variable, 784
- default\_week\_format system variable, 784
- defer-table-indexes option
  - mysqlpump, 525
- DEFINER privileges, 2494, 4081
- DEGREES(), 1916
- delay option
  - ndbinfo\_select\_all, 3585
- DELAYED, 2289
  - INSERT modifier, 2284
- Delayed insert
  - thread command, 1621
- delayed replication, 3131
- Delayed\_errors status variable, 913
- delayed\_insert\_limit system variable, 785
- Delayed\_insert\_threads status variable, 913
- delayed\_insert\_timeout system variable, 786
- delayed\_queue\_size system variable, 786
- Delayed\_writes status variable, 913
- delay\_key\_write system variable, 784, 2922
- DELETE, 2274
  - and NDB Cluster, 3322
- delete, 5317
- delete buffering, 5317
- delete option
  - mysqlimport, 507
  - ndb\_index\_stat, 3673
- DELETE privilege, 1100
- delete-master-logs option
  - mysqldump, 486
- delete-orphans option
  - ndb\_blob\_tool, 3610
- deleting
  - accounts, 1121
  - database, 2265
  - foreign key, 2168, 2237
  - function, 2466
  - index, 2167, 2266
  - primary key, 2167

---

- rows, 4573
- schema, 2265
- table, 2268
- user, 2439
- users, 2439
- deleting from main table
  - thread state, 1624
- deleting from reference tables
  - thread state, 1624
- deletion
  - mysql.sock, 4567
- delimiter command
  - mysql, 421
- delimiter option
  - mysql, 407
  - mysqlslap, 560
  - ndb\_select\_all, 3724
- demo\_test table, 2873
- denormalized, 5317
- deprecated features, 18
  - bootstrap, 22
  - comments, 22
  - des-key-file, 21
  - fix-db-names, 22
  - fix-table-names, 22
  - ignore-db-dir, 21
  - log-warnings, 20
  - skip-comments, 22
  - skip-innodb, 20
  - ssl, 20
  - ssl-verify-server-cert, 20
  - temp-pool, 20
- ALTER DATABASE, 22
- binlog\_max\_flush\_queue\_time, 20
- character\_set\_database, 20
- collation\_database, 20
- comment stripping, 22
- COM\_FIELD\_LIST, 22
- COM\_PROCESS\_INFO, 22
- COM\_PROCESS\_KILL, 22
- COM\_REFRESH, 22
- CREATE TEMPORARY TABLE, 23
- DB2, 19
- DECODE(), 21
- DES\_DECRYPT(), 21
- DES\_ENCRYPT(), 21
- DES\_KEY\_FILE, 21
- DTrace, 23
- embedded server library, 22
- ENCODE(), 21
- ENCRYPT(), 21
- ERROR\_FOR\_DIVISION\_BY\_ZERO, 19
- EXPLAIN EXTENDED, 21
- EXPLAIN PARTITIONS, 21

---

FLUSH QUERY CACHE, 20  
GRANT, 19  
GROUP BY sorting, 21  
have\_crypt, 21  
HAVE\_CRYPT, 21  
have\_query\_cache, 20  
IDENTIFIED BY PASSWORD, 19  
ignore\_db\_dirs, 21  
InnoDB shared tablespaces, 23  
INNODB\_LOCKS, 21  
INNODB\_LOCK\_WAITS, 21  
innodb\_support\_xa, 20  
JSON\_MERGE(), 23  
libmysqld, 22  
log\_warnings, 20  
MAXDB, 19  
MBREqual(), 21  
metadata\_locks\_cache\_size, 20  
metadata\_locks\_hash\_instances, 20  
MSSQL, 19  
myisamchk --parallel-recover, 23  
myisam\_repair\_threads, 23  
MYSQL323, 19  
MYSQL40, 19  
mysqld\_safe, 22  
mysql\_install\_db, 22  
mysql\_kill(), 22  
mysql\_list\_fields(), 22  
mysql\_list\_processes(), 22  
MYSQL\_OPT\_SSL\_ENFORCE, 20  
MYSQL\_OPT\_SSL\_VERIFY\_SERVER\_CERT, 20  
mysql\_plugin, 22  
mysql\_refresh(), 22  
mysql\_shutdown(), 22  
ndb\_cache\_check\_time, 20  
NO\_FIELD\_OPTIONS, 19  
NO\_KEY\_OPTIONS, 19  
NO\_TABLE\_OPTIONS, 19  
NO\_ZERO\_DATE, 19  
NO\_ZERO\_IN\_DATE, 19  
old\_passwords, 19  
ORACLE, 19  
PASSWORD(), 19  
performance\_timers, 21  
perror, 23  
POSTGRESQL, 19  
pre-5.1 database name conversion, 22  
PROCEDURE ANALYSE(), 21  
PROFILING, 21  
Qcache\_free\_blocks, 20  
Qcache\_free\_memory, 20  
Qcache\_inserts, 20, 20  
Qcache\_lowmem\_prunes, 20  
Qcache\_not\_cached, 20

---

- Qcache\_queries\_in\_cache, 20
- Qcache\_total\_blocks, 20
- query cache, 20
- query\_cache\_limit, 20
- query\_cache\_min\_res\_unit, 20
- query\_cache\_size, 20
- query\_cache\_type, 20
- query\_cache\_wlock\_invalidate, 20
- replace, 23
- RESET QUERY CACHE, 20
- resolveip, 22
- resolve\_stack\_dump, 22
- setup\_timers, 21
- spatial functions, 21
- SQL mode, 19, 19
- SQL\_CACHE, 20
- sql\_log\_bin, 21
- SQL\_NO\_CACHE, 20
- sync\_frm, 20
- sys.version, 21
- tx\_isolation, 20
- tx\_read\_only, 20
- \N as NULL, 21
- derived tables, 2333
  - materialization prevention, 1498
  - optimization, 1489, 1497
  - updatable views, 4077
- des-key-file option
  - mysqld, 743
- DESC, 2537
- descending index, 5317
- descending option
  - ndb\_select\_all, 3724
- DESCRIBE, 291, 2537
- description option
  - myisamchk, 589
- design
  - issues, 4577
- DES\_DECRYPT(), 2028
  - deprecated features, 21
- DES\_ENCRYPT(), 2028
  - deprecated features, 21
- DES\_KEY\_FILE
  - deprecated features, 21
- detach option
  - mysqlslap, 560
- development of NDB Cluster, 3294
- development source tree, 192
- diagnostics() procedure
  - sys schema, 4440
- dictionary collation, German, 1712, 1759, 1759
- DictTrace, 3460
- dict\_obj\_info
  - ndbinfo table, 3861

---

dict\_obj\_types  
  ndbinfo table, 3862

diff-default option  
  ndb\_config, 3617

digits, 1792

Dimension(), 2060

directory structure  
  default, 80

dirty page, 2741, 5318

dirty read, 5318

disable named command  
  mysql, 407

--disable option prefix, 319

disable-indexes option  
  ndb\_restore, 3699

disable-keys option  
  mysqldump, 495

disable-log-bin option  
  mysqlbinlog, 622

disable-partition-engine-check option  
  mysqld, 744

disabled\_storage\_engines system variable, 786

DISABLE\_PSI\_COND option  
  CMake, 208

DISABLE\_PSI\_FILE option  
  CMake, 208

DISABLE\_PSI\_IDLE option  
  CMake, 208

DISABLE\_PSI\_MEMORY option  
  CMake, 208

DISABLE\_PSI\_METADATA option  
  CMake, 208

DISABLE\_PSI\_MUTEX option  
  CMake, 208

DISABLE\_PSI\_PS option  
  CMake, 209

DISABLE\_PSI\_RWLOCK option  
  CMake, 208

DISABLE\_PSI\_SOCKET option  
  CMake, 208

DISABLE\_PSI\_SP option  
  CMake, 208

DISABLE\_PSI\_STAGE option  
  CMake, 209

DISABLE\_PSI\_STATEMENT option  
  CMake, 209

DISABLE\_PSI\_STATEMENT\_DIGEST option  
  CMake, 209

DISABLE\_PSI\_TABLE option  
  CMake, 209

DISABLE\_PSI\_THREAD option  
  CMake, 209

DISABLE\_PSI\_TRANSACTION option  
  CMake, 209



---

DISCARD TABLESPACE, 2170, 2574  
discard\_or\_import\_tablespace  
  thread state, 1624  
disconnect-slave-event-count option  
  mysqld, 3025  
disconnecting  
  from the server, 269  
disconnect\_on\_expired\_password system variable, 787  
Disjoint(), 2077  
Disk Data tables (NDB Cluster) (see [NDB Cluster Disk Data](#))  
disk failure  
  InnoDB, 2865  
disk full, 4565  
disk I/O, 1538  
disk option  
  ndb\_select\_all, 3724  
disk performance, 1606  
disk-based, 5318  
disk-bound, 5318  
DiskIOThreadPool, 3482, 3486  
Diskless, 3434  
diskpagebuffer  
  ndbinfo table, 3864  
DiskPageBufferEntries, 3480  
DiskPageBufferMemory, 3481, 3486  
disks  
  splitting data across, 1609  
diskscan option  
  ndb\_delete\_all, 3627  
DiskSyncSize, 3449  
disk\_write\_speed\_aggregate  
  ndbinfo table, 3863  
disk\_write\_speed\_aggregate\_node  
  ndbinfo table, 3864  
disk\_write\_speed\_base  
  ndbinfo table, 3862  
display size, 1792  
display triggers, 2520  
display width, 1792  
displaying  
  database information, 540  
  information  
    Cardinality, 2495  
    Collation, 2495  
    SHOW, 2473, 2477, 2519  
    SHOW statement, 2494, 2496  
  table status, 2516  
Distance(), 2073  
DISTINCT, 280, 1482  
  AVG(), 2117  
  COUNT(), 2118  
  MAX(), 2121  
  MIN(), 2121  
  SELECT modifier, 2316

---

- SUM(), 2122
- DISTINCTROW
  - SELECT modifier, 2316
- distinguished name
  - LDAP authentication, 1208
- distributed privileges (NDB Cluster), 3826
  - and NDB API applications, 3829
- DIV, 1913
- division (/), 1913
- div\_precision\_increment system variable, 788
- DML, 2273, 5318
  - DELETE statement, 2274
  - INSERT statement, 2280
  - UPDATE statement, 2340
- DN (see [distinguished name](#))
- DNS, 949
- DNS SRV records, 1241
- DO, 2278
- DocBook XML
  - documentation source format, 4
- Docker, 254
- Docker images
  - on Windows, 173
- document id, 5318
- document store, 3253
  - MySQL as a, 3253
- Documentation
  - in Chinese, 4518
  - in Japanese, 4518
  - in Korean, 4518
- dont-ignore-systab-0 option
  - ndb\_restore, 3699
- DOUBLE data type, 1795
- DOUBLE PRECISION data type, 1796
- double quote ("), 1653, 2106
- doublewrite buffer, 918, 2704, 2761, 5318
- downgrades
  - NDB Cluster, 3357, 3794
- downgrading, 258
- downloading, 63
- DOWNLOAD\_BOOST option
  - CMake, 209
- DOWNLOAD\_BOOST\_TIMEOUT option
  - CMake, 209
- drop, 5319
- DROP ... IF EXISTS
  - and replication, 3135
- DROP DATABASE, 2265
- Drop DB
  - thread command, 1621
- DROP EVENT, 2266
- DROP FOREIGN KEY, 2168, 2237
- DROP FUNCTION, 2267
- DROP FUNCTION statement, 2466

---

DROP INDEX, 2167, 2266  
DROP LOGFILE GROUP, 2267  
    (see also [NDB Cluster Disk Data](#))  
DROP NODEGROUP command (NDB Cluster), 3755  
DROP PREPARE, 2386  
DROP PRIMARY KEY, 2167  
DROP privilege, 1100  
DROP PROCEDURE, 2267  
DROP SCHEMA, 2265  
DROP SERVER, 2268  
DROP TABLE, 2268  
    and NDB Cluster, 3322  
DROP TABLESPACE, 2269  
    general tablespace, 2269  
DROP TRIGGER, 2270  
DROP USER statement, 1118, 2439  
DROP VIEW, 2270  
drop-source option  
    ndb\_move\_data, 3681  
dropping  
    accounts, 1121  
    user, 2439  
dry-scp option  
    ndb\_error\_reporter, 3649  
DSN, 5319  
DTrace, 1055  
    deprecated features, 23  
DUAL, 2312  
dump option  
    myisam\_ftdump, 576  
    ndb\_index\_stat, 3674  
    ndb\_redo\_log\_reader, 3689  
dump-date option  
    mysqldump, 483  
dump-file option  
    ndb\_blob\_tool, 3610  
dump-slave option  
    mysqldump, 486  
DUMPFIL, 2319  
dumping  
    databases and tables, 465, 515  
Duplicate Weedout  
    semijoin strategy, 1491  
duplicate-key error, 2586  
dynamic cursor, 5319  
dynamic row format, 2700, 5319  
dynamic SQL, 5319  
dynamic statement, 5319  
dynamic table characteristics, 2925

## E

early adopter, 5319  
early-plugin-load option

---

- mysqld, 744
- edit command
  - mysql, 422
- ego command
  - mysql, 422
- Eiffel, 5320
- Eiffel Wrapper, 4484
- ELT(), 1949
- embedded, 5320
- embedded MySQL server library, 4476
- embedded option
  - mysql\_config, 645
- embedded server library
  - deprecated features, 22
- embedded-libs option
  - mysql\_config, 645
- enable option prefix, 319
- enable-cleartext-plugin option
  - mysql, 407
  - mysqladmin, 444
  - mysqlcheck, 459
  - mysqldump, 475
  - mysqlimport, 508
  - mysqlshow, 545
  - mysqlslap, 561
- ENABLED\_LOCAL\_INFILE option
  - CMake, 210, 1091
- ENABLED\_PROFILING option
  - CMake, 210
- EnablePartialLcp, 3423
- EnableRedoControl, 3428
- ENABLE\_DOWNLOADS option
  - CMake, 209
- ENABLE\_DTRACE option
  - CMake, 210
- ENABLE\_GCOV option
  - CMake, 210
- ENABLE\_GPROF option
  - CMake, 210
- ENCODE(), 2029
  - deprecated features, 21
- ENCRYPT(), 2029
  - deprecated features, 21
- encrypted connections, 1148
  - as mandatory, 1155
  - command options, 327
- encryption, 1087, 1148, 2726
- encryption functions, 2021
- end
  - thread state, 1624
- END, 2387
- end-page option
  - innochecksum, 570
- EndPoint(), 2063

---

end\_markers\_in\_json system variable, 788  
enforce\_gtid\_consistency system variable, 3072  
engine condition pushdown, 1455  
engine option  
  mysqlslap, 561  
ENGINES  
  INFORMATION\_SCHEMA table, 4111  
engine\_cost  
  system table, 1581  
engine\_cost table  
  system table, 970  
ENTER SINGLE USER MODE command (NDB Cluster), 3756  
entering  
  queries, 270  
enterprise components  
  MySQL Enterprise Audit, 4487  
  MySQL Enterprise Backup, 4485  
  MySQL Enterprise Data Masking and De-Identification, 4487  
  MySQL Enterprise Encryption, 4486  
  MySQL Enterprise Firewall, 4487  
  MySQL Enterprise Security, 4486  
  MySQL Enterprise Thread Pool, 4487  
  telemetry, 4488  
enterprise extensions  
  MySQL Enterprise Audit, 1294  
  MySQL Enterprise Data Masking and De-Identification, 1381  
  MySQL Enterprise Encryption, 1399  
  MySQL Enterprise Firewall, 1365  
  MySQL Enterprise Security, 1190, 1201, 1206  
  MySQL Enterprise Thread Pool, 1001  
ENUM  
  size, 1866  
ENUM data type, 1819, 1824  
Envelope(), 2060  
environment variable  
  AUTHENTICATION\_LDAP\_CLIENT\_LOG, 651, 1232  
  AUTHENTICATION\_PAM\_LOG, 651, 1200  
  CC, 220, 651  
  CXX, 220, 651  
  DBI\_TRACE, 651, 1048  
  DBI\_USER, 651  
  HOME, 426, 651  
  LDAPNOINIT, 1211  
  LD\_LIBRARY\_PATH, 267  
  LD\_RUN\_PATH, 267, 651  
  LIBMYSQL\_ENABLE\_CLEARTEXT\_PLUGIN, 651  
  LIBMYSQL\_PLUGINS, 651  
  LIBMYSQL\_PLUGIN\_DIR, 651  
  MYSQLX\_TCP\_PORT, 651  
  MYSQLX\_UNIX\_PORT, 651  
  MYSQL\_DEBUG, 308, 651, 1052  
  MYSQL\_GROUP\_SUFFIX, 651  
  MYSQL\_HISTFILE, 426, 651  
  MYSQL\_HISTIGNORE, 426, 651

---

- MYSQL\_HOME, 651
- MYSQL\_HOST, 338, 651
- MYSQL\_OPENSSL\_UDF\_DH\_BITS\_THRESHOLD, 651, 1402
- MYSQL\_OPENSSL\_UDF\_DSA\_BITS\_THRESHOLD, 651, 1402
- MYSQL\_OPENSSL\_UDF\_RSA\_BITS\_THRESHOLD, 651, 1402
- MYSQL\_PS1, 651
- MYSQL\_PWD, 308, 338, 651
- MYSQL\_TCP\_PORT, 308, 651, 1044, 1045
- MYSQL\_TEST\_LOGIN\_FILE, 318, 605, 651
- MYSQL\_TEST\_TRACE\_CRASH, 651
- MYSQL\_TEST\_TRACE\_DEBUG, 651
- MYSQL\_UNIX\_PORT, 308, 651, 1044, 1045
- PATH, 124, 130, 231, 309, 651
- PKG\_CONFIG\_PATH, 651
- TMPDIR, 308, 651, 4566
- TZ, 651, 956, 4568
- UMASK, 651, 4559
- UMASK\_DIR, 651, 4560
- USER, 338, 651
- environment variables, 308, 340, 1143
  - list of, 650
- epoch, 1802
- equal (=), 1900
- Equals(), 2078
- eq\_ref join type
  - optimizer, 1553
- Errcode, 648
- errins-delay option
  - ndb\_import, 3659
- errins-type option
  - ndb\_import, 3659
- errno, 648
- Error
  - thread command, 1621
- ERROR Events (NDB Cluster), 3788
- error handling
  - application, 1094
- error log, 5320
- error logs (NDB Cluster), 3580
- error messages
  - can't find file, 4559
  - Can't reopen table, 4576
  - displaying, 648
  - languages, 1768, 1768
  - The used command is not allowed with this MySQL version, 1091
- error-insert option
  - ndb\_move\_data, 3681
- errors
  - access denied, 4548
  - and replication, 3149
  - checking tables for, 1435
  - common, 4547
  - directory checksum, 183
  - in subqueries, 2336

---

- known, 4577
- list of, 4548
- lost connection, 4551
- reporting, 41, 41
- sources of information, 4545
- error\_count system variable, 789
- ERROR\_FOR\_DIVISION\_BY\_ZERO
  - deprecated features, 19
- ERROR\_FOR\_DIVISION\_BY\_ZERO SQL mode, 934
- error\_messages
  - ndbinfo table, 3866
- escape (\), 1653, 2106
- escape sequences
  - option files, 314
  - strings, 1651
- establishing encrypted connections, 1150
- estimating
  - query performance, 1565
- event groups, 2376, 3083
- event log format (NDB Cluster), 3783
- event logs (NDB Cluster), 3780, 3781, 3782
- EVENT privilege, 1100
- event scheduler, 4057
  - thread states, 1634
- Event Scheduler, 4067
  - altering events, 2154
  - and MySQL privileges, 4072
  - and mysqladmin debug, 4071
  - and replication, 3144, 3144
  - and SHOW PROCESSLIST, 4068
  - concepts, 4067
  - creating events, 2184
  - dropping events, 2266
  - enabling and disabling, 4068
  - event metadata, 4070
  - obtaining status information, 4071
  - SQL statements, 4070
  - starting and stopping, 4068
  - time representation, 4071
- event severity levels (NDB Cluster), 3782
- event table
  - system table, 968
- event types (NDB Cluster), 3781, 3783
- EventLogBufferSize, 3455
- events, 4057, 4067
  - altering, 2154
  - creating, 2184
  - dropping, 2266
  - metadata, 4070
  - restrictions, 4090
  - status variables, 4074
- EVENTS
  - INFORMATION\_SCHEMA table, 4073, 4112
- events option

---

mysqldump, 493  
mysqlpump, 525  
events\_stages\_current table  
    performance\_schema, 4275  
events\_stages\_history table  
    performance\_schema, 4276  
events\_stages\_history\_long table  
    performance\_schema, 4277  
events\_stages\_summary\_by\_account\_by\_event\_name table  
    performance\_schema, 4325  
events\_stages\_summary\_by\_host\_by\_event\_name table  
    performance\_schema, 4325  
events\_stages\_summary\_by\_thread\_by\_event\_name table  
    performance\_schema, 4325  
events\_stages\_summary\_by\_user\_by\_event\_name table  
    performance\_schema, 4325  
events\_stages\_summary\_global\_by\_event\_name table  
    performance\_schema, 4325  
events\_statements\_current table  
    performance\_schema, 4281  
events\_statements\_history table  
    performance\_schema, 4285  
events\_statements\_history\_long table  
    performance\_schema, 4285  
events\_statements\_summary\_by\_account\_by\_event\_name table  
    performance\_schema, 4326  
events\_statements\_summary\_by\_digest table  
    performance\_schema, 4326  
events\_statements\_summary\_by\_host\_by\_event\_name table  
    performance\_schema, 4326  
events\_statements\_summary\_by\_program table  
    performance\_schema, 4326  
events\_statements\_summary\_by\_thread\_by\_event\_name table  
    performance\_schema, 4326  
events\_statements\_summary\_by\_user\_by\_event\_name table  
    performance\_schema, 4326  
events\_statements\_summary\_global\_by\_event\_name table  
    performance\_schema, 4326  
events\_transactions\_current table  
    performance\_schema, 4292  
events\_transactions\_history table  
    performance\_schema, 4295  
events\_transactions\_history\_long table  
    performance\_schema, 4295  
events\_transactions\_summary\_by\_account\_by\_event table  
    performance\_schema, 4329  
events\_transactions\_summary\_by\_host\_by\_event\_name table  
    performance\_schema, 4329  
events\_transactions\_summary\_by\_thread\_by\_event\_name table  
    performance\_schema, 4329  
events\_transactions\_summary\_by\_user\_by\_event\_name table  
    performance\_schema, 4329  
events\_transactions\_summary\_global\_by\_event\_name table  
    performance\_schema, 4329



---

- events\_waits\_current table
  - performance\_schema, 4267
- events\_waits\_history table
  - performance\_schema, 4270
- events\_waits\_history\_long table
  - performance\_schema, 4271
- events\_waits\_summary\_by\_account\_by\_event\_name table
  - performance\_schema, 4323
- events\_waits\_summary\_by\_host\_by\_event\_name table
  - performance\_schema, 4323
- events\_waits\_summary\_by\_instance table
  - performance\_schema, 4323
- events\_waits\_summary\_by\_thread\_by\_event\_name table
  - performance\_schema, 4323
- events\_waits\_summary\_by\_user\_by\_event\_name table
  - performance\_schema, 4323
- events\_waits\_summary\_global\_by\_event\_name table
  - performance\_schema, 4323
- event\_scheduler system variable, 789
- eviction, 5320
- exact-value literals, 2141
- exact-value numeric literals, 1654, 2142
- example option
  - mysqld\_multi, 355
- EXAMPLE storage engine, 2915, 2949
- examples
  - compressed tables, 600
  - myisamchk output, 589
  - queries, 294
- exception interceptor, 5320
- exceptions table
  - NDB Cluster Replication, 3971
- exclude-databases option
  - mysqlpump, 526
  - ndb\_restore, 3699
- exclude-events option
  - mysqlpump, 526
- exclude-gtids option
  - mysqlbinlog, 622
- exclude-intermediate-sql-tables option
  - ndb\_restore, 3700
- exclude-missing-columns option
  - ndb\_move\_data, 3681
  - ndb\_restore, 3700
- exclude-missing-tables option
  - ndb\_restore, 3700
- exclude-routines option
  - mysqlpump, 526
- exclude-tables option
  - mysqlpump, 526
  - ndb\_restore, 3700
- exclude-triggers option
  - mysqlpump, 526
- exclude-users option

---

- mysqlpump, 527
- exclusive lock, 2612, 5320
- Execute
  - thread command, 1622
- EXECUTE, 2382, 2386
- execute option
  - mysql, 407
  - ndb\_mgm, 3604
- EXECUTE privilege, 1100
- ExecuteOnComputer, 3394, 3402, 3495
- execute\_prepared\_stmt() procedure
  - sys schema, 4442
- executing
  - thread state, 1625
- executing SQL statements from text files, 292, 430
- Execution of init\_command
  - thread state, 1625
- execution threads (NDB Cluster), 3469
- EXISTS
  - with subqueries, 2332
- EXISTS() operator, 1902
- exit command
  - mysql, 422
- EXIT command (NDB Cluster), 3757
- EXIT SINGLE USER MODE command (NDB Cluster), 3756
- exit-info option
  - mysqld, 746
- EXP(), 1917
- expired password
  - resetting, 1125
- expired passwords, 1126
- expire\_logs\_days system variable, 3062
- EXPLAIN, 1547, 2537, 4030, 4031
- EXPLAIN EXTENDED
  - deprecated features, 21
- EXPLAIN PARTITIONS
  - deprecated features, 21
- EXPLAIN used with partitioned tables, 4030
- explicit default values, 1860
- explicit\_defaults\_for\_timestamp system variable, 790
- EXPORT\_SET(), 1949
- expression aliases, 2129, 2312
- expression syntax, 1701
- expressions
  - extended, 285
- extend-check option
  - myisamchk, 584, 586
- extended option
  - mysqlcheck, 458
- extended-insert option
  - mysqldump, 495
  - mysqlpump, 527
- extensions
  - to standard SQL, 46

---

- extent, 5320
- ExteriorRing(), 2066
- external locking, 746, 864, 1434, 1604, 1627
- external-locking option
  - mysqld, 746
- external\_user system variable, 791
- extra-file option
  - my\_print\_defaults, 646
- extra-node-info option
  - ndb\_desc, 3637
- extra-partition-info option
  - ndb\_desc, 3637
- extra-sql-file option
  - mysql\_install\_db, 367
- EXTRACT(), 1930
- extracting
  - dates, 282
- ExtractValue(), 2009
- extract\_schema\_from\_file\_name() function
  - sys schema, 4459
- extract\_table\_from\_file\_name() function
  - sys schema, 4459
- ExtraSendBufferMemory
  - API nodes, 3498
  - data nodes, 3487
  - management nodes, 3399

## F

- failover, 5321
  - in NDB Cluster replication, 3952
  - Java clients, 3288
- failure detection
  - Group Replication, 3171
- FALSE, 1654, 1660
  - testing for, 1904, 1904
- false literal
  - JSON, 1847
- FAQs
  - C API, 4531
  - Connectors and APIs, 4531
  - InnoDB Data-at-Rest Encryption, 4539
  - libmysql, 4531
  - NDB Cluster, 4505
  - replication, 4532
  - Virtualization Support, 4542
- Fast Index Creation, 5321
- fast option
  - myisamchk, 585
  - mysqlcheck, 459
- fast shutdown, 5321
- features of MySQL, 6
- features, deprecated (see [deprecated features](#))
- features, new (see [new features](#))

---

features, removed (see [removed features](#))  
FEDERATED storage engine, 2915, 2943  
Fetch  
    thread command, 1622  
FETCH, 2396  
field  
    changing, 2166  
Field List  
    thread command, 1622  
FIELD(), 1949  
fields option  
    ndb\_config, 3618  
fields-enclosed-by option  
    mysqldump, 490, 508  
    ndb\_import, 3659  
    ndb\_restore, 3702  
fields-escaped-by option  
    mysqldump, 490, 508  
    ndb\_import, 3660  
fields-optionally-enclosed-by option  
    mysqldump, 490, 508  
    ndb\_import, 3660  
    ndb\_restore, 3702  
fields-terminated-by option  
    mysqldump, 489, 508  
    ndb\_import, 3660  
    ndb\_restore, 3702  
FILE, 1951  
file descriptors  
    innodb\_open\_files, 2791  
    log tables, 973  
    max\_connections, 1525  
    MERGE, 2942  
    open\_files\_limit, 625, 834  
    partitioned MyISAM tables, 4044  
    table\_definition\_cache, 875  
    table\_open\_cache, 876, 1525  
    too many open files, 4558  
file format, 2691, 5321  
    Antelope, 2681  
    Barracuda, 2673  
    identifying, 2695  
    modifying, 2696  
FILE privilege, 1100  
file-per-table, 2566, 5322  
files  
    binary log, 978  
    created by CREATE TABLE, 2228  
    DDL log, 993  
    error messages, 1768  
    general query log, 976  
    log, 993  
    metadata log, 993  
    not found message, 4559

---

- permissions, 4559
- repairing, 585
- script, 292
- size limits, 1528
- slow query log, 991
- text, 430, 501

FILES

- INFORMATION\_SCHEMA table, 4116
- filesort optimization, 1478, 1581
- FileSystemPath, 3407
- FileSystemPathDataFiles, 3483
- FileSystemPathDD, 3482
- FileSystemPathUndoFiles, 3484
- file\_instances table
  - performance\_schema, 4261
- file\_summary\_by\_event\_name table
  - performance\_schema, 4331
- file\_summary\_by\_instance table
  - performance\_schema, 4331
- fill factor, 2587, 5322
- fill\_help\_tables.sql, 961
- FIND\_IN\_SET(), 1949
- Finished reading one binlog; switching to next binlog
  - thread state, 1630
- firewall table reference
  - INFORMATION\_SCHEMA, 4200
- firewalls (software)
  - and NDB Cluster, 3924, 3926
- Firewall\_access\_denied status variable, 1381
- Firewall\_access\_granted status variable, 1381
- Firewall\_access\_suspicious status variable, 1381
- Firewall\_cached\_entries status variable, 1381
- firewall\_users MySQL Enterprise Firewall table, 1377
- firewall\_users table
  - system table, 970
- firewall\_whitelist MySQL Enterprise Firewall table, 1377
- firewall\_whitelist table
  - system table, 970
- FirstMatch
  - semijoin strategy, 1491
- fix-db-names option
  - mysqlcheck, 459
- fix-table-names option
  - mysqlcheck, 459
- FIXED data type, 1795
- fixed row format, 5322
- fixed-point arithmetic, 2141
- FLOAT data type, 1795, 1795, 1795
- floating-point number, 1795
- floating-point values
  - and replication, 3141
- floats, 1654
- FLOOR(), 1917
- flow control functions, 1908

---

FLUSH  
  and replication, 3141  
flush, 5322  
flush list, 5322  
flush option  
  mysqld, 746  
FLUSH QUERY CACHE  
  deprecated features, 20  
FLUSH statement, 2527  
flush system variable, 791  
flush tables, 438  
flush-logs option  
  mysqldump, 497  
flush-privileges option  
  mysqldump, 497  
flushing, 2646  
Flush\_commands status variable, 913  
flush\_rewrite\_rules() Rewriter function, 1015  
flush\_time system variable, 792  
FOR UPDATE, 2316  
FORCE  
  plugin activation option, 999  
FORCE INDEX, 1577, 4575  
FORCE KEY, 1577  
force option  
  myisamchk, 585, 586  
  myisampack, 599  
  mysql, 407  
  mysqladmin, 444  
  mysqlcheck, 459  
  mysqldump, 484  
  mysqlimport, 508  
  mysql\_upgrade, 389  
force-if-open option  
  mysqlbinlog, 622  
force-read option  
  mysqlbinlog, 622  
FORCE\_PLUS\_PERMANENT  
  plugin activation option, 999  
FORCE\_UNSUPPORTED\_COMPILER option  
  CMake, 210  
foreign key, 5323  
  constraint, 54, 54  
  deleting, 2168, 2237  
FOREIGN KEY constraint, 5323  
foreign key constraints, 2232  
FOREIGN KEY constraints  
  and online DDL, 2725  
foreign keys, 50, 296, 2168  
foreign\_key\_checks system variable, 792  
FORMAT(), 1950  
format\_bytes() function  
  sys schema, 4460  
format\_path() function

---

- sys schema, 4460
- format\_statement() function
  - sys schema, 4461
- format\_time() function
  - sys schema, 4462
- formfeed (f), 2106
- FOUND\_ROWS(), 2039
- fractional seconds
  - and replication, 3141
- fractional seconds precision, 1792, 1801
- fragment replicas (NDB Cluster), 3290
- FragmentLogFileSize, 3422
- FRAGMENT\_COUNT\_TYPE (NDB\_TABLE) (OBSOLETE)
  - NDB Cluster, 2250
- FreeBSD troubleshooting, 221
- freeing items
  - thread state, 1625
- .frm file, 5321
- FROM, 2313
- FROM\_BASE64(), 1950
- FROM\_DAYS(), 1930
- FROM\_UNIXTIME(), 1930
- fs option
  - ndb\_error\_reporter, 3649
- FTS, 5323
- ft\_boolean\_syntax system variable, 793
- ft\_max\_word\_len myisamchk variable, 582
- ft\_max\_word\_len system variable, 793
- ft\_min\_word\_len myisamchk variable, 582
- ft\_min\_word\_len system variable, 794
- ft\_query\_expansion\_limit system variable, 794
- ft\_stopword\_file myisamchk variable, 582
- ft\_stopword\_file system variable, 794
- full backup, 5323
- full disk, 4565
- full table scan, 5323
- full table scans
  - avoiding, 1488
- full-text index
  - InnoDB, 2589
  - monitoring, 2593
- full-text queries
  - optimization, 1510
- full-text search, 1972, 5323
- FULLTEXT, 1972
- fulltext
  - stopword list, 1986
- FULLTEXT index, 5323
- FULLTEXT initialization
  - thread state, 1625
- fulltext join type
  - optimizer, 1553
- FULLY\_REPLICATED (NDB\_TABLE)
  - NDB Cluster, 2251

---

- func table
  - system table, 968, 1037
- function
  - creating, 2465
  - deleting, 2466
- function installation
  - keyring, 1276
- function names
  - parsing, 1669
  - resolving ambiguity, 1669
- functional dependence, 938, 2126, 2130
- functions, 1870
  - aggregate, 2115
  - and replication, 3141
  - arithmetic, 2018
  - bit, 2018
  - cast, 2000
  - date and time, 1922
  - encryption, 2021
  - flow control, 1908
  - for SELECT and WHERE clauses, 1870
  - GROUP BY, 2115
  - grouping, 1898
  - GTIDs, 2113
  - information, 2035
  - loadable, 2465, 2466
  - locking, 2033
  - mathematical, 1914
  - miscellaneous, 2133
  - stored, 4059
  - string, 1944
  - string comparison, 1962
- fuzzy checkpointing, 5324

## G

- GA, 5324
  - MySQL releases, 62
- GAC, 5324
- gap, 5324
- gap event, 3934
- gap lock, 2612, 5324
  - InnoDB, 2628, 2779
- gb2312, gbk, 4518
- gci option
  - ndb\_select\_all, 3725
- gci64 option
  - ndb\_select\_all, 3725
- GCP Stop errors (NDB Cluster), 3486
- gdb
  - using, 1047
- gdb option
  - mysqld, 746
- Gemalto SafeNet KeySecure Appliance



---

- keyring\_okv keyring plugin, 1266
- general information, 1
- General Public License, 5
- general query log, 976, 5324
- general table reference
  - INFORMATION\_SCHEMA, 4105
- general tablespace, 5324
- general\_log system variable, 795
- general\_log table
  - system table, 969
- general\_log\_file system variable, 795
- generated column, 5325
- generated columns
  - ALTER TABLE, 2178
  - CREATE TABLE, 2240
  - CREATE TRIGGER, 2259
  - CREATE VIEW, 2264
  - INFORMATION\_SCHEMA.COLUMNS table, 4110
  - INSERT, 2282
  - new features, 16
  - REPLACE, 2309
  - secondary indexes, 2243
  - SHOW COLUMNS statement, 2478, 4109
  - UPDATE, 2342
  - views, 4077
- gen\_blacklist() MySQL Enterprise Data Masking and De-Identification function, 1397
- gen\_dictionary() MySQL Enterprise Data Masking and De-Identification function, 1397
- gen\_dictionary\_drop() MySQL Enterprise Data Masking and De-Identification function, 1398
- gen\_dictionary\_load() MySQL Enterprise Data Masking and De-Identification function, 1399
- gen\_range() MySQL Enterprise Data Masking and De-Identification function, 1394
- gen\_rnd\_email() MySQL Enterprise Data Masking and De-Identification function, 1395
- gen\_rnd\_pan() MySQL Enterprise Data Masking and De-Identification function, 1395
- gen\_rnd\_ssn() MySQL Enterprise Data Masking and De-Identification function, 1396
- gen\_rnd\_us\_phone() MySQL Enterprise Data Masking and De-Identification function, 1396
- geographic feature, 1830
- GeomCollFromText(), 2052
- GeomCollFromWKB(), 2055
- geometrically valid
  - GIS values, 1841
  - spatial values, 1841
- geometry, 1830
- GEOMETRY data type, 1831
- geometry values
  - internal storage format, 1840
  - WKB format, 1839
  - WKT format, 1838
- GEOMETRYCOLLECTION data type, 1831
- GeometryCollection(), 2058
- GeometryCollectionFromText(), 2052
- GeometryCollectionFromWKB(), 2055
- GeometryFromText(), 2052
- GeometryFromWKB(), 2055
- GeometryN(), 2068
- GeometryType(), 2060

---

- GeomFromText(), 2052
- GeomFromWKB(), 2055
- geospatial feature, 1830
- German dictionary collation, 1712, 1759, 1759
- German phone book collation, 1712, 1759, 1759
- GET DIAGNOSTICS, 2401
- get-server-public-key option, 328
  - mysql, 408
  - mysqladmin, 444
  - mysqlbinlog, 622
  - mysqlcheck, 460
  - mysqldump, 475
  - mysqlimport, 508
  - mysqlpump, 527
  - mysqlshow, 546
  - mysqlslap, 561
- getting MySQL, 63
- GET\_FORMAT(), 1931
- GET\_LOCK(), 2033
- GIS, 1829
- GIS data types
  - storage requirements, 1866
- GIS values
  - geometrically valid, 1841
- Git tree, 192
- Glassfish, 5325
- GLength(), 2063
- GLOBAL
  - SET statement, 2468
- global privileges, 2440, 2451
- global transaction, 5325
- GLOBAL\_STATUS
  - INFORMATION\_SCHEMA table, 4123
- GLOBAL\_VARIABLES
  - INFORMATION\_SCHEMA table, 4123
- go command
  - mysql, 422
- Google Test, 209
- GRANT
  - deprecated features, 19
- GRANT OPTION privilege, 1100
- GRANT statement, 1118, 2440
- grant table distribution (NDB Cluster), 3826
- grant tables
  - columns\_priv table, 968, 1105
  - db table, 233, 968, 1105
  - procs\_priv table, 968, 1105
  - proxies\_priv, 1134
  - proxies\_priv table, 233, 968, 1105
  - sorting, 1115, 1117
  - structure, 1104
  - tables\_priv table, 968, 1105
  - user table, 233, 968, 1105
- granting

---

- privileges, 2440
- grants
  - display, 2493
- graph option
  - ndb\_top, 3743
- greater than (>), 1901
- greater than or equal (>=), 1901
- greatest timestamp wins (conflict resolution), 3968
- greatest timestamp, delete wins (conflict resolution), 3968
- GREATEST(), 1902
- grep option
  - mysqldumpslow, 643
- Group (NDB Cluster), 3563
- GROUP BY
  - aliases in, 2129
  - extensions to standard SQL, 2126, 2314
  - implicit sorting, 1478
  - maximum sort length, 2314
  - WITH ROLLUP, 2122
- GROUP BY functions, 2115
- GROUP BY optimizing, 1480
- GROUP BY sorting
  - deprecated features, 21
- group commit, 5325
- group preferences
  - LDAP authentication, 1217
- Group Replication, 3165
  - adding a second instance, 3179
  - adding additional instances, 3181
  - adding instances, 3179
  - allowlist, 3207
  - and audit\_log plugin, 1364, 3187
  - asynchronous replication, 3167
  - background, 3166
  - choosing mode, 3191
  - configuring instances, 3174
  - data definition language statements, 3238
  - data manipulation statements, 3237
  - deploying in multi primary or single primary mode, 3191
  - deploying in single primary mode, 3172
  - deploying instances, 3173
  - details, 3170
  - distributed recovery, 3238
  - distributed recovery basics, 3238
  - distributed recovery usage advice and limitations, 3244
  - election process, 3192
  - examples of use case scenarios, 3170
  - failure detection, 3171
  - frequently asked questions, 3232
  - getting started, 3172
  - Group Communication System, 3236
  - group membership, 3170
  - group\_replication\_ip\_whitelist, 3207
  - ip address allowlisting, 3206

---

- launching, 3177
- limitations, 3186
- message compression, 3245
- modes, 3191
- monitoring, 3188
- multi primary mode, 3192
- MySQL Enterprise Backup, 3201
- network partitioning, 3194
- observability, 3245
- operations, 3191
- Paxos, 3236
- plugin architecture, 3236
- primary secondary replication, 3167
- recovering from a point in time, 3239
- replication group member stats, 3190
- replication technologies, 3167
- replication\_group\_members table, 3190
- requirements, 3184
- requirements and limitations, 3184
- restarting, 3199
- secure socket layer support, 3208
- security, 3206
- server states, 3189
- server variables, 3210
- single primary mode, 3192
- ssl support, 3208
- summary, 3168
- system variables, 3211
- technical details, 3236
- the group, 3237
- tuning recovery, 3193
- use cases, 3169
- user credentials, 3176
- view, 3170
- view changes, 3240

Group Replication and Performance Schema

- new features, 18

Group Replication SQL statements

- new features, 18

grouping

- expressions, 1898

GROUP\_CONCAT(), 2118

group\_concat\_max\_len system variable, 795

group\_replication\_allow\_local\_disjoint\_gtids\_join system variable, 3213

group\_replication\_allow\_local\_lower\_version\_join system variable, 3213

group\_replication\_auto\_increment\_increment system variable, 3214

group\_replication\_bootstrap\_group system variable, 3215

group\_replication\_components\_stop\_timeout system variable, 3215

group\_replication\_compression\_threshold system variable, 3215

group\_replication\_enforce\_update\_everywhere\_checks system variable, 3216

group\_replication\_exit\_state\_action system variable, 3216

group\_replication\_flow\_control\_applier\_threshold system variable, 3218

group\_replication\_flow\_control\_certifier\_threshold system variable, 3218

group\_replication\_flow\_control\_hold\_percent system variable, 3219

---

group\_replication\_flow\_control\_max\_quota system variable, 3219  
group\_replication\_flow\_control\_member\_quota\_percent system variable, 3219  
group\_replication\_flow\_control\_min\_quota system variable, 3220  
group\_replication\_flow\_control\_min\_recovery\_quota system variable, 3220  
group\_replication\_flow\_control\_mode system variable, 3220  
group\_replication\_force\_members system variable, 3221  
group\_replication\_group\_name system variable, 3221  
group\_replication\_group\_seeds system variable, 3222  
group\_replication\_gtid\_assignment\_block\_size system variable, 3222  
group\_replication\_ip\_whitelist, 3223  
group\_replication\_local\_address system variable, 3224  
group\_replication\_member\_weight system variable, 3225  
group\_replication\_poll\_spin\_loops system variable, 3225  
group\_replication\_primary\_member status variable, 913  
group\_replication\_recovery\_complete\_at system variable, 3226  
group\_replication\_recovery\_reconnect\_interval system variable, 3226  
group\_replication\_recovery\_retry\_count system variable, 3226  
group\_replication\_recovery\_ssl\_ca system variable, 3227  
group\_replication\_recovery\_ssl\_capath system variable, 3227  
group\_replication\_recovery\_ssl\_cert system variable, 3227  
group\_replication\_recovery\_ssl\_cipher system variable, 3228  
group\_replication\_recovery\_ssl\_crl system variable, 3228  
group\_replication\_recovery\_ssl\_crlpath system variable, 3228  
group\_replication\_recovery\_ssl\_key system variable, 3228  
group\_replication\_recovery\_ssl\_verify\_server\_cert system variable, 3229  
group\_replication\_recovery\_use\_ssl system variable, 3229  
group\_replication\_single\_primary\_mode system variable, 3229  
group\_replication\_ssl\_mode system variable, 3230  
group\_replication\_start\_on\_boot system variable, 3230  
group\_replication\_transaction\_size\_limit system variable, 3230  
group\_replication\_unreachable\_majority\_timeout, 3231  
GTID functions, 2113  
GTID sets  
    representation, 2967  
GTIDs, 2965  
    and failover, 2978  
    and scaleout, 2978  
    auto-positioning, 2975  
    concepts, 2966  
    gtid\_purged, 2973  
    life cycle, 2970  
    logging, 2968  
    replication with, 2976  
    restrictions, 2981  
gtid\_executed system variable, 3073  
gtid\_executed table  
    system table, 969, 2968  
gtid\_executed\_compression\_period, 3074  
gtid\_executed\_compression\_period system variable  
    mysql.gtid\_executed table, 2970  
gtid\_mode system variable, 3074  
gtid\_next system variable, 3075  
gtid\_owned system variable, 3076  
gtid\_purged, 2973

---

gtid\_purged system variable, 3076  
GTID\_SUBSET(), 2113  
GTID\_SUBTRACT(), 2114  
GUID, 5325

## H

HANDLER, 2279  
    new features, 17  
Handlers, 2398  
Handler\_commit status variable, 913  
Handler\_delete status variable, 914  
Handler\_discover status variable, 3538  
Handler\_external\_lock status variable, 914  
Handler\_mrr\_init status variable, 914  
Handler\_prepare status variable, 914  
Handler\_read\_first status variable, 914  
Handler\_read\_key status variable, 914  
Handler\_read\_last status variable, 914  
Handler\_read\_next status variable, 914  
Handler\_read\_prev status variable, 914  
Handler\_read\_rnd status variable, 914  
Handler\_read\_rnd\_next status variable, 914  
Handler\_rollback status variable, 915  
Handler\_savepoint status variable, 915  
Handler\_savepoint\_rollback status variable, 915  
Handler\_update status variable, 915  
Handler\_write status variable, 915  
hash index, 5325  
hash indexes, 1514  
hash partitioning, 4000  
hash partitions  
    managing, 4020  
    splitting and merging, 4020  
have\_compress system variable, 796  
have\_crypt  
    deprecated features, 21  
HAVE\_CRYPT  
    deprecated features, 21  
have\_crypt system variable, 796  
have\_dynamic\_loading system variable, 796  
have\_geometry system variable, 796  
have\_openssl system variable, 796  
have\_profiling system variable, 796  
have\_query\_cache  
    deprecated features, 20  
have\_query\_cache system variable, 796  
have\_rtree\_keys system variable, 796  
have\_ssl system variable, 796  
have\_statement\_timeout system variable, 797  
have\_symlink system variable, 797  
HAVING clause, 2314  
HDD, 5326  
header option

---

- ndb\_select\_all, 3725
- header-file option
  - comp\_err, 360
- HEAP storage engine, 2915, 2928
- heartbeat, 5326
- HeartbeatIntervalDbApi, 3442
- HeartbeatIntervalDbDb, 3441
- HeartbeatIntervalMgmdMgmd
  - management nodes, 3400
- HeartbeatOrder, 3442
- HeartbeatThreadPriority, 3399, 3498
- help action
  - MySQLInstallerConsole, 113
- help command
  - mysql, 421
- HELP command (NDB Cluster), 3756
- help option
  - comp\_err, 360
  - innochecksum, 568
  - myisamchk, 580
  - myisampack, 598
  - myisam\_ftdump, 576
  - mysql, 399
  - mysqladmin, 441
  - mysqlbinlog, 617
  - mysqlcheck, 455
  - mysqld, 739
  - mysqldump, 484
  - mysqldumpslow, 642
  - mysqld\_multi, 355
  - mysqld\_safe, 344
  - mysqlimport, 505
  - mysqlpump, 520
  - mysqlshow, 543
  - mysqlslap, 555
  - mysql\_config\_editor, 608
  - mysql\_install\_db, 365
  - mysql\_plugin, 372
  - mysql\_secure\_installation, 375
  - mysql\_ssl\_rsa\_setup, 380
  - mysql\_upgrade, 387
  - my\_print\_defaults, 646
  - ndbd, 3575
  - ndbinfo\_select\_all, 3585
  - ndb\_blob\_tool, 3610
  - ndb\_config, 3618
  - ndb\_delete\_all, 3627
  - ndb\_desc, 3638
  - ndb\_drop\_index, 3642
  - ndb\_drop\_table, 3647
  - ndb\_error\_reporter, 3649
  - ndb\_import, 3660
  - ndb\_index\_stat, 3674
  - ndb\_mgm, 3604

---

- ndb\_mgmd, 3594
- ndb\_move\_data, 3681
- ndb\_perror, 3684
- ndb\_restore, 3703
- ndb\_select\_all, 3725
- ndb\_select\_count, 3731
- ndb\_show\_tables, 3735
- ndb\_top, 3743
- ndb\_waiter, 3751
- perror, 649
- resolveip, 650
- resolve\_stack\_dump, 647
- HELP option
  - myisamchk, 580
- HELP statement, 2540
- help tables
  - system tables, 969
- help\_category table
  - system table, 969
- help\_keyword table
  - system table, 969
- help\_relation table
  - system table, 969
- help\_topic table
  - system table, 969
- hex option
  - ndb\_restore, 3703
- HEX(), 1917, 1950
- hex-blob option
  - mysqldump, 490
  - mysqlpump, 527
- hexadecimal literal introducer, 1658
- hexadecimal literals, 1657
- hexdump option
  - mysqlbinlog, 623
- high-water mark, 5326
- HIGH\_NOT\_PRECEDENCE SQL mode, 934
- HIGH\_PRIORITY
  - INSERT modifier, 2284
  - SELECT modifier, 2316
- hints, 47
  - index, 1577, 2313
  - optimizer, 1571
- histignore option
  - mysql, 408
- history list, 5326
- history of MySQL, 8
- hole punching, 5326
- HOME environment variable, 426, 651
- host, 5326
- host cache, 949
- host name
  - default, 335
- host name caching, 949



---

- host name resolution, 949
- host names, 335
  - in account names, 1111
  - in default account, 233
- host option, 324
  - mysql, 408
  - mysqladmin, 445
  - mysqlbinlog, 623
  - mysqlcheck, 460
  - mysqldump, 476
  - mysqldumpslow, 643
  - mysqlimport, 509
  - mysqlpump, 527
  - mysqlshow, 546
  - mysqlslap, 561
  - mysql\_secure\_installation, 376
  - mysql\_upgrade, 389
  - ndb\_config, 3618
  - ndb\_top, 3743
- HostName, 3395, 3403, 3495
- HostName (NDB Cluster), 3923
- hostname system variable, 798
- HostName1, 3554, 3563
- HostName2, 3555, 3564
- hosts table
  - performance\_schema, 4298
- host\_cache table
  - performance\_schema, 949, 4342
- host\_summary view
  - sys schema, 4398
- host\_summary\_by\_file\_io view
  - sys schema, 4399
- host\_summary\_by\_file\_io\_type view
  - sys schema, 4399
- host\_summary\_by\_stages view
  - sys schema, 4400
- host\_summary\_by\_statement\_latency view
  - sys schema, 4400
- host\_summary\_by\_statement\_type view
  - sys schema, 4401
- hot, 5326
- hot backup, 5326
- HOUR(), 1932
- html option
  - mysql, 408

## I

- i-am-a-dummy option
  - mysql, 415
- ib-file set, 2692, 5327
- ibbackup\_logfile, 5327
- .ibd file, 5327
- ibdata file, 2228, 5328

---

ibtmp file, 5328  
.ibz file, 5327  
ib\_logfile, 5328  
icc  
    MySQL builds, 81  
Id, 3393, 3493  
idempotent option  
    mysqlbinlog, 623  
IDENTIFIED BY PASSWORD  
    deprecated features, 19  
identifiers, 1660  
    case sensitivity, 1665  
    quoting, 1661  
identity system variable, 798  
idlesleep option  
    ndb\_import, 3660  
idlespin option  
    ndb\_import, 3661  
IF, 2391  
IF(), 1909  
IFNULL(), 1910  
IGNORE  
    DELETE modifier, 2276  
    INSERT modifier, 2284  
    LOAD DATA modifier, 2292  
    UPDATE modifier, 2342  
    with partitioned tables, 945, 2284  
IGNORE INDEX, 1577  
IGNORE KEY, 1577  
ignore option  
    mysqlimport, 509  
ignore-db-dir option  
    mysqld, 747  
ignore-error option  
    mysqldump, 493  
ignore-extended-pk-updates option  
    ndb\_restore, 3703  
ignore-lines option  
    mysqlimport, 509  
    ndb\_import, 3661  
ignore-spaces option  
    mysql, 409  
ignore-table option  
    mysqldump, 494  
IGNORE\_AIO\_CHECK option  
    CMake, 210  
ignore\_builtin\_innodb system variable, 2740  
ignore\_db\_dirs  
    deprecated features, 21  
ignore\_db\_dirs system variable, 798  
IGNORE\_SPACE SQL mode, 934  
ilist, 5328  
implicit default values, 1860  
implicit GROUP BY sorting, 1478

---

implicit row lock, 5328  
IMPORT TABLESPACE, 2170, 2574  
importing  
  data, 430, 501  
importing data  
  NDB Cluster, 3813  
IN, 2330  
IN(), 1903  
in-file option  
  comp\_err, 361  
in-memory database, 5328  
include option  
  mysql\_config, 645  
include-databases option  
  mysqlpump, 528  
  ndb\_restore, 3703  
include-events option  
  mysqlpump, 528  
include-gtids option  
  mysqlbinlog, 623  
include-master-host-port option  
  mysqldump, 487  
include-routines option  
  mysqlpump, 528  
include-tables option  
  mysqlpump, 528  
  ndb\_restore, 3704  
include-triggers option  
  mysqlpump, 528  
include-users option  
  mysqlpump, 528  
increasing with replication  
  speed, 2953  
incremental backup, 5328  
incremental recovery, 1430  
  using NDB Cluster replication, 3959  
index, 5329  
  deleting, 2167, 2266  
  rebuilding, 256  
  sorted index builds, 2588  
index cache, 5329  
index condition pushdown, 5329  
  new features, 17  
INDEX DIRECTORY  
  and replication, 3140  
index dives  
  range optimization, 1451  
index dives (for statistics estimation), 2666  
index extensions, 1515  
index hint, 5329  
index hints, 1577, 2313  
index join type  
  optimizer, 1555  
index prefix, 5329

---

- index prefixes
  - partitioning, 4046
- INDEX privilege, 1100
- index statistics
  - NDB, 3489
- index-record lock
  - InnoDB, 2628, 2779
- indexed temporary table
  - semijoin strategy, 1491
- indexes, 2188
  - and BLOB columns, 1509, 2206
  - and IS NULL, 1514
  - and LIKE, 1514
  - and ndb\_restore, 3710
  - and NULL values, 2207
  - and TEXT columns, 1509, 2206
  - assigning to key cache, 2526
  - BLOB columns, 2190
  - block size, 802
  - column prefixes, 1509
  - columns, 1509
  - leftmost prefix of, 1508, 1512
  - multi-column, 1511
  - multiple-part, 2188
  - names, 1660
  - TEXT columns, 2190
  - TIMESTAMP lookups, 1519
  - use of, 1507
- IndexMemory, 3409
- IndexStatAutoCreate
  - data nodes, 3489
- IndexStatAutoUpdate
  - data nodes, 3490
- IndexStatSaveScale
  - data nodes, 3491
- IndexStatSaveSize
  - data nodes, 3490
- IndexStatTriggerPct
  - data nodes, 3491
- IndexStatTriggerScale
  - data nodes, 3492
- IndexStatUpdateDelay
  - data nodes, 3492
- index\_merge join type
  - optimizer, 1554
- index\_subquery join type
  - optimizer, 1554
- indirect indexes
  - NDB Cluster, 2245
- INET6\_ATON(), 2135
- INET6\_NTOA(), 2136
- INET\_ATON(), 2134
- INET\_NTOA(), 2135
- infimum record, 5329

---

- INFO Events (NDB Cluster), 3789
- info option
  - innochecksum, 568
- information functions, 2035
- information option
  - myisamchk, 585
- INFORMATION SCHEMA
  - InnoDB tables, 2815
- INFORMATION\_SCHEMA, 4098, 5330
  - and security issues, 3928
  - collation and searching, 1742
  - connection control table reference, 4199
  - connection control tables, 4199
  - firewall table reference, 4200
  - general table reference, 4105
  - general tables, 4105
  - InnoDB table reference, 4152
  - InnoDB tables, 4152
  - INNODB\_CMP table, 2815
  - INNODB\_CMPMEM table, 2816
  - INNODB\_CMPMEM\_RESET table, 2816
  - INNODB\_CMP\_RESET table, 2815
  - INNODB\_LOCKS table, 2817
  - INNODB\_LOCK\_WAITS table, 2817
  - INNODB\_TRX table, 2817
  - MySQL Enterprise Firewall tables, 4200
  - table reference, 4101
  - thread pool table reference, 4195
  - Thread pool tables, 4194
- INFORMATION\_SCHEMA queries
  - optimization, 1500
- INFORMATION\_SCHEMA.ENGINES table
  - and NDB Cluster, 3914
- INFORMATION\_SCHEMA.GLOBAL\_STATUS table
  - and NDB Cluster, 3921
- INFORMATION\_SCHEMA.GLOBAL\_VARIABLES table
  - and NDB Cluster, 3916
- INFORMATION\_SCHEMA.PLUGINS table
  - and NDB Cluster, 3922
- INFO\_BIN file
  - binary distribution configuration options, 43, 185
- init
  - thread state, 1625
- Init DB
  - thread command, 1622
- init-command option
  - mysql, 409
- InitFragmentLogFiles, 3423
- initial option
  - ndbd, 3576
  - ndbmtd, 3576
  - ndb\_mgmd, 3595
- initial-start option
  - ndbd, 3577

---

- ndbmysqld, 3577
- initialize option
  - mysqld, 747
- initialize-insecure option
  - mysqld, 747
- Initialized
  - thread state, 1634
- InitialLogFileGroup, 3484
- InitialNoOfOpenFiles, 3422
- InitialTablespace, 3485
- init\_connect system variable, 799
- init\_file system variable, 799
- init\_slave system variable, 3026
- injection
  - SQL, 1092, 1365, 2017, 2382
  - XPath code, 2016
- INNER JOIN, 2319
- innochecksum, 306, 568
  - allow-mismatches option, 571
  - count option, 569
  - end-page option, 570
  - help option, 568
  - info option, 568
  - log option, 573
  - no-check option, 571
  - page option, 570
  - page-type-dump option, 573
  - page-type-summary option, 573
  - read from standard in option, 574
  - start-page option, 570
  - strict-check option, 571
  - verbose option, 569
  - version option, 569
  - write option, 572
- InnoDB, 2545, 5330
  - .frm files, 2562
  - adaptive hash index, 2561
  - and application feature requirements, 3317
  - application performance, 2579
  - applications supported, 3317
  - architecture, 2552
  - asynchronous I/O, 2654
  - auto-inc lock, 2612
  - auto-increment columns, 2580
  - autocommit mode, 2620, 2620
  - availability, 3315
  - backups, 2864
  - change buffer, 2557
  - checkpoints, 2706
  - clustered index, 2587
  - COMPACT row format, 2699
  - compared to NDB Cluster, 3315, 3315, 3317, 3317
  - configuration parameters, 2731
  - consistent reads, 2621

---

corruption, 2865  
crash recovery, 2866, 2866, 2867  
creating tables, 2562  
data files, 2594  
deadlock detection, 2630  
deadlock example, 2629  
deadlocks, 2577, 2629, 2630  
disk failure, 2865  
disk I/O, 2704  
disk I/O optimization, 1538  
DYNAMIC row format, 2701, 2701  
exclusive lock, 2612  
file space management, 2705  
file-per-table tablespace, 2597  
files, 2580  
full-text indexes, 2589  
gap lock, 2612, 2628, 2779  
in-memory structures, 2552  
index-record lock, 2628, 2779  
insert-intention lock, 2612  
intention lock, 2612  
limitations, 2913  
limits, 2911  
Linux, 2654  
lock modes, 2612  
locking, 2612, 2612, 2624  
locking reads, 2623  
log files, 2610  
memory usage, 2575  
migrating tables, 2573  
Monitors, 2904  
multi-versioning, 2550  
new features, 11  
next-key lock, 2612, 2628, 2779  
NFS, 2633  
on-disk structures, 2562  
online DDL, 2707  
page size, 2587  
physical index structure, 2587  
point-in-time recovery, 2865  
primary keys, 2563, 2579  
raw partitions, 2596  
record-level locks, 2628, 2779  
recovery, 2865  
redo log, 2609  
REDUNDANT row format, 2698  
replication, 2868  
restrictions, 2913  
row format, 2563, 2703  
secondary index, 2587  
semi-consistent read, 2779  
shared lock, 2612  
Solaris issues, 183  
sorted index builds, 2588

---

- storage, 2578
- storage layout, 2577
- system variables, 2731
- table properties, 2563
- tables, 2562
  - converting from other storage engines, 2575
- transaction model, 2612, 2616
- transactions, 2576
- transferring data, 2578
- troubleshooting, 2903
  - cannot open datafile, 2907
  - CREATE TABLE failure, 2906
  - data dictionary problems, 2906
  - deadlocks, 2629, 2630
  - defragmenting tables, 2706
  - I/O problems, 2904
  - online DDL, 2725
  - open file error, 2907
  - orphan intermediate tables, 2907
  - orphan temporary tables, 2908
  - performance problems, 1532
  - recovery problems, 2905
  - restoring orphan ibd files, 2910
  - SQL errors, 2911
  - tablespace does not exist, 2909
- InnoDB buffer pool, 1583, 2555, 2639, 2644, 2644, 2645, 2648
- InnoDB Cluster
  - introduction, 3279
- InnoDB Monitors, 2856
  - enabling, 2857
  - output, 2859
- innodb option
  - mysqld, 2737
- InnoDB parameters, new
  - innodb\_file\_format\_check, 2694
  - innodb\_large\_prefix, 2777
- InnoDB predicate locks, 2616
- InnoDB shared tablespaces
  - deprecated features, 23
- InnoDB storage engine, 2545, 2915
- InnoDB Table Monitor
  - removed features, 25
- InnoDB table reference
  - INFORMATION\_SCHEMA, 4152
- InnoDB tables
  - storage requirements, 1862
- InnoDB Tablespace Monitor
  - removed features, 25
- innodb-status-file option
  - mysqld, 2738
- innodb\_adaptive\_flushing system variable, 2741
- innodb\_adaptive\_flushing\_lwm system variable, 2741
- innodb\_adaptive\_hash\_index
  - and innodb\_thread\_concurrency, 2652



---

innodb\_adaptive\_hash\_index system variable, 2741  
innodb\_adaptive\_hash\_index\_parts variable, 2742  
innodb\_adaptive\_max\_sleep\_delay system variable, 2742  
innodb\_additional\_mem\_pool\_size  
    removed features, 25  
innodb\_additional\_mem\_pool\_size system variable  
    and innodb\_use\_sys\_malloc, 2652  
innodb\_api\_bk\_commit\_interval system variable, 2743  
innodb\_api\_disable\_rowlock system variable, 2743  
innodb\_api\_enable\_binlog system variable, 2744  
innodb\_api\_enable\_mdll system variable, 2744  
innodb\_api\_trx\_level system variable, 2744  
innodb\_autoextend\_increment system variable, 2745  
innodb\_autoinc\_lock\_mode, 5330  
innodb\_autoinc\_lock\_mode system variable, 2745  
InnoDB\_available\_undo\_logs status variable, 915  
innodb\_background\_drop\_list\_empty system variable, 2745  
INNODB\_BUFFER\_PAGE  
    INFORMATION\_SCHEMA table, 4154  
INNODB\_BUFFER\_PAGE\_LRU  
    INFORMATION\_SCHEMA table, 4157  
InnoDB\_buffer\_pool\_bytes\_data status variable, 916  
InnoDB\_buffer\_pool\_bytes\_dirty status variable, 916  
innodb\_buffer\_pool\_chunk\_size system variable, 2746  
innodb\_buffer\_pool\_dump\_at\_shutdown system variable, 2747  
innodb\_buffer\_pool\_dump\_now system variable, 2747  
innodb\_buffer\_pool\_dump\_pct system variable, 2748  
InnoDB\_buffer\_pool\_dump\_status status variable, 915  
innodb\_buffer\_pool\_filename system variable, 2748  
innodb\_buffer\_pool\_instances system variable, 2748  
innodb\_buffer\_pool\_load\_abort system variable, 2749  
innodb\_buffer\_pool\_load\_at\_startup system variable, 2750  
innodb\_buffer\_pool\_load\_now system variable, 2750  
InnoDB\_buffer\_pool\_load\_status status variable, 915  
InnoDB\_buffer\_pool\_pages\_data status variable, 916  
InnoDB\_buffer\_pool\_pages\_dirty status variable, 916  
InnoDB\_buffer\_pool\_pages\_flushed status variable, 916  
InnoDB\_buffer\_pool\_pages\_free status variable, 916  
InnoDB\_buffer\_pool\_pages\_latched status variable, 916  
InnoDB\_buffer\_pool\_pages\_misc status variable, 916  
InnoDB\_buffer\_pool\_pages\_total status variable, 916  
InnoDB\_buffer\_pool\_reads status variable, 917  
InnoDB\_buffer\_pool\_read\_ahead status variable, 916  
InnoDB\_buffer\_pool\_read\_ahead\_evicted status variable, 916  
InnoDB\_buffer\_pool\_read\_ahead\_rnd status variable, 917  
InnoDB\_buffer\_pool\_read\_requests status variable, 917  
InnoDB\_buffer\_pool\_resize\_status status variable, 917  
innodb\_buffer\_pool\_size system variable, 2751  
INNODB\_BUFFER\_POOL\_STATS  
    INFORMATION\_SCHEMA table, 4160  
InnoDB\_buffer\_pool\_wait\_free status variable, 917  
InnoDB\_buffer\_pool\_write\_requests status variable, 917  
innodb\_buffer\_stats\_by\_schema view  
    sys schema, 4402

---

innodb\_buffer\_stats\_by\_table view  
  sys schema, 4403

innodb\_change\_buffering, 2558

innodb\_change\_buffering system variable, 2752

innodb\_change\_buffering\_debug, 2753

innodb\_change\_buffer\_max\_size system variable, 2752

innodb\_checksums system variable, 2755

innodb\_checksum\_algorithm system variable, 2753

INNODB\_CMP  
  INFORMATION\_SCHEMA table, 4163

INNODB\_CMPMEM  
  INFORMATION\_SCHEMA table, 4164

INNODB\_CMPMEM\_RESET  
  INFORMATION\_SCHEMA table, 4164

INNODB\_CMP\_PER\_INDEX  
  INFORMATION\_SCHEMA table, 4166

innodb\_cmp\_per\_index\_enabled system variable, 2756

INNODB\_CMP\_PER\_INDEX\_RESET  
  INFORMATION\_SCHEMA table, 4166

INNODB\_CMP\_RESET  
  INFORMATION\_SCHEMA table, 4163

innodb\_commit\_concurrency system variable, 2756

innodb\_compression\_failure\_threshold\_pct system variable, 2757

innodb\_compression\_level system variable, 2757

innodb\_compression\_pad\_pct\_max system variable, 2758

innodb\_compress\_debug, 2756

innodb\_concurrency\_tickets, 2652

innodb\_concurrency\_tickets system variable, 2758

innodb\_create\_intrinsic  
  removed features, 25

innodb\_data\_file\_path system variable, 2759

InnoDB\_data\_fsyncs status variable, 917

innodb\_data\_home\_dir system variable, 2759

InnoDB\_data\_pending\_fsyncs status variable, 917

InnoDB\_data\_pending\_reads status variable, 917

InnoDB\_data\_pending\_writes status variable, 917

InnoDB\_data\_read status variable, 917

InnoDB\_data\_reads status variable, 917

InnoDB\_data\_writes status variable, 918

InnoDB\_data\_written status variable, 918

InnoDB\_dblwr\_pages\_written status variable, 918

InnoDB\_dblwr\_writes status variable, 918

innodb\_deadlock\_detect system variable, 2760

innodb\_default\_row\_format, 2701

innodb\_default\_row\_format system variable, 2760

innodb\_disable\_resize\_buffer\_pool\_debug, 2761

innodb\_disable\_sort\_file\_cache system variable, 2761

innodb\_doublewrite system variable, 2761

innodb\_fast\_shutdown system variable, 2762

innodb\_file\_format, 2691, 5330  
  Antelope, 2681  
  Barracuda, 2673  
  identifying, 2695

innodb\_file\_format system variable, 2763

---

innodb\_file\_format\_check, 2694  
innodb\_file\_format\_check system variable, 2764  
innodb\_file\_format\_max system variable, 2764  
innodb\_file\_per\_table, 2673, 5330  
innodb\_file\_per\_table system variable, 2765  
innodb\_fill\_factor system variable, 2765  
innodb\_fil\_make\_page\_dirty\_debug, 2762  
innodb\_flushing\_avg\_loops system variable, 2770  
innodb\_flush\_log\_at\_timeout system variable, 2766  
innodb\_flush\_log\_at\_trx\_commit system variable, 2766  
innodb\_flush\_method system variable, 2767  
innodb\_flush\_neighbors system variable, 2769  
innodb\_flush\_sync system variable, 2770  
innodb\_force\_load\_corrupted system variable, 2770  
innodb\_force\_recovery system variable, 2771  
    DROP TABLE, 2269  
innodb\_ft\_aux\_table system variable, 2771  
INNODB\_FT\_BEING\_DELETED  
    INFORMATION\_SCHEMA table, 4167  
innodb\_ft\_cache\_size system variable, 2771  
INNODB\_FT\_CONFIG  
    INFORMATION\_SCHEMA table, 4168  
INNODB\_FT\_DEFAULT\_STOPWORD  
    INFORMATION\_SCHEMA table, 4169  
INNODB\_FT\_DELETED  
    INFORMATION\_SCHEMA table, 4170  
innodb\_ft\_enable\_diag\_print system variable, 2772  
innodb\_ft\_enable\_stopword system variable, 2772  
INNODB\_FT\_INDEX\_CACHE  
    INFORMATION\_SCHEMA table, 4171  
INNODB\_FT\_INDEX\_TABLE  
    INFORMATION\_SCHEMA table, 4173  
innodb\_ft\_max\_token\_size system variable, 2773  
innodb\_ft\_min\_token\_size system variable, 2773  
innodb\_ft\_num\_word\_optimize system variable, 2774  
innodb\_ft\_result\_cache\_limit system variable, 2774  
innodb\_ft\_server\_stopword\_table system variable, 2775  
innodb\_ft\_sort\_pll\_degree system variable, 2775  
innodb\_ft\_total\_cache\_size system variable, 2775  
innodb\_ft\_user\_stopword\_table system variable, 2776  
InnoDB\_have\_atomic\_builtins status variable, 918  
innodb\_index\_stats table  
    system table, 970, 2659  
innodb\_io\_capacity, 2655  
innodb\_io\_capacity system variable, 2776  
innodb\_io\_capacity\_max system variable, 2777  
innodb\_large\_prefix system variable, 2777  
innodb\_limit\_optimistic\_insert\_debug, 2778  
INNODB\_LOCKS  
    deprecated features, 21  
    INFORMATION\_SCHEMA table, 4174  
innodb\_locks\_unsafe\_for\_binlog system variable, 2779  
innodb\_lock\_monitor  
    removed features, 25

---

## INNODB\_LOCK\_WAITS

deprecated features, 21

INFORMATION\_SCHEMA table, 4176

innodb\_lock\_waits view

sys schema, 4404

innodb\_lock\_wait\_timeout, 5331

innodb\_lock\_wait\_timeout system variable, 2778

innodb\_log\_buffer\_size system variable, 2781

innodb\_log\_checkpoint\_now system variable, 2782

innodb\_log\_checksums system variable, 2782

innodb\_log\_checksum\_algorithm

removed features, 25

innodb\_log\_compressed\_pages system variable, 2782

innodb\_log\_files\_in\_group system variable, 2784

innodb\_log\_file\_size system variable, 2783

innodb\_log\_group\_home\_dir system variable, 2784

Innodb\_log\_waits status variable, 918

Innodb\_log\_writes status variable, 918

innodb\_log\_write\_ahead\_size system variable, 2784

Innodb\_log\_write\_requests status variable, 918

innodb\_lru\_scan\_depth system variable, 2785

innodb\_max\_dirty\_pages\_pct system variable, 2785

innodb\_max\_dirty\_pages\_pct\_lwm system variable, 2786

innodb\_max\_purge\_lag system variable, 2786

innodb\_max\_purge\_lag\_delay system variable, 2787

innodb\_max\_undo\_log\_size system variable, 2787

innodb\_memcache database, 2873, 2897

innodb\_memcached\_config.sql script, 2873

innodb\_merge\_threshold\_set\_all\_debug, 2787

## INNODB\_METRICS

INFORMATION\_SCHEMA table, 4177

innodb\_mirrored\_log\_groups

removed features, 24

innodb\_monitor

removed features, 25

innodb\_monitor\_disable system variable, 2788

innodb\_monitor\_enable system variable, 2788

innodb\_monitor\_reset system variable, 2788

innodb\_monitor\_reset\_all system variable, 2789

innodb\_numa\_interleave variable, 2789

Innodb\_num\_open\_files status variable, 918

innodb\_old\_blocks\_pct, 2644

innodb\_old\_blocks\_pct system variable, 2790

innodb\_old\_blocks\_time, 2644

innodb\_old\_blocks\_time system variable, 2790

innodb\_online\_alter\_log\_max\_size system variable, 2791

innodb\_open\_files system variable, 2791

innodb\_optimize\_fulltext\_only system variable, 2792

innodb\_optimize\_point\_storage

removed features, 25

Innodb\_os\_log\_fsyncs status variable, 918

Innodb\_os\_log\_pending\_fsyncs status variable, 918

Innodb\_os\_log\_pending\_writes status variable, 918

Innodb\_os\_log\_written status variable, 918

---

Innodb\_pages\_created status variable, 919  
Innodb\_pages\_read status variable, 919  
Innodb\_pages\_written status variable, 919  
INNODB\_PAGE\_ATOMIC\_REF\_COUNT  
  removed features, 25  
innodb\_page\_cleaners system variable, 2792  
innodb\_page\_size status variable, 918  
innodb\_page\_size system variable, 2793  
innodb\_print\_all\_deadlocks system variable, 2794  
  innodb\_print\_all\_deadlocks, 2794  
innodb\_purge\_batch\_size system variable, 2795  
innodb\_purge\_rseg\_truncate\_frequency system variable, 2795  
innodb\_purge\_threads system variable, 2795  
innodb\_random\_read\_ahead system variable, 2796  
innodb\_read\_ahead\_threshold, 2645  
innodb\_read\_ahead\_threshold system variable, 2796  
innodb\_read\_io\_threads, 2653  
innodb\_read\_io\_threads system variable, 2797  
innodb\_read\_only system variable, 2797  
innodb\_replication\_delay system variable, 2798  
innodb\_rollback\_on\_timeout system variable, 2798  
innodb\_rollback\_segments system variable, 2798  
Innodb\_rows\_deleted status variable, 919  
Innodb\_rows\_inserted status variable, 919  
Innodb\_rows\_read status variable, 919  
Innodb\_rows\_updated status variable, 919  
Innodb\_row\_lock\_current\_waits status variable, 919  
Innodb\_row\_lock\_time status variable, 919  
Innodb\_row\_lock\_time\_avg status variable, 919  
Innodb\_row\_lock\_time\_max status variable, 919  
Innodb\_row\_lock\_waits status variable, 919  
innodb\_saved\_page\_number\_debug, 2799  
innodb\_sort\_buffer\_size system variable, 2799  
innodb\_spin\_wait\_delay, 2656  
innodb\_spin\_wait\_delay system variable, 2800  
innodb\_stats\_auto\_recalc system variable, 2800  
innodb\_stats\_include\_delete\_marked system variable, 2661, 2801  
innodb\_stats\_method system variable, 2801  
innodb\_stats\_on\_metadata system variable, 2802  
innodb\_stats\_persistent system variable  
  innodb\_stats\_persistent, 2802  
innodb\_stats\_persistent\_sample\_pages system variable, 2802  
innodb\_stats\_sample\_pages system variable, 2803  
innodb\_stats\_transient\_sample\_pages, 2666  
innodb\_stats\_transient\_sample\_pages system variable, 2803  
innodb\_status\_output system variable, 2804  
innodb\_status\_output\_locks system variable, 2804  
innodb\_stat\_persistent system variable, 2802  
innodb\_strict\_mode, 5331  
innodb\_strict\_mode system variable, 2805  
innodb\_support\_xa  
  deprecated features, 20  
innodb\_support\_xa system variable, 2805  
innodb\_sync\_array\_size system variable, 2806

---

innodb\_sync\_debug, 2806  
innodb\_sync\_spin\_loops system variable, 2806  
INNODB\_SYS\_COLUMNS  
    INFORMATION\_SCHEMA table, 4179  
INNODB\_SYS\_DATAFILES  
    INFORMATION\_SCHEMA table, 4180  
INNODB\_SYS\_FIELDS  
    INFORMATION\_SCHEMA table, 4181  
INNODB\_SYS\_FOREIGN  
    INFORMATION\_SCHEMA table, 4182  
INNODB\_SYS\_FOREIGN\_COLS  
    INFORMATION\_SCHEMA table, 4183  
INNODB\_SYS\_INDEXES  
    INFORMATION\_SCHEMA table, 4183  
INNODB\_SYS\_TABLES  
    INFORMATION\_SCHEMA table, 4185  
INNODB\_SYS\_TABLESPACES  
    INFORMATION\_SCHEMA table, 4186  
INNODB\_SYS\_TABLESTATS  
    INFORMATION\_SCHEMA table, 4188  
INNODB\_SYS\_VIRTUAL  
    INFORMATION\_SCHEMA table, 4189  
innodb\_table\_locks system variable, 2807  
innodb\_table\_stats table  
    system table, 970, 2659  
innodb\_temp\_data\_file\_path system variable, 2807  
INNODB\_TEMP\_TABLE\_INFO  
    INFORMATION\_SCHEMA table, 4190  
innodb\_thread\_concurrency, 2652  
innodb\_thread\_concurrency system variable, 2808  
innodb\_thread\_sleep\_delay, 2652  
innodb\_thread\_sleep\_delay system variable, 2810  
innodb\_tmpdir system variable, 2810  
InnoDB\_truncated\_status\_writes status variable, 919  
INNODB\_TRX  
    INFORMATION\_SCHEMA table, 4192  
innodb\_trx\_purge\_view\_update\_only\_debug, 2811  
innodb\_trx\_rseg\_n\_slots\_debug, 2811  
innodb\_undo\_directory system variable, 2811  
innodb\_undo\_logs system variable, 2812  
innodb\_undo\_log\_truncate system variable, 2812  
innodb\_undo\_tablespaces system variable, 2813  
innodb\_use\_native\_aio, 2654  
innodb\_use\_native\_aio system variable, 2814  
innodb\_use\_sys\_malloc  
    and innodb\_thread\_concurrency, 2652  
    removed features, 25  
innodb\_use\_sys\_malloc system variable, 2652  
innodb\_version system variable, 2814  
innodb\_write\_io\_threads, 2653  
innodb\_write\_io\_threads system variable, 2814  
Innovation Series, 5331  
INOUT parameter  
    condition handling, 2424

---

- input-type option
  - ndb\_import, 3661
- input-workers option
  - ndb\_import, 3661
- insecure option
  - mysql\_install\_db, 367
- INSERT, 1505, 2280
- insert, 5331
- INSERT ... SELECT, 2284
- insert buffer, 5331
- insert buffering, 5331
  - disabling, 2558
- INSERT DELAYED, 2289, 2289
  - removed features, 24
- insert intention lock, 5331
- INSERT privilege, 1100
- INSERT(), 1950
- insert-ignore option
  - mysqldump, 496
  - mysqlpump, 529
- insert-intention lock, 2612
- insertable views
  - insertable, 4077
- inserting
  - speed of, 1505
- InsertRecoveryWork, 3308, 3428
- inserts
  - concurrent, 1598, 1601
- insert\_id system variable, 799
- install action
  - MySQLInstallerConsole, 113
- install option
  - mysqld, 748
  - ndbd, 3577
  - ndbmtd, 3577
  - ndb\_mgmd, 3595
- INSTALL PLUGIN statement, 2466
- install-manual option
  - mysqld, 748
- Installation, 110
- installation layouts, 80
- installation overview, 185
- installing
  - binary distribution, 81
  - Linux RPM packages, 157
  - macOS DMG packages, 133
  - overview, 60
  - Perl, 265
  - Perl on Windows, 266
  - Solaris PKG packages, 183
  - source distribution, 185
- installing loadable functions, 1036
- installing NDB Cluster, 3331
  - Debian Linux, 3339

---

- Linux, 3333
- Linux binary release, 3334
- Linux RPM, 3336
- Linux source release, 3340
- Ubuntu Linux, 3340
- Windows, 3341
- Windows binary release, 3342
- Windows source, 3345
- installing plugins, 996, 2466
- INSTALL\_BINDIR option
  - CMake, 204
- INSTALL\_DOCDIR option
  - CMake, 204
- INSTALL\_DOCREADMEDIR option
  - CMake, 204
- INSTALL\_INCLUDEDIR option
  - CMake, 204
- INSTALL\_INFODIR option
  - CMake, 204
- INSTALL\_LAYOUT option
  - CMake, 204
- INSTALL\_LIBDIR option
  - CMake, 204
- INSTALL\_MANDIR option
  - CMake, 205
- INSTALL\_MYSQLKEYRINGDIR option
  - CMake, 205
- INSTALL\_MYSQLSHAREDIR option
  - CMake, 205
- INSTALL\_MYSQLTESTDIR option
  - CMake, 205
- INSTALL\_PKGCONFIGDIR option
  - CMake, 205
- INSTALL\_PLUGINDIR option
  - CMake, 205
- INSTALL\_SBINDIR option
  - CMake, 205
- INSTALL\_SCRIPTDIR option
  - CMake, 205
- INSTALL\_SECURE\_FILE\_PRIVDIR option
  - CMake, 205
- INSTALL\_SECURE\_FILE\_PRIV\_EMBEDDEDIR option
  - CMake, 205
- INSTALL\_SHAREDIR option
  - CMake, 205
- INSTALL\_SUPPORTFILESDIR option
  - CMake, 206
- instance, 5332
- instance option
  - mysqldumpslow, 643
- INSTR(), 1951
- instrumentation, 5332
- INT data type, 1794
- integer arithmetic, 2141



---

INTEGER data type, 1794  
integers, 1654  
intention lock, 2612, 5332  
interactive option  
    ndb\_mgmd, 3595  
interactive\_timeout system variable, 799  
interceptor, 5332  
InteriorRingN(), 2066  
internal locking, 1597  
internal memory allocator  
    disabling, 2652  
internal storage format  
    geometry values, 1840  
internal\_tmp\_disk\_storage\_engine system variable, 800  
Intersects(), 2078  
INTERVAL  
    temporal interval syntax, 1703  
interval syntax, 1703  
INTERVAL(), 1903  
INTO  
    SELECT, 2317  
intrinsic temporary table, 5332  
introducer  
    binary character set, 1767  
    bit-value literal, 1659  
    character set, 1723  
    hexadecimal literal, 1658  
    string literal, 1652, 1721  
invalid data  
    constraint, 55  
invalidating query cache entries  
    thread state, 1630  
inverted index, 5332  
invisible index, 2188  
INVOKER privileges, 2494, 4081  
IOPS, 5332  
io\_by\_thread\_by\_latency view  
    sys schema, 4406  
io\_global\_by\_file\_by\_bytes view  
    sys schema, 4406  
io\_global\_by\_file\_by\_latency view  
    sys schema, 4407  
io\_global\_by\_wait\_by\_bytes view  
    sys schema, 4408  
io\_global\_by\_wait\_by\_latency view  
    sys schema, 4409  
IP addresses  
    in account names, 1111  
IPv6 addresses  
    in account names, 1111  
IPv6 connections, 864  
IS boolean\_value, 1904  
IS NOT boolean\_value, 1904  
IS NOT DISTINCT FROM operator, 1900

---

- IS NOT NULL, 1904
- IS NULL, 1475, 1904
  - and indexes, 1514
- IsClosed(), 2063
- IsEmpty(), 2060
- .isl file, 5327
- ISNULL(), 1905
- ISOLATION LEVEL, 2355
- isolation level, 2617, 5332
- IsSimple(), 2060
- IS\_FREE\_LOCK(), 2035
- IS\_IPV4(), 2136
- IS\_IPV4\_COMPAT(), 2137
- IS\_IPV4\_MAPPED(), 2137
- IS\_IPV6(), 2137
- IS\_USED\_LOCK(), 2035
- ITERATE, 2393
- iterations option
  - mysqslap, 561

## J

- J2EE, 5333
- Japanese character sets
  - conversion, 4518
- Japanese, Korean, Chinese character sets
  - frequently asked questions, 4518
- Java, 4476, 5333
- JBoss, 5333
- JDBC, 4473, 5333
- jdbc:mysql:loadbalance://, 3288
- JNDI, 5333
- join, 5333
  - nested-loop algorithm, 1462
- JOIN, 2319
- join algorithm
  - Block Nested-Loop, 1459
  - Nested-Loop, 1459
- join option
  - myisampack, 599
- join type
  - ALL, 1555
  - const, 1553
  - eq\_ref, 1553
  - fulltext, 1553
  - index, 1555
  - index\_merge, 1554
  - index\_subquery, 1554
  - range, 1554
  - ref, 1553
  - ref\_or\_null, 1554
  - system, 1553
  - unique\_subquery, 1554
- joins

---

USING versus ON, 2324  
join\_buffer\_size system variable, 800  
JSON

- array, 1847
- autowrapped values, 1851
- false literal, 1847
- NDB Cluster, 2245
- new features, 14
- normalized values, 1851
- null literal, 1847
- null, true, and false literals, 1849
- object, 1847
- quote mark handling, 1850
- scalar, 1847
- sensible values, 1851
- string, 1847
- temporal values, 1847
- true literal, 1847
- valid values, 1848

JSON data type, 1846  
JSON functions, 2085, 2085  
JSON\_APPEND(), 2097  
JSON\_ARRAY(), 2087  
JSON\_ARRAYAGG(), 2119  
JSON\_ARRAY\_APPEND(), 2097  
JSON\_ARRAY\_INSERT(), 2098  
JSON\_CONTAINS(), 2088  
JSON\_CONTAINS\_PATH(), 2089  
JSON\_DEPTH(), 2107  
JSON\_EXTRACT(), 2089  
JSON\_INSERT(), 2099  
JSON\_KEYS(), 2094  
JSON\_LENGTH(), 2107  
JSON\_MERGE(), 1852, 2100

- deprecated features, 23

JSON\_MERGE\_PATCH(), 2100  
JSON\_MERGE\_PRESERVE(), 2102  
JSON\_OBJECT(), 2087  
JSON\_OBJECTAGG(), 2120  
JSON\_PRETTY(), 2110  
JSON\_QUOTE(), 2087  
JSON\_REMOVE(), 2103  
JSON\_REPLACE(), 2104  
JSON\_SEARCH(), 2094  
JSON\_SET(), 2104  
JSON\_STORAGE\_SIZE(), 2111  
JSON\_TYPE(), 2108  
JSON\_UNQUOTE(), 2105  
JSON\_VALID(), 2109

## K

keep-state option

- ndb\_import, 3662

---

keep\_files\_on\_create system variable, 801

Key cache

  MyISAM, 1584

key cache

  assigning indexes to, 2526

key management

  keyring, 1276

key migration

  keyring, 1272

key partitioning, 4004

key partitions

  managing, 4020

  splitting and merging, 4020

key space

  MyISAM, 2923

key-value store, 1515

keyring, 1257

  key management, 1276

keyring functions

  general purpose, 1276

  installing, 1276

  keyring\_key\_fetch(), 1281

  keyring\_key\_generate(), 1281

  keyring\_key\_length\_fetch(), 1282

  keyring\_key\_remove(), 1282

  keyring\_key\_store(), 1283

  keyring\_key\_type\_fetch(), 1283

  plugin specific, 1283

  uninstalling, 1276

  using, 1277

keyring key migration, 1272

keyring plugins

  keyring\_aws, 1268

  keyring\_encrypted\_file, 1261

  keyring\_file, 1260

  keyring\_okv, 1262

keyring service functions

  my\_key\_fetch(), 1034

  my\_key\_generate(), 1034

  my\_key\_remove(), 1035

  my\_key\_store(), 1035

keyring system variables, 1286

keyring-migration-destination option

  mysqld, 1285

keyring-migration-host option

  mysqld, 1285

keyring-migration-password option

  mysqld, 1285

keyring-migration-port option

  mysqld, 1285

keyring-migration-socket option

  mysqld, 1286

keyring-migration-source option

  mysqld, 1286

---

- keyring-migration-user option
  - mysqld, 1286
- keyring\_aws functions
  - keyring\_aws\_rotate\_cmk(), 1283
  - keyring\_aws\_rotate\_keys(), 1284
- keyring\_aws keyring plugin, 1268
- keyring\_aws plugin, 2726
  - installing, 1258
- keyring\_aws\_cmk\_id system variable, 1287
- keyring\_aws\_conf\_file system variable, 1287
- keyring\_aws\_data\_file system variable, 1287
- keyring\_aws\_region system variable, 1288
- keyring\_aws\_rotate\_cmk() keyring\_aws function, 1283
- keyring\_aws\_rotate\_keys() keyring\_aws function, 1284
- keyring\_encrypted\_file keyring plugin, 1261
- keyring\_encrypted\_file plugin, 2726
  - installing, 1258
- keyring\_encrypted\_file\_data system variable, 1290
- keyring\_encrypted\_file\_password system variable, 1291
- keyring\_file keyring plugin, 1260
- keyring\_file plugin, 2726
  - installing, 1258
- keyring\_file\_data system variable, 1292
- keyring\_key\_fetch() keyring function, 1281
- keyring\_key\_generate() keyring function, 1281
- keyring\_key\_length\_fetch() keyring function, 1282
- keyring\_key\_remove() keyring function, 1282
- keyring\_key\_store() keyring function, 1283
- keyring\_key\_type\_fetch() keyring function, 1283
- keyring\_okv keyring plugin, 1262
  - configuring, 1263
    - Gemalto SafeNet KeySecure Appliance, 1266
    - Oracle Key Vault, 1264
    - Townsend Alliance Key Manager, 1267
- keyring\_okv plugin, 2726
  - installing, 1258
- keyring\_okv\_conf\_dir system variable, 1293
- keyring\_operations system variable, 1294
- keyring\_udf plugin
  - installing, 1276
  - uninstalling, 1276
- keys, 1509
  - foreign, 50, 296
  - multi-column, 1511
  - searching on two, 299
- keys option
  - mysqlshow, 546
- keys-used option
  - myisamchk, 586
- keystore, 5333
- keywords, 1673
- Key\_blocks\_not\_flushed status variable, 919
- Key\_blocks\_unused status variable, 920
- Key\_blocks\_used status variable, 920

---

KEY\_BLOCK\_SIZE, 2673, 2678, 5334  
key\_buffer\_size myisamchk variable, 582  
key\_buffer\_size system variable, 802  
key\_cache\_age\_threshold system variable, 803  
key\_cache\_block\_size system variable, 803  
key\_cache\_division\_limit system variable, 804  
KEY\_COLUMN\_USAGE  
    INFORMATION\_SCHEMA table, 4124  
Key\_reads status variable, 920  
Key\_read\_requests status variable, 920  
Key\_writes status variable, 920  
Key\_write\_requests status variable, 920  
Kill  
    thread command, 1622  
KILL statement, 2534  
Killed  
    thread state, 1625  
Killing slave  
    thread state, 1633  
known errors, 4577  
Korean, 4518

## L

labels  
    stored program block, 2387  
language option  
    mysqld, 748  
language support  
    error messages, 1768  
lap option  
    ndb\_redo\_log\_reader, 3689  
large page support, 1615  
large tables  
    NDB Cluster, 2217  
large-pages option  
    mysqld, 749  
large\_files\_support system variable, 804  
large\_pages system variable, 804  
large\_page\_size system variable, 804  
LAST\_DAY(), 1932  
last\_insert\_id system variable, 805  
LAST\_INSERT\_ID(), 2040, 2283  
    and replication, 3133  
    and stored routines, 4061  
    and triggers, 4061  
Last\_query\_cost status variable, 920  
Last\_query\_partial\_plans status variable, 920  
latch, 5334  
LateAlloc, 3435  
latest\_file\_io view  
    sys schema, 4410  
layout of installation, 80  
lc-messages option

---

- mysqld, 749
- mysql\_install\_db, 368
- lc-messages-dir option
  - mysqld, 750
  - mysql\_install\_db, 368
- LCASE(), 1951
- LCP control, 3308
- LcpScanProgressTimeout, 3424
- lcp\_simulator.cc (test program), 3427
- lc\_messages system variable, 805
- lc\_messages\_dir system variable, 805
- lc\_time\_names system variable, 805
- LDAP
  - authentication, 1206
- LDAP authentication
  - client-side logging, 1232
  - server-side logging, 1232, 1240
  - WITH\_AUTHENTICATION\_LDAP CMake option, 212
- ldap.conf configuration file, 1211
- LDAPNOINIT environment variable, 1211
- LDML syntax, 1780
- LD\_LIBRARY\_PATH environment variable, 267
- LD\_RUN\_PATH environment variable, 267, 651
- LEAST(), 1905
- LEAVE, 2393
- ledir option
  - mysqld\_safe, 345
- LEFT JOIN, 1466, 2319
- LEFT OUTER JOIN, 2319
- LEFT(), 1951
- leftmost prefix of indexes, 1508, 1512
- legal names, 1660
- length option
  - myisam\_ftdump, 576
- LENGTH(), 1951
- less than (<), 1901
- less than or equal (<=), 1901
- libaio, 81, 163, 210
- libmysql, 5334
  - FAQ, 4531
- libmysqlclient, 5334
- libmysqlclient library, 4473
- libmysqld, 4476, 5334
  - deprecated features, 22
  - options, 4478
- libmysqld library, 4473
- libmysqld-libs option
  - mysql\_config, 645
- LIBMYSQL\_ENABLE\_CLEARTEXT\_PLUGIN environment variable, 651
- LIBMYSQL\_PLUGINS environment variable, 651
- LIBMYSQL\_PLUGIN\_DIR environment variable, 651
- library
  - libmysqlclient, 4473
  - libmysqld, 4473

---

- libs option
  - mysql\_config, 645
- libs\_r option
  - mysql\_config, 645
- license system variable, 806
- lifecycle interceptor, 5334
- LIKE, 1962
  - and indexes, 1514
  - and wildcards, 1514
- LIMIT, 2039, 2315
  - and replication, 3145
  - optimizations, 1483
- limitations
  - InnoDB, 2913
  - replication, 3132
- limitations of NDB Cluster, 3318
- limits
  - file-size, 1528
  - InnoDB, 2911
  - maximum columns per table, 1530
  - maximum number of databases, 1528, 2183
  - maximum number of tables, 1528, 2205
  - maximum row size, 1530
  - maximum tables per join, 2321
  - maximum tables per view, 4094
  - table size, 1528
- line-numbers option
  - mysql, 409
- linear hash partitioning, 4002
- linear key partitioning, 4005
- linefeed (`\n`), 1653, 2106, 2295
- LineFromText(), 2052
- LineFromWKB(), 2055
- lines-terminated-by option
  - mysqldump, 490, 509
  - ndb\_import, 3662
  - ndb\_restore, 3704
- LINestring data type, 1831
- LineString(), 2058
- LineStringFromText(), 2052
- LineStringFromWKB(), 2055
- links
  - symbolic, 1608
- list, 5334
- list action
  - MySQLInstallerConsole, 116
- list partitioning, 3990, 3993
- list partitions
  - adding and dropping, 4014
  - managing, 4014
- list\_add() function
  - sys schema, 4462
- list\_drop() function
  - sys schema, 4463



---

literals, 1651  
  bit value, 1659  
  boolean, 1660  
  date, 1655  
  hexadecimal, 1657  
  numeric, 1654  
  string, 1651  
  time, 1655  
LN(), 1917  
load balancing, 5334  
LOAD DATA, 2289, 4571  
  and replication, 3146  
  LOCAL loading, 1090  
load emulation, 550  
LOAD INDEX INTO CACHE  
  and partitioning, 4045  
LOAD XML, 2300  
loadable function  
  creating, 2465  
  deleting, 2466  
loadable functions, 1035  
  API, 1036  
  installing, 1036  
  reference, 1891  
  uninstalling, 1036  
loading  
  tables, 277  
LOAD\_FILE(), 1951  
load\_rewrite\_rules() Rewriter function, 1015  
local option  
  mysqlimport, 510, 1091  
local-infile option  
  mysql, 409, 1091  
local-load option  
  mysqlbinlog, 624  
local-service option  
  mysqld, 750  
localhost, 5334  
  special treatment of, 336  
LOCALTIME, 1932  
LOCALTIMESTAMP, 1932  
local\_infile system variable, 806, 1090  
LOCATE(), 1952  
LocationDomainId (API nodes), 3496  
LocationDomainId (data nodes), 3404  
LocationDomainId (management nodes), 3395  
lock, 5335  
lock escalation, 5335  
LOCK IN SHARE MODE, 2316  
lock mode, 5335  
Lock Monitor, 2857, 2859  
lock option  
  mysqldumpslow, 643  
  ndb\_select\_all, 3725

---

- LOCK TABLES, 2349
- LOCK TABLES privilege, 1100
- lock-all-tables option
  - mysqldump, 498
- lock-tables option
  - mysqldump, 498
  - mysqlimport, 510
- Locked\_connects status variable, 920
- locked\_in\_memory system variable, 807
- LockExecuteThreadToCPU, 3465
- locking, 1606, 2612, 5335
  - external, 746, 864, 1434, 1604, 1627
  - information schema, 2817
  - InnoDB, 2612
  - internal, 1597
  - metadata, 1601
  - row-level, 1597
  - table-level, 1597
- locking functions, 2033
- locking methods, 1597
- locking read, 5335
- locking service
  - installing, 1030
  - mysql\_acquire\_locking\_service\_locks() C function, 1029
  - mysql\_release\_locking\_service\_locks() C function, 1029
  - service\_get\_read\_locks() function, 1033
  - service\_get\_write\_locks() function, 1033
  - service\_release\_locks() function, 1033
  - uninstalling, 1030
- locking\_service service, 1028
- LockMaintThreadsToCPU, 3466
- LockPagesInMainMemory, 3435
- locks\_per\_fragment
  - ndbinfo table, 3868
- lock\_wait\_timeout system variable, 806
- log, 5335
- log buffer, 5336
- log file, 5336
- log files
  - maintaining, 993
- log files (NDB Cluster), 3580
  - ndbmtd, 3588
- log group, 5336
- log option
  - innochecksum, 573
  - mysqld\_multi, 356
- LOG(), 1917
- log-bin option
  - mysqld, 3048
- log-bin-index option
  - mysqld, 3049
- log-error option
  - mysqld, 750
  - mysqldump, 484

---

- mysql\_safe, 345
- log-error-file option
  - mysqlpump, 529
- log-isam option
  - mysqld, 750
- log-level option
  - ndb\_import, 3662
- log-name option
  - ndb\_mgmd, 3596
- log-raw option
  - mysqld, 751
- log-short-format option
  - mysqld, 751
- log-tc option
  - mysqld, 751
- log-tc-size option
  - mysqld, 751
- log-warnings option
  - mysqld, 752, 3014
- LOG10(), 1918
- LOG2(), 1918
- logbuffer-size option
  - ndbd, 3577
  - ndbmtd, 3577
- logbuffers
  - ndbinfo table, 3870
- LogDestination, 3396
- logging
  - new features, 16
  - passwords, 1080
- logging commands (NDB Cluster), 3781
- logging slow query
  - thread state, 1625
- logical, 5336
- logical backup, 5336
- logical operators, 1905
- login
  - thread state, 1625
- login-file option
  - mysql\_install\_db, 368
- login-path option, 318
  - mysql, 409
  - mysqladmin, 445
  - mysqlbinlog, 624
  - mysqlcheck, 460
  - mysqldump, 476
  - mysqlimport, 510
  - mysqlpump, 529
  - mysqlshow, 546
  - mysqlslap, 562
  - mysql\_install\_db, 368
  - mysql\_upgrade, 389
  - my\_print\_defaults, 647
  - ndbd, 3578

---

- ndbinfo\_select\_all, 3585
- ndb\_blob\_tool, 3610
- ndb\_config, 3618
- ndb\_delete\_all, 3628
- ndb\_desc, 3638
- ndb\_drop\_index, 3642
- ndb\_drop\_table, 3647
- ndb\_import, 3662
- ndb\_index\_stat, 3674
- ndb\_mgm, 3604
- ndb\_mgmd, 3596
- ndb\_move\_data, 3681
- ndb\_restore, 3705
- ndb\_select\_all, 3725
- ndb\_select\_count, 3731
- ndb\_show\_tables, 3736
- ndb\_top, 3744
- ndb\_waiter, 3751
- LogLevelCheckpoint, 3456
- LogLevelCongestion, 3458
- LogLevelConnection, 3457
- LogLevelError, 3457
- LogLevelInfo, 3458
- LogLevelNodeRestart, 3457
- LogLevelShutdown, 3456
- LogLevelStartup, 3455
- LogLevelStatistic, 3456
- logs
  - flushing, 971
  - server, 970
- logspaces
  - ndbinfo table, 3871
- log\_bin system variable, 3063
- log\_bin\_basename system variable, 3063
- log\_bin\_index system variable, 3063
- log\_bin\_trust\_function\_creators system variable, 3064
- log\_bin\_use\_v1\_row\_events system variable, 3064
- log\_builtin\_as\_identified\_by\_password system variable, 3065
- log\_error system variable, 807
- log\_error\_verbosity system variable, 807
- log\_output system variable, 808
- log\_queries\_not\_using\_indexes system variable, 808
- log\_slave\_updates system variable, 3065
- log\_slow\_admin\_statements system variable
  - mysqld, 809
- log\_slow\_slave\_statements system variable, 3026
- log\_statements\_unsafe\_for\_binlog system variable, 3066
- log\_syslog system variable, 809
- log\_syslog\_facility system variable, 809
- log\_syslog\_include\_pid system variable, 810
- log\_syslog\_tag system variable, 810
- log\_throttle\_queries\_not\_using\_indexes system variable, 811
- log\_timestamps system variable, 810
- log\_warnings

---

- deprecated features, 20
- log\_warnings system variable, 811
- Long Data
  - thread command, 1622
- LONG data type, 1822
- LONGBLOB data type, 1819
- LongMessageBuffer, 3418
- LONGTEXT data type, 1819
- long\_query\_time system variable, 812
- LOOP, 2393
  - labels, 2387
- loops option
  - ndbinfo\_select\_all, 3585
  - ndb\_index\_stat, 3674
  - ndb\_show\_tables, 3736
- Loose Index Scan
  - GROUP BY optimizing, 1480
- loose option prefix, 319
- LooseScan
  - semijoin strategy, 1491
- loose\_, 5336
- lossy-conversions option
  - ndb\_move\_data, 3681
  - ndb\_restore, 3705
- lost connection errors, 4551
- lost+found directory, 747
- low-priority option
  - mysqlimport, 510
- low-water mark, 5336
- LOWER(), 1952
- lower\_case\_file\_system system variable, 813
  - GRANT, 2446
- lower\_case\_table\_names system variable, 814
- LOW\_PRIORITY
  - DELETE modifier, 2276, 2277
  - INSERT modifier, 2284
  - UPDATE modifier, 2328, 2341
- low\_priority\_updates system variable, 813
- LPAD(), 1952
- LRU, 5336
- LRU page replacement, 2644
- LSN, 5336
- LTRIM(), 1952
- LTS Series, 5337
- lz4\_decompress, 307, 648

## M

- macOS
  - installation, 133
- main features of MySQL, 6
- maintaining
  - log files, 993
  - tables, 1438

---

maintenance  
  tables, 450

MAKEDATE(), 1932

MAKETIME(), 1932

MAKE\_SET(), 1953

Making temporary file (append) before replaying LOAD DATA INFILE  
  thread state, 1632

Making temporary file (create) before replaying LOAD DATA INFILE  
  thread state, 1632

malicious SQL statements  
  and NDB Cluster, 3928

manage keys  
  thread state, 1625

management client (NDB Cluster), 3601  
  (see also mgm)

management node (NDB Cluster)  
  defined, 3287

management nodes (NDB Cluster), 3588  
  (see also mgmd)

managing NDB Cluster, 3754

managing NDB Cluster processes, 3570

manual  
  available formats, 2  
  online location, 2  
  syntax conventions, 2  
  typographical conventions, 2

mask\_inner() MySQL Enterprise Data Masking and De-Identification function, 1391

mask\_outer() MySQL Enterprise Data Masking and De-Identification function, 1391

mask\_pan() MySQL Enterprise Data Masking and De-Identification function, 1392

mask\_pan\_relaxed() MySQL Enterprise Data Masking and De-Identification function, 1393

mask\_ssn() MySQL Enterprise Data Masking and De-Identification function, 1394

Master has sent all binlog to slave; waiting for more updates  
  thread state, 1630

master thread, 5337

master-data option  
  mysqldump, 487

master-info-file option  
  mysqld, 3015

master-retry-count option  
  mysqld, 3015

master\_info\_repository system variable, 3026, 3098

MASTER\_POS\_WAIT(), 2138

master\_verify\_checksum system variable, 3066

MATCH ... AGAINST(), 1972

matching  
  patterns, 285

materialization  
  derived tables, 1497  
  subqueries, 1492  
  view references, 1497

math, 2141

mathematical functions, 1914

MAX(), 2121

MAX(DISTINCT), 2121

---

- max-allowed-packet option
  - mysql, 410
  - mysqldump, 496
  - mysqlpump, 529
  - mysql\_upgrade, 389
- max-binlog-dump-events option
  - mysqld, 3052
- max-join-size option
  - mysql, 410
- max-record-length option
  - myisamchk, 587
- max-relay-log-size option
  - mysqld, 3015
- max-rows option
  - ndb\_import, 3662
- MaxAllocate, 3421
- MaxBufferedEpochBytes, 3447
- MaxBufferedEpochs, 3447
- MAXDB
  - deprecated features, 19
- MAXDB SQL mode, 940
- MaxDiskWriteSpeed, 3449
- MaxDiskWriteSpeedOtherNodeRestart, 3450
- MaxDiskWriteSpeedOwnRestart, 3450
- MaxDMLOperationsPerTransaction, 3415
- MaxFKBuildBatchSize, 3418
- maximum option prefix, 319
- maximums
  - maximum columns per table, 1530
  - maximum number of databases, 1528, 2183
  - maximum number of tables, 1528, 2205
  - maximum row size, 1530
  - maximum tables per join, 2321
  - maximum tables per view, 4094
  - table size, 1528
- MaxLCPStartDelay, 3425
- MaxNoOfAttributes, 3429
- MaxNoOfConcurrentIndexOperations, 3416
- MaxNoOfConcurrentOperations, 3414
- MaxNoOfConcurrentScans, 3419
- MaxNoOfConcurrentSubOperations, 3433
- MaxNoOfConcurrentTransactions, 3413
- MaxNoOfExecutionThreads
  - ndbmtd, 3469
- MaxNoOfFiredTriggers, 3416
- MaxNoOfLocalOperations, 3415
- MaxNoOfLocalScans, 3419
- MaxNoOfOpenFiles, 3424
- MaxNoOfOrderedIndexes, 3430
- MaxNoOfSavedMessages, 3425
- MaxNoOfSubscribers, 3432
- MaxNoOfSubscriptions, 3432
- MaxNoOfTables, 3429
- MaxNoOfTriggers, 3431

---

MaxNoOfUniqueHashIndexes, 3431  
MaxParallelCopyInstances, 3420  
MaxParallelScansPerFragment, 3420  
MaxReorgBuildBatchSize, 3420  
MaxScanBatchSize, 3499  
MaxSendDelay, 3472  
MaxStartFailRetries, 3489  
MaxUIBuildBatchSize, 3421  
max\_allowed\_packet  
    and replication, 3146  
max\_allowed\_packet system variable, 814  
max\_binlog\_cache\_size system variable, 3066  
max\_binlog\_size system variable, 3067  
max\_binlog\_stmt\_cache\_size system variable, 3068  
MAX\_BLOB\_PART\_SIZE, 2247  
max\_connections system variable, 815  
MAX\_CONNECTIONS\_PER\_HOUR, 1140  
max\_connect\_errors system variable, 815  
max\_delayed\_threads system variable, 816  
max\_digest\_length system variable, 816  
max\_error\_count system variable, 817  
max\_execution\_time system variable, 817  
Max\_execution\_time\_exceeded status variable, 920  
Max\_execution\_time\_set status variable, 920  
Max\_execution\_time\_set\_failed status variable, 921  
max\_heap\_table\_size system variable, 818  
MAX\_INDEXES option  
    CMake, 210  
max\_insert\_delayed\_threads system variable, 818  
max\_join\_size system variable, 433, 819  
max\_length\_for\_sort\_data system variable, 819  
max\_points\_in\_geometry system variable, 820  
max\_prepared\_stmt\_count system variable, 820  
MAX\_QUERIES\_PER\_HOUR, 1140  
max\_relay\_log\_size system variable, 3027  
MAX\_ROWS  
    and NDB Cluster, 3983  
    NDB Cluster, 2217  
max\_seeks\_for\_key system variable, 820  
max\_sort\_length system variable, 821  
max\_sp\_recursion\_depth system variable, 821  
max\_tmp\_tables system variable, 821  
MAX\_UPDATES\_PER\_HOUR, 1140  
Max\_used\_connections status variable, 921  
Max\_used\_connections\_time status variable, 921  
MAX\_USER\_CONNECTIONS, 1140  
max\_user\_connections system variable, 822  
max\_write\_lock\_count system variable, 822  
MBR, 2075  
MBRContains(), 2075  
MBRCoveredBy(), 2075  
MBRCovers(), 2076  
MBRDisjoint(), 2076  
MBREqual(), 2076



---

- deprecated features, 21
- MBREquals(), 2076
- MBRIntersects(), 2077
- MBROverlaps(), 2077
- MBRTouches(), 2077
- MBRWithin(), 2077
- MD5(), 2030
- MDL, 5337
- measured-load option
  - ndb\_top, 3744
- MeCab full-text parser plugin
  - new features, 11
- mecab\_charset status variable, 921
- mecab\_rc\_file system variable, 823
- medium trust, 5337
- medium-check option
  - myisamchk, 585
  - mysqlcheck, 460
- MEDIUMBLOB data type, 1818
- MEDIUMINT data type, 1794
- MEDIUMTEXT data type, 1818
- membership
  - ndbinfo table, 3871
- memcached, 2870, 5338
- MEMCACHED\_HOME option
  - CMake, 218
- MEMCACHED\_SASL\_PWDB environment variable, 2879
- memcapable command, 2871
- memlock option
  - mysqld, 752
- memory allocation library, 180, 346
- memory allocator
  - innodb\_use\_sys\_malloc, 2652
- MEMORY storage engine, 2915, 2928
  - and replication, 3146
  - optimization, 1510
- memory usage
  - myisamchk, 596
- memory use, 1611
  - in NDB Cluster, 3322
  - monitoring, 1613
  - Performance Schema, 4215
- memoryusage
  - ndbinfo table, 3873
- memory\_by\_host\_by\_current\_bytes view
  - sys schema, 4410
- memory\_by\_thread\_by\_current\_bytes view
  - sys schema, 4411
- memory\_by\_user\_by\_current\_bytes view
  - sys schema, 4411
- memory\_global\_by\_current\_bytes view
  - sys schema, 4412
- memory\_global\_total view
  - sys schema, 4413

---

- memory\_per\_fragment
  - ndbinfo table, 3874
- memory\_summary\_by\_account\_by\_event\_name table
  - performance\_schema, 4337
- memory\_summary\_by\_host\_by\_event\_name table
  - performance\_schema, 4337
- memory\_summary\_by\_thread\_by\_event\_name table
  - performance\_schema, 4337
- memory\_summary\_by\_user\_by\_event\_name table
  - performance\_schema, 4337
- memory\_summary\_global\_by\_event\_name table
  - performance\_schema, 4337
- MemReportFrequency, 3458
- merge, 5338
- MERGE storage engine, 2915, 2938
- MERGE tables
  - defined, 2938
- merging
  - derived tables, 1497
  - view references, 1497
- merging JSON values, 1852
- metadata
  - database, 4098
  - database object, 1714
  - InnoDB, 4152
  - stored routines, 4061
  - triggers, 4066
  - views, 4080
- metadata lock, 5338
- metadata locking, 1601, 4315
- metadata log, 993
- metadata\_locks table
  - performance\_schema, 4315
- metadata\_locks\_cache\_size
  - deprecated features, 20
- metadata\_locks\_cache\_size system variable, 823
- metadata\_locks\_hash\_instances
  - deprecated features, 20
- metadata\_locks\_hash\_instances system variable, 823
- methods
  - locking, 1597
- metrics counter, 5338
- metrics view
  - sys schema, 4413
- mgmd (NDB Cluster)
  - defined, 3287
  - (see also [management node \(NDB Cluster\)](#))
- MICROSECOND(), 1933
- MID(), 1953
- midpoint insertion, 2644
- midpoint insertion strategy, 5338
- milestone
  - MySQL releases, 62
- MIN(), 2121

---

MIN(DISTINCT), 2121  
MinDiskWriteSpeed, 3451  
MinFreePct, 3412  
mini-transaction, 5338  
minimum bounding rectangle, 2075  
minus  
    unary (-), 1912  
MINUTE(), 1933  
min\_examined\_row\_limit system variable, 824  
mirror sites, 63  
miscellaneous functions, 2133  
mixed statements (Replication), 3154  
mixed-mode insert, 5338  
MLineFromText(), 2052  
MLineFromWKB(), 2055  
MM.MySQL, 5339  
MOD (modulo), 1918  
MOD(), 1918  
modes  
    batch, 292  
modify action  
    MySQLInstallerConsole, 116  
modulo (%), 1918  
modulo (MOD), 1918  
monitor  
    terminal, 269  
monitor option  
    ndb\_import, 3663  
monitoring, 1613, 2555, 2560, 2593, 2643, 2650, 2679, 2851, 2853  
    multi-source replication, 2997  
    threads, 1619  
Monitors, 2856  
    enabling, 2857  
    InnoDB, 2904  
    output, 2859  
Mono, 5339  
MONTH(), 1933  
MONTHNAME(), 1933  
MPointFromText(), 2052  
MPointFromWKB(), 2056  
MPolyFromText(), 2053  
MPolyFromWKB(), 2056  
.MRG file, 5337  
msql2mysql  
    removed features, 25  
MSSQL  
    deprecated features, 19  
MSSQL SQL mode, 940  
multi mysqld, 353  
multi-column indexes, 1511  
multi-core, 5339  
Multi-Range Read  
    optimization, 1469  
multi-source replication, 2993

---

- adding binary log source, 2996
- adding GTID source, 2995
- configuring, 2993
- error messages, 2993
- in NDB Cluster, 3965
- monitoring, 2997
- new features, 18
- overview, 2993
- performance schema, 2997
- provisioning, 2994
- resetting replica, 2996
- starting replica, 2996
- stopping replica, 2996
- tutorials, 2993

- multibyte character sets, 4558
- multibyte characters, 1771
- MULTILINESTRING data type, 1831
- MultiLineString(), 2058
- MultiLineStringFromText(), 2052
- MultiLineStringFromWKB(), 2055
- multiple buffer pools, 2644
- multiple servers, 1038
- multiple-part index, 2188
- multiplication (\*), 1913
- MULTIPOINT data type, 1831
- MultiPoint(), 2058
- MultiPointFromText(), 2052
- MultiPointFromWKB(), 2056
- MULTIPOLYGON data type, 1831
- MultiPolygon(), 2058
- MultiPolygonFromText(), 2053
- MultiPolygonFromWKB(), 2056
- mutex, 5339
- mutex wait
  - monitoring, 2853
- mutex\_instances table
  - performance\_schema, 4262
- MUTEX\_TYPE option
  - CMake, 211
- MVCC, 5339
- MVCC (multi-version concurrency control), 2550
- My
  - derivation, 8
- my-print-defaults option
  - mysql\_plugin, 372
- my.cnf, 5339
  - and NDB Cluster, 3350, 3383, 3384
  - in NDB Cluster, 3815
- my.cnf option file, 3132
- my.ini, 5339
- mycnf option
  - ndb\_config, 3618
  - ndb\_mgmd, 3596
- .MYD file, 5337

---

.MYI file, 5337  
MyISAM  
    compressed tables, 598, 2926  
    converting tables to InnoDB, 2575  
MyISAM key cache, 1584  
MyISAM storage engine, 2915, 2919  
mysam-block-size option  
    mysqld, 753  
mysamchk, 306, 576  
    analyze option, 588  
    backup option, 585  
    block-search option, 588  
    character-sets-dir option, 586  
    check option, 584  
    check-only-changed option, 584  
    correct-checksum option, 586  
    data-file-length option, 586  
    debug option, 580  
    defaults-extra-file option, 581  
    defaults-file option, 581  
    defaults-group-suffix option, 581  
    description option, 589  
    example output, 589  
    extend-check option, 584, 586  
    fast option, 584  
    force option, 585, 586  
    help option, 580  
    HELP option, 580  
    information option, 585  
    keys-used option, 586  
    max-record-length option, 587  
    medium-check option, 585  
    no-defaults option, 581  
    options, 580  
    parallel-recover option, 587  
    print-defaults option, 582  
    quick option, 587  
    read-only option, 585  
    recover option, 587  
    safe-recover option, 587  
    set-auto-increment[ option, 589  
    set-collation option, 588  
    silent option, 582  
    sort-index option, 589  
    sort-records option, 589  
    sort-recover option, 588  
    tmpdir option, 588  
    unpack option, 588  
    update-state option, 585  
    verbose option, 582  
    version option, 582  
    wait option, 582  
mysamchk --parallel-recover  
    deprecated features, 23

---

- myisamlog, 306, 596
- myisampack, 306, 598, 2240, 2926
  - backup option, 598
  - character-sets-dir option, 599
  - debug option, 599
  - force option, 599
  - help option, 598
  - join option, 599
  - silent option, 599
  - test option, 599
  - tmpdir option, 600
  - verbose option, 600
  - version option, 600
  - wait option, 600
- myisam\_block\_size myisamchk variable, 582
- myisam\_data\_pointer\_size system variable, 824
- myisam\_ftdump, 306, 575
  - count option, 576
  - dump option, 576
  - help option, 576
  - length option, 576
  - stats option, 576
  - verbose option, 576
- myisam\_max\_sort\_file\_size system variable, 825, 2923
- myisam\_mmap\_size system variable, 825
- myisam\_recover\_options system variable, 826, 2923
- myisam\_repair\_threads
  - deprecated features, 23
- myisam\_repair\_threads system variable, 827
- myisam\_sort\_buffer\_size myisamchk variable, 582
- myisam\_sort\_buffer\_size system variable, 827, 2923
- myisam\_stats\_method system variable, 828
- myisam\_use\_mmap system variable, 828
- MyODBC drivers, 5339
- MySQL
  - debugging, 1045
  - defined, 4
  - introduction, 4
  - pronunciation, 5
  - upgrading, 382
- mysql, 305, 393, 5339
  - auto-rehash option, 399
  - auto-vertical-output option, 400
  - batch option, 400
  - binary-as-hex option, 400
  - binary-mode option, 401
  - bind-address option, 401
  - character-sets-dir option, 401
  - charset command, 421
  - clear command, 421
  - column-names option, 401
  - column-type-info option, 402
  - commands option, 403
  - comments option, 404

---

compress option, 404  
connect command, 421  
connect-expired-password option, 404  
connect-timeout option, 405  
database option, 405  
debug option, 405  
debug-check option, 405  
debug-info option, 405  
default-auth option, 406  
default-character-set option, 406  
defaults-extra-file option, 406  
defaults-file option, 406  
defaults-group-suffix option, 407  
delimiter command, 421  
delimiter option, 407  
disable named commands, 407  
edit command, 422  
ego command, 422  
enable-clear-text-plugin option, 407  
execute option, 407  
exit command, 422  
force option, 407  
get-server-public-key option, 408  
go command, 422  
help command, 421  
help option, 399  
histignore option, 408  
host option, 408  
html option, 408  
i-am-a-dummy option, 415  
ignore-spaces option, 409  
init-command option, 409  
line-numbers option, 409  
local-infile option, 409, 1091  
login-path option, 409  
max-allowed-packet option, 410  
max-join-size option, 410  
named-commands option, 410  
net-buffer-length option, 410  
no-auto-rehash option, 410  
no-beep option, 410  
no-defaults option, 411  
nopager command, 422  
notee command, 422  
nowarning command, 422  
one-database option, 411  
pager command, 422  
pager option, 411  
password option, 412  
pipe option, 412  
plugin-dir option, 412  
port option, 412  
print command, 422  
print-defaults option, 413

---

- prompt command, 423
- prompt option, 413
- protocol option, 413
- quick option, 413
- quit command, 423
- raw option, 414
- reconnect option, 415
- rehash command, 423
- resetconnection command, 423
- safe-updates option, 415
- secure-auth option, 415
- select-limit option, 415
- server-public-key-path option, 416
- shared-memory-base-name option, 416
- show-warnings option, 416
- sigint-ignore option, 416
- silent option, 417
- skip-column-names option, 417
- skip-line-numbers option, 417
- socket option, 417
- source command, 423
- SSL options, 417
- status command, 424
- syslog option, 418
- system command, 424
- table option, 418
- tee command, 424
- tee option, 418
- tls-version option, 418
- unbuffered option, 419
- use command, 424
- user option, 419
- verbose option, 419
- version option, 419
- vertical option, 419
- wait option, 419
- warnings command, 424
- xml option, 419
- MySQL APT Repository, 157, 252
- MySQL binary distribution, 62
- MySQL C API, 4482
- mysql client
  - new features, 16
- mysql client parser
  - versus mysqld parser, 434
- MySQL Cluster Manager
  - and ndb\_mgm, 3755
- mysql command options, 394
- mysql commands
  - list of, 420
- mysql database
  - gtid\_executed table, 2968
- MySQL Dolphin name, 8
- MySQL Enterprise Audit, 1294, 4487



---

MySQL Enterprise Backup, 4485  
  Group Replication, 3201

MySQL Enterprise Data Masking and De-Identification, 1381, 4487

MySQL Enterprise Data Masking and De-Identification functions  
  gen\_blacklist(), 1397  
  gen\_dictionary(), 1397  
  gen\_dictionary\_drop(), 1398  
  gen\_dictionary\_load(), 1399  
  gen\_range(), 1394  
  gen\_rnd\_email(), 1395  
  gen\_rnd\_pan(), 1395  
  gen\_rnd\_ssn(), 1396  
  gen\_rnd\_us\_phone(), 1396  
  mask\_inner(), 1391  
  mask\_outer(), 1391  
  mask\_pan(), 1392  
  mask\_pan\_relaxed(), 1393  
  mask\_ssn(), 1394

MySQL Enterprise Data Masking and De-Identification plugin  
  elements, 1383

MySQL Enterprise Encryption, 1399, 4486

MySQL Enterprise Firewall, 1365, 4487  
  installing, 1367  
  using, 1369

MySQL Enterprise Firewall functions  
  mysql\_firewall\_flush\_status(), 1380  
  normalize\_statement(), 1380  
  read\_firewall\_users(), 1379  
  read\_firewall\_whitelist(), 1379  
  set\_firewall\_mode(), 1379

MySQL Enterprise Firewall stored procedures  
  sp\_reload\_firewall\_rules(), 1378  
  sp\_set\_firewall\_mode(), 1378

MySQL Enterprise Firewall tables  
  firewall\_users, 1377  
  firewall\_whitelist, 1377

MySQL Enterprise Security, 1190, 1201, 1206, 4486

MySQL Enterprise Thread Pool, 1001, 4487  
  elements, 1002  
  installing, 1002

MySQL Enterprise Transparent Data Encryption, 2726

MySQL history, 8

mysql history file, 426

MySQL Installer, 89

MySQL name, 8

MySQL privileges  
  and NDB Cluster, 3927

mysql prompt command, 425

MySQL server  
  mysqld, 341, 658

MySQL Shell, 3251  
  NoSQL, 3251

MySQL SLES Repository, 157, 252

mysql source (command for reading from text files), 293, 430

---

MySQL source distribution, 62  
MySQL storage engines, 2915  
MySQL system tables  
    and NDB Cluster, 3927  
    and replication, 3147  
MySQL version, 63  
MySQL Yum Repository, 150, 154, 250  
mysql \. (command for reading from text files), 293, 430  
mysql.event table, 4074  
mysql.gtid\_executed table, 2968  
    compression, 2969  
    thread/sql/compress\_gtid\_table, 2970  
mysql.server, 304, 351  
    basedir option, 353  
    datadir option, 353  
    pid-file option, 353  
    service-startup-timeout option, 353  
mysql.slave\_master\_info table, 3098  
mysql.slave\_relay\_log\_info table, 3098  
mysql.sock  
    protection, 4567  
MYSQL323  
    deprecated features, 19  
MYSQL323 SQL mode, 940  
MYSQL40  
    deprecated features, 19  
MYSQL40 SQL mode, 941  
mysqlaccess  
    removed features, 25  
mysqladmin, 305, 435, 2184, 2266, 2515, 2521, 2527, 2534  
    bind-address option, 441  
    character-sets-dir option, 441  
    compress option, 442  
    connect-timeout option, 442  
    count option, 442  
    debug option, 442  
    debug-check option, 442  
    debug-info option, 443  
    default-auth option, 443  
    default-character-set option, 443  
    defaults-extra-file option, 443  
    defaults-file option, 443  
    defaults-group-suffix option, 444  
    enable-cleartext-plugin option, 444  
    force option, 444  
    get-server-public-key option, 444  
    help option, 441  
    host option, 445  
    login-path option, 445  
    no-beep option, 445  
    no-defaults option, 445  
    password option, 446  
    pipe option, 446  
    plugin-dir option, 446

---

- port option, 446
- print-defaults option, 446
- protocol option, 447
- relative option, 447
- secure-auth option, 447
- server-public-key-path option, 448
- shared-memory-base-name option, 448
- show-warnings option, 447
- shutdown-timeout option, 448
- silent option, 448
- sleep option, 449
- socket option, 449
- SSL options, 449
- tls-version option, 449
- user option, 449
- verbose option, 450
- version option, 450
- vertical option, 450
- wait option, 450
- mysqladmin command options, 438
- mysqladmin option
  - mysqld\_multi, 356
- mysqlbackup command, 5340
- mysqlbinlog, 307, 611
  - base64-output option, 617
  - bind-address option, 618
  - binlog-row-event-max-size option, 618
  - character-sets-dir option, 618
  - connection-server-id option, 619
  - database option, 619
  - debug option, 620
  - debug-check option, 620
  - debug-info option, 621
  - default-auth option, 621
  - defaults-extra-file option, 621
  - defaults-file option, 621
  - defaults-group-suffix option, 621
  - disable-log-bin option, 622
  - exclude-gtids option, 622
  - force-if-open option, 622
  - force-read option, 622
  - get-server-public-key option, 622
  - help option, 617
  - hexdump option, 623
  - host option, 623
  - idempotent option, 623
  - include-gtids option, 623
  - local-load option, 624
  - login-path option, 624
  - new features, 16
  - no-defaults option, 624
  - offset option, 624
  - open-files-limit option, 625
  - password option, 625

---

- plugin-dir option, 625
- port option, 625
- print-defaults option, 625
- protocol option, 626
- raw option, 626
- read-from-remote-master option, 626
- read-from-remote-server option, 626
- result-file option, 627
- rewrite-db option, 627
- secure-auth option, 628
- server-id option, 628
- server-id-bits option, 628
- server-public-key-path option, 629
- set-charset option, 629
- shared-memory-base-name option, 629
- short-form option, 629
- skip-gtids option, 630
- socket option, 630
- SSL options, 630
- start-datetime option, 630
- start-position option, 631
- stop-datetime option, 631
- stop-never option, 631
- stop-never-slave-server-id option, 631
- stop-position option, 632
- tls-version option, 632
- to-last-log option, 632
- user option, 632
- verbose option, 632
- verify-binlog-checksum option, 633
- version option, 633

mysqlbug

- removed features, 25

mysqlcheck, 305, 450

- all-databases option, 455
- all-in-1 option, 455
- analyze option, 455
- auto-repair option, 455
- bind-address option, 455
- character-sets-dir option, 456
- check option, 456
- check-only-changed option, 456
- check-upgrade option, 456
- compress option, 456
- databases option, 456
- debug option, 456
- debug-check option, 457
- debug-info option, 457
- default-auth option, 458
- default-character-set option, 457
- defaults-extra-file option, 457
- defaults-file option, 457
- defaults-group-suffix option, 458
- enable-cleartext-plugin option, 459

---

extended option, 458  
fast option, 459  
fix-db-names option, 459  
fix-table-names option, 459  
force option, 459  
get-server-public-key option, 460  
help option, 455  
host option, 460  
login-path option, 460  
medium-check option, 460  
no-defaults option, 460  
optimize option, 461  
password option, 461  
pipe option, 461  
plugin-dir option, 461  
port option, 462  
print-defaults option, 462  
protocol option, 462  
quick option, 462  
repair option, 462  
secure-auth option, 463  
server-public-key-path option, 463  
shared-memory-base-name option, 464  
silent option, 464  
skip-database option, 464  
socket option, 464  
SSL options, 464  
tables option, 464  
tls-version option, 465  
use-frm option, 465  
user option, 465  
verbose option, 465  
version option, 465  
write-binlog option, 465  
mysqlclient, 5340  
mysqld, 304, 5340  
  abort-slave-event-count option, 3025  
  allow-suspicious-udfs option, 739  
  ansi option, 739  
  as NDB Cluster process, 3505, 3814  
  audit-log option, 1354  
  basedir option, 740  
  binlog-checksum option, 3052  
  binlog-do-db option, 3049  
  binlog-ignore-db option, 3051  
  binlog-row-event-max-size option, 3048  
  bootstrap option, 740  
  character-set-client-handshake option, 740  
  chroot option, 741  
  command options, 738  
  console option, 741  
  core-file option, 741  
  daemonize option, 741  
  datadir option, 742

---

debug option, 742  
debug-sync-timeout option, 742  
default-time-zone option, 743  
defaults-extra-file option, 743  
defaults-file option, 743  
defaults-group-suffix option, 743  
des-key-file option, 743  
disable-partition-engine-check option, 744  
disconnect-slave-event-count option, 3025  
early-plugin-load option, 744  
exit codes, 966  
exit-info option, 746  
external-locking option, 746  
flush option, 746  
gdb option, 746  
help option, 739  
ignore-db-dir option, 747  
initialize option, 747  
initialize-insecure option, 747  
innodb option, 2737  
innodb-status-file option, 2738  
install option, 748  
install-manual option, 748  
keyring-migration-destination option, 1285  
keyring-migration-host option, 1285  
keyring-migration-password option, 1285  
keyring-migration-port option, 1285  
keyring-migration-socket option, 1286  
keyring-migration-source option, 1286  
keyring-migration-user option, 1286  
language option, 748  
large-pages option, 749  
lc-messages option, 749  
lc-messages-dir option, 750  
local-service option, 750  
log-bin option, 3048  
log-bin-index option, 3049  
log-error option, 750  
log-isam option, 750  
log-raw option, 751  
log-short-format option, 751  
log-tc option, 751  
log-tc-size option, 751  
log-warnings option, 752, 3014  
log\_slow\_admin\_statements system variable, 809  
master-info-file option, 3015  
master-retry-count option, 3015  
max-binlog-dump-events option, 3052  
max-relay-log-size option, 3015  
memlock option, 752  
myisam-block-size option, 753  
MySQL server, 341, 658  
ndb-allow-copying-alter-table option, 3505  
ndb-batch-size option, 3506

---

ndb-blob-read-batch-bytes option, 3507  
ndb-blob-write-batch-bytes option, 3508  
ndb-cluster-connection-pool option, 3506  
ndb-cluster-connection-pool-nodeids option, 3507  
ndb-connectstring option, 3508  
ndb-log-apply-status, 3510  
ndb-log-empty-epochs, 3510  
ndb-log-empty-update, 3511  
ndb-log-exclusive-reads, 3511  
ndb-log-fail-terminate, 3511  
ndb-log-orig, 3511  
ndb-log-transaction-id, 3512  
ndb-nodeid, 3514  
ndb-optimization-delay option, 3515  
ndb-optimized-node-selection option, 3515  
ndb-transid-mysql-connection-map option, 3515  
ndb-wait-connected option, 3516  
ndb-wait-setup option, 3516  
ndbcluster option, 3505  
no-defaults option, 753  
old-style-user-limits option, 753  
partition option, 754  
performance-schema-consumer-events-stages-current option, 4357  
performance-schema-consumer-events-stages-history option, 4357  
performance-schema-consumer-events-stages-history-long option, 4357  
performance-schema-consumer-events-statements-current option, 4357  
performance-schema-consumer-events-statements-history option, 4357  
performance-schema-consumer-events-statements-history-long option, 4358  
performance-schema-consumer-events-transactions-current option, 4358  
performance-schema-consumer-events-transactions-history option, 4358  
performance-schema-consumer-events-transactions-history-long option, 4358  
performance-schema-consumer-events-waits-current option, 4358  
performance-schema-consumer-events-waits-history option, 4358  
performance-schema-consumer-events-waits-history-long option, 4358  
performance-schema-consumer-global-instrumentation option, 4358  
performance-schema-consumer-statements-digest option, 4358  
performance-schema-consumer-thread-instrumentation option, 4358  
performance-schema-consumer-xxx option, 4357  
performance-schema-instrument option, 4357  
plugin option prefix, 755  
plugin-load option, 754  
plugin-load-add option, 755  
port option, 756  
port-open-timeout option, 756  
print-defaults option, 756  
relay-log-purge option, 3016  
relay-log-space-limit option, 3016  
remove option, 756  
replicate-do-db option, 3016  
replicate-do-table option, 3019  
replicate-ignore-db option, 3018  
replicate-ignore-table option, 3020  
replicate-rewrite-db option, 3020  
replicate-same-server-id option, 3021

---

- replicate-wild-do-table option, 3021
- replicate-wild-ignore-table option, 3022
- role in NDB Cluster (see SQL Node (NDB Cluster))
- safe-user-create option, 757
- server\_uuid variable, 2999
- show-slave-auth-info option, 3006
- skip-grant-tables option, 757
- skip-host-cache option, 758
- skip-innodb option, 759, 2738
- skip-ndbcluster option, 3517
- skip-new option, 759
- skip-partition option, 759
- skip-show-database option, 759
- skip-slave-start option, 3023
- skip-ssl option, 761
- skip-stack-trace option, 760
- skip-symbolic-links option, 762
- slave-skip-errors option, 3023
- slave-sql-verify-checksum option, 3024
- slow-start-timeout option, 760
- socket option, 760
- sporadic-binlog-dump-fail option, 3052
- sql-mode option, 760
- ssl option, 761
- standalone option, 762
- starting, 1089
- super-large-pages option, 762
- symbolic-links option, 762
- sysdate-is-now option, 763
- tc-heuristic-recover option, 763
- temp-pool option, 763
- tmpdir option, 764
- transaction-isolation option, 764
- transaction-read-only option, 764
- user option, 765
- validate-password option, 1252
- validate-user-plugins option, 765
- verbose option, 766
- version option, 766
- mysqld (NDB Cluster), 3570
- mysqld option
  - malloc-lib, 346
  - mysqld\_multi, 356
  - mysqld\_safe, 347
  - mysql\_plugin, 372
- mysqld options, 659
- mysqld options and variables
  - NDB Cluster, 3505
- mysqld parser
  - versus mysql client parser, 434
- mysqld system variables, 659
- mysqld-file option
  - mysql\_install\_db, 369
- mysqld-safe-log-timestamps option



---

- mysqld\_safe, 345
- mysqld-version option
  - mysqld\_safe, 347
- MySQLdb, 5340
- mysqldump, 258, 306, 465, 5340
  - add-drop-database option, 481
  - add-drop-table option, 481
  - add-drop-trigger option, 481
  - add-locks option, 497
  - all-databases option, 493
  - all-tablespaces option, 481
  - allow-keywords option, 482
  - apply-slave-statements option, 485
  - bind-address option, 474
  - character-sets-dir option, 485
  - comments option, 482
  - compact option, 489
  - compatible option, 489
  - complete-insert option, 489
  - compress option, 475
  - create-options option, 489
  - databases option, 493
  - debug option, 482
  - debug-check option, 483
  - debug-info option, 483
  - default-auth option, 475
  - default-character-set option, 485
  - defaults-extra-file option, 479
  - defaults-file option, 480
  - defaults-group-suffix option, 480
  - delete-master-logs option, 486
  - disable-keys option, 495
  - dump-date option, 483
  - dump-slave option, 486
  - enable-cleartext-plugin option, 475
  - events option, 493
  - extended-insert option, 495
  - fields-enclosed-by option, 490, 508
  - fields-escaped-by option, 490, 508
  - fields-optionally-enclosed-by option, 490, 508
  - fields-terminated-by option, 489, 508
  - flush-logs option, 497
  - flush-privileges option, 497
  - force option, 484
  - get-server-public-key option, 475
  - help option, 484
  - hex-blob option, 490
  - host option, 476
  - ignore-error option, 493
  - ignore-table option, 494
  - include-master-host-port option, 487
  - insert-ignore option, 496
  - lines-terminated-by option, 490, 509
  - lock-all-tables option, 498

---

lock-tables option, 498  
log-error option, 484  
login-path option, 476  
master-data option, 487  
max-allowed-packet option, 496  
net-buffer-length option, 496  
no-autocommit option, 498  
no-create-db option, 481  
no-create-info option, 482  
no-data option, 494  
no-defaults option, 480  
no-set-names option, 485  
no-tablespaces option, 482  
opt option, 496  
order-by-primary option, 498  
password option, 476  
pipe option, 477  
plugin-dir option, 477  
port option, 477  
print-defaults option, 481  
problems, 501, 4095  
protocol option, 477  
quick option, 497  
quote-names option, 490  
replace option, 482  
result-file option, 491  
routines option, 494  
secure-auth option, 477  
server-public-key-path option, 478  
set-charset option, 485  
set-gtid-purged option, 488  
shared-memory-base-name option, 499  
single-transaction option, 499  
skip-comments option, 484  
skip-mysql-schema option, 478  
skip-opt option, 497  
socket option, 479  
SSL options, 479  
tab option, 491  
tables option, 494  
tls-version option, 479  
triggers option, 495  
tz-utc option, 491  
user option, 479  
using for backups, 1424  
verbose option, 484  
version option, 484  
views, 501, 4095  
where option, 495  
workarounds, 501, 4095  
xml option, 492  
mysqldumpslow, 307, 641  
  abstract-numbers option, 643  
  debug option, 642

---

- grep option, 643
- help option, 642
- host option, 643
- instance option, 643
- lock option, 643
- reverse option, 643
- sort option, 643
- top option, 643
- verbose option, 644
- mysqld\_multi, 304, 353
  - defaults-extra-file option, 355
  - defaults-file option, 355
  - example option, 355
  - help option, 355
  - log option, 356
  - mysqladmin option, 356
  - mysqld option, 356
  - no-defaults option, 355
  - no-log option, 356
  - password option, 356
  - silent option, 357
  - tcp-ip option, 357
  - user option, 357
  - verbose option, 357
  - version option, 357
- mysqld\_safe, 304, 341
  - basedir option, 344
  - core-file-size option, 344
  - datadir option, 344
  - defaults-extra-file option, 344
  - defaults-file option, 345
  - deprecated features, 22
  - help option, 344
  - ledir option, 345
  - log-error option, 345
  - malloc-lib option, 346
  - mysqld option, 347
  - mysqld-safe-log-timestamps option, 345
  - mysqld-version option, 347
  - nice option, 348
  - no-defaults option, 348
  - open-files-limit option, 348
  - pid-file option, 348
  - plugin-dir option, 349
  - port option, 349
  - skip-kill-mysqld option, 349
  - skip-syslog option, 349
  - socket option, 349
  - syslog option, 349
  - syslog-tag option, 350
  - timezone option, 350
  - user option, 350
- mysqlhotcopy
  - removed features, 25

---

mysqlimport, 258, 306, 501, 2289  
  bind-address option, 505  
  character-sets-dir option, 505  
  columns option, 505  
  compress option, 505  
  debug option, 506  
  debug-check option, 506  
  debug-info option, 506  
  default-auth option, 506  
  default-character-set option, 506  
  defaults-extra-file option, 507  
  defaults-file option, 507  
  defaults-group-suffix option, 507  
  delete option, 507  
  enable-cleartext-plugin option, 508  
  force option, 508  
  get-server-public-key option, 508  
  help option, 505  
  host option, 509  
  ignore option, 509  
  ignore-lines option, 509  
  local option, 510, 1091  
  lock-tables option, 510  
  login-path option, 510  
  low-priority option, 510  
  no-defaults option, 510  
  password option, 511  
  pipe option, 511  
  plugin-dir option, 511  
  port option, 511  
  print-defaults option, 512  
  protocol option, 512  
  replace option, 512  
  secure-auth option, 513  
  server-public-key-path option, 513  
  shared-memory-base-name option, 513  
  silent option, 514  
  socket option, 514  
  SSL options, 514  
  tls-version option, 514  
  use-threads option, 515  
  user option, 514  
  verbose option, 515  
  version option, 515

MySQLInstallerConsole, 110  
  configure action, 112  
  help action, 113  
  install action, 113  
  list action, 116  
  modify action, 116  
  remove action, 117  
  set action, 117  
  status action, 118  
  update action, 119

---

upgrade action, 119  
mysqlpump, 306, 515  
  add-drop-database option, 520  
  add-drop-table option, 521  
  add-drop-user option, 521  
  add-locks option, 521  
  all-databases option, 521  
  bind-address option, 521  
  character-sets-dir option, 521  
  complete-insert option, 522  
  compress option, 522  
  compress-output option, 522  
  databases option, 522  
  debug option, 523  
  debug-check option, 523  
  debug-info option, 523  
  default-auth option, 523  
  default-character-set option, 524  
  default-parallelism option, 524  
  defaults-extra-file option, 524  
  defaults-file option, 524  
  defaults-group-suffix option, 525  
  defer-table-indexes option, 525  
  events option, 525  
  exclude-databases option, 526  
  exclude-events option, 526  
  exclude-routines option, 526  
  exclude-tables option, 526  
  exclude-triggers option, 526  
  exclude-users option, 527  
  extended-insert option, 527  
  get-server-public-key option, 527  
  help option, 520  
  hex-blob option, 527  
  host option, 527  
  include-databases option, 528  
  include-events option, 528  
  include-routines option, 528  
  include-tables option, 528  
  include-triggers option, 528  
  include-users option, 528  
  insert-ignore option, 529  
  log-error-file option, 529  
  login-path option, 529  
  max-allowed-packet option, 529  
  net-buffer-length option, 529  
  no-create-db option, 530  
  no-create-info option, 530  
  no-defaults option, 530  
  object selection, 537  
  parallel-schemas option, 530  
  parallelism, 538  
  password option, 531  
  plugin-dir option, 531

---

- port option, 531
- print-defaults option, 531
- protocol option, 532
- replace option, 532
- restrictions, 539
- result-file option, 532
- routines option, 532
- secure-auth option, 533
- server-public-key-path option, 533
- set-charset option, 533
- set-gtid-purged option, 534
- single-transaction option, 534
- skip-definer option, 535
- skip-dump-rows option, 535
- socket option, 535
- SSL options, 535
- tls-version option, 536
- triggers option, 536
- tz-utc option, 536
- user option, 536
- users option, 536
- version option, 537
- watch-progress option, 537

mysqlsh, 306

mysqlshow, 306, 540

- bind-address option, 543
- character-sets-dir option, 543
- compress option, 543
- count option, 543
- debug option, 544
- debug-check option, 544
- debug-info option, 544
- default-auth option, 544
- default-character-set option, 544
- defaults-extra-file option, 545
- defaults-file option, 545
- defaults-group-suffix option, 545
- enable-cleartext-plugin option, 545
- get-server-public-key option, 546
- help option, 543
- host option, 546
- keys option, 546
- login-path option, 546
- no-defaults option, 546
- password option, 547
- pipe option, 547
- plugin-dir option, 547
- port option, 548
- print-defaults option, 548
- protocol option, 548
- secure-auth option, 548
- server-public-key-path option, 549
- shared-memory-base-name option, 549
- show-table-type option, 549

---

socket option, 549  
SSL options, 550  
status option, 550  
tls-version option, 550  
user option, 550  
verbose option, 550  
version option, 550  
mysqlslap, 306, 550  
  auto-generate-sql option, 556  
  auto-generate-sql-add-autoincrement option, 556  
  auto-generate-sql-execute-number option, 556  
  auto-generate-sql-guid-primary option, 556  
  auto-generate-sql-load-type option, 556  
  auto-generate-sql-secondary-indexes option, 557  
  auto-generate-sql-unique-query-number option, 557  
  auto-generate-sql-unique-write-number option, 557  
  auto-generate-sql-write-number option, 557  
  commit option, 557  
  compress option, 558  
  concurrency option, 558  
  create option, 558  
  create-schema option, 558  
  csv option, 558  
  debug option, 559  
  debug-check option, 559  
  debug-info option, 559  
  default-auth option, 559  
  defaults-extra-file option, 559  
  defaults-file option, 560  
  defaults-group-suffix option, 560  
  delimiter option, 560  
  detach option, 560  
  enable-cleartext-plugin option, 561  
  engine option, 561  
  get-server-public-key option, 561  
  help option, 555  
  host option, 561  
  iterations option, 561  
  login-path option, 562  
  no-defaults option, 562  
  no-drop option, 562  
  number-char-cols option, 562  
  number-int-cols option, 562  
  number-of-queries option, 563  
  only-print option, 563  
  password option, 563  
  pipe option, 563  
  plugin-dir option, 564  
  port option, 564  
  post-query option, 564  
  post-system option, 564  
  pre-query option, 564  
  pre-system option, 564  
  print-defaults option, 565

---

- protocol option, 565
- query option, 565
- secure-auth option, 565
- server-public-key-path option, 566
- shared-memory-base-name option, 566
- silent option, 566
- socket option, 566
- sql-mode option, 567
- SSL options, 567
- tls-version option, 567
- user option, 567
- verbose option, 567
- version option, 567
- mysqlx, 3266
  - mysqlx\_bind\_address system variable, 3267
  - mysqlx\_connect\_timeout system variable, 3267
  - mysqlx\_idle\_worker\_thread\_timeout system variable, 3268
  - mysqlx\_max\_allowed\_packet system variable, 3268
  - mysqlx\_max\_connections system variable, 3268
  - mysqlx\_min\_worker\_threads system variable, 3269
  - mysqlx\_port system variable, 3269
  - mysqlx\_port\_open\_timeout system variable, 3270
  - mysqlx\_socket system variable, 3270
  - mysqlx\_ssl\_ca system variable, 3271
  - mysqlx\_ssl\_capath system variable, 3271
  - mysqlx\_ssl\_cert system variable, 3271
  - mysqlx\_ssl\_cipher system variable, 3272
  - mysqlx\_ssl\_crl system variable, 3272
  - mysqlx\_ssl\_crlpath system variable, 3272
  - mysqlx\_ssl\_key system variable, 3272
- MYSQLX\_TCP\_PORT environment variable, 651
- MYSQLX\_TCP\_PORT option
  - CMake, 211
- MYSQLX\_UNIX\_ADDR option
  - CMake, 211
- MYSQLX\_UNIX\_PORT environment variable, 651
- mysql\_acquire\_locking\_service\_locks() C function
  - locking service, 1029
- mysql\_clear\_password authentication plugin, 1189
- mysql\_cluster\_backup\_privileges, 3826
- mysql\_cluster\_move\_grant\_tables, 3826
- mysql\_cluster\_move\_privileges, 3826
- mysql\_cluster\_privileges\_are\_distributed, 3827
- mysql\_cluster\_restore\_local\_privileges, 3828
- mysql\_cluster\_restore\_privileges, 3828
- mysql\_cluster\_restore\_privileges\_from\_local, 3828
- mysql\_config, 644
  - cflags option, 644
  - cxxflags option, 645
  - embedded option, 645
  - embedded-libs option, 645
  - include option, 645
  - libmysqld-libs option, 645
  - libs option, 645



---

- libs\_r option, 645
- plugindir option, 645
- port option, 645
- socket option, 645
- variable option, 645
- version option, 645
- mysql\_config\_editor, 307, 605
  - debug option, 608
  - help option, 608
  - verbose option, 608
  - version option, 608
- mysql\_config\_server, 644
- mysql\_convert\_table\_format
  - removed features, 25
- MYSQL\_DATADIR option
  - CMake, 206
- MYSQL\_DEBUG environment variable, 308, 651, 1052
- mysql\_find\_rows
  - removed features, 25
- mysql\_firewall\_flush\_status() MySQL Enterprise Firewall function, 1380
- mysql\_firewall\_mode system variable, 1380
- mysql\_firewall\_trace system variable, 1380
- MYSQL\_FIREWALL\_USERS
  - INFORMATION\_SCHEMA table, 4201
- MYSQL\_FIREWALL\_WHITELIST
  - INFORMATION\_SCHEMA table, 4201
- mysql\_fix\_extensions
  - removed features, 25
- MYSQL\_GROUP\_SUFFIX environment variable, 651
- MYSQL\_HISTFILE environment variable, 426, 651
- MYSQL\_HISTIGNORE environment variable, 426, 651
- MYSQL\_HOME environment variable, 651
- MYSQL\_HOST environment variable, 338, 651
- mysql\_info(), 2160, 2283, 2300, 2342
- mysql\_insert\_id(), 2283
- mysql\_install\_db, 305, 361
  - admin-auth-plugin option, 365
  - admin-host option, 365
  - admin-require-ssl option, 365
  - admin-user option, 366
  - basedir option, 366
  - builddir option, 366
  - datadir option, 366
  - defaults option, 366
  - defaults-extra-file option, 367
  - defaults-file option, 367
  - deprecated features, 22
  - extra-sql-file option, 367
  - help option, 365
  - insecure option, 367
  - lc-messages option, 368
  - lc-messages-dir option, 368
  - login-file option, 368
  - login-path option, 368

---

- mysqld-file option, 369
- no-defaults option, 369
- random-password-file option, 369
- skip-sys-schema option, 370
- srcdir option, 370
- user option, 370
- verbose option, 370
- version option, 370
- mysql\_keyring service, 1033
- mysql\_kill()
  - deprecated features, 22
- mysql\_list\_fields()
  - deprecated features, 22
- mysql\_list\_processes()
  - deprecated features, 22
- MYSQL\_MAINTAINER\_MODE option
  - CMake, 211
- mysql\_native\_password authentication plugin, 1174
- mysql\_native\_password\_proxy\_users system variable, 828, 1138
- mysql\_no\_login authentication plugin, 1219
- mysql\_old\_password
  - removed features, 23
- mysql\_old\_password authentication plugin, 1175
- MYSQL\_OPENSSL\_UDF\_DH\_BITS\_THRESHOLD environment variable, 651, 1402
- MYSQL\_OPENSSL\_UDF\_DSA\_BITS\_THRESHOLD environment variable, 651, 1402
- MYSQL\_OPENSSL\_UDF\_RSA\_BITS\_THRESHOLD environment variable, 651, 1402
- mysql\_options()
  - MYSQL\_OPT\_LOCAL\_INFILE, 1091
- MYSQL\_OPT\_SSL\_ENFORCE
  - deprecated features, 20
- MYSQL\_OPT\_SSL\_VERIFY\_SERVER\_CERT
  - deprecated features, 20
- mysql\_plugin, 305, 370
  - basedir option, 372
  - datadir option, 372
  - deprecated features, 22
  - help option, 372
  - my-print-defaults option, 372
  - mysqld option, 372
  - no-defaults option, 372
  - plugin-dir option, 373
  - plugin-ini option, 373
  - print-defaults option, 373
  - verbose option, 373
  - version option, 373
- MYSQL\_PROJECT\_NAME option
  - CMake, 211
- MYSQL\_PS1 environment variable, 651
- MYSQL\_PWD environment variable, 308, 338, 651
- mysql\_real\_escape\_string\_quote(), 1654, 1954
- mysql\_refresh()
  - deprecated features, 22
- mysql\_release\_locking\_service\_locks() C function
  - locking service, 1029

---

mysql\_secure\_installation, 305, 373  
  defaults-extra-file option, 375  
  defaults-file option, 376  
  defaults-group-suffix option, 376  
  help option, 375  
  host option, 376  
  no-defaults option, 376  
  password option, 376  
  port option, 377  
  print-defaults option, 377  
  protocol option, 377  
  socket option, 377  
  SSL options, 377  
  tls-version option, 378  
  use-default option, 378  
  user option, 378  
mysql\_session\_track\_get\_first() C API function, 963  
mysql\_session\_track\_get\_next() C API function, 963  
mysql\_setpermission  
  removed features, 25  
mysql\_shutdown()  
  deprecated features, 22  
mysql\_ssl\_rsa\_setup, 305, 378  
  datadir option, 381  
  help option, 380  
  suffix option, 381  
  uid option, 381  
  verbose option, 381  
  version option, 381  
MYSQL\_TCP\_PORT environment variable, 308, 651, 1044, 1045  
MYSQL\_TCP\_PORT option  
  CMake, 211  
MYSQL\_TEST\_LOGIN\_FILE environment variable, 318, 605, 651  
MYSQL\_TEST\_TRACE\_CRASH environment variable, 651  
MYSQL\_TEST\_TRACE\_DEBUG environment variable, 651  
mysql\_tzinfo\_to\_sql, 305, 381  
MYSQL\_UNIX\_ADDR option  
  CMake, 211  
MYSQL\_UNIX\_PORT environment variable, 308, 651, 1044, 1045  
mysql\_upgrade, 305, 382  
  bind-address option, 387  
  character-sets-dir option, 387  
  compress option, 387  
  debug option, 387  
  debug-check option, 387  
  debug-info option, 388  
  default-auth option, 388  
  default-character-set option, 388  
  defaults-extra-file option, 388  
  defaults-file option, 388  
  defaults-group-suffix option, 388  
  force option, 389  
  help option, 387  
  host option, 389

---

- login-path option, 389
- max-allowed-packet option, 389
- mysql\_upgrade\_info file, 384
- net-buffer-length option, 390
- no-defaults option, 390
- password option, 390
- pipe option, 390
- plugin-dir option, 391
- port option, 391
- print-defaults option, 391
- protocol option, 391
- shared-memory-base-name option, 391
- skip-sys-schema option, 392
- socket option, 392
- SSL options, 392
- tls-version option, 392
- upgrade-system-tables option, 392
- user option, 393
- verbose option, 393
- version-check option, 393
- write-binlog option, 393
- mysql\_upgrade\_info file
  - mysql\_upgrade, 384
- mysql\_waitpid
  - removed features, 25
- mysql\_zap
  - removed features, 25
- my\_key\_fetch() keyring service function, 1034
- my\_key\_generate() keyring service function, 1034
- my\_key\_remove() keyring service function, 1035
- my\_key\_store() keyring service function, 1035
- my\_print\_defaults, 307, 646
  - config-file option, 646
  - debug option, 646
  - defaults-extra-file option, 646
  - defaults-file option, 646
  - defaults-group-suffix option, 646
  - extra-file option, 646
  - help option, 646
  - login-path option, 647
  - no-defaults option, 647
  - show option, 647
  - verbose option, 647
  - version option, 647

## N

- Name, 3504
- name-file option
  - comp\_err, 361
- named pipes, 122, 128
- named time zone support
  - Unknown or incorrect time zone, 957
- named-commands option

---

- mysql, 410
- named\_pipe system variable, 829
- named\_pipe\_full\_access\_group system variable, 829
- names, 1660
  - case sensitivity, 1665
  - variables, 1697
- NAME\_CONST(), 2138, 4089
- naming
  - releases of MySQL, 62
- NATIONAL CHAR data type, 1817
- NATIONAL VARCHAR data type, 1817
- native backup and restore
  - backup identifiers, 3811
- native C API, 5340
- native functions
  - reference, 1871
- native operators
  - reference, 1871
- NATURAL JOIN, 2319
- natural key, 5340
- NATURAL LEFT JOIN, 2319
- NATURAL LEFT OUTER JOIN, 2319
- NATURAL RIGHT JOIN, 2319
- NATURAL RIGHT OUTER JOIN, 2319
- NCHAR data type, 1817
- NDB API
  - and distributed grant tables, 3829
  - and distributed privileges, 3829
- NDB API counters (NDB Cluster), 3829
  - scope, 3832
  - status variables associated with, 3835
  - types, 3833
- NDB API database objects
  - and NDB Cluster replication, 3933
- NDB API replica status variables
  - and NDB Cluster Replication, 3931
- NDB Cluster, 3282
  - "quick" configuration, 3362
  - administration, 3505, 3571, 3588, 3601, 3601, 3755, 3790
  - and application feature requirements, 3317
  - and DNS, 3332
  - and INFORMATION\_SCHEMA, 3928
  - and IP addressing, 3332
  - and MySQL privileges, 3927
  - and MySQL root user, 3927, 3929
  - and networking, 3293
  - and transactions, 3409
  - API node, 3287, 3493
  - applications supported, 3317
  - availability, 3315
  - available platforms, 3283
  - BACKUP Events, 3789
  - backups, 3690, 3808, 3809, 3809, 3812, 3813
  - CHECKPOINT Events, 3784

---

- cluster logs, 3780, 3781
- CLUSTERLOG commands, 3782
- CLUSTERLOG STATISTICS command, 3790
- commands, 3505, 3571, 3588, 3601, 3755
- compared to InnoDB, 3315, 3315, 3317, 3317
- compared to standalone MySQL Server, 3315, 3315, 3317, 3317
- concepts, 3287
- configuration, 3331, 3361, 3362, 3391, 3393, 3401, 3493, 3600, 3815
- configuration (example), 3384
- configuration changes, 3794
- configuration files, 3350, 3383
- configuration parameters, 3364, 3365, 3371, 3372, 3373
- configuring, 3812
- CONNECT command, 3755
- CONNECTION Events, 3783
- connection string, 3390
- CREATE NODEGROUP command, 3755
- data node, 3287, 3401
- data nodes, 3570, 3587
- defining node hosts, 3391
- direct connections between nodes, 3560
- Disk Data tables (see [NDB Cluster Disk Data](#))
- DROP NODEGROUP command, 3755
- ENTER SINGLE USER MODE command, 3756
- ERROR Events, 3788
- error logs, 3580
- event log format, 3783
- event logging thresholds, 3782
- event logs, 3780, 3781
- event severity levels, 3782
- event types, 3781, 3783
- execution threads, 3469
- EXIT command, 3757
- EXIT SINGLE USER MODE command, 3756
- FAQ, 4505
- fragment replicas, 3290
- FULLY\_REPLICATED (NDB\_TABLE), 2251
- GCP Stop errors, 3486
- general description, 3285
- HELP command, 3756
- HostName parameter
  - and security, 3923
- importing data, 3813
- indirect indexes, 2245
- INFO Events, 3788
- information sources, 3285
- insecurity of communication protocols, 3923
- installation, 3331
- installation (Linux), 3333
- installation (Windows), 3341
- installing .deb file (Linux), 3340
- installing binary (Windows), 3342
- installing binary release (Linux), 3334
- installing from source (Linux), 3340

---

installing from source (Windows), 3345  
installing RPM (Linux), 3336  
interconnects, 3289, 3570  
Java clients, 3288  
JSON, 2245  
large tables, 2217  
log files, 3580, 3588  
logging commands, 3781  
management client (ndb\_mgm), 3601  
management commands, 3790  
management node, 3287, 3393  
management nodes, 3588  
managing, 3754  
MAX\_ROWS, 2217  
memory usage and recovery, 3322, 3795  
mgm client, 3755  
mgm management client, 3790  
mgm process, 3601  
mgmd process, 3588  
monitoring, 3829  
multiple management servers, 3796  
mysqld options and variables for, 3505  
mysqld process, 3505, 3814  
ndbd, 3570  
ndbd process, 3571, 3792  
ndbinfo\_select\_all, 3581  
ndbmtd, 3587  
ndb\_mgm, 3352, 3601  
ndb\_mgmd process, 3588  
network configuration  
    and security, 3924  
networking, 3560, 3561  
node failure (single user mode), 3797  
node identifiers, 3564, 3564  
node logs, 3780  
NODELOG DEBUG command, 3756  
NODERESTART Events, 3785  
nodes and node groups, 3290  
nodes and types, 3287  
NOLOGGING (NDB\_TABLE), 2249  
partitioning support, 3321  
partitions, 3290  
PARTITION\_BALANCE (NDB\_TABLE), 2250  
performing queries, 3353  
preparing for replication, 3948  
process management, 3570  
PROMPT command, 3757  
QUIT command, 3757  
READ\_BACKUP (NDB\_TABLE), 2249  
replication, 3930  
    (see also [NDB Cluster replication](#))  
REPORT command, 3757  
requirements, 3293  
resetting, 3795

---

- RESTART command, 3758
- restarting, 3356
- restoring backups, 3690
- rolling restarts (multiple management servers), 3796
- runtime statistics, 3790
- SCHEMA Events, 3788
- security, 3923
  - and firewalls, 3924, 3926
  - and HostName parameter, 3923
  - and network configuration, 3924
  - and network ports, 3926
  - and remote administration, 3927
  - networking, 3923
- security procedures, 3929
- shared memory transport, 3561
- SHOW command, 3758
- SHUTDOWN command, 3759
- shutting down, 3356
- single user mode, 3756, 3796
- SINGLEUSER Events, 3789
- SQL node, 3287, 3493
- SQL nodes, 3814
- SQL statements for monitoring, 3914
- START BACKUP command, 3954
- START command, 3760
- start phases (summary), 3792
- starting, 3362
- starting nodes, 3346, 3352
- starting or restarting, 3792
- STARTUP Events, 3784
- STATISTICS Events, 3787
- STATUS command, 3759
- status variables, 3538
- STOP command, 3760
- storage requirements, 1862
- thread states, 1633
- trace files, 3581
- transaction handling, 3325
- transaction isolation level, 3323
- transporters, 3289, 3570
  - shared memory (SHM), 3561
  - TCP/IP, 3560
- troubleshooting backups, 3813
- upgrades and downgrades, 3357, 3794
- USING HASH, 2192
  - using tables and data, 3353
- NDB Cluster 7.5, 3294
- NDB Cluster 7.6, 3294
- NDB Cluster Auto-Installer (NO LONGER SUPPORTED), 3361, 3361
- NDB Cluster Disk Data, 3816
  - creating log file groups, 3817
  - creating tables, 3816, 3818
  - creating tablespaces, 3818
  - dropping Disk Data objects, 3820



---

- storage requirements, 3821
- NDB Cluster How-To, 3331
- NDB Cluster limitations, 3318
  - and differences from standard MySQL limits, 3322
  - binary logging, 3328
  - database objects, 3326
  - Disk Data storage, 3329
  - error handling and reporting, 3326
  - geometry data types, 3320
  - implementation, 3328
  - imposed by configuration, 3322
  - JSON columns, 3321
  - memory usage and transaction handling, 3325
  - multiple management servers, 3330
  - multiple MySQL servers, 3330
  - partitioning, 3321
  - performance, 3328
  - syntax, 3318
  - transactions, 3323
  - unsupported features, 3327
- NDB Cluster processes, 3570
- NDB Cluster programs, 3570
- NDB Cluster replication, 3930
  - and --initial option, 3938
  - and circular replication, 3934
  - and NDB API database objects, 3933
  - and primary key, 3937
  - and single point of failure, 3951
  - and unique keys, 3937
  - backups, 3954
  - bidirectional replication, 3960
  - circular replication, 3960
  - concepts, 3932, 3932
  - conflict resolution, 3965
  - failover, 3951, 3952
  - gap event, 3934
  - known issues, 3933
  - loss of connection, 3933
  - point-in-time recovery, 3959
  - preparing, 3947
  - read conflict detection and resolution, 3976
  - requirements, 3932
  - reset-replica.pl backup automation script, 3956
  - restoring from backup, 3954
  - starting, 3949
  - storage engines other than NDB on replica, 3938
  - synchronization of source and replica, 3956
  - system tables used, 3940
- NDB Cluster Replication
  - and NDB API replica status variables, 3931
- NDB Cluster replication conflict resolution
  - exceptions table, 3971
- NDB comment options, 2246
- ndb option

---

- ndb\_perror, 3684
- pererror, 649
- NDB statistics variables
  - and NDB API counters, 3835
- NDB statistics variables (NDB Cluster), 3829
  - scope, 3832
  - types, 3833
- NDB storage engine (see [NDB Cluster](#))
  - FAQ, 4505
- NDB tables
  - and MySQL root user, 3927
- NDB utilities
  - security issues, 3930
- NDB\$CFT\_CAUSE, 3973
- NDB\$EPOCH(), 3968
  - limitations, 3969
- NDB\$EPOCH2(), 3970
- NDB\$EPOCH2\_TRANS(), 3971
- NDB\$EPOCH\_TRANS(), 3968, 3970
- NDB\$MAX(), 3968
- NDB\$MAX\_DELETE\_WIN(), 3968
- NDB\$OLD, 3967
- NDB\$OP\_TYPE, 3972
- NDB\$ORIG\_TRANSID, 3973
- ndb-allow-copying-alter-table option
  - mysqld, 3505
- ndb-batch-size option
  - mysqld, 3506
- ndb-blob-read-batch-bytes option
  - mysqld, 3507
- ndb-blob-write-batch-bytes option
  - mysqld, 3508
- ndb-cluster-connection-pool option
  - mysqld, 3506
- ndb-cluster-connection-pool-nodeids option
  - mysqld, 3507
- ndb-connectstring option
  - mysqld, 3508
  - ndbd, 3578
  - ndbinfo\_select\_all, 3586
  - ndb\_blob\_tool, 3610
  - ndb\_config, 3619
  - ndb\_delete\_all, 3628
  - ndb\_desc, 3638
  - ndb\_drop\_index, 3642
  - ndb\_drop\_table, 3647
  - ndb\_import, 3663
  - ndb\_index\_stat, 3674
  - ndb\_mgm, 3604
  - ndb\_mgmd, 3596
  - ndb\_move\_data, 3681
  - ndb\_restore, 3705
  - ndb\_select\_all, 3725
  - ndb\_select\_count, 3731

---

- ndb\_show\_tables, 3736
- ndb\_waiter, 3751
- ndb-default-column-format option (NDB Cluster), 3509
- ndb-deferred-constraints option (NDB Cluster), 3509
- ndb-distribution option (NDB Cluster), 3509
- ndb-log-apply-status option
  - mysqld, 3510
- ndb-log-empty-epochs option
  - mysqld, 3510
- ndb-log-empty-update option
  - mysqld, 3511
- ndb-log-exclusive-reads option
  - mysqld, 3511
- ndb-log-fail-terminate option
  - mysqld, 3511
- ndb-log-orig option
  - mysqld, 3511
- ndb-log-transaction-id option
  - mysqld, 3512
- ndb-log-update-as-write
  - conflict resolution, 3966
- ndb-log-update-as-write option (NDB Cluster), 3512
- ndb-log-update-minimal option (NDB Cluster), 3513
- ndb-log-update-write, 3947
- ndb-log-updated-only, 3947
- ndb-log-updated-only option (NDB Cluster), 3513
- ndb-mgmd-host option
  - ndbd, 3578
  - ndbinfo\_select\_all, 3586
  - ndb\_blob\_tool, 3610
  - ndb\_config, 3619
  - ndb\_delete\_all, 3628
  - ndb\_desc, 3638
  - ndb\_drop\_index, 3643
  - ndb\_drop\_table, 3647
  - ndb\_import, 3663
  - ndb\_index\_stat, 3674
  - ndb\_mgm, 3604
  - ndb\_mgmd, 3596
  - ndb\_move\_data, 3681
  - ndb\_restore, 3705
  - ndb\_select\_all, 3726
  - ndb\_select\_count, 3731
  - ndb\_show\_tables, 3736
  - ndb\_waiter, 3751
- ndb-mgmd-host option (NDB Cluster), 3514
- ndb-nodegroup-map option
  - ndb\_restore, 3706
- ndb-nodeid option
  - mysqld, 3514
  - ndbd, 3578
  - ndbinfo\_select\_all, 3586
  - ndb\_blob\_tool, 3610
  - ndb\_config, 3619

---

- ndb\_delete\_all, 3628
- ndb\_desc, 3638
- ndb\_drop\_index, 3643
- ndb\_drop\_table, 3648
- ndb\_import, 3663
- ndb\_index\_stat, 3675
- ndb\_mgm, 3605
- ndb\_mgmd, 3596
- ndb\_move\_data, 3682
- ndb\_restore, 3706
- ndb\_select\_all, 3726
- ndb\_select\_count, 3731
- ndb\_show\_tables, 3736
- ndb\_waiter, 3751
- ndb-optimization-delay option
  - mysqld, 3515
- ndb-optimized-node-selection option
  - mysqld, 3515
  - ndbd, 3578
  - ndbinfo\_select\_all, 3586
  - ndb\_blob\_tool, 3611
  - ndb\_config, 3619
  - ndb\_delete\_all, 3628
  - ndb\_desc, 3638
  - ndb\_drop\_index, 3643
  - ndb\_drop\_table, 3648
  - ndb\_import, 3664
  - ndb\_index\_stat, 3675
  - ndb\_mgm, 3605
  - ndb\_mgmd, 3597
  - ndb\_move\_data, 3682
  - ndb\_restore, 3706
  - ndb\_select\_all, 3726
  - ndb\_select\_count, 3731
  - ndb\_show\_tables, 3736
  - ndb\_waiter, 3751
- ndb-transid-mysql-connection-map option
  - mysqld, 3515
- ndb-wait-connected option
  - mysqld, 3516
- ndb-wait-setup option
  - mysqld, 3516
- ndbcluster option
  - mysqld, 3505
- NDBCLUSTER storage engine (see [NDB Cluster](#))
- ndbd, 3570, 3570
  - n option, 3579
  - character-sets-dir option, 3573
  - connect-delay option, 3573
  - connect-retries option, 3574
  - connect-retry-delay option, 3574
  - connect-string option, 3574
  - core-file option, 3574
  - defaults-extra-file option, 3575

---

- defaults-file option, 3575
- defaults-group-suffix option, 3575
- help option, 3575
- initial option, 3576
- initial-start option, 3577
- install option, 3577
- logbuffer-size option, 3577
- login-path option, 3578
- ndb-connectstring option, 3578
- ndb-mgmd-host option, 3578
- ndb-nodeid option, 3578
- ndb-optimized-node-selection option, 3578
- no-defaults option, 3579
- nostart option, 3579
- nowait-nodes option, 3579
- print-defaults option, 3579
- remove option, 3579
- usage option, 3580
- verbose option, 3580
- version option, 3580
- ndbd (NDB Cluster)
  - defined, 3287
  - (see also [data node \(NDB Cluster\)](#))
- ndbinfo database, 3840
  - and query cache, 3843
  - basic usage, 3844
  - determining support for, 3840
- ndbinfo\_database system variable, 3536
- ndbinfo\_max\_bytes system variable, 3536
- ndbinfo\_max\_rows system variable, 3536
- ndbinfo\_offline system variable, 3537
- ndbinfo\_select\_all, 3570, 3581
  - l option, 3585
  - character-sets-dir option, 3584
  - connect-retries option, 3584
  - connect-retry-delay option, 3584
  - connect-string option, 3584
  - core-file option, 3584
  - defaults-extra-file option, 3584
  - defaults-file option, 3585
  - defaults-group-suffix option, 3585
  - delay option, 3585
  - help option, 3585
  - login-path option, 3585
  - loops option, 3585
  - ndb-connectstring option, 3586
  - ndb-mgmd-host option, 3586
  - ndb-nodeid option, 3586
  - ndb-optimized-node-selection option, 3586
  - no-defaults option, 3586
  - print-defaults option, 3586
  - usage option, 3587
  - version option, 3587
- ndbinfo\_show\_hidden system variable, 3537

---

ndbinfo\_table\_prefix system variable, 3537  
ndbinfo\_version system variable, 3538, 3538  
ndbmtd, 3570, 3587  
  -n option, 3579  
  configuration, 3472, 3473, 3473  
  connect-delay option, 3573  
  connect-retries option, 3574  
  connect-retry-delay option, 3574  
  initial option, 3576  
  initial-start option, 3577  
  install option, 3577  
  logbuffer-size option, 3577  
  MaxNoOfExecutionThreads, 3469  
  nstart option, 3579  
  nowait-nodes option, 3579  
  remove option, 3579  
  trace files, 3588, 3588  
  verbose option, 3580  
Ndb\_api\_adaptive\_send\_deferred\_count status variable, 3538  
Ndb\_api\_adaptive\_send\_deferred\_count\_session status variable, 3538  
Ndb\_api\_adaptive\_send\_deferred\_count\_slave status variable, 3538  
Ndb\_api\_adaptive\_send\_forced\_count status variable, 3538  
Ndb\_api\_adaptive\_send\_forced\_count\_session status variable, 3538  
Ndb\_api\_adaptive\_send\_forced\_count\_slave status variable, 3539  
Ndb\_api\_adaptive\_send\_unforced\_count status variable, 3539  
Ndb\_api\_adaptive\_send\_unforced\_count\_slave session variable, 3539  
Ndb\_api\_adaptive\_send\_unforced\_count\_slave status variable, 3539  
Ndb\_api\_bytes\_received\_count status variable, 3540  
Ndb\_api\_bytes\_received\_count\_session status variable, 3540  
Ndb\_api\_bytes\_received\_count\_slave status variable, 3540  
Ndb\_api\_bytes\_sent\_count status variable, 3539  
Ndb\_api\_bytes\_sent\_count\_session status variable, 3539  
Ndb\_api\_bytes\_sent\_count\_slave status variable, 3539  
Ndb\_api\_event\_bytes\_count status variable, 3541  
Ndb\_api\_event\_bytes\_count\_injector status variable, 3541  
Ndb\_api\_event\_data\_count status variable, 3540  
Ndb\_api\_event\_data\_count\_injector status variable, 3540  
Ndb\_api\_event\_nodata\_count status variable, 3541  
Ndb\_api\_event\_nodata\_count\_injector status variable, 3540  
Ndb\_api\_pk\_op\_count status variable, 3541  
Ndb\_api\_pk\_op\_count\_session status variable, 3541  
Ndb\_api\_pk\_op\_count\_slave status variable, 3541  
Ndb\_api\_pruned\_scan\_count status variable, 3542  
Ndb\_api\_pruned\_scan\_count\_session status variable, 3542  
Ndb\_api\_pruned\_scan\_count\_slave status variable, 3542  
Ndb\_api\_range\_scan\_count status variable, 3542  
Ndb\_api\_range\_scan\_count\_session status variable, 3542  
Ndb\_api\_range\_scan\_count\_slave status variable, 3542  
Ndb\_api\_read\_row\_count status variable, 3543  
Ndb\_api\_read\_row\_count\_session status variable, 3543  
Ndb\_api\_read\_row\_count\_slave status variable, 3543  
Ndb\_api\_scan\_batch\_count status variable, 3544  
Ndb\_api\_scan\_batch\_count\_session status variable, 3543  
Ndb\_api\_scan\_batch\_count\_slave status variable, 3543

---

Ndb\_api\_table\_scan\_count status variable, 3544  
Ndb\_api\_table\_scan\_count\_session status variable, 3544  
Ndb\_api\_table\_scan\_count\_slave status variable, 3544  
Ndb\_api\_trans\_abort\_count status variable, 3545  
Ndb\_api\_trans\_abort\_count\_session status variable, 3544  
Ndb\_api\_trans\_abort\_count\_slave status variable, 3544  
Ndb\_api\_trans\_close\_count status variable, 3545  
Ndb\_api\_trans\_close\_count\_session status variable, 3545  
Ndb\_api\_trans\_close\_count\_slave status variable, 3545  
Ndb\_api\_trans\_commit\_count status variable, 3546  
Ndb\_api\_trans\_commit\_count\_session status variable, 3545  
Ndb\_api\_trans\_commit\_count\_slave status variable, 3546  
Ndb\_api\_trans\_local\_read\_row\_count status variable, 3546  
Ndb\_api\_trans\_local\_read\_row\_count\_session status variable, 3546  
Ndb\_api\_trans\_local\_read\_row\_count\_slave status variable, 3546  
Ndb\_api\_trans\_start\_count status variable, 3547  
Ndb\_api\_trans\_start\_count\_session status variable, 3546  
Ndb\_api\_trans\_start\_count\_slave status variable, 3547  
Ndb\_api\_uk\_op\_count status variable, 3547  
Ndb\_api\_uk\_op\_count\_session status variable, 3547  
Ndb\_api\_uk\_op\_count\_slave status variable, 3547  
Ndb\_api\_wait\_exec\_complete\_count status variable, 3548  
Ndb\_api\_wait\_exec\_complete\_count\_session status variable, 3547  
Ndb\_api\_wait\_exec\_complete\_count\_slave status variable, 3548  
Ndb\_api\_wait\_meta\_request\_count status variable, 3548  
Ndb\_api\_wait\_meta\_request\_count\_session status variable, 3548  
Ndb\_api\_wait\_meta\_request\_count\_slave status variable, 3548  
Ndb\_api\_wait\_nanos\_count status variable, 3549  
Ndb\_api\_wait\_nanos\_count\_session status variable, 3548  
Ndb\_api\_wait\_nanos\_count\_slave status variable, 3549  
Ndb\_api\_wait\_scan\_result\_count status variable, 3549  
Ndb\_api\_wait\_scan\_result\_count\_session status variable, 3549  
Ndb\_api\_wait\_scan\_result\_count\_slave status variable, 3549  
ndb\_apply\_status table (NDB Cluster replication), 3941, 3952  
(see also [NDB Cluster replication](#))  
ndb\_autoincrement\_prefetch\_sz system variable, 3517  
ndb\_binlog\_index table  
  system table, 970  
ndb\_binlog\_index table (NDB Cluster replication), 3942, 3953  
(see also [NDB Cluster replication](#))  
ndb\_blob\_tool, 3570, 3606  
  add-missing option, 3608  
  character-sets-dir option, 3608  
  check-missing option, 3608  
  check-orphans option, 3608  
  connect-retries option, 3608  
  connect-retry-delay option, 3608  
  connect-string option, 3609  
  core-file option, 3609  
  database option, 3609  
  defaults-extra-file option, 3609  
  defaults-file option, 3609  
  defaults-group-suffix option, 3609  
  delete-orphans option, 3610

---

dump-file option, 3610  
help option, 3610  
login-path option, 3610  
ndb-connectstring option, 3610  
ndb-mgmd-host option, 3610  
ndb-nodeid option, 3610  
ndb-optimized-node-selection option, 3611  
no-defaults option, 3611  
print-defaults option, 3611  
usage option, 3611  
verbose option, 3611  
version option, 3611  
ndb\_cache\_check\_time  
  deprecated features, 20  
ndb\_cache\_check\_time system variable, 3517  
ndb\_clear\_apply\_status system variable, 3518  
Ndb\_cluster\_node\_id status variable, 3550  
NDB\_COLUMN, 2247  
ndb\_config, 3570, 3612  
  character-sets-dir option, 3615  
  config-file option, 3616  
  configinfo option, 3615  
  config\_from\_node option, 3616  
  connect-retries option, 3616  
  connect-retry-delay option, 3616  
  connect-string option, 3617  
  connections option, 3616  
  core-file option, 3617  
  defaults-extra-file option, 3617  
  defaults-file option, 3617  
  defaults-group-suffix option, 3617  
  diff-default option, 3617  
  fields option, 3618  
  help option, 3618  
  host option, 3618  
  login-path option, 3618  
  mycnf option, 3618  
  ndb-connectstring option, 3619  
  ndb-mgmd-host option, 3619  
  ndb-nodeid option, 3619  
  ndb-optimized-node-selection option, 3619  
  no-defaults option, 3619  
  nodeid option, 3619  
  nodes option, 3620  
  print-defaults option, 3620  
  query option, 3620, 3620  
  query-all option, 3620  
  rows option, 3620  
  system option, 3621  
  type option, 3621  
  usage option, 3621  
  version option, 3621  
  xml option, 3621  
Ndb\_config\_from\_host status variable, 3550



---

Ndb\_config\_from\_port status variable, 3550  
Ndb\_conflict\_fn\_epoch status variable, 3550  
Ndb\_conflict\_fn\_epoch2 status variable, 3550  
Ndb\_conflict\_fn\_epoch2\_trans status variable, 3550  
Ndb\_conflict\_fn\_epoch\_trans status variable, 3550  
Ndb\_conflict\_fn\_max status variable, 3550  
Ndb\_conflict\_fn\_max\_del\_win status variable, 3551  
Ndb\_conflict\_fn\_old status variable, 3551  
Ndb\_conflict\_last\_conflict\_epoch status variable, 3551  
Ndb\_conflict\_last\_stable\_epoch status variable, 3551  
Ndb\_conflict\_reflected\_op\_discard\_count status variable, 3551  
Ndb\_conflict\_reflected\_op\_prepare\_count status variable, 3551  
Ndb\_conflict\_refresh\_op\_count status variable, 3551  
Ndb\_conflict\_trans\_conflict\_commit\_count status variable, 3552  
Ndb\_conflict\_trans\_detect\_iter\_count status variable, 3552  
Ndb\_conflict\_trans\_reject\_count status variable, 3552  
Ndb\_conflict\_trans\_row\_conflict\_count status variable, 3551  
Ndb\_conflict\_trans\_row\_reject\_count status variable, 3552  
ndb\_cpcd, 3570, 3624  
ndb\_data\_node\_neighbour system variable, 3518  
ndb\_default\_column\_format system variable, 3519  
ndb\_deferred\_constraints system variable, 3519  
ndb\_delete\_all, 3570, 3624  
    character-sets-dir option, 3626  
    connect-retries option, 3626  
    connect-retry-delay option, 3626  
    connect-string option, 3626  
    core-file option, 3627  
    database option, 3627  
    defaults-extra-file option, 3627  
    defaults-file option, 3627  
    defaults-group-suffix option, 3627  
    diskscan option, 3627  
    help option, 3627  
    login-path option, 3628  
    ndb-connectstring option, 3628  
    ndb-mgmd-host option, 3628  
    ndb-nodeid option, 3628  
    ndb-optimized-node-selection option, 3628  
    no-defaults option, 3628  
    print-defaults option, 3628  
    transactional option, 3629  
    tupscan option, 3629  
    usage option, 3629  
    version option, 3629  
ndb\_desc, 3570, 3629  
    auto-inc option, 3636  
    blob-info option, 3636  
    character-sets-dir option, 3636  
    connect-retries option, 3636  
    connect-retry-delay option, 3636  
    connect-string option, 3636  
    context option, 3637  
    core-file option, 3637

---

- database option, 3637
- defaults-extra-file option, 3637
- defaults-file option, 3637
- defaults-group-suffix option, 3637
- extra-node-info option, 3637
- extra-partition-info option, 3637
- help option, 3638
- login-path option, 3638
- ndb-connectstring option, 3638
- ndb-mgmd-host option, 3638
- ndb-nodeid option, 3638
- ndb-optimized-node-selection option, 3638
- no-defaults option, 3638
- print-defaults option, 3639
- retries option, 3639
- table option, 3639
- unqualified option, 3639
- usage option, 3639
- version option, 3639
- ndb\_distribution system variable, 3520
- ndb\_dist\_priv.sql, 3826
- ndb\_drop\_index, 3570, 3639
  - character-sets-dir option, 3641
  - connect-retries option, 3641
  - connect-retry-delay option, 3641
  - connect-string option, 3641
  - core-file option, 3641
  - database option, 3641
  - defaults-extra-file option, 3642
  - defaults-file option, 3642
  - defaults-group-suffix option, 3642
  - help option, 3642
  - login-path option, 3642
  - ndb-connectstring option, 3642
  - ndb-mgmd-host option, 3643
  - ndb-nodeid option, 3643
  - ndb-optimized-node-selection option, 3643
  - no-defaults option, 3643
  - print-defaults option, 3643
  - usage option, 3643
  - version option, 3643
- ndb\_drop\_table, 3570, 3644
  - character-sets-dir option, 3646
  - connect-retries option, 3646
  - connect-retry-delay option, 3646
  - connect-string option, 3646
  - core-file option, 3646
  - database option, 3646
  - defaults-extra-file option, 3646
  - defaults-file option, 3647
  - defaults-group-suffix option, 3647
  - help option, 3647
  - login-path option, 3647
  - ndb-connectstring option, 3647

---

ndb-mgmd-host option, 3647  
ndb-nodeid option, 3648  
ndb-optimized-node-selection option, 3648  
no-defaults option, 3648  
print-defaults option, 3648  
usage option, 3648  
version option, 3648  
Ndb\_epoch\_delete\_delete\_count status variable, 3552  
ndb\_error\_reporter, 3570, 3648  
  connection-timeout option, 3649  
  dry-scp option, 3649  
  fs option, 3649  
  help option, 3649  
  options, 3649  
  skip-nodegroup option, 3650  
ndb\_eventbuffer\_free\_percent system variable, 3520  
ndb\_eventbuffer\_max\_alloc system variable, 3520  
Ndb\_execute\_count status variable, 3552  
ndb\_extra\_logging system variable, 3521  
ndb\_force\_send system variable, 3521  
ndb\_fully\_replicated system variable, 3521  
ndb\_import, 3570, 3650  
  abort-on-error option, 3655  
  ai-increment option, 3655  
  ai-offset option, 3655  
  ai-prefetch-sz option, 3656  
  character-sets-dir option, 3656  
  connect-retries option, 3656  
  connect-retry-delay option, 3656  
  connect-string option, 3657  
  connections option, 3657  
  continue option, 3657  
  core-file option, 3657  
  csvopt option, 3657  
  db-workers option, 3658  
  defaults-extra-file option, 3658  
  defaults-file option, 3658  
  defaults-group-suffix option, 3659  
  errins-delay option, 3659  
  errins-type option, 3659  
  fields-enclosed-by option, 3659  
  fields-escaped-by option, 3660  
  fields-optionally-enclosed-by option, 3660  
  fields-terminated-by option, 3660  
  help option, 3660  
  idlesleep option, 3660  
  idlespin option, 3661  
  ignore-lines option, 3661  
  input-type option, 3661  
  input-workers option, 3661  
  keep-state option, 3662  
  lines-terminated-by option, 3662  
  log-level option, 3662  
  login-path option, 3662

---

max-rows option, 3662  
monitor option, 3663  
ndb-connectstring option, 3663  
ndb-mgmd-host option, 3663  
ndb-nodeid option, 3663  
ndb-optimized-node-selection option, 3664  
no-asynch option, 3664  
no-defaults option, 3664  
no-hint option, 3664  
opbatch option, 3664  
opbytes option, 3664  
output-type option, 3665  
output-workers option, 3665  
pagecnt option, 3665  
pagesize option, 3665  
polltimeout option, 3666  
print-defaults option, 3666  
rejects option, 3666  
resume option, 3666  
rowbatch option, 3667  
rowbytes option, 3667  
state-dir option, 3667  
stats option, 3667  
tempdelay option, 3667  
temperrors option, 3668  
usage option, 3668  
verbose option, 3668  
version option, 3668  
ndb\_index\_stat, 3570, 3669  
-d option, 3673  
character-sets-dir option, 3672  
connect-retries option, 3672  
connect-retry-delay option, 3672  
connect-string option, 3673  
core-file option, 3673  
database option, 3673  
defaults-extra-file option, 3673  
defaults-file option, 3673  
defaults-group-suffix option, 3673  
delete option, 3673  
dump option, 3674  
example, 3669  
help option, 3674  
interpreting output, 3669  
login-path option, 3674  
loops option, 3674  
ndb-connectstring option, 3674  
ndb-mgmd-host option, 3674  
ndb-nodeid option, 3675  
ndb-optimized-node-selection option, 3675  
no-defaults option, 3675  
print-defaults option, 3675  
query option, 3675  
sys-check option, 3676

---

- sys-create option, 3675
- sys-create-if-not-exist option, 3676
- sys-create-if-not-valid option, 3676
- sys-drop option, 3675
- sys-skip-events option, 3676
- sys-skip-tables option, 3676
- update option, 3676
- usage option, 3676
- verbose option, 3676
- version option, 3676
- ndb\_index\_stat\_enable system variable, 3522
- ndb\_index\_stat\_option system variable, 3522
- ndb\_join\_pushdown system variable, 3524
- Ndb\_last\_commit\_epoch\_server status variable, 3552
- Ndb\_last\_commit\_epoch\_session status variable, 3552
- ndb\_log\_apply\_status system variable, 3526
- ndb\_log\_apply\_status variable (NDB Cluster replication), 3952
- ndb\_log\_bin system variable, 3526
- ndb\_log\_binlog\_index system variable, 3526
- ndb\_log\_empty\_epochs system variable, 3527
- ndb\_log\_empty\_update system variable, 3527
- ndb\_log\_exclusive\_reads (system variable), 3977
- ndb\_log\_exclusive\_reads system variable, 3527
- ndb\_log\_orig system variable, 3527
- ndb\_log\_transaction\_id system variable, 3528
- ndb\_mgm, 3570, 3600 (see mgm)
  - e option, 3604
  - character-sets-dir option, 3602
  - connect-retries option, 3602
  - connect-retry-delay option, 3603
  - connect-string option, 3603
  - core-file option, 3603
  - defaults-extra-file option, 3603
  - defaults-file option, 3603
  - defaults-group-suffix option, 3603
  - execute option, 3604
  - help option, 3604
  - login-path option, 3604
  - ndb-connectstring option, 3604
  - ndb-mgmd-host option, 3604
  - ndb-nodeid option, 3605
  - ndb-optimized-node-selection option, 3605
  - no-defaults option, 3605
  - print-defaults option, 3605
  - usage option, 3605
  - using with MySQL Cluster Manager, 3755
  - version option, 3606
- ndb\_mgm (NDB Cluster management node client), 3352
- ndb\_mgmd, 3570 (see mgmd)
  - d option, 3594
  - f option, 3592
  - P option, 3599
  - v option, 3600
  - bind-address option, 3591

---

- character-sets-dir option, 3591
- config-cache option, 3591
- config-file option, 3592
- configdir option, 3593
- connect-retries option, 3593
- connect-retry-delay option, 3593
- connect-string option, 3593
- core-file option, 3594
- daemon option, 3594
- defaults-extra-file option, 3594
- defaults-file option, 3594
- defaults-group-suffix option, 3594
- help option, 3594
- initial option, 3595
- install option, 3595
- interactive option, 3595
- log-name option, 3596
- login-path option, 3596
- mycnf option, 3596
- ndb-connectstring option, 3596
- ndb-mgmd-host option, 3596
- ndb-nodeid option, 3596
- ndb-optimized-node-selection option, 3597
- no-defaults option, 3597
- no-nodeid-checks option, 3597
- nodaemon option, 3597
- nowait-nodes option, 3597
- print-defaults option, 3599
- print-full-config option, 3599
- reload option, 3599
- remove option, 3599
- skip-config-file option, 3600
- usage option, 3600
- verbose option, 3600
- version option, 3600
- ndb\_mgmd (NDB Cluster process), 3588
- ndb\_mgmd (NDB Cluster)
  - defined, 3287
  - (see also [management node \(NDB Cluster\)](#))
- ndb\_move\_data, 3570, 3677
  - abort-on-error option, 3679
  - character-sets-dir option, 3679
  - connect-retries option, 3680
  - connect-retry-delay option, 3679
  - connect-string option, 3680
  - core-file option, 3680
  - database option, 3680
  - defaults-extra-file option, 3680
  - defaults-file option, 3680
  - defaults-group-suffix option, 3680
  - drop-source option, 3681
  - error-insert option, 3681
  - exclude-missing-columns option, 3681
  - help option, 3681

---

- login-path option, 3681
- lossy-conversions option, 3681
- ndb-connectstring option, 3681
- ndb-mgmd-host option, 3681
- ndb-nodeid option, 3682
- ndb-optimized-node-selection option, 3682
- no-defaults option, 3682
- print-defaults option, 3682
- promote-attributes option, 3682
- staging-tries option, 3682
- usage option, 3683
- verbose option, 3683
- version option, 3683
- Ndb\_number\_of\_data\_nodes status variable, 3552
- ndb\_optimized\_node\_selection system variable, 3528
- ndb\_perror, 3683
  - help option, 3684
  - ndb option, 3684
  - silent option, 3684
  - verbose option, 3685
  - version option, 3685
- ndb\_print\_backup\_file, 3570, 3685
- ndb\_print\_file, 3570, 3685
- ndb\_print\_frag\_file, 3570, 3686
- ndb\_print\_schema\_file, 3570, 3687
- ndb\_print\_sys\_file, 3570, 3687
- Ndb\_pruned\_scan\_count status variable, 3553
- Ndb\_pushed\_queries\_defined status variable, 3552
- Ndb\_pushed\_queries\_dropped status variable, 3553
- Ndb\_pushed\_queries\_executed status variable, 3553
- Ndb\_pushed\_reads status variable, 3553
- ndb\_read\_backup
  - and NDB\_TABLE, 2249
- ndb\_read\_backup system variable, 3529
- ndb\_rcv\_thread\_activation\_threshold system variable, 3530
- ndb\_rcv\_thread\_cpu\_mask system variable, 3530
- ndb\_redo\_log\_reader, 3687
  - dump option, 3689
  - lap option, 3689
  - twiddle option, 3690
- ndb\_replication table, 3943
- ndb\_report\_thresh\_binlog\_epoch\_slip system variable, 3530
- ndb\_report\_thresh\_binlog\_mem\_usage system variable, 3531
- ndb\_restore, 3690
  - allow-pk-changes option, 3695
  - and circular replication, 3962
  - and distributed privileges, 3828
  - append option, 3697
  - backup-path option, 3697
  - backupid option, 3697
  - character-sets-dir option, 3698
  - connect option, 3698
  - connect-retries option, 3698
  - connect-retry-delay option, 3698

---

connect-string option, 3698  
core-file option, 3699  
defaults-extra-file option, 3699  
defaults-file option, 3699  
defaults-group-suffix option, 3699  
disable-indexes option, 3699  
dont-ignore-systab-0 option, 3699  
errors, 3716  
exclude-databases option, 3699  
exclude-intermediate-sql-tables option, 3700  
exclude-missing-columns option, 3700  
exclude-missing-tables option, 3700  
exclude-tables option, 3700  
fields-enclosed-by option, 3702  
fields-optionally-enclosed-by option, 3702  
fields-terminated-by option, 3702  
help option, 3703  
hex option, 3703  
ignore-extended-pk-updates option, 3703  
include-databases option, 3703  
include-tables option, 3704  
lines-terminated-by option, 3704  
login-path option, 3705  
lossy-conversions option, 3705  
ndb-connectstring option, 3705  
ndb-mgmd-host option, 3705  
ndb-nodegroup-map option, 3706  
ndb-nodeid option, 3706  
ndb-optimized-node-selection option, 3706  
no-binlog option, 3706  
no-defaults option, 3706  
no-restore-disk-objects option, 3706  
no-upgrade option, 3706  
nodeid option, 3706  
num-slices option, 3707  
parallelism option, 3707  
preserve-trailing-spaces option, 3708  
print option, 3708  
print-data option, 3708  
print-defaults option, 3709  
print-log option, 3709  
print-meta option, 3709  
print-sql-log option, 3709  
progress-frequency option, 3709  
promote-attributes option, 3709  
rebuild-indexes option, 3710  
remap-column option, 3711  
restore-data option, 3712  
restore-epoch option, 3712  
restore-meta option, 3712  
restore-privilege-tables option, 3713  
rewrite-database option, 3713  
skip-broken-objects option, 3713  
skip-table-check option, 3714



---

skip-unknown-objects option, 3714  
slice-id option, 3714  
tab option, 3714  
timestamp-printouts option, 3715  
typical and required options, 3715  
usage option, 3715  
verbose option, 3715  
version option, 3715  
ndb\_row\_checksum system variable, 3531  
Ndb\_scan\_count status variable, 3553  
ndb\_select\_all, 3570, 3721  
  character-sets-dir option, 3723  
  connect-retries option, 3723  
  connect-retry-delay option, 3723  
  connect-string option, 3723  
  core-file option, 3724  
  database option, 3724  
  defaults-extra-file option, 3724  
  defaults-file option, 3724  
  defaults-group-suffix option, 3724  
  delimiter option, 3724  
  descending option, 3724  
  disk option, 3724  
  gci option, 3725  
  gci64 option, 3725  
  header option, 3725  
  help option, 3725  
  lock option, 3725  
  login-path option, 3725  
  ndb-connectstring option, 3725  
  ndb-mgmd-host option, 3726  
  ndb-nodeid option, 3726  
  ndb-optimized-node-selection option, 3726  
  no-defaults option, 3726  
  nodata option, 3725  
  order option, 3726  
  parallelism option, 3726  
  print-defaults option, 3726  
  rowid option, 3726  
  tupscan option, 3726  
  usage option, 3727  
  useHexFormat option, 3727  
  version option, 3727  
ndb\_select\_count, 3570, 3728  
  character-sets-dir option, 3729  
  connect-retries option, 3729  
  connect-retry-delay option, 3730  
  connect-string option, 3730  
  core-file option, 3730  
  defaults-extra-file option, 3730  
  defaults-file option, 3730  
  defaults-group-suffix option, 3730  
  help option, 3731  
  login-path option, 3731

---

- ndb-connectstring option, 3731
- ndb-mgmd-host option, 3731
- ndb-nodeid option, 3731
- ndb-optimized-node-selection option, 3731
- no-defaults option, 3732
- print-defaults option, 3732
- usage option, 3732
- version option, 3732
- ndb\_setup.py (NO LONGER SUPPORTED), 3570
- ndb\_show\_foreign\_key\_mock\_tables system variable, 3532
- ndb\_show\_tables, 3570, 3732
  - character-sets-dir option, 3734
  - connect-retries option, 3734
  - connect-retry-delay option, 3734
  - connect-string option, 3734
  - core-file option, 3735
  - database option, 3735
  - defaults-extra-file option, 3735
  - defaults-file option, 3735
  - defaults-group-suffix option, 3735
  - help option, 3735
  - login-path option, 3736
  - loops option, 3736
  - ndb-connectstring option, 3736
  - ndb-mgmd-host option, 3736
  - ndb-nodeid option, 3736
  - ndb-optimized-node-selection option, 3736
  - no-defaults option, 3736
  - parsable option, 3737
  - print-defaults option, 3737
  - show-temp-status option, 3737
  - type option, 3737
  - unqualified option, 3737
  - usage option, 3737
  - version option, 3737
- ndb\_size.pl, 3570, 3737
- ndb\_size.pl script, 1863
- ndb\_slave\_conflict\_role system variable, 3532
- Ndb\_slave\_max\_replicated\_epoch status variable, 3553
- Ndb\_system\_name status variable, 3553
- NDB\_TABLE, 2214, 2249
- ndb\_table\_no\_logging system variable, 3532
- ndb\_table\_temporary system variable, 3533
- ndb\_top, 3570, 3740
  - color option, 3742
  - defaults-extra-file option, 3743
  - defaults-file option, 3743
  - defaults-group-suffix option, 3743
  - graph option, 3743
  - help option, 3743
  - host option, 3743
  - login-path option, 3744
  - measured-load option, 3744
  - no-defaults option, 3744

---

- node-id option, 3744
- os-load option, 3744
- passwd option, 3744
- password option, 3745
- port option, 3745
- print-defaults option, 3745
- sleep-time option, 3745
- socket option, 3745
- sort option, 3745
- text option, 3746
- usage option, 3746
- user option, 3746
- ndb\_transid\_mysql\_connection\_map
  - INFORMATION\_SCHEMA table, 4125
- ndb\_use\_copying\_alter\_table system variable, 3533
- ndb\_use\_exact\_count system variable, 3533
- ndb\_use\_transactions system variable, 3533
- ndb\_version system variable, 3534
- ndb\_version\_string system variable, 3534
- ndb\_waiter, 3570, 3747
  - character-sets-dir option, 3749
  - connect-retries option, 3749
  - connect-retry-delay option, 3750
  - connect-string option, 3750
  - core-file option, 3750
  - defaults-extra-file option, 3750
  - defaults-file option, 3750
  - defaults-group-suffix option, 3750
  - help option, 3751
  - login-path option, 3751
  - ndb-connectstring option, 3751
  - ndb-mgmd-host option, 3751
  - ndb-nodeid option, 3751
  - ndb-optimized-node-selection option, 3751
  - no-contact option, 3751
  - no-defaults option, 3752
  - not-started option, 3752
  - nowait-nodes option, 3752
  - print-defaults option, 3752
  - single-user option, 3752
  - timeout option, 3752
  - usage option, 3752
  - version option, 3752
  - wait-nodes option, 3753
- negative values, 1654
- neighbor page, 5341
- nested queries, 2327
- Nested-Loop join algorithm, 1459
- nested-loop join algorithm, 1462
- .NET, 5340
- net-buffer-length option
  - mysql, 410
  - mysqldump, 496
  - mysqlpump, 529

---

- mysql\_upgrade, 390
- netmask notation
  - in account names, 1112
- network ports
  - and NDB Cluster, 3926
- net\_buffer\_length system variable, 830
- net\_read\_timeout system variable, 830
- net\_retry\_count system variable, 830
- net\_write\_timeout system variable, 831
- new features, 9
  - ALTER TABLE partition validation, 17
  - character sets, 17
  - condition handling, 15
  - generated columns, 16
  - Group Replication and Performance Schema, 18
  - Group Replication SQL statements, 18
  - HANDLER, 17
  - index condition pushdown, 17
  - InnoDB, 11
  - JSON, 14
  - logging, 16
  - MeCab full-text parser plugin, 11
  - multi-source replication, 18
  - mysql client, 16
  - mysqlbinlog, 16
  - ngram full-text parser plugin, 11
  - online ALTER TABLE, 11
  - optimizer, 15
  - replication source, 17
  - security, 9
  - show\_compatibility\_56, 15
  - source dump thread, 17
  - SQL mode, 10
  - sys schema, 15
  - system and status variables, 15
  - test suite, 18
  - triggers, 16
- new features in NDB Cluster, 3294
- new system variable, 831
- newline (\n), 1653, 2106, 2295
- next-key lock, 2612, 5341
  - InnoDB, 2628, 2779
- NFS
  - InnoDB, 2633
- ngram full-text parser plugin
  - new features, 11
- ngram\_token\_size system variable, 831
- nice option
  - mysqld\_safe, 348
- no matching rows, 4573
- no-asynch option
  - ndb\_import, 3664
- no-auto-rehash option
  - mysql, 410

---

no-autocommit option  
mysqldump, 498

no-beep option  
mysql, 410  
mysqladmin, 445

no-binlog option  
ndb\_restore, 3706

no-check option  
innochecksum, 571

no-contact option  
ndb\_waiter, 3751

no-create-db option  
mysqldump, 481  
mysqlpump, 530

no-create-info option  
mysqldump, 482  
mysqlpump, 530

no-data option  
mysqldump, 494

no-defaults option, 318  
myisamchk, 581  
mysql, 411  
mysqladmin, 445  
mysqlbinlog, 624  
mysqlcheck, 460  
mysqld, 753  
mysqldump, 480  
mysqld\_multi, 355  
mysqld\_safe, 348  
mysqlimport, 510  
mysqlpump, 530  
mysqlshow, 546  
mysqlslap, 562  
mysql\_install\_db, 369  
mysql\_plugin, 372  
mysql\_secure\_installation, 376  
mysql\_upgrade, 390  
my\_print\_defaults, 647  
ndbd, 3579  
ndbinfo\_select\_all, 3586  
ndb\_blob\_tool, 3611  
ndb\_config, 3619  
ndb\_delete\_all, 3628  
ndb\_desc, 3638  
ndb\_drop\_index, 3643  
ndb\_drop\_table, 3648  
ndb\_import, 3664  
ndb\_index\_stat, 3675  
ndb\_mgm, 3605  
ndb\_mgmd, 3597  
ndb\_move\_data, 3682  
ndb\_restore, 3706  
ndb\_select\_all, 3726  
ndb\_select\_count, 3732

---

- ndb\_show\_tables, 3736
- ndb\_top, 3744
- ndb\_waiter, 3752
- no-drop option
  - mysqlslap, 562
- no-hint option
  - ndb\_import, 3664
- no-log option
  - mysqld\_multi, 356
- no-nodeid-checks option
  - ndb\_mgmd, 3597
- no-restore-disk-objects option
  - ndb\_restore, 3706
- no-set-names option
  - mysqldump, 485
- no-tablespaces option
  - mysqldump, 482
- no-upgrade option
  - ndb\_restore, 3706
- nodaemon option
  - ndb\_mgmd, 3597
- nodata option
  - ndb\_select\_all, 3725
- node groups (NDB Cluster), 3290
- node logs (NDB Cluster), 3780
- node-id option
  - ndb\_top, 3744
- NodeGroup, 3404
- NodId, 3394, 3402, 3494
- nodeid option
  - ndb\_config, 3619
  - ndb\_restore, 3706
- NodId1, 3555, 3564
- NodId2, 3555, 3564
- NodIdServer, 3556, 3565
- NODELOG DEBUG command (NDB Cluster), 3756
- NODERESTART Events (NDB Cluster), 3785
- nodes
  - ndbinfo table, 3886
- nodes option
  - ndb\_config, 3620
- NOLOGGING, 2249
- NOLOGGING (NDB\_TABLE)
  - NDB Cluster, 2249
- non-locking read, 5341
- non-repeatable read, 5341
- nonblocking I/O, 5341
- nondelimited strings, 1656
- nondeterministic functions
  - optimization, 1486
  - replication, 1486
- nonlogging tables
  - NDB Cluster, 2249, 3532
- Nontransactional tables, 4572

---

NoOfFragmentLogFiles, 3426  
NoOfFragmentLogParts, 3473  
NoOfReplicas, 3405  
nopager command  
  mysql, 422  
normalized, 5341  
normalized JSON values, 1851  
normalize\_statement() MySQL Enterprise Firewall function, 1380  
NoSQL, 3251, 5342  
NoSQL database  
  MySQL as a, 3253  
nostart option  
  ndbd, 3579  
  ndbmt, 3579  
NOT  
  logical, 1906  
NOT BETWEEN, 1902  
not equal (!=), 1900  
not equal (<>), 1900  
NOT EXISTS  
  with subqueries, 2332  
NOT EXISTS() operator, 1902  
NOT IN, 1903  
NOT LIKE, 1964  
NOT NULL  
  constraint, 55  
NOT NULL constraint, 5342  
NOT REGEXP, 1966  
not-started option  
  ndb\_waiter, 3752  
notee command  
  mysql, 422  
Not\_flushed\_delayed\_rows status variable, 921  
NOW(), 1933  
NOWAIT (START BACKUP command), 3810  
nowait-nodes option  
  ndbd, 3579  
  ndbmt, 3579  
  ndb\_mgmd, 3597  
  ndb\_waiter, 3752  
nowarning command  
  mysql, 422  
NO\_AUTO\_CREATE\_USER SQL mode, 935  
NO\_AUTO\_VALUE\_ON\_ZERO SQL mode, 935  
NO\_BACKSLASH\_ESCAPES SQL mode, 936  
NO\_DIR\_IN\_CREATE SQL mode, 936  
NO\_ENGINE\_SUBSTITUTION SQL mode, 936  
NO\_FIELD\_OPTIONS  
  deprecated features, 19  
NO\_FIELD\_OPTIONS SQL mode, 936  
NO\_KEY\_OPTIONS  
  deprecated features, 19  
NO\_KEY\_OPTIONS SQL mode, 936  
NO\_TABLE\_OPTIONS

---

- deprecated features, 19
- NO\_TABLE\_OPTIONS SQL mode, 936
- NO\_UNSIGNED\_SUBTRACTION SQL mode, 936
- NO\_ZERO\_DATE
  - deprecated features, 19
- NO\_ZERO\_DATE SQL mode, 938
- NO\_ZERO\_IN\_DATE
  - deprecated features, 19
- NO\_ZERO\_IN\_DATE SQL mode, 938
- NUL, 1652, 2295
- NULL, 284, 4570, 5342
  - ORDER BY, 1478, 2314
  - testing for null, 1900, 1902, 1904, 1904, 1910
- null literal
  - JSON, 1847
- NULL value, 284, 1660
  - ORDER BY, 1660
- NULL values
  - and AUTO\_INCREMENT columns, 4571
  - and indexes, 2207
  - and TIMESTAMP columns, 4571
  - vs. empty values, 4570
- NULL-complemented row, 1463, 1467
- null-rejected condition, 1467
- NULLIF(), 1910
- num-slices option
  - ndb\_restore, 3707
- Numa, 3466
- number-char-cols option
  - mysqslap, 562
- number-int-cols option
  - mysqslap, 562
- number-of-queries option
  - mysqslap, 563
- numbers, 1654
- NUMERIC data type, 1795
- numeric data types, 1792
  - storage requirements, 1863
- numeric literals
  - approximate-value, 1654, 2142
  - exact-value, 1654, 2142
- numeric precision, 1792
- numeric scale, 1792
- numeric-dump-file option
  - resolve\_stack\_dump, 647
- NumInteriorRings(), 2066
- NumPoints(), 2063
- NVARCHAR data type, 1817

## O

- object
  - JSON, 1847
- objects



---

- stored, 4057
- objects\_summary\_global\_by\_type table
  - performance\_schema, 4330
- obtaining information about partitions, 4030
- OCT(), 1953
- OCTET\_LENGTH(), 1953
- ODBC, 5342
- ODBC compatibility, 867, 1664, 1795, 1893, 1904, 2208, 2322
- ODBC\_INCLUDES option
  - CMake, 206
- ODBC\_LIB\_DIR option
  - CMake, 206
- ODirect, 3436
- ODirectSyncFlag, 3436
- OFF
  - plugin activation option, 999
- off-page column, 5343
- offline\_mode system variable, 832
- offset option
  - mysqlbinlog, 624
- OGC (see [Open Geospatial Consortium](#))
- OLAP, 2122
- old system variable, 832
- old-style-user-limits option
  - mysqld, 753
- old\_alter\_table system variable, 833
- OLD\_PASSWORD()
  - removed features, 24
- old\_passwords
  - deprecated features, 19
  - removed features, 24
- old\_passwords system variable, 833
- OLTP, 5343
- ON
  - plugin activation option, 999
- ON DUPLICATE KEY
  - INSERT modifier, 2284
- ON DUPLICATE KEY UPDATE, 2280
- ON versus USING
  - joins, 2324
- one-database option
  - mysql, 411
- Ongoing\_anonymous\_gtid\_violating\_transaction\_count status variable, 921
- Ongoing\_anonymous\_transaction\_count status variable, 921
- Ongoing\_automatic\_gtid\_violating\_transaction\_count status variable, 921
- online, 5343
- online ALTER TABLE
  - new features, 11
- online DDL, 2707, 2708, 5343
  - concurrency, 2720
  - limitations, 2725
- online location of manual, 2
- online upgrades and downgrades (NDB Cluster), 3794
  - order of node updates, 3795

---

- only-print option
  - mysqslap, 563
- ONLY\_FULL\_GROUP\_BY
  - SQL mode, 2126
- ONLY\_FULL\_GROUP\_BY SQL mode, 938
- opbatch option
  - ndb\_import, 3664
- opbytes option
  - ndb\_import, 3664
- OPEN, 2396
- Open Geospatial Consortium, 1829
- Open Source
  - defined, 5
- open tables, 438, 1525
- open-files-limit option
  - mysqlbinlog, 625
  - mysqld\_safe, 348
- Opened\_files status variable, 921
- Opened\_tables status variable, 922
- Opened\_table\_definitions status variable, 922
- OpenGIS, 1829
- opening
  - tables, 1525
- Opening master dump table
  - thread state, 1633
- Opening mysql.ndb\_apply\_status
  - thread state, 1633
- Opening tables
  - thread state, 1625
- OpenLDAP configuration
  - ldap.conf file, 1211
- opens, 438
- OpenSSL, 193, 1148
  - compared to yaSSL, 1171
- OpenSSL versus yaSSL
  - detecting, 1172
- Open\_files status variable, 921
- open\_files\_limit system variable, 834
- Open\_streams status variable, 921
- Open\_tables status variable, 921
- Open\_table\_definitions status variable, 921
- operating systems
  - file-size limits, 1528
  - supported, 62
- operations
  - arithmetic, 1912
- operations\_per\_fragment
  - ndbinfo table, 3888
- operators, 1870
  - arithmetic, 2018
  - assignment, 1697, 1907
  - bit, 2018
  - cast, 1911, 2000
  - logical, 1905

---

- precedence, 1898
- string, 1944
  - string comparison, 1962
- .OPT file, 5342
- opt option
  - mysqldump, 496
- optimistic, 5343
- optimization, 1443, 1538
  - Batched Key Access, 1470, 1472
  - benchmarking, 1617
  - BLOB types, 1524
  - Block Nested-Loop, 1470, 1471
  - character and string types, 1523
  - data change statements, 1505
  - data size, 1521
  - DELETE statements, 1506
  - derived tables, 1489
  - disk I/O, 1606
  - foreign keys, 1509
  - full table scans, 1488
  - full-text queries, 1510
  - indexes, 1507
  - INFORMATION\_SCHEMA queries, 1500
  - InnoDB tables, 1532
  - INSERT statements, 1505
  - many tables, 1525
  - MEMORY storage engine, 1510
  - MEMORY tables, 1547
  - memory usage, 1611
  - Multi-Range Read, 1469
  - MyISAM tables, 1543
  - nondeterministic functions, 1486
  - numeric types, 1523
  - Performance Schema queries, 1502
  - PERFORMANCE\_SCHEMA, 1619
  - primary keys, 1509
  - REPAIR TABLE statements, 1545
  - SELECT statements, 1445
  - spatial queries, 1510
  - SQL statements, 1444
  - subqueries, 1489
  - subquery, 1493
  - subquery materialization, 1492
  - tips, 1507
  - UPDATE statements, 1506
  - views, 1489
  - WHERE clauses, 1446
- optimization (NDB), 1455, 3524
- optimizations, 1453
  - LIMIT clause, 1483
  - row constructors, 1487
- optimize option
  - mysqlcheck, 461
- OPTIMIZE TABLE

---

- and partitioning, 4029
- OPTIMIZE TABLE statement, 2460
- optimizer, 5344
  - and replication, 3148
  - controlling, 1566
  - cost model, 1580
  - new features, 15
  - query plan evaluation, 1566
  - switchable optimizations, 1566
- optimizer hints, 1571
- optimizer statistics
  - for InnoDB tables, 2659
- Optimizer Statistics, 2666
- optimizer\_prune\_level system variable, 835
- optimizer\_search\_depth system variable, 835
- optimizer\_switch system variable, 835, 1566
- OPTIMIZER\_TRACE
  - INFORMATION\_SCHEMA table, 4126
- OPTIMIZER\_TRACE option
  - CMake, 211
- optimizer\_trace system variable, 837
- optimizer\_trace\_features system variable, 838
- optimizer\_trace\_limit system variable, 838
- optimizer\_trace\_max\_mem\_size system variable, 838
- optimizer\_trace\_offset system variable, 839
- optimizing
  - DISTINCT, 1482
  - filesort, 1478, 1581
  - GROUP BY, 1480
  - LEFT JOIN, 1466
  - ORDER BY, 1476
  - outer joins, 1466
  - RIGHT JOIN, 1466
  - tables, 1438
  - thread state, 1626
- option, 5344
- option file, 5344
- option files, 311, 1143
  - .my.cnf, 311, 313, 337, 1045, 1079, 1143
  - .mylogin.cnf, 311, 605
  - C:\my.cnf, 1045
  - escape sequences, 314
  - my.cnf, 3132
- option prefix
  - disable, 319
  - enable, 319
  - loose, 319
  - maximum, 319
  - skip, 319
- option prefixes
  - removed features, 24
- options
  - boolean, 319
  - CMake, 194

---

- command-line
  - mysql, 394
  - mysqladmin, 438
- embedded server, 4478
- libmysqld, 4478
- myisamchk, 580
- mysqld, 659
- provided by MySQL, 269
- replication, 3132
- OR, 299, 1453
  - bitwise, 2018
  - logical, 1906
- OR Index Merge optimization, 1453
- ORACLE
  - deprecated features, 19
- Oracle compatibility, 48, 2122, 2166, 2538
- Oracle Key Vault, 2726
  - keyring\_okv keyring plugin, 1264
- ORACLE SQL mode, 941
- ORD(), 1953
- ORDER BY, 281, 2170, 2313
  - maximum sort length, 2314
  - NULL, 1478, 2314
  - NULL value, 1660
- ORDER BY optimization, 1476
- order option
  - ndb\_select\_all, 3726
- order-by-primary option
  - mysqldump, 498
- orphan stored objects, 4082
- os-load option
  - ndb\_top, 3744
- Out of resources error
  - and partitioned tables, 4044
- OUT parameter
  - condition handling, 2424
- out-dir option
  - comp\_err, 361
- out-file option
  - comp\_err, 361
- out-of-range handling, 1798
- outer joins
  - optimizing, 1466
- OUTFILE, 2318
- output-type option
  - ndb\_import, 3665
- output-workers option
  - ndb\_import, 3665
- overflow handling, 1798
- overflow page, 5344
- Overlaps(), 2078
- OverloadLimit, 3556, 3565
- overview, 1

---

## P

PAD SPACE collations, 1740, 1820  
PAD\_CHAR\_TO\_FULL\_LENGTH SQL mode, 939  
page, 5344  
page cleaner, 5344  
page compression, 2687  
page option  
    innochecksum, 570  
page size, 5345  
    InnoDB, 2587  
page-type-dump option  
    innochecksum, 573  
page-type-summary option  
    innochecksum, 573  
pagecnt option  
    ndb\_import, 3665  
pager command  
    mysql, 422  
pager option  
    mysql, 412  
pagesize option  
    ndb\_import, 3665  
PAM  
    pluggable authentication, 1190  
.par file, 5344  
parallel-recover option  
    myisamchk, 587  
parallel-schemas option  
    mysqlpump, 530  
parallelism option  
    ndb\_restore, 3707  
parameters  
    server, 658  
PARAMETERS  
    INFORMATION\_SCHEMA table, 4127  
parent table, 5345  
parentheses ( and ), 1898  
parsable option  
    ndb\_show\_tables, 3737  
parser\_max\_mem\_size system variable, 839  
partial backup, 5345  
partial index, 5345  
partial trust, 5345  
partial updates  
    and replication, 3149  
PARTITION, 3979  
PARTITION BY LIST COLUMNS, 3993  
PARTITION BY RANGE COLUMNS, 3993  
partition management, 4013  
partition option  
    mysqld, 754  
partition pruning, 4032  
partitioning, 3979

---

- advantages, 3984
- and dates, 3984
- and foreign keys, 4045
- and FULLTEXT indexes, 4045
- and key cache, 4045
- and query cache, 4045
- and replication, 3148, 3150
- and SQL mode, 3150, 4042
- and subqueries, 4046
- and temporary tables, 4045, 4049
- by hash, 4000
- by key, 4003
- by linear hash, 4002
- by linear key, 4005
- by list, 3990
- by range, 3986
- COLUMNS, 3992
- concepts, 3981
- data type of partitioning key, 4046
- enabling, 3979
- functions allowed in partitioning expressions, 4053
- index prefixes, 4046
- keys, 3983
- limitations, 4041
- operators not permitted in partitioning expressions, 4041
- operators supported in partitioning expressions, 4041
- optimization, 4031, 4032
- partitioning expression, 3983
- resources, 3981
- storage engines (limitations), 4052
- subpartitioning, 4047
- support, 3979
- support in NDB Cluster, 3321
- tables, 3979
- types, 3984

Partitioning

- maximum number of partitions, 4044

partitioning information statements, 4030

partitioning keys and primary keys, 4049

partitioning keys and unique keys, 4049

partitions

- adding and dropping, 4013
- analyzing, 4029
- checking, 4029
- managing, 4013
- modifying, 4013
- optimizing, 4029
- repairing, 4029
- splitting and merging, 4013
- truncating, 4013

PARTITIONS

- INFORMATION\_SCHEMA table, 4128

partitions (NDB Cluster), 3290

PARTITION\_BALANCE, 2249

---

PARTITION\_BALANCE (NDB\_TABLE)  
  NDB Cluster, 2250  
passwd option  
  ndb\_top, 3744  
password  
  resetting expired, 1125  
  root user, 233  
password encryption  
  reversibility of, 2030  
password management, 1123  
password option, 324  
  mysql, 412  
  mysqladmin, 446  
  mysqlbinlog, 625  
  mysqlcheck, 461  
  mysqldump, 476  
  mysqld\_multi, 356  
  mysqlimport, 511  
  mysqlpump, 531  
  mysqlshow, 547  
  mysqlslap, 563  
  mysql\_secure\_installation, 376  
  mysql\_upgrade, 390  
  ndb\_top, 3745  
password policy, 1249  
password validation, 1249  
PASSWORD(), 2030, 4557  
  deprecated features, 19  
passwords  
  administrator guidelines, 1080  
  expiration, 1126  
  for the InnoDB memcached interface, 2879  
  for users, 1095  
  forgotten, 4560  
  hashing, 1081  
  logging, 1080  
  lost, 4560  
  resetting, 1126, 4560  
  security, 1078, 1094  
  setting, 1122, 2447, 2452  
  user guidelines, 1078  
PATH environment variable, 124, 130, 231, 309, 651  
path name separators  
  Windows, 314  
pattern matching, 285, 1965  
performance, 1443  
  benchmarks, 1618  
  disk I/O, 1606  
  estimating, 1565  
Performance Schema, 2849, 4206, 5345  
  event filtering, 4220  
  memory use, 4215  
  table reference, 4251  
Performance Schema queries



---

optimization, 1502

performance-schema-consumer-events-stages-current option  
mysql, 4357

performance-schema-consumer-events-stages-history option  
mysql, 4357

performance-schema-consumer-events-stages-history-long option  
mysql, 4357

performance-schema-consumer-events-statements-current option  
mysql, 4357

performance-schema-consumer-events-statements-history option  
mysql, 4357

performance-schema-consumer-events-statements-history-long option  
mysql, 4358

performance-schema-consumer-events-transactions-current option  
mysql, 4358

performance-schema-consumer-events-transactions-history option  
mysql, 4358

performance-schema-consumer-events-transactions-history-long option  
mysql, 4358

performance-schema-consumer-events-waits-current option  
mysql, 4358

performance-schema-consumer-events-waits-history option  
mysql, 4358

performance-schema-consumer-events-waits-history-long option  
mysql, 4358

performance-schema-consumer-global-instrumentation option  
mysql, 4358

performance-schema-consumer-statements-digest option  
mysql, 4358

performance-schema-consumer-thread-instrumentation option  
mysql, 4358

performance-schema-consumer-xxx option  
mysql, 4357

performance-schema-instrument option  
mysql, 4357

performance\_schema

- accounts table, 4298
- cond\_instances table, 4261
- events\_stages\_current table, 4275
- events\_stages\_history table, 4276
- events\_stages\_history\_long table, 4277
- events\_stages\_summary\_by\_account\_by\_event\_name table, 4325
- events\_stages\_summary\_by\_host\_by\_event\_name table, 4325
- events\_stages\_summary\_by\_thread\_by\_event\_name table, 4325
- events\_stages\_summary\_by\_user\_by\_event\_name table, 4325
- events\_stages\_summary\_global\_by\_event\_name table, 4325
- events\_statements\_current table, 4281
- events\_statements\_history table, 4285
- events\_statements\_history\_long table, 4285
- events\_statements\_summary\_by\_account\_by\_event\_name table, 4326
- events\_statements\_summary\_by\_digest table, 4326
- events\_statements\_summary\_by\_host\_by\_event\_name table, 4326
- events\_statements\_summary\_by\_program table, 4326
- events\_statements\_summary\_by\_thread\_by\_event\_name table, 4326

---

events\_statements\_summary\_by\_user\_by\_event\_name table, 4326  
events\_statements\_summary\_global\_by\_event\_name table, 4326  
events\_transactions\_current table, 4292  
events\_transactions\_history table, 4295  
events\_transactions\_history\_long table, 4295  
events\_transactions\_summary\_by\_account\_by\_event table, 4329  
events\_transactions\_summary\_by\_host\_by\_event\_name table, 4329  
events\_transactions\_summary\_by\_thread\_by\_event\_name table, 4329  
events\_transactions\_summary\_by\_user\_by\_event\_name table, 4329  
events\_transactions\_summary\_global\_by\_event\_name table, 4329  
events\_waits\_current table, 4267  
events\_waits\_history table, 4270  
events\_waits\_history\_long table, 4271  
events\_waits\_summary\_by\_account\_by\_event\_name table, 4323  
events\_waits\_summary\_by\_host\_by\_event\_name table, 4323  
events\_waits\_summary\_by\_instance table, 4323  
events\_waits\_summary\_by\_thread\_by\_event\_name table, 4323  
events\_waits\_summary\_by\_user\_by\_event\_name table, 4323  
events\_waits\_summary\_global\_by\_event\_name table, 4323  
file\_instances table, 4261  
file\_summary\_by\_event\_name table, 4331  
file\_summary\_by\_instance table, 4331  
hosts table, 4298  
host\_cache table, 949, 4342  
memory\_summary\_by\_account\_by\_event\_name table, 4337  
memory\_summary\_by\_host\_by\_event\_name table, 4337  
memory\_summary\_by\_thread\_by\_event\_name table, 4337  
memory\_summary\_by\_user\_by\_event\_name table, 4337  
memory\_summary\_global\_by\_event\_name table, 4337  
metadata\_locks table, 4314  
mutex\_instances table, 4262  
objects\_summary\_global\_by\_type table, 4330  
performance\_timers table, 4345  
prepared\_statements\_instances table, 4326  
processlist table, 4345  
replication\_applier\_configuration, 4309  
replication\_applier\_status, 4310  
replication\_applier\_status\_by\_coordinator, 4310  
replication\_applier\_status\_by\_worker, 4311  
replication\_connection\_configuration, 4306  
replication\_connection\_status, 4308  
replication\_group\_members, 4314  
replication\_group\_member\_stats, 4313  
rwlock\_instances table, 4263  
session\_account\_connect\_attrs table, 4301  
session\_connect\_attrs table, 4302  
setup\_actors table, 4255  
setup\_consumers table, 4256  
setup\_instruments table, 4257  
setup\_objects table, 4258  
setup\_timers table, 4260  
socket\_instances table, 4263  
socket\_summary\_by\_event\_name table, 4336  
socket\_summary\_by\_instance table, 4336

---

table\_handles table, 4317  
table\_io\_waits\_summary\_by\_index\_usage table, 4333  
table\_io\_waits\_summary\_by\_table table, 4332  
table\_lock\_waits\_summary\_by\_table table, 4334  
thread table, 4348  
users table, 4299  
user\_variables\_by\_thread table, 4302  
performance\_schema database, 4206  
    restrictions, 4385  
    TRUNCATE TABLE, 4250, 4385  
PERFORMANCE\_SCHEMA storage engine, 4206  
performance\_schema system variable, 4359  
performance\_schema.global\_status table  
    and NDB Cluster, 3922  
performance\_schema.global\_variables table  
    and NDB Cluster, 3918  
Performance\_schema\_accounts\_lost status variable, 4376  
performance\_schema\_accounts\_size system variable, 4359  
Performance\_schema\_cond\_classes\_lost status variable, 4376  
Performance\_schema\_cond\_instances\_lost status variable, 4376  
performance\_schema\_digests\_size system variable, 4360  
Performance\_schema\_digest\_lost status variable, 4376  
performance\_schema\_events\_stages\_history\_long\_size system variable, 4360  
performance\_schema\_events\_stages\_history\_size system variable, 4361  
performance\_schema\_events\_statements\_history\_long\_size system variable, 4361  
performance\_schema\_events\_statements\_history\_size system variable, 4361  
performance\_schema\_events\_transactions\_history\_long\_size system variable, 4362  
performance\_schema\_events\_transactions\_history\_size system variable, 4362  
performance\_schema\_events\_waits\_history\_long\_size system variable, 4362  
performance\_schema\_events\_waits\_history\_size system variable, 4363  
Performance\_schema\_file\_classes\_lost status variable, 4377  
Performance\_schema\_file\_handles\_lost status variable, 4377  
Performance\_schema\_file\_instances\_lost status variable, 4377  
Performance\_schema\_hosts\_lost status variable, 4377  
performance\_schema\_hosts\_size system variable, 4363  
Performance\_schema\_index\_stat\_lost status variable, 4377  
Performance\_schema\_locker\_lost status variable, 4377  
performance\_schema\_max\_cond\_classes system variable, 4363  
performance\_schema\_max\_cond\_instances system variable, 4364  
performance\_schema\_max\_digest\_length system variable, 4364  
performance\_schema\_max\_file\_classes system variable, 4365  
performance\_schema\_max\_file\_handles system variable, 4365  
performance\_schema\_max\_file\_instances system variable, 4365  
performance\_schema\_max\_index\_stat system variable, 4366  
performance\_schema\_max\_memory\_classes system variable, 4366  
performance\_schema\_max\_metadata\_locks system variable, 4366  
performance\_schema\_max\_mutex\_classes system variable, 4367  
performance\_schema\_max\_mutex\_instances system variable, 4367  
performance\_schema\_max\_prepared\_statements\_instances system variable, 4367  
performance\_schema\_max\_program\_instances system variable, 4368  
performance\_schema\_max\_rwlock\_classes system variable, 4368  
performance\_schema\_max\_rwlock\_instances system variable, 4369  
performance\_schema\_max\_socket\_classes system variable, 4369  
performance\_schema\_max\_socket\_instances system variable, 4369

---

- performance\_schema\_max\_sql\_text\_length system variable, 4370
- performance\_schema\_max\_stage\_classes system variable, 4370
- performance\_schema\_max\_statement\_classes system variable, 4370
- performance\_schema\_max\_statement\_stack system variable, 4371
- performance\_schema\_max\_table\_handles system variable, 4371
- performance\_schema\_max\_table\_instances system variable, 4372
- performance\_schema\_max\_table\_lock\_stat system variable, 4372
- performance\_schema\_max\_thread\_classes system variable, 4373
- performance\_schema\_max\_thread\_instances system variable, 4373
- Performance\_schema\_memory\_classes\_lost status variable, 4377
- Performance\_schema\_metadata\_lock\_lost status variable, 4377
- Performance\_schema\_mutex\_classes\_lost status variable, 4377
- Performance\_schema\_mutex\_instances\_lost status variable, 4377
- Performance\_schema\_nested\_statement\_lost status variable, 4377
- Performance\_schema\_prepared\_statements\_lost status variable, 4377
- Performance\_schema\_program\_lost status variable, 4378
- Performance\_schema\_rwlock\_classes\_lost status variable, 4378
- Performance\_schema\_rwlock\_instances\_lost status variable, 4378
- Performance\_schema\_session\_connect\_attrs\_lost status variable, 4378
- performance\_schema\_session\_connect\_attrs\_size system variable, 4373
- performance\_schema\_setup\_actors\_size system variable, 4374
- performance\_schema\_setup\_objects\_size system variable, 4374
- performance\_schema\_show\_processlist system variable, 4375
- Performance\_schema\_socket\_classes\_lost status variable, 4378
- Performance\_schema\_socket\_instances\_lost status variable, 4378
- Performance\_schema\_stage\_classes\_lost status variable, 4378
- Performance\_schema\_statement\_classes\_lost status variable, 4378
- Performance\_schema\_table\_handles\_lost status variable, 4378
- Performance\_schema\_table\_instances\_lost status variable, 4378
- Performance\_schema\_table\_lock\_stat\_lost status variable, 4378
- Performance\_schema\_thread\_classes\_lost status variable, 4378
- Performance\_schema\_thread\_instances\_lost status variable, 4379
- Performance\_schema\_users\_lost status variable, 4379
- performance\_schema\_users\_size system variable, 4375
- performance\_timers
  - deprecated features, 21
- performance\_timers table
  - performance\_schema, 4345
- PERIOD\_ADD(), 1934
- PERIOD\_DIFF(), 1934
- Perl, 5345
  - installing, 265
  - installing on Windows, 266
- Perl API, 4482, 5346
- Perl DBI/DBD
  - installation problems, 267
- permission checks
  - effect on speed, 1506
- perror, 307, 648
  - deprecated features, 23
  - help option, 649
  - ndb option, 649
  - silent option, 649
  - verbose option, 649

---

- version option, 649
- persistent statistics, 5346
- pessimistic, 5346
- phantom, 5346
- phantom rows, 2628
- phone book collation, German, 1712, 1759, 1759
- PHP, 5346
- PHP API, 5346
- physical, 5346
- physical backup, 5347
- PI(), 1919
- pid-file option
  - mysql.server, 353
  - mysqld\_safe, 348
- pid\_file system variable, 839
- Ping
  - thread command, 1622
- pipe option, 325
  - mysql, 412, 461
  - mysqladmin, 446
  - mysqldump, 477
  - mysqlimport, 511
  - mysqlshow, 547
  - mysqslap, 563
  - mysql\_upgrade, 390
- PIPES\_AS\_CONCAT SQL mode, 939
- PITR, 5347
- PKG\_CONFIG\_PATH environment variable, 651
- plan stability, 5347
- platforms
  - supported, 62
- pluggable authentication
  - PAM, 1190
  - restrictions, 1130
  - Windows, 1201
- plugin
  - audit\_log, 1294
- plugin activation options
  - FORCE, 999
  - FORCE\_PLUS\_PERMANENT, 999
  - OFF, 999
  - ON, 999
- plugin API, 995
- plugin installing
  - audit\_log, 1295
  - CONNECTION\_CONTROL, 1243
  - CONNECTION\_CONTROL\_FAILED\_LOGIN\_ATTEMPTS, 1243
  - Data Masking, 1383
  - keyring\_aws, 1258
  - keyring\_encrypted\_file, 1258
  - keyring\_file, 1258
  - keyring\_okv, 1258
  - keyring\_udf, 1276
  - MySQL Enterprise Firewall plugins, 1367

---

- MySQL Enterprise Thread Pool, 1002
- Rewriter query rewrite plugin, 1008
- validate\_password, 1251
- Version Tokens, 1016
- plugin option prefix
  - mysqld, 755
- plugin service
  - locking\_service, 1028
  - mysql\_keyring, 1033
- plugin services, 1027
- plugin table
  - system table, 969
- plugin uninstalling
  - Data Masking, 1383
  - Rewriter query rewrite plugin, 1008
  - Version Tokens, 1016
- plugin-dir option, 325
  - mysql, 412
  - mysqladmin, 446
  - mysqlbinlog, 625
  - mysqlcheck, 461
  - mysqldump, 477
  - mysqld\_safe, 349
  - mysqlimport, 511
  - mysqlpump, 531
  - mysqlshow, 547
  - mysqlslap, 564
  - mysql\_plugin, 373
  - mysql\_upgrade, 391
- plugin-ini option
  - mysql\_plugin, 373
- plugin-load option
  - mysqld, 754
- plugin-load-add option
  - mysqld, 755
- plugindir option
  - mysql\_config, 645
- plugins
  - activating, 996
  - installing, 996, 2466
  - security, 1173
  - server, 995
  - uninstalling, 996, 2468
- PLUGINS
  - INFORMATION\_SCHEMA table, 4132
- plugin\_dir system variable, 840
- POINT data type, 1831
- Point(), 2058
- point-in-time recovery, 1430, 5347
  - InnoDB, 2865
  - using NDB Cluster replication, 3959
- PointFromText(), 2053
- PointFromWKB(), 2056
- PointN(), 2063

---

- polltimeout option
  - ndb\_import, 3666
- PolyFromText(), 2053
- PolyFromWKB(), 2056
- POLYGON data type, 1831
- Polygon(), 2058
- PolygonFromText(), 2053
- PolygonFromWKB(), 2056
- port, 5347
- port option, 325
  - mysql, 412
  - mysqladmin, 446
  - mysqlbinlog, 625
  - mysqlcheck, 462
  - mysqld, 756
  - mysqldump, 477
  - mysqld\_safe, 349
  - mysqlimport, 511
  - mysqlpump, 531
  - mysqlshow, 548
  - mysqlslap, 564
  - mysql\_config, 645
  - mysql\_secure\_installation, 377
  - mysql\_upgrade, 391
  - ndb\_top, 3745
- port system variable, 840
- port-open-timeout option
  - mysqld, 756
- portability, 1444
  - types, 1867
- PortNumber, 3395, 3565
- PortNumber (OBSOLETE), 3556
- PortNumberStats, 3398
- ports, 211, 211, 229, 335, 625, 650, 1043, 1076, 1142, 1173, 4263, 4548
- POSITION(), 1953
- post-filtering
  - Performance Schema, 4220
- post-query option
  - mysqlslap, 564
- post-system option
  - mysqlslap, 564
- POSTGRESQL
  - deprecated features, 19
- PostgreSQL compatibility, 49
- POSTGRESQL SQL mode, 941
- postinstall
  - multiple servers, 1038
- postinstallation
  - setup and testing, 222
- POWER(), 1919
- POWER(), 1919
- pre-4.1 passwords
  - removed features, 23
- pre-5.1 database name conversion

---

- deprecated features, 22
- pre-filtering
  - Performance Schema, 4220
- pre-query option
  - mysqslap, 564
- pre-system option
  - mysqslap, 564
- precedence
  - command options, 309
  - operator, 1898
- precision
  - arithmetic, 2141
  - fractional seconds, 1792, 1801
  - numeric, 1792
- precision math, 2141
- preload\_buffer\_size system variable, 840
- Prepare
  - thread command, 1622
- PREPARE, 2382, 2386
  - XA transactions, 2359
- prepared backup, 5347
- prepared statement, 5347
- prepared statements, 2382, 2386, 2386, 2386
  - repreparation, 1595
- prepared\_statements\_instances table
  - performance\_schema, 4326
- Prepared\_stmt\_count status variable, 922
- preparing
  - thread state, 1626
- preparing for alter table
  - thread state, 1626
- PreSendChecksum, 3557, 3566
- preserve-trailing-spaces option
  - ndb\_restore, 3708
- primary key, 5347
  - constraint, 54
  - deleting, 2167
- PRIMARY KEY, 2167, 2209
- primary keys
  - and partitioning keys, 4049
- PrimaryMGMNode, 3504
- print command
  - mysql, 422
- print option
  - ndb\_restore, 3708
- print-data option
  - ndb\_restore, 3708
- print-defaults option, 318
  - myisamchk, 582
  - mysql, 413
  - mysqladmin, 446
  - mysqlbinlog, 625
  - mysqlcheck, 462
  - mysqld, 756



---

- mysqldump, 481
- mysqlimport, 512
- mysqlpump, 531
- mysqlshow, 548
- mysqslap, 565
- mysql\_plugin, 373
- mysql\_secure\_installation, 377
- mysql\_upgrade, 391
- ndbd, 3579
- ndbinfo\_select\_all, 3586
- ndb\_blob\_tool, 3611
- ndb\_config, 3620
- ndb\_delete\_all, 3628
- ndb\_desc, 3639
- ndb\_drop\_index, 3643
- ndb\_drop\_table, 3648
- ndb\_import, 3666
- ndb\_index\_stat, 3675
- ndb\_mgm, 3605
- ndb\_mgmd, 3599
- ndb\_move\_data, 3682
- ndb\_restore, 3709
- ndb\_select\_all, 3726
- ndb\_select\_count, 3732
- ndb\_show\_tables, 3737
- ndb\_top, 3745
- ndb\_waiter, 3752
- print-full-config option
  - ndb\_mgmd, 3599
- print-log option
  - ndb\_restore, 3709
- print-meta option
  - ndb\_restore, 3709
- print-sql-log option
  - ndb\_restore, 3709
- privilege
  - changes, 1121
- privilege checks
  - effect on speed, 1506
- privilege information
  - location, 1104
- privilege system, 1094
- privileges
  - access, 1094
  - adding, 1118
  - ALL, 1099
  - ALL PRIVILEGES, 1099
  - ALTER, 1099
  - ALTER ROUTINE, 1099
  - and replication, 3147
  - checking, 1120
  - CREATE, 1099
  - CREATE ROUTINE, 1099
  - CREATE TABLESPACE, 1099

---

CREATE TEMPORARY TABLES, 1099  
CREATE USER, 1099  
CREATE VIEW, 1099  
default, 233  
DEFINER, 2494, 4081  
DELETE, 1100  
deleting, 2439  
display, 2493  
DROP, 1100  
dropping, 2439  
EVENT, 1100  
EXECUTE, 1100  
FILE, 1100  
GRANT OPTION, 1100  
granting, 2440  
INDEX, 1100  
INSERT, 1100  
INVOKER, 2494, 4081  
LOCK TABLES, 1100  
PROCESS, 1101  
PROXY, 1101  
REFERENCES, 1101  
RELOAD, 1101  
REPLICATION CLIENT, 1101  
REPLICATION SLAVE, 1102  
revoking, 1120, 2451  
SELECT, 1102  
SHOW DATABASES, 1102  
SHOW VIEW, 1102  
SHUTDOWN, 1102  
SQL SECURITY, 4081  
stored objects, 4081  
SUPER, 1102  
TEMPORARY tables, 1099, 2230, 2448  
TRIGGER, 1103  
UPDATE, 1103  
USAGE, 1103  
problems  
  access denied errors, 4548  
  common errors, 4547  
  compiling MySQL server, 220  
  DATE columns, 4569  
  date values, 1804  
  installing on Solaris, 183  
  installing Perl, 267  
  lost connection errors, 4551  
  reporting, 2, 41  
  starting the server, 229  
  table locking, 1599  
  time zone, 4568  
proc table  
  system table, 969  
PROCEDURE, 2316  
PROCEDURE ANALYSE(), 1524

---

- deprecated features, 21
- procedures
  - stored, 4059
- process, 5348
- process management (NDB Cluster), 3570
- PROCESS privilege, 1101
- processes
  - display, 2500
  - monitoring, 1619
  - ndbinfo table, 3891
- Processing events
  - thread state, 1633
- Processing events from schema table
  - thread state, 1633
- Processlist
  - thread command, 1622
- PROCESSLIST, 2500
  - INFORMATION\_SCHEMA table, 4133
  - possible inconsistency with INFORMATION\_SCHEMA tables, 2824
- processlist
  - monitoring, 4345
- processlist table
  - performance\_schema, 4345
- processlist view
  - sys schema, 4414
- procs\_priv table
  - system table, 968, 1105
- PROFILING
  - deprecated features, 21
  - INFORMATION\_SCHEMA table, 4134
- profiling system variable, 841
- profiling\_history\_size system variable, 841
- program variables
  - setting, 319
- program-development utilities, 307
- programs
  - administrative, 306
  - client, 305
  - stored, 2387, 4057
  - utility, 306
- progress-frequency option
  - ndb\_restore, 3709
- promote-attributes option
  - ndb\_move\_data, 3682
  - ndb\_restore, 3709
- prompt command
  - mysql, 423
- PROMPT command (NDB Cluster), 3757
- prompt option
  - mysql, 413
- prompts
  - meanings, 272
- pronunciation
  - MySQL, 5

---

- protocol option, 326
  - mysql, 413
  - mysqladmin, 447
  - mysqlbinlog, 626
  - mysqlcheck, 462
  - mysqldump, 477
  - mysqlimport, 512
  - mysqlpump, 532
  - mysqlshow, 548
  - mysqslap, 565
  - mysql\_secure\_installation, 377
  - mysql\_upgrade, 391
- protocol\_version system variable, 841
- proxies\_priv
  - grant table, 1134
- proxies\_priv table
  - system table, 233, 968, 1105
- proximity search, 1977
- Proxy, 3557
- PROXY privilege, 1101
- proxy user mapping
  - LDAP authentication, 1217
- proxy users, 1132
  - conflict with anonymous users, 1136
  - default proxy user, 1135
  - LDAP authentication, 1214
  - PAM authentication, 1197
  - PROXY privilege, 1134
  - server user mapping, 1138
  - system variables, 1139
  - Windows authentication, 1204
- proxy\_user system variable, 841
- pseudo-record, 5348
- pseudo\_slave\_mode system variable, 841
- pseudo\_thread\_id system variable, 842
- ps\_check\_lost\_instrumentation view
  - sys schema, 4416
- ps\_is\_account\_enabled() function
  - sys schema, 4463
- ps\_is\_consumer\_enabled() function
  - sys schema, 4463
- ps\_is\_instrument\_default\_enabled() function
  - sys schema, 4464
- ps\_is\_instrument\_default\_timed() function
  - sys schema, 4464
- ps\_is\_thread\_instrumented() function
  - sys schema, 4465
- ps\_setup\_disable\_background\_threads() procedure
  - sys schema, 4442
- ps\_setup\_disable\_consumer() procedure
  - sys schema, 4443
- ps\_setup\_disable\_instrument() procedure
  - sys schema, 4443
- ps\_setup\_disable\_thread() procedure

---

sys schema, 4444  
ps\_setup\_enable\_background\_threads() procedure  
sys schema, 4444  
ps\_setup\_enable\_consumer() procedure  
sys schema, 4445  
ps\_setup\_enable\_instrument() procedure  
sys schema, 4445  
ps\_setup\_enable\_thread() procedure  
sys schema, 4446  
ps\_setup\_reload\_saved() procedure  
sys schema, 4446  
ps\_setup\_reset\_to\_default() procedure  
sys schema, 4446  
ps\_setup\_save() procedure  
sys schema, 4447  
ps\_setup\_show\_disabled() procedure  
sys schema, 4447  
ps\_setup\_show\_disabled\_consumers() procedure  
sys schema, 4448  
ps\_setup\_show\_disabled\_instruments() procedure  
sys schema, 4448  
ps\_setup\_show\_enabled() procedure  
sys schema, 4449  
ps\_setup\_show\_enabled\_consumers() procedure  
sys schema, 4450  
ps\_setup\_show\_enabled\_instruments() procedure  
sys schema, 4450  
ps\_statement\_avg\_latency\_histogram() procedure  
sys schema, 4450  
ps\_thread\_account() function  
sys schema, 4465  
ps\_thread\_id() function  
sys schema, 4466  
ps\_thread\_stack() function  
sys schema, 4466  
ps\_thread\_trx\_info() function  
sys schema, 4466  
ps\_trace\_statement\_digest() procedure  
sys schema, 4451  
ps\_trace\_thread() procedure  
sys schema, 4453  
ps\_truncate\_all\_tables() procedure  
sys schema, 4454  
Pthreads, 5348  
purge, 2657, 5348  
PURGE BINARY LOGS, 2363  
purge buffering, 5348  
purge configuration, 2657  
purge lag, 5348  
PURGE MASTER LOGS, 2363  
purge scheduling, 2657  
purge thread, 5348  
Purging old relay logs  
thread state, 1626

---

pushdown joins (NDB), 3524  
Python, 4476, 5348  
    third-party driver, 4483  
Python API, 5348

## Q

Qcache\_free\_blocks  
    deprecated features, 20  
Qcache\_free\_blocks status variable, 922  
Qcache\_free\_memory  
    deprecated features, 20  
Qcache\_free\_memory status variable, 922  
Qcache\_hits status variable, 922  
Qcache\_inserts  
    deprecated features, 20, 20  
Qcache\_inserts status variable, 922  
Qcache\_lowmem\_prunes  
    deprecated features, 20  
Qcache\_lowmem\_prunes status variable, 923  
Qcache\_not\_cached  
    deprecated features, 20  
Qcache\_not\_cached status variable, 923  
Qcache\_queries\_in\_cache  
    deprecated features, 20  
Qcache\_queries\_in\_cache status variable, 923  
Qcache\_total\_blocks  
    deprecated features, 20  
Qcache\_total\_blocks status variable, 923  
QUARTER(), 1934  
queries  
    entering, 270  
    estimating performance, 1565  
    examples, 294  
    speed of, 1444  
Queries status variable, 923  
Query  
    thread command, 1622  
query, 5349  
query cache  
    and ndbinfo database tables, 3843  
    and partitioned tables, 4045  
    deprecated features, 20  
    thread states, 1629  
Query Cache, 1588  
query end  
    thread state, 1626  
query execution plan, 5349  
query expansion, 1983  
query option  
    mysqslap, 565  
    ndb\_config, 3620, 3620  
    ndb\_index\_stat, 3675  
query rewrite plugins

---

- Rewriter, 1007
- query-all option
  - ndb\_config, 3620
- query\_alloc\_block\_size system variable, 842
- query\_cache\_limit
  - deprecated features, 20
- query\_cache\_limit system variable, 843
- query\_cache\_min\_res\_unit
  - deprecated features, 20
- query\_cache\_min\_res\_unit system variable, 843
- query\_cache\_size
  - deprecated features, 20
- query\_cache\_size system variable, 844
- query\_cache\_type
  - deprecated features, 20
- query\_cache\_type system variable, 844
- query\_cache\_wlock\_invalidate
  - deprecated features, 20
- query\_cache\_wlock\_invalidate system variable, 845
- query\_prealloc\_size system variable, 846
- questions, 438
- Questions status variable, 923
- Queueing master event to the relay log
  - thread state, 1631
- QUICK
  - DELETE modifier, 2276, 2277
- quick option
  - myisamchk, 587
  - mysql, 413
  - mysqlcheck, 462
  - mysqldump, 497
- quiesce, 5349
- Quit
  - thread command, 1622
- quit command
  - mysql, 423
- QUIT command (NDB Cluster), 3757
- quotation marks
  - in strings, 1653
- QUOTE(), 1654, 1953
- quote-names option
  - mysqldump, 490
- quote\_identifier() function
  - sys schema, 4468
- quoting, 1654
  - account names, 1111
  - column alias, 1662, 4572
  - host names in account names, 1111
  - schema objects, 2442
  - user names in account names, 1111
- quoting binary data, 1654
- quoting of identifiers, 1661

---

## R

- R-tree, 5349
- RADIANS(), 1919
- RAID, 5349
- RAND(), 1919
- random dive, 5349
- random-password-file option
  - mysql\_install\_db, 369
- RANDOM\_BYTES(), 2031
- rand\_seed1 system variable, 846
- rand\_seed2 system variable, 847
- range join type
  - optimizer, 1554
- range partitioning, 3986, 3993
- range partitions
  - adding and dropping, 4014
  - managing, 4014
- range\_alloc\_block\_size system variable, 847
- range\_optimizer\_max\_mem\_size system variable, 847
- raw backup, 5349
- raw option
  - mysql, 414
  - mysqlbinlog, 626
- raw partitions, 2596
- rbr\_exec\_mode system variable, 847
- RC
  - MySQL releases, 62
- READ COMMITTED, 5350
  - implementation in NDB Cluster, 3323
  - transaction isolation level, 2618
- read conflict detection and resolution
  - in NDB Cluster Replication, 3976
- read from standard in
  - innochecksum, 574
- read phenomena, 5350
- READ UNCOMMITTED, 5350
  - transaction isolation level, 2620
- read view, 5350
- read-ahead, 5350
  - linear, 2645
  - random, 2645
- read-from-remote-master option
  - mysqlbinlog, 626
- read-from-remote-server option
  - mysqlbinlog, 626
- read-only option
  - myisamchk, 585
- read-only transaction, 5350
- Reading event from the relay log
  - thread state, 1632
- Reading master dump table data
  - thread state, 1633
- READ\_BACKUP, 2249



---

READ\_BACKUP (NDB\_TABLE)  
  NDB Cluster, 2249  
read\_buffer\_size myisamchk variable, 582  
read\_buffer\_size system variable, 848  
read\_firewall\_users() MySQL Enterprise Firewall function, 1379  
read\_firewall\_whitelist() MySQL Enterprise Firewall function, 1379  
read\_only system variable, 849  
read\_rnd\_buffer\_size system variable, 850  
REAL data type, 1796  
RealtimeScheduler, 3467  
REAL\_AS\_FLOAT SQL mode, 939  
rebuild-indexes option  
  ndb\_restore, 3710  
Rebuilding the index on master dump table  
  thread state, 1633  
ReceiveBufferMemory, 3557  
Receiving from client  
  thread state, 1626  
reconfiguring, 220  
reconnect option  
  mysql, 415  
Reconnecting after a failed binlog dump request  
  thread state, 1631  
Reconnecting after a failed master event read  
  thread state, 1631  
reconnection  
  automatic, 4349  
record lock, 5351  
record-level locks  
  InnoDB, 2628, 2779  
RECOVER  
  XA transactions, 2359  
recover option  
  myisamchk, 587  
recovery  
  from crash, 1434  
  incremental, 1430  
  InnoDB, 2865  
  point in time, 1430  
RecoveryWork, 3426  
redo, 5351  
redo log, 2609, 2610, 5351  
  controlling usage, 3308  
redo log archiving, 5351  
RedoBuffer, 3454  
RedoOverCommitCounter  
  data nodes, 3487  
RedoOverCommitLimit  
  data nodes, 3488  
reducing  
  data size, 1521  
redundant row format, 2698, 5351  
ref join type  
  optimizer, 1553

---

references, 2168  
REFERENCES privilege, 1101  
referential integrity, 2545, 5351  
REFERENTIAL\_CONSTRAINTS  
  INFORMATION\_SCHEMA table, 4135  
Refresh  
  thread command, 1622  
ref\_or\_null, 1475  
ref\_or\_null join type  
  optimizer, 1554  
REGEXP, 1966  
REGEXP operator, 1965  
Register Slave  
  thread command, 1622  
Registering slave on master  
  thread state, 1631  
regular expression syntax, 1965  
rehash command  
  mysql, 423  
rejects option  
  ndb\_import, 3666  
relational, 5351  
relational databases  
  defined, 5  
relative option  
  mysqladmin, 447  
relay log (replication), 3098  
relay-log-purge option  
  mysqld, 3016  
relay-log-space-limit option  
  mysqld, 3016  
relay\_log system variable, 3027  
relay\_log\_basename system variable, 3028  
relay\_log\_index system variable, 3028  
relay\_log\_info\_file system variable, 3029  
relay\_log\_info\_repository system variable, 3029, 3098  
relay\_log\_purge system variable, 3030  
relay\_log\_recovery system variable, 3030  
relay\_log\_space\_limit system variable, 3031  
release numbers, 62  
RELEASE SAVEPOINT, 2348  
releases  
  GA, 62  
  milestone, 62  
  naming scheme, 62  
  RC, 62  
RELEASE\_ALL\_LOCKS(), 2035  
RELEASE\_LOCK(), 2035  
relevance, 5352  
reload option  
  ndb\_mgmd, 3599  
RELOAD privilege, 1101  
remap-column option  
  ndb\_restore, 3711

---

- remote administration (NDB Cluster)
  - and security issues, 3927
- remove action
  - MySQLInstallerConsole, 117
- remove option
  - mysqld, 756
  - ndbd, 3579
  - ndbmtd, 3579
  - ndb\_mgmd, 3599
- removed features, 23
  - basedir, 24
  - datadir, 24
  - secure-auth, 23
  - skip-secure-auth, 23
  - tmpdir, 24
  - ALTER IGNORE TABLE, 24
  - binary-configure.sh, 25
  - database symlinking, 24
  - InnoDB Table Monitor, 25
  - InnoDB Tablespace Monitor, 25
  - innodb\_additional\_mem\_pool\_size, 25
  - innodb\_create\_intrinsic, 25
  - innodb\_lock\_monitor, 25
  - innodb\_log\_checksum\_algorithm, 25
  - innodb\_mirrored\_log\_groups, 24
  - innodb\_monitor, 25
  - innodb\_optimize\_point\_storage, 25
  - INNODB\_PAGE\_ATOMIC\_REF\_COUNT, 25
  - innodb\_use\_sys\_malloc, 25
  - INSERT DELAYED, 24
  - mysql2mysql, 25
  - myisam\_repair\_threads, 25
  - mysqlaccess, 25
  - mysqlbug, 25
  - mysqlhotcopy, 25
  - mysql\_convert\_table\_format, 25
  - mysql\_find\_rows, 25
  - mysql\_fix\_extensions, 25
  - mysql\_old\_password, 23
  - mysql\_setpermission, 25
  - mysql\_waitpid, 25
  - mysql\_zap, 25
  - OLD\_PASSWORD(), 24
  - old\_passwords, 24
  - option prefixes, 24
  - pre-4.1 passwords, 23
  - secure\_auth, 23
  - SHOW ENGINE INNODB MUTEX, 24
  - storage\_engine, 24
  - thread\_concurrency, 24
  - timed\_mutexes, 24
  - YEAR(2), 24
- Removing duplicates
  - thread state, 1626

---

- removing tmp table
  - thread state, 1626
- rename
  - thread state, 1626
- rename database, 2271
- rename result table
  - thread state, 1626
- RENAME TABLE, 2271
- RENAME USER statement, 2451
- renaming user accounts, 2451
- Reopen tables
  - thread state, 1626
- repair
  - tables, 450
- Repair by sorting
  - thread state, 1626
- Repair done
  - thread state, 1626
- repair option
  - mysqlcheck, 462
- repair options
  - myisamchk, 585
- REPAIR TABLE
  - and partitioning, 4029
  - and replication, 3148
- REPAIR TABLE statement, 2463
  - and replication, 2463
  - options, 2464
  - output, 2465
  - partitioning support, 2464
  - storage engine support, 2464
- Repair with keycache
  - thread state, 1626
- repairing
  - tables, 1435
- REPEAT, 2393
  - labels, 2387
- REPEAT(), 1954
- REPEATABLE READ, 5352
  - transaction isolation level, 2617
- repertoire, 5352
  - character set, 1713, 1747
  - string, 1713
- replace, 307
  - deprecated features, 23
- REPLACE, 2308
  - LOAD DATA modifier, 2292
- replace option
  - mysqldump, 482
  - mysqlimport, 512
  - mysqlpump, 532
- replace utility, 649
- REPLACE(), 1954
- replica, 5352

---

- replicas
  - statements, 2366
- replicate-do-db option
  - mysqld, 3016
- replicate-do-table option
  - mysqld, 3019
- replicate-ignore-db option
  - mysqld, 3018
- replicate-ignore-table option
  - mysqld, 3020
- replicate-rewrite-db option
  - mysqld, 3020
- replicate-same-server-id option
  - mysqld, 3021
- replicate-wild-do-table option
  - mysqld, 3021
- replicate-wild-ignore-table option
  - mysqld, 3022
- replication, 2953, 5352
  - and AUTO\_INCREMENT, 3133
  - and character sets, 3134
  - and CHECKSUM TABLE statement, 3134
  - and CREATE ... IF NOT EXISTS, 3134
  - and CREATE TABLE ... SELECT, 3134
  - and DATA DIRECTORY, 3140
  - and DROP ... IF EXISTS, 3135
  - and errors on replica, 3149
  - and floating-point values, 3141
  - and FLUSH, 3141
  - and fractional seconds, 3141
  - and functions, 3141
  - and INDEX DIRECTORY, 3140
  - and invoked features, 3144
  - and LAST\_INSERT\_ID(), 3133
  - and LIMIT, 3145
  - and LOAD DATA, 3146
  - and max\_allowed\_packet, 3146
  - and MEMORY tables, 3146
  - and mysql (system) database, 3147
  - and partial updates, 3149
  - and partitioned tables, 3148
  - and partitioning, 3150
  - and privileges, 3147
  - and query optimizer, 3148
  - and REPAIR TABLE statement, 2463, 3148
  - and reserved words, 3148
  - and scheduled events, 3144, 3144
  - and SQL mode, 3150
  - and stored routines, 3144
  - and temporary tables, 3150
  - and time zones, 3151
  - and TIMESTAMP, 3133
  - and transactions, 3151, 3153
  - and triggers, 3144, 3155

---

- and TRUNCATE TABLE, 3156
- and user name length, 3156
- and variables, 3156
- and views, 3158
- attribute demotion, 3138
- attribute promotion, 3138
- BLACKHOLE, 3133
- circular, 3934
- crashes, 3149
- delayed, 3131
- group, 3165
- in NDB Cluster, 3930
  - (see also [NDB Cluster replication](#))
- nondeterministic functions, 1486
- relay log, 3098
- replication metadata repositories, 3098
- row-based vs statement-based, 3085
- safe and unsafe statements, 3089
- semisynchronous, 3125
- shutdown and restart, 3149, 3150
- statements incompatible with STATEMENT format, 3086
- timeouts, 3151
- unexpected halt, 3114
- with differing tables on source and replica, 3136

- replication channel
  - commands, 3092
  - compatibility, 3093
  - naming conventions, 3095
  - startup options, 3094
- replication channels, 3091
- REPLICATION CLIENT privilege, 1101
- replication filtering options
  - and case sensitivity, 3105
- replication formats
  - compared, 3085
- replication implementation, 3084
- replication limitations, 3132
- replication metadata repositories, 3098
- replication mode, 2987
  - concepts, 2987
  - disabling online, 2991
  - enabling online, 2989
  - verifying anonymous transactions, 2992
- replication options, 3132
- replication replica
  - thread states, 1630, 1632, 1632
- replication server
  - statements, 2381
- REPLICATION SLAVE privilege, 1102
- replication source
  - new features, 17
  - thread states, 1630
- replication source servers
  - statements, 2363

---

replication technologies, 3167  
replication, asynchronous (see [NDB Cluster replication](#))  
replication\_applier\_configuration  
    performance\_schema, 4309  
replication\_applier\_status  
    performance\_schema, 4310  
replication\_applier\_status\_by\_coordinator  
    performance\_schema, 4310  
replication\_applier\_status\_by\_worker  
    performance\_schema, 4311  
replication\_connection\_configuration  
    performance\_schema, 4306  
replication\_connection\_status  
    performance\_schema, 4308  
replication\_group\_members  
    performance\_schema, 4314  
replication\_group\_member\_stats  
    performance\_schema, 4313  
replication\_optimize\_for\_static\_plugin\_config system variable, 3032  
replication\_sender\_observe\_commit\_only system variable, 3032  
REPORT command (NDB Cluster), 3757  
reporting  
    bugs, 2, 41  
    errors, 41  
    problems, 2  
report\_host system variable, 3032  
report\_password system variable, 3033  
report\_port system variable, 3033  
report\_user system variable, 3034  
REPRODUCIBLE\_BUILD option  
    CMake, 211  
Requesting binlog dump  
    thread state, 1631  
REQUIRE option  
    ALTER USER, 2429  
    CREATE USER statement, 2436  
    GRANT statement, 2449  
require\_secure\_transport system variable, 850  
reserved user accounts, 1121  
reserved words, 1673  
    and replication, 3148  
RESET MASTER, 2364  
RESET MASTER statement, 2536  
RESET QUERY CACHE  
    deprecated features, 20  
RESET SLAVE, 2375  
RESET SLAVE ALL, 2375  
RESET SLAVE statement, 2536  
Reset stmt  
    thread command, 1622  
reset-replica.pl  
    NDB Cluster replication, 3956  
resetconnection command  
    mysql, 423

---

- resetting expired password, 1125
- RESIGNAL, 2407
- resolveip, 307, 650
  - deprecated features, 22
  - help option, 650
  - silent option, 650
  - version option, 650
- resolve\_stack\_dump, 307, 647
  - deprecated features, 22
  - help option, 647
  - numeric-dump-file option, 647
  - symbols-file option, 648
  - version option, 648
- resource limits
  - user accounts, 822, 1140, 2430, 2438, 2450
- resources
  - ndbinfo table, 3893
- RESTART command (NDB Cluster), 3758
- restarting
  - the server, 232
- RestartOnErrorInsert, 3437
- RestartSubscriberConnectTimeout, 3453
- restart\_info
  - ndbinfo table, 3894
- restore, 5353
- restore-data option
  - ndb\_restore, 3712
- restore-epoch option
  - ndb\_restore, 3712
- restore-meta option
  - ndb\_restore, 3712
- restore-privilege-tables option
  - ndb\_restore, 3713
- restoring backups
  - in NDB Cluster, 3690
- restoring from backup
  - in NDB Cluster replication, 3954
- restoring NDB backups
  - between NDB release series, 3716
  - to earlier versions of NDB, 3716
  - to later versions of NDB, 3717
- restrictions
  - character sets, 1767
  - events, 4090
  - InnoDB, 2913
  - performance\_schema database, 4385
  - pluggable authentication, 1130
  - server-side cursors, 2396
  - signals, 2424
  - stored routines, 4090
  - subqueries, 2339
  - triggers, 4090
  - views, 4094
  - XA transactions, 2361



---

result-file option  
  mysqlbinlog, 627  
  mysqldump, 491  
  mysqlpump, 532

resume option  
  ndb\_import, 3666

retries option  
  ndb\_desc, 3639

retrieving  
  data from tables, 278

RETURN, 2394

return (\r), 1653, 2106, 2295

reverse option  
  mysqldumpslow, 643

REVERSE(), 1954

REVOKE statement, 1118, 2451

revoking  
  privileges, 2451

rewrite-database option  
  ndb\_restore, 3713

rewrite-db option  
  mysqlbinlog, 627

Rewriter functions  
  flush\_rewrite\_rules(), 1015  
  load\_rewrite\_rules(), 1015

Rewriter query rewrite plugin, 1007  
  installing, 1008  
  uninstalling, 1008

rewriter\_enabled system variable, 1015

Rewriter\_number\_loaded\_rules status variable, 1015

Rewriter\_number\_reloads status variable, 1016

Rewriter\_number\_rewritten\_queries status variable, 1016

Rewriter\_reload\_error status variable, 1016

rewriter\_verbose system variable, 1015

RIGHT JOIN, 1466, 2319

RIGHT OUTER JOIN, 2319

RIGHT(), 1954

RLIKE, 1966

ROLLBACK, 2344  
  XA transactions, 2359

rollback, 5353

rollback segment, 2604, 2605, 5353

ROLLBACK TO SAVEPOINT, 2348

Rolling back  
  thread state, 1627

rolling restart (NDB Cluster), 3794

ROLLUP, 2122

root password, 233

root user, 1076  
  password resetting, 4560

ROUND(), 1921

rounding, 2141

rounding errors, 1794

routines

---

- stored, 4057, 4059
- ROUTINES
  - INFORMATION\_SCHEMA table, 4136
- routines option
  - mysqldump, 494
  - mysqlpump, 532
- ROW, 2331
- row, 5353
- row constructors, 2331
  - optimizations, 1487
- row format, 5353
- row lock, 5353
- row size
  - maximum, 1530
- row subqueries, 2331
- row-based replication, 5353
  - advantages, 3087
  - disadvantages, 3088
- row-level locking, 1597, 5354
- rowbatch option
  - ndb\_import, 3667
- rowbytes option
  - ndb\_import, 3667
- rowid option
  - ndb\_select\_all, 3726
- rows
  - counting, 287
  - deleting, 4573
  - matching problems, 4573
  - selecting, 279
  - sorting, 281
- rows option
  - ndb\_config, 3620
- ROW\_COUNT(), 2044
- ROW\_FORMAT
  - COMPACT, 2699
  - COMPRESSED, 2673, 2701
  - DYNAMIC, 2700
  - REDUNDANT, 2698
- RPAD(), 1954
- Rpl\_semi\_sync\_master\_clients status variable, 924
- rpl\_semi\_sync\_master\_enabled system variable, 3010
- Rpl\_semi\_sync\_master\_net\_avg\_wait\_time status variable, 924
- Rpl\_semi\_sync\_master\_net\_waits status variable, 924
- Rpl\_semi\_sync\_master\_net\_wait\_time status variable, 924
- Rpl\_semi\_sync\_master\_no\_times status variable, 924
- Rpl\_semi\_sync\_master\_no\_tx status variable, 924
- Rpl\_semi\_sync\_master\_status status variable, 924
- Rpl\_semi\_sync\_master\_timefunc\_failures status variable, 924
- rpl\_semi\_sync\_master\_timeout system variable, 3010
- rpl\_semi\_sync\_master\_trace\_level system variable, 3011
- Rpl\_semi\_sync\_master\_tx\_avg\_wait\_time status variable, 924
- Rpl\_semi\_sync\_master\_tx\_waits status variable, 925
- Rpl\_semi\_sync\_master\_tx\_wait\_time status variable, 925

---

rpl\_semi\_sync\_master\_wait\_for\_slave\_count system variable, 3011  
rpl\_semi\_sync\_master\_wait\_no\_slave system variable, 3012  
rpl\_semi\_sync\_master\_wait\_point system variable, 3012  
Rpl\_semi\_sync\_master\_wait\_pos\_backtraverse status variable, 925  
Rpl\_semi\_sync\_master\_wait\_sessions status variable, 925  
Rpl\_semi\_sync\_master\_yes\_tx status variable, 925  
rpl\_semi\_sync\_slave\_enabled system variable, 3034  
Rpl\_semi\_sync\_slave\_status status variable, 925  
rpl\_semi\_sync\_slave\_trace\_level system variable, 3034  
rpl\_stop\_slave\_timeout system variable, 3035  
RPM file, 150, 154, 157  
RPM Package Manager, 157  
Rsa\_public\_key status variable, 925  
RTRIM(), 1955  
Ruby, 5354  
Ruby API, 4483, 5354  
running  
    ANSI mode, 47  
    batch mode, 292  
    multiple servers, 1038  
    queries, 270  
running CMake after prior invocation, 190, 220  
rw-lock, 5354  
rwlock\_instances table  
    performance\_schema, 4263

## S

safe statement (replication)  
    defined, 3089  
safe-recover option  
    myisamchk, 587  
safe-updates mode, 433  
safe-updates option  
    mysql, 415, 433  
safe-user-create option  
    mysqld, 757  
SafeNet KeySecure Appliance  
    keyring\_okv keyring plugin, 1266  
Sakila, 8  
same value wins (conflict resolution), 3967  
sandbox mode  
    for expired-password accounts, 1126  
SASL, 2879  
    authentication, 1206  
SAVEPOINT, 2348  
savepoint, 5354  
Saving state  
    thread state, 1627  
scalability, 5354  
Scalable Coherent Interface (NDB Cluster) (OBSOLETE), 3570  
scalar  
    JSON, 1847  
scale

---

- arithmetic, 2141
  - numeric, 1792
- scale out, 5355
- scale up, 5355
- SchedulerExecutionTimer, 3467
- SchedulerResponsiveness, 3467
- SchedulerSpinTimer, 3468
- schema, 5355
  - altering, 2152
  - creating, 2183
  - deleting, 2265
- SCHEMA Events (NDB Cluster), 3788
- SCHEMA(), 2045
- SCHEMATA
  - INFORMATION\_SCHEMA table, 4139
- schema\_auto\_increment\_columns view
  - sys schema, 4416
- schema\_index\_statistics view
  - sys schema, 4417
- schema\_object\_overview view
  - sys schema, 4418
- SCHEMA\_PRIVILEGES
  - INFORMATION\_SCHEMA table, 4140
- schema\_redundant\_indexes view
  - sys schema, 4419
- schema\_tables\_with\_full\_table\_scans view
  - sys schema, 4424
- schema\_table\_lock\_waits view
  - sys schema, 4420
- schema\_table\_statistics view
  - sys schema, 4421
- schema\_table\_statistics\_with\_buffer view
  - sys schema, 4423
- schema\_unused\_indexes view
  - sys schema, 4425
- SCI (NDB Cluster) (OBSOLETE), 3570
- script files, 292
- scripts, 341, 353
  - SQL, 393
- search index, 5355
- searching
  - and case sensitivity, 4568
  - full-text, 1972
  - MySQL Web pages, 41
  - two keys, 299
- Searching rows for update
  - thread state, 1627
- SECOND(), 1934
- secondary index, 5355
  - InnoDB, 2587
- secure connections, 1148
  - command options, 327
- secure-auth option, 326
  - mysql, 415

---

- mysqladmin, 447
- mysqlbinlog, 628
- mysqlcheck, 463
- mysqldump, 477
- mysqlimport, 513
- mysqlpump, 533
- mysqlshow, 548
- mysqlslap, 565
- secure\_auth
  - removed features, 23
- secure\_auth system variable, 851
- secure\_file\_priv system variable, 851
- securing an NDB Cluster, 3929
- security
  - against attackers, 1087
  - and malicious SQL statements, 3928
  - and NDB utilities, 3930
  - for the InnoDB memcached interface, 2879
  - new features, 9
  - plugins, 1173
- security system, 1094
- SEC\_TO\_TIME(), 1934
- segment, 5355
- SELECT
  - INTO, 2317
  - LIMIT, 2310
  - optimizing, 1547, 2537
  - Query Cache, 1588
- SELECT INTO TABLE, 50
- SELECT privilege, 1102
- select-limit option
  - mysql, 415
- selecting
  - databases, 274
- selectivity, 5356
- Select\_full\_join status variable, 925
- Select\_full\_range\_join status variable, 925
- Select\_range status variable, 925
- Select\_range\_check status variable, 926
- Select\_scan status variable, 926
- SELinux, 1407
  - Document Store TCP port context, 1411
  - error log file context, 1410
  - file context, 1409
  - Group Replication TCP port context, 1411
  - LDAP authentication, 1210
  - mode, 1409
  - MySQL data directory context, 1410
  - MySQL feature TCP port context, 1411
  - MySQL Server policies, 1409
  - mysqld TCP port context, 1411
  - PID file context, 1410
  - secure\_file\_priv directory context, 1410
  - status, 1408

---

- TCP port context, 1411
- troubleshooting, 1412
- Unix domain file context, 1410
- semi-consistent read, 5356
  - InnoDB, 2779
- semijoins, 1489
- semisynchronous replication, 3125
  - administrative interface, 3128
  - configuration, 3129
  - installation, 3129
  - monitoring, 3131
- SendBufferMemory, 3558, 3566
- Sending binlog event to slave
  - thread state, 1630
- sending cached result to client
  - thread state, 1630
- Sending to client
  - thread state, 1627
- SendSignalId, 3558, 3566
- sensible JSON values, 1851
- SEQUENCE, 299
- sequence emulation, 2043
- sequences, 299
- SERIAL, 1792, 1794
- SERIAL DEFAULT VALUE, 1860
- SERIALIZABLE, 5356
  - transaction isolation level, 2620
- server, 5356
  - connecting, 269, 335
  - debugging, 1045
  - disconnecting, 269
  - logs, 970
  - restart, 232
  - shutdown, 231
  - signal handling, 653
  - starting, 223
  - starting and stopping, 235
  - starting problems, 229
- server administration, 435
- server configuration, 658
- server connections
  - command options, 323
- server plugins, 995
- server variables, 2521 (see [system variables](#))
  - Group Replication, 3210
- server-id option
  - mysqlbinlog, 628
- server-id-bits option
  - mysqlbinlog, 628
- server-public-key-path option, 328
  - mysql, 416
  - mysqladmin, 448
  - mysqlbinlog, 629
  - mysqlcheck, 463

---

- mysqldump, 478
- mysqlimport, 513
- mysqlpump, 533
- mysqlshow, 549
- mysqlslap, 566
- server-side cursors
  - restrictions, 2396
- server-side prepared statement, 5356
- ServerPort, 3403
- servers
  - multiple, 1038
- servers table
  - system table, 970
- server\_cost
  - system table, 1580
- server\_cost table
  - system table, 970
- server\_id system variable, 2998
- server\_id\_bits system variable, 3534, 3534
- server\_locks
  - ndbinfo table, 3897
- server\_operations
  - ndbinfo table, 3899
- server\_transactions
  - ndbinfo table, 3901
- server\_uuid system variable
  - mysqld, 2999
- service-startup-timeout option
  - mysql.server, 353
- services
  - for plugins, 1027
- service\_get\_read\_locks() function
  - locking service, 1033
- service\_get\_write\_locks() function
  - locking service, 1033
- service\_release\_locks() function
  - locking service, 1033
- servlet, 5356
- SESSION
  - SET statement, 2468
- session state
  - change tracking, 962
- session state information, 852, 853, 853, 854
- session track gtids, 852
- session trackers
  - SESSION\_TRACK\_GTIDS, 963
  - SESSION\_TRACK\_SCHEMA, 963
  - SESSION\_TRACK\_STATE\_CHANGE, 963
  - SESSION\_TRACK\_SYSTEM\_VARIABLES, 963
  - SESSION\_TRACK\_TRANSACTION\_CHARACTERISTICS, 963
  - SESSION\_TRACK\_TRANSACTION\_STATE, 963
- session variables
  - and replication, 3156
- session view

---

- sys schema, 4425
- session\_account\_connect\_attrs table
  - performance\_schema, 4301
- session\_connect\_attrs table
  - performance\_schema, 4302
- session\_ssl\_status view
  - sys schema, 4425
- SESSION\_STATUS
  - INFORMATION\_SCHEMA table, 4123
- SESSION\_TRACK\_GTIDS session tracker, 963
- session\_track\_gtids system variable, 852, 963
- SESSION\_TRACK\_SCHEMA session tracker, 963
- session\_track\_schema system variable, 853, 963
- SESSION\_TRACK\_STATE\_CHANGE session tracker, 963
- session\_track\_state\_change system variable, 853, 963
- SESSION\_TRACK\_SYSTEM\_VARIABLES session tracker, 963
- session\_track\_system\_variables system variable, 854, 963
- SESSION\_TRACK\_TRANSACTION\_CHARACTERISTICS session tracker, 963
- session\_track\_transaction\_info system variable, 855
- SESSION\_TRACK\_TRANSACTION\_STATE session tracker, 963
- SESSION\_USER(), 2045
- SESSION\_VARIABLES
  - INFORMATION\_SCHEMA table, 4123
- SET
  - CHARACTER SET, 1726
  - NAMES, 1726
  - size, 1866
- set action
  - MySQLInstallerConsole, 117
- SET CHARACTER SET statement, 2472
- SET CHARSET statement, 2472
- SET data type, 1819, 1827
- SET GLOBAL sql\_slave\_skip\_counter, 2376, 3083
- SET GLOBAL statement, 894
- SET NAMES, 1732
- SET NAMES statement, 2472
- Set option
  - thread command, 1622
- SET PASSWORD statement, 2452
- SET SESSION statement, 894
- SET sql\_log\_bin, 2365
- SET statement
  - assignment operator, 1908
  - CHARACTER SET, 2472
  - CHARSET, 2472
  - NAMES, 2472
  - variable assignment, 2468
- SET TRANSACTION, 2355
- set-auto-increment[ option
  - myisamchk, 589
- set-charset option
  - mysqlbinlog, 629
  - mysqldump, 485
  - mysqlpump, 533



---

set-collation option  
  myisamchk, 588

set-gtid-purged option  
  mysqldump, 488  
  mysqlpump, 534

setting  
  passwords, 1122

setting passwords, 2452

setting program variables, 319

setup  
  postinstallation, 222  
  thread state, 1627

setup\_actors table  
  performance\_schema, 4255

setup\_consumers table  
  performance\_schema, 4256

setup\_instruments table  
  performance\_schema, 4257

setup\_objects table  
  performance\_schema, 4258

setup\_timers  
  deprecated features, 21

setup\_timers table  
  performance\_schema, 4260

set\_firewall\_mode() MySQL Enterprise Firewall function, 1379

SHA(), 2031

SHA1(), 2031

SHA2(), 2032

sha256\_password authentication plugin, 1184

sha256\_password\_auto\_generate\_rsa\_keys system variable, 856

sha256\_password\_private\_key\_path system variable, 856

sha256\_password\_proxy\_users system variable, 857, 1138

sha256\_password\_public\_key\_path system variable, 857

shared lock, 2612, 5357

Shared memory parameters (NDB)  
  PortNumber, 3565

shared memory transporter (see [NDB Cluster](#))

shared tablespace, 5357

shared-memory-base-name option, 327  
  mysql, 416  
  mysqladmin, 448  
  mysqlbinlog, 629  
  mysqlcheck, 464  
  mysqldump, 499  
  mysqlimport, 513  
  mysqlshow, 549  
  mysqlslap, 566  
  mysql\_upgrade, 391

SharedGlobalMemory, 3481

shared\_memory system variable, 857

shared\_memory\_base\_name system variable, 858

sharp checkpoint, 5357

shell syntax, 4

ShmKey, 3567

---

ShmSize, 3567  
ShmSpinTime, 3568  
short-form option  
  mysqlbinlog, 629  
SHOW  
  in NDB Cluster management client, 3364  
SHOW BINARY LOGS statement, 2473, 2474  
SHOW BINLOG EVENTS statement, 2473, 2474  
SHOW CHARACTER SET statement, 2473, 2475  
SHOW COLLATION statement, 2473, 2476  
SHOW COLUMNS statement, 2473, 2477  
SHOW command (NDB Cluster), 3758  
SHOW CREATE DATABASE statement, 2473, 2479  
SHOW CREATE EVENT statement, 2473  
SHOW CREATE FUNCTION statement, 2473, 2480  
SHOW CREATE PROCEDURE statement, 2473, 2480  
SHOW CREATE SCHEMA statement, 2473, 2479  
SHOW CREATE TABLE statement, 2473, 2480  
SHOW CREATE TRIGGER statement, 2473, 2481  
SHOW CREATE USER statement, 2482  
SHOW CREATE VIEW statement, 2473, 2482  
SHOW DATABASES privilege, 1102  
SHOW DATABASES statement, 2473, 2483  
SHOW ENGINE  
  and NDB Cluster, 3914  
SHOW ENGINE INNODB MUTEX  
  removed features, 24  
SHOW ENGINE INNODB STATUS  
  and innodb\_use\_sys\_malloc, 2652  
SHOW ENGINE INNODB STATUS statement, 2484  
SHOW ENGINE NDB STATUS, 3914  
SHOW ENGINE NDBCLUSTER STATUS, 3914  
SHOW ENGINE statement, 2473, 2484  
SHOW ENGINES  
  and NDB Cluster, 3914  
SHOW ENGINES statement, 2473, 2488  
SHOW ERRORS statement, 2473, 2490  
SHOW EVENTS statement, 2473, 2491  
SHOW extensions, 4201  
SHOW FIELDS statement, 2473, 2477  
SHOW FUNCTION CODE statement, 2473, 2493  
SHOW FUNCTION STATUS statement, 2473, 2493  
SHOW GRANTS statement, 2473, 2493  
SHOW INDEX statement, 2473, 2494  
SHOW KEYS statement, 2473, 2494  
SHOW MASTER LOGS statement, 2473, 2474  
SHOW MASTER STATUS statement, 2473, 2496  
SHOW OPEN TABLES statement, 2473, 2496  
show option  
  my\_print\_defaults, 647  
SHOW PLUGINS statement, 2473, 2497  
SHOW PRIVILEGES statement, 2473, 2498  
SHOW PROCEDURE CODE statement, 2473, 2499  
SHOW PROCEDURE STATUS statement, 2473, 2500

---

SHOW PROCESSLIST statement, 2473, 2500  
SHOW PROFILE statement, 2473, 2502  
SHOW PROFILES statement, 2473, 2502, 2505  
SHOW RELAYLOG EVENTS statement, 2473, 2505  
SHOW SCHEDULER STATUS, 4071  
SHOW SCHEMAS statement, 2483  
SHOW SLAVE HOSTS statement, 2473, 2506  
SHOW SLAVE STATUS statement, 2473, 2507  
SHOW STATUS  
    and NDB Cluster, 3919  
SHOW STATUS statement, 2473, 2515  
SHOW STORAGE ENGINES statement, 2488  
SHOW TABLE STATUS statement, 2473, 2516  
SHOW TABLES statement, 2473, 2519  
SHOW TRIGGERS statement, 2473, 2520  
SHOW VARIABLES  
    and NDB Cluster, 3915  
SHOW VARIABLES statement, 2473, 2521  
SHOW VIEW privilege, 1102  
SHOW WARNINGS statement, 2473, 2523  
SHOW with WHERE, 4098, 4201  
show-slave-auth-info option  
    mysqld, 3006  
show-table-type option  
    mysqlshow, 549  
show-temp-status option  
    ndb\_show\_tables, 3737  
show-warnings option  
    mysql, 416  
    mysqladmin, 447  
showing  
    database information, 540  
show\_compatibility\_56  
    new features, 15  
show\_compatibility\_56 system variable, 858  
show\_create\_table\_verbosity system variable, 863  
show\_old\_temporals system variable, 863  
shutdown, 5357  
    server, 965  
Shutdown  
    thread command, 1623  
SHUTDOWN command (NDB Cluster), 3759  
SHUTDOWN privilege, 1102  
SHUTDOWN statement, 2537  
shutdown-timeout option  
    mysqladmin, 448  
shutting down  
    the server, 231  
Shutting down  
    thread state, 1633  
SIGHUP signal  
    log maintenance, 994  
    server response, 653, 2528  
SIGINT signal

---

- client response, 655
  - mysql client, 416
  - server response, 653, 1048
- sigint-ignore option
  - mysql, 416
- SIGN(), 1921
- SIGNAL, 2412
- signal handling, 653
- signals
  - client response, 655
  - restrictions, 2424
  - server response, 653
- SigNum, 3568
- SIGPIPE signal
  - client response, 655
- SIGTERM signal
  - server response, 653, 2537
- silent column changes, 2239
- silent option
  - myisamchk, 582
  - myisampack, 599
  - mysql, 417
  - mysqladmin, 448
  - mysqlcheck, 464
  - mysqld\_multi, 357
  - mysqlimport, 514
  - mysqlslap, 566
  - ndb\_perror, 3684
  - perror, 649
  - resolveip, 650
- SIN(), 1922
- single quote (\'), 1653
- single user mode (NDB Cluster), 3756, 3796
  - and ndb\_restore, 3690
- single-transaction option
  - mysqldump, 499
  - mysqlpump, 534
- single-user option
  - ndb\_waiter, 3752
- SINGLEUSER Events (NDB Cluster), 3789
- size of tables, 1528
- sizes
  - display, 1792
- skip option prefix, 319
- skip-broken-objects option
  - ndb\_restore, 3713
- skip-column-names option
  - mysql, 417
- skip-comments option
  - mysqldump, 484
- skip-config-file option
  - ndb\_mgmd, 3600
- skip-database option
  - mysqlcheck, 464

---

skip-definer option  
  mysqlpump, 535

skip-dump-rows option  
  mysqlpump, 535

skip-grant-tables option  
  mysqld, 757

skip-gtids option  
  mysqlbinlog, 630

skip-host-cache option  
  mysqld, 758

skip-innodb option  
  mysqld, 759, 2738

skip-kill-mysqld option  
  mysqld\_safe, 349

skip-line-numbers option  
  mysql, 417

skip-mysql-schema option  
  mysqldump, 478

skip-ndbcluster option  
  mysqld, 3517

skip-new option  
  mysqld, 759

skip-nodegroup option  
  ndb\_error\_reporter, 3650

skip-opt option  
  mysqldump, 497

skip-partition option  
  mysqld, 759

skip-show-database option  
  mysqld, 759

skip-slave-start option  
  mysqld, 3023

skip-ssl option, 329  
  mysqld, 761

skip-stack-trace option  
  mysqld, 760

skip-symbolic-links option  
  mysqld, 762

skip-sys-schema option  
  mysql\_install\_db, 370  
  mysql\_upgrade, 392

skip-syslog option  
  mysqld\_safe, 349

skip-table-check option  
  ndb\_restore, 3714

skip-unknown-objects option  
  ndb\_restore, 3714

skip\_external\_locking system variable, 864

skip\_name\_resolve system variable, 864

skip\_networking system variable, 865

skip\_show\_database system variable, 865

Slave has read all relay log; waiting for more updates  
  thread state, 1632

slave-skip-errors option

---

- mysqld, 3023
- slave-sql-verify-checksum option
  - mysqld, 3024
- slave\_allow\_batching, 3951
- slave\_allow\_batching system variable, 3535
- slave\_checkpoint\_group system variable, 3035
- slave\_checkpoint\_period system variable, 3036
- slave\_compressed\_protocol system variable, 3037
- slave\_exec\_mode system variable, 3037
- Slave\_heartbeat\_period status variable, 926
- Slave\_last\_heartbeat status variable, 926
- slave\_load\_tmpdir system variable, 3037
- slave\_master\_info table
  - system table, 970
- slave\_max\_allowed\_packet system variable, 3038
- slave\_net\_timeout system variable, 3039
- Slave\_open\_temp\_tables status variable, 926
- slave\_parallel\_type system variable, 3039
- slave\_parallel\_workers system variable, 3040
- slave\_pending\_jobs\_size\_max system variable, 3041
- slave\_preserve\_commit\_order, 3041
- Slave\_received\_heartbeats status variable, 927
- slave\_relay\_log\_info table
  - system table, 970
- Slave\_retried\_transactions status variable, 927
- Slave\_rows\_last\_search\_algorithm\_used status variable, 927
- slave\_rows\_search\_algorithms system variable, 3042
- Slave\_running status variable, 927
- slave\_skip\_errors system variable, 3043
- slave\_sql\_verify\_checksum system variable, 3043
- slave\_transaction\_retries system variable, 3044
- slave\_type\_conversions system variable, 3044
- slave\_worker\_info table
  - system table, 970
- Sleep
  - thread command, 1623
- sleep option
  - mysqladmin, 449
- SLEEP(), 2139
- sleep-time option
  - ndb\_top, 3745
- slice-id option
  - ndb\_restore, 3714
- slow queries, 438
- slow query log, 991, 5357
- slow shutdown, 5357
- slow-start-timeout option
  - mysqld, 760
- Slow\_launch\_threads status variable, 928
- slow\_launch\_time system variable, 865
- slow\_log table
  - system table, 969
- Slow\_queries status variable, 928
- slow\_query\_log system variable, 866

---

slow\_query\_log\_file system variable, 866  
SMALLINT data type, 1794  
snapshot, 5357  
SNAPSHOTEND (START BACKUP command), 3810  
SNAPSHOTSTART (START BACKUP command), 3810  
socket option, 327  
    mysql, 417  
    mysqladmin, 449  
    mysqlbinlog, 630  
    mysqlcheck, 464  
    mysqld, 760  
    mysqldump, 479  
    mysqld\_safe, 349  
    mysqlimport, 514  
    mysqlpump, 535  
    mysqlshow, 549  
    mysqlslap, 566  
    mysql\_config, 645  
    mysql\_secure\_installation, 377  
    mysql\_upgrade, 392  
    ndb\_top, 3745  
socket system variable, 866  
socket\_instances table  
    performance\_schema, 4263  
socket\_summary\_by\_event\_name table  
    performance\_schema, 4336  
socket\_summary\_by\_instance table  
    performance\_schema, 4336  
Solaris  
    installation, 183  
Solaris installation problems, 183  
Solaris troubleshooting, 221  
Solaris x86\_64 issues, 1538  
SOME, 2330  
sort buffer, 5357  
sort option  
    mysqldumpslow, 643  
    ndb\_top, 3745  
sort-index option  
    myisamchk, 589  
sort-records option  
    myisamchk, 589  
sort-recover option  
    myisamchk, 588  
sorting  
    data, 281  
    grant tables, 1115, 1117  
    table rows, 281  
Sorting for group  
    thread state, 1627  
Sorting for order  
    thread state, 1627  
Sorting index  
    thread state, 1627

---

- Sorting result
  - thread state, 1627
- sort\_buffer\_size myisamchk variable, 582
- sort\_buffer\_size system variable, 867
- sort\_key\_blocks myisamchk variable, 582
- Sort\_merge\_passes status variable, 928
- Sort\_range status variable, 928
- Sort\_rows status variable, 928
- Sort\_scan status variable, 928
- SOUNDEX(), 1955
- SOUNDS LIKE, 1955
- source, 5357
- source (mysql client command), 293, 430
- source command
  - mysql, 423
- source distribution
  - installing, 185
- source dump thread
  - new features, 17
- space ID, 5358
- SPACE(), 1955
- sparse file, 5358
- spatial data types, 1829
  - storage requirements, 1866
- spatial extensions in MySQL, 1829
- spatial functions, 2045
  - deprecated features, 21
- SPATIAL index
  - InnoDB predicate locks, 2616
- spatial queries
  - optimization, 1510
- spatial values
  - syntactically well-formed, 1841
- speed
  - increasing with replication, 2953
  - inserting, 1505
  - of queries, 1445
- spin, 5358
- sporadic-binlog-dump-fail option
  - mysqld, 3052
- Spring, 5358
- sp\_reload\_firewall\_rules() MySQL Enterprise Firewall stored procedure, 1378
- sp\_set\_firewall\_mode() MySQL Enterprise Firewall stored procedure, 1378
- SQL, 5358
  - defined, 5
- SQL injection, 1092, 1365, 2017, 2382
- SQL mode, 931
  - ALLOW\_INVALID\_DATES, 934
  - and partitioning, 3150, 4042
  - and replication, 3150
  - ANSI, 933, 940
  - ANSI\_QUOTES, 934
  - DB2, 940
  - deprecated features, 19, 19



---

- ERROR\_FOR\_DIVISION\_BY\_ZERO, 934
- HIGH\_NOT\_PRECEDENCE, 934
- IGNORE\_SPACE, 934
- MAXDB, 940
- MSSQL, 940
- MYSQL323, 940
- MYSQL40, 941
- new features, 10
- NO\_AUTO\_CREATE\_USER, 935
- NO\_AUTO\_VALUE\_ON\_ZERO, 935
- NO\_BACKSLASH\_ESCAPES, 936
- NO\_DIR\_IN\_CREATE, 936
- NO\_ENGINE\_SUBSTITUTION, 936
- NO\_FIELD\_OPTIONS, 936
- NO\_KEY\_OPTIONS, 936
- NO\_TABLE\_OPTIONS, 936
- NO\_UNSIGNED\_SUBTRACTION, 936
- NO\_ZERO\_DATE, 938
- NO\_ZERO\_IN\_DATE, 938
- ONLY\_FULL\_GROUP\_BY, 938, 2126
- ORACLE, 941
- PAD\_CHAR\_TO\_FULL\_LENGTH, 939
- PIPES\_AS\_CONCAT, 939
- POSTGRESQL, 941
- REAL\_AS\_FLOAT, 939
- strict, 933
- STRICT\_ALL\_TABLES, 939
- STRICT\_TRANS\_TABLES, 933, 939
- TRADITIONAL, 933, 941
- SQL node (NDB Cluster)
  - defined, 3287
- SQL nodes (NDB Cluster), 3814
- SQL scripts, 393
- SQL SECURITY
  - effect on privileges, 4081
- SQL statements
  - replicas, 2366
  - replication server, 2381
  - replication source servers, 2363
- SQL statements relating to NDB Cluster, 3914
- SQL-92
  - extensions to, 46
- sql-mode option
  - mysqld, 760
  - mysqslap, 567
- SQLState, 5358
- sql\_auto\_is\_null system variable, 867
- SQL\_BIG\_RESULT
  - SELECT modifier, 2317
- sql\_big\_selects system variable, 868
- SQL\_BUFFER\_RESULT
  - SELECT modifier, 2317
- sql\_buffer\_result system variable, 868
- SQL\_CACHE, 1592

---

- deprecated features, 20
- SELECT modifier, 2317
- SQL\_CALC\_FOUND\_ROWS, 1483
- SELECT modifier, 2317
- sql\_log\_bin
  - deprecated features, 21
- sql\_log\_bin system variable, 3068
- sql\_log\_off system variable, 868
- sql\_mode system variable, 869
- sql\_notes system variable, 870
- SQL\_NO\_CACHE, 1592
  - deprecated features, 20
  - SELECT modifier, 2317
- sql\_quote\_show\_create system variable, 870
- sql\_safe\_updates system variable, 433, 870
- sql\_select\_limit system variable, 433, 871
- sql\_slave\_skip\_counter, 2376, 3083
- sql\_slave\_skip\_counter system variable, 3045
- SQL\_SMALL\_RESULT
  - SELECT modifier, 2317
- sql\_warnings system variable, 871
- SQRT(), 1922
- square brackets, 1792
- srcdir option
  - mysql\_install\_db, 370
- SRID values
  - handling by spatial functions, 2051
- SRID(), 2060
- SSD, 2672, 5358
- SSH, 1087, 1173
- SSL, 1148, 5358
  - command options, 327
  - establishing connections, 1150
  - OpenSSL compared to yaSSL, 1171
  - X.509 Basics, 1148
- SSL library
  - configuring, 193
- ssl option, 329
  - mysqld, 761
- SSL options
  - mysql, 417
  - mysqladmin, 449
  - mysqlbinlog, 630
  - mysqlcheck, 464
  - mysqldump, 479
  - mysqlimport, 514
  - mysqlpump, 535
  - mysqlshow, 550
  - mysqlslap, 567
  - mysql\_secure\_installation, 377
  - mysql\_upgrade, 392
- SSL related options
  - ALTER USER, 2429
  - CREATE USER statement, 2436

---

- GRANT statement, 2449
- ssl-ca option, 330
- ssl-capath option, 330
- ssl-cert option, 330
- ssl-cipher option, 331
- ssl-crl option, 331
- ssl-crlpath option, 331
- ssl-key option, 332
- ssl-mode option, 332
- ssl-verify-server-cert option, 334
- Ssl\_accepts status variable, 928
- Ssl\_accept\_renegotiates status variable, 928
- ssl\_ca system variable, 871
- Ssl\_callback\_cache\_hits status variable, 928
- ssl\_capath system variable, 872
- ssl\_cert system variable, 872
- Ssl\_cipher status variable, 928
- ssl\_cipher system variable, 872
- Ssl\_cipher\_list status variable, 928
- Ssl\_client\_connects status variable, 928
- Ssl\_connect\_renegotiates status variable, 928
- ssl\_crl system variable, 873
- ssl\_crlpath system variable, 873
- Ssl\_ctx\_verify\_depth status variable, 929
- Ssl\_ctx\_verify\_mode status variable, 929
- Ssl\_default\_timeout status variable, 929
- Ssl\_finished\_accepts status variable, 929
- Ssl\_finished\_connects status variable, 929
- ssl\_key system variable, 873
- Ssl\_server\_not\_after status variable, 929
- Ssl\_server\_not\_before status variable, 929
- Ssl\_sessions\_reused status variable, 929
- Ssl\_session\_cache\_hits status variable, 929
- Ssl\_session\_cache\_misses status variable, 929
- Ssl\_session\_cache\_mode status variable, 929
- Ssl\_session\_cache\_overflows status variable, 929
- Ssl\_session\_cache\_size status variable, 929
- Ssl\_session\_cache\_timeouts status variable, 929
- Ssl\_used\_session\_cache\_entries status variable, 930
- Ssl\_verify\_depth status variable, 930
- Ssl\_verify\_mode status variable, 930
- Ssl\_version status variable, 930
- staging-tries option
  - ndb\_move\_data, 3682
- standalone option
  - mysqld, 762
- Standard Monitor, 2857, 2859, 2862
- Standard SQL
  - differences from, 50, 2450
  - extensions to, 46, 47
- standards compatibility, 46
- START
  - XA transactions, 2359
- START BACKUP

---

- NOWAIT, 3810
- SNAPSHOTEND, 3810
- SNAPSHOTSTART, 3810
- syntax, 3809
- WAIT COMPLETED, 3810
- WAIT STARTED, 3810
- START command (NDB Cluster), 3760
- START GROUP\_REPLICATION, 2381
- START SLAVE, 2376
- START TRANSACTION, 2344
- start-datetime option
  - mysqlbinlog, 630
- start-page option
  - innochecksum, 570
- start-position option
  - mysqlbinlog, 631
- StartConnectBackoffMaxTime, 3502
- StartFailRetryDelay, 3489
- StartFailureTimeout, 3440
- starting
  - comments, 53
  - mysqld, 1089
  - the server, 223
  - the server automatically, 235
  - thread state, 1627
- Starting many servers, 1038
- StartNoNodeGroupTimeout, 3441
- StartPartialTimeout, 3439
- StartPartitionedTimeout, 3440
- StartPoint(), 2066
- startup, 5359
- STARTUP Events (NDB Cluster), 3784
- startup options
  - default, 311
  - replication channel, 3094
- startup parameters, 658
  - mysql, 394
  - mysqladmin, 438
  - tuning, 1606
- StartupStatusReportFrequency, 3459
- state-dir option
  - ndb\_import, 3667
- state-file option
  - comp\_err, 361
- statement interceptor, 5359
- statement termination
  - Control+C, 394, 416
- statement-based replication, 5359
  - advantages, 3085
  - disadvantages, 3086
  - unsafe statements, 3086
- statements
  - compound, 2387
  - CREATE USER, 1118

---

- DROP USER, 1118
- GRANT, 1118
- replicas, 2366
- replication server, 2381
- replication source servers, 2363
- REVOKE, 1118
- statements\_with\_errors\_or\_warnings view
  - sys schema, 4427
- statements\_with\_full\_table\_scans view
  - sys schema, 4428
- statements\_with\_runtimes\_in\_95th\_percentile view
  - sys schema, 4429
- statements\_with\_sorting view
  - sys schema, 4431
- statements\_with\_temp\_tables view
  - sys schema, 4432
- statement\_analysis view
  - sys schema, 4426
- statement\_performance\_analyzer() procedure
  - sys schema, 4454
- Statistics
  - thread command, 1623
- statistics, 5359
  - thread state, 1627
- STATISTICS
  - INFORMATION\_SCHEMA table, 4141
- STATISTICS Events (NDB Cluster), 3787
- stats option
  - myisam\_ftdump, 576
  - ndb\_import, 3667
- stats\_method myisamchk variable, 582
- status
  - tables, 2516
- status action
  - MySQLInstallerConsole, 118
- status command
  - mysql, 424
  - results, 437
- STATUS command (NDB Cluster), 3759
- status option
  - mysqlshow, 550
- status variable
  - Aborted\_clients, 910
  - Aborted\_connects, 910
  - Audit\_log\_current\_size, 1363
  - Audit\_log\_events, 1364
  - Audit\_log\_events\_filtered, 1364
  - Audit\_log\_events\_lost, 1364
  - Audit\_log\_events\_written, 1364
  - Audit\_log\_event\_max\_drop\_size, 1363
  - Audit\_log\_total\_size, 1364
  - Audit\_log\_write\_waits, 1364
  - Binlog\_cache\_disk\_use, 910
  - Binlog\_cache\_use, 910

---

Binlog\_stmt\_cache\_disk\_use, 910  
Binlog\_stmt\_cache\_use, 910  
Bytes\_received, 911  
Bytes\_sent, 911  
Compression, 912  
Connections, 912  
Connection\_control\_delay\_generated, 1249  
Connection\_errors\_accept, 912  
Connection\_errors\_internal, 912  
Connection\_errors\_max\_connections, 912  
Connection\_errors\_peer\_address, 912  
Connection\_errors\_select, 912  
Connection\_errors\_tcpwrap, 912  
Created\_tmp\_disk\_tables, 913  
Created\_tmp\_files, 913  
Created\_tmp\_tables, 913  
Delayed\_errors, 913  
Delayed\_insert\_threads, 913  
Delayed\_writes, 913  
Firewall\_access\_denied, 1381  
Firewall\_access\_granted, 1381  
Firewall\_access\_suspicious, 1381  
Firewall\_cached\_entries, 1381  
Flush\_commands, 913  
group\_replication\_primary\_member, 913  
Handler\_commit, 913  
Handler\_delete, 914  
Handler\_discover, 3538  
Handler\_external\_lock, 914  
Handler\_mrr\_init, 914  
Handler\_prepare, 914  
Handler\_read\_first, 914  
Handler\_read\_key, 914  
Handler\_read\_last, 914  
Handler\_read\_next, 914  
Handler\_read\_prev, 914  
Handler\_read\_rnd, 914  
Handler\_read\_rnd\_next, 914  
Handler\_rollback, 915  
Handler\_savepoint, 915  
Handler\_savepoint\_rollback, 915  
Handler\_update, 915  
Handler\_write, 915  
InnoDB\_available\_undo\_logs, 915  
InnoDB\_buffer\_pool\_bytes\_data, 916  
InnoDB\_buffer\_pool\_bytes\_dirty, 916  
InnoDB\_buffer\_pool\_dump\_status, 915  
InnoDB\_buffer\_pool\_load\_status, 915  
InnoDB\_buffer\_pool\_pages\_data, 916  
InnoDB\_buffer\_pool\_pages\_dirty, 916  
InnoDB\_buffer\_pool\_pages\_flushed, 916  
InnoDB\_buffer\_pool\_pages\_free, 916  
InnoDB\_buffer\_pool\_pages\_latched, 916  
InnoDB\_buffer\_pool\_pages\_misc, 916

---

Innodb\_buffer\_pool\_pages\_total, 916  
Innodb\_buffer\_pool\_reads, 917  
Innodb\_buffer\_pool\_read\_ahead, 916  
Innodb\_buffer\_pool\_read\_ahead\_evicted, 916  
Innodb\_buffer\_pool\_read\_ahead\_rnd, 917  
Innodb\_buffer\_pool\_read\_requests, 917  
Innodb\_buffer\_pool\_resize\_status, 917  
Innodb\_buffer\_pool\_wait\_free, 917  
Innodb\_buffer\_pool\_write\_requests, 917  
Innodb\_data\_fsyncs, 917  
Innodb\_data\_pending\_fsyncs, 917  
Innodb\_data\_pending\_reads, 917  
Innodb\_data\_pending\_writes, 917  
Innodb\_data\_read, 917  
Innodb\_data\_reads, 917  
Innodb\_data\_writes, 918  
Innodb\_data\_written, 918  
Innodb\_dblwr\_pages\_written, 918  
Innodb\_dblwr\_writes, 918  
Innodb\_have\_atomic\_builtins, 918  
Innodb\_log\_waits, 918  
Innodb\_log\_writes, 918  
Innodb\_log\_write\_requests, 918  
Innodb\_num\_open\_files, 918  
Innodb\_os\_log\_fsyncs, 918  
Innodb\_os\_log\_pending\_fsyncs, 918  
Innodb\_os\_log\_pending\_writes, 918  
Innodb\_os\_log\_written, 918  
Innodb\_pages\_created, 919  
Innodb\_pages\_read, 919  
Innodb\_pages\_written, 919  
Innodb\_page\_size, 918  
Innodb\_rows\_deleted, 919  
Innodb\_rows\_inserted, 919  
Innodb\_rows\_read, 919  
Innodb\_rows\_updated, 919  
Innodb\_row\_lock\_current\_waits, 919  
Innodb\_row\_lock\_time, 919  
Innodb\_row\_lock\_time\_avg, 919  
Innodb\_row\_lock\_time\_max, 919  
Innodb\_row\_lock\_waits, 919  
Innodb\_truncated\_status\_writes, 919  
Key\_blocks\_not\_flushed, 919  
Key\_blocks\_unused, 920  
Key\_blocks\_used, 920  
Key\_reads, 920  
Key\_read\_requests, 920  
Key\_writes, 920  
Key\_write\_requests, 920  
Last\_query\_cost, 920  
Last\_query\_partial\_plans, 920  
Locked\_connects, 920  
Max\_execution\_time\_exceeded, 920  
Max\_execution\_time\_set, 920

---

Max\_execution\_time\_set\_failed, 921  
Max\_used\_connections, 921  
Max\_used\_connections\_time, 921  
mecab\_charset, 921  
Ndb\_api\_adaptive\_send\_deferred\_count, 3538  
Ndb\_api\_adaptive\_send\_deferred\_count\_session, 3538  
Ndb\_api\_adaptive\_send\_deferred\_count\_slave, 3538  
Ndb\_api\_adaptive\_send\_forced\_count, 3538  
Ndb\_api\_adaptive\_send\_forced\_count\_session, 3538  
Ndb\_api\_adaptive\_send\_forced\_count\_slave, 3539  
Ndb\_api\_adaptive\_send\_unforced\_count, 3539  
Ndb\_api\_adaptive\_send\_unforced\_count\_session, 3539  
Ndb\_api\_adaptive\_send\_unforced\_count\_slave, 3539  
Ndb\_api\_bytes\_received\_count, 3540  
Ndb\_api\_bytes\_received\_count\_session, 3540  
Ndb\_api\_bytes\_received\_count\_slave, 3540  
Ndb\_api\_bytes\_sent\_count, 3539  
Ndb\_api\_bytes\_sent\_count\_session, 3539  
Ndb\_api\_bytes\_sent\_count\_slave, 3539  
Ndb\_api\_event\_bytes\_count, 3541  
Ndb\_api\_event\_bytes\_count\_injector, 3541  
Ndb\_api\_event\_data\_count, 3540  
Ndb\_api\_event\_data\_count\_injector, 3540  
Ndb\_api\_event\_nondata\_count, 3541  
Ndb\_api\_event\_nondata\_count\_injector, 3540  
Ndb\_api\_pk\_op\_count, 3541  
Ndb\_api\_pk\_op\_count\_session, 3541  
Ndb\_api\_pk\_op\_count\_slave, 3541  
Ndb\_api\_pruned\_scan\_count, 3542  
Ndb\_api\_pruned\_scan\_count\_session, 3542  
Ndb\_api\_pruned\_scan\_count\_slave, 3542  
Ndb\_api\_range\_scan\_count, 3542  
Ndb\_api\_range\_scan\_count\_session, 3542  
Ndb\_api\_range\_scan\_count\_slave, 3542  
Ndb\_api\_read\_row\_count, 3543  
Ndb\_api\_read\_row\_count\_session, 3543  
Ndb\_api\_read\_row\_count\_slave, 3543  
Ndb\_api\_scan\_batch\_count, 3544  
Ndb\_api\_scan\_batch\_count\_session, 3543  
Ndb\_api\_scan\_batch\_count\_slave, 3543  
Ndb\_api\_table\_scan\_count, 3544  
Ndb\_api\_table\_scan\_count\_session, 3544  
Ndb\_api\_table\_scan\_count\_slave, 3544  
Ndb\_api\_trans\_abort\_count, 3545  
Ndb\_api\_trans\_abort\_count\_session, 3544  
Ndb\_api\_trans\_abort\_count\_slave, 3544  
Ndb\_api\_trans\_close\_count, 3545  
Ndb\_api\_trans\_close\_count\_session, 3545  
Ndb\_api\_trans\_close\_count\_slave, 3545  
Ndb\_api\_trans\_commit\_count, 3546  
Ndb\_api\_trans\_commit\_count\_session, 3545  
Ndb\_api\_trans\_commit\_count\_slave, 3546  
Ndb\_api\_trans\_local\_read\_row\_count, 3546  
Ndb\_api\_trans\_local\_read\_row\_count\_session, 3546



---

Ndb\_api\_trans\_local\_read\_row\_count\_slave, 3546  
Ndb\_api\_trans\_start\_count, 3547  
Ndb\_api\_trans\_start\_count\_session, 3546  
Ndb\_api\_trans\_start\_count\_slave, 3547  
Ndb\_api\_uk\_op\_count, 3547  
Ndb\_api\_uk\_op\_count\_session, 3547  
Ndb\_api\_uk\_op\_count\_slave, 3547  
Ndb\_api\_wait\_exec\_complete\_count, 3548  
Ndb\_api\_wait\_exec\_complete\_count\_session, 3547  
Ndb\_api\_wait\_exec\_complete\_count\_slave, 3548  
Ndb\_api\_wait\_meta\_request\_count, 3548  
Ndb\_api\_wait\_meta\_request\_count\_session, 3548  
Ndb\_api\_wait\_meta\_request\_count\_slave, 3548  
Ndb\_api\_wait\_nanos\_count, 3549  
Ndb\_api\_wait\_nanos\_count\_session, 3548  
Ndb\_api\_wait\_nanos\_count\_slave, 3549  
Ndb\_api\_wait\_scan\_result\_count, 3549  
Ndb\_api\_wait\_scan\_result\_count\_session, 3549  
Ndb\_api\_wait\_scan\_result\_count\_slave, 3549  
Ndb\_cluster\_node\_id, 3550  
Ndb\_config\_from\_host, 3550  
Ndb\_config\_from\_port, 3550  
Ndb\_conflict\_fn\_epoch, 3550  
Ndb\_conflict\_fn\_epoch2, 3550  
Ndb\_conflict\_fn\_epoch2\_trans, 3550  
Ndb\_conflict\_fn\_epoch\_trans, 3550  
Ndb\_conflict\_fn\_max, 3550  
Ndb\_conflict\_fn\_max\_del\_win, 3551  
Ndb\_conflict\_fn\_old, 3551  
Ndb\_conflict\_last\_conflict\_epoch, 3551  
Ndb\_conflict\_last\_stable\_epoch, 3551  
Ndb\_conflict\_reflected\_op\_discard\_count, 3551  
Ndb\_conflict\_reflected\_op\_prepare\_count, 3551  
Ndb\_conflict\_refresh\_op\_count, 3551  
Ndb\_conflict\_trans\_conflict\_commit\_count, 3552  
Ndb\_conflict\_trans\_detect\_iter\_count, 3552  
Ndb\_conflict\_trans\_reject\_count, 3552  
Ndb\_conflict\_trans\_row\_conflict\_count, 3551  
Ndb\_conflict\_trans\_row\_reject\_count, 3552  
Ndb\_epoch\_delete\_delete\_count, 3552  
Ndb\_execute\_count, 3552  
Ndb\_last\_commit\_epoch\_server, 3552  
Ndb\_last\_commit\_epoch\_session, 3552  
Ndb\_number\_of\_data\_nodes, 3552  
Ndb\_pruned\_scan\_count, 3553  
Ndb\_pushed\_queries\_defined, 3552  
Ndb\_pushed\_queries\_dropped, 3553  
Ndb\_pushed\_queries\_executed, 3553  
Ndb\_pushed\_reads, 3553  
Ndb\_scan\_count, 3553  
Ndb\_slave\_max\_replicated\_epoch, 3553  
Ndb\_system\_name, 3553  
Not\_flushed\_delayed\_rows, 921  
Ongoing\_anonymous\_gtid\_violating\_transaction\_count, 921

---

Ongoing\_anonymous\_transaction\_count, 921  
Ongoing\_automatic\_gtid\_violating\_transaction\_count, 921  
Opened\_files, 921  
Opened\_tables, 922  
Opened\_table\_definitions, 922  
Open\_files, 921  
Open\_streams, 921  
Open\_tables, 921  
Open\_table\_definitions, 921  
Performance\_schema\_accounts\_lost, 4376  
Performance\_schema\_cond\_classes\_lost, 4376  
Performance\_schema\_cond\_instances\_lost, 4376  
Performance\_schema\_digest\_lost, 4376  
Performance\_schema\_file\_classes\_lost, 4377  
Performance\_schema\_file\_handles\_lost, 4377  
Performance\_schema\_file\_instances\_lost, 4377  
Performance\_schema\_hosts\_lost, 4377  
Performance\_schema\_index\_stat\_lost, 4377  
Performance\_schema\_locker\_lost, 4377  
Performance\_schema\_memory\_classes\_lost, 4377  
Performance\_schema\_metadata\_lock\_lost, 4377  
Performance\_schema\_mutex\_classes\_lost, 4377  
Performance\_schema\_mutex\_instances\_lost, 4377  
Performance\_schema\_nested\_statement\_lost, 4377  
Performance\_schema\_prepared\_statements\_lost, 4377  
Performance\_schema\_program\_lost, 4378  
Performance\_schema\_rwlock\_classes\_lost, 4378  
Performance\_schema\_rwlock\_instances\_lost, 4378  
Performance\_schema\_session\_connect\_attrs\_lost, 4378  
Performance\_schema\_socket\_classes\_lost, 4378  
Performance\_schema\_socket\_instances\_lost, 4378  
Performance\_schema\_stage\_classes\_lost, 4378  
Performance\_schema\_statement\_classes\_lost, 4378  
Performance\_schema\_table\_handles\_lost, 4378  
Performance\_schema\_table\_instances\_lost, 4378  
Performance\_schema\_table\_lock\_stat\_lost, 4378  
Performance\_schema\_thread\_classes\_lost, 4378  
Performance\_schema\_thread\_instances\_lost, 4379  
Performance\_schema\_users\_lost, 4379  
Prepared\_stmt\_count, 922  
Qcache\_free\_blocks, 922  
Qcache\_free\_memory, 922  
Qcache\_hits, 922  
Qcache\_inserts, 922  
Qcache\_lowmem\_prunes, 923  
Qcache\_not\_cached, 923  
Qcache\_queries\_in\_cache, 923  
Qcache\_total\_blocks, 923  
Queries, 923  
Questions, 923  
Rewriter\_number\_loaded\_rules, 1015  
Rewriter\_number\_reloads, 1016  
Rewriter\_number\_rewritten\_queries, 1016  
Rewriter\_reload\_error, 1016

---

Rpl\_semi\_sync\_master\_clients, 924  
Rpl\_semi\_sync\_master\_net\_avg\_wait\_time, 924  
Rpl\_semi\_sync\_master\_net\_waits, 924  
Rpl\_semi\_sync\_master\_net\_wait\_time, 924  
Rpl\_semi\_sync\_master\_no\_times, 924  
Rpl\_semi\_sync\_master\_no\_tx, 924  
Rpl\_semi\_sync\_master\_status, 924  
Rpl\_semi\_sync\_master\_timefunc\_failures, 924  
Rpl\_semi\_sync\_master\_tx\_avg\_wait\_time, 924  
Rpl\_semi\_sync\_master\_tx\_waits, 925  
Rpl\_semi\_sync\_master\_tx\_wait\_time, 925  
Rpl\_semi\_sync\_master\_wait\_pos\_backtraverse, 925  
Rpl\_semi\_sync\_master\_wait\_sessions, 925  
Rpl\_semi\_sync\_master\_yes\_tx, 925  
Rpl\_semi\_sync\_slave\_status, 925  
Rsa\_public\_key, 925  
Select\_full\_join, 925  
Select\_full\_range\_join, 925  
Select\_range, 925  
Select\_range\_check, 926  
Select\_scan, 926  
Slave\_heartbeat\_period, 926  
Slave\_last\_heartbeat, 926  
Slave\_open\_temp\_tables, 926  
Slave\_received\_heartbeats, 927  
Slave\_retried\_transactions, 927  
Slave\_rows\_last\_search\_algorithm\_used, 927  
Slave\_running, 927  
Slow\_launch\_threads, 928  
Slow\_queries, 928  
Sort\_merge\_passes, 928  
Sort\_range, 928  
Sort\_rows, 928  
Sort\_scan, 928  
Ssl\_accepts, 928  
Ssl\_accept\_renegotiates, 928  
Ssl\_callback\_cache\_hits, 928  
Ssl\_cipher, 928  
Ssl\_cipher\_list, 928  
Ssl\_client\_connects, 928  
Ssl\_connect\_renegotiates, 928  
Ssl\_ctx\_verify\_depth, 929  
Ssl\_ctx\_verify\_mode, 929  
Ssl\_default\_timeout, 929  
Ssl\_finished\_accepts, 929  
Ssl\_finished\_connects, 929  
Ssl\_server\_not\_after, 929  
Ssl\_server\_not\_before, 929  
Ssl\_sessions\_reused, 929  
Ssl\_session\_cache\_hits, 929  
Ssl\_session\_cache\_misses, 929  
Ssl\_session\_cache\_mode, 929  
Ssl\_session\_cache\_overflows, 929  
Ssl\_session\_cache\_size, 929

---

- Ssl\_session\_cache\_timeouts, 929
- Ssl\_used\_session\_cache\_entries, 930
- Ssl\_verify\_depth, 930
- Ssl\_verify\_mode, 930
- Ssl\_version, 930
- Table\_locks\_immediate, 930
- Table\_locks\_waited, 930
- Table\_open\_cache\_hits, 930
- Table\_open\_cache\_misses, 930
- Table\_open\_cache\_overflows, 930
- Tc\_log\_max\_pages\_used, 931
- Tc\_log\_page\_siz, 931
- Tc\_log\_page\_waits, 931
- Threads\_cached, 931
- Threads\_connected, 931
- Threads\_created, 931
- Threads\_running, 931
- Uptime, 931
- Uptime\_since\_flush\_status, 931
- validate\_password\_dictionary\_file\_last\_parsed, 1257
- validate\_password\_dictionary\_file\_words\_count, 1257
- status variables, 909, 2515
  - NDB Cluster, 3538
  - NDB Cluster replication conflict detection, 3973
- STD(), 2122
- STDDEV(), 2122
- STDDEV\_POP(), 2122
- STDDEV\_SAMP(), 2122
- stemming, 5359
- STOP command (NDB Cluster), 3760
- STOP GROUP\_REPLICATION, 2382
- STOP SLAVE, 2380
- stop-datetime option
  - mysqlbinlog, 631
- stop-never option
  - mysqlbinlog, 631
- stop-never-slave-server-id option
  - mysqlbinlog, 631
- stop-position option
  - mysqlbinlog, 632
- StopOnError, 3437
- stopping
  - the server, 235
- stopword, 5359
- stopword list
  - user-defined, 1986
- stopwords, 1984
- storage engine, 5360
  - ARCHIVE, 2934
  - InnoDB, 2545
  - PERFORMANCE\_SCHEMA, 4206
- storage engines
  - and application feature requirements, 3317
  - applications supported, 3317

---

- availability, 3315
- choosing, 2915
- differences between NDB and InnoDB, 3315
- usage scenarios, 3317
- storage nodes - see data nodes, ndbd (see [data nodes](#), [ndbd](#))
- storage nodes - see data nodes, ndbd, ndbmtd (see [data nodes](#), [ndbd](#), [ndbmtd](#))
- storage requirements
  - data types, 1862
  - date data types, 1863
  - InnoDB tables, 1862
  - NDB Cluster, 1862
  - numeric data types, 1863
  - spatial data types, 1866
  - string data types, 1864
  - time data types, 1863
- storage space
  - minimizing, 1521
- storage\_engine
  - removed features, 24
- stored functions, 4059
- stored generated column, 5360
- stored object, 5360
- stored object privileges, 4081
- stored objects, 4057
  - orphan, 4082
- stored procedures, 4059
- stored program, 5360
- stored programs, 2387, 4057
  - reparsing, 1595
- stored routine, 5360
- stored routines, 4057, 4059
  - and replication, 3144
  - LAST\_INSERT\_ID(), 4061
  - metadata, 4061
  - restrictions, 4090
- stored\_program\_cache system variable, 874
- storing result in query cache
  - thread state, 1630
- STRAIGHT\_JOIN, 1466, 1548, 1562, 2319, 2539
  - join type, 1490
  - SELECT modifier, 1490, 2316
- STRCMP(), 1965
- strict mode, 5360
- strict SQL mode, 933
- strict-check option
  - innochecksum, 571
- STRICT\_ALL\_TABLES SQL mode, 939
- STRICT\_TRANS\_TABLES SQL mode, 933, 939
- string
  - JSON, 1847
- string collating, 1771
- string comparison functions, 1962
- string comparison operators, 1962
- string comparisons

---

- case sensitivity, 1962
- string concatenation, 1651, 1948
- string data types, 1815
  - storage requirements, 1864
- string functions, 1944
- string literal introducer, 1652, 1721
- string literals, 1651
- string operators, 1944
- string replacement
  - replace utility, 649
- string types, 1815
- StringMemory, 3411
- strings
  - defined, 1651
  - escape sequences, 1651
  - nondelimited, 1656
  - repertoire, 1713
- striping
  - defined, 1607
- STR\_TO\_DATE(), 1935
- ST\_Area(), 2066
- ST\_AsBinary(), 2059
- ST\_AsGeoJSON(), 2080
- ST\_AsText(), 2059
- ST\_Buffer(), 2070
- ST\_Buffer\_Strategy(), 2071
- ST\_Centroid(), 2067
- ST\_Contains(), 2073
- ST\_ConvexHull(), 2071
- ST\_Crosses(), 2073
- ST\_Difference(), 2071
- ST\_Dimension(), 2061
- ST\_Disjoint(), 2074
- ST\_Distance(), 2074
- ST\_Distance\_Sphere(), 2082
- ST\_EndPoint(), 2064
- ST\_Envelope(), 2061
- ST\_Equals(), 2074
- ST\_ExteriorRing(), 2067
- ST\_GeoHash(), 2078
- ST\_GeomCollFromText(), 2053
- ST\_GeomCollFromWKB(), 2056
- ST\_GeometryCollectionFromText(), 2053
- ST\_GeometryCollectionFromWKB(), 2056
- ST\_GeometryFromText(), 2053
- ST\_GeometryFromWKB(), 2057
- ST\_GeometryN(), 2068
- ST\_GeometryType(), 2061
- ST\_GeomFromGeoJSON(), 2081
- ST\_GeomFromText(), 2053
- ST\_GeomFromWKB(), 2057
- ST\_InteriorRingN(), 2068
- ST\_Intersection(), 2072
- ST\_Intersects(), 2074

---

ST\_IsClosed(), 2064  
ST\_IsEmpty(), 2062  
ST\_IsSimple(), 2062  
ST\_IsValid(), 2082  
ST\_LatFromGeoHash(), 2079  
ST\_Length(), 2064  
ST\_LineFromText(), 2054  
ST\_LineFromWKB(), 2057  
ST\_LineStringFromText(), 2054  
ST\_LineStringFromWKB(), 2057  
ST\_LongFromGeoHash(), 2079  
ST\_MakeEnvelope(), 2083  
ST\_MLineFromText(), 2054  
ST\_MLineFromWKB(), 2057  
ST\_MPointFromText(), 2054  
ST\_MPointFromWKB(), 2057  
ST\_MPolyFromText(), 2054  
ST\_MPolyFromWKB(), 2057  
ST\_MultiLineStringFromText(), 2054  
ST\_MultiLineStringFromWKB(), 2057  
ST\_MultiPointFromText(), 2054  
ST\_MultiPointFromWKB(), 2057  
ST\_MultiPolygonFromText(), 2054  
ST\_MultiPolygonFromWKB(), 2057  
ST\_NumGeometries(), 2069  
ST\_NumInteriorRing(), 2068  
ST\_NumInteriorRings(), 2068  
ST\_NumPoints(), 2065  
ST\_Overlaps(), 2074  
ST\_PointFromGeoHash(), 2080  
ST\_PointFromText(), 2054  
ST\_PointFromWKB(), 2057  
ST\_PointN(), 2065  
ST\_PolyFromText(), 2054  
ST\_PolyFromWKB(), 2058  
ST\_PolygonFromText(), 2054  
ST\_PolygonFromWKB(), 2058  
ST\_Simplify(), 2084  
ST\_SRID(), 2062  
ST\_StartPoint(), 2065  
ST\_SymDifference(), 2072  
ST\_Touches(), 2075  
ST\_Union(), 2072  
ST\_Validate(), 2084  
ST\_Within(), 2075  
ST\_X(), 2062  
ST\_Y(), 2062  
SUBDATE(), 1936  
sublist, 5360  
SUBPARTITION BY KEY  
    known issues, 4047  
subpartitioning, 4005  
subpartitions, 4005  
    known issues, 4047

---

- subqueries, 2327
  - correlated, 2332
  - errors, 2336
  - in FROM clause (see [derived tables](#))
  - optimization, 1489, 1493
  - restrictions, 2339
  - rewriting as joins, 2339
  - with ALL, 2330
  - with ANY, IN, SOME, 2330
  - with EXISTS, 2332
  - with NOT EXISTS, 2332
  - with row constructors, 2331
- subquery (see [subqueries](#))
- subquery materialization, 1492
- subselects, 2327
- SUBSTR(), 1955
- SUBSTRING(), 1956
- SUBSTRING\_INDEX(), 1956
- SUBTIME(), 1936
- subtraction (-), 1912
- suffix option
  - mysql\_ssl\_rsa\_setup, 381
- SUM(), 2122
- SUM(DISTINCT), 2122
- SUNPRO\_CXX\_LIBRARY option
  - CMake, 218
- SUPER privilege, 1102
- super-large-pages option
  - mysqld, 762
- superuser, 233
- super\_read\_only system variable, 874
- support
  - for operating systems, 62
  - for platforms, 62
- suppression
  - default values, 55
- supremum record, 5360
- surrogate key, 5360
- symbolic links, 1608, 1609
  - databases, 1608
  - tables, 1608
  - Windows, 1609
- symbolic-links option
  - mysqld, 762
- symbols-file option
  - resolve\_stack\_dump, 648
- synchronization of source and replica
  - in NDB Cluster Replication, 3956
- Syncing ndb table schema operation and binlog
  - thread state, 1633
- sync\_binlog system variable, 3069
- sync\_frm
  - deprecated features, 20
- sync\_frm system variable, 875



---

sync\_master\_info system variable, 3045  
sync\_relay\_log system variable, 3046  
sync\_relay\_log\_info system variable, 3046  
syntactically well-formed  
    GIS values, 1841  
    spatial values, 1841  
syntax  
    regular expression, 1965  
syntax conventions, 2  
synthetic key, 5361  
sys schema, 4207  
    create\_synonym\_db() procedure, 4440  
    diagnostics() procedure, 4440  
    execute\_prepared\_stmt() procedure, 4442  
    extract\_schema\_from\_file\_name() function, 4459  
    extract\_table\_from\_file\_name() function, 4459  
    format\_bytes() function, 4460  
    format\_path() function, 4460  
    format\_statement() function, 4461  
    format\_time() function, 4462  
    host\_summary view, 4398  
    host\_summary\_by\_file\_io view, 4399  
    host\_summary\_by\_file\_io\_type view, 4399  
    host\_summary\_by\_stages view, 4400  
    host\_summary\_by\_statement\_latency view, 4400  
    host\_summary\_by\_statement\_type view, 4401  
    innodb\_buffer\_stats\_by\_schema view, 4402  
    innodb\_buffer\_stats\_by\_table view, 4403  
    innodb\_lock\_waits view, 4404  
    io\_by\_thread\_by\_latency view, 4406  
    io\_global\_by\_file\_by\_bytes view, 4406  
    io\_global\_by\_file\_by\_latency view, 4407  
    io\_global\_by\_wait\_by\_bytes view, 4408  
    io\_global\_by\_wait\_by\_latency view, 4409  
    latest\_file\_io view, 4410  
    list\_add() function, 4462  
    list\_drop() function, 4463  
    memory\_by\_host\_by\_current\_bytes view, 4410  
    memory\_by\_thread\_by\_current\_bytes view, 4411  
    memory\_by\_user\_by\_current\_bytes view, 4411  
    memory\_global\_by\_current\_bytes view, 4412  
    memory\_global\_total view, 4413  
    metrics view, 4413  
    new features, 15  
    object ownership, 4387  
    processlist view, 4414  
    ps\_check\_lost\_instrumentation view, 4416  
    ps\_is\_account\_enabled() function, 4463  
    ps\_is\_consumer\_enabled() function, 4463  
    ps\_is\_instrument\_default\_enabled() function, 4464  
    ps\_is\_instrument\_default\_timed() function, 4464  
    ps\_is\_thread\_instrumented() function, 4465  
    ps\_setup\_disable\_background\_threads() procedure, 4443  
    ps\_setup\_disable\_consumer() procedure, 4443

---

ps\_setup\_disable\_instrument() procedure, 4443  
ps\_setup\_disable\_thread() procedure, 4444  
ps\_setup\_enable\_background\_threads() procedure, 4444  
ps\_setup\_enable\_consumer() procedure, 4445  
ps\_setup\_enable\_instrument() procedure, 4445  
ps\_setup\_enable\_thread() procedure, 4446  
ps\_setup\_reload\_saved() procedure, 4446  
ps\_setup\_reset\_to\_default() procedure, 4446  
ps\_setup\_save() procedure, 4447  
ps\_setup\_show\_disabled() procedure, 4447  
ps\_setup\_show\_disabled\_consumers() procedure, 4448  
ps\_setup\_show\_disabled\_instruments() procedure, 4449  
ps\_setup\_show\_enabled() procedure, 4449  
ps\_setup\_show\_enabled\_consumers() procedure, 4450  
ps\_setup\_show\_enabled\_instruments() procedure, 4450  
ps\_statement\_avg\_latency\_histogram() procedure, 4450  
ps\_thread\_account() function, 4465  
ps\_thread\_id() function, 4466  
ps\_thread\_stack() function, 4466  
ps\_thread\_trx\_info() function, 4466  
ps\_trace\_statement\_digest() procedure, 4451  
ps\_trace\_thread() procedure, 4453  
ps\_truncate\_all\_tables() procedure, 4454  
quote\_identifier() function, 4468  
schema\_auto\_increment\_columns view, 4416  
schema\_index\_statistics view, 4417  
schema\_object\_overview view, 4418  
schema\_redundant\_indexes view, 4419  
schema\_tables\_with\_full\_table\_scans view, 4424  
schema\_table\_lock\_waits view, 4420  
schema\_table\_statistics view, 4421  
schema\_table\_statistics\_with\_buffer view, 4423  
schema\_unused\_indexes view, 4425  
session view, 4425  
session\_ssl\_status view, 4425  
statements\_with\_errors\_or\_warnings view, 4427  
statements\_with\_full\_table\_scans view, 4428  
statements\_with\_runtimes\_in\_95th\_percentile view, 4429  
statements\_with\_sorting view, 4431  
statements\_with\_temp\_tables view, 4432  
statement\_analysis view, 4426  
statement\_performance\_analyzer() procedure, 4454  
sys\_config table, 4395  
sys\_get\_config() function, 4469  
table\_exists() procedure, 4458  
user\_summary view, 4432  
user\_summary\_by\_file\_io view, 4433  
user\_summary\_by\_file\_io\_type view, 4434  
user\_summary\_by\_stages view, 4434  
user\_summary\_by\_statement\_latency view, 4435  
user\_summary\_by\_statement\_type view, 4436  
version view, 4436  
version\_major() function, 4470  
version\_minor() function, 4470

---

version\_patch() function, 4470  
waits\_by\_host\_by\_latency view, 4438  
waits\_by\_user\_by\_latency view, 4438  
waits\_global\_by\_latency view, 4439  
wait\_classes\_global\_by\_avg\_latency view, 4437  
wait\_classes\_global\_by\_latency view, 4437  
x\$ views, 4398  
x\$host\_summary view, 4398  
x\$host\_summary\_by\_file\_io view, 4399  
x\$host\_summary\_by\_file\_io\_type view, 4399  
x\$host\_summary\_by\_stages view, 4400  
x\$host\_summary\_by\_statement\_latency view, 4400  
x\$host\_summary\_by\_statement\_type view, 4401  
x\$innodb\_buffer\_stats\_by\_schema view, 4402  
x\$innodb\_buffer\_stats\_by\_table view, 4403  
x\$innodb\_lock\_waits view, 4404  
x\$io\_by\_thread\_by\_latency view, 4406  
x\$io\_global\_by\_file\_by\_bytes view, 4406  
x\$io\_global\_by\_file\_by\_latency view, 4407  
x\$io\_global\_by\_wait\_by\_bytes view, 4408  
x\$io\_global\_by\_wait\_by\_latency view, 4409  
x\$latest\_file\_io view, 4410  
x\$memory\_by\_host\_by\_current\_bytes view, 4410  
x\$memory\_by\_thread\_by\_current\_bytes view, 4411  
x\$memory\_by\_user\_by\_current\_bytes view, 4411  
x\$memory\_global\_by\_current\_bytes view, 4412  
x\$memory\_global\_total view, 4413  
x\$processlist view, 4414  
x\$schema\_flattened\_keys view, 4419  
x\$schema\_index\_statistics view, 4417  
x\$schema\_tables\_with\_full\_table\_scans view, 4424  
x\$schema\_table\_lock\_waits view, 4420  
x\$schema\_table\_statistics view, 4421  
x\$schema\_table\_statistics\_with\_buffer view, 4423  
x\$session view, 4425  
x\$statements\_with\_errors\_or\_warnings view, 4427  
x\$statements\_with\_full\_table\_scans view, 4428  
x\$statements\_with\_runtimes\_in\_95th\_percentile view, 4429  
x\$statements\_with\_sorting view, 4431  
x\$statements\_with\_temp\_tables view, 4432  
x\$statement\_analysis view, 4426  
x\$user\_summary view, 4432  
x\$user\_summary\_by\_file\_io view, 4433  
x\$user\_summary\_by\_file\_io\_type view, 4434  
x\$user\_summary\_by\_stages view, 4434  
x\$user\_summary\_by\_statement\_latency view, 4435  
x\$user\_summary\_by\_statement\_type view, 4436  
x\$waits\_by\_host\_by\_latency view, 4438  
x\$waits\_by\_user\_by\_latency view, 4438  
x\$waits\_global\_by\_latency view, 4439  
x\$wait\_classes\_global\_by\_avg\_latency view, 4437  
x\$wait\_classes\_global\_by\_latency view, 4437  
sys-check option  
  ndb\_index\_stat, 3676

---

- sys-create option
  - ndb\_index\_stat, 3675
- sys-create-if-not-exist option
  - ndb\_index\_stat, 3676
- sys-create-if-not-valid option
  - ndb\_index\_stat, 3676
- sys-drop option
  - ndb\_index\_stat, 3675
- sys-skip-events option
  - ndb\_index\_stat, 3676
- sys-skip-tables option
  - ndb\_index\_stat, 3676
- sys.version
  - deprecated features, 21
- SYSCONFDIR option
  - CMake, 206
- SYSDATE(), 1937
- sysdate-is-now option
  - mysqld, 763
- syslog option
  - mysql, 418
  - mysqld\_safe, 349
- syslog-tag option
  - mysqld\_safe, 350
- system
  - privilege, 1094
  - security, 1076
- system and status variables
  - new features, 15
- system command
  - mysql, 424
- System lock
  - thread state, 1627
- system optimization, 1606
- system option
  - ndb\_config, 3621
- system table
  - optimizer, 1553, 2316
- system tables
  - audit\_log\_filter table, 970
  - audit\_log\_user table, 970
  - columns\_priv table, 968, 1105
  - db table, 233, 968, 1105
  - engine\_cost, 1581
  - engine\_cost table, 970
  - event table, 968
  - firewall\_users table, 970
  - firewall\_whitelist table, 970
  - func table, 968, 1037
  - general\_log table, 969
  - gtid\_executed table, 969, 2968
  - help tables, 969
  - help\_category table, 969
  - help\_keyword table, 969

---

help\_relation table, 969  
help\_topic table, 969  
innodb\_index\_stats table, 970, 2659  
innodb\_table\_stats table, 970, 2659  
ndb\_binlog\_index table, 970  
plugin table, 969  
proc table, 969  
procs\_priv table, 968, 1105  
proxies\_priv table, 233, 968, 1105  
servers table, 970  
server\_cost, 1580  
server\_cost table, 970  
slave\_master\_info table, 970  
slave\_relay\_log\_info table, 970  
slave\_worker\_info table, 970  
slow\_log table, 969  
tables\_priv table, 968, 1105  
time zone tables, 969  
time\_zone table, 969  
time\_zone\_leap\_second table, 969  
time\_zone\_name table, 969  
time\_zone\_transition table, 969  
time\_zone\_transition\_type table, 969  
user table, 233, 968, 1105  
system tablespace, 5361  
system variable  
  audit\_log\_buffer\_size, 1355  
  audit\_log\_compression, 1355  
  audit\_log\_connection\_policy, 1356  
  audit\_log\_current\_session, 1356  
  audit\_log\_disable, 1357  
  audit\_log\_encryption, 1357  
  audit\_log\_exclude\_accounts, 1357  
  audit\_log\_file, 1324, 1358  
  audit\_log\_filter\_id, 1358  
  audit\_log\_flush, 1359  
  audit\_log\_format, 1359  
  audit\_log\_format\_unix\_timestamp, 1359  
  audit\_log\_include\_accounts, 1360  
  audit\_log\_policy, 1360  
  audit\_log\_read\_buffer\_size, 1327, 1361  
  audit\_log\_rotate\_on\_size, 1362  
  audit\_log\_statement\_policy, 1362  
  audit\_log\_strategy, 1363  
  authentication\_ldap\_sasl\_auth\_method\_name, 1227  
  authentication\_ldap\_sasl\_bind\_base\_dn, 1228  
  authentication\_ldap\_sasl\_bind\_root\_dn, 1228  
  authentication\_ldap\_sasl\_bind\_root\_pwd, 1229  
  authentication\_ldap\_sasl\_ca\_path, 1229  
  authentication\_ldap\_sasl\_group\_search\_attr, 1229  
  authentication\_ldap\_sasl\_group\_search\_filter, 1230  
  authentication\_ldap\_sasl\_init\_pool\_size, 1231  
  authentication\_ldap\_sasl\_log\_status, 1232  
  authentication\_ldap\_sasl\_max\_pool\_size, 1232

---

authentication\_ldap\_sasl\_server\_host, 1233  
authentication\_ldap\_sasl\_server\_port, 1233  
authentication\_ldap\_sasl\_tls, 1233  
authentication\_ldap\_sasl\_user\_search\_attr, 1234  
authentication\_ldap\_simple\_auth\_method\_name, 1234  
authentication\_ldap\_simple\_bind\_base\_dn, 1235  
authentication\_ldap\_simple\_bind\_root\_dn, 1236  
authentication\_ldap\_simple\_bind\_root\_pwd, 1237  
authentication\_ldap\_simple\_ca\_path, 1237  
authentication\_ldap\_simple\_group\_search\_attr, 1237  
authentication\_ldap\_simple\_group\_search\_filter, 1238  
authentication\_ldap\_simple\_init\_pool\_size, 1238  
authentication\_ldap\_simple\_log\_status, 1239  
authentication\_ldap\_simple\_max\_pool\_size, 1240  
authentication\_ldap\_simple\_server\_host, 1240  
authentication\_ldap\_simple\_server\_port, 1242  
authentication\_ldap\_simple\_tls, 1242  
authentication\_ldap\_simple\_user\_search\_attr, 1242  
authentication\_windows\_log\_level, 768  
authentication\_windows\_use\_principal\_name, 768  
autocommit, 769  
automatic\_sp\_privileges, 769  
auto\_generate\_certs, 770  
auto\_increment\_increment, 3007  
auto\_increment\_offset, 3010  
avoid\_temporal\_upgrade, 770  
back\_log, 770  
basedir, 771  
big\_tables, 771  
bind\_address, 772  
binlog\_cache\_size, 3053  
binlog\_checksum, 3053  
binlog\_direct\_non\_transactional\_updates, 3054  
binlog\_error\_action, 3055  
binlog\_format, 3055  
binlog\_group\_commit\_sync\_delay, 3056  
binlog\_group\_commit\_sync\_no\_delay\_count, 3057  
binlog\_gtid\_simple\_recovery, 3071  
binlog\_max\_flush\_queue\_time, 3058  
binlog\_order\_commits, 3058  
binlog\_rows\_query\_log\_events, 3060  
binlog\_row\_image, 3059  
binlog\_stmt\_cache\_size, 3061  
binlog\_transaction\_dependency\_history\_size, 3062  
binlog\_transaction\_dependency\_tracking, 3061  
block\_encryption\_mode, 773  
bulk\_insert\_buffer\_size, 773, 2922  
character\_sets\_dir, 776  
character\_set\_client, 774  
character\_set\_connection, 774  
character\_set\_database, 774  
character\_set\_filesystem, 775  
character\_set\_results, 775  
character\_set\_server, 775

---

character\_set\_system, 776  
check\_proxy\_users, 776, 1138  
collation\_connection, 777  
collation\_database, 777  
collation\_server, 777  
completion\_type, 777  
concurrent\_insert, 778  
connection\_control\_failed\_connections\_threshold, 1247  
connection\_control\_max\_connection\_delay, 1248  
connection\_control\_min\_connection\_delay, 1248  
connect\_timeout, 779  
core\_file, 779  
daemon\_memcached\_enable\_binlog, 2738  
daemon\_memcached\_engine\_lib\_name, 2738  
daemon\_memcached\_engine\_lib\_path, 2739  
daemon\_memcached\_option, 2739  
daemon\_memcached\_r\_batch\_size, 2740  
daemon\_memcached\_w\_batch\_size, 2740  
datadir, 780  
datetime\_format, 780  
date\_format, 780  
debug, 780  
debug\_sync, 781  
default\_authentication\_plugin, 781  
default\_password\_lifetime, 782  
default\_storage\_engine, 783  
default\_tmp\_storage\_engine, 784  
default\_week\_format, 784  
delayed\_insert\_limit, 785  
delayed\_insert\_timeout, 786  
delayed\_queue\_size, 786  
delay\_key\_write, 784, 2922  
disabled\_storage\_engines, 786  
disconnect\_on\_expired\_password, 787  
div\_precision\_increment, 788  
end\_markers\_in\_json, 788  
error\_count, 789  
event\_scheduler, 789  
expire\_logs\_days, 3062  
explicit\_defaults\_for\_timestamp, 790  
external\_user, 791  
flush, 791  
flush\_time, 792  
foreign\_key\_checks, 792  
ft\_boolean\_syntax, 793  
ft\_max\_word\_len, 793  
ft\_min\_word\_len, 794  
ft\_query\_expansion\_limit, 794  
ft\_stopword\_file, 794  
general\_log, 795  
general\_log\_file, 795  
group\_concat\_max\_len, 795  
group\_replication\_allow\_local\_disjoint\_gtids\_join, 3213  
group\_replication\_allow\_local\_lower\_version\_join, 3213

---

group\_replication\_auto\_increment\_increment, 3214  
group\_replication\_bootstrap\_group, 3215  
group\_replication\_components\_stop\_timeout, 3215  
group\_replication\_compression\_threshold, 3215  
group\_replication\_enforce\_update\_everywhere\_checks, 3216  
group\_replication\_exit\_state\_action, 3216  
group\_replication\_flow\_control\_applier\_threshold, 3218  
group\_replication\_flow\_control\_certifier\_threshold, 3218  
group\_replication\_flow\_control\_hold\_percent, 3219  
group\_replication\_flow\_control\_max\_quota, 3219  
group\_replication\_flow\_control\_member\_quota\_percent, 3219  
group\_replication\_flow\_control\_min\_quota, 3220  
group\_replication\_flow\_control\_min\_recovery\_quota, 3220  
group\_replication\_flow\_control\_mode, 3220  
group\_replication\_force\_members, 3221  
group\_replication\_group\_name, 3221  
group\_replication\_group\_seeds, 3222  
group\_replication\_gtid\_assignment\_block\_size, 3222  
group\_replication\_ip\_whitelist, 3223  
group\_replication\_local\_address, 3224  
group\_replication\_member\_weight, 3225  
group\_replication\_poll\_spin\_loops, 3225  
group\_replication\_recovery\_complete\_at, 3226  
group\_replication\_recovery\_reconnect\_interval, 3226  
group\_replication\_recovery\_retry\_count, 3226  
group\_replication\_recovery\_ssl\_ca, 3227  
group\_replication\_recovery\_ssl\_capath, 3227  
group\_replication\_recovery\_ssl\_cert, 3227  
group\_replication\_recovery\_ssl\_cipher, 3228  
group\_replication\_recovery\_ssl\_crl, 3228  
group\_replication\_recovery\_ssl\_crlpath, 3228  
group\_replication\_recovery\_ssl\_key, 3228  
group\_replication\_recovery\_ssl\_verify\_server\_cert, 3229  
group\_replication\_recovery\_use\_ssl, 3229  
group\_replication\_single\_primary\_mode, 3229  
group\_replication\_ssl\_mode, 3230  
group\_replication\_start\_on\_boot, 3230  
group\_replication\_transaction\_size\_limit, 3230  
group\_replication\_unreachable\_majority\_timeout, 3231  
gtid\_executed, 3073  
gtid\_executed\_compression\_period, 3074  
gtid\_purged, 3076  
have\_compress, 796  
have\_crypt, 796  
have\_dynamic\_loading, 796  
have\_geometry, 796  
have\_openssl, 796  
have\_profiling, 796  
have\_query\_cache, 796  
have\_rtree\_keys, 796  
have\_ssl, 796  
have\_statement\_timeout, 797  
have\_symlink, 797  
hostname, 798



---

identity, 798  
ignore\_builtin\_innodb, 2740  
ignore\_db\_dirs, 798  
init\_connect, 799  
init\_file, 799  
init\_slave, 3026  
innodb\_adaptive\_flushing, 2741  
innodb\_adaptive\_flushing\_lwm, 2741  
innodb\_adaptive\_hash\_index, 2741  
innodb\_adaptive\_hash\_index\_parts, 2742  
innodb\_adaptive\_max\_sleep\_delay, 2742  
innodb\_api\_bk\_commit\_interval, 2743  
innodb\_api\_disable\_rowlock, 2743  
innodb\_api\_enable\_binlog, 2744  
innodb\_api\_enable\_mdl, 2744  
innodb\_api\_trx\_level, 2744  
innodb\_autoextend\_increment, 2745  
innodb\_autoinc\_lock\_mode, 2745  
innodb\_background\_drop\_list\_empty, 2745  
innodb\_buffer\_pool\_chunk\_size, 2746  
innodb\_buffer\_pool\_dump\_at\_shutdown, 2747  
innodb\_buffer\_pool\_dump\_now, 2747  
innodb\_buffer\_pool\_dump\_pct, 2748  
innodb\_buffer\_pool\_filename, 2748  
innodb\_buffer\_pool\_instances, 2748  
innodb\_buffer\_pool\_load\_abort, 2749  
innodb\_buffer\_pool\_load\_at\_startup, 2750  
innodb\_buffer\_pool\_load\_now, 2750  
innodb\_buffer\_pool\_size, 2751  
innodb\_change\_buffering, 2752  
innodb\_change\_buffering\_debug, 2753  
innodb\_change\_buffer\_max\_size, 2752  
innodb\_checksums, 2755  
innodb\_checksum\_algorithm, 2753  
innodb\_cmp\_per\_index\_enabled, 2756  
innodb\_commit\_concurrency, 2756  
innodb\_compression\_failure\_threshold\_pct, 2757  
innodb\_compression\_level, 2757  
innodb\_compression\_pad\_pct\_max, 2758  
innodb\_compress\_debug, 2756  
innodb\_concurrency\_tickets, 2758  
innodb\_data\_file\_path, 2759  
innodb\_data\_home\_dir, 2759  
innodb\_deadlock\_detect, 2760  
innodb\_default\_row\_format, 2760  
innodb\_disable\_resize\_buffer\_pool\_debug, 2761  
innodb\_disable\_sort\_file\_cache, 2761  
innodb\_doublewrite, 2761  
innodb\_fast\_shutdown, 2762  
innodb\_file\_format, 2763  
innodb\_file\_format\_check, 2764  
innodb\_file\_format\_max, 2764  
innodb\_file\_per\_table, 2765  
innodb\_fill\_factor, 2765

---

innodb\_fil\_make\_page\_dirty\_debug, 2762  
innodb\_flushing\_avg\_loops, 2770  
innodb\_flush\_log\_at\_timeout, 2766  
innodb\_flush\_log\_at\_trx\_commit, 2766  
innodb\_flush\_method, 2767  
innodb\_flush\_neighbors, 2769  
innodb\_flush\_sync, 2770  
innodb\_force\_load\_corrupted, 2770  
innodb\_force\_recovery, 2771  
innodb\_ft\_aux\_table, 2771  
innodb\_ft\_cache\_size, 2771  
innodb\_ft\_enable\_diag\_print, 2772  
innodb\_ft\_enable\_stopword, 2772  
innodb\_ft\_max\_token\_size, 2773  
innodb\_ft\_min\_token\_size, 2773  
innodb\_ft\_num\_word\_optimize, 2774  
innodb\_ft\_result\_cache\_limit, 2774  
innodb\_ft\_server\_stopword\_table, 2775  
innodb\_ft\_sort\_pll\_degree, 2775  
innodb\_ft\_total\_cache\_size, 2775  
innodb\_ft\_user\_stopword\_table, 2776  
innodb\_io\_capacity, 2776  
innodb\_io\_capacity\_max, 2777  
innodb\_limit\_optimistic\_insert\_debug, 2778  
innodb\_locks\_unsafe\_for\_binlog, 2779  
innodb\_lock\_wait\_timeout, 2778  
innodb\_log\_buffer\_size, 2781  
innodb\_log\_checkpoint\_now, 2782  
innodb\_log\_checksums, 2782  
innodb\_log\_compressed\_pages, 2782  
innodb\_log\_files\_in\_group, 2784  
innodb\_log\_file\_size, 2783  
innodb\_log\_group\_home\_dir, 2784  
innodb\_log\_write\_ahead\_size, 2784  
innodb\_lru\_scan\_depth, 2785  
innodb\_max\_dirty\_pages\_pct, 2785  
innodb\_max\_dirty\_pages\_pct\_lwm, 2786  
innodb\_max\_purge\_lag, 2786  
innodb\_max\_purge\_lag\_delay, 2787  
innodb\_max\_undo\_log\_size, 2787  
innodb\_merge\_threshold\_set\_all\_debug, 2787  
innodb\_monitor\_disable, 2788  
innodb\_monitor\_enable, 2788  
innodb\_monitor\_reset, 2788  
innodb\_monitor\_reset\_all, 2789  
innodb\_numa\_interleave, 2789  
innodb\_old\_blocks\_pct, 2790  
innodb\_old\_blocks\_time, 2790  
innodb\_online\_alter\_log\_max\_size, 2791  
innodb\_open\_files, 2791  
innodb\_optimize\_fulltext\_only, 2792  
innodb\_page\_cleaners, 2792  
innodb\_page\_size, 2793  
innodb\_purge\_batch\_size, 2795

---

innodb\_purge\_rseg\_truncate\_frequency, 2795  
innodb\_purge\_threads, 2795  
innodb\_random\_read\_ahead, 2796  
innodb\_read\_ahead\_threshold, 2796  
innodb\_read\_io\_threads, 2797  
innodb\_read\_only, 2797  
innodb\_replication\_delay, 2798  
innodb\_rollback\_on\_timeout, 2798  
innodb\_rollback\_segments, 2798  
innodb\_saved\_page\_number\_debug, 2799  
innodb\_sort\_buffer\_size, 2799  
innodb\_spin\_wait\_delay, 2800  
innodb\_stats\_auto\_recalc, 2800  
innodb\_stats\_include\_delete\_marked, 2661, 2801  
innodb\_stats\_method, 2801  
innodb\_stats\_on\_metadata, 2802  
innodb\_stats\_persistent\_sample\_pages, 2802  
innodb\_stats\_sample\_pages, 2803  
innodb\_stats\_transient\_sample\_pages, 2803  
innodb\_status\_output, 2804  
innodb\_status\_output\_locks, 2804  
innodb\_strict\_mode, 2805  
innodb\_support\_xa, 2805  
innodb\_sync\_array\_size, 2806  
innodb\_sync\_debug, 2806  
innodb\_sync\_spin\_loops, 2806  
innodb\_table\_locks, 2807  
innodb\_temp\_data\_file\_path, 2807  
innodb\_thread\_concurrency, 2808  
innodb\_thread\_sleep\_delay, 2810  
innodb\_tmpdir, 2810  
innodb\_trx\_purge\_view\_update\_only\_debug, 2811  
innodb\_trx\_rseg\_n\_slots\_debug, 2811  
innodb\_undo\_directory, 2811  
innodb\_undo\_log\_truncate, 2812  
innodb\_undo\_tablespace, 2813  
innodb\_use\_native\_aio, 2814  
innodb\_version, 2814  
innodb\_write\_io\_threads, 2814  
insert\_id, 799  
interactive\_timeout, 799  
internal\_tmp\_disk\_storage\_engine, 800  
join\_buffer\_size, 800  
keep\_files\_on\_create, 801  
keyring\_aws\_cmk\_id, 1287  
keyring\_aws\_conf\_file, 1287  
keyring\_aws\_data\_file, 1287  
keyring\_aws\_region, 1288  
keyring\_encrypted\_file\_data, 1290  
keyring\_encrypted\_file\_password, 1291  
keyring\_file\_data, 1292  
keyring\_okv\_conf\_dir, 1293  
keyring\_operations, 1294  
key\_buffer\_size, 802

---

key\_cache\_age\_threshold, 803  
key\_cache\_block\_size, 803  
key\_cache\_division\_limit, 804  
large\_files\_support, 804  
large\_pages, 804  
large\_page\_size, 804  
last\_insert\_id, 805  
lc\_messages, 805  
lc\_messages\_dir, 805  
lc\_time\_names, 805  
license, 806  
local\_infile, 806, 1090  
locked\_in\_memory, 807  
lock\_wait\_timeout, 806  
log\_bin, 3063  
log\_bin\_basename, 3063  
log\_bin\_index, 3063  
log\_bin\_trust\_function\_creators, 3064  
log\_bin\_use\_v1\_row\_events, 3064  
log\_built\_in\_as\_identified\_by\_password, 3065  
log\_error, 807  
log\_error\_verbosity, 807  
log\_output, 808  
log\_queries\_not\_using\_indexes, 808  
log\_slave\_updates, 3065  
log\_slow\_slave\_statements, 3026  
log\_statements\_unsafe\_for\_binlog, 3066  
log\_syslog, 809  
log\_syslog\_facility, 809  
log\_syslog\_include\_pid, 810  
log\_syslog\_tag, 810  
log\_throttle\_queries\_not\_using\_indexes, 811  
log\_timestamps, 810  
log\_warnings, 811  
long\_query\_time, 812  
lower\_case\_file\_system, 813  
lower\_case\_table\_names, 814  
low\_priority\_updates, 813  
master\_info\_repository, 3026  
master\_verify\_checksum, 3066  
max\_allowed\_packet, 814  
max\_binlog\_cache\_size, 3066  
max\_binlog\_size, 3067  
max\_binlog\_stmt\_cache\_size, 3068  
max\_connections, 815  
max\_connect\_errors, 815  
max\_delayed\_threads, 816  
max\_digest\_length, 816  
max\_error\_count, 817  
max\_execution\_time, 817  
max\_heap\_table\_size, 818  
max\_insert\_delayed\_threads, 818  
max\_join\_size, 433, 819  
max\_length\_for\_sort\_data, 819

---

max\_points\_in\_geometry, 820  
max\_prepared\_stmt\_count, 820  
max\_relay\_log\_size, 3027  
max\_seeks\_for\_key, 820  
max\_sort\_length, 821  
max\_sp\_recursion\_depth, 821  
max\_tmp\_tables, 821  
max\_user\_connections, 822  
max\_write\_lock\_count, 822  
mecab\_rc\_file, 823  
metadata\_locks\_cache\_size, 823  
metadata\_locks\_hash\_instances, 823  
min\_examined\_row\_limit, 824  
myisam\_data\_pointer\_size, 824  
myisam\_max\_sort\_file\_size, 825, 2923  
myisam\_mmap\_size, 825  
myisam\_recover\_options, 826, 2923  
myisam\_repair\_threads, 827  
myisam\_sort\_buffer\_size, 827, 2923  
myisam\_stats\_method, 828  
myisam\_use\_mmap, 828  
mysqlx\_bind\_address, 3267  
mysqlx\_connect\_timeout, 3267  
mysqlx\_idle\_worker\_thread\_timeout, 3268  
mysqlx\_max\_allowed\_packet, 3268  
mysqlx\_max\_connections, 3268  
mysqlx\_min\_worker\_threads, 3269  
mysqlx\_port, 3269  
mysqlx\_port\_open\_timeout, 3270  
mysqlx\_socket, 3270  
mysqlx\_ssl\_ca, 3271  
mysqlx\_ssl\_capath, 3271  
mysqlx\_ssl\_cert, 3271  
mysqlx\_ssl\_cipher, 3272  
mysqlx\_ssl\_crl, 3272  
mysqlx\_ssl\_crlpath, 3272  
mysqlx\_ssl\_key, 3272  
mysql\_firewall\_mode, 1380  
mysql\_firewall\_trace, 1380  
mysql\_native\_password\_proxy\_users, 828, 1138  
named\_pipe, 829  
named\_pipe\_full\_access\_group, 829  
ndbinfo\_database, 3536  
ndbinfo\_max\_bytes, 3536  
ndbinfo\_max\_rows, 3536  
ndbinfo\_offline, 3537  
ndbinfo\_show\_hidden, 3537  
ndbinfo\_table\_prefix, 3537  
ndbinfo\_version, 3538, 3538  
ndb\_autoincrement\_prefetch\_sz, 3517  
ndb\_cache\_check\_time, 3517  
ndb\_clear\_apply\_status, 3518  
ndb\_data\_node\_neighbour, 3518  
ndb\_default\_column\_format, 3519

---

ndb\_deferred\_constraints, 3519  
ndb\_distribution, 3520  
ndb\_eventbuffer\_free\_percent, 3520  
ndb\_eventbuffer\_max\_alloc, 3520  
ndb\_extra\_logging, 3521  
ndb\_force\_send, 3521  
ndb\_fully\_replicated, 3521  
ndb\_index\_stat\_enable, 3522  
ndb\_index\_stat\_option, 3522  
ndb\_join\_pushdown, 3524  
ndb\_log\_apply\_status, 3526  
ndb\_log\_bin, 3526  
ndb\_log\_binlog\_index, 3526  
ndb\_log\_empty\_epochs, 3527  
ndb\_log\_empty\_update, 3527  
ndb\_log\_exclusive\_reads, 3527  
ndb\_log\_orig, 3527  
ndb\_log\_transaction\_id, 3528  
ndb\_optimized\_node\_selection, 3528  
ndb\_read\_backup, 3529  
ndb\_rcv\_thread\_activation\_threshold, 3530  
ndb\_rcv\_thread\_cpu\_mask, 3530  
ndb\_report\_thresh\_binlog\_epoch\_slip, 3530  
ndb\_report\_thresh\_binlog\_mem\_usage, 3531  
ndb\_row\_checksum, 3531  
ndb\_show\_foreign\_key\_mock\_tables, 3532  
ndb\_slave\_conflict\_role, 3532  
ndb\_table\_no\_logging, 3532  
ndb\_table\_temporary, 3533  
ndb\_use\_copying\_alter\_table, 3533  
ndb\_use\_exact\_count, 3533  
ndb\_use\_transactions, 3533  
ndb\_version, 3534  
ndb\_version\_string, 3534  
net\_buffer\_length, 830  
net\_read\_timeout, 830  
net\_retry\_count, 830  
net\_write\_timeout, 831  
new, 831  
ngram\_token\_size, 831  
offline\_mode, 832  
old, 832  
old\_alter\_table, 833  
old\_passwords, 833  
open\_files\_limit, 834  
optimizer\_prune\_level, 835  
optimizer\_search\_depth, 835  
optimizer\_switch, 835  
optimizer\_trace, 837  
optimizer\_trace\_features, 838  
optimizer\_trace\_limit, 838  
optimizer\_trace\_max\_mem\_size, 838  
optimizer\_trace\_offset, 839  
parser\_max\_mem\_size, 839

---

performance\_schema, 4359  
performance\_schema\_accounts\_size, 4359  
performance\_schema\_digests\_size, 4360  
performance\_schema\_events\_stages\_history\_long\_size, 4360  
performance\_schema\_events\_stages\_history\_size, 4361  
performance\_schema\_events\_statements\_history\_long\_size, 4361  
performance\_schema\_events\_statements\_history\_size, 4361  
performance\_schema\_events\_transactions\_history\_long\_size, 4362  
performance\_schema\_events\_transactions\_history\_size, 4362  
performance\_schema\_events\_waits\_history\_long\_size, 4362  
performance\_schema\_events\_waits\_history\_size, 4363  
performance\_schema\_hosts\_size, 4363  
performance\_schema\_max\_cond\_classes, 4363  
performance\_schema\_max\_cond\_instances, 4364  
performance\_schema\_max\_digest\_length, 4364  
performance\_schema\_max\_file\_classes, 4365  
performance\_schema\_max\_file\_handles, 4365  
performance\_schema\_max\_file\_instances, 4365  
performance\_schema\_max\_index\_stat, 4366  
performance\_schema\_max\_memory\_classes, 4366  
performance\_schema\_max\_metadata\_locks, 4366  
performance\_schema\_max\_mutex\_classes, 4367  
performance\_schema\_max\_mutex\_instances, 4367  
performance\_schema\_max\_prepared\_statements\_instances, 4367  
performance\_schema\_max\_program\_instances, 4368  
performance\_schema\_max\_rwlock\_classes, 4368  
performance\_schema\_max\_rwlock\_instances, 4369  
performance\_schema\_max\_socket\_classes, 4369  
performance\_schema\_max\_socket\_instances, 4369  
performance\_schema\_max\_sql\_text\_length, 4370  
performance\_schema\_max\_stage\_classes, 4370  
performance\_schema\_max\_statement\_classes, 4370  
performance\_schema\_max\_statement\_stack, 4371  
performance\_schema\_max\_table\_handles, 4371  
performance\_schema\_max\_table\_instances, 4372  
performance\_schema\_max\_table\_lock\_stat, 4372  
performance\_schema\_max\_thread\_classes, 4373  
performance\_schema\_max\_thread\_instances, 4373  
performance\_schema\_session\_connect\_attrs\_size, 4373  
performance\_schema\_setup\_actors\_size, 4374  
performance\_schema\_setup\_objects\_size, 4374  
performance\_schema\_show\_processlist, 4375  
performance\_schema\_users\_size, 4375  
pid\_file, 839  
plugin\_dir, 840  
port, 840  
preload\_buffer\_size, 840  
profiling, 841  
profiling\_history\_size, 841  
protocol\_version, 841  
proxy\_user, 841  
pseudo\_slave\_mode, 841  
pseudo\_thread\_id, 842  
query\_alloc\_block\_size, 842

---

query\_cache\_limit, 843  
query\_cache\_min\_res\_unit, 843  
query\_cache\_size, 844  
query\_cache\_type, 844  
query\_cache\_wlock\_invalidate, 845  
query\_prealloc\_size, 846  
rand\_seed1, 846  
rand\_seed2, 847  
range\_alloc\_block\_size, 847  
range\_optimizer\_max\_mem\_size, 847  
rbr\_exec\_mode, 847  
read\_buffer\_size, 848  
read\_only, 849  
read\_rnd\_buffer\_size, 850  
relay\_log, 3027  
relay\_log\_basename, 3028  
relay\_log\_index, 3028  
relay\_log\_info\_file, 3029  
relay\_log\_info\_repository, 3029  
relay\_log\_purge, 3030  
relay\_log\_recovery, 3030  
relay\_log\_space\_limit, 3031  
replication\_optimize\_for\_static\_plugin\_config, 3032  
replication\_sender\_observe\_commit\_only, 3032  
report\_host, 3032  
report\_password, 3033  
report\_port, 3033  
report\_user, 3034  
require\_secure\_transport, 850  
rewriter\_enabled, 1015  
rewriter\_verbose, 1015  
rpl\_semi\_sync\_master\_enabled, 3010  
rpl\_semi\_sync\_master\_timeout, 3010  
rpl\_semi\_sync\_master\_trace\_level, 3011  
rpl\_semi\_sync\_master\_wait\_for\_slave\_count, 3011  
rpl\_semi\_sync\_master\_wait\_no\_slave, 3012  
rpl\_semi\_sync\_master\_wait\_point, 3012  
rpl\_semi\_sync\_slave\_enabled, 3034  
rpl\_semi\_sync\_slave\_trace\_level, 3034  
rpl\_stop\_slave\_timeout, 3035  
secure\_auth, 851  
secure\_file\_priv, 851  
server\_id, 2998  
server\_id\_bits, 3534, 3534  
session\_track\_gtids, 852, 963  
session\_track\_schema, 853, 963  
session\_track\_state\_change, 853, 963  
session\_track\_system\_variables, 854, 963  
session\_track\_transaction\_info, 855  
sha256\_password\_auto\_generate\_rsa\_keys, 856  
sha256\_password\_private\_key\_path, 856  
sha256\_password\_proxy\_users, 857, 1138  
sha256\_password\_public\_key\_path, 857  
shared\_memory, 857



---

shared\_memory\_base\_name, 858  
show\_compatibility\_56, 858  
show\_create\_table\_verbosity, 863  
show\_old\_temporals, 863  
skip\_external\_locking, 864  
skip\_name\_resolve, 864  
skip\_networking, 865  
skip\_show\_database, 865  
slave\_allow\_batching, 3535  
slave\_checkpoint\_group, 3035  
slave\_checkpoint\_period, 3036  
slave\_compressed\_protocol, 3037  
slave\_exec\_mode, 3037  
slave\_load\_tmpdir, 3037  
slave\_max\_allowed\_packet, 3038  
slave\_net\_timeout, 3039  
slave\_parallel\_type, 3039  
slave\_parallel\_workers, 3040  
slave\_pending\_jobs\_size\_max, 3041  
slave\_preserve\_commit\_order, 3041  
slave\_rows\_search\_algorithms, 3042  
slave\_skip\_errors, 3043  
slave\_sql\_verify\_checksum, 3043  
slave\_transaction\_retries, 3044  
slave\_type\_conversions, 3044  
slow\_launch\_time, 865  
slow\_query\_log, 866  
slow\_query\_log\_file, 866  
socket, 866  
sort\_buffer\_size, 867  
sql\_auto\_is\_null, 867  
sql\_big\_selects, 868  
sql\_buffer\_result, 868  
sql\_log\_bin, 3068  
sql\_log\_off, 868  
sql\_mode, 869  
sql\_notes, 870  
sql\_quote\_show\_create, 870  
sql\_safe\_updates, 433, 870  
sql\_select\_limit, 433, 871  
sql\_slave\_skip\_counter, 3045  
sql\_warnings, 871  
ssl\_ca, 871  
ssl\_capath, 872  
ssl\_cert, 872  
ssl\_cipher, 872  
ssl\_crl, 873  
ssl\_crlpath, 873  
ssl\_key, 873  
stored\_program\_cache, 874  
super\_read\_only, 874  
sync\_binlog, 3069  
sync\_frm, 875  
sync\_master\_info, 3045

---

sync\_relay\_log, 3046  
sync\_relay\_log\_info, 3046  
system\_time\_zone, 875, 956  
table\_definition\_cache, 875  
table\_open\_cache, 876  
table\_open\_cache\_instances, 877  
thread\_cache\_size, 877  
thread\_handling, 878  
thread\_pool\_algorithm, 878  
thread\_pool\_high\_priority\_connection, 879  
thread\_pool\_max\_unused\_threads, 879  
thread\_pool\_prio\_kickup\_timer, 880  
thread\_pool\_size, 880  
thread\_pool\_stall\_limit, 880  
thread\_stack, 881  
timestamp, 882  
time\_format, 881  
time\_zone, 881, 956  
tls\_version, 882  
tmpdir, 883  
tmp\_table\_size, 883  
transaction\_alloc\_block\_size, 884  
transaction\_allow\_batching, 3535  
transaction\_isolation, 884  
transaction\_prealloc\_size, 886  
transaction\_read\_only, 887  
transaction\_write\_set\_extraction, 3070  
tx\_isolation, 888  
tx\_read\_only, 889  
unique\_checks, 889  
updatable\_views\_with\_limit, 889  
validate\_password\_check\_user\_name, 1253  
validate\_password\_dictionary\_file, 1254  
validate\_password\_length, 1255  
validate\_password\_mixed\_case\_count, 1255  
validate\_password\_number\_count, 1255  
validate\_password\_policy, 1256  
validate\_password\_special\_char\_count, 1256  
version, 890  
version\_comment, 890  
version\_compile\_machine, 890  
version\_compile\_os, 890  
version\_tokens\_session, 1026  
version\_tokens\_session\_number, 1027  
wait\_timeout, 891  
warning\_count, 891  
system variables, 766, 891, 2521  
  and replication, 3156  
  enforce\_gtid\_consistency, 3072  
  gtid\_mode, 3074  
  gtid\_next, 3075  
  gtid\_owned, 3076  
  mysqld, 659  
  privileges required, 894

---

- systemd
  - CMake SYSTEMD\_PID\_DIR option, 206
  - CMake SYSTEMD\_SERVICE\_NAME option, 206
  - CMake WITH\_SYSTEMD option, 216
  - managing mysqld, 177
  - mysqld daemonize option, 741
  - mysqld exit codes, 966
- SYSTEMD\_PID\_DIR option
  - CMake, 206
- SYSTEMD\_SERVICE\_NAME option
  - CMake, 206
- system\_time\_zone system variable, 875, 956
- SYSTEM\_USER(), 2045
- sys\_config table
  - sys schema, 4395
- sys\_get\_config() function
  - sys schema, 4469

## T

- tab (\t), 1653, 2106, 2295
- tab option
  - mysqldump, 491
  - ndb\_restore, 3714
- table, 5361
  - changing, 2158, 2168, 4575
  - deleting, 2268
  - rebuilding, 256
  - repair, 256
  - row size, 1862
- table aliases, 2313
- table cache, 1525
- table comment options (NDB), 2246
- table description
  - myisamchk, 589
- table is full, 772, 4556
- table lock, 5362
- table names
  - case sensitivity, 47, 1665
- table option
  - mysql, 418
  - ndb\_desc, 3639
- table pullout
  - semijoin strategy, 1491
- table reference
  - INFORMATION\_SCHEMA, 4101
  - Performance Schema, 4251
- table scan, 2644
- table type, 5362
  - choosing, 2915
- table-level locking, 1597
- tables
  - BLACKHOLE, 2936
  - checking, 584

---

cloning, 2230  
closing, 1525  
compressed, 598  
compressed format, 2926  
const, 1553  
constant, 1446  
copying, 2231  
counting rows, 287  
creating, 275  
CSV, 2933  
defragment, 2925  
defragmenting, 1439, 2460  
deleting rows, 4573  
displaying, 540  
displaying status, 2516  
dumping, 465, 515  
dynamic, 2925  
error checking, 1435  
EXAMPLE, 2949  
FEDERATED, 2943  
flush, 438  
fragmentation, 2460  
HEAP, 2928  
importing, 2566  
improving performance, 1521  
information, 589  
information about, 291  
InnoDB, 2545  
loading data, 277  
maintenance, 450  
maintenance schedule, 1438  
maximum size, 1528  
MEMORY, 2928  
MERGE, 2938  
merging, 2938  
multiple, 289  
MyISAM, 2919  
names, 1660  
open, 1525  
opening, 1525  
optimizing, 1438  
partitioning, 2938  
repair, 450  
repairing, 1435  
retrieving data, 278  
selecting columns, 280  
selecting rows, 279  
sorting rows, 281  
symbolic links, 1608  
system, 1553  
TEMPORARY, 2230  
too many, 1526

TABLES  
  INFORMATION\_SCHEMA table, 4142

---

tables option  
  mysqlcheck, 464  
  mysqldump, 494  
tablespace, 2597, 5362  
TABLESPACES  
  INFORMATION\_SCHEMA table, 4146  
tables\_priv table  
  system table, 968, 1105  
TABLE\_CONSTRAINTS  
  INFORMATION\_SCHEMA table, 4146  
table\_definition\_cache system variable, 875  
table\_distribution\_status  
  ndbinfo table, 3902  
table\_exists() procedure  
  sys schema, 4458  
table\_fragments  
  ndbinfo table, 3903  
table\_handles table  
  performance\_schema, 4317  
table\_info  
  ndbinfo table, 3905  
table\_io\_waits\_summary\_by\_index\_usage table  
  performance\_schema, 4333  
table\_io\_waits\_summary\_by\_table table  
  performance\_schema, 4332  
Table\_locks\_immediate status variable, 930  
Table\_locks\_waited status variable, 930  
table\_lock\_waits\_summary\_by\_table table  
  performance\_schema, 4334  
table\_open\_cache, 1525  
table\_open\_cache system variable, 876  
Table\_open\_cache\_hits status variable, 930  
table\_open\_cache\_instances system variable, 877  
Table\_open\_cache\_misses status variable, 930  
Table\_open\_cache\_overflows status variable, 930  
TABLE\_PRIVILEGES  
  INFORMATION\_SCHEMA table, 4147  
table\_replicas  
  ndbinfo table, 3905  
TAN(), 1922  
tar  
  problems on Solaris, 183, 183  
tc-heuristic-recover option  
  mysqld, 763  
Tcl, 5363  
Tcl API, 4484  
TCP parameters (NDB)  
  NodeIdServer, 3556  
  Proxy, 3557  
tcp-ip option  
  mysqld\_multi, 357  
TCP/IP, 122, 128, 211, 211, 335, 349, 377, 412, 625, 645, 650, 756, 947, 1038, 1087, 1142, 4263, 4548  
TCP\_MAXSEG\_SIZE, 3558  
TCP\_RCV\_BUF\_SIZE, 3559

---

- TCP\_SND\_BUF\_SIZE, 3559
- Tc\_log\_max\_pages\_used status variable, 931
- Tc\_log\_page\_size status variable, 931
- Tc\_log\_page\_waits status variable, 931
- tc\_time\_track\_stats
  - ndbinfo table, 3907
- tee command
  - mysql, 424
- tee option
  - mysql, 418
- temp-pool option
  - mysqld, 763
- tempdelay option
  - ndb\_import, 3667
- temperrors option
  - ndb\_import, 3668
- temporal interval syntax, 1703
- temporal values
  - JSON, 1847
- temporary files, 4566
- temporary table, 5363
- TEMPORARY table privileges, 1099, 2230, 2448
- temporary tables
  - and replication, 3150
  - internal, 1526
  - problems, 4576
- TEMPORARY tables, 2230
  - renaming, 2271
- temporary tablespace, 5363
- terminal monitor
  - defined, 269
- test option
  - myisampack, 599
- test suite
  - new features, 18
- testing
  - connection to the server, 1113
  - installation, 223
  - postinstallation, 222
- test\_plugin\_server authentication plugin, 1224
- TEXT
  - size, 1865
- text collection, 5363
- TEXT columns
  - default values, 1823
  - indexes, 2190, 2190
  - indexing, 1509, 2206
- TEXT data type, 1818, 1822
- text files
  - importing, 430, 501, 2289
- text option
  - ndb\_top, 3746
- The used command is not allowed with this MySQL version
  - error message, 1091

---

thread, 5363  
thread cache, 947  
thread command

- Binlog Dump, 1621
- Change user, 1621
- Close stmt, 1621
- Connect, 1621
- Connect Out, 1621
- Create DB, 1621
- Daemon, 1621
- Debug, 1621
- Delayed insert, 1621
- Drop DB, 1621
- Error, 1621
- Execute, 1622
- Fetch, 1622
- Field List, 1622
- Init DB, 1622
- Kill, 1622
- Long Data, 1622
- Ping, 1622
- Prepare, 1622
- Processlist, 1622
- Query, 1622
- Quit, 1622
- Refresh, 1622
- Register Slave, 1622
- Reset stmt, 1622
- Set option, 1622
- Shutdown, 1623
- Sleep, 1623
- Statistics, 1623
- Time, 1623

thread commands, 1621  
thread pool table reference

- INFORMATION\_SCHEMA, 4195

thread state

- After create, 1623
- altering table, 1623
- Analyzing, 1623
- Changing master, 1633
- Checking master version, 1630
- checking permissions, 1623
- checking privileges on cached query, 1629
- checking query cache for query, 1630
- Checking table, 1623
- cleaning up, 1623
- Clearing, 1634
- closing tables, 1623
- committing alter table to storage engine, 1623
- Committing events to binlog, 1633
- Connecting to master, 1631
- converting HEAP to ondisk, 1623
- copy to tmp table, 1624

---

Copying to group table, 1624  
Copying to tmp table, 1624  
Copying to tmp table on disk, 1624  
Creating index, 1624  
Creating sort index, 1624  
creating table, 1624  
Creating tmp table, 1624  
deleting from main table, 1624  
deleting from reference tables, 1624  
discard\_or\_import\_tablespace, 1624  
end, 1624  
executing, 1625  
Execution of init\_command, 1625  
Finished reading one binlog; switching to next binlog, 1630  
freeing items, 1625  
FULLTEXT initialization, 1625  
init, 1625  
Initialized, 1634  
invalidating query cache entries, 1630  
Killed, 1625  
Killing slave, 1633  
logging slow query, 1625  
login, 1625  
Making temporary file (append) before replaying LOAD DATA INFILE, 1632  
Making temporary file (create) before replaying LOAD DATA INFILE, 1632  
manage keys, 1625  
Master has sent all binlog to slave; waiting for more updates, 1630  
Opening master dump table, 1633  
Opening mysql.ndb\_apply\_status, 1633  
Opening tables, 1625  
optimizing, 1626  
preparing, 1626  
preparing for alter table, 1626  
Processing events, 1633  
Processing events from schema table, 1633  
Purging old relay logs, 1626  
query end, 1626  
Queueing master event to the relay log, 1631  
Reading event from the relay log, 1632  
Reading master dump table data, 1633  
Rebuilding the index on master dump table, 1633  
Receiving from client, 1626  
Reconnecting after a failed binlog dump request, 1631  
Reconnecting after a failed master event read, 1631  
Registering slave on master, 1631  
Removing duplicates, 1626  
removing tmp table, 1626  
rename, 1626  
rename result table, 1626  
Reopen tables, 1626  
Repair by sorting, 1626  
Repair done, 1626  
Repair with keycache, 1626  
Requesting binlog dump, 1631



---

Rolling back, 1627  
Saving state, 1627  
Searching rows for update, 1627  
Sending binlog event to slave, 1630  
sending cached result to client, 1630  
Sending to client, 1627  
setup, 1627  
Shutting down, 1633  
Slave has read all relay log; waiting for more updates, 1632  
Sorting for group, 1627  
Sorting for order, 1627  
Sorting index, 1627  
Sorting result, 1627  
starting, 1627  
statistics, 1627  
storing result in query cache, 1630  
Syncing ndb table schema operation and binlog, 1633  
System lock, 1627  
update, 1628  
Updating, 1628  
updating main table, 1628  
updating reference tables, 1628  
User lock, 1628  
User sleep, 1628  
Waiting for allowed to take ndbcluster global schema lock, 1633  
Waiting for an event from Coordinator, 1632  
Waiting for commit lock, 1628  
Waiting for event from ndbcluster, 1633  
Waiting for first event from ndbcluster, 1633  
Waiting for global read lock, 1628, 1629  
Waiting for its turn to commit, 1631  
Waiting for master to send event, 1631  
Waiting for master update, 1631  
Waiting for ndbcluster binlog update to reach current position, 1633  
Waiting for ndbcluster global schema lock, 1633  
Waiting for ndbcluster to start, 1633  
Waiting for next activation, 1634  
Waiting for query cache lock, 1630  
Waiting for scheduler to stop, 1634  
Waiting for schema epoch, 1634  
Waiting for schema metadata lock, 1629  
Waiting for slave mutex on exit, 1631, 1632  
Waiting for Slave Workers to free pending events, 1632  
Waiting for stored function metadata lock, 1629  
Waiting for stored procedure metadata lock, 1629  
Waiting for table flush, 1628  
Waiting for table level lock, 1629  
Waiting for table metadata lock, 1629  
Waiting for tables, 1628  
Waiting for the next event in relay log, 1632  
Waiting for the slave SQL thread to free enough relay log space, 1631  
Waiting for trigger metadata lock, 1629  
Waiting on cond, 1629  
Waiting on empty queue, 1634

---

- Waiting to finalize termination, 1630
- Waiting to reconnect after a failed binlog dump request, 1631
- Waiting to reconnect after a failed master event read, 1631
- Waiting until MASTER\_DELAY seconds after master executed event, 1632
- Writing to net, 1629
- thread states, 1619
  - event scheduler, 1634
  - general, 1623
  - NDB Cluster, 1633
  - query cache, 1629
  - replication replica, 1630, 1632, 1632
  - replication source, 1630
- thread table
  - performance\_schema, 4349
- thread/sql/compress\_gtid\_table, 2970
- threadblocks
  - ndbinfo table, 3908
- ThreadConfig, 3473
- ThreadPool (see [DiskIOThreadPool](#))
- threads, 438, 2500
  - display, 2500
  - monitoring, 1619, 2500, 4133, 4349
  - ndbinfo table, 3909
- threadstat
  - ndbinfo table, 3910
- Threads\_cached status variable, 931
- Threads\_connected status variable, 931
- Threads\_created status variable, 931
- Threads\_running status variable, 931
- thread\_cache\_size system variable, 877
- thread\_concurrency
  - removed features, 24
- thread\_handling system variable, 878
- thread\_pool\_algorithm system variable, 878
- thread\_pool\_high\_priority\_connection system variable, 879
- thread\_pool\_max\_unused\_threads system variable, 879
- thread\_pool\_prio\_kickup\_timer system variable, 880
- thread\_pool\_size system variable, 880
- thread\_pool\_stall\_limit system variable, 880
- thread\_stack system variable, 881
- Time
  - thread command, 1623
- TIME data type, 1803, 1805
- time data types
  - storage requirements, 1863
- time literals, 1655
- time representation
  - Event Scheduler, 4071
- time zone problems, 4568
- time zone tables, 381
  - system tables, 969
- time zones
  - and replication, 3151
  - leap seconds, 960

---

- support, 956
- upgrading, 959
- TIME(), 1937
- TimeBetweenEpochs, 3446
- TimeBetweenEpochsTimeout, 3446
- TimeBetweenGlobalCheckpoints, 3445, 3486
- TimeBetweenGlobalCheckpointsTimeout, 3445
- TimeBetweenInactiveTransactionAbortCheck, 3447
- TimeBetweenLocalCheckpoints, 3444
- TimeBetweenWatchDogCheck, 3438
- TimeBetweenWatchDogCheckInitial, 3439
- TIMEDIFF(), 1938
- timed\_mutexes
  - removed features, 24
- timeout, 779, 2033
- timeout option
  - ndb\_waiter, 3752
- timeouts (replication), 3151
- TIMESTAMP
  - and NULL values, 4571
  - and replication, 3133
  - indexes, 1519
  - initialization and updating, 1809
- TIMESTAMP data type, 1802, 1803
- timestamp system variable, 882
- TIMESTAMP(), 1938
- timestamp-printouts option
  - ndb\_restore, 3715
- TIMESTAMPADD(), 1938
- TIMESTAMPDIFF(), 1938
- timezone option
  - mysqld\_safe, 350
- time\_format system variable, 881
- TIME\_FORMAT(), 1939
- TIME\_TO\_SEC(), 1939
- time\_zone system variable, 881, 956
- time\_zone table
  - system table, 969
- time\_zone\_leap\_second table
  - system table, 969
- time\_zone\_name table
  - system table, 969
- time\_zone\_transition table
  - system table, 969
- time\_zone\_transition\_type table
  - system table, 969
- TINYBLOB data type, 1818
- TINYINT data type, 1793
- TINYTEXT data type, 1818
- tips
  - optimization, 1507
- TLS, 1148
  - command options, 327
  - establishing connections, 1150

---

- TLS related options
  - ALTER USER, 2429
  - CREATE USER statement, 2436
- tls-version option, 335
  - mysql, 418
  - mysqladmin, 449
  - mysqlbinlog, 632
  - mysqlcheck, 465
  - mysqldump, 479
  - mysqlimport, 514
  - mysqlpump, 536
  - mysqlshow, 550
  - mysqlslap, 567
  - mysql\_secure\_installation, 378
  - mysql\_upgrade, 392
- tls\_version system variable, 882
- TMPDIR environment variable, 308, 651, 4566
- TMPDIR option
  - CMake, 206
- tmpdir option
  - myisamchk, 588
  - myisampack, 600
  - mysqld, 764
- tmpdir system variable, 883
- tmp\_table\_size system variable, 883
- to-last-log option
  - mysqlbinlog, 632
- Tomcat, 5363
- too many open files, 4558
- tools
  - command-line, 110, 393
  - mysqld\_multi, 353
  - mysqld\_safe, 341
- top option
  - mysqldumpslow, 644
- torn page, 2704, 5364
- TotalSendBufferMemory
  - API and SQL nodes, 3499
  - data nodes, 3487
  - management nodes, 3400
- Touches(), 2075
- Townsend Alliance Key Manager
  - keyring\_okv keyring plugin, 1267
- TO\_BASE64(), 1956
- TO\_DAYS(), 1939
- TO\_SECONDS(), 1940
- TPS, 5364
- TP\_THREAD\_GROUP\_STATE
  - INFORMATION\_SCHEMA table, 4195
- TP\_THREAD\_GROUP\_STATS
  - INFORMATION\_SCHEMA table, 4197
- TP\_THREAD\_STATE
  - INFORMATION\_SCHEMA table, 4199
- trace DBI method, 1048

---

trace files  
  ndbmtd, 3588  
trace files (NDB Cluster), 3581  
TRADITIONAL SQL mode, 933, 941  
trailing spaces  
  CHAR, 1817, 1819  
  ENUM, 1825  
  in comparisons, 1819  
  SET, 1827  
  VARCHAR, 1817, 1819  
transaction, 5364  
transaction access mode, 2355  
transaction ID, 5364  
transaction isolation level, 2355  
  NDB Cluster, 3323  
  READ COMMITTED, 2618  
  READ UNCOMMITTED, 2620  
  REPEATABLE READ, 2617  
  SERIALIZABLE, 2620  
transaction state  
  change tracking, 962  
transaction-isolation option  
  mysqld, 764  
transaction-read-only option  
  mysqld, 764  
transaction-safe tables, 2545  
transactional option  
  ndb\_delete\_all, 3629  
TransactionBufferMemory, 3417  
TransactionDeadlockDetectionTimeout, 3448  
TransactionInactiveTimeout, 3448  
transactions, 2612  
  and replication, 3151, 3153  
  isolation levels, 2617  
  metadata locking, 1601  
  support, 2545  
transaction\_alloc\_block\_size system variable, 884  
transaction\_allow\_batching session variable (NDB Cluster), 3535  
transaction\_isolation system variable, 884  
transaction\_prealloc\_size system variable, 886  
transaction\_read\_only system variable, 887  
transaction\_write\_set\_extraction, 3070  
transparent data encryption, 2726  
transparent page compression, 5364  
transportable tablespace, 5364  
Transportable Tablespaces, 2566  
transporters  
  ndbinfo table, 3911  
.TRG file, 5361  
TRIGGER privilege, 1103  
triggers, 2258, 2270, 2520, 4057, 4062  
  and replication, 3144, 3155  
  LAST\_INSERT\_ID(), 4061  
  metadata, 4066

---

- new features, 16
- restrictions, 4090
- TRIGGERS
  - INFORMATION\_SCHEMA table, 4148
- triggers option
  - mysqldump, 495
  - mysqlpump, 536
- TRIM(), 1957
- .TRN file, 5361
- troubleshooting, 4545, 5364
  - ALTER TABLE problems, 4575
  - compiling MySQL server, 220
  - connection problems, 1142
  - InnoDB deadlocks, 2629, 2630
  - InnoDB errors, 2911
  - InnoDB recovery problems, 2905
  - InnoDB table fragmentation, 2706
  - replication, 3161
  - startup problems, 229
  - with MySQL Performance Schema, 4380
- TRUE, 1654, 1660
  - testing for, 1904, 1904
- true literal
  - JSON, 1847
- truncate, 5365
- TRUNCATE TABLE, 2272
  - and NDB Cluster, 3322
  - and replication, 3156
  - performance\_schema database, 4250, 4385
- TRUNCATE(), 1922
- truststore, 5365
- tuning, 1443
  - InnoDB compressed tables, 2675
- tuple, 5365
- tupscan option
  - ndb\_delete\_all, 3629
  - ndb\_select\_all, 3726
- tutorial, 269
- twiddle option
  - ndb\_redo\_log\_reader, 3690
- two-phase commit, 914, 914, 2805, 5365
- TwoPassInitialNodeRestartCopy, 3468
- tx\_isolation
  - deprecated features, 20
- tx\_isolation system variable, 888
- tx\_read\_only
  - deprecated features, 20
- tx\_read\_only system variable, 889
- type conversions, 1893, 1899
- type option
  - ndb\_config, 3621
  - ndb\_show\_tables, 3737
- types
  - columns, 1792, 1866

---

- data, 1792
- date and time, 1800
- numeric, 1792
- of tables, 2915
- portability, 1867
- string, 1815
- typographical conventions, 2
- TZ environment variable, 651, 956, 4568
- tz-utc option
  - mysqldump, 491
  - mysqlpump, 536

## U

- UCASE(), 1957
- UCS-2, 1710
- ucs2 character set, 1747
  - as client character set, 1727
- UDFs (see [loadable functions](#))
- uid option
  - mysql\_ssl\_rsa\_setup, 381
- ulimit, 4559
- UMASK environment variable, 651, 4559
- UMASK\_DIR environment variable, 651, 4560
- unary minus (-), 1912
- unblocking blocked hosts, 952
- unbuffered option
  - mysql, 419
- UNCOMPRESS(), 2032
- UNCOMPRESSED\_LENGTH(), 2032
- undo, 5365
- undo log, 2604, 2605, 5365
- undo log segment, 5365
- undo tablespace, 2605, 5366
- undo tablespaces, 2604
- UndoDataBuffer, 3454
- UndoIndexBuffer, 3453
- unexpected halt
  - replication, 3030, 3114
- UNHEX(), 1957
- Unicode, 1710, 5366
- Unicode character (U), 2106
- Unicode Collation Algorithm, 1753
- UNINSTALL PLUGIN statement, 2468
- uninstalling loadable functions, 1036
- uninstalling plugins, 996, 2468
- UNION, 299, 2325
- UNIQUE, 2167
- unique constraint, 5366
- unique index, 5366
- unique key, 5366
  - constraint, 54
- unique keys
  - and partitioning keys, 4049

---

- unique\_checks system variable, 889
- unique\_subquery join type
  - optimizer, 1554
- Unix signal handling, 653
- UNIX\_TIMESTAMP(), 1941
- UNKNOWN
  - testing for, 1904, 1904
- Unknown column ... in 'on clause', 2324, 2325
- Unknown or incorrect time zone
  - error, 957
- unloading
  - tables, 278
- UNLOCK TABLES, 2349
- unnamed views, 2333
- unpack option
  - myisamchk, 588
- unqualified option
  - ndb\_desc, 3639
  - ndb\_show\_tables, 3737
- unsafe statement (replication)
  - defined, 3089
- unsafe statements (replication), 3090
- UNSIGNED, 1792, 1797
- UNTIL, 2393
- updatable views, 4077
- updatable\_views\_with\_limit system variable, 889
- UPDATE, 50, 2340
- update
  - thread state, 1628
- update action
  - MySQLInstallerConsole, 119
- update option
  - ndb\_index\_stat, 3676
- UPDATE privilege, 1103
- update-state option
  - myisamchk, 585
- UpdateXML(), 2011
- Updating
  - thread state, 1628
- updating main table
  - thread state, 1628
- updating reference tables
  - thread state, 1628
- upgrade action
  - MySQLInstallerConsole, 119
- upgrade-system-tables option
  - mysql\_upgrade, 392
- upgrades
  - NDB Cluster, 3357, 3794
- upgrades and downgrades (NDB Cluster)
  - compatibility between versions, 3357
- upgrading, 236
  - a Docker installation of MySQL, 254
  - different architecture, 257



---

- with directly-downloaded RPM Packages, 254
- with MySQL APT Repository, 252
- with MySQL SLES Repository, 252
- with MySQL Yum Repository, 250

upgrading MySQL, 382

UPPER(), 1958

uptime, 438

Uptime status variable, 931

Uptime\_since\_flush\_status status variable, 931

URLs for downloading MySQL, 63

usage option

- ndbd, 3580
- ndbinfo\_select\_all, 3587
- ndb\_blob\_tool, 3611
- ndb\_config, 3621
- ndb\_delete\_all, 3629
- ndb\_desc, 3639
- ndb\_drop\_index, 3643
- ndb\_drop\_table, 3648
- ndb\_import, 3668
- ndb\_index\_stat, 3676
- ndb\_mgm, 3605
- ndb\_mgmd, 3600
- ndb\_move\_data, 3683
- ndb\_restore, 3715
- ndb\_select\_all, 3727
- ndb\_select\_count, 3732
- ndb\_show\_tables, 3737
- ndb\_top, 3746
- ndb\_waiter, 3752

USAGE privilege, 1103

USE, 2542

use command

- mysql, 424

USE INDEX, 1577

USE KEY, 1577

use-default option

- mysql\_secure\_installation, 378

use-frn option

- mysqlcheck, 465

use-threads option

- mysqlimport, 515

useHexFormat option

- ndb\_select\_all, 3727

user

- root, 233

user accounts

- altering, 2425
- creating, 1118, 2432
- renaming, 2451
- reserved, 1121
- resource limits, 822, 1140, 2430, 2438, 2450

USER environment variable, 338, 651

User lock

---

- thread state, 1628
- user management, 1094
- user name length
  - and replication, 3156
- user names
  - and passwords, 1095
  - in account names, 1111
  - in default account, 233
- user option, 327
  - mysql, 419
  - mysqladmin, 449
  - mysqlbinlog, 632
  - mysqlcheck, 465
  - mysqld, 765
  - mysqldump, 479
  - mysqld\_multi, 357
  - mysqld\_safe, 350
  - mysqlimport, 514
  - mysqlpump, 536
  - mysqlshow, 550
  - mysqslap, 567
  - mysql\_install\_db, 370
  - mysql\_secure\_installation, 378
  - mysql\_upgrade, 393
  - ndb\_top, 3746
- user privileges
  - adding, 1118
  - checking, 1120
  - deleting, 2439
  - dropping, 2439
  - revoking, 1120
- User sleep
  - thread state, 1628
- user table
  - account\_locked column, 1108
  - sorting, 1115
  - system table, 233, 968, 1105
- user variables
  - and replication, 3156
- USER(), 2045
- user-defined functions (see [loadable functions](#))
- user-defined variables, 1697
- users
  - deleting, 1121, 2439
- users option
  - mysqlpump, 537
- users table
  - performance\_schema, 4299
- USER\_PRIVILEGES INFORMATION\_SCHEMA table, 4150
- user\_summary view
  - sys schema, 4432
- user\_summary\_by\_file\_io view
  - sys schema, 4433

---

- user\_summary\_by\_file\_io\_type view
  - sys schema, 4434
- user\_summary\_by\_stages view
  - sys schema, 4434
- user\_summary\_by\_statement\_latency view
  - sys schema, 4435
- user\_summary\_by\_statement\_type view
  - sys schema, 4435
- user\_variables\_by\_thread table
  - performance\_schema, 4302
- UseShm, 3438
- USING HASH
  - with NDB tables, 2192
- using multiple disks to start data, 1609
- using NDB Cluster programs, 3570
- USING versus ON
  - joins, 2324
- UTC\_DATE(), 1942
- UTC\_TIME(), 1942
- UTC\_TIMESTAMP(), 1942
- UTF-8, 1710
  - database object metadata, 1714
- utf16 character set, 1748
  - as client character set, 1727
- utf16le character set, 1748
  - as client character set, 1727
- utf16\_bin collation, 1757
- utf32 character set, 1748
  - as client character set, 1727
- utf8 character set, 1747
  - alias for utf8mb3, 1747, 1747
- utf8mb3 character set, 1747
  - utf8 alias, 1747, 1747
- utf8mb4 character set, 1746
- utilities
  - program-development, 307
- utility programs, 306
- UUID(), 2140
- UUID\_SHORT(), 2140

## V

- valid
  - GIS values, 1841
  - spatial values, 1841
- valid JSON values, 1848
- valid numbers
  - examples, 1654
- validate-password option
  - mysqld, 1252
- validate-user-plugins option
  - mysqld, 765
- validate\_password plugin, 1249
  - configuring, 1252

---

- installing, 1251
- options, 1252
- status variables, 1257
- system variables, 1253
- validate\_password\_check\_user\_name system variable, 1253
- validate\_password\_dictionary\_file system variable, 1254
- validate\_password\_dictionary\_file\_last\_parsed status variable, 1257
- validate\_password\_dictionary\_file\_words\_count status variable, 1257
- validate\_password\_length system variable, 1255
- validate\_password\_mixed\_case\_count system variable, 1255
- validate\_password\_number\_count system variable, 1255
- validate\_password\_policy system variable, 1256
- validate\_password\_special\_char\_count system variable, 1256
- VALIDATE\_PASSWORD\_STRENGTH(), 2032
- VALUES(), 2141
- VARBINARY data type, 1818, 1821
- VARCHAR
  - size, 1865
- VARCHAR data type, 1815, 1817
- VARCHARACTER data type, 1817
- variable option
  - mysql\_config, 645
- variable-length type, 5366
- variables
  - and replication, 3156
  - environment, 308
  - server, 2521
  - status, 909, 2515
  - system, 766, 891, 2521
  - user defined, 1697
- VARIANCE(), 2122
- VAR\_POP(), 2122
- VAR\_SAMP(), 2122
- verbose option
  - innochecksum, 569
  - myisamchk, 582
  - myisampack, 600
  - myisam\_ftdump, 576
  - mysql, 419
  - mysqladmin, 450
  - mysqlbinlog, 632
  - mysqlcheck, 465
  - mysqld, 766
  - mysqldump, 484
  - mysqldumpslow, 644
  - mysqld\_multi, 357
  - mysqlimport, 515
  - mysqlshow, 550
  - mysqslap, 567
  - mysql\_config\_editor, 608
  - mysql\_install\_db, 370
  - mysql\_plugin, 373
  - mysql\_ssl\_rsa\_setup, 381
  - mysql\_upgrade, 393

---

- my\_print\_defaults, 647
- ndbd, 3580
- ndbmtd, 3580
- ndb\_blob\_tool, 3611
- ndb\_import, 3668
- ndb\_index\_stat, 3676
- ndb\_mgmd, 3600
- ndb\_move\_data, 3683
- ndb\_perror, 3685
- ndb\_restore, 3715
- perror, 649
- verify-binlog-checksum option
  - mysqlbinlog, 633
- version
  - choosing, 62
  - latest, 63
- VERSION file
  - CMake, 221
- version option
  - comp\_err, 361
  - innochecksum, 569
  - myisamchk, 582
  - myisampack, 600
  - mysql, 419
  - mysqladmin, 450
  - mysqlbinlog, 633
  - mysqlcheck, 465
  - mysqld, 766
  - mysqldump, 484
  - mysqld\_multi, 357
  - mysqlimport, 515
  - mysqlpump, 537
  - mysqlshow, 550
  - mysqlslap, 567
  - mysql\_config, 645
  - mysql\_config\_editor, 608
  - mysql\_install\_db, 370
  - mysql\_plugin, 373
  - mysql\_ssl\_rsa\_setup, 381
  - my\_print\_defaults, 647
  - ndbd, 3580
  - ndbinfo\_select\_all, 3587
  - ndb\_blob\_tool, 3611
  - ndb\_config, 3621
  - ndb\_delete\_all, 3629
  - ndb\_desc, 3639
  - ndb\_drop\_index, 3643
  - ndb\_drop\_table, 3648
  - ndb\_import, 3668
  - ndb\_index\_stat, 3676
  - ndb\_mgm, 3606
  - ndb\_mgmd, 3600
  - ndb\_move\_data, 3683
  - ndb\_perror, 3685

---

- ndb\_restore, 3715
- ndb\_select\_all, 3727
- ndb\_select\_count, 3732
- ndb\_show\_tables, 3737
- ndb\_waiter, 3752
- perror, 649
- resolveip, 650
- resolve\_stack\_dump, 648
- version system variable, 890
- Version Tokens, 1016
- Version Tokens functions
  - version\_tokens\_delete(), 1024
  - version\_tokens\_edit(), 1024
  - version\_tokens\_lock\_exclusive(), 1025
  - version\_tokens\_lock\_shared(), 1025
  - version\_tokens\_set(), 1024
  - version\_tokens\_show(), 1025
  - version\_tokens\_unlock(), 1025
- Version Tokens plugin
  - elements, 1016
  - installing, 1016
  - reference, 1023
  - uninstalling, 1016
  - using, 1017
- version view
  - sys schema, 4436
- VERSION(), 2045
- version-check option
  - mysql\_upgrade, 393
- version\_comment system variable, 890
- version\_compile\_machine system variable, 890
- version\_compile\_os system variable, 890
- version\_major() function
  - sys schema, 4470
- version\_minor() function
  - sys schema, 4470
- version\_patch() function
  - sys schema, 4470
- version\_tokens\_delete() Version Tokens function, 1024
- version\_tokens\_edit() Version Tokens function, 1024
- version\_tokens\_lock\_exclusive() Version Tokens function, 1025
- version\_tokens\_lock\_shared() Version Tokens function, 1025
- version\_tokens\_session system variable, 1026
- version\_tokens\_session\_number system variable, 1027
- version\_tokens\_set() Version Tokens function, 1024
- version\_tokens\_show() Version Tokens function, 1025
- version\_tokens\_unlock() Version Tokens function, 1025
- vertical option
  - mysql, 419
  - mysqladmin, 450
- victim, 5367
- Vietnamese, 4518
- view, 5367
- views, 2260, 4057, 4075

---

- algorithms, 4075
- and replication, 3158
- limitations, 4095
- materialization prevention, 1498
- metadata, 4080
- optimization, 1489, 1497
- privileges, 4095
- problems, 4095
- restrictions, 4094
- updatable, 2260, 4077

## VIEWS

- INFORMATION\_SCHEMA table, 4150
- virtual generated column, 5367
- virtual index, 5367
- Visual Studio, 5367

## W

- wait, 5367
- WAIT COMPLETED (START BACKUP command), 3810
- wait option
  - myisamchk, 582
  - myisampack, 600
  - mysql, 419
  - mysqladmin, 450
- WAIT STARTED (START BACKUP command), 3810
- wait-nodes option
  - ndb\_waiter, 3753
- Waiting for allowed to take ndbcluster global schema lock
  - thread state, 1633
- Waiting for an event from Coordinator
  - thread state, 1632
- Waiting for commit lock
  - thread state, 1628
- Waiting for event from ndbcluster
  - thread state, 1633
- Waiting for event metadata lock
  - thread state, 1629
- Waiting for event read lock
  - thread state, 1629
- Waiting for first event from ndbcluster
  - thread state, 1633
- Waiting for global read lock
  - thread state, 1628
- Waiting for its turn to commit
  - thread state, 1631
- Waiting for master to send event
  - thread state, 1631
- Waiting for master update
  - thread state, 1631
- Waiting for ndbcluster binlog update to reach current position
  - thread state, 1633
- Waiting for ndbcluster global schema lock
  - thread state, 1633

---

Waiting for ndbcluster to start  
thread state, 1633

Waiting for next activation  
thread state, 1634

Waiting for query cache lock  
thread state, 1630

Waiting for scheduler to stop  
thread state, 1634

Waiting for schema epoch  
thread state, 1634

Waiting for schema metadata lock  
thread state, 1629

Waiting for slave mutex on exit  
thread state, 1631, 1632

Waiting for Slave Workers to free pending events  
thread state, 1632

Waiting for stored function metadata lock  
thread state, 1629

Waiting for stored procedure metadata lock  
thread state, 1629

Waiting for table flush  
thread state, 1628

Waiting for table level lock  
thread state, 1629

Waiting for table metadata lock  
thread state, 1629

Waiting for tables  
thread state, 1628

Waiting for the next event in relay log  
thread state, 1632

Waiting for the slave SQL thread to free enough relay log space  
thread state, 1631

Waiting for trigger metadata lock  
thread state, 1629

Waiting on cond  
thread state, 1629

Waiting on empty queue  
thread state, 1634

Waiting to finalize termination  
thread state, 1630

Waiting to reconnect after a failed binlog dump request  
thread state, 1631

Waiting to reconnect after a failed master event read  
thread state, 1631

Waiting until MASTER\_DELAY seconds after master executed event  
thread state, 1632

waits\_by\_host\_by\_latency view  
sys schema, 4438

waits\_by\_user\_by\_latency view  
sys schema, 4438

waits\_global\_by\_latency view  
sys schema, 4439

wait\_classes\_global\_by\_avg\_latency view  
sys schema, 4437



---

- wait\_classes\_global\_by\_latency view
  - sys schema, 4437
- WAIT\_FOR\_EXECUTED\_GTID\_SET(), 2114
- wait\_timeout system variable, 891
- WAIT\_UNTIL\_SQL\_THREAD\_AFTER\_GTIDS(), 2115
- Wan, 3399, 3501
- warm backup, 5367
- warm up, 5368
- warnings command
  - mysql, 424
- warning\_count system variable, 891
- watch-progress option
  - mysqlpump, 537
- WatchDogImmediateKill, 3460
- WEEK(), 1942
- WEEKDAY(), 1944
- WEEKOFYEAR(), 1944
- WEIGHT\_STRING(), 1959
- well-formed
  - GIS values, 1841
  - spatial values, 1841
- Well-Known Binary format
  - geometry values, 1839
- Well-Known Text format
  - geometry values, 1838
- WHERE, 1446
  - with SHOW, 4098, 4201
- where option
  - mysqldump, 495
- WHILE, 2394
  - labels, 2387
- widths
  - display, 1792
- Wildcard character (%), 1653
- Wildcard character (\_), 1653
- wildcards
  - and LIKE, 1514
  - in account names, 1112
  - in mysql.columns\_priv table, 1117
  - in mysql.db table, 1116
  - in mysql.procs\_priv table, 1117
  - in mysql.tables\_priv table, 1117
- Windows
  - interactive history, 431
  - MySQL restrictions, 132
  - path name separators, 314
  - pluggable authentication, 1201
  - upgrading, 252
- WIN\_DEBUG\_NO\_INLINE option
  - CMake, 211
- WITH ROLLUP, 2122
- Within(), 2078
- WITHOUT\_SERVER option
  - CMake, 217

---

WITH\_ASAN option  
CMake, 212

WITH\_ASAN\_SCOPE option  
CMake, 212

WITH\_AUTHENTICATION\_LDAP option  
CMake, 212

WITH\_AUTHENTICATION\_PAM option  
CMake, 212

WITH\_AWS\_SDK option  
CMake, 212

WITH\_BOOST option  
CMake, 212

WITH\_BUNDLED\_LIBEVENT option  
CMake, 219

WITH\_BUNDLED\_MEMCACHED option  
CMake, 219

WITH\_CLASSPATH option  
CMake, 219

WITH\_CLIENT\_PROTOCOL\_TRACING option  
CMake, 213

WITH\_CURL option  
CMake, 213

WITH\_DEBUG option  
CMake, 213

WITH\_DEFAULT\_COMPILER\_OPTIONS option  
CMake, 218

WITH\_DEFAULT\_FEATURE\_SET option  
CMake, 213

WITH\_EDITLINE option  
CMake, 213

WITH\_EMBEDDED\_SERVER option  
CMake, 214

WITH\_EMBEDDED\_SHARED\_LIBRARY option  
CMake, 214

WITH\_ERROR\_INSERT option  
CMake, 219

WITH\_EXTRA\_CHARSETS option  
CMake, 214

WITH\_GMOCK option  
CMake, 214

WITH\_INNODB\_EXTRA\_DEBUG option  
CMake, 214

WITH\_INNODB\_MEMCACHED option  
CMake, 214

WITH\_KEYRING\_TEST option  
CMake, 214

WITH\_LDAP option  
CMake, 214

WITH\_LIBEVENT option  
CMake, 215

WITH\_LIBWRAP option  
CMake, 215

WITH\_LZ4 option  
CMake, 215

---

WITH\_MECAB option  
  CMake, 215

WITH\_MSAN option  
  CMake, 215

WITH\_MSCRT\_DEBUG option  
  CMake, 215

WITH\_NDBAPI\_EXAMPLES option  
  CMake, 219

WITH\_NDBCLUSTER option  
  CMake, 219

WITH\_NDBCLUSTER\_STORAGE\_ENGINE option  
  CMake, 219

WITH\_NDBMTD option  
  CMake, 219

WITH\_NDB\_BINLOG option  
  CMake, 219

WITH\_NDB\_DEBUG option  
  CMake, 219

WITH\_NDB\_JAVA option  
  CMake, 219

WITH\_NDB\_PORT option  
  CMake, 219

WITH\_NDB\_TEST option  
  CMake, 220

WITH\_NUMA option  
  CMake, 215

WITH\_PROTOBUF option  
  CMake, 216

WITH\_RAPID option  
  CMake, 216

WITH\_SASL option  
  CMake, 216

WITH\_SSL option  
  CMake, 216

WITH\_SYSTEMD option  
  CMake, 216

WITH\_TEST\_TRACE\_PLUGIN option  
  CMake, 217

WITH\_UBSAN option  
  CMake, 217

WITH\_UNIT\_TESTS option  
  CMake, 217

WITH\_UNIXODBC option  
  CMake, 217

WITH\_VALGRIND option  
  CMake, 217

WITH\_ZLIB option  
  CMake, 217

WKB format  
  geometry values, 1839

WKT format  
  geometry values, 1838

workload, 5368

wrappers

---

- Eiffel, 4484
- write combining, 5368
- write option
  - innochecksum, 572
- write-binlog option
  - mysqlcheck, 465
  - mysql\_upgrade, 393
- write\_buffer\_size myisamchk variable, 582
- Writing to net
  - thread state, 1629

## X

- X Plugin, 3263
- X Plugin option
  - mysqlx, 3266
- x\$ views
  - sys schema, 4398
- x\$host\_summary view
  - sys schema, 4398
- x\$host\_summary\_by\_file\_io view
  - sys schema, 4399
- x\$host\_summary\_by\_file\_io\_type view
  - sys schema, 4399
- x\$host\_summary\_by\_stages view
  - sys schema, 4400
- x\$host\_summary\_by\_statement\_latency view
  - sys schema, 4400
- x\$host\_summary\_by\_statement\_type view
  - sys schema, 4401
- x\$innodb\_buffer\_stats\_by\_schema view
  - sys schema, 4402
- x\$innodb\_buffer\_stats\_by\_table view
  - sys schema, 4403
- x\$innodb\_lock\_waits view
  - sys schema, 4404
- x\$io\_by\_thread\_by\_latency view
  - sys schema, 4406
- x\$io\_global\_by\_file\_by\_bytes view
  - sys schema, 4406
- x\$io\_global\_by\_file\_by\_latency view
  - sys schema, 4407
- x\$io\_global\_by\_wait\_by\_bytes view
  - sys schema, 4408
- x\$io\_global\_by\_wait\_by\_latency view
  - sys schema, 4409
- x\$latest\_file\_io view
  - sys schema, 4410
- x\$memory\_by\_host\_by\_current\_bytes view
  - sys schema, 4410
- x\$memory\_by\_thread\_by\_current\_bytes view
  - sys schema, 4411
- x\$memory\_by\_user\_by\_current\_bytes view
  - sys schema, 4411

---

x\$memory\_global\_by\_current\_bytes view  
sys schema, 4412

x\$memory\_global\_total view  
sys schema, 4413

x\$processlist view  
sys schema, 4414

x\$schema\_flattened\_keys view  
sys schema, 4419

x\$schema\_index\_statistics view  
sys schema, 4417

x\$schema\_tables\_with\_full\_table\_scans view  
sys schema, 4424

x\$schema\_table\_lock\_waits view  
sys schema, 4420

x\$schema\_table\_statistics view  
sys schema, 4421

x\$schema\_table\_statistics\_with\_buffer view  
sys schema, 4423

x\$session view  
sys schema, 4425

x\$statements\_with\_errors\_or\_warnings view  
sys schema, 4427

x\$statements\_with\_full\_table\_scans view  
sys schema, 4428

x\$statements\_with\_runtimes\_in\_95th\_percentile view  
sys schema, 4429

x\$statements\_with\_sorting view  
sys schema, 4431

x\$statements\_with\_temp\_tables view  
sys schema, 4432

x\$statement\_analysis view  
sys schema, 4426

x\$user\_summary view  
sys schema, 4432

x\$user\_summary\_by\_file\_io view  
sys schema, 4433

x\$user\_summary\_by\_file\_io\_type view  
sys schema, 4434

x\$user\_summary\_by\_stages view  
sys schema, 4434

x\$user\_summary\_by\_statement\_latency view  
sys schema, 4435

x\$user\_summary\_by\_statement\_type view  
sys schema, 4436

x\$waits\_by\_host\_by\_latency view  
sys schema, 4438

x\$waits\_by\_user\_by\_latency view  
sys schema, 4438

x\$waits\_global\_by\_latency view  
sys schema, 4439

x\$wait\_classes\_global\_by\_avg\_latency view  
sys schema, 4437

x\$wait\_classes\_global\_by\_latency view  
sys schema, 4437

---

- X(), 2063
- X.509/Certificate, 1148
- XA, 5368
- XA BEGIN, 2359
- XA COMMIT, 2359
- XA PREPARE, 2359
- XA RECOVER, 2359
- XA ROLLBACK, 2359
- XA START, 2359
- XA transactions, 2358
  - restrictions, 2361
  - transaction identifiers, 2359
- xid
  - XA transaction identifier, 2359
- xml option
  - mysql, 419
  - mysqldump, 492
  - ndb\_config, 3621
- XOR
  - bitwise, 2019
  - logical, 1907
- XPath code injection, 2016

## Y

- Y(), 2063
- yaSSL, 193, 1148
  - compared to OpenSSL, 1171
- yaSSL versus OpenSSL
  - detecting, 1172
- YEAR data type, 1803, 1806
- YEAR(), 1944
- YEAR(2)
  - removed features, 24
- YEARWEEK(), 1944
- Yen sign (Japanese), 4518
- young, 5368
- Your password does not satisfy the current policy requirements
  - password error, 1250

## Z

- ZEROFILL, 1792, 1797
- zlib\_decompress, 308, 650

## C Function Index

### **mysql\_affected\_rows()**

- [Section 13.2.1, "CALL Statement"](#)
- [Section 12.15, "Information Functions"](#)
- [Section 13.2.5, "INSERT Statement"](#)
- [Section 13.2.8, "REPLACE Statement"](#)

### **mysql\_change\_user()**

- [Section 4.5.1.2, "mysql Client Commands"](#)

---

## **mysql\_close()**

Section B.3.2.9, “Communication Errors and Aborted Connections”

## **mysql\_errno()**

Section 6.4.5.4, “Audit Log File Formats”  
Section B.2, “Error Information Interfaces”  
Section 13.6.7.5, “SIGLAL Statement”

## **mysql\_error()**

Section B.2, “Error Information Interfaces”  
Section 13.6.7.5, “SIGLAL Statement”

## **mysql\_escape\_string()**

Section 6.1.7, “Client Programming Security Guidelines”

## **mysql\_fetch\_row()**

Section 15.8.1, “FEDERATED Storage Engine Overview”

## **mysql\_free\_result()**

Section B.3.2.12, “Commands out of sync”

## **mysql\_get\_character\_set\_info()**

Section 10.14.2, “Choosing a Collation ID”

## **mysql\_info()**

Section 13.1.8, “ALTER TABLE Statement”  
Section 13.2.5, “INSERT Statement”  
Section 13.2.6, “LOAD DATA Statement”  
Section 1.6.3.1, “PRIMARY KEY and UNIQUE Index Constraints”  
Section 13.2.11, “UPDATE Statement”

## **mysql\_insert\_id()**

Section 13.1.18, “CREATE TABLE Statement”  
Section 12.15, “Information Functions”  
Section 13.2.5, “INSERT Statement”  
Section 5.1.7, “Server System Variables”  
Section 3.6.9, “Using AUTO\_INCREMENT”

## **mysql\_kill()**

Section 1.3, “What Is New in MySQL 5.7”

## **mysql\_library\_end()**

Section 27.6, “libmysqld, the Embedded MySQL Server Library”

## **mysql\_library\_init()**

Section 27.6, “libmysqld, the Embedded MySQL Server Library”  
Section 27.6.3, “Options with the Embedded Server”

## **mysql\_list\_fields()**

Section 1.3, “What Is New in MySQL 5.7”

---

## **mysql\_list\_processes()**

Section 1.3, “What Is New in MySQL 5.7”

## **mysql\_next\_result()**

Section 13.2.1, “CALL Statement”

## **mysql\_options()**

Section 6.2.1, “Account User Names and Passwords”

Section 6.4.1.4, “Caching SHA-2 Pluggable Authentication”

Section 6.4.1.6, “Client-Side Cleartext Pluggable Authentication”

Section 10.4, “Connection Character Sets and Collations”

Section 4.2.6, “Connection Compression Control”

Section B.3.2.7, “MySQL server has gone away”

Section 25.12.9, “Performance Schema Connection Attribute Tables”

Section 6.1.6, “Security Considerations for LOAD DATA LOCAL”

Section 6.2.12, “Server Handling of Expired Passwords”

Section 6.4.1.5, “SHA-256 Pluggable Authentication”

Section 5.7.4, “Using Client Programs in a Multiple-Server Environment”

Section 1.3, “What Is New in MySQL 5.7”

## **mysql\_options4()**

Section 25.12.9, “Performance Schema Connection Attribute Tables”

## **mysql\_ping()**

Section B.3.2.7, “MySQL server has gone away”

## **mysql\_query()**

Section 13.2.1, “CALL Statement”

Section 1.3, “What Is New in MySQL 5.7”

## **mysql\_real\_connect()**

Section 13.2.1, “CALL Statement”

Chapter 12, *Functions and Operators*

Section 12.15, “Information Functions”

Section 13.2.5.2, “INSERT ... ON DUPLICATE KEY UPDATE Statement”

Section 13.2.5, “INSERT Statement”

Section 13.5, “Prepared Statements”

Section 6.2.12, “Server Handling of Expired Passwords”

Section 5.1.7, “Server System Variables”

Section 23.2.1, “Stored Routine Syntax”

Section 4.10, “Unix Signal Handling in MySQL”

Section 5.7.4, “Using Client Programs in a Multiple-Server Environment”

## **mysql\_real\_escape\_string\_quote()**

Section 6.1.7, “Client Programming Security Guidelines”

Section 11.4.6, “Populating Spatial Columns”

Section 9.1.1, “String Literals”

## **mysql\_real\_query()**

Section 13.2.1, “CALL Statement”

Section 15.8.1, “FEDERATED Storage Engine Overview”



---

## **mysql\_refresh()**

Section 1.3, “What Is New in MySQL 5.7”

## **mysql\_session\_track\_get\_first()**

Section 5.1.15, “Server Tracking of Client Session State”

## **mysql\_session\_track\_get\_next()**

Section 5.1.15, “Server Tracking of Client Session State”

## **mysql\_shutdown()**

Section 6.2.2, “Privileges Provided by MySQL”

Section 13.7.6.7, “SHUTDOWN Statement”

## **mysql\_sqlstate()**

Section B.2, “Error Information Interfaces”

Section 13.6.7.5, “SIGNAL Statement”

## **mysql\_stmt\_attr\_set()**

Section 13.6.6.5, “Restrictions on Server-Side Cursors”

## **mysql\_stmt\_close()**

Section 25.12.6.4, “The prepared\_statements\_instances Table”

## **mysql\_stmt\_errno()**

Section B.2, “Error Information Interfaces”

## **mysql\_stmt\_error()**

Section B.2, “Error Information Interfaces”

## **mysql\_stmt\_execute()**

Section 8.10.3.1, “How the Query Cache Operates”

Section 25.12.6.4, “The prepared\_statements\_instances Table”

## **mysql\_stmt\_next\_result()**

Section 13.2.1, “CALL Statement”

## **mysql\_stmt\_prepare()**

Section 8.10.4, “Caching of Prepared Statements and Stored Programs”

Section 8.10.3.1, “How the Query Cache Operates”

Section 13.5, “Prepared Statements”

Section 25.12.6.4, “The prepared\_statements\_instances Table”

## **mysql\_stmt\_send\_long\_data()**

Section 5.1.7, “Server System Variables”

## **mysql\_stmt\_sqlstate()**

Section B.2, “Error Information Interfaces”

## **mysql\_store\_result()**

Section B.3.2.12, “Commands out of sync”

---

[Section 15.8.1, “FEDERATED Storage Engine Overview”](#)  
[Section 4.5.1, “mysql — The MySQL Command-Line Client”](#)

## **mysql\_thread\_end()**

[Section 27.6, “libmysqld, the Embedded MySQL Server Library”](#)

## **mysql\_thread\_init()**

[Section 27.6, “libmysqld, the Embedded MySQL Server Library”](#)

## **mysql\_use\_result()**

[Section B.3.2.12, “Commands out of sync”](#)  
[Section 4.5.1, “mysql — The MySQL Command-Line Client”](#)  
[Section B.3.2.6, “Out of memory”](#)

## **mysql\_warning\_count()**

[Section B.2, “Error Information Interfaces”](#)  
[Section 13.7.5.40, “SHOW WARNINGS Statement”](#)

# Command Index

[A](#) | [B](#) | [C](#) | [D](#) | [E](#) | [G](#) | [H](#) | [I](#) | [J](#) | [K](#) | [L](#) | [M](#) | [N](#) | [O](#) | [P](#) | [R](#) | [S](#) | [T](#) | [U](#) | [V](#) | [W](#) | [Y](#) | [Z](#)

## **A**

[\[index top\]](#)

## **Access**

[Section 13.2.2, “DELETE Statement”](#)

## **addgroup**

[Section 21.3.1.1, “Installing an NDB Cluster Binary Release on Linux”](#)  
[Section 2.2, “Installing MySQL on Unix/Linux Using Generic Binaries”](#)

## **addr2line**

[Section 5.8.1.5, “Using a Stack Trace”](#)

## **adduser**

[Section 21.3.1.1, “Installing an NDB Cluster Binary Release on Linux”](#)  
[Section 2.2, “Installing MySQL on Unix/Linux Using Generic Binaries”](#)

## **ALTER TABLE**

[Section 21.6.12, “Online Operations with ALTER TABLE in NDB Cluster”](#)

## **APF**

[Section 21.6.18.1, “NDB Cluster Security and Networking Issues”](#)

## **apt-get**

[Section 2.5.8, “Installing MySQL on Linux from the Native Software Repositories”](#)  
[Section 2.5.6, “Installing MySQL on Linux Using Debian Packages from Oracle”](#)

---

[Section 14.21.4, “Security Considerations for the InnoDB memcached Plugin”](#)

## **audit2allow**

[Section 6.7.6, “Troubleshooting SELinux”](#)

## **B**

[\[index top\]](#)

## **bash**

[Section 1.1, “About This Manual”](#)

[Section 6.1.2.1, “End-User Guidelines for Password Security”](#)

[Section 2.4.1, “General Notes on Installing MySQL on macOS”](#)

[Section 4.2.1, “Invoking MySQL Programs”](#)

[Section 16.1.6.3, “Replica Server Options and Variables”](#)

[Section 4.2.7, “Setting Environment Variables”](#)

## **binary-configure.sh**

[Section 1.3, “What Is New in MySQL 5.7”](#)

## **bison**

[Section 2.8.8, “Dealing with Problems Compiling MySQL”](#)

[Section 2.8.2, “Source Installation Prerequisites”](#)

## **C**

[\[index top\]](#)

## **c++filt**

[Section 5.8.1.5, “Using a Stack Trace”](#)

## **cat**

[Section 14.15, “InnoDB Startup Options and System Variables”](#)

[Section 4.5.1.1, “mysql Client Options”](#)

## **cd**

[Resetting the Root Password: Windows Systems](#)

## **chkconfig**

[Section 21.3.1.1, “Installing an NDB Cluster Binary Release on Linux”](#)

[Section 2.5.8, “Installing MySQL on Linux from the Native Software Repositories”](#)

[Section 4.3.3, “mysql.server — MySQL Server Startup Script”](#)

## **chmod**

[Section 6.4.4.7, “Migrating Keys Between Keyring Keystores”](#)

## **chown**

[Section 6.4.4.7, “Migrating Keys Between Keyring Keystores”](#)

## **CMake**

[Section 10.13, “Adding a Character Set”](#)

---

Section 21.3.1.4, “Building NDB Cluster from Source on Linux”  
Section B.3.2.15, “Can't initialize character set”  
Section 21.3.2.2, “Compiling and Installing NDB Cluster from Source on Windows”  
Section 10.5, “Configuring Application Character Set and Collation”  
Section 2.8.6, “Configuring SSL Library Support”  
Section 2.8.8, “Dealing with Problems Compiling MySQL”  
Section 4.9, “Environment Variables”  
Section 21.1, “General Information”  
Section B.3.3.6, “How to Protect or Change the MySQL Unix Socket File”  
Section 14.15, “InnoDB Startup Options and System Variables”  
Section 2.8.5, “Installing MySQL Using a Development Source Tree”  
Section 2.8.4, “Installing MySQL Using a Standard Source Distribution”  
Section 6.4.4.12, “Keyring System Variables”  
Section 2.5.10, “Managing MySQL Server with systemd”  
Section 21.6.10, “MySQL Server Usage for NDB Cluster”  
Section 2.8.7, “MySQL Source-Configuration Options”  
Section 25.2, “Performance Schema Build Configuration”  
Section 27.6.2, “Restrictions When Using the Embedded MySQL Server”  
Section 5.7.3, “Running Multiple MySQL Instances on Unix”  
Section 6.1.6, “Security Considerations for LOAD DATA LOCAL”  
Section 10.3.2, “Server Character Set and Collation”  
Section 5.1.6, “Server Command Options”  
Section 5.1.7, “Server System Variables”  
Section 2.8.2, “Source Installation Prerequisites”  
Section 15.5, “The ARCHIVE Storage Engine”  
Section 15.6, “The BLACKHOLE Storage Engine”  
Section 15.9, “The EXAMPLE Storage Engine”  
Section 15.8, “The FEDERATED Storage Engine”  
Section 1.2.2, “The Main Features of MySQL”  
Section 25.12.16.3, “The processlist Table”  
Section 5.8.4, “Tracing mysqld Using DTrace”  
Section 4.2.2.2, “Using Option Files”  
Section 1.3, “What Is New in MySQL 5.7”  
Section B.3.3.3, “What to Do If MySQL Keeps Crashing”

## **Cmake**

Section 2.8.4, “Installing MySQL Using a Standard Source Distribution”

## **cmake**

Section 2.8.7, “MySQL Source-Configuration Options”  
Section 14.21.4, “Security Considerations for the InnoDB memcached Plugin”

## **cmd**

Resetting the Root Password: Windows Systems

## **cmd.exe**

Section 1.1, “About This Manual”  
Section 4.6.1, “innochecksum — Offline InnoDB File Checksum Utility”  
Section 4.2.1, “Invoking MySQL Programs”

## **command.com**

Section 1.1, “About This Manual”  
Section 4.2.1, “Invoking MySQL Programs”

---

## **comp\_err**

Section 4.4.1, “[comp\\_err — Compile MySQL Error Message File](#)”  
Section 4.1, “[Overview of MySQL Programs](#)”

## **configure**

Section 1.1, “[About This Manual](#)”  
Section 1.5, “[How to Report Bugs or Problems](#)”

## **copy**

[Creating a Data Snapshot Using Raw Data Files](#)

## **coreadm**

Section 2.7, “[Installing MySQL on Solaris](#)”  
Section 5.1.6, “[Server Command Options](#)”

## **cp**

Section 16.1.2.6, “[Adding Replicas to a Replication Topology](#)”  
Section 16.3.1.2, “[Backing Up Raw Data from a Replica](#)”  
Section 7.1, “[Backup and Recovery Types](#)”  
[Creating a Data Snapshot Using Raw Data Files](#)

## **cron**

Section B.3.2.2, “[Can't connect to \[local\] MySQL server](#)”  
Section 13.7.2.2, “[CHECK TABLE Statement](#)”  
Section 15.2.1, “[MyISAM Startup Options](#)”  
Section 5.4.7, “[Server Log Maintenance](#)”  
Section 7.6.5, “[Setting Up a MyISAM Table Maintenance Schedule](#)”  
Section 3.5, “[Using mysql in Batch Mode](#)”

## **csch**

Section 1.1, “[About This Manual](#)”  
Section 4.2.1, “[Invoking MySQL Programs](#)”  
Section 4.2.7, “[Setting Environment Variables](#)”

## **D**

[\[index top\]](#)

## **daemon\_memcached**

Section 14.21.5.2, “[Adapting a memcached Application for the InnoDB memcached Plugin](#)”  
Section 14.21.2, “[InnoDB memcached Architecture](#)”

## **date**

Section 4.3.2, “[mysqld\\_safe — MySQL Server Startup Script](#)”

## **df**

Section B.3.1, “[How to Determine What Is Causing a Problem](#)”

## **dig**

Section 4.8.4, “[resolveip — Resolve Host name to IP Address or Vice Versa](#)”  
Section 1.3, “[What Is New in MySQL 5.7](#)”

---

## Directory Utility

[Section 2.4.1, “General Notes on Installing MySQL on macOS”](#)

### dnf

[Section 2.5.5, “Installing MySQL on Linux Using RPM Packages from Oracle”](#)

[Section 2.5.1, “Installing MySQL on Linux Using the MySQL Yum Repository”](#)

[Section 21.3.1.2, “Installing NDB Cluster from RPM”](#)

[Section 2.10.10, “Upgrading MySQL with Directly-Downloaded RPM Packages”](#)

[Section 2.10.5, “Upgrading MySQL with the MySQL Yum Repository”](#)

### dnf config-manager

[Section 2.5.1, “Installing MySQL on Linux Using the MySQL Yum Repository”](#)

### docker exec

[Section 2.5.7.1, “Basic Steps for MySQL Server Deployment with Docker”](#)

### docker images

[Section 2.5.7.1, “Basic Steps for MySQL Server Deployment with Docker”](#)

### docker inspect

[Section 2.5.7.2, “More Topics on Deploying MySQL Server with Docker”](#)

### docker logs mysqld-container

[Section 2.5.7.2, “More Topics on Deploying MySQL Server with Docker”](#)

### docker ps

[Section 2.5.7.1, “Basic Steps for MySQL Server Deployment with Docker”](#)

### docker pull

[Section 2.5.7.1, “Basic Steps for MySQL Server Deployment with Docker”](#)

[Section 2.5.7.2, “More Topics on Deploying MySQL Server with Docker”](#)

### docker rm

[Section 2.5.7.1, “Basic Steps for MySQL Server Deployment with Docker”](#)

### docker run

[Section 2.5.7.1, “Basic Steps for MySQL Server Deployment with Docker”](#)

[Section 2.5.7.2, “More Topics on Deploying MySQL Server with Docker”](#)

### docker stop

[Section 2.5.7.1, “Basic Steps for MySQL Server Deployment with Docker”](#)

### dpkg

[Section 2.5.6, “Installing MySQL on Linux Using Debian Packages from Oracle”](#)

### dump

[Creating a Data Snapshot Using Raw Data Files](#)

## E

[\[index top\]](#)

---

## **execute()**

[Section 19.3, “Quick-Start Guide: MySQL for Visual Studio”](#)

## **export**

[Section 2.8.8, “Dealing with Problems Compiling MySQL”](#)

## **G**

[\[index top\]](#)

## **gcc**

[Section 27.6.1, “Compiling Programs with libmysqld”](#)

[Section 2.12.3, “Problems Using the Perl DBI/DBD Interface”](#)

## **gcov**

[Section 2.8.7, “MySQL Source-Configuration Options”](#)

## **gdb**

[Section 5.8.1.1, “Compiling MySQL for Debugging”](#)

[Section 5.8.1.4, “Debugging mysqld under gdb”](#)

[Section B.3.3.3, “What to Do If MySQL Keeps Crashing”](#)

## **getenforce**

[Section 6.7.2, “Changing the SELinux Mode”](#)

## **git branch**

[Section 2.8.5, “Installing MySQL Using a Development Source Tree”](#)

## **git checkout**

[Section 2.8.5, “Installing MySQL Using a Development Source Tree”](#)

## **git log**

[Section 2.8.5, “Installing MySQL Using a Development Source Tree”](#)

## **git pull**

[Section 2.8.5, “Installing MySQL Using a Development Source Tree”](#)

## **gmake**

[Section 2.8.4, “Installing MySQL Using a Standard Source Distribution”](#)

[Section 2.8.2, “Source Installation Prerequisites”](#)

## **GnuPG**

[Section 2.1.4.2, “Signature Checking Using GnuPG”](#)

## **gnutar**

[Section 2.2, “Installing MySQL on Unix/Linux Using Generic Binaries”](#)

[Section 2.8.2, “Source Installation Prerequisites”](#)

## **gogoc**

[Section 5.1.12.5, “Obtaining an IPv6 Address from a Broker”](#)

---

## **gpg**

[Section 2.1.4.2, “Signature Checking Using GnuPG”](#)

## **gprof**

[Section 2.8.7, “MySQL Source-Configuration Options”](#)

## **grep**

[Section 4.6.8, “mysqldumpslow — Summarize Slow Query Log Files”](#)

[Section 3.3.4.7, “Pattern Matching”](#)

## **groupadd**

[Section 21.3.1.1, “Installing an NDB Cluster Binary Release on Linux”](#)

[Section 2.7, “Installing MySQL on Solaris”](#)

[Section 2.2, “Installing MySQL on Unix/Linux Using Generic Binaries”](#)

## **gtar**

[Section 2.7, “Installing MySQL on Solaris”](#)

[Section 2.2, “Installing MySQL on Unix/Linux Using Generic Binaries”](#)

[Section 2.8.2, “Source Installation Prerequisites”](#)

## **gunzip**

[Section 6.4.5.5, “Configuring Audit Logging Characteristics”](#)

[Section 2.2, “Installing MySQL on Unix/Linux Using Generic Binaries”](#)

[Section 2.8.4, “Installing MySQL Using a Standard Source Distribution”](#)

## **gzip**

[Section 6.4.5.5, “Configuring Audit Logging Characteristics”](#)

[Section 21.4.3.6, “Defining NDB Cluster Data Nodes”](#)

[Section 1.5, “How to Report Bugs or Problems”](#)

[Section 2.4, “Installing MySQL on macOS”](#)

## **H**

[\[index top\]](#)

## **help contents**

[Section 4.5.1.4, “mysql Client Server-Side Help”](#)

## **host**

[Section 4.8.4, “resolveip — Resolve Host name to IP Address or Vice Versa”](#)

[Section 1.3, “What Is New in MySQL 5.7”](#)

## **hostname**

[Section B.3.2.2, “Can't connect to \[local\] MySQL server”](#)

## **I**

[\[index top\]](#)

## **icc**

[Section 2.1.6, “Compiler-Specific Build Characteristics”](#)



---

## **ifconfig**

[Section 5.1.12.1, “Verifying System Support for IPv6”](#)

## **innochecksum**

[Section 13.7.2.2, “CHECK TABLE Statement”](#)

[Section 4.6.1, “innochecksum — Offline InnoDB File Checksum Utility”](#)

[MySQL Glossary](#)

[Section 4.1, “Overview of MySQL Programs”](#)

[Section 1.3, “What Is New in MySQL 5.7”](#)

## **InnoDB**

[Section 13.1.8, “ALTER TABLE Statement”](#)

## **iptables**

[Section 17.8, “Frequently Asked Questions”](#)

[Section 21.6.18.1, “NDB Cluster Security and Networking Issues”](#)

## **J**

[\[index top\]](#)

## **java**

[Section 6.4.4.4, “Using the keyring\\_okv KMIP Plugin”](#)

## **K**

[\[index top\]](#)

## **kill**

[Section B.3.2.2, “Can’t connect to \[local\] MySQL server”](#)

[Section 21.4.3.6, “Defining NDB Cluster Data Nodes”](#)

[Section 21.5.1, “ndbd — The NDB Cluster Data Node Daemon”](#)

[Section 21.6.5, “Performing a Rolling Restart of an NDB Cluster”](#)

[Section 4.10, “Unix Signal Handling in MySQL”](#)

## **ksh**

[Section 4.2.1, “Invoking MySQL Programs”](#)

[Section 4.2.7, “Setting Environment Variables”](#)

## **kswapd**

[Section 21.4.3.6, “Defining NDB Cluster Data Nodes”](#)

## **L**

[\[index top\]](#)

## **launchd**

[Section 2.4.3, “Installing a MySQL Launch Daemon”](#)

## **less**

[Section 4.5.1.2, “mysql Client Commands”](#)

---

[Section 4.5.1.1, “mysql Client Options”](#)

## In

[Section 2.2, “Installing MySQL on Unix/Linux Using Generic Binaries”](#)

[Section 8.12.3.2, “Using Symbolic Links for MyISAM Tables on Unix”](#)

## logger

[Section 4.3.2, “mysqld\\_safe — MySQL Server Startup Script”](#)

## ls

[Section 6.7, “SELinux”](#)

## Is of +L1

[Section B.3.3.5, “Where MySQL Stores Temporary Files”](#)

## lz4

[Section 2.8.7, “MySQL Source-Configuration Options”](#)

[Section 4.5.6, “mysqldump — A Database Backup Program”](#)

## lz4\_decompress

[Section 4.8.1, “lz4\\_decompress — Decompress mysqldump LZ4-Compressed Output”](#)

[Section 2.8.7, “MySQL Source-Configuration Options”](#)

[Section 4.5.6, “mysqldump — A Database Backup Program”](#)

[Section 4.1, “Overview of MySQL Programs”](#)

[Section 4.8.5, “zlib\\_decompress — Decompress mysqldump ZLIB-Compressed Output”](#)

## M

[\[index top\]](#)

## m4

[Section 2.8.2, “Source Installation Prerequisites”](#)

## make

[Section 2.8.8, “Dealing with Problems Compiling MySQL”](#)

[Section 2.8.4, “Installing MySQL Using a Standard Source Distribution”](#)

[Section 2.12.3, “Problems Using the Perl DBI/DBD Interface”](#)

[Section 2.8.2, “Source Installation Prerequisites”](#)

## make && make install

[Section 21.3.1.4, “Building NDB Cluster from Source on Linux”](#)

## make install

[Section 21.3.1.4, “Building NDB Cluster from Source on Linux”](#)

## make package

[Section 2.8.4, “Installing MySQL Using a Standard Source Distribution”](#)

[Section 2.8.7, “MySQL Source-Configuration Options”](#)

## make test

[Section 2.8.5, “Installing MySQL Using a Development Source Tree”](#)

---

[Section 2.12.1, “Installing Perl on Unix”](#)

## **make VERBOSE=1**

[Section 2.8.8, “Dealing with Problems Compiling MySQL”](#)

## **md5**

[Section 2.1.4.1, “Verifying the MD5 Checksum”](#)

## **md5.exe**

[Section 2.1.4.1, “Verifying the MD5 Checksum”](#)

## **md5sum**

[Section 2.1.4.1, “Verifying the MD5 Checksum”](#)

## **memcached**

[Section 14.21.5.2, “Adapting a memcached Application for the InnoDB memcached Plugin”](#)

[Section 14.21.5.1, “Adapting an Existing MySQL Schema for the InnoDB memcached Plugin”](#)

[Section 14.21.5.5, “Adapting DML Statements to memcached Operations”](#)

[Section 14.21.1, “Benefits of the InnoDB memcached Plugin”](#)

[Section 14.21.5.4, “Controlling Transactional Behavior of the InnoDB memcached Plugin”](#)

[Section 14.21.2, “InnoDB memcached Architecture”](#)

[Section 14.21, “InnoDB memcached Plugin”](#)

[Section 14.21.7, “InnoDB memcached Plugin Internals”](#)

[Section 14.15, “InnoDB Startup Options and System Variables”](#)

[MySQL Glossary](#)

[Section 14.21.5.6, “Performing DML and DDL Statements on the Underlying InnoDB Table”](#)

[Section 14.21.4, “Security Considerations for the InnoDB memcached Plugin”](#)

[Section 14.21.3, “Setting Up the InnoDB memcached Plugin”](#)

[Section 14.21.6, “The InnoDB memcached Plugin and Replication”](#)

[Section 14.21.8, “Troubleshooting the InnoDB memcached Plugin”](#)

[Section 14.21.5.3, “Tuning InnoDB memcached Plugin Performance”](#)

[Section 14.21.5, “Writing Applications for the InnoDB memcached Plugin”](#)

## **memcapable**

[Section 14.21.2, “InnoDB memcached Architecture”](#)

## **memslap**

[Section 14.21.5.3, “Tuning InnoDB memcached Plugin Performance”](#)

## **mgmd**

[Section 21.3.2.1, “Installing NDB Cluster on Windows from a Binary Release”](#)

[Section 21.3, “NDB Cluster Installation”](#)

## **mkdir**

[Section 13.1.11, “CREATE DATABASE Statement”](#)

## **mklink**

[Section 8.12.3.3, “Using Symbolic Links for Databases on Windows”](#)

[Section 1.3, “What Is New in MySQL 5.7”](#)

## **more**

[Section 4.5.1.2, “mysql Client Commands”](#)

---

Section 4.5.1.1, “mysql Client Options”

## **mysql2mysql**

Section 1.3, “What Is New in MySQL 5.7”

## **mv**

Section 5.4.2.6, “Error Log File Flushing and Renaming”

Section 5.4.7, “Server Log Maintenance”

Section 5.4.3, “The General Query Log”

## **my\_print\_defaults**

Section 4.7.2, “my\_print\_defaults — Display Options from Option Files”

Section 4.4.3, “mysql\_plugin — Configure MySQL Server Plugins”

Section 4.1, “Overview of MySQL Programs”

Section 4.7, “Program Development Utilities”

## **myisam\_ftdump**

Section 12.9, “Full-Text Search Functions”

Section 4.6.2, “myisam\_ftdump — Display Full-Text Index information”

Section 4.1, “Overview of MySQL Programs”

## **myisamchk**

Section 13.7.2.1, “ANALYZE TABLE Statement”

Section 8.6.2, “Bulk Data Loading for MyISAM Tables”

Section 13.7.2.2, “CHECK TABLE Statement”

Section 15.2.3.3, “Compressed Table Characteristics”

Section 15.2.4.1, “Corrupted MyISAM Tables”

Section 7.2, “Database Backup Methods”

Section 5.8.1, “Debugging a MySQL Server”

Section 13.2.2, “DELETE Statement”

Section 15.2.3.2, “Dynamic Table Characteristics”

Section 8.8.2, “EXPLAIN Output Format”

Section 8.11.5, “External Locking”

Section 12.9.6, “Fine-Tuning MySQL Full-Text Search”

Section 7.6.2, “How to Check MyISAM Tables for Errors”

Section 7.6.3, “How to Repair MyISAM Tables”

Section 1.5, “How to Report Bugs or Problems”

Section 8.3.7, “InnoDB and MyISAM Index Statistics Collection”

Section 8.4.6, “Limits on Table Size”

Section 13.7.6.5, “LOAD INDEX INTO CACHE Statement”

Section 22.3.4, “Maintenance of Partitions”

Section 5.8.1.7, “Making a Test Case If You Experience Table Corruption”

Section 15.2.1, “MyISAM Startup Options”

Section 7.6, “MyISAM Table Maintenance and Crash Recovery”

Section 7.6.4, “MyISAM Table Optimization”

Section 15.2.3, “MyISAM Table Storage Formats”

Section 4.6.3.2, “myisamchk Check Options”

Section 4.6.3.1, “myisamchk General Options”

Section 4.6.3.6, “myisamchk Memory Usage”

Section 4.6.3.3, “myisamchk Repair Options”

Section 4.6.3, “myisamchk — MyISAM Table-Maintenance Utility”

Section 4.6.5, “myisampack — Generate Compressed, Read-Only MyISAM Tables”

Section 4.6.3.5, “Obtaining Table Information with myisamchk”

---

Section 8.6.1, “Optimizing MyISAM Queries”  
Section 8.6.3, “Optimizing REPAIR TABLE Statements”  
Section 4.6.3.4, “Other myisamchk Options”  
Section 4.1, “Overview of MySQL Programs”  
Section 15.2.4.2, “Problems from Tables Not Being Closed Properly”  
Section 13.7.2.5, “REPAIR TABLE Statement”  
Section 22.6, “Restrictions and Limitations on Partitioning”  
Section 5.1.7, “Server System Variables”  
Section 7.6.5, “Setting Up a MyISAM Table Maintenance Schedule”  
Section 13.7.5.22, “SHOW INDEX Statement”  
Section 13.7.5.36, “SHOW TABLE STATUS Statement”  
Section 15.2.3.1, “Static (Fixed-Length) Table Characteristics”  
Section 8.12.1, “System Factors”  
Section 24.3.24, “The INFORMATION\_SCHEMA STATISTICS Table”  
Section 24.3.25, “The INFORMATION\_SCHEMA TABLES Table”  
Section 1.2.2, “The Main Features of MySQL”  
Section 15.2, “The MyISAM Storage Engine”  
Section 7.6.1, “Using myisamchk for Crash Recovery”  
Section 5.8.1.6, “Using Server Logs to Find Causes of Errors in mysqld”  
Section 8.12.3.2, “Using Symbolic Links for MyISAM Tables on Unix”  
Section B.3.3.3, “What to Do If MySQL Keeps Crashing”

## **myisamchk \*.MYI**

Section 7.6.3, “How to Repair MyISAM Tables”

## **myisamchk tbl\_name**

Section 7.6.2, “How to Check MyISAM Tables for Errors”

## **myisamlog**

Section 4.6.4, “myisamlog — Display MyISAM Log File Contents”  
Section 4.1, “Overview of MySQL Programs”

## **myisampack**

Section 8.6.2, “Bulk Data Loading for MyISAM Tables”  
Section 15.2.3.3, “Compressed Table Characteristics”  
Section 13.1.18, “CREATE TABLE Statement”  
Section 8.11.5, “External Locking”  
Section 8.4.6, “Limits on Table Size”  
Section 15.7.1, “MERGE Table Advantages and Disadvantages”  
Section 15.2.3, “MyISAM Table Storage Formats”  
Section 4.6.3.3, “myisamchk Repair Options”  
Section 4.6.5, “myisampack — Generate Compressed, Read-Only MyISAM Tables”  
Section 4.6.3.5, “Obtaining Table Information with myisamchk”  
Section 8.4.1, “Optimizing Data Size”  
Section 4.1, “Overview of MySQL Programs”  
Section 22.6, “Restrictions and Limitations on Partitioning”  
Section 13.1.18.6, “Silent Column Specification Changes”  
Section 15.7, “The MERGE Storage Engine”  
Section 15.2, “The MyISAM Storage Engine”

## **mysql**

Section 1.1, “About This Manual”  
Section 16.1.5.4, “Adding a Binary Log Based Source to a Multi-Source Replica”

---

Section 6.2.7, “Adding Accounts, Assigning Privileges, and Dropping Accounts”  
Section 16.1.5.3, “Adding GTID-Based Sources to a Multi-Source Replica”  
Section 21.6.7.2, “Adding NDB Cluster Data Nodes Online: Basic procedure”  
Section 21.6.7.3, “Adding NDB Cluster Data Nodes Online: Detailed Example”  
Section 21.6.7.1, “Adding NDB Cluster Data Nodes Online: General Issues”  
Section 12.19.1, “Aggregate Function Descriptions”  
Section 13.1.8.1, “ALTER TABLE Partition Operations”  
Section 6.4.5.11, “Audit Log Reference”  
Section 7.1, “Backup and Recovery Types”  
Section 2.5.7.1, “Basic Steps for MySQL Server Deployment with Docker”  
Section 13.6.1, “BEGIN ... END Compound Statement”  
Section 6.4.1.4, “Caching SHA-2 Pluggable Authentication”  
Section 12.10, “Cast Functions and Operators”  
Section 2.10.3, “Changes in MySQL 5.7”  
Section 6.4.1.6, “Client-Side Cleartext Pluggable Authentication”  
Section 4.2.2.3, “Command-Line Options that Affect Option-File Handling”  
Section 21.6.1, “Commands in the NDB Cluster Management Client”  
Section 9.6, “Comments”  
Section 21.4, “Configuration of NDB Cluster”  
Section 10.5, “Configuring Application Character Set and Collation”  
Section 16.1.5.1, “Configuring Multi-Source Replication”  
Section 6.3.1, “Configuring MySQL to Use Encrypted Connections”  
Section 14.8.11.2, “Configuring Non-Persistent Optimizer Statistics Parameters”  
Section 3.1, “Connecting to and Disconnecting from the Server”  
Section 4.2.4, “Connecting to the MySQL Server Using Command Options”  
Section 5.1.12.4, “Connecting Using IPv6 Nonlocal Host Addresses”  
Section 5.1.12.3, “Connecting Using the IPv6 Local Host Address”  
Section 10.4, “Connection Character Sets and Collations”  
Section 4.2.5, “Connection Transport Protocols”  
Section 14.6.1.5, “Converting Tables from MyISAM to InnoDB”  
Section 2.10.13, “Copying MySQL Databases to Another Machine”  
Section 13.1.16, “CREATE PROCEDURE and CREATE FUNCTION Statements”  
Section 3.3.1, “Creating and Selecting a Database”  
Section 2.3.4.7, “Customizing the PATH for MySQL Tools”  
Section 5.8.2, “Debugging a MySQL Client”  
Section 21.4.3.7, “Defining SQL and Other API Nodes in an NDB Cluster”  
Section 23.1, “Defining Stored Programs”  
Section 8.15.13, “Displaying Traces in Other Applications”  
Section 21.6.13, “Distributed Privileges Using Shared Grant Tables”  
Section 2.11.5, “Downgrade Troubleshooting”  
Section 2.11, “Downgrading MySQL”  
Section 14.18.2, “Enabling InnoDB Monitors”  
Section 12.13, “Encryption and Compression Functions”  
Section 6.1.2.1, “End-User Guidelines for Password Security”  
Section 3.2, “Entering Queries”  
Section 4.9, “Environment Variables”  
Section B.2, “Error Information Interfaces”  
Section B.1, “Error Message Sources and Elements”  
Section 21.6.2.3, “Event Buffer Reporting in the Cluster Log”  
Section 23.4.2, “Event Scheduler Configuration”  
Section 7.3, “Example Backup and Recovery Strategy”  
Section 3.6, “Examples of Common Queries”  
Section 22.3.3, “Exchanging Partitions and Subpartitions with Tables”  
Section 4.5.1.5, “Executing SQL Statements from a Text File”

---

Chapter 12, *Functions and Operators*  
Section 12.17.3, “Functions That Search JSON Values”  
Section 21.1, “General Information”  
Section 2.4.1, “General Notes on Installing MySQL on macOS”  
Section 13.6.7.3, “GET DIAGNOSTICS Statement”  
Section 13.7.1.4, “GRANT Statement”  
Section B.3.1, “How to Determine What Is Causing a Problem”  
Section 14.7.5.3, “How to Minimize and Handle Deadlocks”  
Section 1.5, “How to Report Bugs or Problems”  
Section 6.1.5, “How to Run MySQL as a Normal User”  
Section B.3.2.13, “Ignoring user”  
Section 21.6.9, “Importing Data Into MySQL Cluster”  
Section 12.15, “Information Functions”  
Section 21.3.2.3, “Initial Startup of NDB Cluster on Windows”  
Section 14.19.2, “InnoDB Recovery”  
Section 2.2, “Installing MySQL on Unix/Linux Using Generic Binaries”  
Section 21.3.1.2, “Installing NDB Cluster from RPM”  
Section 21.3.2.1, “Installing NDB Cluster on Windows from a Binary Release”  
Section 4.2.1, “Invoking MySQL Programs”  
Section 21.2.7.8, “Issues Exclusive to NDB Cluster”  
Section 17.2.1.4, “Launching Group Replication”  
Section 6.4.1.9, “LDAP Pluggable Authentication”  
Section 8.2.1.17, “LIMIT Query Optimization”  
Section 13.2.6, “LOAD DATA Statement”  
Section 13.2.7, “LOAD XML Statement”  
Section 7.4.5.1, “Making a Copy of a Database”  
Section 6.1.3, “Making MySQL Secure Against Attackers”  
Section 21.6, “Management of NDB Cluster”  
Section 8.13.1, “Measuring the Speed of Expressions and Functions”  
Section 12.20, “Miscellaneous Functions”  
Section 2.5.7.2, “More Topics on Deploying MySQL Server with Docker”  
Section A.11, “MySQL 5.7 FAQ: MySQL Chinese, Japanese, and Korean Character Sets”  
Section A.10, “MySQL 5.7 FAQ: NDB Cluster”  
Section 4.5.1.2, “mysql Client Commands”  
Section 4.5.1.3, “mysql Client Logging”  
Section 4.5.1.1, “mysql Client Options”  
Section 4.5.1.4, “mysql Client Server-Side Help”  
Section 4.5.1.6, “mysql Client Tips”  
Section 6.5.5, “MySQL Enterprise Data Masking and De-Identification Function Descriptions”  
MySQL Glossary  
Section 2.3.3.1, “MySQL Installer Initial Setup”  
Section 5.1.13, “MySQL Server Time Zone Support”  
Section 21.6.10, “MySQL Server Usage for NDB Cluster”  
Chapter 18, *MySQL Shell*  
Section 4.5.1, “mysql — The MySQL Command-Line Client”  
Section 4.3.3, “mysql.server — MySQL Server Startup Script”  
Section 4.6.6, “mysql\_config\_editor — MySQL Configuration Utility”  
Section 4.4.2, “mysql\_install\_db — Initialize MySQL Data Directory”  
Section 4.4.6, “mysql\_tzinfo\_to\_sql — Load the Time Zone Tables”  
Section 4.4.7, “mysql\_upgrade — Check and Upgrade MySQL Tables”  
Section 4.6.7, “mysqlbinlog — Utility for Processing Binary Log Files”  
Section 4.5.4, “mysqldump — A Database Backup Program”  
Section 4.5.6, “mysqlpump — A Database Backup Program”  
Section 4.5.7, “mysqlshow — Display Database, Table, and Column Information”

---

Section 21.6.14, “NDB API Statistics Counters and Variables”  
Section 21.7.9, “NDB Cluster Backups With NDB Cluster Replication”  
Section 21.6.11.1, “NDB Cluster Disk Data Objects”  
Section 21.3.5, “NDB Cluster Example with Tables and Data”  
Section 21.7, “NDB Cluster Replication”  
NDB Cluster System Variables  
Section 21.5.10, “ndb\_desc — Describe NDB Tables”  
Section 21.5.14, “ndb\_import — Import CSV Data Into NDB”  
Section 21.5.15, “ndb\_index\_stat — NDB Index Statistics Utility”  
Section 21.5.5, “ndb\_mgm — The NDB Cluster Management Client”  
Section 21.6.15, “ndbinfo: The NDB Cluster Information Database”  
Section 21.5.2, “ndbinfo\_select\_all — Select From ndbinfo Tables”  
Section 8.9.3, “Optimizer Hints”  
Section 4.2.2.6, “Option Defaults, Options Expecting Values, and the = Sign”  
Section B.3.2.6, “Out of memory”  
Section 4.1, “Overview of MySQL Programs”  
Section B.3.2.8, “Packet Too Large”  
Section 6.4.1.7, “PAM Pluggable Authentication”  
Section 6.1.2.4, “Password Hashing in MySQL”  
Section 6.2.13, “Pluggable Authentication”  
Section 7.5.1, “Point-in-Time Recovery Using Binary Log”  
Section 13.5, “Prepared Statements”  
Section 21.7.5, “Preparing the NDB Cluster for Replication”  
Section 4.2.2.4, “Program Option Modifiers”  
Section 16.1.5.2, “Provisioning a Multi-Source Replica for GTID-Based Replication”  
Section 22.2.3.1, “RANGE COLUMNS partitioning”  
Section 2.10.12, “Rebuilding or Repairing Tables or Indexes”  
Section 7.4.4, “Reloading Delimited-Text Format Backups”  
Section 7.4.2, “Reloading SQL-Format Backups”  
Resetting the Root Password: Generic Instructions  
Restoring an NDB backup to a later version of NDB Cluster  
Restoring to More Nodes Than the Original  
Section 13.7.1.6, “REVOKE Statement”  
Section 2.9.4, “Securing the Initial MySQL Account”  
Section 6.1.6, “Security Considerations for LOAD DATA LOCAL”  
Section 6.2.12, “Server Handling of Expired Passwords”  
Section 5.1.7, “Server System Variables”  
Section 5.1.14, “Server-Side Help Support”  
Section 13.1.18.9, “Setting NDB Comment Options”  
Section 19.2, “Setting Up MySQL as a Document Store”  
Section 6.4.1.5, “SHA-256 Pluggable Authentication”  
Section 13.7.5.34, “SHOW SLAVE STATUS Statement”  
Section 13.7.5.40, “SHOW WARNINGS Statement”  
Section 13.6.7.5, “SIGNAL Statement”  
Section 6.4.1.11, “Socket Peer-Credential Pluggable Authentication”  
Section 4.2.2, “Specifying Program Options”  
Section 16.1.5.5, “Starting Multi-Source Replicas”  
Section 2.3.4.8, “Starting MySQL as a Windows Service”  
Section 21.7.6, “Starting NDB Cluster Replication (Single Replication Channel)”  
Section 12.8.1, “String Comparison Functions and Operators”  
Section 12.8, “String Functions and Operators”  
Section 9.1.1, “String Literals”  
Section 2.9.3, “Testing the Server”  
Section 11.3.3, “The BINARY and VARBINARY Types”



---

Section 10.10.8, “The Binary Character Set”  
Section 11.3.4, “The BLOB and TEXT Types”  
Section 26.4.4.2, “The diagnostics() Procedure”  
Section 21.6.15.27, “The ndbinfo memory\_per\_fragment Table”  
Section 21.6.15.44, “The ndbinfo transporters Table”  
Section 23.3.1, “Trigger Syntax and Examples”  
Section 14.22.3, “Troubleshooting InnoDB Data Dictionary Operations”  
Section 6.2.17, “Troubleshooting Problems Connecting to MySQL”  
Chapter 3, *Tutorial*  
Section 4.10, “Unix Signal Handling in MySQL”  
Section 2.10, “Upgrading MySQL”  
Section 2.10.10, “Upgrading MySQL with Directly-Downloaded RPM Packages”  
Section 7.3.2, “Using Backups for Recovery”  
Section 16.1.3.5, “Using GTIDs for Failover and Scaleout”  
Section 17.5.5, “Using MySQL Enterprise Backup with Group Replication”  
Section 6.4.6.3, “Using MySQL Enterprise Firewall”  
Section 3.5, “Using mysql in Batch Mode”  
Section 4.6.7.3, “Using mysqlbinlog to Back Up Binary Log Files”  
Section 7.4, “Using mysqldump for Backups”  
Section 4.2.2.2, “Using Option Files”  
Section 4.2.2.1, “Using Options on the Command Line”  
Section 4.2.2.5, “Using Options to Set Program Variables”  
Section 5.8.1.6, “Using Server Logs to Find Causes of Errors in mysqld”  
Section 8.12.3.3, “Using Symbolic Links for Databases on Windows”  
Section 1.3, “What Is New in MySQL 5.7”  
Section 21.2.4.1, “What is New in NDB Cluster 7.5”  
Section 21.2.4.2, “What is New in NDB Cluster 7.6”  
Section 2.3.6, “Windows Postinstallation Procedures”  
Section 12.11, “XML Functions”

## **mysql < dump\_file**

Section 2.10.3, “Changes in MySQL 5.7”

## **mysql ...**

Section 5.8.1.1, “Compiling MySQL for Debugging”

## **mysql-test-run.pl**

Section 4.6.6, “mysql\_config\_editor — MySQL Configuration Utility”

Section 4.2.2.2, “Using Option Files”

## **mysql.exe**

Section 21.3.2.3, “Initial Startup of NDB Cluster on Windows”

Section 21.3.2.1, “Installing NDB Cluster on Windows from a Binary Release”

Section 4.5.1.6, “mysql Client Tips”

## **mysql.server**

Section 2.5, “Installing MySQL on Linux”

Section 21.3.1.2, “Installing NDB Cluster from RPM”

Section 6.1.3, “Making MySQL Secure Against Attackers”

Section 4.3.3, “mysql.server — MySQL Server Startup Script”

Section 4.6.8, “mysqldumpslow — Summarize Slow Query Log Files”

Section 4.1, “Overview of MySQL Programs”

Section 5.1.6, “Server Command Options”

---

[Section 2.9.5, “Starting and Stopping MySQL Automatically”](#)  
[Section B.3.3.7, “Time Zone Problems”](#)

## **mysql.server stop**

[Section 4.3.3, “mysql.server — MySQL Server Startup Script”](#)

## **mysql\_client\_test\_embedded**

[Section 1.3, “What Is New in MySQL 5.7”](#)

## **mysql\_config**

[Section 27.6.1, “Compiling Programs with libmysqld”](#)  
[Section 2.8.8, “Dealing with Problems Compiling MySQL”](#)  
[Section 4.7.1, “mysql\\_config — Display Options for Compiling Clients”](#)  
[Section 4.1, “Overview of MySQL Programs”](#)  
[Section 1.3, “What Is New in MySQL 5.7”](#)

## **mysql\_config\_editor**

[Section 4.2.2.3, “Command-Line Options that Affect Option-File Handling”](#)  
[Section 6.1.2.1, “End-User Guidelines for Password Security”](#)  
[Section 4.9, “Environment Variables”](#)  
[Section 4.7.2, “my\\_print\\_defaults — Display Options from Option Files”](#)  
[Section 4.6.3.1, “myisamchk General Options”](#)  
[Section 4.5.1.1, “mysql Client Options”](#)  
[Section 4.6.6, “mysql\\_config\\_editor — MySQL Configuration Utility”](#)  
[Section 4.4.2, “mysql\\_install\\_db — Initialize MySQL Data Directory”](#)  
[Section 4.4.4, “mysql\\_secure\\_installation — Improve MySQL Installation Security”](#)  
[Section 4.4.7, “mysql\\_upgrade — Check and Upgrade MySQL Tables”](#)  
[Section 4.5.2, “mysqladmin — A MySQL Server Administration Program”](#)  
[Section 4.6.7, “mysqlbinlog — Utility for Processing Binary Log Files”](#)  
[Section 4.5.3, “mysqlcheck — A Table Maintenance Program”](#)  
[Section 4.5.4, “mysqldump — A Database Backup Program”](#)  
[Section 4.5.5, “mysqlimport — A Data Import Program”](#)  
[Section 4.5.6, “mysqldump — A Database Backup Program”](#)  
[Section 4.5.7, “mysqlshow — Display Database, Table, and Column Information”](#)  
[Section 4.5.8, “mysqlslap — A Load Emulation Client”](#)  
[Section 4.1, “Overview of MySQL Programs”](#)  
[Section 4.2.2.2, “Using Option Files”](#)

## **mysql\_convert\_table\_format**

[Section 1.3, “What Is New in MySQL 5.7”](#)

## **mysql\_find\_rows**

[Section 1.3, “What Is New in MySQL 5.7”](#)

## **mysql\_fix\_extensions**

[Section 1.3, “What Is New in MySQL 5.7”](#)

## **mysql\_install\_db**

[Section 2.10.3, “Changes in MySQL 5.7”](#)  
[Section 2.8.7, “MySQL Source-Configuration Options”](#)  
[Section 4.4.2, “mysql\\_install\\_db — Initialize MySQL Data Directory”](#)  
[Section 4.1, “Overview of MySQL Programs”](#)

---

[Section 5.1.6, “Server Command Options”](#)  
[Section 1.3, “What Is New in MySQL 5.7”](#)

## **mysql\_plugin**

[Section 4.4.3, “mysql\\_plugin — Configure MySQL Server Plugins”](#)  
[Section 4.1, “Overview of MySQL Programs”](#)  
[Section 1.3, “What Is New in MySQL 5.7”](#)

## **mysql\_secure\_installation**

[Section 2.9.1, “Initializing the Data Directory”](#)  
[Section 2.5.8, “Installing MySQL on Linux from the Native Software Repositories”](#)  
[Section 2.5.6, “Installing MySQL on Linux Using Debian Packages from Oracle”](#)  
[Section 2.7.1, “Installing MySQL on Solaris Using a Solaris PKG”](#)  
[Section 4.4.2, “mysql\\_install\\_db — Initialize MySQL Data Directory”](#)  
[Section 4.4.4, “mysql\\_secure\\_installation — Improve MySQL Installation Security”](#)  
[Section 4.1, “Overview of MySQL Programs”](#)  
[Section 2.9.4, “Securing the Initial MySQL Account”](#)

## **mysql\_server\_config**

[Section 4.7.1, “mysql\\_config — Display Options for Compiling Clients”](#)

## **mysql\_setpermission**

[Section 1.3, “What Is New in MySQL 5.7”](#)

## **mysql\_ssl\_rsa\_setup**

[Section 4.2.3, “Command Options for Connecting to the Server”](#)  
[Section 6.3.1, “Configuring MySQL to Use Encrypted Connections”](#)  
[Section 6.3.3.3, “Creating RSA Keys Using openssl”](#)  
[Section 6.3.3.1, “Creating SSL and RSA Certificates and Keys using MySQL”](#)  
[Section 6.3.3.2, “Creating SSL Certificates and Keys Using openssl”](#)  
[Section 2.9.1, “Initializing the Data Directory”](#)  
[Section 4.4.5, “mysql\\_ssl\\_rsa\\_setup — Create SSL/RSA Files”](#)  
[Section 4.1, “Overview of MySQL Programs”](#)  
[Section 6.3, “Using Encrypted Connections”](#)  
[Section 1.3, “What Is New in MySQL 5.7”](#)

## **mysql\_stmt\_execute()**

[Section 5.1.9, “Server Status Variables”](#)

## **mysql\_stmt\_prepare()**

[Section 5.1.9, “Server Status Variables”](#)

## **mysql\_tzinfo\_to\_sql**

[Section 5.1.13, “MySQL Server Time Zone Support”](#)  
[Section 4.4.6, “mysql\\_tzinfo\\_to\\_sql — Load the Time Zone Tables”](#)  
[Section 4.1, “Overview of MySQL Programs”](#)

## **mysql\_upgrade**

[Section 11.2.5, “2-Digit YEAR\(2\) Limitations and Migrating to 4-Digit YEAR”](#)  
[Section 6.2.7, “Adding Accounts, Assigning Privileges, and Dropping Accounts”](#)  
[Section 13.1.1, “ALTER DATABASE Statement”](#)  
[Section 13.1.8.1, “ALTER TABLE Partition Operations”](#)

---

Section 13.1.8, “ALTER TABLE Statement”  
Section 2.10.3, “Changes in MySQL 5.7”  
Section 17.2.1.2, “Configuring an Instance for Group Replication”  
Section 2.11.3, “Downgrade Notes”  
Section 2.11.4, “Downgrading Binary and Package-based Installations on Unix/Linux”  
Section B.3.2.13, “Ignoring user”  
Section 6.4.5.2, “Installing or Uninstalling MySQL Enterprise Audit”  
Section 6.4.1.3, “Migrating Away from Pre-4.1 Password Hashing and the `mysql_old_password` Plugin”  
Chapter 26, *MySQL sys Schema*  
Section 4.4.2, “`mysql_install_db` — Initialize MySQL Data Directory”  
Section 4.4.7, “`mysql_upgrade` — Check and Upgrade MySQL Tables”  
Section 21.7.4, “NDB Cluster Replication Schema and Tables”  
Section 4.1, “Overview of MySQL Programs”  
Section 6.1.2.4, “Password Hashing in MySQL”  
Section 2.10.12, “Rebuilding or Repairing Tables or Indexes”  
Section 2.5.2, “Replacing a Third-Party Distribution of MySQL Using the MySQL Yum Repository”  
Section 16.1.3.6, “Restrictions on Replication with GTIDs”  
Section 5.1.6, “Server Command Options”  
Section 5.1.7, “Server System Variables”  
Section 19.2, “Setting Up MySQL as a Document Store”  
Section 16.4.3, “Upgrading a Replication Topology”  
Section 21.3.7.1, “Upgrading and Downgrading NDB 7.5”  
Section 2.10.4, “Upgrading MySQL Binary or Package-based Installations on Unix/Linux”  
Section 2.10.8, “Upgrading MySQL on Windows”  
Section 2.10.10, “Upgrading MySQL with Directly-Downloaded RPM Packages”  
Section 2.10.5, “Upgrading MySQL with the MySQL Yum Repository”  
Section 1.3, “What Is New in MySQL 5.7”  
Section 21.2.4.1, “What is New in NDB Cluster 7.5”

## **mysql\_waitpid**

Section 1.3, “What Is New in MySQL 5.7”

## **mysql\_zap**

Section 1.3, “What Is New in MySQL 5.7”

## **mysqlaccess**

Section 1.3, “What Is New in MySQL 5.7”

## **mysqladmin**

Section 6.2.10, “Assigning Account Passwords”  
Section 16.3.1.1, “Backing Up a Replica Using `mysqldump`”  
Section 6.4.1.4, “Caching SHA-2 Pluggable Authentication”  
Section B.3.2.2, “Can't connect to [local] MySQL server”  
Section 6.4.1.6, “Client-Side Cleartext Pluggable Authentication”  
Section 5.1.1, “Configuring the Server”  
Section 4.2.4, “Connecting to the MySQL Server Using Command Options”  
Section 10.4, “Connection Character Sets and Collations”  
Section 13.1.11, “CREATE DATABASE Statement”  
Section 2.3.4.7, “Customizing the PATH for MySQL Tools”  
Section 5.8.1, “Debugging a MySQL Server”  
Section 13.1.22, “DROP DATABASE Statement”  
Section 13.7.6.3, “FLUSH Statement”  
Section 2.4.1, “General Notes on Installing MySQL on macOS”

---

[Section B.3.1, “How to Determine What Is Causing a Problem”](#)  
[Section 7.6.3, “How to Repair MyISAM Tables”](#)  
[Section 1.5, “How to Report Bugs or Problems”](#)  
[Section 21.3.1.2, “Installing NDB Cluster from RPM”](#)  
[Section 17.4, “Monitoring Group Replication”](#)  
[Section A.11, “MySQL 5.7 FAQ: MySQL Chinese, Japanese, and Korean Character Sets”](#)  
[Section 2.3.3.1, “MySQL Installer Initial Setup”](#)  
[Section 5.4, “MySQL Server Logs”](#)  
[Section 4.6.6, “mysql\\_config\\_editor — MySQL Configuration Utility”](#)  
[Section 4.4.2, “mysql\\_install\\_db — Initialize MySQL Data Directory”](#)  
[Section 4.5.2, “mysqladmin — A MySQL Server Administration Program”](#)  
[Section 4.3.4, “mysqld\\_multi — Manage Multiple MySQL Servers”](#)  
[Section 4.1, “Overview of MySQL Programs”](#)  
[Section 25.12.9, “Performance Schema Connection Attribute Tables”](#)  
[Section 6.2.13, “Pluggable Authentication”](#)  
[Section 6.2.2, “Privileges Provided by MySQL”](#)  
[Section 5.7.3, “Running Multiple MySQL Instances on Unix”](#)  
[Section 2.9.4, “Securing the Initial MySQL Account”](#)  
[Section 16.1.3.4, “Setting Up Replication Using GTIDs”](#)  
[Section 6.4.1.5, “SHA-256 Pluggable Authentication”](#)  
[Section 2.3.4.8, “Starting MySQL as a Windows Service”](#)  
[Section 2.3.4.6, “Starting MySQL from the Windows Command Line”](#)  
[Section 2.9.3, “Testing the Server”](#)  
[Section 1.2.2, “The Main Features of MySQL”](#)  
[Section 5.1.16, “The Server Shutdown Process”](#)  
[Section 2.10.8, “Upgrading MySQL on Windows”](#)  
[Section 4.2.2.2, “Using Option Files”](#)  
[Section 4.2.2.1, “Using Options on the Command Line”](#)  
[Section B.3.3.3, “What to Do If MySQL Keeps Crashing”](#)

## **mysqladmin debug**

[Section 5.8.1, “Debugging a MySQL Server”](#)  
[Section 23.4.5, “Event Scheduler Status”](#)  
[Section 13.7.1.4, “GRANT Statement”](#)  
[Section 6.2.2, “Privileges Provided by MySQL”](#)

## **mysqladmin extended-status**

[Section 13.7.5.35, “SHOW STATUS Statement”](#)

## **mysqladmin flush-hosts**

[Section 5.1.11.2, “DNS Lookups and the Host Cache”](#)  
[Section 6.2.17, “Troubleshooting Problems Connecting to MySQL”](#)

## **mysqladmin flush-logs**

[Section 7.3.3, “Backup Strategy Summary”](#)  
[Section 5.4.2.6, “Error Log File Flushing and Renaming”](#)  
[Section 7.3.1, “Establishing a Backup Policy”](#)  
[Section 4.5.2, “mysqladmin — A MySQL Server Administration Program”](#)  
[Section 5.4.7, “Server Log Maintenance”](#)  
[Section 16.2.4.1, “The Relay Log”](#)

## **mysqladmin flush-logs binary**

[Section 5.4.4, “The Binary Log”](#)

---

## **mysqladmin flush-privileges**

[Section 2.10.13, “Copying MySQL Databases to Another Machine”](#)  
[Section 6.2.3, “Grant Tables”](#)  
[Section 4.5.2, “mysqladmin — A MySQL Server Administration Program”](#)  
[Section 5.1.6, “Server Command Options”](#)  
[Section 6.2.17, “Troubleshooting Problems Connecting to MySQL”](#)  
[Section 6.2.9, “When Privilege Changes Take Effect”](#)

## **mysqladmin flush-tables**

[Section 8.6.2, “Bulk Data Loading for MyISAM Tables”](#)  
[Section 8.11.5, “External Locking”](#)  
[Section 8.4.3.1, “How MySQL Opens and Closes Tables”](#)  
[Section 8.12.4.1, “How MySQL Uses Memory”](#)  
[Section 4.6.5, “mysampack — Generate Compressed, Read-Only MyISAM Tables”](#)  
[Section 7.6.1, “Using mysamchk for Crash Recovery”](#)

## **mysqladmin flush-xxx**

[Section 6.2.7, “Adding Accounts, Assigning Privileges, and Dropping Accounts”](#)

## **mysqladmin kill**

[Section B.3.3.4, “How MySQL Handles a Full Disk”](#)  
[Section 13.7.6.4, “KILL Statement”](#)  
[Section 12.14, “Locking Functions”](#)  
[Section B.3.2.7, “MySQL server has gone away”](#)  
[Section 6.2.2, “Privileges Provided by MySQL”](#)

## **mysqladmin password**

[Section 4.5.2, “mysqladmin — A MySQL Server Administration Program”](#)

## **mysqladmin processlist**

[Section 8.14.1, “Accessing the Process List”](#)  
[Section 6.2.7, “Adding Accounts, Assigning Privileges, and Dropping Accounts”](#)  
[Section 13.7.6.4, “KILL Statement”](#)  
[Section 6.1.3, “Making MySQL Secure Against Attackers”](#)  
[Section 6.2.2, “Privileges Provided by MySQL”](#)  
[Section 25.12.16.3, “The processlist Table”](#)

## **mysqladmin processlist status**

[Section 5.8.1, “Debugging a MySQL Server”](#)

## **mysqladmin refresh**

[Section 6.2.7, “Adding Accounts, Assigning Privileges, and Dropping Accounts”](#)  
[Section 8.4.3.1, “How MySQL Opens and Closes Tables”](#)  
[Section 5.4.7, “Server Log Maintenance”](#)

## **mysqladmin reload**

[Section 6.2.7, “Adding Accounts, Assigning Privileges, and Dropping Accounts”](#)  
[Section 6.2.3, “Grant Tables”](#)  
[Section 1.5, “How to Report Bugs or Problems”](#)  
[Section 5.1.6, “Server Command Options”](#)  
[Section 6.2.16, “Setting Account Resource Limits”](#)

---

[Section 6.2.9, “When Privilege Changes Take Effect”](#)

## **mysqladmin reload version**

[Section 1.5, “How to Report Bugs or Problems”](#)

## **mysqladmin shutdown**

[Section 6.2.6, “Access Control, Stage 2: Request Verification”](#)

[Section 21.6.7.3, “Adding NDB Cluster Data Nodes Online: Detailed Example”](#)

[Section 5.8.1.2, “Creating Trace Files”](#)

[Section 13.7.1.4, “GRANT Statement”](#)

[Section 7.6.3, “How to Repair MyISAM Tables”](#)

[Section 6.1.5, “How to Run MySQL as a Normal User”](#)

[Section 2.4.2, “Installing MySQL on macOS Using Native Packages”](#)

[Section 5.8.1.7, “Making a Test Case If You Experience Table Corruption”](#)

[Section A.10, “MySQL 5.7 FAQ: NDB Cluster”](#)

[Section 4.3.3, “mysql.server — MySQL Server Startup Script”](#)

[Section 4.5.2, “mysqladmin — A MySQL Server Administration Program”](#)

[Section 21.5.14, “ndb\\_import — Import CSV Data Into NDB”](#)

[Section 6.2.2, “Privileges Provided by MySQL”](#)

[Section 16.4.1.29, “Replication and Temporary Tables”](#)

[Section 21.3.6, “Safe Shutdown and Restart of NDB Cluster”](#)

[Section 13.7.6.7, “SHUTDOWN Statement”](#)

[Section 2.3.4.8, “Starting MySQL as a Windows Service”](#)

[Section 5.1.16, “The Server Shutdown Process”](#)

[Section B.3.3.3, “What to Do If MySQL Keeps Crashing”](#)

## **mysqladmin status**

[Section 8.4.3.1, “How MySQL Opens and Closes Tables”](#)

[Section 4.5.2, “mysqladmin — A MySQL Server Administration Program”](#)

## **mysqladmin variables**

[Section B.3.2.7, “MySQL server has gone away”](#)

[Section 13.7.5.39, “SHOW VARIABLES Statement”](#)

## **mysqladmin variables extended-status processlist**

[Section 1.5, “How to Report Bugs or Problems”](#)

## **mysqladmin ver**

[Section 5.8.1.1, “Compiling MySQL for Debugging”](#)

## **mysqladmin version**

[Section B.3.2.2, “Can't connect to \[local\] MySQL server”](#)

[Section 1.5, “How to Report Bugs or Problems”](#)

[Section B.3.2.7, “MySQL server has gone away”](#)

[Section 2.9.3, “Testing the Server”](#)

[Section B.3.3.3, “What to Do If MySQL Keeps Crashing”](#)

## **mysqlanalyze**

[Section 4.5.3, “mysqlcheck — A Table Maintenance Program”](#)

## **mysqlbackup**

[Section 7.1, “Backup and Recovery Types”](#)

---

Creating a Data Snapshot Using Raw Data Files  
Section 14.19.1, “InnoDB Backup”  
MySQL Glossary  
Section 4.5.4, “mysqldump — A Database Backup Program”  
Section 16.1.3.5, “Using GTIDs for Failover and Scaleout”

## **mysqlbinlog**

Section 16.2.1.1, “Advantages and Disadvantages of Statement-Based and Row-Based Replication”  
Section 13.7.6.1, “BINLOG Statement”  
Section 12.12, “Bit Functions and Operators”  
Section 6.4.1.4, “Caching SHA-2 Pluggable Authentication”  
Command Probes  
Section 16.1.3.1, “GTID Format and Storage”  
Section 16.1.3.2, “GTID Life Cycle”  
Section 16.4.5, “How to Report Replication Bugs or Problems”  
Section 14.19.2, “InnoDB Recovery”  
Section B.3.7, “Known Issues in MySQL”  
Section 12.20, “Miscellaneous Functions”  
Section 4.5.1.1, “mysql Client Options”  
MySQL Glossary  
Section 4.6.7.1, “mysqlbinlog Hex Dump Format”  
Section 4.6.7.2, “mysqlbinlog Row Event Display”  
Section 4.6.7, “mysqlbinlog — Utility for Processing Binary Log Files”  
NDB Cluster System Variables  
Section 4.1, “Overview of MySQL Programs”  
Section 25.12.9, “Performance Schema Connection Attribute Tables”  
Section 7.5.1, “Point-in-Time Recovery Using Binary Log”  
Section 7.5.2, “Point-in-Time Recovery Using Event Positions”  
Section 21.7.9.2, “Point-In-Time Recovery Using NDB Cluster Replication”  
Section 6.2.2, “Privileges Provided by MySQL”  
Section 16.4.1.18, “Replication and LOAD DATA”  
Section 16.4.1.37, “Replication and Variables”  
Section 5.1.7, “Server System Variables”  
Section 6.4.1.5, “SHA-256 Pluggable Authentication”  
Section 13.7.5.2, “SHOW BINLOG EVENTS Statement”  
Section 13.7.5.32, “SHOW RELAYLOG EVENTS Statement”  
Section 16.1.7.3, “Skipping Transactions”  
Section 4.6.7.4, “Specifying the mysqlbinlog Server ID”  
Section 13.4.2.5, “START SLAVE Statement”  
Section 5.4.4, “The Binary Log”  
Section 5.4.3, “The General Query Log”  
Section 16.2.4.1, “The Relay Log”  
Section 16.2.1.2, “Usage of Row-Based Logging and Replication”  
Section 7.3.2, “Using Backups for Recovery”  
Section 16.1.3.5, “Using GTIDs for Failover and Scaleout”  
Section 4.6.7.3, “Using mysqlbinlog to Back Up Binary Log Files”  
Section 1.3, “What Is New in MySQL 5.7”

## **mysqlbinlog binary-log-file | mysql**

Section 5.8.1.7, “Making a Test Case If You Experience Table Corruption”

## **mysqlbinlog|mysql**

Section B.3.7, “Known Issues in MySQL”



---

## mysqlbug

Section 1.3, “What Is New in MySQL 5.7”

## mysqlcheck

Section 13.1.1, “ALTER DATABASE Statement”  
Section 6.4.1.4, “Caching SHA-2 Pluggable Authentication”  
Section 6.4.1.6, “Client-Side Cleartext Pluggable Authentication”  
Section 10.4, “Connection Character Sets and Collations”  
Section 22.3.4, “Maintenance of Partitions”  
Section 9.2.4, “Mapping of Identifiers to File Names”  
Section 4.7.2, “my\_print\_defaults — Display Options from Option Files”  
Section 7.6, “MyISAM Table Maintenance and Crash Recovery”  
Section 4.5.3, “mysqlcheck — A Table Maintenance Program”  
Section 4.1, “Overview of MySQL Programs”  
Section 2.10.12, “Rebuilding or Repairing Tables or Indexes”  
Section 22.6, “Restrictions and Limitations on Partitioning”  
Section 5.1.7, “Server System Variables”  
Section 6.4.1.5, “SHA-256 Pluggable Authentication”  
Section 1.2.2, “The Main Features of MySQL”  
Section 15.2, “The MyISAM Storage Engine”  
Section 1.3, “What Is New in MySQL 5.7”

## mysqld

Section 1.1, “About This Manual”  
Section 8.2.1.20, “Avoiding Full Table Scans”  
Section 2.5.7.1, “Basic Steps for MySQL Server Deployment with Docker”  
Section 5.4.4.1, “Binary Logging Formats”  
Section 16.1.6.4, “Binary Logging Options and Variables”  
Section 21.3.1.4, “Building NDB Cluster from Source on Linux”  
Section B.3.2.2, “Can't connect to [local] MySQL server”  
Section B.3.2.11, “Can't create/write to file”  
Section B.3.2.15, “Can't initialize character set”  
Section 13.4.2.2, “CHANGE REPLICATION FILTER Statement”  
Section 2.10.3, “Changes in MySQL 5.7”  
Section 21.6.1, “Commands in the NDB Cluster Management Client”  
Section 9.6, “Comments”  
Section B.3.2.9, “Communication Errors and Aborted Connections”  
Section 4.4.1, “comp\_err — Compile MySQL Error Message File”  
Section 5.8.1.1, “Compiling MySQL for Debugging”  
Section 21.4, “Configuration of NDB Cluster”  
Section 2.8.6, “Configuring SSL Library Support”  
Section 5.1.1, “Configuring the Server”  
Section 5.1.11.1, “Connection Interfaces”  
Section 14.21.5.4, “Controlling Transactional Behavior of the InnoDB memcached Plugin”  
Section 15.2.4.1, “Corrupted MyISAM Tables”  
Section 13.1.18, “CREATE TABLE Statement”  
Section 5.8.1.2, “Creating Trace Files”  
Section 14.7.5, “Deadlocks in InnoDB”  
Section 5.8.1, “Debugging a MySQL Server”  
Section 5.8.1.4, “Debugging mysqld under gdb”  
Section 21.4.3.6, “Defining NDB Cluster Data Nodes”  
Section 21.4.3.7, “Defining SQL and Other API Nodes in an NDB Cluster”  
Section 5.1.11.2, “DNS Lookups and the Host Cache”

---

Section 14.6.5, “Doublewrite Buffer”  
Section 2.11.3, “Downgrade Notes”  
Section 2.11.4, “Downgrading Binary and Package-based Installations on Unix/Linux”  
Section 14.10.1, “Enabling File Formats”  
Section 14.18.2, “Enabling InnoDB Monitors”  
Section 8.12.4.3, “Enabling Large Page Support”  
Section 4.9, “Environment Variables”  
Section 5.4.2.6, “Error Log File Flushing and Renaming”  
Section 5.4.2.5, “Error Log Output Format”  
Section 5.4.2.2, “Error Logging on Unix and Unix-Like Systems”  
Section 5.4.2.1, “Error Logging on Windows”  
Section 5.4.2.3, “Error Logging to the System Log”  
Section 21.6.2.3, “Event Buffer Reporting in the Cluster Log”  
Section 8.11.5, “External Locking”  
Section B.3.2.16, “File Not Found and Similar Errors”  
Section 14.6.3.2, “File-Per-Table Tablespaces”  
Section 12.9.6, “Fine-Tuning MySQL Full-Text Search”  
Section 14.22.2, “Forcing InnoDB Recovery”  
Section 21.1, “General Information”  
Section 21.7.2, “General Requirements for NDB Cluster Replication”  
Section 8.14.3, “General Thread States”  
Section 8.12.4.1, “How MySQL Uses Memory”  
Section B.3.1, “How to Determine What Is Causing a Problem”  
Section 7.6.3, “How to Repair MyISAM Tables”  
Section 1.5, “How to Report Bugs or Problems”  
Section 6.1.5, “How to Run MySQL as a Normal User”  
Section 9.2.3, “Identifier Case Sensitivity”  
Section B.3.2.13, “Ignoring user”  
Section 21.7.8, “Implementing Failover with NDB Cluster Replication”  
Section 12.15, “Information Functions”  
Section 21.3.3, “Initial Configuration of NDB Cluster”  
Section 21.3.4, “Initial Startup of NDB Cluster”  
Section 2.9.1, “Initializing the Data Directory”  
Section 14.19.1, “InnoDB Backup”  
Section 14.12.1, “InnoDB Disk I/O”  
Section 14.21.2, “InnoDB memcached Architecture”  
Section 14.19.2, “InnoDB Recovery”  
Section 14.8.1, “InnoDB Startup Configuration”  
Section 14.15, “InnoDB Startup Options and System Variables”  
Section 14.22, “InnoDB Troubleshooting”  
Section 13.2.5.2, “INSERT ... ON DUPLICATE KEY UPDATE Statement”  
Section 13.2.5, “INSERT Statement”  
Section 21.3.1, “Installation of NDB Cluster on Linux”  
Section 21.3.1.1, “Installing an NDB Cluster Binary Release on Linux”  
Section 2.5.5, “Installing MySQL on Linux Using RPM Packages from Oracle”  
Section 2.4.2, “Installing MySQL on macOS Using Native Packages”  
Section 2.7, “Installing MySQL on Solaris”  
Section 2.2, “Installing MySQL on Unix/Linux Using Generic Binaries”  
Section 21.3.1.2, “Installing NDB Cluster from RPM”  
Section 21.3.2.1, “Installing NDB Cluster on Windows from a Binary Release”  
Section 21.3.2.4, “Installing NDB Cluster Processes as Windows Services”  
Section 21.2.7.8, “Issues Exclusive to NDB Cluster”  
Section 13.7.6.4, “KILL Statement”  
Section 21.7.3, “Known Issues in NDB Cluster Replication”

---

Section 13.2.6, “LOAD DATA Statement”  
Section 13.3.5, “LOCK TABLES and UNLOCK TABLES Statements”  
Section 12.14, “Locking Functions”  
Section 5.8.1.7, “Making a Test Case If You Experience Table Corruption”  
Section 6.1.3, “Making MySQL Secure Against Attackers”  
Section 21.6, “Management of NDB Cluster”  
Section 2.5.10, “Managing MySQL Server with systemd”  
Section 6.4.4.7, “Migrating Keys Between Keyring Keystores”  
Section 12.20, “Miscellaneous Functions”  
Section 5.4.4.3, “Mixed Binary Logging Format”  
Section 14.6.1.4, “Moving or Copying InnoDB Tables”  
Section 15.2.1, “MyISAM Startup Options”  
Section 4.6.3.2, “myisamchk Check Options”  
Section 4.6.3.1, “myisamchk General Options”  
Section 4.6.3, “myisamchk — MyISAM Table-Maintenance Utility”  
Section 4.6.5, “myisampack — Generate Compressed, Read-Only MyISAM Tables”  
Section A.1, “MySQL 5.7 FAQ: General”  
Section A.11, “MySQL 5.7 FAQ: MySQL Chinese, Japanese, and Korean Character Sets”  
Section A.10, “MySQL 5.7 FAQ: NDB Cluster”  
Section A.3, “MySQL 5.7 FAQ: Server SQL Mode”  
Section 4.5.1.6, “mysql Client Tips”  
MySQL Glossary  
Section 2.3.1, “MySQL Installation Layout on Microsoft Windows”  
Chapter 5, *MySQL Server Administration*  
Section B.3.2.7, “MySQL server has gone away”  
Section 5.4, “MySQL Server Logs”  
MySQL Server Options for NDB Cluster  
Section 5.1.13, “MySQL Server Time Zone Support”  
Section 21.6.10, “MySQL Server Usage for NDB Cluster”  
Section 21.2.6, “MySQL Server Using InnoDB Compared with NDB Cluster”  
Section 2.8.7, “MySQL Source-Configuration Options”  
Section 1.6, “MySQL Standards Compliance”  
Chapter 26, *MySQL sys Schema*  
Section 4.3.3, “mysql.server — MySQL Server Startup Script”  
Section 4.4.2, “mysql\_install\_db — Initialize MySQL Data Directory”  
Section 4.4.3, “mysql\_plugin — Configure MySQL Server Plugins”  
Section 4.6.7, “mysqlbinlog — Utility for Processing Binary Log Files”  
Section 4.5.3, “mysqlcheck — A Table Maintenance Program”  
Section 4.3.1, “mysqld — The MySQL Server”  
Section 4.3.4, “mysqld\_multi — Manage Multiple MySQL Servers”  
Section 4.3.2, “mysqld\_safe — MySQL Server Startup Script”  
Section 4.5.4, “mysqldump — A Database Backup Program”  
Section 21.6.14, “NDB API Statistics Counters and Variables”  
Section 21.6.18.3, “NDB Cluster and MySQL Security Procedures”  
Section 21.4.3.1, “NDB Cluster Configuration: Basic Example”  
Section 21.2.1, “NDB Cluster Core Concepts”  
Section 21.3, “NDB Cluster Installation”  
Section 21.4.2.5, “NDB Cluster mysqld Option and Variable Reference”  
Section 21.2.2, “NDB Cluster Nodes, Node Groups, Fragment Replicas, and Partitions”  
Section 21.2, “NDB Cluster Overview”  
Section 21.5, “NDB Cluster Programs”  
Section 21.7, “NDB Cluster Replication”  
Section 21.7.11, “NDB Cluster Replication Conflict Resolution”  
Section 21.7.4, “NDB Cluster Replication Schema and Tables”

---

Section 21.7.10, “NDB Cluster Replication: Bidirectional and Circular Replication”  
NDB Cluster Status Variables  
NDB Cluster System Variables  
Section 21.5.14, “ndb\_import — Import CSV Data Into NDB”  
Section 21.5.4, “ndb\_mgmd — The NDB Cluster Management Server Daemon”  
Section 21.5.24, “ndb\_restore — Restore an NDB Cluster Backup”  
Section 21.5.27, “ndb\_show\_tables — Display List of NDB Tables”  
Section 21.5.29, “ndb\_top — View CPU usage information for NDB threads”  
Section 21.6.15, “ndbinfo: The NDB Cluster Information Database”  
Section 21.2.7.1, “Noncompliance with SQL Syntax in NDB Cluster”  
Section 21.6.12, “Online Operations with ALTER TABLE in NDB Cluster”  
Section 13.7.2.4, “OPTIMIZE TABLE Statement”  
Section B.3.5, “Optimizer-Related Issues”  
Section 27.6.3, “Options with the Embedded Server”  
Section 21.2.5.1, “Options, Variables, and Parameters Added, Deprecated or Removed in NDB 7.5”  
Section 21.2.5.2, “Options, Variables, and Parameters Added, Deprecated or Removed in NDB 7.6”  
Section 4.1, “Overview of MySQL Programs”  
Section 21.4.2, “Overview of NDB Cluster Configuration Parameters, Options, and Variables”  
Section B.3.2.8, “Packet Too Large”  
Section 25.3, “Performance Schema Startup Configuration”  
Section 21.6.5, “Performing a Rolling Restart of an NDB Cluster”  
Section 21.7.5, “Preparing the NDB Cluster for Replication”  
Section 15.2.4.2, “Problems from Tables Not Being Closed Properly”  
Section B.3.3.1, “Problems with File Permissions”  
Section 4.2.2.4, “Program Option Modifiers”  
Section 8.10.3.3, “Query Cache Configuration”  
Section 13.7.2.5, “REPAIR TABLE Statement”  
Section 16.1.6.1, “Replication and Binary Logging Option and Variable Reference”  
Section 16.1.6, “Replication and Binary Logging Options and Variables”  
Section 16.4.1.26, “Replication and Source or Replica Shutdowns”  
Section 16.4.1.32, “Replication and Transaction Inconsistencies”  
Section 16.2.4.2, “Replication Metadata Repositories”  
Section 16.1.6.2, “Replication Source Options and Variables”  
Section 13.4.2.3, “RESET SLAVE Statement”  
Resetting the Root Password: Unix and Unix-Like Systems  
Resetting the Root Password: Windows Systems  
Section 4.7.3, “resolve\_stack\_dump — Resolve Numeric Stack Trace Dump to Symbols”  
Restoring an NDB backup to a later version of NDB Cluster  
Restoring an NDB backup to a previous version of NDB Cluster  
Restoring to More Nodes Than the Original  
Section B.3.4.5, “Rollback Failure for Nontransactional Tables”  
Section 5.7, “Running Multiple MySQL Instances on One Machine”  
Section 2.9.4, “Securing the Initial MySQL Account”  
Section 6.1.6, “Security Considerations for LOAD DATA LOCAL”  
Section 6.1.4, “Security-Related mysqld Options and Variables”  
Section 13.2.9.1, “SELECT ... INTO Statement”  
Section 2.3.4.3, “Selecting a MySQL Server Type”  
Section 6.7, “SELinux”  
Section 4.3, “Server and Server-Startup Programs”  
Section 10.3.2, “Server Character Set and Collation”  
Section 5.1.6, “Server Command Options”  
Section 5.4.7, “Server Log Maintenance”  
Section 5.1.9, “Server Status Variables”  
Section 5.1.7, “Server System Variables”

---

Section 10.12, “Setting the Error Message Language”  
Section 6.7.5.2, “Setting the TCP Port Context for MySQL Features”  
Section 6.7.5.1, “Setting the TCP Port Context for mysqld”  
Section 7.6.5, “Setting Up a MyISAM Table Maintenance Schedule”  
Section 16.1.3.4, “Setting Up Replication Using GTIDs”  
Section 14.21.3, “Setting Up the InnoDB memcached Plugin”  
Section 13.7.5.15, “SHOW ENGINE Statement”  
Section 4.2.2, “Specifying Program Options”  
Section 13.4.2.5, “START SLAVE Statement”  
Section 2.9.5, “Starting and Stopping MySQL Automatically”  
Section 5.7.2.2, “Starting Multiple MySQL Instances as Windows Services”  
Section 5.7.2.1, “Starting Multiple MySQL Instances at the Windows Command Line”  
Section 2.3.4.8, “Starting MySQL as a Windows Service”  
Section 2.3.4.6, “Starting MySQL from the Windows Command Line”  
Section 21.7.6, “Starting NDB Cluster Replication (Single Replication Channel)”  
Section 16.2.2.3, “Startup Options and Replication Channels”  
Section 16.3.7, “Switching Sources During Failover”  
Section 8.11.2, “Table Locking Issues”  
Section B.3.2.17, “Table-Corruption Issues”  
Section 2.3.4.9, “Testing The MySQL Installation”  
Section 2.9.3, “Testing the Server”  
Section 5.4.4, “The Binary Log”  
Section 15.6, “The BLACKHOLE Storage Engine”  
Section 5.8.3, “The DEBUG Package”  
Section 5.4.6, “The DDL Log”  
Section 5.4.2, “The Error Log”  
Section 5.4.3, “The General Query Log”  
Section 14.21.6, “The InnoDB memcached Plugin and Replication”  
Section 15.2, “The MyISAM Storage Engine”  
Section 8.10.3, “The MySQL Query Cache”  
Section 5.1, “The MySQL Server”  
Section 21.6.15.29, “The ndbinfo operations\_per\_fragment Table”  
Section 21.6.15.33, “The ndbinfo server\_locks Table”  
Section 5.4.5, “The Slow Query Log”  
Section B.3.3.7, “Time Zone Problems”  
Section B.3.2.5, “Too many connections”  
Section 5.8.4, “Tracing mysqld Using DTrace”  
Section 2.3.5, “Troubleshooting a Microsoft Windows MySQL Server Installation”  
Section 14.22.1, “Troubleshooting InnoDB I/O Problems”  
Section 6.2.17, “Troubleshooting Problems Connecting to MySQL”  
Section 2.9.2.1, “Troubleshooting Problems Starting the MySQL Server”  
Section 4.10, “Unix Signal Handling in MySQL”  
Section 2.10.11, “Upgrade Troubleshooting”  
Section 21.3.7.1, “Upgrading and Downgrading NDB 7.5”  
Section 2.10.8, “Upgrading MySQL on Windows”  
Section 2.10.10, “Upgrading MySQL with Directly-Downloaded RPM Packages”  
Section 5.8.1.5, “Using a Stack Trace”  
Section 7.6.1, “Using myisamchk for Crash Recovery”  
Section 4.2.2.2, “Using Option Files”  
Section 5.8.1.6, “Using Server Logs to Find Causes of Errors in mysqld”  
Section 8.12.3.3, “Using Symbolic Links for Databases on Windows”  
Section 8.12.3.2, “Using Symbolic Links for MyISAM Tables on Unix”  
Section 21.7.7, “Using Two Replication Channels for NDB Cluster Replication”  
Section 5.8.1.3, “Using WER with PDB to create a Windows crashdump”

---

[Section 1.3, “What Is New in MySQL 5.7”](#)  
[Section 21.2.4.1, “What is New in NDB Cluster 7.5”](#)  
[Section 21.2.4.2, “What is New in NDB Cluster 7.6”](#)  
[Section B.3.3.3, “What to Do If MySQL Keeps Crashing”](#)  
[Section 6.2.9, “When Privilege Changes Take Effect”](#)  
[Section B.3.3.5, “Where MySQL Stores Temporary Files”](#)  
[Section 2.1.2, “Which MySQL Version and Distribution to Install”](#)

## **mysqld mysqld.trace**

[Section 5.8.1.2, “Creating Trace Files”](#)

## **mysqld-debug**

[Section 5.8.1.2, “Creating Trace Files”](#)  
[Section 2.2, “Installing MySQL on Unix/Linux Using Generic Binaries”](#)  
[Section 4.3.1, “mysqld — The MySQL Server”](#)  
[Section 4.3.2, “mysqld\\_safe — MySQL Server Startup Script”](#)  
[Section 2.3.4.3, “Selecting a MySQL Server Type”](#)

## **mysqld.exe**

[Section 21.3.2.3, “Initial Startup of NDB Cluster on Windows”](#)  
[Section 21.3.2.1, “Installing NDB Cluster on Windows from a Binary Release”](#)  
[Section 21.3.2.4, “Installing NDB Cluster Processes as Windows Services”](#)

## **mysqld\_multi**

[Section 2.5.10, “Managing MySQL Server with systemd”](#)  
[Section 4.3.4, “mysqld\\_multi — Manage Multiple MySQL Servers”](#)  
[Section 4.1, “Overview of MySQL Programs”](#)  
[Section 5.7.3, “Running Multiple MySQL Instances on Unix”](#)

## **mysqld\_multi.server**

[Section 2.5.10, “Managing MySQL Server with systemd”](#)

## **mysqld\_safe**

[Section 21.6.7.3, “Adding NDB Cluster Data Nodes Online: Detailed Example”](#)  
[Section 2.10.3, “Changes in MySQL 5.7”](#)  
[Section 5.8.1.1, “Compiling MySQL for Debugging”](#)  
[Section 5.1.1, “Configuring the Server”](#)  
[Section 2.11.3, “Downgrade Notes”](#)  
[Section 2.11.4, “Downgrading Binary and Package-based Installations on Unix/Linux”](#)  
[Section 5.4.2.2, “Error Logging on Unix and Unix-Like Systems”](#)  
[Section 5.4.2.3, “Error Logging to the System Log”](#)  
[Section B.3.2.16, “File Not Found and Similar Errors”](#)  
[Section B.3.3.6, “How to Protect or Change the MySQL Unix Socket File”](#)  
[Section 14.22, “InnoDB Troubleshooting”](#)  
[Section 21.3.1.2, “Installing NDB Cluster from RPM”](#)  
[Section 6.1.3, “Making MySQL Secure Against Attackers”](#)  
[Section 2.5.10, “Managing MySQL Server with systemd”](#)  
[Section A.10, “MySQL 5.7 FAQ: NDB Cluster”](#)  
[Section 5.1.13, “MySQL Server Time Zone Support”](#)  
[Section 2.8.7, “MySQL Source-Configuration Options”](#)  
[Section 4.3.3, “mysql.server — MySQL Server Startup Script”](#)  
[Section 4.3.4, “mysqld\\_multi — Manage Multiple MySQL Servers”](#)

---

Section 4.3.2, “mysqld\_safe — MySQL Server Startup Script”  
Section 21.6.18.3, “NDB Cluster and MySQL Security Procedures”  
Section 4.2.2.6, “Option Defaults, Options Expecting Values, and the = Sign”  
Section 4.1, “Overview of MySQL Programs”  
Section B.3.2.8, “Packet Too Large”  
Section B.3.3.1, “Problems with File Permissions”  
Section 5.7, “Running Multiple MySQL Instances on One Machine”  
Section 5.7.3, “Running Multiple MySQL Instances on Unix”  
Section 5.1.6, “Server Command Options”  
Section 5.1.7, “Server System Variables”  
Section 2.9.5, “Starting and Stopping MySQL Automatically”  
Section 2.9.2, “Starting the Server”  
Section 2.9.3, “Testing the Server”  
Section 5.4.2, “The Error Log”  
Section B.3.3.7, “Time Zone Problems”  
Section 2.9.2.1, “Troubleshooting Problems Starting the MySQL Server”  
Section 2.10.4, “Upgrading MySQL Binary or Package-based Installations on Unix/Linux”  
Section 4.2.2.2, “Using Option Files”  
Section 1.3, “What Is New in MySQL 5.7”

## **mysqldump**

Section 11.2.5, “2-Digit YEAR(2) Limitations and Migrating to 4-Digit YEAR”  
Section 16.3.1.1, “Backing Up a Replica Using mysqldump”  
Section 16.3.1.3, “Backing Up a Source or Replica by Making It Read Only”  
Chapter 7, *Backup and Recovery*  
Section 7.1, “Backup and Recovery Types”  
Section 7.3.3, “Backup Strategy Summary”  
Section 14.5.1, “Buffer Pool”  
Section 8.5.5, “Bulk Data Loading for InnoDB Tables”  
Section 6.4.1.4, “Caching SHA-2 Pluggable Authentication”  
Section 2.10.3, “Changes in MySQL 5.7”  
Section 16.1.2.4, “Choosing a Method for Data Snapshots”  
Section 6.4.1.6, “Client-Side Cleartext Pluggable Authentication”  
Section 4.2.4, “Connecting to the MySQL Server Using Command Options”  
Section 4.2.5, “Connection Transport Protocols”  
Section 10.9.8, “Converting Between 3-Byte and 4-Byte Unicode Character Sets”  
Section 7.4.5.2, “Copy a Database from one Server to Another”  
Section 2.10.13, “Copying MySQL Databases to Another Machine”  
Section 13.1.18, “CREATE TABLE Statement”  
Section 13.1.19, “CREATE TABLESPACE Statement”  
Creating a Data Snapshot Using mysqldump  
Section 2.3.4.7, “Customizing the PATH for MySQL Tools”  
Section 7.2, “Database Backup Methods”  
Section 14.12.4, “Defragmenting a Table”  
Section 21.6.13, “Distributed Privileges Using Shared Grant Tables”  
Section 2.11.5, “Downgrade Troubleshooting”  
Section 2.11.4, “Downgrading Binary and Package-based Installations on Unix/Linux”  
Section 7.4.3, “Dumping Data in Delimited-Text Format with mysqldump”  
Section 7.4.1, “Dumping Data in SQL Format with mysqldump”  
Section 7.4.5.3, “Dumping Stored Programs”  
Section 7.4.5.4, “Dumping Table Definitions and Content Separately”  
Section 7.3.1, “Establishing a Backup Policy”  
Section 7.3, “Example Backup and Recovery Strategy”

---

Section 13.1.18.5, “FOREIGN KEY Constraints”  
Section 1.5, “How to Report Bugs or Problems”  
Section 9.2.3, “Identifier Case Sensitivity”  
Section 21.6.9, “Importing Data Into MySQL Cluster”  
Section 4.6.1, “innochecksum — Offline InnoDB File Checksum Utility”  
Section 14.19.1, “InnoDB Backup”  
Section 2.6, “Installing MySQL Using Unbreakable Linux Network (ULN)”  
Section 21.3.1.2, “Installing NDB Cluster from RPM”  
Section 13.2.6, “LOAD DATA Statement”  
Section 13.2.7, “LOAD XML Statement”  
Section 7.4.5.1, “Making a Copy of a Database”  
Section 9.2.4, “Mapping of Identifiers to File Names”  
Section 14.6.1.4, “Moving or Copying InnoDB Tables”  
Section A.10, “MySQL 5.7 FAQ: NDB Cluster”  
Section 4.5.1.1, “mysql Client Options”  
Section 5.4, “MySQL Server Logs”  
Section 4.6.6, “mysql\_config\_editor — MySQL Configuration Utility”  
Section 7.4.5, “mysqldump Tips”  
Section 4.5.4, “mysqldump — A Database Backup Program”  
Section 21.3.5, “NDB Cluster Example with Tables and Data”  
Section 21.2, “NDB Cluster Overview”  
Section 21.5.14, “ndb\_import — Import CSV Data Into NDB”  
Section 21.6.15, “ndbinfo: The NDB Cluster Information Database”  
Section 16.1.2.3, “Obtaining the Replication Source’s Binary Log Coordinates”  
Section 21.6.8, “Online Backup of NDB Cluster”  
Section 4.1, “Overview of MySQL Programs”  
Section 25.12.9, “Performance Schema Connection Attribute Tables”  
Section 21.6.5, “Performing a Rolling Restart of an NDB Cluster”  
Section 21.7.9.2, “Point-In-Time Recovery Using NDB Cluster Replication”  
Section 21.7.5, “Preparing the NDB Cluster for Replication”  
Section 6.2.2, “Privileges Provided by MySQL”  
Section B.3.4.8, “Problems with Floating-Point Values”  
Section 16.1.5.2, “Provisioning a Multi-Source Replica for GTID-Based Replication”  
Section 14.8.10, “Purge Configuration”  
Section 2.10.12, “Rebuilding or Repairing Tables or Indexes”  
Section 7.4.4, “Reloading Delimited-Text Format Backups”  
Section 7.4.2, “Reloading SQL-Format Backups”  
Section 16.3.5, “Replicating Different Databases to Different Replicas”  
Section 16.4.1.32, “Replication and Transaction Inconsistencies”  
Restoring an NDB backup to a later version of NDB Cluster  
Restoring an NDB backup to a previous version of NDB Cluster  
Restoring to More Nodes Than the Original  
Section 25.21, “Restrictions on Performance Schema”  
Section 16.1.3.6, “Restrictions on Replication with GTIDs”  
Section 23.9, “Restrictions on Views”  
Section 5.4.1, “Selecting General Query Log and Slow Query Log Output Destinations”  
Section 5.4.7, “Server Log Maintenance”  
Section 5.1.10, “Server SQL Modes”  
Section 5.1.7, “Server System Variables”  
Setting Up Replication with Existing Data  
Section 6.4.1.5, “SHA-256 Pluggable Authentication”  
Section B.3.4.7, “Solving Problems with No Matching Rows”  
Section 2.3.4.8, “Starting MySQL as a Windows Service”  
Section 16.1.3.7, “Stored Function Examples to Manipulate GTIDs”



---

[Section 11.3.4, “The BLOB and TEXT Types”](#)  
[Section 14.21.6, “The InnoDB memcached Plugin and Replication”](#)  
[Section 1.2.2, “The Main Features of MySQL”](#)  
[Section 14.6.3.1, “The System Tablespace”](#)  
[Section 6.2.17, “Troubleshooting Problems Connecting to MySQL”](#)  
[Section 13.7.3.4, “UNINSTALL PLUGIN Statement”](#)  
[Section 2.10.4, “Upgrading MySQL Binary or Package-based Installations on Unix/Linux”](#)  
[Section 16.1.3.5, “Using GTIDs for Failover and Scaleout”](#)  
[Section 4.6.7.3, “Using mysqlbinlog to Back Up Binary Log Files”](#)  
[Section 7.4, “Using mysqldump for Backups”](#)  
[Section 4.2.2.2, “Using Option Files”](#)  
[Section 4.2.2.5, “Using Options to Set Program Variables”](#)  
[Section 16.3.1, “Using Replication for Backups”](#)  
[Section 16.3.3, “Using Replication with Different Source and Replica Storage Engines”](#)  
[Section 26.2, “Using the sys Schema”](#)  
[Section 1.3, “What Is New in MySQL 5.7”](#)  
[Section 12.11, “XML Functions”](#)

## **mysqldump mysql**

[Section 6.2.17, “Troubleshooting Problems Connecting to MySQL”](#)

## **mysqldumpslow**

[Section 4.6.8, “mysqldumpslow — Summarize Slow Query Log Files”](#)  
[Section 4.1, “Overview of MySQL Programs”](#)  
[Section 5.4.5, “The Slow Query Log”](#)

## **mysqlhotcopy**

[Section 1.3, “What Is New in MySQL 5.7”](#)

## **mysqlimport**

[Section 7.1, “Backup and Recovery Types”](#)  
[Section 6.4.1.4, “Caching SHA-2 Pluggable Authentication”](#)  
[Section 10.4, “Connection Character Sets and Collations”](#)  
[Section 2.10.13, “Copying MySQL Databases to Another Machine”](#)  
[Section 7.2, “Database Backup Methods”](#)  
[Section 2.11.5, “Downgrade Troubleshooting”](#)  
[Section 13.2.6, “LOAD DATA Statement”](#)  
[Section 4.5.5, “mysqlimport — A Data Import Program”](#)  
[Section 4.1, “Overview of MySQL Programs”](#)  
[Section 7.4.4, “Reloading Delimited-Text Format Backups”](#)  
[Section 6.1.6, “Security Considerations for LOAD DATA LOCAL”](#)  
[Section 6.4.1.5, “SHA-256 Pluggable Authentication”](#)  
[Section 21.2.4.2, “What is New in NDB Cluster 7.6”](#)

## **MySQLInstallerConsole**

[Section 2.3.3.5, “MySQL Installer Console Reference”](#)

## **MySQLInstallerConsole.exe**

[Section 2.3.3.5, “MySQL Installer Console Reference”](#)  
[Section 2.3.3.1, “MySQL Installer Initial Setup”](#)

## **mysqloptimize**

[Section 4.5.3, “mysqlcheck — A Table Maintenance Program”](#)

---

## mysqlpump

Section 6.4.1.4, “Caching SHA-2 Pluggable Authentication”  
Section 13.1.19, “CREATE TABLESPACE Statement”  
Section 21.6.9, “Importing Data Into MySQL Cluster”  
Section 2.6, “Installing MySQL Using Unbreakable Linux Network (ULN)”  
Section 4.8.1, “lz4\_decompress — Decompress mysqlpump LZ4-Compressed Output”  
Section 4.5.6, “mysqlpump — A Database Backup Program”  
Section 4.1, “Overview of MySQL Programs”  
Section 6.4.1.5, “SHA-256 Pluggable Authentication”  
Section 2.10.4, “Upgrading MySQL Binary or Package-based Installations on Unix/Linux”  
Section 26.2, “Using the sys Schema”  
Section 4.8.5, “zlib\_decompress — Decompress mysqlpump ZLIB-Compressed Output”

## mysqlrepair

Section 4.5.3, “mysqlcheck — A Table Maintenance Program”

## mysqlsh

Section 4.1, “Overview of MySQL Programs”

## mysqlshow

Section 6.4.1.4, “Caching SHA-2 Pluggable Authentication”  
Section 6.4.1.6, “Client-Side Cleartext Pluggable Authentication”  
Section 4.2.4, “Connecting to the MySQL Server Using Command Options”  
Section 10.4, “Connection Character Sets and Collations”  
Section 4.5.7, “mysqlshow — Display Database, Table, and Column Information”  
Section 4.1, “Overview of MySQL Programs”  
Section 6.4.1.5, “SHA-256 Pluggable Authentication”  
Section 13.7.5.14, “SHOW DATABASES Statement”  
Section 13.7.5.22, “SHOW INDEX Statement”  
Section 13.7.5.36, “SHOW TABLE STATUS Statement”  
Section 2.3.4.9, “Testing The MySQL Installation”  
Section 2.9.3, “Testing the Server”  
Section 2.3.6, “Windows Postinstallation Procedures”

## mysqlshow db\_name

Section 13.7.5.37, “SHOW TABLES Statement”

## mysqlshow db\_name tbl\_name

Section 13.7.5.5, “SHOW COLUMNS Statement”

## mysqlslap

Section 6.4.1.4, “Caching SHA-2 Pluggable Authentication”  
Section 6.4.1.6, “Client-Side Cleartext Pluggable Authentication”  
Section 14.17.2, “Monitoring InnoDB Mutex Waits Using Performance Schema”  
Section 4.5.8, “mysqlslap — A Load Emulation Client”  
Section 4.1, “Overview of MySQL Programs”  
Section 6.4.1.5, “SHA-256 Pluggable Authentication”  
Section 8.13.2, “Using Your Own Benchmarks”

## mysqltest

Section 6.4.1.4, “Caching SHA-2 Pluggable Authentication”  
Section 21.3.1.2, “Installing NDB Cluster from RPM”

---

[Section 5.1.15, “Server Tracking of Client Session State”](#)  
[Section 6.4.1.5, “SHA-256 Pluggable Authentication”](#)  
[Section 1.3, “What Is New in MySQL 5.7”](#)

## **mysqltest\_embedded**

[Section 1.3, “What Is New in MySQL 5.7”](#)

## **N**

[\[index top\]](#)

## **ndbmttd**

[Section 21.4.3.6, “Defining NDB Cluster Data Nodes”](#)

## **ndb\_blob\_tool**

[Section 21.5.6, “ndb\\_blob\\_tool — Check and Repair BLOB and TEXT columns of NDB Cluster Tables”](#)  
[Section 21.2.4.1, “What is New in NDB Cluster 7.5”](#)  
[Section 21.2.4.2, “What is New in NDB Cluster 7.6”](#)

## **ndb\_config**

[Section 21.3.1.2, “Installing NDB Cluster from RPM”](#)  
[Section 21.5, “NDB Cluster Programs”](#)  
[Section 21.5.7, “ndb\\_config — Extract NDB Cluster Configuration Information”](#)  
[Section 21.2.4.2, “What is New in NDB Cluster 7.6”](#)

## **ndb\_delete\_all**

[Section 21.5.9, “ndb\\_delete\\_all — Delete All Rows from an NDB Table”](#)

## **ndb\_desc**

[Section 21.6.7.3, “Adding NDB Cluster Data Nodes Online: Detailed Example”](#)  
[Section 21.4.3.6, “Defining NDB Cluster Data Nodes”](#)  
[Section 21.3.1.2, “Installing NDB Cluster from RPM”](#)  
[Section 22.2.5, “KEY Partitioning”](#)  
[Section 21.6.18.3, “NDB Cluster and MySQL Security Procedures”](#)  
[Section 21.6.11.1, “NDB Cluster Disk Data Objects”](#)  
[Section 21.5.10, “ndb\\_desc — Describe NDB Tables”](#)  
[Section 21.5.24, “ndb\\_restore — Restore an NDB Cluster Backup”](#)  
[Section 13.1.18.9, “Setting NDB Comment Options”](#)  
[Section 24.3.9, “The INFORMATION\\_SCHEMA FILES Table”](#)  
[Section 24.3.16, “The INFORMATION\\_SCHEMA PARTITIONS Table”](#)  
[Section 21.6.15.5, “The ndbinfo cluster\\_operations Table”](#)  
[Section 21.6.15.34, “The ndbinfo server\\_operations Table”](#)  
[Section 21.2.4.2, “What is New in NDB Cluster 7.6”](#)

## **ndb\_drop\_index**

[Section 21.5.11, “ndb\\_drop\\_index — Drop Index from an NDB Table”](#)

## **ndb\_drop\_table**

[Section 21.5.11, “ndb\\_drop\\_index — Drop Index from an NDB Table”](#)  
[Section 21.5.12, “ndb\\_drop\\_table — Drop an NDB Table”](#)

## **ndb\_error\_reporter**

[Section 21.5.13, “ndb\\_error\\_reporter — NDB Error-Reporting Utility”](#)

---

## **ndb\_import**

[Section 21.6.9, “Importing Data Into MySQL Cluster”](#)  
[Section 21.5.14, “ndb\\_import — Import CSV Data Into NDB”](#)  
[Section 21.2.4.2, “What is New in NDB Cluster 7.6”](#)

## **ndb\_index\_stat**

[Section 21.5.15, “ndb\\_index\\_stat — NDB Index Statistics Utility”](#)

## **ndb\_mgm**

[Section 21.6.7.3, “Adding NDB Cluster Data Nodes Online: Detailed Example”](#)  
[Section 21.6.7.1, “Adding NDB Cluster Data Nodes Online: General Issues”](#)  
[Section 21.3.1.4, “Building NDB Cluster from Source on Linux”](#)  
[Section 21.6.1, “Commands in the NDB Cluster Management Client”](#)  
[Section 21.6.13, “Distributed Privileges Using Shared Grant Tables”](#)  
[Section 21.6.3, “Event Reports Generated in NDB Cluster”](#)  
[Section 21.1, “General Information”](#)  
[Section 21.3.4, “Initial Startup of NDB Cluster”](#)  
[Section 21.3.2.3, “Initial Startup of NDB Cluster on Windows”](#)  
[Section 21.3.1, “Installation of NDB Cluster on Linux”](#)  
[Section 21.3.1.1, “Installing an NDB Cluster Binary Release on Linux”](#)  
[Section 21.3.1.2, “Installing NDB Cluster from RPM”](#)  
[Section 21.3.1.3, “Installing NDB Cluster Using .deb Files”](#)  
[Section A.10, “MySQL 5.7 FAQ: NDB Cluster”](#)  
[Section 21.2.1, “NDB Cluster Core Concepts”](#)  
[Section 21.6.3.1, “NDB Cluster Logging Management Commands”](#)  
[Section 21.5, “NDB Cluster Programs”](#)  
[Section 21.6.18.1, “NDB Cluster Security and Networking Issues”](#)  
[Section 21.6.6, “NDB Cluster Single User Mode”](#)  
[Section 21.5.5, “ndb\\_mgm — The NDB Cluster Management Client”](#)  
[Section 21.5.4, “ndb\\_mgmd — The NDB Cluster Management Server Daemon”](#)  
[Section 21.5.24, “ndb\\_restore — Restore an NDB Cluster Backup”](#)  
[Section 21.6.8, “Online Backup of NDB Cluster”](#)  
[Section 21.6.5, “Performing a Rolling Restart of an NDB Cluster”](#)  
[Section 21.7.9.2, “Point-In-Time Recovery Using NDB Cluster Replication”](#)  
[Restoring an NDB backup to a later version of NDB Cluster](#)  
[Restoring to More Nodes Than the Original](#)  
[Section 21.3.6, “Safe Shutdown and Restart of NDB Cluster”](#)  
[Section 21.6.15.1, “The ndbinfo arbitrator\\_validity\\_detail Table”](#)  
[Section 21.6.15.25, “The ndbinfo membership Table”](#)  
[Section 21.6.15.26, “The ndbinfo memoryusage Table”](#)  
[Section 21.6.15.28, “The ndbinfo nodes Table”](#)  
[Section 21.6.15.44, “The ndbinfo transporters Table”](#)  
[Section 21.6.8.2, “Using The NDB Cluster Management Client to Create a Backup”](#)  
[Section 21.2.4.1, “What is New in NDB Cluster 7.5”](#)  
[Section 21.2.4.2, “What is New in NDB Cluster 7.6”](#)

## **ndb\_mgm.exe**

[Section 21.3.2.3, “Initial Startup of NDB Cluster on Windows”](#)  
[Section 21.3.2.1, “Installing NDB Cluster on Windows from a Binary Release”](#)

## **ndb\_mgmd**

[Section 21.3.1.4, “Building NDB Cluster from Source on Linux”](#)

---

[Section 21.6.1, “Commands in the NDB Cluster Management Client”](#)  
[Section 21.4.3.5, “Defining an NDB Cluster Management Server”](#)  
[Section 21.4.3.6, “Defining NDB Cluster Data Nodes”](#)  
[Section 21.3.4, “Initial Startup of NDB Cluster”](#)  
[Section 21.3.1, “Installation of NDB Cluster on Linux”](#)  
[Section 21.3.1.1, “Installing an NDB Cluster Binary Release on Linux”](#)  
[Section 21.3.1.2, “Installing NDB Cluster from RPM”](#)  
[Section 21.3.2.1, “Installing NDB Cluster on Windows from a Binary Release”](#)  
[Section 21.3.1.3, “Installing NDB Cluster Using .deb Files”](#)  
[Section A.10, “MySQL 5.7 FAQ: NDB Cluster”](#)  
[Section 2.8.7, “MySQL Source-Configuration Options”](#)  
[Section 21.4.3.1, “NDB Cluster Configuration: Basic Example”](#)  
[Section 21.4.3.3, “NDB Cluster Connection Strings”](#)  
[Section 21.2.1, “NDB Cluster Core Concepts”](#)  
[Section 21.6.3.1, “NDB Cluster Logging Management Commands”](#)  
[Section 21.2.2, “NDB Cluster Nodes, Node Groups, Fragment Replicas, and Partitions”](#)  
[Section 21.5, “NDB Cluster Programs”](#)  
[Section 21.5.14, “ndb\\_import — Import CSV Data Into NDB”](#)  
[Section 21.5.5, “ndb\\_mgm — The NDB Cluster Management Client”](#)  
[Section 21.5.4, “ndb\\_mgmd — The NDB Cluster Management Server Daemon”](#)  
[Section 21.5.1, “ndbd — The NDB Cluster Data Node Daemon”](#)  
[Section 21.6.5, “Performing a Rolling Restart of an NDB Cluster”](#)  
[Section 21.4.1, “Quick Test Setup of NDB Cluster”](#)  
[Section 21.3.6, “Safe Shutdown and Restart of NDB Cluster”](#)  
[Section 21.6.4, “Summary of NDB Cluster Start Phases”](#)  
[Section 21.2.4.2, “What is New in NDB Cluster 7.6”](#)

## **ndb\_mgmd.exe**

[Section 21.3.2.3, “Initial Startup of NDB Cluster on Windows”](#)  
[Section 21.3.2.1, “Installing NDB Cluster on Windows from a Binary Release”](#)  
[Section 21.3.2.4, “Installing NDB Cluster Processes as Windows Services”](#)

## **ndb\_move\_data**

[Section 21.5.16, “ndb\\_move\\_data — NDB Data Copy Utility”](#)

## **ndb\_perror**

[Section B.2, “Error Information Interfaces”](#)  
[Section 21.5.17, “ndb\\_perror — Obtain NDB Error Message Information”](#)  
[Section 4.8.2, “ perror — Display MySQL Error Message Information”](#)  
[Section 21.6.15.21, “The ndbinfo error\\_messages Table”](#)  
[Section 1.3, “What Is New in MySQL 5.7”](#)  
[Section 21.2.4.2, “What is New in NDB Cluster 7.6”](#)

## **ndb\_print\_backup\_file**

[Section 21.5.18, “ndb\\_print\\_backup\\_file — Print NDB Backup File Contents”](#)  
[Section 21.5.20, “ndb\\_print\\_frag\\_file — Print NDB Fragment List File Contents”](#)  
[Section 21.5.21, “ndb\\_print\\_schema\\_file — Print NDB Schema File Contents”](#)  
[Section 21.5.22, “ndb\\_print\\_sys\\_file — Print NDB System File Contents”](#)  
[Section 21.5.23, “ndb\\_redo\\_log\\_reader — Check and Print Content of Cluster Redo Log”](#)

## **ndb\_print\_file**

[Section 21.5.19, “ndb\\_print\\_file — Print NDB Disk Data File Contents”](#)

---

## **ndb\_print\_frag\_file**

Section 21.5.20, “[ndb\\_print\\_frag\\_file — Print NDB Fragment List File Contents](#)”

## **ndb\_print\_schema\_file**

Section 21.5.18, “[ndb\\_print\\_backup\\_file — Print NDB Backup File Contents](#)”

Section 21.5.19, “[ndb\\_print\\_file — Print NDB Disk Data File Contents](#)”

Section 21.5.20, “[ndb\\_print\\_frag\\_file — Print NDB Fragment List File Contents](#)”

Section 21.5.21, “[ndb\\_print\\_schema\\_file — Print NDB Schema File Contents](#)”

Section 21.5.22, “[ndb\\_print\\_sys\\_file — Print NDB System File Contents](#)”

Section 21.5.23, “[ndb\\_redo\\_log\\_reader — Check and Print Content of Cluster Redo Log](#)”

## **ndb\_print\_sys\_file**

Section 21.5.18, “[ndb\\_print\\_backup\\_file — Print NDB Backup File Contents](#)”

Section 21.5.19, “[ndb\\_print\\_file — Print NDB Disk Data File Contents](#)”

Section 21.5.20, “[ndb\\_print\\_frag\\_file — Print NDB Fragment List File Contents](#)”

Section 21.5.21, “[ndb\\_print\\_schema\\_file — Print NDB Schema File Contents](#)”

Section 21.5.22, “[ndb\\_print\\_sys\\_file — Print NDB System File Contents](#)”

## **ndb\_redo\_log\_reader**

Section 21.5.23, “[ndb\\_redo\\_log\\_reader — Check and Print Content of Cluster Redo Log](#)”

## **ndb\_restore**

Section 7.1, “[Backup and Recovery Types](#)”

Section 21.4.3.6, “[Defining NDB Cluster Data Nodes](#)”

Section 21.6.13, “[Distributed Privileges Using Shared Grant Tables](#)”

Section 21.6.9, “[Importing Data Into MySQL Cluster](#)”

Section A.10, “[MySQL 5.7 FAQ: NDB Cluster](#)”

Section 21.7.9, “[NDB Cluster Backups With NDB Cluster Replication](#)”

Section 21.2.1, “[NDB Cluster Core Concepts](#)”

Section 21.2, “[NDB Cluster Overview](#)”

Section 21.5, “[NDB Cluster Programs](#)”

Section 21.7.4, “[NDB Cluster Replication Schema and Tables](#)”

Section 21.7.10, “[NDB Cluster Replication: Bidirectional and Circular Replication](#)”

Section 21.6.6, “[NDB Cluster Single User Mode](#)”

Section 21.5.24, “[ndb\\_restore — Restore an NDB Cluster Backup](#)”

Section 21.6.8, “[Online Backup of NDB Cluster](#)”

Section 21.6.5, “[Performing a Rolling Restart of an NDB Cluster](#)”

Section 21.7.9.2, “[Point-In-Time Recovery Using NDB Cluster Replication](#)”

[Restoring an NDB backup to a later version of NDB Cluster](#)

[Restoring an NDB backup to a previous version of NDB Cluster](#)

[Restoring to Fewer Nodes Than the Original](#)

[Restoring to More Nodes Than the Original](#)

Section 21.2.4.1, “[What is New in NDB Cluster 7.5](#)”

Section 21.2.4.2, “[What is New in NDB Cluster 7.6](#)”

## **ndb\_select\_all**

Section 21.6.18.3, “[NDB Cluster and MySQL Security Procedures](#)”

Section 21.5.25, “[ndb\\_select\\_all — Print Rows from an NDB Table](#)”

Section 21.5.27, “[ndb\\_show\\_tables — Display List of NDB Tables](#)”

## **ndb\_select\_count**

Section 21.5.26, “[ndb\\_select\\_count — Print Row Counts for NDB Tables](#)”

---

## **ndb\_setup.py**

[Section 21.2.4.1, “What is New in NDB Cluster 7.5”](#)

[Section 21.2.4.2, “What is New in NDB Cluster 7.6”](#)

## **ndb\_show\_tables**

[Section 21.6.18.3, “NDB Cluster and MySQL Security Procedures”](#)

[Section 21.5, “NDB Cluster Programs”](#)

[Section 21.5.27, “ndb\\_show\\_tables — Display List of NDB Tables”](#)

[Section 21.6.15.4, “The ndbinfo cluster\\_locks Table”](#)

[Section 21.6.15.5, “The ndbinfo cluster\\_operations Table”](#)

[Section 21.6.15.22, “The ndbinfo locks\\_per\\_fragment Table”](#)

[Section 21.6.15.29, “The ndbinfo operations\\_per\\_fragment Table”](#)

[Section 21.6.15.33, “The ndbinfo server\\_locks Table”](#)

[Section 21.6.15.34, “The ndbinfo server\\_operations Table”](#)

[Section 21.2.4.1, “What is New in NDB Cluster 7.5”](#)

[Section 21.2.4.2, “What is New in NDB Cluster 7.6”](#)

## **ndb\_size.pl**

[Section 11.7, “Data Type Storage Requirements”](#)

[Section A.10, “MySQL 5.7 FAQ: NDB Cluster”](#)

[Section 21.5.28, “ndb\\_size.pl — NDBCLUSTER Size Requirement Estimator”](#)

## **ndb\_top**

[Section 21.5.29, “ndb\\_top — View CPU usage information for NDB threads”](#)

[Section 21.2.4.2, “What is New in NDB Cluster 7.6”](#)

## **ndb\_waiter**

[Section 21.5.30, “ndb\\_waiter — Wait for NDB Cluster to Reach a Given Status”](#)

[Section 21.2.4.1, “What is New in NDB Cluster 7.5”](#)

[Section 21.2.4.2, “What is New in NDB Cluster 7.6”](#)

## **ndbd**

[Section 21.6.7.2, “Adding NDB Cluster Data Nodes Online: Basic procedure”](#)

[Section 21.6.7.3, “Adding NDB Cluster Data Nodes Online: Detailed Example”](#)

[Section 21.3.1.4, “Building NDB Cluster from Source on Linux”](#)

[Section 21.6.1, “Commands in the NDB Cluster Management Client”](#)

[Section 21.4.3.6, “Defining NDB Cluster Data Nodes”](#)

[Section 21.3.4, “Initial Startup of NDB Cluster”](#)

[Section 21.3.1, “Installation of NDB Cluster on Linux”](#)

[Section 21.3.1.1, “Installing an NDB Cluster Binary Release on Linux”](#)

[Section 21.3.1.2, “Installing NDB Cluster from RPM”](#)

[Section 21.3.2.1, “Installing NDB Cluster on Windows from a Binary Release”](#)

[Section 21.3.1.3, “Installing NDB Cluster Using .deb Files”](#)

[Section 21.6, “Management of NDB Cluster”](#)

[Section A.10, “MySQL 5.7 FAQ: NDB Cluster”](#)

[Section 21.7.9, “NDB Cluster Backups With NDB Cluster Replication”](#)

[Section 21.4.3.1, “NDB Cluster Configuration: Basic Example”](#)

[Section 21.2.1, “NDB Cluster Core Concepts”](#)

[Section 21.4.2.1, “NDB Cluster Data Node Configuration Parameters”](#)

[Section 21.3, “NDB Cluster Installation”](#)

[Section 21.2.2, “NDB Cluster Nodes, Node Groups, Fragment Replicas, and Partitions”](#)

[Section 21.5, “NDB Cluster Programs”](#)

---

[Section 21.5.4, “ndb\\_mgmd — The NDB Cluster Management Server Daemon”](#)  
[Section 21.5.30, “ndb\\_waiter — Wait for NDB Cluster to Reach a Given Status”](#)  
[Section 21.5.1, “ndbd — The NDB Cluster Data Node Daemon”](#)  
[Section 21.5.3, “ndbmtd — The NDB Cluster Data Node Daemon \(Multi-Threaded\)”](#)  
[Section 21.4.2, “Overview of NDB Cluster Configuration Parameters, Options, and Variables”](#)  
[Section 21.6.5, “Performing a Rolling Restart of an NDB Cluster”](#)  
[Section 21.7.9.2, “Point-In-Time Recovery Using NDB Cluster Replication”](#)  
[Section 21.4.1, “Quick Test Setup of NDB Cluster”](#)  
[Section 21.4.3.2, “Recommended Starting Configuration for NDB Cluster”](#)  
[Section 21.3.6, “Safe Shutdown and Restart of NDB Cluster”](#)  
[Section 21.6.4, “Summary of NDB Cluster Start Phases”](#)  
[Section 21.6.15.28, “The ndbinfo nodes Table”](#)  
[Section 21.6.3.3, “Using CLUSTERLOG STATISTICS in the NDB Cluster Management Client”](#)

## **ndbd.exe**

[Section 21.3.2.3, “Initial Startup of NDB Cluster on Windows”](#)  
[Section 21.3.2.1, “Installing NDB Cluster on Windows from a Binary Release”](#)  
[Section 21.3.2.4, “Installing NDB Cluster Processes as Windows Services”](#)

## **ndbinfo\_select\_all**

[Section 21.5.2, “ndbinfo\\_select\\_all — Select From ndbinfo Tables”](#)

## **ndbmtd**

[Section 21.6.7.2, “Adding NDB Cluster Data Nodes Online: Basic procedure”](#)  
[Section 21.6.7.3, “Adding NDB Cluster Data Nodes Online: Detailed Example”](#)  
[Section 21.3.1.4, “Building NDB Cluster from Source on Linux”](#)  
[Section 21.4.3.6, “Defining NDB Cluster Data Nodes”](#)  
[Section 21.3.1, “Installation of NDB Cluster on Linux”](#)  
[Section 21.3.1.1, “Installing an NDB Cluster Binary Release on Linux”](#)  
[Section 21.3.1.2, “Installing NDB Cluster from RPM”](#)  
[Section A.10, “MySQL 5.7 FAQ: NDB Cluster”](#)  
[Section 2.8.7, “MySQL Source-Configuration Options”](#)  
[Section 21.2.1, “NDB Cluster Core Concepts”](#)  
[Section 21.4.2.1, “NDB Cluster Data Node Configuration Parameters”](#)  
[Section 21.2.2, “NDB Cluster Nodes, Node Groups, Fragment Replicas, and Partitions”](#)  
[Section 21.5, “NDB Cluster Programs”](#)  
[Section 21.5.4, “ndb\\_mgmd — The NDB Cluster Management Server Daemon”](#)  
[Section 21.5.29, “ndb\\_top — View CPU usage information for NDB threads”](#)  
[Section 21.5.1, “ndbd — The NDB Cluster Data Node Daemon”](#)  
[Section 21.5.3, “ndbmtd — The NDB Cluster Data Node Daemon \(Multi-Threaded\)”](#)  
[Section 21.6.5, “Performing a Rolling Restart of an NDB Cluster”](#)  
[Section 21.7.9.2, “Point-In-Time Recovery Using NDB Cluster Replication”](#)  
[Section 21.4.3.2, “Recommended Starting Configuration for NDB Cluster”](#)  
[Restoring to Fewer Nodes Than the Original](#)  
[Section 21.3.6, “Safe Shutdown and Restart of NDB Cluster”](#)  
[Section 21.6.15.28, “The ndbinfo nodes Table”](#)  
[Section 21.6.15.31, “The ndbinfo resources Table”](#)  
[Section 21.2.4.1, “What is New in NDB Cluster 7.5”](#)  
[Section 21.2.4.2, “What is New in NDB Cluster 7.6”](#)

## **ndbmtd.exe**

[Section 21.3.2.3, “Initial Startup of NDB Cluster on Windows”](#)  
[Section 21.3.2.1, “Installing NDB Cluster on Windows from a Binary Release”](#)



---

[Section 21.3.2.4, “Installing NDB Cluster Processes as Windows Services”](#)

## **NET**

[Section 21.3.2.4, “Installing NDB Cluster Processes as Windows Services”](#)

[Section 2.3.4.8, “Starting MySQL as a Windows Service”](#)

## **NET START**

[Section 21.3.2.4, “Installing NDB Cluster Processes as Windows Services”](#)

[Section 5.7.2.2, “Starting Multiple MySQL Instances as Windows Services”](#)

## **NET START `mysqld_service_name`**

[Section 2.3.4.8, “Starting MySQL as a Windows Service”](#)

[Section 2.3.5, “Troubleshooting a Microsoft Windows MySQL Server Installation”](#)

[Section 2.10.8, “Upgrading MySQL on Windows”](#)

## **NET STOP**

[Section 21.3.2.4, “Installing NDB Cluster Processes as Windows Services”](#)

[Section 5.7.2.2, “Starting Multiple MySQL Instances as Windows Services”](#)

## **NET STOP `mysqld_service_name`**

[Section 2.3.4.8, “Starting MySQL as a Windows Service”](#)

[Section 2.10.8, “Upgrading MySQL on Windows”](#)

## **NET STOP `service_name`**

[Section 21.3.6, “Safe Shutdown and Restart of NDB Cluster”](#)

## **nm**

[Section 4.7.3, “`resolve\_stack\_dump` — Resolve Numeric Stack Trace Dump to Symbols”](#)

[Section 5.8.1.5, “Using a Stack Trace”](#)

## **nslookup**

[Section 4.8.4, “`resolveip` — Resolve Host name to IP Address or Vice Versa”](#)

[Section 1.3, “What Is New in MySQL 5.7”](#)

## **nsupdate**

[Section 16.3.7, “Switching Sources During Failover”](#)

## **numactl**

[Section 21.4.3.6, “Defining NDB Cluster Data Nodes”](#)

## **O**

[\[index top\]](#)

## **okvutil**

[Section 6.4.4.4, “Using the `keyring\_okv` KMIP Plugin”](#)

## **openssl**

[Section 6.4.5.5, “Configuring Audit Logging Characteristics”](#)

[Section 6.3.1, “Configuring MySQL to Use Encrypted Connections”](#)

[Section 6.3.3.3, “Creating RSA Keys Using `openssl`”](#)

---

[Section 6.3.3, “Creating SSL and RSA Certificates and Keys”](#)  
[Section 6.3.3.1, “Creating SSL and RSA Certificates and Keys using MySQL”](#)  
[Section 6.3.3.2, “Creating SSL Certificates and Keys Using openssl”](#)  
[Section 4.4.5, “mysql\\_ssl\\_rsa\\_setup — Create SSL/RSA Files”](#)  
[Section 6.4.4.4, “Using the keyring\\_okv KMIP Plugin”](#)

## **openssl md5 package\_name**

[Section 2.1.4.1, “Verifying the MD5 Checksum”](#)

## **openssl zlib**

[Section 4.5.6, “mysqlpump — A Database Backup Program”](#)

## **P**

[\[index top\]](#)

## **perf**

[Section 25.12.16.4, “The threads Table”](#)

## **perror**

[Section B.3.2.11, “Can’t create/write to file”](#)  
[Section B.2, “Error Information Interfaces”](#)  
[Section B.3.2.16, “File Not Found and Similar Errors”](#)  
[Section 7.6.3, “How to Repair MyISAM Tables”](#)  
[Section A.10, “MySQL 5.7 FAQ: NDB Cluster”](#)  
[Section 21.5.17, “ndb\\_perror — Obtain NDB Error Message Information”](#)  
[Section 4.1, “Overview of MySQL Programs”](#)  
[Section 4.8.2, “perror — Display MySQL Error Message Information”](#)  
[Section 21.6.15.21, “The ndbinfo error\\_messages Table”](#)  
[Section 1.3, “What Is New in MySQL 5.7”](#)  
[Section 21.2.4.2, “What is New in NDB Cluster 7.6”](#)

## **pfexec**

[Section 2.2, “Installing MySQL on Unix/Linux Using Generic Binaries”](#)

## **PGP**

[Section 2.1.4.2, “Signature Checking Using GnuPG”](#)

## **ping6**

[Section 5.1.12.5, “Obtaining an IPv6 Address from a Broker”](#)

## **pkg-config**

[Section 4.9, “Environment Variables”](#)  
[Section 2.8.7, “MySQL Source-Configuration Options”](#)  
[Section 4.7.1, “mysql\\_config — Display Options for Compiling Clients”](#)

## **pkgadd**

[Section 2.7.1, “Installing MySQL on Solaris Using a Solaris PKG”](#)

## **pkgrm**

[Section 2.7.1, “Installing MySQL on Solaris Using a Solaris PKG”](#)

---

## ppm

[Section 2.12, “Perl Installation Notes”](#)

## ps

[Section 6.2.10, “Assigning Account Passwords”](#)

[Section 4.2.4, “Connecting to the MySQL Server Using Command Options”](#)

[Section 6.1.2.1, “End-User Guidelines for Password Security”](#)

[Section 8.12.4.1, “How MySQL Uses Memory”](#)

[Section B.3.1, “How to Determine What Is Causing a Problem”](#)

[Section 4.5.2, “mysqladmin — A MySQL Server Administration Program”](#)

[Section 6.7, “SELinux”](#)

[Section 25.12.16.4, “The threads Table”](#)

[Section 2.9.2.1, “Troubleshooting Problems Starting the MySQL Server”](#)

## ps xa | grep mysqld

[Section B.3.2.2, “Can't connect to \[local\] MySQL server”](#)

## R

[\[index top\]](#)

## rename

[Section 5.4.2.6, “Error Log File Flushing and Renaming”](#)

[Section 5.4.7, “Server Log Maintenance”](#)

[Section 5.4.3, “The General Query Log”](#)

## replace

[Section 4.1, “Overview of MySQL Programs”](#)

[Section 4.8.3, “replace — A String-Replacement Utility”](#)

[Section 16.3.4, “Using Replication for Scale-Out”](#)

[Section 1.3, “What Is New in MySQL 5.7”](#)

## resolve\_stack\_dump

[Section 4.1, “Overview of MySQL Programs”](#)

[Section 4.7.3, “resolve\\_stack\\_dump — Resolve Numeric Stack Trace Dump to Symbols”](#)

[Section 5.8.1.5, “Using a Stack Trace”](#)

[Section 1.3, “What Is New in MySQL 5.7”](#)

## resolveip

[Section 4.1, “Overview of MySQL Programs”](#)

[Section 4.8.4, “resolveip — Resolve Host name to IP Address or Vice Versa”](#)

[Section 1.3, “What Is New in MySQL 5.7”](#)

## restart

[Section 2.5.5, “Installing MySQL on Linux Using RPM Packages from Oracle”](#)

## rm

[Section 13.4.1.1, “PURGE BINARY LOGS Statement”](#)

## rpm

[Section 2.5.5, “Installing MySQL on Linux Using RPM Packages from Oracle”](#)

---

[Section 2.8.4, “Installing MySQL Using a Standard Source Distribution”](#)  
[Section 2.1.4.4, “Signature Checking Using RPM”](#)  
[Section 2.10.10, “Upgrading MySQL with Directly-Downloaded RPM Packages”](#)

## **rpmbuild**

[Section 2.5.5, “Installing MySQL on Linux Using RPM Packages from Oracle”](#)  
[Section 2.8.4, “Installing MySQL Using a Standard Source Distribution”](#)  
[Section 2.8.2, “Source Installation Prerequisites”](#)

## **rsync**

[Section 16.1.2.6, “Adding Replicas to a Replication Topology”](#)  
[Section 7.1, “Backup and Recovery Types”](#)  
[Creating a Data Snapshot Using Raw Data Files](#)

## **S**

[\[index top\]](#)

## **SC**

[Section 2.3.4.8, “Starting MySQL as a Windows Service”](#)

## **SC DELETE**

[Section 21.3.2.4, “Installing NDB Cluster Processes as Windows Services”](#)

## **SC DELETE mysql\_d\_service\_name**

[Section 5.7.2.2, “Starting Multiple MySQL Instances as Windows Services”](#)  
[Section 2.3.4.8, “Starting MySQL as a Windows Service”](#)

## **SC DELETE service\_name**

[Section 21.3.2.4, “Installing NDB Cluster Processes as Windows Services”](#)

## **SC START**

[Section 21.3.2.4, “Installing NDB Cluster Processes as Windows Services”](#)  
[Section 21.6.5, “Performing a Rolling Restart of an NDB Cluster”](#)  
[Section 5.7.2.2, “Starting Multiple MySQL Instances as Windows Services”](#)

## **SC START mysql\_d\_service\_name**

[Section 2.3.5, “Troubleshooting a Microsoft Windows MySQL Server Installation”](#)  
[Section 2.10.8, “Upgrading MySQL on Windows”](#)

## **sc start mysql\_d\_service\_name**

[Section 2.3.4.8, “Starting MySQL as a Windows Service”](#)

## **SC STOP**

[Section 21.3.2.4, “Installing NDB Cluster Processes as Windows Services”](#)  
[Section 21.6.5, “Performing a Rolling Restart of an NDB Cluster”](#)  
[Section 5.7.2.2, “Starting Multiple MySQL Instances as Windows Services”](#)

## **SC STOP mysql\_d\_service\_name**

[Section 2.3.4.8, “Starting MySQL as a Windows Service”](#)

---

## **sc stop mysqld\_service\_name**

[Section 2.3.4.8, “Starting MySQL as a Windows Service”](#)

## **SC STOP service\_name**

[Section 21.3.6, “Safe Shutdown and Restart of NDB Cluster”](#)

## **scp**

[Section 7.1, “Backup and Recovery Types”](#)

[Creating a Data Snapshot Using Raw Data Files](#)

## **sed**

[Section 3.3.4.7, “Pattern Matching”](#)

## **SELECT**

[Section 21.3.5, “NDB Cluster Example with Tables and Data”](#)

## **semanage**

[Section 6.7.6, “Troubleshooting SELinux”](#)

## **semodule**

[Section 6.7.3, “MySQL Server SELinux Policies”](#)

## **service**

[Section 2.5.8, “Installing MySQL on Linux from the Native Software Repositories”](#)

[Section 2.5.5, “Installing MySQL on Linux Using RPM Packages from Oracle”](#)

[Section 2.5.10, “Managing MySQL Server with systemd”](#)

## **Service Control Manager**

[Section 2.3, “Installing MySQL on Microsoft Windows”](#)

[Section 2.3.4.8, “Starting MySQL as a Windows Service”](#)

## **Services**

[Section 21.3.2.4, “Installing NDB Cluster Processes as Windows Services”](#)

[Section 2.3.4.8, “Starting MySQL as a Windows Service”](#)

## **sestatus**

[Section 6.7.2, “Changing the SELinux Mode”](#)

[Section 6.7.1, “Check if SELinux is Enabled”](#)

[Section 17.8, “Frequently Asked Questions”](#)

## **setenforce**

[Section 6.7.2, “Changing the SELinux Mode”](#)

[Section 6.7.6, “Troubleshooting SELinux”](#)

## **setenv**

[Section 4.2.7, “Setting Environment Variables”](#)

## **sh**

[Section 1.1, “About This Manual”](#)

[Section B.3.2.16, “File Not Found and Similar Errors”](#)

---

[Section 4.2.1, “Invoking MySQL Programs”](#)  
[Section 4.2.7, “Setting Environment Variables”](#)

## **SHOW**

[Section 21.4.1, “Quick Test Setup of NDB Cluster”](#)

## **SHOW ERRORS**

[Section A.10, “MySQL 5.7 FAQ: NDB Cluster”](#)

## **SHOW WARNINGS**

[Section A.10, “MySQL 5.7 FAQ: NDB Cluster”](#)

## **sleep**

[Section 4.3.2, “mysqld\\_safe — MySQL Server Startup Script”](#)

## **ssh**

[Section 21.6.18.1, “NDB Cluster Security and Networking Issues”](#)

## **start**

[Section 2.5.5, “Installing MySQL on Linux Using RPM Packages from Oracle”](#)

## **Start>Run>cmd.exe**

[Section 6.3.3.2, “Creating SSL Certificates and Keys Using openssl”](#)

## **status**

[Section 2.5.5, “Installing MySQL on Linux Using RPM Packages from Oracle”](#)

## **stop**

[Section 2.5.5, “Installing MySQL on Linux Using RPM Packages from Oracle”](#)

## **strings**

[Section 6.1.1, “Security Guidelines”](#)

## **su root**

[Section 21.3.1.1, “Installing an NDB Cluster Binary Release on Linux”](#)

## **sudo**

[Section 21.3.1.1, “Installing an NDB Cluster Binary Release on Linux”](#)  
[Section 2.5.5, “Installing MySQL on Linux Using RPM Packages from Oracle”](#)  
[Section 2.2, “Installing MySQL on Unix/Linux Using Generic Binaries”](#)

## **sysctl**

[Section 8.12.4.3, “Enabling Large Page Support”](#)

## **System Preferences...**

[Section 2.4.4, “Installing and Using the MySQL Preference Pane”](#)

## **systemctl**

[Section 2.5.10, “Managing MySQL Server with systemd”](#)

---

## **systemd**

[Section 2.8.7, “MySQL Source-Configuration Options”](#)

## **T**

[\[index top\]](#)

## **tar**

[Section 16.1.2.6, “Adding Replicas to a Replication Topology”](#)

[Section 16.3.1.2, “Backing Up Raw Data from a Replica”](#)

[Section 7.1, “Backup and Recovery Types”](#)

[Creating a Data Snapshot Using Raw Data Files](#)

[Section 3.3, “Creating and Using a Database”](#)

[Section 1.5, “How to Report Bugs or Problems”](#)

[Section 2.5.5, “Installing MySQL on Linux Using RPM Packages from Oracle”](#)

[Section 2.4, “Installing MySQL on macOS”](#)

[Section 2.7, “Installing MySQL on Solaris”](#)

[Section 2.7.1, “Installing MySQL on Solaris Using a Solaris PKG”](#)

[Section 2.2, “Installing MySQL on Unix/Linux Using Generic Binaries”](#)

[Section 2.8.4, “Installing MySQL Using a Standard Source Distribution”](#)

[Section 21.3.1.2, “Installing NDB Cluster from RPM”](#)

[Section 2.12.1, “Installing Perl on Unix”](#)

[Section 2.8.1, “Source Installation Methods”](#)

[Section 2.8.2, “Source Installation Prerequisites”](#)

[Section 6.4.4.4, “Using the keyring\\_okv KMIP Plugin”](#)

[Section 2.1.2, “Which MySQL Version and Distribution to Install”](#)

## **tcpdump**

[Section 6.1.1, “Security Guidelines”](#)

## **tcsch**

[Section 1.1, “About This Manual”](#)

[Section B.3.2.16, “File Not Found and Similar Errors”](#)

[Section 2.4.1, “General Notes on Installing MySQL on macOS”](#)

[Section 4.2.1, “Invoking MySQL Programs”](#)

[Section 4.2.7, “Setting Environment Variables”](#)

## **tee**

[Section 4.5.1.2, “mysql Client Commands”](#)

## **telnet**

[Section 6.1.1, “Security Guidelines”](#)

[Section 14.21.3, “Setting Up the InnoDB memcached Plugin”](#)

## **Terminal**

[Section 2.4, “Installing MySQL on macOS”](#)

## **Text in this style**

[Section 1.1, “About This Manual”](#)

## **top**

[Section B.3.1, “How to Determine What Is Causing a Problem”](#)

---

[Section 21.6.15.30, “The ndbinfo processes Table”](#)

## U

[\[index top\]](#)

## u

[Section 13.7.1.4, “GRANT Statement”](#)

## ulimit

[Section 21.4.3.6, “Defining NDB Cluster Data Nodes”](#)

[Section B.3.2.16, “File Not Found and Similar Errors”](#)

[Section 4.3.2, “mysqld\\_safe — MySQL Server Startup Script”](#)

[Section B.3.2.8, “Packet Too Large”](#)

[Section 5.1.6, “Server Command Options”](#)

[Section 5.1.7, “Server System Variables”](#)

## unix\_chkpwd

[Section 6.4.1.7, “PAM Pluggable Authentication”](#)

## update-rc.d

[Section 21.3.1.1, “Installing an NDB Cluster Binary Release on Linux”](#)

## useradd

[Section 21.3.1.1, “Installing an NDB Cluster Binary Release on Linux”](#)

[Section 2.7, “Installing MySQL on Solaris”](#)

[Section 2.2, “Installing MySQL on Unix/Linux Using Generic Binaries”](#)

## V

[\[index top\]](#)

## vi

[Section 21.3.3, “Initial Configuration of NDB Cluster”](#)

[Section 4.5.1.2, “mysql Client Commands”](#)

[Section 3.3.4.7, “Pattern Matching”](#)

## W

[\[index top\]](#)

## watch

[Section 26.4.4.25, “The statement\\_performance\\_analyzer\(\) Procedure”](#)

## WinDbg

[Section 5.8.1.3, “Using WER with PDB to create a Windows crashdump”](#)

## windbg.exe

[Section 5.8.1.3, “Using WER with PDB to create a Windows crashdump”](#)

## winMd5Sum

[Section 2.1.4.1, “Verifying the MD5 Checksum”](#)



---

## WinZip

Section 16.3.1.2, “Backing Up Raw Data from a Replica”  
Section 2.8.4, “Installing MySQL Using a Standard Source Distribution”  
Section 2.8.2, “Source Installation Prerequisites”

## WordPad

Section 13.2.6, “LOAD DATA Statement”

## Y

[\[index top\]](#)

## yacc

Section 2.8.8, “Dealing with Problems Compiling MySQL”  
Section 9.3, “Keywords and Reserved Words”

## yum

Section 2.5.8, “Installing MySQL on Linux from the Native Software Repositories”  
Section 2.5.5, “Installing MySQL on Linux Using RPM Packages from Oracle”  
Section 2.5.1, “Installing MySQL on Linux Using the MySQL Yum Repository”  
Section 21.3.1.2, “Installing NDB Cluster from RPM”  
Section 2.10.10, “Upgrading MySQL with Directly-Downloaded RPM Packages”  
Section 2.10.5, “Upgrading MySQL with the MySQL Yum Repository”

## yum install

Section 2.5.5, “Installing MySQL on Linux Using RPM Packages from Oracle”  
Section 2.10.10, “Upgrading MySQL with Directly-Downloaded RPM Packages”

## yum update

Section 2.5.1, “Installing MySQL on Linux Using the MySQL Yum Repository”  
Section 2.5.2, “Replacing a Third-Party Distribution of MySQL Using the MySQL Yum Repository”

## yum update mysql-server

Section 2.5.2, “Replacing a Third-Party Distribution of MySQL Using the MySQL Yum Repository”

## yum-config-manager

Section 2.5.1, “Installing MySQL on Linux Using the MySQL Yum Repository”  
Section 2.5.2, “Replacing a Third-Party Distribution of MySQL Using the MySQL Yum Repository”

## Z

[\[index top\]](#)

## zip

Creating a Data Snapshot Using Raw Data Files  
Section 1.5, “How to Report Bugs or Problems”

## zlib\_decompress

Section 4.8.1, “lz4\_decompress — Decompress mysqlpump LZ4-Compressed Output”  
Section 4.5.6, “mysqlpump — A Database Backup Program”  
Section 4.1, “Overview of MySQL Programs”

---

[Section 4.8.5, “zlib\\_decompress — Decompress mysqlpump ZLIB-Compressed Output”](#)

## **zsh**

[Section 4.2.7, “Setting Environment Variables”](#)

## **zypper**

[Section 2.5.5, “Installing MySQL on Linux Using RPM Packages from Oracle”](#)

[Section 2.10.10, “Upgrading MySQL with Directly-Downloaded RPM Packages”](#)

# Function Index

[Symbols](#) | [A](#) | [B](#) | [C](#) | [D](#) | [E](#) | [F](#) | [G](#) | [H](#) | [I](#) | [J](#) | [K](#) | [L](#) | [M](#) | [N](#) | [O](#) | [P](#) | [Q](#) | [R](#) | [S](#) | [T](#) | [U](#) | [V](#) | [W](#) | [X](#) | [Y](#)

## **Symbols**

[\[index top\]](#)

### **%**

[Section 1.6.1, “MySQL Extensions to Standard SQL”](#)

## **A**

[\[index top\]](#)

### **ABS()**

[Section 13.7.3.1, “CREATE FUNCTION Statement for Loadable Functions”](#)

[Section 12.6.2, “Mathematical Functions”](#)

[Section 22.6.3, “Partitioning Limitations Relating to Functions”](#)

### **ACOS()**

[Section 12.6.2, “Mathematical Functions”](#)

### **ADDDATE()**

[Section 12.7, “Date and Time Functions”](#)

### **addslashes()**

[Section 6.1.7, “Client Programming Security Guidelines”](#)

### **ADDTIME()**

[Section 12.7, “Date and Time Functions”](#)

### **AES\_DECRYPT()**

[Section 12.13, “Encryption and Compression Functions”](#)

[Section 8.10.3.1, “How the Query Cache Operates”](#)

[Section 6.6.4, “MySQL Enterprise Encryption Function Descriptions”](#)

[Section 5.1.7, “Server System Variables”](#)

[Section 6.3.4, “SSL Library-Dependent Capabilities”](#)

[Section 1.3, “What Is New in MySQL 5.7”](#)

### **AES\_ENCRYPT()**

[Section 12.13, “Encryption and Compression Functions”](#)

---

[Section 8.10.3.1, “How the Query Cache Operates”](#)  
[Section 6.6.4, “MySQL Enterprise Encryption Function Descriptions”](#)  
[Section 5.1.7, “Server System Variables”](#)  
[Section 6.3.4, “SSL Library-Dependent Capabilities”](#)  
[Section 1.3, “What Is New in MySQL 5.7”](#)

## **ANY\_VALUE()**

[Section 2.10.3, “Changes in MySQL 5.7”](#)  
[Section 12.19.2, “GROUP BY Modifiers”](#)  
[Section 12.20, “Miscellaneous Functions”](#)  
[Section 12.19.3, “MySQL Handling of GROUP BY”](#)  
[Section 5.1.10, “Server SQL Modes”](#)

## **Area()**

[Section 12.16.7.4, “Polygon and MultiPolygon Property Functions”](#)

## **AsBinary()**

[Section 12.16.6, “Geometry Format Conversion Functions”](#)

## **ASCII()**

[Section 13.8.3, “HELP Statement”](#)  
[Section 12.8, “String Functions and Operators”](#)

## **ASIN()**

[Section 12.6.2, “Mathematical Functions”](#)

## **AsText()**

[Section 12.16.6, “Geometry Format Conversion Functions”](#)

## **AsWKB()**

[Section 12.16.6, “Geometry Format Conversion Functions”](#)

## **AsWKT()**

[Section 12.16.6, “Geometry Format Conversion Functions”](#)

## **asymmetric\_decrypt()**

[Section 6.6.4, “MySQL Enterprise Encryption Function Descriptions”](#)

## **asymmetric\_derive()**

[Section 6.6.4, “MySQL Enterprise Encryption Function Descriptions”](#)

## **asymmetric\_encrypt()**

[Section 6.6.4, “MySQL Enterprise Encryption Function Descriptions”](#)

## **asymmetric\_sign()**

[Section 6.6.4, “MySQL Enterprise Encryption Function Descriptions”](#)

## **asymmetric\_verify()**

[Section 6.6.4, “MySQL Enterprise Encryption Function Descriptions”](#)

---

## **ATAN()**

Section 12.6.2, “Mathematical Functions”

## **ATAN2()**

Section 12.6.2, “Mathematical Functions”

## **audit\_log\_encryption\_password\_get()**

Section 6.4.5.11, “Audit Log Reference”

Section 6.4.5.5, “Configuring Audit Logging Characteristics”

## **audit\_log\_encryption\_password\_set()**

Section 6.4.5.11, “Audit Log Reference”

Section 6.4.5.5, “Configuring Audit Logging Characteristics”

## **audit\_log\_filter\_flush()**

Section 6.4.5.7, “Audit Log Filtering”

Section 6.4.5.11, “Audit Log Reference”

## **audit\_log\_filter\_remove\_filter()**

Section 6.4.5.7, “Audit Log Filtering”

Section 6.4.5.11, “Audit Log Reference”

## **audit\_log\_filter\_remove\_user()**

Section 6.4.5.7, “Audit Log Filtering”

Section 6.4.5.11, “Audit Log Reference”

## **audit\_log\_filter\_set\_filter()**

Section 6.4.5.7, “Audit Log Filtering”

Section 6.4.5.11, “Audit Log Reference”

## **audit\_log\_filter\_set\_user()**

Section 6.4.5.7, “Audit Log Filtering”

Section 6.4.5.11, “Audit Log Reference”

## **audit\_log\_read()**

Section 6.4.5.11, “Audit Log Reference”

Section 6.4.5.6, “Reading Audit Log Files”

## **audit\_log\_read\_bookmark()**

Section 6.4.5.11, “Audit Log Reference”

Section 6.4.5.6, “Reading Audit Log Files”

## **AVG()**

Section 12.19.1, “Aggregate Function Descriptions”

Section 11.2.1, “Date and Time Data Type Syntax”

Section 8.2.1.15, “GROUP BY Optimization”

Section 11.3.5, “The ENUM Type”

Section 1.2.2, “The Main Features of MySQL”

Section 11.3.6, “The SET Type”

---

## B

[\[index top\]](#)

### **BENCHMARK()**

Section 8.10.3.1, “How the Query Cache Operates”

Section 12.15, “Information Functions”

Section 8.13.1, “Measuring the Speed of Expressions and Functions”

Section 13.2.10.10, “Optimizing Subqueries”

### **BIN()**

Section 9.1.5, “Bit-Value Literals”

Section 12.8, “String Functions and Operators”

### **BIT\_AND()**

Section 12.19.1, “Aggregate Function Descriptions”

Section 12.12, “Bit Functions and Operators”

Section 1.6.1, “MySQL Extensions to Standard SQL”

### **BIT\_COUNT()**

Section 12.12, “Bit Functions and Operators”

Section 1.6.1, “MySQL Extensions to Standard SQL”

### **BIT\_LENGTH()**

Section 12.8, “String Functions and Operators”

### **BIT\_OR()**

Section 12.19.1, “Aggregate Function Descriptions”

Section 12.12, “Bit Functions and Operators”

Section 1.6.1, “MySQL Extensions to Standard SQL”

### **BIT\_XOR()**

Section 12.19.1, “Aggregate Function Descriptions”

Section 12.12, “Bit Functions and Operators”

Section 1.6.1, “MySQL Extensions to Standard SQL”

### **Buffer()**

Section 12.16.8, “Spatial Operator Functions”

## C

[\[index top\]](#)

### **CAST()**

Section 12.12, “Bit Functions and Operators”

Section 9.1.5, “Bit-Value Literals”

Section 12.10, “Cast Functions and Operators”

Section 12.8.3, “Character Set and Collation of Function Results”

Section 12.4.2, “Comparison Functions and Operators”

Section 11.2.9, “Conversion Between Date and Time Types”

Section 12.7, “Date and Time Functions”

---

[Section 9.5, “Expressions”](#)  
[Section 12.17.2, “Functions That Create JSON Values”](#)  
[Section 9.1.4, “Hexadecimal Literals”](#)  
[Section 1.6.2, “MySQL Differences from Standard SQL”](#)  
[Section 11.5, “The JSON Data Type”](#)  
[Section 12.3, “Type Conversion in Expression Evaluation”](#)  
[Section 9.4, “User-Defined Variables”](#)

## **CAST(expr AS type)**

[Section 12.10, “Cast Functions and Operators”](#)

## **CEIL()**

[Section 12.6.2, “Mathematical Functions”](#)

## **CEILING()**

[Section 22.2.4.1, “LINEAR HASH Partitioning”](#)  
[Section 12.6.2, “Mathematical Functions”](#)  
[Section 22.6.3, “Partitioning Limitations Relating to Functions”](#)

## **Centroid()**

[Section 12.16.7.4, “Polygon and MultiPolygon Property Functions”](#)

## **CHAR()**

[Section 12.13, “Encryption and Compression Functions”](#)  
[Section 4.5.1.1, “mysql Client Options”](#)  
[Section 1.6.1, “MySQL Extensions to Standard SQL”](#)  
[Section 12.8, “String Functions and Operators”](#)

## **CHAR\_LENGTH()**

[Section 12.8, “String Functions and Operators”](#)  
[Section 10.10.1, “Unicode Character Sets”](#)

## **CHARACTER\_LENGTH()**

[Section 12.8, “String Functions and Operators”](#)

## **CHARSET()**

[Section 12.8.3, “Character Set and Collation of Function Results”](#)  
[Section 12.15, “Information Functions”](#)

## **COALESCE()**

[Section 12.4.2, “Comparison Functions and Operators”](#)  
[Section 13.2.9.2, “JOIN Clause”](#)

## **COERCIBILITY()**

[Section 10.8.4, “Collation Coercibility in Expressions”](#)  
[Section 12.15, “Information Functions”](#)

## **COLLATION()**

[Section B.3.4.1, “Case Sensitivity in String Searches”](#)  
[Section 12.8.3, “Character Set and Collation of Function Results”](#)

---

Section 12.15, “Information Functions”

## **COMPRESS()**

Section 12.13, “Encryption and Compression Functions”

Section 2.8.7, “MySQL Source-Configuration Options”

Section 5.1.7, “Server System Variables”

## **CONCAT()**

Section 12.19.1, “Aggregate Function Descriptions”

Section 12.10, “Cast Functions and Operators”

Section 12.8.3, “Character Set and Collation of Function Results”

Section 10.2.1, “Character Set Repertoire”

Section 10.8.4, “Collation Coercibility in Expressions”

Section 13.7.3.1, “CREATE FUNCTION Statement for Loadable Functions”

Section 12.4.3, “Logical Operators”

Section 1.6.1, “MySQL Extensions to Standard SQL”

Section 5.1.10, “Server SQL Modes”

Section 13.7.5.13, “SHOW CREATE VIEW Statement”

Section 12.8, “String Functions and Operators”

Section 24.3.31, “The INFORMATION\_SCHEMA VIEWS Table”

Section 12.3, “Type Conversion in Expression Evaluation”

Section 12.11, “XML Functions”

## **CONCAT\_WS()**

Section 12.19.1, “Aggregate Function Descriptions”

Section 12.8, “String Functions and Operators”

## **CONNECTION\_ID()**

Section 6.4.5.4, “Audit Log File Formats”

Section 13.1.18.7, “CREATE TABLE and Generated Columns”

Section 16.2.1.3, “Determination of Safe and Unsafe Statements in Binary Logging”

Section 8.10.3.1, “How the Query Cache Operates”

Section 12.15, “Information Functions”

Section 13.7.6.4, “KILL Statement”

Section 4.5.1.3, “mysql Client Logging”

Section 5.1.7, “Server System Variables”

Section 13.7.5.29, “SHOW PROCESSLIST Statement”

Section 24.3.18, “The INFORMATION\_SCHEMA PROCESSLIST Table”

Section 25.12.16.3, “The processlist Table”

Section 25.12.16.4, “The threads Table”

## **Contains()**

Section 12.16.9.2, “Spatial Relation Functions That Use Minimum Bounding Rectangles”

## **CONV()**

Section 12.8.3, “Character Set and Collation of Function Results”

Section 12.6.2, “Mathematical Functions”

Section 12.8, “String Functions and Operators”

## **CONVERT()**

Section 12.10, “Cast Functions and Operators”

Section 10.3.8, “Character Set Introducers”

---

Section 10.3.6, “Character String Literal Character Set and Collation”  
Section 12.4.2, “Comparison Functions and Operators”  
Section A.11, “MySQL 5.7 FAQ: MySQL Chinese, Japanese, and Korean Character Sets”  
Section 4.5.1.1, “mysql Client Options”  
Section 6.5.3, “Using MySQL Enterprise Data Masking and De-Identification”

## **CONVERT\_TZ()**

Section 12.7, “Date and Time Functions”  
Section 8.10.3.1, “How the Query Cache Operates”  
Section 8.3.11, “Indexed Lookups from TIMESTAMP Columns”  
Section 13.3.5, “LOCK TABLES and UNLOCK TABLES Statements”  
Section 5.1.7, “Server System Variables”  
Section 5.4.3, “The General Query Log”  
Section 5.4.5, “The Slow Query Log”

## **ConvexHull()**

Section 12.16.8, “Spatial Operator Functions”

## **COS()**

Section 12.6.2, “Mathematical Functions”

## **COT()**

Section 12.6.2, “Mathematical Functions”

## **COUNT()**

Section 12.19.1, “Aggregate Function Descriptions”  
Section 3.3.4.8, “Counting Rows”  
Section 13.7.3.1, “CREATE FUNCTION Statement for Loadable Functions”  
Section 8.2.1.15, “GROUP BY Optimization”  
Section 14.24, “InnoDB Restrictions and Limitations”  
Section 8.4.4, “Internal Temporary Table Use in MySQL”  
Section 21.2.7.3, “Limits Relating to Transaction Handling in NDB Cluster”  
Section 12.20, “Miscellaneous Functions”  
Section 1.6.1, “MySQL Extensions to Standard SQL”  
NDB Cluster Status Variables  
Section 8.2.2.4, “Optimizing Derived Tables and View References with Merging or Materialization”  
Section B.3.4.3, “Problems with NULL Values”  
Section 5.1.10, “Server SQL Modes”  
Section 1.2.2, “The Main Features of MySQL”  
Section 23.5.3, “Updatable and Insertable Views”  
Section 8.2.1.1, “WHERE Clause Optimization”

## **CRC32()**

Section 12.6.2, “Mathematical Functions”

## **create\_asymmetric\_priv\_key()**

Section 4.9, “Environment Variables”  
Section 6.6.4, “MySQL Enterprise Encryption Function Descriptions”  
Section 6.6.2, “MySQL Enterprise Encryption Usage and Examples”

## **create\_asymmetric\_pub\_key()**

Section 6.6.4, “MySQL Enterprise Encryption Function Descriptions”



---

## **create\_dh\_parameters()**

Section 4.9, “Environment Variables”

Section 6.6.4, “MySQL Enterprise Encryption Function Descriptions”

Section 6.6.2, “MySQL Enterprise Encryption Usage and Examples”

## **create\_digest()**

Section 6.6.4, “MySQL Enterprise Encryption Function Descriptions”

## **Crosses()**

Section 12.16.9.1, “Spatial Relation Functions That Use Object Shapes”

## **crypt()**

Section 12.13, “Encryption and Compression Functions”

Section 5.1.7, “Server System Variables”

## **CURDATE()**

Section 12.7, “Date and Time Functions”

Section 3.3.4.5, “Date Calculations”

Section 16.2.1.3, “Determination of Safe and Unsafe Statements in Binary Logging”

Section 8.10.3.1, “How the Query Cache Operates”

## **CURRENT\_DATE**

Section 11.6, “Data Type Default Values”

Section 12.7, “Date and Time Functions”

## **CURRENT\_DATE()**

Section 11.2.9, “Conversion Between Date and Time Types”

Section 12.7, “Date and Time Functions”

Section 16.2.1.3, “Determination of Safe and Unsafe Statements in Binary Logging”

Section 8.10.3.1, “How the Query Cache Operates”

## **CURRENT\_TIME**

Section 12.7, “Date and Time Functions”

## **CURRENT\_TIME()**

Section 12.7, “Date and Time Functions”

Section 16.2.1.3, “Determination of Safe and Unsafe Statements in Binary Logging”

Section 8.10.3.1, “How the Query Cache Operates”

## **CURRENT\_TIMESTAMP**

Section 13.1.8, “ALTER TABLE Statement”

Section 11.2.6, “Automatic Initialization and Updating for TIMESTAMP and DATETIME”

Section 13.1.12, “CREATE EVENT Statement”

Section 11.6, “Data Type Default Values”

Section 12.7, “Date and Time Functions”

Section 5.1.7, “Server System Variables”

## **CURRENT\_TIMESTAMP()**

Section 11.2.6, “Automatic Initialization and Updating for TIMESTAMP and DATETIME”

Section 12.7, “Date and Time Functions”

Section 16.2.1.3, “Determination of Safe and Unsafe Statements in Binary Logging”

---

Section 8.10.3.1, “How the Query Cache Operates”

## **CURRENT\_USER**

Section 13.7.1.1, “ALTER USER Statement”

Section 13.1.12, “CREATE EVENT Statement”

Section 13.1.16, “CREATE PROCEDURE and CREATE FUNCTION Statements”

Section 13.1.20, “CREATE TRIGGER Statement”

Section 13.1.21, “CREATE VIEW Statement”

Section 6.2.3, “Grant Tables”

Section 12.15, “Information Functions”

Section 5.4.4.3, “Mixed Binary Logging Format”

Section 16.4.1.15, “Replication and System Functions”

Section 16.4.1.8, “Replication of CURRENT\_USER()”

Section 13.7.5.12, “SHOW CREATE USER Statement”

Section 6.2.4, “Specifying Account Names”

Section 23.6, “Stored Object Access Control”

## **CURRENT\_USER()**

Section 6.2.5, “Access Control, Stage 1: Connection Verification”

Section 13.7.1.1, “ALTER USER Statement”

Section 6.4.5.4, “Audit Log File Formats”

Section 6.4.2.1, “Connection Control Plugin Installation”

Section 13.1.12, “CREATE EVENT Statement”

Section 13.1.16, “CREATE PROCEDURE and CREATE FUNCTION Statements”

Section 13.1.18.7, “CREATE TABLE and Generated Columns”

Section 13.1.20, “CREATE TRIGGER Statement”

Section 13.1.21, “CREATE VIEW Statement”

Section 6.4.4.8, “General-Purpose Keyring Key-Management Functions”

Section 8.10.3.1, “How the Query Cache Operates”

Section 12.15, “Information Functions”

Section 5.4.4.3, “Mixed Binary Logging Format”

Section 6.4.3.2, “Password Validation Plugin Options and Variables”

Section 6.2.14, “Proxy Users”

Section 16.4.1.15, “Replication and System Functions”

Section 16.4.1.8, “Replication of CURRENT\_USER()”

Section 13.7.1.7, “SET PASSWORD Statement”

Section 13.7.5.12, “SHOW CREATE USER Statement”

Section 6.2.4, “Specifying Account Names”

Section 6.2.18, “SQL-Based Account Activity Auditing”

Section 23.6, “Stored Object Access Control”

Section 5.5.6.2, “The Keyring Service”

Section 10.2.2, “UTF-8 for Metadata”

## **CURTIME()**

Section 12.7, “Date and Time Functions”

Section 16.2.1.3, “Determination of Safe and Unsafe Statements in Binary Logging”

Section 8.10.3.1, “How the Query Cache Operates”

Section 5.1.13, “MySQL Server Time Zone Support”

Section 16.4.1.13, “Replication and Fractional Seconds Support”

## **D**

[\[index top\]](#)

---

## **DATABASE()**

Section 16.1.6.4, “Binary Logging Options and Variables”  
Section 3.3.1, “Creating and Selecting a Database”  
Section 13.1.22, “DROP DATABASE Statement”  
Section 3.4, “Getting Information About Databases and Tables”  
Section 8.10.3.1, “How the Query Cache Operates”  
Section 12.15, “Information Functions”  
Section B.3.7, “Known Issues in MySQL”  
Section 10.2.2, “UTF-8 for Metadata”

## **DATE()**

Section 12.7, “Date and Time Functions”

## **DATE\_ADD()**

Section 12.6.1, “Arithmetic Operators”  
Section 11.2, “Date and Time Data Types”  
Section 12.7, “Date and Time Functions”  
Section 3.3.4.5, “Date Calculations”  
Section 9.5, “Expressions”

## **DATE\_FORMAT()**

Section 12.10, “Cast Functions and Operators”  
Section 12.7, “Date and Time Functions”  
Section 10.16, “MySQL Server Locale Support”  
Section 5.1.7, “Server System Variables”

## **DATE\_SUB()**

Section 11.2, “Date and Time Data Types”  
Section 12.7, “Date and Time Functions”  
Section 9.5, “Expressions”

## **DATEDIFF()**

Section 12.7, “Date and Time Functions”  
Section 22.6.3, “Partitioning Limitations Relating to Functions”

## **DAY()**

Section 12.7, “Date and Time Functions”  
Section 22.6.3, “Partitioning Limitations Relating to Functions”

## **DAYNAME()**

Section 12.7, “Date and Time Functions”  
Section 10.16, “MySQL Server Locale Support”  
Section 5.1.7, “Server System Variables”

## **DAYOFMONTH()**

Section 12.7, “Date and Time Functions”  
Section 3.3.4.5, “Date Calculations”  
Section 22.6.3, “Partitioning Limitations Relating to Functions”

## **DAYOFWEEK()**

Section 12.7, “Date and Time Functions”  
Section 22.6.3, “Partitioning Limitations Relating to Functions”

---

## **DAYOFYEAR()**

[Section 12.7, “Date and Time Functions”](#)  
[Section 22.6.3, “Partitioning Limitations Relating to Functions”](#)  
[Section 22.2, “Partitioning Types”](#)

## **DECODE()**

[Section 12.13, “Encryption and Compression Functions”](#)  
[Section 1.6.1, “MySQL Extensions to Standard SQL”](#)  
[Section 1.3, “What Is New in MySQL 5.7”](#)

## **DEFAULT()**

[Section 13.1.8.2, “ALTER TABLE and Generated Columns”](#)  
[Section 11.6, “Data Type Default Values”](#)  
[Section 13.2.5, “INSERT Statement”](#)  
[Section 12.20, “Miscellaneous Functions”](#)  
[Section 13.2.8, “REPLACE Statement”](#)

## **DEGREES()**

[Section 12.6.2, “Mathematical Functions”](#)

## **DES\_DECRYPT()**

[Section 12.13, “Encryption and Compression Functions”](#)  
[Section 13.7.6.3, “FLUSH Statement”](#)  
[Section 5.1.6, “Server Command Options”](#)  
[Section 1.3, “What Is New in MySQL 5.7”](#)

## **DES\_ENCRYPT()**

[Section 12.13, “Encryption and Compression Functions”](#)  
[Section 13.7.6.3, “FLUSH Statement”](#)  
[Section 6.2.2, “Privileges Provided by MySQL”](#)  
[Section 5.1.6, “Server Command Options”](#)  
[Section 1.3, “What Is New in MySQL 5.7”](#)

## **Dimension()**

[Section 12.16.7.1, “General Geometry Property Functions”](#)

## **Disjoint()**

[Section 12.16.9.2, “Spatial Relation Functions That Use Minimum Bounding Rectangles”](#)

## **Distance()**

[Section 12.16.9.1, “Spatial Relation Functions That Use Object Shapes”](#)

## **E**

[\[index top\]](#)

## **ELT()**

[Section 12.8.3, “Character Set and Collation of Function Results”](#)  
[Section B.3.7, “Known Issues in MySQL”](#)  
[Section 1.6.1, “MySQL Extensions to Standard SQL”](#)  
[Section 12.8, “String Functions and Operators”](#)

---

## **ENCODE()**

Section 12.13, “Encryption and Compression Functions”  
Section 1.6.1, “MySQL Extensions to Standard SQL”  
Section 1.3, “What Is New in MySQL 5.7”

## **ENCRYPT()**

Section 12.13, “Encryption and Compression Functions”  
Section 8.10.3.1, “How the Query Cache Operates”  
Section 1.6.1, “MySQL Extensions to Standard SQL”  
Section 10.11, “Restrictions on Character Sets”  
Section 5.1.7, “Server System Variables”  
Section 1.3, “What Is New in MySQL 5.7”

## **EndPoint()**

Section 12.16.7.3, “LineString and MultiLineString Property Functions”

## **Envelope()**

Section 12.16.7.1, “General Geometry Property Functions”

## **Equals()**

Section 12.16.9.2, “Spatial Relation Functions That Use Minimum Bounding Rectangles”

## **EXP()**

Section 13.1.18, “CREATE TABLE Statement”  
Section 12.6.2, “Mathematical Functions”

## **EXPORT\_SET()**

Section 12.8, “String Functions and Operators”

## **ExteriorRing()**

Section 12.16.7.4, “Polygon and MultiPolygon Property Functions”

## **EXTRACT()**

Section 12.10, “Cast Functions and Operators”  
Section 12.7, “Date and Time Functions”  
Section 9.5, “Expressions”  
Section 22.6.3, “Partitioning Limitations Relating to Functions”

## **ExtractValue()**

Section 12.11, “XML Functions”

## **F**

[\[index top\]](#)

## **FIELD()**

Section 12.8, “String Functions and Operators”

## **FIND\_IN\_SET()**

Section 12.8, “String Functions and Operators”

---

[Section 11.3.6, “The SET Type”](#)

## **FLOOR()**

[Section 12.6.2, “Mathematical Functions”](#)

[Section 12.19.3, “MySQL Handling of GROUP BY”](#)

[Section 22.6.3, “Partitioning Limitations Relating to Functions”](#)

[Section 5.1.7, “Server System Variables”](#)

## **flush\_rewrite\_rules()**

[Rewriter Query Rewrite Plugin Procedures and Functions](#)

## **FORMAT()**

[Section 12.8.3, “Character Set and Collation of Function Results”](#)

[Section 12.6.2, “Mathematical Functions”](#)

[Section 12.20, “Miscellaneous Functions”](#)

[Section 1.6.1, “MySQL Extensions to Standard SQL”](#)

[Section 10.16, “MySQL Server Locale Support”](#)

[Section 12.8, “String Functions and Operators”](#)

## **FOUND\_ROWS()**

[Section 16.2.1.1, “Advantages and Disadvantages of Statement-Based and Row-Based Replication”](#)

[Section 16.2.1.3, “Determination of Safe and Unsafe Statements in Binary Logging”](#)

[Section 8.10.3.1, “How the Query Cache Operates”](#)

[Section 12.15, “Information Functions”](#)

[Section 5.4.4.3, “Mixed Binary Logging Format”](#)

[Section 16.4.1.15, “Replication and System Functions”](#)

## **FROM\_BASE64()**

[Section 12.8, “String Functions and Operators”](#)

## **FROM\_DAYS()**

[Section 12.7, “Date and Time Functions”](#)

[Section 1.6.1, “MySQL Extensions to Standard SQL”](#)

## **FROM\_UNIXTIME()**

[Section 6.4.5.5, “Configuring Audit Logging Characteristics”](#)

[Section 12.7, “Date and Time Functions”](#)

[Section 8.3.11, “Indexed Lookups from TIMESTAMP Columns”](#)

[Section 16.4.1.31, “Replication and Time Zones”](#)

## **G**

[\[index top\]](#)

## **gen\_blacklist()**

[Section 6.5.5, “MySQL Enterprise Data Masking and De-Identification Function Descriptions”](#)

[Section 6.5.3, “Using MySQL Enterprise Data Masking and De-Identification”](#)

## **gen\_dictionary()**

[Section 6.5.5, “MySQL Enterprise Data Masking and De-Identification Function Descriptions”](#)

[Section 6.5.3, “Using MySQL Enterprise Data Masking and De-Identification”](#)

---

## **gen\_dictionary\_drop()**

Section 6.5.5, “MySQL Enterprise Data Masking and De-Identification Function Descriptions”

## **gen\_dictionary\_load()**

Section 6.5.5, “MySQL Enterprise Data Masking and De-Identification Function Descriptions”

Section 6.5.3, “Using MySQL Enterprise Data Masking and De-Identification”

## **gen\_range()**

Section 6.5.5, “MySQL Enterprise Data Masking and De-Identification Function Descriptions”

Section 6.5.3, “Using MySQL Enterprise Data Masking and De-Identification”

## **gen\_rnd\_email()**

Section 6.5.5, “MySQL Enterprise Data Masking and De-Identification Function Descriptions”

Section 6.5.3, “Using MySQL Enterprise Data Masking and De-Identification”

## **gen\_rnd\_pan()**

Section 6.5.5, “MySQL Enterprise Data Masking and De-Identification Function Descriptions”

Section 6.5.3, “Using MySQL Enterprise Data Masking and De-Identification”

## **gen\_rnd\_ssn()**

Section 6.5.5, “MySQL Enterprise Data Masking and De-Identification Function Descriptions”

Section 6.5.3, “Using MySQL Enterprise Data Masking and De-Identification”

## **gen\_rnd\_us\_phone()**

Section 6.5.5, “MySQL Enterprise Data Masking and De-Identification Function Descriptions”

Section 6.5.3, “Using MySQL Enterprise Data Masking and De-Identification”

## **GeomCollFromText()**

Section 12.16.3, “Functions That Create Geometry Values from WKT Values”

## **GeomCollFromWKB()**

Section 12.16.4, “Functions That Create Geometry Values from WKB Values”

## **GeometryCollection()**

Section 12.16.5, “MySQL-Specific Functions That Create Geometry Values”

## **GeometryCollectionFromText()**

Section 12.16.3, “Functions That Create Geometry Values from WKT Values”

## **GeometryCollectionFromWKB()**

Section 12.16.4, “Functions That Create Geometry Values from WKB Values”

## **GeometryFromText()**

Section 12.16.3, “Functions That Create Geometry Values from WKT Values”

## **GeometryFromWKB()**

Section 12.16.4, “Functions That Create Geometry Values from WKB Values”

## **GeometryN()**

Section 12.16.7.5, “GeometryCollection Property Functions”

---

## **GeometryType()**

Section 12.16.7.1, “General Geometry Property Functions”

## **GeomFromText()**

Section 12.16.3, “Functions That Create Geometry Values from WKT Values”

## **GeomFromWKB()**

Section 12.16.4, “Functions That Create Geometry Values from WKB Values”

## **GET\_FORMAT()**

Section 12.7, “Date and Time Functions”

Section 10.16, “MySQL Server Locale Support”

## **GET\_LOCK()**

Section 16.2.1.1, “Advantages and Disadvantages of Statement-Based and Row-Based Replication”

Section 2.10.3, “Changes in MySQL 5.7”

Section 13.1.12, “CREATE EVENT Statement”

Section 16.2.1.3, “Determination of Safe and Unsafe Statements in Binary Logging”

Section 23.4.1, “Event Scheduler Overview”

Section 8.14.3, “General Thread States”

Section 17.3.2, “Group Replication Limitations”

Section 8.10.3.1, “How the Query Cache Operates”

Section 8.11.1, “Internal Locking Methods”

Section 13.7.6.4, “KILL Statement”

Section 21.2.7.10, “Limitations Relating to Multiple NDB Cluster Nodes”

Section 13.3.5, “LOCK TABLES and UNLOCK TABLES Statements”

Section 12.14, “Locking Functions”

Section 8.11.4, “Metadata Locking”

Section 16.4.1.15, “Replication and System Functions”

Section 5.5.6.1, “The Locking Service”

The Locking Service Function Interface

Section 25.12.12.1, “The metadata\_locks Table”

Section 26.4.4.14, “The ps\_setup\_save() Procedure”

## **getusage()**

Section 21.6.15.43, “The ndbinfo threadstat Table”

## **gettimeofday()**

Section 21.6.15.43, “The ndbinfo threadstat Table”

## **GLength()**

Section 12.16.7.3, “LineString and MultiLineString Property Functions”

## **GREATEST()**

Section 12.8.3, “Character Set and Collation of Function Results”

Section 12.4.2, “Comparison Functions and Operators”

Section 11.5, “The JSON Data Type”

## **GROUP\_CONCAT()**

Section 12.19.1, “Aggregate Function Descriptions”

Section 8.4.4, “Internal Temporary Table Use in MySQL”

Section B.3.7, “Known Issues in MySQL”



---

[Section 1.6.1, “MySQL Extensions to Standard SQL”](#)  
[Section 5.1.7, “Server System Variables”](#)  
[Section 11.5, “The JSON Data Type”](#)  
[Section 1.2.2, “The Main Features of MySQL”](#)

## **GROUPING()**

[Section 12.19.2, “GROUP BY Modifiers”](#)

## **GTID\_SUBSET()**

[Section 12.18, “Functions Used with Global Transaction Identifiers \(GTIDs\)”](#)  
[Section 16.1.3.1, “GTID Format and Storage”](#)  
[Section 16.1.3.7, “Stored Function Examples to Manipulate GTIDs”](#)

## **GTID\_SUBTRACT()**

[Section 12.18, “Functions Used with Global Transaction Identifiers \(GTIDs\)”](#)  
[Section 16.1.6.5, “Global Transaction ID System Variables”](#)  
[Section 16.1.3.1, “GTID Format and Storage”](#)  
[Section 16.1.3.7, “Stored Function Examples to Manipulate GTIDs”](#)

## **H**

[\[index top\]](#)

## **HEX()**

[Section 9.1.5, “Bit-Value Literals”](#)  
[Section 12.8.3, “Character Set and Collation of Function Results”](#)  
[Section 10.3.6, “Character String Literal Character Set and Collation”](#)  
[Section 6.4.4.8, “General-Purpose Keyring Key-Management Functions”](#)  
[Section 9.1.4, “Hexadecimal Literals”](#)  
[Section 12.6.2, “Mathematical Functions”](#)  
[Section 12.20, “Miscellaneous Functions”](#)  
[Section A.11, “MySQL 5.7 FAQ: MySQL Chinese, Japanese, and Korean Character Sets”](#)  
[Section 12.8, “String Functions and Operators”](#)

## **HOUR()**

[Section 12.7, “Date and Time Functions”](#)  
[Section 22.6.3, “Partitioning Limitations Relating to Functions”](#)

## **I**

[\[index top\]](#)

## **IF()**

[Section 12.8.3, “Character Set and Collation of Function Results”](#)  
[Section 12.5, “Flow Control Functions”](#)  
[Section 13.6.5.2, “IF Statement”](#)  
[Section 14.16.3, “InnoDB INFORMATION\\_SCHEMA System Tables”](#)  
[Section B.3.7, “Known Issues in MySQL”](#)  
[Section 1.6.1, “MySQL Extensions to Standard SQL”](#)

## **IFNULL()**

[Section 12.5, “Flow Control Functions”](#)

---

Section B.3.4.3, “Problems with NULL Values”

## **INET6\_ATON()**

Section 5.1.12, “IPv6 Support”

Section 12.20, “Miscellaneous Functions”

## **INET6\_NTOA()**

Section 5.1.12, “IPv6 Support”

Section 12.20, “Miscellaneous Functions”

## **INET\_ATON()**

Section 5.1.12, “IPv6 Support”

Section 12.20, “Miscellaneous Functions”

## **INET\_NTOA()**

Section 5.1.12, “IPv6 Support”

Section 12.20, “Miscellaneous Functions”

## **INSERT()**

Section 12.8, “String Functions and Operators”

## **INSTR()**

Section 12.8.3, “Character Set and Collation of Function Results”

Section 12.8, “String Functions and Operators”

## **InteriorRingN()**

Section 12.16.7.4, “Polygon and MultiPolygon Property Functions”

## **Intersects()**

Section 12.16.9.2, “Spatial Relation Functions That Use Minimum Bounding Rectangles”

## **INTERVAL()**

Section 12.4.2, “Comparison Functions and Operators”

## **IS\_FREE\_LOCK()**

Section 16.2.1.1, “Advantages and Disadvantages of Statement-Based and Row-Based Replication”

Section 16.2.1.3, “Determination of Safe and Unsafe Statements in Binary Logging”

Section 8.10.3.1, “How the Query Cache Operates”

Section 12.14, “Locking Functions”

Section 16.4.1.15, “Replication and System Functions”

## **IS\_IPV4()**

Section 12.20, “Miscellaneous Functions”

## **IS\_IPV4\_COMPAT()**

Section 12.20, “Miscellaneous Functions”

## **IS\_IPV4\_MAPPED()**

Section 12.20, “Miscellaneous Functions”

---

## **IS\_IPV6()**

Section 12.20, “Miscellaneous Functions”

## **IS\_USED\_LOCK()**

Section 16.2.1.1, “Advantages and Disadvantages of Statement-Based and Row-Based Replication”

Section 16.2.1.3, “Determination of Safe and Unsafe Statements in Binary Logging”

Section 8.10.3.1, “How the Query Cache Operates”

Section 12.14, “Locking Functions”

Section 16.4.1.15, “Replication and System Functions”

## **IsClosed()**

Section 12.16.7.3, “LineString and MultiLineString Property Functions”

## **IsEmpty()**

Section 12.16.7.1, “General Geometry Property Functions”

## **ISNULL()**

Section 12.4.2, “Comparison Functions and Operators”

## **IsSimple()**

Section 12.16.7.1, “General Geometry Property Functions”

## **J**

[\[index top\]](#)

## **JSON\_APPEND()**

Section 12.17.4, “Functions That Modify JSON Values”

Section 1.3, “What Is New in MySQL 5.7”

## **JSON\_ARRAY()**

Section 12.17.2, “Functions That Create JSON Values”

Section 11.5, “The JSON Data Type”

Section 1.3, “What Is New in MySQL 5.7”

## **JSON\_ARRAY\_APPEND()**

Section 12.17.4, “Functions That Modify JSON Values”

Section 1.3, “What Is New in MySQL 5.7”

## **JSON\_ARRAY\_INSERT()**

Section 12.17.4, “Functions That Modify JSON Values”

Section 1.3, “What Is New in MySQL 5.7”

## **JSON\_ARRAYAGG()**

Section 12.19.1, “Aggregate Function Descriptions”

Section 12.17.2, “Functions That Create JSON Values”

Section 12.17.1, “JSON Function Reference”

Section 1.3, “What Is New in MySQL 5.7”

## **JSON\_CONTAINS()**

Section 12.17.3, “Functions That Search JSON Values”

---

Section 1.3, “What Is New in MySQL 5.7”

## **JSON\_CONTAINS\_PATH()**

Section 12.17.3, “Functions That Search JSON Values”

Section 11.5, “The JSON Data Type”

Section 1.3, “What Is New in MySQL 5.7”

## **JSON\_DEPTH()**

Section 12.17.5, “Functions That Return JSON Value Attributes”

Section 1.3, “What Is New in MySQL 5.7”

## **JSON\_EXTRACT()**

Section 12.17.3, “Functions That Search JSON Values”

Section 13.1.18.8, “Secondary Indexes and Generated Columns”

Section 11.5, “The JSON Data Type”

Section 1.3, “What Is New in MySQL 5.7”

## **JSON\_INSERT()**

Section 12.17.4, “Functions That Modify JSON Values”

Section 11.5, “The JSON Data Type”

Section 1.3, “What Is New in MySQL 5.7”

## **JSON\_KEYS()**

Section 12.17.3, “Functions That Search JSON Values”

Section 1.3, “What Is New in MySQL 5.7”

## **JSON\_LENGTH()**

Section 12.17.5, “Functions That Return JSON Value Attributes”

Section 1.3, “What Is New in MySQL 5.7”

## **JSON\_MERGE()**

Section 12.17.4, “Functions That Modify JSON Values”

Section 11.5, “The JSON Data Type”

Section 1.3, “What Is New in MySQL 5.7”

## **JSON\_MERGE\_PATCH()**

Section 12.17.4, “Functions That Modify JSON Values”

Section 1.3, “What Is New in MySQL 5.7”

## **JSON\_MERGE\_PRESERVE()**

Section 12.17.4, “Functions That Modify JSON Values”

Section 1.3, “What Is New in MySQL 5.7”

## **JSON\_OBJECT()**

Section 12.17.2, “Functions That Create JSON Values”

Section 11.5, “The JSON Data Type”

Section 1.3, “What Is New in MySQL 5.7”

## **JSON\_OBJECTAGG()**

Section 12.19.1, “Aggregate Function Descriptions”

---

[Section 12.17.2, “Functions That Create JSON Values”](#)  
[Section 12.17.1, “JSON Function Reference”](#)  
[Section 1.3, “What Is New in MySQL 5.7”](#)

## **JSON\_PRETTY()**

[Section 12.17.1, “JSON Function Reference”](#)  
[Section 12.17.6, “JSON Utility Functions”](#)  
[Section 1.3, “What Is New in MySQL 5.7”](#)

## **JSON\_QUOTE()**

[Section 12.17.2, “Functions That Create JSON Values”](#)  
[Section 12.17.6, “JSON Utility Functions”](#)  
[Section 1.3, “What Is New in MySQL 5.7”](#)

## **JSON\_REMOVE()**

[Section 12.17.4, “Functions That Modify JSON Values”](#)  
[Section 1.3, “What Is New in MySQL 5.7”](#)

## **JSON\_REPLACE()**

[Section 12.17.4, “Functions That Modify JSON Values”](#)  
[Section 11.5, “The JSON Data Type”](#)  
[Section 1.3, “What Is New in MySQL 5.7”](#)

## **JSON\_SEARCH()**

[Section 12.17.3, “Functions That Search JSON Values”](#)  
[Section 11.5, “The JSON Data Type”](#)  
[Section 1.3, “What Is New in MySQL 5.7”](#)

## **JSON\_SET()**

[Section 12.17.4, “Functions That Modify JSON Values”](#)  
[Section 11.5, “The JSON Data Type”](#)  
[Section 1.3, “What Is New in MySQL 5.7”](#)

## **JSON\_STORAGE\_SIZE()**

[Section 12.17.1, “JSON Function Reference”](#)  
[Section 12.17.6, “JSON Utility Functions”](#)  
[Section 1.3, “What Is New in MySQL 5.7”](#)

## **JSON\_TYPE()**

[Section 12.17.5, “Functions That Return JSON Value Attributes”](#)  
[Section 12.17.3, “Functions That Search JSON Values”](#)  
[Section 11.5, “The JSON Data Type”](#)  
[Section 1.3, “What Is New in MySQL 5.7”](#)

## **JSON\_UNQUOTE()**

[Section 12.17.3, “Functions That Search JSON Values”](#)

## **JSON\_UNQUOTE()**

[Section 12.17.4, “Functions That Modify JSON Values”](#)  
[Section 8.3.10, “Optimizer Use of Generated Column Indexes”](#)  
[Section 13.1.18.8, “Secondary Indexes and Generated Columns”](#)

---

[Section 11.5, “The JSON Data Type”](#)  
[Section 1.3, “What Is New in MySQL 5.7”](#)

## **JSON\_VALID()**

[Section 12.17.5, “Functions That Return JSON Value Attributes”](#)  
[Section 1.3, “What Is New in MySQL 5.7”](#)

## **K**

[\[index top\]](#)

## **keyring\_aws\_rotate\_cmk()**

[Section 6.4.4.9, “Plugin-Specific Keyring Key-Management Functions”](#)  
[Section 6.4.4.5, “Using the keyring\\_aws Amazon Web Services Keyring Plugin”](#)

## **keyring\_aws\_rotate\_keys()**

[Section 6.4.4.9, “Plugin-Specific Keyring Key-Management Functions”](#)  
[Section 6.4.4.5, “Using the keyring\\_aws Amazon Web Services Keyring Plugin”](#)

## **keyring\_key\_fetch()**

[Section 6.4.4.8, “General-Purpose Keyring Key-Management Functions”](#)

## **keyring\_key\_generate()**

[Section 6.4.4.8, “General-Purpose Keyring Key-Management Functions”](#)

## **keyring\_key\_length\_fetch()**

[Section 6.4.4.8, “General-Purpose Keyring Key-Management Functions”](#)

## **keyring\_key\_remove()**

[Section 6.4.4.8, “General-Purpose Keyring Key-Management Functions”](#)

## **keyring\_key\_store()**

[Section 6.4.4.8, “General-Purpose Keyring Key-Management Functions”](#)

## **keyring\_key\_type\_fetch()**

[Section 6.4.4.8, “General-Purpose Keyring Key-Management Functions”](#)

## **L**

[\[index top\]](#)

## **LAST\_DAY()**

[Section 12.7, “Date and Time Functions”](#)

## **LAST\_INSERT\_ID()**

[Section 12.4.2, “Comparison Functions and Operators”](#)  
[Section 13.1.18, “CREATE TABLE Statement”](#)  
[Section 16.2.1.3, “Determination of Safe and Unsafe Statements in Binary Logging”](#)  
[Section 8.10.3.1, “How the Query Cache Operates”](#)  
[Section 12.15, “Information Functions”](#)

---

[Section 13.2.5.2, “INSERT ... ON DUPLICATE KEY UPDATE Statement”](#)  
[Section 13.2.5, “INSERT Statement”](#)  
[Section 13.3.5, “LOCK TABLES and UNLOCK TABLES Statements”](#)  
[Section 1.6.1, “MySQL Extensions to Standard SQL”](#)  
[Section 21.5.24, “ndb\\_restore — Restore an NDB Cluster Backup”](#)  
[Section 16.4.1.1, “Replication and AUTO\\_INCREMENT”](#)  
[Section 16.4.1.15, “Replication and System Functions”](#)  
[Section 5.1.7, “Server System Variables”](#)  
[Section 23.2.4, “Stored Procedures, Functions, Triggers, and LAST\\_INSERT\\_ID\(\)”](#)  
[Section 16.4.4, “Troubleshooting Replication”](#)  
[Section 23.5.3, “Updatable and Insertable Views”](#)  
[Section 3.6.9, “Using AUTO\\_INCREMENT”](#)

## **LCASE()**

[Section 12.8.3, “Character Set and Collation of Function Results”](#)  
[Section 12.8, “String Functions and Operators”](#)

## **LEAST()**

[Section 12.8.3, “Character Set and Collation of Function Results”](#)  
[Section 12.4.2, “Comparison Functions and Operators”](#)  
[Section 11.5, “The JSON Data Type”](#)

## **LEFT()**

[Section 12.8, “String Functions and Operators”](#)

## **LENGTH()**

[Section 11.7, “Data Type Storage Requirements”](#)  
[Section 12.8, “String Functions and Operators”](#)  
[Section 11.4.3, “Supported Spatial Data Formats”](#)

## **Length()**

[Section 12.16.7.3, “LineString and MultiLineString Property Functions”](#)  
[Section 11.4, “Spatial Data Types”](#)

## **LineFromText()**

[Section 12.16.3, “Functions That Create Geometry Values from WKT Values”](#)

## **LineFromWKB()**

[Section 12.16.4, “Functions That Create Geometry Values from WKB Values”](#)

## **LineString()**

[Section 12.16.5, “MySQL-Specific Functions That Create Geometry Values”](#)

## **LineStringFromText()**

[Section 12.16.3, “Functions That Create Geometry Values from WKT Values”](#)

## **LineStringFromWKB()**

[Section 12.16.4, “Functions That Create Geometry Values from WKB Values”](#)

## **LN()**

[Section 12.6.2, “Mathematical Functions”](#)

---

## **LOAD\_FILE()**

Section 16.2.1.1, “Advantages and Disadvantages of Statement-Based and Row-Based Replication”

Section 16.2.1.3, “Determination of Safe and Unsafe Statements in Binary Logging”

Section 8.10.3.1, “How the Query Cache Operates”

Section 13.2.7, “LOAD XML Statement”

Section 5.4.4.3, “Mixed Binary Logging Format”

Section 6.6.2, “MySQL Enterprise Encryption Usage and Examples”

Section 6.2.2, “Privileges Provided by MySQL”

Section 16.4.1.15, “Replication and System Functions”

Section 5.1.7, “Server System Variables”

Section 12.8, “String Functions and Operators”

## **load\_rewrite\_rules()**

Rewriter Query Rewrite Plugin Procedures and Functions

Section 5.5.4, “The Rewriter Query Rewrite Plugin”

## **LOCALTIME**

Section 11.2.6, “Automatic Initialization and Updating for TIMESTAMP and DATETIME”

Section 12.7, “Date and Time Functions”

## **LOCALTIME()**

Section 11.2.6, “Automatic Initialization and Updating for TIMESTAMP and DATETIME”

Section 12.7, “Date and Time Functions”

Section 16.2.1.3, “Determination of Safe and Unsafe Statements in Binary Logging”

## **LOCALTIMESTAMP**

Section 11.2.6, “Automatic Initialization and Updating for TIMESTAMP and DATETIME”

Section 12.7, “Date and Time Functions”

## **LOCALTIMESTAMP()**

Section 11.2.6, “Automatic Initialization and Updating for TIMESTAMP and DATETIME”

Section 12.7, “Date and Time Functions”

Section 16.2.1.3, “Determination of Safe and Unsafe Statements in Binary Logging”

## **LOCATE()**

Section 12.8, “String Functions and Operators”

## **LOG()**

Section 22.2.4.1, “LINEAR HASH Partitioning”

Section 12.6.2, “Mathematical Functions”

## **LOG10()**

Section 12.6.2, “Mathematical Functions”

## **LOG2()**

Section 12.6.2, “Mathematical Functions”

## **LOWER()**

Section 12.10, “Cast Functions and Operators”

Section 12.8.3, “Character Set and Collation of Function Results”

Section 12.8, “String Functions and Operators”



---

[Section 10.10.1, “Unicode Character Sets”](#)  
[Section 10.8.7, “Using Collation in INFORMATION\\_SCHEMA Searches”](#)

## **LPAD()**

[Section 12.8, “String Functions and Operators”](#)

## **LTRIM()**

[Section 12.8.3, “Character Set and Collation of Function Results”](#)  
[Section 12.8, “String Functions and Operators”](#)

## **M**

[\[index top\]](#)

## **MAKE\_SET()**

[Section 12.8, “String Functions and Operators”](#)

## **MAKEDATE()**

[Section 12.7, “Date and Time Functions”](#)

## **MAKETIME()**

[Section 12.7, “Date and Time Functions”](#)

## **mask\_inner()**

[Section 6.5.5, “MySQL Enterprise Data Masking and De-Identification Function Descriptions”](#)  
[Section 6.5.3, “Using MySQL Enterprise Data Masking and De-Identification”](#)

## **mask\_outer()**

[Section 6.5.5, “MySQL Enterprise Data Masking and De-Identification Function Descriptions”](#)  
[Section 6.5.3, “Using MySQL Enterprise Data Masking and De-Identification”](#)

## **mask\_pan()**

[Section 6.5.5, “MySQL Enterprise Data Masking and De-Identification Function Descriptions”](#)  
[Section 6.5.3, “Using MySQL Enterprise Data Masking and De-Identification”](#)

## **mask\_pan\_relaxed()**

[Section 6.5.5, “MySQL Enterprise Data Masking and De-Identification Function Descriptions”](#)  
[Section 6.5.3, “Using MySQL Enterprise Data Masking and De-Identification”](#)

## **mask\_ssn()**

[Section 6.5.5, “MySQL Enterprise Data Masking and De-Identification Function Descriptions”](#)  
[Section 6.5.3, “Using MySQL Enterprise Data Masking and De-Identification”](#)

## **MASTER\_POS\_WAIT()**

[Section 16.2.1.1, “Advantages and Disadvantages of Statement-Based and Row-Based Replication”](#)  
[Section 16.2.2.1, “Commands for Operations on a Single Channel”](#)  
[Section 16.2.2.2, “Compatibility with Previous Replication Statements”](#)  
[Section 16.2.1.3, “Determination of Safe and Unsafe Statements in Binary Logging”](#)  
[Section 8.10.3.1, “How the Query Cache Operates”](#)  
[Section 12.20, “Miscellaneous Functions”](#)

---

[Section A.14, “MySQL 5.7 FAQ: Replication”](#)

## **MATCH**

[Section 9.5, “Expressions”](#)

## **MATCH ()**

[Section 12.9, “Full-Text Search Functions”](#)

## **MATCH()**

[Section 12.9.2, “Boolean Full-Text Searches”](#)

[Section 12.9.6, “Fine-Tuning MySQL Full-Text Search”](#)

[Section 12.9.5, “Full-Text Restrictions”](#)

[Section 12.9, “Full-Text Search Functions”](#)

[Section 14.6.2.4, “InnoDB Full-Text Indexes”](#)

[MySQL Glossary](#)

[Section 12.9.1, “Natural Language Full-Text Searches”](#)

## **MAX()**

[Section 11.2.10, “2-Digit Years in Dates”](#)

[Section 12.19.1, “Aggregate Function Descriptions”](#)

[Section 8.2.1.15, “GROUP BY Optimization”](#)

[Section 8.3.1, “How MySQL Uses Indexes”](#)

[Section B.3.7, “Known Issues in MySQL”](#)

[Section 21.5.24, “ndb\\_restore — Restore an NDB Cluster Backup”](#)

[Section 11.1.1, “Numeric Data Type Syntax”](#)

[Section 8.2.2.4, “Optimizing Derived Tables and View References with Merging or Materialization”](#)

[Section 13.2.10.10, “Optimizing Subqueries”](#)

[Section 5.1.10, “Server SQL Modes”](#)

[Section 24.5.2, “The INFORMATION\\_SCHEMA TP\\_THREAD\\_GROUP\\_STATE Table”](#)

[Section 11.5, “The JSON Data Type”](#)

[Section 1.2.2, “The Main Features of MySQL”](#)

[Section 23.5.3, “Updatable and Insertable Views”](#)

[Section 8.3.9, “Use of Index Extensions”](#)

[Section 3.6.9, “Using AUTO\\_INCREMENT”](#)

## **MBRContains()**

[Section 12.16.9.2, “Spatial Relation Functions That Use Minimum Bounding Rectangles”](#)

[Section 11.4.10, “Using Spatial Indexes”](#)

## **MBRCoveredBy()**

[Section 12.16.9.2, “Spatial Relation Functions That Use Minimum Bounding Rectangles”](#)

## **MBRCovers()**

[Section 12.16.9.2, “Spatial Relation Functions That Use Minimum Bounding Rectangles”](#)

## **MBRDisjoint()**

[Section 12.16.9.2, “Spatial Relation Functions That Use Minimum Bounding Rectangles”](#)

## **MBREqual()**

[Section 12.16.9.2, “Spatial Relation Functions That Use Minimum Bounding Rectangles”](#)

[Section 1.3, “What Is New in MySQL 5.7”](#)

---

## **MBREquals()**

Section 12.16.9.2, “Spatial Relation Functions That Use Minimum Bounding Rectangles”  
Section 1.3, “What Is New in MySQL 5.7”

## **MBRIntersects()**

Section 12.16.9.2, “Spatial Relation Functions That Use Minimum Bounding Rectangles”

## **MBROverlaps()**

Section 12.16.9.2, “Spatial Relation Functions That Use Minimum Bounding Rectangles”

## **MBRTouches()**

Section 12.16.9.2, “Spatial Relation Functions That Use Minimum Bounding Rectangles”

## **MBRWithin()**

Section 12.16.9.2, “Spatial Relation Functions That Use Minimum Bounding Rectangles”  
Section 11.4.10, “Using Spatial Indexes”

## **MD5()**

Section 12.13, “Encryption and Compression Functions”  
Section 22.2.5, “KEY Partitioning”  
Section 1.6.1, “MySQL Extensions to Standard SQL”  
Section 9.2, “Schema Object Names”

## **MICROSECOND()**

Section 12.7, “Date and Time Functions”  
Section 22.6.3, “Partitioning Limitations Relating to Functions”

## **MID()**

Section 12.8.3, “Character Set and Collation of Function Results”  
Section 12.8, “String Functions and Operators”

## **MIN()**

Section 11.2.10, “2-Digit Years in Dates”  
Section 12.19.1, “Aggregate Function Descriptions”  
Section 8.2.1.15, “GROUP BY Optimization”  
Section 8.3.1, “How MySQL Uses Indexes”  
Section B.3.7, “Known Issues in MySQL”  
Section 21.5.24, “ndb\_restore — Restore an NDB Cluster Backup”  
Section 11.1.1, “Numeric Data Type Syntax”  
Section 8.2.2.4, “Optimizing Derived Tables and View References with Merging or Materialization”  
Section 13.2.10.10, “Optimizing Subqueries”  
Section B.3.4.3, “Problems with NULL Values”  
Section 11.5, “The JSON Data Type”  
Section 1.2.2, “The Main Features of MySQL”  
Section 23.5.3, “Updatable and Insertable Views”  
Section 8.3.9, “Use of Index Extensions”  
Section 8.2.1.1, “WHERE Clause Optimization”

## **MINUTE()**

Section 12.7, “Date and Time Functions”  
Section 22.6.3, “Partitioning Limitations Relating to Functions”

---

## **MLineFromText()**

Section 12.16.3, “Functions That Create Geometry Values from WKT Values”

## **MLineFromWKB()**

Section 12.16.4, “Functions That Create Geometry Values from WKB Values”

## **MOD()**

Section 12.6.1, “Arithmetic Operators”

Section 3.3.4.5, “Date Calculations”

Section 12.6.2, “Mathematical Functions”

Section 1.6.1, “MySQL Extensions to Standard SQL”

Section 22.6.3, “Partitioning Limitations Relating to Functions”

Section 5.1.10, “Server SQL Modes”

## **MONTH()**

Section 12.7, “Date and Time Functions”

Section 3.3.4.5, “Date Calculations”

Section 22.6.3, “Partitioning Limitations Relating to Functions”

Section 22.2, “Partitioning Types”

## **MONTHNAME()**

Section 12.7, “Date and Time Functions”

Section 10.16, “MySQL Server Locale Support”

Section 5.1.7, “Server System Variables”

## **MPointFromText()**

Section 12.16.3, “Functions That Create Geometry Values from WKT Values”

## **MPointFromWKB()**

Section 12.16.4, “Functions That Create Geometry Values from WKB Values”

## **MPolyFromText()**

Section 12.16.3, “Functions That Create Geometry Values from WKT Values”

## **MPolyFromWKB()**

Section 12.16.4, “Functions That Create Geometry Values from WKB Values”

## **MultiLineString()**

Section 12.16.5, “MySQL-Specific Functions That Create Geometry Values”

## **MultiLineStringFromText()**

Section 12.16.3, “Functions That Create Geometry Values from WKT Values”

## **MultiLineStringFromWKB()**

Section 12.16.4, “Functions That Create Geometry Values from WKB Values”

## **MultiPoint()**

Section 12.16.5, “MySQL-Specific Functions That Create Geometry Values”

## **MultiPointFromText()**

Section 12.16.3, “Functions That Create Geometry Values from WKT Values”

---

## **MultiPointFromWKB()**

[Section 12.16.4, “Functions That Create Geometry Values from WKB Values”](#)

## **MultiPolygon()**

[Section 12.16.5, “MySQL-Specific Functions That Create Geometry Values”](#)

## **MultiPolygonFromText()**

[Section 12.16.3, “Functions That Create Geometry Values from WKT Values”](#)

## **MultiPolygonFromWKB()**

[Section 12.16.4, “Functions That Create Geometry Values from WKB Values”](#)

## **my\_open()**

[Section 5.1.9, “Server Status Variables”](#)

## **mysql\_firewall\_flush\_status()**

[Section 6.4.6.4, “MySQL Enterprise Firewall Reference”](#)

## **N**

[\[index top\]](#)

## **NAME\_CONST()**

[Section 12.20, “Miscellaneous Functions”](#)

[Section 23.7, “Stored Program Binary Logging”](#)

## **normalize\_statement()**

[Section 6.4.6.4, “MySQL Enterprise Firewall Reference”](#)

## **NOW()**

[Section 16.2.1.1, “Advantages and Disadvantages of Statement-Based and Row-Based Replication”](#)

[Section 11.2.6, “Automatic Initialization and Updating for TIMESTAMP and DATETIME”](#)

[Section 13.1.16, “CREATE PROCEDURE and CREATE FUNCTION Statements”](#)

[Section 13.1.18.7, “CREATE TABLE and Generated Columns”](#)

[Section 11.6, “Data Type Default Values”](#)

[Section 12.7, “Date and Time Functions”](#)

[Section 16.2.1.3, “Determination of Safe and Unsafe Statements in Binary Logging”](#)

[Section 11.2.7, “Fractional Seconds in Time Values”](#)

[Section 8.10.3.1, “How the Query Cache Operates”](#)

[Section A.1, “MySQL 5.7 FAQ: General”](#)

[Section 5.1.13, “MySQL Server Time Zone Support”](#)

[Section 16.4.1.15, “Replication and System Functions”](#)

[Section 16.4.1.31, “Replication and Time Zones”](#)

[Section 5.1.6, “Server Command Options”](#)

[Section 5.1.7, “Server System Variables”](#)

[Section 26.4.3.21, “The metrics View”](#)

[Section 26.4.4.25, “The statement\\_performance\\_analyzer\(\) Procedure”](#)

[Section 11.2.4, “The YEAR Type”](#)

## **NULLIF()**

[Section 12.5, “Flow Control Functions”](#)

---

## **NumGeometries()**

[Section 12.16.7.5, “GeometryCollection Property Functions”](#)

## **NumInteriorRings()**

[Section 12.16.7.4, “Polygon and MultiPolygon Property Functions”](#)

## **NumPoints()**

[Section 12.16.7.3, “LineString and MultiLineString Property Functions”](#)

## **O**

[\[index top\]](#)

## **OCT()**

[Section 12.8, “String Functions and Operators”](#)

## **OCTET\_LENGTH()**

[Section 12.8, “String Functions and Operators”](#)

## **ORD()**

[Section 12.8, “String Functions and Operators”](#)

## **Overlaps()**

[Section 12.16.9.2, “Spatial Relation Functions That Use Minimum Bounding Rectangles”](#)

## **P**

[\[index top\]](#)

## **PASSWORD()**

[Section 16.2.1.3, “Determination of Safe and Unsafe Statements in Binary Logging”](#)

[Section 12.13, “Encryption and Compression Functions”](#)

[Section 8.10.3.1, “How the Query Cache Operates”](#)

[Section B.3.2.13, “Ignoring user”](#)

[Section 22.2.5, “KEY Partitioning”](#)

[Section 1.6.1, “MySQL Extensions to Standard SQL”](#)

[Section 6.1.2.4, “Password Hashing in MySQL”](#)

[Section 6.4.3.2, “Password Validation Plugin Options and Variables”](#)

[Section 6.1.2.3, “Passwords and Logging”](#)

[Section 5.1.7, “Server System Variables”](#)

[Section 13.7.1.7, “SET PASSWORD Statement”](#)

[Section 6.4.3, “The Password Validation Plugin”](#)

[Section 1.3, “What Is New in MySQL 5.7”](#)

## **PERIOD\_ADD()**

[Section 12.7, “Date and Time Functions”](#)

[Section 1.6.1, “MySQL Extensions to Standard SQL”](#)

## **PERIOD\_DIFF()**

[Section 12.7, “Date and Time Functions”](#)

[Section 1.6.1, “MySQL Extensions to Standard SQL”](#)

---

## **PI()**

Section 9.2.5, “Function Name Parsing and Resolution”  
Section 12.6.2, “Mathematical Functions”

## **Point()**

Section 12.16.5, “MySQL-Specific Functions That Create Geometry Values”  
Section 11.4.3, “Supported Spatial Data Formats”

## **PointFromText()**

Section 12.16.3, “Functions That Create Geometry Values from WKT Values”

## **PointFromWKB()**

Section 12.16.4, “Functions That Create Geometry Values from WKB Values”

## **PointN()**

Section 12.16.7.3, “LineString and MultiLineString Property Functions”

## **PolyFromText()**

Section 12.16.3, “Functions That Create Geometry Values from WKT Values”

## **PolyFromWKB()**

Section 12.16.4, “Functions That Create Geometry Values from WKB Values”

## **Polygon()**

Section 12.16.5, “MySQL-Specific Functions That Create Geometry Values”

## **PolygonFromText()**

Section 12.16.3, “Functions That Create Geometry Values from WKT Values”

## **PolygonFromWKB()**

Section 12.16.4, “Functions That Create Geometry Values from WKB Values”

## **POSITION()**

Section 12.8, “String Functions and Operators”

## **POW()**

Section 8.2.1.18, “Function Call Optimization”  
Section 22.2.4, “HASH Partitioning”  
Section 12.6.2, “Mathematical Functions”

## **POWER()**

Section 22.2.4.1, “LINEAR HASH Partitioning”  
Section 12.6.2, “Mathematical Functions”

## **Q**

[\[index top\]](#)

## **QUARTER()**

Section 12.7, “Date and Time Functions”

---

[Section 22.6.3, “Partitioning Limitations Relating to Functions”](#)

## **QUOTE()**

[Section 12.8, “String Functions and Operators”](#)

[Section 9.1.1, “String Literals”](#)

## **R**

[\[index top\]](#)

## **RADIANS()**

[Section 12.6.2, “Mathematical Functions”](#)

## **RAND()**

[Section 16.2.1.1, “Advantages and Disadvantages of Statement-Based and Row-Based Replication”](#)

[Section 13.1.16, “CREATE PROCEDURE and CREATE FUNCTION Statements”](#)

[Section 16.2.1.3, “Determination of Safe and Unsafe Statements in Binary Logging”](#)

[Section 8.2.1.18, “Function Call Optimization”](#)

[Section 8.10.3.1, “How the Query Cache Operates”](#)

[Section 12.6.2, “Mathematical Functions”](#)

[Section 16.4.1.15, “Replication and System Functions”](#)

[Section 5.1.7, “Server System Variables”](#)

## **RANDOM\_BYTES()**

[Section 12.13, “Encryption and Compression Functions”](#)

[Section 8.10.3.1, “How the Query Cache Operates”](#)

## **read\_firewall\_users()**

[Section 6.4.6.4, “MySQL Enterprise Firewall Reference”](#)

## **read\_firewall\_whitelist()**

[Section 6.4.6.4, “MySQL Enterprise Firewall Reference”](#)

## **RELEASE\_ALL\_LOCKS()**

[Section 2.10.3, “Changes in MySQL 5.7”](#)

[Section 8.10.3.1, “How the Query Cache Operates”](#)

[Section 12.14, “Locking Functions”](#)

## **RELEASE\_LOCK()**

[Section 16.2.1.1, “Advantages and Disadvantages of Statement-Based and Row-Based Replication”](#)

[Section 16.2.1.3, “Determination of Safe and Unsafe Statements in Binary Logging”](#)

[Section 13.2.3, “DO Statement”](#)

[Section 8.10.3.1, “How the Query Cache Operates”](#)

[Section 8.11.1, “Internal Locking Methods”](#)

[Section 13.3.5, “LOCK TABLES and UNLOCK TABLES Statements”](#)

[Section 12.14, “Locking Functions”](#)

[Section 16.4.1.15, “Replication and System Functions”](#)

## **REPEAT()**

[Section 12.8.3, “Character Set and Collation of Function Results”](#)

[Section 12.8, “String Functions and Operators”](#)



---

## **REPLACE()**

Section 12.8.3, “Character Set and Collation of Function Results”  
Section 12.8, “String Functions and Operators”

## **REVERSE()**

Section 12.8.3, “Character Set and Collation of Function Results”  
Section 12.8, “String Functions and Operators”

## **RIGHT()**

Section 12.8.3, “Character Set and Collation of Function Results”  
Section 12.8, “String Functions and Operators”

## **ROUND()**

Section 14.16.3, “InnoDB INFORMATION\_SCHEMA System Tables”  
Section 12.6.2, “Mathematical Functions”  
Section 12.21, “Precision Math”  
Section 12.21.5, “Precision Math Examples”  
Section 12.21.4, “Rounding Behavior”

## **ROW\_COUNT()**

Section 13.2.1, “CALL Statement”  
Section 13.2.2, “DELETE Statement”  
Section 16.2.1.3, “Determination of Safe and Unsafe Statements in Binary Logging”  
Section 12.15, “Information Functions”  
Section 13.2.5, “INSERT Statement”  
Section 5.4.4.3, “Mixed Binary Logging Format”  
Section 16.4.1.15, “Replication and System Functions”  
Section 5.1.9, “Server Status Variables”  
Section 13.6.7.7, “The MySQL Diagnostics Area”

## **RPAD()**

Section 12.8.3, “Character Set and Collation of Function Results”  
Section 12.8, “String Functions and Operators”

## **RTRIM()**

Section 12.8.3, “Character Set and Collation of Function Results”  
Section 12.8, “String Functions and Operators”

## **S**

[\[index top\]](#)

## **SCHEMA()**

Section 12.15, “Information Functions”

## **SEC\_TO\_TIME()**

Section 12.7, “Date and Time Functions”

## **SECOND()**

Section 12.7, “Date and Time Functions”

---

Section 22.6.3, “Partitioning Limitations Relating to Functions”

## **service\_get\_read\_locks()**

The Locking Service Function Interface

## **service\_get\_write\_locks()**

The Locking Service Function Interface

## **service\_release\_locks()**

The Locking Service Function Interface

## **SESSION\_USER()**

Section 16.2.1.3, “Determination of Safe and Unsafe Statements in Binary Logging”

Section 12.15, “Information Functions”

Section 10.2.2, “UTF-8 for Metadata”

## **set\_firewall\_mode()**

Section 6.4.6.4, “MySQL Enterprise Firewall Reference”

## **setrlimit()**

Section 5.1.7, “Server System Variables”

## **SHA()**

Section 12.13, “Encryption and Compression Functions”

## **SHA1()**

Section 12.13, “Encryption and Compression Functions”

## **SHA2()**

Section 12.13, “Encryption and Compression Functions”

Section 6.1.1, “Security Guidelines”

Section 5.1.7, “Server System Variables”

Section 1.3, “What Is New in MySQL 5.7”

## **SIGN()**

Section 12.6.2, “Mathematical Functions”

## **SIN()**

Section 12.6.2, “Mathematical Functions”

## **SLEEP()**

Section 16.2.1.1, “Advantages and Disadvantages of Statement-Based and Row-Based Replication”

Section 16.2.1.3, “Determination of Safe and Unsafe Statements in Binary Logging”

Section 8.14.3, “General Thread States”

Section 8.10.3.1, “How the Query Cache Operates”

Section 12.20, “Miscellaneous Functions”

Section 24.5.3, “The INFORMATION\_SCHEMA TP\_THREAD\_GROUP\_STATS Table”

## **SOUNDEX()**

Section 12.8.3, “Character Set and Collation of Function Results”

Section 12.8, “String Functions and Operators”

---

## **SOURCE\_POS\_WAIT()**

Section A.14, “MySQL 5.7 FAQ: Replication”

## **SPACE()**

Section 12.8.3, “Character Set and Collation of Function Results”

Section 12.8, “String Functions and Operators”

## **SQRT()**

Section 12.6.2, “Mathematical Functions”

## **SRID()**

Section 12.16.7.1, “General Geometry Property Functions”

## **ST\_Area()**

Section 12.16.7, “Geometry Property Functions”

Section 12.16.7.4, “Polygon and MultiPolygon Property Functions”

## **ST\_AsBinary()**

Section 11.4.7, “Fetching Spatial Data”

Section 12.16.6, “Geometry Format Conversion Functions”

## **ST\_AsGeoJSON()**

Section 12.16.11, “Spatial GeoJSON Functions”

Section 11.5, “The JSON Data Type”

## **ST\_AsText()**

Section 11.4.7, “Fetching Spatial Data”

Section 12.16.6, “Geometry Format Conversion Functions”

## **ST\_AsWKB()**

Section 12.16.6, “Geometry Format Conversion Functions”

## **ST\_AsWKT()**

Section 12.16.6, “Geometry Format Conversion Functions”

## **ST\_Buffer()**

Section 12.16.8, “Spatial Operator Functions”

## **ST\_Buffer\_Strategy()**

Section 5.1.7, “Server System Variables”

Section 12.16.8, “Spatial Operator Functions”

## **ST\_Centroid()**

Section 12.16.7.4, “Polygon and MultiPolygon Property Functions”

## **ST\_Contains()**

Section 12.16.9.1, “Spatial Relation Functions That Use Object Shapes”

## **ST\_ConvexHull()**

Section 12.16.8, “Spatial Operator Functions”

---

## **ST\_Crosses()**

[Section 12.16.9.1, "Spatial Relation Functions That Use Object Shapes"](#)

## **ST\_Difference()**

[Section 12.16.8, "Spatial Operator Functions"](#)

## **ST\_Dimension()**

[Section 12.16.7.1, "General Geometry Property Functions"](#)

## **ST\_Disjoint()**

[Section 12.16.9.1, "Spatial Relation Functions That Use Object Shapes"](#)

## **ST\_Distance()**

[Section 12.16.9.1, "Spatial Relation Functions That Use Object Shapes"](#)

## **ST\_Distance\_Sphere()**

[Section 12.16.12, "Spatial Convenience Functions"](#)

## **ST\_EndPoint()**

[Section 12.16.7.3, "LineString and MultiLineString Property Functions"](#)

[Section 12.16.8, "Spatial Operator Functions"](#)

## **ST\_Envelope()**

[Section 12.16.7.1, "General Geometry Property Functions"](#)

[Section 12.16.8, "Spatial Operator Functions"](#)

## **ST\_Equals()**

[Section 12.16.9.1, "Spatial Relation Functions That Use Object Shapes"](#)

## **ST\_ExteriorRing()**

[Section 12.16.7.4, "Polygon and MultiPolygon Property Functions"](#)

[Section 12.16.8, "Spatial Operator Functions"](#)

## **ST\_GeoHash()**

[Section 12.16.10, "Spatial Geohash Functions"](#)

## **ST\_GeomCollFromText()**

[Section 12.16.3, "Functions That Create Geometry Values from WKT Values"](#)

## **ST\_GeomCollFromTxt()**

[Section 12.16.3, "Functions That Create Geometry Values from WKT Values"](#)

## **ST\_GeomCollFromWKB()**

[Section 12.16.4, "Functions That Create Geometry Values from WKB Values"](#)

## **ST\_GeometryCollectionFromText()**

[Section 12.16.3, "Functions That Create Geometry Values from WKT Values"](#)

## **ST\_GeometryCollectionFromWKB()**

[Section 12.16.4, "Functions That Create Geometry Values from WKB Values"](#)

---

## **ST\_GeometryFromText()**

Section 12.16.3, “Functions That Create Geometry Values from WKT Values”

## **ST\_GeometryFromWKB()**

Section 12.16.4, “Functions That Create Geometry Values from WKB Values”

## **ST\_GeometryN()**

Section 12.16.7.5, “GeometryCollection Property Functions”

Section 12.16.8, “Spatial Operator Functions”

## **ST\_GeometryType()**

Section 12.16.7.1, “General Geometry Property Functions”

## **ST\_GeomFromGeoJSON()**

Section 12.16.11, “Spatial GeoJSON Functions”

Section 11.5, “The JSON Data Type”

## **ST\_GeomFromText()**

Section 12.16.3, “Functions That Create Geometry Values from WKT Values”

Section 11.4.6, “Populating Spatial Columns”

Section 11.4.3, “Supported Spatial Data Formats”

## **ST\_GeomFromWKB()**

Section 12.16.4, “Functions That Create Geometry Values from WKB Values”

## **ST\_InteriorRingN()**

Section 12.16.7.4, “Polygon and MultiPolygon Property Functions”

Section 12.16.8, “Spatial Operator Functions”

## **ST\_Intersection()**

Section 12.16.8, “Spatial Operator Functions”

## **ST\_Intersects()**

Section 12.16.9.1, “Spatial Relation Functions That Use Object Shapes”

## **ST\_IsClosed()**

Section 12.16.7.3, “LineString and MultiLineString Property Functions”

## **ST\_IsEmpty()**

Section 12.16.7.1, “General Geometry Property Functions”

## **ST\_IsSimple()**

Section 12.16.7.1, “General Geometry Property Functions”

## **ST\_IsValid()**

Section 11.4.4, “Geometry Well-Formedness and Validity”

Section 12.16.12, “Spatial Convenience Functions”

## **ST\_LatFromGeoHash()**

Section 12.16.10, “Spatial Geohash Functions”

---

## **ST\_Length()**

Section 12.16.7.3, “LineString and MultiLineString Property Functions”

Section 11.4, “Spatial Data Types”

Section 12.8, “String Functions and Operators”

## **ST\_LineFromText()**

Section 12.16.3, “Functions That Create Geometry Values from WKT Values”

## **ST\_LineFromWKB()**

Section 12.16.4, “Functions That Create Geometry Values from WKB Values”

## **ST\_LineStringFromText()**

Section 12.16.3, “Functions That Create Geometry Values from WKT Values”

## **ST\_LineStringFromWKB()**

Section 12.16.4, “Functions That Create Geometry Values from WKB Values”

## **ST\_LongFromGeoHash()**

Section 12.16.10, “Spatial Geohash Functions”

## **ST\_MakeEnvelope()**

Section 12.16.12, “Spatial Convenience Functions”

## **ST\_MLineFromText()**

Section 12.16.3, “Functions That Create Geometry Values from WKT Values”

## **ST\_MLineFromWKB()**

Section 12.16.4, “Functions That Create Geometry Values from WKB Values”

## **ST\_MPointFromText()**

Section 12.16.3, “Functions That Create Geometry Values from WKT Values”

Section 11.4.3, “Supported Spatial Data Formats”

## **ST\_MPointFromWKB()**

Section 12.16.4, “Functions That Create Geometry Values from WKB Values”

## **ST\_MPolyFromText()**

Section 12.16.3, “Functions That Create Geometry Values from WKT Values”

## **ST\_MPolyFromWKB()**

Section 12.16.4, “Functions That Create Geometry Values from WKB Values”

## **ST\_MultiLineStringFromText()**

Section 12.16.3, “Functions That Create Geometry Values from WKT Values”

## **ST\_MultiLineStringFromWKB()**

Section 12.16.4, “Functions That Create Geometry Values from WKB Values”

## **ST\_MultiPointFromText()**

Section 12.16.3, “Functions That Create Geometry Values from WKT Values”

---

## **ST\_MultiPointFromWKB()**

Section 12.16.4, “Functions That Create Geometry Values from WKB Values”

## **ST\_MultiPolygonFromText()**

Section 12.16.3, “Functions That Create Geometry Values from WKT Values”

## **ST\_MultiPolygonFromWKB()**

Section 12.16.4, “Functions That Create Geometry Values from WKB Values”

## **ST\_NumGeometries()**

Section 12.16.7.5, “GeometryCollection Property Functions”

## **ST\_NumInteriorRing()**

Section 12.16.7.4, “Polygon and MultiPolygon Property Functions”

## **ST\_NumInteriorRings()**

Section 12.16.7.4, “Polygon and MultiPolygon Property Functions”

## **ST\_NumPoints()**

Section 12.16.7.3, “LineString and MultiLineString Property Functions”

## **ST\_Overlaps()**

Section 12.16.9.1, “Spatial Relation Functions That Use Object Shapes”

## **ST\_PointFromGeoHash()**

Section 12.16.10, “Spatial Geohash Functions”

## **ST\_PointFromText()**

Section 12.16.3, “Functions That Create Geometry Values from WKT Values”

## **ST\_PointFromWKB()**

Section 12.16.4, “Functions That Create Geometry Values from WKB Values”

## **ST\_PointN()**

Section 12.16.7.3, “LineString and MultiLineString Property Functions”

Section 12.16.8, “Spatial Operator Functions”

## **ST\_PolyFromText()**

Section 12.16.3, “Functions That Create Geometry Values from WKT Values”

## **ST\_PolyFromWKB()**

Section 12.16.4, “Functions That Create Geometry Values from WKB Values”

## **ST\_PolygonFromText()**

Section 12.16.3, “Functions That Create Geometry Values from WKT Values”

## **ST\_PolygonFromWKB()**

Section 12.16.4, “Functions That Create Geometry Values from WKB Values”

---

## **ST\_Simplify()**

[Section 12.16.12, “Spatial Convenience Functions”](#)

## **ST\_SRID()**

[Section 12.16.7.1, “General Geometry Property Functions”](#)

## **ST\_StartPoint()**

[Section 12.16.7.3, “LineString and MultiLineString Property Functions”](#)

[Section 12.16.8, “Spatial Operator Functions”](#)

## **ST\_SymDifference()**

[Section 12.16.8, “Spatial Operator Functions”](#)

## **ST\_Touches()**

[Section 12.16.9.1, “Spatial Relation Functions That Use Object Shapes”](#)

## **ST\_Union()**

[Section 12.16.8, “Spatial Operator Functions”](#)

## **ST\_Validate()**

[Section 12.16.12, “Spatial Convenience Functions”](#)

## **ST\_Within()**

[Section 12.16.9.1, “Spatial Relation Functions That Use Object Shapes”](#)

## **ST\_X()**

[Section 12.16.7.2, “Point Property Functions”](#)

[Section 11.4.3, “Supported Spatial Data Formats”](#)

## **ST\_Y()**

[Section 12.16.7.2, “Point Property Functions”](#)

## **StartPoint()**

[Section 12.16.7.3, “LineString and MultiLineString Property Functions”](#)

## **STD()**

[Section 12.19.1, “Aggregate Function Descriptions”](#)

[Section 1.6.1, “MySQL Extensions to Standard SQL”](#)

[Section 1.2.2, “The Main Features of MySQL”](#)

## **STDDEV()**

[Section 12.19.1, “Aggregate Function Descriptions”](#)

## **STDDEV\_POP()**

[Section 12.19.1, “Aggregate Function Descriptions”](#)

## **STDDEV\_SAMP()**

[Section 12.19.1, “Aggregate Function Descriptions”](#)

## **STR\_TO\_DATE()**

[Section 11.2, “Date and Time Data Types”](#)



---

Section 12.7, “Date and Time Functions”  
Section 10.16, “MySQL Server Locale Support”

## **STRCMP()**

Section B.3.4.2, “Problems Using DATE Columns”  
Section 12.8.1, “String Comparison Functions and Operators”

## **SUBDATE()**

Section 12.7, “Date and Time Functions”

## **SUBSTR()**

Section 12.8, “String Functions and Operators”

## **SUBSTRING()**

Section 12.8.3, “Character Set and Collation of Function Results”  
Section 12.8, “String Functions and Operators”

## **SUBSTRING\_INDEX()**

Section 6.2.18, “SQL-Based Account Activity Auditing”  
Section 12.8, “String Functions and Operators”

## **SUBTIME()**

Section 12.7, “Date and Time Functions”

## **SUM()**

Section 12.19.1, “Aggregate Function Descriptions”  
Section 13.7.3.1, “CREATE FUNCTION Statement for Loadable Functions”  
Section 11.2.1, “Date and Time Data Type Syntax”  
Section 8.2.1.15, “GROUP BY Optimization”  
Section 12.20, “Miscellaneous Functions”  
Section 8.2.2.4, “Optimizing Derived Tables and View References with Merging or Materialization”  
Section B.3.4.3, “Problems with NULL Values”  
Section 11.3.5, “The ENUM Type”  
Section 1.2.2, “The Main Features of MySQL”  
Section 11.3.6, “The SET Type”  
Section 23.5.3, “Updatable and Insertable Views”

## **SYSDATE()**

Section 16.2.1.1, “Advantages and Disadvantages of Statement-Based and Row-Based Replication”  
Section 12.7, “Date and Time Functions”  
Section 16.2.1.3, “Determination of Safe and Unsafe Statements in Binary Logging”  
Section 8.10.3.1, “How the Query Cache Operates”  
Section 16.4.1.13, “Replication and Fractional Seconds Support”  
Section 16.4.1.15, “Replication and System Functions”  
Section 5.1.6, “Server Command Options”  
Section 5.1.7, “Server System Variables”

## **SYSTEM\_USER()**

Section 16.2.1.3, “Determination of Safe and Unsafe Statements in Binary Logging”  
Section 12.15, “Information Functions”  
Section 10.2.2, “UTF-8 for Metadata”

---

## T

[\[index top\]](#)

### **TAN()**

[Section 12.6.2, “Mathematical Functions”](#)

### **TIME()**

[Section 12.7, “Date and Time Functions”](#)

### **TIME\_FORMAT()**

[Section 12.10, “Cast Functions and Operators”](#)

[Section 12.7, “Date and Time Functions”](#)

### **TIME\_TO\_SEC()**

[Section 12.7, “Date and Time Functions”](#)

[Section 22.6.3, “Partitioning Limitations Relating to Functions”](#)

### **TIMEDIFF()**

[Section 12.7, “Date and Time Functions”](#)

### **TIMESTAMP()**

[Section 12.7, “Date and Time Functions”](#)

### **TIMESTAMPADD()**

[Section 12.7, “Date and Time Functions”](#)

### **TIMESTAMPDIFF()**

[Section 12.7, “Date and Time Functions”](#)

[Section 3.3.4.5, “Date Calculations”](#)

### **TO\_BASE64()**

[Section 12.8, “String Functions and Operators”](#)

### **TO\_DAYS()**

[Section 12.7, “Date and Time Functions”](#)

[Section 22.2.4, “HASH Partitioning”](#)

[Section 1.6.1, “MySQL Extensions to Standard SQL”](#)

[Section 22.4, “Partition Pruning”](#)

[Section 22.6.3, “Partitioning Limitations Relating to Functions”](#)

[Section 22.2, “Partitioning Types”](#)

### **TO\_SECONDS()**

[Section 12.7, “Date and Time Functions”](#)

[Section 22.4, “Partition Pruning”](#)

[Section 22.6.3, “Partitioning Limitations Relating to Functions”](#)

[Section 22.2, “Partitioning Types”](#)

### **Touches()**

[Section 12.16.9.1, “Spatial Relation Functions That Use Object Shapes”](#)

---

## **TRIM()**

Section 12.8.3, “Character Set and Collation of Function Results”

Section 10.7, “Column Character Set Conversion”

Section 1.6.1, “MySQL Extensions to Standard SQL”

Section 12.8, “String Functions and Operators”

## **TRUNCATE()**

Section 12.6.2, “Mathematical Functions”

## **U**

[\[index top\]](#)

## **UCASE()**

Section 12.8.3, “Character Set and Collation of Function Results”

Section 12.8, “String Functions and Operators”

## **UNCOMPRESS()**

Section 12.13, “Encryption and Compression Functions”

Section 2.8.7, “MySQL Source-Configuration Options”

Section 5.1.7, “Server System Variables”

## **UNCOMPRESSED\_LENGTH()**

Section 12.13, “Encryption and Compression Functions”

## **UNHEX()**

Section 12.13, “Encryption and Compression Functions”

Section 4.5.1.1, “mysql Client Options”

Section 12.8, “String Functions and Operators”

## **UNIX\_TIMESTAMP()**

Section 12.7, “Date and Time Functions”

Section 16.2.1.3, “Determination of Safe and Unsafe Statements in Binary Logging”

Section 8.10.3.1, “How the Query Cache Operates”

Section 8.3.11, “Indexed Lookups from TIMESTAMP Columns”

Section 22.6.3, “Partitioning Limitations Relating to Functions”

Section 22.2.1, “RANGE Partitioning”

Section 5.1.7, “Server System Variables”

Section 26.4.3.21, “The metrics View”

Section B.3.3.7, “Time Zone Problems”

## **UpdateXML()**

Section 12.11, “XML Functions”

## **UPPER()**

Section 12.10, “Cast Functions and Operators”

Section 12.8.3, “Character Set and Collation of Function Results”

Section 10.2.1, “Character Set Repertoire”

Section 12.8, “String Functions and Operators”

Section 10.10.1, “Unicode Character Sets”

Section 10.8.7, “Using Collation in INFORMATION\_SCHEMA Searches”

---

## **USER()**

Section 16.2.1.1, “Advantages and Disadvantages of Statement-Based and Row-Based Replication”

Section 13.7.1.1, “ALTER USER Statement”

Section 10.8.4, “Collation Coercibility in Expressions”

Section 16.2.1.3, “Determination of Safe and Unsafe Statements in Binary Logging”

Section 8.10.3.1, “How the Query Cache Operates”

Section 12.15, “Information Functions”

Section 5.4.4.3, “Mixed Binary Logging Format”

Section 6.4.3.2, “Password Validation Plugin Options and Variables”

Section 6.2.14, “Proxy Users”

Section 16.4.1.15, “Replication and System Functions”

Section 6.2.18, “SQL-Based Account Activity Auditing”

Section 10.2.2, “UTF-8 for Metadata”

## **UTC\_DATE**

Section 12.7, “Date and Time Functions”

## **UTC\_DATE()**

Section 12.7, “Date and Time Functions”

Section 16.2.1.3, “Determination of Safe and Unsafe Statements in Binary Logging”

## **UTC\_TIME**

Section 12.7, “Date and Time Functions”

## **UTC\_TIME()**

Section 12.7, “Date and Time Functions”

Section 16.2.1.3, “Determination of Safe and Unsafe Statements in Binary Logging”

## **UTC\_TIMESTAMP**

Section 12.7, “Date and Time Functions”

## **UTC\_TIMESTAMP()**

Section 12.7, “Date and Time Functions”

Section 16.2.1.3, “Determination of Safe and Unsafe Statements in Binary Logging”

Section 5.1.13, “MySQL Server Time Zone Support”

Section 16.4.1.13, “Replication and Fractional Seconds Support”

## **UUID()**

Section 16.2.1.1, “Advantages and Disadvantages of Statement-Based and Row-Based Replication”

Section 16.1.6.4, “Binary Logging Options and Variables”

Section 16.2.1.3, “Determination of Safe and Unsafe Statements in Binary Logging”

Section 8.2.1.18, “Function Call Optimization”

Section 8.10.3.1, “How the Query Cache Operates”

Section 12.20, “Miscellaneous Functions”

Section 5.4.4.3, “Mixed Binary Logging Format”

Section 16.4.1.15, “Replication and System Functions”

Section 5.4.4.2, “Setting The Binary Log Format”

Section 23.7, “Stored Program Binary Logging”

## **UUID\_SHORT()**

Section 16.2.1.1, “Advantages and Disadvantages of Statement-Based and Row-Based Replication”

---

[Section 16.2.1.3, “Determination of Safe and Unsafe Statements in Binary Logging”](#)  
[Section 8.10.3.1, “How the Query Cache Operates”](#)  
[Section 12.20, “Miscellaneous Functions”](#)

## V

[\[index top\]](#)

### **VALIDATE\_PASSWORD\_STRENGTH()**

[Section 12.13, “Encryption and Compression Functions”](#)  
[Section 6.4.3.2, “Password Validation Plugin Options and Variables”](#)  
[Section 6.4.3, “The Password Validation Plugin”](#)

### **VALUES()**

[Section 13.2.5.2, “INSERT ... ON DUPLICATE KEY UPDATE Statement”](#)  
[Section 12.20, “Miscellaneous Functions”](#)

### **VAR\_POP()**

[Section 12.19.1, “Aggregate Function Descriptions”](#)

### **VAR\_SAMP()**

[Section 12.19.1, “Aggregate Function Descriptions”](#)

### **VARIANCE()**

[Section 12.19.1, “Aggregate Function Descriptions”](#)

### **VERSION()**

[Section 16.2.1.1, “Advantages and Disadvantages of Statement-Based and Row-Based Replication”](#)  
[Section 6.4.5.4, “Audit Log File Formats”](#)  
[Section B.3.4.1, “Case Sensitivity in String Searches”](#)  
[Section 10.8.4, “Collation Coercibility in Expressions”](#)  
[Section 12.15, “Information Functions”](#)  
[Section 16.4.1.15, “Replication and System Functions”](#)  
[Section 26.4.3.47, “The version View”](#)  
[Section 10.2.2, “UTF-8 for Metadata”](#)  
[Section 1.3, “What Is New in MySQL 5.7”](#)

### **version\_tokens\_delete()**

[Section 5.5.5.3, “Using Version Tokens”](#)  
[Section 5.5.5.4, “Version Tokens Reference”](#)

### **version\_tokens\_edit()**

[Section 5.5.5.3, “Using Version Tokens”](#)  
[Section 5.5.5.4, “Version Tokens Reference”](#)

### **version\_tokens\_lock\_exclusive()**

[Section 5.5.5.3, “Using Version Tokens”](#)  
[Section 5.5.5.4, “Version Tokens Reference”](#)

### **version\_tokens\_lock\_shared()**

[Section 5.5.5.3, “Using Version Tokens”](#)  
[Section 5.5.5.4, “Version Tokens Reference”](#)

---

## **version\_tokens\_set()**

Section 5.5.5.3, “Using Version Tokens”  
Section 5.5.5.4, “Version Tokens Reference”

## **version\_tokens\_show()**

Section 5.5.5.3, “Using Version Tokens”  
Section 5.5.5.4, “Version Tokens Reference”

## **version\_tokens\_unlock()**

Section 5.5.5.3, “Using Version Tokens”  
Section 5.5.5.4, “Version Tokens Reference”

## **W**

[\[index top\]](#)

## **WAIT\_FOR\_EXECUTED\_GTID\_SET()**

Section 12.18, “Functions Used with Global Transaction Identifiers (GTIDs)”  
Section 16.1.4.1, “Replication Mode Concepts”

## **WAIT\_UNTIL\_SQL\_THREAD\_AFTER\_GTIDS()**

Section 16.2.2.1, “Commands for Operations on a Single Channel”  
Section 16.2.2.2, “Compatibility with Previous Replication Statements”  
Section 12.18, “Functions Used with Global Transaction Identifiers (GTIDs)”  
Section 13.4.2.5, “START SLAVE Statement”

## **WEEK()**

Section 12.7, “Date and Time Functions”  
Section 5.1.7, “Server System Variables”

## **WEEKDAY()**

Section 12.7, “Date and Time Functions”  
Section 1.6.1, “MySQL Extensions to Standard SQL”  
Section 22.6.3, “Partitioning Limitations Relating to Functions”  
Section 22.2, “Partitioning Types”

## **WEEKOFYEAR()**

Section 12.7, “Date and Time Functions”

## **WEIGHT\_STRING()**

Section 10.14, “Adding a Collation to a Character Set”  
Section B.3.4.1, “Case Sensitivity in String Searches”  
Section 12.8, “String Functions and Operators”  
Section 10.10.1, “Unicode Character Sets”

## **Within()**

Section 12.16.9.2, “Spatial Relation Functions That Use Minimum Bounding Rectangles”

## **X**

[\[index top\]](#)

---

## **X()**

[Section 12.16.7.2, "Point Property Functions"](#)

## **Y**

[\[index top\]](#)

## **Y()**

[Section 12.16.7.2, "Point Property Functions"](#)

## **YEAR()**

[Section 12.7, "Date and Time Functions"](#)

[Section 3.3.4.5, "Date Calculations"](#)

[Section 22.2.4, "HASH Partitioning"](#)

[Section 22.2.7, "How MySQL Partitioning Handles NULL"](#)

[Section 22.3.1, "Management of RANGE and LIST Partitions"](#)

[Section 22.4, "Partition Pruning"](#)

[Section 22.6.3, "Partitioning Limitations Relating to Functions"](#)

[Section 22.2, "Partitioning Types"](#)

[Section 22.2.1, "RANGE Partitioning"](#)

## **YEARWEEK()**

[Section 12.7, "Date and Time Functions"](#)

[Section 22.6.3, "Partitioning Limitations Relating to Functions"](#)

# INFORMATION\_SCHEMA Index

[C](#) | [E](#) | [F](#) | [G](#) | [I](#) | [K](#) | [M](#) | [N](#) | [O](#) | [P](#) | [R](#) | [S](#) | [T](#) | [U](#) | [V](#)

## **C**

[\[index top\]](#)

### **CHARACTER\_SETS**

[Section 10.3.8, "Character Set Introducers"](#)

[Section 10.2, "Character Sets and Collations in MySQL"](#)

[Section 10.3.6, "Character String Literal Character Set and Collation"](#)

[Section 10.3.5, "Column Character Set and Collation"](#)

[Section 10.3.3, "Database Character Set and Collation"](#)

[Section 13.7.5.3, "SHOW CHARACTER SET Statement"](#)

[Section 10.10, "Supported Character Sets and Collations"](#)

[Section 10.3.4, "Table Character Set and Collation"](#)

[Section 24.3.2, "The INFORMATION\\_SCHEMA CHARACTER\\_SETS Table"](#)

### **COLLATION\_CHARACTER\_SET\_APPLICABILITY**

[Section 24.3.4, "The INFORMATION\\_SCHEMA COLLATION\\_CHARACTER\\_SET\\_APPLICABILITY Table"](#)

### **COLLATIONS**

[Section 10.15, "Character Set Configuration"](#)

[Section 10.2, "Character Sets and Collations in MySQL"](#)

[Section 10.14.2, "Choosing a Collation ID"](#)

[Section 8.2.3, "Optimizing INFORMATION\\_SCHEMA Queries"](#)

---

Section 13.7.5.4, “SHOW COLLATION Statement”  
Section 24.3.3, “The INFORMATION\_SCHEMA COLLATIONS Table”

## **COLUMN\_PRIVILEGES**

Section 24.3.6, “The INFORMATION\_SCHEMA COLUMN\_PRIVILEGES Table”

## **COLUMNS**

Section 13.1.18, “CREATE TABLE Statement”  
Section 21.5.15, “ndb\_index\_stat — NDB Index Statistics Utility”  
Section 8.2.3, “Optimizing INFORMATION\_SCHEMA Queries”  
Section 5.1.7, “Server System Variables”  
Section 13.7.5.5, “SHOW COLUMNS Statement”  
Section 24.3.5, “The INFORMATION\_SCHEMA COLUMNS Table”  
Section 24.4.2, “The INFORMATION\_SCHEMA INNODB\_BUFFER\_PAGE Table”  
Section 24.4.3, “The INFORMATION\_SCHEMA INNODB\_BUFFER\_PAGE\_LRU Table”  
Section 24.4.4, “The INFORMATION\_SCHEMA INNODB\_BUFFER\_POOL\_STATS Table”  
Section 24.4.5, “The INFORMATION\_SCHEMA INNODB\_CMP and INNODB\_CMP\_RESET Tables”  
Section 24.4.7, “The INFORMATION\_SCHEMA INNODB\_CMP\_PER\_INDEX and INNODB\_CMP\_PER\_INDEX\_RESET Tables”  
Section 24.4.6, “The INFORMATION\_SCHEMA INNODB\_CMPMEM and INNODB\_CMPMEM\_RESET Tables”  
Section 24.4.8, “The INFORMATION\_SCHEMA INNODB\_FT\_BEING\_DELETED Table”  
Section 24.4.9, “The INFORMATION\_SCHEMA INNODB\_FT\_CONFIG Table”  
Section 24.4.10, “The INFORMATION\_SCHEMA INNODB\_FT\_DEFAULT\_STOPWORD Table”  
Section 24.4.11, “The INFORMATION\_SCHEMA INNODB\_FT\_DELETED Table”  
Section 24.4.12, “The INFORMATION\_SCHEMA INNODB\_FT\_INDEX\_CACHE Table”  
Section 24.4.13, “The INFORMATION\_SCHEMA INNODB\_FT\_INDEX\_TABLE Table”  
Section 24.4.15, “The INFORMATION\_SCHEMA INNODB\_LOCK\_WAITS Table”  
Section 24.4.14, “The INFORMATION\_SCHEMA INNODB\_LOCKS Table”  
Section 24.4.16, “The INFORMATION\_SCHEMA INNODB\_METRICS Table”  
Section 24.4.17, “The INFORMATION\_SCHEMA INNODB\_SYS\_COLUMNS Table”  
Section 24.4.18, “The INFORMATION\_SCHEMA INNODB\_SYS\_DATAFILES Table”  
Section 24.4.19, “The INFORMATION\_SCHEMA INNODB\_SYS\_FIELDS Table”  
Section 24.4.20, “The INFORMATION\_SCHEMA INNODB\_SYS\_FOREIGN Table”  
Section 24.4.21, “The INFORMATION\_SCHEMA INNODB\_SYS\_FOREIGN\_COLS Table”  
Section 24.4.22, “The INFORMATION\_SCHEMA INNODB\_SYS\_INDEXES Table”  
Section 24.4.23, “The INFORMATION\_SCHEMA INNODB\_SYS\_TABLES Table”  
Section 24.4.24, “The INFORMATION\_SCHEMA INNODB\_SYS\_TABLESPACES Table”  
Section 24.4.25, “The INFORMATION\_SCHEMA INNODB\_SYS\_TABLESTATS View”  
Section 24.4.26, “The INFORMATION\_SCHEMA INNODB\_SYS\_VIRTUAL Table”  
Section 24.4.27, “The INFORMATION\_SCHEMA INNODB\_TEMP\_TABLE\_INFO Table”  
Section 24.4.28, “The INFORMATION\_SCHEMA INNODB\_TRX Table”  
Section 2.10.4, “Upgrading MySQL Binary or Package-based Installations on Unix/Linux”

## **CONNECTION\_CONTROL\_FAILED\_LOGIN\_ATTEMPTS**

Section 6.4.2.1, “Connection Control Plugin Installation”  
Section 6.4.2.2, “Connection Control Plugin System and Status Variables”  
Section 24.6.2, “The INFORMATION\_SCHEMA CONNECTION\_CONTROL\_FAILED\_LOGIN\_ATTEMPTS Table”

## **E**

[\[index top\]](#)



---

## ENGINES

- Section 25.1, “Performance Schema Quick Start”
- Section 21.6.17, “Quick Reference: NDB Cluster SQL Statements”
- Section 5.1.7, “Server System Variables”
- Section 13.7.5.16, “SHOW ENGINES Statement”
- Section 24.3.7, “The INFORMATION\_SCHEMA ENGINES Table”
- Section 14.1.3, “Verifying that InnoDB is the Default Storage Engine”

## EVENTS

- Section 23.4.4, “Event Metadata”
- Section 23.4.2, “Event Scheduler Configuration”
- Section 16.4.1.16, “Replication of Invoked Features”
- Section 23.8, “Restrictions on Stored Programs”
- Section 13.7.5.18, “SHOW EVENTS Statement”
- Section 23.4.6, “The Event Scheduler and MySQL Privileges”
- Section 24.3.8, “The INFORMATION\_SCHEMA EVENTS Table”

## F

[\[index top\]](#)

## FILES

- Section 13.1.5, “ALTER LOGFILE GROUP Statement”
- Section 13.1.9, “ALTER TABLESPACE Statement”
- Section 13.1.15, “CREATE LOGFILE GROUP Statement”
- Section 13.1.19, “CREATE TABLESPACE Statement”
- Section 21.6.16, “INFORMATION\_SCHEMA Tables for NDB Cluster”
- Section 21.6.11.1, “NDB Cluster Disk Data Objects”
- Section 21.6.11.3, “NDB Cluster Disk Data Storage Requirements”
- Section 21.5.10, “ndb\_desc — Describe NDB Tables”
- Section 21.6.15, “ndbinfo: The NDB Cluster Information Database”
- Section 6.2.2, “Privileges Provided by MySQL”
- Section 14.16.8, “Retrieving InnoDB Tablespace Metadata from INFORMATION\_SCHEMA.FILES”
- Section 24.3.9, “The INFORMATION\_SCHEMA FILES Table”
- Section 24.4.18, “The INFORMATION\_SCHEMA INNODB\_SYS\_DATAFILES Table”
- Section 24.4.24, “The INFORMATION\_SCHEMA INNODB\_SYS\_TABLESPACES Table”
- Section 24.3.26, “The INFORMATION\_SCHEMA TABLESPACES Table”
- Section 21.6.15.15, “The ndbinfo dict\_obj\_info Table”
- Section 21.6.15.23, “The ndbinfo logbuffers Table”
- Section 21.6.15.24, “The ndbinfo logspaces Table”
- Section 14.6.3.5, “The Temporary Tablespace”

## G

[\[index top\]](#)

## GLOBAL\_STATUS

- Section 21.6, “Management of NDB Cluster”
- Section 21.6.14, “NDB API Statistics Counters and Variables”
- Section 21.7, “NDB Cluster Replication”
- Section 5.1.7, “Server System Variables”
- Section 13.7.5.35, “SHOW STATUS Statement”

---

[Section 24.3.10, “The INFORMATION\\_SCHEMA GLOBAL\\_STATUS and SESSION\\_STATUS Tables”](#)

## **GLOBAL\_VARIABLES**

[Section 5.1.7, “Server System Variables”](#)

[Section 13.7.5.39, “SHOW VARIABLES Statement”](#)

[Section 24.3.11, “The INFORMATION\\_SCHEMA GLOBAL\\_VARIABLES and SESSION\\_VARIABLES Tables”](#)

**I**

[\[index top\]](#)

## **INFORMATION\_SCHEMA**

[Section 21.6.16, “INFORMATION\\_SCHEMA Tables for NDB Cluster”](#)

[Section 14.16, “InnoDB INFORMATION\\_SCHEMA Tables”](#)

[MySQL Glossary](#)

[Section 5.2, “The MySQL Data Directory”](#)

[Section 26.2, “Using the sys Schema”](#)

## **INFORMATION\_SCHEMA.CHARACTER\_SETS**

[Section A.11, “MySQL 5.7 FAQ: MySQL Chinese, Japanese, and Korean Character Sets”](#)

## **INFORMATION\_SCHEMA.COLUMNS**

[Section A.11, “MySQL 5.7 FAQ: MySQL Chinese, Japanese, and Korean Character Sets”](#)

[Section 25.1, “Performance Schema Quick Start”](#)

## **INFORMATION\_SCHEMA.INNOODB\_CMP**

[MySQL Glossary](#)

## **INFORMATION\_SCHEMA.INNOODB\_SYS\_TABLES**

[Section 14.16.3, “InnoDB INFORMATION\\_SCHEMA System Tables”](#)

## **INFORMATION\_SCHEMA.INNOODB\_SYS\_TABLESPACES**

[Section 14.14, “InnoDB Data-at-Rest Encryption”](#)

[Section 14.16.3, “InnoDB INFORMATION\\_SCHEMA System Tables”](#)

## **INFORMATION\_SCHEMA.INNOODB\_SYS\_TABLESTATS**

[Section 14.16.3, “InnoDB INFORMATION\\_SCHEMA System Tables”](#)

## **INFORMATION\_SCHEMA.OPTIMIZER\_TRACE**

[Section 8.15, “Tracing the Optimizer”](#)

[Section 8.15.1, “Typical Usage”](#)

## **INFORMATION\_SCHEMA.PARTITIONS**

[Section 22.2.7, “How MySQL Partitioning Handles NULL”](#)

## **INFORMATION\_SCHEMA.PLUGINS**

[Section 5.5.1, “Installing and Uninstalling Plugins”](#)

## **INFORMATION\_SCHEMA.PROCESSLIST**

[Section 6.2.2, “Privileges Provided by MySQL”](#)

---

## **INFORMATION\_SCHEMA.ROUTINES**

Section A.4, “MySQL 5.7 FAQ: Stored Procedures and Functions”

## **INFORMATION\_SCHEMA.STATISTICS**

Section 21.5.15, “`ndb_index_stat` — NDB Index Statistics Utility”

## **INFORMATION\_SCHEMA.TRIGGERS**

Section A.5, “MySQL 5.7 FAQ: Triggers”

## **INNODB\_BUFFER\_PAGE**

Section 14.5.2, “Change Buffer”

Section 14.16.5, “InnoDB INFORMATION\_SCHEMA Buffer Pool Tables”

Section 26.1, “Prerequisites for Using the sys Schema”

Section 24.4.2, “The INFORMATION\_SCHEMA INNODB\_BUFFER\_PAGE Table”

Section 24.4.3, “The INFORMATION\_SCHEMA INNODB\_BUFFER\_PAGE\_LRU Table”

Section 26.4.3.7, “The `innodb_buffer_stats_by_schema` and `x$innodb_buffer_stats_by_schema` Views”

Section 26.4.3.8, “The `innodb_buffer_stats_by_table` and `x$innodb_buffer_stats_by_table` Views”

## **INNODB\_BUFFER\_PAGE\_LRU**

Section 14.16.5, “InnoDB INFORMATION\_SCHEMA Buffer Pool Tables”

Section 14.8.3.6, “Saving and Restoring the Buffer Pool State”

Section 24.4.3, “The INFORMATION\_SCHEMA INNODB\_BUFFER\_PAGE\_LRU Table”

## **INNODB\_BUFFER\_POOL\_STATS**

Section 14.5.1, “Buffer Pool”

Section 14.16.5, “InnoDB INFORMATION\_SCHEMA Buffer Pool Tables”

Section 24.4.4, “The INFORMATION\_SCHEMA INNODB\_BUFFER\_POOL\_STATS Table”

## **INNODB\_CMP**

Section 14.16.1, “InnoDB INFORMATION\_SCHEMA Tables about Compression”

Section 14.16.1.1, “INNODB\_CMP and INNODB\_CMP\_RESET”

Section 14.16.1.2, “INNODB\_CMPMEM and INNODB\_CMPMEM\_RESET”

Section 14.9.1.4, “Monitoring InnoDB Table Compression at Runtime”

Section 24.4.5, “The INFORMATION\_SCHEMA INNODB\_CMP and INNODB\_CMP\_RESET Tables”

Section 14.9.1.3, “Tuning Compression for InnoDB Tables”

Section 14.16.1.3, “Using the Compression Information Schema Tables”

## **INNODB\_CMP\_PER\_INDEX**

Section 14.15, “InnoDB Startup Options and System Variables”

Section 14.9.1.4, “Monitoring InnoDB Table Compression at Runtime”

Section 24.4.7, “The INFORMATION\_SCHEMA INNODB\_CMP\_PER\_INDEX and INNODB\_CMP\_PER\_INDEX\_RESET Tables”

Section 14.9.1.3, “Tuning Compression for InnoDB Tables”

Section 14.16.1.3, “Using the Compression Information Schema Tables”

## **INNODB\_CMP\_PER\_INDEX\_RESET**

Section 24.4.7, “The INFORMATION\_SCHEMA INNODB\_CMP\_PER\_INDEX and INNODB\_CMP\_PER\_INDEX\_RESET Tables”

## **INNODB\_CMP\_RESET**

Section 14.16.1, “InnoDB INFORMATION\_SCHEMA Tables about Compression”

---

[Section 14.16.1.1, “INNODB\\_CMP and INNODB\\_CMP\\_RESET”](#)  
[Section 14.16.1.2, “INNODB\\_CMPMEM and INNODB\\_CMPMEM\\_RESET”](#)  
[Section 24.4.5, “The INFORMATION\\_SCHEMA INNODB\\_CMP and INNODB\\_CMP\\_RESET Tables”](#)

## **INNODB\_CMPMEM**

[Section 14.16.1, “InnoDB INFORMATION\\_SCHEMA Tables about Compression”](#)  
[Section 14.16.1.2, “INNODB\\_CMPMEM and INNODB\\_CMPMEM\\_RESET”](#)  
[Section 24.4.6, “The INFORMATION\\_SCHEMA INNODB\\_CMPMEM and INNODB\\_CMPMEM\\_RESET Tables”](#)  
[Section 14.16.1.3, “Using the Compression Information Schema Tables”](#)

## **INNODB\_CMPMEM\_RESET**

[Section 14.16.1, “InnoDB INFORMATION\\_SCHEMA Tables about Compression”](#)  
[Section 14.16.1.2, “INNODB\\_CMPMEM and INNODB\\_CMPMEM\\_RESET”](#)  
[Section 24.4.6, “The INFORMATION\\_SCHEMA INNODB\\_CMPMEM and INNODB\\_CMPMEM\\_RESET Tables”](#)

## **INNODB\_FT\_BEING\_DELETED**

[Section 14.6.2.4, “InnoDB Full-Text Indexes”](#)  
[Section 14.16.4, “InnoDB INFORMATION\\_SCHEMA FULLTEXT Index Tables”](#)  
[Section 14.15, “InnoDB Startup Options and System Variables”](#)  
[Section 24.4.8, “The INFORMATION\\_SCHEMA INNODB\\_FT\\_BEING\\_DELETED Table”](#)

## **INNODB\_FT\_CONFIG**

[Section 14.6.2.4, “InnoDB Full-Text Indexes”](#)  
[Section 14.16.4, “InnoDB INFORMATION\\_SCHEMA FULLTEXT Index Tables”](#)  
[Section 14.15, “InnoDB Startup Options and System Variables”](#)  
[Section 24.4.9, “The INFORMATION\\_SCHEMA INNODB\\_FT\\_CONFIG Table”](#)

## **INNODB\_FT\_DEFAULT\_STOPWORD**

[Section 12.9.4, “Full-Text Stopwords”](#)  
[Section 14.6.2.4, “InnoDB Full-Text Indexes”](#)  
[Section 14.16.4, “InnoDB INFORMATION\\_SCHEMA FULLTEXT Index Tables”](#)  
[Section 24.4.10, “The INFORMATION\\_SCHEMA INNODB\\_FT\\_DEFAULT\\_STOPWORD Table”](#)

## **INNODB\_FT\_DELETED**

[Section 14.6.2.4, “InnoDB Full-Text Indexes”](#)  
[Section 14.16.4, “InnoDB INFORMATION\\_SCHEMA FULLTEXT Index Tables”](#)  
[Section 14.15, “InnoDB Startup Options and System Variables”](#)  
[Section 24.4.8, “The INFORMATION\\_SCHEMA INNODB\\_FT\\_BEING\\_DELETED Table”](#)  
[Section 24.4.11, “The INFORMATION\\_SCHEMA INNODB\\_FT\\_DELETED Table”](#)

## **INNODB\_FT\_INDEX\_CACHE**

[Section 14.6.2.4, “InnoDB Full-Text Indexes”](#)  
[Section 14.16.4, “InnoDB INFORMATION\\_SCHEMA FULLTEXT Index Tables”](#)  
[Section 14.15, “InnoDB Startup Options and System Variables”](#)  
[Section 12.9.9, “MeCab Full-Text Parser Plugin”](#)  
[Section 12.9.8, “ngram Full-Text Parser”](#)  
[Section 24.4.12, “The INFORMATION\\_SCHEMA INNODB\\_FT\\_INDEX\\_CACHE Table”](#)

## **INNODB\_FT\_INDEX\_TABLE**

[Section 12.9.4, “Full-Text Stopwords”](#)

---

[Section 14.6.2.4, “InnoDB Full-Text Indexes”](#)  
[Section 14.16.4, “InnoDB INFORMATION\\_SCHEMA FULLTEXT Index Tables”](#)  
[Section 14.15, “InnoDB Startup Options and System Variables”](#)  
[Section 24.4.8, “The INFORMATION\\_SCHEMA INNODB\\_FT\\_BEING\\_DELETED Table”](#)  
[Section 24.4.11, “The INFORMATION\\_SCHEMA INNODB\\_FT\\_DELETED Table”](#)  
[Section 24.4.13, “The INFORMATION\\_SCHEMA INNODB\\_FT\\_INDEX\\_TABLE Table”](#)

## **INNODB\_LOCK\_WAITS**

[Section 14.16.2, “InnoDB INFORMATION\\_SCHEMA Transaction and Locking Information”](#)  
[Section 14.16.2.2, “InnoDB Lock and Lock-Wait Information”](#)  
[Section 14.16.2.3, “Persistence and Consistency of InnoDB Transaction and Locking Information”](#)  
[Section 24.4.15, “The INFORMATION\\_SCHEMA INNODB\\_LOCK\\_WAITS Table”](#)  
[Section 14.16.2.1, “Using InnoDB Transaction and Locking Information”](#)  
[Section 1.3, “What Is New in MySQL 5.7”](#)

## **INNODB\_LOCKS**

[Section 14.16.2, “InnoDB INFORMATION\\_SCHEMA Transaction and Locking Information”](#)  
[Section 14.16.2.2, “InnoDB Lock and Lock-Wait Information”](#)  
[Section 14.16.2.3, “Persistence and Consistency of InnoDB Transaction and Locking Information”](#)  
[Section 24.4.15, “The INFORMATION\\_SCHEMA INNODB\\_LOCK\\_WAITS Table”](#)  
[Section 24.4.14, “The INFORMATION\\_SCHEMA INNODB\\_LOCKS Table”](#)  
[Section 24.4.28, “The INFORMATION\\_SCHEMA INNODB\\_TRX Table”](#)  
[Section 14.16.2.1, “Using InnoDB Transaction and Locking Information”](#)  
[Section 1.3, “What Is New in MySQL 5.7”](#)

## **INNODB\_METRICS**

[Section 14.5.2, “Change Buffer”](#)  
[Section 14.8.12, “Configuring the Merge Threshold for Index Pages”](#)  
[Section 14.16.6, “InnoDB INFORMATION\\_SCHEMA Metrics Table”](#)  
[Section 14.15, “InnoDB Startup Options and System Variables”](#)  
[MySQL Glossary](#)  
[Section 24.4.16, “The INFORMATION\\_SCHEMA INNODB\\_METRICS Table”](#)  
[Section 26.4.3.21, “The metrics View”](#)

## **INNODB\_SYS\_COLUMNS**

[Section 14.16.3, “InnoDB INFORMATION\\_SCHEMA System Tables”](#)  
[Section 24.4.17, “The INFORMATION\\_SCHEMA INNODB\\_SYS\\_COLUMNS Table”](#)  
[Section 24.4.26, “The INFORMATION\\_SCHEMA INNODB\\_SYS\\_VIRTUAL Table”](#)

## **INNODB\_SYS\_DATAFILES**

[Section 14.16.3, “InnoDB INFORMATION\\_SCHEMA System Tables”](#)  
[Section 14.16.8, “Retrieving InnoDB Tablespace Metadata from INFORMATION\\_SCHEMA.FILES”](#)  
[Section 24.3.9, “The INFORMATION\\_SCHEMA FILES Table”](#)  
[Section 24.4.18, “The INFORMATION\\_SCHEMA INNODB\\_SYS\\_DATAFILES Table”](#)  
[Section 24.3.26, “The INFORMATION\\_SCHEMA TABLESPACES Table”](#)

## **INNODB\_SYS\_FIELDS**

[Section 14.16.3, “InnoDB INFORMATION\\_SCHEMA System Tables”](#)  
[Section 24.4.19, “The INFORMATION\\_SCHEMA INNODB\\_SYS\\_FIELDS Table”](#)

## **INNODB\_SYS\_FOREIGN**

[Section 1.6.3.2, “FOREIGN KEY Constraints”](#)

---

[Section 13.1.18.5, “FOREIGN KEY Constraints”](#)  
[Section 14.16.3, “InnoDB INFORMATION\\_SCHEMA System Tables”](#)  
[Section 24.4.20, “The INFORMATION\\_SCHEMA INNO\\_DB\\_SYS\\_FOREIGN Table”](#)

## **INNODB\_SYS\_FOREIGN\_COLS**

[Section 1.6.3.2, “FOREIGN KEY Constraints”](#)  
[Section 13.1.18.5, “FOREIGN KEY Constraints”](#)  
[Section 14.16.3, “InnoDB INFORMATION\\_SCHEMA System Tables”](#)  
[Section 24.4.21, “The INFORMATION\\_SCHEMA INNO\\_DB\\_SYS\\_FOREIGN\\_COLS Table”](#)

## **INNODB\_SYS\_INDEXES**

[Section 14.8.12, “Configuring the Merge Threshold for Index Pages”](#)  
[Section 14.6.2.4, “InnoDB Full-Text Indexes”](#)  
[Section 14.16.3, “InnoDB INFORMATION\\_SCHEMA System Tables”](#)  
[Section 24.4.22, “The INFORMATION\\_SCHEMA INNO\\_DB\\_SYS\\_INDEXES Table”](#)

## **INNODB\_SYS\_TABLES**

[Section 22.3.3, “Exchanging Partitions and Subpartitions with Tables”](#)  
[Section 14.6.2.4, “InnoDB Full-Text Indexes”](#)  
[Section 14.16.3, “InnoDB INFORMATION\\_SCHEMA System Tables”](#)  
[Section 14.11, “InnoDB Row Formats”](#)  
[Section 24.4.23, “The INFORMATION\\_SCHEMA INNO\\_DB\\_SYS\\_TABLES Table”](#)  
[Section 14.22.3, “Troubleshooting InnoDB Data Dictionary Operations”](#)

## **INNODB\_SYS\_TABLESPACES**

[Section 14.16.3, “InnoDB INFORMATION\\_SCHEMA System Tables”](#)  
[Section 14.9.2, “InnoDB Page Compression”](#)  
[Section 14.16.8, “Retrieving InnoDB Tablespace Metadata from INFORMATION\\_SCHEMA.FILES”](#)  
[Section 24.3.9, “The INFORMATION\\_SCHEMA FILES Table”](#)  
[Section 24.4.24, “The INFORMATION\\_SCHEMA INNO\\_DB\\_SYS\\_TABLESPACES Table”](#)  
[Section 24.3.26, “The INFORMATION\\_SCHEMA TABLESPACES Table”](#)

## **INNODB\_SYS\_TABLESTATS**

[Section 13.7.2.1, “ANALYZE TABLE Statement”](#)  
[Section 14.16.3, “InnoDB INFORMATION\\_SCHEMA System Tables”](#)  
[Section 24.4.25, “The INFORMATION\\_SCHEMA INNO\\_DB\\_SYS\\_TABLESTATS View”](#)

## **INNODB\_SYS\_VIRTUAL**

[Section 24.4.26, “The INFORMATION\\_SCHEMA INNO\\_DB\\_SYS\\_VIRTUAL Table”](#)

## **INNODB\_TEMP\_TABLE\_INFO**

[Section 14.16.7, “InnoDB INFORMATION\\_SCHEMA Temporary Table Info Table”](#)  
[Section 14.15, “InnoDB Startup Options and System Variables”](#)  
[Section 24.4.27, “The INFORMATION\\_SCHEMA INNO\\_DB\\_TEMP\\_TABLE\\_INFO Table”](#)  
[Section 14.6.3.5, “The Temporary Tablespace”](#)

## **INNODB\_TRX**

[Section 14.16.2, “InnoDB INFORMATION\\_SCHEMA Transaction and Locking Information”](#)  
[Section 14.16.2.2, “InnoDB Lock and Lock-Wait Information”](#)  
[Section 14.15, “InnoDB Startup Options and System Variables”](#)  
[Section 14.16.2.3, “Persistence and Consistency of InnoDB Transaction and Locking Information”](#)

---

[Section 24.4.14, “The INFORMATION\\_SCHEMA INNODB\\_LOCKS Table”](#)  
[Section 24.4.28, “The INFORMATION\\_SCHEMA INNODB\\_TRX Table”](#)  
[Section 14.16.2.1, “Using InnoDB Transaction and Locking Information”](#)

## K

[\[index top\]](#)

### KEY\_COLUMN\_USAGE

[Section 1.6.3.2, “FOREIGN KEY Constraints”](#)  
[Section 13.1.18.5, “FOREIGN KEY Constraints”](#)  
[Section 8.2.3, “Optimizing INFORMATION\\_SCHEMA Queries”](#)  
[Section 24.3.12, “The INFORMATION\\_SCHEMA KEY\\_COLUMN\\_USAGE Table”](#)

## M

[\[index top\]](#)

### MYSQL\_FIREWALL\_USERS

[Section 6.4.6.4, “MySQL Enterprise Firewall Reference”](#)  
[Section 24.7.2, “The INFORMATION\\_SCHEMA MYSQL\\_FIREWALL\\_USERS Table”](#)

### MYSQL\_FIREWALL\_WHITELIST

[Section 6.4.6.4, “MySQL Enterprise Firewall Reference”](#)  
[Section 24.7.3, “The INFORMATION\\_SCHEMA MYSQL\\_FIREWALL\\_WHITELIST Table”](#)

## N

[\[index top\]](#)

### NDB\_TRANSID\_MYSQL\_CONNECTION\_MAP

[Section 21.6.15.34, “The ndbinfo server\\_operations Table”](#)  
[Section 21.6.15.35, “The ndbinfo server\\_transactions Table”](#)

### ndb\_transid\_mysql\_connection\_map

[Section 21.6.16, “INFORMATION\\_SCHEMA Tables for NDB Cluster”](#)  
[MySQL Server Options for NDB Cluster](#)  
[Section 21.6.15, “ndbinfo: The NDB Cluster Information Database”](#)  
[Section 24.3.13, “The INFORMATION\\_SCHEMA ndb\\_transid\\_mysql\\_connection\\_map Table”](#)

## O

[\[index top\]](#)

### OPTIMIZER\_TRACE

[Section 24.3.14, “The INFORMATION\\_SCHEMA OPTIMIZER\\_TRACE Table”](#)  
[Section 8.15.4, “Tuning Trace Purging”](#)

## P

[\[index top\]](#)

---

## PARAMETERS

Section A.4, “MySQL 5.7 FAQ: Stored Procedures and Functions”  
Section 13.7.5.28, “SHOW PROCEDURE STATUS Statement”  
Section 24.3.15, “The INFORMATION\_SCHEMA PARAMETERS Table”  
Section 24.3.21, “The INFORMATION\_SCHEMA ROUTINES Table”

## PARTITIONS

Section 22.3.3, “Exchanging Partitions and Subpartitions with Tables”  
Section 22.2.7, “How MySQL Partitioning Handles NULL”  
Section 22.2.5, “KEY Partitioning”  
Section 22.3.5, “Obtaining Information About Partitions”  
Section 8.2.3, “Optimizing INFORMATION\_SCHEMA Queries”  
Chapter 22, *Partitioning*  
Section 22.2.3.1, “RANGE COLUMNS partitioning”  
Section 5.1.6, “Server Command Options”  
Section 13.7.5.36, “SHOW TABLE STATUS Statement”  
Section 24.3.16, “The INFORMATION\_SCHEMA PARTITIONS Table”  
Section 24.3.25, “The INFORMATION\_SCHEMA TABLES Table”

## PLUGINS

Section 6.4.2.1, “Connection Control Plugin Installation”  
Section 14.14, “InnoDB Data-at-Rest Encryption”  
Section 13.7.3.3, “INSTALL PLUGIN Statement”  
Section 5.5.1, “Installing and Uninstalling Plugins”  
Section 6.4.5.2, “Installing or Uninstalling MySQL Enterprise Audit”  
Section 6.4.4.10, “Keyring Metadata”  
Section 6.4.4.1, “Keyring Plugin Installation”  
Section 6.4.1.9, “LDAP Pluggable Authentication”  
Section 6.4.1.10, “No-Login Pluggable Authentication”  
Section 5.5.2, “Obtaining Server Plugin Information”  
Section 6.4.1.7, “PAM Pluggable Authentication”  
Chapter 22, *Partitioning*  
Section 6.4.3.1, “Password Validation Plugin Installation”  
Section 21.6.17, “Quick Reference: NDB Cluster SQL Statements”  
Section 16.3.9.2, “Semisynchronous Replication Installation and Configuration”  
Section 5.1.6, “Server Command Options”  
Section 6.4.1.11, “Socket Peer-Credential Pluggable Authentication”  
Section 6.4.1.12, “Test Pluggable Authentication”  
Section 24.3.17, “The INFORMATION\_SCHEMA PLUGINS Table”  
Section 5.5.3.2, “Thread Pool Installation”  
Section 6.4.1.8, “Windows Pluggable Authentication”

## PROCESSLIST

Section 8.14.1, “Accessing the Process List”  
Section 12.15, “Information Functions”  
Section 13.7.6.4, “KILL Statement”  
Section 8.8.4, “Obtaining Execution Plan Information for a Named Connection”  
Section 25.6, “Performance Schema Instrument Naming Conventions”  
Section 25.12.11, “Performance Schema Replication Tables”  
Section 25.12.5, “Performance Schema Stage Event Tables”  
Section 14.16.2.3, “Persistence and Consistency of InnoDB Transaction and Locking Information”  
Section 13.7.5.29, “SHOW PROCESSLIST Statement”  
Section 24.4.28, “The INFORMATION\_SCHEMA INNODB\_TRX Table”



---

[Section 24.3.18, “The INFORMATION\\_SCHEMA PROCESSLIST Table”](#)  
[Section 26.4.3.22, “The processlist and x\\$processlist Views”](#)  
[Section 25.12.16.3, “The processlist Table”](#)  
[Section 25.12.16.4, “The threads Table”](#)  
[Section 14.16.2.1, “Using InnoDB Transaction and Locking Information”](#)

## PROFILING

[Section 13.7.5.30, “SHOW PROFILE Statement”](#)  
[Section 24.3.19, “The INFORMATION\\_SCHEMA PROFILING Table”](#)  
[Section 1.3, “What Is New in MySQL 5.7”](#)

## R

[\[index top\]](#)

## REFERENTIAL\_CONSTRAINTS

[Section 8.2.3, “Optimizing INFORMATION\\_SCHEMA Queries”](#)  
[Section 24.3.20, “The INFORMATION\\_SCHEMA REFERENTIAL\\_CONSTRAINTS Table”](#)

## ROUTINES

[Section 24.1, “Introduction”](#)  
[Section A.4, “MySQL 5.7 FAQ: Stored Procedures and Functions”](#)  
[Section 13.7.5.28, “SHOW PROCEDURE STATUS Statement”](#)  
[Section 23.6, “Stored Object Access Control”](#)  
[Section 23.2.3, “Stored Routine Metadata”](#)  
[Section 24.3.21, “The INFORMATION\\_SCHEMA ROUTINES Table”](#)

## S

[\[index top\]](#)

## SCHEMA\_PRIVILEGES

[Section 24.3.23, “The INFORMATION\\_SCHEMA SCHEMA\\_PRIVILEGES Table”](#)

## SCHEMATA

[Section 6.2.3, “Grant Tables”](#)  
[Section 6.2.2, “Privileges Provided by MySQL”](#)  
[Section 5.1.7, “Server System Variables”](#)  
[Section 13.7.5.14, “SHOW DATABASES Statement”](#)  
[Section 24.3.22, “The INFORMATION\\_SCHEMA SCHEMATA Table”](#)

## SESSION\_STATUS

[Section 21.6, “Management of NDB Cluster”](#)  
[Section 21.6.14, “NDB API Statistics Counters and Variables”](#)  
[Section 21.7, “NDB Cluster Replication”](#)  
[Section 5.1.7, “Server System Variables”](#)  
[Section 13.7.5.35, “SHOW STATUS Statement”](#)  
[Section 24.3.10, “The INFORMATION\\_SCHEMA GLOBAL\\_STATUS and SESSION\\_STATUS Tables”](#)

## SESSION\_VARIABLES

[Section 5.1.7, “Server System Variables”](#)  
[Section 13.7.5.39, “SHOW VARIABLES Statement”](#)

---

[Section 24.3.11, “The INFORMATION\\_SCHEMA GLOBAL\\_VARIABLES and SESSION\\_VARIABLES Tables”](#)

## **STATISTICS**

[Section 13.7.2.1, “ANALYZE TABLE Statement”](#)

[Section 14.8.11.2, “Configuring Non-Persistent Optimizer Statistics Parameters”](#)

[Section 8.9.4, “Index Hints”](#)

[Section 14.15, “InnoDB Startup Options and System Variables”](#)

[Section 8.2.3, “Optimizing INFORMATION\\_SCHEMA Queries”](#)

[Section 13.7.5.22, “SHOW INDEX Statement”](#)

[Section 24.3.24, “The INFORMATION\\_SCHEMA STATISTICS Table”](#)

## **T**

[\[index top\]](#)

## **TABLE\_CONSTRAINTS**

[Section 14.13.1, “Online DDL Operations”](#)

[Section 8.2.3, “Optimizing INFORMATION\\_SCHEMA Queries”](#)

[Section 24.3.20, “The INFORMATION\\_SCHEMA REFERENTIAL\\_CONSTRAINTS Table”](#)

[Section 24.3.27, “The INFORMATION\\_SCHEMA TABLE\\_CONSTRAINTS Table”](#)

## **TABLE\_PRIVILEGES**

[Section 24.3.28, “The INFORMATION\\_SCHEMA TABLE\\_PRIVILEGES Table”](#)

## **TABLES**

[Section 21.6.7.3, “Adding NDB Cluster Data Nodes Online: Detailed Example”](#)

[Section 13.1.8, “ALTER TABLE Statement”](#)

[Section 14.8.11.2, “Configuring Non-Persistent Optimizer Statistics Parameters”](#)

[Section 13.1.18, “CREATE TABLE Statement”](#)

[Section 14.14, “InnoDB Data-at-Rest Encryption”](#)

[Section 14.9.2, “InnoDB Page Compression”](#)

[Section 14.15, “InnoDB Startup Options and System Variables”](#)

[Section 24.1, “Introduction”](#)

[NDB Cluster System Variables](#)

[Section 8.2.3, “Optimizing INFORMATION\\_SCHEMA Queries”](#)

[Section 5.1.6, “Server Command Options”](#)

[Section 13.1.18.9, “Setting NDB Comment Options”](#)

[Section 13.7.5.36, “SHOW TABLE STATUS Statement”](#)

[Section 13.7.5.37, “SHOW TABLES Statement”](#)

[Section 26.4.4.2, “The diagnostics\(\) Procedure”](#)

[Section 24.3.25, “The INFORMATION\\_SCHEMA TABLES Table”](#)

[Section 26.4.2.1, “The sys\\_config Table”](#)

## **TP\_THREAD\_GROUP\_STATE**

[Section 24.5, “INFORMATION\\_SCHEMA Thread Pool Tables”](#)

[Section 24.5.2, “The INFORMATION\\_SCHEMA TP\\_THREAD\\_GROUP\\_STATE Table”](#)

[Section 5.5.3.1, “Thread Pool Elements”](#)

## **TP\_THREAD\_GROUP\_STATS**

[Section 24.5, “INFORMATION\\_SCHEMA Thread Pool Tables”](#)

[Section 24.5.3, “The INFORMATION\\_SCHEMA TP\\_THREAD\\_GROUP\\_STATS Table”](#)

---

[Section 24.5.4, “The INFORMATION\\_SCHEMA TP\\_THREAD\\_STATE Table”](#)  
[Section 5.5.3.1, “Thread Pool Elements”](#)

## **TP\_THREAD\_STATE**

[Section 24.5, “INFORMATION\\_SCHEMA Thread Pool Tables”](#)  
[Section 24.5.2, “The INFORMATION\\_SCHEMA TP\\_THREAD\\_GROUP\\_STATE Table”](#)  
[Section 24.5.4, “The INFORMATION\\_SCHEMA TP\\_THREAD\\_STATE Table”](#)  
[Section 5.5.3.1, “Thread Pool Elements”](#)  
[Section 5.5.3.2, “Thread Pool Installation”](#)

## **TRIGGERS**

[Section 8.2.3, “Optimizing INFORMATION\\_SCHEMA Queries”](#)  
[Section 13.7.5.11, “SHOW CREATE TRIGGER Statement”](#)  
[Section 13.7.5.38, “SHOW TRIGGERS Statement”](#)  
[Section 24.3.29, “The INFORMATION\\_SCHEMA TRIGGERS Table”](#)  
[Section 23.3.2, “Trigger Metadata”](#)

## **U**

[\[index top\]](#)

## **USER\_PRIVILEGES**

[Section 24.3.30, “The INFORMATION\\_SCHEMA USER\\_PRIVILEGES Table”](#)

## **V**

[\[index top\]](#)

## **VIEWS**

[Section 8.2.3, “Optimizing INFORMATION\\_SCHEMA Queries”](#)  
[Section 13.7.5.13, “SHOW CREATE VIEW Statement”](#)  
[Section 24.3.31, “The INFORMATION\\_SCHEMA VIEWS Table”](#)  
[Section 23.5.3, “Updatable and Insertable Views”](#)  
[Section 23.5.5, “View Metadata”](#)

# Join Types Index

[A](#) | [C](#) | [E](#) | [F](#) | [I](#) | [R](#) | [S](#) | [U](#)

## **A**

[\[index top\]](#)

## **ALL**

[Section 8.2.1.20, “Avoiding Full Table Scans”](#)  
[Section 8.2.1.11, “Block Nested-Loop and Batched Key Access Joins”](#)  
[Section 8.8.2, “EXPLAIN Output Format”](#)  
[Section 8.2.1.6, “Nested-Loop Join Algorithms”](#)

## **C**

[\[index top\]](#)

---

## **const**

[Section 8.8.2, “EXPLAIN Output Format”](#)  
[Section 8.8.3, “Extended EXPLAIN Output Format”](#)  
[NDB Cluster System Variables](#)  
[Section 8.2.1.14, “ORDER BY Optimization”](#)  
[Section 8.2.1.2, “Range Optimization”](#)  
[Section 13.2.9, “SELECT Statement”](#)

## **E**

[\[index top\]](#)

## **eq\_ref**

[Section 8.2.1.11, “Block Nested-Loop and Batched Key Access Joins”](#)  
[Section 8.8.2, “EXPLAIN Output Format”](#)  
[Section 8.2.1.5, “Index Condition Pushdown Optimization”](#)  
[Section 15.7.1, “MERGE Table Advantages and Disadvantages”](#)  
[NDB Cluster System Variables](#)  
[Section 8.2.2.3, “Optimizing Subqueries with the EXISTS Strategy”](#)  
[Section 25.12.4.1, “The events\\_waits\\_current Table”](#)

## **F**

[\[index top\]](#)

## **fulltext**

[Section 8.8.2, “EXPLAIN Output Format”](#)

## **I**

[\[index top\]](#)

## **index**

[Section 8.2.1.11, “Block Nested-Loop and Batched Key Access Joins”](#)  
[Section 8.8.2, “EXPLAIN Output Format”](#)  
[Section 8.2.1.6, “Nested-Loop Join Algorithms”](#)

## **index\_merge**

[Section 8.8.2, “EXPLAIN Output Format”](#)  
[Section 8.2.1.3, “Index Merge Optimization”](#)

## **index\_subquery**

[Section 8.8.2, “EXPLAIN Output Format”](#)  
[Section 13.2.10.10, “Optimizing Subqueries”](#)  
[Section 8.2.2.3, “Optimizing Subqueries with the EXISTS Strategy”](#)

## **R**

[\[index top\]](#)

---

## range

[Section 8.2.1.11, “Block Nested-Loop and Batched Key Access Joins”](#)  
[Section 8.8.2, “EXPLAIN Output Format”](#)  
[Section 8.2.1.15, “GROUP BY Optimization”](#)  
[Section 8.2.1.5, “Index Condition Pushdown Optimization”](#)  
[Section 8.2.1.3, “Index Merge Optimization”](#)  
[Section 8.2.1.6, “Nested-Loop Join Algorithms”](#)  
[Section 8.2.1.2, “Range Optimization”](#)

## ref

[Section 8.2.1.11, “Block Nested-Loop and Batched Key Access Joins”](#)  
[Section 8.8.2, “EXPLAIN Output Format”](#)  
[Section 8.8.3, “Extended EXPLAIN Output Format”](#)  
[Section 8.2.1.5, “Index Condition Pushdown Optimization”](#)  
[Section 8.3.7, “InnoDB and MyISAM Index Statistics Collection”](#)  
[Section 15.7.1, “MERGE Table Advantages and Disadvantages”](#)  
[NDB Cluster System Variables](#)  
[Section 8.2.2.4, “Optimizing Derived Tables and View References with Merging or Materialization”](#)  
[Section 8.2.2.3, “Optimizing Subqueries with the EXISTS Strategy”](#)

## ref\_or\_null

[Section 8.8.2, “EXPLAIN Output Format”](#)  
[Section 8.2.1.5, “Index Condition Pushdown Optimization”](#)  
[Section 8.2.1.13, “IS NULL Optimization”](#)  
[Section 8.2.2.3, “Optimizing Subqueries with the EXISTS Strategy”](#)

## S

[\[index top\]](#)

## system

[Section 8.8.2, “EXPLAIN Output Format”](#)  
[Section 8.8.3, “Extended EXPLAIN Output Format”](#)  
[Section 8.2.1.2, “Range Optimization”](#)  
[Section 13.2.9, “SELECT Statement”](#)

## U

[\[index top\]](#)

## unique\_subquery

[Section 8.8.2, “EXPLAIN Output Format”](#)  
[Section 13.2.10.10, “Optimizing Subqueries”](#)  
[Section 8.2.2.3, “Optimizing Subqueries with the EXISTS Strategy”](#)

## Operator Index

[Symbols](#) | [A](#) | [B](#) | [C](#) | [D](#) | [E](#) | [I](#) | [L](#) | [N](#) | [O](#) | [R](#) | [X](#)

## Symbols

[\[index top\]](#)

---

-

Section 12.6.1, "Arithmetic Operators"  
Section 12.10, "Cast Functions and Operators"  
Section 9.5, "Expressions"  
Section 11.1.1, "Numeric Data Type Syntax"  
Section 22.6, "Restrictions and Limitations on Partitioning"

!

Section 9.5, "Expressions"  
Section 12.4.3, "Logical Operators"  
Section 12.4.1, "Operator Precedence"

!=

Section 12.4.2, "Comparison Functions and Operators"  
Section 12.4.1, "Operator Precedence"  
Section 8.2.1.2, "Range Optimization"  
Section 11.5, "The JSON Data Type"

%

Section 12.6.1, "Arithmetic Operators"

&

Section 12.12, "Bit Functions and Operators"  
Section 13.1.18, "CREATE TABLE Statement"  
Section 22.6, "Restrictions and Limitations on Partitioning"

&&

Section 12.4.3, "Logical Operators"  
Section 1.6.1, "MySQL Extensions to Standard SQL"

>

Section 12.4.2, "Comparison Functions and Operators"  
Section 8.3.8, "Comparison of B-Tree and Hash Indexes"  
Section 8.8.2, "EXPLAIN Output Format"  
Section 1.6.1, "MySQL Extensions to Standard SQL"  
Section 12.4.1, "Operator Precedence"  
Section 8.3.10, "Optimizer Use of Generated Column Indexes"  
Section 8.2.1.2, "Range Optimization"  
Section 11.5, "The JSON Data Type"

->

Section 12.17.3, "Functions That Search JSON Values"  
Section 13.1.18.8, "Secondary Indexes and Generated Columns"  
Section 11.5, "The JSON Data Type"

>>

Section 12.12, "Bit Functions and Operators"  
Section 1.6.1, "MySQL Extensions to Standard SQL"  
Section 22.6, "Restrictions and Limitations on Partitioning"

->>

Section 13.1.18.8, "Secondary Indexes and Generated Columns"

---

Section 11.5, “The JSON Data Type”

**>=**

Section 12.4.2, “Comparison Functions and Operators”  
Section 8.3.8, “Comparison of B-Tree and Hash Indexes”  
Section 8.8.2, “EXPLAIN Output Format”  
Section 1.6.1, “MySQL Extensions to Standard SQL”  
Section 12.4.1, “Operator Precedence”  
Section 8.3.10, “Optimizer Use of Generated Column Indexes”  
Section 8.2.1.2, “Range Optimization”  
Section 11.5, “The JSON Data Type”

**<**

Section 12.4.2, “Comparison Functions and Operators”  
Section 8.3.8, “Comparison of B-Tree and Hash Indexes”  
Section 8.8.2, “EXPLAIN Output Format”  
Section 1.6.1, “MySQL Extensions to Standard SQL”  
Section 12.4.1, “Operator Precedence”  
Section 8.3.10, “Optimizer Use of Generated Column Indexes”  
Section 8.2.1.2, “Range Optimization”  
Section 11.5, “The JSON Data Type”  
Section 3.3.4.6, “Working with NULL Values”

**<>**

Section 12.4.2, “Comparison Functions and Operators”  
Section 8.8.2, “EXPLAIN Output Format”  
Section 1.6.1, “MySQL Extensions to Standard SQL”  
Section 12.4.1, “Operator Precedence”  
Section 8.2.1.2, “Range Optimization”  
Section 11.5, “The JSON Data Type”  
Section 3.3.4.6, “Working with NULL Values”

**<<**

Section 12.12, “Bit Functions and Operators”  
Section 1.6.1, “MySQL Extensions to Standard SQL”  
Section 22.6, “Restrictions and Limitations on Partitioning”

**<=**

Section 12.4.2, “Comparison Functions and Operators”  
Section 8.3.8, “Comparison of B-Tree and Hash Indexes”  
Section 8.8.2, “EXPLAIN Output Format”  
Section 1.6.1, “MySQL Extensions to Standard SQL”  
Section 12.4.1, “Operator Precedence”  
Section 8.3.10, “Optimizer Use of Generated Column Indexes”  
Section 8.2.1.2, “Range Optimization”  
Section 11.5, “The JSON Data Type”

**<=>**

Section 12.4.2, “Comparison Functions and Operators”  
Section 8.15.12, “Example”  
Section 8.8.2, “EXPLAIN Output Format”  
Section 1.6.1, “MySQL Extensions to Standard SQL”  
Section 12.4.1, “Operator Precedence”

---

Section 8.2.1.2, “Range Optimization”  
Section 11.5, “The JSON Data Type”  
Section 12.3, “Type Conversion in Expression Evaluation”

\*

Section 12.6.1, “Arithmetic Operators”  
Section 11.1.1, “Numeric Data Type Syntax”  
Section 22.6, “Restrictions and Limitations on Partitioning”

+

Section 12.6.1, “Arithmetic Operators”  
Section 12.10, “Cast Functions and Operators”  
Section 9.5, “Expressions”  
Section 11.1.1, “Numeric Data Type Syntax”  
Section 22.6, “Restrictions and Limitations on Partitioning”

/

Section 12.6.1, “Arithmetic Operators”  
Section 22.6, “Restrictions and Limitations on Partitioning”  
Section 5.1.7, “Server System Variables”

:=

Section 12.4.4, “Assignment Operators”  
Section 12.4.1, “Operator Precedence”  
Section 13.7.4.1, “SET Syntax for Variable Assignment”  
Section 9.4, “User-Defined Variables”

=

Section 12.4.4, “Assignment Operators”  
Section 12.4.2, “Comparison Functions and Operators”  
Section 8.3.8, “Comparison of B-Tree and Hash Indexes”  
Section 8.8.2, “EXPLAIN Output Format”  
Section 1.6.1, “MySQL Extensions to Standard SQL”  
Section 12.4.1, “Operator Precedence”  
Section 8.3.10, “Optimizer Use of Generated Column Indexes”  
Section 8.2.1.2, “Range Optimization”  
Section 13.2.10.12, “Restrictions on Subqueries”  
Section 13.7.4.1, “SET Syntax for Variable Assignment”  
Section 12.8.1, “String Comparison Functions and Operators”  
Section 11.5, “The JSON Data Type”  
Section 9.4, “User-Defined Variables”  
Section 3.3.4.6, “Working with NULL Values”

^

Section 12.12, “Bit Functions and Operators”  
Section 9.5, “Expressions”  
Section 12.4.1, “Operator Precedence”  
Section 22.6, “Restrictions and Limitations on Partitioning”

|

Section 12.12, “Bit Functions and Operators”  
Section 22.6, “Restrictions and Limitations on Partitioning”



---

## ||

Section 12.8.3, “Character Set and Collation of Function Results”  
Section 10.8.2, “COLLATE Clause Precedence”  
Section 9.5, “Expressions”  
Section 12.4.3, “Logical Operators”  
Section 1.6.1, “MySQL Extensions to Standard SQL”  
Section 12.4.1, “Operator Precedence”  
Section 5.1.10, “Server SQL Modes”

~

Section 12.12, “Bit Functions and Operators”  
Section 22.6, “Restrictions and Limitations on Partitioning”

## A

[\[index top\]](#)

## AND

Section 8.3.8, “Comparison of B-Tree and Hash Indexes”  
Section 13.1.18, “CREATE TABLE Statement”  
Section 8.2.1.3, “Index Merge Optimization”  
Section 12.4.3, “Logical Operators”  
Section 1.6.1, “MySQL Extensions to Standard SQL”  
Section 8.2.2.3, “Optimizing Subqueries with the EXISTS Strategy”  
Section 8.2.2.1, “Optimizing Subqueries, Derived Tables, and View References with Semijoin Transformations”  
Section 8.2.1.2, “Range Optimization”  
Section 13.2.10.12, “Restrictions on Subqueries”  
Section 8.2.1.19, “Row Constructor Expression Optimization”  
Section 3.6.7, “Searching on Two Keys”  
Section 3.3.4.2, “Selecting Particular Rows”  
Section 12.8.1, “String Comparison Functions and Operators”  
Section 23.5.2, “View Processing Algorithms”

## B

[\[index top\]](#)

## BETWEEN

Section 12.4.2, “Comparison Functions and Operators”  
Section 8.3.8, “Comparison of B-Tree and Hash Indexes”  
Section 8.2.1.12, “Condition Filtering”  
Section 8.8.2, “EXPLAIN Output Format”  
Section 8.3.10, “Optimizer Use of Generated Column Indexes”  
Section 8.2.1.2, “Range Optimization”  
Section 11.5, “The JSON Data Type”  
Section 12.3, “Type Conversion in Expression Evaluation”

## BINARY

Section 12.10, “Cast Functions and Operators”  
Section 8.4.2.2, “Optimizing for Character and String Types”  
Section 3.3.4.7, “Pattern Matching”

---

[Section 3.3.4.4, “Sorting Rows”](#)

## C

[\[index top\]](#)

### CASE

[Section 13.6.5.1, “CASE Statement”](#)

[Section 9.5, “Expressions”](#)

[Section 12.5, “Flow Control Functions”](#)

[Section 1.6.1, “MySQL Extensions to Standard SQL”](#)

### CASE value WHEN compare\_value THEN result END

[Section 12.5, “Flow Control Functions”](#)

### CASE WHEN condition THEN result END

[Section 12.5, “Flow Control Functions”](#)

### CASE WHEN expr1 = expr2 THEN NULL ELSE expr1 END

[Section 12.5, “Flow Control Functions”](#)

### column->>path

[Section 12.17.3, “Functions That Search JSON Values”](#)

### column->path

[Section 12.17.3, “Functions That Search JSON Values”](#)

[Section 11.5, “The JSON Data Type”](#)

[Section 1.3, “What Is New in MySQL 5.7”](#)

## D

[\[index top\]](#)

### DIV

[Section 12.6.1, “Arithmetic Operators”](#)

[Section 22.6, “Restrictions and Limitations on Partitioning”](#)

## E

[\[index top\]](#)

### EXISTS()

[Section 12.4.2, “Comparison Functions and Operators”](#)

### expr BETWEEN min AND max

[Section 12.4.2, “Comparison Functions and Operators”](#)

### expr IN ()

[Section 12.4.2, “Comparison Functions and Operators”](#)

### expr LIKE pat

[Section 12.8.1, “String Comparison Functions and Operators”](#)

---

## **expr NOT BETWEEN min AND max**

[Section 12.4.2, "Comparison Functions and Operators"](#)

## **expr NOT IN ()**

[Section 12.4.2, "Comparison Functions and Operators"](#)

## **expr NOT LIKE pat**

[Section 12.8.1, "String Comparison Functions and Operators"](#)

## **expr NOT REGEXP pat**

[Section 12.8.2, "Regular Expressions"](#)

## **expr NOT RLIKE pat**

[Section 12.8.2, "Regular Expressions"](#)

## **expr REGEXP pat**

[Section 12.8.2, "Regular Expressions"](#)

## **expr RLIKE pat**

[Section 12.8.2, "Regular Expressions"](#)

## **expr1 SOUNDS LIKE expr2**

[Section 12.8, "String Functions and Operators"](#)

## **I**

[\[index top\]](#)

## **IN()**

[Section 8.8.2, "EXPLAIN Output Format"](#)

[Section 12.4.1, "Operator Precedence"](#)

[Section 8.3.10, "Optimizer Use of Generated Column Indexes"](#)

[Section 8.2.1.2, "Range Optimization"](#)

[Section 8.2.1.19, "Row Constructor Expression Optimization"](#)

[Section 11.5, "The JSON Data Type"](#)

[Section 12.3, "Type Conversion in Expression Evaluation"](#)

## **IS**

[Section 12.4.1, "Operator Precedence"](#)

## **IS boolean\_value**

[Section 12.4.2, "Comparison Functions and Operators"](#)

## **IS NOT boolean\_value**

[Section 12.4.2, "Comparison Functions and Operators"](#)

## **IS NOT NULL**

[Section 12.4.2, "Comparison Functions and Operators"](#)

[Section B.3.4.3, "Problems with NULL Values"](#)

[Section 8.2.1.2, "Range Optimization"](#)

---

[Section 3.3.4.6, “Working with NULL Values”](#)

## **IS NULL**

[Section 12.4.2, “Comparison Functions and Operators”](#)

[Section 8.8.2, “EXPLAIN Output Format”](#)

[Section 8.2.1.13, “IS NULL Optimization”](#)

[Section 8.2.2.3, “Optimizing Subqueries with the EXISTS Strategy”](#)

[Section B.3.4.3, “Problems with NULL Values”](#)

[Section 8.2.1.2, “Range Optimization”](#)

[Section 5.1.7, “Server System Variables”](#)

[Section 3.3.4.6, “Working with NULL Values”](#)

## **L**

[\[index top\]](#)

## **LIKE**

[Section 6.2.6, “Access Control, Stage 2: Request Verification”](#)

[Section 12.10, “Cast Functions and Operators”](#)

[Section 10.2, “Character Sets and Collations in MySQL”](#)

[Section 8.3.8, “Comparison of B-Tree and Hash Indexes”](#)

[Section 8.8.2, “EXPLAIN Output Format”](#)

[Section 24.8, “Extensions to SHOW Statements”](#)

[Section 12.17.3, “Functions That Search JSON Values”](#)

[Section 13.8.3, “HELP Statement”](#)

[Section A.11, “MySQL 5.7 FAQ: MySQL Chinese, Japanese, and Korean Character Sets”](#)

[Section 4.5.1.4, “mysql Client Server-Side Help”](#)

[Section 1.6.1, “MySQL Extensions to Standard SQL”](#)

[Section 21.7.4, “NDB Cluster Replication Schema and Tables”](#)

[Section 12.4.1, “Operator Precedence”](#)

[Section 3.3.4.7, “Pattern Matching”](#)

[Section 25.4.4, “Pre-Filtering by Instrument”](#)

[Section 21.6.17, “Quick Reference: NDB Cluster SQL Statements”](#)

[Section 8.2.1.2, “Range Optimization”](#)

[Section 16.1.6.3, “Replica Server Options and Variables”](#)

[Section 5.1.10, “Server SQL Modes”](#)

[Section 13.7.5.3, “SHOW CHARACTER SET Statement”](#)

[Section 13.7.5.4, “SHOW COLLATION Statement”](#)

[Section 13.7.5.5, “SHOW COLUMNS Statement”](#)

[Section 13.7.5.14, “SHOW DATABASES Statement”](#)

[Section 13.7.5.18, “SHOW EVENTS Statement”](#)

[Section 13.7.5.24, “SHOW OPEN TABLES Statement”](#)

[Section 13.7.5.28, “SHOW PROCEDURE STATUS Statement”](#)

[Section 13.7.5.35, “SHOW STATUS Statement”](#)

[Section 13.7.5.36, “SHOW TABLE STATUS Statement”](#)

[Section 13.7.5.37, “SHOW TABLES Statement”](#)

[Section 13.7.5.38, “SHOW TRIGGERS Statement”](#)

[Section 13.7.5.39, “SHOW VARIABLES Statement”](#)

[Section 6.2.4, “Specifying Account Names”](#)

[Section 12.8.1, “String Comparison Functions and Operators”](#)

[Section 9.1.1, “String Literals”](#)

[Section 5.1.8.3, “Structured System Variables”](#)

[Section 11.3.2, “The CHAR and VARCHAR Types”](#)

---

[Section 26.4.4.5, “The ps\\_setup\\_disable\\_consumer\(\) Procedure”](#)  
[Section 26.4.4.6, “The ps\\_setup\\_disable\\_instrument\(\) Procedure”](#)  
[Section 26.4.4.9, “The ps\\_setup\\_enable\\_consumer\(\) Procedure”](#)  
[Section 26.4.4.10, “The ps\\_setup\\_enable\\_instrument\(\) Procedure”](#)  
[Section 11.3.6, “The SET Type”](#)  
[Section 5.1.8, “Using System Variables”](#)

## **LIKE '\_A%'**

[Section A.11, “MySQL 5.7 FAQ: MySQL Chinese, Japanese, and Korean Character Sets”](#)

## **LIKE 'pattern'**

[Section 8.2.1.2, “Range Optimization”](#)  
[Section 13.7.5, “SHOW Statements”](#)

## **LIKE ... ESCAPE**

[Section B.3.7, “Known Issues in MySQL”](#)

## **N**

[\[index top\]](#)

## **N % M**

[Section 12.6.1, “Arithmetic Operators”](#)  
[Section 12.6.2, “Mathematical Functions”](#)

## **N MOD M**

[Section 12.6.1, “Arithmetic Operators”](#)  
[Section 12.6.2, “Mathematical Functions”](#)

## **NOT**

[Section 12.4.3, “Logical Operators”](#)  
[Section 5.1.10, “Server SQL Modes”](#)

## **NOT EXISTS()**

[Section 12.4.2, “Comparison Functions and Operators”](#)

## **NOT IN()**

[Section 8.2.1.2, “Range Optimization”](#)

## **NOT LIKE**

[Section 3.3.4.7, “Pattern Matching”](#)  
[Section 12.8.1, “String Comparison Functions and Operators”](#)

## **NOT REGEXP**

[Section 1.6.1, “MySQL Extensions to Standard SQL”](#)  
[Section 3.3.4.7, “Pattern Matching”](#)  
[Section 12.8.1, “String Comparison Functions and Operators”](#)

## **NOT RLIKE**

[Section 3.3.4.7, “Pattern Matching”](#)  
[Section 12.8.1, “String Comparison Functions and Operators”](#)

---

## O

[\[index top\]](#)

## OR

[Section 9.5, “Expressions”](#)

[Section 13.7.1.4, “GRANT Statement”](#)

[Section 8.2.1.3, “Index Merge Optimization”](#)

[Section 12.4.3, “Logical Operators”](#)

[Section 1.6.1, “MySQL Extensions to Standard SQL”](#)

[Section 12.4.1, “Operator Precedence”](#)

[Section 8.2.2.3, “Optimizing Subqueries with the EXISTS Strategy”](#)

[Section 8.2.1.2, “Range Optimization”](#)

[Section 8.2.1.19, “Row Constructor Expression Optimization”](#)

[Section 3.6.7, “Searching on Two Keys”](#)

[Section 3.3.4.2, “Selecting Particular Rows”](#)

[Section 5.1.10, “Server SQL Modes”](#)

[Section 12.8.1, “String Comparison Functions and Operators”](#)

## R

[\[index top\]](#)

## REGEXP

[Section 1.6.1, “MySQL Extensions to Standard SQL”](#)

[Section 12.4.1, “Operator Precedence”](#)

[Section 3.3.4.7, “Pattern Matching”](#)

[Section 12.8.2, “Regular Expressions”](#)

[Section 10.11, “Restrictions on Character Sets”](#)

## RLIKE

[Section 3.3.4.7, “Pattern Matching”](#)

[Section 12.8.2, “Regular Expressions”](#)

[Section 10.11, “Restrictions on Character Sets”](#)

## X

[\[index top\]](#)

## XOR

[Section 12.19.1, “Aggregate Function Descriptions”](#)

[Section 12.4.3, “Logical Operators”](#)

## Option Index

[Symbols](#) | [A](#) | [B](#) | [C](#) | [D](#) | [E](#) | [F](#) | [G](#) | [H](#) | [I](#) | [J](#) | [K](#) | [L](#) | [M](#) | [N](#) | [O](#) | [P](#) | [Q](#) | [R](#) | [S](#) | [T](#) | [U](#) | [V](#) | [W](#) | [X](#) | [Y](#) | [Z](#)

## Symbols

[\[index top\]](#)

--

[Section 1.6.2.4, “'--' as the Start of a Comment”](#)

---

Section 4.8.3, “replace — A String-Replacement Utility”

## **-#**

Section 4.4.1, “comp\_err — Compile MySQL Error Message File”  
Section 4.7.2, “my\_print\_defaults — Display Options from Option Files”  
Section 4.6.3.1, “myisamchk General Options”  
Section 4.6.5, “myisampack — Generate Compressed, Read-Only MyISAM Tables”  
Section 4.5.1.1, “mysql Client Options”  
Section 4.6.6, “mysql\_config\_editor — MySQL Configuration Utility”  
Section 4.4.7, “mysql\_upgrade — Check and Upgrade MySQL Tables”  
Section 4.5.2, “mysqladmin — A MySQL Server Administration Program”  
Section 4.6.7, “mysqlbinlog — Utility for Processing Binary Log Files”  
Section 4.5.3, “mysqlcheck — A Table Maintenance Program”  
Section 4.5.4, “mysqldump — A Database Backup Program”  
Section 4.5.5, “mysqlimport — A Data Import Program”  
Section 4.5.6, “mysqlpump — A Database Backup Program”  
Section 4.5.7, “mysqlshow — Display Database, Table, and Column Information”  
Section 4.5.8, “mysqlslap — A Load Emulation Client”  
Section 4.8.3, “replace — A String-Replacement Utility”  
Section 5.1.6, “Server Command Options”  
Section 5.8.3, “The DEBUG Package”

## **-1**

Section 4.5.3, “mysqlcheck — A Table Maintenance Program”

## **-?**

Section 4.4.1, “comp\_err — Compile MySQL Error Message File”  
Section 4.6.1, “innochecksum — Offline InnoDB File Checksum Utility”  
Section 4.7.2, “my\_print\_defaults — Display Options from Option Files”  
Section 4.6.2, “myisam\_ftdump — Display Full-Text Index information”  
Section 4.6.3.1, “myisamchk General Options”  
Section 4.6.4, “myisamlog — Display MyISAM Log File Contents”  
Section 4.6.5, “myisampack — Generate Compressed, Read-Only MyISAM Tables”  
Section 4.5.1.1, “mysql Client Options”  
Section 4.6.6, “mysql\_config\_editor — MySQL Configuration Utility”  
Section 4.4.2, “mysql\_install\_db — Initialize MySQL Data Directory”  
Section 4.4.3, “mysql\_plugin — Configure MySQL Server Plugins”  
Section 4.4.4, “mysql\_secure\_installation — Improve MySQL Installation Security”  
Section 4.5.2, “mysqladmin — A MySQL Server Administration Program”  
Section 4.6.7, “mysqlbinlog — Utility for Processing Binary Log Files”  
Section 4.5.3, “mysqlcheck — A Table Maintenance Program”  
Section 4.5.4, “mysqldump — A Database Backup Program”  
Section 4.5.5, “mysqlimport — A Data Import Program”  
Section 4.5.6, “mysqlpump — A Database Backup Program”  
Section 4.5.7, “mysqlshow — Display Database, Table, and Column Information”  
Section 4.5.8, “mysqlslap — A Load Emulation Client”  
Section 21.5.6, “ndb\_blob\_tool — Check and Repair BLOB and TEXT columns of NDB Cluster Tables”  
Section 21.5.7, “ndb\_config — Extract NDB Cluster Configuration Information”  
Section 21.5.9, “ndb\_delete\_all — Delete All Rows from an NDB Table”  
Section 21.5.10, “ndb\_desc — Describe NDB Tables”  
Section 21.5.11, “ndb\_drop\_index — Drop Index from an NDB Table”  
Section 21.5.12, “ndb\_drop\_table — Drop an NDB Table”  
Section 21.5.13, “ndb\_error\_reporter — NDB Error-Reporting Utility”

---

Section 21.5.14, “[ndb\\_import — Import CSV Data Into NDB](#)”  
Section 21.5.15, “[ndb\\_index\\_stat — NDB Index Statistics Utility](#)”  
Section 21.5.5, “[ndb\\_mgm — The NDB Cluster Management Client](#)”  
Section 21.5.4, “[ndb\\_mgmd — The NDB Cluster Management Server Daemon](#)”  
Section 21.5.16, “[ndb\\_move\\_data — NDB Data Copy Utility](#)”  
Section 21.5.17, “[ndb\\_perror — Obtain NDB Error Message Information](#)”  
Section 21.5.19, “[ndb\\_print\\_file — Print NDB Disk Data File Contents](#)”  
Section 21.5.24, “[ndb\\_restore — Restore an NDB Cluster Backup](#)”  
Section 21.5.25, “[ndb\\_select\\_all — Print Rows from an NDB Table](#)”  
Section 21.5.26, “[ndb\\_select\\_count — Print Row Counts for NDB Tables](#)”  
Section 21.5.27, “[ndb\\_show\\_tables — Display List of NDB Tables](#)”  
Section 21.5.29, “[ndb\\_top — View CPU usage information for NDB threads](#)”  
Section 21.5.30, “[ndb\\_waiter — Wait for NDB Cluster to Reach a Given Status](#)”  
Section 21.5.1, “[ndbd — The NDB Cluster Data Node Daemon](#)”  
Section 21.5.2, “[ndbinfo\\_select\\_all — Select From ndbinfo Tables](#)”  
Section 4.8.2, “[perror — Display MySQL Error Message Information](#)”  
Section 4.8.3, “[replace — A String-Replacement Utility](#)”  
Section 4.8.4, “[resolveip — Resolve Host name to IP Address or Vice Versa](#)”  
Section 5.1.6, “[Server Command Options](#)”  
Section 1.2.2, “[The Main Features of MySQL](#)”  
Section 4.2.2.1, “[Using Options on the Command Line](#)”

**?**

Section 4.4.5, “[mysql\\_ssl\\_rsa\\_setup — Create SSL/RSA Files](#)”

**A**

[[index top](#)]

**-A**

Section 4.5.1.1, “[mysql Client Options](#)”  
Section 4.5.3, “[mysqlcheck — A Table Maintenance Program](#)”  
Section 4.5.4, “[mysqldump — A Database Backup Program](#)”  
Section 4.5.6, “[mysqlpump — A Database Backup Program](#)”  
Section 21.5.16, “[ndb\\_move\\_data — NDB Data Copy Utility](#)”  
Section 21.5.24, “[ndb\\_restore — Restore an NDB Cluster Backup](#)”  
Section 4.6.3.4, “[Other myisamchk Options](#)”

**-a**

Section 21.6.1, “[Commands in the NDB Cluster Management Client](#)”  
Section 4.6.1, “[innochecksum — Offline InnoDB File Checksum Utility](#)”  
Section 7.6.4, “[MyISAM Table Optimization](#)”  
Section 4.5.3, “[mysqlcheck — A Table Maintenance Program](#)”  
Section 4.6.8, “[mysqldumpslow — Summarize Slow Query Log Files](#)”  
Section 4.5.8, “[mysqlslap — A Load Emulation Client](#)”  
Section 21.5.7, “[ndb\\_config — Extract NDB Cluster Configuration Information](#)”  
Section 21.5.10, “[ndb\\_desc — Describe NDB Tables](#)”  
Section 4.6.3.4, “[Other myisamchk Options](#)”  
Section 21.2.4.2, “[What is New in NDB Cluster 7.6](#)”

**--abort-on-error**

Section 21.5.14, “[ndb\\_import — Import CSV Data Into NDB](#)”  
Section 21.5.16, “[ndb\\_move\\_data — NDB Data Copy Utility](#)”



---

## **--abort-slave-event-count**

Section 16.1.6.3, “Replica Server Options and Variables”

## **--add-drop-database**

Section 7.4.1, “Dumping Data in SQL Format with mysqldump”

Section 4.5.4, “mysqldump — A Database Backup Program”

Section 4.5.6, “mysqlpump — A Database Backup Program”

## **--add-drop-table**

Section 2.10.3, “Changes in MySQL 5.7”

Section 4.5.4, “mysqldump — A Database Backup Program”

Section 4.5.6, “mysqlpump — A Database Backup Program”

## **--add-drop-trigger**

Section 4.5.4, “mysqldump — A Database Backup Program”

## **--add-drop-user**

Section 4.5.6, “mysqlpump — A Database Backup Program”

## **--add-locks**

Section 4.5.4, “mysqldump — A Database Backup Program”

Section 4.5.6, “mysqlpump — A Database Backup Program”

## **--add-missing**

Section 21.5.6, “ndb\_blob\_tool — Check and Repair BLOB and TEXT columns of NDB Cluster Tables”

Section 21.2.4.1, “What is New in NDB Cluster 7.5”

Section 21.2.4.2, “What is New in NDB Cluster 7.6”

## **--admin-auth-plugin**

Section 4.4.2, “mysql\_install\_db — Initialize MySQL Data Directory”

## **--admin-host**

Section 4.4.2, “mysql\_install\_db — Initialize MySQL Data Directory”

## **--admin-require-ssl**

Section 4.4.2, “mysql\_install\_db — Initialize MySQL Data Directory”

## **--admin-user**

Section 4.4.2, “mysql\_install\_db — Initialize MySQL Data Directory”

## **--admin-xxx**

Section 4.4.2, “mysql\_install\_db — Initialize MySQL Data Directory”

## **--ai-increment**

Section 21.5.14, “ndb\_import — Import CSV Data Into NDB”

## **--ai-offset**

Section 21.5.14, “ndb\_import — Import CSV Data Into NDB”

## **--ai-prefetch-sz**

Section 21.5.14, “ndb\_import — Import CSV Data Into NDB”

---

## **--all**

Section 4.6.6, “mysql\_config\_editor — MySQL Configuration Utility”

## **--all-databases**

Creating a Data Snapshot Using mysqldump

Section 7.4.1, “Dumping Data in SQL Format with mysqldump”

Section 9.2.4, “Mapping of Identifiers to File Names”

Section 4.5.3, “mysqlcheck — A Table Maintenance Program”

Section 4.5.4, “mysqldump — A Database Backup Program”

Section 4.5.6, “mysqlpump — A Database Backup Program”

Section 21.6.15, “ndbinfo: The NDB Cluster Information Database”

Section 2.10.12, “Rebuilding or Repairing Tables or Indexes”

Section 7.4.2, “Reloading SQL-Format Backups”

Section 5.1.7, “Server System Variables”

Section 2.10.4, “Upgrading MySQL Binary or Package-based Installations on Unix/Linux”

Section 4.6.7.3, “Using mysqlbinlog to Back Up Binary Log Files”

## **--all-in-1**

Section 4.5.3, “mysqlcheck — A Table Maintenance Program”

## **--all-tablespaces**

Section 4.5.4, “mysqldump — A Database Backup Program”

## **--allow-keywords**

Section 4.5.4, “mysqldump — A Database Backup Program”

## **--allow-mismatches**

Section 4.6.1, “innochecksum — Offline InnoDB File Checksum Utility”

## **--allow-pk-changes**

Section 21.5.24, “ndb\_restore — Restore an NDB Cluster Backup”

Section 21.2.4.2, “What is New in NDB Cluster 7.6”

## **--allow-suspicious-udfs**

Section 5.1.6, “Server Command Options”

## **--analyze**

Section 7.6.4, “MyISAM Table Optimization”

Section 4.6.3.1, “myisamchk General Options”

Section 4.5.3, “mysqlcheck — A Table Maintenance Program”

Section 4.6.3.4, “Other myisamchk Options”

Section 5.1.7, “Server System Variables”

## **--ansi**

Section 1.6, “MySQL Standards Compliance”

Section 5.1.6, “Server Command Options”

## **antonio**

Section 6.4.1.7, “PAM Pluggable Authentication”

## **--append**

Section 21.5.24, “ndb\_restore — Restore an NDB Cluster Backup”

---

## **--apply-slave-statements**

Section 4.5.4, “mysqldump — A Database Backup Program”

## **--audit-log**

Section 6.4.5.11, “Audit Log Reference”

Section 6.4.5.2, “Installing or Uninstalling MySQL Enterprise Audit”

## **--auto-generate-sql**

Section 4.5.8, “mysqlslap — A Load Emulation Client”

## **--auto-generate-sql-add-autoincrement**

Section 4.5.8, “mysqlslap — A Load Emulation Client”

## **--auto-generate-sql-execute-number**

Section 4.5.8, “mysqlslap — A Load Emulation Client”

## **--auto-generate-sql-guid-primary**

Section 4.5.8, “mysqlslap — A Load Emulation Client”

## **--auto-generate-sql-load-type**

Section 4.5.8, “mysqlslap — A Load Emulation Client”

## **--auto-generate-sql-secondary-indexes**

Section 4.5.8, “mysqlslap — A Load Emulation Client”

## **--auto-generate-sql-unique-query-number**

Section 4.5.8, “mysqlslap — A Load Emulation Client”

## **--auto-generate-sql-unique-write-number**

Section 4.5.8, “mysqlslap — A Load Emulation Client”

## **--auto-generate-sql-write-number**

Section 4.5.8, “mysqlslap — A Load Emulation Client”

## **--auto-inc**

Section 21.5.10, “ndb\_desc — Describe NDB Tables”

Section 21.2.4.2, “What is New in NDB Cluster 7.6”

## **--auto-rehash**

Section 14.8.11.2, “Configuring Non-Persistent Optimizer Statistics Parameters”

Section 4.5.1.2, “mysql Client Commands”

Section 4.5.1.1, “mysql Client Options”

## **auto-rehash**

Section 14.8.11.2, “Configuring Non-Persistent Optimizer Statistics Parameters”

## **--auto-repair**

Section 4.5.3, “mysqlcheck — A Table Maintenance Program”

## **--auto-vertical-output**

Section 4.5.1.1, “mysql Client Options”

---

## **--autocommit**

Section 5.1.7, “Server System Variables”

## **B**

[[index top](#)]

## **-B**

Section 4.6.3.3, “myisamchk Repair Options”

Section 4.5.1.1, “mysql Client Options”

Section 4.5.3, “mysqlcheck — A Table Maintenance Program”

Section 4.5.4, “mysqldump — A Database Backup Program”

Section 4.5.6, “mysqlpump — A Database Backup Program”

## **-b**

Section 4.6.5, “myisampack — Generate Compressed, Read-Only MyISAM Tables”

Section 4.5.1.1, “mysql Client Options”

Section 4.4.3, “mysql\_plugin — Configure MySQL Server Plugins”

Section 4.5.2, “mysqladmin — A MySQL Server Administration Program”

Section 21.5.10, “ndb\_desc — Describe NDB Tables”

Section 21.5.24, “ndb\_restore — Restore an NDB Cluster Backup”

Section 4.6.3.4, “Other myisamchk Options”

Section 5.1.6, “Server Command Options”

## **--back\_log**

Section 2.7, “Installing MySQL on Solaris”

## **--backup**

Section 4.6.3.3, “myisamchk Repair Options”

Section 4.6.5, “myisampack — Generate Compressed, Read-Only MyISAM Tables”

## **--backup-path**

Section 21.5.24, “ndb\_restore — Restore an NDB Cluster Backup”

Restoring to Fewer Nodes Than the Original

## **backup-path**

Section 21.5.24, “ndb\_restore — Restore an NDB Cluster Backup”

## **--backupid**

Section 21.5.24, “ndb\_restore — Restore an NDB Cluster Backup”

Restoring to Fewer Nodes Than the Original

Section 21.2.4.1, “What is New in NDB Cluster 7.5”

Section 21.2.4.2, “What is New in NDB Cluster 7.6”

## **--base64-output**

Section 16.2.1.1, “Advantages and Disadvantages of Statement-Based and Row-Based Replication”

Section 4.6.7.2, “mysqlbinlog Row Event Display”

Section 4.6.7, “mysqlbinlog — Utility for Processing Binary Log Files”

Section 16.2.1.2, “Usage of Row-Based Logging and Replication”

## **--basedir**

Section 2.9.1, “Initializing the Data Directory”

---

Section 2.8.7, “MySQL Source-Configuration Options”  
Section 4.4.2, “mysql\_install\_db — Initialize MySQL Data Directory”  
Section 4.4.3, “mysql\_plugin — Configure MySQL Server Plugins”  
Section 4.3.2, “mysqld\_safe — MySQL Server Startup Script”  
Section 21.2.7.1, “Noncompliance with SQL Syntax in NDB Cluster”  
Section 5.7, “Running Multiple MySQL Instances on One Machine”  
Section 5.1.6, “Server Command Options”  
Section 2.9.2.1, “Troubleshooting Problems Starting the MySQL Server”  
Section 1.3, “What Is New in MySQL 5.7”

## **basedir**

Section 2.3.4.2, “Creating an Option File”  
Section 4.3.3, “mysql.server — MySQL Server Startup Script”  
Section 2.3.5, “Troubleshooting a Microsoft Windows MySQL Server Installation”

## **--batch**

Section 4.5.1.3, “mysql Client Logging”  
Section 4.5.1.1, “mysql Client Options”

## **--binary-as-hex**

Section 12.19.1, “Aggregate Function Descriptions”  
Section 6.4.5.11, “Audit Log Reference”  
Section 12.10, “Cast Functions and Operators”  
Section 12.13, “Encryption and Compression Functions”  
Section 12.20, “Miscellaneous Functions”  
Section 4.5.1.1, “mysql Client Options”  
Section 6.5.5, “MySQL Enterprise Data Masking and De-Identification Function Descriptions”  
Section 12.8.1, “String Comparison Functions and Operators”  
Section 12.8, “String Functions and Operators”  
Section 9.1.1, “String Literals”  
Section 11.3.3, “The BINARY and VARBINARY Types”  
Section 10.10.8, “The Binary Character Set”  
Section 11.3.4, “The BLOB and TEXT Types”

## **--binary-mode**

Section 9.6, “Comments”  
Section 4.5.1.2, “mysql Client Commands”  
Section 4.5.1.1, “mysql Client Options”  
Section 4.5.1.6, “mysql Client Tips”  
Section 4.6.7, “mysqlbinlog — Utility for Processing Binary Log Files”  
Section 7.5.1, “Point-in-Time Recovery Using Binary Log”

## **--bind-address**

Section 4.5.1.1, “mysql Client Options”  
Section 4.4.7, “mysql\_upgrade — Check and Upgrade MySQL Tables”  
Section 4.5.2, “mysqladmin — A MySQL Server Administration Program”  
Section 4.6.7, “mysqlbinlog — Utility for Processing Binary Log Files”  
Section 4.5.3, “mysqlcheck — A Table Maintenance Program”  
Section 4.5.4, “mysqldump — A Database Backup Program”  
Section 4.5.5, “mysqlimport — A Data Import Program”  
Section 4.5.6, “mysqlpump — A Database Backup Program”  
Section 4.5.7, “mysqlshow — Display Database, Table, and Column Information”  
Section 21.5.4, “ndb\_mgmd — The NDB Cluster Management Server Daemon”

---

[Section 21.5.1, “ndbd — The NDB Cluster Data Node Daemon”](#)

## **--binlog-checksum**

[Section 16.1.6.4, “Binary Logging Options and Variables”](#)

## **--binlog-do-db**

[Section 16.1.6.4, “Binary Logging Options and Variables”](#)

[Section 16.2.5.1, “Evaluation of Database-Level Replication and Binary Logging Options”](#)

[Section 16.2.5, “How Servers Evaluate Replication Filtering Rules”](#)

[Section 21.7.3, “Known Issues in NDB Cluster Replication”](#)

[Section 4.6.7, “mysqlbinlog — Utility for Processing Binary Log Files”](#)

[Section 16.1.6.3, “Replica Server Options and Variables”](#)

[Section 5.4.4, “The Binary Log”](#)

## **--binlog-format**

[Section 5.4.4.1, “Binary Logging Formats”](#)

[Section 21.7.2, “General Requirements for NDB Cluster Replication”](#)

[Section A.4, “MySQL 5.7 FAQ: Stored Procedures and Functions”](#)

[Section 5.4.4.2, “Setting The Binary Log Format”](#)

[Section 21.7.6, “Starting NDB Cluster Replication \(Single Replication Channel\)”](#)

[Section 21.2.7.6, “Unsupported or Missing Features in NDB Cluster”](#)

## **--binlog-ignore-db**

[Section 16.1.6.4, “Binary Logging Options and Variables”](#)

[Section 16.2.5.1, “Evaluation of Database-Level Replication and Binary Logging Options”](#)

[Section 16.2.5, “How Servers Evaluate Replication Filtering Rules”](#)

[Section 21.7.3, “Known Issues in NDB Cluster Replication”](#)

[Section 16.1.6.3, “Replica Server Options and Variables”](#)

[Section 5.4.4, “The Binary Log”](#)

## **--binlog-row-event-max-size**

[Section 16.1.6.4, “Binary Logging Options and Variables”](#)

[Section 4.6.7, “mysqlbinlog — Utility for Processing Binary Log Files”](#)

[Section 5.4.4.2, “Setting The Binary Log Format”](#)

## **--blob-info**

[Section 21.5.10, “ndb\\_desc — Describe NDB Tables”](#)

## **--block-search**

[Section 4.6.3.4, “Other myisamchk Options”](#)

## **--bootstrap**

[Section 5.1.6, “Server Command Options”](#)

[Section 5.1.7, “Server System Variables”](#)

[Section 1.3, “What Is New in MySQL 5.7”](#)

## **--builddir**

[Section 4.4.2, “mysql\\_install\\_db — Initialize MySQL Data Directory”](#)

## **C**

[\[index top\]](#)

---

## **-C**

Section 4.4.1, “[comp\\_err — Compile MySQL Error Message File](#)”  
Section 4.6.1, “[innochecksum — Offline InnoDB File Checksum Utility](#)”  
Section 4.6.3.2, “[myisamchk Check Options](#)”  
Section 4.5.1.1, “[mysql Client Options](#)”  
Section 4.4.7, “[mysql\\_upgrade — Check and Upgrade MySQL Tables](#)”  
Section 4.5.2, “[mysqladmin — A MySQL Server Administration Program](#)”  
Section 4.5.3, “[mysqlcheck — A Table Maintenance Program](#)”  
Section 4.5.4, “[mysqldump — A Database Backup Program](#)”  
Section 4.5.5, “[mysqlimport — A Data Import Program](#)”  
Section 4.5.6, “[mysqlpump — A Database Backup Program](#)”  
Section 4.5.7, “[mysqlshow — Display Database, Table, and Column Information](#)”  
Section 4.5.8, “[mysqlslap — A Load Emulation Client](#)”

## **-C**

Section 4.6.1, “[innochecksum — Offline InnoDB File Checksum Utility](#)”  
Section 21.3.2.1, “[Installing NDB Cluster on Windows from a Binary Release](#)”  
Section 4.7.2, “[my\\_print\\_defaults — Display Options from Option Files](#)”  
Section 4.6.2, “[myisam\\_ftdump — Display Full-Text Index information](#)”  
Section 4.6.3.2, “[myisamchk Check Options](#)”  
Section 4.6.4, “[myisamlog — Display MyISAM Log File Contents](#)”  
Section A.10, “[MySQL 5.7 FAQ: NDB Cluster](#)”  
Section 4.5.1.1, “[mysql Client Options](#)”  
Section 4.5.2, “[mysqladmin — A MySQL Server Administration Program](#)”  
Section 4.6.7, “[mysqlbinlog — Utility for Processing Binary Log Files](#)”  
Section 4.5.3, “[mysqlcheck — A Table Maintenance Program](#)”  
Section 4.5.4, “[mysqldump — A Database Backup Program](#)”  
Section 4.5.5, “[mysqlimport — A Data Import Program](#)”  
Section 4.5.8, “[mysqlslap — A Load Emulation Client](#)”  
Section 21.5.6, “[ndb\\_blob\\_tool — Check and Repair BLOB and TEXT columns of NDB Cluster Tables](#)”  
Section 21.5.7, “[ndb\\_config — Extract NDB Cluster Configuration Information](#)”  
Section 21.5.9, “[ndb\\_delete\\_all — Delete All Rows from an NDB Table](#)”  
Section 21.5.10, “[ndb\\_desc — Describe NDB Tables](#)”  
Section 21.5.11, “[ndb\\_drop\\_index — Drop Index from an NDB Table](#)”  
Section 21.5.12, “[ndb\\_drop\\_table — Drop an NDB Table](#)”  
Section 21.5.14, “[ndb\\_import — Import CSV Data Into NDB](#)”  
Section 21.5.15, “[ndb\\_index\\_stat — NDB Index Statistics Utility](#)”  
Section 21.5.5, “[ndb\\_mgm — The NDB Cluster Management Client](#)”  
Section 21.5.4, “[ndb\\_mgmd — The NDB Cluster Management Server Daemon](#)”  
Section 21.5.16, “[ndb\\_move\\_data — NDB Data Copy Utility](#)”  
Section 21.5.24, “[ndb\\_restore — Restore an NDB Cluster Backup](#)”  
Section 21.5.25, “[ndb\\_select\\_all — Print Rows from an NDB Table](#)”  
Section 21.5.26, “[ndb\\_select\\_count — Print Row Counts for NDB Tables](#)”  
Section 21.5.27, “[ndb\\_show\\_tables — Display List of NDB Tables](#)”  
Section 21.5.29, “[ndb\\_top — View CPU usage information for NDB threads](#)”  
Section 21.5.30, “[ndb\\_waiter — Wait for NDB Cluster to Reach a Given Status](#)”  
Section 21.5.1, “[ndbd — The NDB Cluster Data Node Daemon](#)”  
Section 21.5.2, “[ndbinfo\\_select\\_all — Select From ndbinfo Tables](#)”  
[Restoring to Fewer Nodes Than the Original](#)

## **--cflags**

Section 2.8.8, “[Dealing with Problems Compiling MySQL](#)”

---

Section 4.7.1, “mysql\_config — Display Options for Compiling Clients”

## **--character-set-client-handshake**

Section A.11, “MySQL 5.7 FAQ: MySQL Chinese, Japanese, and Korean Character Sets”

Section 5.1.6, “Server Command Options”

Section 10.10.7.1, “The cp932 Character Set”

## **--character-set-server**

Section 10.15, “Character Set Configuration”

Section 10.5, “Configuring Application Character Set and Collation”

Section A.11, “MySQL 5.7 FAQ: MySQL Chinese, Japanese, and Korean Character Sets”

Section 2.8.7, “MySQL Source-Configuration Options”

Section 10.3.2, “Server Character Set and Collation”

## **--character-sets-dir**

Section B.3.2.15, “Can't initialize character set”

Section 10.15, “Character Set Configuration”

Section 4.6.3.3, “myisamchk Repair Options”

Section 4.6.5, “myisampack — Generate Compressed, Read-Only MyISAM Tables”

Section 4.5.1.1, “mysql Client Options”

Section 4.4.7, “mysql\_upgrade — Check and Upgrade MySQL Tables”

Section 4.5.2, “mysqladmin — A MySQL Server Administration Program”

Section 4.6.7, “mysqlbinlog — Utility for Processing Binary Log Files”

Section 4.5.3, “mysqlcheck — A Table Maintenance Program”

Section 4.5.4, “mysqldump — A Database Backup Program”

Section 4.5.5, “mysqlimport — A Data Import Program”

Section 4.5.6, “mysqlpump — A Database Backup Program”

Section 4.5.7, “mysqlshow — Display Database, Table, and Column Information”

Section 21.5.6, “ndb\_blob\_tool — Check and Repair BLOB and TEXT columns of NDB Cluster Tables”

Section 21.5.7, “ndb\_config — Extract NDB Cluster Configuration Information”

Section 21.5.9, “ndb\_delete\_all — Delete All Rows from an NDB Table”

Section 21.5.10, “ndb\_desc — Describe NDB Tables”

Section 21.5.11, “ndb\_drop\_index — Drop Index from an NDB Table”

Section 21.5.12, “ndb\_drop\_table — Drop an NDB Table”

Section 21.5.14, “ndb\_import — Import CSV Data Into NDB”

Section 21.5.15, “ndb\_index\_stat — NDB Index Statistics Utility”

Section 21.5.5, “ndb\_mgm — The NDB Cluster Management Client”

Section 21.5.4, “ndb\_mgmd — The NDB Cluster Management Server Daemon”

Section 21.5.16, “ndb\_move\_data — NDB Data Copy Utility”

Section 21.5.24, “ndb\_restore — Restore an NDB Cluster Backup”

Section 21.5.25, “ndb\_select\_all — Print Rows from an NDB Table”

Section 21.5.26, “ndb\_select\_count — Print Row Counts for NDB Tables”

Section 21.5.27, “ndb\_show\_tables — Display List of NDB Tables”

Section 21.5.30, “ndb\_waiter — Wait for NDB Cluster to Reach a Given Status”

Section 21.5.1, “ndbd — The NDB Cluster Data Node Daemon”

Section 21.5.2, “ndbinfo\_select\_all — Select From ndbinfo Tables”

## **--charset**

Section 4.4.1, “comp\_err — Compile MySQL Error Message File”

## **--check**

Section 4.6.3.2, “myisamchk Check Options”

Section 4.5.3, “mysqlcheck — A Table Maintenance Program”



---

## **--check-missing**

Section 21.5.6, “[ndb\\_blob\\_tool — Check and Repair BLOB and TEXT columns of NDB Cluster Tables](#)”

Section 21.2.4.1, “[What is New in NDB Cluster 7.5](#)”

Section 21.2.4.2, “[What is New in NDB Cluster 7.6](#)”

## **--check-only-changed**

Section 4.6.3.2, “[myisamchk Check Options](#)”

Section 4.5.3, “[mysqlcheck — A Table Maintenance Program](#)”

## **--check-orphans**

Section 21.5.6, “[ndb\\_blob\\_tool — Check and Repair BLOB and TEXT columns of NDB Cluster Tables](#)”

## **--check-upgrade**

Section 4.5.3, “[mysqlcheck — A Table Maintenance Program](#)”

## **--chroot**

Section 5.1.6, “[Server Command Options](#)”

## **CMAKE\_BUILD\_TYPE**

Section 2.8.7, “[MySQL Source-Configuration Options](#)”

## **CMAKE\_C\_FLAGS**

Section 5.8.1.1, “[Compiling MySQL for Debugging](#)”

Section 2.8.8, “[Dealing with Problems Compiling MySQL](#)”

Section 2.8.7, “[MySQL Source-Configuration Options](#)”

## **CMAKE\_C\_FLAGS\_build\_type**

Section 2.8.7, “[MySQL Source-Configuration Options](#)”

## **CMAKE\_C\_FLAGS\_RELWITHDEBINFO**

Section 2.8.7, “[MySQL Source-Configuration Options](#)”

## **CMAKE\_CXX\_FLAGS**

Section 5.8.1.1, “[Compiling MySQL for Debugging](#)”

Section 2.8.8, “[Dealing with Problems Compiling MySQL](#)”

Section 2.8.7, “[MySQL Source-Configuration Options](#)”

## **CMAKE\_CXX\_FLAGS\_build\_type**

Section 2.8.7, “[MySQL Source-Configuration Options](#)”

## **CMAKE\_CXX\_FLAGS\_RELWITHDEBINFO**

Section 2.8.7, “[MySQL Source-Configuration Options](#)”

## **CMAKE\_INSTALL\_PREFIX**

Section 2.8.5, “[Installing MySQL Using a Development Source Tree](#)”

Section 6.4.4.12, “[Keyring System Variables](#)”

Section 2.8.7, “[MySQL Source-Configuration Options](#)”

Section 5.7.3, “[Running Multiple MySQL Instances on Unix](#)”

Section 5.1.7, “[Server System Variables](#)”

## **CMAKE\_PREFIX\_PATH**

Section 2.8.7, “[MySQL Source-Configuration Options](#)”

---

## **--collation-server**

Section 10.15, “Character Set Configuration”

Section 10.5, “Configuring Application Character Set and Collation”

Section 10.3.2, “Server Character Set and Collation”

## **--collation\_server**

Section 2.8.7, “MySQL Source-Configuration Options”

## **--color**

Section 21.5.29, “ndb\_top — View CPU usage information for NDB threads”

## **--column-names**

Section 4.5.1.1, “mysql Client Options”

Section 4.2.2.4, “Program Option Modifiers”

## **--column-type-info**

Section 8.2.1.17, “LIMIT Query Optimization”

Section 4.5.1.1, “mysql Client Options”

## **--columns**

Section 4.5.5, “mysqlimport — A Data Import Program”

## **--commands**

Section 4.5.1.1, “mysql Client Options”

Section 21.2.4.2, “What is New in NDB Cluster 7.6”

## **--comments**

Section 4.5.1.1, “mysql Client Options”

Section 4.5.4, “mysqldump — A Database Backup Program”

Section 8.9.3, “Optimizer Hints”

Section 1.3, “What Is New in MySQL 5.7”

## **--commit**

Section 4.5.8, “mysqlslap — A Load Emulation Client”

## **--comp**

Section 4.2.2.5, “Using Options to Set Program Variables”

Section 1.3, “What Is New in MySQL 5.7”

## **--compact**

Section 4.5.4, “mysqldump — A Database Backup Program”

## **--compatible**

Section 4.5.4, “mysqldump — A Database Backup Program”

## **COMPILATION\_COMMENT**

Section 5.1.7, “Server System Variables”

## **--complete-insert**

Section 4.5.4, “mysqldump — A Database Backup Program”

---

Section 4.5.6, “mysqlpump — A Database Backup Program”

## **--compr**

Section 4.2.2.5, “Using Options to Set Program Variables”

Section 1.3, “What Is New in MySQL 5.7”

## **--compress**

Section 4.2.6, “Connection Compression Control”

Section 4.5.1.1, “mysql Client Options”

Section 4.4.7, “mysql\_upgrade — Check and Upgrade MySQL Tables”

Section 4.5.2, “mysqladmin — A MySQL Server Administration Program”

Section 4.5.3, “mysqlcheck — A Table Maintenance Program”

Section 4.5.4, “mysqldump — A Database Backup Program”

Section 4.5.5, “mysqlimport — A Data Import Program”

Section 4.5.6, “mysqlpump — A Database Backup Program”

Section 4.5.7, “mysqlshow — Display Database, Table, and Column Information”

Section 4.5.8, “mysqlslap — A Load Emulation Client”

Section 4.2.2.5, “Using Options to Set Program Variables”

Section 1.3, “What Is New in MySQL 5.7”

## **--compress-output**

Section 4.5.6, “mysqlpump — A Database Backup Program”

## **--concurrency**

Section 4.5.8, “mysqlslap — A Load Emulation Client”

## **--config-cache**

Section 21.4.3, “NDB Cluster Configuration Files”

Section 21.5.4, “ndb\_mgmd — The NDB Cluster Management Server Daemon”

## **--config-dir**

Section 21.5.4, “ndb\_mgmd — The NDB Cluster Management Server Daemon”

## **--config-file**

Section 21.3.4, “Initial Startup of NDB Cluster”

Section 21.3.2.3, “Initial Startup of NDB Cluster on Windows”

Section 21.3.2.4, “Installing NDB Cluster Processes as Windows Services”

Section 4.7.2, “my\_print\_defaults — Display Options from Option Files”

Section A.10, “MySQL 5.7 FAQ: NDB Cluster”

Section 21.4.3.1, “NDB Cluster Configuration: Basic Example”

Section 21.5.7, “ndb\_config — Extract NDB Cluster Configuration Information”

Section 21.5.4, “ndb\_mgmd — The NDB Cluster Management Server Daemon”

## **--config-from-node**

Section 21.5.7, “ndb\_config — Extract NDB Cluster Configuration Information”

## **--config\_from\_node**

Section 21.5.7, “ndb\_config — Extract NDB Cluster Configuration Information”

## **--configdir**

Section 21.4.3, “NDB Cluster Configuration Files”

Section 21.5.4, “ndb\_mgmd — The NDB Cluster Management Server Daemon”

---

## **--configinfo**

Section 21.5.7, “[ndb\\_config — Extract NDB Cluster Configuration Information](#)”

## **configure**

Section 2.3.3.5, “[MySQL Installer Console Reference](#)”

## **--connect**

Section 21.5.24, “[ndb\\_restore — Restore an NDB Cluster Backup](#)”

## **--connect-delay**

Section 21.5.1, “[nbd — The NDB Cluster Data Node Daemon](#)”

## **--connect-expired-password**

Section 4.5.1.1, “[mysql Client Options](#)”

Section 6.2.12, “[Server Handling of Expired Passwords](#)”

## **--connect-retries**

Section 21.5.6, “[ndb\\_blob\\_tool — Check and Repair BLOB and TEXT columns of NDB Cluster Tables](#)”

Section 21.5.7, “[ndb\\_config — Extract NDB Cluster Configuration Information](#)”

Section 21.5.9, “[ndb\\_delete\\_all — Delete All Rows from an NDB Table](#)”

Section 21.5.10, “[ndb\\_desc — Describe NDB Tables](#)”

Section 21.5.11, “[ndb\\_drop\\_index — Drop Index from an NDB Table](#)”

Section 21.5.12, “[ndb\\_drop\\_table — Drop an NDB Table](#)”

Section 21.5.14, “[ndb\\_import — Import CSV Data Into NDB](#)”

Section 21.5.15, “[ndb\\_index\\_stat — NDB Index Statistics Utility](#)”

Section 21.5.5, “[ndb\\_mgm — The NDB Cluster Management Client](#)”

Section 21.5.4, “[ndb\\_mgmd — The NDB Cluster Management Server Daemon](#)”

Section 21.5.16, “[ndb\\_move\\_data — NDB Data Copy Utility](#)”

Section 21.5.24, “[ndb\\_restore — Restore an NDB Cluster Backup](#)”

Section 21.5.25, “[ndb\\_select\\_all — Print Rows from an NDB Table](#)”

Section 21.5.26, “[ndb\\_select\\_count — Print Row Counts for NDB Tables](#)”

Section 21.5.27, “[ndb\\_show\\_tables — Display List of NDB Tables](#)”

Section 21.5.30, “[ndb\\_waiter — Wait for NDB Cluster to Reach a Given Status](#)”

Section 21.5.1, “[nbd — The NDB Cluster Data Node Daemon](#)”

Section 21.5.2, “[ndbinfo\\_select\\_all — Select From ndbinfo Tables](#)”

## **--connect-retry-delay**

Section 21.5.6, “[ndb\\_blob\\_tool — Check and Repair BLOB and TEXT columns of NDB Cluster Tables](#)”

Section 21.5.7, “[ndb\\_config — Extract NDB Cluster Configuration Information](#)”

Section 21.5.9, “[ndb\\_delete\\_all — Delete All Rows from an NDB Table](#)”

Section 21.5.10, “[ndb\\_desc — Describe NDB Tables](#)”

Section 21.5.11, “[ndb\\_drop\\_index — Drop Index from an NDB Table](#)”

Section 21.5.12, “[ndb\\_drop\\_table — Drop an NDB Table](#)”

Section 21.5.14, “[ndb\\_import — Import CSV Data Into NDB](#)”

Section 21.5.15, “[ndb\\_index\\_stat — NDB Index Statistics Utility](#)”

Section 21.5.5, “[ndb\\_mgm — The NDB Cluster Management Client](#)”

Section 21.5.4, “[ndb\\_mgmd — The NDB Cluster Management Server Daemon](#)”

Section 21.5.16, “[ndb\\_move\\_data — NDB Data Copy Utility](#)”

Section 21.5.24, “[ndb\\_restore — Restore an NDB Cluster Backup](#)”

Section 21.5.25, “[ndb\\_select\\_all — Print Rows from an NDB Table](#)”

Section 21.5.26, “[ndb\\_select\\_count — Print Row Counts for NDB Tables](#)”

Section 21.5.27, “[ndb\\_show\\_tables — Display List of NDB Tables](#)”

---

Section 21.5.30, “[ndb\\_waiter — Wait for NDB Cluster to Reach a Given Status](#)”  
Section 21.5.1, “[ndbd — The NDB Cluster Data Node Daemon](#)”  
Section 21.5.2, “[ndbinfo\\_select\\_all — Select From ndbinfo Tables](#)”

## **--connect-string**

Section 21.5.6, “[ndb\\_blob\\_tool — Check and Repair BLOB and TEXT columns of NDB Cluster Tables](#)”  
Section 21.5.7, “[ndb\\_config — Extract NDB Cluster Configuration Information](#)”  
Section 21.5.9, “[ndb\\_delete\\_all — Delete All Rows from an NDB Table](#)”  
Section 21.5.10, “[ndb\\_desc — Describe NDB Tables](#)”  
Section 21.5.11, “[ndb\\_drop\\_index — Drop Index from an NDB Table](#)”  
Section 21.5.12, “[ndb\\_drop\\_table — Drop an NDB Table](#)”  
Section 21.5.14, “[ndb\\_import — Import CSV Data Into NDB](#)”  
Section 21.5.15, “[ndb\\_index\\_stat — NDB Index Statistics Utility](#)”  
Section 21.5.5, “[ndb\\_mgm — The NDB Cluster Management Client](#)”  
Section 21.5.4, “[ndb\\_mgmd — The NDB Cluster Management Server Daemon](#)”  
Section 21.5.16, “[ndb\\_move\\_data — NDB Data Copy Utility](#)”  
Section 21.5.24, “[ndb\\_restore — Restore an NDB Cluster Backup](#)”  
Section 21.5.25, “[ndb\\_select\\_all — Print Rows from an NDB Table](#)”  
Section 21.5.26, “[ndb\\_select\\_count — Print Row Counts for NDB Tables](#)”  
Section 21.5.27, “[ndb\\_show\\_tables — Display List of NDB Tables](#)”  
Section 21.5.30, “[ndb\\_waiter — Wait for NDB Cluster to Reach a Given Status](#)”  
Section 21.5.1, “[ndbd — The NDB Cluster Data Node Daemon](#)”  
Section 21.5.2, “[ndbinfo\\_select\\_all — Select From ndbinfo Tables](#)”

## **--connect-timeout**

Section 4.5.1.1, “[mysql Client Options](#)”  
Section 4.5.2, “[mysqladmin — A MySQL Server Administration Program](#)”

## **--connection-control**

Section 6.4.2.1, “[Connection Control Plugin Installation](#)”

## **--connection-control-failed-login-attempts**

Section 6.4.2.1, “[Connection Control Plugin Installation](#)”

## **--connection-server-id**

Section 4.6.7, “[mysqlbinlog — Utility for Processing Binary Log Files](#)”

## **--connection-timeout**

Section 21.5.13, “[ndb\\_error\\_reporter — NDB Error-Reporting Utility](#)”

## **--connections**

Section 21.5.7, “[ndb\\_config — Extract NDB Cluster Configuration Information](#)”  
Section 21.5.14, “[ndb\\_import — Import CSV Data Into NDB](#)”

## **--console**

Section 14.18.2, “[Enabling InnoDB Monitors](#)”  
Section 5.4.2.1, “[Error Logging on Windows](#)”  
Section 21.3.2.3, “[Initial Startup of NDB Cluster on Windows](#)”  
Section 2.9.1, “[Initializing the Data Directory](#)”  
Section 14.22, “[InnoDB Troubleshooting](#)”  
[Resetting the Root Password: Windows Systems](#)  
Section 5.1.6, “[Server Command Options](#)”

---

Section 2.3.4.6, “Starting MySQL from the Windows Command Line”

Section 2.3.4.5, “Starting the Server for the First Time”

## **--context**

Section 21.5.10, “`ndb_desc` — Describe NDB Tables”

Section 21.2.4.2, “What is New in NDB Cluster 7.6”

## **--continue**

Section 21.5.14, “`ndb_import` — Import CSV Data Into NDB”

## **--core-file**

Section 5.8.1.4, “Debugging `mysqld` under `gdb`”

Section 21.5.6, “`ndb_blob_tool` — Check and Repair BLOB and TEXT columns of NDB Cluster Tables”

Section 21.5.7, “`ndb_config` — Extract NDB Cluster Configuration Information”

Section 21.5.9, “`ndb_delete_all` — Delete All Rows from an NDB Table”

Section 21.5.10, “`ndb_desc` — Describe NDB Tables”

Section 21.5.11, “`ndb_drop_index` — Drop Index from an NDB Table”

Section 21.5.12, “`ndb_drop_table` — Drop an NDB Table”

Section 21.5.14, “`ndb_import` — Import CSV Data Into NDB”

Section 21.5.15, “`ndb_index_stat` — NDB Index Statistics Utility”

Section 21.5.5, “`ndb_mgm` — The NDB Cluster Management Client”

Section 21.5.4, “`ndb_mgmd` — The NDB Cluster Management Server Daemon”

Section 21.5.16, “`ndb_move_data` — NDB Data Copy Utility”

Section 21.5.24, “`ndb_restore` — Restore an NDB Cluster Backup”

Section 21.5.25, “`ndb_select_all` — Print Rows from an NDB Table”

Section 21.5.26, “`ndb_select_count` — Print Row Counts for NDB Tables”

Section 21.5.27, “`ndb_show_tables` — Display List of NDB Tables”

Section 21.5.30, “`ndb_waiter` — Wait for NDB Cluster to Reach a Given Status”

Section 21.5.1, “`ndbd` — The NDB Cluster Data Node Daemon”

Section 21.5.2, “`ndbinfo_select_all` — Select From `ndbinfo` Tables”

Section 5.1.6, “Server Command Options”

Section 5.1.7, “Server System Variables”

## **core-file**

Section 5.8.1.3, “Using WER with PDB to create a Windows crashdump”

## **--core-file-size**

Section 2.5.10, “Managing MySQL Server with `systemd`”

Section 4.3.2, “`mysqld_safe` — MySQL Server Startup Script”

Section 5.1.6, “Server Command Options”

## **--correct-checksum**

Section 4.6.3.3, “`myisamchk` Repair Options”

## **--count**

Section 4.6.1, “`innochecksum` — Offline InnoDB File Checksum Utility”

Section 4.6.2, “`myisam_ftdump` — Display Full-Text Index information”

Section 4.5.2, “`mysqladmin` — A MySQL Server Administration Program”

Section 4.5.7, “`mysqlshow` — Display Database, Table, and Column Information”

## **--create**

Section 4.5.8, “`mysqlslap` — A Load Emulation Client”

---

## **--create-options**

[Section 4.5.4, “mysqldump — A Database Backup Program”](#)

## **--create-schema**

[Section 4.5.8, “mysqlslap — A Load Emulation Client”](#)

## **--CSV**

[Section 4.5.8, “mysqlslap — A Load Emulation Client”](#)

## **--csvopt**

[Section 21.5.14, “ndb\\_import — Import CSV Data Into NDB”](#)

## **--cxxflags**

[Section 2.8.8, “Dealing with Problems Compiling MySQL”](#)

[Section 4.7.1, “mysql\\_config — Display Options for Compiling Clients”](#)

## **D**

[\[index top\]](#)

## **-D**

[Section 10.13, “Adding a Character Set”](#)

[Section 21.3.1.4, “Building NDB Cluster from Source on Linux”](#)

[Section B.3.2.15, “Can't initialize character set”](#)

[Section 4.4.1, “comp\\_err — Compile MySQL Error Message File”](#)

[Section 21.3.2.2, “Compiling and Installing NDB Cluster from Source on Windows”](#)

[Section 5.8.1.1, “Compiling MySQL for Debugging”](#)

[Section 27.6.1, “Compiling Programs with libmysqld”](#)

[Section 2.8.6, “Configuring SSL Library Support”](#)

[Section 5.8.2, “Debugging a MySQL Client”](#)

[Section 4.6.1, “innochecksum — Offline InnoDB File Checksum Utility”](#)

[Section 2.8.4, “Installing MySQL Using a Standard Source Distribution”](#)

[Section 2.5.10, “Managing MySQL Server with systemd”](#)

[Section 4.6.3.3, “myisamchk Repair Options”](#)

[Section 4.5.1.1, “mysql Client Options”](#)

[Section 21.6.10, “MySQL Server Usage for NDB Cluster”](#)

[Section 2.8.7, “MySQL Source-Configuration Options”](#)

[Section 4.6.7, “mysqlbinlog — Utility for Processing Binary Log Files”](#)

[Section 4.5.5, “mysqlimport — A Data Import Program”](#)

[Section 21.5.25, “ndb\\_select\\_all — Print Rows from an NDB Table”](#)

[Chapter 22, \*Partitioning\*](#)

[Section 16.1.6.3, “Replica Server Options and Variables”](#)

[Section 5.1.6, “Server Command Options”](#)

[Section 5.1.7, “Server System Variables”](#)

[Section 14.21.3, “Setting Up the InnoDB memcached Plugin”](#)

[Section 15.5, “The ARCHIVE Storage Engine”](#)

[Section 15.6, “The BLACKHOLE Storage Engine”](#)

[Section 15.9, “The EXAMPLE Storage Engine”](#)

[Section 15.8, “The FEDERATED Storage Engine”](#)

[Section 5.8.4, “Tracing mysqld Using DTrace”](#)

[Section B.3.3.3, “What to Do If MySQL Keeps Crashing”](#)

[Section 2.1.2, “Which MySQL Version and Distribution to Install”](#)

---

## **-d**

Section 2.5.7.1, “Basic Steps for MySQL Server Deployment with Docker”  
Section 4.6.2, “mysiam\_ftdump — Display Full-Text Index information”  
Section 4.6.3.1, “mysiamchk General Options”  
Section 4.4.3, “mysql\_plugin — Configure MySQL Server Plugins”  
Section 4.6.7, “mysqlbinlog — Utility for Processing Binary Log Files”  
Section 4.5.4, “mysqldump — A Database Backup Program”  
Section 4.6.8, “mysqldumpslow — Summarize Slow Query Log Files”  
Section 4.5.6, “mysqlpump — A Database Backup Program”  
Section 21.5.6, “ndb\_blob\_tool — Check and Repair BLOB and TEXT columns of NDB Cluster Tables”  
Section 21.5.9, “ndb\_delete\_all — Delete All Rows from an NDB Table”  
Section 21.5.10, “ndb\_desc — Describe NDB Tables”  
Section 21.5.11, “ndb\_drop\_index — Drop Index from an NDB Table”  
Section 21.5.12, “ndb\_drop\_table — Drop an NDB Table”  
Section 21.5.15, “ndb\_index\_stat — NDB Index Statistics Utility”  
Section 21.5.4, “ndb\_mgmd — The NDB Cluster Management Server Daemon”  
Section 21.5.16, “ndb\_move\_data — NDB Data Copy Utility”  
Section 21.5.23, “ndb\_redo\_log\_reader — Check and Print Content of Cluster Redo Log”  
Section 21.5.24, “ndb\_restore — Restore an NDB Cluster Backup”  
Section 21.5.25, “ndb\_select\_all — Print Rows from an NDB Table”  
Section 21.5.26, “ndb\_select\_count — Print Row Counts for NDB Tables”  
Section 21.5.27, “ndb\_show\_tables — Display List of NDB Tables”  
Section 21.5.1, “ndbd — The NDB Cluster Data Node Daemon”  
Section 21.5.2, “ndbinfo\_select\_all — Select From ndbinfo Tables”  
Section 4.6.3.4, “Other mysiamchk Options”  
Section 5.1.7, “Server System Variables”  
Section 6.4.4.4, “Using the keyring\_okv KMIP Plugin”

## **--daemon**

Section 21.5.4, “ndb\_mgmd — The NDB Cluster Management Server Daemon”  
Section 21.5.1, “ndbd — The NDB Cluster Data Node Daemon”

## **--daemonize**

Section 5.1.6, “Server Command Options”

## **--data-file-length**

Section 4.6.3.3, “mysiamchk Repair Options”

## **--database**

Section 4.5.1.1, “mysql Client Options”  
Section 4.6.7, “mysqlbinlog — Utility for Processing Binary Log Files”  
Section 21.5.6, “ndb\_blob\_tool — Check and Repair BLOB and TEXT columns of NDB Cluster Tables”  
Section 21.5.9, “ndb\_delete\_all — Delete All Rows from an NDB Table”  
Section 21.5.10, “ndb\_desc — Describe NDB Tables”  
Section 21.5.11, “ndb\_drop\_index — Drop Index from an NDB Table”  
Section 21.5.12, “ndb\_drop\_table — Drop an NDB Table”  
Section 21.5.15, “ndb\_index\_stat — NDB Index Statistics Utility”  
Section 21.5.16, “ndb\_move\_data — NDB Data Copy Utility”  
Section 21.5.25, “ndb\_select\_all — Print Rows from an NDB Table”  
Section 21.5.26, “ndb\_select\_count — Print Row Counts for NDB Tables”  
Section 21.5.27, “ndb\_show\_tables — Display List of NDB Tables”  
Section 21.5.28, “ndb\_size.pl — NDBCLUSTER Size Requirement Estimator”



---

Section 21.5.2, “ndbinfo\_select\_all — Select From ndbinfo Tables”

## **--databases**

Section 7.4.5.2, “Copy a Database from one Server to Another”

Creating a Data Snapshot Using mysqldump

Section 7.4.1, “Dumping Data in SQL Format with mysqldump”

Section 7.4.5.1, “Making a Copy of a Database”

Section 4.5.3, “mysqlcheck — A Table Maintenance Program”

Section 4.5.4, “mysqldump — A Database Backup Program”

Section 4.5.6, “mysqlpump — A Database Backup Program”

Section 21.6.15, “ndbinfo: The NDB Cluster Information Database”

Section 2.10.12, “Rebuilding or Repairing Tables or Indexes”

Section 7.4.2, “Reloading SQL-Format Backups”

## **--datadir**

Section 2.3.4.2, “Creating an Option File”

Section 2.9.1, “Initializing the Data Directory”

Section 2.8.7, “MySQL Source-Configuration Options”

Section 4.4.2, “mysql\_install\_db — Initialize MySQL Data Directory”

Section 4.4.3, “mysql\_plugin — Configure MySQL Server Plugins”

Section 4.4.5, “mysql\_ssl\_rsa\_setup — Create SSL/RSA Files”

Section 4.3.2, “mysqld\_safe — MySQL Server Startup Script”

Section 21.6.18.3, “NDB Cluster and MySQL Security Procedures”

Section 5.7, “Running Multiple MySQL Instances on One Machine”

Section 5.7.3, “Running Multiple MySQL Instances on Unix”

Section 5.1.6, “Server Command Options”

Section 5.7.1, “Setting Up Multiple Data Directories”

Section 5.2, “The MySQL Data Directory”

Section 2.9.2.1, “Troubleshooting Problems Starting the MySQL Server”

Section 4.2.2.2, “Using Option Files”

Section 1.3, “What Is New in MySQL 5.7”

## **datadir**

Section 2.3.4.2, “Creating an Option File”

Section 2.4.1, “General Notes on Installing MySQL on macOS”

Section 4.3.3, “mysql.server — MySQL Server Startup Script”

Section 2.3.5, “Troubleshooting a Microsoft Windows MySQL Server Installation”

Section 2.3.7, “Windows Platform Restrictions”

## **--db-workers**

Section 21.5.14, “ndb\_import — Import CSV Data Into NDB”

## **--debug**

Section 4.4.1, “comp\_err — Compile MySQL Error Message File”

Section 5.8.1.1, “Compiling MySQL for Debugging”

Section 4.6.1, “innochecksum — Offline InnoDB File Checksum Utility”

Section 4.7.2, “my\_print\_defaults — Display Options from Option Files”

Section 4.6.3.1, “myisamchk General Options”

Section 4.6.5, “myisampack — Generate Compressed, Read-Only MyISAM Tables”

Section 4.5.1.1, “mysql Client Options”

Section 2.8.7, “MySQL Source-Configuration Options”

Section 4.6.6, “mysql\_config\_editor — MySQL Configuration Utility”

Section 4.4.7, “mysql\_upgrade — Check and Upgrade MySQL Tables”

---

Section 4.5.2, “mysqladmin — A MySQL Server Administration Program”  
Section 4.6.7, “mysqlbinlog — Utility for Processing Binary Log Files”  
Section 4.5.3, “mysqlcheck — A Table Maintenance Program”  
Section 4.5.4, “mysqldump — A Database Backup Program”  
Section 4.6.8, “mysqldumpslow — Summarize Slow Query Log Files”  
Section 4.5.5, “mysqlimport — A Data Import Program”  
Section 4.5.6, “mysqlpump — A Database Backup Program”  
Section 4.5.7, “mysqlshow — Display Database, Table, and Column Information”  
Section 4.5.8, “mysqlslap — A Load Emulation Client”  
Section 5.1.6, “Server Command Options”  
Section 5.1.7, “Server System Variables”  
Section 2.3.4.6, “Starting MySQL from the Windows Command Line”  
Section 5.8.3, “The DEBUG Package”  
Section 6.2.17, “Troubleshooting Problems Connecting to MySQL”  
Section 2.9.2.1, “Troubleshooting Problems Starting the MySQL Server”

## **--debug-check**

Section 4.5.1.1, “mysql Client Options”  
Section 4.4.7, “mysql\_upgrade — Check and Upgrade MySQL Tables”  
Section 4.5.2, “mysqladmin — A MySQL Server Administration Program”  
Section 4.6.7, “mysqlbinlog — Utility for Processing Binary Log Files”  
Section 4.5.3, “mysqlcheck — A Table Maintenance Program”  
Section 4.5.4, “mysqldump — A Database Backup Program”  
Section 4.5.5, “mysqlimport — A Data Import Program”  
Section 4.5.6, “mysqlpump — A Database Backup Program”  
Section 4.5.7, “mysqlshow — Display Database, Table, and Column Information”  
Section 4.5.8, “mysqlslap — A Load Emulation Client”

## **--debug-info**

Section 4.4.1, “comp\_err — Compile MySQL Error Message File”  
Section 4.5.1.1, “mysql Client Options”  
Section 4.4.7, “mysql\_upgrade — Check and Upgrade MySQL Tables”  
Section 4.5.2, “mysqladmin — A MySQL Server Administration Program”  
Section 4.6.7, “mysqlbinlog — Utility for Processing Binary Log Files”  
Section 4.5.3, “mysqlcheck — A Table Maintenance Program”  
Section 4.5.4, “mysqldump — A Database Backup Program”  
Section 4.5.5, “mysqlimport — A Data Import Program”  
Section 4.5.6, “mysqlpump — A Database Backup Program”  
Section 4.5.7, “mysqlshow — Display Database, Table, and Column Information”  
Section 4.5.8, “mysqlslap — A Load Emulation Client”

## **--debug-sync-timeout**

Section 5.1.6, “Server Command Options”  
Section 5.1.7, “Server System Variables”

## **--default-auth**

Section 4.2.3, “Command Options for Connecting to the Server”  
Section 4.5.1.1, “mysql Client Options”  
Section 4.4.7, “mysql\_upgrade — Check and Upgrade MySQL Tables”  
Section 4.5.2, “mysqladmin — A MySQL Server Administration Program”  
Section 4.6.7, “mysqlbinlog — Utility for Processing Binary Log Files”  
Section 4.5.3, “mysqlcheck — A Table Maintenance Program”  
Section 4.5.4, “mysqldump — A Database Backup Program”

---

Section 4.5.5, “mysqlimport — A Data Import Program”  
Section 4.5.6, “mysqldump — A Database Backup Program”  
Section 4.5.7, “mysqlshow — Display Database, Table, and Column Information”  
Section 4.5.8, “mysqlslap — A Load Emulation Client”  
Section 6.4.1.1, “Native Pluggable Authentication”  
Section 6.4.1.2, “Old Native Pluggable Authentication”  
Section 6.2.13, “Pluggable Authentication”

## **--default-character-set**

Section 6.2.1, “Account User Names and Passwords”  
Section 10.15, “Character Set Configuration”  
Section 10.5, “Configuring Application Character Set and Collation”  
Section 10.4, “Connection Character Sets and Collations”  
Section 4.5.1.5, “Executing SQL Statements from a Text File”  
Section 13.2.6, “LOAD DATA Statement”  
Section 4.5.1.1, “mysql Client Options”  
Section 4.5.1.6, “mysql Client Tips”  
Section 4.4.7, “mysql\_upgrade — Check and Upgrade MySQL Tables”  
Section 4.5.2, “mysqladmin — A MySQL Server Administration Program”  
Section 4.5.3, “mysqlcheck — A Table Maintenance Program”  
Section 4.5.4, “mysqldump — A Database Backup Program”  
Section 4.5.5, “mysqlimport — A Data Import Program”  
Section 4.5.6, “mysqldump — A Database Backup Program”  
Section 4.5.7, “mysqlshow — Display Database, Table, and Column Information”  
Section 5.1.7, “Server System Variables”

## **--default-parallelism**

Section 4.5.6, “mysqldump — A Database Backup Program”

## **--default-storage-engine**

Section 14.15, “InnoDB Startup Options and System Variables”  
Section 5.1.6, “Server Command Options”

## **--default-time-zone**

Section 5.1.13, “MySQL Server Time Zone Support”  
Section 5.1.6, “Server Command Options”  
Section 5.1.7, “Server System Variables”

## **--default-tmp-storage-engine**

Section 14.15, “InnoDB Startup Options and System Variables”  
Section 5.1.6, “Server Command Options”

## **--default.key\_buffer\_size**

Section 5.1.8.3, “Structured System Variables”

## **DEFAULT\_CHARSET**

Section 10.5, “Configuring Application Character Set and Collation”  
Section 10.3.2, “Server Character Set and Collation”

## **DEFAULT\_COLLATION**

Section 10.5, “Configuring Application Character Set and Collation”  
Section 10.3.2, “Server Character Set and Collation”

---

## **--defaults**

Section 4.4.2, “mysql\_install\_db — Initialize MySQL Data Directory”

## **--defaults-extra-file**

Section 4.2.2.3, “Command-Line Options that Affect Option-File Handling”

Section 2.9.1, “Initializing the Data Directory”

Section 4.7.2, “my\_print\_defaults — Display Options from Option Files”

Section 4.6.3.1, “myisamchk General Options”

Section 4.5.1.1, “mysql Client Options”

Section 4.4.2, “mysql\_install\_db — Initialize MySQL Data Directory”

Section 4.4.4, “mysql\_secure\_installation — Improve MySQL Installation Security”

Section 4.4.7, “mysql\_upgrade — Check and Upgrade MySQL Tables”

Section 4.5.2, “mysqladmin — A MySQL Server Administration Program”

Section 4.6.7, “mysqlbinlog — Utility for Processing Binary Log Files”

Section 4.5.3, “mysqlcheck — A Table Maintenance Program”

Section 4.3.4, “mysqld\_multi — Manage Multiple MySQL Servers”

Section 4.3.2, “mysqld\_safe — MySQL Server Startup Script”

Section 4.5.4, “mysqldump — A Database Backup Program”

Section 4.5.5, “mysqlimport — A Data Import Program”

Section 4.5.6, “mysqlpump — A Database Backup Program”

Section 4.5.7, “mysqlshow — Display Database, Table, and Column Information”

Section 4.5.8, “mysqlslap — A Load Emulation Client”

Section 21.5.6, “ndb\_blob\_tool — Check and Repair BLOB and TEXT columns of NDB Cluster Tables”

Section 21.5.7, “ndb\_config — Extract NDB Cluster Configuration Information”

Section 21.5.9, “ndb\_delete\_all — Delete All Rows from an NDB Table”

Section 21.5.10, “ndb\_desc — Describe NDB Tables”

Section 21.5.11, “ndb\_drop\_index — Drop Index from an NDB Table”

Section 21.5.12, “ndb\_drop\_table — Drop an NDB Table”

Section 21.5.14, “ndb\_import — Import CSV Data Into NDB”

Section 21.5.15, “ndb\_index\_stat — NDB Index Statistics Utility”

Section 21.5.5, “ndb\_mgm — The NDB Cluster Management Client”

Section 21.5.4, “ndb\_mgmd — The NDB Cluster Management Server Daemon”

Section 21.5.16, “ndb\_move\_data — NDB Data Copy Utility”

Section 21.5.17, “ndb\_perror — Obtain NDB Error Message Information”

Section 21.5.24, “ndb\_restore — Restore an NDB Cluster Backup”

Section 21.5.25, “ndb\_select\_all — Print Rows from an NDB Table”

Section 21.5.26, “ndb\_select\_count — Print Row Counts for NDB Tables”

Section 21.5.27, “ndb\_show\_tables — Display List of NDB Tables”

Section 21.5.29, “ndb\_top — View CPU usage information for NDB threads”

Section 21.5.30, “ndb\_waiter — Wait for NDB Cluster to Reach a Given Status”

Section 21.5.1, “nbd — The NDB Cluster Data Node Daemon”

Section 21.5.2, “ndbinfo\_select\_all — Select From ndbinfo Tables”

Section 5.1.6, “Server Command Options”

Section 4.2.2.2, “Using Option Files”

## **--defaults-file**

Section 4.2.2.3, “Command-Line Options that Affect Option-File Handling”

Section 6.1.2.1, “End-User Guidelines for Password Security”

Section 2.9.1, “Initializing the Data Directory”

Section 14.8.1, “InnoDB Startup Configuration”

Section 6.4.4.7, “Migrating Keys Between Keyring Keystores”

Section 4.7.2, “my\_print\_defaults — Display Options from Option Files”

Section 4.6.3.1, “myisamchk General Options”

---

Section 4.5.1.1, “mysql Client Options”  
Section 2.8.7, “MySQL Source-Configuration Options”  
Section 4.4.2, “mysql\_install\_db — Initialize MySQL Data Directory”  
Section 4.4.4, “mysql\_secure\_installation — Improve MySQL Installation Security”  
Section 4.4.7, “mysql\_upgrade — Check and Upgrade MySQL Tables”  
Section 4.5.2, “mysqladmin — A MySQL Server Administration Program”  
Section 4.6.7, “mysqlbinlog — Utility for Processing Binary Log Files”  
Section 4.5.3, “mysqlcheck — A Table Maintenance Program”  
Section 4.3.4, “mysqld\_multi — Manage Multiple MySQL Servers”  
Section 4.3.2, “mysqld\_safe — MySQL Server Startup Script”  
Section 4.5.4, “mysqldump — A Database Backup Program”  
Section 4.5.5, “mysqlimport — A Data Import Program”  
Section 4.5.6, “mysqlpump — A Database Backup Program”  
Section 4.5.7, “mysqlshow — Display Database, Table, and Column Information”  
Section 4.5.8, “mysqlslap — A Load Emulation Client”  
Section 21.5.6, “ndb\_blob\_tool — Check and Repair BLOB and TEXT columns of NDB Cluster Tables”  
Section 21.5.7, “ndb\_config — Extract NDB Cluster Configuration Information”  
Section 21.5.9, “ndb\_delete\_all — Delete All Rows from an NDB Table”  
Section 21.5.10, “ndb\_desc — Describe NDB Tables”  
Section 21.5.11, “ndb\_drop\_index — Drop Index from an NDB Table”  
Section 21.5.12, “ndb\_drop\_table — Drop an NDB Table”  
Section 21.5.14, “ndb\_import — Import CSV Data Into NDB”  
Section 21.5.15, “ndb\_index\_stat — NDB Index Statistics Utility”  
Section 21.5.5, “ndb\_mgm — The NDB Cluster Management Client”  
Section 21.5.4, “ndb\_mgmd — The NDB Cluster Management Server Daemon”  
Section 21.5.16, “ndb\_move\_data — NDB Data Copy Utility”  
Section 21.5.17, “ndb\_perror — Obtain NDB Error Message Information”  
Section 21.5.24, “ndb\_restore — Restore an NDB Cluster Backup”  
Section 21.5.25, “ndb\_select\_all — Print Rows from an NDB Table”  
Section 21.5.26, “ndb\_select\_count — Print Row Counts for NDB Tables”  
Section 21.5.27, “ndb\_show\_tables — Display List of NDB Tables”  
Section 21.5.29, “ndb\_top — View CPU usage information for NDB threads”  
Section 21.5.30, “ndb\_waiter — Wait for NDB Cluster to Reach a Given Status”  
Section 21.5.1, “nbd — The NDB Cluster Data Node Daemon”  
Section 21.5.2, “ndbinfo\_select\_all — Select From ndbinfo Tables”  
Section 27.6.3, “Options with the Embedded Server”  
Resetting the Root Password: Unix and Unix-Like Systems  
Resetting the Root Password: Windows Systems  
Section 5.7, “Running Multiple MySQL Instances on One Machine”  
Section 5.7.3, “Running Multiple MySQL Instances on Unix”  
Section 5.1.6, “Server Command Options”  
Section 5.7.2.2, “Starting Multiple MySQL Instances as Windows Services”  
Section 5.7.2.1, “Starting Multiple MySQL Instances at the Windows Command Line”  
Section 2.3.4.8, “Starting MySQL as a Windows Service”

## **--defaults-group-suffix**

Section 4.2.2.3, “Command-Line Options that Affect Option-File Handling”  
Section 4.9, “Environment Variables”  
Section 4.7.2, “my\_print\_defaults — Display Options from Option Files”  
Section 4.6.3.1, “myisamchk General Options”  
Section 4.5.1.1, “mysql Client Options”  
Section 4.4.4, “mysql\_secure\_installation — Improve MySQL Installation Security”  
Section 4.4.7, “mysql\_upgrade — Check and Upgrade MySQL Tables”

---

Section 4.5.2, “mysqladmin — A MySQL Server Administration Program”  
Section 4.6.7, “mysqlbinlog — Utility for Processing Binary Log Files”  
Section 4.5.3, “mysqlcheck — A Table Maintenance Program”  
Section 4.5.4, “mysqldump — A Database Backup Program”  
Section 4.5.5, “mysqlimport — A Data Import Program”  
Section 4.5.6, “mysqlpump — A Database Backup Program”  
Section 4.5.7, “mysqlshow — Display Database, Table, and Column Information”  
Section 4.5.8, “mysqlslap — A Load Emulation Client”  
Section 21.5.6, “ndb\_blob\_tool — Check and Repair BLOB and TEXT columns of NDB Cluster Tables”  
Section 21.5.7, “ndb\_config — Extract NDB Cluster Configuration Information”  
Section 21.5.9, “ndb\_delete\_all — Delete All Rows from an NDB Table”  
Section 21.5.10, “ndb\_desc — Describe NDB Tables”  
Section 21.5.11, “ndb\_drop\_index — Drop Index from an NDB Table”  
Section 21.5.12, “ndb\_drop\_table — Drop an NDB Table”  
Section 21.5.14, “ndb\_import — Import CSV Data Into NDB”  
Section 21.5.15, “ndb\_index\_stat — NDB Index Statistics Utility”  
Section 21.5.5, “ndb\_mgm — The NDB Cluster Management Client”  
Section 21.5.4, “ndb\_mgmd — The NDB Cluster Management Server Daemon”  
Section 21.5.16, “ndb\_move\_data — NDB Data Copy Utility”  
Section 21.5.17, “ndb\_perror — Obtain NDB Error Message Information”  
Section 21.5.24, “ndb\_restore — Restore an NDB Cluster Backup”  
Section 21.5.25, “ndb\_select\_all — Print Rows from an NDB Table”  
Section 21.5.26, “ndb\_select\_count — Print Row Counts for NDB Tables”  
Section 21.5.27, “ndb\_show\_tables — Display List of NDB Tables”  
Section 21.5.29, “ndb\_top — View CPU usage information for NDB threads”  
Section 21.5.30, “ndb\_waiter — Wait for NDB Cluster to Reach a Given Status”  
Section 21.5.1, “nbd — The NDB Cluster Data Node Daemon”  
Section 21.5.2, “ndbinfo\_select\_all — Select From ndbinfo Tables”  
Section 5.1.6, “Server Command Options”

## **--defer-table-indexes**

Section 4.5.6, “mysqlpump — A Database Backup Program”

## **--delay**

Section 21.5.2, “ndbinfo\_select\_all — Select From ndbinfo Tables”

## **--delay-key-write**

Section 8.11.5, “External Locking”

## **delay\_key\_write**

Section 15.2.1, “MyISAM Startup Options”

## **--delete**

Section 4.5.5, “mysqlimport — A Data Import Program”  
Section 21.5.15, “ndb\_index\_stat — NDB Index Statistics Utility”

## **--delete-master-logs**

Section 4.5.4, “mysqldump — A Database Backup Program”

## **--delete-orphans**

Section 21.5.6, “ndb\_blob\_tool — Check and Repair BLOB and TEXT columns of NDB Cluster Tables”

---

## **--delimiter**

Section 4.5.1.1, “mysql Client Options”

Section 4.5.8, “mysqlslap — A Load Emulation Client”

Section 21.5.25, “ndb\_select\_all — Print Rows from an NDB Table”

## **--demangle**

Section 5.8.1.5, “Using a Stack Trace”

## **--des-key-file**

Section 12.13, “Encryption and Compression Functions”

Section 13.7.6.3, “FLUSH Statement”

Section 5.1.6, “Server Command Options”

Section 1.3, “What Is New in MySQL 5.7”

## **--descending**

Section 21.5.25, “ndb\_select\_all — Print Rows from an NDB Table”

## **--description**

Section 4.6.3.4, “Other myisamchk Options”

## **--detach**

Section 4.5.8, “mysqlslap — A Load Emulation Client”

## **--diff-default**

Section 21.5.7, “ndb\_config — Extract NDB Cluster Configuration Information”

## **--disable**

Section 4.2.2.4, “Program Option Modifiers”

## **--disable-auto-rehash**

Section 14.8.11.2, “Configuring Non-Persistent Optimizer Statistics Parameters”

Section 4.5.1.1, “mysql Client Options”

## **--disable-indexes**

Section 21.5.24, “ndb\_restore — Restore an NDB Cluster Backup”

Restoring to More Nodes Than the Original

## **--disable-innodb**

Section 14.1.5, “Turning Off InnoDB”

Section 1.3, “What Is New in MySQL 5.7”

## **--disable-keys**

Section 4.5.4, “mysqldump — A Database Backup Program”

## **--disable-log-bin**

Section 16.1.6.4, “Binary Logging Options and Variables”

Section 4.6.7, “mysqlbinlog — Utility for Processing Binary Log Files”

## **--disable-named-commands**

Section 4.5.1.1, “mysql Client Options”

---

## **--disable-partition-engine-check**

Chapter 22, *Partitioning*

Section 5.1.6, “Server Command Options”

## **--disable-plugin\_name**

Section 5.5.1, “Installing and Uninstalling Plugins”

## **--disable-ssl**

Section 4.2.3, “Command Options for Connecting to the Server”

Section 5.1.6, “Server Command Options”

Section 6.3, “Using Encrypted Connections”

Section 1.3, “What Is New in MySQL 5.7”

## **DISABLE\_PSI\_THREAD**

Section 25.12.16.3, “The processlist Table”

## **--disconnect-slave-event-count**

Section 16.1.6.3, “Replica Server Options and Variables”

## **--disk**

Section 21.5.25, “`ndb_select_all` — Print Rows from an NDB Table”

## **--diskscan**

Section 21.5.9, “`ndb_delete_all` — Delete All Rows from an NDB Table”

## **--dont-ignore-systab-0**

Section 21.5.24, “`ndb_restore` — Restore an NDB Cluster Backup”

## **--drop-source**

Section 21.5.16, “`ndb_move_data` — NDB Data Copy Utility”

## **--dry-scp**

Section 21.5.13, “`ndb_error_reporter` — NDB Error-Reporting Utility”

## **--dump**

Section 4.6.2, “`mysiam_ftdump` — Display Full-Text Index information”

Section 21.5.15, “`ndb_index_stat` — NDB Index Statistics Utility”

## **--dump-date**

Section 4.5.4, “`mysqldump` — A Database Backup Program”

## **--dump-file**

Section 21.5.6, “`ndb_blob_tool` — Check and Repair BLOB and TEXT columns of NDB Cluster Tables”

## **--dump-slave**

Section 4.5.4, “`mysqldump` — A Database Backup Program”

Section 16.4.1.32, “Replication and Transaction Inconsistencies”

## **E**

[\[index top\]](#)



---

## **-E**

- Section 4.5.1.1, “mysql Client Options”
- Section 4.5.2, “mysqladmin — A MySQL Server Administration Program”
- Section 4.5.4, “mysqldump — A Database Backup Program”

## **-e**

- Section 7.6.2, “How to Check MyISAM Tables for Errors”
- Section 4.6.1, “innochecksum — Offline InnoDB File Checksum Utility”
- Section 13.2.7, “LOAD XML Statement”
- Section 2.5.7.2, “More Topics on Deploying MySQL Server with Docker”
- Section 4.7.2, “my\_print\_defaults — Display Options from Option Files”
- Section 4.6.3.2, “myisamchk Check Options”
- Section 4.6.3.1, “myisamchk General Options”
- Section 4.6.3.3, “myisamchk Repair Options”
- Section A.10, “MySQL 5.7 FAQ: NDB Cluster”
- Section 4.5.1.1, “mysql Client Options”
- Section 4.5.3, “mysqlcheck — A Table Maintenance Program”
- Section 4.5.4, “mysqldump — A Database Backup Program”
- Section 4.5.8, “mysqlslap — A Load Emulation Client”
- Section 21.7.9, “NDB Cluster Backups With NDB Cluster Replication”
- Section 21.5.5, “ndb\_mgm — The NDB Cluster Management Client”
- Section 21.5.24, “ndb\_restore — Restore an NDB Cluster Backup”
- Section 4.6.3.5, “Obtaining Table Information with myisamchk”
- Section 21.3.6, “Safe Shutdown and Restart of NDB Cluster”
- Section 4.2.2.1, “Using Options on the Command Line”
- Section 21.6.8.2, “Using The NDB Cluster Management Client to Create a Backup”

## **--early-plugin-load**

- Section 2.10.3, “Changes in MySQL 5.7”
- Section 5.5.1, “Installing and Uninstalling Plugins”
- Section 6.4.4.1, “Keyring Plugin Installation”
- Section 4.4.7, “mysql\_upgrade — Check and Upgrade MySQL Tables”
- Section 5.1.6, “Server Command Options”
- Section 6.4.4.5, “Using the keyring\_aws Amazon Web Services Keyring Plugin”
- Section 6.4.4.3, “Using the keyring\_encrypted\_file Encrypted File-Based Keyring Plugin”
- Section 6.4.4.2, “Using the keyring\_file File-Based Keyring Plugin”
- Section 6.4.4.4, “Using the keyring\_okv KMIP Plugin”

## **early-plugin-load**

- Section 14.14, “InnoDB Data-at-Rest Encryption”

## **--embedded**

- Section 4.7.1, “mysql\_config — Display Options for Compiling Clients”
- Section 1.3, “What Is New in MySQL 5.7”

## **--embedded-libs**

- Section 4.7.1, “mysql\_config — Display Options for Compiling Clients”
- Section 1.3, “What Is New in MySQL 5.7”

## **--embedded-server**

- Section 1.3, “What Is New in MySQL 5.7”

---

## **--enable-cleartext-plugin**

Section 6.4.1.6, “Client-Side Cleartext Pluggable Authentication”  
Section 6.4.1.9, “LDAP Pluggable Authentication”  
Section 4.5.1.1, “mysql Client Options”  
Section 4.5.2, “mysqladmin — A MySQL Server Administration Program”  
Section 4.5.3, “mysqlcheck — A Table Maintenance Program”  
Section 4.5.4, “mysqldump — A Database Backup Program”  
Section 4.5.5, “mysqlimport — A Data Import Program”  
Section 4.5.7, “mysqlshow — Display Database, Table, and Column Information”  
Section 4.5.8, “mysqlslap — A Load Emulation Client”  
Section 6.4.1.7, “PAM Pluggable Authentication”

## **--enable-plugin\_name**

Section 5.5.1, “Installing and Uninstalling Plugins”

## **--enable-ssl**

Section 4.2.3, “Command Options for Connecting to the Server”  
Section 6.3, “Using Encrypted Connections”  
Section 1.3, “What Is New in MySQL 5.7”

## **ENABLE\_DEBUG\_SYNC**

Section 14.15, “InnoDB Startup Options and System Variables”

## **enabled**

Section 2.5.1, “Installing MySQL on Linux Using the MySQL Yum Repository”  
Section 19.2.1.2, “Installing MySQL Shell on Linux”

## **ENABLED\_LOCAL\_INFILE**

Section 2.8.7, “MySQL Source-Configuration Options”  
Section 6.1.6, “Security Considerations for LOAD DATA LOCAL”

## **--end-page**

Section 4.6.1, “innochecksum — Offline InnoDB File Checksum Utility”

## **--enforce-gtid-consistency**

Section 16.1.6.5, “Global Transaction ID System Variables”  
Section 16.1.3.6, “Restrictions on Replication with GTIDs”

## **--engine**

Section 4.5.8, “mysqlslap — A Load Emulation Client”

## **--env**

Section 2.5.7.2, “More Topics on Deploying MySQL Server with Docker”

## **--errins-delay**

Section 21.5.14, “ndb\_import — Import CSV Data Into NDB”

## **--errins-type**

Section 21.5.14, “ndb\_import — Import CSV Data Into NDB”

## **--error-insert**

Section 21.5.16, “ndb\_move\_data — NDB Data Copy Utility”

---

## **--event-scheduler**

Section 23.4.2, “Event Scheduler Configuration”

## **event-scheduler**

Section 23.4.2, “Event Scheduler Configuration”

## **--events**

Section 7.4.5.3, “Dumping Stored Programs”

Section 7.4.5.4, “Dumping Table Definitions and Content Separately”

Section 4.5.4, “mysqldump — A Database Backup Program”

Section 4.5.6, “mysqlpump — A Database Backup Program”

Section 2.10.4, “Upgrading MySQL Binary or Package-based Installations on Unix/Linux”

Section 4.6.7.3, “Using mysqlbinlog to Back Up Binary Log Files”

## **--example**

Section 4.3.4, “mysqld\_multi — Manage Multiple MySQL Servers”

## **--exclude-\***

Section 21.5.24, “ndb\_restore — Restore an NDB Cluster Backup”

## **--exclude-databases**

Section 4.5.6, “mysqlpump — A Database Backup Program”

Section 21.5.24, “ndb\_restore — Restore an NDB Cluster Backup”

## **--exclude-events**

Section 4.5.6, “mysqlpump — A Database Backup Program”

## **--exclude-gtids**

Section 4.6.7, “mysqlbinlog — Utility for Processing Binary Log Files”

## **--exclude-intermediate-sql-tables**

Section 21.5.24, “ndb\_restore — Restore an NDB Cluster Backup”

## **--exclude-missing-columns**

Section 21.5.16, “ndb\_move\_data — NDB Data Copy Utility”

Section 21.5.24, “ndb\_restore — Restore an NDB Cluster Backup”

## **--exclude-missing-tables**

Section 21.5.24, “ndb\_restore — Restore an NDB Cluster Backup”

## **--exclude-routines**

Section 4.5.6, “mysqlpump — A Database Backup Program”

## **--exclude-tables**

Section 4.5.6, “mysqlpump — A Database Backup Program”

Section 21.5.24, “ndb\_restore — Restore an NDB Cluster Backup”

## **--exclude-triggers**

Section 4.5.6, “mysqlpump — A Database Backup Program”

---

## **--exclude-users**

Section 4.5.6, “mysqlpump — A Database Backup Program”

## **--excludedbs**

Section 21.5.28, “ndb\_size.pl — NDBCLUSTER Size Requirement Estimator”

## **--excludetables**

Section 21.5.28, “ndb\_size.pl — NDBCLUSTER Size Requirement Estimator”

## **--execute**

Section 4.5.1.3, “mysql Client Logging”

Section 4.5.1.1, “mysql Client Options”

Section 21.5.5, “ndb\_mgm — The NDB Cluster Management Client”

Section 4.2.2.1, “Using Options on the Command Line”

Section 21.6.8.2, “Using The NDB Cluster Management Client to Create a Backup”

## **--exit-info**

Section 5.1.6, “Server Command Options”

## **--extend-check**

Section 4.6.3.2, “myisamchk Check Options”

Section 4.6.3.1, “myisamchk General Options”

Section 4.6.3.3, “myisamchk Repair Options”

## **--extended**

Section 4.5.3, “mysqlcheck — A Table Maintenance Program”

## **--extended-insert**

Section 4.5.4, “mysqldump — A Database Backup Program”

Section 4.5.6, “mysqlpump — A Database Backup Program”

## **--external-locking**

Section 8.11.5, “External Locking”

Section 15.2.1, “MyISAM Startup Options”

Section 5.1.6, “Server Command Options”

Section 5.1.7, “Server System Variables”

Section 8.12.1, “System Factors”

## **--extra-file**

Section 4.7.2, “my\_print\_defaults — Display Options from Option Files”

## **--extra-node-info**

Section 21.5.10, “ndb\_desc — Describe NDB Tables”

## **--extra-partition-info**

Section 21.5.10, “ndb\_desc — Describe NDB Tables”

Section 21.6.15.5, “The ndbinfo cluster\_operations Table”

Section 21.6.15.34, “The ndbinfo server\_operations Table”

## **--extra-sql-file**

Section 4.4.2, “mysql\_install\_db — Initialize MySQL Data Directory”

---

## F

[\[index top\]](#)

### **-F**

Section 4.4.1, “[comp\\_err — Compile MySQL Error Message File](#)”  
Section 4.6.3.2, “[myisamchk Check Options](#)”  
Section 4.6.4, “[myisamlog — Display MyISAM Log File Contents](#)”  
Section 4.5.1.2, “[mysql Client Commands](#)”  
Section 4.6.7, “[mysqlbinlog — Utility for Processing Binary Log Files](#)”  
Section 4.5.3, “[mysqlcheck — A Table Maintenance Program](#)”  
Section 4.5.4, “[mysqldump — A Database Backup Program](#)”  
Section 4.5.8, “[mysqlslap — A Load Emulation Client](#)”

### **-f**

Section 21.6.1, “[Commands in the NDB Cluster Management Client](#)”  
Section 21.3.4, “[Initial Startup of NDB Cluster](#)”  
Section 21.3.2.3, “[Initial Startup of NDB Cluster on Windows](#)”  
Section 4.6.3.2, “[myisamchk Check Options](#)”  
Section 4.6.3.3, “[myisamchk Repair Options](#)”  
Section 4.6.4, “[myisamlog — Display MyISAM Log File Contents](#)”  
Section 4.6.5, “[myisampack — Generate Compressed, Read-Only MyISAM Tables](#)”  
Section A.10, “[MySQL 5.7 FAQ: NDB Cluster](#)”  
Section 4.5.1.1, “[mysql Client Options](#)”  
Section 4.4.2, “[mysql\\_install\\_db — Initialize MySQL Data Directory](#)”  
Section 4.5.2, “[mysqladmin — A MySQL Server Administration Program](#)”  
Section 4.6.7, “[mysqlbinlog — Utility for Processing Binary Log Files](#)”  
Section 4.5.3, “[mysqlcheck — A Table Maintenance Program](#)”  
Section 4.5.4, “[mysqldump — A Database Backup Program](#)”  
Section 4.5.5, “[mysqlimport — A Data Import Program](#)”  
Section 21.5.7, “[ndb\\_config — Extract NDB Cluster Configuration Information](#)”  
Section 21.5.4, “[ndb\\_mgmd — The NDB Cluster Management Server Daemon](#)”  
Section 21.5.23, “[ndb\\_redo\\_log\\_reader — Check and Print Content of Cluster Redo Log](#)”  
Section 21.5.24, “[ndb\\_restore — Restore an NDB Cluster Backup](#)”  
Section 5.8.1.5, “[Using a Stack Trace](#)”

### **--fast**

Section 4.6.3.2, “[myisamchk Check Options](#)”  
Section 4.5.3, “[mysqlcheck — A Table Maintenance Program](#)”

### **--federated**

Section 15.8, “[The FEDERATED Storage Engine](#)”

### **--fields**

Section 21.5.7, “[ndb\\_config — Extract NDB Cluster Configuration Information](#)”

### **--fields-enclosed-by**

Section 7.4.3, “[Dumping Data in Delimited-Text Format with mysqldump](#)”  
Section 4.5.4, “[mysqldump — A Database Backup Program](#)”  
Section 4.5.5, “[mysqlimport — A Data Import Program](#)”  
Section 21.5.14, “[ndb\\_import — Import CSV Data Into NDB](#)”  
Section 21.5.24, “[ndb\\_restore — Restore an NDB Cluster Backup](#)”

---

## **--fields-escaped-by**

[Section 7.4.3, “Dumping Data in Delimited-Text Format with mysqldump”](#)

[Section 4.5.4, “mysqldump — A Database Backup Program”](#)

[Section 4.5.5, “mysqlimport — A Data Import Program”](#)

[Section 21.5.14, “ndb\\_import — Import CSV Data Into NDB”](#)

## **--fields-optionally-enclosed-by**

[Section 7.4.3, “Dumping Data in Delimited-Text Format with mysqldump”](#)

[Section 4.5.4, “mysqldump — A Database Backup Program”](#)

[Section 4.5.5, “mysqlimport — A Data Import Program”](#)

[Section 21.5.14, “ndb\\_import — Import CSV Data Into NDB”](#)

[Section 21.5.24, “ndb\\_restore — Restore an NDB Cluster Backup”](#)

## **--fields-terminated-by**

[Section 7.4.3, “Dumping Data in Delimited-Text Format with mysqldump”](#)

[Section 4.5.4, “mysqldump — A Database Backup Program”](#)

[Section 4.5.5, “mysqlimport — A Data Import Program”](#)

[Section 21.5.14, “ndb\\_import — Import CSV Data Into NDB”](#)

[Section 21.5.24, “ndb\\_restore — Restore an NDB Cluster Backup”](#)

## **--fields-xxx**

[Section 4.5.4, “mysqldump — A Database Backup Program”](#)

## **--fix-db-names**

[Section 9.2.4, “Mapping of Identifiers to File Names”](#)

[Section 4.5.3, “mysqlcheck — A Table Maintenance Program”](#)

[Section 1.3, “What Is New in MySQL 5.7”](#)

## **--fix-table-names**

[Section 9.2.4, “Mapping of Identifiers to File Names”](#)

[Section 4.5.3, “mysqlcheck — A Table Maintenance Program”](#)

[Section 1.3, “What Is New in MySQL 5.7”](#)

## **--flush**

[Section 5.1.6, “Server Command Options”](#)

[Section 5.1.7, “Server System Variables”](#)

[Section B.3.3.3, “What to Do If MySQL Keeps Crashing”](#)

## **--flush-logs**

[Section 7.3.1, “Establishing a Backup Policy”](#)

[Section 5.4, “MySQL Server Logs”](#)

[Section 4.5.4, “mysqldump — A Database Backup Program”](#)

[Section 6.2.2, “Privileges Provided by MySQL”](#)

## **--flush-privileges**

[Section 2.10.3, “Changes in MySQL 5.7”](#)

[Section 4.5.4, “mysqldump — A Database Backup Program”](#)

## **--force**

[Section 4.6.3.2, “myisamchk Check Options”](#)

[Section 4.6.3.3, “myisamchk Repair Options”](#)

---

[Section 4.6.5, “myisampack — Generate Compressed, Read-Only MyISAM Tables”](#)  
[Section 4.5.1.1, “mysql Client Options”](#)  
[Section 4.4.7, “mysql\\_upgrade — Check and Upgrade MySQL Tables”](#)  
[Section 4.5.2, “mysqladmin — A MySQL Server Administration Program”](#)  
[Section 4.5.3, “mysqlcheck — A Table Maintenance Program”](#)  
[Section 4.5.4, “mysqldump — A Database Backup Program”](#)  
[Section 4.5.5, “mysqlimport — A Data Import Program”](#)  
[Section 21.7.4, “NDB Cluster Replication Schema and Tables”](#)  
[Section 21.3.7.1, “Upgrading and Downgrading NDB 7.5”](#)  
[Section 3.5, “Using mysql in Batch Mode”](#)  
[Section 21.2.4.1, “What is New in NDB Cluster 7.5”](#)

### **--force-if-open**

[Section 4.6.7, “mysqlbinlog — Utility for Processing Binary Log Files”](#)

### **--force-read**

[Section 4.6.7, “mysqlbinlog — Utility for Processing Binary Log Files”](#)

## **FORCE\_UNSUPPORTED\_COMPILER**

[Section 2.8.2, “Source Installation Prerequisites”](#)

### **--foreground**

[Section 21.5.1, “ndbd — The NDB Cluster Data Node Daemon”](#)

### **--format**

[Section 21.5.28, “ndb\\_size.pl — NDBCLUSTER Size Requirement Estimator”](#)

### **--fs**

[Section 21.5.13, “ndb\\_error\\_reporter — NDB Error-Reporting Utility”](#)

## **G**

[\[index top\]](#)

### **-G**

[Section 4.5.1.1, “mysql Client Options”](#)

[Section 4.6.6, “mysql\\_config\\_editor — MySQL Configuration Utility”](#)

### **-g**

[Section 5.8.1.1, “Compiling MySQL for Debugging”](#)

[Section 4.7.2, “my\\_print\\_defaults — Display Options from Option Files”](#)

[Section 4.5.3, “mysqlcheck — A Table Maintenance Program”](#)

[Section 4.6.8, “mysqldumpslow — Summarize Slow Query Log Files”](#)

[Section 21.5.29, “ndb\\_top — View CPU usage information for NDB threads”](#)

### **--gci**

[Section 21.5.25, “ndb\\_select\\_all — Print Rows from an NDB Table”](#)

### **--gci64**

[Section 21.5.25, “ndb\\_select\\_all — Print Rows from an NDB Table”](#)

---

## **--gdb**

[Section 5.8.1.4, “Debugging mysqld under gdb”](#)

[Section 5.1.6, “Server Command Options”](#)

[Section 4.10, “Unix Signal Handling in MySQL”](#)

## **--general-log**

[Section 4.2.2.1, “Using Options on the Command Line”](#)

[Section 5.1.8, “Using System Variables”](#)

## **--general\_log**

[Section 5.4.1, “Selecting General Query Log and Slow Query Log Output Destinations”](#)

[Section 5.4.3, “The General Query Log”](#)

[Section 4.2.2.1, “Using Options on the Command Line”](#)

[Section 5.1.8, “Using System Variables”](#)

## **--general\_log\_file**

[Section 5.7, “Running Multiple MySQL Instances on One Machine”](#)

[Section 5.1.7, “Server System Variables”](#)

[Section 5.4.3, “The General Query Log”](#)

## **--get-server-public-key**

[Section 6.4.1.4, “Caching SHA-2 Pluggable Authentication”](#)

[Section 4.2.3, “Command Options for Connecting to the Server”](#)

[Section 4.5.1.1, “mysql Client Options”](#)

[Section 4.5.2, “mysqladmin — A MySQL Server Administration Program”](#)

[Section 4.6.7, “mysqlbinlog — Utility for Processing Binary Log Files”](#)

[Section 4.5.3, “mysqlcheck — A Table Maintenance Program”](#)

[Section 4.5.4, “mysqldump — A Database Backup Program”](#)

[Section 4.5.5, “mysqlimport — A Data Import Program”](#)

[Section 4.5.6, “mysqlpump — A Database Backup Program”](#)

[Section 4.5.7, “mysqlshow — Display Database, Table, and Column Information”](#)

[Section 4.5.8, “mysqlslap — A Load Emulation Client”](#)

## **--graph**

[Section 21.5.29, “ndb\\_top — View CPU usage information for NDB threads”](#)

## **--gtid-mode**

[Section 16.1.6.5, “Global Transaction ID System Variables”](#)

## **H**

[\[index top\]](#)

## **-H**

[Section 4.4.1, “comp\\_err — Compile MySQL Error Message File”](#)

[Section 4.6.3.1, “myisamchk General Options”](#)

[Section 4.5.1.1, “mysql Client Options”](#)

[Section 4.6.7, “mysqlbinlog — Utility for Processing Binary Log Files”](#)

## **-h**

[Section 1.1, “About This Manual”](#)



---

Section 4.2.3, “Command Options for Connecting to the Server”  
Section 4.2.4, “Connecting to the MySQL Server Using Command Options”  
Section 4.2.1, “Invoking MySQL Programs”  
Section 4.6.2, “myisam\_ftdump — Display Full-Text Index information”  
Section 4.5.1.1, “mysql Client Options”  
Section 4.6.6, “mysql\_config\_editor — MySQL Configuration Utility”  
Section 4.4.4, “mysql\_secure\_installation — Improve MySQL Installation Security”  
Section 4.4.7, “mysql\_upgrade — Check and Upgrade MySQL Tables”  
Section 4.5.2, “mysqladmin — A MySQL Server Administration Program”  
Section 4.6.7, “mysqlbinlog — Utility for Processing Binary Log Files”  
Section 4.5.3, “mysqlcheck — A Table Maintenance Program”  
Section 4.5.4, “mysqldump — A Database Backup Program”  
Section 4.6.8, “mysqldumpslow — Summarize Slow Query Log Files”  
Section 4.5.5, “mysqlimport — A Data Import Program”  
Section 4.5.6, “mysqlpump — A Database Backup Program”  
Section 4.5.7, “mysqlshow — Display Database, Table, and Column Information”  
Section 4.5.8, “mysqlslap — A Load Emulation Client”  
Section 21.5.19, “ndb\_print\_file — Print NDB Disk Data File Contents”  
Section 21.5.25, “ndb\_select\_all — Print Rows from an NDB Table”  
Section 21.5.29, “ndb\_top — View CPU usage information for NDB threads”  
Section 4.7.3, “resolve\_stack\_dump — Resolve Numeric Stack Trace Dump to Symbols”  
Section 5.1.6, “Server Command Options”  
Section 4.2.2.1, “Using Options on the Command Line”

## **HAVE\_CRYPT**

Section 1.3, “What Is New in MySQL 5.7”

### **--header**

Section 21.5.25, “ndb\_select\_all — Print Rows from an NDB Table”

### **--header-file**

Section 4.4.1, “comp\_err — Compile MySQL Error Message File”

### **--HELP**

Section 4.6.3.1, “myisamchk General Options”

### **--help**

Section 4.4.1, “comp\_err — Compile MySQL Error Message File”  
Section 4.6.1, “innochecksum — Offline InnoDB File Checksum Utility”  
Section 21.3.2.4, “Installing NDB Cluster Processes as Windows Services”  
Section 4.7.2, “my\_print\_defaults — Display Options from Option Files”  
Section 4.6.2, “myisam\_ftdump — Display Full-Text Index information”  
Section 4.6.3.1, “myisamchk General Options”  
Section 4.6.5, “myisampack — Generate Compressed, Read-Only MyISAM Tables”  
Section 4.5.1.1, “mysql Client Options”  
Section 4.6.6, “mysql\_config\_editor — MySQL Configuration Utility”  
Section 4.4.2, “mysql\_install\_db — Initialize MySQL Data Directory”  
Section 4.4.3, “mysql\_plugin — Configure MySQL Server Plugins”  
Section 4.4.4, “mysql\_secure\_installation — Improve MySQL Installation Security”  
Section 4.4.5, “mysql\_ssl\_rsa\_setup — Create SSL/RSA Files”  
Section 4.4.7, “mysql\_upgrade — Check and Upgrade MySQL Tables”  
Section 4.5.2, “mysqladmin — A MySQL Server Administration Program”  
Section 4.6.7, “mysqlbinlog — Utility for Processing Binary Log Files”

---

Section 4.5.3, “mysqlcheck — A Table Maintenance Program”  
Section 4.3.4, “mysqld\_multi — Manage Multiple MySQL Servers”  
Section 4.3.2, “mysqld\_safe — MySQL Server Startup Script”  
Section 4.5.4, “mysqldump — A Database Backup Program”  
Section 4.6.8, “mysqldumpslow — Summarize Slow Query Log Files”  
Section 4.5.5, “mysqlimport — A Data Import Program”  
Section 4.5.6, “mysqlpump — A Database Backup Program”  
Section 4.5.7, “mysqlshow — Display Database, Table, and Column Information”  
Section 4.5.8, “mysqlslap — A Load Emulation Client”  
Section 21.5.6, “ndb\_blob\_tool — Check and Repair BLOB and TEXT columns of NDB Cluster Tables”  
Section 21.5.7, “ndb\_config — Extract NDB Cluster Configuration Information”  
Section 21.5.9, “ndb\_delete\_all — Delete All Rows from an NDB Table”  
Section 21.5.10, “ndb\_desc — Describe NDB Tables”  
Section 21.5.11, “ndb\_drop\_index — Drop Index from an NDB Table”  
Section 21.5.12, “ndb\_drop\_table — Drop an NDB Table”  
Section 21.5.13, “ndb\_error\_reporter — NDB Error-Reporting Utility”  
Section 21.5.14, “ndb\_import — Import CSV Data Into NDB”  
Section 21.5.15, “ndb\_index\_stat — NDB Index Statistics Utility”  
Section 21.5.5, “ndb\_mgm — The NDB Cluster Management Client”  
Section 21.5.4, “ndb\_mgmd — The NDB Cluster Management Server Daemon”  
Section 21.5.16, “ndb\_move\_data — NDB Data Copy Utility”  
Section 21.5.17, “ndb\_perror — Obtain NDB Error Message Information”  
Section 21.5.19, “ndb\_print\_file — Print NDB Disk Data File Contents”  
Section 21.5.23, “ndb\_redo\_log\_reader — Check and Print Content of Cluster Redo Log”  
Section 21.5.24, “ndb\_restore — Restore an NDB Cluster Backup”  
Section 21.5.25, “ndb\_select\_all — Print Rows from an NDB Table”  
Section 21.5.26, “ndb\_select\_count — Print Row Counts for NDB Tables”  
Section 21.5.27, “ndb\_show\_tables — Display List of NDB Tables”  
Section 21.5.29, “ndb\_top — View CPU usage information for NDB threads”  
Section 21.5.30, “ndb\_waiter — Wait for NDB Cluster to Reach a Given Status”  
Section 21.5.1, “nbd — The NDB Cluster Data Node Daemon”  
Section 21.5.2, “ndbinfo\_select\_all — Select From ndbinfo Tables”  
Section 4.1, “Overview of MySQL Programs”  
Section 4.8.2, “perror — Display MySQL Error Message Information”  
Section 4.7.3, “resolve\_stack\_dump — Resolve Numeric Stack Trace Dump to Symbols”  
Section 4.8.4, “resolveip — Resolve Host name to IP Address or Vice Versa”  
Section 5.1.6, “Server Command Options”  
Section 2.9.3, “Testing the Server”  
Section 1.2.2, “The Main Features of MySQL”  
Section 2.9.2.1, “Troubleshooting Problems Starting the MySQL Server”  
Chapter 3, *Tutorial*  
Section 4.2.2.2, “Using Option Files”  
Section 4.2.2.1, “Using Options on the Command Line”

## help

Section 2.3.3.5, “MySQL Installer Console Reference”

## --hex

Section 21.5.24, “ndb\_restore — Restore an NDB Cluster Backup”

## --hex-blob

Section 4.5.4, “mysqldump — A Database Backup Program”

Section 4.5.6, “mysqlpump — A Database Backup Program”

---

## **--hexdump**

Section 4.6.7.1, “mysqlbinlog Hex Dump Format”

Section 4.6.7, “mysqlbinlog — Utility for Processing Binary Log Files”

## **--histignore**

Section 4.5.1.3, “mysql Client Logging”

Section 4.5.1.1, “mysql Client Options”

Section 4.5.1.6, “mysql Client Tips”

Section 1.3, “What Is New in MySQL 5.7”

## **--host**

Section 1.1, “About This Manual”

Section 2.10.3, “Changes in MySQL 5.7”

Section 4.2.3, “Command Options for Connecting to the Server”

Section 4.2.4, “Connecting to the MySQL Server Using Command Options”

Section 2.9.1, “Initializing the Data Directory”

Section 4.2.1, “Invoking MySQL Programs”

Section 4.5.1.1, “mysql Client Options”

Section 4.6.6, “mysql\_config\_editor — MySQL Configuration Utility”

Section 4.4.4, “mysql\_secure\_installation — Improve MySQL Installation Security”

Section 4.4.7, “mysql\_upgrade — Check and Upgrade MySQL Tables”

Section 4.5.2, “mysqladmin — A MySQL Server Administration Program”

Section 4.6.7, “mysqlbinlog — Utility for Processing Binary Log Files”

Section 4.5.3, “mysqlcheck — A Table Maintenance Program”

Section 4.5.4, “mysqldump — A Database Backup Program”

Section 4.5.5, “mysqlimport — A Data Import Program”

Section 4.5.6, “mysqlpump — A Database Backup Program”

Section 4.5.7, “mysqlshow — Display Database, Table, and Column Information”

Section 4.5.8, “mysqlslap — A Load Emulation Client”

Section 21.5.7, “ndb\_config — Extract NDB Cluster Configuration Information”

Section 21.5.29, “ndb\_top — View CPU usage information for NDB threads”

Section 4.2.2.6, “Option Defaults, Options Expecting Values, and the = Sign”

Section 5.1.7, “Server System Variables”

Section 6.2.17, “Troubleshooting Problems Connecting to MySQL”

Section 5.7.4, “Using Client Programs in a Multiple-Server Environment”

Section 4.6.7.3, “Using mysqlbinlog to Back Up Binary Log Files”

Section 4.2.2.2, “Using Option Files”

Section 4.2.2.1, “Using Options on the Command Line”

Section 19.4.2.2, “X Plugin Options and System Variables”

## **host**

Section 4.6.6, “mysql\_config\_editor — MySQL Configuration Utility”

Section 4.2.2.2, “Using Option Files”

## **--hostname**

Section 21.5.28, “ndb\_size.pl — NDBCLUSTER Size Requirement Estimator”

## **--html**

Section 4.5.1.1, “mysql Client Options”

## **I**

[\[index top\]](#)

---

## **-l**

Section 4.6.1, “[innochecksum — Offline InnoDB File Checksum Utility](#)”  
Section 4.6.4, “[mysamlog — Display MyISAM Log File Contents](#)”  
Section 4.8.2, “[perror — Display MySQL Error Message Information](#)”  
Section 4.8.3, “[replace — A String-Replacement Utility](#)”  
Section 4.8.4, “[resolveip — Resolve Host name to IP Address or Vice Versa](#)”

## **-i**

Section 21.6.1, “[Commands in the NDB Cluster Management Client](#)”  
Section 7.6.2, “[How to Check MyISAM Tables for Errors](#)”  
Section 4.6.3.2, “[mysamchk Check Options](#)”  
Section 4.6.4, “[mysamlog — Display MyISAM Log File Contents](#)”  
Section 4.5.1.1, “[mysql Client Options](#)”  
Section 4.4.3, “[mysql\\_plugin — Configure MySQL Server Plugins](#)”  
Section 4.5.2, “[mysqladmin — A MySQL Server Administration Program](#)”  
Section 4.5.4, “[mysqldump — A Database Backup Program](#)”  
Section 4.6.8, “[mysqldumpslow — Summarize Slow Query Log Files](#)”  
Section 4.5.5, “[mysqlimport — A Data Import Program](#)”  
Section 4.5.7, “[mysqlshow — Display Database, Table, and Column Information](#)”  
Section 4.5.8, “[mysqlslap — A Load Emulation Client](#)”

## **--i-am-a-dummy**

Section 4.5.1.1, “[mysql Client Options](#)”  
Section 4.5.1.6, “[mysql Client Tips](#)”

## **--id**

Section 21.5.7, “[ndb\\_config — Extract NDB Cluster Configuration Information](#)”

## **--idempotent**

Section 4.6.7, “[mysqlbinlog — Utility for Processing Binary Log Files](#)”  
Section 5.1.7, “[Server System Variables](#)”

## **--idlesleep**

Section 21.5.14, “[ndb\\_import — Import CSV Data Into NDB](#)”

## **--idlespin**

Section 21.5.14, “[ndb\\_import — Import CSV Data Into NDB](#)”

## **--ignore**

Section 4.5.5, “[mysqlimport — A Data Import Program](#)”

## **--ignore-db-dir**

Section 2.9.1, “[Initializing the Data Directory](#)”  
Section 5.1.6, “[Server Command Options](#)”  
Section 5.1.7, “[Server System Variables](#)”  
Section 1.3, “[What Is New in MySQL 5.7](#)”

## **--ignore-error**

Section 4.5.4, “[mysqldump — A Database Backup Program](#)”

## **--ignore-extended-pk-updates**

Section 21.5.24, “[ndb\\_restore — Restore an NDB Cluster Backup](#)”

---

Section 21.2.4.2, “What is New in NDB Cluster 7.6”

### **--ignore-lines**

Section 4.5.5, “mysqlimport — A Data Import Program”

Section 21.5.14, “ndb\_import — Import CSV Data Into NDB”

### **--ignore-spaces**

Section 4.5.1.1, “mysql Client Options”

### **--ignore-table**

Creating a Data Snapshot Using mysqldump

Section 4.5.4, “mysqldump — A Database Backup Program”

### **--in-file**

Section 4.4.1, “comp\_err — Compile MySQL Error Message File”

### **--include**

Section 4.7.1, “mysql\_config — Display Options for Compiling Clients”

### **--include-\***

Section 21.5.24, “ndb\_restore — Restore an NDB Cluster Backup”

### **--include-databases**

Section 4.5.6, “mysqldump — A Database Backup Program”

Section 21.5.24, “ndb\_restore — Restore an NDB Cluster Backup”

### **--include-events**

Section 4.5.6, “mysqldump — A Database Backup Program”

### **--include-gtids**

Section 4.6.7, “mysqlbinlog — Utility for Processing Binary Log Files”

### **--include-master-host-port**

Section 4.5.4, “mysqldump — A Database Backup Program”

### **--include-routines**

Section 4.5.6, “mysqldump — A Database Backup Program”

### **--include-tables**

Section 4.5.6, “mysqldump — A Database Backup Program”

Section 21.5.24, “ndb\_restore — Restore an NDB Cluster Backup”

### **--include-triggers**

Section 4.5.6, “mysqldump — A Database Backup Program”

### **--include-users**

Section 4.5.6, “mysqldump — A Database Backup Program”

### **--info**

Section 4.6.1, “innochecksum — Offline InnoDB File Checksum Utility”

---

Section 4.8.2, “[perror — Display MySQL Error Message Information](#)”  
Section 4.8.4, “[resolveip — Resolve Host name to IP Address or Vice Versa](#)”

## **--information**

Section 4.6.3.2, “[myisamchk Check Options](#)”

## **--init-command**

Section 21.6.9, “[Importing Data Into MySQL Cluster](#)”  
Section 4.5.1.1, “[mysql Client Options](#)”

## **--init\_connect**

Section 10.5, “[Configuring Application Character Set and Collation](#)”

## **--initial**

Section 21.6.7.2, “[Adding NDB Cluster Data Nodes Online: Basic procedure](#)”  
Section 21.6.7.3, “[Adding NDB Cluster Data Nodes Online: Detailed Example](#)”  
Section 21.6.1, “[Commands in the NDB Cluster Management Client](#)”  
Section 21.4.3.5, “[Defining an NDB Cluster Management Server](#)”  
Section 21.4.3.4, “[Defining Computers in an NDB Cluster](#)”  
Section 21.4.3.6, “[Defining NDB Cluster Data Nodes](#)”  
Section 21.4.3.7, “[Defining SQL and Other API Nodes in an NDB Cluster](#)”  
Section 21.4.3.8, “[Defining the System](#)”  
Section 21.6.13, “[Distributed Privileges Using Shared Grant Tables](#)”  
Section 21.3.4, “[Initial Startup of NDB Cluster](#)”  
Section 21.3.2.3, “[Initial Startup of NDB Cluster on Windows](#)”  
Section 21.7.3, “[Known Issues in NDB Cluster Replication](#)”  
Section 21.2.7.10, “[Limitations Relating to Multiple NDB Cluster Nodes](#)”  
Section 21.4.3, “[NDB Cluster Configuration Files](#)”  
Section 21.6.11.3, “[NDB Cluster Disk Data Storage Requirements](#)”  
Section 21.4.3.12, “[NDB Cluster Shared Memory Connections](#)”  
Section 21.4.3.10, “[NDB Cluster TCP/IP Connections](#)”  
Section 21.5.7, “[ndb\\_config — Extract NDB Cluster Configuration Information](#)”  
Section 21.5.4, “[ndb\\_mgmd — The NDB Cluster Management Server Daemon](#)”  
Section 21.5.24, “[ndb\\_restore — Restore an NDB Cluster Backup](#)”  
Section 21.5.1, “[ndbd — The NDB Cluster Data Node Daemon](#)”  
Section 21.5.3, “[ndbmtd — The NDB Cluster Data Node Daemon \(Multi-Threaded\)](#)”  
Section 21.4.2, “[Overview of NDB Cluster Configuration Parameters, Options, and Variables](#)”  
Section 21.6.5, “[Performing a Rolling Restart of an NDB Cluster](#)”  
Section 21.7.9.2, “[Point-In-Time Recovery Using NDB Cluster Replication](#)”  
[Restoring to Fewer Nodes Than the Original](#)  
Section 21.6.4, “[Summary of NDB Cluster Start Phases](#)”  
Section 21.3.7.2, “[Upgrading and Downgrading NDB 7.6](#)”  
Section 21.2.4.2, “[What is New in NDB Cluster 7.6](#)”

## **--initial-start**

Section 21.5.1, “[ndbd — The NDB Cluster Data Node Daemon](#)”

## **--initialize**

Section 2.3.4.2, “[Creating an Option File](#)”  
Section 2.11.4, “[Downgrading Binary and Package-based Installations on Unix/Linux](#)”  
Section 2.9.1, “[Initializing the Data Directory](#)”  
Section 21.3.1.1, “[Installing an NDB Cluster Binary Release on Linux](#)”

---

MySQL Server Options for NDB Cluster  
Chapter 26, *MySQL sys Schema*  
Section 4.4.2, “mysql\_install\_db — Initialize MySQL Data Directory”  
Section 5.1.6, “Server Command Options”  
Section 5.1.7, “Server System Variables”  
Section 14.6.3.1, “The System Tablespace”  
Section 21.3.7.1, “Upgrading and Downgrading NDB 7.5”  
Section 1.3, “What Is New in MySQL 5.7”

### **--initialize-insecure**

Section 2.3.4.2, “Creating an Option File”  
Section 2.11.4, “Downgrading Binary and Package-based Installations on Unix/Linux”  
Section 2.9.1, “Initializing the Data Directory”  
Section 21.3.1.1, “Installing an NDB Cluster Binary Release on Linux”  
Chapter 26, *MySQL sys Schema*  
Section 4.4.2, “mysql\_install\_db — Initialize MySQL Data Directory”  
Section 5.1.6, “Server Command Options”  
Section 5.1.7, “Server System Variables”  
Section 14.6.3.1, “The System Tablespace”  
Section 1.3, “What Is New in MySQL 5.7”

### **--innodb**

Section 14.15, “InnoDB Startup Options and System Variables”  
Section 14.1.5, “Turning Off InnoDB”  
Section 1.3, “What Is New in MySQL 5.7”

### **--innodb-adaptive-hash-index**

Section 14.15, “InnoDB Startup Options and System Variables”

### **--innodb-file-per-table**

Section 5.1.6, “Server Command Options”

### **innodb-file-per-table**

Section 5.1.6, “Server Command Options”

### **--innodb-rollback-on-timeout**

Section 14.22.4, “InnoDB Error Handling”  
Section 14.15, “InnoDB Startup Options and System Variables”

### **--innodb-status-file**

Section 14.18.2, “Enabling InnoDB Monitors”  
Section 14.15, “InnoDB Startup Options and System Variables”

### **--innodb-xxx**

Section 5.1.6, “Server Command Options”

### **--innodb\_file\_per\_table**

Section 8.12.3.3, “Using Symbolic Links for Databases on Windows”

### **innodb\_file\_per\_table**

Creating a Data Snapshot Using Raw Data Files

---

## **INNODB\_PAGE\_ATOMIC\_REF\_COUNT**

Section 1.3, “What Is New in MySQL 5.7”

## **--innodb\_support\_xa**

Section 5.4.4, “The Binary Log”

## **--input-type**

Section 21.5.14, “ndb\_import — Import CSV Data Into NDB”

## **--input-workers**

Section 21.5.14, “ndb\_import — Import CSV Data Into NDB”

## **--insecure**

Section 4.4.2, “mysql\_install\_db — Initialize MySQL Data Directory”

## **--insert-ignore**

Section 4.5.4, “mysqldump — A Database Backup Program”

Section 4.5.6, “mysqlpump — A Database Backup Program”

## **--install**

Section 4.2.2.3, “Command-Line Options that Affect Option-File Handling”

Section 21.3.2.4, “Installing NDB Cluster Processes as Windows Services”

Section 21.5.4, “ndb\_mgmd — The NDB Cluster Management Server Daemon”

Section 21.5.1, “nbd — The NDB Cluster Data Node Daemon”

Section 5.1.6, “Server Command Options”

Section 5.7.2.2, “Starting Multiple MySQL Instances as Windows Services”

Section 2.3.4.8, “Starting MySQL as a Windows Service”

## **install**

Section 2.3.3.5, “MySQL Installer Console Reference”

## **--install-manual**

Section 5.1.6, “Server Command Options”

Section 5.7.2.2, “Starting Multiple MySQL Instances as Windows Services”

Section 2.3.4.8, “Starting MySQL as a Windows Service”

## **INSTALL\_LAYOUT**

Section 6.4.4.12, “Keyring System Variables”

Section 2.8.7, “MySQL Source-Configuration Options”

Section 5.1.7, “Server System Variables”

## **INSTALL\_LIBDIR**

Section 2.8.7, “MySQL Source-Configuration Options”

## **INSTALL\_MYSQLKEYRINGDIR**

Section 6.4.4.12, “Keyring System Variables”

## **INSTALL\_SECURE\_FILE\_PRIV\_EMBEDDEDIR**

Section 2.8.7, “MySQL Source-Configuration Options”

Section 27.6.2, “Restrictions When Using the Embedded MySQL Server”

Section 5.1.7, “Server System Variables”



---

[Section 1.3, “What Is New in MySQL 5.7”](#)

## **INSTALL\_SECURE\_FILE\_PRIVDIR**

[Section 5.1.7, “Server System Variables”](#)

### **--interactive**

[Section 21.5.4, “ndb\\_mgmd — The NDB Cluster Management Server Daemon”](#)

### **--iterations**

[Section 4.5.8, “mysqlslap — A Load Emulation Client”](#)

## **J**

[\[index top\]](#)

### **-j**

[Section 4.6.5, “myisampack — Generate Compressed, Read-Only MyISAM Tables”](#)

[Section 4.5.1.1, “mysql Client Options”](#)

[Section 4.6.7, “mysqlbinlog — Utility for Processing Binary Log Files”](#)

### **--join**

[Section 4.6.5, “myisampack — Generate Compressed, Read-Only MyISAM Tables”](#)

## **K**

[\[index top\]](#)

### **-K**

[Section 4.5.4, “mysqldump — A Database Backup Program”](#)

### **-k**

[Section 4.6.3.3, “myisamchk Repair Options”](#)

[Section 4.4.7, “mysql\\_upgrade — Check and Upgrade MySQL Tables”](#)

[Section 4.5.7, “mysqlshow — Display Database, Table, and Column Information”](#)

### **--keep-state**

[Section 21.5.14, “ndb\\_import — Import CSV Data Into NDB”](#)

### **--keep\_files\_on\_create**

[Section 13.1.18, “CREATE TABLE Statement”](#)

### **--key-buffer**

[Section 4.2.2.5, “Using Options to Set Program Variables”](#)

[Section 1.3, “What Is New in MySQL 5.7”](#)

### **--key-buffer-size**

[Section 4.2.2.5, “Using Options to Set Program Variables”](#)

[Section 1.3, “What Is New in MySQL 5.7”](#)

### **--keyring-migration-destination**

[Section 6.4.4.11, “Keyring Command Options”](#)

---

[Section 6.4.4.7, “Migrating Keys Between Keyring Keystores”](#)

### **--keyring-migration-host**

[Section 6.4.4.11, “Keyring Command Options”](#)

[Section 6.4.4.7, “Migrating Keys Between Keyring Keystores”](#)

### **--keyring-migration-password**

[Section 6.4.4.11, “Keyring Command Options”](#)

[Section 6.4.4.7, “Migrating Keys Between Keyring Keystores”](#)

### **--keyring-migration-port**

[Section 6.4.4.11, “Keyring Command Options”](#)

[Section 6.4.4.7, “Migrating Keys Between Keyring Keystores”](#)

### **--keyring-migration-socket**

[Section 6.4.4.11, “Keyring Command Options”](#)

[Section 6.4.4.7, “Migrating Keys Between Keyring Keystores”](#)

### **--keyring-migration-source**

[Section 6.4.4.11, “Keyring Command Options”](#)

[Section 6.4.4.7, “Migrating Keys Between Keyring Keystores”](#)

### **--keyring-migration-user**

[Section 6.4.4.11, “Keyring Command Options”](#)

[Section 6.4.4.7, “Migrating Keys Between Keyring Keystores”](#)

### **--keys**

[Section 4.5.7, “mysqlshow — Display Database, Table, and Column Information”](#)

### **--keys-used**

[Section 4.6.3.3, “myisamchk Repair Options”](#)

## **L**

[\[index top\]](#)

### **-L**

[Section 4.5.1.1, “mysql Client Options”](#)

[Section 4.5.5, “mysqlimport — A Data Import Program”](#)

[Section 21.5.24, “ndb\\_restore — Restore an NDB Cluster Backup”](#)

[Section 2.12.3, “Problems Using the Perl DBI/DBD Interface”](#)

### **-l**

[Section 4.6.1, “innochecksum — Offline InnoDB File Checksum Utility”](#)

[Section 4.7.2, “my\\_print\\_defaults — Display Options from Option Files”](#)

[Section 4.6.2, “myisam\\_ftdump — Display Full-Text Index information”](#)

[Section 4.6.7, “mysqlbinlog — Utility for Processing Binary Log Files”](#)

[Section 4.5.4, “mysqldump — A Database Backup Program”](#)

[Section 4.6.8, “mysqldumpslow — Summarize Slow Query Log Files”](#)

[Section 4.5.5, “mysqlimport — A Data Import Program”](#)

[Section 21.5.16, “ndb\\_move\\_data — NDB Data Copy Utility”](#)

---

Section 21.5.23, “[ndb\\_redo\\_log\\_reader](#) — Check and Print Content of Cluster Redo Log”  
Section 21.5.25, “[ndb\\_select\\_all](#) — Print Rows from an NDB Table”  
Section 21.5.26, “[ndb\\_select\\_count](#) — Print Row Counts for NDB Tables”  
Section 21.5.27, “[ndb\\_show\\_tables](#) — Display List of NDB Tables”  
Section 21.5.2, “[ndbinfo\\_select\\_all](#) — Select From ndbinfo Tables”

## **--language**

Section 5.1.6, “[Server Command Options](#)”

## **--large-pages**

Section 8.12.4.3, “[Enabling Large Page Support](#)”  
Section 5.1.6, “[Server Command Options](#)”  
Section 5.1.7, “[Server System Variables](#)”

## **--lc-messages**

Section 4.4.2, “[mysql\\_install\\_db](#) — Initialize MySQL Data Directory”  
Section 5.1.6, “[Server Command Options](#)”

## **--lc-messages-dir**

Section 4.4.2, “[mysql\\_install\\_db](#) — Initialize MySQL Data Directory”  
Section 5.1.6, “[Server Command Options](#)”

## **--ledir**

Section 4.3.2, “[mysqld\\_safe](#) — MySQL Server Startup Script”

## **--length**

Section 4.6.2, “[myisam\\_ftdump](#) — Display Full-Text Index information”

## **--libmysqld-libs**

Section 4.7.1, “[mysql\\_config](#) — Display Options for Compiling Clients”  
Section 1.3, “[What Is New in MySQL 5.7](#)”

## **--libs**

Section 4.7.1, “[mysql\\_config](#) — Display Options for Compiling Clients”  
Section 1.3, “[What Is New in MySQL 5.7](#)”

## **--libs\_r**

Section 4.7.1, “[mysql\\_config](#) — Display Options for Compiling Clients”

## **--line-numbers**

Section 4.5.1.1, “[mysql Client Options](#)”

## **--lines-terminated-by**

Section 7.4.3, “[Dumping Data in Delimited-Text Format with mysqldump](#)”  
Section 4.5.4, “[mysqldump](#) — A Database Backup Program”  
Section 4.5.5, “[mysqlimport](#) — A Data Import Program”  
Section 21.5.14, “[ndb\\_import](#) — Import CSV Data Into NDB”  
Section 21.5.24, “[ndb\\_restore](#) — Restore an NDB Cluster Backup”

## **list**

Section 2.3.3.5, “[MySQL Installer Console Reference](#)”

---

## **--loadqueries**

Section 21.5.28, “[ndb\\_size.pl — NDBCLUSTER Size Requirement Estimator](#)”

## **--local**

Section 4.5.5, “[mysqlimport — A Data Import Program](#)”

Section 6.1.6, “[Security Considerations for LOAD DATA LOCAL](#)”

## **--local-infile**

Section 13.2.7, “[LOAD XML Statement](#)”

Section 4.5.1.1, “[mysql Client Options](#)”

Section 2.8.7, “[MySQL Source-Configuration Options](#)”

Section 6.1.6, “[Security Considerations for LOAD DATA LOCAL](#)”

## **--local-load**

Section 4.6.7, “[mysqlbinlog — Utility for Processing Binary Log Files](#)”

## **--local-service**

Section 5.1.6, “[Server Command Options](#)”

Section 2.3.4.8, “[Starting MySQL as a Windows Service](#)”

## **--lock**

Section 21.5.25, “[ndb\\_select\\_all — Print Rows from an NDB Table](#)”

Section 21.5.26, “[ndb\\_select\\_count — Print Row Counts for NDB Tables](#)”

## **--lock-all-tables**

Section 4.5.4, “[mysqldump — A Database Backup Program](#)”

## **--lock-tables**

Section 4.5.4, “[mysqldump — A Database Backup Program](#)”

Section 4.5.5, “[mysqlimport — A Data Import Program](#)”

## **--log**

Section 4.6.1, “[innochecksum — Offline InnoDB File Checksum Utility](#)”

Section 4.3.4, “[mysqld\\_multi — Manage Multiple MySQL Servers](#)”

## **--log-bin**

Section 7.3.3, “[Backup Strategy Summary](#)”

Section 16.1.6.4, “[Binary Logging Options and Variables](#)”

Section 7.2, “[Database Backup Methods](#)”

Section 7.3.1, “[Establishing a Backup Policy](#)”

Section 16.1.6.5, “[Global Transaction ID System Variables](#)”

Section 16.4.5, “[How to Report Replication Bugs or Problems](#)”

Section B.3.7, “[Known Issues in MySQL](#)”

Section 21.2.7.1, “[Noncompliance with SQL Syntax in NDB Cluster](#)”

Section 7.5.1, “[Point-in-Time Recovery Using Binary Log](#)”

Section 13.4.1.1, “[PURGE BINARY LOGS Statement](#)”

Section 16.1.6.3, “[Replica Server Options and Variables](#)”

Section 5.7, “[Running Multiple MySQL Instances on One Machine](#)”

Section 5.4.4.2, “[Setting The Binary Log Format](#)”

Section 23.7, “[Stored Program Binary Logging](#)”

Section 16.3.7, “[Switching Sources During Failover](#)”

---

[Section 5.4.4, “The Binary Log”](#)  
[Section 16.4.4, “Troubleshooting Replication”](#)  
[Section 7.3.2, “Using Backups for Recovery”](#)  
[Section 17.5.5, “Using MySQL Enterprise Backup with Group Replication”](#)  
[Section 4.2.2.1, “Using Options on the Command Line”](#)

## **--log-bin-index**

[Section 16.1.6.4, “Binary Logging Options and Variables”](#)  
[Section 21.2.7.1, “Noncompliance with SQL Syntax in NDB Cluster”](#)  
[Section 5.4.4, “The Binary Log”](#)

## **--log-error**

[Section 5.4.2.2, “Error Logging on Unix and Unix-Like Systems”](#)  
[Section 5.4.2.1, “Error Logging on Windows”](#)  
[Section 5.4.2.3, “Error Logging to the System Log”](#)  
[Section 2.5.7.2, “More Topics on Deploying MySQL Server with Docker”](#)  
[Section 4.3.2, “mysqld\\_safe — MySQL Server Startup Script”](#)  
[Section 4.5.4, “mysqldump — A Database Backup Program”](#)  
[Section 4.2.2.6, “Option Defaults, Options Expecting Values, and the = Sign”](#)  
[Section 5.7, “Running Multiple MySQL Instances on One Machine”](#)  
[Section 5.1.6, “Server Command Options”](#)  
[Section 5.4.7, “Server Log Maintenance”](#)  
[Section 2.3.4.6, “Starting MySQL from the Windows Command Line”](#)  
[Section 2.3.4.5, “Starting the Server for the First Time”](#)

## **--log-error-file**

[Section 4.5.6, “mysqldump — A Database Backup Program”](#)

## **--log-isam**

[Section 4.6.4, “myisamlog — Display MyISAM Log File Contents”](#)  
[Section 5.1.6, “Server Command Options”](#)

## **--log-level**

[Section 21.5.14, “ndb\\_import — Import CSV Data Into NDB”](#)

## **--log-name**

[Section 21.5.4, “ndb\\_mgmd — The NDB Cluster Management Server Daemon”](#)

## **--log-raw**

[Section 6.1.2.3, “Passwords and Logging”](#)  
[Section 5.1.6, “Server Command Options”](#)  
[Section 5.4.3, “The General Query Log”](#)

## **--log-short-format**

[Section 5.1.6, “Server Command Options”](#)  
[Section 5.4.5, “The Slow Query Log”](#)

## **--log-slave-updates**

[Section 16.1.6.5, “Global Transaction ID System Variables”](#)  
[Section 16.4.5, “How to Report Replication Bugs or Problems”](#)  
[Section 16.1.6.3, “Replica Server Options and Variables”](#)

---

Section 16.1.3.4, “Setting Up Replication Using GTIDs”  
Section 16.3.7, “Switching Sources During Failover”  
Section 5.4.4, “The Binary Log”

## **--log-tc**

Section 5.1.6, “Server Command Options”

## **--log-tc-size**

Section 5.1.6, “Server Command Options”  
Section 5.1.9, “Server Status Variables”

## **--log-warnings**

Section 16.1.6.3, “Replica Server Options and Variables”  
Section 5.1.6, “Server Command Options”  
Section 5.1.7, “Server System Variables”  
Section 1.3, “What Is New in MySQL 5.7”

## **--log\_bin**

Section 4.2.2.1, “Using Options on the Command Line”

## **--log\_output**

Section 5.4.1, “Selecting General Query Log and Slow Query Log Output Destinations”

## **--log\_timestamps**

Section 4.3.2, “mysqld\_safe — MySQL Server Startup Script”

## **--logbuffer-size**

Section 21.5.1, “ndbd — The NDB Cluster Data Node Daemon”

## **--login-file**

Section 4.4.2, “mysql\_install\_db — Initialize MySQL Data Directory”

## **--login-path**

Section 4.2.2.3, “Command-Line Options that Affect Option-File Handling”  
Section 4.7.2, “my\_print\_defaults — Display Options from Option Files”  
Section 4.5.1.1, “mysql Client Options”  
Section 4.6.6, “mysql\_config\_editor — MySQL Configuration Utility”  
Section 4.4.2, “mysql\_install\_db — Initialize MySQL Data Directory”  
Section 4.4.7, “mysql\_upgrade — Check and Upgrade MySQL Tables”  
Section 4.5.2, “mysqladmin — A MySQL Server Administration Program”  
Section 4.6.7, “mysqlbinlog — Utility for Processing Binary Log Files”  
Section 4.5.3, “mysqlcheck — A Table Maintenance Program”  
Section 4.5.4, “mysqldump — A Database Backup Program”  
Section 4.5.5, “mysqlexport — A Data Import Program”  
Section 4.5.6, “mysqmpump — A Database Backup Program”  
Section 4.5.7, “mysqlshow — Display Database, Table, and Column Information”  
Section 4.5.8, “mysqlslap — A Load Emulation Client”  
Section 21.5.6, “ndb\_blob\_tool — Check and Repair BLOB and TEXT columns of NDB Cluster Tables”  
Section 21.5.7, “ndb\_config — Extract NDB Cluster Configuration Information”  
Section 21.5.9, “ndb\_delete\_all — Delete All Rows from an NDB Table”  
Section 21.5.10, “ndb\_desc — Describe NDB Tables”

---

[Section 21.5.11, “ndb\\_drop\\_index — Drop Index from an NDB Table”](#)  
[Section 21.5.12, “ndb\\_drop\\_table — Drop an NDB Table”](#)  
[Section 21.5.14, “ndb\\_import — Import CSV Data Into NDB”](#)  
[Section 21.5.15, “ndb\\_index\\_stat — NDB Index Statistics Utility”](#)  
[Section 21.5.5, “ndb\\_mgm — The NDB Cluster Management Client”](#)  
[Section 21.5.4, “ndb\\_mgmd — The NDB Cluster Management Server Daemon”](#)  
[Section 21.5.16, “ndb\\_move\\_data — NDB Data Copy Utility”](#)  
[Section 21.5.17, “ndb\\_perror — Obtain NDB Error Message Information”](#)  
[Section 21.5.24, “ndb\\_restore — Restore an NDB Cluster Backup”](#)  
[Section 21.5.25, “ndb\\_select\\_all — Print Rows from an NDB Table”](#)  
[Section 21.5.26, “ndb\\_select\\_count — Print Row Counts for NDB Tables”](#)  
[Section 21.5.27, “ndb\\_show\\_tables — Display List of NDB Tables”](#)  
[Section 21.5.29, “ndb\\_top — View CPU usage information for NDB threads”](#)  
[Section 21.5.30, “ndb\\_waiter — Wait for NDB Cluster to Reach a Given Status”](#)  
[Section 21.5.1, “ndbd — The NDB Cluster Data Node Daemon”](#)  
[Section 21.5.2, “ndbinfo\\_select\\_all — Select From ndbinfo Tables”](#)  
[Section 4.2.2.2, “Using Option Files”](#)

## **--loops**

[Section 21.5.15, “ndb\\_index\\_stat — NDB Index Statistics Utility”](#)  
[Section 21.5.27, “ndb\\_show\\_tables — Display List of NDB Tables”](#)  
[Section 21.5.2, “ndbinfo\\_select\\_all — Select From ndbinfo Tables”](#)

## **--loose**

[Section 4.2.2.4, “Program Option Modifiers”](#)

## **--loose-opt\_name**

[Section 4.2.2.2, “Using Option Files”](#)

## **--lossy-conversions**

[Section 21.5.16, “ndb\\_move\\_data — NDB Data Copy Utility”](#)  
[Section 21.5.24, “ndb\\_restore — Restore an NDB Cluster Backup”](#)  
[Section 21.2.4.1, “What is New in NDB Cluster 7.5”](#)  
[Section 21.2.4.2, “What is New in NDB Cluster 7.6”](#)

## **--low-priority**

[Section 4.5.5, “mysqlimport — A Data Import Program”](#)

## **--low-priority-updates**

[Section 8.11.3, “Concurrent Inserts”](#)  
[Section 13.2.5, “INSERT Statement”](#)  
[Section 8.11.2, “Table Locking Issues”](#)

## **--lower-case-table-names**

[Section 9.2.3, “Identifier Case Sensitivity”](#)

## **M**

[\[index top\]](#)

## **-m**

[Section 4.6.3.2, “myisamchk Check Options”](#)

---

[Section 4.5.3, “mysqlcheck — A Table Maintenance Program”](#)  
[Section 21.7.9, “NDB Cluster Backups With NDB Cluster Replication”](#)  
[Section 21.5.23, “ndb\\_redo\\_log\\_reader — Check and Print Content of Cluster Redo Log”](#)  
[Section 21.5.24, “ndb\\_restore — Restore an NDB Cluster Backup”](#)  
[Section 21.5.29, “ndb\\_top — View CPU usage information for NDB threads”](#)  
[Restoring to More Nodes Than the Original](#)

## **--malloc-lib**

[Section 2.5.10, “Managing MySQL Server with systemd”](#)  
[Section 4.3.2, “mysqld\\_safe — MySQL Server Startup Script”](#)

## **--master-data**

[Creating a Data Snapshot Using mysqldump](#)  
[Section 7.3.1, “Establishing a Backup Policy”](#)  
[Section 4.5.4, “mysqldump — A Database Backup Program”](#)  
[Section 6.2.2, “Privileges Provided by MySQL”](#)  
[Section 16.1.3.5, “Using GTIDs for Failover and Scaleout”](#)  
[Section 4.6.7.3, “Using mysqlbinlog to Back Up Binary Log Files”](#)

## **--master-info-file**

[Section 16.1.6.3, “Replica Server Options and Variables”](#)  
[Section 16.2.4.2, “Replication Metadata Repositories”](#)

## **--master-retry-count**

[Section 13.4.2.1, “CHANGE MASTER TO Statement”](#)  
[Section 16.1.6.3, “Replica Server Options and Variables”](#)  
[Section 13.7.5.34, “SHOW SLAVE STATUS Statement”](#)

## **--max-allowed-packet**

[Section 4.5.1.1, “mysql Client Options”](#)  
[Section 4.4.7, “mysql\\_upgrade — Check and Upgrade MySQL Tables”](#)  
[Section 4.5.4, “mysqldump — A Database Backup Program”](#)  
[Section 4.5.6, “mysqlpump — A Database Backup Program”](#)

## **--max-binlog-dump-events**

[Section 16.1.6.4, “Binary Logging Options and Variables”](#)

## **--max-binlog-size**

[Section 16.1.6.3, “Replica Server Options and Variables”](#)

## **--max-join-size**

[Section 4.5.1.1, “mysql Client Options”](#)  
[Section 4.5.1.6, “mysql Client Tips”](#)

## **--max-record-length**

[Section 4.6.3.3, “myisamchk Repair Options”](#)  
[Section 13.7.2.5, “REPAIR TABLE Statement”](#)

## **--max-relay-log-size**

[Section 16.1.6.3, “Replica Server Options and Variables”](#)  
[Section 16.2.2.3, “Startup Options and Replication Channels”](#)



---

**--max-rows**

Section 21.5.14, “[ndb\\_import — Import CSV Data Into NDB](#)”

**--max-seeks-for-key**

Section 8.2.1.20, “[Avoiding Full Table Scans](#)”  
Section B.3.5, “[Optimizer-Related Issues](#)”

**--maximum**

Section 4.2.2.4, “[Program Option Modifiers](#)”

**--maximum-back\_log**

Section 4.2.2.4, “[Program Option Modifiers](#)”

**--maximum-innodb-log-file-size**

Section 5.1.8, “[Using System Variables](#)”

**--maximum-max\_heap\_table\_size**

Section 4.2.2.4, “[Program Option Modifiers](#)”

**--maximum-query\_cache\_size**

Section 8.10.3.3, “[Query Cache Configuration](#)”

**--maximum-var\_name**

Section 5.1.6, “[Server Command Options](#)”  
Section 5.1.8, “[Using System Variables](#)”

**--measured-load**

Section 21.5.29, “[ndb\\_top — View CPU usage information for NDB threads](#)”

**--medium-check**

Section 4.6.3.2, “[myisamchk Check Options](#)”  
Section 4.5.3, “[mysqlcheck — A Table Maintenance Program](#)”

**--memlock**

Section 5.1.6, “[Server Command Options](#)”  
Section 5.1.7, “[Server System Variables](#)”  
Section 14.6.3.1, “[The System Tablespace](#)”

**modify**

Section 2.3.3.5, “[MySQL Installer Console Reference](#)”

**--monitor**

Section 21.5.14, “[ndb\\_import — Import CSV Data Into NDB](#)”

**--mount**

Section 2.5.7.2, “[More Topics on Deploying MySQL Server with Docker](#)”

**--my-plugin**

Section 5.5.1, “[Installing and Uninstalling Plugins](#)”

---

## **--my-print-defaults**

[Section 4.4.3, “mysql\\_plugin — Configure MySQL Server Plugins”](#)

## **--my\_plugin**

[Section 5.5.1, “Installing and Uninstalling Plugins”](#)

## **--mycnf**

[Section 21.5.7, “ndb\\_config — Extract NDB Cluster Configuration Information”](#)

[Section 21.5.4, “ndb\\_mgmd — The NDB Cluster Management Server Daemon”](#)

## **--myisam-block-size**

[Section 8.10.2.5, “Key Cache Block Size”](#)

[Section 5.1.6, “Server Command Options”](#)

## **--myisam\_sort\_buffer\_size**

[Section 4.6.3.6, “myisamchk Memory Usage”](#)

## **MYSQL\_ALLOW\_EMPTY\_PASSWORD**

[Section 2.5.7.2, “More Topics on Deploying MySQL Server with Docker”](#)

## **MYSQL\_DATABASE**

[Section 2.5.7.2, “More Topics on Deploying MySQL Server with Docker”](#)

## **MYSQL\_LOG\_CONSOLE**

[Section 2.5.7.2, “More Topics on Deploying MySQL Server with Docker”](#)

## **MYSQL\_MAINTAINER\_MODE**

[Section 2.8.8, “Dealing with Problems Compiling MySQL”](#)

## **MYSQL\_ONETIME\_PASSWORD**

[Section 2.5.7.1, “Basic Steps for MySQL Server Deployment with Docker”](#)

[Section 2.5.7.2, “More Topics on Deploying MySQL Server with Docker”](#)

## **MYSQL\_PASSWORD**

[Section 2.5.7.2, “More Topics on Deploying MySQL Server with Docker”](#)

## **MYSQL\_RANDOM\_ROOT\_PASSWORD**

[Section 2.5.7.2, “More Topics on Deploying MySQL Server with Docker”](#)

## **MYSQL\_ROOT\_HOST**

[Section 2.5.7.2, “More Topics on Deploying MySQL Server with Docker”](#)

## **MYSQL\_ROOT\_PASSWORD**

[Section 2.5.7.2, “More Topics on Deploying MySQL Server with Docker”](#)

## **MYSQL\_TCP\_PORT**

[Section 2.8.5, “Installing MySQL Using a Development Source Tree”](#)

[Section 2.8.7, “MySQL Source-Configuration Options”](#)

---

## **MYSQL\_UNIX\_ADDR**

Section B.3.3.6, “How to Protect or Change the MySQL Unix Socket File”

Section 2.8.5, “Installing MySQL Using a Development Source Tree”

Section 2.8.7, “MySQL Source-Configuration Options”

Section 19.4.2.2, “X Plugin Options and System Variables”

## **MYSQL\_USER**

Section 2.5.7.2, “More Topics on Deploying MySQL Server with Docker”

## **--mysqladmin**

Section 4.3.4, “mysqld\_multi — Manage Multiple MySQL Servers”

## **--mysqld**

Section 4.4.3, “mysql\_plugin — Configure MySQL Server Plugins”

Section 4.3.4, “mysqld\_multi — Manage Multiple MySQL Servers”

Section 4.3.2, “mysqld\_safe — MySQL Server Startup Script”

## **--mysqld-file**

Section 4.4.2, “mysql\_install\_db — Initialize MySQL Data Directory”

## **--mysqld-safe-log-timestamps**

Section 4.3.2, “mysqld\_safe — MySQL Server Startup Script”

## **--mysqld-version**

Section 4.3.2, “mysqld\_safe — MySQL Server Startup Script”

## **--mysqlx**

Section 19.4.2.2, “X Plugin Options and System Variables”

## **MYSQLX\_UNIX\_ADDR**

Section 19.4.2.2, “X Plugin Options and System Variables”

## **N**

[\[index top\]](#)

### **-N**

Section 4.4.1, “comp\_err — Compile MySQL Error Message File”

Section 4.5.1.1, “mysql Client Options”

Section 4.5.4, “mysqldump — A Database Backup Program”

### **-n**

Section 21.6.1, “Commands in the NDB Cluster Management Client”

Section 4.6.1, “innochecksum — Offline InnoDB File Checksum Utility”

Section 4.7.2, “my\_print\_defaults — Display Options from Option Files”

Section 4.6.3.3, “myisamchk Repair Options”

Section 4.5.1.1, “mysql Client Options”

Section 4.5.4, “mysqldump — A Database Backup Program”

Section 4.6.8, “mysqldumpslow — Summarize Slow Query Log Files”

Section 21.5.10, “ndb\_desc — Describe NDB Tables”

---

[Section 21.5.23, “ndb\\_redo\\_log\\_reader — Check and Print Content of Cluster Redo Log”](#)  
[Section 21.5.24, “ndb\\_restore — Restore an NDB Cluster Backup”](#)  
[Section 21.5.29, “ndb\\_top — View CPU usage information for NDB threads”](#)  
[Section 21.5.30, “ndb\\_waiter — Wait for NDB Cluster to Reach a Given Status”](#)  
[Section 21.5.1, “ndbd — The NDB Cluster Data Node Daemon”](#)  
[Section 4.7.3, “resolve\\_stack\\_dump — Resolve Numeric Stack Trace Dump to Symbols”](#)

## **--name**

[Section 2.5.7.1, “Basic Steps for MySQL Server Deployment with Docker”](#)

## **--name-file**

[Section 4.4.1, “comp\\_err — Compile MySQL Error Message File”](#)

## **--named-commands**

[Section 4.5.1.1, “mysql Client Options”](#)

## **--ndb**

[Section 21.5.17, “ndb\\_perror — Obtain NDB Error Message Information”](#)  
[Section 4.8.2, “ perror — Display MySQL Error Message Information”](#)  
[Section 21.6.15.21, “The ndbinfo error\\_messages Table”](#)  
[Section 1.3, “What Is New in MySQL 5.7”](#)  
[Section 21.2.4.2, “What is New in NDB Cluster 7.6”](#)

## **--ndb-allow-copying-alter-table**

[MySQL Server Options for NDB Cluster](#)  
[Section 21.2.4.1, “What is New in NDB Cluster 7.5”](#)

## **--ndb-batch-size**

[MySQL Server Options for NDB Cluster](#)  
[Section 21.7.5, “Preparing the NDB Cluster for Replication”](#)

## **--ndb-blob-read-batch-bytes**

[MySQL Server Options for NDB Cluster](#)

## **--ndb-blob-write-batch-bytes**

[MySQL Server Options for NDB Cluster](#)  
[Section 21.7.5, “Preparing the NDB Cluster for Replication”](#)

## **--ndb-cluster**

[Section A.10, “MySQL 5.7 FAQ: NDB Cluster”](#)

## **--ndb-cluster-connection-pool**

[MySQL Server Options for NDB Cluster](#)  
[Section 21.2.4.1, “What is New in NDB Cluster 7.5”](#)

## **--ndb-cluster-connection-pool-nodeids**

[MySQL Server Options for NDB Cluster](#)  
[Section 21.2.4.1, “What is New in NDB Cluster 7.5”](#)

## **--ndb-connectstring**

[Section 21.3.2.1, “Installing NDB Cluster on Windows from a Binary Release”](#)

---

[Section A.10, “MySQL 5.7 FAQ: NDB Cluster”](#)  
[MySQL Server Options for NDB Cluster](#)  
[Section 21.6.10, “MySQL Server Usage for NDB Cluster”](#)  
[Section 21.6.18.2, “NDB Cluster and MySQL Privileges”](#)  
[Section 21.2.1, “NDB Cluster Core Concepts”](#)  
[Section 21.5.6, “ndb\\_blob\\_tool — Check and Repair BLOB and TEXT columns of NDB Cluster Tables”](#)  
[Section 21.5.7, “ndb\\_config — Extract NDB Cluster Configuration Information”](#)  
[Section 21.5.9, “ndb\\_delete\\_all — Delete All Rows from an NDB Table”](#)  
[Section 21.5.10, “ndb\\_desc — Describe NDB Tables”](#)  
[Section 21.5.11, “ndb\\_drop\\_index — Drop Index from an NDB Table”](#)  
[Section 21.5.12, “ndb\\_drop\\_table — Drop an NDB Table”](#)  
[Section 21.5.14, “ndb\\_import — Import CSV Data Into NDB”](#)  
[Section 21.5.15, “ndb\\_index\\_stat — NDB Index Statistics Utility”](#)  
[Section 21.5.5, “ndb\\_mgm — The NDB Cluster Management Client”](#)  
[Section 21.5.4, “ndb\\_mgmd — The NDB Cluster Management Server Daemon”](#)  
[Section 21.5.16, “ndb\\_move\\_data — NDB Data Copy Utility”](#)  
[Section 21.5.24, “ndb\\_restore — Restore an NDB Cluster Backup”](#)  
[Section 21.5.25, “ndb\\_select\\_all — Print Rows from an NDB Table”](#)  
[Section 21.5.26, “ndb\\_select\\_count — Print Row Counts for NDB Tables”](#)  
[Section 21.5.27, “ndb\\_show\\_tables — Display List of NDB Tables”](#)  
[Section 21.5.30, “ndb\\_waiter — Wait for NDB Cluster to Reach a Given Status”](#)  
[Section 21.5.1, “ndbd — The NDB Cluster Data Node Daemon”](#)  
[Section 21.5.2, “ndbinfo\\_select\\_all — Select From ndbinfo Tables”](#)  
[Section 21.7.5, “Preparing the NDB Cluster for Replication”](#)  
[Section 21.4.3.2, “Recommended Starting Configuration for NDB Cluster”](#)  
[Restoring to Fewer Nodes Than the Original](#)  
[Restoring to More Nodes Than the Original](#)  
[Section 21.2.4.1, “What is New in NDB Cluster 7.5”](#)

## **ndb-connectstring**

[Section 21.5.30, “ndb\\_waiter — Wait for NDB Cluster to Reach a Given Status”](#)

## **--ndb-default-column-format**

[MySQL Server Options for NDB Cluster](#)  
[Section 21.2.4.1, “What is New in NDB Cluster 7.5”](#)

## **--ndb-deferred-constraints**

[MySQL Server Options for NDB Cluster](#)

## **--ndb-distribution**

[MySQL Server Options for NDB Cluster](#)

## **--ndb-log-apply-status**

[MySQL Server Options for NDB Cluster](#)  
[NDB Cluster System Variables](#)

## **--ndb-log-empty-epochs**

[MySQL Server Options for NDB Cluster](#)  
[Section 21.7.4, “NDB Cluster Replication Schema and Tables”](#)

## **--ndb-log-empty-update**

[MySQL Server Options for NDB Cluster](#)

---

## **--ndb-log-exclusive-reads**

MySQL Server Options for NDB Cluster

## **--ndb-log-fail-terminate**

MySQL Server Options for NDB Cluster

Section 21.2.4.1, “What is New in NDB Cluster 7.5”

Section 21.2.4.2, “What is New in NDB Cluster 7.6”

## **--ndb-log-orig**

MySQL Server Options for NDB Cluster

Section 21.7.4, “NDB Cluster Replication Schema and Tables”

NDB Cluster System Variables

## **--ndb-log-transaction-id**

Section 16.1.6.4, “Binary Logging Options and Variables”

MySQL Server Options for NDB Cluster

Section 21.7.11, “NDB Cluster Replication Conflict Resolution”

NDB Cluster System Variables

## **--ndb-log-update-as-write**

Section 21.7.3, “Known Issues in NDB Cluster Replication”

MySQL Server Options for NDB Cluster

Section 21.7.11, “NDB Cluster Replication Conflict Resolution”

Section 21.7.4, “NDB Cluster Replication Schema and Tables”

## **--ndb-log-update-minimal**

MySQL Server Options for NDB Cluster

Section 21.7.4, “NDB Cluster Replication Schema and Tables”

## **--ndb-log-updated-only**

MySQL Server Options for NDB Cluster

Section 21.7.11, “NDB Cluster Replication Conflict Resolution”

Section 21.7.4, “NDB Cluster Replication Schema and Tables”

## **--ndb-mgmd-host**

MySQL Server Options for NDB Cluster

Section 21.5.6, “ndb\_blob\_tool — Check and Repair BLOB and TEXT columns of NDB Cluster Tables”

Section 21.5.7, “ndb\_config — Extract NDB Cluster Configuration Information”

Section 21.5.9, “ndb\_delete\_all — Delete All Rows from an NDB Table”

Section 21.5.10, “ndb\_desc — Describe NDB Tables”

Section 21.5.11, “ndb\_drop\_index — Drop Index from an NDB Table”

Section 21.5.12, “ndb\_drop\_table — Drop an NDB Table”

Section 21.5.14, “ndb\_import — Import CSV Data Into NDB”

Section 21.5.15, “ndb\_index\_stat — NDB Index Statistics Utility”

Section 21.5.5, “ndb\_mgm — The NDB Cluster Management Client”

Section 21.5.4, “ndb\_mgmd — The NDB Cluster Management Server Daemon”

Section 21.5.16, “ndb\_move\_data — NDB Data Copy Utility”

Section 21.5.24, “ndb\_restore — Restore an NDB Cluster Backup”

Section 21.5.25, “ndb\_select\_all — Print Rows from an NDB Table”

Section 21.5.26, “ndb\_select\_count — Print Row Counts for NDB Tables”

Section 21.5.27, “ndb\_show\_tables — Display List of NDB Tables”

---

Section 21.5.30, “[ndb\\_waiter](#) — Wait for NDB Cluster to Reach a Given Status”  
Section 21.5.1, “[ndbd](#) — The NDB Cluster Data Node Daemon”  
Section 21.5.2, “[ndbinfo\\_select\\_all](#) — Select From ndbinfo Tables”

## **--ndb-nodegroup-map**

Section 21.5.24, “[ndb\\_restore](#) — Restore an NDB Cluster Backup”

## **--ndb-nodeid**

MySQL Server Options for NDB Cluster

Section 21.5.6, “[ndb\\_blob\\_tool](#) — Check and Repair BLOB and TEXT columns of NDB Cluster Tables”  
Section 21.5.7, “[ndb\\_config](#) — Extract NDB Cluster Configuration Information”  
Section 21.5.9, “[ndb\\_delete\\_all](#) — Delete All Rows from an NDB Table”  
Section 21.5.10, “[ndb\\_desc](#) — Describe NDB Tables”  
Section 21.5.11, “[ndb\\_drop\\_index](#) — Drop Index from an NDB Table”  
Section 21.5.12, “[ndb\\_drop\\_table](#) — Drop an NDB Table”  
Section 21.5.14, “[ndb\\_import](#) — Import CSV Data Into NDB”  
Section 21.5.15, “[ndb\\_index\\_stat](#) — NDB Index Statistics Utility”  
Section 21.5.5, “[ndb\\_mgm](#) — The NDB Cluster Management Client”  
Section 21.5.4, “[ndb\\_mgmd](#) — The NDB Cluster Management Server Daemon”  
Section 21.5.16, “[ndb\\_move\\_data](#) — NDB Data Copy Utility”  
Section 21.5.24, “[ndb\\_restore](#) — Restore an NDB Cluster Backup”  
Section 21.5.25, “[ndb\\_select\\_all](#) — Print Rows from an NDB Table”  
Section 21.5.26, “[ndb\\_select\\_count](#) — Print Row Counts for NDB Tables”  
Section 21.5.27, “[ndb\\_show\\_tables](#) — Display List of NDB Tables”  
Section 21.5.30, “[ndb\\_waiter](#) — Wait for NDB Cluster to Reach a Given Status”  
Section 21.5.1, “[ndbd](#) — The NDB Cluster Data Node Daemon”  
Section 21.5.2, “[ndbinfo\\_select\\_all](#) — Select From ndbinfo Tables”  
Section 21.2.4.1, “[What is New in NDB Cluster 7.5](#)”

## **--ndb-optimization-delay**

MySQL Server Options for NDB Cluster

Section 13.7.2.4, “[OPTIMIZE TABLE](#) Statement”

## **--ndb-optimized-node-selection**

MySQL Server Options for NDB Cluster

Section 21.5.6, “[ndb\\_blob\\_tool](#) — Check and Repair BLOB and TEXT columns of NDB Cluster Tables”  
Section 21.5.7, “[ndb\\_config](#) — Extract NDB Cluster Configuration Information”  
Section 21.5.9, “[ndb\\_delete\\_all](#) — Delete All Rows from an NDB Table”  
Section 21.5.10, “[ndb\\_desc](#) — Describe NDB Tables”  
Section 21.5.11, “[ndb\\_drop\\_index](#) — Drop Index from an NDB Table”  
Section 21.5.12, “[ndb\\_drop\\_table](#) — Drop an NDB Table”  
Section 21.5.14, “[ndb\\_import](#) — Import CSV Data Into NDB”  
Section 21.5.15, “[ndb\\_index\\_stat](#) — NDB Index Statistics Utility”  
Section 21.5.5, “[ndb\\_mgm](#) — The NDB Cluster Management Client”  
Section 21.5.4, “[ndb\\_mgmd](#) — The NDB Cluster Management Server Daemon”  
Section 21.5.16, “[ndb\\_move\\_data](#) — NDB Data Copy Utility”  
Section 21.5.24, “[ndb\\_restore](#) — Restore an NDB Cluster Backup”  
Section 21.5.25, “[ndb\\_select\\_all](#) — Print Rows from an NDB Table”  
Section 21.5.26, “[ndb\\_select\\_count](#) — Print Row Counts for NDB Tables”  
Section 21.5.27, “[ndb\\_show\\_tables](#) — Display List of NDB Tables”  
Section 21.5.30, “[ndb\\_waiter](#) — Wait for NDB Cluster to Reach a Given Status”  
Section 21.5.1, “[ndbd](#) — The NDB Cluster Data Node Daemon”  
Section 21.5.2, “[ndbinfo\\_select\\_all](#) — Select From ndbinfo Tables”

---

## **--ndb-transid-mysql-connection-map**

MySQL Server Options for NDB Cluster

Section 24.3.13, “The INFORMATION\_SCHEMA ndb\_transid\_mysql\_connection\_map Table”

## **--ndb-wait-connected**

MySQL Server Options for NDB Cluster

## **--ndb-wait-setup**

MySQL Server Options for NDB Cluster

## **--ndbcluster**

Section 21.4, “Configuration of NDB Cluster”

Section 21.3.2.1, “Installing NDB Cluster on Windows from a Binary Release”

Section A.10, “MySQL 5.7 FAQ: NDB Cluster”

MySQL Server Options for NDB Cluster

Section 21.6.10, “MySQL Server Usage for NDB Cluster”

Section 21.6.18.2, “NDB Cluster and MySQL Privileges”

Section 21.2.1, “NDB Cluster Core Concepts”

Section 21.6.15, “ndbinfo: The NDB Cluster Information Database”

Section 21.4.3.2, “Recommended Starting Configuration for NDB Cluster”

Section 5.1.6, “Server Command Options”

Section 13.7.5.16, “SHOW ENGINES Statement”

Section 24.3.7, “The INFORMATION\_SCHEMA ENGINES Table”

Section 21.3.7.1, “Upgrading and Downgrading NDB 7.5”

## **--net-buffer-length**

Section 4.5.1.1, “mysql Client Options”

Section 4.4.7, “mysql\_upgrade — Check and Upgrade MySQL Tables”

Section 4.5.4, “mysqldump — A Database Backup Program”

Section 4.5.6, “mysqlpump — A Database Backup Program”

## **net\_retry\_count**

Section 16.2.3.1, “Monitoring Replication Main Threads”

## **net\_write\_timeout**

Section 16.2.3.1, “Monitoring Replication Main Threads”

## **--network**

Section 2.5.7.2, “More Topics on Deploying MySQL Server with Docker”

## **--nice**

Section 2.5.10, “Managing MySQL Server with systemd”

Section 4.3.2, “mysqld\_safe — MySQL Server Startup Script”

## **--no-asynch**

Section 21.5.14, “ndb\_import — Import CSV Data Into NDB”

## **--no-auto-rehash**

Section 4.5.1.1, “mysql Client Options”

## **--no-autocommit**

Section 4.5.4, “mysqldump — A Database Backup Program”



---

## **--no-beep**

Section 4.5.1.1, “mysql Client Options”

Section 4.5.2, “mysqladmin — A MySQL Server Administration Program”

## **--no-binlog**

Section 21.5.24, “ndb\_restore — Restore an NDB Cluster Backup”

## **--no-check**

Section 4.6.1, “innochecksum — Offline InnoDB File Checksum Utility”

## **--no-contact**

Section 21.5.30, “ndb\_waiter — Wait for NDB Cluster to Reach a Given Status”

## **--no-create-db**

Section 4.5.4, “mysqldump — A Database Backup Program”

Section 4.5.6, “mysqlpump — A Database Backup Program”

## **--no-create-info**

Section 7.4.5.4, “Dumping Table Definitions and Content Separately”

Section 4.5.4, “mysqldump — A Database Backup Program”

Section 4.5.6, “mysqlpump — A Database Backup Program”

## **--no-data**

Section 7.4.5.4, “Dumping Table Definitions and Content Separately”

Section 4.5.4, “mysqldump — A Database Backup Program”

## **--no-defaults**

Section 4.2.2.3, “Command-Line Options that Affect Option-File Handling”

Section 4.7.2, “my\_print\_defaults — Display Options from Option Files”

Section 4.6.3.1, “myisamchk General Options”

Section 4.5.1.1, “mysql Client Options”

Section 4.6.6, “mysql\_config\_editor — MySQL Configuration Utility”

Section 4.4.2, “mysql\_install\_db — Initialize MySQL Data Directory”

Section 4.4.3, “mysql\_plugin — Configure MySQL Server Plugins”

Section 4.4.4, “mysql\_secure\_installation — Improve MySQL Installation Security”

Section 4.4.7, “mysql\_upgrade — Check and Upgrade MySQL Tables”

Section 4.5.2, “mysqladmin — A MySQL Server Administration Program”

Section 4.6.7, “mysqlbinlog — Utility for Processing Binary Log Files”

Section 4.5.3, “mysqlcheck — A Table Maintenance Program”

Section 4.3.4, “mysqld\_multi — Manage Multiple MySQL Servers”

Section 4.3.2, “mysqld\_safe — MySQL Server Startup Script”

Section 4.5.4, “mysqldump — A Database Backup Program”

Section 4.5.5, “mysqlimport — A Data Import Program”

Section 4.5.6, “mysqlpump — A Database Backup Program”

Section 4.5.7, “mysqlshow — Display Database, Table, and Column Information”

Section 4.5.8, “mysqlslap — A Load Emulation Client”

Section 21.5.6, “ndb\_blob\_tool — Check and Repair BLOB and TEXT columns of NDB Cluster Tables”

Section 21.5.7, “ndb\_config — Extract NDB Cluster Configuration Information”

Section 21.5.9, “ndb\_delete\_all — Delete All Rows from an NDB Table”

Section 21.5.10, “ndb\_desc — Describe NDB Tables”

Section 21.5.11, “ndb\_drop\_index — Drop Index from an NDB Table”

Section 21.5.12, “ndb\_drop\_table — Drop an NDB Table”

---

Section 21.5.14, “[ndb\\_import — Import CSV Data Into NDB](#)”  
Section 21.5.15, “[ndb\\_index\\_stat — NDB Index Statistics Utility](#)”  
Section 21.5.5, “[ndb\\_mgm — The NDB Cluster Management Client](#)”  
Section 21.5.4, “[ndb\\_mgmd — The NDB Cluster Management Server Daemon](#)”  
Section 21.5.16, “[ndb\\_move\\_data — NDB Data Copy Utility](#)”  
Section 21.5.17, “[ndb\\_perror — Obtain NDB Error Message Information](#)”  
Section 21.5.24, “[ndb\\_restore — Restore an NDB Cluster Backup](#)”  
Section 21.5.25, “[ndb\\_select\\_all — Print Rows from an NDB Table](#)”  
Section 21.5.26, “[ndb\\_select\\_count — Print Row Counts for NDB Tables](#)”  
Section 21.5.27, “[ndb\\_show\\_tables — Display List of NDB Tables](#)”  
Section 21.5.29, “[ndb\\_top — View CPU usage information for NDB threads](#)”  
Section 21.5.30, “[ndb\\_waiter — Wait for NDB Cluster to Reach a Given Status](#)”  
Section 21.5.1, “[ndbd — The NDB Cluster Data Node Daemon](#)”  
Section 21.5.2, “[ndbinfo\\_select\\_all — Select From ndbinfo Tables](#)”  
Section 5.1.6, “[Server Command Options](#)”  
Section 6.2.17, “[Troubleshooting Problems Connecting to MySQL](#)”  
Section 4.2.2.2, “[Using Option Files](#)”

### **--no-drop**

Section 4.5.8, “[mysqslap — A Load Emulation Client](#)”

### **--no-hint**

Section 21.5.14, “[ndb\\_import — Import CSV Data Into NDB](#)”

### **--no-history-logging**

Section 17.5.5, “[Using MySQL Enterprise Backup with Group Replication](#)”

### **--no-log**

Section 4.3.4, “[mysqld\\_multi — Manage Multiple MySQL Servers](#)”

### **--no-login-paths**

Section 4.6.6, “[mysql\\_config\\_editor — MySQL Configuration Utility](#)”

### **--no-nodeid-checks**

Section 21.5.4, “[ndb\\_mgmd — The NDB Cluster Management Server Daemon](#)”

### **--no-restore-disk-objects**

Section 21.5.24, “[ndb\\_restore — Restore an NDB Cluster Backup](#)”

### **--no-set-names**

Section 4.5.4, “[mysqldump — A Database Backup Program](#)”

### **--no-tablespaces**

Section 4.5.4, “[mysqldump — A Database Backup Program](#)”

### **--no-upgrade**

Section 21.5.24, “[ndb\\_restore — Restore an NDB Cluster Backup](#)”

### **--nodaemon**

Section 21.5.4, “[ndb\\_mgmd — The NDB Cluster Management Server Daemon](#)”  
Section 21.5.1, “[ndbd — The NDB Cluster Data Node Daemon](#)”

---

## **--nodata**

Section 21.5.25, “[ndb\\_select\\_all — Print Rows from an NDB Table](#)”

## **--node-id**

Section 21.5.29, “[ndb\\_top — View CPU usage information for NDB threads](#)”

## **--nodeid**

Section 21.5.7, “[ndb\\_config — Extract NDB Cluster Configuration Information](#)”

Section 21.5.24, “[ndb\\_restore — Restore an NDB Cluster Backup](#)”

Restoring to Fewer Nodes Than the Original

Section 21.2.4.1, “[What is New in NDB Cluster 7.5](#)”

Section 21.2.4.2, “[What is New in NDB Cluster 7.6](#)”

## **--nodes**

Section 21.5.7, “[ndb\\_config — Extract NDB Cluster Configuration Information](#)”

## **--nostart**

Section 21.6.1, “[Commands in the NDB Cluster Management Client](#)”

Section 21.5.1, “[ndbd — The NDB Cluster Data Node Daemon](#)”

## **--not-started**

Section 21.5.30, “[ndb\\_waiter — Wait for NDB Cluster to Reach a Given Status](#)”

## **--nowait-nodes**

Section 21.6.7.3, “[Adding NDB Cluster Data Nodes Online: Detailed Example](#)”

Section 21.4.3.6, “[Defining NDB Cluster Data Nodes](#)”

Section 21.5.4, “[ndb\\_mgmd — The NDB Cluster Management Server Daemon](#)”

Section 21.5.30, “[ndb\\_waiter — Wait for NDB Cluster to Reach a Given Status](#)”

Section 21.5.1, “[ndbd — The NDB Cluster Data Node Daemon](#)”

## **--num-slices**

Section 21.5.24, “[ndb\\_restore — Restore an NDB Cluster Backup](#)”

Section 21.2.4.2, “[What is New in NDB Cluster 7.6](#)”

## **--number-char-cols**

Section 4.5.8, “[mysqlslap — A Load Emulation Client](#)”

## **--number-int-cols**

Section 4.5.8, “[mysqlslap — A Load Emulation Client](#)”

## **--number-of-queries**

Section 4.5.8, “[mysqlslap — A Load Emulation Client](#)”

## **--numeric-dump-file**

Section 4.7.3, “[resolve\\_stack\\_dump — Resolve Numeric Stack Trace Dump to Symbols](#)”

## **O**

[\[index top\]](#)

## **-O**

Section 4.4.1, “[comp\\_err — Compile MySQL Error Message File](#)”

---

Section 2.8.7, “MySQL Source-Configuration Options”

## **-o**

Section 27.6.1, “Compiling Programs with libmysqld”

Section 4.6.3.3, “myisamchk Repair Options”

Section 4.6.4, “myisamlog — Display MyISAM Log File Contents”

Section 4.5.1.1, “mysql Client Options”

Section 4.6.7, “mysqlbinlog — Utility for Processing Binary Log Files”

Section 4.5.3, “mysqlcheck — A Table Maintenance Program”

Section 21.5.25, “ndb\_select\_all — Print Rows from an NDB Table”

Section 21.5.29, “ndb\_top — View CPU usage information for NDB threads”

Section 8.12.2, “Optimizing Disk I/O”

## **--offset**

Section 4.6.7, “mysqlbinlog — Utility for Processing Binary Log Files”

## **--old-style-user-limits**

Section 5.1.6, “Server Command Options”

Section 6.2.16, “Setting Account Resource Limits”

## **--oldpackage**

Section 2.5.5, “Installing MySQL on Linux Using RPM Packages from Oracle”

## **ON**

Section 3.3.4.9, “Using More Than one Table”

## **--one-database**

Section 4.5.1.1, “mysql Client Options”

## **--only-print**

Section 4.5.8, “mysqlslap — A Load Emulation Client”

## **--opbatch**

Section 21.5.14, “ndb\_import — Import CSV Data Into NDB”

## **--opbytes**

Section 21.5.14, “ndb\_import — Import CSV Data Into NDB”

## **--open-files-limit**

Section B.3.2.16, “File Not Found and Similar Errors”

Section 2.5.10, “Managing MySQL Server with systemd”

Section 4.6.7, “mysqlbinlog — Utility for Processing Binary Log Files”

Section 4.3.2, “mysqld\_safe — MySQL Server Startup Script”

Section 5.1.7, “Server System Variables”

## **openssl**

Section 4.5.6, “mysqlpump — A Database Backup Program”

## **--opt**

Section 8.5.5, “Bulk Data Loading for InnoDB Tables”

Section 4.5.4, “mysqldump — A Database Backup Program”

---

## **--opt\_name**

[Section 4.2.2.2, “Using Option Files”](#)

## **--optimize**

[Section 4.5.3, “mysqlcheck — A Table Maintenance Program”](#)

## **--order**

[Section 21.5.25, “ndb\\_select\\_all — Print Rows from an NDB Table”](#)

## **--order-by-primary**

[Section 4.5.4, “mysqldump — A Database Backup Program”](#)

## **--os-load**

[Section 21.5.29, “ndb\\_top — View CPU usage information for NDB threads”](#)

## **--out-dir**

[Section 4.4.1, “comp\\_err — Compile MySQL Error Message File”](#)

## **--out-file**

[Section 4.4.1, “comp\\_err — Compile MySQL Error Message File”](#)

## **--output-type**

[Section 21.5.14, “ndb\\_import — Import CSV Data Into NDB”](#)

## **--output-workers**

[Section 21.5.14, “ndb\\_import — Import CSV Data Into NDB”](#)

## **P**

[\[index top\]](#)

## **-P**

[Section 4.2.3, “Command Options for Connecting to the Server”](#)

[Section 4.2.4, “Connecting to the MySQL Server Using Command Options”](#)

[Section 4.2.1, “Invoking MySQL Programs”](#)

[Section 4.5.1.1, “mysql Client Options”](#)

[Section 4.6.6, “mysql\\_config\\_editor — MySQL Configuration Utility”](#)

[Section 4.4.3, “mysql\\_plugin — Configure MySQL Server Plugins”](#)

[Section 4.4.4, “mysql\\_secure\\_installation — Improve MySQL Installation Security”](#)

[Section 4.4.7, “mysql\\_upgrade — Check and Upgrade MySQL Tables”](#)

[Section 4.5.2, “mysqladmin — A MySQL Server Administration Program”](#)

[Section 4.6.7, “mysqlbinlog — Utility for Processing Binary Log Files”](#)

[Section 4.5.3, “mysqlcheck — A Table Maintenance Program”](#)

[Section 4.5.4, “mysqldump — A Database Backup Program”](#)

[Section 4.5.5, “mysqlimport — A Data Import Program”](#)

[Section 4.5.6, “mysqlpump — A Database Backup Program”](#)

[Section 4.5.7, “mysqlshow — Display Database, Table, and Column Information”](#)

[Section 4.5.8, “mysqlslap — A Load Emulation Client”](#)

[Section 21.5.4, “ndb\\_mgmd — The NDB Cluster Management Server Daemon”](#)

[Section 21.5.24, “ndb\\_restore — Restore an NDB Cluster Backup”](#)

[Section 21.5.29, “ndb\\_top — View CPU usage information for NDB threads”](#)

---

Section 5.1.6, “Server Command Options”

## **-p**

Section 6.2.1, “Account User Names and Passwords”  
Section 21.6.7.3, “Adding NDB Cluster Data Nodes Online: Detailed Example”  
Section 4.2.3, “Command Options for Connecting to the Server”  
Section 4.2.4, “Connecting to the MySQL Server Using Command Options”  
Section 2.11, “Downgrading MySQL”  
Section 6.1.2.1, “End-User Guidelines for Password Security”  
Section 4.6.1, “innochecksum — Offline InnoDB File Checksum Utility”  
Section 4.2.1, “Invoking MySQL Programs”  
Section 22.2.5, “KEY Partitioning”  
Section 4.6.3.3, “myisamchk Repair Options”  
Section 4.6.4, “myisamlog — Display MyISAM Log File Contents”  
Section 4.5.1.1, “mysql Client Options”  
Section 4.6.6, “mysql\_config\_editor — MySQL Configuration Utility”  
Section 4.4.3, “mysql\_plugin — Configure MySQL Server Plugins”  
Section 4.4.4, “mysql\_secure\_installation — Improve MySQL Installation Security”  
Section 4.4.7, “mysql\_upgrade — Check and Upgrade MySQL Tables”  
Section 4.5.2, “mysqldadmin — A MySQL Server Administration Program”  
Section 4.6.7, “mysqlbinlog — Utility for Processing Binary Log Files”  
Section 4.5.3, “mysqlcheck — A Table Maintenance Program”  
Section 4.5.4, “mysqldump — A Database Backup Program”  
Section 4.5.5, “mysqlimport — A Data Import Program”  
Section 4.5.6, “mysqlpump — A Database Backup Program”  
Section 4.5.7, “mysqlshow — Display Database, Table, and Column Information”  
Section 4.5.8, “mysqlslap — A Load Emulation Client”  
Section 21.5.10, “ndb\_desc — Describe NDB Tables”  
Section 21.5.23, “ndb\_redo\_log\_reader — Check and Print Content of Cluster Redo Log”  
Section 21.5.24, “ndb\_restore — Restore an NDB Cluster Backup”  
Section 21.5.25, “ndb\_select\_all — Print Rows from an NDB Table”  
Section 21.5.26, “ndb\_select\_count — Print Row Counts for NDB Tables”  
Section 21.5.27, “ndb\_show\_tables — Display List of NDB Tables”  
Section 21.5.29, “ndb\_top — View CPU usage information for NDB threads”  
Section 21.5.2, “ndbinfo\_select\_all — Select From ndbinfo Tables”  
Section B.3.2.4, “Password Fails When Entered Interactively”  
Section 2.3.4.8, “Starting MySQL as a Windows Service”  
Section 2.3.4.6, “Starting MySQL from the Windows Command Line”  
Section 2.3.4.9, “Testing The MySQL Installation”  
Section 2.9.3, “Testing the Server”  
Section 21.6.15.5, “The ndbinfo cluster\_operations Table”  
Section 21.6.15.34, “The ndbinfo server\_operations Table”  
Section 6.2.17, “Troubleshooting Problems Connecting to MySQL”  
Section 2.10, “Upgrading MySQL”  
Section 2.10.8, “Upgrading MySQL on Windows”  
Section 4.2.2.1, “Using Options on the Command Line”  
Section 2.3.6, “Windows Postinstallation Procedures”

## **--page**

Section 4.6.1, “innochecksum — Offline InnoDB File Checksum Utility”

## **--page-type-dump**

Section 4.6.1, “innochecksum — Offline InnoDB File Checksum Utility”

---

## **--page-type-summary**

Section 4.6.1, “[innochecksum — Offline InnoDB File Checksum Utility](#)”

## **--pagecnt**

Section 21.5.14, “[ndb\\_import — Import CSV Data Into NDB](#)”

## **--pager**

Section 4.5.1.2, “[mysql Client Commands](#)”

Section 4.5.1.1, “[mysql Client Options](#)”

## **--pagesize**

Section 21.5.14, “[ndb\\_import — Import CSV Data Into NDB](#)”

## **--parallel-recover**

Section 4.6.3.3, “[myisamchk Repair Options](#)”

## **--parallel-schemas**

Section 4.5.6, “[mysqldump — A Database Backup Program](#)”

## **--parallelism**

Section 21.5.24, “[ndb\\_restore — Restore an NDB Cluster Backup](#)”

Section 21.5.25, “[ndb\\_select\\_all — Print Rows from an NDB Table](#)”

Section 21.5.26, “[ndb\\_select\\_count — Print Row Counts for NDB Tables](#)”

Section 21.5.2, “[ndbinfo\\_select\\_all — Select From ndbinfo Tables](#)”

## **parallelism**

Section 21.5.25, “[ndb\\_select\\_all — Print Rows from an NDB Table](#)”

## **--parsable**

Section 21.5.27, “[ndb\\_show\\_tables — Display List of NDB Tables](#)”

## **--partition**

Section 5.1.6, “[Server Command Options](#)”

## **--passwd**

Section 21.5.29, “[ndb\\_top — View CPU usage information for NDB threads](#)”

## **--password**

Section 6.2.1, “[Account User Names and Passwords](#)”

Section 4.2.3, “[Command Options for Connecting to the Server](#)”

Section 4.2.4, “[Connecting to the MySQL Server Using Command Options](#)”

Section 6.1.2.1, “[End-User Guidelines for Password Security](#)”

Section 7.3, “[Example Backup and Recovery Strategy](#)”

Section 4.2.1, “[Invoking MySQL Programs](#)”

Section 4.5.1.1, “[mysql Client Options](#)”

Section 4.6.6, “[mysql\\_config\\_editor — MySQL Configuration Utility](#)”

Section 4.4.4, “[mysql\\_secure\\_installation — Improve MySQL Installation Security](#)”

Section 4.4.7, “[mysql\\_upgrade — Check and Upgrade MySQL Tables](#)”

Section 4.5.2, “[mysqladmin — A MySQL Server Administration Program](#)”

Section 4.6.7, “[mysqlbinlog — Utility for Processing Binary Log Files](#)”

Section 4.5.3, “[mysqlcheck — A Table Maintenance Program](#)”

---

[Section 4.3.4, “mysqld\\_multi — Manage Multiple MySQL Servers”](#)  
[Section 4.5.4, “mysqldump — A Database Backup Program”](#)  
[Section 4.5.5, “mysqlimport — A Data Import Program”](#)  
[Section 4.5.6, “mysqlpump — A Database Backup Program”](#)  
[Section 4.5.7, “mysqlshow — Display Database, Table, and Column Information”](#)  
[Section 4.5.8, “mysqlslap — A Load Emulation Client”](#)  
[Section 21.5.28, “ndb\\_size.pl — NDBCLUSTER Size Requirement Estimator”](#)  
[Section 21.5.29, “ndb\\_top — View CPU usage information for NDB threads”](#)  
[Section B.3.2.4, “Password Fails When Entered Interactively”](#)  
[Restoring to More Nodes Than the Original](#)  
[Section 6.4.1.12, “Test Pluggable Authentication”](#)  
[Section 6.2.17, “Troubleshooting Problems Connecting to MySQL”](#)  
[Section 4.6.7.3, “Using mysqlbinlog to Back Up Binary Log Files”](#)  
[Section 4.2.2.1, “Using Options on the Command Line”](#)

## **password**

[Section 4.6.6, “mysql\\_config\\_editor — MySQL Configuration Utility”](#)  
[Section 4.2.2.2, “Using Option Files”](#)

## **--performance-schema-consumer-consumer\_name**

[Section 25.14, “Performance Schema Command Options”](#)

## **--performance-schema-consumer-events-stages-current**

[Section 25.14, “Performance Schema Command Options”](#)

## **--performance-schema-consumer-events-stages-history**

[Section 25.14, “Performance Schema Command Options”](#)

## **--performance-schema-consumer-events-stages-history-long**

[Section 25.14, “Performance Schema Command Options”](#)

## **--performance-schema-consumer-events-statements-current**

[Section 25.14, “Performance Schema Command Options”](#)

## **--performance-schema-consumer-events-statements-history**

[Section 25.14, “Performance Schema Command Options”](#)

## **--performance-schema-consumer-events-statements-history-long**

[Section 25.14, “Performance Schema Command Options”](#)

## **--performance-schema-consumer-events-transactions-current**

[Section 25.14, “Performance Schema Command Options”](#)

## **--performance-schema-consumer-events-transactions-history**

[Section 25.14, “Performance Schema Command Options”](#)

## **--performance-schema-consumer-events-transactions-history-long**

[Section 25.14, “Performance Schema Command Options”](#)

## **--performance-schema-consumer-events-waits-current**

[Section 25.14, “Performance Schema Command Options”](#)



---

## **--performance-schema-consumer-events-waits-history**

Section 25.14, “Performance Schema Command Options”

## **--performance-schema-consumer-events-waits-history-long**

Section 25.14, “Performance Schema Command Options”

## **--performance-schema-consumer-global-instrumentation**

Section 25.14, “Performance Schema Command Options”

## **--performance-schema-consumer-statements-digest**

Section 25.14, “Performance Schema Command Options”

## **--performance-schema-consumer-thread-instrumentation**

Section 25.14, “Performance Schema Command Options”

## **--performance-schema-instrument**

Section 25.14, “Performance Schema Command Options”

Section 25.3, “Performance Schema Startup Configuration”

## **--performance-schema-xxx**

Section 5.1.6, “Server Command Options”

## **--performance\_schema\_max\_mutex\_classes**

Section 25.7, “Performance Schema Status Monitoring”

## **--performance\_schema\_max\_mutex\_instances**

Section 25.7, “Performance Schema Status Monitoring”

## **--pid-file**

Section 5.4.2.1, “Error Logging on Windows”

Section 2.5.10, “Managing MySQL Server with systemd”

Section 4.3.4, “mysql\_multi — Manage Multiple MySQL Servers”

Section 4.3.2, “mysqld\_safe — MySQL Server Startup Script”

Section 5.7, “Running Multiple MySQL Instances on One Machine”

Section 5.1.6, “Server Command Options”

Section 5.4.4, “The Binary Log”

## **pid-file**

Section 4.3.3, “mysql.server — MySQL Server Startup Script”

## **--pipe**

Section 4.2.3, “Command Options for Connecting to the Server”

Section 4.2.4, “Connecting to the MySQL Server Using Command Options”

Section 4.5.1.1, “mysql Client Options”

Section 4.4.7, “mysql\_upgrade — Check and Upgrade MySQL Tables”

Section 4.5.2, “mysqladmin — A MySQL Server Administration Program”

Section 4.5.3, “mysqlcheck — A Table Maintenance Program”

Section 4.5.4, “mysqldump — A Database Backup Program”

Section 4.5.5, “mysqlimport — A Data Import Program”

Section 4.5.7, “mysqlshow — Display Database, Table, and Column Information”

---

Section 4.5.8, “mysqlslap — A Load Emulation Client”  
Section 2.3.4.9, “Testing The MySQL Installation”

## **--plugin**

Section 5.1.6, “Server Command Options”

## **--plugin-dir**

Section 4.2.3, “Command Options for Connecting to the Server”  
Section 6.4.1.9, “LDAP Pluggable Authentication”  
Section 4.5.1.1, “mysql Client Options”  
Section 4.4.3, “mysql\_plugin — Configure MySQL Server Plugins”  
Section 4.4.7, “mysql\_upgrade — Check and Upgrade MySQL Tables”  
Section 4.5.2, “mysqladmin — A MySQL Server Administration Program”  
Section 4.6.7, “mysqlbinlog — Utility for Processing Binary Log Files”  
Section 4.5.3, “mysqlcheck — A Table Maintenance Program”  
Section 4.3.2, “mysqld\_safe — MySQL Server Startup Script”  
Section 4.5.4, “mysqldump — A Database Backup Program”  
Section 4.5.5, “mysqlimport — A Data Import Program”  
Section 4.5.6, “mysqlpump — A Database Backup Program”  
Section 4.5.7, “mysqlshow — Display Database, Table, and Column Information”  
Section 4.5.8, “mysqlslap — A Load Emulation Client”  
Section 6.2.13, “Pluggable Authentication”

## **--plugin-ini**

Section 4.4.3, “mysql\_plugin — Configure MySQL Server Plugins”

## **--plugin-innodb-file-per-table**

Section 5.1.6, “Server Command Options”

## **--plugin-load**

Section 6.4.5.11, “Audit Log Reference”  
Section 13.7.3.3, “INSTALL PLUGIN Statement”  
Section 5.5.1, “Installing and Uninstalling Plugins”  
Section 6.4.4.11, “Keyring Command Options”  
Section 6.4.4.1, “Keyring Plugin Installation”  
Section 2.8.7, “MySQL Source-Configuration Options”  
Section 4.4.3, “mysql\_plugin — Configure MySQL Server Plugins”  
Section 5.1.6, “Server Command Options”  
Section 1.3, “What Is New in MySQL 5.7”  
Section 19.4.2.2, “X Plugin Options and System Variables”

## **--plugin-load-add**

Section 6.4.5.11, “Audit Log Reference”  
Section 6.4.2.1, “Connection Control Plugin Installation”  
Section 5.5.1, “Installing and Uninstalling Plugins”  
Section 6.4.4.1, “Keyring Plugin Installation”  
Section 6.4.1.9, “LDAP Pluggable Authentication”  
Section 4.4.3, “mysql\_plugin — Configure MySQL Server Plugins”  
Section 6.4.1.10, “No-Login Pluggable Authentication”  
Section 6.4.1.7, “PAM Pluggable Authentication”  
Section 6.4.3.1, “Password Validation Plugin Installation”  
Section 6.4.3.2, “Password Validation Plugin Options and Variables”

---

Section 5.1.6, “Server Command Options”  
Section 6.4.1.11, “Socket Peer-Credential Pluggable Authentication”  
Section 6.4.1.12, “Test Pluggable Authentication”  
Section 5.5.3.2, “Thread Pool Installation”  
Section 1.3, “What Is New in MySQL 5.7”  
Section 6.4.1.8, “Windows Pluggable Authentication”  
Section 19.4.2.2, “X Plugin Options and System Variables”

## **plugin-load-add**

Section 17.2.1.2, “Configuring an Instance for Group Replication”

## **--plugin-sql-mode**

Section 5.1.6, “Server Command Options”

## **--plugin-xxx**

Section 5.1.6, “Server Command Options”

## **--plugin\_dir**

Section 2.8.7, “MySQL Source-Configuration Options”

## **--plugin\_name**

Section 5.5.1, “Installing and Uninstalling Plugins”  
Section 4.4.3, “mysql\_plugin — Configure MySQL Server Plugins”

## **PLUGIN\_OPT\_ALLOW\_EARLY**

Section 5.1.6, “Server Command Options”

## **--plugindir**

Section 4.7.1, “mysql\_config — Display Options for Compiling Clients”

## **--polltimeout**

Section 21.5.14, “ndb\_import — Import CSV Data Into NDB”

## **--port**

Section 4.2.3, “Command Options for Connecting to the Server”  
Section 4.2.4, “Connecting to the MySQL Server Using Command Options”  
Section 4.2.1, “Invoking MySQL Programs”  
Section 4.5.1.1, “mysql Client Options”  
Section 2.8.7, “MySQL Source-Configuration Options”  
Section 4.7.1, “mysql\_config — Display Options for Compiling Clients”  
Section 4.6.6, “mysql\_config\_editor — MySQL Configuration Utility”  
Section 4.4.4, “mysql\_secure\_installation — Improve MySQL Installation Security”  
Section 4.4.7, “mysql\_upgrade — Check and Upgrade MySQL Tables”  
Section 4.5.2, “mysqladmin — A MySQL Server Administration Program”  
Section 4.6.7, “mysqlbinlog — Utility for Processing Binary Log Files”  
Section 4.5.3, “mysqlcheck — A Table Maintenance Program”  
Section 4.3.2, “mysqld\_safe — MySQL Server Startup Script”  
Section 4.5.4, “mysqldump — A Database Backup Program”  
Section 4.5.5, “mysqlimport — A Data Import Program”  
Section 4.5.6, “mysqlpump — A Database Backup Program”  
Section 4.5.7, “mysqlshow — Display Database, Table, and Column Information”

---

Section 4.5.8, “mysqlslap — A Load Emulation Client”  
Section 21.5.29, “ndb\_top — View CPU usage information for NDB threads”  
Section 5.7, “Running Multiple MySQL Instances on One Machine”  
Section 5.7.3, “Running Multiple MySQL Instances on Unix”  
Section 5.1.6, “Server Command Options”  
Section 5.1.7, “Server System Variables”  
Section 6.2.17, “Troubleshooting Problems Connecting to MySQL”  
Section 2.9.2.1, “Troubleshooting Problems Starting the MySQL Server”  
Section 5.7.4, “Using Client Programs in a Multiple-Server Environment”

## **port**

Section 4.6.6, “mysql\_config\_editor — MySQL Configuration Utility”  
Section 4.2.2.2, “Using Option Files”

## **--port-open-timeout**

Section 5.1.6, “Server Command Options”

## **--post-query**

Section 4.5.8, “mysqlslap — A Load Emulation Client”

## **--post-system**

Section 4.5.8, “mysqlslap — A Load Emulation Client”

## **--pre-query**

Section 4.5.8, “mysqlslap — A Load Emulation Client”

## **--pre-system**

Section 4.5.8, “mysqlslap — A Load Emulation Client”

## **PREFIX**

Section 21.3.1.4, “Building NDB Cluster from Source on Linux”

## **--preserve-trailing-spaces**

Section 21.5.24, “ndb\_restore — Restore an NDB Cluster Backup”

## **--print**

Section 21.5.24, “ndb\_restore — Restore an NDB Cluster Backup”

## **--print-data**

Section 21.5.24, “ndb\_restore — Restore an NDB Cluster Backup”

## **--print-defaults**

Section 4.2.2.3, “Command-Line Options that Affect Option-File Handling”  
Section 4.6.3.1, “myisamchk General Options”  
Section 4.5.1.1, “mysql Client Options”  
Section 4.4.3, “mysql\_plugin — Configure MySQL Server Plugins”  
Section 4.4.4, “mysql\_secure\_installation — Improve MySQL Installation Security”  
Section 4.4.7, “mysql\_upgrade — Check and Upgrade MySQL Tables”  
Section 4.5.2, “mysqladmin — A MySQL Server Administration Program”  
Section 4.6.7, “mysqlbinlog — Utility for Processing Binary Log Files”  
Section 4.5.3, “mysqlcheck — A Table Maintenance Program”

---

Section 4.5.4, “mysqldump — A Database Backup Program”  
Section 4.5.5, “mysqlimport — A Data Import Program”  
Section 4.5.6, “mysqlpump — A Database Backup Program”  
Section 4.5.7, “mysqlshow — Display Database, Table, and Column Information”  
Section 4.5.8, “mysqlslap — A Load Emulation Client”  
Section 21.5.6, “ndb\_blob\_tool — Check and Repair BLOB and TEXT columns of NDB Cluster Tables”  
Section 21.5.7, “ndb\_config — Extract NDB Cluster Configuration Information”  
Section 21.5.9, “ndb\_delete\_all — Delete All Rows from an NDB Table”  
Section 21.5.10, “ndb\_desc — Describe NDB Tables”  
Section 21.5.11, “ndb\_drop\_index — Drop Index from an NDB Table”  
Section 21.5.12, “ndb\_drop\_table — Drop an NDB Table”  
Section 21.5.14, “ndb\_import — Import CSV Data Into NDB”  
Section 21.5.15, “ndb\_index\_stat — NDB Index Statistics Utility”  
Section 21.5.5, “ndb\_mgm — The NDB Cluster Management Client”  
Section 21.5.4, “ndb\_mgmd — The NDB Cluster Management Server Daemon”  
Section 21.5.16, “ndb\_move\_data — NDB Data Copy Utility”  
Section 21.5.17, “ndb\_perror — Obtain NDB Error Message Information”  
Section 21.5.24, “ndb\_restore — Restore an NDB Cluster Backup”  
Section 21.5.25, “ndb\_select\_all — Print Rows from an NDB Table”  
Section 21.5.26, “ndb\_select\_count — Print Row Counts for NDB Tables”  
Section 21.5.27, “ndb\_show\_tables — Display List of NDB Tables”  
Section 21.5.29, “ndb\_top — View CPU usage information for NDB threads”  
Section 21.5.30, “ndb\_waiter — Wait for NDB Cluster to Reach a Given Status”  
Section 21.5.1, “nbd — The NDB Cluster Data Node Daemon”  
Section 21.5.2, “ndbinfo\_select\_all — Select From ndbinfo Tables”  
Section 5.1.6, “Server Command Options”  
Section 2.10.11, “Upgrade Troubleshooting”

### **--print-full-config**

Section 21.5.4, “ndb\_mgmd — The NDB Cluster Management Server Daemon”

### **--print-log**

Section 21.5.24, “ndb\_restore — Restore an NDB Cluster Backup”

### **--print-meta**

Section 21.5.24, “ndb\_restore — Restore an NDB Cluster Backup”

### **--print-sql-log**

Section 21.5.24, “ndb\_restore — Restore an NDB Cluster Backup”

Section 21.2.4.1, “What is New in NDB Cluster 7.5”

### **print-sql-log**

Section 21.5.24, “ndb\_restore — Restore an NDB Cluster Backup”

### **--print\_\***

Section 21.5.24, “ndb\_restore — Restore an NDB Cluster Backup”

### **--progress-frequency**

Section 21.5.24, “ndb\_restore — Restore an NDB Cluster Backup”

### **--promote-attributes**

Section 21.5.16, “ndb\_move\_data — NDB Data Copy Utility”

---

[Section 21.5.24, “ndb\\_restore — Restore an NDB Cluster Backup”](#)  
[Section 21.2.4.1, “What is New in NDB Cluster 7.5”](#)  
[Section 21.2.4.2, “What is New in NDB Cluster 7.6”](#)

## **--prompt**

[Section 4.5.1.2, “mysql Client Commands”](#)  
[Section 4.5.1.1, “mysql Client Options”](#)

## **--protocol**

[Section 4.2.3, “Command Options for Connecting to the Server”](#)  
[Section 4.2.4, “Connecting to the MySQL Server Using Command Options”](#)  
[Section 4.2.5, “Connection Transport Protocols”](#)  
[Section 4.5.1.1, “mysql Client Options”](#)  
[Section 4.4.4, “mysql\\_secure\\_installation — Improve MySQL Installation Security”](#)  
[Section 4.4.7, “mysql\\_upgrade — Check and Upgrade MySQL Tables”](#)  
[Section 4.5.2, “mysqladmin — A MySQL Server Administration Program”](#)  
[Section 4.6.7, “mysqlbinlog — Utility for Processing Binary Log Files”](#)  
[Section 4.5.3, “mysqlcheck — A Table Maintenance Program”](#)  
[Section 4.5.4, “mysqldump — A Database Backup Program”](#)  
[Section 4.5.5, “mysqlimport — A Data Import Program”](#)  
[Section 4.5.6, “mysqlpump — A Database Backup Program”](#)  
[Section 4.5.7, “mysqlshow — Display Database, Table, and Column Information”](#)  
[Section 4.5.8, “mysqlslap — A Load Emulation Client”](#)  
[Section 5.7.3, “Running Multiple MySQL Instances on Unix”](#)  
[Section 2.3.4.5, “Starting the Server for the First Time”](#)  
[Section 2.3.4.9, “Testing The MySQL Installation”](#)  
[Section 1.2.2, “The Main Features of MySQL”](#)  
[Section 5.7.4, “Using Client Programs in a Multiple-Server Environment”](#)

## **Q**

[\[index top\]](#)

## **-Q**

[Section 4.5.4, “mysqldump — A Database Backup Program”](#)

## **-q**

[Section 4.6.3.3, “myisamchk Repair Options”](#)  
[Section 4.5.1.1, “mysql Client Options”](#)  
[Section 4.5.3, “mysqlcheck — A Table Maintenance Program”](#)  
[Section 4.5.4, “mysqldump — A Database Backup Program”](#)  
[Section 4.5.8, “mysqlslap — A Load Emulation Client”](#)  
[Section 21.5.7, “ndb\\_config — Extract NDB Cluster Configuration Information”](#)  
[Section 21.5.19, “ndb\\_print\\_file — Print NDB Disk Data File Contents”](#)

## **--query**

[Section 4.5.8, “mysqlslap — A Load Emulation Client”](#)  
[Section 21.5.7, “ndb\\_config — Extract NDB Cluster Configuration Information”](#)  
[Section 21.5.15, “ndb\\_index\\_stat — NDB Index Statistics Utility”](#)

## **--query-all**

[Section 21.5.7, “ndb\\_config — Extract NDB Cluster Configuration Information”](#)

---

## **--query-cache-size**

Section 8.11.5, “External Locking”

## **--quick**

Section 4.6.3.6, “myisamchk Memory Usage”

Section 4.6.3.3, “myisamchk Repair Options”

Section 4.5.1.1, “mysql Client Options”

Section 4.5.1, “mysql — The MySQL Command-Line Client”

Section 4.5.3, “mysqlcheck — A Table Maintenance Program”

Section 4.5.4, “mysqldump — A Database Backup Program”

Section B.3.2.6, “Out of memory”

Section 7.6.1, “Using myisamchk for Crash Recovery”

Section 4.2.2.2, “Using Option Files”

## **--quote-names**

Section 4.5.4, “mysqldump — A Database Backup Program”

## **R**

[[index top](#)]

## **-R**

Section 7.6.4, “MyISAM Table Optimization”

Section 4.6.4, “myisamlog — Display MyISAM Log File Contents”

Section 4.6.7, “mysqlbinlog — Utility for Processing Binary Log Files”

Section 4.5.4, “mysqldump — A Database Backup Program”

Section 4.6.3.4, “Other myisamchk Options”

Section 6.2.2, “Privileges Provided by MySQL”

Section 4.6.7.3, “Using mysqlbinlog to Back Up Binary Log Files”

## **-r**

Section 7.6.3, “How to Repair MyISAM Tables”

Section 2.2, “Installing MySQL on Unix/Linux Using Generic Binaries”

Section 4.6.3.2, “myisamchk Check Options”

Section 4.6.3.3, “myisamchk Repair Options”

Section 4.6.4, “myisamlog — Display MyISAM Log File Contents”

Section 4.5.1.1, “mysql Client Options”

Section 4.5.2, “mysqladmin — A MySQL Server Administration Program”

Section 4.6.7, “mysqlbinlog — Utility for Processing Binary Log Files”

Section 4.5.3, “mysqlcheck — A Table Maintenance Program”

Section 4.5.4, “mysqldump — A Database Backup Program”

Section 4.6.8, “mysqldumpslow — Summarize Slow Query Log Files”

Section 4.5.5, “mysqlimport — A Data Import Program”

Section 21.5.7, “ndb\_config — Extract NDB Cluster Configuration Information”

Section 21.5.10, “ndb\_desc — Describe NDB Tables”

Section 21.5.24, “ndb\_restore — Restore an NDB Cluster Backup”

Section 21.5.29, “ndb\_top — View CPU usage information for NDB threads”

Section 21.5.1, “ndbd — The NDB Cluster Data Node Daemon”

Section 5.1.6, “Server Command Options”

## **--random-password-file**

Section 4.4.2, “mysql\_install\_db — Initialize MySQL Data Directory”

---

## **--raw**

[Section 4.5.1.1, “mysql Client Options”](#)

[Section 4.6.7, “mysqlbinlog — Utility for Processing Binary Log Files”](#)

[Section 16.1.3.5, “Using GTIDs for Failover and Scaleout”](#)

[Section 4.6.7.3, “Using mysqlbinlog to Back Up Binary Log Files”](#)

## **--read-from-remote-master**

[Section 4.6.7, “mysqlbinlog — Utility for Processing Binary Log Files”](#)

[Section 6.2.2, “Privileges Provided by MySQL”](#)

[Section 16.1.3.5, “Using GTIDs for Failover and Scaleout”](#)

## **--read-from-remote-server**

[Section 4.6.7, “mysqlbinlog — Utility for Processing Binary Log Files”](#)

[Section 6.2.2, “Privileges Provided by MySQL”](#)

[Section 4.6.7.4, “Specifying the mysqlbinlog Server ID”](#)

[Section 16.1.3.5, “Using GTIDs for Failover and Scaleout”](#)

[Section 4.6.7.3, “Using mysqlbinlog to Back Up Binary Log Files”](#)

## **--read-only**

[Section 4.6.3.2, “myisamchk Check Options”](#)

## **--real\_table\_name**

[Section 21.5.28, “ndb\\_size.pl — NDBCLUSTER Size Requirement Estimator”](#)

## **--rebuild-indexes**

[Section 21.4.3.6, “Defining NDB Cluster Data Nodes”](#)

[Section 21.5.24, “ndb\\_restore — Restore an NDB Cluster Backup”](#)

[Section 21.2.4.2, “What is New in NDB Cluster 7.6”](#)

## **--reconnect**

[Section 4.5.1.1, “mysql Client Options”](#)

## **--recover**

[Section 4.6.3.2, “myisamchk Check Options”](#)

[Section 4.6.3.1, “myisamchk General Options”](#)

[Section 4.6.3.6, “myisamchk Memory Usage”](#)

[Section 4.6.3.3, “myisamchk Repair Options”](#)

## **--rejects**

[Section 21.5.14, “ndb\\_import — Import CSV Data Into NDB”](#)

## **--relative**

[Section 4.5.2, “mysqladmin — A MySQL Server Administration Program”](#)

## **--relay-log**

[Section 16.2.2.3, “Startup Options and Replication Channels”](#)

[Section 17.5.5, “Using MySQL Enterprise Backup with Group Replication”](#)

## **--relay-log-index**

[Section 16.2.2.3, “Startup Options and Replication Channels”](#)



---

## **--relay-log-purge**

Section 16.1.6.3, “Replica Server Options and Variables”

## **--relay-log-recovery**

Section 16.3.2, “Handling an Unexpected Halt of a Replica”

Section 16.1.6.3, “Replica Server Options and Variables”

Section 16.4.1.32, “Replication and Transaction Inconsistencies”

Section 16.2.4.2, “Replication Metadata Repositories”

Section 13.7.5.34, “SHOW SLAVE STATUS Statement”

Section 5.1.16, “The Server Shutdown Process”

## **--relay-log-space-limit**

Section 16.1.6.3, “Replica Server Options and Variables”

Section 16.2.2.3, “Startup Options and Replication Channels”

## **--reload**

Section 21.6.7.2, “Adding NDB Cluster Data Nodes Online: Basic procedure”

Section 21.6.7.3, “Adding NDB Cluster Data Nodes Online: Detailed Example”

Section 21.3.4, “Initial Startup of NDB Cluster”

Section 21.3.2.3, “Initial Startup of NDB Cluster on Windows”

Section 21.2.7.10, “Limitations Relating to Multiple NDB Cluster Nodes”

Section 21.4.3, “NDB Cluster Configuration Files”

Section 21.5.4, “ndb\_mgmd — The NDB Cluster Management Server Daemon”

Section 21.6.5, “Performing a Rolling Restart of an NDB Cluster”

## **--remap-column**

Section 21.5.24, “ndb\_restore — Restore an NDB Cluster Backup”

Section 21.2.4.2, “What is New in NDB Cluster 7.6”

## **--remove**

Section 21.3.2.4, “Installing NDB Cluster Processes as Windows Services”

Section 2.3.3.5, “MySQL Installer Console Reference”

Section 21.5.4, “ndb\_mgmd — The NDB Cluster Management Server Daemon”

Section 21.5.1, “ndbd — The NDB Cluster Data Node Daemon”

Section 5.1.6, “Server Command Options”

Section 5.7.2.2, “Starting Multiple MySQL Instances as Windows Services”

Section 2.3.4.8, “Starting MySQL as a Windows Service”

## **remove**

Section 2.3.3.5, “MySQL Installer Console Reference”

## **--remove{**

Section 21.5.4, “ndb\_mgmd — The NDB Cluster Management Server Daemon”

## **--repair**

Section 4.5.3, “mysqlcheck — A Table Maintenance Program”

## **--replace**

Section 4.5.4, “mysqldump — A Database Backup Program”

Section 4.5.5, “mysqlimport — A Data Import Program”

Section 4.5.6, “mysqlpump — A Database Backup Program”

---

## **--replicate-\***

Section 13.4.2.2, “CHANGE REPLICATION FILTER Statement”  
Section 16.2.5, “How Servers Evaluate Replication Filtering Rules”  
Section 16.1.6.3, “Replica Server Options and Variables”

## **--replicate-\*-db**

Section 16.1.6.3, “Replica Server Options and Variables”  
Section 23.8, “Restrictions on Stored Programs”

## **--replicate-do-\***

Section 21.7.3, “Known Issues in NDB Cluster Replication”

## **--replicate-do-db**

Section 16.1.6.4, “Binary Logging Options and Variables”  
Section 13.4.2.2, “CHANGE REPLICATION FILTER Statement”  
Section 16.2.5.1, “Evaluation of Database-Level Replication and Binary Logging Options”  
Section 16.2.5, “How Servers Evaluate Replication Filtering Rules”  
Section 21.7.3, “Known Issues in NDB Cluster Replication”  
Section 16.1.6.3, “Replica Server Options and Variables”  
Section 16.3.5, “Replicating Different Databases to Different Replicas”  
Section 16.4.1.25, “Replication and Reserved Words”  
Section 16.4.1.29, “Replication and Temporary Tables”  
Section 13.7.5.34, “SHOW SLAVE STATUS Statement”  
Section 13.3.1, “START TRANSACTION, COMMIT, and ROLLBACK Statements”  
Section 5.4.4, “The Binary Log”

## **--replicate-do-table**

Section 13.4.2.2, “CHANGE REPLICATION FILTER Statement”  
Section 16.2.5.2, “Evaluation of Table-Level Replication Options”  
Section 16.2.5.3, “Interactions Between Replication Filtering Options”  
Section 21.7.3, “Known Issues in NDB Cluster Replication”  
Section 16.1.6.3, “Replica Server Options and Variables”  
Section 16.4.1.25, “Replication and Reserved Words”  
Section 16.4.1.15, “Replication and System Functions”  
Section 16.4.1.29, “Replication and Temporary Tables”  
Section 13.7.5.34, “SHOW SLAVE STATUS Statement”  
Section 15.6, “The BLACKHOLE Storage Engine”

## **--replicate-ignore-\***

Section 21.7.3, “Known Issues in NDB Cluster Replication”

## **--replicate-ignore-db**

Section 16.1.6.4, “Binary Logging Options and Variables”  
Section 13.4.2.2, “CHANGE REPLICATION FILTER Statement”  
Section 16.2.5.1, “Evaluation of Database-Level Replication and Binary Logging Options”  
Section 16.2.5, “How Servers Evaluate Replication Filtering Rules”  
Section 16.2.5.3, “Interactions Between Replication Filtering Options”  
Section 21.7.3, “Known Issues in NDB Cluster Replication”  
Section 16.1.6.3, “Replica Server Options and Variables”  
Section 16.4.1.25, “Replication and Reserved Words”  
Section 16.4.1.15, “Replication and System Functions”  
Section 13.7.5.34, “SHOW SLAVE STATUS Statement”

---

Section 13.3.1, “START TRANSACTION, COMMIT, and ROLLBACK Statements”  
Section 5.4.4, “The Binary Log”

### **--replicate-ignore-table**

Section 13.4.2.2, “CHANGE REPLICATION FILTER Statement”  
Section 16.2.5.2, “Evaluation of Table-Level Replication Options”  
Section 21.7.3, “Known Issues in NDB Cluster Replication”  
Section 16.1.6.3, “Replica Server Options and Variables”  
Section 16.4.1.25, “Replication and Reserved Words”  
Section 16.4.1.29, “Replication and Temporary Tables”  
Section 13.7.5.34, “SHOW SLAVE STATUS Statement”  
Section 15.6, “The BLACKHOLE Storage Engine”

### **--replicate-rewrite-db**

Section 13.4.2.2, “CHANGE REPLICATION FILTER Statement”  
Section 16.2.5, “How Servers Evaluate Replication Filtering Rules”  
Section 16.1.6.3, “Replica Server Options and Variables”

### **--replicate-same-server-id**

Section 13.4.2.1, “CHANGE MASTER TO Statement”  
Section 16.1.6.3, “Replica Server Options and Variables”  
Section 16.1.6, “Replication and Binary Logging Options and Variables”

### **--replicate-wild-do-table**

Section 13.4.2.2, “CHANGE REPLICATION FILTER Statement”  
Section 16.2.5.2, “Evaluation of Table-Level Replication Options”  
Section 16.2.5, “How Servers Evaluate Replication Filtering Rules”  
Section 16.1.6.3, “Replica Server Options and Variables”  
Section 16.3.5, “Replicating Different Databases to Different Replicas”  
Section 16.4.1.29, “Replication and Temporary Tables”  
Section 23.8, “Restrictions on Stored Programs”  
Section 13.7.5.34, “SHOW SLAVE STATUS Statement”

### **--replicate-wild-ignore-table**

Section 13.4.2.2, “CHANGE REPLICATION FILTER Statement”  
Section 16.2.5.2, “Evaluation of Table-Level Replication Options”  
Section 21.7.3, “Known Issues in NDB Cluster Replication”  
Section A.14, “MySQL 5.7 FAQ: Replication”  
Section 16.1.6.3, “Replica Server Options and Variables”  
Section 16.4.1.29, “Replication and Temporary Tables”  
Section 13.7.5.34, “SHOW SLAVE STATUS Statement”

### **replication-ignore-table**

Section 16.4.1.38, “Replication and Views”

### **--report-host**

Section 16.1.7.1, “Checking Replication Status”  
Section 17.8, “Frequently Asked Questions”  
Section 13.7.5.33, “SHOW SLAVE HOSTS Statement”

### **--report-password**

Section 16.1.6.2, “Replication Source Options and Variables”

---

Section 13.7.5.33, “SHOW SLAVE HOSTS Statement”

## **--report-port**

Section 13.7.5.33, “SHOW SLAVE HOSTS Statement”

## **--report-user**

Section 16.1.6.2, “Replication Source Options and Variables”

Section 13.7.5.33, “SHOW SLAVE HOSTS Statement”

## **--restore-data**

Section 21.5.24, “ndb\_restore — Restore an NDB Cluster Backup”

Restoring an NDB backup to a previous version of NDB Cluster

Restoring to Fewer Nodes Than the Original

Section 21.2.4.2, “What is New in NDB Cluster 7.6”

## **--restore-epoch**

Section 21.7.9, “NDB Cluster Backups With NDB Cluster Replication”

Section 21.5.24, “ndb\_restore — Restore an NDB Cluster Backup”

Section 21.7.9.2, “Point-In-Time Recovery Using NDB Cluster Replication”

## **--restore-meta**

Section 21.5.24, “ndb\_restore — Restore an NDB Cluster Backup”

Restoring an NDB backup to a later version of NDB Cluster

Restoring to More Nodes Than the Original

Section 21.2.4.1, “What is New in NDB Cluster 7.5”

## **--restore-privilege-tables**

Section 21.6.13, “Distributed Privileges Using Shared Grant Tables”

Section 21.5.24, “ndb\_restore — Restore an NDB Cluster Backup”

## **--result-file**

Section 4.6.7, “mysqlbinlog — Utility for Processing Binary Log Files”

Section 4.5.4, “mysqldump — A Database Backup Program”

Section 4.5.6, “mysqlpump — A Database Backup Program”

Section 4.6.7.3, “Using mysqlbinlog to Back Up Binary Log Files”

## **--resume**

Section 21.5.14, “ndb\_import — Import CSV Data Into NDB”

## **--retries**

Section 21.5.10, “ndb\_desc — Describe NDB Tables”

## **--rewrite-database**

Section 21.5.24, “ndb\_restore — Restore an NDB Cluster Backup”

## **--rewrite-db**

Section 4.6.7, “mysqlbinlog — Utility for Processing Binary Log Files”

Section 1.3, “What Is New in MySQL 5.7”

## **--routines**

Section 7.4.5.3, “Dumping Stored Programs”

---

[Section 7.4.5.4, “Dumping Table Definitions and Content Separately”](#)  
[Section 4.5.4, “mysqldump — A Database Backup Program”](#)  
[Section 4.5.6, “mysqlpump — A Database Backup Program”](#)  
[Section 2.10.4, “Upgrading MySQL Binary or Package-based Installations on Unix/Linux”](#)  
[Section 4.6.7.3, “Using mysqlbinlog to Back Up Binary Log Files”](#)

## **--rowbatch**

[Section 21.5.14, “ndb\\_import — Import CSV Data Into NDB”](#)

## **--rowbytes**

[Section 21.5.14, “ndb\\_import — Import CSV Data Into NDB”](#)

## **--rowid**

[Section 21.5.25, “ndb\\_select\\_all — Print Rows from an NDB Table”](#)

## **--rows**

[Section 21.5.7, “ndb\\_config — Extract NDB Cluster Configuration Information”](#)

## **S**

[\[index top\]](#)

## **-S**

[Section 4.2.3, “Command Options for Connecting to the Server”](#)  
[Section 4.4.1, “comp\\_err — Compile MySQL Error Message File”](#)  
[Section 4.6.1, “innochecksum — Offline InnoDB File Checksum Utility”](#)  
[Section 4.2.1, “Invoking MySQL Programs”](#)  
[Section 7.6.4, “MyISAM Table Optimization”](#)  
[Section 4.5.1.2, “mysql Client Commands”](#)  
[Section 4.5.1.1, “mysql Client Options”](#)  
[Section 4.6.6, “mysql\\_config\\_editor — MySQL Configuration Utility”](#)  
[Section 4.4.4, “mysql\\_secure\\_installation — Improve MySQL Installation Security”](#)  
[Section 4.4.7, “mysql\\_upgrade — Check and Upgrade MySQL Tables”](#)  
[Section 4.5.2, “mysqladmin — A MySQL Server Administration Program”](#)  
[Section 4.6.7, “mysqlbinlog — Utility for Processing Binary Log Files”](#)  
[Section 4.5.3, “mysqlcheck — A Table Maintenance Program”](#)  
[Section 4.5.4, “mysqldump — A Database Backup Program”](#)  
[Section 4.5.5, “mysqlimport — A Data Import Program”](#)  
[Section 4.5.6, “mysqlpump — A Database Backup Program”](#)  
[Section 4.5.7, “mysqlshow — Display Database, Table, and Column Information”](#)  
[Section 4.5.8, “mysqlslap — A Load Emulation Client”](#)  
[Section 21.5.29, “ndb\\_top — View CPU usage information for NDB threads”](#)  
[Section 4.6.3.4, “Other myisamchk Options”](#)

## **-S**

[Section 7.6.2, “How to Check MyISAM Tables for Errors”](#)  
[Section 7.6.3, “How to Repair MyISAM Tables”](#)  
[Section 4.6.1, “innochecksum — Offline InnoDB File Checksum Utility”](#)  
[Section 2.2, “Installing MySQL on Unix/Linux Using Generic Binaries”](#)  
[Section 4.7.2, “my\\_print\\_defaults — Display Options from Option Files”](#)  
[Section 4.6.2, “myisam\\_ftdump — Display Full-Text Index information”](#)  
[Section 4.6.3.1, “myisamchk General Options”](#)  
[Section 4.6.5, “myisampack — Generate Compressed, Read-Only MyISAM Tables”](#)

---

Section 4.5.1.1, “mysql Client Options”  
Section 4.4.7, “mysql\_upgrade — Check and Upgrade MySQL Tables”  
Section 4.5.2, “mysqladmin — A MySQL Server Administration Program”  
Section 4.6.7, “mysqlbinlog — Utility for Processing Binary Log Files”  
Section 4.5.3, “mysqlcheck — A Table Maintenance Program”  
Section 4.6.8, “mysqldumpslow — Summarize Slow Query Log Files”  
Section 4.5.5, “mysqlimport — A Data Import Program”  
Section 4.5.8, “mysqlslap — A Load Emulation Client”  
Section 21.5.17, “ndb\_perror — Obtain NDB Error Message Information”  
Section 21.5.24, “ndb\_restore — Restore an NDB Cluster Backup”  
Section 21.5.29, “ndb\_top — View CPU usage information for NDB threads”  
Section 4.8.2, “perror — Display MySQL Error Message Information”  
Section 4.8.3, “replace — A String-Replacement Utility”  
Section 4.7.3, “resolve\_stack\_dump — Resolve Numeric Stack Trace Dump to Symbols”  
Section 4.8.4, “resolveip — Resolve Host name to IP Address or Vice Versa”  
Section 7.6.5, “Setting Up a MyISAM Table Maintenance Schedule”

### **--safe-recover**

Section 4.6.3.1, “myisamchk General Options”  
Section 4.6.3.6, “myisamchk Memory Usage”  
Section 4.6.3.3, “myisamchk Repair Options”

### **--safe-updates**

Section 4.5.1.2, “mysql Client Commands”  
Section 4.5.1.1, “mysql Client Options”  
Section 4.5.1.6, “mysql Client Tips”  
Section 5.1.7, “Server System Variables”

### **--safe-user-create**

Section 5.1.6, “Server Command Options”

### **--savequeries**

Section 21.5.28, “ndb\_size.pl — NDBCLUSTER Size Requirement Estimator”

### **--secure-auth**

Section 2.10.3, “Changes in MySQL 5.7”  
Section 4.2.3, “Command Options for Connecting to the Server”  
Section 6.4.1.3, “Migrating Away from Pre-4.1 Password Hashing and the mysql\_old\_password Plugin”  
Section 4.5.1.1, “mysql Client Options”  
Section 4.5.2, “mysqladmin — A MySQL Server Administration Program”  
Section 4.6.7, “mysqlbinlog — Utility for Processing Binary Log Files”  
Section 4.5.3, “mysqlcheck — A Table Maintenance Program”  
Section 4.5.4, “mysqldump — A Database Backup Program”  
Section 4.5.5, “mysqlimport — A Data Import Program”  
Section 4.5.6, “mysqlpump — A Database Backup Program”  
Section 4.5.7, “mysqlshow — Display Database, Table, and Column Information”  
Section 4.5.8, “mysqlslap — A Load Emulation Client”  
Section 6.1.2.4, “Password Hashing in MySQL”  
Section 1.3, “What Is New in MySQL 5.7”

### **--select-limit**

Section 4.5.1.1, “mysql Client Options”  
Section 4.5.1.6, “mysql Client Tips”

---

## **--server-arg**

Section 1.3, “What Is New in MySQL 5.7”

## **--server-file**

Section 1.3, “What Is New in MySQL 5.7”

## **--server-id**

Section 21.7.2, “General Requirements for NDB Cluster Replication”  
Section 4.6.7, “mysqlbinlog — Utility for Processing Binary Log Files”  
Section 13.7.5.33, “SHOW SLAVE HOSTS Statement”

## **--server-id-bits**

Section 4.6.7, “mysqlbinlog — Utility for Processing Binary Log Files”

## **--server-public-key-path**

Section 6.4.1.4, “Caching SHA-2 Pluggable Authentication”  
Section 4.2.3, “Command Options for Connecting to the Server”  
Section 4.5.1.1, “mysql Client Options”  
Section 4.5.2, “mysqladmin — A MySQL Server Administration Program”  
Section 4.6.7, “mysqlbinlog — Utility for Processing Binary Log Files”  
Section 4.5.3, “mysqlcheck — A Table Maintenance Program”  
Section 4.5.4, “mysqldump — A Database Backup Program”  
Section 4.5.5, “mysqlimport — A Data Import Program”  
Section 4.5.6, “mysqlpump — A Database Backup Program”  
Section 4.5.7, “mysqlshow — Display Database, Table, and Column Information”  
Section 4.5.8, “mysqlslap — A Load Emulation Client”  
Section 6.4.1.5, “SHA-256 Pluggable Authentication”

## **service-startup-timeout**

Section 4.3.3, “mysql.server — MySQL Server Startup Script”

## **--set**

Section 2.3.3.5, “MySQL Installer Console Reference”

## **set**

Section 2.3.3.5, “MySQL Installer Console Reference”

## **--set-auto-increment**

Section 4.6.3.4, “Other myisamchk Options”

## **--set-charset**

Section 4.6.7, “mysqlbinlog — Utility for Processing Binary Log Files”  
Section 4.5.4, “mysqldump — A Database Backup Program”  
Section 4.5.6, “mysqlpump — A Database Backup Program”

## **--set-collation**

Section 4.6.3.3, “myisamchk Repair Options”

## **--set-gtid-purged**

Section 4.5.4, “mysqldump — A Database Backup Program”  
Section 4.5.6, “mysqlpump — A Database Backup Program”  
Section 16.1.3.7, “Stored Function Examples to Manipulate GTIDs”

---

Section 16.1.3.5, “Using GTIDs for Failover and Scaleout”

## **--shared-memory-base-name**

Section 4.2.3, “Command Options for Connecting to the Server”  
Section 4.5.1.1, “mysql Client Options”  
Section 4.4.7, “mysql\_upgrade — Check and Upgrade MySQL Tables”  
Section 4.5.2, “mysqladmin — A MySQL Server Administration Program”  
Section 4.6.7, “mysqlbinlog — Utility for Processing Binary Log Files”  
Section 4.5.3, “mysqlcheck — A Table Maintenance Program”  
Section 4.5.4, “mysqldump — A Database Backup Program”  
Section 4.5.5, “mysqlimport — A Data Import Program”  
Section 4.5.7, “mysqlshow — Display Database, Table, and Column Information”  
Section 4.5.8, “mysqlslap — A Load Emulation Client”  
Section 5.7, “Running Multiple MySQL Instances on One Machine”  
Section 5.7.4, “Using Client Programs in a Multiple-Server Environment”

## **--short-form**

Section 4.6.7, “mysqlbinlog — Utility for Processing Binary Log Files”

## **--show**

Section 4.7.2, “my\_print\_defaults — Display Options from Option Files”

## **--show-slave-auth-info**

Section 16.1.6.3, “Replica Server Options and Variables”  
Section 16.1.6.2, “Replication Source Options and Variables”  
Section 13.7.5.33, “SHOW SLAVE HOSTS Statement”

## **--show-table-type**

Section 4.5.7, “mysqlshow — Display Database, Table, and Column Information”

## **--show-temp-status**

Section 21.5.27, “ndb\_show\_tables — Display List of NDB Tables”

## **--show-warnings**

Section 4.5.1.1, “mysql Client Options”  
Section 4.5.2, “mysqladmin — A MySQL Server Administration Program”

## **--shutdown-timeout**

Section 4.5.2, “mysqladmin — A MySQL Server Administration Program”

## **--sigint-ignore**

Section 4.5.1.1, “mysql Client Options”  
Section 4.10, “Unix Signal Handling in MySQL”

## **--silent**

Section 4.6.3.1, “myisamchk General Options”  
Section 4.6.5, “myisampack — Generate Compressed, Read-Only MyISAM Tables”  
Section 4.5.1.1, “mysql Client Options”  
Section 4.5.2, “mysqladmin — A MySQL Server Administration Program”  
Section 4.5.3, “mysqlcheck — A Table Maintenance Program”  
Section 4.3.4, “mysqld\_multi — Manage Multiple MySQL Servers”  
Section 4.5.5, “mysqlimport — A Data Import Program”



---

Section 4.5.8, “mysqlslap — A Load Emulation Client”  
Section 21.5.17, “ndb\_perror — Obtain NDB Error Message Information”  
Section 4.8.2, “perror — Display MySQL Error Message Information”  
Section 4.8.4, “resolveip — Resolve Host name to IP Address or Vice Versa”  
Section 7.6.5, “Setting Up a MyISAM Table Maintenance Schedule”

### **--single-transaction**

Section 7.2, “Database Backup Methods”  
Section 7.3.1, “Establishing a Backup Policy”  
Section 14.19.1, “InnoDB Backup”  
Section 4.5.4, “mysqldump — A Database Backup Program”  
Section 4.5.6, “mysqlpump — A Database Backup Program”  
Section 14.8.10, “Purge Configuration”

### **--single-user**

Section 21.5.30, “ndb\_waiter — Wait for NDB Cluster to Reach a Given Status”

### **--skip**

Section 4.5.4, “mysqldump — A Database Backup Program”  
Section 4.2.2.4, “Program Option Modifiers”  
Section 5.1.6, “Server Command Options”

### **--skip-add-drop-table**

Section 4.5.4, “mysqldump — A Database Backup Program”

### **--skip-add-locks**

Section 4.5.4, “mysqldump — A Database Backup Program”

### **--skip-auto-rehash**

Section 4.5.1.1, “mysql Client Options”  
Section 14.22.3, “Troubleshooting InnoDB Data Dictionary Operations”

### **--skip-binlog**

Section 17.5.5, “Using MySQL Enterprise Backup with Group Replication”

### **--skip-broken-objects**

Section 21.5.24, “ndb\_restore — Restore an NDB Cluster Backup”

### **--skip-character-set-client-handshake**

Section A.11, “MySQL 5.7 FAQ: MySQL Chinese, Japanese, and Korean Character Sets”  
Section 5.1.6, “Server Command Options”  
Section 5.1.7, “Server System Variables”  
Section 10.10.7.1, “The cp932 Character Set”

### **--skip-color**

Section 21.5.29, “ndb\_top — View CPU usage information for NDB threads”

### **--skip-colors**

Section 21.5.29, “ndb\_top — View CPU usage information for NDB threads”

### **--skip-column-names**

Section 4.5.1.1, “mysql Client Options”

---

## **--skip-commands**

Section 21.2.4.2, “What is New in NDB Cluster 7.6”

## **--skip-comments**

Section 4.5.1.1, “mysql Client Options”

Section 4.5.4, “mysqldump — A Database Backup Program”

Section 1.3, “What Is New in MySQL 5.7”

## **--skip-config-cache**

Section 21.5.4, “ndb\_mgmd — The NDB Cluster Management Server Daemon”

## **--skip-config-file**

Section 21.5.4, “ndb\_mgmd — The NDB Cluster Management Server Daemon”

## **--skip-database**

Section 4.5.3, “mysqlcheck — A Table Maintenance Program”

## **--skip-defer-table-indexes**

Section 4.5.6, “mysqlpump — A Database Backup Program”

## **--skip-definer**

Section 4.5.6, “mysqlpump — A Database Backup Program”

## **--skip-disable-keys**

Section 4.5.4, “mysqldump — A Database Backup Program”

## **--skip-dump-date**

Section 4.5.4, “mysqldump — A Database Backup Program”

## **--skip-dump-rows**

Section 4.5.6, “mysqlpump — A Database Backup Program”

## **--skip-engine\_name**

Section 13.7.5.16, “SHOW ENGINES Statement”

Section 24.3.7, “The INFORMATION\_SCHEMA ENGINES Table”

## **--skip-events**

Section 7.4.5.3, “Dumping Stored Programs”

Section 4.5.6, “mysqlpump — A Database Backup Program”

## **--skip-extended-insert**

Section 4.5.4, “mysqldump — A Database Backup Program”

## **--skip-external-locking**

Section 8.11.5, “External Locking”

Section 8.14.3, “General Thread States”

Section 5.1.6, “Server Command Options”

Section 5.1.7, “Server System Variables”

Section 8.12.1, “System Factors”

---

Section B.3.3.3, “What to Do If MySQL Keeps Crashing”

### **--skip-federated**

Section 16.3.3, “Using Replication with Different Source and Replica Storage Engines”

### **--skip-grant**

Section 4.2.2.5, “Using Options to Set Program Variables”

Section 1.3, “What Is New in MySQL 5.7”

### **--skip-grant-tables**

Section 2.10.3, “Changes in MySQL 5.7”

Section 13.7.3.1, “CREATE FUNCTION Statement for Loadable Functions”

Section 21.6.13, “Distributed Privileges Using Shared Grant Tables”

Section 23.4.2, “Event Scheduler Configuration”

Section 13.7.6.3, “FLUSH Statement”

Section 13.7.3.3, “INSTALL PLUGIN Statement”

Section 5.6.1, “Installing and Uninstalling Loadable Functions”

Section 5.5.1, “Installing and Uninstalling Plugins”

Section 4.5.2, “mysqladmin — A MySQL Server Administration Program”

Section 6.2.13, “Pluggable Authentication”

Resetting the Root Password: Generic Instructions

Section 5.1.6, “Server Command Options”

Section 5.1.7, “Server System Variables”

Section 5.3, “The mysql System Database”

Section 6.2.17, “Troubleshooting Problems Connecting to MySQL”

Section 4.2.2.1, “Using Options on the Command Line”

Section 4.2.2.5, “Using Options to Set Program Variables”

Section 1.3, “What Is New in MySQL 5.7”

Section 6.2.9, “When Privilege Changes Take Effect”

### **--skip-graphs**

Section 21.5.29, “ndb\_top — View CPU usage information for NDB threads”

### **--skip-gtids**

Section 4.6.7, “mysqlbinlog — Utility for Processing Binary Log Files”

### **--skip-host-cache**

Section 5.1.11.2, “DNS Lookups and the Host Cache”

Section 5.1.6, “Server Command Options”

Section 5.1.7, “Server System Variables”

Section 6.2.17, “Troubleshooting Problems Connecting to MySQL”

### **--skip-innodb**

Section 14.15, “InnoDB Startup Options and System Variables”

Section 5.5.1, “Installing and Uninstalling Plugins”

Section A.14, “MySQL 5.7 FAQ: Replication”

Section 5.1.6, “Server Command Options”

Section 14.1.5, “Turning Off InnoDB”

Section 1.3, “What Is New in MySQL 5.7”

### **--skip-innodb-adaptive-hash-index**

Section 14.15, “InnoDB Startup Options and System Variables”

---

## **--skip-innodb-checksums**

Section 14.15, “InnoDB Startup Options and System Variables”

## **--skip-innodb-doublewrite**

Section 14.15, “InnoDB Startup Options and System Variables”

## **--skip-kill-mysqld**

Section 4.3.2, “mysqld\_safe — MySQL Server Startup Script”

## **--skip-line-numbers**

Section 4.5.1.1, “mysql Client Options”

## **--skip-lock-tables**

Section 4.5.4, “mysqldump — A Database Backup Program”

## **--skip-log-bin**

Section 16.1.6.4, “Binary Logging Options and Variables”

Section 16.1.3.4, “Setting Up Replication Using GTIDs”

Section 16.4.3, “Upgrading a Replication Topology”

## **--skip-mysql-schema**

Section 4.5.4, “mysqldump — A Database Backup Program”

## **--skip-named-commands**

Section 4.5.1.1, “mysql Client Options”

## **--skip-ndb-optimized-node-selection**

MySQL Server Options for NDB Cluster

Section 21.5.6, “ndb\_blob\_tool — Check and Repair BLOB and TEXT columns of NDB Cluster Tables”

Section 21.5.7, “ndb\_config — Extract NDB Cluster Configuration Information”

Section 21.5.9, “ndb\_delete\_all — Delete All Rows from an NDB Table”

Section 21.5.10, “ndb\_desc — Describe NDB Tables”

Section 21.5.11, “ndb\_drop\_index — Drop Index from an NDB Table”

Section 21.5.12, “ndb\_drop\_table — Drop an NDB Table”

Section 21.5.14, “ndb\_import — Import CSV Data Into NDB”

Section 21.5.15, “ndb\_index\_stat — NDB Index Statistics Utility”

Section 21.5.5, “ndb\_mgm — The NDB Cluster Management Client”

Section 21.5.4, “ndb\_mgmd — The NDB Cluster Management Server Daemon”

Section 21.5.16, “ndb\_move\_data — NDB Data Copy Utility”

Section 21.5.24, “ndb\_restore — Restore an NDB Cluster Backup”

Section 21.5.25, “ndb\_select\_all — Print Rows from an NDB Table”

Section 21.5.26, “ndb\_select\_count — Print Row Counts for NDB Tables”

Section 21.5.27, “ndb\_show\_tables — Display List of NDB Tables”

Section 21.5.30, “ndb\_waiter — Wait for NDB Cluster to Reach a Given Status”

Section 21.5.1, “ndbd — The NDB Cluster Data Node Daemon”

Section 21.5.2, “ndbinfo\_select\_all — Select From ndbinfo Tables”

## **--skip-ndbcluster**

MySQL Server Options for NDB Cluster

Section 21.4.2.5, “NDB Cluster mysqld Option and Variable Reference”

---

## **--skip-new**

Section 5.8.1, “Debugging a MySQL Server”  
Section 13.7.2.4, “OPTIMIZE TABLE Statement”  
Section 5.1.6, “Server Command Options”  
Section 5.1.7, “Server System Variables”

## **--skip-nodegroup**

Section 21.5.13, “ndb\_error\_reporter — NDB Error-Reporting Utility”

## **--skip-opt**

Section 4.5.4, “mysqldump — A Database Backup Program”

## **--skip-pager**

Section 4.5.1.1, “mysql Client Options”

## **--skip-partition**

Chapter 22, *Partitioning*  
Section 5.1.6, “Server Command Options”

## **--skip-password**

Section 4.2.3, “Command Options for Connecting to the Server”  
Section 4.2.4, “Connecting to the MySQL Server Using Command Options”  
Section 4.5.1.1, “mysql Client Options”  
Section 4.4.7, “mysql\_upgrade — Check and Upgrade MySQL Tables”  
Section 4.5.2, “mysqladmin — A MySQL Server Administration Program”  
Section 4.6.7, “mysqlbinlog — Utility for Processing Binary Log Files”  
Section 4.5.3, “mysqlcheck — A Table Maintenance Program”  
Section 4.5.4, “mysqldump — A Database Backup Program”  
Section 4.5.5, “mysqlimport — A Data Import Program”  
Section 4.5.6, “mysqlpump — A Database Backup Program”  
Section 4.5.7, “mysqlshow — Display Database, Table, and Column Information”  
Section 4.5.8, “mysqlslap — A Load Emulation Client”

## **--skip-plugin-innodb-file-per-table**

Section 5.1.6, “Server Command Options”

## **--skip-plugin\_name**

Section 5.5.1, “Installing and Uninstalling Plugins”

## **--skip-quick**

Section 4.5.4, “mysqldump — A Database Backup Program”

## **--skip-quote-names**

Section 4.5.4, “mysqldump — A Database Backup Program”

## **--skip-reconnect**

Section 4.5.1.1, “mysql Client Options”  
Section 4.5.1.6, “mysql Client Tips”

## **--skip-relaylog**

Section 17.5.5, “Using MySQL Enterprise Backup with Group Replication”

---

## **--skip-routines**

Section 7.4.5.3, “Dumping Stored Programs”

Section 4.5.6, “mysqldump — A Database Backup Program”

## **--skip-safe-updates**

Section 4.5.1.1, “mysql Client Options”

## **--skip-secure-auth**

Section 2.10.3, “Changes in MySQL 5.7”

Section 4.2.3, “Command Options for Connecting to the Server”

Section 4.5.1.1, “mysql Client Options”

Section 4.5.2, “mysqladmin — A MySQL Server Administration Program”

Section 4.6.7, “mysqlbinlog — Utility for Processing Binary Log Files”

Section 4.5.3, “mysqlcheck — A Table Maintenance Program”

Section 4.5.4, “mysqldump — A Database Backup Program”

Section 4.5.5, “mysqlimport — A Data Import Program”

Section 4.5.6, “mysqldump — A Database Backup Program”

Section 4.5.7, “mysqlshow — Display Database, Table, and Column Information”

Section 4.5.8, “mysqlslap — A Load Emulation Client”

Section 1.3, “What Is New in MySQL 5.7”

## **--skip-set-charset**

Section 4.5.4, “mysqldump — A Database Backup Program”

Section 4.5.6, “mysqldump — A Database Backup Program”

## **--skip-show-database**

Section 6.2.2, “Privileges Provided by MySQL”

Section 5.1.6, “Server Command Options”

Section 13.7.5.14, “SHOW DATABASES Statement”

## **--skip-slave-start**

Section 16.1.2.6, “Adding Replicas to a Replication Topology”

Section 21.7.9, “NDB Cluster Backups With NDB Cluster Replication”

Section 21.7.5, “Preparing the NDB Cluster for Replication”

Section 16.1.6.3, “Replica Server Options and Variables”

Section 16.1.3.4, “Setting Up Replication Using GTIDs”

Setting Up Replication with Existing Data

Section 13.4.2.5, “START SLAVE Statement”

Section 21.7.6, “Starting NDB Cluster Replication (Single Replication Channel)”

Section 16.2.2.3, “Startup Options and Replication Channels”

Section 16.4.4, “Troubleshooting Replication”

Section 16.4.3, “Upgrading a Replication Topology”

## **--skip-sort**

Section 21.5.29, “ndb\_top — View CPU usage information for NDB threads”

## **--skip-ssl**

Section 4.2.3, “Command Options for Connecting to the Server”

Section 5.1.6, “Server Command Options”

Section 6.3, “Using Encrypted Connections”

Section 1.3, “What Is New in MySQL 5.7”

---

## **--skip-stack-trace**

Section 5.8.1.4, “Debugging mysqld under gdb”  
Section 5.1.6, “Server Command Options”

## **--skip-super-large-pages**

Section 8.12.4.3, “Enabling Large Page Support”  
Section 5.1.6, “Server Command Options”

## **--skip-symbolic-links**

Section 13.1.18, “CREATE TABLE Statement”  
Section 6.1.3, “Making MySQL Secure Against Attackers”  
Section 5.1.6, “Server Command Options”  
Section 5.1.7, “Server System Variables”  
Section 8.12.3.3, “Using Symbolic Links for Databases on Windows”  
Section 8.12.3.2, “Using Symbolic Links for MyISAM Tables on Unix”

## **--skip-sys-schema**

Chapter 26, *MySQL sys Schema*  
Section 4.4.2, “mysql\_install\_db — Initialize MySQL Data Directory”  
Section 4.4.7, “mysql\_upgrade — Check and Upgrade MySQL Tables”

## **--skip-syslog**

Section 5.4.2.3, “Error Logging to the System Log”  
Section 4.3.2, “mysqld\_safe — MySQL Server Startup Script”

## **--skip-table-check**

Section 21.5.24, “ndb\_restore — Restore an NDB Cluster Backup”

## **--skip-triggers**

Section 7.4.5.3, “Dumping Stored Programs”  
Section 4.5.4, “mysqldump — A Database Backup Program”  
Section 4.5.6, “mysqlpump — A Database Backup Program”

## **--skip-tz-utc**

Section 4.5.4, “mysqldump — A Database Backup Program”  
Section 4.5.6, “mysqlpump — A Database Backup Program”

## **--skip-unknown-objects**

Section 21.5.24, “ndb\_restore — Restore an NDB Cluster Backup”

## **--skip-version-check**

Section 4.4.7, “mysql\_upgrade — Check and Upgrade MySQL Tables”

## **--skip-warn**

Section 4.6.6, “mysql\_config\_editor — MySQL Configuration Utility”

## **--skip-watch-progress**

Section 4.5.6, “mysqlpump — A Database Backup Program”

## **--skip-write-binlog**

Section 11.2.5, “2-Digit YEAR(2) Limitations and Migrating to 4-Digit YEAR”

---

Section 4.5.3, “mysqlcheck — A Table Maintenance Program”

### **--skip\_grant\_tables**

Section 4.2.2.1, “Using Options on the Command Line”

### **--slave-parallel-workers**

Section 16.2.2.3, “Startup Options and Replication Channels”

### **--slave-skip-counter**

Section 16.2.2.3, “Startup Options and Replication Channels”

### **--slave-skip-errors**

Section 21.7.8, “Implementing Failover with NDB Cluster Replication”

Section 16.4.1.27, “Replica Errors During Replication”

Section 16.1.6.3, “Replica Server Options and Variables”

### **--slave-sql-verify-checksum**

Section 16.1.6.4, “Binary Logging Options and Variables”

Section 16.1.6.3, “Replica Server Options and Variables”

### **--slave\_net\_timeout**

Section 16.2.2.3, “Startup Options and Replication Channels”

### **--sleep**

Section 4.5.2, “mysqladmin — A MySQL Server Administration Program”

### **--sleep-time**

Section 21.5.29, “ndb\_top — View CPU usage information for NDB threads”

### **--slice-id**

Section 21.5.24, “ndb\_restore — Restore an NDB Cluster Backup”

Section 21.2.4.2, “What is New in NDB Cluster 7.6”

### **slice-id**

Section 21.5.24, “ndb\_restore — Restore an NDB Cluster Backup”

### **--slow-start-timeout**

Section 5.1.6, “Server Command Options”

### **--slow\_query\_log**

Section 5.4.1, “Selecting General Query Log and Slow Query Log Output Destinations”

Section 5.4.5, “The Slow Query Log”

### **--slow\_query\_log\_file**

Section 5.7, “Running Multiple MySQL Instances on One Machine”

Section 5.4.5, “The Slow Query Log”

### **--socket**

Section B.3.2.2, “Can't connect to [local] MySQL server”

Section 4.2.3, “Command Options for Connecting to the Server”

Section 4.2.4, “Connecting to the MySQL Server Using Command Options”



---

[Section 2.5.7.3, “Deploying MySQL on Windows and Other Non-Linux Platforms with Docker”](#)  
[Section B.3.3.6, “How to Protect or Change the MySQL Unix Socket File”](#)  
[Section 4.2.1, “Invoking MySQL Programs”](#)  
[Section 4.5.1.1, “mysql Client Options”](#)  
[Section 2.8.7, “MySQL Source-Configuration Options”](#)  
[Section 4.7.1, “mysql\\_config — Display Options for Compiling Clients”](#)  
[Section 4.6.6, “mysql\\_config\\_editor — MySQL Configuration Utility”](#)  
[Section 4.4.4, “mysql\\_secure\\_installation — Improve MySQL Installation Security”](#)  
[Section 4.4.7, “mysql\\_upgrade — Check and Upgrade MySQL Tables”](#)  
[Section 4.5.2, “mysqladmin — A MySQL Server Administration Program”](#)  
[Section 4.6.7, “mysqlbinlog — Utility for Processing Binary Log Files”](#)  
[Section 4.5.3, “mysqlcheck — A Table Maintenance Program”](#)  
[Section 4.3.2, “mysqld\\_safe — MySQL Server Startup Script”](#)  
[Section 4.5.4, “mysqldump — A Database Backup Program”](#)  
[Section 4.5.5, “mysqlimport — A Data Import Program”](#)  
[Section 4.5.6, “mysqlpump — A Database Backup Program”](#)  
[Section 4.5.7, “mysqlshow — Display Database, Table, and Column Information”](#)  
[Section 4.5.8, “mysqlslap — A Load Emulation Client”](#)  
[Section 21.5.28, “ndb\\_size.pl — NDBCLUSTER Size Requirement Estimator”](#)  
[Section 21.5.29, “ndb\\_top — View CPU usage information for NDB threads”](#)  
[Section 5.7, “Running Multiple MySQL Instances on One Machine”](#)  
[Section 5.7.3, “Running Multiple MySQL Instances on Unix”](#)  
[Section 5.1.6, “Server Command Options”](#)  
[Section 2.3.4.9, “Testing The MySQL Installation”](#)  
[Section 6.2.17, “Troubleshooting Problems Connecting to MySQL”](#)  
[Section 5.7.4, “Using Client Programs in a Multiple-Server Environment”](#)

## **socket**

[Section 4.6.6, “mysql\\_config\\_editor — MySQL Configuration Utility”](#)  
[Section 4.2.2.2, “Using Option Files”](#)

## **--sort**

[Section 21.5.29, “ndb\\_top — View CPU usage information for NDB threads”](#)

## **--sort-index**

[Section 7.6.4, “MyISAM Table Optimization”](#)  
[Section 4.6.3.4, “Other myisamchk Options”](#)

## **--sort-records**

[Section 7.6.4, “MyISAM Table Optimization”](#)  
[Section 4.6.3.4, “Other myisamchk Options”](#)

## **--sort-recover**

[Section 4.6.3.1, “myisamchk General Options”](#)  
[Section 4.6.3.6, “myisamchk Memory Usage”](#)  
[Section 4.6.3.3, “myisamchk Repair Options”](#)

## **--sort\_buffer\_size**

[Section 5.1.6, “Server Command Options”](#)

## **--sporadic-binlog-dump-fail**

[Section 16.1.6.4, “Binary Logging Options and Variables”](#)

---

## **--sql-mode**

Chapter 12, *Functions and Operators*  
Section A.3, “MySQL 5.7 FAQ: Server SQL Mode”  
Section 4.5.8, “mysqlslap — A Load Emulation Client”  
Section 5.1.6, “Server Command Options”  
Section 5.1.10, “Server SQL Modes”

## **sql-mode**

Section 5.1.10, “Server SQL Modes”

## **--srcdir**

Section 4.4.2, “mysql\_install\_db — Initialize MySQL Data Directory”

## **--ssl**

Section 4.2.3, “Command Options for Connecting to the Server”  
Section 6.3.1, “Configuring MySQL to Use Encrypted Connections”  
Section 6.3.3.1, “Creating SSL and RSA Certificates and Keys using MySQL”  
Section 4.5.1.1, “mysql Client Options”  
Section 4.4.4, “mysql\_secure\_installation — Improve MySQL Installation Security”  
Section 4.4.5, “mysql\_ssl\_rsa\_setup — Create SSL/RSA Files”  
Section 4.4.7, “mysql\_upgrade — Check and Upgrade MySQL Tables”  
Section 4.5.2, “mysqladmin — A MySQL Server Administration Program”  
Section 4.6.7, “mysqlbinlog — Utility for Processing Binary Log Files”  
Section 4.5.3, “mysqlcheck — A Table Maintenance Program”  
Section 4.5.4, “mysqldump — A Database Backup Program”  
Section 4.5.5, “mysqlimport — A Data Import Program”  
Section 4.5.6, “mysqlpump — A Database Backup Program”  
Section 4.5.7, “mysqlshow — Display Database, Table, and Column Information”  
Section 4.5.8, “mysqlslap — A Load Emulation Client”  
Section 5.1.6, “Server Command Options”  
Section 5.1.7, “Server System Variables”  
Section 6.3, “Using Encrypted Connections”  
Section 1.3, “What Is New in MySQL 5.7”

## **--ssl\***

Section 4.5.1.1, “mysql Client Options”  
Section 4.4.4, “mysql\_secure\_installation — Improve MySQL Installation Security”  
Section 4.4.7, “mysql\_upgrade — Check and Upgrade MySQL Tables”  
Section 4.5.2, “mysqladmin — A MySQL Server Administration Program”  
Section 4.6.7, “mysqlbinlog — Utility for Processing Binary Log Files”  
Section 4.5.3, “mysqlcheck — A Table Maintenance Program”  
Section 4.5.4, “mysqldump — A Database Backup Program”  
Section 4.5.5, “mysqlimport — A Data Import Program”  
Section 4.5.6, “mysqlpump — A Database Backup Program”  
Section 4.5.7, “mysqlshow — Display Database, Table, and Column Information”  
Section 4.5.8, “mysqlslap — A Load Emulation Client”

## **--ssl-ca**

Section 13.7.1.1, “ALTER USER Statement”  
Section 4.2.3, “Command Options for Connecting to the Server”  
Section 6.3.1, “Configuring MySQL to Use Encrypted Connections”  
Section 13.7.1.2, “CREATE USER Statement”

---

Section 6.3.3.2, “Creating SSL Certificates and Keys Using openssl”  
Section 4.4.5, “mysql\_ssl\_rsa\_setup — Create SSL/RSA Files”  
Section 5.1.6, “Server Command Options”  
Section 6.3.4, “SSL Library-Dependent Capabilities”  
Section 6.3, “Using Encrypted Connections”

## **--ssl-capath**

Section 4.2.3, “Command Options for Connecting to the Server”  
Section 6.3.1, “Configuring MySQL to Use Encrypted Connections”  
Section 5.1.6, “Server Command Options”  
Section 16.3.8, “Setting Up Replication to Use Encrypted Connections”  
Section 6.3.4, “SSL Library-Dependent Capabilities”

## **--ssl-cert**

Section 13.7.1.1, “ALTER USER Statement”  
Section 4.2.3, “Command Options for Connecting to the Server”  
Section 6.3.1, “Configuring MySQL to Use Encrypted Connections”  
Section 13.7.1.2, “CREATE USER Statement”  
Section 6.3.3.2, “Creating SSL Certificates and Keys Using openssl”  
Section 4.4.5, “mysql\_ssl\_rsa\_setup — Create SSL/RSA Files”  
Section 6.3, “Using Encrypted Connections”

## **--ssl-cipher**

Section 4.2.3, “Command Options for Connecting to the Server”  
Section 6.3.1, “Configuring MySQL to Use Encrypted Connections”  
Section 6.3.2, “Encrypted Connection TLS Protocols and Ciphers”  
Section 6.3.4, “SSL Library-Dependent Capabilities”

## **--ssl-crl**

Section 4.2.3, “Command Options for Connecting to the Server”  
Section 6.3.1, “Configuring MySQL to Use Encrypted Connections”  
Section 6.3.4, “SSL Library-Dependent Capabilities”

## **--ssl-crlpath**

Section 4.2.3, “Command Options for Connecting to the Server”  
Section 6.3.1, “Configuring MySQL to Use Encrypted Connections”  
Section 6.3.4, “SSL Library-Dependent Capabilities”

## **--ssl-key**

Section 13.7.1.1, “ALTER USER Statement”  
Section 4.2.3, “Command Options for Connecting to the Server”  
Section 6.3.1, “Configuring MySQL to Use Encrypted Connections”  
Section 13.7.1.2, “CREATE USER Statement”  
Section 6.3.3.2, “Creating SSL Certificates and Keys Using openssl”  
Section 4.4.5, “mysql\_ssl\_rsa\_setup — Create SSL/RSA Files”  
Section 6.3, “Using Encrypted Connections”

## **--ssl-mode**

Section 13.7.1.1, “ALTER USER Statement”  
Section 4.2.3, “Command Options for Connecting to the Server”  
Section 6.3.1, “Configuring MySQL to Use Encrypted Connections”

---

[Section 13.7.1.2, “CREATE USER Statement”](#)  
[Section 6.1.6, “Security Considerations for LOAD DATA LOCAL”](#)  
[Section 16.3.8, “Setting Up Replication to Use Encrypted Connections”](#)  
[Section 6.3, “Using Encrypted Connections”](#)  
[Section 1.3, “What Is New in MySQL 5.7”](#)

### **--ssl-verify-server-cert**

[Section 4.2.3, “Command Options for Connecting to the Server”](#)  
[Section 16.3.8, “Setting Up Replication to Use Encrypted Connections”](#)  
[Section 6.3, “Using Encrypted Connections”](#)  
[Section 1.3, “What Is New in MySQL 5.7”](#)

### **--ssl-xxx**

[Section 6.3.1, “Configuring MySQL to Use Encrypted Connections”](#)  
[Section 2.8.6, “Configuring SSL Library Support”](#)  
[Section 16.3.8, “Setting Up Replication to Use Encrypted Connections”](#)  
[Section 6.3, “Using Encrypted Connections”](#)

### **--staging-tries**

[Section 21.5.16, “ndb\\_move\\_data — NDB Data Copy Utility”](#)

### **--standalone**

[Section 5.8.1.2, “Creating Trace Files”](#)  
[Section 5.1.6, “Server Command Options”](#)  
[Section 2.3.4.6, “Starting MySQL from the Windows Command Line”](#)

### **--start-datetime**

[Section 4.6.7, “mysqlbinlog — Utility for Processing Binary Log Files”](#)  
[Section 7.5.2, “Point-in-Time Recovery Using Event Positions”](#)

### **--start-page**

[Section 4.6.1, “innochecksum — Offline InnoDB File Checksum Utility”](#)

### **--start-position**

[Section 4.6.7, “mysqlbinlog — Utility for Processing Binary Log Files”](#)  
[Section 7.5.2, “Point-in-Time Recovery Using Event Positions”](#)

### **--state-dir**

[Section 21.5.14, “ndb\\_import — Import CSV Data Into NDB”](#)

### **--state-file**

[Section 4.4.1, “comp\\_err — Compile MySQL Error Message File”](#)

### **--stats**

[Section 4.6.2, “myisam\\_ftdump — Display Full-Text Index information”](#)  
[Section 21.5.14, “ndb\\_import — Import CSV Data Into NDB”](#)

### **--status**

[Section 2.3.3.5, “MySQL Installer Console Reference”](#)  
[Section 4.5.7, “mysqlshow — Display Database, Table, and Column Information”](#)

---

## **status**

Section 2.3.3.5, “MySQL Installer Console Reference”

## **--stop-datetime**

Section 4.6.7, “mysqlbinlog — Utility for Processing Binary Log Files”  
Section 7.5.2, “Point-in-Time Recovery Using Event Positions”

## **--stop-never**

Section 4.6.7, “mysqlbinlog — Utility for Processing Binary Log Files”  
Section 4.6.7.4, “Specifying the mysqlbinlog Server ID”  
Section 4.6.7.3, “Using mysqlbinlog to Back Up Binary Log Files”

## **--stop-never-slave-server-id**

Section 4.6.7, “mysqlbinlog — Utility for Processing Binary Log Files”  
Section 4.6.7.4, “Specifying the mysqlbinlog Server ID”  
Section 4.6.7.3, “Using mysqlbinlog to Back Up Binary Log Files”

## **--stop-position**

Section 4.6.7, “mysqlbinlog — Utility for Processing Binary Log Files”  
Section 7.5.2, “Point-in-Time Recovery Using Event Positions”

## **--strict-check**

Section 4.6.1, “innochecksum — Offline InnoDB File Checksum Utility”

## **--suffix**

Section 6.3.3.1, “Creating SSL and RSA Certificates and Keys using MySQL”  
Section 4.4.5, “mysql\_ssl\_rsa\_setup — Create SSL/RSA Files”

## **--super-large-pages**

Section 8.12.4.3, “Enabling Large Page Support”  
Section 5.1.6, “Server Command Options”

## **--symbolic-links**

Section 5.1.6, “Server Command Options”

## **--symbols-file**

Section 4.7.3, “resolve\_stack\_dump — Resolve Numeric Stack Trace Dump to Symbols”

## **--sys-\***

Section 21.5.15, “ndb\_index\_stat — NDB Index Statistics Utility”

## **--sys-check**

Section 21.5.15, “ndb\_index\_stat — NDB Index Statistics Utility”

## **--sys-create**

Section 21.5.15, “ndb\_index\_stat — NDB Index Statistics Utility”

## **--sys-create-if-not-exist**

Section 21.5.15, “ndb\_index\_stat — NDB Index Statistics Utility”

---

## **--sys-create-if-not-valid**

Section 21.5.15, “[ndb\\_index\\_stat — NDB Index Statistics Utility](#)”

## **--sys-drop**

Section 21.5.15, “[ndb\\_index\\_stat — NDB Index Statistics Utility](#)”

## **--sys-skip-events**

Section 21.5.15, “[ndb\\_index\\_stat — NDB Index Statistics Utility](#)”

## **--sys-skip-tables**

Section 21.5.15, “[ndb\\_index\\_stat — NDB Index Statistics Utility](#)”

## **SYSCONFDIR**

Section 4.2.2.2, “[Using Option Files](#)”

## **--sysdate-is-now**

Section 16.2.1.1, “[Advantages and Disadvantages of Statement-Based and Row-Based Replication](#)”

Section 12.7, “[Date and Time Functions](#)”

Section 16.4.1.15, “[Replication and System Functions](#)”

Section 5.1.6, “[Server Command Options](#)”

Section 5.1.7, “[Server System Variables](#)”

## **--syslog**

Section 4.9, “[Environment Variables](#)”

Section 5.4.2.3, “[Error Logging to the System Log](#)”

Section 2.5.10, “[Managing MySQL Server with systemd](#)”

Section 4.5.1.3, “[mysql Client Logging](#)”

Section 4.5.1.1, “[mysql Client Options](#)”

Section 4.5.1.6, “[mysql Client Tips](#)”

Section 4.3.2, “[mysqld\\_safe — MySQL Server Startup Script](#)”

Section 1.3, “[What Is New in MySQL 5.7](#)”

## **--syslog-tag**

Section 5.4.2.3, “[Error Logging to the System Log](#)”

Section 4.3.2, “[mysqld\\_safe — MySQL Server Startup Script](#)”

## **--system**

Section 21.5.7, “[ndb\\_config — Extract NDB Cluster Configuration Information](#)”

## **--system-command**

Section 4.5.1.1, “[mysql Client Options](#)”

## **T**

[\[index top\]](#)

## **-T**

Section 4.4.1, “[comp\\_err — Compile MySQL Error Message File](#)”

Section 4.6.3.2, “[myisamchk Check Options](#)”

Section 4.6.5, “[myisampack — Generate Compressed, Read-Only MyISAM Tables](#)”

---

Section 4.5.1.1, “mysql Client Options”  
Section 4.4.7, “mysql\_upgrade — Check and Upgrade MySQL Tables”  
Section 4.5.4, “mysqldump — A Database Backup Program”  
Section 4.5.6, “mysqlpump — A Database Backup Program”  
Section 4.5.8, “mysqlslap — A Load Emulation Client”  
Section 21.5.24, “ndb\_restore — Restore an NDB Cluster Backup”  
Section 5.1.6, “Server Command Options”

## **-t**

Section 4.6.3.3, “myisamchk Repair Options”  
Section 4.6.5, “myisampack — Generate Compressed, Read-Only MyISAM Tables”  
Section 4.5.1.1, “mysql Client Options”  
Section 4.6.7, “mysqlbinlog — Utility for Processing Binary Log Files”  
Section 4.5.4, “mysqldump — A Database Backup Program”  
Section 4.6.8, “mysqldumpslow — Summarize Slow Query Log Files”  
Section 4.5.6, “mysqlpump — A Database Backup Program”  
Section 4.5.7, “mysqlshow — Display Database, Table, and Column Information”  
Section 21.5.9, “ndb\_delete\_all — Delete All Rows from an NDB Table”  
Section 21.5.10, “ndb\_desc — Describe NDB Tables”  
Section 21.5.5, “ndb\_mgm — The NDB Cluster Management Client”  
Section 21.5.23, “ndb\_redo\_log\_reader — Check and Print Content of Cluster Redo Log”  
Section 21.5.25, “ndb\_select\_all — Print Rows from an NDB Table”  
Section 21.5.27, “ndb\_show\_tables — Display List of NDB Tables”  
Section 21.5.29, “ndb\_top — View CPU usage information for NDB threads”  
Section 21.5.30, “ndb\_waiter — Wait for NDB Cluster to Reach a Given Status”  
Section 5.1.6, “Server Command Options”

## **--tab**

Section 7.1, “Backup and Recovery Types”  
Section 7.2, “Database Backup Methods”  
Section 7.4.3, “Dumping Data in Delimited-Text Format with mysqldump”  
Section 4.5.4, “mysqldump — A Database Backup Program”  
Section 21.5.14, “ndb\_import — Import CSV Data Into NDB”  
Section 21.5.24, “ndb\_restore — Restore an NDB Cluster Backup”  
Section 7.4, “Using mysqldump for Backups”

## **--table**

Section 4.5.1.1, “mysql Client Options”  
Section 21.5.10, “ndb\_desc — Describe NDB Tables”

## **--tables**

Section 4.5.3, “mysqlcheck — A Table Maintenance Program”  
Section 4.5.4, “mysqldump — A Database Backup Program”

## **--tc-heuristic-recover**

Section 5.1.6, “Server Command Options”

## **--tcp-ip**

Section 4.3.4, “mysqld\_multi — Manage Multiple MySQL Servers”

## **--tee**

Section 4.5.1.2, “mysql Client Commands”

---

Section 4.5.1.1, “mysql Client Options”

## **--temp-pool**

Section 5.1.6, “Server Command Options”

Section 1.3, “What Is New in MySQL 5.7”

## **--tempdelay**

Section 21.5.14, “ndb\_import — Import CSV Data Into NDB”

## **--temperrors**

Section 21.5.14, “ndb\_import — Import CSV Data Into NDB”

## **--test**

Section 4.6.5, “myisampack — Generate Compressed, Read-Only MyISAM Tables”

## **Text**

Section 1.1, “About This Manual”

## **--text**

Section 21.5.29, “ndb\_top — View CPU usage information for NDB threads”

## **--thread\_cache\_size**

Section 5.8.1.4, “Debugging mysqld under gdb”

## **--timeout**

Section 21.5.30, “ndb\_waiter — Wait for NDB Cluster to Reach a Given Status”

## **--timestamp-printouts**

Section 21.5.24, “ndb\_restore — Restore an NDB Cluster Backup”

## **--timestamp-printouts{**

Section 21.5.24, “ndb\_restore — Restore an NDB Cluster Backup”

## **--timezone**

Section 5.1.13, “MySQL Server Time Zone Support”

Section 4.3.2, “mysqld\_safe — MySQL Server Startup Script”

Section 5.1.7, “Server System Variables”

Section B.3.3.7, “Time Zone Problems”

## **--tls-version**

Section 4.2.3, “Command Options for Connecting to the Server”

Section 6.3.1, “Configuring MySQL to Use Encrypted Connections”

Section 6.3.2, “Encrypted Connection TLS Protocols and Ciphers”

Section 4.5.1.1, “mysql Client Options”

Section 4.4.4, “mysql\_secure\_installation — Improve MySQL Installation Security”

Section 4.4.7, “mysql\_upgrade — Check and Upgrade MySQL Tables”

Section 4.5.2, “mysqladmin — A MySQL Server Administration Program”

Section 4.6.7, “mysqlbinlog — Utility for Processing Binary Log Files”

Section 4.5.3, “mysqlcheck — A Table Maintenance Program”

Section 4.5.4, “mysqldump — A Database Backup Program”

Section 4.5.5, “mysqlimport — A Data Import Program”



---

[Section 4.5.6, “mysqlpump — A Database Backup Program”](#)  
[Section 4.5.7, “mysqlshow — Display Database, Table, and Column Information”](#)  
[Section 4.5.8, “mysqlslap — A Load Emulation Client”](#)  
[Section 6.3, “Using Encrypted Connections”](#)

## **--tmpdir**

[Section B.3.2.11, “Can’t create/write to file”](#)  
[Section 4.6.3.6, “myisamchk Memory Usage”](#)  
[Section 4.6.3.3, “myisamchk Repair Options”](#)  
[Section 4.6.5, “myisampack — Generate Compressed, Read-Only MyISAM Tables”](#)  
[Section 5.7, “Running Multiple MySQL Instances on One Machine”](#)  
[Section 5.1.6, “Server Command Options”](#)  
[Section 2.3.4.8, “Starting MySQL as a Windows Service”](#)  
[Section 1.3, “What Is New in MySQL 5.7”](#)  
[Section B.3.3.5, “Where MySQL Stores Temporary Files”](#)

## **tmpdir**

[Section 2.3, “Installing MySQL on Microsoft Windows”](#)

## **--to-last-log**

[Section 4.6.7, “mysqlbinlog — Utility for Processing Binary Log Files”](#)  
[Section 4.6.7.4, “Specifying the mysqlbinlog Server ID”](#)  
[Section 4.6.7.3, “Using mysqlbinlog to Back Up Binary Log Files”](#)

## **--transaction-isolation**

[Section 5.1.6, “Server Command Options”](#)  
[Section 5.1.7, “Server System Variables”](#)  
[Section 13.3.6, “SET TRANSACTION Statement”](#)  
[Section 14.7.2.1, “Transaction Isolation Levels”](#)  
[Section 1.3, “What Is New in MySQL 5.7”](#)

## **--transaction-read-only**

[Section 5.1.6, “Server Command Options”](#)  
[Section 5.1.7, “Server System Variables”](#)  
[Section 13.3.6, “SET TRANSACTION Statement”](#)  
[Section 1.3, “What Is New in MySQL 5.7”](#)

## **--transactional**

[Section 21.5.9, “ndb\\_delete\\_all — Delete All Rows from an NDB Table”](#)

## **--triggers**

[Section 7.4.5.3, “Dumping Stored Programs”](#)  
[Section 4.5.4, “mysqldump — A Database Backup Program”](#)  
[Section 4.5.6, “mysqlpump — A Database Backup Program”](#)

## **--try-reconnect**

[Section 21.5.5, “ndb\\_mgm — The NDB Cluster Management Client”](#)

## **--tupscan**

[Section 21.5.9, “ndb\\_delete\\_all — Delete All Rows from an NDB Table”](#)  
[Section 21.5.25, “ndb\\_select\\_all — Print Rows from an NDB Table”](#)

---

## **--type**

Section 21.5.7, “[ndb\\_config](#) — Extract NDB Cluster Configuration Information”  
Section 21.5.27, “[ndb\\_show\\_tables](#) — Display List of NDB Tables”

## **--tz-utc**

Section 4.5.4, “[mysqldump](#) — A Database Backup Program”  
Section 4.5.6, “[mysqlpump](#) — A Database Backup Program”

## **U**

[[index top](#)]

## **-U**

Section 4.6.3.2, “[myisamchk](#) Check Options”  
Section 4.5.1.1, “[mysql](#) Client Options”

## **-u**

Section 6.2.1, “[Account User Names and Passwords](#)”  
Section 4.2.3, “[Command Options for Connecting to the Server](#)”  
Section 2.11, “[Downgrading MySQL](#)”  
Section 4.2.1, “[Invoking MySQL Programs](#)”  
Section 4.6.3.3, “[myisamchk](#) Repair Options”  
Section 4.6.4, “[myisamlog](#) — Display MyISAM Log File Contents”  
Section 4.5.1.1, “[mysql](#) Client Options”  
Section 4.6.6, “[mysql\\_config\\_editor](#) — MySQL Configuration Utility”  
Section 4.4.2, “[mysql\\_install\\_db](#) — Initialize MySQL Data Directory”  
Section 4.4.4, “[mysql\\_secure\\_installation](#) — Improve MySQL Installation Security”  
Section 4.4.7, “[mysql\\_upgrade](#) — Check and Upgrade MySQL Tables”  
Section 4.5.2, “[mysqladmin](#) — A MySQL Server Administration Program”  
Section 4.6.7, “[mysqlbinlog](#) — Utility for Processing Binary Log Files”  
Section 4.5.3, “[mysqlcheck](#) — A Table Maintenance Program”  
Section 4.5.4, “[mysqldump](#) — A Database Backup Program”  
Section 4.5.5, “[mysqlimport](#) — A Data Import Program”  
Section 4.5.6, “[mysqlpump](#) — A Database Backup Program”  
Section 4.5.7, “[mysqlshow](#) — Display Database, Table, and Column Information”  
Section 4.5.8, “[mysqlslap](#) — A Load Emulation Client”  
Section 21.5.10, “[ndb\\_desc](#) — Describe NDB Tables”  
Section 21.5.24, “[ndb\\_restore](#) — Restore an NDB Cluster Backup”  
Section 21.5.27, “[ndb\\_show\\_tables](#) — Display List of NDB Tables”  
Section 21.5.29, “[ndb\\_top](#) — View CPU usage information for NDB threads”  
Section 5.1.6, “[Server Command Options](#)”  
Section 2.3.4.9, “[Testing The MySQL Installation](#)”  
Section 2.9.3, “[Testing the Server](#)”  
Section 2.10, “[Upgrading MySQL](#)”  
Section 2.3.6, “[Windows Postinstallation Procedures](#)”

## **--uid**

Section 6.3.3.1, “[Creating SSL and RSA Certificates and Keys using MySQL](#)”  
Section 4.4.5, “[mysql\\_ssl\\_rsa\\_setup](#) — Create SSL/RSA Files”

## **--unbuffered**

Section 4.5.1.1, “[mysql](#) Client Options”

---

## **--unpack**

Section 15.2.3, “MyISAM Table Storage Formats”

Section 4.6.3.3, “myisamchk Repair Options”

Section 4.6.5, “myisampack — Generate Compressed, Read-Only MyISAM Tables”

## **--unqualified**

Section 21.5.10, “ndb\_desc — Describe NDB Tables”

Section 21.5.27, “ndb\_show\_tables — Display List of NDB Tables”

## **--update**

Section 21.5.15, “ndb\_index\_stat — NDB Index Statistics Utility”

## **update**

Section 2.3.3.5, “MySQL Installer Console Reference”

## **--update-state**

Section 7.6.3, “How to Repair MyISAM Tables”

Section 4.6.3.2, “myisamchk Check Options”

Section 15.2, “The MyISAM Storage Engine”

## **--upgrade**

Section 2.3.3.5, “MySQL Installer Console Reference”

Section 2.3.3.4, “MySQL Installer Product Catalog and Dashboard”

## **upgrade**

Section 2.3.3.5, “MySQL Installer Console Reference”

## **--upgrade-system-tables**

Section 4.4.7, “mysql\_upgrade — Check and Upgrade MySQL Tables”

Section 21.7.4, “NDB Cluster Replication Schema and Tables”

Section 21.3.7.1, “Upgrading and Downgrading NDB 7.5”

Section 21.2.4.1, “What is New in NDB Cluster 7.5”

## **--usage**

Section 21.5.6, “ndb\_blob\_tool — Check and Repair BLOB and TEXT columns of NDB Cluster Tables”

Section 21.5.7, “ndb\_config — Extract NDB Cluster Configuration Information”

Section 21.5.9, “ndb\_delete\_all — Delete All Rows from an NDB Table”

Section 21.5.10, “ndb\_desc — Describe NDB Tables”

Section 21.5.11, “ndb\_drop\_index — Drop Index from an NDB Table”

Section 21.5.12, “ndb\_drop\_table — Drop an NDB Table”

Section 21.5.14, “ndb\_import — Import CSV Data Into NDB”

Section 21.5.15, “ndb\_index\_stat — NDB Index Statistics Utility”

Section 21.5.5, “ndb\_mgm — The NDB Cluster Management Client”

Section 21.5.4, “ndb\_mgmd — The NDB Cluster Management Server Daemon”

Section 21.5.16, “ndb\_move\_data — NDB Data Copy Utility”

Section 21.5.24, “ndb\_restore — Restore an NDB Cluster Backup”

Section 21.5.25, “ndb\_select\_all — Print Rows from an NDB Table”

Section 21.5.26, “ndb\_select\_count — Print Row Counts for NDB Tables”

Section 21.5.27, “ndb\_show\_tables — Display List of NDB Tables”

Section 21.5.29, “ndb\_top — View CPU usage information for NDB threads”

Section 21.5.30, “ndb\_waiter — Wait for NDB Cluster to Reach a Given Status”

---

Section 21.5.1, “ndbd — The NDB Cluster Data Node Daemon”  
Section 21.5.2, “ndbinfo\_select\_all — Select From ndbinfo Tables”

## **--use-default**

Section 4.4.4, “mysql\_secure\_installation — Improve MySQL Installation Security”

## **--use-frm**

Section 4.5.3, “mysqlcheck — A Table Maintenance Program”

## **--use-threads**

Section 4.5.5, “mysqlimport — A Data Import Program”

## **--useHexFormat**

Section 21.5.25, “ndb\_select\_all — Print Rows from an NDB Table”

## **--user**

Section 6.2.1, “Account User Names and Passwords”  
Section 4.2.3, “Command Options for Connecting to the Server”  
Section 7.3, “Example Backup and Recovery Strategy”  
Section B.3.2.16, “File Not Found and Similar Errors”  
Section 6.1.5, “How to Run MySQL as a Normal User”  
Section 2.9.1, “Initializing the Data Directory”  
Section 4.2.1, “Invoking MySQL Programs”  
Section 6.1.3, “Making MySQL Secure Against Attackers”  
Section 6.4.4.7, “Migrating Keys Between Keyring Keystores”  
Section 4.5.1.3, “mysql Client Logging”  
Section 4.5.1.1, “mysql Client Options”  
Section 4.6.6, “mysql\_config\_editor — MySQL Configuration Utility”  
Section 4.4.2, “mysql\_install\_db — Initialize MySQL Data Directory”  
Section 4.4.4, “mysql\_secure\_installation — Improve MySQL Installation Security”  
Section 4.4.7, “mysql\_upgrade — Check and Upgrade MySQL Tables”  
Section 4.5.2, “mysqladmin — A MySQL Server Administration Program”  
Section 4.6.7, “mysqlbinlog — Utility for Processing Binary Log Files”  
Section 4.5.3, “mysqlcheck — A Table Maintenance Program”  
Section 4.3.4, “mysqld\_multi — Manage Multiple MySQL Servers”  
Section 4.3.2, “mysqld\_safe — MySQL Server Startup Script”  
Section 4.5.4, “mysqldump — A Database Backup Program”  
Section 4.5.5, “mysqlimport — A Data Import Program”  
Section 4.5.6, “mysqlpump — A Database Backup Program”  
Section 4.5.7, “mysqlshow — Display Database, Table, and Column Information”  
Section 4.5.8, “mysqlslap — A Load Emulation Client”  
Section 21.6.18.3, “NDB Cluster and MySQL Security Procedures”  
Section 21.5.28, “ndb\_size.pl — NDBCLUSTER Size Requirement Estimator”  
Section 21.5.29, “ndb\_top — View CPU usage information for NDB threads”  
Section 4.2.2.6, “Option Defaults, Options Expecting Values, and the = Sign”  
Resetting the Root Password: Unix and Unix-Like Systems  
Restoring to More Nodes Than the Original  
Section 5.1.6, “Server Command Options”  
Section 6.4.1.11, “Socket Peer-Credential Pluggable Authentication”  
Section 4.2.2, “Specifying Program Options”  
Section 2.9.2, “Starting the Server”  
Section 6.4.1.12, “Test Pluggable Authentication”  
Section 4.6.7.3, “Using mysqlbinlog to Back Up Binary Log Files”

---

Section 4.2.2.2, “Using Option Files”

## **user**

Section 4.6.6, “mysql\_config\_editor — MySQL Configuration Utility”

Section 4.2.2.2, “Using Option Files”

## **--users**

Section 4.5.6, “mysqlpump — A Database Backup Program”

## **V**

[[index top](#)]

## **-V**

Section 4.4.1, “comp\_err — Compile MySQL Error Message File”

Section 4.6.1, “innochecksum — Offline InnoDB File Checksum Utility”

Section 4.7.2, “my\_print\_defaults — Display Options from Option Files”

Section 4.6.3.1, “myisamchk General Options”

Section 4.6.4, “myisamlog — Display MyISAM Log File Contents”

Section 4.6.5, “myisampack — Generate Compressed, Read-Only MyISAM Tables”

Section 4.5.1.1, “mysql Client Options”

Section 4.6.6, “mysql\_config\_editor — MySQL Configuration Utility”

Section 4.4.2, “mysql\_install\_db — Initialize MySQL Data Directory”

Section 4.4.3, “mysql\_plugin — Configure MySQL Server Plugins”

Section 4.4.5, “mysql\_ssl\_rsa\_setup — Create SSL/RSA Files”

Section 4.5.2, “mysqladmin — A MySQL Server Administration Program”

Section 4.6.7, “mysqlbinlog — Utility for Processing Binary Log Files”

Section 4.5.3, “mysqlcheck — A Table Maintenance Program”

Section 4.5.4, “mysqldump — A Database Backup Program”

Section 4.5.5, “mysqlimport — A Data Import Program”

Section 4.5.6, “mysqlpump — A Database Backup Program”

Section 4.5.7, “mysqlshow — Display Database, Table, and Column Information”

Section 4.5.8, “mysqlslap — A Load Emulation Client”

Section 21.5.6, “ndb\_blob\_tool — Check and Repair BLOB and TEXT columns of NDB Cluster Tables”

Section 21.5.7, “ndb\_config — Extract NDB Cluster Configuration Information”

Section 21.5.9, “ndb\_delete\_all — Delete All Rows from an NDB Table”

Section 21.5.10, “ndb\_desc — Describe NDB Tables”

Section 21.5.11, “ndb\_drop\_index — Drop Index from an NDB Table”

Section 21.5.12, “ndb\_drop\_table — Drop an NDB Table”

Section 21.5.14, “ndb\_import — Import CSV Data Into NDB”

Section 21.5.15, “ndb\_index\_stat — NDB Index Statistics Utility”

Section 21.5.5, “ndb\_mgm — The NDB Cluster Management Client”

Section 21.5.4, “ndb\_mgmd — The NDB Cluster Management Server Daemon”

Section 21.5.16, “ndb\_move\_data — NDB Data Copy Utility”

Section 21.5.17, “ndb\_perror — Obtain NDB Error Message Information”

Section 21.5.24, “ndb\_restore — Restore an NDB Cluster Backup”

Section 21.5.25, “ndb\_select\_all — Print Rows from an NDB Table”

Section 21.5.26, “ndb\_select\_count — Print Row Counts for NDB Tables”

Section 21.5.27, “ndb\_show\_tables — Display List of NDB Tables”

Section 21.5.30, “ndb\_waiter — Wait for NDB Cluster to Reach a Given Status”

Section 21.5.1, “ndbd — The NDB Cluster Data Node Daemon”

Section 21.5.2, “ndbinfo\_select\_all — Select From ndbinfo Tables”

Section 4.8.2, “perror — Display MySQL Error Message Information”

---

Section 4.8.3, “replace — A String-Replacement Utility”  
Section 4.7.3, “resolve\_stack\_dump — Resolve Numeric Stack Trace Dump to Symbols”  
Section 4.8.4, “resolveip — Resolve Host name to IP Address or Vice Versa”  
Section 5.1.6, “Server Command Options”  
Section 4.2.2.1, “Using Options on the Command Line”

## **-v**

Section 16.1.6.4, “Binary Logging Options and Variables”  
Section 7.6.2, “How to Check MyISAM Tables for Errors”  
Section 4.6.1, “innochecksum — Offline InnoDB File Checksum Utility”  
Section 4.7.2, “my\_print\_defaults — Display Options from Option Files”  
Section 4.6.2, “myisam\_ftdump — Display Full-Text Index information”  
Section 4.6.3.1, “myisamchk General Options”  
Section 4.6.4, “myisamlog — Display MyISAM Log File Contents”  
Section 4.6.5, “myisampack — Generate Compressed, Read-Only MyISAM Tables”  
Section 4.5.1.1, “mysql Client Options”  
Section 4.6.6, “mysql\_config\_editor — MySQL Configuration Utility”  
Section 4.4.2, “mysql\_install\_db — Initialize MySQL Data Directory”  
Section 4.4.3, “mysql\_plugin — Configure MySQL Server Plugins”  
Section 4.4.5, “mysql\_ssl\_rsa\_setup — Create SSL/RSA Files”  
Section 4.5.2, “mysqladmin — A MySQL Server Administration Program”  
Section 4.6.7.2, “mysqlbinlog Row Event Display”  
Section 4.6.7, “mysqlbinlog — Utility for Processing Binary Log Files”  
Section 4.5.3, “mysqlcheck — A Table Maintenance Program”  
Section 4.5.4, “mysqldump — A Database Backup Program”  
Section 4.6.8, “mysqldumpslow — Summarize Slow Query Log Files”  
Section 4.5.5, “mysqlimport — A Data Import Program”  
Section 4.5.7, “mysqlshow — Display Database, Table, and Column Information”  
Section 4.5.8, “mysqlslap — A Load Emulation Client”  
Section 21.5.6, “ndb\_blob\_tool — Check and Repair BLOB and TEXT columns of NDB Cluster Tables”  
Section 21.5.14, “ndb\_import — Import CSV Data Into NDB”  
Section 21.5.15, “ndb\_index\_stat — NDB Index Statistics Utility”  
Section 21.5.4, “ndb\_mgmd — The NDB Cluster Management Server Daemon”  
Section 21.5.17, “ndb\_perror — Obtain NDB Error Message Information”  
Section 21.5.19, “ndb\_print\_file — Print NDB Disk Data File Contents”  
Section 21.5.1, “ndbd — The NDB Cluster Data Node Daemon”  
Section 4.6.3.5, “Obtaining Table Information with myisamchk”  
Section 4.8.2, “perror — Display MySQL Error Message Information”  
Section 4.8.3, “replace — A String-Replacement Utility”  
Section 5.1.6, “Server Command Options”  
Section 4.2.2.1, “Using Options on the Command Line”  
Section 6.4.4.4, “Using the keyring\_okv KMIP Plugin”

## **--validate-password**

Section 6.4.3.1, “Password Validation Plugin Installation”  
Section 6.4.3.2, “Password Validation Plugin Options and Variables”

## **--validate-user-plugins**

Section 5.1.6, “Server Command Options”

## **--var\_name**

Section 14.15, “InnoDB Startup Options and System Variables”  
Section 4.6.3.1, “myisamchk General Options”

---

Section 5.1.6, “Server Command Options”

## **--variable**

Section 4.7.1, “mysql\_config — Display Options for Compiling Clients”

## **--verbose**

Section 16.2.1.1, “Advantages and Disadvantages of Statement-Based and Row-Based Replication”  
Section 16.1.6.4, “Binary Logging Options and Variables”  
Section 21.6.1, “Commands in the NDB Cluster Management Client”  
Section 4.5.1.5, “Executing SQL Statements from a Text File”  
Section 4.6.1, “innochecksum — Offline InnoDB File Checksum Utility”  
Section 4.7.2, “my\_print\_defaults — Display Options from Option Files”  
Section 4.6.2, “myisam\_ftdump — Display Full-Text Index information”  
Section 4.6.3.1, “myisamchk General Options”  
Section 4.6.5, “myisampack — Generate Compressed, Read-Only MyISAM Tables”  
Section 4.5.1.1, “mysql Client Options”  
Section 4.6.6, “mysql\_config\_editor — MySQL Configuration Utility”  
Section 4.4.2, “mysql\_install\_db — Initialize MySQL Data Directory”  
Section 4.4.3, “mysql\_plugin — Configure MySQL Server Plugins”  
Section 4.4.5, “mysql\_ssl\_rsa\_setup — Create SSL/RSA Files”  
Section 4.4.7, “mysql\_upgrade — Check and Upgrade MySQL Tables”  
Section 4.5.2, “mysqladmin — A MySQL Server Administration Program”  
Section 4.6.7.2, “mysqlbinlog Row Event Display”  
Section 4.6.7, “mysqlbinlog — Utility for Processing Binary Log Files”  
Section 4.5.3, “mysqlcheck — A Table Maintenance Program”  
Section 4.3.4, “mysqld\_multi — Manage Multiple MySQL Servers”  
Section 4.5.4, “mysqldump — A Database Backup Program”  
Section 4.6.8, “mysqldumpslow — Summarize Slow Query Log Files”  
Section 4.5.5, “mysqlimport — A Data Import Program”  
Section 4.5.7, “mysqlshow — Display Database, Table, and Column Information”  
Section 4.5.8, “mysqlslap — A Load Emulation Client”  
Section 21.5.6, “ndb\_blob\_tool — Check and Repair BLOB and TEXT columns of NDB Cluster Tables”  
Section 21.5.14, “ndb\_import — Import CSV Data Into NDB”  
Section 21.5.15, “ndb\_index\_stat — NDB Index Statistics Utility”  
Section 21.5.4, “ndb\_mgmd — The NDB Cluster Management Server Daemon”  
Section 21.5.16, “ndb\_move\_data — NDB Data Copy Utility”  
Section 21.5.17, “ndb\_perror — Obtain NDB Error Message Information”  
Section 21.5.24, “ndb\_restore — Restore an NDB Cluster Backup”  
Section 21.5.1, “ndbd — The NDB Cluster Data Node Daemon”  
Section 4.6.3.4, “Other myisamchk Options”  
Section 4.8.2, “perror — Display MySQL Error Message Information”  
Section 5.1.6, “Server Command Options”  
Section 2.9.2.1, “Troubleshooting Problems Starting the MySQL Server”  
Section 16.2.1.2, “Usage of Row-Based Logging and Replication”  
Section 4.2.2.2, “Using Option Files”  
Section 4.2.2.1, “Using Options on the Command Line”

## **--verify-binlog-checksum**

Section 4.6.7, “mysqlbinlog — Utility for Processing Binary Log Files”

## **--version**

Section 4.4.1, “comp\_err — Compile MySQL Error Message File”  
Section 4.6.1, “innochecksum — Offline InnoDB File Checksum Utility”

---

Section 4.7.2, “my\_print\_defaults — Display Options from Option Files”  
Section 4.6.3.1, “myisamchk General Options”  
Section 4.6.5, “myisampack — Generate Compressed, Read-Only MyISAM Tables”  
Section 4.5.1.1, “mysql Client Options”  
Section 4.7.1, “mysql\_config — Display Options for Compiling Clients”  
Section 4.6.6, “mysql\_config\_editor — MySQL Configuration Utility”  
Section 4.4.2, “mysql\_install\_db — Initialize MySQL Data Directory”  
Section 4.4.3, “mysql\_plugin — Configure MySQL Server Plugins”  
Section 4.4.5, “mysql\_ssl\_rsa\_setup — Create SSL/RSA Files”  
Section 4.5.2, “mysqladmin — A MySQL Server Administration Program”  
Section 4.6.7, “mysqlbinlog — Utility for Processing Binary Log Files”  
Section 4.5.3, “mysqlcheck — A Table Maintenance Program”  
Section 4.3.4, “mysqld\_multi — Manage Multiple MySQL Servers”  
Section 4.5.4, “mysqldump — A Database Backup Program”  
Section 4.5.5, “mysqlimport — A Data Import Program”  
Section 4.5.6, “mysqlpump — A Database Backup Program”  
Section 4.5.7, “mysqlshow — Display Database, Table, and Column Information”  
Section 4.5.8, “mysqlslap — A Load Emulation Client”  
Section 21.5.6, “ndb\_blob\_tool — Check and Repair BLOB and TEXT columns of NDB Cluster Tables”  
Section 21.5.7, “ndb\_config — Extract NDB Cluster Configuration Information”  
Section 21.5.9, “ndb\_delete\_all — Delete All Rows from an NDB Table”  
Section 21.5.10, “ndb\_desc — Describe NDB Tables”  
Section 21.5.11, “ndb\_drop\_index — Drop Index from an NDB Table”  
Section 21.5.12, “ndb\_drop\_table — Drop an NDB Table”  
Section 21.5.14, “ndb\_import — Import CSV Data Into NDB”  
Section 21.5.15, “ndb\_index\_stat — NDB Index Statistics Utility”  
Section 21.5.5, “ndb\_mgm — The NDB Cluster Management Client”  
Section 21.5.4, “ndb\_mgmd — The NDB Cluster Management Server Daemon”  
Section 21.5.16, “ndb\_move\_data — NDB Data Copy Utility”  
Section 21.5.17, “ndb\_perror — Obtain NDB Error Message Information”  
Section 21.5.24, “ndb\_restore — Restore an NDB Cluster Backup”  
Section 21.5.25, “ndb\_select\_all — Print Rows from an NDB Table”  
Section 21.5.26, “ndb\_select\_count — Print Row Counts for NDB Tables”  
Section 21.5.27, “ndb\_show\_tables — Display List of NDB Tables”  
Section 21.5.30, “ndb\_waiter — Wait for NDB Cluster to Reach a Given Status”  
Section 21.5.1, “nbd — The NDB Cluster Data Node Daemon”  
Section 21.5.2, “ndbinfo\_select\_all — Select From ndbinfo Tables”  
Section 4.8.2, “perror — Display MySQL Error Message Information”  
Section 4.7.3, “resolve\_stack\_dump — Resolve Numeric Stack Trace Dump to Symbols”  
Section 4.8.4, “resolveip — Resolve Host name to IP Address or Vice Versa”  
Section 5.1.6, “Server Command Options”  
Section 4.2.2.1, “Using Options on the Command Line”

## **--version-check**

Section 4.4.7, “mysql\_upgrade — Check and Upgrade MySQL Tables”

## **--vertical**

Section 1.5, “How to Report Bugs or Problems”

Section 4.5.1.1, “mysql Client Options”

Section 4.5.2, “mysqladmin — A MySQL Server Administration Program”

## **W**

[[index top](#)]



---

## **-W**

Section 4.2.3, “Command Options for Connecting to the Server”  
Section 4.5.1.1, “mysql Client Options”  
Section 4.4.7, “mysql\_upgrade — Check and Upgrade MySQL Tables”  
Section 4.5.2, “mysqladmin — A MySQL Server Administration Program”  
Section 4.5.3, “mysqlcheck — A Table Maintenance Program”  
Section 4.5.4, “mysqldump — A Database Backup Program”  
Section 4.5.5, “mysqlimport — A Data Import Program”  
Section 4.5.7, “mysqlshow — Display Database, Table, and Column Information”  
Section 4.5.8, “mysqlslap — A Load Emulation Client”  
Section 5.1.6, “Server Command Options”

## **-W**

Section 4.6.1, “innochecksum — Offline InnoDB File Checksum Utility”  
Section 4.6.3.1, “myisamchk General Options”  
Section 4.6.4, “myisamlog — Display MyISAM Log File Contents”  
Section 4.6.5, “myisampack — Generate Compressed, Read-Only MyISAM Tables”  
Section 4.5.1.1, “mysql Client Options”  
Section 4.6.6, “mysql\_config\_editor — MySQL Configuration Utility”  
Section 4.5.2, “mysqladmin — A MySQL Server Administration Program”  
Section 4.5.4, “mysqldump — A Database Backup Program”  
Section 21.5.30, “ndb\_waiter — Wait for NDB Cluster to Reach a Given Status”

## **--wait**

Section 4.6.3.1, “myisamchk General Options”  
Section 4.6.5, “myisampack — Generate Compressed, Read-Only MyISAM Tables”  
Section 4.5.1.1, “mysql Client Options”  
Section 4.5.2, “mysqladmin — A MySQL Server Administration Program”

## **--wait-nodes**

Section 21.5.30, “ndb\_waiter — Wait for NDB Cluster to Reach a Given Status”

## **--warn**

Section 4.6.6, “mysql\_config\_editor — MySQL Configuration Utility”

## **--watch-progress**

Section 4.5.6, “mysqlpump — A Database Backup Program”

## **--where**

Section 4.5.4, “mysqldump — A Database Backup Program”

## **WITH\_BOOST**

Section 2.8.7, “MySQL Source-Configuration Options”  
Section 2.8.2, “Source Installation Prerequisites”

## **WITH\_CLASSPATH**

Section 21.3.1.4, “Building NDB Cluster from Source on Linux”  
Section 21.3.2.2, “Compiling and Installing NDB Cluster from Source on Windows”

## **WITH\_CLIENT\_PROTOCOL\_TRACING**

Section 2.8.7, “MySQL Source-Configuration Options”

---

## **WITH\_DEBUG**

Section 14.15, “InnoDB Startup Options and System Variables”  
Section 4.6.3.1, “myisamchk General Options”  
Section 4.6.5, “myisampack — Generate Compressed, Read-Only MyISAM Tables”  
Section 4.5.1.1, “mysql Client Options”  
Section 2.8.7, “MySQL Source-Configuration Options”  
Section 4.6.6, “mysql\_config\_editor — MySQL Configuration Utility”  
Section 4.5.2, “mysqladmin — A MySQL Server Administration Program”  
Section 4.6.7, “mysqlbinlog — Utility for Processing Binary Log Files”  
Section 4.5.3, “mysqlcheck — A Table Maintenance Program”  
Section 4.5.4, “mysqldump — A Database Backup Program”  
Section 4.6.8, “mysqldumpslow — Summarize Slow Query Log Files”  
Section 4.5.5, “mysqlimport — A Data Import Program”  
Section 4.5.6, “mysqlpump — A Database Backup Program”  
Section 4.5.7, “mysqlshow — Display Database, Table, and Column Information”  
Section 4.5.8, “mysqlslap — A Load Emulation Client”  
Section 13.7.5.15, “SHOW ENGINE Statement”

## **WITH\_EDITLINE**

Section 2.8.7, “MySQL Source-Configuration Options”

## **WITH\_EMBEDDED\_SERVER**

Section 1.3, “What Is New in MySQL 5.7”

## **WITH\_EMBEDDED\_SHARED\_LIBRARY**

Section 1.3, “What Is New in MySQL 5.7”

## **WITH\_GMOCK**

Section 2.8.7, “MySQL Source-Configuration Options”

## **WITH\_LIBEDIT**

Section 2.8.7, “MySQL Source-Configuration Options”

## **WITH\_LZ4**

Section 2.8.7, “MySQL Source-Configuration Options”

## **WITH\_MECAB**

Section 12.9.9, “MeCab Full-Text Parser Plugin”

## **WITH\_NDB\_JAVA**

Section 21.3.1.4, “Building NDB Cluster from Source on Linux”  
Section 21.3.2.2, “Compiling and Installing NDB Cluster from Source on Windows”

## **WITH\_NDBCLUSTER**

Section 21.3.1.4, “Building NDB Cluster from Source on Linux”  
Section 21.3.2.2, “Compiling and Installing NDB Cluster from Source on Windows”  
Section 2.8.7, “MySQL Source-Configuration Options”

## **WITH\_NDBCLUSTER\_STORAGE\_ENGINE**

Section 21.3.1.4, “Building NDB Cluster from Source on Linux”

---

[Section 21.3.2.2, “Compiling and Installing NDB Cluster from Source on Windows”](#)

## **WITH\_NUMA**

[Section 14.15, “InnoDB Startup Options and System Variables”](#)

[Section 2.8.7, “MySQL Source-Configuration Options”](#)

## **WITH\_SSL**

[Section 2.8.6, “Configuring SSL Library Support”](#)

[Section 2.8.7, “MySQL Source-Configuration Options”](#)

[Section 2.8.2, “Source Installation Prerequisites”](#)

## **WITH\_SYSTEMD**

[Section 2.8.7, “MySQL Source-Configuration Options”](#)

## **WITH\_TEST\_TRACE\_PLUGIN**

[Section 2.8.7, “MySQL Source-Configuration Options”](#)

## **WITH\_ZLIB**

[Section 2.8.7, “MySQL Source-Configuration Options”](#)

## **--write**

[Section 4.6.1, “innochecksum — Offline InnoDB File Checksum Utility”](#)

## **--write-binlog**

[Section 4.4.7, “mysql\\_upgrade — Check and Upgrade MySQL Tables”](#)

[Section 4.5.3, “mysqlcheck — A Table Maintenance Program”](#)

[Section 16.1.3.6, “Restrictions on Replication with GTIDs”](#)

[Section 16.4.3, “Upgrading a Replication Topology”](#)

## **X**

[\[index top\]](#)

## **-X**

[Section 4.5.1.2, “mysql Client Commands”](#)

[Section 4.5.1.1, “mysql Client Options”](#)

[Section 4.5.4, “mysqldump — A Database Backup Program”](#)

## **-x**

[Section 4.5.4, “mysqldump — A Database Backup Program”](#)

[Section 4.5.8, “mysqlslap — A Load Emulation Client”](#)

[Section 21.5.10, “ndb\\_desc — Describe NDB Tables”](#)

[Section 21.5.25, “ndb\\_select\\_all — Print Rows from an NDB Table”](#)

[Section 21.5.29, “ndb\\_top — View CPU usage information for NDB threads”](#)

[Section 21.2.4.2, “What is New in NDB Cluster 7.6”](#)

## **--xml**

[Section 13.2.7, “LOAD XML Statement”](#)

[Section 4.5.1.1, “mysql Client Options”](#)

[Section 4.5.4, “mysqldump — A Database Backup Program”](#)

[Section 21.5.7, “ndb\\_config — Extract NDB Cluster Configuration Information”](#)

[Section 12.11, “XML Functions”](#)

---

## Y

[\[index top\]](#)

### -Y

[Section 4.5.4, “mysqldump — A Database Backup Program”](#)

### -y

[Section 4.5.4, “mysqldump — A Database Backup Program”](#)

[Section 4.5.8, “mysqlslap — A Load Emulation Client”](#)

## Z

[\[index top\]](#)

### -Z

[Section 21.5.24, “ndb\\_restore — Restore an NDB Cluster Backup”](#)

[Section 21.5.25, “ndb\\_select\\_all — Print Rows from an NDB Table”](#)

## Privileges Index

[A](#) | [B](#) | [C](#) | [D](#) | [E](#) | [F](#) | [G](#) | [I](#) | [L](#) | [N](#) | [P](#) | [R](#) | [S](#) | [T](#) | [U](#) | [X](#)

## A

[\[index top\]](#)

### ALL

[Section 13.7.1.4, “GRANT Statement”](#)

[Section 6.2.2, “Privileges Provided by MySQL”](#)

### ALL PRIVILEGES

[Section 6.2.2, “Privileges Provided by MySQL”](#)

### ALTER

[Section 13.1.1, “ALTER DATABASE Statement”](#)

[Section 13.1.8, “ALTER TABLE Statement”](#)

[Section 22.3.3, “Exchanging Partitions and Subpartitions with Tables”](#)

[Section 13.7.1.4, “GRANT Statement”](#)

[Section 6.2.2, “Privileges Provided by MySQL”](#)

[Section 13.1.33, “RENAME TABLE Statement”](#)

### ALTER ROUTINE

[Section 13.1.3, “ALTER FUNCTION Statement”](#)

[Section 13.1.6, “ALTER PROCEDURE Statement”](#)

[Section 16.1.6.4, “Binary Logging Options and Variables”](#)

[Section 13.1.16, “CREATE PROCEDURE and CREATE FUNCTION Statements”](#)

[Section 13.1.27, “DROP PROCEDURE and DROP FUNCTION Statements”](#)

[Section 13.7.1.4, “GRANT Statement”](#)

[Section 6.2.2, “Privileges Provided by MySQL”](#)

[Section 5.1.7, “Server System Variables”](#)

[Section 23.7, “Stored Program Binary Logging”](#)

[Section 23.2.2, “Stored Routines and MySQL Privileges”](#)

---

## B

[\[index top\]](#)

### **BINLOG\_ADMIN**

[Section 13.4.1.1, “PURGE BINARY LOGS Statement”](#)

## C

[\[index top\]](#)

### **CREATE**

[Section 13.1.8, “ALTER TABLE Statement”](#)

[Section 13.1.11, “CREATE DATABASE Statement”](#)

[Section 13.1.18, “CREATE TABLE Statement”](#)

[Section 22.3.3, “Exchanging Partitions and Subpartitions with Tables”](#)

[Section 13.7.1.4, “GRANT Statement”](#)

[Section 6.2.2, “Privileges Provided by MySQL”](#)

[Section 13.1.33, “RENAME TABLE Statement”](#)

### **CREATE ROUTINE**

[Section 16.1.6.4, “Binary Logging Options and Variables”](#)

[Section 13.1.16, “CREATE PROCEDURE and CREATE FUNCTION Statements”](#)

[Section 13.7.1.4, “GRANT Statement”](#)

[Section A.4, “MySQL 5.7 FAQ: Stored Procedures and Functions”](#)

[Section 6.2.2, “Privileges Provided by MySQL”](#)

[Section 23.7, “Stored Program Binary Logging”](#)

[Section 23.2.2, “Stored Routines and MySQL Privileges”](#)

### **CREATE TABLESPACE**

[Section 13.7.1.4, “GRANT Statement”](#)

[Section 6.2.2, “Privileges Provided by MySQL”](#)

### **CREATE TEMPORARY TABLES**

[Section 13.1.18.2, “CREATE TEMPORARY TABLE Statement”](#)

[Section 13.7.1.4, “GRANT Statement”](#)

[Section 6.2.2, “Privileges Provided by MySQL”](#)

### **CREATE USER**

[Section 6.2.7, “Adding Accounts, Assigning Privileges, and Dropping Accounts”](#)

[Section 13.7.1.1, “ALTER USER Statement”](#)

[Section 6.2.10, “Assigning Account Passwords”](#)

[Section 13.7.1.2, “CREATE USER Statement”](#)

[Section 13.7.1.3, “DROP USER Statement”](#)

[Section 13.7.1.4, “GRANT Statement”](#)

[Section 6.2.2, “Privileges Provided by MySQL”](#)

[Section 13.7.1.5, “RENAME USER Statement”](#)

[Section 13.7.1.6, “REVOKE Statement”](#)

### **CREATE VIEW**

[Section 13.1.10, “ALTER VIEW Statement”](#)

[Section 13.1.21, “CREATE VIEW Statement”](#)

[Section 13.7.1.4, “GRANT Statement”](#)

---

[Section 6.2.2, “Privileges Provided by MySQL”](#)  
[Section 23.9, “Restrictions on Views”](#)

## D

[\[index top\]](#)

### DELETE

[Section 6.2.6, “Access Control, Stage 2: Request Verification”](#)  
[Section 2.10.3, “Changes in MySQL 5.7”](#)  
[Section 13.1.18, “CREATE TABLE Statement”](#)  
[Section 13.2.2, “DELETE Statement”](#)  
[Section 13.7.3.2, “DROP FUNCTION Statement for Loadable Functions”](#)  
[Section 13.7.1.3, “DROP USER Statement”](#)  
[Section 13.7.1.4, “GRANT Statement”](#)  
[Section 5.6.1, “Installing and Uninstalling Loadable Functions”](#)  
[Section 5.5.1, “Installing and Uninstalling Plugins”](#)  
[Section 21.6.18.2, “NDB Cluster and MySQL Privileges”](#)  
[Section 6.2.2, “Privileges Provided by MySQL”](#)  
[Section 13.2.8, “REPLACE Statement”](#)  
[Section 15.7, “The MERGE Storage Engine”](#)  
[Section 25.12.2.4, “The setup\\_objects Table”](#)  
[Section 13.7.3.4, “UNINSTALL PLUGIN Statement”](#)

### DROP

[Section 6.2, “Access Control and Account Management”](#)  
[Section 13.1.8, “ALTER TABLE Statement”](#)  
[Section 13.1.10, “ALTER VIEW Statement”](#)  
[Section 13.1.21, “CREATE VIEW Statement”](#)  
[Section 5.1.11.2, “DNS Lookups and the Host Cache”](#)  
[Section 13.1.22, “DROP DATABASE Statement”](#)  
[Section 13.1.29, “DROP TABLE Statement”](#)  
[Section 13.1.32, “DROP VIEW Statement”](#)  
[Section 22.3.3, “Exchanging Partitions and Subpartitions with Tables”](#)  
[Section 13.7.1.4, “GRANT Statement”](#)  
[Section 22.3.1, “Management of RANGE and LIST Partitions”](#)  
[Section 6.6.1, “MySQL Enterprise Encryption Installation”](#)  
[Section 25.11, “Performance Schema General Table Characteristics”](#)  
[Section 6.2.2, “Privileges Provided by MySQL”](#)  
[Section 13.1.33, “RENAME TABLE Statement”](#)  
[Section 25.12.16.1, “The host\\_cache Table”](#)  
[Section 13.1.34, “TRUNCATE TABLE Statement”](#)

## E

[\[index top\]](#)

### EVENT

[Section 13.1.2, “ALTER EVENT Statement”](#)  
[Section 13.1.12, “CREATE EVENT Statement”](#)  
[Section 13.1.23, “DROP EVENT Statement”](#)  
[Section 23.4.1, “Event Scheduler Overview”](#)  
[Section 23.4.3, “Event Syntax”](#)

---

[Section 13.7.1.4, “GRANT Statement”](#)  
[Section 4.5.4, “mysqldump — A Database Backup Program”](#)  
[Section 4.5.6, “mysqlpump — A Database Backup Program”](#)  
[Section 6.2.2, “Privileges Provided by MySQL”](#)  
[Section 13.7.5.7, “SHOW CREATE EVENT Statement”](#)  
[Section 13.7.5.18, “SHOW EVENTS Statement”](#)  
[Section 23.4.6, “The Event Scheduler and MySQL Privileges”](#)

## EXECUTE

[Section 13.1.16, “CREATE PROCEDURE and CREATE FUNCTION Statements”](#)  
[Section 13.1.27, “DROP PROCEDURE and DROP FUNCTION Statements”](#)  
[Section 6.4.4.8, “General-Purpose Keyring Key-Management Functions”](#)  
[Section 13.7.1.4, “GRANT Statement”](#)  
[Section 26.1, “Prerequisites for Using the sys Schema”](#)  
[Section 6.2.2, “Privileges Provided by MySQL”](#)  
[Section 5.1.7, “Server System Variables”](#)  
[Section 23.6, “Stored Object Access Control”](#)  
[Section 23.2.2, “Stored Routines and MySQL Privileges”](#)  
[Section 6.4.6.3, “Using MySQL Enterprise Firewall”](#)

## F

[\[index top\]](#)

## FILE

[Section 13.1.18, “CREATE TABLE Statement”](#)  
[Section 7.4.3, “Dumping Data in Delimited-Text Format with mysqldump”](#)  
[Section 13.7.1.4, “GRANT Statement”](#)  
[Section 6.2.3, “Grant Tables”](#)  
[Section 13.2.6, “LOAD DATA Statement”](#)  
[Section 13.2.7, “LOAD XML Statement”](#)  
[Section 6.1.3, “Making MySQL Secure Against Attackers”](#)  
[Section 6.6.2, “MySQL Enterprise Encryption Usage and Examples”](#)  
[Section 4.5.4, “mysqldump — A Database Backup Program”](#)  
[Section 6.2.2, “Privileges Provided by MySQL”](#)  
[Section 13.2.9.1, “SELECT ... INTO Statement”](#)  
[Section 5.1.7, “Server System Variables”](#)  
[Section 12.8, “String Functions and Operators”](#)  
[Section 11.3.4, “The BLOB and TEXT Types”](#)  
[Section 6.2.17, “Troubleshooting Problems Connecting to MySQL”](#)

## G

[\[index top\]](#)

## GRANT OPTION

[Section 13.7.1.4, “GRANT Statement”](#)  
[Section 6.2.2, “Privileges Provided by MySQL”](#)  
[Section 13.7.1.6, “REVOKE Statement”](#)  
[Section 24.3.6, “The INFORMATION\\_SCHEMA COLUMN\\_PRIVILEGES Table”](#)  
[Section 24.3.23, “The INFORMATION\\_SCHEMA SCHEMA\\_PRIVILEGES Table”](#)  
[Section 24.3.28, “The INFORMATION\\_SCHEMA TABLE\\_PRIVILEGES Table”](#)  
[Section 24.3.30, “The INFORMATION\\_SCHEMA USER\\_PRIVILEGES Table”](#)

---

## **GROUP\_REPLICATION\_ADMIN**

[Section 13.4.3.2, “STOP GROUP\\_REPLICATION Statement”](#)

### **I**

[\[index top\]](#)

## **INDEX**

[Section 13.1.8, “ALTER TABLE Statement”](#)

[Section 13.7.1.4, “GRANT Statement”](#)

[Section 6.2.2, “Privileges Provided by MySQL”](#)

## **INSERT**

[Section 6.2.6, “Access Control, Stage 2: Request Verification”](#)

[Section 13.1.8, “ALTER TABLE Statement”](#)

[Section 13.7.2.1, “ANALYZE TABLE Statement”](#)

[Section 6.2.10, “Assigning Account Passwords”](#)

[Section 2.10.3, “Changes in MySQL 5.7”](#)

[Section 13.7.3.1, “CREATE FUNCTION Statement for Loadable Functions”](#)

[Section 13.7.1.2, “CREATE USER Statement”](#)

[Section 13.1.21, “CREATE VIEW Statement”](#)

[Section 22.3.3, “Exchanging Partitions and Subpartitions with Tables”](#)

[Section 13.7.1.4, “GRANT Statement”](#)

[Section 13.2.5, “INSERT Statement”](#)

[Section 13.7.3.3, “INSTALL PLUGIN Statement”](#)

[Section 5.6.1, “Installing and Uninstalling Loadable Functions”](#)

[Section 5.5.1, “Installing and Uninstalling Plugins”](#)

[Section 6.6.1, “MySQL Enterprise Encryption Installation”](#)

[Section 13.7.2.4, “OPTIMIZE TABLE Statement”](#)

[Section 15.11.1, “Pluggable Storage Engine Architecture”](#)

[Section 26.1, “Prerequisites for Using the sys Schema”](#)

[Section 6.2.2, “Privileges Provided by MySQL”](#)

[Section 13.1.33, “RENAME TABLE Statement”](#)

[Section 13.7.2.5, “REPAIR TABLE Statement”](#)

[Section 13.2.8, “REPLACE Statement”](#)

[Section 5.1.6, “Server Command Options”](#)

[Section 19.2, “Setting Up MySQL as a Document Store”](#)

[Section 23.6, “Stored Object Access Control”](#)

[Section 23.4.6, “The Event Scheduler and MySQL Privileges”](#)

[Section 25.12.2.4, “The setup\\_objects Table”](#)

### **L**

[\[index top\]](#)

## **LOCK TABLES**

[Section 13.7.6.3, “FLUSH Statement”](#)

[Section 13.7.1.4, “GRANT Statement”](#)

[Section 13.3.5, “LOCK TABLES and UNLOCK TABLES Statements”](#)

[Section 4.5.4, “mysqldump — A Database Backup Program”](#)

[Section 4.5.6, “mysqlpump — A Database Backup Program”](#)

[Section 6.2.2, “Privileges Provided by MySQL”](#)



---

## N

[\[index top\]](#)

### NDB\_STORED\_USER

[Restoring an NDB backup to a previous version of NDB Cluster](#)

## P

[\[index top\]](#)

### PROCESS

[Section 8.14.1, “Accessing the Process List”](#)

[Section 6.2.7, “Adding Accounts, Assigning Privileges, and Dropping Accounts”](#)

[Section 5.1.11.1, “Connection Interfaces”](#)

[Section 14.18.2, “Enabling InnoDB Monitors”](#)

[Section 23.4.2, “Event Scheduler Configuration”](#)

[Section 13.7.1.4, “GRANT Statement”](#)

[Section 24.1, “Introduction”](#)

[Section 13.7.6.4, “KILL Statement”](#)

[Section 6.1.3, “Making MySQL Secure Against Attackers”](#)

[Section 21.6.10, “MySQL Server Usage for NDB Cluster”](#)

[Section 4.5.4, “mysqldump — A Database Backup Program”](#)

[Section 8.8.4, “Obtaining Execution Plan Information for a Named Connection”](#)

[Section 26.1, “Prerequisites for Using the sys Schema”](#)

[Section 6.2.2, “Privileges Provided by MySQL”](#)

[Section 13.7.5.15, “SHOW ENGINE Statement”](#)

[Section 13.7.5.29, “SHOW PROCESSLIST Statement”](#)

[Section 24.3.9, “The INFORMATION\\_SCHEMA FILES Table”](#)

[Section 24.4.2, “The INFORMATION\\_SCHEMA INNODB\\_BUFFER\\_PAGE Table”](#)

[Section 24.4.3, “The INFORMATION\\_SCHEMA INNODB\\_BUFFER\\_PAGE\\_LRU Table”](#)

[Section 24.4.4, “The INFORMATION\\_SCHEMA INNODB\\_BUFFER\\_POOL\\_STATS Table”](#)

[Section 24.4.5, “The INFORMATION\\_SCHEMA INNODB\\_CMP and INNODB\\_CMP\\_RESET Tables”](#)

[Section 24.4.7, “The INFORMATION\\_SCHEMA INNODB\\_CMP\\_PER\\_INDEX and INNODB\\_CMP\\_PER\\_INDEX\\_RESET Tables”](#)

[Section 24.4.6, “The INFORMATION\\_SCHEMA INNODB\\_CMPMEM and INNODB\\_CMPMEM\\_RESET Tables”](#)

[Section 24.4.8, “The INFORMATION\\_SCHEMA INNODB\\_FT\\_BEING\\_DELETED Table”](#)

[Section 24.4.9, “The INFORMATION\\_SCHEMA INNODB\\_FT\\_CONFIG Table”](#)

[Section 24.4.10, “The INFORMATION\\_SCHEMA INNODB\\_FT\\_DEFAULT\\_STOPWORD Table”](#)

[Section 24.4.11, “The INFORMATION\\_SCHEMA INNODB\\_FT\\_DELETED Table”](#)

[Section 24.4.12, “The INFORMATION\\_SCHEMA INNODB\\_FT\\_INDEX\\_CACHE Table”](#)

[Section 24.4.13, “The INFORMATION\\_SCHEMA INNODB\\_FT\\_INDEX\\_TABLE Table”](#)

[Section 24.4.15, “The INFORMATION\\_SCHEMA INNODB\\_LOCK\\_WAITS Table”](#)

[Section 24.4.14, “The INFORMATION\\_SCHEMA INNODB\\_LOCKS Table”](#)

[Section 24.4.16, “The INFORMATION\\_SCHEMA INNODB\\_METRICS Table”](#)

[Section 24.4.17, “The INFORMATION\\_SCHEMA INNODB\\_SYS\\_COLUMNS Table”](#)

[Section 24.4.18, “The INFORMATION\\_SCHEMA INNODB\\_SYS\\_DATAFILES Table”](#)

[Section 24.4.19, “The INFORMATION\\_SCHEMA INNODB\\_SYS\\_FIELDS Table”](#)

[Section 24.4.20, “The INFORMATION\\_SCHEMA INNODB\\_SYS\\_FOREIGN Table”](#)

[Section 24.4.21, “The INFORMATION\\_SCHEMA INNODB\\_SYS\\_FOREIGN\\_COLS Table”](#)

[Section 24.4.22, “The INFORMATION\\_SCHEMA INNODB\\_SYS\\_INDEXES Table”](#)

[Section 24.4.23, “The INFORMATION\\_SCHEMA INNODB\\_SYS\\_TABLES Table”](#)

---

[Section 24.4.24, “The INFORMATION\\_SCHEMA INNODB\\_SYS\\_TABLESPACES Table”](#)  
[Section 24.4.25, “The INFORMATION\\_SCHEMA INNODB\\_SYS\\_TABLESTATS View”](#)  
[Section 24.4.26, “The INFORMATION\\_SCHEMA INNODB\\_SYS\\_VIRTUAL Table”](#)  
[Section 24.4.27, “The INFORMATION\\_SCHEMA INNODB\\_TEMP\\_TABLE\\_INFO Table”](#)  
[Section 24.4.28, “The INFORMATION\\_SCHEMA INNODB\\_TRX Table”](#)  
[Section 24.3.18, “The INFORMATION\\_SCHEMA PROCESSLIST Table”](#)  
[Section 25.12.16.3, “The processlist Table”](#)  
[Section 25.12.16.4, “The threads Table”](#)  
[Section B.3.2.5, “Too many connections”](#)

## PROXY

[Section 13.7.1.4, “GRANT Statement”](#)  
[Section 6.2.3, “Grant Tables”](#)  
[Section 6.4.1.9, “LDAP Pluggable Authentication”](#)  
[Section 6.4.1.7, “PAM Pluggable Authentication”](#)  
[Section 6.2.2, “Privileges Provided by MySQL”](#)  
[Section 6.2.14, “Proxy Users”](#)  
[Section 2.9.4, “Securing the Initial MySQL Account”](#)  
[Section 25.12.16.1, “The host\\_cache Table”](#)  
[Section 6.4.1.8, “Windows Pluggable Authentication”](#)

## PROXY ... WITH GRANT OPTION

[Section 6.2.14, “Proxy Users”](#)

## R

[\[index top\]](#)

## REFERENCES

[Section 2.10.3, “Changes in MySQL 5.7”](#)  
[Section 13.1.18.5, “FOREIGN KEY Constraints”](#)  
[Section 13.7.1.4, “GRANT Statement”](#)  
[Section 6.2.2, “Privileges Provided by MySQL”](#)

## RELOAD

[Section 6.2.6, “Access Control, Stage 2: Request Verification”](#)  
[Section 6.2.7, “Adding Accounts, Assigning Privileges, and Dropping Accounts”](#)  
[Section 5.1.11.2, “DNS Lookups and the Host Cache”](#)  
[Section 12.13, “Encryption and Compression Functions”](#)  
[Section 13.7.6.3, “FLUSH Statement”](#)  
[Section 13.7.1.4, “GRANT Statement”](#)  
[Section 6.2.3, “Grant Tables”](#)  
[Section 4.5.4, “mysqldump — A Database Backup Program”](#)  
[Section 6.2.2, “Privileges Provided by MySQL”](#)  
[Section 13.4.1.2, “RESET MASTER Statement”](#)  
[Section 13.4.2.3, “RESET SLAVE Statement”](#)  
[Section 13.7.6.6, “RESET Statement”](#)  
[Section 5.4.7, “Server Log Maintenance”](#)

## REPLICATION CLIENT

[Section 13.7.1.4, “GRANT Statement”](#)  
[Section 6.2.2, “Privileges Provided by MySQL”](#)  
[Section 13.7.5.1, “SHOW BINARY LOGS Statement”](#)

---

[Section 13.7.5.23, "SHOW MASTER STATUS Statement"](#)

[Section 13.7.5.34, "SHOW SLAVE STATUS Statement"](#)

## REPLICATION SLAVE

[Section 16.1.5.1, "Configuring Multi-Source Replication"](#)

[Section 16.1.2.2, "Creating a User for Replication"](#)

[Section 13.7.1.4, "GRANT Statement"](#)

[Section 4.6.7, "mysqlbinlog — Utility for Processing Binary Log Files"](#)

[Section 6.2.2, "Privileges Provided by MySQL"](#)

[Section 16.3.8, "Setting Up Replication to Use Encrypted Connections"](#)

[Section 13.7.5.2, "SHOW BINLOG EVENTS Statement"](#)

[Section 13.7.5.32, "SHOW RELAYLOG EVENTS Statement"](#)

[Section 13.7.5.33, "SHOW SLAVE HOSTS Statement"](#)

[Section 17.2.1.3, "User Credentials"](#)

## S

[\[index top\]](#)

## SELECT

[Section 6.2, "Access Control and Account Management"](#)

[Section 6.2.6, "Access Control, Stage 2: Request Verification"](#)

[Section 13.7.2.1, "ANALYZE TABLE Statement"](#)

[Section 2.10.3, "Changes in MySQL 5.7"](#)

[Section 13.7.2.3, "CHECKSUM TABLE Statement"](#)

[Section 13.1.16, "CREATE PROCEDURE and CREATE FUNCTION Statements"](#)

[Section 13.1.18.3, "CREATE TABLE ... LIKE Statement"](#)

[Section 13.1.18, "CREATE TABLE Statement"](#)

[Section 13.1.20, "CREATE TRIGGER Statement"](#)

[Section 13.1.21, "CREATE VIEW Statement"](#)

[Section 13.2.2, "DELETE Statement"](#)

[Section 13.7.6.3, "FLUSH Statement"](#)

[Section 13.7.1.4, "GRANT Statement"](#)

[Section 13.2.5, "INSERT Statement"](#)

[Section 13.3.5, "LOCK TABLES and UNLOCK TABLES Statements"](#)

[Section 25.20, "Migrating to Performance Schema System and Status Variable Tables"](#)

[Section 6.4.6.4, "MySQL Enterprise Firewall Reference"](#)

[Section 4.5.4, "mysqldump — A Database Backup Program"](#)

[Section 4.5.6, "mysqlpump — A Database Backup Program"](#)

[Section 21.6.18.2, "NDB Cluster and MySQL Privileges"](#)

[Section 13.7.2.4, "OPTIMIZE TABLE Statement"](#)

[Section 25.11, "Performance Schema General Table Characteristics"](#)

[Section 26.1, "Prerequisites for Using the sys Schema"](#)

[Section 6.2.2, "Privileges Provided by MySQL"](#)

[Section 13.7.2.5, "REPAIR TABLE Statement"](#)

[Section 23.9, "Restrictions on Views"](#)

[Section 5.1.7, "Server System Variables"](#)

[Section 13.7.5.12, "SHOW CREATE USER Statement"](#)

[Section 13.7.5.13, "SHOW CREATE VIEW Statement"](#)

[Section 13.7.5.21, "SHOW GRANTS Statement"](#)

[Section 23.6, "Stored Object Access Control"](#)

[Section 23.4.6, "The Event Scheduler and MySQL Privileges"](#)

[Section 15.7, "The MERGE Storage Engine"](#)

---

Section 25.12.16.4, “The threads Table”  
Section 23.3.1, “Trigger Syntax and Examples”  
Section 13.2.11, “UPDATE Statement”  
Section 21.2.4.2, “What is New in NDB Cluster 7.6”

## SHOW DATABASES

Section 13.7.1.4, “GRANT Statement”  
Section 6.2.2, “Privileges Provided by MySQL”  
Section 5.1.7, “Server System Variables”  
Section 13.7.5.14, “SHOW DATABASES Statement”

## SHOW VIEW

Section 13.8.2, “EXPLAIN Statement”  
Section 13.7.1.4, “GRANT Statement”  
Section 4.5.4, “mysqldump — A Database Backup Program”  
Section 4.5.6, “mysqldump — A Database Backup Program”  
Section 6.2.2, “Privileges Provided by MySQL”  
Section 23.9, “Restrictions on Views”  
Section 13.7.5.13, “SHOW CREATE VIEW Statement”  
Section 24.3.31, “The INFORMATION\_SCHEMA VIEWS Table”

## SHUTDOWN

Section 6.2.6, “Access Control, Stage 2: Request Verification”  
Section 13.7.1.4, “GRANT Statement”  
Section 6.2.3, “Grant Tables”  
Section 4.3.4, “mysqld\_multi — Manage Multiple MySQL Servers”  
Section 6.2.2, “Privileges Provided by MySQL”  
Section 16.1.3.4, “Setting Up Replication Using GTIDs”  
Section 13.7.6.7, “SHUTDOWN Statement”  
Section 5.1.16, “The Server Shutdown Process”  
Section 4.10, “Unix Signal Handling in MySQL”

## SUPER

Section 13.7.1, “Account Management Statements”  
Section 13.1.3, “ALTER FUNCTION Statement”  
Section 13.1.4, “ALTER INSTANCE Statement”  
Section 13.1.7, “ALTER SERVER Statement”  
Section 13.7.1.1, “ALTER USER Statement”  
Section 13.1.10, “ALTER VIEW Statement”  
Section 6.2.10, “Assigning Account Passwords”  
Section 6.4.5.7, “Audit Log Filtering”  
Section 6.4.5.11, “Audit Log Reference”  
Section 16.1.6.4, “Binary Logging Options and Variables”  
Section 13.7.6.1, “BINLOG Statement”  
Section 13.4.2.1, “CHANGE MASTER TO Statement”  
Section 13.4.2.2, “CHANGE REPLICATION FILTER Statement”  
Section 10.5, “Configuring Application Character Set and Collation”  
Section 5.1.11.1, “Connection Interfaces”  
Section 13.1.16, “CREATE PROCEDURE and CREATE FUNCTION Statements”  
Section 13.1.17, “CREATE SERVER Statement”  
Section 13.1.20, “CREATE TRIGGER Statement”  
Section 13.7.1.2, “CREATE USER Statement”  
Section 6.4.5.9, “Disabling Audit Logging”

---

Section 5.1.11.2, “DNS Lookups and the Host Cache”  
Section 13.1.28, “DROP SERVER Statement”  
Section 13.7.1.3, “DROP USER Statement”  
Section 12.13, “Encryption and Compression Functions”  
Section 13.7.1.4, “GRANT Statement”  
Section 14.14, “InnoDB Data-at-Rest Encryption”  
Section 13.7.6.4, “KILL Statement”  
Section 6.1.3, “Making MySQL Secure Against Attackers”  
Section 6.4.4.7, “Migrating Keys Between Keyring Keystores”  
Section A.4, “MySQL 5.7 FAQ: Stored Procedures and Functions”  
Section 6.5.1, “MySQL Enterprise Data Masking and De-Identification Elements”  
Section 6.5.5, “MySQL Enterprise Data Masking and De-Identification Function Descriptions”  
Section 6.4.6.4, “MySQL Enterprise Firewall Reference”  
Section 5.1.13, “MySQL Server Time Zone Support”  
Section 4.5.2, “mysqladmin — A MySQL Server Administration Program”  
Section 6.4.4.9, “Plugin-Specific Keyring Key-Management Functions”  
Section 6.2.2, “Privileges Provided by MySQL”  
Section 13.7.1.5, “RENAME USER Statement”  
Section 13.7.1.6, “REVOKE Statement”  
Section 16.3.9.2, “Semisynchronous Replication Installation and Configuration”  
Section 5.1.10, “Server SQL Modes”  
Section 5.1.7, “Server System Variables”  
Section 13.7.1.7, “SET PASSWORD Statement”  
Section 13.3.6, “SET TRANSACTION Statement”  
Section 16.1.2, “Setting Up Binary Log File Position Based Replication”  
Section 16.1.3.4, “Setting Up Replication Using GTIDs”  
Section 13.7.5.1, “SHOW BINARY LOGS Statement”  
Section 13.7.5.23, “SHOW MASTER STATUS Statement”  
Section 13.7.5.29, “SHOW PROCESSLIST Statement”  
Section 13.7.5.34, “SHOW SLAVE STATUS Statement”  
Section 13.4.3.1, “START GROUP\_REPLICATION Statement”  
Section 13.4.2.5, “START SLAVE Statement”  
Section 13.3.1, “START TRANSACTION, COMMIT, and ROLLBACK Statements”  
Section 13.4.3.2, “STOP GROUP\_REPLICATION Statement”  
Section 13.4.2.6, “STOP SLAVE Statement”  
Section 23.6, “Stored Object Access Control”  
Section 23.7, “Stored Program Binary Logging”  
Section 5.1.8.1, “System Variable Privileges”  
Section 26.4.4.2, “The diagnostics() Procedure”  
Section B.3.2.5, “Too many connections”  
Section 6.4.6.3, “Using MySQL Enterprise Firewall”  
Section 5.5.5.3, “Using Version Tokens”  
Section 5.5.5.1, “Version Tokens Elements”  
Section 5.5.5.4, “Version Tokens Reference”

## **SYSTEM\_USER**

Section 25.12.16.3, “The processlist Table”

## **T**

[\[index top\]](#)

## **TRIGGER**

Section 13.1.20, “CREATE TRIGGER Statement”

---

[Section 13.1.31, “DROP TRIGGER Statement”](#)  
[Section 13.7.1.4, “GRANT Statement”](#)  
[Section 4.5.4, “mysqldump — A Database Backup Program”](#)  
[Section 4.5.6, “mysqlpump — A Database Backup Program”](#)  
[Section 6.2.2, “Privileges Provided by MySQL”](#)  
[Section 13.7.5.11, “SHOW CREATE TRIGGER Statement”](#)  
[Section 13.7.5.38, “SHOW TRIGGERS Statement”](#)  
[Section 24.3.29, “The INFORMATION\\_SCHEMA TRIGGERS Table”](#)

## U

[\[index top\]](#)

## UPDATE

[Section 13.7.1.1, “ALTER USER Statement”](#)  
[Section 6.2.10, “Assigning Account Passwords”](#)  
[Section 2.10.3, “Changes in MySQL 5.7”](#)  
[Section 13.1.18, “CREATE TABLE Statement”](#)  
[Section 13.1.20, “CREATE TRIGGER Statement”](#)  
[Section 13.7.1.4, “GRANT Statement”](#)  
[Section 13.2.5, “INSERT Statement”](#)  
[Section 21.6.18.2, “NDB Cluster and MySQL Privileges”](#)  
[Section 25.11, “Performance Schema General Table Characteristics”](#)  
[Section 25.4, “Performance Schema Runtime Configuration”](#)  
[Section 25.12.2, “Performance Schema Setup Tables”](#)  
[Section 26.1, “Prerequisites for Using the sys Schema”](#)  
[Section 6.2.2, “Privileges Provided by MySQL”](#)  
[Section 13.7.1.5, “RENAME USER Statement”](#)  
[Section 13.7.1.6, “REVOKE Statement”](#)  
[Section 13.7.1.7, “SET PASSWORD Statement”](#)  
[Section 23.6, “Stored Object Access Control”](#)  
[Section 15.7, “The MERGE Storage Engine”](#)  
[Section 25.12.2.4, “The setup\\_objects Table”](#)  
[Section 23.3.1, “Trigger Syntax and Examples”](#)  
[Section 13.2.11, “UPDATE Statement”](#)

## USAGE

[Section 13.7.1.4, “GRANT Statement”](#)  
[Section 6.2.2, “Privileges Provided by MySQL”](#)

## X

[\[index top\]](#)

## XA\_RECOVER\_ADMIN

[Section 5.1.7, “Server System Variables”](#)

## SQL Modes Index

[A](#) | [D](#) | [E](#) | [H](#) | [I](#) | [M](#) | [N](#) | [O](#) | [P](#) | [R](#) | [S](#) | [T](#)

## A

[\[index top\]](#)

---

## **ALLOW\_INVALID\_DATES**

[Section 11.2, “Date and Time Data Types”](#)

[Section 12.7, “Date and Time Functions”](#)

[Section B.3.4.2, “Problems Using DATE Columns”](#)

[Section 5.1.10, “Server SQL Modes”](#)

[Section 11.2.2, “The DATE, DATETIME, and TIMESTAMP Types”](#)

## **ANSI**

[Section 2.10.3, “Changes in MySQL 5.7”](#)

[Section 9.2.5, “Function Name Parsing and Resolution”](#)

[Section 5.1.10, “Server SQL Modes”](#)

[Section 13.7.5.13, “SHOW CREATE VIEW Statement”](#)

[Section 24.3.31, “The INFORMATION\\_SCHEMA VIEWS Table”](#)

## **ANSI\_QUOTES**

[Section 13.1.18.5, “FOREIGN KEY Constraints”](#)

[Section 4.5.1.6, “mysql Client Tips”](#)

[Section 1.6.1, “MySQL Extensions to Standard SQL”](#)

[Section 4.5.4, “mysqldump — A Database Backup Program”](#)

[Section 8.9.3, “Optimizer Hints”](#)

[Section 9.2, “Schema Object Names”](#)

[Section 5.1.10, “Server SQL Modes”](#)

[Section 9.1.1, “String Literals”](#)

## **D**

[\[index top\]](#)

## **DB2**

[Section 5.1.10, “Server SQL Modes”](#)

[Section 1.3, “What Is New in MySQL 5.7”](#)

## **E**

[\[index top\]](#)

## **ERROR\_FOR\_DIVISION\_BY\_ZERO**

[Section 12.21.3, “Expression Handling”](#)

[Section A.3, “MySQL 5.7 FAQ: Server SQL Mode”](#)

[Section 12.21.5, “Precision Math Examples”](#)

[Section 5.1.10, “Server SQL Modes”](#)

[Section 1.3, “What Is New in MySQL 5.7”](#)

## **H**

[\[index top\]](#)

## **HIGH\_NOT\_PRECEDENCE**

[Section 9.5, “Expressions”](#)

[Section 12.4.1, “Operator Precedence”](#)

[Section 5.1.10, “Server SQL Modes”](#)

---

## I

[\[index top\]](#)

### **IGNORE\_SPACE**

Section 13.1.16, “CREATE PROCEDURE and CREATE FUNCTION Statements”

Section 9.2.5, “Function Name Parsing and Resolution”

Section 4.5.1.1, “mysql Client Options”

Section 5.1.10, “Server SQL Modes”

## M

[\[index top\]](#)

### **MAXDB**

Section 11.2.1, “Date and Time Data Type Syntax”

Section 5.1.10, “Server SQL Modes”

Section 11.2.2, “The DATE, DATETIME, and TIMESTAMP Types”

Section 1.3, “What Is New in MySQL 5.7”

### **MSSQL**

Section 5.1.10, “Server SQL Modes”

Section 1.3, “What Is New in MySQL 5.7”

### **MYSQL323**

Section 5.1.10, “Server SQL Modes”

Section 1.3, “What Is New in MySQL 5.7”

### **MYSQL40**

Section 5.1.10, “Server SQL Modes”

Section 1.3, “What Is New in MySQL 5.7”

## N

[\[index top\]](#)

### **NO\_AUTO\_CREATE\_USER**

Section 13.7.1.4, “GRANT Statement”

Section A.3, “MySQL 5.7 FAQ: Server SQL Mode”

Section 5.1.10, “Server SQL Modes”

Section 1.3, “What Is New in MySQL 5.7”

### **NO\_AUTO\_VALUE\_ON\_ZERO**

Section 13.1.18, “CREATE TABLE Statement”

Section 11.1.6, “Numeric Type Attributes”

Section 5.1.10, “Server SQL Modes”

Section 3.6.9, “Using AUTO\_INCREMENT”

### **NO\_BACKSLASH\_ESCAPES**

Section 12.17.4, “Functions That Modify JSON Values”

Section 12.8.2, “Regular Expressions”

Section 5.1.10, “Server SQL Modes”

Section 12.8.1, “String Comparison Functions and Operators”



---

Section 9.1.1, “String Literals”  
Section 11.5, “The JSON Data Type”

## **NO\_DIR\_IN\_CREATE**

Section 13.1.18, “CREATE TABLE Statement”  
Section 16.4.1.11, “Replication and DIRECTORY Table Options”  
Section 16.4.1.37, “Replication and Variables”  
Section 5.1.10, “Server SQL Modes”  
Section 22.2.6, “Subpartitioning”  
Section 5.4.4, “The Binary Log”

## **NO\_ENGINE\_SUBSTITUTION**

Section 13.1.8, “ALTER TABLE Statement”  
Section 2.10.3, “Changes in MySQL 5.7”  
Section 13.1.18, “CREATE TABLE Statement”  
Section 5.5.1, “Installing and Uninstalling Plugins”  
Section A.3, “MySQL 5.7 FAQ: Server SQL Mode”  
Section 5.1.10, “Server SQL Modes”  
Section 15.1, “Setting the Storage Engine”  
Section 16.3.3, “Using Replication with Different Source and Replica Storage Engines”  
Section 1.3, “What Is New in MySQL 5.7”

## **NO\_FIELD\_OPTIONS**

Section 5.1.10, “Server SQL Modes”  
Section 1.3, “What Is New in MySQL 5.7”

## **NO\_KEY\_OPTIONS**

Section 5.1.10, “Server SQL Modes”  
Section 1.3, “What Is New in MySQL 5.7”

## **NO\_TABLE\_OPTIONS**

Section 5.1.10, “Server SQL Modes”  
Section 1.3, “What Is New in MySQL 5.7”

## **NO\_UNSIGNED\_SUBTRACTION**

Section 12.6.1, “Arithmetic Operators”  
Section 12.10, “Cast Functions and Operators”  
Section 11.1.1, “Numeric Data Type Syntax”  
Section 11.1.7, “Out-of-Range and Overflow Handling”  
Section 22.6, “Restrictions and Limitations on Partitioning”  
Section 5.1.10, “Server SQL Modes”

## **NO\_ZERO\_DATE**

Section 11.2.6, “Automatic Initialization and Updating for TIMESTAMP and DATETIME”  
Section 12.10, “Cast Functions and Operators”  
Section 13.1.18, “CREATE TABLE Statement”  
Section 11.2, “Date and Time Data Types”  
Section 12.7, “Date and Time Functions”  
Section 13.2.6, “LOAD DATA Statement”  
Section A.3, “MySQL 5.7 FAQ: Server SQL Mode”  
Section B.3.4.2, “Problems Using DATE Columns”  
Section 5.1.10, “Server SQL Modes”

---

[Section 5.1.7, “Server System Variables”](#)  
[Section 11.2.2, “The DATE, DATETIME, and TIMESTAMP Types”](#)  
[Section 1.3, “What Is New in MySQL 5.7”](#)

## **NO\_ZERO\_IN\_DATE**

[Section 13.1.18, “CREATE TABLE Statement”](#)  
[Section 11.2, “Date and Time Data Types”](#)  
[Section 13.2.6, “LOAD DATA Statement”](#)  
[Section A.3, “MySQL 5.7 FAQ: Server SQL Mode”](#)  
[Section B.3.4.2, “Problems Using DATE Columns”](#)  
[Section 5.1.10, “Server SQL Modes”](#)  
[Section 1.3, “What Is New in MySQL 5.7”](#)

## **O**

[\[index top\]](#)

## **ONLY\_FULL\_GROUP\_BY**

[Section 2.10.3, “Changes in MySQL 5.7”](#)  
[Section 3.3.4.8, “Counting Rows”](#)  
[Section 12.19.2, “GROUP BY Modifiers”](#)  
[Section 12.20, “Miscellaneous Functions”](#)  
[Section A.3, “MySQL 5.7 FAQ: Server SQL Mode”](#)  
[Section 12.19.3, “MySQL Handling of GROUP BY”](#)  
[Section 5.1.10, “Server SQL Modes”](#)  
[Section 1.3, “What Is New in MySQL 5.7”](#)

## **ORACLE**

[Section 5.1.10, “Server SQL Modes”](#)  
[Section 1.3, “What Is New in MySQL 5.7”](#)

## **P**

[\[index top\]](#)

## **PAD\_CHAR\_TO\_FULL\_LENGTH**

[Section 5.1.10, “Server SQL Modes”](#)  
[Section 11.3.1, “String Data Type Syntax”](#)  
[Section 11.3.2, “The CHAR and VARCHAR Types”](#)

## **PIPES\_AS\_CONCAT**

[Section 9.5, “Expressions”](#)  
[Section 12.4.3, “Logical Operators”](#)  
[Section 12.4.1, “Operator Precedence”](#)  
[Section 5.1.10, “Server SQL Modes”](#)

## **POSTGRESQL**

[Section 5.1.10, “Server SQL Modes”](#)  
[Section 1.3, “What Is New in MySQL 5.7”](#)

## **R**

[\[index top\]](#)

---

## REAL\_AS\_FLOAT

[Section 11.1.1, “Numeric Data Type Syntax”](#)  
[Section 11.1, “Numeric Data Types”](#)  
[Section 5.1.10, “Server SQL Modes”](#)

## S

[\[index top\]](#)

## STRICT\_ALL\_TABLES

[Section 1.6.3.3, “Constraints on Invalid Data”](#)  
[Section 12.21.3, “Expression Handling”](#)  
[Section A.3, “MySQL 5.7 FAQ: Server SQL Mode”](#)  
[Section 5.1.10, “Server SQL Modes”](#)  
[Section 16.4.3, “Upgrading a Replication Topology”](#)

## STRICT\_TRANS\_TABLES

[Section 2.10.3, “Changes in MySQL 5.7”](#)  
[Section 1.6.3.3, “Constraints on Invalid Data”](#)  
[Section 12.21.3, “Expression Handling”](#)  
[Section A.3, “MySQL 5.7 FAQ: Server SQL Mode”](#)  
[Section 5.1.10, “Server SQL Modes”](#)  
[Section 16.4.3, “Upgrading a Replication Topology”](#)  
[Section 1.3, “What Is New in MySQL 5.7”](#)

## T

[\[index top\]](#)

## TRADITIONAL

[Section 11.2.6, “Automatic Initialization and Updating for TIMESTAMP and DATETIME”](#)  
[Section 12.21.3, “Expression Handling”](#)  
[Section A.3, “MySQL 5.7 FAQ: Server SQL Mode”](#)  
[Section 5.1.10, “Server SQL Modes”](#)  
[Section 5.1.7, “Server System Variables”](#)

## Statement/Syntax Index

[A](#) | [B](#) | [C](#) | [D](#) | [E](#) | [F](#) | [G](#) | [H](#) | [I](#) | [K](#) | [L](#) | [O](#) | [P](#) | [R](#) | [S](#) | [T](#) | [U](#) | [W](#) | [X](#)

## A

[\[index top\]](#)

## ADD PARTITION

[Section 14.13.1, “Online DDL Operations”](#)

## ALTER DATABASE

[Section 13.1.1, “ALTER DATABASE Statement”](#)  
[Section 10.5, “Configuring Application Character Set and Collation”](#)  
[Section 10.3.3, “Database Character Set and Collation”](#)  
[Section 16.2.5.1, “Evaluation of Database-Level Replication and Binary Logging Options”](#)  
[Section 16.2.5, “How Servers Evaluate Replication Filtering Rules”](#)

---

[Section 9.2.4, “Mapping of Identifiers to File Names”](#)  
[Section 1.6.1, “MySQL Extensions to Standard SQL”](#)  
[Section 4.6.7, “mysqlbinlog — Utility for Processing Binary Log Files”](#)  
[Section 4.5.4, “mysqldump — A Database Backup Program”](#)  
[Section 16.1.6.3, “Replica Server Options and Variables”](#)  
[Section 1.3, “What Is New in MySQL 5.7”](#)

## **ALTER DATABASE ... UPGRADE DATA DIRECTORY NAME**

[Section 13.3.3, “Statements That Cause an Implicit Commit”](#)

## **ALTER EVENT**

[Section 13.1.2, “ALTER EVENT Statement”](#)  
[Section 13.1.12, “CREATE EVENT Statement”](#)  
[Section 23.4.4, “Event Metadata”](#)  
[Section 23.4.1, “Event Scheduler Overview”](#)  
[Section 23.4.3, “Event Syntax”](#)  
[Section 12.15, “Information Functions”](#)  
[Section 16.4.1.8, “Replication of CURRENT\\_USER\(\)”](#)  
[Section 16.4.1.16, “Replication of Invoked Features”](#)  
[Section 23.8, “Restrictions on Stored Programs”](#)  
[Section 13.7.5.18, “SHOW EVENTS Statement”](#)  
[Section 13.3.3, “Statements That Cause an Implicit Commit”](#)  
[Section 23.6, “Stored Object Access Control”](#)  
[Section 23.7, “Stored Program Binary Logging”](#)  
[Section 23.4.6, “The Event Scheduler and MySQL Privileges”](#)  
[Section 24.3.8, “The INFORMATION\\_SCHEMA EVENTS Table”](#)

## **ALTER EVENT event\_name ENABLE**

[Section 16.4.1.16, “Replication of Invoked Features”](#)

## **ALTER FUNCTION**

[Section 13.1.3, “ALTER FUNCTION Statement”](#)  
[Section 13.3.3, “Statements That Cause an Implicit Commit”](#)  
[Section 23.7, “Stored Program Binary Logging”](#)  
[Section 23.2.1, “Stored Routine Syntax”](#)

## **ALTER IGNORE TABLE**

[Section 22.3.4, “Maintenance of Partitions”](#)

## **ALTER INSTANCE ROTATE INNODB MASTER KEY**

[Section 14.14, “InnoDB Data-at-Rest Encryption”](#)  
[Section A.17, “MySQL 5.7 FAQ: InnoDB Data-at-Rest Encryption”](#)

## **ALTER LOGFILE GROUP**

[Section 13.1.5, “ALTER LOGFILE GROUP Statement”](#)  
[Section 21.4.3.6, “Defining NDB Cluster Data Nodes”](#)  
[Section 21.2.7.8, “Issues Exclusive to NDB Cluster”](#)  
[Section 21.6.11.1, “NDB Cluster Disk Data Objects”](#)  
[Section 24.3.9, “The INFORMATION\\_SCHEMA FILES Table”](#)

## **ALTER PROCEDURE**

[Section 13.1.6, “ALTER PROCEDURE Statement”](#)  
[Section 13.3.3, “Statements That Cause an Implicit Commit”](#)

---

Section 23.7, “Stored Program Binary Logging”  
Section 23.2.1, “Stored Routine Syntax”

## **ALTER SCHEMA**

Section 13.1.1, “ALTER DATABASE Statement”

## **ALTER SERVER**

Section 16.1.6.5, “Global Transaction ID System Variables”  
Section 6.2.2, “Privileges Provided by MySQL”  
Section 16.4.1.7, “Replication of CREATE SERVER, ALTER SERVER, and DROP SERVER”  
Section 13.3.3, “Statements That Cause an Implicit Commit”

## **ALTER TABLE**

Section 11.2.5, “2-Digit YEAR(2) Limitations and Migrating to 4-Digit YEAR”  
Section 21.6.7.3, “Adding NDB Cluster Data Nodes Online: Detailed Example”  
Section 13.1.8.2, “ALTER TABLE and Generated Columns”  
Section 13.1.8.3, “ALTER TABLE Examples”  
Section 13.1.8.1, “ALTER TABLE Partition Operations”  
Section 13.1.8, “ALTER TABLE Statement”  
Section 14.6.1.6, “AUTO\_INCREMENT Handling in InnoDB”  
Section 16.1.6.4, “Binary Logging Options and Variables”  
Section 13.7.2.2, “CHECK TABLE Statement”  
Section 10.3.5, “Column Character Set and Collation”  
Section 10.7, “Column Character Set Conversion”  
Section 8.3.4, “Column Indexes”  
Section 14.8.11, “Configuring Optimizer Statistics for InnoDB”  
Configuring Optimizer Statistics Parameters for Individual Tables  
Section 14.8.12, “Configuring the Merge Threshold for Index Pages”  
Section 14.7.2.3, “Consistent Nonlocking Reads”  
Section 14.21.5.4, “Controlling Transactional Behavior of the InnoDB memcached Plugin”  
Section 10.9.8, “Converting Between 3-Byte and 4-Byte Unicode Character Sets”  
Section 14.6.1.5, “Converting Tables from MyISAM to InnoDB”  
Section 13.1.14, “CREATE INDEX Statement”  
Section 13.1.18, “CREATE TABLE Statement”  
Section 3.3.2, “Creating a Table”  
Section 14.9.1.2, “Creating Compressed Tables”  
Section 14.6.1.1, “Creating InnoDB Tables”  
Section 11.4.5, “Creating Spatial Columns”  
Section 11.4.9, “Creating Spatial Indexes”  
Section 14.6.1.2, “Creating Tables Externally”  
Section 21.4.3.6, “Defining NDB Cluster Data Nodes”  
Section 14.12.4, “Defragmenting a Table”  
Section 13.1.25, “DROP INDEX Statement”  
Section 14.10.1, “Enabling File Formats”  
Section 14.8.11.3, “Estimating ANALYZE TABLE Complexity for InnoDB Tables”  
Section 22.3.3, “Exchanging Partitions and Subpartitions with Tables”  
Section 8.8.2, “EXPLAIN Output Format”  
Section 15.8.3, “FEDERATED Storage Engine Notes and Tips”  
Section 14.6.3.2, “File-Per-Table Tablespace”  
Section 12.9.6, “Fine-Tuning MySQL Full-Text Search”  
Section 14.22.2, “Forcing InnoDB Recovery”  
Section 1.6.3.2, “FOREIGN KEY Constraints”  
Section 13.1.18.5, “FOREIGN KEY Constraints”

---

Section 12.9, “Full-Text Search Functions”  
Section 14.6.3.3, “General Tablespaces”  
Section 8.14.3, “General Thread States”  
Section 13.7.1.4, “GRANT Statement”  
Section 14.9.1.5, “How Compression Works for InnoDB Tables”  
Section B.3.3.4, “How MySQL Handles a Full Disk”  
Section 8.10.3.1, “How the Query Cache Operates”  
Section 7.6.3, “How to Repair MyISAM Tables”  
Section 12.15, “Information Functions”  
Section 21.3.3, “Initial Configuration of NDB Cluster”  
Section 8.3.7, “InnoDB and MyISAM Index Statistics Collection”  
Section 14.13, “InnoDB and Online DDL”  
Section 14.14, “InnoDB Data-at-Rest Encryption”  
Section 14.6.2.4, “InnoDB Full-Text Indexes”  
Section 14.17, “InnoDB Integration with MySQL Performance Schema”  
Section 14.9.2, “InnoDB Page Compression”  
Section 14.11, “InnoDB Row Formats”  
Section 14.15, “InnoDB Startup Options and System Variables”  
Section 14.9.1, “InnoDB Table Compression”  
Section 21.2.7.8, “Issues Exclusive to NDB Cluster”  
Section 13.7.6.4, “KILL Statement”  
Section B.3.7, “Known Issues in MySQL”  
Section 21.2.7.10, “Limitations Relating to Multiple NDB Cluster Nodes”  
Section 21.2.7.2, “Limits and Differences of NDB Cluster from Standard MySQL Limits”  
Section 8.4.6, “Limits on Table Size”  
Section 21.2.7.3, “Limits Relating to Transaction Handling in NDB Cluster”  
Section 13.3.5, “LOCK TABLES and UNLOCK TABLES Statements”  
Section 22.3.4, “Maintenance of Partitions”  
Section 22.3.2, “Management of HASH and KEY Partitions”  
Section 22.3.1, “Management of RANGE and LIST Partitions”  
Section 12.9.9, “MeCab Full-Text Parser Plugin”  
Section 15.7.2, “MERGE Table Problems”  
Section 14.17.1, “Monitoring ALTER TABLE Progress for InnoDB Tables Using Performance Schema”  
Section 14.6.1.4, “Moving or Copying InnoDB Tables”  
Section 15.2.1, “MyISAM Startup Options”  
Section 15.2.3, “MyISAM Table Storage Formats”  
Section 4.6.3.1, “myisamchk General Options”  
Section A.10, “MySQL 5.7 FAQ: NDB Cluster”  
Section 1.6.1, “MySQL Extensions to Standard SQL”  
MySQL Glossary  
MySQL Server Options for NDB Cluster  
Section 4.5.4, “mysqldump — A Database Backup Program”  
Section 4.5.6, “mysqldump — A Database Backup Program”  
Section 21.4.3.1, “NDB Cluster Configuration: Basic Example”  
Section 21.6.11.1, “NDB Cluster Disk Data Objects”  
Section 21.3.5, “NDB Cluster Example with Tables and Data”  
Section 21.7.4, “NDB Cluster Replication Schema and Tables”  
NDB Cluster System Variables  
Section 21.5.10, “ndb\_desc — Describe NDB Tables”  
Section 21.5.24, “ndb\_restore — Restore an NDB Cluster Backup”  
Section 12.9.8, “ngram Full-Text Parser”  
Section 21.2.7.1, “Noncompliance with SQL Syntax in NDB Cluster”  
Section 14.13.5, “Online DDL Failure Conditions”  
Section 14.13.6, “Online DDL Limitations”

---

Section 14.13.1, “Online DDL Operations”  
Section 14.13.2, “Online DDL Performance and Concurrency”  
Section 21.6.12, “Online Operations with ALTER TABLE in NDB Cluster”  
Section 13.7.2.4, “OPTIMIZE TABLE Statement”  
Section 8.4.1, “Optimizing Data Size”  
Section 11.1.7, “Out-of-Range and Overflow Handling”  
Section 22.1, “Overview of Partitioning in MySQL”  
Section 14.9.1.1, “Overview of Table Compression”  
Section 22.3, “Partition Management”  
Section 22.6.4, “Partitioning and Locking”  
Section 22.6.1, “Partitioning Keys, Primary Keys, and Unique Keys”  
Section 22.6.2, “Partitioning Limitations Relating to Storage Engines”  
Section 25.12.5, “Performance Schema Stage Event Tables”  
Section 6.2.2, “Privileges Provided by MySQL”  
Section B.3.6.1, “Problems with ALTER TABLE”  
Section 22.2.3.1, “RANGE COLUMNS partitioning”  
Section 22.2.1, “RANGE Partitioning”  
Section 2.10.12, “Rebuilding or Repairing Tables or Indexes”  
Section 13.1.33, “RENAME TABLE Statement”  
Section 16.4.1.1, “Replication and AUTO\_INCREMENT”  
Section 16.4.1.25, “Replication and Reserved Words”  
Replication with More Columns on Source or Replica  
Section 22.6, “Restrictions and Limitations on Partitioning”  
Section 23.9, “Restrictions on Views”  
Section 5.4.1, “Selecting General Query Log and Slow Query Log Output Destinations”  
Section 5.1.6, “Server Command Options”  
Section 5.1.10, “Server SQL Modes”  
Section 5.1.7, “Server System Variables”  
Section 13.1.18.9, “Setting NDB Comment Options”  
Section 5.4.4.2, “Setting The Binary Log Format”  
Section 15.1, “Setting the Storage Engine”  
Section 13.7.5.15, “SHOW ENGINE Statement”  
Section 13.7.5.22, “SHOW INDEX Statement”  
Section 13.7.5.40, “SHOW WARNINGS Statement”  
Section 13.1.18.6, “Silent Column Specification Changes”  
Section 14.13.4, “Simplifying DDL Statements with Online DDL”  
Section 14.9.1.7, “SQL Compression Syntax Warnings and Errors”  
Section 13.3.3, “Statements That Cause an Implicit Commit”  
Section 11.3.1, “String Data Type Syntax”  
Section 10.3.4, “Table Character Set and Collation”  
Section B.3.6.2, “TEMPORARY Table Problems”  
Section 24.4.23, “The INFORMATION\_SCHEMA INNODB\_SYS\_TABLES Table”  
Section 24.3.16, “The INFORMATION\_SCHEMA PARTITIONS Table”  
Section 24.3.24, “The INFORMATION\_SCHEMA STATISTICS Table”  
Section 15.3, “The MEMORY Storage Engine”  
Section 15.2, “The MyISAM Storage Engine”  
Section 5.4.5, “The Slow Query Log”  
Section 14.22.3, “Troubleshooting InnoDB Data Dictionary Operations”  
Section 21.2.7.6, “Unsupported or Missing Features in NDB Cluster”  
Section 3.6.9, “Using AUTO\_INCREMENT”  
Section 16.3.3, “Using Replication with Different Source and Replica Storage Engines”  
Section 8.12.3.2, “Using Symbolic Links for MyISAM Tables on Unix”  
Section 14.10.2, “Verifying File Format Compatibility”  
Section 1.3, “What Is New in MySQL 5.7”

---

[Section 21.2.4.1, “What is New in NDB Cluster 7.5”](#)  
[Section B.3.3.3, “What to Do If MySQL Keeps Crashing”](#)

## **ALTER TABLE ... ADD FOREIGN KEY**

[Section 13.1.8, “ALTER TABLE Statement”](#)

## **ALTER TABLE ... ADD PARTITION**

[Section 22.3.1, “Management of RANGE and LIST Partitions”](#)

## **ALTER TABLE ... ALGORITHM=COPY**

[Section 13.1.8, “ALTER TABLE Statement”](#)  
[Section 13.1.18.5, “FOREIGN KEY Constraints”](#)

## **ALTER TABLE ... ALGORITHM=DEFAULT|INPLACE|COPY**

[Section 21.6.12, “Online Operations with ALTER TABLE in NDB Cluster”](#)

## **ALTER TABLE ... ALGORITHM=INPLACE**

[Section 13.1.8, “ALTER TABLE Statement”](#)  
[Section 13.1.18.5, “FOREIGN KEY Constraints”](#)  
[Section 14.13.6, “Online DDL Limitations”](#)  
[Section 1.3, “What Is New in MySQL 5.7”](#)

## **ALTER TABLE ... ALGORITHM=INPLACE ...**

[Section 21.2.4.1, “What is New in NDB Cluster 7.5”](#)

## **ALTER TABLE ... ALGORITHM=INPLACE, REORGANIZE PARTITION**

[Section 21.6.7.2, “Adding NDB Cluster Data Nodes Online: Basic procedure”](#)  
[Section 21.6.7.3, “Adding NDB Cluster Data Nodes Online: Detailed Example”](#)

## **ALTER TABLE ... COMPRESSION**

[Section 14.9.2, “InnoDB Page Compression”](#)

## **ALTER TABLE ... COMPRESSION=None**

[Section 14.9.2, “InnoDB Page Compression”](#)

## **ALTER TABLE ... DISABLE KEYS**

[Section 13.2.6, “LOAD DATA Statement”](#)

## **ALTER TABLE ... DISCARD PARTITION ... TABLESPACE**

[Section 14.6.1.3, “Importing InnoDB Tables”](#)

## **ALTER TABLE ... DISCARD TABLESPACE**

[Section 13.1.19, “CREATE TABLESPACE Statement”](#)  
[Section 14.6.3.3, “General Tablespaces”](#)  
[Section 14.6.1.3, “Importing InnoDB Tables”](#)  
[MySQL Glossary](#)

## **ALTER TABLE ... DROP FOREIGN KEY**

[Section 13.1.8, “ALTER TABLE Statement”](#)

## **ALTER TABLE ... DROP PARTITION**

[Section 16.4.1.23, “Replication and Partitioning”](#)



---

## **ALTER TABLE ... ENABLE KEYS**

[Section 13.2.6, “LOAD DATA Statement”](#)

## **ALTER TABLE ... ENCRYPTION**

[Section 13.1.4, “ALTER INSTANCE Statement”](#)

## **ALTER TABLE ... ENGINE**

[Section 5.1.7, “Server System Variables”](#)

## **ALTER TABLE ... ENGINE = MEMORY**

[Section 16.4.1.20, “Replication and MEMORY Tables”](#)

## **ALTER TABLE ... ENGINE = NDB**

[Section 21.6.13, “Distributed Privileges Using Shared Grant Tables”](#)

## **ALTER TABLE ... ENGINE permitted\_engine**

[Section 5.1.7, “Server System Variables”](#)

## **ALTER TABLE ... ENGINE=INNODB**

[Section 21.7.4, “NDB Cluster Replication Schema and Tables”](#)

[Section 21.3.7.1, “Upgrading and Downgrading NDB 7.5”](#)

[Section 1.3, “What Is New in MySQL 5.7”](#)

[Section 21.2.4.1, “What is New in NDB Cluster 7.5”](#)

## **ALTER TABLE ... ENGINE=NDB**

[Section 21.5.14, “ndb\\_import — Import CSV Data Into NDB”](#)

## **ALTER TABLE ... EXCHANGE PARTITION**

[Section 13.1.8.1, “ALTER TABLE Partition Operations”](#)

[Section 22.3.3, “Exchanging Partitions and Subpartitions with Tables”](#)

[Section 22.6.4, “Partitioning and Locking”](#)

[Section 1.3, “What Is New in MySQL 5.7”](#)

## **ALTER TABLE ... FORCE**

[Section 13.7.2.4, “OPTIMIZE TABLE Statement”](#)

[Section 1.3, “What Is New in MySQL 5.7”](#)

## **ALTER TABLE ... IMPORT PARTITION ... TABLESPACE**

[Section 14.6.1.3, “Importing InnoDB Tables”](#)

## **ALTER TABLE ... IMPORT TABLESPACE**

[Section 14.6.1.3, “Importing InnoDB Tables”](#)

[Section 14.6.1.4, “Moving or Copying InnoDB Tables”](#)

[MySQL Glossary](#)

## **ALTER TABLE ... OPTIMIZE PARTITION**

[Section 22.3.4, “Maintenance of Partitions”](#)

[Section 22.6.2, “Partitioning Limitations Relating to Storage Engines”](#)

## **ALTER TABLE ... PARTITION BY**

[Section 22.6.1, “Partitioning Keys, Primary Keys, and Unique Keys”](#)

---

## **ALTER TABLE ... PARTITION BY ...**

[Section 22.3.1, “Management of RANGE and LIST Partitions”](#)  
[Section 22.6, “Restrictions and Limitations on Partitioning”](#)

## **ALTER TABLE ... RENAME**

[Section 8.12.3.2, “Using Symbolic Links for MyISAM Tables on Unix”](#)

## **ALTER TABLE ... REORGANIZE PARTITION**

[Section 21.6.7.3, “Adding NDB Cluster Data Nodes Online: Detailed Example”](#)  
[Section 21.6.7.1, “Adding NDB Cluster Data Nodes Online: General Issues”](#)  
[Section 21.6.1, “Commands in the NDB Cluster Management Client”](#)

## **ALTER TABLE ... REPAIR PARTITION**

[Section 22.3.3, “Exchanging Partitions and Subpartitions with Tables”](#)  
[Section 22.3.4, “Maintenance of Partitions”](#)

## **ALTER TABLE ... TABLESPACE**

[Section 13.1.19, “CREATE TABLESPACE Statement”](#)  
[Section 14.6.3.2, “File-Per-Table Tablespaces”](#)

## **ALTER TABLE ... TRUNCATE PARTITION**

[Section 22.3.4, “Maintenance of Partitions”](#)  
[Section 22.3, “Partition Management”](#)  
[Section 22.6.4, “Partitioning and Locking”](#)

## **ALTER TABLE ... TRUNCATE PARTITION ALL**

[Section 22.3.4, “Maintenance of Partitions”](#)

## **ALTER TABLE ... UPGRADE PARTITIONING**

[Section 4.4.7, “mysql\\_upgrade — Check and Upgrade MySQL Tables”](#)  
[Section 1.3, “What Is New in MySQL 5.7”](#)

## **ALTER TABLE ...IMPORT TABLESPACE**

[Section 13.1.19, “CREATE TABLESPACE Statement”](#)  
[Section 14.6.3.3, “General Tablespaces”](#)

## **ALTER TABLE EXCHANGE PARTITION**

[Section 22.3.3, “Exchanging Partitions and Subpartitions with Tables”](#)

## **ALTER TABLE mysql.ndb\_apply\_status ENGINE=MyISAM**

[Section 21.7.3, “Known Issues in NDB Cluster Replication”](#)

## **ALTER TABLE t TRUNCATE PARTITION ()**

[Section 13.2.2, “DELETE Statement”](#)

## **ALTER TABLE t3 DROP PARTITION p2**

[Section 5.4.6, “The DDL Log”](#)

## **ALTER TABLE table\_name ENGINE=InnoDB;**

[Section 14.1.4, “Testing and Benchmarking with InnoDB”](#)

---

## **ALTER TABLE table\_name REORGANIZE PARTITION**

[Section 21.6.7.3, “Adding NDB Cluster Data Nodes Online: Detailed Example”](#)

## **ALTER TABLE table\_name UPGRADE PARTITIONING**

[Section 2.10.3, “Changes in MySQL 5.7”](#)

## **ALTER TABLE tbl\_name COMPRESSION='None'**

[Section 2.11.3, “Downgrade Notes”](#)

## **ALTER TABLE tbl\_name ENCRYPTION = 'Y'**

[Section A.17, “MySQL 5.7 FAQ: InnoDB Data-at-Rest Encryption”](#)

## **ALTER TABLE tbl\_name ENGINE=INNODB**

[Section 13.1.8, “ALTER TABLE Statement”](#)

[Section 14.12.4, “Defragmenting a Table”](#)

## **ALTER TABLE tbl\_name FORCE**

[Section 13.1.8, “ALTER TABLE Statement”](#)

[Section 14.12.4, “Defragmenting a Table”](#)

## **ALTER TABLE tbl\_name TABLESPACE tablespace\_name**

[Section 13.1.19, “CREATE TABLESPACE Statement”](#)

[Section 14.6.3.3, “General Tablespaces”](#)

[MySQL Glossary](#)

[Section 1.3, “What Is New in MySQL 5.7”](#)

## **ALTER TABLESPACE**

[Section 13.1.9, “ALTER TABLESPACE Statement”](#)

[Section 13.1.19, “CREATE TABLESPACE Statement”](#)

[Section 21.4.3.6, “Defining NDB Cluster Data Nodes”](#)

[Section 13.1.30, “DROP TABLESPACE Statement”](#)

[Section 14.6.3.3, “General Tablespaces”](#)

[Section 21.2.7.8, “Issues Exclusive to NDB Cluster”](#)

[Section 21.6.11.1, “NDB Cluster Disk Data Objects”](#)

[Section 13.3.3, “Statements That Cause an Implicit Commit”](#)

[Section 24.3.9, “The INFORMATION\\_SCHEMA FILES Table”](#)

## **ALTER TABLESPACE ... ADD DATAFILE**

[Section 13.1.19, “CREATE TABLESPACE Statement”](#)

## **ALTER TABLESPACE ... DROP DATAFILE**

[Section 13.1.30, “DROP TABLESPACE Statement”](#)

## **ALTER TABLESPACE ... DROP DATATFILE**

[Section 13.1.19, “CREATE TABLESPACE Statement”](#)

## **ALTER TABLESPACE ... ENGINE**

[Section 5.1.7, “Server System Variables”](#)

## **ALTER TABLESPACE tablespace\_name ENCRYPTION = 'Y'**

[Section A.17, “MySQL 5.7 FAQ: InnoDB Data-at-Rest Encryption”](#)

---

## ALTER USER

[Section 6.2.5, “Access Control, Stage 1: Connection Verification”](#)  
[Section 6.2.15, “Account Locking”](#)  
[Section 13.7.1.1, “ALTER USER Statement”](#)  
[Section 6.2.10, “Assigning Account Passwords”](#)  
[Section 16.1.6.4, “Binary Logging Options and Variables”](#)  
[Section 4.2.3, “Command Options for Connecting to the Server”](#)  
[Section 6.3.1, “Configuring MySQL to Use Encrypted Connections”](#)  
[Section 6.1.2.1, “End-User Guidelines for Password Security”](#)  
[Section 13.7.1.4, “GRANT Statement”](#)  
[Section 6.2.3, “Grant Tables”](#)  
[Section 2.9.1, “Initializing the Data Directory”](#)  
[Section 6.1.3, “Making MySQL Secure Against Attackers”](#)  
[Section 6.4.1.3, “Migrating Away from Pre-4.1 Password Hashing and the mysql\\_old\\_password Plugin”](#)  
[Section 4.4.7, “mysql\\_upgrade — Check and Upgrade MySQL Tables”](#)  
[Section 6.2.11, “Password Management”](#)  
[Section 6.4.3.2, “Password Validation Plugin Options and Variables”](#)  
[Section 6.2.2, “Privileges Provided by MySQL”](#)  
[Section 6.2.14, “Proxy Users”](#)  
[Resetting the Root Password: Generic Instructions](#)  
[Resetting the Root Password: Unix and Unix-Like Systems](#)  
[Resetting the Root Password: Windows Systems](#)  
[Section 6.2.12, “Server Handling of Expired Passwords”](#)  
[Section 5.1.7, “Server System Variables”](#)  
[Section 13.7.1.7, “SET PASSWORD Statement”](#)  
[Section 6.2.16, “Setting Account Resource Limits”](#)  
[Section 6.4.1.11, “Socket Peer-Credential Pluggable Authentication”](#)  
[Section 13.3.3, “Statements That Cause an Implicit Commit”](#)  
[Section 6.4.3, “The Password Validation Plugin”](#)  
[Section 1.3, “What Is New in MySQL 5.7”](#)

## ALTER VIEW

[Section 13.1.10, “ALTER VIEW Statement”](#)  
[Section 12.15, “Information Functions”](#)  
[Section 16.4.1.8, “Replication of CURRENT\\_USER\(\)”](#)  
[Section 23.8, “Restrictions on Stored Programs”](#)  
[Section 13.3.3, “Statements That Cause an Implicit Commit”](#)  
[Section 23.6, “Stored Object Access Control”](#)  
[Section 23.5.2, “View Processing Algorithms”](#)  
[Section 23.5.1, “View Syntax”](#)

## ANALYZE PARTITION

[Section 14.13.1, “Online DDL Operations”](#)

## ANALYZE TABLE

[Section 13.1.8, “ALTER TABLE Statement”](#)  
[Section 13.7.2.1, “ANALYZE TABLE Statement”](#)  
[Configuring Automatic Statistics Calculation for Persistent Optimizer Statistics](#)  
[Section 14.8.11.2, “Configuring Non-Persistent Optimizer Statistics Parameters”](#)  
[Section 14.8.11, “Configuring Optimizer Statistics for InnoDB”](#)  
[Configuring Optimizer Statistics Parameters for Individual Tables](#)  
[Configuring the Number of Sampled Pages for InnoDB Optimizer Statistics](#)  
[Section 13.1.14, “CREATE INDEX Statement”](#)

---

Section 13.1.18, “CREATE TABLE Statement”  
Section 14.8.11.3, “Estimating ANALYZE TABLE Complexity for InnoDB Tables”  
Section 8.8.2, “EXPLAIN Output Format”  
Section 13.8.2, “EXPLAIN Statement”  
Section 12.9.6, “Fine-Tuning MySQL Full-Text Search”  
Section 8.14.3, “General Thread States”  
Section 16.1.6.5, “Global Transaction ID System Variables”  
Including Delete-marked Records in Persistent Statistics Calculations  
Section 8.3.7, “InnoDB and MyISAM Index Statistics Collection”  
InnoDB Persistent Statistics Tables  
InnoDB Persistent Statistics Tables Example  
Section 14.15, “InnoDB Startup Options and System Variables”  
Section 22.3.4, “Maintenance of Partitions”  
Section 15.7.2, “MERGE Table Problems”  
Section 7.6, “MyISAM Table Maintenance and Crash Recovery”  
Section 4.6.3.1, “myisamchk General Options”  
Section 1.6.1, “MySQL Extensions to Standard SQL”  
MySQL Glossary  
Section 4.5.3, “mysqlcheck — A Table Maintenance Program”  
Section 21.5.15, “ndb\_index\_stat — NDB Index Statistics Utility”  
Section 8.6.1, “Optimizing MyISAM Queries”  
Section 8.8.1, “Optimizing Queries with EXPLAIN”  
Section 8.2.1, “Optimizing SELECT Statements”  
Section 6.2.2, “Privileges Provided by MySQL”  
Section 8.2.1.2, “Range Optimization”  
Section 16.4.1.14, “Replication and FLUSH”  
Section 22.6, “Restrictions and Limitations on Partitioning”  
Section 5.1.7, “Server System Variables”  
Section 13.7.5.22, “SHOW INDEX Statement”  
Section 13.3.3, “Statements That Cause an Implicit Commit”  
Section 24.4.25, “The INFORMATION\_SCHEMA INNODB\_SYS\_TABLESTATS View”  
Section 24.3.24, “The INFORMATION\_SCHEMA STATISTICS Table”  
Section 5.4.5, “The Slow Query Log”

## B

[[index top](#)]

### BEGIN

Section 14.7.2.2, “autocommit, Commit, and Rollback”  
Section 13.6.1, “BEGIN ... END Compound Statement”  
Section 21.7.11, “NDB Cluster Replication Conflict Resolution”  
Section 25.12.7, “Performance Schema Transaction Tables”  
Section 16.1.6.3, “Replica Server Options and Variables”  
Section 16.4.1.33, “Replication and Transactions”  
Section 23.8, “Restrictions on Stored Programs”  
Section 5.1.7, “Server System Variables”  
Section 13.3.3, “Statements That Cause an Implicit Commit”  
Section 23.7, “Stored Program Binary Logging”  
Section 25.12.7.1, “The events\_transactions\_current Table”

### BEGIN ... END

Section 13.6.1, “BEGIN ... END Compound Statement”

---

Section 13.6.5.1, “CASE Statement”  
Section 13.6, “Compound Statements”  
Section 13.1.20, “CREATE TRIGGER Statement”  
Section 13.6.6.1, “Cursor CLOSE Statement”  
Section 13.6.6.3, “Cursor FETCH Statement”  
Section 13.6.7.2, “DECLARE ... HANDLER Statement”  
Section 13.6.3, “DECLARE Statement”  
Section 23.1, “Defining Stored Programs”  
Section 23.4.1, “Event Scheduler Overview”  
Section 13.6.5.4, “LEAVE Statement”  
Section 13.6.4.1, “Local Variable DECLARE Statement”  
Section 13.6.4.2, “Local Variable Scope and Resolution”  
Section 23.8, “Restrictions on Stored Programs”  
Section 13.6.7.6, “Scope Rules for Handlers”  
Section 13.3.1, “START TRANSACTION, COMMIT, and ROLLBACK Statements”  
Section 13.6.2, “Statement Labels”  
Section 13.3.3, “Statements That Cause an Implicit Commit”  
Section 23.3.1, “Trigger Syntax and Examples”

## **BINLOG**

Section 13.7.6.1, “BINLOG Statement”  
Section 4.6.7.2, “mysqlbinlog Row Event Display”  
Section 4.6.7, “mysqlbinlog — Utility for Processing Binary Log Files”  
Section 6.2.2, “Privileges Provided by MySQL”  
Section 5.1.7, “Server System Variables”

## **C**

[[index top](#)]

## **CACHE INDEX**

Section 13.7.6.2, “CACHE INDEX Statement”  
Section 16.1.6.5, “Global Transaction ID System Variables”  
Section 8.10.2.4, “Index Preloading”  
Section 13.7.6.5, “LOAD INDEX INTO CACHE Statement”  
Section 8.10.2.2, “Multiple Key Caches”  
Section 22.6, “Restrictions and Limitations on Partitioning”  
Section 13.3.3, “Statements That Cause an Implicit Commit”

## **CALL**

Section 13.2.1, “CALL Statement”  
Section 13.1.16, “CREATE PROCEDURE and CREATE FUNCTION Statements”  
Section 13.5, “Prepared Statements”  
Section 23.6, “Stored Object Access Control”  
Chapter 23, *Stored Objects*  
Section 23.7, “Stored Program Binary Logging”  
Section 23.2.1, “Stored Routine Syntax”  
Section 8.15.3, “Traceable Statements”  
Section 23.3.1, “Trigger Syntax and Examples”

## **CALL p()**

Section 13.6.7.4, “RESIGNAL Statement”

---

## **CALL stored\_procedure()**

Section 22.6.4, “Partitioning and Locking”

## **CASE**

Section 8.10.4, “Caching of Prepared Statements and Stored Programs”

Section 13.6.5.1, “CASE Statement”

Section 12.5, “Flow Control Functions”

Section 13.6.5, “Flow Control Statements”

Section 8.15.3, “Traceable Statements”

## **CHANGE MASTER TO**

Section 16.1.5.4, “Adding a Binary Log Based Source to a Multi-Source Replica”

Section 16.1.5.3, “Adding GTID-Based Sources to a Multi-Source Replica”

Section 6.2.10, “Assigning Account Passwords”

Section 16.3.1.2, “Backing Up Raw Data from a Replica”

Section 16.1.1, “Binary Log File Position Based Replication Configuration Overview”

Section 13.4.2.1, “CHANGE MASTER TO Statement”

Section 2.10.3, “Changes in MySQL 5.7”

Section 16.1.7.1, “Checking Replication Status”

Section 16.2.2.1, “Commands for Operations on a Single Channel”

Section 16.2.2.2, “Compatibility with Previous Replication Statements”

Creating a Data Snapshot Using mysqldump

Section 16.3.10, “Delayed Replication”

Section 6.3.2, “Encrypted Connection TLS Protocols and Ciphers”

Section 17.8, “Frequently Asked Questions”

Section 16.1.6.5, “Global Transaction ID System Variables”

Section 13.7.1.4, “GRANT Statement”

Section 16.1.3.3, “GTID Auto-Positioning”

Section 16.3.2, “Handling an Unexpected Halt of a Replica”

Section 21.7.8, “Implementing Failover with NDB Cluster Replication”

Section 4.5.4, “mysqldump — A Database Backup Program”

Section 21.7.9, “NDB Cluster Backups With NDB Cluster Replication”

Section 21.7.10, “NDB Cluster Replication: Bidirectional and Circular Replication”

Section 25.12.11, “Performance Schema Replication Tables”

Section 21.7.5, “Preparing the NDB Cluster for Replication”

Section 6.2.2, “Privileges Provided by MySQL”

Section 16.1.6.3, “Replica Server Options and Variables”

Section 16.1.6, “Replication and Binary Logging Options and Variables”

Section 16.4.1.26, “Replication and Source or Replica Shutdowns”

Section 16.4.1.32, “Replication and Transaction Inconsistencies”

Section 16.2.4.2, “Replication Metadata Repositories”

Section 8.14.8, “Replication Replica Connection Thread States”

Section 8.14.6, “Replication Replica I/O Thread States”

Section 8.14.7, “Replication Replica SQL Thread States”

Section 13.4.2.3, “RESET SLAVE Statement”

Section 16.1.3.6, “Restrictions on Replication with GTIDs”

Section 5.1.9, “Server Status Variables”

Setting the Source Configuration on the Replica

Setting Up Replication between a New Source and Replicas

Section 16.3.8, “Setting Up Replication to Use Encrypted Connections”

Section 16.1.3.4, “Setting Up Replication Using GTIDs”

Setting Up Replication with Existing Data

Section 13.7.5.34, “SHOW SLAVE STATUS Statement”

---

Skipping Transactions With `CHANGE MASTER TO`  
Skipping Transactions Without GTIDs  
Section 13.4.2.5, “START SLAVE Statement”  
Section 13.3.3, “Statements That Cause an Implicit Commit”  
Section 16.3.7, “Switching Sources During Failover”  
Section 14.21.6, “The InnoDB memcached Plugin and Replication”  
Section 25.12.11.3, “The replication\_applier\_configuration Table”  
Section 25.12.11.1, “The replication\_connection\_configuration Table”  
Section 16.2.1.2, “Usage of Row-Based Logging and Replication”  
Section 17.2.1.3, “User Credentials”  
Section 16.1.3.5, “Using GTIDs for Failover and Scaleout”  
Section 1.3, “What Is New in MySQL 5.7”

## **CHANGE REPLICATION FILTER**

Section 13.4.2.2, “CHANGE REPLICATION FILTER Statement”  
Section 6.2.2, “Privileges Provided by MySQL”  
Section 5.1.9, “Server Status Variables”

## **CHANGE REPLICATION FILTER REPLICATE\_DO\_DB**

Section 16.1.6.3, “Replica Server Options and Variables”

## **CHANGE REPLICATION FILTER REPLICATE\_DO\_TABLE**

Section 16.1.6.3, “Replica Server Options and Variables”

## **CHANGE REPLICATION FILTER REPLICATE\_IGNORE\_DB**

Section 16.1.6.3, “Replica Server Options and Variables”

## **CHANGE REPLICATION FILTER REPLICATE\_IGNORE\_TABLE**

Section 16.1.6.3, “Replica Server Options and Variables”

## **CHANGE REPLICATION FILTER REPLICATE\_REWRITE\_DB**

Section 16.1.6.3, “Replica Server Options and Variables”

## **CHANGE REPLICATION FILTER REPLICATE\_WILD\_DO\_TABLE**

Section 16.1.6.3, “Replica Server Options and Variables”

## **CHANGE REPLICATION FILTER REPLICATE\_WILD\_IGNORE\_TABLE**

Section 16.1.6.3, “Replica Server Options and Variables”

## **CHECK PARTITION**

Section 14.13.1, “Online DDL Operations”

## **CHECK TABLE**

Section 11.2.5, “2-Digit YEAR(2) Limitations and Migrating to 4-Digit YEAR”  
Section 13.1.8.1, “ALTER TABLE Partition Operations”  
Section 2.10.3, “Changes in MySQL 5.7”  
Section 13.7.2.2, “CHECK TABLE Statement”  
Section 15.2.4.1, “Corrupted MyISAM Tables”  
Section 13.1.16, “CREATE PROCEDURE and CREATE FUNCTION Statements”  
Section 13.1.21, “CREATE VIEW Statement”



---

[Section 8.11.5, “External Locking”](#)  
[Section 16.1.6.5, “Global Transaction ID System Variables”](#)  
[Section 7.6.3, “How to Repair MyISAM Tables”](#)  
[Section 1.5, “How to Report Bugs or Problems”](#)  
[Section 4.6.1, “innochecksum — Offline InnoDB File Checksum Utility”](#)  
[Section 14.19.2, “InnoDB Recovery”](#)  
[Section 14.22, “InnoDB Troubleshooting”](#)  
[Section 22.3.4, “Maintenance of Partitions”](#)  
[Section 7.6, “MyISAM Table Maintenance and Crash Recovery”](#)  
[Section 4.6.3, “myisamchk — MyISAM Table-Maintenance Utility”](#)  
[Section A.6, “MySQL 5.7 FAQ: Views”](#)  
[Section 1.6.1, “MySQL Extensions to Standard SQL”](#)  
[Section B.3.2.7, “MySQL server has gone away”](#)  
[Section 4.4.7, “mysql\\_upgrade — Check and Upgrade MySQL Tables”](#)  
[Section 4.5.3, “mysqlcheck — A Table Maintenance Program”](#)  
[Section 15.2.4.2, “Problems from Tables Not Being Closed Properly”](#)  
[Section 2.10.12, “Rebuilding or Repairing Tables or Indexes”](#)  
[Section 15.4.1, “Repairing and Checking CSV Tables”](#)  
[Restoring an NDB backup to a later version of NDB Cluster](#)  
[Section 22.6, “Restrictions and Limitations on Partitioning”](#)  
[Section 13.6.6.5, “Restrictions on Server-Side Cursors”](#)  
[Section 23.8, “Restrictions on Stored Programs”](#)  
[Section 23.9, “Restrictions on Views”](#)  
[Section 5.4.1, “Selecting General Query Log and Slow Query Log Output Destinations”](#)  
[Section 5.1.7, “Server System Variables”](#)  
[Section 7.6.5, “Setting Up a MyISAM Table Maintenance Schedule”](#)  
[Section 13.3.3, “Statements That Cause an Implicit Commit”](#)  
[Section 15.5, “The ARCHIVE Storage Engine”](#)  
[Section 15.7, “The MERGE Storage Engine”](#)  
[Section 5.4.5, “The Slow Query Log”](#)

## **CHECK TABLE ... EXTENDED**

[Section 13.7.2.2, “CHECK TABLE Statement”](#)

## **CHECK TABLE ... FOR UPGRADE**

[Section 2.10.3, “Changes in MySQL 5.7”](#)  
[Section 13.7.2.2, “CHECK TABLE Statement”](#)  
[Section 13.7.2.5, “REPAIR TABLE Statement”](#)

## **CHECK TABLE QUICK**

[Section 13.7.2.2, “CHECK TABLE Statement”](#)

## **CHECKSUM TABLE**

[Section 13.7.2.3, “CHECKSUM TABLE Statement”](#)  
[Section 13.1.18, “CREATE TABLE Statement”](#)  
[Section 16.4.1.4, “Replication and CHECKSUM TABLE”](#)

## **CHECKSUM TABLE ... QUICK**

[Section 13.7.2.3, “CHECKSUM TABLE Statement”](#)

## **COALESCE PARTITION**

[Section 14.13.1, “Online DDL Operations”](#)

---

## COMMIT

[Section 14.7.2.2, “autocommit, Commit, and Rollback”](#)  
[Section 8.5.5, “Bulk Data Loading for InnoDB Tables”](#)  
[Section 14.6.1.5, “Converting Tables from MyISAM to InnoDB”](#)  
[Section 13.1.16, “CREATE PROCEDURE and CREATE FUNCTION Statements”](#)  
[Section 14.2, “InnoDB and the ACID Model”](#)  
[Section 14.15, “InnoDB Startup Options and System Variables”](#)  
[Section 14.7.3, “Locks Set by Different SQL Statements in InnoDB”](#)  
[Section 4.5.4, “mysqldump — A Database Backup Program”](#)  
[NDB Cluster System Variables](#)  
[Section 16.1.2.3, “Obtaining the Replication Source’s Binary Log Coordinates”](#)  
[Section 8.5.3, “Optimizing InnoDB Read-Only Transactions”](#)  
[Section 25.12.7, “Performance Schema Transaction Tables”](#)  
[Section 16.1.6.3, “Replica Server Options and Variables”](#)  
[Section 16.4.1.33, “Replication and Transactions”](#)  
[Rewriter Query Rewrite Plugin Procedures and Functions](#)  
[Section 13.3.4, “SAVEPOINT, ROLLBACK TO SAVEPOINT, and RELEASE SAVEPOINT Statements”](#)  
[Section 5.1.9, “Server Status Variables”](#)  
[Section 5.1.7, “Server System Variables”](#)  
[Section 5.1.15, “Server Tracking of Client Session State”](#)  
[Section 13.7.5.36, “SHOW TABLE STATUS Statement”](#)  
[Section 13.3.1, “START TRANSACTION, COMMIT, and ROLLBACK Statements”](#)  
[Section 13.3.3, “Statements That Cause an Implicit Commit”](#)  
[Section 23.7, “Stored Program Binary Logging”](#)  
[Section 5.4.4, “The Binary Log”](#)  
[Section 25.12.7.1, “The events\\_transactions\\_current Table”](#)  
[Section 24.3.25, “The INFORMATION\\_SCHEMA TABLES Table”](#)  
[Section 13.3, “Transactional and Locking Statements”](#)  
[Section 23.3.1, “Trigger Syntax and Examples”](#)

## COMMIT AND CHAIN

[Section 25.12.7, “Performance Schema Transaction Tables”](#)  
[Section 5.1.15, “Server Tracking of Client Session State”](#)

## COMPRESSION

[Section 14.14, “InnoDB Data-at-Rest Encryption”](#)

## CREATE DATABASE

[Section 7.1, “Backup and Recovery Types”](#)  
[Section 10.5, “Configuring Application Character Set and Collation”](#)  
[Section 7.4.5.2, “Copy a Database from one Server to Another”](#)  
[Section 13.1.11, “CREATE DATABASE Statement”](#)  
[Section 10.3.3, “Database Character Set and Collation”](#)  
[Section 7.4.1, “Dumping Data in SQL Format with mysqldump”](#)  
[Section 16.2.5.1, “Evaluation of Database-Level Replication and Binary Logging Options”](#)  
[Section 16.2.5, “How Servers Evaluate Replication Filtering Rules”](#)  
[Section 9.2.3, “Identifier Case Sensitivity”](#)  
[Section 21.2.7.8, “Issues Exclusive to NDB Cluster”](#)  
[Section 1.6.1, “MySQL Extensions to Standard SQL”](#)  
[Section 4.6.7, “mysqlbinlog — Utility for Processing Binary Log Files”](#)  
[Section 4.5.4, “mysqldump — A Database Backup Program”](#)  
[Section 4.5.6, “mysqlpump — A Database Backup Program”](#)  
[Section 21.7.9, “NDB Cluster Backups With NDB Cluster Replication”](#)

---

[Section 25.6, “Performance Schema Instrument Naming Conventions”](#)  
[Section 7.4.2, “Reloading SQL-Format Backups”](#)  
[Section 16.1.6.3, “Replica Server Options and Variables”](#)  
[Section 10.3.2, “Server Character Set and Collation”](#)  
[Section 13.7.5.6, “SHOW CREATE DATABASE Statement”](#)  
[Section 13.3.3, “Statements That Cause an Implicit Commit”](#)

## **CREATE DATABASE dbx**

[Section 16.2.5, “How Servers Evaluate Replication Filtering Rules”](#)

## **CREATE DATABASE IF NOT EXISTS**

[Section 16.4.1.5, “Replication of CREATE ... IF NOT EXISTS Statements”](#)

## **CREATE EVENT**

[Section 13.1.2, “ALTER EVENT Statement”](#)  
[Section 13.1.12, “CREATE EVENT Statement”](#)  
[Section 23.4.4, “Event Metadata”](#)  
[Section 23.4.3, “Event Syntax”](#)  
[Section 9.5, “Expressions”](#)  
[Section 12.15, “Information Functions”](#)  
[Section 4.5.4, “mysqldump — A Database Backup Program”](#)  
[Section 4.5.6, “mysqlpump — A Database Backup Program”](#)  
[Section 16.4.1.8, “Replication of CURRENT\\_USER\(\)”](#)  
[Section 16.4.1.16, “Replication of Invoked Features”](#)  
[Section 23.8, “Restrictions on Stored Programs”](#)  
[Section 5.1.6, “Server Command Options”](#)  
[Section 13.7.5.7, “SHOW CREATE EVENT Statement”](#)  
[Section 13.7.5.18, “SHOW EVENTS Statement”](#)  
[Section 13.3.3, “Statements That Cause an Implicit Commit”](#)  
[Chapter 23, \*Stored Objects\*](#)  
[Section 23.7, “Stored Program Binary Logging”](#)  
[Section 23.4.6, “The Event Scheduler and MySQL Privileges”](#)  
[Section 24.3.8, “The INFORMATION\\_SCHEMA EVENTS Table”](#)  
[Section 5.3, “The mysql System Database”](#)

## **CREATE EVENT IF NOT EXISTS**

[Section 16.4.1.5, “Replication of CREATE ... IF NOT EXISTS Statements”](#)

## **CREATE FULLTEXT INDEX**

[Section 8.5.5, “Bulk Data Loading for InnoDB Tables”](#)

## **CREATE FUNCTION**

[Section 13.1.3, “ALTER FUNCTION Statement”](#)  
[Section 13.1.13, “CREATE FUNCTION Statement”](#)  
[Section 13.7.3.1, “CREATE FUNCTION Statement for Loadable Functions”](#)  
[Section 13.1.16, “CREATE PROCEDURE and CREATE FUNCTION Statements”](#)  
[Section 13.7.3.2, “DROP FUNCTION Statement for Loadable Functions”](#)  
[Section 9.2.5, “Function Name Parsing and Resolution”](#)  
[Section 6.4.4.8, “General-Purpose Keyring Key-Management Functions”](#)  
[Section 12.15, “Information Functions”](#)  
[Section 5.6.1, “Installing and Uninstalling Loadable Functions”](#)  
[Section 6.5.2, “Installing or Uninstalling MySQL Enterprise Data Masking and De-Identification”](#)

---

Section 5.5.5.2, “Installing or Uninstalling Version Tokens”  
Section 6.6.1, “MySQL Enterprise Encryption Installation”  
Section 4.5.4, “mysqldump — A Database Backup Program”  
Section 4.5.6, “mysqldump — A Database Backup Program”  
Section 5.6.2, “Obtaining Information About Loadable Functions”  
Section 16.4.1.8, “Replication of CURRENT\_USER()”  
Section 16.4.1.16, “Replication of Invoked Features”  
Section 23.8, “Restrictions on Stored Programs”  
Section 5.1.6, “Server Command Options”  
Section 13.3.3, “Statements That Cause an Implicit Commit”  
Chapter 23, *Stored Objects*  
Section 23.7, “Stored Program Binary Logging”  
Section 23.2.1, “Stored Routine Syntax”  
The Locking Service Function Interface  
Section 5.3, “The mysql System Database”  
Section 2.10.11, “Upgrade Troubleshooting”

## **CREATE INDEX**

Section 8.3.4, “Column Indexes”  
Section 14.8.12, “Configuring the Merge Threshold for Index Pages”  
Section 14.21.5.4, “Controlling Transactional Behavior of the InnoDB memcached Plugin”  
Section 13.1.14, “CREATE INDEX Statement”  
Section 13.1.18, “CREATE TABLE Statement”  
Section 11.4.9, “Creating Spatial Indexes”  
Section 12.9, “Full-Text Search Functions”  
Section 14.9.1.5, “How Compression Works for InnoDB Tables”  
Section 14.6.2.4, “InnoDB Full-Text Indexes”  
Section 12.9.9, “MeCab Full-Text Parser Plugin”  
MySQL Glossary  
Section 12.9.8, “ngram Full-Text Parser”  
Section 14.13.1, “Online DDL Operations”  
Section 21.6.12, “Online Operations with ALTER TABLE in NDB Cluster”  
Section 8.7, “Optimizing for MEMORY Tables”  
Section 5.1.7, “Server System Variables”  
Section 13.7.5.22, “SHOW INDEX Statement”  
Section 13.3.3, “Statements That Cause an Implicit Commit”  
Section 24.3.24, “The INFORMATION\_SCHEMA STATISTICS Table”  
Section 5.4.5, “The Slow Query Log”  
Section 21.2.7.6, “Unsupported or Missing Features in NDB Cluster”

## **CREATE LOGFILE GROUP**

Section 13.1.5, “ALTER LOGFILE GROUP Statement”  
Section 13.1.15, “CREATE LOGFILE GROUP Statement”  
Section 13.1.19, “CREATE TABLESPACE Statement”  
Section 21.4.3.6, “Defining NDB Cluster Data Nodes”  
Section 21.2.7.8, “Issues Exclusive to NDB Cluster”  
Section 4.5.4, “mysqldump — A Database Backup Program”  
Section 21.6.11.1, “NDB Cluster Disk Data Objects”  
Section 24.3.9, “The INFORMATION\_SCHEMA FILES Table”  
Section 21.6.15.31, “The ndbinfo resources Table”

## **CREATE OR REPLACE VIEW**

Section 13.1.21, “CREATE VIEW Statement”

---

Section 23.9, “Restrictions on Views”

## **CREATE PROCEDURE**

Section 13.1.6, “ALTER PROCEDURE Statement”

Section 13.2.1, “CALL Statement”

Section 13.1.16, “CREATE PROCEDURE and CREATE FUNCTION Statements”

Section 12.15, “Information Functions”

Section 4.5.4, “mysqldump — A Database Backup Program”

Section 4.5.6, “mysqldump — A Database Backup Program”

Section 16.4.1.8, “Replication of CURRENT\_USER()”

Section 16.4.1.16, “Replication of Invoked Features”

Section 23.8, “Restrictions on Stored Programs”

Section 13.3.3, “Statements That Cause an Implicit Commit”

Chapter 23, *Stored Objects*

Section 23.7, “Stored Program Binary Logging”

Section 23.2.1, “Stored Routine Syntax”

## **CREATE SCHEMA**

Section 13.1.11, “CREATE DATABASE Statement”

Section 21.2.7.8, “Issues Exclusive to NDB Cluster”

Section 21.7.9, “NDB Cluster Backups With NDB Cluster Replication”

## **CREATE SERVER**

Section 13.1.7, “ALTER SERVER Statement”

Section 15.8.2.2, “Creating a FEDERATED Table Using CREATE SERVER”

Section 15.8.3, “FEDERATED Storage Engine Notes and Tips”

Section 13.7.6.3, “FLUSH Statement”

Section 16.1.6.5, “Global Transaction ID System Variables”

Section 8.12.4.1, “How MySQL Uses Memory”

Section 15.8.2, “How to Create FEDERATED Tables”

Section 6.2.2, “Privileges Provided by MySQL”

Section 16.4.1.7, “Replication of CREATE SERVER, ALTER SERVER, and DROP SERVER”

Section 13.3.3, “Statements That Cause an Implicit Commit”

## **CREATE TABLE**

Section 13.1.8.3, “ALTER TABLE Examples”

Section 13.1.8.1, “ALTER TABLE Partition Operations”

Section 13.1.8, “ALTER TABLE Statement”

Chapter 15, *Alternative Storage Engines*

Section 14.6.1.6, “AUTO\_INCREMENT Handling in InnoDB”

Section 7.1, “Backup and Recovery Types”

Section 16.1.6.4, “Binary Logging Options and Variables”

Section 2.10.3, “Changes in MySQL 5.7”

Section 10.3.5, “Column Character Set and Collation”

Section 8.3.4, “Column Indexes”

Section 14.8.11, “Configuring Optimizer Statistics for InnoDB”

Configuring Optimizer Statistics Parameters for Individual Tables

Section 14.8.12, “Configuring the Merge Threshold for Index Pages”

Section 14.6.1.5, “Converting Tables from MyISAM to InnoDB”

Section 13.1.12, “CREATE EVENT Statement”

Section 13.1.14, “CREATE INDEX Statement”

Section 13.1.17, “CREATE SERVER Statement”

Section 13.1.18.3, “CREATE TABLE ... LIKE Statement”

---

Section 13.1.18.4, “CREATE TABLE ... SELECT Statement”  
Section 13.1.18.7, “CREATE TABLE and Generated Columns”  
Section 13.1.18, “CREATE TABLE Statement”  
Section 13.1.19, “CREATE TABLESPACE Statement”  
Section 13.1.18.2, “CREATE TEMPORARY TABLE Statement”  
Section 15.8.2.1, “Creating a FEDERATED Table Using CONNECTION”  
Section 3.3.2, “Creating a Table”  
Section 14.9.1.2, “Creating Compressed Tables”  
Section 14.6.1.1, “Creating InnoDB Tables”  
Section 11.4.5, “Creating Spatial Columns”  
Section 11.4.9, “Creating Spatial Indexes”  
Section 7.2, “Database Backup Methods”  
Section 10.3.3, “Database Character Set and Collation”  
Section 21.4.3.6, “Defining NDB Cluster Data Nodes”  
Section 7.4.3, “Dumping Data in Delimited-Text Format with mysqldump”  
Section 14.10.1, “Enabling File Formats”  
Section B.2, “Error Information Interfaces”  
Section 14.8.11.3, “Estimating ANALYZE TABLE Complexity for InnoDB Tables”  
Section 14.6.3.2, “File-Per-Table Tablespaces”  
Section 1.6.3.2, “FOREIGN KEY Constraints”  
Section 13.1.18.5, “FOREIGN KEY Constraints”  
Section 12.9, “Full-Text Search Functions”  
Section 14.6.3.3, “General Tablespaces”  
Section 3.4, “Getting Information About Databases and Tables”  
Section 16.1.3.1, “GTID Format and Storage”  
Section 16.1.3.2, “GTID Life Cycle”  
Section 22.2.4, “HASH Partitioning”  
Section 13.8.3, “HELP Statement”  
Section 14.9.1.5, “How Compression Works for InnoDB Tables”  
Section 22.2.7, “How MySQL Partitioning Handles NULL”  
Section 8.12.4.1, “How MySQL Uses Memory”  
Section 9.2.3, “Identifier Case Sensitivity”  
Section 14.6.1.3, “Importing InnoDB Tables”  
Section 12.15, “Information Functions”  
Section 21.3.3, “Initial Configuration of NDB Cluster”  
Section 14.20, “InnoDB and MySQL Replication”  
Section 14.14, “InnoDB Data-at-Rest Encryption”  
Section 14.6.2.4, “InnoDB Full-Text Indexes”  
Section 14.16.3, “InnoDB INFORMATION\_SCHEMA System Tables”  
Section 14.9.2, “InnoDB Page Compression”  
Section 14.11, “InnoDB Row Formats”  
Section 14.15, “InnoDB Startup Options and System Variables”  
Section 14.9.1, “InnoDB Table Compression”  
Section 14.22, “InnoDB Troubleshooting”  
Section 16.2.5.3, “Interactions Between Replication Filtering Options”  
Section 8.4.4, “Internal Temporary Table Use in MySQL”  
Section 14.1, “Introduction to InnoDB”  
Section 21.2.7.8, “Issues Exclusive to NDB Cluster”  
Section 22.2.5, “KEY Partitioning”  
Section 21.2.7.5, “Limits Associated with Database Objects in NDB Cluster”  
Section 8.4.6, “Limits on Table Size”  
Section 21.2.7.3, “Limits Relating to Transaction Handling in NDB Cluster”  
Section 22.2.2, “LIST Partitioning”  
Section 13.2.7, “LOAD XML Statement”

---

Section 3.3.3, “Loading Data into a Table”  
Section 13.3.5, “LOCK TABLES and UNLOCK TABLES Statements”  
Section 5.4.4.4, “Logging Format for Changes to mysql Database Tables”  
Section 22.3.1, “Management of RANGE and LIST Partitions”  
Section 12.9.9, “MeCab Full-Text Parser Plugin”  
Section 15.2.3, “MyISAM Table Storage Formats”  
Section A.10, “MySQL 5.7 FAQ: NDB Cluster”  
Section 4.5.1.1, “mysql Client Options”  
Section 1.6.1, “MySQL Extensions to Standard SQL”  
MySQL Glossary  
Section 4.5.4, “mysqldump — A Database Backup Program”  
Section 4.5.6, “mysqlpump — A Database Backup Program”  
Section 21.6.14, “NDB API Statistics Counters and Variables”  
Section 21.4.3.1, “NDB Cluster Configuration: Basic Example”  
Section 21.6.11.1, “NDB Cluster Disk Data Objects”  
NDB Cluster System Variables  
Section 21.5.6, “ndb\_blob\_tool — Check and Repair BLOB and TEXT columns of NDB Cluster Tables”  
Section 21.5.10, “ndb\_desc — Describe NDB Tables”  
Section 12.9.8, “ngram Full-Text Parser”  
Section 21.2.7.1, “Noncompliance with SQL Syntax in NDB Cluster”  
Section 14.13.1, “Online DDL Operations”  
Section 21.6.12, “Online Operations with ALTER TABLE in NDB Cluster”  
Section 8.4.1, “Optimizing Data Size”  
Section 8.5.7, “Optimizing InnoDB DDL Operations”  
Section 22.1, “Overview of Partitioning in MySQL”  
Section 14.9.1.1, “Overview of Table Compression”  
Section 22.3, “Partition Management”  
Section 22.6.1, “Partitioning Keys, Primary Keys, and Unique Keys”  
Section 22.6.3, “Partitioning Limitations Relating to Functions”  
Section 22.6.2, “Partitioning Limitations Relating to Storage Engines”  
Section 22.2, “Partitioning Types”  
Section 6.2.2, “Privileges Provided by MySQL”  
Section 22.2.3.1, “RANGE COLUMNS partitioning”  
Section 22.2.1, “RANGE Partitioning”  
Section 7.4.4, “Reloading Delimited-Text Format Backups”  
Section 13.2.8, “REPLACE Statement”  
Section 16.4.1.1, “Replication and AUTO\_INCREMENT”  
Section 16.4.1.3, “Replication and Character Sets”  
Section 16.4.1.11, “Replication and DIRECTORY Table Options”  
Section 16.4.1.13, “Replication and Fractional Seconds Support”  
Section 16.4.1.15, “Replication and System Functions”  
Section 16.4.1.6, “Replication of CREATE TABLE ... SELECT Statements”  
Replication with More Columns on Source or Replica  
Restoring an NDB backup to a previous version of NDB Cluster  
Section 22.6, “Restrictions and Limitations on Partitioning”  
Section 5.4.1, “Selecting General Query Log and Slow Query Log Output Destinations”  
Section 5.1.6, “Server Command Options”  
Section 5.1.10, “Server SQL Modes”  
Section 5.1.7, “Server System Variables”  
Section 5.4.4.2, “Setting The Binary Log Format”  
Section 15.1, “Setting the Storage Engine”  
Section 13.7.5.5, “SHOW COLUMNS Statement”  
Section 13.7.5.10, “SHOW CREATE TABLE Statement”  
Section 13.7.5.15, “SHOW ENGINE Statement”

---

Section 13.7.5.22, “SHOW INDEX Statement”  
Section 13.7.5.36, “SHOW TABLE STATUS Statement”  
Section 13.7.5.40, “SHOW WARNINGS Statement”  
Section 13.1.18.6, “Silent Column Specification Changes”  
Section 14.9.1.7, “SQL Compression Syntax Warnings and Errors”  
Section 13.3.3, “Statements That Cause an Implicit Commit”  
Section 11.3.1, “String Data Type Syntax”  
Section 22.2.6, “Subpartitioning”  
Section 10.3.4, “Table Character Set and Collation”  
Section 14.1.4, “Testing and Benchmarking with InnoDB”  
Section 15.5, “The ARCHIVE Storage Engine”  
Section 11.3.5, “The ENUM Type”  
Section 24.4.23, “The INFORMATION\_SCHEMA INNODB\_SYS\_TABLES Table”  
Section 24.3.16, “The INFORMATION\_SCHEMA PARTITIONS Table”  
Section 24.3.24, “The INFORMATION\_SCHEMA STATISTICS Table”  
Section 24.3.25, “The INFORMATION\_SCHEMA TABLES Table”  
Section 15.3, “The MEMORY Storage Engine”  
Section 15.2, “The MyISAM Storage Engine”  
Section 13.2.10.1, “The Subquery as Scalar Operand”  
Section 14.22.3, “Troubleshooting InnoDB Data Dictionary Operations”  
Section 13.1.34, “TRUNCATE TABLE Statement”  
Section 13.7.3.4, “UNINSTALL PLUGIN Statement”  
Section 21.2.7.6, “Unsupported or Missing Features in NDB Cluster”  
Section 3.6.9, “Using AUTO\_INCREMENT”  
Section 3.3.4.9, “Using More Than one Table”  
Section 7.4, “Using mysqldump for Backups”  
Section 16.3.3, “Using Replication with Different Source and Replica Storage Engines”  
Section 8.12.3, “Using Symbolic Links”  
Section 8.12.3.2, “Using Symbolic Links for MyISAM Tables on Unix”  
Section 1.3, “What Is New in MySQL 5.7”  
Section 21.2.4.1, “What is New in NDB Cluster 7.5”  
Section 2.3.7, “Windows Platform Restrictions”

## **CREATE TABLE ... ENCRYPTION**

Section 13.1.4, “ALTER INSTANCE Statement”

## **CREATE TABLE ... LIKE**

Section 13.1.18.3, “CREATE TABLE ... LIKE Statement”  
Section 13.1.18.7, “CREATE TABLE and Generated Columns”  
Section 13.3.5, “LOCK TABLES and UNLOCK TABLES Statements”  
Section 16.4.1.1, “Replication and AUTO\_INCREMENT”  
Section 15.7, “The MERGE Storage Engine”

## **CREATE TABLE ... ROW\_FORMAT=COMPRESSED**

Section 2.10.3, “Changes in MySQL 5.7”

## **CREATE TABLE ... SELECT**

Section 16.2.1.1, “Advantages and Disadvantages of Statement-Based and Row-Based Replication”  
Section 12.10, “Cast Functions and Operators”  
Section 14.7.2.3, “Consistent Nonlocking Reads”  
Section 13.1.18.4, “CREATE TABLE ... SELECT Statement”  
Section 13.1.18.7, “CREATE TABLE and Generated Columns”  
Section 16.1.6.5, “Global Transaction ID System Variables”



---

[Section 16.1.3.2, “GTID Life Cycle”](#)  
[Section B.3.7, “Known Issues in MySQL”](#)  
[Section 5.4.4.4, “Logging Format for Changes to mysql Database Tables”](#)  
[Section 16.4.1.6, “Replication of CREATE TABLE ... SELECT Statements”](#)  
[Section 16.1.3.6, “Restrictions on Replication with GTIDs”](#)  
[Section 1.6.2.1, “SELECT INTO TABLE Differences”](#)  
[Section 13.2.9, “SELECT Statement”](#)  
[Section 5.1.10, “Server SQL Modes”](#)  
[Section 13.3.3, “Statements That Cause an Implicit Commit”](#)  
[Section 23.7, “Stored Program Binary Logging”](#)  
[Section 12.3, “Type Conversion in Expression Evaluation”](#)

## **CREATE TABLE ... SELECT ...**

[Section 14.7.3, “Locks Set by Different SQL Statements in InnoDB”](#)  
[Section 22.3.1, “Management of RANGE and LIST Partitions”](#)

## **CREATE TABLE ... TABLESPACE**

[Section 13.1.8, “ALTER TABLE Statement”](#)  
[Section 13.1.19, “CREATE TABLESPACE Statement”](#)  
[Section 14.6.1.1, “Creating InnoDB Tables”](#)  
[Section 14.6.1.2, “Creating Tables Externally”](#)  
[Section 14.6.3.2, “File-Per-Table Tablespaces”](#)

## **CREATE TABLE IF NOT EXISTS**

[Section 16.4.1.5, “Replication of CREATE ... IF NOT EXISTS Statements”](#)

## **CREATE TABLE IF NOT EXISTS ... LIKE**

[Section 16.4.1.5, “Replication of CREATE ... IF NOT EXISTS Statements”](#)

## **CREATE TABLE IF NOT EXISTS ... SELECT**

[Section 16.4.1.5, “Replication of CREATE ... IF NOT EXISTS Statements”](#)

## **CREATE TABLE LIKE**

[Section 21.5.14, “ndb\\_import — Import CSV Data Into NDB”](#)

## **CREATE TABLE new\_table SELECT ... FROM old\_table ...**

[Section 13.1.18.4, “CREATE TABLE ... SELECT Statement”](#)  
[Section 13.2.9, “SELECT Statement”](#)

## **CREATE TABLE tbl\_name ... TABLESPACE tablespace\_name**

[Section 13.1.19, “CREATE TABLESPACE Statement”](#)  
[Section 14.6.3.3, “General Tablespaces”](#)  
[MySQL Glossary](#)  
[Section 1.3, “What Is New in MySQL 5.7”](#)

## **CREATE TABLE...AS SELECT**

[Section 8.2.1, “Optimizing SELECT Statements”](#)

## **CREATE TABLESPACE**

[Section 13.1.9, “ALTER TABLESPACE Statement”](#)  
[Section 13.1.19, “CREATE TABLESPACE Statement”](#)

---

Section 21.4.3.6, “Defining NDB Cluster Data Nodes”  
Section 13.1.30, “DROP TABLESPACE Statement”  
Section 14.12.2, “File Space Management”  
Section 14.6.3.3, “General Tablespaces”  
Section 21.2.7.8, “Issues Exclusive to NDB Cluster”  
MySQL Glossary  
Section 4.5.4, “mysqldump — A Database Backup Program”  
Section 4.5.6, “mysqlpump — A Database Backup Program”  
Section 21.6.11.1, “NDB Cluster Disk Data Objects”  
Section 5.1.7, “Server System Variables”  
Section 13.3.3, “Statements That Cause an Implicit Commit”  
Section 24.3.9, “The INFORMATION\_SCHEMA FILES Table”  
Section 24.4.23, “The INFORMATION\_SCHEMA INNODB\_SYS\_TABLES Table”  
Section 1.3, “What Is New in MySQL 5.7”

## **CREATE TEMPORARY TABLE**

Section 13.1.18, “CREATE TABLE Statement”  
Section 13.1.18.2, “CREATE TEMPORARY TABLE Statement”  
Section 16.1.6.5, “Global Transaction ID System Variables”  
Section 13.7.1.4, “GRANT Statement”  
Section A.10, “MySQL 5.7 FAQ: NDB Cluster”  
Section 4.6.7, “mysqlbinlog — Utility for Processing Binary Log Files”  
Section 6.2.2, “Privileges Provided by MySQL”  
Section 16.1.3.6, “Restrictions on Replication with GTIDs”  
Section 5.1.7, “Server System Variables”  
Section 15.1, “Setting the Storage Engine”  
Section 13.3.3, “Statements That Cause an Implicit Commit”  
Section B.3.6.2, “TEMPORARY Table Problems”  
Section 1.3, “What Is New in MySQL 5.7”

## **CREATE TRIGGER**

Section 13.1.20, “CREATE TRIGGER Statement”  
Section 12.15, “Information Functions”  
Section A.5, “MySQL 5.7 FAQ: Triggers”  
Section 4.5.4, “mysqldump — A Database Backup Program”  
Section 8.2.2.3, “Optimizing Subqueries with the EXISTS Strategy”  
Section 16.4.1.8, “Replication of CURRENT\_USER()”  
Section 16.4.1.16, “Replication of Invoked Features”  
Section 23.8, “Restrictions on Stored Programs”  
Section 13.7.5.11, “SHOW CREATE TRIGGER Statement”  
Section 13.3.3, “Statements That Cause an Implicit Commit”  
Chapter 23, *Stored Objects*  
Section 23.7, “Stored Program Binary Logging”  
Section 23.3.1, “Trigger Syntax and Examples”

## **CREATE UNDO TABLESPACE**

MySQL Glossary

## **CREATE USER**

Section 6.2, “Access Control and Account Management”  
Section 6.2.5, “Access Control, Stage 1: Connection Verification”  
Section 6.2.15, “Account Locking”  
Section 6.2.1, “Account User Names and Passwords”

---

Section 6.2.7, “Adding Accounts, Assigning Privileges, and Dropping Accounts”  
Section 6.2.10, “Assigning Account Passwords”  
Section 16.1.6.4, “Binary Logging Options and Variables”  
Section 6.4.1.4, “Caching SHA-2 Pluggable Authentication”  
Section 4.2.3, “Command Options for Connecting to the Server”  
Section 6.3.1, “Configuring MySQL to Use Encrypted Connections”  
Section 5.1.12.3, “Connecting Using the IPv6 Local Host Address”  
Section 13.7.1.2, “CREATE USER Statement”  
Section 16.1.2.2, “Creating a User for Replication”  
Section 12.13, “Encryption and Compression Functions”  
Section 6.1.2.1, “End-User Guidelines for Password Security”  
Section 13.7.6.3, “FLUSH Statement”  
Section 13.7.1.4, “GRANT Statement”  
Section 6.2.3, “Grant Tables”  
Section 8.12.4.1, “How MySQL Uses Memory”  
Section 2.9.1, “Initializing the Data Directory”  
Section 5.1.12, “IPv6 Support”  
Section 6.4.1.9, “LDAP Pluggable Authentication”  
Section 5.4.4.4, “Logging Format for Changes to mysql Database Tables”  
Section 6.1.3, “Making MySQL Secure Against Attackers”  
Section 4.5.6, “mysqldump — A Database Backup Program”  
Section 21.6.18.2, “NDB Cluster and MySQL Privileges”  
Section 6.4.1.10, “No-Login Pluggable Authentication”  
Section 6.4.1.7, “PAM Pluggable Authentication”  
Section 6.1.2.4, “Password Hashing in MySQL”  
Section 6.2.11, “Password Management”  
Section 6.1.2.3, “Passwords and Logging”  
Section 21.7.5, “Preparing the NDB Cluster for Replication”  
Section 6.2.2, “Privileges Provided by MySQL”  
Section 6.2.14, “Proxy Users”  
Section 5.1.10, “Server SQL Modes”  
Section 5.1.7, “Server System Variables”  
Section 6.2.16, “Setting Account Resource Limits”  
Section 6.4.1.5, “SHA-256 Pluggable Authentication”  
Section 13.7.5.12, “SHOW CREATE USER Statement”  
Section 6.4.1.11, “Socket Peer-Credential Pluggable Authentication”  
Section 6.2.4, “Specifying Account Names”  
Section 13.3.3, “Statements That Cause an Implicit Commit”  
Section 6.4.3, “The Password Validation Plugin”  
Section 6.3, “Using Encrypted Connections”  
Section 19.4.1, “Using Encrypted Connections with X Plugin”  
Section 6.4.6.3, “Using MySQL Enterprise Firewall”  
Section 1.3, “What Is New in MySQL 5.7”  
Section 6.4.1.8, “Windows Pluggable Authentication”

## **CREATE VIEW**

Section 13.1.10, “ALTER VIEW Statement”  
Section 13.1.21, “CREATE VIEW Statement”  
Section 8.14.3, “General Thread States”  
Section 9.2.1, “Identifier Length Limits”  
Section 12.15, “Information Functions”  
Section 13.3.5, “LOCK TABLES and UNLOCK TABLES Statements”  
Section 22.6.4, “Partitioning and Locking”

---

[Section 6.2.2, “Privileges Provided by MySQL”](#)  
[Section 16.4.1.8, “Replication of CURRENT\\_USER\(\)”](#)  
[Section 23.9, “Restrictions on Views”](#)  
[Section 13.7.5.13, “SHOW CREATE VIEW Statement”](#)  
[Section 13.3.3, “Statements That Cause an Implicit Commit”](#)  
[Chapter 23, \*Stored Objects\*](#)  
[Section 24.3.31, “The INFORMATION\\_SCHEMA VIEWS Table”](#)  
[Section 23.5.3, “Updatable and Insertable Views”](#)  
[Section 23.5.2, “View Processing Algorithms”](#)  
[Section 23.5.1, “View Syntax”](#)

## D

[\[index top\]](#)

### DEALLOCATE PREPARE

[Section 13.5.3, “DEALLOCATE PREPARE Statement”](#)  
[Section 13.5.1, “PREPARE Statement”](#)  
[Section 13.5, “Prepared Statements”](#)  
[Section 23.8, “Restrictions on Stored Programs”](#)  
[Section 5.1.9, “Server Status Variables”](#)  
[Section 25.12.6.4, “The prepared\\_statements\\_instances Table”](#)

### DECLARE

[Section 13.1.16, “CREATE PROCEDURE and CREATE FUNCTION Statements”](#)  
[Section 13.6.3, “DECLARE Statement”](#)  
[Section 13.6.7.3, “GET DIAGNOSTICS Statement”](#)  
[Section 13.6.7.5, “SIGNAL Statement”](#)  
[Section 8.15.3, “Traceable Statements”](#)  
[Section 13.6.4, “Variables in Stored Programs”](#)

### DECLARE ... CONDITION

[Section 13.6.7, “Condition Handling”](#)  
[Section 13.6.7.1, “DECLARE ... CONDITION Statement”](#)  
[Section 13.6.7.2, “DECLARE ... HANDLER Statement”](#)  
[Section 13.6.7.5, “SIGNAL Statement”](#)

### DECLARE ... HANDLER

[Section 13.6.7, “Condition Handling”](#)  
[Section 13.6.7.1, “DECLARE ... CONDITION Statement”](#)  
[Section 13.6.7.2, “DECLARE ... HANDLER Statement”](#)  
[Section 13.6.7.5, “SIGNAL Statement”](#)

### DELETE

[Section 6.2, “Access Control and Account Management”](#)  
[Section 14.21.5.5, “Adapting DML Statements to memcached Operations”](#)  
[Section 6.2.7, “Adding Accounts, Assigning Privileges, and Dropping Accounts”](#)  
[Section 16.2.1.1, “Advantages and Disadvantages of Statement-Based and Row-Based Replication”](#)  
[Section 13.1.8.1, “ALTER TABLE Partition Operations”](#)  
[Section 6.4.5.7, “Audit Log Filtering”](#)  
[Section 6.4.5.11, “Audit Log Reference”](#)  
[Section 14.1.2, “Best Practices for InnoDB Tables”](#)

---

Section 16.1.6.4, “Binary Logging Options and Variables”  
Section 8.6.2, “Bulk Data Loading for MyISAM Tables”  
Section 14.5.2, “Change Buffer”  
Section 2.10.3, “Changes in MySQL 5.7”  
Section 14.9.1.6, “Compression for OLTP Workloads”  
Section 14.7.2.3, “Consistent Nonlocking Reads”  
Section 14.6.1.5, “Converting Tables from MyISAM to InnoDB”  
Section 13.1.16, “CREATE PROCEDURE and CREATE FUNCTION Statements”  
Section 13.1.20, “CREATE TRIGGER Statement”  
Section 13.1.21, “CREATE VIEW Statement”  
Section 13.2.2, “DELETE Statement”  
Section B.3.4.6, “Deleting Rows from Related Tables”  
Section 2.11.3, “Downgrade Notes”  
Section 8.8.2, “EXPLAIN Output Format”  
Section 13.8.2, “EXPLAIN Statement”  
Section 8.8.3, “Extended EXPLAIN Output Format”  
Section 15.8.3, “FEDERATED Storage Engine Notes and Tips”  
Section 14.22.2, “Forcing InnoDB Recovery”  
Section 13.1.18.5, “FOREIGN KEY Constraints”  
Section 12.9.5, “Full-Text Restrictions”  
Chapter 12, *Functions and Operators*  
Section 8.14.3, “General Thread States”  
Section 13.7.1.4, “GRANT Statement”  
Section 6.2.3, “Grant Tables”  
Section 8.10.3.1, “How the Query Cache Operates”  
Section 21.6.9, “Importing Data Into MySQL Cluster”  
Section 8.9.4, “Index Hints”  
Section 12.15, “Information Functions”  
Section 14.20, “InnoDB and MySQL Replication”  
Section 14.15, “InnoDB Startup Options and System Variables”  
Section 8.11.1, “Internal Locking Methods”  
Section 24.1, “Introduction”  
Section 13.2.9.2, “JOIN Clause”  
Section 9.3, “Keywords and Reserved Words”  
Section 13.7.6.4, “KILL Statement”  
Section B.3.7, “Known Issues in MySQL”  
Section 21.2.7.2, “Limits and Differences of NDB Cluster from Standard MySQL Limits”  
Section 21.2.7.3, “Limits Relating to Transaction Handling in NDB Cluster”  
Section 22.2.2, “LIST Partitioning”  
Section 14.7.3, “Locks Set by Different SQL Statements in InnoDB”  
Section 5.4.4.4, “Logging Format for Changes to mysql Database Tables”  
Section 22.3.1, “Management of RANGE and LIST Partitions”  
Section 15.7.2, “MERGE Table Problems”  
Section 4.5.1.1, “mysql Client Options”  
Section 4.5.1.6, “mysql Client Tips”  
Section 1.6.1, “MySQL Extensions to Standard SQL”  
MySQL Glossary  
Section 21.6.18.3, “NDB Cluster and MySQL Security Procedures”  
Section 21.6.11.1, “NDB Cluster Disk Data Objects”  
Section 21.5.9, “ndb\_delete\_all — Delete All Rows from an NDB Table”  
Section 8.8.4, “Obtaining Execution Plan Information for a Named Connection”  
Section 14.13.1, “Online DDL Operations”  
Section 8.9.3, “Optimizer Hints”  
Section 8.2.4, “Optimizing Data Change Statements”

---

Section 8.8.1, “Optimizing Queries with EXPLAIN”  
Section 8.2.1, “Optimizing SELECT Statements”  
Section 8.2.2, “Optimizing Subqueries, Derived Tables, and View References”  
Section 22.1, “Overview of Partitioning in MySQL”  
Section 22.4, “Partition Pruning”  
Section 22.5, “Partition Selection”  
Section 21.6.5, “Performing a Rolling Restart of an NDB Cluster”  
Section 6.2.2, “Privileges Provided by MySQL”  
Section 14.8.10, “Purge Configuration”  
Section 8.14.4, “Query Cache Thread States”  
Section 8.2.1.2, “Range Optimization”  
Section 22.2.1, “RANGE Partitioning”  
Section 16.1.6.3, “Replica Server Options and Variables”  
Section 16.4.1.17, “Replication and LIMIT”  
Section 16.4.1.20, “Replication and MEMORY Tables”  
Section 16.4.1.22, “Replication and the Query Optimizer”  
Section 16.4.1.34, “Replication and Triggers”  
Section 13.2.10.11, “Rewriting Subqueries as Joins”  
Section 3.3.4.1, “Selecting All Data”  
Section 5.4.1, “Selecting General Query Log and Slow Query Log Output Destinations”  
Section 5.1.10, “Server SQL Modes”  
Section 5.1.9, “Server Status Variables”  
Section 5.1.7, “Server System Variables”  
Section 13.7.5.36, “SHOW TABLE STATUS Statement”  
Statement Probes  
Section 13.2.10, “Subqueries”  
Section 13.2.10.9, “Subquery Errors”  
Section 8.11.2, “Table Locking Issues”  
Section 15.5, “The ARCHIVE Storage Engine”  
Section 5.4.4, “The Binary Log”  
Section 15.6, “The BLACKHOLE Storage Engine”  
Section 24.4.25, “The INFORMATION\_SCHEMA INNODB\_SYS\_TABLESTATS View”  
Section 24.3.25, “The INFORMATION\_SCHEMA TABLES Table”  
Section 24.3.31, “The INFORMATION\_SCHEMA VIEWS Table”  
Section 1.2.2, “The Main Features of MySQL”  
Section 15.3, “The MEMORY Storage Engine”  
Section 15.7, “The MERGE Storage Engine”  
Section 8.15.3, “Traceable Statements”  
Section 14.7.2.1, “Transaction Isolation Levels”  
Section 23.3.1, “Trigger Syntax and Examples”  
Section 6.2.17, “Troubleshooting Problems Connecting to MySQL”  
Section 13.1.34, “TRUNCATE TABLE Statement”  
Section 14.6.7, “Undo Logs”  
Section 23.5.3, “Updatable and Insertable Views”  
Section 16.2.1.2, “Usage of Row-Based Logging and Replication”  
Section 1.3, “What Is New in MySQL 5.7”  
Section 6.2.9, “When Privilege Changes Take Effect”  
Section 8.2.1.1, “WHERE Clause Optimization”  
Section 6.4.5.8, “Writing Audit Log Filter Definitions”

## **DELETE FROM ... WHERE ...**

Section 14.7.3, “Locks Set by Different SQL Statements in InnoDB”

---

## **DELETE FROM t1,t2**

Statement Probes

## **DESCRIBE**

Section 3.3.2, “Creating a Table”  
Section 13.8.1, “DESCRIBE Statement”  
Section 13.8.2, “EXPLAIN Statement”  
Section 24.8, “Extensions to SHOW Statements”  
Section 1.6.2.3, “FOREIGN KEY Constraint Differences”  
Section 3.4, “Getting Information About Databases and Tables”  
Section 8.4.4, “Internal Temporary Table Use in MySQL”  
Section 13.7.5.5, “SHOW COLUMNS Statement”  
Section 13.1.18.6, “Silent Column Specification Changes”  
Section 10.2.2, “UTF-8 for Metadata”

## **DISCARD PARTITION**

Section 14.13.1, “Online DDL Operations”

## **DISCARD PARTITION ... TABLESPACE**

Section 13.1.8.1, “ALTER TABLE Partition Operations”

## **DO**

Section 13.1.2, “ALTER EVENT Statement”  
Section 13.1.12, “CREATE EVENT Statement”  
Section 13.2.3, “DO Statement”  
Section 12.14, “Locking Functions”  
Section 5.4.4.4, “Logging Format for Changes to mysql Database Tables”  
Section 1.6.1, “MySQL Extensions to Standard SQL”  
Section 22.6.4, “Partitioning and Locking”  
Section 23.8, “Restrictions on Stored Programs”  
Section 23.7, “Stored Program Binary Logging”  
Section 13.2.10, “Subqueries”  
Section 24.3.8, “The INFORMATION\_SCHEMA EVENTS Table”  
Section 8.15.3, “Traceable Statements”

## **DROP DATABASE**

Section 13.1.22, “DROP DATABASE Statement”  
Section 13.1.30, “DROP TABLESPACE Statement”  
Section 7.4.1, “Dumping Data in SQL Format with mysqldump”  
Section 16.2.5.1, “Evaluation of Database-Level Replication and Binary Logging Options”  
Section 14.6.3.3, “General Tablespaces”  
Section 16.2.5, “How Servers Evaluate Replication Filtering Rules”  
Section 8.10.3.1, “How the Query Cache Operates”  
Section 21.6.9, “Importing Data Into MySQL Cluster”  
Section 21.2.7.8, “Issues Exclusive to NDB Cluster”  
Section 1.6.1, “MySQL Extensions to Standard SQL”  
Section 4.6.7, “mysqlbinlog — Utility for Processing Binary Log Files”  
Section 4.5.4, “mysqldump — A Database Backup Program”  
Section 4.5.6, “mysqlpump — A Database Backup Program”  
Section 16.1.6.3, “Replica Server Options and Variables”  
Section 13.3.3, “Statements That Cause an Implicit Commit”  
Section 2.3.7, “Windows Platform Restrictions”

---

## **DROP DATABASE IF EXISTS**

Section 16.4.1.9, “Replication of DROP ... IF EXISTS Statements”

## **DROP EVENT**

Section 23.4.3, “Event Syntax”

Section 16.4.1.16, “Replication of Invoked Features”

Section 13.3.3, “Statements That Cause an Implicit Commit”

Section 23.7, “Stored Program Binary Logging”

Section 23.4.6, “The Event Scheduler and MySQL Privileges”

## **DROP FUNCTION**

Section 13.1.3, “ALTER FUNCTION Statement”

Section 13.7.3.1, “CREATE FUNCTION Statement for Loadable Functions”

Section 13.1.24, “DROP FUNCTION Statement”

Section 13.7.3.2, “DROP FUNCTION Statement for Loadable Functions”

Section 13.1.27, “DROP PROCEDURE and DROP FUNCTION Statements”

Section 9.2.5, “Function Name Parsing and Resolution”

Section 6.4.4.8, “General-Purpose Keyring Key-Management Functions”

Section 5.6.1, “Installing and Uninstalling Loadable Functions”

Section 6.5.2, “Installing or Uninstalling MySQL Enterprise Data Masking and De-Identification”

Section 5.5.5.2, “Installing or Uninstalling Version Tokens”

Section 6.6.1, “MySQL Enterprise Encryption Installation”

Section 16.4.1.16, “Replication of Invoked Features”

Section 13.3.3, “Statements That Cause an Implicit Commit”

Section 23.7, “Stored Program Binary Logging”

Section 23.2.1, “Stored Routine Syntax”

The Locking Service Function Interface

Section 2.10.11, “Upgrade Troubleshooting”

## **DROP INDEX**

Section 13.1.8, “ALTER TABLE Statement”

Section 11.4.9, “Creating Spatial Indexes”

Section 13.1.25, “DROP INDEX Statement”

Section 1.6.1, “MySQL Extensions to Standard SQL”

MySQL Glossary

Section 14.13.1, “Online DDL Operations”

Section 21.6.12, “Online Operations with ALTER TABLE in NDB Cluster”

Section 5.1.7, “Server System Variables”

Section 13.3.3, “Statements That Cause an Implicit Commit”

Section 5.4.5, “The Slow Query Log”

## **DROP LOGFILE GROUP**

Section 13.1.26, “DROP LOGFILE GROUP Statement”

Section 21.2.7.8, “Issues Exclusive to NDB Cluster”

## **DROP PARTITION**

Section 14.13.1, “Online DDL Operations”

## **DROP PREPARE**

Section 25.12.6.4, “The prepared\_statements\_instances Table”



---

## DROP PROCEDURE

Section 13.1.6, “ALTER PROCEDURE Statement”  
Section 16.4.1.16, “Replication of Invoked Features”  
Section 13.3.3, “Statements That Cause an Implicit Commit”  
Section 23.7, “Stored Program Binary Logging”  
Section 23.2.1, “Stored Routine Syntax”

## DROP SCHEMA

Section 13.1.22, “DROP DATABASE Statement”  
Section 21.2.7.8, “Issues Exclusive to NDB Cluster”  
Section 5.1.7, “Server System Variables”

## DROP SERVER

Section 13.7.6.3, “FLUSH Statement”  
Section 16.1.6.5, “Global Transaction ID System Variables”  
Section 8.12.4.1, “How MySQL Uses Memory”  
Section 6.2.2, “Privileges Provided by MySQL”  
Section 16.4.1.7, “Replication of CREATE SERVER, ALTER SERVER, and DROP SERVER”  
Section 13.3.3, “Statements That Cause an Implicit Commit”

## DROP TABLE

Section 21.6.7.1, “Adding NDB Cluster Data Nodes Online: General Issues”  
Section 13.1.8, “ALTER TABLE Statement”  
Section 6.4.5.4, “Audit Log File Formats”  
Section 21.6.1, “Commands in the NDB Cluster Management Client”  
Section 14.7.2.3, “Consistent Nonlocking Reads”  
Section 13.1.19, “CREATE TABLESPACE Statement”  
Section 13.1.18.2, “CREATE TEMPORARY TABLE Statement”  
Section 13.1.20, “CREATE TRIGGER Statement”  
Section 13.1.29, “DROP TABLE Statement”  
Section 15.8.3, “FEDERATED Storage Engine Notes and Tips”  
Section 14.6.3.2, “File-Per-Table Tablespaces”  
Section 14.22.2, “Forcing InnoDB Recovery”  
Section 14.6.3.3, “General Tablespaces”  
Section 16.1.6.5, “Global Transaction ID System Variables”  
Section 16.1.3.2, “GTID Life Cycle”  
Section 8.10.3.1, “How the Query Cache Operates”  
Section 21.6.9, “Importing Data Into MySQL Cluster”  
Section 12.15, “Information Functions”  
Section 21.2.7.8, “Issues Exclusive to NDB Cluster”  
Section 21.2.7.2, “Limits and Differences of NDB Cluster from Standard MySQL Limits”  
Section 13.3.5, “LOCK TABLES and UNLOCK TABLES Statements”  
Section 15.7.2, “MERGE Table Problems”  
Section 4.5.1.1, “mysql Client Options”  
Section 1.6.1, “MySQL Extensions to Standard SQL”  
MySQL Glossary  
Section 4.5.4, “mysqldump — A Database Backup Program”  
Section 4.5.6, “mysqlpump — A Database Backup Program”  
Section 21.5.11, “ndb\_drop\_index — Drop Index from an NDB Table”  
Section 21.5.12, “ndb\_drop\_table — Drop an NDB Table”  
Section 8.5.7, “Optimizing InnoDB DDL Operations”  
Section 21.7.9.2, “Point-In-Time Recovery Using NDB Cluster Replication”  
Section 6.2.2, “Privileges Provided by MySQL”

---

[Section 23.9, “Restrictions on Views”](#)  
[Section 13.6.7.6, “Scope Rules for Handlers”](#)  
[Section 5.4.1, “Selecting General Query Log and Slow Query Log Output Destinations”](#)  
[Section 5.1.6, “Server Command Options”](#)  
[Section 5.1.7, “Server System Variables”](#)  
[Section 5.4.4.2, “Setting The Binary Log Format”](#)  
[Section 13.6.7.5, “SIGLAL Statement”](#)  
[Section 13.3.3, “Statements That Cause an Implicit Commit”](#)  
[Section 15.3, “The MEMORY Storage Engine”](#)  
[Section 15.7, “The MERGE Storage Engine”](#)  
[Section 13.6.7.7, “The MySQL Diagnostics Area”](#)  
[Section 14.22.3, “Troubleshooting InnoDB Data Dictionary Operations”](#)  
[Section 13.1.34, “TRUNCATE TABLE Statement”](#)  
[Section 13.7.3.4, “UNINSTALL PLUGIN Statement”](#)  
[Section 1.3, “What Is New in MySQL 5.7”](#)

## **DROP TABLE IF EXISTS**

[Section 16.4.1.9, “Replication of DROP ... IF EXISTS Statements”](#)

## **DROP TABLE IF EXISTS mysql.user mysql.db mysql.tables\_priv mysql.columns\_priv mysql.procs\_priv**

[Section 21.6.13, “Distributed Privileges Using Shared Grant Tables”](#)

## **DROP TABLESPACE**

[Section 14.6.3.3, “General Tablespaces”](#)  
[Section 21.2.7.8, “Issues Exclusive to NDB Cluster”](#)  
[Section 5.1.7, “Server System Variables”](#)  
[Section 13.3.3, “Statements That Cause an Implicit Commit”](#)

## **DROP TABLESPACE tablespace\_name**

[Section 14.6.3.3, “General Tablespaces”](#)

## **DROP TEMPORARY TABLE**

[Section 16.1.6.5, “Global Transaction ID System Variables”](#)  
[Section 16.1.3.6, “Restrictions on Replication with GTIDs”](#)

## **DROP TRIGGER**

[Section 13.1.31, “DROP TRIGGER Statement”](#)  
[Section A.5, “MySQL 5.7 FAQ: Triggers”](#)  
[Section 4.5.4, “mysqldump — A Database Backup Program”](#)  
[Section 16.4.1.16, “Replication of Invoked Features”](#)  
[Section 13.3.3, “Statements That Cause an Implicit Commit”](#)  
[Section 23.3.1, “Trigger Syntax and Examples”](#)

## **DROP USER**

[Section 6.2.1, “Account User Names and Passwords”](#)  
[Section 6.2.7, “Adding Accounts, Assigning Privileges, and Dropping Accounts”](#)  
[Section 13.7.1.3, “DROP USER Statement”](#)  
[Section 13.7.6.3, “FLUSH Statement”](#)  
[Section 13.7.1.4, “GRANT Statement”](#)  
[Section 8.12.4.1, “How MySQL Uses Memory”](#)  
[Section 12.15, “Information Functions”](#)

---

[Section 4.5.6, “mysqlpump — A Database Backup Program”](#)  
[Section 21.6.18.2, “NDB Cluster and MySQL Privileges”](#)  
[Section 6.2.2, “Privileges Provided by MySQL”](#)  
[Section 16.4.1.8, “Replication of CURRENT\\_USER\(\)”](#)  
[Section 13.7.1.6, “REVOKE Statement”](#)  
[Section 13.3.3, “Statements That Cause an Implicit Commit”](#)  
[Section 23.6, “Stored Object Access Control”](#)  
[Section 23.4.6, “The Event Scheduler and MySQL Privileges”](#)

## **DROP VIEW**

[Section 13.1.32, “DROP VIEW Statement”](#)  
[Section 13.3.5, “LOCK TABLES and UNLOCK TABLES Statements”](#)  
[Section 23.9, “Restrictions on Views”](#)  
[Section 13.3.3, “Statements That Cause an Implicit Commit”](#)  
[Section 23.5.1, “View Syntax”](#)

## **DROP VIEW IF EXISTS**

[Section 16.4.1.9, “Replication of DROP ... IF EXISTS Statements”](#)

## **E**

[\[index top\]](#)

## **ENCRYPTION**

[Section 14.14, “InnoDB Data-at-Rest Encryption”](#)

## **EXCHANGE PARTITION**

[Section 14.13.1, “Online DDL Operations”](#)

## **EXECUTE**

[Section 13.2.1, “CALL Statement”](#)  
[Section 13.5.2, “EXECUTE Statement”](#)  
[Section 13.5.1, “PREPARE Statement”](#)  
[Section 13.5, “Prepared Statements”](#)  
[Section 23.8, “Restrictions on Stored Programs”](#)  
[Section 5.1.9, “Server Status Variables”](#)  
[Section 25.12.6.4, “The prepared\\_statements\\_instances Table”](#)

## **EXPLAIN**

[Section 13.1.8, “ALTER TABLE Statement”](#)  
[Section 8.2.1.20, “Avoiding Full Table Scans”](#)  
[Section 8.2.1.11, “Block Nested-Loop and Batched Key Access Joins”](#)  
[Section 8.3.4, “Column Indexes”](#)  
[Section 8.2.1.12, “Condition Filtering”](#)  
[Configuring the Number of Sampled Pages for InnoDB Optimizer Statistics](#)  
[Section 13.1.16, “CREATE PROCEDURE and CREATE FUNCTION Statements”](#)  
[Section 5.8.1, “Debugging a MySQL Server”](#)  
[Section 13.2.10.8, “Derived Tables”](#)  
[Section 13.8.1, “DESCRIBE Statement”](#)  
[Section 8.2.1.16, “DISTINCT Optimization”](#)  
[Section 8.2.1.4, “Engine Condition Pushdown Optimization”](#)  
[Section 8.15.12, “Example”](#)  
[Section 8.8.2, “EXPLAIN Output Format”](#)

---

Section 13.8.2, “EXPLAIN Statement”  
Section 8.8.3, “Extended EXPLAIN Output Format”  
Section 12.17.3, “Functions That Search JSON Values”  
Section 8.2.1.15, “GROUP BY Optimization”  
Section 8.2.1.5, “Index Condition Pushdown Optimization”  
Section 8.9.4, “Index Hints”  
Section 8.2.1.3, “Index Merge Optimization”  
Section 8.4.4, “Internal Temporary Table Use in MySQL”  
Section 24.1, “Introduction”  
Section 8.2.1.13, “IS NULL Optimization”  
Section 8.2.1.17, “LIMIT Query Optimization”  
Section 8.2.1.10, “Multi-Range Read Optimization”  
Section 4.5.1.6, “mysql Client Tips”  
Chapter 25, *MySQL Performance Schema*  
NDB Cluster Status Variables  
NDB Cluster System Variables  
Section 8.8.4, “Obtaining Execution Plan Information for a Named Connection”  
Section 22.3.5, “Obtaining Information About Partitions”  
Section 8.9.3, “Optimizer Hints”  
Section 8.3.10, “Optimizer Use of Generated Column Indexes”  
Section B.3.5, “Optimizer-Related Issues”  
Section 8.2.2.4, “Optimizing Derived Tables and View References with Merging or Materialization”  
Section 8.2.3, “Optimizing INFORMATION\_SCHEMA Queries”  
Section 8.8.1, “Optimizing Queries with EXPLAIN”  
Section 8.2.1, “Optimizing SELECT Statements”  
Section 13.2.10.10, “Optimizing Subqueries”  
Section 8.2.2.2, “Optimizing Subqueries with Materialization”  
Section 8.2.2.3, “Optimizing Subqueries with the EXISTS Strategy”  
Section 8.2.2.1, “Optimizing Subqueries, Derived Tables, and View References with Semijoin Transformations”  
Section 8.2.1.14, “ORDER BY Optimization”  
Section 22.4, “Partition Pruning”  
Section 6.2.2, “Privileges Provided by MySQL”  
Section 8.2.1.2, “Range Optimization”  
Section 23.8, “Restrictions on Stored Programs”  
Section 13.1.18.8, “Secondary Indexes and Generated Columns”  
Section 13.2.9, “SELECT Statement”  
Section 8.15.10, “Selecting Optimizer Features to Trace”  
Section 13.7.5.40, “SHOW WARNINGS Statement”  
Section B.3.4.7, “Solving Problems with No Matching Rows”  
Section 1.2.2, “The Main Features of MySQL”  
Section 26.4.4.22, “The ps\_trace\_statement\_digest() Procedure”  
Section 8.15.3, “Traceable Statements”  
Section 8.8, “Understanding the Query Execution Plan”  
Section 8.3.9, “Use of Index Extensions”  
Section 5.8.1.6, “Using Server Logs to Find Causes of Errors in mysqld”  
Section 11.4.10, “Using Spatial Indexes”  
Section 8.3.6, “Verifying Index Usage”  
Section 1.3, “What Is New in MySQL 5.7”  
Section 21.2.4.1, “What is New in NDB Cluster 7.5”

## **EXPLAIN EXTENDED**

Section 8.8.2, “EXPLAIN Output Format”

---

[Section 13.8.2, “EXPLAIN Statement”](#)  
[Section 8.8.3, “Extended EXPLAIN Output Format”](#)

## **EXPLAIN FOR CONNECTION**

[Section 8.8.2, “EXPLAIN Output Format”](#)  
[Section 8.8.4, “Obtaining Execution Plan Information for a Named Connection”](#)  
[Section 5.1.9, “Server Status Variables”](#)

## **EXPLAIN FORMAT=JSON**

[Section 8.15.2, “System Variables Controlling Tracing”](#)

## **EXPLAIN PARTITIONS**

[Section 8.8.2, “EXPLAIN Output Format”](#)  
[Section 13.8.2, “EXPLAIN Statement”](#)  
[Section 22.3.5, “Obtaining Information About Partitions”](#)

## **EXPLAIN SELECT**

[Section 13.2.10.8, “Derived Tables”](#)  
[Section 8.8.2, “EXPLAIN Output Format”](#)  
[Section 14.7.5.3, “How to Minimize and Handle Deadlocks”](#)  
[Section 1.5, “How to Report Bugs or Problems”](#)  
[Section 1.6.1, “MySQL Extensions to Standard SQL”](#)  
[Section 22.3.5, “Obtaining Information About Partitions”](#)

## **EXPLAIN SELECT COUNT()**

[Section 22.2.1, “RANGE Partitioning”](#)

## **EXPLAIN tbl\_name**

[Section 8.8.1, “Optimizing Queries with EXPLAIN”](#)

## **F**

[\[index top\]](#)

## **FETCH**

[Section 13.6.6.2, “Cursor DECLARE Statement”](#)  
[Section 13.6.6.3, “Cursor FETCH Statement”](#)  
[Section 23.8, “Restrictions on Stored Programs”](#)

## **FETCH ... INTO var\_list**

[Section 13.6.4, “Variables in Stored Programs”](#)

## **FLUSH**

[Section 7.3.1, “Establishing a Backup Policy”](#)  
[Section 13.7.6.3, “FLUSH Statement”](#)  
[Section 16.1.6.5, “Global Transaction ID System Variables”](#)  
[Section 13.7.1.4, “GRANT Statement”](#)  
[Section 1.6.1, “MySQL Extensions to Standard SQL”](#)  
[Section 4.5.4, “mysqldump — A Database Backup Program”](#)  
[Section 6.2.2, “Privileges Provided by MySQL”](#)  
[Section 16.4.1.14, “Replication and FLUSH”](#)  
[Section 13.7.6.6, “RESET Statement”](#)

---

[Section 23.8, “Restrictions on Stored Programs”](#)  
[Section 13.3.3, “Statements That Cause an Implicit Commit”](#)  
[Section 4.10, “Unix Signal Handling in MySQL”](#)  
[Section 1.3, “What Is New in MySQL 5.7”](#)

## **FLUSH BINARY LOGS**

[Section 13.7.6.3, “FLUSH Statement”](#)  
[Section 5.4.7, “Server Log Maintenance”](#)

## **FLUSH DES\_KEY\_FILE**

[Section 12.13, “Encryption and Compression Functions”](#)  
[Section 13.7.6.3, “FLUSH Statement”](#)

## **FLUSH ENGINE LOGS**

[Section 13.7.6.3, “FLUSH Statement”](#)

## **FLUSH ERROR LOGS**

[Section 5.4.2.6, “Error Log File Flushing and Renaming”](#)  
[Section 13.7.6.3, “FLUSH Statement”](#)

## **FLUSH GENERAL LOGS**

[Section 13.7.6.3, “FLUSH Statement”](#)

## **FLUSH HOSTS**

[Section 5.1.11.2, “DNS Lookups and the Host Cache”](#)  
[Section 13.7.6.3, “FLUSH Statement”](#)

## **FLUSH LOGS**

[Section 7.3.3, “Backup Strategy Summary”](#)  
[Section 7.2, “Database Backup Methods”](#)  
[Section 16.1.4.3, “Disabling GTID Transactions Online”](#)  
[Section 16.1.4.2, “Enabling GTID Transactions Online”](#)  
[Section 5.4.2.6, “Error Log File Flushing and Renaming”](#)  
[Section 7.3.1, “Establishing a Backup Policy”](#)  
[Section 13.7.6.3, “FLUSH Statement”](#)  
[Section 5.4, “MySQL Server Logs”](#)  
[Section 4.5.2, “mysqladmin — A MySQL Server Administration Program”](#)  
[Section 16.4.1.14, “Replication and FLUSH”](#)  
[Section 5.4.1, “Selecting General Query Log and Slow Query Log Output Destinations”](#)  
[Section 5.4.7, “Server Log Maintenance”](#)  
[Section 5.1.9, “Server Status Variables”](#)  
[Section 16.1.3.4, “Setting Up Replication Using GTIDs”](#)  
[Section 16.2.4.1, “The Relay Log”](#)  
[Section 16.1.3.5, “Using GTIDs for Failover and Scaleout”](#)

## **FLUSH OPTIMIZER\_COSTS**

[Section 13.7.6.3, “FLUSH Statement”](#)  
[Section 8.9.5, “The Optimizer Cost Model”](#)

## **FLUSH PRIVILEGES**

[Section 1.1, “About This Manual”](#)  
[Section 21.6.13, “Distributed Privileges Using Shared Grant Tables”](#)

---

[Section 13.7.6.3, “FLUSH Statement”](#)  
[Section 6.2.3, “Grant Tables”](#)  
[Section 8.12.4.1, “How MySQL Uses Memory”](#)  
[Section 4.5.4, “mysqldump — A Database Backup Program”](#)  
[Section 21.6.18.3, “NDB Cluster and MySQL Security Procedures”](#)  
[Section 16.4.1.14, “Replication and FLUSH”](#)  
[Section 5.1.6, “Server Command Options”](#)  
[Section 6.2.16, “Setting Account Resource Limits”](#)  
[Section 6.2.17, “Troubleshooting Problems Connecting to MySQL”](#)  
[Section 6.2.9, “When Privilege Changes Take Effect”](#)

## **FLUSH QUERY CACHE**

[Section 13.7.6.3, “FLUSH Statement”](#)  
[Section 8.10.3.4, “Query Cache Status and Maintenance”](#)  
[Section 1.3, “What Is New in MySQL 5.7”](#)

## **FLUSH RELAY LOGS**

[Section 16.2.2.1, “Commands for Operations on a Single Channel”](#)  
[Section 16.2.2.2, “Compatibility with Previous Replication Statements”](#)  
[Section 13.7.6.3, “FLUSH Statement”](#)

## **FLUSH RELAY LOGS FOR CHANNEL `channel`**

[Section 13.7.6.3, “FLUSH Statement”](#)

## **FLUSH SLOW LOGS**

[Section 13.7.6.3, “FLUSH Statement”](#)

## **FLUSH STATUS**

[Section 13.7.6.3, “FLUSH Statement”](#)  
[Section 17.4, “Monitoring Group Replication”](#)  
[Section 25.12.14, “Performance Schema Status Variable Tables”](#)  
[Section 5.1.9, “Server Status Variables”](#)  
[Section 5.1.7, “Server System Variables”](#)  
[Section 25.12.15.10, “Status Variable Summary Tables”](#)  
[Section 8.3.9, “Use of Index Extensions”](#)

## **FLUSH TABLE**

[Section 13.7.6.3, “FLUSH Statement”](#)

## **FLUSH TABLES**

[Section 8.6.2, “Bulk Data Loading for MyISAM Tables”](#)  
[Section 8.10.4, “Caching of Prepared Statements and Stored Programs”](#)  
[Section 13.7.6.3, “FLUSH Statement”](#)  
[Section 8.14.3, “General Thread States”](#)  
[Section 13.2.4, “HANDLER Statement”](#)  
[Section 8.4.3.1, “How MySQL Opens and Closes Tables”](#)  
[Section 8.12.4.1, “How MySQL Uses Memory”](#)  
[Section 15.7.2, “MERGE Table Problems”](#)  
[Section 4.6.3, “myisamchk — MyISAM Table-Maintenance Utility”](#)  
[Section 16.1.2.3, “Obtaining the Replication Source’s Binary Log Coordinates”](#)  
[Section 15.2.4.2, “Problems from Tables Not Being Closed Properly”](#)  
[Section 8.10.3.4, “Query Cache Status and Maintenance”](#)

---

[Section 16.4.1.14, “Replication and FLUSH”](#)  
[Section 22.6, “Restrictions and Limitations on Partitioning”](#)  
[Section 5.4.1, “Selecting General Query Log and Slow Query Log Output Destinations”](#)  
[Section 5.1.9, “Server Status Variables”](#)  
[Section 5.1.7, “Server System Variables”](#)  
[Section 8.3.9, “Use of Index Extensions”](#)

## **FLUSH TABLES ... FOR EXPORT**

[Section 14.6.1.2, “Creating Tables Externally”](#)  
[Section 13.7.6.3, “FLUSH Statement”](#)  
[Section 14.6.1.3, “Importing InnoDB Tables”](#)  
[MySQL Glossary](#)

## **FLUSH TABLES ...FOR EXPORT**

[Section 13.7.6.3, “FLUSH Statement”](#)

## **FLUSH TABLES tbl\_name ...**

[Section 13.7.6.3, “FLUSH Statement”](#)

## **FLUSH TABLES tbl\_name ... FOR EXPORT**

[Section 13.7.6.3, “FLUSH Statement”](#)

## **FLUSH TABLES tbl\_name ... WITH READ LOCK**

[Section 13.7.6.3, “FLUSH Statement”](#)

## **FLUSH TABLES tbl\_name WITH READ LOCK**

[Section 13.2.4, “HANDLER Statement”](#)

## **FLUSH TABLES WITH READ LOCK**

[Section 7.2, “Database Backup Methods”](#)  
[Section 7.3.1, “Establishing a Backup Policy”](#)  
[Section 13.7.6.3, “FLUSH Statement”](#)  
[Section 8.14.3, “General Thread States”](#)  
[Section 13.3.5, “LOCK TABLES and UNLOCK TABLES Statements”](#)  
[MySQL Glossary](#)  
[Section 4.5.4, “mysqldump — A Database Backup Program”](#)  
[Section 16.1.2.3, “Obtaining the Replication Source’s Binary Log Coordinates”](#)  
[Section 16.4.1.14, “Replication and FLUSH”](#)  
[Section 13.3.7.3, “Restrictions on XA Transactions”](#)  
[Section 5.4.1, “Selecting General Query Log and Slow Query Log Output Destinations”](#)  
[Section 5.1.7, “Server System Variables”](#)  
[Section 13.3.1, “START TRANSACTION, COMMIT, and ROLLBACK Statements”](#)  
[Section 13.3.3, “Statements That Cause an Implicit Commit”](#)  
[Section 25.12.12.1, “The metadata\\_locks Table”](#)

## **FLUSH USER\_RESOURCES**

[Section 13.7.6.3, “FLUSH Statement”](#)  
[Section 6.2.16, “Setting Account Resource Limits”](#)

## **G**

[\[index top\]](#)



---

## GET DIAGNOSTICS

[Section 13.6.7, “Condition Handling”](#)  
[Section B.2, “Error Information Interfaces”](#)  
[Section 13.6.7.3, “GET DIAGNOSTICS Statement”](#)  
[Section 13.6.7.4, “RESIGNAL Statement”](#)  
[Section 13.6.7.9, “Restrictions on Condition Handling”](#)  
[Section 23.8, “Restrictions on Stored Programs”](#)  
[Section 5.1.7, “Server System Variables”](#)  
[Section 13.7.5.40, “SHOW WARNINGS Statement”](#)  
[Section 13.6.7.5, “SIGNAL Statement”](#)  
[Section 13.6.7.7, “The MySQL Diagnostics Area”](#)

## GET STACKED DIAGNOSTICS

[Section 13.6.7.3, “GET DIAGNOSTICS Statement”](#)  
[Section 13.6.7.7, “The MySQL Diagnostics Area”](#)  
[Section 1.3, “What Is New in MySQL 5.7”](#)

## GRANT

[Section 6.2, “Access Control and Account Management”](#)  
[Section 6.2.6, “Access Control, Stage 2: Request Verification”](#)  
[Section 6.2.1, “Account User Names and Passwords”](#)  
[Section 6.2.7, “Adding Accounts, Assigning Privileges, and Dropping Accounts”](#)  
[Section 16.2.1.1, “Advantages and Disadvantages of Statement-Based and Row-Based Replication”](#)  
[Section 14.8.2, “Configuring InnoDB for Read-Only Operation”](#)  
[Section 5.1.12.3, “Connecting Using the IPv6 Local Host Address”](#)  
[Section 13.7.1.2, “CREATE USER Statement”](#)  
[Section 16.1.2.2, “Creating a User for Replication”](#)  
[Section 12.13, “Encryption and Compression Functions”](#)  
[Section 16.2.5.2, “Evaluation of Table-Level Replication Options”](#)  
[Section 13.7.6.3, “FLUSH Statement”](#)  
[Section 13.7.1.4, “GRANT Statement”](#)  
[Section 6.2.3, “Grant Tables”](#)  
[Section 8.12.4.1, “How MySQL Uses Memory”](#)  
[Section 12.15, “Information Functions”](#)  
[Section 2.9.1, “Initializing the Data Directory”](#)  
[Section 5.1.12, “IPv6 Support”](#)  
[Section 5.4.4.4, “Logging Format for Changes to mysql Database Tables”](#)  
[Section A.14, “MySQL 5.7 FAQ: Replication”](#)  
[MySQL Glossary](#)  
[Section 4.5.6, “mysqldump — A Database Backup Program”](#)  
[Section 21.6.18.2, “NDB Cluster and MySQL Privileges”](#)  
[Section 8.2.5, “Optimizing Database Privileges”](#)  
[Section 6.1.2.4, “Password Hashing in MySQL”](#)  
[Section 6.1.2.3, “Passwords and Logging”](#)  
[Section 21.7.5, “Preparing the NDB Cluster for Replication”](#)  
[Section 6.2.2, “Privileges Provided by MySQL”](#)  
[Section 6.2.14, “Proxy Users”](#)  
[Section 16.1.6.3, “Replica Server Options and Variables”](#)  
[Section 16.4.1.14, “Replication and FLUSH”](#)  
[Section 16.4.1.8, “Replication of CURRENT\\_USER\(\)”](#)  
[Section 16.4.1.21, “Replication of the mysql System Database”](#)  
[Section 13.7.1.6, “REVOKE Statement”](#)

---

[Section 6.1.1, “Security Guidelines”](#)  
[Section 5.1.6, “Server Command Options”](#)  
[Section 5.1.10, “Server SQL Modes”](#)  
[Section 5.1.7, “Server System Variables”](#)  
[Section 13.7.5.21, “SHOW GRANTS Statement”](#)  
[Section 6.2.4, “Specifying Account Names”](#)  
[Section 13.3.3, “Statements That Cause an Implicit Commit”](#)  
[Section 23.4.6, “The Event Scheduler and MySQL Privileges”](#)  
[Section 6.4.3, “The Password Validation Plugin”](#)  
[Section 6.4.6.3, “Using MySQL Enterprise Firewall”](#)  
[Section 1.3, “What Is New in MySQL 5.7”](#)  
[Section 6.2.9, “When Privilege Changes Take Effect”](#)  
[Section 6.4.1.8, “Windows Pluggable Authentication”](#)

## **GRANT ALL**

[Section 13.7.1.4, “GRANT Statement”](#)

## **GRANT EVENT**

[Section 23.4.6, “The Event Scheduler and MySQL Privileges”](#)

## **GROUP BY**

[Section 14.1.1, “Benefits of Using InnoDB Tables”](#)

## **H**

[\[index top\]](#)

## **HANDLER**

[Section 15.8.3, “FEDERATED Storage Engine Notes and Tips”](#)  
[Section 13.7.6.3, “FLUSH Statement”](#)  
[Section A.4, “MySQL 5.7 FAQ: Stored Procedures and Functions”](#)  
[Section 1.6, “MySQL Standards Compliance”](#)  
[Section 22.6, “Restrictions and Limitations on Partitioning”](#)  
[Section 5.1.7, “Server System Variables”](#)  
[Section 1.3, “What Is New in MySQL 5.7”](#)

## **HANDLER ... CLOSE**

[Section 13.7.5.24, “SHOW OPEN TABLES Statement”](#)

## **HANDLER ... OPEN**

[Section 13.7.5.24, “SHOW OPEN TABLES Statement”](#)

## **HANDLER ... READ**

[Section 23.8, “Restrictions on Stored Programs”](#)

## **HANDLER OPEN**

[Section 13.2.4, “HANDLER Statement”](#)  
[Section 13.1.34, “TRUNCATE TABLE Statement”](#)

## **HELP**

[Section 13.8.3, “HELP Statement”](#)

---

[Section 2.9.1, “Initializing the Data Directory”](#)  
[Section 13.3.5, “LOCK TABLES and UNLOCK TABLES Statements”](#)  
[Section 5.1.14, “Server-Side Help Support”](#)

## I

[\[index top\]](#)

## IF

[Section 8.10.4, “Caching of Prepared Statements and Stored Programs”](#)  
[Section 13.6.7.2, “DECLARE ... HANDLER Statement”](#)  
[Section 12.5, “Flow Control Functions”](#)  
[Section 13.6.5, “Flow Control Statements”](#)  
[Section 13.6.5.2, “IF Statement”](#)  
[Section 8.15.3, “Traceable Statements”](#)

## IMPORT PARTITION

[Section 14.13.1, “Online DDL Operations”](#)

## IMPORT PARTITION ... TABLESPACE

[Section 13.1.8.1, “ALTER TABLE Partition Operations”](#)

## INSERT

[Section 6.2, “Access Control and Account Management”](#)  
[Section 6.2.6, “Access Control, Stage 2: Request Verification”](#)  
[Section 6.2.7, “Adding Accounts, Assigning Privileges, and Dropping Accounts”](#)  
[Section 16.2.1.1, “Advantages and Disadvantages of Statement-Based and Row-Based Replication”](#)  
[Section 6.4.5.7, “Audit Log Filtering”](#)  
[Section 6.4.5.11, “Audit Log Reference”](#)  
[Section 14.6.1.6, “AUTO\\_INCREMENT Handling in InnoDB”](#)  
[Section 14.7.2.2, “autocommit, Commit, and Rollback”](#)  
[Section 7.1, “Backup and Recovery Types”](#)  
[Section 14.1.2, “Best Practices for InnoDB Tables”](#)  
[Section 8.5.5, “Bulk Data Loading for InnoDB Tables”](#)  
[Section 8.6.2, “Bulk Data Loading for MyISAM Tables”](#)  
[Section 8.10.4, “Caching of Prepared Statements and Stored Programs”](#)  
[Section 14.5.2, “Change Buffer”](#)  
[Section 2.10.3, “Changes in MySQL 5.7”](#)  
[Section 10.7, “Column Character Set Conversion”](#)  
[Section 14.9.1.6, “Compression for OLTP Workloads”](#)  
[Section 8.11.3, “Concurrent Inserts”](#)  
[Section 1.6.3.3, “Constraints on Invalid Data”](#)  
[Section 14.6.1.5, “Converting Tables from MyISAM to InnoDB”](#)  
[Section 13.1.14, “CREATE INDEX Statement”](#)  
[Section 13.1.16, “CREATE PROCEDURE and CREATE FUNCTION Statements”](#)  
[Section 13.1.18.7, “CREATE TABLE and Generated Columns”](#)  
[Section 13.1.18.2, “CREATE TEMPORARY TABLE Statement”](#)  
[Section 13.1.20, “CREATE TRIGGER Statement”](#)  
[Section 13.1.21, “CREATE VIEW Statement”](#)  
[Section 15.8.2.1, “Creating a FEDERATED Table Using CONNECTION”](#)  
[Section 11.6, “Data Type Default Values”](#)  
[Section 11.2.1, “Date and Time Data Type Syntax”](#)  
[Section 13.6.7.2, “DECLARE ... HANDLER Statement”](#)

---

Section 13.2.2, “DELETE Statement”  
Section 16.2.1.3, “Determination of Safe and Unsafe Statements in Binary Logging”  
Section 2.11.3, “Downgrade Notes”  
Section 7.3.1, “Establishing a Backup Policy”  
Section 8.8.2, “EXPLAIN Output Format”  
Section 13.8.2, “EXPLAIN Statement”  
Section 12.21.3, “Expression Handling”  
Section 8.8.3, “Extended EXPLAIN Output Format”  
Section 15.8.3, “FEDERATED Storage Engine Notes and Tips”  
Section 14.22.2, “Forcing InnoDB Recovery”  
Section 13.1.18.5, “FOREIGN KEY Constraints”  
Section 12.9.5, “Full-Text Restrictions”  
Section 8.14.3, “General Thread States”  
Section 13.7.1.4, “GRANT Statement”  
Section 6.2.3, “Grant Tables”  
Section 8.10.3.1, “How the Query Cache Operates”  
Section 12.15, “Information Functions”  
Section 14.7.1, “InnoDB Locking”  
Section 14.15, “InnoDB Startup Options and System Variables”  
Section 13.2.5.2, “INSERT ... ON DUPLICATE KEY UPDATE Statement”  
Section 13.2.5.1, “INSERT ... SELECT Statement”  
Section 13.2.5.3, “INSERT DELAYED Statement”  
Section 13.2.5, “INSERT Statement”  
Section 16.2.5.3, “Interactions Between Replication Filtering Options”  
Section 8.11.1, “Internal Locking Methods”  
Section 24.1, “Introduction”  
Section 21.2.7.3, “Limits Relating to Transaction Handling in NDB Cluster”  
Section 22.2.2, “LIST Partitioning”  
Section 13.2.6, “LOAD DATA Statement”  
Section 3.3.3, “Loading Data into a Table”  
Section 13.3.5, “LOCK TABLES and UNLOCK TABLES Statements”  
Section 14.7.3, “Locks Set by Different SQL Statements in InnoDB”  
Section 5.4.4.4, “Logging Format for Changes to mysql Database Tables”  
Section 22.3.1, “Management of RANGE and LIST Partitions”  
Section 15.7.2, “MERGE Table Problems”  
Section 8.11.4, “Metadata Locking”  
Section 12.20, “Miscellaneous Functions”  
Section A.1, “MySQL 5.7 FAQ: General”  
Section A.11, “MySQL 5.7 FAQ: MySQL Chinese, Japanese, and Korean Character Sets”  
Section A.5, “MySQL 5.7 FAQ: Triggers”  
Section A.6, “MySQL 5.7 FAQ: Views”  
Section 4.5.1.1, “mysql Client Options”  
Section 6.6.2, “MySQL Enterprise Encryption Usage and Examples”  
Section 1.6.1, “MySQL Extensions to Standard SQL”  
MySQL Glossary  
Section B.3.2.7, “MySQL server has gone away”  
Section 4.6.7, “mysqlbinlog — Utility for Processing Binary Log Files”  
Section 4.5.4, “mysqldump — A Database Backup Program”  
Section 4.5.6, “mysqlpump — A Database Backup Program”  
Section 21.6.14, “NDB API Statistics Counters and Variables”  
Section 21.6.11.1, “NDB Cluster Disk Data Objects”  
Section 21.3.5, “NDB Cluster Example with Tables and Data”  
Section 21.7.11, “NDB Cluster Replication Conflict Resolution”  
Section 8.8.4, “Obtaining Execution Plan Information for a Named Connection”

---

Section 14.13.1, “Online DDL Operations”  
Section 13.7.2.4, “OPTIMIZE TABLE Statement”  
Section 8.9.3, “Optimizer Hints”  
Section 8.2.4, “Optimizing Data Change Statements”  
Section 8.2.4.1, “Optimizing INSERT Statements”  
Section 8.6.1, “Optimizing MyISAM Queries”  
Section 8.8.1, “Optimizing Queries with EXPLAIN”  
Section 11.1.7, “Out-of-Range and Overflow Handling”  
Section 22.1, “Overview of Partitioning in MySQL”  
Section 22.4, “Partition Pruning”  
Section 22.5, “Partition Selection”  
Section 22.6.4, “Partitioning and Locking”  
Section 6.1.2.3, “Passwords and Logging”  
Section 25.12.6, “Performance Schema Statement Event Tables”  
Section 21.6.5, “Performing a Rolling Restart of an NDB Cluster”  
Section 11.4.6, “Populating Spatial Columns”  
Section 25.4.6, “Pre-Filtering by Thread”  
Section 1.6.3.1, “PRIMARY KEY and UNIQUE Index Constraints”  
Section 6.2.2, “Privileges Provided by MySQL”  
Section 14.8.10, “Purge Configuration”  
Section 8.14.4, “Query Cache Thread States”  
Section 22.2.1, “RANGE Partitioning”  
Section 13.2.8, “REPLACE Statement”  
Section 16.4.1.27, “Replica Errors During Replication”  
Section 16.4.1.1, “Replication and AUTO\_INCREMENT”  
Section 16.4.1.28, “Replication and Server SQL Mode”  
Section 16.4.1.15, “Replication and System Functions”  
Section 16.4.1.34, “Replication and Triggers”  
Section 16.4.1.37, “Replication and Variables”  
Section 16.1.6.2, “Replication Source Options and Variables”  
Section 22.6, “Restrictions and Limitations on Partitioning”  
Row-Level Probes  
Section 13.1.18.8, “Secondary Indexes and Generated Columns”  
Section 5.4.1, “Selecting General Query Log and Slow Query Log Output Destinations”  
Section 5.1.10, “Server SQL Modes”  
Section 5.1.7, “Server System Variables”  
Section 13.7.5.27, “SHOW PROCEDURE CODE Statement”  
Section 13.7.5.36, “SHOW TABLE STATUS Statement”  
Section 13.7.5.40, “SHOW WARNINGS Statement”  
Statement Probes  
Section 23.7, “Stored Program Binary Logging”  
Section 13.2.10, “Subqueries”  
Section 8.11.2, “Table Locking Issues”  
Section 15.5, “The ARCHIVE Storage Engine”  
Section 10.8.5, “The binary Collation Compared to \_bin Collations”  
Section 5.4.4, “The Binary Log”  
Section 15.6, “The BLACKHOLE Storage Engine”  
Section 24.3.25, “The INFORMATION\_SCHEMA TABLES Table”  
Section 24.3.31, “The INFORMATION\_SCHEMA VIEWS Table”  
Section 1.2.2, “The Main Features of MySQL”  
Section 15.7, “The MERGE Storage Engine”  
Section 15.2, “The MyISAM Storage Engine”  
Section 8.10.3, “The MySQL Query Cache”  
Section 5.1.16, “The Server Shutdown Process”

---

[Section 8.15.3, “Traceable Statements”](#)  
[Section 14.7.2.1, “Transaction Isolation Levels”](#)  
[Section 23.3.1, “Trigger Syntax and Examples”](#)  
[Section 6.2.17, “Troubleshooting Problems Connecting to MySQL”](#)  
[Section 14.21.8, “Troubleshooting the InnoDB memcached Plugin”](#)  
[Section 14.6.7, “Undo Logs”](#)  
[Section 23.5.3, “Updatable and Insertable Views”](#)  
[Section 13.2.11, “UPDATE Statement”](#)  
[Section 14.16.2.1, “Using InnoDB Transaction and Locking Information”](#)  
[Section 5.5.4.2, “Using the Rewriter Query Rewrite Plugin”](#)  
[Section 23.3, “Using Triggers”](#)  
[Section 1.3, “What Is New in MySQL 5.7”](#)  
[Section 6.2.9, “When Privilege Changes Take Effect”](#)  
[Section 6.4.5.8, “Writing Audit Log Filter Definitions”](#)

## **INSERT ... ()**

[Statement Probes](#)

## **INSERT ... ON DUPLICATE KEY UPDATE**

[Section 14.6.1.6, “AUTO\\_INCREMENT Handling in InnoDB”](#)  
[Section 16.2.1.3, “Determination of Safe and Unsafe Statements in Binary Logging”](#)  
[Section 15.8.3, “FEDERATED Storage Engine Notes and Tips”](#)  
[Section 12.15, “Information Functions”](#)  
[Section 13.2.5.2, “INSERT ... ON DUPLICATE KEY UPDATE Statement”](#)  
[Section 13.2.5, “INSERT Statement”](#)  
[Section 21.7.3, “Known Issues in NDB Cluster Replication”](#)  
[Section 14.7.3, “Locks Set by Different SQL Statements in InnoDB”](#)  
[Section 15.7.2, “MERGE Table Problems”](#)  
[Section 12.20, “Miscellaneous Functions”](#)  
[MySQL Glossary](#)  
[Section 22.6.4, “Partitioning and Locking”](#)

## **INSERT ... SELECT**

[Section 16.2.1.1, “Advantages and Disadvantages of Statement-Based and Row-Based Replication”](#)  
[Section 14.6.1.6, “AUTO\\_INCREMENT Handling in InnoDB”](#)  
[Section 8.11.3, “Concurrent Inserts”](#)  
[Section 13.2.5.2, “INSERT ... ON DUPLICATE KEY UPDATE Statement”](#)  
[Section 13.2.5.1, “INSERT ... SELECT Statement”](#)  
[Section 13.2.5, “INSERT Statement”](#)  
[Section 8.4.4, “Internal Temporary Table Use in MySQL”](#)  
[Section B.3.7, “Known Issues in MySQL”](#)  
[Section 14.7.3, “Locks Set by Different SQL Statements in InnoDB”](#)  
[NDB Cluster System Variables](#)  
[Section 22.5, “Partition Selection”](#)  
[Section 22.6.4, “Partitioning and Locking”](#)  
[Section 16.4.1.17, “Replication and LIMIT”](#)  
[Section 5.1.7, “Server System Variables”](#)  
[Statement Probes](#)  
[Section 5.4.4, “The Binary Log”](#)

## **INSERT ... SELECT ON DUPLICATE KEY UPDATE**

[Section 13.2.5.2, “INSERT ... ON DUPLICATE KEY UPDATE Statement”](#)  
[Section 13.2.5.1, “INSERT ... SELECT Statement”](#)

---

## **INSERT ... SET**

Section 13.2.5, “INSERT Statement”

## **INSERT ... VALUES**

Section 13.2.5, “INSERT Statement”

## **INSERT DELAYED**

Section 13.2.5.3, “INSERT DELAYED Statement”

Section 13.2.5, “INSERT Statement”

Section 1.3, “What Is New in MySQL 5.7”

## **INSERT IGNORE**

Section 1.6.3.3, “Constraints on Invalid Data”

Section 1.6.3.4, “ENUM and SET Constraints”

Section 12.15, “Information Functions”

Section 13.2.5, “INSERT Statement”

Section 4.5.4, “mysqldump — A Database Backup Program”

Section 4.5.6, “mysqlpump — A Database Backup Program”

Section 5.1.10, “Server SQL Modes”

## **INSERT IGNORE ... SELECT**

Section 13.2.5.1, “INSERT ... SELECT Statement”

## **INSERT INTO ... SELECT**

Section 6.2.6, “Access Control, Stage 2: Request Verification”

Section 14.7.2.3, “Consistent Nonlocking Reads”

Section 1.6.3.3, “Constraints on Invalid Data”

Section 13.1.12, “CREATE EVENT Statement”

Section 13.2.5, “INSERT Statement”

Section 1.6.2.1, “SELECT INTO TABLE Differences”

Section 15.3, “The MEMORY Storage Engine”

Section 6.4.5.8, “Writing Audit Log Filter Definitions”

## **INSERT INTO ... SELECT FROM memory\_table**

Section 16.4.1.20, “Replication and MEMORY Tables”

## **INSERT INTO...SELECT**

Section 8.2.1, “Optimizing SELECT Statements”

## **INSTALL PLUGIN**

Section 6.4.5.7, “Audit Log Filtering”

Section 6.4.5.11, “Audit Log Reference”

Section 6.4.2.1, “Connection Control Plugin Installation”

Section 13.7.6.3, “FLUSH Statement”

Section 6.4.4.8, “General-Purpose Keyring Key-Management Functions”

Section 8.12.4.1, “How MySQL Uses Memory”

Section 13.7.3.3, “INSTALL PLUGIN Statement”

Section 5.5.1, “Installing and Uninstalling Plugins”

Section 6.4.5.2, “Installing or Uninstalling MySQL Enterprise Audit”

Section 6.5.2, “Installing or Uninstalling MySQL Enterprise Data Masking and De-Identification”

Section 6.4.6.2, “Installing or Uninstalling MySQL Enterprise Firewall”

---

[Section 5.5.5.2, “Installing or Uninstalling Version Tokens”](#)  
[Section 6.4.4.1, “Keyring Plugin Installation”](#)  
[Section 6.4.1.9, “LDAP Pluggable Authentication”](#)  
[Section 12.9.9, “MeCab Full-Text Parser Plugin”](#)  
[Section 2.8.7, “MySQL Source-Configuration Options”](#)  
[Section 4.4.3, “mysql\\_plugin — Configure MySQL Server Plugins”](#)  
[Section 6.4.1.10, “No-Login Pluggable Authentication”](#)  
[Section 5.5.2, “Obtaining Server Plugin Information”](#)  
[Section 6.4.1.7, “PAM Pluggable Authentication”](#)  
[Section 6.4.3.1, “Password Validation Plugin Installation”](#)  
[Section 6.4.3.2, “Password Validation Plugin Options and Variables”](#)  
[Section 15.11.1, “Pluggable Storage Engine Architecture”](#)  
[Section 16.3.9.1, “Semisynchronous Replication Administrative Interface”](#)  
[Section 16.3.9.2, “Semisynchronous Replication Installation and Configuration”](#)  
[Section 5.1.6, “Server Command Options”](#)  
[Section 5.1.7, “Server System Variables”](#)  
[Section 14.21.3, “Setting Up the InnoDB memcached Plugin”](#)  
[Section 13.7.5.25, “SHOW PLUGINS Statement”](#)  
[Section 6.4.1.11, “Socket Peer-Credential Pluggable Authentication”](#)  
[Section 13.3.3, “Statements That Cause an Implicit Commit”](#)  
[Section 6.4.1.12, “Test Pluggable Authentication”](#)  
[Section 24.3.17, “The INFORMATION\\_SCHEMA PLUGINS Table”](#)  
[Section 5.3, “The mysql System Database”](#)  
[Section 14.21.8, “Troubleshooting the InnoDB memcached Plugin”](#)  
[Section 13.7.3.4, “UNINSTALL PLUGIN Statement”](#)  
[Section 6.4.4.5, “Using the keyring\\_aws Amazon Web Services Keyring Plugin”](#)  
[Section 1.3, “What Is New in MySQL 5.7”](#)  
[Section 6.4.1.8, “Windows Pluggable Authentication”](#)  
[Section 19.4.2.2, “X Plugin Options and System Variables”](#)

## ITERATE

[Section 13.6.7.2, “DECLARE ... HANDLER Statement”](#)  
[Section 13.6.5, “Flow Control Statements”](#)  
[Section 13.6.5.3, “ITERATE Statement”](#)  
[Section 13.6.2, “Statement Labels”](#)

## K

[\[index top\]](#)

## KILL

[Section 8.14, “Examining Server Thread \(Process\) Information”](#)  
[Section 8.14.3, “General Thread States”](#)  
[Section 13.7.1.4, “GRANT Statement”](#)  
[Section 16.1.3.2, “GTID Life Cycle”](#)  
[Section 13.7.6.4, “KILL Statement”](#)  
[Section 13.3.5, “LOCK TABLES and UNLOCK TABLES Statements”](#)  
[Section B.3.2.7, “MySQL server has gone away”](#)  
[Section 6.2.2, “Privileges Provided by MySQL”](#)  
[Section 16.4.1.32, “Replication and Transaction Inconsistencies”](#)  
[Section 13.7.5.29, “SHOW PROCESSLIST Statement”](#)  
[Section 13.4.2.6, “STOP SLAVE Statement”](#)  
[Section 26.4.3.9, “The innodb\\_lock\\_waits and x\\$innodb\\_lock\\_waits Views”](#)



---

[Section 26.4.3.28, “The schema\\_table\\_lock\\_waits and x\\$schema\\_table\\_lock\\_waits Views”](#)  
[Section 1.3, “What Is New in MySQL 5.7”](#)

## **KILL CONNECTION**

[Section 13.7.6.4, “KILL Statement”](#)  
[Section 13.4.2.6, “STOP SLAVE Statement”](#)  
[Section 5.1.16, “The Server Shutdown Process”](#)

## **KILL QUERY**

[Section 13.7.6.4, “KILL Statement”](#)  
[Section 12.20, “Miscellaneous Functions”](#)  
[Section 13.4.2.6, “STOP SLAVE Statement”](#)  
[Section 5.1.16, “The Server Shutdown Process”](#)

## **L**

[\[index top\]](#)

## **LEAVE**

[Section 13.6.7.2, “DECLARE ... HANDLER Statement”](#)  
[Section 13.6.5, “Flow Control Statements”](#)  
[Section 13.6.5.4, “LEAVE Statement”](#)  
[Section 13.6.5.5, “LOOP Statement”](#)  
[Section 23.8, “Restrictions on Stored Programs”](#)  
[Section 13.6.5.7, “RETURN Statement”](#)  
[Section 13.6.2, “Statement Labels”](#)

## **LOAD DATA**

[Section 6.4.5.4, “Audit Log File Formats”](#)  
[Section 6.4.5.12, “Audit Log Restrictions”](#)  
[Section 14.6.1.6, “AUTO\\_INCREMENT Handling in InnoDB”](#)  
[Section 16.3.1.2, “Backing Up Raw Data from a Replica”](#)  
[Section 7.1, “Backup and Recovery Types”](#)  
[Section 8.6.2, “Bulk Data Loading for MyISAM Tables”](#)  
[Section 8.11.3, “Concurrent Inserts”](#)  
[Section 13.1.20, “CREATE TRIGGER Statement”](#)  
[Section 7.2, “Database Backup Methods”](#)  
[Section 10.3.3, “Database Character Set and Collation”](#)  
[Section 16.2.1.3, “Determination of Safe and Unsafe Statements in Binary Logging”](#)  
[Section 13.1.18.5, “FOREIGN KEY Constraints”](#)  
[Section B.3.3.4, “How MySQL Handles a Full Disk”](#)  
[Section 12.15, “Information Functions”](#)  
[Section B.3.7, “Known Issues in MySQL”](#)  
[Section 21.2.7.3, “Limits Relating to Transaction Handling in NDB Cluster”](#)  
[Section 13.2.6, “LOAD DATA Statement”](#)  
[Section 13.2.7, “LOAD XML Statement”](#)  
[Section 3.3.3, “Loading Data into a Table”](#)  
[Section 5.4.4.4, “Logging Format for Changes to mysql Database Tables”](#)  
[Section 6.1.3, “Making MySQL Secure Against Attackers”](#)  
[Section 15.2.1, “MyISAM Startup Options”](#)  
[Section 4.5.1.1, “mysql Client Options”](#)  
[Section 1.6.1, “MySQL Extensions to Standard SQL”](#)  
[Section 4.6.7, “mysqlbinlog — Utility for Processing Binary Log Files”](#)

---

Section 4.5.4, “mysqldump — A Database Backup Program”  
Section 4.5.5, “mysqlimport — A Data Import Program”  
Section 21.5.14, “ndb\_import — Import CSV Data Into NDB”  
Section 21.5.27, “ndb\_show\_tables — Display List of NDB Tables”  
Section 9.1.7, “NULL Values”  
Section 8.2.4.1, “Optimizing INSERT Statements”  
Section 11.1.7, “Out-of-Range and Overflow Handling”  
Section 4.1, “Overview of MySQL Programs”  
Section 22.1, “Overview of Partitioning in MySQL”  
Section 22.5, “Partition Selection”  
Section 22.6.4, “Partitioning and Locking”  
Section 21.6.5, “Performing a Rolling Restart of an NDB Cluster”  
Section 6.2.2, “Privileges Provided by MySQL”  
Section B.3.4.3, “Problems with NULL Values”  
Section 7.4.4, “Reloading Delimited-Text Format Backups”  
Section 16.1.6.3, “Replica Server Options and Variables”  
Section 16.4.1.18, “Replication and LOAD DATA”  
Section 8.14.7, “Replication Replica SQL Thread States”  
Section 22.6, “Restrictions and Limitations on Partitioning”  
Section 10.11, “Restrictions on Character Sets”  
Section 23.8, “Restrictions on Stored Programs”  
Section 6.1.6, “Security Considerations for LOAD DATA LOCAL”  
Section 13.2.9.1, “SELECT ... INTO Statement”  
Section 3.3.4.1, “Selecting All Data”  
Section 5.1.6, “Server Command Options”  
Section 5.1.10, “Server SQL Modes”  
Section 5.1.7, “Server System Variables”  
Section 13.7.5.40, “SHOW WARNINGS Statement”  
Section 13.3.3, “Statements That Cause an Implicit Commit”  
Section 13.2.10, “Subqueries”  
Section 11.3.5, “The ENUM Type”  
Section 15.3, “The MEMORY Storage Engine”  
Section 13.2.10.1, “The Subquery as Scalar Operand”  
Section 6.2.17, “Troubleshooting Problems Connecting to MySQL”  
Section 9.4, “User-Defined Variables”  
Section 23.3, “Using Triggers”  
Section 1.3, “What Is New in MySQL 5.7”  
Section 21.2.4.2, “What is New in NDB Cluster 7.6”  
Section B.3.3.5, “Where MySQL Stores Temporary Files”  
Section 2.3.7, “Windows Platform Restrictions”

## **LOAD DATA ... REPLACE**

Section 13.2.8, “REPLACE Statement”

## **LOAD DATA LOCAL**

Section 13.2.6, “LOAD DATA Statement”  
Section 2.8.7, “MySQL Source-Configuration Options”  
Section 4.6.7, “mysqlbinlog — Utility for Processing Binary Log Files”  
Section 6.1.6, “Security Considerations for LOAD DATA LOCAL”  
Section 5.1.7, “Server System Variables”

## **LOAD DATA LOCAL INFILE**

Section 6.1.6, “Security Considerations for LOAD DATA LOCAL”

---

## LOAD INDEX INTO CACHE

- Section 13.7.6.2, “CACHE INDEX Statement”
- Section 16.1.6.5, “Global Transaction ID System Variables”
- Section 8.10.2.4, “Index Preloading”
- Section 13.7.6.5, “LOAD INDEX INTO CACHE Statement”
- Section 22.6, “Restrictions and Limitations on Partitioning”
- Section 13.3.3, “Statements That Cause an Implicit Commit”

## LOAD INDEX INTO CACHE ... IGNORE LEAVES

- Section 13.7.6.5, “LOAD INDEX INTO CACHE Statement”

## LOAD XML

- Section 13.2.7, “LOAD XML Statement”
- Section 22.1, “Overview of Partitioning in MySQL”
- Section 22.5, “Partition Selection”
- Section 23.8, “Restrictions on Stored Programs”
- Section 5.1.10, “Server SQL Modes”

## LOAD XML LOCAL

- Section 13.2.7, “LOAD XML Statement”

## LOCK TABLE

- Section 8.11.3, “Concurrent Inserts”
- Section 8.14.3, “General Thread States”
- Section B.3.6.1, “Problems with ALTER TABLE”

## LOCK TABLES

- Section 14.1.2, “Best Practices for InnoDB Tables”
- Section 8.6.2, “Bulk Data Loading for MyISAM Tables”
- Section 13.1.11, “CREATE DATABASE Statement”
- Section 13.1.18.3, “CREATE TABLE ... LIKE Statement”
- Section 13.1.20, “CREATE TRIGGER Statement”
- Section 14.7.5.2, “Deadlock Detection”
- Section 14.7.5, “Deadlocks in InnoDB”
- Section 13.7.6.3, “FLUSH Statement”
- Section 8.14.3, “General Thread States”
- Section 13.7.1.4, “GRANT Statement”
- Section 14.7.5.3, “How to Minimize and Handle Deadlocks”
- Section 14.15, “InnoDB Startup Options and System Variables”
- Section 8.11.1, “Internal Locking Methods”
- Section 21.2.7.10, “Limitations Relating to Multiple NDB Cluster Nodes”
- Section 13.3.5, “LOCK TABLES and UNLOCK TABLES Statements”
- Section 14.7.3, “Locks Set by Different SQL Statements in InnoDB”
- Section 15.7.2, “MERGE Table Problems”
- Section 8.11.4, “Metadata Locking”
- Section 4.5.4, “mysqldump — A Database Backup Program”
- Section 4.5.6, “mysqlpump — A Database Backup Program”
- Section 22.6.4, “Partitioning and Locking”
- Section 6.2.2, “Privileges Provided by MySQL”
- Section 15.2.4.2, “Problems from Tables Not Being Closed Properly”
- Section 23.8, “Restrictions on Stored Programs”
- Section 5.4.1, “Selecting General Query Log and Slow Query Log Output Destinations”

---

[Section 5.1.7, “Server System Variables”](#)  
[Section 13.3.1, “START TRANSACTION, COMMIT, and ROLLBACK Statements”](#)  
[Section 13.3.3, “Statements That Cause an Implicit Commit”](#)  
[Section 8.12.1, “System Factors”](#)  
[Section 8.11.2, “Table Locking Issues”](#)

## **LOCK TABLES ... READ**

[Section 13.7.6.3, “FLUSH Statement”](#)  
[Section 14.15, “InnoDB Startup Options and System Variables”](#)  
[Section 14.7.3, “Locks Set by Different SQL Statements in InnoDB”](#)  
[Section 8.11.4, “Metadata Locking”](#)

## **LOCK TABLES ... WRITE**

[Section 14.7.1, “InnoDB Locking”](#)  
[Section 14.15, “InnoDB Startup Options and System Variables”](#)  
[Section 14.7.3, “Locks Set by Different SQL Statements in InnoDB”](#)

## **LOOP**

[Section 13.6.5, “Flow Control Statements”](#)  
[Section 13.6.5.3, “ITERATE Statement”](#)  
[Section 13.6.5.4, “LEAVE Statement”](#)  
[Section 13.6.5.5, “LOOP Statement”](#)  
[Section 13.6.2, “Statement Labels”](#)

## **O**

[\[index top\]](#)

## **OPTIMIZE PARTITION**

[Section 14.13.1, “Online DDL Operations”](#)

## **OPTIMIZE TABLE**

[Section 21.6.7.2, “Adding NDB Cluster Data Nodes Online: Basic procedure”](#)  
[Section 21.6.7.3, “Adding NDB Cluster Data Nodes Online: Detailed Example”](#)  
[Section 5.8.1, “Debugging a MySQL Server”](#)  
[Section 13.2.2, “DELETE Statement”](#)  
[Section 2.11.3, “Downgrade Notes”](#)  
[Section 15.2.3.2, “Dynamic Table Characteristics”](#)  
[Section 12.9.6, “Fine-Tuning MySQL Full-Text Search”](#)  
[Section 8.14.3, “General Thread States”](#)  
[Section 16.1.6.5, “Global Transaction ID System Variables”](#)  
[Section B.3.3.4, “How MySQL Handles a Full Disk”](#)  
[Section 14.6.1.3, “Importing InnoDB Tables”](#)  
[Section 14.16.4, “InnoDB INFORMATION\\_SCHEMA FULLTEXT Index Tables”](#)  
[Section 14.9.2, “InnoDB Page Compression”](#)  
[Section 14.11, “InnoDB Row Formats”](#)  
[Section 14.15, “InnoDB Startup Options and System Variables”](#)  
[Section 13.7.6.4, “KILL Statement”](#)  
[Section 21.2.7.2, “Limits and Differences of NDB Cluster from Standard MySQL Limits”](#)  
[Section 22.3.4, “Maintenance of Partitions”](#)  
[Section 15.7.2, “MERGE Table Problems”](#)  
[Section 7.6, “MyISAM Table Maintenance and Crash Recovery”](#)  
[Section 7.6.4, “MyISAM Table Optimization”](#)

---

[Section 4.6.3.1, “mysiamchk General Options”](#)  
[Section 1.6.1, “MySQL Extensions to Standard SQL”](#)  
[MySQL Server Options for NDB Cluster](#)  
[Section 4.5.3, “mysqlcheck — A Table Maintenance Program”](#)  
[Section 21.6.11.3, “NDB Cluster Disk Data Storage Requirements”](#)  
[Section 14.13.6, “Online DDL Limitations”](#)  
[Section 21.6.12, “Online Operations with ALTER TABLE in NDB Cluster”](#)  
[Section 13.7.2.4, “OPTIMIZE TABLE Statement”](#)  
[Section 8.6.1, “Optimizing MyISAM Queries”](#)  
[Section 8.2.4.2, “Optimizing UPDATE Statements”](#)  
[Section 8.2.6, “Other Optimization Tips”](#)  
[Section 6.2.2, “Privileges Provided by MySQL”](#)  
[Section 16.4.1.14, “Replication and FLUSH”](#)  
[Section 22.6, “Restrictions and Limitations on Partitioning”](#)  
[Section 5.1.6, “Server Command Options”](#)  
[Section 5.1.7, “Server System Variables”](#)  
[Section 7.6.5, “Setting Up a MyISAM Table Maintenance Schedule”](#)  
[Section 13.3.3, “Statements That Cause an Implicit Commit”](#)  
[Section 15.2.3.1, “Static \(Fixed-Length\) Table Characteristics”](#)  
[Section 15.5, “The ARCHIVE Storage Engine”](#)  
[Section 24.4.8, “The INFORMATION\\_SCHEMA INNODB\\_FT\\_BEING\\_DELETED Table”](#)  
[Section 24.4.9, “The INFORMATION\\_SCHEMA INNODB\\_FT\\_CONFIG Table”](#)  
[Section 24.4.11, “The INFORMATION\\_SCHEMA INNODB\\_FT\\_DELETED Table”](#)  
[Section 24.4.12, “The INFORMATION\\_SCHEMA INNODB\\_FT\\_INDEX\\_CACHE Table”](#)  
[Section 24.4.13, “The INFORMATION\\_SCHEMA INNODB\\_FT\\_INDEX\\_TABLE Table”](#)  
[Section 21.6.15.27, “The ndbinfo memory\\_per\\_fragment Table”](#)  
[Section 5.1.16, “The Server Shutdown Process”](#)  
[Section 5.4.5, “The Slow Query Log”](#)  
[Section 8.12.3.2, “Using Symbolic Links for MyISAM Tables on Unix”](#)  
[Section 1.3, “What Is New in MySQL 5.7”](#)

## ORDER BY

[Section 14.1.1, “Benefits of Using InnoDB Tables”](#)

## P

[\[index top\]](#)

## PARTITION BY

[Section 14.13.1, “Online DDL Operations”](#)

## PREPARE

[Section 8.10.4, “Caching of Prepared Statements and Stored Programs”](#)  
[Section 13.2.1, “CALL Statement”](#)  
[Section 13.5.3, “DEALLOCATE PREPARE Statement”](#)  
[Section 13.5.2, “EXECUTE Statement”](#)  
[Section 9.2.3, “Identifier Case Sensitivity”](#)  
[Section 8.11.4, “Metadata Locking”](#)  
[Section 13.5.1, “PREPARE Statement”](#)  
[Section 13.5, “Prepared Statements”](#)  
[Section 23.8, “Restrictions on Stored Programs”](#)  
[Section 5.1.9, “Server Status Variables”](#)  
[Section 25.12.6.4, “The prepared\\_statements\\_instances Table”](#)

---

## PURGE BINARY LOGS

[Section 16.1.6.4, “Binary Logging Options and Variables”](#)  
[Section 7.3.1, “Establishing a Backup Policy”](#)  
[Section 13.7.1.4, “GRANT Statement”](#)  
[Section 4.5.4, “mysqldump — A Database Backup Program”](#)  
[Section 6.2.2, “Privileges Provided by MySQL”](#)  
[Section 13.4.1.1, “PURGE BINARY LOGS Statement”](#)  
[Section 13.4.1.2, “RESET MASTER Statement”](#)  
[Section 5.4.7, “Server Log Maintenance”](#)  
[Section 5.4.4, “The Binary Log”](#)  
[Section 16.1.3.5, “Using GTIDs for Failover and Scaleout”](#)

## R

[\[index top\]](#)

## REBUILD PARTITION

[Section 14.13.1, “Online DDL Operations”](#)

## RELEASE SAVEPOINT

[Section 25.12.7, “Performance Schema Transaction Tables”](#)  
[Section 13.3.4, “SAVEPOINT, ROLLBACK TO SAVEPOINT, and RELEASE SAVEPOINT Statements”](#)  
[Section 25.12.7.1, “The events\\_transactions\\_current Table”](#)

## REMOVE PARTITIONING

[Section 14.13.1, “Online DDL Operations”](#)

## RENAME TABLE

[Section 13.1.8, “ALTER TABLE Statement”](#)  
[Section 13.2.2, “DELETE Statement”](#)  
[Section 8.14.3, “General Thread States”](#)  
[Section 9.2.3, “Identifier Case Sensitivity”](#)  
[Section 8.11.4, “Metadata Locking”](#)  
[Section 14.6.1.4, “Moving or Copying InnoDB Tables”](#)  
[Section 1.6.1, “MySQL Extensions to Standard SQL”](#)  
[Section 4.5.4, “mysqldump — A Database Backup Program”](#)  
[Section 4.5.6, “mysqlpump — A Database Backup Program”](#)  
[Section 14.13.1, “Online DDL Operations”](#)  
[Section 13.1.33, “RENAME TABLE Statement”](#)  
[Section 5.4.1, “Selecting General Query Log and Slow Query Log Output Destinations”](#)  
[Section 13.3.3, “Statements That Cause an Implicit Commit”](#)  
[Section 8.12.3.2, “Using Symbolic Links for MyISAM Tables on Unix”](#)

## RENAME USER

[Section 13.7.1.4, “GRANT Statement”](#)  
[Section 12.15, “Information Functions”](#)  
[Section 5.4.4.4, “Logging Format for Changes to mysql Database Tables”](#)  
[Section 6.2.2, “Privileges Provided by MySQL”](#)  
[Section 13.7.1.5, “RENAME USER Statement”](#)  
[Section 16.4.1.8, “Replication of CURRENT\\_USER\(\)”](#)  
[Section 13.3.3, “Statements That Cause an Implicit Commit”](#)  
[Section 23.6, “Stored Object Access Control”](#)

---

[Section 23.4.6, “The Event Scheduler and MySQL Privileges”](#)  
[Section 6.2.9, “When Privilege Changes Take Effect”](#)

## **REORGANIZE PARTITION**

[Section 14.13.1, “Online DDL Operations”](#)

## **REPAIR PARTITION**

[Section 14.13.1, “Online DDL Operations”](#)

## **REPAIR TABLE**

[Section 11.2.5, “2-Digit YEAR\(2\) Limitations and Migrating to 4-Digit YEAR”](#)  
[Section 13.1.8.1, “ALTER TABLE Partition Operations”](#)  
[Section 13.1.8, “ALTER TABLE Statement”](#)  
[Section 2.10.3, “Changes in MySQL 5.7”](#)  
[Section 13.7.2.2, “CHECK TABLE Statement”](#)  
[Section 15.2.4.1, “Corrupted MyISAM Tables”](#)  
[Section 7.2, “Database Backup Methods”](#)  
[Section 22.3.3, “Exchanging Partitions and Subpartitions with Tables”](#)  
[Section 8.11.5, “External Locking”](#)  
[Section 12.9.6, “Fine-Tuning MySQL Full-Text Search”](#)  
[Section 8.14.3, “General Thread States”](#)  
[Section 16.1.6.5, “Global Transaction ID System Variables”](#)  
[Section B.3.3.4, “How MySQL Handles a Full Disk”](#)  
[Section 7.6.3, “How to Repair MyISAM Tables”](#)  
[Section 1.5, “How to Report Bugs or Problems”](#)  
[Section 13.7.6.4, “KILL Statement”](#)  
[Section 13.2.6, “LOAD DATA Statement”](#)  
[Section 22.3.4, “Maintenance of Partitions”](#)  
[Section 15.7.2, “MERGE Table Problems”](#)  
[Section 15.2.1, “MyISAM Startup Options”](#)  
[Section 7.6, “MyISAM Table Maintenance and Crash Recovery”](#)  
[Section 4.6.3.1, “myisamchk General Options”](#)  
[Section 4.6.3, “myisamchk — MyISAM Table-Maintenance Utility”](#)  
[Section 1.6.1, “MySQL Extensions to Standard SQL”](#)  
[Section 4.5.3, “mysqlcheck — A Table Maintenance Program”](#)  
[Section 8.6.3, “Optimizing REPAIR TABLE Statements”](#)  
[Section 6.2.2, “Privileges Provided by MySQL”](#)  
[Section 15.2.4.2, “Problems from Tables Not Being Closed Properly”](#)  
[Section B.3.6.1, “Problems with ALTER TABLE”](#)  
[Section 2.10.12, “Rebuilding or Repairing Tables or Indexes”](#)  
[Section 13.7.2.5, “REPAIR TABLE Statement”](#)  
[Section 15.4.1, “Repairing and Checking CSV Tables”](#)  
[Section 16.4.1.14, “Replication and FLUSH”](#)  
[Section 16.4.1.24, “Replication and REPAIR TABLE”](#)  
[Restoring an NDB backup to a later version of NDB Cluster](#)  
[Section 22.6, “Restrictions and Limitations on Partitioning”](#)  
[Section 5.1.7, “Server System Variables”](#)  
[Section 7.6.5, “Setting Up a MyISAM Table Maintenance Schedule”](#)  
[Section 13.3.3, “Statements That Cause an Implicit Commit”](#)  
[Section 15.5, “The ARCHIVE Storage Engine”](#)  
[Section 5.1.16, “The Server Shutdown Process”](#)  
[Section 5.4.5, “The Slow Query Log”](#)  
[Section 8.12.3.2, “Using Symbolic Links for MyISAM Tables on Unix”](#)

---

## REPEAT

- Section 13.6.7.2, “DECLARE ... HANDLER Statement”
- Section 23.1, “Defining Stored Programs”
- Section 13.6.5, “Flow Control Statements”
- Section 13.6.5.3, “ITERATE Statement”
- Section 13.6.5.4, “LEAVE Statement”
- Section 13.6.5.6, “REPEAT Statement”
- Section 13.6.2, “Statement Labels”

## REPLACE

- Section 16.2.1.1, “Advantages and Disadvantages of Statement-Based and Row-Based Replication”
- Section 14.6.1.6, “AUTO\_INCREMENT Handling in InnoDB”
- Section 13.1.18.7, “CREATE TABLE and Generated Columns”
- Section 13.1.20, “CREATE TRIGGER Statement”
- Section 11.6, “Data Type Default Values”
- Section 8.8.2, “EXPLAIN Output Format”
- Section 13.8.2, “EXPLAIN Statement”
- Section 8.8.3, “Extended EXPLAIN Output Format”
- Section 12.15, “Information Functions”
- Section 13.2.5, “INSERT Statement”
- Section B.3.7, “Known Issues in MySQL”
- Section 14.7.3, “Locks Set by Different SQL Statements in InnoDB”
- Section 5.4.4.4, “Logging Format for Changes to mysql Database Tables”
- Section 15.7.2, “MERGE Table Problems”
- Section 1.6.1, “MySQL Extensions to Standard SQL”
- Section B.3.2.7, “MySQL server has gone away”
- Section 4.5.4, “mysqldump — A Database Backup Program”
- Section 4.5.6, “mysqlpump — A Database Backup Program”
- Section 8.8.4, “Obtaining Execution Plan Information for a Named Connection”
- Section 8.9.3, “Optimizer Hints”
- Section 8.8.1, “Optimizing Queries with EXPLAIN”
- Section 22.1, “Overview of Partitioning in MySQL”
- Section 22.5, “Partition Selection”
- Section 22.6.4, “Partitioning and Locking”
- Section 13.2.8, “REPLACE Statement”
- Section 22.6, “Restrictions and Limitations on Partitioning”
- Section 13.2.10, “Subqueries”
- Section 15.5, “The ARCHIVE Storage Engine”
- Section 1.2.2, “The Main Features of MySQL”
- Section 21.6.15.29, “The ndbinfo operations\_per\_fragment Table”
- Section 8.15.3, “Traceable Statements”
- Section 13.2.11, “UPDATE Statement”
- Section 6.4.5.8, “Writing Audit Log Filter Definitions”

## REPLACE ... SELECT

- Section 14.6.1.6, “AUTO\_INCREMENT Handling in InnoDB”
- Section B.3.7, “Known Issues in MySQL”

## REPLACE DELAYED

- Section 1.3, “What Is New in MySQL 5.7”

## RESET

- Section 13.7.6.3, “FLUSH Statement”



---

[Section 16.1.6.5, “Global Transaction ID System Variables”](#)  
[Section 1.6.1, “MySQL Extensions to Standard SQL”](#)  
[Section 6.2.2, “Privileges Provided by MySQL”](#)  
[Section 13.7.6.6, “RESET Statement”](#)  
[Section 13.3.3, “Statements That Cause an Implicit Commit”](#)

## **RESET MASTER**

[Section 16.1.6.5, “Global Transaction ID System Variables”](#)  
[Section 16.1.3.1, “GTID Format and Storage”](#)  
[Section 16.1.3.2, “GTID Life Cycle”](#)  
[Section 21.7.3, “Known Issues in NDB Cluster Replication”](#)  
[Section 16.1.5.2, “Provisioning a Multi-Source Replica for GTID-Based Replication”](#)  
[Section 13.4.1.2, “RESET MASTER Statement”](#)  
[Section 13.4.2.3, “RESET SLAVE Statement”](#)  
[Section 16.1.5.7, “Resetting Multi-Source Replicas”](#)  
[Section 13.7.5.34, “SHOW SLAVE STATUS Statement”](#)  
[Section 16.3.7, “Switching Sources During Failover”](#)  
[Section 5.4.4, “The Binary Log”](#)  
[Section 25.12.11.5, “The replication\\_applier\\_status\\_by\\_coordinator Table”](#)  
[Section 25.12.11.6, “The replication\\_applier\\_status\\_by\\_worker Table”](#)  
[Section 25.12.11.2, “The replication\\_connection\\_status Table”](#)

## **RESET QUERY CACHE**

[Section 8.14.4, “Query Cache Thread States”](#)  
[Section 13.7.6.6, “RESET Statement”](#)  
[Section 1.3, “What Is New in MySQL 5.7”](#)

## **RESET SLAVE**

[Section 13.4.2.1, “CHANGE MASTER TO Statement”](#)  
[Section 16.2.2.1, “Commands for Operations on a Single Channel”](#)  
[Section 16.2.2.2, “Compatibility with Previous Replication Statements”](#)  
[Section 16.3.10, “Delayed Replication”](#)  
[Section 16.1.3.2, “GTID Life Cycle”](#)  
[Section 21.7.3, “Known Issues in NDB Cluster Replication”](#)  
[NDB Cluster System Variables](#)  
[Section 16.1.6, “Replication and Binary Logging Options and Variables”](#)  
[Section 16.4.1.32, “Replication and Transaction Inconsistencies”](#)  
[Section 16.2.4.2, “Replication Metadata Repositories”](#)  
[Section 13.4.1.2, “RESET MASTER Statement”](#)  
[Section 13.4.2.3, “RESET SLAVE Statement”](#)  
[Section 16.1.5.7, “Resetting Multi-Source Replicas”](#)  
[Section 13.7.5.34, “SHOW SLAVE STATUS Statement”](#)  
[Section 13.3.3, “Statements That Cause an Implicit Commit”](#)  
[Section 25.12.11.5, “The replication\\_applier\\_status\\_by\\_coordinator Table”](#)  
[Section 25.12.11.6, “The replication\\_applier\\_status\\_by\\_worker Table”](#)  
[Section 25.12.11.2, “The replication\\_connection\\_status Table”](#)

## **RESET SLAVE ALL**

[Section 13.4.2.1, “CHANGE MASTER TO Statement”](#)  
[Section 13.4.2.3, “RESET SLAVE Statement”](#)

## **RESIGNAL**

[Section 13.6.7, “Condition Handling”](#)

---

Section 13.6.7.8, “Condition Handling and OUT or INOUT Parameters”  
Section 13.6.7.1, “DECLARE ... CONDITION Statement”  
Section 13.6.7.2, “DECLARE ... HANDLER Statement”  
Section 13.6.7.3, “GET DIAGNOSTICS Statement”  
Section 13.6.7.4, “RESIGNAL Statement”  
Section 13.6.7.9, “Restrictions on Condition Handling”  
Section 23.8, “Restrictions on Stored Programs”  
Section 13.6.7.6, “Scope Rules for Handlers”  
Section 13.6.7.5, “SIGNAL Statement”  
Section 13.6.7.7, “The MySQL Diagnostics Area”

## **RETURN**

Section 8.10.4, “Caching of Prepared Statements and Stored Programs”  
Section 13.1.16, “CREATE PROCEDURE and CREATE FUNCTION Statements”  
Section 13.6.5, “Flow Control Statements”  
Section 13.6.5.5, “LOOP Statement”  
Section 23.8, “Restrictions on Stored Programs”  
Section 13.6.5.7, “RETURN Statement”  
Section 13.6.7.5, “SIGNAL Statement”  
Section 13.6.7.7, “The MySQL Diagnostics Area”  
Section 8.15.3, “Traceable Statements”

## **REVOKE**

Section 6.2, “Access Control and Account Management”  
Section 6.2.1, “Account User Names and Passwords”  
Section 6.2.7, “Adding Accounts, Assigning Privileges, and Dropping Accounts”  
Section 16.2.1.1, “Advantages and Disadvantages of Statement-Based and Row-Based Replication”  
Section 14.8.2, “Configuring InnoDB for Read-Only Operation”  
Section 13.7.6.3, “FLUSH Statement”  
Section 13.7.1.4, “GRANT Statement”  
Section 6.2.3, “Grant Tables”  
Section 8.12.4.1, “How MySQL Uses Memory”  
Section 12.15, “Information Functions”  
Section 5.1.12, “IPv6 Support”  
Section 5.4.4.4, “Logging Format for Changes to mysql Database Tables”  
Section A.14, “MySQL 5.7 FAQ: Replication”  
Section 1.6.2, “MySQL Differences from Standard SQL”  
MySQL Glossary  
Section 21.6.18.2, “NDB Cluster and MySQL Privileges”  
Section 6.2.2, “Privileges Provided by MySQL”  
Section 6.2.14, “Proxy Users”  
Section 16.4.1.8, “Replication of CURRENT\_USER()”  
Section 16.4.1.21, “Replication of the mysql System Database”  
Section 13.7.1.6, “REVOKE Statement”  
Section 6.1.1, “Security Guidelines”  
Section 5.1.7, “Server System Variables”  
Section 13.3.3, “Statements That Cause an Implicit Commit”  
Section 23.4.6, “The Event Scheduler and MySQL Privileges”  
Section 6.2.9, “When Privilege Changes Take Effect”

## **REVOKE ALL PRIVILEGES**

Section 13.7.1.4, “GRANT Statement”  
Section 6.2.2, “Privileges Provided by MySQL”

---

## ROLLBACK

[Section 14.7.2.2, “autocommit, Commit, and Rollback”](#)  
[Section 14.6.1.5, “Converting Tables from MyISAM to InnoDB”](#)  
[Section 12.15, “Information Functions”](#)  
[Section 14.2, “InnoDB and the ACID Model”](#)  
[Section 14.22.4, “InnoDB Error Handling”](#)  
[Section 13.3.5, “LOCK TABLES and UNLOCK TABLES Statements”](#)  
[Section 25.12.7, “Performance Schema Transaction Tables”](#)  
[Section 16.1.6.3, “Replica Server Options and Variables”](#)  
[Section 16.4.1.33, “Replication and Transactions”](#)  
[Section B.3.4.5, “Rollback Failure for Nontransactional Tables”](#)  
[Section 13.3.4, “SAVEPOINT, ROLLBACK TO SAVEPOINT, and RELEASE SAVEPOINT Statements”](#)  
[Section 5.1.7, “Server System Variables”](#)  
[Section 13.3.1, “START TRANSACTION, COMMIT, and ROLLBACK Statements”](#)  
[Section 13.3.2, “Statements That Cannot Be Rolled Back”](#)  
[Section 13.3.3, “Statements That Cause an Implicit Commit”](#)  
[Section 23.7, “Stored Program Binary Logging”](#)  
[Section 5.4.4, “The Binary Log”](#)  
[Section 25.12.7.1, “The events\\_transactions\\_current Table”](#)  
[Section 13.3, “Transactional and Locking Statements”](#)  
[Section 23.3.1, “Trigger Syntax and Examples”](#)

## ROLLBACK TO SAVEPOINT

[Section 25.12.7, “Performance Schema Transaction Tables”](#)  
[Section 13.3.4, “SAVEPOINT, ROLLBACK TO SAVEPOINT, and RELEASE SAVEPOINT Statements”](#)  
[Section 25.12.7.1, “The events\\_transactions\\_current Table”](#)

## ROLLBACK to SAVEPOINT

[Section 23.3.1, “Trigger Syntax and Examples”](#)

## S

[\[index top\]](#)

## SAVEPOINT

[Section 25.12.7, “Performance Schema Transaction Tables”](#)  
[Section 13.3.4, “SAVEPOINT, ROLLBACK TO SAVEPOINT, and RELEASE SAVEPOINT Statements”](#)  
[Section 25.12.7.1, “The events\\_transactions\\_current Table”](#)

## SELECT

[Section 1.1, “About This Manual”](#)  
[Section 6.2, “Access Control and Account Management”](#)  
[Section 12.19.1, “Aggregate Function Descriptions”](#)  
[Section 13.1.8, “ALTER TABLE Statement”](#)  
[Section 13.1.10, “ALTER VIEW Statement”](#)  
[Section 12.4.4, “Assignment Operators”](#)  
[Section 6.4.5.4, “Audit Log File Formats”](#)  
[Section 14.6.1.6, “AUTO\\_INCREMENT Handling in InnoDB”](#)  
[Section 14.7.2.2, “autocommit, Commit, and Rollback”](#)  
[Section 16.1.6.4, “Binary Logging Options and Variables”](#)  
[Section 8.6.2, “Bulk Data Loading for MyISAM Tables”](#)  
[Section 8.10.4, “Caching of Prepared Statements and Stored Programs”](#)

---

Section 2.10.3, “Changes in MySQL 5.7”  
Section 6.1.7, “Client Programming Security Guidelines”  
Section 12.4.2, “Comparison Functions and Operators”  
Section 8.3.8, “Comparison of B-Tree and Hash Indexes”  
Section 8.11.3, “Concurrent Inserts”  
Section 10.4, “Connection Character Sets and Collations”  
Section 14.7.2.3, “Consistent Nonlocking Reads”  
Section 14.6.1.5, “Converting Tables from MyISAM to InnoDB”  
Section 13.1.12, “CREATE EVENT Statement”  
Section 13.1.14, “CREATE INDEX Statement”  
Section 13.1.16, “CREATE PROCEDURE and CREATE FUNCTION Statements”  
Section 13.1.18.4, “CREATE TABLE ... SELECT Statement”  
Section 13.1.18.7, “CREATE TABLE and Generated Columns”  
Section 13.1.18, “CREATE TABLE Statement”  
Section 13.1.18.2, “CREATE TEMPORARY TABLE Statement”  
Section 13.1.21, “CREATE VIEW Statement”  
Section 15.8.2.1, “Creating a FEDERATED Table Using CONNECTION”  
Section 3.3.1, “Creating and Selecting a Database”  
Section 13.6.6.2, “Cursor DECLARE Statement”  
Section 13.6.6.3, “Cursor FETCH Statement”  
Section 13.2.2, “DELETE Statement”  
Section 13.2.10.8, “Derived Tables”  
Section 8.4.3.2, “Disadvantages of Creating Many Tables in the Same Database”  
Section 5.1.11.2, “DNS Lookups and the Host Cache”  
Section 13.2.3, “DO Statement”  
Section 3.2, “Entering Queries”  
Section 23.4.2, “Event Scheduler Configuration”  
Section 10.8.6, “Examples of the Effect of Collation”  
Section 8.8.2, “EXPLAIN Output Format”  
Section 13.8.2, “EXPLAIN Statement”  
Section 8.8.3, “Extended EXPLAIN Output Format”  
Section 15.8.3, “FEDERATED Storage Engine Notes and Tips”  
Section 14.22.2, “Forcing InnoDB Recovery”  
Section 8.2.1.18, “Function Call Optimization”  
Chapter 12, *Functions and Operators*  
Section 12.17.3, “Functions That Search JSON Values”  
Section 8.14.3, “General Thread States”  
Section 13.7.1.4, “GRANT Statement”  
Section 13.2.4, “HANDLER Statement”  
Section 22.2.7, “How MySQL Partitioning Handles NULL”  
Section 8.10.3.1, “How the Query Cache Operates”  
Section 14.7.5.3, “How to Minimize and Handle Deadlocks”  
Section 1.5, “How to Report Bugs or Problems”  
Section 8.9.4, “Index Hints”  
Section 12.15, “Information Functions”  
Section 14.15, “InnoDB Startup Options and System Variables”  
Section 13.2.5.2, “INSERT ... ON DUPLICATE KEY UPDATE Statement”  
Section 13.2.5.1, “INSERT ... SELECT Statement”  
Section 13.2.5, “INSERT Statement”  
Section 8.11.1, “Internal Locking Methods”  
Section 8.4.4, “Internal Temporary Table Use in MySQL”  
Section 24.1, “Introduction”  
Section 13.2.9.2, “JOIN Clause”  
Section 9.3, “Keywords and Reserved Words”

---

Section 13.7.6.4, “KILL Statement”  
Section B.3.7, “Known Issues in MySQL”  
Section 6.4.5.10, “Legacy Mode Audit Log Filtering”  
Section 21.2.7.3, “Limits Relating to Transaction Handling in NDB Cluster”  
Section 13.2.7, “LOAD XML Statement”  
Section 13.6.4.2, “Local Variable Scope and Resolution”  
Section 13.3.5, “LOCK TABLES and UNLOCK TABLES Statements”  
Section 14.7.2.4, “Locking Reads”  
Section 14.7.3, “Locks Set by Different SQL Statements in InnoDB”  
Section 5.4.4.4, “Logging Format for Changes to mysql Database Tables”  
Section 6.1.3, “Making MySQL Secure Against Attackers”  
Section 22.3.1, “Management of RANGE and LIST Partitions”  
Section 15.7.2, “MERGE Table Problems”  
Section 8.3.5, “Multiple-Column Indexes”  
Section 7.6.4, “MyISAM Table Optimization”  
Section A.11, “MySQL 5.7 FAQ: MySQL Chinese, Japanese, and Korean Character Sets”  
Section A.14, “MySQL 5.7 FAQ: Replication”  
Section A.4, “MySQL 5.7 FAQ: Stored Procedures and Functions”  
Section 4.5.1.1, “mysql Client Options”  
Section 4.5.1.6, “mysql Client Tips”  
Section 6.6.2, “MySQL Enterprise Encryption Usage and Examples”  
Section 1.6.1, “MySQL Extensions to Standard SQL”  
MySQL Glossary  
Section 12.19.3, “MySQL Handling of GROUP BY”  
Chapter 25, *MySQL Performance Schema*  
Section 4.5.4, “mysqldump — A Database Backup Program”  
Section 4.5.6, “mysqlpump — A Database Backup Program”  
Section 4.5.8, “mysqlslap — A Load Emulation Client”  
Section 12.9.1, “Natural Language Full-Text Searches”  
Section 21.6.11.1, “NDB Cluster Disk Data Objects”  
Section 21.3.5, “NDB Cluster Example with Tables and Data”  
Section 21.7.11, “NDB Cluster Replication Conflict Resolution”  
Section 21.7.4, “NDB Cluster Replication Schema and Tables”  
NDB Cluster Status Variables  
NDB Cluster System Variables  
Section 21.5.25, “ndb\_select\_all — Print Rows from an NDB Table”  
Section 21.6.15, “ndbinfo: The NDB Cluster Information Database”  
Section 8.8.4, “Obtaining Execution Plan Information for a Named Connection”  
Section 22.3.5, “Obtaining Information About Partitions”  
Section 14.13.2, “Online DDL Performance and Concurrency”  
Section 8.3, “Optimization and Indexes”  
Section 8.9.3, “Optimizer Hints”  
Section B.3.5, “Optimizer-Related Issues”  
Section 8.2.2.4, “Optimizing Derived Tables and View References with Merging or Materialization”  
Section 8.5.3, “Optimizing InnoDB Read-Only Transactions”  
Section 8.5.2, “Optimizing InnoDB Transaction Management”  
Section 8.6.1, “Optimizing MyISAM Queries”  
Section 8.8.1, “Optimizing Queries with EXPLAIN”  
Section 8.2.1, “Optimizing SELECT Statements”  
Section 8.2.2.3, “Optimizing Subqueries with the EXISTS Strategy”  
Section 8.2.2.1, “Optimizing Subqueries, Derived Tables, and View References with Semijoin Transformations”  
Section 8.2.4.2, “Optimizing UPDATE Statements”  
Section 4.6.3.4, “Other myisamchk Options”

---

Section 22.4, “Partition Pruning”  
Section 22.5, “Partition Selection”  
Section 22.6.4, “Partitioning and Locking”  
Section 25.6, “Performance Schema Instrument Naming Conventions”  
Section 25.12.11, “Performance Schema Replication Tables”  
Section 14.7.4, “Phantom Rows”  
Section 6.2.2, “Privileges Provided by MySQL”  
Section B.3.4.2, “Problems Using DATE Columns”  
Section B.3.4.8, “Problems with Floating-Point Values”  
Section 14.8.10, “Purge Configuration”  
Section 8.10.3.2, “Query Cache SELECT Options”  
Section 8.10.3.4, “Query Cache Status and Maintenance”  
Section 8.14.4, “Query Cache Thread States”  
Section 21.6.17, “Quick Reference: NDB Cluster SQL Statements”  
Section 22.2.3.1, “RANGE COLUMNS partitioning”  
Section 8.2.1.2, “Range Optimization”  
Section 13.2.8, “REPLACE Statement”  
Section 16.1.6.3, “Replica Server Options and Variables”  
Section 16.2, “Replication Implementation”  
Section 16.4.1.5, “Replication of CREATE ... IF NOT EXISTS Statements”  
Section 16.4.1.16, “Replication of Invoked Features”  
Section 16.1.6.2, “Replication Source Options and Variables”  
Section 23.8, “Restrictions on Stored Programs”  
Section 3.3.4, “Retrieving Information from a Table”  
Section 3.6.7, “Searching on Two Keys”  
Section 13.1.18.8, “Secondary Indexes and Generated Columns”  
Section 13.2.9.1, “SELECT ... INTO Statement”  
Section 13.2.9, “SELECT Statement”  
Section 3.3.4.1, “Selecting All Data”  
Section 3.3.4.2, “Selecting Particular Rows”  
Section 5.1.10, “Server SQL Modes”  
Section 5.1.9, “Server Status Variables”  
Section 5.1.7, “Server System Variables”  
Section 13.7.4.1, “SET Syntax for Variable Assignment”  
Section 13.7.5.2, “SHOW BINLOG EVENTS Statement”  
Section 13.7.5.9, “SHOW CREATE PROCEDURE Statement”  
Section 13.7.5.13, “SHOW CREATE VIEW Statement”  
Section 13.7.5.17, “SHOW ERRORS Statement”  
Section 13.7.5.27, “SHOW PROCEDURE CODE Statement”  
Section 13.7.5.28, “SHOW PROCEDURE STATUS Statement”  
Section 13.7.5.29, “SHOW PROCESSLIST Statement”  
Section 13.7.5.32, “SHOW RELAYLOG EVENTS Statement”  
Section 13.7.5, “SHOW Statements”  
Section 13.7.5.39, “SHOW VARIABLES Statement”  
Section 13.7.5.40, “SHOW WARNINGS Statement”  
Section B.3.4.7, “Solving Problems with No Matching Rows”  
Section 13.3.1, “START TRANSACTION, COMMIT, and ROLLBACK Statements”  
Statement Probes  
Section 23.7, “Stored Program Binary Logging”  
Section 23.2.1, “Stored Routine Syntax”  
Section 9.1.1, “String Literals”  
Section 13.2.10, “Subqueries”  
Section 13.2.10.6, “Subqueries with EXISTS or NOT EXISTS”  
Section 13.2.10.9, “Subquery Errors”

---

Section 8.11.2, “Table Locking Issues”  
Section 15.5, “The ARCHIVE Storage Engine”  
Section 5.4.4, “The Binary Log”  
Section 11.3.5, “The ENUM Type”  
Section 25.12.16.1, “The host\_cache Table”  
Section 24.3.5, “The INFORMATION\_SCHEMA COLUMNS Table”  
Section 24.3.8, “The INFORMATION\_SCHEMA EVENTS Table”  
Section 24.3.11, “The INFORMATION\_SCHEMA GLOBAL\_VARIABLES and SESSION\_VARIABLES Tables”  
Section 24.4.28, “The INFORMATION\_SCHEMA INNODB\_TRX Table”  
Section 24.3.18, “The INFORMATION\_SCHEMA PROCESSLIST Table”  
Section 24.3.21, “The INFORMATION\_SCHEMA ROUTINES Table”  
Section 24.3.31, “The INFORMATION\_SCHEMA VIEWS Table”  
Section 11.5, “The JSON Data Type”  
Section 1.2.2, “The Main Features of MySQL”  
Section 15.7, “The MERGE Storage Engine”  
Section 8.10.3, “The MySQL Query Cache”  
Section 21.6.15.28, “The ndbinfo nodes Table”  
Section 25.12.16.3, “The processlist Table”  
Section 5.5.4, “The Rewriter Query Rewrite Plugin”  
Section 13.2.10.1, “The Subquery as Scalar Operand”  
Section 25.12.16.4, “The threads Table”  
Section 8.15.3, “Traceable Statements”  
Section 14.7.2.1, “Transaction Isolation Levels”  
Section 23.3.1, “Trigger Syntax and Examples”  
Section 8.15.4, “Tuning Trace Purging”  
Section 12.3, “Type Conversion in Expression Evaluation”  
Section 13.2.9.3, “UNION Clause”  
Section 13.2.11, “UPDATE Statement”  
Section 9.4, “User-Defined Variables”  
Section 14.16.2.1, “Using InnoDB Transaction and Locking Information”  
Section 4.2.2.1, “Using Options on the Command Line”  
Section 8.4.2.4, “Using PROCEDURE ANALYSE”  
Section 5.8.1.6, “Using Server Logs to Find Causes of Errors in mysqld”  
Section 11.4.10, “Using Spatial Indexes”  
Section 5.5.4.2, “Using the Rewriter Query Rewrite Plugin”  
Section 10.2.2, “UTF-8 for Metadata”  
Section 5.5.5.4, “Version Tokens Reference”  
Section 23.5.1, “View Syntax”  
Section 1.3, “What Is New in MySQL 5.7”  
Section 8.2.1.1, “WHERE Clause Optimization”  
Section B.3.3.5, “Where MySQL Stores Temporary Files”  
Section 6.4.5.8, “Writing Audit Log Filter Definitions”

## **SELECT \***

Section 11.3.4, “The BLOB and TEXT Types”

## **SELECT \* FROM t PARTITION ()**

Section 22.1, “Overview of Partitioning in MySQL”

## **SELECT \* INTO OUTFILE 'file\_name' FROM tbl\_name**

Section 7.2, “Database Backup Methods”

---

## **SELECT ... FOR UPDATE**

[Section 14.1.2, “Best Practices for InnoDB Tables”](#)  
[Section 14.7.5, “Deadlocks in InnoDB”](#)  
[Section 14.7.5.3, “How to Minimize and Handle Deadlocks”](#)  
[Section 14.7.1, “InnoDB Locking”](#)  
[Section 14.7.2.4, “Locking Reads”](#)  
[Section 14.7.3, “Locks Set by Different SQL Statements in InnoDB”](#)

## **SELECT ... FROM**

[Section 14.7.3, “Locks Set by Different SQL Statements in InnoDB”](#)

## **SELECT ... INTO**

[Section 13.1.12, “CREATE EVENT Statement”](#)  
[Section 13.6.4.2, “Local Variable Scope and Resolution”](#)  
[Section 16.4.1.15, “Replication and System Functions”](#)  
[Section 13.2.9.1, “SELECT ... INTO Statement”](#)  
[Section 1.6.2.1, “SELECT INTO TABLE Differences”](#)  
[Section 13.2.9, “SELECT Statement”](#)

## **SELECT ... INTO DUMPFILE**

[Section 6.1.3, “Making MySQL Secure Against Attackers”](#)  
[Section 5.1.7, “Server System Variables”](#)

## **SELECT ... INTO OUTFILE**

[Section 1.1, “About This Manual”](#)  
[Section 7.1, “Backup and Recovery Types”](#)  
[Section 7.4.3, “Dumping Data in Delimited-Text Format with mysqldump”](#)  
[Section 14.22.2, “Forcing InnoDB Recovery”](#)  
[Section 13.2.6, “LOAD DATA Statement”](#)  
[Section 6.1.3, “Making MySQL Secure Against Attackers”](#)  
[Section 9.1.7, “NULL Values”](#)  
[Section 6.2.2, “Privileges Provided by MySQL”](#)  
[Section 13.2.9.1, “SELECT ... INTO Statement”](#)  
[Section 1.6.2.1, “SELECT INTO TABLE Differences”](#)  
[Section 5.1.6, “Server Command Options”](#)  
[Section 5.1.7, “Server System Variables”](#)  
[Section 6.2.17, “Troubleshooting Problems Connecting to MySQL”](#)  
[Section 1.3, “What Is New in MySQL 5.7”](#)  
[Section 2.3.7, “Windows Platform Restrictions”](#)

## **SELECT ... INTO OUTFILE 'file\_name'**

[Section 13.2.9.1, “SELECT ... INTO Statement”](#)

## **SELECT ... INTO var\_list**

[Section 23.8, “Restrictions on Stored Programs”](#)  
[Section 13.6.4, “Variables in Stored Programs”](#)

## **SELECT ... LOCK IN SHARE MODE**

[Section 14.7.5.3, “How to Minimize and Handle Deadlocks”](#)  
[Section 14.7.1, “InnoDB Locking”](#)  
[Section 21.2.7.3, “Limits Relating to Transaction Handling in NDB Cluster”](#)



---

[Section 14.7.2.4, “Locking Reads”](#)  
[Section 14.7.3, “Locks Set by Different SQL Statements in InnoDB”](#)  
[Section 14.7.2.1, “Transaction Isolation Levels”](#)

## **SELECT DISTINCT**

[Configuring the Number of Sampled Pages for InnoDB Optimizer Statistics](#)  
[Section 8.14.3, “General Thread States”](#)  
[Section 8.2.2.1, “Optimizing Subqueries, Derived Tables, and View References with Semijoin Transformations”](#)

## **SELECT INTO ... OUTFILE**

[Section 21.5.14, “ndb\\_import — Import CSV Data Into NDB”](#)

## **SELECT INTO OUTFILE**

[Section 21.5.14, “ndb\\_import — Import CSV Data Into NDB”](#)

## **SELECT SLEEP()**

[Section 5.1.10, “Server SQL Modes”](#)

## **SET**

[Section 12.4.4, “Assignment Operators”](#)  
[Section 16.1.6.4, “Binary Logging Options and Variables”](#)  
[Section 12.1, “Built-In Function and Operator Reference”](#)  
[Section 14.8.3.1, “Configuring InnoDB Buffer Pool Size”](#)  
[Section 14.8.8, “Configuring InnoDB I/O Capacity”](#)  
[Section 14.8.11.2, “Configuring Non-Persistent Optimizer Statistics Parameters”](#)  
[Section 10.4, “Connection Character Sets and Collations”](#)  
[Section 14.9.1.2, “Creating Compressed Tables”](#)  
[Section 23.1, “Defining Stored Programs”](#)  
[Section 6.4.5.9, “Disabling Audit Logging”](#)  
[Section 23.4.2, “Event Scheduler Configuration”](#)  
[Chapter 12, \*Functions and Operators\*](#)  
[Section 16.1.6.5, “Global Transaction ID System Variables”](#)  
[Section 21.6.9, “Importing Data Into MySQL Cluster”](#)  
[Section 12.15, “Information Functions”](#)  
[Section 14.15, “InnoDB Startup Options and System Variables”](#)  
[Section 4.5.1.6, “mysql Client Tips”](#)  
[Section 6.6.2, “MySQL Enterprise Encryption Usage and Examples”](#)  
[Section 1.6.1, “MySQL Extensions to Standard SQL”](#)  
[Section 21.7.11, “NDB Cluster Replication Conflict Resolution”](#)  
[Section 12.4, “Operators”](#)  
[Section 22.6.4, “Partitioning and Locking”](#)  
[Section 6.2.11, “Password Management”](#)  
[Section 8.10.3.3, “Query Cache Configuration”](#)  
[Section 16.1.6.3, “Replica Server Options and Variables”](#)  
[Section 16.1.6.2, “Replication Source Options and Variables”](#)  
[Section 13.4.2.3, “RESET SLAVE Statement”](#)  
[Section 5.1.6, “Server Command Options”](#)  
[Section 6.2.12, “Server Handling of Expired Passwords”](#)  
[Section 5.1.10, “Server SQL Modes”](#)  
[Section 5.1.7, “Server System Variables”](#)  
[Section 13.7.4, “SET Statements”](#)  
[Section 13.7.4.1, “SET Syntax for Variable Assignment”](#)

---

Section 13.3.6, “SET TRANSACTION Statement”  
Section 13.7.5.39, “SHOW VARIABLES Statement”  
Section 23.7, “Stored Program Binary Logging”  
Section 13.2.10, “Subqueries”  
Section 5.1.8.1, “System Variable Privileges”  
Section 13.6.7.7, “The MySQL Diagnostics Area”  
Section 5.4.5, “The Slow Query Log”  
Section 8.15.3, “Traceable Statements”  
Section 23.3.1, “Trigger Syntax and Examples”  
Section 8.15.4, “Tuning Trace Purging”  
Section 8.15.1, “Typical Usage”  
Section 9.4, “User-Defined Variables”  
Section 4.2.2.1, “Using Options on the Command Line”  
Section 4.2.2.5, “Using Options to Set Program Variables”  
Section 5.1.8, “Using System Variables”  
Section 13.6.4, “Variables in Stored Programs”

## **SET @@GLOBAL.gtid\_purged**

Section 4.5.4, “mysqldump — A Database Backup Program”  
Section 4.5.6, “mysqlpump — A Database Backup Program”

## **SET @@GLOBAL.ndb\_slave\_conflict\_role = 'NONE'**

NDB Cluster System Variables

## **SET autocommit**

Section 8.5.5, “Bulk Data Loading for InnoDB Tables”  
Section 13.3, “Transactional and Locking Statements”

## **SET autocommit = 0**

Section 16.3.9, “Semisynchronous Replication”

## **SET CHARACTER SET**

Section 10.4, “Connection Character Sets and Collations”  
Section 13.7.4.2, “SET CHARACTER SET Statement”  
Section 13.7.4, “SET Statements”  
Section 10.9, “Unicode Support”

## **SET CHARACTER SET 'charset\_name'**

Section 10.4, “Connection Character Sets and Collations”

## **SET CHARACTER SET charset\_name**

Section 10.4, “Connection Character Sets and Collations”

## **SET GLOBAL**

Section 14.5.2, “Change Buffer”  
Section 14.8.3.4, “Configuring InnoDB Buffer Pool Prefetching (Read-Ahead)”  
Section 14.8.8, “Configuring InnoDB I/O Capacity”  
Section 14.8.9, “Configuring Spin Lock Polling”  
Section 6.4.2.1, “Connection Control Plugin Installation”  
Section 14.6.3.2, “File-Per-Table Tablespaces”  
Section 13.7.1.4, “GRANT Statement”

---

[Section 14.15, “InnoDB Startup Options and System Variables”](#)  
[Section 14.8.3.3, “Making the Buffer Pool Scan Resistant”](#)  
[Section 8.10.2.2, “Multiple Key Caches”](#)  
[Section 16.3.9.2, “Semisynchronous Replication Installation and Configuration”](#)  
[Section 6.4.4.5, “Using the keyring\\_aws Amazon Web Services Keyring Plugin”](#)

## **SET GLOBAL SQL\_LOG\_BIN**

[Section 1.3, “What Is New in MySQL 5.7”](#)

## **SET GLOBAL sql\_slave\_skip\_counter**

[Section 13.4.2.4, “SET GLOBAL sql\\_slave\\_skip\\_counter Syntax”](#)

## **SET GLOBAL TRANSACTION READ ONLY**

[Section B.3.7, “Known Issues in MySQL”](#)

## **SET NAMES**

[Section 10.3.6, “Character String Literal Character Set and Collation”](#)  
[Section 10.5, “Configuring Application Character Set and Collation”](#)  
[Section 10.4, “Connection Character Sets and Collations”](#)  
[Section 10.6, “Error Message Character Set”](#)  
[Section 13.2.6, “LOAD DATA Statement”](#)  
[Section A.11, “MySQL 5.7 FAQ: MySQL Chinese, Japanese, and Korean Character Sets”](#)  
[Section 4.5.1.2, “mysql Client Commands”](#)  
[Section 4.5.4, “mysqldump — A Database Backup Program”](#)  
[Section 4.5.6, “mysqlpump — A Database Backup Program”](#)  
[Section 5.1.7, “Server System Variables”](#)  
[Section 13.7.4.3, “SET NAMES Statement”](#)  
[Section 13.7.4, “SET Statements”](#)  
[Section 10.10.7.2, “The gb18030 Character Set”](#)  
[Section 12.3, “Type Conversion in Expression Evaluation”](#)  
[Section 10.9, “Unicode Support”](#)  
[Section 10.2.2, “UTF-8 for Metadata”](#)

## **SET NAMES 'charset\_name'**

[Section 10.4, “Connection Character Sets and Collations”](#)

## **SET NAMES 'cp1251'**

[Section 10.4, “Connection Character Sets and Collations”](#)

## **SET NAMES charset\_name**

[Section 4.6.7, “mysqlbinlog — Utility for Processing Binary Log Files”](#)

## **SET NAMES default\_character\_set**

[Section 4.5.4, “mysqldump — A Database Backup Program”](#)  
[Section 4.5.6, “mysqlpump — A Database Backup Program”](#)

## **SET PASSWORD**

[Section 16.1.6.4, “Binary Logging Options and Variables”](#)  
[Section 6.2.3, “Grant Tables”](#)  
[Section 12.15, “Information Functions”](#)  
[Section 5.4.4.4, “Logging Format for Changes to mysql Database Tables”](#)

---

[Section 4.4.2, “mysql\\_install\\_db — Initialize MySQL Data Directory”](#)  
[Section 6.1.2.4, “Password Hashing in MySQL”](#)  
[Section 6.2.11, “Password Management”](#)  
[Section 6.4.3.2, “Password Validation Plugin Options and Variables”](#)  
[Section 6.1.2.3, “Passwords and Logging”](#)  
[Section 16.4.1.37, “Replication and Variables”](#)  
[Section 16.4.1.8, “Replication of CURRENT\\_USER\(\)”](#)  
[Resetting the Root Password: Generic Instructions](#)  
[Section 6.2.12, “Server Handling of Expired Passwords”](#)  
[Section 13.7.1.7, “SET PASSWORD Statement”](#)  
[Section 13.7.4, “SET Statements”](#)  
[Section 6.2.4, “Specifying Account Names”](#)  
[Section 13.3.3, “Statements That Cause an Implicit Commit”](#)  
[Section 6.4.3, “The Password Validation Plugin”](#)  
[Section 6.2.9, “When Privilege Changes Take Effect”](#)

## **SET PASSWORD ... = 'auth\_string'**

[Section 13.7.1.7, “SET PASSWORD Statement”](#)  
[Section 1.3, “What Is New in MySQL 5.7”](#)

## **SET PASSWORD ... = PASSWORD()**

[Section 13.7.1.7, “SET PASSWORD Statement”](#)  
[Section 1.3, “What Is New in MySQL 5.7”](#)

## **SET PERSIST**

[Section A.9, “MySQL 5.7 FAQ: Security”](#)

## **SET SESSION**

[Section 5.1.8.1, “System Variable Privileges”](#)

## **SET SESSION TRANSACTION ISOLATION LEVEL**

[Section 5.1.7, “Server System Variables”](#)

## **SET SESSION TRANSACTION {READ WRITE | READ ONLY}**

[Section 5.1.7, “Server System Variables”](#)

## **SET sql\_log\_bin = 0**

[Section 4.6.7, “mysqlbinlog — Utility for Processing Binary Log Files”](#)

## **SET sql\_log\_bin=OFF**

[Section 5.4.4, “The Binary Log”](#)

## **SET sql\_mode='modes'**

[Section A.3, “MySQL 5.7 FAQ: Server SQL Mode”](#)

## **SET TIMESTAMP = value**

[Section 8.14.1, “Accessing the Process List”](#)

## **SET TRANSACTION**

[Section 14.2, “InnoDB and the ACID Model”](#)

---

[Section 5.1.6, “Server Command Options”](#)  
[Section 5.1.7, “Server System Variables”](#)  
[Section 5.1.15, “Server Tracking of Client Session State”](#)  
[Section 13.3.6, “SET TRANSACTION Statement”](#)  
[Section 13.3.1, “START TRANSACTION, COMMIT, and ROLLBACK Statements”](#)  
[Section 14.7.2.1, “Transaction Isolation Levels”](#)

## **SET TRANSACTION ISOLATION LEVEL**

[Section 5.1.7, “Server System Variables”](#)  
[Section 13.7.4, “SET Statements”](#)  
[Section 13.3.1, “START TRANSACTION, COMMIT, and ROLLBACK Statements”](#)

## **SET TRANSACTION ISOLATION LEVEL READ UNCOMMITTED**

[Section 14.21.6, “The InnoDB memcached Plugin and Replication”](#)

## **SET TRANSACTION {READ WRITE | READ ONLY}**

[Section 5.1.7, “Server System Variables”](#)

## **SET var\_name = value**

[Section 13.7.4, “SET Statements”](#)

## **SHOW**

[Section 13.1.12, “CREATE EVENT Statement”](#)  
[Section 13.1.16, “CREATE PROCEDURE and CREATE FUNCTION Statements”](#)  
[Section 3.3, “Creating and Using a Database”](#)  
[Section 13.6.6.2, “Cursor DECLARE Statement”](#)  
[Section 24.8, “Extensions to SHOW Statements”](#)  
[Section 24.1, “Introduction”](#)  
[Section 9.2.4, “Mapping of Identifiers to File Names”](#)  
[Section A.14, “MySQL 5.7 FAQ: Replication”](#)  
[Section 1.6.1, “MySQL Extensions to Standard SQL”](#)  
[Section 4.5.7, “mysqlshow — Display Database, Table, and Column Information”](#)  
[Section 25.1, “Performance Schema Quick Start”](#)  
[Section 23.8, “Restrictions on Stored Programs”](#)  
[Section 13.7.5.5, “SHOW COLUMNS Statement”](#)  
[Section 13.7.5, “SHOW Statements”](#)  
[Section 13.7.5.37, “SHOW TABLES Statement”](#)  
[Section 13.4.1, “SQL Statements for Controlling Replication Source Servers”](#)  
[Section 5.4.4, “The Binary Log”](#)  
[Section 1.2.2, “The Main Features of MySQL”](#)  
[Section 26.2, “Using the sys Schema”](#)  
[Section 10.2.2, “UTF-8 for Metadata”](#)

## **SHOW BINARY LOGS**

[Section 6.2.2, “Privileges Provided by MySQL”](#)  
[Section 13.4.1.1, “PURGE BINARY LOGS Statement”](#)  
[Section 13.7.5.1, “SHOW BINARY LOGS Statement”](#)  
[Section 13.4.1, “SQL Statements for Controlling Replication Source Servers”](#)  
[Section 4.6.7.3, “Using mysqlbinlog to Back Up Binary Log Files”](#)

## **SHOW BINLOG EVENTS**

[Section 21.7.4, “NDB Cluster Replication Schema and Tables”](#)

---

Section 6.2.2, “Privileges Provided by MySQL”  
Section 13.6.6.5, “Restrictions on Server-Side Cursors”  
Section 13.7.5.2, “SHOW BINLOG EVENTS Statement”  
Section 16.1.7.3, “Skipping Transactions”  
Skipping Transactions With GTIDs  
Section 13.4.1, “SQL Statements for Controlling Replication Source Servers”  
Section 13.4.2.5, “START SLAVE Statement”

## SHOW CHARACTER SET

Section 13.1.1, “ALTER DATABASE Statement”  
Section 10.3.8, “Character Set Introducers”  
Section 10.2, “Character Sets and Collations in MySQL”  
Section 10.3.6, “Character String Literal Character Set and Collation”  
Section 10.3.5, “Column Character Set and Collation”  
Section 13.1.11, “CREATE DATABASE Statement”  
Section 10.3.3, “Database Character Set and Collation”  
Section 24.8, “Extensions to SHOW Statements”  
Section A.11, “MySQL 5.7 FAQ: MySQL Chinese, Japanese, and Korean Character Sets”  
Section 13.7.5.3, “SHOW CHARACTER SET Statement”  
Section 10.10, “Supported Character Sets and Collations”  
Section 10.3.4, “Table Character Set and Collation”  
Section 24.3.2, “The INFORMATION\_SCHEMA CHARACTER\_SETS Table”

## SHOW COLLATION

Section 13.1.1, “ALTER DATABASE Statement”  
Section 10.15, “Character Set Configuration”  
Section 10.2, “Character Sets and Collations in MySQL”  
Section 10.14.2, “Choosing a Collation ID”  
Section 13.1.11, “CREATE DATABASE Statement”  
Section 2.8.7, “MySQL Source-Configuration Options”  
Section 13.7.5.4, “SHOW COLLATION Statement”  
Section 24.3.4, “The INFORMATION\_SCHEMA COLLATION\_CHARACTER\_SET\_APPLICABILITY Table”  
Section 24.3.3, “The INFORMATION\_SCHEMA COLLATIONS Table”

## SHOW COLUMNS

Section 13.8.2, “EXPLAIN Statement”  
Section 24.8, “Extensions to SHOW Statements”  
Section 8.4.4, “Internal Temporary Table Use in MySQL”  
Section 25.1, “Performance Schema Quick Start”  
Section 13.7.5.5, “SHOW COLUMNS Statement”  
Section 24.3.5, “The INFORMATION\_SCHEMA COLUMNS Table”  
Section 24.4.2, “The INFORMATION\_SCHEMA INNODB\_BUFFER\_PAGE Table”  
Section 24.4.3, “The INFORMATION\_SCHEMA INNODB\_BUFFER\_PAGE\_LRU Table”  
Section 24.4.4, “The INFORMATION\_SCHEMA INNODB\_BUFFER\_POOL\_STATS Table”  
Section 24.4.5, “The INFORMATION\_SCHEMA INNODB\_CMP and INNODB\_CMP\_RESET Tables”  
Section 24.4.7, “The INFORMATION\_SCHEMA INNODB\_CMP\_PER\_INDEX and INNODB\_CMP\_PER\_INDEX\_RESET Tables”  
Section 24.4.6, “The INFORMATION\_SCHEMA INNODB\_CMPMEM and INNODB\_CMPMEM\_RESET Tables”  
Section 24.4.8, “The INFORMATION\_SCHEMA INNODB\_FT\_BEING\_DELETED Table”  
Section 24.4.9, “The INFORMATION\_SCHEMA INNODB\_FT\_CONFIG Table”  
Section 24.4.10, “The INFORMATION\_SCHEMA INNODB\_FT\_DEFAULT\_STOPWORD Table”  
Section 24.4.11, “The INFORMATION\_SCHEMA INNODB\_FT\_DELETED Table”

---

[Section 24.4.12, “The INFORMATION\\_SCHEMA INNODB\\_FT\\_INDEX\\_CACHE Table”](#)  
[Section 24.4.13, “The INFORMATION\\_SCHEMA INNODB\\_FT\\_INDEX\\_TABLE Table”](#)  
[Section 24.4.15, “The INFORMATION\\_SCHEMA INNODB\\_LOCK\\_WAITS Table”](#)  
[Section 24.4.14, “The INFORMATION\\_SCHEMA INNODB\\_LOCKS Table”](#)  
[Section 24.4.16, “The INFORMATION\\_SCHEMA INNODB\\_METRICS Table”](#)  
[Section 24.4.17, “The INFORMATION\\_SCHEMA INNODB\\_SYS\\_COLUMNS Table”](#)  
[Section 24.4.18, “The INFORMATION\\_SCHEMA INNODB\\_SYS\\_DATAFILES Table”](#)  
[Section 24.4.19, “The INFORMATION\\_SCHEMA INNODB\\_SYS\\_FIELDS Table”](#)  
[Section 24.4.20, “The INFORMATION\\_SCHEMA INNODB\\_SYS\\_FOREIGN Table”](#)  
[Section 24.4.21, “The INFORMATION\\_SCHEMA INNODB\\_SYS\\_FOREIGN\\_COLS Table”](#)  
[Section 24.4.22, “The INFORMATION\\_SCHEMA INNODB\\_SYS\\_INDEXES Table”](#)  
[Section 24.4.23, “The INFORMATION\\_SCHEMA INNODB\\_SYS\\_TABLES Table”](#)  
[Section 24.4.24, “The INFORMATION\\_SCHEMA INNODB\\_SYS\\_TABLESPACES Table”](#)  
[Section 24.4.25, “The INFORMATION\\_SCHEMA INNODB\\_SYS\\_TABLESTATS View”](#)  
[Section 24.4.26, “The INFORMATION\\_SCHEMA INNODB\\_SYS\\_VIRTUAL Table”](#)  
[Section 24.4.27, “The INFORMATION\\_SCHEMA INNODB\\_TEMP\\_TABLE\\_INFO Table”](#)  
[Section 24.4.28, “The INFORMATION\\_SCHEMA INNODB\\_TRX Table”](#)  
[Section 1.3, “What Is New in MySQL 5.7”](#)

## **SHOW COLUMNS FROM tbl\_name LIKE 'enum\_col'**

[Section 11.3.5, “The ENUM Type”](#)

## **SHOW COUNT()**

[Section 13.7.5.17, “SHOW ERRORS Statement”](#)  
[Section 13.7.5.40, “SHOW WARNINGS Statement”](#)

## **SHOW CREATE DATABASE**

[Section 5.1.7, “Server System Variables”](#)  
[Section 13.7.5.6, “SHOW CREATE DATABASE Statement”](#)

## **SHOW CREATE EVENT**

[Section 23.4.4, “Event Metadata”](#)  
[Section 13.7.5.18, “SHOW EVENTS Statement”](#)  
[Section 23.4.6, “The Event Scheduler and MySQL Privileges”](#)

## **SHOW CREATE FUNCTION**

[Section 13.1.16, “CREATE PROCEDURE and CREATE FUNCTION Statements”](#)  
[Section 1.5, “How to Report Bugs or Problems”](#)  
[Section A.4, “MySQL 5.7 FAQ: Stored Procedures and Functions”](#)  
[Section 13.7.5.9, “SHOW CREATE PROCEDURE Statement”](#)  
[Section 23.2.3, “Stored Routine Metadata”](#)

## **SHOW CREATE PROCEDURE**

[Section 13.1.16, “CREATE PROCEDURE and CREATE FUNCTION Statements”](#)  
[Section 1.5, “How to Report Bugs or Problems”](#)  
[Section A.4, “MySQL 5.7 FAQ: Stored Procedures and Functions”](#)  
[Section 13.7.5.8, “SHOW CREATE FUNCTION Statement”](#)  
[Section 23.2.3, “Stored Routine Metadata”](#)

## **SHOW CREATE SCHEMA**

[Section 13.7.5.6, “SHOW CREATE DATABASE Statement”](#)

---

## SHOW CREATE TABLE

Section 13.1.8.1, “ALTER TABLE Partition Operations”  
Section 13.1.8, “ALTER TABLE Statement”  
Section 14.8.12, “Configuring the Merge Threshold for Index Pages”  
Section 13.1.18, “CREATE TABLE Statement”  
Section 14.9.1.2, “Creating Compressed Tables”  
Section 11.6, “Data Type Default Values”  
Section 13.8.2, “EXPLAIN Statement”  
Section 1.6.2.3, “FOREIGN KEY Constraint Differences”  
Section 13.1.18.5, “FOREIGN KEY Constraints”  
Section 3.4, “Getting Information About Databases and Tables”  
Section 15.8.2, “How to Create FEDERATED Tables”  
Section 7.6.3, “How to Repair MyISAM Tables”  
Section 14.6.1.3, “Importing InnoDB Tables”  
Section 14.9.2, “InnoDB Page Compression”  
Section 22.2.5, “KEY Partitioning”  
Section 22.3.1, “Management of RANGE and LIST Partitions”  
Section 21.6.11.1, “NDB Cluster Disk Data Objects”  
NDB Cluster System Variables  
Section 21.5.10, “ndb\_desc — Describe NDB Tables”  
Section 21.5.24, “ndb\_restore — Restore an NDB Cluster Backup”  
Section 21.2.7.1, “Noncompliance with SQL Syntax in NDB Cluster”  
Section 22.3.5, “Obtaining Information About Partitions”  
Section 25.1, “Performance Schema Quick Start”  
Section 2.10.12, “Rebuilding or Repairing Tables or Indexes”  
Section 5.1.10, “Server SQL Modes”  
Section 5.1.7, “Server System Variables”  
Section 13.1.18.9, “Setting NDB Comment Options”  
Section 13.7.5.5, “SHOW COLUMNS Statement”  
Section 13.7.5.10, “SHOW CREATE TABLE Statement”  
Section 13.1.18.6, “Silent Column Specification Changes”

## SHOW CREATE TRIGGER

Section 13.7.5.11, “SHOW CREATE TRIGGER Statement”  
Section 23.3.2, “Trigger Metadata”

## SHOW CREATE USER

Section 6.2.15, “Account Locking”  
Section 6.2.7, “Adding Accounts, Assigning Privileges, and Dropping Accounts”  
Section 6.2.3, “Grant Tables”  
Section 13.7.5.21, “SHOW GRANTS Statement”

## SHOW CREATE VIEW

Section 13.1.21, “CREATE VIEW Statement”  
Section 13.7.1.4, “GRANT Statement”  
Section 6.2.2, “Privileges Provided by MySQL”  
Section 23.9, “Restrictions on Views”  
Section 13.7.5.13, “SHOW CREATE VIEW Statement”  
Section 24.3.31, “The INFORMATION\_SCHEMA VIEWS Table”  
Section 23.5.5, “View Metadata”

## SHOW DATABASES

Section 13.1.11, “CREATE DATABASE Statement”



---

[Section 3.3, “Creating and Using a Database”](#)  
[Section 24.8, “Extensions to SHOW Statements”](#)  
[Section 3.4, “Getting Information About Databases and Tables”](#)  
[Section 13.7.1.4, “GRANT Statement”](#)  
[Section 6.2.3, “Grant Tables”](#)  
[Section 9.2.3, “Identifier Case Sensitivity”](#)  
[Section 24.1, “Introduction”](#)  
[Section 21.6.18.2, “NDB Cluster and MySQL Privileges”](#)  
[Section 21.6.15, “ndbinfo: The NDB Cluster Information Database”](#)  
[Section 25.2, “Performance Schema Build Configuration”](#)  
[Section 6.2.2, “Privileges Provided by MySQL”](#)  
[Section 5.1.6, “Server Command Options”](#)  
[Section 5.1.7, “Server System Variables”](#)  
[Section 13.7.5.14, “SHOW DATABASES Statement”](#)  
[Section 24.3.22, “The INFORMATION\\_SCHEMA SCHEMATA Table”](#)

## **SHOW ENGINE**

[Section 6.2.2, “Privileges Provided by MySQL”](#)  
[Section 13.7.5.15, “SHOW ENGINE Statement”](#)

## **SHOW ENGINE INNODB MUTEX**

[Section 14.18.3, “InnoDB Standard Monitor and Lock Monitor Output”](#)  
[Section 14.15, “InnoDB Startup Options and System Variables”](#)  
[Section 13.7.5.15, “SHOW ENGINE Statement”](#)  
[Section 1.3, “What Is New in MySQL 5.7”](#)

## **SHOW ENGINE INNODB STATUS**

[Section 14.5.3, “Adaptive Hash Index”](#)  
[Section 14.5.1, “Buffer Pool”](#)  
[Section 14.8.2, “Configuring InnoDB for Read-Only Operation”](#)  
[Section 14.6.1.5, “Converting Tables from MyISAM to InnoDB”](#)  
[Section 14.7.5, “Deadlocks in InnoDB”](#)  
[Section 14.18.2, “Enabling InnoDB Monitors”](#)  
[Section B.2, “Error Information Interfaces”](#)  
[Section 13.1.18.5, “FOREIGN KEY Constraints”](#)  
[Section 14.7.5.3, “How to Minimize and Handle Deadlocks”](#)  
[Section 14.16.5, “InnoDB INFORMATION\\_SCHEMA Buffer Pool Tables”](#)  
[Section 14.16.6, “InnoDB INFORMATION\\_SCHEMA Metrics Table”](#)  
[Section 14.16.3, “InnoDB INFORMATION\\_SCHEMA System Tables”](#)  
[Section 14.7.1, “InnoDB Locking”](#)  
[Section 14.18.3, “InnoDB Standard Monitor and Lock Monitor Output”](#)  
[Section 14.15, “InnoDB Startup Options and System Variables”](#)  
[Section 14.6.1.4, “Moving or Copying InnoDB Tables”](#)  
[MySQL Glossary](#)  
[Section 8.5.8, “Optimizing InnoDB Disk I/O”](#)  
[Section 8.5.3, “Optimizing InnoDB Read-Only Transactions”](#)  
[Section 14.8.10, “Purge Configuration”](#)  
[Section 13.7.5.15, “SHOW ENGINE Statement”](#)  
[Section 24.4.4, “The INFORMATION\\_SCHEMA INNODB\\_BUFFER\\_POOL\\_STATS Table”](#)

## **SHOW ENGINE NDB STATUS**

[Section 21.3.2.3, “Initial Startup of NDB Cluster on Windows”](#)  
[Section 21.6, “Management of NDB Cluster”](#)

---

Section 21.7.4, “NDB Cluster Replication Schema and Tables”  
Section 21.6.17, “Quick Reference: NDB Cluster SQL Statements”

## **SHOW ENGINE NDBCLUSTER STATUS**

MySQL Server Options for NDB Cluster  
Section 21.6.17, “Quick Reference: NDB Cluster SQL Statements”

## **SHOW ENGINE PERFORMANCE\_SCHEMA STATUS**

Section 25.10, “Performance Schema Statement Digests”  
Section 25.7, “Performance Schema Status Monitoring”  
Section 13.7.5.15, “SHOW ENGINE Statement”

## **SHOW ENGINES**

Chapter 15, *Alternative Storage Engines*  
Section A.10, “MySQL 5.7 FAQ: NDB Cluster”  
Section 21.6.10, “MySQL Server Usage for NDB Cluster”  
Section 21.6.15, “ndbinfo: The NDB Cluster Information Database”  
Section 25.2, “Performance Schema Build Configuration”  
Section 25.1, “Performance Schema Quick Start”  
Section 21.6.17, “Quick Reference: NDB Cluster SQL Statements”  
Section 2.3.4.3, “Selecting a MySQL Server Type”  
Section 5.1.7, “Server System Variables”  
Section 13.7.5.16, “SHOW ENGINES Statement”  
Section 15.5, “The ARCHIVE Storage Engine”  
Section 15.6, “The BLACKHOLE Storage Engine”  
Section 24.3.7, “The INFORMATION\_SCHEMA ENGINES Table”  
Section 14.1.3, “Verifying that InnoDB is the Default Storage Engine”

## **SHOW ERRORS**

Section B.2, “Error Information Interfaces”  
Section 13.6.7.3, “GET DIAGNOSTICS Statement”  
Section 13.6.7.4, “RESIGNAL Statement”  
Section 5.1.7, “Server System Variables”  
Section 13.7.5.17, “SHOW ERRORS Statement”  
Section 13.7.5.40, “SHOW WARNINGS Statement”  
Section 13.6.7.5, “SIGNAL Statement”  
Section 13.6.7.7, “The MySQL Diagnostics Area”

## **SHOW EVENTS**

Section 23.4.4, “Event Metadata”  
Section 16.4.1.16, “Replication of Invoked Features”  
Section 13.7.5.18, “SHOW EVENTS Statement”  
Section 23.4.6, “The Event Scheduler and MySQL Privileges”  
Section 24.3.8, “The INFORMATION\_SCHEMA EVENTS Table”

## **SHOW FULL COLUMNS**

Section 13.1.18, “CREATE TABLE Statement”  
Section 24.3.6, “The INFORMATION\_SCHEMA COLUMN\_PRIVILEGES Table”

## **SHOW FULL PROCESSLIST**

Section 8.14.1, “Accessing the Process List”

---

[Section 4.5.2, “mysqladmin — A MySQL Server Administration Program”](#)  
[Section 14.13.2, “Online DDL Performance and Concurrency”](#)

## **SHOW FULL TABLES**

[Section 4.5.7, “mysqlshow — Display Database, Table, and Column Information”](#)

## **SHOW FUNCTION CODE**

[Section 13.7.5.27, “SHOW PROCEDURE CODE Statement”](#)  
[Section 23.2.3, “Stored Routine Metadata”](#)

## **SHOW FUNCTION STATUS**

[Section 13.7.5.28, “SHOW PROCEDURE STATUS Statement”](#)  
[Section 23.2.3, “Stored Routine Metadata”](#)

## **SHOW GLOBAL STATUS**

[NDB Cluster Status Variables](#)  
[Section 5.1.7, “Server System Variables”](#)  
[Section 24.3.10, “The INFORMATION\\_SCHEMA GLOBAL\\_STATUS and SESSION\\_STATUS Tables”](#)

## **SHOW GLOBAL VARIABLES**

[Section 5.1.7, “Server System Variables”](#)  
[Section 24.3.11, “The INFORMATION\\_SCHEMA GLOBAL\\_VARIABLES and SESSION\\_VARIABLES Tables”](#)

## **SHOW GRANTS**

[Section 6.2, “Access Control and Account Management”](#)  
[Section 6.2.7, “Adding Accounts, Assigning Privileges, and Dropping Accounts”](#)  
[Section 13.7.1.4, “GRANT Statement”](#)  
[Section 6.2.3, “Grant Tables”](#)  
[Section 6.2.2, “Privileges Provided by MySQL”](#)  
[Section 13.7.1.6, “REVOKE Statement”](#)  
[Section 6.1.1, “Security Guidelines”](#)  
[Section 13.7.5.12, “SHOW CREATE USER Statement”](#)  
[Section 13.7.5.21, “SHOW GRANTS Statement”](#)  
[Section 13.7.5.26, “SHOW PRIVILEGES Statement”](#)  
[Section 6.2.17, “Troubleshooting Problems Connecting to MySQL”](#)

## **SHOW INDEX**

[Section 13.7.2.1, “ANALYZE TABLE Statement”](#)  
[Section 14.8.11.2, “Configuring Non-Persistent Optimizer Statistics Parameters”](#)  
[Section 14.8.12, “Configuring the Merge Threshold for Index Pages”](#)  
[Section 8.8.2, “EXPLAIN Output Format”](#)  
[Section 13.8.2, “EXPLAIN Statement”](#)  
[Section 8.9.4, “Index Hints”](#)  
[Section 8.3.7, “InnoDB and MyISAM Index Statistics Collection”](#)  
[Section 21.5.15, “ndb\\_index\\_stat — NDB Index Statistics Utility”](#)  
[Section 8.9.3, “Optimizer Hints”](#)  
[Section 4.6.3.4, “Other myisamchk Options”](#)  
[Section 13.7.5.5, “SHOW COLUMNS Statement”](#)  
[Section 13.7.5.22, “SHOW INDEX Statement”](#)  
[Section 24.3.24, “The INFORMATION\\_SCHEMA STATISTICS Table”](#)

---

Section 24.3.27, “The INFORMATION\_SCHEMA TABLE\_CONSTRAINTS Table”  
Section 21.2.4.1, “What is New in NDB Cluster 7.5”

## **SHOW MASTER LOGS**

Section 13.7.5.1, “SHOW BINARY LOGS Statement”

## **SHOW MASTER STATUS**

Section 16.1.6.5, “Global Transaction ID System Variables”  
Section 16.4.5, “How to Report Replication Bugs or Problems”  
Section 4.5.4, “mysqldump — A Database Backup Program”  
Section 21.7.9, “NDB Cluster Backups With NDB Cluster Replication”  
Section 16.1.2.3, “Obtaining the Replication Source’s Binary Log Coordinates”  
Section 6.2.2, “Privileges Provided by MySQL”  
Section 13.7.5.34, “SHOW SLAVE STATUS Statement”  
Section 13.4.1, “SQL Statements for Controlling Replication Source Servers”  
Section 14.21.6, “The InnoDB memcached Plugin and Replication”  
Section 16.4.4, “Troubleshooting Replication”

## **SHOW OPEN TABLES**

Section 13.7.5.24, “SHOW OPEN TABLES Statement”

## **SHOW PLUGINS**

Section 6.4.2.1, “Connection Control Plugin Installation”  
Section 14.14, “InnoDB Data-at-Rest Encryption”  
Section 13.7.3.3, “INSTALL PLUGIN Statement”  
Section 5.5.1, “Installing and Uninstalling Plugins”  
Section 6.4.5.2, “Installing or Uninstalling MySQL Enterprise Audit”  
Section 6.4.4.10, “Keyring Metadata”  
Section 6.4.4.1, “Keyring Plugin Installation”  
Section 6.4.1.9, “LDAP Pluggable Authentication”  
Section 12.9.9, “MeCab Full-Text Parser Plugin”  
Section A.10, “MySQL 5.7 FAQ: NDB Cluster”  
MySQL Server Options for NDB Cluster  
Section 21.6.15, “ndbinfo: The NDB Cluster Information Database”  
Section 6.4.1.10, “No-Login Pluggable Authentication”  
Section 5.5.2, “Obtaining Server Plugin Information”  
Section 6.4.1.7, “PAM Pluggable Authentication”  
Chapter 22, *Partitioning*  
Section 6.4.3.1, “Password Validation Plugin Installation”  
Section 21.6.17, “Quick Reference: NDB Cluster SQL Statements”  
Section 16.3.9.2, “Semisynchronous Replication Installation and Configuration”  
Section 5.1.6, “Server Command Options”  
Section 13.7.5.25, “SHOW PLUGINS Statement”  
Section 6.4.1.11, “Socket Peer-Credential Pluggable Authentication”  
Section 6.4.1.12, “Test Pluggable Authentication”  
Section 24.3.13, “The INFORMATION\_SCHEMA ndb\_transid\_mysql\_connection\_map Table”  
Section 24.3.17, “The INFORMATION\_SCHEMA PLUGINS Table”  
Section 5.5.3.2, “Thread Pool Installation”  
Section 6.4.1.8, “Windows Pluggable Authentication”

## **SHOW PRIVILEGES**

Section 13.7.5.26, “SHOW PRIVILEGES Statement”

---

## SHOW PROCEDURE CODE

[Section 13.7.5.19, “SHOW FUNCTION CODE Statement”](#)

[Section 23.2.3, “Stored Routine Metadata”](#)

## SHOW PROCEDURE STATUS

[Section 13.7.5.20, “SHOW FUNCTION STATUS Statement”](#)

[Section 23.2.3, “Stored Routine Metadata”](#)

## SHOW PROCESSLIST

[Section 8.14.1, “Accessing the Process List”](#)

[Section 13.4.2.1, “CHANGE MASTER TO Statement”](#)

[Section 16.1.7.1, “Checking Replication Status”](#)

Command Probes

[Section 5.1.11.1, “Connection Interfaces”](#)

Connection Probes

[Section 16.3.10, “Delayed Replication”](#)

[Section 23.4.2, “Event Scheduler Configuration”](#)

[Section 13.7.1.4, “GRANT Statement”](#)

[Section 16.1.3.1, “GTID Format and Storage”](#)

[Section 12.15, “Information Functions”](#)

[Section 14.22.4, “InnoDB Error Handling”](#)

[Section 13.7.6.4, “KILL Statement”](#)

[Section 6.1.3, “Making MySQL Secure Against Attackers”](#)

[Section 16.2.3.1, “Monitoring Replication Main Threads”](#)

[Section A.14, “MySQL 5.7 FAQ: Replication”](#)

[Section 21.6.10, “MySQL Server Usage for NDB Cluster”](#)

[Section 4.5.2, “mysqladmin — A MySQL Server Administration Program”](#)

[Section 8.8.4, “Obtaining Execution Plan Information for a Named Connection”](#)

[Section 25.6, “Performance Schema Instrument Naming Conventions”](#)

[Section 25.12.5, “Performance Schema Stage Event Tables”](#)

[Section 25.15, “Performance Schema System Variables”](#)

[Section 6.2.2, “Privileges Provided by MySQL”](#)

Query Execution Probes

Query Probes

[Section 16.2.3, “Replication Threads”](#)

[Section 13.7.5.29, “SHOW PROCESSLIST Statement”](#)

[Section 13.7.5.30, “SHOW PROFILE Statement”](#)

[Section 13.7.5.34, “SHOW SLAVE STATUS Statement”](#)

[Section 13.4.2.5, “START SLAVE Statement”](#)

[Section 13.3.1, “START TRANSACTION, COMMIT, and ROLLBACK Statements”](#)

[Section 16.3.7, “Switching Sources During Failover”](#)

[Section 24.3.13, “The INFORMATION\\_SCHEMA ndb\\_transid\\_mysql\\_connection\\_map Table”](#)

[Section 24.3.18, “The INFORMATION\\_SCHEMA PROCESSLIST Table”](#)

[Section 21.6.15.33, “The ndbinfo server\\_locks Table”](#)

[Section 21.6.15.34, “The ndbinfo server\\_operations Table”](#)

[Section 21.6.15.35, “The ndbinfo server\\_transactions Table”](#)

[Section 26.4.3.22, “The processlist and x\\$processlist Views”](#)

[Section 25.12.16.3, “The processlist Table”](#)

[Section 26.4.5.13, “The ps\\_is\\_thread\\_instrumented\(\) Function”](#)

[Section 26.4.4.7, “The ps\\_setup\\_disable\\_thread\(\) Procedure”](#)

[Section 26.4.4.11, “The ps\\_setup\\_enable\\_thread\(\) Procedure”](#)

[Section 26.4.5.15, “The ps\\_thread\\_id\(\) Function”](#)

[Section 25.12.16.4, “The threads Table”](#)

---

[Section B.3.2.5, “Too many connections”](#)  
[Section 16.4.4, “Troubleshooting Replication”](#)  
[Section 1.3, “What Is New in MySQL 5.7”](#)

## **SHOW PROFILE**

[Section 8.14.3, “General Thread States”](#)  
[Section 2.8.7, “MySQL Source-Configuration Options”](#)  
[Section 25.19.1, “Query Profiling Using Performance Schema”](#)  
[Section 5.1.7, “Server System Variables”](#)  
[Section 13.7.5.30, “SHOW PROFILE Statement”](#)  
[Section 13.7.5.31, “SHOW PROFILES Statement”](#)  
[Section 24.3.19, “The INFORMATION\\_SCHEMA PROFILING Table”](#)

## **SHOW PROFILES**

[Section 2.8.7, “MySQL Source-Configuration Options”](#)  
[Section 25.19.1, “Query Profiling Using Performance Schema”](#)  
[Section 5.1.7, “Server System Variables”](#)  
[Section 13.7.5.30, “SHOW PROFILE Statement”](#)  
[Section 13.7.5.31, “SHOW PROFILES Statement”](#)  
[Section 24.3.19, “The INFORMATION\\_SCHEMA PROFILING Table”](#)

## **SHOW RELAYLOG EVENTS**

[Section 16.2.2.1, “Commands for Operations on a Single Channel”](#)  
[Section 16.2.2.2, “Compatibility with Previous Replication Statements”](#)  
[Section 6.2.2, “Privileges Provided by MySQL”](#)  
[Section 13.7.5.2, “SHOW BINLOG EVENTS Statement”](#)  
[Section 13.7.5.32, “SHOW RELAYLOG EVENTS Statement”](#)  
[Section 16.1.7.3, “Skipping Transactions”](#)  
[Skipping Transactions With GTIDs](#)  
[Section 13.4.2, “SQL Statements for Controlling Replica Servers”](#)

## **SHOW REPLICA | SLAVE STATUS**

[Section A.14, “MySQL 5.7 FAQ: Replication”](#)

## **SHOW SCHEMAS**

[Section 13.7.5.14, “SHOW DATABASES Statement”](#)

## **SHOW SESSION STATUS**

[NDB Cluster Status Variables](#)  
[Section 24.3.10, “The INFORMATION\\_SCHEMA GLOBAL\\_STATUS and SESSION\\_STATUS Tables”](#)

## **SHOW SESSION VARIABLES**

[Section 24.3.11, “The INFORMATION\\_SCHEMA GLOBAL\\_VARIABLES and SESSION\\_VARIABLES Tables”](#)

## **SHOW SLAVE HOSTS**

[Section 16.1.7.1, “Checking Replication Status”](#)  
[Section 6.2.2, “Privileges Provided by MySQL”](#)  
[Section 16.1.6.3, “Replica Server Options and Variables”](#)  
[Section 16.1.6, “Replication and Binary Logging Options and Variables”](#)  
[Section 16.1.6.2, “Replication Source Options and Variables”](#)

---

Section 13.4.1, “SQL Statements for Controlling Replication Source Servers”

## **SHOW SLAVE STATUS**

Section 16.1.2.6, “Adding Replicas to a Replication Topology”  
Section 13.4.2.1, “CHANGE MASTER TO Statement”  
Section 16.1.7.1, “Checking Replication Status”  
Section 16.2.2.1, “Commands for Operations on a Single Channel”  
Section 16.2.2.2, “Compatibility with Previous Replication Statements”  
Section 16.3.10, “Delayed Replication”  
Section B.2, “Error Information Interfaces”  
Section 16.1.6.5, “Global Transaction ID System Variables”  
Section 16.4.5, “How to Report Replication Bugs or Problems”  
Section 21.7.8, “Implementing Failover with NDB Cluster Replication”  
Section 21.7.3, “Known Issues in NDB Cluster Replication”  
Section 16.2.3.1, “Monitoring Replication Main Threads”  
Section 4.5.4, “mysqldump — A Database Backup Program”  
Section 25.12.11, “Performance Schema Replication Tables”  
Section 6.2.2, “Privileges Provided by MySQL”  
Section 13.4.1.1, “PURGE BINARY LOGS Statement”  
Section 16.4.1.27, “Replica Errors During Replication”  
Section 16.1.6.3, “Replica Server Options and Variables”  
Section 16.1.6, “Replication and Binary Logging Options and Variables”  
Section 16.4.1.32, “Replication and Transaction Inconsistencies”  
Section 16.2.4.2, “Replication Metadata Repositories”  
Section 16.1.4.1, “Replication Mode Concepts”  
Section 8.14.6, “Replication Replica I/O Thread States”  
Section 16.2.3, “Replication Threads”  
Section 16.1.3.6, “Restrictions on Replication with GTIDs”  
Section 16.3.8, “Setting Up Replication to Use Encrypted Connections”  
Section 13.7.5.23, “SHOW MASTER STATUS Statement”  
Section 13.7.5.34, “SHOW SLAVE STATUS Statement”  
Section 13.4.2, “SQL Statements for Controlling Replica Servers”  
Section 13.4.2.5, “START SLAVE Statement”  
Section 16.1.5.5, “Starting Multi-Source Replicas”  
Section 25.12.11.3, “The replication\_applier\_configuration Table”  
Section 25.12.11.4, “The replication\_applier\_status Table”  
Section 25.12.11.5, “The replication\_applier\_status\_by\_coordinator Table”  
Section 25.12.11.6, “The replication\_applier\_status\_by\_worker Table”  
Section 25.12.11.1, “The replication\_connection\_configuration Table”  
Section 25.12.11.2, “The replication\_connection\_status Table”  
Section 16.4.4, “Troubleshooting Replication”  
Section 1.3, “What Is New in MySQL 5.7”

## **SHOW STATUS**

Section 2.10.3, “Changes in MySQL 5.7”  
Section 16.1.7.1, “Checking Replication Status”  
Section 21.4.3.7, “Defining SQL and Other API Nodes in an NDB Cluster”  
Section 21.6, “Management of NDB Cluster”  
Section 25.20, “Migrating to Performance Schema System and Status Variable Tables”  
MySQL Server Options for NDB Cluster  
Section 21.6.14, “NDB API Statistics Counters and Variables”  
Section 21.7, “NDB Cluster Replication”  
Section 25.12.11, “Performance Schema Replication Tables”

---

Section 25.15, “Performance Schema System Variables”  
Section 8.10.3.4, “Query Cache Status and Maintenance”  
Section 21.6.17, “Quick Reference: NDB Cluster SQL Statements”  
Section 16.4.1.29, “Replication and Temporary Tables”  
Section 16.4.1.30, “Replication Retries and Timeouts”  
Section 23.8, “Restrictions on Stored Programs”  
Section 16.3.9.3, “Semisynchronous Replication Monitoring”  
Section 5.1.9, “Server Status Variables”  
Section 5.1.7, “Server System Variables”  
Section 13.7.5.35, “SHOW STATUS Statement”  
Section 8.3.9, “Use of Index Extensions”  
Section 1.3, “What Is New in MySQL 5.7”

## **SHOW STATUS LIKE 'perf%'**

Section 25.7, “Performance Schema Status Monitoring”

## **SHOW TABLE STATUS**

Section 12.19.1, “Aggregate Function Descriptions”  
Section 14.6.1.6, “AUTO\_INCREMENT Handling in InnoDB”  
Section 14.8.11.2, “Configuring Non-Persistent Optimizer Statistics Parameters”  
Section 13.1.18, “CREATE TABLE Statement”  
Section 14.6.1.1, “Creating InnoDB Tables”  
Section 13.8.2, “EXPLAIN Statement”  
Section 14.12.2, “File Space Management”  
Section 14.24, “InnoDB Restrictions and Limitations”  
Section 14.11, “InnoDB Row Formats”  
Section 14.15, “InnoDB Startup Options and System Variables”  
MySQL Glossary  
Section 22.3.5, “Obtaining Information About Partitions”  
Section 13.7.5.5, “SHOW COLUMNS Statement”  
Section 13.7.5.10, “SHOW CREATE TABLE Statement”  
Section 13.7.5.36, “SHOW TABLE STATUS Statement”  
Section 15.5, “The ARCHIVE Storage Engine”  
Section 24.3.25, “The INFORMATION\_SCHEMA TABLES Table”

## **SHOW TABLES**

Section 3.3.2, “Creating a Table”  
Section 24.8, “Extensions to SHOW Statements”  
Section 9.2.3, “Identifier Case Sensitivity”  
Section 14.16, “InnoDB INFORMATION\_SCHEMA Tables”  
Section 24.1, “Introduction”  
Section 9.2.4, “Mapping of Identifiers to File Names”  
MySQL Glossary  
Section 21.7.10, “NDB Cluster Replication: Bidirectional and Circular Replication”  
Section 21.5.24, “ndb\_restore — Restore an NDB Cluster Backup”  
Section 21.6.15, “ndbinfo: The NDB Cluster Information Database”  
Section 5.1.6, “Server Command Options”  
Section 13.7.5.36, “SHOW TABLE STATUS Statement”  
Section 13.7.5.37, “SHOW TABLES Statement”  
Section B.3.2.14, “Table 'tbl\_name' doesn't exist”  
Section B.3.6.2, “TEMPORARY Table Problems”  
Section 24.3.25, “The INFORMATION\_SCHEMA TABLES Table”  
Section 6.4.6.3, “Using MySQL Enterprise Firewall”



---

## **SHOW TABLES FROM some\_ndb\_database**

Section 21.6.18.2, “NDB Cluster and MySQL Privileges”

## **SHOW TRIGGERS**

Section A.5, “MySQL 5.7 FAQ: Triggers”

Section 13.7.5.38, “SHOW TRIGGERS Statement”

Section 24.3.29, “The INFORMATION\_SCHEMA TRIGGERS Table”

Section 23.3.2, “Trigger Metadata”

## **SHOW VARIABLES**

Section 2.10.3, “Changes in MySQL 5.7”

Section 23.4.2, “Event Scheduler Configuration”

Section 14.6.1.3, “Importing InnoDB Tables”

Section 6.4.4.12, “Keyring System Variables”

Section 6.4.5.10, “Legacy Mode Audit Log Filtering”

Section 25.20, “Migrating to Performance Schema System and Status Variable Tables”

Section 16.1.5.8, “Multi-Source Replication Monitoring”

Section A.11, “MySQL 5.7 FAQ: MySQL Chinese, Japanese, and Korean Character Sets”

Section 25.3, “Performance Schema Startup Configuration”

Section 25.15, “Performance Schema System Variables”

Section 21.6.17, “Quick Reference: NDB Cluster SQL Statements”

Section 16.1.6.3, “Replica Server Options and Variables”

Section 5.7, “Running Multiple MySQL Instances on One Machine”

Section 16.3.9.3, “Semisynchronous Replication Monitoring”

Section 5.1.6, “Server Command Options”

Section 5.1.7, “Server System Variables”

Section 13.7.4.1, “SET Syntax for Variable Assignment”

Section 13.7.5.39, “SHOW VARIABLES Statement”

Section 21.7.6, “Starting NDB Cluster Replication (Single Replication Channel)”

Section 5.1.8, “Using System Variables”

Section 1.3, “What Is New in MySQL 5.7”

Section 6.4.5.8, “Writing Audit Log Filter Definitions”

## **SHOW WARNINGS**

Section 16.2.1.1, “Advantages and Disadvantages of Statement-Based and Row-Based Replication”

Section 13.1.8, “ALTER TABLE Statement”

Section 10.14.4.3, “Diagnostics During Index.xml Parsing”

Section 13.1.27, “DROP PROCEDURE and DROP FUNCTION Statements”

Section 13.1.29, “DROP TABLE Statement”

Section B.2, “Error Information Interfaces”

Section 8.8.2, “EXPLAIN Output Format”

Section 13.8.2, “EXPLAIN Statement”

Section 8.8.3, “Extended EXPLAIN Output Format”

Section 9.2.5, “Function Name Parsing and Resolution”

Section 13.6.7.3, “GET DIAGNOSTICS Statement”

Section 13.2.6, “LOAD DATA Statement”

Section 5.4.4.3, “Mixed Binary Logging Format”

Section 4.5.1.6, “mysql Client Tips”

Section 8.9.3, “Optimizer Hints”

Section 8.3.10, “Optimizer Use of Generated Column Indexes”

Section 8.8.1, “Optimizing Queries with EXPLAIN”

Section 8.2.2.2, “Optimizing Subqueries with Materialization”

Section 8.2.2.3, “Optimizing Subqueries with the EXISTS Strategy”

---

[Section 8.2.2.1, “Optimizing Subqueries, Derived Tables, and View References with Semijoin Transformations”](#)  
[Section 1.6.3.1, “PRIMARY KEY and UNIQUE Index Constraints”](#)  
[Section 12.21.4, “Rounding Behavior”](#)  
[Section 13.1.18.8, “Secondary Indexes and Generated Columns”](#)  
[Section 5.1.7, “Server System Variables”](#)  
[Section 13.7.5.17, “SHOW ERRORS Statement”](#)  
[Section 13.7.5.40, “SHOW WARNINGS Statement”](#)  
[Section 13.6.7.5, “SIGNAL Statement”](#)  
[Section 13.6.7.7, “The MySQL Diagnostics Area”](#)  
[Section 5.5.4.2, “Using the Rewriter Query Rewrite Plugin”](#)

## **SHUTDOWN**

[Section 6.2.2, “Privileges Provided by MySQL”](#)  
[Section 5.1.9, “Server Status Variables”](#)  
[Section 13.7.6.7, “SHUTDOWN Statement”](#)  
[Section 4.10, “Unix Signal Handling in MySQL”](#)  
[Section 1.3, “What Is New in MySQL 5.7”](#)

## **SIGNAL**

[Section 13.6.7, “Condition Handling”](#)  
[Section 13.6.7.1, “DECLARE ... CONDITION Statement”](#)  
[Section 13.6.7.2, “DECLARE ... HANDLER Statement”](#)  
[Section 12.15, “Information Functions”](#)  
[Section 13.6.7.4, “RESIGNAL Statement”](#)  
[Section 13.6.7.9, “Restrictions on Condition Handling”](#)  
[Section 23.8, “Restrictions on Stored Programs”](#)  
[Section 13.6.7.6, “Scope Rules for Handlers”](#)  
[Section 13.6.7.5, “SIGNAL Statement”](#)  
[Section 13.6.7.7, “The MySQL Diagnostics Area”](#)

## **SQL\_AFTER\_MTS\_GAPS**

[Section 13.7.5.34, “SHOW SLAVE STATUS Statement”](#)

## **START GROUP\_REPLICATION**

[Section 17.2.1.5, “Bootstrapping the Group”](#)  
[Section 17.8, “Frequently Asked Questions”](#)  
[Section 17.6.1, “Group Replication IP Address Allowlisting”](#)  
[Section 17.7.1, “Group Replication System Variables”](#)  
[Section 17.5.3, “Network Partitioning”](#)  
[Section 17.5.4, “Restarting a Group”](#)  
[Section 1.3, “What Is New in MySQL 5.7”](#)

## **START REPLICA**

[Section 16.4.3, “Upgrading a Replication Topology”](#)

## **START SLAVE**

[Section 16.1.2.6, “Adding Replicas to a Replication Topology”](#)  
[Section 16.1.6.4, “Binary Logging Options and Variables”](#)  
[Section 13.4.2.1, “CHANGE MASTER TO Statement”](#)  
[Section 16.2.2.1, “Commands for Operations on a Single Channel”](#)  
[Section 16.2.2.2, “Compatibility with Previous Replication Statements”](#)

---

Section 16.3.10, “Delayed Replication”  
Section 16.1.6.5, “Global Transaction ID System Variables”  
Section 16.1.3.1, “GTID Format and Storage”  
Section 21.7.8, “Implementing Failover with NDB Cluster Replication”  
Section 4.5.4, “mysqldump — A Database Backup Program”  
Section 21.7.10, “NDB Cluster Replication: Bidirectional and Circular Replication”  
Section 21.5.24, “ndb\_restore — Restore an NDB Cluster Backup”  
Section 6.1.2.3, “Passwords and Logging”  
Section 16.1.7.2, “Pausing Replication on the Replica”  
Section 25.12.11, “Performance Schema Replication Tables”  
Section 16.4.1.27, “Replica Errors During Replication”  
Section 16.1.6.3, “Replica Server Options and Variables”  
Section 16.3.5, “Replicating Different Databases to Different Replicas”  
Section 16.1.6, “Replication and Binary Logging Options and Variables”  
Section 16.4.1.32, “Replication and Transaction Inconsistencies”  
Section 16.2.3, “Replication Threads”  
Section 13.4.2.3, “RESET SLAVE Statement”  
Section 16.3.9.2, “Semisynchronous Replication Installation and Configuration”  
Section 13.7.5.34, “SHOW SLAVE STATUS Statement”  
Section 16.1.7.3, “Skipping Transactions”  
Skipping Transactions With GTIDs  
Skipping Transactions With `SET GLOBAL sql_slave_skip_counter`  
Section 16.1.5.5, “Starting Multi-Source Replicas”  
Section 21.7.6, “Starting NDB Cluster Replication (Single Replication Channel)”  
Section 13.3.3, “Statements That Cause an Implicit Commit”  
Section 13.4.2.6, “STOP SLAVE Statement”  
Section 16.3.7, “Switching Sources During Failover”  
Section 16.4.4, “Troubleshooting Replication”  
Section 16.4.3, “Upgrading a Replication Topology”  
Section 21.7.7, “Using Two Replication Channels for NDB Cluster Replication”

## **START SLAVE SQL\_THREAD**

Section 13.4.2.2, “CHANGE REPLICATION FILTER Statement”

## **START SLAVE UNTIL**

Section 16.1.6.3, “Replica Server Options and Variables”

## **START SLAVE UNTIL SQL\_AFTER\_MTS\_GAPS**

Section 13.4.2.1, “CHANGE MASTER TO Statement”  
Section 16.3.2, “Handling an Unexpected Halt of a Replica”  
Section 16.1.6.3, “Replica Server Options and Variables”  
Section 16.4.1.32, “Replication and Transaction Inconsistencies”  
Section 13.7.5.34, “SHOW SLAVE STATUS Statement”

## **START TRANSACTION**

Section 14.7.2.2, “autocommit, Commit, and Rollback”  
Section 13.6.1, “BEGIN ... END Compound Statement”  
Section 13.7.6.3, “FLUSH Statement”  
Section 14.7.5.3, “How to Minimize and Handle Deadlocks”  
Section 13.3.5, “LOCK TABLES and UNLOCK TABLES Statements”  
Section 14.7.2.4, “Locking Reads”  
Section 4.5.4, “mysqldump — A Database Backup Program”  
Section 4.5.6, “mysqlpump — A Database Backup Program”

---

[Section 8.5.3, “Optimizing InnoDB Read-Only Transactions”](#)  
[Section 25.12.7, “Performance Schema Transaction Tables”](#)  
[Section 23.8, “Restrictions on Stored Programs”](#)  
[Section 16.3.9, “Semisynchronous Replication”](#)  
[Section 5.1.7, “Server System Variables”](#)  
[Section 5.1.15, “Server Tracking of Client Session State”](#)  
[Section 13.3.6, “SET TRANSACTION Statement”](#)  
[Section 13.3.1, “START TRANSACTION, COMMIT, and ROLLBACK Statements”](#)  
[Section 13.3.3, “Statements That Cause an Implicit Commit”](#)  
[Section 25.12.7.1, “The events\\_transactions\\_current Table”](#)  
[Section 13.3, “Transactional and Locking Statements”](#)  
[Section 23.3.1, “Trigger Syntax and Examples”](#)  
[Section 13.3.7.2, “XA Transaction States”](#)

## **START TRANSACTION READ ONLY**

[MySQL Glossary](#)

[Section 8.5.3, “Optimizing InnoDB Read-Only Transactions”](#)

## **START TRANSACTION WITH CONSISTENT SNAPSHOT**

[Section 14.7.2.3, “Consistent Nonlocking Reads”](#)

## **STATS\_PERSISTENT=0**

[Section 14.8.11.2, “Configuring Non-Persistent Optimizer Statistics Parameters”](#)

## **STATS\_PERSISTENT=1**

[Section 14.8.11.1, “Configuring Persistent Optimizer Statistics Parameters”](#)

## **STOP GROUP REPLICATION**

[Section 17.7.1, “Group Replication System Variables”](#)

[Section 13.4.2.3, “RESET SLAVE Statement”](#)

## **STOP GROUP\_REPLICATION**

[Section 17.8, “Frequently Asked Questions”](#)

[Section 17.6.1, “Group Replication IP Address Allowlisting”](#)

[Section 17.7.1, “Group Replication System Variables”](#)

[Section 17.5.4, “Restarting a Group”](#)

[Section 13.4.3.2, “STOP GROUP\\_REPLICATION Statement”](#)

[Section 1.3, “What Is New in MySQL 5.7”](#)

## **STOP SLAVE**

[Section 16.1.2.6, “Adding Replicas to a Replication Topology”](#)

[Section 16.1.6.4, “Binary Logging Options and Variables”](#)

[Section 13.4.2.1, “CHANGE MASTER TO Statement”](#)

[Section 16.1.7.1, “Checking Replication Status”](#)

[Section 16.2.2.1, “Commands for Operations on a Single Channel”](#)

[Section 16.2.2.2, “Compatibility with Previous Replication Statements”](#)

[Section 16.3.10, “Delayed Replication”](#)

[Section 16.1.6.5, “Global Transaction ID System Variables”](#)

[Section 16.1.3.2, “GTID Life Cycle”](#)

[Section 4.5.4, “mysqldump — A Database Backup Program”](#)

[Section 16.1.7.2, “Pausing Replication on the Replica”](#)

[Section 25.12.11, “Performance Schema Replication Tables”](#)

---

[Section 16.1.6.3, “Replica Server Options and Variables”](#)  
[Section 16.1.6, “Replication and Binary Logging Options and Variables”](#)  
[Section 16.4.1.32, “Replication and Transaction Inconsistencies”](#)  
[Section 13.4.1.2, “RESET MASTER Statement”](#)  
[Section 13.4.2.3, “RESET SLAVE Statement”](#)  
[Section 16.3.9.2, “Semisynchronous Replication Installation and Configuration”](#)  
[Section 13.3.3, “Statements That Cause an Implicit Commit”](#)  
[Section 13.4.2.6, “STOP SLAVE Statement”](#)  
[Section 16.1.5.6, “Stopping Multi-Source Replicas”](#)  
[Section 16.3.7, “Switching Sources During Failover”](#)  
[Section 25.12.11.6, “The replication\\_applier\\_status\\_by\\_worker Table”](#)  
[Section 16.2.1.2, “Usage of Row-Based Logging and Replication”](#)  
[Section 1.3, “What Is New in MySQL 5.7”](#)

## **STOP SLAVE SQL\_THREAD**

[Section 13.4.2.2, “CHANGE REPLICATION FILTER Statement”](#)  
[Section 16.2.1.2, “Usage of Row-Based Logging and Replication”](#)

## **T**

[\[index top\]](#)

## **TABLE**

[Section 22.2.2, “LIST Partitioning”](#)  
[Section 21.6.15.27, “The ndbinfo memory\\_per\\_fragment Table”](#)

## **TRUNCATE PARTITION**

[Section 14.13.1, “Online DDL Operations”](#)

## **TRUNCATE TABLE**

[Section 14.21.5.5, “Adapting DML Statements to memcached Operations”](#)  
[Section 21.6.7.1, “Adding NDB Cluster Data Nodes Online: General Issues”](#)  
[Section 21.6.1, “Commands in the NDB Cluster Management Client”](#)  
[Section 15.2.3.3, “Compressed Table Characteristics”](#)  
[Section 14.6.1.5, “Converting Tables from MyISAM to InnoDB”](#)  
[Section 13.1.20, “CREATE TRIGGER Statement”](#)  
[Section 13.2.2, “DELETE Statement”](#)  
[Section 5.1.11.2, “DNS Lookups and the Host Cache”](#)  
[Section 25.4.3, “Event Pre-Filtering”](#)  
[Section 15.8.3, “FEDERATED Storage Engine Notes and Tips”](#)  
[Section 25.12.15.6, “File I/O Summary Tables”](#)  
[Section 14.6.3.2, “File-Per-Table Tablespaces”](#)  
[Section 13.2.4, “HANDLER Statement”](#)  
[Section 8.10.3.1, “How the Query Cache Operates”](#)  
[Section 14.21.7, “InnoDB memcached Plugin Internals”](#)  
[Section 21.2.7.2, “Limits and Differences of NDB Cluster from Standard MySQL Limits”](#)  
[Section 21.2.7.3, “Limits Relating to Transaction Handling in NDB Cluster”](#)  
[Section 13.3.5, “LOCK TABLES and UNLOCK TABLES Statements”](#)  
[Section 5.4.4.4, “Logging Format for Changes to mysql Database Tables”](#)  
[Section 22.3.4, “Maintenance of Partitions”](#)  
[Section 22.3.1, “Management of RANGE and LIST Partitions”](#)  
[Section 25.12.15.9, “Memory Summary Tables”](#)  
[Section 15.7.2, “MERGE Table Problems”](#)

---

## MySQL Glossary

Section 4.5.4, “mysqldump — A Database Backup Program”  
Section 4.5.6, “mysqlpump — A Database Backup Program”  
Section 21.5.9, “ndb\_delete\_all — Delete All Rows from an NDB Table”  
Section 25.12.15.5, “Object Wait Summary Table”  
Section 8.5.7, “Optimizing InnoDB DDL Operations”  
Section 25.12.8, “Performance Schema Connection Tables”  
Section 25.4.1, “Performance Schema Event Timing”  
Section 25.11, “Performance Schema General Table Characteristics”  
Section 25.12.14, “Performance Schema Status Variable Tables”  
Section 25.12.15, “Performance Schema Summary Tables”  
Section 25.12.13, “Performance Schema System Variable Tables”  
Section 25.12.10, “Performance Schema User-Defined Variable Tables”  
Section 21.7.9.2, “Point-In-Time Recovery Using NDB Cluster Replication”  
Section 6.2.2, “Privileges Provided by MySQL”  
Section 16.4.1.20, “Replication and MEMORY Tables”  
Section 16.4.1.35, “Replication and TRUNCATE TABLE”  
Section 5.4.1, “Selecting General Query Log and Slow Query Log Output Destinations”  
Section 5.1.7, “Server System Variables”  
Section 25.12.15.8, “Socket Summary Tables”  
Section 25.12.15.2, “Stage Summary Tables”  
Section 25.12.15.3, “Statement Summary Tables”  
Section 13.3.3, “Statements That Cause an Implicit Commit”  
Section 25.12.15.10, “Status Variable Summary Tables”  
Section 25.12.8.1, “The accounts Table”  
Section 25.12.3.1, “The cond\_instances Table”  
Section 25.12.5.1, “The events\_stages\_current Table”  
Section 25.12.5.2, “The events\_stages\_history Table”  
Section 25.12.5.3, “The events\_stages\_history\_long Table”  
Section 25.12.6.1, “The events\_statements\_current Table”  
Section 25.12.6.2, “The events\_statements\_history Table”  
Section 25.12.6.3, “The events\_statements\_history\_long Table”  
Section 25.12.7.1, “The events\_transactions\_current Table”  
Section 25.12.7.2, “The events\_transactions\_history Table”  
Section 25.12.7.3, “The events\_transactions\_history\_long Table”  
Section 25.12.4.1, “The events\_waits\_current Table”  
Section 25.12.4.2, “The events\_waits\_history Table”  
Section 25.12.4.3, “The events\_waits\_history\_long Table”  
Section 25.12.3.2, “The file\_instances Table”  
Section 25.12.16.1, “The host\_cache Table”  
Section 25.12.8.2, “The hosts Table”  
Section 24.4.22, “The INFORMATION\_SCHEMA INNODB\_SYS\_INDEXES Table”  
Section 24.4.23, “The INFORMATION\_SCHEMA INNODB\_SYS\_TABLES Table”  
Section 14.21.6, “The InnoDB memcached Plugin and Replication”  
Section 15.3, “The MEMORY Storage Engine”  
Section 25.12.12.1, “The metadata\_locks Table”  
Section 25.12.3.3, “The mutex\_instances Table”  
Section 25.12.16.2, “The performance\_timers Table”  
Section 25.12.6.4, “The prepared\_statements\_instances Table”  
Section 25.12.16.3, “The processlist Table”  
Section 26.4.4.24, “The ps\_truncate\_all\_tables() Procedure”  
Section 25.12.11.3, “The replication\_applier\_configuration Table”  
Section 25.12.11.4, “The replication\_applier\_status Table”  
Section 25.12.11.5, “The replication\_applier\_status\_by\_coordinator Table”

---

[Section 25.12.11.6, “The replication\\_applier\\_status\\_by\\_worker Table”](#)  
[Section 25.12.11.1, “The replication\\_connection\\_configuration Table”](#)  
[Section 25.12.11.2, “The replication\\_connection\\_status Table”](#)  
[Section 25.12.11.7, “The replication\\_group\\_member\\_stats Table”](#)  
[Section 25.12.11.8, “The replication\\_group\\_members Table”](#)  
[Section 25.12.3.4, “The rwlock\\_instances Table”](#)  
[Section 25.12.9.1, “The session\\_account\\_connect\\_attrs Table”](#)  
[Section 25.12.9.2, “The session\\_connect\\_attrs Table”](#)  
[Section 25.12.2.1, “The setup\\_actors Table”](#)  
[Section 25.12.2.2, “The setup\\_consumers Table”](#)  
[Section 25.12.2.3, “The setup\\_instruments Table”](#)  
[Section 25.12.2.4, “The setup\\_objects Table”](#)  
[Section 25.12.2.5, “The setup\\_timers Table”](#)  
[Section 25.12.3.5, “The socket\\_instances Table”](#)  
[Section 25.12.12.2, “The table\\_handles Table”](#)  
[The table\\_io\\_waits\\_summary\\_by\\_index\\_usage Table](#)  
[The table\\_io\\_waits\\_summary\\_by\\_table Table](#)  
[The table\\_lock\\_waits\\_summary\\_by\\_table Table](#)  
[Section 25.12.16.4, “The threads Table”](#)  
[Section 25.12.8.3, “The users Table”](#)  
[Section 25.12.15.4, “Transaction Summary Tables”](#)  
[Section 13.1.34, “TRUNCATE TABLE Statement”](#)  
[Section 25.12.15.1, “Wait Event Summary Tables”](#)  
[Section 1.3, “What Is New in MySQL 5.7”](#)  
[Section 6.4.5.8, “Writing Audit Log Filter Definitions”](#)

## **TRUNCATE TABLE performance\_schema.host\_cache**

[Section 13.7.6.3, “FLUSH Statement”](#)

## **U**

[\[index top\]](#)

## **UNINSTALL PLUGIN**

[Section 6.4.5.7, “Audit Log Filtering”](#)  
[Section 6.4.5.11, “Audit Log Reference”](#)  
[Section 13.7.6.3, “FLUSH Statement”](#)  
[Section 6.4.4.8, “General-Purpose Keyring Key-Management Functions”](#)  
[Section 8.12.4.1, “How MySQL Uses Memory”](#)  
[Section 13.7.3.3, “INSTALL PLUGIN Statement”](#)  
[Section 5.5.1, “Installing and Uninstalling Plugins”](#)  
[Section 6.5.2, “Installing or Uninstalling MySQL Enterprise Data Masking and De-Identification”](#)  
[Section 5.5.5.2, “Installing or Uninstalling Version Tokens”](#)  
[Section 6.4.1.9, “LDAP Pluggable Authentication”](#)  
[Section 4.4.3, “mysql\\_plugin — Configure MySQL Server Plugins”](#)  
[Section 6.4.1.10, “No-Login Pluggable Authentication”](#)  
[Section 6.4.1.7, “PAM Pluggable Authentication”](#)  
[Section 25.18, “Performance Schema and Plugins”](#)  
[Section 15.11.1, “Pluggable Storage Engine Architecture”](#)  
[Section 13.7.5.25, “SHOW PLUGINS Statement”](#)  
[Section 6.4.1.11, “Socket Peer-Credential Pluggable Authentication”](#)  
[Section 13.3.3, “Statements That Cause an Implicit Commit”](#)  
[Section 6.4.1.12, “Test Pluggable Authentication”](#)

---

Section 24.3.17, “The INFORMATION\_SCHEMA PLUGINS Table”  
Section 13.7.3.4, “UNINSTALL PLUGIN Statement”  
Section 6.4.4.5, “Using the keyring\_aws Amazon Web Services Keyring Plugin”  
Section 6.4.1.8, “Windows Pluggable Authentication”

## **UNION**

Section 2.10.3, “Changes in MySQL 5.7”  
Section 12.8.3, “Character Set and Collation of Function Results”  
Section 13.1.18, “CREATE TABLE Statement”  
Section 13.1.21, “CREATE VIEW Statement”  
Section 8.8.2, “EXPLAIN Output Format”  
Section 12.15, “Information Functions”  
Section 13.2.5.2, “INSERT ... ON DUPLICATE KEY UPDATE Statement”  
Section 8.4.4, “Internal Temporary Table Use in MySQL”  
Section 14.7.3, “Locks Set by Different SQL Statements in InnoDB”  
Section 11.1.6, “Numeric Type Attributes”  
Section 8.2.2.4, “Optimizing Derived Tables and View References with Merging or Materialization”  
Section 8.2.2.1, “Optimizing Subqueries, Derived Tables, and View References with Semijoin Transformations”  
Section 8.2.1.2, “Range Optimization”  
Section 3.6.7, “Searching on Two Keys”  
Section 13.2.9.1, “SELECT ... INTO Statement”  
Section 13.2.9, “SELECT Statement”  
Section 5.1.9, “Server Status Variables”  
Section 13.2.10, “Subqueries”  
Section 15.7, “The MERGE Storage Engine”  
Section 13.2.9.3, “UNION Clause”  
Section 23.5.3, “Updatable and Insertable Views”  
Section 8.4.2.4, “Using PROCEDURE ANALYSE”  
Section 23.5.1, “View Syntax”  
Section 12.11, “XML Functions”

## **UNION ALL**

Section 12.15, “Information Functions”  
Section 8.4.4, “Internal Temporary Table Use in MySQL”  
Section 8.2.2.4, “Optimizing Derived Tables and View References with Merging or Materialization”  
Section 13.2.9.3, “UNION Clause”  
Section 23.5.3, “Updatable and Insertable Views”

## **UNION DISTINCT**

Section 13.2.9.3, “UNION Clause”

## **UNLOCK TABLES**

Section 8.6.2, “Bulk Data Loading for MyISAM Tables”  
Section 7.2, “Database Backup Methods”  
Section 13.7.6.3, “FLUSH Statement”  
Section 14.7.5.3, “How to Minimize and Handle Deadlocks”  
Section 14.6.1.3, “Importing InnoDB Tables”  
Section 13.3.5, “LOCK TABLES and UNLOCK TABLES Statements”  
Section 14.7.3, “Locks Set by Different SQL Statements in InnoDB”  
Section 4.5.4, “mysqldump — A Database Backup Program”  
Section 4.5.6, “mysqlpump — A Database Backup Program”  
Section 23.8, “Restrictions on Stored Programs”



---

Section 13.3.1, “START TRANSACTION, COMMIT, and ROLLBACK Statements”  
Section 13.3.3, “Statements That Cause an Implicit Commit”  
Section 8.12.1, “System Factors”

## UPDATE

Section 6.2, “Access Control and Account Management”  
Section 6.2.6, “Access Control, Stage 2: Request Verification”  
Section 6.2.7, “Adding Accounts, Assigning Privileges, and Dropping Accounts”  
Section 16.2.1.1, “Advantages and Disadvantages of Statement-Based and Row-Based Replication”  
Section 12.4.4, “Assignment Operators”  
Section 6.4.5.7, “Audit Log Filtering”  
Section 6.4.5.11, “Audit Log Reference”  
Section 14.6.1.6, “AUTO\_INCREMENT Handling in InnoDB”  
Section 14.1.2, “Best Practices for InnoDB Tables”  
Section 16.1.6.4, “Binary Logging Options and Variables”  
Section 12.1, “Built-In Function and Operator Reference”  
Section 8.5.5, “Bulk Data Loading for InnoDB Tables”  
Section 8.6.2, “Bulk Data Loading for MyISAM Tables”  
Section 8.10.4, “Caching of Prepared Statements and Stored Programs”  
Section 14.5.2, “Change Buffer”  
Section 2.10.3, “Changes in MySQL 5.7”  
Section 13.7.2.2, “CHECK TABLE Statement”  
Section 10.7, “Column Character Set Conversion”  
Section 14.9.1.6, “Compression for OLTP Workloads”  
Section 14.8.12, “Configuring the Merge Threshold for Index Pages”  
Section 14.7.2.3, “Consistent Nonlocking Reads”  
Section 1.6.3.3, “Constraints on Invalid Data”  
Section 14.6.1.5, “Converting Tables from MyISAM to InnoDB”  
Section 13.1.18.7, “CREATE TABLE and Generated Columns”  
Section 13.1.18.2, “CREATE TEMPORARY TABLE Statement”  
Section 13.1.20, “CREATE TRIGGER Statement”  
Section 13.1.21, “CREATE VIEW Statement”  
Section 15.8.2.1, “Creating a FEDERATED Table Using CONNECTION”  
Section 11.6, “Data Type Default Values”  
Section 11.2.1, “Date and Time Data Type Syntax”  
Section 14.7.5, “Deadlocks in InnoDB”  
Section 2.11.3, “Downgrade Notes”  
Section 8.8.2, “EXPLAIN Output Format”  
Section 13.8.2, “EXPLAIN Statement”  
Section 8.8.3, “Extended EXPLAIN Output Format”  
Section 15.8.3, “FEDERATED Storage Engine Notes and Tips”  
Section 14.22.2, “Forcing InnoDB Recovery”  
Section 1.6.2.3, “FOREIGN KEY Constraint Differences”  
Section 13.1.18.5, “FOREIGN KEY Constraints”  
Section 12.9.5, “Full-Text Restrictions”  
Section 8.2.1.18, “Function Call Optimization”  
Chapter 12, *Functions and Operators*  
Section 8.14.3, “General Thread States”  
Section 13.7.1.4, “GRANT Statement”  
Section 6.2.3, “Grant Tables”  
Section 8.10.3.1, “How the Query Cache Operates”  
Section 21.6.9, “Importing Data Into MySQL Cluster”  
Section 8.9.4, “Index Hints”

---

Section 12.15, “Information Functions”  
Section 14.7.1, “InnoDB Locking”  
Section 14.15, “InnoDB Startup Options and System Variables”  
Section 13.2.5.2, “INSERT ... ON DUPLICATE KEY UPDATE Statement”  
Section 13.2.5, “INSERT Statement”  
Section 16.2.5.3, “Interactions Between Replication Filtering Options”  
Section 8.11.1, “Internal Locking Methods”  
Section 8.4.4, “Internal Temporary Table Use in MySQL”  
Section 24.1, “Introduction”  
Section 13.2.9.2, “JOIN Clause”  
Section 13.7.6.4, “KILL Statement”  
Section B.3.7, “Known Issues in MySQL”  
Section 21.7.3, “Known Issues in NDB Cluster Replication”  
Section 13.2.6, “LOAD DATA Statement”  
Section 13.3.5, “LOCK TABLES and UNLOCK TABLES Statements”  
Section 14.7.2.4, “Locking Reads”  
Section 14.7.3, “Locks Set by Different SQL Statements in InnoDB”  
Section 5.4.4.4, “Logging Format for Changes to mysql Database Tables”  
Section 12.20, “Miscellaneous Functions”  
Section A.4, “MySQL 5.7 FAQ: Stored Procedures and Functions”  
Section 4.5.1.1, “mysql Client Options”  
Section 4.5.1.6, “mysql Client Tips”  
Section 1.6.1, “MySQL Extensions to Standard SQL”  
MySQL Glossary  
Section 4.6.7.2, “mysqlbinlog Row Event Display”  
Section 21.6.11.1, “NDB Cluster Disk Data Objects”  
Section 21.7.11, “NDB Cluster Replication Conflict Resolution”  
Section 8.8.4, “Obtaining Execution Plan Information for a Named Connection”  
Section 14.13.1, “Online DDL Operations”  
Section 12.4, “Operators”  
Section 8.9.3, “Optimizer Hints”  
Section 8.2.4, “Optimizing Data Change Statements”  
Section 8.8.1, “Optimizing Queries with EXPLAIN”  
Section 8.2.2, “Optimizing Subqueries, Derived Tables, and View References”  
Section 11.1.7, “Out-of-Range and Overflow Handling”  
Section 22.1, “Overview of Partitioning in MySQL”  
Section 22.4, “Partition Pruning”  
Section 22.5, “Partition Selection”  
Section 22.6.4, “Partitioning and Locking”  
Section 6.1.2.3, “Passwords and Logging”  
Section 25.4.6, “Pre-Filtering by Thread”  
Section 1.6.3.1, “PRIMARY KEY and UNIQUE Index Constraints”  
Section 6.2.2, “Privileges Provided by MySQL”  
Section B.3.4.2, “Problems Using DATE Columns”  
Section 14.8.10, “Purge Configuration”  
Section 8.2.1.2, “Range Optimization”  
Section 16.4.1.27, “Replica Errors During Replication”  
Section 16.1.6.3, “Replica Server Options and Variables”  
Section 16.4.1.17, “Replication and LIMIT”  
Section 16.4.1.22, “Replication and the Query Optimizer”  
Section 16.4.1.34, “Replication and Triggers”  
Section 22.6, “Restrictions and Limitations on Partitioning”  
Section 13.2.10.11, “Rewriting Subqueries as Joins”  
Section 13.1.18.8, “Secondary Indexes and Generated Columns”

---

Section 3.3.4.1, “Selecting All Data”  
Section 5.4.1, “Selecting General Query Log and Slow Query Log Output Destinations”  
Section 5.1.10, “Server SQL Modes”  
Section 5.1.9, “Server Status Variables”  
Section 5.1.7, “Server System Variables”  
Section 13.7.5.36, “SHOW TABLE STATUS Statement”  
Section 13.7.5.40, “SHOW WARNINGS Statement”  
Statement Probes  
Section 13.2.10, “Subqueries”  
Section 13.2.10.9, “Subquery Errors”  
Section 8.11.2, “Table Locking Issues”  
Section 15.5, “The ARCHIVE Storage Engine”  
Section 10.8.5, “The binary Collation Compared to \_bin Collations”  
Section 5.4.4, “The Binary Log”  
Section 15.6, “The BLACKHOLE Storage Engine”  
Section 24.4.25, “The INFORMATION\_SCHEMA INNODB\_SYS\_TABLESTATS View”  
Section 24.3.25, “The INFORMATION\_SCHEMA TABLES Table”  
Section 24.3.31, “The INFORMATION\_SCHEMA VIEWS Table”  
Section 1.2.2, “The Main Features of MySQL”  
Section 15.7, “The MERGE Storage Engine”  
Section 15.2, “The MyISAM Storage Engine”  
Section 5.1.16, “The Server Shutdown Process”  
Section 26.4.2.3, “The sys\_config\_update\_set\_user Trigger”  
Section 8.15.3, “Traceable Statements”  
Section 14.7.2.1, “Transaction Isolation Levels”  
Section 23.3.1, “Trigger Syntax and Examples”  
Section 6.2.17, “Troubleshooting Problems Connecting to MySQL”  
Section 14.6.7, “Undo Logs”  
Section 23.5.3, “Updatable and Insertable Views”  
Section 1.6.2.2, “UPDATE Differences”  
Section 13.2.11, “UPDATE Statement”  
Section 16.2.1.2, “Usage of Row-Based Logging and Replication”  
Section 1.3, “What Is New in MySQL 5.7”  
Section 6.2.9, “When Privilege Changes Take Effect”  
Section 8.2.1.1, “WHERE Clause Optimization”  
Section 6.4.5.8, “Writing Audit Log Filter Definitions”

## **UPDATE ... ()**

Section 14.7.2.3, “Consistent Nonlocking Reads”

## **UPDATE ... WHERE**

Section 14.7.5, “Deadlocks in InnoDB”

## **UPDATE ... WHERE ...**

Section 14.7.3, “Locks Set by Different SQL Statements in InnoDB”

## **UPDATE IGNORE**

Section 5.1.10, “Server SQL Modes”  
Section 13.2.11, “UPDATE Statement”

## **UPDATE t1,t2 ...**

Statement Probes

---

## USE

[Section 16.1.6.4, “Binary Logging Options and Variables”](#)  
[Section 7.4.5.2, “Copy a Database from one Server to Another”](#)  
[Section 13.1.16, “CREATE PROCEDURE and CREATE FUNCTION Statements”](#)  
[Section 3.3.1, “Creating and Selecting a Database”](#)  
[Section 3.3, “Creating and Using a Database”](#)  
[Section 7.4.1, “Dumping Data in SQL Format with mysqldump”](#)  
[Section 16.2.5.1, “Evaluation of Database-Level Replication and Binary Logging Options”](#)  
[Section 16.2.5.3, “Interactions Between Replication Filtering Options”](#)  
[Section 24.1, “Introduction”](#)  
[Section 4.5.1.1, “mysql Client Options”](#)  
[Section 4.6.7, “mysqlbinlog — Utility for Processing Binary Log Files”](#)  
[Section 4.5.4, “mysqldump — A Database Backup Program”](#)  
[Section 4.5.6, “mysqlpump — A Database Backup Program”](#)  
[Section 21.6.15, “ndbinfo: The NDB Cluster Information Database”](#)  
[Section 7.4.2, “Reloading SQL-Format Backups”](#)  
[Section 16.1.6.3, “Replica Server Options and Variables”](#)  
[Section 23.2.1, “Stored Routine Syntax”](#)  
[Section 13.8.4, “USE Statement”](#)

## USE db2

[Section 4.6.7, “mysqlbinlog — Utility for Processing Binary Log Files”](#)

## USE db\_name

[Section 4.5.1.1, “mysql Client Options”](#)

## USE test

[Section 4.6.7, “mysqlbinlog — Utility for Processing Binary Log Files”](#)

## W

[\[index top\]](#)

## WHERE

[Section 14.1.1, “Benefits of Using InnoDB Tables”](#)

## WHILE

[Section 13.6.5, “Flow Control Statements”](#)  
[Section 13.6.5.3, “ITERATE Statement”](#)  
[Section 13.6.5.4, “LEAVE Statement”](#)  
[Section 13.6.2, “Statement Labels”](#)  
[Section 13.6.5.8, “WHILE Statement”](#)

## X

[\[index top\]](#)

## XA BEGIN

[Section 25.12.7, “Performance Schema Transaction Tables”](#)

## XA COMMIT

[Section 2.11.4, “Downgrading Binary and Package-based Installations on Unix/Linux”](#)

---

[Section 25.12.7, “Performance Schema Transaction Tables”](#)  
[Section 5.1.7, “Server System Variables”](#)  
[Section 25.12.7.1, “The events\\_transactions\\_current Table”](#)  
[Section 2.10.4, “Upgrading MySQL Binary or Package-based Installations on Unix/Linux”](#)  
[Section 13.3.7.2, “XA Transaction States”](#)

## **XA END**

[Section 13.3.7.3, “Restrictions on XA Transactions”](#)  
[Section 25.12.7.1, “The events\\_transactions\\_current Table”](#)  
[Section 13.3.7.1, “XA Transaction SQL Statements”](#)  
[Section 13.3.7.2, “XA Transaction States”](#)

## **XA PREPARE**

[Section 5.1.7, “Server System Variables”](#)  
[Section 25.12.7.1, “The events\\_transactions\\_current Table”](#)  
[Section 13.3.7.2, “XA Transaction States”](#)

## **XA RECOVER**

[Section 2.11.4, “Downgrading Binary and Package-based Installations on Unix/Linux”](#)  
[Section 13.3.7.3, “Restrictions on XA Transactions”](#)  
[Section 25.12.7.1, “The events\\_transactions\\_current Table”](#)  
[Section 2.10.4, “Upgrading MySQL Binary or Package-based Installations on Unix/Linux”](#)  
[Section 13.3.7.1, “XA Transaction SQL Statements”](#)  
[Section 13.3.7.2, “XA Transaction States”](#)

## **XA ROLLBACK**

[Section 2.11.4, “Downgrading Binary and Package-based Installations on Unix/Linux”](#)  
[Section 25.12.7, “Performance Schema Transaction Tables”](#)  
[Section 5.1.7, “Server System Variables”](#)  
[Section 25.12.7.1, “The events\\_transactions\\_current Table”](#)  
[Section 2.10.4, “Upgrading MySQL Binary or Package-based Installations on Unix/Linux”](#)  
[Section 13.3.7.2, “XA Transaction States”](#)

## **XA START**

[Section 25.12.7, “Performance Schema Transaction Tables”](#)  
[Section 13.3.7.3, “Restrictions on XA Transactions”](#)  
[Section 5.1.7, “Server System Variables”](#)  
[Section 25.12.7.1, “The events\\_transactions\\_current Table”](#)  
[Section 13.3.7.1, “XA Transaction SQL Statements”](#)  
[Section 13.3.7.2, “XA Transaction States”](#)

## **XA START xid**

[Section 13.3.7.1, “XA Transaction SQL Statements”](#)

## Status Variable Index

[A](#) | [B](#) | [C](#) | [D](#) | [F](#) | [G](#) | [H](#) | [I](#) | [K](#) | [L](#) | [M](#) | [N](#) | [O](#) | [P](#) | [Q](#) | [R](#) | [S](#) | [T](#) | [U](#) | [V](#)

### **A**

[\[index top\]](#)

---

## **Aborted\_clients**

[Section B.3.2.9, “Communication Errors and Aborted Connections”](#)  
[Section 5.1.9, “Server Status Variables”](#)

## **Aborted\_connects**

[Section B.3.2.9, “Communication Errors and Aborted Connections”](#)  
[Section 5.1.9, “Server Status Variables”](#)

## **Audit\_log\_current\_size**

[Section 6.4.5.11, “Audit Log Reference”](#)

## **Audit\_log\_event\_max\_drop\_size**

[Section 6.4.5.11, “Audit Log Reference”](#)

## **Audit\_log\_events**

[Section 6.4.5.11, “Audit Log Reference”](#)

## **Audit\_log\_events\_filtered**

[Section 6.4.5.11, “Audit Log Reference”](#)

## **Audit\_log\_events\_lost**

[Section 6.4.5.11, “Audit Log Reference”](#)

## **Audit\_log\_events\_written**

[Section 6.4.5.11, “Audit Log Reference”](#)

## **Audit\_log\_total\_size**

[Section 6.4.5.11, “Audit Log Reference”](#)

## **Audit\_log\_write\_waits**

[Section 6.4.5.11, “Audit Log Reference”](#)

## **B**

[\[index top\]](#)

## **Binlog\_cache\_disk\_use**

[Section 16.1.6.4, “Binary Logging Options and Variables”](#)  
[Section 5.1.9, “Server Status Variables”](#)  
[Section 5.4.4, “The Binary Log”](#)

## **Binlog\_cache\_use**

[Section 16.1.6.4, “Binary Logging Options and Variables”](#)  
[Section 5.1.9, “Server Status Variables”](#)  
[Section 5.4.4, “The Binary Log”](#)

## **Binlog\_stmt\_cache\_disk\_use**

[Section 16.1.6.4, “Binary Logging Options and Variables”](#)

---

[Section 5.1.9, “Server Status Variables”](#)

## **Binlog\_stmt\_cache\_use**

[Section 16.1.6.4, “Binary Logging Options and Variables”](#)

[Section 5.1.9, “Server Status Variables”](#)

## **Bytes\_received**

[Section 5.1.9, “Server Status Variables”](#)

## **Bytes\_sent**

[Section 5.1.9, “Server Status Variables”](#)

## **C**

[\[index top\]](#)

## **Caching\_sha2\_password\_rsa\_public\_key**

[Section 6.4.1.4, “Caching SHA-2 Pluggable Authentication”](#)

## **Com\_flush**

[Section 5.1.9, “Server Status Variables”](#)

## **Com\_shutdown**

[Section 13.7.6.7, “SHUTDOWN Statement”](#)

## **Com\_stmt\_reprepare**

[Section 8.10.4, “Caching of Prepared Statements and Stored Programs”](#)

## **Compression**

[Section 5.1.9, “Server Status Variables”](#)

## **Connection\_control\_delay\_generated**

[Section 6.4.2.1, “Connection Control Plugin Installation”](#)

[Section 6.4.2.2, “Connection Control Plugin System and Status Variables”](#)

## **Connection\_errors\_accept**

[Section 5.1.9, “Server Status Variables”](#)

## **Connection\_errors\_internal**

[Section 5.1.9, “Server Status Variables”](#)

## **Connection\_errors\_max\_connections**

[Section 5.1.11.1, “Connection Interfaces”](#)

[Section 5.1.9, “Server Status Variables”](#)

## **Connection\_errors\_peer\_address**

[Section 5.1.9, “Server Status Variables”](#)

## **Connection\_errors\_select**

[Section 5.1.9, “Server Status Variables”](#)

---

## **Connection\_errors\_tcpwrap**

[Section 5.1.9, “Server Status Variables”](#)

## **Connection\_errors\_xxx**

[Section 5.1.11.2, “DNS Lookups and the Host Cache”](#)

[Section 5.1.9, “Server Status Variables”](#)

## **Connections**

[Section 5.1.9, “Server Status Variables”](#)

[Section 5.1.7, “Server System Variables”](#)

## **Created\_tmp\_disk\_tables**

[Section 8.4.4, “Internal Temporary Table Use in MySQL”](#)

[Section 5.1.9, “Server Status Variables”](#)

[Section 5.1.7, “Server System Variables”](#)

[Section 25.12.6.1, “The events\\_statements\\_current Table”](#)

## **Created\_tmp\_files**

[Section 5.1.9, “Server Status Variables”](#)

## **Created\_tmp\_tables**

[Section 8.4.4, “Internal Temporary Table Use in MySQL”](#)

[Section 5.1.9, “Server Status Variables”](#)

[Section 5.1.7, “Server System Variables”](#)

[Section 13.7.5.35, “SHOW STATUS Statement”](#)

[Section 25.12.6.1, “The events\\_statements\\_current Table”](#)

## **D**

[\[index top\]](#)

## **Delayed\_errors**

[Section 5.1.9, “Server Status Variables”](#)

## **Delayed\_insert\_threads**

[Section 5.1.9, “Server Status Variables”](#)

## **Delayed\_writes**

[Section 5.1.9, “Server Status Variables”](#)

## **F**

[\[index top\]](#)

## **Firewall\_access\_denied**

[Section 6.4.6.4, “MySQL Enterprise Firewall Reference”](#)

## **Firewall\_access\_granted**

[Section 6.4.6.4, “MySQL Enterprise Firewall Reference”](#)

[Section 6.4.6.3, “Using MySQL Enterprise Firewall”](#)



---

## **Firewall\_access\_suspicious**

[Section 6.4.6.4, “MySQL Enterprise Firewall Reference”](#)

## **Firewall\_cached\_entries**

[Section 6.4.6.4, “MySQL Enterprise Firewall Reference”](#)

## **Flush\_commands**

[Section 5.1.9, “Server Status Variables”](#)

## **G**

[\[index top\]](#)

## **group\_replication\_primary\_member**

[Section 17.7.2, “Group Replication Status Variables”](#)

[Section 5.1.9, “Server Status Variables”](#)

## **H**

[\[index top\]](#)

## **Handler\_commit**

[Section 5.1.9, “Server Status Variables”](#)

## **Handler\_delete**

[Section 5.1.9, “Server Status Variables”](#)

## **Handler\_discover**

[NDB Cluster Status Variables](#)

## **Handler\_external\_lock**

[Section 5.1.9, “Server Status Variables”](#)

## **Handler\_mrr\_init**

[Section 5.1.9, “Server Status Variables”](#)

## **Handler\_prepare**

[Section 5.1.9, “Server Status Variables”](#)

## **Handler\_read\_first**

[Section 5.1.9, “Server Status Variables”](#)

## **Handler\_read\_key**

[Section 5.1.9, “Server Status Variables”](#)

## **Handler\_read\_last**

[Section 5.1.9, “Server Status Variables”](#)

## **Handler\_read\_next**

[Section 5.1.9, “Server Status Variables”](#)

---

[Section 8.3.9, “Use of Index Extensions”](#)

## **Handler\_read\_prev**

[Section 5.1.9, “Server Status Variables”](#)

## **Handler\_read\_rnd**

[Section 5.1.9, “Server Status Variables”](#)

## **Handler\_read\_rnd\_next**

[Section 5.1.9, “Server Status Variables”](#)

## **Handler\_rollback**

[Section 5.1.9, “Server Status Variables”](#)

## **Handler\_savepoint**

[Section 5.1.9, “Server Status Variables”](#)

## **Handler\_savepoint\_rollback**

[Section 5.1.9, “Server Status Variables”](#)

## **Handler\_update**

[Section 5.1.9, “Server Status Variables”](#)

## **Handler\_write**

[Section 5.1.9, “Server Status Variables”](#)

## **I**

[\[index top\]](#)

## **Innodb\_available\_undo\_logs**

[Section 5.1.9, “Server Status Variables”](#)

## **Innodb\_buffer\_pool\_bytes\_data**

[Section 5.1.9, “Server Status Variables”](#)

## **Innodb\_buffer\_pool\_bytes\_dirty**

[Section 5.1.9, “Server Status Variables”](#)

## **Innodb\_buffer\_pool\_dump\_status**

[Section 14.15, “InnoDB Startup Options and System Variables”](#)

[Section 5.1.9, “Server Status Variables”](#)

## **Innodb\_buffer\_pool\_load\_status**

[Section 14.15, “InnoDB Startup Options and System Variables”](#)

[Section 5.1.9, “Server Status Variables”](#)

## **Innodb\_buffer\_pool\_pages\_data**

[Section 5.1.9, “Server Status Variables”](#)

---

## **Innodb\_buffer\_pool\_pages\_dirty**

Section 5.1.9, “Server Status Variables”

## **Innodb\_buffer\_pool\_pages\_flushed**

Section 5.1.9, “Server Status Variables”

## **Innodb\_buffer\_pool\_pages\_free**

Section 5.1.9, “Server Status Variables”

## **Innodb\_buffer\_pool\_pages\_latched**

Section 5.1.9, “Server Status Variables”

## **Innodb\_buffer\_pool\_pages\_misc**

Section 5.1.9, “Server Status Variables”

## **Innodb\_buffer\_pool\_pages\_total**

Section 5.1.9, “Server Status Variables”

## **Innodb\_buffer\_pool\_read\_ahead**

Section 14.8.3.4, “Configuring InnoDB Buffer Pool Prefetching (Read-Ahead)”

Section 14.15, “InnoDB Startup Options and System Variables”

Section 5.1.9, “Server Status Variables”

## **Innodb\_buffer\_pool\_read\_ahead\_evicted**

Section 14.8.3.4, “Configuring InnoDB Buffer Pool Prefetching (Read-Ahead)”

Section 14.15, “InnoDB Startup Options and System Variables”

Section 5.1.9, “Server Status Variables”

## **Innodb\_buffer\_pool\_read\_ahead\_rnd**

Section 14.8.3.4, “Configuring InnoDB Buffer Pool Prefetching (Read-Ahead)”

Section 5.1.9, “Server Status Variables”

## **Innodb\_buffer\_pool\_read\_requests**

Section 5.1.9, “Server Status Variables”

## **Innodb\_buffer\_pool\_reads**

Section 5.1.9, “Server Status Variables”

## **Innodb\_buffer\_pool\_resize\_status**

Section 14.8.3.1, “Configuring InnoDB Buffer Pool Size”

Section 14.15, “InnoDB Startup Options and System Variables”

Section 5.1.9, “Server Status Variables”

Section 1.3, “What Is New in MySQL 5.7”

## **Innodb\_buffer\_pool\_wait\_free**

Section 5.1.9, “Server Status Variables”

## **Innodb\_buffer\_pool\_write\_requests**

Section 5.1.9, “Server Status Variables”

---

## **Innodb\_data\_fsyncs**

Section 14.15, “InnoDB Startup Options and System Variables”

Section 5.1.9, “Server Status Variables”

## **Innodb\_data\_pending\_fsyncs**

Section 5.1.9, “Server Status Variables”

## **Innodb\_data\_pending\_reads**

Section 5.1.9, “Server Status Variables”

## **Innodb\_data\_pending\_writes**

Section 5.1.9, “Server Status Variables”

## **Innodb\_data\_read**

Section 5.1.9, “Server Status Variables”

## **Innodb\_data\_reads**

Section 5.1.9, “Server Status Variables”

## **Innodb\_data\_writes**

Section 5.1.9, “Server Status Variables”

## **Innodb\_data\_written**

Section 5.1.9, “Server Status Variables”

## **Innodb\_dblwr\_pages\_written**

Section 5.1.9, “Server Status Variables”

## **Innodb\_dblwr\_writes**

Section 5.1.9, “Server Status Variables”

## **Innodb\_have\_atomic\_builtins**

Section 5.1.9, “Server Status Variables”

## **Innodb\_log\_waits**

Section 5.1.9, “Server Status Variables”

## **Innodb\_log\_write\_requests**

Section 5.1.9, “Server Status Variables”

## **Innodb\_log\_writes**

Section 5.1.9, “Server Status Variables”

## **Innodb\_num\_open\_files**

Section 5.1.9, “Server Status Variables”

## **Innodb\_os\_log\_fsyncs**

Section 5.1.9, “Server Status Variables”

---

## **Innodb\_os\_log\_pending\_fsyncs**

Section 5.1.9, “Server Status Variables”

## **Innodb\_os\_log\_pending\_writes**

Section 5.1.9, “Server Status Variables”

## **Innodb\_os\_log\_written**

Section 14.15, “InnoDB Startup Options and System Variables”  
Section 5.1.9, “Server Status Variables”

## **Innodb\_page\_size**

Section 5.1.9, “Server Status Variables”

## **Innodb\_pages\_created**

Section 5.1.9, “Server Status Variables”

## **Innodb\_pages\_read**

Section 5.1.9, “Server Status Variables”

## **Innodb\_pages\_written**

Section 5.1.9, “Server Status Variables”

## **Innodb\_row\_lock\_current\_waits**

Section 5.1.9, “Server Status Variables”

## **Innodb\_row\_lock\_time**

Section 5.1.9, “Server Status Variables”

## **Innodb\_row\_lock\_time\_avg**

Section 5.1.9, “Server Status Variables”

## **Innodb\_row\_lock\_time\_max**

Section 5.1.9, “Server Status Variables”

## **Innodb\_row\_lock\_waits**

Section 5.1.9, “Server Status Variables”

## **Innodb\_rows\_deleted**

Section 5.1.9, “Server Status Variables”

## **Innodb\_rows\_inserted**

Section 5.1.9, “Server Status Variables”

## **Innodb\_rows\_read**

Section 5.1.9, “Server Status Variables”

## **Innodb\_rows\_updated**

Section 5.1.9, “Server Status Variables”

---

## **Innodb\_truncated\_status\_writes**

Section 5.1.9, “Server Status Variables”

## **K**

[\[index top\]](#)

## **Key\_blocks\_not\_flushed**

Section 5.1.9, “Server Status Variables”

## **Key\_blocks\_unused**

Section 5.1.9, “Server Status Variables”

Section 5.1.7, “Server System Variables”

## **Key\_blocks\_used**

Section 5.1.9, “Server Status Variables”

## **Key\_read\_requests**

Section 5.1.9, “Server Status Variables”

Section 5.1.7, “Server System Variables”

## **Key\_reads**

Section 5.1.9, “Server Status Variables”

Section 5.1.7, “Server System Variables”

## **Key\_write\_requests**

Section 5.1.9, “Server Status Variables”

Section 5.1.7, “Server System Variables”

## **Key\_writes**

Section 5.1.9, “Server Status Variables”

Section 5.1.7, “Server System Variables”

## **L**

[\[index top\]](#)

## **Last\_query\_cost**

Section 5.1.9, “Server Status Variables”

## **Last\_query\_partial\_plans**

Section 5.1.9, “Server Status Variables”

## **Locked\_connects**

Section 6.2.15, “Account Locking”

Section 5.1.9, “Server Status Variables”

## **M**

[\[index top\]](#)

---

## **Max\_execution\_time\_exceeded**

[Section 5.1.9, “Server Status Variables”](#)

## **Max\_execution\_time\_set**

[Section 5.1.9, “Server Status Variables”](#)

## **Max\_execution\_time\_set\_failed**

[Section 5.1.9, “Server Status Variables”](#)

## **Max\_used\_connections**

[Section 13.7.6.3, “FLUSH Statement”](#)

[Section 5.1.9, “Server Status Variables”](#)

[Section 5.1.7, “Server System Variables”](#)

## **Max\_used\_connections\_time**

[Section 5.1.9, “Server Status Variables”](#)

## **mecab\_charset**

[Section 12.9.9, “MeCab Full-Text Parser Plugin”](#)

[Section 5.1.9, “Server Status Variables”](#)

## **Mysqlx\_address**

[Section 19.4.2.3, “X Plugin Status Variables”](#)

## **Mysqlx\_bytes\_received**

[Section 19.4.2.3, “X Plugin Status Variables”](#)

## **Mysqlx\_bytes\_sent**

[Section 19.4.2.3, “X Plugin Status Variables”](#)

## **Mysqlx\_connection\_accept\_errors**

[Section 19.4.2.3, “X Plugin Status Variables”](#)

## **Mysqlx\_connection\_errors**

[Section 19.4.2.3, “X Plugin Status Variables”](#)

## **Mysqlx\_connections\_accepted**

[Section 19.4.2.3, “X Plugin Status Variables”](#)

## **Mysqlx\_connections\_closed**

[Section 19.4.2.3, “X Plugin Status Variables”](#)

## **Mysqlx\_connections\_rejected**

[Section 19.4.2.3, “X Plugin Status Variables”](#)

## **Mysqlx\_crud\_create\_view**

[Section 19.4.2.3, “X Plugin Status Variables”](#)

## **Mysqlx\_crud\_delete**

[Section 19.4.2.3, “X Plugin Status Variables”](#)

---

## **Mysqlx\_crud\_drop\_view**

Section 19.4.2.3, “X Plugin Status Variables”

## **Mysqlx\_crud\_find**

Section 19.4.2.3, “X Plugin Status Variables”

## **Mysqlx\_crud\_insert**

Section 19.4.2.3, “X Plugin Status Variables”

## **Mysqlx\_crud\_modify\_view**

Section 19.4.2.3, “X Plugin Status Variables”

## **Mysqlx\_crud\_update**

Section 19.4.2.3, “X Plugin Status Variables”

## **Mysqlx\_errors\_sent**

Section 19.4.2.3, “X Plugin Status Variables”

## **Mysqlx\_errors\_unknown\_message\_type**

Section 19.4.2.3, “X Plugin Status Variables”

## **Mysqlx\_expect\_close**

Section 19.4.2.3, “X Plugin Status Variables”

## **Mysqlx\_expect\_open**

Section 19.4.2.3, “X Plugin Status Variables”

## **Mysqlx\_init\_error**

Section 19.4.2.3, “X Plugin Status Variables”

## **Mysqlx\_notice\_other\_sent**

Section 19.4.2.3, “X Plugin Status Variables”

## **Mysqlx\_notice\_warning\_sent**

Section 19.4.2.3, “X Plugin Status Variables”

## **Mysqlx\_port**

Section 19.4.2.3, “X Plugin Status Variables”

## **Mysqlx\_rows\_sent**

Section 19.4.2.3, “X Plugin Status Variables”

## **Mysqlx\_sessions**

Section 19.4.2.3, “X Plugin Status Variables”

## **Mysqlx\_sessions\_accepted**

Section 19.4.2.3, “X Plugin Status Variables”

## **Mysqlx\_sessions\_closed**

Section 19.4.2.3, “X Plugin Status Variables”



---

## **Mysqlx\_sessions\_fatal\_error**

Section 19.4.2.3, “X Plugin Status Variables”

## **Mysqlx\_sessions\_killed**

Section 19.4.2.3, “X Plugin Status Variables”

## **Mysqlx\_sessions\_rejected**

Section 19.4.2.3, “X Plugin Status Variables”

## **Mysqlx\_socket**

Section 19.4.2.3, “X Plugin Status Variables”

## **Mysqlx\_ssl\_accept\_renegotiates**

Section 19.4.2.3, “X Plugin Status Variables”

## **Mysqlx\_ssl\_accepts**

Section 19.4.2.3, “X Plugin Status Variables”

## **Mysqlx\_ssl\_active**

Section 19.4.2.3, “X Plugin Status Variables”

## **Mysqlx\_ssl\_cipher**

Section 19.4.2.3, “X Plugin Status Variables”

## **Mysqlx\_ssl\_cipher\_list**

Section 19.4.2.3, “X Plugin Status Variables”

## **Mysqlx\_ssl\_ctx\_verify\_depth**

Section 19.4.2.3, “X Plugin Status Variables”

## **Mysqlx\_ssl\_ctx\_verify\_mode**

Section 19.4.2.3, “X Plugin Status Variables”

## **Mysqlx\_ssl\_finished\_accepts**

Section 19.4.2.3, “X Plugin Status Variables”

## **Mysqlx\_ssl\_server\_not\_after**

Section 19.4.2.3, “X Plugin Status Variables”

## **Mysqlx\_ssl\_server\_not\_before**

Section 19.4.2.3, “X Plugin Status Variables”

## **Mysqlx\_ssl\_verify\_depth**

Section 19.4.2.3, “X Plugin Status Variables”

## **Mysqlx\_ssl\_verify\_mode**

Section 19.4.2.3, “X Plugin Status Variables”

## **Mysqlx\_ssl\_version**

Section 19.4.2.3, “X Plugin Status Variables”

---

## **Mysqlx\_stmt\_create\_collection**

Section 19.4.2.3, “X Plugin Status Variables”

## **Mysqlx\_stmt\_create\_collection\_index**

Section 19.4.2.3, “X Plugin Status Variables”

## **Mysqlx\_stmt\_disable\_notices**

Section 19.4.2.3, “X Plugin Status Variables”

## **Mysqlx\_stmt\_drop\_collection**

Section 19.4.2.3, “X Plugin Status Variables”

## **Mysqlx\_stmt\_drop\_collection\_index**

Section 19.4.2.3, “X Plugin Status Variables”

## **Mysqlx\_stmt\_enable\_notices**

Section 19.4.2.3, “X Plugin Status Variables”

## **Mysqlx\_stmt\_ensure\_collection**

Section 19.4.2.3, “X Plugin Status Variables”

## **Mysqlx\_stmt\_execute\_mysqlx**

Section 19.4.2.3, “X Plugin Status Variables”

## **Mysqlx\_stmt\_execute\_sql**

Section 19.4.2.3, “X Plugin Status Variables”

## **Mysqlx\_stmt\_execute\_xplugin**

Section 19.4.2.3, “X Plugin Status Variables”

## **Mysqlx\_stmt\_kill\_client**

Section 19.4.2.3, “X Plugin Status Variables”

## **Mysqlx\_stmt\_list\_clients**

Section 19.4.2.3, “X Plugin Status Variables”

## **Mysqlx\_stmt\_list\_notices**

Section 19.4.2.3, “X Plugin Status Variables”

## **Mysqlx\_stmt\_list\_objects**

Section 19.4.2.3, “X Plugin Status Variables”

## **Mysqlx\_stmt\_ping**

Section 19.4.2.3, “X Plugin Status Variables”

## **Mysqlx\_worker\_threads**

Section 19.4.2.3, “X Plugin Status Variables”

## **Mysqlx\_worker\_threads\_active**

Section 19.4.2.3, “X Plugin Status Variables”

---

## N

[\[index top\]](#)

### **Ndb\_api\_adaptive\_send\_deferred\_count**

[NDB Cluster Status Variables](#)

### **Ndb\_api\_adaptive\_send\_deferred\_count\_session**

[NDB Cluster Status Variables](#)

### **Ndb\_api\_adaptive\_send\_deferred\_count\_slave**

[NDB Cluster Status Variables](#)

### **Ndb\_api\_adaptive\_send\_forced\_count**

[NDB Cluster Status Variables](#)

### **Ndb\_api\_adaptive\_send\_forced\_count\_session**

[NDB Cluster Status Variables](#)

### **Ndb\_api\_adaptive\_send\_forced\_count\_slave**

[NDB Cluster Status Variables](#)

### **Ndb\_api\_adaptive\_send\_unforced\_count**

[NDB Cluster Status Variables](#)

### **Ndb\_api\_adaptive\_send\_unforced\_count\_session**

[NDB Cluster Status Variables](#)

### **Ndb\_api\_adaptive\_send\_unforced\_count\_slave**

[NDB Cluster Status Variables](#)

### **Ndb\_api\_bytes\_received\_count**

[Section 21.6.14, “NDB API Statistics Counters and Variables”](#)

[NDB Cluster Status Variables](#)

### **Ndb\_api\_bytes\_received\_count\_session**

[Section 21.6.14, “NDB API Statistics Counters and Variables”](#)

[NDB Cluster Status Variables](#)

### **Ndb\_api\_bytes\_received\_count\_slave**

[Section 21.6.14, “NDB API Statistics Counters and Variables”](#)

[NDB Cluster Status Variables](#)

### **Ndb\_api\_bytes\_sent\_count**

[Section 21.6.14, “NDB API Statistics Counters and Variables”](#)

[NDB Cluster Status Variables](#)

### **Ndb\_api\_bytes\_sent\_count\_session**

[Section 21.6.14, “NDB API Statistics Counters and Variables”](#)

[NDB Cluster Status Variables](#)

---

## **Ndb\_api\_bytes\_sent\_count\_slave**

Section 21.6.14, “NDB API Statistics Counters and Variables”  
NDB Cluster Status Variables

## **Ndb\_api\_event\_bytes\_count**

Section 21.6.14, “NDB API Statistics Counters and Variables”  
NDB Cluster Status Variables

## **Ndb\_api\_event\_bytes\_count\_injector**

Section 21.6.14, “NDB API Statistics Counters and Variables”  
NDB Cluster Status Variables

## **Ndb\_api\_event\_data\_count**

Section 21.6.14, “NDB API Statistics Counters and Variables”  
NDB Cluster Status Variables

## **Ndb\_api\_event\_data\_count\_injector**

Section 21.6.14, “NDB API Statistics Counters and Variables”  
NDB Cluster Status Variables

## **Ndb\_api\_event\_nondata\_count**

Section 21.6.14, “NDB API Statistics Counters and Variables”  
NDB Cluster Status Variables

## **Ndb\_api\_event\_nondata\_count\_injector**

Section 21.6.14, “NDB API Statistics Counters and Variables”  
NDB Cluster Status Variables

## **Ndb\_api\_pk\_op\_count**

Section 21.6.14, “NDB API Statistics Counters and Variables”  
NDB Cluster Status Variables

## **Ndb\_api\_pk\_op\_count\_session**

Section 21.6.14, “NDB API Statistics Counters and Variables”  
NDB Cluster Status Variables

## **Ndb\_api\_pk\_op\_count\_slave**

Section 21.6.14, “NDB API Statistics Counters and Variables”  
NDB Cluster Status Variables

## **Ndb\_api\_pruned\_scan\_count**

Section 21.6.14, “NDB API Statistics Counters and Variables”  
NDB Cluster Status Variables

## **Ndb\_api\_pruned\_scan\_count\_session**

Section 21.6.14, “NDB API Statistics Counters and Variables”  
NDB Cluster Status Variables

## **Ndb\_api\_pruned\_scan\_count\_slave**

Section 21.6.14, “NDB API Statistics Counters and Variables”  
NDB Cluster Status Variables

---

## **Ndb\_api\_range\_scan\_count**

Section 21.6.14, “NDB API Statistics Counters and Variables”  
NDB Cluster Status Variables

## **Ndb\_api\_range\_scan\_count\_session**

Section 21.6.14, “NDB API Statistics Counters and Variables”  
NDB Cluster Status Variables

## **Ndb\_api\_range\_scan\_count\_slave**

Section 21.6.14, “NDB API Statistics Counters and Variables”  
NDB Cluster Status Variables

## **Ndb\_api\_read\_row\_count**

Section 21.6.14, “NDB API Statistics Counters and Variables”  
NDB Cluster Status Variables

## **Ndb\_api\_read\_row\_count\_session**

Section 21.6.14, “NDB API Statistics Counters and Variables”  
NDB Cluster Status Variables

## **Ndb\_api\_read\_row\_count\_slave**

Section 21.6.14, “NDB API Statistics Counters and Variables”  
NDB Cluster Status Variables

## **Ndb\_api\_scan\_batch\_count**

Section 21.6.14, “NDB API Statistics Counters and Variables”  
NDB Cluster Status Variables

## **Ndb\_api\_scan\_batch\_count\_session**

Section 21.6.14, “NDB API Statistics Counters and Variables”  
NDB Cluster Status Variables

## **Ndb\_api\_scan\_batch\_count\_slave**

Section 21.6.14, “NDB API Statistics Counters and Variables”  
NDB Cluster Status Variables

## **Ndb\_api\_table\_scan\_count**

Section 21.6.14, “NDB API Statistics Counters and Variables”  
NDB Cluster Status Variables

## **Ndb\_api\_table\_scan\_count\_session**

Section 21.6.14, “NDB API Statistics Counters and Variables”  
NDB Cluster Status Variables

## **Ndb\_api\_table\_scan\_count\_slave**

Section 21.6.14, “NDB API Statistics Counters and Variables”  
NDB Cluster Status Variables

## **Ndb\_api\_trans\_abort\_count**

Section 21.6.14, “NDB API Statistics Counters and Variables”  
NDB Cluster Status Variables

---

## **Ndb\_api\_trans\_abort\_count\_session**

Section 21.6.14, “NDB API Statistics Counters and Variables”  
NDB Cluster Status Variables

## **Ndb\_api\_trans\_abort\_count\_slave**

Section 21.6.14, “NDB API Statistics Counters and Variables”  
NDB Cluster Status Variables

## **Ndb\_api\_trans\_close\_count**

Section 21.6.14, “NDB API Statistics Counters and Variables”  
NDB Cluster Status Variables

## **Ndb\_api\_trans\_close\_count\_session**

Section 21.6.14, “NDB API Statistics Counters and Variables”  
NDB Cluster Status Variables

## **Ndb\_api\_trans\_close\_count\_slave**

Section 21.6.14, “NDB API Statistics Counters and Variables”  
NDB Cluster Status Variables

## **Ndb\_api\_trans\_commit\_count**

Section 21.6.14, “NDB API Statistics Counters and Variables”  
NDB Cluster Status Variables

## **Ndb\_api\_trans\_commit\_count\_session**

Section 21.6.14, “NDB API Statistics Counters and Variables”  
NDB Cluster Status Variables

## **Ndb\_api\_trans\_commit\_count\_slave**

Section 21.6.14, “NDB API Statistics Counters and Variables”  
NDB Cluster Status Variables

## **Ndb\_api\_trans\_local\_read\_row\_count**

Section 21.6.14, “NDB API Statistics Counters and Variables”  
NDB Cluster Status Variables

## **Ndb\_api\_trans\_local\_read\_row\_count\_session**

Section 21.6.14, “NDB API Statistics Counters and Variables”  
NDB Cluster Status Variables

## **Ndb\_api\_trans\_local\_read\_row\_count\_slave**

Section 21.6.14, “NDB API Statistics Counters and Variables”  
NDB Cluster Status Variables

## **Ndb\_api\_trans\_start\_count**

Section 21.6.14, “NDB API Statistics Counters and Variables”  
NDB Cluster Status Variables

## **Ndb\_api\_trans\_start\_count\_session**

Section 21.6.14, “NDB API Statistics Counters and Variables”  
NDB Cluster Status Variables

---

## **Ndb\_api\_trans\_start\_count\_slave**

Section 21.6.14, “NDB API Statistics Counters and Variables”  
NDB Cluster Status Variables

## **Ndb\_api\_uk\_op\_count**

Section 21.6.14, “NDB API Statistics Counters and Variables”  
NDB Cluster Status Variables

## **Ndb\_api\_uk\_op\_count\_session**

Section 21.6.14, “NDB API Statistics Counters and Variables”  
NDB Cluster Status Variables

## **Ndb\_api\_uk\_op\_count\_slave**

Section 21.6.14, “NDB API Statistics Counters and Variables”  
NDB Cluster Status Variables

## **Ndb\_api\_wait\_exec\_complete\_count**

Section 21.6.14, “NDB API Statistics Counters and Variables”  
NDB Cluster Status Variables

## **Ndb\_api\_wait\_exec\_complete\_count\_session**

Section 21.6.14, “NDB API Statistics Counters and Variables”  
NDB Cluster Status Variables

## **Ndb\_api\_wait\_exec\_complete\_count\_slave**

Section 21.6.14, “NDB API Statistics Counters and Variables”  
NDB Cluster Status Variables

## **Ndb\_api\_wait\_meta\_request\_count**

Section 21.6.14, “NDB API Statistics Counters and Variables”  
NDB Cluster Status Variables

## **Ndb\_api\_wait\_meta\_request\_count\_session**

Section 21.6.14, “NDB API Statistics Counters and Variables”  
NDB Cluster Status Variables

## **Ndb\_api\_wait\_meta\_request\_count\_slave**

Section 21.6.14, “NDB API Statistics Counters and Variables”  
NDB Cluster Status Variables

## **Ndb\_api\_wait\_nanos\_count**

Section 21.6.14, “NDB API Statistics Counters and Variables”  
NDB Cluster Status Variables

## **Ndb\_api\_wait\_nanos\_count\_session**

Section 21.6.14, “NDB API Statistics Counters and Variables”  
NDB Cluster Status Variables

## **Ndb\_api\_wait\_nanos\_count\_slave**

Section 21.6.14, “NDB API Statistics Counters and Variables”  
NDB Cluster Status Variables

---

## **Ndb\_api\_wait\_scan\_result\_count**

Section 21.6.14, “NDB API Statistics Counters and Variables”  
NDB Cluster Status Variables

## **Ndb\_api\_wait\_scan\_result\_count\_session**

Section 21.6.14, “NDB API Statistics Counters and Variables”  
NDB Cluster Status Variables

## **Ndb\_api\_wait\_scan\_result\_count\_slave**

Section 21.6.14, “NDB API Statistics Counters and Variables”  
NDB Cluster Status Variables

## **Ndb\_cluster\_node\_id**

NDB Cluster Status Variables

## **Ndb\_config\_from\_host**

NDB Cluster Status Variables

## **Ndb\_config\_from\_port**

NDB Cluster Status Variables

## **Ndb\_conflict\_fn\_epoch**

Section 21.7.11, “NDB Cluster Replication Conflict Resolution”  
NDB Cluster Status Variables

## **Ndb\_conflict\_fn\_epoch2**

Section 21.7.11, “NDB Cluster Replication Conflict Resolution”  
NDB Cluster Status Variables

## **Ndb\_conflict\_fn\_epoch2\_trans**

Section 21.7.11, “NDB Cluster Replication Conflict Resolution”  
NDB Cluster Status Variables

## **Ndb\_conflict\_fn\_epoch\_trans**

Section 21.7.11, “NDB Cluster Replication Conflict Resolution”  
NDB Cluster Status Variables

## **Ndb\_conflict\_fn\_max**

Section 21.7.11, “NDB Cluster Replication Conflict Resolution”  
NDB Cluster Status Variables

## **Ndb\_conflict\_fn\_max\_del\_win**

Section 21.7.11, “NDB Cluster Replication Conflict Resolution”  
NDB Cluster Status Variables

## **Ndb\_conflict\_fn\_old**

Section 21.7.11, “NDB Cluster Replication Conflict Resolution”  
NDB Cluster Status Variables

## **Ndb\_conflict\_last\_conflict\_epoch**

NDB Cluster Status Variables



---

## **Ndb\_conflict\_last\_stable\_epoch**

[NDB Cluster Status Variables](#)

## **Ndb\_conflict\_reflected\_op\_discard\_count**

Section 21.7.11, “NDB Cluster Replication Conflict Resolution”

[NDB Cluster Status Variables](#)

## **Ndb\_conflict\_reflected\_op\_prepare\_count**

Section 21.7.11, “NDB Cluster Replication Conflict Resolution”

[NDB Cluster Status Variables](#)

## **Ndb\_conflict\_refresh\_op\_count**

[NDB Cluster Status Variables](#)

## **Ndb\_conflict\_trans\_conflict\_commit\_count**

[NDB Cluster Status Variables](#)

## **Ndb\_conflict\_trans\_detect\_iter\_count**

[NDB Cluster Status Variables](#)

## **Ndb\_conflict\_trans\_reject\_count**

[NDB Cluster Status Variables](#)

## **Ndb\_conflict\_trans\_row\_conflict\_count**

[NDB Cluster Status Variables](#)

## **Ndb\_conflict\_trans\_row\_reject\_count**

Section 21.7.11, “NDB Cluster Replication Conflict Resolution”

[NDB Cluster Status Variables](#)

## **Ndb\_epoch\_delete\_delete\_count**

[NDB Cluster Status Variables](#)

## **Ndb\_execute\_count**

[NDB Cluster Status Variables](#)

## **Ndb\_last\_commit\_epoch\_server**

[NDB Cluster Status Variables](#)

## **Ndb\_last\_commit\_epoch\_session**

[NDB Cluster Status Variables](#)

## **Ndb\_number\_of\_data\_nodes**

[NDB Cluster Status Variables](#)

## **Ndb\_pruned\_scan\_count**

[NDB Cluster Status Variables](#)

## **Ndb\_pushed\_queries\_defined**

[NDB Cluster Status Variables](#)

---

[NDB Cluster System Variables](#)

## **Ndb\_pushed\_queries\_dropped**

[NDB Cluster Status Variables](#)

[NDB Cluster System Variables](#)

## **Ndb\_pushed\_queries\_executed**

[NDB Cluster Status Variables](#)

[NDB Cluster System Variables](#)

## **Ndb\_pushed\_reads**

[NDB Cluster Status Variables](#)

[NDB Cluster System Variables](#)

## **Ndb\_scan\_count**

[NDB Cluster Status Variables](#)

## **Ndb\_slave\_max\_replicated\_epoch**

[NDB Cluster Status Variables](#)

## **Ndb\_system\_name**

[Section 21.4.3.8, “Defining the System”](#)

[NDB Cluster Status Variables](#)

[Section 21.2.4.1, “What is New in NDB Cluster 7.5”](#)

[Section 21.2.4.2, “What is New in NDB Cluster 7.6”](#)

## **Not\_flushed\_delayed\_rows**

[Section 5.1.9, “Server Status Variables”](#)

## **O**

[\[index top\]](#)

## **Ongoing\_anonymous\_gtid\_violating\_transaction\_count**

[Section 5.1.9, “Server Status Variables”](#)

## **Ongoing\_anonymous\_transaction\_count**

[Section 5.1.9, “Server Status Variables”](#)

## **Ongoing\_automatic\_gtid\_violating\_transaction\_count**

[Section 5.1.9, “Server Status Variables”](#)

## **Open\_files**

[Section 5.1.9, “Server Status Variables”](#)

## **Open\_streams**

[Section 5.1.9, “Server Status Variables”](#)

## **Open\_table\_definitions**

[Section 5.1.9, “Server Status Variables”](#)

---

## **Open\_tables**

[Section 5.1.9, “Server Status Variables”](#)

## **Opened\_files**

[Section 5.1.9, “Server Status Variables”](#)

## **Opened\_table\_definitions**

[Section 5.1.9, “Server Status Variables”](#)

## **Opened\_tables**

[Section 8.4.3.1, “How MySQL Opens and Closes Tables”](#)

[Section 5.1.9, “Server Status Variables”](#)

[Section 5.1.7, “Server System Variables”](#)

## **P**

[\[index top\]](#)

## **Performance\_schema\_accounts\_lost**

[Section 25.16, “Performance Schema Status Variables”](#)

## **Performance\_schema\_cond\_classes\_lost**

[Section 25.16, “Performance Schema Status Variables”](#)

## **Performance\_schema\_cond\_instances\_lost**

[Section 25.16, “Performance Schema Status Variables”](#)

## **Performance\_schema\_digest\_lost**

[Section 25.16, “Performance Schema Status Variables”](#)

[Section 25.15, “Performance Schema System Variables”](#)

## **Performance\_schema\_file\_classes\_lost**

[Section 25.16, “Performance Schema Status Variables”](#)

## **Performance\_schema\_file\_handles\_lost**

[Section 25.16, “Performance Schema Status Variables”](#)

## **Performance\_schema\_file\_instances\_lost**

[Section 25.16, “Performance Schema Status Variables”](#)

## **Performance\_schema\_hosts\_lost**

[Section 25.16, “Performance Schema Status Variables”](#)

## **Performance\_schema\_index\_stat\_lost**

[Section 25.16, “Performance Schema Status Variables”](#)

[Section 25.15, “Performance Schema System Variables”](#)

## **Performance\_schema\_locker\_lost**

[Section 25.16, “Performance Schema Status Variables”](#)

---

## **Performance\_schema\_memory\_classes\_lost**

Section 25.16, “Performance Schema Status Variables”

## **Performance\_schema\_metadata\_lock\_lost**

Section 25.16, “Performance Schema Status Variables”  
Section 25.15, “Performance Schema System Variables”

## **Performance\_schema\_mutex\_classes\_lost**

Section 25.7, “Performance Schema Status Monitoring”  
Section 25.16, “Performance Schema Status Variables”

## **Performance\_schema\_mutex\_instances\_lost**

Section 25.7, “Performance Schema Status Monitoring”  
Section 25.16, “Performance Schema Status Variables”

## **Performance\_schema\_nested\_statement\_lost**

Section 25.16, “Performance Schema Status Variables”  
Section 25.15, “Performance Schema System Variables”

## **Performance\_schema\_prepared\_statements\_lost**

Section 25.16, “Performance Schema Status Variables”  
Section 25.15, “Performance Schema System Variables”  
Section 25.12.6.4, “The prepared\_statements\_instances Table”

## **Performance\_schema\_program\_lost**

Section 25.16, “Performance Schema Status Variables”  
Section 25.15, “Performance Schema System Variables”

## **Performance\_schema\_rwlock\_classes\_lost**

Section 25.16, “Performance Schema Status Variables”

## **Performance\_schema\_rwlock\_instances\_lost**

Section 25.16, “Performance Schema Status Variables”

## **Performance\_schema\_session\_connect\_attrs\_lost**

Section 25.12.9, “Performance Schema Connection Attribute Tables”  
Section 25.16, “Performance Schema Status Variables”  
Section 25.15, “Performance Schema System Variables”

## **Performance\_schema\_socket\_classes\_lost**

Section 25.16, “Performance Schema Status Variables”

## **Performance\_schema\_socket\_instances\_lost**

Section 25.16, “Performance Schema Status Variables”

## **Performance\_schema\_stage\_classes\_lost**

Section 25.16, “Performance Schema Status Variables”

## **Performance\_schema\_statement\_classes\_lost**

Section 25.16, “Performance Schema Status Variables”

---

## **Performance\_schema\_table\_handles\_lost**

[Section 25.16, “Performance Schema Status Variables”](#)  
[Section 25.15, “Performance Schema System Variables”](#)

## **Performance\_schema\_table\_instances\_lost**

[Section 25.16, “Performance Schema Status Variables”](#)

## **Performance\_schema\_table\_lock\_stat\_lost**

[Section 25.16, “Performance Schema Status Variables”](#)  
[Section 25.15, “Performance Schema System Variables”](#)

## **Performance\_schema\_thread\_classes\_lost**

[Section 25.16, “Performance Schema Status Variables”](#)

## **Performance\_schema\_thread\_instances\_lost**

[Section 25.16, “Performance Schema Status Variables”](#)  
[Section 25.12.13, “Performance Schema System Variable Tables”](#)  
[Section 25.15, “Performance Schema System Variables”](#)

## **Performance\_schema\_users\_lost**

[Section 25.16, “Performance Schema Status Variables”](#)

## **Prepared\_stmt\_count**

[Section 5.1.9, “Server Status Variables”](#)

## **Q**

[\[index top\]](#)

## **Qcache\_free\_blocks**

[Section 8.10.3.3, “Query Cache Configuration”](#)  
[Section 8.10.3.4, “Query Cache Status and Maintenance”](#)  
[Section 5.1.9, “Server Status Variables”](#)  
[Section 1.3, “What Is New in MySQL 5.7”](#)

## **Qcache\_free\_memory**

[Section 5.1.9, “Server Status Variables”](#)  
[Section 1.3, “What Is New in MySQL 5.7”](#)

## **Qcache\_hits**

[Section 8.10.3.1, “How the Query Cache Operates”](#)  
[Section 5.1.9, “Server Status Variables”](#)  
[Section 1.3, “What Is New in MySQL 5.7”](#)

## **Qcache\_inserts**

[Section 5.1.9, “Server Status Variables”](#)  
[Section 1.3, “What Is New in MySQL 5.7”](#)

## **Qcache\_lowmem\_prunes**

[Section 8.10.3.3, “Query Cache Configuration”](#)  
[Section 8.10.3.4, “Query Cache Status and Maintenance”](#)

---

[Section 5.1.9, “Server Status Variables”](#)  
[Section 1.3, “What Is New in MySQL 5.7”](#)

## **Qcache\_not\_cached**

[Section 5.1.9, “Server Status Variables”](#)  
[Section 1.3, “What Is New in MySQL 5.7”](#)

## **Qcache\_queries\_in\_cache**

[Section 8.10.3.3, “Query Cache Configuration”](#)  
[Section 5.1.9, “Server Status Variables”](#)  
[Section 1.3, “What Is New in MySQL 5.7”](#)

## **Qcache\_total\_blocks**

[Section 8.10.3.3, “Query Cache Configuration”](#)  
[Section 8.10.3.4, “Query Cache Status and Maintenance”](#)  
[Section 5.1.9, “Server Status Variables”](#)  
[Section 1.3, “What Is New in MySQL 5.7”](#)

## **Queries**

[Section 5.1.9, “Server Status Variables”](#)

## **Questions**

[Section 4.5.2, “mysqladmin — A MySQL Server Administration Program”](#)  
[Section 5.1.9, “Server Status Variables”](#)

## **R**

[\[index top\]](#)

## **Rewriter\_number\_loaded\_rules**

[Rewriter Query Rewrite Plugin Status Variables](#)

## **Rewriter\_number\_reloads**

[Rewriter Query Rewrite Plugin Status Variables](#)

## **Rewriter\_number\_rewritten\_queries**

[Rewriter Query Rewrite Plugin Status Variables](#)

## **Rewriter\_reload\_error**

[Rewriter Query Rewrite Plugin Procedures and Functions](#)  
[Rewriter Query Rewrite Plugin Rules Table](#)  
[Rewriter Query Rewrite Plugin Status Variables](#)  
[Section 5.5.4.2, “Using the Rewriter Query Rewrite Plugin”](#)

## **Rpl\_semi\_sync\_master\_clients**

[Section 16.3.9.1, “Semisynchronous Replication Administrative Interface”](#)  
[Section 16.3.9.3, “Semisynchronous Replication Monitoring”](#)  
[Section 5.1.9, “Server Status Variables”](#)

## **Rpl\_semi\_sync\_master\_net\_avg\_wait\_time**

[Section 5.1.9, “Server Status Variables”](#)

---

## **Rpl\_semi\_sync\_master\_net\_wait\_time**

Section 5.1.9, “Server Status Variables”

## **Rpl\_semi\_sync\_master\_net\_waits**

Section 5.1.9, “Server Status Variables”

## **Rpl\_semi\_sync\_master\_no\_times**

Section 5.1.9, “Server Status Variables”

## **Rpl\_semi\_sync\_master\_no\_tx**

Section 16.3.9.1, “Semisynchronous Replication Administrative Interface”

Section 16.3.9.3, “Semisynchronous Replication Monitoring”

Section 5.1.9, “Server Status Variables”

## **Rpl\_semi\_sync\_master\_status**

Section 16.3.9.1, “Semisynchronous Replication Administrative Interface”

Section 16.3.9.3, “Semisynchronous Replication Monitoring”

Section 5.1.9, “Server Status Variables”

## **Rpl\_semi\_sync\_master\_timefunc\_failures**

Section 5.1.9, “Server Status Variables”

## **Rpl\_semi\_sync\_master\_tx\_avg\_wait\_time**

Section 5.1.9, “Server Status Variables”

## **Rpl\_semi\_sync\_master\_tx\_wait\_time**

Section 5.1.9, “Server Status Variables”

## **Rpl\_semi\_sync\_master\_tx\_waits**

Section 5.1.9, “Server Status Variables”

## **Rpl\_semi\_sync\_master\_wait\_pos\_backtraverse**

Section 5.1.9, “Server Status Variables”

## **Rpl\_semi\_sync\_master\_wait\_sessions**

Section 5.1.9, “Server Status Variables”

## **Rpl\_semi\_sync\_master\_yes\_tx**

Section 16.3.9.1, “Semisynchronous Replication Administrative Interface”

Section 16.3.9.3, “Semisynchronous Replication Monitoring”

Section 5.1.9, “Server Status Variables”

## **Rpl\_semi\_sync\_slave\_status**

Section 16.3.9.1, “Semisynchronous Replication Administrative Interface”

Section 16.3.9.3, “Semisynchronous Replication Monitoring”

Section 5.1.9, “Server Status Variables”

## **Rsa\_public\_key**

Section 5.1.9, “Server Status Variables”

Section 6.4.1.5, “SHA-256 Pluggable Authentication”

---

Section 6.3.4, “SSL Library-Dependent Capabilities”

## S

[[index top](#)]

### **Select\_full\_join**

Section 5.1.9, “Server Status Variables”

Section 25.12.6.1, “The events\_statements\_current Table”

### **Select\_full\_range\_join**

Section 5.1.9, “Server Status Variables”

Section 25.12.6.1, “The events\_statements\_current Table”

### **Select\_range**

Section 5.1.9, “Server Status Variables”

Section 25.12.6.1, “The events\_statements\_current Table”

### **Select\_range\_check**

Section 5.1.9, “Server Status Variables”

Section 25.12.6.1, “The events\_statements\_current Table”

### **Select\_scan**

Section 5.1.9, “Server Status Variables”

Section 25.12.6.1, “The events\_statements\_current Table”

### **Slave\_heartbeat\_period**

Section 16.1.7.1, “Checking Replication Status”

Section 25.12.11, “Performance Schema Replication Tables”

Section 13.4.2.3, “RESET SLAVE Statement”

Section 5.1.9, “Server Status Variables”

### **Slave\_last\_heartbeat**

Section 16.1.7.1, “Checking Replication Status”

Section 25.12.11, “Performance Schema Replication Tables”

Section 5.1.9, “Server Status Variables”

### **Slave\_open\_temp\_tables**

Section 13.4.2.1, “CHANGE MASTER TO Statement”

Section 16.4.1.29, “Replication and Temporary Tables”

Section 5.1.9, “Server Status Variables”

Section 13.4.2.6, “STOP SLAVE Statement”

Section 1.3, “What Is New in MySQL 5.7”

### **Slave\_received\_heartbeats**

Section 13.4.2.1, “CHANGE MASTER TO Statement”

Section 16.1.7.1, “Checking Replication Status”

Section 25.12.11, “Performance Schema Replication Tables”

Section 5.1.9, “Server Status Variables”

### **Slave\_retried\_transactions**

Section 16.1.7.1, “Checking Replication Status”



---

Section 25.12.11, “Performance Schema Replication Tables”  
Section 5.1.9, “Server Status Variables”

## **Slave\_rows\_last\_search\_algorithm\_used**

Section 5.1.9, “Server Status Variables”

## **Slave\_running**

Section 16.1.7.1, “Checking Replication Status”  
Section 25.12.11, “Performance Schema Replication Tables”  
Section 5.1.9, “Server Status Variables”  
Section 13.7.5.34, “SHOW SLAVE STATUS Statement”

## **Slow\_launch\_threads**

Section 5.1.9, “Server Status Variables”  
Section 5.1.7, “Server System Variables”

## **Slow\_queries**

Section 5.1.9, “Server Status Variables”  
Section 5.1.7, “Server System Variables”

## **Sort\_merge\_passes**

Section 8.2.1.14, “ORDER BY Optimization”  
Section 5.1.9, “Server Status Variables”  
Section 5.1.7, “Server System Variables”  
Section 25.12.6.1, “The events\_statements\_current Table”

## **Sort\_range**

Section 5.1.9, “Server Status Variables”  
Section 25.12.6.1, “The events\_statements\_current Table”

## **Sort\_rows**

Section 5.1.9, “Server Status Variables”  
Section 25.12.6.1, “The events\_statements\_current Table”

## **Sort\_scan**

Section 5.1.9, “Server Status Variables”  
Section 25.12.6.1, “The events\_statements\_current Table”

## **Ssl\_accept\_renegotiates**

Section 5.1.9, “Server Status Variables”

## **Ssl\_accepts**

Section 5.1.9, “Server Status Variables”

## **Ssl\_callback\_cache\_hits**

Section 5.1.9, “Server Status Variables”

## **Ssl\_cipher**

Section 6.3.1, “Configuring MySQL to Use Encrypted Connections”  
Section 6.3.2, “Encrypted Connection TLS Protocols and Ciphers”

---

Section 5.1.9, “Server Status Variables”

## **Ssl\_cipher\_list**

Section 6.3.2, “Encrypted Connection TLS Protocols and Ciphers”

Section 5.1.9, “Server Status Variables”

## **Ssl\_client\_connects**

Section 5.1.9, “Server Status Variables”

## **Ssl\_connect\_renegotiates**

Section 5.1.9, “Server Status Variables”

## **Ssl\_ctx\_verify\_depth**

Section 5.1.9, “Server Status Variables”

## **Ssl\_ctx\_verify\_mode**

Section 5.1.9, “Server Status Variables”

## **Ssl\_default\_timeout**

Section 5.1.9, “Server Status Variables”

## **Ssl\_finished\_accepts**

Section 5.1.9, “Server Status Variables”

## **Ssl\_finished\_connects**

Section 5.1.9, “Server Status Variables”

## **Ssl\_server\_not\_after**

Section 5.1.9, “Server Status Variables”

## **Ssl\_server\_not\_before**

Section 5.1.9, “Server Status Variables”

## **Ssl\_session\_cache\_hits**

Section 5.1.9, “Server Status Variables”

## **Ssl\_session\_cache\_misses**

Section 5.1.9, “Server Status Variables”

## **Ssl\_session\_cache\_mode**

Section 5.1.9, “Server Status Variables”

## **Ssl\_session\_cache\_overflows**

Section 5.1.9, “Server Status Variables”

## **Ssl\_session\_cache\_size**

Section 5.1.9, “Server Status Variables”

## **Ssl\_session\_cache\_timeouts**

Section 5.1.9, “Server Status Variables”

---

## **Ssl\_sessions\_reused**

[Section 5.1.9, "Server Status Variables"](#)

## **Ssl\_used\_session\_cache\_entries**

[Section 5.1.9, "Server Status Variables"](#)

## **Ssl\_verify\_depth**

[Section 5.1.9, "Server Status Variables"](#)

## **Ssl\_verify\_mode**

[Section 5.1.9, "Server Status Variables"](#)

## **Ssl\_version**

[Section 6.3.2, "Encrypted Connection TLS Protocols and Ciphers"](#)

[Section 5.1.9, "Server Status Variables"](#)

## **T**

[\[index top\]](#)

## **Table\_locks\_immediate**

[Section 8.11.1, "Internal Locking Methods"](#)

[Section 5.1.9, "Server Status Variables"](#)

## **Table\_locks\_waited**

[Section 8.11.1, "Internal Locking Methods"](#)

[Section 5.1.9, "Server Status Variables"](#)

## **Table\_open\_cache\_hits**

[Section 5.1.9, "Server Status Variables"](#)

## **Table\_open\_cache\_misses**

[Section 5.1.9, "Server Status Variables"](#)

## **Table\_open\_cache\_overflows**

[Section 5.1.9, "Server Status Variables"](#)

## **Tc\_log\_max\_pages\_used**

[Section 5.1.9, "Server Status Variables"](#)

## **Tc\_log\_page\_size**

[Section 5.1.9, "Server Status Variables"](#)

## **Tc\_log\_page\_waits**

[Section 5.1.9, "Server Status Variables"](#)

## **Threads\_cached**

[Section 5.1.11.1, "Connection Interfaces"](#)

[Section 5.1.9, "Server Status Variables"](#)

---

## **Threads\_connected**

[Section 5.1.9, “Server Status Variables”](#)

## **Threads\_created**

[Section 5.1.11.1, “Connection Interfaces”](#)

[Section 5.1.9, “Server Status Variables”](#)

[Section 5.1.7, “Server System Variables”](#)

## **Threads\_running**

[Section A.15, “MySQL 5.7 FAQ: MySQL Enterprise Thread Pool”](#)

[Section 5.1.9, “Server Status Variables”](#)

## **U**

[\[index top\]](#)

## **Uptime**

[Section 4.5.2, “mysqladmin — A MySQL Server Administration Program”](#)

[Section 5.1.9, “Server Status Variables”](#)

## **Uptime\_since\_flush\_status**

[Section 5.1.9, “Server Status Variables”](#)

## **V**

[\[index top\]](#)

## **validate\_password\_dictionary\_file\_last\_parsed**

[Section 6.4.3.2, “Password Validation Plugin Options and Variables”](#)

## **validate\_password\_dictionary\_file\_words\_count**

[Section 6.4.3.2, “Password Validation Plugin Options and Variables”](#)

# System Variable Index

[A](#) | [B](#) | [C](#) | [D](#) | [E](#) | [F](#) | [G](#) | [H](#) | [I](#) | [J](#) | [K](#) | [L](#) | [M](#) | [N](#) | [O](#) | [P](#) | [Q](#) | [R](#) | [S](#) | [T](#) | [U](#) | [V](#) | [W](#)

## **A**

[\[index top\]](#)

## **audit\_log\_buffer\_size**

[Section 6.4.5.11, “Audit Log Reference”](#)

[Section 6.4.5.5, “Configuring Audit Logging Characteristics”](#)

## **audit\_log\_compression**

[Section 6.4.5.11, “Audit Log Reference”](#)

[Section 6.4.5.5, “Configuring Audit Logging Characteristics”](#)

## **audit\_log\_connection\_policy**

[Section 6.4.5.11, “Audit Log Reference”](#)

---

[Section 6.4.5.10, “Legacy Mode Audit Log Filtering”](#)  
[Section 6.4.5.8, “Writing Audit Log Filter Definitions”](#)

### **audit\_log\_current\_session**

[Section 6.4.5.11, “Audit Log Reference”](#)

### **audit\_log\_disable**

[Section 6.4.5.11, “Audit Log Reference”](#)  
[Section 6.4.5.9, “Disabling Audit Logging”](#)

### **audit\_log\_encryption**

[Section 6.4.5.11, “Audit Log Reference”](#)  
[Section 6.4.5.5, “Configuring Audit Logging Characteristics”](#)

### **audit\_log\_exclude\_accounts**

[Section 6.4.5.11, “Audit Log Reference”](#)  
[Section 6.4.5.10, “Legacy Mode Audit Log Filtering”](#)  
[Section 6.4.5.8, “Writing Audit Log Filter Definitions”](#)

### **audit\_log\_file**

[Section 6.4.5.11, “Audit Log Reference”](#)  
[Section 6.4.5.5, “Configuring Audit Logging Characteristics”](#)  
[Section 2.5.7.2, “More Topics on Deploying MySQL Server with Docker”](#)  
[Section 6.4.5, “MySQL Enterprise Audit”](#)  
[Section 6.4.5.3, “MySQL Enterprise Audit Security Considerations”](#)  
[Section 6.4.5.6, “Reading Audit Log Files”](#)

### **audit\_log\_filter\_id**

[Section 6.4.5.7, “Audit Log Filtering”](#)  
[Section 6.4.5.11, “Audit Log Reference”](#)  
[Section 6.4.5.8, “Writing Audit Log Filter Definitions”](#)

### **audit\_log\_flush**

[Section 6.4.5.11, “Audit Log Reference”](#)  
[Section 6.4.5.5, “Configuring Audit Logging Characteristics”](#)

### **audit\_log\_format**

[Section 6.4.5.4, “Audit Log File Formats”](#)  
[Section 6.4.5.11, “Audit Log Reference”](#)  
[Section 6.4.5.5, “Configuring Audit Logging Characteristics”](#)  
[Section 6.4.5, “MySQL Enterprise Audit”](#)

### **audit\_log\_format\_unix\_timestamp**

[Section 6.4.5.4, “Audit Log File Formats”](#)  
[Section 6.4.5.11, “Audit Log Reference”](#)  
[Section 6.4.5.5, “Configuring Audit Logging Characteristics”](#)

### **audit\_log\_include\_accounts**

[Section 6.4.5.11, “Audit Log Reference”](#)  
[Section 6.4.5.10, “Legacy Mode Audit Log Filtering”](#)  
[Section 6.4.5.8, “Writing Audit Log Filter Definitions”](#)

---

## **audit\_log\_policy**

[Section 6.4.5.11, "Audit Log Reference"](#)  
[Section 6.4.5.10, "Legacy Mode Audit Log Filtering"](#)  
[Section 5.1.8, "Using System Variables"](#)  
[Section 6.4.5.8, "Writing Audit Log Filter Definitions"](#)

## **audit\_log\_read\_buffer\_size**

[Section 6.4.5.11, "Audit Log Reference"](#)  
[Section 6.4.5.6, "Reading Audit Log Files"](#)

## **audit\_log\_rotate\_on\_size**

[Section 6.4.5.11, "Audit Log Reference"](#)  
[Section 6.4.5.5, "Configuring Audit Logging Characteristics"](#)

## **audit\_log\_statement\_policy**

[Section 6.4.5.11, "Audit Log Reference"](#)  
[Section 6.4.5.10, "Legacy Mode Audit Log Filtering"](#)  
[Section 6.4.5.8, "Writing Audit Log Filter Definitions"](#)

## **audit\_log\_strategy**

[Section 6.4.5.11, "Audit Log Reference"](#)  
[Section 6.4.5.5, "Configuring Audit Logging Characteristics"](#)

## **authentication\_ldap\_sasl\_auth\_method\_name**

[Section 6.4.1.9, "LDAP Pluggable Authentication"](#)  
[Section 6.4.1.13, "Pluggable Authentication System Variables"](#)

## **authentication\_ldap\_sasl\_bind\_base\_dn**

[Section 6.4.1.13, "Pluggable Authentication System Variables"](#)

## **authentication\_ldap\_sasl\_bind\_root\_dn**

[Section 6.4.1.13, "Pluggable Authentication System Variables"](#)

## **authentication\_ldap\_sasl\_bind\_root\_pwd**

[Section 6.4.1.13, "Pluggable Authentication System Variables"](#)

## **authentication\_ldap\_sasl\_ca\_path**

[Section 6.4.1.9, "LDAP Pluggable Authentication"](#)  
[Section 6.4.1.13, "Pluggable Authentication System Variables"](#)

## **authentication\_ldap\_sasl\_group\_search\_attr**

[Section 6.4.1.9, "LDAP Pluggable Authentication"](#)  
[Section 6.4.1.13, "Pluggable Authentication System Variables"](#)

## **authentication\_ldap\_sasl\_group\_search\_filter**

[Section 6.4.1.13, "Pluggable Authentication System Variables"](#)

## **authentication\_ldap\_sasl\_init\_pool\_size**

[Section 6.4.1.13, "Pluggable Authentication System Variables"](#)

---

## **authentication\_ldap\_sasl\_log\_status**

Section 6.4.1.13, “Pluggable Authentication System Variables”

## **authentication\_ldap\_sasl\_max\_pool\_size**

Section 6.4.1.13, “Pluggable Authentication System Variables”

## **authentication\_ldap\_sasl\_server\_host**

Section 6.4.1.13, “Pluggable Authentication System Variables”

## **authentication\_ldap\_sasl\_server\_port**

Section 6.4.1.13, “Pluggable Authentication System Variables”

## **authentication\_ldap\_sasl\_tls**

Section 6.4.1.9, “LDAP Pluggable Authentication”

Section 6.4.1.13, “Pluggable Authentication System Variables”

## **authentication\_ldap\_sasl\_user\_search\_attr**

Section 6.4.1.9, “LDAP Pluggable Authentication”

Section 6.4.1.13, “Pluggable Authentication System Variables”

## **authentication\_ldap\_simple\_auth\_method\_name**

Section 6.4.1.9, “LDAP Pluggable Authentication”

Section 6.4.1.13, “Pluggable Authentication System Variables”

## **authentication\_ldap\_simple\_bind\_base\_dn**

Section 6.4.1.13, “Pluggable Authentication System Variables”

## **authentication\_ldap\_simple\_bind\_root\_dn**

Section 6.4.1.13, “Pluggable Authentication System Variables”

## **authentication\_ldap\_simple\_bind\_root\_pwd**

Section 6.4.1.13, “Pluggable Authentication System Variables”

## **authentication\_ldap\_simple\_ca\_path**

Section 6.4.1.9, “LDAP Pluggable Authentication”

Section 6.4.1.13, “Pluggable Authentication System Variables”

## **authentication\_ldap\_simple\_group\_search\_attr**

Section 6.4.1.9, “LDAP Pluggable Authentication”

Section 6.4.1.13, “Pluggable Authentication System Variables”

## **authentication\_ldap\_simple\_group\_search\_filter**

Section 6.4.1.13, “Pluggable Authentication System Variables”

## **authentication\_ldap\_simple\_init\_pool\_size**

Section 6.4.1.13, “Pluggable Authentication System Variables”

## **authentication\_ldap\_simple\_log\_status**

Section 6.4.1.13, “Pluggable Authentication System Variables”

---

## **authentication\_ldap\_simple\_max\_pool\_size**

Section 6.4.1.13, “Pluggable Authentication System Variables”

## **authentication\_ldap\_simple\_server\_host**

Section 6.4.1.13, “Pluggable Authentication System Variables”

## **authentication\_ldap\_simple\_server\_port**

Section 6.4.1.13, “Pluggable Authentication System Variables”

## **authentication\_ldap\_simple\_tls**

Section 6.4.1.9, “LDAP Pluggable Authentication”

Section 6.4.1.13, “Pluggable Authentication System Variables”

## **authentication\_ldap\_simple\_user\_search\_attr**

Section 6.4.1.9, “LDAP Pluggable Authentication”

Section 6.4.1.13, “Pluggable Authentication System Variables”

## **authentication\_windows\_log\_level**

Section 5.1.7, “Server System Variables”

Section 6.4.1.8, “Windows Pluggable Authentication”

## **authentication\_windows\_use\_principal\_name**

Section 5.1.7, “Server System Variables”

Section 6.4.1.8, “Windows Pluggable Authentication”

## **auto\_generate\_certs**

Section 6.3.3.1, “Creating SSL and RSA Certificates and Keys using MySQL”

Section 5.1.7, “Server System Variables”

Section 6.3.4, “SSL Library-Dependent Capabilities”

Section 6.3, “Using Encrypted Connections”

## **auto\_increment\_increment**

Section 14.6.1.6, “AUTO\_INCREMENT Handling in InnoDB”

Section 17.8, “Frequently Asked Questions”

Section 17.7.1, “Group Replication System Variables”

Section 5.4.4.3, “Mixed Binary Logging Format”

Section A.1, “MySQL 5.7 FAQ: General”

Section 21.5.14, “ndb\_import — Import CSV Data Into NDB”

Section 16.4.1.37, “Replication and Variables”

Section 16.1.6.2, “Replication Source Options and Variables”

Section 3.6.9, “Using AUTO\_INCREMENT”

## **auto\_increment\_offset**

Section 14.6.1.6, “AUTO\_INCREMENT Handling in InnoDB”

Section 17.8, “Frequently Asked Questions”

Section 17.7.1, “Group Replication System Variables”

Section 5.4.4.3, “Mixed Binary Logging Format”

Section A.1, “MySQL 5.7 FAQ: General”

Section 21.5.14, “ndb\_import — Import CSV Data Into NDB”

Section 16.4.1.37, “Replication and Variables”

Section 16.1.6.2, “Replication Source Options and Variables”

Section 3.6.9, “Using AUTO\_INCREMENT”



---

## **AUTOCOMMIT**

Section 16.4.1.33, “Replication and Transactions”

### **autocommit**

Section 14.7.2.2, “autocommit, Commit, and Rollback”

Section 14.6.1.5, “Converting Tables from MyISAM to InnoDB”

Section 14.7.5.2, “Deadlock Detection”

Section 13.2.2, “DELETE Statement”

Section 14.2, “InnoDB and the ACID Model”

Section 14.7, “InnoDB Locking and Transaction Model”

Section 14.15, “InnoDB Startup Options and System Variables”

Section 13.3.5, “LOCK TABLES and UNLOCK TABLES Statements”

Section 14.7.2.4, “Locking Reads”

Section 14.7.3, “Locks Set by Different SQL Statements in InnoDB”

Section 14.6.1.4, “Moving or Copying InnoDB Tables”

NDB Cluster System Variables

Section 8.5.3, “Optimizing InnoDB Read-Only Transactions”

Section 25.12.7, “Performance Schema Transaction Tables”

Section 14.8.10, “Purge Configuration”

Section 16.4.1.33, “Replication and Transactions”

Section 16.1.3.6, “Restrictions on Replication with GTIDs”

Section 5.1.7, “Server System Variables”

Section 13.3.1, “START TRANSACTION, COMMIT, and ROLLBACK Statements”

Section 24.4.28, “The INFORMATION\_SCHEMA INNODB\_TRX Table”

Section 5.5.3.3, “Thread Pool Operation”

Section 14.7.2.1, “Transaction Isolation Levels”

### **automatic\_sp\_privileges**

Section 13.1.6, “ALTER PROCEDURE Statement”

Section 13.1.16, “CREATE PROCEDURE and CREATE FUNCTION Statements”

Section 5.1.6, “Server Command Options”

Section 5.1.7, “Server System Variables”

Section 23.2.2, “Stored Routines and MySQL Privileges”

### **avoid\_temporal\_upgrade**

Section 2.10.3, “Changes in MySQL 5.7”

Section 13.7.2.2, “CHECK TABLE Statement”

Section 13.7.2.5, “REPAIR TABLE Statement”

Section 5.1.7, “Server System Variables”

## **B**

[\[index top\]](#)

### **back\_log**

Section 5.1.7, “Server System Variables”

### **basedir**

Section 13.7.3.3, “INSTALL PLUGIN Statement”

Section 2.4.3, “Installing a MySQL Launch Daemon”

Section 5.1.6, “Server Command Options”

Section 5.1.7, “Server System Variables”

---

## **big\_tables**

[Section 8.4.4, “Internal Temporary Table Use in MySQL”](#)

[Section 5.1.7, “Server System Variables”](#)

## **bind\_address**

[Section B.3.2.2, “Can't connect to \[local\] MySQL server”](#)

[Section 5.1.12.2, “Configuring the MySQL Server to Permit IPv6 Connections”](#)

[Section 5.1.12.4, “Connecting Using IPv6 Nonlocal Host Addresses”](#)

[Section 5.1.12.3, “Connecting Using the IPv6 Local Host Address”](#)

[Section 17.6.1, “Group Replication IP Address Allowlisting”](#)

[Section 5.1.12, “IPv6 Support”](#)

[Section 4.3.4, “mysqld\\_multi — Manage Multiple MySQL Servers”](#)

[Section 5.1.12.5, “Obtaining an IPv6 Address from a Broker”](#)

[Section 5.7, “Running Multiple MySQL Instances on One Machine”](#)

[Section 5.1.7, “Server System Variables”](#)

[Section 21.6.15.30, “The ndbinfo processes Table”](#)

[Section 6.2.17, “Troubleshooting Problems Connecting to MySQL”](#)

[Section 19.4.2.2, “X Plugin Options and System Variables”](#)

## **binlog**

[Section 17.3.2, “Group Replication Limitations”](#)

[Section 17.3.1, “Group Replication Requirements”](#)

## **binlog\_cache\_size**

[Section 16.1.6.4, “Binary Logging Options and Variables”](#)

[Section 5.1.9, “Server Status Variables”](#)

[Section 5.4.4, “The Binary Log”](#)

## **binlog\_checksum**

[Section 16.1.6.4, “Binary Logging Options and Variables”](#)

[MySQL Glossary](#)

[Section 16.4.1.33, “Replication and Transactions”](#)

[Section 5.4.4, “The Binary Log”](#)

## **binlog\_direct\_non\_transactional\_updates**

[Section 16.1.6.4, “Binary Logging Options and Variables”](#)

[Section 16.4.1.33, “Replication and Transactions”](#)

## **binlog\_error\_action**

[Section 16.1.6.4, “Binary Logging Options and Variables”](#)

[Section 16.1.6.5, “Global Transaction ID System Variables”](#)

[Section 16.1.3.1, “GTID Format and Storage”](#)

[Section 5.4.4, “The Binary Log”](#)

## **binlog\_format**

[Section 16.1.6.4, “Binary Logging Options and Variables”](#)

[Section 2.10.3, “Changes in MySQL 5.7”](#)

[Section 12.7, “Date and Time Functions”](#)

[Section 16.2.1.3, “Determination of Safe and Unsafe Statements in Binary Logging”](#)

[Section 16.2.5.1, “Evaluation of Database-Level Replication and Binary Logging Options”](#)

[Section 16.2.5.2, “Evaluation of Table-Level Replication Options”](#)

[Section 16.1.3.2, “GTID Life Cycle”](#)

---

[Section 12.15, “Information Functions”](#)  
[Section 16.2.5.3, “Interactions Between Replication Filtering Options”](#)  
[Section 12.14, “Locking Functions”](#)  
[Section 5.4.4.4, “Logging Format for Changes to mysql Database Tables”](#)  
[Section 12.6.2, “Mathematical Functions”](#)  
[Section 12.20, “Miscellaneous Functions”](#)  
[Section 5.4.4.3, “Mixed Binary Logging Format”](#)  
[Section A.14, “MySQL 5.7 FAQ: Replication”](#)  
[Section 4.6.7, “mysqlbinlog — Utility for Processing Binary Log Files”](#)  
[Section 6.2.2, “Privileges Provided by MySQL”](#)  
[Section 16.1.6.3, “Replica Server Options and Variables”](#)  
[Section 16.4.1.2, “Replication and BLACKHOLE Tables”](#)  
[Section 16.4.1.18, “Replication and LOAD DATA”](#)  
[Section 16.4.1.20, “Replication and MEMORY Tables”](#)  
[Section 16.4.1.29, “Replication and Temporary Tables”](#)  
[Section 16.4.1.33, “Replication and Transactions”](#)  
[Section 16.2.1, “Replication Formats”](#)  
[Section 16.4.1.21, “Replication of the mysql System Database”](#)  
[Section 16.1.3.6, “Restrictions on Replication with GTIDs”](#)  
[Section 13.3.7.3, “Restrictions on XA Transactions”](#)  
[Section 5.4.4.2, “Setting The Binary Log Format”](#)  
[Section 23.7, “Stored Program Binary Logging”](#)  
[Section 5.1.8.1, “System Variable Privileges”](#)  
[Section 15.6, “The BLACKHOLE Storage Engine”](#)  
[Section 5.4.3, “The General Query Log”](#)  
[Section 14.21.6, “The InnoDB memcached Plugin and Replication”](#)  
[Section 5.4.5, “The Slow Query Log”](#)  
[Section 14.7.2.1, “Transaction Isolation Levels”](#)  
[Section 16.4.3, “Upgrading a Replication Topology”](#)  
[Section 16.2.1.2, “Usage of Row-Based Logging and Replication”](#)

## **binlog\_group\_commit\_sync\_delay**

[Section 16.1.6.4, “Binary Logging Options and Variables”](#)

## **binlog\_group\_commit\_sync\_no\_delay\_count**

[Section 16.1.6.4, “Binary Logging Options and Variables”](#)

## **binlog\_gtid\_simple\_recovery**

[Section 16.1.6.5, “Global Transaction ID System Variables”](#)

[Section 16.1.3.2, “GTID Life Cycle”](#)

## **binlog\_max\_flush\_queue\_time**

[Section 16.1.6.4, “Binary Logging Options and Variables”](#)

[Section 1.3, “What Is New in MySQL 5.7”](#)

## **binlog\_order\_commits**

[Section 16.1.6.4, “Binary Logging Options and Variables”](#)

## **binlog\_row\_image**

[Section 16.2.1.1, “Advantages and Disadvantages of Statement-Based and Row-Based Replication”](#)

[Section 16.1.6.4, “Binary Logging Options and Variables”](#)

[Section 8.5.8, “Optimizing InnoDB Disk I/O”](#)

---

## **binlog\_rows\_query\_log\_events**

[Section 16.2.1.1, “Advantages and Disadvantages of Statement-Based and Row-Based Replication”](#)

## **binlog\_stmt\_cache\_size**

[Section 16.1.6.4, “Binary Logging Options and Variables”](#)

[Section 5.1.9, “Server Status Variables”](#)

## **binlog\_transaction\_dependency\_history\_size**

[Section 16.1.6.4, “Binary Logging Options and Variables”](#)

## **binlog\_transaction\_dependency\_tracking**

[Section 16.1.6.4, “Binary Logging Options and Variables”](#)

[Section 16.1.6.3, “Replica Server Options and Variables”](#)

## **block\_encryption\_mode**

[Section 12.13, “Encryption and Compression Functions”](#)

[Section 5.1.7, “Server System Variables”](#)

## **bulk\_insert\_buffer\_size**

[Section 15.2.1, “MyISAM Startup Options”](#)

[Section 8.2.4.1, “Optimizing INSERT Statements”](#)

[Section 5.1.7, “Server System Variables”](#)

## **C**

[\[index top\]](#)

## **caching\_sha**

[Section 6.4.1.4, “Caching SHA-2 Pluggable Authentication”](#)

## **character\_set\_client**

[Section 10.15, “Character Set Configuration”](#)

[Section 10.4, “Connection Character Sets and Collations”](#)

[Section 13.2.6, “LOAD DATA Statement”](#)

[Section 5.4.4.3, “Mixed Binary Logging Format”](#)

[Section A.11, “MySQL 5.7 FAQ: MySQL Chinese, Japanese, and Korean Character Sets”](#)

[Section 16.4.1.37, “Replication and Variables”](#)

[Section 5.1.7, “Server System Variables”](#)

[Section 13.7.4.2, “SET CHARACTER SET Statement”](#)

[Section 13.7.4.3, “SET NAMES Statement”](#)

[Section 13.7.5.7, “SHOW CREATE EVENT Statement”](#)

[Section 13.7.5.9, “SHOW CREATE PROCEDURE Statement”](#)

[Section 13.7.5.11, “SHOW CREATE TRIGGER Statement”](#)

[Section 13.7.5.13, “SHOW CREATE VIEW Statement”](#)

[Section 13.7.5.18, “SHOW EVENTS Statement”](#)

[Section 13.7.5.28, “SHOW PROCEDURE STATUS Statement”](#)

[Section 13.7.5.38, “SHOW TRIGGERS Statement”](#)

[Section 5.4.4, “The Binary Log”](#)

[Section 24.3.8, “The INFORMATION\\_SCHEMA EVENTS Table”](#)

[Section 24.3.21, “The INFORMATION\\_SCHEMA ROUTINES Table”](#)

[Section 24.3.29, “The INFORMATION\\_SCHEMA TRIGGERS Table”](#)

[Section 24.3.31, “The INFORMATION\\_SCHEMA VIEWS Table”](#)

---

Section 5.5.4.2, “Using the Rewriter Query Rewrite Plugin”

## **character\_set\_connection**

Section 12.10, “Cast Functions and Operators”  
Section 12.8.3, “Character Set and Collation of Function Results”  
Section 10.3.8, “Character Set Introducers”  
Section 10.2.1, “Character Set Repertoire”  
Section 10.3.6, “Character String Literal Character Set and Collation”  
Section 10.8.4, “Collation Coercibility in Expressions”  
Section 10.4, “Connection Character Sets and Collations”  
Section 12.7, “Date and Time Functions”  
Section 12.13, “Encryption and Compression Functions”  
Section 5.4.4.3, “Mixed Binary Logging Format”  
Section A.11, “MySQL 5.7 FAQ: MySQL Chinese, Japanese, and Korean Character Sets”  
Section 10.16, “MySQL Server Locale Support”  
Section 16.4.1.37, “Replication and Variables”  
Section 5.1.7, “Server System Variables”  
Section 13.7.4.2, “SET CHARACTER SET Statement”  
Section 13.7.4.3, “SET NAMES Statement”  
Section 9.1.1, “String Literals”  
Section 12.3, “Type Conversion in Expression Evaluation”

## **character\_set\_database**

Section 13.1.8, “ALTER TABLE Statement”  
Section 10.4, “Connection Character Sets and Collations”  
Section 13.1.16, “CREATE PROCEDURE and CREATE FUNCTION Statements”  
Section 10.3.3, “Database Character Set and Collation”  
Section 13.2.6, “LOAD DATA Statement”  
Section 5.4.4.3, “Mixed Binary Logging Format”  
Section 16.4.1.37, “Replication and Variables”  
Section 5.1.7, “Server System Variables”  
Section 13.7.4.2, “SET CHARACTER SET Statement”  
Section 1.3, “What Is New in MySQL 5.7”

## **character\_set\_filesystem**

Section 13.2.6, “LOAD DATA Statement”  
Section 13.2.9.1, “SELECT ... INTO Statement”  
Section 5.1.7, “Server System Variables”  
Section 12.8, “String Functions and Operators”

## **character\_set\_results**

Section 10.4, “Connection Character Sets and Collations”  
Section 10.6, “Error Message Character Set”  
Section A.11, “MySQL 5.7 FAQ: MySQL Chinese, Japanese, and Korean Character Sets”  
Section 5.1.7, “Server System Variables”  
Section 13.7.4.2, “SET CHARACTER SET Statement”  
Section 13.7.4.3, “SET NAMES Statement”  
Section 10.2.2, “UTF-8 for Metadata”

## **character\_set\_server**

Section 10.15, “Character Set Configuration”  
Section 10.4, “Connection Character Sets and Collations”  
Section 10.3.3, “Database Character Set and Collation”

---

Section 12.9.4, “Full-Text Stopwords”  
Section 5.4.4.3, “Mixed Binary Logging Format”  
Section 16.4.1.3, “Replication and Character Sets”  
Section 16.4.1.37, “Replication and Variables”  
Section 10.3.2, “Server Character Set and Collation”  
Section 5.1.7, “Server System Variables”

## **character\_set\_system**

Section 10.15, “Character Set Configuration”  
Section 5.1.7, “Server System Variables”  
Section 10.2.2, “UTF-8 for Metadata”

## **character\_sets\_dir**

Section 10.14.3, “Adding a Simple Collation to an 8-Bit Character Set”  
Section 10.14.4.1, “Defining a UCA Collation Using LDML Syntax”  
Section 5.1.7, “Server System Variables”

## **check\_proxy\_users**

Section 6.2.14, “Proxy Users”  
Section 5.1.7, “Server System Variables”

## **collation\_connection**

Section 12.10, “Cast Functions and Operators”  
Section 12.8.3, “Character Set and Collation of Function Results”  
Section 10.3.8, “Character Set Introducers”  
Section 10.3.6, “Character String Literal Character Set and Collation”  
Section 10.8.4, “Collation Coercibility in Expressions”  
Section 10.4, “Connection Character Sets and Collations”  
Section 12.7, “Date and Time Functions”  
Section 12.13, “Encryption and Compression Functions”  
Section 5.4.4.3, “Mixed Binary Logging Format”  
Section 16.4.1.37, “Replication and Variables”  
Section 5.1.7, “Server System Variables”  
Section 13.7.4.3, “SET NAMES Statement”  
Section 13.7.5.7, “SHOW CREATE EVENT Statement”  
Section 13.7.5.9, “SHOW CREATE PROCEDURE Statement”  
Section 13.7.5.11, “SHOW CREATE TRIGGER Statement”  
Section 13.7.5.13, “SHOW CREATE VIEW Statement”  
Section 13.7.5.18, “SHOW EVENTS Statement”  
Section 13.7.5.28, “SHOW PROCEDURE STATUS Statement”  
Section 13.7.5.38, “SHOW TRIGGERS Statement”  
Section 5.4.4, “The Binary Log”  
Section 24.3.8, “The INFORMATION\_SCHEMA EVENTS Table”  
Section 24.3.21, “The INFORMATION\_SCHEMA ROUTINES Table”  
Section 24.3.29, “The INFORMATION\_SCHEMA TRIGGERS Table”  
Section 24.3.31, “The INFORMATION\_SCHEMA VIEWS Table”  
Section 12.3, “Type Conversion in Expression Evaluation”

## **collation\_database**

Section 10.4, “Connection Character Sets and Collations”  
Section 13.1.16, “CREATE PROCEDURE and CREATE FUNCTION Statements”  
Section 10.3.3, “Database Character Set and Collation”  
Section 5.4.4.3, “Mixed Binary Logging Format”

---

[Section 16.4.1.37, “Replication and Variables”](#)  
[Section 5.1.7, “Server System Variables”](#)  
[Section 5.4.4, “The Binary Log”](#)  
[Section 1.3, “What Is New in MySQL 5.7”](#)

## **collation\_server**

[Section 10.4, “Connection Character Sets and Collations”](#)  
[Section 10.3.3, “Database Character Set and Collation”](#)  
[Section 12.9.4, “Full-Text Stopwords”](#)  
[Section 5.4.4.3, “Mixed Binary Logging Format”](#)  
[Section 16.4.1.37, “Replication and Variables”](#)  
[Section 10.3.2, “Server Character Set and Collation”](#)  
[Section 5.1.7, “Server System Variables”](#)  
[Section 5.4.4, “The Binary Log”](#)

## **completion\_type**

[Section 5.1.7, “Server System Variables”](#)  
[Section 13.3.1, “START TRANSACTION, COMMIT, and ROLLBACK Statements”](#)

## **concurrent\_insert**

[Section 8.11.3, “Concurrent Inserts”](#)  
[Section 8.11.1, “Internal Locking Methods”](#)  
[Section 8.6.1, “Optimizing MyISAM Queries”](#)  
[Section 5.1.6, “Server Command Options”](#)  
[Section 5.1.7, “Server System Variables”](#)

## **connect\_timeout**

[Section B.3.2.9, “Communication Errors and Aborted Connections”](#)  
[Section B.3.2.3, “Lost connection to MySQL server”](#)  
[Section 5.1.7, “Server System Variables”](#)  
[Section 19.4.2.2, “X Plugin Options and System Variables”](#)

## **connection\_control\_failed\_connections\_threshold**

[Section 6.4.2.1, “Connection Control Plugin Installation”](#)  
[Section 6.4.2.2, “Connection Control Plugin System and Status Variables”](#)  
[Section 24.6.2, “The INFORMATION\\_SCHEMA CONNECTION\\_CONTROL\\_FAILED\\_LOGIN\\_ATTEMPTS Table”](#)

## **connection\_control\_max\_connection\_delay**

[Section 6.4.2.1, “Connection Control Plugin Installation”](#)  
[Section 6.4.2.2, “Connection Control Plugin System and Status Variables”](#)

## **connection\_control\_min\_connection\_delay**

[Section 6.4.2.1, “Connection Control Plugin Installation”](#)  
[Section 6.4.2.2, “Connection Control Plugin System and Status Variables”](#)

## **core\_file**

[Section 5.1.7, “Server System Variables”](#)

## **D**

[\[index top\]](#)

---

## **daemon\_memcached\_enable\_binlog**

[Section 14.15, “InnoDB Startup Options and System Variables”](#)

## **daemon\_memcached\_engine\_lib\_name**

[Section 14.15, “InnoDB Startup Options and System Variables”](#)

[Section 14.21.3, “Setting Up the InnoDB memcached Plugin”](#)

## **daemon\_memcached\_engine\_lib\_path**

[Section 14.15, “InnoDB Startup Options and System Variables”](#)

[Section 14.21.3, “Setting Up the InnoDB memcached Plugin”](#)

## **daemon\_memcached\_option**

[Section 14.21.2, “InnoDB memcached Architecture”](#)

[Section 14.15, “InnoDB Startup Options and System Variables”](#)

[Section 14.21.4, “Security Considerations for the InnoDB memcached Plugin”](#)

[Section 14.21.3, “Setting Up the InnoDB memcached Plugin”](#)

[Section 14.21.8, “Troubleshooting the InnoDB memcached Plugin”](#)

## **daemon\_memcached\_r\_batch\_size**

[Section 14.21.2, “InnoDB memcached Architecture”](#)

[Section 14.15, “InnoDB Startup Options and System Variables”](#)

[Section 14.21.5.6, “Performing DML and DDL Statements on the Underlying InnoDB Table”](#)

[Section 14.21.3, “Setting Up the InnoDB memcached Plugin”](#)

[Section 14.21.6, “The InnoDB memcached Plugin and Replication”](#)

[Section 14.21.5.3, “Tuning InnoDB memcached Plugin Performance”](#)

## **daemon\_memcached\_w\_batch\_size**

[Section 14.21.5.4, “Controlling Transactional Behavior of the InnoDB memcached Plugin”](#)

[Section 14.21.2, “InnoDB memcached Architecture”](#)

[Section 14.15, “InnoDB Startup Options and System Variables”](#)

[Section 14.21.5.6, “Performing DML and DDL Statements on the Underlying InnoDB Table”](#)

[Section 14.21.3, “Setting Up the InnoDB memcached Plugin”](#)

[Section 14.21.6, “The InnoDB memcached Plugin and Replication”](#)

[Section 14.21.5.3, “Tuning InnoDB memcached Plugin Performance”](#)

## **datadir**

[Section 17.2.1.2, “Configuring an Instance for Group Replication”](#)

[Section 13.1.19, “CREATE TABLESPACE Statement”](#)

[Section 14.8.1, “InnoDB Startup Configuration”](#)

[Section 14.15, “InnoDB Startup Options and System Variables”](#)

[Section 2.4.3, “Installing a MySQL Launch Daemon”](#)

[Section 2.3, “Installing MySQL on Microsoft Windows”](#)

[MySQL Glossary](#)

[Section 5.1.6, “Server Command Options”](#)

[Section 5.1.7, “Server System Variables”](#)

[Section 24.3.9, “The INFORMATION\\_SCHEMA FILES Table”](#)

## **date\_format**

[Section 5.1.7, “Server System Variables”](#)

## **datetime\_format**

[Section 5.1.7, “Server System Variables”](#)



---

## **debug**

Section 5.1.7, “Server System Variables”  
Section 5.8.3, “The DBUG Package”

## **debug\_sync**

Section 5.1.7, “Server System Variables”

## **default**

Section 15.1, “Setting the Storage Engine”  
Section 14.1.4, “Testing and Benchmarking with InnoDB”

## **default\_authentication\_plugin**

Section 13.7.1.1, “ALTER USER Statement”  
Section 6.4.1, “Authentication Plugins”  
Section 13.7.1.2, “CREATE USER Statement”  
Section 6.2.13, “Pluggable Authentication”  
Section 5.1.7, “Server System Variables”  
Section 6.4.1.5, “SHA-256 Pluggable Authentication”

## **default\_password\_lifetime**

Section 13.7.1.1, “ALTER USER Statement”  
Section 13.7.1.2, “CREATE USER Statement”  
Section 6.2.3, “Grant Tables”  
Section 6.2.11, “Password Management”  
Section 5.1.7, “Server System Variables”

## **default\_storage\_engine**

Section 13.1.15, “CREATE LOGFILE GROUP Statement”  
Section 13.1.18, “CREATE TABLE Statement”  
Section 13.1.19, “CREATE TABLESPACE Statement”  
Section 13.1.30, “DROP TABLESPACE Statement”  
Section 14.6.3.3, “General Tablespaces”  
Section 5.5.1, “Installing and Uninstalling Plugins”  
Section 16.4.1.37, “Replication and Variables”  
Section 5.1.7, “Server System Variables”  
Section 15.1, “Setting the Storage Engine”  
Section 16.3.3, “Using Replication with Different Source and Replica Storage Engines”  
Section 1.3, “What Is New in MySQL 5.7”

## **default\_table\_encryption**

Section 17.7.1, “Group Replication System Variables”

## **default\_tmp\_storage\_engine**

Section 5.5.1, “Installing and Uninstalling Plugins”  
Section 5.1.7, “Server System Variables”  
Section 15.1, “Setting the Storage Engine”  
Section 14.6.3.5, “The Temporary Tablespace”

## **default\_week\_format**

Section 12.7, “Date and Time Functions”  
Section 22.6.3, “Partitioning Limitations Relating to Functions”

---

[Section 5.1.7, “Server System Variables”](#)

## **delay\_key\_write**

[Section 13.1.18, “CREATE TABLE Statement”](#)

[Section 8.11.5, “External Locking”](#)

[Section A.14, “MySQL 5.7 FAQ: Replication”](#)

[Section 5.1.6, “Server Command Options”](#)

[Section 5.1.7, “Server System Variables”](#)

[Section B.3.3.3, “What to Do If MySQL Keeps Crashing”](#)

## **delayed\_insert\_limit**

[Section 5.1.7, “Server System Variables”](#)

## **delayed\_insert\_timeout**

[Section 5.1.7, “Server System Variables”](#)

## **delayed\_queue\_size**

[Section 5.1.7, “Server System Variables”](#)

## **disabled\_storage\_engines**

[Section 17.2.1.2, “Configuring an Instance for Group Replication”](#)

[Section 17.3.1, “Group Replication Requirements”](#)

[Section A.2, “MySQL 5.7 FAQ: Storage Engines”](#)

[Section 4.4.7, “mysql\\_upgrade — Check and Upgrade MySQL Tables”](#)

[Section 5.1.6, “Server Command Options”](#)

[Section 5.1.7, “Server System Variables”](#)

## **disconnect\_on\_expired\_password**

[Section 6.2.12, “Server Handling of Expired Passwords”](#)

[Section 5.1.7, “Server System Variables”](#)

## **div\_precision\_increment**

[Section 12.6.1, “Arithmetic Operators”](#)

[Section 5.1.7, “Server System Variables”](#)

## **E**

[\[index top\]](#)

## **end\_markers\_in\_json**

[Section 8.15.13, “Displaying Traces in Other Applications”](#)

[Section 13.8.2, “EXPLAIN Statement”](#)

[Section 5.1.7, “Server System Variables”](#)

[Section 8.15.2, “System Variables Controlling Tracing”](#)

[Section 8.15.9, “The end\\_markers\\_in\\_json System Variable”](#)

## **enforce\_gtid\_consistency**

[Section 16.1.4.3, “Disabling GTID Transactions Online”](#)

[Section 16.1.6.5, “Global Transaction ID System Variables”](#)

[Section 17.3.1, “Group Replication Requirements”](#)

[Section 16.1.4.1, “Replication Mode Concepts”](#)

[Section 16.1.3.6, “Restrictions on Replication with GTIDs”](#)

---

[Section 16.1.3.4, “Setting Up Replication Using GTIDs”](#)

## **eq\_range\_index\_dive\_limit**

[Section 8.2.1.2, “Range Optimization”](#)

[Section 5.1.7, “Server System Variables”](#)

## **error\_count**

[Section B.2, “Error Information Interfaces”](#)

[Section 13.5, “Prepared Statements”](#)

[Section 5.1.7, “Server System Variables”](#)

[Section 13.7.5.17, “SHOW ERRORS Statement”](#)

[Section 13.6.7.7, “The MySQL Diagnostics Area”](#)

## **event**

[Section 14.8.2, “Configuring InnoDB for Read-Only Operation”](#)

## **event\_scheduler**

[Section 23.4.2, “Event Scheduler Configuration”](#)

[Section 27.6.2, “Restrictions When Using the Embedded MySQL Server”](#)

[Section 5.1.7, “Server System Variables”](#)

[Section 23.4.6, “The Event Scheduler and MySQL Privileges”](#)

## **expire\_logs\_days**

[Section 16.1.6.4, “Binary Logging Options and Variables”](#)

[Section 13.4.1.1, “PURGE BINARY LOGS Statement”](#)

[Section 5.4.7, “Server Log Maintenance”](#)

## **explicit\_defaults\_for\_timestamp**

[Section 11.2.6, “Automatic Initialization and Updating for TIMESTAMP and DATETIME”](#)

[Section 11.6, “Data Type Default Values”](#)

[Section 11.2.1, “Date and Time Data Type Syntax”](#)

[Section B.3.4.3, “Problems with NULL Values”](#)

[Section 5.1.7, “Server System Variables”](#)

## **external\_user**

[Section 6.4.5.4, “Audit Log File Formats”](#)

[Section 6.2.14, “Proxy Users”](#)

[Section 5.1.7, “Server System Variables”](#)

## **F**

[\[index top\]](#)

## **flush**

[Section 5.1.7, “Server System Variables”](#)

## **flush\_time**

[Section 5.1.6, “Server Command Options”](#)

[Section 5.1.7, “Server System Variables”](#)

## **foreign\_key\_checks**

[Section 13.1.8, “ALTER TABLE Statement”](#)

---

[Section 13.1.18.5, “FOREIGN KEY Constraints”](#)  
[Section 21.6.9, “Importing Data Into MySQL Cluster”](#)  
[Section 14.6.1.3, “Importing InnoDB Tables”](#)  
[Section 5.4.4.3, “Mixed Binary Logging Format”](#)  
[NDB Cluster System Variables](#)  
[Section 14.13.1, “Online DDL Operations”](#)  
[Section 16.4.1.37, “Replication and Variables”](#)  
[Section 5.1.10, “Server SQL Modes”](#)  
[Section 5.1.7, “Server System Variables”](#)  
[Section 5.4.4, “The Binary Log”](#)

## **ft\_boolean\_syntax**

[Section 12.9.2, “Boolean Full-Text Searches”](#)  
[Section 12.9.6, “Fine-Tuning MySQL Full-Text Search”](#)  
[Section 5.1.7, “Server System Variables”](#)

## **ft\_max\_word\_len**

[Section 12.9.2, “Boolean Full-Text Searches”](#)  
[Creating a Data Snapshot Using Raw Data Files](#)  
[Section 12.9.6, “Fine-Tuning MySQL Full-Text Search”](#)  
[Section 12.9.8, “ngram Full-Text Parser”](#)  
[Section 5.1.7, “Server System Variables”](#)

## **ft\_min\_word\_len**

[Section 12.9.2, “Boolean Full-Text Searches”](#)  
[Creating a Data Snapshot Using Raw Data Files](#)  
[Section 12.9.6, “Fine-Tuning MySQL Full-Text Search”](#)  
[Section 12.9.9, “MeCab Full-Text Parser Plugin”](#)  
[Section 12.9.1, “Natural Language Full-Text Searches”](#)  
[Section 12.9.8, “ngram Full-Text Parser”](#)  
[Section 5.1.7, “Server System Variables”](#)

## **ft\_query\_expansion\_limit**

[Section 5.1.7, “Server System Variables”](#)

## **ft\_stopword\_file**

[Section 12.9.2, “Boolean Full-Text Searches”](#)  
[Creating a Data Snapshot Using Raw Data Files](#)  
[Section 12.9.6, “Fine-Tuning MySQL Full-Text Search”](#)  
[Section 12.9.4, “Full-Text Stopwords”](#)  
[Section 12.9.1, “Natural Language Full-Text Searches”](#)  
[Section 5.1.7, “Server System Variables”](#)

## **G**

[\[index top\]](#)

## **general\_log**

[MySQL Glossary](#)  
[Section 5.4.1, “Selecting General Query Log and Slow Query Log Output Destinations”](#)  
[Section 5.1.7, “Server System Variables”](#)  
[Section 5.4.3, “The General Query Log”](#)

---

## **general\_log\_file**

[Section 5.4.1, “Selecting General Query Log and Slow Query Log Output Destinations”](#)

[Section 5.1.7, “Server System Variables”](#)

[Section 5.4.3, “The General Query Log”](#)

## **group\_concat\_max\_len**

[Section 12.19.1, “Aggregate Function Descriptions”](#)

[Section 5.1.7, “Server System Variables”](#)

## **group\_replication\_allow\_local\_disjoint\_gtids\_join**

[Section 17.7.1, “Group Replication System Variables”](#)

## **group\_replication\_allow\_local\_lower\_version\_join**

[Section 17.7.1, “Group Replication System Variables”](#)

## **group\_replication\_auto\_increment\_increment**

[Section 17.8, “Frequently Asked Questions”](#)

[Section 17.7.1, “Group Replication System Variables”](#)

[Section 16.1.6.2, “Replication Source Options and Variables”](#)

## **group\_replication\_bootstrap\_group**

[Adding a Second Instance](#)

[Section 17.2.1.5, “Bootstrapping the Group”](#)

[Section 17.2.1.2, “Configuring an Instance for Group Replication”](#)

[Section 17.7.1, “Group Replication System Variables”](#)

[Section 17.5.4, “Restarting a Group”](#)

## **group\_replication\_components\_stop\_timeout**

[Section 17.7.1, “Group Replication System Variables”](#)

## **group\_replication\_compression\_threshold**

[Section 17.3.2, “Group Replication Limitations”](#)

[Section 17.7.1, “Group Replication System Variables”](#)

[Section 17.9.7.2, “Message Compression”](#)

## **group\_replication\_enforce\_update\_everywhere\_checks**

[Section 17.5.1, “Deploying in Multi-Primary or Single-Primary Mode”](#)

[Section 17.3.2, “Group Replication Limitations”](#)

[Section 17.7.1, “Group Replication System Variables”](#)

## **group\_replication\_exit\_state\_action**

[Section 17.7.1, “Group Replication System Variables”](#)

## **group\_replication\_flow\_control\_applier\_threshold**

[Section 17.7.1, “Group Replication System Variables”](#)

## **group\_replication\_flow\_control\_certifier\_threshold**

[Section 17.7.1, “Group Replication System Variables”](#)

## **group\_replication\_flow\_control\_hold\_percent**

[Section 17.7.1, “Group Replication System Variables”](#)

---

## **group\_replication\_flow\_control\_max\_quota**

Section 17.7.1, “Group Replication System Variables”

## **group\_replication\_flow\_control\_member\_quota\_percent**

Section 17.7.1, “Group Replication System Variables”

## **group\_replication\_flow\_control\_min\_quota**

Section 17.7.1, “Group Replication System Variables”

## **group\_replication\_flow\_control\_min\_recovery\_quota**

Section 17.7.1, “Group Replication System Variables”

## **group\_replication\_flow\_control\_mode**

Section 17.7.1, “Group Replication System Variables”

## **group\_replication\_flow\_control\_period**

Section 17.4.3, “The replication\_group\_member\_stats Table”

## **group\_replication\_force\_members**

Section 17.7.1, “Group Replication System Variables”

Section 17.5.3, “Network Partitioning”

## **group\_replication\_group\_name**

Section 17.2.1.2, “Configuring an Instance for Group Replication”

Section 17.7.1, “Group Replication System Variables”

## **group\_replication\_group\_seeds**

Section 17.2.1.2, “Configuring an Instance for Group Replication”

Section 17.2.2, “Deploying Group Replication Locally”

Section 17.7.1, “Group Replication System Variables”

## **group\_replication\_gtid\_assignment\_block\_size**

Section 17.7.1, “Group Replication System Variables”

## **group\_replication\_ip\_whitelist**

Section 17.6.1, “Group Replication IP Address Allowlisting”

Section 17.7.1, “Group Replication System Variables”

## **group\_replication\_local\_address**

Section 17.2.1.2, “Configuring an Instance for Group Replication”

Section 17.2.2, “Deploying Group Replication Locally”

Section 17.8, “Frequently Asked Questions”

Section 17.6.1, “Group Replication IP Address Allowlisting”

Section 17.7.1, “Group Replication System Variables”

Section 6.7.5.2, “Setting the TCP Port Context for MySQL Features”

Section 25.12.11.8, “The replication\_group\_members Table”

## **group\_replication\_member\_weight**

Section 17.7.1, “Group Replication System Variables”

Section 17.5.1.1, “Single-Primary Mode”

---

## **group\_replication\_poll\_spin\_loops**

Section 17.9.7.1, “Fine Tuning the Group Communication Thread”  
Section 17.7.1, “Group Replication System Variables”

## **group\_replication\_recovery\_complete\_at**

Section 17.7.1, “Group Replication System Variables”

## **group\_replication\_recovery\_reconnect\_interval**

Section 17.7.1, “Group Replication System Variables”  
Section 17.5.2, “Tuning Recovery”

## **group\_replication\_recovery\_retry\_count**

Section 17.7.1, “Group Replication System Variables”  
Section 17.5.2, “Tuning Recovery”

## **group\_replication\_recovery\_ssl\_ca**

Section 17.7.1, “Group Replication System Variables”

## **group\_replication\_recovery\_ssl\_capath**

Section 17.7.1, “Group Replication System Variables”

## **group\_replication\_recovery\_ssl\_cert**

Section 17.7.1, “Group Replication System Variables”

## **group\_replication\_recovery\_ssl\_cipher**

Section 17.7.1, “Group Replication System Variables”

## **group\_replication\_recovery\_ssl\_crl**

Section 17.7.1, “Group Replication System Variables”

## **group\_replication\_recovery\_ssl\_crlpath**

Section 17.7.1, “Group Replication System Variables”

## **group\_replication\_recovery\_ssl\_key**

Section 17.7.1, “Group Replication System Variables”

## **group\_replication\_recovery\_ssl\_verify\_server\_cert**

Section 17.7.1, “Group Replication System Variables”

## **group\_replication\_recovery\_use\_ssl**

Section 17.7.1, “Group Replication System Variables”

## **group\_replication\_single\_primary\_mode**

Section 17.3.2, “Group Replication Limitations”  
Section 17.7.1, “Group Replication System Variables”

## **group\_replication\_ssl\_mode**

Section 17.6.2, “Group Replication Secure Socket Layer (SSL) Support”  
Section 17.7.1, “Group Replication System Variables”

---

## **group\_replication\_start\_on\_boot**

[Section 17.2.1.2, “Configuring an Instance for Group Replication”](#)

[Section 17.7.1, “Group Replication System Variables”](#)

[Section 17.5.4, “Restarting a Group”](#)

## **group\_replication\_transaction\_size\_limit**

[Section 17.3.2, “Group Replication Limitations”](#)

[Section 17.7.1, “Group Replication System Variables”](#)

## **group\_replication\_unreachable\_majority\_timeout**

[Section 17.7.1, “Group Replication System Variables”](#)

## **gtid\_executed**

[Section 16.1.6.5, “Global Transaction ID System Variables”](#)

[Section 16.1.3.3, “GTID Auto-Positioning”](#)

[Section 16.1.3.1, “GTID Format and Storage”](#)

[Section 16.1.3.2, “GTID Life Cycle”](#)

[Section 25.12.11, “Performance Schema Replication Tables”](#)

[Section 16.1.5.2, “Provisioning a Multi-Source Replica for GTID-Based Replication”](#)

[Section 16.1.6.3, “Replica Server Options and Variables”](#)

[Section 16.1.4.1, “Replication Mode Concepts”](#)

[Section 13.4.1.2, “RESET MASTER Statement”](#)

[Section 17.5.4, “Restarting a Group”](#)

[Section 16.1.3.6, “Restrictions on Replication with GTIDs”](#)

[Section 5.1.7, “Server System Variables”](#)

[Section 13.7.5.23, “SHOW MASTER STATUS Statement”](#)

[Section 13.7.5.34, “SHOW SLAVE STATUS Statement”](#)

[Section 16.1.3.7, “Stored Function Examples to Manipulate GTIDs”](#)

[Section 16.1.3.5, “Using GTIDs for Failover and Scaleout”](#)

[Section 17.5.5, “Using MySQL Enterprise Backup with Group Replication”](#)

## **gtid\_executed\_compression\_period**

[Section 16.1.6.5, “Global Transaction ID System Variables”](#)

[Section 16.1.3.1, “GTID Format and Storage”](#)

## **GTID\_MODE**

[Section 13.4.2.1, “CHANGE MASTER TO Statement”](#)

[Section 16.1.3.3, “GTID Auto-Positioning”](#)

## **gtid\_mode**

[Section 16.1.5.3, “Adding GTID-Based Sources to a Multi-Source Replica”](#)

[Section 16.1.6.4, “Binary Logging Options and Variables”](#)

[Section 16.1.4.3, “Disabling GTID Transactions Online”](#)

[Section 16.1.4.2, “Enabling GTID Transactions Online”](#)

[Section 12.18, “Functions Used with Global Transaction Identifiers \(GTIDs\)”](#)

[Section 16.1.6.5, “Global Transaction ID System Variables”](#)

[Section 17.3.1, “Group Replication Requirements”](#)

[Section 16.1.3.1, “GTID Format and Storage”](#)

[Section 16.3.2, “Handling an Unexpected Halt of a Replica”](#)

[Section 4.4.7, “mysql\\_upgrade — Check and Upgrade MySQL Tables”](#)

[Section 4.5.4, “mysqldump — A Database Backup Program”](#)

[Section 16.1.6.3, “Replica Server Options and Variables”](#)



---

[Section 16.1.4.1, “Replication Mode Concepts”](#)  
[Section 13.4.1.2, “RESET MASTER Statement”](#)  
[Section 13.4.2.3, “RESET SLAVE Statement”](#)  
[Section 16.1.3.6, “Restrictions on Replication with GTIDs”](#)  
[Section 16.1.3.4, “Setting Up Replication Using GTIDs”](#)  
[Section 16.1.7.3, “Skipping Transactions”](#)  
[Skipping Transactions With GTIDs](#)  
[Skipping Transactions With `SET GLOBAL sql\_slave\_skip\_counter`](#)  
[Skipping Transactions Without GTIDs](#)  
[Section 25.12.7.1, “The `events\_transactions\_current` Table”](#)  
[Section 25.12.11.6, “The `replication\_applier\_status\_by\_worker` Table”](#)  
[Section 16.4.3, “Upgrading a Replication Topology”](#)  
[Section 2.10.4, “Upgrading MySQL Binary or Package-based Installations on Unix/Linux”](#)  
[Section 16.1.3.5, “Using GTIDs for Failover and Scaleout”](#)

## **gtid\_next**

[Section 16.1.6.5, “Global Transaction ID System Variables”](#)  
[Section 16.1.3.1, “GTID Format and Storage”](#)  
[Section 16.1.3.2, “GTID Life Cycle”](#)  
[Section 16.1.4.1, “Replication Mode Concepts”](#)  
[Section 5.1.9, “Server Status Variables”](#)  
[Section 13.4.2.6, “STOP SLAVE Statement”](#)  
[Section 25.12.7.1, “The `events\_transactions\_current` Table”](#)  
[Section 25.12.11.6, “The `replication\_applier\_status\_by\_worker` Table”](#)

## **gtid\_owned**

[Section 16.1.6.5, “Global Transaction ID System Variables”](#)  
[Section 16.1.3.2, “GTID Life Cycle”](#)

## **gtid\_purged**

[Section 13.4.2.1, “CHANGE MASTER TO Statement”](#)  
[Section 16.1.6.5, “Global Transaction ID System Variables”](#)  
[Section 17.3.1, “Group Replication Requirements”](#)  
[Section 16.1.3.3, “GTID Auto-Positioning”](#)  
[Section 16.1.3.1, “GTID Format and Storage”](#)  
[Section 16.1.3.2, “GTID Life Cycle”](#)  
[Section 16.1.5.2, “Provisioning a Multi-Source Replica for GTID-Based Replication”](#)  
[Section 16.1.4.1, “Replication Mode Concepts”](#)  
[Section 13.4.1.2, “RESET MASTER Statement”](#)  
[Section 16.1.3.7, “Stored Function Examples to Manipulate GTIDs”](#)  
[Section 16.1.3.5, “Using GTIDs for Failover and Scaleout”](#)

## **H**

[\[index top\]](#)

## **have\_compress**

[Section 5.1.7, “Server System Variables”](#)

## **have\_crypt**

[Section 5.1.7, “Server System Variables”](#)  
[Section 1.3, “What Is New in MySQL 5.7”](#)

---

## **have\_dynamic\_loading**

[Section 16.3.9.2, “Semisynchronous Replication Installation and Configuration”](#)

[Section 5.1.7, “Server System Variables”](#)

## **have\_geometry**

[Section 5.1.7, “Server System Variables”](#)

## **have\_openssl**

[Section 5.1.7, “Server System Variables”](#)

## **have\_profiling**

[Section 5.1.7, “Server System Variables”](#)

## **have\_query\_cache**

[Section 8.10.3.3, “Query Cache Configuration”](#)

[Section 5.1.7, “Server System Variables”](#)

[Section 1.3, “What Is New in MySQL 5.7”](#)

## **have\_rtree\_keys**

[Section 5.1.7, “Server System Variables”](#)

## **have\_ssl**

[Section 2.8.6, “Configuring SSL Library Support”](#)

[Section 5.1.7, “Server System Variables”](#)

## **have\_statement\_timeout**

[Section 5.1.7, “Server System Variables”](#)

## **have\_symlink**

[Section 5.1.7, “Server System Variables”](#)

[Section 8.12.3.3, “Using Symbolic Links for Databases on Windows”](#)

[Section 8.12.3.2, “Using Symbolic Links for MyISAM Tables on Unix”](#)

## **host\_cache\_size**

[Section 5.1.11.2, “DNS Lookups and the Host Cache”](#)

[Section 5.1.6, “Server Command Options”](#)

[Section 5.1.7, “Server System Variables”](#)

[Section 25.12.16.1, “The host\\_cache Table”](#)

## **hostname**

[Section 17.2.1.2, “Configuring an Instance for Group Replication”](#)

[Section 17.8, “Frequently Asked Questions”](#)

[Section 5.1.7, “Server System Variables”](#)

[Section 25.12.11.8, “The replication\\_group\\_members Table”](#)

## **I**

[\[index top\]](#)

## **identity**

[Section 5.4.4.3, “Mixed Binary Logging Format”](#)

---

[Section 16.4.1.37, “Replication and Variables”](#)  
[Section 5.1.7, “Server System Variables”](#)

## **ignore\_db\_dirs**

[Section 5.1.6, “Server Command Options”](#)  
[Section 5.1.7, “Server System Variables”](#)  
[Section 1.3, “What Is New in MySQL 5.7”](#)

## **init\_connect**

[Section 10.5, “Configuring Application Character Set and Collation”](#)  
[Section 6.2.2, “Privileges Provided by MySQL”](#)  
[Section 16.1.6.3, “Replica Server Options and Variables”](#)  
[Section 5.1.7, “Server System Variables”](#)  
[Section 25.12.16.1, “The host\\_cache Table”](#)

## **init\_file**

[Section 2.9.1, “Initializing the Data Directory”](#)  
[Section 8.10.2.2, “Multiple Key Caches”](#)  
[Section 25.4, “Performance Schema Runtime Configuration”](#)  
[Section 16.4.1.20, “Replication and MEMORY Tables”](#)  
[Resetting the Root Password: Unix and Unix-Like Systems](#)  
[Resetting the Root Password: Windows Systems](#)  
[Section 5.1.6, “Server Command Options”](#)  
[Section 5.1.7, “Server System Variables”](#)  
[Section 15.3, “The MEMORY Storage Engine”](#)

## **init\_slave**

[Section 16.1.6.3, “Replica Server Options and Variables”](#)

## **innodb**

[Section 14.8.2, “Configuring InnoDB for Read-Only Operation”](#)  
[Section A.16, “MySQL 5.7 FAQ: InnoDB Change Buffer”](#)

## **innodb\_adaptive\_flushing**

[Section 14.8.3.5, “Configuring Buffer Pool Flushing”](#)  
[Section 14.15, “InnoDB Startup Options and System Variables”](#)

## **innodb\_adaptive\_flushing\_lwm**

[Section 14.8.3.5, “Configuring Buffer Pool Flushing”](#)  
[Section 14.15, “InnoDB Startup Options and System Variables”](#)

## **innodb\_adaptive\_hash\_index**

[Section 14.5.3, “Adaptive Hash Index”](#)  
[Section 14.8.5, “Configuring Thread Concurrency for InnoDB”](#)  
[Section 14.15, “InnoDB Startup Options and System Variables”](#)  
[MySQL Glossary](#)  
[Section 8.5.9, “Optimizing InnoDB Configuration Variables”](#)  
[Section 13.1.34, “TRUNCATE TABLE Statement”](#)

## **innodb\_adaptive\_hash\_index\_parts**

[Section 14.5.3, “Adaptive Hash Index”](#)  
[Section 14.15, “InnoDB Startup Options and System Variables”](#)

---

Section 24.4.28, “The INFORMATION\_SCHEMA INNODB\_TRX Table”

### **innodb\_adaptive\_max\_sleep\_delay**

Section 14.8.5, “Configuring Thread Concurrency for InnoDB”  
Section 14.15, “InnoDB Startup Options and System Variables”

### **innodb\_api\_bk\_commit\_interval**

Section 14.21.5.4, “Controlling Transactional Behavior of the InnoDB memcached Plugin”  
Section 14.21.2, “InnoDB memcached Architecture”  
Section 14.15, “InnoDB Startup Options and System Variables”

### **innodb\_api\_disable\_rowlock**

Section 14.21.5.4, “Controlling Transactional Behavior of the InnoDB memcached Plugin”  
Section 14.15, “InnoDB Startup Options and System Variables”

### **innodb\_api\_enable\_binlog**

Section 14.15, “InnoDB Startup Options and System Variables”  
Section 14.21.6, “The InnoDB memcached Plugin and Replication”

### **innodb\_api\_enable\_md1**

Section 14.21.5.4, “Controlling Transactional Behavior of the InnoDB memcached Plugin”  
Section 14.21.2, “InnoDB memcached Architecture”  
Section 14.15, “InnoDB Startup Options and System Variables”

### **innodb\_api\_trx\_level**

Section 14.21.5.4, “Controlling Transactional Behavior of the InnoDB memcached Plugin”  
Section 14.21.2, “InnoDB memcached Architecture”  
Section 14.15, “InnoDB Startup Options and System Variables”

### **innodb\_autoextend\_increment**

Section 14.6.3.2, “File-Per-Table Tablespaces”  
Section 14.8.1, “InnoDB Startup Configuration”  
Section 14.15, “InnoDB Startup Options and System Variables”  
MySQL Glossary  
Section 14.6.3.1, “The System Tablespace”

### **innodb\_autoinc\_lock\_mode**

Section 14.6.1.6, “AUTO\_INCREMENT Handling in InnoDB”  
Section 8.5.5, “Bulk Data Loading for InnoDB Tables”  
Section 12.15, “Information Functions”  
Section 14.7.1, “InnoDB Locking”  
Section 14.15, “InnoDB Startup Options and System Variables”  
Section 14.7.3, “Locks Set by Different SQL Statements in InnoDB”  
MySQL Glossary

### **innodb\_background\_drop\_list\_empty**

Section 14.15, “InnoDB Startup Options and System Variables”

### **innodb\_buffer\_pool\_chunk\_size**

Section 14.8.3.1, “Configuring InnoDB Buffer Pool Size”  
Section 8.12.4.3, “Enabling Large Page Support”

---

[Section 14.15, “InnoDB Startup Options and System Variables”](#)  
[Section 1.3, “What Is New in MySQL 5.7”](#)

## **innodb\_buffer\_pool\_dump\_at\_shutdown**

[Section 14.15, “InnoDB Startup Options and System Variables”](#)  
[MySQL Glossary](#)

[Section 14.8.3.6, “Saving and Restoring the Buffer Pool State”](#)

## **innodb\_buffer\_pool\_dump\_now**

[Section 14.15, “InnoDB Startup Options and System Variables”](#)  
[Section 14.8.3.6, “Saving and Restoring the Buffer Pool State”](#)

## **innodb\_buffer\_pool\_dump\_pct**

[Section 14.15, “InnoDB Startup Options and System Variables”](#)  
[Section 14.8.3.6, “Saving and Restoring the Buffer Pool State”](#)  
[Section 1.3, “What Is New in MySQL 5.7”](#)

## **innodb\_buffer\_pool\_filename**

[Section 14.15, “InnoDB Startup Options and System Variables”](#)  
[Section 14.8.3.6, “Saving and Restoring the Buffer Pool State”](#)

## **innodb\_buffer\_pool\_instances**

[Section 14.8.3.5, “Configuring Buffer Pool Flushing”](#)  
[Section 14.8.3.1, “Configuring InnoDB Buffer Pool Size”](#)  
[Section 14.8.3.2, “Configuring Multiple Buffer Pool Instances”](#)  
[Section 8.12.4.1, “How MySQL Uses Memory”](#)  
[Section 14.8.1, “InnoDB Startup Configuration”](#)  
[Section 14.15, “InnoDB Startup Options and System Variables”](#)  
[MySQL Glossary](#)  
[Section 14.21.5.3, “Tuning InnoDB memcached Plugin Performance”](#)

## **innodb\_buffer\_pool\_load\_abort**

[Section 14.15, “InnoDB Startup Options and System Variables”](#)  
[Section 5.1.9, “Server Status Variables”](#)

## **innodb\_buffer\_pool\_load\_at\_startup**

[Section 14.15, “InnoDB Startup Options and System Variables”](#)  
[MySQL Glossary](#)  
[Section 14.8.3.6, “Saving and Restoring the Buffer Pool State”](#)  
[Section 5.1.9, “Server Status Variables”](#)

## **innodb\_buffer\_pool\_load\_now**

[Section 14.15, “InnoDB Startup Options and System Variables”](#)  
[Section 14.8.3.6, “Saving and Restoring the Buffer Pool State”](#)  
[Section 5.1.9, “Server Status Variables”](#)

## **innodb\_buffer\_pool\_size**

[Section 14.9.1.6, “Compression for OLTP Workloads”](#)  
[Section 14.8.3.1, “Configuring InnoDB Buffer Pool Size”](#)  
[Section 14.8.3.2, “Configuring Multiple Buffer Pool Instances”](#)  
[Section 14.6.1.5, “Converting Tables from MyISAM to InnoDB”](#)  
[Section 8.12.4.3, “Enabling Large Page Support”](#)

---

[Section 8.12.4.1, “How MySQL Uses Memory”](#)  
[Section 14.8.1, “InnoDB Startup Configuration”](#)  
[Section 14.15, “InnoDB Startup Options and System Variables”](#)  
[MySQL Glossary](#)  
[Section 8.5.8, “Optimizing InnoDB Disk I/O”](#)  
[Section 5.1.9, “Server Status Variables”](#)  
[Section 14.21.5.3, “Tuning InnoDB memcached Plugin Performance”](#)  
[Section 1.3, “What Is New in MySQL 5.7”](#)

## **innodb\_change\_buffer\_max\_size**

[Section 14.5.2, “Change Buffer”](#)  
[Section 14.15, “InnoDB Startup Options and System Variables”](#)  
[Section A.16, “MySQL 5.7 FAQ: InnoDB Change Buffer”](#)  
[MySQL Glossary](#)

## **innodb\_change\_buffering**

[Section 14.5.2, “Change Buffer”](#)  
[Section 14.8.2, “Configuring InnoDB for Read-Only Operation”](#)  
[Section 14.15, “InnoDB Startup Options and System Variables”](#)  
[MySQL Glossary](#)  
[Section 8.5.2, “Optimizing InnoDB Transaction Management”](#)

## **innodb\_change\_buffering\_debug**

[Section 14.15, “InnoDB Startup Options and System Variables”](#)

## **innodb\_checksum\_algorithm**

[Section 14.1.1, “Benefits of Using InnoDB Tables”](#)  
[Section 14.15, “InnoDB Startup Options and System Variables”](#)  
[MySQL Glossary](#)  
[Section 8.5.8, “Optimizing InnoDB Disk I/O”](#)

## **innodb\_checksums**

[Section 14.15, “InnoDB Startup Options and System Variables”](#)

## **innodb\_cmp\_per\_index\_enabled**

[Section 14.15, “InnoDB Startup Options and System Variables”](#)  
[Section 14.9.1.4, “Monitoring InnoDB Table Compression at Runtime”](#)  
[Section 24.4.7, “The INFORMATION\\_SCHEMA INNODB\\_CMP\\_PER\\_INDEX and INNODB\\_CMP\\_PER\\_INDEX\\_RESET Tables”](#)  
[Section 14.9.1.3, “Tuning Compression for InnoDB Tables”](#)

## **innodb\_commit\_concurrency**

[Section 14.15, “InnoDB Startup Options and System Variables”](#)

## **innodb\_compress\_debug**

[Section 14.15, “InnoDB Startup Options and System Variables”](#)

## **innodb\_compression\_failure\_threshold\_pct**

[Section 14.9.1.6, “Compression for OLTP Workloads”](#)  
[Section 14.9.1.5, “How Compression Works for InnoDB Tables”](#)  
[Section 14.15, “InnoDB Startup Options and System Variables”](#)  
[MySQL Glossary](#)

---

[Section 14.9.1.3, “Tuning Compression for InnoDB Tables”](#)

## **innodb\_compression\_level**

[Section 14.9.1.6, “Compression for OLTP Workloads”](#)

[Section 14.9.1.5, “How Compression Works for InnoDB Tables”](#)

[Section 14.15, “InnoDB Startup Options and System Variables”](#)

[MySQL Glossary](#)

[Section 14.9.1.3, “Tuning Compression for InnoDB Tables”](#)

## **innodb\_compression\_pad\_pct\_max**

[Section 14.9.1.6, “Compression for OLTP Workloads”](#)

[Section 14.9.1.5, “How Compression Works for InnoDB Tables”](#)

[Section 14.15, “InnoDB Startup Options and System Variables”](#)

[MySQL Glossary](#)

[Section 14.9.1.3, “Tuning Compression for InnoDB Tables”](#)

## **innodb\_concurrency\_tickets**

[Section 14.8.5, “Configuring Thread Concurrency for InnoDB”](#)

[Section 14.15, “InnoDB Startup Options and System Variables”](#)

[Section 8.5.9, “Optimizing InnoDB Configuration Variables”](#)

[Section 24.4.28, “The INFORMATION\\_SCHEMA INNODB\\_TRX Table”](#)

## **innodb\_data\_file\_path**

[Section 14.12.2, “File Space Management”](#)

[Section 2.9.1, “Initializing the Data Directory”](#)

[Section 4.6.1, “innochecksum — Offline InnoDB File Checksum Utility”](#)

[Section 14.8.1, “InnoDB Startup Configuration”](#)

[Section 14.15, “InnoDB Startup Options and System Variables”](#)

[Section 4.4.2, “mysql\\_install\\_db — Initialize MySQL Data Directory”](#)

[Section 24.3.9, “The INFORMATION\\_SCHEMA FILES Table”](#)

[Section 14.6.3.1, “The System Tablespace”](#)

[Section 14.22.1, “Troubleshooting InnoDB I/O Problems”](#)

## **innodb\_data\_home\_dir**

[Section 2.9.1, “Initializing the Data Directory”](#)

[Section 14.8.1, “InnoDB Startup Configuration”](#)

[Section 14.15, “InnoDB Startup Options and System Variables”](#)

[Section 4.4.2, “mysql\\_install\\_db — Initialize MySQL Data Directory”](#)

[Section 14.6.3.5, “The Temporary Tablespace”](#)

[Section 14.22.1, “Troubleshooting InnoDB I/O Problems”](#)

[Section 17.5.5, “Using MySQL Enterprise Backup with Group Replication”](#)

## **innodb\_deadlock\_detect**

[Section 14.6.1.5, “Converting Tables from MyISAM to InnoDB”](#)

[Section 14.7.5.2, “Deadlock Detection”](#)

[Section 14.7.5, “Deadlocks in InnoDB”](#)

[Section 14.15, “InnoDB Startup Options and System Variables”](#)

[Section 8.11.1, “Internal Locking Methods”](#)

[MySQL Glossary](#)

## **innodb\_default\_row\_format**

[Section 2.10.3, “Changes in MySQL 5.7”](#)

---

[Section 13.1.18, “CREATE TABLE Statement”](#)  
[Section 14.6.1.1, “Creating InnoDB Tables”](#)  
[Section 14.6.1.3, “Importing InnoDB Tables”](#)  
[Section 14.11, “InnoDB Row Formats”](#)  
[Section 14.15, “InnoDB Startup Options and System Variables”](#)  
[MySQL Glossary](#)  
[Section 8.4.1, “Optimizing Data Size”](#)  
[Section 1.3, “What Is New in MySQL 5.7”](#)

## **innodb\_disable\_resize\_buffer\_pool\_debug**

[Section 14.15, “InnoDB Startup Options and System Variables”](#)

## **innodb\_disable\_sort\_file\_cache**

[Section 14.15, “InnoDB Startup Options and System Variables”](#)

## **innodb\_doublewrite**

[Section 14.6.5, “Doublewrite Buffer”](#)  
[Section 14.12.1, “InnoDB Disk I/O”](#)  
[Section 14.8.1, “InnoDB Startup Configuration”](#)  
[Section 14.15, “InnoDB Startup Options and System Variables”](#)  
[Section 8.5.8, “Optimizing InnoDB Disk I/O”](#)  
[Section 14.21.5.3, “Tuning InnoDB memcached Plugin Performance”](#)

## **innodb\_fast\_shutdown**

[Section 2.10.3, “Changes in MySQL 5.7”](#)  
[Section 14.10.2.1, “Compatibility Check When InnoDB Is Started”](#)  
[Section 2.11.3, “Downgrade Notes”](#)  
[Section 2.11.4, “Downgrading Binary and Package-based Installations on Unix/Linux”](#)  
[Section 14.19.2, “InnoDB Recovery”](#)  
[Section 14.15, “InnoDB Startup Options and System Variables”](#)  
[MySQL Glossary](#)  
[Section 5.1.16, “The Server Shutdown Process”](#)  
[Section 2.10.4, “Upgrading MySQL Binary or Package-based Installations on Unix/Linux”](#)

## **innodb\_fil\_make\_page\_dirty\_debug**

[Section 14.15, “InnoDB Startup Options and System Variables”](#)

## **innodb\_file\_format**

[Section 14.10.2.2, “Compatibility Check When a Table Is Opened”](#)  
[Section 14.10.2.1, “Compatibility Check When InnoDB Is Started”](#)  
[Section 10.9.8, “Converting Between 3-Byte and 4-Byte Unicode Character Sets”](#)  
[Section 14.6.1.5, “Converting Tables from MyISAM to InnoDB”](#)  
[Section 13.1.19, “CREATE TABLESPACE Statement”](#)  
[Section 14.9.1.2, “Creating Compressed Tables”](#)  
[Section 14.10.1, “Enabling File Formats”](#)  
[Section 14.6.3.3, “General Tablespaces”](#)  
[Section 14.9.1.5, “How Compression Works for InnoDB Tables”](#)  
[Section 14.10.3, “Identifying the File Format in Use”](#)  
[Section 14.10, “InnoDB File-Format Management”](#)  
[Section 14.11, “InnoDB Row Formats”](#)  
[Section 14.15, “InnoDB Startup Options and System Variables”](#)  
[MySQL Glossary](#)  
[Section 14.9.1.7, “SQL Compression Syntax Warnings and Errors”](#)



---

## **innodb\_file\_format\_check**

Section 14.10.2.2, “Compatibility Check When a Table Is Opened”  
Section 14.10.2.1, “Compatibility Check When InnoDB Is Started”  
Section 14.10, “InnoDB File-Format Management”  
Section 14.15, “InnoDB Startup Options and System Variables”

## **innodb\_file\_format\_max**

Section 13.1.19, “CREATE TABLESPACE Statement”  
Section 14.10, “InnoDB File-Format Management”  
Section 14.15, “InnoDB Startup Options and System Variables”

## **innodb\_file\_per**

Section 14.15, “InnoDB Startup Options and System Variables”

## **innodb\_file\_per\_table**

Section 14.1.2, “Best Practices for InnoDB Tables”  
Section 10.9.8, “Converting Between 3-Byte and 4-Byte Unicode Character Sets”  
Section 14.6.1.5, “Converting Tables from MyISAM to InnoDB”  
Section 13.1.18, “CREATE TABLE Statement”  
Section 13.1.19, “CREATE TABLESPACE Statement”  
Section 14.9.1.2, “Creating Compressed Tables”  
Section 14.6.1.1, “Creating InnoDB Tables”  
Section 14.6.1.2, “Creating Tables Externally”  
Section 14.12.2, “File Space Management”  
Section 14.6.3.2, “File-Per-Table Tablespaces”  
Section 13.1.18.1, “Files Created by CREATE TABLE”  
Section 13.7.6.3, “FLUSH Statement”  
Section 14.6.3.3, “General Tablespaces”  
Section 14.9.1.5, “How Compression Works for InnoDB Tables”  
Section 14.6.1.3, “Importing InnoDB Tables”  
Section 14.2, “InnoDB and the ACID Model”  
Section 14.14, “InnoDB Data-at-Rest Encryption”  
Section 14.11, “InnoDB Row Formats”  
Section 14.15, “InnoDB Startup Options and System Variables”  
MySQL Glossary  
Section 13.7.2.4, “OPTIMIZE TABLE Statement”  
Section 14.12.5, “Reclaiming Disk Space with TRUNCATE TABLE”  
Section 16.3.5, “Replicating Different Databases to Different Replicas”  
Section 22.6, “Restrictions and Limitations on Partitioning”  
Section 14.9.1.7, “SQL Compression Syntax Warnings and Errors”  
Section 14.6.3.5, “The Temporary Tablespace”  
Section 14.22.3, “Troubleshooting InnoDB Data Dictionary Operations”

## **innodb\_fill\_factor**

Section 14.15, “InnoDB Startup Options and System Variables”  
Section 14.6.2.3, “Sorted Index Builds”  
Section 14.6.2.2, “The Physical Structure of an InnoDB Index”  
Section 1.3, “What Is New in MySQL 5.7”

## **innodb\_flush\_log\_at\_timeout**

Section 14.15, “InnoDB Startup Options and System Variables”  
Section 14.5.4, “Log Buffer”

---

## **innodb\_flush\_log\_at\_trx\_commit**

[Section 16.1.6.4, “Binary Logging Options and Variables”](#)  
[Section 16.3.2, “Handling an Unexpected Halt of a Replica”](#)  
[Section 14.2, “InnoDB and the ACID Model”](#)  
[Section 14.15, “InnoDB Startup Options and System Variables”](#)  
[Section 14.5.4, “Log Buffer”](#)  
[Section 8.5.2, “Optimizing InnoDB Transaction Management”](#)  
[Section 16.4.1.26, “Replication and Source or Replica Shutdowns”](#)  
[Section 14.21.5.3, “Tuning InnoDB memcached Plugin Performance”](#)

## **innodb\_flush\_method**

[Section 14.6.5, “Doublewrite Buffer”](#)  
[Section 14.6.3.2, “File-Per-Table Tablespaces”](#)  
[Section 14.12.1, “InnoDB Disk I/O”](#)  
[Section 14.8.1, “InnoDB Startup Configuration”](#)  
[Section 14.15, “InnoDB Startup Options and System Variables”](#)  
[Section 2.3, “Installing MySQL on Microsoft Windows”](#)  
[Section 8.5.8, “Optimizing InnoDB Disk I/O”](#)  
[Section 5.1.9, “Server Status Variables”](#)  
[Section 14.21.5.3, “Tuning InnoDB memcached Plugin Performance”](#)

## **innodb\_flush\_neighbors**

[Section 14.8.3.5, “Configuring Buffer Pool Flushing”](#)  
[Section 14.15, “InnoDB Startup Options and System Variables”](#)  
[MySQL Glossary](#)  
[Section 8.5.8, “Optimizing InnoDB Disk I/O”](#)

## **innodb\_flush\_sync**

[Section 14.8.8, “Configuring InnoDB I/O Capacity”](#)  
[Section 14.15, “InnoDB Startup Options and System Variables”](#)

## **innodb\_flushing\_avg\_loops**

[Section 14.8.3.5, “Configuring Buffer Pool Flushing”](#)  
[Section 14.15, “InnoDB Startup Options and System Variables”](#)

## **innodb\_force\_load\_corrupted**

[Section 14.15, “InnoDB Startup Options and System Variables”](#)

## **innodb\_force\_recovery**

[Section 13.1.29, “DROP TABLE Statement”](#)  
[Section 14.22.2, “Forcing InnoDB Recovery”](#)  
[Section 1.5, “How to Report Bugs or Problems”](#)  
[Section 14.19.2, “InnoDB Recovery”](#)  
[Section 14.15, “InnoDB Startup Options and System Variables”](#)  
[Section 8.5.2, “Optimizing InnoDB Transaction Management”](#)  
[Section 2.10.12, “Rebuilding or Repairing Tables or Indexes”](#)

## **innodb\_ft\_aux\_table**

[Section 14.16.4, “InnoDB INFORMATION\\_SCHEMA FULLTEXT Index Tables”](#)  
[Section 14.15, “InnoDB Startup Options and System Variables”](#)  
[Section 24.4.8, “The INFORMATION\\_SCHEMA INNODB\\_FT\\_BEING\\_DELETED Table”](#)

---

[Section 24.4.9, “The INFORMATION\\_SCHEMA INNODB\\_FT\\_CONFIG Table”](#)  
[Section 24.4.11, “The INFORMATION\\_SCHEMA INNODB\\_FT\\_DELETED Table”](#)  
[Section 24.4.12, “The INFORMATION\\_SCHEMA INNODB\\_FT\\_INDEX\\_CACHE Table”](#)  
[Section 24.4.13, “The INFORMATION\\_SCHEMA INNODB\\_FT\\_INDEX\\_TABLE Table”](#)

### **innodb\_ft\_cache\_size**

[Section 14.6.2.4, “InnoDB Full-Text Indexes”](#)  
[Section 14.16.4, “InnoDB INFORMATION\\_SCHEMA FULLTEXT Index Tables”](#)  
[Section 14.15, “InnoDB Startup Options and System Variables”](#)  
[MySQL Glossary](#)  
[Section 24.4.12, “The INFORMATION\\_SCHEMA INNODB\\_FT\\_INDEX\\_CACHE Table”](#)

### **innodb\_ft\_enable\_diag\_print**

[Section 14.15, “InnoDB Startup Options and System Variables”](#)

### **innodb\_ft\_enable\_stopword**

[Section 12.9.2, “Boolean Full-Text Searches”](#)  
[Section 12.9.6, “Fine-Tuning MySQL Full-Text Search”](#)  
[Section 14.15, “InnoDB Startup Options and System Variables”](#)  
[Section 12.9.1, “Natural Language Full-Text Searches”](#)

### **innodb\_ft\_max\_token\_size**

[Section 12.9.2, “Boolean Full-Text Searches”](#)  
[Section 12.9.6, “Fine-Tuning MySQL Full-Text Search”](#)  
[Section 12.9.4, “Full-Text Stopwords”](#)  
[Section 14.15, “InnoDB Startup Options and System Variables”](#)  
[Section 12.9.8, “ngram Full-Text Parser”](#)

### **innodb\_ft\_min\_token\_size**

[Section 12.9.2, “Boolean Full-Text Searches”](#)  
[Section 12.9.6, “Fine-Tuning MySQL Full-Text Search”](#)  
[Section 12.9.4, “Full-Text Stopwords”](#)  
[Section 14.15, “InnoDB Startup Options and System Variables”](#)  
[Section 12.9.9, “MeCab Full-Text Parser Plugin”](#)  
[Section 12.9.1, “Natural Language Full-Text Searches”](#)  
[Section 12.9.8, “ngram Full-Text Parser”](#)

### **innodb\_ft\_num\_word\_optimize**

[Section 12.9.6, “Fine-Tuning MySQL Full-Text Search”](#)  
[Section 14.15, “InnoDB Startup Options and System Variables”](#)  
[Section 13.7.2.4, “OPTIMIZE TABLE Statement”](#)

### **innodb\_ft\_result\_cache\_limit**

[Section 14.15, “InnoDB Startup Options and System Variables”](#)

### **innodb\_ft\_server\_stopword\_table**

[Section 12.9.2, “Boolean Full-Text Searches”](#)  
[Section 12.9.6, “Fine-Tuning MySQL Full-Text Search”](#)  
[Section 12.9.4, “Full-Text Stopwords”](#)  
[Section 14.15, “InnoDB Startup Options and System Variables”](#)  
[Section 12.9.1, “Natural Language Full-Text Searches”](#)  
[Section 24.4.10, “The INFORMATION\\_SCHEMA INNODB\\_FT\\_DEFAULT\\_STOPWORD Table”](#)

---

## **innodb\_ft\_sort\_pll\_degree**

[Section 14.6.2.4, “InnoDB Full-Text Indexes”](#)

[Section 14.15, “InnoDB Startup Options and System Variables”](#)

## **innodb\_ft\_total\_cache\_size**

[Section 14.6.2.4, “InnoDB Full-Text Indexes”](#)

[Section 14.16.4, “InnoDB INFORMATION\\_SCHEMA FULLTEXT Index Tables”](#)

[Section 14.15, “InnoDB Startup Options and System Variables”](#)

[Section 24.4.12, “The INFORMATION\\_SCHEMA INNODB\\_FT\\_INDEX\\_CACHE Table”](#)

## **innodb\_ft\_user\_stopword\_table**

[Section 12.9.2, “Boolean Full-Text Searches”](#)

[Section 12.9.6, “Fine-Tuning MySQL Full-Text Search”](#)

[Section 12.9.4, “Full-Text Stopwords”](#)

[Section 14.15, “InnoDB Startup Options and System Variables”](#)

[Section 12.9.1, “Natural Language Full-Text Searches”](#)

[Section 24.4.10, “The INFORMATION\\_SCHEMA INNODB\\_FT\\_DEFAULT\\_STOPWORD Table”](#)

## **innodb\_io\_capacity**

[Section 14.8.3.5, “Configuring Buffer Pool Flushing”](#)

[Section 14.8.8, “Configuring InnoDB I/O Capacity”](#)

[Section 14.15, “InnoDB Startup Options and System Variables”](#)

[Section A.16, “MySQL 5.7 FAQ: InnoDB Change Buffer”](#)

[Section 8.5.8, “Optimizing InnoDB Disk I/O”](#)

[Section 1.3, “What Is New in MySQL 5.7”](#)

## **innodb\_io\_capacity\_max**

[Section 14.8.3.5, “Configuring Buffer Pool Flushing”](#)

[Section 14.8.8, “Configuring InnoDB I/O Capacity”](#)

[Section 14.15, “InnoDB Startup Options and System Variables”](#)

[Section 8.5.8, “Optimizing InnoDB Disk I/O”](#)

## **innodb\_large\_prefix**

[Section 8.3.4, “Column Indexes”](#)

[Section 10.9.8, “Converting Between 3-Byte and 4-Byte Unicode Character Sets”](#)

[Section 13.1.14, “CREATE INDEX Statement”](#)

[Section 13.1.18, “CREATE TABLE Statement”](#)

[Section 14.10, “InnoDB File-Format Management”](#)

[Section 14.23, “InnoDB Limits”](#)

[Section 14.11, “InnoDB Row Formats”](#)

[Section 14.15, “InnoDB Startup Options and System Variables”](#)

[MySQL Glossary](#)

## **innodb\_limit\_optimistic\_insert\_debug**

[Section 14.15, “InnoDB Startup Options and System Variables”](#)

## **innodb\_lock\_wait\_timeout**

[Section 14.6.1.5, “Converting Tables from MyISAM to InnoDB”](#)

[Section 14.7.5.2, “Deadlock Detection”](#)

[Section 14.7.5, “Deadlocks in InnoDB”](#)

[Section 14.15, “InnoDB Startup Options and System Variables”](#)

[Section 8.11.1, “Internal Locking Methods”](#)

---

MySQL Glossary  
Section 16.1.6.3, “Replica Server Options and Variables”  
Section 16.4.1.30, “Replication Retries and Timeouts”

## **innodb\_locks\_unsafe\_for\_binlog**

Section 14.7.2.3, “Consistent Nonlocking Reads”  
Section 14.7.1, “InnoDB Locking”  
Section 14.15, “InnoDB Startup Options and System Variables”  
Section 14.7.3, “Locks Set by Different SQL Statements in InnoDB”  
MySQL Glossary  
Section 14.7.2.1, “Transaction Isolation Levels”

## **innodb\_log\_buffer\_size**

Section 14.8.1, “InnoDB Startup Configuration”  
Section 14.15, “InnoDB Startup Options and System Variables”  
Section 14.5.4, “Log Buffer”  
MySQL Glossary  
Section 8.5.4, “Optimizing InnoDB Redo Logging”

## **innodb\_log\_checkpoint\_now**

Section 14.15, “InnoDB Startup Options and System Variables”

## **innodb\_log\_checksums**

Section 14.15, “InnoDB Startup Options and System Variables”

## **innodb\_log\_compressed\_pages**

Section 14.9.1.6, “Compression for OLTP Workloads”  
Section 14.15, “InnoDB Startup Options and System Variables”  
Section 8.5.8, “Optimizing InnoDB Disk I/O”

## **innodb\_log\_file\_size**

Section 14.8.3.5, “Configuring Buffer Pool Flushing”  
Section 14.8.2, “Configuring InnoDB for Read-Only Operation”  
Section 2.9.1, “Initializing the Data Directory”  
Section 14.8.1, “InnoDB Startup Configuration”  
Section 14.15, “InnoDB Startup Options and System Variables”  
Section 4.4.2, “mysql\_install\_db — Initialize MySQL Data Directory”  
Section 8.5.8, “Optimizing InnoDB Disk I/O”  
Section 8.5.4, “Optimizing InnoDB Redo Logging”  
Section 14.6.6, “Redo Log”  
Section 5.1.8, “Using System Variables”

## **innodb\_log\_files\_in\_group**

Section 14.8.1, “InnoDB Startup Configuration”  
Section 14.15, “InnoDB Startup Options and System Variables”  
Section 8.5.4, “Optimizing InnoDB Redo Logging”  
Section 14.6.6, “Redo Log”

## **innodb\_log\_group\_home\_dir**

Section 2.9.1, “Initializing the Data Directory”  
Section 14.8.1, “InnoDB Startup Configuration”  
Section 14.15, “InnoDB Startup Options and System Variables”

---

[Section 4.4.2, “mysql\\_install\\_db — Initialize MySQL Data Directory”](#)  
[Section 14.6.3.4, “Undo Tablespaces”](#)  
[Section 17.5.5, “Using MySQL Enterprise Backup with Group Replication”](#)

### **innodb\_log\_write\_ahead\_size**

[Section 14.15, “InnoDB Startup Options and System Variables”](#)  
[Section 8.5.4, “Optimizing InnoDB Redo Logging”](#)

### **innodb\_lru\_scan\_depth**

[Section 14.8.3.5, “Configuring Buffer Pool Flushing”](#)  
[Section 14.15, “InnoDB Startup Options and System Variables”](#)

### **innodb\_max\_dirty\_pages\_pct**

[Section 14.8.3.5, “Configuring Buffer Pool Flushing”](#)  
[Section 14.15, “InnoDB Startup Options and System Variables”](#)  
[Section 8.5.8, “Optimizing InnoDB Disk I/O”](#)

### **innodb\_max\_dirty\_pages\_pct\_lwm**

[Section 14.8.3.5, “Configuring Buffer Pool Flushing”](#)  
[Section 14.15, “InnoDB Startup Options and System Variables”](#)

### **innodb\_max\_purge\_lag**

[Section 14.3, “InnoDB Multi-Versioning”](#)  
[Section 14.15, “InnoDB Startup Options and System Variables”](#)  
[MySQL Glossary](#)  
[Section 14.8.10, “Purge Configuration”](#)

### **innodb\_max\_purge\_lag\_delay**

[Section 14.15, “InnoDB Startup Options and System Variables”](#)  
[Section 14.8.10, “Purge Configuration”](#)

### **innodb\_max\_undo\_log\_size**

[Section 14.15, “InnoDB Startup Options and System Variables”](#)  
[Section 14.6.3.4, “Undo Tablespaces”](#)

### **innodb\_merge\_threshold\_set\_all\_debug**

[Section 14.15, “InnoDB Startup Options and System Variables”](#)

### **innodb\_monitor\_disable**

[Section 14.16.6, “InnoDB INFORMATION\\_SCHEMA Metrics Table”](#)  
[Section 14.15, “InnoDB Startup Options and System Variables”](#)  
[Section 13.7.5.15, “SHOW ENGINE Statement”](#)  
[Section 24.4.16, “The INFORMATION\\_SCHEMA INNODB\\_METRICS Table”](#)

### **innodb\_monitor\_enable**

[Section 14.16.6, “InnoDB INFORMATION\\_SCHEMA Metrics Table”](#)  
[Section 14.15, “InnoDB Startup Options and System Variables”](#)  
[Section 13.7.5.15, “SHOW ENGINE Statement”](#)  
[Section 24.4.16, “The INFORMATION\\_SCHEMA INNODB\\_METRICS Table”](#)

### **innodb\_monitor\_reset**

[Section 14.16.6, “InnoDB INFORMATION\\_SCHEMA Metrics Table”](#)

---

[Section 14.15, “InnoDB Startup Options and System Variables”](#)  
[Section 24.4.16, “The INFORMATION\\_SCHEMA INNODB\\_METRICS Table”](#)

### **innodb\_monitor\_reset\_all**

[Section 14.16.6, “InnoDB INFORMATION\\_SCHEMA Metrics Table”](#)  
[Section 14.15, “InnoDB Startup Options and System Variables”](#)  
[Section 24.4.16, “The INFORMATION\\_SCHEMA INNODB\\_METRICS Table”](#)

### **innodb\_numa\_interleave**

[Section 14.15, “InnoDB Startup Options and System Variables”](#)

### **innodb\_old\_blocks\_pct**

[Section 14.15, “InnoDB Startup Options and System Variables”](#)  
[Section 14.8.3.3, “Making the Buffer Pool Scan Resistant”](#)  
[MySQL Glossary](#)

### **innodb\_old\_blocks\_time**

[Section 14.5.1, “Buffer Pool”](#)  
[Section 14.15, “InnoDB Startup Options and System Variables”](#)  
[Section 14.8.3.3, “Making the Buffer Pool Scan Resistant”](#)

### **innodb\_online\_alter\_log\_max\_size**

[Section 14.15, “InnoDB Startup Options and System Variables”](#)  
[MySQL Glossary](#)  
[Section 14.13.5, “Online DDL Failure Conditions”](#)  
[Section 14.13.3, “Online DDL Space Requirements”](#)

### **innodb\_open\_files**

[Section 14.15, “InnoDB Startup Options and System Variables”](#)  
[Section 5.1.7, “Server System Variables”](#)

### **innodb\_optimize\_fulltext\_only**

[Section 12.9.6, “Fine-Tuning MySQL Full-Text Search”](#)  
[Section 14.6.2.4, “InnoDB Full-Text Indexes”](#)  
[Section 14.16.4, “InnoDB INFORMATION\\_SCHEMA FULLTEXT Index Tables”](#)  
[Section 14.15, “InnoDB Startup Options and System Variables”](#)  
[Section 13.7.2.4, “OPTIMIZE TABLE Statement”](#)  
[Section 24.4.13, “The INFORMATION\\_SCHEMA INNODB\\_FT\\_INDEX\\_TABLE Table”](#)

### **innodb\_page\_cleaners**

[Section 14.8.3.5, “Configuring Buffer Pool Flushing”](#)  
[Section 14.15, “InnoDB Startup Options and System Variables”](#)  
[MySQL Glossary](#)  
[Section 1.3, “What Is New in MySQL 5.7”](#)

### **innodb\_page\_size**

[Section 14.6.1.5, “Converting Tables from MyISAM to InnoDB”](#)  
[Section 13.1.18, “CREATE TABLE Statement”](#)  
[Section 13.1.19, “CREATE TABLESPACE Statement”](#)  
[Section 14.9.1.2, “Creating Compressed Tables”](#)  
[Section 14.8.11.3, “Estimating ANALYZE TABLE Complexity for InnoDB Tables”](#)  
[Section 14.12.2, “File Space Management”](#)

---

[Section 14.6.3.3, “General Tablespaces”](#)  
[Section 14.9.1.5, “How Compression Works for InnoDB Tables”](#)  
[Section 14.6.1.3, “Importing InnoDB Tables”](#)  
[Section 14.23, “InnoDB Limits”](#)  
[Section 14.9.2, “InnoDB Page Compression”](#)  
[Section 14.24, “InnoDB Restrictions and Limitations”](#)  
[Section 14.8.1, “InnoDB Startup Configuration”](#)  
[Section 14.15, “InnoDB Startup Options and System Variables”](#)  
[Section 8.4.7, “Limits on Table Column Count and Row Size”](#)  
[MySQL Glossary](#)  
[Section 8.5.8, “Optimizing InnoDB Disk I/O”](#)  
[Section 8.5.4, “Optimizing InnoDB Redo Logging”](#)  
[Section 14.9.1.1, “Overview of Table Compression”](#)  
[Section 24.3.9, “The INFORMATION\\_SCHEMA FILES Table”](#)  
[Section 14.6.2.2, “The Physical Structure of an InnoDB Index”](#)  
[Section 14.21.8, “Troubleshooting the InnoDB memcached Plugin”](#)  
[Section 14.6.7, “Undo Logs”](#)  
[Section 14.6.3.4, “Undo Tablespaces”](#)

### **innodb\_print\_all\_deadlocks**

[Section 14.6.1.5, “Converting Tables from MyISAM to InnoDB”](#)  
[Section 14.7.5, “Deadlocks in InnoDB”](#)  
[Section 14.7.5.3, “How to Minimize and Handle Deadlocks”](#)  
[Section 14.15, “InnoDB Startup Options and System Variables”](#)  
[Section 14.22, “InnoDB Troubleshooting”](#)

### **innodb\_purge\_batch\_size**

[Section 14.15, “InnoDB Startup Options and System Variables”](#)  
[Section 14.8.10, “Purge Configuration”](#)

### **innodb\_purge\_rseg\_truncate\_frequency**

[Section 14.15, “InnoDB Startup Options and System Variables”](#)  
[Section 14.8.10, “Purge Configuration”](#)  
[Section 14.6.3.4, “Undo Tablespaces”](#)

### **innodb\_purge\_threads**

[Section 14.15, “InnoDB Startup Options and System Variables”](#)  
[MySQL Glossary](#)  
[Section 14.8.10, “Purge Configuration”](#)

### **innodb\_random\_read\_ahead**

[Section 14.8.3.4, “Configuring InnoDB Buffer Pool Prefetching \(Read-Ahead\)”](#)  
[Section 14.15, “InnoDB Startup Options and System Variables”](#)  
[MySQL Glossary](#)

### **innodb\_read\_ahead\_threshold**

[Section 14.8.3.4, “Configuring InnoDB Buffer Pool Prefetching \(Read-Ahead\)”](#)  
[Section 14.15, “InnoDB Startup Options and System Variables”](#)

### **innodb\_read\_io\_threads**

[Section 14.8.6, “Configuring the Number of Background InnoDB I/O Threads”](#)  
[Section 14.18.3, “InnoDB Standard Monitor and Lock Monitor Output”](#)



---

Section 14.15, “InnoDB Startup Options and System Variables”  
Section 14.8.7, “Using Asynchronous I/O on Linux”

### **innodb\_read\_only**

Section 14.15, “InnoDB Startup Options and System Variables”

### **innodb\_replication\_delay**

Section 14.15, “InnoDB Startup Options and System Variables”

### **innodb\_rollback\_on\_timeout**

Section 14.15, “InnoDB Startup Options and System Variables”

### **innodb\_rollback\_segments**

Section 14.8.1, “InnoDB Startup Configuration”  
Section 14.15, “InnoDB Startup Options and System Variables”  
Section 5.1.9, “Server Status Variables”  
Section 14.6.7, “Undo Logs”  
Section 14.6.3.4, “Undo Tablespaces”

### **innodb\_saved\_page\_number\_debug**

Section 14.15, “InnoDB Startup Options and System Variables”

### **innodb\_sort\_buffer\_size**

Section 14.15, “InnoDB Startup Options and System Variables”  
MySQL Glossary  
Section 14.13.3, “Online DDL Space Requirements”

### **innodb\_spin\_wait\_delay**

Section 14.8.9, “Configuring Spin Lock Polling”  
Section 14.15, “InnoDB Startup Options and System Variables”

### **innodb\_stats\_auto\_recalc**

Configuring Automatic Statistics Calculation for Persistent Optimizer Statistics  
Section 14.8.11, “Configuring Optimizer Statistics for InnoDB”  
Configuring Optimizer Statistics Parameters for Individual Tables  
Section 13.1.18, “CREATE TABLE Statement”  
InnoDB Persistent Statistics Tables Example  
Section 14.15, “InnoDB Startup Options and System Variables”

### **innodb\_stats\_include\_delete\_marked**

Including Delete-marked Records in Persistent Statistics Calculations  
Section 14.15, “InnoDB Startup Options and System Variables”

### **innodb\_stats\_method**

Section 8.3.7, “InnoDB and MyISAM Index Statistics Collection”  
Section 14.15, “InnoDB Startup Options and System Variables”  
MySQL Glossary

### **innodb\_stats\_on\_metadata**

Section 14.8.11.2, “Configuring Non-Persistent Optimizer Statistics Parameters”  
Section 14.15, “InnoDB Startup Options and System Variables”

---

## **innodb\_stats\_persistent**

[Section 13.7.2.1, “ANALYZE TABLE Statement”](#)  
[Section 14.8.11.2, “Configuring Non-Persistent Optimizer Statistics Parameters”](#)  
[Section 14.8.11, “Configuring Optimizer Statistics for InnoDB”](#)  
[Configuring Optimizer Statistics Parameters for Individual Tables](#)  
[Section 14.8.11.1, “Configuring Persistent Optimizer Statistics Parameters”](#)  
[Section 13.1.14, “CREATE INDEX Statement”](#)  
[Section 13.1.18, “CREATE TABLE Statement”](#)  
[Section 14.8.11.3, “Estimating ANALYZE TABLE Complexity for InnoDB Tables”](#)  
[Section 14.15, “InnoDB Startup Options and System Variables”](#)  
[Section 8.5.10, “Optimizing InnoDB for Systems with Many Tables”](#)

## **innodb\_stats\_persistent\_sample\_pages**

[Section 13.7.2.1, “ANALYZE TABLE Statement”](#)  
[Configuring Optimizer Statistics Parameters for Individual Tables](#)  
[Configuring the Number of Sampled Pages for InnoDB Optimizer Statistics](#)  
[Section 14.8.11.3, “Estimating ANALYZE TABLE Complexity for InnoDB Tables”](#)  
[Section 14.15, “InnoDB Startup Options and System Variables”](#)

## **innodb\_stats\_sample\_pages**

[Section 14.15, “InnoDB Startup Options and System Variables”](#)

## **innodb\_stats\_transient\_sample\_pages**

[Section 13.7.2.1, “ANALYZE TABLE Statement”](#)  
[Section 14.8.11.2, “Configuring Non-Persistent Optimizer Statistics Parameters”](#)  
[Section 14.8.11.3, “Estimating ANALYZE TABLE Complexity for InnoDB Tables”](#)  
[Section 14.15, “InnoDB Startup Options and System Variables”](#)

## **innodb\_status\_output**

[Section 14.18.2, “Enabling InnoDB Monitors”](#)  
[Section 14.15, “InnoDB Startup Options and System Variables”](#)  
[Section 1.3, “What Is New in MySQL 5.7”](#)

## **innodb\_status\_output\_locks**

[Section 14.18.2, “Enabling InnoDB Monitors”](#)  
[Section 14.15, “InnoDB Startup Options and System Variables”](#)  
[Section 1.3, “What Is New in MySQL 5.7”](#)

## **innodb\_strict\_mode**

[Section 13.1.18, “CREATE TABLE Statement”](#)  
[Section 13.1.19, “CREATE TABLESPACE Statement”](#)  
[Section 14.9.1.5, “How Compression Works for InnoDB Tables”](#)  
[Section 14.15, “InnoDB Startup Options and System Variables”](#)  
[MySQL Glossary](#)  
[Section 5.1.10, “Server SQL Modes”](#)  
[Section 14.9.1.7, “SQL Compression Syntax Warnings and Errors”](#)

## **innodb\_support\_xa**

[Section 14.15, “InnoDB Startup Options and System Variables”](#)  
[MySQL Glossary](#)  
[Section 8.5.2, “Optimizing InnoDB Transaction Management”](#)  
[Section 5.4.4, “The Binary Log”](#)

---

[Section 14.21.5.3, "Tuning InnoDB memcached Plugin Performance"](#)  
[Section 1.3, "What Is New in MySQL 5.7"](#)

## **innodb\_sync\_array\_size**

[Section 14.15, "InnoDB Startup Options and System Variables"](#)

## **innodb\_sync\_debug**

[Section 14.15, "InnoDB Startup Options and System Variables"](#)  
[Section 2.8.7, "MySQL Source-Configuration Options"](#)

## **innodb\_sync\_spin\_loops**

[Section 14.15, "InnoDB Startup Options and System Variables"](#)

## **innodb\_table\_locks**

[Section 14.15, "InnoDB Startup Options and System Variables"](#)  
[Section 14.7.3, "Locks Set by Different SQL Statements in InnoDB"](#)

## **innodb\_temp\_data\_file\_path**

[Section 14.8.2, "Configuring InnoDB for Read-Only Operation"](#)  
[Section 14.8.1, "InnoDB Startup Configuration"](#)  
[Section 14.15, "InnoDB Startup Options and System Variables"](#)  
[MySQL Glossary](#)  
[Section 24.3.9, "The INFORMATION\\_SCHEMA FILES Table"](#)  
[Section 24.4.27, "The INFORMATION\\_SCHEMA INNODB\\_TEMP\\_TABLE\\_INFO Table"](#)  
[Section 14.6.3.5, "The Temporary Tablespace"](#)  
[Section 1.3, "What Is New in MySQL 5.7"](#)

## **innodb\_thread\_concurrency**

[Section 14.8.5, "Configuring Thread Concurrency for InnoDB"](#)  
[Section 14.18.3, "InnoDB Standard Monitor and Lock Monitor Output"](#)  
[Section 14.15, "InnoDB Startup Options and System Variables"](#)  
[Section A.15, "MySQL 5.7 FAQ: MySQL Enterprise Thread Pool"](#)  
[Section 8.5.9, "Optimizing InnoDB Configuration Variables"](#)

## **innodb\_thread\_sleep\_delay**

[Section 14.8.5, "Configuring Thread Concurrency for InnoDB"](#)  
[Section 14.15, "InnoDB Startup Options and System Variables"](#)

## **innodb\_tmpdir**

[Section 14.15, "InnoDB Startup Options and System Variables"](#)  
[Section 14.13.5, "Online DDL Failure Conditions"](#)  
[Section 14.13.3, "Online DDL Space Requirements"](#)

## **innodb\_trx\_purge\_view\_update\_only\_debug**

[Section 14.15, "InnoDB Startup Options and System Variables"](#)

## **innodb\_trx\_rseg\_n\_slots\_debug**

[Section 14.15, "InnoDB Startup Options and System Variables"](#)

## **innodb\_undo\_directory**

[Section 14.8.2, "Configuring InnoDB for Read-Only Operation"](#)

---

[Section 14.8.1, “InnoDB Startup Configuration”](#)  
[Section 14.15, “InnoDB Startup Options and System Variables”](#)  
[Section 14.6.3.4, “Undo Tablespaces”](#)  
[Section 17.5.5, “Using MySQL Enterprise Backup with Group Replication”](#)

## **innodb\_undo\_log\_truncate**

[Section 14.15, “InnoDB Startup Options and System Variables”](#)  
[Section 14.6.3.4, “Undo Tablespaces”](#)  
[Section 1.3, “What Is New in MySQL 5.7”](#)

## **innodb\_undo\_logs**

[Section 14.15, “InnoDB Startup Options and System Variables”](#)

## **innodb\_undo\_tablespaces**

[Section 14.8.2, “Configuring InnoDB for Read-Only Operation”](#)  
[Section 14.8.1, “InnoDB Startup Configuration”](#)  
[Section 14.15, “InnoDB Startup Options and System Variables”](#)  
[MySQL Glossary](#)  
[Section 14.6.3.4, “Undo Tablespaces”](#)

## **innodb\_use\_native\_aio**

[Section 14.15, “InnoDB Startup Options and System Variables”](#)  
[MySQL Glossary](#)  
[Section 8.5.8, “Optimizing InnoDB Disk I/O”](#)  
[Section 14.8.7, “Using Asynchronous I/O on Linux”](#)

## **innodb\_version**

[Section 14.15, “InnoDB Startup Options and System Variables”](#)

## **innodb\_write\_io\_threads**

[Section 14.8.6, “Configuring the Number of Background InnoDB I/O Threads”](#)  
[Section 14.18.3, “InnoDB Standard Monitor and Lock Monitor Output”](#)  
[Section 14.15, “InnoDB Startup Options and System Variables”](#)  
[Section 14.8.7, “Using Asynchronous I/O on Linux”](#)

## **insert\_id**

[Section 15.8.3, “FEDERATED Storage Engine Notes and Tips”](#)  
[Section 5.1.7, “Server System Variables”](#)

## **interactive\_timeout**

[Section B.3.2.9, “Communication Errors and Aborted Connections”](#)  
[Section 5.1.7, “Server System Variables”](#)

## **internal\_tmp\_disk\_storage\_engine**

[Section 8.12.4.1, “How MySQL Uses Memory”](#)  
[Section 8.4.4, “Internal Temporary Table Use in MySQL”](#)  
[Section 5.1.7, “Server System Variables”](#)  
[Section 14.6.3.5, “The Temporary Tablespace”](#)

## **J**

[\[index top\]](#)

---

## **join\_buffer\_size**

[Section 8.2.1.11, “Block Nested-Loop and Batched Key Access Joins”](#)

[Section 8.2.1.6, “Nested-Loop Join Algorithms”](#)

[Section 5.1.7, “Server System Variables”](#)

## **K**

[\[index top\]](#)

## **keep\_files\_on\_create**

[Section 5.1.7, “Server System Variables”](#)

## **key\_buffer\_size**

[Section 8.6.2, “Bulk Data Loading for MyISAM Tables”](#)

[Section 5.1.1, “Configuring the Server”](#)

[Section 14.6.1.5, “Converting Tables from MyISAM to InnoDB”](#)

[Section 8.8.5, “Estimating Query Performance”](#)

[Section 8.12.4.1, “How MySQL Uses Memory”](#)

[Section 7.6.3, “How to Repair MyISAM Tables”](#)

[Section 14.8.1, “InnoDB Startup Configuration”](#)

[Section B.3.7, “Known Issues in MySQL”](#)

[Section 8.10.2.2, “Multiple Key Caches”](#)

[Section 8.2.4.3, “Optimizing DELETE Statements”](#)

[Section 8.6.3, “Optimizing REPAIR TABLE Statements”](#)

[Section 8.10.2.6, “Restructuring a Key Cache”](#)

[Section 5.1.9, “Server Status Variables”](#)

[Section 5.1.7, “Server System Variables”](#)

[Section 5.1.8.3, “Structured System Variables”](#)

[Section 8.10.2, “The MyISAM Key Cache”](#)

## **key\_cache\_age\_threshold**

[Section 8.10.2.3, “Midpoint Insertion Strategy”](#)

[Section 5.1.7, “Server System Variables”](#)

[Section 5.1.8.3, “Structured System Variables”](#)

## **key\_cache\_block\_size**

[Section 8.10.2.5, “Key Cache Block Size”](#)

[Section 8.10.2.6, “Restructuring a Key Cache”](#)

[Section 5.1.7, “Server System Variables”](#)

[Section 5.1.8.3, “Structured System Variables”](#)

## **key\_cache\_division\_limit**

[Section 8.10.2.3, “Midpoint Insertion Strategy”](#)

[Section 5.1.7, “Server System Variables”](#)

[Section 5.1.8.3, “Structured System Variables”](#)

## **keyring\_aws\_cmk\_id**

[Section 6.4.4.12, “Keyring System Variables”](#)

[Section 6.4.4.9, “Plugin-Specific Keyring Key-Management Functions”](#)

[Section 6.4.4.5, “Using the keyring\\_aws Amazon Web Services Keyring Plugin”](#)

---

## **keyring\_aws\_conf\_file**

[Section 6.4.4.12, “Keyring System Variables”](#)

[Section 6.4.4.5, “Using the keyring\\_aws Amazon Web Services Keyring Plugin”](#)

## **keyring\_aws\_data\_file**

[Section 6.4.4.12, “Keyring System Variables”](#)

[Section 6.4.4.9, “Plugin-Specific Keyring Key-Management Functions”](#)

[Section 6.4.4.5, “Using the keyring\\_aws Amazon Web Services Keyring Plugin”](#)

## **keyring\_aws\_region**

[Section 6.4.4.12, “Keyring System Variables”](#)

[Section 6.4.4.5, “Using the keyring\\_aws Amazon Web Services Keyring Plugin”](#)

## **keyring\_encrypted\_file\_data**

[Section 14.14, “InnoDB Data-at-Rest Encryption”](#)

[Section 6.4.4.12, “Keyring System Variables”](#)

[Section 2.8.7, “MySQL Source-Configuration Options”](#)

[Section 6.4.4.3, “Using the keyring\\_encrypted\\_file Encrypted File-Based Keyring Plugin”](#)

## **keyring\_encrypted\_file\_password**

[Section 6.4.4.12, “Keyring System Variables”](#)

[Section 6.4.4.3, “Using the keyring\\_encrypted\\_file Encrypted File-Based Keyring Plugin”](#)

## **keyring\_file\_data**

[Section 14.14, “InnoDB Data-at-Rest Encryption”](#)

[Section 6.4.4.12, “Keyring System Variables”](#)

[Section 6.4.4.7, “Migrating Keys Between Keyring Keystores”](#)

[Section 2.8.7, “MySQL Source-Configuration Options”](#)

[Section 6.4.4.2, “Using the keyring\\_file File-Based Keyring Plugin”](#)

## **keyring\_okv\_conf\_dir**

[Section 6.4.4.12, “Keyring System Variables”](#)

[Section 6.4.4.4, “Using the keyring\\_okv KMIP Plugin”](#)

## **keyring\_operations**

[Section 6.4.4.12, “Keyring System Variables”](#)

[Section 6.4.4.7, “Migrating Keys Between Keyring Keystores”](#)

## **L**

[\[index top\]](#)

## **large\_files\_support**

[Section 22.6, “Restrictions and Limitations on Partitioning”](#)

[Section 5.1.7, “Server System Variables”](#)

## **large\_page\_size**

[Section 5.1.7, “Server System Variables”](#)

## **large\_pages**

[Section 5.1.7, “Server System Variables”](#)

---

## **last\_insert\_id**

Section 5.4.4.3, “Mixed Binary Logging Format”  
Section 16.4.1.37, “Replication and Variables”  
Section 5.1.7, “Server System Variables”

## **lc\_messages**

Section 5.1.7, “Server System Variables”  
Section 10.12, “Setting the Error Message Language”

## **lc\_messages\_dir**

Section 5.1.7, “Server System Variables”  
Section 10.12, “Setting the Error Message Language”

## **lc\_time\_names**

Section 12.7, “Date and Time Functions”  
Section 5.4.4.3, “Mixed Binary Logging Format”  
Section 10.16, “MySQL Server Locale Support”  
Section 16.4.1.37, “Replication and Variables”  
Section 5.1.7, “Server System Variables”  
Section 12.8, “String Functions and Operators”

## **license**

Section 5.1.7, “Server System Variables”

## **local**

Section 13.2.7, “LOAD XML Statement”

## **local\_infile**

Section 13.2.6, “LOAD DATA Statement”  
Section 2.8.7, “MySQL Source-Configuration Options”  
Section 6.1.6, “Security Considerations for LOAD DATA LOCAL”  
Section 5.1.7, “Server System Variables”

## **lock\_wait\_timeout**

Section 5.1.7, “Server System Variables”

## **locked\_in\_memory**

Section 5.1.7, “Server System Variables”

## **log**

Section 16.1.5.4, “Adding a Binary Log Based Source to a Multi-Source Replica”  
Section 17.3.1, “Group Replication Requirements”  
Section 14.15, “InnoDB Startup Options and System Variables”  
Section 16.4.1.32, “Replication and Transaction Inconsistencies”  
Section 16.2.2.3, “Startup Options and Replication Channels”  
Section 14.21.6, “The InnoDB memcached Plugin and Replication”

## **log\_bin**

Section 16.1.6.4, “Binary Logging Options and Variables”  
NDB Cluster System Variables  
Section 13.4.1.2, “RESET MASTER Statement”

---

[Section 5.4.4.2, “Setting The Binary Log Format”](#)  
[Section 5.4.4, “The Binary Log”](#)

## **log\_bin\_basename**

[Section 16.1.6.4, “Binary Logging Options and Variables”](#)

## **log\_bin\_index**

[Section 16.1.6.4, “Binary Logging Options and Variables”](#)

## **log\_bin\_trust\_function\_creators**

[Section 16.1.6.4, “Binary Logging Options and Variables”](#)  
[Section A.4, “MySQL 5.7 FAQ: Stored Procedures and Functions”](#)  
[Section 23.7, “Stored Program Binary Logging”](#)

## **log\_bin\_use\_v**

[Section 16.1.6.4, “Binary Logging Options and Variables”](#)  
[MySQL Server Options for NDB Cluster](#)  
[Section 21.7.11, “NDB Cluster Replication Conflict Resolution”](#)

## **log\_builtin\_as\_identified\_by\_password**

[Section 16.1.6.4, “Binary Logging Options and Variables”](#)  
[Section 13.7.5.12, “SHOW CREATE USER Statement”](#)

## **log\_error**

[Section 5.4.2.2, “Error Logging on Unix and Unix-Like Systems”](#)  
[Section 5.4.2.1, “Error Logging on Windows”](#)  
[Section 2.4.3, “Installing a MySQL Launch Daemon”](#)  
[Section 2.5.7.2, “More Topics on Deploying MySQL Server with Docker”](#)  
[Section 5.1.7, “Server System Variables”](#)

## **log\_error\_verbosity**

[Section B.3.2.9, “Communication Errors and Aborted Connections”](#)  
[Section 5.4.2.4, “Error Log Filtering”](#)  
[Section 5.4.4.3, “Mixed Binary Logging Format”](#)  
[Section B.3.2.7, “MySQL server has gone away”](#)  
[Section 25.12.9, “Performance Schema Connection Attribute Tables”](#)  
[Section 25.15, “Performance Schema System Variables”](#)  
[Section 16.1.6.3, “Replica Server Options and Variables”](#)  
[Section 5.1.6, “Server Command Options”](#)  
[Section 5.1.7, “Server System Variables”](#)  
[Section 6.4.6.3, “Using MySQL Enterprise Firewall”](#)  
[Section 1.3, “What Is New in MySQL 5.7”](#)

## **log\_output**

[Section 5.4.1, “Selecting General Query Log and Slow Query Log Output Destinations”](#)  
[Section 5.1.7, “Server System Variables”](#)  
[Section 5.4.3, “The General Query Log”](#)  
[Section 5.4.5, “The Slow Query Log”](#)

## **log\_queries\_not\_using\_indexes**

[Section 5.1.7, “Server System Variables”](#)  
[Section 5.4.5, “The Slow Query Log”](#)



---

## **log\_replica\_updates**

[Section 16.1.3.7, “Stored Function Examples to Manipulate GTIDs”](#)

## **log\_slave\_updates**

[Section 16.1.6.4, “Binary Logging Options and Variables”](#)

[Section 16.1.3.1, “GTID Format and Storage”](#)

[Section 16.3.6, “Improving Replication Performance”](#)

[Section 21.7.3, “Known Issues in NDB Cluster Replication”](#)

[MySQL Server Options for NDB Cluster](#)

[Section 21.7.10, “NDB Cluster Replication: Bidirectional and Circular Replication”](#)

[NDB Cluster System Variables](#)

[Section 16.1.6.3, “Replica Server Options and Variables”](#)

## **log\_slow\_admin\_statements**

[Section 5.1.7, “Server System Variables”](#)

[Section 5.4.5, “The Slow Query Log”](#)

## **log\_slow\_slave\_statements**

[Section 16.1.6.3, “Replica Server Options and Variables”](#)

[Section 5.4.5, “The Slow Query Log”](#)

## **log\_statements\_unsafe\_for\_binlog**

[Section 16.1.6.4, “Binary Logging Options and Variables”](#)

## **log\_syslog**

[Section 5.4.2.1, “Error Logging on Windows”](#)

[Section 5.4.2.3, “Error Logging to the System Log”](#)

[Section 2.5.10, “Managing MySQL Server with systemd”](#)

[Section 4.3.2, “mysqld\\_safe — MySQL Server Startup Script”](#)

[Section 5.1.7, “Server System Variables”](#)

## **log\_syslog\_facility**

[Section 5.4.2.3, “Error Logging to the System Log”](#)

[Section 4.3.2, “mysqld\\_safe — MySQL Server Startup Script”](#)

[Section 5.1.7, “Server System Variables”](#)

## **log\_syslog\_include\_pid**

[Section 5.4.2.3, “Error Logging to the System Log”](#)

[Section 5.1.7, “Server System Variables”](#)

## **log\_syslog\_tag**

[Section 5.4.2.3, “Error Logging to the System Log”](#)

[Section 4.3.2, “mysqld\\_safe — MySQL Server Startup Script”](#)

[Section 5.1.7, “Server System Variables”](#)

## **log\_throttle\_queries\_not\_using\_indexes**

[Section 5.1.7, “Server System Variables”](#)

[Section 5.4.5, “The Slow Query Log”](#)

## **log\_timestamps**

[Section 5.4.2.5, “Error Log Output Format”](#)

[Section 5.1.7, “Server System Variables”](#)

---

[Section 5.4.3, “The General Query Log”](#)  
[Section 5.4.5, “The Slow Query Log”](#)

## **log\_warnings**

[Section 16.1.6.3, “Replica Server Options and Variables”](#)  
[Section 5.1.6, “Server Command Options”](#)  
[Section 5.1.7, “Server System Variables”](#)  
[Section 1.3, “What Is New in MySQL 5.7”](#)

## **long\_query\_time**

[Section 5.4, “MySQL Server Logs”](#)  
[Section 4.5.2, “mysqladmin — A MySQL Server Administration Program”](#)  
[Section 16.1.6.3, “Replica Server Options and Variables”](#)  
[Section 5.1.9, “Server Status Variables”](#)  
[Section 5.1.7, “Server System Variables”](#)  
[Section 5.4.5, “The Slow Query Log”](#)

## **low\_priority\_updates**

[Section A.14, “MySQL 5.7 FAQ: Replication”](#)  
[Section 5.1.7, “Server System Variables”](#)  
[Section 8.11.2, “Table Locking Issues”](#)

## **lower**

[Section 17.3.1, “Group Replication Requirements”](#)

## **lower\_case\_file\_system**

[Section 5.1.7, “Server System Variables”](#)

## **lower\_case\_table\_names**

[Advanced Options](#)  
[Section 13.1.18.5, “FOREIGN KEY Constraints”](#)  
[Section 13.7.1.4, “GRANT Statement”](#)  
[Section 17.7.1, “Group Replication System Variables”](#)  
[Section 16.2.5, “How Servers Evaluate Replication Filtering Rules”](#)  
[Section 1.5, “How to Report Bugs or Problems”](#)  
[Section 9.2.3, “Identifier Case Sensitivity”](#)  
[Section 14.6.1.3, “Importing InnoDB Tables”](#)  
[Section 16.4.1.37, “Replication and Variables”](#)  
[Section 13.7.1.6, “REVOKE Statement”](#)  
[Section 5.1.7, “Server System Variables”](#)  
[Section 13.7.5.37, “SHOW TABLES Statement”](#)  
[Section 24.4.17, “The INFORMATION\\_SCHEMA INNODB\\_SYS\\_COLUMNS Table”](#)  
[Section 24.4.23, “The INFORMATION\\_SCHEMA INNODB\\_SYS\\_TABLES Table”](#)  
[Section 10.8.7, “Using Collation in INFORMATION\\_SCHEMA Searches”](#)

## **M**

[\[index top\]](#)

## **master\_info\_repository**

[Section 13.4.2.1, “CHANGE MASTER TO Statement”](#)  
[Section 16.1.5.1, “Configuring Multi-Source Replication”](#)  
[Section 13.7.6.3, “FLUSH Statement”](#)

---

Section 17.3.1, “Group Replication Requirements”  
Section 14.15, “InnoDB Startup Options and System Variables”  
Section 16.1.6.3, “Replica Server Options and Variables”  
Section 16.2.4.2, “Replication Metadata Repositories”  
Section 13.4.2.3, “RESET SLAVE Statement”  
Section 13.3.7.3, “Restrictions on XA Transactions”  
Setting Up Replication with Existing Data  
Section 16.2.2.3, “Startup Options and Replication Channels”

## **master\_verify\_checksum**

Section 16.1.6.4, “Binary Logging Options and Variables”  
MySQL Glossary  
Section 5.4.4, “The Binary Log”

## **max\_allowed\_packet**

Section 12.19.1, “Aggregate Function Descriptions”  
Section B.3.2.9, “Communication Errors and Aborted Connections”  
Section 12.4.2, “Comparison Functions and Operators”  
Section 11.7, “Data Type Storage Requirements”  
Section B.3.4.6, “Deleting Rows from Related Tables”  
Section 8.12.4.1, “How MySQL Uses Memory”  
Section B.3.2.3, “Lost connection to MySQL server”  
Section B.3.2.7, “MySQL server has gone away”  
Section 4.5.4, “mysqldump — A Database Backup Program”  
Section 21.7.11, “NDB Cluster Replication Conflict Resolution”  
Section B.3.2.8, “Packet Too Large”  
Section 16.1.6.3, “Replica Server Options and Variables”  
Section 16.4.1.19, “Replication and max\_allowed\_packet”  
Section 5.1.7, “Server System Variables”  
Section 12.8, “String Functions and Operators”  
Section 11.3.4, “The BLOB and TEXT Types”  
Section 11.5, “The JSON Data Type”  
Section 5.5.5.3, “Using Version Tokens”  
Section 19.4.2.2, “X Plugin Options and System Variables”

## **max\_binlog\_cache\_size**

Section 16.1.6.4, “Binary Logging Options and Variables”  
Section 5.4.4, “The Binary Log”

## **max\_binlog\_size**

Section 16.1.6.4, “Binary Logging Options and Variables”  
Section 5.4, “MySQL Server Logs”  
Section 16.1.6.3, “Replica Server Options and Variables”  
Section 5.4.7, “Server Log Maintenance”  
Section 5.4.4, “The Binary Log”  
Section 16.2.4.1, “The Relay Log”

## **max\_binlog\_stmt\_cache\_size**

Section 16.1.6.4, “Binary Logging Options and Variables”

## **max\_connect\_errors**

Section 5.1.11.2, “DNS Lookups and the Host Cache”  
Section 5.1.7, “Server System Variables”

---

Section 25.12.16.1, “The host\_cache Table”

## **max\_connections**

Section 16.1.6.4, “Binary Logging Options and Variables”  
Section 5.1.11.1, “Connection Interfaces”  
Section 5.8.1.4, “Debugging mysqld under gdb”  
Section B.3.2.16, “File Not Found and Similar Errors”  
Section 8.4.3.1, “How MySQL Opens and Closes Tables”  
Section 25.15, “Performance Schema System Variables”  
Section 6.2.2, “Privileges Provided by MySQL”  
Section 5.1.9, “Server Status Variables”  
Section 5.1.7, “Server System Variables”  
Section 25.12.16.3, “The processlist Table”  
Section 5.5.3.3, “Thread Pool Operation”  
Section B.3.2.5, “Too many connections”  
Section 19.4.2.2, “X Plugin Options and System Variables”

## **max\_delayed\_threads**

Section 5.1.7, “Server System Variables”

## **max\_digest\_length**

Section 8.12.4.1, “How MySQL Uses Memory”  
Section 25.10, “Performance Schema Statement Digests”  
Section 25.15, “Performance Schema System Variables”  
Section 5.1.7, “Server System Variables”  
Section 6.4.6.3, “Using MySQL Enterprise Firewall”

## **max\_error\_count**

Section 13.2.6, “LOAD DATA Statement”  
Section 13.6.7.4, “RESIGNAL Statement”  
Section 5.1.7, “Server System Variables”  
Section 13.7.5.17, “SHOW ERRORS Statement”  
Section 13.7.5.40, “SHOW WARNINGS Statement”  
Section 13.6.7.7, “The MySQL Diagnostics Area”

## **max\_execution\_time**

Section 8.9.3, “Optimizer Hints”  
Section 5.1.9, “Server Status Variables”  
Section 5.1.7, “Server System Variables”

## **max\_heap\_table\_size**

Section 8.12.4.1, “How MySQL Uses Memory”  
Section 8.4.4, “Internal Temporary Table Use in MySQL”  
Section 8.4.6, “Limits on Table Size”  
Section 16.4.1.20, “Replication and MEMORY Tables”  
Section 16.4.1.37, “Replication and Variables”  
Section 13.6.6.5, “Restrictions on Server-Side Cursors”  
Section 5.1.7, “Server System Variables”  
Section 15.3, “The MEMORY Storage Engine”

## **max\_insert\_delayed\_threads**

Section 5.1.7, “Server System Variables”

---

## **max\_join\_size**

Section 8.8.2, “EXPLAIN Output Format”  
Section 4.5.1.6, “mysql Client Tips”  
Section 5.1.7, “Server System Variables”  
Section 13.7.4.1, “SET Syntax for Variable Assignment”

## **max\_length\_for\_sort\_data**

Section 8.2.1.14, “ORDER BY Optimization”  
Section 5.1.7, “Server System Variables”

## **max\_points\_in\_geometry**

Section 5.1.7, “Server System Variables”  
Section 12.16.8, “Spatial Operator Functions”

## **max\_prepared\_stmt\_count**

Section 8.10.4, “Caching of Prepared Statements and Stored Programs”  
Section 13.5.3, “DEALLOCATE PREPARE Statement”  
Section 25.15, “Performance Schema System Variables”  
Section 13.5, “Prepared Statements”  
Section 5.1.9, “Server Status Variables”  
Section 5.1.7, “Server System Variables”

## **max\_relay\_log\_size**

Section 16.1.6.4, “Binary Logging Options and Variables”  
Section 16.1.6.3, “Replica Server Options and Variables”  
Section 16.2.4.1, “The Relay Log”

## **max\_seeks\_for\_key**

Section 13.7.2.1, “ANALYZE TABLE Statement”  
Section 5.1.7, “Server System Variables”

## **max\_sort\_length**

Section B.3.7, “Known Issues in MySQL”  
Section 8.2.1.14, “ORDER BY Optimization”  
Section 13.2.9, “SELECT Statement”  
Section 5.1.7, “Server System Variables”  
Section 11.3.4, “The BLOB and TEXT Types”  
Section 11.5, “The JSON Data Type”

## **max\_sp\_recursion\_depth**

Section 5.1.7, “Server System Variables”  
Section 23.2.1, “Stored Routine Syntax”

## **max\_tmp\_tables**

Section 5.1.7, “Server System Variables”

## **max\_user\_connections**

Section 13.7.1.1, “ALTER USER Statement”  
Section 13.7.1.2, “CREATE USER Statement”  
Section 13.7.6.3, “FLUSH Statement”  
Section 6.1.3, “Making MySQL Secure Against Attackers”

---

Section 5.1.7, “Server System Variables”  
Section 6.2.16, “Setting Account Resource Limits”

### **max\_write\_lock\_count**

Section 13.3.5, “LOCK TABLES and UNLOCK TABLES Statements”  
Section 8.11.4, “Metadata Locking”  
Section 5.1.7, “Server System Variables”  
Section 8.11.2, “Table Locking Issues”

### **mecab\_rc\_file**

Section 12.9.9, “MeCab Full-Text Parser Plugin”

### **metadata\_locks\_cache\_size**

Section 5.1.7, “Server System Variables”  
Section 1.3, “What Is New in MySQL 5.7”

### **metadata\_locks\_hash\_instances**

Section 5.1.7, “Server System Variables”  
Section 1.3, “What Is New in MySQL 5.7”

### **min\_examined\_row\_limit**

Section 5.1.7, “Server System Variables”  
Section 5.4.5, “The Slow Query Log”

### **multi\_range\_count**

Section 5.1.7, “Server System Variables”

### **myisam\_data\_pointer\_size**

Section 13.1.18, “CREATE TABLE Statement”  
Section 8.4.6, “Limits on Table Size”  
Section 5.1.7, “Server System Variables”

### **myisam\_max\_sort\_file\_size**

Section 15.2.1, “MyISAM Startup Options”  
Section 8.6.3, “Optimizing REPAIR TABLE Statements”  
Section 22.6, “Restrictions and Limitations on Partitioning”  
Section 5.1.7, “Server System Variables”

### **myisam\_mmap\_size**

Section 5.1.7, “Server System Variables”

### **myisam\_recover\_options**

Section 15.2.1, “MyISAM Startup Options”  
Section 8.6.1, “Optimizing MyISAM Queries”  
Section 5.1.7, “Server System Variables”  
Section 7.6.5, “Setting Up a MyISAM Table Maintenance Schedule”  
Section B.3.2.17, “Table-Corruption Issues”  
Section 15.2, “The MyISAM Storage Engine”  
Section 5.8.1.6, “Using Server Logs to Find Causes of Errors in mysqld”

### **myisam\_repair\_threads**

Section 5.1.7, “Server System Variables”

---

Section 1.3, “What Is New in MySQL 5.7”

### **myisam\_sort\_buffer\_size**

Section 13.1.8, “ALTER TABLE Statement”

Section 15.2.1, “MyISAM Startup Options”

Section 8.6.3, “Optimizing REPAIR TABLE Statements”

Section 5.1.7, “Server System Variables”

### **myisam\_stats\_method**

Section 8.3.7, “InnoDB and MyISAM Index Statistics Collection”

Section 5.1.7, “Server System Variables”

### **myisam\_use\_mmap**

Section 8.12.4.1, “How MySQL Uses Memory”

Section 5.1.7, “Server System Variables”

### **mysql\_firewall\_mode**

Section 6.4.6.4, “MySQL Enterprise Firewall Reference”

Section 6.4.6.3, “Using MySQL Enterprise Firewall”

### **mysql\_firewall\_trace**

Section 6.4.6.4, “MySQL Enterprise Firewall Reference”

Section 6.4.6.3, “Using MySQL Enterprise Firewall”

### **mysql\_native\_password\_proxy\_users**

Section 6.2.14, “Proxy Users”

Section 5.1.7, “Server System Variables”

### **mysqlx\_bind\_address**

Section 19.4.2.2, “X Plugin Options and System Variables”

### **mysqlx\_connect\_timeout**

Section 19.4.2.2, “X Plugin Options and System Variables”

### **mysqlx\_idle\_worker\_thread\_timeout**

Section 19.4.2.2, “X Plugin Options and System Variables”

### **mysqlx\_max\_allowed\_packet**

Section 19.4.2.2, “X Plugin Options and System Variables”

### **mysqlx\_max\_connections**

Section 19.4.2.2, “X Plugin Options and System Variables”

### **mysqlx\_min\_worker\_threads**

Section 19.4.2.2, “X Plugin Options and System Variables”

### **mysqlx\_port**

Section 2.8.7, “MySQL Source-Configuration Options”

Section 6.7.5.2, “Setting the TCP Port Context for MySQL Features”

---

[Section 19.4.2.2, “X Plugin Options and System Variables”](#)

## **mysqlx\_port\_open\_timeout**

[Section 19.4.2.2, “X Plugin Options and System Variables”](#)

## **mysqlx\_socket**

[Section 19.4.2.2, “X Plugin Options and System Variables”](#)

## **mysqlx\_ssl\_ca**

[Section 19.4.2.2, “X Plugin Options and System Variables”](#)

## **mysqlx\_ssl\_capath**

[Section 19.4.2.2, “X Plugin Options and System Variables”](#)

## **mysqlx\_ssl\_cert**

[Section 19.4.2.2, “X Plugin Options and System Variables”](#)

## **mysqlx\_ssl\_cipher**

[Section 19.4.2.2, “X Plugin Options and System Variables”](#)

## **mysqlx\_ssl\_crl**

[Section 19.4.2.2, “X Plugin Options and System Variables”](#)

## **mysqlx\_ssl\_crlpath**

[Section 19.4.2.2, “X Plugin Options and System Variables”](#)

## **mysqlx\_ssl\_key**

[Section 19.4.2.2, “X Plugin Options and System Variables”](#)

## **N**

[\[index top\]](#)

## **named\_pipe**

[Section B.3.2.2, “Can't connect to \[local\] MySQL server”](#)

[Section 4.2.3, “Command Options for Connecting to the Server”](#)

[Section 4.2.4, “Connecting to the MySQL Server Using Command Options”](#)

[Section 4.5.1.1, “mysql Client Options”](#)

[Section 4.4.4, “mysql\\_secure\\_installation — Improve MySQL Installation Security”](#)

[Section 4.4.7, “mysql\\_upgrade — Check and Upgrade MySQL Tables”](#)

[Section 4.5.2, “mysqladmin — A MySQL Server Administration Program”](#)

[Section 4.6.7, “mysqlbinlog — Utility for Processing Binary Log Files”](#)

[Section 4.5.3, “mysqlcheck — A Table Maintenance Program”](#)

[Section 4.5.4, “mysqldump — A Database Backup Program”](#)

[Section 4.5.5, “mysqlimport — A Data Import Program”](#)

[Section 4.5.6, “mysqlpump — A Database Backup Program”](#)

[Section 4.5.7, “mysqlshow — Display Database, Table, and Column Information”](#)

[Section 4.5.8, “mysqlslap — A Load Emulation Client”](#)

[Resetting the Root Password: Generic Instructions](#)

[Section 2.3.4.3, “Selecting a MySQL Server Type”](#)

[Section 5.1.7, “Server System Variables”](#)



---

Section 1.2.2, “The Main Features of MySQL”  
Type and Networking

## **named\_pipe\_full\_access\_group**

Section 4.2.3, “Command Options for Connecting to the Server”  
Section 4.2.4, “Connecting to the MySQL Server Using Command Options”  
Section 4.2.5, “Connection Transport Protocols”  
Section 4.5.1.1, “mysql Client Options”  
Section 4.4.4, “mysql\_secure\_installation — Improve MySQL Installation Security”  
Section 4.4.7, “mysql\_upgrade — Check and Upgrade MySQL Tables”  
Section 4.5.2, “mysqladmin — A MySQL Server Administration Program”  
Section 4.6.7, “mysqlbinlog — Utility for Processing Binary Log Files”  
Section 4.5.3, “mysqlcheck — A Table Maintenance Program”  
Section 4.5.4, “mysqldump — A Database Backup Program”  
Section 4.5.5, “mysqlimport — A Data Import Program”  
Section 4.5.6, “mysqlpump — A Database Backup Program”  
Section 4.5.7, “mysqlshow — Display Database, Table, and Column Information”  
Section 4.5.8, “mysqlslap — A Load Emulation Client”  
Section 5.1.7, “Server System Variables”  
Section 1.3, “What Is New in MySQL 5.7”

## **ndb\_autoincrement\_prefetch\_sz**

NDB Cluster System Variables  
Section 21.5.14, “ndb\_import — Import CSV Data Into NDB”

## **ndb\_cache\_check\_time**

NDB Cluster System Variables  
Section 1.3, “What Is New in MySQL 5.7”

## **ndb\_clear\_apply\_status**

NDB Cluster System Variables  
Section 13.4.2.3, “RESET SLAVE Statement”

## **ndb\_data\_node\_neighbour**

NDB Cluster System Variables  
Section 13.1.18.9, “Setting NDB Comment Options”  
Section 21.2.4.1, “What is New in NDB Cluster 7.5”

## **ndb\_default\_column\_format**

NDB Cluster System Variables  
Section 21.2.4.1, “What is New in NDB Cluster 7.5”

## **ndb\_deferred\_constraints**

NDB Cluster System Variables

## **ndb\_distribution**

NDB Cluster System Variables

## **ndb\_eventbuffer\_free\_percent**

Section 21.6.2.3, “Event Buffer Reporting in the Cluster Log”  
NDB Cluster System Variables

---

## **ndb\_eventbuffer\_max\_alloc**

Section 21.6.2.3, “Event Buffer Reporting in the Cluster Log”  
NDB Cluster System Variables

## **ndb\_extra\_logging**

NDB Cluster System Variables

## **ndb\_force\_send**

NDB Cluster System Variables

## **ndb\_fully\_replicated**

NDB Cluster System Variables

## **ndb\_index\_stat\_enable**

NDB Cluster System Variables

## **ndb\_index\_stat\_option**

NDB Cluster System Variables

## **ndb\_join\_pushdown**

Section 8.8.2, “EXPLAIN Output Format”  
NDB Cluster System Variables

## **ndb\_log\_apply\_status**

Section 21.7.10, “NDB Cluster Replication: Bidirectional and Circular Replication”  
NDB Cluster System Variables

## **ndb\_log\_bin**

NDB Cluster System Variables

## **ndb\_log\_binlog\_index**

NDB Cluster System Variables

## **ndb\_log\_empty\_epochs**

NDB Cluster System Variables

## **ndb\_log\_empty\_update**

NDB Cluster System Variables

## **ndb\_log\_exclusive\_reads**

MySQL Server Options for NDB Cluster  
Section 21.7.11, “NDB Cluster Replication Conflict Resolution”  
NDB Cluster System Variables

## **ndb\_log\_orig**

NDB Cluster System Variables

## **ndb\_log\_transaction\_id**

NDB Cluster System Variables

---

## **ndb\_optimized\_node\_selection**

NDB Cluster System Variables

Section 21.4.3.10, “NDB Cluster TCP/IP Connections”

Section 21.6.3.3, “Using CLUSTERLOG STATISTICS in the NDB Cluster Management Client”

## **ndb\_read\_backup**

NDB Cluster System Variables

Section 13.1.18.9, “Setting NDB Comment Options”

Section 21.2.4.1, “What is New in NDB Cluster 7.5”

## **ndb\_recv\_thread\_activation\_threshold**

NDB Cluster System Variables

## **ndb\_recv\_thread\_cpu\_mask**

NDB Cluster System Variables

## **ndb\_report\_thresh\_binlog\_epoch\_slip**

Section 21.6.2.3, “Event Buffer Reporting in the Cluster Log”

NDB Cluster System Variables

## **ndb\_report\_thresh\_binlog\_mem\_usage**

Section 21.6.2.3, “Event Buffer Reporting in the Cluster Log”

NDB Cluster System Variables

## **ndb\_row\_checksum**

NDB Cluster System Variables

## **ndb\_show\_foreign\_key\_mock\_tables**

NDB Cluster System Variables

## **ndb\_slave\_conflict\_role**

Section 21.7.11, “NDB Cluster Replication Conflict Resolution”

NDB Cluster System Variables

## **ndb\_table\_no\_logging**

NDB Cluster System Variables

Section 13.1.18.9, “Setting NDB Comment Options”

## **ndb\_table\_temporary**

NDB Cluster System Variables

## **ndb\_use\_copying\_alter\_table**

NDB Cluster System Variables

## **ndb\_use\_exact\_count**

NDB Cluster System Variables

## **ndb\_use\_transactions**

Section 21.6.9, “Importing Data Into MySQL Cluster”

NDB Cluster System Variables

---

## **ndb\_version**

[NDB Cluster System Variables](#)

## **ndb\_version\_string**

[NDB Cluster System Variables](#)

## **ndbinfo\_database**

[NDB Cluster System Variables](#)

## **ndbinfo\_max\_bytes**

[NDB Cluster System Variables](#)

## **ndbinfo\_max\_rows**

[NDB Cluster System Variables](#)

## **ndbinfo\_offline**

[NDB Cluster System Variables](#)

## **ndbinfo\_show\_hidden**

[NDB Cluster System Variables](#)

[Section 21.6.15, “ndbinfo: The NDB Cluster Information Database”](#)

[Section 21.6.15.5, “The ndbinfo cluster\\_operations Table”](#)

[Section 21.6.15.6, “The ndbinfo cluster\\_transactions Table”](#)

[Section 21.6.15.34, “The ndbinfo server\\_operations Table”](#)

[Section 21.6.15.35, “The ndbinfo server\\_transactions Table”](#)

## **ndbinfo\_table\_prefix**

[NDB Cluster System Variables](#)

## **ndbinfo\_version**

[NDB Cluster System Variables](#)

## **net\_buffer\_length**

[Section 8.12.4.1, “How MySQL Uses Memory”](#)

[Section 4.5.4, “mysqldump — A Database Backup Program”](#)

[Section 4.5.6, “mysqlpump — A Database Backup Program”](#)

[Section 5.1.7, “Server System Variables”](#)

## **net\_read\_timeout**

[Section B.3.2.3, “Lost connection to MySQL server”](#)

[Section 5.1.7, “Server System Variables”](#)

## **net\_retry\_count**

[Section 5.1.7, “Server System Variables”](#)

## **net\_write\_timeout**

[Section 5.1.7, “Server System Variables”](#)

## **new**

[Section 22.6.2, “Partitioning Limitations Relating to Storage Engines”](#)

---

[Section 5.1.7, “Server System Variables”](#)

## **ngram\_token\_size**

[Section 12.9.2, “Boolean Full-Text Searches”](#)  
[Section 12.9.6, “Fine-Tuning MySQL Full-Text Search”](#)  
[Section 12.9.4, “Full-Text Stopwords”](#)  
[Section 12.9.1, “Natural Language Full-Text Searches”](#)  
[Section 12.9.8, “ngram Full-Text Parser”](#)

## **O**

[\[index top\]](#)

## **offline\_mode**

[Section 6.2.2, “Privileges Provided by MySQL”](#)  
[Section 5.1.7, “Server System Variables”](#)

## **old**

[Section 8.9.4, “Index Hints”](#)  
[Section 5.1.7, “Server System Variables”](#)

## **old\_alter\_table**

[Section 13.1.8, “ALTER TABLE Statement”](#)  
[Section 14.13, “InnoDB and Online DDL”](#)  
[Section 14.13.2, “Online DDL Performance and Concurrency”](#)  
[Section 13.7.2.4, “OPTIMIZE TABLE Statement”](#)  
[Section 5.1.7, “Server System Variables”](#)  
[Section 14.13.4, “Simplifying DDL Statements with Online DDL”](#)

## **old\_passwords**

[Section 2.10.3, “Changes in MySQL 5.7”](#)  
[Section 12.13, “Encryption and Compression Functions”](#)  
[Section 6.1.2.4, “Password Hashing in MySQL”](#)  
[Section 6.2.11, “Password Management”](#)  
[Section 6.2.12, “Server Handling of Expired Passwords”](#)  
[Section 5.1.7, “Server System Variables”](#)  
[Section 13.7.1.7, “SET PASSWORD Statement”](#)  
[Section 1.3, “What Is New in MySQL 5.7”](#)

## **open\_files\_limit**

[Section 5.1.11.1, “Connection Interfaces”](#)  
[Section B.3.2.16, “File Not Found and Similar Errors”](#)  
[Section 8.4.3.1, “How MySQL Opens and Closes Tables”](#)  
[Section 2.5.10, “Managing MySQL Server with systemd”](#)  
[Section 25.15, “Performance Schema System Variables”](#)  
[Section 22.6, “Restrictions and Limitations on Partitioning”](#)  
[Section 5.4.1, “Selecting General Query Log and Slow Query Log Output Destinations”](#)  
[Section 5.1.7, “Server System Variables”](#)

## **optimizer\_prune\_level**

[Section 8.9.1, “Controlling Query Plan Evaluation”](#)  
[Section 8.9.3, “Optimizer Hints”](#)

---

Section 8.2.2.1, “Optimizing Subqueries, Derived Tables, and View References with Semijoin Transformations”  
Section 5.1.7, “Server System Variables”

## **optimizer\_search\_depth**

Section 8.9.1, “Controlling Query Plan Evaluation”  
Section 5.1.7, “Server System Variables”

## **optimizer\_switch**

Section 8.2.1.11, “Block Nested-Loop and Batched Key Access Joins”  
Section 2.10.3, “Changes in MySQL 5.7”  
Section 8.2.1.12, “Condition Filtering”  
Section 8.2.1.4, “Engine Condition Pushdown Optimization”  
Section 8.2.1.5, “Index Condition Pushdown Optimization”  
Section 8.2.1.3, “Index Merge Optimization”  
Section 8.2.1.17, “LIMIT Query Optimization”  
Section 8.2.1.10, “Multi-Range Read Optimization”  
Section 8.9.3, “Optimizer Hints”  
Section 8.2.2.4, “Optimizing Derived Tables and View References with Merging or Materialization”  
Section 8.2.2.2, “Optimizing Subqueries with Materialization”  
Section 8.2.2.3, “Optimizing Subqueries with the EXISTS Strategy”  
Section 8.2.2.1, “Optimizing Subqueries, Derived Tables, and View References with Semijoin Transformations”  
Section 5.1.7, “Server System Variables”  
Section 8.9.2, “Switchable Optimizations”  
Section 26.4.5.7, “The list\_add() Function”  
Section 13.2.11, “UPDATE Statement”  
Section 8.3.9, “Use of Index Extensions”  
Section 23.5.2, “View Processing Algorithms”  
Section 1.3, “What Is New in MySQL 5.7”

## **optimizer\_trace**

Section 5.1.7, “Server System Variables”  
Section 8.15.2, “System Variables Controlling Tracing”  
Section 24.3.14, “The INFORMATION\_SCHEMA OPTIMIZER\_TRACE Table”  
Section 8.15.1, “Typical Usage”

## **optimizer\_trace\_features**

Section 8.15.10, “Selecting Optimizer Features to Trace”  
Section 5.1.7, “Server System Variables”  
Section 8.15.2, “System Variables Controlling Tracing”

## **optimizer\_trace\_limit**

Section 5.1.7, “Server System Variables”  
Section 8.15.2, “System Variables Controlling Tracing”  
Section 8.15.4, “Tuning Trace Purging”

## **optimizer\_trace\_max\_mem\_size**

Section 5.1.7, “Server System Variables”  
Section 8.15.2, “System Variables Controlling Tracing”  
Section 24.3.14, “The INFORMATION\_SCHEMA OPTIMIZER\_TRACE Table”  
Section 8.15.5, “Tracing Memory Usage”

---

## **optimizer\_trace\_offset**

[Section 5.1.7, “Server System Variables”](#)

[Section 8.15.2, “System Variables Controlling Tracing”](#)

[Section 8.15.4, “Tuning Trace Purging”](#)

## **P**

[\[index top\]](#)

## **parser\_max\_mem\_size**

[Section 5.1.7, “Server System Variables”](#)

## **performance\_schema**

[Section 25.1, “Performance Schema Quick Start”](#)

[Section 25.3, “Performance Schema Startup Configuration”](#)

[Section 25.15, “Performance Schema System Variables”](#)

[Section 25.12.16.3, “The processlist Table”](#)

## **performance\_schema\_accounts\_size**

[Section 25.12.14, “Performance Schema Status Variable Tables”](#)

[Section 25.15, “Performance Schema System Variables”](#)

[Section 25.12.15.10, “Status Variable Summary Tables”](#)

[Section 25.12.8.1, “The accounts Table”](#)

## **performance\_schema\_digests\_size**

[Section 25.10, “Performance Schema Statement Digests”](#)

[Section 25.16, “Performance Schema Status Variables”](#)

[Section 25.15, “Performance Schema System Variables”](#)

[Section 25.12.15.3, “Statement Summary Tables”](#)

## **performance\_schema\_events\_stages\_history\_long\_size**

[Section 25.15, “Performance Schema System Variables”](#)

[Section 25.12.5.3, “The events\\_stages\\_history\\_long Table”](#)

## **performance\_schema\_events\_stages\_history\_size**

[Section 25.15, “Performance Schema System Variables”](#)

[Section 25.12.5.2, “The events\\_stages\\_history Table”](#)

## **performance\_schema\_events\_statements\_history\_long\_size**

[Section 25.15, “Performance Schema System Variables”](#)

[Section 25.12.6.3, “The events\\_statements\\_history\\_long Table”](#)

## **performance\_schema\_events\_statements\_history\_size**

[Section 25.15, “Performance Schema System Variables”](#)

[Section 25.12.6.2, “The events\\_statements\\_history Table”](#)

## **performance\_schema\_events\_transactions\_history\_long\_size**

[Section 25.15, “Performance Schema System Variables”](#)

[Section 25.12.7.3, “The events\\_transactions\\_history\\_long Table”](#)

## **performance\_schema\_events\_transactions\_history\_size**

[Section 25.15, “Performance Schema System Variables”](#)

---

Section 25.12.7.2, “The events\_transactions\_history Table”

## **performance\_schema\_events\_waits\_history\_long\_size**

Section 25.15, “Performance Schema System Variables”  
Section 25.12, “Performance Schema Table Descriptions”  
Section 13.7.5.15, “SHOW ENGINE Statement”  
Section 25.12.4.3, “The events\_waits\_history\_long Table”

## **performance\_schema\_events\_waits\_history\_size**

Section 25.15, “Performance Schema System Variables”  
Section 25.12, “Performance Schema Table Descriptions”  
Section 13.7.5.15, “SHOW ENGINE Statement”  
Section 25.12.4.2, “The events\_waits\_history Table”

## **performance\_schema\_hosts\_size**

Section 25.12.14, “Performance Schema Status Variable Tables”  
Section 25.15, “Performance Schema System Variables”  
Section 25.12.15.10, “Status Variable Summary Tables”  
Section 25.12.8.2, “The hosts Table”

## **performance\_schema\_max\_cond\_classes**

Section 25.15, “Performance Schema System Variables”

## **performance\_schema\_max\_cond\_instances**

Section 25.15, “Performance Schema System Variables”

## **performance\_schema\_max\_digest\_length**

Section 25.10, “Performance Schema Statement Digests”  
Section 25.15, “Performance Schema System Variables”  
Section 5.1.7, “Server System Variables”  
Section 25.12.6.1, “The events\_statements\_current Table”

## **performance\_schema\_max\_file\_classes**

Section 25.15, “Performance Schema System Variables”

## **performance\_schema\_max\_file\_handles**

Section 25.15, “Performance Schema System Variables”

## **performance\_schema\_max\_file\_instances**

Section 25.15, “Performance Schema System Variables”

## **performance\_schema\_max\_index\_stat**

Section 25.16, “Performance Schema Status Variables”  
Section 25.15, “Performance Schema System Variables”

## **performance\_schema\_max\_memory\_classes**

Section 25.15, “Performance Schema System Variables”

## **performance\_schema\_max\_metadata\_locks**

Section 25.16, “Performance Schema Status Variables”  
Section 25.15, “Performance Schema System Variables”



---

[Section 25.12.12.1, “The metadata\\_locks Table”](#)

## **performance\_schema\_max\_mutex\_classes**

[Section 25.7, “Performance Schema Status Monitoring”](#)

[Section 25.15, “Performance Schema System Variables”](#)

## **performance\_schema\_max\_mutex\_instances**

[Section 25.15, “Performance Schema System Variables”](#)

## **performance\_schema\_max\_prepared\_statements\_instances**

[Section 25.16, “Performance Schema Status Variables”](#)

[Section 25.15, “Performance Schema System Variables”](#)

[Section 25.12.6.4, “The prepared\\_statements\\_instances Table”](#)

## **performance\_schema\_max\_program\_instances**

[Section 25.16, “Performance Schema Status Variables”](#)

[Section 25.15, “Performance Schema System Variables”](#)

## **performance\_schema\_max\_rwlock\_classes**

[Section 25.15, “Performance Schema System Variables”](#)

## **performance\_schema\_max\_rwlock\_instances**

[Section 25.15, “Performance Schema System Variables”](#)

## **performance\_schema\_max\_socket\_classes**

[Section 25.15, “Performance Schema System Variables”](#)

## **performance\_schema\_max\_socket\_instances**

[Section 25.15, “Performance Schema System Variables”](#)

## **performance\_schema\_max\_sql\_text\_length**

[Section 25.10, “Performance Schema Statement Digests”](#)

[Section 25.15, “Performance Schema System Variables”](#)

[Section 25.12.6.1, “The events\\_statements\\_current Table”](#)

## **performance\_schema\_max\_stage\_classes**

[Section 25.15, “Performance Schema System Variables”](#)

[Section 25.12.16.3, “The processlist Table”](#)

## **performance\_schema\_max\_statement\_classes**

[Section 25.15, “Performance Schema System Variables”](#)

## **performance\_schema\_max\_statement\_stack**

[Section 25.16, “Performance Schema Status Variables”](#)

[Section 25.15, “Performance Schema System Variables”](#)

## **performance\_schema\_max\_table\_handles**

[Section 25.16, “Performance Schema Status Variables”](#)

[Section 25.15, “Performance Schema System Variables”](#)

[Section 25.12.12.2, “The table\\_handles Table”](#)

---

## **performance\_schema\_max\_table\_instances**

[Section 25.15, “Performance Schema System Variables”](#)

## **performance\_schema\_max\_table\_lock\_stat**

[Section 25.16, “Performance Schema Status Variables”](#)  
[Section 25.15, “Performance Schema System Variables”](#)

## **performance\_schema\_max\_thread\_classes**

[Section 25.15, “Performance Schema System Variables”](#)  
[Section 25.12.16.3, “The processlist Table”](#)

## **performance\_schema\_max\_thread\_instances**

[Section 25.12.14, “Performance Schema Status Variable Tables”](#)  
[Section 25.16, “Performance Schema Status Variables”](#)  
[Section 25.15, “Performance Schema System Variables”](#)  
[Section 13.7.5.15, “SHOW ENGINE Statement”](#)  
[Section 25.12.16.3, “The processlist Table”](#)

## **performance\_schema\_session\_connect\_attrs\_size**

[Section 25.12.9, “Performance Schema Connection Attribute Tables”](#)  
[Section 25.16, “Performance Schema Status Variables”](#)  
[Section 25.15, “Performance Schema System Variables”](#)

## **performance\_schema\_setup\_actors\_size**

[Section 25.15, “Performance Schema System Variables”](#)  
[Section 25.12.2.1, “The setup\\_actors Table”](#)

## **performance\_schema\_setup\_objects\_size**

[Section 25.15, “Performance Schema System Variables”](#)  
[Section 25.12.2.4, “The setup\\_objects Table”](#)

## **performance\_schema\_show\_processlist**

[Section 25.15, “Performance Schema System Variables”](#)  
[Section 25.12.16.3, “The processlist Table”](#)

## **performance\_schema\_users\_size**

[Section 25.12.14, “Performance Schema Status Variable Tables”](#)  
[Section 25.15, “Performance Schema System Variables”](#)  
[Section 25.12.15.10, “Status Variable Summary Tables”](#)  
[Section 25.12.8.3, “The users Table”](#)

## **pid**

[Section 14.8.2, “Configuring InnoDB for Read-Only Operation”](#)

## **pid\_file**

[Section 2.4.3, “Installing a MySQL Launch Daemon”](#)  
[Section 5.1.7, “Server System Variables”](#)

## **plugin\_dir**

[Section 6.1.2.2, “Administrator Guidelines for Password Security”](#)

---

Section 6.4.2.1, “Connection Control Plugin Installation”  
Section 13.7.3.1, “CREATE FUNCTION Statement for Loadable Functions”  
Section 6.4.4.8, “General-Purpose Keyring Key-Management Functions”  
Section 13.7.3.3, “INSTALL PLUGIN Statement”  
Section 2.4.3, “Installing a MySQL Launch Daemon”  
Section 5.5.1, “Installing and Uninstalling Plugins”  
Section 2.5.5, “Installing MySQL on Linux Using RPM Packages from Oracle”  
Section 6.4.5.2, “Installing or Uninstalling MySQL Enterprise Audit”  
Section 6.5.2, “Installing or Uninstalling MySQL Enterprise Data Masking and De-Identification”  
Section 5.5.5.2, “Installing or Uninstalling Version Tokens”  
Section 6.4.4.11, “Keyring Command Options”  
Section 6.4.4.1, “Keyring Plugin Installation”  
Section 6.4.1.9, “LDAP Pluggable Authentication”  
Section 6.1.3, “Making MySQL Secure Against Attackers”  
Section 6.6.1, “MySQL Enterprise Encryption Installation”  
Section 6.4.1.10, “No-Login Pluggable Authentication”  
Section 5.6.2, “Obtaining Information About Loadable Functions”  
Section 6.4.1.7, “PAM Pluggable Authentication”  
Section 6.4.3.1, “Password Validation Plugin Installation”  
Section 6.2.13, “Pluggable Authentication”  
Section 15.11.1, “Pluggable Storage Engine Architecture”  
Section 16.3.9.2, “Semisynchronous Replication Installation and Configuration”  
Section 5.1.6, “Server Command Options”  
Section 5.1.7, “Server System Variables”  
Section 14.21.3, “Setting Up the InnoDB memcached Plugin”  
Section 13.7.5.25, “SHOW PLUGINS Statement”  
Section 6.4.1.11, “Socket Peer-Credential Pluggable Authentication”  
Section 6.4.1.12, “Test Pluggable Authentication”  
Section 24.3.17, “The INFORMATION\_SCHEMA PLUGINS Table”  
The Locking Service Function Interface  
Section 5.5.3.2, “Thread Pool Installation”  
Section 6.4.1.8, “Windows Pluggable Authentication”

## **port**

Section B.3.2.2, “Can’t connect to [local] MySQL server”  
Section 17.2.1.2, “Configuring an Instance for Group Replication”  
Section 17.8, “Frequently Asked Questions”  
Section 5.1.7, “Server System Variables”  
Section 6.7.5.1, “Setting the TCP Port Context for mysqld”  
Section 25.12.11.8, “The replication\_group\_members Table”  
Section 19.4.2.2, “X Plugin Options and System Variables”

## **preload\_buffer\_size**

Section 5.1.7, “Server System Variables”

## **profiling**

Section 5.1.7, “Server System Variables”  
Section 13.7.5.30, “SHOW PROFILE Statement”  
Section 24.3.19, “The INFORMATION\_SCHEMA PROFILING Table”

## **profiling\_history\_size**

Section 5.1.7, “Server System Variables”  
Section 13.7.5.30, “SHOW PROFILE Statement”

---

## **protocol\_version**

[Section 5.1.7, “Server System Variables”](#)

## **proxy\_user**

[Section 6.2.14, “Proxy Users”](#)

[Section 5.1.7, “Server System Variables”](#)

## **pseudo\_slave\_mode**

[Section 4.6.7, “mysqlbinlog — Utility for Processing Binary Log Files”](#)

[Section 5.1.7, “Server System Variables”](#)

## **pseudo\_thread\_id**

[Section 12.15, “Information Functions”](#)

[Section 5.4.4.3, “Mixed Binary Logging Format”](#)

[Section 16.4.1.37, “Replication and Variables”](#)

[Section 5.1.7, “Server System Variables”](#)

## **Q**

[\[index top\]](#)

## **query\_alloc\_block\_size**

[Section 5.1.7, “Server System Variables”](#)

## **query\_cache\_limit**

[Section 8.10.3.3, “Query Cache Configuration”](#)

[Section 5.1.7, “Server System Variables”](#)

[Section 1.3, “What Is New in MySQL 5.7”](#)

## **query\_cache\_min\_res\_unit**

[Section 8.10.3.3, “Query Cache Configuration”](#)

[Section 5.1.7, “Server System Variables”](#)

[Section 1.3, “What Is New in MySQL 5.7”](#)

## **query\_cache\_size**

[Section 8.10.3.3, “Query Cache Configuration”](#)

[Section 5.1.7, “Server System Variables”](#)

[Section 8.10.3, “The MySQL Query Cache”](#)

[Section 1.3, “What Is New in MySQL 5.7”](#)

## **query\_cache\_type**

[Section 8.10.3.3, “Query Cache Configuration”](#)

[Section 8.10.3.2, “Query Cache SELECT Options”](#)

[Section 13.2.9, “SELECT Statement”](#)

[Section 5.1.9, “Server Status Variables”](#)

[Section 5.1.7, “Server System Variables”](#)

[Section 1.3, “What Is New in MySQL 5.7”](#)

## **query\_cache\_wlock\_invalidate**

[Section 5.1.7, “Server System Variables”](#)

[Section 1.3, “What Is New in MySQL 5.7”](#)

---

## **query\_prealloc\_size**

[Section 5.1.7, “Server System Variables”](#)

## **R**

[\[index top\]](#)

## **rand\_seed**

[Section 5.1.7, “Server System Variables”](#)

## **range\_alloc\_block\_size**

[Section 5.1.7, “Server System Variables”](#)

## **range\_optimizer\_max\_mem\_size**

[Section 4.5.1.6, “mysql Client Tips”](#)

[Section 8.2.1.2, “Range Optimization”](#)

[Section 5.1.7, “Server System Variables”](#)

## **rbr\_exec\_mode**

[Section 5.1.7, “Server System Variables”](#)

## **read\_buffer\_size**

[Section 8.12.4.1, “How MySQL Uses Memory”](#)

[Section 8.6.3, “Optimizing REPAIR TABLE Statements”](#)

[Section 5.1.7, “Server System Variables”](#)

## **read\_only**

[Section 13.7.1, “Account Management Statements”](#)

[Section 13.7.1.1, “ALTER USER Statement”](#)

[Section 6.2.10, “Assigning Account Passwords”](#)

[Section 16.3.1.3, “Backing Up a Source or Replica by Making It Read Only”](#)

[Section 13.7.1.2, “CREATE USER Statement”](#)

[Section 13.7.1.3, “DROP USER Statement”](#)

[Section 13.7.6.3, “FLUSH Statement”](#)

[Section 8.14.3, “General Thread States”](#)

[Section 13.7.1.4, “GRANT Statement”](#)

[Section B.3.7, “Known Issues in MySQL”](#)

[Section 6.2.2, “Privileges Provided by MySQL”](#)

[Section 13.7.1.5, “RENAME USER Statement”](#)

[Section 16.4.1.37, “Replication and Variables”](#)

[Section 13.7.1.6, “REVOKE Statement”](#)

[Section 5.4.1, “Selecting General Query Log and Slow Query Log Output Destinations”](#)

[Section 5.1.7, “Server System Variables”](#)

[Section 13.7.1.7, “SET PASSWORD Statement”](#)

[Section 16.1.3.4, “Setting Up Replication Using GTIDs”](#)

[Section 13.3.1, “START TRANSACTION, COMMIT, and ROLLBACK Statements”](#)

## **read\_rnd\_buffer\_size**

[Section 5.1.1, “Configuring the Server”](#)

[Section 8.12.4.1, “How MySQL Uses Memory”](#)

[Section 8.2.1.10, “Multi-Range Read Optimization”](#)

[Section 8.2.1.14, “ORDER BY Optimization”](#)

---

[Section 5.1.7, “Server System Variables”](#)

## **relay**

[Section 16.2.2.3, “Startup Options and Replication Channels”](#)

## **relay\_log**

[Section 16.1.2.6, “Adding Replicas to a Replication Topology”](#)

[Section 17.8, “Frequently Asked Questions”](#)

[Section 16.3.6, “Improving Replication Performance”](#)

[Section 16.1.6.3, “Replica Server Options and Variables”](#)

[Section 16.2.2.4, “Replication Channel Naming Conventions”](#)

[Section 16.2.4.1, “The Relay Log”](#)

## **relay\_log\_basename**

[Section 16.1.6.3, “Replica Server Options and Variables”](#)

## **relay\_log\_index**

[Section 16.1.2.6, “Adding Replicas to a Replication Topology”](#)

[Section 16.1.6.3, “Replica Server Options and Variables”](#)

[Section 16.2.4.1, “The Relay Log”](#)

## **relay\_log\_info\_file**

[Section 16.1.6.3, “Replica Server Options and Variables”](#)

[Section 16.2.4.2, “Replication Metadata Repositories”](#)

## **relay\_log\_info\_repository**

[Section 16.1.5.1, “Configuring Multi-Source Replication”](#)

[Section 13.7.6.3, “FLUSH Statement”](#)

[Section 17.3.1, “Group Replication Requirements”](#)

[Section 16.3.2, “Handling an Unexpected Halt of a Replica”](#)

[Section 14.15, “InnoDB Startup Options and System Variables”](#)

[Section 16.1.6.3, “Replica Server Options and Variables”](#)

[Section 16.2.4.2, “Replication Metadata Repositories”](#)

[Section 13.3.7.3, “Restrictions on XA Transactions”](#)

[Section 16.2.2.3, “Startup Options and Replication Channels”](#)

## **relay\_log\_purge**

[Section 13.4.2.1, “CHANGE MASTER TO Statement”](#)

[Section 16.1.6.3, “Replica Server Options and Variables”](#)

[Section 13.7.5.34, “SHOW SLAVE STATUS Statement”](#)

## **relay\_log\_recovery**

[Section 16.3.2, “Handling an Unexpected Halt of a Replica”](#)

[Section 16.1.6.3, “Replica Server Options and Variables”](#)

## **relay\_log\_space\_limit**

[Section 16.1.6.3, “Replica Server Options and Variables”](#)

[Section 8.14.6, “Replication Replica I/O Thread States”](#)

[Section 16.2.2.3, “Startup Options and Replication Channels”](#)

## **replica\_sql\_verify\_checksum**

[MySQL Glossary](#)

---

## **replication\_optimize\_for\_static\_plugin\_config**

[Section 16.1.6.3, “Replica Server Options and Variables”](#)

[Section 16.3.9.1, “Semisynchronous Replication Administrative Interface”](#)

## **replication\_sender\_observe\_commit\_only**

[Section 16.1.6.3, “Replica Server Options and Variables”](#)

[Section 16.3.9.1, “Semisynchronous Replication Administrative Interface”](#)

## **report\_host**

[Section 17.2.2, “Deploying Group Replication Locally”](#)

[Section 16.1.6.3, “Replica Server Options and Variables”](#)

[Section 17.2.1.3, “User Credentials”](#)

## **report\_password**

[Section 16.1.6.3, “Replica Server Options and Variables”](#)

## **report\_port**

[Section 17.8, “Frequently Asked Questions”](#)

[Section 16.1.6.3, “Replica Server Options and Variables”](#)

## **report\_user**

[Section 16.1.6.3, “Replica Server Options and Variables”](#)

## **require\_secure\_transport**

[Section 6.3.1, “Configuring MySQL to Use Encrypted Connections”](#)

[Section 4.2.5, “Connection Transport Protocols”](#)

[Section 5.1.7, “Server System Variables”](#)

[Section 6.3, “Using Encrypted Connections”](#)

[Section 19.4.1, “Using Encrypted Connections with X Plugin”](#)

## **rewriter\_enabled**

[Rewriter Query Rewrite Plugin System Variables](#)

[Section 5.5.4.2, “Using the Rewriter Query Rewrite Plugin”](#)

## **rewriter\_verbose**

[Rewriter Query Rewrite Plugin System Variables](#)

## **rpl\_semi\_sync\_master\_enabled**

[Section 16.1.6.2, “Replication Source Options and Variables”](#)

[Section 16.3.9.1, “Semisynchronous Replication Administrative Interface”](#)

[Section 16.3.9.2, “Semisynchronous Replication Installation and Configuration”](#)

[Section 16.3.9.3, “Semisynchronous Replication Monitoring”](#)

## **rpl\_semi\_sync\_master\_timeout**

[Section 16.1.6.2, “Replication Source Options and Variables”](#)

[Section 16.3.9.1, “Semisynchronous Replication Administrative Interface”](#)

[Section 16.3.9.2, “Semisynchronous Replication Installation and Configuration”](#)

## **rpl\_semi\_sync\_master\_trace\_level**

[Section 16.1.6.3, “Replica Server Options and Variables”](#)

[Section 16.1.6.2, “Replication Source Options and Variables”](#)

---

## **rpl\_semi\_sync\_master\_wait\_for\_slave\_count**

[Section 16.1.6.2, “Replication Source Options and Variables”](#)

[Section 16.3.9, “Semisynchronous Replication”](#)

## **rpl\_semi\_sync\_master\_wait\_no\_slave**

[Section 16.1.6.2, “Replication Source Options and Variables”](#)

## **rpl\_semi\_sync\_master\_wait\_point**

[Section 16.1.6.2, “Replication Source Options and Variables”](#)

[Section 16.3.9, “Semisynchronous Replication”](#)

## **rpl\_semi\_sync\_slave\_enabled**

[Section 16.1.6.3, “Replica Server Options and Variables”](#)

[Section 16.3.9.1, “Semisynchronous Replication Administrative Interface”](#)

[Section 16.3.9.2, “Semisynchronous Replication Installation and Configuration”](#)

## **rpl\_semi\_sync\_slave\_trace\_level**

[Section 16.1.6.3, “Replica Server Options and Variables”](#)

## **rpl\_stop\_slave\_timeout**

[Section 16.1.6.3, “Replica Server Options and Variables”](#)

[Section 16.4.1.32, “Replication and Transaction Inconsistencies”](#)

[Section 13.4.2.6, “STOP SLAVE Statement”](#)

## **S**

[\[index top\]](#)

## **secure\_auth**

[Section 2.10.3, “Changes in MySQL 5.7”](#)

[Section 6.4.1.3, “Migrating Away from Pre-4.1 Password Hashing and the mysql\\_old\\_password Plugin”](#)

[Section 6.1.2.4, “Password Hashing in MySQL”](#)

[Section 5.1.7, “Server System Variables”](#)

[Section 1.3, “What Is New in MySQL 5.7”](#)

## **secure\_file\_priv**

[Section 2.9.1, “Initializing the Data Directory”](#)

[Section 2.5.5, “Installing MySQL on Linux Using RPM Packages from Oracle”](#)

[Section 13.2.6, “LOAD DATA Statement”](#)

[Section 6.1.3, “Making MySQL Secure Against Attackers”](#)

[Section 6.5.5, “MySQL Enterprise Data Masking and De-Identification Function Descriptions”](#)

[Section 2.8.7, “MySQL Source-Configuration Options”](#)

[Section 6.2.2, “Privileges Provided by MySQL”](#)

[Section 27.6.2, “Restrictions When Using the Embedded MySQL Server”](#)

[Section 13.2.9.1, “SELECT ... INTO Statement”](#)

[Section 6.7.4, “SELinux File Context”](#)

[Section 5.1.7, “Server System Variables”](#)

[Section 12.8, “String Functions and Operators”](#)

[Section 6.5.3, “Using MySQL Enterprise Data Masking and De-Identification”](#)

## **server\_id**

[Adding a Second Instance](#)



---

Section 16.1.2.6, “Adding Replicas to a Replication Topology”  
Advanced Options  
Section 6.4.5.4, “Audit Log File Formats”  
Section 16.1.1, “Binary Log File Position Based Replication Configuration Overview”  
Section 16.1.6.4, “Binary Logging Options and Variables”  
Section 17.2.1.2, “Configuring an Instance for Group Replication”  
Section 17.3.1, “Group Replication Requirements”  
Section 12.20, “Miscellaneous Functions”  
Section 4.6.7, “mysqlbinlog — Utility for Processing Binary Log Files”  
NDB Cluster System Variables  
Section 25.12.11, “Performance Schema Replication Tables”  
Section 16.1.6.3, “Replica Server Options and Variables”  
Section 16.1.6, “Replication and Binary Logging Options and Variables”  
Section 16.1.6.2, “Replication Source Options and Variables”  
Setting the Replica Configuration  
Section 16.1.2.1, “Setting the Replication Source Configuration”  
Section 16.1.3.4, “Setting Up Replication Using GTIDs”  
Setting Up Replication with Existing Data  
Section 13.7.5.34, “SHOW SLAVE STATUS Statement”  
Section 16.4.4, “Troubleshooting Replication”  
Section 16.2.1.2, “Usage of Row-Based Logging and Replication”

## **server\_id\_bits**

NDB Cluster System Variables

## **server\_uuid**

Section 16.1.3.1, “GTID Format and Storage”  
Section 25.12.11, “Performance Schema Replication Tables”  
Section 16.1.6, “Replication and Binary Logging Options and Variables”  
Section 13.7.5.34, “SHOW SLAVE STATUS Statement”  
Section 17.5.1.1, “Single-Primary Mode”  
Section 16.1.3.7, “Stored Function Examples to Manipulate GTIDs”  
Section 25.12.11.2, “The replication\_connection\_status Table”  
Section 17.4.2, “The replication\_group\_members Table”  
Section 17.5.5, “Using MySQL Enterprise Backup with Group Replication”

## **session\_track\_gtids**

Section 16.1.6.5, “Global Transaction ID System Variables”  
Section 16.1.4.1, “Replication Mode Concepts”  
Section 5.1.7, “Server System Variables”  
Section 5.1.15, “Server Tracking of Client Session State”

## **session\_track\_schema**

Section 5.1.7, “Server System Variables”  
Section 5.1.15, “Server Tracking of Client Session State”

## **session\_track\_state\_change**

Section 5.1.7, “Server System Variables”  
Section 5.1.15, “Server Tracking of Client Session State”

## **session\_track\_system\_variables**

Section 5.1.7, “Server System Variables”  
Section 5.1.15, “Server Tracking of Client Session State”

---

## **session\_track\_transaction\_info**

[Section 5.1.7, “Server System Variables”](#)

[Section 5.1.15, “Server Tracking of Client Session State”](#)

## **sha**

[Section 6.3.3.1, “Creating SSL and RSA Certificates and Keys using MySQL”](#)

[Section 6.2.14, “Proxy Users”](#)

[Section 5.1.9, “Server Status Variables”](#)

[Section 5.1.7, “Server System Variables”](#)

[Section 6.4.1.5, “SHA-256 Pluggable Authentication”](#)

[Section 6.3.4, “SSL Library-Dependent Capabilities”](#)

[Section 6.3, “Using Encrypted Connections”](#)

## **shared\_memory**

[Section 4.2.3, “Command Options for Connecting to the Server”](#)

[Section 4.2.4, “Connecting to the MySQL Server Using Command Options”](#)

[Section 4.5.1.1, “mysql Client Options”](#)

[Section 4.4.7, “mysql\\_upgrade — Check and Upgrade MySQL Tables”](#)

[Section 4.5.2, “mysqladmin — A MySQL Server Administration Program”](#)

[Section 4.6.7, “mysqlbinlog — Utility for Processing Binary Log Files”](#)

[Section 4.5.3, “mysqlcheck — A Table Maintenance Program”](#)

[Section 4.5.4, “mysqldump — A Database Backup Program”](#)

[Section 4.5.5, “mysqlimport — A Data Import Program”](#)

[Section 4.5.7, “mysqlshow — Display Database, Table, and Column Information”](#)

[Section 4.5.8, “mysqlslap — A Load Emulation Client”](#)

[Resetting the Root Password: Generic Instructions](#)

[Section 5.1.7, “Server System Variables”](#)

[Section 5.7.2.1, “Starting Multiple MySQL Instances at the Windows Command Line”](#)

[Section 2.3.4.5, “Starting the Server for the First Time”](#)

[Section 1.2.2, “The Main Features of MySQL”](#)

[Type and Networking](#)

## **shared\_memory\_base\_name**

[Section 5.1.7, “Server System Variables”](#)

[Section 5.7.2.1, “Starting Multiple MySQL Instances at the Windows Command Line”](#)

## **show\_compatibility\_**

[Section 2.10.3, “Changes in MySQL 5.7”](#)

[Section 13.7.6.3, “FLUSH Statement”](#)

[Section 25.20, “Migrating to Performance Schema System and Status Variable Tables”](#)

[Section 25.12.14, “Performance Schema Status Variable Tables”](#)

[Section 25.12.13, “Performance Schema System Variable Tables”](#)

[Section 21.6.17, “Quick Reference: NDB Cluster SQL Statements”](#)

[Section 5.1.9, “Server Status Variables”](#)

[Section 5.1.7, “Server System Variables”](#)

[Section 13.7.5.35, “SHOW STATUS Statement”](#)

[Section 13.7.5.39, “SHOW VARIABLES Statement”](#)

[Section 25.12.15.10, “Status Variable Summary Tables”](#)

[Section 24.3.10, “The INFORMATION\\_SCHEMA GLOBAL\\_STATUS and SESSION\\_STATUS Tables”](#)

[Section 24.3.11, “The INFORMATION\\_SCHEMA GLOBAL\\_VARIABLES and SESSION\\_VARIABLES Tables”](#)

[Section 1.3, “What Is New in MySQL 5.7”](#)

---

## **show\_create\_table\_verbosity**

Section 5.1.7, “Server System Variables”

## **show\_old\_temporals**

Section 5.1.7, “Server System Variables”

## **skip\_external\_locking**

Section 8.11.5, “External Locking”

Section 5.1.7, “Server System Variables”

## **skip\_name\_resolve**

Section 2.10.3, “Changes in MySQL 5.7”

Section 5.1.11.2, “DNS Lookups and the Host Cache”

Section 17.8, “Frequently Asked Questions”

Section 2.9.1, “Initializing the Data Directory”

Section 5.1.7, “Server System Variables”

Section 2.3.4.9, “Testing The MySQL Installation”

Section 6.2.17, “Troubleshooting Problems Connecting to MySQL”

## **skip\_networking**

Section B.3.2.2, “Can't connect to [local] MySQL server”

Section 5.1.11.2, “DNS Lookups and the Host Cache”

Section A.14, “MySQL 5.7 FAQ: Replication”

Section B.3.2.7, “MySQL server has gone away”

Section 6.2.13, “Pluggable Authentication”

Resetting the Root Password: Generic Instructions

Section 5.1.7, “Server System Variables”

Section 16.1.2.1, “Setting the Replication Source Configuration”

Section 21.6.15.30, “The ndbinfo processes Table”

Section 6.2.17, “Troubleshooting Problems Connecting to MySQL”

Section 16.4.4, “Troubleshooting Replication”

Section 16.4.3, “Upgrading a Replication Topology”

Section 19.4.2.3, “X Plugin Status Variables”

## **skip\_replica\_start**

Section 13.4.3.1, “START GROUP\_REPLICATION Statement”

## **skip\_show\_database**

Section 5.1.6, “Server Command Options”

Section 5.1.7, “Server System Variables”

## **skip\_slave\_start**

Section 16.4.3, “Upgrading a Replication Topology”

## **slave**

Section 16.2.2.3, “Startup Options and Replication Channels”

## **slave\_allow\_batching**

NDB Cluster System Variables

Section 21.7.5, “Preparing the NDB Cluster for Replication”

Section 21.7.6, “Starting NDB Cluster Replication (Single Replication Channel)”

---

## **slave\_checkpoint\_group**

[Section 21.7.3, “Known Issues in NDB Cluster Replication”](#)  
[Section 12.20, “Miscellaneous Functions”](#)  
[Section 16.1.6.3, “Replica Server Options and Variables”](#)  
[Section 16.2.2.3, “Startup Options and Replication Channels”](#)

## **slave\_checkpoint\_period**

[Section 12.20, “Miscellaneous Functions”](#)  
[Section 16.1.6.3, “Replica Server Options and Variables”](#)

## **slave\_compressed\_protocol**

[Section 4.2.6, “Connection Compression Control”](#)  
[Section 16.1.6.3, “Replica Server Options and Variables”](#)

## **slave\_exec\_mode**

[Section 21.7.3, “Known Issues in NDB Cluster Replication”](#)  
[Section 16.1.6.3, “Replica Server Options and Variables”](#)  
[Section 16.4.1.20, “Replication and MEMORY Tables”](#)  
[Section 16.2.1.2, “Usage of Row-Based Logging and Replication”](#)

## **slave\_load\_tmpdir**

[Section 16.3.1.2, “Backing Up Raw Data from a Replica”](#)  
[Section 7.2, “Database Backup Methods”](#)  
[Section 16.1.6.3, “Replica Server Options and Variables”](#)  
[Section 5.1.6, “Server Command Options”](#)  
[Section 5.1.7, “Server System Variables”](#)  
[Section B.3.3.5, “Where MySQL Stores Temporary Files”](#)

## **slave\_max\_allowed\_packet**

[Section 17.3.2, “Group Replication Limitations”](#)  
[Section 16.1.6.3, “Replica Server Options and Variables”](#)  
[Section 16.4.1.19, “Replication and max\\_allowed\\_packet”](#)

## **slave\_net\_timeout**

[Section 13.4.2.1, “CHANGE MASTER TO Statement”](#)  
[Section 2.10.3, “Changes in MySQL 5.7”](#)  
[Section 16.1.7.1, “Checking Replication Status”](#)  
[Section 16.1.6.3, “Replica Server Options and Variables”](#)  
[Section 16.4.1.26, “Replication and Source or Replica Shutdowns”](#)  
[Section 8.14.6, “Replication Replica I/O Thread States”](#)  
[Section 5.1.7, “Server System Variables”](#)

## **slave\_parallel\_type**

[Section 16.1.6.4, “Binary Logging Options and Variables”](#)  
[Section 17.3.1, “Group Replication Requirements”](#)  
[Section 16.2.3.2, “Monitoring Replication Applier Worker Threads”](#)  
[Section 16.1.6.3, “Replica Server Options and Variables”](#)  
[Section 16.4.1.32, “Replication and Transaction Inconsistencies”](#)

## **slave\_parallel\_workers**

[Section 13.4.2.1, “CHANGE MASTER TO Statement”](#)

---

[Section 17.3.1, “Group Replication Requirements”](#)  
[Section 16.1.3.2, “GTID Life Cycle”](#)  
[Section 21.7.3, “Known Issues in NDB Cluster Replication”](#)  
[Section 16.1.5, “MySQL Multi-Source Replication”](#)  
[Section 25.12.11, “Performance Schema Replication Tables”](#)  
[Section 16.1.6.3, “Replica Server Options and Variables”](#)  
[Section 16.4.1.19, “Replication and max\\_allowed\\_packet”](#)  
[Section 16.4.1.32, “Replication and Transaction Inconsistencies”](#)  
[Section 16.2.2, “Replication Channels”](#)  
[Section 8.14.7, “Replication Replica SQL Thread States”](#)  
[Section 16.2.3, “Replication Threads”](#)  
[Section 13.4.2.5, “START SLAVE Statement”](#)  
[Section 13.4.2.6, “STOP SLAVE Statement”](#)

### **slave\_pending\_jobs\_size\_max**

[Section 16.2.3.2, “Monitoring Replication Applier Worker Threads”](#)  
[Section 16.1.6.3, “Replica Server Options and Variables”](#)  
[Section 16.4.1.19, “Replication and max\\_allowed\\_packet”](#)  
[Section 8.14.7, “Replication Replica SQL Thread States”](#)

### **slave\_preserve\_commit\_order**

[Section 16.1.6.4, “Binary Logging Options and Variables”](#)  
[Section 17.3.1, “Group Replication Requirements”](#)  
[Section 16.1.3.2, “GTID Life Cycle”](#)  
[Section 16.1.6.3, “Replica Server Options and Variables”](#)  
[Section 16.4.1.32, “Replication and Transaction Inconsistencies”](#)  
[Section 8.14.6, “Replication Replica I/O Thread States”](#)

### **slave\_rows\_search\_algorithms**

[Section 16.1.6.3, “Replica Server Options and Variables”](#)  
[Section 5.1.9, “Server Status Variables”](#)

### **slave\_skip\_errors**

[Section 16.1.6.3, “Replica Server Options and Variables”](#)

### **slave\_sql\_verify\_checksum**

[MySQL Glossary](#)  
[Section 16.1.6.3, “Replica Server Options and Variables”](#)  
[Section 5.4.4, “The Binary Log”](#)

### **slave\_transaction\_retries**

[Section 16.1.6.3, “Replica Server Options and Variables”](#)  
[Section 16.4.1.30, “Replication Retries and Timeouts”](#)  
[Section 16.2.2.3, “Startup Options and Replication Channels”](#)  
[Section 25.12.11.4, “The replication\\_applier\\_status Table”](#)

### **slave\_type\_conversions**

[Section 21.7.3, “Known Issues in NDB Cluster Replication”](#)  
[Section 16.1.6.3, “Replica Server Options and Variables”](#)

### **slow\_launch\_time**

[Section 5.1.9, “Server Status Variables”](#)

---

[Section 5.1.7, “Server System Variables”](#)

## **slow\_query\_log**

[Section 5.4.1, “Selecting General Query Log and Slow Query Log Output Destinations”](#)

[Section 5.1.7, “Server System Variables”](#)

[Section 5.4.5, “The Slow Query Log”](#)

## **slow\_query\_log\_file**

[Section 5.4.1, “Selecting General Query Log and Slow Query Log Output Destinations”](#)

[Section 5.1.7, “Server System Variables”](#)

[Section 5.4.5, “The Slow Query Log”](#)

## **socket**

[Section 5.1.7, “Server System Variables”](#)

[Section 19.4.2.2, “X Plugin Options and System Variables”](#)

## **sort\_buffer\_size**

[Section 7.6.3, “How to Repair MyISAM Tables”](#)

[Section 8.2.1.14, “ORDER BY Optimization”](#)

[Section 5.1.6, “Server Command Options”](#)

[Section 5.1.9, “Server Status Variables”](#)

[Section 5.1.7, “Server System Variables”](#)

[Section 13.7.4.1, “SET Syntax for Variable Assignment”](#)

## **source\_verify\_checksum**

[MySQL Glossary](#)

## **sql\_auto\_is\_null**

[Section 12.4.2, “Comparison Functions and Operators”](#)

[Section 13.1.18, “CREATE TABLE Statement”](#)

[Section 5.4.4.3, “Mixed Binary Logging Format”](#)

[Section 16.4.1.37, “Replication and Variables”](#)

[Section 5.1.7, “Server System Variables”](#)

[Section 5.4.4, “The Binary Log”](#)

## **sql\_big\_selects**

[Section 5.1.7, “Server System Variables”](#)

## **sql\_buffer\_result**

[Section 5.1.7, “Server System Variables”](#)

## **sql\_log\_bin**

[Section 16.1.6.4, “Binary Logging Options and Variables”](#)

[Section 21.7.3, “Known Issues in NDB Cluster Replication”](#)

[Section 4.6.7, “mysqlbinlog — Utility for Processing Binary Log Files”](#)

[Section 21.7.4, “NDB Cluster Replication Schema and Tables”](#)

[Section 6.2.2, “Privileges Provided by MySQL”](#)

[Section 13.4.1.3, “SET sql\\_log\\_bin Statement”](#)

[Section 5.1.8.1, “System Variable Privileges”](#)

[Section 26.4.4.2, “The diagnostics\(\) Procedure”](#)

[Section 26.4.4.12, “The ps\\_setup\\_reload\\_saved\(\) Procedure”](#)

---

[Section 26.4.4.14, “The ps\\_setup\\_save\(\) Procedure”](#)  
[Section 26.4.4.22, “The ps\\_trace\\_statement\\_digest\(\) Procedure”](#)  
[Section 26.4.4.23, “The ps\\_trace\\_thread\(\) Procedure”](#)  
[Section 26.4.4.25, “The statement\\_performance\\_analyzer\(\) Procedure”](#)  
[Section 16.4.3, “Upgrading a Replication Topology”](#)  
[Section 1.3, “What Is New in MySQL 5.7”](#)

## **sql\_log\_off**

[MySQL Glossary](#)

[Section 6.2.2, “Privileges Provided by MySQL”](#)  
[Section 5.4.1, “Selecting General Query Log and Slow Query Log Output Destinations”](#)  
[Section 5.1.7, “Server System Variables”](#)  
[Section 5.4.3, “The General Query Log”](#)

## **SQL\_MODE**

[Section 14.13.1, “Online DDL Operations”](#)

## **sql\_mode**

[Section 14.1.2, “Best Practices for InnoDB Tables”](#)  
[Section 2.10.3, “Changes in MySQL 5.7”](#)  
[Section 13.1.12, “CREATE EVENT Statement”](#)  
[Section 13.1.16, “CREATE PROCEDURE and CREATE FUNCTION Statements”](#)  
[Section 13.1.20, “CREATE TRIGGER Statement”](#)  
[Section 12.21.3, “Expression Handling”](#)  
[Section 11.2.7, “Fractional Seconds in Time Values”](#)  
[Section 1.5, “How to Report Bugs or Problems”](#)  
[Section 13.2.6, “LOAD DATA Statement”](#)  
[Section 5.4.4.3, “Mixed Binary Logging Format”](#)  
[Section 1.6, “MySQL Standards Compliance”](#)  
[Section 4.4.2, “mysql\\_install\\_db — Initialize MySQL Data Directory”](#)  
[Section B.3.4.2, “Problems Using DATE Columns”](#)  
[Section 16.4.1.37, “Replication and Variables”](#)  
[Section 5.1.10, “Server SQL Modes”](#)  
[Section 5.1.7, “Server System Variables”](#)  
[Section 13.7.5.13, “SHOW CREATE VIEW Statement”](#)  
[Section 13.6.7.5, “SIGNAL Statement”](#)  
[Section 5.4.4, “The Binary Log”](#)  
[Section 24.3.31, “The INFORMATION\\_SCHEMA VIEWS Table”](#)  
[Section 26.4.5.7, “The list\\_add\(\) Function”](#)  
[Section 4.2.2.2, “Using Option Files”](#)  
[Section 5.1.8, “Using System Variables”](#)  
[Section 1.3, “What Is New in MySQL 5.7”](#)

## **sql\_notes**

[Section B.2, “Error Information Interfaces”](#)  
[Section 5.1.7, “Server System Variables”](#)  
[Section 13.7.5.40, “SHOW WARNINGS Statement”](#)  
[Section 13.6.7.7, “The MySQL Diagnostics Area”](#)

## **sql\_quote\_show\_create**

[Section 5.1.7, “Server System Variables”](#)  
[Section 13.7.5.6, “SHOW CREATE DATABASE Statement”](#)  
[Section 13.7.5.10, “SHOW CREATE TABLE Statement”](#)

---

## **sql\_safe\_updates**

[Section 4.5.1.6, “mysql Client Tips”](#)  
[Section 8.2.1.2, “Range Optimization”](#)  
[Section 5.1.7, “Server System Variables”](#)

## **sql\_select\_limit**

[Section 4.5.1.6, “mysql Client Tips”](#)  
[Section 5.1.7, “Server System Variables”](#)

## **sql\_slave\_skip\_counter**

[Section 16.1.6.3, “Replica Server Options and Variables”](#)  
[Section 16.1.4.1, “Replication Mode Concepts”](#)  
[Section 16.1.3.6, “Restrictions on Replication with GTIDs”](#)  
[Section 13.7.5.34, “SHOW SLAVE STATUS Statement”](#)  
[Skipping Transactions With `SET GLOBAL sql\_slave\_skip\_counter`](#)

## **sql\_warnings**

[Section 5.1.7, “Server System Variables”](#)

## **ssl\_ca**

[Section 4.2.3, “Command Options for Connecting to the Server”](#)  
[Section 6.3.1, “Configuring MySQL to Use Encrypted Connections”](#)  
[Section 6.3.3.1, “Creating SSL and RSA Certificates and Keys using MySQL”](#)  
[Section 6.3.3.2, “Creating SSL Certificates and Keys Using openssl”](#)  
[Section 5.1.7, “Server System Variables”](#)  
[Section 16.3.8, “Setting Up Replication to Use Encrypted Connections”](#)  
[Section 6.3.4, “SSL Library-Dependent Capabilities”](#)  
[Section 19.4.2.2, “X Plugin Options and System Variables”](#)

## **ssl\_capath**

[Section 4.2.3, “Command Options for Connecting to the Server”](#)  
[Section 6.3.1, “Configuring MySQL to Use Encrypted Connections”](#)  
[Section 5.1.7, “Server System Variables”](#)  
[Section 6.3.4, “SSL Library-Dependent Capabilities”](#)  
[Section 19.4.2.2, “X Plugin Options and System Variables”](#)

## **ssl\_cert**

[Section 4.2.3, “Command Options for Connecting to the Server”](#)  
[Section 6.3.1, “Configuring MySQL to Use Encrypted Connections”](#)  
[Section 6.3.3.1, “Creating SSL and RSA Certificates and Keys using MySQL”](#)  
[Section 6.3.3.2, “Creating SSL Certificates and Keys Using openssl”](#)  
[Section 6.3.2, “Encrypted Connection TLS Protocols and Ciphers”](#)  
[Section 5.1.6, “Server Command Options”](#)  
[Section 5.1.7, “Server System Variables”](#)  
[Section 16.3.8, “Setting Up Replication to Use Encrypted Connections”](#)  
[Section 19.4.2.2, “X Plugin Options and System Variables”](#)

## **ssl\_cipher**

[Section 4.2.3, “Command Options for Connecting to the Server”](#)  
[Section 6.3.1, “Configuring MySQL to Use Encrypted Connections”](#)  
[Section 6.3.2, “Encrypted Connection TLS Protocols and Ciphers”](#)  
[Section 4.4.5, “mysql\\_ssl\\_rsa\\_setup — Create SSL/RSA Files”](#)



---

Section 5.1.7, “Server System Variables”  
Section 6.3.4, “SSL Library-Dependent Capabilities”  
Section 19.4.2.2, “X Plugin Options and System Variables”

## **ssl\_crl**

Section 4.2.3, “Command Options for Connecting to the Server”  
Section 6.3.1, “Configuring MySQL to Use Encrypted Connections”  
Section 5.1.7, “Server System Variables”  
Section 6.3.4, “SSL Library-Dependent Capabilities”  
Section 19.4.2.2, “X Plugin Options and System Variables”

## **ssl\_crlpath**

Section 4.2.3, “Command Options for Connecting to the Server”  
Section 6.3.1, “Configuring MySQL to Use Encrypted Connections”  
Section 5.1.7, “Server System Variables”  
Section 6.3.4, “SSL Library-Dependent Capabilities”  
Section 19.4.2.2, “X Plugin Options and System Variables”

## **ssl\_key**

Section 4.2.3, “Command Options for Connecting to the Server”  
Section 6.3.1, “Configuring MySQL to Use Encrypted Connections”  
Section 6.3.3.1, “Creating SSL and RSA Certificates and Keys using MySQL”  
Section 6.3.3.2, “Creating SSL Certificates and Keys Using openssl”  
Section 5.1.6, “Server Command Options”  
Section 5.1.7, “Server System Variables”  
Section 16.3.8, “Setting Up Replication to Use Encrypted Connections”  
Section 19.4.2.2, “X Plugin Options and System Variables”

## **stored\_program\_cache**

Section 8.10.4, “Caching of Prepared Statements and Stored Programs”  
Section 5.1.7, “Server System Variables”

## **super**

Section 17.5.1.1, “Single-Primary Mode”

## **super\_read\_only**

Adding a Second Instance  
Section 13.7.6.3, “FLUSH Statement”  
Section 17.4.1, “Group Replication Server States”  
Section 17.7.1, “Group Replication System Variables”  
Section 5.1.7, “Server System Variables”  
Section 13.4.3.1, “START GROUP\_REPLICATION Statement”  
Section 13.4.3.2, “STOP GROUP\_REPLICATION Statement”

## **sync\_binlog**

Section 16.1.6.4, “Binary Logging Options and Variables”  
Section 16.1.3.3, “GTID Auto-Positioning”  
Section 14.2, “InnoDB and the ACID Model”  
Section 14.15, “InnoDB Startup Options and System Variables”  
Section 16.4.1.26, “Replication and Source or Replica Shutdowns”  
Section 5.4.4, “The Binary Log”  
Section 4.6.7.3, “Using mysqlbinlog to Back Up Binary Log Files”

---

## **sync\_frm**

Section 5.1.7, “Server System Variables”  
Section 1.3, “What Is New in MySQL 5.7”

## **sync\_master\_info**

Section 16.1.6.3, “Replica Server Options and Variables”

## **sync\_relay\_log**

Section 16.3.2, “Handling an Unexpected Halt of a Replica”  
Section 16.1.6.3, “Replica Server Options and Variables”

## **sync\_relay\_log\_info**

Section 16.1.6.3, “Replica Server Options and Variables”  
Section 16.4.1.26, “Replication and Source or Replica Shutdowns”

## **system\_time\_zone**

Section 5.1.13, “MySQL Server Time Zone Support”  
Section 16.4.1.31, “Replication and Time Zones”  
Section 5.1.6, “Server Command Options”  
Section 5.1.7, “Server System Variables”

## **T**

[[index top](#)]

## **table\_definition\_cache**

Section 8.12.4.1, “How MySQL Uses Memory”  
Section 5.1.7, “Server System Variables”

## **table\_open\_cache**

Section 5.1.1, “Configuring the Server”  
Section B.3.2.16, “File Not Found and Similar Errors”  
Section 8.14.3, “General Thread States”  
Section 8.4.3.1, “How MySQL Opens and Closes Tables”  
Section 8.12.4.1, “How MySQL Uses Memory”  
Section 14.15, “InnoDB Startup Options and System Variables”  
Section 5.1.9, “Server Status Variables”  
Section 5.1.7, “Server System Variables”

## **table\_open\_cache\_instances**

Section 5.4.1, “Selecting General Query Log and Slow Query Log Output Destinations”  
Section 5.1.9, “Server Status Variables”  
Section 5.1.7, “Server System Variables”

## **thread\_cache\_size**

Section 5.1.11.1, “Connection Interfaces”  
Section 5.8.1.4, “Debugging mysqld under gdb”  
Section 5.1.9, “Server Status Variables”  
Section 5.1.7, “Server System Variables”

## **thread\_handling**

Section 5.1.7, “Server System Variables”

---

Section 5.5.3.1, “Thread Pool Elements”

## **thread\_pool\_algorithm**

Section 5.1.7, “Server System Variables”

Section 24.5.2, “The INFORMATION\_SCHEMA TP\_THREAD\_GROUP\_STATE Table”

Section 5.5.3.3, “Thread Pool Operation”

## **thread\_pool\_high\_priority\_connection**

Section 5.1.7, “Server System Variables”

Section 5.5.3.3, “Thread Pool Operation”

## **thread\_pool\_max\_unused\_threads**

Section 5.1.7, “Server System Variables”

Section 5.5.3.3, “Thread Pool Operation”

## **thread\_pool\_prio\_kickup\_timer**

Section 5.1.7, “Server System Variables”

Section 24.5.2, “The INFORMATION\_SCHEMA TP\_THREAD\_GROUP\_STATE Table”

Section 24.5.3, “The INFORMATION\_SCHEMA TP\_THREAD\_GROUP\_STATS Table”

Section 5.5.3.3, “Thread Pool Operation”

Section 5.5.3.4, “Thread Pool Tuning”

## **thread\_pool\_size**

Section 5.1.7, “Server System Variables”

Section 5.5.3.3, “Thread Pool Operation”

Section 5.5.3.4, “Thread Pool Tuning”

## **thread\_pool\_stall\_limit**

Section 5.1.7, “Server System Variables”

Section 24.5.2, “The INFORMATION\_SCHEMA TP\_THREAD\_GROUP\_STATE Table”

Section 24.5.3, “The INFORMATION\_SCHEMA TP\_THREAD\_GROUP\_STATS Table”

Section 5.5.3.3, “Thread Pool Operation”

Section 5.5.3.4, “Thread Pool Tuning”

## **thread\_stack**

Section 5.1.11.1, “Connection Interfaces”

Section 8.12.4.1, “How MySQL Uses Memory”

Section 5.1.7, “Server System Variables”

Section 23.2.1, “Stored Routine Syntax”

## **time\_format**

Section 5.1.7, “Server System Variables”

## **time\_zone**

Section 13.1.12, “CREATE EVENT Statement”

Section 12.7, “Date and Time Functions”

Section 23.4.4, “Event Metadata”

Section 5.4.4.3, “Mixed Binary Logging Format”

Section 5.1.13, “MySQL Server Time Zone Support”

Section 16.4.1.31, “Replication and Time Zones”

Section 16.4.1.37, “Replication and Variables”

---

[Section 5.1.6, “Server Command Options”](#)  
[Section 5.1.7, “Server System Variables”](#)  
[Section 11.2.2, “The DATE, DATETIME, and TIMESTAMP Types”](#)  
[Section 5.4.3, “The General Query Log”](#)  
[Section 5.4.5, “The Slow Query Log”](#)

## **timestamp**

[Section 15.8.3, “FEDERATED Storage Engine Notes and Tips”](#)  
[Section 5.4.4.3, “Mixed Binary Logging Format”](#)  
[Section 16.4.1.37, “Replication and Variables”](#)  
[Section 5.1.7, “Server System Variables”](#)

## **tls**

[Section A.9, “MySQL 5.7 FAQ: Security”](#)

## **tls\_version**

[Section 4.2.3, “Command Options for Connecting to the Server”](#)  
[Section 6.3.1, “Configuring MySQL to Use Encrypted Connections”](#)  
[Section 6.3.2, “Encrypted Connection TLS Protocols and Ciphers”](#)  
[Section 5.1.7, “Server System Variables”](#)  
[Section 16.3.8, “Setting Up Replication to Use Encrypted Connections”](#)  
[Section 6.3, “Using Encrypted Connections”](#)  
[Section 19.4.1, “Using Encrypted Connections with X Plugin”](#)

## **tmp\_table\_size**

[Section 8.12.4.1, “How MySQL Uses Memory”](#)  
[Section 8.4.4, “Internal Temporary Table Use in MySQL”](#)  
[Section 13.6.6.5, “Restrictions on Server-Side Cursors”](#)  
[Section 5.1.7, “Server System Variables”](#)  
[Type and Networking](#)

## **tmpdir**

[Section 16.3.1.2, “Backing Up Raw Data from a Replica”](#)  
[Section B.3.2.11, “Can’t create/write to file”](#)  
[Section 7.2, “Database Backup Methods”](#)  
[Section 14.15, “InnoDB Startup Options and System Variables”](#)  
[Section 2.8.7, “MySQL Source-Configuration Options”](#)  
[Section 14.13.5, “Online DDL Failure Conditions”](#)  
[Section 14.13.3, “Online DDL Space Requirements”](#)  
[Section 8.2.1.14, “ORDER BY Optimization”](#)  
[Section 16.1.6.3, “Replica Server Options and Variables”](#)  
[Section 5.1.7, “Server System Variables”](#)  
[Section 24.4.27, “The INFORMATION\\_SCHEMA INNODB\\_TEMP\\_TABLE\\_INFO Table”](#)

## **transaction**

[Section 17.3.1, “Group Replication Requirements”](#)

## **transaction\_alloc\_block\_size**

[Section 5.1.7, “Server System Variables”](#)

## **transaction\_allow\_batching**

[NDB Cluster System Variables](#)

---

## **transaction\_isolation**

[Section 5.1.6, “Server Command Options”](#)  
[Section 5.1.7, “Server System Variables”](#)  
[Section 5.1.15, “Server Tracking of Client Session State”](#)  
[Section 13.3.6, “SET TRANSACTION Statement”](#)  
[Section 1.3, “What Is New in MySQL 5.7”](#)

## **transaction\_prealloc\_size**

[Section 5.1.7, “Server System Variables”](#)

## **transaction\_read\_only**

[Section 5.1.6, “Server Command Options”](#)  
[Section 5.1.7, “Server System Variables”](#)  
[Section 5.1.15, “Server Tracking of Client Session State”](#)  
[Section 13.3.6, “SET TRANSACTION Statement”](#)  
[Section 1.3, “What Is New in MySQL 5.7”](#)

## **transaction\_write\_set\_extraction**

[Section 16.1.6.4, “Binary Logging Options and Variables”](#)  
[Section 17.7.1, “Group Replication System Variables”](#)

## **tx\_isolation**

[Section 5.1.6, “Server Command Options”](#)  
[Section 5.1.7, “Server System Variables”](#)  
[Section 13.3.6, “SET TRANSACTION Statement”](#)  
[Section 1.3, “What Is New in MySQL 5.7”](#)

## **tx\_read\_only**

[Section 5.1.6, “Server Command Options”](#)  
[Section 5.1.7, “Server System Variables”](#)  
[Section 13.3.6, “SET TRANSACTION Statement”](#)  
[Section 1.3, “What Is New in MySQL 5.7”](#)

## **U**

[\[index top\]](#)

## **unique\_checks**

[Section 14.6.1.5, “Converting Tables from MyISAM to InnoDB”](#)  
[Section 5.4.4.3, “Mixed Binary Logging Format”](#)  
[Section 16.4.1.37, “Replication and Variables”](#)  
[Section 5.1.7, “Server System Variables”](#)  
[Section 5.4.4, “The Binary Log”](#)

## **updatable\_views\_with\_limit**

[Section 5.1.7, “Server System Variables”](#)  
[Section 23.5.3, “Updatable and Insertable Views”](#)

## **V**

[\[index top\]](#)

---

## **validate\_password\_check\_user\_name**

[Section 12.13, “Encryption and Compression Functions”](#)

[Section 6.4.3.2, “Password Validation Plugin Options and Variables”](#)

[Section 6.4.3, “The Password Validation Plugin”](#)

## **validate\_password\_dictionary\_file**

[Section 6.4.3.2, “Password Validation Plugin Options and Variables”](#)

[Section 6.4.3, “The Password Validation Plugin”](#)

## **validate\_password\_length**

[Section 12.13, “Encryption and Compression Functions”](#)

[Section 6.4.3.2, “Password Validation Plugin Options and Variables”](#)

[Section 6.4.3, “The Password Validation Plugin”](#)

## **validate\_password\_mixed\_case\_count**

[Section 6.4.3.2, “Password Validation Plugin Options and Variables”](#)

[Section 6.4.3, “The Password Validation Plugin”](#)

## **validate\_password\_number\_count**

[Section 6.4.3.2, “Password Validation Plugin Options and Variables”](#)

[Section 6.4.3, “The Password Validation Plugin”](#)

## **validate\_password\_policy**

[Section 6.4.3.2, “Password Validation Plugin Options and Variables”](#)

[Section 6.4.3, “The Password Validation Plugin”](#)

## **validate\_password\_special\_char\_count**

[Section 6.4.3.2, “Password Validation Plugin Options and Variables”](#)

[Section 6.4.3, “The Password Validation Plugin”](#)

## **version**

[Section 6.4.5.4, “Audit Log File Formats”](#)

[Section 12.15, “Information Functions”](#)

[Section 14.15, “InnoDB Startup Options and System Variables”](#)

[Section 5.1.7, “Server System Variables”](#)

## **version\_comment**

[Section 5.1.7, “Server System Variables”](#)

[Section 13.7.5.39, “SHOW VARIABLES Statement”](#)

## **version\_compile\_machine**

[Section 5.1.7, “Server System Variables”](#)

## **version\_compile\_os**

[Section 5.1.7, “Server System Variables”](#)

## **version\_tokens\_session**

[Section 5.5.5.3, “Using Version Tokens”](#)

[Section 5.5.5.4, “Version Tokens Reference”](#)

---

## **version\_tokens\_session\_number**

[Section 5.5.5.4, “Version Tokens Reference”](#)

## **W**

[\[index top\]](#)

## **wait\_timeout**

[Section B.3.2.9, “Communication Errors and Aborted Connections”](#)

[Section B.3.2.7, “MySQL server has gone away”](#)

[Section 5.1.7, “Server System Variables”](#)

## **warning\_count**

[Section B.2, “Error Information Interfaces”](#)

[Section 13.5, “Prepared Statements”](#)

[Section 5.1.7, “Server System Variables”](#)

[Section 13.7.5.17, “SHOW ERRORS Statement”](#)

[Section 13.7.5.40, “SHOW WARNINGS Statement”](#)

[Section 13.6.7.5, “SIGNAL Statement”](#)

[Section 13.6.7.7, “The MySQL Diagnostics Area”](#)

# Transaction Isolation Level Index

[R](#) | [S](#)

## **R**

[\[index top\]](#)

## **READ COMMITTED**

[Section 14.7.2.3, “Consistent Nonlocking Reads”](#)

[Section 21.2.6.1, “Differences Between the NDB and InnoDB Storage Engines”](#)

[Section 17.3.2, “Group Replication Limitations”](#)

[Section 14.7.5.3, “How to Minimize and Handle Deadlocks”](#)

[Section 14.7.1, “InnoDB Locking”](#)

[Section 14.15, “InnoDB Startup Options and System Variables”](#)

[Section 21.2.7.3, “Limits Relating to Transaction Handling in NDB Cluster”](#)

[Section 14.7.3, “Locks Set by Different SQL Statements in InnoDB”](#)

[Section A.1, “MySQL 5.7 FAQ: General”](#)

[Section A.10, “MySQL 5.7 FAQ: NDB Cluster”](#)

[Section 21.2.6.3, “NDB and InnoDB Feature Usage Summary”](#)

[Section 8.5.2, “Optimizing InnoDB Transaction Management”](#)

[Section 13.3.6, “SET TRANSACTION Statement”](#)

[Section 5.4.4.2, “Setting The Binary Log Format”](#)

[Section 25.12.7.1, “The events\\_transactions\\_current Table”](#)

[Section 14.7.2.1, “Transaction Isolation Levels”](#)

## **READ UNCOMMITTED**

[Section 14.7.2.3, “Consistent Nonlocking Reads”](#)

[Including Delete-marked Records in Persistent Statistics Calculations](#)

[Section 14.21.2, “InnoDB memcached Architecture”](#)

[Section 14.15, “InnoDB Startup Options and System Variables”](#)

---

[Section 21.2.7.3, “Limits Relating to Transaction Handling in NDB Cluster”](#)  
[Section 14.21.5.6, “Performing DML and DDL Statements on the Underlying InnoDB Table”](#)  
[Section 13.3.6, “SET TRANSACTION Statement”](#)  
[Section 5.4.4.2, “Setting The Binary Log Format”](#)  
[Section 25.12.7.1, “The events\\_transactions\\_current Table”](#)  
[Section 14.7.2.1, “Transaction Isolation Levels”](#)

## **READ-COMMITTED**

[Section 5.1.6, “Server Command Options”](#)  
[Section 13.3.6, “SET TRANSACTION Statement”](#)

## **READ-UNCOMMITTED**

[Section 5.1.6, “Server Command Options”](#)  
[Section 13.3.6, “SET TRANSACTION Statement”](#)

## **REPEATABLE READ**

[Section 14.7.2.3, “Consistent Nonlocking Reads”](#)  
[Section 14.21.5.4, “Controlling Transactional Behavior of the InnoDB memcached Plugin”](#)  
[Section 17.3.2, “Group Replication Limitations”](#)  
[Section 14.7.1, “InnoDB Locking”](#)  
[Section 14.15, “InnoDB Startup Options and System Variables”](#)  
[Section 21.2.7.3, “Limits Relating to Transaction Handling in NDB Cluster”](#)  
[Section 5.4.4.3, “Mixed Binary Logging Format”](#)  
[Section 4.5.4, “mysqldump — A Database Backup Program”](#)  
[Section 4.5.6, “mysqlpump — A Database Backup Program”](#)  
[Section 8.5.2, “Optimizing InnoDB Transaction Management”](#)  
[Section 25.12.7, “Performance Schema Transaction Tables”](#)  
[Section 13.3.6, “SET TRANSACTION Statement”](#)  
[Section 13.3.1, “START TRANSACTION, COMMIT, and ROLLBACK Statements”](#)  
[Section 25.12.7.1, “The events\\_transactions\\_current Table”](#)  
[Section 14.7.2.1, “Transaction Isolation Levels”](#)  
[Section 13.3.7, “XA Transactions”](#)

## **REPEATABLE-READ**

[Section 5.1.6, “Server Command Options”](#)  
[Section 5.1.7, “Server System Variables”](#)  
[Section 13.3.6, “SET TRANSACTION Statement”](#)

## **S**

[\[index top\]](#)

## **SERIALIZABLE**

[Section 17.3.2, “Group Replication Limitations”](#)  
[Section 8.10.3.1, “How the Query Cache Operates”](#)  
[Section 14.7.1, “InnoDB Locking”](#)  
[Section 14.15, “InnoDB Startup Options and System Variables”](#)  
[Section 21.2.7.3, “Limits Relating to Transaction Handling in NDB Cluster”](#)  
[Section 14.7.3, “Locks Set by Different SQL Statements in InnoDB”](#)  
[Section 5.4.4.3, “Mixed Binary Logging Format”](#)  
[Section 25.12.7, “Performance Schema Transaction Tables”](#)  
[Section 5.1.6, “Server Command Options”](#)  
[Section 13.3.6, “SET TRANSACTION Statement”](#)



---

[Section 13.3.1, "START TRANSACTION, COMMIT, and ROLLBACK Statements"](#)  
[Section 25.12.7.1, "The events\\_transactions\\_current Table"](#)  
[Section 14.7.2.1, "Transaction Isolation Levels"](#)  
[Section 13.3.7, "XA Transactions"](#)



---

# MySQL Glossary

These terms are commonly used in information about the MySQL database server. This glossary originated as a reference for terminology about the InnoDB storage engine, and the majority of definitions are InnoDB-related.

## A

### .ARM file

Metadata for [ARCHIVE](#) tables. Contrast with **.ARZ file**. Files with this extension are always included in backups produced by the `mysqlbackup` command of the **MySQL Enterprise Backup** product.

See Also [.ARZ file](#), [MySQL Enterprise Backup](#), [mysqlbackup command](#).

### .ARZ file

Data for ARCHIVE tables. Contrast with **.ARM file**. Files with this extension are always included in backups produced by the `mysqlbackup` command of the **MySQL Enterprise Backup** product.

See Also [.ARM file](#), [MySQL Enterprise Backup](#), [mysqlbackup command](#).

### ACID

An acronym standing for atomicity, consistency, isolation, and durability. These properties are all desirable in a database system, and are all closely tied to the notion of a **transaction**. The transactional features of [InnoDB](#) adhere to the ACID principles.

Transactions are **atomic** units of work that can be **committed** or **rolled back**. When a transaction makes multiple changes to the database, either all the changes succeed when the transaction is committed, or all the changes are undone when the transaction is rolled back.

The database remains in a consistent state at all times — after each commit or rollback, and while transactions are in progress. If related data is being updated across multiple tables, queries see either all old values or all new values, not a mix of old and new values.

Transactions are protected (isolated) from each other while they are in progress; they cannot interfere with each other or see each other's uncommitted data. This isolation is achieved through the **locking** mechanism. Experienced users can adjust the **isolation level**, trading off less protection in favor of increased performance and **concurrency**, when they can be sure that the transactions really do not interfere with each other.

The results of transactions are durable: once a commit operation succeeds, the changes made by that transaction are safe from power failures, system crashes, race conditions, or other potential dangers that many non-database applications are vulnerable to. Durability typically involves writing to disk storage, with a certain amount of redundancy to protect against power failures or software crashes during write operations. (In [InnoDB](#), the **doublewrite buffer** assists with durability.)

See Also [atomic](#), [commit](#), [concurrency](#), [doublewrite buffer](#), [isolation level](#), [locking](#), [rollback](#), [transaction](#).

### adaptive flushing

An algorithm for [InnoDB](#) tables that smooths out the I/O overhead introduced by **checkpoints**. Instead of **flushing** all modified **pages** from the **buffer pool** to the **data files** at once, MySQL periodically flushes small sets of modified pages. The adaptive flushing algorithm extends this process by estimating the optimal rate to perform these periodic flushes, based on the rate of flushing and how fast **redo** information is generated.

See Also [buffer pool](#), [checkpoint](#), [data files](#), [flush](#), [InnoDB](#), [page](#), [redo log](#).

### adaptive hash index

An optimization for [InnoDB](#) tables that can speed up lookups using `=` and `IN` operators, by constructing a **hash index** in memory. MySQL monitors index searches for [InnoDB](#) tables, and if queries could benefit from a hash index, it builds one automatically for index **pages** that are frequently accessed. In a sense, the adaptive hash index configures MySQL at runtime to take advantage of ample main memory, coming closer to the architecture of main-memory databases. This feature is controlled by the `innodb_adaptive_hash_index` configuration

---

option. Because this feature benefits some workloads and not others, and the memory used for the hash index is reserved in the **buffer pool**, typically you should benchmark with this feature both enabled and disabled.

The hash index is always built based on an existing **B-tree** index on the table. MySQL can build a hash index on a prefix of any length of the key defined for the B-tree, depending on the pattern of searches against the index. A hash index can be partial; the whole B-tree index does not need to be cached in the buffer pool.

See Also [B-tree](#), [buffer pool](#), [hash index](#), [page](#), [secondary index](#).

#### ADO.NET

An object-relational mapping (ORM) framework for applications built using .NET technologies such as **ASP.NET**. Such applications can interface with MySQL through the **Connector/NET** component.

See Also [.NET](#), [ASP.net](#), [Connector/NET](#), [Mono](#), [Visual Studio](#).

#### AIO

Acronym for **asynchronous I/O**. You might see this acronym in [InnoDB](#) messages or keywords.

See Also [asynchronous I/O](#).

#### ANSI

In **ODBC**, an alternative method of supporting character sets and other internationalization aspects. Contrast with **Unicode**. **Connector/ODBC** 3.51 is an ANSI driver, while Connector/ODBC 5.1 is a Unicode driver.

See Also [Connector/ODBC](#), [ODBC](#), [Unicode](#).

#### Antelope

The code name for the original [InnoDB file format](#). It supports the **REDUNDANT** and **COMPACT** row formats, but not the newer **DYNAMIC** and **COMPRESSED** row formats available in the **Barracuda** file format.

See Also [Barracuda](#), [compact row format](#), [compressed row format](#), [dynamic row format](#), [file format](#), [innodb\\_file\\_format](#), [redundant row format](#).

#### API

APIs provide low-level access to the MySQL protocol and MySQL resources from **client** programs. Contrast with the higher-level access provided by a **Connector**.

See Also [C API](#), [client](#), [connector](#), [native C API](#), [Perl API](#), [PHP API](#), [Python API](#), [Ruby API](#).

#### application programming interface (API)

A set of functions or procedures. An API provides a stable set of names and types for functions, procedures, parameters, and return values.

#### apply

When a backup produced by the **MySQL Enterprise Backup** product does not include the most recent changes that occurred while the backup was underway, the process of updating the backup files to include those changes is known as the **apply** step. It is specified by the [apply-log](#) option of the [mysqlbackup](#) command.

Before the changes are applied, we refer to the files as a **raw backup**. After the changes are applied, we refer to the files as a **prepared backup**. The changes are recorded in the [ibbackup\\_logfile](#) file; once the apply step is finished, this file is no longer necessary.

See Also [hot backup](#), [ibbackup\\_logfile](#), [MySQL Enterprise Backup](#), [prepared backup](#), [raw backup](#).

#### ASP.net

A framework for developing web-based applications using .NET technologies and languages. Such applications can interface with MySQL through the **Connector/NET** component.

Another technology for writing server-side web pages with MySQL is **PHP**.

See Also [.NET](#), [ADO.NET](#), [Connector/NET](#), [Mono](#), [PHP](#), [Visual Studio](#).

#### assembly

A library of compiled code in a .NET system, accessed through **Connector/NET**. Stored in the **GAC** to allow versioning without naming conflicts.

---

See Also [.NET](#), [GAC](#).

#### asynchronous I/O

A type of I/O operation that allows other processing to proceed before the I/O is completed. Also known as **nonblocking I/O** and abbreviated as **AIO**. [InnoDB](#) uses this type of I/O for certain operations that can run in parallel without affecting the reliability of the database, such as reading pages into the **buffer pool** that have not actually been requested, but might be needed soon.

Historically, [InnoDB](#) used asynchronous I/O on Windows systems only. Starting with the [InnoDB Plugin 1.1](#) and [MySQL 5.5](#), [InnoDB](#) uses asynchronous I/O on Linux systems. This change introduces a dependency on [libaio](#). Asynchronous I/O on Linux systems is configured using the `innodb_use_native_aio` option, which is enabled by default. On other Unix-like systems, [InnoDB](#) uses synchronous I/O only.

See Also [buffer pool](#), [nonblocking I/O](#).

#### atomic

In the SQL context, **transactions** are units of work that either succeed entirely (when **committed**) or have no effect at all (when **rolled back**). The indivisible ("atomic") property of transactions is the "A" in the acronym **ACID**.

See Also [ACID](#), [commit](#), [rollback](#), [transaction](#).

#### atomic DDL

An atomic *DDL* statement is one that combines the *data dictionary* updates, *storage engine* operations, and *binary log* writes associated with a DDL operation into a single, atomic transaction. The transaction is either fully committed or rolled back, even if the server halts during the operation. Atomic DDL support was added in [MySQL 8.0](#). For more information, see [Atomic Data Definition Statement Support](#).

See Also [binary log](#), [data dictionary](#), [DDL](#), [storage engine](#).

#### atomic instruction

Special instructions provided by the CPU, to ensure that critical low-level operations cannot be interrupted.

#### auto-increment

A property of a table column (specified by the `AUTO_INCREMENT` keyword) that automatically adds an ascending sequence of values in the column.

It saves work for the developer, not to have to produce new unique values when inserting new rows. It provides useful information for the query optimizer, because the column is known to be not null and with unique values. The values from such a column can be used as lookup keys in various contexts, and because they are auto-generated there is no reason to ever change them; for this reason, primary key columns are often specified as auto-incrementing.

Auto-increment columns can be problematic with statement-based replication, because replaying the statements on a replica might not produce the same set of column values as on the source, due to timing issues. When you have an auto-incrementing primary key, you can use statement-based replication only with the setting `innodb_autoinc_lock_mode=1`. If you have `innodb_autoinc_lock_mode=2`, which allows higher concurrency for insert operations, use **row-based replication** rather than **statement-based replication**. The setting `innodb_autoinc_lock_mode=0` should not be used except for compatibility purposes.

Consecutive lock mode (`innodb_autoinc_lock_mode=1`) is the default setting prior to [MySQL 8.0.3](#). As of [MySQL 8.0.3](#), interleaved lock mode (`innodb_autoinc_lock_mode=2`) is the default, which reflects the change from statement-based to row-based replication as the default replication type.

See Also [auto-increment locking](#), [innodb\\_autoinc\\_lock\\_mode](#), [primary key](#), [row-based replication](#), [statement-based replication](#).

#### auto-increment locking

The convenience of an **auto-increment** primary key involves some tradeoff with concurrency. In the simplest case, if one transaction is inserting values into the table, any other transactions must wait to do their own inserts into that table, so that rows inserted by the first transaction receive consecutive primary key values.

---

InnoDB includes optimizations and the `innodb_autoinc_lock_mode` option so that you can configure and optimal balance between predictable sequences of auto-increment values and maximum **concurrency** for insert operations.

See Also [auto-increment](#), [concurrency](#), [innodb\\_autoinc\\_lock\\_mode](#).

#### autocommit

A setting that causes a **commit** operation after each **SQL** statement. This mode is not recommended for working with InnoDB tables with **transactions** that span several statements. It can help performance for **read-only transactions** on InnoDB tables, where it minimizes overhead from **locking** and generation of **undo** data, especially in MySQL 5.6.4 and up. It is also appropriate for working with MyISAM tables, where transactions are not applicable.

See Also [commit](#), [locking](#), [read-only transaction](#), [SQL](#), [transaction](#), [undo](#).

#### availability

The ability to cope with, and if necessary recover from, failures on the host, including failures of MySQL, the operating system, or the hardware and maintenance activity that may otherwise cause downtime. Often paired with **scalability** as critical aspects of a large-scale deployment.

See Also [scalability](#).

#### MySQL Enterprise Backup

A licensed product that performs **hot backups** of MySQL databases. It offers the most efficiency and flexibility when backing up InnoDB tables, but can also back up MyISAM and other kinds of tables.

See Also [hot backup](#), [InnoDB](#).

## B

#### B-tree

A tree data structure that is popular for use in database indexes. The structure is kept sorted at all times, enabling fast lookup for exact matches (equals operator) and ranges (for example, greater than, less than, and [BETWEEN](#) operators). This type of index is available for most storage engines, such as InnoDB and MyISAM.

Because B-tree nodes can have many children, a B-tree is not the same as a binary tree, which is limited to 2 children per node.

Contrast with **hash index**, which is only available in the [MEMORY](#) storage engine. The [MEMORY](#) storage engine can also use B-tree indexes, and you should choose B-tree indexes for [MEMORY](#) tables if some queries use range operators.

The use of the term B-tree is intended as a reference to the general class of index design. B-tree structures used by MySQL storage engines may be regarded as variants due to sophistications not present in a classic B-tree design. For related information, refer to the InnoDB Page Structure [Fil Header](#) section of the [MySQL Internals Manual](#).

See Also [hash index](#).

#### backticks

Identifiers within MySQL SQL statements must be quoted using the backtick character (```) if they contain special characters or reserved words. For example, to refer to a table named `FOO#BAR` or a column named `SELECT`, you would specify the identifiers as ``FOO#BAR`` and ``SELECT``. Since the backticks provide an extra level of safety, they are used extensively in program-generated SQL statements, where the identifier names might not be known in advance.

Many other database systems use double quotation marks (`"`) around such special names. For portability, you can enable [ANSI\\_QUOTES](#) mode in MySQL and use double quotation marks instead of backticks to qualify identifier names.

See Also [SQL](#).

---

## backup

The process of copying some or all table data and metadata from a MySQL instance, for safekeeping. Can also refer to the set of copied files. This is a crucial task for DBAs. The reverse of this process is the **restore** operation.

With MySQL, **physical backups** are performed by the **MySQL Enterprise Backup** product, and **logical backups** are performed by the `mysqldump` command. These techniques have different characteristics in terms of size and representation of the backup data, and speed (especially speed of the restore operation).

Backups are further classified as **hot**, **warm**, or **cold** depending on how much they interfere with normal database operation. (Hot backups have the least interference, cold backups the most.)

See Also [cold backup](#), [hot backup](#), [logical backup](#), [MySQL Enterprise Backup](#), [mysqldump](#), [physical backup](#), [warm backup](#).

## Barracuda

The code name for an **InnoDB file format** that supports the **COMPRESSED** row format that enables InnoDB table compression, and the **DYNAMIC** row format that improves the storage layout for long variable-length columns.

The **MySQL Enterprise Backup** product version 3.5 and above supports backing up tablespaces that use the Barracuda file format.

See Also [Antelope](#), [compact row format](#), [compressed row format](#), [dynamic row format](#), [file format](#), [file-per-table](#), [general tablespace](#), [innodb\\_file\\_format](#), [MySQL Enterprise Backup](#), [row format](#), [system tablespace](#).

## base column

A non-generated table column upon which a stored generated column or virtual generated column is based. In other words, a base column is a non-generated table column that is part of a generated column definition.

See Also [generated column](#), [stored generated column](#), [virtual generated column](#).

## beta

An early stage in the life of a software product, when it is available only for evaluation, typically without a definite release number or a number less than 1. **InnoDB** does not use the beta designation, preferring an **early adopter** phase that can extend over several point releases, leading to a **GA** release.

See Also [early adopter](#), [GA](#).

## binary log

A file containing a record of all statements or row changes that attempt to change table data. The contents of the binary log can be replayed to bring replicas up to date in a **replication** scenario, or to bring a database up to date after restoring table data from a backup. The binary logging feature can be turned on and off, although Oracle recommends always enabling it if you use replication or perform backups.

You can examine the contents of the binary log, or replay it during replication or recovery, by using the `mysqlbinlog` command. For full information about the binary log, see [Section 5.4.4, “The Binary Log”](#). For MySQL configuration options related to the binary log, see [Section 16.1.6.4, “Binary Logging Options and Variables”](#).

For the **MySQL Enterprise Backup** product, the file name of the binary log and the current position within the file are important details. To record this information for the source when taking a backup in a replication context, you can specify the `--slave-info` option.

Prior to MySQL 5.0, a similar capability was available, known as the update log. In MySQL 5.0 and higher, the binary log replaces the update log.

See Also [binlog](#), [MySQL Enterprise Backup](#), [replication](#).

## binlog

An informal name for the **binary log** file. For example, you might see this abbreviation used in e-mail messages or forum discussions.

See Also [binary log](#).

---

## blind query expansion

A special mode of **full-text search** enabled by the `WITH QUERY EXPANSION` clause. It performs the search twice, where the search phrase for the second search is the original search phrase concatenated with the few most highly relevant documents from the first search. This technique is mainly applicable for short search phrases, perhaps only a single word. It can uncover relevant matches where the precise search term does not occur in the document.

See Also [full-text search](#).

## BLOB

An SQL data type (`TINYBLOB`, `BLOB`, `MEDIUMBLOB`, and `LONGBLOB`) for objects containing any kind of binary data, of arbitrary size. Used for storing documents, images, sound files, and other kinds of information that cannot easily be decomposed to rows and columns within a MySQL table. The techniques for handling BLOBs within a MySQL application vary with each **Connector** and **API**. MySQL `Connector/ODBC` defines `BLOB` values as `LONGVARBINARY`. For large, free-form collections of character data, the industry term is **CLOB**, represented by the MySQL `TEXT` data types.

See Also [API](#), [CLOB](#), [connector](#), [Connector/ODBC](#).

## bottleneck

A portion of a system that is constrained in size or capacity, that has the effect of limiting overall throughput. For example, a memory area might be smaller than necessary; access to a single required resource might prevent multiple CPU cores from running simultaneously; or waiting for disk I/O to complete might prevent the CPU from running at full capacity. Removing bottlenecks tends to improve **concurrency**. For example, the ability to have multiple `InnoDB` **buffer pool** instances reduces contention when multiple sessions read from and write to the buffer pool simultaneously.

See Also [buffer pool](#), [concurrency](#).

## bounce

A **shutdown** operation immediately followed by a restart. Ideally with a relatively short **warmup** period so that performance and throughput quickly return to a high level.

See Also [shutdown](#).

## buddy allocator

A mechanism for managing different-sized **pages** in the `InnoDB` **buffer pool**.

See Also [buffer pool](#), [page](#), [page size](#).

## buffer

A memory or disk area used for temporary storage. Data is buffered in memory so that it can be written to disk efficiently, with a few large I/O operations rather than many small ones. Data is buffered on disk for greater reliability, so that it can be recovered even when a **crash** or other failure occurs at the worst possible time. The main types of buffers used by `InnoDB` are the **buffer pool**, the **doublewrite buffer**, and the **change buffer**.

See Also [buffer pool](#), [change buffer](#), [crash](#), [doublewrite buffer](#).

## buffer pool

The memory area that holds cached `InnoDB` data for both tables and indexes. For efficiency of high-volume read operations, the buffer pool is divided into **pages** that can potentially hold multiple rows. For efficiency of cache management, the buffer pool is implemented as a linked list of pages; data that is rarely used is aged out of the cache, using a variation of the **LRU** algorithm. On systems with large memory, you can improve concurrency by dividing the buffer pool into multiple **buffer pool instances**.

Several `InnoDB` status variables, `INFORMATION_SCHEMA` tables, and `performance_schema` tables help to monitor the internal workings of the buffer pool. Starting in MySQL 5.6, you can avoid a lengthy warmup period after restarting the server, particularly for instances with large buffer pools, by saving the buffer pool state at server shutdown and restoring the buffer pool to the same state at server startup. See [Section 14.8.3.6, “Saving and Restoring the Buffer Pool State”](#).

See Also [buffer pool instance](#), [LRU](#), [page](#), [warm up](#).



---

## buffer pool instance

Any of the multiple regions into which the **buffer pool** can be divided, controlled by the [innodb\\_buffer\\_pool\\_instances](#) configuration option. The total memory size specified by [innodb\\_buffer\\_pool\\_size](#) is divided among all buffer pool instances. Typically, having multiple buffer pool instances is appropriate for systems that allocate multiple gigabytes to the **InnoDB** buffer pool, with each instance being one gigabyte or larger. On systems loading or looking up large amounts of data in the buffer pool from many concurrent sessions, having multiple buffer pool instances reduces contention for exclusive access to data structures that manage the buffer pool.

See Also [buffer pool](#).

## built-in

The built-in **InnoDB** storage engine within MySQL is the original form of distribution for the storage engine. Contrast with the **InnoDB Plugin**. Starting with MySQL 5.5, the InnoDB Plugin is merged back into the MySQL code base as the built-in **InnoDB** storage engine (known as InnoDB 1.1).

This distinction is important mainly in MySQL 5.1, where a feature or bug fix might apply to the InnoDB Plugin but not the built-in **InnoDB**, or vice versa.

See Also [InnoDB](#).

## business rules

The relationships and sequences of actions that form the basis of business software, used to run a commercial company. Sometimes these rules are dictated by law, other times by company policy. Careful planning ensures that the relationships encoded and enforced by the database, and the actions performed through application logic, accurately reflect the real policies of the company and can handle real-life situations.

For example, an employee leaving a company might trigger a sequence of actions from the human resources department. The human resources database might also need the flexibility to represent data about a person who has been hired, but not yet started work. Closing an account at an online service might result in data being removed from a database, or the data might be moved or flagged so that it could be recovered if the account is re-opened. A company might establish policies regarding salary maximums, minimums, and adjustments, in addition to basic sanity checks such as the salary not being a negative number. A retail database might not allow a purchase with the same serial number to be returned more than once, or might not allow credit card purchases above a certain value, while a database used to detect fraud might allow these kinds of things.

See Also [relational](#).

# C

## .cfg file

A metadata file used with the **InnoDB transportable tablespace** feature. It is produced by the command `FLUSH TABLES ... FOR EXPORT`, puts one or more tables in a consistent state that can be copied to another server. The `.cfg` file is copied along with the corresponding **.ibd file**, and used to adjust the internal values of the `.ibd` file, such as the **space ID**, during the `ALTER TABLE ... IMPORT TABLESPACE` step.

See Also [.ibd file](#), [space ID](#), [transportable tablespace](#).

## C

A programming language that combines portability with performance and access to low-level hardware features, making it a popular choice for writing operating systems, drivers, and other kinds of system software. Many complex applications, languages, and reusable modules feature pieces written in C, tied together with high-level components written in other languages. Its core syntax is familiar to **C++**, **Java**, and **C#** developers.

See Also [C API](#), [C++](#), [C#](#), [Java](#).

## C API

The **C API** code is distributed with MySQL. It is included in the **libmysqlclient** library and enables **C** programs to access a database.

See Also [API](#), [C](#), [libmysqlclient](#).

---

## C#

A programming language combining strong typing and object-oriented features, running within the Microsoft **.NET** framework or its open-source counterpart **Mono**. Often used for creating applications with the **ASP.net** framework. Its syntax is familiar to **C**, **C++** and **Java** developers.  
See Also [.NET](#), [ASP.net](#), [C](#), [Connector/NET](#), [C++](#), [Java](#), [Mono](#).

## C++

A programming language with core syntax familiar to **C** developers. Provides access to low-level operations for performance, combined with higher-level data types, object-oriented features, and garbage collection. To write C++ applications for MySQL, you use the **Connector/C++** component.  
See Also [C](#), [Connector/C++](#).

## cache

The general term for any memory area that stores copies of data for frequent or high-speed retrieval. In [InnoDB](#), the primary kind of cache structure is the **buffer pool**.  
See Also [buffer](#), [buffer pool](#).

## cardinality

The number of different values in a table **column**. When queries refer to columns that have an associated **index**, the cardinality of each column influences which access method is most efficient. For example, for a column with a **unique constraint**, the number of different values is equal to the number of rows in the table. If a table has a million rows but only 10 different values for a particular column, each value occurs (on average) 100,000 times. A query such as `SELECT c1 FROM t1 WHERE c1 = 50;` thus might return 1 row or a huge number of rows, and the database server might process the query differently depending on the cardinality of `c1`.

If the values in a column have a very uneven distribution, the cardinality might not be a good way to determine the best query plan. For example, `SELECT c1 FROM t1 WHERE c1 = x;` might return 1 row when `x=50` and a million rows when `x=30`. In such a case, you might need to use **index hints** to pass along advice about which lookup method is more efficient for a particular query.

Cardinality can also apply to the number of distinct values present in multiple columns, as in a **composite index**.  
See Also [column](#), [composite index](#), [index](#), [index hint](#), [persistent statistics](#), [random dive](#), [selectivity](#), [unique constraint](#).

## change buffer

A special data structure that records changes to **pages** in **secondary indexes**. These values could result from SQL `INSERT`, `UPDATE`, or `DELETE` statements (**DML**). The set of features involving the change buffer is known collectively as **change buffering**, consisting of **insert buffering**, **delete buffering**, and **purge buffering**.

Changes are only recorded in the change buffer when the relevant page from the secondary index is not in the **buffer pool**. When the relevant index page is brought into the buffer pool while associated changes are still in the change buffer, the changes for that page are applied in the buffer pool (**merged**) using the data from the change buffer. Periodically, the **purge** operation that runs during times when the system is mostly idle, or during a slow shutdown, writes the new index pages to disk. The purge operation can write the disk blocks for a series of index values more efficiently than if each value were written to disk immediately.

Physically, the change buffer is part of the **system tablespace**, so that the index changes remain buffered across database restarts. The changes are only applied (**merged**) when the pages are brought into the buffer pool due to some other read operation.

The kinds and amount of data stored in the change buffer are governed by the `innodb_change_buffering` and `innodb_change_buffer_max_size` configuration options. To see information about the current data in the change buffer, issue the `SHOW ENGINE INNODB STATUS` command.

Formerly known as the **insert buffer**.

---

See Also [buffer pool](#), [change buffering](#), [delete buffering](#), [DML](#), [insert buffer](#), [insert buffering](#), [merge](#), [page](#), [purge](#), [purge buffering](#), [secondary index](#), [system tablespace](#).

#### change buffering

The general term for the features involving the **change buffer**, consisting of **insert buffering**, **delete buffering**, and **purge buffering**. Index changes resulting from SQL statements, which could normally involve random I/O operations, are held back and performed periodically by a background **thread**. This sequence of operations can write the disk blocks for a series of index values more efficiently than if each value were written to disk immediately. Controlled by the [innodb\\_change\\_buffering](#) and [innodb\\_change\\_buffer\\_max\\_size](#) configuration options.

See Also [change buffer](#), [delete buffering](#), [insert buffering](#), [purge buffering](#).

#### checkpoint

As changes are made to data pages that are cached in the **buffer pool**, those changes are written to the **data files** sometime later, a process known as **flushing**. The checkpoint is a record of the latest changes (represented by an **LSN** value) that have been successfully written to the data files.

See Also [buffer pool](#), [data files](#), [flush](#), [fuzzy checkpointing](#), [LSN](#).

#### checksum

In **InnoDB**, a validation mechanism to detect corruption when a **page** in a **tablespace** is read from disk into the **InnoDB buffer pool**. This feature is controlled by the [innodb\\_checksums](#) configuration option in MySQL 5.5. [innodb\\_checksums](#) is deprecated in MySQL 5.6.3, replaced by [innodb\\_checksum\\_algorithm](#).

The [innochecksum](#) command helps diagnose corruption problems by testing the checksum values for a specified **tablespace** file while the MySQL server is shut down.

MySQL also uses checksums for replication purposes. For details, see the configuration options [binlog\\_checksum](#), [source\\_verify\\_checksum](#) or [master\\_verify\\_checksum](#), and [replica\\_sql\\_verify\\_checksum](#) or [slave\\_sql\\_verify\\_checksum](#).

See Also [buffer pool](#), [page](#), [tablespace](#).

#### child table

In a **foreign key** relationship, a child table is one whose rows refer (or point) to rows in another table with an identical value for a specific column. This is the table that contains the **FOREIGN KEY ... REFERENCES** clause and optionally **ON UPDATE** and **ON DELETE** clauses. The corresponding row in the **parent table** must exist before the row can be created in the child table. The values in the child table can prevent delete or update operations on the parent table, or can cause automatic deletion or updates in the child table, based on the **ON CASCADE** option used when creating the foreign key.

See Also [foreign key](#), [parent table](#).

#### clean page

A **page** in the **InnoDB buffer pool** where all changes made in memory have also been written (**flushed**) to the **data files**. The opposite of a **dirty page**.

See Also [buffer pool](#), [data files](#), [dirty page](#), [flush](#), [page](#).

#### clean shutdown

A **shutdown** that completes without errors and applies all changes to **InnoDB** tables before finishing, as opposed to a **crash** or a **fast shutdown**. Synonym for **slow shutdown**.

See Also [crash](#), [fast shutdown](#), [shutdown](#), [slow shutdown](#).

#### client

A program that runs outside the database server, communicating with the database by sending requests through a **Connector**, or an **API** made available through **client libraries**. It can run on the same physical machine as the database server, or on a remote machine connected over a network. It can be a special-purpose database application, or a general-purpose program like the [mysql](#) command-line processor.

See Also [API](#), [client libraries](#), [connector](#), [mysql](#), [server](#).

---

## client libraries

Files containing collections of functions for working with databases. By compiling your program with these libraries, or installing them on the same system as your application, you can run a database application (known as a **client**) on a machine that does not have the MySQL server installed; the application accesses the database over a network. With MySQL, you can use the **libmysqlclient** library from the MySQL server itself. See Also [client](#), [libmysqlclient](#).

## client-side prepared statement

A type of **prepared statement** where the caching and reuse are managed locally, emulating the functionality of **server-side prepared statements**. Historically, used by some **Connector/J**, **Connector/ODBC**, and **Connector/PHP** developers to work around issues with server-side stored procedures. With modern MySQL server versions, server-side prepared statements are recommended for performance, scalability, and memory efficiency. See Also [Connector/J](#), [Connector/ODBC](#), [Connector/PHP](#), [prepared statement](#).

## CLOB

An SQL data type ([TINYTEXT](#), [TEXT](#), [MEDIUMTEXT](#), or [LONGTEXT](#)) for objects containing any kind of character data, of arbitrary size. Used for storing text-based documents, with associated character set and collation order. The techniques for handling CLOBs within a MySQL application vary with each **Connector** and **API**. MySQL Connector/ODBC defines [TEXT](#) values as [LONGVARCHAR](#). For storing binary data, the equivalent is the **BLOB** type.

See Also [API](#), [BLOB](#), [connector](#), [Connector/ODBC](#).

## clustered index

The [InnoDB](#) term for a **primary key** index. [InnoDB](#) table storage is organized based on the values of the primary key columns, to speed up queries and sorts involving the primary key columns. For best performance, choose the primary key columns carefully based on the most performance-critical queries. Because modifying the columns of the clustered index is an expensive operation, choose primary columns that are rarely or never updated.

In the Oracle Database product, this type of table is known as an **index-organized table**.

See Also [index](#), [primary key](#), [secondary index](#).

## cold backup

A **backup** taken while the database is shut down. For busy applications and websites, this might not be practical, and you might prefer a **warm backup** or a **hot backup**.

See Also [backup](#), [hot backup](#), [warm backup](#).

## column

A data item within a **row**, whose storage and semantics are defined by a data type. Each **table** and **index** is largely defined by the set of columns it contains.

Each column has a **cardinality** value. A column can be the **primary key** for its table, or part of the primary key. A column can be subject to a **unique constraint**, a **NOT NULL constraint**, or both. Values in different columns, even across different tables, can be linked by a **foreign key** relationship.

In discussions of MySQL internal operations, sometimes **field** is used as a synonym.

See Also [cardinality](#), [foreign key](#), [index](#), [NOT NULL constraint](#), [primary key](#), [row](#), [table](#), [unique constraint](#).

## column index

An **index** on a single column.

See Also [composite index](#), [index](#).

## column prefix

When an **index** is created with a length specification, such as `CREATE INDEX idx ON t1 (c1(N))`, only the first N characters of the column value are stored in the index. Keeping the index prefix small makes the

---

index compact, and the memory and disk I/O savings help performance. (Although making the index prefix too small can hinder query optimization by making rows with different values appear to the query optimizer to be duplicates.)

For columns containing binary values or long text strings, where sorting is not a major consideration and storing the entire value in the index would waste space, the index automatically uses the first N (typically 768) characters of the value to do lookups and sorts.

See Also [index](#).

#### command interceptor

Synonym for **statement interceptor**. One aspect of the **interceptor** design pattern available for both **Connector/NET** and **Connector/J**. What Connector/NET calls a command, Connector/J refers to as a statement. Contrast with **exception interceptor**.

See Also [Connector/J](#), [Connector/NET](#), [exception interceptor](#), [interceptor](#), [statement interceptor](#).

#### commit

A **SQL** statement that ends a **transaction**, making permanent any changes made by the transaction. It is the opposite of **rollback**, which undoes any changes made in the transaction.

**InnoDB** uses an **optimistic** mechanism for commits, so that changes can be written to the data files before the commit actually occurs. This technique makes the commit itself faster, with the tradeoff that more work is required in case of a rollback.

By default, MySQL uses the **autocommit** setting, which automatically issues a commit following each SQL statement.

See Also [autocommit](#), [optimistic](#), [rollback](#), [SQL](#), [transaction](#).

#### compact row format

The default **InnoDB row format** for InnoDB tables from MySQL 5.0.3 to MySQL 5.7.8. As of MySQL 5.7.9, the default row format is defined by the `innodb_default_row_format` configuration option, which has a default setting of **DYNAMIC**. The **COMPACT** row format provides a more compact representation for nulls and variable-length columns than the prior default (**REDUNDANT** row format).

For additional information about **InnoDB COMPACT** row format, see [Section 14.11, "InnoDB Row Formats"](#).

See Also [Antelope](#), [dynamic row format](#), [file format](#), [redundant row format](#), [row format](#).

#### composite index

An **index** that includes multiple columns.

See Also [index](#).

#### compressed backup

The compression feature of the **MySQL Enterprise Backup** product makes a compressed copy of each tablespace, changing the extension from `.ibd` to `.ibz`. Compressing backup data allows you to keep more backups on hand, and reduces the time to transfer backups to a different server. The data is uncompressed during the restore operation. When a compressed backup operation processes a table that is already compressed, it skips the compression step for that table, because compressing again would result in little or no space savings.

A set of files produced by the **MySQL Enterprise Backup** product, where each **tablespace** is compressed. The compressed files are renamed with a `.ibz` file extension.

Applying **compression** at the start of the backup process helps to avoid storage overhead during the compression process, and to avoid network overhead when transferring the backup files to another server. The process of **applying** the **binary log** takes longer, and requires uncompressing the backup files.

See Also [apply](#), [binary log](#), [compression](#), [hot backup](#), [MySQL Enterprise Backup](#), [tablespace](#).

---

#### compressed row format

A **row format** that enables data and index **compression** for [InnoDB](#) tables. It was introduced in the [InnoDB Plugin](#), available as part of the **Barracuda** file format. Large fields are stored away from the page that holds the rest of the row data, as in **dynamic row format**. Both index pages and large fields are compressed, yielding memory and disk savings. Depending on the structure of the data, the decrease in memory and disk usage might or might not outweigh the performance overhead of uncompressing the data as it is used. See [Section 14.9, “InnoDB Table and Page Compression”](#) for usage details.

For additional information about [InnoDB COMPRESSED](#) row format, see [DYNAMIC Row Format](#).  
See Also [Barracuda](#), [compression](#), [dynamic row format](#), [row format](#).

#### compressed table

A table for which the data is stored in compressed form. For [InnoDB](#), it is a table created with [ROW\\_FORMAT=COMPRESSED](#). See [Section 14.9, “InnoDB Table and Page Compression”](#) for more information.  
See Also [compressed row format](#), [compression](#).

#### compression

A feature with wide-ranging benefits from using less disk space, performing less I/O, and using less memory for caching.

[InnoDB](#) supports both table-level and page-level compression. [InnoDB](#) page compression is also referred to as **transparent page compression**. For more information about [InnoDB](#) compression, see [Section 14.9, “InnoDB Table and Page Compression”](#).

Another type of compression is the **compressed backup** feature of the **MySQL Enterprise Backup** product. See Also [Barracuda](#), [buffer pool](#), [compressed backup](#), [compressed row format](#), [DML](#), [transparent page compression](#).

#### compression failure

Not actually an error, rather an expensive operation that can occur when using **compression** in combination with **DML** operations. It occurs when: updates to a compressed **page** overflow the area on the page reserved for recording modifications; the page is compressed again, with all changes applied to the table data; the re-compressed data does not fit on the original page, requiring MySQL to split the data into two new pages and compress each one separately. To check the frequency of this condition, query the [INFORMATION\\_SCHEMA.INNODB\\_CMP](#) table and check how much the value of the [COMPRESS\\_OPS](#) column exceeds the value of the [COMPRESS\\_OPS\\_OK](#) column. Ideally, compression failures do not occur often; when they do, you can adjust the [innodb\\_compression\\_level](#), [innodb\\_compression\\_failure\\_threshold\\_pct](#), and [innodb\\_compression\\_pad\\_pct\\_max](#) configuration options.  
See Also [compression](#), [DML](#), [page](#).

#### concatenated index

See [composite index](#).

#### concurrency

The ability of multiple operations (in database terminology, **transactions**) to run simultaneously, without interfering with each other. Concurrency is also involved with performance, because ideally the protection for multiple simultaneous transactions works with a minimum of performance overhead, using efficient mechanisms for **locking**.  
See Also [ACID](#), [locking](#), [transaction](#).

#### configuration file

The file that holds the **option** values used by MySQL at startup. Traditionally, on Linux and Unix this file is named [my.cnf](#), and on Windows it is named [my.ini](#). You can set a number of options related to [InnoDB](#) under the [\[mysqld\]](#) section of the file.

See [Section 4.2.2.2, “Using Option Files”](#) for information about where MySQL searches for configuration files.

---

When you use the **MySQL Enterprise Backup** product, you typically use two configuration files: one that specifies where the data comes from and how it is structured (which could be the original configuration file for your server), and a stripped-down one containing only a small set of options that specify where the backup data goes and how it is structured. The configuration files used with the **MySQL Enterprise Backup** product must contain certain options that are typically left out of regular configuration files, so you might need to add options to your existing configuration file for use with **MySQL Enterprise Backup**.

See Also [my.cnf](#), [MySQL Enterprise Backup](#), [option](#), [option file](#).

#### connection

The communication channel between an application and a MySQL server. The performance and scalability of a database applications is influenced by on how quickly a database connection can be established, how many can be made simultaneously, and how long they persist. The parameters such as **host**, **port**, and so on are represented as a **connection string** in **Connector/NET**, and as a **DSN** in **Connector/ODBC**. High-traffic systems make use of an optimization known as the **connection pool**.

See Also [connection pool](#), [connection string](#), [Connector/NET](#), [Connector/ODBC](#), [DSN](#), [host](#), [port](#).

#### connection pool

A cache area that allows database **connections** to be reused within the same application or across different applications, rather than setting up and tearing down a new connection for every database operation. This technique is common with **J2EE** application servers. **Java** applications using **Connector/J** can use the connection pool features of **Tomcat** and other application servers. The reuse is transparent to applications; the application still opens and closes the connection as usual.

See Also [connection](#), [Connector/J](#), [J2EE](#), [Tomcat](#).

#### connection string

A representation of the parameters for a database **connection**, encoded as a string literal so that it can be used in program code. The parts of the string represent connection parameters such as **host** and **port**. A connection string contains several key-value pairs, separated by semicolons. Each key-value pair is joined with an equal sign. Frequently used with **Connector/NET** applications; see [Creating a Connector/NET Connection String](#) for details.

See Also [connection](#), [Connector/NET](#), [host](#), [port](#).

#### connector

MySQL Connectors provide connectivity to the MySQL server for **client** programs. Several programming languages and frameworks each have their own associated Connector. Contrast with the lower-level access provided by an **API**.

See Also [API](#), [client](#), [Connector/C++](#), [Connector/J](#), [Connector/NET](#), [Connector/ODBC](#).

#### Connector/C++

Connector/C++ 8.0 can be used to access MySQL servers that implement a **document store**, or in a traditional way using SQL queries. It enables development of C++ applications using X DevAPI, or plain C applications using X DevAPI for C. It also enables development of C++ applications that use the legacy JDBC-based API from Connector/C++ 1.1. For more information, see [MySQL Connector/C++ 9.5 Developer Guide](#).

See Also [client](#), [connector](#), [JDBC](#).

#### Connector/J

A **JDBC** driver that provides connectivity for **client** applications developed in the **Java** programming language. Different versions are available that are compatible with the JDBC 3.0 and JDBC 4.0 specifications. MySQL Connector/J is a JDBC Type 4 driver: a pure-Java implementation of the MySQL protocol that does not rely on the MySQL **client libraries**. For full details, see [MySQL Connector/J Developer Guide](#).

See Also [client](#), [client libraries](#), [connector](#), [Java](#), [JDBC](#).

#### Connector/NET

A MySQL **connector** for developers writing applications using languages, technologies, and frameworks such as **C#**, **.NET**, **Mono**, **Visual Studio**, **ASP.net**, and **ADO.net**.

---

See Also [ADO.NET](#), [ASP.net](#), [connector](#), [C#](#), [Mono](#), [Visual Studio](#).

#### Connector/ODBC

The family of MySQL ODBC drivers that provide access to a MySQL database using the industry standard Open Database Connectivity (**ODBC**) API. Formerly called MyODBC drivers. For full details, see [MySQL Connector/ODBC Developer Guide](#).

See Also [connector](#), [ODBC](#).

#### Connector/PHP

A version of the `mysql` and `mysql_i` APIs for **PHP** optimized for the Windows operating system.

See Also [connector](#), [PHP](#), [PHP API](#).

#### consistent read

A read operation that uses **snapshot** information to present query results based on a point in time, regardless of changes performed by other transactions running at the same time. If queried data has been changed by another transaction, the original data is reconstructed based on the contents of the **undo log**. This technique avoids some of the **locking** issues that can reduce **concurrency** by forcing transactions to wait for other transactions to finish.

With **REPEATABLE READ isolation level**, the snapshot is based on the time when the first read operation is performed. With **READ COMMITTED** isolation level, the snapshot is reset to the time of each consistent read operation.

Consistent read is the default mode in which **InnoDB** processes **SELECT** statements in **READ COMMITTED** and **REPEATABLE READ** isolation levels. Because a consistent read does not set any locks on the tables it accesses, other sessions are free to modify those tables while a consistent read is being performed on the table.

For technical details about the applicable isolation levels, see [Section 14.7.2.3, “Consistent Nonlocking Reads”](#). See Also [concurrency](#), [isolation level](#), [locking](#), [READ COMMITTED](#), [REPEATABLE READ](#), [snapshot](#), [transaction](#), [undo log](#).

#### constraint

An automatic test that can block database changes to prevent data from becoming inconsistent. (In computer science terms, a kind of assertion related to an invariant condition.) Constraints are a crucial component of the **ACID** philosophy, to maintain data consistency. Constraints supported by MySQL include **FOREIGN KEY constraints** and **unique constraints**.

See Also [ACID](#), [foreign key](#), [unique constraint](#).

#### counter

A value that is incremented by a particular kind of **InnoDB** operation. Useful for measuring how busy a server is, troubleshooting the sources of performance issues, and testing whether changes (for example, to configuration settings or indexes used by queries) have the desired low-level effects. Different kinds of counters are available through **Performance Schema** tables and **INFORMATION\_SCHEMA** tables, particularly **INFORMATION\_SCHEMA.INNODB\_METRICS**.

See Also [INFORMATION\\_SCHEMA](#), [metrics counter](#), [Performance Schema](#).

#### covering index

An **index** that includes all the columns retrieved by a query. Instead of using the index values as pointers to find the full table rows, the query returns values from the index structure, saving disk I/O. **InnoDB** can apply this optimization technique to more indexes than MyISAM can, because **InnoDB secondary indexes** also include the **primary key** columns. **InnoDB** cannot apply this technique for queries against tables modified by a transaction, until that transaction ends.

Any **column index** or **composite index** could act as a covering index, given the right query. Design your indexes and queries to take advantage of this optimization technique wherever possible.



---

See Also [column index](#), [composite index](#), [index](#), [primary key](#), [secondary index](#).

#### CPU-bound

A type of **workload** where the primary **bottleneck** is CPU operations in memory. Typically involves read-intensive operations where the results can all be cached in the **buffer pool**.

See Also [bottleneck](#), [buffer pool](#), [workload](#).

#### crash

MySQL uses the term “crash” to refer generally to any unexpected **shutdown** operation where the server cannot do its normal cleanup. For example, a crash could happen due to a hardware fault on the database server machine or storage device; a power failure; a potential data mismatch that causes the MySQL server to halt; a **fast shutdown** initiated by the DBA; or many other reasons. The robust, automatic **crash recovery** for **InnoDB** tables ensures that data is made consistent when the server is restarted, without any extra work for the DBA.

See Also [crash recovery](#), [fast shutdown](#), [InnoDB](#), [shutdown](#).

#### crash recovery

The cleanup activities that occur when MySQL is started again after a **crash**. For **InnoDB** tables, changes from incomplete transactions are replayed using data from the **redo log**. Changes that were **committed** before the crash, but not yet written into the **data files**, are reconstructed from the **doublewrite buffer**. When the database is shut down normally, this type of activity is performed during shutdown by the **purge** operation.

During normal operation, committed data can be stored in the **change buffer** for a period of time before being written to the data files. There is always a tradeoff between keeping the data files up-to-date, which introduces performance overhead during normal operation, and buffering the data, which can make shutdown and crash recovery take longer.

See Also [change buffer](#), [commit](#), [crash](#), [data files](#), [doublewrite buffer](#), [InnoDB](#), [purge](#), [redo log](#).

#### CRUD

Acronym for “create, read, update, delete”, a common sequence of operations in database applications. Often denotes a class of applications with relatively simple database usage (basic **DDL**, **DML** and **query** statements in **SQL**) that can be implemented quickly in any language.

See Also [DDL](#), [DML](#), [query](#), [SQL](#).

#### cursor

An internal MySQL data structure that represents the result set of an SQL statement. Often used with **prepared statements** and **dynamic SQL**. It works like an iterator in other high-level languages, producing each value from the result set as requested.

Although SQL usually handles the processing of cursors for you, you might delve into the inner workings when dealing with performance-critical code.

See Also [dynamic SQL](#), [prepared statement](#), [query](#).

## D

#### data definition language

See [DDL](#).

#### data dictionary

Metadata that keeps track of InnoDB-related objects such as **tables**, **indexes**, and table **columns**. This metadata is physically located in the **InnoDB system tablespace**. For historical reasons, it overlaps to some degree with information stored in the **.frm files**.

Because the **MySQL Enterprise Backup** product always backs up the system tablespace, all backups include the contents of the data dictionary.

See Also [column](#), [file-per-table](#), [.frm file](#), [index](#), [MySQL Enterprise Backup](#), [system tablespace](#), [table](#).

---

#### data directory

The directory under which each MySQL **instance** keeps the **data files** for [InnoDB](#) and the directories representing individual databases. Controlled by the `datadir` configuration option.

See Also [data files](#), [instance](#).

#### data files

The files that physically contain **table** and **index** data.

The [InnoDB system tablespace](#), which holds the [InnoDB data dictionary](#) and is capable of holding data for multiple [InnoDB](#) tables, is represented by one or more `.ibdata` data files.

File-per-table tablespaces, which hold data for a single [InnoDB](#) table, are represented by a `.ibd` data file.

General tablespaces (introduced in MySQL 5.7.6), which can hold data for multiple [InnoDB](#) tables, are also represented by a `.ibd` data file.

See Also [data dictionary](#), [file-per-table](#), [general tablespace](#), [.ibd file](#), [ibdata file](#), [index](#), [system tablespace](#), [table](#), [tablespace](#).

#### data manipulation language

See [DML](#).

#### data warehouse

A database system or application that primarily runs large **queries**. The read-only or read-mostly data might be organized in **denormalized** form for query efficiency. Can benefit from the optimizations for **read-only transactions** in MySQL 5.6 and higher. Contrast with **OLTP**.

See Also [denormalized](#), [OLTP](#), [query](#), [read-only transaction](#).

#### database

Within the MySQL **data directory**, each database is represented by a separate directory. The [InnoDB system tablespace](#), which can hold table data from multiple databases within a MySQL **instance**, is kept in **data files** that reside outside of individual database directories. When **file-per-table** mode is enabled, the **.ibd files** representing individual [InnoDB](#) tables are stored inside the database directories unless created elsewhere using the `DATA DIRECTORY` clause. General tablespaces, introduced in MySQL 5.7.6, also hold table data in **.ibd files**. Unlike file-per-table **.ibd files**, general tablespace **.ibd files** can hold table data from multiple databases within a MySQL **instance**, and can be assigned to directories relative to or independent of the MySQL data directory.

For long-time MySQL users, a database is a familiar notion. Users coming from an Oracle Database background may find that the MySQL meaning of a database is closer to what Oracle Database calls a **schema**.

See Also [data files](#), [file-per-table](#), [.ibd file](#), [instance](#), [schema](#), [system tablespace](#).

#### DCL

Data control language, a set of **SQL** statements for managing privileges. In MySQL, consists of the [GRANT](#) and [REVOKE](#) statements. Contrast with **DDL** and **DML**.

See Also [DDL](#), [DML](#), [SQL](#).

#### DDEX provider

A feature that lets you use the data design tools within **Visual Studio** to manipulate the schema and objects within a MySQL database. For MySQL applications using **Connector/NET**, the MySQL Visual Studio Plugin acts as a DDEX provider with MySQL 5.0 and later.

See Also [Visual Studio](#).

#### DDL

Data definition language, a set of **SQL** statements for manipulating the database itself rather than individual table rows. Includes all forms of the [CREATE](#), [ALTER](#), and [DROP](#) statements. Also includes the [TRUNCATE](#) statement, because it works differently than a `DELETE FROM table_name` statement, even though the ultimate effect is similar.

---

DDL statements automatically **commit** the current **transaction**; they cannot be **rolled back**.

The **InnoDB online DDL** feature enhances performance for `CREATE INDEX`, `DROP INDEX`, and many types of `ALTER TABLE` operations. See [Section 14.13, “InnoDB and Online DDL”](#) for more information. Also, the **InnoDB file-per-table** setting can affect the behavior of `DROP TABLE` and `TRUNCATE TABLE` operations.

Contrast with **DML** and **DCL**.

See Also [commit](#), [DCL](#), [DML](#), [file-per-table](#), [rollback](#), [SQL](#), [transaction](#).

#### deadlock

A situation where different **transactions** are unable to proceed, because each holds a **lock** that the other needs. Because both transactions are waiting for a resource to become available, neither one ever releases the locks it holds.

A deadlock can occur when the transactions lock rows in multiple tables (through statements such as `UPDATE` or `SELECT ... FOR UPDATE`), but in the opposite order. A deadlock can also occur when such statements lock ranges of index records and **gaps**, with each transaction acquiring some locks but not others due to a timing issue.

For background information on how deadlocks are automatically detected and handled, see [Section 14.7.5.2, “Deadlock Detection”](#). For tips on avoiding and recovering from deadlock conditions, see [Section 14.7.5.3, “How to Minimize and Handle Deadlocks”](#).

See Also [gap](#), [lock](#), [transaction](#).

#### deadlock detection

A mechanism that automatically detects when a **deadlock** occurs, and automatically **rolls back** one of the **transactions** involved (the **victim**). Deadlock detection can be disabled using the `innodb_deadlock_detect` configuration option.

See Also [deadlock](#), [rollback](#), [transaction](#), [victim](#).

#### delete

When **InnoDB** processes a `DELETE` statement, the rows are immediately marked for deletion and no longer are returned by queries. The storage is reclaimed sometime later, during the periodic garbage collection known as the **purge** operation. For removing large quantities of data, related operations with their own performance characteristics are `TRUNCATE` and `DROP`.

See Also [drop](#), [purge](#), [truncate](#).

#### delete buffering

The technique of storing changes to secondary index pages, resulting from `DELETE` operations, in the **change buffer** rather than writing the changes immediately, so that the physical writes can be performed to minimize random I/O. (Because delete operations are a two-step process, this operation buffers the write that normally marks an index record for deletion.) It is one of the types of **change buffering**; the others are **insert buffering** and **purge buffering**.

See Also [change buffer](#), [change buffering](#), [insert buffer](#), [insert buffering](#), [purge buffering](#).

#### denormalized

A data storage strategy that duplicates data across different tables, rather than linking the tables with **foreign keys** and **join** queries. Typically used in **data warehouse** applications, where the data is not updated after loading. In such applications, query performance is more important than making it simple to maintain consistent data during updates. Contrast with **normalized**.

See Also [data warehouse](#), [foreign key](#), [join](#), [normalized](#).

#### descending index

A type of **index** available with some database systems, where index storage is optimized to process `ORDER BY column DESC` clauses. Currently, although MySQL allows the `DESC` keyword in the `CREATE TABLE` statement, it does not use any special storage layout for the resulting index.

---

See Also [index](#).

#### dirty page

A **page** in the [InnoDB buffer pool](#) that has been updated in memory, where the changes are not yet written (**flushed**) to the **data files**. The opposite of a **clean page**.

See Also [buffer pool](#), [clean page](#), [data files](#), [flush](#), [page](#).

#### dirty read

An operation that retrieves unreliable data, data that was updated by another transaction but not yet **committed**. It is only possible with the **isolation level** known as **read uncommitted**.

This kind of operation does not adhere to the **ACID** principle of database design. It is considered very risky, because the data could be **rolled back**, or updated further before being committed; then, the transaction doing the dirty read would be using data that was never confirmed as accurate.

Its opposite is **consistent read**, where [InnoDB](#) ensures that a transaction does not read information updated by another transaction, even if the other transaction commits in the meantime.

See Also [ACID](#), [commit](#), [consistent read](#), [isolation level](#), [READ UNCOMMITTED](#), [rollback](#).

#### disk-based

A kind of database that primarily organizes data on disk storage (hard drives or equivalent). Data is brought back and forth between disk and memory to be operated upon. It is the opposite of an **in-memory database**. Although [InnoDB](#) is disk-based, it also contains features such as the **buffer pool**, multiple buffer pool instances, and the **adaptive hash index** that allow certain kinds of workloads to work primarily from memory.

See Also [adaptive hash index](#), [buffer pool](#), [in-memory database](#).

#### disk-bound

A type of **workload** where the primary **bottleneck** is disk I/O. (Also known as **I/O-bound**.) Typically involves frequent writes to disk, or random reads of more data than can fit into the **buffer pool**.

See Also [bottleneck](#), [buffer pool](#), [workload](#).

#### DML

Data manipulation language, a set of **SQL** statements for performing [INSERT](#), [UPDATE](#), and [DELETE](#) operations. The [SELECT](#) statement is sometimes considered as a DML statement, because the [SELECT ... FOR UPDATE](#) form is subject to the same considerations for **locking** as [INSERT](#), [UPDATE](#), and [DELETE](#).

DML statements for an [InnoDB](#) table operate in the context of a **transaction**, so their effects can be **committed** or **rolled back** as a single unit.

Contrast with **DDL** and **DCL**.

See Also [commit](#), [DCL](#), [DDL](#), [locking](#), [rollback](#), [SQL](#), [transaction](#).

#### document id

In the [InnoDB full-text search](#) feature, a special column in the table containing the **FULLTEXT index**, to uniquely identify the document associated with each **ilist** value. Its name is [FTS\\_DOC\\_ID](#) (uppercase required). The column itself must be of [BIGINT UNSIGNED NOT NULL](#) type, with a unique index named [FTS\\_DOC\\_ID\\_INDEX](#). Preferably, you define this column when creating the table. If [InnoDB](#) must add the column to the table while creating a **FULLTEXT** index, the indexing operation is considerably more expensive.

See Also [full-text search](#), [FULLTEXT index](#), [ilist](#).

#### doublewrite buffer

[InnoDB](#) uses a file flush technique called doublewrite. Before writing **pages** to the **data files**, [InnoDB](#) first writes them to a storage area called the doublewrite buffer. Only after the write and the flush to the doublewrite buffer have completed, does [InnoDB](#) write the pages to their proper positions in the data file. If there is an operating system, storage subsystem or [mysqld](#) process crash in the middle of a page write, [InnoDB](#) can find a good copy of the page from the doublewrite buffer during **crash recovery**.

---

Although data is always written twice, the doublewrite buffer does not require twice as much I/O overhead or twice as many I/O operations. Data is written to the buffer itself as a large sequential chunk, with a single `fsync()` call to the operating system.

See Also [crash recovery](#), [data files](#), [page](#), [purge](#).

#### drop

A kind of **DDL** operation that removes a schema object, through a statement such as `DROP TABLE` or `DROP INDEX`. It maps internally to an `ALTER TABLE` statement. From an `InnoDB` perspective, the performance considerations of such operations involve the time that the **data dictionary** is locked to ensure that interrelated objects are all updated, and the time to update memory structures such as the **buffer pool**. For a **table**, the drop operation has somewhat different characteristics than a **truncate** operation (`TRUNCATE TABLE` statement).

See Also [buffer pool](#), [data dictionary](#), [DDL](#), [table](#), [truncate](#).

#### DSN

Acronym for “Database Source Name”. It is the encoding for **connection** information within **Connector/ODBC**. See [Configuring a Connector/ODBC DSN on Windows](#) for full details. It is the equivalent of the **connection string** used by **Connector/NET**.

See Also [connection](#), [connection string](#), [Connector/NET](#), [Connector/ODBC](#).

#### dynamic cursor

A type of **cursor** supported by **ODBC** that can pick up new and changed results when the rows are read again. Whether and how quickly the changes are visible to the cursor depends on the type of table involved (transactional or non-transactional) and the isolation level for transactional tables. Support for dynamic cursors must be explicitly enabled.

See Also [cursor](#), [ODBC](#).

#### dynamic row format

A row format introduced in the `InnoDB` Plugin, available as part of the **Barracuda file format**. Because long variable-length column values are stored outside of the page that holds the row data, it is very efficient for rows that include large objects. Since the large fields are typically not accessed to evaluate query conditions, they are not brought into the **buffer pool** as often, resulting in fewer I/O operations and better utilization of cache memory.

As of MySQL 5.7.9, the default row format is defined by `innodb_default_row_format`, which has a default value of `DYNAMIC`.

For additional information about `InnoDB DYNAMIC` row format, see [DYNAMIC Row Format](#).

See Also [Barracuda](#), [buffer pool](#), [file format](#), [row format](#).

#### dynamic SQL

A feature that lets you create and execute **prepared statements** using more robust, secure, and efficient methods to substitute parameter values than the naive technique of concatenating the parts of the statement into a string variable.

See Also [prepared statement](#).

#### dynamic statement

A **prepared statement** created and executed through **dynamic SQL**.

See Also [dynamic SQL](#), [prepared statement](#).

## E

#### early adopter

A stage similar to **beta**, when a software product is typically evaluated for performance, functionality, and compatibility in a non-mission-critical setting.

See Also [beta](#).

---

## Eiffel

A programming language including many object-oriented features. Some of its concepts are familiar to **Java** and **C#** developers. For the open-source Eiffel **API** for MySQL, see [Section 27.13, “MySQL Eiffel Wrapper”](#).  
See Also [API](#), [C#](#), [Java](#).

## embedded

The embedded MySQL server library (**libmysqld**) makes it possible to run a full-featured MySQL server inside a **client** application. The main benefits are increased speed and more simple management for embedded applications.  
See Also [client](#), [libmysqld](#).

## error log

A type of **log** showing information about MySQL startup and critical runtime errors and **crash** information. For details, see [Section 5.4.2, “The Error Log”](#).  
See Also [crash](#), [log](#).

## eviction

The process of removing an item from a cache or other temporary storage area, such as the **InnoDB buffer pool**. Often, but not always, uses the **LRU** algorithm to determine which item to remove. When a **dirty page** is evicted, its contents are **flushed** to disk, and any dirty **neighbor pages** might be flushed also.  
See Also [buffer pool](#), [dirty page](#), [flush](#), [LRU](#), [neighbor page](#).

## exception interceptor

A type of **interceptor** for tracing, debugging, or augmenting SQL errors encountered by a database application. For example, the interceptor code could issue a [SHOW WARNINGS](#) statement to retrieve additional information, and add descriptive text or even change the type of the exception returned to the application. Because the interceptor code is only called when SQL statements return errors, it does not impose any performance penalty on the application during normal (error-free) operation.

In **Java** applications using **Connector/J**, setting up this type of interceptor involves implementing the [com.mysql.jdbc.ExceptionInterceptor](#) interface, and adding a [exceptionInterceptors](#) property to the **connection string**.

In **Visual Studio** applications using **Connector/NET**, setting up this type of interceptor involves defining a class that inherits from the [BaseExceptionInterceptor](#) class and specifying that class name as part of the connection string.

See Also [Connector/J](#), [Connector/NET](#), [interceptor](#), [Java](#), [Visual Studio](#).

## exclusive lock

A kind of **lock** that prevents any other **transaction** from locking the same row. Depending on the transaction **isolation level**, this kind of lock might block other transactions from writing to the same row, or might also block other transactions from reading the same row. The default **InnoDB** isolation level, **REPEATABLE READ**, enables higher **concurrency** by allowing transactions to read rows that have exclusive locks, a technique known as **consistent read**.

See Also [concurrency](#), [consistent read](#), [isolation level](#), [lock](#), [REPEATABLE READ](#), [shared lock](#), [transaction](#).

## extent

A group of **pages** within a **tablespace**. For the default **page size** of 16KB, an extent contains 64 pages. In MySQL 5.6, the page size for an **InnoDB** instance can be 4KB, 8KB, or 16KB, controlled by the [innodb\\_page\\_size](#) configuration option. For 4KB, 8KB, and 16KB pages sizes, the extent size is always 1MB (or 1048576 bytes).

Support for 32KB and 64KB **InnoDB** page sizes was added in MySQL 5.7.6. For a 32KB page size, the extent size is 2MB. For a 64KB page size, the extent size is 4MB.

**InnoDB** features such as **segments**, **read-ahead** requests and the **doublewrite buffer** use I/O operations that read, write, allocate, or free data one extent at a time.

---

See Also [doublewrite buffer](#), [page](#), [page size](#), [read-ahead](#), [segment](#), [tablespace](#).

## F

### .frm file

A file containing the metadata, such as the table definition, of a MySQL table.

For backups, you must always keep the full set of `.frm` files along with the backup data to be able to restore tables that are altered or dropped after the backup.

Although each `InnoDB` table has a `.frm` file, `InnoDB` maintains its own table metadata in the **system tablespace**.

`.frm` files are backed up by the **MySQL Enterprise Backup** product. These files must not be modified by an `ALTER TABLE` operation while the backup is taking place, which is why backups that include non-`InnoDB` tables perform a `FLUSH TABLES WITH READ LOCK` operation to freeze such activity while backing up `.frm` files. Restoring a backup can result in `.frm` files being created, changed, or removed to match the state of the database at the time of the backup.

See Also [data dictionary](#), [MySQL Enterprise Backup](#), [system tablespace](#).

### failover

The ability to automatically switch to a standby server in the event of a failure. In the MySQL context, failover involves a standby database server. Often supported within **J2EE** environments by the application server or framework.

See Also [Connector/J](#), [J2EE](#).

### Fast Index Creation

A capability first introduced in the `InnoDB` Plugin, now part of MySQL in 5.5 and higher, that speeds up creation of `InnoDB` **secondary indexes** by avoiding the need to completely rewrite the associated table. The speedup applies to dropping secondary indexes also.

Because index maintenance can add performance overhead to many data transfer operations, consider doing operations such as `ALTER TABLE ... ENGINE=INNODB` or `INSERT INTO ... SELECT * FROM ...` without any secondary indexes in place, and creating the indexes afterward.

In MySQL 5.6, this feature becomes more general. You can read and write to tables while an index is being created, and many more kinds of `ALTER TABLE` operations can be performed without copying the table, without blocking **DML** operations, or both. Thus in MySQL 5.6 and higher, this set of features is referred to as **online DDL** rather than Fast Index Creation.

For related information, see [Section 14.13, “InnoDB and Online DDL”](#).

See Also [DML](#), [index](#), [online DDL](#), [secondary index](#).

### fast shutdown

The default **shutdown** procedure for `InnoDB`, based on the configuration setting `innodb_fast_shutdown=1`. To save time, certain **flush** operations are skipped. This type of shutdown is safe during normal usage, because the flush operations are performed during the next startup, using the same mechanism as in **crash recovery**.

In cases where the database is being shut down for an upgrade or downgrade, do a **slow shutdown** instead to ensure that all relevant changes are applied to the **data files** during the shutdown.

See Also [crash recovery](#), [data files](#), [flush](#), [shutdown](#), [slow shutdown](#).

### file format

The file format for `InnoDB` tables, enabled using the `innodb_file_format` configuration option. Supported file formats are **Antelope** and **Barracuda**. Antelope is the original `InnoDB` file format and supports the **REDUNDANT**

---

and **COMPACT** row formats. Barracuda is the newer [InnoDB](#) file format and supports the **COMPRESSED** and **DYNAMIC** row formats.

See Also [Antelope](#), [Barracuda](#), [file-per-table](#), [.ibd file](#), [ibdata file](#), [row format](#).

#### file-per-table

A general name for the setting controlled by the [innodb\\_file\\_per\\_table](#) option, which is an important configuration option that affects aspects of [InnoDB](#) file storage, availability of features, and I/O characteristics. As of MySQL 5.6.7, [innodb\\_file\\_per\\_table](#) is enabled by default.

With the [innodb\\_file\\_per\\_table](#) option enabled, you can create a table in its own **.ibd file** rather than in the shared **ibdata files** of the **system tablespace**. When table data is stored in an individual **.ibd file**, you have more flexibility to choose **row formats** required for features such as data **compression**. The [TRUNCATE TABLE](#) operation is also faster, and reclaimed space can be used by the operating system rather than remaining reserved for [InnoDB](#).

The **MySQL Enterprise Backup** product is more flexible for tables that are in their own files. For example, tables can be excluded from a backup, but only if they are in separate files. Thus, this setting is suitable for tables that are backed up less frequently or on a different schedule.

See Also [compressed row format](#), [compression](#), [file format](#), [.ibd file](#), [ibdata file](#), [innodb\\_file\\_per\\_table](#), [MySQL Enterprise Backup](#), [row format](#), [system tablespace](#).

#### fill factor

In an [InnoDB index](#), the proportion of a **page** that is taken up by index data before the page is split. The unused space when index data is first divided between pages allows for rows to be updated with longer string values without requiring expensive index maintenance operations. If the fill factor is too low, the index consumes more space than needed, causing extra I/O overhead when reading the index. If the fill factor is too high, any update that increases the length of column values can cause extra I/O overhead for index maintenance. See [Section 14.6.2.2, “The Physical Structure of an InnoDB Index”](#) for more information.

See Also [index](#), [page](#).

#### fixed row format

This row format is used by the [MyISAM](#) storage engine, not by [InnoDB](#). If you create an [InnoDB](#) table with the option [ROW\\_FORMAT=FIXED](#) in MySQL 5.7.6 or earlier, [InnoDB](#) uses the **compact row format** instead, although the [FIXED](#) value might still show up in output such as [SHOW TABLE STATUS](#) reports. As of MySQL 5.7.7, [InnoDB](#) returns an error if [ROW\\_FORMAT=FIXED](#) is specified.

See Also [compact row format](#), [row format](#).

#### flush

To write changes to the database files, that had been buffered in a memory area or a temporary disk storage area. The [InnoDB](#) storage structures that are periodically flushed include the **redo log**, the **undo log**, and the **buffer pool**.

Flushing can happen because a memory area becomes full and the system needs to free some space, because a **commit** operation means the changes from a transaction can be finalized, or because a **slow shutdown** operation means that all outstanding work should be finalized. When it is not critical to flush all the buffered data at once, [InnoDB](#) can use a technique called **fuzzy checkpointing** to flush small batches of pages to spread out the I/O overhead.

See Also [buffer pool](#), [commit](#), [fuzzy checkpointing](#), [redo log](#), [slow shutdown](#), [undo log](#).

#### flush list

An internal [InnoDB](#) data structure that tracks **dirty pages** in the **buffer pool**: that is, **pages** that have been changed and need to be written back out to disk. This data structure is updated frequently by [InnoDB](#) internal **mini-transactions**, and so is protected by its own **mutex** to allow concurrent access to the buffer pool.

See Also [buffer pool](#), [dirty page](#), [LRU](#), [mini-transaction](#), [mutex](#), [page](#), [page cleaner](#).



---

## foreign key

A type of pointer relationship, between rows in separate [InnoDB](#) tables. The foreign key relationship is defined on one column in both the **parent table** and the **child table**.

In addition to enabling fast lookup of related information, foreign keys help to enforce **referential integrity**, by preventing any of these pointers from becoming invalid as data is inserted, updated, and deleted. This enforcement mechanism is a type of **constraint**. A row that points to another table cannot be inserted if the associated foreign key value does not exist in the other table. If a row is deleted or its foreign key value changed, and rows in another table point to that foreign key value, the foreign key can be set up to prevent the deletion, cause the corresponding column values in the other table to become **null**, or automatically delete the corresponding rows in the other table.

One of the stages in designing a **normalized** database is to identify data that is duplicated, separate that data into a new table, and set up a foreign key relationship so that the multiple tables can be queried like a single table, using a **join** operation.

See Also [child table](#), [FOREIGN KEY constraint](#), [join](#), [normalized](#), [NULL](#), [parent table](#), [referential integrity](#), [relational](#).

## FOREIGN KEY constraint

The type of **constraint** that maintains database consistency through a **foreign key** relationship. Like other kinds of constraints, it can prevent data from being inserted or updated if data would become inconsistent; in this case, the inconsistency being prevented is between data in multiple tables. Alternatively, when a **DML** operation is performed, [FOREIGN KEY](#) constraints can cause data in **child rows** to be deleted, changed to different values, or set to **null**, based on the [ON CASCADE](#) option specified when creating the foreign key.

See Also [child table](#), [constraint](#), [DML](#), [foreign key](#), [NULL](#).

## FTS

In most contexts, an acronym for **full-text search**. Sometimes in performance discussions, an acronym for **full table scan**.

See Also [full table scan](#), [full-text search](#).

## full backup

A **backup** that includes all the **tables** in each MySQL **database**, and all the databases in a MySQL **instance**. Contrast with **partial backup**.

See Also [backup](#), [database](#), [instance](#), [partial backup](#), [table](#).

## full table scan

An operation that requires reading the entire contents of a table, rather than just selected portions using an **index**. Typically performed either with small lookup tables, or in data warehousing situations with large tables where all available data is aggregated and analyzed. How frequently these operations occur, and the sizes of the tables relative to available memory, have implications for the algorithms used in query optimization and managing the **buffer pool**.

The purpose of indexes is to allow lookups for specific values or ranges of values within a large table, thus avoiding full table scans when practical.

See Also [buffer pool](#), [index](#).

## full-text search

The MySQL feature for finding words, phrases, Boolean combinations of words, and so on within table data, in a faster, more convenient, and more flexible way than using the SQL [LIKE](#) operator or writing your own application-level search algorithm. It uses the SQL function [MATCH \( \)](#) and **FULLTEXT indexes**.

See Also [FULLTEXT index](#).

## FULLTEXT index

The special kind of **index** that holds the **search index** in the MySQL **full-text search** mechanism. Represents the words from values of a column, omitting any that are specified as **stopwords**. Originally, only available for [MyISAM](#) tables. Starting in MySQL 5.6.4, it is also available for **InnoDB** tables.

---

See Also [full-text search](#), [index](#), [InnoDB](#), [search index](#), [stopword](#).

#### fuzzy checkpointing

A technique that **flushes** small batches of **dirty pages** from the **buffer pool**, rather than flushing all dirty pages at once which would disrupt database processing.

See Also [buffer pool](#), [dirty page](#), [flush](#).

## G

### GA

“Generally available”, the stage when a software product leaves **beta** and is available for sale, official support, and production use.

See Also [beta](#).

### GAC

Acronym for “Global Assembly Cache”. A central area for storing libraries (**assemblies**) on a **.NET** system. Physically consists of nested folders, treated as a single virtual folder by the **.NET CLR**.

See Also [.NET](#), [assembly](#).

### gap

A place in an [InnoDB index](#) data structure where new values could be inserted. When you lock a set of rows with a statement such as `SELECT ... FOR UPDATE`, [InnoDB](#) can create locks that apply to the gaps as well as the actual values in the index. For example, if you select all values greater than 10 for update, a gap lock prevents another transaction from inserting a new value that is greater than 10. The **supremum record** and **infimum record** represent the gaps containing all values greater than or less than all the current index values.

See Also [concurrency](#), [gap lock](#), [index](#), [infimum record](#), [isolation level](#), [supremum record](#).

### gap lock

A **lock** on a **gap** between index records, or a lock on the gap before the first or after the last index record. For example, `SELECT c1 FROM t WHERE c1 BETWEEN 10 and 20 FOR UPDATE;` prevents other transactions from inserting a value of 15 into the column `t.c1`, whether or not there was already any such value in the column, because the gaps between all existing values in the range are locked. Contrast with **record lock** and **next-key lock**.

Gap locks are part of the tradeoff between performance and **concurrency**, and are used in some transaction **isolation levels** and not others.

See Also [gap](#), [infimum record](#), [lock](#), [next-key lock](#), [record lock](#), [supremum record](#).

### general log

See [general query log](#).

### general query log

A type of **log** used for diagnosis and troubleshooting of SQL statements processed by the MySQL server. Can be stored in a file or in a database table. You must enable this feature through the `general_log` configuration option to use it. You can disable it for a specific connection through the `sql_log_off` configuration option.

Records a broader range of queries than the **slow query log**. Unlike the **binary log**, which is used for replication, the general query log contains `SELECT` statements and does not maintain strict ordering. For more information, see [Section 5.4.3, “The General Query Log”](#).

See Also [binary log](#), [log](#), [slow query log](#).

### general tablespace

A shared [InnoDB tablespace](#) created using `CREATE TABLESPACE` syntax. General tablespaces can be created outside of the MySQL data directory, are capable of holding multiple **tables**, and support tables of all row formats. General tablespaces were introduced in MySQL 5.7.6.

---

Tables are added to a general tablespace using `CREATE TABLE tbl_name ... TABLESPACE [=] tablespace_name` or `ALTER TABLE tbl_name TABLESPACE [=] tablespace_name` syntax.

Contrast with **system tablespace** and **file-per-table** tablespace.

For more information, see [Section 14.6.3.3, “General Tablespaces”](#).  
See Also [file-per-table](#), [system tablespace](#), [table](#), [tablespace](#).

generated column

A column whose values are computed from an expression included in the column definition. A generated column can be **virtual** or **stored**.

See Also [base column](#), [stored generated column](#), [virtual generated column](#).

generated stored column

See [stored generated column](#).

generated virtual column

See [virtual generated column](#).

Glassfish

See Also [J2EE](#).

global transaction

A type of **transaction** involved in **XA** operations. It consists of several actions that are transactional in themselves, but that all must either complete successfully as a group, or all be rolled back as a group. In essence, this extends **ACID** properties “up a level” so that multiple ACID transactions can be executed in concert as components of a global operation that also has ACID properties.

See Also [ACID](#), [transaction](#), [XA](#).

group commit

An **InnoDB** optimization that performs some low-level I/O operations (log write) once for a set of **commit** operations, rather than flushing and syncing separately for each commit.

See Also [binary log](#), [commit](#).

GUID

Acronym for “globally unique identifier”, an ID value that can be used to associate data across different databases, languages, operating systems, and so on. (As an alternative to using sequential integers, where the same values could appear in different tables, databases, and so on referring to different data.) Older MySQL versions represented it as `BINARY(16)`. Currently, it is represented as `CHAR(36)`. MySQL has a `UUID()` function that returns GUID values in character format, and a `UUID_SHORT()` function that returns GUID values in integer format. Because successive GUID values are not necessarily in ascending sort order, it is not an efficient value to use as a primary key for large InnoDB tables.

## H

hash index

A type of **index** intended for queries that use equality operators, rather than range operators such as greater-than or `BETWEEN`. It is available for **MEMORY** tables. Although hash indexes are the default for **MEMORY** tables for historic reasons, that storage engine also supports **B-tree** indexes, which are often a better choice for general-purpose queries.

MySQL includes a variant of this index type, the **adaptive hash index**, that is constructed automatically for **InnoDB** tables if needed based on runtime conditions.

See Also [adaptive hash index](#), [B-tree](#), [index](#), [InnoDB](#).

---

## HDD

Acronym for “hard disk drive”. Refers to storage media using spinning platters, usually when comparing and contrasting with **SSD**. Its performance characteristics can influence the throughput of a **disk-based** workload. See Also [disk-based](#), [SSD](#).

## heartbeat

A periodic message that is sent to indicate that a system is functioning properly. In a **replication** context, if the **source** stops sending such messages, one of the **replicas** can take its place. Similar techniques can be used between the servers in a cluster environment, to confirm that all of them are operating properly. See Also [replication](#), [source](#).

## high-water mark

A value representing an upper limit, either a hard limit that should not be exceeded at runtime, or a record of the maximum value that was actually reached. Contrast with **low-water mark**. See Also [low-water mark](#).

## history list

A list of **transactions** with delete-marked records scheduled to be processed by the **InnoDB purge** operation. Recorded in the **undo log**. The length of the history list is reported by the command `SHOW ENGINE INNODB STATUS`. If the history list grows longer than the value of the `innodb_max_purge_lag` configuration option, each **DML** operation is delayed slightly to allow the purge operation to finish **flushing** the deleted records.

Also known as **purge lag**.

See Also [DML](#), [flush](#), [purge](#), [purge lag](#), [rollback segment](#), [transaction](#), [undo log](#).

## hole punching

Releasing empty blocks from a page. The **InnoDB transparent page compression** feature relies on hole punching support. For more information, see [Section 14.9.2, “InnoDB Page Compression”](#). See Also [sparse file](#), [transparent page compression](#).

## host

The network name of a database server, used to establish a **connection**. Often specified in conjunction with a **port**. In some contexts, the IP address `127.0.0.1` works better than the special name `localhost` for accessing a database on the same server as the application.

See Also [connection](#), [localhost](#), [port](#).

## hot

A condition where a row, table, or internal data structure is accessed so frequently, requiring some form of locking or mutual exclusion, that it results in a performance or scalability issue.

Although “hot” typically indicates an undesirable condition, a **hot backup** is the preferred type of backup.

See Also [hot backup](#).

## hot backup

A backup taken while the database is running and applications are reading and writing to it. The backup involves more than simply copying data files: it must include any data that was inserted or updated while the backup was in process; it must exclude any data that was deleted while the backup was in process; and it must ignore any changes that were not committed.

The Oracle product that performs hot backups, of **InnoDB** tables especially but also tables from **MyISAM** and other storage engines, is known as **MySQL Enterprise Backup**.

The hot backup process consists of two stages. The initial copying of the data files produces a **raw backup**. The **apply** step incorporates any changes to the database that happened while the backup was running. Applying the changes produces a **prepared** backup; these files are ready to be restored whenever necessary.

See Also [apply](#), [MySQL Enterprise Backup](#), [prepared backup](#), [raw backup](#).

---

## .ibd file

The data file for **file-per-table** tablespaces and general tablespaces. File-per-table tablespace `.ibd` files contain a single table and associated index data. **General tablespace** `.ibd` files may contain table and index data for multiple tables. General tablespaces were introduced in MySQL 5.7.6.

The `.ibd` file extension does not apply to the **system tablespace**, which consists of one or more **ibdata files**.

If a file-per-table tablespace or general tablespace is created with the `DATA DIRECTORY =` clause, the `.ibd` file is located at the specified path, outside the normal data directory, and is pointed to by a **.isl file**.

When a `.ibd` file is included in a compressed backup by the **MySQL Enterprise Backup** product, the compressed equivalent is a `.ibz` file.

See Also [database](#), [file-per-table](#), [general tablespace](#), [ibdata file](#), [.ibz file](#), [innodb\\_file\\_per\\_table](#), [.isl file](#), [MySQL Enterprise Backup](#), [system tablespace](#).

## .ibz file

When the **MySQL Enterprise Backup** product performs a **compressed backup**, it transforms each **tablespace** file that is created using the **file-per-table** setting from a `.ibd` extension to a `.ibz` extension.

The compression applied during backup is distinct from the **compressed row format** that keeps table data compressed during normal operation. A compressed backup operation skips the compression step for a tablespace that is already in compressed row format, as compressing a second time would slow down the backup but produce little or no space savings.

See Also [compressed backup](#), [compressed row format](#), [file-per-table](#), [.ibd file](#), [MySQL Enterprise Backup](#), [tablespace](#).

## .isl file

A file that specifies the location of an **.ibd file** for an **InnoDB** table created with the `DATA DIRECTORY =` clause in MySQL 5.6 and higher, or with the `CREATE TABLESPACE ... ADD DATAFILE` clause in MySQL 5.7 and higher. It functions like a symbolic link, without the platform restrictions of the actual symbolic link mechanism.

You can store **InnoDB tablespaces** outside the **database** directory, for example, on an especially large or fast storage device depending on the usage of the table. For details, see [Section 14.6.1.2, "Creating Tables Externally"](#), and [Section 14.6.3.3, "General Tablespaces"](#).

See Also [database](#), [.ibd file](#), [table](#), [tablespace](#).

## I/O-bound

See [disk-bound](#).

## ib-file set

The set of files managed by **InnoDB** within a MySQL database: the **system tablespace**, **file-per-table** tablespace files, and **redo log** files. Depending on MySQL version and **InnoDB** configuration, may also include **general tablespace**, **temporary tablespace**, and **undo tablespace** files. This term is sometimes used in detailed discussions of **InnoDB** file structures and formats to refer to the set of files managed by **InnoDB** within a MySQL database.

See Also [database](#), [file-per-table](#), [general tablespace](#), [redo log](#), [system tablespace](#), [temporary tablespace](#), [undo tablespace](#).

## ibbackup\_logfile

A supplemental backup file created by the **MySQL Enterprise Backup** product during a **hot backup** operation. It contains information about any data changes that occurred while the backup was running. The initial backup files, including `ibbackup_logfile`, are known as a **raw backup**, because the changes that occurred during the backup operation are not yet incorporated. After you perform the **apply** step to the raw backup files, the resulting files do include those final data changes, and are known as a **prepared backup**. At this stage, the `ibbackup_logfile` file is no longer necessary.

---

See Also [apply](#), [hot backup](#), [MySQL Enterprise Backup](#), [prepared backup](#), [raw backup](#).

#### ibdata file

A set of files with names such as `ibdata1`, `ibdata2`, and so on, that make up the **InnoDB system tablespace**. For information about the structures and data that reside in the system tablespace `ibdata` files, see [Section 14.6.3.1, “The System Tablespace”](#).

Growth of the `ibdata` files is influenced by the `innodb_autoextend_increment` configuration option. See Also [change buffer](#), [data dictionary](#), [doublewrite buffer](#), [file-per-table](#), [.ibd file](#), [innodb\\_file\\_per\\_table](#), [system tablespace](#), [undo log](#).

#### ibtmp file

The **InnoDB temporary tablespace data file** for non-compressed **InnoDB temporary tables** and related objects. The configuration file option, `innodb_temp_data_file_path`, allows users to define a relative path for the temporary tablespace data file. If `innodb_temp_data_file_path` is not specified, the default behavior is to create a single auto-extending 12MB data file named `ibtmp1` in the data directory, alongside `ibdata1`. See Also [data files](#), [temporary table](#), [temporary tablespace](#).

#### ib\_logfile

A set of files, typically named `ib_logfile0` and `ib_logfile1`, that form the **redo log**. Also sometimes referred to as the **log group**. These files record statements that attempt to change data in **InnoDB** tables. These statements are replayed automatically to correct data written by incomplete transactions, on startup following a crash.

This data cannot be used for manual recovery; for that type of operation, use the **binary log**. See Also [binary log](#), [log group](#), [redo log](#).

#### ilist

Within an **InnoDB FULLTEXT index**, the data structure consisting of a document ID and positional information for a token (that is, a particular word). See Also [FULLTEXT index](#).

#### implicit row lock

A row lock that **InnoDB** acquires to ensure consistency, without you specifically requesting it. See Also [row lock](#).

#### in-memory database

A type of database system that maintains data in memory, to avoid overhead due to disk I/O and translation between disk blocks and memory areas. Some in-memory databases sacrifice durability (the “D” in the **ACID** design philosophy) and are vulnerable to hardware, power, and other types of failures, making them more suitable for read-only operations. Other in-memory databases do use durability mechanisms such as logging changes to disk or using non-volatile memory.

MySQL features that address the same kinds of memory-intensive processing include the **InnoDB buffer pool**, **adaptive hash index**, and **read-only transaction** optimization, the **MEMORY** storage engine, the **MyISAM** key cache, and the MySQL query cache.

See Also [ACID](#), [adaptive hash index](#), [buffer pool](#), [disk-based](#), [read-only transaction](#).

#### incremental backup

A type of **hot backup**, performed by the **MySQL Enterprise Backup** product, that only saves data changed since some point in time. Having a full backup and a succession of incremental backups lets you reconstruct backup data over a long period, without the storage overhead of keeping several full backups on hand. You can restore the full backup and then apply each of the incremental backups in succession, or you can keep the full backup up-to-date by applying each incremental backup to it, then perform a single restore operation.

The granularity of changed data is at the **page** level. A page might actually cover more than one row. Each changed page is included in the backup.

---

See Also [hot backup](#), [MySQL Enterprise Backup](#), [page](#).

#### index

A data structure that provides a fast lookup capability for **rows** of a **table**, typically by forming a tree structure (**B-tree**) representing all the values of a particular **column** or set of columns.

[InnoDB](#) tables always have a **clustered index** representing the **primary key**. They can also have one or more **secondary indexes** defined on one or more columns. Depending on their structure, secondary indexes can be classified as **partial**, **column**, or **composite** indexes.

Indexes are a crucial aspect of **query** performance. Database architects design tables, queries, and indexes to allow fast lookups for data needed by applications. The ideal database design uses a **covering index** where practical; the query results are computed entirely from the index, without reading the actual table data. Each **foreign key** constraint also requires an index, to efficiently check whether values exist in both the **parent** and **child** tables.

Although a B-tree index is the most common, a different kind of data structure is used for **hash indexes**, as in the [MEMORY](#) storage engine and the [InnoDB adaptive hash index](#). **R-tree** indexes are used for spatial indexing of multi-dimensional information.

See Also [adaptive hash index](#), [B-tree](#), [child table](#), [clustered index](#), [column index](#), [composite index](#), [covering index](#), [foreign key](#), [hash index](#), [parent table](#), [partial index](#), [primary key](#), [query](#), [R-tree](#), [row](#), [secondary index](#), [table](#).

#### index cache

A memory area that holds the token data for [InnoDB full-text search](#). It buffers the data to minimize disk I/O when data is inserted or updated in columns that are part of a **FULLTEXT index**. The token data is written to disk when the index cache becomes full. Each [InnoDB FULLTEXT](#) index has its own separate index cache, whose size is controlled by the configuration option `innodb_ft_cache_size`.

See Also [full-text search](#), [FULLTEXT index](#).

#### index condition pushdown

Index condition pushdown (ICP) is an optimization that pushes part of a [WHERE](#) condition down to the storage engine if parts of the condition can be evaluated using fields from the **index**. ICP can reduce the number of times the **storage engine** must access the base table and the number of times the MySQL server must access the storage engine. For more information, see [Section 8.2.1.5, “Index Condition Pushdown Optimization”](#).

See Also [index](#), [storage engine](#).

#### index hint

Extended SQL syntax for overriding the **indexes** recommended by the optimizer. For example, the [FORCE INDEX](#), [USE INDEX](#), and [IGNORE INDEX](#) clauses. Typically used when indexed columns have unevenly distributed values, resulting in inaccurate **cardinality** estimates.

See Also [cardinality](#), [index](#).

#### index prefix

In an **index** that applies to multiple columns (known as a **composite index**), the initial or leading columns of the index. A query that references the first 1, 2, 3, and so on columns of a composite index can use the index, even if the query does not reference all the columns in the index.

See Also [composite index](#), [index](#).

#### index statistics

See [statistics](#).

#### infimum record

A **pseudo-record** in an **index**, representing the **gap** below the smallest value in that index. If a transaction has a statement such as `SELECT ... FROM ... WHERE col < 10 FOR UPDATE;`, and the smallest value in the column is 5, it is a lock on the infimum record that prevents other transactions from inserting even smaller values such as 0, -10, and so on.

---

See Also [gap](#), [index](#), [pseudo-record](#), [supremum record](#).

## INFORMATION\_SCHEMA

The name of the **database** that provides a query interface to the MySQL **data dictionary**. (This name is defined by the ANSI SQL standard.) To examine information (metadata) about the database, you can query tables such as `INFORMATION_SCHEMA.TABLES` and `INFORMATION_SCHEMA.COLUMNS`, rather than using `SHOW` commands that produce unstructured output.

The `INFORMATION_SCHEMA` database also contains tables specific to **InnoDB** that provide a query interface to the **InnoDB** data dictionary. You use these tables not to see how the database is structured, but to get real-time information about the workings of **InnoDB** tables to help with performance monitoring, tuning, and troubleshooting.

See Also [data dictionary](#), [database](#), [InnoDB](#).

## InnoDB

A MySQL component that combines high performance with **transactional** capability for reliability, robustness, and concurrent access. It embodies the **ACID** design philosophy. Represented as a **storage engine**, it handles tables created or altered with the `ENGINE=INNODB` clause. See [Chapter 14, The InnoDB Storage Engine](#) for architectural details and administration procedures, and [Section 8.5, “Optimizing for InnoDB Tables”](#) for performance advice.

In MySQL 5.5 and higher, **InnoDB** is the default storage engine for new tables and the `ENGINE=INNODB` clause is not required.

**InnoDB** tables are ideally suited for **hot backups**. See [Section 28.1, “MySQL Enterprise Backup Overview”](#) for information about the **MySQL Enterprise Backup** product for backing up MySQL servers without interrupting normal processing.

See Also [ACID](#), [hot backup](#), [MySQL Enterprise Backup](#), [storage engine](#), [transaction](#).

## innodb\_autoinc\_lock\_mode

The `innodb_autoinc_lock_mode` option controls the algorithm used for **auto-increment locking**. When you have an auto-incrementing **primary key**, you can use statement-based replication only with the setting `innodb_autoinc_lock_mode=1`. This setting is known as *consecutive* lock mode, because multi-row inserts within a transaction receive consecutive auto-increment values. If you have `innodb_autoinc_lock_mode=2`, which allows higher concurrency for insert operations, use row-based replication rather than statement-based replication. This setting is known as *interleaved* lock mode, because multiple multi-row insert statements running at the same time can receive **auto-increment** values that are interleaved. The setting `innodb_autoinc_lock_mode=0` should not be used except for compatibility purposes.

Consecutive lock mode (`innodb_autoinc_lock_mode=1`) is the default setting prior to MySQL 8.0.3. As of MySQL 8.0.3, interleaved lock mode (`innodb_autoinc_lock_mode=2`) is the default, which reflects the change from statement-based to row-based replication as the default replication type.

See Also [auto-increment](#), [auto-increment locking](#), [mixed-mode insert](#), [primary key](#).

## innodb\_file\_format

The `innodb_file_format` option defines the **file format** to use for new **InnoDB** file-per-table **tablespaces**. Currently, you can specify the **Antelope** and **Barracuda** file formats.

See Also [Antelope](#), [Barracuda](#), [file format](#), [file-per-table](#), [general tablespace](#), [innodb\\_file\\_per\\_table](#), [system tablespace](#), [tablespace](#).

## innodb\_file\_per\_table

An important configuration option that affects many aspects of **InnoDB** file storage, availability of features, and I/O characteristics. In MySQL 5.6.7 and higher, it is enabled by default. The `innodb_file_per_table` option turns on **file-per-table** mode. With this mode enabled, a newly created **InnoDB** table and associated indexes can be stored in a file-per-table **.ibd file**, outside the **system tablespace**.



---

This option affects the performance and storage considerations for a number of SQL statements, such as [DROP TABLE](#) and [TRUNCATE TABLE](#).

Enabling the [innodb\\_file\\_per\\_table](#) option allows you to take advantage of features such as table **compression** and named-table backups in **MySQL Enterprise Backup**.

For more information, see [innodb\\_file\\_per\\_table](#), and [Section 14.6.3.2, “File-Per-Table Tablespaces”](#). See Also [compression](#), [file-per-table](#), [.ibd file](#), [MySQL Enterprise Backup](#), [system tablespace](#).

#### innodb\_lock\_wait\_timeout

The [innodb\\_lock\\_wait\\_timeout](#) option sets the balance between **waiting** for shared resources to become available, or giving up and handling the error, retrying, or doing alternative processing in your application. Rolls back any **InnoDB** transaction that waits more than a specified time to acquire a **lock**. Especially useful if **deadlocks** are caused by updates to multiple tables controlled by different storage engines; such deadlocks are not **detected** automatically.

See Also [deadlock](#), [deadlock detection](#), [lock](#), [wait](#).

#### innodb\_strict\_mode

The [innodb\\_strict\\_mode](#) option controls whether **InnoDB** operates in **strict mode**, where conditions that are normally treated as warnings, cause errors instead (and the underlying statements fail).

See Also [strict mode](#).

#### Innovation Series

Innovation releases with the same major version form an Innovation series. For example, MySQL 8.1 through 8.3 form the MySQL 8 Innovation series.

See Also [LTS Series](#).

#### insert

One of the primary **DML** operations in **SQL**. The performance of inserts is a key factor in **data warehouse** systems that load millions of rows into tables, and **OLTP** systems where many concurrent connections might insert rows into the same table, in arbitrary order. If insert performance is important to you, you should learn about **InnoDB** features such as the **insert buffer** used in **change buffering**, and **auto-increment** columns.

See Also [auto-increment](#), [change buffering](#), [data warehouse](#), [DML](#), [InnoDB](#), [insert buffer](#), [OLTP](#), [SQL](#).

#### insert buffer

The former name of the **change buffer**. In MySQL 5.5, support was added for buffering changes to secondary index pages for [DELETE](#) and [UPDATE](#) operations. Previously, only changes resulting from [INSERT](#) operations were buffered. The preferred term is now *change buffer*.

See Also [change buffer](#), [change buffering](#).

#### insert buffering

The technique of storing changes to secondary index pages, resulting from [INSERT](#) operations, in the **change buffer** rather than writing the changes immediately, so that the physical writes can be performed to minimize random I/O. It is one of the types of **change buffering**; the others are **delete buffering** and **purge buffering**.

Insert buffering is not used if the secondary index is **unique**, because the uniqueness of new values cannot be verified before the new entries are written out. Other kinds of change buffering do work for unique indexes.

See Also [change buffer](#), [change buffering](#), [delete buffering](#), [insert buffer](#), [purge buffering](#), [unique index](#).

#### insert intention lock

A type of **gap lock** that is set by [INSERT](#) operations prior to row insertion. This type of **lock** signals the intent to insert in such a way that multiple transactions inserting into the same index gap need not wait for each other if they are not inserting at the same position within the gap. For more information, see [Section 14.7.1, “InnoDB Locking”](#).

See Also [gap lock](#), [lock](#), [next-key lock](#).

---

## instance

A single **mysqld** daemon managing a **data directory** representing one or more **databases** with a set of **tables**. It is common in development, testing, and some **replication** scenarios to have multiple instances on the same **server** machine, each managing its own data directory and listening on its own port or socket. With one instance running a **disk-bound** workload, the server might still have extra CPU and memory capacity to run additional instances.

See Also [data directory](#), [database](#), [disk-bound](#), [mysqld](#), [replication](#), [server](#), [table](#).

## instrumentation

Modifications at the source code level to collect performance data for tuning and debugging. In MySQL, data collected by instrumentation is exposed through an SQL interface using the [INFORMATION\\_SCHEMA](#) and [PERFORMANCE\\_SCHEMA](#) databases.

See Also [INFORMATION\\_SCHEMA](#), [Performance Schema](#).

## intention exclusive lock

See [intention lock](#).

## intention lock

A kind of **lock** that applies to the table, used to indicate the kind of lock the **transaction** intends to acquire on rows in the table. Different transactions can acquire different kinds of intention locks on the same table, but the first transaction to acquire an *intention exclusive* (IX) lock on a table prevents other transactions from acquiring any S or X locks on the table. Conversely, the first transaction to acquire an *intention shared* (IS) lock on a table prevents other transactions from acquiring any X locks on the table. The two-phase process allows the lock requests to be resolved in order, without blocking locks and corresponding operations that are compatible. For more information about this locking mechanism, see [Section 14.7.1, “InnoDB Locking”](#).

See Also [lock](#), [lock mode](#), [locking](#), [transaction](#).

## intention shared lock

See [intention lock](#).

## interceptor

Code for instrumenting or debugging some aspect of an application, which can be enabled without recompiling or changing the source of the application itself.

See Also [command interceptor](#), [Connector/J](#), [Connector/NET](#), [exception interceptor](#).

## intrinsic temporary table

An optimized internal [InnoDB](#) temporary table used by the *optimizer*.

See Also [optimizer](#).

## inverted index

A data structure optimized for document retrieval systems, used in the implementation of [InnoDB full-text search](#). The [InnoDB FULLTEXT index](#), implemented as an inverted index, records the position of each word within a document, rather than the location of a table row. A single column value (a document stored as a text string) is represented by many entries in the inverted index.

See Also [full-text search](#), [FULLTEXT index](#), [iist](#).

## IOPS

Acronym for **I/O operations per second**. A common measurement for busy systems, particularly **OLTP** applications. If this value is near the maximum that the storage devices can handle, the application can become **disk-bound**, limiting **scalability**.

See Also [disk-bound](#), [OLTP](#), [scalability](#).

## isolation level

One of the foundations of database processing. Isolation is the **I** in the acronym **ACID**; the isolation level is the setting that fine-tunes the balance between performance and reliability, consistency, and reproducibility of results when multiple **transactions** are making changes and performing queries at the same time.

---

From highest amount of consistency and protection to the least, the isolation levels supported by InnoDB are: **SERIALIZABLE**, **REPEATABLE READ**, **READ COMMITTED**, and **READ UNCOMMITTED**.

With **InnoDB** tables, many users can keep the default isolation level (*REPEATABLE READ*) for all operations. Expert users might choose the **READ COMMITTED** level as they push the boundaries of scalability with **OLTP** processing, or during data warehousing operations where minor inconsistencies do not affect the aggregate results of large amounts of data. The levels on the edges (**SERIALIZABLE** and **READ UNCOMMITTED**) change the processing behavior to such an extent that they are rarely used.

See Also [ACID](#), [OLTP](#), [READ COMMITTED](#), [READ UNCOMMITTED](#), [REPEATABLE READ](#), [SERIALIZABLE](#), [transaction](#).

## J

### J2EE

Java Platform, Enterprise Edition: Oracle's enterprise Java platform. It consists of an API and a runtime environment for enterprise-class Java applications. For full details, see <http://www.oracle.com/technetwork/java/javaeec/overview/index.html>. With MySQL applications, you typically use **Connector/J** for database access, and an application server such as **Tomcat** or **JBoss** to handle the middle-tier work, and optionally a framework such as **Spring**. Database-related features often offered within a J2EE stack include a **connection pool** and **failover** support.

See Also [connection pool](#), [Connector/J](#), [failover](#), [Java](#), [JBoss](#), [Spring](#), [Tomcat](#).

### Java

A programming language combining high performance, rich built-in features and data types, object-oriented mechanisms, extensive standard library, and wide range of reusable third-party modules. Enterprise development is supported by many frameworks, application servers, and other technologies. Much of its syntax is familiar to **C** and **C++** developers. To write Java applications with MySQL, you use the **JDBC** driver known as **Connector/J**.  
See Also [C](#), [Connector/J](#), [C++](#), [JDBC](#).

### JBoss

See Also [J2EE](#).

### JDBC

Abbreviation for “Java Database Connectivity”, an **API** for database access from **Java** applications. Java developers writing MySQL applications use the **Connector/J** component as their JDBC driver.

See Also [API](#), [Connector/J](#), [J2EE](#), [Java](#).

### JNDI

See Also [Java](#).

### join

A **query** that retrieves data from more than one table, by referencing columns in the tables that hold identical values. Ideally, these columns are part of an **InnoDB foreign key** relationship, which ensures **referential integrity** and that the join columns are **indexed**. Often used to save space and improve query performance by replacing repeated strings with numeric IDs, in a **normalized** data design.

See Also [foreign key](#), [index](#), [normalized](#), [query](#), [referential integrity](#).

## K

### keystore

See Also [SSL](#).

---

## KEY\_BLOCK\_SIZE

An option to specify the size of data pages within an [InnoDB](#) table that uses **compressed row format**. The default is 8 kilobytes. Lower values risk hitting internal limits that depend on the combination of row size and compression percentage.

For [MyISAM](#) tables, [KEY\\_BLOCK\\_SIZE](#) optionally specifies the size in bytes to use for index key blocks. The value is treated as a hint; a different size could be used if necessary. A [KEY\\_BLOCK\\_SIZE](#) value specified for an individual index definition overrides a table-level [KEY\\_BLOCK\\_SIZE](#) value.

See Also [compressed row format](#).

## L

### latch

A lightweight structure used by [InnoDB](#) to implement a **lock** for its own internal memory structures, typically held for a brief time measured in milliseconds or microseconds. A general term that includes both **mutexes** (for exclusive access) and **rw-locks** (for shared access). Certain latches are the focus of [InnoDB](#) performance tuning. Statistics about latch use and contention are available through the **Performance Schema** interface.

See Also [lock](#), [locking](#), [mutex](#), [Performance Schema](#), [rw-lock](#).

### libmysql

Informal name for the **libmysqlclient** library.

See Also [libmysqlclient](#).

### libmysqlclient

The library file, named [libmysqlclient.a](#) or [libmysqlclient.so](#), that is typically linked into **client** programs written in **C**. Sometimes known informally as **libmysql** or the **mysqlclient** library.

See Also [client](#), [libmysql](#), [mysqlclient](#).

### libmysqld

This **embedded** MySQL server library makes it possible to run a full-featured MySQL server inside a **client** application. The main benefits are increased speed and more simple management for embedded applications. You link with the [libmysqld](#) library rather than **libmysqlclient**. The API is identical between all three of these libraries.

See Also [client](#), [embedded](#), [libmysql](#), [libmysqlclient](#).

### lifecycle interceptor

A type of **interceptor** supported by **Connector/J**. It involves implementing the interface

[com.mysql.jdbc.ConnectionLifecycleInterceptor](#).

See Also [Connector/J](#), [interceptor](#).

### list

The [InnoDB](#) **buffer pool** is represented as a list of memory **pages**. The list is reordered as new pages are accessed and enter the buffer pool, as pages within the buffer pool are accessed again and are considered newer, and as pages that are not accessed for a long time are **evicted** from the buffer pool. The buffer pool is divided into **sublists**, and the replacement policy is a variation of the familiar **LRU** technique.

See Also [buffer pool](#), [eviction](#), [LRU](#), [page](#), [sublist](#).

### load balancing

A technique for scaling read-only connections by sending query requests to different slave servers in a replication or Cluster configuration. With **Connector/J**, load balancing is enabled through the [com.mysql.jdbc.ReplicationDriver](#) class and controlled by the configuration property [loadBalanceStrategy](#).

See Also [Connector/J](#), [J2EE](#).

### localhost

---

See Also [connection](#).

#### lock

The high-level notion of an object that controls access to a resource, such as a table, row, or internal data structure, as part of a **locking** strategy. For intensive performance tuning, you might delve into the actual structures that implement locks, such as **mutexes** and **latches**.

See Also [latch](#), [lock mode](#), [locking](#), [mutex](#).

#### lock escalation

An operation used in some database systems that converts many **row locks** into a single **table lock**, saving memory space but reducing concurrent access to the table. **InnoDB** uses a space-efficient representation for row locks, so that **lock** escalation is not needed.

See Also [locking](#), [row lock](#), [table lock](#).

#### lock mode

A shared (S) **lock** allows a **transaction** to read a row. Multiple transactions can acquire an S lock on that same row at the same time.

An exclusive (X) lock allows a transaction to update or delete a row. No other transaction can acquire any kind of lock on that same row at the same time.

**Intention locks** apply to the table, and are used to indicate what kind of lock the transaction intends to acquire on rows in the table. Different transactions can acquire different kinds of intention locks on the same table, but the first transaction to acquire an intention exclusive (IX) lock on a table prevents other transactions from acquiring any S or X locks on the table. Conversely, the first transaction to acquire an intention shared (IS) lock on a table prevents other transactions from acquiring any X locks on the table. The two-phase process allows the lock requests to be resolved in order, without blocking locks and corresponding operations that are compatible.

See Also [intention lock](#), [lock](#), [locking](#), [transaction](#).

#### locking

The system of protecting a **transaction** from seeing or changing data that is being queried or changed by other transactions. The **locking** strategy must balance reliability and consistency of database operations (the principles of the **ACID** philosophy) against the performance needed for good **concurrency**. Fine-tuning the locking strategy often involves choosing an **isolation level** and ensuring all your database operations are safe and reliable for that isolation level.

See Also [ACID](#), [concurrency](#), [isolation level](#), [locking](#), [transaction](#).

#### locking read

A **SELECT** statement that also performs a **locking** operation on an **InnoDB** table. Either **SELECT ... FOR UPDATE** or **SELECT ... LOCK IN SHARE MODE**. It has the potential to produce a **deadlock**, depending on the **isolation level** of the transaction. The opposite of a **non-locking read**. Not allowed for global tables in a **read-only transaction**.

**SELECT ... FOR SHARE** replaces **SELECT ... LOCK IN SHARE MODE** in MySQL 8.0.1, but **LOCK IN SHARE MODE** remains available for backward compatibility.

See [Section 14.7.2.4, “Locking Reads”](#).

See Also [deadlock](#), [isolation level](#), [locking](#), [non-locking read](#), [read-only transaction](#).

#### log

In the **InnoDB** context, “log” or “log files” typically refers to the **redo log** represented by the **ib\_logfileN** files. Another type of **InnoDB** log is the **undo log**, which is a storage area that holds copies of data modified by active transactions.

Other kinds of logs that are important in MySQL are the **error log** (for diagnosing startup and runtime problems), **binary log** (for working with replication and performing point-in-time restores), the **general query log** (for diagnosing application problems), and the **slow query log** (for diagnosing performance problems).

---

See Also [binary log](#), [error log](#), [general query log](#), [ib\\_logfile](#), [redo log](#), [slow query log](#), [undo log](#).

#### log buffer

The memory area that holds data to be written to the **log files** that make up the **redo log**. It is controlled by the [innodb\\_log\\_buffer\\_size](#) configuration option.

See Also [log file](#), [redo log](#).

#### log file

One of the **ib\_logfileN** files that make up the **redo log**. Data is written to these files from the **log buffer** memory area.

See Also [ib\\_logfile](#), [log buffer](#), [redo log](#).

#### log group

The set of files that make up the **redo log**, typically named [ib\\_logfile0](#) and [ib\\_logfile1](#). (For that reason, sometimes referred to collectively as **ib\_logfile**.)

See Also [ib\\_logfile](#), [redo log](#).

#### logical

A type of operation that involves high-level, abstract aspects such as tables, queries, indexes, and other SQL concepts. Typically, logical aspects are important to make database administration and application development convenient and usable. Contrast with **physical**.

See Also [logical backup](#), [physical](#).

#### logical backup

A **backup** that reproduces table structure and data, without copying the actual data files. For example, the [mysqldump](#) command produces a logical backup, because its output contains statements such as [CREATE TABLE](#) and [INSERT](#) that can re-create the data. Contrast with **physical backup**. A logical backup offers flexibility (for example, you could edit table definitions or insert statements before restoring), but can take substantially longer to **restore** than a physical backup.

See Also [backup](#), [mysqldump](#), [physical backup](#), [restore](#).

#### loose\_

A prefix added to [InnoDB](#) configuration options after server **startup**, so any new configuration options not recognized by the current level of MySQL do not cause a startup failure. MySQL processes configuration options that start with this prefix, but gives a warning rather than a failure if the part after the prefix is not a recognized option.

See Also [startup](#).

#### low-water mark

A value representing a lower limit, typically a threshold value at which some corrective action begins or becomes more aggressive. Contrast with **high-water mark**.

See Also [high-water mark](#).

#### LRU

An acronym for “least recently used”, a common method for managing storage areas. The items that have not been used recently are **evicted** when space is needed to cache newer items. [InnoDB](#) uses the LRU mechanism by default to manage the **pages** within the **buffer pool**, but makes exceptions in cases where a page might be read only a single time, such as during a **full table scan**. This variation of the LRU algorithm is called the **midpoint insertion strategy**. For more information, see [Section 14.5.1, “Buffer Pool”](#).

See Also [buffer pool](#), [eviction](#), [full table scan](#), [midpoint insertion strategy](#), [page](#).

#### LSN

Acronym for “log sequence number”. This arbitrary, ever-increasing value represents a point in time corresponding to operations recorded in the **redo log**. (This point in time is regardless of **transaction** boundaries; it can fall in the middle of one or more transactions.) It is used internally by [InnoDB](#) during **crash recovery** and for managing the **buffer pool**.

---

Prior to MySQL 5.6.3, the LSN was a 4-byte unsigned integer. The LSN became an 8-byte unsigned integer in MySQL 5.6.3 when the redo log file size limit increased from 4GB to 512GB, as additional bytes were required to store extra size information. Applications built on MySQL 5.6.3 or later that use LSN values should use 64-bit rather than 32-bit variables to store and compare LSN values.

In the **MySQL Enterprise Backup** product, you can specify an LSN to represent the point in time from which to take an **incremental backup**. The relevant LSN is displayed by the output of the `mysqlbackup` command. Once you have the LSN corresponding to the time of a full backup, you can specify that value to take a subsequent incremental backup, whose output contains another LSN for the next incremental backup.

See Also [buffer pool](#), [crash recovery](#), [incremental backup](#), [MySQL Enterprise Backup](#), [redo log](#), [transaction](#).

## LTS Series

LTS releases with the same major version number form an LTS series. For example, all MySQL 8.4.x releases form the MySQL 8.4 LTS series.

Note: MySQL 8.0 is a Bugfix series that preceded the LTS release model.

See Also [Innovation Series](#).

# M

## .MRG file

A file containing references to other tables, used by the `MERGE` storage engine. Files with this extension are always included in backups produced by the `mysqlbackup` command of the **MySQL Enterprise Backup** product.

See Also [MySQL Enterprise Backup](#), [mysqlbackup command](#).

## .MYD file

A file that MySQL uses to store data for a `MyISAM` table.

See Also [.MYI file](#), [MySQL Enterprise Backup](#), [mysqlbackup command](#).

## .MYI file

A file that MySQL uses to store indexes for a `MyISAM` table.

See Also [.MYD file](#), [MySQL Enterprise Backup](#), [mysqlbackup command](#).

## master

See [source](#).

## master thread

An `InnoDB` **thread** that performs various tasks in the background. Most of these tasks are I/O related, such as writing changes from the **change buffer** to the appropriate secondary indexes.

To improve **concurrency**, sometimes actions are moved from the master thread to separate background threads. For example, in MySQL 5.6 and higher, **dirty pages** are **flushed** from the **buffer pool** by the **page cleaner** thread rather than the master thread.

See Also [buffer pool](#), [change buffer](#), [concurrency](#), [dirty page](#), [flush](#), [page cleaner](#), [thread](#).

## MDL

Acronym for “metadata lock”.

See Also [metadata lock](#).

## medium trust

Synonym for **partial trust**. Because the range of trust settings is so broad, “partial trust” is preferred, to avoid the implication that there are only three levels (low, medium, and full).

See Also [Connector/NET](#), [partial trust](#).

---

## memcached

A popular component of many MySQL and **NoSQL** software stacks, allowing fast reads and writes for single values and caching the results entirely in memory. Traditionally, applications required extra logic to write the same data to a MySQL database for permanent storage, or to read data from a MySQL database when it was not cached yet in memory. Now, applications can use the simple `memcached` protocol, supported by client libraries for many languages, to communicate directly with MySQL servers using `InnoDB` or `NDB` tables. These NoSQL interfaces to MySQL tables allow applications to achieve higher read and write performance than by issuing SQL statements directly, and can simplify application logic and deployment configurations for systems that already incorporate `memcached` for in-memory caching.  
See Also [NoSQL](#).

## merge

To apply changes to data cached in memory, such as when a page is brought into the **buffer pool**, and any applicable changes recorded in the **change buffer** are incorporated into the page in the buffer pool. The updated data is eventually written to the **tablespace** by the **flush** mechanism.  
See Also [buffer pool](#), [change buffer](#), [flush](#), [tablespace](#).

## metadata lock

A type of **lock** that prevents **DDL** operations on a table that is being used at the same time by another **transaction**. For details, see [Section 8.11.4, “Metadata Locking”](#).

Enhancements to **online** operations, particularly in MySQL 5.6 and higher, are focused on reducing the amount of metadata locking. The objective is for DDL operations that do not change the table structure (such as `CREATE INDEX` and `DROP INDEX` for `InnoDB` tables) to proceed while the table is being queried, updated, and so on by other transactions.

See Also [DDL](#), [lock](#), [online](#), [transaction](#).

## metrics counter

A feature implemented by the `INNODB_METRICS` table in the `INFORMATION_SCHEMA`, in MySQL 5.6 and higher. You can query **counts** and totals for low-level `InnoDB` operations, and use the results for performance tuning in combination with data from the **Performance Schema**.

See Also [counter](#), [INFORMATION\\_SCHEMA](#), [Performance Schema](#).

## midpoint insertion strategy

The technique of initially bringing **pages** into the `InnoDB` **buffer pool** not at the “newest” end of the list, but instead somewhere in the middle. The exact location of this point can vary, based on the setting of the `innodb_old_blocks_pct` option. The intent is that pages that are only read once, such as during a **full table scan**, can be aged out of the buffer pool sooner than with a strict **LRU** algorithm. For more information, see [Section 14.5.1, “Buffer Pool”](#).

See Also [buffer pool](#), [full table scan](#), [LRU](#), [page](#).

## mini-transaction

An internal phase of `InnoDB` processing, when making changes at the **physical** level to internal data structures during **DML** operations. A mini-transaction (mtr) has no notion of **rollback**; multiple mini-transactions can occur within a single **transaction**. Mini-transactions write information to the **redo log** that is used during **crash recovery**. A mini-transaction can also happen outside the context of a regular transaction, for example during **purge** processing by background threads.

See Also [commit](#), [crash recovery](#), [DML](#), [physical](#), [purge](#), [redo log](#), [rollback](#), [transaction](#).

## mixed-mode insert

An `INSERT` statement where **auto-increment** values are specified for some but not all of the new rows. For example, a multi-value `INSERT` could specify a value for the auto-increment column in some cases and `NULL` in other cases. `InnoDB` generates auto-increment values for the rows where the column value was specified as `NULL`. Another example is an `INSERT ... ON DUPLICATE KEY UPDATE` statement, where auto-increment values might be generated but not used, for any duplicate rows that are processed as `UPDATE` rather than `INSERT` statements.



---

Can cause consistency issues between **source** and **replica** servers in a **replication** configuration. Can require adjusting the value of the **innodb\_autoinc\_lock\_mode** configuration option.  
See Also [auto-increment](#), [innodb\\_autoinc\\_lock\\_mode](#), [replica](#), [replication](#), [source](#).

#### MM.MySQL

An older JDBC driver for MySQL that evolved into **Connector/J** when it was integrated with the MySQL product.  
See Also [Connector/J](#).

#### Mono

An Open Source framework developed by Novell, that works with **Connector/NET** and **C#** applications on Linux platforms.  
See Also [Connector/NET](#), [C#](#).

#### mtr

See [mini-transaction](#).

#### multi-core

A type of processor that can take advantage of multithreaded programs, such as the MySQL server.

#### multiversion concurrency control

See [MVCC](#).

#### mutex

Informal abbreviation for “mutex variable”. (Mutex itself is short for “mutual exclusion”.) The low-level object that **InnoDB** uses to represent and enforce exclusive-access **locks** to internal in-memory data structures. Once the lock is acquired, any other process, thread, and so on is prevented from acquiring the same lock. Contrast with **rw-locks**, which **InnoDB** uses to represent and enforce shared-access **locks** to internal in-memory data structures. Mutexes and rw-locks are known collectively as **latches**.  
See Also [latch](#), [lock](#), [Performance Schema](#), [Pthreads](#), [rw-lock](#).

#### MVCC

Acronym for “multiversion concurrency control”. This technique lets **InnoDB transactions** with certain **isolation levels** perform **consistent read** operations; that is, to query rows that are being updated by other transactions, and see the values from before those updates occurred. This is a powerful technique to increase **concurrency**, by allowing queries to proceed without waiting due to **locks** held by the other transactions.

This technique is not universal in the database world. Some other database products, and some other MySQL storage engines, do not support it.

See Also [ACID](#), [concurrency](#), [consistent read](#), [isolation level](#), [lock](#), [transaction](#).

#### my.cnf

The name, on Unix or Linux systems, of the MySQL **option file**.

See Also [my.ini](#), [option file](#).

#### my.ini

The name, on Windows systems, of the MySQL **option file**.

See Also [my.cnf](#), [option file](#).

#### MyODBC drivers

Obsolete name for **Connector/ODBC**.

See Also [Connector/ODBC](#).

#### mysql

The **mysql** program is the command-line interpreter for the MySQL database. It processes **SQL** statements, and also MySQL-specific commands such as **SHOW TABLES**, by passing requests to the **mysqld** daemon.

---

See Also [mysqld](#), [SQL](#).

#### mysqlbackup command

A command-line tool of the **MySQL Enterprise Backup** product. It performs a **hot backup** operation for [InnoDB](#) tables, and a **warm backup** for [MyISAM](#) and other kinds of tables. See [Section 28.1, “MySQL Enterprise Backup Overview”](#) for more information about this command.

See Also [hot backup](#), [MySQL Enterprise Backup](#), [warm backup](#).

#### mysqlclient

The informal name for the library that is implemented by the file **libmysqlclient**, with extension `.a` or `.so`.

See Also [libmysqlclient](#).

#### mysqld

[mysqld](#), also known as MySQL Server, is a single multithreaded program that does most of the work in a MySQL installation. It does not spawn additional processes. MySQL Server manages access to the MySQL data directory that contains databases, tables, and other information such as log files and status files.

[mysqld](#) runs as a Unix daemon or Windows service, constantly waiting for requests and performing maintenance work in the background.

See Also [instance](#), [mysql](#).

#### MySQLdb

The name of the open-source **Python** module that forms the basis of the **MySQL Python API**.

See Also [Python](#), [Python API](#).

#### mysqldump

A command that performs a **logical backup** of some combination of databases, tables, and table data. The results are SQL statements that reproduce the original schema objects, data, or both. For substantial amounts of data, a **physical backup** solution such as **MySQL Enterprise Backup** is faster, particularly for the **restore** operation.

See Also [logical backup](#), [MySQL Enterprise Backup](#), [physical backup](#), [restore](#).

## N

### .NET

See Also [ADO.NET](#), [ASP.net](#), [Connector/.NET](#), [Mono](#), [Visual Studio](#).

#### native C API

Synonym for **libmysqlclient**.

See Also [libmysql](#).

#### natural key

An indexed column, typically a **primary key**, where the values have some real-world significance. Usually advised against because:

- If the value should ever change, there is potentially a lot of index maintenance to re-sort the **clustered index** and update the copies of the primary key value that are repeated in each **secondary index**.
- Even seemingly stable values can change in unpredictable ways that are difficult to represent correctly in the database. For example, one country can change into two or several, making the original country code obsolete. Or, rules about unique values might have exceptions. For example, even if taxpayer IDs are intended to be unique to a single person, a database might have to handle records that violate that rule, such as in cases of identity theft. Taxpayer IDs and other sensitive ID numbers also make poor primary keys, because they may need to be secured, encrypted, and otherwise treated differently than other columns.

---

Thus, it is typically better to use arbitrary numeric values to form a **synthetic key**, for example using an **auto-increment** column.

See Also [auto-increment](#), [clustered index](#), [primary key](#), [secondary index](#), [synthetic key](#).

neighbor page

Any **page** in the same **extent** as a particular page. When a page is selected to be **flushed**, any neighbor pages that are **dirty** are typically flushed as well, as an I/O optimization for traditional hard disks. In MySQL 5.6 and up, this behavior can be controlled by the configuration variable `innodb_flush_neighbors`; you might turn that setting off for SSD drives, which do not have the same overhead for writing smaller batches of data at random locations.

See Also [dirty page](#), [extent](#), [flush](#), [page](#).

next-key lock

A combination of a **record lock** on the index record and a [gap lock](#) on the gap before the index record.

See Also [gap lock](#), [locking](#), [record lock](#).

non-locking read

A **query** that does not use the `SELECT ... FOR UPDATE` or `SELECT ... LOCK IN SHARE MODE` clauses. The only kind of query allowed for global tables in a **read-only transaction**. The opposite of a **locking read**. See [Section 14.7.2.3, "Consistent Nonlocking Reads"](#).

`SELECT ... FOR SHARE` replaces `SELECT ... LOCK IN SHARE MODE` in MySQL 8.0.1, but `LOCK IN SHARE MODE` remains available for backward compatibility.

See Also [locking read](#), [query](#), [read-only transaction](#).

non-repeatable read

The situation when a query retrieves data, and a later query within the same **transaction** retrieves what should be the same data, but the queries return different results (changed by another transaction committing in the meantime).

This kind of operation goes against the **ACID** principle of database design. Within a transaction, data should be consistent, with predictable and stable relationships.

Among different **isolation levels**, non-repeatable reads are prevented by the **serializable read** and **repeatable read** levels, and allowed by the **consistent read**, and **read uncommitted** levels.

See Also [ACID](#), [consistent read](#), [isolation level](#), [READ UNCOMMITTED](#), [REPEATABLE READ](#), [SERIALIZABLE](#), [transaction](#).

nonblocking I/O

An industry term that means the same as **asynchronous I/O**.

See Also [asynchronous I/O](#).

normalized

A database design strategy where data is split into multiple tables, and duplicate values condensed into single rows represented by an ID, to avoid storing, querying, and updating redundant or lengthy values. It is typically used in **OLTP** applications.

For example, an address might be given a unique ID, so that a census database could represent the relationship **lives at this address** by associating that ID with each member of a family, rather than storing multiple copies of a complex value such as **123 Main Street, Anytown, USA**.

For another example, although a simple address book application might store each phone number in the same table as a person's name and address, a phone company database might give each phone number a special ID, and store the numbers and IDs in a separate table. This normalized representation could simplify large-scale updates when area codes split apart.

---

Normalization is not always recommended. Data that is primarily queried, and only updated by deleting entirely and reloading, is often kept in fewer, larger tables with redundant copies of duplicate values. This data representation is referred to as **denormalized**, and is frequently found in data warehousing applications. See Also [denormalized](#), [foreign key](#), [OLTP](#), [relational](#).

## NoSQL

A broad term for a set of data access technologies that do not use the **SQL** language as their primary mechanism for reading and writing data. Some NoSQL technologies act as key-value stores, only accepting single-value reads and writes; some relax the restrictions of the **ACID** methodology; still others do not require a pre-planned **schema**. MySQL users can combine NoSQL-style processing for speed and simplicity with SQL operations for flexibility and convenience, by using the **memcached** API to directly access some kinds of MySQL tables.

See Also [ACID](#), [memcached](#), [schema](#), [SQL](#).

## NOT NULL constraint

A type of **constraint** that specifies that a **column** cannot contain any **NULL** values. It helps to preserve **referential integrity**, as the database server can identify data with erroneous missing values. It also helps in the arithmetic involved in query optimization, allowing the optimizer to predict the number of entries in an index on that column.

See Also [column](#), [constraint](#), [NULL](#), [primary key](#), [referential integrity](#).

## NULL

A special value in **SQL**, indicating the absence of data. Any arithmetic operation or equality test involving a **NULL** value, in turn produces a **NULL** result. (Thus it is similar to the IEEE floating-point concept of NaN, “not a number”.) Any aggregate calculation such as [AVG \( \)](#) ignores rows with **NULL** values, when determining how many rows to divide by. The only test that works with **NULL** values uses the SQL idioms [IS NULL](#) or [IS NOT NULL](#).

**NULL** values play a part in **index** operations, because for performance a database must minimize the overhead of keeping track of missing data values. Typically, **NULL** values are not stored in an index, because a query that tests an indexed column using a standard comparison operator could never match a row with a **NULL** value for that column. For the same reason, unique indexes do not prevent **NULL** values; those values simply are not represented in the index. Declaring a [NOT NULL](#) constraint on a column provides reassurance that there are no rows left out of the index, allowing for better query optimization (accurate counting of rows and estimation of whether to use the index).

Because the **primary key** must be able to uniquely identify every row in the table, a single-column primary key cannot contain any **NULL** values, and a multi-column primary key cannot contain any rows with **NULL** values in all columns.

Although the Oracle database allows a **NULL** value to be concatenated with a string, **InnoDB** treats the result of such an operation as **NULL**.

See Also [index](#), [primary key](#), [SQL](#).

## O

### .OPT file

A file containing database configuration information. Files with this extension are included in backups produced by the [mysqlbackup](#) command of the **MySQL Enterprise Backup** product.

See Also [MySQL Enterprise Backup](#), [mysqlbackup command](#).

### ODBC

Acronym for Open Database Connectivity, an industry-standard API. Typically used with Windows-based servers, or applications that require ODBC to communicate with MySQL. The MySQL ODBC driver is called **Connector/ODBC**.

See Also [Connector/ODBC](#).

---

## off-page column

A column containing variable-length data (such as [BLOB](#) and [VARCHAR](#)) that is too long to fit on a **B-tree** page. The data is stored in **overflow pages**. The **DYNAMIC** row format is more efficient for such storage than the older **COMPACT** row format.

See Also [B-tree](#), [compact row format](#), [dynamic row format](#), [overflow page](#).

## OLTP

Acronym for “Online Transaction Processing”. A database system, or a database application, that runs a workload with many **transactions**, with frequent writes as well as reads, typically affecting small amounts of data at a time. For example, an airline reservation system or an application that processes bank deposits. The data might be organized in **normalized** form for a balance between **DML** (insert/update/delete) efficiency and **query** efficiency. Contrast with **data warehouse**.

With its **row-level locking** and **transactional** capability, **InnoDB** is the ideal storage engine for MySQL tables used in OLTP applications.

See Also [data warehouse](#), [DML](#), [InnoDB](#), [query](#), [row lock](#), [transaction](#).

## online

A type of operation that involves no downtime, blocking, or restricted operation for the database. Typically applied to **DDL**. Operations that shorten the periods of restricted operation, such as **fast index creation**, have evolved into a wider set of **online DDL** operations in MySQL 5.6.

In the context of backups, a **hot backup** is an online operation and a **warm backup** is partially an online operation.

See Also [DDL](#), [Fast Index Creation](#), [hot backup](#), [online DDL](#), [warm backup](#).

## online DDL

A feature that improves the performance, concurrency, and availability of **InnoDB** tables during **DDL** (primarily [ALTER TABLE](#)) operations. See [Section 14.13, “InnoDB and Online DDL”](#) for details.

The details vary according to the type of operation. In some cases, the table can be modified concurrently while the [ALTER TABLE](#) is in progress. The operation might be able to be performed without a table copy, or using a specially optimized type of table copy. DML log space usage for in-place operations is controlled by the [innodb\\_online\\_alter\\_log\\_max\\_size](#) configuration option.

This feature is an enhancement of the **Fast Index Creation** feature in MySQL 5.5.

See Also [DDL](#), [Fast Index Creation](#), [online](#).

## optimistic

A methodology that guides low-level implementation decisions for a relational database system. The requirements of performance and **concurrency** in a relational database mean that operations must be started or dispatched quickly. The requirements of consistency and **referential integrity** mean that any operation could fail: a transaction might be rolled back, a **DML** operation could violate a constraint, a request for a lock could cause a deadlock, a network error could cause a timeout. An optimistic strategy is one that assumes most requests or attempts succeed, so that relatively little work is done to prepare for the failure case. When this assumption is true, the database does little unnecessary work; when requests do fail, extra work must be done to clean up and undo changes.

**InnoDB** uses optimistic strategies for operations such as **locking** and **commits**. For example, data changed by a transaction can be written to the data files before the commit occurs, making the commit itself very fast, but requiring more work to undo the changes if the transaction is rolled back.

The opposite of an optimistic strategy is a **pessimistic** one, where a system is optimized to deal with operations that are unreliable and frequently unsuccessful. This methodology is rare in a database system, because so much care goes into choosing reliable hardware, networks, and algorithms.

---

See Also [commit](#), [concurrency](#), [DML](#), [locking](#), [pessimistic](#), [referential integrity](#).

#### optimizer

The MySQL component that determines the best **indexes** and **join** order to use for a **query**, based on characteristics and data distribution of the relevant **tables**.

See Also [index](#), [join](#), [query](#), [table](#).

#### option

A configuration parameter for MySQL, either stored in the **option file** or passed on the command line.

For the **options** that apply to **InnoDB** tables, each option name starts with the prefix `innodb_`.

See Also [InnoDB](#), [option](#), [option file](#).

#### option file

The file that holds the configuration **options** for the MySQL instance. Traditionally, on Linux and Unix this file is named `my.cnf`, and on Windows it is named `my.ini`.

See Also [configuration file](#), [my.cnf](#), [my.ini](#), [option](#).

#### overflow page

Separately allocated disk **pages** that hold variable-length columns (such as **BLOB** and **VARCHAR**) that are too long to fit on a **B-tree** page. The associated columns are known as **off-page columns**.

See Also [B-tree](#), [off-page column](#), [page](#).

## P

#### .par file

A file containing partition definitions. Files with this extension are included in backups produced by the `mysqlbackup` command of the **MySQL Enterprise Backup** product.

With the introduction of native partitioning support for **InnoDB** tables in MySQL 5.7.6, `.par` files are no longer created for partitioned **InnoDB** tables. Partitioned **MyISAM** tables continue to use `.par` files in MySQL 5.7. In MySQL 8.0, partitioning support is only provided by the **InnoDB** storage engine. As such, `.par` files are no longer used as of MySQL 8.0.

See Also [MySQL Enterprise Backup](#), [mysqlbackup command](#).

#### page

A unit representing how much data **InnoDB** transfers at any one time between disk (the **data files**) and memory (the **buffer pool**). A page can contain one or more **rows**, depending on how much data is in each row. If a row does not fit entirely into a single page, **InnoDB** sets up additional pointer-style data structures so that the information about the row can be stored in one page.

One way to fit more data in each page is to use **compressed row format**. For tables that use BLOBs or large text fields, **compact row format** allows those large columns to be stored separately from the rest of the row, reducing I/O overhead and memory usage for queries that do not reference those columns.

When **InnoDB** reads or writes sets of pages as a batch to increase I/O throughput, it reads or writes an **extent** at a time.

All the **InnoDB** disk data structures within a MySQL instance share the same **page size**.

See Also [buffer pool](#), [compact row format](#), [compressed row format](#), [data files](#), [extent](#), [page size](#), [row](#).

#### page cleaner

An **InnoDB** background **thread** that **flushes dirty pages** from the **buffer pool**. Prior to MySQL 5.6, this activity was performed by the **master thread**. The number of page cleaner threads is controlled by the `innodb_page_cleaners` configuration option, introduced in MySQL 5.7.4.

---

See Also [buffer pool](#), [dirty page](#), [flush](#), [master thread](#), [thread](#).

#### page size

For releases up to and including MySQL 5.5, the size of each **InnoDB page** is fixed at 16 kilobytes. This value represents a balance: large enough to hold the data for most rows, yet small enough to minimize the performance overhead of transferring unneeded data to memory. Other values are not tested or supported.

Starting in MySQL 5.6, the page size for an **InnoDB instance** can be either 4KB, 8KB, or 16KB, controlled by the `innodb_page_size` configuration option. As of MySQL 5.7.6, **InnoDB** also supports 32KB and 64KB page sizes. For 32KB and 64KB page sizes, `ROW_FORMAT=COMPRESSED` is not supported and the maximum record size is 16KB.

Page size is set when creating the MySQL instance, and it remains constant afterward. The same page size applies to all **InnoDB tablespaces**, including the **system tablespace**, **file-per-table** tablespaces, and **general tablespaces**.

Smaller page sizes can help performance with storage devices that use small block sizes, particularly for **SSD** devices in **disk-bound** workloads, such as for **OLTP** applications. As individual rows are updated, less data is copied into memory, written to disk, reorganized, locked, and so on.

See Also [disk-bound](#), [file-per-table](#), [general tablespace](#), [instance](#), [OLTP](#), [page](#), [SSD](#), [system tablespace](#), [tablespace](#).

#### parent table

The table in a **foreign key** relationship that holds the initial column values pointed to from the **child table**. The consequences of deleting, or updating rows in the parent table depend on the `ON UPDATE` and `ON DELETE` clauses in the foreign key definition. Rows with corresponding values in the child table could be automatically deleted or updated in turn, or those columns could be set to `NULL`, or the operation could be prevented.

See Also [child table](#), [foreign key](#).

#### partial backup

A **backup** that contains some of the **tables** in a MySQL database, or some of the databases in a MySQL instance. Contrast with **full backup**.

See Also [backup](#), [full backup](#), [table](#).

#### partial index

An **index** that represents only part of a column value, typically the first N characters (the **prefix**) of a long `VARCHAR` value.

See Also [index](#), [index prefix](#).

#### partial trust

An execution environment typically used by hosting providers, where applications have some permissions but not others. For example, applications might be able to access a database server over a network, but be “sandboxed” with regard to reading and writing local files.

See Also [Connector/NET](#).

#### Performance Schema

The `performance_schema` schema, in MySQL 5.5 and up, presents a set of tables that you can query to get detailed information about the performance characteristics of many internal parts of the MySQL server. See [Chapter 25, MySQL Performance Schema](#).

See Also [INFORMATION\\_SCHEMA](#), [latch](#), [mutex](#), [rw-lock](#).

#### Perl

A programming language with roots in Unix scripting and report generation. Incorporates high-performance regular expressions and file I/O. Large collection of reusable modules available through repositories such as CPAN.

See Also [Perl API](#).

---

## Perl API

An open-source **API** for MySQL applications written in the **Perl** language. Implemented through the [DBI](#) and [DBD::mysql](#) modules. For details, see [Section 27.9, “MySQL Perl API”](#).

See Also [API](#), [Perl](#).

## persistent statistics

A feature that stores **index** statistics for [InnoDB tables](#) on disk, providing better **plan stability** for **queries**. For more information, see [Section 14.8.11.1, “Configuring Persistent Optimizer Statistics Parameters”](#).

See Also [index](#), [optimizer](#), [plan stability](#), [query](#), [table](#).

## pessimistic

A methodology that sacrifices performance or concurrency in favor of safety. It is appropriate if a high proportion of requests or attempts might fail, or if the consequences of a failed request are severe. [InnoDB](#) uses what is known as a pessimistic **locking** strategy, to minimize the chance of **deadlocks**. At the application level, you might avoid deadlocks by using a pessimistic strategy of acquiring all locks needed by a transaction at the very beginning.

Many built-in database mechanisms use the opposite **optimistic** methodology.

See Also [deadlock](#), [locking](#), [optimistic](#).

## phantom

A row that appears in the result set of a query, but not in the result set of an earlier query. For example, if a query is run twice within a **transaction**, and in the meantime, another transaction commits after inserting a new row or updating a row so that it matches the [WHERE](#) clause of the query.

This occurrence is known as a phantom read. It is harder to guard against than a **non-repeatable read**, because locking all the rows from the first query result set does not prevent the changes that cause the phantom to appear.

Among different **isolation levels**, phantom reads are prevented by the **serializable read** level, and allowed by the **repeatable read**, **consistent read**, and **read uncommitted** levels.

See Also [consistent read](#), [isolation level](#), [non-repeatable read](#), [READ UNCOMMITTED](#), [REPEATABLE READ](#), [SERIALIZABLE](#), [transaction](#).

## PHP

A programming language originating with web applications. The code is typically embedded as blocks within the source of a web page, with the output substituted into the page as it is transmitted by the web server. This is in contrast to applications such as CGI scripts that print output in the form of an entire web page. The PHP style of coding is used for highly interactive and dynamic web pages. Modern PHP programs can also be run as command-line or GUI applications.

MySQL applications are written using one of the **PHP APIs**. Reusable modules can be written in **C** and called from PHP.

Another technology for writing server-side web pages with MySQL is **ASP.net**.

See Also [ASP.net](#), [C](#), [PHP API](#).

## PHP API

Several **APIs** are available for writing MySQL applications in the **PHP** language: the original MySQL API ([MySQL](#)) the MySQL Improved Extension ([MySQLi](#)) the MySQL Native Driver ([MySQLnd](#)) the MySQL functions ([PDO\\_MYSQL](#)), and Connector/PHP. For details, see [MySQL and PHP](#).

See Also [API](#), [PHP](#).

## physical

A type of operation that involves hardware-related aspects such as disk blocks, memory pages, files, bits, disk reads, and so on. Typically, physical aspects are important during expert-level performance tuning and problem diagnosis. Contrast with **logical**.



---

See Also [logical](#), [physical backup](#).

#### physical backup

A **backup** that copies the actual data files. For example, the `mysqlbackup` command of the **MySQL Enterprise Backup** product produces a physical backup, because its output contains data files that can be used directly by the `mysqld` server, resulting in a faster **restore** operation. Contrast with **logical backup**.

See Also [backup](#), [logical backup](#), [MySQL Enterprise Backup](#), [restore](#).

#### PITR

Acronym for **point-in-time recovery**.

See Also [point-in-time recovery](#).

#### plan stability

A property of a **query execution plan**, where the optimizer makes the same choices each time for a given **query**, so that performance is consistent and predictable.

See Also [query](#), [query execution plan](#).

#### point-in-time recovery

The process of restoring a **backup** to recreate the state of the database at a specific date and time. Commonly abbreviated “PITR”. Because it is unlikely that the specified time corresponds exactly to the time of a backup, this technique usually requires a combination of a **physical backup** and a **logical backup**. For example, with the **MySQL Enterprise Backup** product, you restore the last backup that you took before the specified point in time, then replay changes from the **binary log** between the time of the backup and the PITR time.

See Also [backup](#), [binary log](#), [logical backup](#), [MySQL Enterprise Backup](#), [physical backup](#).

#### port

The number of the TCP/IP socket the database server listens on, used to establish a **connection**. Often specified in conjunction with a **host**. Depending on your use of network encryption, there might be one port for unencrypted traffic and another port for **SSL** connections.

See Also [connection](#), [host](#), [SSL](#).

#### prefix

See [index prefix](#).

#### prepared backup

A set of backup files, produced by the **MySQL Enterprise Backup** product, after all the stages of applying **binary logs** and **incremental backups** are finished. The resulting files are ready to be **restored**. Prior to the apply steps, the files are known as a **raw backup**.

See Also [binary log](#), [hot backup](#), [incremental backup](#), [MySQL Enterprise Backup](#), [raw backup](#), [restore](#).

#### prepared statement

An SQL statement that is analyzed in advance to determine an efficient execution plan. It can be executed multiple times, without the overhead for parsing and analysis each time. Different values can be substituted for literals in the `WHERE` clause each time, through the use of placeholders. This substitution technique improves security, protecting against some kinds of SQL injection attacks. You can also reduce the overhead for converting and copying return values to program variables.

Although you can use prepared statements directly through SQL syntax, the various **Connectors** have programming interfaces for manipulating prepared statements, and these APIs are more efficient than going through SQL.

See Also [client-side prepared statement](#), [connector](#), [server-side prepared statement](#).

#### primary key

A set of columns—and by implication, the index based on this set of columns—that can uniquely identify every row in a table. As such, it must be a unique index that does not contain any `NULL` values.

---

[InnoDB](#) requires that every table has such an index (also called the **clustered index** or **cluster index**), and organizes the table storage based on the column values of the primary key.

When choosing primary key values, consider using arbitrary values (a **synthetic key**) rather than relying on values derived from some other source (a **natural key**).

See Also [clustered index](#), [index](#), [natural key](#), [synthetic key](#).

#### process

An instance of an executing program. The operating system switches between multiple running processes, allowing for a certain degree of **concurrency**. On most operating systems, processes can contain multiple **threads** of execution that share resources. Context-switching between threads is faster than the equivalent switching between processes.

See Also [concurrency](#), [thread](#).

#### pseudo-record

An artificial record in an index, used for **locking** key values or ranges that do not currently exist.

See Also [infimum record](#), [locking](#), [supremum record](#).

#### Pthreads

The POSIX threads standard, which defines an API for threading and locking operations on Unix and Linux systems. On Unix and Linux systems, [InnoDB](#) uses this implementation for **mutexes**.

See Also [mutex](#).

#### purge

A type of garbage collection performed by one or more separate background threads (controlled by [innodb\\_purge\\_threads](#)) that runs on a periodic schedule. Purge parses and processes **undo log** pages from the **history list** for the purpose of removing clustered and secondary index records that were marked for deletion (by previous [DELETE](#) statements) and are no longer required for **MVCC** or **rollback**. Purge frees undo log pages from the history list after processing them.

See Also [history list](#), [MVCC](#), [rollback](#), [undo log](#).

#### purge buffering

The technique of storing changes to secondary index pages, resulting from [DELETE](#) operations, in the **change buffer** rather than writing the changes immediately, so that the physical writes can be performed to minimize random I/O. (Because delete operations are a two-step process, this operation buffers the write that normally purges an index record that was previously marked for deletion.) It is one of the types of **change buffering**; the others are **insert buffering** and **delete buffering**.

See Also [change buffer](#), [change buffering](#), [delete buffering](#), [insert buffer](#), [insert buffering](#).

#### purge lag

Another name for the [InnoDB history list](#). Related to the [innodb\\_max\\_purge\\_lag](#) configuration option.

See Also [history list](#), [purge](#).

#### purge thread

A **thread** within the [InnoDB](#) process that is dedicated to performing the periodic **purge** operation. In MySQL 5.6 and higher, multiple purge threads are enabled by the [innodb\\_purge\\_threads](#) configuration option.

See Also [purge](#), [thread](#).

#### Python

A programming language used in a broad range of fields, from Unix scripting to large-scale applications. Includes runtime typing, built-in high-level data types, object-oriented features, and an extensive standard library. Often used as a “glue” language between components written in other languages. The MySQL **Python API** is the open-source **MySQLdb** module.

See Also [MySQLdb](#), [Python API](#).

#### Python API

---

See Also [API](#), [Python](#).

## Q

### query

In **SQL**, an operation that reads information from one or more **tables**. Depending on the organization of data and the parameters of the query, the lookup might be optimized by consulting an **index**. If multiple tables are involved, the query is known as a **join**.

For historical reasons, sometimes discussions of internal processing for statements use “query” in a broader sense, including other types of MySQL statements such as **DDL** and **DML** statements.

See Also [DDL](#), [DML](#), [index](#), [join](#), [SQL](#), [table](#).

### query execution plan

The set of decisions made by the optimizer about how to perform a **query** most efficiently, including which **index** or indexes to use, and the order in which to **join** tables. **Plan stability** involves the same choices being made consistently for a given query.

See Also [index](#), [join](#), [plan stability](#), [query](#).

### query log

See [general query log](#).

### quiesce

To reduce the amount of database activity, often in preparation for an operation such as an [ALTER TABLE](#), a **backup**, or a **shutdown**. Might or might not involve doing as much **flushing** as possible, so that **InnoDB** does not continue doing background I/O.

In MySQL 5.6 and higher, the syntax [FLUSH TABLES . . . FOR EXPORT](#) writes some data to disk for **InnoDB** tables that make it simpler to back up those tables by copying the data files.

See Also [backup](#), [flush](#), [InnoDB](#), [shutdown](#).

## R

### R-tree

A tree data structure used for spatial indexing of multi-dimensional data such as geographical coordinates, rectangles or polygons.

See Also [B-tree](#).

### RAID

Acronym for “Redundant Array of Inexpensive Drives”. Spreading I/O operations across multiple drives enables greater **concurrency** at the hardware level, and improves the efficiency of low-level write operations that otherwise would be performed in sequence.

See Also [concurrency](#).

### random dive

A technique for quickly estimating the number of different values in a column (the column's **cardinality**). **InnoDB** samples pages at random from the index and uses that data to estimate the number of different values.

See Also [cardinality](#).

### raw backup

The initial set of backup files produced by the **MySQL Enterprise Backup** product, before the changes reflected in the **binary log** and any **incremental backups** are applied. At this stage, the files are not ready to **restore**. After these changes are applied, the files are known as a **prepared backup**.

---

See Also [binary log](#), [hot backup](#), [ibbackup\\_logfile](#), [incremental backup](#), [MySQL Enterprise Backup](#), [prepared backup](#), [restore](#).

## READ COMMITTED

An **isolation level** that uses a **locking** strategy that relaxes some of the protection between **transactions**, in the interest of performance. Transactions cannot see uncommitted data from other transactions, but they can see data that is committed by another transaction after the current transaction started. Thus, a transaction never sees any bad data, but the data that it does see may depend to some extent on the timing of other transactions.

When a transaction with this isolation level performs `UPDATE ... WHERE` or `DELETE ... WHERE` operations, other transactions might have to wait. The transaction can perform `SELECT ... FOR UPDATE`, and `LOCK IN SHARE MODE` operations without making other transactions wait.

`SELECT ... FOR SHARE` replaces `SELECT ... LOCK IN SHARE MODE` in MySQL 8.0.1, but `LOCK IN SHARE MODE` remains available for backward compatibility.

See Also [ACID](#), [isolation level](#), [locking](#), [REPEATABLE READ](#), [SERIALIZABLE](#), [transaction](#).

## read phenomena

Phenomena such as **dirty reads**, **non-repeatable reads**, and **phantom** reads which can occur when a transaction reads data that another transaction has modified.

See Also [dirty read](#), [non-repeatable read](#), [phantom](#).

## READ UNCOMMITTED

The **isolation level** that provides the least amount of protection between transactions. Queries employ a **locking** strategy that allows them to proceed in situations where they would normally wait for another transaction. However, this extra performance comes at the cost of less reliable results, including data that has been changed by other transactions and not committed yet (known as **dirty read**). Use this isolation level with great caution, and be aware that the results might not be consistent or reproducible, depending on what other transactions are doing at the same time. Typically, transactions with this isolation level only do queries, not insert, update, or delete operations.

See Also [ACID](#), [dirty read](#), [isolation level](#), [locking](#), [transaction](#).

## read view

An internal snapshot used by the **MVCC** mechanism of [InnoDB](#). Certain **transactions**, depending on their **isolation level**, see the data values as they were at the time the transaction (or in some cases, the statement) started. Isolation levels that use a read view are **REPEATABLE READ**, **READ COMMITTED**, and **READ UNCOMMITTED**.

See Also [isolation level](#), [MVCC](#), [READ COMMITTED](#), [READ UNCOMMITTED](#), [REPEATABLE READ](#), [transaction](#).

## read-ahead

A type of I/O request that prefetches a group of **pages** (an entire **extent**) into the **buffer pool** asynchronously, in case these pages are needed soon. The linear read-ahead technique prefetches all the pages of one extent based on access patterns for pages in the preceding extent. The random read-ahead technique prefetches all the pages for an extent once a certain number of pages from the same extent are in the buffer pool.

Random read-ahead is not part of MySQL 5.5, but is re-introduced in MySQL 5.6 under the control of the [innodb\\_random\\_read\\_ahead](#) configuration option.

See Also [buffer pool](#), [extent](#), [page](#).

## read-only transaction

A type of **transaction** that can be optimized for [InnoDB](#) tables by eliminating some of the bookkeeping involved with creating a **read view** for each transaction. Can only perform **non-locking read** queries. It can be started explicitly with the syntax `START TRANSACTION READ ONLY`, or automatically under certain conditions. See [Section 8.5.3, "Optimizing InnoDB Read-Only Transactions"](#) for details.

---

See Also [non-locking read](#), [read view](#), [transaction](#).

#### record lock

A **lock** on an index record. For example, `SELECT c1 FROM t WHERE c1 = 10 FOR UPDATE;` prevents any other transaction from inserting, updating, or deleting rows where the value of `t.c1` is 10. Contrast with **gap lock** and **next-key lock**.

See Also [gap lock](#), [lock](#), [next-key lock](#).

#### redo

The data, in units of records, recorded in the **redo log** when **DML** statements make changes to **InnoDB** tables. It is used during **crash recovery** to correct data written by incomplete **transactions**. The ever-increasing **LSN** value represents the cumulative amount of redo data that has passed through the redo log.

See Also [crash recovery](#), [DML](#), [LSN](#), [redo log](#), [transaction](#).

#### redo log

A disk-based data structure used during **crash recovery**, to correct data written by incomplete **transactions**. During normal operation, it encodes requests to change **InnoDB** table data, which result from SQL statements or low-level API calls. Modifications that did not finish updating the **data files** before an unexpected **shutdown** are replayed automatically.

The redo log is physically represented on disk as a set of redo log files. Redo log data is encoded in terms of records affected; this data is collectively referred to as **redo**. The passage of data through the redo log is represented by an ever-increasing **LSN** value.

For more information, see [Section 14.6.6, “Redo Log”](#)

See Also [crash recovery](#), [data files](#), [ib\\_logfile](#), [log buffer](#), [LSN](#), [redo](#), [shutdown](#), [transaction](#).

#### redo log archiving

An **InnoDB** feature that, when enabled, sequentially writes redo log records to an archive file to avoid potential loss of data than can occur when a backup utility fails to keep pace with redo log generation while a backup operation is in progress. For more information, see [Redo Log Archiving](#).

See Also [redo log](#).

#### redundant row format

The oldest **InnoDB** **row format**. Prior to MySQL 5.0.3, it was the only row format available in **InnoDB**. From MySQL 5.0.3 to MySQL 5.7.8, the default row format is **COMPACT**. As of MySQL 5.7.9, the default row format is defined by the `innodb_default_row_format` configuration option, which has a default setting of **DYNAMIC**. You can still specify the **REDUNDANT** row format for compatibility with older **InnoDB** tables.

For more information, see [Section 14.11, “InnoDB Row Formats”](#).

See Also [compact row format](#), [dynamic row format](#), [row format](#).

#### referential integrity

The technique of maintaining data always in a consistent format, part of the **ACID** philosophy. In particular, data in different tables is kept consistent through the use of **foreign key constraints**, which can prevent changes from happening or automatically propagate those changes to all related tables. Related mechanisms include the **unique constraint**, which prevents duplicate values from being inserted by mistake, and the **NOT NULL constraint**, which prevents blank values from being inserted by mistake.

See Also [ACID](#), [FOREIGN KEY constraint](#), [NOT NULL constraint](#), [unique constraint](#).

#### relational

An important aspect of modern database systems. The database server encodes and enforces relationships such as one-to-one, one-to-many, many-to-one, and uniqueness. For example, a person might have zero, one, or many phone numbers in an address database; a single phone number might be associated with several family members. In a financial database, a person might be required to have exactly one taxpayer ID, and any taxpayer ID could only be associated with one person.

---

The database server can use these relationships to prevent bad data from being inserted, and to find efficient ways to look up information. For example, if a value is declared to be unique, the server can stop searching as soon as the first match is found, and it can reject attempts to insert a second copy of the same value.

At the database level, these relationships are expressed through SQL features such as **columns** within a table, unique and **NOT NULL constraints**, **foreign keys**, and different kinds of join operations. Complex relationships typically involve data split between more than one table. Often, the data is **normalized**, so that duplicate values in one-to-many relationships are stored only once.

In a mathematical context, the relations within a database are derived from set theory. For example, the **OR** and **AND** operators of a **WHERE** clause represent the notions of union and intersection. See Also [ACID](#), [column](#), [constraint](#), [foreign key](#), [normalized](#).

relevance

In the **full-text search** feature, a number signifying the similarity between the search string and the data in the **FULLTEXT index**. For example, when you search for a single word, that word is typically more relevant for a row where it occurs several times in the text than a row where it appears only once. See Also [full-text search](#), [FULLTEXT index](#).

REPEATABLE READ

The default **isolation level** for **InnoDB**. It prevents any rows that are queried from being changed by other **transactions**, thus blocking **non-repeatable reads** but not **phantom** reads. It uses a moderately strict **locking** strategy so that all queries within a transaction see data from the same snapshot, that is, the data as it was at the time the transaction started.

When a transaction with this isolation level performs **UPDATE ... WHERE**, **DELETE ... WHERE**, **SELECT ... FOR UPDATE**, and **LOCK IN SHARE MODE** operations, other transactions might have to wait.

**SELECT ... FOR SHARE** replaces **SELECT ... LOCK IN SHARE MODE** in MySQL 8.0.1, but **LOCK IN SHARE MODE** remains available for backward compatibility.

See Also [ACID](#), [consistent read](#), [isolation level](#), [locking](#), [phantom](#), [transaction](#).

repertoire

Repertoire is a term applied to character sets. A character set repertoire is the collection of characters in the set. See [Section 10.2.1, "Character Set Repertoire"](#).

replica

A database **server** machine in a **replication** topology that receives changes from another server (the **source**) and applies those same changes. Thus it maintains the same contents as the source, although it might lag somewhat behind.

In MySQL, replicas are commonly used in disaster recovery, to take the place of a source that fails. They are also commonly used for testing software upgrades and new settings, to ensure that database configuration changes do not cause problems with performance or reliability.

Replicas typically have high workloads, because they process all the **DML** (write) operations relayed from the source, as well as user queries. To ensure that replicas can apply changes from the source fast enough, they frequently have fast I/O devices and sufficient CPU and memory to run multiple database instances on the same server. For example, the source might use hard drive storage while the replicas use **SSDs**.

See Also [DML](#), [replication](#), [server](#), [source](#), [SSD](#).

replication

The practice of sending changes from a **source**, to one or more **replicas**, so that all databases have the same data. This technique has a wide range of uses, such as load-balancing for better scalability, disaster recovery, and testing software upgrades and configuration changes. The changes can be sent between the databases by methods called **row-based replication** and **statement-based replication**.

---

See Also [replica](#), [row-based replication](#), [source](#), [statement-based replication](#).

#### restore

The process of putting a set of backup files from the **MySQL Enterprise Backup** product in place for use by MySQL. This operation can be performed to fix a corrupted database, to return to some earlier point in time, or (in a **replication** context) to set up a new **replica**. In the **MySQL Enterprise Backup** product, this operation is performed by the `copy-back` option of the `mysqlbackup` command.

See Also [hot backup](#), [MySQL Enterprise Backup](#), [mysqlbackup command](#), [prepared backup](#), [replica](#), [replication](#).

#### rollback

A **SQL** statement that ends a **transaction**, undoing any changes made by the transaction. It is the opposite of **commit**, which makes permanent any changes made in the transaction.

By default, MySQL uses the **autocommit** setting, which automatically issues a commit following each SQL statement. You must change this setting before you can use the rollback technique.

See Also [ACID](#), [autocommit](#), [commit](#), [SQL](#), [transaction](#).

#### rollback segment

The storage area containing the **undo logs**. Rollback segments have traditionally resided in the **system tablespace**. As of MySQL 5.6, rollback segments can reside in **undo tablespaces**. As of MySQL 5.7, rollback segments are also allocated to the *global temporary tablespace*.

See Also [system tablespace](#), [undo log](#), [undo tablespace](#).

#### row

The logical data structure defined by a set of **columns**. A set of rows makes up a **table**. Within **InnoDB data files**, each **page** can contain one or more rows.

Although **InnoDB** uses the term **row format** for consistency with MySQL syntax, the row format is a property of each table and applies to all rows in that table.

See Also [column](#), [data files](#), [page](#), [row format](#), [table](#).

#### row format

The disk storage format for **rows** of an **InnoDB table**. As **InnoDB** gains new capabilities such as **compression**, new row formats are introduced to support the resulting improvements in storage efficiency and performance.

The row format of an **InnoDB** table is specified by the `ROW_FORMAT` option or by the `innodb_default_row_format` configuration option (introduced in MySQL 5.7.9). Row formats include `REDUNDANT`, `COMPACT`, `COMPRESSED`, and `DYNAMIC`. To view the row format of an **InnoDB** table, issue the `SHOW TABLE STATUS` statement or query **InnoDB** table metadata in the `INFORMATION_SCHEMA`.

See Also [compact row format](#), [compressed row format](#), [compression](#), [dynamic row format](#), [redundant row format](#), [row](#), [table](#).

#### row lock

A **lock** that prevents a row from being accessed in an incompatible way by another **transaction**. Other rows in the same table can be freely written to by other transactions. This is the type of **locking** done by **DML** operations on **InnoDB** tables.

Contrast with **table locks** used by **MyISAM**, or during **DDL** operations on **InnoDB** tables that cannot be done with **online DDL**; those locks block concurrent access to the table.

See Also [DDL](#), [DML](#), [InnoDB](#), [lock](#), [locking](#), [online DDL](#), [table lock](#), [transaction](#).

#### row-based replication

A form of **replication** where events are propagated from the **source** specifying how to change individual rows on the **replica**. It is safe to use for all settings of the `innodb_autoinc_lock_mode` option.

See Also [auto-increment locking](#), [innodb\\_autoinc\\_lock\\_mode](#), [replica](#), [replication](#), [source](#), [statement-based replication](#).

---

## row-level locking

The **locking** mechanism used for **InnoDB** tables, relying on **row locks** rather than **table locks**. Multiple **transactions** can modify the same table concurrently. Only if two transactions try to modify the same row does one of the transactions wait for the other to complete (and release its row locks).

See Also [InnoDB](#), [locking](#), [row lock](#), [table lock](#), [transaction](#).

## Ruby

A programming language that emphasizes dynamic typing and object-oriented programming. Some syntax is familiar to **Perl** developers.

See Also [API](#), [Perl](#), [Ruby API](#).

## Ruby API

`mysql2`, based based on the **libmysqlclient** API library, is available for Ruby programmers developing MySQL applications. For more information, see [Section 27.11, “MySQL Ruby APIs”](#).

See Also [libmysql](#), [Ruby](#).

## rw-lock

The low-level object that **InnoDB** uses to represent and enforce shared-access **locks** to internal in-memory data structures following certain rules. Contrast with **mutexes**, which **InnoDB** uses to represent and enforce exclusive access to internal in-memory data structures. Mutexes and rw-locks are known collectively as **latches**.

`rw-lock` types include `s-locks` (shared locks), `x-locks` (exclusive locks), and `sx-locks` (shared-exclusive locks).

- An `s-lock` provides read access to a common resource.
- An `x-lock` provides write access to a common resource while not permitting inconsistent reads by other threads.
- An `sx-lock` provides write access to a common resource while permitting inconsistent reads by other threads. `sx-locks` were introduced in MySQL 5.7 to optimize concurrency and improve scalability for read-write workloads.

The following matrix summarizes rw-lock type compatibility.

	<code>S</code>	<code>SX</code>	<code>X</code>
<code>S</code>	Compatible	Compatible	Conflict
<code>SX</code>	Compatible	Conflict	Conflict
<code>X</code>	Conflict	Conflict	Conflict

See Also [latch](#), [lock](#), [mutex](#), [Performance Schema](#).

# S

## savepoint

Savepoints help to implement nested **transactions**. They can be used to provide scope to operations on tables that are part of a larger transaction. For example, scheduling a trip in a reservation system might involve booking several different flights; if a desired flight is unavailable, you might **roll back** the changes involved in booking that one leg, without rolling back the earlier flights that were successfully booked.

See Also [rollback](#), [transaction](#).

## scalability

The ability to add more work and issue more simultaneous requests to a system, without a sudden drop in performance due to exceeding the limits of system capacity. Software architecture, hardware configuration,



---

application coding, and type of workload all play a part in scalability. When the system reaches its maximum capacity, popular techniques for increasing scalability are **scale up** (increasing the capacity of existing hardware or software) and **scale out** (adding new servers and more instances of MySQL). Often paired with **availability** as critical aspects of a large-scale deployment.

See Also [availability](#), [scale out](#), [scale up](#).

#### scale out

A technique for increasing **scalability** by adding new servers and more instances of MySQL. For example, setting up replication, NDB Cluster, connection pooling, or other features that spread work across a group of servers. Contrast with **scale up**.

See Also [scalability](#), [scale up](#).

#### scale up

A technique for increasing **scalability** by increasing the capacity of existing hardware or software. For example, increasing the memory on a server and adjusting memory-related parameters such as [innodb\\_buffer\\_pool\\_size](#) and [innodb\\_buffer\\_pool\\_instances](#). Contrast with **scale out**.

See Also [scalability](#), [scale out](#).

#### schema

Conceptually, a schema is a set of interrelated database objects, such as tables, table columns, data types of the columns, indexes, foreign keys, and so on. These objects are connected through SQL syntax, because the columns make up the tables, the foreign keys refer to tables and columns, and so on. Ideally, they are also connected logically, working together as part of a unified application or flexible framework. For example, the **INFORMATION\_SCHEMA** and **performance\_schema** databases use “schema” in their names to emphasize the close relationships between the tables and columns they contain.

In MySQL, physically, a **schema** is synonymous with a **database**. You can substitute the keyword [SCHEMA](#) instead of [DATABASE](#) in MySQL SQL syntax, for example using [CREATE SCHEMA](#) instead of [CREATE DATABASE](#).

Some other database products draw a distinction. For example, in the Oracle Database product, a **schema** represents only a part of a database: the tables and other objects owned by a single user.

See Also [database](#), [INFORMATION\\_SCHEMA](#), [Performance Schema](#).

#### search index

In MySQL, **full-text search** queries use a special kind of index, the **FULLTEXT index**. In MySQL 5.6.4 and up, [InnoDB](#) and [MyISAM](#) tables both support [FULLTEXT](#) indexes; formerly, these indexes were only available for [MyISAM](#) tables.

See Also [full-text search](#), [FULLTEXT index](#).

#### secondary index

A type of [InnoDB index](#) that represents a subset of table columns. An [InnoDB](#) table can have zero, one, or many secondary indexes. (Contrast with the **clustered index**, which is required for each [InnoDB](#) table, and stores the data for all the table columns.)

A secondary index can be used to satisfy queries that only require values from the indexed columns. For more complex queries, it can be used to identify the relevant rows in the table, which are then retrieved through lookups using the clustered index.

Creating and dropping secondary indexes has traditionally involved significant overhead from copying all the data in the [InnoDB](#) table. The **fast index creation** feature makes both [CREATE INDEX](#) and [DROP INDEX](#) statements much faster for [InnoDB](#) secondary indexes.

See Also [clustered index](#), [Fast Index Creation](#), [index](#).

#### segment

A division within an [InnoDB tablespace](#). If a tablespace is analogous to a directory, the segments are analogous to files within that directory. A segment can grow. New segments can be created.

---

For example, within a **file-per-table** tablespace, table data is in one segment and each associated index is in its own segment. The **system tablespace** contains many different segments, because it can hold many tables and their associated indexes. Prior to MySQL 8.0, the system tablespace also includes one or more **rollback segments** used for **undo logs**.

Segments grow and shrink as data is inserted and deleted. When a segment needs more room, it is extended by one **extent** (1 megabyte) at a time. Similarly, a segment releases one extent's worth of space when all the data in that extent is no longer needed.

See Also [extent](#), [file-per-table](#), [rollback segment](#), [system tablespace](#), [tablespace](#), [undo log](#).

#### selectivity

A property of data distribution, the number of distinct values in a column (its **cardinality**) divided by the number of records in the table. High selectivity means that the column values are relatively unique, and can be retrieved efficiently through an index. If you (or the query optimizer) can predict that a test in a **WHERE** clause only matches a small number (or proportion) of rows in a table, the overall **query** tends to be efficient if it evaluates that test first, using an index.

See Also [cardinality](#), [query](#).

#### semi-consistent read

A type of read operation used for **UPDATE** statements, that is a combination of **READ COMMITTED** and **consistent read**. When an **UPDATE** statement examines a row that is already locked, **InnoDB** returns the latest committed version to MySQL so that MySQL can determine whether the row matches the **WHERE** condition of the **UPDATE**. If the row matches (must be updated), MySQL reads the row again, and this time **InnoDB** either locks it or waits for a lock on it. This type of read operation can only happen when the transaction has the **READ COMMITTED isolation level**, or when the `innodb_locks_unsafe_for_binlog` option is enabled. `innodb_locks_unsafe_for_binlog` was removed in MySQL 8.0.

See Also [consistent read](#), [isolation level](#), [READ COMMITTED](#).

#### SERIALIZABLE

The **isolation level** that uses the most conservative locking strategy, to prevent any other **transactions** from inserting or changing data that was read by this transaction, until it is finished. This way, the same query can be run over and over within a transaction, and be certain to retrieve the same set of results each time. Any attempt to change data that was committed by another transaction since the start of the current transaction, cause the current transaction to wait.

This is the default isolation level specified by the SQL standard. In practice, this degree of strictness is rarely needed, so the default isolation level for **InnoDB** is the next most strict, **REPEATABLE READ**.

See Also [ACID](#), [consistent read](#), [isolation level](#), [locking](#), [REPEATABLE READ](#), [transaction](#).

#### server

A type of program that runs continuously, waiting to receive and act upon requests from another program (the **client**). Because often an entire computer is dedicated to running one or more server programs (such as a database server, a web server, an application server, or some combination of these), the term **server** can also refer to the computer that runs the server software.

See Also [client](#), [mysqld](#).

#### server-side prepared statement

A **prepared statement** managed by the MySQL server. Historically, issues with server-side prepared statements led **Connector/J** and **Connector/PHP** developers to sometimes use **client-side prepared statements** instead. With modern MySQL server versions, server-side prepared statements are recommended for performance, scalability, and memory efficiency.

See Also [client-side prepared statement](#), [Connector/J](#), [Connector/PHP](#), [prepared statement](#).

#### servlet

---

See Also [Connector/J](#).

#### shared lock

A kind of **lock** that allows other **transactions** to read the locked object, and to also acquire other shared locks on it, but not to write to it. The opposite of **exclusive lock**.

See Also [exclusive lock](#), [lock](#), [transaction](#).

#### shared tablespace

Another way of referring to the **system tablespace** or a **general tablespace**. General tablespaces were introduced in MySQL 5.7. More than one table can reside in a shared tablespace. Only a single table can reside in a *file-per-table* tablespace.

See Also [general tablespace](#), [system tablespace](#).

#### sharp checkpoint

The process of **flushing** to disk all **dirty** buffer pool pages whose redo entries are contained in certain portion of the **redo log**. Occurs before [InnoDB](#) reuses a portion of a log file; the log files are used in a circular fashion. Typically occurs with write-intensive **workloads**.

See Also [dirty page](#), [flush](#), [redo log](#), [workload](#).

#### shutdown

The process of stopping the MySQL server. By default, this process cleans up operations for **InnoDB** tables, so [InnoDB](#) can be **slow** to shut down, but fast to start up later. If you skip the cleanup operations, it is **fast** to shut down but the cleanup must be performed during the next restart.

The shutdown mode for [InnoDB](#) is controlled by the `innodb_fast_shutdown` option.

See Also [fast shutdown](#), [InnoDB](#), [slow shutdown](#), [startup](#).

#### slave

See [replica](#).

#### slow query log

A type of **log** used for performance tuning of SQL statements processed by the MySQL server. The log information is stored in a file. You must enable this feature to use it. You control which categories of “slow” SQL statements are logged. For more information, see [Section 5.4.5, “The Slow Query Log”](#).

See Also [general query log](#), [log](#).

#### slow shutdown

A type of **shutdown** that does additional [InnoDB](#) flushing operations before completing. Also known as a **clean shutdown**. Specified by the configuration parameter `innodb_fast_shutdown=0` or the command `SET GLOBAL innodb_fast_shutdown=0`; . Although the shutdown itself can take longer, that time should be saved on the subsequent startup.

See Also [clean shutdown](#), [fast shutdown](#), [shutdown](#).

#### snapshot

A representation of data at a particular time, which remains the same even as changes are **committed** by other **transactions**. Used by certain **isolation levels** to allow **consistent reads**.

See Also [commit](#), [consistent read](#), [isolation level](#), [transaction](#).

#### sort buffer

The buffer used for sorting data during creation of an [InnoDB](#) index. Sort buffer size is configured using the `innodb_sort_buffer_size` configuration option.

#### source

A database server machine in a **replication** scenario that processes the initial insert, update, and delete requests for data. These changes are propagated to, and repeated on, other servers known as **replicas**.

See Also [replica](#), [replication](#).

---

## space ID

An identifier used to uniquely identify an **InnoDB tablespace** within a MySQL instance. The space ID for the **system tablespace** is always zero; this same ID applies to all tables within the system tablespace or within a general tablespace. Each **file-per-table** tablespace and **general tablespace** has its own space ID.

Prior to MySQL 5.6, this hardcoded value presented difficulties in moving **InnoDB** tablespace files between MySQL instances. Starting in MySQL 5.6, you can copy tablespace files between instances by using the **transportable tablespace** feature involving the statements `FLUSH TABLES ... FOR EXPORT`, `ALTER TABLE ... DISCARD TABLESPACE`, and `ALTER TABLE ... IMPORT TABLESPACE`. The information needed to adjust the space ID is conveyed in the **.cfg file** which you copy along with the tablespace. See [Section 14.6.1.3, “Importing InnoDB Tables”](#) for details.

See Also [.cfg file](#), [file-per-table](#), [general tablespace](#), [.ibd file](#), [system tablespace](#), [tablespace](#), [transportable tablespace](#).

## sparse file

A type of file that uses file system space more efficiently by writing metadata representing empty blocks to disk instead of writing the actual empty space. The **InnoDB transparent page compression** feature relies on sparse file support. For more information, see [Section 14.9.2, “InnoDB Page Compression”](#).

See Also [hole punching](#), [transparent page compression](#).

## spin

A type of **wait** operation that continuously tests whether a resource becomes available. This technique is used for resources that are typically held only for brief periods, where it is more efficient to wait in a “busy loop” than to put the thread to sleep and perform a context switch. If the resource does not become available within a short time, the spin loop ceases and another wait technique is used.

See Also [latch](#), [lock](#), [mutex](#), [wait](#).

## Spring

A Java-based application framework designed for assisting in application design by providing a way to configure components.

See Also [J2EE](#).

## SQL

The Structured Query Language that is standard for performing database operations. Often divided into the categories **DDL**, **DML**, and **queries**. MySQL includes some additional statement categories such as **replication**. See [Chapter 9, \*Language Structure\*](#) for the building blocks of SQL syntax, [Chapter 11, \*Data Types\*](#) for the data types to use for MySQL table columns, [Chapter 13, \*SQL Statements\*](#) for details about SQL statements and their associated categories, and [Chapter 12, \*Functions and Operators\*](#) for standard and MySQL-specific functions to use in queries.

See Also [DDL](#), [DML](#), [query](#), [replication](#).

## SQLState

An error code defined by the **JDBC** standard, for exception handling by applications using **Connector/J**.

See Also [Connector/J](#), [JDBC](#).

## SSD

Acronym for “solid-state drive”. A type of storage device with different performance characteristics than a traditional hard disk drive (**HDD**): smaller storage capacity, faster for random reads, no moving parts, and with a number of considerations affecting write performance. Its performance characteristics can influence the throughput of a **disk-bound** workload.

See Also [disk-bound](#), [HDD](#).

## SSL

Acronym for “secure sockets layer”. Provides the encryption layer for network communication between an application and a MySQL database server.

---

See Also [keystore](#), [truststore](#).

#### startup

The process of starting the MySQL server. Typically done by one of the programs listed in [Section 4.3, “Server and Server-Startup Programs”](#). The opposite of **shutdown**.

See Also [shutdown](#).

#### statement interceptor

A type of **interceptor** for tracing, debugging, or augmenting SQL statements issued by a database application. Sometimes also known as a **command interceptor**.

In **Java** applications using **Connector/J**, setting up this type of interceptor involves implementing the `com.mysql.jdbc.StatementInterceptorV2` interface, and adding a `statementInterceptors` property to the **connection string**.

In **Visual Studio** applications using **Connector/NET**, setting up this type of interceptor involves defining a class that inherits from the `BaseCommandInterceptor` class and specifying that class name as part of the connection string.

See Also [command interceptor](#), [connection string](#), [Connector/J](#), [Connector/NET](#), [interceptor](#), [Java](#), [Visual Studio](#).

#### statement-based replication

A form of **replication** where SQL statements are sent from the **source** and replayed on the **replica**. It requires some care with the setting for the `innodb_autoinc_lock_mode` option, to avoid potential timing problems with **auto-increment locking**.

See Also [auto-increment locking](#), [innodb\\_autoinc\\_lock\\_mode](#), [replica](#), [replication](#), [row-based replication](#), [source](#).

#### statistics

Estimated values relating to each **InnoDB table** and **index**, used to construct an efficient **query execution plan**. The main values are the **cardinality** (number of distinct values) and the total number of table rows or index entries. The statistics for the table represent the data in its **primary key** index. The statistics for a **secondary index** represent the rows covered by that index.

The values are estimated rather than counted precisely because at any moment, different **transactions** can be inserting and deleting rows from the same table. To keep the values from being recalculated frequently, you can enable **persistent statistics**, where the values are stored in **InnoDB** system tables, and refreshed only when you issue an `ANALYZE TABLE` statement.

You can control how **NULL** values are treated when calculating statistics through the `innodb_stats_method` configuration option.

Other types of statistics are available for database objects and database activity through the **INFORMATION\_SCHEMA** and **PERFORMANCE\_SCHEMA** tables.

See Also [cardinality](#), [index](#), [INFORMATION\\_SCHEMA](#), [NULL](#), [Performance Schema](#), [persistent statistics](#), [primary key](#), [query execution plan](#), [secondary index](#), [table](#), [transaction](#).

#### stemming

The ability to search for different variations of a word based on a common root word, such as singular and plural, or past, present, and future verb tense. This feature is currently supported in **MyISAM full-text search** feature but not in **FULLTEXT indexes** for **InnoDB** tables.

See Also [full-text search](#), [FULLTEXT index](#).

#### stopword

In a **FULLTEXT index**, a word that is considered common or trivial enough that it is omitted from the **search index** and ignored in search queries. Different configuration settings control stopwords processing for **InnoDB** and **MyISAM** tables. See [Section 12.9.4, “Full-Text Stopwords”](#) for details.

---

See Also [FULLTEXT index](#), [search index](#).

#### storage engine

A component of the MySQL database that performs the low-level work of storing, updating, and querying data. In MySQL 5.5 and higher, **InnoDB** is the default storage engine for new tables, superceding [MyISAM](#). Different storage engines are designed with different tradeoffs between factors such as memory usage versus disk usage, read speed versus write speed, and speed versus robustness. Each storage engine manages specific tables, so we refer to [InnoDB tables](#), [MyISAM tables](#), and so on.

The **MySQL Enterprise Backup** product is optimized for backing up [InnoDB](#) tables. It can also back up tables handled by [MyISAM](#) and other storage engines.

See Also [InnoDB](#), [MySQL Enterprise Backup](#), [table type](#).

#### stored generated column

A column whose values are computed from an expression included in the column definition. Column values are evaluated and stored when rows are inserted or updated. A stored generated column requires storage space and can be indexed.

Contrast with **virtual generated column**.

See Also [base column](#), [generated column](#), [virtual generated column](#).

#### stored object

A stored program or view.

#### stored program

A stored routine (procedure or function), trigger, or Event Scheduler event.

#### stored routine

A stored procedure or function.

#### strict mode

The general name for the setting controlled by the [innodb\\_strict\\_mode](#) option. Turning on this setting causes certain conditions that are normally treated as warnings, to be considered errors. For example, certain invalid combinations of options related to **file format** and **row format**, that normally produce a warning and continue with default values, now cause the `CREATE TABLE` operation to fail. [innodb\\_strict\\_mode](#) is enabled by default in MySQL 5.7.

MySQL also has something called strict mode. See [Section 5.1.10, “Server SQL Modes”](#).

See Also [file format](#), [innodb\\_strict\\_mode](#), [row format](#).

#### sublist

Within the list structure that represents the **buffer pool**, pages that are relatively old and relatively new are represented by different portions of the **list**. A set of parameters control the size of these portions and the dividing point between the new and old pages.

See Also [buffer pool](#), [eviction](#), [list](#), [LRU](#).

#### supremum record

A **pseudo-record** in an index, representing the **gap** above the largest value in that index. If a transaction has a statement such as `SELECT ... FROM ... WHERE col > 10 FOR UPDATE;`, and the largest value in the column is 20, it is a lock on the supremum record that prevents other transactions from inserting even larger values such as 50, 100, and so on.

See Also [gap](#), [infimum record](#), [pseudo-record](#).

#### surrogate key

Synonym name for **synthetic key**.

See Also [synthetic key](#).

---

synthetic key

An indexed column, typically a **primary key**, where the values are assigned arbitrarily. Often done using an **auto-increment** column. By treating the value as completely arbitrary, you can avoid overly restrictive rules and faulty application assumptions. For example, a numeric sequence representing employee numbers might have a gap if an employee was approved for hiring but never actually joined. Or employee number 100 might have a later hiring date than employee number 500, if they left the company and later rejoined. Numeric values also produce shorter values of predictable length. For example, storing numeric codes meaning “Road”, “Boulevard”, “Expressway”, and so on is more space-efficient than repeating those strings over and over.

Also known as a **surrogate key**. Contrast with **natural key**.  
See Also [auto-increment](#), [natural key](#), [primary key](#), [surrogate key](#).

system tablespace

One or more data files (**ibdata files**) containing metadata for **InnoDB**-related objects (the **InnoDB data dictionary**), and the storage areas for the **change buffer**, the **doublewrite buffer**, and possibly **undo logs**. It may also contain table and index data for **InnoDB** tables if tables were created in the system tablespace instead of **file-per-table** or **general tablespaces**. The data and metadata in the system tablespace apply to all **databases** in a MySQL instance.

Prior to MySQL 5.6.7, the default was to keep all **InnoDB** tables and indexes inside the system tablespace, often causing this file to become very large. Because the system tablespace never shrinks, storage problems could arise if large amounts of temporary data were loaded and then deleted. In MySQL 5.7, the default is **file-per-table** mode, where each table and its associated indexes are stored in a separate **.ibd file**. This default makes it easier to use **InnoDB** features that rely on the **Barracuda** file format, such as table **compression**, efficient storage of **off-page columns**, and large index key prefixes (`innodb_large_prefix`).

The `innodb_undo_tablespaces` option defines the number of undo tablespaces for undo logs.

Keeping all table data in the system tablespace or in separate **.ibd** files has implications for storage management in general. The **MySQL Enterprise Backup** product might back up a small set of large files, or many smaller files. On systems with thousands of tables, the file system operations to process thousands of **.ibd** files can cause bottlenecks.

**InnoDB** introduced general tablespaces in MySQL 5.7.6, which are also represented by **.ibd** files. General tablespaces are shared tablespaces created using `CREATE TABLESPACE` syntax. They can be created outside of the MySQL data directory, are capable of holding multiple tables, and support tables of all row formats. See Also [Barracuda](#), [change buffer](#), [compression](#), [data dictionary](#), [database](#), [doublewrite buffer](#), [dynamic row format](#), [file-per-table](#), [general tablespace](#), [.ibd file](#), [ibdata file](#), [innodb\\_file\\_per\\_table](#), [instance](#), [MySQL Enterprise Backup](#), [off-page column](#), [tablespace](#), [undo log](#).

## T

.TRG file

A file containing trigger parameters. Files with this extension are always included in backups produced by the `mysqlbackup` command of the **MySQL Enterprise Backup** product.  
See Also [MySQL Enterprise Backup](#), [mysqlbackup command](#), [.TRN file](#).

.TRN file

A file containing trigger namespace information. Files with this extension are always included in backups produced by the `mysqlbackup` command of the **MySQL Enterprise Backup** product.  
See Also [MySQL Enterprise Backup](#), [mysqlbackup command](#), [.TRG file](#).

table

Each MySQL table is associated with a particular **storage engine**. **InnoDB** tables have particular **physical** and **logical** characteristics that affect performance, **scalability**, **backup**, administration, and application development.

---

In terms of file storage, an [InnoDB](#) table belongs to one of the following tablespace types:

- The shared [InnoDB system tablespace](#), which is comprised of one or more **ibdata files**.
- A **file-per-table** tablespace, comprised of an individual **.ibd file**.
- A shared **general tablespace**, comprised of an individual **.ibd** file. General tablespaces were introduced in MySQL 5.7.6.

**.ibd** data files contain both table and **index** data.

[InnoDB](#) tables created in file-per-table tablespaces can use the **Barracuda** file format, and Barracuda tables can use **DYNAMIC** or **COMPRESSED** row format. These row formats enable [InnoDB](#) features such as **compression**, efficient storage of **off-page columns**, and large index key prefixes (see [innodb\\_large\\_prefix](#)). General tablespaces support all row formats regardless of the [innodb\\_file\\_format](#) setting.

Up to MySQL 5.7.5, [InnoDB](#) tables inside the system tablespace had to use the **Antelope** file format for backward compatibility with MySQL 5.1 and earlier. The **Antelope** file format supports **COMPACT** and **REDUNDANT** row format. The system tablespace supports tables that use **DYNAMIC** row format as of MySQL 5.7.6.

The **rows** of an [InnoDB](#) table are organized into an index structure known as the **clustered index**, with entries sorted based on the **primary key** columns of the table. Data access is optimized for queries that filter and sort on the primary key columns, and each index contains a copy of the associated primary key columns for each entry. Modifying values for any of the primary key columns is an expensive operation. Thus an important aspect of [InnoDB](#) table design is choosing a primary key with columns that are used in the most important queries, and keeping the primary key short, with rarely changing values.

See Also [Antelope](#), [backup](#), [Barracuda](#), [clustered index](#), [compact row format](#), [compressed row format](#), [compression](#), [dynamic row format](#), [Fast Index Creation](#), [file-per-table](#), [.ibd file](#), [index](#), [off-page column](#), [primary key](#), [redundant row format](#), [row](#), [system tablespace](#), [tablespace](#).

#### table lock

A lock that prevents any other **transaction** from accessing a table. [InnoDB](#) makes considerable effort to make such locks unnecessary, by using techniques such as **online DDL**, **row locks** and **consistent reads** for processing **DML** statements and **queries**. You can create such a lock through SQL using the [LOCK TABLE](#) statement; one of the steps in migrating from other database systems or MySQL storage engines is to remove such statements wherever practical.

See Also [consistent read](#), [DML](#), [lock](#), [locking](#), [online DDL](#), [query](#), [row lock](#), [table](#), [transaction](#).

#### table scan

See [full table scan](#).

#### table statistics

See [statistics](#).

#### table type

Obsolete synonym for **storage engine**. We refer to [InnoDB](#) tables, [MyISAM](#) tables, and so on.

See Also [InnoDB](#), [storage engine](#).

#### tablespace

A data file that can hold data for one or more [InnoDB tables](#) and associated **indexes**.

The **system tablespace** contains the [InnoDB data dictionary](#), and prior to MySQL 5.6 holds all other [InnoDB](#) tables by default.



---

The `innodb_file_per_table` option, enabled by default in MySQL 5.6 and higher, allows tables to be created in their own tablespaces. File-per-table tablespaces support features such as efficient storage of **off-page columns**, table compression, and transportable tablespaces. See [Section 14.6.3.2, “File-Per-Table Tablespaces”](#) for details.

InnoDB introduced general tablespaces in MySQL 5.7.6. General tablespaces are shared tablespaces created using `CREATE TABLESPACE` syntax. They can be created outside of the MySQL data directory, are capable of holding multiple tables, and support tables of all row formats.

MySQL NDB Cluster also groups its tables into tablespaces. See [Section 21.6.11.1, “NDB Cluster Disk Data Objects”](#) for details.

See Also [compressed row format](#), [data dictionary](#), [data files](#), [file-per-table](#), [general tablespace](#), [index](#), [innodb\\_file\\_per\\_table](#), [system tablespace](#), [table](#).

## Tcl

A programming language originating in the Unix scripting world. Sometimes extended by code written in **C**, **C++**, or **Java**. For the open-source Tcl **API** for MySQL, see [Section 27.12, “MySQL Tcl API”](#).

See Also [API](#).

## temporary table

A **table** whose data does not need to be truly permanent. For example, temporary tables might be used as storage areas for intermediate results in complicated calculations or transformations; this intermediate data would not need to be recovered after a crash. Database products can take various shortcuts to improve the performance of operations on temporary tables, by being less scrupulous about writing data to disk and other measures to protect the data across restarts.

Sometimes, the data itself is removed automatically at a set time, such as when the transaction ends or when the session ends. With some database products, the table itself is removed automatically too.

See Also [table](#).

## temporary tablespace

The tablespace for non-compressed InnoDB **temporary tables** and related objects, introduced in MySQL 5.7. The `innodb_temp_data_file_path` configuration file option defines the relative path, name, size, and attributes for temporary tablespace data files. If `innodb_temp_data_file_path` is not specified, the default behavior is to create a single auto-extending 12MB data file named `ibtmp1` in the data directory. The temporary tablespace is recreated on each server start and receives a dynamically generated space ID. The temporary tablespace cannot reside on a raw device. Startup is refused if the temporary tablespace cannot be created.

The temporary tablespace is removed on normal shutdown or on an aborted initialization. The temporary tablespace is not removed when a crash occurs. In this case, the database administrator may remove the temporary tablespace manually or restart the server with the same configuration, which removes and recreates the temporary tablespace.

See Also [temporary table](#).

## text collection

The set of columns included in a **FULLTEXT index**.

See Also [FULLTEXT index](#).

## thread

A unit of processing that is typically more lightweight than a **process**, allowing for greater **concurrency**.

See Also [concurrency](#), [master thread](#), [process](#), [Pthreads](#).

## Tomcat

An open source **J2EE** application server, implementing the Java Servlet and JavaServer Pages programming technologies. Consists of a web server and Java servlet container. With MySQL, typically used in conjunction with **Connector/J**.

---

See Also [J2EE](#).

#### torn page

An error condition that can occur due to a combination of I/O device configuration and hardware failure. If data is written out in chunks smaller than the [InnoDB page size](#) (by default, 16KB), a hardware failure while writing could result in only part of a page being stored to disk. The [InnoDB doublewrite buffer](#) guards against this possibility. See Also [doublewrite buffer](#).

#### TPS

Acronym for “**transactions** per second”, a unit of measurement sometimes used in benchmarks. Its value depends on the **workload** represented by a particular benchmark test, combined with factors that you control such as the hardware capacity and database configuration.

See Also [transaction](#), [workload](#).

#### transaction

Transactions are atomic units of work that can be **committed** or **rolled back**. When a transaction makes multiple changes to the database, either all the changes succeed when the transaction is committed, or all the changes are undone when the transaction is rolled back.

Database transactions, as implemented by [InnoDB](#), have properties that are collectively known by the acronym **ACID**, for atomicity, consistency, isolation, and durability.

See Also [ACID](#), [commit](#), [isolation level](#), [lock](#), [rollback](#).

#### transaction ID

An internal field associated with each **row**. This field is physically changed by [INSERT](#), [UPDATE](#), and [DELETE](#) operations to record which **transaction** has locked the row.

See Also [implicit row lock](#), [row](#), [transaction](#).

#### transparent page compression

A feature added in MySQL 5.7.8 that permits page-level compression for [InnoDB](#) tables that reside in **file-per-table** tablespaces. Page compression is enabled by specifying the [COMPRESSION](#) attribute with [CREATE TABLE](#) or [ALTER TABLE](#). For more information, see [Section 14.9.2, “InnoDB Page Compression”](#).

See Also [file-per-table](#), [hole punching](#), [sparse file](#).

#### transportable tablespace

A feature that allows a **tablespace** to be moved from one instance to another. Traditionally, this has not been possible for [InnoDB](#) tablespaces because all table data was part of the **system tablespace**. In MySQL 5.6 and higher, the [FLUSH TABLES ... FOR EXPORT](#) syntax prepares an [InnoDB](#) table for copying to another server; running [ALTER TABLE ... DISCARD TABLESPACE](#) and [ALTER TABLE ... IMPORT TABLESPACE](#) on the other server brings the copied data file into the other instance. A separate **.cfg file**, copied along with the **.ibd file**, is used to update the table metadata (for example the **space ID**) as the tablespace is imported. See [Section 14.6.1.3, “Importing InnoDB Tables”](#) for usage information.

See Also [.cfg file](#), [.ibd file](#), [space ID](#), [system tablespace](#), [tablespace](#).

#### troubleshooting

The process of determining the source of a problem. Some of the resources for troubleshooting MySQL problems include:

- [Section 2.9.2.1, “Troubleshooting Problems Starting the MySQL Server”](#)
- [Section 6.2.17, “Troubleshooting Problems Connecting to MySQL”](#)
- [Section B.3.3.2, “How to Reset the Root Password”](#)
- [Section B.3.2, “Common Errors When Using MySQL Programs”](#)
- [Section 14.22, “InnoDB Troubleshooting”](#).

---

## truncate

A **DDL** operation that removes the entire contents of a table, while leaving the table and related indexes intact. Contrast with **drop**. Although conceptually it has the same result as a `DELETE` statement with no `WHERE` clause, it operates differently behind the scenes: `InnoDB` creates a new empty table, drops the old table, then renames the new table to take the place of the old one. Because this is a DDL operation, it cannot be **rolled back**.

If the table being truncated contains **foreign keys** that reference another table, the truncation operation uses a slower method of operation, deleting one row at a time so that corresponding rows in the referenced table can be deleted as needed by any `ON DELETE CASCADE` clause. (MySQL 5.5 and higher do not allow this slower form of truncate, and return an error instead if foreign keys are involved. In this case, use a `DELETE` statement instead. See Also [DDL](#), [drop](#), [foreign key](#), [rollback](#).

## truststore

See Also [SSL](#).

## tuple

A technical term designating an ordered set of elements. It is an abstract notion, used in formal discussions of database theory. In the database field, tuples are usually represented by the columns of a table row. They could also be represented by the result sets of queries, for example, queries that retrieved only some columns of a table, or columns from joined tables.

See Also [cursor](#).

## two-phase commit

An operation that is part of a distributed **transaction**, under the **XA** specification. (Sometimes abbreviated as 2PC.) When multiple databases participate in the transaction, either all databases **commit** the changes, or all databases **roll back** the changes.

See Also [commit](#), [rollback](#), [transaction](#), [XA](#).

# U

## undo

Data that is maintained throughout the life of a **transaction**, recording all changes so that they can be undone in case of a **rollback** operation. It is stored in **undo logs** either within the **system tablespace** (in MySQL 5.7 or earlier) or in separate **undo tablespaces**. As of MySQL 8.0, undo logs reside in undo tablespaces by default. See Also [rollback](#), [rollback segment](#), [system tablespace](#), [transaction](#), [undo log](#), [undo tablespace](#).

## undo buffer

See [undo log](#).

## undo log

A storage area that holds copies of data modified by active **transactions**. If another transaction needs to see the original data (as part of a **consistent read** operation), the unmodified data is retrieved from this storage area.

In MySQL 5.6 and MySQL 5.7, you can use the `innodb_undo_tablespaces` variable have undo logs reside in **undo tablespaces**, which can be placed on another storage device such as an **SSD**. In MySQL 8.0, undo logs reside in two default undo tablespaces that are created when MySQL is initialized, and additional undo tablespaces can be created using `CREATE UNDO TABLESPACE` syntax.

The undo log is split into separate portions, the **insert undo buffer** and the **update undo buffer**.

See Also [consistent read](#), [rollback segment](#), [SSD](#), [system tablespace](#), [transaction](#), [undo tablespace](#).

## undo log segment

A collection of **undo logs**. Undo log segments exists within **rollback segments**. An undo log segment might contain undo logs from multiple transactions. An undo log segment can only be used by one transaction at a time

---

but can be reused after it is released at transaction **commit** or **rollback**. May also be referred to as an “undo segment”.

See Also [commit](#), [rollback](#), [rollback segment](#), [undo log](#).

#### undo tablespace

An undo tablespace contains **undo logs**. Undo logs exist within **undo log segments**, which are contained within **rollback segments**. Rollback segments have traditionally resided in the system tablespace. As of MySQL 5.6, rollback segments can reside in undo tablespaces. In MySQL 5.6 and MySQL 5.7, the number of undo tablespaces is controlled by the `innodb_undo_tablespaces` configuration option. In MySQL 8.0, two default undo tablespaces are created when the MySQL instance is initialized, and additional undo tablespaces can be created using `CREATE UNDO TABLESPACE` syntax.

For more information, see [Section 14.6.3.4, “Undo Tablespaces”](#).

See Also [rollback segment](#), [system tablespace](#), [undo log](#), [undo log segment](#).

#### Unicode

A system for supporting national characters, character sets, code pages, and other internationalization aspects in a flexible and standardized way.

Unicode support is an important aspect of the **ODBC** standard. **Connector/ODBC 5.1** is a Unicode driver, as opposed to Connector/ODBC 3.51, which is an **ANSI** driver.

See Also [ANSI](#), [Connector/ODBC](#), [ODBC](#).

#### unique constraint

A kind of **constraint** that asserts that a column cannot contain any duplicate values. In terms of **relational algebra**, it is used to specify 1-to-1 relationships. For efficiency in checking whether a value can be inserted (that is, the value does not already exist in the column), a unique constraint is supported by an underlying **unique index**.

See Also [constraint](#), [relational](#), [unique index](#).

#### unique index

An index on a column or set of columns that have a **unique constraint**. Because the index is known not to contain any duplicate values, certain kinds of lookups and count operations are more efficient than in the normal kind of index. Most of the lookups against this type of index are simply to determine if a certain value exists or not. The number of values in the index is the same as the number of rows in the table, or at least the number of rows with non-null values for the associated columns.

**Change buffering** optimization does not apply to unique indexes. As a workaround, you can temporarily set `unique_checks=0` while doing a bulk data load into an **InnoDB** table.

See Also [cardinality](#), [change buffering](#), [unique constraint](#), [unique key](#).

#### unique key

The set of columns (one or more) comprising a **unique index**. When you can define a `WHERE` condition that matches exactly one row, and the query can use an associated unique index, the lookup and error handling can be performed very efficiently.

See Also [cardinality](#), [unique constraint](#), [unique index](#).

## V

#### variable-length type

A data type of variable length. `VARCHAR`, `VARBINARY`, and `BLOB` and `TEXT` types are variable-length types.

**InnoDB** treats fixed-length fields greater than or equal to 768 bytes in length as variable-length fields, which can be stored **off-page**. For example, a `CHAR(255)` column can exceed 768 bytes if the maximum byte length of the character set is greater than 3, as it is with `utf8mb4`.

---

See Also [off-page column](#), [overflow page](#).

#### victim

The **transaction** that is automatically chosen to be **rolled back** when a **deadlock** is detected. [InnoDB](#) rolls back the transaction that has updated the fewest rows.

**Deadlock detection** can be disabled using the [innodb\\_deadlock\\_detect](#) configuration option.

See Also [deadlock](#), [deadlock detection](#), [innodb\\_lock\\_wait\\_timeout](#), [transaction](#).

#### view

A stored query that when invoked produces a result set. A view acts as a virtual table.

#### virtual column

See [virtual generated column](#).

#### virtual generated column

A column whose values are computed from an expression included in the column definition. Column values are not stored, but are evaluated when rows are read, immediately after any [BEFORE](#) triggers. A virtual generated column takes no storage. [InnoDB](#) supports secondary indexes on virtual generated columns.

Contrast with **stored generated column**.

See Also [base column](#), [generated column](#), [stored generated column](#).

#### virtual index

A virtual index is a **secondary index** on one or more **virtual generated columns** or on a combination of virtual generated columns and regular columns or stored generated columns. For more information, see [Section 13.1.18.8, “Secondary Indexes and Generated Columns”](#).

See Also [secondary index](#), [stored generated column](#), [virtual generated column](#).

#### Visual Studio

For supported versions of Visual Studio, see the following references:

- Connector/NET: [Connector/NET Versions](#)
- Connector/C++ 8.0: [Platform Support and Prerequisites](#)

See Also [Connector/C++](#), [Connector/NET](#).

## W

#### wait

When an operation, such as acquiring a **lock**, **mutex**, or **latch**, cannot be completed immediately, [InnoDB](#) pauses and tries again. The mechanism for pausing is elaborate enough that this operation has its own name, the **wait**. Individual threads are paused using a combination of internal [InnoDB](#) scheduling, operating system [wait\(\)](#) calls, and short-duration **spin** loops.

On systems with heavy load and many transactions, you might use the output from the [SHOW INNODB STATUS](#) command or **Performance Schema** to determine whether threads are spending too much time waiting, and if so, how you can improve **concurrency**.

See Also [concurrency](#), [latch](#), [lock](#), [mutex](#), [Performance Schema](#), [spin](#).

#### warm backup

A **backup** taken while the database is running, but that restricts some database operations during the backup process. For example, tables might become read-only. For busy applications and websites, you might prefer a **hot backup**.

See Also [backup](#), [cold backup](#), [hot backup](#).

---

## warm up

To run a system under a typical **workload** for some time after startup, so that the **buffer pool** and other memory regions are filled as they would be under normal conditions. This process happens naturally over time when a MySQL server is restarted or subjected to a new workload.

Typically, you run a workload for some time to warm up the buffer pool before running performance tests, to ensure consistent results across multiple runs; otherwise, performance might be artificially low during the first run.

In MySQL 5.6, you can speed up the warmup process by enabling the [innodb\\_buffer\\_pool\\_dump\\_at\\_shutdown](#) and [innodb\\_buffer\\_pool\\_load\\_at\\_startup](#) configuration options, to bring the contents of the buffer pool back into memory after a restart. These options are enabled by default in MySQL 5.7. See [Section 14.8.3.6, “Saving and Restoring the Buffer Pool State”](#).  
See Also [buffer pool](#), [workload](#).

## workload

The combination and volume of **SQL** and other database operations, performed by a database application during typical or peak usage. You can subject the database to a particular workload during performance testing to identify **bottlenecks**, or during capacity planning.

See Also [bottleneck](#), [CPU-bound](#), [disk-bound](#), [SQL](#).

## write combining

An optimization technique that reduces write operations when **dirty pages** are **flushed** from the [InnoDB buffer pool](#). If a row in a page is updated multiple times, or multiple rows on the same page are updated, all of those changes are stored to the data files in a single write operation rather than one write for each change.

See Also [buffer pool](#), [dirty page](#), [flush](#).

# X

## XA

A standard interface for coordinating distributed **transactions**, allowing multiple databases to participate in a transaction while maintaining **ACID** compliance. For full details, see [Section 13.3.7, “XA Transactions”](#).

XA Distributed Transaction support is enabled by default. If you are not using this feature, you can disable the [innodb\\_support\\_xa](#) configuration option, avoiding the performance overhead of an extra fsync for each transaction.

As of MySQL 5.7.10, disabling [innodb\\_support\\_xa](#) is not permitted as it makes replication unsafe and prevents performance gains associated with **binary log** group commit. The [innodb\\_support\\_xa](#) configuration option is removed in MySQL 8.0.

See Also [ACID](#), [binary log](#), [commit](#), [transaction](#), [two-phase commit](#).

# Y

## young

A characteristic of a **page** in the [InnoDB buffer pool](#) meaning that it has been accessed recently, and so is moved within the buffer pool data structure, so that it is not **flushed** too soon by the **LRU** algorithm. This term is used in some **INFORMATION\_SCHEMA** column names of tables related to the buffer pool.

See Also [buffer pool](#), [flush](#), [INFORMATION\\_SCHEMA](#), [LRU](#), [page](#).